

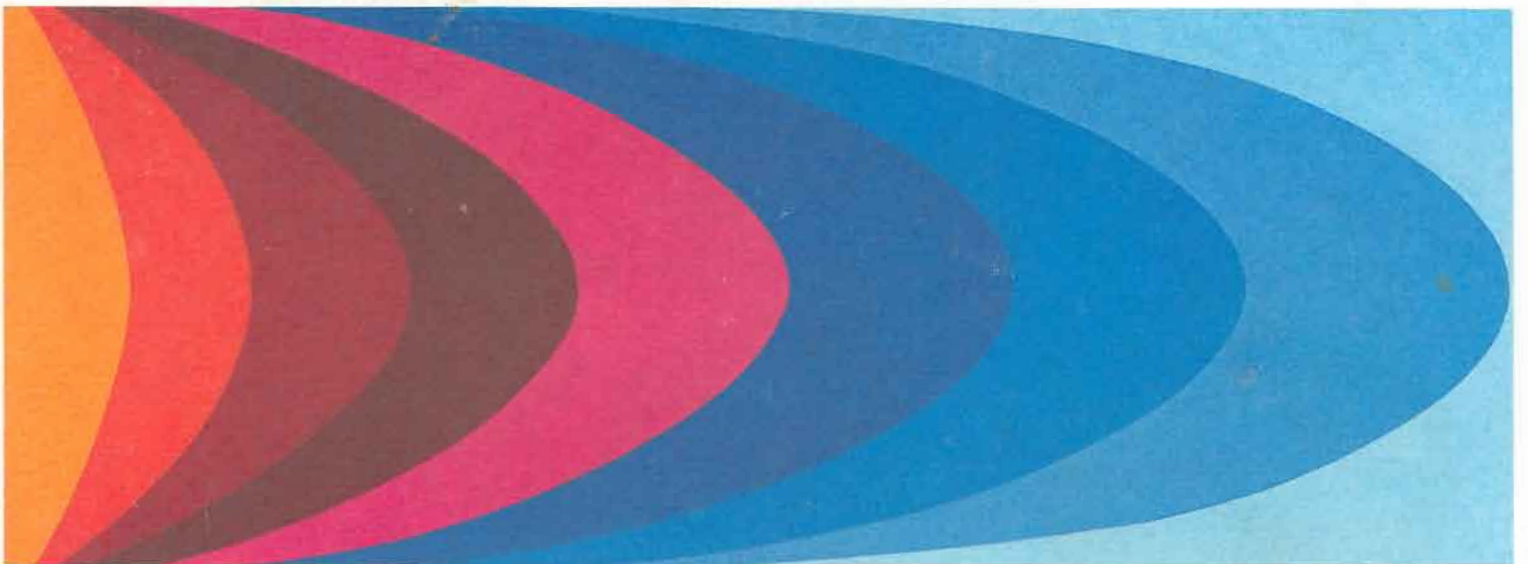

HEWLETT
PACKARD

1987

ELECTRONIC MEASUREMENT • DESIGN • COMPUTATION



GENERAL INDEX

Computers, Peripherals & Calculators

Artificial Intelligence Workstations.....	86
Business Computers.....	66
Calculators.....	60
Computers.....	48, 66, 72
CRT & Data Entry Systems.....	97
Data Acquisition Systems.....	282

Datacom Network Testing.....	360
Disc Drives.....	100
Engineering Workstations.....	72
Handheld Computers.....	60
Hewlett-Packard Interface Bus.....	123
Hewlett-Packard Interface Loop.....	64

General-Purpose Electronic Measurement

Amplifiers.....	488
Automatic Test Systems.....	183
Board Test Systems.....	351
Component Testers.....	212
Computer-Aided Test.....	164

Data Analyzers/Generators.....	479
Digital Circuit Testers.....	343
Digital IC Tester.....	239
DMMs, DVMs.....	187

Electronic Counters.....	304
Fiber Optics.....	574
F & T Standards.....	334
Frequency Synthesizers.....	407
Function Generators.....	407

RF & Microwave Measurement

Amplifiers.....	488
Automatic Test Systems.....	183
Coaxial Test Equipment.....	550
Digital Radio Testing.....	392
Electronic Counters.....	304

Frequency Synthesizers.....	407
Microwave Counters.....	306
Microwave Link Analyzers.....	390
Microwave Semiconductors.....	737
Microwave Test Equipment.....	550

Logic & Processor-Based Circuit Analysis

Board Test Systems.....	351
Data Generators/Analyzers.....	479
Digital Circuit Testers.....	343
Digital IC Tester.....	239

IC Troubleshooters.....	343
Logic Analyzers.....	397
Microprocessor Development System.....	148

CAE/CAD

Digital IC Design Verification.....	239
Digital Oscilloscopes.....	426
Electronic Design System (CAE).....	143
Engineering Graphics System.....	156
Finite Element Analysis.....	157

Fourier Analyzers.....	697
Logic Analyzers.....	397
ME Modeling (2D).....	158
ME/CAD System.....	158

Data Acquisition & Control

Automatic Test Systems.....	183
Board Test Systems.....	351
Component Testers.....	212
Computers.....	48, 66, 72
Computer-Aided Test.....	164

Data Acquisition Systems.....	282
Digital Circuit Testers.....	343
Digital IC Tester.....	239
Disc Drives.....	100
Electronic Counters.....	304

Telecommunications & Data Communications

Amplifiers.....	488
Data Generators.....	479
Data & Voice Testing.....	368
Data Communications Test.....	360
Digital Communications Measurements.....	377
Digital Radio Testing.....	392

Fiber Optics.....	574
Frequency Synthesizers.....	407
LAN Protocol Analyzer.....	366
Microwave Counters.....	306
Microwave Radio Testing.....	393, 568
Microwave Test Equipment.....	550

CAT/HP-IB

Analyzers: Data, Logic, Network, Signal.....	397, 479, 594, 642
Automatic Test Systems.....	183
Component & Board Testers.....	212, 351
Computer-Aided Test.....	164
Computers & Peripherals.....	48, 66, 72, 96, 128

Data Acquisition Systems.....	282
Data Communications Test.....	360
Digital IC & Circuit Testers.....	239, 343
Electronic Counters.....	304
Fiber Optics.....	574
HP-IB Extenders.....	136

Other Products

Adapters.....	740
Analytical Instruments for Chemistry.....	734
Cabinet Accessories.....	748
Cables.....	740

Digital Education Products.....	347
Dimensional Measurement.....	730
Frequency & Time Standards.....	334
Laser Interferometers.....	730

HP Computer Museum
www.hpmuseum.net

For research and education purposes only.

Prices Subject to Change

Prices in this catalog are subject to change. Prices prevailing at the time an order is received will apply. To determine a product's delivered price, just contact your nearest HP office. A listing of HP office locations starts on page 769. For more on shipping, prices and terms of sale, please refer to page 756.



HP-IB Extenders.....136	Personal Computers.....48, 80	Supplies & Accessories..... 120, 766
IBM PC Compatible Computers..... 48, 66, 80, 95	Portable Computers.....54, 81	Support.....757
Multiprogrammers.....172	Precision Architecture Computers..... 68, 75	Tape Drives.....100-104
Networking..... 58, 84	Protocol Analyzers.....366	Technical Computers.....72
Peripherals.....96	Recorders, Printers, Plotters..... 106, 109, 446, 451	Technical Office Automation.....90
		Terminals.....97

HP-IB.....123	Network Analyzers.....594	Power Supplies.....256	Signal Generators.....520
HP-IL.....64	Oscillators.....407	Pulse Generators.....466	Support.....757
Impedance Analyzers.....213	Oscilloscopes.....426	Recorders, Printers..... 106, 451	Sweep Oscillators.....491
LCR Meters.....222	PC Instruments.....202	Semiconductor Testers.....237	Waveform Analyzers..... 426, 446
Logic Analyzers.....397	Plotters..... 109, 451	Signal Analyzers.....642	Waveform Synthesizers.....407

Millimeter-Wave Equipment.....548	Power Meters.....582	Sweep Oscillators.....491
Network Analyzers.....594	RF Impedance Analyzer.....218	Transceiver Test Equipment.....725
Noise Figure Meter.....590	Signal Analyzers.....642	Waveguide Test Equipment.....550
Oscilloscopes.....426	Signal Generators.....520	Vector Modulation Test Equipment.....568
Plotters.....109, 451	Support.....757	Video Test Equipment.....358

Plotters.....109, 451
Signature Analyzers.....346
Support.....757

ME/Test..... 158, 160	Personal Computers.....52	Support.....142
Microprocessor Development Systems.....148	Plotters.....109, 451	Technical Office Automation.....90
Microwave CAE.....146	Printed Circuit Design System.....154	Third-Party Software.....163
Overview.....137	Signal Analyzers.....642	Workstations..... 72, 140

Hewlett-Packard Interface Bus.....123	PC Instruments.....202	Support.....757
Hewlett-Packard Interface Loop.....64	Recorders, Plotters & Printers..... 106, 108, 446, 451	Switches.....166
Multimeters.....187	Semiconductor Testers.....237	Waveform Analyzers..... 426, 446
Multiprogrammers.....172		

Network Analyzers..... 213, 594	PCM Testing.....377	Sweep Oscillators.....491
Noise Figure Meter.....590	Pulse Generators.....466	Telecommunications Test.....377
Plotters.....109, 451	Radio & FDM Carrier Testing.....383, 396	Transceiver Test Equipment.....725
Power Meters.....582	Signal Generators.....520	Vector Modulation Test Equipment.....568
Private VF Circuit Testing.....396	Support.....757	Video Test Equipment.....358

HP-IB Overview & Product Summary.....123	Plotters & Recorders.....109, 451	Switches, Switch Driver..... 166, 554
Multimeters.....187	Power Meter.....582	Telecommunications Test.....377
Multiprogrammers.....172	Power Supplies.....256	Vector Modulation Test.....568
Noise Figure Meter.....590	Semiconductor Test Equipment.....237	Video Test Equipment.....358
Oscilloscopes.....426	Signal Sources..... 407, 466, 479, 491, 520	Waveform Analyzers..... 426, 446
PC Instruments.....202	Support.....757	

Medical Instrumentation.....738	Pressure & Temperature.....732
Microwave Semiconductors.....737	Support.....757
Operating Cases.....746	Transit Cases.....742
Optoelectronic Devices.....736	X-Ray Systems.....754

CONTENTS

ALPHABETICAL INDEX	23
MODEL NUMBER INDEX	35
Customer Support	757
New Product Highlights.....	1
About Hewlett-Packard	19
Free Publications	755
Ordering Information.....	756
Sales & Support Offices	769
Information Request Cards.....	Back of catalog

PRODUCT SECTIONS

Amplifiers	488	Millimetre Wave Testing	548
Analytical Instruments for Chemistry.....	734	Network Analyzers.....	594
Board Test Systems	351	Noise Figure Meter	590
Business Computer Systems.....	66	Operating Cases.....	746
Cabinet Accessories.....	748	Oscilloscopes & Waveform Analyzers.....	426
Cables & Adapters	740	PC Instruments.....	202
Component Measurement	212	Personal Computers & Calculators	48
Computer Aided Test	164	Plotters & Recorders.....	451
Computer Peripherals.....	96	Power Meters.....	582
Data Acquisition Systems	282	Power Supplies.....	256
Data Communications Test Equipment.....	360	Pressure & Temperature.....	732
Data Generators & Data Analyzers	479	Pulse Generators.....	466
Design Automation.....	137	Signal Analyzers.....	642
Digital Circuit Testers.....	343	Signal Generators	520
Digital Multimeters.....	187	Solid State Devices	736
Dimensional Measurements	730	Semiconductor Test Equipment	237
Electronic Counters.....	304	Sweep Oscillators.....	491
Fiber Optic Test Equipment	574	Technical Computer Systems.....	72
Frequency & Time Standards.....	334	Telecommunications Test Equipment.....	377
Frequency, Function & Waveform Synthesizers.....	407	Transceiver Test Equipment	725
Hewlett-Packard Interface Bus.....	123	Transit Cases	742
Logic Analyzers.....	397	Vector Modulation Generators & Analyzers	568
Medical Instrumentation.....	738	Video Test Equipment.....	358
Microwave Test Equipment	550	X-Ray Equipment	754



Identifies products having the Hewlett-Packard Interface Bus (HP-IB) capability. HP-IB is our implementation of ANSI/IEEE Standard 488, "Digital interface for programmable instrumentation." For the complete story, see pages 123-132.



Identifies products having Hewlett-Packard Interface Loop (HP-IL) capability. HP-IL provides serial loop interfacing for portable, battery-powered systems on the bench or in the field. See page 64.



Identifies newly introduced products or capabilities. New products are also indicated by **boldface** listings in the Model Number Index.



Identifies products available by **Fast-Ship Service**. **Fast-Ship Service** is the quick way for you to choose from thousands of HP products, order them by phone and receive expedited delivery. For more information, see page 766.

Specifications describe the product's performance. Parameters that are described as **typical**, **nominal**, or **approximately** (\approx) are supplemental characteristics intended to provide information useful to applying the product.



The HP Portable PLUS Personal Computer

More than just a portable computer, the Portable PLUS is a powerful, durable traveling companion that shares information and peripherals with desktops or acts as a terminal to mainframes. It now has 256K-bytes of continuous RAM, expandable to 1.28M-bytes, and includes a high-contrast liquid-crystal display that offers superb readability. In one small package, you can carry all the tools you need to be productive in the field or while traveling.

The Portable PLUS is easily tailored to handle varying duties with the programs and data that you use most often installed directly in the computer as plug-in ROMs. You also have the option of loading disc-based software into the Electronic Disc of the Portable PLUS. In either case, there is no need to carry discs or disc drives - just the lap-sized Portable PLUS. See page 54.

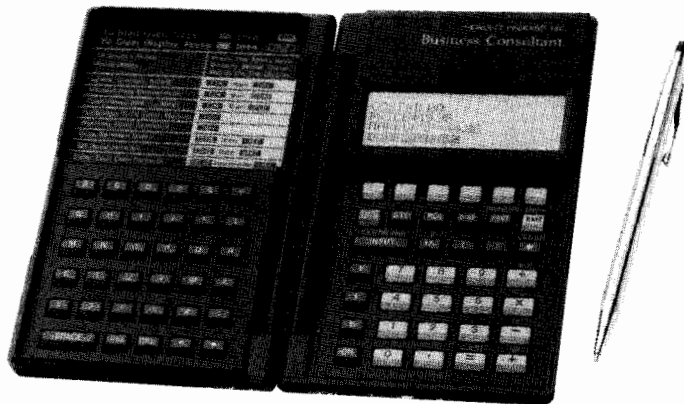

HP-18C Business Consultant Professional Calculator

The Business Consultant is a whole new idea in calculators that uses softkeys and built-in menus to make solving standard business problems easier than ever before. And it introduces an innovative new formula solver function that allows the customization of the calculator to individual needs. Simply provide the Business Consultant with all but one of the values in a formula, and it solves for the unknown. See page 60.



HP-94 Handheld Industrial Computer

The HP-94 Handheld Industrial Computer is designed for item tracking and field data collection in applications such as manufacturing, route accounting, sales force automation, field service and health care.

Enter data with any one of three bar code wands, the redefinable keyboard or built-in serial port. A backlight makes it easy to read the display in dark areas. The HP-94 can be programmed to edit data as it is entered and to prompt for correction of inaccurate entries. Application software is developed separately and downloaded to the HP-94. The HP-94 weighs less than two pounds and is easy to carry in one hand or attached to a clipboard. See page 61.



HP 9000 Series 800 Model 840 Computer System

The HP 9000 Series 800 Model 840 is a new HP-UX based supermini-computer system using HP Precision architecture. It has the raw computational power, 4.5 MIPS and 2 million B1D Whetstones/second, to run computer simulations or to serve the computational needs of a network of CAD/CAE workstations. Its predictable real-time response equips it to function effectively as an area manager for multiple cell controllers on the factory floor or to perform other real-time monitoring and control functions. The Model 840's industry-standard operating system, HP-UX, adheres to AT&T's System V Interface Definition, Issue 1, and it offers true real-time capabilities. See page 75.



HP Artificial Intelligence Development Systems

HP's Artificial Intelligence Development Systems are bundled systems of hardware and software developed by HP to meet the needs of AI application developers. Users may choose either a monochromatic or color display. This is the same system that HP researchers and developers of AI-based software are using. Components of these bundles are offered at cost-saving prices and are selected to provide optimum price-performance. The systems run on HP 9000 Series 300 technical workstations using the HP-UX operating system. See page 86.



HP Series 300 DOS Coprocessor System

The HP Series 300 DOS Coprocessor System provides IBM PC/AT MS-DOS software compatibility for the HP 9000 Series 300 technical workstations. The system includes an 80286 coprocessor DIO card (with socket for 80287) and associated emulation software. The complete system requires the HP-UX 5.1 Application Execution Environment, approximately 2 Mbytes RAM, and works with either the Model 310 or 320 processor. To provide compatibility with existing PC AT software, the HP 9127A 5 1/4-inch, 360-Kbyte, double-sided, double-density disc drive is available. The system provides compatibility with thousands of readily available MS-DOS software applications. See page 91.

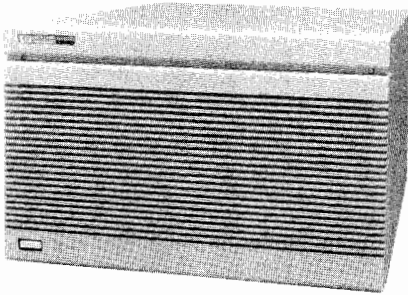

HP 2426E/F Micro 16 Computers

The HP 2426E and 2426F Computers provide HP 1000 A600+ processing power in a new package that is smaller, lower cost, and with higher maximum operating temperature than any previous HP 1000 Computer. Their size, low cost, and superior environmental tolerance make the HP 2426E and HP 2426F especially well-suited as factory-floor cell controllers. See page 94.



The HP Technical Vectra Personal Computer

Technical Vectra is a family of plug-in enhancements and software that equips the Vectra PC to meet the diverse needs of engineers and scientists. Many different configurations are possible, including systems for data acquisition and analysis, instrument control, drafting, computer-aided engineering, and technical report writing.

Specific enhancements include three display systems (with high-resolution graphics in up to 256 simultaneous colors), a high-speed math coprocessor, data acquisition cards, specialized programming languages, HP-IB control accessories, and HP's family of personal instrumentation. Vectra's modular design and seven IBM PC/AT-compatible I/O slots make changes and expansion easy. See page 52.

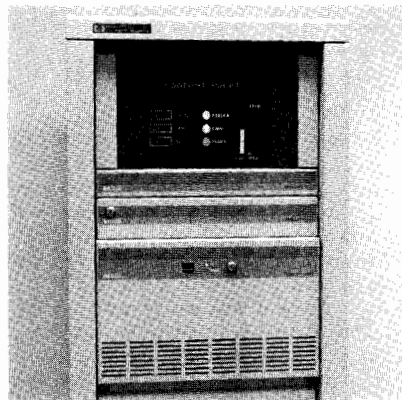

HP 72411A VECTRA Industrial PC

The HP 72411A is a Vectra PC in a ruggedized package for operation in the hot, humid, dirty conditions often encountered on the factory floor. The HP 72411A can be used for low-end workcell control, as a complement to larger workcells (acting as an operator interface), and can utilize other PC-DOS based applications for manufacturing that can benefit from the relatively low price and wide availability of IBM PC/AT-compatible hosts. See page 95.

HP 37204A HP-IB Extender

The new HP 37204A multi-point HP-IB extender can turn your HP-IB system into a distributed system, with equipment dispersed throughout your factory or office.

HP-IB was originally designed for bench-top systems where equipment was within close range of the computer. The HP 37204A adds distance, up to 1250 metres per link, to give you the flexibility to situate HP-IB devices where you want. HP-IB bytes are converted into serial form for transmission over 75-ohm coax. Options are available to use fiber optics. A system can be extended by simply dropping in HP 37204As, and there is no need to write special software.

Multi-point capability allows you to daisy-chain remote sites using only one HP 37204A at each site, all controlled from a single computer port. Another feature, chain truncation, allows the computer site to continue operating even if a remote fault or power failure causes serial communication to cease.

The HP 37204A can be used to control multiple ATE systems from a central computer, for remote data acquisition/control, or for remote plotters/printers. See page 136.

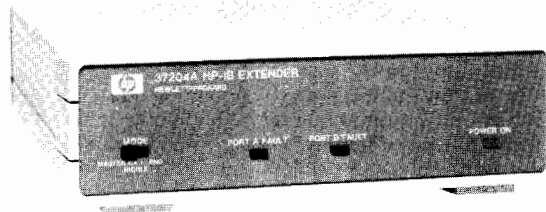

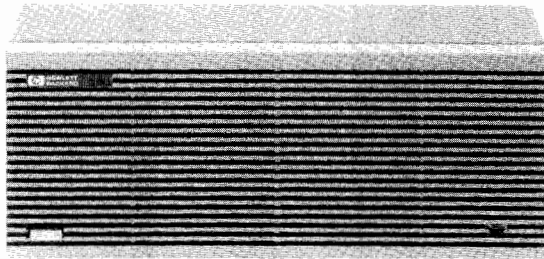

HP 260 Series 30 and Series 40

The HP 260 Series 30 and Series 40 are fully compatible, easy-to-use and easy-to-implement systems. They are ideally suited to commercial applications for small- to mid-sized companies. The Series 30 is a low-cost entry-level system. The Series 40 is a high-performance system featuring disc caching.

Both series support up to 15 concurrent users/tasks and a wide range of peripherals. In addition, several popular personal computers can be integrated into an HP 260 solution, giving you the power of a data-base-oriented system and the personal productivity of PCs.

As your organization expands, the HP 260 can grow with you without jeopardizing your hardware and software investments. A comprehensive upgrade program ensures a smooth growth path to HP 3000 business computers. See page 66.

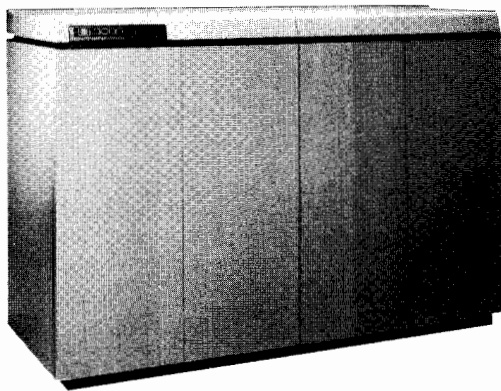

HP 3000 Series 70

The Series 70 is a new high-performance member of the HP 3000 family of compatible, interactive business systems. Offering a large 128K-byte memory cache and 8M-byte main memory standard, the Series 70 provides eight times the throughput of the HP 3000 Series 37, HP's entry-level commercial system. Performing as a distributed mainframe, the Series 70 has the processing power to handle a full range of distributed data processing needs for hundreds of users.

The Series 70 is suited to stand-alone operation and can perform a wide range of tasks for divisions in large companies or fill the EDP needs of an entire company. The extensive data communications capabilities of the Series 70 make it an excellent choice as a major node or as the central computer in distributed networks. In addition to its on-line interactive capabilities, the Series 70 performs equally well in batch processing applications. Whether the needs are for large distributed networks, intensive interactive sessions, or for dedicated stand-alone applications, the Series 70 provides the performance required. See page 67.

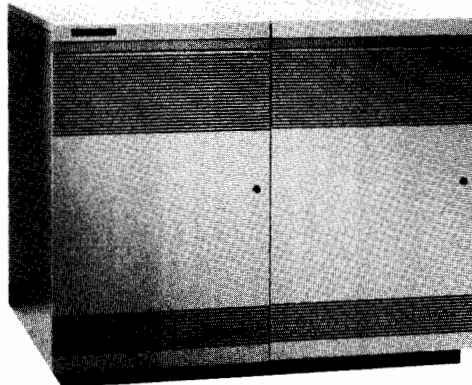

HP 3000 Series 930

The Series 930 is the first member of the HP 3000 family to utilize the RISC-based HP Precision Architecture. Using the enhanced MPE XL operating system, the Series 930 provides high performance in multi-user, multi-tasking interactive and batch environments. As a new member of the proven HP 3000 family, the Series 930 provides powerful extensions to the highly-regarded networking and data management capabilities for which the HP 3000 systems are known. In addition to enhanced support for data base applications, the Series 930 also excels in computationally-intensive EDP environments.

Applications software packages are available to support a wide variety of financial, manufacturing, and office applications on HP 3000 systems. With these capabilities, the Series 930 provides a true high-performance, general-purpose business computing solution. It continues the HP 3000 tradition of a broad family of software-compatible, cost-effective business systems. See page 67.

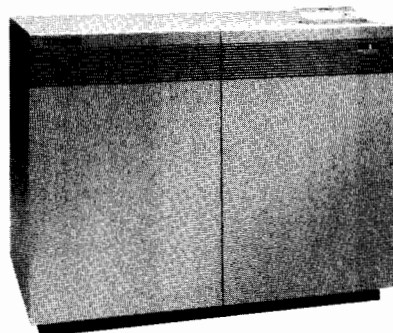

HP 3000 Series 950

The Series 950, the highest-performance member of the HP 3000 family, is the first HP 3000 to utilize Hewlett-Packard's proprietary NMOS III VLSI technology. Use of this state-of-the-art VLSI technology in conjunction with HP's Precision Architecture for the 900 Series of HP 3000 computers results in 6.7 MIPS processor performance. The entire processor is contained on a single NMOS III chip, resulting in higher reliability and a simpler design. The Series 950 was designed to provide an easy upgrade path from the HP 3000 Series 70 and Series 930 systems. See page 67.

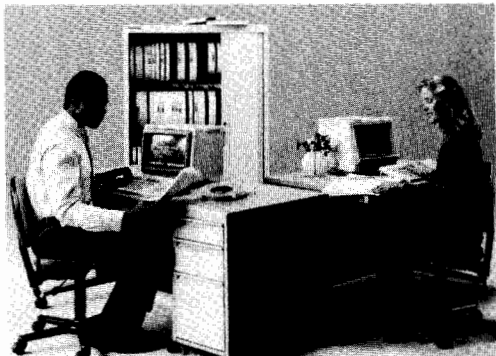

ALLBASE

ALLBASE is a new data-base management system for the HP 3000 Series 900 business computer systems. It combines HPIMAGE, a network-model interface, with HPSQL, an industry-standard SQL relational interface. Its dual-access capability allows users to share data bases, giving them access to current information while eliminating the need for redundant data. With ALLBASE, users can now choose the data base access method most appropriate for their application needs. See page 68.

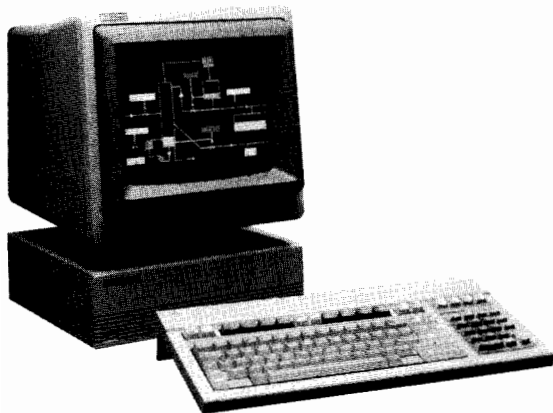

HP 2397A Color Graphics Terminal

Designed for both business and technical applications, the HP 2397A Color Graphics Terminal provides full-color graphics and color alphanumerics and supports a wide variety of input and output options. It is a high quality yet affordable solution for the color graphics terminal needs of HP 3000, HP 1000 and HP 9000 Computer users. Besides its extensive graphics features, the HP 2397A provides full-color alphanumeric capabilities, including math, italic, bold and line-drawing characters, up to twelve pages of memory, and enhanced vertical scrolling to support 160-column text. See page 97.

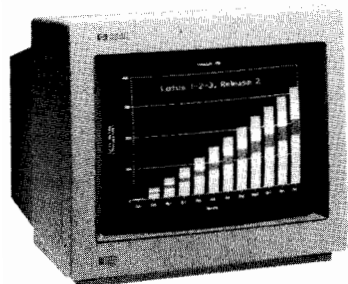

HP 35743A Enhanced Graphics Display

Designed for use with the HP Vectra Personal Computer, the HP 35743A Enhanced Graphics Display monitor offers a 13-inch color display. It features TTL video input, a palette of 64 colors (16 displayable at one time), dual scan input, and two resolution modes (640 × 350 and 640 × 200). Tilt and swivel base is optional. See page 99.

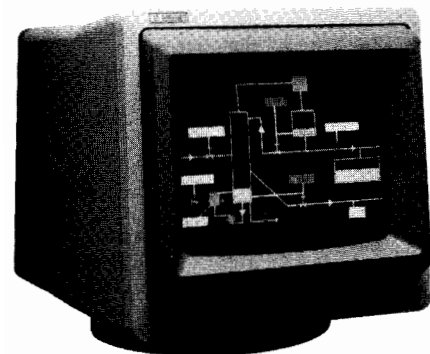

HP 35741 Color Monitor

Used with many HP computer systems, terminals and personal computers, the HP 35741 Color Monitor provides a 600 × 400 dot display with analog video inputs for a continuous spectrum of colors. Features include a 12-inch non-glare screen, integrated tilt and swivel, front-panel controls and an HP-HIL interface that supports the HP Touch accessory. See page 99.



NEW PRODUCT HIGHLIGHTS

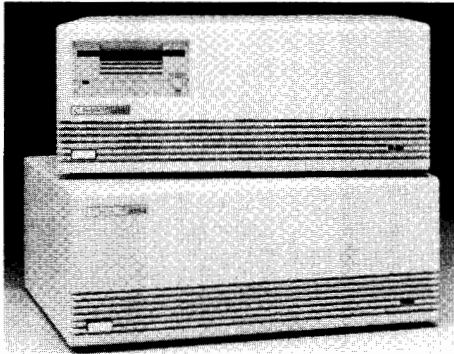

HP 9133L, 9134L Disc Drives

The HP 9133L combines the storage of a 40-megabyte hard disc with the backup and interchange capabilities of removable 3½-inch micro-floppies. The HP 9134L is a hard-disc-only version of the HP 9133L. Supported on the HP Touchscreen II as well as the HP 9000 Series 200 and 300 computers, the HP 9133L and 9134L meet the requirements of both business and technical applications. See page 100.

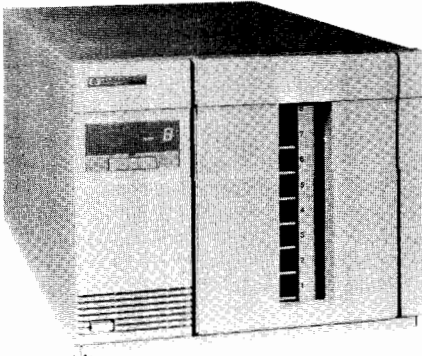

HP 35401A ¼-inch Cartridge Autochanger Tape Drive

The HP 35401A provides an unattended backup solution for computer systems with up to 536 megabytes of disc storage. By combining the major components of the HP 9144A tape drive with an autochanger mechanism, the HP 35401A automates cartridge loading and unloading and allows the tape drive to access up to eight cartridges from a removable magazine. Its small size, quiet operation and ease of use make it ideal for the office environment. The new cartridge autochanger drive is supported on HP 3000 and HP 9000 computers. See page 104.

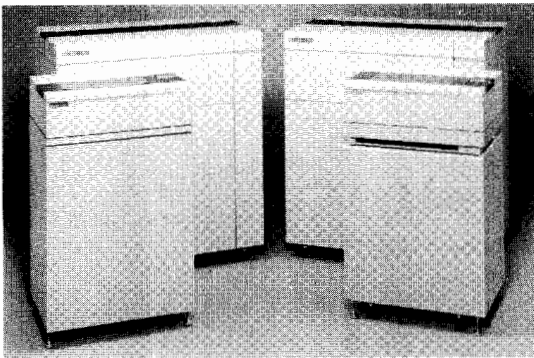

HP 2563B, 2564B, 2566B, 2567B Dot Matrix Impact Printers

Models HP 2563B, 2564B, and 2566B replace discontinued models HP 2563A, 2565A, and 2566A. Improvements include the addition of 12, 13.3 and 15 characters-per-inch Roman-8 character sets and a higher-resolution 140 × 144 dots-per-inch matrix for graphics. These improvements are also included in a new addition to the family, the HP 2567B, which prints at 1200 lines per minute with an optional speed of 1600 lines per minute. See page 105.

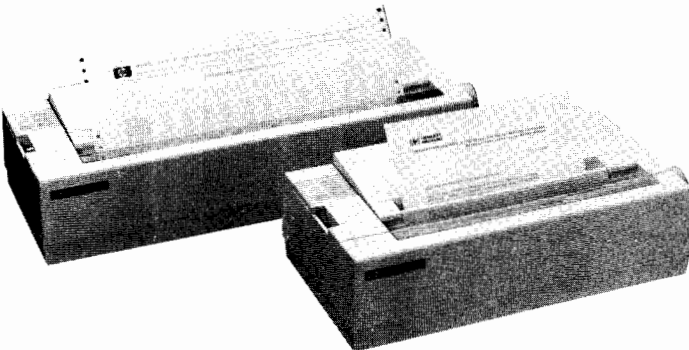

HP QuietJet and QuietJet Plus Printers

Hewlett-Packard's inkjet family now includes two full-featured personal printers, the QuietJet Printer for standard 8-inch paper and the QuietJet Plus Printer for paper up to 15 inches in width. Both printers offer the same high-quality printing and quiet operation for a variety of hosts, from the HP Vectra and Portable PCs to IBM and Apple PCs. Supported on most popular software, these printers offer full-featured printing for word processing, data processing, and graphics applications.

The QuietJet family offers near letter-quality printing for important letters and reports and three graphics densities for superior charts and illustrations. Six print pitches, plus bold, underlining, superscripts and subscripts ensure printing flexibility for a variety of printing needs. See page 106.



HP LaserJet 500 PLUS

With its two, 250-sheet input bins, the HP LaserJet 500 PLUS printer enables HP Vectra PC, HP Touchscreen PC, IBM PC and IBM PC compatibles to print documents on more than one size of paper. In addition to having all the capabilities of the HP LaserJet PLUS printer, the LaserJet 500 PLUS enables users to select the appropriate paper bin remotely from the PC keyboard. It automatically outputs pages of a document face down, in the order they are read. The LaserJet 500 PLUS is ideal for multi-user environments. See page 105.

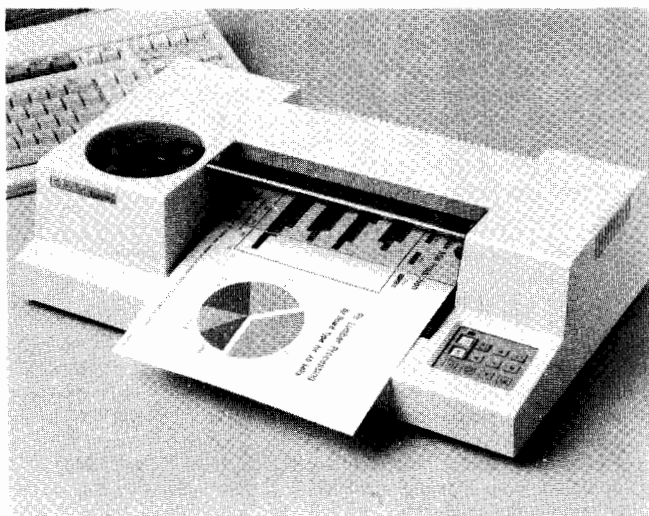

HP ColorPro Graphics Plotter

The HP ColorPro plotter is an 8-pen, A4/A-size plotter designed to provide quality color graphics for business and scientific applications. The ColorPro plotter handles overhead transparency film and two types of paper, regular and glossy.

In a business setting, the ColorPro plotter can turn out presentation-quality graphics in minutes, graphics that help reinforce key points and illustrate numerical data. In laboratory and testing environments, the plotter provides color hardcopy output for data acquisition or smart instrument systems.

When your graphics needs expand, a ROM cartridge slot lets the ColorPro plotter keep up with your changing needs, such as emerging graphics standards. The Graphics Enhancement Cartridge, available as an accessory, adds advanced capabilities, such as a larger buffer and more HP-GL commands.

The HP ColorPro plotter provides the same high quality you've come to expect from Hewlett-Packard. It has resolution of 0.025 mm (0.001 in.) for smooth circles and straight diagonals and repeatability of 0.1 mm (0.004 in.) for closed circles and square corners. And it comes with a choice of two interfaces, RS-232-C/CCITT V.24 or HP-IB (IEEE 488-1978). See page 110.

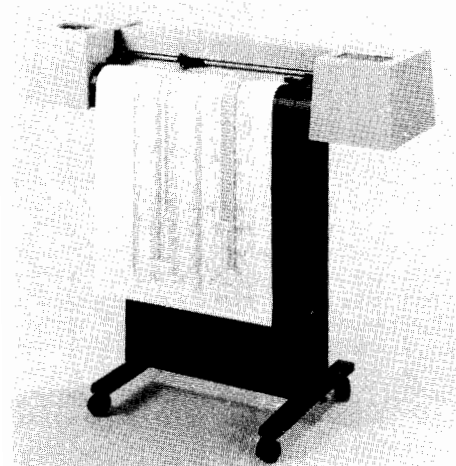

HP DraftPro Plotter

The HP DraftPro plotter is a low-cost, 8-pen drafting plotter designed especially for you and your personal CAD system. The DraftPro plotter plots on C- and D-size sheets of paper, vellum and polyester film. And it draws with fiber-tip pens, disposable liquid-ink pens, and refillable liquid-ink pens. Whether you create electrical schematics, floor plans, part renderings or topographical maps, the DraftPro plotter offers the professional-quality output your work deserves at a price you can afford.

The DraftPro plotter has a mechanical resolution of 0.013 mm (0.0005 in.) and an addressable resolution of 0.025 mm (0.001 in.) to ensure you get smooth arcs and crisp letters. And with DraftPro's repeatability of 0.10 mm (0.004 in.), your drawings will have precise corners and circles that close. The DraftPro plotter connects easily to almost any HP or other personal computer or workstation. An RS-232-C/CCITT V.24 interface comes standard; HP-IB (IEEE 488-1978) can be ordered as an accessory. See page 114.

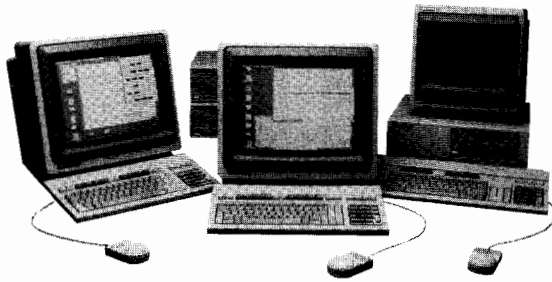

HP DesignCenter EE Series Electronic Design System

HP's Electronic Design System provides an integrated computer-aided engineering (CAE) solution for automated electronic hardware design. HP Electronic Design System includes more than 3000 digital and analog component library parts, a powerful schematic editor, HILO-3 logic simulation, analog simulation, links to physical layout systems, and a user interface that simplifies interaction with design and verification tools. HP Electronic Design System is divided into five sections: Design Capture System, Design Verification System for HILO-3, Analog Workbench (R), design interfaces to physical layout systems, and parts libraries. The full system is designed to run on the HP 9000 Series 300 technical workstations. A low-cost, entry-level station based on the HP Vectra PC and IBM PC/AT provides design capture, parts libraries, design interfaces to physical layout tools, and remote access to design verification for both digital and analog designs. See page 143.

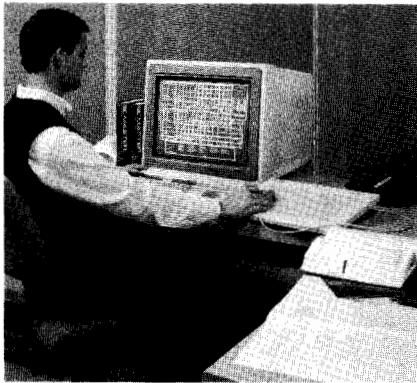

HP DesignCenter EE Series Printed Circuit Design System

Hewlett-Packard's Printed Circuit Design System is a computer-aided design (CAD) solution that couples printed circuit board layout to electrical engineering design, manufacturing and test. HP Printed Circuit Design System is a part of HP DesignCenter, an integrated design environment for electrical, mechanical and software engineering teams. It transfers all the functionality of a mainframe-based system to a networked workstation environment. The software has been evolving for more than 10 years, and provides a highly tuned base for HP's integrated CAD solution. The system provides packing, placing and routing features that can automatically lay out digital, analog and mixed digital/analog printed circuit boards with through-hole and surface-mount technologies, and contains extensive facilities for thick-film hybrid design. HP Printed Circuit Design System is based on the popular, modular HP 9000 Series 320 technical workstation and HP-UX operating system. Individual workstations as well as large systems can be configured for particular applications in a powerful local-area network (LAN). HP-UX adheres to AT&T's UNIX™ System V Interface definition Issue 1 (UNIX is a trademark of AT&T in the U.S.A. and other countries). See page 154.

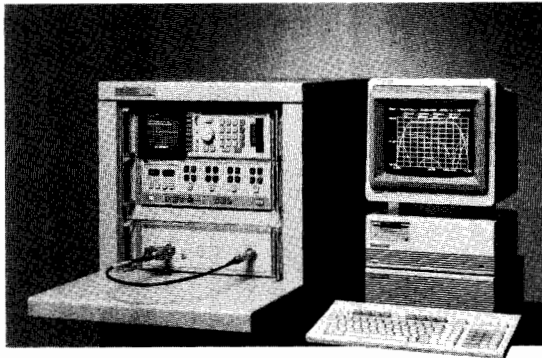

Microwave CAE Workstations

HP offers CAE systems for microwave design engineers in the form of two "personal microwave workstations." The HP 85201S is based on the HP 9000 Series 300 Computer, and the HP 85200S uses the HP Vectra PC. On-site installation and verification of both the computer and CAE software are included with these systems.

The software is an integrated family of programs from the "Touchstone"™ series created by EEsof, Inc. It is a linear circuit simulation and optimization package that can also predict production yields. With their friendly, menu-driven operation, built-in text editors, and interactive tuners, the Touchstone programs are powerful yet very easy to use. And because the software can read data directly from an HP 8510 or 8753 vector network analyzer, it can embed actual devices (at specific bias and temperature conditions) into simulated circuits. See page 146.



HP DesignCenter ME Series 5, 10 & 30

HP DesignCenter ME Series 5, 10 & 30 comprise a family of mechanical engineering CAD products for drafting, 2D design and solids modeling, respectively. All three products provide the same friendly user interface to greatly reduce learning time. ME Series 5 provides comprehensive drafting capabilities. ME Series 10 provides all the functionality of ME Series 5 and adds extensive 2D design and integration. ME Series 30 adds true solids modeling capabilities by adapting the use of 2D design techniques to model creation. ME Series 5 and 10 run on the complete range of HP 9000 Series 300 technical workstations under either the Pascal or HP-UX operating systems. ME Series 30 is available on the 32-bit HP 9000 Series 320 technical workstations running the HP-UX operating system. Networking capabilities such as HP 9000 LAN allow users to set up a distributed system featuring all three products configured to address the full range of mechanical engineering CAD requirements. See page 158.



HP DesignCenter ME Series 90

HP DesignCenter ME Series 90 is an expandable, off-the-shelf multichannel test system with applications in structural testing and analysis, vibration analysis, control system testing and general signal analysis from 61 μ Hz to 51.2 kHz. ME Series 90 closes the design loop by linking HP's computer-aided design tools with test results. Dynamic mechanical testing completes this link by allowing the engineer to compare the mechanical performance of the prototype or final product with the analytical model developed with other CAE tools. Dynamic mechanical testing can also be used throughout the life of a product to troubleshoot noise and vibration problems. ME Series 90 is based on the HP 9000 Series 300 technical workstation, combined with HP measurement hardware and HP software for signal processing and structural analysis. See page 160.



HP 64000-UX Microprocessor Development Environment

Hewlett-Packard's new HP 64000-UX Microprocessor Development Environment is a natural evolution of the HP 64000 Logic Development System, and is compatible with the existing HP 64000 system. In addition, the new development environment offers many significant new capabilities. It shares a common workstation platform with other design engineering tools of Hewlett-Packard's DesignCenter. The HP-UX operating system also supports applications such as structured analysis and design, project management, spreadsheets, and word processing. The modularity of the HP 64000-UX environment allows custom configuration of multiuser, multitasking design systems. Support of industry-standard LANs, IEEE 802.3 and Ethernet protocols, and RS-232 further expand the capabilities of this environment.

Add to all this flexibility and compatibility Hewlett-Packard's emulation and analysis support for over 40 microprocessors and you discover a powerful microprocessor development environment for a very economical cost per user. See page 148.



HP 3065AT Advanced Technologies Board Test System

The HP 3065AT is the newest member of the HP 3065 Board Test Family. The HP 44680A through 44685A Advanced Technologies Hardware and Software Packages transform the basically in-circuit board test system into a combinational HP 3065AT Advanced Technologies Tester. It is designed for the enhanced testing of VLSI, ASIC, and SMD based printed circuit boards.

The HP 3065AT Tester features high-speed data capture, clock speeds for testing 32-bit microprocessors, and advanced control line capability for bus emulation testing. These test features provide significant capability for improving detection and diagnostics of manufacturing defects and parts faults. This enhanced test capability provides yields of 98 to 99 percent on PCBs. See page 352.

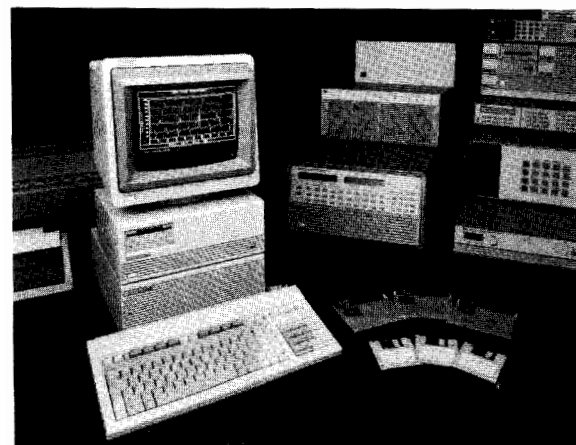

HP Data Acquisition Manager (DACQ/300)

HP DACQ/300 is a general-purpose Data Acquisition Manager for the HP 9000 Series 300 and 200 BASIC workstations. DACQ/300 reduces your software development time and performs up to 90 percent of your software task. Add DACQ/300 subroutines to your BASIC program to retrieve data from any HP-IB instrument. Use DACQ/300 to create a data base, store your data on any Series 300 supported disc drive, and display, print, or plot that data. DACQ/300 can create color plots or real-time strip charts. Analyze the data (FFTs and inverse FFTs, scaling, limit checks, statistics) or convert the data (thermocouple, thermistor, RTD, and strain conversions) to engineering units, regardless of its source. In short, use DACQ/300 to handle all of your data management needs. See page 302.

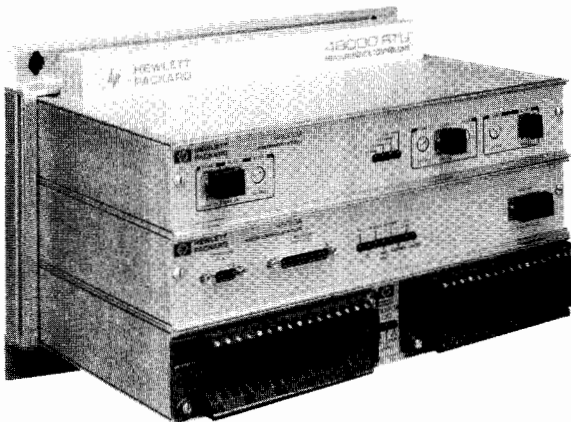

HP 48000 RTU Measurement and Control Unit

Designed as a remote data acquisition and control unit, the HP 48000 RTU addresses a broad range of system applications in harsh industrial environments.

The use of CMOS technology contributes to the wide operating temperature range and low power consumption of the HP 48000 RTU. Aluminum module enclosures protect the circuit boards from physical damage, while minimizing contamination and reducing the potential of ESD damage.

The use of 4807X Application Development Software on one of several HP personal computers provides system designers with a powerful, yet cost-effective development package.

Over 60 signal processing functions can be configured in the HP 48000 database. These signal processing functions, in conjunction with incrementally-compiled multi-tasking BASIC, make it easy to implement intelligent processing and control.

The 48000 RTU hardware is designed in modular blocks, allowing for the addition of I/O modules for future expansion. The configurable I/O module (CIO) facilitates a free-form mix of I/O field point types. As a result, the CIO can be custom configured to the application.

Radio/modem/wireline datacom options provide a networking solution for virtually every application. See page 290.

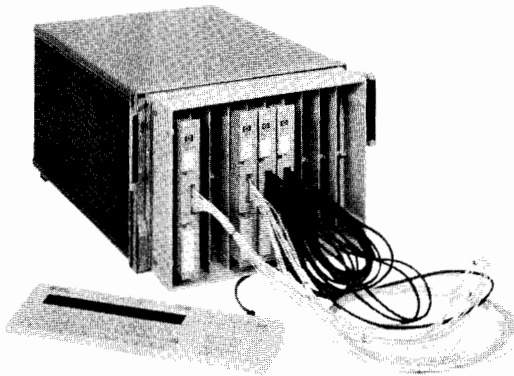

HP 3235A Switch/Test Unit

The HP 3235A Switch/Test Unit reduces development time of HP-IB systems and improves their throughput by providing off-the-shelf switching and interfacing. Under HP-IB control, the HP 3235A routes signals between devices under test (DUTs) and test equipment. For additional flexibility and convenience, an optional quick-interconnect fixture adapts the HP 3235A to a variety of DUTs.

The HP 3235A's ten-slot card cage accepts any combination of seven switching modules, a digital multimeter module, a digital input/output module and a breadboard module. Built-in analog and trigger busses route signals for measurement, stimulus, or triggering, and a keyboard-style control panel aids system debugging. For large systems, up to ten additional ten-slot HP 3235E extenders can be slaved to each HP 3235A. See page 166.

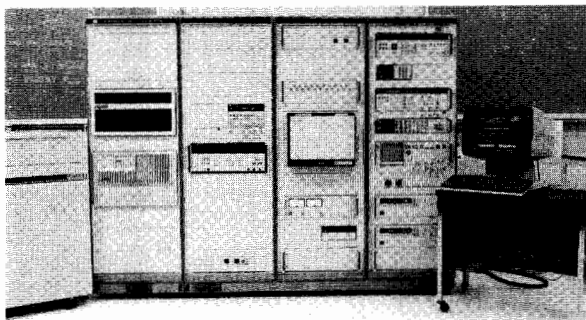

HP Automatic Test System Enhancements

HP ATS now provides a better solution for automatic testing at the system level. Dynamic digital testing and low-cost switching make HP ATS more versatile than ever before. A new Digital Test Unit offers dynamic test capability with 10 - 20 MHz data rates, 512 channels with memory depth of 4 kbits / channel, tri-state logic and a high-speed interface.

Switching capability based on the new HP 3235A provides high performance at reduced cost. In addition, HP ATS is now fully supported on the HP 1000 A-Series Computer. This enhancement package provides a new, wider range of capability to meet a broad variety of automatic test needs. See page 183.

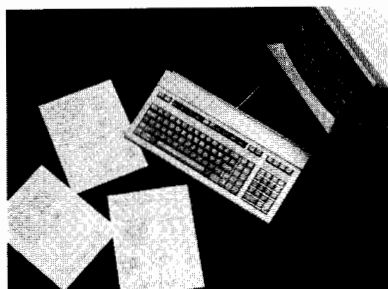

Function Test Manager/300 Test Software

Functional Test Manager/300 is a computer-aided test (CAT) software package designed to speed development of HP-IB functional test systems. Based on the HP 9000 Series 200/300 Computers running BASIC, HP FTM/300 reduces test software development by up to 50 percent, is optimized for test throughput, gives users the flexibility to customize to specific test needs, provides a turnkey statistical quality control (SQC) package complete with reports and graphics, and allows transfer of test data to other computing environments for further test analysis and reporting. See page 185.

HP 4278A High Speed C-D Meter

To improve the efficiency and reliability of production go/no-go testing and incoming or outgoing inspection of ceramic, film and mica capacitors, the HP 4278A performs capacitance and loss factor (D, Q, ESR or G) measurements with a combination of high speed and high accuracy.

The HP 4278A makes C-D measurements with a basic accuracy of $\pm 0.05\% \pm 0.0002D$ at 1 MHz and $\pm 0.07\% \pm 0.0005D$ at 1 kHz, 6-digit resolution, and a measurement time of 18.6 ms. When reduced accuracy is acceptable, measurement times of 6.7 ms or 10.4 ms can be selected. Capacitance measurement range is from 1 pF to 1024 pF full scale (2048 pF maximum) at 1 MHz and 100 pF to 100 μ F full scale at 1 kHz. Low-noise, high-stability circuit design enables the HP 4278A to make high-speed measurements of low dissipation factors with a resolution of 0.00001.

With its built-in comparator, the HP 4278A can output comparison/decision results for sorting capacitors into a maximum of 10 bins. When used with the handler interface and data I/O interface options, the HP 4278A can easily be combined with a component handler and a system controller to fully automate capacitor testing, sorting, and quality control data processing, and to increase production efficiency. See page 226.

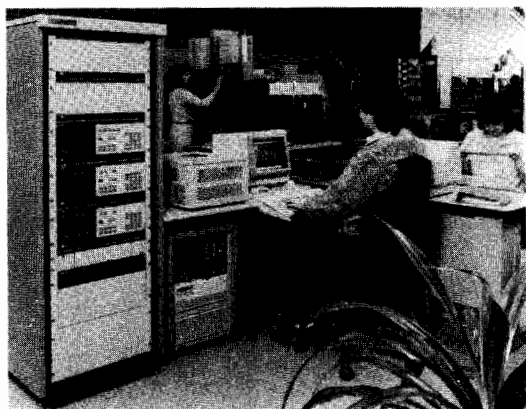
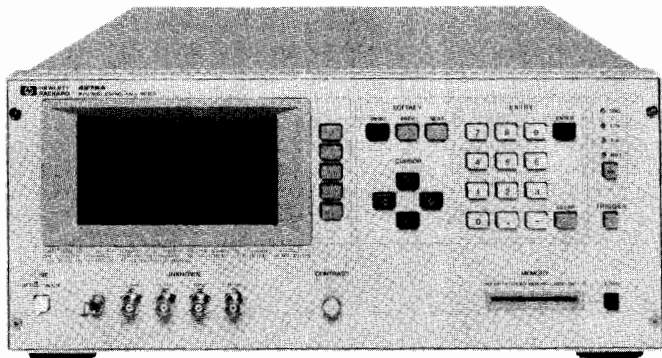

HP 81810S IC Test System

Hewlett-Packard now offers a complete digital IC test system. Based on the HP 8180/8181/8182, the HP 81810S IC Test System includes a system rack, a series 200 or 300 HP computer, and a new software package that supports softkey-driven interactive test, test program generation, and CAE links to IC design workstations. The new HP 15466A Test Head allows you to test devices with up to 256 pins. The system is optimized for at-speed functional and ac/dc parametric tests. It is very modular in terms of channel count, performance and price, thus addressing a wide span of applications in IC design verification and prototype characterization, failure analysis, low-volume production and incoming inspection. See page 239.



HP 94401A AC Analysis Software

You no longer have to rely on dc model parameters to characterize a high-frequency device. TECAP's at-speed characterization lets you know your device characteristics at the operating frequency for maximum circuit-simulation accuracy and confidence.

TECAP allows you to completely analyze non-linear characteristics of active devices with respect to frequency, bias, temperature, and signal power level. You can quickly generate easy-to-read plots of RB vs. IB and f_T vs. IC to accurately determine your device's optimum operating frequency or switching speed.

With TECAP you can vary frequency and bias to measure all S, H, Y and Z parameters. For this measured data, you can extract ac model parameters to obtain resistance and transmit time information for your devices. Then you can use the powerful TECAP simulator to directly compare the ac non-linear SPICE model equations to the measured high-frequency device behavior.

TECAP gives you the non-linear, high-frequency simulation tools you need to accurately predict your high-speed bipolar, gallium arsenide, and MMIC device models in tough, real-world situations. For the first time, you can extract ac model parameters and immediately verify RF and microwave device performance. See page 254.



New Fiber Optic Products

Hewlett-Packard has added to its existing fiber optic line new long wavelength measurement equipment: a power meter, an LED source, an attenuator, a switch and a power splitter. The HP 8152A Optical Average Power Meter features two independent optical inputs and operates between 850 and 1700 nm. The HP 8154B LED Source incorporates a 1300-nm LED that outputs -20 dBm. The HP 8158B Optical Attenuator covers both multi- and single-mode applications at 1300 and 1550 nm over an attenuation range of 0 to 60 dB. The HP 8159A Optical Switch offers excellent repeatability of 0.2 dB and insertion loss of less than 3.5 dB, including two connectors. See pages 577-580.

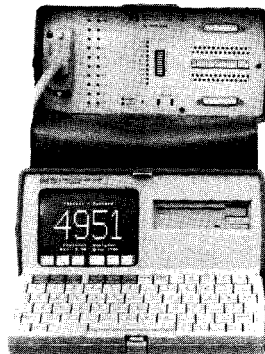

HP 4951C Protocol Analyzer

The new HP 4951C Protocol Analyzer includes all the features of the HP 4951B (monitors and decodes data transmissions, simulates datacom network components, performs bit error rate tests, and remotely transfers data and programs), but has changed the mass store media from cassette tape to micro-floppy disc ($3\frac{1}{2}$ ""). The HP 4951C comes standard with a software package that allows it to be used as an asynchronous terminal. A software package that allows SNA, DDCMP and X.25 to be analyzed is available.

The HP 4951C also provides canned 3270 testing packages as accessories. These software accessories—along with the standard analysis of SDLC, HDLC, BSC and most other character-synchronous or asynchronous protocols—mean that users of all major data communications protocols can do their jobs faster, more easily and more thoroughly than before. See page 363.

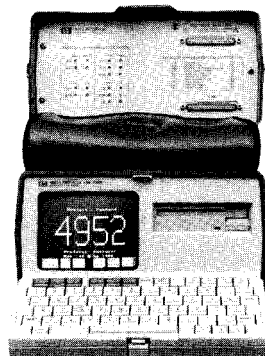

HP 4952A Protocol Analyzer

The new HP 4952A Protocol Analyzer is a 64-kbps, highly-portable test instrument for installing, troubleshooting and designing data communications equipment. It has a micro-floppy disc for mass storage, which provides compatibility with the new HP 4951C. The HP 4952A allows you to monitor and decode data transmissions in all the common protocols, including SNA and X.25. Network components can be simulated and bit error rate tests performed. Data, programs and setups can be remotely transferred to an unattended HP 4952A. Together the HP 4952A and the HP 4951C form a family of affordable, portable protocol analyzers. See page 363.

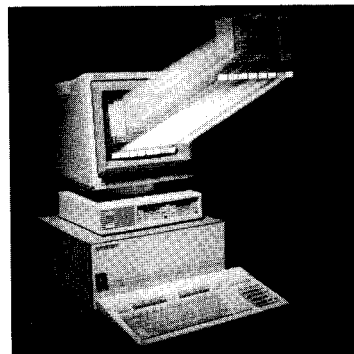

HP 4971S LAN Protocol Analyzer

The HP 4971S is a LAN protocol analyzer for troubleshooting on local area networks employing Ethernet or IEEE 802.3 protocols on a 10-Mbps baseband coaxial medium or other mediums with Ethernet-compatible interfaces. This LAN protocol analyzer is a comprehensive, easy-to-use troubleshooting tool for fast problem isolation and maintenance of local area networks. It completely decodes IEEE 802.3/Ethernet data frames and it allows you to view the upper-layer protocols. Being able to view interactions between the nodes assists you in fast problem isolation. The HP 4971S also allows you to monitor traffic on the network, generate data frames to test other nodes, write programs to verify network performance, and download programs via an RS-232C link to another HP 4971S for troubleshooting a LAN in a distant location. See page 366.

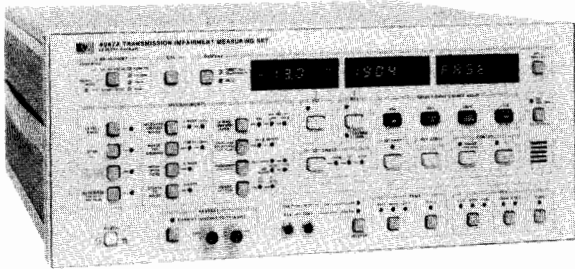

HP 4947A Transmission Impairment Measuring Set (TIMS)

The HP 4947A Transmission Impairment Measuring Set (TIMS) tests voicegrade datacom circuits to North American standards. It has the high measurement capability needed to check the guaranteed quality of a circuit and track down tough problems on long-haul data networks. In addition, it has many features that boost operator productivity: an easy-to-use front panel, an automatic measurement sequence to speed up loopback or end-to-end testing, and direct print/plot output to an HP ThinkJet printer for low-cost, hard-copy circuit records. All this performance comes at an unprecedentedly low price.

This latest member of the HP TIMS family will suit telephone companies and carriers, but also brings high-performance analog testing within the test budgets of many datacom end users. Within a data center, the HP 4947A helps identify problems to the modem or the line so that the right vendor can be called first time. See page 373.

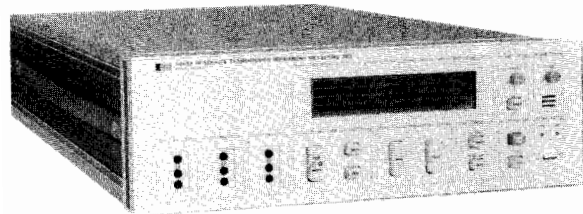

HP 4948A In-service Transmission Impairment Measuring Set (ITIMS)

The new HP 4948A In-service Transmission Impairment Measuring Set (ITIMS) tests the performance of leased data circuits carrying voicegrade modem signals while they are still handling traffic. The HP 4948A is able to work with a variety of standard North American and CCITT modems in the 2.4 - 9.6 kb/s range.

The instrument's in-service capability offers real help towards improved circuit availability. When there is a problem, trouble-shooting can start immediately, without taking a line down, because the line signal itself is the stimulus and no other operator is needed to send a test signal.

The HP 4948A makes long-term monitoring a practical possibility, so intermittent events can be captured or, on critical circuits, deteriorations can be detected and fixed before they affect data communications.

The HP 4948A can be bridged across a line anywhere along its length without disturbing the signal. It is easy to use because it can automatically identify any suitable modem signal and measure all impairments simultaneously.

The HP 4948A can check results against limits, drive a printer, and gather up to a week's data in its own logging store. It is a powerful new tool for suppliers and users of analog data circuits. See page 374.

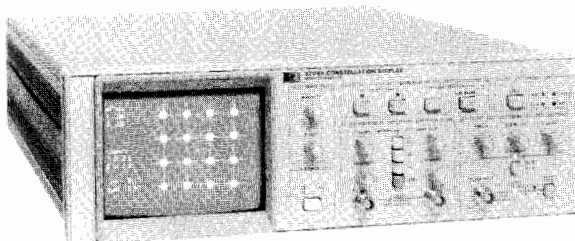

HP 3709A Constellation Display

Designed primarily for maintenance applications, the new HP 3709A Constellation Display offers in-service performance monitoring and fast troubleshooting of digital microwave radio systems.

The HP 3709A takes advantage of a technique called constellation pattern analysis to show amplitude and phase distortions of a radio signal. Because many degradations and impairments produce characteristic effects on the radio's constellation pattern, an examination of this pattern using the HP 3709A allows these degradations and impairments to be readily identified.

By performing measurements on the constellation pattern, the effects of impairments can be quantified and the obtained values used for reports or as the basis for radio adjustments. For convenience, a printout of the constellation pattern and measurements can be produced on an HP ThinkJet printer.

The HP 3709A can be used stand-alone or coupled to a computer to permit a more in-depth analysis of the radio signal data. See page 394.

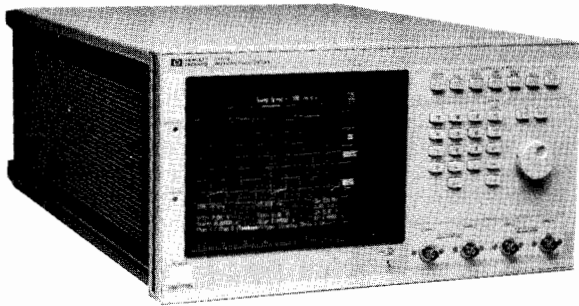

HP 54111D High-performance Digitizing Oscilloscope

The HP 54111D extends HP's popular 54100-series digitizing oscilloscopes into the single-shot capture and deep memory areas. The first oscilloscope to provide a 1-gigasample/second digitizing rate, the HP 54111D is a two-channel, 500-MHz bandwidth instrument. It provides 8K memory simultaneously on both channels.

The HP 54111D also offers an extensive feature set that includes automatic pulse parameter measurements and autoscaling, digital storage, a functional color display, logic triggering, and flexible probing. See page 436.

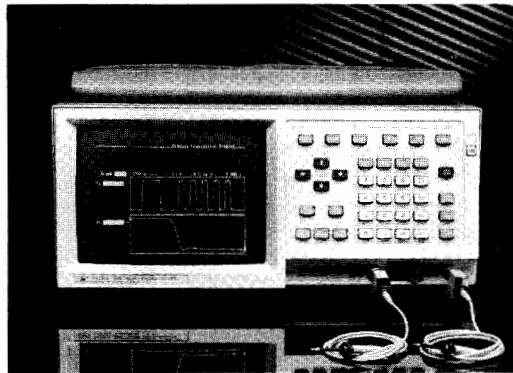

HP 54201A, 54201D Digitizing Oscilloscopes

Two new digitizing oscilloscopes, the HP 54201A and HP 54201D, expand HP's presence in the low-priced, multi-purpose digitizing scope market. With a 300-MHz bandwidth and 200-megasample/second digitizing rate, these products offer measurement capabilities and features for engineers working with analog circuitry, digital circuitry, or system integration. The D model adds 27-bit logic triggering capability. See page 428.

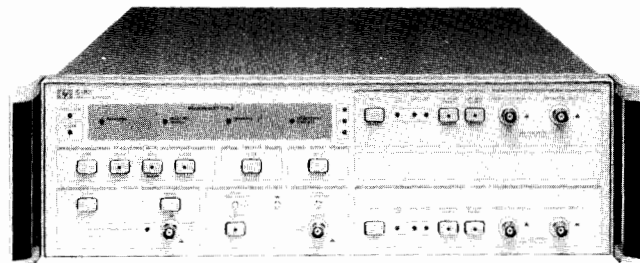

HP 5183A Waveform Recorder

With outstanding resolution and dynamic accuracy, the HP 5183A digitizes modulated and infrequently occurring waveforms to provide high-quality data for your computer analysis. The HP 5183A Waveform Recorder offers two simultaneous differential-input channels, each with a 12-bit (~ 72 dB dynamic range) A/D converter, 4-Msample/second maximum digitizing rate, and 64-ksample memory. With Option 512 you get 256 ksamples of memory per channel, which can be configured to 512 ksamples for one channel.

Software supplied with the HP 5183A includes instrument setup and data-transfer routines in either BASIC or Pascal for use with your HP Series 200 or 300 Computer. The data-transfer routines allow you to move data from the waveform recorder to the computer at a rate of 250 kbytes/second. In addition to this driver software, signal-processing software completes your waveform analysis system. See page 441.



HP 8180B, 8181B Data Generators and HP 8182B Data Analyzer

The HP 8180B, 8181B Data Generators and HP 8182B Data Analyzer are enhanced versions of the HP 8180A, 8181A and 8182A, which have already gained broad acceptance in high-speed digital IC/circuit test. With the B versions offering 16 times the vector memory depth of the A versions, Hewlett-Packard responds to the growing demand for functional test of complex ICs. This demand results mainly from the evolution of application-specific ICs (ASICs), which requires prototype testers to accept the large number of test patterns used by designers during simulation. See page 483.

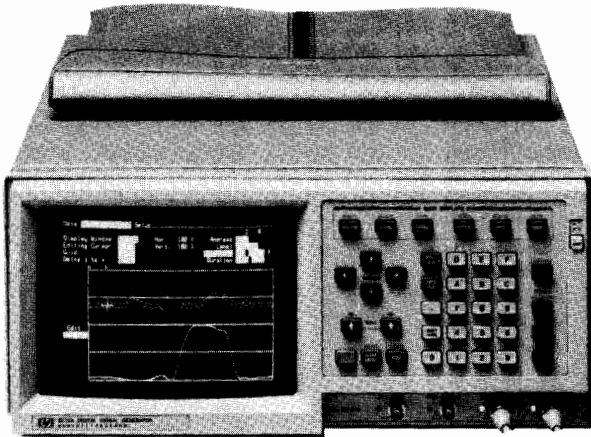

HP 8175A Dual Arbitrary Waveform Generator

Bridging the gap between digital and analog areas becomes feasible with the new Dual Arbitrary Waveform Generator, Option 002 of the HP 8175A Digital Signal Generator. Two fully synchronized output signals, each totally different from the other in shape and output level, are available for testing analog devices with two different inputs. Independent programming of digital and analog data allows stimulation of the device under test on 14 digital outputs and one analog output at the same time. The variable data point duration between two data points can differ between 20 ns and 9.99 seconds. The two 50-ohm outputs provide 16 V p-p, up to 32 V p-p into an open circuit. When configured with an HP 1631 Logic Analyzer, the HP 8175A forms part of a complete test set-up for digital and analog applications. See page 480.

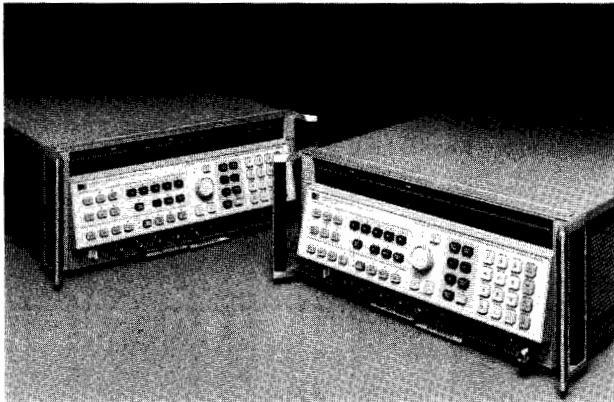

HP 8340B, 8341B Synthesized Sweepers

The HP 8340B and 8341B represent the new standard of excellence in synthesized sweepers, providing the high performance of a synthesized source and the versatility of a sweep oscillator. These instruments also offer several new features that were not available on earlier models (the HP 8340A and 8341A), allowing them to meet the performance requirements of an even larger number of applications. The HP 8340B and 8341B now have frequency modulation standard, and offer an external source module leveling mode that enhances the operation with the HP 83550-series Millimeter-wave Source Modules. And for applications that demand excellent harmonic performance, choose the HP 8341B Option 003 and get harmonics and subharmonics that are at least 50 dB below the carrier from 1.4 to 20.0 GHz. See page 494.

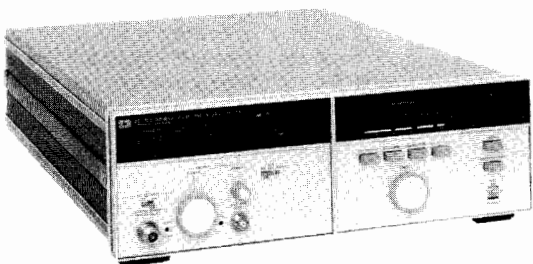

HP 8671B Synthesized CW Generator

For applications that need precise CW signals from 2 to 18 GHz at low cost, choose the HP 8671B Synthesized CW Generator. It provides programmable synthesized CW signals (1, 2, 3 kHz resolution) under HP-IB control with output level range from -120 to $+8$ dBm. This generator is ideal for LO substitution and for down-conversion applications such as microwave noise-figure measurements. See page 542.

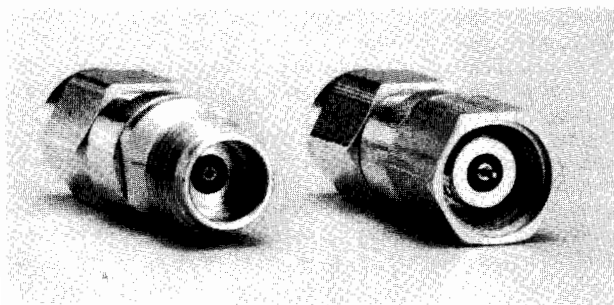

The 2.4-mm Coaxial Connector

The 2.4-mm connector permits microwave components and systems to operate with coaxial interconnections at frequencies up to 50 GHz. Such systems need no longer be restricted to waveguide. Using the 2.4-mm connector, broadband devices operating from dc to 50 GHz are possible, simplifying and speeding the design and manufacture of components and systems.

This new connector features a rugged interface with excellent return loss characteristics and highly repeatable performance at reasonable cost. See page 563.

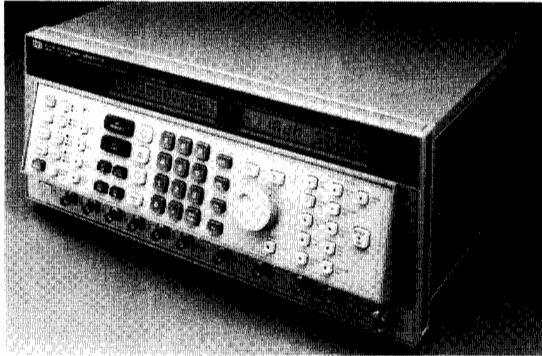

HP 8780A Vector Signal Generator

Most modern microwave systems, such as digital communications and coherent radar/EW, now depend on complex modulation formats for higher performance. To simulate these modulation requirements, the HP 8780A generates frequencies from 50 MHz to 3 GHz and accepts digital-data-stream inputs for modulation formats such as QPSK and 16/64-QAM up to 150 Mbaud. Other wideband modulations include FM to 100 MHz deviation and pulsing with transition times from 1 nanosecond to 1 millisecond. In combination with the HP 8980A Vector Analyzer, these two new system test instruments provide powerful measurement capabilities for the latest system requirements. See page 570.

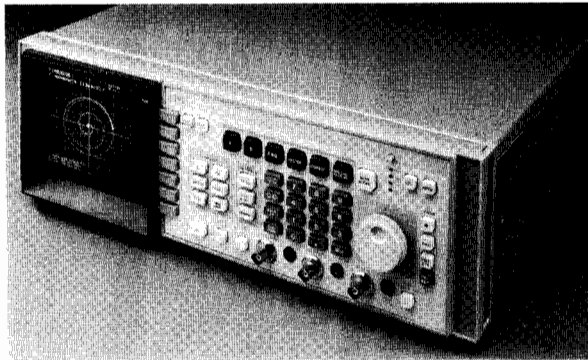

HP 8980A Vector Analyzer

The HP 8980A Vector Analyzer is a high-speed, two-channel sampling oscilloscope with equal and balanced X-Y display processing. It is ideally suited for analyzing the complex modulation formats of modern microwave digital communications and radar/EW systems. It can display the vector/phase or constellation data or, in the time domain, can show the "eye" diagram of either the in-phase or quadrature signal. The 350-MHz bandwidth and 12-bit resolution signal processing provide real-time visual displays of magnitude and phase, making the HP 8980A ideal for pulsed network analysis. See page 572.

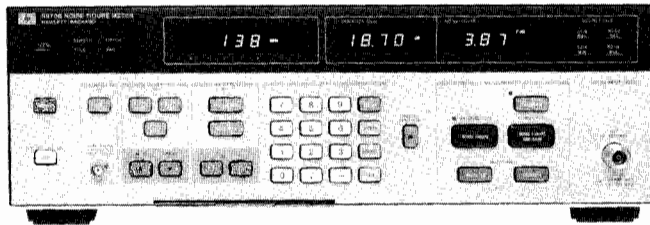

HP 8970B Noise Figure Meter

An improved version of the widely-accepted HP 8970A now makes noise figure measurements with even more convenience and speed. The B model has a frequency range of 10 to 1600 MHz and improved scope display controls. The internal firmware now also provides faster data processing and measurements. The memory stores excess noise calibration factors for three separate noise sources. Most importantly, it is fully compatible with the new HP 8971B Microwave Noise Figure Test Set for assembling a system for characterizing noise figures of components from 10 MHz to 18 GHz. Without the use of an external computer, the HP 8970B can control the external local oscillator, microwave test set and a plotter. See page 591.

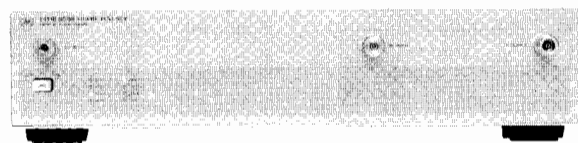

HP 8971B Noise Figure Test Set

Noise figure measurements on microwave devices and components previously required a build-it-yourself down-converter with all its user concerns for single- vs. double-sideband mixing, second stage noise corrections, amplifier saturations and more. The HP 8971B Microwave Noise Figure Test Set provides a fully-configured and specified solution to these measurement problems by integrating a tracking preselection filter, low-noise amplifiers, and other circuitry to remove many of the subtle problems of microwave down-converters. Combining a local oscillator, such as the HP 8671B Synthesized CW Generator, with the HP 8970B Noise Figure Meter brings the convenience, repeatability and accuracy of RF noise figure measurements to the entire 10 MHz to 18 GHz range. See page 592.

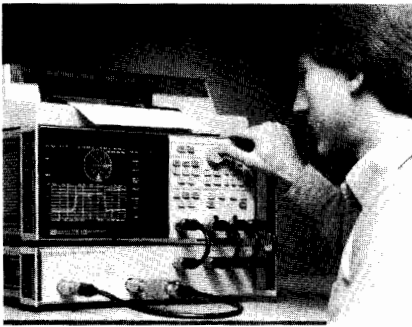

HP 8753A Network Analyzer

The HP 8753A Network Analyzer provides cost-effective RF network measurements from 300 kHz to 3 GHz with outstanding performance. It can simultaneously measure the transmission and reflection characteristics of RF components, devices or networks over a wide 100 dB of dynamic range. The integrated synthesized source provides 1-Hz resolution with >100 mW of output power.

Ideal for both production test and R&D environments, the HP 8753A provides automated measurement efficiency without the use of an external computer. Utilize the built-in pass/fail limit line testing, the arbitrary frequency list testing, the saving/recalling of instrument states and data to/from an external disc, the direct hardcopy of data to printers and plotters, and the full accuracy enhancement capability to maximize measurement throughput and measurement accuracy. Complete sets of measurement accessories are available for 50- and 75-ohm impedance environments.

Optionally, time domain analysis provides the ability to view the response of a test device as a function of time or distance (time domain reflectometry) and yields fast, useful coaxial fault location measurements or SAW device spurious time response characterization. See page 623.

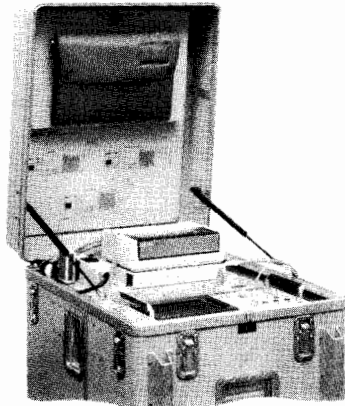

HP 8328A Transmission Line Test System

The HP 8328A Transmission Line Test System is all you need to test and troubleshoot transmission lines. Test the performance of waveguide runs and coaxial lines with swept-frequency measurements of insertion loss and return loss. Use the fault location capability to plot return loss or SWR as a function of distance to find impedance mismatches quickly and without guesswork.

Contained in a rugged, transportable cart, the HP 8328A is a versatile system for measuring transmission lines and reflection/transmission parameters from 10 MHz to 18 GHz. An HP 8757A and a software program that provides control from the front-panel keys of the analyzer is the heart of the system, and an HP 9000 Model 310 computer provides system control.

Fast, accurate fault location provides clear, unambiguous data on the location and magnitude of transmission line faults. High resolution, automatic data correction for attenuation and multiple mismatches, fast computation of the FFT, and rapid graphics produce corrected plots in less than 20 seconds. See page 611.

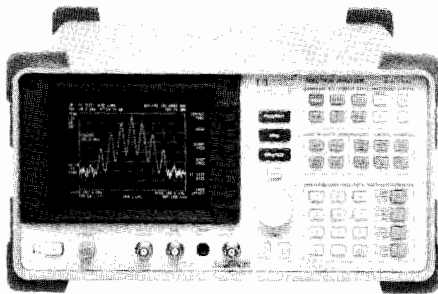

HP 8590A Portable RF Spectrum Analyzer

A portable, automatic RF spectrum analyzer priced substantially below any of our previous high-frequency models is now available. The new HP 8590A (10 kHz to 1.5 GHz) is fully programmable, yet light enough (13.5 kg) and compact enough (213mm × 366mm × 460mm) for field use. This analyzer is intended for bench applications in R&D and manufacturing, and for on-site measurements at antenna installations and other remote locations.

Three digital interface options—HP-IB (IEEE-488), HP-IL and RS-232C—enable the portable RF spectrum analyzer to be programmed from a wide variety of computers, such as HP technical computers, personal computers (including the IBM PC), and handheld computers. With the HP-71B handheld computer and the small HP ThinkJet printer, report-quality documentation can be obtained right at a test site, and the entire spectrum analysis system can be carried easily by one person. See page 678.

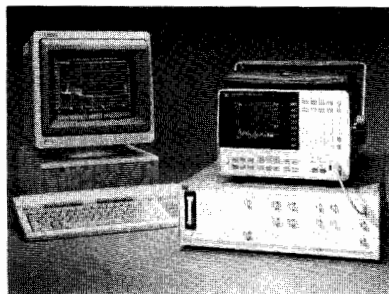

HP 3048A Phase Noise Measurement System

Fast, accurate measurements of a signal's phase noise can be the key to efficiently designing and repeatably producing low-noise oscillators and system components for radars, satellites and other high-technology equipment. The HP 3048A combines high-performance phase-noise-detection hardware with powerful software to automatically produce measurements of ± 2 dB accuracy. Carriers from 5 MHz to 18 GHz are measured directly and user-supplied external phase detectors allow calibrated measurements of signals outside that range. The system produces continuous plots of all detected spurs and phase noise over an offset frequency range of 0.001 Hz to 100 kHz (optionally to 40 MHz). Output formats include $L(f)$, spectral density, Allan Variance, residual FM and integrated noise. A noise monitor mode provides a continuous real-time look at a device's phase noise or spurs to give immediate feedback on changes to the device under test. A variety of reference sources can be controlled by the HP 3048A system—for example, the low noise HP 8662A and 8663A Synthesized Signal Generators, the HP 11729C Carrier Noise Test Set, or the user's own source with a manual-operation mode. See page 707.

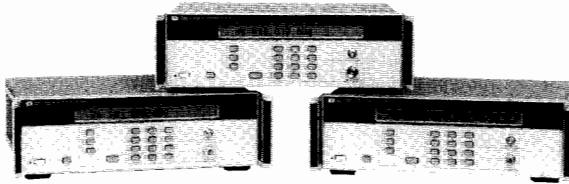

HP 5350B, 5351B, 5352B Microwave Frequency Counters

Covering frequencies to 20, 26.5, and 40 GHz respectively, these counters give you exceptional performance at affordable prices. Because of the GaAs (gallium arsenide) technology used in these products, you can now get a 40 GHz direct-input counter without having to purchase expensive mixers.

These counters have remarkable sensitivity. They can detect signals as low as -40 dBm (-30 dBm for HP 5352B), making measurements of low-level signals simple and inexpensive. Also, because of the reduced acquisition time of 60 milliseconds, these counters can now track your source drift to 1 GHz/second effortlessly. In addition, these counters have wide FM tolerance for communications applications, scaling and offset functions, keyboard and display lockout, and HP-IB standard.

Their fast measurement throughput makes these counters ideal test system components. In automatic mode, they can deliver more than 100 measurements/second over HP-IB (120 in manual). This exceptional systems performance saves you money by reducing required test time. See page 306.



HP 5061B Cesium Beam Frequency Standard

The HP 5061B Cesium Beam Frequency Standard is another step in maintaining HP's leadership in the frequency and time marketplace by providing improved value without an increase in price. This primary frequency standard provides a specified accuracy of $\pm 4 \times 10^{-12}$ which is important for metrology, communications, scientific and space applications as well as in navigation and tracking systems.

Additional features in the HP 5061B include a 10-MHz output, a new optional LCD clock that provides the time-of-day and a 1 pulse-per-second output signal, and a new optional Ni-cad battery and battery charger module that significantly increases the standby operating time. The HP 5061B has also joined the ever-increasing list of HP instruments that extend the support commitment to a minimum of 10 years after active manufacture. See page 335.

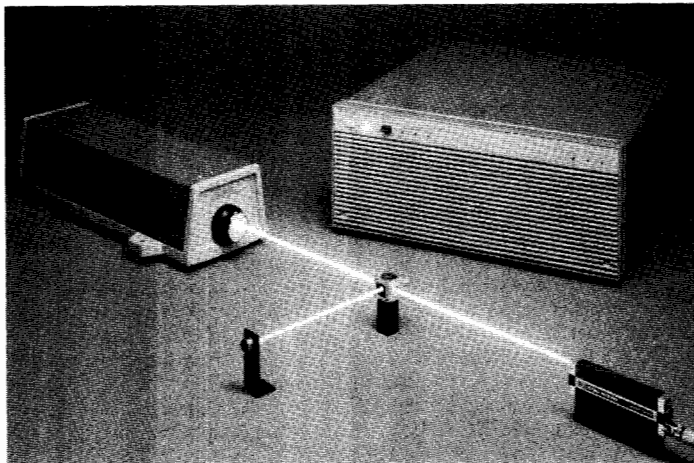

HP 5527A Laser Position Transducer

The new HP 5527A Laser Position Transducer offers an easy way to configure and integrate a position-feedback system. Part of this transducer is the new HP 5507A Laser Position Transducer Electronics. This electronics interface contains improved performance features such as a high slew rate with high resolution (16 inches/second slew rate, $\lambda/64$ resolution). The packaging of the HP 5507A ensures low noise operation and high reliability combined with ease of programming and fast data transfer.

While the HP 5527A Laser Position Transducer has widespread applications, it is an essential part of the equipment used to manufacture small-geometry Integrated Circuits (ICs). Also available is the HP 10715A Differential Interferometer, which offers better long-term stability and accuracy by minimizing deadpath. See page 730.



HP in Profile

Hewlett-Packard Company is in the business of developing, manufacturing and marketing measurement and computation products and systems used by people in science, engineering, business, industry, education and medicine. These products are known for their high quality, reliability and advanced technology and include calculators, computers and peripherals, electronic instruments, instruments for chemical analysis, medical instrumentation, and electronic components.

Headquartered in Palo Alto, California, Hewlett-Packard employs approximately 84,000 people worldwide, of whom some 56,000 work in the U.S.A. Product research and manufacturing activity is highly decentralized, with facilities in the U.S., the UK, Europe, Japan, Southeast Asia, Latin America and Canada. The worldwide sales organization includes more than 100 sales and support offices in the U.S., and some 275 sales and support offices and distributorships in 75 other countries.

With 1985 sales in excess of 6.4 billion dollars, HP is ranked in the top 60 U.S. industrial corporations. Over 40 percent of these sales were generated outside the United States.

HP Instruments

Hewlett-Packard's first product, developed in 1939, was an audio oscillator based on a new and innovative design. In the company's first 20 years, this oscillator was the foundation for an ever-broadening line of test and measurement instruments used primarily by engineers and scientists. The first HP catalog, published in 1943, used 24 pages to describe a total product offering of 12 instruments. This 1987 edition has nearly 800 pages on which are detailed some 1,700 instruments, computers and accessories out of the company's total offering of more than 10,000 products. Customers use HP instruments to evaluate the performance of their own electrical equipment, in developing products, in controlling quality and manufacturing processes, and in field service applications.

In addition to the electronics industry, major markets for HP instru-

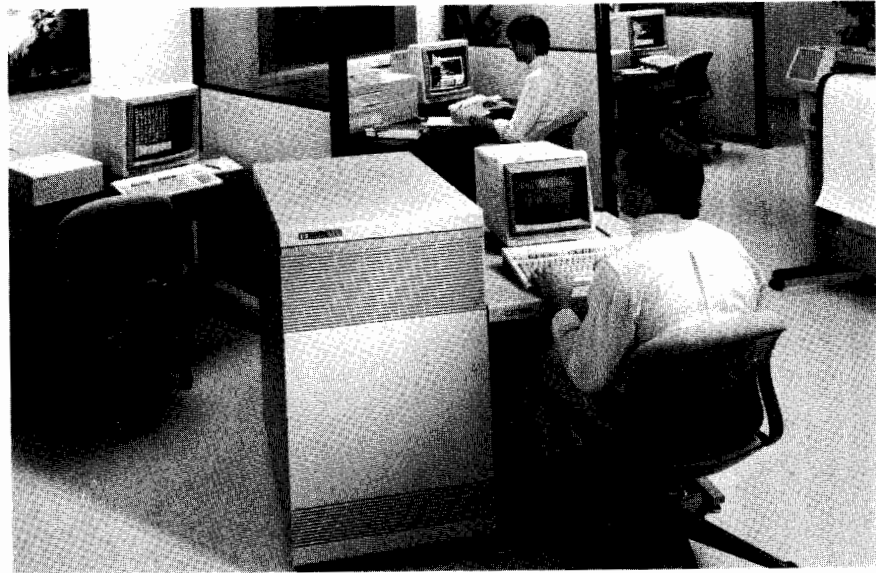

The HP 9000 Series 800 computers are products of the company's Spectrum program, the most intensive and far-reaching research-and-development project in HP's history. These computers employ Hewlett-Packard's new HP Precision Architecture, which is based on the principles of reduced-instruction-set computing (RISC). The performance made possible by these designs allows HP to offer a line of complete, consistent, state-of-the-art computing platforms whose breadth is equalled by few other companies.

The Series 800 will extend and converge the high end of HP's existing computer-aided-design and -engineering systems (the HP 9000 Series) and computer-integrated-manufacturing systems (the HP 1000 Series). The Model 840 shown here operates as a general-purpose super minicomputer for engineering applications, with a 4.5 MIPS CPU that supports 24 megabytes of main memory. Its UNIX* operating system also provides the real-time response and control features needed for factory-floor applications.

*UNIX is a trademark of AT&T in the U.S.A. and other countries.

ments include telecommunications, aerospace, aviation, and scientific research. In fact, HP instruments are used in almost every industry where precise testing, measurement and control are required.

HP Computers

HP's first computer was introduced in 1966. Its purpose was to gather and analyze the data produced by HP electronic instruments. Today, HP computers and their peripheral devices (terminals, mass storage devices, printers and plotters) are themselves a major product line and account for a substantial portion of the company's sales. The broad range of HP computation products and systems offers solutions for businesses, manufacturers and individuals as well as engineers and scientists.

HP leadership in key technical computer markets has been the outgrowth of the company's strong familiarity with engineering, scientific and manufacturing applications. By

linking networks of personal computers and terminals, powerful HP mini-computers provide mainframe capabilities for thousands of businesses and industries. Other computers are optimized for control of instrument systems, making it easier for customers to design and assemble electronic test systems.

HP's advanced data communications technology is the key to the enhanced productivity of such computerized systems. With the ability to combine words, data, and graphics, HP computer networks automate the many tasks involved. Specific application solutions along these lines are offered not only to engineers and scientists but also to manufacturers, distributors, retailers, financial institutions, hospitals, government agencies and schools.

HP Measurement Systems

Under the impact of a growing scarcity and rising cost of technical manpower, the need is accelerating for



System designers and maintenance personnel alike are demanding expanded performance from smaller instruments. HP is answering this trend throughout its entire product line. Good examples are the HP 54201A/D digitizing oscilloscopes, which can serve markets as diverse as automotive electronics, aviation and telecommunications. Due to such capabilities as 300-MHz repetitive bandwidths, ± 200 picosecond time-interval accuracy, statistical-delay measurements, waveform math and portability, they have found uses both on the lab bench and in automated test systems.

measurement systems, with their higher speed, accuracy, repeatability and productivity. HP instruments and computers are designed with systems in mind.

In 1965 HP set about creating its own internal standard for the interfacing of future HP instruments and HP computers. That standard became a worldwide standard, IEEE-488, and it is used by several hundred manufacturers in more than 14 countries. We call this standard HP-IB, the Hewlett-Packard Interface Bus. In this catalog system-ready products are marked with the symbol



In all cases the goal of HP systems is to provide essential information in useful form and in the most efficient and timely manner. The end result is

improved productivity of our customers' processes and organizations—the unifying purpose of HP's business.

Other HP Products

In addition to electronic measurement and computation products, HP manufactures a number of other product lines, all of them related by basic electronics technology. Among these are electronic components such as microwave semiconductor and optoelectronic devices. Other important fields of interest include medicine and analytical chemistry. Today, hospitals and clinics use HP equipment for patient monitoring, diagnosis and therapy, as well as data management. Analytical instruments are widely used in the chemical, energy, pharmaceutical and food industries, as well as in medical and chemical research programs for government and industry.

HP Innovation

The continuing growth of Hewlett-Packard is based to a significant degree on a strong commitment to research and development. Between 8 and 10 percent of sales revenue is invested in R&D. In 1985 this amounted to 685 million dollars. This increasing investment has enabled HP to stay at the forefront of technology and to maintain a steady flow of new and useful products. Well over half of the company's 1985 orders were for products introduced during the previous three years, a clear indication of the importance of HP's product-development efforts.

Each of HP's 55 product divisions has the primary responsibility for developing its own products. Together, the product divisions account for close to 85 percent of the company's annual R&D budget. The remaining 15 percent is invested in more basic, higher risk, longer term research undertaken by HP Laboratories, the central source of technical support for the divisions. Through endeavors in various areas of science and technology, the corporate laboratories also help the company develop new areas of business. Customers benefit through access to computers and instruments that are at the forefront of technology.

HP Support

The same high level of engineering excellence that HP commits to the development of advanced products also goes into creating high quality support services. Hewlett-Packard's support organization consists of a worldwide sales and service network staffed by highly trained engineers and technicians. Our support starts before you purchase an HP product and continues long after the product has been delivered.

Before you purchase a product or system, HP sales representatives are available to help you assess your needs and choose the product or system that meets your immediate and longer term requirements.

If your needs are best filled by an instrument system, we offer applications and training support to help you obtain full use of your system, hardware support to help maximize system up time, and software support to keep your system software current and productive.

To help you plan your system and its use, we offer the consulting and training expertise of experienced systems engineers. For the installation and maintenance of your system and its components, we offer the services of customer engineers. And for the long-term support of your system, HP offers an extensive menu of services. The menu includes contract or as-needed calibration and repair with on-site and at-HP options, as appropriate. Update services are available for both software and hardware, as is training for your own service personnel.

HP's worldwide support network ensures prompt availability of replacement parts throughout the production life of products and beyond. Replacement parts services also include parts stocking recommendations based on extensive component reliability histories and the numbers and mix of HP products to be supported.

For products requiring consumable supplies, such as recording paper, ribbons and magnetic media, we offer fast, convenient service from well-stocked supply centers that can also provide personal computers and software, peripherals and terminals, cables and connectors, workstation furniture, books and learning aids.

HP's comprehensive support also includes extensive information services. In addition to supplying excellent hardware and software manuals, HP makes available a wide variety of no-charge publications to help you choose the HP products that best fill your needs, to help you benefit from applications knowledge acquired by users inside and outside of HP, and to help you maintain your HP products. These publications range from new-product announcements, catalogs,

product family brochures and single-product data sheets, through application notes and programming aids, to service notes and maintenance periodicals.

The support services outlined above are described in more detail in the back sections of this catalog. Your nearest HP office can either supply the support services you need or help you obtain them. The locations of HP of-

fices are listed on the back pages of this catalog.

The HP Catalog

This catalog is divided into sections that are based on product families: circuit test systems, oscilloscopes, signal analyzers, telecommunications test equipment and so on. Many of these sections are prefaced by descriptions of basic kinds of measurements and the techniques of measurement

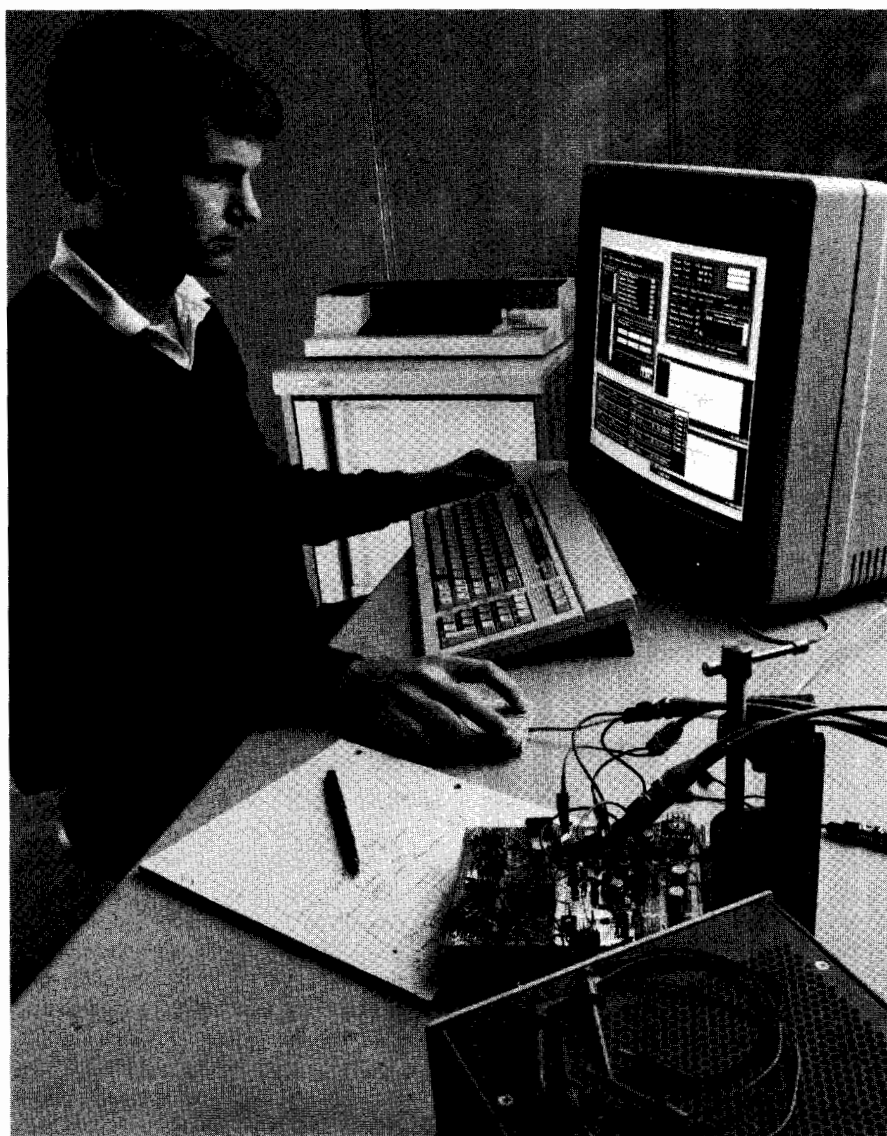

The products of modern technology are placing unprecedented demands on test and measurement instrumentation. HP is meeting these demands by developing integrated, multi-channel systems whose test capabilities are married to computer controllers. A product that typifies this design philosophy is the HP 3565S signal processing system, which can provide signal characterization and stimulus-response testing in the time, frequency and amplitude domains from dc to 51.2 kHz. With HP-VISTA Signal Processing Software, configurable measurement hardware, and an HP 9000 Series 300 workstation, the HP 3565S can monitor and measure as many as 62 signals simultaneously.

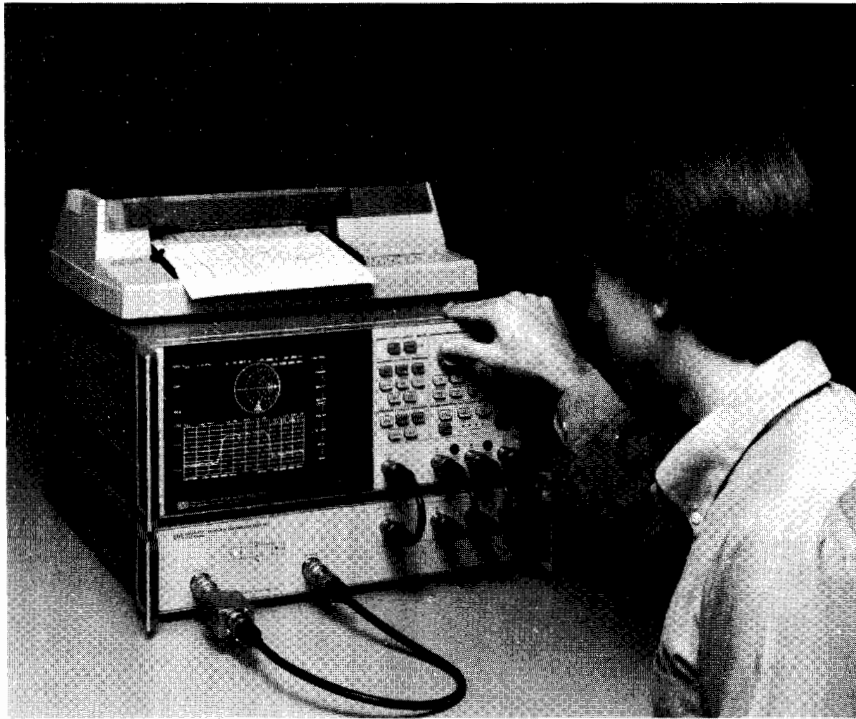

Enhancements of traditional instruments at times demand radical changes in product design and construction. Nowhere is this more evident than in the HP 8753A RF network analyzer, capable of measurements between 300 kHz and 3 GHz with resolutions of 0.001 dB and 0.01 degree over a 100-dB dynamic range. The integration of major functional elements has resulted in improved accuracy, faster measurements, fewer parts, increased reliability and lowered costs.

that are associated with the featured products.

Products described in this catalog are indexed three ways: generally, by type or application; alphabetically, by type, application, and name; and numerically by HP model number. The general index is located inside the front cover, the alphabetical index begins on page 23, and the numerical index begins on page 35.

Product descriptions are as complete as reasonably possible in a publication such as this. For some products, however, it will be necessary to refer to a data sheet for a full set of specifications. Data sheets are available on request at local HP sales offices.

Contacting HP

Locations of HP sales and service offices are listed on the back pages of this catalog. The listing also indicates the types of products normally available through each office (not

all offices handle the full line of HP products).

Your calls to your local HP office will be routed to the person best qualified to give you assistance if you tell the operator your specific product interest: instruments, computers, medical, analytical, or components.

Our sales force is made up of specialists in each of these five major product areas. Staff engineers are always available during business hours to respond to your needs or to obtain answers from appropriate sources. Our HP sales representatives are supported by the HP systems engineering organization, which has specialists in measurement and computation systems.

Information on product availability, prices and order status is immediately available through our worldwide order processing network.

Suggestions Welcomed

The purpose of this catalog is to give you the most information possible

about Hewlett-Packard products, along with some company background that may be useful in reaching decisions as to product and system needs. The major emphasis in this catalog is instrument products and systems, with some representation by HP's other product categories. Literature describing these other product categories in detail is available through your local sales office.

If you have any comments and suggestions about how we can make this catalog more useful to you, please let us know by writing to:

Hewlett-Packard Co.
Steve Duer
Catalog Manager
3200 Hillview Avenue
Palo Alto, CA 94304



A

AC

- Digital Voltmeters 187-199
- Probes 201
- True RMS Voltmeters 200

Access and Test System 396

Accessories

- Adapters 581, 632, 740
- Cabinets 748
- Cables/Connectors 133, 201, 581, 606, 632, 637, 638, 740
- Camera, Solid State 681, 684
- Computer 766
- Connectors, Adapters 564, 581, 740
- Data Generator/Analyzer 484
- EMI Measurement 674-677
- HP Touch 50, 52, 99
- IC Test 241, 484
- Logic Analyzer 403
- Network Analyzer 213, 557, 594-641
- Operating Cases 746
- Optical 581
- Oscilloscope 431, 448, 450
- PC Instruments 208
- Personal Computer Networking 58
- Pulse Generator 477
- Signal Generator 537
- SLMS 384
- Spectrum Analyzer 675-677, 693, 694
- Transit Cases 742
- Voltmeter 201
- Waveguide 549, 564, 556, 559-566, 634

Active Probes 347

Adapters

- 50-75Ω 537, 563, 607, 626, 694
- APC-3.5 740
- APC-7® 740
- Cables/Connectors 740, 321
- Optical 581
- Quasi-Peak 675
- Waveguide 564

AdvanceLink 58

AdvanceNet 58

Air Line Extensions 566

Alphanumeric LED Displays 736

AM/FM Signal Generators 522-536, 544, 546

AM/FM/φM Modulation Analyzer 716

AM/FM/φM Signal Generators 522-532

AM/FM Test Source 716

Amplifiers

- Broadband Power 488-490
- Broadband Preamp 489
- Distribution 341
- Power Supply 279
- Microwave 488, 489
- RF 490

Analog

- Circuit Test System 354

- Converters, A-D 89, 172, 177, 180, 184, 187-199, 286, 294, 446, 452
- Input/Output Cards For HP-1000 A-Series 184
- Voltmeters 188, 200
- Workbench 143

Analizers

- Audio 719
- Audio Spectrum 685
- Automatic Network 616, 629
- Automatic Scalar Network 600
- Automatic Spectrum 650, 655, 662-671, 697, 705, 707
- Customer Support 759-764, 766
- Data 479, 484
- Data Line 378
- Digital Transmission 381, 572
- Distortion 376, 719-724
- Fourier (FFT) 697
- Frequency Stability 709, 711
- Gain-Phase 612, 618, 213
- Impedance/Gain-Phase 213
- LAN Protocol 366, 367
- LF Impedance 216
- Logic 397-406
- Microwave Link 390
- Modulation 572, 716
- Network 620-641, 213
- Phase Noise 707-711
- Phase Noise, Side Band 707-711
- Primary Multiplex 378
- Protocol 363-365
- RF Impedance 218
- RF Signal Modulation 716
- Scalar Network 600-611
- Selective Level 376, 385
- Semiconductor Parameter 246
- Spectrum 650-706
- Signature 343-346
- Training 759
- Video 358
- Wave 376, 385, 642, 653, 724
- Waveform 426, 446, 452

Applications Support 760

APC-3.5 series Adapters 740

APC-7® series Adapters 740

Arbitrary Waveform Generator, Duel 481

Arbitrary Waveform Synthesizer 410

Artificial Intelligence 86

ASYST® Scientific Software 209

Atomic Clock/Frequency Standard 334

Attenuators

- Coaxial, Fixed 552
- Coaxial, Microwave, OEM 552
- Optical 580
- Test System 714
- Waveguide 556

B

- Bar Code Printers 105

*A registered trademark of the Bunker Ramo Corporation

ASYST® is a trademark of the Macmillan Software Company.



- Bar Code Readers 734, 737
 Bar Code Wand, Digital 62, 737
 Bar Graph Array, LED 737
 Baseband Video Measurement System 358
 Battery Operated
 Calculators/Computers 54, 60-65
 Counters 317, 330-333
 Disc Drive 100
 DMM 200-199
 Microwave Power Meter 585
 Beam Lead Diode 736
 Bias Networks 633
 Bias Supply, Transistor 633
 Bit Error Rate Test Sets 379, 380
 Bipolar Transistors 737
 BNC Series Adapters 740
 Board Test Fixtures 357
 Board Tester, Analog 352-354
 Board Tester, Digital 352-354
 Breadboard Cards, Multiprogrammer 177, 180
 Breadboard, PC Instruments 207
 Bridges, Directional 603, 625
 Broadband Amplifiers 488-490
 Business Computer System 66-71
- C**
- Cabinet Accessories 748
 Cabinet Identification 748, 752
 Cable Assemblies 740
 Cable Kit, Scalar Analyzer 607
 Cables/Connectors 740
 Cables, HP-IB 133
 Cables, HP-MSIB 659
 Cables, Optical 581
 CAD Software 154-157, 160
 Calculators, Handheld Computers & Peripherals
 Bar Code Wands, Digital 62
 Card Reader 61, 62
 Cassette Drive 62
 Catalog 766
 Financial Programmable 60
 I/O ROM 61
 Memory Modules 61
 Optical Wand 61
 Printer/Plotter 61
 Scientific Programmables 60
 Calibration Data, Attenuators 552, 554
 Calibration Kits (Network Analyzer) 607, 626-628,
 632, 634
 Calibration Service 763
 Calibrators
 AM/FM (HP 8901A/B) 718
 Power Meter, for HP 432 Series 588
 Range, for HP 435B Power Meter 585
 Scalar, for HP 8757A 607
 Time Interval 319
 Cardiography/Cardiovascular Instrumentation 738
 Capacitance Meters 226, 252
 Carrier Testing 383
 Carts, Instrumentation 450
 Cases, Combining 752
 Catalog, Computer Users Supplies and Accessories 766
 Catalog, Technical Software 163
 Cavity Frequency Meters 559
 Cellular Radio Test System 725
 Cesium Beam Frequency Standard 335
 ChemStations 734
 Chromatographs, Gas 734
 Chromatographs, Liquid 734
 Circuit Test Systems 352-354
 Circuit Testers, Digital 347-350, 352-354
 Clip, Logic 349
 Clock, Atomic 335
 Clock, Digital 135
 C Meter 226, 252
 C Meter/C-V Plotter 252
 Coaxial
 Accessories 550-567, 740
 Adapters 564, 563, 626-628
 Air Lines 566
 Attenuators 552
 Crystal Detectors 560, 561
 Directional Couplers 558
 Dual Directional Coupler 558
 Fixed Attenuators 552
 Filters 565
 Frequency Meters 559
 Low-Pass Filters 321, 565, 606
 Noise Sources 592
 Pad Attenuators 552
 Power Sensors 586, 589
 Shorts 563, 567
 Sliding Loads 567
 Slotted Line Carriage 562
 Slotted Line 562
 Slotted Section 562
 Step Attenuators 555
 Switches 166-169, 551
 Terminations 563, 567
 Thermistor Mounts 589
 Thermocouple Mounts 586
 Waveguide Adapters 564
 Comb Generator 694
 Combining Cases 752
 Communications, Data 48, 50, 53, 54, 58, 66,
 69, 71, 84, 360-376
 Communications Test Equipment 213, 360-376,
 377-396, 413, 425, 479-487, 574-581, 642-724, 725-729
 Communications Test Set 370
 Comparator, Logic 349
 Comparator, Phase 336
 Component & Semiconductor Measurement
 Digital IC Test System 246, 239
 Digital IC Testers 246, 239, 483
 Impedance, LCR Meters 212-236
 Semiconductor Parametric Test 242-255
 Components, Solid State 736, 737
 Computer-Aided Design (CAD) 52, 96, 112,
 154-157, 160
 Computer-Aided Engineering (CAE) 137, 143, 146,
 148, 154, 156
 Computer-Aided Test 164



- Computers & Peripherals
- Artificial Intelligence 86
 - Automatic Test Systems 164-186, 352-355
 - Business Computer Systems 66-71
 - Color Computers 79-75
 - Common Lisp Development Environment 86
 - Computer Users Catalog 766
 - Controllers 82-77
 - Disc Drives 88, 96, 96, 100, 104
 - Disc/Tape Drives 88, 96, 100, 104
 - Display Boards 77
 - Display Terminals, CRT 97-99
 - DOS Coprocessor 91
 - Engineering Workstations 52, 72-95, 137-163
 - Flexible Disc Drives 88, 96, 100
 - Graphics 87
 - Handheld Computers 61
 - HP-IL Peripherals 61, 96, 122
 - Interactive Terminals 97-99
 - Interfacing Summary 88, 122
 - Modems 62
 - Modular Computers 52, 82, 80-76
 - Monitors 96, 99
 - Networking and Data Communications 48, 50, 53, 54, 58, 66, 69, 71, 84, 355
 - Personal Computers 50-55, 80-82
 - Plotters 72, 96, 108-117
 - Portable Computers 54, 61, 81
 - Printers 88, 96, 105
 - Real-Time Systems 92
 - Supplies and Accessories 120, 766
 - Support 757
 - Tape Drives 88, 96, 100, 104
 - Technical Computers 52, 72-74
 - Technical Office Automation 90
 - Technical Software Catalog 163
- Connector Adapters 563, 626-628, 740
- Connectors, Microwave Precision 740
- Connectors, Optical 581
- Constellation Display 394
- Controllers 76-82
- Converters
- A-to-D 89, 172, 177, 180, 184, 197-199, 244, 294, 446, 452
 - D-to-A 134, 135, 176, 177, 180, 184, 204, 277, 295
- Serial-to-Parallel 134
- Counters, Electronic
- Counter/Synchronizer 311
 - Counter/Timers 318-320, 322-333
 - Counter/Tracking Generator 685
 - Digital Multimeter/Counters 292, 294, 344
 - DVM/DMMs 325-329
 - HP-IB /HP-IL 316
 - Low Cost 316, 333
 - Microwave 306-315
 - Microwave Source, Synchronizer 311
 - PC Instruments Universal Counter 205
 - Plug-In Adapter 322
 - Portable, Battery Operated 316, 330-333
 - Pulsed RF 314
- Reciprocal 292-295, 306, 314-318, 322, 330-332
- Time Interval 318, 322-333
- Time Interval Probes 321
- Universal 318-333
- Counter/Totalizer Card 177, 180, 295
- Coupler, Acoustic 62
- Couplers, Directional (Coax and Waveguide) 558, 559
- CRT Displays 97-99
- Crystal Detectors 560, 561
- Crystal Oscillators 340
- Current Tracer, Digital 348
- Custom Products, Handhelds 63
- Customer Support 757
- D**
- D/A Converters 134, 135, 176, 177, 180, 184, 204, 277, 295
- D/A Converter Cards, Multiprogrammer 177, 180
- Data
- Acquisition Systems 172-183, 282-303, 446, 452
 - Acquisition System Training 759
 - Analyzer 479, 484
 - Communications 48, 50, 53, 54, 58, 66, 69, 71, 84, 360-376
 - Error Analyzer 369
 - Generators 381, 479
 - Interchange 100
 - Transmission Test Set 369
- Data Acquisition
- Measurement and Control Unit 290
 - PC Instruments Data Logging Package 210
 - PC Instruments Data Acquisition Software 208
 - Systems 172-183, 282-303, 446, 452
 - System Training 759
 - Voltmeters/Counters 187-201, 204, 205, 282-301, 322-333
- Datcommunications Test Equipment
- Bit Error Rate Test Sets 369, 370
 - Data Line Analyzers 378
 - General Information 360, 368
 - LAN Protocol Analyzer 366, 367
 - Network Circuit Access Test Set 371
 - Protocol Analyzer 363
 - Selective Voltmeter 376
 - Spectrum Analyzers 642-694
 - Transmission Impairment Test Sets 368-375
 - Vector Modulation Generator/Analyzer 395, 568
- DC**
- Milliammeters 187-201
 - Picoammeter 249
 - Source/Monitor 251
 - Voltmeters 187-201, 204, 292-301, 324-330
- DC Power Supplies**
- Amplifier/Power Supply 279
 - Autoranging 266, 274, 276
 - Condensed Listing 257-259
 - Constant-Current Sources 281
 - Digitally Controlled 278
 - Dual Tracking 261, 264, 272
 - General Information 256
 - General Purpose: 10-30 W Output 261



- General Purpose: 25-200 W Output 264
 General Purpose: 100-2000 W Output 266, 268
 General Purpose: 300-11,000 W Output 270
 HP-IB Programmable 207, 257-259, 272, 274-278
 PC Instruments 20V 207
 PC Instruments 50V 207
 Precision Voltage Sources 278, 280
 Programmable 207, 257-259, 272, 274-278
 Source/Monitor 251
 Specifications, Definitions 260
 Transistor Bias 633
 Decade Capacitor 236
 Degaussers 336, 464, 465
 Delay Generators 472-478, 483
 Design Automation
 Computers 76, 77, 80, 140
 Overview 137
 Selection Guide 139
 Support Programs 142
 Technical Computing Environment 140
 Third-Party Software 163
 DesignCenter Products 137-163
 Detectors
 Adapter 605
 Coaxial, Microwave, OEM 560
 Crystal, Coaxial and Waveguide 560, 561
 Diode Array 734
 Error 380, 381
 Fluorescence 734
 Infrared 735
 Scalar 605
 Slotted Line 562
 Development Systems, Logic 148
 Differential Gain/Phase, Video System 358
 Digital
 AC Voltmeters 187-199
 Analyzer, Logic 401
 Analyzers, Signature 343-346
 Bar Code Wand 62, 737
 Board Testers 352-354
 Capacitance Meter 252
 Cassette Drive 62
 Circuit Test 343-349, 352-354
 Communications Generator/Analyzer 568
 Constellation Display 394
 Current Tracer 348
 DC Voltmeters 187-201, 204, 292-301, 324-330
 DC Voltmeter/Counters 325-330
 Education Course 347
 IC Testers 239, 246, 352, 483
 IC Test System 239
 Impedance Analyzers 213-221
 In-Circuit Board Test Systems 352-354
 Input/Analog Comparator Cards 177, 180
 Input/Output Card HP-1000 Series 184
 Input/Output Module 294
 Input Cards, Multiprogrammer 177, 180
 I/O for PC Instruments 203
 LCR Meters 222-235
 Microprocessor Troubleshooting 148, 343-346, 351
 Modulation Analyzer 572
 Modulation Signal Generators 395, 570
 Multimeters 187-199
 Multimeters, Signature 343-345
 Noise Figure Meter 592
 Output Cards, Multiprogrammer 177, 180
 PC Board Test System 352-354
 Power Meters 582-589
 Pressure Gauge 732
 Programmable Power Supplies 207, 257-259, 272, 274-278
 Signal Analyzers 343-347
 Signal Generators 479-487, 570
 Signature Analyzers 343-347
 Spectrum Analyzers 642-706
 Stimuli 479-487
 Thermocouple Card, Multiprogrammer 180
 Thermometers 292-295, 733
 D/A Current Converter Cards 177, 180, 295,
 D/A Voltage Converter Cards 177, 180, 295
 Transmission Analyzer 381
 Troubleshooting 343-349
 Voltmeters 187-199
 Digital-to-Analog Converters 134, 135, 176,
 177, 180, 184, 204, 277, 295
 Digitizing Oscilloscopes 426-435
 Dimensional Measurements 730
 Diodes 736
 Diode Array Spectrophotometers 735
 Directional Bridges 603
 Disc Drives 96, 100, 104
 Disc/Tape Drives 96, 100, 104
 Distortion Analyzers 716-724
 Distribution Amplifier 341
 DOS Coprocessor 91
 Double Balanced Mixer 561
 Doubler, Frequency 537
 Down Converters 390, 537, 693
 Drafting, Mechanical Engineering 158
 Drafting Plotters 96, 112-117
 Dual Tracking Power Supplies 271, 264, 272
 Dual VHF Switch Module 171
 Dual Voltage DAC for PC Instruments 204
 Dynamic Signal Analyzer 697, 699, 702
E
 Eight-Pen Plotters 96, 110, 112-117
 Emitters/Detectors 736
 Optical Reflective Sensor 736
 Electrical Engineering (EE) DesignCenter 137-156
 Electronic Counters 304-333
 Electronic Mail 70, 71
 EMI Measurement Software and Accessories 675-677
 EMI Measurement Systems 674, 681
 Emulators, Microprocessor 148
 Engineering Documentation Software 156
 Engineering Graphics 156
 Engineering Workstations 75-78
 EPROM Development Kit 148
 Error Rate Measurements 379-381
 Extenders, HP-IB 136



F

FDM Measurement Systems	388, 396
FDM Network Monitoring Systems	383, 388, 396
Fiber Optics	
Adapters	581
Attenuator	580
Average Power Meter	578
Cables	581, 736
Connectors	581, 736
Heads	576, 578, 581
LED Source	579
Multiplexer	736
Pulse Power Meter	576
Receiver	577
Signal Sources	575, 579
Switch	577
Test Equipment	574-581
Transmitters/Receivers	736
Filters	
Coaxial and Waveguide	565
High Pass	606
Low Pass	321, 565, 606, 681
Film Recorder	96, 118
Finite Element Analysis System	157
Fourier Analyzer	697, 699, 702
FM Modulation Analyzer	716
FM Signal Generators	522-532, 543-546
Frequency	
Counters	194-196, 205, 292-295, 304-312
Counter/Tracking Generator	685
Doublers	537
Meters, Coaxial and Waveguide	559
Reference Card, Multiprogrammer	177, 180
Stability Analyzer	707, 709
Synthesizers	522-532, 543-546, 494-497
Frequency Standards	334-336
Cesium	334
Distribution Amplifier	341
Frequency and Time Standards	
General Information	334
Quartz	340
Rubidium	337
Standby Power Supplies	342
Frequency Selective Meter and	
Tracking Oscillator	385, 416
Function Generators	407-414, 418-425
Function Generator for PC Instruments	205
Furniture, Workstation	766

G

Gas Chromatographs	734
GC/FTIR Systems	735
GC/Mass Spectrometer Systems	734
Generators	
Arbitrary Waveform	410, 481
Data	381, 479-487
Delay	472-478, 483
Digital Modulation	570, 395
Function	407-414, 418-425
Jitter	382
Noise	592

Optical, Pulse/Function	575
Pattern	379-382, 479-487
PRBS	480, 487
Pulse	466-478
Pulse/Function	407-409, 418-425, 467
Signal	520-547
Square Wave	407-425
Sweep	412-417, 423, 491-519, 541
Timing	478
Tracking	385, 416, 659, 681, 685, 689, 691
Vector	570
Vector Modulation	570, 395
Waveform	444
Word	379, 381, 477, 487
Graphics	
Displays	96-98, 8.29
Film Recorder	96, 118
Generator (HP-IB Interface for displays)	109
Plotters	96, 108-117, 452
Printers	96, 105-107
Software	57, 70, 71, 87, 90, 117, 137, 138, 163, 453
Supplies	120
Technical Computers	87
Terminals	72, 79, 77, 76, 87, 88, 97

H

Handheld Calculators & Computers	60-65, 766
Hardware Support	765
Harmonic Mixers (Coaxial and Waveguide)	693
Hewlett-Packard Interface Bus (HP-IB)	123
Hewlett-Packard Interface Loop (HP-IL)	64, 65, 292, 293
HP-FE Software	157
HP-IB	
ASCII-to-Parallel Converter	134
Attenuator/Switch Driver	554
Cables	133
Channel Selector	378
Computers	76-79
Digital Clock	135
Digital-to-Analog Converter	89, 134
Extenders	136
Frequency Counters	306-318, 322-333
General Information	123-128
Logic Analyzers	397
Oscilloscopes	426
Relay Actuator	134, 554
Spectrum Analyzers	655-684, 697-704
Switch	166-171, 135
Switch Controller	384
Switch/Control Unit	170, 554
Switch Driver	554
Time Synthesizer	478
Training	125
VHF Switch	166-171, 135
HP-IL	64, 65, 678
HP-HIL	50, 77

I

IC Design Analysis Software	254
IC Testers, Digital	239, 246, 352, 483



IC Test System, Digital	239	Current Tracer	348
IGES Translator Software	156	Comparator	349
Impedance Analyzers	213-221	Development System	148
Impedance/Gain-Phase Analyzer	213	Pattern Generator	486
Impedance Meter	220	Probes	347
Impedance Transformers (50-75 Ω)	694	Pulser	348
In-circuit Functional Tester	352	Signal Sources	466, 479
Indicators, LED	736	Troubleshooting Kit	350
Industrial Data Acquisition/Control Unit	290	M	
Infrared Detector	735	Magnetic Tape Recorders, Analog	463
Integral, The	81	Mail, Electronic	70, 71
Integrators	735	Mass Selective Detectors	734
Interface Bus (HP-IB)	123-128	Mass Spectrometers	734
Interface Cards for Computers	89	Matrix Switch (HP-IB)	166, 170, 248, 551
Interface Cards & Software for PC Instruments	208	Measurement and Control Cards,	
Interface Loop (HP-IL)	64, 65	HP-1000 A-Series	184
Interface Kits		Measurement Graphics Software	446, 452
HP-IL	62	Measurement Plotting System	446, 452
IBM Disc/Tape	100	Measuring Receiver	712
Multiprogrammer	174, 175, 178, 179	Mechanical Engineering	
Interfacing Summary for Computers	88, 122	Design	157-160, 157-162
Interference & Noise Test Set	394	DesignCenter	137-142
Interference & Noise Measurement System	394	Drafting	158
Internal Modems	59	Modal Analysis	160
Interrupt Card, Multiprogrammer	177, 180	Solids Modeling	158
Interferometers, Laser	730	Test	160
I-Q Tutor Training Kit	393	Medical Instrumentation	738
Isolators, Optical	736	Memory Card, Multiprogrammer	177
Isolators, Waveguide	565	Memory Modules, HP-41 and HP-71	61
J		Meters	
Jitter Generator & Receiver	382	AC	187-201
K		Capacitance	222-233, 252
Kits, Rack Mounting	748, 749, 752	Carrier Noise	709, 711
Kits, Fiber Optic Link	736	Digital Multimeter	187-199
L		Distortion	376, 719-724
Laboratory Automation Systems	735	Frequency	194-196, 205, 292-295, 304-312, 559
LAN Protocol Analyzer	366, 367	High Resistance	235
Laser Interferometers	730	Impedance	212-235
Laser Printers	96, 105-107	LCR	222-235
Laser Position Transducer	730	LCZ	228
Laser Transducer System	731	Low Resistance	192, 235
LC/MS Systems	734	Modulation	716
LCR Meters	222-235	Multifunction	187-199
LCZ Meters	228	Noise Figure	592
LED Displays	736	Ohmmeter	187-199
LED Indicators	736	PC Instruments Digital Multimeter	204
LF Impedance Analyzer	216	Peak Power	589
Light Bar Modules, LED	736	Picoampere	249
Light Emitting Diodes	736	Power (RF/Microwave)	582
Limiters	694	Q	234
Line printers	105	Signature	343-346
Linear Structural Analysis	157	Standing-Wave-Ratio (SWR)	562
Liquid Chromatographs	734	Susceptance	213, 216, 218, 222
Local Area Networks	59, 69, 84	True RMS	187-199
Logic		Vector Impedance	220
Analyzer, Development Systems	148	Microassay Systems for Bioscience	735
Analyzer Training Courses	758	Microprocessor	
Analyzers	397	Bus Analyzer	148
Clip	349	Development Environment	148
		Development Station	148
		Emulation	148



- PROM Programming 148
 Software Analyzer 148
 Training 347
 Troubleshooting 151, 343-346
- Microwave**
 Amplifiers 488, 489
 Computer-Aided Engineering System 10.10
 Counters 306-315
 Diodes 736
 Down-Converter 709
 Link Analyzers 390
 Measurement System 714
 Modulation, Vector Generator/Analyzer 568
 Network Analyzers 594-641
 Noise Figure Meter 592
 Noise Figure Test Set 591
 Power Measuring Equipment 582
 Radio Testing 383
 Semiconductors 736
 Signal Generators 520
 Source Synchronizer 311
 Spectrum Analyzers 655-669, 681, 685, 687-692
 Sweep Oscillators 491-519
 Synthesizers 494-497, 541-546
 Test Equipment 550
 Transistors 737
- Millimetre Wave Instrumentation**
 Adapters 564
 Attenuators 556
 Bends 564
 Counters 306, 313
 Detectors 561
 Directional Couplers 559
 Frequency Meters 559
 General Information 548
 Harmonic Mixers 693
 Network Analyzer 634
 Power Sensors 586
 Shorts 567
 Spectrum Analyzers 655, 662, 672, 666, 689
 Straight Sections 564
 Sweep Oscillator 510-512, 548
 Synthesized Sweeper 510-512, 548
 Terminations 567
 Twists 564
- Milliohmmeters 192, 235
 Miniature Fiber Optic Link 736
 Mixers, Double-Balanced 561
 Mixers, Coaxial and Waveguide 561, 693
 Modal Analysis 160
 Modems 59, 62, 390
 Modular Computers 52, 82, 79
 Modulation Analyzer 716, 572
 Modulator/Demodulator 59, 62, 390
 Modulators, Absorptive 540, 547, 607
 Modulators, PIN 547
 Modulation Test Source 570, 716
 Modules (HP-41, HP-71) 61
 Monitoring and Control 290
 Monitors 96, 99
 Multimeters 187-201
- Multimeter, Signature 343
 Multiplex (Primary) Analyzer 378
 Multiplexers 166-171, 196, 292-301
 Multiprogrammers 172-182
- N**
 Network Analysis, General Information 594-599
 Network Analyzers 213, 594-641
 Automatic 600, 609, 616
 Automatic Scalar 600, 609
 Impedance/Gain-Phase 213
 Millimeter-Wave 634
 Scalar 600-611
 Training Courses 635
 Vector 623-640
 Networking for Business Computers 66, 69, 71
 Networking for HP 9000 Computers 84
 Networking for Personal Computers 48, 50, 53, 54, 58
 Noise
 Figure Meter 592
 Generator 592
 Measurements 394, 590, 707, 709
 Microwave Noise Figure Test Set 591
 Noise and Interference Test Set 394
 Noise and Interference Measurement System 394
- O**
 Obstetrical and Neonatal Instrumentation 738
- OEM**
 Computers 92-74
 Displays, CRT 97-99
 Graphics Plotters 109-117
 HP-IL Interface Kit 62
 Measurement Plotting System 446, 452
 Microwave Attenuators 552
 Microwave Components 737
 Microwave Crystal Detectors 560
 Microwave Switches 551
 Optoelectronic Components 736
 Power Supplies 256
 Printers 105
- Ohmmeters 187-201
 Operating Cases 746
- Optical**
 Accessories 581
 Adapters 581
 Attenuator 580
 Average Power Meter 578
 Cables 581
 Connectors 581
 Heads 576, 578, 581
 LED Source 579
 Pulse Power Meter 576
 Receiver 577
 Signal Source 575, 579
 Switch 577
- Optocouplers 736
 Optoelectronics 736
 OR Monitors 739
- Oscillators**
 Audio 409
 Function 407-413, 418-425



- General Information 407
 Low Frequency 385, 410-417, 419-425
 Sinewave 385, 407-424, 719
 Squarewave 407-425
 Sweep 412-417, 423, 491-519, 719
 Synthesized Sweep 412-417, 494-497, 541
 Oscilloscopes 426
 Accessories 431, 448, 450
 Digital Waveform Storage 438-443
 Digitizing 206, 426-442
 PC Instruments Digitizing Oscilloscope 206
 Software, Waveform Measurement Library 443, 445,
 Spectrum Analyzer Plug-In 655-661, 681-684
 Testmobiles 450
- P**
- pA Meter/DC Voltage Source 249
 Pad, Coaxial Attenuator 552
 Page Printer 96, 105
 Parameter Extraction Software 254
 Patient Monitors 739
 Pattern Generator, Digital 479
 Pattern Generator/Error Detector 379, 380
 PC Board Testers 352-354
 PC Instruments 48, 202-211
 PCM Test Equipment 377-382
 Peak Power Meters 589
 Perinatal Instrumentation 738
 Peripherals, Computer 61, 88, 96-122
 Personal Calculators & Handheld Computers 60-65
 Personal Computers 48, 82-80
 Personal Computer (PC) Instruments 48, 202-211
 Personal Productivity Center 70
 Phase Comparator 336
 Phase Meters 618, 622
 Phase Modulation Analyzer 572, 716
 Phase Noise Measurement 707, 709
 PIN Diodes 737
 PIN Modulators, Microwave 547
 Plotter Accessories and Supplies 120
 Plotters, Drafting 96, 114-117
 Plotters, Graphics 96, 108-117, 452
 Portable PLUS, The 54
 Power Amplifiers 488-490
 Power Dividers 557, 581, 578, 607, 626
 Power Meter Calibrators 588
 Power Meter/Measuring Receiver 712
 Power Meter, Optical 576, 578
 Power Meters, RF & Microwave 582-589, 712
 Power Sensors, RF & Microwave 586, 589, 712
 Power Splitters, Coaxial 557, 607
 Power Splitters, Optical 581, 578
 Power Supplies
 Amplifier/Power Supplies 279
 Atomic Clock 342
 Condensed Listing 257-259
 Constant Current Sources 281
 Digitally Controlled 278
 Dual Tracking 262, 264
 Frequency Standards 342
 HP-IB Programmable 272, 274, 276
 Laboratory 261-281
 Multiprogrammer Control 256-259
 Precision Current, Voltage Sources 280
 Programmable 256-259
 Specifications, Definitions 259
 Standby 342
 Power Supply/Amplifier 279
 PRBS Generators 480, 487
 Preamplifiers 321, 490
 Precision Coaxial Connectors 740
 Precision Digitizing Oscilloscopes 438-443
 Precision Frequency Reference 659
 Precision Frequency Sources 334-336
 Precision Oscillator 340
 Preprocessor, Logic State Development System 152
 Preprocessors, Logic Analyzer 403
 Preselectors 675, 685
 Pressure Probes, Quartz 732
 Primary Multiplex Analyzer 378
 Printed Circuit Design 154
 Printers
 Graphics 96, 105
 Impact 105
 Laser 96, 105-107
 Line 96, 105
 Page 105
 Supplies 766
 Thermal 61, 62, 96, 106
 Probes
 Accessories 201, 347
 Close-Field 677, 694
 Digital Multimeter 201
 High Frequency 201
 Impedance 214
 Logic 347
 Oscilloscope 431, 448, 450
 Pressure 732
 Slotted Line 562
 Temperature 201, 733
 Time Interval 321
 Voltage Divider 201
 Programming Development Aids, HP-47 & HP-71 63
 Programming Development Aids, HP Series 80 82
 Programming Development Aids, The Integral 81
 Protocol Analyzers 360-365, 366, 367
 Pulse Adder, Splitter, Inverter 477
 Pulse Generators 466-478
 Configurable 477
 High Power 472
 Programmable 468-471
 Pulse/Function Generators 407-409, 418-425, 467
 Pulse/Function Generator, Optical 575
 Pulsers, Logic 348
- Q**
- Q Meter 234
 Quartz Frequency Standard 340
 Quasi-Peak Adapter 675
 Quartz Pressure Probe 732
 Quartz Pressure Set 732
 Quartz Thermometer 733



R	
Rack Mount Kits	748, 749, 752
Rack Shelf for PC Instruments	208
Rack Slides	749, 750, 753
Radio System Testing	392
Radio Test System	725
Range Calibrator (for HP 435B Power Meter)	585
Readers, Card (HP-41 CV/CX)	61
Receiver, Measuring	712
Receiver, Optical	577
Recorders	
Instrumentation Tape	463
Measurement Plotting System	452-455
Waveform	426-445, 446, 452-462
X-Y	451-462, 446
Reflection/Transmission Test Sets	631, 634, 639
Relay Actuator (HP-IB)	170, 171, 294, 295, 554, 134
Relay Actuator for PC Instruments	207
Relay Output Card, Multiprogrammer	177, 180
Remote Terminal Unit	290
Resistance Meter	187-201
Resuscitation Instrumentation	739
RF	
Amplifiers	490
Impedance Analyzer	218
Preselector	675
Signal Generators	522-536
Spectrum Analyzers	650, 653, 655, 662, 664, 670, 678, 681, 685
Switch	166-169
Test System	725
RMS Voltmeters	187-199
ROMs, for Portable PLUS	54
Rotary Air Line, Coaxial	566
Rotary Joint, Coaxial	566
Rotary Vane Attenuators, Waveguide	556
Rubidium Frequency Standard	337
S	
S-Parameter Test Sets	631, 638, 640
Scalar Network Analyzers	600-611
Scanner	166-171, 194-196, 248, 292, 294, 295
Scanner Cards, Multiprogrammer	177, 180
Schottky Diodes	736
Selective Level Measuring Set	384
Selective Level Voltmeters	376, 384, 385
Semiconductor/Component Test Systems	245, 239
Semiconductor Parameter Analysis System	244
Semiconductor Parameter Analyzer	246
Semiconductor Parameter Extraction Software	254
Semiconductor Parametric Test System	242
Sensor Modules	713
Sensors, Power	586, 713
Service	766
Shorts, Coaxial	567
Shorts, Waveguide	567
Signal Analyzers	
Audio	719
Digital	572
Distortion	376, 719-724
General Information	642
Modulation	716
Phase Noise	707-711
Spectrum	650-706
Video	358
Signal Generators	
Accessories	537, 540, 547
Avionics	536
Calibration	715
General Information	520
HF, VHF, UHF, SHF	522-536, 538-546
Microwave	538-546
Programmable	522-532, 541-546
Pulse Modulator	547
Service Kits	524, 527
Sweep	527
Synthesized	494-497, 522-532, 541-546
Signal Monitoring Software	673
Signal Sources	407-425, 466-478, 491-519, 520-547
Signal Sources, Optical	575, 579
Signal Sources, Programmable	418-420, 423, 467-471, 522-532, 541-546
Signature Analysis	343-346
Signature Analyzer, Digital	346
Signature Multimeter, Digital	343
Single Sideband Phase Noise Test System	707
Single Sideband Phase Noise Test Set	709
Slides for Rack Mounting	749, 750, 753
Sliding Load (Coaxial and Waveguide)	567
Slotted Lines (Coaxial and Waveguide)	562
SMA, SMB, SMC Series Adapters	740
Software	
Applications Solutions	56, 64, 68, 87, 90, 354
ASYST Scientific	209
Business	66-71
CAD	52, 154-163
Computer-Aided Engineering, Microwave	146
Data Acquisition	302
Data Base Management	56, 68, 70, 71
Datacom	53, 54, 56, 66, 69, 71
Electronic Design	143
Engineering Documentation	156
Engineering Graphics Systems (EGS)	156
Finite Element Analysis	157
Functional Test	185
Graphics	53, 57, 70, 71, 87, 117, 156, 452
HP FE	157
HP-41	64
HP-71	64
IGES Translator	156
Mechanical Design & Drafting	156, 158, 452
Mechanical Engineering	158, 160
Microprocessor Development	148
NC Drill	156
Operating System (for HP 3000)	68
Parameter Extraction (TECAP)	254
PC Instruments Data Acquisition	208
Photoplotter/NC Drill	156
Portable PLUS Personal Computer	55, 56
Printed Circuit Design	154
Programming	56, 68



- Series 80 82
Signal Monitoring 673
Spectrum Analyzer System 669, 673, 676
Spreadsheets 57, 68, 70, 71
Technical Documentation 156
Technical Office Automation 90
Technical Software Solutions 163
Terminal Emulation 54, 56, 59, 66, 71
Test 185
The Integral 81
Touchscreen II Personal Computer 51, 56
Translator (IGES) 156
Vectra Personal Computer 53, 56, 80
Vector Network Analyzer 633
Waveform Measurement 443
Waveform Generator 445, 410
Word Processing 57, 70, 71
- Software Pacs
Active Device Measurement 633
Attenuator Test 714
Basic Network Measurement 633
Cellular Radio Test 728
Function Test 185
Scalar Network Analyzer 600, 610
Signal Generator Test 715
Signal Monitoring 673
Transceiver Test 726
Video Test 359
- Software Support 762
- Solid State
Displays, Lamps, Optocouplers, Fiber Optics 736
Diodes, Transistors, Integrated Products 737
- Solids Modeling 158
- Source, AM/FM Test 531
- Sources, Optical 575, 579
- Sources, Signal 407-425, 466-478, 491-519, 520-547
- Spectrophotometer, Diode Array 735
- Spectrum Analyzers, General Information 642
- Spectrum Analyzers 650-706
- Spectrum Analyzer Preselector 675, 685
- Stability Analyzer, Frequency 707, 709
- Standard Capacitor Sets 236
- Standards, Frequency and Time 334-336
- Standby Power Supply 342
- Standing Wave Ratio (SWR) Meter 562
- Step Attenuators, Coaxial 555-556
- Stepping Motor Control 180
- Stimuli, Digital 466-478, 479-487
- Storage-Normalizer 641
- Structural Analysis 158, 160
- Supervisory Control/Data Acquisition Unit 290
- Supplies, Plotter & Printer 120, 766
- Support, Customer 757
- Sweep Oscillators, General Information 491
- Sweep Oscillators 412-417, 423, 491-519, 719
- Sweep Signal Generators 524, 527, 541-546
- Sweeper Synthesizers 412, 416, 417, 494-497, 541
- Switch Controller, HP-IB 170, 384, 554
- Switches
AC Power Controller 296-301
- Access, Distribution and Bidirectional 384
- Actuators 166-171, 194-196, 292, 301, 554
- HP-IB Driver 554
- Coaxial, Five-Port 292-295, 551
- Coaxial, Microwave OEM 551
- Matrix Microwave 551
- Matrix (HP-IB) 166-171
- Optical 577
- Relay Multiplexer for PC Instruments 203
- Switch/Test Unit 166
- SPDT 551
- VHF Switch, HP-IB 166, 170, 171, 135
- Swivel Adapter 566
- Synchronizer/Counter 311
- Synchronizer, Microwave Source 311
- Synthesized Function Generator 410
- Synthesized Signal Generators 494, 522-532, 541-546
- Synthesized Signal Sources 412-417, 494, 522-532, 541-546
- Synthesized Sweep Oscillators 412-417, 494, 541
- Synthesizer, Arbitrary Waveform 410
- Synthesizer, Time 478
- Synthesizers, Frequency 412-417, 494, 522-532, 541-546
- Systems
Attenuator Calibration 582
- Automatic Test 183
- Board Test 351-357
- CAD 137-163
- Computer-Aided Engineering, Microwave 146
- Data Acquisition 282-303
- Digital IC Test 239
- Laser Measurement 731
- Microprocessor Development 148
- Noise & Interference Measurement 394
- Phase Noise Measurement 707, 711
- Power Sensor Calibration 582
- Real-Time Computer 92
- Semiconductor Test 242-245
- Transceiver Test 725
- Transmission Line Test 611
- Video Measurement 358
- Waveform Generation 445, 410
- Waveform Measurement 441, 443, 445
- System I, System II Cabinets 748, 752
- T**
Tape Degausser 464, 465
- Tape Drives 96, 100, 104
- Tape Recorders, Analog Magnetic 463
- TECAP Parameter Extraction Software 254
- Technical Computers and Peripherals 52, 72-74
- Artificial Intelligence 86
- Computers 52, 82-75
- Computing Overview 72
- Controllers 82-76
- Disc Drives 96, 100, 109
- DOS Coprocessor 91
- Engineering Workstations 75-77
- Graphics 87
- HP-IB Interface 89
- HP-IL/HP Series 80 Interface 62



Integral, The	81	Transmission Impairment Measuring Sets	373, 374, 369-372
I/O Expander	172	Transmission Line Test Sets	611
Interfacing Summary	89, 122	Vector Modulation Generator/Analyzer	393, 570, 572
Micro Winchester Disc Drives	100	Voice & Data Testing	368
Multiprogrammer: I/O Expander & Converter	172	Temperature Measurement	197-199, 292-301, 733
Networking	84	Terminal Emulation	54, 56, 59, 71
Operating Systems	83	Terminals, Display	96-99
Parallel Asynchronous FIFO Interface	75	Termination Panel, Multiprogrammer	182
Peripherals	88	Terminations, Coaxial and Waveguide	566, 563
Plotters	96, 109-117	Test Head	484
Printers	105	Testmobiles	450
Real-Time Systems	92	Test Set, Digital Logic	350
Selection Guide	74	Test Set, Signal Generator Calibration	715
Six-Channel Interface	75	Test System, Automatic	183
Software Catalog	163	Test System, Digital IC	239
Technical Office Automation	90	Thermal Analysis	157
Technical Documentation Software	156	Thermistor Sensors, Coaxial and Waveguide	589
Telecommunications Test Equipment	376, 377-396, 568	Thermocouple Power Meters	583, 584, 585
Access Switch	384	Thermocouple Power Sensors	586
Audio Channel Selector: HP-IB Controlled	378	Thermocouple Scanning Cards	292-301
Balanced 2/4-wire Audio Channel Selector	378	Thermometer, Quartz	733
Bidirectional Switch	384	Time Base (HP 7035B)	456
Carrier Testing	376, 383, 385, 388	Time Interval Calibrator	319
Cellular Radio Test Equipment	725	Time Interval Counters	318, 322-333
Constellation Display	394	Time Module, HP-41	61
Controller, Switch	384	Time Standards	334
Data Generator	381	Time Synthesizer	478
Detector, Error	364, 381	Timer/Pacer Cards, Multiprogrammer	177, 180
Digital Modulation Generator/Analyzer	570, 572	Timing Generator, HP-IB	478
Digital Transmission Analyzer	381	TNC Adapters	740
Down Converter	390	Touch-Hold Probe	201
Error Rate Measurements	379-381	Touch Accessory, HP	50, 52, 99
FDM Measurements	383-389, 396	Tracer, Current	348
FDM Surveillance Software	388, 396	Tracking Generators	385, 416, 659, 681, 685 689, 691
HP-IB Controlled Channel Selector	378	Tracking Generator Module (HP 70310A)	659
I-Q Tutor Training Course	393	Training, Logic	347
Jitter Generator & Receiver	382	Training, Microprocessor	347
Microwave Counters	306-315	Training Support	758
Microwave Link Analyzers	390	Transceiver Modulation Analyzer	716
Microwave Network Analyzers	634-631	Transceiver Test System	725
Microwave Radio Testing	383	Transfer Function Analyzer	697
Microwave Upconverter	391	Transient Digitizers	426-445
Modulation Analyzer	572, 712, 716	Transient Generators	410, 444
Modulator/Demodulator	390	Transient Recorders	426-445
Noise and Interference Test Set	394	Transmission Impairment Measuring Sets	373, 374, 369-372
Noise and Interference Measurement System	394	Transmission Line Test Software	611
Pattern Generator/Error Detector	379	Transmission Line Test System	612
PCM Terminal Test Set	378	Transmission Test Sets	370
PCM Testing	377-382	Transistor Bias Supply	633
Power Meters	582	Transistor Test Fixtures	633, 638, 640
Primary Multiplex Analyzer	378	Transistors, Bipolar	737
Remote Access and Test System	396	Transit Cases	742
Remote Automatic Surveillance Systems	396	Troubleshooting, Digital	350
RF Radio Testing	725	True RMS Voltmeters	187-199
Selective Level Measuring Sets	384, 385, 388	Tuners, Microwave	565
Selective Level Meters	384, 385, 388	Type N Series Adapters	740
SLMS Accessories	384	Type N Short	563, 567
Spectrum Analyzers	642-694		
Switch, Access	384		
Switch Controller	384, 554		

**U**

UHF Signal Generators	524, 527, 530, 540
Ultrasound Imaging	738
Upconverter Simulator for Microwave Link Analyzer	391

V

Vector Film Recorder	118
Vector Generator	479
Vector Impedance Meter	220
Vector Modulation Generator/Analyzer	395, 568
Vector Network Analyzers	612, 620-640
Vector Voltmeter	622
VECTRA Industrial PC	95
Verification Kits (Network Analyzer)	632
VHF Signal Generator	533, 536
VHF Switch Module	166-171, 135
Vibration Analyzer	699, 702
Video Measurement System	358
Voice/Data Testing	368
Voltmeters	187-201
Analog	188, 200
Digital	187-201

W

Waveform Analyzers	426-445, 446, 452, 697, 699, 702
Digitizers	426-445

Generator, Arbitrary	481
Recorders	426-445, 446, 452-462
Synthesizer, Arbitrary	410
Waveguide Adapters	564
Attenuators	556
Calibration Kits	634
Coaxial Adapters	564
Detectors	561, 605
Directional Couplers	559
Frequency Meters	559
Harmonic Mixers	561, 693
Holders	566
Low-Pass Filters	565
Movable Shorts	567
Slide Screw Tuners	565
Sliding Loads	567
Sliding Shorts	567
Stand	566
Terminations	567
Thermistor Mounts	589
Variable Attenuators	556
Wideband Amplifiers	488, 490
Word Generators	479, 477

X

X-Ray Systems, Scientific & Industrial	754
X-Y Recorders	451-462, 446



HP-11C Programmable Scientific Calculator	60
HP-12C Programmable Financial Calculator	60
HP-15C Programmable Scientific Calculator with Matrices	60
HP-16C Programmable Calculator for Computer Science.....	60
HP-18C Business Consultant Professional Calculator	60
HP-25 The Vectra Personal Computer.....	52
HP-35 The Vectra Personal Computer.....	52
HP-41CV/CX Advanced Programmable Calculators.....	60
HP-41 CV/CX Opt. 001 Custom Calculator.....	63
HP-45 The Vectra Personal Computer.....	52
HP-71B Handheld Computer	61
HP-94 Handheld Industrial Computer	61
HP-85B Personal Computer.....	82
HP-86B Personal Computer.....	82

100

105B Quartz Oscillator	340
HP 110 - The Portable PLUS	54
141T System Spectrum Analyzers.....	685
141T Spectrum Analyzer Mainframe.....	686
HP 150 Touchscreen II Personal Computer.....	50

200

214B Pulse Generator.....	472
HP 260 Series 30 & 401 Business Computer Systems	66
281 Series Coaxial-Waveguide Adapters	564
292 Series Waveguide-Waveguide Adapters.....	564

300

334A Distortion Analyzer	723
339A Distortion Measuring Set.....	722
346A/B/C Noise Source	592
355 Series Coaxial Step Attenuators	554
360 Series Coaxial Low-pass Filters	565
362A Series Waveguide Low-pass Filters	565
365 Series mm-Wave Waveguide Isolators	565
370 Series mm-Wave Fixed Attenuators.....	556
382 Series Waveguide Precision Variable Attenuators.....	556

400

415E SWR Meter.....	562
420C Coaxial Crystal Detector	560
422A/C Series Waveguide Crystal Detectors.....	561
423A/B Coaxial Crystal Detectors.....	560
424A Series Waveguide Crystal Detectors.....	560
432 Series Power Meters.....	588
435B Power Meter.....	585
436A Power Meter	584
436A-E40 Power Sensor Calibration System.....	582
438A Dual Power Meter	583
438A Option 700 MATE - Programmed Power Meter	583
442B Slotted Line RF Probe.....	562
447B Slotted Line Detector Probe	562
478A Coaxial Thermistor Mount	589
486A Series Waveguide Thermistor Mounts	589

500

532 Series Waveguide Frequency Meters.....	559
536A Coaxial Frequency Meter.....	559
537A Coaxial Frequency Meter.....	559
545A Logic Probe.....	347
546A Logic Pulser	348
547A Current Tracer.....	348
548A Logic Clip	349

700

752 Series Waveguide Directional Couplers	559
774D Coaxial Dual Directional Coupler	558

775D Coaxial Dual Directional Coupler	558
776D Coaxial Dual Directional Coupler	558
777D Coaxial Dual Directional Coupler	558
778D Coaxial Dual Directional Coupler	558
779D Coaxial Directional Coupler	558

800

809C Slotted Line Carriage	562
816A Coaxial Slotted Section	562
853A Spectrum Analyzer Display	682
870A Series Waveguide Slide Screw Tuners.....	565
897 Series E-, H-Plane Waveguide Bends.....	564
898 Series Waveguide Twists.....	564
899 Series Waveguide Straight Sections	564

900

905A Coaxial Sliding Load.....	567
908A Coaxial 50-Ohm Termination.....	566
909A/C/D/E Coaxial 50-Ohm Termination.....	566
910 Series Waveguide Terminations.....	567
911A/C Coaxial Sliding Loads.....	567
914 Series Waveguide Sliding Loads.....	567
920 Series Waveguide Moving Shorts	567
923A Waveguide Sliding Short.....	567

1000

HP 1000 Computers and Systems.....	92
1000/26 Computer System	92
1000/27 Computer System	92
1000/29 Computer System	92
1000/60 Computer System	92
1008A Testmobile	450
1040A Diode-Array Detector.....	734
1046A Fluorescence Detector	734
1051A & 1052A Combining Cases.....	752
1090 Liquid Chromatograph Systems	734
1630A/D/G Logic Analyzers.....	401
1631A/D Logic Analyzers.....	398
1631 A/D + 24D Logic Analysis Measurement Techniques	398
1645A Date Error Analyzer.....	369

2000

2106BK Board Computer.....	94
2113E Computer	94
2137A Computer	94
2139A Computer	94
2156B Computer	94
2178C Model 60 Computer Systems	93
2196C/D Model 26 Computer Systems	93
2197C/D Model 27 Computer Systems	93
2199C/D Model 29 Computer Systems	93
2225A/B/C/D ThinkJet Personal Printer	106
2227A QuietJet Printer	106
2228A QuietJet Plus Printer	106
2392A Display Terminal	98
2393A Graphics Terminal.....	97
2394A Data Entry Terminal.....	98
2397A Color Graphics Terminal	97
2426E/F Micro 16 Computers	94
2486A Micro 26 Computer System	93
2487A Micro 27 Computer System	93
2489A Micro 29 Computer System	93
2563B Line Printer	105
2564B Line Printer	105
2566B Line Printer	105
2567B Line Printer	105
2603A Daisywheel Printer	106
2680A Laser Printing System	105
2685B Laser Print Station.....	105

MODEL NUMBER INDEX

New product listings are printed in bold face type



2686A LaserJet Printer	105, 107
2686A Option 300 LaserJet PLUS Printer	105, 107
2686D LaserJet 500 Plus Printer	105, 107
2686TA Tempest LaserJet Printer	105
2686TA Option 200/210 Tempest LaserJet Plus Printer	105
2689A Laser Printing System	105
2804A Quartz Thermometer	733
2813C Quartz Pressure Probe	732
2813D Quartz Pressure Set	732
2816A Pressure Signal Processor	732
2932A General Purpose Printer	106
2934A Business Printer	106

3000

HP 3000 Series 37, 42, 58, 70, 930, 950 Business Computer Systems	67
3046A/B Selective Level Measuring System	388
3048A Phase Noise Measurement System	707
3055S PC Based Data Acquisition Unit	288
3060A/3061A/3062A User's Course	759
3061A/3062A In-circuit Functional Test System (HP-IB)	354
3065 Board Test Family (HP-IB)	352
3065C + 24D Board Test System User Training	759
3235A Switch/Test Unit	166
3312A Function Generator	422
3314A Function Generator	423
3325A Function Generator/Frequency Synthesizer/Sweeper	412
3326A Two-Channel Synthesizer (HP-IB)	414
3335A Frequency Synthesizer	416
3336A/B/C Synthesizer/Level Generator	385, 417
3390 Series Integrators	735
3400A RMS Voltmeter	200
3421A Data Acquisition/Control Unit	286
3437A High Speed Digital Voltmeter	197
3455A 6½ Digit DMM	197
3456A Systems DVM	192
3457A Multimeter	194
3466A 4½ Digit Autoranging DMM	200
3468A/B 5½ Digit Multimeter (HP-IL)	198
3478A 5½ Digit Multimeter (HP-IB)	190
3488A Switch Control Unit (HP-IB)	170
3497A Data Acquisition/Control Unit	294
3498A Extender	295
3551A Transmission Test Set	370
3552A Transmission Test Set	370
3561A Dynamic Signal Analyzer (HP-IB)	699
3562A Dynamic Signal Analyzer (HP-IB)	702
3575A Gain/Phase Meter	618
3577A Network Analyzer (HP-IB)	612
3577S Network Analyzer System	617
3580A Spectrum Analyzer	695
3581A Wave Analyzer	724
3581C Selective Voltmeter	376
3582A Spectrum Analyzer	697
3585A Spectrum Analyzer	650
3586A/B Selective Level Meter	385
3586C Wave Analyzer	653
3708A Noise and Interference Test Set	394
3708S Noise and Interference Measurement System	394
3709A Constellation Display	394
3711A IF/BB Transmitter (70/140 MHz IF)	390
3712A IF/BB Receiver (70/140 MHz IF)	390
3717A 70 MHz Modulator/Demodulator	390
3730B Down Converter: RF to IF	390
3736B RF Module (1.7 to 4.2 GHz)	390
3737B RF Module (3.7 to 8.5 GHz)	390
3738B RF Module (5.9 to 11.7 GHz)	390
3739B RF Module (10.7 to 14.5 GHz)	390
3746A Selective Level Measuring Set (32 MHz)	384

3754A Access Switch	384
3755A Switch Controller	384
3756A 90 MHz Bi-directional Switch	384
3757A 8.5 MHz Access Switch	384
3762A Data Generator	381
3763A Error Detector	381
3764A Digital Transmission Analyzer	381
3776A PCM Terminal Test Set	378
3776B PCM Terminal Test Set	378
3777A HP-IB-Controlled Channel Selector	378
3779C Primary Multiplex Analyzer (CEPT)	378
3779D Primary Multiplex Analyzer (Bell)	378
3780A Pattern Generator/Error Detector	379
3781A Pattern Generator (CEPT and CCITT Compatible)	380
3781B Pattern Generator (BELL Compatible)	380
3782A Error Detector (CEPT and CCITT Compatible)	380
3782B Error Detector (BELL Compatible)	380
3785A Jitter Generator & Receiver (CEPT)	382
3785B Jitter Generator & Receiver (Bell)	382
3852A Data Acquisition/Control Unit	296
3852S Data Acquisition/Control System	296
3964A Instrumentation Tape Recorder	464
3968A Instrumentation Tape Recorder	464

4000

4061A Semiconductor/Component Test System	245
4062B Semiconductor Parametric Test System	242
4063A Semiconductor Parameter Analysis System	244
4085M Switching Matrix	248
4140B pA Meter/DC Voltage Source	249
4141B DC Source/Monitor	251
4145B Semiconductor Parameter Analyzer	246
4191A RF Impedance Analyzer	218
4192A LF Impedance Analyzer	216
4193A Vector Impedance Meter	220
4194A Impedance/Gain - Phase Analyzer	213
4261A Digital LCR Meter	232
4262A Digital LCR Meter	232
4274A Multifrequency LCR Meter	222
4275A Multifrequency LCR Meter	222
4276A LCZ Meter	228
4277A LCZ Meter	228
4278A 1 kHz/1 MHz Capacitance Meter	226
4280A 1 MHz C Meter/C-V Plotter	252
4328A Milliohmeter	235
4329A High Resistance Meter	235
4342A Q Meter	234
4440B Decade Capacitor	236
4760A Cardiology Instrumentation	738
4925B Bit Error Rate Test Set	369
4935A Transmission Impairment Measuring Set	370
4936A Transmission Impairment Measuring Set	370
4937A Transmission Impairment Measuring Set	371
4938A Network Circuit Access Test Set	371
4945A Transmission Impairment Measuring Set	372
4947A Transmission Impairment Measuring Set	373
4948A In-Service Transmission Impairment Measuring Set	374
4951C Protocol Analyzer	363
4952A Protocol Analyzer	363
4953A Protocol Analyzer	364
4955A Protocol Analyzer	365
4955A + 24A Protocol Analyzer User's Training	759
4971S LAN Protocol Analyzer	366

5000

5005A Signature Multimeter	343
5005B Signature Multimeter	344
5006A Signature Analyzer	346
5011T Logic Troubleshooting Kit	350



5021A Logic Troubleshooting Kit	350
5022A Logic Troubleshooting Kit	350
5023A Logic Troubleshooting Kit	350
5024A Logic Troubleshooting Kit	350
5036A Microprocessor Lab	347
5061B Cesium Beam Frequency Standard	335
E21-5061B Flying Clock (Cesium).....	337
5065A Rubidium Frequency Standard.....	335
E21-5065A Portable Rubidium Time Standard.....	337
5087A Distribution Amplifier	341
5089A Standby Power Supply	342
5180A Waveform Recorder	442
5180S Waveform Measurement System	442
5180T,U Precision Digitizing Oscilloscopes	438-442
5182A Waveform Recorder/Generator.....	444
5182S Waveform Generation System.....	445
5183A Waveform Recorder	441
5183T,U Precision Digitizing Oscilloscopes	438
5314A Universal Counter	333
5315A, 5315B Universal Counters	330
5316A Universal Counter	330
5328B Universal Counter	329
5334A Universal Counter	324
5335A Universal Counter	326
5340A Microwave Frequency Counter.....	312
5342A Microwave Frequency Counter.....	309
5343A Microwave Frequency Counter.....	309
5344S Microwave Source Synchronizer	311
5345A Electronic Counter	313, 322
5350B Microwave Frequency Counter	306
5351B Microwave Frequency Counter	306
5352B Microwave Frequency Counter	306
5355A Automatic Frequency Converter.....	313
5356A, B, C, D Frequency Converter Heads	313
5359A Time Synthesizer	478
5363B Time Interval Probes	321
5370B Universal Time Interval Counter	318
5384A Frequency Counter	316
5385A Frequency Counter	316
5386A Frequency Counter	316
5501A Laser Transducer System.....	731
5527A Laser Position Transducer	730
5528A Laser Measurement System	731
5880A Gas Chromatograph	734
5890A Gas Chromatograph	734
5965A Infrared Detector	735
5970B Mass Selective Detector	734
5988A GC/Mass Spectrometer.....	734
5988A LC/Mass Spectrometer.....	734
5995C GC/Mass Spectrometer	734
6000	
6002A Autoranging DC Power Supply	276
6010A 1000 Watt Autoranging Power Supply.....	266
6011A 1000 Watt Autoranging Power Supply.....	266
6012B 200 Watt Autoranging Power Supply	266
6023A 200 Watt Autoranging Power Supply.....	266
6024A 200 Watt Autoranging DC Power Supply.....	266
6030A 1000 Watt Autoranging System Power Supply.....	274
6031A 1000 Watt Autoranging System Power Supply.....	274
6032A 1000 Watt Autoranging System Power Supply.....	274
6033A 200 Watt Autoranging System Power Supply.....	274
6038A 200 Watt Autoranging System Power Supply.....	274
6114A & 6115A Precision DC Power Supplies	280
6129C-6131C Digitally Controlled Voltage Sources	278
6140A Digital Current Source.....	278
6177C Precision DC Current Source.....	281
6181C Precision DC Current Source.....	281
6186C Precision DC Current Source.....	281
6200B-6209B DC Power Supplies	261-263

6212B-6218B DC Power Supplies	261-263
6227B Dual Tracking DC Power Supply.....	264
6228B Dual Tracking DC Power Supply.....	264
6234A Dual Output Power Supply	261-263
6235A Triple Output Power Supply	262
6236B Triple Output DC Power Supply.....	262
6237B Triple Output DC Power Supply.....	262
6253A Dual Output DC Power Supply	264
6255A Dual Output DC Power Supply	264
6259B DC Power Supply.....	268
6260B DC Power Supply.....	268
6261B DC Power Supply.....	268
6263B DC Power Supply.....	268
6264B DC Power Supply.....	268
6266B DC Power Supply.....	268
6267B DC Power Supply.....	268
6268B DC Power Supply.....	268
6269B DC Power Supply.....	268
6274B DC Power Supply.....	268
6281A DC Power Supply	264
6282A DC Power Supply	264
6284A DC Power Supply	264
6286A DC Power Supply	264
6289A DC Power Supply	264
6291A DC Power Supply	264
6294A DC Power Supply	264
6296A DC Power Supply	264
6299A DC Power Supply	264
6434B DC Power Supply	270
6443B DC Power Supply.....	270
6448B DC Power Supply.....	270
6453A DC Power Supply	270
6456B DC Power Supply	270
6459A DC Power Supply	270
6464C DC Power Supply	270
6466C DC Power Supply	270
6469C DC Power Supply	270
6472C DC Power Supply	270
6475C DC Power Supply	270
6477C DC Power Supply	270
6479C DC Power Supply	270
6483C DC Power Supply	270
6621A System Power Supply	272
6622A System Power Supply	272
6623A System Power Supply	272
6624A System Power Supply	272
6824A DC Power Supply/Amplifier.....	279
6825A DC Power Supply/Amplifier.....	279
6826A DC Power Supply/Amplifier.....	279
6827A DC Power Supply/Amplifier.....	279
6940B Multiprogrammer	179
6941B Multiprogrammer Extender	179
6942A Multiprogrammer	175
6942S Computer Aided Test System.....	178
6943A Multiprogrammer Extender	175
6944A Series 200 Multiprogrammer	174
6944A + 24D Multiprogrammer's User Course	758
6944S Series 200 Multiprogrammer System.....	178

7000

7015B X-Y Recorder.....	456
7035B X-Y Recorder.....	456
7045B X-Y Recorder.....	458
7046B X-Y Recorder.....	458
7090A Measurement Plotting System	446, 452
7440A ColorPro Plotter	88, 110
7475A 6-Pen Graphics Plotter	88, 111
7510A Vector Film Recorder.....	88, 118
7550A 8-Pen Graphics Plotter	88, 112
7570A DraftPro Plotter	114

New product listings are printed in bold face type



7580B 8-Pen Drafting Plotter	116	8444A Tracking Generator	685
7585B 8-Pen Drafting Plotter	116	8444A Option 059 Tracking Generator	681, 685
7586B 8-Pen Drafting Plotter	116	8445B Automatic Preselector	685
7673A Automatic Sampler	734	8447 Series Amplifiers	490
7690A Portable Barcode Reader	734	8451A Diode Array Spectrophotometer	735
7907A Disc/Tape Drive	103	8452A Diode Array Spectrophotometer	735
7911P/R Disc/Tape Drives	101	8470A/B Coaxial Crystal Detectors	560
7912P/R Disc/Tape Drives	101	8471A Coaxial Crystal Detector	560
7914CT Disc/Tape Drive	101	8473B/C Coaxial Crystal Detectors	560
7914P/R Disc/Tape Drives	101	8477A Power Meter Calibrator	588
7914ST Disc/Tape Drive	101	8478B Coaxial Thermistor Mount	589
7933H/G Disc Drives	103	8481A/B/H Power Sensors	586
7935H/G Disc Drives	103	8482A/B/H Power Sensors	586
7941A Disc Drive	102	8483A Power Sensor	586
7942A Disc/Tape Drive	102	8484A Power Sensor	586
7945A Disc Drive	102	8485A Power Sensor	586
7946A Disc/Tape Drive	102	8486A mm-Wave Power Sensor	586
7974A 1/2" Magnetic Tape Subsystem	104	8491A/B Coaxial Fixed Attenuators	552
7974A with NRZI Option	104	8492A Coaxial Fixed Attenuator	552
7978B 1/2" Magnetic Tape Subsystem	104	8493A/B/C Coaxial Fixed Attenuators	552
\$000			
8005B Pulse Generator	473	8494A/B/G/H Coaxial Step Attenuators	554
8011A Pulse Generator	473	8495A/B/D/G/H/K Coaxial Step Attenuators	554
8012B Pulse Generator	474	8496A/B/G/H Coaxial Step Attenuators	554
8013B Pulse Generator	474	8497K Coaxial Step Attenuator	554
8015A Pulse Generator	475	8498A Coaxial Fixed Attenuator	552
8016A Word Generator	485	8510A Network Analyzer	629
8018A Serial Data Generator	487	8510A + 24D Network Analyzer User's Course	635
8080A Mainframe	477	8510S Network Analyzers	635
8081A Repetition Rate Generator, 300 MHz	477	8510T Network Analyzer System	630
8082A Pulse Generator	476	8511A Frequency Converter	631
8083A Output Amplifier, 300 MHz	477	8512A Reflection/Transmission Test Set (500 MHz-18 GHz)	631
8084A Word Generator, 300 MHz	477	8513A Reflection/Transmission Test Set (45 MHz-26.5 GHz)	631
8091A Repetition Rate Generator, 1 GHz	477	8514A S-Parameter Test Set (500 MHz-18 GHz)	631
8092A Delay Generator/Frequency Divider	477	8515A S-Parameter Test Set (45 MHz-26.5 GHz)	631
8093A Output Amplifier, 1 GHz	477	8552A Spectrum Analyzer—IF Section	685
8111A 1 Hz-20 MHz Pulse/Function Generator	421	8552B Spectrum Analyzer—IF Section	685
8112A Programmable Pulse Generator	468	8553B Spectrum Analyzer, Tuning Section	685
8116A Pulse/Function Generator	419	8554B Spectrum Analyzer, Tuning Section	685
8150A Optical Signal Source	575	8555A Spectrum Analyzer, Tuning Section	685
8151A Optical Pulse Power Meter	576	8556A Spectrum Analyzer, Tuning Section	685
8152A Optical Average Power Meter	578	8557A Spectrum Analyzer	681
8154B LED Source 1300 nm	579	8558B Spectrum Analyzer	681
8158B Optical Attenuator	580	8559A Spectrum Analyzer	681
8159A Optical Switch	577	8565A Spectrum Analyzer	691
8160A Programmable Pulse Generator	469	8566B Spectrum Analyzer	662, 666, 672
8161A Programmable Pulse Generator	469	8566A + 24D Spectrum Analyzer Programming	759
8165A Programmable Signal Source	418	8566S Automatic Spectrum Analyzer	669
8170A Logic Pattern Generator	486	8567A Spectrum Analyzer	670, 672
8175A Digital Signal Generator	480	8568A + 24D Spectrum Analyzer Programming	759
8180A Data Generator	239, 483	8568B Spectrum Analyzer	662, 664, 672
8180A + 24A Operating & Programming Techniques Course	759	8568S Automatic Spectrum Analyzer	669
8181A Data Generator Extender	241, 483	8569B Spectrum Analyzer	689
8182A Data Analyzer	239, 483	8570A Spectrum Analyzer	687
8328A/S Transmission Line Test Set	611	8573A CISPR EMI Spectrum Analyzer/Receiver	674
8340B Synthesized Sweeper	494, 541, 548	8574A CISPR EMI Spectrum Analyzer/Receiver	674
8341B Synthesized Sweeper	494, 541, 548	8590A Portable RF Spectrum Analyzer	678
8349B Microwave Amplifier	489, 548	8614A Signal Generator	540
8350B Sweep Oscillator Mainframe	391, 498, 548	8616A Signal Generator	540
8403A Modulator	547	8620C Sweep Oscillator	391, 513
8405A Vector Voltmeter	622	8640B AM/FM Signal Generator	533
8406A Comb Generator	694	8640B Option 004, Avionics Signal Generator	536
8410C Network Analyzer Mainframe	637	8642A/B Synthesized Signal Generators	524
8410S series Network Analyzers	636	8656B Synthesized Signal Generator	522
8411A Harmonic Frequency Converter	637	8660A Synthesized Signal Generator	530
8412B Phase-Magnitude Display	637	8660C Synthesized Signal Generator	530
8414B Polar Display	637	8662A Synthesized Signal Generator	527
8418B Auxiliary Power Supply	637	8663A Synthesized Signal Generator	527
8443A Tracking Generator-Counter	685	8671B Synthesized CW Generator	542
		8672A Synthesized Signal Generator (2 to 18 GHz)	546
		8672S MW Synthesized Generator (0.1 to 18 GHz)	546



8673B Synthesized Generator (2 to 26.5 GHz) 544
8673C/D Synthesized Signal Generators
(0.1 to 18/26 GHz) 544
8673E Synthesized Signal Generator
(2 to 18 GHz) 543
8683A/B/D Signal Generators 539
8684A/B/D Signal Generators 539
8717B Transistor Bias Supply 633
8721A Coaxial Directional Bridge 557
8731-8735 series PIN Modulators 547
8743B Reflection/Transmission Test Unit 639
8745A S-Parameter Test Set 638
8746B S-Parameter Test Set 640
8748A S-Parameter Test Set 621
8750A Storage-Normalizer 641
8753A Network Analyzer 623
8754A Network Analyzer 620, 621
8756A Scalar Network Analyzer 609
8757A Scalar Network Analyzer 602
8757S Automatic Scalar Network Analyzer System 600
8761A,B Coaxial Switches 551
8770A Arbitrary Waveform Synthesizer 410
8770S Waveform Synthesizer System 410
8780A Vector Signal Generator 395, 570
8900C/D Peak Power Meters 589
8901A Modulation Analyzer 716
8901B Modulation Analyzer 716
8902A Measuring Receiver 712
8902S Microwave Measurement System 714
8903B Audio Analyzer 719
8903E Distortion Analyzer 719
8952A Signal Generator Test Set 715
8953A Transceiver Test Set 725
8954A Transceiver Interface 728
8955A RF Test System 725
8956A System Interface 728
8957S Cellular Radio Test System 725
8958A Cellular Radio Interface 728
8970B Noise Figure Meter 592
8971B Microwave Noise Figure Test Set 591
8980A Vector Analyzer 395, 572

9000

HP 9000 Engineering Workstations 72, 140
9020A HP 9000 Series 500 Model 520A Color Computer 76
9020B HP 9000 Series 500 Model 520B Monochrome
Computer 76
9020C HP 9000 Series 500 Model 520C Color Computer 76
9020AS HP 9000 Series 500 Model 520AS Workstation 76
9020AT HP 9000 Series 500 Model 520AT Workstation 76
9050A HP 9000 Series 500 Model 550A Workstation 76
9050AM HP 9000 Series 500 Model 550AM Computer 76
9050AT HP 9000 Series 500 Model 550AT Computer 76
9050AU HP 9000 Series 500 Model 550AU Computer Shell 76
9060AM HP 9000 Series 500 Model 560AM Computer 76
9114B Double-Sided 3½" Disc Drive 100
9122D/S 3½" Microfloppy Disc Drive 100
9123D Dual 3½" Drive (for HP Touchscreen II) 100
9127A Single-Sided 5¼" Flexible Disc Drive 100
9133H 20 Mbyte Winchester/3½" Microfloppy 100
9133L 40 Mbyte Winchester/3½" Microfloppy 100
9134H 20 Mbyte Winchester Hard Disc 100
9134L 40 Mbyte Winchester Hard Disc 100
9142A ¼" Tape Subsystem 100
9144A ¼" High Performance Tape Subsystem 104
9153A 10 Mbyte Winchester/3½" Microfloppy 100
9154A 10 Mbyte Winchester Hard Disc 100
9411B Switch Controller 183
9412A Modular Switch 183
9413A VHF Switch 183

9414A Matrix Switch 183
9741A HP 9000 Series 800 Model 840 System 75
9807A The Integral Personal Computer 81
9816S HP 9000 Series 200 Model 216S Computer 79
9826A HP 9000 Series 200 Model 226A Controller/Computer 79
9826S HP 9000 Series 200 Model 226S Controller/Computer 79
9836CU HP 9000 Series 200 Model 236CU Color Computer 79
9836U HP 9000 Series 200 Model 236U Computer/
Workstation 79
9888A Bus Expander 89
9915B HP 9000 Series 80 Model 9915B Modular Computer 82
9920A HP 9000 Series 200 Model 220A Modular Computer 79
9920S HP 9000 Series 200 Model 220S Modular Computer 79

10000

10021A PC Instruments Oscilloscope Probe 208
10023A Temperature Probe 201
10040A PC Instruments Oscilloscope Probe 208
10062A Protective Cover 481
10110B BNC Male to Dual Banana Plug 740
10111A Shielded Banana Plug to BNC Female 740
10113A Triple Banana Plug to Dual BNC Female 740
10233A Printer Interconnect Cable for HP 1645A 369
10269B 9-Probe Interface 403
10275A PDP-11 UNIBUS Interface 403
10276A LSI-11 Interface 403
10342B Bus Preprocessor 403
10387A Interface, Type 303 Modems (HP 1645A) 369
10388A Interface, CCITT V.35 (HP 1645A) 369
10389A Interface, Breakout Box (RS-232C/V.24)
(HP 1645A) 369
10501A Cable Assembly 740
10502A Cable Assembly 740
10503A Cable Assembly 740
10514A Double-Balanced Mixer 561
10529A Logic Comparator 349
10534A Double-Balanced Mixer 561
10541A Reference Boards 349
10541B Preprogrammed Reference Boards 349
10590A Plug-in Adapter (HP 5345A) 322
10595A Board Extender Kit (HP 5345A) 322
10638A Degausser 336
10715A Differential Interferometer 730
10821A Probe Accessory Kit (HP 5363B) 321
10833A/B/C/D HP-IB Cables 133
10834A HP-IB Cable Adapter 133
10842A Extender Board Kit (HP 5342/5343/5344S) 308
10855A Broadband Preamplifier 321
10856A Low Pass Filter Kit 321
10870A Service Kit (HP 5370B) 318
10871A Service Kit (HP 5180A) 443
10872A Parallel Interface 443
10873A Rack Mount Kit 443
10874A Slide Mount Kit 443
10875A/B DMA Cables 443

11000

11002A Test Leads 740
11003A Test Leads 740
11035A Cable Assembly 740
11096B High Frequency Probe 201
11340A/B/C HP-IL Cable Assemblies 292
11500A/B Cable Assemblies 740
11501A Cable Assembly 740
11509A Fuseholder 537
11511A Coaxial Short 567
11512A Coaxial Short 567
11515A Waveguide Adapter 564
11516A Waveguide Adapter 564
11517A Mixer 693



MODEL NUMBER INDEX

New product listings are printed in bold face type

11518A-11520A Waveguide Taper Sections.....	693	11740S Phase Noise Measurement System.....	711
11524A APC-7 to N (female) Adapter.....	740	11776A Waveform Generation Software.....	410
11525A APC-7 to N (male) Adapter.....	740	11790A/B Software Application Pac for HP 8953A & 9816S, 9826S, 9836S.....	726
11533A APC-7 to SMA (male) Adapter.....	740	11791A Software for HP 8955A, 9816S & 9836S.....	726
11534A APC-7 to SMA (female) Adapter.....	740	11792A Sensor Module.....	715
11536A Probe Tee for HP 8405A.....	622	11793A Microwave Converter.....	715
11540A Waveguide Stand.....	566	11794A Software Pac.....	715
11545A-11548A Waveguide Holders.....	566	11795A Software Pac.....	715
11549A Power Splitter for HP 8405A.....	622	11797A Cellular Radio Test Software.....	726
11565A Coaxial Short.....	567	11799A Signaling Unit.....	726
11566A Air Line Extension.....	566	11801A/B/C On-Site Service Kits for HP 8642A/B.....	524
11567A Air Line Extension.....	566	11805A Software Application Pac for HP 8953A.....	726
11570A Accessory Kit for HP 8405A.....	622	11806A Attenuator Calibration Software for HP 8902S, 8952S.....	714
11581A Attenuator Set.....	552	11850C/D Power Splitters.....	626
11582A Attenuator Set.....	552	11851B RF Cable Kit for HP 8505A.....	626
11583A/C Attenuator Sets.....	552	11852B 50-75 Ω Minimum Loss Pad.....	626
11588A Swivel Adapter.....	566	11853A 50 Ω Type N Accessory Kit.....	627
11590B Bias Network.....	633	11854A 50 Ω BNC Accessory Kit.....	627
11600B Transistor Fixture.....	638	11855A 75 Ω Type N Accessory Kit.....	627
11602B Transistor Fixture.....	638	11856A 75 Ω BNC Accessory Kit.....	627
11605A Flexible Arm for HP 8743A.....	639	11857B/D Test Port Extension Cables for HP 85046A & B.....	627
11606A Rotary Air Line.....	566	11858A Transistor Fixture Adapter.....	627
11608A Transistor Fixture.....	640	11866A APC-7 Calibration Kit.....	637
11609A Cable Kit for HP 8410S.....	637	11867A RF Limiter.....	694
11610B Test Port Extension Cable.....	639	11869A Adapter for HP 86200 Series Sweeper Plug-ins.....	391, 500
11612A Bias Network.....	633	11870A Low Pass Filter.....	681
11613A Calibrator for HP 8757A.....	607	11900 Series 2.4 mm Coaxial Adapters.....	563, 740
11614A Firmware Enhancement for HP 8757A.....	605	11940A Close-Field Probe.....	677, 694
11635A Bias Decoupling Network.....	633	11970 Series Harmonic Mixers.....	561, 693
11636A/B Power Dividers.....	557, 607	11971 Series Harmonic Mixers.....	561, 693
11643A Series Millimeter-Wave Test Set Kits.....	634	11975A Microwave Power Amplifier.....	488
11644A Series Millimeter-Wave Calibration Kits.....	634	12000	
11650A Accessory Kit for HP 8410S.....	637	12060B 8-Channel Analog Input Card.....	184
11661B Frequency Extension Module.....	530	12061A 32-Channel Analog Input Expansion Card.....	184
11664A/D/E Detector for HP 8755, 8756 and 8757.....	605	12062A 4-Channel Analog Output Card.....	184
11664C Detector Adapter for HP 8755, 8756 and 8757.....	605	12063A 32-Channel Digital Multifunction Card.....	184
11665B Modulator for HP 8755, 8756 and 8757.....	605	12153A A700 Writable Control Store Card.....	94
11667A/B Power Splitters.....	557, 607	12156A A700 Floating Point Processor.....	94
11668A High Pass Filter for HP 8755, 8756 and 8757.....	607	12157A A-Series Battery Backup System.....	94
11672A Service Accessory Kit for HP 8660A/C.....	530	13000	
11675B Leveling Cable Assembly for HP 784C.....	391	13064A Tape Degausser.....	464
11678A Low Pass Filter Kit.....	606	14000	
11679A/B Extension Cables for HP 8755, 8756 and 8757.....	607	14513A Rack Kit (for one unit, 3 1/2 in. H).....	263, 265
11683A Range Calibrator.....	585	14515A Rack Kit (for one unit, 5 1/4 in. H).....	265
11684/5/6/8/9A Low Pass Filters.....	607	14521B Rack Kit (for Bench Series).....	263
11687A Adapter, 50 to 75 Ω	537	14523A Rack Kit (for two units, 3 1/2 in. H).....	263, 265
11690A Frequency Doubler.....	537	14525A Rack Kit (for two units, 5 1/4 in. H).....	265
11691D Coaxial Directional Coupler.....	558	14533B Pocket Programmer.....	278
11692D Coaxial Dual Directional Coupler.....	558	14534A Pocket Programmer Cable.....	278
11693A Limiter.....	694	14535A Interface Kit, DCPS-to-HP 1000 Computers.....	278
11694A Matching Transformer, 50-75 Ω	694	14536A DCPS Chaining Cable.....	278
11707A Test Plug-in.....	530	14540A 1000 Cable Assembly, Multiprogrammer-to HP 1000 Computers.....	179
11708A Attenuator (for Calibrating HP 8484A).....	586	14541A Chaining Cable, HP 6940B or 6941B to HP 6941B.....	179
11710B Down Converter.....	537	14550B Interface Kit, Multiprogrammer-to- HP 1000 Computers.....	179
11712A Service Support Kit (for HP 8671A, 8672A/S).....	544	14551A Multiprogrammer Service Kit.....	179
11713A Attenuator/Switch Driver.....	554	14558A Termination Panel.....	179, 182
11714A Service Support Kit (for HP 8662A, 8663A).....	527	14711A Field Service Kit.....	175
11715A AM/FM Test Source.....	718	14711D Field Service Kit.....	182
11716A/B Interconnection Kits.....	554	14752A Computer Aided Test Programming Package.....	174, 178
11717A Attenuator/Switch Rack Mount Kit.....	554	14752R Right to Reproduce CAT Program Pkg.....	174, 178
11720A Pulse Modulator.....	540		
11721A Frequency Doubler.....	713		
11722A Sensor Module.....	713		
11723B Software Application Pac for HP 8953A & 85B.....	726		
11726A Support Kit for HP 8673B/C/D.....	544		
11729C Carrier Noise Test Set.....	709		
11731A Frequency Extension Retrofit Kit.....	546		
11732A Frequency Extension Retrofit Kit.....	546		
11736A/B I-Q Tutor Training Kit.....	393		



14801A PC Instruments Rack Shelf.....	208
14802A PC Instruments Terminal Block.....	208
14855A PC Instruments Data Acquisition System.....	208
14856A PC Instruments Data Acquisition System.....	208
14858A ASYST™ Scientific Software.....	209

15000

15104A Pulse Adder/Splitter.....	477
15115A Pulse Splitter/Inverter.....	477
15116A Pulse Inverter.....	477
15179A Rack Adapter Frame.....	474
15406A-15423A HP 8180A/82A Accessories.....	484
15408A-15411A HP 8175A Accessories.....	481
15413B Tristate Pod for HP 8180A/81A.....	484
15414A Tristate Unit for HP 8180A/81A.....	484
15415A Plug-on Miniprobe.....	481
15424A Performance Board.....	241, 484
15425A Test Head.....	241, 484
15426A Receptacles.....	484
15427A DUT Board.....	484
15428A Relays.....	484
15429A Solder-in Receptacles.....	481
15430A Cable for Master-Slave Operation.....	481
15453A-15458A HP 8170A Accessories.....	486
15461A ECL Pod.....	481
15462A TTL/CMOS Pod.....	481
15463A Trigger Pod.....	481
15475A Optical Cleaning Kit.....	581
15512A Cable.....	378
15513A Cable.....	378
15515B Loop Holding Unit.....	378
15518A/B/C Loop Holding Accessories.....	378
15580A 20 MHz High-Impedance Active Probe.....	384
15581B 25 MHz High-Impedance Passive Probe.....	384
15582A Return Loss Kit.....	384
15589A Instrument Cart.....	384

16000

16005A Probe.....	235
16006A Probe.....	235
16007A/B Test Leads.....	235
16008A Resistivity Cell.....	235
16014A Series Loss Test Adapter.....	234
16023B DC Bias Controller.....	225
16034B Test Fixture for Chip Components.....	215
16047A Direct Coupled Test Fixture.....	215
16047B Test Fixture with Safety Cover.....	225
16047C Test Fixture for High Frequencies.....	215
16047D Direct Coupled Test Fixture.....	215
16048A Test Leads, BNC.....	215
16048B Test Leads, RF Miniature.....	215
16048C Test Leads, Alligator Clips.....	215
16048D Test Leads, BNC (2m).....	231
16053A Test Leads.....	250
16054A Connection Selector.....	250
16055A Test Fixture.....	250
16056A Current Divider.....	250
16058A Test Fixture.....	247
16061A Test Fixture.....	233
16062A Test Leads.....	233
16063A Test Leads.....	233
16064A Retrofit Kit for Comparator.....	231
16065A External DC Bias Test Fixture.....	215
16066A Test Fixture Adapter.....	243
16067A 24-pin DIP Low Leakage Fixture.....	243
16068A 48-pin DIP Low Leakage Fixture.....	243
16069A Universal Low Leakage Fixture.....	243
16070A General Purpose DIP Fixture.....	243
16071A Universal Fixture.....	243

ASYST™ is a trademark of Macmillan Software Company.

16072A Personality Board.....	243
16075A Relay Test Adapter.....	243
16076A System Test Module.....	243
16077A Extension Cable Fixture.....	243
16080A Direct Coupled Test Fixture.....	253
16081A Test Leads.....	253
16082A Test Leads.....	253
16083A Pulse Bias Noise Clipper.....	253
16085A Terminal Adapter.....	215
16086A Accessory Kit.....	215
16091A Coaxial Fixture Set.....	219
16092A Spring Clip Fixture.....	219, 221
16093A/B Binding Post Fixture.....	219, 221
16094A Probe Fixture.....	219
16095A Probe Fixture.....	217
16096A 2-Port Component Test Fixture.....	217
16097A Accessory Kit.....	217
16099A Test Fixture Adapter.....	221
16117A Low Noise Test Leads.....	235
16143A Probe Cable.....	235
16262B Software Disc Set.....	243
16262C Application Software.....	243
16380A/C Standard Capacitor Sets.....	236
16451A Dielectric Test Adapter.....	234
16462A Auxiliary Capacitor.....	234
16470A/B/C Reference Inductors.....	234

17000

17090B Measurement Graphics Software.....	452
17108A Time Base.....	456
17580B HP-ISPP Software.....	117

18000

18107A External Oscillator (HP 2804A).....	733
18110A Laboratory Probe and Cal Module, 26 mm (1 in.) (HP 2804A).....	733
18111A Laboratory Probe and Cal Module, 232 mm (9.1 in.) (HP 2804A).....	733
18132A Rack Mount.....	371
18134A Carrying Case.....	371
18135A RS-232C/V.24 Interface Pod.....	365
18136A RS-449/422A/423A Interface Pod.....	365
18137A V.35 Interface Pod.....	365
18138A X.25 Interface Kit.....	365
18139A MIL-188C Pod.....	365
18140A Breakout Box.....	365
18141A Service Kit.....	365
18142A BASIC Field Retrofit Kit.....	365
18145A Remote Testing Package.....	365
18146A CCITT #7 Decode Package.....	365
18150JA X.25 DTE, DCE Conformance Test, Certification System.....	365
18153A SNA Analysis.....	364, 365
18154A X.21 Interface Kit.....	364
18155A BSC-Framed X.25 Decode.....	364, 365
18161A Ladder Bracket.....	371
18162A HP-IB Module.....	372
18163A RS-232C Module.....	372
18165A HP-IL Module.....	372
18169A Rack Mount.....	372
18170A Soft Vinyl Carrying Case.....	372
18174A RS-449/422A/423A.....	363
18176A Hard Transit Case.....	372
18177A V.35 Interface Pod.....	363
18178A X.21 Interface Pod.....	363
18179A RS-232C/V.24 Interface Pod.....	363
18180A Combination RS-232C/V.24, RS-449/422A/423A Interface.....	363
18183A RS-232C/V.24 Interface.....	369

MODEL NUMBER INDEX

New product listings are printed in bold face type



18184A V.35 Interface.....	369
18185A 115V Power Module.....	369, 371
18190A Soft Vinyl Carrying Case.....	363
18191A Rack Mount.....	369
18192A Soft Vinyl Carrying Case.....	369
18194A 220V Power Module.....	369, 371
18197A X.21/RS-232C/V.24 Interface Kit.....	363
18198A State Simulator.....	364, 365
18199A CCITT #7/CC27 Analysis.....	364, 365
18200A Katakana Character Set (JIS-8).....	365
18260A X.21/RS-232C/V.24 Interface Pod.....	363
18261A SNA Analysis.....	363
18262A Async Terminal Emulator.....	363
18290A X.21 DTE Analysis Pack.....	365
18310A SNA Protocol Testing Environment/Emulation.....	364, 365
18331D SNA Analysis DDCMP X.25 Analysis/Simulation.....	363
18322D 3270 Tester.....	363
19000	
19749A Cable Management System.....	75
20000	
26030A Forms Tractor.....	106, 107
26030E Sheetfeeder.....	106, 107
27110B HP-IB Interface.....	75, 89
27112A General-Purpose Interface.....	89
27114A Parallel Async AFI Interface.....	75, 89
27116A HP-CIO Extender Card.....	89
27122A RJE/500 Interface.....	85, 89
27123A SRM Interface.....	84
27125B LAN/9000 Series 500 Link.....	85, 89
27128A Asynchronous Serial Interface.....	89
27130B Eight-Channel Multiplex Card.....	89
27140A Async 6-Channel Multiplexer.....	75, 89
27505A HP Word/150.....	57
27506F AdvanceWrite I.....	53, 57
27507F AdvanceWrite II.....	53, 57
27508F AdvanceWrite III.....	53, 57
29340S Single Bin Sheetfeeder.....	106, 107
30000	
33300 Series Coaxial Step Attenuators.....	556
33311B/C Coaxial Switches.....	551
33312B/C Coaxial Switches.....	551
33313B/C Coaxial Switches.....	551
33320 Series Coaxial Step Attenuators.....	556
33330B/C/D Coaxial Crystal Detectors.....	560
33340A/B/C Coaxial Attenuators.....	552
34110A Carrying Case.....	201
34111A High Voltage Probe.....	201
34112A Touch-Hold Probe.....	201
34118A Test Lead Kit.....	201
34800/801 Functional Test Manager/300.....	185
35151D The Calendar.....	57
35152D The List Manager.....	57
35153D The Writer.....	57
35154D The Speller.....	57
35155D The Planner.....	57
35156D The Personal Correspondence Pack.....	57
35157D The Personal Organizer Pack.....	57
35177M JetStart (for HP ThinkJet).....	56
35178M LaserStart (for HP LaserJet).....	56
35184A Sideways (for Touchscreen PC and ThinkJet printer).....	57
35186B Microsoft COBOL Compiler (for Vectra PC).....	57
35186C Microsoft FORTRAN Compiler (for Vectra PC).....	57
35186D Microsoft Pascal Compiler (for Vectra PC).....	57
35186E Microsoft C Compiler (for Vectra PC).....	57
35190A Microsoft BASIC Interpreter (for Vectra PC).....	57
35190B Microsoft BASIC Compiler (for Vectra PC).....	57
35190D Microsoft WORD (for Vectra PC).....	57
35190F Typing Tutor (for Vectra PC).....	57
35190G Teach Yourself WordStar (for Vectra PC).....	57
35190H ThinkTank.....	57
35190J LaserControl 100 (for Vectra PC and LaserJet printer).....	57
35401A 1/4" Cartridge Tape Drive.....	104
35650A HP ME Series 90 Measurement Hardware	
Mainframe.....	160
35651A HP ME Series 90 HP-IB/Signal Processing Module.....	160
35652A HP ME Series 90 Input Module.....	160
35653A HP ME Series 90 Source Module.....	160
35675A Accuracy Enhancement Software.....	616
35676A/B 50/75 Ohm Reflection/Transmission Test Kit.....	615
35677A/B 50/75 Ohm S-Parameter Test Set.....	615
35678A/B 50/75 Ohm Type N Calibration Kit.....	617
35679A/B 50/75 Ohm Type N Port Extension Cables.....	617
35723A HP Touch Accessory.....	51, 99
35731A/B Monochrome Monitor.....	51, 99
35741A/B Color Monitor.....	53, 99
35743A/B Enhanced Graphics Display.....	99
36217A Allbase/HP-UX.....	75
36568A HPMessage.....	56
36569E HPMessage.....	56
36890F Print Central.....	57
36898A HP Access.....	56
36898F HP Access.....	56
37050S FDM Network Monitoring System.....	396
37051S FDM Measurement System.....	396
37100S Remote Access and Test System.....	396
37201A HP-IB Extender.....	136
37204A Multipoint HP-IB Extender.....	136
40000	
41941A/B Impedance Probe Kits.....	213
43700 Flash X-Ray Systems.....	754
43855A Cabinet X-Ray Systems.....	754
44458A/B Data Acquisition Manager.....	303
44462A 10 Channel Multiplexer Assembly.....	287
44463A Extra Connector Block.....	287
44464A Breadboard Assembly.....	287
44465A 8-Bit In, 8-Bit Out Digital I/O Assembly.....	287
44466A Extra Connector Block for HP 44465A.....	287
44469A Seven 10:1 Dividers.....	287
44538A Standard Test Fixture Kit.....	357
44539A Large Test Fixture Kit.....	357
44540A Dual Test Fixture Kit.....	357
44582A BTL PLUS Software for HP 3061, 3062 Systems.....	355
44670A NS/3065 Software for HP 3065 Family.....	355
44671A PR PLUS Software.....	355
44672A Q-STATS II Software.....	355
45070A HP 260 Series 30 SPU.....	66
45071A I/O Extender.....	66
45072A HP 260 Series 40 SPU.....	66
45310A BASIC Programmer's Library.....	56
45311A ICON Design System.....	56
45400D WordStar®.....	57
45405A Deluxe VisiCalc.....	57
45406E TextCharts.....	57
45411A Drawing Gallery.....	57
45412A VT100 Terminal Emulator.....	56
45416A Condor™3.....	56
45418A Executive MemoMaker.....	57
45419C Programmer's Tools.....	56
45420G/H MemoMaker.....	90
45421A Executive Card Manager.....	56
45423A Financial Calculator.....	57
45424A MultiMate.....	57
45427D WordStar Professional®.....	57
45429A WordStar Professional Options.....	57
45431A AdvanceLink.....	56
45433A Gallery Picture Library Vol. II.....	57



45435A Touchscreen Programmer's Tools.....	56
45437A The Gallery Collection.....	57
45438G/H Management Solution HP-UX.....	90
45441D Executive Card Manager: Templates.....	56
45442A ExecuDesk System.....	56
45443A Forms Master.....	56
45444A ExecuDesk.....	56
45445D BASIC by Microsoft®.....	56
45446D Compiled BASIC by Microsoft.....	56
45447D Pascal by Microsoft.....	56
45448A COBOL by Microsoft.....	56
45449D FORTRAN by Microsoft.....	56
45450D GW™ BASIC by Microsoft.....	56
45452D Lattice® C Compiler.....	56
45462A/B Picture Perfect™.....	57, 90
45463A/B Diagraph™.....	57, 90
45468D dBASE II®.....	56
45473D MicroSoft MultiPlan™.....	90
45474D MicroSoft WORD.....	57
45480B Data Grapher/200.....	90
45481B Context MBA™.....	90
45482A 1-2-3® from Lotus®.....	57
45482K 1-2-3 from Lotus.....	57
45498A Symphony® from Lotus.....	56
45504K MemoMaker/Time Management, Opt. 400.....	57
45513A Charting Gallery.....	57
45515G/H TK!Solver®/HP-UX.....	90
45516/17/18/19G TK!SolverPack®/HP-UX Software.....	90
45524G/H MicroTrak™/HP-UX.....	90
45537B Graphics Editor/200.....	90
45538B Text Editor/200.....	90
45540A Painter.....	57
45545A R:Base™ 4000.....	56
45549K Microsoft® WORD, Opt. 400.....	57
45554K MultiMate™, Opt. 400.....	57
45555K Executive Card Manager, Opt. 400.....	56
45556D Microsoft SPELL.....	57
45563A R:Base 5000.....	56
45568A Office Activities Portfolio.....	57
45569A Chemical/Petrochemical Portfolio.....	57
45570A Business Management Portfolio.....	57
45571A HPDraw Figures Portfolio.....	57
45624A Touchscreen MS-DOS User's Guide.....	51
45625A Touchscreen Technical Reference Manual.....	51
45640A Touchscreen Internal Modem.....	56
45641B Touchscreen 3278 Emulation Accessory with File Transfer.....	56
45711C Portable PLUS PC (256K RAM).....	55
45711D Portable PLUS PC (without built-in modem).....	55
45711E Portable PLUS PC (512K RAM).....	55
45711F Portable PLUS PC (without built-in modem).....	55
45816A 20M-byte Internal Disc Subsystem.....	53
45816M 20M-byte Internal Hard-Disc Drive.....	53
45817A 40M-byte Internal Disc Subsystem.....	53
45817M 40M-byte Internal Hard-Disc Drive.....	53
45849A Touchscreen II CPU.....	51
45850A Touchscreen II CPU with Terminal Kit.....	51
45851A Touchscreen II CPU with PC Kit.....	51
45885A 8087 Co-Processor Accessory.....	51
45885A 8087 Co-Processor Accessory (optional, for Touchscreen II).....	51
46021A HP-HIL Keyboard.....	77
46060A HP-HIL Mouse.....	77
46080A-46089A HP 9000 Series 300 HP-HIL Devices.....	77
46094A, 46095A HP 9000 Series 300 HP-HIL Devices.....	77
48000 Remote Terminal Unit.....	290

50000

50004A HP 6942A Multiprogrammer User's Course.....	182
---	-----

50011B HP-IB Instrument Control Using Series 200/300 BASIC.....	758
50015A Data Acquisition and Control Fundamentals.....	759
50950A HP LAN Network Services for VAX.....	84
50952B HP LAN Network/ARPA Services, HP 9000 Series 300.....	84
50954A HP LAN Network/ARPA Services, HP 9000 Series 500.....	84
50961A SRM Coax Interface.....	89
51800A Waveform Measurement System.....	443
51810A, R Video-Measurement Set.....	359
51810S Video-Measurement System.....	358
51820A Waveform Generation Software.....	445
52126A Intel Multibus Interface.....	403, 406
54001A 1-GHz Miniature Active Probe Pod.....	435, 448
54002A 50Ω BNC Input Pod.....	435, 448
54003A 1-MΩ Probe Pod.....	435, 448
54100A 1-GHz Digitizing Oscilloscope.....	432
54100D 1-GHz Logic Triggering Digitizing Oscilloscope.....	432
54100M MATE Digitizing Oscilloscope.....	434
54110D 1-GHz Color Digitizing Oscilloscope.....	432
54111D 500-MHz Logic Triggering Digitizing Oscilloscope.....	436
54200A 50-MHz Digitizing Oscilloscope.....	428
54200D 50-MHz Logic Triggering Digitizing Oscilloscope.....	428
54201A 300-MHz Digitizing Oscilloscope.....	428
54201D 300-MHz Logic Triggering Digitizing Oscilloscope.....	428
54300A Probe Multiplexer.....	448
59301A ASCII-Parallel Converter.....	134
59303A Digital-to-Analog Converter.....	134
59306A HP-IB Relay Actuator.....	134
59307A HP-IB VHF Switch.....	135
59309A HP-IB Digital Clock.....	135
59401A Bus System Analyzer.....	133
59500A Multiprogrammer HP-IB Interface.....	179
59501B HP-IB Power Supply Programmer.....	135, 277
59991A-K34 Broadband Linear Phase Comparator.....	336
59992A-J06 Time Interval Calibrator.....	319
59992A-K70 Rack Mount Adapter Kit (HP 5342A, 5343A).....	319

60000

61001A PC Instruments System Power Unit.....	208
61010A PC Instruments Digital I/O.....	203
61011A PC Instruments Relay Multiplexer.....	203
61012A PC Instruments Dual Voltage DAC.....	204
61013A PC Instruments Digital Multimeter.....	204
61014A PC Instruments Function Generator.....	205
61015A PC Instruments Universal Counter.....	205, 206
61016A PC Instruments Digitizing Oscilloscope.....	206
61017A PC Instruments Relay Actuator.....	207
61018A PC Instruments Breadboard.....	207
61019A PC Instruments 20-Volt Power Supply.....	207
61025A PC Instruments 50-Volt Power Supply.....	207
61060A PC Instruments Interface for HP Touchscreen.....	208
61061B PC Instruments Interface for HP Vectra PC, IBM PC and AT&T PC 6300.....	208
61086B PC Instruments Data Logging Package for HP Touchscreen.....	210
61087B PC Instruments Data Logging Package for Vectra PC, IBM PC, and AT&T PC 6300.....	210
61088B PC Instruments Electronic Bench Package for HP Touchscreen.....	210
61089B PC Instruments Electronic Bench Package for Vectra PC, IBM PC, and AT&T PC 6300.....	210
64000 Logic Development System.....	148
64000 Logic Development Concepts and Measurements.....	758

MODEL NUMBER INDEX

New product listings are printed in bold face type



64000 System Pascal Programming Course	758	69721A Digital-to-Analog Current Converter Card	177
64070A HP 64000-UX, High-Speed DEC VAX Interface	148	69730A Relay Output Card	177
64100A HP 64000-UX Microprocessor Development Environment, Development Station	148	69731B Digital Output Card	177
64110A HP 64000-UX, Transportable Development System	148	69735A Pulse Train Output/Stepping Motor Control Card	177
642XXS HP 64000-UX, Emulation Subsystems	148	69736A Timer/Pacer Card	177
64276X HP 64000-UX, Microprogram Development Subsystem	148	69750A Scan Control/Pacer Card	177
64302A HP 64000-UX, Emulation Bus Analyzer	148	69751A Analog-to-Digital Converter Card	177
64310A HP 64000-UX, Software Performance Analyzer	148	69752A 64 Channel FET Scanner Card	177
64310A + 24A Software Performance Analyzer Training	758	69754A 32 Channel Relay Scanner Card	177
64320S 25MHz Logic State Software Analyzer	153	69755A 16 Channel FET Scanner Card	177
64330 High-Level Software Analyzer	151	69759A 500 kHz A/D Converter Card	177
64340 Real-Time, High-Level Software Analyzer	151	69770A Isolated Digital Input Card	177
6434XX HP 64000-UX, Real-Time, High-Level Software Analyzer	148	69771A Digital Input/Analog Comparator Card	177
64500S HP 64000-UX PROM Programming Subsystem	148	69775A Counter/Totalizer Card	177
64600 Series Preprocessors	152	69776A Interrupt Card	177
64600S + 24F Hardware/Timing Analyzer Training	758	69790B Memory Card	177
64610S HP 64000-UX High-Speed Timing/State	148	69791A/69792A 1 Megaword Memory System	177
64620S HP 64000-UX Logic State/Software	148	69793A Breadboard Card	177
64800 Series Cross Assemblers/Compilers	153		
68324F Office Activities Portfolio	57	70000	
68325F Chemical/Petrochemical Portfolio	57	70001A Modular Measurement System Mainframe	659
68326F Business Management Portfolio	57	70205A Graphics Display Module	659
68327F HPDraw Figures Portfolio	57	70206A System Graphics Display	659
68330F Executive MemoMaker	57	70300A Tracking Generator Module	659
68331F Executive Card Manager	56	70310A Precision Frequency Reference Module	659
68332F Executive Spreadsheet	57	70800A/B/C/D/E HP-MSIB Cables	659
68333F AdvanceLink 2392	56	70900A Local Oscillator Module	659
68335F Executive Card Manager: Templates	56	70902A IF Section Module (Res BW 10 Hz - 300 kHz)	659
68336F R:Base 5000	56	70903A IF Section Module (Res BW 100 kHz - 3 MHz)	659
68338F MultiMate	57	70904A RF Section Module (100 Hz - 2.9 GHz)	659
68339F Symphony from Lotus	56	70905A RF Section Module (50 kHz - 22 GHz)	659
68340F 1-2-3 from Lotus	57	70906A RF Section Module (50 kHz - 26.5 GHz)	659
68341F WordStar® 2000	57	70907A External Mixer Interface Module	659
68342F WordStar 2000 Plus	57	71000S Spectrum Analyzer System Reference	655
68343F MultiMate Advantage	57	71100A RF Spectrum Analyzer (100 Hz - 2.9 GHz)	655, 658
68345F WordStar	57	71200A Microwave Spectrum Analyzer (50 kHz - 22/26.5 GHz)	655, 658
68346F WordStar Professional	57	71300A Millimeter Spectrum Analyzer	655, 658
68350F Charting Gallery	57	72411A VECTRA Industrial Personal Computer	95
68351F Drawing Gallery	57	72425A HP Vectra Model 25 Personal Computer	53, 80
68352F Gallery Collection	57	72435A HP Vectra Model 35 Personal Computer	53, 80
69280A Breadboard Card	180	72445A HP Vectra Model 45 Personal Computer	53, 80
69321B D/A Voltage Converter	180	72475A Vectra Office, Model 1	53
69322A Quad D/A Voltage Converter Card	180	72485A Vectra Office, Model 2	53
69331B Digital Output Card	180	74210A Design Capture System for HP 9000 Model 320	145
69332A Open Collector Output Card	180	74210B Design Capture System for HP Vectra PC and PC/AT	145
69335A Stepping Motor Control Card	180	74230A Design Verification Interface for HILO-3	145
69336B High Speed Scanner Card	180	74230B HILO-3 Logic Simulator	145
69351C Voltage Regulator Card	180	74230C HILO-3 Simulator Models	145
69370A D/A Current Converter Card	180	74230D HILO-3 Fault Simulator	145
69380A Breadboard Output Card	180	74230S HP Design Verification Subsystem	145
69422A High Speed A/D Converter Card	180	74250A HP Design Interface for SCICARDS	145
69423A Low Level A/D Converter Card	180	74250B HP Design Interface for Calay	145
69430A Isolated Digital Input Card	180	74250C HP Design Interface for HP-EGS	145
69431A Digital Input Card	180	74250D HP Design Interface for HP-PCDS	145
69433A Relay Output With Readback Card	180	74260A TTL Parts Library	145
69434A Event Sense Card	180	74260B MDS Parts Library	145
69435A Pulse Counter Card	180	74260C ECL Parts Library	145
69436A Process Interrupt Card	180	74260D μP Parts Library	145
69480A Breadboard Input Card	180	74260E PLD Parts Library	145
69500A Unloaded Resistance Output Card	180	74305A/R HP EGS, Engineering Graphics System Software	156
69501A-69513A Power Supply Control Cards	180	74306A HP EGS, Add-on Modules	156
69520A Power Supply Programming Card	180	74400A/R HP Printed Circuit Design System	155
69602B Timer/Pacer Card	180	74401A/R HP Printed Circuit Design System, Design Module	155
69700A-69706A Resistance Output Cards	177		
69709A Power Supply Control Card	177		
69720A Digital-to-Analog Voltage Converter Card	177		



74402A/R HP Printed Circuit Design System, Autorouter Module.....	155	82867K YTERM 3278 Emulation, Opt. 630.....	56
74403A/R HP Printed Circuit Design System, Library Module.....	155	82870K AdvanceMail, Opt. 400.....	57
74650A HP Design Interface for Analog Workbench.....	145	82912A 9-Inch Monitor (HP-85B, HP-86B).....	82
74661A R,L,C Parts Library.....	145	82913A 12-Inch Monitor (HP-85B, HP-86B).....	82, 85
74661B Semiconductor Parts Library.....	145	82938A HP-IL/Series 80 Interface.....	62
74791S ME Series 90 Multi-channel Test System.....	162	82973A HP-IL Interface Card.....	62
74792S ME Series 90 Multi-channel Test System.....	162	83522A 0.01-2.4 GHz RF Plug-in for HP 8350B.....	504
74793S ME Series 90 Multi-channel Test System.....	162	83525A/B 0.01-8.4 GHz RF Plug-in for HP 8350B.....	504
74796D ME Series 90 META-MODAL Software.....	162	83540A/B 2-8.4 GHz RF Plug-in for HP 8350B.....	506
74796E ME Series 90 META-MODS Software.....	162	83545A 5.9-12.4 GHz RF Plug-in for HP 8350B.....	506
74796F ME Series 90 META-FORCE Software.....	162	83550A 8-20 GHz RF Plug-in for HP 8350B.....	506
74796G ME Series 90 Bundled META Software.....	162	83554A 26.5-40 GHz Millimeter-Wave Source Module.....	510, 548
74796H ME Series 90 META-MODAL for HP 3562S.....	162	83555A 33-50 GHz Millimeter-Wave Source Module.....	510, 548
74796J ME Series 90 Bundled META for HP 3562S.....	162	83556A 40-60 GHz Millimeter-Wave Source Module.....	510, 548
74836A ME Series 30 Solids Modeling.....	159	83570A 18-26.5 GHz RF Plug-in for HP 8350B.....	508
79232U HP PROLOG Artificial Intelligence Language.....	86	83572A/B 26.5-40 GHz RF Plug-in for HP 8350B.....	508
		83590A 2-20 GHz RF Plug-in for HP 8350B.....	502
80000		83592A/B/C 0.01-20 GHz RF Plug-in for HP 8350B.....	502
81000BS Optical Power Splitter.....	578, 581	83594A 2-26.5 GHz RF Plug-in for HP 8350B.....	502
81511A Optical Head, 550 to 950 nm.....	576	83595A 0.01-26.5 GHz RF Plug-in for HP 8350B.....	502
81512A Optical Head, 900 to 1725 nm.....	576	84811A Peak Power Sensor.....	589
81519A Optical Receiver.....	577	85013A Basic Measurements Application Pac (HP 8510A).....	633
81521B Optical Head, 850 to 1700 nm.....	578, 581	85014A Active Device Measurements Application Pac (HP 8510A).....	633
81800A Software Pac.....	239, 241, 484	85015B System Software for HP 8756S and 8757S.....	600, 610
81810S Digital IC Test System.....	239	85016B Transmission Line Test Software for HP 8756S and 8757S.....	600, 610
82104A Card Reader (HP-41CV/CX).....	61	85020A/B RF Directional Bridge for HP 8755, 8756, 8757.....	603
82143A Printer/Plotter (HP-41CV/CX).....	61	85022A System Cable Kit for HP 8756S and 8757S.....	605
82153A Optical Wand (HP-41CV/CX).....	61	85023A/B/C/D System Verification Kit for HP 8756S and 8757S.....	607
82160A HP-IL Module (HP-41CV/CX).....	61	85025A/B AC/DC Detector for HP 8757A.....	605
82161A Digital Cassette Drive.....	62	85025C Detector Adapter for HP 8757A.....	605
82162A Printer/Plotter.....	62	85026A Waveguide Detector for HP 8757A.....	605
82164A HP-IL/RS-232C Interface.....	62	85027A/B/C Microwave Directional Bridge for HP-8755, 8756, 8757.....	603
82165A HP-IL/GPIO Interface.....	62	85029A 7mm Verification Kit.....	627
82166C HP-IL Interface Kit.....	62	85031B APC-7 Calibration Kit for HP 8753A.....	627
82168A Acoustic Coupler.....	62	85032B 50 Ω Type-N Calibration Kit.....	627
82169A HP-IL/HP-IB Interface.....	62	85033C 3.5mm Calibration Kit.....	627
82180A Extended Functions/Memory Module (HP-41CV).....	60	85036B 75 Ω Type-N Calibration Kit.....	627
82181A Extended Memory Module.....	60	85041A Transistor Test Fixture Kit.....	633
82182A Time Module (HP-41CV).....	61	85043A System Rack Kit.....	630
82183A Extended I/O Module.....	61	85043B System Rack.....	627
82184A Plotter Module.....	61	85044A/B Transmission/Reflection Test Set.....	557, 625
82240A Thermal Printer.....	61	85046A/B S-Parameter Test Set for HP 8753A.....	625, 626
82400A Card Reader (HP-71B).....	62	85050A 7mm Calibration Kit.....	632
82401A HP-IL Interface (HP-71B).....	62	85051A 7mm Verification Kit.....	632
82402A Dual HP-IL Adapter.....	62	85052A 3.5mm Calibration Kit.....	632
82420A 4K Memory Module (HP-71B).....	61	85053A 3.5mm Verification Kit.....	632
82440A Software Development Utility (HP-71B).....	63	85054A Type N Calibration Kit.....	632
82470A RS-232C Level Converter.....	62	85100A LO/IF Kit for mm-Wave 8510.....	634
82477A HP-IL Link.....	63	85129A Millimeter-Wave Measurement Software for HP 8510A.....	634
82478A FORTH Assembly/Debugger.....	63	85130A Special 3.5mm to 7mm Adapter Kit.....	632
82479A Data Acquisition Pac (HP-71/HP 3421A).....	64	85131A 3.5mm Test Port Return Cable.....	632
82487A Custom Keyboard Overlays (HP-71B).....	63	85131B 3.5mm Test Port Return Cable Set.....	632
82491-82494A/B Custom Modules (HP-71B).....	63	85132A 7mm Test Port Return Cable.....	632
82501A Custom Keyboard Overlays (HP-41).....	63	85132B 7mm Test Port Return Cable Set.....	632
82502A Custom Magnetic Cards (HP-41).....	63	85138A/B 2.4mm 50 Ω Terminations.....	563
82504A Custom Keyboard Touchpads.....	63	85140A/B 2.4mm Short Circuits.....	563
82508A/B Custom Modules (HP-41).....	63	85141A/B 2.4mm Open Circuits.....	563
82509A/B Custom Modules (HP-41).....	63	85170A Touchstone™ Microwave CAE Software for HP 85200S.....	146
82520A Software Development System (HP-94).....	62	85171A Touchstone™ Microwave CAE Software for HP 85201S.....	146
82722A Custom Magnetic Cards (HP-71B).....	63	85200S Personal Microwave Workstation with Vectra PC.....	146
82815J HP-UX Tools for HP Integral PC.....	85	85201S Personal Microwave Workstation with Series 300.....	146
82821A Data Comm Pack for HP Integral PC.....	85		
82856J HP-UX Tools for HP Integral PC.....	85		
82862K BASIC by Microsoft, Opt. 400.....	56		
82863K REFLECTION 1™, Opt. 400.....	56		
82866KD Localization, German—Opt. 400.....	57		
82866KF Localization, French—Opt. 400.....	57		
82866KZ Localization, Italian—Opt. 400.....	57		

MODEL NUMBER INDEX

New product listings are printed in bold face type

85650A Quasi-Peak Adapter675
 85685A RF Preselector675
 85863A BASIC Software Library for HP 8566A/B or 8568A/B669
 85864C EMI Measurement Software for HP 8566A/B or 8568A/B676
 85865B Signal Monitoring Software for HP 8566A/B or 8568A/B673
 85867A EMI Receiver Functions677
 85870A Open-Site EMI Measurement System Software676
 86200 Series RF Plug-ins for HP 8620C, 8350B513
 86220A RF Plug-in for HP 8620C, 8350B518
 86222A/B RF Plug-ins for HP 8620C, 8350B516
 86235A RF Plug-in for HP 8620C, 8350B518
 86240A/B/C RF Plug-ins for HP 8620C, 8350B517
 86241A 3.2-6.5 GHz RF Plug-in for HP 8620C, 8350B518
 86242D 5.9-9 GHz RF Plug-in for HP 8620C, 8350B518
 86245A 5.9-12.4 GHz RF Plug-in for HP 8620C, 8350B518
 86250D 8-12.4 GHz RF Plug-in for HP 8620C, 8350B518
 86251A 7.5-18.6 GHz RF Plug-in for HP 8620C, 8350B517
 86260A 12.4-18 GHz RF Plug-in for HP 8620C, 8350B518
 86260B 10-15.5 GHz RF Plug-in for HP 8620C, 8350B518
 86260C 17-22 GHz RF Plug-in for HP 8620C, 8350B518
 86290B/C RF Plug-ins for HP 8620C, 8350B515
 86601A 0.01-110 MHz RF Section531
 86602B 1-1300 MHz RF Section531
 86603A 1-2600 MHz RF Section531
 86631B Auxiliary Section532
 86632B AM/FM Modulation Section532
 86633B AM/FM Modulation Section532
 86634A θ M Modulation Section532
 86635A θ M/FM Modulation Section532
 86720A Frequency Extension Unit546
 88500A IBM Disc/Tape Interface100

90000

91290A 5/4" HP Qualified Media100
 92192A 3 1/2" Doublesided Microfloppy100
 92198A/B/C HP-IL 80-Column Video Interface62
92205K/L/M/N/P HP-IL Acoustic Couplers62
 92242L 60.0 Mbyte Tape100
 92242S 15.0 Mbyte Tape100
 92248BA Cross Reference Utility56
 92430A HP Fortran 77/HP-UX75
 92431A HP Pascal/HP-UX75
 92436A Starbase Graphics Library75
 92437A DGL, AGP, Starbase Graphics Libraries75
 92438A Development System Bundle75
 92440A HPtoday Developer Pack75
 92441A HPtoday Run Time Environment75
 92442A ALLBASE/HP-UX, HPtoday Developer Pack75
 93453A 32-User HP-UX License75
 93454A 64-User HP-UX License75
94401A TECAP AC Analysis Software254
 94445A TECAP-Parameter Extraction Software254
 97033A HP-UX 5.0 Operating System83
 97050B Single-User BASIC for Model 52083
 97057A HP Windows/900083
 97068A HP Technical BASIC Interpreter83
 97070A Single-User HP-UX for Model 52083
 97071A Single-User FORTRAN 77 Compiler for HP-UX83
 97072A Single-User Pascal Compiler for HP-UX83
 97079A Single-User HP-UX for Models 540, 550, 56083
 97080A Multi-User HP-UX for Model 52083
 97081A Multi-User FORTRAN 77 Compiler for HP-UX83
 97082A Multi-User Pascal Compiler for HP-UX83
 97086A HP 1000 to HP 9000 Applications Migration83
 97089A Multi-User HP-UX for Model 540, 550, 56083
 98150B HP 9915B Program Development Kit82
 98155A HP 9915B Keyboard82

98194A LAN/9000 Series 800 Link75
 98195A NS/9000 Series 800 Software75
 98242A I/O Card Cage Upgrade Kit77
 98243A HP Series 300 Processor Upgrade Kit77
 98253A EPROM Programmer Interface89
 98255A EPROM Card89
 98256A 256-Kbyte RAM77, 89
 98257A, P 1-Mbyte RAM Card77, 89, 146
 98259A Magnetic Bubble Memory Card89
 98286A DOS Coprocessor Interface Card78
98286S DOS Coprocessor System Tape, Disc Options78, 91
 98286T Tape, Disc Options for DOS Coprocessor System with Memory Enhancement78
 98287A Series 300/98700H Interface89
 98304C HP EGS General Drawing142
 98304D HP EGS Electrical Engineering142
 98304E HP EGS Mechanical Engineering142
 98304F Customizing HP EGS142
 98310A, R HP EGS Photoplotter/NC Drill Utility, Right-to-Copy156
 98311A, R HP EGS, IGES Translator, Right-to-Copy156
 98353A HP-FE Software157
 98358A, R VME Bus Software Drivers78
 98360A +61A, +65A, +65B HP DRAFT Implementation Assistance142
98363A ME Series 5 (Pascal)159
 98363A +24D HP ME Series 5/10 Fundamentals158
98365A ME Series 10 (Pascal)159
 98365A +24D HP ME Series Advanced Concepts142
98366A ME Series 10 (HP-UX)159
 98501A BASIC Programming142
 98502A HP 9845 Basic Operations and Programming142
 98503A BASIC/IO Programming142
 98510A Series 200 BASIC Operations and Programming142
 98511A Series 200 Pascal Operations and Programming142
 98515A HP-UX 5.1 Application Execution Environment83
 98517A/97A HP-UX 5.1 Programming Environment83
 98518A/98A HP-UX FORTRAN 77 Compiler83
 98519A/99A HP-UX Pascal Compiler83
 98520A/600A HP-UX DGL/AGP Graphics Library83
 98524A HPL Operations and Programming142
 98531A HP 9000 Series 300 DOS Coprocessor Software91
 98532X HP-FE Training Course142
 98534A/X HP DRAFT Customer Education142
 98542A Monochrome Video Board77, 87
 98543A Color Video Board77, 87
 98544B Monochrome Video Board77, 87
 98546B Monochrome Alpha/Graphics Video Board77, 87
 98547A Color Video Board77, 87
 98561A/B Series SPUs77
 98561C Model 320U System77, 146
 98568A Eight-Slot I/O Expander89
 98580A Measurement Automation System78
 98581A Entry Design Automation System78
 98582B Monochrome Workstation78
 98582L Monochrome Workstation System78
 98583B Six-Plane Color Workstation78
 98584A Monochrome AI Workstation78, 86
 98585A Color AI Development System78, 86
 98586A Eight-Plane Color Workstation78
 98600A HP-UX DGL/AGP Graphics Library87
 98601A BASIC 2.0 Language System89
 98602A BASIC 2.0 Plus Extensions89
 98603A BASIC 4.0 Language System83, 87, 89
 98604A HPL 2.0 Language System89
 98613A/B RAM-Based BASIC Language Systems83
 98614A RAM-Based HPL 2.0 Language System83
 98615B/C RAM-Based Pascal Language Systems83, 146
 98620B Two Channel DMA Controller89
 98622A GPIO Interface89
 98623A BCD Interface89



98624A HP-IB Interface.....	89	98819A HP TechWriter Software.....	156
98625A/B High-Speed HP-IB Disc Interface	89	98820A/B/C HP Statistics Library.....	90
98626A RS-232C Serial Interface.....	89	98821A Numerical Analysis.....	90
98627A RGB Color Video Interface	89		
98628A Datacomm Interface.....	89		
98630A Breadboard Interface	89		
98633A HP 6944A Multiprogrammer Interface	89		
98635A Floating Point Math Board.....	89		
98640A ADC Card	89		
98641A RJE 2780/3780 Interface	85, 89		
98642A 4-port RS-232C MUX Interface	89		
98643A HP LAN 300 Link	85, 89		
98646A VMEbus Interface.....	77		
98647A PC Instruments Interface for HP 9000 Series 200/300.....	208		
98670/80A HP-UX Operating Systems.....	83	00041-15042 Automatic Start and Cassette Duplication Module (HP-41CV/CX)	60
98672A GKS Graphics Library.....	87	00041-15043 HP-IL Development Module (HP-41CV/CX).....	61
98673A GKS Graphics Library.....	87	00071-90068 Vol. I: Detailed Design Description.....	63
98678A HP Development Environment for Common LISP.....	86	00071-90069 Vol. II: Entry Point and Poll Interfaces	63
98679A Execution License for Common LISP	86	00071-90070 Vol. III: Operating System Source Listings	63
98690A PDI Development Package for HP 98691A	89	00071-90104 Vol. II: Entry Point and Poll Interfaces.....	63
98691A Programmable Datacomm Interface	89	00071-90105 Vol. III: Operating System Source Listings	63
98693A SRM Access for HP-UX.....	83	0960-0054 SMA-Female Short (50 Ohm)	567
98695A IBM 3270 Coax Interface.....	89	0960-0055 SMA-Male Short (50 Ohm).....	567
98700A Display Controller	77	1250-XXXX Series Adapters and Connectors	740
98700H Color Graphics Subsystem.....	87	1251-2277 Dual Banana Plug to BNC Female	740
98701A Additional Graphics Memory for HP 98700H.....	77, 89	1251-2816 Dual Banana Plug (for Cable).....	740
98710A Graphics Accelerator.....	77, 87, 89	1460-XXXX Series Cabinet Parts.....	751
98720A Graphics Subsystem	87	1490-XXXX Series Slide Kits, Casters	753
98791B HP 2392A/VT100 Terminal Emulator	85	1494-XXXX Series Slide Kits	750
98797/98A RJE Software for HP-UX.....	83	5040-XXXX Series Rack Frames.....	752
98800J,V,U Plot Trak/HP-UX	90	5060-XXXX Control Panel Covers	752
98801V,W Alis/HP-UX	90	5060-XXXX Filler Panels.....	752
98815A Graphics Presentation	90	5060-XXXX Rack Adapter Frames.....	752
98817A Project Management	90	5060-XXXX Rack Mounting Kits.....	752
		5060-XXXX Series Racking Accessories, Covers.....	752, 753
		5061-XXXX Series System II Cabinet Parts.....	748
		8120-18XX Cables and Adapters	740
		9211-XXXX Series Operating Cases	746
		9211-XXXX Series Transit Cases	746
		11000-XXXXXX Series Cables	740
		82401-90023 Internal Design Specifications, HP-IL (HP-71)	63

PERSONAL COMPUTERS & CALCULATORS

Overview and Matrix

Touchscreen II, Vectra, Portable PLUS, HP-94, HP-71

Advanced Personal Computers

Hewlett-Packard computers were first developed to meet a growing need for complex automatic test systems in industry. In the 20 years since the first HP computer was introduced, we've expanded our product line to include innovative personal computers for professional, business, office, and computation systems.

Sophisticated test and measurement instruments, such as those used today in research and manufacturing, require equally sophisticated controllers. Linking Hewlett-Packard's advanced personal computers to instrumentation creates a practical, cost-effective way to program and perform test procedures, analyze and compare data, and record and plot results. Coupled with powerful software tailored to your specific application, HP computers and instruments provide an integrated single-vendor approach to a wide variety of measurement and computation environments.

Factory automation managers, data processing experts, and professionals in office management, engineering, and scientific environments can find an HP personal computer to fit their needs — as well as one that supports the level of assistance required for successful automation of an instrument system. With many built-in applications and programming aids, plus an unequaled variety of peripherals and accessories, HP computers provide a range of computing power for both novices and experienced users.

Touchscreen II — Personal computers that offer an easy introduction to office automation and computer-controlled instruments. The HP Touch accessory lets you control your system by simply touching the screen.

Touchscreen HP-IB Controller and Touchscreen PCIB Controller — Integrating the Touchscreen II and the test and measurement instruments you use every day. We provide the hardware and software to control instrumentation on the IEEE-488 bus and HP PC Instruments Bus, using the Touchscreen II. See the "Hewlett-Packard Interface Bus" section of this catalog for more information.

Vectra — Personal computers that have your future in mind, with a modular design that lets you configure a system to your requirements, while retaining add-on capabilities that don't penalize your system operation or budget. Designed for software and hardware compatibility with the IBM® PC/AT®; HP enhancements include higher performance and greater versatility in video input device management and mass storage support. The Manufacturing Vectra handles manufacturing applications such as data collection, report generation, and quality checks. The Technical Vectra is flexible enough to handle instrument control, computer-aided engineering, and office-automation tasks — all in one system.

Vectra Office — Workstations that combine the Vectra personal computer and HP AdvanceWrite software, with features that are competitive with any dedicated word-processing system.

Portable PLUS — Personal computers that carry full-size computing features in a portable package, giving you a battery-powered mobile companion that communicates with desktops and mainframes.

HP-94 and HP-71 — Handheld computers that communicate with desktops and mainframes and that have full-size computing features in a small portable package, which you can take to the field for data collection or to the manufacturing floor for low-cost control.

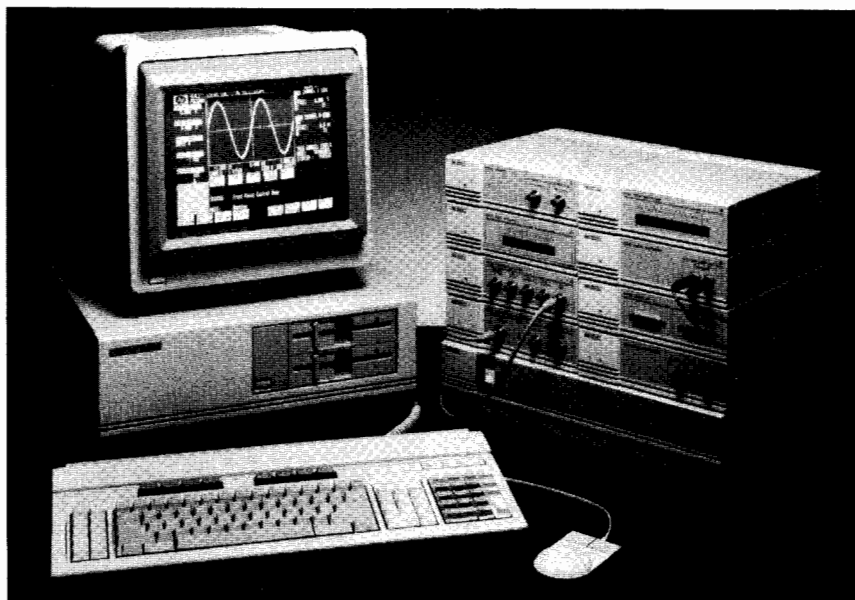

Using the HP PC Instruments Bus (PCIB) and HP's PC Instruments, you can easily create your own automated test and measurement systems.

PC Instruments — Personal-computer instrumentation products that form a unique hardware and software system, linking test and measurement instruments with personal computers. You can simultaneously monitor and control as many as eight different instruments per PC Instruments interface card from the screen of your HP Vectra and Touchscreen II PCs, IBM PC/XT™/ATs, and AT&T PC 6300s. See the "PC Instruments" section for complete information on these products.

Advanced HP personal computers are also at the heart of IEEE-488-based and other automated measurement systems and computer-aided engineering systems, providing quick solutions to design, simulation, modeling, and test problems. In addition, such products as the Semiconductor Productivity Network, Manufacturing Resource Planning, and the HP Materials, Production, and Management programs combine the efficiency of HP personal computers with the strength of HP mainframes. For complete information on these applications, refer to the "Technical Computer Systems" and "Business Computer Systems" sections of this catalog.

Computational Tools for Instrument Control and Data Collection

HP's advanced calculators and handheld computers offer portability with the power of a computer. Designed for use in science, engineering, and mathematics, they can stand alone or be used as part of a system. Handheld computers are ideal as system controllers or in remote data collection in field or manufacturing environments.

Advanced calculators and a handheld computer can be enhanced to increase calculating options. And they can become the intelligent center of a system by adding the Hewlett-Packard Interface Loop (HP-IL). HP-IL is a bit-serial interface for battery-operable systems; it provides the link to instruments, peripherals, desktop computers, modems, and terminals. With HP-IL and add-ons, the handheld computer can transfer information collected from remote sites, or monitor and control production operations, processes,

and experiments. Applications include those that connect HP-IL systems to RS-232C devices, high-performance HP-IB computers and lab equipment, and control equipment operating with parallel bus structures.

A rugged handheld industrial computer is designed for use in remote data collection and item tracking — applications where it's impossible to use desktop computers and terminals. It can be programmed to collect (with or without a bar-code wand), process, and store data — and then communicate directly to an HP 3000, IBM 8100, or other host computer via built-in serial interface or via modem. Software is developed in BASIC or 8088 assembly language using the HP Vectra PC or IBM PC/XT/AT. A truck-mounted printer is available for mobile applications.

Sharing Information and Resources

Networking capabilities provide the links between individual personal computers, mainframes, minicomputers, and associated peripherals. Successful networking, however, is more than just sharing information and peripherals. It is the efficient integration of data management functions: transparent access to information; management of data and resources; and compatible, reliable storage.

As a leader in developing industry-wide networking and communications standards, HP offers a full range of personal computers, workstations, and host computers that you can configure into fully integrated systems that are exactly suited to your application. The links in such systems are made through the HP AdvanceNet architecture, which encompasses our overall range of networking products.

HP AdvanceNet products address the physical connection (link) and the network services (software) requirements for local area, site-

IBM PC/XT is a U.S. trademark of International Business Machines Corporation.

MS-DOS and GW-BASIC are U.S. trademarks of Microsoft Corporation.

IBM and PC/AT are U.S. registered trademarks of International Business Machines Corporation.

DEC is a registered trademark of Digital Equipment Corporation.



wide, and global-wide networks. HP AdvanceNet has optimized solutions for integrated business systems (office), design (engineering and scientific), and operations (manufacturing), and ties them all together in a total business network. To assist in integrating multi-vendor systems, HP AdvanceNet offers products for both interactive and batch communications between HP systems and IBM systems (mainframes and PCs), and for file transfer to and from DEC® VAX systems.

The broad range of networking alternatives supported by HP AdvanceNet offers the greatest latitude for network design, implementation, and growth. HP AdvanceNet products are based on industry standards, many of which HP has helped create, for maximum compatibility, today and tomorrow.

HP Personal Computers

This chart briefly summarizes HP's wide range of personal computer products. Refer to the "Peripherals" section, page 121, for descriptions of peripherals and accessory products. For more information on each personal computer, see the pages referenced in the matrix, below. Software information is provided in the "Software Choices" section of this catalog.

If you have more questions about a computer or its usefulness for your application, please call the local Hewlett-Packard Sales and Service Office listed in the telephone directory white pages, or see page 769. Ask for the computer department. **For your nearest HP dealer in the U.S., call toll-free 800-FOR-HPPC.**

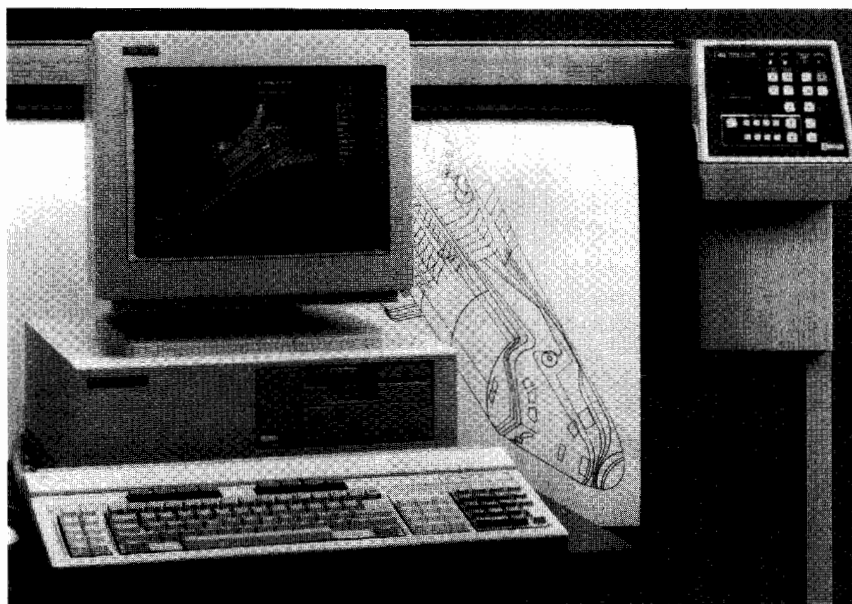

The HP Vectra PC's performance and flexibility make it a natural choice for computer-aided design and engineering.

Personal Computer Matrix

Computer	Touchscreen II	Vectra	Portable PLUS	HP-94	HP-71
Microprocessor/CPU	Intel 8088	Intel 80286	Intel 80C86	Intel-80C88-compatible (NEC μ PD70108)	HP
Operating System	MS™-DOS 3.2 PAM	MS-DOS 3.1	MS-DOS 2.11 PAM	HP BASIC Interpreter	HP BASIC (64K ROM-based)
Languages	BASIC, COBOL, FORTRAN, GW™-BASIC, C Compiler, Pascal	BASIC, MS-DOS macro-assembler	See "Software Choices," page 56	BASIC, 80C88 Assembler	BASIC, Forth, Assembler
Memory	160K ROM, 256K RAM Expands to 640K	256K RAM Expands to 3.64M	256K or 512K RAM Expands to 1.28M	64K, 128K, or 256K RAM; Expands to 256K	17.5K RAM Expands to 33.5K (129K w/module)
Mass Storage	Multiple configurations	Multiple configurations	Multiple configurations	None	Multiple configurations
Networking Data Comm. I/O	Built-in: 1 HP-IB port, 1 RS-232C/RS-422 port, 1 RS-232C port, add'l. HP-HIL port; Centronics, OfficeShare LAN	HP-IB, HP-IL, HP-HIL, RS-232C, RS-422, internal modem, Centronics, OfficeShare LAN	HP-IL, RS-232C, Portable/Desktop Link, internal modem	Serial	HP-IL, HP-IB, RS-232C, GPIO
I/O Slots	4	7	2	1	4
Display	HP Touch, 12 inch 27-line x 80-col.	HP Touch, 12 inch monochrome/color	High-contrast flat-panel LCD 25-line x 80-col.	4-line x 20-character LCD with backlight	22-character LCD scroll to 96 char. 25-line x 80-col.
Keyboard	HP-HIL device port; Function keys: 8 screen-labeled, 12 programmable	HP-HIL device port; Enhanced IBM PC/AT layout	Full size 8 function keys Shifted numeric keypad	ABC format Numeric keypad	Block QWERTY Numeric keypad
Refer to Page	50	52	54	61	61



PERSONAL COMPUTERS & CALCULATORS

The Touchscreen II Personal Computer

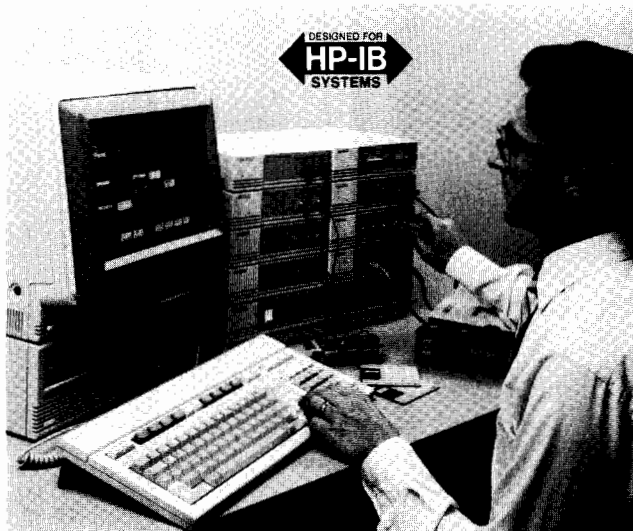

The HP Touchscreen II PC, with a Winchester disc drive, is ideal for use with test and measurement instruments.

The Touchscreen II Personal Computer

The Touchscreen II is a natural for business and industrial systems. It delivers the processing power and memory space necessary to execute lengthy, complex applications. And with more than 1000 software packages, you can design office-automation or instrument-controller systems using the Touchscreen II and discover solutions you never thought possible with a personal computer.

Touchscreen II PC Features

- 8 MHz Intel 8088 microprocessor
- 8 MHz Intel 8087 co-processor (optional)
- HP Touch Accessory
- MS™-DOS 3.2
- Personal Applications Manager (PAM) and disc utilities
- Support in the U.S. for more than 1000 software packages
- High-resolution graphics display
- Hewlett-Packard Human Interface Link (HP-HIL)
- Low-profile keyboard
- Flexible data communications features
- Choice of dual microfloppy or Winchester hard disc storage
- Productivity in IBM environments
- 256K-byte RAM, expandable to 640K bytes
- 160K-byte ROM
- 12-inch screen with built-in display tilt
- Four accessory slots
- Built-in HP 2623 terminal features

Personal Applications Manager (PAM)

The PAM is the primary interface between the user and the MS-DOS 3.2 operating system. PAM is an operating system "shell" that provides an attractive alternative to confusing MS-DOS commands, and has been designed to work harmoniously with HP Touch to facilitate ease of use. For users who want to work directly with the MS-DOS command structure, PAM can easily be bypassed.

HP Touch Accessory

Hewlett-Packard's Touchscreen II personal computer encourages "hands-on" interaction. HP Touch is provided as a user-installable accessory. Unlike any other touch-sensitive display available today, HP Touch is totally integrated into the system. Other touch screens use overlays that distort the display; HP Touch does not interfere, either physically or visually, with the display. A matrix of light beams is created using a series of light-emitting diodes (LEDs) embedded along the vertical and horizontal sides of the display.

HP-HIL Device Port

The Hewlett-Packard Human Interface Link (HP-HIL) port on the keyboard adds new dimensions for input via the HP Mouse for Graphics Gallery applications or the Graphics Tablet with Drawing Gallery applications. You can install and use HP-HIL devices without reconfiguring the system.

These devices can be used separately or together, and since each device connects to the last one, new devices don't need extra ports on the computer. In addition, the easily transportable input devices can be shared on several different systems: simply unplug a device from one system and plug it into another.

Graphics Display

The Touchscreen II's display monitor, a full-size 12-inch screen, provides high-quality resolution for sharp, clear text and graphics. The 27-line by 80-column screen is ergonomically designed for user comfort, and includes built-in display tilt for maximum convenience. Lines 25 and 26 are designated for labeling function keys, and line 27 is reserved for system status and error messages.

Keyboard

The low-profile keyboard has 107 sculptured keys with dished home keys, and includes full local editing keys (cursor control, display scroll, next- and previous-page jump, and insert/delete keys for both single characters and lines). An 18-key numeric pad may be used as a graphics keypad for terminal applications. The keyboard includes eight screen-labeled and 12 programmable function keys, and is connected to the terminal by an 8-foot coiled cable.

System Expansion

The Touchscreen II comes with four accessory slots to accommodate a number of solutions for expanding your system. The built-in HP-IB interface allows you to add storage space: large-capacity Winchester options of 10M bytes, 20M bytes, and 40M bytes, plus back-up tape storage devices. Tailor the Touchscreen II: choose from a full spectrum of Hewlett-Packard printers, plotters, modems, accessories, and software to match your current and future requirements. An Intel 8087 co-processor accessory is available for speedy real-number computation using FORTRAN, Pascal, and C programming languages and the MS-DOS macroassembler.

Ergonomic Design

The Touchscreen II is ergonomically designed for user comfort and convenience. With its small footprint and cable cover system, you can put the Touchscreen II flush against a wall and set a disc drive or printer on top, leaving more space on your desk. The power switch, brightness control, and keyboard connector are located on the front and side panels for easy access.

Data Communications

The HP Touchscreen II comes standard with one RS-232C port, an additional RS-232C or RS-422 port, one HP-HIL port on the keyboard, and one HP-IB port. The Touchscreen II, with its built-in terminal capability, can take advantage of HP's powerful networking options to share information with other computer systems ranging from the Portable PLUS to HP, IBM®, and DEC® mainframes.

Other capabilities include IBM 3278 terminal emulation with file transfer, VT100 terminal emulation, and AdvanceLink. AdvanceLink is a software package that permits ASCII and binary file transfer between Touchscreens, Vectras, other HP computer systems (e.g., the HP 3000), and IBM PCs. Additional data communications capabilities include OfficeShare LAN, the HP AdvanceNet-compatible PC LAN. See the "Networking" section of this catalog for data communications product descriptions.

8087 Co-Processor Accessory

Increased speed and precision in arithmetic, logarithmic, and trigonometric functions are provided by the addition of an Intel 8087 processor as a companion to the Touchscreen II's 8088. The 8087 can multiply 32- and 64-bit floating-point numbers up to 100 times faster than the 8088, depending upon the application. It is supported by the Pascal, Lattice® C, and FORTRAN compilers and MS-DOS macroassembler offered on the Touchscreen II. The 8087 co-processor plugs into the Touchscreen II processor board and does not occupy an accessory slot. It must be installed by an HP customer engineer or authorized HP personal computer dealer.



Software Solutions

The Touchscreen II is designed to meet the needs of business, industrial, engineering, and manufacturing professionals by managing work through the use of sophisticated, industry-standard and -specific programs. Most of the best-selling software packages now run on the HP Touchscreen II, and have been enhanced to take advantage of such easy-to-use Touchscreen II features as HP Touch, softkeys, and PAM.

In addition to the applications software, there is a wide selection of programming languages and programmer's tools available for the Touchscreen. Such software tools as BASIC, Compiled BASIC, GW™-BASIC, Pascal, COBOL, and Lattice C compiler, as well as assemblers, utilities, and various graphics tools, help you develop custom programs.

Hewlett-Packard is committed to a comprehensive third-party software development program. This new software is directly aimed at giving you more productivity tools for business, engineering, scientific, and analytical applications. Refer to *Software and Accessories for the HP Touchscreen and Portable Personal Computers*, and the "Software Choices" section of this catalog, for up-to-date software information.

Specifications

Microprocessor/CPU: Intel 8088, 8 MHz

Operating System: MS-DOS 3.2

Memory: 256K-byte RAM, expandable to 640K bytes; 160K-byte ROM

Display: 27-line by 80-column, 12-inch diagonal screen

Display Enhancements: Inverse video, underline, blinking, half-bright, or any combination

Alphanumeric: 640 x 378 pixels

Graphics: 512 x 390 pixels

Alternate Graphics: 640x400 pixels (not supported by firmware/terminal mode)

Optional HP Touch Accessory: User-installable

Character Set: Roman8, line-drawing, Math Standard, bold and italics, depending on applications

Total of 896 characters; local language characters

6 x 9 enhanced dot matrix in 8 x 14 dot-character cell

Keyboard:

Detachable, typewriter-style with 8-ft. (2.43 m) coiled cable

One HP-HIL device port

Full ASCII code

Eight screen-labeled function keys;

12 programmable function keys

Auto repeat, N-key rollover, cursor controls

18-key numeric/graphics pad

Weight:

CPU: 27 pounds (12.27 kg) (without keyboard)

Keyboard: 4.7 pounds (2.14 kg)

Dimensions:

CPU/display: 12.8 x 14.6 x 13.4 inches (325 x 370 x 342 mm)

Keyboard, flat: 18 x 8.9 x 1.2 inches (456 x 225 x 30 mm)*

Keyboard, standing: 18 x 8.9 x 2.3 inches (456 x 225 x 58 mm)

*Home-row height per ZH1/618 (German Ergonomic Standard)

Peripherals and Accessories for the Touchscreen II PC

See the "Peripherals" section, page 121, for product descriptions of peripherals and accessories.

How to Order Your Touchscreen II PC

For more information on the Touchscreen II, contact your HP sales representative or your local HP personal computer dealer.

For the nearest dealer in the U.S., call toll-free: 800-FOR-HPPC

Ordering Information

Price

Touchscreen II Personal Computer		
HP 45849A	Touchscreen II CPU	\$2205
HP 45851A	Touchscreen II CPU with PC Kit*	\$2560
HP 35723A	HP Touch Accessory (user-installable option)	\$400 ☎
HP 9123D	Dual 3½-inch Microfloppy Disc Drive (710K bytes each drive)	\$715
HP 45885A	8087 Co-Processor Accessory (optional)	\$595
HP 9153A	10M-Byte Winchester/Microfloppy, or	\$1940
HP 9133H	20M-Byte Winchester/Microfloppy, or	\$2740 **
HP 9133L	40M-Byte Winchester/Microfloppy	\$4240
*The Touchscreen II basic system comes with the CPU/terminal (HP 2623 features — block mode with graphics), 256K bytes of memory, one RS-232C port, an additional RS-232C or RS-422 port, one HP-IB port, a system port for the HP Touch accessory, an internal expansion slot for the 8087 co-processor accessory or other custom boards, four accessory slots, and a 12-inch display. The PC kit includes the HP extended keyboard with HP-HIL port and keyboard cable, power cord, and disc drive cable, plus the Operating System Master Disc and Work Master Disc (containing MS-DOS 3.2, PAM, and disc utilities), and full documentation.		
**10% discount when ordered with Touchscreen		
Touchscreen II Terminal		
HP 45850A	Touchscreen II CPU with Terminal Kit	\$2460
HP 35723A	HP Touch Accessory (user-installable option)	\$400 ☎
The Touchscreen II Terminal includes the Touchscreen II CPU and Terminal Kit. The Terminal Kit includes the HP extended keyboard with HP-HIL port and keyboard cable, power cord, and complete documentation for using the Touchscreen II as a terminal.		
Touchscreen Instrument Controllers		
HP 45861A	Touchscreen HP-IB Controller	\$3430
The Touchscreen HP-IB Controller includes the Touchscreen II CPU with PC Kit and the HP-IB Command Library.		
HP 45862A	Touchscreen PCIB Controller	\$4935
The Touchscreen PCIB Controller includes the Touchscreen II CPU with PC Kit, 384K RAM Board, PC Instruments Interface, and GW-BASIC.		
HP 35723A	HP Touch Accessory (user-installable option)	\$400 ☎
Reference Documentation		
HP 45624A	Touchscreen MS-DOS User's Guide	\$50
HP 45625A	Touchscreen Technical Reference Manual	\$100
HP 45435A	Touchscreen Programmer's Tools	\$295

MS-DOS and GW-BASIC are U.S. trademarks of Microsoft Corporation.

IBM is a U.S. registered trademark of International Business Machines Corporation.

DEC is a U.S. registered trademark of Digital Equipment Corporation.

Lattice is a U.S. registered trademark of Lattice, Inc.

☎ Fast-Ship product—see page 766.



PERSONAL COMPUTERS & CALCULATORS

The Vectra Personal Computer



The powerful HP Vectra Personal Computer, designed to be IBM PC/AT-compatible.

Versatile and Flexible

Hewlett-Packard's Vectra Personal Computer has been designed to simplify your computing needs. You can select the exact combination of hardware and software that is best for your business today, without restricting your options for the future. The Vectra PC is based on the Intel 80286 microprocessor. You can start with either a 256K-byte or 640K-byte memory, which can be expanded to more than 3M bytes. Add to your system any time, from an almost unlimited range of compatible hardware and software by HP, IBM, and numerous other manufacturers.

The Vectra PC is designed to be compatible with the IBM® PC/AT®, yet is smaller, more powerful, and easier to use. Its MS™-DOS 3.1 operating system lets you run virtually all IBM PC/AT-compatible software, so you can choose from among the most popular programs.

Vectra PC Features

- 8 MHz Intel 80286 16-bit microprocessor
- Optional 5.33 MHz or 8 MHz Intel 80287 numeric co-processor
- Vectra Disc Operating System (optional):
 - MS-DOS 3.1
 - Personal Applications Manager (PAM)
- Optional BASIC Interpreter and MS-DOS macroassembler
- HP Human Interface Loop (HP-HIL) accessory port
- HP Touch accessory, HP Mouse, graphics tablets, bar-code wand (optional)
- Flexible data communications options
- Supports flexible and hard-disc storage
- Hardware and software compatible with IBM PC/AT
- 64K-byte ROM
- Sockets for two additional ROM chips
- 256K-byte and 640K-byte RAM; expandable up to 3.64M bytes
- Three shelves for half-height data-storage cartridges:
 - Two shelves with front access for flexible-disc drives
 - One shelf for hard-disc drive
- Seven IBM PC/AT-compatible I/O accessory slots
- Detachable keyboard with HP-HIL port (compatible with the IBM PC/AT, with HP enhancements)
- Choice of monochrome or color display systems
- 3278 terminal emulator
- 20M-byte half-height and 40M-byte full-height internal hard discs (optional)

Manufacturing Vectra

The Manufacturing Vectra has been designed to work with HP 1000 A-Series computers to provide programmable device support. While the HP 1000 handles control functions, the Manufacturing Vectra concentrates on functions such as data collection, report generation, and quality checks. With over 50 verified manufacturing software packages available, Manufacturing Vectra is an ideal product for the manufacturing environment.

Technical Vectra

Hewlett-Packard has designed a family of special-purpose plug-in cards, graphics systems, and software to meet the computing needs of scientists and engineers. The Vectra PC's modular design makes possible a wide variety of configurations, including systems for data acquisition, instrument control, computer-aided design and drafting, analysis, and office-automation tasks. Specific enhancements include a choice of displays, including a 13-inch display, that provide superior resolution and palettes of up to 256 colors; a high-speed math co-processor; data-acquisition cards; an HP-IB control accessory; specialized programming languages; and HP's family of personal instrumentation.

Personal Applications Manager (PAM)

HP's PAM is an operating system shell that serves as the primary interface between the user and the MS-DOS 3.1 operating system. The screen identifies a single function key you press to start any given application. PAM has been designed to work with HP Touch, HP Mouse, or keyboard to facilitate ease of use. For experienced users who want to work directly with the MS-DOS command structure, PAM can easily be bypassed.

HP Touch Accessory

HP Touch, an optional user-installable accessory, provides an easy-to-use, touch-sensitive display.

Ergonomic Design

The adjustable-tilt Vectra keyboard has 103 step-sculptured keys with tactile feedback and color-coded legends. The keyboard includes 18 function keys, a numeric keypad with cursor control, a separate cursor-control pad, and an HP-HIL port, and is connected to the terminal by an 8-foot coiled cable.

Choose from monochrome or color display systems — whichever best meets your needs. All HP displays feature sharp, clear text and graphics. The screens are ergonomically designed for user comfort, and include built-in display tilt and swivel for maximum convenience.

System Expansion

The Vectra PC comes with seven IBM PC/AT-compatible accessory slots that accommodate a number of options for system expansion. These options include memory cards, data communications interfaces, and graphics boards.

A full spectrum of Hewlett-Packard printers, plotters, modems, accessories, external storage devices, and software is available to meet your current and future requirements. And the 80287 co-processor accessory is available for fast real-number computation.

Storage Solutions

To increase Vectra's data-storage capacity, you can add up to three internal data storage devices plus external disc and tape drives. You can start with a 360K-byte or 1.2M-byte 5¼-inch flexible disc and add more later. There are also 20M-byte and 40M-byte internal hard discs and internal hard-disc subsystems.

Software Solutions

The Vectra PC offers a full range of choices in software, from off-the-shelf IBM PC/AT applications to popular business programs. It runs such business applications as WordStar®, VisiCalc®, R:Base™ 5000, and 1-2-3® from Lotus®, and will let you access most information-retrieval services. Executive Card Manager is an easy-to-use file manager with a built-in report writer, autodial feature, and more; Executive Card Manager: Templates gives you 21 modifiable formats for various business applications.

HP Graphics Gallery software is also available for the Vectra PC. These software products enable you to create professional-quality presentations and reports. Included in the Graphics Gallery series are Drawing Gallery, Charting Gallery, and Graphics Portfolios. And Gallery graphics can be easily merged with documents created using HP's Executive MemoMaker.

Refer to the *Vectra Software and Accessories Guide* or ask your HP representative or dealer for up-to-date information on software and accessories for the Vectra PC. Also see the "Software Choices" section of this catalog.



Data and Voice Communications

HP's Vectra PC has many communications options: RS-232C/Centronics ports, RS-232C/422 ports, 1200-baud and 2400-baud modems, HP-IL port, HP-IB communications port, and HP 2392, IBM 3278, and DEC® VT100 terminal emulators—more than enough for all your data communications needs. Vectra's sophisticated communications capabilities let you take advantage of HP's powerful networking options to share information with a range of computer systems, including the HP Portable PLUS and Touchscreen II personal computers, IBM personal computers, and HP, IBM, and other host computers.

OfficeShare LAN, the HP AdvanceNet-compatible local area network (LAN), will link as many as 30 Vectra personal computers (or Vectra PCs and IBM PCs) for sharing data, data storage, printers, plotters, electronic mail, etc. See the "Networking and Data Communications" section of this catalog for complete product descriptions of communications accessories.

Office Talk is a sophisticated voice communications product that features a telephone directory, telephone management, voice messaging, an appointments diary, and a memo pad. Office Talk consists of a software application and an I/O card; it runs on the HP Vectra PC and on IBM PC/AT-compatibles.

Specifications

System Processing Unit (SPU): Intel 80286, 8 MHz

Optional Numeric Co-Processor: 5.33 MHz Intel 80287

Operating System: MS-DOS 3.1

Memory: 256K-byte or 640K-byte RAM in 128K-byte increments; expandable to 3.64M bytes

Keyboard:

- Detachable, with 8-ft. coiled cable
- Adjustable tilt feature
- One HP-HIL port
- Eighteen function keys

Weight:

- SPU with one flexible disc drive: 26 pounds (11.8 kg)
- Keyboard: 4.2 pounds (1.9 kg)

Dimensions:

- SPU: 16.7 x 15.4 x 6.3 inches (42.5 x 39.0 x 16.0 cm)
- Keyboard, flat: 20.6 x 8.8 x 1.3 inches (52.5 x 22.0 x 3.5 cm)

Peripherals and Accessories for the Vectra PC

See the "Peripherals" section, page 121, for product descriptions of peripherals and accessories.

The Vectra Office

The Vectra PC is the basis of another Hewlett-Packard offering: the Vectra Office. The Vectra Office combines a Vectra PC with HP AdvanceWrite software. It offers the performance of a dedicated word processor and the flexibility of an IBM PC/AT-compatible personal computer. The software is available in three levels of word-processing power—AdvanceWrite I, AdvanceWrite II, and AdvanceWrite III—to meet the needs of a broad range of users.

Vectra Office comes in two preassembled models: Model 1, which has dual 360K-byte flexible-disc drives, and Model 2, which has one 360K-byte flexible-disc drive and one 20M-byte hard-disc subsystem.

Specifications (only items differing from Vectra PC are listed):

Memory: 640K RAM, expandable to 3.64M

Keyboard: Includes overlays that map the keyboard (including 18 function keys) to AdvanceWrite commands

Weight:

- Model 1, not including keyboard: 31.5 lbs. (14.3 kg)
- Model 2, not including keyboard: 32.4 lbs. (14.7 kg)
- Keyboard: 4.2 lbs. (1.9 kg)

Dimensions: SPU footprint: 1.8 sq. ft. (.17m²)

How to Order Your Vectra PC or Vectra Office

For more information on the Vectra PC or Vectra Office, contact your HP sales representative or your local HP personal computer dealer.

For the nearest dealer in the U.S., call toll-free: 800-FOR-HPPC

Ordering Information

		Price
HP 72425A	Vectra Model 25 PC The Vectra personal computer Model 25 includes an SPU with 256K bytes of memory and one 360K-byte internal 5¼-inch flexible disc drive, a keyboard, and documentation.	\$3099
HP 72435A	Vectra Model 35 PC The Vectra personal computer Model 35 includes an SPU with 256K bytes of memory and one 1.2M-byte internal 5¼-inch flexible disc drive, a keyboard, and documentation.	\$3229
HP 72445A	Vectra Model 45 PC The Vectra personal computer Model 45 includes an SPU with 640K bytes of memory and one 1.2M-byte internal 5¼-inch flexible disc drive, a keyboard, and documentation.	\$3249
HP 45816M	20M-byte Internal Hard-Disc Drive	\$970
HP 45817M	40M-byte Internal Hard-Disc Drive	\$1870
HP 45816A	20M-byte Internal Disc Subsystem	\$1370
HP 45817A	40M-byte Internal Disc Subsystem	\$2170
HP 72475A	Vectra Office Model 1 Includes an SPU, 640K RAM, keyboard, Multimode Video Adapter, Multimode Color Adapter, security lock, dual RS-232C/422 interface, two 360K flexible-disc drives, disc operating system, and <i>Vectra Office Users' Guide</i> .	\$4129
HP 72485A	Vectra Office Model 2 The same as Model 1, but a 20M-byte hard-disc subsystem replaces one 360K-byte flexible-disc drive.	\$5299

Vectra Office orders must include one product from each of the following two categories:

Monitors:

HP 35731A	12-inch Monochrome Monitor	\$325
HP 35741A	12-inch Color Monitor	\$995

AdvanceWrite Software:

HP 27506F	AdvanceWrite I	TBA
HP 27507F	AdvanceWrite II	TBA
HP 27508F	AdvanceWrite III	TBA

IBM PC/XT is a U.S. trademark of International Business Machines Corporation.
MS-DOS is a U.S. trademark of Microsoft Corporation.
R:Base is a U.S. trademark of Microrim, Inc.

IBM and PC/AT are U.S. registered trademarks of International Business Machines Corporation.
DEC is a U.S. registered trademark of Digital Equipment Corporation.
WordStar is a U.S. registered trademark of MicroPro International Corporation.
VisiCalc is a U.S. registered trademark of Software Arts Products Inc.
1-2-3 and Lotus are U.S. registered trademarks of Lotus Development Corporation.



PERSONAL COMPUTERS & CALCULATORS

The Portable PLUS PC

The HP Portable PLUS Personal Computer

More than just a portable computer, the Portable PLUS is a powerful, durable traveling companion that shares information and peripherals with desktops or acts as a terminal to mainframes. And, it's now enhanced with a high-contrast flat-panel liquid-crystal display.

The Portable PLUS is easily tailored to handle varying duties, with the programs and data that you use most often installed directly on the computer as plug-in ROMs. You also have the option of loading disc-based software into the Electronic Disc of the Portable PLUS. In either case, there is no need to carry discs or disc drives.

Portable PLUS Features

- Full 16-bit CMOS 80C86 microprocessor
- Continuous Memory expands from 256K to 1.28M bytes
- Plug-in ROM software
- Built-in Electronic Disc (E-Disc) drive
- Personal Applications Manager (PAM)
- MSTM-DOS 2.11
- Built-in HP-IL, RS-232C, and optional modem interface ports
- HP Link and Portable-Desktop Link for data and peripheral sharing
- Built-in terminal emulation
- Data-compatible with HP and IBM environments
- Full keyboard and numeric keypad
- Full-size 25-line by 80-column high-contrast LCD screen
- Integrated 20-hour power supply
- Two accessory slots

Big Features in a Small Package

At under ten pounds, and no larger than a three-ring binder, the Portable PLUS is the most durable lap-sized computer for professionals on the go. It offers a full-size high-contrast display and keyboard with numeric keypad for fast field calculations, plus the built-in HP-IL and RS-232C interfaces for fast data transfer to peripherals, desktop computers, or mainframes. And it runs on rechargeable batteries for up to 20 hours.

The Portable PLUS's autostart capability lets you skip over the PAM menu and begin computing sessions in a custom program. And the integrated power supply and Continuous Memory let you return instantly to interrupted work, making it the most convenient portable to use whenever and wherever your work takes you.

Personal Applications Manager (PAM)

Serving as the main menu on the Portable PLUS, the PAM is the interface between the user and the operating system, providing an alternative to complex MS-DOS command structures, and an easy keystroke format.

Plug-In ROM Software

The Portable PLUS runs full-feature software in a plug-in ROM, containing everything necessary to complete your work. This ROM-based software offers the reliability and speed of a Winchester disc. Frequently accessed programs can be user-installed into the Portable PLUS, eliminating the need for a separate disc drive. And loading programs is fast (as much as five times faster than floppy discs). You can choose to install your own custom-designed ROM- or EPROM-based applications.

Built-in E-Disc Mass Storage

The HP Electronic Disc (E-Disc) is a convenient method of temporarily storing data and programs while the Portable PLUS is being used away from an HP 9114B Portable Disc Drive, Touchscreen or Vectra PC, or IBM® PC. With the Portable PLUS's expandable RAM, there is plenty of room for disc-based programs and large data files, and it's fast: E-Disc loads and accepts programs and data up to 10 times faster than a traditional floppy-disc drive. The E-Disc is much more durable than a built-in floppy disc, and it extends battery life by requiring much less power.

Sharing with Desktops

The HP Portable-Desktop Link connects the Portable PLUS with the HP Touchscreen II and HP Vectra personal computers and the IBM PC family. By installing an HP Interface Loop (HP-IL) and software on your desktop computer, you can quickly transfer data or applications software between the Portable PLUS and the desktop model. In addition, printers connected to the desktop computer can be used as output devices for the Portable PLUS.



The HP Portable PLUS PC is a durable, reliable, lap-sized portable computer designed for mobile computing conditions.

Data Communications and Terminal Emulation

The Portable PLUS built-in Terminal Emulator supports an optional 300/1200-bps modem and a serial interface connection to allow transfer of files with host computers as well as information networks. Using REFLECTION 1TM terminal-emulation software, the Portable PLUS supports full block mode terminal communications, emulates the HP 2392 and DEC® VT102 terminals, runs HP DESK and IBM PROFS applications, and supports automated and unattended file transfer using a built-in command language.

Optional Modem — This Hayes-compatible internal modem enables communications over normal dial-up telephone lines at speeds up to 1200 bps, cutting the cost of long-distance data communications. The auto-answer and auto-dial features, using either Touch-ToneTM or pulse dialing, make the Portable PLUS a perfect companion for remote-location data communications.

IBM Terminal Emulation — With HP's 3270 SNA® emulator for the Portable PLUS, you can connect to an IBM host from almost anywhere. The product (hardware plus software) offers 3270 terminal emulation with file transfer to and from MVS/TSO, VM/CMS, and CICS host files. The emulator, with a synchronous modem and telephone line, gives you the convenience of a portable terminal and the power of a portable PC.

Other methods for data communications with an IBM host are also available. The Portable PLUS running REFLECTION 1 emulation software can be used in conjunction with an HP 3000 minicomputer to access IBM hosts. Also, the Portable PLUS with REFLECTION 1 can emulate a full-screen IBM 3278 display station by using IBM or third-party protocol converters. IBM 3278 terminal emulation, including file-transfer capabilities, is supported with YTERM or SIM3278/PCTM software on the Portable PLUS. As with REFLECTION 1, these products require protocol converters residing on the IBM host. This terminal emulation capability is the path to accessing most mainframe applications that typically function on IBM 3270-type terminals.

PPC Access — The full block mode capability of the Portable PLUS with REFLECTION 1 allows access to HP's Personal Productivity Center. This permits such operations as full-screen editing within the functions of HP DeskManager.

Liquid-Crystal Display (LCD)

The Portable PLUS uses advanced LCD technology and a non-glare surface to improve the readability of its 25-line by 80-column display. The flat panel, variable contrast, and tilt features contribute to user comfort. With an optional video interface, a CRT monitor can be connected to duplicate the Portable PLUS's display.

Keyboard

The full-size keyboard on the Portable PLUS offers the features of a desktop computer: 75 sculptured keys, eight screen-labeled function keys, shifted 10-key numeric keypad, and flexible key mapping. The numeric keypad speeds the work of entering figures into such programs as spreadsheets, test and measurement calculations, and data analysis.



Memory and Expansion Ports

The Portable PLUS has two expansion ports that can be used for additional memory, plug-in ROM software, or other special-function cards. The Software Drawer holds up to 12 user-installed ROMs of 32K- or 128K-byte capacity. The Memory Drawer includes 128K bytes of Continuous Memory RAM; two additional 128K memory cards can be added to the drawer. Random access memory (RAM) space is allocated by the user to system memory or E-Disc. System memory is used for program execution and data file operations; the E-Disc is used for program and data storage.

Battery Power

The Portable PLUS's 20-hour battery life is twice as long as most other portables, providing an average of two weeks of computing time between recharges. And the Portable PLUS can be used during battery recharging. A sophisticated memory-protection scheme ensures that your data will be preserved in the Portable PLUS for approximately one month, and the PAM screen provides a continuous display of power reserves. When the power reserve reaches 5%, the computer automatically turns off until the recharger is connected to it, protecting your data until you get to a power source.

Software Solutions

The Portable PLUS combines its powerful ROM-based software and E-Disc capability with the fast MS-DOS 2.11 operating system and large-capacity user memory to deliver the computing performance of traditional desktop models. Whenever your work takes you into the field, flies you around the country, or follows you home, your Portable PLUS is packed with software solutions to all your computation problems.

ROM-Based Applications — A wide range of high-productivity software is available for the Portable PLUS: choose from such popular core applications as 1-2-3* from Lotus®, Microsoft® WORD™, Microsoft BASIC, MultiMate™, HP's Executive Card Manager, MemoMaker/Time Management, and REFLECTION 1 (HP block mode 2392 and VT102 terminal emulator).

Custom ROM Applications — Hewlett-Packard's custom ROM program enables you to design software for specific applications. Either programs or data can be installed on industry-standard 32K-byte or 128K-byte custom ROMs, or 32K-byte EPROMs. A maximum capacity of twenty-four 128K-byte ROMs can be achieved using both Software Drawers. The flexible configuration of the ROM disc permits program execution from RAM or ROM.

Disc-Based Software — In addition to the plug-in ROM software, there is a wide selection of disc-based software available through HP and third-party vendors. Such tools as GW™.BASIC and Pascal programming languages, and the Lattice® C Compiler, will enhance custom program development. Application software that can be loaded from floppy discs into the E-Disc includes data base managers such as dBASE® II, data communications and networking programs, accounting systems, and a variety of personal solution packages, such as The List Manager and The Speller.

Refer to *Software and Accessories for the HP Touchscreen and Portable Personal Computers*, and the "Software Choices" section of this catalog, for up-to-date software information.

Specifications

Microprocessor: 16-bit Intel 80C86, 5.33 MHz

Operating System: MS-DOS 2.11

Memory: 256K-byte continuous user RAM, expandable to 1.28M bytes; 192K-byte expandable ROM

Expansion Capability: Two plug-in ports for 128K RAM Memory Drawer and 12-socket ROM Software Drawer. (Memory Drawer can be expanded to a maximum of 384K bytes by use of additional memory cards.)

Built-In Mass Storage: Electronic Disc

Bundled Software:

PAM — Personal Applications Manager
 HPLINK — For the Portable-Desktop Link
 TERM — Terminal link for REFLECTION 1 emulation
 SECURE — Password protection utility
 EDLIN — Low-level MS-DOS text editor
 Self-diagnostics utility

Display: Flat panel, high-contrast, liquid-crystal, anti-glare screen with variable tilt and contrast

Alphanumeric: 25-lines by 80-columns

Graphics: 200 x 480 pixels

Display Enhancements: Inverse video, underline, blinking, half-bright, and all combinations

Character Set: Roman8, extended character set, multiple character fonts

Keyboard: Full size, 75 sculptured keys, eight screen-labeled function keys, shifted numeric keypad, flexible key mapping

Data Communications: Built-in HP-IL and 9-pin RS-232C

Modem: Optional 300/1200 bps, direct-connect, pulse and tone dial, Hayes command compatible

Power Supply: Three permanently installed lead acid gel D-cell batteries; battery recharger

Battery:

Typical Use: 20 hours on full charge (if used continuously under normal operating conditions).

Memory Retention: 6 months on full charge; 1 month from time of low-level indicator (20% charge); 1 week from time of automatic shut-off.

Weight:

Basic unit — under 9 pounds (4 kg)

Maximum configuration — under 10 pounds (4.5 kg)

Dimensions: 13 x 10 x 3 inches (330 x 254 x 76 mm)

How to Order Your Portable PLUS

For more information on the Portable PLUS, contact your HP sales representative or your local HP personal computer dealer.

For the nearest dealer in the U.S., call toll-free: 800-FOR-HPPC

Ordering Information

		Price
HP 45711C	The HP Portable PLUS Personal Computer. The HP Portable PLUS basic system comes with 256K bytes of RAM; 192K bytes of ROM; two plug-in ports for RAM and ROM expansion; built-in E-Disc mass storage; MS-DOS 2.11 and PAM with bundled utilities; high-contrast flat-panel LCD display with 25-line by 80-column screen; full-size keyboard; built-in HP-IL, 1200-bps modem, and RS-232C communications ports; integrated power supply and battery recharger; soft carrying case with shoulder strap; and complete documentation.	\$8190
HP 45711D	Same as HP 45711C, but without built-in modem.	\$7695
HP 45711E	Same as HP 45711C, but with 512K bytes of RAM.	\$3890
HP 45711F	Same as HP 45711E, but without built-in modem.	\$3395

Peripherals and Accessories for the Portable PLUS

See the "Peripherals" section, page 121, for product descriptions of peripherals and accessories.

MS-DOS is a U.S. trademark of Microsoft Corporation.

REFLECTION 1 is a U.S. trademark of Walker Richer & Quinn, Inc.

Touch-Tone is a U.S. trademark of Western Electric.

SIM327B/PC is a trademark (pending) of Simware, Inc.

Microsoft WORD and GW-BASIC are U.S. trademarks of Microsoft Corporation.

MultiMate is a U.S. trademark of Multimite International Corporation, a subsidiary of Ashton-Tate Corporation.

IBM and SNA are U.S. registered trademarks of International Business Machines Corporation.

DEC is a U.S. registered trademark of Digital Equipment Corporation.

1-2-3 and Lotus are U.S. registered trademarks of Lotus Development Corporation.

Microsoft is a U.S. registered trademark of Microsoft Corporation.

Lattice is a U.S. registered trademark of Lattice, Inc.

dBASE is a U.S. registered trademark of Ashton-Tate Corporation.

PERSONAL COMPUTERS & CALCULATORS

Software Choices

Vectra, Touchscreen II, Portable PLUS



The HP Vectra PC supports a variety of peripherals and runs hundreds of industry-standard software packages.

Hewlett-Packard: Your Source for Software Solutions

The programs listed in this section are for use on the HP Touchscreen II, HP Vectra, HP Portable PLUS, IBM, and IBM-compatible personal computers. Refer to *Software and Accessories for the HP Touchscreen and Portable Personal Computers* for additional information.

The Hewlett-Packard *Software Selection Guide* features listings of HP software products that can be used to automate test and measurement applications. Associated computer-aided engineering software packages are also included.

Software Package Order Number Designations

The last letter in each software package order number indicates the personal computer(s) that supports the package. (Does not apply to numbers ending with †.)

Order No.	Personal Computer
A	Touchscreen II
C	Portable PLUS
D	Touchscreen II and Portable PLUS
F,E	Vectra and IBM PC-compatibles
K	Portable PLUS Plug-In ROM
M	Peripherals

Order No.	Description	Price
Programming		
HP 45445D	BASIC by Microsoft®	\$300
HP 82862K†	BASIC by Microsoft, Opt. 400	\$300
HP 45446D	Compiled BASIC by Microsoft	\$395
HP 45450D	GW™-BASIC by Microsoft	\$395
HP 45448A	COBOL by Microsoft	\$750
HP 92248BA	Cross-Reference Utility	\$49
HP 45449D	FORTRAN by Microsoft	\$395
HP 45447D	Pascal by Microsoft	\$350
HP 45435A	Touchscreen Programmer's Tools	\$295
HP 45310A	BASIC Programmer's Library	\$110
HP 45419C	Programmer's Tools	\$295
HP 45452D	Lattice® C Compiler	\$495
HP 45311A	ICON Design System	\$99
HP 45443A	Forms Master	\$295

Data Communications and Networking

HP 45431A	AdvanceLink	\$295
HP 68333F	AdvanceLink 2392	\$295
HP 45641B†	Touchscreen 3278 Emulation Accessory with File Transfer REFLECTION 1™, Opt. 400	\$1200
HP 82863K	Touchscreen Internal Modem	\$395
HP 45640A	VT100 Terminal Emulator	\$475
HP 45412A	HPMessage	\$180
HP 36569E	HPMessage	TBA
HP 36568A	HPMessage	TBA
HP 35177M	JetStart (for use with ThinkJet personal printer)	\$45
HP 35178M	LaserStart (for use with LaserJet printer)	\$95
HP 82867K	YTERM 3278 Emulation, Opt. 630	\$95

Data Base Management

HP 36898A	HP Access	\$625
HP 36898F	HP Access	\$625
HP 45416A	Condor™ 3	\$700
HP 45468D	dBASE® II	\$500
HP 45421A	Executive Card Manager	\$295
HP 45441D	Executive Card Manager: Templates	\$125
HP 68331F	Executive Card Manager	\$295
HP 68335F	Executive Card Manager: Templates	\$125
HP 45555K	Executive Card Manager, Opt. 400	\$295
HP 45545A	R:Base™ 4000	\$495
HP 45563A	R:Base 5000	\$700
HP 68336F	R:Base 5000	\$700

Integrated Solutions

HP 45442A	ExecuDesk System: ExecuDesk, Executive MemoMaker, Deluxe VisiCalc®, Executive Card Manager, Charting Gallery, Financial Calculator	\$995
HP 45444A	ExecuDesk	\$95
HP 45498A	Symphony® from Lotus®	\$695
HP 68339F	Symphony from Lotus	\$695



Electronic Spreadsheets

HP 68332F	Executive Spreadsheet	\$250	☎
HP 45482A	1-2-3* from Lotus	\$495	☎
HP 45482K	1-2-3 from Lotus, Opt. 400	\$495	☎
HP 68340F	1-2-3 from Lotus	\$495	☎
HP 45405A	Deluxe VisiCalc	\$250	☎
HP 45423A	Financial Calculator	\$39.95	☎

Personal Solutions

HP 35151D†	The Calendar	\$49.95	☎
HP 35152D†	The List Manager	\$49.95	☎
HP 35153D†	The Writer	\$49.95	☎
HP 35154D†	The Speller	\$49.95	☎
HP 35155D†	The Planner	\$49.95	☎
HP 35156D†	The Personal Correspondence Pack	\$125	☎
HP 35157D†	The Personal Organizer Pack	\$125	☎

Localization (Translation)

HP 82866KD	Localization, German—Opt. 400	\$150
HP 82866KF	Localization, French—Opt. 400	\$150
HP 82866KZ	Localization, Italian—Opt. 400	\$150

Word Processing

HP 27506F	AdvanceWrite I (Vectra only)	TBA	☎
HP 27507F	AdvanceWrite II (Vectra only)	TBA	☎
HP 27508F	AdvanceWrite III (Vectra only)	TBA	☎
HP 45400D	WordStar®	\$350	☎
HP 45427D	WordStar Professional®	\$550	☎
HP 45429D	WordStar Professional Options	\$250	☎
HP 68345F	WordStar	\$350	☎
HP 68346F	WordStar Professional	\$495	☎
HP 68341F	WordStar 2000	\$495	☎
HP 68342F	WordStar 2000 Plus	\$595	☎
HP 45418A	Executive MemoMaker	\$245	☎
HP 68330F	Executive MemoMaker	\$245	☎
HP 45504K	MemoMaker/Time Management, Opt. 400	\$195	☎
HP 27505A	HPWord/150	TBA	
HP 82870K	AdvanceMail, Opt. 400	\$295	
HP 45549K	Microsoft WORD™, Opt. 400	\$375	☎
HP 45474D	Microsoft WORD	\$375	☎
HP 45556D	Microsoft SPELL	\$80	☎
HP 45554K	MultiMate™, Opt. 400	\$495	☎
HP 45424A	MultiMate	\$495	☎
HP 68338F	MultiMate	\$495	☎
HP 68343F	MultiMate Advantage	\$595	☎

Graphics

HP 45513A	Charting Gallery	\$265	☎
HP 45411A	Drawing Gallery	\$345	☎
HP 45437A	The Gallery Collection (Charting Gallery, Drawing Gallery, Gallery Picture Library Vol. II)	\$585	☎
HP 45433A	Gallery Picture Library Vol. II	\$95	☎
HP 68350F	Charting Gallery	\$295	
HP 68351F	Drawing Gallery	\$395	
HP 68352F	The Gallery Collection	\$695	
HP 68324F	Office Activities Portfolio	\$95	
HP 68325F	Chemical/Petrochemical Portfolio	\$150	
HP 68326F	Business Management Portfolio	\$95	
HP 68327F	HPDraw Figures Portfolio	TBA	
HP 45568A	Office Activities Portfolio	\$95	
HP 45569A	Chemical/Petrochemical Portfolio	TBA	
HP 45570A	Business Management Portfolio	\$95	
HP 45571A	HPDraw Figures Portfolio	TBA	
HP 45463A	Diagraph™	\$435	☎
HP 45462A	Picture Perfect™	\$325	☎
HP 45406E	TextCharts	\$200	☎
HP 45540A	Painter	\$149	☎

Host Services

HP 36890F	Print Central	\$180
-----------	---------------	-------

The following products, available through HP's Direct Marketing Division, are vendor-supported.

HP 35186D†	Microsoft Pascal Compiler (Vectra)	\$300	☎
HP 35190B†	Microsoft BASIC Compiler (Vectra)	\$395	☎
HP 35186E†	Microsoft C Compiler (Vectra)	\$500	☎
HP 35186B†	Microsoft COBOL Compiler (Vectra)	\$700	☎
HP 35186C†	Microsoft FORTRAN Compiler (Vectra)	\$350	☎
HP 35190A†	Microsoft BASIC Interpreter (Vectra)	\$350	☎
HP 35190D†	Microsoft WORD (Vectra)	\$375	☎
HP 35190J†	LaserControl 100 (for Vectra and LaserJet printer)	\$150	☎
HP 35190H†	ThinkTank	\$195	☎
HP 35184A†	Sideways (for Touchscreen and ThinkJet printer)	\$69.95	☎
HP 35190F†	Typing Tutor (Vectra)	\$49.95	☎
HP 35190G†	Teach Yourself WordStar (Vectra)	\$75	☎
HP 45953A†	Vectra Assembler (Vectra)	\$100	☎

☎ Fast-Ship product — see page 766.

☎ Fast-Ship product — see page 766.

GW-BASIC and Microsoft WORD are U.S. trademarks of Microsoft Corporation.
 REFLECTION 1 is a U.S. trademark of Walker Richer & Quinn, Inc.
 Condor is a U.S. trademark of Condor Computer Corporation.
 R:Base is a U.S. trademark of Microrim, Inc.
 MultiMate is a U.S. trademark of Multimatte International Corporation, a subsidiary of Ashton-Tate Corporation.
 Diagraph and Picture Perfect are U.S. trademarks of Computer Support Corporation.

Microsoft is a U.S. registered trademark of Microsoft Corporation.
 Lattice is a U.S. registered trademark of Lattice, Inc.
 dBASE is a U.S. registered trademark of Ashton-Tate Corporation.
 VisiCalc is a U.S. registered trademark of Software Arts Products Inc.
 Lotus, 1-2-3, and Symphony are U.S. registered trademarks of Lotus Development Corporation.
 WordStar and WordStar Professional are U.S. registered trademarks of MicroPro International Corporation.



The HP Vectra personal computer helps automate offices by providing access to HP 3000 and DEC minicomputers and IBM mainframes. The Vectra PC can also exchange information with IBM PCs and with the HP Portable PLUS personal computer.

Personal Computers and Networking

Local area networks (LANs) are the links that connect individual (and sometimes incompatible) personal computers, mainframes, minicomputers, and related peripherals. The network is a data- and resource-sharing system; each individual network node can easily and reliably communicate and exchange information with other nodes.

Compatibility:

HP has been among the leaders in the development of industry-wide standards for networking and communications. Our personal computers, workstations, and host computers communicate via a network based on ISO, IEEE, and other industry standards. **Industry Standards** — HP uses the International Standard Organization (ISO) seven-layer Open Systems Interconnect (OSI) Reference Model as the basis for its HP AdvanceNet architecture. The X.25 standard for public or private data networks and the IEEE 802.3 standard for local area networks represent standards within the OSI Reference Model.

Communications with Other Vendors — Both batch and interactive communications in System Network Architecture (SNA®) and bisync environments are supported by HP AdvanceNet, and new product developments will enhance compatibility with SNA,

and will add IBM's DCA/DIA. In addition, HP has products that allow DEC® VAX computers to communicate with HP systems using HP's Network Services (NS) Network File Transfer (NFT).

HP AdvanceNet

Hewlett-Packard's AdvanceNet is a communications strategy and network architecture designed to provide a broad range of networking alternatives. HP AdvanceNet delivers workable solutions to a multitude of data communications problems in the areas of integrated business systems, engineering and scientific design, and manufacturing operations, and ties them all together with integrated business networks. These capabilities provide you with fast and effective communications that improve the productivity of users and programmers alike.

In developing HP AdvanceNet, HP combined unique products and solutions that focus on cost-efficient yet expandable networking. HP AdvanceNet offers price and performance alternatives for existing and new systems, as well as the flexibility to enlarge and enhance the system as your needs evolve. And your long-term investment in networking is protected by the many alternatives for system upgrades and connections that are supported by HP AdvanceNet.

Hewlett-Packard's network management products enable you to easily design, configure, monitor, and control your network.

Architecture Interfacing

HP AdvanceNet unites two data processing methods: HP's local interactive access to processing and IBM's centralized batch processing. The SNA approach used by IBM performs the same functions, with different implementations, as the OSI reference model. The HP AdvanceNet strategy interfaces HP equipment with IBM and IBM plug-compatible products for both SNA and bisync environments.

Comprehensive networking architecture integrates the elements of various vendors' hardware and software products to achieve a network that is transparent to the user. This transparency permits interaction within multi-vendor systems, and allows a remote system to operate with the same capabilities as a local system. HP AdvanceNet, which follows the OSI Reference Model and standard protocols, is just such a comprehensive architecture.

The components most suitable for your application can be selected from different vendors without compromising the unique needs of your data communications environment. The chosen components must communicate with the HP products in your network. The compatibility of future hardware and software additions to your HP AdvanceNet system is ensured by HP's commitment to industry standards.



AdvanceLink

The extensive data communications capabilities of AdvanceLink connect your Touchscreen II to IBM® PCs, to other Touchscreen IIs, to the Vectra personal computer, and to modems. With AdvanceLink, the Touchscreen II can transfer files between most mainframes, public data bases, and personal computers.

The powerful command language of AdvanceLink lets you automate such repetitive tasks as modem dialing and logging onto remote computers or public information systems. In addition, the AdvanceLink functions are easily controlled from the Personal Applications Manager (PAM) menu.

You can exchange information with HP 3000s and HP 1000s, and with AdvanceLink running on other Touchscreen II PCs, Vectra PCs, and IBM PCs. Both ASCII and binary files can be transferred using full-duplex modems and phone lines or by a direct cable connection between the Touchscreen IIs and the IBM PC.

Touchscreen 3278 Emulation

You can gain access to software and data bases on an IBM host computer when the Touchscreen 3278 Emulation Accessory with File Transfer is installed on your Touchscreen II. The terminal emulation function offers the advantages of an IBM 3278 terminal plus the convenience of local computing. And the File Transfer feature lets you upload and download files, and use the host computer to transfer data between the Touchscreens and IBM PCs.

3270 SNA Emulator for the Vectra PC

HP's 3270 SNA emulator for the Vectra PC lets you connect to an IBM host with multiple simultaneous host sessions. The product (hardware plus software) offers 3270 terminal emulation with file transfer to and from MVS/TSO, VM/CMS, and CICS host files using IBM's 3270 host file-transfer protocols. The 3270 SNA emulator, in conjunction with a synchronous modem and a telephone line, offers the convenience of a 3270 remote terminal and the power of a PC.

3270 SNA Emulator for the Portable PLUS

With HP's 3270 SNA emulator for the Portable PLUS, you can connect to an IBM host from almost anywhere. The product (hardware plus software) offers 3270 terminal emulation with file transfer to and from MVS/TSO, VM/CMS, and CICS host files. The emulator, with a synchronous modem and a telephone line, gives you the convenience of a portable terminal and the power of a portable PC.

Acculink™

DEC VT100 and VT52 terminals can be emulated using Acculink on the Touchscreen II or Vectra PC. You can run DEC mini-computer-based application software and exchange ASCII and binary files. Acculink supports easy terminal emulation, including error checking and macro file construction.

Vectra and Touchscreen Internal Modems

Exchanging information over phone lines between Touchscreen IIs and Vectras, or between these and other personal computers, is as easy as plugging in a phone jack. The Internal Modem installed on your Touchscreen II or Vectra offers the capability of tapping into data bases and using subscription services. Its 1200-baud operation means fast communications and lower phone bills, while older systems remain compatible with its 300-baud rate. With AdvanceLink and the Internal Modem on your HP personal computer, you can exchange files with a remote HP 3000 computer.

Portable-Desktop Link

More than a cable and interface card, the Portable-Desktop Link (PDL) connects the HP Portable PLUS personal computer and the Touchscreen II, Vectra, or the IBM PC, creating an efficient data-exchange network. The Portable PLUS is linked to the Touchscreens and Vectras with the HP Extended I/O Accessory and to the IBM PC with the

HP-IL Interface Card. The Portable PLUS can take advantage of these links to use printers or disc drives connected to the desktop personal computer.

HP OfficeShare LAN

OfficeShare LAN is HP's personal computer local area network; it connects personal computers for file and peripheral sharing. OfficeShare software also provides LAN connections to HP 3000 business computers.

- Industry-standard IEEE 802.3
- Uses MS™-DOS 3.1
- Up to 30 personal computers per 185-meter segment
- Links personal computers (HP and IBM)
- Compatible with HP AdvanceNet for HP 3000 access
- Transparent remote file access (RFA) and peripheral sharing

Up to 30 personal computers can be connected to each 185-meter network segment of the OfficeShare LAN, using any HP Touchscreen or Vectra with a hard disc as a network server.

The RFA feature allows network users to store and access files on shared discs connected to the server. This access is transparent to the personal computer user, eliminating the need to learn another file-access method. In addition, transparent printer access enables the personal computers to share printers.

The OfficeShare LAN, linked to HP 3000 computer, offers users increased capabilities. The personal computers can access the HP 3000 as terminals, with the ability to develop HP 3000 application software. This HP AdvanceNet connection also provides access to HPDesk, remote data bases, larger printers, and file transfer using AdvanceLink.

PERSONAL COMPUTERS & CALCULATORS

Personal Computation

Models HP-11C, HP 12-C, HP-15C, HP-16C, HP-28, HP-41CV, HP-41CX

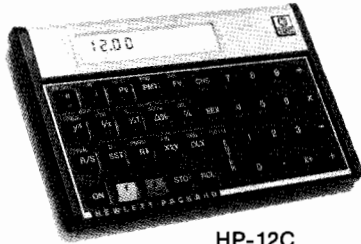

HP-12C

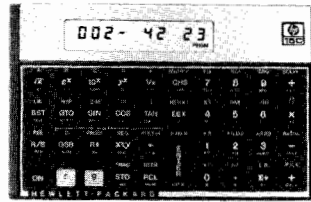

HP-15C

What's Right for You?

Whether it's a business or scientific calculator, or a handheld computer, Hewlett-Packard products can give you the sense of pride that comes from knowing you own a computational tool that has been designed—in every detail—to be the finest of its kind.

The HP-11C, HP-12C, HP-15C and HP-16C are stand-alone programmable calculators. The Business Consultant professional calculator can be enhanced with an optional cordless printer.

The HP-41 calculator and HP-71 Handheld Computer are expandable and highly customizable. The Custom Products Program provides personalized solutions for your applications. To assemble completely portable systems, as well as to communicate with instruments and computers, use the versatile HP-IL Interface.

The HP-94 Handheld Industrial Computer is expandable, rugged, portable—designed for industrial use.

Business Calculators

HP-12C Programmable Financial Calculator

The HP-12C is a powerful financial calculator that is a favorite of business professionals in banking, real estate and investment. It features Time Value of Money functions, discounted cash flow functions (NPV and IRR), plus bond functions that calculate yield-to-maturity and price.

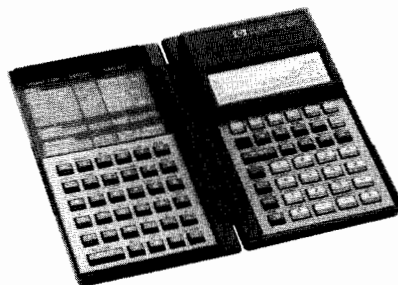

HP-18C
The Business Consultant

Business Consultant

This innovative calculator for business professionals sets a new standard in ease of use. Standard business formulas are built in, and menus and softkeys make these functions easy: interest rates, payment schedules, statistics, internal rate of return, markup and margin, interest rate conversions, and time and appointments. A unique formula solver function allows users to enter formulas for personalized business problems in their own words. The calculator has a four-line by 23-character LCD display plus separate alpha and numeric keyboards. Application booklets are available. Features a wireless infrared printer interface.

Scientific Calculators

HP-11C Programmable Scientific Calculator

Scientists, engineers and mathematicians will use these built-in functions: statistics, a random number generator, trigonometrics, hyperbolic and inverses as well as permutations and combinations. The HP-11C's programmability allows subroutine and indirect addressing plus conditional tests and flags.

HP-15C Programmable Scientific Calculator With Matrices

The HP-15C has special functions that help scientists, engineers and mathematicians solve problems involving matrices and complex arithmetic. Built-in matrix functions operate on up to five matrices (a maximum of 64 elements). The HP-15C has SOLVE and integration functions built in for doing derivatives and integrals, plus 448 program lines with insert and delete editing.

HP-16C Programmable Calculator for Computer Science

The HP-16C is specifically designed for computer science and digital electronic applications. Number base modes make it easy to convert between binary, octal, decimal and hexadecimal bases. In addition to calling and editing programs, the HP-16C has extensive bit manipulation capability.

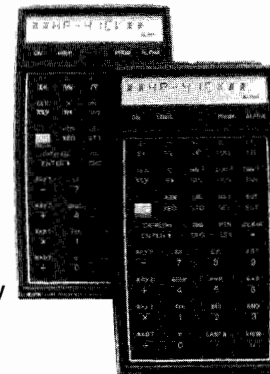

HP-41CV

HP-41CX

HP-41CV and HP-41CX Advanced Programmable Calculators

The HP-41CV and HP-41CX provide the heart of expandable computational systems. In addition to input/output capability, they provide portability and touch-key simplicity.

In addition to all the built-in functions of the HP-41CV, the HP-41CX features built-in Time and Extended Functions/Memory modules, a text-file editing function and 19 other functions.

Choose from a broad range of HP-written Application Pacs and Solutions Books plus Users' Library programs. A Custom Products Program is available for those who require customized software solutions in large quantities (see page 63.)

HP-41 Specifications

User memory (bytes): 2,233 (319 registers) built into HP-41CX/CV; 6,433 (919 registers) maximum.

Extended memory (bytes): 868 (124 registers) built into HP-41CX; HP 82180A Extended Functions/Memory Module, 868 (124 registers) optional for HP-41CV.

Extended memory modules (bytes): HP 82181A Extended Memory Module, 1,666 (238 registers) optional for HP-41CX/CV.

Built-in functions: Over 200 in HP-41CX; over 128 in HP-41CV.

Keyboard: Redefinable, alphanumeric (HP-41CX/CV).

Display: LCD, 10 digits; 12 alpha characters (scroll to 24) (HP-41CX/CV).

PERSONAL COMPUTERS & CALCULATORS

61

Personal Computation

Models HP-71, HP-94, Enhancements & Peripherals



HP-71B



HP-94



Power requirements: Four 1.5V, size N batteries (HP-41CX/CV).
Size: 3.3 x 7.9 x 14.2 cm (1.3 x 3.1 x 5.7 in) (HP-41CX/CV).

HP-71 Handheld Computer

The HP-71 Handheld Computer is a powerful computational tool for individuals and is also well suited to manufacturing applications like quality control, portable data acquisition and test instrument control. Its full CMOS CPU has a 4-bit intelligent external bus and 64-bit internal registers.

The HP-71 uses a powerful BASIC language that runs nearly as fast as compiled BASIC and allows structured programming techniques. It supports a sophisticated file management system and an advanced calculator mode (CALC). The operating system can be further enhanced by using FORTH or assembler languages.

Optional HP-IL interfacing provides input/output capability, and four ports accept memory modules or application software. Customized applications through the Custom Products program.

Documented internal specifications allow development of hardware, software, interfaces and firmware. (See the Custom Products and Programming Development Aids on page 63.)

HP-71 Specifications

User memory (bytes): 17.5K built in, 33.5K (145.5K using value-added supplier modules) maximum

Read only memory (bytes): 64K built in, 320K maximum.

Memory modules (bytes): HP 82420A, 4K (user memory—add a maximum of four); 16K, 32K, 48K or 64K (read only memory—add a maximum of four).

Transfer rate (bytes/sec): 8K (copying to a loop, no devices on loop); 6.4K (copying in a file); 4.5K (OUTPUT statement, no formatting (USING)); 4K (ENTER statement, no formatting (USING) and version 1B of the HP-IL module).

Programming languages: HP BASIC (built in); FORTH and assembler (optional).

Keyboard: Block QWERTY, redefinable, alphanumeric with separate numeric keypad.

Display: LCD, 22 characters (scroll to 96).

Power requirements: Four 1.5V, size AAA alkaline batteries.

Size: 19 x 9.7 x 2.5 cm (7.5 x 3.8 x 1.0 in).

HP-94 Handheld Industrial Computer

The high-quality, rugged and compact HP-94 Handheld Industrial Computer is designed for field data collection and item tracking. Application software for the HP-94 is developed in BASIC or assembly language using the HP 82520A Software Development system and a computer like the HP Vectra PC or IBM PC, PC/XT or PC/AT. Programs are downloaded from the development system via a serial interface cable and level converter.

The HP-94 has a serial interface that provides RS-232C protocol with 0-5 volt signal levels, a built-in bar code interface and an audio jack for use in noisy environments. The backlit display makes it easy to read in dark locations.

The serial interface permits communication with a host computer, software development system, modems, printers and other peripherals at up to 9600 baud. Data can be entered with any one of the three bar code wands, the redefinable keyboard or the serial port.

The HP-94 reads popular bar codes including 3-of-9 Code, Interleaved 2-of-5 Code, UPC/EAN/JAN, Codabar, Code 128 and full ASCII Code 39. (HP 82431A Battery Recharger sold separately.)

HP-94 Specifications

User memory (bytes): 64K, 128K or 256K built in, 256K maximum.

Read only memory (bytes): 32K built-in operating system.

Options (bytes): With 64K or 128K built in, add either a 40K RAM card or a ROM/EPROM card; insert a maximum of 128K ROM or EPROM into the card.

Service upgrade (bytes): With 128K RAM built in, one additional 128K memory board can be installed in the HP-94E.

Maximum capacity (bytes): 256K

Transfer rate (baud): 150, 300, 600, 1200, 2400, 4800, 9600.

Programming languages: BASIC; assembler.

Keyboard: ABC format, redefinable, alphanumeric (numeric keypad by pressing a key).

Display: 4-line x 20-character LCD with backlight.

Power requirements: 4.8 volt rechargeable NiCad batteries.

Size: 14.6 x 16.5 x 3.8 cm (5.75 x 6.5 x 1.5 in).

Weight: 716 g (1.6 lb) with batteries.

Ordering Information

Model	Price
HP-11C	\$ 56.00
HP-15C	99.00
HP-16C	120.00
HP-12C	99.00
HP-18C Business Consultant	175.00
HP-41CV	249.00
HP-41CX	525.00
HP-71 Handheld Computer	1,395.00
HP-94D 64K-byte Handheld Industrial Computer	2,095.00
HP-94E 128K-byte Handheld Industrial Computer	2,795.00
HP-94F 256K-byte Handheld Industrial Computer	

Enhancements and HP-IL Peripherals

Business Consultant

HP 82240A Thermal Printer

An infrared beam provides a cordless connection with the calculator from up to 18 inches away. Prints 24 characters per line in 5x8 dot matrix using the Roman-8 character set plus 10 additional special math characters. Uses batteries or optional AC adapter.

HP-41:

HP 82182A Time Module

With this module (built into the HP-41CX), the HP-41CV can become a time-scheduled system controller, alarm clock, appointment reminder, calendar, timer or even an advanced stopwatch.

HP 82160A HP-IL Interface Module

Plugs into any one of the four ports in the HP-41, connecting it with HP-IL peripherals and instruments, and to HP-IB, RS-232C and GPIO devices using interface converters. Gives the HP-41 control of up to 30 devices on the loop. Typical HP-41 transfer rate: 150 bytes/second.

HP 82183A Extended I/O Module

Provides 59 I/O functions beyond those provided by the HP 82160A HP-IL Module.

HP 82184A Plotter Module

Provides plotting and bar code printing capability for the HP-41 using the HP 82162A Printer/Plotter. Plotting programs are included in the module.

HP 82104A Card Reader

Allows programs and data to be saved on magnetic cards which contain 32 registers, 16 per side. Adds over 30 control functions to the HP-41.

HP 82143A Thermal Printer/Plotter

Quietly provides numeric, upper- and lower-case alpha, double-wide characters, high-resolution plotting capabilities, and intensity control. Allows user-defined special characters.

HP 82153A Optical Wand

Easily inputs data or programs into the HP-41 when passed across a printed page of HP-41 bar code.

00041-15042 Automatic Start and Cassette Duplication Module

Lets you write programs that automatically set status, configure memory, access peripherals, or provide prompts.

☎ Fast-Ship product — see page 766.



PERSONAL COMPUTERS & CALCULATORS

Personal Computation

HP-IL Instruments & Interfaces, HP-IL Interfaces for Other Computers

00041-15043 HP-IL Development Module

Allows you to change the contents of any control register, poll certain status bits and add a second HP-41 to the HP-IL loop.

HP-71:

HP 82401A HP-IL Interface

Allows direct connection to any HP-IL product, and to HP-IB, RS-232C, and GPIO devices using interface converters. Facilitates simultaneous control of up to 30 devices on the loop.

HP 82402A Dual HP-IL Adapter

Allows the HP-71 to have two independent, isolated HP-IL loops simultaneously, using only one port and two HP-IL modules.

HP 82400A Card Reader

Provides inexpensive storage for programs and data. Cards can be encoded so they may be executed, but not viewed or edited, to ensure against overwriting. Provides automatic verification.

HP 92205K/L/M/N/P HP-IL Acoustic Couplers

Provides remote communications capabilities at 300 baud over telephone lines through HP-IL. Accesses "dial-up" computer systems. Complies with European CCITT V21 requirements. Use with HP 82488A Data Communications Pac. (Europe only.)

HP-94:

HP 82520A Software Development System (SDS)

The SDS is used to develop application programs for the HP-94 in BASIC or 8088 assembly languages using the HP Vectra PC, IBM PC, PC/XT or PC/AT computer. See an HP sales rep for details.

HP 82470A RS-232C Level Converter

Converts the 0- to 5-volt signals sent from the HP-94 serial port to the \pm 9-volt levels required to communicate with some RS-232C printers and modems. (HP 82435A cable required.)

HP 16965C, HP 16963C and HP 16961C Bar Code Wands

These high, medium and low resolution contact wands have rugged yet lightweight metal cases, replaceable sealed sapphire tips and high ambient light performance for operation in direct sunlight.

HP-41 and HP-71:

HP 82161A Digital Cassette Drive

Uses a digital-quality mini-cassette to store up to 128K bytes of information. Number of tracks, 2; Density, 335 bits/cm (850 bits/inch); format, 256 bytes/record (8 bits/byte); formatted capacity, 512 records (131,072 bytes).

HP 82162A Thermal Printer/Plotter

Provides numeric upper- and lower-case alpha, doublewide characters and intensity control.

The chief feature distinguishing the HP 82162A from the HP 82143A dedicated Printer/Plotter is that it has a 101-character buffer for enhanced graphics and bar code printing capabilities and a FORMAT function which automatically centers or justifies copy to the left and right margins.

HP 2225B ThinkJet Personal Printer

See numerical index for page number.

HP 9114B Disc Drive

See numerical index for page number.

HP 82168A Acoustic Coupler (modem)

Provides remote communications capabilities at 300 baud over telephone lines through HP-IL. Accesses "dial-up" computer systems. Use anywhere a conventional (G-type) receiver is available. When used with the HP-41, the Extended I/O Module is required.

Ordering Information

HP-18C Business Consultant:

HP 82240A Thermal Printer (110V) 135.00 ☎

HP 82241A Adapter, U.S. (110V) 15.00 ☎

HP-41:

HP 82180A Extended Functions/Memory Module 75.00 ☎

HP 82181A Extended Memory Module 75.00 ☎

HP 82182A Time Module 75.00 ☎

HP 82160A HP-IL Interface Module 125.00 ☎

HP 82183A Extended I/O Module 75.00 ☎

HP 82184A Plotter Module 75.00 ☎

HP 82104A Card Reader 195.00 ☎

HP 82143A Thermal Printer/Plotter 385.00 ☎

HP 82153A Optical Wand 125.00 ☎

00041-15042 Automatic Start and Cassette Duplication Module 35.00 ☎

00041-15043 HP-IL Development Module 75.00 ☎



HP 82169A

HP-71:

HP 82420A 4K-Byte Memory Module 75.00 ☎

HP 82401A HP-IL Interface 125.00 ☎

HP 82402A Dual HP-IL Adapter 85.00 ☎

HP 82400A Card Reader 165.00 ☎

HP 92205K HP-IL Acoustic Coupler (Belgium) 295.00

HP 92205L HP-IL Acoustic Coupler (U.K.) 295.00

HP 92205M HP-IL Acoustic Coupler (Germany) 295.00

HP 92205N HP-IL Acoustic Coupler 295.00

(Other countries)

HP 92205P HP-IL Acoustic Coupler (France) 295.00

HP-94:

HP 82520A Software Development System 795.00

HP 82470A RS-232C Level Converter 240.00

HP 16965C Bar Code Wand TBA

HP 16963C Bar Code Wand TBA

HP 16961C Bar Code Wand TBA

HP-41 and HP-71:

HP 82161A Digital Cassette Drive 550.00 ☎

HP 82162A Thermal Printer/Plotter 450.00 ☎

HP 82168A Acoustic Coupler 495.00 ☎

HP-IL Instruments and Interfaces

HP-41 and HP-71

Instrument Options

See numerical index for page numbers. HP 3468A Digital Multimeter; HP 3421A Data Acquisition/Control Unit; HP 5384A/HP 5385A Opt. 003 Frequency Counters; HP 1630A/D/G and HP 1631A/D Logic Analyzers; HP 4945A Transmission Impairment Measuring Set.

HP 82164A HP-IL/RS-232C Interface

Translates HP-IL signals into RS-232C signals, and vice versa, for connection of HP-IL systems with RS-232C systems. Provides bit-serial asynchronous data communication. AC adapter included.

HP 82169A HP-IL/HP-IB Interface

Permits linkage of HP-IL systems with HP-IB (IEEE 488, 1978) computers and lab equipment. When a controller is used, it can be either an HP-IL or HP-IB device. AC adapter included.

HP 82165A HP-IL/GPIO Interface

Allows HP-IL to control equipment operating with parallel bus structures. Contains I/O buffering and a built-in power supply that operates from an HP standard AC adapter that is included.

HP 92198A/B/C Mountain Computer HP-IL 80-Column Video Interface

Display data and listings on a standard video monitor. Add an RF modulator and use it with a conventional TV set.

HP-IL Interfaces for Other Computers

HP 82938A HP-IL/Series 80 Interface

Provides a communication link between portable battery-operable products and larger computers. Allows use of Series 80 built-in graphics.

HP 45643A Extended I/O Accessory

Provides a communication link between The PORTABLE and the Touchscreen, Touchscreen MAX and Vectra (and HP-71, using HP 82477A HP-IL Link software) computers via the HP-IL interface.

HP 82973A HP-IL Interface Card

Provides a communication link between The PORTABLE and IBM PC/XT (and HP-71, using HP 82477A HP-IL Link software) computers via HP-IL interfacing.

HP 82166C HP-IL Interface Kit

A design kit that provides the special components needed to incorporate HP-IL into other devices.

☎ Fast-Ship product—see page 766.



Ordering Information

HP-41 and HP-71:

HP 82164A HP-IL/RS-232C Interface	295.00 ☎
HP 82169A HP-IL/HP-IB Interface	395.00 ☎
HP 82165A HP-IL/GPIO Interface	295.00 ☎
HP 92198A Mountain Computer HP-IL 80-Column Video Interface (U.S.)	295.00 ☎
HP 92198B Mountain Computer HP-IL 80-Column Video Interface (Europe)	340.00
HP 92198C Mountain Computer HP-IL 80-Column Video Interface (U.K.)	340.00
HP 82938A HP-IL/Series 80 Interface	295.00
HP 45643A Extended I/O Accessory	175.00 ☎
HP 82973A HP-IL Interface Card	150.00 ☎
HP 82166C HP-IL Interface Kit	395.00 ☎

Accessories

Accessories such as owner's manuals, programming pads, magnetic cards, thermal paper, battery packs, rechargers and software manuals are readily available for all types of HP calculators.

Custom Products and Programming Development Aids

Through customization, the powerful HP-41 and HP-71 can be tailored with personalized software to perform the functions that will increase performance productivity.

Using programs written by customers or value-added suppliers, the HP-41 and HP-71 can be customized using Custom ROMs, EPROMs and Keyboard Overlays. The HP-41 can also be customized with Custom Keyboard Touchpads and Bar Code.

The services of Independent Custom Consultants (ICCs) make the customization process easy. (A list of ICCs is available from your HP Sales Representative.) Choose and contact an ICC to help decide if customized HP products can help meet your needs.

HP-41:

HP-41CV or HP-41CX Opt. 001 Custom Calculator

The shifted function labels are removed from the keys, eliminating unnecessary and possibly distracting nomenclature.

HP 82504A Custom Keyboard Touchpads

Relabel the HP-41 keyboard with special functions assigned to each key. Available in a variety of background and printing colors.

HP Bar Code

Provides cost-efficient storage on paper that's easy to use, duplicate and distribute.

HP-71:

HP 82440A Software Development Utility

Allows development of HP-71 BASIC, FORTH or assembly language source files using an HP-86, HP-87 or IBM PC.

HP 82477A HP-IL Link

This software enables transfer, via HP-IL, of most types of files between the HP-71 and MS-DOS personal computers that have HP-IL capability. It allows the PC to be used as a full-sized keyboard and display for the HP-71.

HP 82478A FORTH Assembly/Debugger

Provides an extended software development environment for the HP-71, and allows you to control execution and view status information of an assembly language program. The FORTH operating system is very effective for instrument control applications. FORTH routines can be called from BASIC and vice versa.

Plug-In Module Simulation Procedure (PMSP)

Simulate any Custom ROM Module developed for the HP-71 through one of its memory ports. This sheet explains the procedure (available through an HP Sales Representative or ICC).

☎, Fast-Ship product — see page 766.

Price

HP-71 Internal Design Specifications (IDS) Documents

00071-90068 Volume I: Detailed Design Description	
00071-90069 Volume II: Entry Point and Poll Interfaces (Use with 1BBBB version of HP-71 operating system.)	
00071-90070 Volume III: Operating System Source Listings (Use with 1BBBB version of HP-71 operating system.)	
00071-90104 Volume II: Entry Point and Poll Interfaces (Use with 2CCCC version of HP-71 operating system.)	
00071-90105 Volume III: Operating System Source Listings (Use with 2CCCC version of HP-71 operating system.)	
82401-90023 Internal Design Specifications, HP-IL	
Provides details on the HP-IL interface, including entry points and source code listing.	
00071-90071 Hardware Design Specifications	
Provides details on hardware bus specifications.	

HP-41 and HP-71 Custom ROM Modules

HP-41: HP 82508A/B, HP 82509A/B

Provide 4K or 8K bytes of memory with each module, or nearly 21,000 program lines with up to four 8K-byte modules.

HP-71: HP 82491A/B, HP 82492A/B, HP 82493A/B, HP 82494A/B

Provide 16K, 32K, 48K or 64K bytes of program storage in a plug-in module. May be used in quantities of one to four for a maximum capacity of 256K bytes of ROM. (Minimum order: 100 modules.)

HP-41 and HP-71 Custom Keyboard Overlays

HP-41: HP 82501A

HP-71: HP 82487A

Relabel the keyboard with special user-defined functions assigned to each key. Available in a variety of colors.

Ordering Information

HP-41:	
HP-41CV Opt. 001 Custom Calculator	175.00
HP-41CX Opt. 001 Custom Calculator	249.00

Price

HP-71:

HP 82440A Software Development Utility	35.00 ☎
HP 82477A HP-IL Link	95.00 ☎
HP 82478A FORTH Assembly/Debugger	175.00 ☎
00071-90068 Volume I: Detailed Design Description	50.00
00071-90069 Volume II: Entry Point and Poll Interfaces (Use with 1BBBB version of HP-71 operating system.)	50.00
00071-90070 Volume III: Operating System Source (Use with 1BBBB version of HP-71 operating system.)	200.00
00071-90104 Volume II: Entry Point and Poll Interfaces (Use with 2CCCC version of HP-71 operating system.)	50.00
00071-90105 Volume III: Operating System Source (Use with 2CCCC version of HP-71 operating system.)	200.00
82401-90023 Internal Design Specifications, HP-IL	60.00
00071-90071 Hardware Design Specifications	200.00
☎ Fast-Ship product — see page 766.	

Users' Library

The Users' Library is a source of programs written and submitted by users of HP-41 calculators and the HP-71 Handheld Computer. Documentation includes instructions and program listings. Software is available prerecorded on magnetic cards, mini-cassettes, or HP-IL 3½" discs. A custom cassette/disc duplication service is available. Subscribers receive a complete list of programs, plus notification of special discounts, contests and special promotions. For more information, contact the Users' Library, Dept. 39UL, 1000 N.E. Circle Blvd., Corvallis, OR 97330.



PERSONAL COMPUTERS & CALCULATORS

Personal Computation

Software, HP-Interface Loop (HP-IL)

Software

HP offers software packages as application pacs, solutions books and application booklets. Application pacs come with a manual, plug-in module, and when applicable, prerecorded magnetic cards, a keyboard overlay and quick reference card. Solutions books come with complete documentation. Magnetic cards, mini-data cassettes or HP-IL 3 1/2" discs are available. Application booklets stand alone. Available from dealers and HP Representatives.

HP-11C:

00011-90009 HP-11C Solutions Handbook

Price

15.00 ☎

HP-12C:

00012-90021 HP-12C Leasing Applications Handbook

15.00 ☎

00012-90015 HP-12C Real Estate Applications Handbook

15.00 ☎

00012-90009 HP-12C Solutions Handbook

15.00 ☎

00012-90022 HP-12C Training Guide

15.00 ☎

HP-15C:

00015-90011 HP-15C Advanced Functions Handbook

15.00 ☎

Business Consultant:

Application booklets

00018-90034 Banking Consultant

7.95 ☎

00018-90035 Business Finance Consultant

7.95 ☎

00018-90036 Direct Sales Consultant

7.95 ☎

00018-90037 Manufacturing Consultant

7.95 ☎

00018-90038 Marketing Consultant

7.95 ☎

00018-90039 Personal Investment Consultant

7.95 ☎

00018-90040 Real Estate Consultant

7.95 ☎

00018-90041 Small Business Consultant

7.95 ☎

HP-41:

Application Pacs

00041-15055 HP-41 Advantage

\$49.00 ☎

00041-15018 Aviation (for pre-flight use)

35.00 ☎

00041-15024 Clinical Lab & Nuclear Medicine

35.00 ☎

00041-15006 Circuit Analysis

35.00 ☎

00041-15004 Financial Decisions

35.00 ☎

00041-15049 Math/Statistics

45.00 ☎

00041-15022 Games

35.00 ☎

00041-15023 Home Management

35.00 ☎

00041-15016 Real Estate

45.00 ☎

00041-15019 Thermal & Transport Science

35.00 ☎

00041-15039 Petroleum Fluids

75.00 ☎

00041-15026 Securities

35.00 ☎

00041-15001 Standard Applications

35.00 ☎

00041-15002 Statistics

35.00 ☎

00041-15027 Stress Analysis-Mechanical Engineering

35.00 ☎

00041-15021 Structural Analysis-Civil Engineering

45.00 ☎

00041-15005 Surveying

35.00 ☎

00041-15020 Machine Design

35.00 ☎

00041-15017 Navigation

45.00 ☎

00041-15042 Auto/Start Duplication ROM

35.00 ☎

00041-15043 HP-41 HP-IL Development Module

75.00 ☎

Solutions Books

Business:

00041-90094 Business Statistics/Marketing/Sales

15.00 ☎

00041-90096 Home Construction Estimating

15.00 ☎

00041-90086 Lending, Savings, & Leasing

15.00 ☎

00041-90136 Real Estate

15.00 ☎

00041-90137 Small Business

15.00 ☎

Engineering:

00041-90093 Antennas

15.00 ☎

00041-90100 Chemical Engineering

15.00 ☎

00041-90089 Civil Engineering

15.00 ☎

00041-90092 Control Systems

15.00 ☎

00041-90088 Electrical Engineering

15.00 ☎

00041-90139 Fluid Dynamics & Hydraulics

15.00 ☎

00041-90140 Heating, Ventilating & Air

15.00 ☎

Conditioning

00041-90090 Mechanical Engineering

15.00 ☎

00041-90138 Solar Engineering

15.00 ☎

00041-90441 Structural Design (cassette based)

35.00 ☎

Computation:

00041-90084 Geometry

15.00 ☎

00041-90083 High-Level Math

15.00 ☎

00041-90082 Test Statistics

15.00 ☎

Other:

00041-90145 Calendars

15.00 ☎

00041-90102 Chemistry

15.00 ☎

00041-90099 Games I

15.00 ☎

00041-90443 Games II

15.00 ☎

00041-90143 Optometry I (General)

15.00 ☎

00041-90144 Optometry II (Contact Lenses)

15.00 ☎

00041-90142 Physics

15.00 ☎

00041-90141 Surveying

15.00 ☎

00041-90395 Time Module Solutions I

15.00 ☎

HP-71:

Application Pacs

HP 82481A AC Steady State Circuit Analysis

75.00 ☎

HP 82484A Curve Fitting

95.00 ☎

HP 82479A Data Acquisition

195.00 ☎

HP 82488A Data Communications

95.00 ☎

HP 82482A Finance

75.00 ☎

HP 82480A Math

95.00 ☎

HP 82440A Software Development Utility (with mini-cassette)

35.00 ☎

HP 82489A AMPI (TM) Statistics

95.00 ☎

HP 82483A Surveying

95.00 ☎

HP 82485A Text Editor

75.00 ☎

HP 82490A HP-41 Translator

95.00 ☎

Solutions Books

00071-90065 Games

15.00 ☎

00071-90066 General Utilities

15.00 ☎

00071-90064 Math

15.00 ☎

AMPI™ Statistics is a trademark of American Micro Products, Inc.

Hewlett-Packard Interface Loop (HP-IL)

The Hewlett-Packard Interface Loop, HP-IL, is a bit-serial interface designed for low cost battery-operable systems. HP-IL allows HP-41 calculators and HP-71, The PORTABLE, HP 150 and other computers to be used as system controllers, capable of transmitting and receiving data, and performing a wide variety of information management functions. In addition, HP-IL allows the HP-41 and HP-71 to be used for instrument control.

In HP-IL systems, devices are connected by two-wire cables leading from the output port of one device to the input port of the next, until all devices form a closed loop. This loop structure provides a unique capability through: auto address assignment, device capability identification, power ON/OFF control, and error checking.

For additional information or a demonstration of Hewlett-Packard professional calculators and handheld computers, visit your nearest HP sales representative or HP dealer. In the US, for the location and number of the one nearest you call toll-free 1-800-FOR-HPPC (1-800-367-4772).

☎ Fast-Ship product — see page 766.



HP-IL Products and Applications Summary

Model	Application	See Page
HP-41 Advanced Calculator (with HP 82160A HP-IL Interface Module)	Control: HP-IL bench/field controller Computation: Field data collection	60
HP-71 Handheld Computer (with HP 82401A HP-IL Interface)	Control: HP-IL bench/field controller Computation: Data acquisition, field analysis	61
Series 80 Personal Computers (with HP 82938A Interface)	HP-IL bench controller; field data analysis control	82
The PORTABLE (with HP-IL built in)	Computation and field analysis Remote transaction processing Battery or AC operation	54
The PORTABLE PLUS (with HP-IL built in)	Computation and field analysis Remote transaction processing Battery or AC operation	55
The Integral PC (with HP 82924A HP-IL Interface)	HP-IL bench controller; field data analysis control	81
HP 82402A Dual HP-IL Adapter	Allows two HP 82401A HP-IL modules to be plugged into the HP-71 simultaneously.	62
HP 82169A HP-IB Interface	Bench conversion from HP-IL to IEEE-488 computers, peripherals and instruments	62
HP 82164A RS-232C Interface	Bench conversion between HP-IL and RS-232C signals for terminals, modems, computers and peripherals	62
HP 82165A GPIO Interface	Bench conversion between HP-IL and parallel devices Digital data acquisition interface from HP-IL to most computers	62
HP 82938A Series 80 Interface	Bench conversion from HP-IL to Series 80 Personal Computers	62
HP 82166C HP-IL Interface Kit	Components that can be built into a device, providing HP-IL capability	62
HP 45643A Extended I/O Accessory	Driving HP-IL peripherals, including ThinkJet, plus parallel printers Allows communication between The PORTABLE and Touchscreen, and Touchscreen MAX	62
HP 82973A HP-IL Interface Card	Allows communication, using HP-IL, between The PORTABLE and the IBM PC/XT. Driving HP-IL peripherals	62
HP 82161A Digital Cassette Drive	Bench/field program storage Bench/field data storage Bench/field data logging Field data collection	62
HP 82162A Thermal Printer/Plotter	Bench/field hard copy Data logging Simple plotting Computational hard copy	62
ThinkJet Printer (HP-IL option)	Bench/field full-page, hard-copy output Low noise environments High-resolution graphics and text Battery operation	106

Model	Application	See Page
HP 9114B 3 1/2" Flexible Disc Drive (with HP-IL built in)	Bench/field program storage Bench/field data storage Bench/field data logging Bench/field data collection Bench/field data exchange with Series 80 and Series 200 personal computers Battery or AC operation	100
HP 82168A Acoustic Coupler (Modem)	Remote communications capability Telephone data access	62
HP 1630A/D/G and HP 1631A/D Logic Analyzers	Bench logic design, development, and testing Digital diagnosis and debugging Timing analysis, state analysis, performance analysis, and interactive state/timing analysis	397
HP 3421A Data Acquisition/Control Unit	Bench/field automated measurement, channel selections and control Lab bench experimentation and control Portable experimentation and data collection	292 293
HP 3468A/B Digital Multimeters	Bench/field automated measurement Scientific experimentation Lab bench experimentation & trouble shooting Bench/field automated service & diagnostic tool	198 199
HP 4945A Transmission Impairment Measuring Set (TIMS)	Bench testing of voice grade data channels, program channels, and high speed digital channels Master/slave capability for end-to-end testing Automatic gain slope measurement Programmable sweep	372
HP 5384A/HP 5385A Opt. 003 Frequency Counters	Bench, systems, field-automated measurement	374

HP-IB and HP-IL

HP-IL is a low-cost, low-power alternative below HP-IB in price and performance.

Although HP-IB and HP-IL serve the same basic function—interfacing controllers, instruments and peripherals—they differ in many respects.

1. Because of HP-IL's lower power consumption, it is usable with portable, battery-powered systems. Generally, HP-IB is not.
2. HP-IL system components will generally be low cost and have moderate performance; HP-IB system components are medium- to high-performance and generally cost more.
3. HP-IL systems work at relatively low data rates compared to HP-IB, and relatively high data rates compared to RS-232C. For example, the HP-71 and The PORTABLE can transmit at speeds of 5K to 6K bytes per second (50,000 to 60,000 baud on RS-232C). HP-IL maximum data rate at a 100 metre distance is 20K bytes per second; this rate is not dependent on HP-IL cable length.
4. HP-IL allows device separations of up to 100 metres with shielded, twisted pairs (10 metres with zip cord). HP-IB requires extender hardware for long distance connections.

BUSINESS COMPUTER SYSTEMS

HP 260 Business Computers



The user-friendly, reliable HP 260 is designed for small businesses requiring a powerful computing system.

HP 260 Business Computers

HP 260 business computers are multi-user, multi-tasking systems designed to meet the needs of small- to mid-size businesses. They are user-installable, and feature uncomplicated operation — facilitated by softkey-driven processing and the use of full-screen displays that resemble standard business forms. The IMAGE/260 data base management system, included with HP 260 computers, provides data accuracy, protection from unauthorized access, and savings in data-storage costs. It also enables information retrieval and reporting by non-programmers.

HP 260 Series 30 and Series 40

The low-end Series 30 and the high-end, high-performance Series 40 are fully compatible and can each be connected to the same number of peripheral devices. The very affordable Series 30 is recommended for configurations with one to four users. The Series 40 features disc caching, which results in increased system performance, and supports up to 15 concurrent users/tasks. To allow connection with the greatest possible number of peripheral devices, Hewlett-Packard offers an I/O extender that provides slots for additional I/O boards.

Growth Opportunities

Hewlett-Packard offers a wide range of high-quality peripherals, including mass storage devices, workstations, data-entry terminals, printers, and plotters, that provide an economical way to expand your HP 260 system. Also, both the Series 30 and the Series 40 are upgradable to higher-performance systems. The two series are software-compatible, so it's quick and easy to upgrade from the Series 30 to the more powerful Series 40.

There is also a compatible growth path from the HP 260 computers to HP 3000 systems, because the HP Business BASIC/V language enables HP 260 programs to run on HP 3000 systems. To protect your investment in hardware, HP offers upgrade allowances for any hardware that cannot be integrated into an HP 3000 system.

PC Integration

The latest release of the HP 260 operating system provides support of terminal emulators running on several popular personal computers, including AdvanceLink on the HP Touchscreen II PC, AdvanceLink 2392 on the HP Vectra PC and IBM® PC/XT™/AT®, and REFLECTION 1™ on the HP Portable PLUS.

Any of the personal computers can be used as direct- or modem-connect HP 260 workstations with bidirectional file-transfer capabilities. Hewlett-Packard personal computers are especially easy to use with an HP 260 system, because they include a Personal Applications Manager (PAM) that can initiate HP 260 applications. This makes it easy to incorporate a personal computer's personal productivity capabilities, such as word processing, spreadsheet analysis, and decision-support graphics, into the multi-user HP 260 environment.

Data Communications

HP 260 systems can communicate with personal computers, HP 3000 systems, HP 250 systems, and other HP 260 systems. They can also emulate IBM 2780/3780 batch terminals.

Application Software

The friendly yet powerful BASIC/260 programming language makes HP 260 systems very useful tools for program development. Programmer productivity is enhanced by the comprehensive FORMS/260 program and the QUERY/260 data base inquiry system.

A wide selection of application software is available from HP Value-Added System Suppliers. Value-Added System Suppliers are independent companies that use their industry expertise to provide innovative HP-260-based solutions. They have applications that address the specific needs of many different types of businesses, from manufacturing plants to medical practices. In addition, the System Suppliers can provide services such as system installation, system management training, application software training, application software maintenance and support, and business consulting.

Specifications

Microprocessor: 16-bit Hewlett-Packard proprietary

Operating System: BASIC Operating System

Memory: Series 30 standard with 512K bytes; Series 40 standard with 1M byte

Expansion Capability: Two integrated RS-232C ports standard on both models; with I/O extender, slots are available for up to 2M-bytes memory, two 4-port video MUX boards, two 5-port ASI boards, one peripheral interface channel (HP-IB parallel interface), and one INP board

Weight: Series 30, Series 40, I/O extender (each): 12 kg (approx. 26.5 lbs.)

Dimensions: Series 30, Series 40, I/O extender (each): 128(h) x 325(w) x 380(d) mm (approx. 5.0 x 12.8 x 15.0 inches)

Ordering Information

HP 45070A HP 260 Series 30 SPU includes 512K-bytes memory, two RS-232C ports, one peripheral interface channel (HP-IB), system software, and a standard manual set.

HP 45072A HP 260 Series 40 SPU includes disc caching, 1M-byte memory, two RS-232C ports, one peripheral interface channel (HP-IB), system software, and a standard manual set.

HP 45071A I/O extender: provides five additional board slots.

For more information on HP 260 solutions, contact your HP sales representative or your local HP 260 Value-Added System Supplier.



HP 3000 business computers protect your investment in information management systems.

Integrated Information Systems

Hewlett-Packard pioneered distributed data processing for keeping track of inventories and payables, generating invoices, organizing payrolls, and producing timely reports. Collection, access, and dissemination of data are made easy for any organization, from large corporate headquarters to branch offices and departments. HP also developed business automation systems that meet all the transaction processing demands of today's offices. This includes functions such as word processing, electronic mail, and report writing.

HP's productivity solutions for your office include the HP 3000 family of integrated information systems. The strength of HP communications products along with the flexibility of these systems lets you place cost-efficient, task-oriented computers where you need them.

The HP 3000 Family

The HP 3000 family of business computers combines hardware, software, communications, and support in one integrated information management system. Over 25,000 HP 3000 systems are used in a wide range of office and manufacturing environments worldwide. Well known for reliability and ease of use, HP 3000s simultaneously manage on-line transaction processing, batch processing, programming, and data communications. HP 3000 systems provide both the performance advantages of leading-edge technology and the security of a fully compatible growth path.

To complement the HP 3000, Hewlett-Packard provides comprehensive networking capabilities, high-quality peripheral devices and workstations, personal computers, and a wide range of ready-to-run software. And because the HP 3000 has been well established for more than a decade, numerous third-party products are available for it.

The HP 3000 Family Tradition

Hewlett-Packard continues to implement the strategy that has guided the development of the HP 3000 family from its beginning. This strategy integrates:

Software compatibility. All members of the HP 3000 family share a common operating environment, so applications can be run on higher-performance models without conversion.

Expanding product line. The HP 3000 family continues to expand, providing you with a broad, compatible range of systems from which to choose.

Easy growth path to higher performance. HP 3000 systems are always upgradable to higher-performance systems. Software and peripheral compatibility, as well as generous upgrade allowances, make it easy for you to adjust your computing power to handle growing workloads and meet new demands.

Ease of use. Among system operators, end users, and programmers, the HP 3000 has a well-deserved reputation of being easy to use. As part of HP's Personal Productivity Center, the HP 3000 extends beyond data processing to increase the productivity of all of your end users. By combining the flexibility of personal computers with the processing power of the HP 3000, Hewlett-Packard allows you to enhance the information-processing capabilities of your entire organization.

Comprehensive network solutions. The HP 3000 offers a wide variety of workstation-to-system, system-to-system, and system-to-mainframe communications capabilities.

Lasting value. By protecting your investment in software and hardware through compatibility and upgradability, and by maximizing your productivity with easy-to-use systems, Hewlett-Packard ensures that you get a maximum return on your investment in HP 3000 solutions.

To complement its superior software and hardware, HP provides a full range of documentation, training, and consulting programs, ensuring that you get the maximum benefit from your HP 3000.

HP 3000 Business Computer Systems

The HP 3000 family features a compatible growth path and a wide choice of systems, ranging from small distributed office systems to large data base hosts that can handle your company's business computing needs. The HP 3000 family includes the Series 37, Series 42, Series 58, Series 70, Series 930, and Series 950 systems.



BUSINESS COMPUTER SYSTEMS

(cont'd)

- Series 37** Specifically designed for an office environment, the Series 37 is ideal for branch offices, departments, and small businesses. As with all HP 3000s, the Series 37 can concurrently handle on-line transaction processing and program development, batch processing, office applications, and data communications. It will support up to 32 users.
- Series 42** The powerful, cost-effective Series 42 can be the primary computer for a small company, be dedicated to a single application in a large company, or serve as a node in a network of computers. The Series 42 supports up to 92 users.
- Series 58** A mid-range system supporting up to 152 users, the Series 58 can operate as a stand-alone system or as the central computer (or major node) in a distributed-processing system.
- Series 70** The Series 70 is a high-performance system for large business applications; it provides eight times the throughput of the Series 37. Suitable for stand-alone operation or as the central computer (or major node) in large distributed networks, the Series 70 will support up to 400 users.
- Series 930** The first of a new generation of high-performance HP 3000s, the Series 930 supports up to 400 users and processes 4.5 million instructions per second (MIPS). Based on a simplified, technologically advanced design, the Series 930 is smaller, consumes less power, and is more reliable than typical systems in its performance class.
- Series 950** The highest-performance system in the HP 3000 family, the Series 950 is the first to use Hewlett-Packard's proprietary NMOS-III VLSI technology. Its single-board processor performance of 6.7 MIPS is 50% higher than that of the Series 930.

The 900 Series systems are based on HP Precision Architecture, a new architecture that represents a fundamental change in computer design: it increases computer performance by simplifying the computer instruction set. HP Precision Architecture is a Reduced Instruction Set Computer (RISC) architecture, in which a simplified, uniform set of frequently processed instructions is executed directly in the hardware. This results in substantially higher levels of performance.

The MPE Operating System

All members of the HP 3000 family use the MPE (Multi Programming Executive) operating system, a very powerful, multi-user, multi-tasking operating system. MPE V is the version used by Series 37, 42, 58, and 70 systems. MPE XL, an enhanced version of MPE for the 900 Series systems, has been designed to take advantage of the high-performance capabilities of HP Precision Architecture. The MPE operating system allows easy system management and productive application development.

Programming Languages

HP 3000 systems are optimized for on-line transaction-processing environments. Programmers can choose from a wide variety of high-level languages, such as COBOL, FORTRAN, RPG, BASIC, and Pascal, to best fit the application requirements.

Software to Manage Your Information Processing Needs

Hewlett-Packard was the first in the industry to put a data base management system on a minicomputer: IMAGE on the HP 3000. With more than 20,000 active installations of IMAGE, HP has the largest installed base of data base management systems in the industry. Continuing its leadership role in data base technology, HP has developed ALLBASE, a new data base management system for the 900 Series systems.

ALLBASE combines both a network and a relational interface in one data base management system. HPIMAGE, the network interface, is an enhanced superset of the previous versions of IMAGE. It provides optimal performance for applications with high-volume, repetitive transactions, such as production planning.

HPSQL, ALLBASE's relational interface, is fully compatible with the de facto industry standard, SQL (Structured Query Language). HPSQL provides users with increased flexibility and programmer productivity.

For the Series 37, 42, 58, and 70 systems, the network and rela-

tional data base management systems are available separately. HP TurboIMAGE, the network model, is included in the fundamental operating-system software; HPSQL/V, the relational model, is available as a separate product.

Hewlett-Packard's data base management systems are complemented by and integrated with other tools that combine to form HP's "Information Management Framework":

System Dictionary provides a single source for documenting all aspects of the system, from data definitions to configuration information. This makes it easier to develop and maintain applications, and to manage system resources. System Dictionary can be customized to meet your business needs.

Business Report Writer allows the development of sophisticated reports through easy-to-use menus, and makes it easy to combine data from several sources in a single report.

Inform is an interactive inquiry and report-generation facility designed for managers, purchasers, clerks, and secretaries. It allows easy access to data.

HPAccess is a personal computer application that enables users to access information from up to three data bases simultaneously. It then automatically translates the data into popular PC applications such as Lotus® 1-2-3® and dBASE® II.

HPAccess Central increases the number of data bases available to HPAccess users to include IMAGE and TurboIMAGE data bases on the HP 3000.

Programming productivity is increased by tools such as **VPLUS** and **HP Toolset**. VPLUS is an easy-to-use forms-design and screen-handling tool for programmers. HP Toolset provides a high-productivity, integrated environment for application development. It includes facilities for full-screen editing, symbolic debugging, and version management of source code.

HP also offers **Transact**, a high-level programming language for transaction-processing applications. Transact is a procedural language that provides the functionality of third-generation languages such as COBOL, combined with a comprehensive set of powerful verbs that can perform several functions in a single command.

Hewlett-Packard Application Software

Hewlett-Packard offers a wide variety of software for your HP 3000, for applications such as manufacturing, accounting and financial planning, and system management.

HP Financial Accounting is an on-line, interactive, totally integrated software application composed of eight accounting modules: General Ledger, Accounts Payable, Accounts Receivable, Dual Ledger, Allocator, Report Facility, Interface Facility, and General Accounting. HP Financial Accounting provides you with immediate on-line access to the financial information you need to efficiently run your business.

HP Financial Budgeting is an interactive application system for budgeting, financial planning, and expense control. It has been designed specifically to meet the needs of controllers and financial analysts of large companies.

HP Just-In-Time Manufacturing (HP JIT) is a customizable, interactive application that manages the planning and control functions of Just-In-Time manufacturers. HP JIT modules are grouped in three categories: Manufacturing Specifications, Materials Planning, and Manufacturing Control. HP JIT is easily customized without programming to meet the specific requirements of your business.

HP Production Cost Management (HP PCM) is an easy-to-use cost-accounting system for manufacturing. It provides Work-In-Progress Valuation and Variancing. It also creates General Ledger entries for both material and labor transactions and for the financial variances that it calculates.

HP Materials Management/3000 helps manage the materials planning and control functions of a manufacturing operation. This flexible software can be customized for a wide variety of manufacturing environments.

HP Production Management/3000 is an interactive application system for managing manufacturing production planning and control. This work-order-based system is ideal for discrete manufacturers who fabricate/assemble multi-part products in lots.

HP Maintenance Management provides the tools to better manage your maintenance tasks, including work order control, preventive-maintenance scheduling, and spare-parts inventory.

HP Purchasing is a fully integrated system that handles Purchase Order Requests, Purchase Order Management, Vendor Management,



Receipts, and Returns. HP Purchasing also posts the appropriate information to HP General Ledger and HP Accounts Payable as transactions occur.

Silhouette/3000 is HP's most complete high-availability solution for the HP 3000. It automatically duplicates IMAGE and TurboIMAGE data bases on multiple HP 3000 systems. Silhouette/3000 is customer-installable and easy to use. It provides high system availability, application availability during system backup, and load balancing across HP 3000 systems.

Hundreds of high-quality software products encompassing a broad range of applications are also available for the HP 3000 from third-party software suppliers.

Networking and Data Communications

Hewlett-Packard's AdvanceNet is a communications strategy and network architecture designed to provide a broad range of networking alternatives. HP AdvanceNet products enable you to link all of your company's data resources — workstations, minicomputers, and mainframes — in a high-speed, user-transparent network.

HP AdvanceNet unites two data processing methods: HP's local interactive access to processing and IBM's centralized batch process-

ing. The SNA® approach used by IBM performs the same functions, with different implementations, as the OSI reference model. The HP AdvanceNet approach interfaces HP equipment with IBM and IBM-plug-compatible products for both SNA and Bisync environments.

Local area networks (LANs) are the links that connect individual personal computers, mainframes, minicomputers, and related peripherals. A network is a data- and resource-sharing system; each individual network node can easily and reliably communicate and exchange information with other nodes.

HP 3000 users can increase productivity through high-speed LANs. Hewlett-Packard's LAN/3000 Link and NS/3000 (Network Services) software form a powerful local network that's easy to install, use, maintain, and expand. The LAN/3000 Link includes everything you need to connect your HP 3000 to an industry-standard LAN. And the NS/3000 software provides sophisticated networking capabilities.

The components most suitable for your application can be selected from different vendors without compromising the unique needs of your data communications environment. The compatibility of future hardware and software additions to your HP AdvanceNet system is ensured by HP's commitment to industry-standard modeling.

1-2-3 and Lotus are U.S. registered trademarks of Lotus Development Corporation.
dBASE is a U.S. registered trademark of Ashton-Tate Corporation.
SNA is a U.S. registered trademark of International Business Machines Corporation.

HP 3000 Business Computers	Series 37	Series 42	Series 58	Series 70	Series 930	Series 950
Relative Performance	1	2	3	8	12	18
Technology	CMOS	TTL	TTL	ECL	TTL	NMOS III
Main Memory (MB)	.5-4	1-3	4-8	8-16	16-24	Up to 64
Workstations	32	92	152	400	400	N.A.
Disc Storage (GB)	2.1	3.2	4.2	9.7	9.7	N.A.
Data Base Management Systems	IMAGE, HPSQL	IMAGE, HPSQL	IMAGE, HPSQL	IMAGE, HPSQL	ALLBASE	ALLBASE



BUSINESS COMPUTER SYSTEMS

Personal Productivity Center



HP's Personal Productivity Center offers a variety of powerful business systems to meet your office and data processing needs.

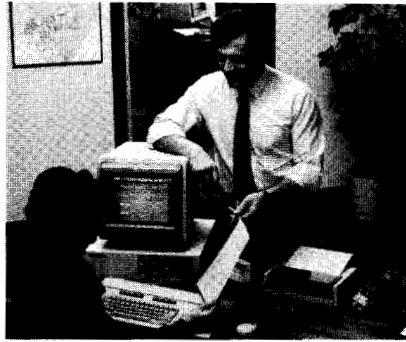

OFFICE PRODUCTIVITY SOLUTIONS

Hewlett-Packard's Personal Productivity Center (PPC) is a powerful office information system that combines the strengths of personal computing, office applications, distributed data processing, and networking. The PPC allows you to link computers of all sizes into the system that suits you best, from individual workstations to departmental and company-wide networks. At all levels, the PPC provides an integrated solution for accessing, interpreting, and exchanging information. The Personal Productivity Center comprises hardware, applications, and services, as described below.

PPC hardware includes the HP 3000 family of business computers as well as Hewlett-Packard's Vectra, Touchscreen, and Portable PLUS personal computers — and even allows for the integration of IBM® PCs. The Personal Productivity Center also includes a wide range of HP printers and plotters, including the ThinkJet and LaserJet printers, high-volume department printers such as the 2680 laser printer, and a variety of high-quality color plotters.

Personal productivity applications, such as word processing and graphics, are available on each of HP's personal computers. They are also available to users of terminals on HP 3000 systems, and to IBM PC users.

Personal Productivity Center services, such as electronic mail, printer sharing, and data base access, are designed to increase the effectiveness of workgroups by linking personal computers, terminals, minicomputers, mainframes, and peripherals in an integrated office information system. These services are available both for small workgroups, using a local area network (LAN), and for the full range of HP 3000 systems — and can even link into IBM mainframes.

The Personal Productivity Center's flexibility is due to its scalable system architecture, which makes it easy to alter, upgrade, and expand the PPC's hardware and software components. Because of this, the Personal Productivity Center is able to meet a wide range of needs, including those of an individual personal computer user, a small workgroup of users sharing data bases and peripherals, a large department, and a corporation with complex data processing and networking needs.

PERSONAL APPLICATIONS

Both personal computers and terminals can serve as workstations in the Personal Productivity Center. Hewlett-Packard offers a full line of applications for each.

Personal Computer Applications

Word Processing

AdvanceWrite I, II, and III, designed for the HP Vectra PC, provide performance and functionality traditionally found only in dedicated word processors. AdvanceWrite III also offers spreadsheet integration and a Wordbase Manager that allows users to find and index documents and files by merely typing in a desired keyword. AdvanceWrite is available in three performance levels and can be purchased with the Vectra PC in a complete preassembled system — the HP Vectra Office — that provides the performance of a dedicated word processing system and the flexibility of a personal computer.

HPWord/150 provides comprehensive word processing capabilities for the HP Touchscreen Personal Computer. It has the same user interface and keystrokes as HPWord/3000, and the two products are file compatible.

Executive MemoMaker enables business professionals and managers to create polished letters, memos, and reports. It is designed to be easy to use, and includes powerful features such as spelling correction and the ability to merge MemoMaker text with graphics created using HP Graphics Gallery software. Executive MemoMaker is available for the HP Vectra and Touchscreen PCs, and for the IBM PC/XT™/AT®. (MemoMaker provides similar capabilities for the Portable PLUS.)

Graphics

Hewlett-Packard's Graphics Gallery brings professional-quality business graphics to HP Vectra, HP Touchscreen, and IBM PC/XT/AT personal computers. Graphics Gallery makes it easy to create colorful overhead transparencies for presentations, or crisp printed graphics for reports. And graphics created using Graphics Gallery can be included in Executive MemoMaker documents to provide integrated text and graphics. Graphics Gallery consists of Charting Gallery, Drawing Gallery, and Gallery Portfolios:

Charting Gallery enables you to create colorful pie, bar, and line charts. Information for the charts can be entered manually,

and spreadsheet graphics created in 1-2-3® or Symphony® from Lotus® can be converted directly into Gallery graphics.

Drawing Gallery makes it easy to create visuals such as organization charts, flow charts, logos, and presentation slides. It includes a portfolio of pictures that you can use to enhance your presentation and reporting graphics. In addition, graphics created in Charting Gallery can be freely edited to include custom logos, borders, and Gallery Portfolio pictures.

Gallery Portfolios include over 1000 ready-made pictures for use with Drawing Gallery. Gallery Portfolios make it easy for non-artists to produce professional-quality graphics.

Data Management

Executive Card Manager is an information management system designed for business professionals. It combines a simple interface (based on the familiar desktop card file) with numerous powerful features, including a built-in report writer, capacity for up to 64,000 records, and powerful sort and search capabilities. Executive Card Manager runs on HP's entire line of personal computers and on the IBM PC.

R:Base™ 5000 is a high-performance, full-featured relational data base management system that meets the needs of novice, intermediate, and expert users. It includes a report writer, a forms generator, and an application generator. R:Base 5000 is available on the HP Vectra and Touchscreen personal computers.

Spreadsheets

Executive Spreadsheet enables business professionals to easily prepare budgets, forecast sales and expenses, and perform other financial projections. Especially valuable is its ability to easily consolidate information from various spreadsheets, including 1-2-3 from Lotus, Microsoft®'s Multiplan®, and Deluxe VisiCalc®. Executive Spreadsheet runs on the HP Vectra PC and on the IBM PC/XT/AT.

1-2-3 from Lotus combines spreadsheet, file management, and graphics capabilities in one program. It allows you to insert data from your data files into spreadsheets and then graph the results. And, if you make changes to a spreadsheet, the graph will be updated automatically. Data from 1-2-3 spreadsheets can be transferred directly into Charting Gallery to produce high-quality charts. 1-2-3 from Lotus is available on the HP Vectra, Touchscreen, and Portable PLUS personal computers.

Applications Integration

HP ExecuDesk integrates HP Touchscreen PC applications such as Executive Card Manager, Executive MemoMaker, and Graphics Gallery, allowing you to transfer information between applications and switch from one application to another quickly and easily.



Terminal Emulation

AdvanceLink is a software package that allows an HP Touchscreen PC to transfer files to and from other Touchscreen PCs, HP Vectra PCs, IBM PCs, and HP 3000s, and to use the Touchscreen's built-in terminal capabilities. AdvanceLink also has a powerful command language that lets you automate repetitive tasks.

AdvanceLink 2392 provides HP 3000 terminal emulation for the HP Vectra PC and the IBM PC/AT, allowing users to run the many applications written for the HP 3000 and other computers and use the PC as a smart terminal. AdvanceLink 2392 emulates HP 2392, DEC® VT52, and DEC VT100 terminals, and it has a powerful command language for automating repetitive tasks.

REFLECTION 1™ provides HP 3000 terminal emulation for the Portable PLUS. It includes file-transfer capabilities and a command language that lets you automate repetitive tasks.

HP 3000 Terminal Applications

Word Processing

HPWord/3000 is a sophisticated and easy-to-use secretarial word processor that runs on MPE-V-based HP 3000 business computers. HPDraw and HPEasyChart figure files can be included in HPWord/3000 documents for integrated text and graphics.

TDP/3000 is a powerful command-driven document production system, ideal for creating documentation manuals and other complex publications.

Graphics

HPDraw enables you to create presentation-quality graphics on MPE-V-based HP 3000s. It includes a wide range of text fonts, line types, geometric shapes, symbols, and simple figures from a figure library, as well as allowing you to design your own figures.

HPEasyChart enables you to create pie, bar, and line charts, and scattergrams, on MPE-V-based HP 3000s. It can accept data from files created by Query, HPListKeeper, and Inform/V.

HP Decision Support Graphics/3000 (DSG/3000) is a graphics software product designed for technically sophisticated office users on MPE-V-based HP 3000s. It provides an interactive interface for the production of pie, line, and bar charts, and scattergrams, drawn from numerical information kept in any data file on the HP 3000. DSG/3000 procedures allow for production graphics such as including charts in periodically generated reports.

HP 3000 Business Graphics Package includes HPDraw, HPEasyChart, and DSG/3000 as a single purchase at a 37% discount.

HP Map is a business mapping program for producing zone, dot, and combination zone/dot maps to be used in presentations or included in TDP/3000 or HPWord documents printed to a system laser printer.

HP Graphics Curator/3000 allows you to exchange PC graphics from Charting Gallery and Drawing Gallery files with HP 3000 graphics, including those in HPDraw, HPEasyChart, and DSG/3000.

Data Management

HPListKeeper allows you to create, edit, search, sort, and print information in the form of simple lists. Data can be manipulated easily and can be merged with HPWord/3000 documents to produce individually customized mailings.

Spreadsheets

Deluxe VisiCalc/3000 enables business professionals to easily prepare budgets, forecast sales and expenses, and perform other financial projections. It is able to easily consolidate information from various spreadsheets, including 1-2-3 from Lotus, Multiplan, and others.

Applications Integration

HPDeskManager provides a complete office environment for terminal users within the Personal Productivity Center. It offers a set of tightly integrated office applications, including word processing, electronic mail, electronic filing, and appointment scheduling. It also provides access to other HP 3000 office applications, such as HPWord/3000, HPDraw, and Deluxe VisiCalc/3000, and can be customized to provide access to data processing applications on the HP 3000.

WORKGROUP SERVICES

The Personal Productivity Center provides services that link personal computer users within a workgroup, enabling individuals to share information and resources.

OfficeShare LAN is a local area network (LAN) that connects Vectra PCs, Touchscreen II PCs, and IBM PC/XT/ATs, enabling them to share printers, plotters, and hard discs. The OfficeShare LAN can also be connected to an HP 3000 computer.

DEPARTMENT SERVICES

The Personal Productivity Center combines the flexibility of the personal computer with the power of the HP 3000. It meets the data processing and office information needs of departments of all sizes by providing services such as electronic mail and data base access to both PC and terminal users.

Electronic Mail and Information Sharing

HPDeskManager enables users to send messages and text or data files, including spreadsheets, graphics, and word processing documents, to other users on the network. It also provides transparent file conversion so users of different applications, such as MemoMaker and HPWord/150, can exchange information easily.

AdvanceMail provides electronic mail and file-sharing capabilities for HP Vectra PC, HP Touchscreen II PC, and IBM PC users. AdvanceMail enables PC users to compose messages (which can include PC files) and then automatically link into the HPDeskManager electronic mail network to send the messages.

Data Base Access

HPAccess gives personal computer users access to, and a relational view of, up to three data bases simultaneously, and then automatically translates the selected data into any of a variety of PC file formats. It can access IMAGE, TurboIMAGE, and personal computer data bases, and it determines the security clearance of individual users. HPAccess runs on the HP Vectra and Touchscreen II PCs, and on IBM PCs.

Query/V provides terminal users with access to HP 3000 IMAGE data bases.

Resource Sharing

Print Central allows Vectra PC, Touchscreen II PC, and IBM PC users to direct the output of their personal computer applications to shared office and system printers, without leaving the application they are working in.

CORPORATE CONNECTIONS

In addition to supporting IBM PCs as Personal Productivity Center workstations, Hewlett-Packard offers products that connect the Personal Productivity Center with IBM's Professional Office System (PROFS) and IBM's Distributed Office Support System (DISOSS). With these products, even corporations with large investments in IBM systems can take full advantage of the benefits of HP's Personal Productivity Center.

HPOfficeConnect to PROFS enables HPDeskManager and IBM PROFS users to communicate with each other through their own electronic mail systems.

HPOfficeConnect to DISOSS links the HPDeskManager and IBM DISOSS systems so that documents can be exchanged between the two. It also gives HPDeskManager users access to DISOSS library services. (HPOfficeConnect software resides on the HP 3000, not on the IBM mainframe.)

HP OFFICE-ASSIST

To help you get the most out of your Personal Productivity Center, Hewlett-Packard offers a structured implementation service called HP OFFICE-ASSIST. Experienced HP representatives help you define your company's goals in implementing office information systems, develop a plan of action to meet those goals, and help you monitor and control the implementation process, to ensure that it is successful.

HP provides comprehensive, ongoing support services to maximize the productive use of your system.

IBM PC/XT is a U.S. trademark of International Business Machines Corporation.

R:Base is a U.S. trademark of Microrim, Inc.

REFLECTION 1 is a U.S. trademark of Walker Richer & Quinn, Inc.

IBM and PC/AT are U.S. registered trademarks of International Business Machines, Inc.

Lotus, Symphony, and 1-2-3 are U.S. registered trademarks of Lotus Development Corporation.

Microsoft and Multiplan are U.S. registered trademarks of Microsoft Corporation.

VisiCalc is a U.S. registered trademark of Software Arts Products, Inc.

DEC is a U.S. registered trademark of Digital Equipment Corporation.

TECHNICAL COMPUTER SYSTEMS

Measurement & Design Automation, Manufacturing & Real-Time Monitoring & Control
General Information

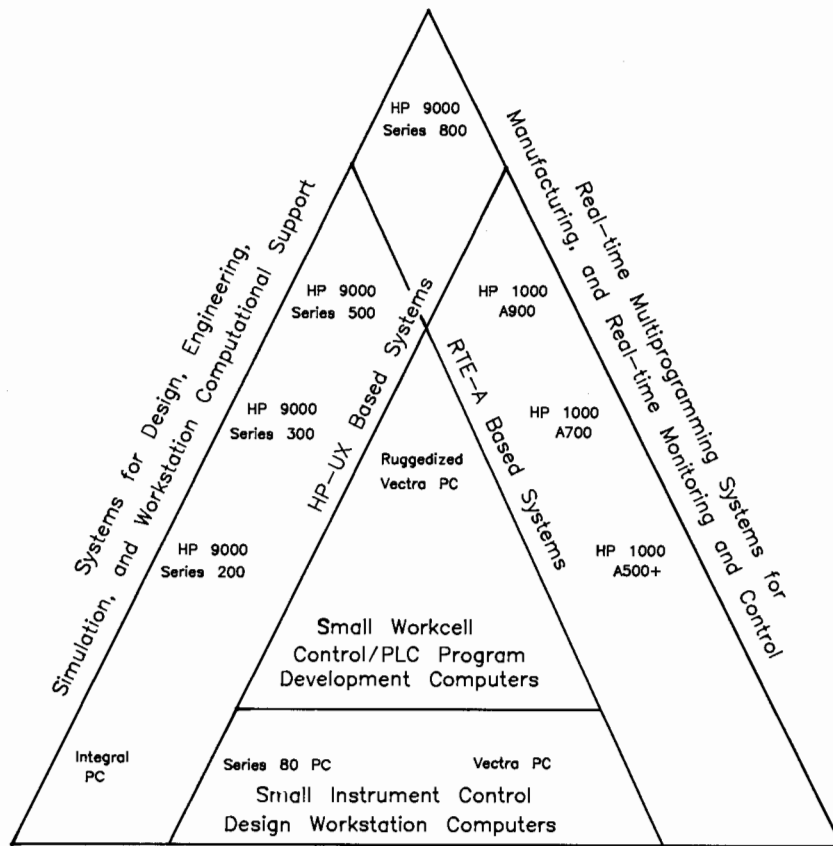

Technical Computer Systems

Hewlett-Packard offers a wide range of technical computer systems for design, measurement automation, manufacturing, and real-time monitoring and control, as illustrated in the diagram above. The table on the facing page provides comparative data on the variety of technical systems available from HP.

HP 9000 Series 800

Hewlett-Packard's newest computer system is the HP 9000 Series 800 Model 840 4.5 MIPS supermini computer system. The computing power, user capacity, and HP-UX operating system of the Model 840 equip it well to provide workstation support of multiple HP 9000 Series 200, 300 and 500 systems used for measurement automation, CAD and CAE applications. For CAE/CAD applications, Model 840 operates as a high-performance software-development computer, a workstation server or a centralized computer node for files, databases and peripherals. It delivers the power necessary to handle such high-level engineering functions as circuit simulation, finite-element analysis, PC-board routing, image analysis, detailed statistical studies, software development and complex project management.

HP-UX on the Model 840 provides real-time functionality similar to RTE-A in HP 1000 systems. This real-time capability, and extensive support of applications migration from HP 1000 systems, makes the Model 840 an excellent manufacturing Area Management system for supervision and support

of HP 1000 Workcell Control Systems on the factory floor. The Model 840 is also a strong performer in real-time monitoring and control applications, such as control of orbiting satellites or communications networks.

HP 9000 Series 500

HP 9000 Series 500 systems are based on a proprietary 32-bit processor chip with over 450,000 transistors and 1 MIPS execution speed. Addition of plug-in CPU cards boosts Series 500 speed even further. This kind of computational power equips the Series 500 for 3-dimensional modelling, finite element analysis, processing of complex matrices, and many other CAE and CAD uses. The Series 500 can be used either as a high-end engineering workstation, or as a multi-user system, supporting up to 16 users. As the high end in a Series 200-500 measurement automation combination, the Series 500 supports the most computationally demanding tasks, freeing the Series 200 to gather data, display results, and interact quickly with the user.

HP 9000 Series 300

The HP 9000 Series 300 is a flexible computer system offering a wide range of capabilities. A low entry price, low-end workstation is offered for dedicated instrument control applications. On the high end, Series 300 workstations provide complex engineering design capability and increased computation performance. Adding the HP Common LISP Development Environment transforms the Series 300 into a powerful artificial intelligence software programming

system. Or add the HP DOS Coprocessor to make a Series 300 workstation IBM PC/AT compatible—both an engineering and personal computer in one box!

HP 9000 Series 200 Systems

The HP 9000 Series 200 is a line of technical workstations best-suited for less compute-intensive workloads. They are especially well-suited for standalone use as instrument controllers. However, the Series 200 is equipped to handle light to moderate computational workloads and can offload excess workload to an interfaced Series 500 machine.

Technical PC Systems

The Integral PC is an HP-UX based, portable PC that can communicate with HP 9000 systems via the uucp capability of HP-UX. The HP 9915B is a small, modular, execute-only computer for use as a specialized controller. The VECTRA PC and VECTRA Industrial PC combine the ability to support PC-DOS based applications for design and manufacturing that can benefit from the low price and wide availability of IBM PC/AT compatible hosts. HP Series 80 PCs are suitable for some personal computer and limited controller functions.

HP 1000 A-Series Systems

HP 1000 A-Series systems provide real-time operation at three different performance levels (A900, A700, and A600+), as listed in the facing table. Predictable response to real-time events equips these systems to function effectively as factory floor workcell controllers, or in other applications that require real-time responsiveness.

Communications

HP technical computer systems can communicate with each other, via various networking protocols, a topic discussed on pages 84 and 85.

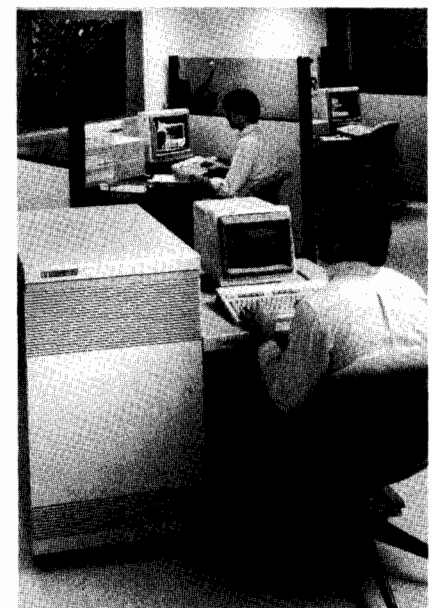



Hewlett-Packard Technical Computer Systems Summary

Processor	Base Speed	Fltg Pt Speed (KWIPS-B1D)	Main Memory	Virtual Memory	Oper. Systems	Number of Users	Program Languages	System Software	Networking
HP 9000 Model 840 page 75	4.5 MIPS	2000	8 to 24 MB	281,000 68	HP-UX	16, 32, or 60	C FORTRAN Pascal	HP ALLBASE; HPtoday; Starbase and DGL/AGP Graphics	LAN Link to HP 1000 and HP 9000; ARPA/Berkeley Net- work Services; and uucp comm to other UNIX systems
HP 9000 Series 500 page 76	1 to 2.7 MIPS; 1 MIP with 1 cpu; 2.7 MIPS with 3 cpus.	600 to 1500	2 to 10 MB	46M	HP-UX	1, 16, 32 or 64	C FORTRAN Pascal	IMAGE DBMS; HPtoday; and HP-GKS, Starbase, and DGL/AGP Graphics	LAN Link to HP 1000, HP 3000, & HP 9000; and uucp comm to other UNIX systems
					BASIC	1	BASIC	3-D Graphics	SRM, IBM/RJE
HP 9000 Series 300 page 77	0.4 to 1.4 MIPS	150 to 640	1 to 7.5 MB	16 MB or 4 GB	HP-UX	1 or 16	C FORTRAN Pascal LISP	HP Windows; HPtoday; and HP-GKS, Starbase, and DGL/AGP Graphics HP Allbase	LAN Link to HP 1000, HP 3000, & HP 9000; and uucp comm to other UNIX systems ARPA/Berkeley Network Services
					BASIC	1	BASIC		SRM IBM 3270 IBM 2780/3780 RJE
					Pascal	1	Pascal	DGL Graphics	
HP 9000 Series 200 page 79	0.2 to 0.9 MIPS	50 to 150	0.5 to 6 MB	not appl.	HP-UX	1 or 16	C FORTRAN Pascal	HPtoday; and HP-GKS, Starbase, DGL/AGP, and EGS Graphics,	LAN Link to HP 1000, HP 3000, & HP 9000; and uucp comm to other UNIX systems
					BASIC	1	BASIC		SRM IBM 3270 IBM/RJE
					Pascal	1	Pascal	DGL Graphics	
HP 9915B Modular Series 80 Computers page 82	0.1 MIPS	Not Spec'd	32 kB & 32 kB to 416 kB E-disc	not appl.	BASIC	1	BASIC, on HP 85 Desktop Computer	None	RS-232-C comm with HP 1000 and HP 3000
HP Vectra and Ruggedized Vectra PCs pages 80 and 95	0.3 MIPS	45 To 100	256 kB to 3.64 MB	not appl.	MS-DOS 3.1	1	BASIC, MS-DOS Macro- assembler	IBM PC/AT compatible software, incl. design & industrial applications software	RS-232-C comm with HP 1000, HP 3000, and HP 9000
HP 1000 A900 page 92	1.2 MIPS	800	0.75 to 24 MB	128 MB for data,	RTE-A	Up to 20	FORTRAN Pascal BASIC	IMAGE DBMS; DGL/AGP Graphics; PMC/1000; QDM/1000; PCIF/1000; & Datapair/ 1000	LAN Link to HP 1000, HP 3000, & HP 9000; NS/1000 pt-pt comm. w/HP 1000 & HP 3000; and RJE, MRJE, & Prog-to-Prog comm. with IBM & plug- compatible systems
HP 1000 A700 page 92	0.4 MIPS	370	0.5 to 8 MB	7.75 MB for code					
HP 1000 A600+ page 92	0.4 MIPS	20							
HP Integral PC page 81	Not Spec'd	Not Spec'd	0.5 to 7 MB	not appl.	HP-UX/ RO	1	C BASIC	HP Windows; Graphic Art; Microtrak; Multiplan; & TK!Solver	uucp comm to other UNIX systems; and RS-232-C comm. to information services

TECHNICAL COMPUTER SYSTEMS

Measurement Automation General Information

Measurement Automation

Hewlett-Packard has for many years been a leading supplier of computers and engineering workstations for measurement automation, data acquisition, automatic testing and factory automation.

Today, the breadth and flexibility of this family of computers and workstations makes it by far and away the best answer to your automation needs.

HP 9000 computers are optimized to work effectively with the more than 1,400 Hewlett-Packard instruments and peripherals via the company's HP-IB industry-standard interface. No other system makes it easier to build a measurement system to meet your needs. And all the components can come from a company long known for its high standards of quality.

Computer-Aided Test

HP 9000 technical computers, coupled with HP data acquisition systems and instruments you'll find in this catalog, make it easy to build custom test systems for use in R&D environments for unattended testing, or for manufacturing test and quality control applications. When used with high-speed data acquisition systems, engineers can capture and analyze data in real time.

Manufacturing and Industrial Monitoring

Accurate monitoring of analog and digital signals is key to product quality in both manufacturing and industrial environments. HP 9000 computers combine computational speed and reliability for real-time data acquisition, even in harsh environments. Engineers can immediately spot trends or deviations in critical variables or processes. The new HP Industrial Vectra helps users take advantage of the growing choice of IBM PC/AT-compatible software for the factory floor, and is ruggedized for harsh environments (see page 95.)

Laboratory Monitoring and Analysis

Analytical applications also can be automated with HP 9000 Technical Computers. Using the same systems that are in use in other departments allows easy transfer of data to and from the lab. High-level I/O programming extensions and HP-IB instrument control make it quick and easy to build custom systems.

HP 9000 Series 300

HP 9000 Series 300 is the flagship of the measurement automation fleet. The modularity of this series of computers allows users to build the computer they need. Select from a low-cost MC 68010 or super-fast MC 68020 processor, add from a family of displays, depending on your need for color or black and white, high or low resolution. Choose an operating/language system from easy-to-use BASIC, Pascal or HP-UX with C, Pascal or FORTRAN. All have state-of-the-art I/O programming extensions to help you get up and running in minimum time. Then choose the mass memory you need and pick the internal memory from 256 kB up to 7.5 MB. Finally, select from a wide variety of

HP-HIL input devices, and you have a custom controller. For IBM PC/AT compatibility, add the new HP DOS Coprocessor and have both a superb controller and a personal computer.

HP 9000 Series 200

These computers are based on the MC 68000 microprocessors, with 16/32-bit internal architecture. They come in a variety of packaging form factors ranging from a 19" rack-mount controller to a smaller unit including an integrated flexible disc drive and display. Series 200 computers provide cost-effective, reliable service for engineering and scientific computation where high-speed and data handling are required.

HP 9000 Technical Vectra

HP 9000 Technical Vectra is smaller, more powerful and easier to use than the IBM PC/AT, yet lets you run virtually all the same software, so you can choose from a large selection of PC/AT-compatible programs to help get your job done.

HP 9000 Integral Personal Computer

The HP Integral Personal Computer provides the performance of an HP-UX operating system in a transportable, easy-to-use system that provides everything you need in one package: computer, printer, keyboard, monitor, mass storage and an optional mouse.

HP 9000 Series 80

Personal Computers HP 9000 Series 80 Personal Computers are low-cost systems for use as dedicated instrument controllers and data collection systems in all technical fields, including manufacturing, production test, machine tools and medical instrumentation.

INSTRUMENT CONTROLLER COMPARISON MATRIX

CONTROLLER FAMILY		41C	71B	80	150 II	IPC	VECTRA	200	300
OPERATING SYSTEM	RPN	•							
	MS-DOS				•		•		•
	BASIC		•	•				•	•
	PASCAL							•	•
	HP-UX					•		•	•
INTERNAL DOCUMENTATION							○	•	•
LANGUAGES	BASIC		•	•	•	•	•	•	•
	COMPILED BASIC				•	•	•	○	○
	PASCAL				•	•	•	•	•
	FORTRAN				•	•	•	•	•
	C				•	•	•	•	•
LISP								•	
PROLOG								•	
ADA						○	•	•	
RAM	MINIMUM	2.2 KB	17.5 KB	128 KB	256 KB	512 KB	256 KB	256 KB	500 KB
	MAXIMUM	4.2 KB	33.5 KB	640 KB	640 KB	5.5 MB	640 KB	7.5 MB	7.5 MB
INTERFACES	HP-IB	•	•	•	•	•	•	•	•
	PC-IB				•		•	•	•
	GPIO			•		•		•	•
	HP-IL	•	•	•	•	•	•	•	•
	RS-232	•	•	•	•	•	•	•	•
	HP-HIL				•	•	•	•	•
	RS-232 MUX							•	•
	BCD			•		•		•	•
CUSTOM (BREADBOARD)								•	•
VME CONNECTION								•	•
NETWORKING	LAN				•		•	•	•
	SRM							•	•
	X.25							•	•
DISPLAYS	LED/LCD	•	•						
	MONOCHROME E.L.					•			
	MONOCHROME CRT			•	•	•	•	•	•
	COLOR CRT						•	•	•
TRANSPORTABLE	•	•			•				
CUSTOMER TRAINING	I/O	•	•	•	•	•	•	•	•
	SYSTEM USE	•	•	•	•	•	•	•	•

NOTES: - SOME FEATURES DO NOT APPLY TO ALL CONTROLLERS WITHIN A FAMILY OR TO ALL OPERATING SYSTEMS
 • AVAILABLE FROM HP ○ AVAILABLE FROM THIRD PARTY *HP 82169A

TECHNICAL COMPUTER SYSTEMS

HP 9000 Series 800 Model 840 System

75



- Supermini performance
- Real-time functionality
- Standards-based software

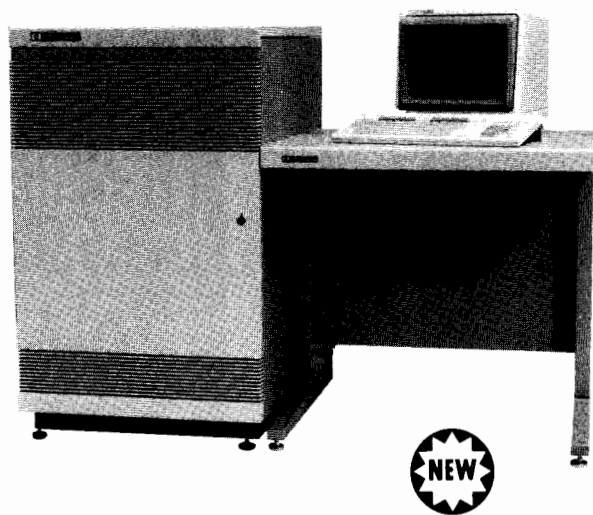

Superminicomputer performance based on HP Precision Architecture

The new HP 9000 Series 800 Model 840 is Hewlett-Packard's first technical computer system based on the new foundation of HP Precision Architecture. Running under the HP-UX operating system, the Model 840 offers up to three times the CPU performance available on the HP 9000 Series 500 Model 550 or HP 1000 A900 system. Significant enhancements equip HP-UX to support real-time applications, making the Model 840 system a logical, high-capacity, high-performance extension of both the HP 9000 and HP 1000 computer system product lines. The Model 840 as an extension of the HP 1000 product line is specifically supported by extensive PORT/HP-UX facilities for applications migration from HP 1000 systems. The HP-UX based HP 9000 Series 500, 300, and 200 systems are highly compatible with the Model 840 because they operate under the same operating system, making data interchange and applications migration among HP 9000 systems virtually effortless.

Superior Price/Performance for Wide Applicability

The inherent design economy of HP Precision Architecture makes the 4.5 MIPS/2000KWIPS-B1D performance of the Model 840 more affordable than other superminis with comparable specifications. The Model 840 is thus readily applicable to support of computation-intensive applications of networks of engineering/design workstations, as a Computational Node, File Server, or Peripheral or Network Server. Its large capacity and industry-standard HP-UX operating system affords an excellent environment for application developers. In manufacturing, the Model 840 has the capability needed to function with great effectiveness as an Area Manager in the CIM hierarchy, supervising and supporting HP 1000 workcell control systems on the factory floor. Its real-time functionality, capacity, and power also equip the Model 840 for demanding real-time monitoring and control jobs, such as real-time management of telecommunication networks.

Real-time Functionality for Real-World Applications

HP-UX incorporates true real-time functionality. Predictable response to interrupts gives the Model 840 the ability to keep critical real-world processes under control. Automatic power-fail recovery restarts the Model 840 at the program statement whose execution was interrupted by a power failure. Priority-based pre-emptive scheduling gives execution preference to the most important programs so they can run immediately, if necessary. Process locking can keep programs and data in memory for fastest real-time response.

The Flexibility and Power of Industry-Standard Software

As important as the true real-time performance of HP-UX is the fact that it has been achieved without compromising the compliance of HP-UX with the AT&T System V Interface Definition Issue 1 (SVID). HP-UX includes an optimizing C language compiler, a powerful symbolic debugger, and all of the other application development support features normally included with a full-featured UNIX® system. Additional optimizing compilers are available for FORTRAN 77 and Pascal programming. HP's new ALLBASE DBMS, which supports both industry-standard SQL relational data management and IMAGE network-model data management, is available. HPtoday can be added for fast, easy development of transaction entry and reporting applications. Graphics support includes the Starbase 2-D and 3-D graphics library, an implementaton of the ANSI CG-VDI specifications, and the DGL and AGP graphics libraries for compatibility with existing applications that use those libraries. HP-UX and its supported software subsystems comply with official and de facto standards to the maximum extent practicable, to assure the widest possible usability of programs within the HP 9000 and HP 1000 system families and with respect to non-HP computer systems.

Networking

The Model 840 communicates with HP 9000 and HP 1000 systems via LAN/9000 Series 800 and NS/9000 Series 800 communications products. Additional capability for communication with other UNIX systems, including non-HP systems, is offered by the ARPA Services/800 network services product.

Unique Native Language Support

HP-UX supports localization and use of applications in 16 different native languages. This facilitates adaptation of software applications for use in different countries or local environments. The multiple native language support provided in HP-UX is available only from Hewlett-Packard.

Ordering Information

	Price
HP 9000 Series 800 Model 840 System* w/8MB memory, Floating Point coprocessor, HP-UX operating system with 16-user license, and multiplexer and HP-IB interfaces.	HP 9741A \$113,500
Additional 8MB of RAM (max. of two HP 19748A per HP 9741A)	HP 19748A \$48,000
Cable Management System for up to 66 terminals, including a table for the system console.	HP 19749A \$900
HP-IB Interface	HP 27110B \$1,010
Parallel Asynchronous FIFO Interface	HP 27114A \$1,600
Asynchronous 6-chan Multiplexer Interface	HP 27140A \$2,400
32-user HP-UX License.	HP 93453A \$10,000
Credit for upgrade from 16-user license.	Opt 0A0 -\$5,000
64-user HP-UX License (I/O capacity limits number of users to 60, max., in the Model 840 system)	HP 93454A \$15,000
Credit for upgrade from 16-user license.	Opt 0A1 -\$5,000
Credit for upgrade from 32-user license.	Opt 0A2 -\$10,000
HP FORTRAN 77/HP-UX	HP 92430A \$7,000
HP Pascal/HP-UX	HP 92431A \$7,000
ALLBASE/HP-UX	HP 36217A \$25,000
HPtoday Developer Pack	HP 92440A \$25,000
HPtoday Run Time Environment	HP 92441A \$3,000
Starbase Graphics Library	HP 92436A \$4,000
DGL, AGP, and Starbase Graphics Libraries	HP 92437A \$5,750
Development system bundle, including FORTRAN 77 and Pascal compilers and DGL, AGP, and Starbase Graphics Libraries	HP 92438A \$14,000
ALLBASE/HP-UX and HPtoday Developer Pack	HP 92442A \$40,000
LAN/9000 Series 800 Link (interface and software)	HP 98194A \$6,000
NS/9000 Series 800 Software	HP 98195A \$4,000
ARPA Services/800	HP 50980A \$10,000

*The HP 9741A requires system console and system disc for operation.

© UNIX is a trademark of AT&T in the U.S.A. and other countries.

TECHNICAL COMPUTER SYSTEMS

HP 9000 Technical Computers

HP 9000 Series 300 Technical Workstations

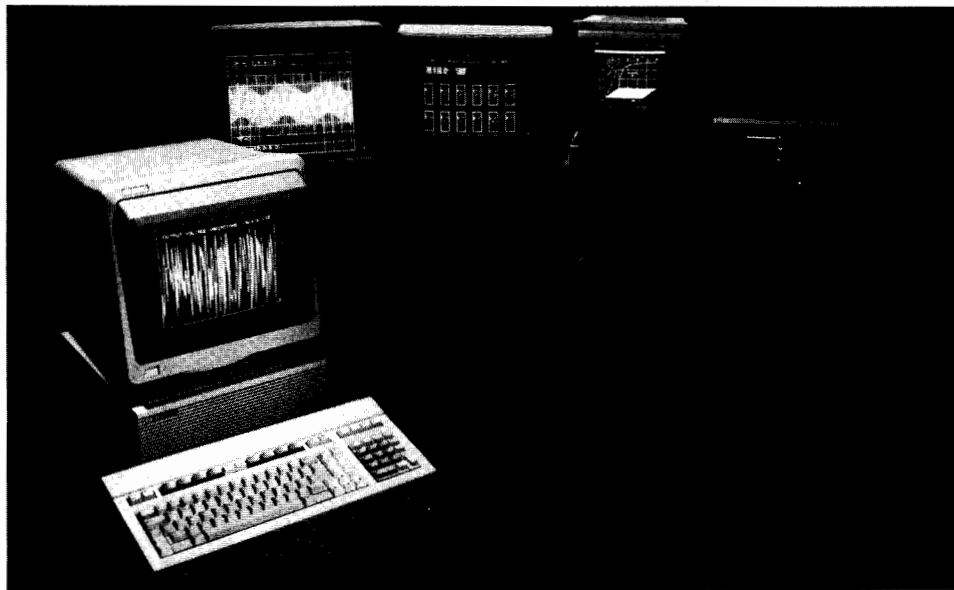

Series 300 and Display Options

SPU Accessories

EIA 19-inch rack mounting kit—for 35731A	HP 98567A	\$225
EIA 19-inch rack mounting kit—for 35741A	HP 98567B	\$225
EIA 19-inch rack mounting kit—for SPU	HP 98569A	\$235

DOS Coprocessor System

DOS Coprocessor System—Includes 98286A DOS Coprocessor and 98531A DOS Coprocessor Software. Requires HP-UX 5.1, minimum 98515A

¼-inch tape	Opt. 022	HP 98286S	\$1,295
3½-inch disc	Opt. 045	HP 98286S	\$1,295

DOS Coprocessor—Interface card only HP 98286A \$950

DOS Coprocessor Software—Software only

¼-inch tape	Opt. 002	HP 98531A	\$495
3½-inch disc	Opt. 045	HP 98531A	\$495

DOS System with Memory Enhancement Kit—

includes 98286S and 1 Mbyte RAM card			
¼-inch tape	Opt. 022	HP 98286T	\$2,195
3½-inch disc	Opt. 045	HP 98286T	\$2,195

Right to Reproduce DOS

Coprocessor Software HP 98531R \$295

VMEbus Connection

HP 9000 VMEbus Interface—Includes DIO interface card, VME card, cable and manual HP 98646A \$1,272

VMEbus Software Drivers—

Pascal on 3½-inch disc	Opt. 244	HP 98358A	\$106
Pascal on 5¼-inch disc	Opt. 242	HP 98358A	\$106
HP-UX on 3½-inch disc	Opt. 344	HP 98358A	\$212
HP-UX on 5¼-inch disc	Opt. 342	HP 98358A	\$212
BASIC on 3½-inch disc	Opt. 444	HP 98358A	\$106
BASIC on 5¼-inch disc	Opt. 442	HP 98358A	\$106

Right to reproduce VMEbus Software drivers

Right to reproduce Pascal	Opt. 200	HP 98358R	\$53
Right to reproduce HP-UX	Opt. 300	HP 98358R	\$106
Right to reproduce BASIC	Opt. 400	HP 98358R	\$53

Series 300 Bundled Systems

Measurement Automation System—

Based on Model 310, offers 1 Mbyte RAM standard, 35731A 12" monochrome monitor, 46020A Keyboard, BASIC 4.0. Includes a 10 MHz MC68010 Processor, HP-IB, RS-232, HP-HIL and medium resolution monochromatic video interfaces, battery-backed real-time clock, four slot card cage for additional memory, I/O and access cards. HP 98580A \$5,750

Low-Cost Color Workstation—

Based on Model 310, consisting of 98561A SPU opt. 003, 98543A medium resolution color Video Board, 35741A 12" Color Monitor,

46020A Keyboard. Includes a 10 MHz MC 68010 processor with a built-in 1 Mbyte RAM, HP-IB, RS-232, HP-HIL Interfaces, battery-backed real-time clock, a four-slot card cage for additional memory, I/O and accessory cards. HP 98581A \$8,050

Model 320M High-performance Monochrome Workstation—

For software engineering, technical office automation, electrical engineering schematic capture and verification, artificial intelligence development and 2D mechanical engineering design applications.

Includes 16.6 MHz 68020 CPU with 68881 floating point coprocessor; 4 Mbytes RAM; 17-inch monochrome display; HP-IB, HP-IB disc, HP-HIL, RS-232 and LAN interfaces; HP-UX Application Execution Environment and LAN software. System also includes 1-m HP-IB cable; keyboard with cable; two-button mouse; HP-HIL ID module; DMA card; expander unit and battery-backed real-time clock. HP 98582B \$15,600

Model 320ML Low-cost Monochrome Workstation and Disc—

Applications same as Model 320M. Includes everything contained in Model 320M, plus a 44 Mbyte Winchester disc drive and a 630 kbyte microfloppy disc drive. HP 98582L \$19,000

Model 320C High-performance six-plane color workstation—

Applications include electrical engineering, VLSI design and printed-circuit board layout.

Includes everything contained in Model 320M, except that the monochrome display is replaced by a six-plane color display with 1024 × 768 pixel resolution and 19-inch monitor. HP 98583B \$24,000

Model 320CX High-Performance 8-plane Color Workstation with Graphics Accelerator—

Applications include electrical engineering, physical design, and 2½D and 3D mechanical engineering and AEC design for this top-of-the-line Series 300 system. Structured similarly to the 320M and 320C, with the Graphics Accelerator added. HP 98586A \$34,900

Monochrome AI Development System—

Applications will include artificial intelligence and software development.

Includes everything contained in Model 320M, plus an additional 2 Mbytes of RAM, the full HP-UX operating system, and the HP Common Lisp Development Environment. HP 98584A \$21,400

Color AI Development System—

Applications will include artificial intelligence and software development.

Includes everything contained in Model 320C, plus an additional 2 Mbytes of RAM, the full HP-UX operating system, and the HP Common Lisp Development Environment. HP 98585A \$29,800



Model 216

HP 9000 Series 200

The Series 200 is HP's line of technical workstations, based on the Motorola MC68000 family of micro-processors, with 16/32-bit internal architecture. The 68010 processor at 12.5 MHz is used in the 9920U/T and 9836U/CU/T/CT models. Other Series 200 models use a 68000 processor at 8 MHz. For engineering or scientific calculations which require high speed and data-handling capabilities, Series 200 computers can provide cost-effective, reliable performance.

Model 220

The Model 220 Modular Computer is rack-mountable with separately available keyboards, monitors, and disc drives. It can serve in complex design and engineering problems and is compatible with HP instruments for all types of measurement, test, and control applications.

The Model 220A has 128 Kbyte RAM, built-in HP-IB interface, and a 15 slot backplane, and is compatible with BASIC 3.0, Pascal 3.0 and SRM. The Model 220U has the 12.5 MHz processor and will support 7.5 Mbyte internal RAM. It includes the HP-IB interface and eight backplane slots. It is compatible with BASIC 3.0, Pascal 3.0, SRM, and single- or multi-user HP-UX.

Model 226

The Model 226 Technical Computer is equally at home in instrument/test control applications or computational assignments, and is ideal for CAT applications.

The Model 226A features a 178mm (7-inch) monochrome CRT with 400x300 graphics, 128 Kbyte internal RAM, integrated 5 1/4 inch flexible disc drive, integrated keyboard, and HP-IB interface. It has an eight-slot backplane, can support up to 7.25 Mbytes internal RAM, and is compatible with BASIC, HPL, Pascal, and SRM.

Model 236

The Model 236s are the most integrated of the Series 200s and have applications from electronic design to mechanical drafting to computerized graphics. The Models 236A/C (base systems) and Models 236S/CS (bundled systems) feature the 8 MHz processor board, while the Models 236U/CU (base systems) and Models 236T/CT (bundled systems) have the 12.5 MHz processor.

The Model 236A Technical Computer features a 310mm (12-inch) monochrome CRT with 512x390 graphics, 128 Kbyte internal RAM, two integrated 5 1/4 inch flexible disc drives, integrated keyboard, and HP-IB interface. It has an eight-slot backplane, supports up to 7.25 Mbyte RAM, and is compatible with BASIC 3.0 and Pascal 3.0. The Model 236C includes the integrated keyboard, interface, disc drives,

eight backplane slots and RAM capacity of the Model 236A, but substitutes a 12" color CRT with 512x390x4 programmable map graphics and 4,096 color shades. It is compatible with BASIC 3.0 and Pascal 3.0.

The Model 236U has the 12.5 MHz processor, and the same CRT, keyboard, disc drives, backplane slots and interface as the Model 236A. It is compatible with BASIC, HPL, and Pascal. It will support up to 7.25 Mbyte internal RAM. The Model 236CU has the 12.5 MHz processor, and features the same keyboard, color CRT, interface, backplane slots and disc drives as the Model 236C.

Series 200 Bundled Systems

Model 216

The Model 216S has a 229mm (9-inch) monochrome CRT with 400x300 graphics, detached keyboard, 256 Kbyte internal RAM, plus an additional 256 Kbyte RAM (512 Kbyte total), and two backplane slots. It is compatible with BASIC, HPL and Pascal. HP-IB and RS-232C interfaces are built in. An option (opt. 256) is provided to delete BASIC and 256K RAM if desired.

Model 220

The Model 220S includes the Model 220A base system plus 2M HP-IB cable, rack mount kit, HP 98203A keyboard and 3M extension cord, HP 98204A Composite Video Card set, and an additional 512 Kbyte RAM (640Kb total). It includes BASIC 3.0 and Pascal 3.0.

Model 226

The Model 226S Computer includes the Model 226A base system, an additional 512 Kbyte RAM (640Kb RAM total), BASIC 3.0 and Pascal 3.0.

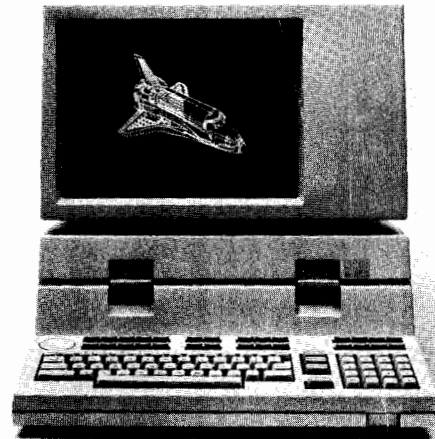

Model 236

Model 236

The Model 236CS includes the Model 236C base color system, with an additional 512Kb RAM (640Kb total), BASIC 3.0 and Pascal 3.0. It has six additional backplane slots.

The Model 236S is based on the Model 236A, includes 512 Kbyte additional RAM (640Kb RAM total), BASIC 3.0 and Pascal 3.0. Six backplane slots are available.

Ordering Information

Model 216S Computer with BASIC	9816S	\$5,650
Model 220A Modular Computer	9920A	4,950
Model 220S Modular Computer with Keyboard, BASIC, Pascal and 640 kbyte RAM	9920S	8,800
Model 226A Computer/Instrument Controller	9826A	10,500
Model 226S Computer/Controller with BASIC, Pascal, SRM and 640 kbyte RAM	9826S	12,700
Model 236U Computer with 12.5 MHz processor	9836U	14,950
Model 236CU Color Computer with 12.5 MHz Processor	9836CU	18,350



TECHNICAL COMPUTER SYSTEMS

HP 9000 Technical Computers

HP Vectra Personal Computer



Versatile and Flexible

Hewlett-Packard's Vectra Personal Computer has been designed to simplify your computing needs. You can select the exact combination of hardware and software that is best for your business today, without restricting your options for the future. The heart of the system is the Vectra PC's 8 MHz Intel 80286 microprocessor. You can start with either a 256K-byte or 640K-byte memory, which can be expanded to more than 3M-bytes. Add to your system any time, from an almost unlimited range of compatible hardware and software by HP, IBM, and numerous other manufacturers.

Vectra's features offer the greatest flexibility of any desk-top personal computer. It is compatible with the IBM® PC/AT®, yet is smaller, more powerful, and easier to use. Vectra's MS-DOS® 3.1 operating system lets you run virtually all IBM PC/AT-compatible software, so you can choose from among the most popular programs.

HP has designed a family of special-purpose interfaces, graphics systems and software that meet the computing demands of engineers and scientists. Thanks to Vectra's modular design, a wide variety of configurations is possible—including systems for data acquisition, instrument control, computer-aided design and drafting, analysis and more common office automation tasks.

Specific enhancements include high-resolution, 256-color graphics, a high-speed math coprocessor, an HP-IB control accessory, specialized programming languages and HP's family of personal instrumentation.

Vectra Features

- 8 MHz Intel 80286 16-bit microprocessor
- Optional 5.33 MHz or 8 MHz Intel 80287 numeric co-processor
- Vectra Disc Operating System (optional):
 - MS-DOS 3.1
 - Personal Applications Manager (PAM)
- Optional BASIC Interpreter and MS-DOS Macro Assembler
- Hewlett-Packard Human Interface Loop (HP-HIL) accessory port
- Flexible data communications options
- Supports flexible and hard-disc storage
- Hardware and software compatible with IBM PC/AT
- 64K-byte ROM
- Sockets for two additional ROM chips
- 256K-byte and 640K-byte RAM; expandable up to 3.64M bytes

- Three half-height data storage cartridge shelves:
 - Two shelves with front access for flexible disc drives
 - One hard-disc shelf
- Seven PC/AT-compatible I/O accessory slots
- Detachable keyboard with HP-HIL port (compatible with the IBM PC/AT, with HP enhancements)
- Choice of 640 × 400 monochrome, 640 × 350 × 16-color or 640 × 480 × 256-color displays.
- 3278 terminal emulator
- 20M-byte half-height and 40M-byte full-height internal hard discs (optional)

Specifications

System Processing Unit: Intel 80286, 8 MHz

Optional Numeric Co-Processors: 5.3 MHz or 8 MHz Intel 80287s

Operating System: MS-DOS 3.1

Memory: 256K-byte or 640K-byte RAM in 128K-byte increments; expandable to 3.64M bytes

Keyboard:

- Detachable, with 8-ft. coiled cable
- Adjustable tilt feature
- One HP-HIL port
- Eighteen function keys

Weight:

- SPU with one flexible disc drive: 26 pounds (11.8 kilograms)
- Keyboard: 4.2 pounds (1.9 kilograms)

Dimensions:

- SPU: 16.7 × 15.4 × 6.3 inches (42.5 × 39.0 × 16.0 cm)
- Keyboard, flat: 20.6 × 8.8 × 1.3 inches (52.5 × 22.0 × 3.5 cm)

Peripherals and Accessories for the Vectra PC

See the "Peripherals" section, page 96, for product descriptions of peripherals and accessories.

How to Order Your Vectra Personal Computer

For more information on the Vectra, contact your HP sales representative or your local HP personal computer dealer.

For the nearest dealer in the U.S., call toll-free: 800-FOR-HPPC

Ordering Information

	Price
Vectra Model 45 —System SPU with 640kB memory, 1.2MB floppy drive and keyboard.	HP 72445A \$3249
Vectra Model 50 —Same as Model 45, plus 20MB floppy drive and keyboard.	HP 72450A \$4695
Vectra Model 60 —Same as Model 50, but with high-speed 40MB hard disc.	HP 72460A \$5495
Vectra CAE/CAD System —Includes Model 60, plus enhanced color display system, high-speed (8-MHz) coprocessor and DOS. All components pre-installed and tested at HP.	HP 82964E \$8009
Vectra Instrument Control System —Includes Model 45, plus a second 360kB floppy, monochrome display, serial/parallel card, HP-IB card and I/O libraries, DOS and BASIC. All components pre-installed and tested at HP.	HP 82964M \$4808

MS-DOS® is a U.S. trademark of Microsoft Corp.
IBM PC/AT® is a U.S. trademark of International Business Machines Corporation.

IBM is a registered U.S. trademark of International Business Machines Corporation

TECHNICAL COMPUTER SYSTEMS

HP 9000 Technical Computers

HP Integral Personal Computer

81

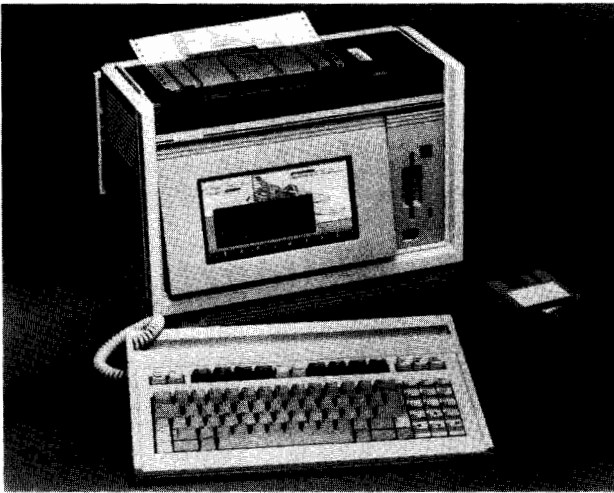

The HP Integral Personal Computer is a transportable, HP-UX computer system for solution creators developing workstation-class software for mobile applications.

The HP Integral Personal Computer

The HP Integral Personal Computer delivers the performance of an HP-UX operating system in a fully integrated, affordable and easy-to-use package. The HP-UX operating system adheres to AT&T's System V Interface Definition, Issue 1. Everything you need for full computing power—a printer, keyboard, monitor, mass storage, and an optional HP Mouse—is provided in the transportable Integral PC.

The standard 512K bytes of memory is expandable to 2.5M bytes; with Bus Expanders, the RAM can be boosted up to 7M bytes. And, there's 512K bytes of ROM, with the built-in HP-UX, Hewlett-Packard's customized version of the UNIX System V operating system. HP-UX incorporates a superset of industry-standard capabilities, such as powerful real-time control and shared memory enhancements. Also included in ROM is the Personal Applications Manager (PAM), a friendly user interface, and the HP Windows multi-window manager.

PAM simplifies the user approach to the powerful operating system, and has been customized for the Integral PC's multi-tasking environment. For high-end users, the Integral PC also offers traditional UNIX operating system shells.

The Integral PC Features

- Motorola 68000, 16/32-bit microprocessor, 8 MHz
- 16-bit graphics processor
- 512K byte ROM contains:
 - HP-UX kernel
 - HP Windows
 - Personal Applications Manager (PAM)
- Standard 512K byte RAM expands to:
 - 2.5M bytes in main system
 - 7M bytes with Bus Expanders
- Microfloppy 3½ inch disc drive, 710K byte
- Amber/black electroluminescent 9-inch display
- Two Hewlett-Packard Human Interface Loop (HP-HIL) connectors
- Built-in HP ThinkJet Printer
- Fully functional, typewriter-style keyboard
- HP-IB interface
- Two expansion ports; extendable to ten with bus expander option
- Compatible with HP 9000 family of HP-UX computers

HP-UX and the Integral PC

The UNIX operating system, written in the high-level C language, is uniquely capable of operating on a wide range of hardware—from micros to mainframes. HP-UX is a genuine UNIX operating system product, which lets the Integral PC transcend the architectural barriers of such systems as MSTM-DOS and PC-DOSTM for powerful software development programs.

The HP-UX kernel is stored in ROM, providing the Integral PC with on-board power. You can run UNIX-operating-system-based software programs and applications installed on 3½ inch floppy discs, eliminating the necessity of a Winchester hard disc.

UNIX Operating System Software Library

A substantial number of UNIX-based tools are available, especially for software development, text processing, and communications. The library includes Pascal, FORTRAN, and "C" compilers, designed primarily for programming experts. Additionally, a Device Independent Library (DIL) provides high-level language control of instruments through compiled languages. This saves time when programming high-performance computer-aided test solutions.

Real-time extensions are available through HP-UX to provide reliable interrupt handling and priority setting in a multi-tasking instrument control environment.

Graphics Display

The Integral PC features a 9-inch, 24-line x 80-column, amber and black electroluminescent (EL) display. The flat panel display is tilt-adjustable, compact, and very readable. The Integral PC's bit-mapped display uses square pixels, which produce excellent, high-quality graphics. It has 256 pixels vertically and 512 pixels horizontally. The 16-bit graphics processor supports high-speed line drawing and can change windows rapidly.

Specifications

Microprocessor/CPU: Motorola 68000, 16/32-bit processor running at 8 MHz

Graphics Processor: 16-bit, with 32K bytes of dedicated RAM

Operating System: HP-UX (UNIX System V)

Memory: 512K bytes ROM

512K bytes RAM, expandable to 2.5M bytes in main system and to 7M bytes with I/O expanders

Mass Storage: Single 710K byte double-sided, double-density 3½ inch microfloppy

Display: 9-inch electroluminescent (EL), 24-line x 80-column screen with adjustable tilt; 256 x 512 pixels

Keyboard: Fully spaced, 90-key, full-travel typewriter-style HP-HIL compatible

Eight function keys

Numeric pad

Flexible key mapping

Internal Printer: Built-in ThinkJet

150 cps

1K byte buffer

11 x 12 dot character matrix text print resolution

96 x 96 or 192 x 96 dots per inch graphics resolution

Bold and underline print modes

Less than 50 dB sound pressure printing noise

Input/Output: HP-IB, two HP-HIL, and two expansion ports (can be extended to ten ports using two Bus Extenders)

Weight: 25 pounds (11.4 kilograms)

Dimensions: 7 x 13 x 16 inches (178 x 330 x 406 mm)

How to Order Your Integral Personal Computer

For more information on the Integral PC, contact your HP sales representative or your local HP personal computer dealer.

Ordering Information

		Price
HP 9807A	The Integral Personal Computer	\$4995
	The Integral PC comes complete with the HP-UX operating system, 16/32-bit microprocessor and graphics processor, 512K-byte ROM, 512K-byte RAM, 710K-byte 3½ inch microfloppy disc drive, 9-inch EL display, built-in ThinkJet Printer that includes 50 sheets of paper and a printhead, low-profile 90-key keyboard with numeric keypad, internal clock and speaker, power cable, six applications and utilities discs, and comprehensive documentation.	



TECHNICAL COMPUTER SYSTEMS

HP 9000 Technical Computers

Series 80 Personal Computers and HP 9915B



Low-cost data acquisition and dedicated applications are the specialty of the HP-85B.

The Series 80 Personal Computers

The HP-85B and HP-86B Series 80 products are powerful, easy-to-use personal computers that serve as programmable tools for technical analysis and as dedicated controllers for data collection systems, machine tools, and medical instrumentation. The Series 80 product offerings include an exceptionally broad choice of options, with everything from language enhancement ROMs to a variety of interfaces. With a number of software packages available, you can choose a comprehensive, reliable solution for instrumentation control problems.

The HP-85B personal computer supports low cost data acquisition and dedicated applications requiring ease of programming, strong I/O capability, and a compact integrated system. The built-in CRT, printer, and mass storage give it a unique physical package, and the easily expanded backplane offers exceptional versatility.

The HP-86B is configured as a modular system with separate monitor and disc drive. It offers greater power than the HP-85B, while retaining the strong computational and interfacing capabilities. The BASIC language on the HP-86B is a superset of the HP-85B language, and the HP-86B memory is expandable up to 640K bytes.

Electronic Disc

HP's Electronic Disc simulates an electro-mechanical disc drive, but with extremely high speed. Programs written for mechanical memory can be modified to run from high-speed electronic memory, and any portion of program memory on the HP-86B can be reconfigured to use as electronic disc.

An Exceptional Input/Output Device

The ability of the Series 80 to interface to and communicate with a variety of devices, such as instruments, machinery and custom products, is supported by a combination of hardware features and software capabilities. One example is the ease of programming using the I/O ROM: dozens of unique commands facilitate communication with external devices. Buffered transfers let you talk to a slow instrument while continuing with other activities, and interrupt branching lets you service an interrupting instrument while maintaining control of all communications activity.

Programming a variety of I/O interfaces is simplified by the use of common protocol. Typically, the same commands are used to communicate over RS-232C, HP-IB, GPIO, BCD, and other interfaces. In addition, interfaces are easily installed, without tools or disassembly, in a slot on the back of the computer. And virtually any digital device can be interfaced and connected to a Series 80 personal computer.

The HP 9915B is a modular computer derived from the HP-85B but excludes keyboard, crt, tape drive and printer. This makes it ideal for integration into an automated system, omitting features not needed in a pre-programmed controller. Its optimal applications are in automated testing, measurement and control applications where durability is essential. In these applications, the HP 9915B can be used as a front end controller or host-controlled by other computers.

The HP 9915B is a viable alternative to custom-made microcomputer systems and board computers, which are expensive but difficult to engineer, program and develop.

The HP 9915B is an extended version of the earlier HP 9915A model. Software compatibility with the HP 9915A allows customers to switch over to the HP 9915B very easily.

Efficient Program Development

Programs for the HP 9915B can be developed and debugged on the HP-85B and transferred to the HP 9915B via either EPROM, tape cartridge, or other Mass Storage devices. Applications can be running in about half the time it would take for a microcomputer or board computer.

By using a Program Development Kit and other accessories the HP 9915B can also be used as its own development station.

For non-volatile storage and fast loading in industrial environments, the HP 9915B accepts 32K bytes of EPROM storage for application programs. Program development software is available that allows the designer to program EPROMS with commercially available PROM programmers.

32K Byte of user read/write memory and 32K byte of built-in Electronic Disc (E-Disc) read/write memory are available in the HP 9915B. The E-Disc memory can be expanded to up to 416K bytes by inserting memory modules into the I/O ports. The E-Disc is electronically accessed by a built-in Mass Storage/E-Disc ROM set and makes data transfer about 150 times faster than data transfer using tape.

Ordering Information

		Price
HP-85B Personal Computer	HP 85B	\$3,495
HP-86B Personal Computer	HP 86B	\$1,695
9-Inch Monitor	HP 82912A	\$295
12-Inch Monitor	HP 82913A	\$325
HP 9915B Modular Computer with 32k RAM	HP 9915B	\$1,920
Built-in Tape Drive	Opt. 001	\$425
Operator Interface Capability	Opt. 002	\$350
64k E-disc Memory Module	HP 82908A	\$445
128k E-disc Memory Module	HP 82909A	\$595
HP 9915B Program Development Kit	HP 98150B	\$610
HP 9915B Keyboard	HP 98155A	\$425

Peripherals and Accessories for the Series 80

See page 88 for product descriptions of peripherals for series 80 computers.

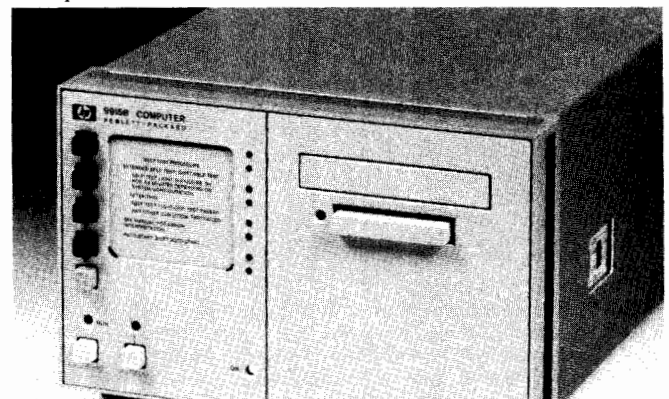

☎ Fast-ship product — see page 766



Series 800 Languages and Operating Systems

Hewlett-Packard's Precision-Architecture HP 9000 Series 800 Model 840 is based on HP's HP-UX operating system, which complies with the AT&T System V Interface Definition Issue 1. HP-UX for the Model 840 provides true real-time performance. The Model 840 comes with a 16-user HP-UX license. Other operating system and language options include:

32-user HP-UX license	HP 93453A	\$10,000
Credit for upgrade from 16-user license	Opt. 0A0	-5,000
64-user HP-UX license (I/O capacity limits users to 60 maximum, in Model 840)	HP 93454A	\$10,000
Credit for upgrade from 16-user license	Opt. 0A1	-5,000
Credit for upgrade from 32-user license	Opt. 0A2	-10,000
HP Fortran 77/HP-UX	HP 92430A	\$7,000
HP Pascal/HP-UX	HP 92431A	\$7,000

Series 500 Languages and Operating Systems

Single-user BASIC for Model 520.

Multi-tasking using internal 10-Mbyte disc as system disc (specify medium)	HP 97050B	\$2,500
2D-3D Graphics	HP 97052B	\$1,200
IMAGE/QUERY 9000 (BASIC)	HP 97053B	\$1,200
BASIC Asynchronous Terminal Emulator	HP 97056A	\$505
Shared Resource Management Software (Requires HP 27123A Interface)	HP 97058A	\$200
HP Technical BASIC Interpreter	HP 97068	\$2,000
Single-user HP-UX for Model 520	HP 97070	\$2,020
Multi-user HP-UX for Model 520	HP 97080	\$5,000
Single-user HP-UX for Models 540,550,560	HP 97079	\$2,020
Multi-user HP-UX for Models 540,550,560	HP 97089	\$5,000
Single-user Pascal compiler for HP-UX	HP 97072	\$2,020
Multi-user Pascal compiler for HP-UX	HP 97082	\$4,500
Single-user FORTRAN 77 compiler for HP-UX	HP 97071	\$2,020
Multi-user FORTRAN 77 compiler for HP-UX	HP 97081	\$4,500
HP Windows/9000	HP 97057/69	\$300
HP 1000 to HP 9000 Applications Migration Transports programs from HP 1000 RTE-6/VM to HP 9000 HP-UX	HP 97086	\$1,010

Series 200 and 300 Languages and Operating Systems

HP-UX Language

HP-UX 5.0 Operating System. Includes Windows/9000, Personal Applications Manager (PAM), C Compiler, FORTRAN 77 Compiler, Pascal Compiler, MC680X0 Assembler, Symbolic Debugger, RS-232 Data Communications, Device I/O Library, Starbase Graphics Library and DGL/AGP Graphics Library

Multi-user **HP 97033A** \$4,000

HP-UX 5.1 Application Execution Environment. Includes HP-UX Kernel, installation software, HP Windows/9000 and Personal Applications Manager (PAM)

Single-user **HP 98515A** \$350

HP-UX 5.1 Programming Environment. Includes commands, C Compiler, MC680X0 assembler, Symbolic Debugger, RS-232 Data Communications, Device I/O and Starbase Graphics Libraries. Requires 98515A for single-user only.

Single-user	HP 98517A/97A	\$900
Multi-user		\$1,440
HP-UX FORTRAN 77 Compiler. Requires 98517A/97A.		
Single-user	HP 98518A/98A	\$500
Multi-user		\$800
HP-UX Pascal Compiler. Both require 98517A/97A		
Single-user	HP 98519A/99A	\$500
Multi-user		\$800
HP-UX DGL/AGP Graphics Library. Requires 98517A/97A.		
Single-user	HP 98520A/600A	\$1,000
Multi-user		\$1,600
SRM Access Utilities for HP-UX.		
Single-user	HP 98693A	\$500
Multi-user		\$500
RJE Software for HP-UX.		
Single-user	HP 98797A/98A	\$1,010
Multi-user		\$2,525
HP-UX Operating System		
Single-user	HP 98670A	\$2,500
Multi-user	HP 98680A	\$4,000

BASIC Language

ROM-based BASIC 4.0 Language System. Includes one ROM board, BASIC 4.0 Manual Kit and BASIC 4.0 Utilities Pack (for Series 200 and 300).

Single-user **HP 98603A** \$1,860

RAM-based BASIC 4.0 Language System. Includes one system disc set, BASIC 4.0 Utilities Pack and Manuals (for Series 200 and 300).

Single-user **HP 98613B** \$860

ROM-based BASIC 2.0 Language System. Includes one system ROM board, BASIC 2.0 Language Manual Kit and BASIC 2.0 Utilities Pack.

Single-user **HP 98601A** \$1,450

ROM-based BASIC 2.0 Plus Extensions 2.1. Includes one ROM board, BASIC 2.0 with Extensions Manual Kit and BASIC 2.0 Utilities Pack.

Single-user **HP 98602A** \$3,000

RAM-based BASIC 3.0 Language System. Includes system flexible disc and Language Extensions disc, BASIC 3.0 Language Manual Kit and 2.0 Utilities.

Single-user **HP 98613A** \$860

Pascal Language

RAM-based Pascal 3.1 Language System. Includes system disc set and Pascal 3.1 Manual Set (for Series 200 and 300).

Single-user **HP 98615C** \$995

RAM-based Pascal 3.0 Language System. Includes system flexible disc set and Pascal 3.0 Language Manual Kit.

Single-user **HP 98615B** \$995

HPL Language

ROM-based HPL 2.0 Language System. Includes one system ROM board, HPL 2.0 Language Manual Kit and HPL 2.0 Utilities (not available for Models 220 or 236C).

Single-user **HP 98604A** \$1,415

RAM-based HPL 2.1 Language System. Includes system flexible disc, HPL 2.0 Language Manual Kit and HPL 2.0 Utilities Pack (not available for Models 220 or 236C).

Single-user **HP 98614A** \$355



TECHNICAL COMPUTER SYSTEMS

HP 9000 Technical Computers

Networking

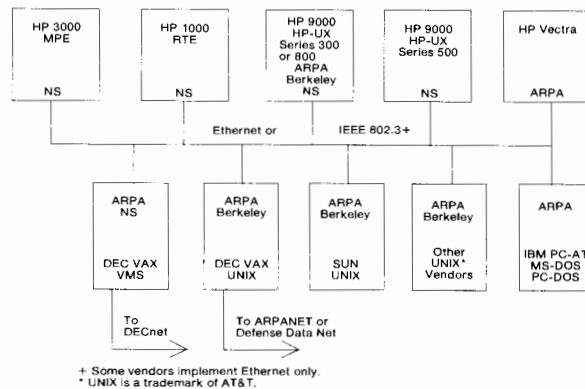

HP 9000 Series 200, 300, 500 and 800 computers using the HP-UX operating system can connect directly to the Ethernet/IEEE 802.3 local area network (LAN).

HP Networking

HP networking is an effective means of harnessing and controlling the vast amounts of data created in companies using different vendors with different equipment. Our strategy, called HP AdvanceNet, allows these companies to access and manipulate data throughout their entire computing network. By addressing key issues, HP has developed this long-term networking strategy to satisfy your communication needs:

- **Transparency:** The goal is to create networks so transparent that the user will have the same capabilities on a remote system that are available on a local system.
- **Flexibility:** A broad range of data communication alternatives for both local and remote communication, combined with a variety of upgrades, provide the flexibility to enlarge and modify as needs dictate. This provides true, long-term investment protection.
- **Industry Standard Protocols:** The end goal of industry standards is also the main objective of networking: achieving interconnectivity between different equipment from different vendors. Any effective networking solution is built and designed with a firm commitment to industry standards.
- **Reliability:** A networking solution is only as good as the company that develops, sells and services it.

By addressing these key issues, Hewlett-Packard provides a well-balanced, workable networking solution that helps you move and manage information from workstation to workstation, from department to department or throughout an entire company. It addresses the networking needs of today and tomorrow, providing a total solution that grows with your company.

Local Area Network (LAN)

An HP 9000 Series 300, 500 or 800 computer running the HP-UX operating system can be a node on the Ethernet/IEEE 802.3 LAN. Up to 30 nodes can be connected by a ThinLAN coax cable up to 185 meters long. Up to 100 nodes can connect to a ThickLAN coax cable up to 500 meters long. The ThinLAN and ThickLAN cables can be joined with up to two repeaters to cover distances up to 555 and 1500 meters respectively. The link speed is 10 Mbps.

The HP 9000 Series 300, 500 and 800 computers running HP-UX support HP's Network Services (NS) for Network File Transfer (NFT) and Remote File Access HP-UX (RFA/HP-UX). NS NFT is also available for the DEC VAX VMS, HP 3000 and HP 1000 (Call your local HP sales office for the specific networking configuration you need). RFA/HP-UX allows remote file sharing between HP-UX systems. In addition, Series 300 and Series 800 HP-UX supports the TCP/IP-based ARPA and Berkeley network services. The ARPA capabilities are File Transfer Protocol, TELNET (virtual terminal) and Simple Mail Transfer Protocol. The Berkeley capabilities are remote

copy, remote login, sendmail, remote shell (remote command execution), sockets (interprocess communication), and utilities. Since the ARPA and Berkeley networking services are de facto industry standards, Series 300 and Series 800 HP-UX systems can communicate with computers from many other vendors. The diagram at left represents HP 9000 computers networked in a multi-vendor environment. For any two systems to communicate, they must run the same type of software (ARPA to ARPA, Berkeley to Berkeley, NS to NS).

HP-UX Data Communications

Most UNIX and UNIX-like operating systems provide asynchronous communications between two computers using standard commands. These commands include uucp (UNIX to UNIX copy) for file transfer, cu (call UNIX) for terminal access (virtual terminal) and uux (UNIX to UNIX execute) for remote command execution. These commands are bundled with the HP-UX operating system for the HP 9000 Series 200, 300, 500 and 800. The HP-UX Tools package provides these commands for the Integral PC. The DataComm Pack for the Integral PC offers additional flexibility and versatility in asynchronous communications with non-UNIX computers.

Asynchronous communication takes place over hardwired, leased, dial-up and X.25 lines. An RS-232 interface is sufficient for hardwired operation. All other connections require a modem-compatible interface and cable. An X.25 connection requires a modem port on an HP 2334A Multi-MUX X.25 cluster controller or comparable PAD (Packet Assembler-Disassembler).

Additional file transfer capabilities are available for some of the HP 9000 Series. The Kermit file transfer program popular on MS-DOS systems is bundled with HP-UX for the Series 200, 300 and 500. Kermit is also available for the Integral PC through the public domain. The UMODEM file transfer program popular on microcomputers is bundled with HP-UX on the Series 200, 300 and 500, and is part of the DataComm Pack for the Integral PC. Kermit or UMODEM must also be available on the computer that the HP 9000 is communicating with. The Remote Job Entry products for the Series 200, 300 and 500 can transfer files to IBM hosts by emulating the IBM 2780 Data Transmission Terminal and the IBM 3780 Data Communications Terminal.

HP Shared Resource Management

HP 9000 Series 200s, 300s and 500s running the BASIC or Pascal operating systems can connect directly to a proprietary SRM network in order to share information and peripherals (see below). Up to 25 nodes can connect to an SRM coax cable up to 1000 meters long. Multiple SRM networks may be connected to a server and/or workstation for a total of 63 workstations per server. The link speed is 700 Kbps.

HP 9000 Series computers running HP BASIC or Pascal operating systems can connect directly to HP's Shared Resource Management (SRM) network.

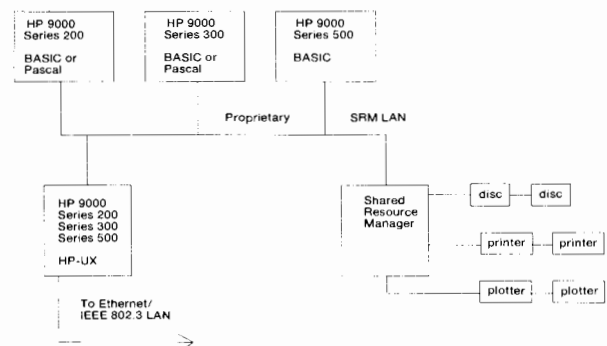



A server called the Shared Resource Manager is a node on the network that provides a shared hierarchical file system and spooled printer and plotter support. Workstations communicate only with the server(s) and vice-versa.

BASIC and Pascal workstations can be discless using the server's file system as their sole file system (including system boot). HP-UX workstations may be included in the SRM network. HP-UX workstations transfer files to and from the SRM Server and submit data for spooling to a printer and plotter by writing to a file in one of the server's spool directories.

Terminal Emulators

A terminal emulator program running on an HP 9000 controls the keyboard and display so that the workstation behaves like a terminal when connected to a host computer. The HP 9000 may emulate a generic ASCII terminal or a vendor-specific terminal such as an HP 2392A, DEC VT100 or IBM 3278. HP's terminal emulator programs usually include file transfer capability. The physical connections are point-to-point, RS-232-C or coax and either hardwired or modem. HP offers the following terminal emulators for the HP 9000 family.

- Data Comm Pack for the Integral PC
 - Data Comm Pack for the Series 80
 - AdvanceLink 2392 (includes VT100 and VT52) for the HP Vectra
 - 3278 Emulator for the HP Vectra
 - HP 2392A/VT100 Terminal Emulator for the Series 200/300 (standalone or Pascal)
 - 3278 Emulator for the Series 200/300 (standalone or Pascal)
 - Asynchronous Terminal Emulator for the Series 500 (BASIC)
- Many other terminal emulators are available through third parties (See page 163).

Ordering Information

Local Area Network (LAN)

HP-UX Tools for Integral PC	HP 82856J	\$ 495
Network Services-ARPA Services/300	HP 50952B	\$ 995
LAN/9000 Series 300 Link	HP 98643A	\$1300

Network Services/9000 Series 500	HP 50954A	\$4000
LAN/9000 Series 500 Link	HP 27125B	\$2550
Network Services/9000 Series 800	HP 98195A	\$4000
ARPA Services/800	HP 50980A	\$10,000
LAN/9000 Series 800 Link	HP 98194A	\$6000
Network Services for the VAX	HP 50950A	\$5000/7000

HP-UX Data Communications

HP-UX Tools for Integral PC	HP 82856J	\$ 495
DataComm Pack for Integral PC	HP 82815J	\$ 195
RJE/200 Emulator	HP 50966A	\$1500
RJE/300 Emulator	HP 50967A	\$1500
RJE/300/200 Interface	HP 98641A	\$1250
RJE/500 Emulator	HP 50968A	\$2500
RJE/500 Interface	HP 27122A	\$2115

Shared Resource Management

Resource Management Server	HP 50960A	\$4995
Keyboard (ASCII) for Server	HP 46020A	\$ 225
12-inch Video Monitor for Server	HP 82913A	\$ 325
SRM Coax Interface for Series 200/300	HP 50962A	\$ 845
Coax Adapter/Interface for Series 500	HP 50961A #500	\$2395

Terminal Emulators

Data Comm Pack for Integral PC	HP 82815J	\$ 195
Data Comm Pack for Series 80	HP 82821A	\$ 200
Advancelink 2392 for Vectra	HP 68333F	\$ 295
3278 Emulator for Vectra	HP 50920A	\$1195
HP 2392A/VT100 Terminal Emulator for Series 200/300 Standalone or Pascal	HP 98791B	\$ 500
3278 Emulator for Series 200/300 Standalone or Pascal	HP 50955A	\$1500
Asynchronous Terminal Emulator for Series 500 BASIC	HP 97056A	\$ 500

Summary of HP 9000 Networking

Feature	Product Class	Local Area Network	HP-UX Async Data Comm	Shared Resource Management	Terminal Emulators
Operating System		HP-UX	HP-UX	BASIC Pascal HP-UX	various
Network Services ¹		FT, TA, M, RCX, IPC, RFA, LLA	FT, TA, M, RCX	RFA (BASIC and Pascal) FT (HP-UX)	FT, TA
Systems on Network		HP, DEC, Sun, most UNIX hosts	any UNIX, most async hosts	HP 9000	HP, DEC, IBM, most async hosts
Link rate		10 Mbps	9.6 Kbps	700 Kbps	9.6 Kbps
Maximum distance		1500 meters	unlimited	1000 meters	unlimited
Maximum nodes		255	unlimited	25	unlimited
Connect method		coax	RS-232C X.25	coax	RS-232-C

¹FT-file transfer, TA-terminal access, M-mail, RCX-remote command execution, IPC-interprocess communication, RFA-remote file access, LLA-link level access



TECHNICAL COMPUTER SYSTEMS

HP 9000 Technical Computers

Artificial Intelligence Development Environments

Artificial Intelligence

There are many changes occurring in software development. One of the most significant is that Artificial Intelligence (AI) techniques are moving swiftly out of the laboratory into industry. This is especially true for symbolic, logic and knowledge-based programming.

AI techniques can and will be used in practically all computer applications. These AI techniques are being used to create new applications and can be melded with existing software to increase its scope and usability.

HP has recognized the need for specialized software to help in the design and creation of applications using AI. HP has taken an approach of offering a balance of AI and conventional computing technology in a single system. This offers the application designer the best of both technologies.

Symbolic Programming

LISP, LISt Processing language, was developed in the late 50s to aid in the development of computer programs which could replicate human thinking. Common LISP is the dialect of LISP which has become the defacto standard.

LISP provides improved symbolic computing, automatic management of dynamic data structures, ease of language extension, equivalence between data and source code and a combination of features which allow incremental software development.

HP's Development Environment for Common LISP is a software product designed for the development of LISP-based applications. It balances the capability of symbolic computing with the capabilities of a general-purpose workstation. The benefits include:

- An integrated development environment to improve productivity for both LISP and traditional languages
- Common LISP, the standard of LISP dialects, for portability
- An optimized compiler for good performance on a workstation
- A symbolic debugging environment for faster LISP development
- HP-UX access to leverage the tools and libraries of a standard operating system
- Traditional language access to use existing software in FORTRAN, Pascal and C
- A range of workstations and peripherals to tailor the computer system to the application

Logic Programming

PROLOG (PROgramming in LOGic), first developed in Europe in the early 1970s, is rapidly gaining in popularity. The Japanese have chosen it as the basic language for their Fifth Generation Computer Project.

Unlike conventional programming languages which force the programmer to write programs that are prescriptions of how to solve a problem, PROLOG lets the programmer describe the problem via symbolic logic in much the same way humans reason.

HP PROLOG resides on top of Common LISP, which lets the user combine the best qualities of both languages. The benefits of HP PROLOG include:

- Ability to blend PROLOG and Common LISP code
- One development environment to learn for both languages
- Combination of Edinburgh C-PROLOG syntax for portability and an s-expression syntax more similar to LISP
- A more powerful implementation for serious applications with extensions including improved I/O, more data types, a package system and a richer set of control structures.

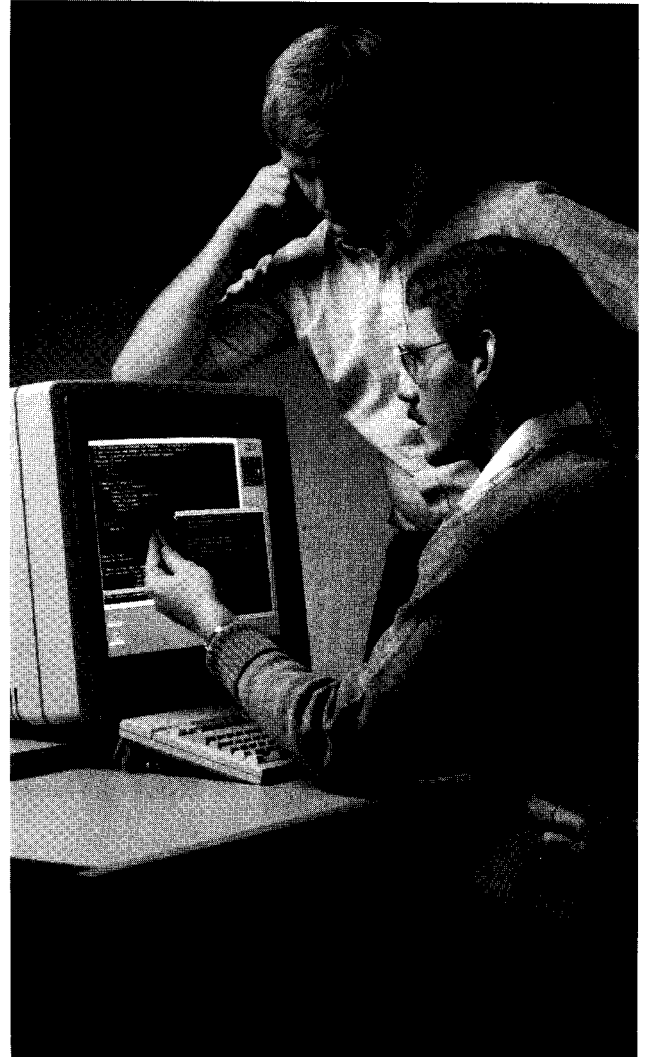

Artificial Intelligence software techniques can and will be used in practically all types of computer applications. AI will, over the coming years, be used to increase the scope and capability of existing applications, and to create whole new applications. HP offers development systems that provide Common Lisp and Prolog, combined with the best conventional computing technology.

Knowledge Based Programming

The field of Artificial Intelligence has been greatly enhanced by independent software companies. This is especially true in knowledge-based programming and expert system tools. Check the HP Software Supplier Catalog under "AI" and you will find the leading vendors represented (see page 163).

Ordering Information

In addition to the software products, HP has created AI Development Systems, which are bundles of hardware (excluding discs) and software tailored to the needs of software developers at a more attractive price.

Development Environment for Common LISP	98678A	\$ 4,000
HP PROLOG	79232U	4,050
Monochrome AI Development System	98584A	21,400
Color AI Development System	98585A	29,800
Execution License for Common LISP	98679A	750

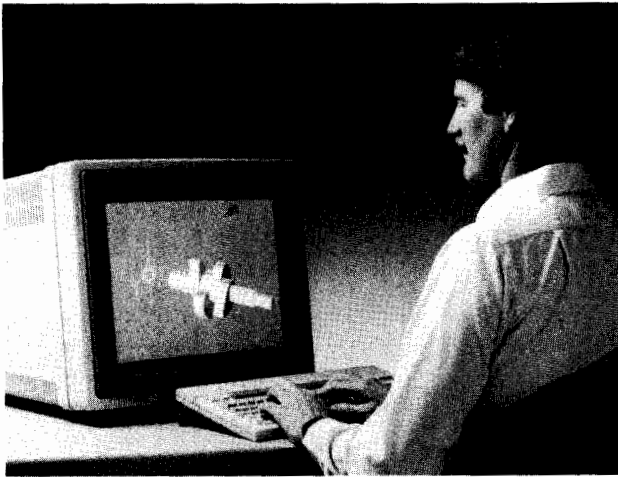

High-performance graphics subsystems

HP 9000 Graphics Hardware

HP offers a variety of graphics display options for the Model 9000 workstations which allows the user to customize the workstation to provide the desired graphics performance.

HP 9000 Series 300 Display Options

The modularity of the Series 300 allows the system to be configured into one of four different display options providing medium and high resolution graphics on either monochrome or color displays. All video options are supported by the BASIC, PASCAL and HP-UX operating systems.

HP 98542A video board provides 512 X 400 pixel resolution on a monochrome display. It operates with the 35731A 12 inch monochrome monitor. \$800

HP 98543A video board provides 512 X 400 pixel resolution on a color display. It can display 16 simultaneous colors from a color palette of over 16 million colors. The 98543A operates with the 35741A 12 inch color monitor. \$2,400

HP 98544B video board provides 1024 X 768 pixel resolution on a monochrome display. It operates with the 98781B 17 inch monochrome monitor. \$1,400

HP 98546B video board provides compatibility with Series 200 displays. It is a 512 X 400 pixel monochrome alpha/graphics video board which operates with the 35731A monitor. \$850

HP 98547A video board provides 1024 X 768 pixel resolution on a color display. This board provides a total of 6 video memory planes which can be used to display 64 colors from a color palette of over 16 million colors. Alternatively, the board may be used to display 16 colors and provide 2 overlay planes. The 98547A operates with the 98782A and 98785A color monitors or the 98781B greyscale monitor. \$4,500

HP 9000 Graphics Subsystems

HP 98700H is a 4-plane high-performance color graphics subsystem which may be used with either the Series 300 or Series 500 systems. An optional graphics accelerator, **HP 98710A**, provides hardware assist for accelerated transforms and clipping, features especially suitable for 3D wireframe applications requiring interactive response. With the **HP 98701A**, the 98700H may be further upgraded to a total of 8 color planes to provide 256 colors on a 1024x768 resolution display. The **HP 98700H** comes bundled with a keyboard and 19 inch color monitor. It is connected to the system bus with an interface card which takes one I/O slot.

HP 98700H \$15,000
 HP 98701A \$ 2,740
 HP 98710A \$ 7,310

HP 98720A is an extensible high-performance graphics subsystem for the Series 300 workstations. The base system is provided with a 1280 X 1024 resolution 60 Hz non-interlaced color display and 4 independent graphics/alpha overlay planes which will display 16 colors from a palette of over 16 million colors. With the **HP 98721A** graphics accelerator, the **HP 98720A** subsystem may be optimized to provide interactive response for such applications as solids modeling, molecular modeling, terrain modeling, high-end AEC, and imaging. The accelerator provides the hardware assistance for fast rendering of smoothly shaded objects with automatic hidden surface removal and

multiple light sources. The system is expandable to 36 planes of graphics memory in increments of 8 planes with the **HP 98722A** memory upgrade.

HP 98720A \$11,000
 HP 98721A \$10,000
 HP 98722A \$ 4,500

HP 9000 Graphics Software

HP provides a set of software tools which allow the application programmer to interact with, and send graphics output to, a wide variety of graphics display devices. HP provides industry standard tools based on CG-VDI, GKS and other industry standards. The intent of these standards is to provide a common interface to graphics devices across the industry.

Starbase Graphics Library is a high performance 2-D and 3-D graphics library for the HP 9000 family. It is included with HP-UX and is an extension of the ANSI VD-CGI standard currently under development. Starbase provides procedures to perform basic graphics operations including lines, markers, text, polygons and B-splines. Control functions, inquiry functions and echoing are also supported. Starbase is capable of applying 2-D and 3-D transformations to output primitives, generating high quality text and shaded polygons and providing synchronous and asynchronous input to the application.

HP 98XXXX Starbase Driver Development Guide is a set of documentation that provides instructions on how to develop device drivers for the Starbase graphics library and devices not supported by HP.

HP 98672A/98673A HP-GKS graphics library is fully compatible with Level 2b of the ANSI/ISO Graphical Kernel System standard. The library provides application portability and high performance for HP-UX, accessible from FORTRAN, C and Pascal.

Series 300 HP 98672A \$ 1,000
 Series 500 HP 98673A \$ 3,000

HP 98520A/600A consists of two sets of procedure libraries: DGL (Device-independent Graphics Library) and AGP (Advanced Graphics Package). Both can be called from application programs. The library must be used in conjunction with the HP-UX operating system.

Series 300 HP 98520A \$ 1,000
 Series 500 HP 98600A \$ 2,600

HP 98683X/84X DGL Skeleton Device Handler allows interfacing to HP graphics libraries. The Skeleton Handler is largely FORTRAN source code which may be used as a template to add the commands that direct a chosen device to perform desired functions.

Series 300 HP 98603 \$ 495
 Series 500 HP 98684 \$ 1,000

HP 9000 Graphics Hardware Summary

Model	98542A	98543A	98544B	98546A	98547A	98700H	98720A
Resolution	512 X 400	512 X 400	1024 X 768	512 X 400	1024 X 768	1024 X 768	1280 X 1024
Color Planes	1	4	1	1	6**	4‡	4‡
Colors*	1 mono-chrome	16	1 mono-chrome	1 mono-chrome	16 or 64	16-256	16 - 16Mil
Monitor Supported††	35731A/B 12"	35741A/B 12"	98781B 17"	35731A 12"	98782A 19" 98785A 16" 98781B 17"	98782A 19" 98781B 17"	98784A 19"
Available Options							
- 4 plane graphics memory	N/A	N/A	N/A	N/A	N/A	98701A	N/A
- 8 plane graphics memory	N/A	N/A	N/A	N/A	N/A	N/A	98722A
- Graphics accelerator	N/A	N/A	N/A	N/A	N/A	98710A	98721A
Systems Supported							
- Series 300	YES	YES	YES	YES	YES	YES	YES
- Series 500	NO	NO	NO	NO	NO	YES	NO
Operating Systems Supported							
- HP-UX	YES	YES	YES	YES	YES	YES	YES
- BASIC	YES	YES	YES	YES	YES	NO	NO
- PASCAL	YES	YES	YES	YES	YES	NO	NO

*Displayable colors from a palette of 16 million. When using the 98781B greyscale monitor on a color system, colors pertain to shades of grey.

**98547A may be used to display 16 colors with two overlay planes or 64 colors with no overlay planes.

‡98700H and 98720A base systems provide 4 color planes and may be upgraded with memory options to provide a total of 8 and 36 planes respectively. See options.

††All monitors have switch-selectable 115/230VAC. "B" versions are preset to local power settings and have local product regulatory approval.

TECHNICAL COMPUTER SYSTEMS

Peripheral Interfacing Summary

This table shows peripherals that can be connected to many Hewlett-Packard technical computers. Information about EMI compliance and support of a specific system is available from a Hewlett-Packard sales office in your area. For peripheral interfacing information on the HP Integral and HP Vectra Personal Computers, see page 122.

HP Technical Computer Peripheral Interfacing Summary*

HP Product	Description	Page	HP 9915B	Series 200		Series 300			Series 500		Ser. 800	HP 1000 Series	
			85B 86B	B	P	B	P	U	B	U	U	E	A
2225A	ThinkJet (HP-IB)	106	•	•	•	•	•	•	•	•			
2225B/C	ThinkJet (HP-IL/Parallel)	106											
2225D	ThinkJet (RS-232C)	106		•	•	•	•	•	•	•	•		•
2227A	QuietJet Plus (RS-232C)	106		•	•	•	•	•	•	•	•		•
2392A	Alphanumeric terminal	98						•		•	•	•	•
2393A	Graphics terminal	97						•		•	•	•	•
2394A	Data Entry Terminal	98						•		•	•	•	•
2397A	Color graphics terminal	97						•		•	•	•	•
2563A/64B/66B	Line printers, 300/600/900 lpm	105		•	•	•	•	•	•	•	•	•	•
2567B	Line printer, 1200 lpm	105		•	•	•	•	•	•	•	•		
2603A	Daisywheel impact printer	106		•	•	•	•	•	•	•			
2686A/D	LaserJet [Plus, 500]	105		•	•	•	•	•	•	•	•		•
2680A	45 ppm laser printer	105								•	•		•
2932/34A	Impact printers, 200 cps	107	•	•	•	•	•	•	•	•	•	•	•
35401A	536 Mbyte tape autochanger	104		•	•	•	•	•	•	•	•		
37201A	HP-IB Extender (RS-232C)	136	•	•	•	•	•	•	•	•			•
37204A	HP-IB Extender (Coax)	136	•	•	•	•	•	•	•	•		•	•
46060A	HP Mouse (HP-HIL)	77		•	•	•	•	•	•	•	•		
46085A	Control Dial Module (HP-HIL)	77		•	•	•	•	•	•	•			
46086A	32 Button Box (HP-HIL)	77		•	•	•	•	•	•	•			
46087A/B	A/B-size digitizers (HP-HIL)	77		•	•	•	•	•	•	•	•		
46095A	3-button mouse (HP-HIL)	77		•	•	•	•	•	•	•			
7440A	ColorPro plotter	110		•	•	•	•	•	•	•	•	•	•
7475A	Plotter, A/B-size, 6-pen	111	•	•	•	•	•	•	•	•	•	•	•
7510A	Film recorder	118		•	•	•	•	•	•	•	•	•	•
7550A	Auto-feed plotter, A/B, 8-pen	112	•	•	•	•	•	•	•	•	•	•	•
7570A	DraftPro plotter	114		•	•	•	•		•	•	•		•
7580/85B	Drafting plotters, A→D/E-size	116	•	•	•	•	•	•	•	•	•	•	•
7586B	Roll-feed 7585B plotter	116	•	•	•	•	•	•	•	•	•	•	•
7907A	Cartridge disc, 20/20 Mbytes	103		•	•	•	•	•		•		•	•
7914CT/P/R	Disc/ctg. tape, 132 Mbyte	102		•	•	•	•	•	•	•	•	•	•
7914ST	Disc/9-tk tape, 132 Mbyte	102						•	•	•	•		•
7933/35H	Disc, 404 Mbyte fixed/rem.	103						•	•	•	•	•	•
7933/35XP	7933/35H plus cache	103										•	•
7941/45A	Disc, 24/55 Mbyte	102		•	•	•	•	•	•	•		•	•
7942/46A	Disc/tape, 24/55 Mbyte	101		•	•	•	•	•	•	•		•	•
7974A	Tape, 1600/800 cpi 9-track	104						•	•	•	•	•	•
7978B	Tape, 6250/1600 cpi 9-track	104						•	•	•	•		•
9122D/S	Flexible disc, 3½-in.	100		•	•	•	•	•	•	•	•	•	•
9127A	Flexible disc, 5¼-in.	100		•	•	•	•	•	•	•	•		
9133/34H	Disc, 20-22 Mbyte winchester	100		•	•	•	•	•	•	•			•
9133/34L	Disc, 40-44 Mbyte winchester	100		•	•	•	•	•	•	•			•
9144A	Tape, ¼-in. cartridge	100		•	•	•	•	•	•	•	•	•	•
9153/54A	Disc, 10 Mbyte winchester	100		•	•	•	•	•	•	•			
92916A	Bar code reader (HP-HIL)	77		•	•	•	•	•	•	•	•		
98700H	Graphics display station	87				•	•	•		•			
98720A	Graphics controller	87						•					

* Depending upon the computer and peripherals used, this table may not reflect special requirements or limitations involved in an intended configuration. Consult your HP sales representative or authorized dealer for details.



Series 800 and 500 Interfaces

The following interfaces and memory enhancements are available for HP 9000 Series 800 and Series 500 Technical Computers:

3+5 Mbyte RAM Controller/Array	Series 800	HP 19748A	\$48,000
HP-IB Interface —Allows communication with as many as 31 HP-IB-compatible device addresses and 15 standard device loads	Series 800 & 500	HP 27110B	\$1,010
GPIO Interface —Provides 16 bits of latched input and output data for bidirectional information transfer and control of GPIO-compatible devices.	Series 500	HP 27112A	700
Parallel AFI Interface	Series 800	HP 27114A	1,600
HP-CIO Service Extender —Extender card for out-of-card-cage access to HP-CIO interface card.	Series 800 & 500	HP 27116A	400
RJE Interface —Used by HP-UX 97077/87 software for batch transmission to another computer using IBM 2780/378 binary synchronous protocol.	Series 500	HP 27122A	2,115
LAN Interface —Provides connection to IEEE 802.3 or Ethernet LAN.	Series 500	HP 27125B	2,550
ASI Interface —Single-channel asynchronous interface for linking to RS-232C-compatible device.	Series 500	HP 27128A	910
Eight-channel Multiplexer Interface —Supports up to eight RS-232C devices.	Series 500	HP 27130B	2,100
Six-channel Modem Multiplexer Interface —Supports up to six RS-232C/CCITT-V.22-compatible devices	Series 800 & 500	HP 27140A	2,400
SRM Interface —For BASIC and HP-UX access to shared discs, printers and plotters on Shared Resource Management (SRM) system.	Series 500	HP 50961A	2,395
RGB Interface —Color video interface to display color graphics on external monitor, used with BASIC 97052, HP-UX 97074/84 and Graphics software 97075/85.	Series 500	HP 97062A	2,520
Lan/800 Link and Transport protocols	Series 800	HP 98194A	6,000
High-Resolution Graphics Display Station —Provides four plane color graphics display, 1024 × 768 resolution, 19-in monitor, keyboard and cables.	Series 500	HP 98700H	15,000
Extra four planes graphics memory for 98700H —	Series 500	HP 98701A	2,740
Graphics Accelerator for 98700H	Series 500	HP 98710A	7,310
Series 200 and 300 Interfaces			
3278 Display Station Emulator	Series 300	HP 50955A	1,500
SRM Coax Interface —Provides connection to Shared Resource Management (SRM) System	Series 200 & 300	HP 50962A	845
EPROM Programmer Interface —EPROM programmer card for installation in any HP-DIO backplane slot.	Series 300	HP 98253A	1,500
EPROM Card —Contains 16 sockets for EPROMs to allow up to 256 kbytes of storage using INTEL 27128 EPROMs.	Series 200 & 300	HP 98255A	300
RAM Memory Card, 256 kbyte	Series 300	HP 98256A	600
RAM Memory Card, 1 Mbyte	Series 300	HP 98257A	1,450
Bubble Memory Interface, 128 kbytes —Non-volatile memory that appears like flexible disc to operating system	Series 300	HP 98259A	1,900

Interface to connect 98700H

Series 300	HP 98287A	655	
Bus Expander —Provides eight additional DIO card slots with four slots for either memory or I/O and four slots for memory only	Series 300	HP 98568A	1,900
BASIC 4.0 ROM Card	Series 300	HP 98603A	1,860
DMA Controller, 2-channel	Series 200 & 300	HP 98620B	500
GPIO Interface —Provides 16 bits of latched input and output data for bidirectional information transfer, and permits interfacing to GPIO-compatible equipment.	Series 200 & 300	HP 98622A	355
BCD Interface —Connects Series 300 with bit-parallel, digit-parallel, binary-coded decimal services for data input.	Series 200 & 300	HP 98623A	385
HP-IB Interface —Provides communication with as many as 14 HP-IB-compatible instruments.	Series 200 & 300	HP 98624A	330
High-Speed Disc Interface —Connects disc drives and other high-speed HP-IB devices.	Series 200 & 300	HP 98625A/B	605
Serial Interface, RS-232C —Simple, asynchronous serial communications.	Series 200 & 300	HP 98626A/44A	380
RGB Color Video Output Interface —Graphics output device with programmable display formats up to 512 × 512 resolution	Series 200 & 300	HP 98627A	1,010
Data Communications Interface —Protocol management and electrical levels for asynchronous serial communications	Series 200 & 300	HP 98628A	485
Breadboard Interface —Backplane buffering circuits and dual-inline holes for user-mounted circuit components.	Series 300	HP 98630A	320
6944A Multiprogrammer Interface	Series 300	HP 98633A	350
Floating Point Math Board —Provides hardware floating point capability for Series 200 and Model 310 computers.	Series 200 & 300	HP 98635A	975
Analog-to-Digital Card (ADC) —Provides seven channels of 55,000 readings per second for data acquisition	Series 200 & 300	HP 98640A	990
RJE 2780/3780 Interface —Emulates IBM 2780/3780 when used with 98797/98A/R/M software in an HP-UX system with asynchronous modem.	Series 200 & 300	HP 98641A	1,250
RS-232C MUX Interface, 4-port —Three direct connect and one modem port.	Series 200 & 300	HP 98642A	600
LAN 300 Link —Connects to IEEE 802.3 or Ethernet, 10-Mbyte/second ThinLAN.	Series 300	HP 98643A	1,300
VME Interface —Connects Series 200/300 computers to VMEbus card cage.	Series 200 & 300	HP 98646A	1,272
Programmable Datacommunication Interface (PDI) Development Package for 98691A	Series 300	HP 98690A	405
Programmable Datacommunication Interface (PDI) . Development package for special data communications or serial interfacing.	Series 200 & 300	HP 98691A	650
IBM 3270 Coax Interface —Connects Models 216/220/236 to IBM 3270-compatible controller.	Series 300	HP 98695A	1,200
HP-DIO Bus Extender —Provides 16 additional card slots with eight slots for either memory or I/O and eight slots for memory only.	Series 200 & 300	HP 9888A	3,530

TECHNICAL COMPUTER SYSTEMS

Technical Office Automation Software

HP 9000 Series 200, 300, 500 and Integral PC

Technical Office Automation

Technical Office Automation Software is a key part of the Technical Computing Environment HP provides for its customers. Research shows that engineers typically spend more than 50% of their time planning, communicating and documenting their work—doing what HP calls Technical Office Automation. Using HP Technical Office Automation software, you can meet your documentation, analysis and presentation needs and increase your productivity.

The following Technical Office Automation software is licensed, marketed and fully supported by HP. Additional Technical Office Automation applications are available from the HP Plus program and are listed in the HP Technical Software Catalog (see page 163).

Integrated Software

Alis®/HP-UX is an HP DesignCenter product that provides document composition, spreadsheet analysis, business or data graphics, sketching graphics, personal database, calendar/time management and electronic mail. Alis/HP-UX uses active integration to combine text, spreadsheet, and graphics into compound documents that appear on bit-mapped devices in a "what-you-see-is-what-you-get" format.

Context MBA™ performs spreadsheet modeling, word processing, business graphics, database management, forms and telecommunications.

Graphics

Picture Perfect™ creates bar, pie, line and combined bar/line charts.

Diagraph™ clip-art software creates a variety of presentation aids, organizational charts, diagrams, forms, signs and flow charts.

Graphics Editor creates charts and diagrams

Data Grapher turns numbers into charts and graphs

Graphics Presentations creates bar, line and pie charts

Word Processing

MemoMaker/HP-UX creates memos, letters and reports

Text Editor creates memos, letters and reports

Spreadsheet

Multiplan®/HP-UX provides financial modeling, forecasting and calculation of engineering and scientific formulas.

Math and Statistics

Statistics Library, Statistics Library Part I, Statistics Library Part II provides an economical set of routines for data exploration, analysis and graphics display.

Numerical Analysis provides seven commonly used analysis routines which may be added to application programs.

TK!Solver®/HP-UX solves complex math models using either your own design or specialized templates called TK!SolverPacks®/HP-UX.

Project Management

MicroTrak™/HP-UX provides a critical-path method scheduling system for managing complex projects.

PlotTrak™/HP-UX takes the schedule generated by MicroTrak/HP-UX and produces time-scaled precedence network diagrams or GANTT (bar) charts.

Project Management incorporates PERT, CPM, and MPM network analysis and produces GANTT charts.

Bundles

The Management Solution/HP-UX gives you MemoMaker/HP-UX, MicroTrak/HP-UX and Multiplan/HP-UX at a saving of 15% over their combined list prices.

Ordering Information

Product	Product Numbers				
	Series 200 HP-UX, 2.1, 2.2 and the Integral PC Running 2.1 or 5.0	Series 200 and 300 HP-UX 5.1	Series 500 HP-UX 5.0	Series 200 and 300 Basic 4.0	Series 200 and 300 Stand alone
Alis/HP-UX		HP 98801V (single-user) \$2500 HP 98801W (1-4 user) \$4000			
MicroTrak/HP-UX	HP 45524G \$775 HP 45524H \$1550	HP 45524V \$775 HP 45524W \$1550	HP 45524U \$2500		
PlotTrak/HP-UX	HP 98800J* \$500	HP 98800V \$500 HP 98800W \$1000	HP 98800U \$1500		
Picture Perfect/HP-UX	HP 45462J** \$595	HP 45462V‡ \$595			
Diagraph/HP-UX	HP 45463J** \$695	HP 45463V‡ \$695			
TK!Solver/HP-UX	HP 45515G \$499 HP 45515H \$999	HP 45515V \$499 HP 45515W \$999	HP 45515U \$1495		
TK!SolverPacks/HP-UX:					
Financial Mgt	HP 45516G \$125	HP 45516V \$225	HP 45516U \$225		
Mechanical Engineering	HP 45517G \$125	HP 45517V \$225	HP 45517U \$225		
Building Design & Construction	HP 45518G \$125	HP 45518V \$225	HP 45518U \$225		
Introductory Science	HP 45519G \$125	HP 45519V \$225	HP 45519U \$225		
Multiplan/HP-UX	HP 45473G \$345 HP 45473H \$595	HP 45473V \$395 HP 45473W \$695			
MemoMaker/HP-UX	HP 45420G \$195 HP 45420H \$395	HP 45420V \$245 HP 45420W \$495			
Management Solution/HP-UX	HP 45438G \$1118 HP 45438H \$2159	HP 45438V \$1195 HP 45438W \$2329			
Picture Perfect					HP 45462B** \$595
Diagraph					HP 45463B** \$695
Data Grapher					HP 45480B \$375
Graphics Editor					HP 45537B \$525
Text Editor				HP 45538B \$325	
Statistics Library				HP 98820A \$1500	
Statistics Library Part I				HP 98820B \$925	
Statistics Library Part II				HP 98820C \$750	
Numerical Analysis				HP 98821A \$500	
Project Management				HP 98817A \$500	
Graphics Presentation				HP 98815A \$750	
Context MBA					HP 45481B** \$795

Note:

§Series 200 console not supported; Alis/HP-UX is supported only on terminals running on these systems.

*'G' and 'V' suffixes designate single-user products.

'H' and 'W' suffixes designate multi-user products.

'U' suffix designates multi-user Series 500 products.

*Supported only on the Integral Personal Computer.

†Supported on the Integral PC running HP-UX 5.0.

‡Supported on the Series 300 only.

**Requires the Display Compatibility Interface (HP 98546A) to run on the Series 300.

Alis® is a registered trademark of APPLIX, Inc.

MicroTrak™ is a trademark of SoftTrak™ Systems.

PlotTrak™ is a trademark of SoftTrak™ Systems.

Picture Perfect™ is a trademark of Computer Support Corporation.

Diagraph™ is a trademark licensed to Computer Support Corporation.

Context MBA™ is a trademark of Context Management Systems.

*TK!Solver/HP-UX is required to operate a TK!SolverPack/HP-UX template program.

TK!Solver® and TK!SolverPack® are registered trademarks of Universal Technical Systems.

Multiplan® is a registered trademark of MicroSoft Corporation.



HP's new Series 300 DOS Coprocessor bridges the gap between UNIX and MS-DOS operating systems, creating a dual-purpose computer.

Series 300 DOS Coprocessor

HP's new Series 300 DOS Coprocessor System provides PC AT PC-DOS software compatibility for HP 9000 Series 300 Technical Workstations. HP 9000 Series 300 workstations can now use literally thousands of DOS technical office automation software applications.

Running in an HP-UX environment, the HP Series 300 DOS coprocessor bridges the gap between the UNIX* and MS-DOS operating systems, creating a dual-purpose computer.

Best of Both Worlds

With the addition of the HP Series 300 DOS coprocessor, the Series 300 technical computer also can function as a personal computer. By having access to thousands of MS-DOS applications, productivity is increased on the Series 300 by easily handling everyday routine tasks, such as word processing, presentation graphics, project management, database management and spreadsheet analysis.

PC-AT on a Plug-in-Card

The DOS coprocessor system consists of a variety of hardware and software components. When combined with the DOS coprocessor software, the hardware plug-in card provides all the necessary components of a PC-AT software-compatible environment, including a high-performance 80286 processor with a socket for an 80287 numeric coprocessor, completely contained on one 5¼-inch by 6½-inch DIO interface card.

The DOS coprocessor software consists of many elements, including a PC-AT compatible version of MS-DOS—configured to emulate IBM's PC-DOS™ 3.1—Vectra's Personal Applications Manager (PAM), an extensive utility set, and utilities to interchange BASIC, Pascal, or HP-UX ASCII files with MS-DOS format.

MS-DOS Integration within HP-UX

The coprocessor is based on HP-UX and requires the application-execution environment (AXE). MS-DOS operates as a true HP-UX task. This offers MS-DOS integration with features of HP-UX, such as networking (uucp, cu, LAN), multi-tasking, windowing and file sharing between HP-UX and MS-DOS (one DOS task and one DOS window).

BASIC/Pascal Integration

The system has also been designed to make it easier for the BASIC/Pascal Series 300 customer to use. Capabilities include:

1. Ability to configure the system to directly boot DOS from BASIC/Pascal. This effectively hides HP-UX from view, for those who prefer not to use it. This technique also frees a significant amount of hard disc space.
2. The 98286T bundled system provides the DOS Coprocessor System and an additional 1Mbyte memory card, priced to save some 40% on the purchase of an additional memory card.

3. All new HP 9133H and 9134H 20-Mbyte disc drives are shipped with a new configuration option which allows segmentation of the hard disc into two volumes of approximately 5 and 15 Mbytes. Using this setting, a BASIC customer could install BASIC in the 5-Mbyte section and HP-UX/DOS in the 15-Mbyte section. This feature also is available for all existing HP 9133H and 9134H drives by ordering an inexpensive ROM upgrade.

Shared-system Resources

The DOS coprocessor system is designed to take advantage of shared-system resources wherever possible. The following components, for example, are shared between HP-UX and MS-DOS: keyboard, memory, displays, printers and plotters, file system, and RS-232-C ports. Designing the system in this fashion provides a degree of DOS/UNIX operating systems integration unapproached in the industry.

In fact, the majority of the MS-DOS file system exists entirely within the HP-UX file system. A specialized DOS drive letter, preset at D:, provides a 'view' of the entire resident HP-UX file system. The user can then, using standard DOS commands, manipulate the HP-UX file system. For example, the DOS user could make directories and store and retrieve the majority of his DOS files directly from the HP-UX file system. Since all DOS files that are located on drive D: are visible also from HP-UX, these files could be manipulated using features previously available only to HP-UX files (i.e. networking). Another important benefit gained is the effective elimination of DOS's 32Mbyte hard disc volume size limitation. Drive C: is configured to appear to DOS as a standard PC AT 20Mbyte hard disc. Using this drive, even applications that directly manipulate DOS's file system are compatible. To HP-UX, this drive appears as a standard file.

The DOS coprocessor system uses existing Series 300 system memory for a more effective distribution of memory between MS-DOS and HP-UX. At the beginning of an emulation session, the user can select how much of the main-system memory should be allocated to the coprocessor.

When the coprocessor is not running, all memory purchased for the Series 300 can be utilized by the controlling operating system. The coprocessor software also has the ability to emulate the Lotus/Intel/Microsoft EMS (expanded memory specification) using standard system memory.

The software provided emulates popular video adaptors, including the standard monochrome-display adaptor, the color-graphics adaptor (CGA) and the Hercules graphics adaptor. These display resolutions are mapped onto a number of different Series 300 monitors offering multiple window sizes, gray scaling (with CGA emulation on monochrome monitors), and improved fonts.

IBM-Compatible Floppy Drive

In order to provide true off-the-shelf IBM PC-AT software compatibility, a 360-Kbyte, 5¼-inch, IBM-compatible floppy drive—the HP 9127A—is available. Providing DOS compatibility, the drive is able to read, write and format HP discs as well as provide compatibility to thousands of PC-AT MS-DOS software applications and data.

Ordering Information

	Price
HP Series 300 DOS coprocessor card	HP 98286A \$950
HP Series 300 DOS coprocessor software	HP 98531A \$495
HP Series 300 DOS coprocessor system (includes card and software)	HP 98286S \$1,295
HP Series 300 DOS/Memory Enhancement Kit (includes 1 megabyte of RAM and HP 98286S)	HP 98286T \$2,195
HP 360 Kbyte 5¼-inch IBM-compatible floppy	HP 9127A \$995
HP numeric coprocessor (80287)	HP 45987A \$375
ROM Upgrade Kit	HP 09133-89903 \$46*

*Requires installation by HP Customer Engineer

TECHNICAL COMPUTER SYSTEMS

Multi-User Real-Time Computer Systems

HP1000 Systems

- Computer-aided manufacturing
- Computer-aided test
- Real-time monitoring and control

HP 1000 Systems — Real-Time Solutions for Manufacturing and Engineering

HP 1000 is a complete, compatible family of multi-user systems, interfaces, peripherals, and software uniquely qualified to satisfy your manufacturing productivity needs at every level. HP 1000 systems provide you with the power and versatility needed for real-time monitoring and control applications — from process monitoring and control to supervising a network of computers.

A Choice of Processing Power Levels

HP 1000 systems offer a choice of three general levels of processing power, as summarized below.

Performance Level	HP 1000 Processor	Base Speed (MIPS)	Floating Point Speed (KWIPS-BID)
1	A600+ E-Series	0.4	20 12
2	A700	0.4	370*
3	A900	1.2	900

*With hardware floating point processor, which is optional in Micro 27 system, standard in Model 27 system.

Flexible, Versatile Micro/1000, Rack-Mount or Micro 16 Packaging

HP 1000 Computer Systems based on A600+, A700, and A900 processors are available in an economical Micro/1000 package that can be placed on a table or bench, installed in a space-saving vertical floor-mount that features roll-about convenience and portability, or rack mounted in a larger cabinet. In addition to its compactness and convenience, the Micro/1000 package can also incorporate integrated mass storage (a 20 megabyte mini Winchester disc and a 630 kilobyte microfloppy disc). For applications that need more card cage slots than the Micro/1000 package provides, A600+, A700, and A900 processors and E-Series based systems are available in larger rack mounted configurations.

For low-end applications, the A600+ processor is also available in a low-cost, 6-slot Micro 16 Plus bundle (photo on page 94). This bundle offers the computer, right-to-execute RTE-A, multiplexer and disc interfaces, plus disc memory and cartridge tape subsystem at significant package price savings.

Real Time Executive (RTE) Operating System-Based Compatibility

Compatibility of design throughout the HP 1000 family enables you to harness the precise level of power you need for a specific application and also gives you a clear growth path. Even after you've matched the proper combination of HP 1000 products to your initial needs, you remain free to choose an impressive number of options to keep pace with your growth. Or, if your needs change, you can smoothly reconfigure your HP 1000 to handle new applications. This compatibility extends through:

- HP 1000 Computers. The A600+, A700, A900 and E-Series computers use the same basic instruction set, so you can change processors to fit your needs with little effect on software, peripherals, or operator training. Within the A-Series (A600+, A700, and A900), software will run on all three processors without change. You can use the near "supermini" capability of the A900 for developing programs to run on the highly cost-effective A600+ computer or the mid-range A700 computer.
- HP 1000 Systems Expansion. You can move up from the smallest memory-based system to the largest disc-based system at any time — all at once or in increments.

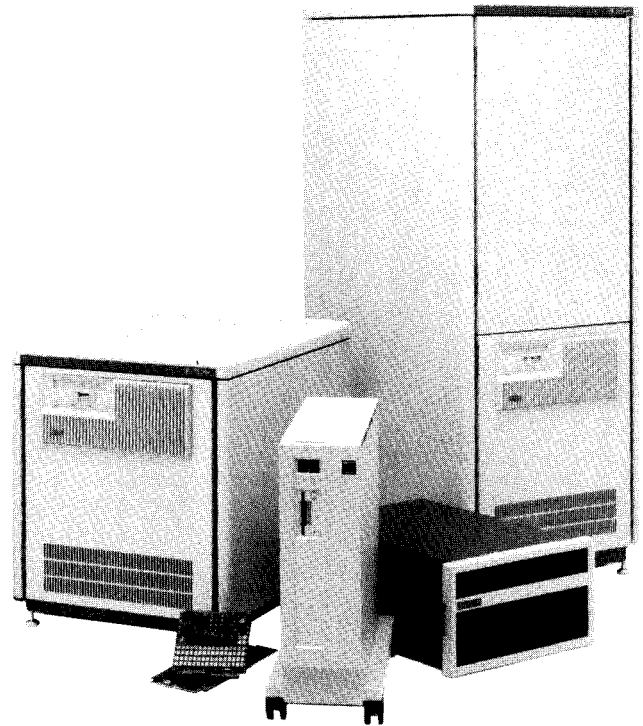

- RTE Operating System. HP's Real-Time Executive (RTE) operating system provides a solid, secure foundation of system services that are common across all of the supported HP 1000 computers. You can choose the RTE system and configuration that best suits your application and be confident that high-level language programs written and executed on one RTE system will execute on others as well with minimal modification (no change at all between A-Series computers).
- HP 1000 Software. HP 1000 software products for program development, data base management, graphics, and distributed systems networking are supported across the entire HP 1000 product line. In addition, software for process control, quality decision management, and programmable controller communications are supported in all A-Series computers. This universality of HP 1000 software helps you to tailor comprehensive, coherent solutions to your specific application needs. Further help is available from a growing array of HP 1000 software offered by third party suppliers under the HP PLUS software program.

Seven HP 1000 System Models to Choose From

The HP 1000 family includes three A-Series systems with Micro/1000 packaging, three A-Series systems in rack cabinet, and E-Series systems in rack cabinet. Each is based on a system processor unit that includes the computer, system console and disc interfaces, the system cabinet, and the RTE operating system. With a hard disc and optional software, each model can be used to develop programs in BASIC, FORTRAN 77, Pascal, and Macro/1000 Assembly language. All systems also support data base management, graphics, and distributed systems networking.

HP 1000 systems support sharable memory-resident data arrays up to 1.998 megabytes and virtual data arrays up to 128 megabytes in main memory and on disc. An enhancement package to RTE-A, called VC+, provides virtual code support for the development and execution of large programs — up to 7.75 megabytes — with automatic and transparent segmentation.

A wide choice of peripherals, I/O cards (including measurement and control cards, and an integral modem card), and software can be added to work together on your applications to maximize the value of your system investment. HP 1000 computers are well-suited to many application areas, but especially those listed on the following page.



Plant Automation

HP's wide range of hardware and software supports automation of instruments and machines as well as monitoring and control of real-time processes. The HP 1000 can help improve productivity and reduce costs. For low point-count data acquisition, test and control applications, A-Series Measurement and Control Cards provide many analog interfacing functions without the need for an add-on peripheral device. For details, see page 184.

Computer Networking

HP's networking software makes it easy to connect HP 1000 systems and other systems across a city or a continent, sharing vital information throughout the network. LAN link is now available for fast Local Area communications.

Data Base Management

Informed management decisions flow easily and confidently from the timely, accurate information maintained in an Image/1000 data base.

Interactive Graphics

Hewlett-Packard offers a complete line of graphics hardware and software — products for simplifying presentation of complex data or developing product designs. In addition to supporting the traditional graphic displays such as bar charts, pie charts, and histograms, Graphics/1000 software gives you the interactive, two and three dimensional capability needed for computer-aided drafting, mapping and design.

Compatibility with HP 9000 Model 840

PORT/HP-UX applications migration tools supplied with the HP 9000 Series 800 Model 840 system promote compatibility of HP 1000 systems with the Model 840. Multiple HP 1000 systems used as factory floor cell controllers can thus benefit from supervision and support by Model 840 systems used as Area Managers at Level 2 in the CIM hierarchy, or in similar supporting host roles. Also see description of the HP 9000 Series 800 Model 840 on page 75.

Automated Test Systems

An HP Automated Test System can be configured from the HP 1000 A ATS 1000 E-Series computers and a wide range of electronic instruments to perform virtually any electronic test application.

Ordering Information

	Price
HP 1000 Micro 26 Sys Proc Unit* w/512kB memory	\$10,000
HP 1000 Micro 27 Sys Proc Unit* w/512kB memory	\$13,100
HP 1000 Micro 29 Sys Proc Unit* w/768kB memory	\$24,600
HP 1000 Model 26 Sys Proc Unit* w/512kB memory	\$15,560
HP 1000 Model 27 Sys Proc Unit* w/512kB memory	\$23,250
HP 1000 Model 29 Sys Proc Unit* w/768kB memory	\$33,400
HP 1000 Model 60 Sys Proc Unit* w/256kB memory	\$24,750
HP 2456A Micro 16+ (A600+) Sys Bundle* w/512 kB memory	\$7,015
HP 2459A Micro 29+ (A900) Sys Bundle w/1.5 MB mem, 40 MB disc & 67 MB Cartridge Tape Subsys	\$33,550

*Requires system console and system disc for operation.

HP 1000 System Summary

	Micro 26	Micro 27	Micro 29	Model 26	Model 27	Model 29	Model 60
Base system computer type	HP 2486A	HP 2487A	HP 2489A	HP 2196C/D	HP 2197C/D	HP 2199C/D	HP 2178C
Memory cycle time	454 ns	500 ns	181 ns*	454 ns	500 ns	181 ns*	665 ns
Operating system	RTE-A	RTE-A	RTE-A	RTE-A	RTE-A	RTE-A	RTE-6/VM
Virtual Code+ available?	Yes	Yes	Yes	Yes	Yes	Yes	No
Recommended system console terminal	HP 2392A	HP 2392A	HP 2392A	HP 2392A	HP 2392A	HP 2392A	HP 2392A
I/O Channels Available	10-45	8-42	7-41	16-48	13-48	13-48	11-27
Maximum memory	4MB Parity or 8MB ECC	4MB Parity or 8MB ECC	6MB ECC	4MB Parity or 8MB ECC	4MB Parity or 8MB ECC	24MB ECC	2MB Parity or ECC
Recommended system discs	Optional built-in, 20MB fixed & 630kB microfloppy discs			HP 7911R (28.1MB)	HP 7911R (28.1MB)	HP 7914R (132.1MB)	HP 7911R (28.1MB)
Alternative disc choices	HP 7907A/7911/7912/7914/CT/P/R/7933H/7935H/7941A/7942A/7945A/7946A			HP 7907A/7911R/7912R/7914R/7933H/7935H/7941A/7942A/7945A/7946A		HP 7906M/MR/7907A/7911R/7912R/7914R 7920M/7925M/7933H/7935H 19-404MB	
	23-404MB			23-404MB			
Flexible disc available?	Yes	Yes	Yes	Yes	Yes	Yes	Yes
H/W floating point?	No	Optional	Yes	No	Yes	Yes	No
Graphics/1000-II available?	Yes	Yes	Yes	Yes	Yes	Yes	Yes
PMC/1000 available?	Yes	Yes	Yes	Yes	Yes	Yes	No
QDM/1000 available?	No	No	No	Yes	Yes	Yes	No
Programmable controller interface avail?	Yes	Yes	Yes	Yes	Yes	Yes	No
Meas & Cntrl I/F available?	Yes	Yes	Yes	Yes	Yes	Yes	No
Image/1000-II available?	Yes	Yes	Yes	Yes	Yes	Yes	Yes
DS/1000-IV communication w/HP 1000 & 3000 available?	Yes	Yes	Yes	Yes	Yes	Yes	Yes
LAN Link Available?	Yes	Yes	Yes	Yes	Yes	Yes	No
Communication with IBM systems avail?	Yes	Yes	Yes	Yes	Yes	Yes	Yes
Data Link support?	Yes	Yes	Yes	Yes	Yes	Yes	Yes
ATS/1000 Integration Services available?	Yes	Yes	Yes	Yes	Yes	Yes	Yes

* Average effective access time, assuming 88% cache hit rate.

TECHNICAL COMPUTER SYSTEMS

HP 1000 A-Series and E-Series Computers

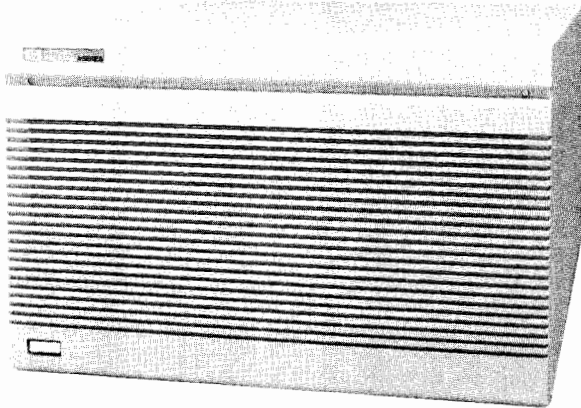

New HP 2426E/F Micro 16 (A600+) Computer in low-cost, 6-slot package has the highest maximum operating temperature specification (to 60°C) of any HP 1000 Computer, making it especially suitable for workcell control or other applications on the factory floor.

HP 1000 A-Series

A-Series computers implement a distributed intelligence I/O design in which each I/O card has its own processor. This processor controls direct access transfers to/from memory with extra intelligence that supports chained multiblock transfers without interrupting the CPU. This leaves the CPU free to concentrate on arithmetic tasks with few interruptions and great efficiency.

The A600+ microcomputer offers 0.4 MIPS base execution speed and double precision floating point firmware. The A600+, price/performance leader of low-cost microcomputers, supports VC+ enhancements and is available as a two-board computer, 20-slot box computer, 6-slot Micro 16 computers (shown above), system, or Micro/26 computer.

The A700 computer adds optional floating point hardware with scientific and vector instruction sets to the basic capability of the A600+ microcomputer for superior support of computer simulation, graphics, and other computation-intensive uses. The A700 is also microprogrammable, so it can be optimized for higher performance or user-customized applications. It is available as a system, Micro 27 computer, or 20-slot box computer.

The A900 computer incorporates a pipeline implementation and a cache memory scheme, providing three times the performance of an

A700 computer. The A900's hardware floating point processor and scientific vector instruction sets are built-in, and 768k bytes of ECC memory is standard, assuring system integrity. The A900 is the ultimate computation machine designed to meet the most demanding needs of OEMs, system designers, software suppliers and end users. It is available as a system, Micro 29 Computer or 20-slot box computer.

HP 1000 E-Series

The E-Series computer provides variable microcycle timing, microprogrammable block I/O, a microprocessor port, asynchronous memory, and large control store address space. E-Series computers are available in two models, HP 2109E and 2113E, with up to 2 Mbytes of mainframe memory and 9 or 14 I/O channels, expandable to 46 channels. (Also available as HP 2109EK board computer.)

Alternate Memory Systems

HP continues its lead in memory technology by being the first to offer 256k RAM memory: a 2 megabyte error correcting code (ECC) board for the A600+ and A700, and a 3 megabyte ECC memory board for the A900.

Parity checking memory is standard in HP 1000 memory systems for the A600+, A700, and E-Series. And, for very large systems in critical applications, Error Correcting Code (ECC), standard in the A900 and optional in the A600+, A700, and E-Series, detects and corrects all single-bit errors and detects all double-bit errors.

Ordering Information

	Price
HP 2106BK A600+ Board Computer w/128 kB memory	\$3,410
HP 2156B A600+ Computer w/128 kB memory	\$7,590
HP 2137A A700 Computer w/128 kB memory	\$9,820
HP 2139A A900 Computer w/768 kB memory	\$23,900
HP 2426E Micro 16 (A600+) Computer w/512 kB parity memory	\$5,400
HP 2426F Micro 16 (A600+) Computer w/1 Mb ECC memory	\$7,400
HP 2436A Micro 26 (A600+) Computer w/128 kB parity memory	\$5,600
HP 2436E Micro 26 (A600+) Computer w/512 kB parity memory	\$6,600
HP 2437A Micro 27 (A700) Computer w/128 kB parity memory	\$8,800
HP 2439A Micro 29 (A900) Computer w/768 kB memory	\$19,800
HP 2109E E-Series Computer w/64 kB memory	\$10,575
HP 2113E E-Series Computer w/128 kB memory	\$13,175
HP 12153A A700 Writable Control Store Card	\$2,010
HP 12156A A700 Floating Point Processor	\$4,310
HP 12157A A-Series Battery Backup System	\$555

Quantity discounts are available.

A complete list of HP 1000 computer accessories is available from your HP Sales Office.

TECHNICAL COMPUTER SYSTEMS

Ruggedized Personal Computers for Manufacturing

Model 72411A

95

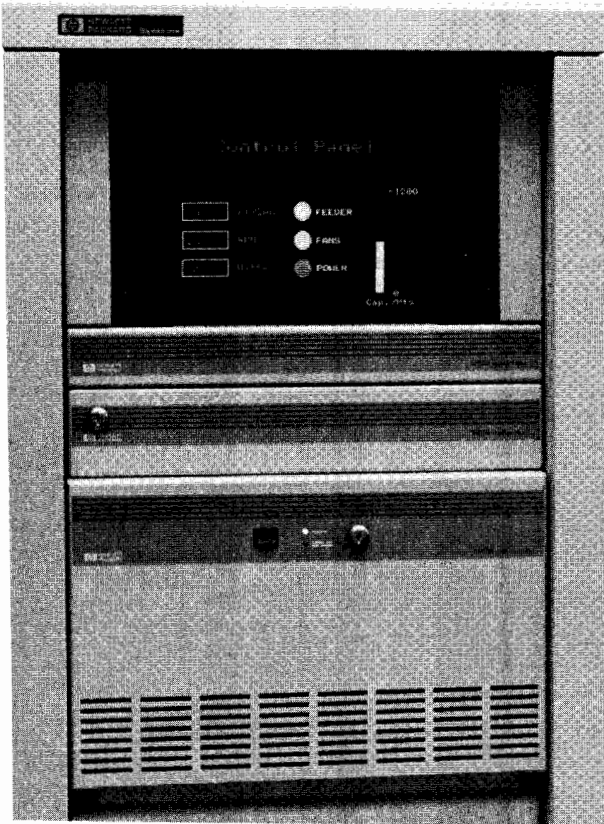

Packaging designed to thrive on the factory floor

The HP 72411A's rack-mountable industrial packaging protects the VECTRA PC from the hot, humid, dirty conditions of the factory floor, enabling it to perform at temperatures to 60°C, humidity to 95%, altitude to 15,000 feet, shock to 1.5g's peak, and vibration to 0.43g, rms (excluding use of flexible disc media above 50°C or 80% relative humidity).

Protected mass storage

The flexible disc drive used for loading and backup of software is protected from environmental contamination behind a rugged, full-width metal access door. An extremely rugged 20 MB internal hard disc, optional for fast-access mass storage, is completely sealed to protect it from environmental contamination.

Airflow cleaned by a front-panel replaceable filter

The VECTRA Industrial PC is cooled by two fans, which draw in outside air through a fine filter that rejects contaminants. Cleaning of the air filter is facilitated by its easy accessibility behind the swing-down door that opens for access to the flexible disc.

A ruggedized color display

Display is provided by a rack-mountable, HP 35745A Industrial Enhanced Graphics Display. Resolution of this 13-inch color display is 640 x 350 pixels.

AC input power conditioning for wide range operation

A power line conditioner supplies the VECTRA Industrial PC and its color display with ac power. The line conditioner converts input line voltages in the range of 86-140V rms, 57-63 Hz in the United States, 172 to 278V rms, 47-53 Hz in Europe, to the voltages required for normal operation of the VECTRA Industrial PC and its display.

A wide choice of industrial applications software

The low price and wide availability of IBM PCs has encouraged the development of many different PC-DOS based software packages for use on the factory floor. The new HP 72411A VECTRA Industrial Personal Computer is now available to support such applications with performance based on an 8MHz clock. Many different industrial application software packages are available to support such diverse applications as factory floor data acquisition, analysis, dedicated control, programmable device support, numerical controlled machining, and quality management. A complete list is available in Hewlett-Packard's Manufacturing Solutions catalog, which is available through Hewlett-Packard field sales offices.

Ordering Information

		Price
HP 72411A	VECTRA Industrial PC w/640 kB main memory and 1.2 MB flexible disc	\$6,295
HP 35745A	Industrial Enhanced Graphics Display	\$1,495
HP 45983A	Enhanced Graphics Adapter	\$695
HP 12131A	Keyboard Rack	\$250
HP 45951A	VECTRA Disc Operating System	\$85
HP 45816A	20 MB Internal hard disc subsystem	\$1,395
HP 45973A	0.5 MB Memory Expansion Card	\$595
HP 45974A	1 MB Memory Expansion Card	\$995
HP 45987A	Numeric Co-processor	\$375
HP 24540A	Serial/Parallel Interface	\$150
HP 24541A	Dual RS-232/422 Interface	\$220
HP 68333F	AdvanceLink 2392 software	\$295
HP 92916A	Bar Code Reader	\$590



Hewlett-Packard Computer Peripherals

What if . . .

Your computer peripheral requirements for input and storage of data, preparation of reports, presentations, charts, graphs, and drawings could be met by a single vendor?

They can.

What if . . .

Your vendor offered flexible solutions for changing needs such as desktop publishing and PC CAD?

Hewlett-Packard does.

Examine the following pages to see the dozens of Hewlett-Packard peripherals available for your HP computer system, and for your IBM, DEC, Apple, or other popular computer. HP's peripherals are supported by hundreds of software packages including the most popular computing packages for graphics, spreadsheets, word processing, and desktop publishing.

Terminals

Terminals range from monochrome to color monitors, from business to technical applications, from low-cost display to powerful data entry terminals.

Data storage

Data or mass storage choices range from removable to fixed discs, from 10 Mbyte to 571 Mbyte disc capacity, from 1/4-inch to 1/2-inch tape subsystems for disc backup and file storage.

Printers

Printers range from low cost personal convenience printers to near-letter-quality (NLQ) and letter-quality (LQ) printers to line printers and versatile, high resolution laser printing systems.

Plotters and Supplies

Plotters range from business and technical plotters for preparing report graphs, overhead transparencies and technical drawings to high performance drafting plotters for maps, drawings, and designs.

Film Recorder

HP's film recorder creates bright, colorful 35-mm slides.

Graphic Displays

Graphic displays integrate softcopy graphics into production test and measurement systems as well as analytical instrumentation.

Compatibility, Reliability, Support

Compatibility is a major commitment with HP peripherals to help you get long-term value from both your hardware and your software. And our time-honored practice of making reliable products extends from the lab to the office, with an extensive service and support network.

You can get a total computing solution from the total supplier, with Hewlett-Packard peripherals!

Hewlett-Packard's Proven Performance with Peripherals

- 26 years in graphics
- 15 years in digital plotters
- 17 years in 1/2-inch tape drives
- 13 years in cartridge tape drives
- 12 years in impact dot matrix printers
- 17 years in thermal printers



- Supports HP Touch, graphics tablet, mouse, and bar code reader
- High quality graphics (two resolution modes; 512x390 and 640x400)
- Complete independent alphanumeric
- Up to 12 pages of memory

- High quality color display
- Supports HP Touch, graphics tablet, mouse and bar code reader
- Graphics software support
- Hardcopy and video interface
- Complete color alphanumeric

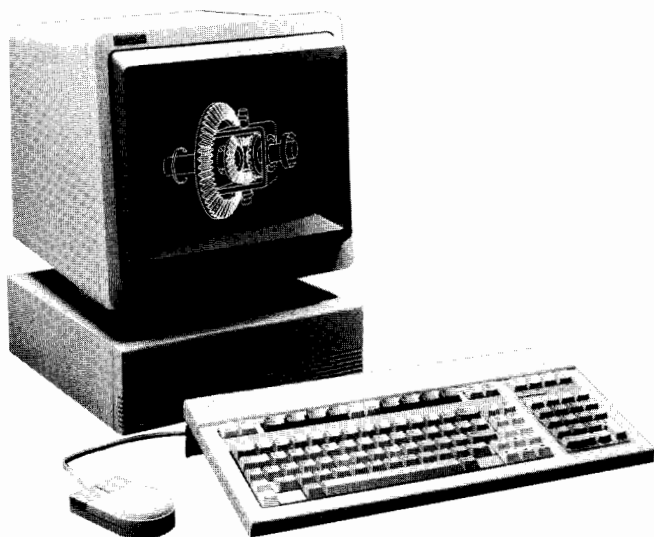

HP 2393A

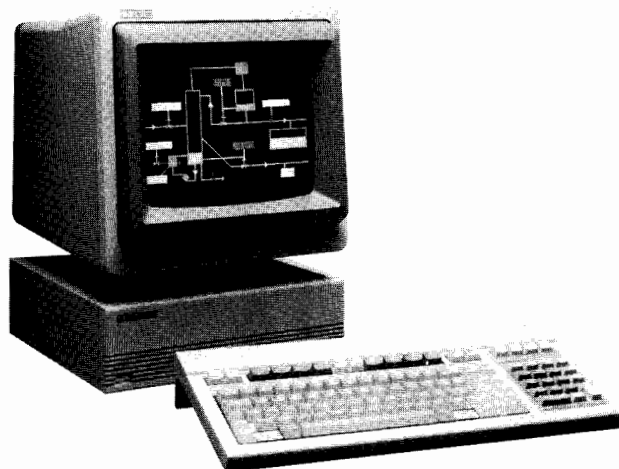

HP 2397A

HP 2393A Graphics Terminal

The HP 2393A combines bit-mapped vector graphics on a monochrome raster display with comprehensive alphanumeric capabilities. You'll find it a versatile terminal in many applications.

The 2393A's unique HP-HIL (Human Interface Link) interface lets you connect multiple input devices—like HP-Touch, Mouse, Graphics Tablet and Bar Code Reader.

The 2393A also offers a range of output options, so you can connect it to printers, plotters, film recorders and large screen projectors.

Software support for the 2393A includes popular HP packages like DSG/3000, HP DRAW, HP EASYCHART, HP MAP, Graphics 1000/II and Graphics 9000. In addition, you can use the 2393A with many third-party software packages, including Precision Visuals™ DI-3000™ and GRAFMAKER™, ISSCO®'s DISSPLA® and TELL-A-GRAF®, and SAS Institute's SAS/GRAPH™. The 2393A has ANSI X3.64 and TEKTRONIX® 4010/4014 compatibility too, so you can use it on a variety of computer systems.

The HP 2393A is one of the most flexible graphics terminals in its class, providing quality and reliability at a surprisingly affordable price.

HP 2393A Graphics Terminal

\$2095 ☎

Precision Visuals, DI-3000 and GRAFMAKER are trademarks of Precision Visuals, Inc.

ISSCO, DISSPLA and TELL-A-GRAF are registered trademarks of Integrated Software Systems Corporation.

SAS/GRAPH is a trademark of SAS Institute, Inc.

☎ Fast-Ship product — see page 766.

HP 2397A Color Graphics Terminal

The HP 2397A offers a high quality color raster display with fast vector graphics. With all the features and software support of the 2393A monochrome graphics terminal, the 2397A is ideally suited for both business and technical applications.

Eight basic colors can be displayed from a palette of 64 (more using dithering patterns), making user-defined colors easily accessible, including those that match HP plotter pens.

With polyline vectors and local polygonal area fill, the 2397A can be used to create shapes, symbols and typefaces quickly and easily.

The 2397A also provides color alphanumeric. Up to eight color pairs (foreground / background) can be used on a per character basis to differentiate text and identify critical fields.

The 2397A supports a variety of output devices, including printers, plotters, large screen projectors, monitors and film recorders.

HP 2397A Color Graphics Terminal

\$3095 ☎

☎ Fast-Ship product — see page 766

COMPUTER PERIPHERALS

Interactive Terminals

Models 2392A, 2394A



- Compact size
- Block/forms mode
- Up to 4 pages of memory (additional 4 pages optional)
- Integral tilt and swivel
- Optional printer port
- High resolution display
- Local forms cache
- Advanced edit checks
- Up to 8 pages of memory

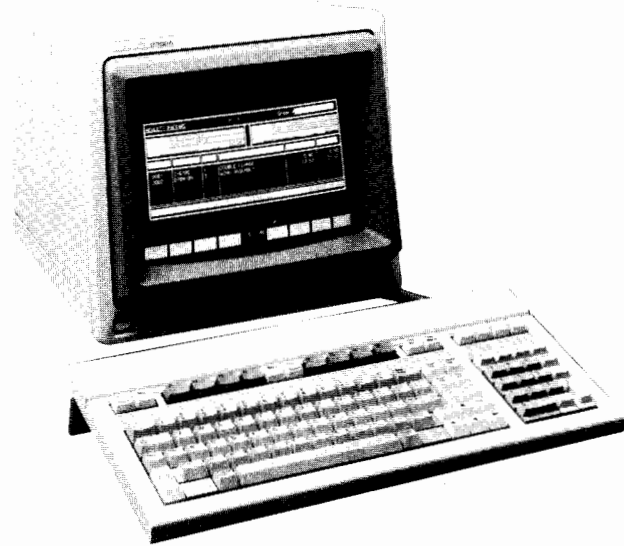

HP 2392A

HP 2392A Display Terminal

The HP 2392A is a compact, low cost, block mode terminal designed for a wide range of applications — from data entry to program development. Features like integral tilt and swivel, 12-inch diagonal anti-glare screen, and a low-profile, adjustable keyboard help make your work more pleasant. With smooth scrolling, you can easily view up to 4 pages of text or data (up to 8 pages optional). Data entry applications are made easier using forms mode and the standard line drawing set to emulate existing paper forms. High speed datacomm (up to 19,200 bits per second) shortens response time.

It is also easy for you to generate hardcopy, since the 2392A has an optional user-installable printer port. Choose between an RS232C serial or a Centronics®-type parallel interface module.

Besides being compatible with HP computers and software, the 2392A has a no-cost ANSI (American National Standards Institute) option so it can communicate with ANSI "speaking" computer systems too — like DEC® computers.

HP 2392A Display Terminal

\$1375 ☛



HP 2394A

HP 2394A Data Entry Terminal

Traditional data entry applications involve repeated downloading of forms from the computer for data input. The HP 2394A Data Entry Terminal, however, offers a more innovative approach.

The 2394A stores forms locally in the terminal's memory to be displayed quickly — without system downloading. Local edit checks on the 2394A let you know immediately when an error is made, so you don't send mistakes to the system. And the 2394A's modified data tag feature reduces data communication traffic, transmitting to the system only those fields that have been modified. This lets you use your system resources, data communications equipment, and networking facilities more efficiently. The advanced capabilities of the 2394A make it an ideal workstation in HP 3000/VPLUS or HP/IBM Interactive Mainframe Facility applications.

The data entry operator's work is further enhanced by the 2394A's ergonomic design — providing all the popular features and capabilities of the HP 2392A Display Terminal.

HP 2394A Data Entry Terminal

\$1875 ☛

COMPUTER PERIPHERALS

Monitors

Models 35731, 35741, 35743, 35723A

99

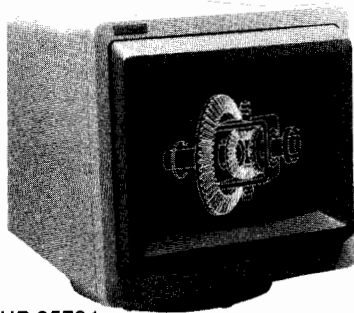

HP 35731

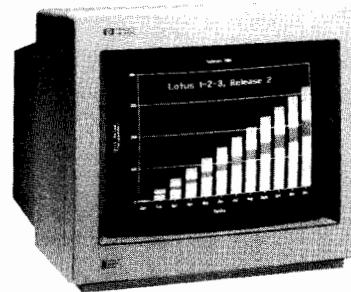

HP 35743

35731 HP Monochrome Monitor

The 35731 HP Monochrome Monitor is a 12-inch, high resolution monochrome video display unit used as an integral component of HP terminals, PCs and workstations.

The monitor features an easy-to-read green phosphor display, as well as compatibility with HP systems that use 512x390 or 640x400 resolutions. It supports the HP Touch Accessory via the HP-HIL interface.

Ergonomic features on the monitor include an anti-glare screen and built-in tilt and swivel for adjusting the screen viewing angle. The monitor also has front panel brightness and contrast controls to make display adjustments more convenient for you.

Ordering Information

35731A HP Monochrome Monitor
35731B HP Monochrome (International)

Price

\$325
\$340

35743 HP Enhanced Graphics Display

The 35743 HP Enhanced Graphics Display is a high resolution color CRT display with a 13-inch screen. The Enhanced Graphics Display offers dual resolution modes (640 x 350 and 640 x 200). Designed specifically for use on the HP Vectra Personal Computer, the Enhanced Graphics Display supports a wide range of software products, since it is compatible with the industry standard Enhanced Graphics Adapter.

The Enhanced Graphics Display features TTL video input with up to 16 colors displayable out of a palette of up to 64 colors. The 35743 also has a dual scan input to allow automatic selection between 15.75 and 21.75 scan frequencies.

The 35743 Display offers an optional tilt and swivel mechanism (PN 82959S) for enhancing ease of use.

Ordering Information

35743A HP Enhanced Graphics Display
35741B HP Enhanced Graphics Display (International)

Price

\$845
910

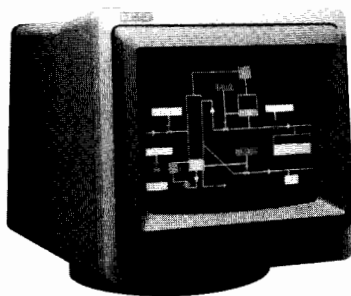

HP 35741

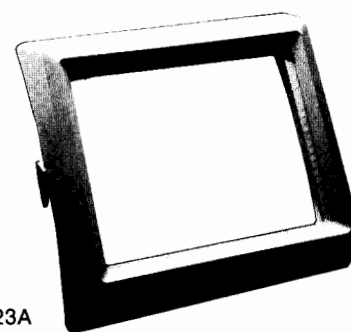

HP 35723A

35741 HP Color Monitor

The 35741 HP Color Monitor provides a 12-inch RGB analog color video display with a 640 x 400 resolution. Like the 35731 Monochrome Monitor, this monitor is used with many HP computer systems, terminals, PC's and workstations.

The color monitor features RGB P22 color phosphor, with analog video inputs capable of providing a continuous spectrum of colors. The HP-HIL interface supports the HP Touch accessory.

With convenient front panel controls, a non-glare screen and integrated tilt and swivel, the color monitor offers state-of-the art ergonomics.

Ordering information

35741A HP Color Monitor
35741B HP Color Monitor (International)

Price

\$995
995

35723A HP Touch Accessory

The 35723A HP Touch Accessory is a 12-inch, user-installable touchscreen bezel. When you add HP touch to your HP computer or terminal that supports the HP-HIL (Human Interface Loop), you transform your ordinary screen into an interactive touchscreen. HP Touch gives you an easy and natural way of communicating with your computer.

HP Touch has a maximum resolution of 43 vertical by 57 horizontal, giving you 2451 touch points. You can define touch areas of varying shapes and sizes, giving you programming flexibility for a wide range of applications.

35723A HP Touch Accessory

☎ Fast-Ship product — see page 766.

\$400 ☎



COMPUTER PERIPHERALS

Personal Data Storage

Models 9114B, 9122D/S, 9123D, 9127A, 9133H, 9134H, 9133L, 9134L, 9142A, 9153A, 9154A, 88500A

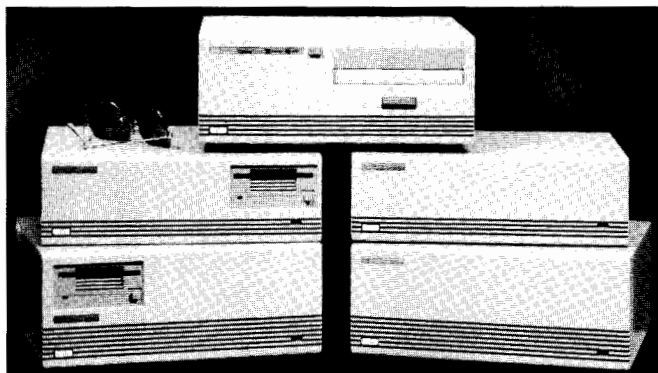

Hewlett-Packard offers you a full line of data storage solutions to fit your personal or technical computer requirements. HP's wide range of disc drives cover a variety of prices, capacities and performance.

3 1/2" Microfloppy Personal Data Storage Solutions

HP 9122D Dual 3 1/2" Drive—HP 9122S Single 3 1/2" Drive

The HP 9122D is a highly reliable, double-sided 3 1/2" microfloppy designed for use with HP's desktop and personal computers. Available in both dual and single configurations, the HP 9122D and HP 9122S provide up to 1420 and 710 Kbytes of formatted capacity, respectively. This disc drive is supported on the Series 80, Touchscreen and Touchscreen II personal computer and HP 9000-Series 200, 300, and 500.

HP 9114B Portable 3 1/2" Disc Drive

Designed for HP's Portable computer family as well as, Series 40 and Series 70, the HP 9114B provides up to 710 Kbytes of formatted capacity in a lightweight, battery-operated package. The 3 1/2" disc drive reads, writes, and initializes double-sided media in both single-sided and double-sided formats. This feature allows data exchange with single-sided drives currently in use.

HP 9123D Dual 3 1/2" Drive (for HP Touchscreen II Personal Computers) See pg. 50

Hard Disc Personal Data Storage Solutions

HP 9153A/9154A 10 Megabyte Winchester Hard Disc

The HP 9153A combines the storage and performance capabilities of HP's 10 Mbyte hard disc with the backup and interchange capabilities of the 3 1/2" microfloppy in one compact package. The removable media is fully compatible with the HP 9122D/S, HP 9123D and HP 9114B data storage units. The 9154A, hard disc only model, adds Winchester performance and convenience to floppy-based computer systems. These models are supported on the Touchscreen II, HP 9000-Series 200, 300 and 500 and Series 80 computers.

HP 9133H/9134H 20 Megabyte Winchester Hard Disc

The storage capabilities of HP's 20 Mbyte hard disc with the backup and interface capabilities of the 3 1/2" microfloppy are combined in the HP 9133H. The removable media is fully compatible with the HP 9122D/S, the HP 9123D, and HP 9114B data storage units. The HP 9133H and 9134H are well suited for business and technical large memory applications—general accounting, data base management, and integrated applications. They are supported on the Touchscreen II, Series 80, and HP 9000-Series 200, 300, and Series 500 computers.

New HP 9133L/9134L 40 Mbyte Winchester Hard Discs

The HP 9133L combines the storage and performance capabilities of the 40 Mbyte hard disc with the backup and interchange capabilities of the 3 1/2" microfloppy. The removable media is fully compatible with the HP 9122D/S, 9123D, and 9114B data storage units.

The HP 9134L is a stand-alone hard disc Winchester. The HP 9133L and 9134L are ideal for both business and technical applications such as CAD/CAM, data base management, and accounting. They are supported on the HP Touchscreen II and the HP 9000-Series 200, 300 and Series 500 computers.

1/4" Tape Backup Solution

HP 9142A 1/4" Tape Subsystem

The HP 9142A is a 1/4" streaming tape backup solution designed for personal computers. This drive stores approximately 13 to 52 Mbytes of information on the HP Touchscreen and Touch screen II PCs and up to 60 Mbytes on the IBM PC/XT/AT and COMPAQ Portable. This subsystem allows both file and image backup and restore operations. The format, utilizing 50% data redundancy, offers error correction for increased data reliability. The HP 9142A transfers data at a rate of 2 Mbytes/minute and 1 Mbyte/minute with verification.

Interface Solutions

HP 88500A Disc/Tape Interface

Hewlett-Packard provides you with an interface solution to connect your HP tape or disc to your IBM PC/XT/AT, COMPAQ Portable, AT & T 6300 and Olivetti M24. This easy-to-install system includes the powerful Data Manager and Tape Backup software. One short slot interface card allows you to connect up to 7 discs and 1 tape. The HP 88500A supports the 9154A, 9134H and 9134L discs as well as the 9142A tape.

Data Interchange

New HP 9127A—Single 5 1/4" Flexible Disc Drive

The HP 9127A is a single 5 1/4" disc drive that gives the HP Touchscreen and Touchscreen II data compatibility with the IBM-PC via 5 1/4" discs. Connected by HP-IB to the Touchscreen computers, the drive can read, write, and initialize discs in IBM-PC format as well as HP format. The discs can be moved between IBM and HP computer systems for easy data exchange. The 9127A can also read copy-protected DOS software with the HP Series 300 DOS coprocessor card.

Ordering Information

	Price
HP 9114B Double-sided 3 1/2" Disc Drive	\$ 795
HP 9122D Double-sided 3 1/2" Dual Disc Drive	\$1390
HP 9122S Double-sided 3 1/2" Single Disc Drive	\$1090
HP 9123D Double-sided 3 1/2" Dual Drive	\$ 715
HP 9127A Single-sided 5 1/4" Flexible Disc Drive	\$ 995
HP 9133H 20 Mbyte Hard Disc plus 3 1/2" Microfloppy	\$2740
HP 9134H 20 Mbyte Hard Disc (Winchester only)	\$2390
HP 9133L 40 Mbyte Hard Disc plus 3 1/2" Microfloppy	\$4450
HP 9134L 40 Mbyte Hard Disc (Winchester only)	\$4050
HP 9142A 1/4" Tape Backup Subsystem	\$1990
HP 9153A 10 Mbyte Hard Disc plus 3 1/2" Microfloppy	\$1940
HP 9154A 10 Mbyte Hard Disc (Winchester only)	\$1690
HP 88500A IBM Disc/Tape Interface	\$ 199 ☎
HP 91290A 5 1/4" HP Qualified Media (Box of 10)	\$ 58 ☎
HP 92192A 3 1/2" Double-sided Microfloppy (Box of 10)	\$ 69 ☎
HP 92242S 15 Mbyte Tape (9142 only-Box of 5 tapes)	\$ 129 ☎
HP 92242L 60 Mbyte Tape (9142 only-Box of 5 tapes)	\$ 180 ☎

See the Technical Data Sheet #5953-6857, "Data Storage for Personal and Portable Computers" for detailed support information.

☎ Fast ship product see page 766

COMPUTER PERIPHERALS

CS/80 Disc Drive Family

Models 7911, 7912, 7914, 7914CT, 7914ST



- Performance
- Reliability
- Serviceability

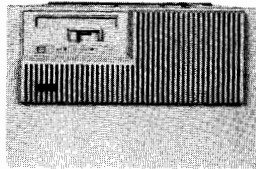

HP 7911R, 7912R, 7914R

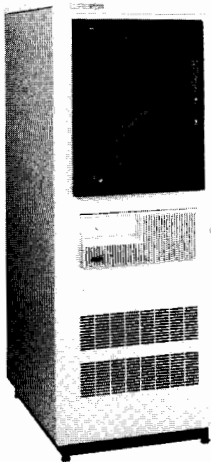

HP 7914ST

- Integral self test and diagnostics
- Internal microprocessor controller

7914CT

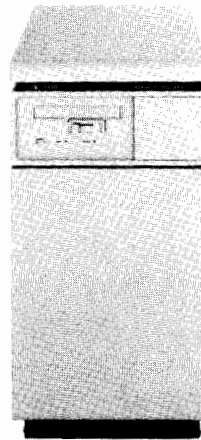

HP 7911P,
7912P,
7914P

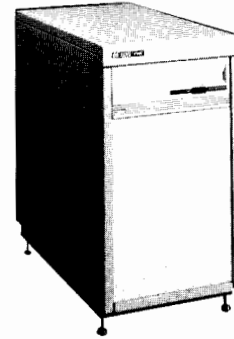

Hewlett-Packard offers the HP 7911, 7912, and 7914 family of disc products. To ensure flexibility in configuring mass storage needs, each disc product employs the same efficient command structure (CS/80) and the same interface standard (HP-IB), allowing you to mix and match a wide range of compatible storage solutions with little or no need for additional control hardware or software modification.

All of the CS/80 family disc products contain a sophisticated, internal controller which performs advanced, self-diagnostic routines to facilitate maintenance and servicing. These self-diagnostic capabilities, coupled with careful design and engineering, promote a highly reliable and serviceable disc drive which will provide greater system uptime and productivity.

HP 7911, 7912, 7914 Disc/Tape Drives

These Disc/Tape Drives are a family of products designed to satisfy all peripheral storage requirements in a single compact package. Each product utilizes a unique integrated storage concept, featuring a reliable Winchester disc mechanism for mass storage, and a 1/4-inch cartridge tape drive for backup and user I/O.

The product line provides mass storage capacities from 28.1 to 132.1 Mbytes; they include the 7911 (28.1 Mbytes), 7912 (65.6 Mbytes), and 7914 (132.1 Mbytes).

HP 7914ST Mass Storage Subsystem

The HP 7914ST is a complete mass storage subsystem offering 132 megabytes of Winchester disc storage and an HP 7974A half-inch tape drive in a 1600mm high system cabinet. An option for a second 132-Mbyte disc drive in the same cabinet is also available.

HP 7914 CT Disc/Tape Drive

The 7914 CT disc/tape package combines the 7914 disc drive with the 9144A 1/4 inch cartridge tape drive in a mobile mini-rack (Rosebud family cabinet). The new cartridge tape drive has read after write capabilities which helps to reduce image backup time.

Operating Characteristics

Electromagnetic Emissions

The 7911, 7912, and 7914 are designed to meet FCC Docket 20780 for Class A computing devices. For Europe, they are designed to meet VDE 0871 for Level A computing devices and are FTZ licensed on some HP systems.

Safety

The HP 7911, 7912, and 7914 meet all applicable safety standards of the following: CSA 22.2 No. 154, IEC 380 and 435, UL 114 and UL 478.

Ordering Information

Ordering Information	Price
HP 7911P/R (28.1 Mbytes)	\$13,750
HP 7912P/R (65.6 Mbytes)	\$14,800
HP 7914P/R (132.1 Mbytes)	\$17,350
Opt 001: Dedicated tape controller (for HP 7911, 7912, and 7914)	add \$ 1,840
Opt 015: 220-volt operation	N/C
Opt 140: Delete cartridge tape drive	less \$ 3,570
HP 7914ST (132.1 Mbytes)	\$27,500
Opt 002: Adds cartridge tape drive and second controller (for HP 3000 only)	add \$ 5,410
Opt 015: 220-volt operation	N/C
Opt 114: Adds second HP 7914R (less cartridge tape drive)	add \$13,830
Opt 240: Adds cartridge tape drive to first HP 7914R	add \$ 3,570
HP 7914CT (132.1Mb)	\$17,350
Opt 015 220-volt operation	N/C
Opt 140 Delete cartridge tape drive	less 3,500



COMPUTER PERIPHERALS

CS/80 Desktop Disc Drive Family

Models 7941A, 7945A, 7942A, 7946A

- Customer installable
- Convenient desktop package
- Quiet operation

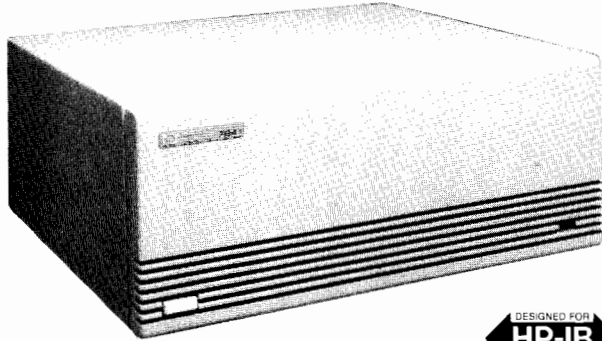

HP 7941A

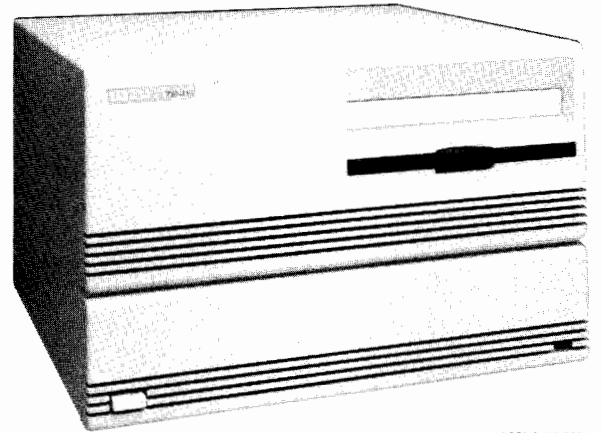

HP 7946A



HP 7941A/45A and HP 7942A/46A

The HP 7941A and HP 7945A are 24- and 55-Mbyte disc drives, respectively. The HP 7942A and HP 7946A products feature the same 24 and 55 megabyte capacities but include a 1/4-inch cartridge tape drive integrated into a single unit. These products are designed and priced for use on entry-level multi-user systems and high performance work stations.

Both the disc products and the disc/tape products employ the same efficient command structure (CS/80) and HP-IB interface as the HP 7911, 7912, 7914, 7933, and 7935 mass storage products. This commonality in command structure allows you to mix and match a wide range of compatible mass storage solutions.

The disc and the disc/tape products are customer installable and contain extensive self-test capabilities resident in the controller. Both package designs provide quick access to all replaceable assemblies.

The disc and disc/tape products are quiet enough to operate unnoticed in an office environment and are small enough to place on top of a desk. Both feature adapter kits to fit in 19-inch EIA rack enclosures or in HP's mobile mini-rack.

With a 30ms average disc seek time and a typical data transfer rate of one megabyte per minute for the tape drive, these disc and disc/tape products provide the performance needed for the entry-level multi-user systems and high performance work stations.

Features

HP 7941A and HP 7945A Disc Drive

- Small stand-alone desktop cabinet (HxWxD = 130mm x 325mm x 285mm)
- Quiet operation with sound pressure <95 dBa.
- Customer installable
- Average seek time of 30ms
- Fits in 19-inch EIA rack enclosure with an HP 19500B adapter kit

Features

HP 7942A and HP 7946A Disc/Tape Drive

- Customer installable
- The disc drives have an average seek time of 30ms. The tape drive can typically transfer data at one megabyte per minute.
- The tape drive has read-after-write capabilities and automatic error detection and correction for enhanced data reliability
- Small stand-alone desktop cabinet (HxWxD = (208mm x 325mm x 285mm))
- Quiet operation with sound power <50 dBa.
- Fits in 19-inch EIA rack enclosure with an HP 19501A adapter kit

Description

HP 7941A/7945A Disc Drives

The HP 7941A and HP 7945A are 24- and 55-Mbyte disc drives. Each of these products includes a fixed Winchester disc drive, intelligent HP-IB Command Set 80 controller and power supply — all in a compact desktop package.

Description

HP 7942A/7946 Disc/Tape Drives

The HP 7942A and HP 7946A are mass storage systems combining either a 24-Mbyte or a 55-Mbyte fixed disc drive with a built-in 1/4-inch cartridge tape drive, intelligent HP-IB Command Set 80 Controller and power supply — all in a compact desktop package. A single controller integrates and controls the tape and disc drives.

Operating Characteristics

Electromagnetic Emissions

Radiated and conducted interference:

- HP 7941A, 7942A, 7945A, 7946A - For U.S.A., designed to meet FCC Docket 20780 for Class B computing peripheral devices.
- HP 7941A, 7942A, 7945A, 7946A - For Europe, designed to meet VDE 0871 for Level B computing devices. FTZ licensed on some HP systems. Refer to your local sales representative for more information.

Safety

The HP 7941A, 7942A, 7945A, 7946A meet all applicable safety standards of the following:

- IEC 380 and 435
- UL 114 and 478
- CSA 22.2 no. 154

Ordering Information

Ordering Information	Price
HP 7941A (24Mbyte) disc	\$ 4,500
HP 7945A (55Mbyte) disc	\$ 6,000
HP 7942A (24Mbyte disc/tape cartridge)	\$ 7,700
HP 7946A (55Mbyte disc/tape cartridge)	\$ 9,200
Opt 015 Voltage selector set for 230V (For non-U.S. shipments)	N/C
Opt 550 Deletes one-metre HP-IB cable	Less \$80
HP 19500B Rack kit for mounting HP 7941A and HP 7945A in 19-inch EIA rack enclosures	\$85
HP 19501A Rack kit for mounting HP 7942A and HP 7946A in 19-inch EIA rack enclosures	\$165

COMPUTER PERIPHERALS

CS/80 Disc Drive Family Continued

Models 7907A, 7933XP, 7935XP

103



- Performance
- Reliability
- Serviceability

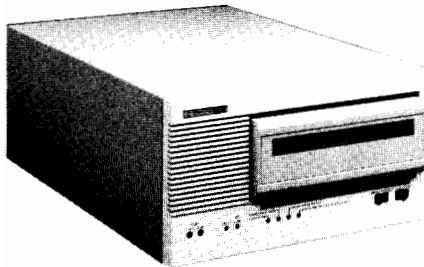

HP 7907



The HP 7907A is a complete peripheral storage product providing user I/O, mass storage, and backup capabilities. The 7907A combines a state-of-the-art fixed/removable disc mechanism with an intelligent controller using the CS/80/HP-IB protocol. The result is a high performance, environmentally rugged disc sub-system providing a cost effective backup and software distribution capability as well as an easy path to data interchange between systems.

Features

Disc Drive

- 41 Mbytes of formatted disc storage
- 20.5 Mbytes of fixed storage/20.5 Mbytes of removable storage in an easy to use front-loading 8" cartridge
- HP standard CS/80/HP-IB protocol
- Average seek time 30 ms
- Ramp-loaded heads for added reliability
- Front panel or system activated image backup/restore in less than 3 minutes
- Environmentally rugged design
- Available in either an HP92211A cabinet or standard 19" EIA rackmount
- Customer installable

Description

The HP 7907A is a complete mass storage subsystem featuring 20.5 Mbytes of formatted removable storage in an easy-to-use front loading configuration. Add to this an additional 20.5 Mbytes of formatted fixed storage, a fast 45 ms Total Device Average Transaction Time, a small light-weight package, 19" EIA rackmount capability and an offline backup capability and you have an ideal mass storage system for applications such as Automatic Test, On-Site Data Logging, and Computer Aided Engineering.

Electromagnetic Emissions

Radiated and conducted interference:

- HP 7907A-For U.S.A. designed to meet FCC Docket 20780 for Class B computing devices.
- HP 7907A-For Europe, designed to meet applicable VDE 0871 requirements for computing devices.

Safety

The HP7907A meets all applicable safety standards of the following:

- IEC 380 and 435
- UL 114 and 478
- CSA C22.2 No. 154

- Integral Self Test and Diagnostics
- Internal Microprocessor Controller

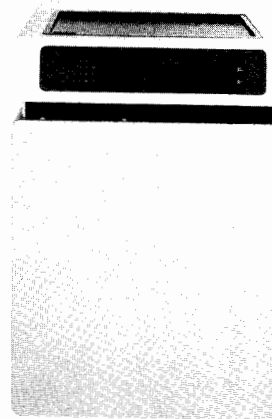

HP 7933XP,
7935XP



HP 7933H Disc Drive

The HP 7933H Disc Drive is a 404-MB fixed media device that provides high levels of performance, reliability, and serviceability. The performance of the HP 7933H promotes overall greater system efficiency. The advanced reliability and serviceability features are reflected by the exceptionally low maintenance costs of this product.

HP 7935H Disc Drive

The HP 7935H Disc Drive is a removable media device that provides 404 Mbytes of removable media for increased system flexibility and greater system uptime for private data volume configurations and disc-to-disc backup/restore operations.

HP 7933XP/7935XP Disc Drives

The HP 7933XP and the HP 7935XP are the same as the disc drives above, but include one megabyte of controller cache memory for higher performance.

Electromagnetic Emissions

All models of the HP 7933 and HP 7935 are designed to meet FCC Docket 20780 for Class A computing devices. For Europe, they are designed to meet VDE 0871 for Level A computing devices and are FTZ licensed on some HP systems.

Safety

All models of the HP 7933 and HP 7935 meet all applicable safety standards of the following:

- CSA 22.2 No. 154
- IEC 380 and 435
- UL 114 and UL 478

Ordering Information

HP 7907A (41 Mbytes)	\$12,500
Opt 015: 240V/50Hz	N/C
Opt 550: Delete HP-IB Cable	less 85
HP 7933H (404 Mbytes)	\$25,700
HP 7933XP (404 Mbytes)	\$27,200
HP 7935H (404 Mbytes)	\$28,300
HP 7935XP (404 Mbytes)	\$29,800
Standard Input Power: 208 volts	N/C
Opt 120: For 120-volt operation in U.S.A., Canada	N/C
Opt 210: For 208-volt operation in Canada	N/C
Opt 220: For 220-volt operation in Canada	N/C
Opt 221: For 220-volt operation in continental Europe	N/C
Opt 222: For 220-volt operation in Switzerland	N/C
Opt 223: For 220-volt operation in Denmark	N/C
Opt 241: For 240-volt operation in United Kingdom	N/C
Opt 242: For 240-volt operation in Australia, New Zealand	N/C

COMPUTER PERIPHERALS

Tape Drives

Models 35401A, 9144A, 7978B, 7974A

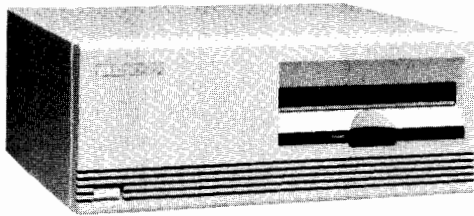

HP 9144A 1/4 inch Cartridge Tape Drive

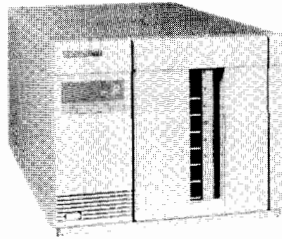

HP 35401A 1/4-inch Cartridge Autochanger Tape Drive

The Hewlett-Packard family of tape drives provide a range of solutions to meet your format, capacity, and performance needs. The five major applications for our tape drives are:

- Backup protection against operator error and disc failure
- Archival storage for economical, long term data preservation
- Data exchange with other computers
- Software distribution
- Online mass storage for data logging and tape processing

1/4-inch Tape Backup Solutions

HP 35401A 1/4-inch Cartridge Autochanger Tape Drive

The HP 35401A provides an unattended backup solution for computer systems with up to 536 megabytes of disc storage. By combining the major components of the HP 9144A tape drive with an autochanger mechanism, the HP 35401A automates cartridge loading and unloading and allows the tape drive to access up to eight cartridges from a removable magazine. The drive's read-while-write and extensive error correction capabilities ensure data integrity. Its small size, quiet operation and ease of use, make it ideal for the office environment.

The 1/4 inch cartridge drive can backup large amounts of data with no operator intervention necessary. In addition to backup, the drive can also be used for software duplication and data exchange. It uses 67 megabyte cartridges and has the same cartridge and data format as the HP 9144A and HP's range of integrated cartridge tape/disc drives (HP 7911/12/14/42/46). This means that you can exchange data between any of these drives configured on similar systems. Support for the HP 35401A is provided by the following HP systems: HP 3000 Series 37,39,40/42,44/48,52,58,64/68,70 and the HP 9000 Series 200,300,500.

HP 9144A 1/4-inch Cartridge Tape Drive

The HP 9144A provides a 1/4-inch tape solution for HP's high performance workstations and small multi-user systems with 15 to 134 megabytes of disc storage. With a data transfer rate of up to 2 megabytes per minute and a cartridge capacity of 67 megabytes, it is a cost effective and convenient backup alternative to multiple floppy discs. The drive offers a read-while-write feature, Media Monitor, and extensive error detection and correction capabilities. It is format compatible with the HP 35401A and HP 7911/12/14/42/46 integrated cartridge subsystems. (HP 9144A cartridges are not compatible with HP 9142A cartridges).

The HP 9144A is supported on the following HP systems. HP 3000 Series 37,39,40/42,44/48,52,58,64,68,70, HP 1000 A Series, HP 9000 Series 200,300,500, and HP Touchscreen PC (HP 150B), Touchscreen II (HP 150C).



HP 7978B and HP 7974A 1/2" Magnetic Tape Subsystems

1/2-inch Tape Backup Solutions

HP 7978B High Performance 1/2-inch Tape Drive

The HP 7978B 1/2-inch tape drive is designed for fast, reliable backup of large systems with greater than 400 megabytes of disc storage. This tape subsystem offers both 6250 cpi (GCR) and 1600 cpi (PE) densities. The GCR formatted capacity of approximately 140 megabytes per 2400 foot reel reduces data storage costs. This streaming drive features 75 ips read-write speed and provides up to three times the data transfer rate of the HP 7974A. Streaming performance is achieved using Immediate Response and Read-Ahead buffering. Increased reliability, extensive front panel diagnostics and ease of repair are additional benefits of the HP 7978B. The drive is mounted in an upright cabinet and includes an HP-IB interface. The HP 7978B is supported on the HP 1000 A Series, the HP 3000 Series 37,39,40/42,44/48,52,58,64,68,70, 930, 950 and the HP 9000, Series 300,500,840.

HP 7974A 1/2-inch Tape Drive

The HP 7974A is used as a general system tape drive for midrange systems with 100 to 500 megabytes of disc storage. The standard drive offers 1600 cpi (PE), with the option to add 800 cpi (NRZI) if required for data interchange. The drive operates in both streaming and start-stop modes to accommodate various application requirements. The 100 ips streaming mode operation with a data transfer rate of approximately 8 megabytes per minute, optimizes backup. With a smaller electronic buffer than the HP 7978B, the HP 7974A uses tension arm buffers and a 50 ips start-stop operation for efficient file by file transactions. Support is provided by the following systems: HP 1000 A Series, E/F Series, HP 3000 Series 37,39,40/42,44/48,64/68,70,930,950 and the HP 9000 Series 300,500,840.

Ordering Information

HP 7974A 1/2" tape drive (1600 cpi)	\$13,500
HP 7974A with NRZI option (1600/800 cpi), Opt 800	\$16,500
HP 7978B 1/2" tape drive (6250/1600 cpi)	\$24,000
HP 9144A 1/4" tape drive	\$ 3,450
HP 9144A (for use with HP 150/Touchscreen) Opt 150	\$ 3,450
HP 35401A 1/4" cartridge autochanger tape drive	\$ 6,700

See the technical data sheet #5953-6868, "The HP Family of 1/2-inch and 1/4-inch tape drives" for detailed product information.

COMPUTER PERIPHERALS

105

Line Printers, Laser Printers



Models 2563B, 2564B, 2566B, 2567B, 2680A, 2685B, 2689A, 2686A, 2686D, 2686TA

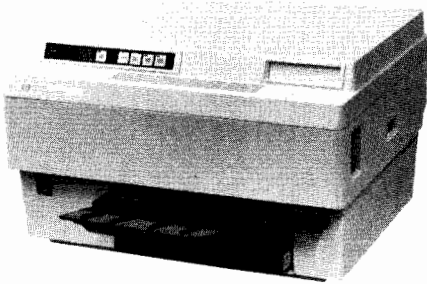

LaserJet, LaserJet PLUS



LaserJet 500 PLUS

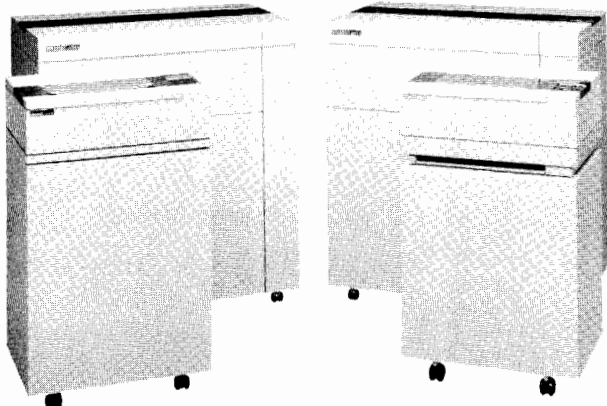

2564B 2566B 2567B 2563B

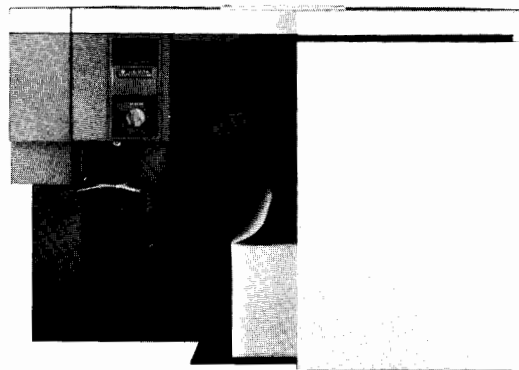

2680A

Line Printers

HP 2563B, 2564B, 2566B, 2567B

The HP 2563B, 2564B, 2566B, and 2567B are a fully supported line-matrix printer family, printing in standard mode at 300, 600, 900, and 1200 lpm, respectively. Model HP 2567B will also print at 1600 lpm sparse print speed, using draft quality characters. The 256X family offers many special use features such as graphics, bar code printing, multiple character sets, 16-channel vertical format control, high density and compressed printing. The 256X family utilizes the Hewlett-Packard Printer Command Language which enables upward and downward compatibility with other Hewlett-Packard printers.

Laser Printers

HP LaserJet/LaserJet PLUS Printers

The HP LaserJet and LaserJet PLUS printers are low-cost, professional PC laser printers that provide letter-quality text and graphics for workstation-based applications. The LaserJet and LaserJet PLUS printers print at eight pages per minute and are compatible with the HP Vectra PC, HP 150, IBM and IBM compatibles, DEC, Wang, Apple and others. In addition to the LaserJet printer's features, the LaserJet PLUS printer provides 1/2 mb of memory for higher density graphics, forms design capability, downloadable fonts and a dual (RS232/Centronics) interface. The LaserJet PLUS printer is expanded into applications such as document workstation printing, enhanced merged text and graphics, and the electronic publication marketplace.

HP LaserJet 500 PLUS Printer

In addition to all the capabilities of the LaserJet PLUS printer, the HP LaserJet 500 PLUS printer has additional paper handling capabilities. The printer's two 250 sheet input trays and one 250 sheet output tray make printing correct order output jobs and off-set printing easy. The LaserJet 500 PLUS is the ideal laser printer for multi-page documents and multiuser environments.

HP TEMPEST LaserJet/LaserJet PLUS Printers

The TEMPEST LaserJet and LaserJet PLUS printers offer laser printing for government applications requiring security protection. Using the containment method, the TEMPEST LaserJet and LaserJet PLUS are the perfect PC laser printers for government

agencies, military, and defense contractors. All fonts available for the LaserJet family are also available in a tempered cartridge for the TEMPEST LaserJet and LaserJet PLUS printers. A special shielded cable is also required. (Currently available only in the U.S.)

HP 2680A/85B

The HP 2680A Laser Printing System operates at 45 pages per minute on plain 8.5-inch by 11-inch fanfold paper. It features continuous paper feed for paper-handling reliability, non-contact fusing, and a data control system that is capable of handling variable size characters, electronic forms, and up to four pages of print on one sheet of paper. The HP 2685B print station provides remote printing solutions with a configuration which includes the HP 2680A laser printer, controller, terminal, disc drive, and magnetic tape.

HP 2689A

The HP 2689A Laser Printing System provides IBM mainframe (and compatible) computer users a cost-effective way to enjoy the benefits of laser printing. The HP 2689A communicates to the IBM mainframe through the HP 26029A interface unit and the HP 2680A laser printer. This IBM mainframe plug-compatible laser printer operates at 45 ppm on plain 8.5-inch by 11-inch fanfold paper. The HP 2689A laser printer is known for its high reliability, affordability, and easy implementation.

Output Design Service

HP also offers an Output Design Service. This service is a personalized form design, logo and signature scanning service.

Ordering Information

	Price
HP 2563B Line Printer	\$7.350
HP 2564B Line Printer	\$12.445
HP 2566B Line Printer	\$21.766
HP 2567B Line Printer	\$28.050
HP LaserJet Printer	\$2.995
HP LaserJet PLUS Printer	\$3.995
HP LaserJet 500 PLUS Printer	\$4.995
HP TEMPEST LaserJet Printer	\$6.250
HP TEMPEST LaserJet PLUS Printer	\$7.495
HP 2680A Laser Printing System	\$84.400
HP 2685B Laser Printing System	\$119.740
HP 2689A Laser Printing System	\$99.950



COMPUTER PERIPHERALS

Workstation Printers

Models ThinkJet, QuietJet, QuietJet Plus, 2932A, 2934A, 2603A, LaserJet

THINKJET FAMILY

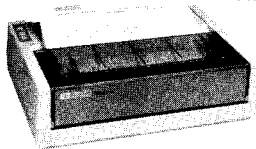

HP 2934A/HP 29340S

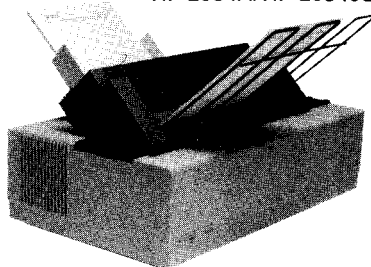

QUIETJET FAMILY

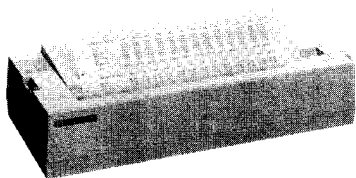

HP 2932A

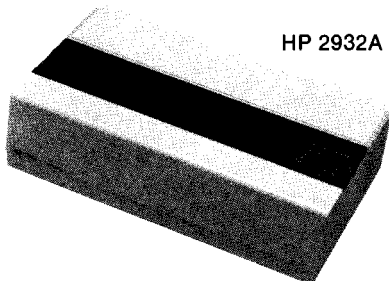

HP 2603A/HP 26030E

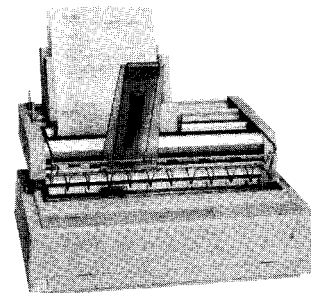

LASERJET FAMILY

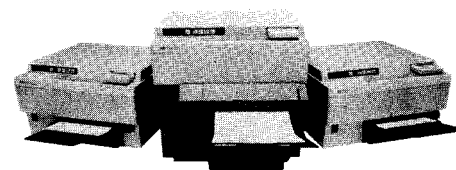

Personal Printers

The ThinkJet Printer

- 150 cps
- Quiet operation
- Compact

The low-cost ThinkJet family of personal printers offers quiet, compact personal printing. The ThinkJet printers feature a disposable print head cartridge, high quality printing, and both friction and pin-feed capability.

The QuietJet Printer

- 160 cps (192 cps in 12 pitch)
- Quiet operation
- Near letter-quality printing (48 cps at 12 pitch)

The QuietJet Printer offers quiet, high-quality 80-column printing (132 columns in compressed print mode). Draft, near letter-quality, and compressed printing are easily selected via the friendly front key panel. A wide range of JetSeries supplies and accessories assure quality output for all your printing needs.

The QuietJet Plus Printer

- 160 cps (192 cps in 12 pitch)
- Quiet operation
- Near letter-quality printing (48 cps at 12 pitch)

This wide carriage QuietJet Plus Printer offers quiet, quality printing for a variety of tasks including labels, reports, and spreadsheets. Draft, near letter-quality, and compressed printing can be conveniently selected via the friendly front key panel.

JetSeries Supplies and Accessories

- Wide range of supplies and accessories
- Shipped within 24 hours
- Toll-free number: 800-538-8787

A full range of supplies and accessories including wide paper for spreadsheet printing, sticky-back labels, even single-color ink cartridges in black, red, blue or green assure quiet quality printing for a variety of applications.

General Purpose Business Printers

The HP 2932A General Purpose Printer

- 200 cps
- Paper-handling flexibility
- Last-form tearoff

The HP 2932A Printer offers 200 cps printing and a variety of paper-handling features for printing applications requiring versatility and high reliability. Typical applications include financial reports, customer invoices, and factory floor lists, and is frequently shared among several users.

The HP 2934A Business Printer

- 200 cps
- Near letter-quality and automatic bar code generation
- Word processing print features
- Plug-in font cartridges

The HP 2934A Printer offers multipart forms capability, 136-column printing and paper handling features. When matched with the HP 29340S Single-bin Sheet Feeder, it provides an excellent single-printer solution for a variety of business printing needs.

Letter-quality Printers

The HP 2603A Daisywheel Printer

- 45 cps (Shannon text), 48 cps (burst speed)
- Triple-bin sheet and envelope feeder accessory
- Lower sound rating (58.5 dBA)

The HP 2603A Printer offers full-formed character printing for office and administrative professionals. Ideal for text processing applications, the HP 2603A is compatible with a variety of software packages. Accessories include a forms tractor, the HP 26030A, and the HP 26030E Triple-bin Sheet Feeder.

The LaserJet Printer

- 8-page per minute printing
- Mixed text and graphics
- Character font flexibility

The LaserJet Personal Printer provides letter-quality text and graphics. Its fast printing and quiet operation make it an ideal workstation printer for a variety of applications. It utilizes a disposable cartridge that contains the main printing components.

Printer	Speed	Print Quality	Graphics	Multipact Forms	Sheet Feeder	Noise
ThinkJet Printer	• 150 cps	• 11×12 Dot Matrix	Yes	No	No	<50 dBA
QuietJet Printer	• 160 cps (10 cpi) • 192 cps (12 cpi) • 40 cps (10 cpi, NLQ) • 45 cps (12 cpi, NLQ)	• 19×12 Dot Matrix • 19×12 Dot Matrix • 19×24 Dot Matrix • 19×24 Dot Matrix	Yes	No	No	48 dBA
QuietJet Plus Printer	• 160 cps (10 cpi) • 192 cps (12 cpi) • 40 cps (10 cpi, NLQ) • 48 cps (12 cpi, NLQ)	• 19×12 Dot Matrix • 19×12 Dot Matrix • 19×24 Dot Matrix • 19×24 Dot Matrix	Yes	No	No	48 dBA
HP 2932A General Purpose Printer	• 200 cps	• 9×12 Dot Matrix	Yes	Yes	No	63 dBA
HP 2934A Business Printer	• 200 cps • 67 cps (NLQ)	• 9×12 Dot Matrix • 36×24 Dot Matrix	Yes	Yes	Accessory: HP 29340S Single Bin Sheet Feeder	63 dBA
LaserJet Printer	• 8 ppm	• Letter Quality	Yes	No	Yes (Built-in)	<55 dBA
HP 2603A Daisywheel Printer	• 45 cps • 48 cps burst speed	• Letter Quality • Full Font Impact	No	Yes	Accessory: 26030E Dual Bin and Envelope Feeder	58.5 dBA

☎ Fast-Ship product — see page 766.

Ordering Information

ThinkJet HP2225A: Standard interface: HP-IB	\$495
ThinkJet HP2225B: Standard interface: HP-IL	495
ThinkJet HP2225C: Standard interface: Centronics Parallel	495
ThinkJet HP2225D: Standard interface: RS-232C	495
QuietJet Plus HP2227A: Dual mode interface: RS-232C and Centronics	799
QuietJet HP2228A: Dual mode interface: RS-232C and Centronics	599
HP2603A Daisywheel: Standard interface: RS-232C	1495
accessories: HP26030A forms tractor mechanism	299
HP26030E triple-bin sheet feeder	999
LaserJet HP2686A: Standard interface:	3495
HP2932A: Standard interface: RS-232C	2595
interface options: RS-422 (#035)	50
Centronics (#042)	50
HP-IB (#046)	150
HP2934A: Standard interface: RS-232C	2995
interface options: Multipoint Synchronous (#034)	200
RS-422 (#035)	50
SNS/Data Link (#039)	200
Centronics-type (#042)	50
HP-IB (#046)	150
accessory: HP29340S single-bin sheet feeder	650

COMPUTER PERIPHERALS

Introduction to Hardcopy Graphics

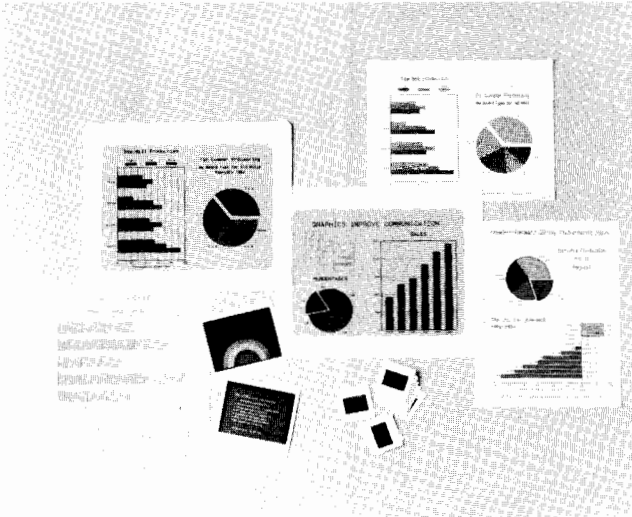

In fields as diverse as engineering, chemistry, medicine, finance, and marketing, the need for hardcopy graphics is growing. The reason is simple: graphics provide a comprehensive, easy-to-understand overview of numerical data.

Producing hardcopy graphics does not have to be difficult or expensive. Basically, there are three types of devices used to produce graphics—printers, plotters and film recorders. Each has its own applications. Printers are raster devices which use closely spaced dots to create working-quality drawings generally in black and white. Plotters, on the other hand, are vector devices which produce colorful, visually perfect graphics with sharp lines and smooth curves. And the HP 7510 vector film recorder produces colorful 35-mm slides for formal presentations.

With Hewlett-Packard graphics peripherals, you can quickly generate professional, hardcopy graphs and charts from design, measurement, and computational data.

Data Display Graphics

Data analysis usually requires extrapolating trends over time, studying relationships between variables, making comparisons between entities, and looking for exceptions and variances. All these lend themselves to graphic portrayal.

By using graphics, you eliminate printouts with pertinent data buried in long listings of hundreds or even thousands of variables. Effective graphics can help you spot key ideas, trends, and relationships that might otherwise go unnoticed. In addition, graphics can improve communications at meetings, and make you appear more professional and better prepared. Reports can be shorter, and easier to understand.

Design Graphics

Hardcopy graphics are a vital part of the computer-aided design and computer-assisted drafting fields. Tedious and time-consuming plans and schematics can be produced quickly and accurately using a plotter. HP drafting plotters create visually perfect drawings for applications in mechanical, electrical, and civil engineering, architecture, and drafting.

Interfaces

There are two interfaces for connecting HP plotters and the HP 7510 color film recorder with HP and non-HP computer systems: the HP-IB (IEEE-488-1978) and the RS-232-C/CCITT V.24. These options make it easy to integrate an HP plotter into almost any computer system.

HP-GL

Hewlett-Packard plotters understand HP-GL (Hewlett-Packard Graphics Language), a set of easy-to-understand mnemonic commands for controlling machine functions such as character generation and axis production. These internal commands simplify programming; for example, it often takes just one or two instructions to draw arcs or circles or define and fill a polygon.

Plotting Media and Pen Choices

Each HP plotter uses chart paper and at least one additional medium: plots can be drawn on transparency film for overhead projection, on high-gloss presentation paper for reports or graphic hand-outs, or on vellum, double-matte polyester film, and tracing bond for engineering and drafting drawings.

HP makes three types of pens—fiber-tip, roller-ball, and liquid-ink drafting pens. The fiber-tip pens for both paper and transparency film come in two widths, a fine tip for grids, tick marks, and labels, and a wide tip for bold titles, heavy lines, and filled-in areas. For engineering and drafting media, refillable drafting pens come in six standard widths, and disposable drafting pens come in four widths and multiple colors. Roller-ball pens in one width and four colors.

Intelligent Pen Control

All HP plotters change pens automatically under program control so no operator intervention is necessary. To produce graphics of consistently high quality, HP plotters precisely control pen movements through the use of sophisticated electronic circuitry. As pens descend, their motion is automatically damped to preserve pen tips. When pens are returned to their stalls after use, they are automatically capped so they stay fresh and last longer.

Graphics Software

HP plotters are supported on most Hewlett-Packard computer systems, desktop computers, and intelligent terminals. In addition, many popular graphics application and integrated software packages support these plotters on HP and non-HP computer systems and personal computers.

Film Recorder Output

With the standard 35-mm camera back, the HP 7510 color film recorder can accommodate 35-mm slide and print film, and Polaroid instant slide film. With an optional camera back, the recorder can also use instant print film.

Reliability

HP plotters, and the HP 7510 color film recorder, are built for professionals by professionals. HP has been manufacturing graphics plotters for over 15 years. An HP's commitment to product integrity means quality is built-in to every plotter and film recorder we make.



ColorPro (HP 7440A)

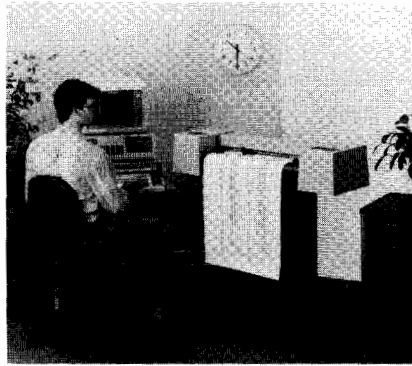

DraftPro (HP 7570A)

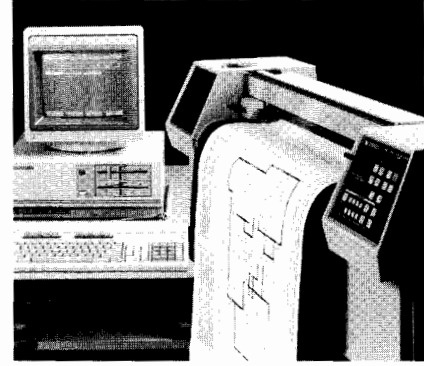

HP 7580B

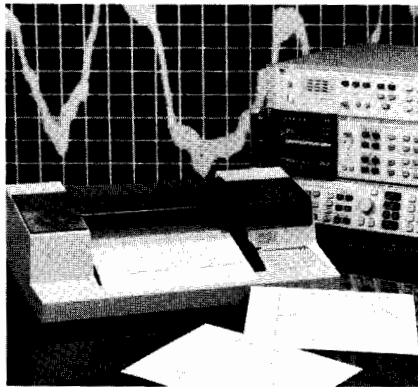

HP 7475A

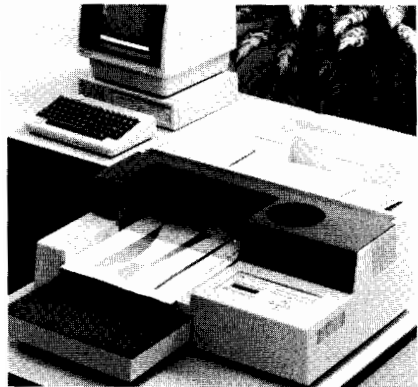

HP 7550A

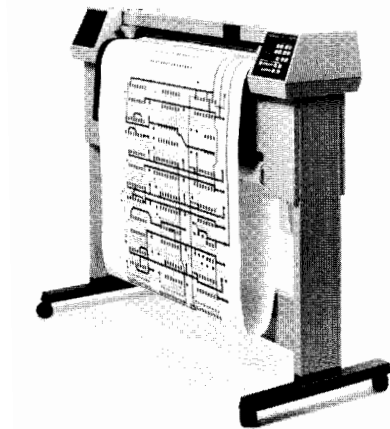

HP 7586B

HP Plotter Selection Guide

HP Model	Number of pens	Pen types	Media sizes	Media types	Media load methods	Interfaces	Page
ColorPro (HP 7440A)	8 in carousel	Paper, transparency	A4/A	Paper, transparency film	Manual sheet loading for all media types	RS-232-C/CCITT V.24 or (HP-IB) IEEE-488	110
HP 7475A	6 in carousel	Paper, transparency, liquid-ink	A4/A, A3/B	Paper, transparency film, polyester film	Manual sheet loading for all media types	RS-232-C/CCITT V.24 or (HP-IB) IEEE-488	111
HP 7550A	8 in carousel	Paper, transparency, liquid-ink, roller-ball	A4/A, A3/B	Paper, transparency film, vellum, polyester film	Automatic sheet feed for paper, transparency film Manual sheet loading for all media types	RS-232-C/CCITT V.24 or (HP-IB) IEEE-488	112
DraftPro (HP 7570A)	8 in carousel	Paper, liquid-ink	A2/C, A1/D	Paper, vellum, polyester film	Manual sheet loading for all media types	RS-232-C/CCITT V.24 (standard) (HP-IB) IEEE-488 (optional)	114
HP 7580B HP 7585B	8 in carousel	Paper, liquid-ink, roller-ball	A4/A, A3/B, A2/C, A1/D, (A0/E HP 7585B only)	Paper, vellum, tracing bond, polyester film	Manual sheet loading for all media types	RS-232-C/CCITT V.24 and (HP-IB) IEEE-488	116
HP 7586B	8 in carousel	Paper, liquid-ink, roller-ball	A4/A, A3/B, A2/C, A1/D, A0/E	Paper, vellum, tracing bond, polyester film	Automatic roll feed for all media types except tracing bond Manual sheet loading for all media types	RS-232-C/CCITT V.24 and (HP-IB) IEEE-488	116



COMPUTER PERIPHERALS

Scientific Measurement/Business Plotter

ColorPro Plotter

- 8-pen carousel
- Handles A4/A-size paper, transparency film



The HP ColorPro eight-pen plotter is designed to provide quick, presentation-quality color visuals for business and scientific applications. It draws with fiber-tip pens on overhead transparency film and regular and glossy paper.

The ColorPro plotter is designed for professionals who make decisions from numbers and make presentations with numbers. Whether you're drawing overheads for a meeting or recording data from a smart instrument, output quality is important. The exceptional line quality of the ColorPro plotter makes drawings and charts perfect for most professional presentations or reports.

High-Quality Output

With an addressable step size of 0.025 mm (0.001 in.), the ColorPro plotter can draw up to 1000 points in a 1-inch line. That means you get ruler-straight lines, even on the diagonal. And when commanded to return to the same point with no pen change, the plotter achieves this repeatability within 0.1 mm (0.004 in.). This precision helps ensure that circles are closed and bar and pie charts are properly aligned.

Eight-pen Carousel for Color and Convenience

Once you load the ColorPro plotter's eight-pen carousel, you have access to a spectrum of colors in two different widths — thick pens for headings, thin pens for details. And the pens are capped when not in use to prolong pen life.

Programming Features

If you plan on creating your own graphics programs, you can utilize the HP-GL instructions resident in the ColorPro plotter. HP-GL (Hewlett-Packard Graphics Language) is a simple but powerful command set that controls plotting functions such as pen movement, labeling, character set selection, and axis placement. Order the HP ColorPro Programming Manual (Part No. 07440-90001) for complete explanations and examples of the plotter's graphics and interfacing instructions.

- High-quality output
- ROM cartridge slot

Compatibility

With a choice of two interfaces, RS-232-C/CCITT V.24 or HP-IB (IEEE 488-1978), the HP ColorPro plotter works with virtually all personal computers. It can also be connected to a variety of HP and non-HP minicomputers or mainframes, but does not provide eavesdrop capability in these environments.

ROM Cartridge Slot

To keep up with your expanding needs (such as emerging graphics standards), the ColorPro plotter has a ROM cartridge slot. HP offers a Graphics Enhancement Cartridge as an accessory to the ColorPro plotter. The cartridge adds more advanced capabilities to your ColorPro plotter such as additional HP-GL instructions to draw arcs, circles and polygons; a larger RS-232-C buffer (1024 bytes); and 14 ISO character sets.

Graphics Software

The ColorPro plotter is supported by a wide variety of graphics application packages for HP as well as non-HP computer systems. Details are available from any HP sales and support office.

Specifications

Resolution: smallest addressable step size, 0.025 mm (0.001 in.)

Repeatability: with a given pen, 0.1 mm (0.004 in.)

Pen velocity (each axis): pen up, approx. 52.0 cm/s (20.5 in./s); pen down, maximum, approx. 40.0 cm/s (15.7 in./s); programmable, 1.0 to 40.0 cm/s in 1.0 cm/s increments

Acceleration: approximately 1.2 g's

Environmental range: operating, 0°C to 55°C, 5% to 95% Rh (at 40°C), non-operating, -40°C to 75°C

Maximum plotting area: pen axis, 191 mm (7.5 in.) for A and A4; paper axis, 272 mm (10.7 in.) for A4, 257 mm (10.1 in.) for A

Interfaces: HP-IB (IEEE 488-1978) interface which implements IEEE 488-1978 standards; RS-232-C/CCITT V.24, asynchronous serial ASCII with switch selectable baud rates of 75, 110, 150, 200, 300, 600, 1200, 2400, 4800, 9600; 60-byte buffer

Power requirements: source, 100, 120, 200, 240 V ~ -10%, +5%; frequency, 48-66 Hz; consumption, 20 W maximum

Size: height, 125 mm (4.9 in.); width, 460 mm (18.1 in.); depth, 308 mm (12.1 in.)

Weight: net, 5.5 kg (12.0 lb); shipping, approx. 8.6 kg (19.0 lb)

FCC: FCC certified to conform to limits set for radio frequency interference when used with a class B computing device. Meets or exceeds IEC-380, IEC-435, UL-478

Accessories Supplied

HP ColorPro Graphics Plotter Operating Manual

Power supply

An assortment of pens and media are also supplied with the plotter. The media size and appropriate power supply are determined by plotter destination.

NOTE: Interface cables are not supplied with the plotter. They must be ordered separately.

Ordering Information

HP 7440A ColorPro Plotter

HP 17440A Graphics Enhancement Cartridge

Options

001 RS-232-C/CCITT V.24 (cable not included)

002 HP-IB (IEEE 488-1978) (cable not included)

Interface Cables

HP 13242G M-M special RS-232-C cable for use with Option 001, HP 150 Personal Computers, HP Vectra PC with HP 24541A interface

HP 17255D M-F special RS-232-C cable for use with Option 001, IBM PC, AT&T Personal Computers

HP 24542G M-M special RS-232-C cable for use with Option 001, HP Vectra PC with HP 24540A interface, IBM AT

HP 10833A HP-IB 1-metre cable for use with Option 002

☎ Fast-Ship product — see page 766.

Price

\$1295.00 ☎

\$150.00 ☎

N/C

N/C

\$69.00 ☎

\$40.00 ☎

\$50.00 ☎

\$80.00 ☎



- High-quality output
- Drafting capability
- Choice of A3/B and A4/A media sizes

- Six-pen carousel
- Plots on paper, transparency film, polyester film
- Plots using fiber-tip and liquid-ink pens

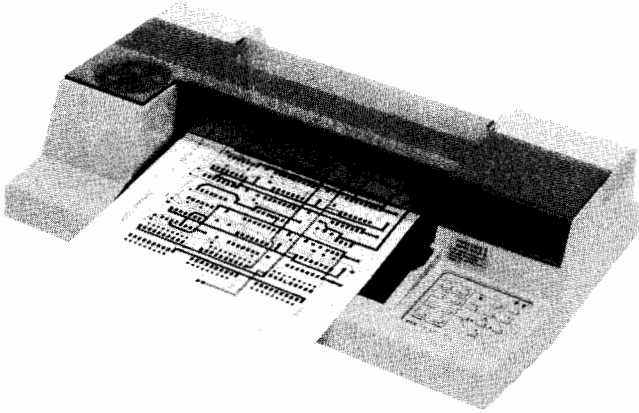

The HP 7475A is a low-cost plotter that provides the kind of graphics excellence and versatility you would expect to find in a much more expensive plotter. The HP 7475A produces fast, high-quality drawings for business, design, and measurement professionals.

With the HP 7475A, you have your choice of two media sizes — A4/A-size for colorful report and presentation graphics, and A3/B-size plots for PERT charts, schematics, engineering drawings, and design applications. You can switch chart sizes with the push of a button.

If you need a vertical format, you can use the front panel keys to rotate the chart 90 degrees. And if you need to digitize, you can do that from the front panel, too.

The HP 7475A accepts four different types of media — chart paper, glossy presentation paper, overhead transparency film and double-matte polyester film. And you have a choice of two different pen types — fiber-tip pens for paper and overhead transparencies and liquid-ink drafting pens for high-quality drawings on polyester film. Fiber-tip pens are available in ten colors and two tip widths. Refillable short-body drafting pens come in three different tip widths.

Applications

Business: The A3/B-size capability of the HP 7475A makes it the ideal plotter for PERT charts, organization charts, flow charts, or small flip charts. And the HP 7475A produces colorful A4/A-size charts for reports, meetings, and presentations.

Design: Perfect as an entry level drafting plotter or an inexpensive companion to your design system, the HP 7475A creates liquid-ink drawings on polyester film for frequently handled archival copies or check plots using fiber-tip pens on paper.

Measurement: The HP 7475A adds hardcopy graphics capability to intelligent instruments and instrument systems with an HP-IB (IEEE 488-1978) interface. Many systems (with or without display screens) can have the benefits of high-quality, hardcopy graphics plotted directly from measured data. (See page 29.1 for more information.)

High-Quality Output

With an addressable step size of 0.025 mm (0.001 in.), the HP 7475A can plot up to 1000 points in a 1-inch line. When commanded to return to the same point with no pen change, the plotter achieves this repeatability within 0.1 mm (0.004 in.). Because of the outstanding resolution and repeatability, the HP 7475A produces straight, professional-quality lines.

Special Programming Features

If you create your own graphics programs, you'll be glad to learn that the HP 7475A contains over 50 HP-GL (Hewlett-Packard Graphics Language) instructions to control such functions as arc and circle generation, and area fill in pie and bar charts. Plus, the HP 7475A has 19 internal character sets, including ISO European sets, Katakana, ASCII, and Roman 8 extensions.

Interface Options

The HP 7475A is easy to interface with most HP and non-HP computers because you have the choice of two interface options — either RS-232-C/CCITT V.24 or HP-IB (IEEE 488-1978). By adding an eavesdrop cable you can connect the HP 7475A in series with a computer and a terminal.

Graphics Software

The HP 7475A is supported on a wide variety of business and design graphics application packages for HP as well as non-HP computer systems. Details are available from any HP sales and service office.

Specifications

Resolution: Smallest addressable step size, 0.025 mm (0.001 in.)

Repeatability: with a given pen, 0.1 mm (0.004 in.); from pen to pen, 0.2 mm (0.008 in.)

Pen velocity (each axis): pen up, 50.8 cm/s (20 in./s); pen down, maximum, 38.1 cm/s (15 in./s); programmable, 1 to 38 cm/s in 1 cm/s increments

Acceleration: approximately 2 g's

Environmental range: operating, 0°C to 55°C; non-operating, -40°C to 75°C

Plotting area: x-axis, 258 mm (10.2 in.), A/B; 275 mm (10.8 in.), A4/A3; y-axis, 198 mm (7.80 in.), A; 192 mm (7.56 in.), A4; 414 mm (16.3 in.), B; 402 mm (15.8 in.), A3

Interfaces: HP-IB (IEEE 488-1978) implements the following functions as defined in IEEE 488-1978 — SH1, AH1, T2, TE0, LE0, SR1, RL0, DC1, DT0, L2, PP0 (listen only or address less than 7, otherwise PP2); RS-232-C/CCITT V.24, asynchronous serial ASCII with switch selectable baud rates of 75, 110, 150, 200, 300, 600, 1200, 2400, 4800, 9600. External clock input capabilities with intermediate baud rates of up to 9600 baud; 1024 byte buffer

Power requirements: source, 100, 120, 220, 240 V~ -10%, +5%; frequency, 48-66Hz

Size: height, 127 mm (5 in.); width, 568 mm (22.4 in.); depth, 367 mm (14.5 in.)

Weight: net, 7 kg (16.0 lb); shipping, approx. 11 kg (24.0 lb)

FCC: FCC certified to limits set for radio frequency interface when used with a class B computing device

Accessories Supplied

HP 07475-90001 Interfacing and Programming Manual

HP 07475-90002 Operation and Interconnection Manual

HP 07475-90003 Reference Card

Power cords and an assortment of pens and drawing media are also supplied with the plotters. The media size and destination.

NOTE: Interface cables are not supplied with the plotter. They must be ordered separately.

Ordering Information

001 RS-232-C/CCITT V.24 (cable not included)

002 HP-IB (IEEE 488-1978) (cable not included)

HP 7475A Six-pen Graphics Plotter

Available from Instruments Direct 800-523-2121 (U.S. only)

☎ Fast-Ship product — see page 766.

Price

N/C

N/C

\$1895 ☎

COMPUTER PERIPHERALS

High Speed/High Performance Plotter

Model 7550A

- Ideal for high-volume, shared environments
- Requires minimum operator supervision
- Uses drafting media, pens
- High throughput
- 6 g acceleration, 80 cm/s (31.5 in./s)
- Accepts A3/B- and A4/A-size media



HP 7550A

Hewlett-Packard's sheet feed 7550A plotter is an innovative graphics tool for business and technical users alike. Automatic cut sheet feed capability for paper and transparencies makes the HP 7550A ideal for unattended plotting or multiple color copies. With an unmatched 6 g of acceleration, the HP 7550A can produce quick graphs for problem-solving or decision making, or working drawings for drafting or design systems. And the HP 7550A meets Hewlett-Packard's high performance standards, so it creates professional-looking graphs for reports and presentations.

Fast Throughput

The HP 7550A's fast acceleration and pen speed mean shorter plotting time. The HP 7550A draws in any direction at 80 cm/s (31.5 in./s) and letters at approximately 7-9 characters per second. It uses the powerful MC68000 16-bit microprocessor. The HP 7550A is also equipped with a replot capability so if an entire plot will fit in the replot buffer (\approx 12K bytes), the HP 7550A can produce up to 99 original color copies without rerunning the program, freeing your computer to go on with other tasks.

Minimum Operator Supervision

The HP 7550A eliminates manual paper handling of A3/B- and A4/A- size sheets of paper, and transparency film. The carousel allows eight pens to be loaded at once, and the plotter caps the pens when not in use to keep ink fresh. The HP 7550A automatically senses the type of carousel loaded, then sets the optimal pen speed and force. It also senses what paper size is being used.

High Quality Output

With an addressable resolution of 0.025 mm (0.001 in.) and mechanical resolution of 0.006 mm (0.00025 in.), the HP 7550A makes smooth arcs and draws lines that meet precisely. It also has a curved line generator which can be invoked when exceptionally smooth curves are required.

With 20 character sets, the HP 7550A is ideal for international business. Choices include Katakana and ISO European languages for Denmark, France, Germany, Italy, Norway, Portugal, Spain, Sweden, and the United Kingdom. The HP 7550A letters in two fonts: arc font with proportional spacing for maximum readability and stick font with fixed character spacing for speed.

Features

The front-panel display and function keys guide users through each plotter setup, report plotter status, and give program messages. The HP 7550A rotates graphs 90 degrees for a choice of either horizontal or vertical formats, and aligns graphs to pre-printed forms and grids, all from the front panel.

The HP 7550A accepts standard A4/A- and A3/B-size paper, double-matte polyester film, vellum, and A4/A-size transparency film. Pen choices include liquid-ink, roller-ball, paper, and transparency pens. Because of its complete device control command set and dual interface - HP-IB (IEEE-488) and RS-232-C/CCITT V.24, the HP 7550A is adaptable to most system environments.

Technical Applications

The drawing quality, media flexibility, automatic sheet feed and fast plotting time of the HP 7550A make it ideal for quick working drawings or small format final drawings in computer-aided design, or for technical graphics in manufacturing, testing, or research and development. The HP 7550A is supported by many technical graphics software packages; the HP 7550A can draw A3/B-size check plots and working drawings to help relieve overburdened drafting plotters, produce quick, problem-solving graphs or engineering analyses, and plot charts and graphs on transparency film for technical presentations. And the HP 7550A does it all quickly and easily.

Business Applications

The HP 7550A is suited to business graphics users who appreciate the value of color hardcopy graphics, need quality graphics in quantity, and want a plotter that requires a minimum of operator supervision. Financial graphs, project schedules, forecasts and text charts are typical uses for a HP 7550A in a business environment. And both HP and non-HP graphics software packages make it easy for anyone to use the HP 7550A.

Software

Software support is available for the HP 7550A on many HP and non-HP computer systems, as well as HP and non-HP personal computers. In addition to HP's Industry Standard Plotting Package (see page 117), a variety of graphics packages for nonprogrammers is available. These software packages cover both business and technical applications. Complete information is available from any HP Sales and Support office.

Specifications

Media sizes: accommodates ISO A4 (210 x 297 mm), ANSI A (8.5 x 11 in.), ISO A3 (297 x 420 mm), and ANSI B (11 x 17 in.)

Maximum plotting area: pen axis, 254 mm (9.97 in.) for A/B, 272 mm (10.65 in.) for A4/A3; paper axis, 411 mm (16.12 in.) for B, 399 mm (15.65 in.) for A3, 196 mm (7.68 in.) for A, 190 mm (7.45 in.) for A4.

Resolution: smallest addressable step size is 0.025 mm (0.001 in.); mechanical resolution is 0.006 mm (0.00025 in.)

Repeatability: with a given pen, 0.1 mm (0.004 in.)

Pen Velocity: pen down, maximum, 80 cm/s (31.5 in./s) in increments of 1 cm/s, from the front panel 10 to 80 cm/s (4 to 31.5 in./s) in increments of 5 cm/s; pen up 80 cm/s (31.5 in./s)

Acceleration: maximum approximately 6 g's; programmable from 1 to 6 g's in increments of 1 g.

Pen force: 15 to 66 grams

Power requirements: source, 100, 120, 220, 240 V, -10%, +5%; frequency, 48 - 66 Hz; consumption, 100 W maximum

Interfaces: HP-IB implements the following HP-IB functions as defined in IEEE 488-1978: SH1, AH1, T6, L3, SR1, RLO, DC1, DT0, C0, PP0, for listen only, PP1 for address greater than 7, and PP2 for address of 7 or less, device address front panel selectable, default value - 5; RS-232-C/CCITT V.24, asynchronous serial ASCII with front panel selectable baud rates of 75, 110, 150, 200, 300, 600, 1200, 2400, and 9600, default value - 2400

Buffer size: default, 1024 bytes; from the program expandable to 12K bytes

Character sets: 20 sets, each in two character fonts, including, the following ISO registered sets: International Reference Version (002); United Kingdom (004), U.S. ASCII (006), Swedish (010), Swedish for Names (011), Katakana (013), JIS ASCII (014), Italian (015),

Portuguese (016), Spanish (017), German (021), French (025), Norwegian (060), Norwegian II (061), plus HP 9825 character set, French/German, Scandinavian, Spanish/Latin America, Special Symbols, and Roman 8 Extensions

Environmental range: operating, 0°C to 55°C; nonoperating, -40°C to 75°C; automatic sheet feeder, operating with paper, 10 - 40 C and 0 - 80% RH, with transparency film, 15 - 35°C and 25 - 75% RH

Size: height, 215 mm (8.5 in.); width, 670 mm (26.4 in.); depth with A4/A loading tray/no catcher, 432 mm (17.0 in.), A4/A loading tray with catcher, 682 mm (26.8 in.), A3/B loading tray/no catcher, 635 mm (25.0 in.), A3/B loading tray with catcher, 896 mm (35.3 in.)

Weight: net approximately 17.3 kg (38.0 lb), shipping approximately 25.0 kg (55.0 lb)

Pens: 8 per carousel: fiber-tip, roller-ball, and liquid-ink

Media: manual feed, chart paper, high-gloss paper, transparency film, vellum, double-matte polyester mylar film; automatic sheet-feed, chart paper and transparency film.

Accessories Supplied

Interfacing and Programming Manual	HP Part Number
Operation and Interconnection Guide	07550-90001
Pocket Guide	07550-90002
A4/A Media Loading Tray	07550-90003
A4/A Paper Catcher	07550-60152
Pen carousel for fiber-tip transparency pens	07550-40167
Pen carousel for fiber-tip paper pens	07550-60050
	07550-60051

A power cord and an assortment of fiber-tip pens, paper and transparency media are also supplied with the plotter. The media size and appropriate power cord are determined by destination. Drafting pens and drafting media are available; please refer to the Computer Users Catalog for a complete listing.

Ordering Information

Interface cables	Price
HP 17355D Male-female RS-232-C/CCITT V.24 cable for use in remote modem environments; pins 1-25 wired end-to-end	\$60 ☎
HP 17255F Female-female RS-232-C/CCITT V.24 cable, adapted for use with IBM personal computer interface	\$40 ☎
HP 17255D Male-female RS-232-C/CCITT V.24 cable, adapted for use with HP 150 personal computer interface	\$40 ☎
HP 17855A RS-422-A adapter cable	\$200 ☎
HP 10833A or 45529A HP-IB 1-metre cable; RFI shielded	\$80 ☎
HP 10833B or 45529B HP-IB 2-metre cable; RFI shielded	\$90 ☎

Accessories Available

HP 17526A A3-size Media Handling Kit, including media loading tray, media catcher, 50 sheets A3-size plotter paper	\$160 ☎
HP 17525A B-size Media Handling Kit, including media loading tray, media catcher, 50 sheets B-size plotter paper	\$160 ☎

HP 7550A Graphics Plotter **\$3900 ☎**
☎ Fast-Ship product — see page 766.



COMPUTER PERIPHERALS

Low-cost, Eight-pen Drafting Plotter

HP DraftPro Plotter

- Professional, quality output
- Solid software support
- Pens and media for every application
- A2/C/Architectural C- and A1/D/Architectural D-size media

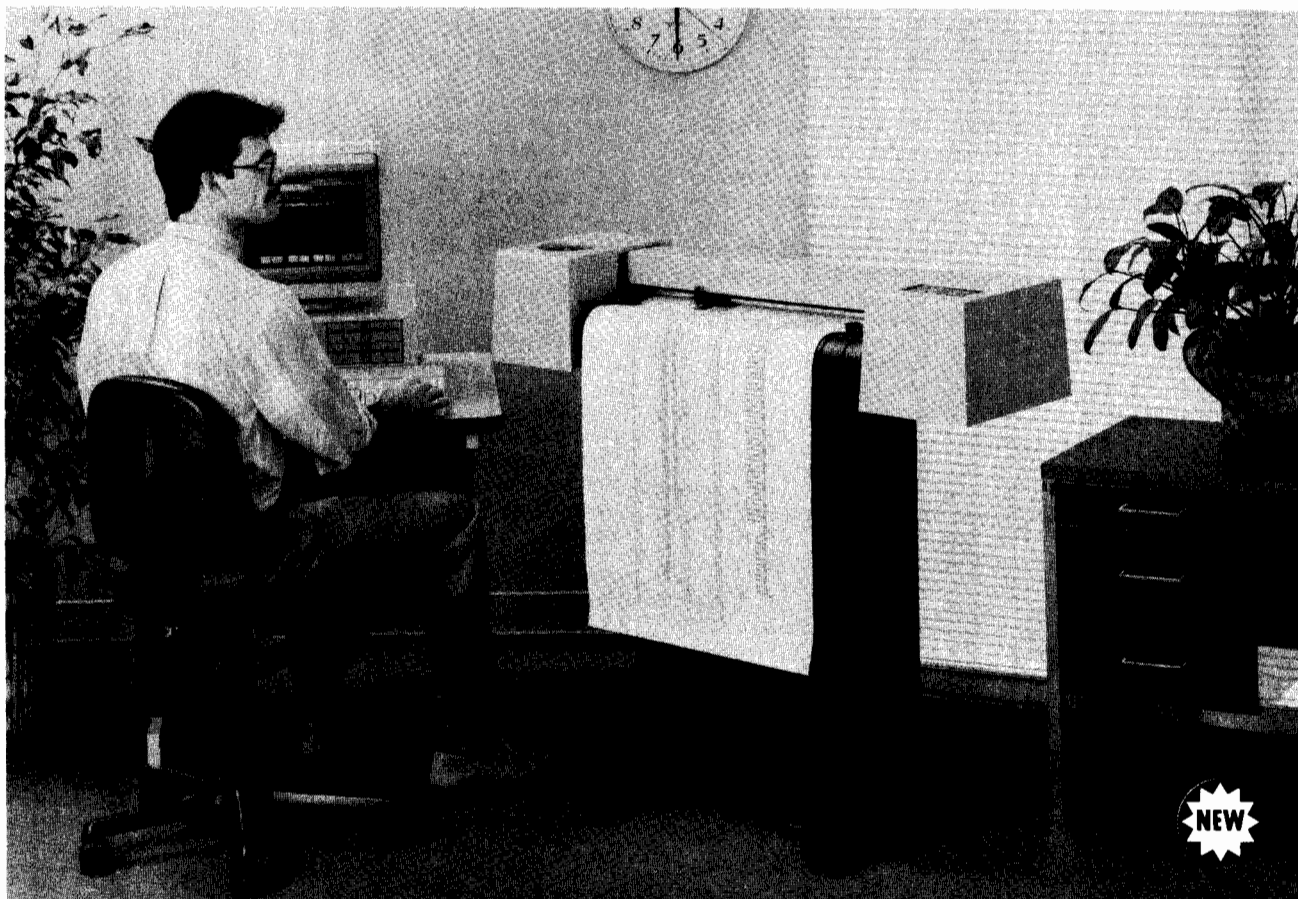

The HP DraftPro plotter is an 8-pen drafting plotter that's been designed especially for you and your personal CAD system. The HP DraftPro plots on single sheets with widths from 550 mm to 640 mm and lengths from 400 mm to 1000 mm. That includes ISO A2 and A3 sizes, ANSI C and D sizes, and Architectural C and D sizes.

Whether you create electrical schematics, floor plans, part renderings, or topographical maps, the DraftPro plotter offers the professional-quality output your work deserves — at a price you can afford.

High-Quality Output

When your drawings look good, you look good. So you need high-quality output that reflects the professional nature of your work. The DraftPro plotter provides the high-quality output you expect from a Hewlett-Packard product.

The DraftPro plotter has a mechanical resolution of 0.013 mm (0.0005 in.) and an addressable resolution of 0.025 mm (0.001 in.) to ensure you get smooth arcs and crisp letters. And with DraftPro's repeatability of 0.10 mm (0.004 in.), your drawings will have precise corners and circles that close.

For applications that require precision plotting, accuracy is an important specification. Accuracy refers to the difference in length between distance the plotter is instructed to draw and the distance it actually draws. The DraftPro plotter is accurate to within 0.5 mm (0.02 in.) or 0.2% of the specified line length, whichever is greater.

Media and Pen Flexibility

Different types of media are appropriate for different applications. And for best results, it's important to use pens that are compatible with your media. The DraftPro plotter plots on paper, vellum, and polyester film. And it draws with fiber-tip pens, disposable liquid-ink pens, and refillable liquid-ink pens.

The HP DraftPro also allows you to choose one of eight different plotting speeds right from the front-panel. You can select the speed that is most appropriate for your pen/media combination.

Eight-pen Carousel

The DraftPro plotter's eight-pen carousel means you have access to a wide variety of colors and line widths for every drawing. During a plot, pens are changed automatically and they are automatically capped when not in use. Two carousels come with every DraftPro plotter — one for fiber-tip pens, and one for drafting pens.

High Throughput

Hewlett-Packard knows that you don't have time to sit around and wait for your plots to finish. In addition to its 2 g acceleration and 50 cm/s (19.7 in./s) velocity, the DraftPro plotter has several features that help minimize plotting time.

The DraftPro plotter has a "pen sorting" feature; the plotter minimizes the number of pen picks by grouping lines of the same color together and drawing them at the same time. In addition, the HP DraftPro has strong communication abilities, and raises and lowers the pen quickly.



Easy-to-Use

With the HP DraftPro, you can start producing drawings the same day you unpack the plotter. The paper and pen loading procedures are simple, and the front-panel controls can be mastered in minutes. And when you're loading media, the HP DraftPro automatically senses the sheet size and sets the margins accordingly.

The DraftPro plotter is small and lightweight, so it fits almost anywhere. And because it has its own set of wheels, the DraftPro is easy to move and easy to share.

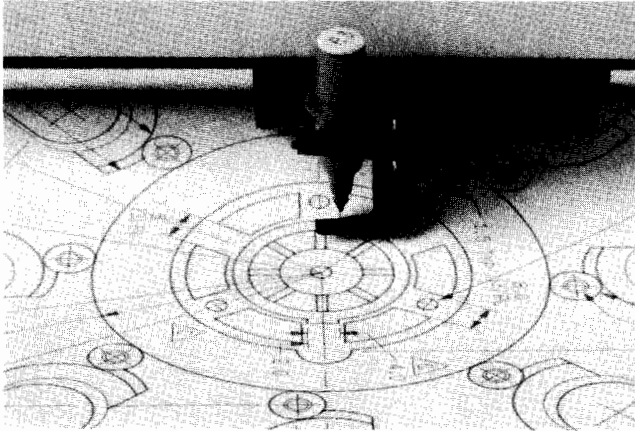

Powerful Command Set

Programmers will be glad to know the HP DraftPro supports more than 80 HP-GL (Hewlett-Packard Graphics Language) commands. With just a few commands, you can label; draw lines, arcs, and circles; or select one of 20 international character sets.

Hardware and Software Compatibility

The DraftPro plotter connects easily to almost any HP or other personal computer or workstation. An RS-232-C/CCITT V.24 interface comes standard; HP-IB (IEEE 488-1978) can be ordered as an accessory.

Like all HP drafting plotters, the DraftPro is supported by the leading software vendors. Check with your local HP sales and support office for complete software information. Or contact your current software vendor about their support for the DraftPro.

Specifications

Media sizes: accommodates widths from 550 mm to 640 mm, lengths from 400 mm to 1000 mm. These measurements include A2/C/Architectural C- and A1/D/Architectural D-size media.

Margins: Expanded mode, 5 mm (0.2 in.) on three edges, 31 mm (1.2 in.) on the fourth; Normal mode, 15 mm (0.59 in.) on three edges, 39 mm (1.5 in.) on the fourth.

Resolution: smallest addressable move, 0.025 mm (0.001 in.); mechanical resolution, 0.013 mm (0.0005 in.)

Repeatability: (for the same pen): 0.10 mm (0.004 in.); (pen to pen): 0.20 mm (0.008 in.). These specifications are for 0.08 mm (0.003 in.) polyester film.

Accuracy: 0.5 mm (0.02 in.) or 0.2% of the specified line length, whichever is greater. These specifications are for 0.08 mm (0.03 in.) polyester film.

Pen Velocity: pen down, 40 cm/s (15.7 in./s); pen up, 50 cm/s (19.7 in./s)

Acceleration: 2 g

Pen Cycle Time: 100 ms

Power requirements: source, 100, 120, 220, 240 V \pm 10%; frequency, 47.5-66 Hz; consumption, less than 80 W maximum.

Interfaces: RS-232-C/CCITT V.24, HP-IB (IEEE 488-1978) available as an accessory. HP-IB (IEEE 488-1978), implements the following HP-IB functions as defined in IEEE 488-1978: SH1, AH1, T6, L3, SR1, RL0, DC1, DT0, C0, PP0 for listen-only, PP1 for address greater than 7, and PP2 for address of 7 or less. For more on these codes, refer to the HP-IB section of this catalog.

Buffer size: 7448 bytes (to be shared between user-definable I/O, polygon, and pen sort buffers)

Environmental Range: operating temperature, 0° C to 55° C; non-operating temperature, -40° C to 75° C; relative humidity, 5% to 95% (in 0° C to 40° C)

Size: height, 1030 mm (40.6 in.); width, 1140 mm (44.9 in.); depth, 520 mm (20.5 in.)

Weight: 30 kg (66 lb)

Pens: 8-pen carousel: fiber-tip, disposable liquid-ink, and refillable liquid-ink drafting pens.

Media: Paper, vellum, and double-matte polyester film.

Accessories Supplied

User's Guide

Power Cord

Media Sampler Kit

5 sheets of architectural D-size paper

Fiber-tip pens (0.3 mm)

Pkg of 5 (black, green, red, and yellow)

Carousels

Fiber-tip pen carousel

Liquid-ink drafting pen carousel

Grit Wheel Brush

Hewlett-Packard Drafting Supplies Catalog

(P/N 5958-2698 [D] or 5958-2697)

Ordering Information

HP 7570A DraftPro Plotter

HP 17570A HP-IB Cartridge

Price

\$5,400

\$295

Accessories Available

Description

HP-IB Installation Instructions

Programmer's Reference (available in English only)

Programmer's Pocket Guide (available in English only)

Hardware Support Manual

Part Number

07570-90014

07570-90001

07570-90003

07570-90000

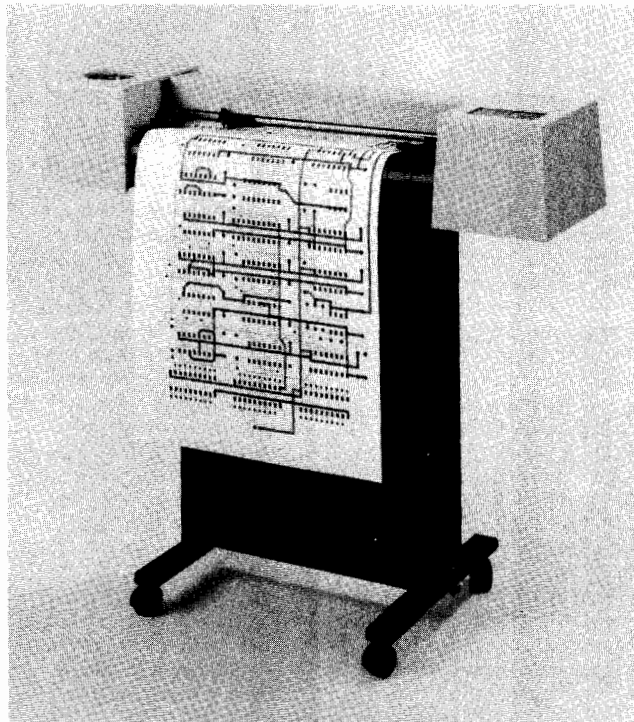

COMPUTER PERIPHERALS

Eight-pen Drafting Plotters

Models 7580B, 7585B, 7586B



- HP 7580B accepts sheets up to ISO A1 (ANSI D)
- HP 7585B, 7586B accept sheets up to ISO AO (ANSI E)
- HP 7586B accepts rolls up to 919 mm (36.2 in.)
- Choice of pen, media combinations
- Frame-to-frame long-axis plotting on HP 7586B
- HP-IB and RS-232-C/CCITT V.24 (switch selectable)

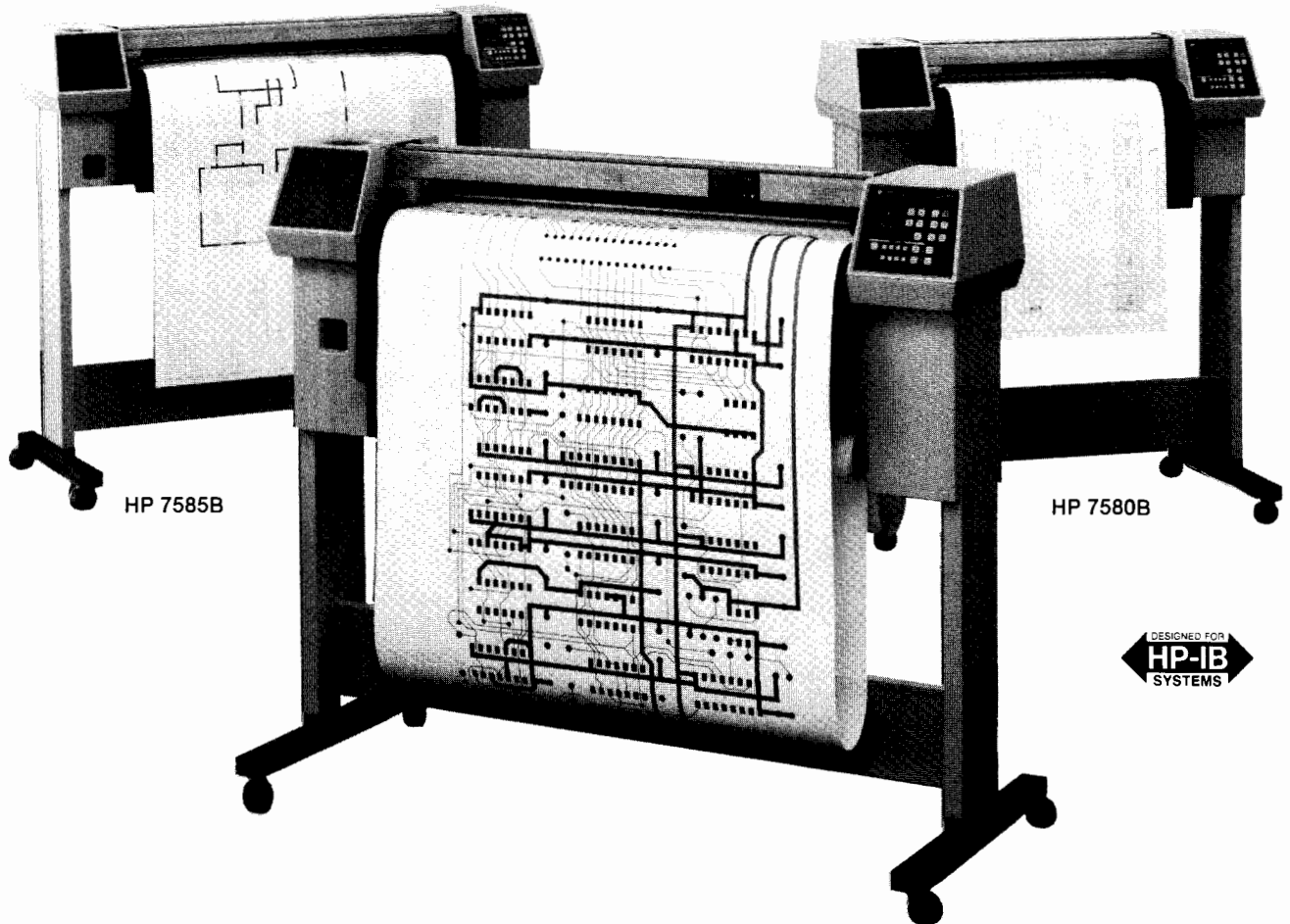

HP 7585B

HP 7580B



HP 7586B

HP drafting plotters are built for the design professional. HP drafting plotters are reliable because designers depend on their plotters—and when the drafting plotter goes down, so does productivity. And HP drafting plotters are fast—because designers don't have time to sit around and wait for plots to finish. And they produce high quality drawings—because the quality of the plotter output reflects the quality of a designer's work.

HP offers an entire family of full-size, high-performance drafting plotters—the HP 7580, 7585, and 7586. The only difference between these plotters is media size. The HP 7580B accepts sheets ranging from ISO A4 through A1 (ANSI A through D). The HP 7585B accepts sheets ranging from ISO A4 through A0 (ANSI A through E). The HP 7586B is a combined single-sheet and roll-feed plotter. It accepts sheets ranging from ISO A4 through A0 (ANSI A through E), plus it plots on rolls in standard widths up to 919 mm (36.2 in.) and lengths up to 46 m (150 ft).

All three drafting plotters draw on individual sheets of paper, vellum, double-matte polyester film, and tracing bond. The HP 7586B also draws on rolls of paper, vellum and polyester film. Users have a choice of roller-ball, fiber-tip, and liquid-ink drafting pens in various colors and line widths. When not in use, pens rest in an eight-pen carousel and are capped automatically. Common uses in industry include computer-aided drafting; computer-aided design of printed circuit boards, integrated circuits, and mechanical parts; architectural or civil engineering design; and mapping applications.

Roll Feed Available on HP 7586B

The HP 7586B roll-feed plotter is designed for high volume, continuous feed, and long-axis plotting. With the HP 7586B, you can run large numbers of plots, then store them neatly on a roll or remove each plot as it is finished. The HP 7586B's frame-to-frame long-axis technique allows you to draw plots up to 46 m (150 ft). Long-axis plots are divided into sections and drawn one frame at a time. And the plotter automatically aligns each section to ensure the plot continues exactly where it left off.

Advanced Pen Control and Writing Systems

When a sheet is loaded, the HP drafting plotters automatically sense the sheet size and set the limits of pen motion. These plotters also sense which type of pen carousel has been loaded, and automatically choose the proper velocity, acceleration and pen force settings for the various ink and media combinations.

In addition, these plotters have an intelligent pen control system. On descent, pen motion is damped as the pen approaches the surface of the medium so that delicate pen tips are not damaged and pen bounce is minimized. Pens last longer and plotted lines are uniform from start to finish.

High Quality Output

While the addressable resolution of the HP drafting plotters is excellent at 0.025 mm (0.001 in.), the pen and the drawing medium actually move on an even finer grid to create high quality lines. These movements are servo controlled with a mechanical resolution of 0.003 mm (0.00012 in.).

A microprocessor keeps pen velocity and acceleration constant regardless of direction so diagonal lines are the same quality as lines drawn parallel to the axes.

High Throughput

At 60 cm/s maximum velocity and 4 g's of acceleration, HP drafting plotters are fast. When a slower speed is required to accommodate a drawing medium, throughput remains high because pen-up movements are always executed at maximum speed, and pen lift delays are kept to a minimum because the pen is lifted slightly on small moves (as when labeling) and to maximum height only on long moves.

Simple, Powerful Command Set

Programming is easy using the Hewlett-Packard Graphics Language (HP-GL). The commands implemented on the plotters allow the user to draw lines, circles, arcs, to position labels, change character size, slant and direction, digitize, and more. They can rescale the plotting area in convenient user-defined units, rotate the plot 90 degrees, or "window" and plot only a portion of the original plot. Included in these commands are several area-fill instructions which make it easy to use patterns or solid coloring in wedges, rectangles, and polygons.

In addition, these plotters offer quality labeling. Each has 21 character sets in three fonts to provide the programmer with a large range of annotation capabilities including mapping symbols, special centered symbols, and foreign language characters.

Software Support

HP drafting plotters are supported on a number of application software packages for HP and non-HP computers.

For users of Industry Standard FORTRAN subroutines, a software package, HP-ISPP (Hewlett-Packard Industry Standard Plotting Package), is available. HP ISPP contains 15 graphics subroutines and can be easily installed on most ASCII-based systems that offer the equivalent of 32,000 16-bit words for user application program space.

Contact your HP sales representative for current software information.

Specifications

Media sizes

HP 7580B (sheets): minimum, 203 x 267 mm (8 x 10.5 in.); maximum, 622 x 1231.9 mm (24.5 in. x 48.5 in.); includes standard sizes A4/A, A3/B, A2/C, A1/D

HP 7585B and 7586B (sheets): minimum, 203 x 267 mm (8 x 10.5 in.); maximum 927 x 1231.9 mm (36.5 x 48.5 in.); includes standard sizes A4/A, A3/B, A2/C, A1/D, A0/E, excludes some nonstandard sizes between A3/B and A2/C

HP 7586B (rolls): width, 267 mm (10.5 in.) to 298 mm (11.75 in.) and 546 mm (21.5 in.) to 919 mm (36.2), length 46 meters (150 ft), roll core, inner diameter, 51 mm ± 1.6 mm (2.0 in.)

Maximum Plotting Area: Single sheets, drawing sheet less margins; roll media, roll width times frame length less margins; long-axis plotting, roll width less 30 mm (1.2 in.) margin times roll length.

Frame Lengths for Roll Media: Roll widths less than 298.5 mm (11.75 in.), 431.8 mm (17 in.); roll widths greater than 721.4 mm (28.4 in.), 1219.2 mm (48 in.); roll widths between 298.5 and 721.4 mm, 914.4 mm (36 in.)

Margins: Sheets, normal mode, three margins approx. 15 mm (.59 in.) each, fourth margin approx. 39 mm (1.5 in.); expand mode, three margins approx. 5 mm (.2 in.) each, fourth margin approx. 29 mm (1.1 in.)

Rolls, normal mode, 15 mm (.59) each side, expand mode, not recommended

Resolution: smallest addressable move, 0.025 mm (0.001 in.); mechanical resolution, 0.003 mm (0.00012 in.)

Repeatability (for a given pen): on paper, vellum, or 0.075 mm (0.003 in.) double-matte polyester film at 10-30 C: 0.10 mm (0.004 in.)

Endpoint Accuracy: on double-matte polyester film (3 mil) at 18-30°C, level floor: 0.1% of the move or 0.25 mm (0.0098 in.), whichever is greater.

Pen velocity: pen down, maximum: 60 cm/s (24 in./s) independent of vector direction; programmable: 1 to 60 cm/s in 1-cm increments (0.4 to 24 in./s); front panel selectable: 10 to 60 cm/s in 10-cm increments (4 to 24 in./s); front panel selectable: 10 to 60 cm/s in 10-cm increments (4 to 24 in./s). Pen up, 60 cm/s (24 in./s) independent of vector direction.

Acceleration: maximum, 4 g (39 m/s², 129 ft/s²); programmable, 1 to 4 g in 1-g increments (9.7 to 39 m/s², 32 to 128 ft/s²).

Pen force: programmable and front panel selectable: 10 to 66 grams in 8-gram increments.

Power requirements: source, 100, 120, 220, 240 V ~ -10%, +5%; frequency, 48-66 Hz single phase; consumption, 182 W max.

Interfaces (selectable from a rear-panel switch): HP-IB (IEEE 488-1978), implements the following HP-IB functions as defined in IEEE 488-1978: SH1, AH1, T6, L3, SR1, RL0, DC1, DT0, C0, PP0 for listen-only, PP1 for address greater than 7, and PP2 for address of 7 or less. For more on these codes, refer to the HP-IB section of this catalog.

RS-232-C/CCITT V.24, asynchronous serial ASCII with switch selectable baud rates of 50, 75, 110, 134.5, 150, 200, 300, 600, 1200, 1800, 2400, 3600, 4800, 7200 and 9600.

Buffer Size: 18,432 bytes

Environmental Range: operating: temperature, 0°C to 55°C, relative humidity, sheets, 5% to 95% (0°C to 40°C), rolls, 30% to 70% (10°C to 30°C); nonoperating: temperature, -40°C to 75°C

Size: HP 7580B, height, 1188 mm (46.8 in.), width, 1087 mm (42.8 in.), depth, 557 mm (21.9 in.)

HP 7585B and 7586B, height, 1188 mm (46.8 in.), width, 1392 mm (54.8 in.), depth, 557 mm (21.9 in.)

Weight: HP 7580B, net weight, 59.1 kg (130 lb), shipping weight, approx. 114 kg (250 lb)

HP 7585B, net weight, 70.4 kg (155 lb), shipping weight, approx. 131 kg (290 lb)

HP 7586B, net weight, 86.4 kg (190 lb), shipping weight, approx. 147.8 kg (325 lb)

Pens: 8 per carousel: fiber-tip, drafting, roller-ball.

Media: most standard paper, vellum, and double-matte polyester film, 3 or 4 mil thick.

Accessories Supplied

	HP Part No.
Interfacing and Programming Manual	07580-90034
Operator's Manual	07580-90033
Programmer's Reference Card	07580-90035
3 Pen Carousels	
Drafting pen carousel	07580-60081
Roller ball carousel	07580-60082
Fiber tip carousel	07580-60035
Male-to-male RS-232-C/CCITT V.24 cable	17355M
An assortment of pens and various drawing media and cleaning supplies are also provided with the plotter. Drafting media and other plotter supplies are available from Hewlett-Packard.	
HP Drafting Supplies Catalog	5957-4118

Ordering Information

	Price
HP 7580B Drafting Plotter	\$ 9,900
HP 7585B Drafting Plotter	\$12,900
HP 7586B Drafting Plotter	\$16,900

Options

051 for use with HP 9000, Series 200 computers	N/C
052 for use with HP Series 100 personal computers	N/C
053 for use with HP 3000 computers	N/C
058 for use with HP Series 80 personal computers	N/C
059 for use with HP 9000, Series 500 computers	N/C
060 for use with HP 1000 computers	N/C
065 for use with non-HP computers	N/C
HP 17580BHP-ISPP Software (specify media option from Table 1)	\$300

Table 1

No.	Media Options for HP-ISPP	Price
001	800 BPI magnetic tape, 9-track, unlabeled, unblocked, 72 byte fixed-length records, ASCII character code	N/C
002	1600 BPI magnetic tape, 9-track, unlabeled, unblocked, 72 byte fixed-length records, ASCII character code	N/C
003	Flexible diskette, single-sided, single-density, compatible with Digital Equipment Corporation RX01 dual drive used under RT-11 operating system	N/C

COMPUTER PERIPHERALS

Color Film Recorder Model 7510

- High-quality 35-mm slides
- Vector technology
- High-resolution output
- Multi-user capability
- Easy-to-use
- Dual interface, RS-232-C and HP-IB

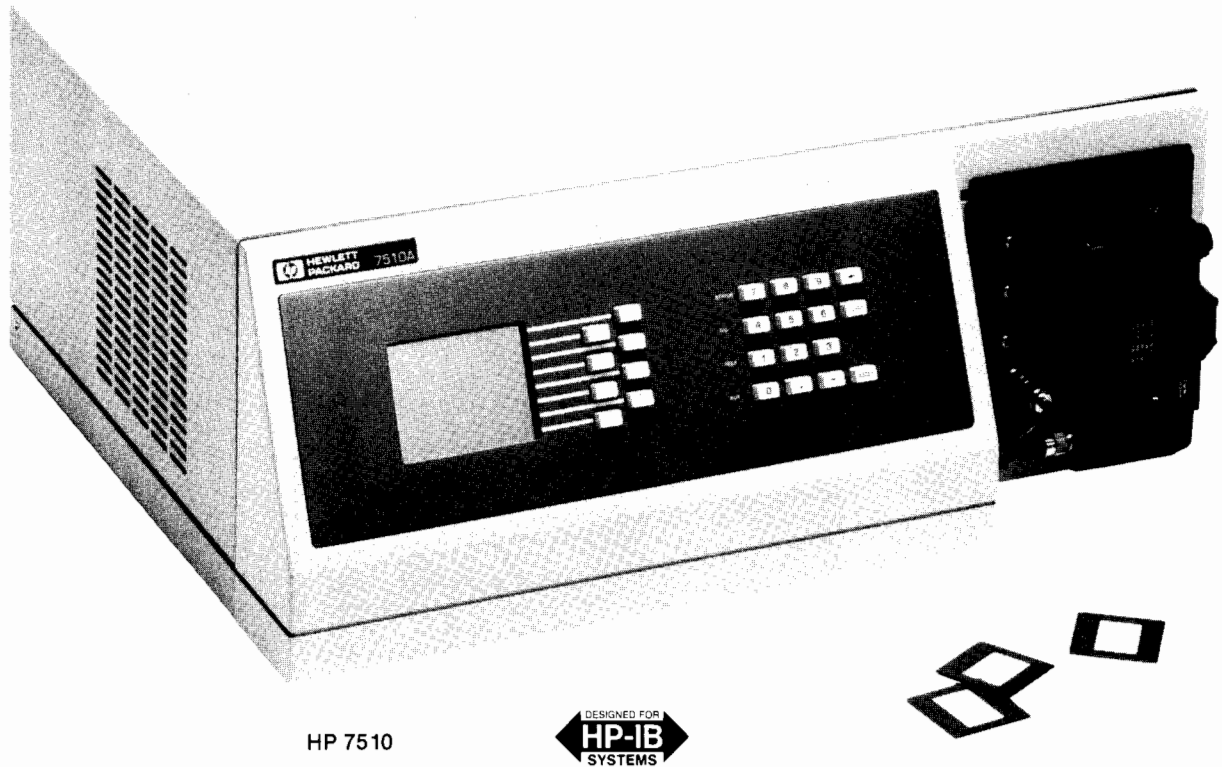

The HP 7510 color film recorder produces high-quality 35-mm slides for business and technical presentations. Bright, colorful slides help maximize audience impact and speaker credibility, and add polish to your presentation. And even with advanced capabilities, the HP 7510 is simple to use, and requires no technical or artistic expertise.

Highest Quality Slides

Nothing attracts and holds audience attention like high-resolution 35-mm slides. While most slide-making systems use raster technology or rely on screen resolution, the HP 7510 uses vector technology with a 16,322 line addressable resolution. That's so you get smooth curves and diagonal lines without "jaggies."

Camera Modules and Output Options

The HP 7510 comes with a 35-mm camera back that accommodates 35-mm slide and print film, and Polaroid instant slide film. Prints can be used to preview or proofread slides, as hardcopies to include in reports, or as visuals for your script or storyboard.

One optional camera back is available, a Polaroid camera back which accommodates instant print film.

Variety of Color Choices

The HP 7510 uses a system of internal color filters that allow you to create charts and graphs using 16 million different colors. An easy-to-use, large liquid crystal display gives you access to color-coordinated palettes.

Ease Of Use

Using the HP 7510 requires no special expertise. Just turn the HP 7510 on, create your chart using graphics software, and load the film in the recorder. Everything else is automatic. All that is left for you to do is remove the results.

Convenience

An HP 7510 film recorder can take the panic out of last-minute presentations, fine-tuning, or periodic updates. With the HP 7510, you get same-day or even immediate results. Most slides can be recorded on film in a matter of minutes; after that, your 35-mm film can be sent to an overnight or one-hour developer. For rush jobs, you can use Polaroid instant slide film.

By using an HP 7510 instead of a slide-making service, you can keep confidential data confidential. If you have sales figures, or details about a new product, your information never has to leave your office.



Multi-user Capability

The HP 7510 color film recorder is designed to be a shared peripheral. A centrally located HP 7510 can receive input from many users so several departments can benefit from the use of slides. Because everything is automatic, there's no need for constant operator supervision.

Two Built-in Interfaces

To make interfacing easy, the HP 7510 comes with two built-in interfaces, RS-232-C/CCITT V.24 and HP-IB (IEEE-488-1978). It's compatible with most personal, mini, and mainframe computer systems. And the HP 7510 has two RS-232-C connectors, so it can be connected in series with a computer and terminal.

Sophisticated Features

If you plan to do your own programming, you'll appreciate the HP 7510's internal intelligence. The HP 7510 contains HP-GL (Hewlett-Packard Graphics Language) instructions that let you perform complex drawing tasks with minimal effort. Firmware features include film compensation curves, polygon fill, automatic film advance, exposure counter, and camera module sensing. To speed system communications, the HP 7510 features the powerful MC 68000 microprocessor.

Graphics Software

Because the HP 7510 uses vector technology, it accepts the vector output produced by most graphics software directly — eliminating the need for expensive vector-to-raster conversion cards.

The HP 7510 is supported by many of the same software packages that support HP's line of plotters. Contact the nearest HP sales and support office for specific information, or contact the vendor of your current graphics software for details about their support plans.

Specifications

Resolution: addressable points per frame, 16,344 x 10,896

Film supported: using supplied 35-mm camera module, 35-mm slide film — Kodachrome 25 and 64, Ektachrome 100 and 200, Polarachrome 40, Fujichrome 100 and 200, Agfachrome 100 and 200; 35-mm print films — Kodacolor 100, Fujicolor 100, Agfacolor 100; using optional Polaroid instant print camera module, Polaroid 331 and 339.



Environmental range: operating, 0°C to 55°C; non-operating, -40°C to 75°C

Interfaces: HP-IB (IEEE 488-1978) implements the following functions as defined in IEEE 488 — SH1, AH1, T6, L3, SR1, RL0, DC1, DT0, C0, PP2 for address 7 or less, PP1 for address greater than 7, and PP0; RS-232-C/CCITT V.24 asynchronous serial ASCII with switch selectable baud rates of 75, 110, 150, 200, 300, 600, 1200, 2400, 4800, 9600; 1024-byte buffer

Power requirements: source, 100, 120, 200, 240 V ~ -10%, +5%; frequency, 48-66 Hz; 150 W maximum

Size: height, 215 mm (8.5 in.); width, 609 mm (24 in.); depth, 457 mm (18 in.)

Weight: net, 20.8 kg (46 lbs.); shipping, approx. 25 kg (55 lbs.)

FCC: FCC certified to limits sets for radio frequency interface when used with a class B computing device

Accessories Supplied

35-mm Camera Module
HP 7510 Operating Manual
Appropriate power cord, determined by destination
Note: interface cables are not supplied with the film recorder. They must be ordered separately.

Part Number

HP 17510A
07510-90902

Ordering Information

HP 7510 Color Film Recorder

Price

\$13,900

Options

HP 17510A 35-mm Camera Module (in addition to supplied module)	\$2,500
HP 17515A Polaroid Instant Print Camera Module	\$1,600

COMPUTER PERIPHERALS

Plotter Supplies

- New designer color system



Hewlett-Packard offers a complete line of pens, drawing media, and accessories, including pen holders, digitizing sites, drafting pen tips, and cleaning aids. And all these supplies are manufactured in the HP tradition of quality — quality that you'll see reflected in your work.

Designer Color System

HP's family of compatible plotter supplies consists of fiber-tip paper pens and transparency pens, non-glossy plotter paper, glossy plotter paper and transparency plotter film. The fiber-tip pens are available in 10 matching colors so that you can create paper duplicates of your transparencies. Pen colors are black, green, aqua, blue, violet, red-violet, red, orange, yellow and brown. Pens are available in narrow and wide line widths (0.3 mm and 0.7 mm for paper pens; 0.3 mm and 0.6 mm for transparency pens).

Paper pens can be used on all plotters except recorder types. You can obtain high quality results with HP non-glossy plotter paper for everyday graphs and large quantities. Use HP glossy paper for reports and presentations. Transparency pens can be used on the HP ColorPro, 7470, 7475, 7550, 7090, 9872, 7220/7221, and 7225 plotters with HP transparency film for overhead presentations or with HP glossy paper for presentation handouts.

Convenient, economical starter kits are available for the first time plotter use. Each kit contains all the supplies needed to start preparing either paper graphics or overhead transparencies. HP's Non-Glossy Paper and Pen Plotter Kit contains all supplies for paper graphics — 15 fiber-tip paper pens in 10 colors and 2 line widths, 250 sheets of non-glossy plotter paper and HP's "A Personal Guide to Professional Business Graphics". HP's Transparency Plotter Kit contains all supplies for overhead transparencies — 15 fiber-tip transparency pens in 10 colors and 2 line widths, 50 sheets of transparency film and HP's "A Personal Guide to Professional Business Graphics".

- New disposable drafting pens

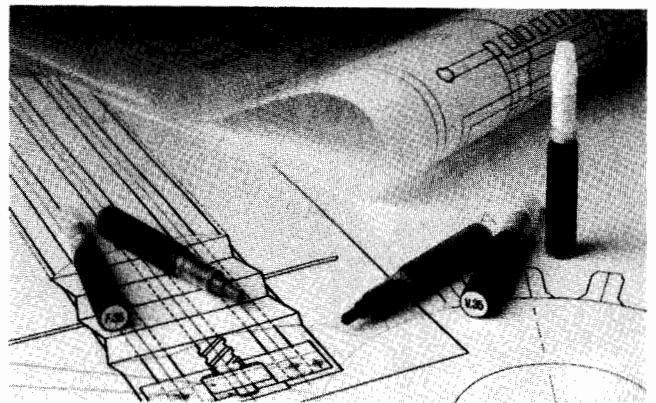

Technical Drafting Applications

Hewlett-Packard offers three different types of pens and four different types of media so you can select the pen/media combination that's right for your application. Fiber-tip pens are available in ten colors for use on plotter paper. Roller-ball pens come in four colors. In addition to four line widths for disposable drafting pens, HP offers long-body and short-body drafting pens in six line widths.

Sheets of plotter paper, vellum, tracing bond, and polyester film, are available in a range of five sizes, both English (A to E) and metric (A4 to A0). Polyester film, vellum, and plotter paper come in 914.4 mm (36 in.) and 609.6 mm (24 in.) rolls for use with the HP 7586B roll-feed drafting plotter.

Disposable Drafting Pens

These pens are designed especially for preliminary drawings and checkplots on plotter paper or final drawings on vellum. Disposable drafting pens come in four line widths and eight colors. Our new pens for use with polyester film produce the same, final plot, archival drawings you've come to expect with a refillable drafting pen but without the messy cleaning or refilling.

Ordering Information

Plotter supplies may be ordered through HP's direct telephone ordering service, from any HP sales and support office, or from your local retail dealer. The HP Computer User's Catalog (P/N 5953-2450) describes the complete range of plotter supplies and accessories.

For Best Results

	Paper	Glossy Paper Transparency Film	Tracing Bond	Vellum	Polyester Film
Fiber-tip pens (paper)	HP ColorPro HP 7475 HP 7550 HP DraftPro HP 7580 HP 7585 HP 7586				
Fiber-tip pens (transparency)		HP ColorPro HP 7475 HP 7550			
Roller-ball pens			HP 7550 HP 7580 HP 7585 HP 7586		
Disposable drafting Pens	HP 7550 HP 7580 HP 7585 HP 7586			HP 7550 HP DraftPro HP 7580 HP 7585 HP 7586	HP 7550 HP DraftPro HP 7580 HP 7585 HP 7586
Refillable drafting pens				HP 7550 HP DraftPro HP 7580 HP 7585 HP 7586	HP 7550 HP DraftPro HP 7580 HP 7585 HP 7586

COMPUTER PERIPHERALS

Commercial Computer Peripherals

Interfacing Summary

121



HP Commercial Computer Interfacing Summary¹

This table shows peripherals that can be connected to many Hewlett-Packard commercial computers. Information about EMI compliance

and support of a specific system is available from a Hewlett-Packard sales office in your area.

Peripherals Commercial Computers

	See Page	HP 260 Series 30 & 40	HP 3000s														
			Series	30R/	37/		40/										
			III R	33R	37XE	39	40SX	42	44	42XP	48	58	64	68	70	930	950
Personal Mass Storage																	
HP9133D/H	100	•															
HP9133L	100	•															
HP9134D/H	100	•															
HP9134L	100	•															
HP 9144A	100				•	•	•	•	•	•	•	•	•	•	•	•	•
System Storage																	
HP 7911/12	101	•		•		•	•	•	•	•	•	•	•	•	•	•	•
HP 7914	101					•	•	•	•	•	•	•	•	•	•	•	•
HP 7914CT	101					•	•	•	•	•	•	•	•	•	•	•	•
HP 7914ST	101					•	•	•	•	•	•	•	•	•	•	•	•
HP 7933/35H	103		•	•	•	•	•	•	•	•	•	•	•	•	•	•	•
HP 7933/35XP	103	•				•	•	•	•	•	•	•	•	•	•	•	•
HP 7941A	102	•															
HP 7942A	102	•															
HP 7945A	102	•				•*	•*	•*	•*	•*	•*	•*	•*	•*	•*	•*	•*
HP 7946A	102	•															
Tape Drives																	
HP 7974A	104					•	•	•	•	•	•	•	•	•	•	•	•
HP 7978B	104					•	•	•	•	•	•	•	•	•	•	•	•
HP 35401A	104					•	•	•	•	•	•	•	•	•	•	•	•
Workstation Printers																	
HP 2225A/B/C/D ThinkJet	106	•															
HP 2932/34A	107	•															
HP 2603A	106	•	•	•	•	•	•	•	•	•	•	•	•	•	•	•	•
HP 2686 LaserJet	105	•				•	•	•	•	•	•	•	•	•	•	•	•
HP 2686 LaserJet PLUS	105	•				•	•	•	•	•	•	•	•	•	•	•	•
HP 2686D LaserJet 500 PLUS	105	•				•	•	•	•	•	•	•	•	•	•	•	•
System Printers																	
HP 2563A	105	•	•	•	•	•	•	•	•	•	•	•	•	•	•	•	•
HP 2564B	105					•	•	•	•	•	•	•	•	•	•	•	•
HP 2565/66B	105		•	•	•	•	•	•	•	•	•	•	•	•	•	•	•
HP 2567B	105		•	•	•	•	•	•	•	•	•	•	•	•	•	•	•
HP 2688A	105					•	•	•	•	•	•	•	•	•	•	•	•
HP 2680A	105			•	•	•	•	•	•	•	•	•	•	•	•	•	•
HP 2685B	105					•	•	•	•	•	•	•	•	•	•	•	•
Plotters																	
HP 7440A ColorPro	110	•	•	•	•	•	•	•	•	•	•	•	•	•	•	•	•
HP 7470A	‡		•	•	•	•	•	•	•	•	•	•	•	•	•	•	•
HP 7475A	111	•	•	•	•	•	•	•	•	•	•	•	•	•	•	•	•
HP 7550A	112	•	•	•	•	•	•	•	•	•	•	•	•	•	•	•	•
HP 7570A DraftPro	114		•	•	•	•	•	•	•	•	•	•	•	•	•	•	•
HP 7580B	116		•	•	•	•	•	•	•	•	•	•	•	•	•	•	•
HP 7585B	116		•	•	•	•	•	•	•	•	•	•	•	•	•	•	•
HP 7586B	116		•	•	•	•	•	•	•	•	•	•	•	•	•	•	•
Film Recorders																	
HP 7510	118	•	•	•	•	•	•	•	•	•	•	•	•	•	•	•	•

¹This abbreviated interfacing summary is designed as a quick reference guide for peripherals supported on HP's commercial systems. Since configuring peripherals on systems can involve specific cabling, I/O board and operating system requirements as well as software support issues, consult your HP sales representative or authorized dealer before making a final selection. Use this interfacing summary as a guideline ONLY. Data is subject to change without notice.

*Special requirements or device limitations are involved in this configuration. Consult your HP sales representative or dealer for details.

‡For more information consult your HP representative or dealer.



COMPUTER PERIPHERALS

Personal & Portable Computer Peripherals

Interfacing Summary

HP Personal & Portable Computer Interfacing Summary¹

This table shows peripherals that can be connected to many Hewlett-Packard personal & portable computers. Information about EMI com-

pliance and support of a specific system is available from a Hewlett-Packard sales office in your area.

Peripherals Personal & Portable Computers

	See Page	Series 80		The Portable PLUS	The Integral	Series 100		Vectra PC
		85	86			Touchscreen	Touchscreen II	
Personal Mass Storage								
HP 9114B	100			•				
HP 9122D/S	100	••	••	••	•			••
HP 9127A	100			••		•		
HP 9133/34D	100	•	•	•		•		
HP 9133H	100	••	••		•			
HP 9133L	100				•			
HP 9134H	100	••	••	••	•			••
HP 9134L	100				•			•
HP 9142A	100				•	•		••
HP 9144A	100				•	•		
HP 9153A	100	••	••	••	•			•
HP 9154A	100	••	••	••	•			•
Workstation Printers								
HP 2225A/B/C/D ThinkJet	106	•	•	•	•	•	•	•
HP 2227A QuietJet Plus	106			•		•	•	•
HP 2932/34A	107	•	•	••	•	•	•	•
HP 2603A	106			••	•	•	•	•
HP 2686 LaserJet	105			••	•	•	•	•
HP 2686 LaserJet PLUS	105			•	•	•	•	•
HP 2686D LaserJet 500 PLUS	105			•	•	•	•	•
Plotters								
HP 7440A ColorPro	110			•	•	•	•	•
HP 7470A	†	•	•	•	•	•	•	•
HP 7475A	111		•	•	•	•	•	•
HP 7550A	112		•	•	•	•	•	•
HP 7570A DraftPro	114				••	•	•	•
HP 7580B	116		•	•	•	•	•	•
HP 7585B	116		•	•	•	•	•	•
HP 7586B	116				•	•	•	•
Film Recorders								
HP 7510	118			•	•	•	•	•

	See Page	IBM				Apple				DEC		AT&T	Com-paq	TI	Wang	Olivetti M24
		PC	XT	AT	PCjr	Ile	Ilc	III	Mac-Intosh	350 PRO	Rain-bow	PC 6300		PRO	PC	
Personal Mass Storage																
HP 9114B	100	•	•													
HP 9134H	100	••	••	••								•	••			
HP 9134L	100	••	••	••								••	••			••
HP 9142A	100	••	••	••								•	••			
HP 9154A	100	••	••	••								•	••			
Workstation Printers																
HP 2225A/B/C/D ThinkJet	106	•	•	•	•	•	•	•	•			•	•	•		
HP 2227A QuietJet Plus	106	•	•	•	•	•	•	•	•			•	•			
HP 2686 LaserJet	105	•	•	•	•	•	•	•	••		•	•	•			
HP 2686 LaserJet PLUS	105	•	•	•	•	•	•	•	••		•	•	•			
HP 2686D LaserJet 500 PLUS	105	•	•	•	•	•	•	•	••		•	•	•			
Plotters																
HP 7440A ColorPro	110	•	•	•	•	•	•	•	•	•	•	•	•	•	•	•
HP 7470A	†	•	•	•	•	•	•	•	•	•	•	•	•	•	•	•
HP 7475A	111	•	•	•	•	•	•	•	•	•	•	•	•	•	•	•
HP 7550A	112	•	•	•	•	•	•	•	•	•	•	•	•	•	•	•
HP 7570A DraftPro	114	•	•	•	•	•	•	•	•	•	•	•	•	•	•	•
HP 7580B	116	•	•	•	•	•	•	•	•	•	•	•	•	•	•	•
HP 7585B	116	•	•	•	•	•	•	•	•	•	•	•	•	•	•	•
HP 7586B	116	•	•	•	•	•	•	•	•	•	•	•	•	•	•	•
Film Recorders																
HP 7510	118	•	•	•	•	•	•	•	•	•	•					

This abbreviated interfacing summary is designed as a quick reference guide for peripherals supported on HP's personal and portable computers. Since configuring peripherals on systems can involve specific cabling, I/O board and operating system requirements as well as software support issues, consult your HP sales representative or authorized dealer before making a final selection. Use this interfacing summary as a guideline ONLY. Data is subject to change without notice.
¹Special requirements or device limitations are involved in this configuration. Consult your HP sales representative or dealer for details.
[†]For more information consult your HP sales representative or dealer.

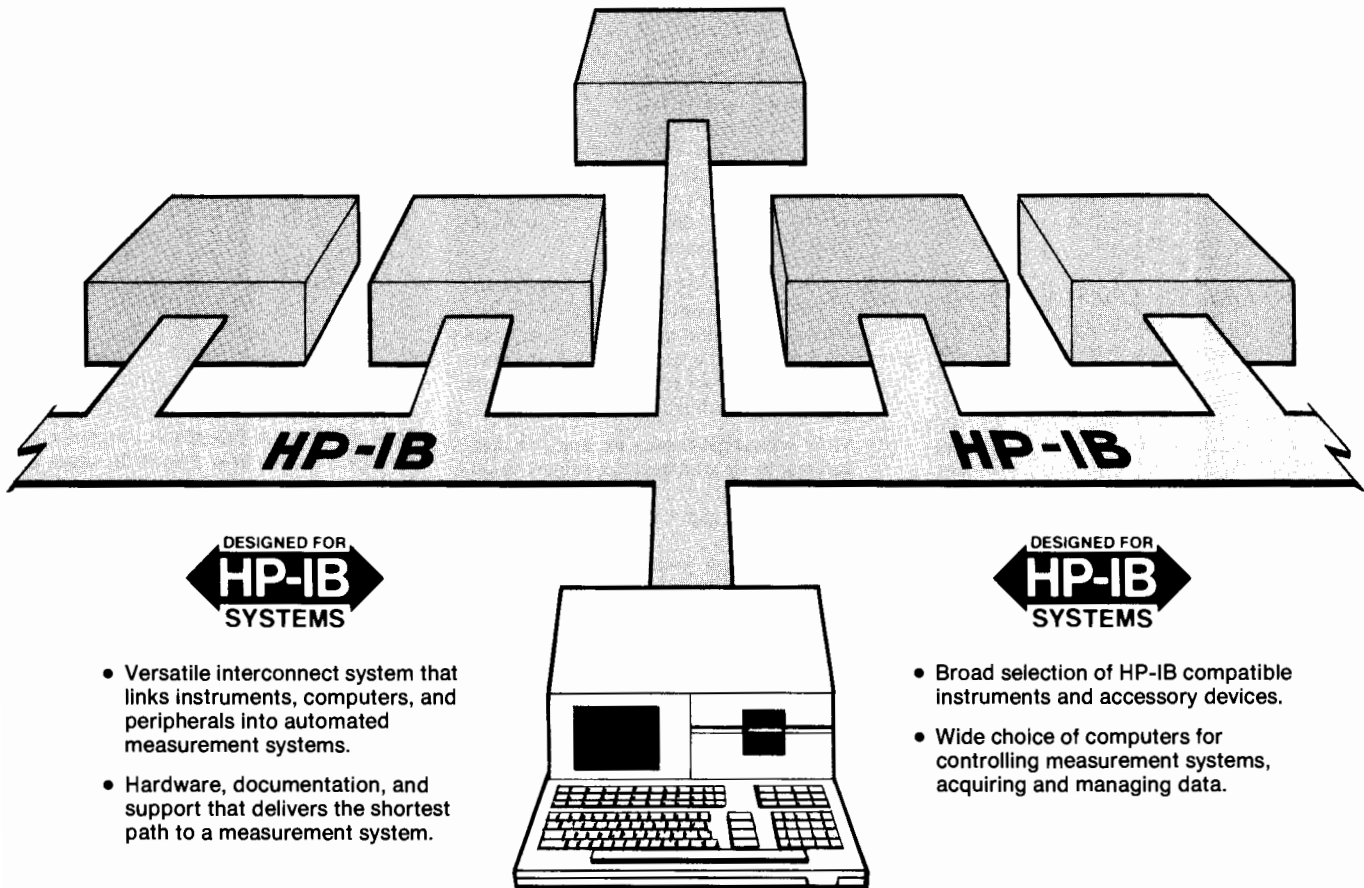

- Versatile interconnect system that links instruments, computers, and peripherals into automated measurement systems.
- Hardware, documentation, and support that delivers the shortest path to a measurement system.

- Broad selection of HP-IB compatible instruments and accessory devices.
- Wide choice of computers for controlling measurement systems, acquiring and managing data.

Advantages of HP-IB Systems

There are many applications where the measurement power of interactive instruments can be further enhanced by coupling them to desktop or minicomputers. Operating in a remote mode can provide more exact, error-corrected results as compared with conventional manual operation techniques.

Presently, three major parameters combine to reduce significantly the engineering development costs of configuring measurement systems:

1. The Hewlett-Packard Interface Bus, also known as "HP-IB";
2. Distributed computing through the growing number of "smart" instruments with internal microprocessors;
3. The broad choice of computers ranging from "friendly", easy-to-program desktop computers to more sophisticated computer systems capable of managing multi-station instrument clusters and complex data bases.

Relationship Between HP-IB and Other Interface Standards

Hewlett-Packard is committed to the overall advancement of measurement technology and has for some time been working on the problems of simplifying and standardizing means of instrumentation interfacing. An example of such an effort is the intimate involvement with the HP-IB from its conception at HP to its present status as a world instrumentation interface standard (IEEE 488-1978 and IEC 625-1).

In mid-1972, Hewlett-Packard began to participate in various international standardization bodies. The U.S. Advisory Committee, composed of diverse interests represented by both users and manufacturers, first established initial goals, then adopted the interface concept utilized by the HP Interface Bus as an appropriate starting point. A draft document was subsequently written and evaluated by members of the Committee, then submitted as the U.S. Proposal to the IEC (International Electrotechnical

Commission) Working Group in the autumn of 1972. Since then, the interface definition has undergone a number of minor changes to accommodate various needs at the international level.

In September 1974, the parent technical committee, IEC TC66, approved the main interface draft document for a formal ballot among the member nations of the IEC. Balloting took place in 1976, and IEC recommendation 625-1 was adopted. The IEC recommendation, using a different connector, is totally compatible with the present definition of the HP-IB.

Meanwhile, the IEEE Standards Board approved IEEE Standard 488-1975 "Digital Interface for Programmable Instrumentation", first published in 1975 and again published in 1978 with minor editorial changes as IEEE Standard 488-1978. The IEEE standard is also fully compatible with the HP-IB. In January 1976, the American National Standards Institute adopted the



HEWLETT-PACKARD INTERFACE BUS

Versatile Interconnect System for Instruments and Controllers



General Information

IEEE Standard and published it initially as ANSI Standard MC 1.1.

The standardized interface concept is now widely accepted. Hundreds of manufacturers in more than fourteen countries offer thousands of products that use the HP-IB concepts articulated in IEEE-488. As more instrumentation interface standards evolve from the HP-IB, we will clearly indicate the relationship of the Hewlett-Packard Interface Bus to those standards, just as we have done with ANSI/IEEE Standard 488 and IEC Publication 625-1.

Why the HP Interface Bus Name?

As the list of HP products available with the "new digital interface" grew, our customers sought a convenient way to identify those products having the interface capability. In response, in 1974 we adopted the name "Hewlett-Packard Interface Bus" or simply "HP-IB". We will continue to use the identifying name and this symbol:



Both are used with appropriate HP products so that their interface capabilities may be readily identified.

The Hewlett-Packard Interface Bus fully complies with IEEE Standard 488. As such, it incorporates the mechanical, electrical and functional specifications of the Standard. A fourth and vital element of any interface system is the operational aspect of a product at both the human-machine interface and machine-machine interface at the HP-IB port. HP-IB capability provides additional user

benefits that are beyond the scope of IEEE Standard 488. Typical user conveniences include high-level language implementation of interface functions, underscored program codes on the front panel of the instruments for easy programming, convenient data output formats, and designed-in "Learn Mode" capabilities. In addition, we provide complete support documentation in the form of programming and interfacing guides, application notes and operation manuals that illustrate the added benefits for users of products with HP-IB capability.

Single-Source Systems Approach

The decision to use a "system" instead of conventional manual methods must be based on an engineering evaluation of benefits versus costs. The many benefits associated with a systems approach include:

- More consistent results in repeated measurements—a system is not subject to operator fatigue.
- Greater throughput because systems are generally faster.
- More thorough testing because system speed allows more parameters to be measured in a shorter time.
- Results expressed in engineering or scientific units, because many systems controllers are capable of on-line data manipulation.
- Greater accuracy because system errors can be measured automatically, stored and accounted for in the results.
- "Adaptive" data acquisition wherein a system can be programmed to branch to other measurements to help pinpoint when it senses an abnormal condition.
- Measurement results can be stored in computer memory or on hard copy.



This HP 8574A Spectrum Analyzer/EMI Receiver shows how a specific need, EMI testing, can be met by combining multi-purpose instruments and specialized accessories, interconnecting them via HP-IB, and controlling them with a desktop computer.

It is our objective to make the integration of instrumentation systems easier by providing instruments and computers designed for systems applications. Computers are designed with HP-IB options that allow easy hook-up to the bus and incorporate easy-to-use bus commands in their software. HP's policy when designing HP-IB compatible instruments is to eliminate interfacing ambiguities associated with controllers and instruments operating per the ANSI/IEEE and IEC standards by adopting guidelines for consistent interface design.

Proper training on system components is very important for efficient use of any interface system. Therefore, we offer training at sales and service offices worldwide on HP desktop computers, computer systems and instruments as they relate to the HP-IB. In the area of HP-IB support documentation, we offer general interface technical descriptions, Operating and Service Manuals with programming information, Instrument/Controller Introductory Operating Guides, Quick Reference Guides and Application Notes.

Technical assistance during system development is available at most local HP sales and service offices from resident systems engineers who specialize in desktop computers, computer systems and instruments.

How the HP Interface Bus Operates

All active interface circuitry is contained within the various HP-IB devices, and the interconnecting cable (containing 16 signal lines) is entirely passive. The cable's role is

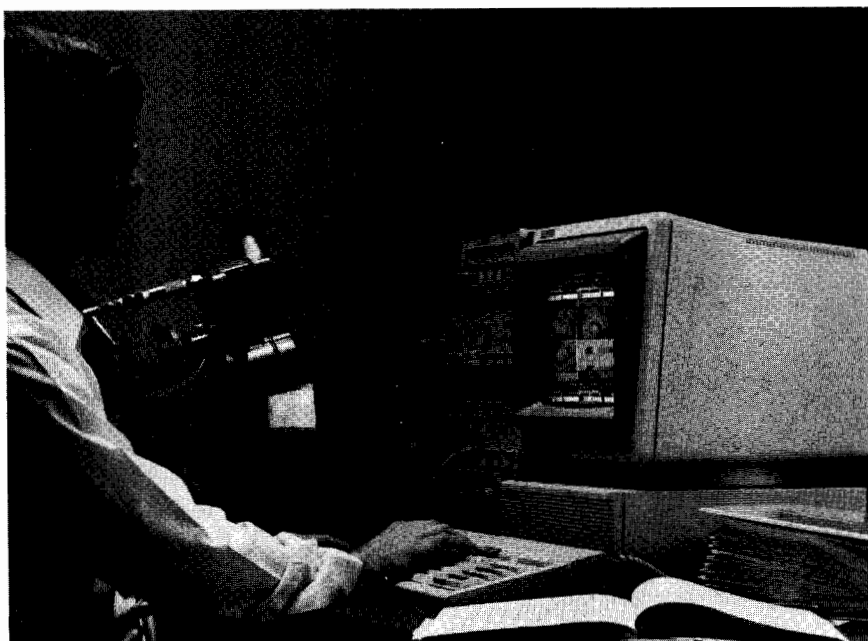

The HP 9000 family of technical workstations offers an extensive line of HP-IB system controllers in its Series 200, 300 and 500. These controllers are easy to program with the help of HP BASIC, Pascal or HP-UX operating systems.

limited to that of interconnecting all devices in parallel so that any one device may transfer data to one or more other participating devices.

Every participating device (instrument, controller, accessory module) must be able to perform at least one of the roles of TALKER, LISTENER or CONTROLLER. A TALKER can transmit data to other devices via the bus, and a LISTENER can receive data from other devices via the bus. Some devices can perform both roles (e.g., a programmable instrument can LISTEN to receive its control instructions and TALK to send its measurement results).

A minimum HP-IB system consists of one TALKER and one LISTENER, without a CONTROLLER. In this configuration, data transfer is limited to direct transfer between one device manually set to "talk only" and one or more devices manually set to "listen only" (e.g., a measuring instrument talking to a printer for semi-automatic data logging).

A CONTROLLER manages the operation of the bus system primarily by designating which devices are to send and receive data, and it may also command specific actions within other devices.

The full flexibility and power of the HP-IB become more apparent, however, when one device that can serve as CONTROLLER/TALKER/LISTENER (e.g., calculator or computer) is interconnected with other devices that may be either TALKERS or LISTENERS, or both (e.g., frequency synthesizers, counters, power meters, relay actuators, displays, printers), depending on the application. An HP-IB controller participates in the measurement by being programmed to schedule measurement tasks, set up individual devices so that they can perform these tasks, monitor the progress of the measurement as it proceeds, and interpret the results of the measurement. HP offers controllers that can be programmed in high-level languages such as BASIC, FORTRAN, HPL, and Pascal.

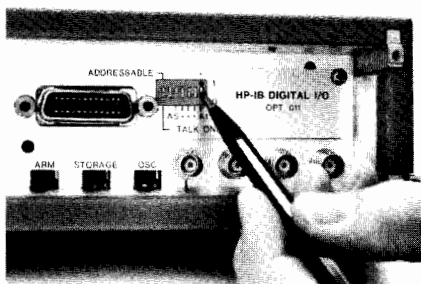

Rear panel switches are set so instrument will either be addressable by controller in a multi-device system, or will simply "talk only" to another device such as a printer.

HP-IB Connections and Structure

The HP-IB has a party-line structure where all devices on the bus are connected in parallel. The 16 signal lines within the passive interconnecting HP-IB cable are grouped into three clusters according to their functions:

1. Data Bus (8 signal lines)
2. Data Byte Transfer Control Bus (3 signal lines)
3. General Interface Management Bus (5 signal lines).

The DATA BUS consists of eight signal lines that carry data in bit-parallel, byte-serial format across the interface. These signal lines carry addresses, program data, measurement data, universal commands and status bytes to and from devices interconnected in a system. Identification of the type of data present on the DIO signal lines is indicated by the ATN (attention) signal. When the ATN signal is true (asserted), either addresses or universal commands are present on the data bus and all connected devices are required to monitor the DIO lines. When the ATN message is false, device-dependent data (e.g., programming data) is carried between devices previously addressed to talk and listen.

Transfer of each byte on the Data Bus is accomplished via a set of three signal lines: DAV (data valid), NRFD (not ready for da-

ta), and NDAC (not data accepted). These signals operate in an interlocked handshake mode. Two signal lines, NRFD and NDAC, are each connected in a logical AND (wired OR) to all devices connected to the interface. The DAV signal is sent by the talker and received by potential listeners whereas the NRFD and NDAC signals are sent by potential listeners and received by the talker.

The General Interface Management Lines manage the bus to effect an orderly flow of messages. The IFC (interface clear) message places the interface system in a known quiescent state. SRQ (service request) is used by a device to indicate the need for attention or service and to request an interruption of the current sequence of events. REN (remote enable) is used to select between two alternate sources of device program data. EOI (end or identify) is used to indicate the end of a multiple byte transfer sequence or, in conjunction with ATN, to execute a polling sequence.

It is not possible in this limited space to go into detail on each signal line's role. But you should note that every HP-IB device need not be able to respond to all the lines. As a practical and cost-effective matter, each HP-IB device usually responds only to those lines that are pertinent to its typical function on the bus. (Details are covered in each device's operating manual.)

HP-IB Training and Support

To assist you in configuring HP-IB measurement systems, Hewlett-Packard has field sales people trained in electronic instruments, desktop computers and computer systems. Also available for technical consultation are computing controller systems engineers and HP-IB instrumentation specialists.

HP-IB training courses on HP-IB controllers and instruments are listed below. Courses are conducted at a convenient HP location. Some courses can be taught at your site with special arrangements.

- HP-IB Theory
- HP-IB for MOS-DOS Personal Computers
- HP-IB Instrument Control Using HP Series 200/300 BASIC
- HP-IB Instrument Control Using HP 1000E/F Series Controllers

HP-IB Service and Warranty Considerations

Hewlett-Packard has dedicated measurement system service people who perform on-site maintenance of HP instrumentation on customer-configured systems as well as HP-configured systems. Service contract coverage is available to meet your specific measurement system service needs and can be tailored to include extended warranty, calibration and extended hours of coverage. Contact your local sales and service office for further information on HP-IB service contract information.

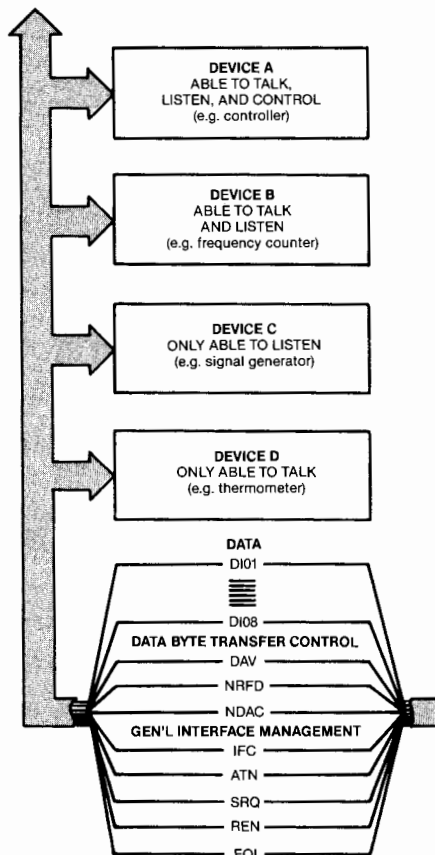

Interface connections and bus structure.

Microwave Radio Performance Testing	3708S	Model 216 & Series 300	Noise and Interference Measurement System: automatic measurements of microwave radars under flat fade conditions	394
-------------------------------------	-------	------------------------	--	-----



HEWLETT-PACKARD INTERFACE BUS

Versatile Interconnect System for Instruments and Controllers



Individual HP-IB Product Summary

Individual Hewlett-Packard Products Available with HP-IB Capability

Products Related to	HP Model	Product Name/Characteristics	Page
Control and Computation	25	Vectra Personal Computer	52
	35	Vectra Personal Computer	52
	45	Vectra Personal Computer	52
	85B	Personal Computer (uses HP 82937A Interface)	82
	86B	Personal Computer (HP 82937A interface built-in)	82
	HP 150	Touchscreen Personal Computer	50
	HP 260 Series 30	Business Computer System	66
	HP 260 Series 40	Business Computer System	66
	HP 1000 A600+	Computer (HP 2156B, 2426E/F and 2436A/E; uses HP 12009A Interface)	92
	HP 1000 A700	High Performance Computer (HP 2137A and 2437A; uses HP 12009A Interface)	92
	HP 1000 A900	High Performance Computer (HP 2139A and 2439A; uses HP 12009A interface)	92
	HP 1000 E-series	Computers (HP 2109E & 2113E use HP 59310B Interface)	92
	HP 3000 Series 37	Business Computer System	67
	HP 3000 Series 42	Business Computer System	67
	HP 3000 Series 58	Business Computer System	67
	HP 3000 Series 70	Business Computer System	67
	HP 3000 Series 930	Business Computer System	67
	HP 3000 Series 950	Business Computer System	67
	9020A/B/C/AS/AT Model 520	Integrated Workstation	76
	9050 Model 550	Single- or Multi-User Workstation	76
	9060 Model 560	Multi-User Supermicro/Minicomputer	76
	9741A Model 840	Precision Architecture Computer/Server	75
	9816A/S Model 216	Personal Technical Computer	79
	9836U/CU/T/CT Model 236	Technical Computer	79
	98580A Model 310	Measurement Automation Workstation	77
	98581A Model 310	Low-Cost Color Workstation	77
	98582B Model 320M	High-Performance Monochrome Workstation	77
	98582L Model 320ML	Low-Cost Monochrome Workstation and Disc	77
	98583B Model 320C	High-Performance Six-Plane Color Workstation	77
	98584A	Monochrome Artificial Intelligence Development System	77
	98585A	Color Artificial Intelligence Development System	77
	98586A Model 320CX	High-Performance Eight-Plane Color Workstation with Graphics Accelerator	77
	9915B	Modular Run-Only Computer	82
	9920A/S Model 220	Modular HP-UX Computer	79
72425A/35A/45A	Vectra Personal Computers	80	
Distance Extension	37201A	HP-IB Extender: long distance via modems and telephone lines	136
	37204A	HP-IB Extender: up to 1250 metres via coaxial or fiber-optic cable	136
Stimulus	3314A	Function Generator: 0.001 Hz to 19.99 MHz	423
	3325A	Synthesizer/Function Generator/Sweeper: 1 μ Hz to 21 MHz	412
	3326A	Two-Channel Synthesizer: dc to 13 MHz	414
	3335A	Synthesizer/Level Generator: 200 Hz to 81 MHz	416
	3336A/B/C	Synthesizer/Level Generator: 10 Hz to 21 MHz	417
	3708A	Noise and Interference Test Set	394
	3764A	Digital Transmission Analyzer	381
	3781A	Pattern Generator: CEPT and CCITT PCM/TDM Systems	379
	3781B	Pattern Generator: BELL PCM/TDM Systems	380
	4140B	pA Meter/DC Voltage Source	249
	4141B	DC Source/Monitor	251
	4145B	Semiconductor Parameter Analyzer	246
	5182A	Waveform Recorder/Generator: 20 MHz, 10 bits, 16K word memory	444
	5359A	Time Synthesizer: 1 ns accuracy: 50 ps increments, 100 ps jitter	478
	6002A Option 001	DC Power Supply: 200 W autoranging. Listen only	276
	6030A	System Power Supply: 1000W, 200 Vdc, 17A, autoranging with status readback	274
	6031A	System Power Supply: 1000W, 20 Vdc, 120A, autoranging with status readback	274
	6032A	System Power Supply: 1000W, 60 Vdc, 50A, autoranging with status readback	274
	6033A	System Power Supply: 200W, 20 Vdc, 30A, autoranging with status readback	274
	6038A	System Power Supply: 200W, 60 Vdc, 10A, autoranging with status readback	274
	6129C Opt. P05 or J99	Precision Voltage Source: ± 50 Vdc at 5 A (requires HP 59301A)	278
	6130C Opt. P05 or J99	Precision Voltage Source: ± 50 Vdc at 1A (requires HP 59301A)	278
	6131C Opt. P05 or J99	Precision Voltage Source: ± 100 Vdc at 0.5 A (requires HP 59301A)	278
	6140A Opt. P05 or J99	Precision Current Source: ± 100 mA at 100 Vdc (requires HP 59301A)	278
	6621A	System Power Supply: dual output, dual range, 20V/4A or 7V/10A per output	272
	6622A	System Power Supply: dual output, dual range, 10V/1.6A or 20V/4A per output	272
	6623A	System Power Supply: triple output	272
	6624A	System Power Supply: quad output	272
	6940B	Multiprogrammer (requires HP 59500A)	179
	6942A	Multiprogrammer: automatic test, data acquisition and control	178
	8016A Option 001	Word Generator: 9 x 32 bit. Listen only	485
	8018A Option 001	Serial Data Generator: 50 MHz, 2048-bit memory. Listen only	487
	8112A	Programmable Low Cost Pulse Generator: 20 ns to 950 ms period	468
	8116A	Programmable Pulse/Function Generator: 1 mHz to 50 MHz	419
8150A	Optical Signal Source: 850 nm, 250 MHz	575	
8154B	LED Source: 1300 nm, ± 0.02 dB/h	579	

Individual Hewlett-Packard Products Available with HP-IB Capability (cont.)

Products Related to	HP Model	Product Name/Characteristics	Page
Stimulus (cont.)	8160A	Programmable Pulse Generator: 20 ns to 999 ms period	469
	8161A	Programmable Pulse Generator: 10 ns to 980 ms period	469
	8165A	Programmable Signal Source: 0.001 Hz to 50 MHz	418
	8170A	Logic Pattern Generator: 8 x 4096/12 x 2048 bit; 2 MHz	486
	8175A	Digital Signal Generator: 24 x 1024/2 x 8192 bit; 50/100 MHz	480
	8180A	Data Generator: 50 MHz, 1024 bit/channel	477
	8181A	Data Generator Extender	483
	8340B	Synthesized Sweeper: 10 MHz to 26.5 GHz	494
	8341B	Synthesized Sweeper: 10 MHz to 20 GHz	494
	8350B	Sweep Oscillator: 10 MHz to 40 GHz	498
	8620C Option 011	Sweep Oscillator: 10 MHz to 22 GHz	513
	8642A/B	Synthesized Signal Generator: 100 kHz to 1.057/2.115 GHz	524
	8656B	Signal Generator: 0.1 to 990 MHz	522
	8660A, C Option 005	Synthesized Signal Generators: 10 kHz to 2.6 GHz. Listen only	530
	8662A	Synthesized Signal Generator: 10 kHz to 1280 MHz.	527
	8663A	Synthesized Signal Generator: 100 kHz to 2560 MHz.	527
	8671B	Synthesized CW Generator: 2 to 18 GHz	542
	8672A	Synthesized Signal Generator: 2 to 18 GHz	546
	8672S	Synthesized Signal Generator: 100 MHz to 18 GHz	546
	8673B/E	Synthesized Signal Generator: 2 to 26.5 GHz/2 to 18 GHz	544, 543
	8673C/D	Synthesized Signal Generator: 50 MHz to 18/26.5 GHz	545
	8770A	Arbitrary Waveform Synthesizer: dc to 50 MHz	410
	8780A	Vector Generator: complex modulation, 50 MHz to 3 GHz	570
	59501B	Power Supply Programmer: Isolated D-to-A Converter ± 10 Vdc at 10 mA	135, 277
Measurement	436A Option 022	Power Meter: -70 dBm to +44 dBm, to 50 GHz	584
	438A	Dual-channel Digital Power Meter: -70 dBm to +44 dBm, to 50 GHz	583
	853A	Spectrum Analyzer Display	681-684
	1630A/D/G	Logic Analyzer	397
	1631A/D	Logic Analyzers with built-in scopes	397
	2804A Option 010	Quartz Thermometer: 0.05°C accuracy	733
	3421A	Data Acquisition/Control Unit	292
	3437A	System Digital Voltmeter: high speed, 3½ digits	197
	3455A	Digital Voltmeter: 5½ or 6½ digits, auto calibration	197
	3456A	Digital Voltmeter: 3½ to 6½ digit voltmeter, 1 nV sensitivity	192
	3457A	Multimeter: 3½ to 6½ digits; measures voltage, current, resistance, frequency	194
	3478A	Digital Multimeter: 3½ to 5½ digits; 5 functions	190
	3497A	Data Acquisition Control Unit	294
	3561A	Dynamic Signal Analyzer: 125 μ Hz to 100 kHz	699
	3562A	Dynamic Signal Analyzer: dual channel, 64 μ Hz to 100 kHz	702
	3577A	Network Analyzer: 5 Hz to 200 MHz	612
	3582A	2-channel Real Time (FFT) Spectrum Analyzer	697
	3585A	Swept Spectrum Analyzer: 20 Hz to 40 MHz	650
	3586A/B/C	Selective Level Meters: 50 Hz to 32.5 MHz	385, 653
	3708A	Noise and Interference Test Set	394
	3709A	Constellation Display	394
	3717A	Wideband 70 MHz modem	390
	3746A	32.5 MHz Selective Level Measuring Set: CCITT and Bell FDM Systems	384
	3764A	Digital Transmission Analyzer	381
	3776A	PCM Terminal Test Set: CEPT/CCITT networks	378
	3776B	PCM Terminal Test Set: Bell/Japanese/CCITT networks	378
	3779C	Primary Multiplex Analyzer: CEPT 2 Mb/s PCM systems	378
	3779D	Primary Multiplex Analyzer: Bell 1.5 Mb/s PCM systems	378
	3781A/3782A	Pattern Generator/Error Detector: CEPT and CCITT PCM/TDM systems	380
	3781B/3782B	Pattern Generator/Error Detector: Bell PCM/TDM systems	380
	3785A	Jitter Generator and Receiver: CEPT PCM/TDM systems	382
	3785B	Jitter Generator and Receiver: Bell PCM/TDM systems	382
	3852A	Data Acquisition/Control System	296
	4140B	pA Meter/DC Voltage Source	249
	4141B	DC Source/Monitor	251
	4145B	Semiconductor Parameter Analyzer	246
	4191A	RF Impedance Analyzer: 1 to 1000 MHz	218
	4192A	LF Impedance Analyzer: 5 Hz to 13 MHz	216
	4193A	Vector Impedance Meter: 400 kHz to 110 MHz	220
	4194A	Impedance/Gain-Phase Analyzer	213
	4262A Option 101	Digital LCR Meter	232
	4274A	Multifrequency LCR Meter: 11 spots, 100 Hz to 100 kHz	222
	4275A	Multifrequency LCR Meter: 10 spots, 10 kHz to 10 MHz	222
	4276A	LCZ Meter: 801 spots, 100 Hz to 20 kHz	228
	4277A	LCZ Meter: 701 spots, 10 kHz to 1 MHz	228
	4278A	Capacitance Meter: 1 kHz/1 MHz	226
	4280A	1-MHz C Meter/C-V Plotter	252
4945A Option 101	Transmission Impairment Measurement System (TIMS)	372	
4947A	Transmission Impairment Measuring Set	373	



Individual HP-IB Product Summary

Individual Hewlett-Packard Products Available with HP-IB Capability (cont.)

Products Related to	HP Model	Product Name/Characteristics	Page
Measurement (cont.)	4948A	In-Service Transmission Impairment Measuring Set	374
	4955A	Protocol Analyzer	365
	5005B	System Signature Multimeter	344
	5006A	Signature Analyzer	346
	5180A	Waveform Recorder	442
	5316A	Universal Counter: 100 MHz/1.3 GHz, 100 ns TI	330
	5328B	Universal Counter: to 512 MHz, 10 ns TI	329
	5334A	Automatic Universal Counter: 100 MHz/1.3 GHz, 2ns TI	324
	5335A	Automatic Universal Counter: 200 MHz/1.3 GHz, 2ns TI	326
	5340A Option 011	Automatic Microwave Counter: 10 Hz to 18 GHz	312
	5342A Option 011	Automatic Microwave Counter: 10 Hz to 18 GHz	309
	5343A Option 011	Microwave Frequency Counter: 10 Hz to 26.5 GHz	309
	5344S	Microwave Source Synchronizer: 0.5 GHz to 18 GHz	311
	5345A Option 011,012	General Purpose Plug-In Counter	313
	5350B	Microwave Frequency Counter: 10 Hz to 20 GHz	306
	5351B	Microwave Frequency Counter: 10 Hz to 26.5 GHz	306
	5352B	Microwave Frequency Counter: 10 Hz to 40 GHz	306
	5355A	Pulse, CW Counter: 400 Hz to 110 GHz	313
	5356A/B/C/D	Frequency Converter	313
	5363B	Time Interval Probes	321
	5370B	Precision Time Interval Counter: ±20 ps single-shot resolution	318
	5384A	225 MHz Frequency Counter	316
	5385A	1 GHz Frequency Counter	316
	5386A	Frequency Counter: 3 GHz	316
	5501A	Laser Transducer	731
	5527A	Laser Position Transducer	730
	5528A	Laser Measurement System	731
	6030A	System Power Supply: 1000 W, 200 Vdc, 17A, autoranging with status readback	274
	6031A	System Power Supply: 1000 W, 20 Vdc, 120 A, autoranging with status readback	274
	6032A	System Power Supply: 1000 W, 60 Vdc, 30 A, autoranging with status readback	274
	6033A	System Power Supply: 200 W, 20 Vdc, 30 A, autoranging with status readback	274
	6038A	System Power Supply: 200 W, 60 Vdc, 10 A, autoranging with status readback	274
	6621A	System Power Supply: dual output, dual range, 20V/4A or 7V/10A per output	272
	6622A	System Power Supply: dual output, dual range, 50V/1.6A or 20V/4A per output	272
	6623A	System Power Supply: triple output	272
	6624A	System Power Supply: quad output	272
	6940B	Multiprogrammer (requires HP 59500A interface)	179
	6942A	Multiprogrammer: automatic test, data acquisition and control	175
	7090A	Measurement Plotting System: 3-channel A-D converter to 3 kHz	446
	8151A	Optical Pulse Power Meter: 250 MHz	576
	8152A	Optical Average Power Meter: 2 channel, 850-1700 nm	578
	8182A	Data Analyzer: 50 MHz real-time capability; 1024 bit/channel	483
	8510A	Network Analyzer	629
	8558B Option E98	EMI Measurement System	681
	8566B	Spectrum Analyzer: 100 Hz to 324 GHz	662, 666
	8567A	Spectrum Analyzer: 10 kHz to 1.5 GHz	670
	8568B	Spectrum Analyzer: 100 Hz to 1.5 GHz	662, 664
	8569B	Spectrum Analyzer: 10 MHz to 115 GHz	689
	8570A	Spectrum Analyzer: 10 MHz to 22 GHz	687
	8590A	Spectrum Analyzer: 10 kHz to 1.5 GHz	678
	8753A	RF Network Analyzer: 300 kHz to 3.0 GHz	623
	8756A/8757A	Scalar Network Analyzer: 10 MHz to 60 GHz	609, 602
8901A	Modulation Analyzer: 150 kHz to 1.3 GHz	716	
8901B	Modulation Analyzer: 150 kHz to 1.3 GHz	716	
8902A	Measuring Receiver: 150 kHz to 1.3 GHz	712	
8903B	Audio Analyzer: 20 Hz to 100 kHz	719	
8903E	Distortion Analyzer: 20 Hz to 100 kHz	719	
8954A	Transceiver Interface	728	
8956A	System Interface	728	
8958A	Cellular Radio Interface	729	
8970B	Noise Figure Meter: 10 to 1600 MHz	592	
8971B	Microwave Noise Figure Test Set: 2 to 18 GHz	591	
8980A	Vector Analyzer, X-Y Display: 350 MHz	572	
11729C	Carrier Noise Test Set: 5 MHz to 18 GHz	709	

Individual Hewlett-Packard Products Available with HP-IB Capability (cont.)

Products Related to	HP Model	Product Name/Characteristics	Page	
Measurement (cont.)	54100A/D, 54110D	Digitizing Oscilloscopes: 1 GHz	432	
	54200A/D, 54201A/D	Digitizing Oscilloscopes: 200 M samples/s; 50 MHz, 300 MHz	428	
	54300A	Probe Multiplexer	448	
	59992A-J06	Time Interval Calibrator	319	
	70300A	Tracking Generator Module: 20 Hz to 2.9 GHz	659	
	70310A	Precision Frequency Reference Module	659	
	71100A	RF Spectrum Analyzer: 100 Hz to 2.9 GHz	655	
	71200A	Microwave Spectrum Analyzer	655	
	71300A	Millimeter Wave Spectrum Analyzer	655	
	85650A	Quasi-Peak Adapter	675	
	85685A	RF Preselector: 20 Hz to 2 GHz	675	
	Switching, Scanning, Translation or Timing	3235A	Switch/Test Unit	166
		3326A	Two-Channel Synthesizer/Sweeper: dc to 13 MHz	414
3421A		Scanner: to 30 channels; A/D converter	292	
3488A		Versatile switching for automated testing (VHF, matrix general purpose)	170	
3497A		Data Acquisition/Control Unit	294	
3754A		25 MHz Access Switch (requires HP 3755A switch controller)	384	
3756A		90 MHz Switch (requires HP 3755A)	384	
3757A		8.5 MHz Access Switch (requires HP 3755A)	384	
3777A		Telecommunications Channel Selector: up to 30 channels; dc to 110 kHz	378	
3852A		Data Acquisition/Control Unit	296	
4085M		Switching Matrix	248	
6940B		Multiprogrammer (requires HP 59500 interface)	179	
6942A		Multiprogrammer (no interface required)	175	
8158B		Optical Attenuator: 1250-1600 nm, single- and multi-mode	580	
8159A		Optical switch: 780-1300 nm	577	
9411B		Switch Controller	183	
9412A		Modular Switch (requires HP 9411B switch controller)	183	
9413A		VHF Switch (requires HP 9411B)	183	
9414A		Matrix Switch (requires HP 9411B)	183	
11713A		Attenuator/Switch Driver: controls coax switches, step attenuators and microwave matrix switches	554	
59301A		ASCII-to-Parallel Converter: string to 16 characters	134	
59303A		Digital-to-Analog Converter	134	
59306A		Relay Actuator: for programmable switches, attenuators	134	
59307A		VHF Switch: two 50-ohm, bidirectional, dc to 500 MHz	135	
59309A		Digital Clock: month, day, hour, minute, second	135	
59501B		Power Supply Programmer: isolated D-to-A converter ± 10 Vdc at 10 mA	135, 277	
Storage		3964A Option 007	Instrumentation Tape Recorder: 4 channel, listen only	464
	3968A Option 007	Instrumentation Tape Recorder: 8 channel, listen only	464	
	5180A	Waveform Recorder (digital oscilloscope): 20 MHz, 10 bits, 16K-word capacity	442	
	7907A	Disc Drive: 20 Mb fixed, 20 Mb removable	103	
	7911P/R	Disc/Tape Drives: 28.1 Mb fixed, 67 Mb 1/4" tape cartridge	101	
	7912P/R	Disc/Tape Drives: 65.6 Mb fixed, 67 Mb 1/4" tape cartridge	101	
	7914CT	Disc/Tape Drive: 132.1 Mb fixed with HP 9144A tape cartridge	101	
	7914P/R	Disc/Tape Drives: 132.1 Mb fixed, 67 Mb 1/4" tape cartridge	101	
	7914ST	Disc/Tape Drives: 132.1 Mb fixed, 1/2" reel-to-reel tape	101	
	7933H/XP	Disc Drive: 404 Mb fixed	103	
	7935H/XP	Disc Drive: 404 Mb removable	103	
	7941A	Disc Drive: 24 Mb fixed	102	
	7942A	Disc/Tape Drive: 24 Mb fixed, 67 Mb 1/4" tape cartridge	102	
	7945A	Disc Drive: 55 Mb fixed	102	
	7946A	Disc/Tape Drive: 55 Mb fixed, 67 Mb 1/4" tape cartridge	102	
	7974A	1/2" Magnetic Tape Subsystem: 40 Mb formatted capacity	104	
	7978B	1/2" Magnetic Tape Subsystem: 140 Mb formatted capacity	104	
	9114B	Portable 3 1/2" Disc Drive: 710 Kb formatted capacity	100	
	9122D/S	Double-sided 3 1/2" Disc Drive: 1420 Kb dual (HP 9122D), 710 Kb single-sided (HP 9122S), random access storage	100	
	9123D	Dual 3 1/2" Drive for HP Touchscreen II	100	
	9127A	Single 5 1/4" Flexible Disc Drive: up to 360 Kb formatted, IBM/HP format compatible	100	
9133H	20 Megabyte Winchester hard disc plus 3 1/2" microfloppy	100		
9133L	40 Megabyte Winchester hard disc plus 3 1/2" microfloppy	100		
9134H	20 Megabyte Winchester hard disc: stand-alone model	100		



HEWLETT-PACKARD INTERFACE BUS

Versatile Interconnect System for Instruments and Controllers

Individual HP-IB Product Summary



Individual Hewlett-Packard Products Available with HP-IB Capability (cont.)

Products Related to	HP Model	Product Name/Characteristics	Page
Storage (Cont.)	9134L	40 Megabyte Winchester hard disc: stand-alone model	100
	9142A	1/4" Tape Backup Subsystem: up to 60 Mb formatted capacity	100
	9144A	1/4" Tape Backup Subsystem: 16 and 67 Mb formatted capacity	104
	9153A	10 Megabyte Winchester Hard Disc plus 3 1/2" microfloppy	100
	9154A	10 Megabyte Winchester Hard Disc: stand-alone model	100
	35401A	Tape Drive: 1/4" cartridge autochanger	104
	88500A	IBM Disc/Tape Interface: single 5 1/4" disc drive providing data compatibility with IBM-PC from the HP Touchscreen	100
Printers, Plotters, Recorders	2225A	ThinkJet Ink-jet Printer	106
	2563B, 2564B	Line Printers: 300, 600 lines/minute dot matrix	105
	2566B, 2567B	Line Printers: 900/1200 lines/minute dot matrix	105
	2680A	Laser Page Printer	105
	2932A	Impact Printer	106
	2934A	Dual Mode Impact Printer	106
	7090A	Measurement Plotting System: 6-pen	452
	7440A	Graphics Plotter: 8-pen	110
	7475A	Graphics Plotter: 6-pen	111
	7510A	Color Film Recorder: 35mm slides	118
	7550A	Automatic Sheet-Feed 8-Pen Plotter	112
7580B, 7585B, 7586B	Large Format Drafting Plotters	116	
Interface Cabling	10833A-10833D	HP-IB Interconnection Cables	133
	10834A	HP-IB Interconnection Cable Adapter: 2.3 cm (0.91 in.)	133
Design/Serviceing	59401A	Bus System Analyzer	133

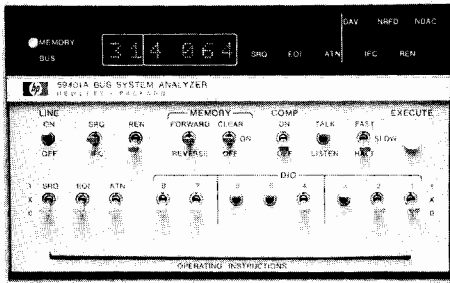

HP 59401A

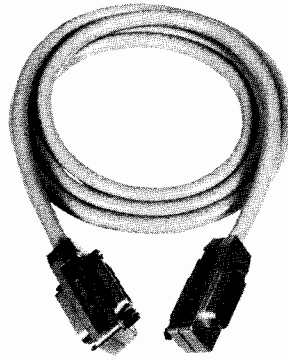

HP 10833A/B/C/D

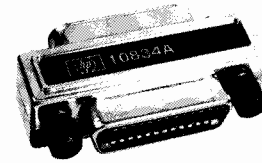

HP 10834A

HP 59401A Bus System Analyzer

The HP-IB (IEEE 488) concept has greatly simplified many of those things which have in the past made instrument interfacing a burdensome task. Even so, software errors can occur if the system designer does not completely understand the bus system or the capabilities of the instruments and other devices being interfaced. Hardware problems can occur if the instruments/devices are not functioning properly, or if they are not completely compatible with the bus standard.

The HP 59401A Bus System Analyzer is especially useful in design and service work. It simplifies and speeds up the diagnosis of software and hardware problems by allowing the user to see the status of all bus lines, including the actual characters on the bus data lines. Because the HP 59401A can also drive all bus lines, it can completely exercise another Talker, Listener or Controller—which is especially useful in verifying compatibility of new or user-designed products with the HP-IB.

There are several choices of analyzer operating speed. It may be operated at one character at a time (useful for software debugging), at 2 characters per second, or at regular bus speed. It may also be operated at a variable rate as determined by the external clock input.

The analyzer's 32 character memory can be used to store bus characters in the Listen mode, or to output characters to the bus in the Talk mode. When the analyzer is in the Compare mode, a stream of bus traffic may be stopped on a pre-selected character—and at that time a trigger pulse is available, which is very useful when analyzing transient or timing problems related to the bus.

HP 59401A Specifications

Display: monitors all bus lines. Represents data lines, any memory location, or DIO front panel switch settings; in octal code and ASCII character.

Listen mode: stores up to 32 characters of bus traffic in memory for real time and repetitive testing. In Compare mode, halts bus traffic when a selected character is present, and user can display any one of the previous 31 characters stored in memory.

Timing: accept <750 ns; ready <750 ns.

Talk mode: bus lines can be driven directly from front panel switches; memory can be loaded from front panel switches for driving bus with a 32 character sequence.

Timing: (1) data changed >500 ns before DAV pulled low; (2) ATN driven low >1 μ s before DAV pulled low; (3) DAV driven high <700 ns after NDAC is false; (4) DAV driven low <700 ns after NRFD is false, if conditions 1 and 2 are met.

Operating speeds: one character at a time, 2 characters per second, regular bus speed, or variable rate determined by external clock input; in either Listen or Talk mode.

External clock input: 1 standard power TTL gate input; \leq 10 MHz repetition rate.

Compare output: provides 1 standard power TTL gate output (LOW TRUE) sync pulse when bus character is same as front panel switches.

HP-IB load: 1 bus load (capable of driving 14 other bus devices).

General

Temperature ranges: operating, 0 to 50°C; storage, -40 to +75°C.

Humidity: 95% relative, 0 to 40°C.

Power requirements: 100, 120, 220, or 240 V +5%, -10%; 48 to 66 Hz; \leq 42 VA.

Size: 145.5 H, 205.1 W, 495.3 mm D (5.730" x 8.075" x 19.500").

Weight: net, 5.64 kg (12.44 lb).

Accessories

HP 5061-9689 (metric) front handle kit

HP 10833B 2 m (6.6 ft) bus cable, furnished

Price

\$55

HP 59401A Bus System Analyzer

\$4000

HP-IB Interconnection Cables

Cables for interconnecting HP-IB devices are available in four different lengths. The connector block at both ends of each HP-IB cable (photo above) has a plug on one side and a matching receptacle on the other, so that several cables may be conveniently connected in parallel, thus simplifying system interconnection. Lock screws provide for secure mounting of each connector block to an HP-IB instrument, or to another cable connector block.

SPECIAL NOTE: HP-IB cables are not always included with individual HP-IB devices, particularly those that normally connect directly to an HP computing controller. (The HP-IB interface for HP computing controllers contains the necessary cable and connector). Product listings in this catalog should be checked to see if HP-IB cables are furnished.

The HP 10833 series of cables feature an improved shielding design to help improve RFI levels in systems. This series of cables, with the RFI shielding, exhibits significantly lower radiated emissions than previous HP-IB cables.

The HP 10834A adapter is a shielded HP-IB to HP-IB adapter. It provides additional clearance (approximately 2.3 cm) between the HP-IB cable and the rear panel of the instrument. This allows easier access to switches, cables, and other connectors that may be in close proximity to the HP-IB connector.

Ordering Information

HP 10833A HP-IB Cable, 1m (3.3 ft)

HP 10833B HP-IB Cable, 2m (6.6 ft)

HP 10833C HP-IB Cable, 4m (13.2 ft)

HP 10833D HP-IB Cable, 0.5m (1.6 ft)

HP 10834A Adapter

☞ Fast-Ship product — see page 766.

Price

\$80 ☞

90 ☞

\$100 ☞

\$80 ☞

\$30 ☞

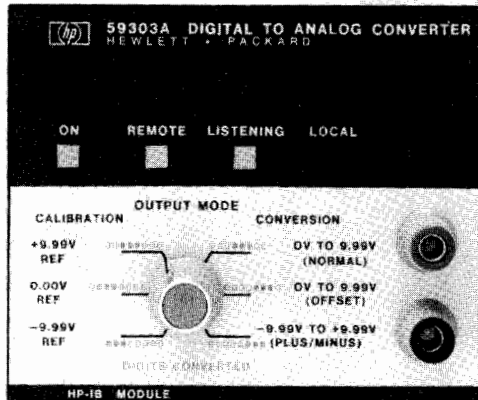

HP 59303A

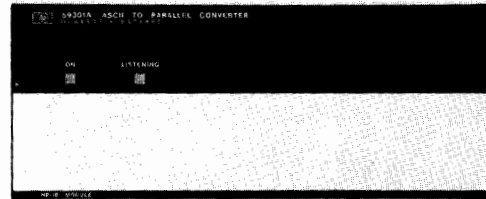

HP 59301A

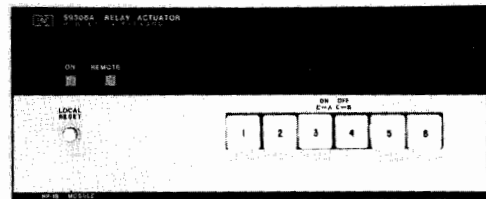

HP 59306A

HP-IB Accessory Modules

Modules in the HP 59300, 59400 and 59500-series are ideal building blocks for use with instruments to extend measurement capabilities. Modules listed here can be interconnected via the HP-IB to HP measuring instruments, signal sources and recording devices capable of operating directly on the HP-IB. In addition, these modules frequently serve as useful ways to interconnect with devices which are not themselves capable of direct HP-IB operation.

Instrument requirements differ. Some only output or accept data on the HP-IB. Others can be remotely programmed by ASCII characters sent along the HP-IB. These modules can work with instruments on any of these levels with or without a controller. Each module having controls can be operated stand-alone from its front panel, or it can be placed in automatic operation under program control.

Module provision for stand-alone, local operation also has important system benefits. The operator can set up and check out the system under manual control, avoiding otherwise complex and time consuming error tracing. Each module has status indicator lights that make it easy to monitor operation.

HP 59301A ASCII-to-Parallel Converter

Accepts byte-serial ASCII characters from the HP-IB and converts them to parallel output. In operation, ASCII characters transmitted serially along the bus are converted into 4-bit characters with the first ASCII character received being interpreted as the most significant digit. A string of up to 16 characters terminated by linefeed is converted and placed upon the output lines. The linefeed character causes the HP 59301A to output a print command (strobe).

With the HP 59301A, instruments controlled via BCD or binary can be operated using HP-IB. For example, the HP 59301A can be used with HP 6129C through 6131C and 6140A (Option J99 or P05) digitally-controlled power supplies for HP-IB programmable voltage and current. The HP 59301A can additionally be used to control other functions using its hexadecimal format.

General

Size: 101.6 mm H¹ x 212.9 mm W x 294.6 mm D (4 in. x 8.38 in. x 11.6 in.).

Weight: net 1.70 kg (3.78 lb). Shipping 2.33 kg (5.16 lb).

HP 59303A Digital-to-Analog Converter

\$1000

HP 59303A Digital-to-Analog Converter

Accepts a string of serial ASCII characters and converts any three consecutive input digits to an analog output voltage, accurate to 0.1% in 30 μ s. Fully programmable via the HP-IB or manually operated from the front panel. A concentric control on the front panel makes it easy to select the digit group for conversion and the output mode. The conversion switch is used to select the three digits of the character string that the DAC will change into analog voltage. The three output modes (NORMAL, OFFSET, and PLUS/MINUS) make the converter convenient for use directly with a variety of data logging devices, avoiding the need for auxiliary equipment to shift zero level or change polarity.

A primary application for the HP 59303A is to present on a logging device the data points being taken with a measuring instrument (like a frequency counter). A controller is not required for operation. Compatible logging devices include strip chart recorders, X-Y plotters, and displays.

General

Size: 101.6 mm H¹ x 105.9 mm W x 294.6 mm D (4 in. x 4.17 in. x 11.6 in.).

Weight: net 2.61 kg (5.80 lb). Shipping 3.17 kg (7.04 lb).

HP 59303A Digital-to-Analog Converter

\$2400

HP 59306A Relay Actuator

Has six Form-C relays that provide for control of external devices either manually from front panel pushbuttons or remotely from the HP-IB. Relay contacts are specified to switch 24 V dc or 115 V ac at 0.5 A. Each relay can be programmed independently or multiple relays can be switched together. Front panel pushbuttons light to indicate the state of each relay.

The HP 59306A is ideal for providing control of microwave coaxial switches (HP 8761 A/B) as well as control of microwave programmable step attenuators (HP 8494 through 8496 G/H) using external dc power supplies.

General

Size: 101.6 mm H¹ x 212.9 mm W x 294.6 mm D (4 in. x 8.38 in. x 11.6 in.).

Weight: net 2.64 kg (5.87 lb). Shipping 3.23 kg (7.18 lb).

HP 59306A Relay Actuator

\$1300

¹Height includes feet. With feet removed height is 88.1 mm (3.45").



HEWLETT-PACKARD INTERFACE BUS

Versatile Interconnect System for Instruments & Controllers

Models 59307A, 59309A, 59501B

135

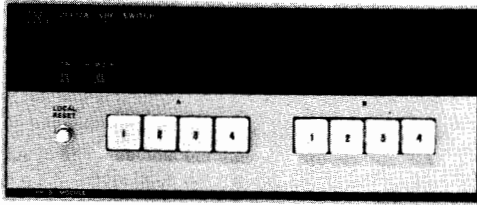

HP 59307A

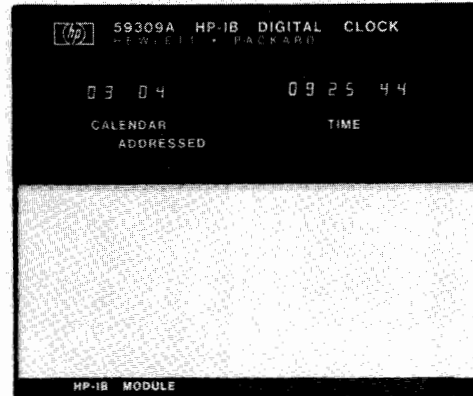

HP 59309A

HP 59307A Dual VHF Switch

This module provides two single pole 4-throw switches controlled from front panel pushbuttons or remotely from the HP-IB. The HP 59307A is a dc to 500 MHz 50 Ω switch designed to maintain fast pulse transition times. The switches are independent and bidirectional for optimum use in multiplexing 50 Ω signal lines into measuring instruments. The HP 59307A is ideal to switch a standard delay, frequency, or voltage into a measurement loop for purposes of system calibration.

General

Size: 101.6 mm H¹ x 212.9 mm W x 294.6 mm D (4 in. x 8.38 in. x 11.6 in.).

Weight: net 2.64 kg (5.87 lb). Shipping 3.23 kg (7.18 lb).

HP 59307A VHF Switch

\$1100



HP 59501B

HP 59309A HP-IB Digital Clock

Displays month, day, hour, minute, and second, and upon command will output time via the interface bus. Time can be set into the clock by local control, or by remote commands received from the HP-IB. The clock accepts a small internal battery which can provide more than a day's standby in case of short power interruptions. Additionally, an auxiliary power supply such as the K10-59992 can sustain the clock for up to one year.

General

Size: 101.6 mm H¹ x 105.9 mm W x 294.6 mm D (4 in. x 4.17 in. x 11.6 in.).

Weight: net 1.70 kg (3.78 lb). Shipping 2.84 kg (6.31 lb).

HP 59309A HP-IB Digital Clock

\$1800

HP 59501B Power Supply Programmer (Isolated DAC)

This single-channel digital-to-analog converter can control a wide range of power supplies (output voltage, or current), as well as other analog programmable devices. It may also be used as a low level signal source, depending on the speed of the controller. It has two output ranges (0–1 and 0–10 V dc in unipolar mode; –1 to +1 and –10 to +10 V dc in bipolar mode), as well as photo-isolators which electrical-ly separate HP-IB control and data lines from power supply circuitry by up to 600 V dc. (For additional details see page 277).

General

Size: 101.6 mm H¹ x 212.9 mm W x 194.6 mm D (4 in. x 8.38 in. x 11.6 in.).

Weight: net 2.61 kg (5.80 lb). Shipping 3.17 kg (7.04 lb).

HP 59501B Power Supply Programmer

\$200

¹Height includes feet. With feet removed height is 88.1 mm (3.45").

HP Model	Description	Dimensions—max. height x width x depth mm (inches)	Net Weight kg (lb)	Shipping Weight kg (lb)	Price
59301A	ASCII-to-Parallel Converter	101.6 x 212.9 x 294.6 (4 x 8.38 x 11.6)	1.70 (3.78)	2.32 (5.16)	1300
59303A	Digital-to-Analog Converter	101.6 x 105.9 x 294.6 (4 x 4.17 x 11.6)	2.61 (5.80)	3.17 (7.04)	1300
59306A	Relay Actuator	101.6 x 212.9 x 294.6 (4 x 8.38 x 11.6)	2.64 (5.87)	3.23 (7.18)	1300
59307A	VHF Switch	101.6 x 212.9 x 294.6 (4 x 8.38 x 11.6)	2.64 (5.87)	3.23 (7.18)	1300
59309A	HP-IB Digital Clock	101.6 x 105.9 x 294.6 (4 x 4.17 x 11.6)	1.70 (3.78)	2.84 (6.31)	1300
59401A	Bus System Analyzer	145.5 x 205.1 x 495.3 (5.73 x 8.08 x 19.5)	5.64 (12.44)	9.1 (20)	1300
59501B	Power Supply Programmer	101.6 x 212.9 x 294.6 (4 x 8.38 x 11.6)	2.61 (5.80)	3.17 (7.04)	1300



HEWLETT-PACKARD INTERFACE BUS

Versatile Interconnect System for Instruments and Controllers

Models 37201A, 37204A

HP 37204A

- High-speed HP-IB extension up to 1250 metres
- Adds flexibility to the design of ATE, data acquisition/control, or office systems
- Multi-point capability allows up to 30 remote sites
- Coaxial cable or optical fiber serial link
- Drops into a system without requiring software changes
- Error-free transmission and new chain-truncation feature ensure uninterrupted operation of computer

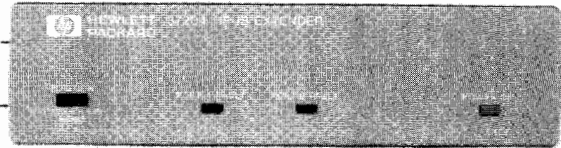

HP 37204A



HP 37201A

- Long-distance HP-IB extension over telephone lines (leased or dial-up)
- Data acquisition systems can operate over unlimited distances
- Multi-drop capability
- Use with full-duplex synchronous/asynchronous modems from 300 to 19,200 bit/s
- RS-366 or CCITT V.25 autodial capability

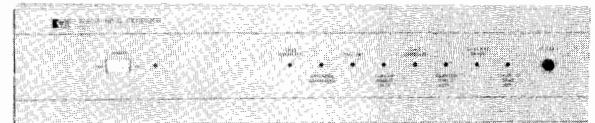

HP 37201A



HP 37204A Multi-point HP-IB Extender

Adding HP 37204As to an HP-IB system allows the 2-metre separation between HP-IB devices to be extended up to 1250 metres. The HP 37204A is "transparent" to HP-IB commands and data, therefore, software changes are not needed to turn a bench-top system into an extended system. Multi-point capability means remote sites can be daisy-chained together, using only one HP 37204A at each site. Chain truncation allows the computer site to continue operation, even in the event of remote power failure or link failure.

The HP 37204A has a maximum HP-IB transfer rate of 60 kbyte/s, however, the maximum achievable rate depends on many factors, such as speed and behaviour of each device connected to the HP-IB, number of remote sites, and distance. Increased absolute transmission delay affects parallel poll response time, and makes HP-IB extension inadvisable for some high-speed memory peripherals.

The following table shows some examples of maximum transfer rate. It should be noted that the serial transmission rate over coaxial cable must be reduced to 1/10th speed for distances greater than 250 metres.

Average Inter-extender Cable Length	Number of Extenders per Chain		
	2	3	5
100 metres - coaxial cable	54 kbyte/s	26 kbyte/s	14 kbyte/s
optical fiber	52 kbyte/s	25 kbyte/s	13 kbyte/s
500 metres - coaxial cable	5.9 kbyte/s	2.8 kbyte/s	1.4 kbyte/s
optical fiber	36 kbyte/s	17 kbyte/s	9 kbyte/s

Ordering Information

HP 37204A: Equipped with dual coaxial ports.	\$925.00
Option 001: Fiber-optic interface - end. Adds a single fiber-optic port.	\$460.00
Option 002: Fiber-optic interface - middle. Adds dual fiber-optic ports. Required for the middle of a multi-point optical-fiber chain.	\$860.00
Option 303: Half-width rack mount adapter for mounting adjacent to instruments with an HP SYSTEM II cabinet.	\$75.00
Option 305: Standard 19-inch rack mount adapter. Holds one or two HP 37204As (includes pop-out blanking panel).	\$75.00

Cables

HP 92179G: 75 ohm shielded coaxial cable (min order 100 metres).	\$0.77/m
HP 92226A: Male BNC connectors for above. Two required per cable.	\$4.00
HP 39200B Option 001: Duplex fiber-optic cable. Ready fitted with HFBR-4000 series connectors.	\$3.20

☎ Fast ship product - see page 766.

HP 37201A HP-IB Extender

The HP 37201A allows HP-IB devices to be interconnected over virtually unlimited distances. It is used in conjunction with modems where the HP 37204A does not have sufficient range (ie >1250 metres).

The HP 37201A is "transparent" to most HP-IB commands, therefore in most cases, software modifications will not be needed to add HP 37201As into a system. Exceptions are that parallel poll and pass control functions are not supported. Software commands are required to use auto-dial, multi-drop, and idle facilities described below. Error correction ensures trouble-free performance, even over the worst phone lines. Multi-drop operation is possible using leased lines and modems with transmission (carrier) controlled by "request-to-send". Unlike the HP 37204A, remote sites must be accessed sequentially. The HP 37201A has an idle mode to allow faster operation at the computer site when remote communication is not required.

The data interface is compatible with RS-232-C/CCITT V.24 and V.28 standards. Full-duplex asynchronous or synchronous modems may be used. Asynchronous data rates provided are 150, 300, 600, 1200 bit/s. It should be noted that asynchronous modems must be capable of supporting 11-bit words (9 bits + start & stop bits). Although most asynchronous modems are insensitive to word length, some BELL 212 type modems only support up to 10-bit words, and so must be operated in synchronous mode. Synchronous modems can be operated at any bit rate up to 19.2 kbit/s.

The HP 37201A has an RS-366/CCITT V.25 parallel autodial interface. For many applications, the HP 37212A/B Modem can offer an alternative autodial solution. It requires a spare RS-232-C port on your computer, but obviates the need for a separate RS-366/CCITT V.25 autodialler. Manually-dialled connections are also supported.

The data byte transfer rate of the HP 37201A depends primarily on the serial data rate, data link length, and data link error rate. The following nominal transfer rates are for a short error-free link.

Synchronous modem interface: 744 data byte/s at 19.2 kbit/s, and pro-rata at lower serial rates.

Asynchronous modem interface: 38 data byte/s at 1200 bit/s, and pro-rata at lower serial rates.

Ordering Information

Ordering Information	Prices
HP 37201A HP-IB Extender	\$2,450
Option 907: Front handle kit	\$57
Option 908: Rack flange kit	\$37
Option 909: Front handle/rack flange kit	\$81



Design Automation

Design automation is the process of using computer-automated productivity tools to improve the quality of new products and the speed with which they can be moved through the design cycle and into manufacturing. When implemented effectively, design automation has a powerful, positive effect not only on quality and time to market, but on production costs, product reliability and other factors that ultimately affect the competitive position and profitability of your company.

Design automation has become something much greater than an opportunity for aggressive firms looking for a competitive edge. It is now crucial for survival in a growing number of markets.

Hewlett-Packard's approach to design automation has been to develop an integrated design environment that enables engineering teams in electronic, mechanical and software projects to link their efforts through the entire design process, from concept through manufacturing.

Introducing HP DesignCenter™

HP DesignCenter is an integrated design environment for electronic, mechanical and software engineers, where tasks can be planned, executed and managed more effectively. HP DesignCenter includes tools for data management, documentation and communication, not just design automation software. It runs on a family of powerful workstations that link, through industry-standard networks, to computers from HP and other vendors.

DesignCenter will help the individual design engineer by providing an integrated set of tools to speed the design process from idea to final production, while also improving overall quality. DesignCenter comes with the support, documentation and training to ensure productive use of design tools.

HP Design Automation

Products	Page
HP Technical Computer Platform	140
HP Support	142

HP DesignCenter Electronic Engineering CAE/CAD Products

HP Electronic Design System	143
HP Microwave CAE System	146
HP 64000-UX Microprocessor Development Environment	148
HP Printed Circuit Design System	154
HP Engineering Graphics System	156

HP DesignCenter Mechanical Engineering CAD/CAM Products

HP Finite Element Analysis System	157
HP ME Series 5, 10 & 30	158
HP ME Series 90 Test System	160

Value-added Solutions

HP Technical Software Catalog	163
-------------------------------	-----

HP 9000 Family

The HP 9000 family of technical computers is the foundation for HP DesignCenter. HP 9000 products include the Series 200, 300, 500 and 800 Technical Computers. This includes the Model 840 Precision Architecture computer

(see page 75). The use of these computers in the design automation environment is discussed on page 140. Another section of this catalog is devoted to detailed discussions of HP technical computer products, beginning on page 72) HP's 9000 family features the HP-UX operating system which adheres to AT&T's UNIX* System V interface definition, Issue 1. Individual workstations as well as total systems can be configured in a powerful IEEE 802.3 local-area network (LAN). See page 84 for networking information.

HP customer support in training and consulting ensures that the solutions you select can be used to the greatest advantage to you and your company. See design automation support details on page 142.

Electronic CAE/CAD Products

HP Electronic Design System (NEW) captures both digital and analog schematics for automated electronic hardware design. The system includes more than 3000 logic and analog component library parts, a powerful schematic editor, HILO-3 logic simulation, analog simulation through the Analog Workbench, links to physical layout systems and a user interface that simplifies interaction with the design and verification tools. The HP Electronic Design System is available as a high-end system for use on the HP 9000 Series 300 technical workstation, or as a low-cost, entry-level station based on the HP Vectra PC or IBM PC/AT. See page 143.

*UNIX is a registered trademark of AT&T in the U.S.A. and other countries.

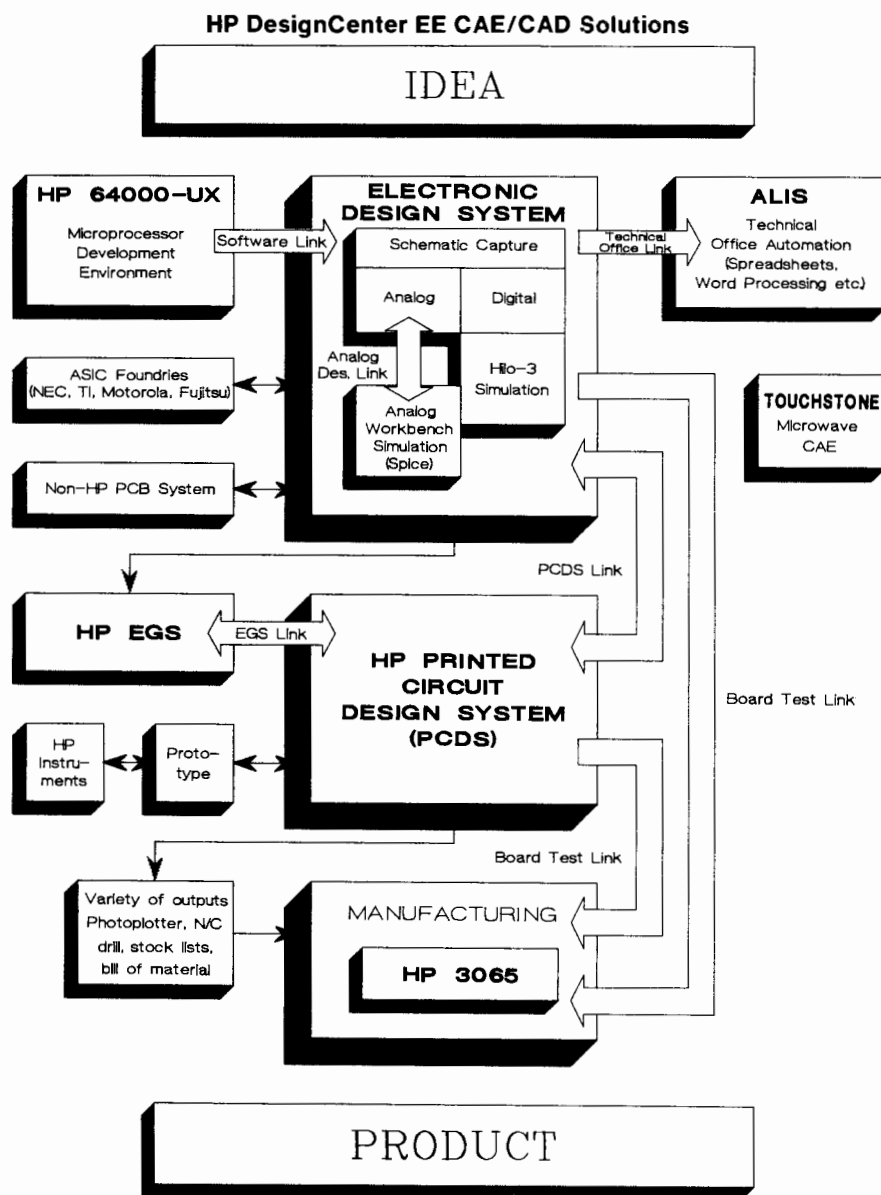

HP Microwave CAE Workstations (NEW) provide an integrated solution for simulation and optimization during the microwave CAE design process. The two "personal microwave workstations" are based on the HP 9000 Series 300 workstation and the HP Vectra Personal Computer. Both use an integrated family of software from the "Touchstone"™ series created by EEsof, Inc. The systems provide linear circuit simulation and optimization, production yield prediction and direct data entry from HP vector network analyzers. Both also feature menu-driven operation, built-in text editing and an interactive tuner. See page 146.

HP 64000-UX Microprocessor Development Environment (NEW) is a natural evolution of HP's 64000 Logic Development System. The new family of microprocessor development tools is fully compatible with the existing 64000 family, but adds a number of new capabilities. HP 64000-UX now is fully integrated into the DesignCenter family, and uses the same computer platform, and provides links to other DesignCenter solutions. The system now provides versatile networking to popular software on systems such as DEC VAX and the IBM PC. In-circuit emulators, language systems and analysis tools now are available for 8-, 16- and 32-bit microprocessors. A broad selection of price/performance options helps to select the best system for your needs. See page 148.

HP Teamwork/Structured Analysis (NEW) is a companion product to HP 64000-UX, and the first in a series of products that will help software engineers develop and manage software specifications. HP Teamwork/Structured Analysis enables a software development team to capture design requirements quickly and easily, organize them into models, evaluate and maintain them for large and small designs. The product helps eliminate unnecessary redesigns and thus reduces the cost of the software development process. See page 150.

HP Printed Circuit Design System (NEW) couples printed-circuit-board layout to electrical engineering design, manufacturing and test. The system allows PCB designers to create highly manufacturable boards that perform as the design engineer intended. HP Printed Circuit Design System provides packing, placing and routing features to automatically lay out digital, analog and mixed digital/analog boards with through-hole and surface-mount technologies, with extensive facilities for thick-film hybrid design. The system's open and documented design-file format eliminates redundant data entry and makes it easy to generate manufacturing and test reports. HP Printed Circuit Design System software is derived from Northern Telecom Incorporated (NTI), and its subsidiary, Bell Northern Research (BNR). See page 154.

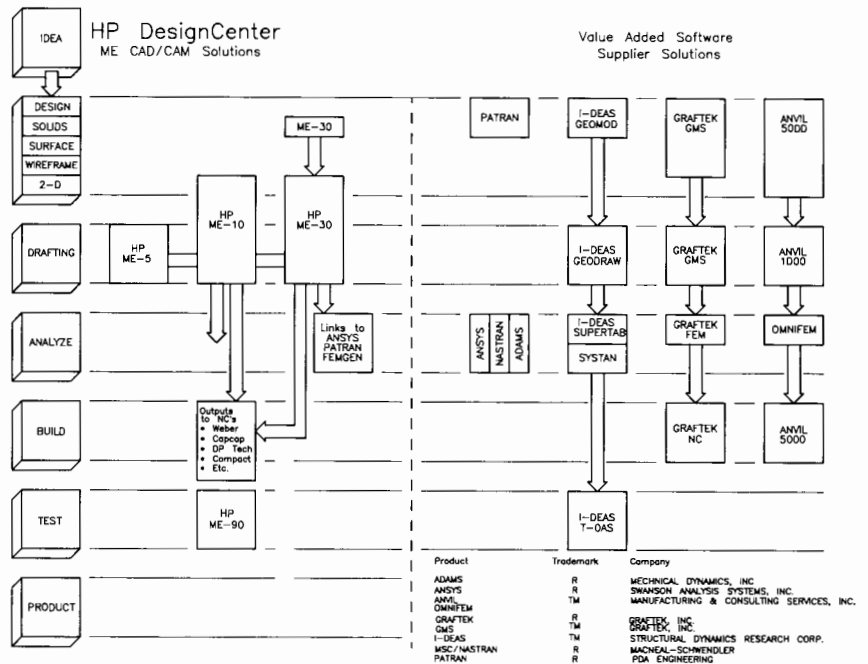

HP Engineering Graphics System (EGS) provides interactive printed circuit board layout and schematic drawing, as well as mechanical drafting for the enclosures to house PCB designs. The product also includes a general drawing module for artwork such as overhead slides, project planning diagrams and floor plans. HP EGS can be easily customized to perform specialized CAD tasks. See page 156.

HP EE Test solutions are the most highly rated in the business. HP is a leading supplier of logic analyzers, digitizing oscilloscopes, radio and microwave frequency sources and analyzers, low-frequency dynamic signal analyzers, board test systems and other products. Through extensive use of HP-IB (HP's implementation of IEEE 488), these products can be used in automated test systems, as well as in standalone applications, to verify design prototypes or production processes. See the alphabetical index of this catalog for the specific instruments of interest to you.

Mechanical CAD/CAM Products

HP FE is a general-purpose finite element analysis system for linear-structural and thermal analysis of 2D, axisymmetric and 3D structures and solids. The system solves the majority of standard problems in structural mechanics and heat-transfer analysis in the fields of mechanical, electromechanical and civil engineering. See page 157.

HP Series 5, 10 & 30 Mechanical Engineering Systems are a family of CAD products for mechanical drafting, 2D design and solids modeling, respectively. All three use the same user interface, developed to dramatically reduce system learning time to quickly improve designer productivity. ME Series 5, 10 & 30 provide a range of functions for design through modeling and drafting of complex mechanical parts and assemblies. The result is reduced prototyping requirements and faster creation and modification of drawings. See page 158.

HP ME Series 90 Test System is an expandable, off-the-shelf multichannel test system with applications in structural testing and analysis, vibration analysis, control system testing and general signal analysis in low frequency ranges. HP ME Series 90 closes the design loop by linking modeled performance from design tools with prototype test for a direct comparison of the theoretical with the actual. The system is expandable for up to 62 total channels. See page 160.

HP Mechanical Engineering Test Products have grown out of the company's longstanding involvement with state-of-the-art instrumentation for vibration and structural analysis and test. In addition to the CAD/CAM products listed below, HP offers a large family of mechanical testing solutions. See page 642.



Lots of Links

Ideally, a new product design should work right the first time, but many companies average six iterations. Integration is the key to reducing the number of times designs must be reworked. HP DesignCenter EE Series products can be tightly linked. See diagram on page 137.

HP Electronic Design System provides strong links to HP Technical Office Automation, HP EGS, HP 64000-UX Microprocessor Development Environment, HP Printed Circuit Design System and the HP 3065 Board Test System, with additional links to Racal Redac, Calay, Computerivision, GenRad HiChip physical modeling and ASIC foundry links to NEC, Motorola, TI and others. HP Printed Circuit Design System not only receives net lists and parts information from HP Electronic Design System, but sends back engineering changes and back-annotation data.

Value-added Solutions

To increase the breadth of solutions available to HP customers, Hewlett-Packard actively seeks out and relies upon the expertise of Value-Added Software Suppliers to augment HP's proprietary solutions. More than 300 independent software vendors are working with HP to provide a large selection of software products for technical applications. See page 163

Sensitivity of Profits Over Product Life

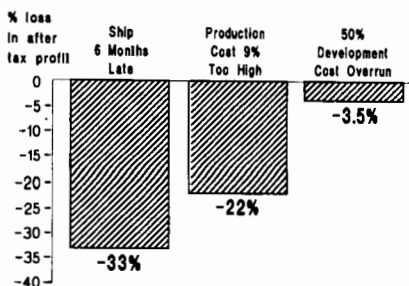

Why CAE/CAD/CAM?

During the past few years, several factors have influenced the typical product design process in ways that make the design engineer's task more demanding. Increasing global competition has compressed product development time as well as product life cycles, making the time saved in development even more critical than in the past.

The shorter the development time, the sooner the product goes to market and the longer the sales life of the product. A recent electronics industry study compared the impacts on product profitability of development costs, product costs and late product introduction.*

Using a representative high-growth market with 5-year product life, 12% annual price erosion, and 20% growth per year, an overrun of 50% in product development costs will decrease after-tax profits by 3.5%. In contrast, a production-cost overrun of only 9% results in a 22% decrease in after-tax profits. Even more significant, a six-month delay in introduction costs 33% of the after-tax profits.

(* Figure from Donald Reinstein, McKinsey & Co, Los Angeles, CA, Electronic Business, July 1983, P. 86. Copyright 1983, Cahners Publishing Company)

CAE/CAD/CAM

A Strategic Decision

Purchase of any computer system is an important decision that requires looking beyond today's needs and currently available product features to expected future requirements and growth paths: This is especially true in CAE/CAD/CAM since the user's entire design-to-manufacturing cycle can be linked to the selection of a CAE vendor. With technology and design requirements changing at an ever-increasing pace, the strategic directions of alternative CAE vendors are an important factor in the selection process.

HP's product strategy is founded on a major corporate commitment to the CAE/CAD/CAM business. The company's engineering expertise, reputation for quality and experience in test, measurement and technical computing, as well as its respected worldwide support organization, all contribute to HP's position as a leading supplier of CAE/CAD/CAM solutions.

Summary

Hewlett-Packard has for many years been a leading supplier of computers and engineering workstations for measurement automation, data acquisition, automatic test, factory automation and many other technical applications.

Today, by combining its expertise in technical computers with its experience in state-of-the-art electronic design, HP supplies high-quality design systems to help improve the productivity of electronic, mechanical and software engineers.

Computer-aided engineering and design capabilities applied throughout the design cycle improve efficiency and quality at each step in the process and enhance communication and coordination between steps. With the increased capabilities and lower costs of technical workstations, peripherals, test equipment and application software, it is becoming feasible for every area of the factory to use these tools in collaboration so each can truly influence products in appropriate stages of design and development.

With the HP DesignCenter, an engineer will have access to a comprehensive offering of CAE/CAD/CAM solutions for electronic, mechanical and software development. Along with this comes the support, training and service that has distinguished Hewlett-Packard over the years, and that is so important to the successful use of these complex systems.

When the best solutions may be available through applications software from third parties and independent software vendors, HP cultivates relationships with other leaders in the market. This combination of the HP DesignCenter offerings complemented by renowned third-party products, provides the customer with the widest possible range of design automation solutions.

HP is committed to a technical and business relationship with CAE/CAD/CAM customers, which begins when the HP field engineer helps to define and analyze the customers' specific needs. This continues through system installation and implementation and extends through the life of the system and beyond as needs expand and new products become available.

Contact

HP's CAE/CAD/CAM offerings are continually expanding as new products are introduced at a rapid pace. The products on the following pages represent the current state of the HP DesignCenter family, but are by no means the whole story.

Contact your nearest Hewlett-Packard sales office for the more detailed information on HP's growing family of products for design automation solutions in CAE/CAD/CAM.



DESIGN AUTOMATION

HP DesignCenter

Technical Computers—The Foundation for Design Automation

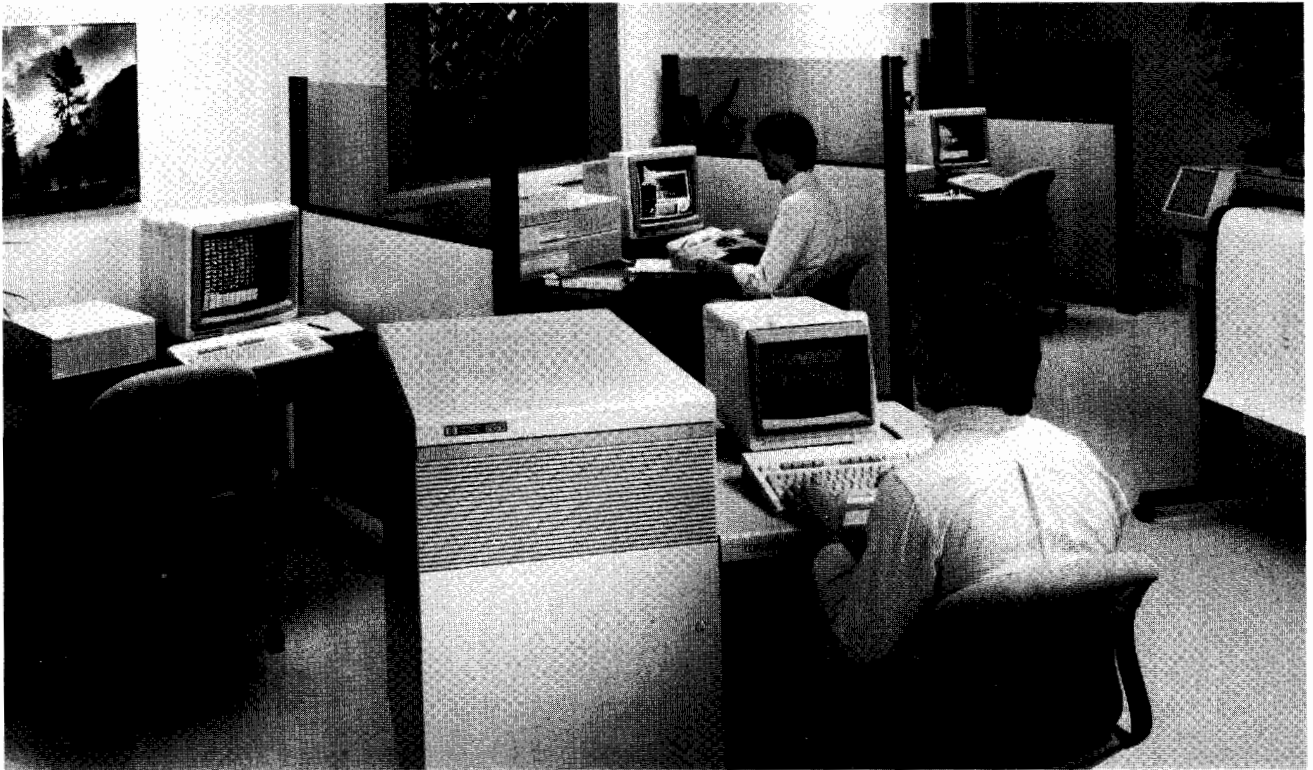

The Foundation

Success in implementing CAE/CAD/CAM for design automation depends not only on software solutions to design problems, but on using a family of computers and workstations that meets the demands of those solutions, both today and tomorrow. Engineers in these fields must have a broad selection of computer systems to meet the needs of a number of applications, both for their own development work, and as delivery vehicles for developed products.

These computer systems must provide flexibility in configuration choices for displays, programming languages and operating systems, internal memory and peripherals. HP provides all this in its HP 9000 family of computers, and makes them available with a range of supporting products for networking, graphics, artificial intelligence, interfacing and technical office automation.

HP DesignCenter
Technical Computing Environment

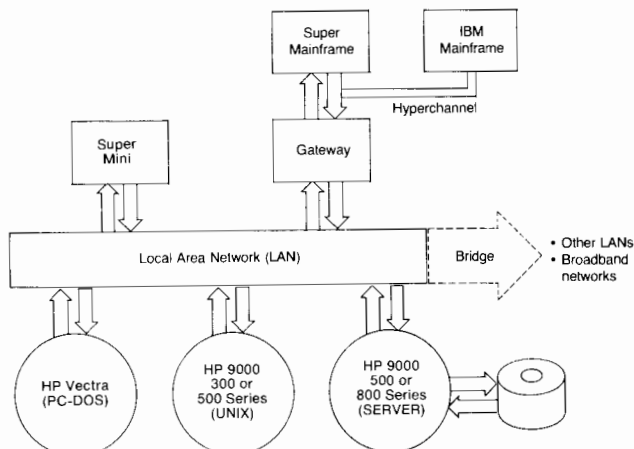

Technical Computing Environment

Hewlett-Packard's technical computing environment, shown in the diagram at left, is comprised of computing systems, networking, high-resolution graphics, advanced data management systems, human interface tools, operating systems, languages and a wide range of peripherals. HP is committed to UNIX* as a standard operating system, and to leading industry networking standards such as IEEE 802.3 and ARPA/Berkeley. Conformance to these and other standards allows systems to be configured into a powerful local area network (LAN), and provides an open system environment to support multivendor solutions. A hyperchannel gateway is available to provide high-performance networking to supercomputers and mainframes.

Low Cost of Ownership

Hewlett-Packard's low cost of ownership reflects the quality of its computers, developed over years of computer design, manufacturing and support that have placed more than 150,000 HP 9000 technical computers in businesses around the world.

HP-UX

HP-UX is the primary operating system offered on the HP 9000 family, offering compatibility with a large number of other UNIX systems. This makes available a virtually unlimited expanse of applications, beyond the large selection available directly from HP. For information on software for HP 9000 technical computer systems developed by third party software vendors, see page 163 in this section.

Along with HP-UX, HP 9000 technical computers run Hewlett-Packard's BASIC and Pascal language systems. HP BASIC offers the ease-of-use of an interpreted language, yet features exceptional operating speed, while HP Pascal is both powerful and flexible, and so can help design engineers to fine-tune programs close to machine level.

Networking

HP has worked hard to maintain compatibility across the HP 9000 family. A glance at the HP 9000 Family Comparison Chart on the facing page shows that nearly all members of the HP 9000 family are available with an industry-standard operating system (HP-UX, which

*UNIX is a trademark of AT&T.



HP 9000 FAMILY COMPARISON CHART

Computer	Integral PC	Vectra	Series 200	Series 300	Series 500	Series 800
Microprocessor/CPU	Motorola 68000	Intel 80286	Motorola 68000	Motorola 68010/20	Proprietary	Proprietary
Operating System	HP-UX	PC-DOS	HP BASIC, Pascal, HP-UX	HP BASIC, Pascal, HP-UX	HP BASIC, HP-UX	HP-UX
Languages	BASIC, C	BASIC, GW BASIC Lattice or MS C Compiler Pascal	BASIC, Fortran, C, Pascal	BASIC, Fortran C, Pascal	BASIC, Fortran 77,	C Fortran Pascal
Memory	512K RAM Expands to 5.5M	256K RAM Expands to 3.6M	256K RAM Expands to 7.5M	7.5M physical, (68010 - 16M virtual) (68020 - 4 Gbytes Virtual)	512K RAM Expands to 10M	8-24M
Mass Storage	Built-in 3½" disc	Multiple Config.	Multiple Config.	Multiple Config.	Multiple Config.	Multiple Config.
Networking I/O	HP-IB RS-232	HP-IB HP-IL HP-HIL RS-232C	HP-IB, RS-232 IEEE 802.3 IBM RJE SRM	HP-IB HP-HIL RS-232 IEEE 802.3 HP 9000 LAN ARPA/Berkeley	HP-IB IEEE 802.3 RS-232 SRM	HP 9000 LAN ARPA/Berkeley
I/O slots	2	7	2 - 8	4 - 12	4 - 8	
Display	9in. 24 lines × 80 col.	HP Touch 12in. 24 lines × 80 col.	7in. to 17in. 25 lines × 80 col.	12in. to 19in. 48 lines × 128 col.	12in. to 19in. 48 lines × 128 col.	
Keyboard	90 key typewriter style	HP-HIL device port	Multiple config.	HP 46021 ASCII standard (others available)	ASCII standard others avail.	

adheres to AT&T's UNIX* System V interface definition Issue I). See page 83 for details on languages and operating systems.

ARPA/Berkeley Networking Services add another level of capability to the HP 9000 family, making this defacto networking standard available on the Series 300 and 800 for communication among themselves, and with non-HP computers including products from Digital and Sun. HP 9000 LAN also adds depth to the ability of HP systems to communicate quickly and effectively with other computers. See page 84 for details.

OEMs and ISVs

Original equipment manufacturers (OEMs) and independent software vendors (ISVs) both will find modularity and flexibility built into the HP 9000 family will make their job easier. Software developers find it much easier and faster to design software products on a system that is well equipped. But for delivery to the final customer, many of the features that make software design easier are no longer necessary. For these needs, the complete software compatibility of the Series 300 family, coupled with its extreme modularity, make it a natural. Series 300 models are available from the Model 320CX with 8-plane color and a graphics accelerator, down to the monochrome Model 310. See page 77 for more information.

HP 9000 Family

Hewlett-Packard's HP 9000 family of technical computers and workstations has evolved to meet those needs. The computer family now covers a broad range that includes:

- The latest in superminicomputers and workstation servers; the HP 9000 Model 840, based on HP's Precision Architecture
- Supermicro/minicomputers, represented by the HP 9000 Series 500 for design automation, as well as by the HP 1000 family for manufacturing automation
- Instrument controllers, including the HP 9000 Series 200, Series 300 Model 310, and HP Vectra
- Engineering workstations, including the HP 9000 Series 300 Model 310 and 320, as well as the Series 500 Model 520

- Personal Computers/low-cost technical computers, including HP Vectra, The Integral, the Series 80 computers and HP 9000 Series 300 Model 310

For more detailed information on the HP 9000 family of technical computers, please see the Technical Computer Systems pages of this catalog:

HP 9000 Technical Computer Systems	Page
HP 9000 General Information	72
HP 9000 Series 800	75
HP 9000 Series 500	76
HP 9000 Series 300	77
HP 9000 Series 200	79
Technical Vectra	80
Integral PC	81
Series 80	82
Languages and Operating Systems	83
Networking	84
Artificial Intelligence Products	86
Graphics	87
Peripherals	88
Interfacing	89
Technical Office Automation	90
HP 9000 DOS Coprocessor	91

Measurement Automation

The same flexibility that makes Hewlett-Packard technical computers excel for design automation applications has made them perform well in measurement automation applications for many years. Computer-aided test, test and engineering evaluation and analysis, manufacturing and industrial monitoring and laboratory monitoring and analysis are just a few of the applications. See page 82 for more information.

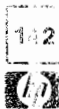

DESIGN AUTOMATION

Customer Support for Design Automation

A good design automation system is comprised of engineering workstations, peripherals, software and support.

The purchase of hardware and software alone does not lead to a fully productive system. That's why Hewlett-Packard has a **complete support solution** available to help you with your design automation system - from the investigation phase through selection, installation, operation and even future expansion of your system.

Beginning with **planning** phase of your design automation system, your HP Sales Representative and HP's Application Engineering Organization (AEO) work together to provide you with seminars, literature, demonstrations, Return-On-Investment evaluation, and benchmarks.

After you have selected the product/s which best suit your needs, HP's support services are available to help you with the **implementation** and **operation** of your system. **Implementation** includes everything from installation of your system to training courses, special assistance (HP-ASSIST), consulting and custom project services to help you quickly get up and running.

After your system is in place and your people are trained, HP support can help you with the productivity of your day-to-day **operation**: HP Response Centers can provide help from technical specialists over the telephone; hardware and software maintenance contracts are available for cost-effective service; updates for manuals and service notes can enhance performance and reliability of your HP products; and advanced training for your users help you utilize your equipment to the fullest and receive the highest return on your investment.

The following diagram will show you HP's wide range of support services and where they fit:

Range and Scope of Support for Design Automation

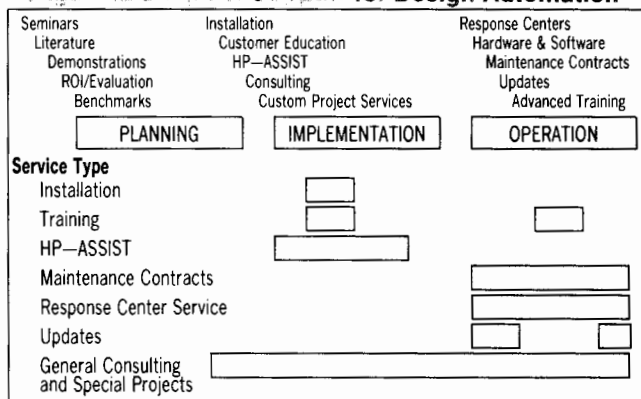

Following is a list of available Customer Education and HP-ASSIST support for the **implementation** phase of your design automation system:

Workstation Education

HP 9000 HP-UX System

Course	Days	Description
35073A	3	HP-UX System Administration for Series 200
35128A	5	Introduction to HP-UX
35129A	3	HP-UX System Administration for Series 500
35130A	5	Programming in C language
HP 9000 Language Systems		
97005B	3	HP 9000 BASIC Upgrade for Series 500
98501A	4	BASIC Programming
98502A	5	HP 9845 BASIC Operations and Programming
98503A	4	BASIC I/O Programming
98510A	5	Series 200 BASIC Operations and Programming
98511A	5	Series 200 Pascal Operations & Programming
98524A	5	HPL Operations and Programming

EE Design Support

Customer Education

98304C	3	HP EGS General Drawing
98304D	2	HP EGS Electrical Engineering
98304E	2	HP EGS Mechanical Engineering
98304F	2	Customizing HP EGS

Course	Days	Description
74490A	5	PCB Design with PCDS
74493A	3	Building Parts with PCDS
74494A	2	PCDS System Management
64100A +24D	2	64000 System Concepts & Measurement
64310A +24D	1	Software Performance Analysis
64600S +24D	1	Advanced Timing/Hardware Analysis
64620S +24D	1	Advanced State/Software Analysis
64810S +24D	2	Pascal/64000 on 8080/8085
64812A +24D	2	Pascal Programming on Z80
64814A +24D	2	Pascal on 8086/8088
64815A +24D	2	Pascal on 68000
64817A +24D	3	Host Pascal Programming

HP Assist	*	HP EGS-ASSIST Implementation Assistance
98305A +60A	*	HP EGS-ASSIST Implementation Assistance for Shared Resource Manager
98305A +60B	*	HP PCDS-ASSIST Implementation Analysis and Project Implementation Assistance.
74400A +60A	*	HP PCDS-ASSIST Implementation Analysis and Project Implementation Assistance using a Local Area Network.
74400A +60B	*	HP PCDS-ASSIST Implementation Analysis and Project Implementation Assistance using a Local Area Network.

ME Design Support

Customer Education

98363A +24D	3	HP ME Series 5/10 Fundamentals
98365A +24D	2	Advanced concepts with HP ME Series 10
98534A/X	4	HP-DRAFT (HP site or customer site)
98532X	5	HP-FE Training Course

HP Assist	*	HP DRAFT-ASSIST Implementation Analysis
98360A +61A	*	HP DRAFT-ASSIST Project Implementation Assistance
98360A +65A	*	HP DRAFT-ASSIST Project Implementation Assistance for Shared Resource Manager
98360A +65B	*	HP DRAFT-ASSIST Project Implementation Assistance for Shared Resource Manager

*Varies

HP's training courses are designed for all different levels of expertise - from system managers to program developers and application users. HP-ASSIST is people helping people. HP people helping your people adjust to changes in their computerized environment.

The following matrix will give you a quick overview of available HP support for your design automation system:

Support Product Availability Matrix

	Consulting	Installation	Account management	Response Center	Software materials	On-site workstation service	Return-to-HP service	On-site system service	Training
HP EGS	●		●	●	●				●
HP ME Series 5/10	●	●	●	●	●				●
HP DRAFT				●	●				●
HP-FE	●			●	●				●
Languages/OS Series 200/300	●			†	●				●
Languages/OS Series 500	●			●	●				●
Series 200		●					●	●	●
Series 300		●					●	●	●
Series 500		●						●	●
HP-Integral				●			●	●	●

†HP-UX only

New support products are continuously being added. Please contact your local HP sales office for availability details.

For more information about HP's wide range of support programs, please turn to pages 757 - 765 of this Catalog.

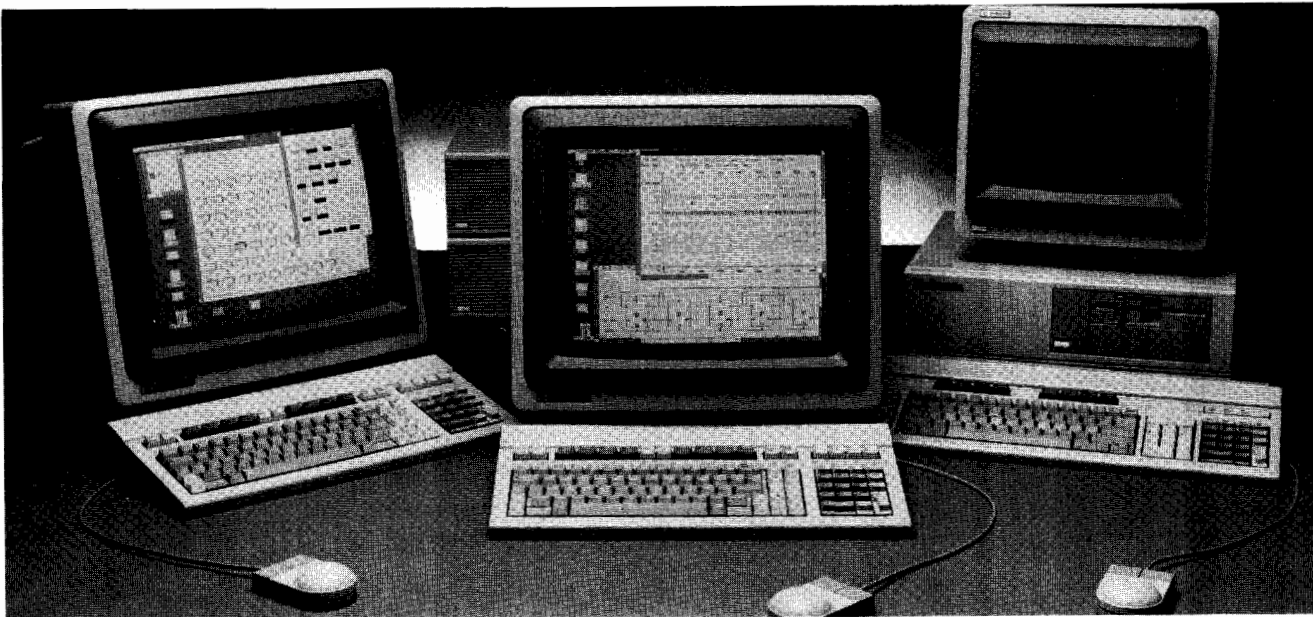

HP Electronic Design System

Hewlett-Packard's computer-aided engineering system provides an integrated solution for automating electronic hardware design. This system includes more than 3000 logic and analog component library parts, a powerful schematic editor, HILO-3 logic simulation, links to analog simulation and physical layout systems and a user interface that simplifies interaction with design and verification tools.

Available on the HP 9000 Model 320 workstation, Hewlett-Packard's CAE solution is divided into five areas: Design Capture System, Design Verification System for HILO-3, Analog Workbench® by Analog Design Tools, Inc, design interfaces to physical layout systems, and parts libraries.

A low-cost, entry-level station, based on the HP Vectra PC and the IBM PC/AT, provides design capture, parts libraries, design interfaces to physical layout tools and remote access to design verification for digital designs. As design needs grow, engineers can move to the more powerful Model 320 workstation without having to learn a new user interface or lose productivity.

Team Design with Networking

The HP AdvanceNet network supporting IEEE 802.3 protocol provides the means for team communication among electronic designers and other members in the design environment. Furthermore, electronic design stations can physically coexist with other equipment in the network on coaxial cable.

Large designs may be partitioned among a variety of stations, and later combined on a Model 320 network node. These individual design portions from other designers are transferred over the network to a central workstation and assembled into the complete hierarchical design. HILO-3 simulation is then performed on the complete logic design either locally or remotely on a shared simulation node. For analog designs, the user transfers the circuit to the Analog Workbench for simulation and analysis.

Project management is simplified with a networked environment. Files can be archived and managed centrally to prevent duplication and unauthorized access. The progress of each team member can be reviewed easily by remotely accessing files on Model 320 workstations, or on a personal computer station, transferring them over the network.

The HP Software Link with the HP 64000-UX Microprocessor Development Environment simplifies initializing memory contents. Model 320 workstations can remotely access RAM/ROM contents files over the network to be incorporated into the simulation netlist. The memory contents files can be transferred to any workstation to create the complete HILO-3 simulation netlist locally.

Another convenient and cost-saving advantage of networking is the ability to share peripherals. Printing and plotting requests can be handled over the network by a workstation controlling those peripherals.

Illustrated in the diagram on the next page is a network of workstations that a large design team might use. For example, a logic design can be started on the interactive personal computer station at the engineer's desk. At some point in the design, logical simulation may be desired. The engineer then creates a HILO-3 simulation file which includes control information, graphically-produced stimulus file, a netlist and any memory contents files.

This simulation file is sent over the network for processing by the Model 320 that serves as the simulation node. When the simulation is finished, the engineer is notified that the run is complete. The file is then transferred back to the personal computer with the results viewed from the design environment. Designers can handle analog designs by transferring the schematic to the Analog Workbench.

Other groups in an organization would find networking valuable. The documentation or physical design group can access the most current revision of a document or design from a station on the network. The files can be archived on a large disc at any of the workstations.

HP's design environment uses pop-up menus, icons and multiple-window management to accelerate the CAE learning curve.

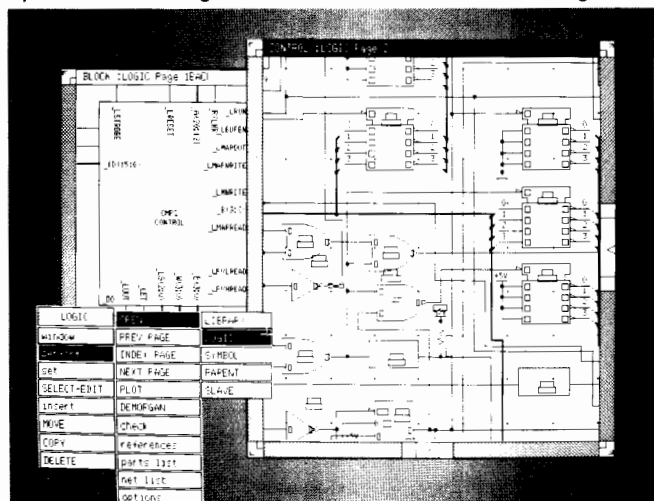

*Analog Workbench is a trademark of Analog Design Tools, Inc.



DESIGN AUTOMATION

EE DesignCenter

HP Electronic Design System

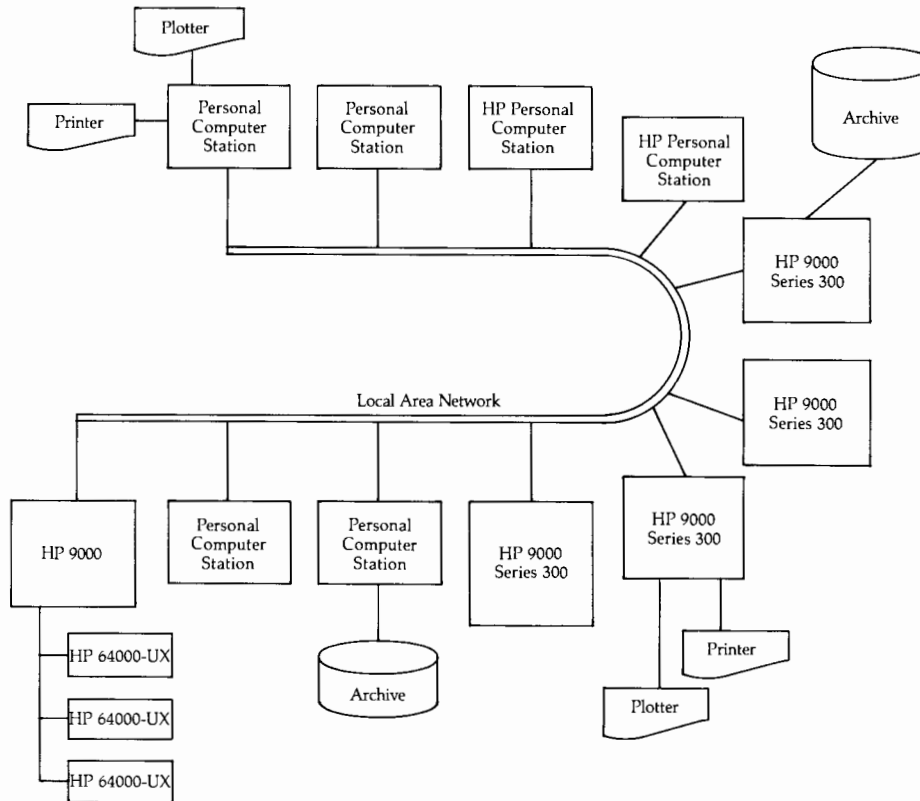

HP Electronic Design System makes possible systems ranging from a single standalone workstation to very powerful networks linking a number of personal computers, workstations and peripherals on a Local Area Network.

Use the System Productively from the Start

The investment in time required to become productive on a CAE system is a major concern. The HP electronic design system environment reduces startup time considerably with easy-to-learn design tools.

Accelerate the Learning Curve

An advanced user interface aids in design with pop-up menus, icons and multiple-window management. System operations are performed naturally, so the time often spent learning and relearning a system is virtually eliminated. The on-line HELP facility is easily invoked by pressing a button on the mouse.

Start Designing with a Large Library

The Design Capture System can be used to start designing immediately, rather than first spending time building library parts necessary for the design. The HP workstations offer a large selection of libraries including more than 3000 off-the-shelf TTL, ECL, MOS, microprocessor and passive and active analog parts. Both library parts and designs may be shared over the network.

Discover Logic Errors Early

On-line electrical rule checking occurs interactively while the designer is editing the schematic. In addition to the traditional connectivity checks for pins and nets (wires and buses), automatic load checking is performed on both flat and hierarchical designs. These early checks save time by identifying many circuit errors prior to simulation.

Generate Quality Forms and Documentation

The Design Capture System's integrated forms and documents tools automate the documentation process. In addition to the ability to merge text and graphics, these tools provide a documentation system that tracks the design.

Forms are used to establish a standard outline and format for engineering documents. Documents may contain one of these forms,

Integrated forms and documentation tools allow documentation to track design.

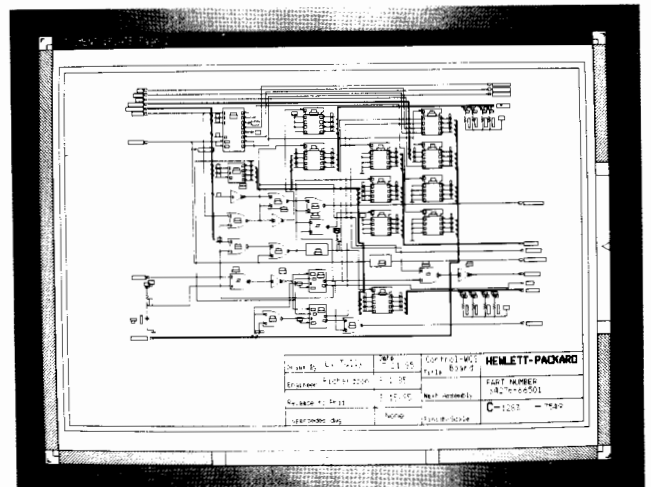

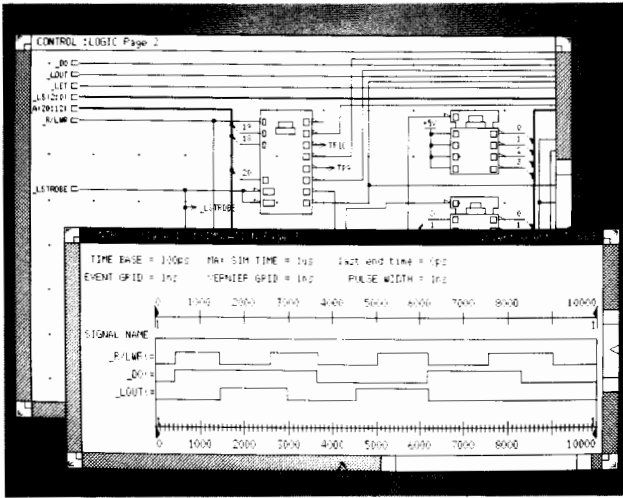

HP logic design verification tools, based on the industry standard HILO-3 simulator, are tightly coupled to the Design Capture System.

views of a design, notes to explain the circuit, or text inserted from an external file. Printer and plotter output is available in any ANSI or ISO industry-standard page size. This output can be automatically scaled or rotated at print time to best fit the page size or orientation.

Verify Logic Designs Through Simulation

The Design Verification System for HILO-3 provides accurate simulation results quickly. Verification tools in this industry-proven system help users develop optimized designs. Results are easily viewed through the Design Capture System interface. System designers have access to a large model library of TTL, ECL, and MOS parts as well as many complex microprocessors such as the Intel 8086 or the Motorola 68000.

Use Flexible Constructs for Functional Modeling

HILO-3 Hardware Description Language (HDL) provides flexible, functional modeling constructs, such as event expressions, register transfer functions, Boolean and arithmetic operators, loop constructs and conditionals. Since HDL is an event-driven, non-procedural language, asynchronous signals such as interrupts can be modeled just as they occur in hardware. Multilevel support in HILO-3 allows simulation of designs, even when some parts are specified at a functional level only.

Link Hardware and Software Design Tools

Designs containing a microprocessor with associated RAM/ROM models can be checked for hardware/software integration problems through the tight linkage of HP 64000-UX microprocessor software development tools and the HILO-3 simulator. The HP Software Link provides an effective means to test microcode and hardware interaction while still in the simulation phase of development.

Verify Analog Designs Through Simulation

Designers can use the Design Capture System to create their schematics. They can then transfer the analog portion of their schematic to Analog Design Tools' Analog Workbench® for simulation and analysis. Data from these schematics can be maintained and passed to physical design and documentation.

This Design Interface to the Analog Workbench allows the user to enjoy the benefits of both powerful analog simulation as well as documentation capability and interface to CAD systems.

Transfer Design Information Between Systems

Integrated tools for access and transfer of design information help ensure connectivity and naming consistency with physical design systems.

When a bill of materials or specific netlist is required, the Design Database Language (DDL) aids in quickly performing these tasks. Back annotation of physical design information is also straightforward with the flexibility built into DDL.

HP Design Interfaces provide bidirectional turnkey links to transfer information to and from physical design systems. Logical and physical netlists are compared and any inconsistencies highlighted. Design information is easily back annotated from a physical design file with a menu selection. In addition to HP's own printed circuit design system and HP EGS, HP Design Interfaces link non-HP CAD systems, such as SCICARDS and Calay printed circuit board systems.

Additional Applications

Electronic design workstations can be used for performing a variety of tasks. Application software for project management, word processing, presentation graphics, spreadsheet analysis and more are available for the entire workstation family.

Selecting an Electronic Design System

Model 74200 Electronic Design System is a complex and dynamic family of design tools. It is recommended that an HP Field Engineer be contacted for a suggested configuration that will fit your application. Prices for selected components are listed below.

Ordering Information	Price
Design Capture System for HP 9000 Model 320	74210A \$8,000
Design Capture System for HP Vectra PC and PC/AT	74210B 8,000
Design Verification Interface for HILO-3 (includes HP Software Link)	74230A 4,000
HILO-3 Logic Simulator	74230B 9,000
HILO-3 Simulator Models	74230C 5,000
HILO-3 Fault Simulator	74230D 5,000
Design Verification Subsystem (includes 74230A, 74230B, and 74230C)	74230S 18,000
HP Design Interface for SCICARDS	74250A 3,000
HP Design Interface for Calay	74250B 3,000
HP Design Interface for HP-EGS	74250C 1,900
HP Design Interface for HP-PCDS	74250D 3,000
HP Design Interface for Analog Workbench	74650A 2,000
TTL Parts Library	74260A 2,000
MOS Parts Library	74260B 1,000
ECL Parts Library	74260C 1,000
Microprocessor Parts Library	74260D 1,500
PLD Parts Library	74260E 1,000
R,L,C Parts Library	74661A 1,500
Semiconductor Parts Library	74661B 1,500

Analog design information can be transferred to the Analog Workbench module for analog simulation and analysis.

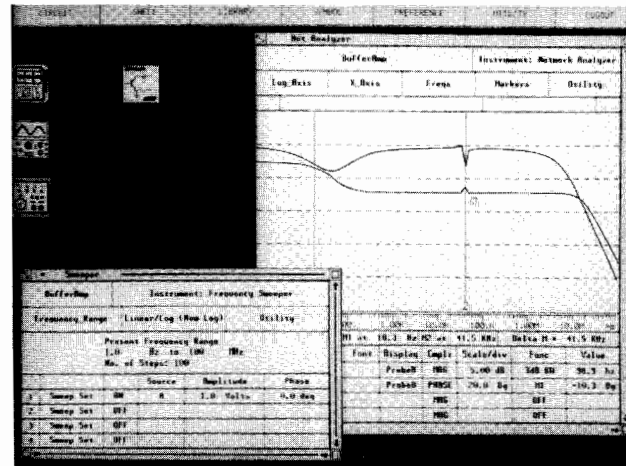

DESIGN AUTOMATION

Personal Microwave Workstation

Models HP 85200S & 85201S



The Personal Microwave Workstation Your Key to Engineering Productivity

The HP 85200S and 85201S Personal Microwave Workstations bring Computer-aided Engineering (CAE) tools to the microwave designer. These powerful desktop systems, built on the HP 9000 series 300 computers and the HP Vectra PC, combine with peripherals, instruments, software, and support to put the power of CAE where it belongs — right on your bench. They overcome the disadvantages of timeshared mainframe computers and are convenient and easy to use. When ordered with the HP 85170A or 85171A software, these workstations are installed at your site.

Design Microwave Circuits Faster

With the personal microwave workstation, you can devote more of your time to circuit design and decrease your dependence on building and testing prototypes.

Using manual design techniques, you build and discard several prototypes before achieving your design goals. CAE lets you refine your design before you build it. Because you build fewer prototypes, you achieve your goals faster and with less expense.

Integrate Component Measurements with Design

Use the personal microwave workstation to measure components with an HP 8510 or 8753 Network Analyzer and simulate their performance in a finished circuit.

The Personal Microwave Workstation Goes Beyond CAE

A wide variety of engineering applications will run on the HP 85201S and 85200S workstations.

The HP 85201S (HP 9000 series 300 computers) is not only an extraordinary CAE workstation, it is also ideal for controlling instruments and a host of other applications. You can process technical

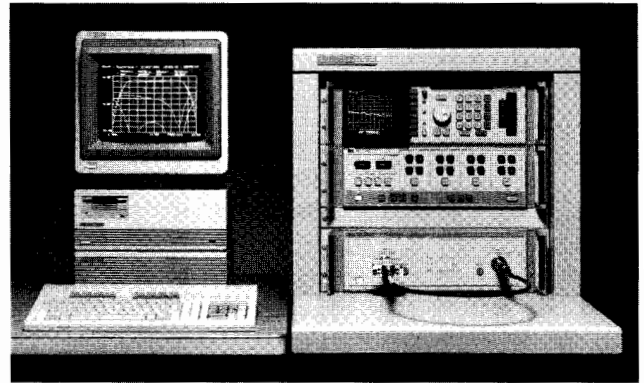

drawings with the Engineering Graphics System (HP 98305A), communicate with the corporate mainframe with the Terminal Emulator software (HP 98791B), and prepare reports with word processing and presentation graphics software. You can also upgrade your series 300 workstation to the HP-UX operating system, Hewlett-Packard's enhanced implementation of UNIX™ Version V.

The HP 85200S (HP Vectra PC) combines the power of microwave CAE with the diversity of industry standard applications under MS™-DOS. Some of these applications include spreadsheet analysis with Lotus 1-2-3™ (HP 68340F), word processing with WordStar 2000™ (HP 68341F), database management, and terminal emulation.

UNIX is a trademark of AT&T. MS-DOS is a trademark of Microsoft, Inc. Lotus and 1-2-3 are trademarks of Lotus Development Corp. WordStar is a trademark of MicroPro International Corp.

Ordering Information

HP 85200S Personal Microwave Workstation

Required Items	Price
Basic Workstation:	
HP 85200S Personal Microwave Workstation	\$0
HP 72445A Vectra PC Model 45	\$3,249
HP 45983A Enhanced Graphics Adapter	\$695
HP 35743A Enhanced Graphics Monitor	\$845
HP 45987A Numeric Coprocessor Accessory	\$375
HP 82990A HP-IB Interface Card and Command Library	\$400
HP 24540A Serial/Parallel Interface	\$150
Choose ONE of the following:	
HP 45816A 20M byte Internal Hard Disc Subsystem	\$1,325
HP 45817A 40M byte Internal Hard Disc Subsystem	\$2,195
Software:	
HP 85170A Integrated Touchstone software	\$11,800
HP 45951A Vectra Disc Operating System	\$85
Optional Items	
Printer Option:	
HP 2225C Thinkjet Printer with Parallel interface	\$495
HP 24542D Parallel Printer Cable, 2 meters	\$55
Plotter Option:	
HP 7440A Opt. 002 ColorPro 8-Pen Plotter	\$1,295
HP 10833A HP-IB Cable, 1 meter	\$81
Software Option:	
HP 35186D Microsoft Pascal Compiler (required to add your own models with Touchstone Sr.)	\$300

Ordering Information

HP 85201S Personal Microwave Workstation

Required Items	Price
Basic Workstation:	
HP 85201S Personal Microwave Workstation	\$0
HP 9133H 20M byte Hard Disc Drive with 3.5" Floppy	\$2,740
Choose ONE of the following SETS:	
HP 98561C Model 320 System	\$13,000
HP 46021A HP-HIL Keyboard	\$225
HP 98543A Medium-resolution Color Video Board	\$2,400
HP 35741A 12-inch Color Monitor	\$995
---OR---	
HP 98581A Model 310 Entry Design Automation System	\$7,580
HP 98257A 1M byte RAM card (2 required)	\$1,450
HP 98635A Floating Point Math Card	\$975
Software:	
HP 85171A Integrated Touchstone software	\$11,800
Optional Items	
Printer Option:	
HP 2225A Thinkjet Printer with HP-IB interface	\$495
HP 10833A HP-IB Cable, 1 meter	\$81
Plotter Option:	
HP 7440A Opt. 002 ColorPro 8-Pen Plotter	\$1,295
HP 10833A HP-IB Cable, 1 meter	\$81
Software Option:	
HP 98615C Pascal 3.1 Language System (option 045) (required to add your own models with Touchstone Sr.)	\$995

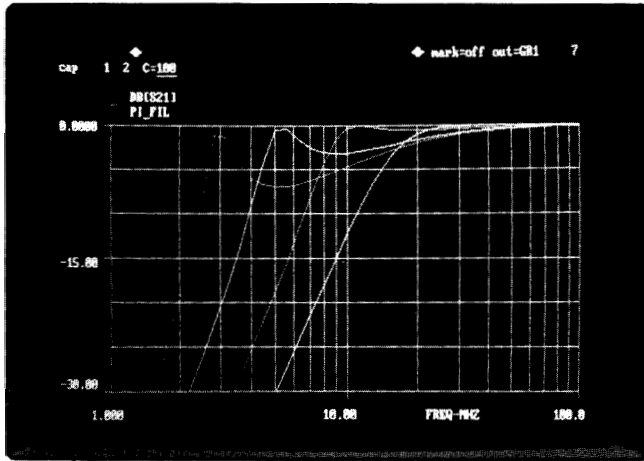

Principal Features

- Friendly, menu driven operation
- Interactive full-screen editor
- Linear analysis with about 100 circuit elements
- User-defined circuit elements
- Interactive tuner
- Random and gradient optimization
- Network analyzer data interface
- Monte Carlo yield prediction
- Spreadsheet style transmission line synthesis
- Comprehensive support and documentation

The Touchstone Family of Software Accelerates Your RF & Microwave Designs

The Touchstone software family is a combination of microwave computer-aided engineering tools: Touchstone™, Touchstone Sr.™, Touchstone Monte Carlo™, and LineCalc™. They allow you to simulate your circuit and refine it even before you build a prototype. The Touchstone family of software helps you get it right the first time, saving you time and money by facilitating design changes while everything is still "on paper." It is tailored to run on the personal microwave workstation, a desktop computing system that is both powerful and convenient. The Touchstone family of software enhances your productivity over manual design methods in the following four ways.

Model a Wide Range of Linear Circuits

Touchstone uses a variety of information (from mathematical models to actual devices) and in-circuit mathematical facilities to simulate a wide range of linear circuits.

It has mathematical models for approximately 100 circuit elements, including lumped components, microstrip and stripline structures, and many other specialized circuit elements. Moreover, Touchstone Sr. allows you to incorporate your own proprietary models into the Touchstone family of software. This gives you greater control over the accuracy of your designs while maintaining their privacy.

Touchstone reads measured device data from disc files and HP vector network analyzers. Transistor data from several manufacturers is included with the Touchstone family of software for your convenience. For optimum accuracy, you may include error-corrected data directly from an HP 8510 or 8753 vector network analyzer. This lets you design with devices at the bias and ambient temperature of your choice.

Improve Throughput

The Touchstone family of software makes simulations easy. You describe your circuit file using Touchstone's full screen text editor. It allows you to manipulate your circuit file quickly so you can spend your time interpreting data.

When you're ready for analysis, Touchstone calculates a broad range of information about your circuit's performance. In addition to S-parameters and group delay, Touchstone calculates noise figure, stability, simultaneous match conditions, and various gains, with "circles" capability for each.

The output appears quickly because the Touchstone software family runs on the Personal Microwave Workstation, a dedicated computer system whose only task is to work for you. The results may be formatted in a tabular list by frequency or plotted on a rectangular grid or Smith Chart, and viewed on a color monitor, plotter, or printer.

Achieve Higher Quality Designs

Touchstone is more than an analytical tool; it also improves circuit designs. The tuner and the optimizer help you progress toward the best possible design, and neither requires special expertise.

The tuner allows you to interactively change the numeric parameters of your circuit and immediately view the results of the change overlaid with the original results. It shows you which changes improve your circuit and those which do not affect its performance.

For greater convenience, Touchstone can optimize your circuit values automatically. Choose one of two optimizers (random or gradient) to drive your circuit's response into the acceptance windows that you specify. This lets you find the optimum values of up to 25 independent variables.

Verify Designs Before Building Them

TouchstoneMC helps you verify that your designs are manufacturable and work within specifications. In practice, variations of a host of factors can cause even good theoretical designs to miss design goals. Monte Carlo yield prediction and the tuner let you spot potential problems before they occur.

TouchstoneMC is able to predict production yields. You model the parasitics, establish the tolerances of the components of your circuit, and specify response acceptance windows, and TouchstoneMC performs a "Monte Carlo" style yield analysis.

The tuner can also be used to vary component values by small amounts to assess circuit sensitivities. This makes your circuits easier to build and saves money on parts cost and warranty service. Using the tuner and algebraic equations within your circuit to manipulate the "temperature" or "bias", you can also verify that your circuit functions properly over a specified range. Together, the tuner and yield prediction give you an excellent indication of the feasibility of your design.

Ordering Information

HP 85170A: The Touchstone software for the HP Vectra PC based	\$11,800 (US)
Personal Microwave Workstation (HP 85200S)	
HP 85171A: The Touchstone software for the HP 9000 Series 300 based	\$11,800 (US)
Personal Microwave Workstation (HP 85201S)	

Touchstone, Touchstone Sr., TouchstoneMC, and LineCalc are trademarks of EESof, Inc.

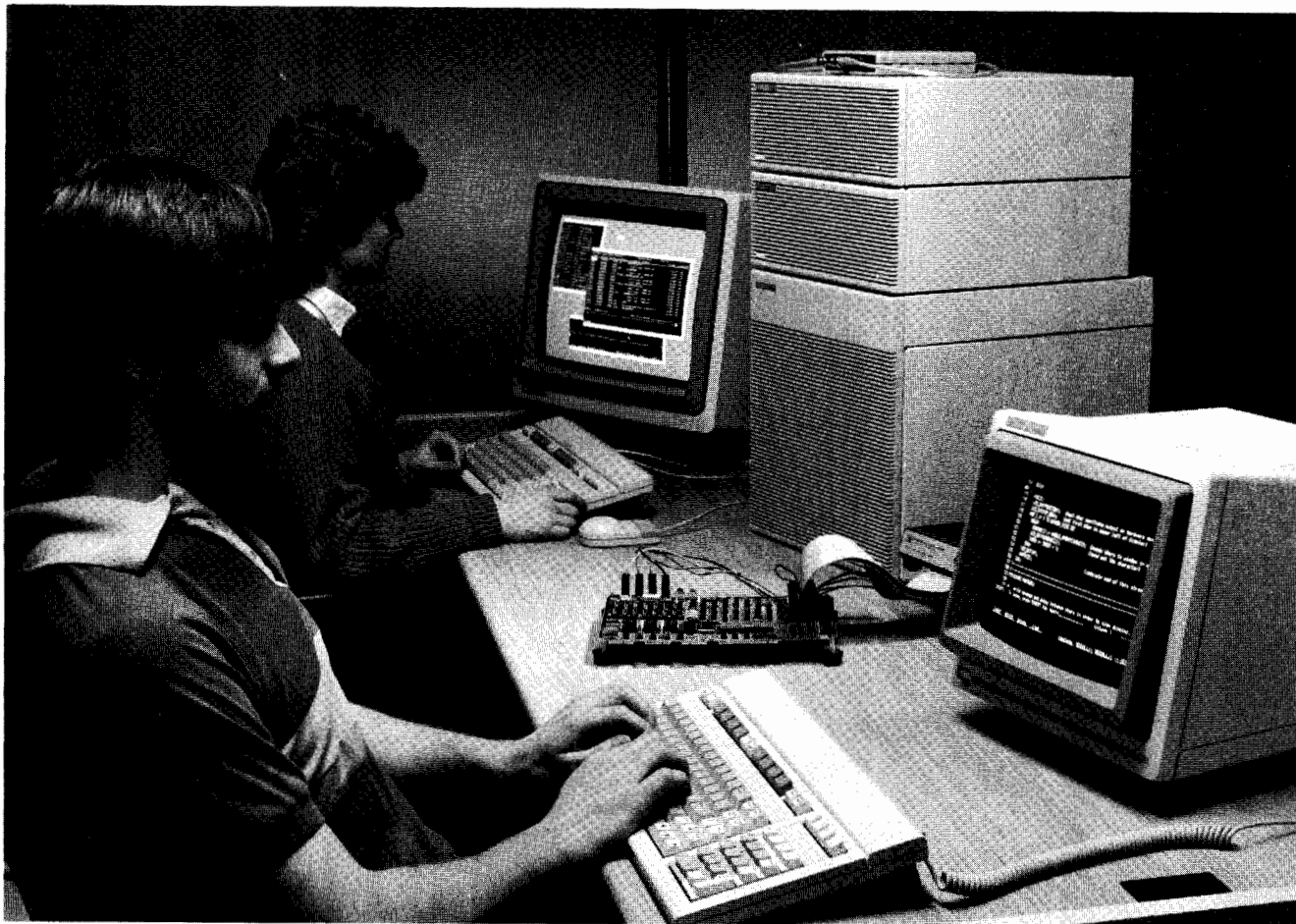

HP 64000-UX Microprocessor Development Environment

The HP 64000-UX Microprocessor Development Environment provides a powerful solution to the development of microprocessor-based systems. The modular structure gives you the ability to select only the subsystems needed for a cost-effective solution to your development application. You also have the flexibility to expand the development environment as your need for additional measurements grows.

This modular system can be easily configured for single- or multi-user design environments. A wide selection of platforms, memory, peripherals, as well as hardware, software, and integration design tools ensures that the optimum configuration is available to solve your design problem. For intensive hardware/software designs, there are links to host computers, schematic capture, simulation, physical modeling and board test.

Shortening the Design Cycle

The HP 64000-UX is an effective solution to shortening the microprocessor based system design cycle. It combines advanced software development, real-time emulation, sophisticated hardware/software analysis capabilities and the power of the HP-UX* operating system.

Configuration flexibility combines with ease of operation to form a system that allows you to develop your product rapidly. Software project management tools running under the HP-UX operating system ensure smooth progress during the development cycle. Software engineers benefit from tightly-coupled, high-level development and analysis tools. Real-time performance analysis tools quickly point to system bottlenecks, allowing significant improvements in performance in a fraction of the time required when using conventional techniques.

Powerful, interactive, yet easy-to-use emulation and timing analysis speeds hardware development. The HP 64000-UX environment allows many engineers to share the same data base and combines interactive tools for hardware/software design tasks. System integration, often the

most time-consuming system development phase, is greatly enhanced. All this means product development schedules are shorter and better products get to market sooner. Central to the HP 64000-UX software design environment are the HP 9000 model 320 workstations, running the HP-UX operating system, high-performance HP peripherals and advanced software—all configured for maximum productivity and cost effectiveness. The HP 64000-UX can grow with your needs and provide complete assurance that your investment is protected.

A System to Match Your Needs

HP 64000-UX workstations are capable of performing standalone or in clusters sharing peripherals. Expansion of a single, hard-disc-based station to a multistation system is as simple as connecting another station to the bus.

Large design environments can benefit from the HP 9000 series of computers running the HP-UX* operating system. The HP 9000 family of computers ranges from single user systems to multiuser systems. The computer connects directly to an HP 64120A instrumentation card cage system bus so that it shares the same data base with the development system.

HP 9000 series computers offer powerful networking capabilities for easy sharing of data between teams while preserving team independence for project management purposes.

The HP-UX operating system provides software revision control systems and automatic compiling and linking to ensure that only the current version of a module is used by team members.

HP 64000-UX software development and data communications software is available to run on DEC-VAX† series computers. This means that you can protect existing investments and still take advantage of all the power of the HP microprocessor development environment. For very intensive microprocessor based system designs, there are links to host computers, schematic capture, simulation, physical modeling, and board test.

* HP-UX complies with the AT&T System V Interface Definition Issue 1.

† DEC and VAX are trademarks of Digital Equipment Corporation

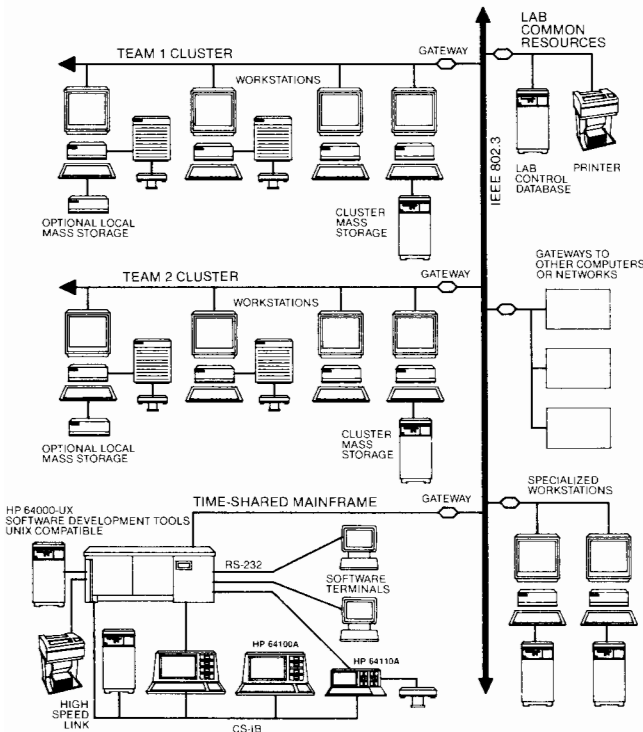

The HP 64000-UX Microprocessor Development Environment is easy to tailor to your design needs. Up to six stations can be assembled in a single cluster for small- to medium-sized teams with a central data base. Larger teams link to a multi-user HP-UX computer.

Hosted on HP 9000 Model 320

With the HP 9000 Model 320 computer as a host platform, the HP 64000-UX becomes an integral part of the HP DesignCenter environment. The Model 320 is a versatile host that can support four terminals on a single HP 64120 card cage. The Model 320 can also be clustered in multiple systems on a local area network (LAN) to handle large design groups. There are also network links for connection to large host computers.

The HP 64000-UX Microprocessor Development Environment offers significant capabilities:

- Integration with HP's DesignCenter design automation system to support CAE/CAD/CAEE solutions on a platform common with the microprocessor development system.
- An open system with versatile networking to popular microprocessor software development environments such as DEC VAX and IBM PC.
- In-circuit emulators, language systems, and powerful analysis tools for 8-, 16-, and 32-bit microprocessors.
- HP Computer-aided Software Engineering tools (CASE) which address the entire microprocessor software design cycle.
- An outstanding range of price/performance options, ranging from low cost RS-232 terminals to powerful, dedicated HP-UX workstations. Small to large design teams are supported with equal flexibility.

Modularity Provides Flexibility and Economy

A variety of system configurations are possible with the modular components in the HP 64000-UX microprocessor development environment. Starting with the powerful HP 9000 Model 320 computer as the controller, you can build a flexible development environment that supports a single user, a small development team, or a large team linked over a LAN. The MC68020-based Model 320 runs the HP-UX operating environment which provides exceptional performance for microprocessor-based development.

The Model 320 controls access to the instrumentation card cage which houses up to 10 feature cards for HP emulators and analyzers.

Up to four card cages can be controlled by a single Model 320 computer. One Model 320 can support up to ten users performing a variety of development tasks such as coding, compilation, emulation, analysis, etc.

Further variations in configuration are achieved by networking several Model 320s with some serving as workstations and others as dedicated file servers or emulation/analysis nodes which can be accessed from any terminal or workstation on the network. Even larger systems can be configured through a networked connection with a time-shared host computer. This network could include the DEC VAX, IBM PC, or other HP 9000 computers. This configuration allows for continuity of software development tasks currently under way or previously developed on host computers. It provides time-shared users access to powerful emulation and analysis tools via the IEEE 802.3 LAN and ARPA/Berkeley services. These services can include access to or transfer of remote files, as well as remote program execution.

System Environment Features

An HP 64120A instrumentation cardcage houses the HP 64000 emulators and analyzers. Feature control software for these tools runs on the HP 9000 Model 320 Technical Workstation. User interfaces on RS-232 terminals and Series 300 displays are consistent with the HP 64100/64110 stations, eliminating the need for current users to learn a new interface.

Users can choose from the most comprehensive language support available today for microprocessor development. Cross assemblers and compilers are available for more than 40 popular microprocessors and custom designs.

Computer-aided software engineering tools (CASE) increase the efficiency and accuracy of software specifications and reduce development costs.

Flexible Connection to Host Computers

The HP 64000-UX system environment provides connectivity and compatibility with popular host computer environments. Users can continue to use existing host computers while adding instrumentation peripherals at their convenience. DEC VAX, IBM-PC and compatibles are supported via a LAN connection and software packages from HP to ensure a "turnkey" solution.

A special configuration package (HP 64121A), consisting of an HP 64120A instrumentation cardcage plus a controller for the Model 320 computer optimizes this application. HP also offers Pascal, C and assembly language software tools for DEC VAX computers.

Multiple users on host computers can have access to emulators and analyzers residing in single- or multiple-instrumentation cardcages. This eliminates the need to duplicate expensive hardware at each station and greatly reduces the cost per user.

The HP 64000-UX window manager allows execution of simultaneous tasks in multiple windows. A separate task can be performed from the keyboard while the system is executing an emulation.

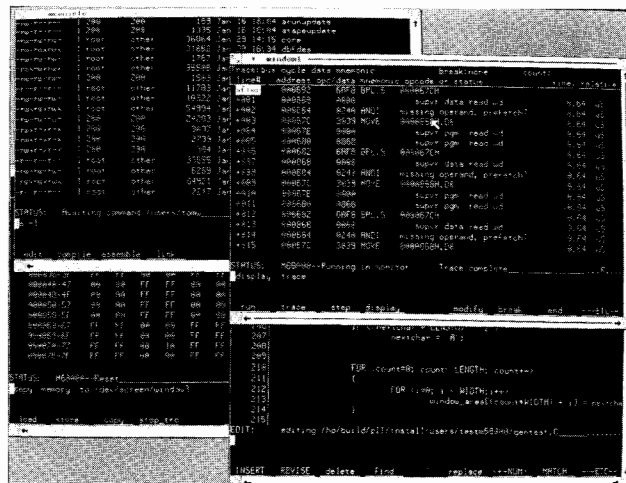



DESIGN AUTOMATION

HP DesignCenter

HP 64000-UX Microprocessor Development Environment

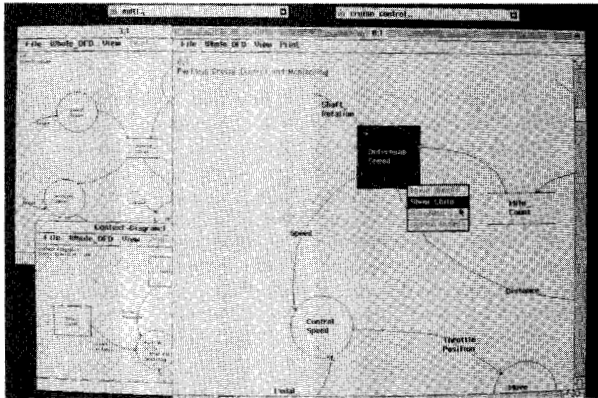

HP Teamwork/SA user interface windows provide a simultaneous view of a data flow diagram from a variety of viewpoints. Pull-down menus permit easy function selection.

Compatibility with Existing 64000 Systems

HP cross compilers and assemblers currently running on the HP 9000 Series 500 and HP 9000 Series 300 computers, DEC VAX computers and HP 64000 stations are fully compatible with the new microprocessor development environment.

Existing HP 64100 and 64110 stations are hardware and software compatible with the development environment for protection of your system investment. Migration paths are available for expanding existing HP 64000 stations, hosted HP 9000 Model 500s or DEC VAXs into the system design environment.

HP DesignCenter

HP 64000-UX Microprocessor Development Environment is part of the HP DesignCenter, an integrated family of solutions for electronic mechanical and software engineering. HP DesignCenter consists of systems, software and support in computer-aided engineering, design and manufacturing (CAE/CAD/CAM).

HP DesignCenter's foundation is the modular HP 9000 Series 300 Technical Workstation and HP-UX operating system, derived from UNIX* System V interface definition. This platform allows users to configure individual workstations as well as total systems in a powerful local area network.

The HP 64000-UX environment also allows fast and easy transfer of design information for verification in the HP Electronic Design System. ROM images created for printed circuit-board designs can be passed to a logic simulator running on the same HP 9000 series 300 workstation. This eliminates ROM initialization by hand, reducing errors and design iterations.

Broad Price/Performance Range

By using HP 9000 Series 300 Technical Workstations in networking and general-purpose computing, the HP 64000-UX system environment becomes far more flexible and configurable. Users can work from low cost RS-232 terminals, a selection of workstations, or a combination of these for a broad range of price/performance options.

In addition, the HP 9000 series 300 offers a selection of displays, additional I/O or RAM card slots, and built-in HP-IB, RS-232-C and HP-HIL interfaces. A wide selection of HP and third party software for data management, documentation and communication is also available.

Structured Analysis

HP Teamwork/SA helps software engineers define, document and evaluate complex software requirements. This system provides computer-aided support for creating, checking and maintaining software specifications using the structured analysis method of requirements definition. Automatic drafting, error detection and model management eliminate the time-consuming clerical tasks usually associated with structured analysis.

HP Teamwork/SA runs on the HP 9000 Model 320 engineering workstation with the HP-UX operating system. The HP 9000 and HP-UX combination provides a powerful, flexible environment for software development. Textual specifications created using HP

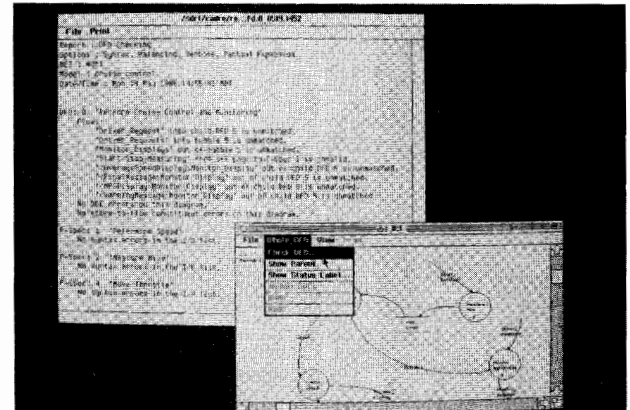

The HP Teamwork/SA Consistency Checker detects specification errors within and between data flow diagrams, data dictionary entries, and process specifications.

Teamwork/SA can be moved into the HP-UX file system, where they can be used with HP editors, compilers and debuggers, including the HP 64000 cross compilers for microprocessors. With HP teamwork/SA you can produce clear, complete software specifications that result in improved software quality and reduced software maintenance costs.

Simplified Database

HP Teamwork/SA integrates a number of innovative features that help the engineer through each step in the development of software specifications.

A project library serves as a central database for everyone working on a specific project. The library, which is transparent to users, includes data flow diagrams, data dictionaries, process specifications, annotations and project management data. A mouse helps users rapidly manipulate and select from a wide range of graphic entities for easy development of data flow diagrams.

Comparison of Project Specifications

HP Teamwork/SA's user interface provides "windows" into the project library. Library objects are displayed in windows on a large, high-resolution, bit-mapped screen that lets the user view a vast amount of information exactly as it would appear on a printed page. Engineers can view the project model from a variety of viewpoints simultaneously for a comparison of software specifications.

"Intelligent" Editor

The editing system is an integrated set of specialized tools for creating and maintaining software specifications. The central tool of structured analysis, the data flow diagram (DFD), is created and maintained through the DFD editor. Process specifications, data dictionaries and annotations are similarly supported with editors optimized for each structure.

The HP Teamwork/SA graphics editing system is intelligent and syntax-directed. It knows the established rules for building data flow diagrams and their relationships to other objects in the specification, virtually eliminating syntax errors.

Designers interact with the editors via mouse selection of graphic components and operations, with much greater speed than could ever be done with pencil and paper. The intelligent syntax-directed graphics editing system uses established rules for making DFDs and their relationships to other objects in the specification. Along with the Consistency Checker, this helps to detect problems in a specification while it is created, which reduces the time it takes to check for errors and increases the accuracy of the specification.

Complete models or arbitrary sub-models can be checked at any time, telling the user where further work is needed. Because the consistency checker is automatic, it makes the error detection process much more thorough and accurate than manual detection. HP Teamwork/SA model-configuration management function allows data flow diagrams to be collected into leveled sets. Analysis can be initiated at any level, and then proceed either up or down the model set. The diagrams can be combined, expanded and repartitioned as necessary.



MICROPROCESSOR	HP 64000 System Support										Host Computer Software			
	EMULATOR	CROSS ASSEMBLER/LINKER	PASCAL CROSS-COMPILER	C CROSS-COMPILER	STATE ANALYSIS PREPROCESSOR	HIGH-LEVEL ANALYSIS	ASSEMBLER/LINKER	PASCAL LANGUAGE SYSTEM	C LANGUAGE SYSTEM	Pascal Language System	PL Language System	PL Language System		
Fairchild	F9450	■	■	■	■	■	■	■	■	■	■	■	■	■
Hitachi	HD 6301V/6303R	■	■	■	■	■	■	■	■	■	■	■	■	■
Intel	8048/8049	■	■	■	■	■	■	■	■	■	■	■	■	■
	8051/8751/8031	■	■	■	■	■	■	■	■	■	■	■	■	■
	8080 *	■	■	■	■	■	■	■	■	■	■	■	■	■
	8085	■	■	■	■	■	■	■	■	■	■	■	■	■
	8086/80C86	■	■	■	■	■	■	■	■	■	■	■	■	■
	8088/80C88	■	■	■	■	■	■	■	■	■	■	■	■	■
	80186	■	■	■	■	■	■	■	■	■	■	■	■	■
	80188	■	■	■	■	■	■	■	■	■	■	■	■	■
	80286 *	■	■	■	■	■	■	■	■	■	■	■	■	■
	Motorola	6800/68A00/68B00 *	■	■	■	■	■	■	■	■	■	■	■	■
6802/6808 *		■	■	■	■	■	■	■	■	■	■	■	■	■
6801/6803		■	■	■	■	■	■	■	■	■	■	■	■	■
6805R/6805U		■	■	■	■	■	■	■	■	■	■	■	■	■
6805P		■	■	■	■	■	■	■	■	■	■	■	■	■
6809/68A09/68B09		■	■	■	■	■	■	■	■	■	■	■	■	■
6809E/68A09E/68B09E		■	■	■	■	■	■	■	■	■	■	■	■	■
146805E2		■	■	■	■	■	■	■	■	■	■	■	■	■
146805G2		■	■	■	■	■	■	■	■	■	■	■	■	■
68000		■	■	■	■	■	■	■	■	■	■	■	■	■
68008		■	■	■	■	■	■	■	■	■	■	■	■	■
68010		■	■	■	■	■	■	■	■	■	■	■	■	■
68020	■	■	■	■	■	■	■	■	■	■	■	■	■	
NEC	70116	■	■	■	■	■	■	■	■	■	■	■	■	■
	70106	■	■	■	■	■	■	■	■	■	■	■	■	■
National	NSC800	■	■	■	■	■	■	■	■	■	■	■	■	■
Texas Instruments	TMS32010/320M10 *	■	■	■	■	■	■	■	■	■	■	■	■	■
Zilog	Z8001	■	■	■	■	■	■	■	■	■	■	■	■	■
	Z8002	■	■	■	■	■	■	■	■	■	■	■	■	■
	Z80 *	■	■	■	■	■	■	■	■	■	■	■	■	■
User Definable	ROM	■	■	■	■	■	■	■	■	■	■	■	■	■
Microprogrammable (bit slice)	General-purpose development subsystem with state analysis and run control	■	■	■	■	■	■	■	■	■	■	■	■	■

Summary of processors supported by the HP 64000-UX Microprocessor Development Environment.

Specification Tracking

The HP Teamwork/SA annotation facility allows users to capture and store information necessary to the system model, but does not fit into the standard structured model. The annotation editor allows any textual input. Annotations can be associated with many portions of the structured specification.

A project data facility in HP Teamwork/SA helps managers track project progress. It collects information about the development of the specification and related documents and maintains a status label for each item. This allows better schedule data estimation and metrics development for future projects.

Emulation

The HP 64000 Logic Development System offers a wide selection of emulators to support microprocessor-based product development. These emulators provide an essential link between the software development environment and the target system. Programs developed on the HP 64000 system or compatible computers are run on the emulator subsystem for real-time debug and analysis. Processor run controls in the emulator allow you to single-step, display and modify memory. Modifications and improvements to software are made quickly and easily in the early design phases; emulation gives you the flexibility to experiment before committing a product to firmware. Features of an HP 64000 emulation subsystem include:

- Real-time emulation mode without inserted wait states
- Run-time controls for single cycling and register display
- Mapping memory blocks to emulation or target memory
- Simulated I/O using HP 64000 System resources
- High-speed emulation memory

For microprocessors that are not presently supported with a dedicated HP 64000 System emulator, a custom emulator can be developed using Model 64274S User-Definable Emulator as a base. For ROM-based systems, there is a ROM Emulator, Model 64272S, to provide a controlled environment for software execution and analysis. Both user-defined emulators are powerful alternative tools for applications not served by processor-specific HP 64000 System emulators.

*Supported on HP 64100A/64110A stations

An emulation bus analyzer should be added to the subsystem to monitor activity on the emulator bus. Model 64302A analyzer provides real-time traces of address, data and status/control signals. Displays may be in the microprocessor mnemonics or in an appropriate numerical base.

For multiprocessor applications, emulators may be used interactively with the Intermodule Bus (IMB). The IMB links emulation bus analyzers for cross-arming modes, and the IMB can also establish larger measurement systems for interactive emulators, timing analyzers, and/or state analyzers. When emulation and analysis subsystems reside in separate stations, an IMB extender (HP 64303A) is available for cross-station measurement systems.

Analysis

Analysis and system integration are major functions when designing and developing superior microprocessor-based products. The HP 64000 System offers five analysis subsystems to meet measurement needs for troubleshooting, debugging, and optimizing target systems. The HP 64302A Emulation Bus Analyzer is a basic real-time analyzer used with an emulation subsystem. As well as providing the displays and triggering conditions for the emulator, the HP 64302A analyzer is the emulator's access point for interactive emulation/analysis; in addition, it supports the High-Level Software Analyzer (HP 64330) for analysis in high-level programming languages of C and Pascal. The HP 64340 Real-time, High-level Software Analyzer is a hardware and software package that operates with an appropriate HP 64000 emulation subsystem. HP 64310A Software Performance Analyzer is also used with an emulator, providing overview measurements that aid in system-level evaluations. For complex problem solving, HP 64610S Logic Timing/State Analyzer and HP 64620S Logic State/Software Analyzer are high performance analyzers that may be used separately or interactively.

High-level Software Analysis (HP 64100A/64110A)

Two High-Level Software Analyzers offer HP 64000 System users an advanced, yet easy-to-use, feature set for analysis of programs written in Pascal or C. The analyzers are processor specific, for troubleshooting and debugging software written for the target microprocessor. Measurements are specified and displayed in the high-level context used in generating the software to simplify correlations between executing software and written programs. Two series are available: HP 64330 High-level Software Analyzers and HP 64340 Real-time, High-level Software Analyzers.

Basic features of these analyzers include:

- Measurements for global and detailed views of high-level software execution
- Variable values are displayed in their native data type (Boolean, integer, real, scalar, structured types, etc.)

The HP 64340 Real-time, High-level Analyzer Trace Statements Measurement displays executed source lines along with the values of all variables referenced. A hierarchy of measurements streamlines troubleshooting from a global view of module execution down to the detail of variable values.

```

HP 6430 Software Analyzer: Slot 4 with 64000 Emulator: Slot 4
Source          Symbol      Value      Stat      Time(s)
94 TIME_OUT := TIME_OUT + 1;      WORD      0 write   0.5 uS
95 UNTIL (WORD * 2) OR (TIME_OUT * TIME_OUT      0 read   1.7 uS
95          TIME_OUT                1 write  1.6 uS
95          WORD                    0 read   1.0 uS
95          TIME_OUT                1 read   4.0 uS
96 WAIT(TEN);                      *          3.5 uS
93 WORD := ACIA_STATUS;             * ACIA_STATUS 0 read   0.7 uS
94 TIME_OUT := TIME_OUT + 1;      WORD      0 write   2.5 uS
95 UNTIL (WORD * 2) OR (TIME_OUT * TIME_OUT      1 read   1.7 uS
95          TIME_OUT                2 write  1.6 uS
95          WORD                    0 read   1.0 uS
95          TIME_OUT                2 read   4.0 uS
96 WAIT(TEN);                      *          3.5 uS
93 WORD := ACIA_STATUS;             * ACIA_STATUS 0 read   0.7 uS
94 TIME_OUT := TIME_OUT + 1;      WORD      0 write   2.5 uS
STATUS: Waiting command _____ 76 _____ 14:18

---Evo--- setup db_check display modify show execute ---Etc---
    
```

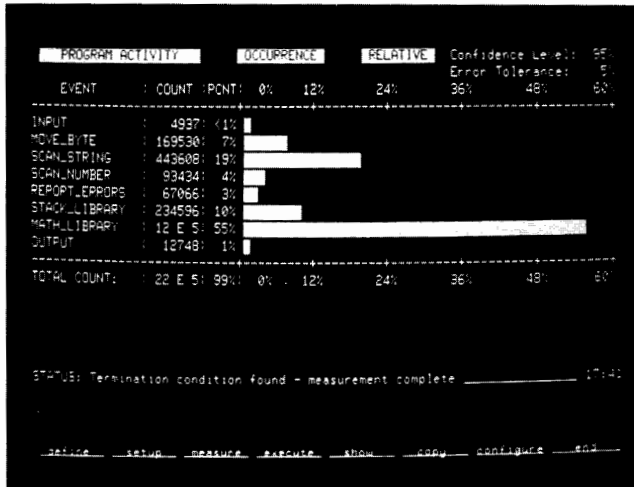

HP 64310A Software Performance Analyzer brings performance analysis measurements to design applications for microprocessor-based products. Six measurements quickly characterize total system performance, allowing the software designer to allocate available resources optimally.

- High compatibility with system cross compilers supports measurement specification using static and dynamic variable names, file, procedure, and function names, as well as high-level source line numbers
- Direct control over target system operation
- Command file speed measurement set-up and execution, facilitating automatic measurements

Additionally, the HP 64340 real-time, high-level analyzers offer:

- Module timing to detect anomalies and analyze performance
- Counts of specified statements to verify software coverage
- Sequencing, windowing and measurement enable/disable to restrict analysis to specific software areas
- Display any source files without exiting the analyzer for convenient comparisons to current source code
- Time tagging of modules or statements as an elementary performance check
- Interactive operation with other HP 64000 analysis and emulation subsystems

Model 64310A Software Performance Analyzer provides overview measurements to aid in evaluating total system effectiveness of programs operating in real time. Global measurements let software designers determine where system resources are being used, in terms of execution times, memory usage and interaction traffic. Software performance measurements aid in determining where to focus optimization efforts for maximum effect on system performance.

- Histogram displays for quick comparisons of software activity
- Tabular displays with continually updated means and standard deviations on current measurement
- Measurement modes of memory and program activity
- Measurement modes of event duration
- Measurement modes of intermodule linkages

Model 64620S Logic State/Software Analyzer offers real-time, transparent software analysis for microprocessor systems. A modular system, the Software Analyzer can be configured for 20 to 120 input channels. The HP 64620S analyzer supports analysis at all levels of complexity for microprocessor systems.

- Multiple trigger parameters using symbols, ranges, NOT, and "don't care" terms as well as file names and line numbers
- Selective data storage for edited state listings
- Powerful 15-level sequencer that may also be used to form one or two measurement windows
- Extensive symbolic tracing for quick setups and easy interpretation
- Real-time, nonintrusive analysis feature set supports debug for high-level programming languages
- Two software performance overview modes for code optimization

- Processor-specific interfaces and inverse assembly for easy hook-ups and state listings in the microprocessor mnemonics

Preprocessors and Interfaces

Preprocessors and interface modules tailor the HP 64620S Logic State/Software Analyzer for use with specific microprocessor systems. Preprocessors provide quick, convenient connections between target systems and the logic analyzer. Inverse assemblers translate collected state events into the processor mnemonics for easy reading and analysis. The interface software automatically sets formats for the logic analyzer to match inputs from the target system processor. Model 64650A General Purpose Preprocessor is used with a 60-channel HP 64620S Analyzer and replaces three HP 64635A data probes and one HP64636A clock probe. Control software and inverse assemblers are included with the processor-specific interface modules that are installed in the preprocessor. The interface modules contain interface circuits and cabling to connect to the target system. Both processor-specific and user-definable interface modules are available.

Timing Analysis

Model 64610S High-speed Timing/State Analyzer subsystem offers powerful, high-resolution, asynchronous and synchronous analysis with extensive postprocessing capabilities. Many triggering modes allow precise positioning of the display window to locate timing margin, state, execution and interaction problems. The analyzer's resources can be allocated to provide wide, fast, glitch, dual-threshold and externally clocked measurements. Postprocessing adds another dimension to timing/state analysis with the ability to perform operations on acquired data, such as automated compare and statistical analysis of raw data. In the external clock mode, you have the ability to analyze the operation of high-speed logic in bit slice, microprogrammable, and state machines in real time. The HP 64610S analyzer offers powerful analysis that is easy to use.

- 8, 16, 24, or 32 channels of timing/state analysis
- Asynchronous sampling from 2 Hz to 400 MHz for excellent resolution
- Synchronous sampling to 125 MHz
- Compare level, range and fault qualifications for state and timing listings
- Memory depth of 4060 samples in wide sample mode and 8140 samples in fast sample mode
- Glitch capture and trigger for glitches as narrow as 3 ns to quickly locate transients
- Dual threshold mode for checking transition times, loading problems, and noise margins

The Microprogram Development Subsystem supports software development for microprogrammable and bit-slice processors and sequencers. Integration of this subsystem with other HP 64000 analysis and emulation tools offers interactive, cross-triggered measurements in multiprocessor environments.



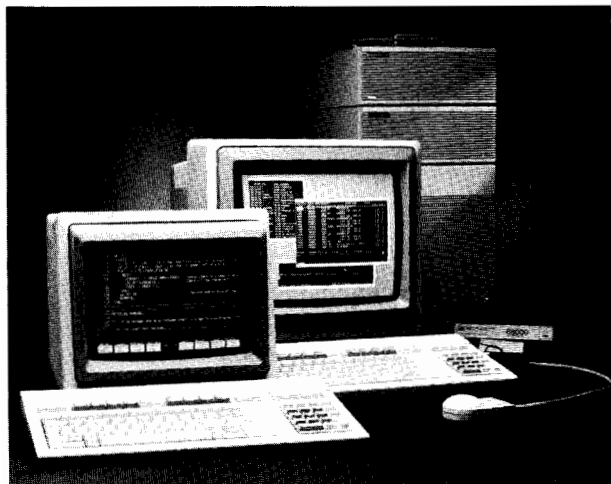

The New HP 64000-UX Microprocessor Development Environment is a natural evolution of the HP 64000 family and is compatible with existing 64000 systems. The new development environment offers many new capabilities, and shares a common workstation platform with many new HP DesignCenter products.

Microprogram Development Subsystem

Model 64276A/B/C

Model 64320S 25 MHz Logic State/Software Analyzer

The HP 64276 Microprogram Development Subsystem and the HP 64320S 25 MHz Logic State/Software Analyzer provide run control and real-time analysis for microprogrammable systems. As integrated subsystems of the HP 64000 Logic Development System, the HP 64276 and the HP 64320S add the power of run control and analysis to all phases of the design, development and maintenance of microprogram-based products.

In order to simplify the writing of your microcode, the HP 64861A User-definable Microassembler is available. With this software package, a microassembler can be created that supports MACROs, word widths up to 128 bits, linking, source code displayed with trace data and errors issued for architecturally incorrect microwords.

The Microprogram Development Subsystem supports software development for a wide variety of microprogrammable processors and sequencers. Integration of the Microprogram Development Subsystem with other powerful HP 64000 analysis and emulation tools allows for interactive, cross-triggered measurements in complex multiprocessor environments.

Features

- Choice of clock control or real-time address jam at break detection offers flexible target system control
- Address ranging and two-level sequencing provide powerful break event specification
- Real-time, nonintrusive analysis of microprogrammed system activity reduces software development time
- Flexible user-definable microassembler provides support for a wide variety of microprogrammable devices
- Microcode source interleaved with analyzer trace data speeds software debugging
- Linking of separately assembled microcode modules accelerates software turnaround time
- MACRO instruction feature of the microassembler improves software engineering productivity
- Modular architecture permits specific Writable Control Store configurations for customized development tools
- Integration of Run Control and analysis capabilities simplify operation
- Interaction with other HP 64000 system emulators and analyzers provides real-time analysis in multiprocessor environments

Selecting a Logic Development System

The HP 64000-UX Microprocessor Development Environment is a complex and dynamic family of microprocessor-based system support tools. Consequently, it is recommended that an HP Field Engineer be contacted for a suggested system configuration that will fit your application. For a copy of our latest HP 64000 brochure, in the U.S., call 1-800-447-3282 (in Colorado call collect 590-3340). Outside the U.S., call your local HP sales office. Prices for selected components are listed below.

Ordering Information

Description	Model
Conversion Kit for HP 64100A to HP 64000-UX configuration	64020A
Conversion Kit for HP 64110A to HP 64000-UX configuration	64021A
External IMB cable to connect two HP 64120A card Cages	64022A
High-speed DEC VAX Interface Development Station	64070A
Dual Flexible Disc Drives	64100A
Transportable Development Station with flexible disc drives	Opt 041 64110A
Instrumentation Card Cage. Supplied with HP 64121A MDE	64120A
Emulation Memory Subsystems 32 kbytes to 1024 kbytes	64156S
HP 64000-UX Microprocessor Development Environment. Includes: one HP 64120A card cage, one HP 98561C/Model 320U Controller with system software to execute HP 64000-UX. Emulation Subsystem, 8-bit uP	64121A 642XXS
Emulation Subsystem, 16-bit uP	642XXS
Microprogram Development Subsystem	64276X
48-channel Emulation Bus Analyzer	64302A
Software Performance Analyzer	64310A
Logic State Software Analyzer for Microprogram Development Subsystem for HP 64000 Logic Development System	64320S
High-level Software Analyzer For HP 64000 Logic Development System	6433XA
Real-time, High-level Software Analyzer for HP 64000 Logic Development System	6434XX
PROM Programming Subsystem for HP 64100A stations	64500S
PROM Programming Subsystem for HP 64000-UX MDE	64550A
PROM specific interfaces for either HP 64500S or 64550A	645XX
High-speed, Timing/State Analyzer 200/400 MHz timing/125 MHz state 8 to 32 channels	64610S
Logic State/Software Analyzer 20 to 120 Channels	64620S
Probe sets for HP 64620S Logic State/Software Analyzer 20 to 120 Channels	64630S
General Purpose Preprocessor	64650A
Processor Specific Interfaces for use with HP 64650A GP Preprocessor	646XXA
HP Teamwork/SA for Structured Analysis	64710S
For HP 9000 Model 320 computer system	Opt 004
Add HP Teamwork/SD to HP Teamwork/SA	64712S
(HP 64710S) for HP 9000 Model 320 computer system	Opt 004
HP Teamwork/RT Real Time Extensions for HP 9000 Model 320 computer system	64715S
Must be used with HP 64710S or 64720S	Opt 004
Adds HP Teamwork/SA to Teamwork/SD	64717S
(HP 64720S) for HP 9000 Model 320 computer system	Opt 004
HP Teamwork/SD for structured design for HP 9000 Model 320 computer system	64720S
Pascal & C Compilers, 8-bit, 16-bit	Opt 004 648XXA/S
Assemblers/Linkers, 8-bit	648XXA
Assemblers/Linkers, 16-bit	648XXA
Host Development Systems	648XXA
User-defined Assembler	64851A
User-defined Inverse Assembler	64856A



HP Printed Circuit Design System

HP Printed Circuit Design System

Hewlett-Packard's Printed Circuit Design System is a computer-aided design (CAD) solution that couples printed circuit board layout to electrical engineering design, manufacturing and test. HP Printed Circuit Design System is a part of HP DesignCenter, an integrated design environment for electrical, mechanical and software engineering teams. HP Printed Circuit Design System consists of systems, software and support in computer-aided engineering, design and manufacturing (CAE/CAD/CAM).

Based on the modular HP 9000 Series 320 technical workstation and HP-UX operating system, individual workstations as well as total systems can be configured for particular applications in a powerful local-area network. HP-UX is derived from UNIX® System V interface definition (UNIX is a trademark of AT&T in the U.S.A. and other countries).

HP Printed Circuit Design System transfers all the functionality of a mainframe-based system to a networked workstation environment. This software has been evolving for over 10 years, and provides a refined and highly tuned base for HP's integrated CAD solution. The system is the physical design link between logic design and manufacturing that allows printed circuit board designers to create highly manufacturable boards that perform as the electrical engineer intended. The open and documented design-file format eliminates redundant data entry and reduces chances for errors by making it easy to enter circuit data and to generate manufacturing and test reports and files.

Features and Capabilities

HP Printed Circuit Design System packing, placing, and routing features can automatically lay out digital, analog and mixed digital/analog boards with through-hole and surface-mount technologies, and contains extensive facilities for thick-film hybrid design.

Designers use a keyboard and either a four-button puck and A- or B-size graphics tablet or a mouse to step through a dynamic, hierarchical menu. The menu structure logically groups commands for quick entry into design areas, and each successive menu displays only the functions appropriate to the current design area. Projects can be quickly initiated by using or modifying the many spacing and placement rules, manufacturing parameters and board blanks provided by

the system. On-line design rule checking notifies board designers of violations as they occur, but immediate correction is optional to allow opportunities for subsequent layout adjustments. To assure all violations are corrected eventually, a batch design rule checker can assess a completed board, automatically noting all previously uncorrected violations.

Entering Circuit Data

Circuit data can be entered into HP Printed Circuit Design System from a variety of sources. Netlist and part information can be electronically input directly from the HP Electronic Design System (see page 143). This link also features automated back annotation and bi-directional engineering change. Synchronization of logical and physical parts libraries eliminates redundant data entry. Designers also can bring in circuit data from the HP Engineering Graphics System (HP EGS—See page 156), as well as data from any vendor's system that supports the Electronic Design Interchange Format (EDIF), version 110. In addition to common EDIF features, HP Printed Circuit Design System EDIF format also includes packaging specification and parts mapping between data bases. Circuit data can also be entered manually.

Modular Software Design

HP Printed Circuit Design System is functionally divided into three modules: Design Module, Autorouter Module and Library Module with Parts Library.

Design System Manager

System interaction begins with the Design System Manager, a program that secures and controls design file access, simplifies data sharing and networking and provides an easy-to-use interface to all applications on a system. The Design System Manager also makes it easier to track and report progress of any portion of a project by hierarchically storing files. In addition, a simple versioning scheme automatically maintains copies of designs in progress, giving designers the flexibility to try innovative layout solutions while maintaining previous versions for comparison and use.

Design System Manager

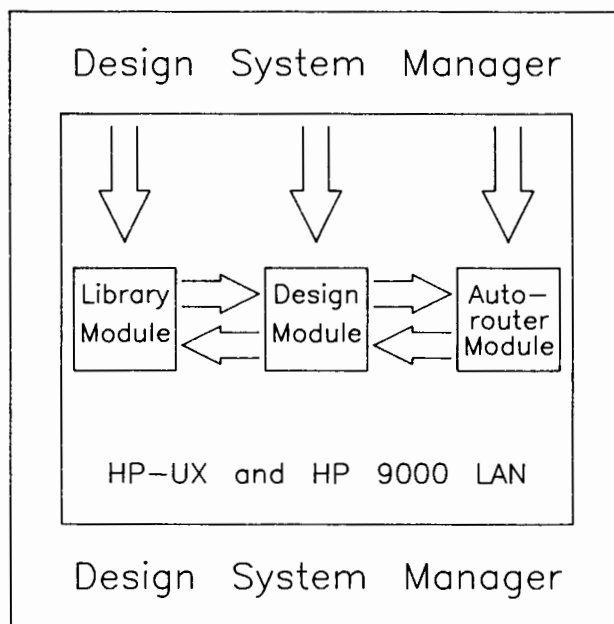

Design Module

Most of a designer's interaction with the system is through the Design Module, which includes powerful automatic tools to aid the designer during printed circuit board layout. The automatic packer, placer and interactive router reside in this module as well as routines for creating highly manufacturable boards, such as "Tidy." Tidy improves the manufacturability of boards by tear-dropping traces into pads to insure solid electrical connections, widening traces to increase electrical reliability and eliminating unnecessary vias to reduce costs.

Autorouter Module

A look-ahead algorithm preplans the most effective routing strategy for both through-hole and surface-mount devices, resulting in a fast automatic router with 100 percent completion rates for most boards. The Autorouter Module can reside within a workstation or on a LAN (Local Area Network) node.

The multiple-pass Autorouter Module routes up to four layers in one pass, with 90- and 45-degree angles to create easier-to-manufacture boards. Automatic routing grids are 50 mil and 25 mil (with one trace between the legs of an IC), and 20 mil (with two traces between the legs of an IC). The Autorouter Module can also handle areas of surface mount technology (SMT) on both sides of the board. Manual routing can be completed to 1 mil, allowing designers to do analog, ECL and more than 2 traces between the legs of an IC. At any time, designers may interrupt the automatic routing, check on progress, and restart the routing as needed.

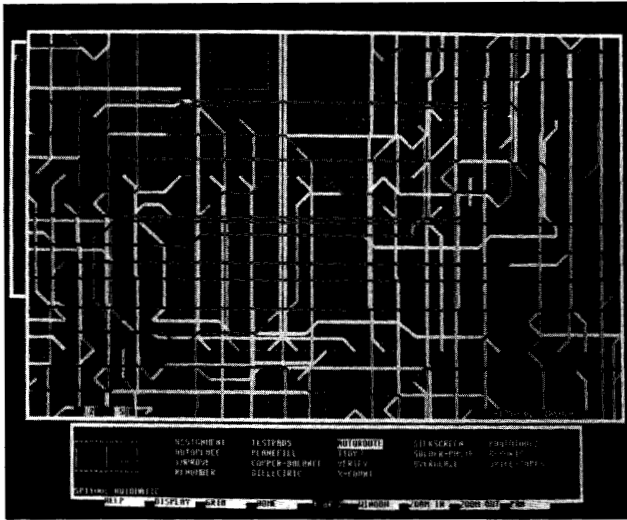

Simplified Autorouter Module screen display

Library Module and Parts Library

More than 4,500 physical parts are included in the starter library. Designers can create, modify, validate, store and access these parts quickly and easily. The system provides strict centralized control over component usage to assure data integrity and standardization of parts.

Manufacturing and Test Links

HP Printed Circuit Design System does not stop with physical layout, but helps assure that the design is accurately transferred to manufacturing by automatically generating a spectrum of reports and files such as photoplotter instructions, numerical-control drill tapes, and production reports. In addition, electrical-topology data can be generated automatically for the HP 3065 board test family to eliminate redundant data entry.

Configuration

The flexibility of the modular HP 9000 Series 320 technical workstation and HP Printed Circuit Design System allows a design team to configure a particular system, then upgrade and extend individual workstations or add to the overall system in a local-area network.

For example, a design team may start with one complete HP Printed Circuit Design System, with all three modules and a high-resolution color monitor. Later the team can add more workstations with only the Design Module, sharing data over industry-standard networking (IEEE 802.3). The automatic router can be moved to a separate workstation with only a small monochrome monitor to serve all the board-layout workstations on a network.

Ordering Information

In addition to the products listed below, Account Management Support, Response Center Support, and Software Materials Subscription are also available.

HP Printed Circuit Design System, complete software, Option 022*	74400A	\$30,000
HP Printed Circuit Design System, complete software, Option 022 , Right-to-copy	74400R	24,000
HP Printed Circuit Design System, Design Module software, Option 022	74401A	10,500
HP Printed Circuit Design System, Design Module software, Option 022 , Right-to-copy	74401R	8,400
HP Printed Circuit Design System, Autorouter Module software, Option 022	74402A	13,500
HP Printed Circuit Design System, Autorouter Module software, Option 022 , Right-to-copy	74402R	10,800
HP Printed Circuit Design System, Library Module software and Parts Library, Option 022	74403A	6,000
HP Printed Circuit Design System, Library Module software and Parts Library, Option 022 , Right-to-copy	74403R	4,800

*Software on 1/4" tape cartridge



Printed circuit design in a networked workstation environment



DESIGN AUTOMATION

EE DesignCenter

HP Engineering Graphics System



HP EGS Engineering Graphics Systems

Hewlett-Packard's Engineering Graphics System (HP EGS) is an easy-to-use, entry-level computer-aided design (CAD) system for printed circuit board (PCB) layout. HP EGS consists of several modules that enable the user to create schematic drawings for PCB layout and generate general artwork ranging from card cage drawings and assembly diagrams to block diagrams and presentation slides. The interactive nature and customizability of HP EGS has been a major factor in the success of the product. HP EGS is currently being used at over 3500 installations worldwide to produce PCB board layouts, schematic drawings, mechanical engineering drawings, and other engineering artwork.

Artwork created on the system can be used directly or moved to more sophisticated design automation tools such as HP Printed Circuit Design System (HP PCDS) and the HP Electronic Design System.

Developed for use on the HP 9000 Series 200 and 300 workstations, HP EGS has numerous built-in productivity tools. Among these are an on-line HELP facility, customizable screen and tablet menus, and user definable macros, or "super commands." In addition, users can develop custom modules for specific applications. The combination of HP EGS with the modular HP 9000 Series 300 workstations provides users with a single-vendor, cost-effective solution to their design automation problems.

HP EGS has been designed to work as a stand-alone system, or in a Shared Resource Management (SRM) system. The SRM system allows multiple workstations to share disc drives, printers and plotters, which can dramatically reduce total system cost. The SRM network also enables HP EGS users to easily share data such as drawings and library parts—offering significant productivity improvement.

Features And Capabilities

At the heart of HP EGS is the graphics editor, the tool used to generate drawings on the screen. Drawing elements, numbers and commands can be entered from the keyboard by making selections from a screen menu with a tablet stylus or mouse; or from a graphics tablet menu with a tablet stylus.

Drawings are created using elements such as lines, circles, rectangles, polygons, arcs and text. Complex, frequently used shapes can be stored as library parts and called up as needed. Shapes on the screen can be altered with screen editing commands. It is easy to copy, delete, scale, rotate or stretch lines and objects. New drawings may also be created by modifying existing drawings. By storing these new drawings in separate files, you can easily maintain multiple revisions.

Pen plots of drawings can be obtained from any one of the full line of HP plotters—from an inexpensive A-size plotter to a roll-feed E-size drafting plotter. Many printers are supported on HP EGS, from the inexpensive ThinkJet printer to the HP LaserJet printer, which provide documentation-quality output for text as well as graphics.

Work Environments

Four specialized work environments or modules are available with HP EGS. The Printed Circuit Board Layout and Schematic Capture Modules are designed to increase the productivity of electronic engineers and designers developing printed circuit boards. The Mechanical Drawing Module assists users in creating drawings of mechanical

assemblies, and the Engineering Graphics Module allows the creation of general-purpose artwork.

The Printed Circuit Board Layout Module facilitates the creation of printed circuit board artwork for electronic designs. Among the productivity features in this module is the Rat's Nest Generator. From a schematic connection list, it produces 'airline' connections between placed PCB components. Users can move components to eliminate trace congestion, and, as components are moved, the connections remain intact. In the placement process, a trace can easily be moved from layer to layer as necessary. A connection list routine compares the schematic connection list and the PCB connection list. A report is generated that notes any discrepancies, providing the user with a validation of the design.

The Schematic Capture Module includes a library of common electronic schematic symbols. Users may also create their own parts, or modify existing ones, to build custom symbol libraries.

Once the schematic design is captured, the resulting connection list information can be passed to the HP EGS PCB Layout Module or another PCB layout system, such as HP Printed Circuit Design System.

The Engineering Graphics Module may be used for a multitude of applications . . . from diagramming PCB card cage assemblies, generating overhead slides, creating project scheduling diagrams, to any other general artwork. This module is where many new users begin to learn how to use HP EGS, and where many sophisticated users come to create their own applications.

The Mechanical Drawing Module is designed to assist engineers and draftspeople in preparing 2-D mechanical drawings. The isometric grid capability allows the user to easily create 2-D representations of 3-D objects. The library for this module includes drawing paper templates, tolerancing and surface texture symbols, and screws and bolts. Both metric and English units are available.

Additional Products

HP TechWriter — Documenting engineering tasks, writing reports, and developing presentation-quality materials that include illustrations consume a major portion of an engineer's time. HP EGS combined with HP TechWriter helps the user deliver high-quality presentation materials. This optional document editor works with the entire Series 200 and 300 family of workstations and electronically merges text with the graphics created by HP EGS. HP TechWriter may also be used independently from HP EGS.

Photoplot/NC Drill — Printed circuit board designers often need to convert their designs into a format suitable for a photoplotter or an NC drill machine. HP's optional photoplot/NC drill feature makes it easy to convert designs into Gerber photoplotter or Excellon drill format.

IGES Translator — Conforming to the Initial Graphics Exchange Specification (IGES), HP's IGES Translator allows users to move HP EGS drawings to other CAD systems or move drawings from other systems to HP EGS. HP EGS can be used as a low-cost front end to your expensive CAD systems.

Ordering Information		Price
Modular HP EGS	74305A	\$6000
add Schematic Capture Module	option 10x	1000
add PC Board Layout Module	option 20x	1000
Modular HP EGS Right-to-Copy	74305R	\$4800
Schematic Capture Module		
Right-to-Copy	option 100	800
PC Board Layout Module		
Right-to-Copy	option 200	800
Add-on Modules for HP EGS	74306A	\$ 0
add Schematic Capture Module	option 10x	2000
add PC Board Layout Module	option 20x	2000
add Mechanical Engineering Module	option 30x	2000
HP EGS Photoplotter/NC Drill Utility	98310A	\$3000
HP EGS Photoplotter/NC Drill	98310R	2100
Right-to-Copy		
HP EGS IGES Translator	98311A	\$5000
HP EGS IGES Translator Right-to-Copy	98311R	3500
HP TechWriter	98819A	\$ 795

NOTE: x in option number is either 2 or 4 and denotes 5 1/4" or 3 1/2" media. Please refer to the HP EGS pricing guide for more detailed pricing information.

Software Description

HP-FE is a general purpose Finite Element system for linear structural and thermal analysis of 2D, axisymmetric and 3D structures and solids consisting of linear elastic materials with homogeneous isotropic and temperature-independent material properties.

The system is able to solve the majority of standard problems in structural mechanics and heat-transfer analysis assuming small displacements and small strain theory and a linear elastic material model. The system is well suited to analyzing medium sized problems encountered in real mechanical, electromechanical and civil engineering environments with a maximum of about 12,000 degrees of freedom.

HP-FE offers the advantages of simplified data preparation with

- Input in free format
- Input through the ME DesignCenter Series IO CAD system
- Powerful graphics capabilities for creation, automatic generation and verification of the Finite Element model
- Numerous output options to clearly display the results of an analysis.

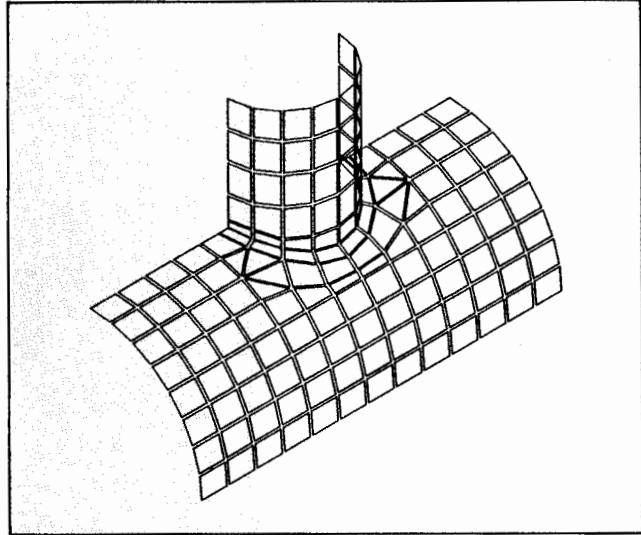

Mesh of Pipe Junction with Element Shrinkage

Types of Analysis

The extensive library of elements in HP-FE allows a structural model to be created for any shape. The analytical capabilities can be summarized as follows:

• Linear elastostatics

To solve for displacements, stresses, and reaction forces in linear elastic solids and structures subjected to applied structural and thermal loads.

• Linear dynamics:

- Mode frequency analysis

To extract natural frequencies and natural mode shapes (undamped free vibration forms and frequencies).

- Linear transient dynamic

To determine the time history solution of the response of a linear elastic structure to a transient dynamic load (general force excitation).

- Linear steady-state dynamic

To determine the steady-state response of a linear elastic structure to a time dependent, periodic force.

- Harmonic response analysis

To determine the steady-state response of a linear elastic structure to a set of harmonic loads of known frequency and amplitude.

• Linear heat transfer analysis:

To determine the steady-state or transient temperature distribution in 2 dimensional, and axisymmetric structures and solids due to temperature gradients and internal or external heat flux and heat sources.

Linear conduction and boundary convection conditions as well as internal heat generation may be considered. The calculated temperature distribution may then be used as input to a subsequent structural analysis.

Pre-Processor

An interactive and fully automatic 3D mesh generator for all element types is available to create Finite Element models. It will generate meshes automatically and display them for checking and modification by interactive editing.

The bandwidth optimizer (automatic node re-numbering) is an essential complement to the mesh generator. Its purpose is to reduce the bandwidth of the global stiffness matrix in order to improve the efficiency of the analysis by minimizing equation solution time and necessary storage capacity.

HP-FE provides an interactive graphics program to help the user to display and check the model in the most convenient way. The program permits rapid plotting of the model data on the graphics screen, plotter or graphics printer.

Post-Processor

HP-FE offers a number of output options within which a user selected subset can be printed or plotted based on the selection of load case, element group, and by element or node number range (e.g. displacements at selected nodes, stresses for selected elements).

Deformed shapes from a model corresponding to different load cases can be superimposed on the undeflected plot or displayed separately. All the features available in plotting the undeflected structural model also apply to the deformed mesh shape.

Specifications

Maximum number of nodes:	2000
Maximum number of elements per group:	500
Maximum number of element groups:	99
Maximum number of load cases:	24
Maximum number of constraint equations:	2000
Maximum number of vibration modes:	24
Maximum number of contour lines:	30
Maximum number of material properties:	100
Maximum number of geometric properties:	100
Maximum number of combined load cases per combination equation:	20
Maximum number of suppressed nodes:	700
Maximum number of nodal forces/temperatures:	1000
Maximum number of prescribed displacements:	1000
Maximum number of load functions in dynamics:	40

Ordering Information

HP 98353A

(designed to run on HP9000 Series 200 and 300)



DESIGN AUTOMATION

ME DesignCenter

ME Series 5, 10 and 30

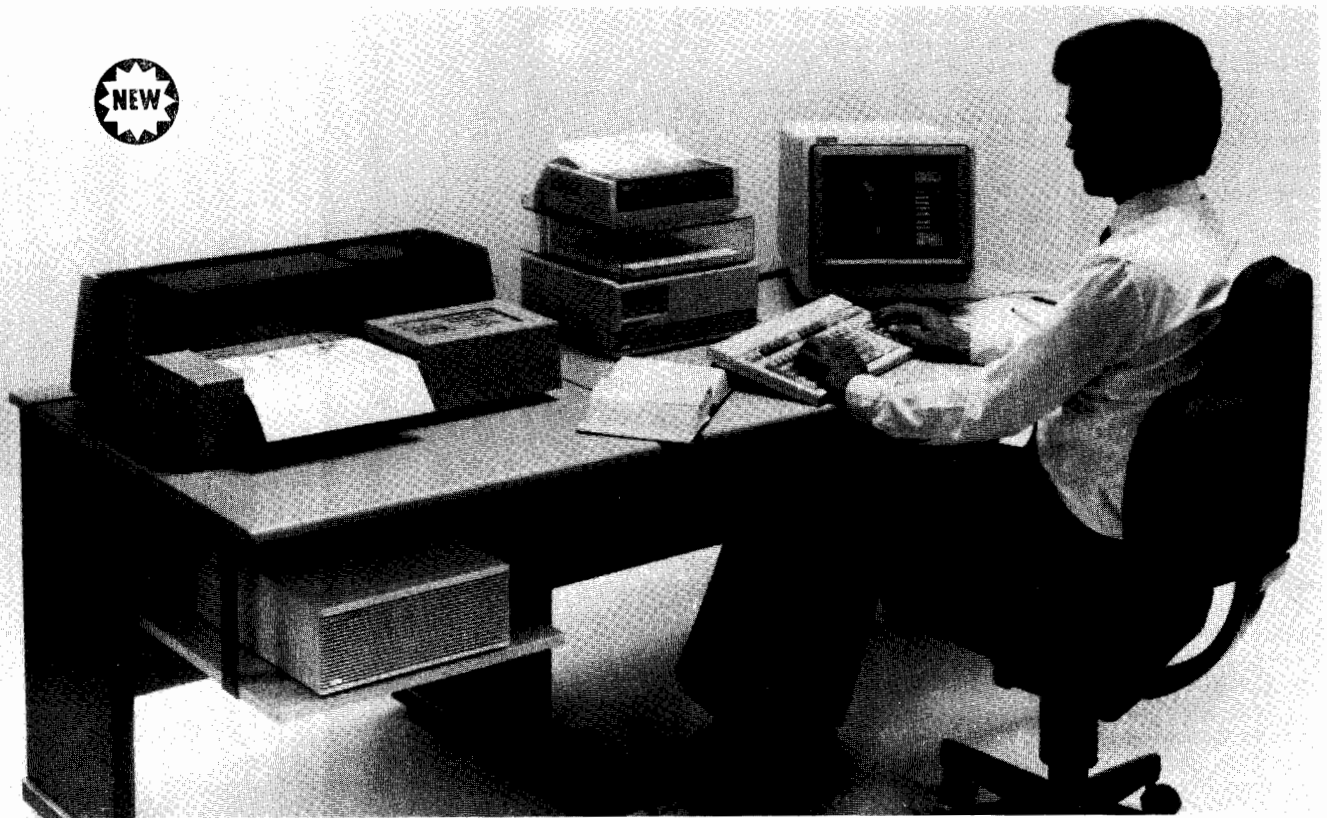

HP's DesignCenter ME Series 5 is an entry-level CAD system for mechanical engineering applications. The user interface and data are fully compatible with HP's ME Series 10 and ME Series 30 systems. The system shown is operating on a low-cost HP 9000 Model 310 technical workstation with medium-resolution color monitor.

ME Series 5, 10 & 30

HP DesignCenter Series 5, 10 and 30 are a family of CAD products for drafting, 2D design and solids modeling, respectively. All three products have been developed using the very same friendly user interface philosophy — drastically reducing the learning time to allow greater designer productivity.

ME Series 5 provides comprehensive drafting functionality. The ME Series 10 adds extensive 2D design and integration capability to this core drafting block. The ME Series 30 takes the power of the ME Series 10 and integrates it with true solids modeling capabilities by adapting the use of 2D design techniques to model creation.

ME Series 5 and 10 run on the complete range of HP 9000 Series 300 engineering workstations under either the Pascal or HP-UX operating systems. ME Series 30 is available on the 32-bit HP 9000 Series 300 workstations running the HP-UX operating system.

Networking capabilities such as LAN allow users to set up a distributed system featuring all three products configured to address the full range of mechanical engineering CAD requirements. Similar networking capabilities allow further integration of CAD stations into manufacturing environments.

User interface

Short learning cycles and friendly system handling are essential for engineering productivity. The ME Series 5, 10 and 30 user interface is menu-driven and provides the ease-of-use beginners require. ME Series 10 and 30 also provide customizing capability for special applications.

Most importantly, the single user interface concept greatly reduces the education and skill needed by your engineers to be able to fully benefit from HP's full range of CAD tools.

In all three products, the user interface is optimized for mechanical design and drafting:

- System functions are directly accessible from the graphics tablet, complemented by screen menu subfunctions.
- Easy-to-follow prompting and understandable commands like fillet and mill enhance user interaction
- Multi-viewport capability eases handling of large and complex models, designs and drawings.
- On-line HELP facility provides detailed explanations of the use of commands.
- Feedback mechanisms such as rubber banding and dynamic component tracking aid creation and modification operations.

ME Series 5 and 10 also offer a screen-only version of the user interface for use with a mouse.

Functionality

ME Series 5, 10 and 30 offer a powerful range of functions for design through modeling to drafting of complex mechanical parts and assemblies. The result is high design efficiency, reduced prototyping requirements and fast creation and modification of drawings.

ME Series 5 drafting features include:

- Comprehensive construction geometry to facilitate accurate positioning of geometry elements
- An electronic 'ruler' to emulate drawing-board techniques that can be moved, rotated and set to isometric coordinate systems
- Full dimensioning capability according to international standards (ANSI, ISO, etc.)
- Dual dimensioning
- Automatic hatching
- Automated detail creation
- Full text input and editing capability

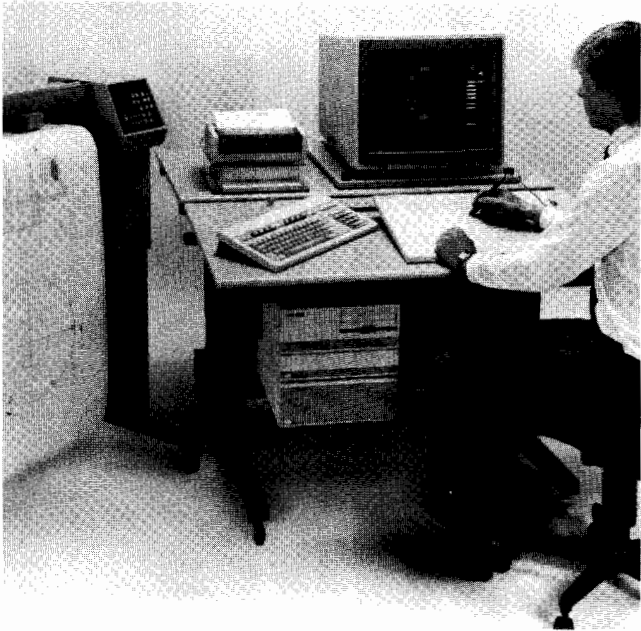

HP's DesignCenter ME Series 10 is an advanced 2D design and drafting system for mechanical engineering applications. As shown here, the ME Series 10 runs on an HP 9000 Model 320 32-bit engineering workstation with high-resolution color.

- Various text fonts according to international standards
- User-definable text font capability
- Leader lines with various terminator capabilities
- Comprehensive set of drafting symbols
- Semi-automatic isometric drawing creation
- Parts and assembly capability
- 'Shared part' feature to allow automatic update of several parts at once
- Unlimited number of layers available for drawing organization
- Modification functionality
- Fully variable drawing scale

ME Series 10 ADDITIONAL design features include:

- Parametric design capability
- Automated 'Design Feature' creation capability
- Advanced geometry modification for adapting designs, including move, copy, scale, rotate and mirror
- Associated information and attributes for material specifications and pricing details
- Measurement capabilities including moment of inertia

ME Series 30 ADDITIONAL solids modeling features include:

- 'Workplane' technique allows 3D model creation from 2D geometry
- Machining functions for model creation, including mill and stamp, to support use of 2D geometry for model creation
- 3D parametric design capability
- 'Primitives' for model creation
- Full assembly modeling capability
- Extensive design checking capability, including mass properties and interference
- Full modification capability for parts and assemblies including move, copy, scale, rotate, mirror and tweak
- Hardware supported dynamic rotation of hidden line and shaded models to enhance visualization

Integration Into Your Environment

ME Series 5, 10 and 30 all offer extensive capabilities to use design data in the manufacturing environment.

ME Series 5 integration capabilities include:

- Parts list information for stock control systems
- Drawing data included in documentation systems such as Alis/HP-UX

ME Series 10 ADDITIONAL integration capabilities include:

- 2D geometry link to NC-programming systems
- 2D geometry link to finite element analysis systems such as HP FE
- IGES translator

ME Series 30 ADDITIONAL integration capabilities include:

- 3D geometry link to NC-programming systems
- 3D geometry link to finite element analysis systems

Training and Support

Full training and support programs are available to ensure successful implementation of ME Series systems.

Support Products include:

- Account Management Support
- Response Center Support
- Manual Update Service

Training courses are structured as follows:

- ME Series 5 Drafting Course 3 days
- ME Series 10 ADDITIONAL 2D Design Course 2 days
- ME Series 30 ADDITIONAL Solids Modeling Course 5 days

Ordering Information

ME Series 30	HP 74836A	\$18,000
ME Series 10 (HP-UX version)	HP 98366A	10,000
ME Series 10 (Pascal version)	HP 98365A	10,000
ME Series 5 (Pascal version)	HP 98363A	5,500

Upgrade programs are available to expand your system capabilities as your requirements grow.

System Capability Matrix

Application	ME Series 5	ME Series 10	ME Series 30
Drafting	•	•	•
2D Design		•	•
Solid Modeling			•
Integration			
Technical Office Automation	•	•	•
Parts List Generation	•	•	•
Output to NC Systems		•	•
Output to FE Systems		•	•
IGES Translator		•	•

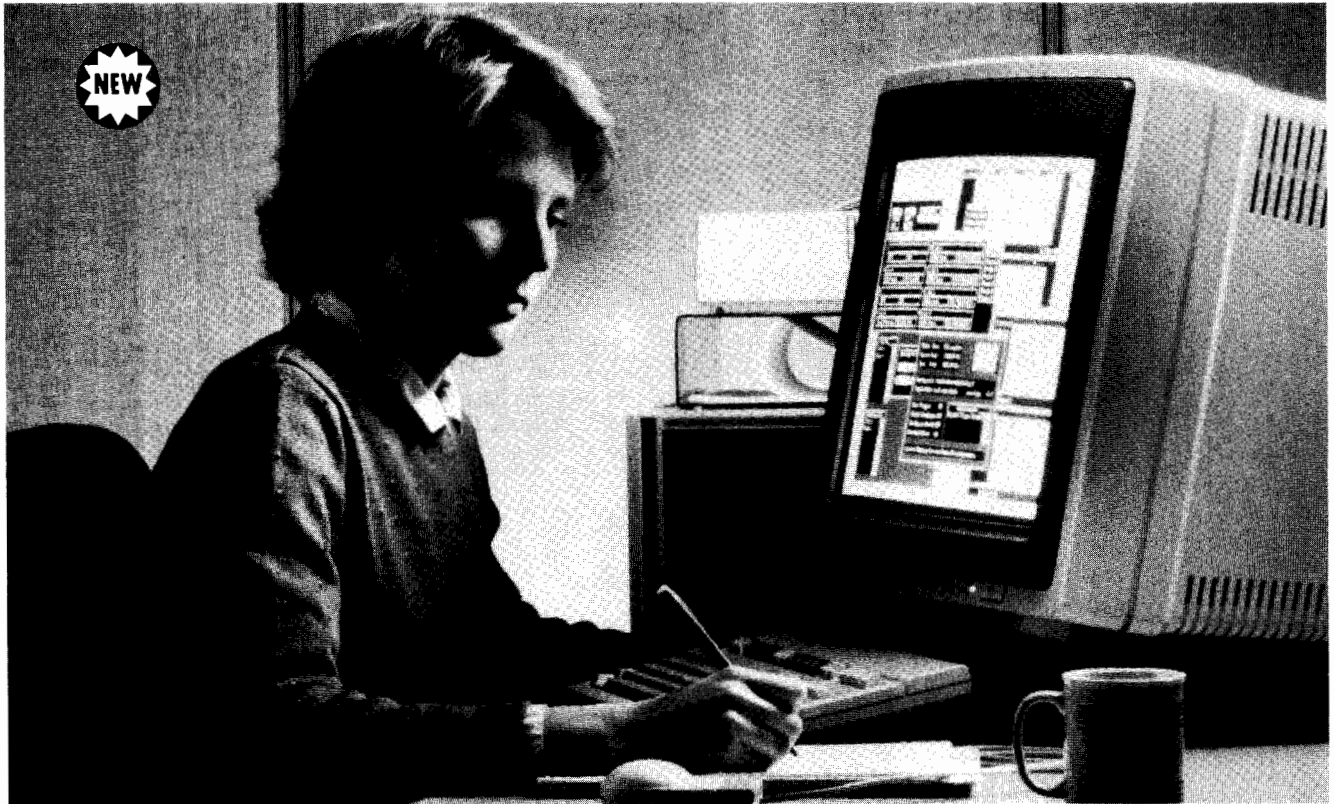

HP's ME Series 90 multichannel test system closes the design loop by linking HP mechanical CAD tools with test results.

ME Series 90 Test System

The ME Series 90 is an expandable, off-the-shelf multichannel test system with applications in structural testing and analysis, vibration analysis, control system testing and general signal analysis from 61 μ Hz to 51.2 kHz. The ME Series 90 closes the design loop by linking HP's computer-aided design tools with test results. Dynamic mechanical testing completes this link by allowing the engineer to compare the mechanical performance of the prototype or final product with the analytical model developed with other CAE tools. In addition, dynamic mechanical testing is used in the design phase and throughout the product life cycle to troubleshoot noise and vibration problems.

The ME Series 90 is a modular, expandable system based on the HP 9000 Series 300 technical computer, HP 35650A Series measurement hardware, HP VISTA Signal Processing Software and the HP META Structural Analysis Software. The system can be configured initially with as few as one input and one source module and expanded up to 62 input and source modules, in any combination. Large channel count systems required for large tests can be partitioned into a number of smaller ones by merely adding additional computers and software packages. For users that require a transportable system, HP META can be used together with the HP 3562A Dual Channel Dynamic Signal Analyzer to form the HP 3562S structural Analysis System.

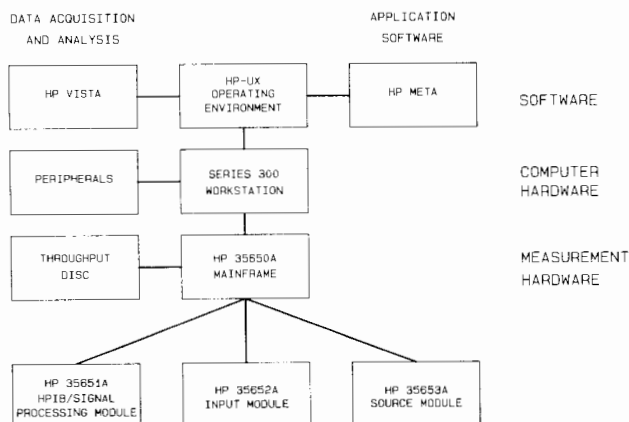

HP ME Series 90 system diagram

Applications

The system completely addresses the analysis of the response of a mechanical system to dynamic loading. Modal analysis testing is an important process of the design optimization process in structures such as aircraft, machine tools and computer disc drive actuators. The applications software allows the engineer to measure these characteristics and simulate design changes before changes are made to the actual structure.

Monitoring the vibration levels of operating machinery can yield useful, important information that can be used to predict failures before they occur. Maintenance can be planned and scheduled and downtime can be minimized. Multichannel analysis provides for continuous monitoring of large, complex installations. Computer aided analysis and database management takes the guesswork out of this analysis.

Environmental vibration testing yields information critical in the design of components that will be exposed to high levels of shock and vibration. Acoustic testing is important in designing quieter products and pinpointing the sources of noise in systems.



System Computer

An HP 9000 Series 300 workstation is the system host for the system applications software running under the HP-UX operating system. The measurement hardware can also be programmed stand-alone with HP-IB programming from a number of HP computers including the series 200 and 300 members of the HP 9000 family and the members of the HP 1000 family of computers.

Measurement Hardware

The 35650A Series measurement hardware consists of the HP 35650A Mainframe, HP 35651A HP-IB/Signal Processing Module, HP 35652A Input Module and the HP 35653A Source Module.

The HP 35650A Mainframe houses the three modules. It provides the power and cooling for the modules in addition to triggering and sampling synchronization. A mainframe holds up to eight modules and up to eight mainframes can be connected together.

The HP 35651A HP-IB/Signal Processor Module provides the link between the other modules and the host computer. It provides for control and management of these modules. It has dedicated processors to perform signal processing functions such as Fast Fourier Transforms and windowing operations. It can control peripherals such as disc drives directly. All of this adds up to high-speed processing and reduction of the calculation burden on the host computer.

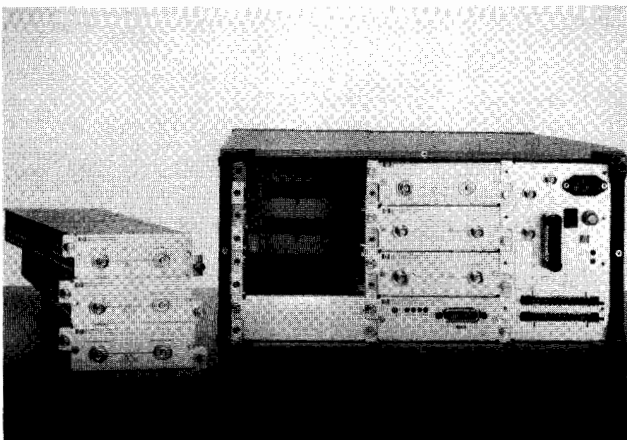

HP ME Series 90 measurement hardware mainframe with modules.

The HP 35652A Input module digitizes signals at a 262 kHz sample rate and has the necessary hardware to provide very accurate frequency domain analysis up to 51.2 kHz. It has fully functional signal conditioning built in that provides complete compatibility with voltage, charge and ICP type signal transducers. The module supports features such as auto-ranging, overload counting and DC offset subtraction to ensure high quality results.

The HP 35653A Source module provides the excitation signals necessary to stimulate the device under test. Random noise and fixed sine wave signals are available in either a continuous or 'gated' format. Multiple uncorrelated noise sources along with the analysis capability of the HP VISTA Signal Processing Software provide for multiple input, multiple output system testing.

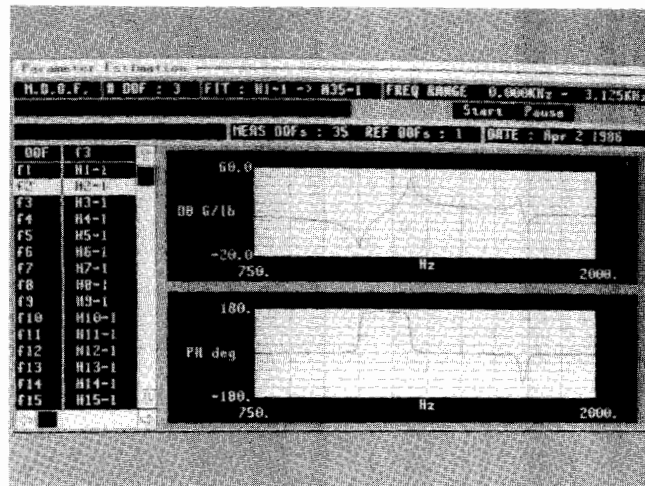

HP VISTA display

HP VISTA Signal Processing Software

The HP VISTA Signal Processing Software provides the capability to produce all of the time, frequency and amplitude domain results used in dynamic mechanical testing. Data can be analyzed on-line or from time domain data stored to a disc at a throughput rate of up to 490K Bytes per second. The software is designed to work with the measurement hardware to produce accurate, calibrated results.

HP VISTA has a friendly user interface based on windows, pop-up menus and a mouse. It is as direct as a benchtop instrument and as friendly as a personal computer. A complete help feature is designed with both beginner and expert in mind.

Features of the software provide for powerful data analysis functions. The display can be formatted in a number of ways including user defined two-dimensional views and spectral maps. Post processing functions include data editing and block math operations. The system can be customized with the user programming capability.

HP META Structural Analysis Software

HP META is an integrated software package that works with either the ME Series 90 Test System or the transportable 3562A Dynamic Signal Analyzer. The products enhance the capabilities of these two products to form flexible, expandable systems for measuring and analyzing the dynamic properties of structures.

META-MODAL provides for the measurement and extraction of resonant frequencies and mode shapes of the structure tested. Advanced curve fitting techniques means less user intervention and more accurate estimates of mode shapes. A wide variety of display formats includes hidden surface removal and selectable surface shading.

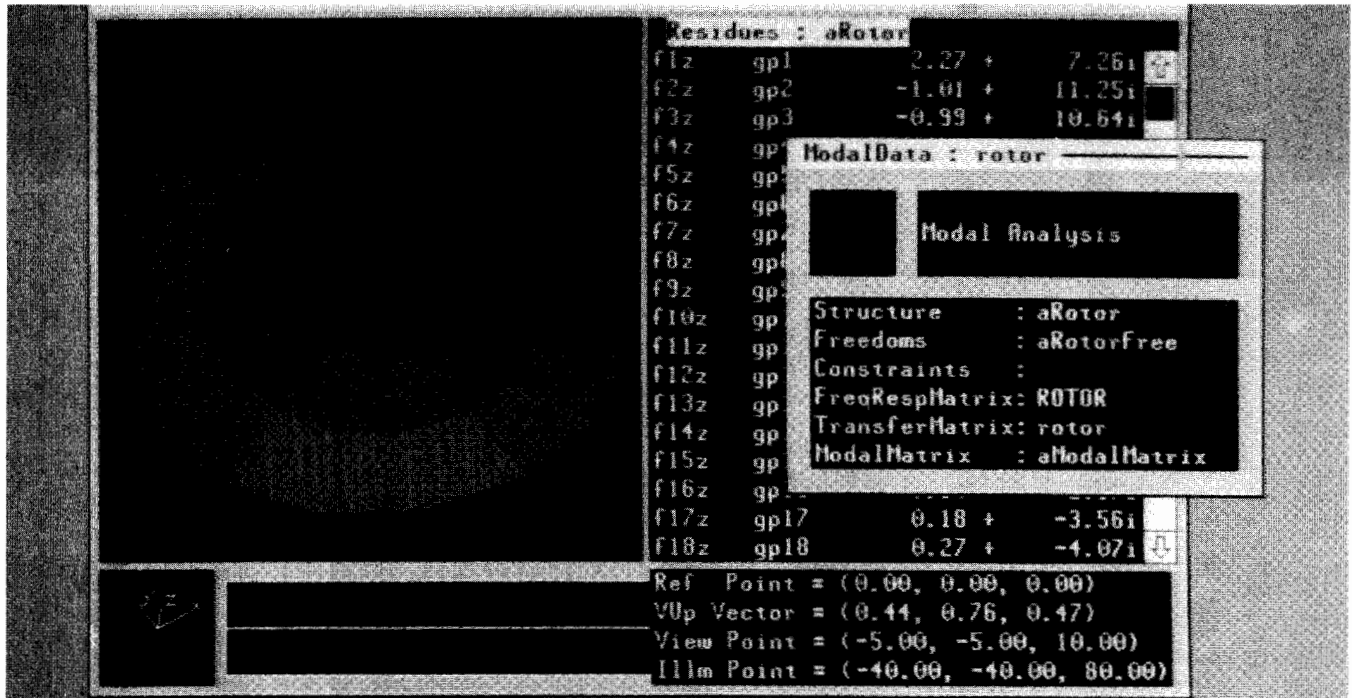

HP META display

META-MODS lets you calculate the effects of structural changes analytically without making physical changes. Two methods are available for simulation, one optimized for speed and the other for accuracy.

META-FORCE allows you to predict how a structure will respond when subjected to arbitrary dynamic forces. The forces can be as simple as sine waves or complex time histories.

Brief Technical Specifications

Measurement Hardware 35650

HP-IB/Signal Processing Module 35651A

FFT Computation Time: 1024-point complex transform in approximately 67 ms

Maximum throughput rate to disc: > 500 K bytes/second

Input Module 35652A

Frequency Range: 61 uHz to 51.2 kHz

Time Record Block Sizes: 64 to 8192 in powers of two

Frequency Line of Resolution: 39% of Time Record Block Size (nominal)

Full Scale Voltage Range: 1.26 mVp (-58 dBVp) to 39.8 Vp (+32 dBVp) in increasing steps of 25% (2 dB)

Full Scale Charge Range: -18 dBpCp to +72 dBpCp in 2 dB steps

Dynamic Range: <-80 dB relative to full scale (Rs = 50 ohms, Cs = 1000 pF, 16 averages, internal sampling)

Source Module 35653A

Signal Types: Random, Sine, Burst Random, Fixed Sine, Variable Pulse

AC Output Level: 1.26 mVp (-58 dBVp) to 10.0 Vp (+20 dBVp) in 0.375 dB steps

HP VISTA Signal Processing Software

Time Domain Measurements: Time record, averaged time record, auto and cross correlation, impulse response and convolution

Frequency Domain Measurements: Frequency response function (multiple input, multiple output), auto and cross power spectrum, power and energy spectral density, linear spectrum, coherence (ordinary, multiple and partial) and convolution

Amplitude Domain Measurements: histogram, probability density function, joint probability density function, cumulative density function

Number of Frequency Spans: 19 baseband and 17 zoom

Windows: hann, flat top, force and response, exponential, P301, P310, user specified and smoothing

HP META Structural Analysis Software

Number of Measurements, Modes, Display Elements and Degrees of Freedom: limited only by disc size

Display Methods: wire frame, surface model with hidden line removal, surface shaded model

Curve Fit Method: frequency domain polynomial

Parameter Estimation Techniques: global least squares error, statistical estimate of poles, pick peaking

Modification Techniques: modal or frequency domain

Modifications allowed: adding or subtracting stiffness or damping, attach a substructure with known properties, resonance specification

Force Response Simulation Inputs: sinusoidal, spectral or transient

Ordering/Configuration Information

Bundled Systems

- One Mainframe, one HP-IB/Signal Processing Module, four Input Modules, one Source Module and HP VISTA 74791S \$27,500
- Two Mainframes, one HP-IB/Signal Processing Module, eight Input Modules, one Source Module and HP VISTA 74792S 43,100
- Three Mainframes, one HP-IB/Signal Processing Module, 16 Input Modules, one Source Module and HP VISTA 74793S 71,250

Measurement Hardware

Mainframe	35650A	2,950
HP-IB/Signal Processing Module	35651A	3,250
Input Module	35652A	3,150
Source Module	35653A	1,750
720 mm Rack	35605A	1,500
1500 mm Rack	35606A	2,000

Software

VISTA	35630A	7,000
META-MODAL	74796D	10,000
META-MODS	74796E	10,000
META-FORCE	74796F	3,000
Bundled META	74796G	18,500
META-MODAL for use with the 3562S	74796H	7,000
Bundled META for use with the 3562S	74796J	16,000

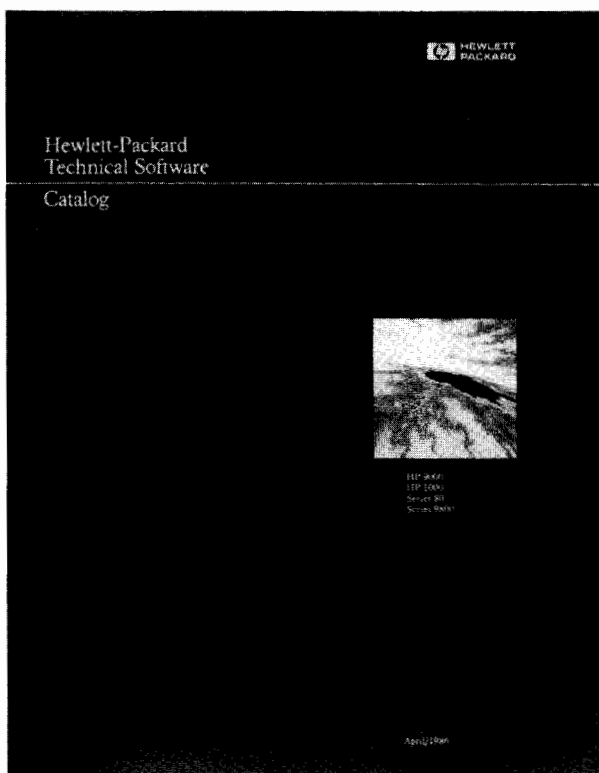

Chemical Engineering	7
Civil Engineering	99
Computer Aided Testing/Lab Automation	24
Data Base Management	49
Data Communications	48
Earth Resources Engineering	50
Electrical Engineering	84
Graphics	53
Languages/Compilers	44
Manufacturing/Process Control	88
Math/Statistics	31
Mechanical Engineering	109
Medical/Health	15
Miscellaneous	23
Software Engineering	61
Professional Support	69
Utilities/Conversion Aids	91
Total	1087

HP Technical Software Catalog

The HP Technical Software Catalog is published twice a year (May and November) and contains more than 1000 software products from both HP and Value Added Software Suppliers.

The products included in this Catalog come from three sources:

1. Software submitted by independent software suppliers to our HP PLUS Program which offers more than 700 technical software packages—from aerospace simulators to water utility operations.
2. Software recruited from specially selected Value Added vendors who have developed software for particular markets associated with HP's Computer Aided Engineering strategy. HP's CAE program places special emphasis on recruiting software vendors in the mechanical, electrical and software engineering markets. Also included in this category are technical office automation or professional support solutions—products that improve engineering productivity such as technical word processing, graphics presentations, spreadsheets, database management, numerical analysis and integrated software packages.
3. HP Proprietary software, which offers you a broad selection of HP-proven technical applications, utilities and integrated solutions. Applications areas range from AC circuit simulation to statistical quality control and from engineering graphics systems to data communications software. Specific information on HP-created software can also be found elsewhere in this and other sections of the HP Catalog.

These products run on the HP 1000, HP 9000, Series 80 and Series 9800 hardware families plus some selected HP Integral, Portable and Vectra computer models. They represent applications from 20 different market/application areas:

Market/Application Area	Number of products listed
Aerospace/Aeronautical Engineering	11
Architect./Structural Eng. & Construction	89
Artificial Intelligence	6
Business Administration	36

HP PLUS Program

To service its more than 300 independent technical software suppliers, HP relies on a vendor program called HP PLUS.

HP PLUS offers you software in three different categories: Listed, Referenced and Distributed. The Listed category is for the supplier with the lowest level of HP involvement in marketing his product. The Referenced category is for user-proven software products. The Distributed category is for software which HP has elected to market, merchandise and sell.

Mechanical Engineering Solutions

HP has selected several of the leading creators of mechanical engineering solutions to work with in linking your design, drafting, analysis and manufacturing groups. These HP Value Added Software Suppliers provide integrated solutions for 2D and 3D design, finite element analysis, solid modeling, geometric modeling, numerical control, computer aided test and tool path generation. These software solutions are widely known and used in the automotive, plastics modeling, nuclear, aerospace, steel fabrication, computer manufacturing, AEC (architectural engineering and construction) and consumer products industries to name just a few.

Electrical Engineering Solutions

To round out our extensive proprietary electrical engineering and computer aided testing offering, HP is working with several Value Added Suppliers to market software for logical design (schematic capture and simulation), physical design (IC and PC board layout) and microprocessor software development. Porting this software from independent sources to the appropriate HP hardware allows us to approach virtually all electrical engineering problems with complete solutions—from simple circuit analysis to IC foundry operations.

Software Engineering Solutions

Database Management Systems, FORTRAN and C programming environments, operating systems and utilities, compilers, debugging aids, artificial intelligence tools and documentation aids are all part of the programmer's tool kit. HP not only markets a large library of its own software engineering applications, it also helps merchandise numerous Value Added Software packages in this area.

New software engineering capabilities that are available from HP and Value Added vendors include relational databases, expert system tools, assemblers, emulators, systems documentors, LISP and PROLOG environments, and software conversion aids.

Ordering Information

The 208-page Hewlett-Packard Technical Software catalog is offered free of charge to HP customers and independent software vendors. For your copy, please contact your local HP Sales Office and ask for HP Publication Number 5953-9598.



COMPUTER AIDED TEST

General Information

The philosophy behind Computer Aided Test (CAT) is simple: If you can raise the quality of your product without raising its cost, your customer is happier and your company is more productive. The formula for executing this plan is equally simple: Monitor incoming parts, manufacturing processes and final products in great detail, and make corrections to improve them.

While the philosophy is simple, the implementation can sometimes be complex. That's where HP can help, with a full complement of computers, software, instruments and interconnect hardware designed specifically to make your CAT task easier.

What to Look For

Beyond the obvious requirement of adequate measurement capability, a good CAT system should increase your productivity in several ways:

Software . . . In most cases, CAT software represents a larger investment than the hardware itself. Good software tools can cut this

investment by more than half. These tools should be easy to use, but not get in the way of system performance. And, you should be able to mix menu programming with lower level code, so that the versatility of the system is not compromised.

Computer . . . The computer should be designed as a superlative I/O device, not adapted from a general purpose design. Its language should be optimized for instrument control, and it should be able to transfer data to other factory floor computers, discs, printers, plotters and displays. A well-designed computer can save enormous amounts of programming time.

Instruments . . . Performance is the first criteria in selecting instruments for CAT. It's a good idea to select an instrument with slightly more performance than the initial specification requires. That way, you don't get trapped when the manufacturing specifications change. Also, the slight addition in capability may allow you to migrate the same test equipment to another application in the future.

Another consideration is throughput speed. By using an intelligent cardcage system, the voltmeter can talk directly to the appropriate multiplexer switch without waiting for the computer, thus optimizing the overall system speed.

Cabling . . . For years, the cabling and fixturing of a CAT system have been neglected by CAT manufacturers. Test engineers had to build their own connection systems. But today HP has commercial units to do most of the critical switching and cable management necessary in a CAT system. The availability of these switch units can save the test engineer literally hundreds of hours of design time.

Productivity . . . In short, a good CAT system is designed to improve manufacturing productivity. It minimizes the design time to build fixtures, write software, and configure systems, and it also minimizes the time required to test production devices.

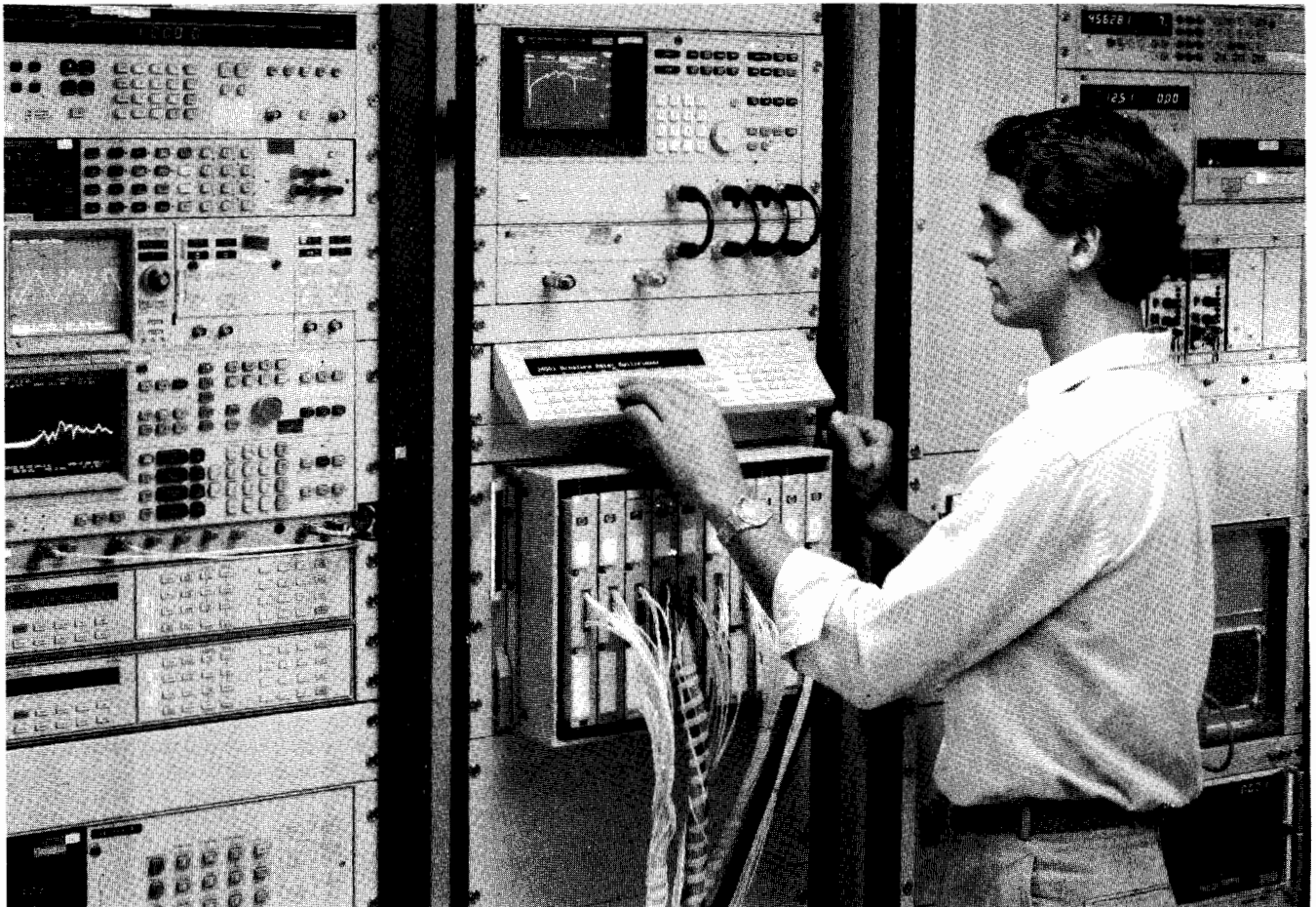

The new HP 3235A Switch/Test Unit performs high integrity switching for signals from dc to 1 GHz. With its mass interconnect fixture, the HP 3235A can route signals from a multitude of instruments to the device under test, saving the test engineer the chore of designing a custom switch, and greatly simplifying cable management.

Programming the HP 3235A is extremely efficient, with high level BASIC commands. Faster test throughput speed is created by downloading test setups, and by direct communication between the internal switches and the internal 6½ digit multimeter.

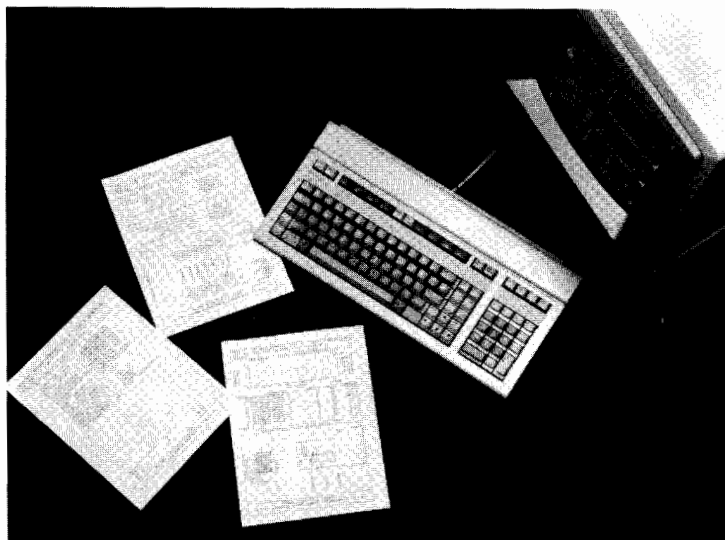

HP's new FTM/300 Functional Test Manager software is designed to replace up to 65% of the custom code you normally write when constructing a CAT system. It uses a friendly forms-entry approach to call pre-written subprograms—programs you no longer have to write or maintain.

HP FTM/300 works on HP 9000 Series 300 computers, and it works with any HP-IB instrument. It is truly a general-purpose software tool to help the CAT programmer develop a test system in a hurry.

The HP 9000/Series 200 and 300 are the industry standard CAT computers. A rich instruction set in HP BASIC with special attention paid to instrument control, and a friendly interactive editor save time not only in writing test software, but in debugging the system hardware and software as well.

With cards as varied as a 500 kHz A/D, stepper motor driver and timer/pacer, as well as inter-card communications, you can be assured that the HP 6942/44 Multi-programmer series can expand to meet your needs for throughput and measurement versatility with the performance so necessary in a CAT system.

The HP 14752A CAT Software is a menu-oriented package dedicated to the HP 6942/44 instruments. It takes advantage of the Multiprogrammers' high speeds while at the same time giving the test engineer an efficient tool to minimize programming time. The result is custom software without a custom price.

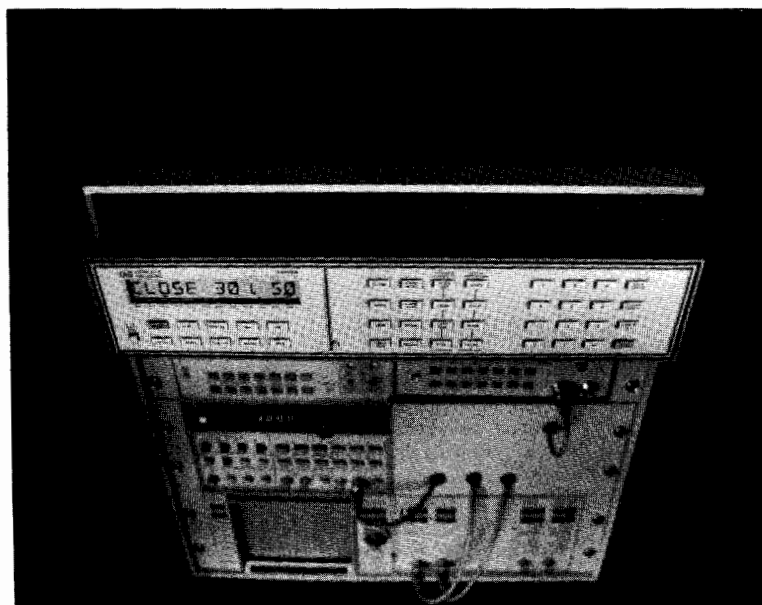

The HP 3488A Switch/Control Unit is a low cost switch product for small to medium CAT systems. The straight forward switch commands make it easy to configure a system that needs multiplexers, matrix switching, or signal routing up to 300 MHz.

For the most demanding applications, the HP 1000/A Series computers have multitasking, multiuser capability. Use them to supervise a complex network of instruments, support very large programs or databases, or obtain the highest speeds from a CAT system.

Test and Measurement cards can be installed into the HP 1000 computer to maximize system speed.

For those who need help configuring a complex HP 1000 CAT system, HP offers a purchased Racking and Cabling service: the ATS/1000.

COMPUTER AIDED TEST

High Performance Switching and Control

HP Model 3235A

- For Medium to Large Systems
- 10-Slot, Intelligent Card Cage
- 7-Switch Modules



- DMM, Digital I/O, Breadboard Modules
- Quick Interconnect Fixture
- Control Panel for Debugging

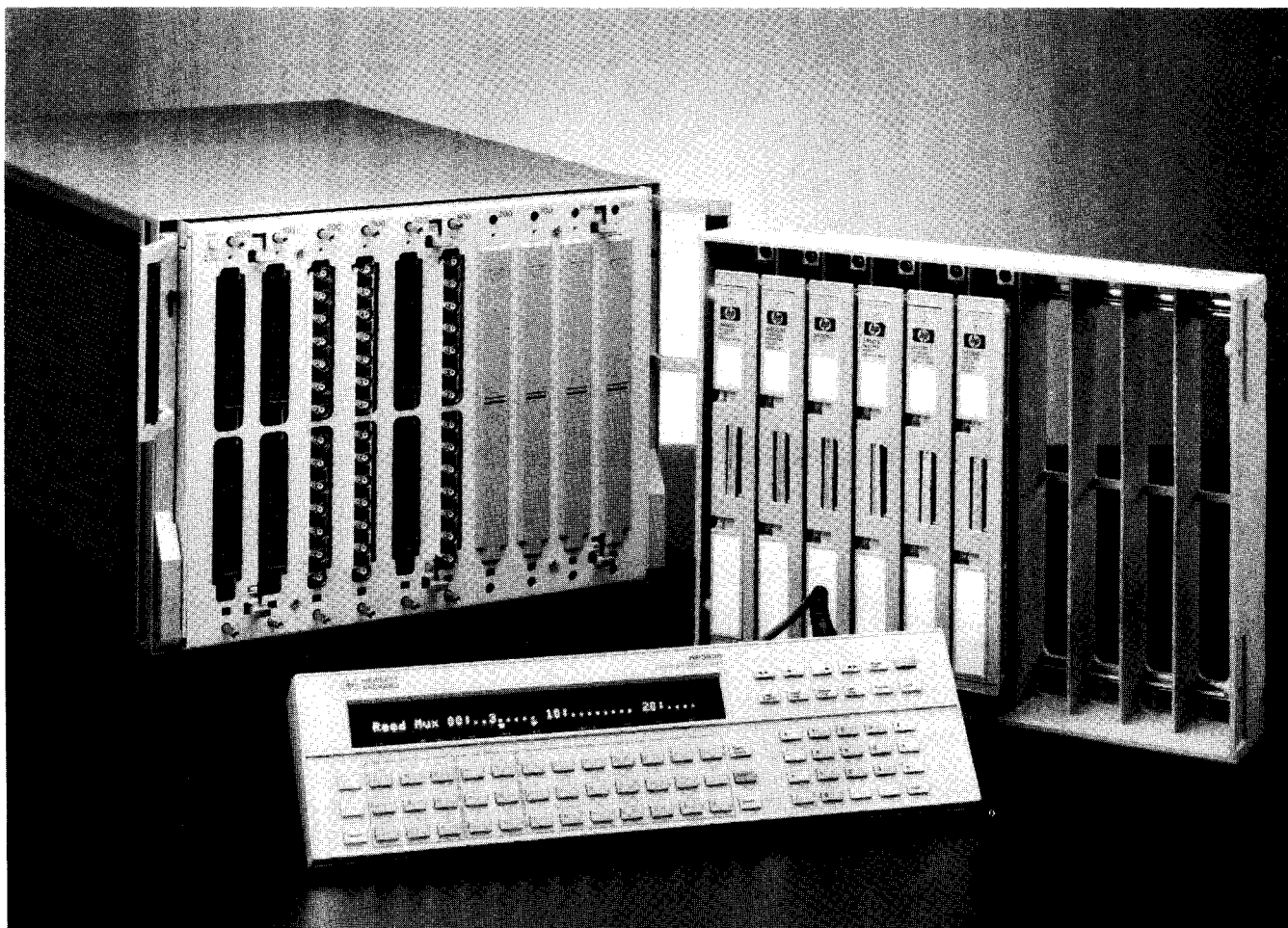

Description

The HP 3235A Switch/Test Unit reduces test development of HP-IB production test systems by providing high performance off-the-shelf switching and interfacing to a wide variety of Devices Under Test (DUT).

This new Switch/Test Unit routes signals between your DUT and source/receiver instruments such as digital multimeters, counters, signal sources and analyzers.

Speed your test system development with:

- off-the-shelf tools
- easy programming
- reduced cabling

Your test system throughput increases with the HP 3235A's:

- intelligence
- plug-in digital multimeter module
- internal bus structure
- Quick Interconnect Fixture

A Reconfigurable Architecture

The HP 3235A chassis is a 10-slot cardcage driven by a 16-bit processor backed with 256k of firmware. You control the cardcage over HP-IB using high level commands for easy programming. Seven different switch modules in various matrix and multiplexer topologies switch signals from DC to 1GHz. Also available is a digital I/O module, a breadboard module, and a DMM module that is a true "instrument-on-a-card."

For applications demanding numerous switch points, up to seven 10-slot HP 3235E Extenders can be slaved to the HP 3235A mainframe. 2560 two-wire analog points can now be controlled from one HP-IB address.

The Quick Interconnect Fixture allows easy reconfiguration of the customer's test system for different test devices. Operator errors are also reduced by minimizing the number of connections that must be made before starting a new test.

Four analog and two trigger buses link the switch and instrumentation modules. These internal paths provide a "soft-wired" connection that can be redefined by your test software. Analog signals get routed conveniently from a multiplexer to the digital multimeter module during scanning. Or, a trigger generated by the digital I/O module can be routed to the digital multimeter module.

To aid in system set up and debugging, a control panel with a full alpha-numeric keypad and electro-luminescent display is available.

Intelligence of a Computer

The powerful firmware of the HP 3235A instructs the plug-in modules with high level commands from the host computer. Storage and recall of hundreds of HP 3235A setups saves sending command sequences from the computer. BASIC language commands in the mainframe such as IF . . . THEN and FOR . . . NEXT, plus variables and math functions keep computer to switch interactions to a minimum, thereby increasing throughput. Use up to 90K bytes of mainframe memory for downloaded subroutines and stored values. Downloaded programs, including user defined data conversions or setups, execute rapidly.

Complete Modularity Means In-Rack Service

The HP 3235A is completely in-rack serviceable, so you never need to remove the card cage from the rack. All assemblies, including power supply, controller, and HP-IB, remove easily because of the modular design.

Simple Operational Verification Before Your Test

The HP 3235A offers three levels of internal self-test as well as a fixtured functional test for the individual plug-in modules. The fixtured test is performed using diagnostic terminal blocks that attach to the modules. These diagnostic fixtures, together with the internal DMM module, verify the integrity of the relay contacts in your system.

32 Channel Multiplexer Modules (HP 34501, HP 34502, HP 34507)

The three 32 channel multiplexers allow scanning or multiple signal connections for low frequency connections. Channels switch two wires (High & Low) with DPST relays. These modules can be used as either input or output multiplexers.

- Armature relays provide quality switching for both high voltage and low level signals.
- Reed relays provide high speed switching with scan rates >500 channels/sec.
- Mercury-wetted relays offer long lifetimes.

32 Channel Multiplexers (one bank shown)

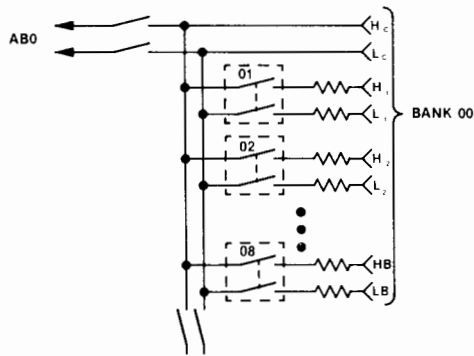

INPUT

CHARACTERISTICS	HP34501	HP34502	HP34507
Maximum Voltage Terminal to Terminal	250V DC or AC RMS	125V DC or AC Peak	250V DC or AC RMS
Terminal to guard or chassis Guard to chassis		250V DC or AC RMS 42V DC+AC Peak	
Maximum Current per channel or common	2A DC or AC RMS	25mA DC or AC RMS	100mA DC or AC RMS
Maximum Power per channel or common	60W (Vmax ≤30VDC) 45W (Vmax >30VDC) or 500VA AC	.5W or .5VA	1W or 1VA
Thermal Offset (one frame)	<3uV	<3uV	<20uV
Insulation Resistance ≤(40 C, 95% RH)	>10 ⁹ Ω	>10 ⁹ Ω	>10 ⁹ Ω
AC PERFORMANCE (Z _L = Z _q = 50Ω)	≤10kHz	≤100kHz	≤1MHz
Crosstalk (dB)	<-90	<-70	<-55

General Purpose Relay Module (HP 34503)

This module provides 16 independent Form C contacts for general signal switching or control of external devices. The high integrity contacts are ideal for switching signals when multiplexing isn't required.

General Purpose Relay (one channel shown)

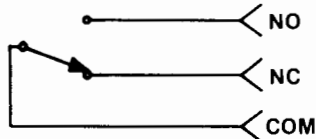

Maximum Voltage

Terminal to terminal: 250 V DC or AC RMS
Terminal to guard or chassis: 250 V DC or AC RMS
Guard to chassis: 42 V DC+AC Peak

Maximum Current per channel or common: 3 A DC or AC RMS

Maximum Power per channel or common: 60 W (Vmax ≤300V DC); 45 W (Vmax > 300V DC); 750VA AC

AC Performance (Z_L=Z_S=50Ω) | ≤10kHz | ≤100kHz | ≤1MHz

Crosstalk (dB)	<-80	<-60	<-40
-----------------------	------	------	------

RF Multiplexer (HP 34505)

The RF Multiplexer provides broadband switching of the high frequency or fast pulse signals. Excellent channel isolation assures quality wide-dynamic-range measurements. The module consists of one 1×3 and two 1×4 ohm multiplexers for bi-directional switching or signals from DC to 1 GHz. Each of the three multiplexer banks are isolated from each other and from ground to prevent ground loops. All channels have 50 ohm characteristic impedance and off-channels can be terminated in 50 ohm.

RF Multiplexer (one bank shown)

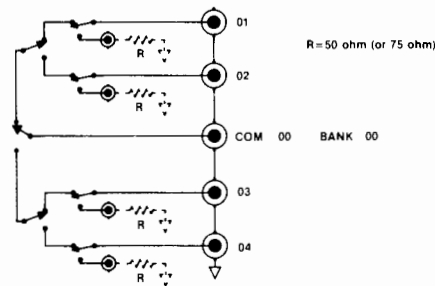

Maximum Voltage: Any center or shield to any other center, shield, guard or chassis; 42V DC+AC Peak. Guard to chassis; 42V DC+AC Peak

Maximum Current per channel or common: 1A DC or AC RMS

Maximum Power per channel or common: 24W or 24 VA. Maximum power per each resistive termination: .25W or .25VA

AC Performance For Z_L = Z_S = 50Ω

	≤10MHz	≤100MHz	≤500MHz	≤1GHz
Insertion Loss (dB): ≤(40°C, 95% RH)	<.03	<.7	<1.5	<3.0
Crosstalk (dB) Channel-Channel	<-90	<-80	<-65	<-55
VSWR	<1.2	<1.25	<1.35	<1.55

Switched-Shield Coaxial Multiplexer Module (HP 34504)

The coaxial module provides two 1×6 multiplexers for input or output scanning in 50 ohm systems or for signals up to 42V or 1A. Each channel switches the shield as well as the center conductor to eliminate ground loops in your system. Switched shields also allow you to measure test points with differing shield potentials.

Switched-Shield Coaxial Multiplexer (one bank shown)

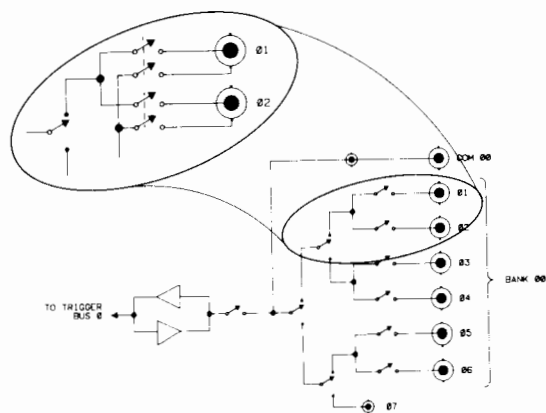



COMPUTER AIDED TEST

High Performance Switching and Control

HP Model 3235A

Maximum Voltage: Any center or shield to any other center, shield, guard or chassis: 42V DC+AC Peak. Guard to Chassis: 42V DC+AC Peak.

AC Performance for $Z_L = Z_S = 50 \Omega$

	$\leq 3\text{MHz}$	$\leq 10\text{MHz}$	$\leq 3\text{MHz}$	$\leq 100\text{MHz}$
Insertion Loss (dB)	<0.4	<0.5	<0.7	<1.0
Crosstalk (dB)	<-115	<-105	<-95	<-85
VSWR	<1.14	<1.14	<1.35	<1.50

Switched-Shield Coaxial Matrix (HP34506)

This 4x8 full crossbar matrix offers highly flexible switching for 50 Ω systems. You can use the matrix to simultaneously connect any of four channels to any of eight channels. Similar to the coaxial multiplexer module, the coaxial matrix switches both center conductors and shields. Intended for 50 Ω systems.

Switched-Shield Coaxial Matrix

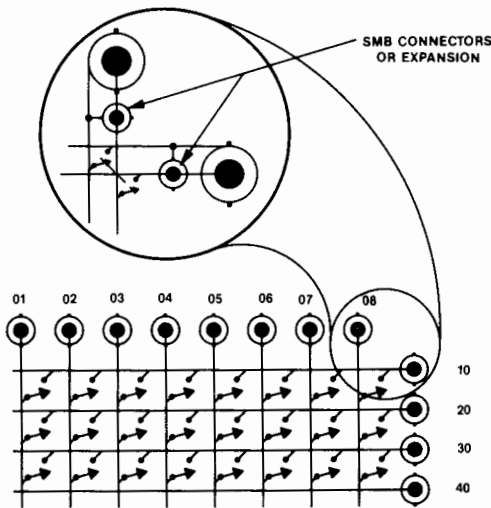

Maximum Voltage: Any center or shield to any other center, shield, guard or chassis: 42V DC+AC Peak. Guard to Chassis: 42V DC+AC Peak.

Maximum Current per row or column: 1A DC or AC RMS

Maximum Power per crosspoint: 24W or 24VA (resistive)

AC Performance for $Z_L = Z_S = 50 \Omega$

	$\leq 1\text{MHz}$	$\leq 3\text{MHz}$	$\leq 10\text{MHz}$	$\leq 30\text{MHz}$
Insertion Loss (dB)	<0.4	<0.5	<0.7	<1.0
Crosstalk (dB)	<-100	<-90	<-75	<-55
VSWR	<1.2	<1.2	<1.2	<1.6

32-Bit Digital Input/Output Module (HP 34522)

Digital sensing and control of your device under test or custom test tools is accommodated with the digital I/O module. Each module provides:

- 32 bi-directional TTL-compatible data lines. The data lines are grouped as four 8-bit ports each with their own handshake lines. The four ports can be configured to handle 8-, 16-, or 32-bit parallel data.
- 8 edge-triggered interrupt lines
- 16 high-power FET outputs furnish switchable high-power current sinks (40V, 500 mA) for actuating external devices
- Read or write rates >40KHz

Breadboard Module (HP 34523)

The breadboard module furnishes a convenient way to incorporate special purpose circuits into your test system. This module lets you interface directly the HP 3235A's backplane control signals and backplane analog and trigger buses.

6½ Digit Multimeter Module (HP 34520)

With the DMM module, you can integrate a high performance system multimeter into your test system without extensive cabling and software programming. The DMM module offers seven functions:

- DC volts with five ranges from 0.03V to 250V and reading rates >1450 rdgs./sec in the 3½ digit mode.
- AC Volts with 1MHz AC Bandwidth
- Two and four-wire resistance measurements
- DC current up to 1.5A, with reading rates as fast as DC Volts and ohms
- AC Current up to 100kHz and 1A.
- Frequency and period from 10 Hz to 1.5MHz with 6½ digit resolution.

The DMM module combines superb analog measurement capability with powerful system flexibility. Measurement inputs can be switched directly from the front of the module or, with the exception of current inputs, from any of the four internal HP 3235 analog buses.

DC Voltage (90 day, $T_{cal} \pm 5^\circ\text{C}$)

Range	Best 6½ Digit Accuracy ¹ ± (% of reading + volts)	Input Resistance
30mV	.0053% + 5.40 μV	>10 G Ω
300mV	.0038% + 5.7 μV	>10G Ω
3.0V	.003% + 8 μV	>10G Ω
30V	.0048% + 220 μV	10 M $\Omega \pm 1\%$
250V	.0063% + 700 μV	10 M $\Omega \pm 1\%$

DC Current (90 day, $T_{cal} \pm 5^\circ\text{C}$)

Range	Best 6½ Digit Accuracy ¹ ± (% of reading + amps)	Max. Burden Voltage at Fullscale
300 μA	.025% + 15.4 nA	0.35 V
3mA	.025% + 15.4 nA	0.35 V
30mA	.025% + 1.54 μA	0.35 V
300mA	.088% + 25.4 μA	0.6 V
1.5A	.088% + 654 μA	1 V

Resistance (2 and 4-wire ohms)² (90 day, $T_{cal} \pm 5^\circ\text{C}$)

Range	Best 6½ Digit Accuracy ¹ ± (% of reading + ohms)	Current Output
30 Ω	.0078% + 5.4m Ω	1mA
300 Ω	.0058% + 5.7m Ω	1mA
3k Ω	.0048% + 9m Ω	1mA
30k Ω	.0048% + 90m Ω	100 μA
300k Ω	.006% + 1 Ω	10 μA
3M Ω	.008% + 15 Ω	1 μA
30M Ω	.032% + 830 Ω	100 nA
300M Ω ³	2.5% + 100k Ω	100 nA
3G Ω ³	25% + 1M Ω	100 nA

1. After one hour warm up, integration time 100 PLC. T_{cal} is the temperature of the calibration environment between 18 and 28°C.

2. For two-wire ohms, add 200M Ω to count error specifications.

3. For two-wire ohms only accuracy is specified following auto-cal (ACAL), under stable conditions ($\pm 1^\circ\text{C}$).

AC Voltage (RMS AC and RMS AC+DC)

ACV Bandwidth: 20 Hz to 1 MHz

Crest Factor: 3.5 to 1 at fullscale

Common Mode Rejection with 1 k Ω imbalance in the low lead, DC to 60 Hz. Guarded: >86dB; non-guarded >66dB.

AC Volts (90 day, $T_{cal} \pm 5^\circ\text{C}$)

Range	(100Hz to 20kHz) Best 5½ Digit Accuracy ¹ ± (% of reading + % of range)		Input Impedance
	AC Coupled	DC Coupled	
30mV	.15% + .0441%	.19% + .169%	1M $\Omega \pm 1\%$ shunted by <90pF
300mV	.15% + .0441%	.19% + .169%	
3.0V	.15% + .0441%	.19% + .169%	
30V	.15% + .0441%	.19% + .169%	
300V	.21% + .053%	.25% + .203%	

1. Accuracy specified for sine wave inputs, >10% of range. DC component <10% of AC component after one hour warm up and within one week of autocal. AC band set to <400 Hz.



AC Current (RMS AC and RMS AC+DC)

ACI Bandwidth: 20 Hz to 100 kHz

Crest Factor: 3.5 to 1 at fullscale

AC Current (90 day, Tcal $\pm 5^\circ\text{C}$)

(100 Hz to 20 kHz) Best 5½ Digit Accuracy ¹ \pm (% of reading + % of range)		
Range	AC Coupled	DC Coupled
30mA	.293% + .101%	.35% + .57%
300mA	.293% + .101%	.35% + .57%
1A	.393% + .3%	.45% + 1.71%

1. Accuracy specified for sine wave inputs, >10% of range. DC component 10% of AC component after one hour warm up and within one week of autocal. AC Band set to <400 Hz.

Frequency and Period: Measures the frequency or period of the AC component of the AC or DC coupled voltage or current input. The counter uses a reciprocal counting technique to give constant resolution independent of input frequency.

Frequency Range: 10 Hz to 1.5 MHz (voltage input)
10 Hz to 100 kHz (current input)

Period Range: .1 s to 667 ns (voltage input)
.1 s to 3.33 μs (current input)

Sensitivity: 10 mV RMS or 100 μA RMS (sinewave)

Triggering: Triggers and counts on zero crossings.

Accuracy: (1 year)

Frequency	Period	\pm % of Reading
10 Hz to 400 Hz	.1 s to 0.25 s	0.05
400 Hz to 1.5 MHz	.025 s to 667 ns	0.01

Measurement Characteristics

	Number of Power Line Cycles (NPLC)					
	100	10	1	.1	.005	.0005
Maximum No. of Useful Digits	6½	6½	6½	5½	4½	3½
Resolution (No. of Bits)	22	22	22	19	15	12
Resolution (PPM)	.33	.33	.33	3.3	33	330
DCV, DCI, Ω Maximum Reading Rate						
60 Hz	.49	4.9	56	360	1250	1450
50 Hz	.4	4	47	312	1250	1450

Environmental:

Operating Temperature: 0-55 C (32-130 F)

Storage Temperature: -40 -75 C (-40 -165F)

Humidity Range: 95% R.H., 0 to 40 C

Power:

Line Voltage: 90-132V (115V) or 192-264 (230V) switch selectable
47-66 Hz. Fused at 5A (115V) or 2.5A (230V).

Size:

HP 3235 Cardcage: 310mm H (without feet) x 426mm W x 594 mm o (12.25"x16.75"x23.4")

Height with Feet: 325mm (12.8")

Depth with Terminal Blocks: 693mm (27.3")

Weight

HP 3235 Cardcage (max.) 21 kg (46 lbs)

Each Module (max.) 5.5 kg (12 lbs)

Shipping

28 kg (61 lbs)

6.6 kg (14.5 lbs)

Ordering Information

HP 3235A Switch/Test Unit \$4400

Opt 560 Add System Expansion Card \$350

Opt 570 3-Meter Cable \$150

Opt 590 Add Quick Interconnect \$750

Opt 908 Rack Mount Kit (HP P/N 03235-80908) \$95

HP 3235E Switch/Test Unit Extender \$3700

HP 34550A Control Panel \$550

HP 34551A Control Panel Rack Mount Kit \$50

HP 34560A System Expansion Card \$600

Plug-in Accessories are supplied with your choice of terminal blocks. Specify an "A" suffix if you want to permanently solder your wiring into place. Specify a "B" suffix if you want a quick, non-soldered connection for your system wiring. Specify a "C" suffix to delete the terminal blocks.

32 Channel Relay Multiplexer Module

HP 34501A (solder-eye lugs) \$1200

HP 34501B (screw-terminals) \$1350

32 Channel Reed Relay Multiplexer Module

HP 34502A (solder-eye lugs) \$1200

HP 34502B (screw terminals) \$1350

General Purpose Relay Module

HP 34503A (solder-eye lugs) \$800

HP 34503B (screw-terminals) \$950

Switched-Shield Coaxial Multiplexer Module

HP 34504A (cable-terminated BNCs) \$1500

HP 34504B (bulkhead BNCs) \$1650

HP 34504C (no terminal block) \$1300

RF Multiplexer Module

HP 34505A (cable-terminated BNCs) \$1300

HP 34505B (bulkhead BNCs) \$1450

HP 34505C (no terminal block) \$1100

Switched-Shield Coaxial Matrix Module

HP 34506A (cable-terminated BNCs) \$1700

HP 34506B (bulkhead BNCs) \$1850

HP 34506C (no terminal block) \$1500

32 Channel Mercury-Wetted Reed Relay Module

HP 34507A (solder-eye lugs) \$1400

HP 34507B (screw-terminals) \$1550

6½ Digit Multimeter Module

HP 34520A (solder-eye lugs) \$2550

HP 34520B (screw-terminals) \$2600

32 Bit Digital Input/Output Module

HP 34522A (solder-eye lugs) \$1100

HP 34522B (screw-terminals) \$1250

Breadboard Module

HP 34523A (solder-eye lugs) \$350

HP 34523B (screw-terminals) \$500

Low Frequency Feedthrough Panel

HP 34594A (solder-eye lugs) \$300

HP 34594B (screw-terminals) \$450

BNC Feedthrough Panel

HP 34593A (cable-terminated BNCs) \$325

HP 34593B (bulkhead BNCs) \$475

HP 34593C (no terminal block) \$125

HP 34581A Coaxial Matrix Cabling Kit \$125

HP 34582A Coaxial Matrix Cabling Kit \$200

HP 34585A 50-Ohm Resistive Termination Kit \$80

HP 34591A Quick Interconnect Fixture \$95

HP 34501D Diagnostic Fixture for the HP 34501, 34502, 34507 Multiplexer Modules \$250

HP 34503D General Purpose Relay Diagnostic Fixture \$250

HP 34504D Coaxial Multiplexer Diagnostic Fixture \$400

HP 34505D RF Multiplexer Diagnostic Fixture \$400

HP 34506D Coaxial Matrix Diagnostic Fixture \$400

HP 34522D Digital I/O Diagnostic Fixture \$250

COMPUTER AIDED TEST

Low Cost, Versatile HP-IB Switching & Control

Model 3488A

- DC—300 MHz signal switching
- Matrix, multiplexer, & general purpose relays
- Digital I/O control & actuation
- Up to 50 channels
- 40 configuration storage registers
- 6 switch & control modules

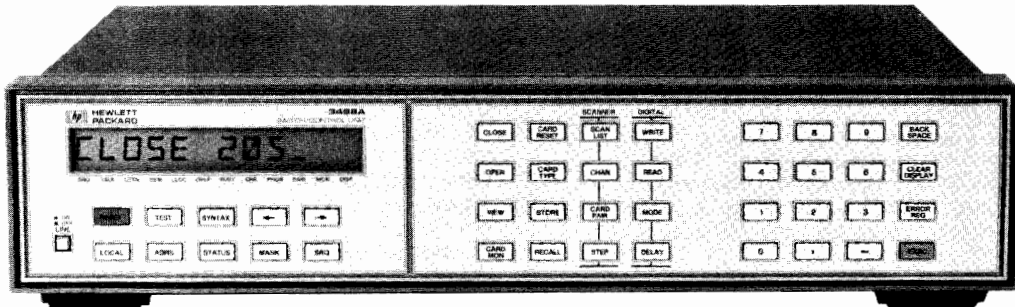

HP 3488A



Description

The HP 3488A Switch/Control Unit brings versatile, HP-IB programmable switching to tests requiring multi-channel measurements. The HP 3488A provides signal switching with the integrity and isolation needed for high performance test systems in production. It also offers a flexible, low cost interconnection solution for automating experiments on the bench and for development testing in the lab. The HP 3488A is designed to hold any combination of up to 5 of the following optional switch and control modules:

- 10 Channel Relay Multiplexer
- 10 Channel General Purpose Relay
- Dual 4 Channel VHF Switch
- 4 x 4 Matrix Switch
- 16 Bit Digital Input/Output
- Breadboard

Flexible Switching

The HP 3488A offers an economical approach to switching flexibility through plug-in modules. The user can select the right combination of switching functions to meet both performance and budget requirements. Testing is simplified by having one solution for connections of low level DVM inputs, high level dc and ac power, and VHF signals to 300 MHz. Additional devices such as microwave relays and programmable attenuators are easily controlled with digital I/O functions. Custom circuitry can also be implemented on breadboard modules.

Versatile Performance

The HP 3488A can store up to 40 complete switch configurations for convenient recall in automated test programs. Switch operation can be with multiple relay closures or with selectable channels in a break-before-make mode. Break-before-make closures and recallable complete switch configurations can be combined in a programmable scan list. The HP 3488A uses removable screw terminal connectors that provide easily interchangeable wiring configurations for each test. Built-in self-test capability assures proper operation.

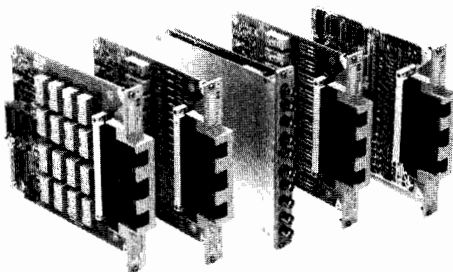

Multiplexer (Opt. 010/HP 44470A)

Option 010 is a 10 channel multiplexer for scanning or multiple signal connections. Channels switch 2 wires (Hi & Lo) with 2PST relays for DVM inputs and other signals up to 250 V and 2A. This module can also be used to multiplex signals to other switching functions such as the matrix module.

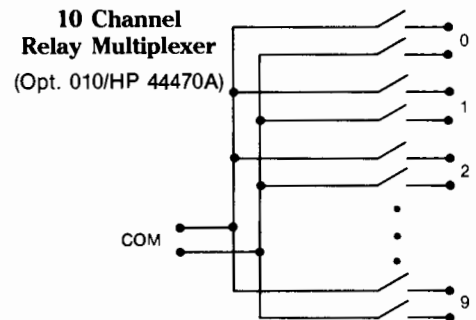

General Purpose Relay (Opt. 011/HP 44471A)

This module consists of 10 SPST independent relays for general signal switching and control of external devices. The quality connections provided make this module ideal for switching signals when multiplexing isn't required or for supplying switchable power to the device under test.

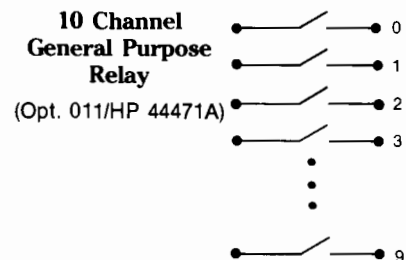

Matrix Switch (Opt. 013/HP 44473A)

Option 013 offers highly flexible switching with a 4 x 4, 2 wire matrix. Any combination of 4 input channels may be connected to any combination of 4 output channels. Each cross point or node in the matrix uses a 2PST relay to switch 2 lines (Hi & Lo) at a time. Multiple 4 x 4 modules can be connected to form larger matrices. Multiplexers can be used in conjunction with this module to effectively expand the number of inputs and outputs of the matrix.

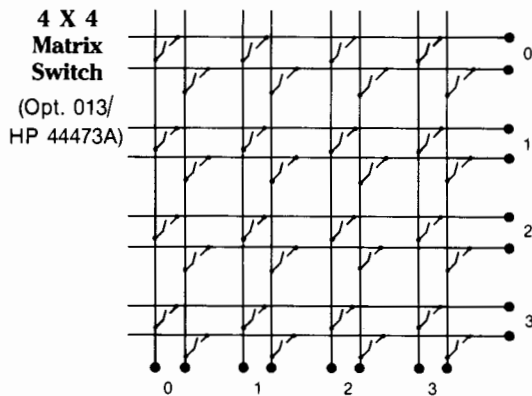

VHF Switch (Opt. 012/HP 44472A)

The VHF module provides broadband switching capability for high frequency and pulse signals. The 2 independent groups of bidirectional 1 x 4 switches can be used for signals from dc to 300 MHz. All channels have 50 ohm characteristic impedance and are break-before-make within a group of 4 channels. Each group is isolated from the other and from ground to prevent ground loops. Excellent isolation makes this module ideal for high frequency signal analyzer measurements requiring a large dynamic range.

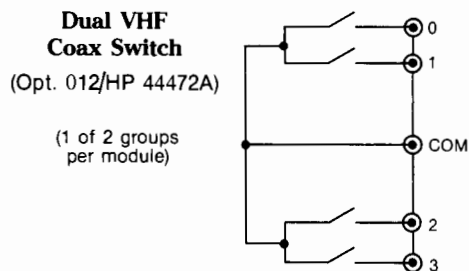

Digital I/O (Opt. 014/HP 44474A)

This module offers 16 very flexible bidirectional I/O lines and 4 TTL compatible handshake lines for sensing and control of external devices. The digital inputs can be used to sense contact closures to ground. Each channel provides current sinks for remote switching of external relays such as the HP 33311 series of coaxial switches.

Breadboard (Opt. 015/HP 44475A)

The breadboard module provides a convenient way to implement custom circuits and special functions that interface directly with the HP 3488A's backplane control signals.

Specifications for Opt. 010/HP 44470A Multiplexer, Opt. 011/HP 44471A General Purpose Relay, and Opt. 013/HP 44473A Matrix Switch Modules

Input Characteristics

Maximum voltage (terminal-terminal or terminal-chassis): 250 V dc, 250 Vac rms, 350 Vac peak

Maximum current: 2A dc, 2A ac rms

Maximum power: 60 W dc, 500 VA ac

Thermal offset: < 3 μ V

DC Isolation (40°C, 60% RH)

Channel-channel, open channel: > 10¹¹ Ω

AC Isolation/Performance

(50 Ω termination)	100 kHz	1 MHz	10 MHz
Insertion Loss (dB)	<0.30	<0.35	<0.90
Crosstalk (dB)	<-73	<-53	<-33

Specifications For Opt. 012/HP 44472A VHF Switch Module

Input Characteristics

Maximum Voltage

Center-center, center-low: 250 Vdc, 30 Vac rms, 42 Vac Peak
Low-chassis, low-low: 42 V dc

Maximum current (per channel): 30 mA dc, 300 mA ac rms

Thermal offset: < 15 μ V per channel

Characteristic impedance: 50 Ω

AC Isolation/Performance

	30 MHz	100 MHz	300 MHz
Crosstalk (dB)			
Chan-Chan	<-100	<-85	<-65
Group-Group	<-85		<-50
Insertion Loss (dB)	<0.5	<0.75	<1.25
VSWR	<1.06	<1.12	<1.43

All channels break-before-make within a group of 4 channels.

Specifications for Opt. 014/HP 44474A Digital I/O Module

I/O Lines

Maximum voltage = +30 Vdc (line-chassis)

Output characteristics: V (high) \geq 2.4 V; V (low) \leq 0.4V

I (low) maximum = 125 mA @ V (low) \leq 1.25 V; fused at 250 mA.

Input characteristics: V (high) \geq 2 V; V (low) \leq 0.8 V

External increment: advances HP 3488A to next programmed configuration on falling edge of TTL pulse.

Channel closed: indicates completion of new configuration; TTL pulse.

General Specifications

Environmental

Temperature: 0 to 55°C; humidity: 95%, 0 to 40°C

Power: 86-132 V/195-250 V, switch selectable; 48 - 440 Hz; 18 VA.

Interface: SH1AH1T6TE0L4LE0SR1RL1PP0DC1DT1E2

Size: 89 mm H (without feet) x 425 mm W x 292 mm D (3.5" x 16.75" x 11.5"). Allow 76 mm (3") additional depth for wiring.

Weight: net: 8.5 kg (18.5 lb). Shipping: 16 kg (36.5 lb).

Connectors (all modules except option 012/HP 44472A VHF switch): Removable screw terminal connector. Each terminal accepts 18-26 gauge (16-40 mils) wire, with strain relief for wiring. Option 012/HP 44472A VHF Switch: BNC connectors.

Ordering and Configuration Information

Switch Modules-Includes Terminal Connectors Price

Opt. 010/HP 44470A: 10 Channel Relay Multiplexer Module \$400

Opt. 011/HP 44471A: 10 Channel General Purpose Relay Module \$400

Opt. 012/HP 44472A: Dual 4 Channel VHF Switch Module \$600

Opt. 013/HP 44473A: 4x4 Matrix Switch Module \$500

Opt. 014/HP 44474A: 16 Bit Digital Input/Output Module \$400

Opt. 015/HP 44475A: Breadboard Module \$170

Rack Mounting and Manuals

Opt. 401: Side Handle Kit (HP P/N 5061-1171) \$20

Opt. 907: Front Handle Kit (HP P/N 5061-1170) \$50

Opt. 908: Rack Flange Kit (HP P/N 5061-1168) \$30

Opt. 909: Rack Flange with Handles (HP P/N 5061-1169) \$72

Opt. 910: Extra Operating & Service Manuals \$75

HP 3488A Switch/Control Unit \$1,400



COMPUTER AIDED TEST

Multiprogrammer: Versatile Basic Building Block for System Integration.

Models 6940B, 6942A, and 6944A

- Isolated power supplies for analog functions
- Mainframe extenders for increased I/O capacity
- Broad range of I/O instrumentation cards

- Easy-to-use, menu-driven software
- Large range of user/application documentation

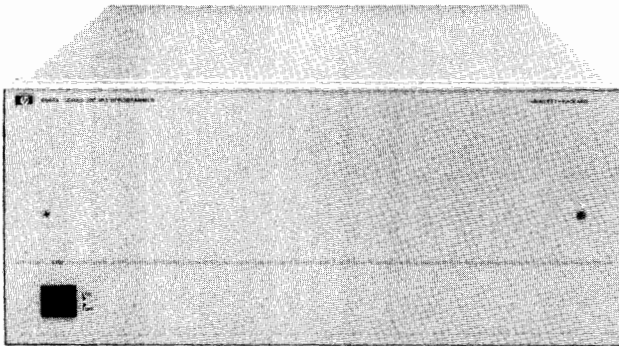

HP 6944A

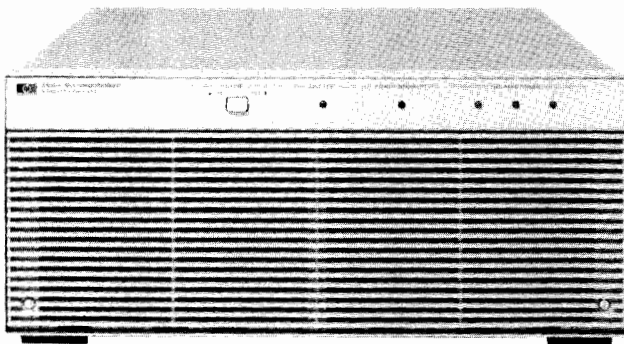

HP 6942A

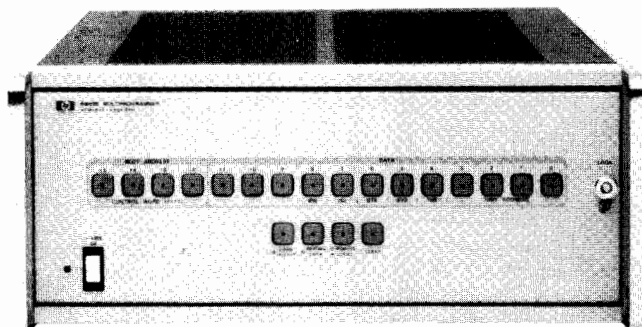

HP 6940B

Introduction

Hewlett-Packard Multiprogrammer products provide solutions for a variety of data acquisition, control and test applications. The application flexibility is due to the architectural features of these products. The plug-in Multiprogrammer I/O cards allow card-to-card communication, isolated inputs and external triggering and provide a wide range of functions. The HP 6940B coupled with the Multiprogrammer Series I I/O cards offers low-cost solutions when operated on the GP-IO Bus. The HP 6942A Multiprogrammer and the Series II I/O cards are a medium-performance, medium-speed, HP-IB solution. For applications requiring a higher level of performance and more speed, the HP 6944A Series 200 Multiprogrammer should be considered for use with the Series II I/O cards.

The I/O cards have many benefits. Multiple-card configurations can be established that provide instrument-like functions. For example: high-speed scanning and multiple simultaneous-buffered analog-to-digital converters. Other features provide precise crystal-controlled timing or pacing of I/O operations. This allows the modular construction of instrumentation functions such as frequency measurement, time interval measurement and programmable pulse generation. The card-to-card communication feature allows the I/O operation of the Multiprogrammer to operate independently of the computer. The computer is then free to perform other tasks until it receives an interrupt from the Multiprogrammer. If the application requires the process to control data collection, it can be accomplished via the external trigger feature. This feature allows the process to time or pace operations independently of the computer. In addition, I/O data can be stored in the Multiprogrammer's plug-in memory system, allowing high-speed operation of other tasks the computer must perform.

HP 6944A Features

- Data transfer rate of 180,000 readings/second
- Dedicated interface (HP 98633A) to HP Series 200 computers
- Direct to disc at 180K words/second
- HP 14752A CAT programming package
- HP Multiprogrammer Series II I/O cards

HP 6942A Features

- Data transfer rate 18,000 readings/second
- HP-IB interface
- HP 14752A CAT programming package
- HP Multiprogrammer Series II I/O cards

HP 6940B Features

- Front panel control
- GP-IO or optional HP-IB interfacing
- Data transfer rate 20,000 readings/second
- HP multiprogrammer Series I I/O cards
- Temperature measurement capability

The Power of the Multiprogrammers

HP Multiprogrammers are used mostly for automatic testing applications for many industries including manufacturers of communications products, circuit boards, aircraft instrumentation, electronic ignitions, dashboard electronics and missile guidance systems. Whether it's high speed data gathering that's needed or the ability to perform parallel tasks while the data is being captured, an HP Multiprogrammer can provide the solution.

Testing Final Assemblies and Subassemblies

HP Multiprogrammers let you configure a flexible, reliable and powerful automatic test and control system for the production environment. HP Multiprogrammers test the final product as well as subassemblies at different stages of the manufacturing process.

The increasing level of sophisticated electronic devices and circuits found in today's automobiles challenges the auto manufacturer to explore equally sophisticated test techniques. High-speed measurements and analyses of multiple channels are key requirements in order to keep the constantly moving assembly lines supplied with high-quality components. Multiprogrammer A/Ds and scanning systems provide this high-speed measurement and multiple channel capability. Output functions, such as the Voltage and Current D/A cards and relay cards in matrix configurations, are used to stimulate electronic subassemblies.

Measure Vibration in Machinery

In vibration analysis applications, the ability to capture waveforms in a wide frequency range, analyze the data and present it using a single system is an important requirement. The 500,000 samples/second digitizing capability of the Multiprogrammer and its local memory cards allow a large range of frequencies to be acquired.

For applications such as oil exploration and electrical power generation where large rotating machinery is used, vibration analysis is critical in ensuring trouble-free operation. Multiprogrammers can capture data and store it in memory while the computer analyzes previously captured data. This results in an uninterrupted stream of information being presented to the tester. In addition, the Multiprogrammers can be set to be event-triggered so that an event-related condition starts the data gathering process without operator intervention.

Product Development and Evaluation

Multiprogrammers are used for developing state-of-the-art products for many aerospace and defense applications. These types of industries require powerful and flexible test systems because of their constant stream of new projects with unique requirements. When testing newly developed prototypes, large quantities of data are usually required in order to fully characterize the behavior of a unit when subjected to differing stimuli. The HP 6944A Multiprogrammer captures data and continuously stores it to an external hard disc at rates up to 200,000 samples/second.

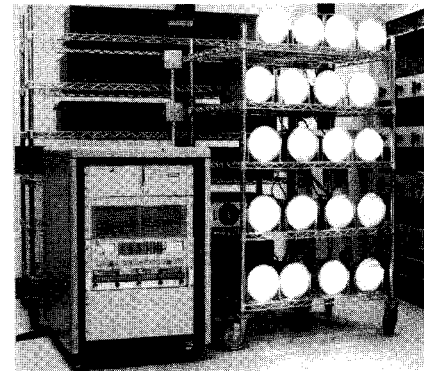
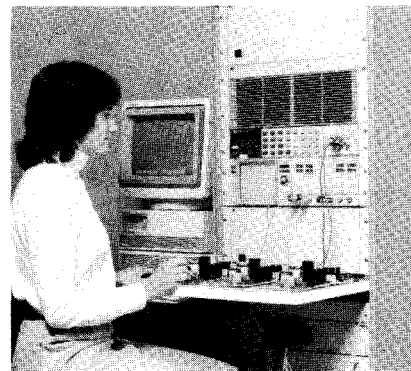
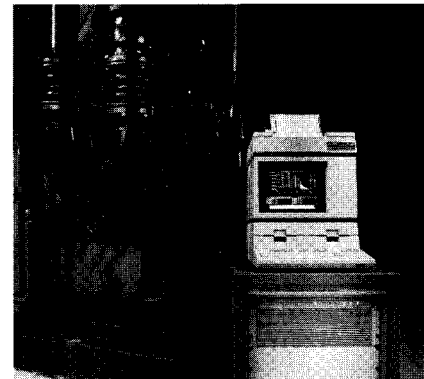
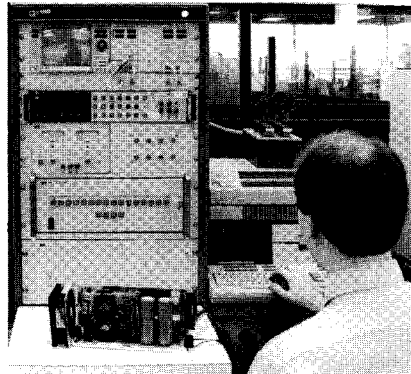
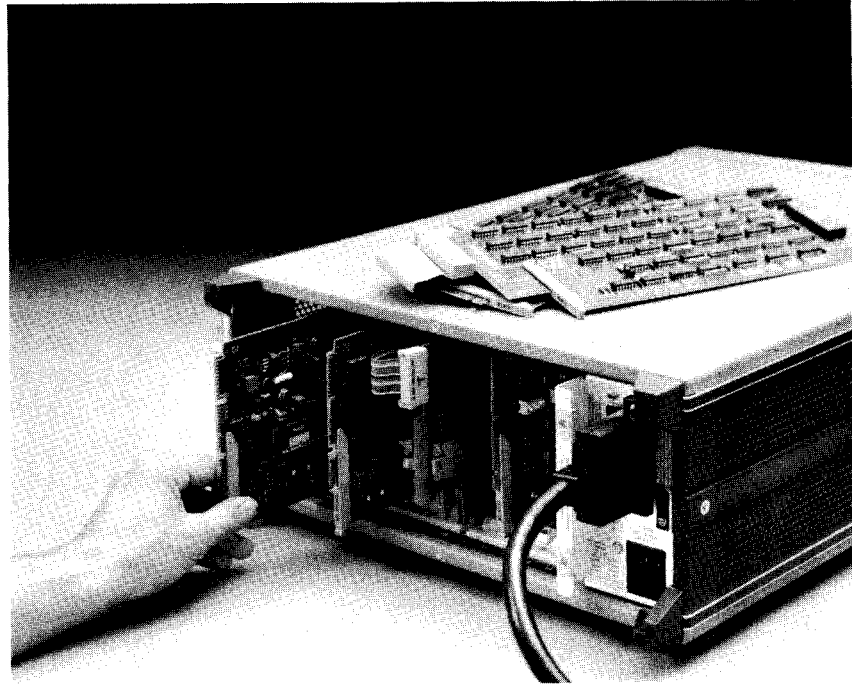

Failure analysis is another important product development process in military applications. A Multiprogrammer system can collect large quantities of data without the presence of an operator. If a failure does occur, the Multiprogrammer can stop the test and signal the operator.

Component Evaluation

There is an increasing push for automation in the production environment to improve efficiency at all stages of the manufacturing process. For example, quality-conscious

manufacturers recognize the importance of thorough incoming component inspection that doesn't sacrifice smooth production flow.

Multiprogrammers satisfy these needs because of their speed and flexibility. Testing can be centrally controlled by a single operator or by several testers by linking a multiple-user computer system, such as the HP 1000 series, to HP 6942A Multiprogrammers. As a result, the manufacturing flow is uninterrupted and enhanced which leads to reduced manufacturing costs.



COMPUTER AIDED TEST

Multiprogrammer: Versatile Building Block Approach to Systems

Model 6944A

- Data transfer rate 180,000 readings/second
- Dedicated interface (HP 98633A) to HP Series 200 Computers

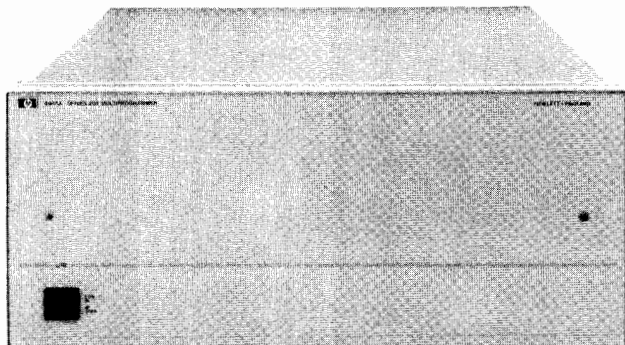

HP 6944A

Description

The HP 6944A Series 200 Multiprogrammer is a high-speed data acquisition and control system designed exclusively for use with HP Series 200/300 computers. The HP 6944A capitalizes on the HP Series 200/300 computer architecture by using the dedicated HP 98633A Multiprogrammer Interface and the HP 98620B DMA Controller to achieve high-speed data transfers.

The powerful HP Multiprogrammer Series II I/O cards provide a broad variety of I/O functions for the HP 6944A. These cards allow the user to configure the HP 6944A to implement many instrumentation functions such as high-speed scanning, analog waveform synthesis, limit checking and transient analysis.

The HP 6944A is programmed exclusively with the HP 14752A Computer Aided Test Programming Package. This software package effectively couples the flexible hardware architecture of the HP 6944A with the BASIC language system of the HP Series 200/300 Computers. The friendliness of this system is such that the system programmer only needs to be able to program in BASIC. The control statements are test oriented and closely linked to the application by a list of "Names" supplied by the user. An easy-to-use, menu-driven configuration process correlates the user-assigned "Names" to the system's I/O functions automatically from the BASIC program. The software, through the same menu-driven process, then leads the system programmer through the hardware configuration. The net result is fast program development, self documenting, and the ability to maintain different configuration files on one disc.

Features

The primary features of the HP 6944A evolve around the architecture of the HP 6944A, HP Series 200/300 Computers, and the Multiprogrammer Series II I/O cards.

The key feature of the HP 6944A is high-speed data transfer. With the HP 6944A, HP 69759A 500 kHz A/D, HP 69791A/92A High-Speed Memory I/O System, and the HP 98620B DMA Controller Card, data may be transferred to an HP Series 200/300 Computer at rates of 180,000 readings/second. Without the HP 98620B DMA Controller Card, transfer rates of nine kilowords/second are achieved.

A second key feature of the HP 6944A is its ability to unburden the HP Series 200/300 Computer from controlling each I/O task of the HP 6944A. This allows the HP Series 200/300 Computer time to perform numerical analysis or manage other instruments during these time periods.

- Direct-to-disc transfer rate of 180,000 words/second
- HP 14752A CAT programming package
- HP Multiprogrammer Series II I/O cards

HP 6944A Specifications

Plug in I/O card positions: Maximum of 15 plug-in output or input cards per mainframe. Removable rear cover provides access to card slots.

Computer interface: The HP 6944A is connected to an HP Series 200 Computer via the HP 98633A Multiprogrammer Interface Card and HP 14704A, B or C cable.

Extender units: Up to eight HP 6944A Series 200 Multiprogrammers can be "linked" to the Series 200 via one HP 98633A Multiprogrammer Interface Card by using HP 14704A, B or C Interface Cables.

Maximum length of a link: A link of up to eight HP 6944A Series 200 Multiprogrammers can be nine metres long, maximum. This maximum length is the sum of the lengths of all the HP 14704A, B or C Interface Cables in the link.

Power supplies: All necessary power supplies for up to 16 I/O cards are built into each HP 6944A frame. Three ± 18 V supplies are isolated from each other and from ground, and are available for powering isolated I/O card circuits.

Cooling: Built-in forced air cooling draws air in through the side vents and exhausts air through the rear cover.

Operating temperature range: 0 degrees C to +55 degrees C.

Power: 100/120/220/240 Vac (switch, selectable), +5% to -10%, 47 to 63 Hz, 650 VA.

Dimensions: 177.0 mm high x 425.5 mm wide x 597.0 mm deep (7.0 in high x 16.25 in wide x 23.5 in deep).

Weight (without I/O cards): Net, 21 kg (46 lb); shipping, 28.6 kg (63 lb).

Ordering Information

Price

Step 1: Select the necessary quantity of HP 6944As.

HP 6944A Series 200 Multiprogrammer \$3700

Option 908: rack mount kit

Option 910: extra operating and service manual

Option W03: converts 1 yr return-to-HP warranty to a 90-day on-site warranty

Step 2: Select the HP Series 200 Multiprogrammer Interface Card for HP 6944A.

HP 98633A Multiprogrammer Interface Card \$350

Step 3: Select number and lengths of cables required for connecting HP 98633A Interface to first frame.

An additional cable is needed for each HP 6944A frame used as an extender.

HP 14704A Multiprogrammer Interface Cable, 1 m (3.3 ft) \$100

HP 14704B Multiprogrammer Interface Cable, 2 m (6.6 ft) \$110

HP 14704C Multiprogrammer Interface Cable, 4 m (13.2 ft) \$130

Step 4: Select HP 14752A to receive necessary CAT software and documentation (mandatory).

Select the option appropriate for the system controller.

HP 14752A Computer Aided Test Programming Package \$2000

Option 044: software provided on 3 1/2" flexible discs N/C

Option 042: software provided on 5 1/4" flexible discs N/C

Option 910: extra set of documentation \$75

HP 14752R: right to reproduce HP 14752A CAT programming package (documentation provided) \$1000



- Action-oriented instructions
- Isolated analog inputs and outputs
- Built-in self test

- Overlapped input and output
- Internal or external pacing
- Easy to configure

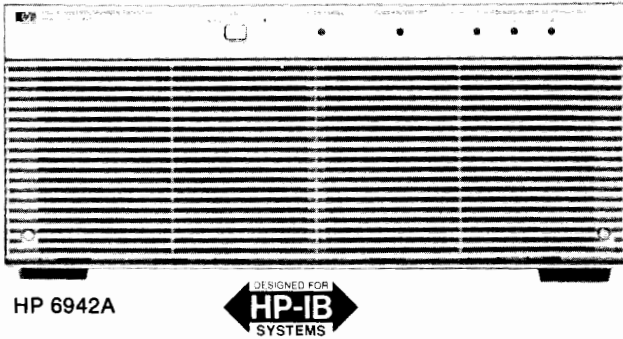

The Multiprogrammer Performs Operations in Parallel

With this one instrument you can control several processes at once. And, while you are controlling the processes, the Multiprogrammer can also be watching for interrupt conditions. The internal microprocessor manages all the parallel operations and monitors the alarm lines; when the operations have completed or if an alarm condition occurs, the Multiprogrammer interrupts the controller.

How does the HP 6942A Connect With Your Controller?

The HP 6942A Multiprogrammer interfaces with your controller (desktop or minicomputer) using the HP-IB, Hewlett-Packard's implementation of IEEE Standard 488 and the identical ANSI Standard MC1.1. Data and status readback make use of the extended bus addressing features of the HP-IB.

Programming Flexibility

Mnemonic, action-oriented instructions make the HP 6942A Multiprogrammer simple to learn and use. For instance, the output instruction "OP" works with all output cards. When you send an instruction, the internal microprocessor checks which type of card you are addressing and automatically converts the data to the proper format for that card. You select the units with which you want to program each card. Whether you want to use volts, millivolts, amps, degrees, feet, or any other units, the Multiprogrammer does the converting for you.

Mainframe Memory Unburdens The Controller

The mainframe memory of the HP 6942A will accept up to 76 instructions from the controller at one time. This leaves your controller free for other processing activities while the Multiprogrammer works on the I/O operations. This mainframe memory may also be used to collect up to 1440 data readings and hold them until the controller is free to take them. (For even more data storage, up to 1 Meg words of data may be stored using the HP 69741A and HP 69792A Memory System Cards.

Real Time Clock

Built-in real-time clock gives you time-of-day readings and pacing of measurements. The clock detects which power line frequency you are using, 50 Hz, or 60 Hz, and automatically synchronizes itself to this frequency. The range of the clock is 65,534 days, with resolution to a tenth of a second.

Computers and Documentation

The HP 6942A can be operated with a wide variety of computers, including the HP Series 80, Series 200, Series 300, Series 1000, 9825, and 9845 computers. Documentation packages are available of these computers. Each one contains a User's Guide with programming examples, a utility program tape or flexible disc, operating and service manuals, and a binder to hold this material. One no-charge documentation option must be specified to select the documentation appropriate for your computer.

Accessories

HP 14700A extender kit: this kit contains the transmission boards which go into the master mainframe (HP 6942A) and the last extender mainframe in the chain.

HP 14701A intermediate extender kit: when more than two mainframes are in a chain, the card in this kit must be used in each intermediate extender mainframe.

HP 14702A chaining cable: this is the cable which chains together the master and extender mainframes. One cable is required for each extender mainframe. Length: 1.5 m (5 ft).

HP 14703A card edge connector: extra connectors for the I/O cards may be ordered in addition to the one supplied with each I/O card.

HP 6942A/6943A Specifications

Plug-in I/O card positions: maximum of 16 plug-in output or input cards per mainframe. Removable rear cover provides access to card slots.

Computer interface (HP 6942A only): the Multiprogrammer is connected to a controller via the Hewlett-Packard Interface Bus (HP-IB), Hewlett-Packard's implementation of IEEE Std. 488.

Real time clock (HP 6942A only): the built-in real time clock is automatically synchronized with the 50/60 Hz ac power line frequency. The clock is read and set with data in the form of days, hours, minutes and seconds with a resolution of 0.1 second.

Extender interface kits (HP 6943A only): each HP 6943A Extender requires one HP 14700A or 14701A Interface Kit and one HP 14702A Chaining Cable for operation with the HP 6942A.

Maximum number of mainframes per chain: up to seven HP 6943A Multiprogrammer Extenders may be placed in a chain with one HP 6942A Multiprogrammer.

Maximum chain length: a chain of mainframes can be up to 152 meters (500 feet) long. This maximum length is the sum of the lengths of all HP 14702A Chaining Cables used in one chain.

Power supplies: all power supplies for up to 16 I/O cards are built-in including three ± 18 V supplies isolated from each other and from the ground.

Cooling: built-in forced air cooling draws air in through the front panel and exhausts air through the ventilated rear cover.

Front panel indicators: five light emitting diodes on the front panel indicate power supply and self-test status.

Operating temperature range: 0°C to 55°C.

Power: 100/120/220/240 Vac (selectable), +5%, -10%, 47 to 63 Hz, 600 VA.

Dimensions: 177.0 mm high x 425.5 mm wide x 597.0 mm deep, (6.969 in. high x 16.250 in. wide x 23.500 in. deep).

Weight (without I/O cards): net, 20 kg (45 lb); shipping, 27 kg (60 lb).

Accessories furnished: PC board Extender Card (HP Part No. 5060-2792).

Ordering Information

	Price
Opt 010-386: One Set Documentation/Software	N/C
Opt 410-786: Extra Documentation/Software	\$101
Opt 908: Rack Flange Kit	\$40
Opt 910: Extra Manual	\$30
Opt W03: Converts 1 yr return-to-HP warranty to a 90-day on-site warranty	N/C
HP 14700A Extender Interface Kit	\$505
HP 14701A Extender Interface Kit	\$450
HP 14702A Chaining Cable	\$300
HP 14703A Spare Card Connector	\$40
HP 6942A Multiprogrammer	\$4400
HP 6943A Multiprogrammer Extender	\$3300



COMPUTER AIDED TEST

Multiprogrammer Series II I/O Cards

Models 69700A-69793A

Multiprogrammer Series II I/O Cards for the HP 6944A/S, 6942A/S and 6901S

For a complete description of the Multiprogrammer Series II I/O Cards, ask for publication 5952-4142.

	Functions	Applications	Cards Used
STIMULUS	<p>Programmable DC Voltage and Current</p>	The output voltage (up to 250V) and current (up to 1000A) of forty different HP power supplies can be programmed to provide bias in automatic test systems or control of electromechanical process equipment.	Resistance Output, HP 69700A-69706A; Power Supply Control, HP 69709A.
	<p>Digital-to-Analog Conversion</p>	Twelve-bit voltage DAC's provide outputs for strip chart, x-y, and analog tape recorders as well as control of analog programmable instruments and stimulus of units under test. Control process equipment with 4-20 mA output.	Voltage DAC, HP 69720A; Current DAC, HP 69721A.
	<p>Analog Waveform Synthesis</p>	The Memory card can continually supply pre-loaded data to the D/A card at rates of up to 100 kHz. Special waveforms may be loaded into the Memory card from the computer and used as stimuli for test and processes. The analog output is isolated from digital ground.	Memory card, HP 69790B; 69791A, 69792A Voltage DAC, HP 69720A; or Current DAC, HP 69721A.
MEASUREMENT	<p>Voltage, Current, and Resistance Measurements</p>	A/D converters may be used to measure voltages from $\pm 50\mu\text{V}$ to $\pm 100\text{V}$ in the presence of 250 V of common-mode noise. Connecting a resistor across the input permits current measurements for 4-20 mA current loops used in process control. Combine the A/D with the current DAC for resistance measurements.	High Speed ADC, HP 69751A, HP 69759A
	<p>Frequency Measurements</p>	The Pulse Counter card accumulates counts over a precise time interval when a Timer card is connected to the enable line of the Counter. The program divides the count by the time interval to measure frequencies from 1 MHz to less than 0.001 Hz.	Counter, HP 69775A; Timer HP 69736A.
	<p>Pulse Counting Preset Up/Down</p>	The Counter may be preset to any value within the count range of 0 to 65,535 and can cause an interrupt when it rolls over. The Counter may be enabled and disabled by pulses or levels. The computer may read the count without disturbing the counting process.	Counter, HP 69775A.
	<p>Offline Analog Acquisition</p>	Differential or single-ended signals may be digitized at rates up to 500 kHz by the A/D, and stored in the Memory system. Each Memory system can store up to one megawords. The digitizing process can take place independent of other Multiprogrammer activity.	High Speed ADC, 69751A; Memory cards, 69790B, 69791A/69792B.
	<p>Scanner Systems</p>	Analog measurements from up to 960 channels may be acquired at 25,000 readings per second depending upon the scanner system configuration. Random access to any channel, as well as continuous scanning, are easily accomplished. (See Application Note AN316-3.)	Cards used: Scan Control, HP 69750A; FET Scanners, 69752A or 69755A; Relay Scanner, HP 69754A; High Speed ADC HP 69751A; Memory card HP 69790B, or 69791A/92A
CONTROL	<p>Digital Output and Switching</p>	Sixteen-bits of data in TTL, open collector, or SPST relay-contact form provide digital control of instruments and indicators. AC power, up to 6, can be switched to 12 loads with a HP 69731B, and HP 14570A AC Power Controller.	Digital Output, HP 69731B; Relay Output, HP 69730A; AC Power Controller, HP 14570A.
	<p>Digital Input</p>	Digital input cards accept 16-bits of data from digital measuring instruments, push-buttons, switches, relays, and other digital devices in the form of logic levels or contact closures. Digital data sources with more than 16-bits of data use several digital input cards.	Digital Input, HP 69771A; Isolated Digital Input, HP 69770A.
	<p>Stepping Motor Control</p>	The Stepping Motor card can produce from 1 to 32767 pulses at either of two outputs (CW or CCW) to control motor translators. Output pulses are also used for pulse-train update of supervisory control stations. The pulse rate (motor speed) is also programmable.	Pulse Train/Stepping Motor, HP 69735A.
	<p>Time and Frequency Reference</p>	Crystal controlled timing pulses, programmable from 1 μs to 18 hours, may be used as a time-base reference for control, measurement, and data acquisition. Period, duty cycle, and number of pulses are all programmable.	Timer, HP 69736A or Pulse Train, HP 69735A.
ALARM	<p>Level Detecting</p>	When signals cross preset levels, the Digital Input card can trigger the interrupt card to interrupt the computer. The alarm trigger levels can be programmed with the D/A or fixed with resistors.	Digital Input HP 69771A; Interrupt card, HP 69776A.
	<p>Event Sensing</p>	A digital word may be used to trigger quick computer response with the interrupt card. The computer responds to the interrupt with a software routine. The interrupt may also cause immediate local response by triggering a preloaded output card.	Interrupt card, HP 69776A.

HP 69752A 64 Channel FET Scanner Card

Scans 64 single-ended channels (± 10.24 V input signal range) at up to 25,000 readings per second. Cards cascable to 960 channels in a single mainframe.

HP 69755A 16 Channel FET Scanner Card

Same as 69752A, except scans 16 channels.

HP 69754A 32 Channel Relay Scanner Card

Scans 32 single-ended (16 double-ended) channels with a ± 100 V input signal range at speeds up to 1000 readings per second (625 readings double-ended). Switches currents up to 50 mA.

HP 69750A Scan Control/Pacer Card

Provides all pacing and control functions for the scanner cards listed above. One required for each group of scanner cards (maximum of 15 cards—see data sheet for further clarification).

HP 69709A Power Supply Control Card

Used for full system control of 6024A and 6012A Autoranging Power Supplies.

HP 14728A Buffered A/D Cable

Used to connect 69751A and 69790B in a buffered A/D configuration.

HP 69700A-69706A Resistance output cards: the output of each of these cards is a programmable resistance value. Twelve mercury wetted relay contacts close across binary weighted precision resistors in a series string. The cards are designed to program the voltage or current output of an HP power supply with option 040.

HP 69720A D/A voltage converter card: provides a high speed, bipolar output voltage programmable from -10.240 V to $+10.235$ V up to 5 mA load current.

HP 69721A D/A current converter card: provides a bipolar -20.480 mA to $+20.475$ mA current output.

HP 69730A Relay output card: provides sixteen independent, normally open, mercury wetted relay contacts. Contacts rated at 100 Vdc; or 1 Amp; and 28 VA.

HP 69731B Digital output card: provides sixteen TTL or CMOS compatible outputs, or sixteen 100 mA open-collector switches.

HP 69735A Pulse train output/stepping motor control card: generates up to 32767 pulses at a programmable frequency.

HP 69736A Timer/pacer card: outputs a programmable pulse from one microsecond to eighteen hours or a programmable square wave.

HP 69751A A/D converter card: this card measures bipolar dc voltages in one of four ranges, ± 100 mV, ± 1 V, ± 10 V, or ± 100 V, with 12 bit resolution at up to 33,000 readings per second.

HP 69770A Isolated digital input card: breaks the path of potential ground loops with an optically coupled isolator in each of the sixteen digital input lines.

HP 69771A Digital input/analog comparator card: monitors up to sixteen contact closures, switches, TTL signals, CMOS signals, or analog signals. The switching threshold can be set to any value between ± 9.5 volts by a screwdriver-adjustable potentiometer on the card or may be externally programmed.

HP 69775A Counter/totalizer card: counts contact closures, TTL or CMOS logic level pulses, or analog waveform transitions in the range of 0 to 65,535.

HP 69776A Interrupt card: compares up to sixteen logic level or contact closure inputs with a sixteen-bit reference word and interrupts for =, \neq , <, > conditions.

HP 69790B Memory card (occupies 2 I/O slots): provides 4096 16-bit words for use with the DAC cards or the ADC cards or for other input/output tasks that need to run independent of other Multiprogrammer or computer tasks. Several Memory cards may be used to implement truly simultaneous operations.

HP 69793A Breadboard card: the generalized grid area on this card may be used for mounting custom circuits.

\$1,210

\$555

\$910

\$655

\$960

\$227

\$555-605

\$705

\$910

\$555

\$405

\$505

\$505

\$960

\$655

\$605

\$730

\$555

\$1,315

\$150

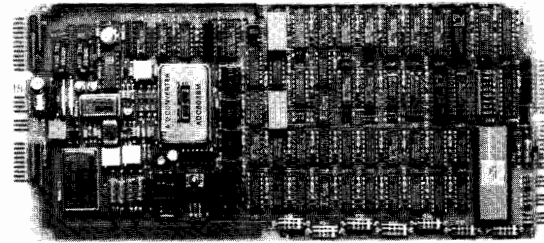

HP 69759A

HP 69759A - 500 kHz A/D

The HP 69759A 500 - kHz A/D converter measures bipolar voltages in four programmable ranges, ± 100 V, ± 10 V, ± 1 V, and ± 100 mV. The digitized values may be read directly by the controller or transferred into HP 69791A and HP 69792A memory buffer cards available for the Multiprogrammer system. Use of memory buffers permits simultaneous digitization of as many as 40 independent signal channels at rates up to 500 kHz per channel. Scanning subsystems designed specifically to work with the HP 69759A card provide additional measurement flexibility and permit expansion up to 7168 channels. Timebase and triggering functions may be added using other Multiprogrammer cards to form a complete analog measurement system that is precisely tailored to the requirements of the specific application.

Application Note 316-5, Data Capture, describes several ways that the HP 69759A can be used with other Multiprogrammer cards to solve several different applications. These descriptions include cable diagrams and program listings for both the HP 14752A and the HP 6942A native instructions.

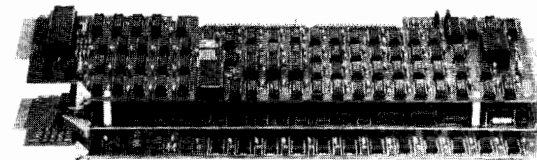

HP 69791A

HP 69791A/92 - Memory System

The HP 69791A and HP 69792A Memory Cards form a buffer used to perform input and output tasks without intervention from the controller. A memory card buffer can be used for inputs or outputs, or both. Data can be acquired at up to 760 kilowords/second or sent at up to 400 kilowords/second.

A memory card buffer has one HP 69791A Memory Card and up to five HP 69792A Memory Expansion Cards for a maximum memory size of 1M (1,048,576 16-bit words). The HP 69791A holds 64k (65,536 16-bit words) and the HP 69792A holds 192k (196,608 16-bit words). The memory card buffer functions as a single memory, regardless of how many HP 69792As are added.

The memory card subsystem can be used with the HP 69751A or HP 69759A A/D cards to input digitized analog measurements. Up to eight HP 69759A A/D Cards can be multiplexed into a single HP 69791A/69792A memory buffer. The A/Ds can be triggered by the same timebase for truly simultaneous readings which are then stored in sequential memory locations. This reduces memory costs and the number of mainframe slots required.

Ordering Information

HP 69759A A/D Converter
HP 69791A Memory Card
HP 69792A Memory Card

Price

\$2300
\$1500
\$1000

COMPUTER AIDED TEST

Multiprogrammer: Computer Aided Test System

Models 6942A/14752A and 6944A/14752A

- Easy to use menu entry
- Faster software development
- Improved HP 6942A performance

Description

The HP 6944A and the HP 6942A are easy to use computer-aided test systems that improve productivity by enabling you to implement your testing requirements more quickly. This is achieved through the use of a companion software package. The HP 14752A is a powerful CAT programming package which replaces the standard two-letter mnemonics of the HP 6942A Multiprogrammer and is the standard programming language for the HP 6944A Series 200 Multiprogrammers.

These systems are friendly and easy to use. Mnemonic-type language is not needed to program the HP 6944A. In addition, the HP 14752A will increase the performance speed of the HP 6942A. The CAT programming packages supports all of the Multiprogrammer Series II I/O cards.

CAT Programming Package

The CAT programming package is a comprehensive collection of software routines that provide the ATE system designer with a high-performance linkage between the BASIC language and Multiprogrammer hardware. Both friendliness and higher performance are combined in the software through an architecture which optimizes total system performance.

Friendliness is achieved by replacing traditional "computer language" statements with test-oriented commands. Communication with all supported instrumentation is via "functional names", chosen by the user, which have a close relationship with the function performed. For example, in the menu below, the name "value", is used to program a HP 69720A Voltage D/A Converter. This lets you program in terms that are familiar to you resulting in programs which are virtually self-documenting. Friendliness is further enhanced by convenient menu entries, which make it easy to enter all function names and parameters.

The CAT programming package reduces the amount of software written by the user thus speeding program development. Productivity is improved by shortening test development time. To create test software, the user enters functional names and other data into a series of menus. Then a program is written in HP-enhanced BASIC to handle all sequencing, computational, and decision-making operations. Whenever a stimulus, acquisition or control function is desired, the BASIC program is instructed to call a routine from the CAT programming package.

Features

Some of the CAT programming package features are highlighted in a menu below. The timeout feature can generate an error if an operation has not completed in a specified time. Since the error can be trapped like any other BASIC error, corrective action can be programmed to occur automatically. Limit-checking prevents out of range values from being executed, and data conversion permits programming with user specified units. Initial values can also be specified and, at run time, sent to all instrumentation with a single command.

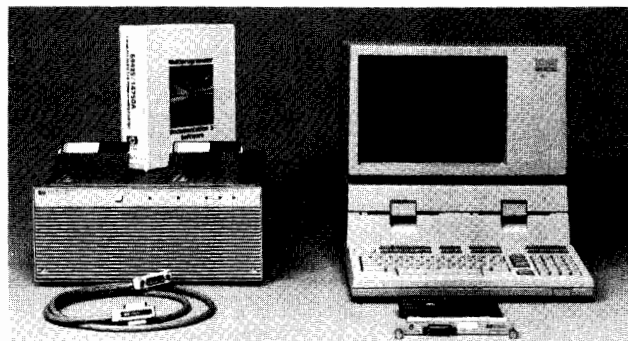
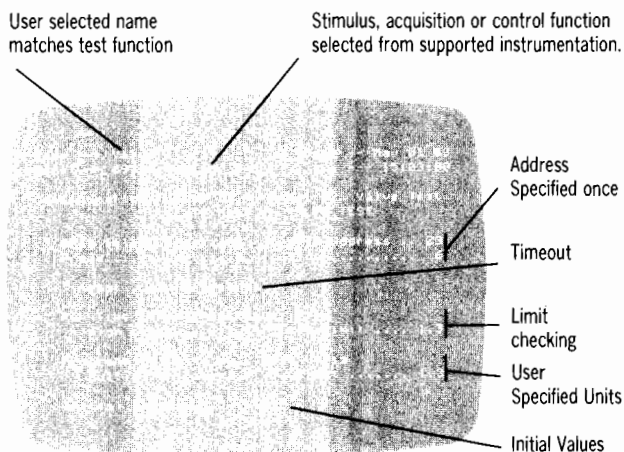

Multiprogrammer Series II I/O Cards

The CAT programming package supports the Multiprogrammer Series II I/O card functions, described on pages 176 and 177, and four popular multiple-card functions. These include combinations such as using a high-speed scanner, A/D, and memory card together. In addition, the HP 3478A 5 1/2-digit Multimeter is supported for applications requiring high-accuracy and high-resolution measurements.

HP 6942A Multiprogrammer

The Multiprogrammer is a high-performance mainframe that provides the necessary interface for up to sixteen plug-in cards. Optional HP 6943A Multiprogrammer Extenders can be added to a system to further expand its capabilities. Up to seven Extenders, each holding up to sixteen plug-in cards, can be chained to one mainframe.

HP 6944A Series 200 Multiprogrammer

The new HP 6944A Series 200 Multiprogrammer is a high-speed mainframe that provides the necessary interface for up to sixteen plug-in cards. The HP 98633A Multiprogrammer interface must be used to operate the HP 6944A. Up to eight HP 6944A Multiprogrammers may be operated from one HP 98633A Multiprogrammer interface.

System Performance Specifications

Mainframe Interface	HP 6942A HP 98624A	HP 6944A HP 98633A
CAT Programming Package	HP 14752A	HP 14752A
Single Data Point Input	1.9 ms	1.5 ms
Single Data Point Output	2.1 ms	1.4 ms
Scaling to User Units	add 0.35 ms	add 0.35 ms
Interrupt Response Time	13.7 ms	13.7 ms
Maximum Block Transfer Input	12,500	180,000*
Maximum Block Transfer Output	18,000	30,000

*HP 98620A DMA controller required.

Product Selection Guides

To order the HP 6942A or HP 6944A, it is recommended that technical data sheet 5952-4142 be used.

Ordering Information

	Price
HP 14752A Computer Aided Test Programming Package	\$2000
Opt 044 3 1/2" Flexible Discs	N/C
Opt 042 5 1/4" Flexible Discs for 9826/9836	N/C
Opt 910 Extra Set of Documentation	\$ 75
HP 14752R Right to Reproduce HP 14752A CAT Programming Package (Interface and Documentation provided)	\$1000

COMPUTER AIDED TEST

Multiprogrammer: Versatile Building Block Approach to Systems

Model 6940B

179



- Front panel control
- GPIO or HP-IB
- Data transfer rate 20,000 readings/second

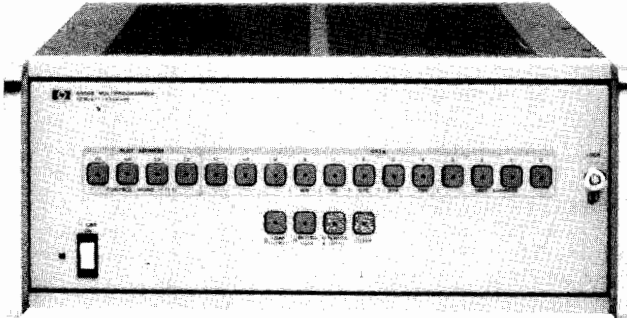

HP 6940B

Description

The HP 6940B Multiprogrammer is a low-cost, medium-speed data acquisition and control system designed to be used with controllers or computers via the GP-IB, a 16-bit parallel interface bus. The HP 6940B is supported by a full complement of I/O cards. These I/O cards provide a broad range of instrumentation functions for acquisition, stimulus, measurement and control.

The HP 6940B is programmed by a set of word formats and octal coding. There are three word formats: a control word that selects the operating mode, a data word used to select and control output cards, and an address word to select and control an input card.

The HP 6940B may also be used as an HP-IB product. This requires an HP 59500A Multiprogrammer Interface Kit. This kit provides conversion of the HP-IB format to 16-bit parallel format.

Features

A full-feature, front-panel switch register permits manual programming of all Multiprogrammer output, input and control functions. Fault isolation or manual system checkout of the computer, multiprogrammer or external devices is accomplished from the front panel.

Another feature of the HP 6940B is isolation of analog cards. Isolation from system ground is provided on analog cards. The HP 6940B has four isolated bias power supplies available to independently power the output circuitry of up to four groups of cards.

The HP 6940B Multiprogrammer has the capability of growing to meet the user's needs. Up to 15 HP 6941B extenders can be added to the system, allowing up to 240 I/O slots to be programmed from a single computer interface. The HP 6941B Multiprogrammer Extender has a blank front panel and all interfacing is provided in the HP 6940B Multiprogrammer.

Specifications

Plug-in I/O card position: Maximum of 15 plug-in input or output cards per mainframe.

Computer Interface: Can be interfaced using the GP-IO, which requires an I/O slot of the computer and a GP-IO interface card. An HP 59500A Multiprogrammer Interface Kit is required for use on the HP-IB.

Extender Units: Up to 15 HP 6941B extenders can be chained together to create 240 programmable I/O slots. Extenders may be separated from one another by up to 30 metres.

Data transfer rate: 20,000 readings/second using the GP-IO interface.

Cooling: Natural convection

Operating temperature range: 0 to +55 degrees Celsius.

Power: 100/120/220/240 Vac (selectable), +5%, -10%, 48 to 440 Hz, 230 watts.

Dimensions: 172.2 mm high x 425.4 mm wide x 539.8 mm deep (6.78 in high x 16.75 in wide x 21.25 in deep).

Weight (without I/O cards): 15.9 kg (35.0 lb) net, 19.5 kg (43.0 lb) shipping.

- Temperature measurement capability
- Multiprogrammer Series I I/O cards

Ordering Information

Step 1 - Select controller

Controller	ROM HP P/N	Description
HP-85B		HP-IB: Option 085 GP-IO: Option 185
HP-86B	00087-15003*	HP-IB: Option 085 GP-IO: Option 185
HP-87XM	00087-15003*	HP-IB: Option 085 GP-IO: Option 185
HP 9826A	N/A	BASIC: Option 026 HPL: Option 126
HP 9836A	N/A	Option 036
HP 1000	N/A	Option 010

*Requires HP 8936A ROM drawer.

Step 2 - Select interface

Interface	GP-IO	HP-IB
HP-85B	HP 6940B Opt 185	HP 59500A and HP-85B Opt 007
HP-86B*	HP 6940B Opt 185	HP 59500A
HP-87XM*	HP 6940B Opt 185	HP 59500A
HP 9826A	HP 98622A Opt 003	HP 59500A, includes 2-metre HP-IB cable
HP 9836A	HP 98622A Opt 003	HP 59500A
HP 1000A	HP 14550B	HP 59500A and HP 59310B

*When ordering an HP-86B or HP-87XM and using HP-IB interface, an HP-IB cable must be ordered, see page 133.

Step 3 - Determine I/O card set

Select I/O functions from Series I I/O cards (See page 176).

Step 4 - Select number of mainframes

	Price
HP 6940B - holds up to 15 I/O cards plus one	\$2500
HP 69351C voltage regulator card.	
Option 10: HP-1000	N/C
Option 85: HP-85B HP-IB	N/C
Option 185: HP-85B GP-IO	\$ 605
Option 028: HP 9826A BASIC	N/C
Option 126: HP 9826A HPL	N/C
Option 036: HP 9836A BASIC	N/C
Option 136: HP 9836A HPL	N/C
Option 908: Rack Mount Hardware for	\$ 40
HP 6941B Extender, additional 15 I/O slots	\$2100
Option 908: Rack Mounting Hardware	\$ 40
HP 14541A Extender Cable; one for each HP 6941B	\$ 125

Step 5 - Determine accessories

HP 59500A Multiprogrammer Interface; required for each HP 6940B on the HP-IB \$1300

Accessories

HP 14540A Main Input Cable Assembly, 3.6 m (12 ft)	\$ 255
HP 14541A Chaining Cable, HP 6940B to HP 6941B	\$ 125
HP 14550B Multiprogrammer Interface Kit for the HP 1000	\$1820
HP 14551A Service Kit for the HP 6940B	\$1715
HP 14555A Connector Kit for Series I Multiprogrammer I/O cards	\$ 20
HP 14556A Software Library for the HP 9825A	\$ 200
HP 14557A Power Supply Interconnect Cable for the HP 69520A Programming Card	\$ 200
HP 14558A Termination Panel; with 40 dual-screw terminals	\$ 125
HP 14560A Cable Assembly for Series I I/O cards; 15 conductors	\$ 81
HP 14561A Cable Assembly for Series I I/O cards; 30 conductors	\$ 125
HP 14562A Cable Assembly for Series I analog I/O cards; two shielded conductors	\$ 35

COMPUTER AIDED TEST

Multiprogrammer: Series I I/O Cards for HP 6940B and 6941B

Power Supply Programming

HP 69500A-69513A Resistance

Programming Cards

\$355-\$405

HP 69500A is supplied without resistors. The HP 69501A-69506A are single output, 12-bit resolution cards designed to program a single HP power supply equipped with Option 040. The HP 69510A-69513A are dual-output cards with six-bit resolution designed to program the current output of HP power supplies equipped with Option 040.

HP 69520A Power Supply Programming Card

\$455

Provides full system control of HP 6023A, 6024A and HP 6011A, 6012A autoranging power supplies. Requires HP 14557A interconnect cable.

Temperature Measurement

HP 69423A Low Level A/D and Scanner Card

\$705

Six channels of thermocouples or other low-level dc sources in the range of ± 20 mV can be measured with resolution of $5 \mu\text{V}$. A seventh channel is used to read the temperature of the isothermal input terminal block. An HP 69351C Voltage Regulator Card is required to provide the regulated isolated bias voltage to the HP 69423A. One HP 69351C will support up to four analog input cards.

Analog Input

HP 69336B High Speed Scanner Card

\$455

This card features a FET multiplexer with 16 single-ended voltage input channels that can be scanned at 20,000 channels/second. Input voltage range is ± 10.24 volts with 100 V isolation from data common. Several cards can be cascaded to provide up to 224 channels.

HP 69422A High Speed A/D Card

\$705

The High Speed A/D Card measures bipolar dc voltages in one of four ranges, ± 100 mV, ± 1 V, ± 10 V, and ± 100 V. The three lower ranges are switch selectable. The ± 100 V input range is connected to an on-board divide-by-ten attenuator. Data conversion rate is 33,000 readings/second.

Analog Output

HP 69321B D/A Voltage Converter Card

\$455

This model provides a high-speed (33 kHz), bipolar output voltage (± 10.24 volts at 5 mA) that is the analog of the digital input data. Dual-rank storage, a feature that allows all D/A cards in a system to change their outputs simultaneously, is provided on the HP 69321B.

HP 69322A Quad D/A Voltage Converter Card

\$605

This D/A card provides four individually programmable, bipolar output voltages (-10.24 V to $+10.22$ V at 5 mA, 16 kHz maximum) that are the analog of the digital data input. Two of the 12 data-bits address the DACs, and the remaining ten data-bits provide the digital input data.

HP 69370A D/A Current Converter Card

\$655

This model provides a high-speed (33 kHz), constant-current output (0 to 20.475 mA at up to 10.5 V) that is the analog of the digital data input. Dual-rank storage, a feature that allows all D/A models in the system to change their outputs simultaneously, is provided on the HP 69370A.

HP 69351C Voltage Regulator Card

\$200

The Voltage Regulator Card provides four regulated, isolated bias supplies for the analog models and is inserted into the voltage regulator slot of the HP 6940B and HP 6941B. The HP 69351C is required for proper operation of the analog input and output models. It will support up to four of these models.

Digital Input

HP 69430A Isolated Digital Input Card

\$255

This card employs photoisolators to provide up to 100 V RMS isolation between the 12 data lines and chassis ground. The model is designed to monitor only circuits that are active. This model may be ordered with any of three different logic options. One of these options must be specified when ordering this model:

Option 069: negative-true TTL logic levels

Option 073: positive-true TTL logic levels

Option 088: positive-true Hi level = ± 12 to 25 V.

HP 69431A Digital Input Card

\$255

The Digital Input Card provides 12 data lines that can be used to monitor contact closure or logic levels referenced to ac earth ground. Gate/flag circuitry provides the HP 69431A with the interface to the computer interrupt system. An option must be specified when ordering this model.

Option 069: negative-true TTL logic levels

Option 073: positive-true TTL logic levels

Option 070: positive-true Hi level = 6 to 14 volts

Digital Output

HP 69331B Digital Output Card

\$255

This model is a general-purpose, 12-bit card with power-on preset, system enable/disable, and gate/flag capabilities. The output lines are jumper selectable for TTL or +12 volt logic levels. The HP 69331B digital output is shipped with TTL logic level configuration.

HP 69332A Open Collector Output Card

\$150

This card is similar to the HP 69331B except it can switch up to 30 volts dc and currents up to 40 mA. The HP 69332A open collector output card is designed to drive lamps and relay coils utilizing an external dc power source. The outputs of the HP 69332A may be random at power-on.

HP 69433A Relay Output with Readback Card

\$305

The relay card provides 12 independent SPST, mercury-wetted, normally-open contact pairs. The HP 69433A also allows the computer to examine the status of the relay coil drive circuits, before and after the contacts are changed. No external handshaking is available with this product.

Functional

HP 69335A Stepping Motor Control Card

\$225

This model can be programmed to generate from 0 to 2047 square-wave pulses at either of two output terminals. The user may also configure the card to generate 0 to 4095 square-wave pulses. An 11-bit binary data word specifies the total steps and Bit-12 specifies direction of rotation.

HP 69435A Pulse Counter Card

\$200

This card will count pulses, up or down, with a maximum square-wave input frequency of 200 kHz. Carry and borrow pulses are generated so that the HP 69435A may be cascaded for greater counting capabilities.

HP 69602A Timer/Pacer Card

\$405

The Timer/Pacer Card provides a full programmable, crystal-controlled time base that can be used to pace Multiprogrammer I/O operations or generate accurate one-shot pulses. The HP 69602A coupled with the HP 69435A can satisfy requirement for frequency measurement (maximum of 200 kHz). Time interval measurement (10 μs to 34 minutes) and time of day (2.8 minutes to 1084 years).

Interrupt

HP 69434A Event Sense Card

\$505

The Event Sense Card monitors up to 12 external contact closures and interrupts the computer when one or more contacts change state with respect to the 12 reference bits stored on the card. Jumpers allow for reconfiguration to provide four logical arguments: equal to, not equal to, greater than, or less than.

HP 69436A Process Interrupt Card

\$405

This card provides an interrupt to the computer when any one or more of the 12 data lines being monitored change state. The HP 69436A has TTL and open collector compatible edge detectors and can detect any logic transition lasting 100 nanoseconds or longer.

Breadboard

HP 69280A Breadboard Card

\$100

The Breadboard Card provides a generalized grid pattern for mounting custom circuitry. The HP 69280A plugs into the HP 6940B and HP 6941B, allowing access to the data lines and power supply lines of the Multiprogrammer backplanes.

HP 69380A Breadboard Output Card

\$150

This breadboard card is similar to the HP 69280A and has output storage buffer circuits that allow the Multiprogrammer backplane output data to drive external or custom circuits. A large portion of the printed circuit board has a plated grid and general-purpose circuit pattern.

HP 69480A Breadboard Input Card

\$150

The Breadboard Input Card is identical to the HP 69380A, except the on-board logic is the input buffer gates for driving the Multiprogrammer backplane.

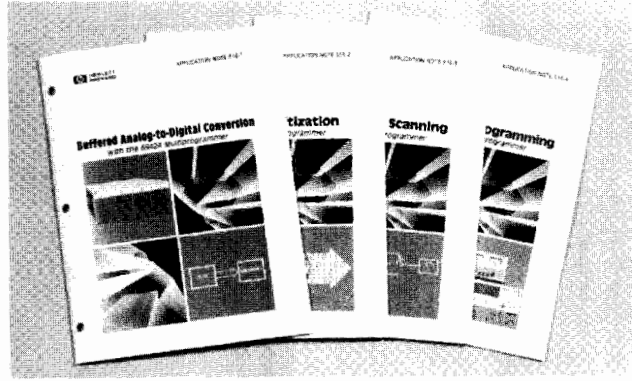
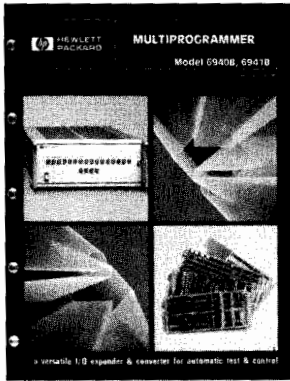

Technical Data

In addition to a broad range of products for integration of data acquisition, control and test systems, Hewlett-Packard provides a selection of technical literature as further support of the Multiprogrammer products. These technical brochures provide detailed operating specifications of the Multiprogrammer product family and are extremely helpful in configuring the best Multiprogrammer package for your application. Other literature available are Product Notes describing a specific product application and Application Notes.

This technical literature will provide information to help you choose the right Multiprogrammer products for your application. The Product Notes augment the Operating and Service Manuals and provide additional information on product configurations and actual applications. The Application Notes are more specific "how to" information aimed at a specific application and product configuration.

This technical literature is provided at no charge upon request. Ask your local Hewlett-Packard field engineer, or use the card at the rear of this catalog.

Publication Title	Publication Number
Multiprogrammer Model 6940B, 6941B	5952-4077
Multiprogrammer Mainframes & Performance Models 6942A, 6944A	5952-4089
Computer Aided Test System Models 6942S, 147501A	5952-4092
HP Series 200 Multiprogrammer System Models 6944S, 6944A, 14751A	5952-4110 5952-4110

Product Notes

A series of product notes is available for the Multiprogrammers. The first two, 6940B-1 and 6940B-2, are product oriented, and describe how to use particular Multiprogrammer cards. The others are product "Application Stories" which describe how Multiprogrammer customers have implemented specific applications.

6940B-1 Scanning with the 6940B Multiprogrammer

Describes use of the HP 69336B FET scanning card for high-speed data acquisition.

6940B-2 Power Supply Control

Describes use of the HP 69520A power supply programming card to control HP autoranging power supplies.

6940B-3 Subassembly Testing

Details Ford Motor Company's use of a building block approach to increase the flexibility of Ford's systems testing while reducing cost and design times.

6940B-4 Automating Manual Equipment

Describes the implementation of the HP 6940B in a radiation monitoring system.

6940B-5 Basic Research

Describes the interfacing of an HP 6940B and HP 9845A to a scanning electron beam microscope.

6940B-6 Product Evaluation

Describes the use by BF Goodrich of the HP 6940B to test the true effectiveness of tires for the different ice, snow, soil and load conditions.

6942A-1 Production Line Testing

Describes Solitron Devices Inc. use of the HP 6942A for hybrid device testing.

6942A-2 Heavy Industry

Describes Northwest Culvert Company's use of the HP 6942A to control metal pipe production and improve process control.

6942A-3 Instrument Control

Describes the use of an HP 6942A to control RF test equipment in an automatic modem test system.

6942A-4 Research and Development

Describes the use of an HP 6942A as control and data acquisition system for a heavy oil pump development test rig.

6942A-5 Materials Evaluation

Describes the use of an HP 6942A to automate the measurement of fluid viscosities.

Application Notes

A new series of application notes introduces a beginner to computer aided test, and makes it easier for any user to implement the most common HP 6942A Multiprogrammer configurations. Each of the notes contains a comprehensive study of an application, and includes theory, wiring information, and software listings for the basic functions. Information on advanced techniques is also provided. Although the programming information is oriented toward the HP 9826A and HP 9836A computers, the concepts are discussed in a general way that allows application to other computers. Copies of these application notes are available through your local HP sales office.

AN316-0 Introduction to Computer Aided Test

This introductory note is designed to take a computer aided test novice through the steps of evaluating, planning, and implementing a sample computer aided test system.

AN316-3 High-Speed FET Scanning

High speed data acquisition from many channels is easily accomplished with the Multiprogrammer scanner system consisting of an HP 69750A or HP 69755A scanner cards. This note covers sequential and random access scanning methods.

AN316-4 Power Supply Programming

Full system control of a power supply, including output voltage and current readback, is possible with a single Multiprogrammer card. The HP 69709A power supply control card is designed for control of HP 6023, HP 6024A, HP 6011, and HP 6012A power supplies equipped with Option 002.

AN316-5 Data Capture

This Application Note covers the full range of data capture capability of the HP 6942A and HP 6944A Multiprogrammers. The emphasis is on analog data capture but digital techniques are also presented. AN316-5 includes sections on random and burst scanning as well as buffering and multiplexing using the Multiprogrammer Memory system. Examples are presented using the HP 14752A CAT Programming statements, as well as Native Instruction programming for the HP 6942A. This Application Note also covers continuous data acquisition to an external hard disc drive. One section deals with performing accurate analog measurements using the Multiprogrammers' I/O cards.

HP 14858A ASYST Product Note

This Product Note provides information on using the ASYST Engineering Software Package to capture, analyze and output data using the HP 6942A Multiprogrammer with the HP Vectra PC or the IBM PC, PC/XT or PC/AT computers. The application which is presented in this document outlines how the power of the ASYST package and the HP 6942A are combined to modify and playback a captured waveform.

COMPUTER AIDED TEST

Multiprogrammer Software

ASYST™ Scientific Software & Programming Library



The ASYST™ Programming Library

The HP 14770A ASYST Programming Library for the HP 6942A Multiprogrammer is a library of software subroutines written using the HP 14858A ASYST Scientific Software. These subroutines, called colon definitions in ASYST, control the flow of data and commands over the HP-IB interface bus between your ASYST based applications program and the HP 6942A Multiprogrammer. The HP 14770A can be viewed as a bidirectional gate controlling the flow of information between your applications program and the HP 6942A. In terms of the system software architecture, the HP 14770A resides between the HP 14858A ASYST Scientific Software and the HP 6942A Multiprogrammer machine language driver.

System Configuration Requirements

As stated previously, the HP 14770A controls the HP 6942A Multiprogrammer family of CAT products and requires the HP 14858A ASYST Scientific Software to operate. A list of system requirements is given below:

- HP VECTRA PC or IBM PC/XT/AT with 640K of memory.
- 8087 or 80287 numeric co-processor.
- DOS 2.0/2.1/3.0/3.1.
- HP Enhanced Graphics Adapter, HP Multimode Video Adapter, IBM Color Graphics Board, IBM Enhanced Color Graphics Adapter, or Hercules Graphics Card.
- HP 14858A ASYST Scientific Software with Option 003 or Option 006 both of which include the HP-IB interface I/O card.
- HP 14770A ASYST Programming Library for the HP 6942A Multiprogrammer.
- HP 6942A Multiprogrammer and required I/O cards.
- HP 10833B HP-IB interface cable.

Applications

If your needs include testing a product while it is in development in the R&D lab, or recommending a production test system for a manufactured product, then this system built around the HP 14770A will solve your problem. The HP 6942A Multiprogrammer offers all the "tools" needed to automate product testing. The HP 14858A ASYST Scientific Software provides sophisticated software for evaluating the test results. The HP 14770A provides the path, for the flow of test results and commands, between the HP 6942A and the HP 14858A. While the HP-Vectra PC provides the workstation platform for the system.

ASYST™ is a trademark of Macmillan Software Company.

Advantages of the HP 14770A ASYST Programming Library

Although the HP 6942A Multiprogrammer can be programmed directly from the HP 14858A ASYST Scientific Software, adding the HP 14770A CAT Software library to your system will simplify programming the HP 6942A and increase programmer productivity. The HP 14770A commands are a high level set of HP-IB and HP 6942A definitions that eliminate the need to program Multiprogrammer I/O operations using the low level generic command set contained within the HP 14858A ASYST Scientific Software.

For More Information

If you would like to learn more about the Hewlett-Packard Multiprogrammer family of CAT products or about the HP 14858A ASYST Scientific Software contact your nearest Hewlett-Packard sales office and ask for the following technical literature:

- HP 6944A and HP 6942A Multiprogrammer Systems for Computer Aided Test (HP literature number 5952-4142).
- ASYST Scientific Software HP Model 14858A for the HP Vectra PC and IBM PC/XT/AT (HP literature number 5952-4159 and 5952-4160).

Ordering Information

	Price
First, order:	
HP 14770A ASYST Programming Library for the HP 6942A Multiprogrammer	\$295
Then, order ASYST with one of the following options. Select one option only.	
HP 14858A Option 001 ASYST Scientific Software	\$1695
HP 14858A Option 002 ASYST Scientific Software with HP-IB Commands	\$1995
HP 14858A Option 003 ASYST Scientific Software with HP-IB Commands and HP-IB Interface Card	\$2295
HP 14858A Option 004 ASYST Scientific Software with PC Instruments Commands	\$1695
HP 14858A Option 005 ASYST Scientific Software with PC Instruments and HP-IB Commands	\$2195
HP 14858A Option 006 ASYST Scientific Software with PC Instruments and HP-IB Commands, and HP-IB Interface Card	\$2495

For more information on ASYST Scientific Software, see page 209.



- Modular general purpose test equipment
- New low cost switching capability
- New dynamic digital test capability

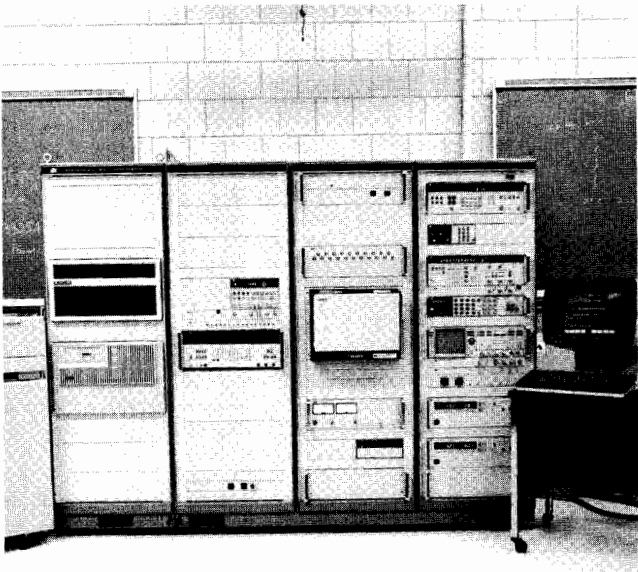

HP Automatic Test Systems

An HP Automatic Test System (HP ATS) provides functional and parametric test capability for digital, analog, or hybrid circuitry at the system or subsystem level. An HP Automatic Test System consists of test instrumentation, switching and interface panel, system controller and HP ATS Integration Services. This modular approach promotes the use of standard products in the design of a test system which meets your exact needs. A broad instrument product line, coupled with computers designed for instrument control, puts HP in an excellent position to provide complete solutions to a wide range of test problems.

With the purchase of an HP ATS you receive a system, fully integrated and tested to Hewlett-Packard standards, rather than a collection of components. An HP Automatic Test System includes all hardware, system software, interfacing and cabling needed to begin development of application software. Alternatively, application software can be purchased through qualified Value-Added Suppliers or your local HP Project Center.

Operation of an HP ATS

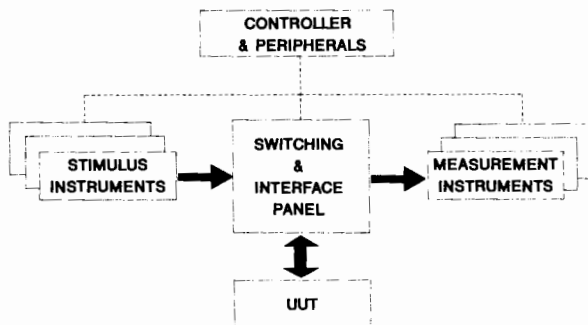

System Components Test Equipment

The use of standard stimulus and response instrumentation enables HP ATS to meet customized needs at the lowest possible cost. Standard HP equipment provides the most cost-effective solution, and customer-furnished equipment can be integrated by HP as well. The following list illustrates equipment typically found in an HP Automatic Test System:

Stimulus

- 3325A Function Generator
- 6032A DC Power Supply
- 8161A Pulse Generator
- 8673B Signal Generator

Response

- 3456A DVM
- 5328B Counter
- 8566B Spectrum Analyzer
- 54100D Digitizing Oscilloscope

Switching

Switches provide the paths to connect test equipment to the UUT (and for self-test). The type of switch needed depends upon the signal to be carried (dc, rf, pulse, current level, etc), the number of connections to be made, and the operating speed. HP ATS switches, featuring a new low-cost multifunction switch based upon the HP 3235A, cover a wide range of switching needs. The HP 9400 switches (HP 9411B Switch Controller, HP 9412A High-Density Multifunction Switch, HP 9413A VHF Switch and HP 9414A Full Matrix Switch) also remain available to meet your switching needs.

Controller

The standard HP Automatic Test System is controlled by an HP 1000 A-series computer, which provides a real-time, multitasking environment as well as networking capability and mass storage. The HP 1000 is optimal where there will be many different types of units under test (UUT), long and complicated test programs, concurrent test development and execution or mandatory UUT fault diagnosis.

Dynamic Digital Test Unit

Required for digital test capability, a DTU (or Digital Word Generator) provides input patterns to the UUT and detects the output responses required for digital testing. The new HP ATS DTU will provide up to 512 channels, with memory depth of at least 4k bits per channel, and 5 memory types. It features real-time hardware compare, tristate logic, and dynamic testing (10 to 20 MHz).

Integration Services

HP's Integration Services allows you to design a test system to meet your needs, without the complications of system integration. Based upon the desired performance level, you select the required test equipment (including customer furnished equipment). HP consolidates and installs the equipment, configures the operating software, provides device subroutines for all standard HP equipment, and performs an on-site system functional test. This verifies that all control paths as well as instrument signal paths cabled into system are functional. You receive a fully integrated, fully installed system, ready for the development and implementation of your application software.

Ordering Information

The design, configuration and purchase of an Automatic Test System is a complex process involving customer, sales representative, and Advanced Manufacturing Systems Operation, the HP division responsible for ATS. The ATS Configuration Guide (HP 5954-8011) acts as a reference and checklist throughout this process. To receive a copy, or for any other information on HP Automatic Test Systems, consult your local HP Sales Office. Price depends on the functionality and complexity of the system.

System prices range from \$150,000 to over \$2,000,000.

COMPUTER AIDED TEST

A-Series Measurement & Control Cards

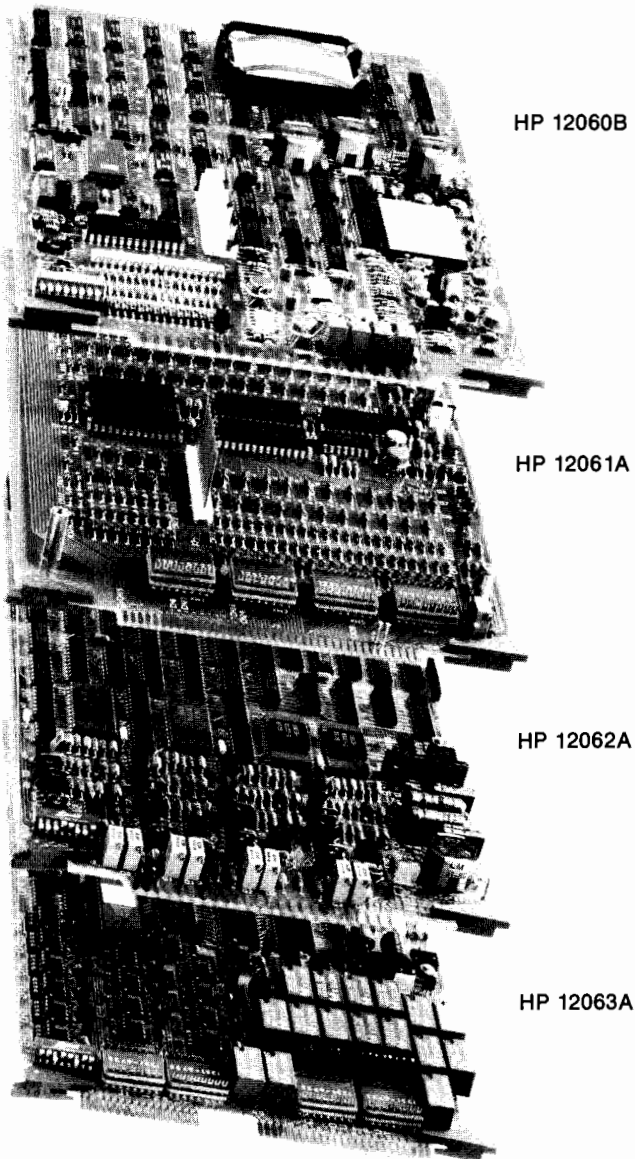

HP 12060B

HP 12061A

HP 12062A

HP 12063A

Description

The HP 12060B, 12061A, 12062A, and 12063A are plug-in cards for HP 1000 A-Series Computers. They provide low cost, high performance, analog and digital I/O for use in distributed measurement and control applications. The A-series product in which these cards are used must have a 25 kHz power supply. Hood connectors with each card allow users to build cables for connection to their applications.

12060B 8 Channel Analog Input Card

The HP 12060B is capable of acquiring up to 55,000 readings per second with 12-bit resolution. Auto scanning or single-channel sampling is possible to 55 kHz. Provisions for external pacing/trigging of sampling and scanning is provided. The HP 12060B includes four programmable full scale ranges from plus or minus 1.28 V to plus or minus 10.24 V. Maximum resolution is 0.625 mV on the 1.28 V range. A separate "zero reference" on the card allows the user to measure actual offset due to temperature drift, and correct readings on all channels for higher accuracy. The card has 8 differential channels.

HP 12061A 32 Channel Analog Input Expansion Card

The HP 12061A provides 32 additional differential inputs for the HP 12060B card. The HP 12061A card fastens directly onto the HP 12060B card, creating a two-board unit that occupies two I/O slots in an HP 1000 A-series computer. Programming information is passed from the HP 12060B directly to the HP 12061A; analog signals on the additional 32 channels are in turn passed back to the HP 12060B for digitizing. The HP 12061A includes removable plug-in headers so the user can add current sense resistors for current loop measurements. These headers allow the board to be adapted to the specific application without soldering components directly on the board and are easily removable for repair purposes.

HP 12062A 4 Channel Analog Output Card

The HP 12062A Analog Output Card provides 4 independent bipolar voltage outputs. Remote sensing per channel provides accurate output voltages to compensate for long distances of field wiring. Undedicated digital outputs may be used in pen up/down control, CRT display, or X-Y plotters. DMA compatibility provides fast analog updates on a per-channel basis or between channels. Programmable time delay between DMA updates provides signal reconstruction capability with a full power bandwidth of 20 kHz.

HP 12063A 32 Channel Digital Multifunction Card

Input Characteristics

The HP 12063B provides 16 fully isolated digital inputs via voltage threshold opto-couplers. Input voltage levels are selectable by the user for each channel by installing the appropriately valued resistors on removable plug-in headers (8 resistors per header = 8 channels). These headers allow the board to be adapted to the specific application without soldering components directly on the board, and are easily removed for repair purposes. Plug-in opto-couplers (supplied) allow user selection of ac or dc coupling for each channel by merely installing the opto-coupler in the ac position or dc position. For ac coupling, a plug-on jumper is provided for each channel to select 60 Hz ac filtering of the rectified input if desired.

Event Detection

In addition to status, any input may be user programmed to function as an interrupt to be generated on the rising edge or falling edge of the input or both (whichever occurs first). This capability is easily activated by the user via loading the appropriate pattern into the three registers. The on-card microprocessor takes over to cause the interrupt to be generated when that event occurs. User programming is required to service the interrupt.

Debounce Delay

The same microprocessor also provides the user-programmable debounce delay up to 246 ms on any input when monitoring contact closures and may be used in both status mode and event sense mode.

Output Characteristics

Sixteen form C (SPDT) relay outputs are provided on the same card. Both the normally open (NO) and normally closed (NC) contacts are available to users. Two removable headers allow for arc suppression devices to be added by the user for *each channel* without soldering directly to the board. Each header handles 8 output channels. Plug-on jumpers select the arc suppression across the NO or NC contacts. An on-card isolated power supply derived from the 25 kHz ac supply in the A-Series processor provides coil power for the relays. This technique minimizes any coupling of relay contact noise in the computer itself.

Ordering Information

HP 12060B 8 Channel Analog/Digital Converter
 HP 12061A 32 Channel Analog Input Expansion
 HP 12062A 4 Channel Digital/Analog Converter
 HP 12063A 32 Channel Digital Multifunction Card

Price

\$1795
 \$895
 \$1295
 \$1645

- Speeds Functional Test Software Development



Description

HP's Functional Test Manager/300 (HP FTM/300) is a general test software package designed for:

- Professionals writing test software for user-configured HP-IB test systems.
- Production functional testing of final products, subassemblies, and components.
- HP 9000 Series 200/300 Computers using BASIC 4.0 operating systems.

HP FTM/300 speeds development of functional test software with:

- Up to two-thirds of total test code already written.
- A framework or shell for developing tests, executing tests, analyzing test data, and transferring test data to other computers.
- Both turnkey tools and subprograms.

You benefit by getting custom test software with one-third the effort. Plus, HP FTM/300 modifies easily for your other functional test requirements. This one package standardizes your functional test software.

Reduce Software Development Time by Up to 65%

Developing test software can be the most time consuming part of making a test system. As a powerful productivity tool, HP FTM/300 reduces the code you write by up to 65%.

HP FTM/300 speeds development in all phases of your test software by combining large portions of turnkey software and a library of subprogram tools into HP FTM/300 framework for developing and executing tests. HP FTM/300 software includes a turnkey SQC package, data storage and retrieval, data formatting and transfer, test sequencers, and program schedulers. A friendly user interface and twelve forms for specifying system characteristics further help developers quickly create test software. Not only will FTM/300 save you months of software development time, but the resulting test system will do more than most custom-developed test systems.

Total Test Software Job

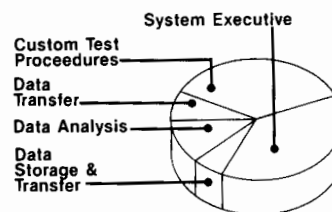

HP FTM/300's Contribution

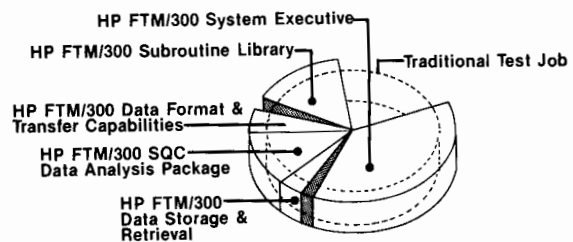

Your Remaining Job

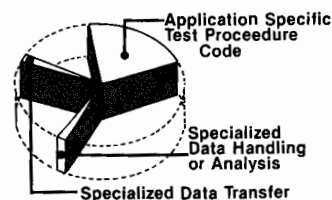

Optimized for Test Throughput

HP FTM/300 executes as fast as most custom test software, and HP FTM/300's high level capabilities can be traded for program execution speed when you need it. With complete access to low level HP 9000 Series 200/300 BASIC 4.0 commands, HP FTM/300 lets test software developers add their own Unit-Under-Test (UUT)-specific routines optimized for speed in critical areas.

Also, HP FTM/300's strategy further optimizes throughput by using intelligent control of test flow, so you only execute necessary tests. For example, HP FTM/300 executes overall functional tests and skips troubleshooting tests unless the overall test fails.

Customize Your Specific Test Needs

HP FTM/300 lets you concentrate on writing the application-specific software such as test procedures by giving you the non-application-specific code. Our studies show about 60% of test software consists of non-application-specific items such as data storage and retrieval, user interface, test sequencing and scheduling, and data analysis. Since HP FTM/300 provides these, you focus on writing custom test procedures. However, as further help, HP FTM/300's sub-program library may contribute up to half of this code. You keep the advantages of custom software with greatly reduced development times.

- Use the power and flexibility of HP 9000 Series 200/300 Computers and BASIC 4.0 in writing your test procedures.
- Re-use existing test procedures.
- Install your programs into HP FTM/300's menu.
- Use HP-supplied tools and software packages.

Data Analysis and Report Generation

Now you can analyze and improve your production process besides just testing your products. HP FTM/300 monitors trends in your process with turnkey statistical quality control (SQC) analysis and report generation. You improve your process and your profits by monitoring production output trends as you tune your process. For a management summary, SQC reports include an overview page listing yield, units passed or failed, and graphics. In addition, this SQC software produces the following charts and graphs:

- Pareto charts for failure analysis
- Histograms of test values
- Control Charts (p and \bar{X} , s) as process monitors

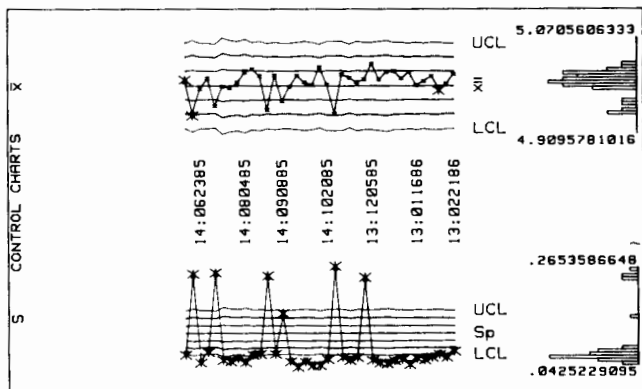

Transfer Test Data to Other Computers

HP FTM/300 formats test data for transfer to other computing environments for further analysis or archiving. Using RS-232 transfer utilities such as HP AdvanceLink, HP FTM/300 test results are moved to DOS computers for access by spreadsheets such as Lotus®

1-2-3®¹ and database managers such as dBASE III Plus on PC-DOS compatible computers or MS™-DOS² computers.

Turnkey FTM/300 software transfers test data from HP FTM/300 to HP Q-STATS II area-wide information manager. HP Q-STATS II, working with the HP 306X Board Test Systems, is a quality solution for the test work cell including data base management, statistical analysis, and presentation quality graphics.

HP FTM/300 formats test data files into ASCII files (comma separated variables (CSV) and DIF for personal computer spreadsheets and data bases). Use any common file transfer means including RS-232, HP-IB, HP's Shared Resource Manager (SRM), or IEEE 802.3 using HP's SRM network and a co-existing HP-UX environment.

Reduce Your Software Maintenance Effort

Because you write up to 65% less code with FTM/300, you maintain less software. Also, HP FTM/300's organization and structure helps you maintain the portion of the software you write because you know how and where it fits in the total software. Using HP FTM/300's forms editor, it's much easier and more error-free to edit an entry in a form than to change lines of code. Now, you have a much smaller problem when a test developer changes jobs.

Standardize on HP FTM/300 for All Your Testing

You further minimize software maintenance and documentation when you standardize on HP FTM/300 as your single test software package. The combination of powerful general test features and the ability to customize HP FTM/300 for each of your test applications makes HP FTM/300 an obvious choice for all your functional test needs.

Product Requirements

Computer: HP 9000 Series 200 or 300 with display enhancements (HP 9826 not supported). Color highly recommended.

Operating System: BASIC 4.0

Memory: 2.25 Mbyte of RAM

Disc: 15 Mbyte recommended for local disc or any HP Shared Resource Manager (SRM) approved disc.

Printer for HP FTM/300 Reports: HP-IB, 80 characters per line; automatic page feed; HP Raster Interface Standard. For example, HP 2225A, HP 9876A, HP 293X, and HP 82906A.

Plotter: Optional

If used, requirements are: HP-IB, HPGL language (automatic sheet feed desirable). For example, HP 75XX, HP 74XX.

Bar Code Reader: Optional. Use HP 92916A.

Ordering Information

HP FTM/300 is available as HP 34800 or HP 34801 for the two different source code protection schemes.

HP 34800A 3.5" disc for computers with HP-HIL \$3500.00

HP 46084A ID Module (order HP 46084A separately)

HP 34800R requires previous purchase of HP 34800A. Requires an HP 46084A HP-HIL ID Module for each copy. (Order HP 46084A separately.) \$2100.00

HP 34801A 3.5" disc for computers without HP-HIL \$3650.00

Includes HP-IB Security Module.

HP 34801B 5.25" disc for computers without HP-HIL \$3650.00

Includes HP-IB Security Module.

HP 34801R Right-to-Use. Requires previous \$2250.00

purchase of HP 34801A (3.5" media). Includes HP-IB Security Module.

HP 34801T Right-to-Use. Requires previous \$2250.00

purchase of HP 34801B (5.25" media). Includes HP-IB Security Module.

HP 34801B (5.25" media). Includes HP-IB Security Module.

¹LOTUS® and 1-2-3® are registered trademarks of Lotus Development Corp.

²MS™-DOS is a trademark of Microsoft, Inc.

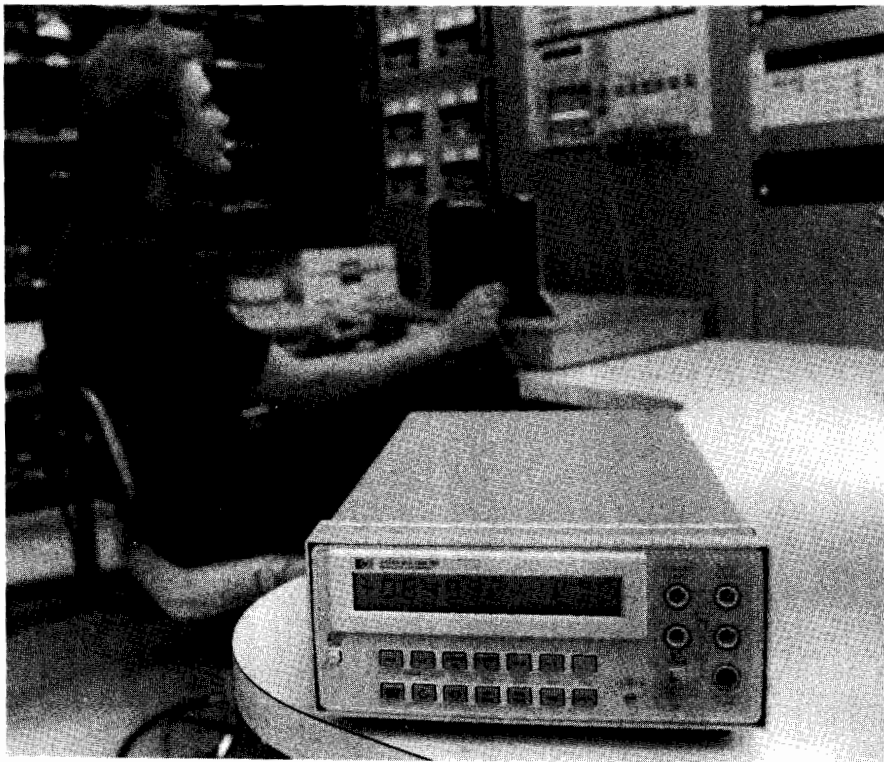

Optimized for Your Measurements

In some system applications, measurement speed is the most important requirement. Other applications demand high accuracy, high resolution, and excellent noise rejection. Often your requirements are somewhere in between. HP's innovative integration technique used in almost all of its DMMs can trade speed for resolution which adds measurement flexibility.

HP's integrating DMMs offer the fastest reading rates available with powerline-related noise rejection. Integration selection (number of powerline cycles) is the key to performance tradeoffs in HP's system DMMs. For example, reading rates are maximized by decreasing resolution and the number of powerline cycles. Conversely, accuracy and resolution are improved by increasing the number of powerline cycles. In short, HP allows you to choose the resolution, accuracy, and noise rejection needed, while maximizing measurement speed.

Offering $3\frac{1}{2}$ to $7\frac{1}{2}$ digit resolution and excellent long term DC accuracy, the new HP 3457A offers you choices between high speed, low resolution (1350 $3\frac{1}{2}$ digit readings/sec) or low speed, high resolution (one $7\frac{1}{2}$ digit reading every two seconds with more than 160 dB effective common mode rejection) measurements.

Hewlett-Packard offers a wide range of Digital Multimeters (DMMs) to meet your measurement requirements. HP offers both high performance DMMs and a full product line of system DMMs.

HP has DMMs ideally suited for many applications, including design and development, production testing, and data acquisition. Measurement-driven applications in R&D and calibration labs need the accuracy and stability of HP's 3456A or 3457A. Many bench measurement problems are easily handled by the HP 3468A/B, a high performance $5\frac{1}{2}$ digit five function DMM.

Production testing requires a wide variety of functions, resolutions, and speeds; the HP 3457A fits those needs. Data acquisition applications may demand the high speed of the HP 3437A or the sensitivity and resolution of the HP 3456A or HP 3457A.

For low-cost HP-IB systems, the $3\frac{1}{2}$ to $5\frac{1}{2}$ digit HP 3478A provides five measurement functions—DC Volts, AC Volts, DC Current, AC Current, and Resistance—with the performance to meet many system requirements without putting a big dent in your instrumentation budget.

When selecting a DMM, besides considering the functions, resolution, accuracy, speed, and price desired, look at the quality, reliability, cost of ownership, system throughput, and flexibility of HP's DMMs.

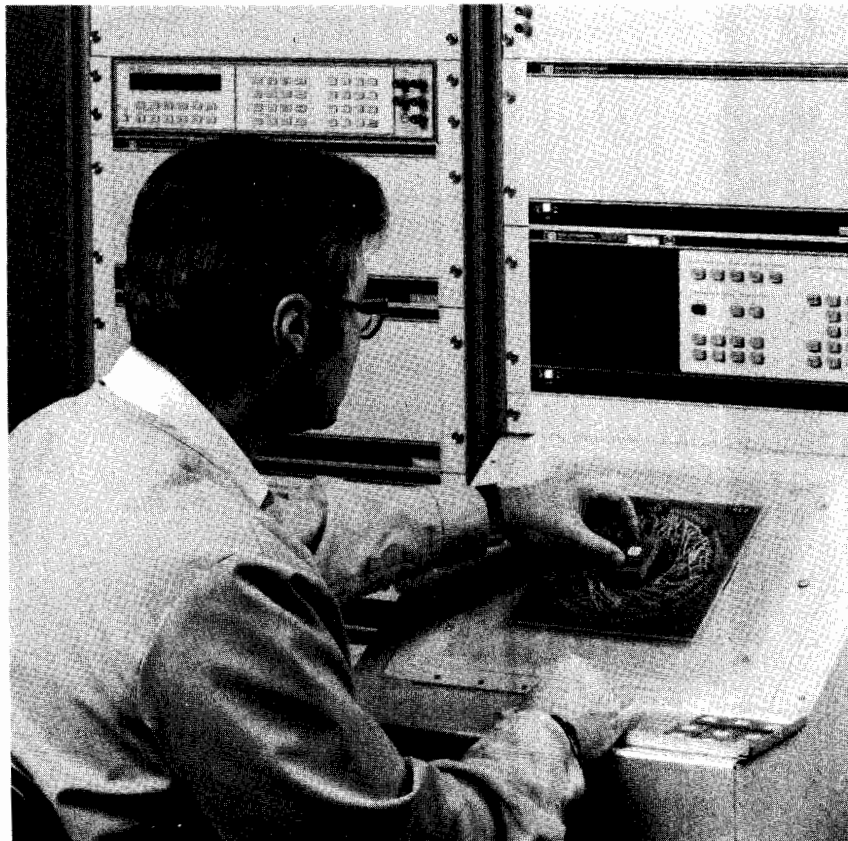



DIGITAL MULTIMETERS

General Information (cont)



High Throughput Reduces Test Time

For system applications, you can increase throughput using DMMs like the HP 3456A. This system DMM is HP's throughput leader when you need to change functions and ranges often to obtain all of your measurements. The ability to change functions and ranges fast while taking measurements is an excellent way of viewing measurement throughput. All of HP's system multimeters share this common strength to help you improve your throughput, and your profits.

Most of HP's system DMMs have a "Voltmeter Complete" pulse output for incrementing channels on external scanners or switches, without the delay of a computer command. An external trigger input is ideal for synchronizing your DMM to your measurement. Interrupt capability allows your system to run more efficiently, since your computer need only provide control when requested by the DMM.

Features such as Pass/Fail Limit testing in the HP 3457A, program memory and reading storage minimize the computer interaction with the DMM. These features are examples of how HP can help you speed-up your system.

SYSTEM DMMs

HP Model	3457A p.194	3456A p.192	3455A p.197	3437A p.197	3478A p.190
GENERAL INFORMATION					
Digits of Resolution	3½ to 6½	3½ to 6½	5½ to 6½	3½	3½ to 5½
Base Price	\$2800	\$4100	\$5600	\$3300	\$995
A/D CONVERSION METHOD					
	Multislope Integration	Multislope Integration	Multislope Integration	Successive Approximation	Multislope Integration
STANDARD FEATURES					
	7 Functions Math, Electronic Calibration,	3 Functions Math, Ratio,	3 Functions Math	DC Volts 5k-(sample/sec) Data Acquisition	5 Functions, Electronic Calibration
OPTIONAL FEATURES					
	Plug-in Multiplexers, 3 Yr. Hardware Support CII Language	Enhanced AC Accuracy, 3 Yr. Hardware Support	Average AC		3 Yr. Hardware Support
DC VOLTAGE					
Ranges	30 mV to 300 V	100 mV to 1000 V	100 mV to 1000 V	100 mV to 10 V	30 mV to 300 V
Sensitivity	10 nV	100 nV	1 µV	100 µV	100 nV
90 Day/1 Yr Best Full Scale Accuracy	0.0019%/0.0027%	0.0017%/0.0025%	0.0051%/0.013%	0.19%/0.23%	0.0047%/0.0067%
Max Readings Per Sec					
60Hz/50Hz Modes					
at 3½ digits	1350/1350	330/290	—	5000/5000	90/85
at 4½ digits	1250/1250	330/290	—	—	35/30
at 5½ digits	360/312	210/180	24/22	—	4.4/3.7
at 6½ digits	53/45	48/40	6/5	—	—
AC VOLTAGE					
Ranges	30 mV to 300 V	1 V to 1000 V	1 V to 1000 V	—	300 mV to 300 V
RESISTANCE					
Ranges	30 Ω to 3 GΩ	100 Ω to 1 GΩ	100 Ω to 10 MΩ	—	30 Ω to 30 MΩ
CURRENT					
DC Ranges Min/Max	300 µA to 1.5 A	—	—	—	300 mA to 3 A
AC Ranges	30 mA to 1.0 A	—	—	—	300 mA to 3 A

BENCH DMMs

HP Model	3468A/B p.198	3466A p.200
GENERAL INFORMATION		
Digits of Resolution	3½ to 5½	4½
Base Price	\$750	\$1200
Rechargeable Battery Operation	—	✓
V & Ω Auto/Manual Ranging	✓	✓
A/D Conversion Method	Multislope Integration	Dual-Slope Integration
AC Conversion Method	True RMS	True RMS
STANDARD FEATURES		
	4-Wire Ohms, Electronic Calibration, HP-IL, Auto/Manual Current Ranging	AC+DC, Diode Test Ohms Zero Adjust
OPTIONAL FEATURES		
	Rechargeable Battery Operation, 3 Yr Hardware Support	Touch-Hold Probe
DC VOLTAGE		
Ranges	300 mV to 300 V	20 mV to 1200 V
Sensitivity	1 μV	1 μV
1 Yr Best Full Scale Accuracy	0.019%	0.035%
Max Readings Per Sec	32	4.7
AC VOLTAGE		
Ranges	300 mV to 300 V	200 mV to 1200 V
RESISTANCE		
Ranges	300 Ω to 30 MΩ	20 Ω to 20 MΩ
CURRENT		
DC Ranges	3 A	200 μA to 2 A
AC Ranges	300 mA to 3 A	200 μA to 2 A

Low Cost of Ownership

HP's DMMs have quality and reliability built-in, plus an optional hardware support feature to prove it.

From concept to implementation, every phase of designing and manufacturing DMMs such as the HP 3468A/B and the HP 3478A have resulted in extremely reliable products.

These field-proven DMMs have lived up to their design expectations. In keeping with the precedent set by the HP 3468A/B and HP 3478A, the new HP 3457A Multimeter emphasizes quality and reliability while offering you performance and convenience rivaling that of competitive DMMs costing twice as much. Reliability of our products is so good that we now offer three years of hardware support for the HP 3437A, 3456A, 3457A, 3468A/B, and 3478A. This option, called W30, has a surprisingly low incremental price. HP's 3468A/B, 3478A, and 3457A DMM's have electronic, "no pots," calibration. Designed-in modularity, and self-test capabilities keep repair time and costs to a minimum. As a result of HP's commitment to quality, you can benefit by reducing your total cost of ownership when purchasing HP DMMs.

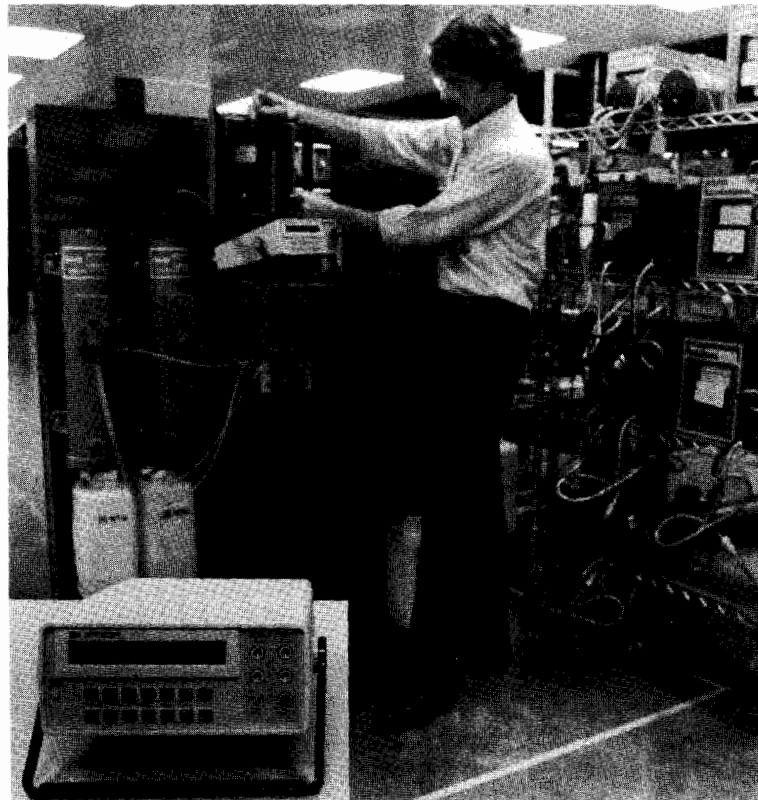



DIGITAL MULTIMETERS

Low Cost 3½ to 5½ Digit HP-IB Multimeter

Model 3478A

- 5 measurement functions
- Up to 90 readings/s
- Electronic calibration
- 100 nanovolt resolution

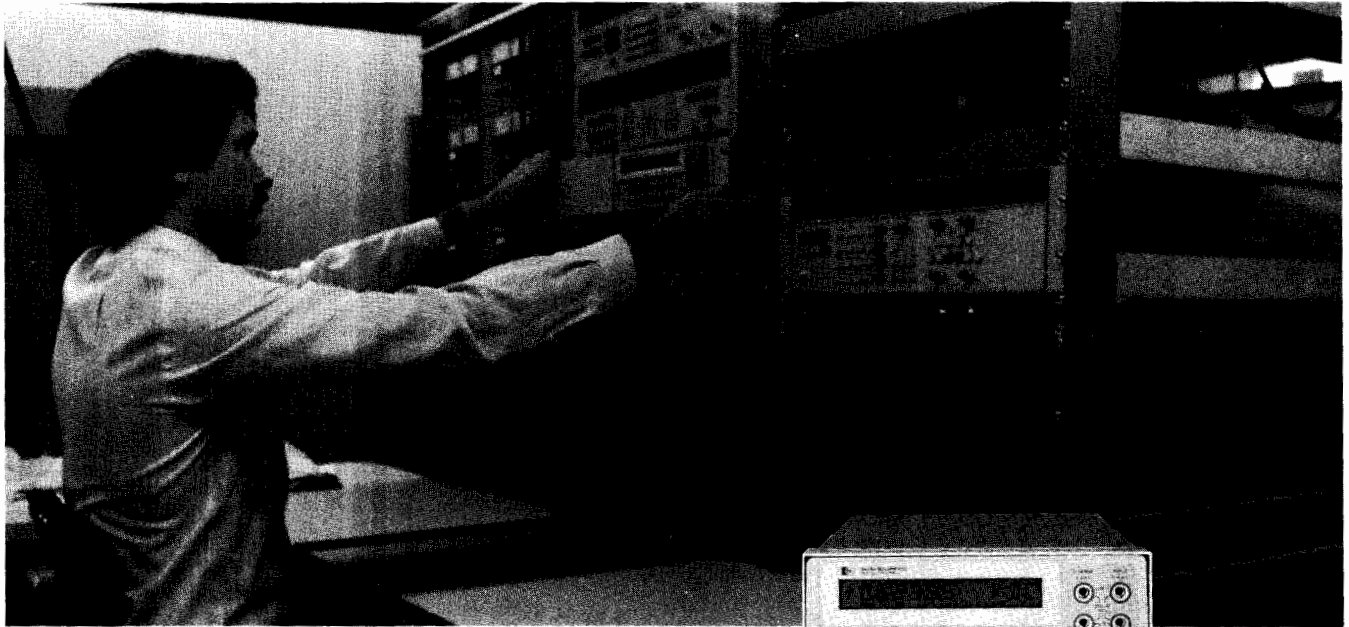

HP 3478A

Description

The HP 3478A provides a low cost, full function, reliable DMM for system measurements. Selectable 3½ to 5½ digit resolution and 5 autoranging functions offer flexibility in automated testing. The HP 3478A can measure DCV, true RMS ACV, 2- and 4-wire ohms, and dc and ac current. Simple, fast electronic calibration eliminates all adjustments to provide a lower cost of ownership.

Low Cost of Ownership

The combination of an extremely reliable DMM with features like complete electronic calibration and self-test gives you the lowest cost of ownership. We're so sure of the HP 3478A's reliability that you can get additional hardware service for less than 2% of the DMMs price per year.

Performance

Selectable speed and resolution provide the right capability for your measurement. The HP 3478A can perform production tests or acquire experimental data at 90 readings/s with 3½ digit resolution, or take 35 readings/s with 130 dB of noise rejection using 4½ digits. The 5½ digit mode offers 100 nVdc and 100 μΩ resolution for precise measurements. True RMS with 300 kHz bandwidth and 4:1 crest factor provides reliable measurements of ac signals. Fast autoranging makes the first reading useful and accurate.

Designed for Systems

Switchable front/rear inputs permit flexible system connections. The Voltmeter Complete output and External Trigger input allow synchronization of the HP 3478A with a scanner for fast multiplexed measurements without the delay of software commands. The test program can write prompt messages or results on the alphanumeric display. The operator can respond by pressing the HP 3478A's SRQ key to interrupt the controller and start the next test. Built-in self-test capability assures proper operation.

Electronic Calibration

Complete calibration of the HP 3478A is accomplished without any internal adjustment or removing the instrument's covers. The simple and fast electronic calibration procedure lowers the cost of ownership. You only need to connect standards to the HP 3478A and store calibration constants in the HP 3478A's non-volatile memory.

Calibration can be done manually from the front panel or automatically using HP-IB.

Specifications

DC Voltage

Input Characteristics

Range	Maximum Reading (5½ digit)	Resolution		
		5½ digit	4½ digit	3½ digit
30 mV	±30.3099 mV	100 nV	1 μV	10 μV
300 mV	±303.099 mV	1 μV	10 μV	100 μV
3 V	±3.03099 V	10 μV	100 μV	1 mV
30 V	±30.3099 V	100 μV	1 mV	10 mV
300 V	±303.099 V	1 mV	10 mV	100 mV

Input resistance: 30 mV, 300 mV, 3 V ranges: $>10^{10} \Omega$
30 V, 300 V ranges: $10 \text{ M}\Omega \pm 1\%$

Maximum input voltage (non-destructive): Hi to Lo: 303 Vrms or 450 V peak; Hi or Lo to Earth Ground: $\pm 500 \text{ V}$ peak

Measurement accuracy: $\pm(\%$ of reading + number of counts). Auto zero ON.

5½ Digit Mode

Range	T _{Cal} * $\pm 1^\circ\text{C}$	T _{Cal} * $\pm 5^\circ\text{C}$	
	24 Hour	90 Day	1 Year
30 mV	0.025 + 40	0.0275 + 40	0.035 + 40
300 mV	0.004 + 4	0.005 + 5	0.007 + 5
3 V	0.003 + 2	0.004 + 2	0.006 + 2
30 V	0.004 + 3	0.005 + 4	0.007 + 4
300 V	0.004 + 2	0.005 + 2	0.007 + 2

*T_{Cal} is the temperature of the environment where the HP 3478A was calibrated. Calibration should be performed with the temperature of the environment between 20°C and 30°C. 24 hour accuracy relative to calibration standards.

4½ and 3½ digit mode: accuracy is the same as 5½ digit mode for % of reading; use 1 count for number of counts on all ranges except 30 mV, use 4 counts.

Temperature coefficient: 0° to 55°C, 5½ digits, auto zero ON. ±(% of reading + number of counts)/°C

Range	Temperature Coefficient
30 mV	0.0028 + 5.0
300 mV	0.0005 + 0.5
3 V	0.0004 + 0.05
30 V	0.0006 + 0.5
300 V	0.0004 + 0.05

Noise rejection: in dB with 1 kΩ imbalance in Lo lead. AC rejection for 50, 60 Hz ± 0.1%. Auto zero ON.

Display	AC NMR	AC ECRM	DC CMR
5½ digits	80	150	140
4½ digits	59	130	140
3½ digits	0	70	140

Maximum Reading Rates (readings/s.)

Line Frequency	Auto Zero and Display	Resolution		
		3½ digits	4½ digits	5½ digits
60 Hz	Off	90	35	4.4
	On	60	20	2.3
50 Hz	Off	85	30	3.7
	On	50	17	1.9

AC Voltage (true rms) **Input Characteristics**

Range	Maximum Reading (5½ Digit)	Resolution		
		5½ Digit	4½ Digit	3½ Digit
300 mV	303.099 mV	1 µV	10 µV	100 µV
3 V	3.03099 V	10 µV	100 µV	1 mV
30 V	30.3099 V	100 µV	1 mV	10 mV
300 V	303.009 V	1 mV	10 mV	100 mV

Input impedance: 1 MΩ ± 1% shunted by <60 pF

Maximum Input Voltage (non-destructive):

Hi to Low: 303 Vrms or 450 V peak

Hi or Lo to Earth Ground: ±500 V peak

Measurement accuracy: ±(% of reading + number of counts). Auto zero ON. 5½ digit display. Accuracy is specified for sinewave inputs only, >10% full scale.

1 Year, T_{Cal}* ±5°C

Frequency	Ranges		
	300 mV	3 V, 30 V	300 V
20-50 Hz	1.14 + 163	1.14 + 102	1.18 + 102
50-100 Hz	0.46 + 163	0.46 + 103	0.50 + 102
100 Hz-20 kHz	0.20 + 120	0.20 + 70	0.24 + 70
20-50 kHz	0.38 + 205	0.26 + 140	0.42 + 140
50-100 kHz	1.20 + 840	0.87 + 780	0.98 + 780
100-300 kHz	10.1 + 3720 (30 V range only)		

Crest factor: >4:1 at full scale

Common mode rejection: with 1 kΩ imbalance in Lo lead, >70 dB, at 60 Hz

Maximum reading rates: 3½ or 4½ digits, 1.4 readings/s; 5½ digits, 1.0 readings/s. First reading is correct within 70 counts of final value when triggered coincident with step input. Add 0.6 seconds for each range change.

Resistance (2-wire Ω, 4-wire Ω) **Input Characteristics**

Range	Maximum Reading (5½ Digit)	Resolution		
		5½ Digit	4½ Digit	3½ Digit
30 Ω	30.3099 Ω	100 µΩ	1 mΩ	10 mΩ
300 Ω	303.099 Ω	1 mΩ	10 mΩ	100 mΩ
3 kΩ	3.03099 kΩ	10 mΩ	100 mΩ	1 Ω
30 kΩ	30.3099 kΩ	100 mΩ	1 Ω	10 Ω
300 kΩ	303.099 kΩ	1 Ω	10 Ω	100 Ω
3 MΩ	3.03099 MΩ	10 Ω	100 Ω	1 kΩ
30 MΩ	30.3099 MΩ	100 Ω	1 kΩ	10 kΩ

Input protection (non destructive): Hi to Lo: ±350 V peak; Hi or Lo to Earth Ground: ±500 V peak.

Measurement accuracy: ±(% of reading + number of counts). Auto zero ON. 5½ digit display. 4-wire ohms.

Range	T _{Cal} * ± 1°C			T _{Cal} * ± 5°C		
	24 Hour	90 Day	1 Year	24 Hour	90 Day	1 Year
30 Ω	0.023 + 35	0.027 + 41	0.034 + 41			
300 Ω	0.0045 + 4	0.012 + 5	0.017 + 5			
3 k-300 kΩ	0.0035 + 2	0.011 + 2	0.016 + 2			
3 MΩ	0.0052 + 2	0.011 + 2	0.016 + 2			
30 MΩ	0.036 + 2	0.066 + 2	0.078 + 2			

Current Through Unknown

Range	30 Ω	300 Ω	3 kΩ	30 kΩ	300 kΩ	3 MΩ	30 MΩ
Current	1 mA	1 mA	1 mA	100 µA	10 µA	1 µA	100 nA

DC Current Input Characteristics

Range	Maximum Reading (5½ Digit)	Resolution		
		5½ Digit	4½ Digit	3½ Digit
300 mA	± 303.099 mA	1 µA	10 µA	100 µA
3 A	± 3.03099 A	10 µA	100 µA	1 mA

Maximum input (non-destructive): 3 A from <250 V source; fuse protected.

Measurement accuracy: ±(% of reading + number of counts). Auto zero ON. 5½ digit display.

Range	T _{Cal} * ± 5°C	
	90 Days	1 Year
300 mA	0.11 + 40	0.15 + 40
3 A (<1 A)	0.14 + 6	0.17 + 6
3 A (>1 A)	1.0 + 30	1.0 + 30

Maximum burden at full scale: 1 V (3 A range), 0.1 V (0.3 A range)

AC Current (true rms responding) **Input Characteristics**

Range	Maximum Reading (5½ Digit)	Resolution		
		5½ Digit	4½ Digit	3½ Digit
300 mA	303.099 mA	1 µA	10 µA	100 µA
3 A	3.03099 A	10 µA	100 µA	1 mA

Maximum input: (non-destructive): 3 A from <250 V source; fuse protected.

Measurement accuracy: ±(% of reading + number of counts). Auto zero ON. 5½ digit display. Accuracy is specified for sinewave inputs only, >10% of full scale.

1 Year, T_{Cal}* ±5°C

Frequency	Ranges	
	300 mA	3 A
20-50 Hz	1.54 + 163	2.24 + 163
50-1 kHz	0.81 + 163	1.50 + 163
1 k-10 kHz	0.72 + 163	1.42 + 163
10 k-20 kHz	0.86 + 163	1.56 + 163

Maximum burden at full scale: 1 V RMS (3A range)

General

Operating temperature: 0 to 55°C

Humidity range: 95% R.H., 0 to 40°C

Power: ac line 48 to 440 Hz; 86 to 250 V, 25 VA max.

Size: 102 mm H x 215 mm W x 356 mm D (4" x 8" x 14");

3½ in. H without feet.

Weight: 3 kg (6.5 lb)

HP-IB Interface Functions: SH1, AH1, T5, TE0, L4, LE0, SR1, RL1, PP0, DC1, DT1, C0

Ordering Information

Choose one N/C power option:

Opt 315: 100 V, 50 Hz; **Opt 335:** 220 V, 50 Hz

Opt 316: 100 V, 60 Hz; **Opt 336:** 220 V, 60 Hz

Opt 325: 120 V, 50 Hz; **Opt 345:** 240 V, 50 Hz

Opt 326: 120 V, 60 Hz; **Opt 346:** 240 V, 60 Hz

Opt W30: Three year extended hardware support

Opt 907: Front Handle Kit (HP P/N 5061-0088)

Opt 908: Rack Mount Kit (HP P/N 5061-0072)

Opt 910: Extra Manuals

Price

\$35.00

\$50.00

\$52.50

\$22.00

HP 3478A Multimeter

\$995

Fast Ship Product—see page 766

DIGITAL MULTIMETERS

6½ to 3½ Digit HP-IB DMM with High Stability

Model 3456A

- Up to 330 readings per second
- 100 nanovolt resolution
- Transfer standard performance

- 100 micro-ohm to 1.0 gigaohm measurement capability
- Offset compensated ohms (OC Ω)
- Fast AC

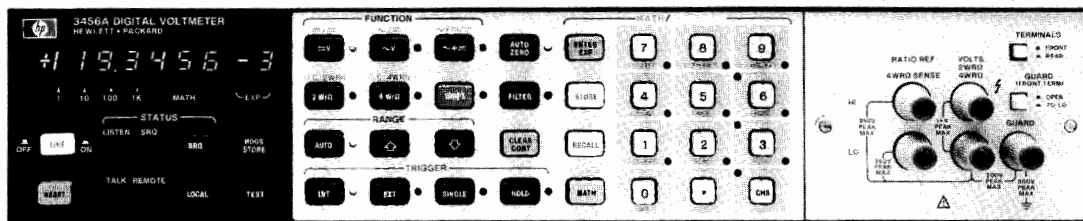

HP 3456A



Description

This microprocessor-based, fully guarded, integrating Digital Multimeter is designed for bench or systems. The HP Model 3456A measures DC, true RMS AC voltage and resistance.

Measurement speed and accuracy can be enhanced for a specific application, using the HP 3456A's selectable integration time (up to 100 power line cycles). An operator can select up to 330 readings/second for high speed bursts or one reading every fifteen minutes for periodic measurements. Resolution of 100 nanovolts at 48 readings/second (6½ digits) to 10 microvolt resolution at 330 readings per second (3½ or 4½ digits) can be selected.

Transfer standard performance is assured with the HP 3456A. With good repeatability and 100 nanovolt sensitivity, accuracy on the ten volt range is ±0.0008% + 2 counts over a 24-hour period at 23°C ±1°C.

Four full-scale, true RMS AC voltage ranges are provided, with reading speeds up to 12 readings per second over a 10 Hz to 250 kHz frequency range. Best accuracy is 0.05%. Crest factor is greater than seven at full scale.

System DMM

Full programmability over HP-IB is standard on the HP 3456A. The front panel indicators on the HP 3456A display range, function and HP-IB status during remote operation. Also on the front panel is a SRQ (Service Request) button which can be used to flag or interrupt a computer. With the HP 3456A's program memory and reading storage capability, the HP 3456A can take measurements and store them while a computer performs some other task.

Another system feature of the HP 3456A is its hardware scanner advance capability for scanned or multiplexed system applications. As soon as the HP 3456A's measurement cycle is complete, a TTL signal is available to trigger a variety of switching instruments like the HP 3497A Data Acquisition/Control Unit to advance to their next channel. Up to 330 channels can be scanned per second without computer interaction.

Bench DMM

With a 2 ppm stability, the HP 3456A is a true transfer standard offering either 100 nanovolt sensitivity or 0.001% accuracy. Other standard features include fast autorange and easy-to-use math functions. The user can scale, limit test, null and make measurements in percent error, dB and dBm, as well as convert thermistor readings to degrees F and C. A statistics function key (STAT) enables the operator to improve the HP 3456A's sensitivity, resolution and accuracy by averaging. Averaging reduces random noise fluctuations and improves sensitivity by a factor of the square root of the number of measurements. For example, for low level signals after 100 measurements, the actual sensitivity of the HP 3456A is approximately 10 nanovolts instead of 100 nanovolts. In addition, STAT enables the

operator to recall the maximum (upper), minimum (lower), and variance.

Calibration of the HP 3456A is fast and convenient since all routine adjustments are accessible from a concealed door in the front panel. Should service be necessary, built-in diagnostics and PC Board modules make the HP 3456A easy to service.

Specifications

DC Voltage

Input Characteristics

RANGE	MAXIMUM READING (5½ digit)	6½ digit	RESOLUTION 5½ digit	4½ digit	INPUT RESISTANCE	MAXIMUM INPUT VOLTAGE
0.1 V	.119999 V	100 nV	1 μV	10 μV	>10 ¹⁰ Ω	±1000 V peak
1.0 V	1.19999 V	1 μV	10 μV	100 μV	>10 ¹⁰ Ω	
10.0 V	11.9999 V	10 μV	100 μV	1 mV	>10 ¹⁰ Ω	
100.0 V	119.999 V	100 μV	1 mV	10 mV	10 MΩ ±5%	
1000.0 V	1000.00 V	1 mV	10 mV	100 mV	10 MΩ ±5%	

Guard to chassis: ±500 V peak

Guard to low: ±200 V peak

Measurement accuracy: ± (% of reading + number of counts). Auto-zero on and filter off.

RANGE	24 hour: 23°C ±1°C		90 days: 23°C ±5°C		1 year: 23°C ±5°C	
	6½ digit (≥10 PLC)	6½ digit (1 PLC)	6½ digit (≥10 PLC)	6½ digit (1 PLC)	6½ digit (≥10 PLC)	6½ digit (1 PLC)
0.1 V	.0022 + 24	0.0024 + 32	0.0026 + 24	0.0027 + 32	0.0034 + 24	0.0035 + 32
1.0 V	0.0009 + 4	0.0012 + 5	0.0016 + 4	0.0017 + 5	0.0024 + 4	0.0025 + 5
10.0 V	0.0008 + 2	0.0011 + 3	0.0015 + 2	0.0016 + 3	0.0023 + 2	0.0024 + 3
100.0 V	0.0011 + 3	0.0014 + 4	0.0018 + 3	0.0019 + 4	0.0026 + 3	0.0027 + 4
1000.0 V	0.0011 + 2	0.0013 + 3	0.0016 + 2	0.0017 + 3	0.0024 + 2	0.0025 + 3

*Add .02 $\left(\frac{\text{Input Voltage}}{1000}\right)^2$ % to % of reading.

Filter ON: rejection is >60 dB at 50 Hz. Add 2 μV to uncertainty for .1 V, 1.0 V and 10 V range and 200 μV for 100 V and 1000 V range.

Response Time

Filter OFF: for preprogrammed settling times (0.0 seconds), error is <0.0005% of input voltage step.

Filter ON: for preprogrammed settling times (.65 seconds), error is <.01% of input voltage step.

NOISE REJECTION (dB) (1 kΩ unbalance in Lo)

	AC ¹ NMR	AC ¹ ECMR	DC ECMR
.01 PLC or .1 PLC	0	90	140
≥1 PLC	60	150	140
≥1 PLC with filter	120	160	140

¹For 50, 60 Hz (depending on option) ±.09%



AC RMS Voltage (AC, AC + DC)

Input Characteristics

RANGE	MAXIMUM READING (5½ digit)		RESOLUTION		INPUT IMPEDANCE	MAXIMUM INPUT VOLTAGE
	6½ digit	5½ digit	5½ digit	4½ digit		
1.0 V	1.19999 V	1 µV	10 µV	100 µV	1 MΩ ± 5% shunted by <90 pF	±1000 V peak (700 V rms) 10 ⁸ VHz
10.0 V	11.9999 V	10 µV	100 µV	1 mV		
100.0 V	119.999 V	100 µV	1 mV	10 mV		
1000.0 V	700.00 V	1 mV	10 mV	100 mV		

Measurement accuracy: ±(% of reading + number of counts). Auto-zero on, > 1% of scale, and dc component < 10% of AC component.

90 days: 23°C ± 5°C

Integration Time	Frequency In Hz					
	In Power Line Cycles	10 to 20	Filter Off → 20 to 30	400-20k 30-20k	20k to 50k 20k to 50k	50k to 100k 50k to 100k
>1~ (6 Digit)*	.47 + 450	.35 + 500	.07 + 730	.17 + 1700	.55 ± 2900	5.0 + 6500
.1~ (5 Digit)	.48 + 90	.36 + 53	.08 + 73	.18 + 173	.56 + 293	5.0 + 653
.01~ (4 Digit)	.56 + 10	.41 + 7	.13 + 9	.23 + 19	.61 + 31	5.1 + 67

*Frequencies > 100 kHz are specified for 1.0 V and 10 V ranges only.

*Integration Time in Power Line Cycles (PLC). For 5½ digits, multiply counts by 0.1. For 4½ digits, multiply counts by 0.01.

Guard to chassis: ±500 V peak

Guard to low: ±200 V peak

DC component > 10% of ac component: (5½ digit) Add ±(0.05% of Reading + 50 counts) to accuracy. For 6½ digit, multiply counts by 10. For 4½ digit, multiply counts by .1. For signals with no AC component, use the 1 kHz ac spec.

Crest factor: >7:1 at full scale.

Common mode rejection (1 kΩ Lo unbalance): >90dB DC to 60 Hz.

Auto-zero OFF: for stable environment ±1°C no accuracy change.

Response time: for preprogrammed settling times, error is <.1% of input voltage step.

Filter OFF: 0.06 seconds

Filter ON: .80 seconds

Resistance (2 WΩ, 4 WΩ, 2 WOCΩ, 4 WOCΩ)

Input Characteristics

RANGE	MAXIMUM READING (5½ digit)		RESOLUTION		CURRENT THROUGH UNKNOWN
	6½ digit	5½ digit	5½ digit	4½ digit	
100 Ω	119.999 Ω	100 µΩ	1 mΩ	10 mΩ	1 mA
1 kΩ	1199.99 Ω	1 mΩ	10 mΩ	100 mΩ	1 mA
10 kΩ	11.9999 kΩ	10 mΩ	100 mΩ	1 Ω	100 µA
100 kΩ	119.999 kΩ	100 mΩ	1 Ω	10 Ω	50 µA
1 MΩ	1199.99 kΩ	1 Ω	10 Ω	100 Ω	5 µA
10 MΩ	11.9999 MΩ	10 Ω	100 Ω	1 kΩ	500 nA
100 MΩ	119.999 MΩ	100 Ω	1 kΩ	10 kΩ	<500 nA ¹
1 GΩ	1000.00 MΩ	1 kΩ	10 kΩ	100 kΩ	<500 nA ¹

¹Ohms source is a 500 nA current source in parallel with a 10 MΩ resistance.

Non-destructive overload: 350 V peak

Measurement accuracy: ± (% of reading + number of counts). Auto-zero on, filter off, and 4-wire ohms.

RANGE	24 hour: 23°C ±1°C		90 days: 23°C ±5°C	
	6½ digit (≥10 PLC)	6½ digit (1 PLC)	6½ digit (≥10 PLC)	6½ digit (1 PLC)
100 Ω	0.003 + 24	0.003 + 32	0.004 + 24	0.004 + 32
1 kΩ	0.002 + 4	0.003 + 5	0.003 + 4	0.004 + 5
10 kΩ	0.002 + 4	0.003 + 5	0.003 + 4	0.004 + 5
100 kΩ	0.002 + 2	0.003 + 3	0.003 + 2	0.004 + 3
1 MΩ	0.006 + 2	0.006 + 3	0.007 + 2	0.007 + 3
10 MΩ	0.041 + 2	0.041 + 3	0.042 + 2	0.042 + 3
100 MΩ	1.3 + 1	1.3 + 1	1.8 + 1	1.8 + 1
1 GΩ	11 + 1	11 + 1	16 + 1	16 + 1

Ratio

Type: DC/DC, AC/DC, or (AC + DC)/DC

Method: 4-wire with Volts Lo input common

$$\text{Ratio} = \frac{\text{Signal Voltage}}{\text{Ref. Hi Voltage} - \text{Ref. Lo Voltage}}$$

Signal measurement: Same as DC Volts, AC Volts, or AC + DC Volts

Reference measurement: automatically selects .1 V, 1 V, or 10 V DC. Volts range and a 0.0 ms. settling time. Filter is off.

Maximum Reference Voltages

Ref. Hi: ±12 V

Ref. Lo: ±9% of Ref. Hi

Ref. Hi-Ref. Lo: ±11.9999 V

Protection: ±340 V peak

Accuracy: total % signal error + total % reference error (same as .1 V, 1 V, or 10 V DC volts)

Reading Rate

Reading rates are with autorange, math, display and filter off. Output is to internal memory using internal trigger and packed mode. Packed output in place of internal memory adds 0.35 ms; ASCII output adds 2.3 ms per reading.

Rates vs. integration time and auto-zero: DC volts and 100 Ω thru 10 kΩ ranges with preprogrammed settling times (–0.0 s.). Also, AC or AC + DC volts and 100 kΩ thru 10 kΩ ranges with 0.0 s delay.

INTEGRATION TIME IN POWER LINE CYCLES (PLC)	RATES (rdgs/second)			
	Auto Zero OFF		Auto Zero ON	
	60 Hz	50 Hz	60 Hz	50 Hz
0.01 (4½ digit)	330	290	210	180
0.10 (5½ digit)	210	180	120	100
1.00 (6½ digit)	48	40	25	20
10.00 (6½ digit)	5.8	4.8	2.9	2.4
100.00 (6½ digit)	.57	.47	.29	.24

Memory

Reading store: Store up to 350 readings. These readings can be recalled from HP-IB interface or front panel

Program memory: can execute an internal program which controls instrument configuration and measurement sequence. Program is input from the HP-IB interface with up to 1400 ASCII characters.

Memory size: total size is 1400 bytes. Memory used is 1 byte per ASCII character + 4 bytes per reading stored.

General

Operating temperature: 0 to 50°C

Warmup time: one hour to meet all specifications

Humidity range: 95% R.H., 0 to 40°C

Storage temperature: –40 to +75°C

Power: 100/120/220/240 V +5%, –10%, 48 Hz to 400 Hz line operation, 45 VA max.

Size: 88.9 mm H x 425.5 mm W x 527.1 mm D (3½" x 16¾" x 20¾")

Weight: net, 10.49 kg (23.13 lb.); shipping, 13.35 kg (29.38 lb.)

Ordering Information

Opt 050: Noise rejection for 50 Hz

Opt 060: Noise rejection for 60 Hz

Opt 907: Front handle kit, P/N 5061–1666

Opt 908: Rack flange kit, P/N 5061–1668

Opt 909: Rack flange and front handle kit, HP P/N 5061–1671

Opt 910: Extra operating & service manual

Opt H01: Enhanced AC accuracy

Opt W30: 3 year hardware support

HP 3456A Digital Voltmeter

Price

N/C

N/C

+ \$50

+ \$30

+ \$72.50

+ \$76

+ \$200

+ \$120

\$4100



DIGITAL MULTIMETERS

3¹/₂ to 6¹/₂ Digit DMM with Extended Resolution to 7¹/₂ Digits

Model 3457A

- Over 1350 Readings/sec at 3¹/₂ Digits
- Seven Functions—DCV, ACV, DCI, ACI, Ohms, Frequency and Period
- Two Plug-in Multiplexer Options
- DC Sensitivity to 10 Nanovolts
- Outstanding Combination of Performance and Price



HP 3457A

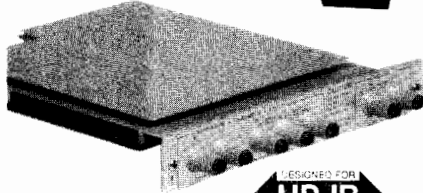

Now With CIIL

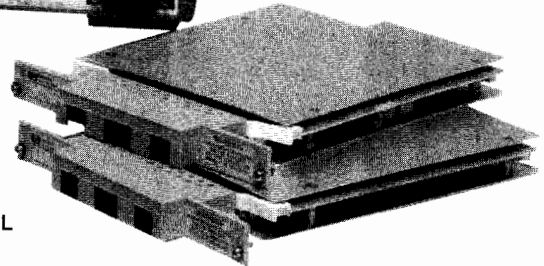

Description

The HP 3457A has seven functions with 3¹/₂ to 6¹/₂ digits of resolution extendable to 7¹/₂ digits at reading rates from 1 reading every 2 seconds to 1350 rds/s and basic DC volts accuracy as good as 5 ppm. In addition, the input of the HP 3457A can be expanded up to ten channels with either of the optional plug-in multiplexer assemblies. On the bench, the front panel operation is extremely flexible and comprehensive. In systems, the Hewlett-Packard Interface Bus (HP-IB) is standard.

Powerful Measurement Management

The HP 3457A combines superb analog measuring capability with equally powerful measurement management. More than 1000 readings or whole measurement sequences can be stored in the HP 3457A for convenient and fast measurement throughput. The present dmm setup can be stored in the non-volatile state memory for convenient reconfiguration of the dmm.

Additional power from math functions can be obtained by using PASS/FAIL limit testing, NULL, SCALE, THERMISTOR linearization, and others. The power of total electronic calibration, including AC volts, makes it easy to maintain instrument performance.

System Features

Keeping with HP's long tradition of systems oriented digital multimeters, the HP 3457A has all the systems features you've come to expect plus more to make interfacing to your computer even easier—features like flexible formatting of ASCII, 16 bit binary, or 32 bit binary data and buffer memory so that you can take measurements

with the HP 3457A at its highest speed. In addition, you'll find the VOLT METER COMPLETE output and EXTERNAL TRIGGER input signals ideal for synchronizing other instrumentation with the HP 3457A. Finally, programmable front-rear terminal switching lets you measure two separate inputs without a scanner.

Hewlett-Packard Multimeter Language (HPML)

Another first for the HP 3457A DMM is an easy-to-use dmm language—HPML. Designed so that software written for today's multimeter will fit tomorrow's, HPML only asks you to define the parameters necessary to accomplish your measurement. For example, if you want to make a measurement on a 9 volt DC signal with 0.01% resolution, the command sequence is "DCV,9,.01".

Control Interface Intermediate Language (CIIL) Option

With Option 700, the HP 3457A responds to standardized DMM CIIL commands via HP-IB. Physically and functionally identical to the standard HP 3457A, Option 700 adds the CIIL command set with a built-in Test Module Adapter (TMA) to the DMM's standard HPML. The HP 3457A is further enhanced by adding the functions of AC and DC current measurement through CIIL through HP-IB.

Three Rear Panel Plug-In Options

Either one of three different optional assemblies may be used with the HP 3457A for different measurement capabilities. Using the multiplexer assemblies will enable up to ten signal channels to be scanned either sequentially or randomly. All of the functional capability offered through the normal front and rear input terminals is available for multiple inputs. Using the high voltage assembly allows single channel measurement of either AC or DC voltages at the rear panel.

For measurement flexibility, the HP 44491A Armature Relay Multiplexer Assembly offers eight two-wire channels and two current/actuator channels. Under software control, the eight two-wire channels can be reconfigured to four 4-wire ohm channels. The two current channels offer automatic make-before-break switching so that the path for current as high as 1.5 A is never broken. In addition, these two channels can be used as external device actuator channels. Each channel can switch up to 150 V. The general purpose multiplexer can close a channel and make a measurement at a maximum rate of 33 channels per second.

For higher speed scanning, the HP 44492A Reed Relay Multiplexer Assembly offers ten two-wire channels. The HP 44492A is useful for switching dcV, acV, ac+dcV, two wire ohms, frequency and period measurement signals with a maximum amplitude of 125 V. The Reed Relay Multiplexer can close a relay and make a measurement at a maximum rate of 300 channels per second.

For measurement of voltages up to 1414 V peak, the HP 44497A High Voltage Assembly offers a 1000:1 attenuator input (channel 1) for the high voltage measurements. In addition, the other rear terminal input (channel 0) can be utilized to perform conventional VDC, VAC, Two-wire and Four-wire Ohms, Period, Frequency, DCI, and ACI measurements. Using the HP 44497A with HP 3457A in the 6 1/2 digit mode will yield a resolution of 1 mV for a 1000 V input. Implementing the MATH Scale function will have the HP 3457A LCD display the measurement results in the correct units of kilovolts.

Abbreviated Technical Specifications 90 day, Tcal ± 5 deg. C

DC Voltage

Range	Maximum Reading	Best 6 1/2 Digit Accuracy ¹ ± (% Rdg + Cnts)		
		% of Reading	Count Error	Input Resistance
30 mv	30.03000 mV	0.0040	365	10 GΩ
300 mv	303.00000 mV	0.0025	39	10 GΩ
3.0 V	3.0300000 V	0.0017	6	10 GΩ
30.0 V	30.300000 V	0.0035	19	10 MΩ
300.0 V	303.00000 V	0.0050	6	10 MΩ

1. After 1 hr warm-up, integration time 100 PLC. Tcal is the temperature of the calibration environment between 18 and 28 deg C.

DC Current

Range	Maximum Reading	Best 6 1/2 Digit Accuracy ¹ ± (% Rdg + Cnts)		
		% of Reading	Count Error	Input Resistance
300 μA	303.00000 μA	0.02	104	1000Ω
3 mA	3.0300000 mA	0.02	104	1000Ω
30 mA	30.300000 mA	0.02	104	100Ω
300 mA	303.00000 mA	0.07	204	10Ω
1.0A	1.0000000 A	0.07	604	0.1Ω

1. After 1 hr warm-up, integration time 100 PLC. Tcal is the temperature of the calibration environment between 18 and 28 deg C.

Resistance (2 and 4 wire ohms)²

Range	Maximum Reading	Best 6 1/2 Digit Accuracy ¹ ± (% Rdg + Cnts)		
		% of Reading	Count Error	Current Output
30 Ohm	30.30000 Ohm	0.0065	315	1 mA
300 Ohm	303.00000 Ohm	0.0045	34	1 mA
3 kOhm	3.0300000 kOhm	0.0035	6	1 mA
30 kOhm	30.300000 kOhm	0.0035	6	100 μA
300 kOhm	303.00000 kOhm	0.0040	7	10 μA
3 MOhm	3.0300000 MOhm	0.0055	12	1 μA
30 MOhm	30.300000 MOhm	0.0250	80	100nA
300 MOhm ³	303.00000 MOhm	1.6	1000	100nA
3.0 GOhm ²	3.0300000 GOhm	16.0	1000	100nA

1. After 1 hr warm up, integration time 100 PLC. Tcal is the temperature of the calibration environment between 18 and 28 deg C.
2. For two-wire ohms, add 200m Ohms to count error specifications.
3. For two-wire ohms only, Accuracy is specified following autocal (ACAL), under stable conditions (±1 deg C).

Maximum Reading Rates (DCV, DCI, and Resistance up to 30 kOhm)²

Power Line Cycles ³	Maximum # of Digits	Readings per Second-60Hz (50Hz)		
		Auto Zero On	Auto Zero Off	NMR
.0005	3 1/2	300	1350	0
.005	4 1/2	280	1250	0
.1	5 1/2	140 (128)	360 (312)	0
1.0	6 1/2	26 (22)	53 (45)	60dB
10	7 1/2	2.5 (2.0)	4.8 (4.0)	80dB
100	7 1/2	.25 (0.2)	0.5 (0.4)	90dB

1. Using Math HIRES mode.
2. Reading rates are specified with zero delay, fixed range, display off, and front panel off. The output is to internal reading memory using single integer format and internal timer.
3. Integration Time in Power Line Cycles (PLC).

Common Mode Rejection (dB): (1 kOhm unbalance in low lead) DC ECMR 140 dB; AC ECMR: <1 PLC, 76 dB; AC ECMR >1 PLC 156 dB, for 50, 60 Hz ±.08%.

True RMS ACV and (AC+DC)V

Bandwidth: 20 Hz to 1 MHz

Crest Factor: 3.5 to 1 at full scale

Common Mode Rejection: (1 kOhm unbalance in LO): >76 dB, DC to 60 Hz

Accuracy: (90 day)

Accuracy specified for sine wave inputs, >10% of range. DC component <10% of AC component after 1 hr warm-up and within one week of autocal. Integration time = 10 PLC. AC Band set to <400 Hz. DC coupled mode requires 2 hour warm-up.

Range	Maximum Reading	(100 Hz to 20 kHz) Best 5 1/2 Digit Accuracy ± (% Rdg + Cnts)			
		AC Coupled		DC Coupled	
		% of Reading	Count Error	% of Reading	Count Error
30mV	32.50000mV	0.13	116	0.17	364
300mV	325.00000mV	0.13	116	0.17	364
3.0V	3.2500000 V	0.13	116	0.17	364
30.0V	32.500000 V	0.13	116	0.17	364
300V	303.00000 V	0.19	116	0.23	364

True RMS ACI and (AC+DC)I

Bandwidth: 20 Hz to 100 kHz Crest Factor: 3.5 to full scale

Accuracy: (90 day)

Accuracy specified for sine wave inputs, >10% of range. DC component <10% of AC component after 1 hr warm-up and within one week of autocal. Integration time = 10 PLC. AC Band set to <400 Hz. DC coupled mode requires 2 hour warm-up.

Range	Maximum Reading	(100 Hz to 20 kHz) Best 5 1/2 Digit Accuracy ± (% Rdg + Cnts)			
		AC Coupled		DC Coupled	
		% of Reading	Count Error	% of Reading	Count Error
30mA	32.50000mA	0.25	290	0.3	1600
300mA	325.00000mA	0.25	290	0.3	1600
1.0A	1.0000000 A	0.35	290	0.4	1600

Reading Rates (ACV and ACI)¹

Power Line Cycles	Maximum # of Digits	Readings per Second .60 Hz (50 Hz)	
		Input <400 Hz (Slow Response)	Input >400 Hz (Fast Response)
.0005	3 1/2	1	9.5
.005	4 1/2	1	9.5
.1	5 1/2	1 (1)	9.25 (9.2)
1	6 1/2	1 (1)	7.25 (6.9)
10	6 1/2	0.7 (0.65)	2.0 (1.7)
100	6 1/2	0.2 (0.17)	0.25 (0.2)

1. Reading rates are specified with preprogrammed delays, fixed range, and Auto Zero on.



DIGITAL MULTIMETERS

3¹/₂ to 6¹/₂ Digit DMM with Extended Resolution to 7¹/₂ Digits

HP Model 3457A (cont.)

Frequency and Period: Measures the frequency or period of the ac component of the ac or dc coupled voltage or current input. The counter uses a reciprocal counting technique to give constant resolution independent of input frequency.

Input Impedance: Refer to AC voltage and current specifications.

Frequency Range: 10 Hz to 1.5 MHz (voltage input)

10 Hz to 100 KHz (current input)

Period Range: .1 s to 667 ns (voltage input)

.1 s to 3.33 us (current input)

Sensitivity: 10 mV or 100 μ A (sinewave)

Triggering: Triggers and counts on zero crossings

Accuracy: (1 year)

Frequency	Period	\pm % of Reading
10 Hz to 400 Hz	.1 s to .025 s	0.05
400 Hz to 1.5 MHz	.025 s to 667 ns	0.01

Maximum Reading Rate: 2.0 rdgs/s for integration time of 1 PLC, AC Band >400 Hz, delay zero and math off, and fixed range.

Memory: 2139 available bytes that can be partitioned into 3 segments, one devoted to storing measurements, one devoted to storing measurement subprograms, and one devoted to storing instrument states.

Math Functions: The HP 3457A performs the following math functions on the measurements—NULL, SCALE, OFFSET, RMS FILTER, SINGLE POLE FILTER, THERMISTOR LINEARIZATION, DB, DBM, % ERROR, PASS/FAIL LIMIT TESTING, and STATISTICS. Two math functions may be used at one time.

General Specifications

Operating Temperature: 0 to 55° C

Warmup Time: one hour to all specifications except where noted

Humidity Range: 95% R.H., 0 to 40° C

Storage Temperature: -40 to +75° C

Power: 100/120/220/240 V \pm 10%, 48 Hz - 66 Hz, 220 V, \pm 10%, 48 Hz to 66 Hz. Fused at .2A (115 V) or 0.08 A (230 V). <30 VA.

Size: 89 mm H (without removable feet) x 425mm W x 292mm D (3.5" x 16.75" x 11.5"). Height (with removable feet): 100 mm (4"). Allow 76mm (3") additional depth for wiring.

Net Weight: 5.05 kgm (11.1 lbs)

Shipping Weight: 9.3 kgm (20.5 lbs)

Plug-in Options

HP 44491A Armature Relay Multiplexer Assembly Input Characteristics:

Eight two-wire armature relay channels and two current/actuator channels. Maximum voltage (terminal-to-terminal or terminal to chassis) 250 Vrms. Maximum current (per channel) -1.0 A DC or AC. Thermal Offset - 3 μ V. Closed channel resistance (end of relay life) - <2 Ohms. Maximum switching and measurement speed - 33 channels/second.

HP 44492A Reed Relay Multiplexer Assembly Input Characteristics:

Ten two-wire reed relay channels. Maximum voltage (terminal-to-terminal or terminal-to-chassis) - 125 V peak. Thermal offset - 3 μ V. Closed channel resistance (end of relay life) - <4 Ohms. Specified for <100 kHz ac volts and frequency operation. Maximum switching and measurement speed - 300 channels/second.

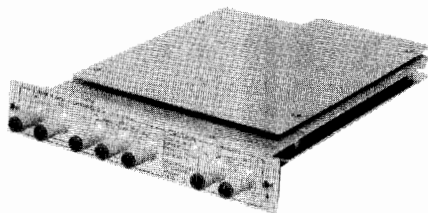

HP 44497A High Voltage Attenuator Assembly Input Characteristics: Two relay channels, channel 1 devoted to high voltage measurements. Maximum High-to-Low voltage of 1000 Volts DC or AC rms. Maximum Low-to-Earth voltage of 350 V Peak Non-destructive Overload voltage of 1700 V Peak, 1200 Volts DC. Attenuator accuracy to be added to HP 3457A range and function accuracy for total accuracy.

DC 0.030% of reading

20 Hz - 1 KHz 2.8% of reading

1 KHz - 10 KHz 10.0% of reading

Note: One year accuracy applies to Tcal \pm 5%, NPLC=1 or greater. Specifications are for low-to-earth voltage less than 0.1 times the High-to-Earth voltage.

Armature Relay (44491A)

Reed Relay (44492A)

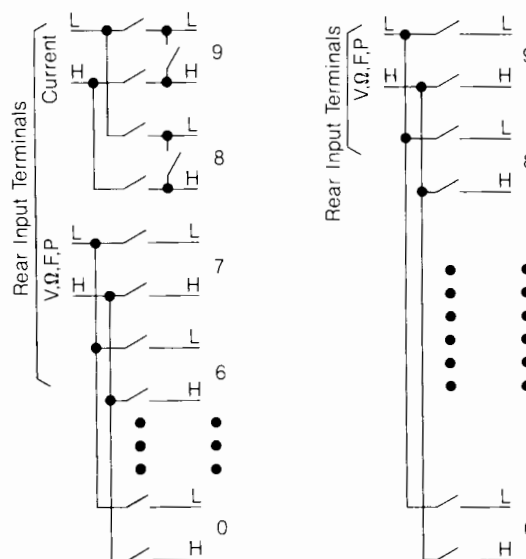

Model 3457A Multimeter

*HP 44491A Armature Relay Multiplexer Assembly \$450

*HP 44492A Reed Relay Multiplexer Assembly \$450

*HP 44497A High Voltage Attenuator Assembly \$375

Option 401: Side Handle Kit (P/N 5061-1171) \$20

Option 700: CIIL Language \$950

Option 907: Front Handle Kit (P/N 5061-1170) \$50

Option 908: Rack Flange Kit (P/N 5061-1168) \$30

Option 909: Rack Flange and Front Handle Kit (P/N 5061-1169) \$72

Option 910: Extra Operating and Service Manual \$75

Option W30: Two years of additional hardware support \$80

Accessories:

HP 44490A Rack Slide Kit for 30 inch depth racks \$225

HP 44493A Screw Terminal Connector for HP 44491A includes strain relief and housing \$60

HP 44494A Screw Terminal Connector for HP 44492A includes strain relief and housing \$60

HP 34118A Test Lead Kit \$25

HP 11096B RF Probe, detects AC voltage up to 700 MHz \$175

HP 34111A High Voltage Probe, 1000 to 1, DC high voltage divider for up to 40 kVDC \$200

HP 34119A High Voltage Probe, 1000:1, AC & DC Voltage Divider for up to 5000V \$125

HP 44414A: Four Thermistor Pack \$60

03457-10085 Calibration Software (85B Computer) \$100

03457-10200 Calibration Software (200 Series Computer) \$100

*Plug-in options may be ordered and shipped separately without a HP 3457A mainframe. Unless otherwise specified, the optional plug-in accessories will be shipped with the HP 3457A mainframe.

Price
\$2800

DIGITAL MULTIMETERS

System Digital Multimeters

Model 3437A, 3455A

197



- 5½/6½-Digit DVM with Auto Cal
- High Speed 3½ Digit System Voltmeter

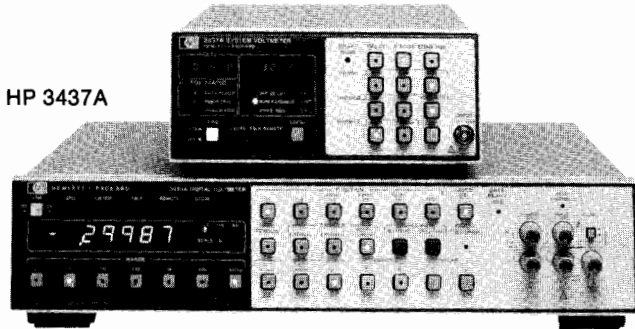

HP 3437A

HP 3455A

HP 3437A Description

The Hewlett-Packard 3437A System Voltmeter is designed for systems. It is a 3½-digit, high-speed dc voltmeter with sample and hold. The standard unit measures dc volts, provides trigger delay, burst reading capability and Hewlett-Packard Interface Bus (HP-IB).

There are three dc floating input ranges: 0.1V, 1.0V and 10.0V full scale with a maximum display of "1998." Sample and Hold allow the HP 3437A to be an instantaneous reading voltmeter. The trigger delay can be set from 0.1µs to 1.0 second and the number of readings can be set from 0 to 9999 readings.

Performance

Static Accuracy (90 days, 23°C ± 5°C)

10 V range: ±(0.05% of reading + 1.6 counts).

Static accuracy temperature coefficient (0°C–50°C):
±(0.002% reading + 0.05 counts) / °C.

Input Characteristics

10 V range: R = 1 MΩ ± 20%; C < 75 pF.

Maximum input voltage high to low on all ranges: < ±30 V peak.

Maximum voltage low to chassis: ±42 V peak.

Maximum reading rate (remote, N Rdgs. > 1, and a zero delay listener)

ASCII: 3600 readings/s.

Packed: 5700 readings/s.

Input Bandwidth (3 dB)

1 V and 10 V range: 1.0 MHz.

General

Operating temperature: 0 to 55°C.

Storage temperature: -40°C to 75°C.

Humidity range: < 95% R.H., 0°C to 40°C.

Power: 100 V, 120 V, 220 V, 240 V +5%, -10%, 48 Hz to 440 Hz line operation, < 42 VA.

Size: 88.9 mm H x 212.7 mm W x 527.1 mm D (3½" x 8¾" x 20¾").

Weight: net, 5.6 kg (12 lb 4 oz). Shipping, 7.6 kg (16 lb 12 oz).

HP 3437A System Voltmeter

\$3300

Option W30: extended warranty

\$95

HP 3455A Description

Hewlett-Packard's 3455A Digital Voltmeter is a microprocessor controlled 5½- or 6½-digit integrating voltmeter for bench or systems applications. The standard instrument measures dc volts, ac volts, and resistance. HP-IB and auto or manual ranging are also standard.

Measuring Speed

The HP 3455A is fully guarded and has greater than 60 dB normal mode noise rejection at reading rates of up to 24 readings per second on all dc ranges. Ohms reading rates are up to 12 readings/second and an ac fast mode gives reading rates of up to 13 readings/second at

frequencies above 300 Hz. (Readings/second given for 60 Hz operation and high resolution off.)

Performance

DC measurements can be made with up to 1µV sensitivity. Ohms measurements are made with either a 2-wire and 4-wire mode. The High Resolution (6½-digit) mode gives dc and ohms measurements with greater than 1 part per million resolution. The standard true rms converter gives ac measurements from 30 Hz to 1 MHz. Complex signals with crest factors of up to 7:1 at full scale can be measured.

Specifications

Accuracy ± (% of reading + counts)

24 hrs: 23°C ± 1°C		
Range	24 Hrs.	90 Days
1 V	0.003 + 4	0.006 + 4
10 V	0.002 + 3	0.005 + 3
100 & 1000 V	0.004 + 3	0.007 + 3

Input resistance: 0.1 V through 10 V range: > 10¹⁰ ohms. 100 V and 1000 V range: 10 megohm ± 0.1% with Auto Cal. "off."

Maximum input voltage: High to low input terminals: ±1000 V peak; **Guard to chassis:** ±500 V peak; **Guard to low terminal:** ±200 V peak.

NMR at 50 or 60 Hz ± 0.1%: > 60 dB.

ECMR with 1 kΩ Unbalance in Lo at DC: > 160dB;

AC Voltage (rms converter)

Input Impedance

Front terminals: 2 MΩ ± 1% shunted by less than 105 pf.

Rear terminals: 2 MΩ ± 1% shunted by less than 90 pf.

Maximum Input Voltage

High to low terminals: ±1400 volts peak; 10⁷ VHz max.

Guard to chassis: ±500 V peak; **Guard to low terminal:** ±200 V peak.

Crest factor: 7:1 at full scale.

Performance (rms converter)

Accuracy: [± % of reading + counts] (ac coupled)

Fast ACV	300 Hz to 20 kHz	20 kHz to 100 kHz	100 kHz to 250 kHz	250 kHz to 500 kHz	500 kHz to 1 MHz
	ACV	30 Hz to 20 kHz			
90 days 23°C ± 5°C	0.05 + 50	0.50 + 100	2.00 + 250	5.00 + 500	6.00 + 3100

Accuracy ± (% of reading + counts) 4-wire kΩ

24 hours: 23°C ± 1°C		
Range	24 Hours	90 Days
1 kΩ	0.0025 + 4	0.0035 + 5
10 kΩ	0.0045 + 4	0.0060 + 5
100 kΩ	0.0020 + 5	0.0035 + 6
1000 kΩ	0.0120 + 4	0.0135 + 5
10,000 kΩ	0.1000 + 4	0.1000 + 5

Maximum Reading Rates for Remote Operations. (Rdgs/s)

Function	50 Hz	60 Hz
DCV	22	24
Ohms	11	12
ACV (rms)	1.1	1.3
Fast ACV (rms)	12	13

General

Power: 100 V, 120 V, 240 V +5% -10%, 48-400 Hz; < 60 VA.

Size: 88.9 H x 425.5 W x 527.1 mm D (3.5" x 16.75" x 20.75").

Weight: net, 9.38 kg (20.7 lb); shipping, 11.8 kg (26 lb).

Options

001: average converter

Price
less \$100

HP 3455A Digital Voltmeter

Option W30: extended warranty

\$5600
\$95



DIGITAL MULTIMETERS

High Performance 5½ to 3½ Digit Bench DMM

Models 3468A/B

- Five functions
- Electronic calibration
- 5½ to 3½ digits

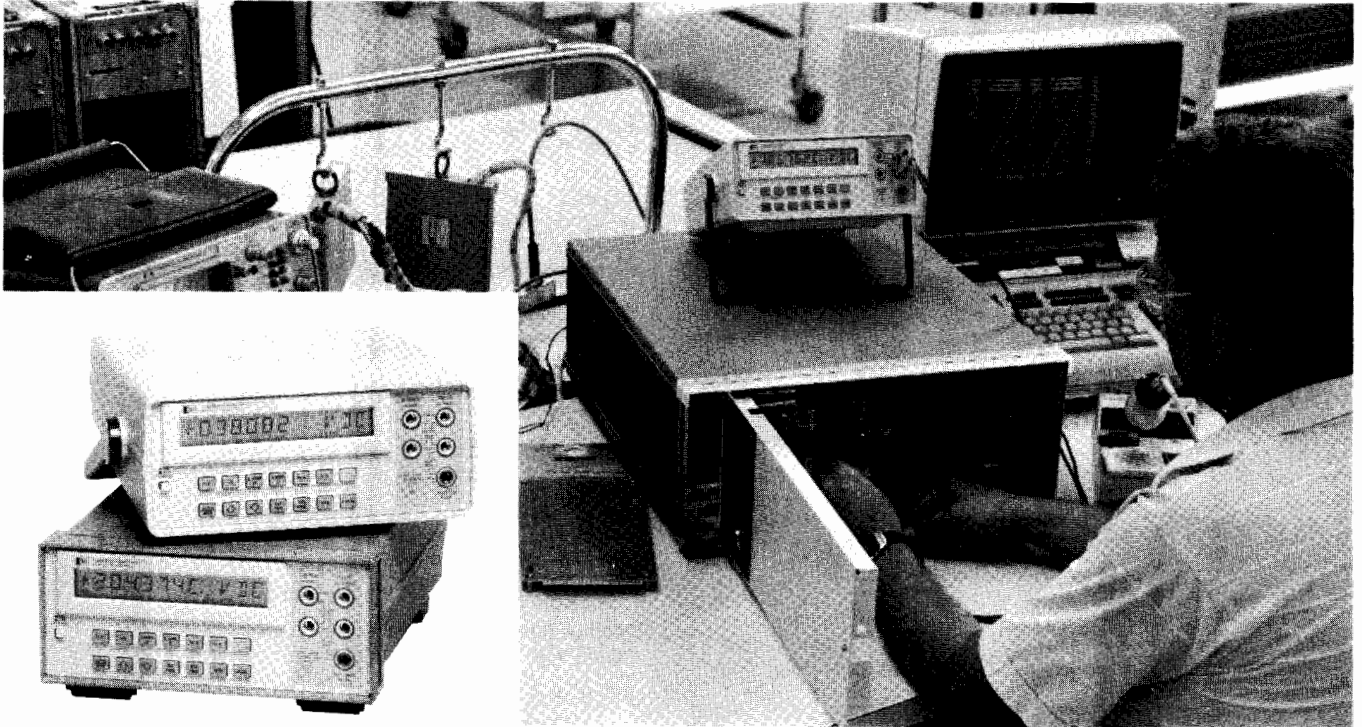

HP 3468A/B

Description

The HP Models 3468A/B are autoranging 5½ to 3½ digit DMMs, with the five functions of dc volts, true RMS ac volts, 2- and 4-wire ohms, dc current and true RMS ac current. They are low-cost, highly reliable DMMs which can be completely calibrated electronically, either manually from the front panel or remotely in an automatic calibration system. Remote calibration is made possible by the built-in HP-IL (Hewlett-Packard Interface Loop) interface which provides complete programmability of functions, ranges and modifiers.

The HP 3468A comes in a streamlined portable package with a handle for convenient carrying, whereas the HP 3468B comes in a plastic system case for easy rack mounting. Both are available with a rechargeable battery and battery charging circuitry for portable measurements.

High Performance

The HP 3468A/B have 5 functions with selectable 5½, 4½ or 3½ digit resolution. DC and true RMS ac voltage measurements are provided from 0.3 volt full scale range with 1 µV sensitivity up to 300 volts. The bandwidth of the true RMS ac converter is from 20 Hz to 100 kHz on all ranges and up to 300 kHz on the 30 V range. Either 2 or 4-wire ohms measurements can be selected with a maximum range of 30 MΩ. Both dc and true RMS ac current capability is provided up to 3 A. All functions on the HP 3468A/B incorporate fast autoranging. The HP 3468A/B use an integrating analog to digital conversion technique for high noise rejection. The selectable 3½, 4½ or 5½ digits of resolution allows flexibility for choosing speed or noise rejection.

Electronic Calibration

Complete calibration of the HP 3468A/B is done electronically, either manually from the front panel or remotely in an automatic calibration system. There are no internal adjustments necessary. Complete calibration of all functions is done without removal of the instrument's covers, thus saving valuable time and reducing cost. The calibration procedure for the HP 3468A/B involves connecting a calibration standard to the input, then pressing three keystrokes to store one calibration constant in CMOS RAM for each range and function. When the HP 3468A/B make a measurement, each reading is corrected according to the calibration constants that have been stored. The internal CMOS RAM used in the HP 3468A/B is powered by a

lithium battery to create a non-volatile memory capable of holding the calibration constants for more than ten years.

HP-IL

The HP Models 3468A/B are fully programmable with HP-IL, a two-wire serial interface, and the HP-41C/CV handheld calculators or the more powerful HP Series 80 computers. HP-IL provides automatic measurements and adds computational power to these bench DMMs.

Battery

The optional battery pack includes a rechargeable battery and the battery charger circuitry for up to five hours of continuous measurements.

DC Voltage

Input Characteristics

Range	Maximum Reading (5½ digit)	Resolution		
		5½ digit	4½ digit	3½ digit
0.3 V	±0.301000 V	1 µV	10 µV	100 µV
3 V	± 3.01000 V	10 µV	100 µV	1 mV
30 V	± 30.1000 V	100 µV	1 mV	10 mV
300 V	± 301.000 V	1 mV	10 mV	100 mV

Input resistance: 0.3 V, 3 V ranges: > 10¹⁰ Ω

30 V, 300 V ranges: 10 MΩ ± 1%

Maximum Input Voltage (non-destructive)

Hi to Lo: 301 Vrms or 450 V peak

Hi or Lo to Earth Ground: ±500 V peak

Measurement accuracy: ±(% of reading + number of counts). Auto zero ON. 5½ digits.

Range	TCal*±1°C 24 Hour	TCal*±5°C	
		90 Day	1 Year
0.3 V	0.005 + 4	0.009 + 5	0.02 + 5
3 V	0.0035 + 2	0.0072 + 2	0.0181 + 2
30 V	0.005 + 3	0.009 + 3	0.02 + 3
300 V	0.0055 + 2	0.009 + 2	0.02 + 2

*TCal is the temperature of the environment where the 3468A/B was calibrated. Calibration should be performed with the temperature of the environment between 20°C and 30°C.

HP Model 3468A/B (cont.)

Temperature coefficient: 0°C to 55°C, 5½ digits, auto zero ON.
± (% of reading + number of counts)/°C.

Range	Temperature Coefficient
0.3 V, 30 V	0.0008 + 0.5
3 V, 300 V	0.0007 + .05

Noise rejection: in dB, with 1 kΩ imbalance in Lo lead. AC rejection for 50, 60 Hz ±0.1%. Auto zero ON.

Display	AC NMR	AC ECMR	DC CMR
5½ digits	80	150	140
4½ digits	59	130	140
3½ digits	0	70	140

Maximum reading rate with HP-85: 32 readings/second.

Maximum reading rate with HP-41CV: 2 readings/second.

Resistance (2-wire Ω, 4-wire Ω)

Input Characteristics

Range	Maximum Reading (5½ digit)	Resolution		
		5½ digit	4½ digit	3½ digit
300 Ω	301.000 Ω	1 mΩ	10 mΩ	100 mΩ
3 kΩ	3.01000 kΩ	10 mΩ	100 mΩ	1 Ω
30 kΩ	30.1000 kΩ	100 mΩ	1 Ω	10 Ω
300 kΩ	301.000 kΩ	1 Ω	10 Ω	100 Ω
3 MΩ	3.01000 MΩ	10 Ω	100 Ω	1 kΩ
30 MΩ	30.1000 MΩ	100 Ω	1 kΩ	10 kΩ

Input protection (non-destructive): ± 350 V peak.

Measurement accuracy: ±(% of reading + number of counts). Auto zero ON. 5½ digit display. 4-wire ohms.

Range	T _{Cal} ±1°C 24 Hour	T _{Cal} ±5°C	
		90 Day	1 Year
300 Ω	.0045 + 4	.012 + 5	.017 + 5
3 kΩ-300 kΩ	.0035 + 2	.011 + 2	.016 + 2
3 MΩ	.0052 + 2	.011 + 2	.016 + 2
30 MΩ	.036 + 2	.066 + 2	.078 + 2

Current Through Unknown

Range	300 Ω	3 kΩ	30 kΩ	300 kΩ	3 MΩ	30 MΩ
Current	1 mA	1 mA	100 μA	10 μA	1 μA	100 nA

Maximum open circuit voltage: 6.5 V

AC Voltage (true RMS responding)

Input Characteristics

Range	Maximum Reading (5½ digit)	Resolution		
		5½ digit	4½ digit	3½ digit
0.3 V	0.301000 V	1 μV	10 μV	100 μV
3 V	3.01000 V	10 μV	100 μV	1 mV
30 V	30.1000 V	100 μV	1 mV	10 mV
300 V	301.000 V	1 mV	10 mV	100 mV

Input impedance: 1 MΩ ±1% shunted by <60 pF.

Maximum input voltage (non-destructive): 301 Vrms or 450 V peak.

Measurement accuracy: ±(% of reading + number of counts) Auto zero ON. 5½ digit display. Accuracy is specified for sinewave inputs only, >10% of full scale.

1 Year, T_{Cal} ±5°C

Frequency	Ranges		
	0.3V	3 V, 30 V	300 V
20-50 Hz	1.14 + 163	1.14 + 102	1.18 + 102
50-100 Hz	0.46 + 163	0.46 + 103	0.5 + 102
100 Hz-20 kHz	0.29 + 163	0.26 + 102	0.33 + 102
20-50 kHz	0.56 + 247	0.41 + 180	0.55 + 180
50-100 kHz	1.74 + 882	1.05 + 825	1.26 + 825
100 k-300 kHz	10.1 + 3720 (30 V range only)		

Crest factor: >4:1 at full scale.

DC Current
Input Characteristics

Range	Maximum Reading (5½ digit)	Resolution		
		5½ digit	4½ digit	3½ digit
3 A	± 3.01000 A	10 μA	100 μA	1 mA

Maximum input (non-destructive): 3 A from <250 V source; fuse protected.

Measurement accuracy: ±(% of reading + number of counts). Auto zero ON. 5½ digit display.

Range	T _{Cal} ±5°C	
	90 Days	1 Year
3 A, <1 A input	0.14 + 6	0.17 + 6
3 A, >1 A input	1.0 + 30	1.0 + 30

AC Current (true RMS responding)

Input Characteristics

Range	Maximum Reading (5½ digit)	Resolution		
		5½ digit	4½ digit	3½ digit
3 A	0.301000 A	1 μA	10 μA	100 μA
3 A	3.01000 A	10 μA	100 μA	1 mA

Maximum input (non-destructive): 3 A from <250 V source; fuse protected.

Measurement accuracy: ±(% of reading + number of counts). Auto zero ON. 5½ digit display. Accuracy specified for sinewave inputs only, >10% of full scale.

1 Year, T_{Cal} ±5°C

Frequency	Ranges	
	0.3 A	3 A
20-50 Hz	1.77 + 163	2.5 + 163
50-1 kHz	1.1 + 163	1.8 + 163
1 k-10 kHz	1.0 + 163	1.7 + 163
10 k-20 kHz	1.14 + 163	1.84 + 163

General Information

Operating temperature: 0 to 55°C

Humidity range: 95% R.H., 0 to 40°C

Power: AC line 48 to 440 Hz, 86 to 250 V, (see configuration)

Battery: (Opt 001) Rechargeable lead-acid; minimum continuous operation for 5 hours at 25°C; recharge time is 16 hours with HP 3468A/B off and 36 hours with HP 3468A/B on.

Size: HP 3468A: 98.4 mm H x 238.1 mm W x 276.2 mm D (3.88 in. H x 9.38 in. W x 10.88 in. D). 3468B: 89 mm H x 213 mm W x 275 mm D (without feet), 3.5 in. H x 8.38 in. W x 10.83 in. D.

Weight: HP 3468A/B—2.1 kg (4.63 lb); HP 3468A/B with Opt 001—3.1 kg (6.83 lb).

Configuration: order one power and frequency option at no charge from below.

Opt 315: 100 V, 50 Hz; **Opt 335:** 220 V, 50 Hz

Opt 316: 100 V, 60 Hz; **Opt 336:** 220 V, 60 Hz

Opt 325: 120 V, 50 Hz; **Opt 345:** 240 V, 50 Hz

Opt 326: 120 V, 60 Hz; **Opt 346:** 240 V, 60 Hz

Ordering Information

HP 3468A DMM in Streamlined Portable Case with HP-IL and test probes.

HP 3468B DMM in Rack and Stack Case with HP-IL and test probes.

Options and Accessories.

HP 3468A/B Option W30, add 3 year Extended Hardware Support

HP 3468A/B Option 001, add Rechargeable Battery Pack

HP 3468B Option 401, add Side Handle Kit

(HP P/N 5061-1171)

HP 3468B Option 907, add Front Handle Kit

(HP P/N 5061-1170)

HP 3468B Option 908, add Rack Mount Kit for a Single Instrument (HP P/N 5060-0173)

HP P/N 5060-0174 Rack Mount Kit for rack mounting

two instruments side-by-side

☎ Fast-Ship product - See page 766

Price

\$750 ☎

\$750 ☎

\$25

\$150

\$20

\$50

\$52.50

\$70.00



DIGITAL MULTIMETERS

Bench, General Purpose and Wide Bandwidth

HP Model 3466A and HP Model 3400A

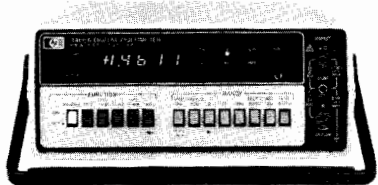

HP 3466A

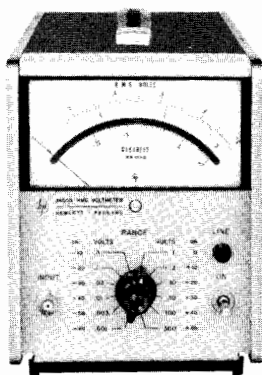

HP 3400A

Description

The HP 3466A is a 4½ digit Multimeter with autoranging volts and ohms. Functional capability includes ACV, DCV, (ac + dc) V, ACI, DCI, (ac + dc) I, Ω , and diode test. AC measurements are true rms with selectable ac or dc coupling. Available with rechargeable batteries or ac power only, it has 1 μ V dc and 1 m Ω sensitivity with zero adjustment on lowest ranges to compensate for external offsets.

Specifications

DC Voltmeter

Voltage Range	Maximum Display	Accuracy: (1 yr., 18 to 28°C) ±(% of reading + # of counts)
20 mV	± 19.999 mV	(.05 + 3)
200 mV	± 199.99 mV	(.04 + 2)
2 V	± 1.9999 V	(.03 + 1)
20 V	± 19.999 V	(.03 + 1)
200 V	± 199.99 V	(.035 + 1), <700 V input
1200 V	± 1199.9 V	(.055 + 1), >700 V input

AC Voltmeter

AC converter: true-rms responding, true-rms calibrated
Maximum input: (ac + dc): ± 1200 V dc; ±1700 V (dc + peak ac), ac: ±600 V dc; 1700 V (peak ac + dc), 10⁷ V · Hz.

Crest factor: 4:1 at full scale.

Accuracy (with display of ≥10% of range): 1 yr., 18 to 28°C sinusoidal waveform.

AC TRMS: (20 Hz to 100 kHz)

Frequency Range	±(% of reading + # of counts)
20 Hz to 30 Hz	(2 + 50)
30 Hz to 50 Hz	(1 + 30)
50 Hz to 10 kHz	(0.3 + 20)
10 kHz to 20 kHz	(1 + 40)
20 kHz to 100 kHz	(2 + 150)

DC + AC TRMS: dc + (20 Hz to 100 kHz).

Ohmmeter

Ohms Range	Maximum Display	Current Through Unknown	Accuracy: 1 yr., 18 to 28°C ±(% of reading + # of counts)
20 Ω	19.999 Ω	5 mA	.08 + 2
200 Ω	199.99 Ω	5 mA	.08 + 2
2 k Ω	1.9999 k Ω	1 mA	.03 + 1
20 k Ω	19.999 k Ω	100 μ A	.03 + 1
200 k Ω	199.99 k Ω	10 μ A	.03 + 1
2000 k Ω	1999.9 k Ω	1 μ A	.04 + 1
20 M Ω	19.999 M Ω	100 nA	.15 + 1

Input protection: 250 V rms or 350 V (dc + peak ac).

DC Current and True RMS AC Current

Current Range	DC Current ±(% reading + # of counts)
200 μ A, 2mA, 20 MA	(.07 + 2)
200 mA	(0.15 + 2)
2000 mA	(0.5 + 2)

AC Current Accuracy:

Range	Frequency	±(% of reading + # of counts)
200 μ A–200 mA	20 Hz–30 Hz	2 + 50
	30 Hz–10 kHz	0.9 + 35
2000 mA	20 Hz–30 Hz	2 + 50
	30 Hz–10 kHz	1.2 + 20

Ordering Information

HP 3466A Digital Multimeter. Standard configuration in a streamlined portable case with handle, ac line power, batteries and charger, and test leads.

HP 3466A Opt. 001, streamlined portable case, ac line power only. less \$75

HP 3466A Opt. 002, rack and stack case, ac line power only. (Rack mount kit not included.) less \$10

Price

\$1200 ☎

Description

The Hewlett-Packard Model 3400A is a true root-mean-square (rms) voltmeter, providing a meter indication proportional to the dc heating power of the input waveform.

Six-decade frequency coverage makes the HP 3400A extremely flexible for all audio and most RF measurements and permits the measurement of broadband noise and fast-rise pulses.

Pulses or other non-sinusoids with crest factors (ratio of peak to rms) up to 10:1 can be measured full scale. Crest factor is inversely proportional to meter deflection, permitting up to 100:1 crest factor at 10% of full scale.

Permanent plots of measured data and higher resolution measurements can be obtained by connecting an X-Y plotter, strip chart recorder or digital voltmeter to the convenient rear-panel dc output. The dc output provides a linear 0 to 1 volt drive proportional to meter deflection.

Specifications

Voltage range: 1 mV to 300 V full scale, 12 ranges.

dB range: –72 to +52 dBm (0 dBm = 1 mW into 600 Ω).

Frequency range: 10 Hz to 10 MHz.

Response: responds to rms value (heating value) of the input signal for all waveforms.

Meter accuracy: % of full scale (20°C to 30°C)*

10Hz	50Hz	1MHz	2MHz	3MHz	10MHz
±5%	±1%	±2%	±3%	±5%	

AC-to-DC converter accuracy: % of full scale (20°C to 30°C)*

10Hz	50Hz	1MHz	2MHz	3MHz	10MHz
±5%	±0.75%	±2%	±3%	±5%	

* TC: ±0.1% from 0°C to 20°C and 30°C to 55°C.

Crest factor: (ratio of peak to rms amplitude of input signal): 10 to 1 at full scale (except where limited by maximum input) inversely proportional to meter deflection (e.g., 20 to 1 at half-scale, 100 to 1 at tenth scale).

Input impedance: from 0.001 V to 0.3 V range: 10 M Ω shunted by <50 pF. From 1.0 V to 300 V range: 10 M Ω shunted by <20 pF. ac coupled input.

Output: negative 1 V dc into open circuit at full-scale deflection, proportional to meter deflection from 10–100% of full scale. 1 mA maximum; nominal source impedance is 1000 Ω . Output noise <1 mV rms.

Accessories furnished: 10110A Adapter, BNC to dual banana jack.

Ordering Information

HP 3400A Opt 001 spreads out the dB scale by making it the top scale of the meter. add \$40

Rear terminals in parallel with front panel terminals and linear log scale uppermost on the meter face are available on special order.

HP 3400A RMS Voltmeter

\$1750

☎ Fast ship product - see page 766.

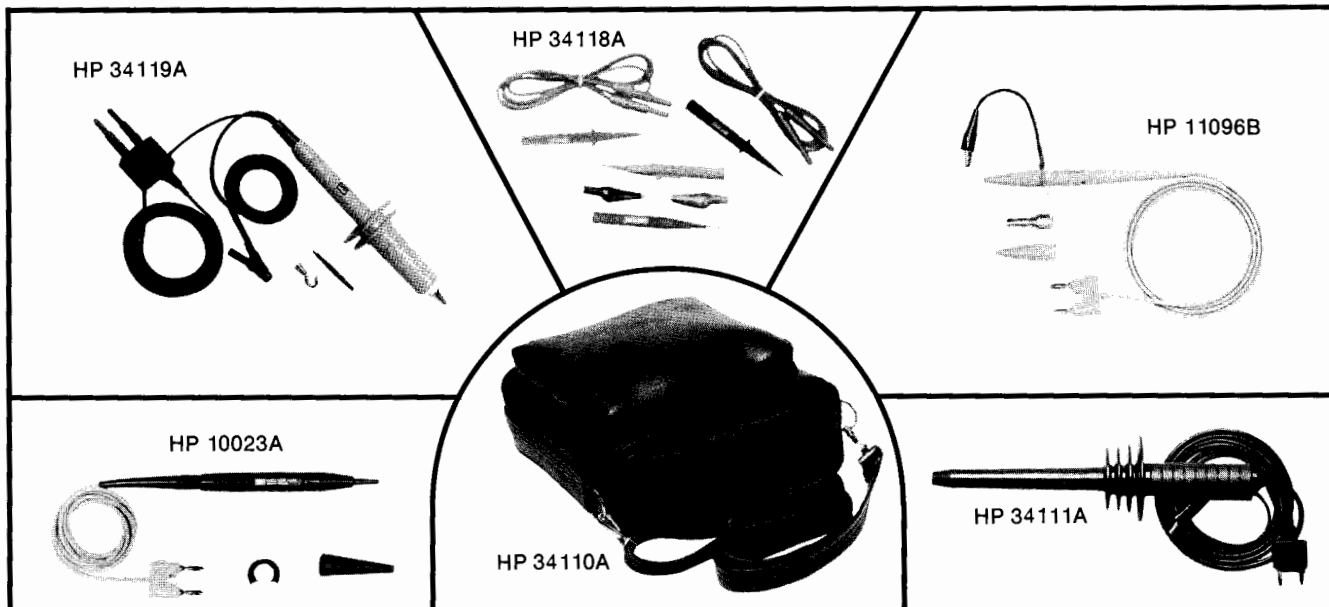

HP 10023A Temperature Probe

The HP Model 10023A Temperature Probe provides the fast, accurate temperature measurements needed in a wide variety of thermal design, diagnostic, and testing applications. Surface temperature measurements are read directly in degrees Celsius on general purpose digital multimeters having an input impedance of ≥ 10 megohms. A pencil-like probe tip easily accesses small components and a press-to-read switch makes measurements easy.

The probe is a self-contained temperature-to-voltage transducer with a forward-biased diode chip providing calibrated linear output of $1 \text{ mV}/^\circ\text{C}$. The entire electronics assembly, including integrated circuits and battery is packaged in the probe barrel.

A standard dual banana plug output connector provides universal connection to digital voltmeters.

HP 10023A Specifications

Electrical

Measurement range: -55°C to $+150^\circ\text{C}$.

Output: $1 \text{ mV}/^\circ\text{C}$.

Short term repeatability: $\pm 0.3^\circ\text{C}$ (minimum of 48 h).

Accuracy: $\pm 2^\circ\text{C}$ from 0°C to 100°C , decreasing linearly to $+2^\circ\text{C}$, -4°C at -55°C and $+4^\circ\text{C}$, -2°C at $+150^\circ\text{C}$.

Maximum voltage at tip: 600 V (dc + peak ac).

Tip capacitance to ground: approx 0.5 pF .

Thermal response: $< 3 \text{ s}$ to settle within 2°C of final reading (liquid measurement) for a 100°C temperature change.

DMM input R: $\geq 10 \text{ M}\Omega$

General

Operating environment (probe tip to approx. 13 mm (0.5 in) from probe tip): temperature, -55°C to $+150^\circ\text{C}$; altitude, to 4600 m (15 000 ft); vibration, vibrated in three planes for 15 min each with 0.38 mm (0.015 in) excursion, 10 to 55 Hz.

Operating environment (probe body): temperature, 0°C to 60°C (battery limitation); humidity (non-condensing), to 95% relative humidity at $+40^\circ\text{C}$, altitude and vibration same as those for probe tip.

Overall length: approx 1.4 m (53 in.).

Weight: net, 85 g (3 oz); shipping, 312 g (11 oz).

Battery life: approx 50 h (varies with ambient temperature).

Accessories supplied: one replacement battery (HP 1420-0256), one sliding lock collar (HP 10023-23201), and one probe tip cover (HP 00547-40005).

Ordering Information

Part Number	Price
HP 10023A Temperature Probe	\$330
HP P/N 10023-60001 Replacement tip, includes pre-calibrated tip and matching compensation network	\$120
HP 11096B High Frequency Probe	\$195

HP 11096B High Frequency Probe

Converts dc voltmeter with $10 \text{ M}\Omega$ input to peak-responding high-frequency ac voltmeter. Works with any dc voltmeter with $10 \text{ M}\Omega$ input impedance.

HP 11096B Specifications

Voltage range: 0.25 to 30 Vrms.

Transfer Accuracy (when used with $10 \text{ M}\Omega \pm 10\%$ dc voltmeter):

Frequency	Accuracy
100 kHz	$\pm 0.5 \text{ dB}$
100 MHz	$\pm 1.2 \text{ dB}$
500 MHz	$\pm 1.2 \text{ dB}$

Down 3 dB at 10 kHz and 700 MHz.

Input impedance: $4 \text{ M}\Omega$ shunted by 3 pF .

Maximum input: 30 V rms ac; 200 V dc.

HP 34111A DC Hi-Voltage Probe

1000:1 divider will accept up to 40 kV. Input $Z = 10^9 \Omega$. Divider accuracy meets specifications when connected to $10 \text{ M}\Omega$ input resistance instrument.

Division Ratio Accuracy

0-20 kV	$< 4\%$
30-40 kV	$< 4\%$
20-30 kV	$< 2\%$

Divider has interchangeable hook and pointed tip.

HP 34119A High Voltage Probe

This 1000:1 divider probe will accept either 5000 Vdc or 5000 Vac rms. Input $Z = 500 \text{ M}\Omega$ at 3 pF . It can be used with DMM's having an input resistance of $10 \text{ M}\Omega$ for dc, and $1 \text{ M}\Omega$ for ac, selectable through a switch on the probe. Supplied with the probe is a domed tip, a hook tip, and a trimmer tool for ac voltage compensation.

AC Voltage Input Derating: 5 kV at frequencies less than 350 kHz, 2.5 kV at frequencies from 250 kHz to 1 MHz.

Operating Modes DC (10M): DMM Input Resistance must be $10 \text{ M}\Omega \pm 1\%$. ac (1M): DMM input resistance must be $1 \text{ M}\Omega \pm 1\%$.

DC Division Ratio Accuracy: 1.5% of reading.

AC Division Ratio Accuracy: $\pm 1.5\%$ of reading at frequencies less than 100 kHz, $\pm 2.5\%$ of reading at frequencies from 100 kHz to 1 MHz.

Ordering Information

Part Number	Price
HP 34110A Carrying Case for $\frac{1}{2}$ Rack Size Instruments	\$45
HP 34111A DC Hi-Voltage Probe	\$200
HP 34118A Test Lead Kit	\$25
HP 34119A High Voltage Probe	\$125



PC INSTRUMENTS

General Information

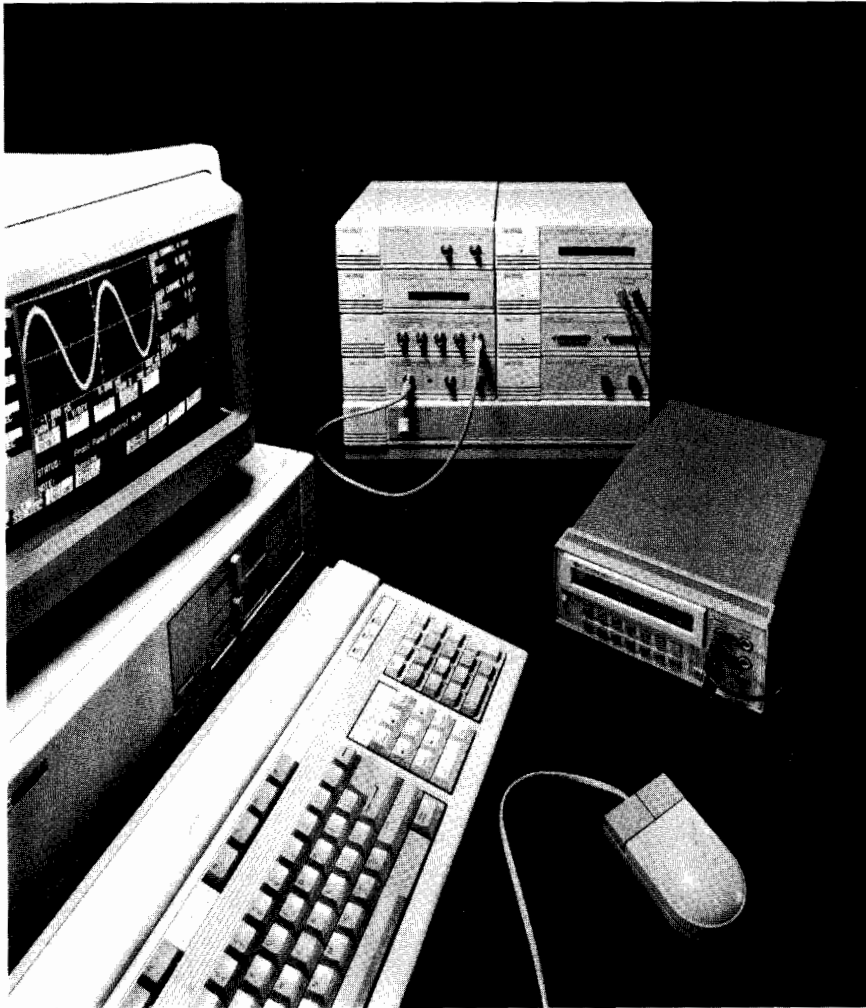

Advanced Personal Computer Instrumentation

HP PC Instruments link test and measurement instrumentation to the HP Vectra PC, IBM PC/XT/AT, HP 9000 Series 200/300, AT&T PC 6300, and HP 150 Touchscreen PC. This instrumentation system represents a cost-effective way to achieve fast and consistent test results for many applications. PC Instruments are used primarily as entry level computer-aided-test (CAT) solutions for production test with other applications in research and development, and education.

PCIB Interface

The interface between each instrument and your computer is via HP PCIB - the HP PC Instruments Bus. PCIB is implemented with a single interface card which plugs into one long slot in the computer's backplane. You can monitor and control up to eight instrument modules with a single interface. Multiple interfaces can be added allowing control of more PC Instruments.

Powerful System Software - The Heart of HP PC Instruments

PC Instruments system software makes it easy for you to use the system in either a manual or a programmed mode. For manual

mode operation, the soft front panel duplicates the instrument-control panels of traditional instruments on your CRT screen. Because the PC Instruments programming library for BASIC uses high-level commands, it's easy to customize or develop your own application programs in BASIC.

PC Instruments Speed Test Development Time

The PC Instruments system software uses the same high-level, easy-to-remember commands in BASIC, such as OUTPUT and MEASURE, to control all of the instruments. These commands, together with other system software features, let you develop your own PC Instruments test programs in approximately half the time that it would normally take to program traditional instruments.

PC Instruments system software also provides time-saving debugging features. The soft front panels let you see the status of all instruments in the system at a glance. And you can easily switch between panels and your BASIC program for simple program debugging.

In addition, many instrument configurations can be easily set and stored on disc in one or more state files through the use of the

soft front panel. These state files can then be recalled and executed during a BASIC program with the INITIALIZE.SYSTEM command. With this feature, you can save the instrument settings for a variety of tests and instantly recall complete setups for any one of the tests with a single command.

Manual Mode Simplicity

For manual mode operation the system software generates a soft front panel on your computer screen that duplicates the front panel of its traditional instrument counterpart. You interact with the panel as you would with any other instrument to set functions, ranges and values, and to take measurements. Monitor and control adjustments to each instrument are performed through the use of cursor keys, a mouse, or the HP Touchscreen.

Mix and Match PC Instruments with HP-IB Instruments

For optimum price and performance, mix traditional HP-IB instruments with any of the PC Instrument modules. For instance, you can combine an HP-IB 3457A high-performance DMM with PC Instruments to create a system capable of performing various tests (with PC Instruments modules) and making critical voltage measurements (with the HP 3457A) while still maintaining an overall low-cost test system. Both PC Instruments and HP-IB instruments can be controlled from the same BASIC program.

Optional Software Packages

Optional HP data acquisition software provides simple menu-driven programs to get you up and running quickly for voltage scanning and temperature measurement applications. And ASYST Scientific Software (available directly from Hewlett-Packard) integrates PC Instruments and HP-IB instruments with powerful analytical, statistical, and graphic capabilities.

In addition, PC Instruments are compatible with a number of third-party software solutions, such as Lotus 1-2-3.

Modular System Design

PC Instruments consist of ten advanced instrumentation modules, each with its own isolated power pack. These instruments are extremely compact and stackable to conserve bench space. For manufacturing environments, the optional rack shelf allows up to four PC Instruments to be mounted in standard 19-inch racks.

Since the PC Instrument modules are located outside the personal computer, valuable expansion slots are conserved, and the instruments are removed from the noisy environment of the PC. The simple design of the modules allows easy access to the measurement terminals and easy expansion of the instrument system as necessary.

In addition, an optional system power unit provides convenient, space-effective storage for the power packs of up to eight PC Instruments. Used on the bench, the system power unit provides an ideal base for PC Instruments. It is also rack mountable.

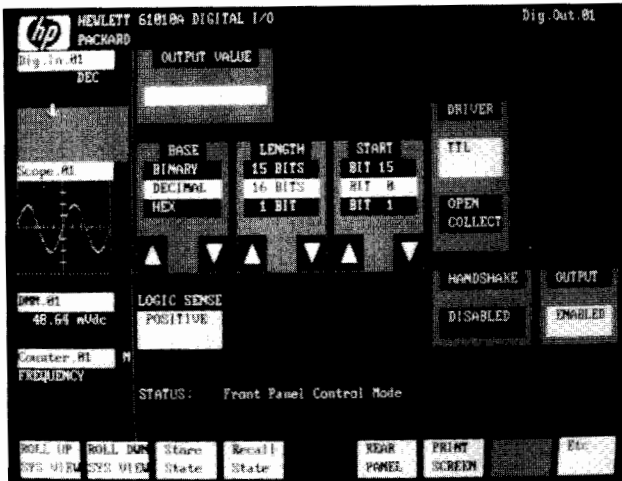

HP 61010A Digital I/O

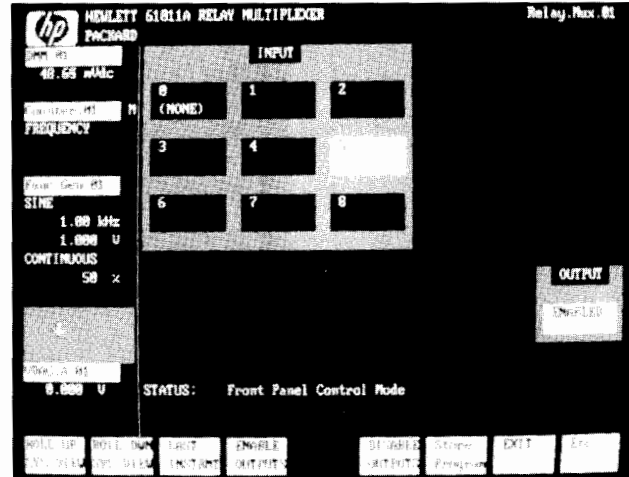

HP 61011A Relay Multiplexer

PC Instruments General Specifications

The following specifications hold for all PC Instruments modules, except where noted otherwise.

Operating Temperature Range: 0°C to 40°C.

Storage Temperature Range: -40°C to +80°C.

Instrument Dimensions: L = 295 mm (11.62 in); W = 212 mm (8.35 in); H = 64.5 mm (2.54 in). Each instrument comes with a power pack which provides isolated power.

Power Pack Specifications: L = 110 mm (4.33 in); W = 90 mm (3.54 in); H = 64.5 mm (2.54 in); Wgt = 0.87 kg (1.91 lbs).

Input Voltage Domestic Power Pack: 120 Vac \pm 12.5%, 57-63 Hz, 25 VA max.

Input Voltage International Power Pack(s): 100, 220 or 240 Vac, \pm 12.5%, 47-66 Hz, 25 VA max.

PC Instruments meet IEC 348 standards.

HP 61010A Digital I/O

The HP 61010A Digital I/O can be used as both an input and an output device. It has 16 independent input lines and 16 independent output lines, which can be addressed as variable length words up to 16 bits long. The input and output connectors include two data control lines each. Both random asynchronous and synchronous transfers are available.

The instrument comes with two shrouded connectors for solder terminals. Accessory block (HP 14802A) allows easy screw termination.

User Connections: 16 input data bits; 2 input data control signals; 16 output data bits; 2 output data control signals.

Digital Input Data Characteristics

Input Voltage Range: \pm 10 V max.

Input Impedance: 100 k ohm pullup resistor to +5 V.

Input Logic Threshold: Programmable to \pm 10 V, Resolution = 80 mV, Accuracy = \pm 160 mV.

Digital Output Data Characteristics

TTL Mode: V_{ol} = 0.4 V max @ I_{ol} = 16 mA max.

V_{oh} = 2.4 V min @ I_{oh} = -4 mA max.

Open Collector Mode: V_{ol} = 0.4 V max @ I_{ol} = 16 mA max.

V_{oh} = 0.7 V max @ I_{oh} = 40 mA max.

V_{oh} = 12 V max (pullup resistor to external supply).

Output Disabled Mode:

I_{oz} = -5uA max (with output bit pulled down to ground).

I_{oz} = 250uA max (with output bit pulled up to +12 V).

Data Control Signals

ODAV (Output Data Available): Same as output data bit.

ODAC (Output Data Accepted): V_{il} = 0.0 V to 0.4 V, V_{ih} = 2.4 V to 5.0 V (10 k ohm pullup resistor to +5 V); Minimum pulse width = 10 us.

IDAV (Input Data Available): V_{il} = 0.0 V to 0.4 V, V_{ih} = 2.4 V to 5.0 V (10 k ohm pullup resistor to +5 V); Minimum pulse width = 10 us.

IDAC (Input Data Accepted): Same as output data bit.

Data Transfer Time: OUTPUT or MEASURE statement, hand-shake disabled: HP Vectra PC: 8.0 ms/word.

HP Series 310: 1.5 ms/word.

Weight: 1.26 kg (2.78 lbs).

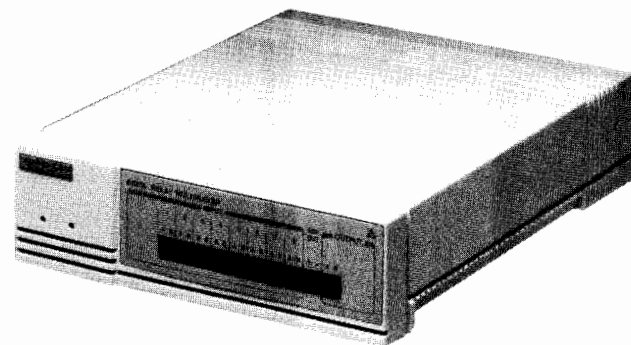

HP 61011A Relay Multiplexer

The HP 61011A Relay Multiplexer features break-before-make scanning of up to eight double-ended channels. The relays are bi-directional so that they may be used to send up to eight signals to a single destination, or distribute one source among eight output channels. The 61011A can be teamed with a digital multimeter to provide thermocouple scanning. An onboard temperature reference allows accurate absolute temperature measurement.

The Relay Multiplexer comes with a plug-in screw terminal block for easy connection of user inputs and outputs.

User Connections: 8 Double-ended inputs; 1 Temperature reference voltage output; 1 Double-ended output.

Channel Select Time: OUTPUT statement, including automatic break-before-make: HP Vectra PC: 36 ms.

HP Series 310: 30 ms.

Input Switching Characteristics

Max Voltage: 250 Vdc, 250 Vac rms, 350 Vac peak.

Max Current: (Per channel or module) 1 Amp dc, 1 Amp ac rms.

Max Power: (Per channel or module) 50 W dc, 250 VA ac.

Resistance (Input to Output): 1 ohm typical.

Thermal Offset (Input to Output): < 6 uV max.

Isolation Voltage Rating: 250 Vdc, 250 Vac rms, 350 Vac peak between any two input terminals or between an input and ground.

DC Isolation Resistance: (< 40°C, 80% RH)

Open Channel > 2 x 10⁸ ohms

Channel-Channel > 2 x 10⁸ ohms

Channel-Ground > 2 x 10⁸ ohms

AC Characteristics (50 ohm termination):

	100 kHz	1 MHz	10 MHz
Crosstalk (input to input) (dB)	< -73	< -53	< -33
Feedthrough (input to output) (dB)	< -73	< -53	< -33
Insertion Loss (input to output) (dB)	< 0.2	< 0.3	< 0.5
Capacitance			
(Open Channel, Channel to Channel)			< 5 pF
(Closed Channel)			< 25 pF
(Channel to Chassis)			< 50 pF



PC INSTRUMENTS

Instrument Modules

Models 61012A and 61013A

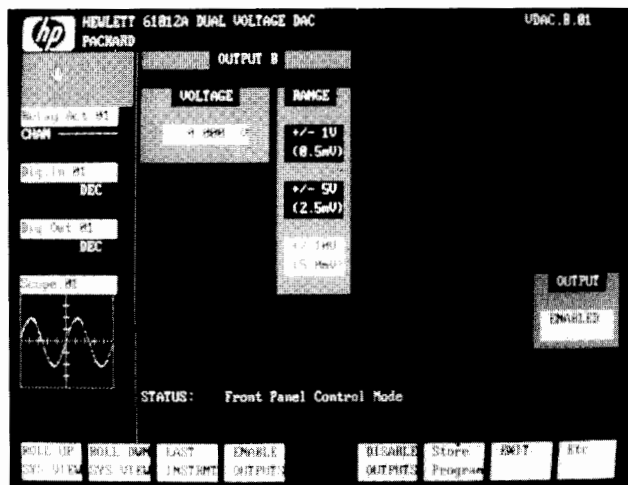

HP 61012A Dual Voltage DAC

HP 61012A Dual Voltage DAC

The HP 61012A Dual Voltage DAC supplies two independently controlled voltage sources in three standard ranges. Each voltage source is electrically isolated.

The Dual Voltage DAC comes with two plug-in screw terminal blocks.

Output Voltage (at up to 5 mA):

- 1 V to + 1 V with 0.5 mV resolution.
- 5 V to + 5 V with 2.5 mV resolution.
- 10 V to +10 V with 5.0 mV resolution.

Accuracy:	Range	23°C ± 5°C	0°C - 40°C
	± 1 V	0.050% ± 0.6 mV	0.25 % ± 0.6 mV
	± 5 V	0.050% ± 3.0 mV	0.25 % ± 3.0 mV
	±10 V	0.025% ± 6.0 mV	0.125% ± 6.0 mV

Ripple and Noise: Less than 3 mV p-p, 20 Hz to 20 MHz.

Output Protection: Outputs can withstand a short circuit for unlimited time.

Settling Time: Output voltage settles within 1 LSB of final value in less than 1 ms.

Programming Time: Time to change the voltage output of either source using an OUTPUT statement: HP Vectra PC: 15 ms
HP Series 310: 7 ms

Isolation Voltage Rating: 250 Vdc, 250 Vac rms or 350 Vac peak between outputs or between either voltage output and ground.

Output Disabled Mode: 100 k ohm resistance across outputs.

Weight: 1.11 kg (2.44 lbs).

HP 61013A Digital Multimeter

The HP 61013A Digital Multimeter measures dc voltages, ac voltages, and ohms. Its features include full programmability, autoranging, and true rms.

The Digital Multimeter comes with two shrouded leads, test probes, and grabber clips.

Digits: 4½

Functions: ±DC Volts, AC Volts (true rms), Ohms.

Programmable Ranges:

	Range	Max Display	Resolution
DC (±) or AC Volts (rms)	200 mV	199.99 mV	0.01 mV
	2 V	1.9999 V	0.0001 V (0.1 mV)
	20 V	19.999 V	0.001 V (1 mV)
	200 V	199.99 V	0.01 V (10 mV)
Resistance	200 ohms	199.99 ohms	0.01 ohms
	2 k ohms	1.9999 k ohms	0.0001 k ohms (0.1 ohms)
	20 k ohms	19.999 k ohms	0.001 k ohms (1 ohm)
	200 k ohms	199.99 k ohms	0.01 k ohms (10 ohms)
	2 M ohms	1.9999 M ohms	0.0001 M ohms (100 ohms)
	20 M ohms	19.999 M ohms	0.001 M ohms (1 k ohms)

General

Accuracy (at 23°C ± 5°C, 80% RH) All ac specifications given for a sine wave.

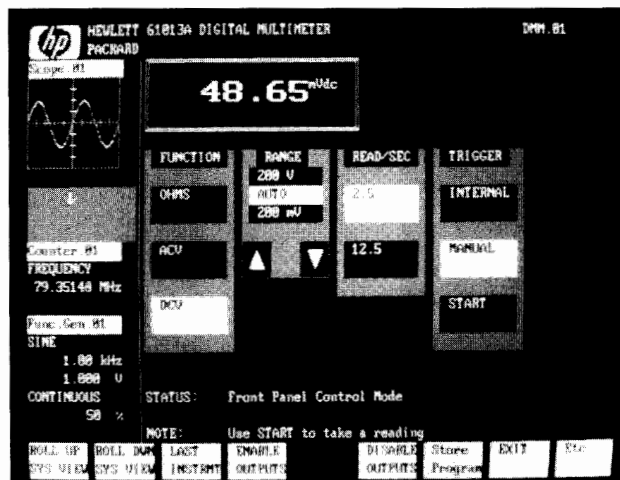

HP 61013A Digital Multimeter

2.5 readings/second:

DC Volts: ±0.05% of reading ±4 counts.

AC Volts (45 Hz to 500 Hz): ±0.5% of reading ±50 counts.

AC Volts (30 Hz to 45 Hz, 500 Hz to 1 kHz): ±1% of reading ±50 counts.

Ohms: ±0.1% of reading ±4 counts (200, 2 k, 20 k, 200 k, 2 M ohm ranges). ±0.35% of reading ±4 counts (20 M ohm range).

12.5 readings/second:

DC Volts: ±0.05% of reading ±10 counts.

AC Volts (45 Hz to 500 Hz): ±0.5% of reading ±56 counts.

AC Volts (30 Hz to 45 Hz, 500 Hz to 1 kHz): ±1% of reading ±56 counts.

Ohms: ±0.1% of reading ±10 counts (200, 2 k, 20 k, 200 k, 2 M ohm ranges). ±0.35% of reading ±10 counts (20 M ohm range).

Accuracy (0°C - 40°C, 80% RH)

2.5 readings/second:

DC Volts: ±0.1% of reading ±8 counts.

AC Volts (45 Hz to 500 Hz): ±0.75% of reading ±100 counts.

AC Volts (30 Hz to 45 Hz, 500 Hz to 1 kHz): ±1.5% of reading ±100 counts.

Ohms: ±0.2% of reading ±7 counts (200, 2 k, 20 k, 200 k, 2 M ohm ranges). ±0.5% of reading ±12 counts (20 M ohm range).

12.5 readings/second:

DC Volts: ±0.1% of reading ±14 counts.

AC Volts (45 Hz to 500 Hz): ±0.75% of reading ±106 counts.

AC Volts (30 Hz to 45 Hz, 500 Hz to 1 kHz): ±1.5% of reading ±106 counts.

Ohms: ±0.2% of reading ±13 counts (200, 2 k, 20 k, 200 k, 2 M ohm ranges). ±0.5% of reading ±18 counts (20 M ohm range).

Maximum Settling Time: DC: 150 ms (to 0.01%)

AC: 350 ms (to 0.1%)

Ohms: 75 ms (to 0.01%)

Maximum Measurement Rate: 12.5 readings/second (80 ms/reading with a MEASURE statement).

Programmable Measurement Rates: 2.5 readings/second or 12.5 readings/second.

Input Impedance: 10 M ohms minimum all dc ranges; 1 M ohms on all ac ranges.

Input Overvoltage Protection: 350 V peak (non-destructive).

Common Mode Rejection

DC Range 50/60 Hz NMR 50/60 Hz ECMRR* DC CMRR*

2.5/s > 60 dB > 120 dB > 120 dB

12.5/s 0 dB > 60 dB > 120 dB

AC Range DC-60 Hz CMRR* DC CMRR*

2.5/s or 12.5/s > 60 dB > 120 dB

*With 1K in LO lead.

Isolation Voltage Rating: 250 Vdc, 250 Vac rms, 350 Vac peak between any input terminal and ground.

Weight: 1.02 kg (2.25 lbs).

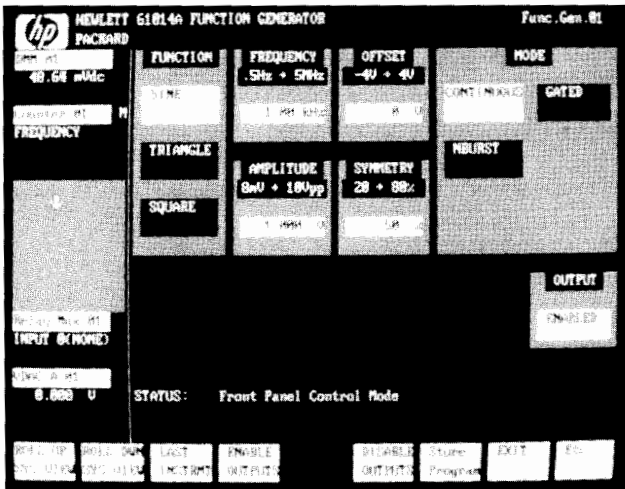

HP 61014A Function Generator

HP 61014A Function Generator

The HP 61014A Function Generator generates sine waves, square waves, triangle waves, ramps and pulses. The function, frequency, amplitude and offset can be set programmatically. The burst feature allows you to program a discrete number of cycles ranging from 1 to 65536. Inputs for VCO and AM modulation are also provided.

Specifications: All specifications are given at full rated output into a 50 ohm load unless otherwise noted.

Symmetry Range for Sine, Square, Triangle Waves: 20% to 80% of duty cycle up to 500 kHz; 50% of duty cycle up to 5 MHz.

Sine Wave Distortion:

10 Hz to 50 kHz: All harmonics >40 dB below fundamental.
50 kHz to 5 MHz: All harmonics >30 dB below fundamental.

Square Wave Rise Time and Fall Time:

10% to 90% at 1 MHz: <50 ns (typical), <75 ns (maximum).

Triangle Linearity Error: <3% at 1 kHz.

Output Impedance: 50 ohms ±10%.

Flatness (Measured with respect to a 1 kHz sine wave reference):

10 Hz to 100 kHz: Better than ±3% (in a single output range).
100 kHz to 5 MHz: Better than ±18% (in a single output range).

Amplitude Characteristics

Amplitude range: 8 mV to 10 V p-p.
Resolution: 0.8 V to 10 V: 40 mV. below 0.8 V: 4 mV.
Offset: Programmable from -4 V to 4 V.
Offset Accuracy: ±5% ±0.2 V (function amplitude >0.1 V p-p).
±5% ±2.5 mV (function amplitude <0.1 V p-p).
Maximum Amplitude Including Offset: 5 V

Output Frequency Characteristics

Frequency Range: 0.5 Hz to 5 MHz.
Resolution: 0.5 Hz to 50 Hz: 0.1 Hz
50 Hz to 500 Hz: 1 Hz
500 Hz to 5 kHz: 10 Hz
5 kHz to 50 kHz: 100 Hz
50 kHz to 500 kHz: 1 kHz
500 kHz to 5 MHz: 10 kHz

Accuracy: ±4% of the maximum frequency in each of the ranges listed above.

External Modulation Characteristics

Amplitude Modulation:
Modulating signal: dc to >100 kHz. Carrier Envelope Distortion at 70% sine wave modulation with $f_c = 1$ MHz and $f_m = 1$ kHz: <2% typical.

VCO: The output frequency can be decreased from the maximum frequency associated with any given resolution: >100 to 1. The frequency versus voltage curve will be linear to within ±2% of maximum frequency associated with any given resolution.

Output Control Characteristics

Free Run Mode: Continuous Operation.
N-Burst Mode: The burst feature allows you to program a discrete number of cycles ranging from 1 to 65536.
Gate Mode: A logic zero applied to the gate input causes continuous operation. A logic one applied to the gate input will stop the output.

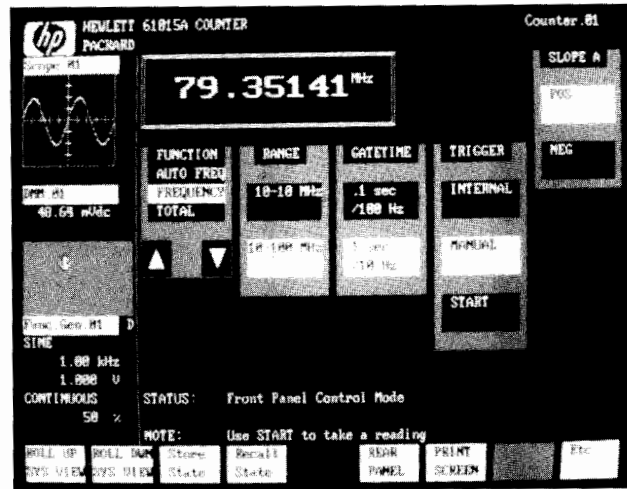

HP 61015A Universal Counter

Sync Output: A TTL compatible square wave output at the frequency of operation.

Disable Output Mode: This command opens a relay in series with the output. The sync output remains operational.

Short Circuit Protection: A protection circuit reduces the signal to a safe level if the output is short circuited.

Weight: 1.56 kg (3.44 lbs).

HP 61015A Universal Counter

The HP 61015A Counter is a 100 MHz universal counter. It decodes commands from your computer, measures the input waveform, and returns the 8-digit measurement value back to the computer. Modes include frequency, period, and totalize for Channel A input. Channel B input is provided for frequency ratio and time interval measurement. Additional modes include auto-frequency and auto-period which use a reciprocal counting technique.

Input Frequency Limits

Input A (positive slope): 10 Hz to 100 MHz with prescaler.
10 Hz to 10 MHz without prescaler.
Input A (negative slope): 10 Hz to 90 MHz with prescaler.
10 Hz to 9 MHz without prescaler.
Input B (positive or negative slope): 10 Hz to 2.5 MHz.

Input Characteristics

Input A Sensitivity: 40 mV rms (10 Hz to 100 MHz).
Input B Sensitivity: 40 mV rms (10 Hz to 2.5 MHz).
Input Coupling: AC on both inputs.
Input Impedance: 1 M ohm (nominal) shunted by 30 pF.

Frequency (Input A)

Ranges: 10 Hz to 10 MHz (LSD = 10 Hz with 0.1 s gate time).
10 Hz to 10 MHz (LSD = 1 Hz with 1 s gate time).
10 Hz to 10 MHz (LSD = 0.1 Hz with 10 s gate time).
10 Hz to 100 MHz (LSD = 100 Hz with 0.1 s gate time).
10 Hz to 100 MHz (LSD = 10 Hz with 1 s gate time).

Resolution: ±LSD

Accuracy: ±LSD ±(time base error in ppm) x frequency.

Auto-Frequency (Input A)

Range: 10 Hz to 100 MHz

Period (Input A)

Range: 400 ns to 0.1 s. Number of cycles of averaging (N) may be programmed from 1 to 1000 in decade steps.
LSD = 100 ns for 1 cycle averaging.
LSD = 10 ns for 10 cycle averaging.
LSD = 1 ns for 100 cycle averaging.
LSD = 0.1 ns for 1000 cycle averaging.
Resolution: ±LSD.

Accuracy: ±LSD ±1.4 x [(trigger error)/N] ± (time base error in ppm) x period.

Auto-Period (Input A): Range: 10 Hz to 100 MHz.

Time Interval

Range: 250 ns to 10 s.
LSD Displayed: 100 ns.
Resolution: ±LSD.

Accuracy: ±LSD ± START trigger error ± STOP trigger error ± (time base error in ppm) x (time interval).



PC INSTRUMENTS

Instrument Modules

Models 61015A (cont.) and 61016A

HP 61015A Universal Counter (continued)

Ratio

Range: Channel A: 10 Hz to 100 MHz.
Channel B: 10 Hz to 2.5 MHz.

LSD Displayed: 10 Hz to 10 MHz: 1 part in (A/B) x N.
10 Hz to 100 MHz: 1 part in (A/B) x N x 0.1.

Resolution: \pm LSD.

Accuracy: ± 1 count of $A \pm [(B \text{ trigger error}) \times (\text{frequency } A)]/N$
where N is the number of cycles of averaging for channel B input. N may be programmed from 1 to 1000 in decade steps.

Totalize (A)

Range: 10 Hz to 100 MHz.

Resolution: 10 Hz to 10 MHz: ± 1 count.
10 Hz to 100 MHz: ± 10 counts.

Time Base

Frequency: 10 MHz.

Time base error: ± 10 ppm.

General

Trigger Error: $\sqrt{(80 \text{ uV})^2 + e_n^2}$ (rms)

input slew rate at trig. pt. (uV/s)

Where e_n is the rms noise in mV of the input for a 100 MHz bandwidth in Channel A and 10 MHz bandwidth in Channel B.

Maximum Measurement Rate: 10 readings/second (100 ms/reading with a MEASURE statement).

Operating Humidity Range: <80%.

Weight: 0.60 kg (1.31 lbs).

HP 61016A Digitizing Oscilloscope

The HP 61016A Digitizing Oscilloscope is fully programmable, providing such features as automatic scaling, auto trigger, self-calibration, and direct readout of delta voltage and delta time. Waveforms captured using sophisticated random repetitive sampling techniques can be saved and recalled for analysis. This 50 MHz scope has an external trigger input and delayed trigger capability.

Specifications

All specifications are valid after the instrument has reached a stable temperature, and self-calibration is performed.

Vertical

Bandwidth: 0 to 50 MHz with dc coupling; 10 Hz to 50 MHz with ac coupling.

Input Coupling: ac, dc.

Input RC: 1 Meg $\pm 2\%$ shunted by approx. 18 pF.

Max Input Voltage: ± 40 V (dc + peak ac).

Range: 40 mV to 40 V.

Resolution: (trigger level set within vertical range and offset to zero).

Vertical Range	Resolution
40 mV - 80 mV	0.67 mV
160 mV - 40 V	range/240

Gain Accuracy: $\pm 3\%$.

Zero Offset Error: $\pm 3\%$ full scale ± 3.0 mV.

Offset Range	Vertical Range	Offset Range
	40 mV - 4 V	$\pm 1.5 \times$ range
	8 V - 16 V	± 12 volts
	40 V	Not available

Timebase

Range: 100 ns to 5 s in 1-2-5 sequence.

Resolution	Timebase	Resolution
	100 ns - 200 ns	1 ns
	500 ns - 5 s	range/250

Delay Range: -0.5 to 250 x timebase range, with trigger referenced to center.

Trigger

Source: Either channel, pos or neg slope; or external trigger.

Range: $\pm 2 \times$ vertical range, limited to ± 20 V.

Specification	Vertical Range	
	40 mV - 1.6 V	4 V - 40 V
Sensitivity:	15 mV	400 mV
(<10 MHz)	40 mV	1.0 V
(>10 MHz)		
Level Accuracy:	$\pm 3\%$	$\pm 3\%$
	$\pm 10\%$ mV	$\pm 250\%$ mV

External Trigger: 1 volt rising edge into 100 k ohms, with a rise-time <1 μ s.

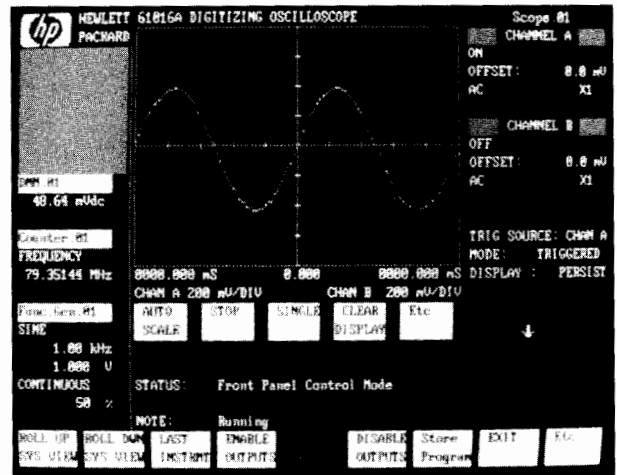

HP 61016A Digitizing Oscilloscope

Characteristics

Vertical:

Offset Accuracy: Zero offset error + gain error.

Noise: 1.5% of full scale or 2.4 mV, whichever is larger.

Single Marker Accuracy: Gain accuracy + zero offset error.

Dual Marker Accuracy: Gain accuracy.

Probe Scaling Factors: 1:1, 10:1.

Probe Compensation Signal: ≈ 500 mV, 7 kHz square wave.

Trigger

Modes: Normal, Auto trigger, Auto level. Auto trigger mode will generate internal triggers at a 40 Hz rate in the absence of input trigger. Auto level will continuously adjust the trigger level to track the input signal with duty cycles between 30% and 70%.

Timebase

Delay Accuracy: $\pm 0.02\% \pm 0.4\%$ of timebase range ± 5 ns.

Single Marker Accuracy: Delay accuracy.

Dual Marker Accuracy: $\pm 0.4\%$ of timebase range ± 2 ns.

Digitizer

A/D Resolution: 8 bits.

Digitizing Technique:

Timebase Range	Acquisition Mode	Digitizing Rate
100 ns - 50 us	Random Repetitive	(not applicable)
100 us - 20 ms	Random Sequential	5.814 kHz
50 ms - 5 s	Flash Acquisition	250/timebase range

Throughput: 300 samples/s on 100 ns range. 700 samples/s on 200 ns to 100 us ranges, increasing to 2500 samples/s at 50 ms.

Measurements

Markers are provided for manual timing and voltage measurements. Automated measurements of the following waveform parameters can be made: Frequency, period, risetime, falltime, +width, -width, p-p volts, and overshoot. Waveforms can be saved and recalled for comparison.

Displays

Variable Persistence: This mode displays samples for a user set time, then erases them. The display time can be varied or set to infinite.

Average: Provides a display of the average of many samples. The averaging runs continuously, and can be set 1, 2, 4, 16, 32, 64, 128.

Autoscale

The Autoscale feature will display both channels with the proper vertical, trigger, and timebase setting. The coupling is set to ac, and the delay is set to zero. Requires a duty cycle of 20% to 80%, an amplitude of >20 mV and a frequency >50 Hz.

Self Calibration

This feature calibrates the vertical, trigger, and timebase to the published specifications. A self calibration occurs when the instrument is first turned on, and can be requested by the user at any time. Calibration time is typically 3 seconds.

Weight: 1.40 kg (3.09 lbs).

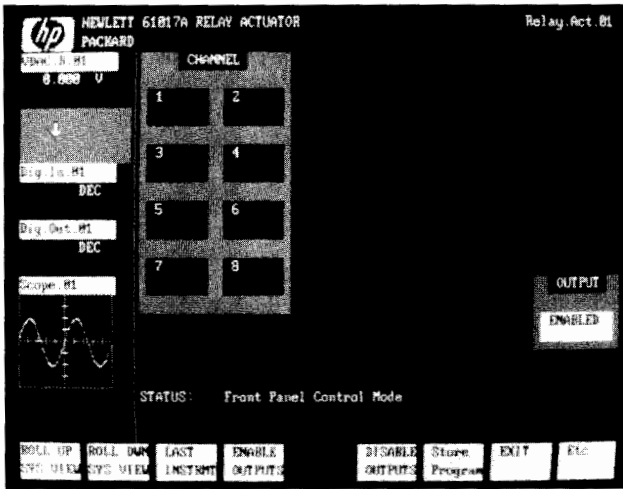

HP 61017A Relay Actuator

HP 61017A Relay Actuator

The HP 61017A Relay Actuator provides programmable control of eight independent relay switches. Each channel can carry up to one ampere of current, or can switch up to 250 volts dc or ac rms.

The Relay Actuator comes with a plug-in screw terminal block for easy connection of user inputs and outputs.

User Connections: 8 independent single-pole channels.

Channel Open or Close Time: Multiple channels, using an OUTPUT statement: HP Vectra PC: 22 ms
HP Series 310: 18 ms

Switching Characteristics

Maximum Voltage: 250 Vdc, 250 Vac rms, 350 Vac peak.

Maximum Current: Per channel: 1 amp dc, 1 amp ac rms.
Per module: 4 amp dc, 4 amp ac rms.

Maximum Power: Per channel: 50 W dc, 250 VA ac
Per module: 200 W dc, 1000 VA ac

Resistance (per channel): 1 ohm typical.

Thermal Offset (per channel): <6 uV maximum.

Isolation Voltage Rating: 250 Vdc, 250 Vac rms, 350 Vac peak between any two input terminals or between an input and ground.

DC Isolation Resistance: (<40°C, 80%RH)

Open Channel	>2 x 10 ⁸ ohms
Channel-Channel	>2 x 10 ⁸ ohms
Channel-Ground	>2 x 10 ⁸ ohms

AC Characteristics (50 ohm termination):

	100 kHz	1 MHz	10 MHz
Crosstalk (input to input) (dB)	<-73	<-53	<-33
Feedthrough (input to output) (dB)	<-73	<-53	<-33
Insertion Loss (input to output) (dB)	<0.2	<0.3	<0.5

Capacitance:

(Open Channel, Channel to Channel) < 5 pF
(Closed Channel) <25 pF
(Channel to Chassis) <50 pF

Weight: 0.95 kg (2.09 lbs).

HP 61018A Breadboard Unit

The HP 61018A Breadboard Unit provides a general purpose circuit board for mounting custom circuits. The unit is in kit form and includes a general purpose circuit board, enclosure, power pack and two different front panels. One panel is blank for adding connectors of your choice. The other panel is designed to accept the two 25-pin connectors, one male and one female, supplied with the kit. These connectors match the input and output connectors of the HP 61010A Digital I/O module, which is particularly suitable for digital communication with the Breadboard Unit. The Breadboard Unit does not connect to the PC Instruments Interface Bus.

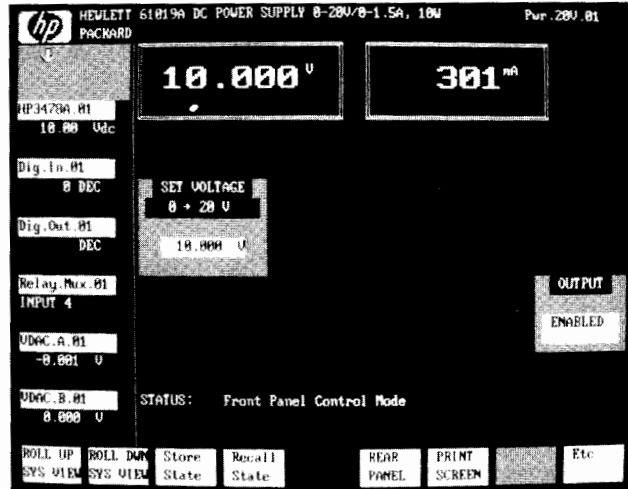

HP 61019A 20 Volt Power Supply

HP 61019A 20 Volt DC Power Supply

The HP 61019A DC Power Supply is a general purpose programmable DC power supply. The supply's output voltage is programmable from 0 to 20 volts with a resolution better than 5 millivolts. The supply has a built-in current limit that is fixed at 1.5 amperes at 5 volts, 0.9 amperes at 10 volts, and 0.5 amperes at 20 volts. Current readback circuitry is included that allows you to monitor the output current. The current readback resolution is better than 7.5 milliamperes. Each DC power supply also has an enable/disable feature that allows you to turn the output on or off to simulate an on/off switch capability.

Output Voltage Range: 0-20 V with better than 5 mV resolution.

Accuracy: At 23°C ± 5°C = 0.1% ± 5 mV; from 0°C to 40°C = 0.2% ± 5 mV.

Output Current Capability: 1.5 A minimum from 0 V to 5 V; decreasing linearly to 0.5 A minimum at 20 V.

Current Readback Accuracy: ± 1%, ± 7 mA with better than 7.5 mA resolution.

Ripple and Noise (PARD): <5 mV p-p (10 Hz to 20 MHz); <1 mV rms (10 Hz to 10 MHz).

Load Effect (Regulation): 0.01% ± 2 mV.

Output Protection: Output is protected against short circuits of unlimited duration.

Output Response Time: (With 5 mV error band; does not include computer command processing time).

Up with full load = 10 ms.

Up with no load = 10 ms.

Down with full load = 400 ms.

Down with 2K ohms load = 800 ms.

Load Transient Recovery: (With 5 mV error band) 10% load current change = 400 us.

Isolation Voltage Rating: (From output terminals to ground) 250 Vac; 250 Vac rms; 350 Vac pk.

Weight: 1.27 kg (2.81 lbs).

HP 61025A 50 Volt DC Power Supply

The HP 61025A DC Power Supply is a general purpose programmable DC power supply. The supply's output voltage is programmable from 0 to 50 volts with a resolution better than 12.5 millivolts. The supply has a built-in current limit that is fixed at .5 amperes at 20 volts, .286 amperes at 35 volts, and .2 amperes at 50 volts. Current readback circuitry is included that allows you to monitor the output current. The current readback resolution is better than 2.5 milliamperes. Each DC power supply also has an enable/disable feature that allows you to turn the output on or off to simulate an on/off switch capability.



PC INSTRUMENTS

Interfaces & Accessories, and Data Acquisition Software

PC Instruments Interfaces

HP 61061B HP Vectra PC, IBM PC/XT/AT and AT&T PC 6300 Interface

HP 61060A HP 150 Touchscreen Interface

HP 98647A HP 9000 Series 200/300 Interface

These products provide a link between the HP Vectra PC, IBM PC/XT/AT, and AT&T PC 6300 (HP 61061B), the HP 150 Touchscreen (HP 61060A), or the HP 9000 Series 200/300 family (HP 98647A) and up to eight PC Instruments. They consist of a PCIB interface card, PC Instruments system software, PC Instruments system documentation, and two control cables. The interface card plugs into one of the accessory slots on the HP 150 Touchscreen, HP Vectra PC, IBM PC/XT/AT, AT&T PC 6300, and the HP 9000 Series 200/300. Maximum distance between computer and the instruments is 1.8 meters.

PC Instruments Accessories

HP 61001A System Power Unit

The optional System Power Unit provides convenient, space-effective storage for the individual power packs of up to eight PC Instruments. Included in the unit are common mode and normal mode line conditioning, a line-spike suppression network, main fuse, PC Instruments system power switch, and two auxiliary unswitched outlets suitable for powering a personal computer and one peripheral. Used on the bench, the System Power Unit provides an ideal base for PC Instruments. It is also rack mountable.

HP 14801A PC Instruments Rack Shelf

The rack mounting kit allows up to four PC Instruments and four power packs to be mounted in standard 19-inch racks. Three blank panels are also included for use when racking fewer than four instruments.

HP 14802A Terminal Block

For use with Digital I/O. Allows easy screw terminations.

HP 5080-2064 Binder and Slipcase

Recommended for systems with more than three instrument modules. Provides neat storage for additional instrument manuals and application software documentation.

HP 10040A/HP 10021A Oscilloscope Probes

General: These miniature probes are recommended for use with the HP 61016AA Digitizing Oscilloscope. Each probe comes with a retractable hook tip, an IC probe tip adapter, an alligator clip, a 20 cm (8 in.) ground lead, eight color-coded indicator sleeves, a grounding spring, and an operating note. The probes have a one meter cable.

HP 10040A Oscilloscope Probe: Miniature Probe with a 10:1 division ratio and 9 pF shunt capacitance.

HP 10021A Oscilloscope Probe: Miniature Probe with a 1:1 division ratio and 36 pF shunt capacitance.

Data Acquisition Software

HP 14856A, HP Vectra PC, IBM PC/XT/AT and AT&T PC 6300 Version

HP 14855A, HP 150 Touchscreen Version

HP's Data Acquisition Software is a menu-driven program that performs voltage scanning, thermocouple scanning, and analog recording. It also includes a graphics utility for presenting information in a simple listing, linear graph, or logarithmic plot form; and it can be easily modified to suit specific applications. The following describes the four applications that the package provides:

Voltage Scanner

The Voltage Scanner supports up to two Relay Multiplexers and one DMM. It scans up to 16 channels.

Scan Rate

List Mode: 8 seconds (for 16 channels). Tabular display of data collected.

Trend Mode: Graphical display of data collected. Post run: 6 seconds (for 16 channels). Collects all data and then plots it. Real Time: 2 seconds (for 3 channels). Collects and plots data at the same time.

List Mode: 0.5 seconds.

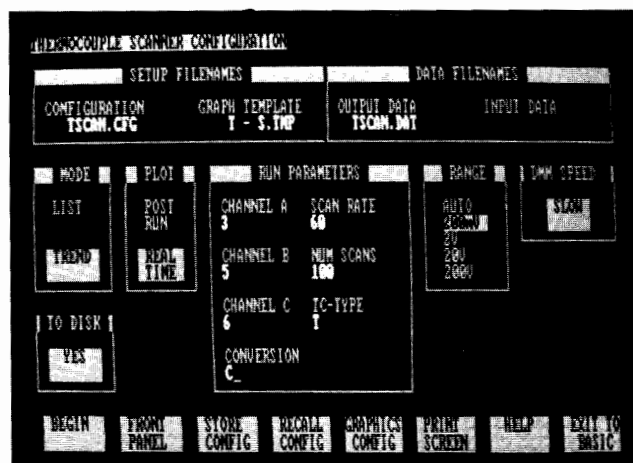

PC Instruments Data Acquisition Software simplifies custom application program development. Shown here is the software configuration for a thermocouple scanning application.

Maximum Channel-to-Channel Delay

Trend Mode: Post Run: 0.375 seconds. Real Time: 0.667 seconds.

Maximum Number of Samples: (Number of Scans) x (Number of Channels) \leq 3000. (Total number of samples with no user modification of program.)

Thermocouple Scanner

The Thermocouple Scanner supports up to two Relay Multiplexers and one DMM. It scans up to 14 thermocouple inputs and provides compensation and linearization for T, J, E, R, K & S type thermocouples.

Scan Rate

List Mode: 25 seconds (for 14 channels).

Trend Mode: Post Run: 25 seconds (for 14 channels). Real Time: 5 seconds (for 3 channels).

Maximum Channel-to-Channel Delay

List Mode: 1.8 seconds.

Trend Mode: Post Run: 1.8 seconds. Real Time: 1.8 seconds.

Maximum Number of Samples: (Number of Scans) x (Number of Channels) \leq 3000. (Total number of samples with no user modification of program.)

Temperature Errors: (Includes reference-junction error, thermal-off voltages, and linearization error; does not include DMM or transducer errors) = $\pm 3.5^\circ\text{C}$.

Analog Recorder

The Analog Recorder supports up to three DMMs. It measures one, two, or three channels vs. time, and one or two channels vs. a third channel.

Sample Interval:

1 channel vs. time	1 second
2 channels vs. time	1.5 seconds
3 channels vs. time	2 seconds
1 channel vs. Channel 1	1 second
2 channels vs. Channel 1	1.5 seconds

Maximum Channel-to-Channel Delay: (Time between successive measurements in one sample interval) = 0.1 second.

Maximum Number of Samples: 500 (Total number of samples with no user modification of program.)

Graphics Utility

The Graphics Utility has 2 Y-axes and plots linear, semi-log, and log-log graphs.

Common To All Applications

Timebase: Range: 1 second to 1800 seconds. Resolution: 1 second.

Plotters: Direct support of HP 7470A and HP 7475A plotters.

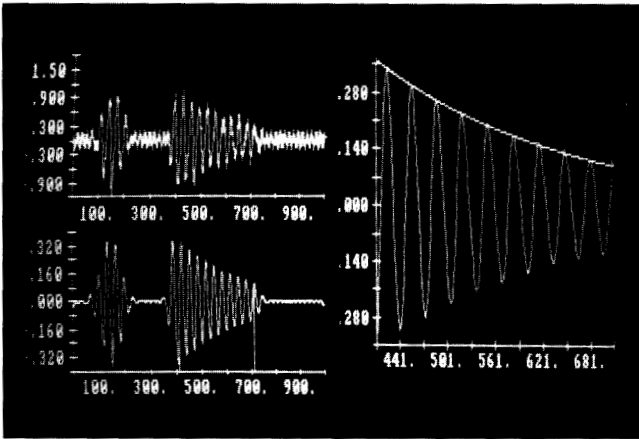

ASYST integrates instrumentation with analytical and graphic functions. On-screen cursors allow interactive selection of cursor segments.

ASYST Scientific Software

ASYST Scientific Software (HP 14858A) is a programming language that integrates HP-IB and PC Instruments with powerful analytical, statistical, and graphic capabilities. ASYST is designed to work in concert with the HP Vectra PC, IBM PC/XT/AT or AT&T PC 6300 to provide the scientist or engineer with straightforward, pre-programmed commands that can be used interactively, or combined and modified as needed.

Mathematical, graphic and statistical capabilities include basic mathematics operators, descriptive statistics, array manipulation and control, automatic plotting and color graphics support, a text editor, file I/O, and a built-in programming language.

Built-in analysis functions include eigenvalues, eigenvectors, polynomials, ANOVA, axonometric and contour plotting, least squares approximations, curve fitting, convolutions, integration, differentiation, smoothing, and fast Fourier transform.

HP-IB and PC Instruments commands provide a "seamless" integration of instrument I/O with these analytical and graphic capabilities.

Graphic, Statistical and Analytical Functions

Data Types: Single or double precision real, integer, or complex values (80-bit double precision); strings; named scalars or arrays. Automatic or user-controlled conversions in mixed expressions between integers, reals, and complex data types. Arrays may have up to 16 dimensions and be as large as 64K bytes apiece.

String Handling: String-to-number conversion, number-to-string conversion, string arrays.

Array Handling Functions: Subarrays, reversal of indices, transposition of dimension, lesser dimension subsets, catenation, lamination, auto entry of array data, scrolling, format control of array data display, generalized inner and outer product, matrix multiplication.

Built-In Full-Screen Text Editor and Array Editor.

Vectors and Matrices: Matrix inversion, determinants, QR factorization and Gram-Schmidt orthogonalization.

Arithmetic Operations and Special Functions: +, -, *, /, **, min, max, neg, abs, inv, sqrt, ln, exp, conj, sin, cos, tan, sec, csc, cot, sinh, cosh, tanh, sech, csch, coth, asin, acos, atan, asech, acsch, acot, asinh, acosh, atanh, asech, acsch, acoth. All arithmetic operators work directly (without loops) on all elements of an array. Mixed expressions of arrays and scalars, or arrays of differing dimensionality are permitted.

Advanced Mathematics: Gamma, Bessel and error functions. Polynomial multiplication, synthetic division, integration, differentiation, shifting, root extraction. Solutions to simultaneous equations. Data

smoothing, differentiation and integration, peak detection, convolutions and filtering. Fast Fourier transform, 2-D FFT and inverse FFT. **Eigenvalues and Eigenvectors:** Eigensystems of Hermitian matrices, spectral slicing, reduction of a general matrix to Hessenberg and triangular form.

Statistical Functions: Mean, variance, mode, median, moments, standard deviation, cumulative distributions, Gaussian, Chi-square, Student-T distributions, random number generation, sort, sort and index.

Advanced Statistics: One- and two-way analysis of variance (ANOVA), F-tests. Least squares polynomials, multilinear regressions, parametric and non-linear curve fitting, weighted least squares, exponential and logarithmic fits, orthogonal polynomials, R^2 (cross-correlation) non-linear regression.

Graphics: Automatic line graphs, scatter plots, bar and pie charts, plotting with error bars. Options include: Color graphics, superposition of plots, multiple graphic windows, polar plots, autoscaling and data fitting, linear or logarithmic display along either axis, strip chart recorder emulation, replotting data subsets with a single keystroke, and support for digital plotters and high-resolution graphics.

Advanced Graphics: Axonometric and contour plots. Plotting with hidden lines removed.

Graphic Readout and Cursors: On-screen graphic cursors controlled by arrow keys, labeling at any location within the graphic area.

Control Structures: If ... else ... then, Begin ... until, Begin ... while ... repeat, Case ... of ... endcase, Do ... loop. Comparisons: =, <, >, ≤, ≥, ≲, not, and, or, xor.

Calls to Assembly Language Routines.

Input/Output: Loading from standard text or arbitrary user-defined files, saving and loading workspace images to disk, direct array I/O to packed-binary disk files, ASCII, BASIC, and DIF-format files.

RS-232 Support: Send and receive single byte information or buffered data. Select baud rate, parity, data bits, stop bits.

HP-IB Commands

Complete IEEE-488 Protocol: Full talker, listener and controller capabilities, DMA, parallel and serial polling, and foreground and background programming using SRQ.

Buffering: Array buffering of data. Buffering of device-dependent commands.

Real-time Synchronization: Triggering, clock-initiated acquisition, software synchronization.

HP PC Instruments Commands

Program the whole family of HP PC Instruments and display soft front panels for manual control. On-line help with information about PC Instruments command syntax. Dynamic error checking and recovery.

ASYST Configuration Guide

Required:

Supported Computers: HP Vectra PC, IBM PC/XT/AT, AT&T PC 6300

Memory Requirements: 512K RAM (minimum), 640K RAM (recommended).

Graphics Adapters: HP Enhanced Graphics Adapter, HP Multimode Video Adapter, IBM Color Graphics Board, IBM Enhanced Color Graphics Adapter, or Hercules Graphics Card.

Numeric Co-Processor: Intel 8087 or 80287.

Disc Drives: Two or more drives, at least one 5.25" floppy disc drive.

Optional:

Printers: HP ThinkJet Models 2225C and 2225D, HP LaserJet, HP Models 2601A, 2603A, 2932A, 2934A, and IBM Graphics Printer.

Plotters: HP 7470A, 7475A, 7440A Colorpro, and HP 7550A.

HP-IB Interface Card: Hewlett-Packard HP-IB card (included in options 003 and 006).

PC Instruments Interface Card: HP 61061B PC Instruments Interface.

For ordering information see page 210.



PC INSTRUMENTS

Ordering Information

Ordering Information

Following are step-by-step instructions for configuring and ordering your PC Instruments system. Included are descriptions, ordering instructions and prices for individual instruments and accessories, and for bundled packages which offer ordering convenience and dollar savings.

Step 1: Refer to the Configuration Guide on page 211 for a listing of supported computer hardware, software, and peripherals suitable for use with PC Instruments. Note that Microsoft BASIC (GW-BASIC or BASICA) and a total of 640 K RAM memory is required for MS-DOS computers. PC Instruments also require a dual floppy or single floppy with hard disc configuration for MS-DOS computers. For HP 9000 Series 200/300 computers, BASIC 4.0 and 1 M byte (typical) is required.

Step 2: Select the correct PC Instruments Interface for your computer.

One interface can control up to eight instrument modules. The system software is included with the interface:

HP 61060A PC Instruments Interface (HP 150 Touchscreen Version) \$500 ☎

HP 61061B PC Instruments Interface (HP Vectra PC, IBM PC/XT/AT and AT&T PC 6300 Version) \$500 ☎

Up to two PC Instruments Interfaces can be accommodated by the HP Vectra PC, HP 150 Touchscreen II, IBM PC/XT/AT, or AT&T PC 6300. Only one PC Instruments Interface can be accommodated by the HP 150B Touchscreen. Each interface occupies one long slot in the computer's backplane.

HP 98647A PC Instruments Interface (HP 9000 Series 200/300 Version) \$850 ☎
(Number of interfaces limited by number of backplane card slots available.)

Step 3: Select the type and quantity of instrument modules:

HP 61010A Digital I/O	\$700 ☎
HP 61011A Relay Multiplexer	\$700 ☎
HP 61012A Dual Voltage DAC	\$800 ☎
HP 61013A Digital Multimeter	\$700 ☎
HP 61014A Function Generator	\$1500 ☎
HP 61015A Universal Counter	\$900 ☎
HP 61016A Digitizing Oscilloscope*	\$1500 ☎
HP 61017A Relay Actuator	\$700 ☎
HP 61018A Breadboard	\$300 ☎
HP 61019A 20 Volt Power Supply	\$900 ☎
HP 61025A 50 Volt Power Supply	\$900 ☎

*Up to five HP 61016A oscilloscopes may be connected to a PC Controller depending on the other instruments present on the PC Instruments Bus (PCIB).

Step 4: Select from these optional software packages: (For MS-DOS computers only.)

HP Data Acquisition Software:	
HP 14856A (For the HP Vectra PC, IBM PC/XT/AT, or AT&T PC 6300)	\$400 ☎
HP 14855A (For the HP 150 Touchscreen)	\$400 ☎
ASYST Scientific Software:* (Select one ASYST option only)	
HP 14858A Opt 001 ASYST Scientific Software	\$1695
Opt 002 ASYST Scientific Software with HP-IB commands	\$1995
Opt 003 ASYST Scientific Software with HP-IB commands and HP-IB Interface card	\$2295
Opt 004 ASYST Scientific Software with PC Instruments commands	\$1995
Opt 005 ASYST Scientific Software with PC Instruments and HP-IB commands	\$2195
Opt 006 ASYST Scientific Software with PC Instruments and HP-IB commands and HP-IB Interface card	\$2495

*The HP 45987A numeric co-processor (80287) is required for use with ASYST Scientific Software.

Price



PC Instruments system power unit and modules.

Step 5: Choose from these optional PC Instruments Accessories:

HP 61001A System Power Unit	\$450 ☎
HP 14801A Rack Shelf	\$125 ☎
HP 14802A Terminal Block	\$175 ☎
HP 5080-2064 Binder and Slipcase	\$15 ☎
HP 10040A 10:1 Oscilloscope Probe	\$125 ☎
HP 10021A 1:1 Oscilloscope Probe	\$75 ☎

PC Instruments Packages

The following packages make it easy to order popular configurations. Just choose the right package for your needs. The Data Logging Packages have what you need to scan up to eight channels. The Electronic Bench Packages provide enough equipment to outfit an entire lab bench.

HP 61086B Data Logging Package (HP 150 Touchscreen Version)	\$2250 ☎
Includes: HP 61060A PC Instruments Interface HP 61011A Relay Multiplexer HP 61013A Digital Multimeter HP 14855A Data Acquisition Software	
HP 61087B Data Logging Package (HP Vectra PC, IBM PC/XT/AT and AT&T PC 6300 Version)	\$2250 ☎
Includes: HP 61061B PC Instruments Interface HP 61011A Relay Multiplexer HP 61013A Digital Multimeter HP 14856A Data Acquisition Software	
HP 61088B Electronic Bench Package (HP 150 Touchscreen Version)	\$7300 ☎
Includes: HP 61060A PC Instruments Interface HP 61011A Relay Multiplexer HP 61012A Dual Voltage DAC HP 61013A Digital Multimeter HP 61014A Function Generator HP 61015A Universal Counter HP 61016A Digitizing Oscilloscope HP 61001A System Power Unit HP 14855A Data Acquisition Software HP 5080-2064 Binder and Slipcase	
HP 61089B Electronic Bench Package (HP Vectra PC, IBM PC/XT/AT and AT&T PC 6300 Version)	\$7300 ☎
Includes: HP 61061B PC Instruments Interface HP 61011A Relay Multiplexer HP 61012A Dual Voltage DAC HP 61013A Digital Multimeter HP 61014A Function Generator HP 61015A Universal Counter HP 61016A Digitizing Oscilloscope HP 61001A System Power Unit HP 14856A Data Acquisition Software HP 5080-2064 Binder and Slipcase	

☎ Fast-Ship product — see page 766.



PC Instruments Computer Configuration and Supported Hardware

COMPATIBLE COMPUTERS:	<ul style="list-style-type: none"> HP Vectra PC 	<ul style="list-style-type: none"> HP 150B Touchscreen PC HP 150B Touchscreen MAX PC HP 150C Touchscreen II 	<ul style="list-style-type: none"> IBM PC IBM PC/XT IBM PC/AT 	<ul style="list-style-type: none"> AT&T PC 6300 	<ul style="list-style-type: none"> All HP 9000 Series 200/300 Computers (2)
REQUIRED AMOUNT OF MEMORY:	<ul style="list-style-type: none"> 640 K RAM 	<ul style="list-style-type: none"> 640 K RAM 	<ul style="list-style-type: none"> 640 K RAM 	<ul style="list-style-type: none"> 640 K RAM 	<ul style="list-style-type: none"> 1 M Byte RAM typical (3)
SUPPORTED RAM:	<ul style="list-style-type: none"> HP 45971A 128 K byte Memory Expansion Kit (up to 3 kits) 640 K byte RAM included with Model 45 Vectra PC 	<ul style="list-style-type: none"> HP 45632A 384 K Memory Expansion Card 	<ul style="list-style-type: none"> IBM Memory Expansion Card Quadram Quadboard (384K) 	<ul style="list-style-type: none"> AT&T Memory Expansion Board 	<ul style="list-style-type: none"> HP 98256A 256 K byte RAM card HP 98257A 1 M byte RAM card
SUPPORTED DISC DRIVES:	<ul style="list-style-type: none"> Internal flexible disc drives (1) <ul style="list-style-type: none"> HP 45811A 360 KB HP 45812A 1.2 MB high capacity HP 45816A 20 MB internal hard disc subsystem with either a 360 KB or 1.2 MB flexible disc drive HP 45817A 40 MB internal hard disc subsystem with either a 360 KB or 1.2 MB flexible disc drive 	<ul style="list-style-type: none"> HP 9122D Dual 3 1/2" Microfloppy; 710 KB each drive HP 9123D Dual 3 1/2" Microfloppy; 710 KB each drive (HP 150C only) HP 9153D 10 MB Winchester with one 3 1/2" Microfloppy HP 9133H 20 MB Winchester with one 3 1/2" Microfloppy HP 9133L 40 MB Winchester with one 3 1/2" Microfloppy HP 9133D 14.8 MB Winchester with one 3 1/2" Microfloppy 	<ul style="list-style-type: none"> Flexible disc drives (1) Winchester with either a 360KB or 1.2 MB flexible disc drive 	<ul style="list-style-type: none"> Standard AT&T flexible disc drive double sided Winchester with flexible disc drive 	<ul style="list-style-type: none"> All disc drives supported by BASIC Language System
SUPPORTED MONITORS:	<ul style="list-style-type: none"> HP 35731A 12" monochrome monitor HP 35741A 12" color monitor HP 35743A EGO 12" color monitor 	<ul style="list-style-type: none"> Standard HP monochrome Touchscreen monitor 	<ul style="list-style-type: none"> IBM Color Monitor IBM Enhanced Color Display 	<ul style="list-style-type: none"> Standard AT&T 6300 monochrome or color 	<ul style="list-style-type: none"> HP 35721A/B/C 14" monochrome monitor HP 35731A/B 12" monochrome monitor HP 35741A/B 12" color monitor HP 98781A 17" high-resolution monochrome monitor HP 98782A 19" high-resolution color monitor (Models 226, 236A, 236C and 216 use built-in monitors)
GRAPHICS ADAPTER (REQUIRED):	<ul style="list-style-type: none"> HP 45981A Multimode Video Adapter HP 45984A Multimode Color Adapter (required for color-use with HP 45981A) HP 45983A Enhanced Graphics Adapter IBM Color Graphics Adapter IBM Enhanced Graphics Adapter Card 	<ul style="list-style-type: none"> Standard HP Touchscreen System feature 	<ul style="list-style-type: none"> IBM Color Graphics Adapter IBM Enhanced Graphics Adapter Card 	<ul style="list-style-type: none"> Standard AT&T 6300 system feature 	<ul style="list-style-type: none"> HP 98542A medium-resolution monochrome HP 98543A medium-resolution color HP 98544A high-resolution monochrome HP 98545A high-resolution color HP 98546A display compatibility interface HP 98204B composite video interface card (Models 226, 236A, 236C, and 216 use built-in graphics adapters)
OPERATING SYSTEM:	<ul style="list-style-type: none"> HP 45951A Vectra DOS 	<ul style="list-style-type: none"> MS-DOS 2.11 or later version 	<ul style="list-style-type: none"> PC-DOS 3.0 or later version 	<ul style="list-style-type: none"> AT&T DOS 2.11 or later version 	<ul style="list-style-type: none"> HP 98613B RAM-based BASIC 4.0 Language System HP 98603A ROM-based BASIC 4.0 Language System
BASIC SOFTWARE:	<ul style="list-style-type: none"> HP 45952A Vectra BASIC Interpreter 	<ul style="list-style-type: none"> HP 45450D GW-BASIC 	<ul style="list-style-type: none"> BASICA 2.0 or later version 	<ul style="list-style-type: none"> GW-BASIC 2.0 or later version 	<ul style="list-style-type: none"> BASIC Language is included in operating system.
Supported Computer Peripherals					
PRINTERS:	<ul style="list-style-type: none"> HP 2225C ThinkJet Printer (Centronics Interface) IBM Graphics Printer 	<ul style="list-style-type: none"> HP 2674A Internal Printer HP 2225A ThinkJet Printer 	<ul style="list-style-type: none"> IBM Graphics Printer HP 2225C ThinkJet Printer (Centronics Interface) 	<ul style="list-style-type: none"> HP 2225C ThinkJet Printer (Centronics Interface) IBM Graphics Printer 	<ul style="list-style-type: none"> All printers supported by BASIC Language System
PLOTTERS:	<ul style="list-style-type: none"> HP 7440A Color-Pro plotter HP 7475A Six-pen plotter 	<ul style="list-style-type: none"> HP 7440A Color-Pro plotter HP 7475A Six-pen plotter 	<ul style="list-style-type: none"> HP 7440A Color-Pro HP 7475A Six-pen plotter 	<ul style="list-style-type: none"> HP 7440A Color-Pro HP 7475A Six-pen plotter 	<ul style="list-style-type: none"> All plotters supported by BASIC Language System
POINTING DEVICES	<ul style="list-style-type: none"> HP 46060A HP-HIL Mouse HP 35723A HP Touch Accessory Microsoft Mouse Mouse Systems Mouse 	<ul style="list-style-type: none"> Built-in Touchscreen 	<ul style="list-style-type: none"> Microsoft Mouse Mouse Systems Mouse 	<ul style="list-style-type: none"> Microsoft Mouse Mouse Systems Mouse 	<ul style="list-style-type: none"> HP 46060A HP-HIL Mouse HP 35723A HP Touch Accessory HP 46063A HP-HIL control knob (Built-in knob is also supported).
BAR-CODE READERS:	<ul style="list-style-type: none"> HP 92916A Bar-code reader 	<ul style="list-style-type: none"> HP 92915A Bar-code reader (for the HP 150B Touchscreen PC) HP 92916A Bar-code reader (for the HP 150C Touchscreen PC) 	<ul style="list-style-type: none"> Available from third-party vendors. 	<ul style="list-style-type: none"> Available from third-party vendors. 	<ul style="list-style-type: none"> HP 92916A Bar-code reader

(1) Flexible disc drive systems can be any combination of two 360 KB/1.2 MB drives or a single 1.2 MB drive.

(2) Soft front panels are not supported on HP Models 216, 226 and 237.

(3) Memory requirements are based on: a) BASIC and loaded binaries; b) Number and types of PC Instruments in system and; c) Size of user's program.



COMPONENT MEASUREMENT

General Information Impedance Measurement

Component and Semiconductor-Parameter Measurement

Component Measurement

An impedance-measuring instrument measures impedance characteristics of electronic components, materials and circuits. HP impedance instruments provide:

1. A broad product line, to fit each application;
2. Full evaluation of impedance characteristics under conditions of varying frequency, test-signal level and DC bias.
3. High-precision, high-resolution impedance measurement, with error correction for test-lead or test-fixture effects.

Impedance-measuring instruments can be divided into two general categories: LCR meters and impedance analyzers. The LCR meter primarily measures the inductance, capacitance and resistance of a test device. The impedance analyzer, in addition to all of the functions of the LCR meter, measures the impedance and phase of the test device, and makes detailed analysis of the impedance measurement.

The major applications of impedance-measurement instruments are in electronic-component materials manufacture and electronic equipment manufacture (electronic component users). Table 1 shows the type of evaluation and the functions required according to instrument application.

Impedance measurements can be divided into two general categories:

1. Tests of whether the test device functions properly under application conditions and
2. Tests under conditions stipulated by MIL or IEC standards.

When type 1 measurements are conducted in an R&D department, the purpose is to shorten development time through careful

Application Area	Component/Material Manufacturer		Component User	
	R&D and QA	Production	Incoming Inspection	R&D
Major Requirements	Verify that device has sufficient performance	Perform GO/NO-GO testing based on MIL, IEC, etc.		Evaluate devices/circuits under actual working conditions
Required Measurement Functions	Multi-function/General Purpose <ul style="list-style-type: none"> • Wide freq. range • Auto freq. sweep • Variable signal level and DC Bias • Multi-parameter • High accuracy and resolution 	High Speed/Single Function <ul style="list-style-type: none"> • High Speed • Fixed frequency level and DC Bias • Single parameter 		Multi-function/General Purpose <ul style="list-style-type: none"> • High frequency resolution • Auto freq. sweep • Variable signal level & DC Bias • Multi-parameter • High accuracy and resolution
HP Product Offering				
Objects for Test	Materials <ul style="list-style-type: none"> • Magnetic materials • Dielectric materials • High polymers • Optical materials (fibers, etc.) • Semiconductor materials • etc. 	Components <ul style="list-style-type: none"> • Capacitors • Inductors • Transformers • Magnetic heads • Piezo electrics • Cables • Resonators • Sensors • Hybrid ICs • Filters • etc. 		Equipment <ul style="list-style-type: none"> • VTRs • Audio/video products • TVs • Communication equipment • Computers • etc.

Table 1. Component-measurement applications and HP products.

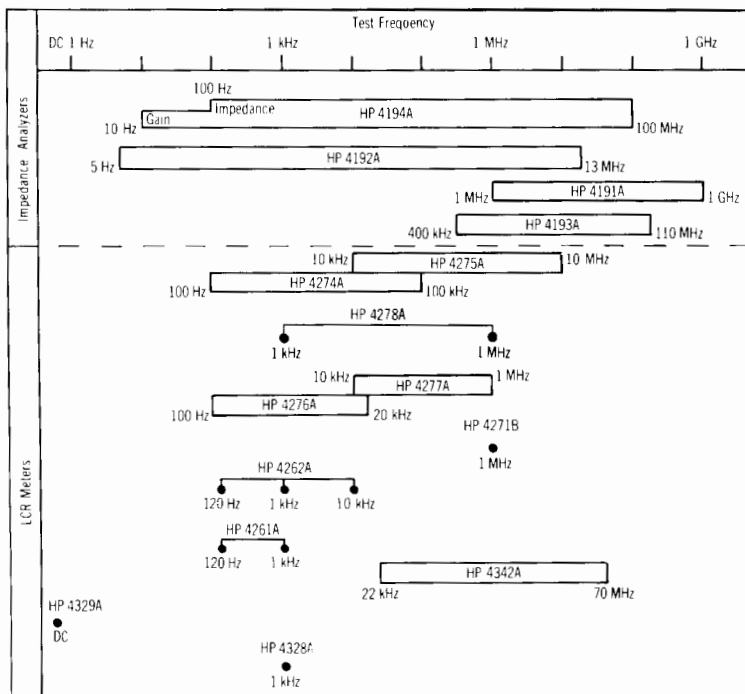

Table 2. HP Component-measurement products vs. test frequency.

evaluation. Therefore, a multi-function, general-purpose instrument for the measurement of many characteristics is required, such as an impedance analyzer or high-resolution LCR meter.

Type 2 measurements are conducted for go/no-go tests in manufacturing or incoming inspection. The measurement data are fed back to vendors or manufacturing processes for correction and improvement. Because of volume, test costs must be minimized. Therefore, a high-speed, single-function instrument may be used. Sorting and interpreting test results may be required, so an LCR meter with a comparator option can be used.

Table 2 shows HP's line of instruments arranged according to measurement frequency and performance. Test frequencies of these instruments range from 5 Hz to 1 GHz, and some have fixed MIL/IEC standard frequencies between 1 kHz and 1 MHz.

Since the time that HP introduced the first digital LCR meter, the company has continued to create high-performance impedance-measurement instruments. Because of this effort, it is now possible for virtually anyone to make the most difficult impedance measurements with ease and great accuracy.

COMPONENT MEASUREMENT

Impedance/Gain-Phase Analyzer

Model 4194A

213



- Flexible Measurement, Computation and Analysis Capabilities on a Color Graphic Display
- Fully Programmable

- High Accuracy and Wide Range
Impedance Measurement:
100Hz to 40MHz, 0.1m Ω to 1.6M Ω , 0.17%
10 kHz to 100 MHz, 0.1 Ω To 1M Ω , 1.5% when used with the HP 41941A/B
Gain-Phase Measurement:
10Hz to 100MHz, -107dBm to +15dBm, 0.1dB resolution

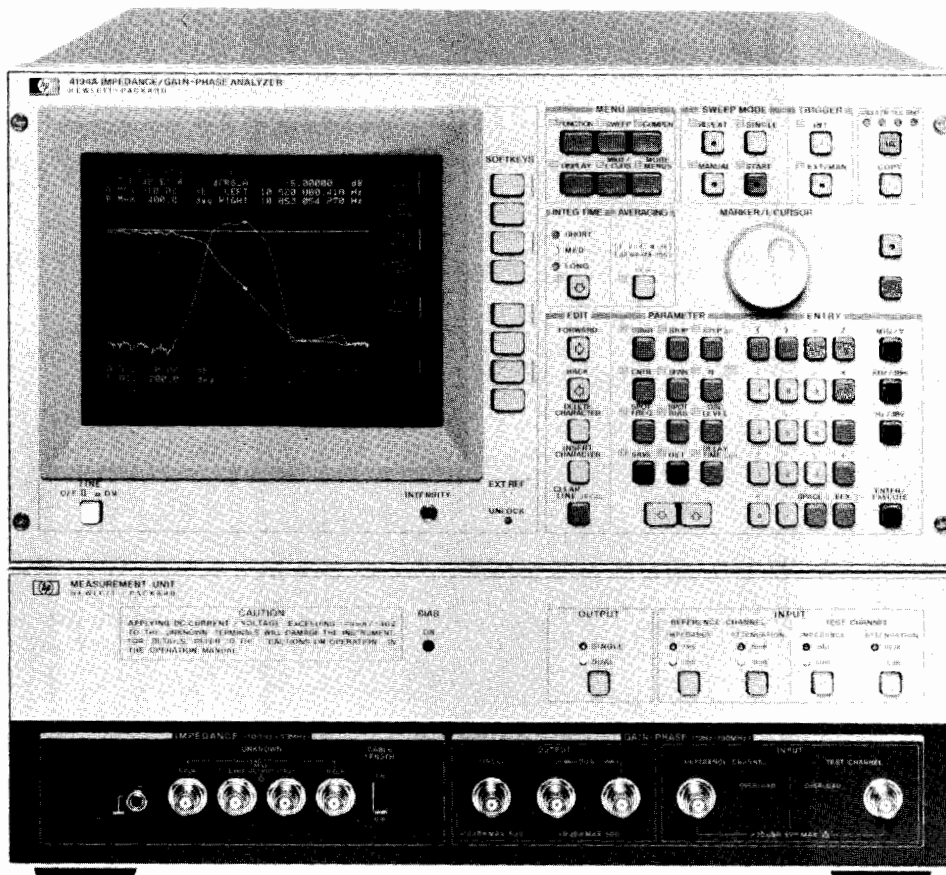

HP 4194A



Description

The HP 4194A Impedance/Gain-Phase Analyzer is an integrated solution for efficient measurement and analysis or go/no-go testing of components and circuits. Detailed impedance and transmission characteristics including secondary parameter derivations can be simply and quickly evaluated or tested. The HP 4194A can contribute to improving engineering productivity and reducing test cost. The analyzer is flexible and has wide measurement capabilities in both impedance and transmission measurements, plus it is fully programmable using Auto Sequence Programming (ASP). Desired measurements and computations, including graphics analysis, can be programmed simply by storing front panel keystroke operations, allowing you to customize measurement, computation and analysis functions. The HP 4194A also features high accuracy and error elimination functions to ensure reliable measurements.

Wide Range Accurate Measurement

Featuring a wide test frequency range — 100Hz to 40MHz for impedance measurements (10kHz to 100MHz when using the HP 41941A/B Impedance Probe Kit) and 10Hz to 100MHz for gain-phase measurements — the HP 4194A satisfies a wide spectrum of needs. Realistic device characteristics can be analyzed under actual operating conditions by varying the test frequency, test signal level, and dc bias. The HP 4194's high degree of measurement accuracy — 0.17% for impedance measurements (1.5% when using the HP 41941A/B) with an amplitude ratio of 0.1 dB — ensures that you'll improve the quality of your test devices.

Quick Analysis

The HP 4194A makes high speed measurements, (approximately 4.5ms per point), displays results on a color CRT, and performs parameter analysis of components and circuits quickly and efficiently; substantially reducing development and evaluation time. The analysis function not only provides you with impedance and transmission characteristics, but also allows you to determine secondary parameters. Using the marker and line cursor functions, you can obtain the resonating frequency of resonators and the pass band width of band pass filters quickly.



COMPONENT MEASUREMENT

Impedance/Gain-Phase Analyzer

Model 4194A (cont.)

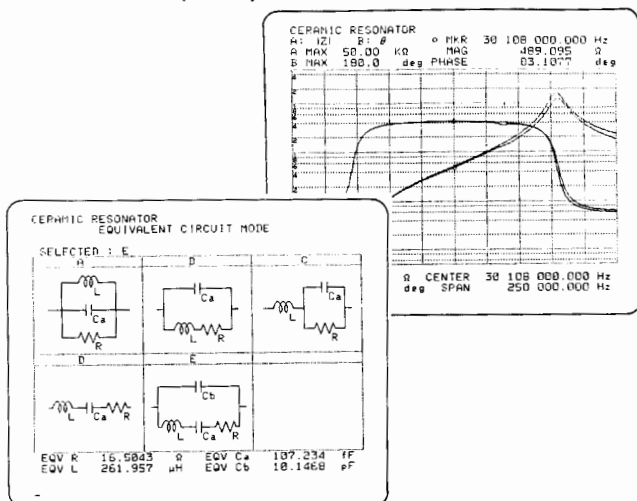

Equivalent Circuit Analysis Function

Using the HP 4194A's Equivalent Circuit Analysis Function, you can easily and quickly obtain those equivalent circuit constants that, until now, required a number of time-consuming, complicated calculations. By using measured values, this unique function can approximate the circuit constant values of five circuit models. For example, a resonator's equivalent circuit elements or a coil's self inductance, lead resistance, and stray capacitance can be easily obtained.

The Equivalent Circuit Analysis function also simulates the frequency characteristics of components by using derived circuit values or values you specify. By using approximation and simulation, you can compare design values to measurement values, and, thereby, improve component design efficiency.

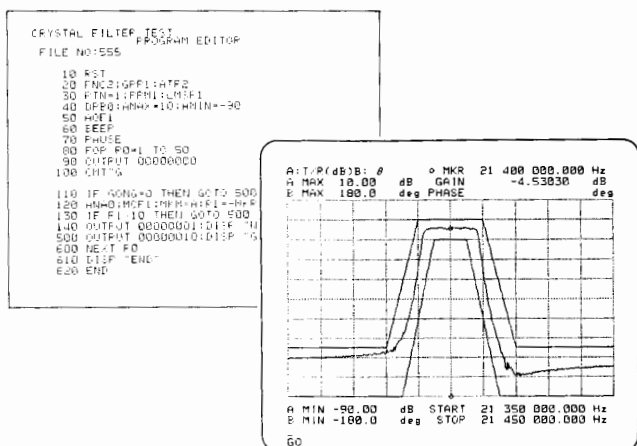

Auto Sequence Program (ASP)

The HP 4194A's ASP function, an internal programming feature, allows you to control all HP 4194A operations (measurement, display, and analysis) without the need for an external computer. By using ASP and actual measurement values, you can readily calculate many secondary parameters that you may need to evaluate. You can then use the HP 4194A's powerful analysis functions to analyze these calculated parameters.

You can also use ASP to enhance such HP 4194A functions as alternate sweep, sweep timing control, and marker tracking. Because ASP eliminates the need for external controller, thereby eliminating data transfer time, the HP 4194A can quickly and efficiently perform production line go/no-go testing of components such as resonators and filters. All these features combine to increase your engineering and manufacturing productivity.

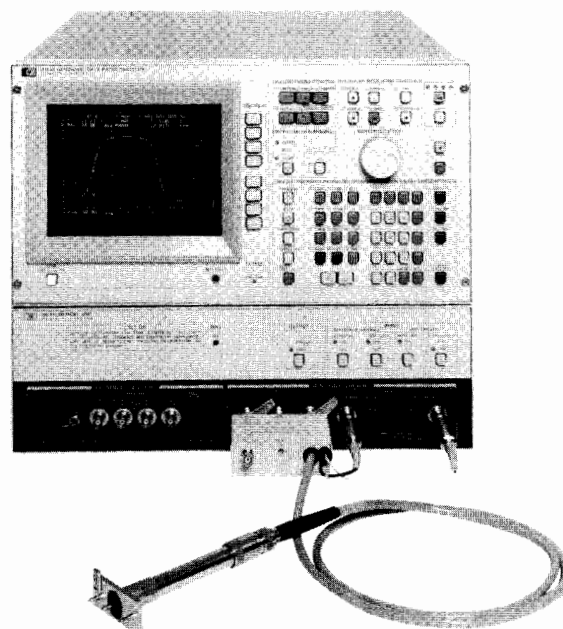

HP 4194A with HP 41941A

Increased Capabilities With The HP 41941A/B Impedance Probe Kit

When using the HP 4194A with the HP 41941A/B Impedance Probe Kit, you can perform reliable impedance evaluations up to 100MHz. Measurement errors due to residual impedance and stray admittance are eliminated by using the calibration standards furnished with the HP 41941A/B and the HP 4194A's automatic calibration function. This makes it possible to make highly accurate measurements (basic measurement accuracy 1.5 to 3%) over a wide measurement range of 100mΩ to 1MΩ. Calibration accuracy is guaranteed to the tips of the HP 41941A (1.5m) and HP 41941B (3m) impedance probes.

The HP 41941A/B can be used as a grounded probe to evaluate the impedance of in-circuit components such as printed circuit patterns, and the input/output impedance of circuits. In addition, you can connect an external dc bias source directly to the HP 41941A/B to perform dc biased measurements up to ±150V/0.5A, to measure the dc characteristics of inductors, capacitors, materials, and semiconductors. To perform swept dc bias measurements, use the HP 4194A's ±40V internal dc bias source.

Specifications

Impedance Measurements

Measurement Parameters: |Z|, |Y|, θ, R, X, G, B, L, C, D, Q. 20 parameter combinations are available.

Test Frequency: 100 Hz - 40 MHz (CABLE LENGTH: 0m), 100Hz - 15 MHz (CABLE LENGTH: 1m), 1mHz resolution.

OSC Level: 10mV - 1Vrms (≤10MHz), 10mV - 0.5Vrms (>10MHz) (UNKNOWN terminal open), 0.1dB (about 1%) resolution

DC Bias: 0 - ±40V, 10mV resolution

Measurement terminal: 4 - terminal pair configuration

Auto Zero Compensation: Automatic compensation for residual impedance and stray admittance of a test fixture.



Measurement Range and Maximum Resolution:

Measurement Parameter	Range	Max Resolution
Z , R, X	100 $\mu\Omega$ to 1.6 M Ω	100 $\mu\Omega$
Y , G, B	1 nS to 10 S	1 nS
θ	$\pm 180^\circ$	0.01 $^\circ$
L	100 pH to 1 KH	100 pH
C	0.1 fF to 10 mF	0.1 fF
D	0.0001 to 10	0.0001
Q	0.1 to 1000	0.1

Basic Measurement Accuracy: 0.17%

Level Monitor: Monitor test voltage across and current through the DUT

Gain-Phase Measurements

Measurement Parameters: Tch/Rch (dB, Linear Ratio), Tch, Rch (V, dBm, dBV), θ (degree, rad), τ

Tch= Test Channel, Rch= Reference Channel, τ = Group Delay

Measurement Frequency: 10Hz - 100MHz, 1mHz resolution

Aperture Frequency Range (Group Delay Measurements): 0.5% - 100% of frequency span

OSC Level: -65dBm - +15dBm, 0.1dB resolution

Measurement Range:

Tch/Rch: 0 - ± 120 dB, 0.001dB resolution

Tch, Rch: -107dBm - -5dBm (0dB Attenuator)
-87dBm - +15dBm (20 dB Attenuator)
0.001dB resolution

θ : $\pm 180^\circ$ (can display phase continuously with the phase scale expansion function), 0.01 $^\circ$ resolution

τ : 0.1ns - 1s, 0.1ns resolution

Basic Measurement Accuracy:

Tch/Rch: 0.1dB, 0.5 $^\circ$

Tch, Rch: 0.35dBm

θ : 0.5 $^\circ$

Level Monitor: Monitor the input level of the Rch and Tch in units of dBm, dBV and Volts.

Impedance Measurements using the HP 4194A/B

The specifications listed below are for the HP 4194A when used with the HP 4194A/B.

Measurement Parameters: |Z|, |Y|, θ , R, X, G, B, L, C, D and Q(1/D). 20 parameter combinations are available.

Frequency Range: 10 kHz - 100 MHz, 1 mHz resolution

OSC Level: Opt. 350: 10 mV - 1.28 Vrms
Opt. 375: 10 mV - 1.54 Vrms

DC Bias: Internal: ± 40 V, ± 20 mA

External: ± 150 V, ± 500 mA, max 25 W

Measurement Range: 100 m Ω - 1 M Ω

Basic Measurement Accuracy:

$\pm 1.5\%$ to 3% (≥ 100 kHz), $\pm 3\%$ to 6% (< 100 kHz)

Temperature Coefficient of Accuracy: ≤ 300 ppm/ $^\circ$ C (≥ 1 MHz)
 ≤ 300 /f ppm/ $^\circ$ C
(< 1 MHz) f: MHz

Level Monitor: Opt. 350: 0 to 1.28 V, 0 to 52 mA
Opt. 375: 0 to 1.54 V, 0 to 42 mA

Cable Length: HP 41941A: 1.5 m, HP 41941B: 3 m

Common Specifications

Trigger Mode: Internal, External and Manual

Sweep Capability:

Sweep Parameter: Frequency, OSC Level, DC Bias (impedance measurements only)

Entry: START/STOP or CENTER/SPAN

Sweep Type: LIN, LOG, ZERO SPAN (DC Bias: LIN or ZERO SPAN only)

Number of Measurement Points: 2 to 401 points

Sweep Functions: Partial Sweep, Expand Markers Sweep, Program Points Measurement

Display

CRT: 7.5 inch color CRT

Display Mode: Rectangular (X- A & B), Rectangular (A - B), Table

Display Control: Autoscale, Superimpose and Storage

Analysis

Maker: Single, Delta, Double Makers

Line-Cursor: Line-Cursor, Delta-Line Cursor

Equivalent Circuit Function: Approximation, Simulation

Arithmetic Operation

Data Register Manipulation: Use arithmetic operations and functions to manipulate data registers.

GO/No-Go Limits

Programming

Auto Sequence Program (ASP): Control the HP 4194A's operation with an internal program language. ASP Programs can be entered using the front panel keys or downloaded from HP-IB.

Program Memory Size: 20kBytes of non-volatile memory

Copy: Dump, Plot, Print Mode

Save/Get: Save up to five kinds of data and measurement conditions in non-volatile memory.

General Specifications

Operating Temperature and Humidity: 0 $^\circ$ C - 40 $^\circ$ C (HP 41941A/B: -20 - +65 $^\circ$ C), $\leq 95\%$ RH at 40 $^\circ$ C

Storage Temperature: -30 $^\circ$ C - +60 $^\circ$ C (HP 41941A/B: -40 - +65 $^\circ$ C)

Safety: Based on IEC - 348, UL - 1244

Power: 100, 120, 220V $\pm 10\%$, 240V - 10% + 5%, 48 - 66Hz, 400VA (max)

Dimensions: 425 (W) x 375 (H) x 620(D) mm

Weight: Approximately 37kg (net)

Reference Data

Typical Measurement Speed:

Impedance: Approximately 3.7ms/point

Gain-Phase: Approximately 3.5ms/point

Impedance when used with the HP 41941A/B: Approximately 6 ms/point

Accessories Furnished

HP 16047D: Direct Coupled Test Fixture

HP 8120-1838: 30cm BNC Cable (2ea) (OPT.350)

HP 04194-61640: 30cm BNC Cable (2ea) (OPT.375)

HP 8120-1839: 60cm NNC Cable (OPT.350)

HP 04194-61641: 60cm NNC Cable (OPT.375)

HP 1250-0080: BNC Adapter

Accessories Available

HP 16085A: Terminal Adapter, used with HP 16092A, HP 16093A/B or HP 16451A.

HP 16086A: Accessory Kit

HP 16092A: Spring Clip Fixture

HP 16093A/B: Binding Post Fixture

HP 16034B: Test Fixture for Chip Component (< 3 MHz)

HP 16047A: Direct Coupled Test Fixture (≤ 13 MHz)

HP 16047C: Direct Coupled Test Fixture

HP 16048A: Test Leads with BNC Connector (≤ 15 MHz)

HP 16048B: Test Leads with RF Miniature (≤ 15 MHz)

HP 16048C: Test Leads with Alligator Clips (< 100 kHz)

HP 16065A: External Bias Fixture (± 200 VDC, ≤ 2 MHz)

HP 41941A: Impedance Probe Kit (1.5m)

HP 41941B: Impedance Probe Kit (3 m)

Ordering Information

4194A Impedance/Gain-Phase Analyzer

Opt 350*: 50 Ohm System

Opt 375*: 75 Ohm System

Opt 001: High Stability Frequency Reference

*Must select either OPT.350 or 375

Fast-Ship product — see page 766.

Price

HP 16085A: \$380

HP 16086A: \$1,450

HP 16092A: \$530

HP 16093A/B: \$200/210

HP 16034B: \$360

HP 16047A: \$260

HP 16047C: \$300

HP 16048A: \$320

HP 16048B: \$320

HP 16048C: \$410

HP 16065A: \$820

HP 41941A: \$1550

HP 41941B: \$1550

Price

4194A Impedance/Gain-Phase Analyzer \$19,800

Opt 350*: \$0

Opt 375*: \$0

Opt 001: \$800



COMPONENT MEASUREMENT

LF Impedance Analyzer (5 Hz to 13 MHz)

Model 4192A

- 5 Hz to 13 MHz variable measuring frequency
- Gain-phase measurement: amplitude, phase, group delay
- Floating or grounded devices
- Impedance measurement: $|Z| \cdot |Y| \cdot \theta \cdot R \cdot X \cdot G \cdot B \cdot L \cdot C \cdot D \cdot Q \cdot \Delta \cdot \Delta\%$
- Standard HP-IB

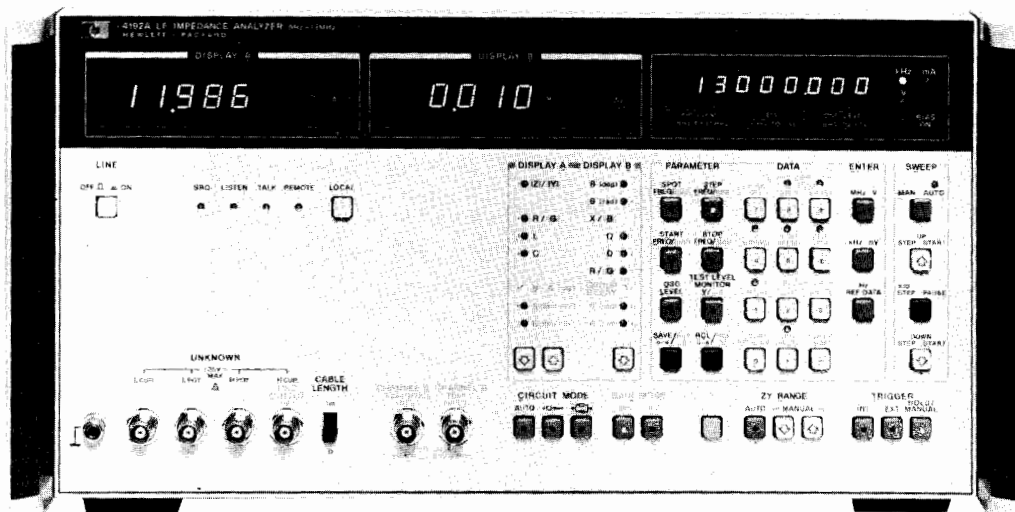

HP 4192A (shown with Opt. 907 handles)



Description

The HP 4192A LF Impedance Analyzer performs both network analysis and impedance analysis on devices such as telecommunication filters, audio/video electronic circuits, and basic electronic components. Both floating and grounded devices can be tested.

Automatic Swept Frequency Measurement of All Impedance Parameters

The HP 4192A can measure 11 impedance parameters ($|Z|$, $|Y|$, θ , R , X , G , B , L , C , D , Q) over a wide range $|Z|$: 0.1 m Ω to 1 M Ω ; $|Y|$: 1 nS to 10 S).

The built-in frequency synthesizer can be set from 5 Hz to 13 MHz with a maximum resolution of 1 mHz. This feature allows accurate characterization of high Q devices such as crystals. Test signal level is variable from 5 mV to 1.1 V with 1 mV resolution. Also, an internal dc bias voltage source provides ± 35 V at 10 mV increments. Thus, the HP 4192A can evaluate components and entire circuits near actual operating conditions.

Specifications (complete specifications on data sheet)

Measuring signal (23 \pm 5 $^{\circ}$ C)

Frequency range: 5 Hz to 13 MHz

Frequency step: 0.001 Hz (5 Hz to 10 kHz), 0.01 Hz (10 kHz to 100 kHz), 0.1 Hz (100 kHz to 1 MHz), 1 Hz (1 MHz to 13 MHz).

Frequency accuracy: ± 50 ppm

OSC level: 5 mV to 1.1 Vrms variable into 50 Ω (amplitude-phase measurement) or open circuit (impedance measurement).

OSC level step: 1 mV (5 mV to 100 mV), 5 mV (100 mV to 1.1 V).

OSC level accuracy: 5 Hz to 1 MHz: $\pm((5 + 10/f)\%$ of setting + 2 mV) where f is in Hz. 1 MHz to 13 MHz: $\pm((4 + 1.5 \times F)\%$ of setting + 2 mV) where F is in MHz.

Level monitor (impedance measurement): current through or voltage across sample can be monitored

Control: spot and sweep via front panel or HP-IB

Measuring Mode

Spot measurement: at specific frequency (or dc bias)

Swept measurement: manual or automatic sweep from START to STOP frequency (or dc bias) at selected STEP frequency (or dc bias) rate

Sweep mode: linear or logarithmic (frequency only)

Recorder outputs: output dc voltage proportional to each measured value, and frequency or dc bias.

Maximum output voltage: ± 1 V

Output voltage accuracy: $\pm(0.5\%$ of voltage + 20 mV)

Key status memory: 5 sets of measuring conditions can be stored and recalled at any time.

HP-IB data output and remote control: standard

Self-test: automatic introspective testing

Trigger: internal, external, manual or HP-IB

Amplitude—Phase Measurement

Parameter measured: relative amplitude B-A (dB) and phase θ (degrees or radians), B-A and group delay, absolute amplitude A (dBm or dBV) or B (dBm or dBV), and deviation (Δ , $\Delta\%$) of all parameters

Reference amplitude: 0 dBV = 1 Vrms, 0 dBm = 1 mW (with 50 Ω termination)

OSC output resistance: 50 Ω

Channels A and B: input impedance: 1 M Ω $\pm 2\%$, shunt capacitance: 25 pF ± 5 pF

Display Range and Resolution

B-A: 0 to ± 100 dB, 0.001 dB (0 to ± 20 dB), 0.01 dB (± 20 to ± 100 dB)

θ : 0 to $\pm 180^{\circ}$, 0.01 $^{\circ}$

Group delay: 0.1 ns to 19 s, max. resolution 4 1/2 digits

A or B: +0.8 to -100 dBV, 0.001 dB (> -20 dB), 0.01 dB (≤ -20 dB), +13.8 to -87 dBm, 0.001 dB (> -20 dBm), 0.01 dB (≤ -20 dBm)

Measuring accuracy (23 \pm 5 $^{\circ}$ C): specified at BNC unknown terminals after 30 minute warmup (test speed: normal or average)

B-A (relative amplitude) and θ (phase) Measurement

Determined by sum of channel A and B accuracies given below (accuracy of each channel changes according to absolute input level)

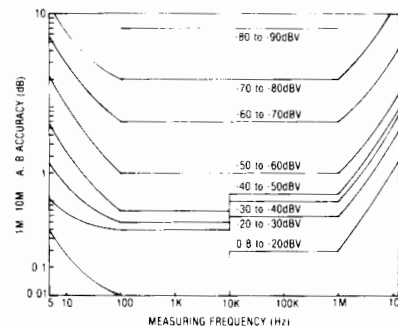

FIGURE 1. GAIN MEASUREMENT ACCURACY

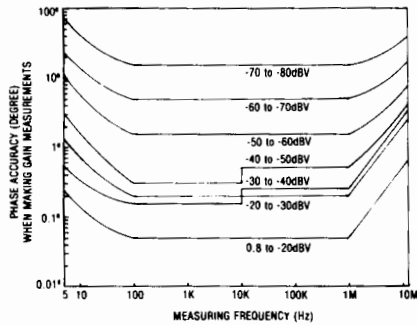

FIGURE 2: PHASE ACCURACY WHEN MAKING GAIN MEASUREMENTS

Impedance Measurement

Parameter measured: $|Z| - \theta$, $|Y| - \theta$, $R - X$, $G - B$, $L - D \cdot Q \cdot R \cdot G$, $C - D \cdot Q \cdot R \cdot G$ and deviation (Δ , $\Delta\%$) of all parameters

Display: 4½ digits, max. display 12999 counts, 19999 for L & C.

Circuit mode: series equivalent circuit (—□—) and parallel equivalent circuit (□—). Automatic selection available.

Auto ZERO adjustment: automatic normalization of the readout offset due to residuals of the test fixture by pushbutton operation (at spot frequency)

Measuring range and accuracy (23 ± 5°C): specified at BNC unknown terminals after 30 minute warmup when OSC level is more than 0.1 V and when auto ZERO adjust is performed (test speed: normal or average). Accuracy given below is only valid when the measured value is equal to full scale of each range.

$|Z| - \theta$, $R - X$ measurement: range: $|Z|$, R , X : 0.1 mΩ to 1.2999 MΩ; θ : -180.00° to +180.00°. Accuracy: R accuracy ($D \geq 10$); X accuracy ($D < 1$)

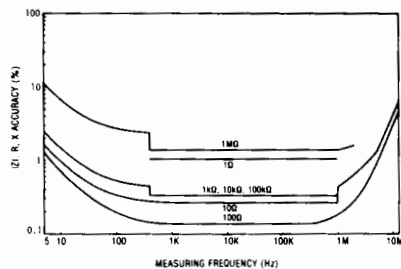

FIGURE 3: |Z|, R, X ACCURACY

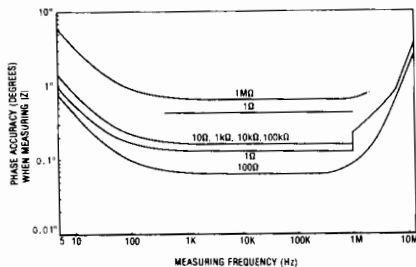

FIGURE 4: PHASE ACCURACY WHEN MEASURING |Z|

$|Y| - \theta$, $G - B$ measurement: range: $|Y|$, G , B : 1 nS to 12.999 S; θ : -180.00° to +180.00°. Accuracy: G accuracy ($D > 1$); B accuracy ($D \leq 0.1$).

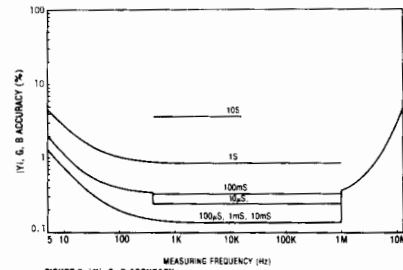

FIGURE 5: |Y|, G, B ACCURACY

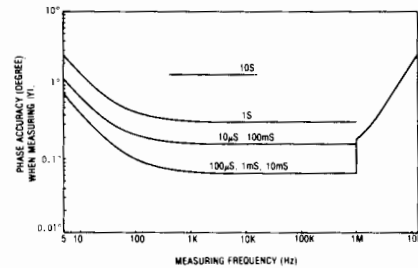

FIGURE 6: PHASE ACCURACY WHEN MEASURING |Y|

L - D · Q, C - D · Q measurement: (automatically calculated from measured Z/Y values)

Parameter	Measuring Range*	Basic Accuracy
L	0.01 nH to 1000 H	0.27%
C	0.1fF to 199** mF	0.15%
D(1/Q)	0.0001 to 19.999	0.001 (C-measurement) 0.003 (L-measurement)

*Varies with measuring frequency except for D(1/Q)

**Accuracy of C ranges over 100 mF is not specified.

Internal dc bias: standard (impedance measurement only)

Voltage range: -35 V to +35 V, 10 mV step

Setting accuracy (23 ± 5°C): 0.5% of setting +5 mV

Bias control: spot and swept, using front panel controls or HP-IB

General

Measuring Time (high speed mode)

B-A and θ , A or B: 88 to 127 ms (≥ 400 Hz)

Impedance parameters: 58 to 91 ms (≥ 1 kHz)

Test Level Monitor Range (impedance measurement)

Voltage: 5 mV to 1.1 V

Current: 1 μA to 11 mA

Operating temperature: 0 to 55°C, $\leq 95\%$ RH at 40°C

Power: 100, 120, 220 V ±10%, 240 V + 5% to -10%, 48 to 66 Hz, 150 VA max.

Size: 425.5 mm W x 235 mm H x 615 mm D (16.75" x 9" x 22.6").

Weight: approx. 19 kg (41.9 lb)

Furnished accessories and parts: HP 16047A test fixture, HP 11048C 50 Ω feed thru terminations (2 ea.), power splitter, HP 11170A BNC cables (2 ea.), BNC adapter

Accessories available

HP 16095A Probe Fixture	\$570
HP 16096A 2-port Component Test Fixture	\$1110
HP 16097A Accessory Kit	\$1,850
HP 16047C Test Fixture	\$300
HP 16048B Test Leads (miniature connector)	\$320
HP 16048C Test Leads with alligator clip	\$410
HP 4274A/4275A's test fixtures/leads are usable with HP 4192A	

HP 4192A LF Impedance Analyzer

Fast-Ship product -- see page 766.

\$13,900



COMPONENT MEASUREMENT

RF Impedance Analyzer

Model 4191A

- 1-1000 MHz variable test frequency with sweep capability
- Direct reading of $|Z| - \theta$, $|Y| - \theta$, $|T| - \theta$;
L • C - R • G • D • Q
R - X, G - B, $\Gamma_x - \Gamma_y$
- High resolution—4½ digit max
- Wide measuring range—1 m Ω - 100 k Ω ($|Z|$)
- Versatile, easy-to-use test fixtures

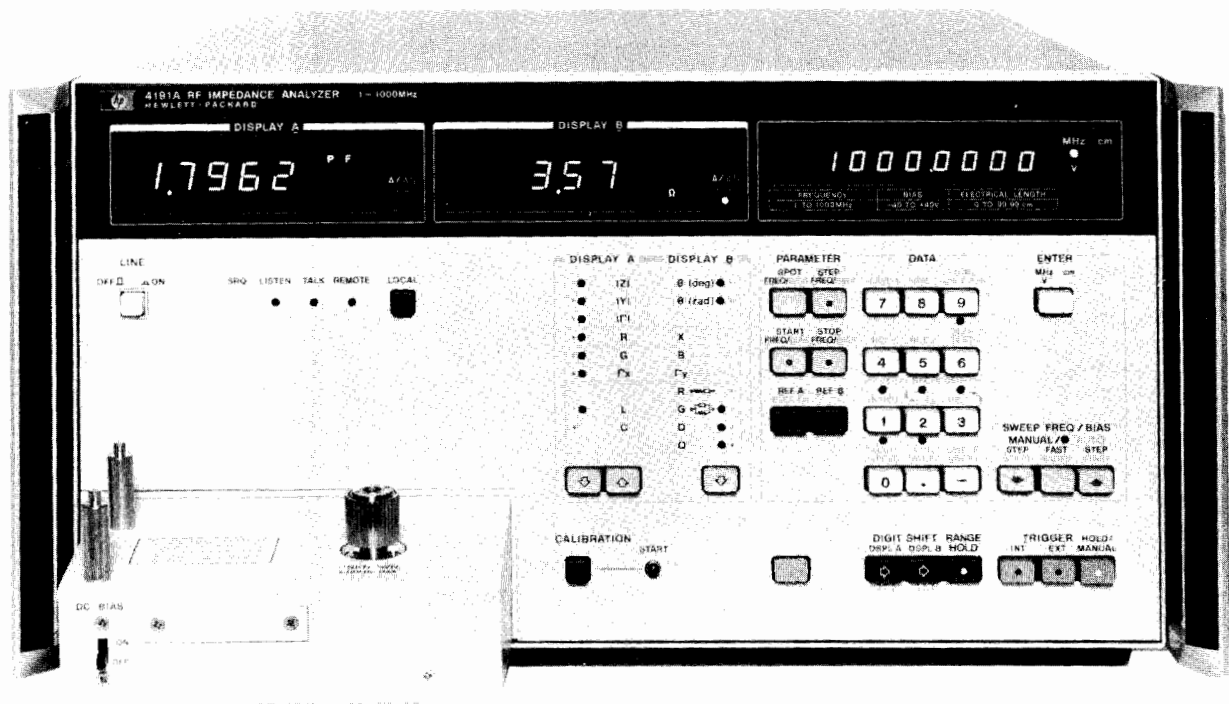

HP 4191A (Shown with Opt 907 Handles)



Description

The HP 4191A RF Impedance Analyzer measures 14 parameters with a maximum resolution of 4½ digits. The internal synthesizer provides variable frequencies from 1 MHz through 1000 MHz covering the UHF, VHF and video bands with automatic sweep capability. An internal dc bias supply with auto sweep function covers the voltage range of ± 40 V in 10 mV steps.

The HP 4191A permits reliable measurements over a wide measuring range. Its outstanding repeatability, frequency response and accuracy are made possible by unique error correction capability and specially designed test fixtures. These features allow the HP 4191A to be used in evaluation of electronic materials, components and circuitry.

The internal synthesizer provides a maximum resolution of 100 Hz (Opt 002) with an accuracy of 3 ppm, allowing small changes in the resonant frequency of the device under test to be easily detected. The swept frequency capability aids in the analysis of frequency characteristics of the device.

Two complete front panel settings (parameter selection and the sweep control) can be stored in a non-volatile memory and recalled at any time with a single key operation. This, together with the standard HP-IB interface, makes the HP 4191A extremely efficient either as a stand-alone or systems instrument.

These unique features permit very wide applications in: (1) semiconductor testing such as surface state evaluation at high frequencies (C-V/G-V and conductance G/ω) characteristics, and the input/output impedance evaluation of diodes and transistors, (2) resonator, filter, and magnetic and dielectric materials testing, (3) evaluation of LCR components such as high frequency chip and leaded components, and (4) testing of communications related components such as cables, connectors, etc.

Specifications

Parameter measured: $|Z| - \theta$, $|Y| - \theta$, $|T| - \theta$
R-X, G-B, $\Gamma_x - \Gamma_y$

L-R • G • D • Q, C-R • G • D • Q

Display: 4½ digit, max display 19999 counts

Deviation Measurement (deviation from stored reference)

Δ : -19999 to +19999 counts

$\Delta\%$: -1999.9 to +1999.9%

Measuring Signal ($23 \pm 5^\circ\text{C}$)

Frequency range: 1 MHz to 1000 MHz

Frequency step: Standard: 100 kHz, 1-500 MHz

200 kHz, 500-1000 MHz

Opt 002: 100 Hz, 1-500 MHz

200 Hz, 500-1000 MHz

Frequency accuracy: ± 3 ppm

Signal level (into 50 Ω): -20 ± 3 dBm

Frequency control: spot and swept

Measuring Mode

Spot measurement: at specific frequency (or dc bias)

Swept measurement: manual or automatic sweep from start to stop frequency (or dc bias) at step frequency (or dc bias) rate in linear or logarithmic form.

Auto Calibration

Automatic error compensation referenced to connected terminations (0 Ω , 50 Ω , 0 S)

Calibration frequency: 51 frequencies including start and stop frequencies.

Electrical length compensation: automatic compensation for electrical length of test fixtures.

Compensating range: 0 to 99.99 cm.

DC Bias

Internal dc Bias

Voltage range: -40 to +40 V, 10 mV step
Setting accuracy: 0.1% of setting +10 mV
Bias control: spot and swept

External dc Bias

Voltage range: -40 to +40 V
Max allowable current: 100 mA

Key status memory: 2 sets of measuring conditions can be stored and recalled at any time. These conditions are kept in storage even when LINE is turned off.

Ranging: Auto/Range hold

Trigger: Internal, External or Manual

Self-test: automatic internal program test

HP-IB data output and remote control: standard

Measuring Range, Resolution and Accuracy

Specified at APC-7 UNKNOWN connector for reflect coefficient measurement at measuring frequency and ambient temperature (0 - 55°C) where calibration is performed after the warm-up time of 40 minutes. Refer to General Information for temperature coefficient and typical measuring range/resolution and accuracies of other measuring parameters (see data sheet for detailed specifications).

Γ - θ / Γ_x - Γ_y Measurement

Measuring Range

Γ , Γ_x , Γ_y : 0.0001 to 1.0000
 θ : 0° to ±180.00° (0 to ± π rad.)
 Γ , Γ_x , Γ_y resolution: 0.0001

Reference Data (Not Specified)

Temperature coefficient for Γ : 0.0001/°C (23 ± 5°C)
Measuring time: <800 ms or <250 ms (high speed mode)
Frequency switching time: ≤ 200 ms

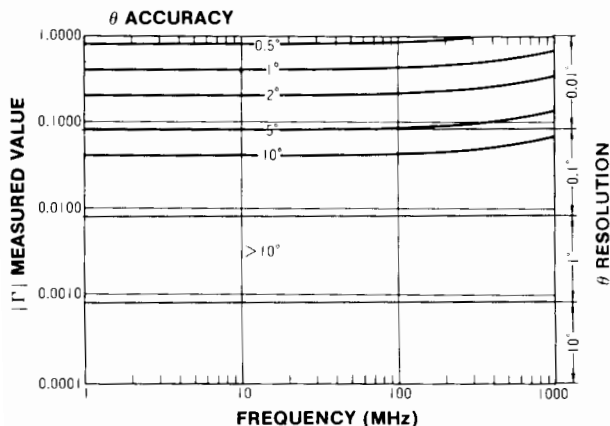
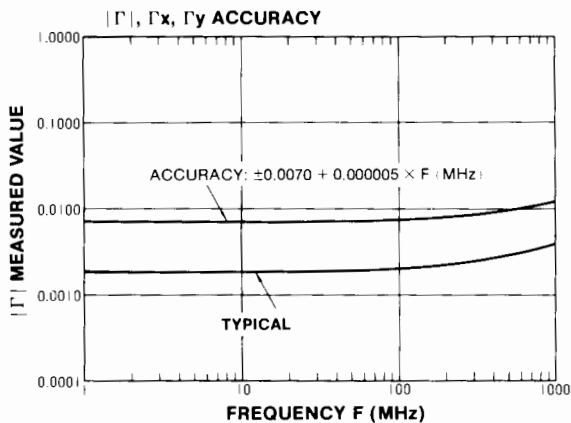

REFERENCE DATA (NOT SPECIFIED)

TYPICAL ACCURACY

Y(S) Z(Ω)

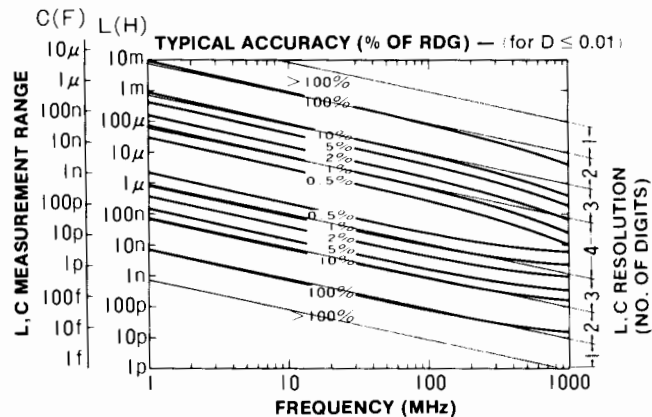
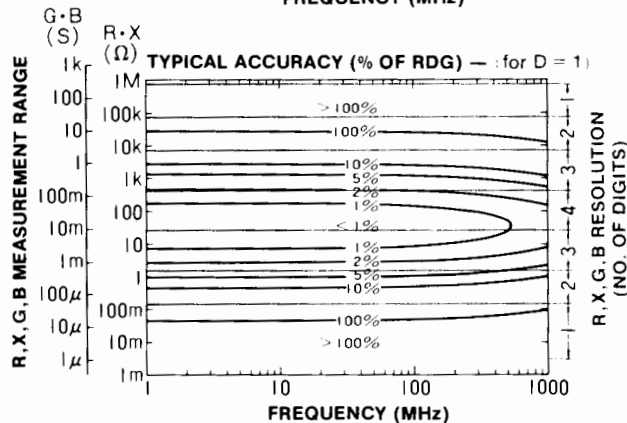
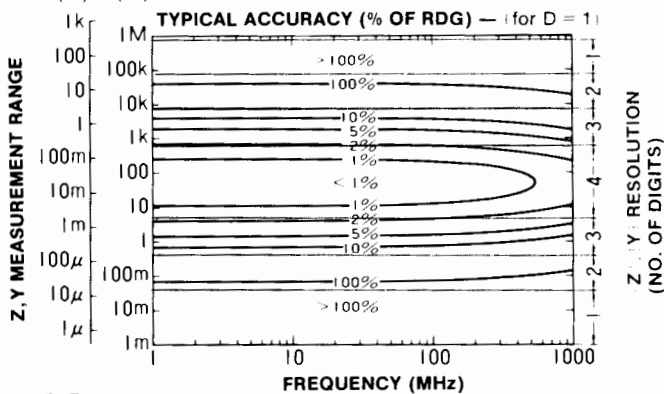

General

Temperature: 0 - 55°C, < 95% RH
Power: 100, 120, 220 V ± 10%, 240 V + 5% - 10%, 48 - 66 Hz, 150 VA max.
Size: 425.5 mm W x 230 H x 574 mm D (16.75" x 9" x 22.6").
Weight: approx. 24 kg (52.8 lb)

Accessories furnished: accessory case (with reference terminations included).

Accessories Available

Accessories Available	Price
HP 16091A Coaxial Test Fixture	\$550
HP 16092A Spring Clip Test Fixture	\$530
HP 16093A Binding Post Test Fixture	\$200
HP 16093B Binding Post Test Fixture	\$210
HP 16094A Probe Fixture	\$180

Options

002: 100 Hz/200 Hz resolution synthesizer	\$1,930
004: Recorder Outputs	\$500

HP 4191A RF Impedance Analyzer **\$16,900**

Fast-Ship product -- see page 766.



COMPONENT MEASUREMENT

Vector Impedance Meter (400 kHz to 110 MHz)

Model 4193A

- 400 kHz to 110 MHz spot or swept frequency
- Measure impedance magnitude (10 mΩ to 120 kΩ) and phase (−180.0° to +180.0°)
- Test components in-circuit and out-of-circuit
- Fixtures include low-grounded probe, spring clip fixture and binding post fixture
- Standard HP-IB and analog outputs

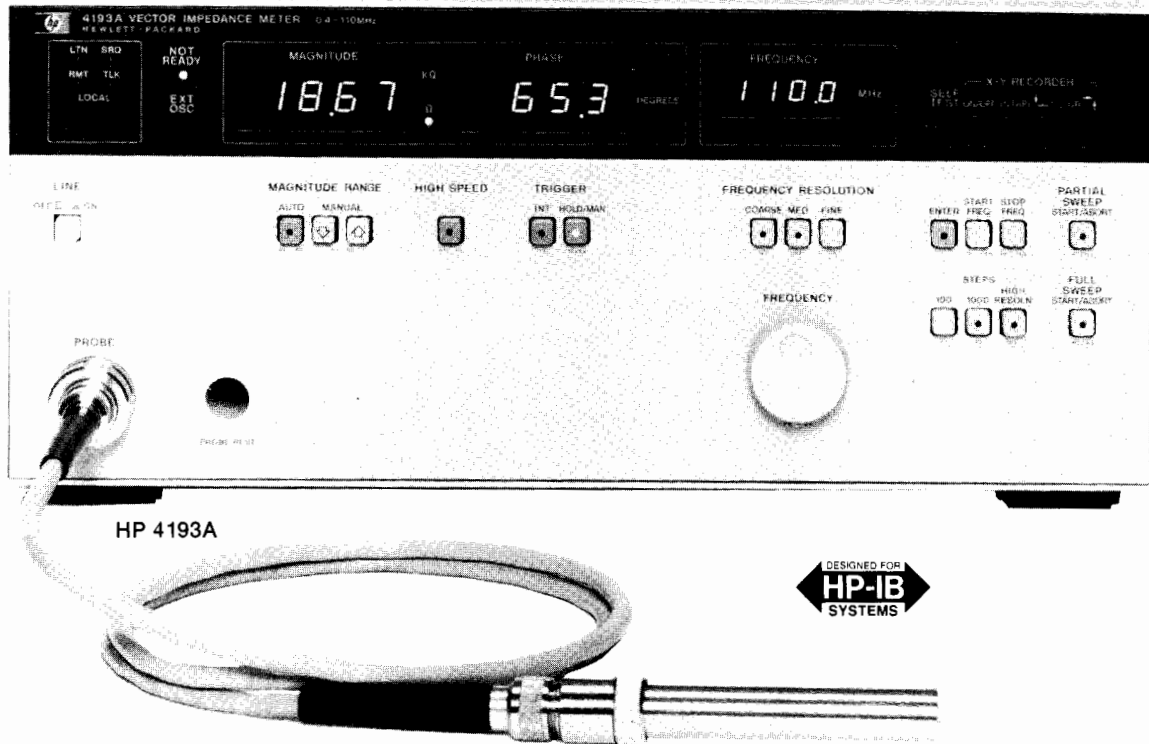

Description

The HP 4193A Vector Impedance Meter measures impedance magnitude and phase. An internal oscillator provides test signals from 400 kHz to 110.0 MHz. The test signal is constant current between 10 μA and 100 μA, depending on |Z| range.

Reliable and Accurate Impedance Measurement

The HP 4193A can measure and display impedance magnitudes from 10 mΩ to 120 kΩ. Impedance phase is displayed from +180.0° to −180.0°. Accuracy is as good as 3.0% of reading (magnitude) and 3.2° (phase).

Also, the HP 4193A's 3½ digit resolution makes it easy to see small changes in measurement results during adjustment procedures, for example.

Frequency Sweep for Complex Component Testing

When testing complex components like ceramic resonators, it is useful (1) to sweep frequency to get the big picture and (2) identify critical impedance points such as the series resonant point. This requires both swept measurement and measurements at individual "spot" frequencies. The HP 4193A can do both.

The HP 4193A can be tuned to any individual frequency from 400 kHz to 110.0 MHz with maximum resolution of 1 kHz. If greater frequency resolution is required, it can be provided by connecting an external synthesized source such as the HP 3335A or HP 8656B to the HP 4193A EXT OSC input.

Flexible internal frequency sweep is an exciting HP 4193A feature. Frequency can be swept linearly over any portion of the HP 4193A frequency range—or swept logarithmically over the entire 400 kHz to 110.0 MHz range.

Test In-Circuit and Out-of-Circuit Components

Several test fixtures help adapt the HP 4193A to your device under test. For example, the handy L-ground probe is useful for in-circuit

testing. The HP 16099A Test Fixture Adapter and three associated fixtures help connect to out-of-circuit devices of various sizes and shapes.

Easy to Use—Both Manually and Under HP-IB Control

The HP 4193A front panel is amazingly simple. In just a few minutes you can become an expert operator. This is a big time saver over most other impedance meters which are usually much more difficult to operate. Plus, the HP 4193A has standard HP-IB, making it a good choice for automated testing in R&D, incoming inspection, production and product assurance.

Specifications

Test Signal Output Specifications

Test signal is output from the furnished low-ground probe.

Frequency range: 400 kHz to 110.0 MHz

Frequency Resolution

400 kHz to 9.999 MHz: 1 kHz resolution

10.00 MHz to 99.99 MHz: 10 kHz resolution

100.0 MHz to 110.0 MHz: 100 kHz resolution

Frequency accuracy: ±0.01% of setting after calibration.

Frequency stability: ±100 ppm per month (0 to 55 °C)

Frequency Control

Spot: spot frequency is set using coarse, medium and fine controls
Full sweep: logarithmic sweep at 43 points over full range of 400 kHz to 110 MHz

Partial sweep: linear sweep from selected START to STOP frequency. Number of steps is selected as 100, 1000 or "HIGH RESOLN". When "HIGH RESOLN" steps are selected, the operator must also select "coarse", "medium" or "fine" resolution.



EXT OSC: increase frequency resolution by connecting an external frequency synthesizer.

Input signal level: 0 dBm to +5 dBm

Input impedance: 50 ohms \pm 10%

Frequency range: 400 kHz to 110 MHz

Impedance Measurement Specifications

Input configuration: low-grounded probe (furnished)

Digital display of impedance: 3½ digits

|Z|: 0 to 1999 counts (0 to 120 counts on 100 kΩ range)

θ: -1800 to +1800 counts (-180 to +180 counts on 100 kΩ range)

Measurement trigger: internal, external, and manual

Measurement range control: auto, hold, and manual

Measurement Range

|Z|: Five decade ranges: 10 Ω, 100 Ω, 1 kΩ, 10 kΩ, 100 kΩ

minimum |Z| (sensitivity): 10 mΩ

maximum |Z|: 120 kΩ

θ: One range: -180.0° to +180.0°

Reference Data

Test Signal Output

Frequency settling time: 5 ms to 400 ms. Best case is when $(\Delta f/f)\%$ is less than 10% (below 10 MHz) and less than 1% (above 10 MHz).

Signal Purity

Spurious: -60 dBc (dBc is dB below carrier)

Harmonics: -30 dBc

Residual FM: measured in a 100 Hz band centered on the carrier

1 MHz to 110 MHz: 100 Hz p-pFM

Test level: constant current source

Z Range	Current in μ A \pm 20%
10 Ω	100
100 Ω	100
1 kΩ	100
10 kΩ	50
100 kΩ	10

|Z| and θ Measurement Accuracy: in the Table below, "f" is in MHz

Range	Accuracy	Measuring Frequency in Megahertz	
		0.4	1
10 Ω Range	Z Accuracy	$\pm[(5.7 + 0.56/f)\% \text{ rdg} + 9 \text{ counts}]$	$\pm[(6.3\% \text{ rdg} + 6 \text{ counts})]$
	θ Accuracy	$\pm[(1.7 + 1.8/f + \frac{35}{ Z \text{ counts}}) \text{ deg}]$	$\pm[(3.3 + 0.20f + \frac{35}{ Z \text{ counts}}) \text{ deg}]$
100 Ω Range	Z Accuracy	$\pm[(2.4 + 0.56/f)\% \text{ rdg} + 4 \text{ counts}]$	$\pm[(3.0\% \text{ rdg} + 4 \text{ counts})]$
	θ Accuracy	$\pm[(1.5 + 1.9/f + \frac{35}{ Z \text{ counts}}) \text{ deg}]$	$\pm[(3.3 + 0.035f + \frac{35}{ Z \text{ counts}}) \text{ deg}]$
1 kΩ Range	Z Accuracy	$\pm[(3.2 + 0.56/f)\% \text{ rdg} + 4 \text{ counts}]$	$\pm[(3.7\% \text{ rdg} + 4 \text{ counts})]$
	θ Accuracy	$\pm[(1.6 + 1.8/f + \frac{35}{ Z \text{ counts}}) \text{ deg}]$	$\pm[(3.3 + 0.11f + \frac{35}{ Z \text{ counts}}) \text{ deg}]$
10 kΩ Range	Z Accuracy	$\pm[(2.9 + 0.56/f)\% \text{ rdg} + 4 \text{ counts}]$	$\pm[(3.2\% + 0.29f)\% \text{ rdg} + 4 \text{ counts}]$
	θ Accuracy	$\pm[(1.8 + 1.9/f + \frac{35}{ Z \text{ counts}}) \text{ deg}]$	$\pm[(3.1 + 0.53f + \frac{35}{ Z \text{ counts}}) \text{ deg}]$
100 kΩ Range	Z Accuracy	$\pm[(3.3 + 0.56/f)\% \text{ rdg} + 4 \text{ counts}]$	$\pm[(0.74 + .53f)\% \text{ rdg} + 4 \text{ counts}]$
	θ Accuracy	$\pm[(3.0 + 1.9/f + \frac{35}{ Z \text{ counts}}) \text{ deg}]$	$\pm[(8.3 + 0.01f + \frac{35}{ Z \text{ counts}}) \text{ deg}]$

Guideline for Use of the |Z| and θ Accuracy Table

- "f" is in MHz.
- "rdg" is display reading, for example, 50.0 ohms.
- "counts" is display counts in the |Z| display.
- "deg" is degrees of arc.

Example: calculate the |Z| and θ accuracy for a device which gives HP 4193A readings of |Z| = 50.0 Ω and θ = -45.0°. Assume an 0.9 MHz test frequency 100 Ω range, and normal measuring speed.

$$|Z| = 50.0 \Omega \pm [(2.4 + \frac{0.56}{0.9})\% \text{ rdg} + 4 \text{ counts}]$$

$$|Z| = 50.0 \Omega \pm [(2.4 + \frac{0.56}{0.9}) * \frac{50.0 \Omega}{100\%} + 4 \text{ counts}]$$

$$|Z| = 50.0 \Omega \pm 1.91 \Omega$$

$$\theta = -45.0^\circ \pm (1.5 + \frac{1.9}{0.9} + \frac{35}{500}) \text{ deg}$$

$$\theta = -45.0^\circ \pm (1.5 + \frac{1.9}{0.9} + \frac{35}{500}) \text{ deg}$$

$$\theta = -45.0^\circ \pm 3.68^\circ$$

Recorder output: dc voltage proportional to measured |Z|, θ and measurement frequency.

Output voltage: accuracy specification for all recorder output voltages is $\pm(1\% + 20 \text{ mVdc})$

|Z|: 0 Vdc (0000 display counts) to +1 Vdc (2000 display counts)

θ: -1 Vdc (-180.0°) to +1 Vdc (+180.0°)

Frequency

Full sweep: 0 Vdc (400 kHz) to +1 Vdc (110 MHz), log sweep

Partial sweep: 0 Vdc (START frequency) to +1 Vdc (STOP frequency), linear sweep

HP-IB remote control and data output: standard

Self-test: standard

Impedance Measurement

Residual Impedance of Probe (at probe tip)

Resistance: $\leq 0.55 \Omega$

Inductance: $\leq (4.9 + 10/f) \text{ nH}$ where f is measuring frequency in MHz

Parallel Capacitance: $\leq 0.11 \text{ pF}$

Measuring speed: assumes range is fixed; recorder output is OFF

HI SPEED: approximately 150 ms per measurement

NORMAL: approximately 1 s per measurement

Ranging time: approximately 1.2s

Temperature coefficient at 23°C \pm 5°C

|Z|: 2 mΩ/°C

θ: 0.02°/°C

General

Operating temperature/humidity: 0 to 55°C, $\leq 95\% \text{ RH @ } 40^\circ\text{C}$. Note that measurement error in 0°C to 55°C temperature range is typically double the error in the 23°C \pm 5°C range.

Power: 100/120/220 V $\pm 10\%$, 240 V -10% to +5%, 48 to 66 Hz, 150 VA max

Size: 426 mm W x 178 mm H x 498 mm D, (16.75" x 7" x 19.6").

Weight: 18 kg (40 lb)

Accessories furnished: low-ground probe kit includes probe, spare pins, spare clips, BNC adapter, component mounting adapter, probe socket and accessory case.

Accessories Available

HP 16099A Test Fixture Adapter (used with HP 16092A and HP 16093A/B)

Price

HP 16092A Spring Clip Fixture (used with HP 16099A)

\$380 ☎

HP 16093A Binding Post Fixture (used with HP 16099A)

\$530 ☎

HP 16093B Binding Post Fixture (used with HP 16099A)

\$200 ☎

HP 16093B Binding Post Fixture (used with HP 16099A)

\$210 ☎

HP 4193A Vector Impedance Meter

\$9,150

☎ Fast-Ship product -- see page 766.



COMPONENT MEASUREMENT

Multi-Frequency LCR Meters

Models 4274A & 4275A

Model 4274A

- Test frequencies – 100 Hz to 100 kHz
- Test signal level – 1 mV to 5 Vrms
- High resolution – 5½ digit: D=0.00001

- Measure L/C – D/Q/ESR/G; $|Z| - \theta$, R-X/B/L/C; $\Delta LCRZ$, $\Delta\%$
- 0.1% basic accuracy

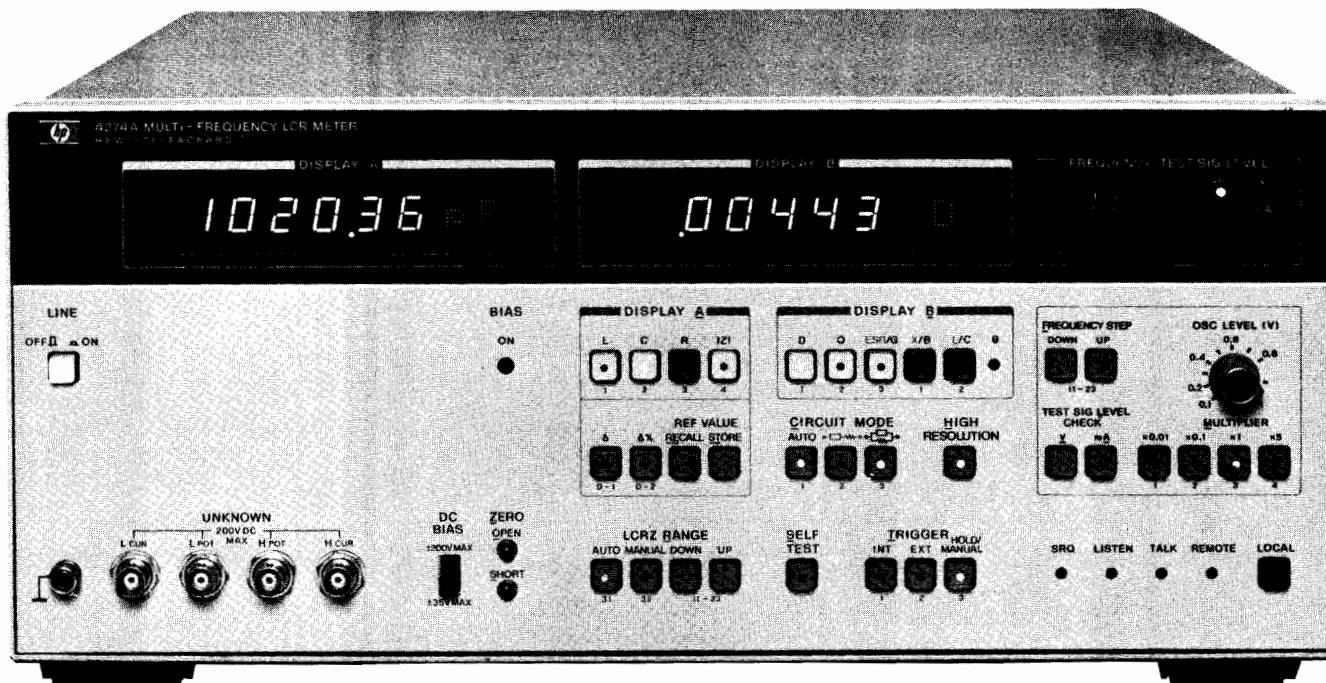

HP 4274A



Description

The HP 4274A and HP 4275A Multi-frequency LCR Meters are recent additions to Hewlett-Packard's new generation of microprocessor-based impedance measuring instrumentation. Both instruments offer a new measuring concept for the evaluation of LCR components, complex components, electronic circuits "tested under actual working conditions", and semiconductor materials. A measurement under conditions similar to the intended use contributes to the improvements in quality and reliability of electronic components, devices and circuits.

Multi-Frequency Capability

To insure the high reliability in circuits and devices, it is most important that they be tested and evaluated at test signals similar to those of actual operating conditions.

The HP 4274A covers the wide frequency range of 100 Hz to 100 kHz in 11 spot frequencies and the HP 4275A has 10 spot frequencies from 10 kHz to 10 MHz, in 1-2-4 step sequence with 1-3-5 as an option. This feature produces the frequency characteristics of components or devices. In addition, two optional special frequencies (for example, 455 kHz and 10.7 MHz) are available within the frequency range of each instrument. This wide frequency range selection offers evaluation of circuit design with a continuously variable test signal over the range of 1 mV to 5 Vrms (to 1 Vrms for the HP 4275A), and with internal dc bias optionally available with 1 mV maximum resolution. The test voltage or current values can be monitored on the 3-digit display for accurately setting the actual conditions under which the device-under-test will operate.

Multi-Parameter Measurements

The HP 4274A and HP 4275A measure equivalent series resistance (ESR), impedance ($|Z|$), phase angle (θ), reactance (X), susceptance (B), and conductance (G), in addition to the conventional L,C,R,D and Q parameters in certain combinations with a dual 5½ digit display, and an HP-IB standard for systems integration.

This wide selection of 11 parameters provides for more accurate evaluation of electronic materials or components with high measurement speed for most needed combined parameters; for example, the C-G measurement of semiconductors, an R-X measurement in circuit design, or the C-ESR or $|Z| - \theta$ measurement of tantalum capacitors.

In addition, a deviation measurement capability ($\Delta, \Delta\%$) for the L,C,R, and $|Z|$ functions displays the difference between the actual value and a stored reference, either as a difference value or in percent. Deviation applications include, for example, a temperature dependence measurement of devices in environmental tests.

Reliable Measurements with 5½ Digit Resolution

The HP 4274A and HP 4275A measure only the value of the component and/or device under test, with 5½ resolution and 0.1% basic accuracy by reducing the possibility of errors due to self or mutual inductance, stray capacitance and/or residual inductance in the test leads or test fixture used. This measurement is obtained by a state-of-the-art four terminal pair configuration and a built-in automatic ZERO-offset capability to compensate for these errors.

Model 4275A

- Test frequencies – 10 kHz to 10 MHz
- Test signal level – 1 mV to 1 Vrms
- 0.1% basic accuracy

- High resolution – 5½ digit; D=0.00001
- Measure L/C – D/Q/ESR/G; $|Z| - \theta$, R-X/B/L/C; $\Delta LCRZ, \Delta\%$

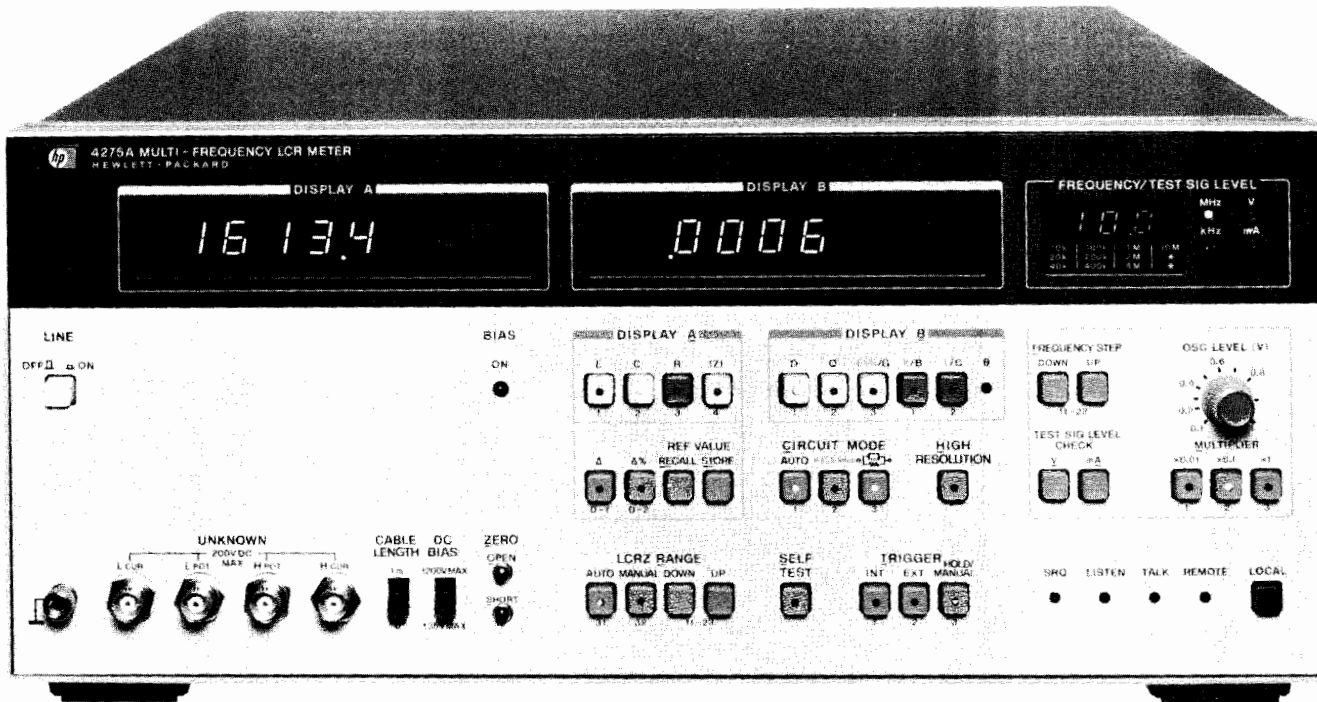

HP 4275A



The fast measurement speed, high resolution, and high accuracy can make major contributions for the component manufacturer and user who is concerned about reducing his costs, improving quality, and throughput efficiency. In these areas, the HP 4274A and the HP 4275A are ideal for D-measurements of film capacitors or insulation material (with the high resolution of 0.00001), the C-G measurements of semiconductors (with maximum resolutions of 0.01 fF, 0.01 nS, respectively), and for the low impedance measurement of aluminum electrolytic capacitors (with a maximum resolution of 0.001 mΩ).

Automatic Semiconductor and Component Measurements with HP-IB

Integrating the HP 4274A and the HP 4275A into an HP-IB controlled system is an excellent method for improving efficiency and cost savings both in the laboratory and on the production line. These automatic measurement systems are assembled by connecting the HP-IB cables between the instruments to be utilized for a specific task.

A system built around the HP 4274A and/or HP 4275A allows the user to obtain useful data for many diverse applications. For example, the evaluation of semiconductors based on the frequency dependence of its C-V characteristics that requires a wide range and fast measurement speeds is easily accomplished with these instruments. The four-terminal pair input configuration and the automatic zero offset capability insures that the measured data is accurate, even in a systems environment.

Sample Applications

Semiconductor Measurements

The evaluation of a semiconductor can be done with a C-V or G-V measurement with the multi-spot frequencies featured in the HP

4274A and HP 4275A, (with C resolution of 0.01 fF and G resolution of 0.01 nS), their two programmable bias sources (maximum resolution 1 mV) and their continuously variable test signal levels (from 1 mVrms).

Of significant use is the evaluation of the doping process and the measurement of the characteristics of MOS or bipolar semiconductor materials which employ a C or G measurement with varying dc bias voltage.

A sample plot of a semiconductor measurement is shown in the figure below. Such measurements at high speed can offer high reliability and high throughput efficiency in the semiconductor manufacturing processes.

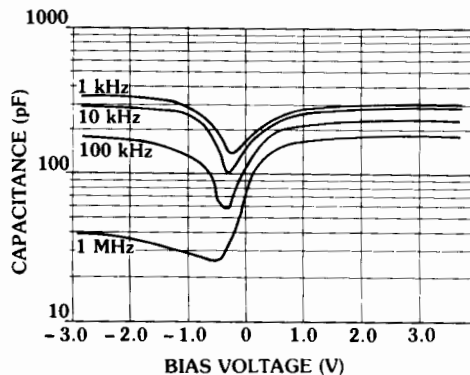



COMPONENT MEASUREMENT

Multi-Frequency LCR Meters

Models 4274A & 4275A (cont.)

Common Specifications (HP 4274A & HP 4275A)

Refer to the HP 4274A & HP 4275A data sheet for details.

Parameters Measured

L: inductance C: capacitance	Q: =1/D ESR: equivalent series resistance	θ: phase angle Δ: deviation for L, C, R, Z,
R: resistance Z: impedance D: dissipation factor	G: conductance X: reactance B: susceptance	Δ%: % of deviation Test frequency Test signal level (voltage or current)

Parameter Combinations

Display A	Display B	
L	D / Q / ESR	D / Q / G
C		
R	X / L	B / C
Z	θ	

Measurement Frequencies, Test Signal Levels, and Full Scale Range

MODEL	HP 4274A	HP 4275A
Measurement frequencies	100 Hz-100 kHz, 11 spots (100 Hz, 120 Hz, 200 Hz, 400 Hz, 1 kHz, 2 kHz, 4 kHz, 10 kHz, 20 kHz, 40 kHz, 100 kHz; ±0.01%)	10 kHz-10 MHz, 10 spots (10 kHz, 20 kHz, 40 kHz, 100 kHz, 200 kHz, 400 kHz, 1 MHz, 2 MHz, 4 MHz, 10 MHz; ±0.01%)
Test signal levels	4-ranges (1 mVrms-5 Vrms) continuously variable	3-ranges (1 mVrms-1 Vrms) continuously variable
Full scale range	L: 100.00 nH - 1000.0 H C: 1.0000 pF - 1.00 F R, Z , ESR, & X: 100.00 mΩ - 10.000 MΩ D: 0.00001 - 9.9999 Q (1/D): 0.01 - 9900 G & B: 1.0000 μS - 100.00 S θ: 0 - ±180°	100.00 nH - 10.00 H 1.0000 pF - 100.00 μF 1.0000 Ω - 10.000 MΩ 0.00001 - 9.9999 0.01 - 9900 1.0000 μS - 10.00 S 0 - ±180°

Accuracy (HP 4274A only): typical C-D, L-D, R-X and |Z|-θ measurement accuracy values are given below.

Displays: dual 5½-digit and single 3-digit; maximum display 199999 (full scale and overrange in high resolution mode), and 4½-digit: maximum display 19999 in normal mode. (Number of digits depends on measurement frequency, test level, and range).

Circuit modes: series equivalent circuit and parallel equivalent circuit. Automatic selection available in AUTO mode.

Deviation measurement: difference between recallable stored reference and displayed is deviation value (count or percent).

Display range: -199999 to +199999 counts in AUTO range. -199999 to +199999 counts in MANUAL range (the sample should be measurable at the selected range).

Percent display range: -199.99% to +199.99%

Ranging: AUTO or MANUAL (UP/DOWN).

Trigger: internal, external or manual.

Measurement terminals: four-terminal pair with guard.

Auto zero adjustment: automatic normalization of the readout off-set due to residuals of the test fixture by pushbutton operation.

Normalization range: C < 20 pF, L < 2000 nH, R < 0.5 Ω, G < 5 μS.

Self test: automatic operational verification check indicates pass or fail condition.

HP-IB data output and remote control: standard.

Memory back-up for storing measurement conditions: standard.

Range: full scale range, accuracy: % of reading + counts (D: accuracy: % of reading + absolute D value + count).

FREQUENCY RANGE	C-D/Q	L-D/Q	R-X	Z -θ
		D-range: 0.00001-9.9999 Q-range: 0.01-9900 (=1/D) (C & D accuracies apply only when C: full scale and D: ≤ 0.1)	D-range: 0.00001-9.9999 Q-range: 0.01-9900 (=1/D) (L & D accuracies apply only when L: full scale and D: ≤ 0.1)	(R accuracies apply only when R: full scale) (X accuracies apply only when R: 1/10 of full scale and X: full scale)
100 Hz	C: 1000 pF-1000 mF, 0.1% + 3 D: 0.33% + 0.0008 + 1	L: 100 μH-10 kH, 0.1% + 3 D: 0.33% + 0.0013 + 1	R: 100 mΩ-10 MΩ, 0.1% + 3 X: 100 mΩ-10 MΩ, 0.1% + 13	Z : 100 mΩ-10 MΩ, 0.1% + 3 θ: ±0.1°
120 Hz	C: 1000 pF-1000 mF, 0.1% + 2 D: 0.32% + 0.0007 + 1	L: 100 μH-10 kH, 0.1% + 3 D: 0.32% + 0.0012 + 1	R: 100 mΩ-10 MΩ, 0.1% + 3 X: 100 mΩ-10 MΩ, 0.1% + 13	Z : 100 mΩ-10 MΩ, 0.1% + 3 θ: ±0.1°
200 Hz	C: 100 pF-100 mF, 0.14% + 1 D: 0.34% + 0.0013 + 1	L: 100 μH-10 kH, 0.1% + 3 D: 0.31% + 0.0011 + 1	R: 100 mΩ-10 MΩ, 0.1% + 3 X: 100 mΩ-10 MΩ, 0.1% + 13	Z : 100 mΩ-10 MΩ, 0.1% + 3 θ: ±0.1°
400 Hz	C: 100 pF-100 mF, 0.1% + 3 D: 0.33% + 0.0008 + 1	L: 10 μH-1000 H, 0.1% + 3 D: 0.33% + 0.0013 + 1	R: 100 mΩ-10 MΩ, 0.1% + 3 X: 100 mΩ-10 MΩ, 0.1% + 13	Z : 100 mΩ-10 MΩ, 0.1% + 3 θ: ±0.1°
1 kHz	C: 100 pF-100 mF, 0.1% + 2 D: 0.32% + 0.0007 + 1	L: 10 μH-1000 H, 0.1% + 3 D: 0.32% + 0.0012 + 1	R: 100 mΩ-10 MΩ, 0.1% + 3 X: 100 mΩ-10 MΩ, 0.1% + 13	Z : 100 mΩ-10 MΩ, 0.1% + 3 θ: ±0.1°
2 kHz	C: 10 pF-10 mF, 0.14% + 1 D: 0.34% + 0.0013 + 1	L: 10 μH-1000 H, 0.1% + 3 D: 0.31% + 0.0011 + 1	R: 100 mΩ-10 MΩ, 0.1% + 3 X: 100 mΩ-10 MΩ, 0.1% + 13	Z : 100 mΩ-10 MΩ, 0.1% + 3 θ: ±0.1°
4 kHz	C: 10 pF-10 mF, 0.1% + 3 D: 0.33% + 0.0008 + 1	L: 1 μH-100 H, 0.1% + 3 D: 0.33% + 0.0013 + 1	R: 100 mΩ-10 MΩ, 0.1% + 3 X: 100 mΩ-10 MΩ, 0.1% + 13	Z : 100 mΩ-10 MΩ, 0.1% + 3 θ: ±0.1°
10 kHz	C: 10 pF-10 mF, 0.1% + 2 D: 0.32% + 0.0007 + 1	L: 1 μH-100 H, 0.1% + 3 D: 0.32% + 0.0012 + 1	R: 100 mΩ-10 MΩ, 0.1% + 3 X: 100 mΩ-10 MΩ, 0.1% + 13	Z : 100 mΩ-10 MΩ, 0.1% + 3 θ: ±0.1°
20 kHz	C: 1 pF-1000 μF, 0.14% + 1 D: 0.34% + 0.0013 + 1	L: 1 μH-100 H, 0.1% + 3 D: 0.31% + 0.0011 + 1	R: 100 mΩ-10 MΩ, 0.1% + 3 X: 100 mΩ-10 MΩ, 0.1% + 13	Z : 100 mΩ-10 MΩ, 0.1% + 3 θ: ±0.1°
40 kHz	C: 1 pF-1000 μF, 0.1% + 3 D: 0.33% + 0.0008 + 1	L: 100 nH-10 H, 0.1% + 3 D: 0.33% + 0.0013 + 1	R: 100 mΩ-10 MΩ, 0.1% + 3 X: 100 mΩ-10 MΩ, 0.1% + 13	Z : 100 mΩ-10 MΩ, 0.1% + 3 θ: ±0.1°
100 kHz	C: 1 pF-1000 μF, 0.1% + 2 D: 0.32% + 0.0007 + 1	L: 100 nH-10 H, 0.1% + 3 D: 0.32% + 0.0012 + 1	R: 100 mΩ-10 MΩ, 0.1% + 3 X: 100 mΩ-10 MΩ, 0.1% + 13	Z : 100 mΩ-10 MΩ, 0.1% + 3 θ: ±0.1°

(Conditions: Warm-up time ≥ 30 minutes, environment temperature: 23°C ± 5°C). Refer to technical data sheet for accuracy details.

Accuracy (HP 4725A only): typical C-D, L-D, R-X and |Z| - θ measurement accuracy values are given below.

Range: full scale range, accuracy: % of reading + counts (D accuracy: % of reading + absolute D value + count).

Frequency Range	C - D/Q	L - D/Q	R - X	Z - θ
	D-range: 0.00001 - 9.9999 Q-range: 0.01-9900 (= 1/D) (C & D accuracies apply only when C: full scale and D: ≤ 0.1)	D-range: 0.00001 - 9.9999 Q-range: 0.01 = 9900 (= 1/D) (L & D accuracies apply only when L: full scale and D: ≤ 0.1)	(R accuracies apply only when R: full scale) (X accuracies apply only when R: 1/10 of full scale and X: full scale)	θ -range: -180.00° - +180.00° (Z & θ accuracies apply only when Z: full scale)
10 kHz	C: 10 pF - 100 μ F, 0.1% + 3 D: 0.33% + 0.008 + 1	L: 10 μ H - 100H, 0.1% + 3 D: 0.33% + 0.0013 + 1	R: 1000 m Ω - 10 M Ω , 0.1% + 3 X: 1000 m Ω - 10 M Ω , 0.1% + 13	Z : 1000 M Ω - 10 m Ω , 0.1% + 3 θ : $\pm 0.1^\circ$
20 kHz	C: 10 pF - 100 μ F, 0.1% + 2 D: 0.32% + 0.0007 + 1	L: 10 μ H - 100 H, 0.1% + 3 D: 0.32% + 0.0012 + 1	R: 1000 m Ω - 10 M Ω , 0.1% + 3 X: 1000 m Ω - 10 M Ω , 0.1% + 13	Z : 1000 M Ω - 10 m Ω , 0.1% + 3 θ : $\pm 0.1^\circ$
40 kHz	C: 1 pF - 10 μ F, 0.14% + 1 D: 0.34% + 0.0009 + 1	L: 10 μ H - 100 H, 0.1% + 3 D: 0.31% + 0.0011 + 1	R: 1000 m Ω - 10 M Ω , 0.1% + 3 X: 1000 m Ω - 10 M Ω , 0.1% + 13	Z : 1000 M Ω - 10 m Ω , 0.1% + 3 θ : $\pm 0.1^\circ$
100 kHz	C: 1 pF - 10 μ F, 0.1% + 3 D: 0.33% + 0.0008 + 1	L: 1 μ H - 10 H, 0.1% + 3 D: 0.33% + 0.0013 + 1	R: 1000 m Ω - 10 M Ω , 0.1% + 3 X: 1000 m Ω - 10 M Ω , 0.1% + 13	Z : 1000 M Ω - 10 m Ω , 0.1% + 3 θ : $\pm 0.1^\circ$
200 kHz	C: 10 pF - 10 μ F, 0.1% + 2 D: 0.32% + 0.0007 + 1	L: 1 μ H - 1000 mH, 0.2% + 3 D: 0.53% + 0.0023 + 1	R: 1000 m Ω - 1 M Ω , 0.2% + 3 X: 1000 m Ω - 1 M Ω , 0.2% + 13	Z : 1000 M Ω - 1 m Ω , 0.2% + 3 θ : $\pm 0.1^\circ$
400 kHz	C: 1 pF - 1000 nF, 0.14% + 1 D: 0.34% + 0.0009 + 1	L: 1 μ H - 1000 mH, 0.2% + 3 D: 0.51% + 0.0021 + 1	R: 1000 m Ω - 1 M Ω , 0.2% + 3 X: 1000 m Ω - 1 M Ω , 0.2% + 13	Z : 1000 M Ω - 1 m Ω , 0.2% + 3 θ : $\pm 0.1^\circ$
1 MHz	C: 1 pF - 1000 nF, 0.1% + 3 D: 0.33% + 0.0008 + 1	L: 100 nH - 100 mH, 0.2% + 3 D: 0.55% + 0.0025 + 1	R: 1000 m Ω - 1 M Ω , 0.2% + 3 X: 1000 m Ω - 1 M Ω , 0.2% + 13	Z : 1000 M Ω - 1 m Ω , 0.2% + 3 θ : $\pm 0.1^\circ$
2 MHz	C: 10 pF - 100 nF, 0.3% + 3 D: 0.55% + 0.0025 + 1	L: 1 μ H - 10 mH, 0.5% + 5 D: 1.0% + 0.0033 + 1	R: 10 Ω - 100 k Ω , 0.5% + 5 X: 10 Ω - 100 k Ω , 0.5% + 15	Z : 10 Ω - 100 k Ω , 0.5% + 5 θ : $\pm 0.2^\circ$
4 MHz	C: 1 pF - 10 nF, 1% + 20 + 0.002 pF D: 3.3% + 0.01 + 1	L: 1 μ H - 10 mH, 1% + 5 D: 2.0% + 0.0063 + 1	R: 10 Ω - 100 k Ω , 2% + 7 X: 10 Ω - 100 k Ω , 2% + 105	Z : 10 Ω - 100 k Ω , 2% + 7 θ : $\pm 0.8^\circ$
10 MHz	C: 1 pF - 10 nF, 2% + 20 + 0.002 pF D: 4% + 0.011 + 1	L: 100 nH - 1 mH, 2% + 7 D: 3.1% + 0.002 + 1	R: 10 Ω - 100 k Ω , 2% + 7 X: 10 Ω - 100 k Ω , 2% + 105	Z : 10 Ω - 100 k Ω , 2% + 7 θ : $\pm 0.8^\circ$

(Conditions: Warm-up time ≥ 30 minutes, environment temperature: 23°C \pm 5°C). Refer to technical data sheet for accuracy details.

General Information
Reference Data

Test Signal Level Monitor

Model	Range		Accuracy
	Voltage	Current	
HP 4274A	0.001 V - 5.00 Vrms	0.001 mA - 100 mArms	\pm (3% of reading + 1 count)
HP 4275A	0.001 V - 1.00 Vrms	0.001 mA - 10.0 mArms	\pm (3% of reading + 1 count) at < 1 MHz \pm (10% of reading + 2 counts) at ≥ 1 MHz

Measurement time: (typical) 140-180 ms (>1 kHz); 140-210 ms ≤ 1 kHz (measurement time depends on range, sample value and off-set adjustment value).

Z - θ measurement time: 170-210 ms >1 kHz; 170-240 ms ≤ 1 kHz.

High resolution mode: approximately 8 times the normal measurement time.

Auto ranging time: 100 ms - 300 ms per range change.

Options

Opt 001: 0 to ± 35 internal dc bias

Range	Steps	Accuracy
\pm (0.00 - 999) V	1 mV	\pm (0.5% of reading + 2 mV)
\pm (1.00 - 9.99)	10 mV	\pm (0.5% of reading + 4 mV)
\pm (10.0 - 35.0)	0.1 V	\pm (0.5% of reading + 20 mV)

Control: HP 16023B dc Bias Controller or remote control with HP-IB

Opt 002: 0 - ± 99.9 V internal dc bias (for C ≤ 0.1 μ F)

Range: \pm (00.0 - 99.9) V, 0.1 V steps

Accuracy: \pm (2% of reading + 40 mV)

Control: same as Opt 001

External dc bias: ± 200 V maximum.

Bias monitor: rear panel BNC connector monitors internal or external input bias.

Opt 004: frequency steps in 1-3-5 sequence.

Special Options

One or two arbitrary test frequencies for each instrument are available. For more details, please contact nearest HP sales office.

Selectable Frequency Range

HP 4274A: 100 Hz to 100 kHz to $\pm 0.1\%$. If two frequencies are added, at least one frequency must satisfy the following equation: $f = 1200/N$ kHz where N is an integer from 12 to 12000.

HP 4275A: 10 kHz to 10.7 MHz $\pm 0.1\%$.

Accessories

HP 16047A: Direct coupled test fixture. Furnished accessory with the HP 4274A and HP 4275A.

HP 16023B: dc Bias Controller, for control of dc bias Opt 001 or 002 Internal Bias Supply. Control range 0 to ± 99.9 V by setting thumbwheel switch.

HP 16034B: Test Fixture for chip components

HP 16047B: Test Fixture with safety cover

HP 16047C: Test Fixture for high frequencies

HP 16048A: Test leads, BNC

HP 16048B: Test leads, RF miniature

HP 16048C: Test leads with alligator clips

Price
N/C

\$340

\$360

\$750

\$300

\$320

\$320

\$410

Options

Opt 001: 0 to ± 35 internal dc bias, max resolution; 1 mV steps

\$870

Opt 002: 0 to ± 99.9 V internal dc bias, resolution: 100 mV steps.

\$810

Opt 004: Frequency steps in 1-3-5 sequence

N/C

Ordering Information

HP 4274A 100 Hz - 100 kHz Multi-Frequency LCR Meter

Price

\$9800

HP 4275A 10 kHz - 10 MHz Multi-Frequency LCR Meter

\$11200

☎ Fast-Ship product—see page 766.



COMPONENT MEASUREMENT

1 kHz / 1 MHz Capacitance Meter

Model 4278A

- Measurement Speed: 6.7ms/10.4ms/18.6ms
- Measurement Parameters: C-D•Q•ESR•G
- C-D Measurement Accuracy:
 - 0.07%, 0.0005(1kHz, 18.6ms)
 - 0.05%, 0.0002(1MHz, 18.6ms)
- High Resolution: 6 digit, D:0.00001
- Intelligent Built-in Comparator: 10-bin Sorting

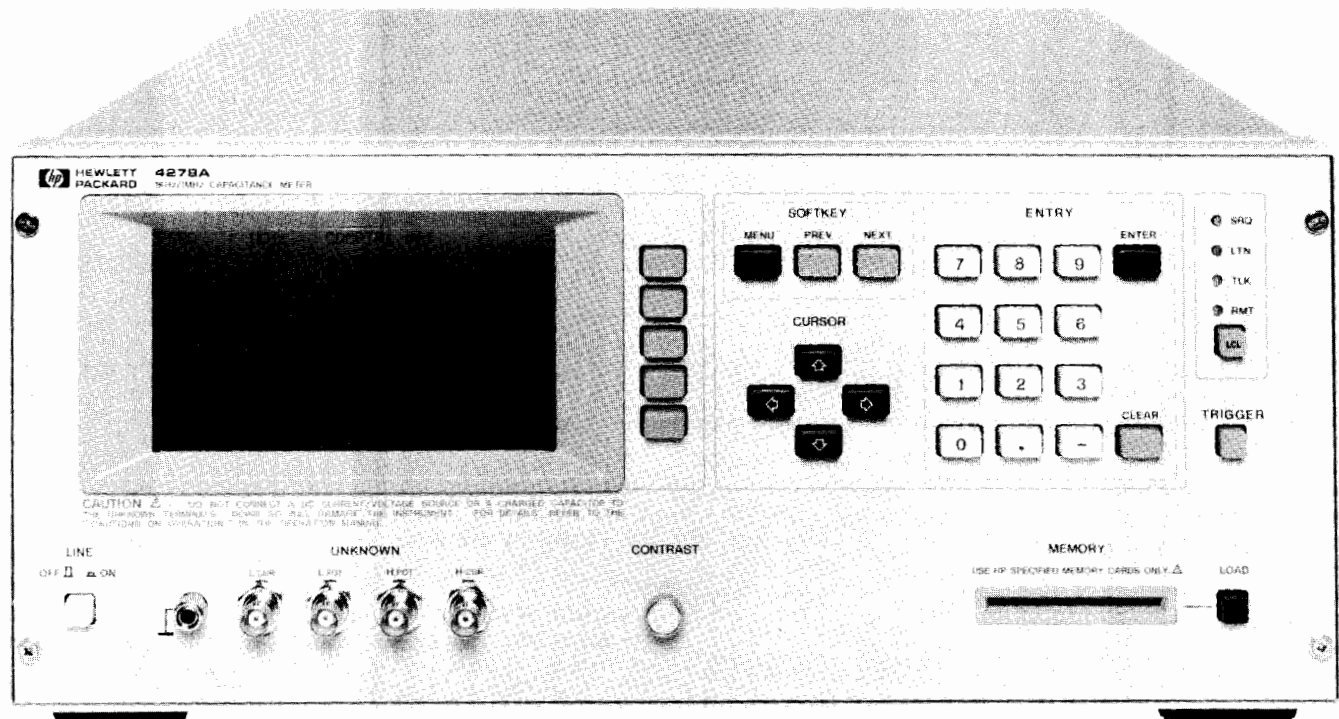

Description

The HP 4278A 1kHz/1MHz Capacitance Meter is a high speed, highly reliable, precision test instrument aimed at incoming/outgoing capacitor inspection applications on the production line and in quality control. The HP 4278A will improve test efficiency by performing comparative measurements of low to medium value capacitors (up to 200 μF —a range that covers most ceramic and film capacitors) several times faster than previously available capacitance meters.

The HP 4278A's standard measurement frequencies and oscillator output levels are 1kHz/1MHz and from 0.1V to 1V in 0.1V steps, respectively. The HP 4278A's ability to make precision capacitance measurements and to measure low dissipation values will give you an edge in improving the quality of your devices.

The built-in comparator function of the HP 4278A gives you the ability to sort parts into ten bins. A high speed HP-IB interface and an optional handler interface are available for combining the HP 4278A with an automatic handler and an external computer to build a total solution for automatic testing and data acquisition and analysis.

High Speed Measurements

One of the HP 4278A's main features is its selection of high measurement speeds: 6.7ms (150 measurements/sec), 10.4ms (95 measurements/sec), or 18.6ms (54 measurements/sec), with a fast settling time. Additionally, the HP 4278A's built-in comparator and high speed HP-IB interface make it possible to construct a measurement system using an automatic handler and an external computer to minimize production test time, and, therefore, cost.

High Accuracy and Resolution

Dissipation factor (D), the parameter measured to determine the quality of capacitors, can be measured with an accuracy of 0.0002 (1MHz) and 0.0005 (1kHz) with a resolution of 0.00001 without degrading measurement speed. The HP 4278A has high capacitance measurement accuracy, 0.05% (1MHz) and 0.07% (1kHz) with 6 full digits of resolution in all measurement ranges, 1pF to 2048 pF (1MHz), and 100pF to 100 μF (1kHz).

The pushbutton zero adjustment function is used to compensate for stray impedance and admittance of the handler and test fixture. The auto calibration function, when used with a capacitance standard, can be used to calibrate the system up to the point of device connection.

Intelligent Built-in Comparator

The intelligent built-in comparator gives the HP 4278A the capability to use nine sets of high and low capacitance values and one set of dissipation limits to sort capacitors into nine bins, according to their capacitance values and whether or not they meet the dissipation limits. Capacitors which are not within the capacitance limits or do not meet the dissipation limits go into the tenth or no-go bin.

All comparator settings can be controlled and monitored using an external computer, and the results of the comparisons can be transferred to a handler interface (optional). All control settings and comparator parameters can be saved on the removable EEPROM memory module (memory card) to facilitate instrument setup and to minimize the chance of an instrument setup error.



Specifications

(refer to data sheet for complete specifications)

Measurement Parameters: C-D/Q•ESR•G

Display: Dot-matrix LCD. Displays measurement values with 4, 5, or 6 digit resolution (max. 999999 counts), front panel control settings, comparator limits, and the comparator's decision output.

Measurement Circuit Modes: Parallel and Series

Test Signals:

Frequency: 1kHz and 1 MHz, $\pm 0.02\%$

Signal Level: 0.1 to 1 Vrms, $\pm 10\%$ ($C \leq 20\mu\text{F}$), in 0.1 Vrms steps

Output Impedances: 1, 10, and 100 Ω , set automatically in accordance with the capacitance range used.

Measurement Terminals: Four-terminal pair, guarded

Cable Length Compensation: 0, 1, or 2m

Open/Short Zero Adjustments: Front panel initiated open and short adjustments to compensate measurement results for the residual impedance and stray admittance of the test fixture used.

Adjustment Ranges: $R \leq 20\ \Omega$, $G \leq 20\ \mu\text{S}$, unlimited for C and L.

Auto Calibration: Push button calibration using stored calibration data to improve capacitance and loss factor value measurement accuracy.

Measurement Time Modes: SHORT, MEDIUM, and LONG

Measurement Times:

Mode	SHORT	MEDIUM	LONG
Time*	6.7ms	10.4ms	18.6ms

* Measurement time includes Settling, Integration (analog measurements), Calculation, and Comparison times.

No additional measurement time is required for measurements performed in an overload (shorted capacitor) condition.

Trigger Modes: Internal, External, or Manual

Measurement Ranges and Accuracies: Specified at the front panel unknown connectors or at the ends of the standard 1m test leads when all of the following conditions are satisfied.

- warm up time ≥ 30 minutes
- ambient temperature $23^\circ\text{C} \pm 5^\circ\text{C}$; rate of temperature change $< 0.2^\circ\text{C}/\text{minute}$; Error tolerances double for 0°C to 55°C .
- test signal level set to 1Vrms
- test cable length set to 0 or 1m
- OPEN and SHORT adjustments performed
- $D \leq 0.1$ at 1 kHz, $D \leq 0.05$ at 1 MHz.

Accuracies are relative to calibration standards.

1kHz C-D/C-Q (1/D) Measurements:

Measurement Range: 0.001pF – 200.000 μF , 0.00001 – 9.99999D

Capacitance Range: 100pF – 100 μF full scale, 7 decade ranges
Table 1 lists the 1kHz C-D/C-Q measurement accuracies. Accuracies are read as \pm (% of reading + % of full scale) for C, and \pm (% of reading + absolute D value) for D.

	Measurement Time Mode		
	SHORT	MEDIUM	LONG *2
C	$\pm (0.4\% + 0.4\%)$	$\pm (0.1\% + 0.05\%)$	$\pm (0.05\% + 0.02\%)$
D	$\pm (0.4\% + 0.004)$	$\pm (0.1\% + 0.001)$	$\pm (0.05\% + 0.0005)$

*2 100 μF range: C: $\pm (0.05\% + 0.05\%)$
D: $\pm (0.05\% + 0.001)$

Table 1. 1 kHz C - D/C - Q (1/D) Measurement Accuracy

1MHz C-D/C-Q (1/D) Measurements:

Normal Mode:

Measurement Range: 0.00001pF – 1280.00pF, 0.00001 – 9.99999D

Capacitance Range: 1pF – 1024pF full scale, 11 binary ranges
Table 2 lists the Normal Mode measurement accuracies. Accuracies are read as \pm (% of reading + % of full scale) for C, and \pm (% of reading + absolute D value) for D.

	Measurement Time Mode		
	SHORT	MEDIUM	LONG
C	$\pm (0.4\% + 0.4\%)$	$\pm (0.2\% + 0.2\%)$	$\pm (0.1\% + 0.1\%)$
D	$\pm (0.4\% + 0.004)$	$\pm (0.2\% + 0.002)$	$\pm (0.1\% + 0.001)$

Table 2. 1 MHz C - D/C - Q (1/D) Measurement Accuracy in NORMAL mode

High Accuracy Mode:

Capacitance Range: max. 2048pF

Capacitance ranges are user-definable. That is, the capacitance value you enter will be the 'center' of the range, and the range covered will be 30% of that value. For example, if you enter 1000pF, the capacitance range will be 700 – 1300pF.

Table 3 lists the High Accuracy Mode measurement accuracies. The accuracies listed correspond to the binary range accuracies, which are dependent upon the capacitance value entered. Accuracies are read as \pm (% of entered capacitance value + absolute C value) for C, and \pm (% of reading + absolute D value) for D.

Entry C Range*	Measurement Time Mode		
	SHORT	MEDIUM	LONG
1024 – 2048pF			C: $\pm (0.07\%)$ D: $\pm (0.07\% + 0.0004)$
512 – 1024pF	C: $\pm (0.4\% + 0.0007\text{pF})$	C: $\pm (0.1\% + 0.0007\text{pF})$	C: $\pm (0.07\%)$ D: $\pm (0.07\% + 0.0003)$
256 – 512pF			C: $\pm (0.05\%)$ D: $\pm (0.05\% + 0.0002)$
2 – 256pF	D: $\pm (0.4\% + 0.004)$	D: $\pm (0.1\% + 0.001)$	C: $\pm (0.07\% + 0.0007\text{pF})$ D: $\pm (0.07\% + 0.0004)$
0 – 2pF			

*Notes: Entry C range applies to the sum of the entry capacitance value and the stray capacitance value obtained at OPEN zero adjustment.

For the range limit values, refer to the accuracies at the lower ranges.

Table 3. 1 MHz C - D/C - Q (1/D) Measurement Accuracy in HIGH ACCURACY mode

Comparator: Ten-bin sorting for capacitance, and go/no-go testing for D, Q, ESR, and G.

Sorting Modes: Sequential sorting into un-nested bands with absolute limits, and tolerance sorting into nested bands with absolute or percent limits.

Self Test: Checks the HP 4278A's basic operation.

Memory Card: External memory for storing and recalling control settings and comparator limits.

General Specifications:

Operating Temperature and Humidity: 0–55°C, 95% RH @ 40°C

Power: 100, 120, 220VAC $\pm 10\%$, 240VAC +5 –10%, 48–66Hz, 200VA max.

Dimensions (in mm): Approximately 426(W) by 177(H) by 498(D)

Weight: Approximately 10kg (22lb., standard)

Reference Data:

Stability: $\leq 1 \times 10^{-4}/\text{day}$ in Measurement Time Mode Long.

HP-IB Data Output Speed: Maximum 100 bytes/ms, typically 3ms for handshake, depending on the system controller.

Accessories Available

HP 16034B: Tweezer-type Test Fixture for Chip Components \$360

HP 16047A: Direct-coupled Test Fixture \$260

HP 16047C: Test Fixture \$300

HP 16048A: Test Leads, BNC (1m) \$320

HP 16048B: Test Leads, SMC (1m) \$320

HP 16048D: Test Leads, BNC (2m) \$410

Refer to the data sheet for the available accessories that require maintenance or calibration.

Ordering Information

HP 4278A 1kHz/1MHz Capacitance Meter \$7000

Opt 001: 1kHz test frequency only –\$750

Opt 002: 1MHz test frequency only –\$330

Opt 003: 1% frequency shift: prevents possible test signal interference when component test contacts are located close to those of other test units N/C

Opt 101: HP-IB compatibility \$220

Opt 201: Handler Interface \$250

Fast-ship product, see page 766.



COMPONENT MEASUREMENT

LCZ Meters

Models 4276A & 4277A

Model 4276A

- 3-digit frequency setting: 100 Hz to 20 kHz (801 spots)
- High speed measurements (1 kHz): 95 ms/meas (4-digit display resolution); 60 ms/meas (3-digit display resolution)
- Measure L/C-D/Q/ESR/G, $|Z| - \theta$, high speed L/C
- 10-bin component sorting-comparator (OPT. 002)
- 0.1% basic accuracy over impedance range of 100 m Ω to 10 M Ω

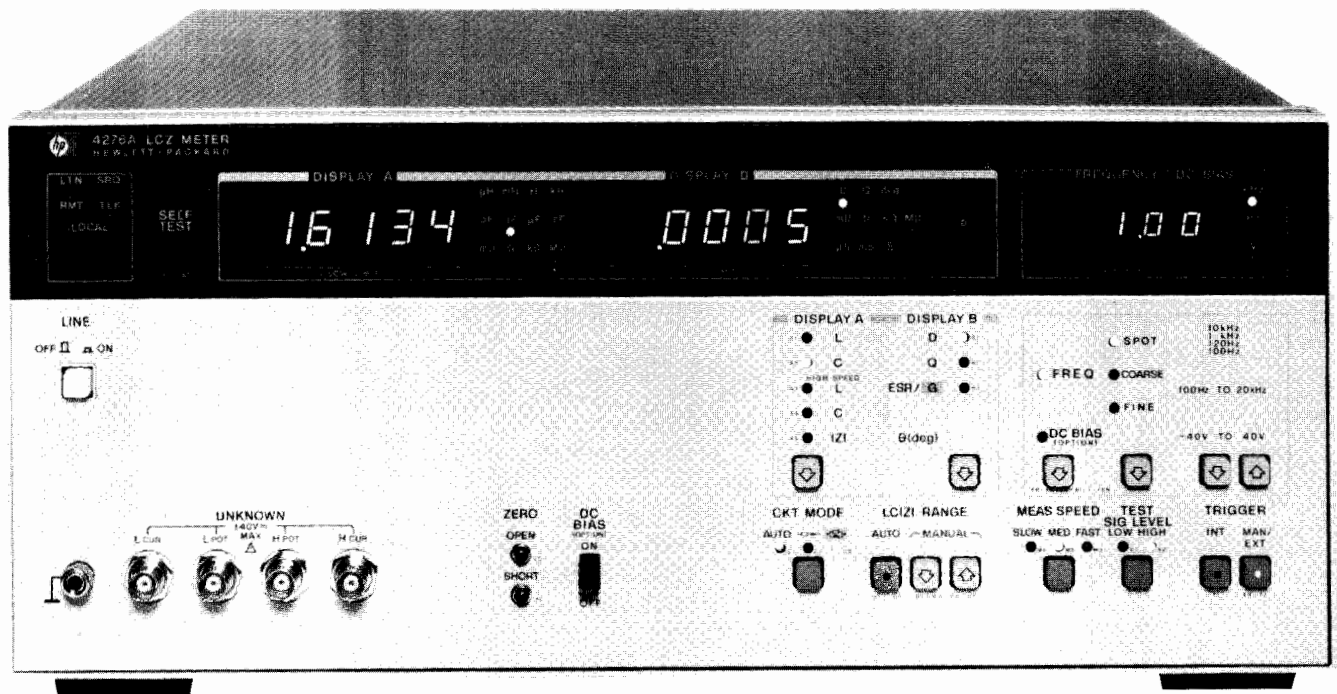

HP 4276A



Description

HP's 4276A and 4277A LCZ Meters are general purpose impedance measuring instruments designed to measure circuit components such as capacitors and inductors using frequency and dc bias conditions identical to those of the intended application. Both HP 4276A and HP 4277A feature variable test frequency (100 Hz – 20 kHz and 10 kHz – 1 MHz respectively), optional dc bias variable from 0 to ± 40 V, multiple parameters (L • C • $|Z|$ • D • Q • ESR • G • θ) with fully automatic high speed measurements, and $4\frac{1}{2}$ digit resolution. The HP 4276A has an impedance range of 100 m Ω to 10 M Ω and the HP 4277A 10 Ω to 1 M Ω .

Both instruments are ideal for production line, quality control, and circuit design applications, and are versatile enough for stand-alone use or systems use under HP-IB control (standard). An optional comparator for 10-bin sorting with measurement time of less than 100 ms make the HP 4276A/4277A a good choice for production line testing of discrete components.

Variable Test Parameters: Frequency, Bias, Signal Level

HP's 4276A and 4277A offer variable test frequency, optional internal dc bias, and selectable test signal level (HIGH and LOW). This makes it possible to measure components under conditions almost identical to those of the intended circuit.

The HP 4276A (100 Hz to 20 kHz) and the HP 4277A (10 kHz to

1 MHz) provide 801 and 701 test frequencies, respectively. Test frequencies of both instruments are linearly spaced along a logarithmic scale. The most commonly used test frequencies for production line measurements—100 Hz, 120 Hz, 1 kHz and 1 MHz, all of which are specified in MIL/IEC standards are included. Frequency setting resolution is 3 digits.

Both instruments feature selectable test signal levels—1 V/50 mV (Cp) (HP 4276A) and 1 V/20 mV (Cp) (HP 4277A)—and both can be equipped with an optional internal dc bias source that is variable from 0 to ± 40 V in 10 mV (0 to 10 V) or 100 mV (10 to 40 V) steps. Thus, bias conditions that suit the measurement and the DUT can be selected, an important consideration for semiconductor C-V measurements.

The features described above satisfy most impedance measurement requirements for component development and circuit design. HP-IB enhances these features.

High Speed Measurements

The HP 4276A and HP 4277A provide high speed measurements with $3\frac{1}{2}$ to $4\frac{1}{2}$ digits resolution. The time required for a C-D measurement, for example, is 95 ms (4-digit) or 60 ms (3-digit) at 1 kHz, and 70 ms (4-digit) or 60 ms (3-digit) at 1 MHz. Even at 120 Hz, a measurement time of 170 ms (4-digit) or 150 ms (3-digit) is possible. Also, when the instrument is set to high speed L or high speed C measurement mode, measurement time is 45 ms (4-digit) or 35 ms (3-digit) at 1 kHz (if D is less than 0.002), and 40 ms (4-digit) or 30 ms (3-digit) at 1 MHz (if D is less than 0.01).

Model 4277A

- 3-digit frequency setting: 10 kHz to 1 MHz (701 spots)
- High speed measurements (1 MHz): 70 ms/meas (4-digit display resolution); 60 ms/meas (3-digit display resolution)
- Measures L/C-D/Q/ESR/G, $|Z|$ - θ . high speed L/C
- 10-bin component sorting-comparator (opt. 002)
- 0.1% basic accuracy over impedance range of 10 Ω to 1 M Ω

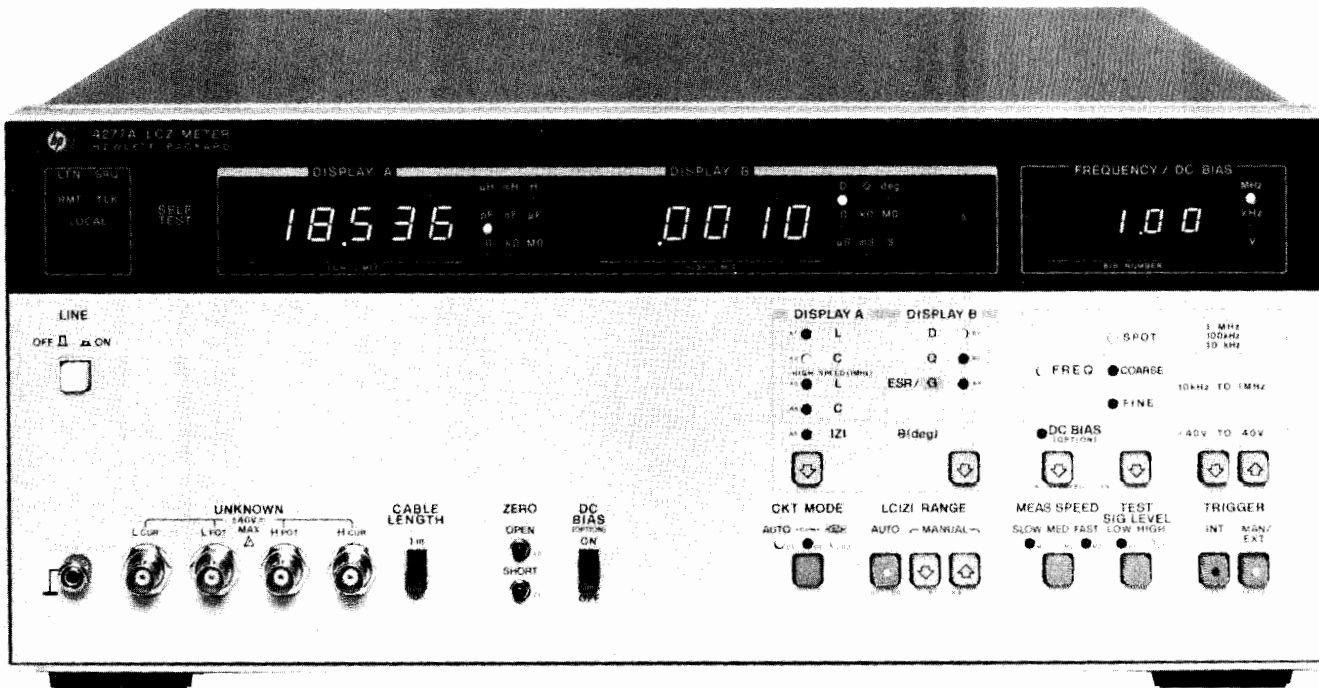

HP 4277A

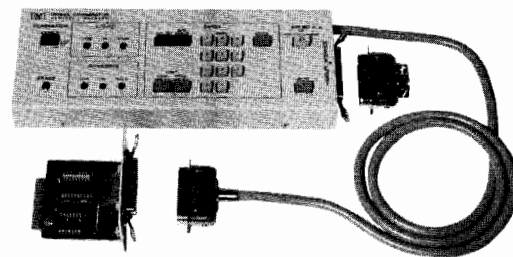

Option 002 Comparator

Such high speeds considerably improve the efficiency and increase the throughput of high volume measurements such as outgoing inspection on the production line and incoming inspection by component end users. If an HP-IB system is configured, measurement efficiency is further improved because HP-IB is capable of packed binary data output format, which can be processed much faster than the usual ASCII format. Even when the HP-IB capability is not used, the HP 4276A/4277A can increase production line throughput if the optional comparator is used.

Optional Ten-Bin Component Sorting

A 10-bin comparator (option 002) is available. Nine sets of bin limits (high and low) can be input for L, C or $|Z|$. Also, high and low limits for D, Q, ESR, or G can be set to provide go/no-go testing.

Multiple bin sorting is especially beneficial on the production line and in incoming inspection. Test costs can be significantly reduced using the HP 4276A/4277A's high speed measuring capability. When the optional handler interface is used for automatic component sorting, measurement efficiency is better than that when using HP-IB. This is because time for data handshake is not needed.

Output data from the handler interface is at TTL or open collector level, which improves system noise immunity. Particularly,

three lines—external trigger and measurement complete signals—are photo-isolated, so a reliable sorting system free from noise can be constructed.

Measurement reliability is improved by other comparator features such as front panel lock-out and auto zeroing of fixture residuals.

Plus, all comparator functions can be HP-IB controlled. So a fully automatic component sorting system can be constructed for use in outgoing/incoming inspection.

Specifications (Refer to data sheet for complete specifications)
Common to HP 4276A and HP 4277A

Parameters measured: C-D•Q•ESR•G

L-D•Q•ESR•G

high speed L, high speed C

$|z|$ - θ and Δ (deviation for any parameter)

Display: 4½ digits (max), maximum display 19999



COMPONENT MEASUREMENT

LCZ Meters

Models 4276A & 4277A (cont.)

Measurement circuit modes: Auto, Parallel, and Series
Frequency control modes: SPOT (100 Hz, 120 Hz, 1 kHz, 10 kHz, 100 kHz, 1 MHz), COARSE (10 freq./decade), and FINE (max. freq. resolution).

Test Signal Level (unknown terminal open)

	HIGH	LOW
HP 4276A	1 Vrms ± 10%*	50 mV ± 20%*(Cp only)
HP 4277A	1 Vrms ± 10%	20 mV ± 15%

*at 1 kHz only

Output impedance: 100 Ω

Ranging modes: Auto and Manual (up-down)

Trigger: Internal, External or Manual

Measurement terminals: 5-terminal (HP 4276A)
 4-terminal pair (HP 4277A)

Measurement speed modes: FAST, MED, and SLOW

Offset adjustments: front panel OPEN and SHORT adjustments to compensate for residual impedance and stray admittance of the test fixture.

Test frequencies: HP 4276A - 100 Hz to 20 kHz ± 0.01% (801 points)

HP 4277A - 10 kHz to 1 MHz ± 0.01% (701 points)

Step Frequency

Test Frequency	Step Frequency
100 Hz-200 Hz	1 Hz
202 Hz-500 Hz	2 Hz
505 Hz-1 kHz	5 Hz
1.01 kHz-2 kHz	10 Hz
2.02 kHz-5 kHz	20 Hz
5.05 kHz-10 kHz	50 Hz
10.1 kHz-20 kHz	100 Hz
20.2 kHz-50 kHz	200 Hz
50.5 kHz-100 kHz	500 Hz
101 kHz-200 kHz	1 kHz
202 kHz-500 kHz	2 kHz
505 kHz-1 MHz	5 kHz

Compensation Frequencies

HP 4276A: 100, 200, 500, 1k, 2k, 5k, 10k, 16k, 20 kHz

HP 4277A: 10k, 20.2k, 50.5k, 100k, 202k, 505k, 700k, 900k, 1 MHz
 Compensation at other frequencies is automatically done using second degree interpolation.

Offset Ranges

	HP 4276A	HP 4277A
OPEN	C ≤ 20 pF G ≤ 0.2 μS	C ≤ 20 pF G ≤ 2 μS
SHORT	Z ≤ 2 Ω	L ≤ 2 μH R ≤ 2 Ω

HP-IB Interface

Remote control: all front panel control settings and HP 16064A (comparator) settings can be controlled using HP-IB.

Data output: parameter measured, equivalent circuit, display status, measured values and decision output of comparator.

Output format: ASCII and packed binary.

Self test: checks HP 4276A/4277A's basic operation.

Measurement accuracy and range: specified at the front panel unknown connectors when all of the following conditions are satisfied:

- (1) warmup time ≥ 30 min.
- (2) test signal level is set to HIGH (1 Vrms)
- (3) measurement speed mode: MED or SLOW
- (4) ambient temperature is 23°C ± 5°C
- (5) cable length switch is set to Om (HP 4277A)
- (6) OPEN and SHORT adjustments have been made
- (7) $D \leq 0.1$ (L-D•Q, C-D•Q, and |Z| - Θ measurements)
 $D \leq 0.002$ (HP 4276A) high speed L/C measurement
 $D \leq 0.01$ (HP 4277A)

Accuracies given in Tables 1 through 6 are read as ±(% of reading + number of counts) for L, C, and |Z|, and ±(number of degrees + number of counts) of Θ.

C-D/C-Q (1/D) measurement accuracy: accuracies for C measurements are given in Table 1 (frequencies other than 100, 120, 1k, and 1 MHz) and Table 2 (100, 120, 1k and 1 MHz only). The HP 4277A's C accuracies in the tables are for the full scale value of each C range.

High Speed C Measurements can be made under the following conditions

	Test Frequency	Measurement Range	D
HP 4276A	All frequencies	All ranges except for the two highest ranges at each frequency	≤ 0.002
HP 4277A	1 MHz	1 pF - 10 nF	≤ 0.01

(Refer to the HP 4276A/4277A data sheet for complete accuracy specifications, including D/Q accuracies)

L-D/L-Q (1/D) Measurement: accuracies for L measurements are given in Table 3 (for frequencies other than 1k, 10k, 100k, and 1 MHz) and Table 4 (for 1k, 10k, 100k, and 1 MHz). The HP 4276A's L accuracies given in the tables are for the full scale value of each L range.

High Speed L Measurement can be made under the following conditions

	Test Frequency	Measurement Range	D
HP 4276A	All frequencies	All ranges except for the two highest ranges at each frequency	≤ 0.002
HP 4277A	1 MHz	1 μH - 100 μH	≤ 0.01

(Refer to the HP 4276A/4277A data sheet for complete accuracy specifications, including D/Q accuracies)

|Z| - Θ Measurement: accuracies for |Z|/Θ measurements are given in Table 5 (HP 4276A) and Table 6 (HP 4277A). Accuracies given in the tables are for the full scale value of each |Z| range.

DC Bias

Internal dc bias (opt.): 0 to ± 40 V

Bias Voltage	Voltage Step	Accuracy (at 23 ± 5°C)
-40.0 to -10.0 V	0.1 V	±(1% of reading + 35 mV)
-9.99 to -0.01 V	0.01 V	±(1% of reading + 10 mV)
0.00 to 9.99 V	0.01 V	±(0.3% of reading + 10 mV)
10.0 to 40.0 V	0.1 V	±(0.5% of reading + 35 mV)

Output resistance: 1020 Ω ± 10% (HP 4276A)

1040 Ω ± 10% (HP 4277A)

Control: front panel or via HP-IB

External dc bias via rear panel: 0 to ± 40 V

Continuous Memory (approx. two weeks)

Memory contents: all front panel key settings, excluding BIAS, offset values, reference for deviation and comparator limit data.

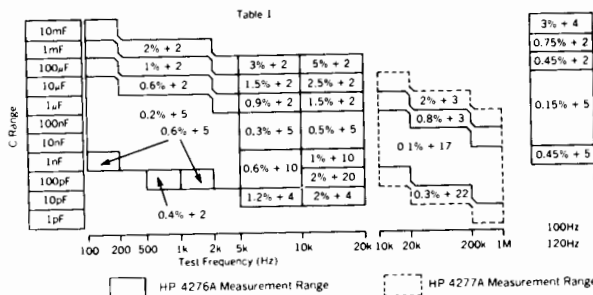

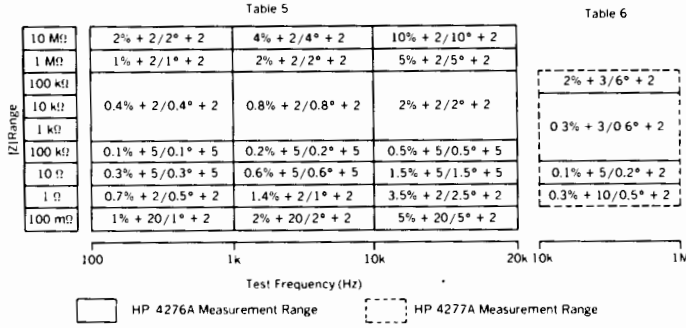
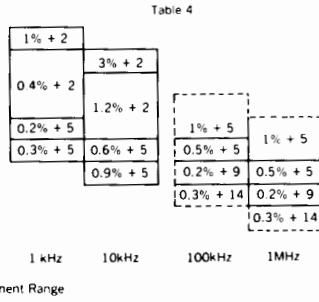
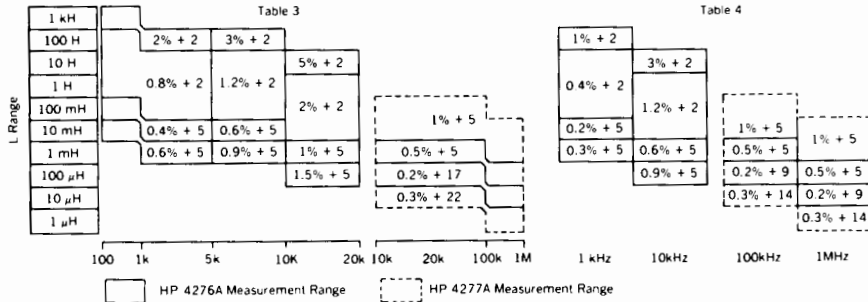

General Measurement Time (Typical)

HP 4276A (circuit mode set to AUTO, and test signal level set to HIGH)
Capacitance measurement: applicable to all ranges except for highest range when measuring low loss capacitors of full scale value.
Inductance measurement: applicable to all ranges except for lowest range when measuring low loss inductors of full scale value.

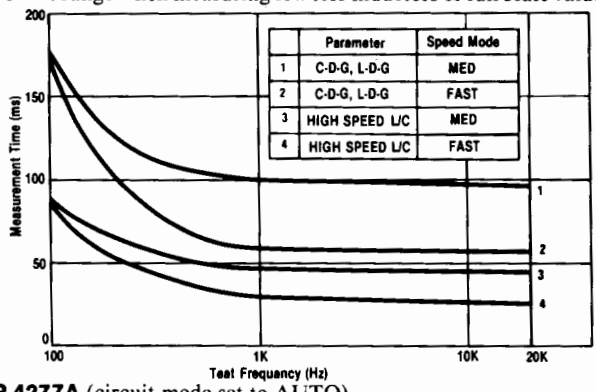

HP 4277A (circuit mode set to AUTO)
Capacitance measurement: applicable to parallel C ranges when measuring low loss capacitors of full scale value.
Inductance measurement: applicable to series L ranges when measuring low loss inductors of full scale value.

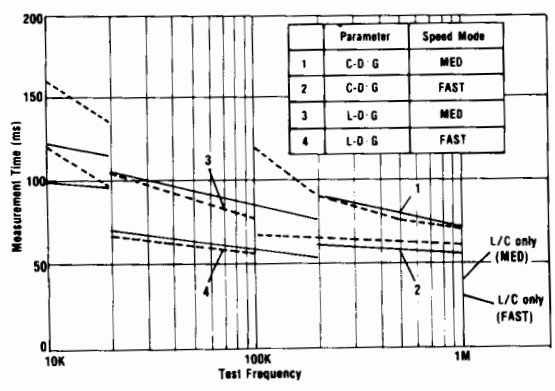

Operating temperature and humidity: 0° to 55°C, ≤ 95% RH at 40°C.
Power requirements: 100/120/220 Vac ±10%, 240 V + 5% - 10%; 48 to 66 Hz.
Power consumption: 65 VA max (HP 4276A); 75 VA max (HP 4277A).
Size: 188 mm H x 426 mm W x 422 mm D (7 1/2" x 16 3/4" x 16 1/2").
Weight: approx. 8.5 kg (18.7 lb).

Options
Opt 001: Internal dc bias, 0 to ±40 V, max resolution 10 mV/100 mV.
Opt 002: 10-bin sorting for L/C/Z and go/no-go testing for D/Q, interfaceable with component handler, usable only with HP 4276A/4277A.

Special Options
HP 4276A Opt H05: 1 kHz C-D measurement only (1V/100mV)
HP 4276A Opt H06: 1 kHz C-D measurement only (1V/300mV)
HP 4276A Opt H07: 1 kHz C-D measurement only (1V/500mV)
HP 4277A Opt H03: Programmable DC bias for high speed C-V measurement (1V/20mV)
HP 4277A Opt H04: Programmable DC bias for high speed C-V measurement (500mV/20mV)
HP 4277A Opt H07: High accuracy DC bias
 Contact your nearest HP sales office for more information.

Accessories
Furnished accessories: HP 16047A Direct Coupled Test Fixture
Accessories Available
HP 16034B: Tweezer Type Test Fixture for Chip Components \$360
HP 16047C: Test Fixture \$300
HP 16048A: Test Leads, BNC (1m) \$320
HP 16048B: Test Leads, RF Miniature (1m) \$320
HP 16048C: Test Leads, with Alligator chips (1m) \$410
HP 16048D: Test Leads, BNC (2m) \$410
HP 16064A: Retrofit Kit for Comparator (HP 4276A/HP 4277A, Opt 002) \$750
HP 16065A: External DC Bias Test Fixture (≤200 V) \$820

Options
001: Internal DC Bias \$210
002: Comparator \$730
Ordering Information
HP 4276A LCZ Meter \$4,750
HP 4277A LCZ Meter \$6,800
 ☎ Fast-Ship product -- see page 766.



COMPONENT MEASUREMENT

Digital LCR Meters

Models 4261A and 4262A

- Automatic balancing, ranging & circuit mode selection
- Test frequencies: HP 4261A, 120 (100) Hz and 1 kHz
HP 4262A, 120 (100) Hz, 1 kHz and 10 kHz
- Versatile accessories and options
- High reliability

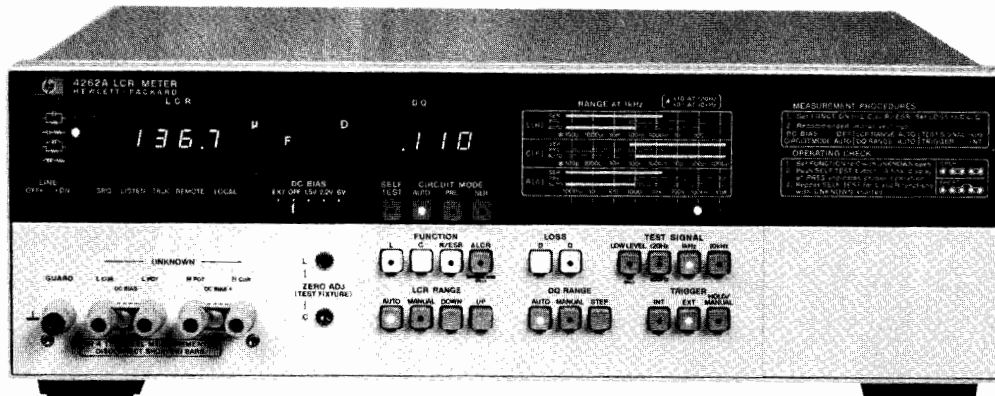

HP 4262A



HP 4261A

Description

The HP 4261A and HP 4262A are 3½ digit LCR meters that meet today's requirements for component measurements. Both instruments feature fully automatic operation over wide measuring ranges. Simply select the measuring functions and one of the test frequencies, then insert the device to be measured. The instrument does the rest—automatically selecting the proper measuring range and equivalent circuit mode. The HP 4261A and HP 4262A basic features are summarized in the table below.

	HP 4261A	HP 4262A
Test Frequency	120 (100) Hz, 1 kHz	120 (100) Hz, 1 kHz, 10 kHz
Signal Level	1 V, 50 mV (Cp)	1 V, 50 mV (Cp)
Parameters Measured	C-D L-D R	C-D • Q L-D • Q R (ESR) Δ (Deviation)
HP-IB	No	Yes (opt.)
Digital Comparison	No	Yes (opt.)
BCD Output	Yes (opt.)	Yes (opt.)

In addition to automatic measurements, the HP 4261A and HP 4262A provide high accuracy (0.2% reading), internal dc bias, and series and parallel equivalent circuit modes.

These relatively low cost and easy-to-use LCR meters are capable of a wide range of applications—measuring electrolytic/ceramic capacitors, filter coils, pulse transformers, internal resistance of dry cells and semiconductor junction capacitance, as well as ordinary LCR components. Extended features of these reliable instruments include optionally available HP-IB (HP 4262A) and BCD (HP 4261A) data output capabilities and a comparator option which is convenient for production line applications.

Specifications (refer to data sheet for complete specifications) Measurement ranges and accuracies: see table on next page. Accuracy applies over a temperature range of 23°C ±5°C (at 0° to 55°C, error doubles). 10 kHz and Q specifications are given only for the HP 4262A.

	HP 4261A	HP 4262A
Parameters measured	L-D, C-D R	L-D • Q, C-D • Q R (ESR), Δ LCR
Display	3½ digits max. display 1900	3½ digits max. display 1999
Test frequency	120 (100) Hz, 1 kHz ±3%	120 (100) Hz, 1 kHz 10 kHz ±3%
Test signal level (typical)	1 V, 50 mV (Cp mode only)	
DC bias	Int	1.5 V, 2.2 V, 6 V ±5%, selectable
	Ext	0 to +30 V
Equivalent circuit modes	auto, parallel, series	
Ranging modes	LCR	auto, manual
	DQ	D only — fixed
Trigger	internal, external, manual	
Measuring terminal	5-terminal configuration	

Deviation measurement (HP 4262A): displays the difference between a stored value (that is, measured value when Δ LCR switch is depressed) and subsequent measured data.

Offset adjustments (HP 4262A): front panel adjustments to compensate for stray capacitance and residual inductance of the test fixture.

C: 0 to 10 pF **L:** 0 to 1 μH

Self-test (HP 4262A): automatically checks the HP 4262A's basic functions.

General

Measuring time (typical): for a 1000 count measurement on a low loss component on a fixed range:

1 kHz, 10 kHz: C/L 220-260 ms, R 120-160 ms

120 (100) Hz: C/L 900 ms, R 700 ms

Ranging Time

1 kHz, 10 kHz: 180 ms/range step

120 (100) Hz: 670 ms/range step

Reading rate: INT (internal trigger) approximately 30 ms between end of measurement cycle and start of the next cycle. EXT (external trigger) measuring cycle is initiated by a remote trigger input.

C-D/C-Q Measurement

Range	C	120 (100) Hz 1 kHz 10 kHz	1000 pF 100.0 pF 10.00 pF	10.00 nF 1000 pF 100.0 pF	100.0 nF 10.00 nF 1000 pF	1000 nF 100.0 nF 10.00 nF	10.00 μF 1000 nF 100.0 nF	100.0 μF 10.00 μF 1000 nF	1000 μF 100.0 μF 10.00 μF	10.00 mF 1000 μF 100.0 μF
		D	0.001 to 1.900 (HP 4261A), 0.001 to 19.9 (HP 4262A)							
	Q* ¹	0.050 to 1000 (4 ranges, HP 4262A)								
C Accuracy* ²		0.2% + 1* ³								
		At 120 (100) Hz, 1 kHz		0.3% + 2			0.5% + 2		1% + 2* ⁴	
		At 10 kHz					1% + 2		5% + 2	
D (1/Q) Accuracy* ²		0.2% + (2 + 200/Cx)				At 120 (100) Hz, 1 kHz				
		0.5% + (2 + 200/Cx)				At 10 kHz				
		At 120 (100) Hz, 1 kHz			0.3% + (2 + Cx/500)				1% + (5 + $\frac{Cx}{500}$)	
		At 10 kHz			0.5% + (2 + Cx/500)			1% + (5 + $\frac{Cx}{500}$)		5% + (5 + $\frac{Cx}{500}$)

*¹Calculated as the reciprocal of D.
²±(% of reading + number of counts), Cx is capacitance readout in counts. Accuracies in this table apply when D < 1.900.
³Add 0.2 pF for HP 4261A.
⁴(5% + 2 counts) at 1 kHz.

L-D/L-Q Measurement

Range	L	120 (100) Hz 1 kHz 10 kHz	1000 μH 100.0 μH 10.00 μH	10.00 mH 1000 μH 100.0 μH	100.0 mH 10.00 mH 1000 μH	1000 mH 100.0 mH 10.00 mH	10.00 H 1000 mH 100.0 mH	100.0 H 10.00 H 1000 mH	1000 H 100.0 H 10.00 H	
		D	0.001 to 1.900 (HP 4261A), 0.001 to 19.9 (HP 4262A)							
	Q* ¹	0.050 to 1000 (4 ranges, HP 4262A)								
L Accuracy* ²		At 120 (100) Hz, 1 kHz			0.3% + 2			1% + 2		
		At 10 kHz						1% + 2		5% + 2
		0.3% + 2		0.2% + 2* ³				At 120 (100) Hz, 1 kHz		
D (1/Q) Accuracy* ²		At 120 (100) Hz, 1 kHz			0.3% + (3 + Lx/500)			1% + (3 + Lx/500)		
		At 10 kHz			0.5% + (3 + Lx/500)			1% + (3 + Lx/500)		5% + (5 + $\frac{Lx}{500}$)
		0.2% + (3 + 200/Lx)				At 120 (100) Hz, 1 kHz				
		0.5% + (3 + 200/Lx)				At 10 kHz				

*¹Calculated as the reciprocal of D.
²±(% of reading + number of counts), Lx is inductance readout in counts. Accuracies in this table apply when test signal level is 1 V and D < 1.900.
³Add 0.2 μH for HP 4261A.

R (ESR)*¹ Measurement

Range	120 (100) Hz 1 kHz 10 kHz	1000 mΩ	10.00 Ω	100.0 Ω	1000 Ω	10.00 kΩ	100.0 kΩ	1000 kΩ	10.00 MΩ	
Accuracy* ²		0.2% + 1				0.3% + 2* ³				

*¹ESR measuring range is from 1 mΩ to 19 kΩ (typical). These values vary depending on the series capacitance or inductance value of the device under test.
²±(% of reading + number of counts).
³±(5% + 2 counts) on 10.00 MΩ range at 10 kHz.

	HP 4261A	HP 4262A
Operating temperature and humidity	0°C to 55°C ≤95% RH at 40°C	
Power requirements	100/120/220/240 V ± 10%	100/120/220 V ± 10%, 240 V + 5% -10%, 48-66 Hz
Power consumption	≤25 VA	≤55 VA
Size	134 H x 213 W x 422 mm D (5 • 1/4" x 8 • 3/8" x 16 • 5/8")	147 H x 426 W x 345 mm D (5 • 3/4" x 16 • 3/4" x 13 • 3/4")
Weight (approx.)	7.5 kg (16.51 lb)	8 kg (17.51 lb)

Options Available

Option	HP 4261A* ¹	HP 4262A* ²
001	BCD data output (L/C/R and D simultaneously)	BCD data output
002	BCD data output (L/D, C/D, R alternately)	—
003	BCD remote control	—
004	—	Digital comparator
101	—	HP-IB

*¹Options 001 and 002 are mutually exclusive.
²Option combinations 101/001 and 101/004 cannot be ordered.

Accessories available: **HP 16061A:** test fixture, direct couple, 5-terminal; **HP 16062A:** test leads with alligator clips, 4-terminal (for low impedance measurements); **HP 16063A:** test leads with alligator clips, 3-terminal (for high impedance measurements).

Ordering Information (4261A)

HP 16061A Test Fixture, Radial/Axial lead devices	\$200 ☎
HP 16062A Test Leads, 4-wire	\$120 ☎
HP 16063A Test Leads, 3-wire	\$110 ☎
Opt 001: BCD Output (Simultaneous)	\$230
Opt 002: BCD Output (Alternately)	\$200
Opt 003: BCD Remote Control	\$105
Opt 010: 100 Hz Test Frequency	N/C
Opt 910: Extra Manual	\$23
HP 4261A Digital LCR Meter	\$2,900

☎ Fast-Ship product -- see page 766.

Ordering Information (HP 4262A)

Opt 001: BCD Output	\$400
Opt 004: Digital Comparator	\$960
Opt 010: 100 Hz Test Frequency	N/C
Opt 101: HP-IB Interface	\$650
Opt 907: Front Handle Kit	\$55
Opt 908: Rack Flange Kit	\$32.50
Opt 909: Rack/Handle Kit	\$80
Opt 910: Extra Manual	\$29
HP 16061A Test Fixture for Radial/Axial Lead Devices	\$200 ☎
HP 16062A Test Cables, 4-wire	\$120 ☎
HP 16063A Test Cables, 3-wire	\$110 ☎
HP 4262A Digital LCR Meter	\$4,000

☎ Fast-Ship product -- see page 766.



COMPONENT MEASUREMENT

Q Meter

Model 4342A

- Frequency range: 22 kHz to 70 MHz
- Q range: 5 to 1000

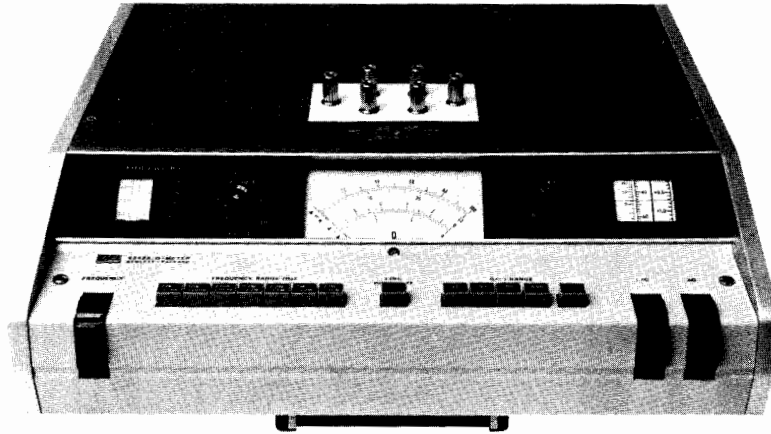

HP 4342A

Description

The direct-reading expanded scale of the HP 4342A permits measurement of Q from 5 to 1000 and readings of very small changes in Q resulting from variation in test parameters. The HP 4342A is solid state with the elimination of specially matched, fragile thermocouple components.

The HP 4342A will measure dissipation factor and dielectric constant of insulating materials. The Q meter can measure coefficient of coupling, mutual inductance, and frequency response of transformers. RF resistance, reactance, and Q of resistors and capacitors can also be determined.

Pushbutton operation of frequency range and Q/ Δ Q range selection provides straightforward measurement. Automatic indication of meter scales, frequency dials and frequency multipliers are featured, adding to simplicity and reading speed.

Specifications

RF Characteristics

RF range: 22 kHz to 70 MHz in 7 bands: 22 to 70 kHz, 70 to 220 kHz, 220 to 700 kHz, 700 to 2200 kHz, 2.2 to 7 MHz, 7 to 22 MHz, 22 to 70 MHz.

HP 4342A Opt 001: 10 kHz to 32 MHz in 7 bands: 10 to 32 kHz, 32 to 100 kHz, 100 to 320 kHz, 320 to 1000 kHz, 1 to 3.2 MHz, 3.2 to 10 MHz, 10 to 32 MHz.

RF accuracy: $\pm 1.5\%$ from 22 kHz to 22 MHz; $\pm 2\%$ from 22 MHz to 70 MHz; $\pm 1\%$ at "L" point on frequency dial.

HP 4342A Opt 001: $\pm 1.5\%$ from 10 kHz to 10 MHz; $\pm 2\%$ from 10 MHz to 32 MHz; $\pm 1\%$ at "L" point on frequency dial.

RF increments: approximately 1% resolution.

Q Measurement Characteristics

Q range: 5 to 1000 in 4 ranges: 5 to 30, 20 to 100, 50 to 300, 200 to 1000.

Q accuracy: % of indicated value: (at 25°C)

Q Freq.	HP 4342A & HP 4342A Opt. 001	HP 4342A
	22 kHz-30MHz	30 MHz-70 MHz
5-300	± 7	± 10
300-600	± 10	± 15
600-1000	± 15	± 20

Q increments: upper scale, 1 from 20 to 100; lower scale, 0.5 from 5 to 30.

Δ Q range: 0 to 100 in 4 ranges: 0 to 3, 0 to 10, 0 to 30, 0 to 100.

Δ Q accuracy: $\pm 10\%$ of full scale.

Δ Q increments: upper scale, 0.1 from 0 to 10; lower scale, 0.05 from 0 to 3.

Inductance Measurement Characteristics

L range: 0.09 μ H to 1.2 H, direct reading at 7 specific frequencies.

L accuracy: $\pm 3\%$ after substitution of residuals (approx. 10 nH).

Resonating Capacitor Characteristics

Capacitor range: main dial, 25 to 470 pF, vernier dial, -5 to $+5$ pF.

Capacitor accuracy: main dial, $\pm 1\%$ or 1 pF, whichever is greater; vernier dial, ± 0.1 pF.

Capacitor increments: main dial, 1 pF from 25 to 30 pF, 2 pF from 30 to 200 pF, 5 pF from 200 to 470 pF; vernier dial, 0.1 pF.

General

Rear Panel Outputs

Frequency monitor: 170 mV rms min. into 50 Ω .

Q analog output: 0 to 1 V ± 50 mV dc after 15 minutes warmup, proportional to meter deflection. Output impedance approximately 1 k Ω .

Over limit signal output: contact closure at the rear panel. Relay contact capacity 0.5 A/15 VA.

Over limit display time: selectable, 1 s or continuously on, after limit exceeded.

Temperature range: 0°C to 50°C.

Power: 115 or 230 V $\pm 10\%$, 50-400 Hz, approximately 40 VA.

Size: 138 mm H x 425 mm W x 414 mm D (5 $\frac{7}{16}$ " x 16 $\frac{3}{4}$ " x 16 $\frac{5}{16}$ ").

Weight: net, 14 kg (31 lb); shipping, 18.45 kg (41 lb).

Accessories Available

HP 16014A series loss test adaptor: designed for measuring low-value inductors and resistors and high-value capacitors.

HP 16451A Dielectric Test Adapter: designed for measuring the dielectric constant, capacitance and dissipation factor of insulating materials.

HP 16462A Auxiliary Capacitor: designed to extend the Q and L measurement capability of the HP 4342A Q Meter. It is especially useful for measuring small inductors at low frequencies.

HP 16470A Reference Inductors: A range of 20 inductors (any of which can be supplied separately) which can be used with the HP 4342A Q Meter when measuring the RF characteristics of capacitors, resistors, or insulating materials.

HP 16470B Stable Inductors: A set of 4 inductors (any of which are separately available) which can be used to compensate indicated Q values and/or instrumental variation in the maintenance of the HP 4342A Q Meter. They are usable over a range of 800 kHz to 50 MHz with excellent long-term temperature stability.

Options and Accessories

	Price
Opt 001: Frequency Range (10 kHz - 32 MHz)	\$290
Opt 910: Extra Manual	\$21
HP 16014A Series Loss Test Adaptor	\$130
HP 16451A Dielectric Test Adapter	\$410
HP 16462A Auxiliary Capacitor	\$530
HP 16470A Reference Inductors, set of 20	\$2000
HP 16470B Stable Inductors, set of 4	\$1150
HP 16470C Complete set of 24 Inductors (HP 16470A + HP 16470B)	\$3100

HP 4342A Q Meter

\$5,950

COMPONENT MEASUREMENT

Milliohmmeter/High Resistance Meter

Model 4328A/4329A

235



- 20 $\mu\Omega$ resolution on 1 m Ω range
- Four terminal measurement
- Low test voltage

- Wide range: 500 k Ω to $2 \times 10^{16} \Omega$
- Selectable test voltages: 10 V to 1000 V

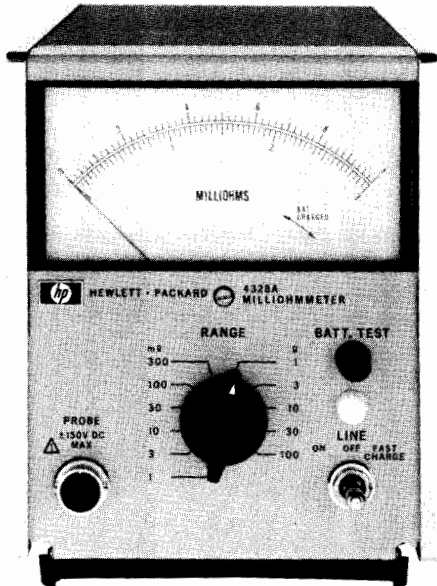

HP 4328A

Description

HP's 4328A Milliohmmeter is a high sensitivity portable instrument for measurement of low resistances. The 1 m Ω to 100 Ω measuring range and 20 $\mu\Omega$ resolution make the HP 4328A ideal for measuring the contact resistance of switches, relays, and connectors and the resistivity of conductors and semiconductors. Series reactances of up to twice the full scale resistance will not affect the accuracy. The maximum voltage across a sample, with the instrument at the proper range, is less than 200 μ V peak. Even at incorrect range settings, the voltage across the sample will not exceed 20 mV peak.

The special probes that allow four-terminal measurement in two probes are furnished with the HP 4328A.

The basic HP 4328A is line operated but Opt 001 permits operation from rechargeable batteries for 15 continuous hours.

Specifications

- Range:** 0.001 to 100 ohms full scale in a 1, 3 sequence.
Accuracy: $\pm 2\%$ of full scale. No additional error is caused by series reactance of samples up to two times full scale.
Measuring frequency: 1000 Hz ± 100 Hz.
Voltage across sample: 200 μ V peak at full scale.
Maximum voltage across sample: 20 mV peak.
Superimposed dc: 150 V dc maximum (external source).
Recorder output: 0.1 V dc output at full scale, output resistance approx. 1 k Ω .
Applied current (mA): constant by range, 150/(full scale value in milliohms).

General

- Power requirements:** 115/230 V $\pm 10\%$, 50 to 60 Hz, 1.5 VA.
Weight: 3.2 kg (7 lb).
Size: 155 mm H x 130 mm W x 280 mm D (6 $\frac{1}{32}$ " x 5 $\frac{1}{8}$ " x 11").
Accessories furnished: HP 16005A Probe, HP 16006A Probe, HP 16007A/B Test Leads and HP 16143A Probe Cable.

Ordering Information

- | | |
|---|--------|
| HP 4328A Milliohmmeter | Price |
| Opt 001: Rechargeable battery operation | \$1950 |
| Opt 910: extra manual | \$120 |
| | \$15 |

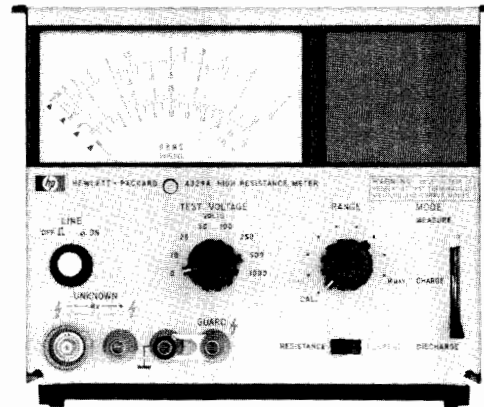

HP 4329A

Description

The HP 4329A is a solid-state insulation resistance meter designed for easy, accurate and direct readings of the very high resistance values typically found in synthetic resins, porcelain, insulating oils and similar materials. It is also useful for measurements in electrical components such as capacitors, transformers, switches and cables. Seven fully regulated dc test voltages (between 10 and 1000 Vdc) are provided as test sources.

The HP 4329A is instantly convertible from ungrounded-to-grounded-sample operation via a simple relocation of the front panel ground strap from "guard" to "+" position.

The HP 4329A also has a current measurement capability. Minute currents as low as 0.05 pA can be readily measured.

The HP 16008A Resistivity Cell, designed for use with the HP 4329A, can safely, rapidly and conveniently measure the volume and surface resistivity of sheet insulation materials (maximum sample size: 125 mm W x 125 mm D x 7 mm H).

Specifications

Resistance Measurement

- Range:** 500 k Ω to $2 \times 10^{16} \Omega$. (Depends on the test voltage).
Accuracy: total accuracy is determined by test voltage and range used. At low resistance end of each scale, accuracy is $\pm 3\%$, near center scale $\pm 5\%$, and near the specified upper limit on the meter scale (a quarter of full scale), accuracy is $\pm 10\%$. Accuracy is not specified above these limits. On all voltage ranges, if multiplier is set to Rmax., an additional $\pm 3\%$ is included.
Test voltages: 10 V, 25 V, 50 V, 100 V, 250 V, 500 V and 1000 V $\pm 3\%$.

Current Measurement

- Range:** 5×10^{-14} to 2×10^{-5} A in 8 ranges.
Accuracy: $\pm 5\%$ of full scale deflection (there can be an additional $\pm 3\%$ error at the top decade).

General

- Recorder output:** 0 to 100 mV dc, proportional to meter deflection; 1 k Ω output resistance.
Power: 115/230 V $\pm 10\%$, 50-60 Hz, approximately 3 VA.
Size: 155 mm H x 198 mm W x 204 mm D (6 $\frac{1}{2}$ " x 7 $\frac{25}{32}$ " x 8 $\frac{25}{32}$ ").
Weight: 3.5 kg (7.7 lb).
Accessory furnished: HP 16117A Low Noise Test Leads.
Accessory available: HP 16008A Resistivity Cell.

Ordering Information

- | | |
|--------------------------------|--------|
| HP 16008A Resistivity cell | Price |
| HP 4329A High resistance meter | \$900 |
| Opt 910: extra manual | \$2500 |
| | \$15 |



COMPONENT MEASUREMENT

Standard Capacitor Set and Decade Capacitor

Models 16380A, 16380C, 4440B

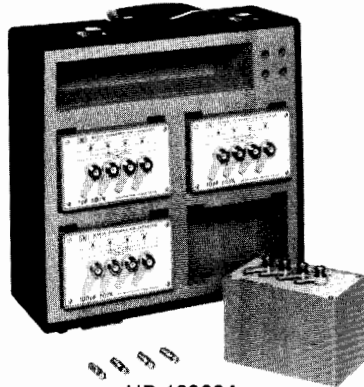

HP 16380A

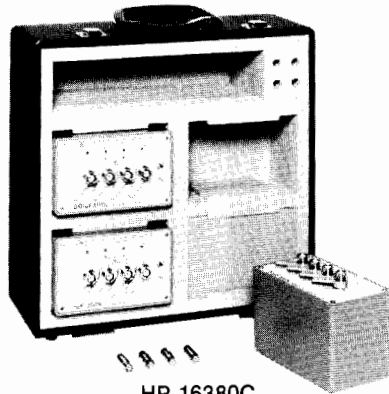

HP 16380C

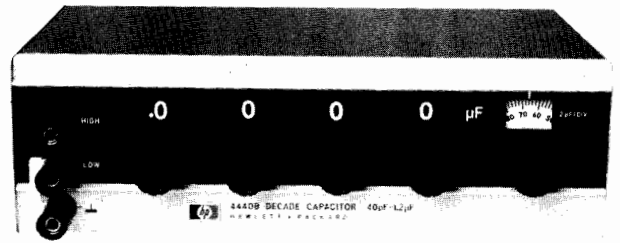

HP 4440B

HP 16380A, HP 16380C Description

The HP 16380A and HP 16380C are precision standard capacitor sets that cover the range of 1 pF to 1 μ F in decade steps. The HP 16380A consists of four discrete air-dielectric capacitors with nominal values of 1 pF, 10 pF, 100 pF, and 1000 pF. Similarly, the HP 16380C consists of four discrete capacitors, but with solid dielectrics and with nominal values of 0.01 μ F, 0.1 μ F, and 1 μ F.

Both the HP 16380A and HP 16380C are furnished with test certification of 0.01% calibration accuracy. Capacitance stability with respect to time varies from capacitor to capacitor but is specified in the range of \pm 50 or \pm 300 ppm/year.

The HP 16380A and HP 16380C both have the four-terminal pair configuration to allow direct connection to any of Hewlett-Packard's many four-terminal pair impedance measuring instruments. The HP 16380A/C can be easily adapted to two-, three-, and five-terminal configurations.

HP 16380A, 16380C Specifications (valid at 1 kHz, 23 \pm 5°C)

HP 16380A

Capacitance	1 pF	10 pF	100 pF	1000 pF
Nominal Accuracy			\pm 0.1%	
Calibration Accuracy			\pm 0.01%	
Stability			<300 ppm/yr	
Dissipation Factor			<0.0001	
Dimensions	112 mm (H) x 142 mm (W) x 88 mm (D)			
Weight	8.0 kg (includes case)			

HP 16380C

Capacitance	0.01 μ F	0.1 μ F	1 μ F
Nominal Accuracy			\pm 0.1%
Calibration Accuracy			\pm 0.01%
Stability			<50 ppm/yr
Dissipation Factor	<0.0004	<0.0005	<0.0007
Dimensions	117 mm (H)x142 mm(W)x88 mm(D)		
Weight	6.3 kg (includes case)		

HP 4440B Description

The Hewlett-Packard 4440B Decade Capacitor is a high accuracy instrument providing usable capacitances from 40 pF to 1.2 μ F. Its 0.25% accuracy makes it an ideal aid for circuit design or as a working standard.

The use of silvered-mica capacitors in all four decades provides higher accuracy, lower dissipation factor and good temperature coefficient. An air capacitor vernier provides 100 pF (from 40 pF to 140 pF) with resolution of 1 pF. Capacitors are housed in a double shield in such a way that increased capacitance from two terminals to three terminals is held to 1 pF.

4440B Specifications

Capacitance: 40 pF to 1.2 μ F in steps of 100 pF with a 40 pF to 140 pF variable air capacitor providing continuous adjustment to better than 2 pF between steps.

Direct reading accuracy: \pm (0.25% + 3 pF) at 1 kHz for three-terminal connection.

Resonant frequency: typical values of the resonant frequency are 450 kHz at 1 μ F, 4 MHz at 0.01 μ F and 40 MHz at 100 pF

Dissipation factor: for $C \geq 1040$ pF, 0.001 max. at 1 kHz.
for $C < 1040$ pF, 0.005 max. at 1 kHz.

Temperature coefficient: $< +70$ ppm/ $^{\circ}$ C.

Insulation resistance: 5 G Ω minimum, after 5 minutes at 500 V dc.

Maximum voltage: 42 Vdc or 30 Vrms.

Weight: net, 2.5 kg (5½ lb); shipping, 3.6 kg (8 lb).

Size: 76 mm H x 264 mm W x 152 mm D (3" x 11" x 6").

Ordering Information

HP 16380A Standard Capacitor Set (1 pF, 10 pF, 100 pF, 1000 pF)

HP 16380C Standard Capacitor Set (0.01 μ F, 0.1 μ F, 1 μ F)

HP 4440B Decade Capacitor

Price

\$2900

\$3600

\$1400

SEMICONDUCTOR TEST EQUIPMENT

General Information

Parametric Measurement

237



Semiconductor Parametric Measurement

Semiconductor parametric measurement instruments are used for measuring and evaluating the electrical characteristics of semiconductors.

Competition within the semiconductor field is fierce, and major goals are: developing new products rapidly, improving yield and reducing costs.

HP semiconductor parametric measurement instruments provide:

1. Precise, high-resolution measurements for accurate and reliable evaluation and
2. Automated operation from measurement through analysis.

Semiconductor measurement applications vary widely, from device R&D to large-volume manufacture on mass-production lines. Measurement equipment must fit the measurement functions required.

In R&D, parametric testers make comprehensive physical and electrical evaluations of new materials, prototype devices and evaluation test patterns. As the integration and performance of semiconductors advance, measurement instruments must have the expandability to adapt to the high resolution and precision demanded by new evaluation methods.

For production departments, parametric testing helps stabilize new processes for mass production and helps make process yield improvements. Functional testing is used mostly in outgoing inspection. Cost reduction for both types of test requires high-speed, multiple-pin measurements and reduced downtime. The yield of new VLSI devices is less than 10 percent, and bad devices must be discarded. The accurate parametric testing pro-

Device Type	No Of Pins	M O S					Bipolar							
		DLTS	C-t	C-V	I-V	DC Parametric	AC Parametric	Functional	Functional	AC Parametric	DC Parametric	I-V	C-V	DLTS
Diodes ● Junction ● Schottky ● MIS	2	HP 4280A					HP 4280A							
		HP 4274A/4275A			HP 4140B		HP 4274A/4275A			HP 4274A/4275A				
		HP 4061A					HP 4061A							
		HP 4064A					HP 4064A							
Transistor	4	HP 4145B					HP 4145B							
	6/12	HP 4063A					HP 4063A							
Test Pattern	12-48	HP 4145B/4085M		HP 4145B/4085M		HP 4145B/4085M		HP 4145B/4085M		HP 4145B/4085M		HP 4145B/4085M		
		HP 4062B		HP 4062B		HP 4062B		HP 4062B		HP 4062B		HP 4062B		
ICs	16-256	HP 81810S					HP 81810S							

Table 1. HP Semiconductor-measurement instruments by device and measurement type.

vided by HP parametric testers can help improve processes and raise yields.

Parametric measurements are generally divided into capacitance (C) and DC, AC, and functional measurements. The following summarize each type of measurement.

1. Capacitance measurements include, primarily, capacitance vs voltage (C-V), capacitance vs time (C-t) and deep-level transient spectroscopy (DLTS) measurements. These capacitance measurements require correct measurement timing and good capacitance measurement resolution.

2. DC measurements measure the DC current vs voltage (I-V). DC parameter evaluation is based on I-V curve evaluation (eg. threshold voltage, breakdown voltage, leakage current). These measurements require high speed and resolution.

3. AC measurements evaluate the dynamic characteristics of the semiconductor device. With a digital IC, timing measurements such as rise time and propagation delay are the primary ones, so timing resolution is important. Determining the AC gain characteristics of linear ICs requires a wide dynamic range over a wide frequency band.

4. Functional testing evaluates the input/output operation and digital characteristics of semiconductor devices, especially logical devices. This measurement creates an input/output truth table and determines whether the desired output is attained or not.

Table 1 shows HP's semiconductor parametric-test line according to the purpose of the device being measured.

Table 2 shows the parametric measurements required by each application area, with the HP parametric-measurement products that apply.

		Lab/R&D			Production		User
		Base Technology	Process Development	Circuit Design	Process Engineering	Testing/Quality Assurance	Incoming Inspection
C	C-V	●	●		●		
	C-t	●	●				
	DLTS	●	●				
D	I-V	●	●	●	●		
	Parameter	●	●	●	●	●	●
AC Parameter				●		●	●
Functional				●		●	●
Instruments	C-V	HP 4274A/4275A					
		HP 4280A					
	I-V	HP 4140B					
	I-V	HP 4145B					
Systems	I-V	HP 4145B & HP 4085M					
		HP 4061A					
	I-V/C-V	HP 4063A					
		HP 4064A					
		HP 4062B					
Functional	HP 81810S						

Table 2. Measurements and HP instruments/systems by application area.



SEMICONDUCTOR TEST EQUIPMENT

General Information

Digital IC Test & Parameter Extraction

Digital IC Test

The need for testing occurs several times in the early life cycle of digital IC's. In order to prove what logic simulation had predicted, the first prototypes encounter functional debugging and critical path analysis in the design centers and foundries. During volume manufacturing, a series of tests are conducted in order to isolate parts which are faulty as a result of a critical process which is prone to distortion. Parts failing are subject to thorough failure analysis because the results gained may help to control and optimize the process. In addition to Quality Control actions at the manufacturer site, the customer tests samples again in Incoming and Materials Engineering. After assembly the device gets tested again at board level until the final product is finished.

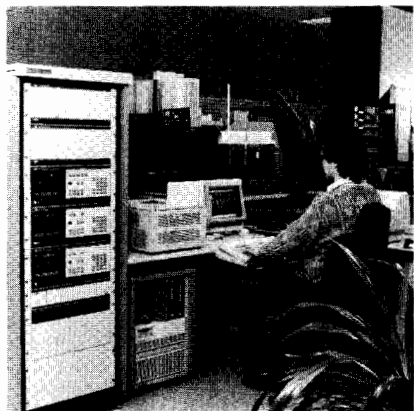

HP 81810S Digital IC Test System

Driving Forces: Application Specific IC's

The evolution of Application Specific IC's (ASICs) is driving the test needs up because ASICs increase the number of different customized designs considerably, while decreasing the volume per design type similarly.

CAE Design impacts Test

Moreover, design and test is becoming more and more a single integral task rather than being distributed between different departments and experts, each dealing either with design or with test. Therefore, a close link between design workstations and simulator databases on the one side, and the test equipment on the other side is necessary and, in addition, an easy, efficient operating environment which makes the test task transparent to the designer.

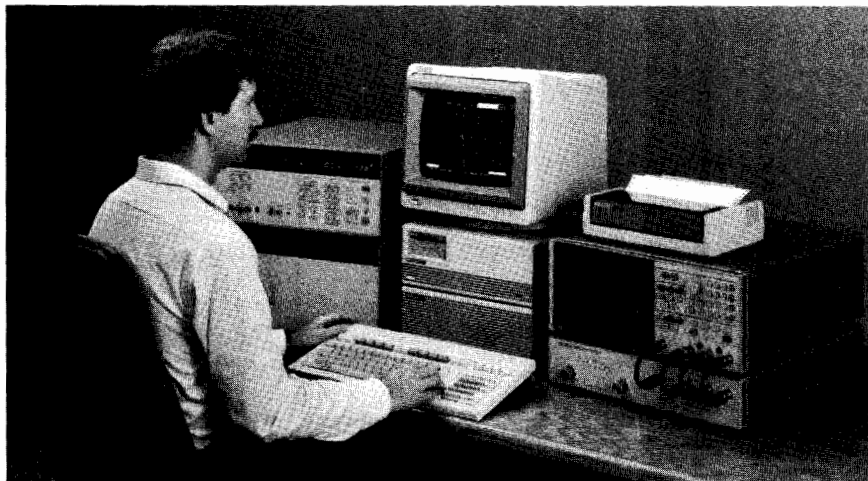

Now, IC designers can save valuable design time by using HP's powerful TECAP system to analyze DC, C-V, and AC behavior of MOS, Bipolar, and Gallium Arsenide devices in an integrated, accurate, and interactive environment.

The HP 81810S IC Test Solutions

The wide span of applications in this market requires different tester capabilities. HP addresses this issue by offering various solutions. This enables an optimum application fit. The idea of this approach is to build up a test system from separate modules which are extremely flexible in functionality, performance and price. As a result of this modularity HP offers solutions ranging from stand-alone operation through small benchtop stimulus-response systems up to complete IC Test Systems (see Model 81810S on page 239 and Models 8180/81/82 A/B on page 483).

CAD Software for Parameter Extraction

HP recently enhanced TECAP (Transistor Electrical Characterization and Analysis Program), used with the company's parametric-measurement equipment. This software package greatly simplifies the task of using mathematical models in circuit design. It measures real devices and computes the parameters needed for circuit-simulation programs such as SPICE.

TECAP Automatically Generates Physically Meaningful Parameters

There are three steps to TECAP's model parameter extraction methodology. First, TECAP identifies regions of device operation to be modeled and measures devices in those regions of operation. You may accomplish parameter "weighting" simply by selecting more data points in each region you wish to emphasize. The model parameters are then automatically grouped into subsets that most directly affect the device characteristics in each of the selected regions of operation. TECAP selects the regions of operation and parameter groupings for the UCB Level 2 and 3 MOS Models and the UCB Gummel-Poon

Bipolar Model, but you also have the flexibility to tailor these to your own extraction strategy.

In the second step, powerful, pre-defined functions quickly extract model parameters directly from the measured data points. This step ensures that you generate a physically meaningful set of final model parameters. Again, you can tailor these functions to your own extraction strategy if necessary.

Finally, if you wish, you can "fine-tune" your model parameters using TECAP's powerful optimizer. This optimizer determines parameter values that minimize the difference between measured and simulated device characteristics. You have the option of setting "boundaries" on each parameter value prior to optimization. These user-defined constraints decrease optimization time and guarantee that your final model parameters will be physically meaningful. The non-linear, least-squares-fit algorithm combines the Gauss-Newton and steepest-descent optimization methods for the most accurate fit.

TECAP provides the environment for complete, automated device characterization inside your company. You have the flexibility to use the standard extraction methodologies, or you can customize the program and use TECAP as a "shell" to integrate and automate your own particular extraction strategies. Either way, TECAP provides a practical, universally-satisfying solution to all of your parameter extraction needs. (See page 254.)



- At-speed functional test
- AC/DC parametric characterization
- 50 MHz vector rate
- 100ps/10mV resolution
- Ease-of-use
- System Software

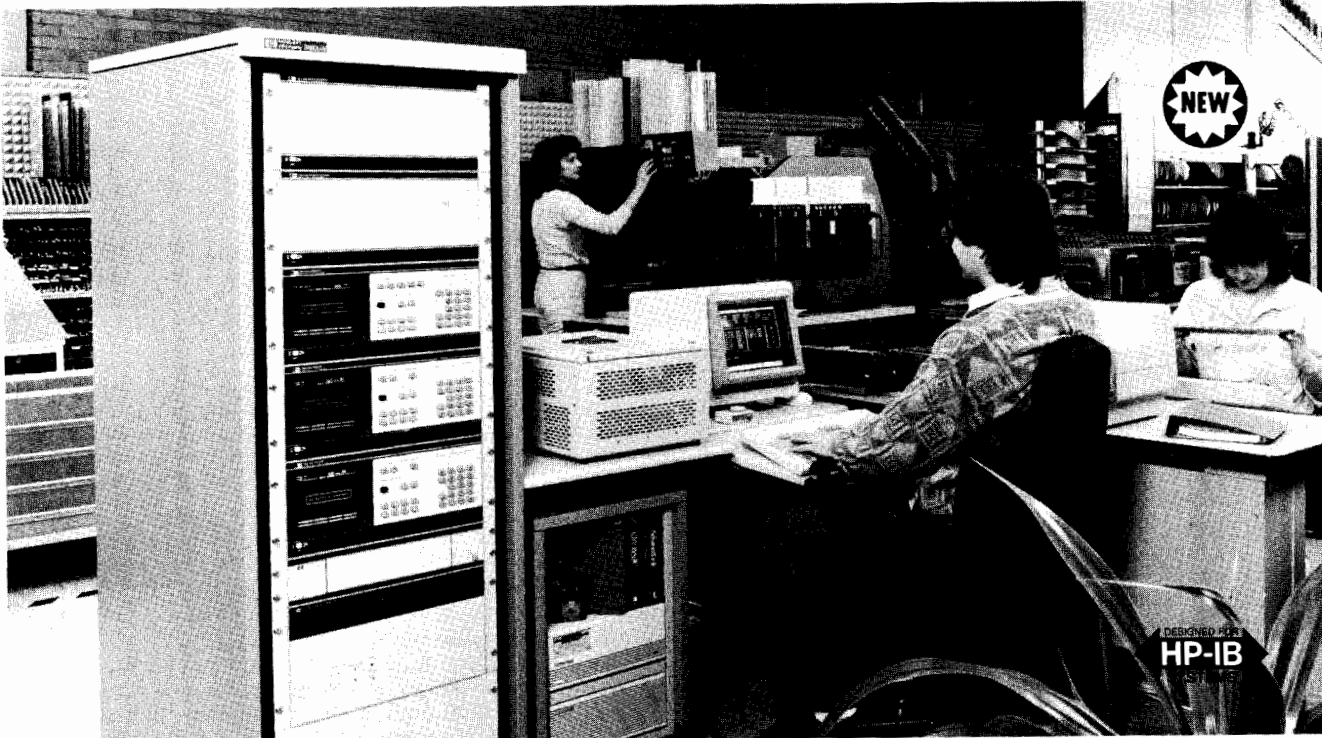

HP 81810S: The actual appearance of the system will depend upon the configuration ordered

The HP 81810S IC Test System, - When It Comes To Professional Digital IC Test

Owing to the modular architecture which allows you to combine instrument modules as required, the system is extremely flexible in terms of functionality, performance and price. This enables you to tailor the system and achieve the optimum application fit in IC Design Verification or Prototype Characterization, Low-Volume Production, Failure Analysis or Incoming Inspection.

Design Verification and Prototype Evaluation

The HP 81810S can be linked directly to a CAE design station database, allowing you to verify exactly what simulation predicted. A "production type" tester would be misused in this application and would hardly be readily available. What's more, as the Prototype Test task shifts away from the tester expert towards the designer of the IC, a transparent operation is required which enables the designer to do the Prototype test as easily as the simulation and get immediate results.

Low-Volume Production Test

Because flexibility does not compromise performance this Test System offers the alternative to "production type" testers when a limited budget and low throughput does not justify such expensive test machines. This is particularly true with Application Specific IC's (ASIC). ASIC's increase the number of different IC's considerably while the volume per device drops at the same rate. Considering that throughput is not an advantage at small volumes, several "small" testers could be used to test different device types in parallel where one "big" machine could not compensate for the various set-up times needed.

Quality Assurance and Failure Analysis

Since Production Test focuses on throughput it is often performed as a functional test with more or less tight "guard-banding". In order to insure specified circuit limits sample parts are subject to thorough characterization. With the HP 81810S this can be done at an excellent cost/performance ratio without burdening the production tester and thus endangering shipments. Parts failing the Production Test have to be subject to thorough analysis because the results gained may help to control and optimize the manufacturing process which is prone to distortion.

Incoming Inspection and Vendor Evaluation

The equipment manufacturer who finally puts the ICs into a board has to check the IC quality in order to reduce PC board test and warranty costs. These checks include sample tests at moderate volumes and in-depth test of parts which are prone to failure. In this application the type of device and type of test may often change. The HP 81810S IC TEST SYSTEM copes with the different requirements with its modular approach which lets the user configure his system according to his individual needs. In addition, the universal HP-IB interface makes the system open to the integration of other measurement equipment, e.g. oscilloscopes, spectrum analyzers, counters, etc. In fact, Hewlett-Packard will supply him with most of the extra equipment he may need.



SEMICONDUCTOR TEST EQUIPMENT

Digital IC Test System

Model HP 81810S (cont'd)

Test System Modules

The HP 81810S is composed of the HP 8180A/B, HP 8181A/B and HP 8182A/B Data Generators and Data Analyzers, the HP 15425A Test Head (including the HP 15424A Performance Board) or HP 15466A Test Head, a systemizing mainframe, the HP 4141B DC Source/Monitor, the HP 6624A Device Power Supply and a range of accessories. Also included is an HP 9000 series 200 or 300 workstation plus the System Software Pac. The key capabilities of these modules are outlined in the following chapters. For more detailed information on these models refer to the respective pages. (See Model Number Index at the beginning of this catalog).

Digital Data Generation, Capture and Analysis - HP 8180/81/82 A/B

For at-speed functional tests the Test System offers programmable digital patterns at clock rates up to 50 MHz. The linear vector memory depth of up to 16kbit/channel allows you to generate and capture the immense number of testvectors required for testing LSI/VLSI devices. Real-time comparison between "expected" data and captured data generates an "Error Map" which gives immediate feedback and increases throughput.

For thorough characterization of a circuits' performance limits, timing edges can be positioned with a best resolution of 100 ps and level pairs can be programmed with a 10 mV resolution. On the Data Capture side, the sampling point can be swept in 100ps steps for measurements of set-up/hold times and propagation delays. "Window Comparison" simultaneously checks proper upper and lower logic levels and timing conditions. The driver and receiver circuits deliver programmable levels and thresholds as required for testing CMOS, TTL, ECL and "mixed" logic. "High Impedance" or 50 Ohm termination is selectable. For high frequency signal transmission the entire signal path, including Test Head is matched to 50 Ohm which ensures the right test signal quality at the point of test.

DC Source/Monitor - HP4141B

Four source/monitor units (SMU) coupled with two voltage source units provide fast access to the DUT's DC parameters such as input and output currents and voltage levels. The PMU's are routed to the desired pin of the IC by switching relays in the Test Head, which simultaneously disconnect the digital drivers/receivers. This integrates high resolution DC measurements and completes the full set of functional and ac-parametric resources of the system.

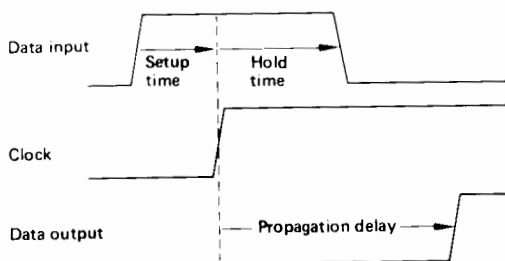

The timing parameters limiting a circuit's maximum data rate

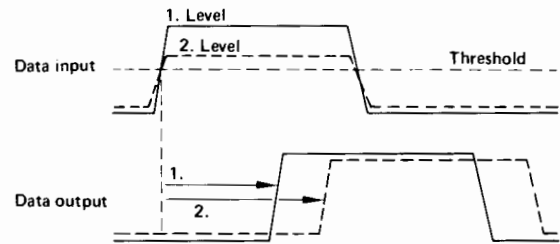

Different propagation delays depending on input threshold overdrive

Power Supplies - HP6624A

The HP 81810S Test System integrates a fully programmable Power Supply featuring four isolated outputs with read-back measurement capabilities and full protection against over-current conditions. This means it can be used to supply the power to the DUT and simultaneously provide other voltages/currents e.g. for DUT load conditions.

Interface to the Device Under Test (DUT) - HP15424A/15425A/15466A

To bring the measurement resources to the DUT, the Test System offers a Performance Board and two types of Test Heads. Featuring a 50 Ohm strip-line technique the DUT interface products are matched to the driver and receiver circuits which ensures the best test signal quality at the device pins. The 15425A Test Head (includes the 15424A Performance Board) allows you to connect up to 84 DUT pins (57 uni-directional and 27 bi-directional). For higher pin counts and when bi-directional pins have to be tested the HP 15466A Test Head is recommended. It allows the connection of up to 256 uni-directional or 128 bi-directional pins. Four DC-parametric measurements can be made simultaneously on one HP 15466A Test Head. The Test Heads are HP-IB controlled which allow you to switch the relays from functional and ac-parametric measurements to dc-parametrics.

Pulse Performance

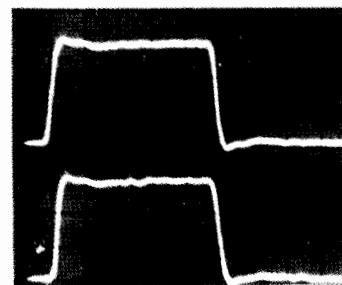

Signal as output from drivers

Signal as received at the Test Head's DUT board

Scale: 10 ns/div. (horiz.)
1 V/div. (vert.)

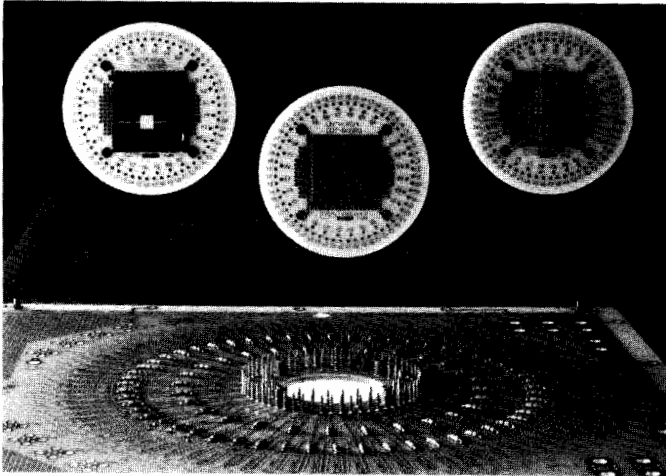

System Controller - HP 9000 Series 200 or 300

The HP 81810S IC TEST SYSTEM is controlled by an HP 9000 computer. It allows you to fully automate your tests or operate the System remotely. It increases the universality of the System, giving access to mass data storage devices and printers. With the RS-232-C interface (in addition to the HP-IB) it also provides links for host computer communication. Operation, Program Generation and links to other systems are supported from the System Software.

Operation

All parameter set-ups and measurements can be programmed by the System Controller via the standard HP-IB interface. This enables interactive operation as well as full automation under program control. Both are supported by the System Software. In addition, data generation, capture and analysis can be directly accessed via the softkey-driven frontpanel of the modules. Also a large CRT provides a transparent overview of the current instrument settings.

System Software

The System Software provides a shell around the hardware resources and enables you to focus on the device under test rather than on the test machine. Because it is easy to use, users need little training to work with this tool. The software package consists of two parts, - Interactive Operation and Program Generation and CAE Links.

Interactive Operation: A softkey-driven menu guides the user through Test System configuration, parameter set-up, pattern editing, pin labeling and assignments etc. These tasks have to be done once per device type, and the information can be stored in the system data base. When performing a test the user quickly sets-up the entire system by calling the configuration from the data base. After a few key-strokes the user can then perform various tests e.g. functional truth-table verification or automatic edge and level search as required for measuring propagation delays or set-up and hold times. The results of the measurements are logged in the data base and can be used for analysis e.g. they can be displayed by means of a Shmoo Plot.

Program Generation: In the program mode, configurations, measurements and analysis routines set-up during interactive operation can be automated by generating a BASIC program. This is supported by file management routines and example measurement programs which can be tailored to a specific device. This module aids the user in generating test programs efficiently since it takes away the burden of task which are common to most devices.



CAE Links

This software module allows you to link directly to the databases of CAE Design Workstations or Host computers running simulation programs. The physical link is via RS-232-C using the System Controller in the VT100 Terminal Emulator Mode. The software provides turn-key programs for downloading data vectors which are compatible with HILO 3 or FACTOR (SENTRY) data formats. After downloading, the testvectors are readily available in the Test System for execution. For other data formats, the software helps the user to create his individual "front-end" to the entire link program.

System Rack

All System Modules except the Controller can be installed in up to three racks depending on the configuration. The rack provides the mechanical housing plus the necessary provisions for over-heat protection and for electrical safety (transformers).

System Characteristics for Data Generation and Data Capture

1Hz - 50MHz Vector Rate

RZ and NRZ Data Formats and Clocks

100ps resolution for Delay and Width (of RZ channels, Clocks and Sampling Point)

10mV resolution for voltage levels and thresholds (programmable, covers CMOS, TTL, ECL)

1 - 16 K linear Vector Memory Depth

Up to 256 uni-directional Channels, up to 128 bi-directional Channels

Real Time Data Comparison, Dual Threshold and Window Comparison, Synchronous and Asynchronous Sampling, Glitch Detection

More Information

For more information on the System modules please refer to the respective pages. (see Model Number Index at the beginning of this catalog). For further configuration, ordering, and technical information, Technical Data Sheets and Application Notes on the products covered in this chapter, please contact your nearest HP sales office.



SEMICONDUCTOR TEST EQUIPMENT

Semiconductor Parametric Test System

Model 4062B

- Precise, high speed probed wafer measurements
- 1pA resolution at all 48 pins

- Easy to program with Probing Pattern Generator
- Virtual front panel simplifies operation

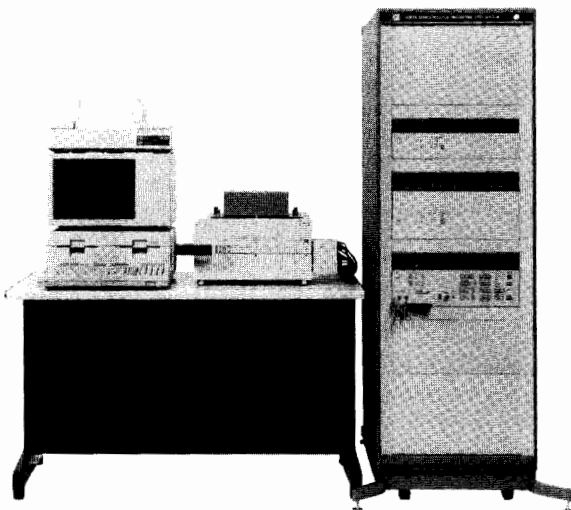

HP 4062B
(System controller, printer and tables are sold separately.)

Description

The HP 4062B Semiconductor Parametric Test System will help you improve IC yield and quality in production plus increase engineering efficiency. The system measures DC voltage/current and 1 MHz capacitance/conductance of wafers with high resolution and speed.

Precise 1pA and 1fF measurements are performed using a low noise switching matrix with up to 48 DUT pins. All specifications are guaranteed on these DUT pins. High speed measurement units provide fast throughput of high resolution measurements for wafer process monitoring and evaluation. Highly reliable measurements performed on wafers can be fed back to design and process engineers to improve your IC yield and quality.

The HP 4062B is programmed with the simple and powerful HP BASIC. Parameter measurements such as threshold voltage or current gain can be made by a two line program using the HP 4062B's measurement utility subprograms. Prober control software is supplied to allow users to easily operate a wafer prober with the HP 4062B. The system software features an extensive program library that includes statistical analysis, trend charts, and the Virtual Front Panel (VFP) for convenient manual measurement. The HP 4062B will help you reduce software development time and increase engineering efficiency with easy programming.

High speed, high resolution measurements

The HP 4062B can perform high speed measurements with 1 pA resolution. Measurement speed is important to customers, especially on production lines. The HP 4062B's switching matrix is designed to eliminate the effects of noise and reduce leakage current while minimizing stray capacitance. The system's measurement instruments were specially developed for high speed, high resolution measurements. Therefore, the total measurement speed, including data transfer, is very high. For example, Vth (threshold voltage) measurement takes approximately 140 ms.

Easy to program

Using the furnished measurement library - e.g., threshold voltage and current gain - you can perform measurements with a one or two line program. You can also quickly create probing programs using the interactive probing pattern generator furnished with the HP 4062B. The HP 4062B's Test Instruction Set (TIS) makes programming easy. TIS programs execute very quickly, ensuring high speed measurement. Also furnished is software for statistical analysis of measurement data. This software allows you to create wafer maps, trend charts, and Scattergrams.

Sample Program Using TIS

```

100 !
110 Connect (Smu1, D)
120 Connect (Smu2, G)
130 Connect (Gnd, S, Sb)
140 Force_v(D, Vd, Vrange, Vlimit)
150 Set_bsearch(G, D, 4, Va, Vb, Ith)
160 Search(Vth)
170 !

```

— Connect DUT
 — Set drain voltage
 — Set binary search conditions
 — Execute binary search

Sample Program Using Utility Library

```

60 !
70 Set_tr(S, G, D, Sb)
80 Vth=FNvth4(Ith, Vd, Va, Vb)
90 !

```

— Connect DUT
 — Measure threshold voltage

Reliable measurements

The switching matrix, test leads and test fixtures are designed specifically for use in a parametric test system to ensure precise high speed measurements and to guarantee the performance of each measurement instrument in the system. The HP 4062B's specifications are guaranteed up to the DUT pins, so the HP 4062B provides practical high speed measurements with 1 pA resolution. In addition, the HP 4062B is easy to maintain and is set up for on-site service to minimize down time.

Software Library

Virtual Front Panel (VFP) Test Instruction Set (TIS)

- Switching matrix control
- DC measurements
- Capacitance measurements
- Timing control
- Prober control
- System initialization

Graphics Library

- C-V graph
- I-V (linear-linear) graph
- I-V (linear-log) graph

Parameter Measurement Library

- Resistivity (2-wire or 4-wire)
- Breakdown voltage
- DC current gain
- Drain current
- Threshold voltage (4 kinds)
- Lateral diffusion effect (ΔL and ΔW)

Auto Prober Control Library

- Probing pattern generation
- Probing control

Data Processing Library

- Data file creation
- Wafer map
- Histogram
- Scatter plot
- Trend chart

Diagnostic Program

System Configuration

- DC Source/Monitor (HP 4141B)
- Switching Matrix (48-pin configuration)
- Switching Matrix Controller
- 1 MHz C Meter/C-V Plotter (HP 4280A)
- Rack Cabinet (HP 29402C)



Specifications

Switching Matrix

Number of pins (to DUT): 48 pins (standard) with options for 12, 24 and 36 pins.

Number of ports (to instrument): 9 ports

High Resolution Source and Monitor Unit: 1 port

Source and Monitor Units: 3 ports

Ground: 1 port

C Measurement: 2 ports

Auxiliary: 2 ports

Maximum allowable voltage between ports: 220 Vdc

Maximum allowable current at pins: 500 mA_{dc}

Maximum stray capacitance between pins: 6 pF

DC Source and Monitor Units

High resolution source and monitor unit (SMU1*): 1 unit

Output/Measurement Range: Current, ± 1 pA - ± 100 mA, Basic Accuracy, 0.3%; Voltage, ± 1 mV - ± 100 V, Basic Accuracy, 0.1%

Source and monitor units (SMU2-4*): 3 units

Output/Measurement Range: Current, ± 100 pA - ± 100 mA, Basic Accuracy, 0.3%; Voltage, ± 1 mV - ± 100 V, Basic Accuracy, 0.1%

Ground unit: 1 unit

Output Voltage: 0V; Accuracy, ± 2 mV

Current Range: ± 500 mA

Voltage source (Vs): 2 units

Output Range: 1 mV - ± 20 V; Basic Accuracy, 0.5%

Voltage monitor (Vm): 2 units

Measurement Range: ± 100 μ V - ± 20 V, Basic Accuracy, 0.2%

*SMU 1-4: Each SMU can function either as a dc voltage source/current monitor or as a dc current source/voltage monitor.

Capacitance-Conductance Measurements

Test frequency: 1 MHz $\pm 0.01\%$

OSC level: 30 mV_{rms} $\pm 20\%$ and 10 mV_{rms} $\pm 20\%$

Measurement range: (Maximum resolution to full scale)

C: 0.001 pF - 1.2 mF; basic accuracy, 0.5%

G: 0.01 μ S - 12 mS; basic accuracy, 1.5%

DC bias voltage for capacitance measurements: ± 100 V

Reference Data

Command Execution Time

Connect (Relays): 8ms

DC Source/Monitor¹:

Force (Current or Voltage): 10ms

Measure (Current or Voltage): 14ms

Sequential Force/Measure: 23ms

Binary Search²: 100ms (10 iterations)

Linear Search³:

80 - 100ms (10 point sweep)

440 - 640ms (100 point sweep)

1. When integration time is short and range is not InA/10nA. Does not include wait time set by user.
2. This command searches a specified measurement value by repetitive halving of the force voltage/current range.
3. This command searches a specified measurement value by using linear sweep.

General Specifications

Operating temperature range: 10°C - 40°C, $\leq 70\%$ RH at 40°C

Permissible temperature change: $\leq 1^\circ\text{C}/5$ minutes

Air cleanliness: class 100,000 or higher clean room required

Power requirements: 100 V, 120 V, 200 V $\pm 10\%$; 240V $+5\%$ - 10%; 48-66 Hz, 510 VA max.

Dimensions: cabinet, 535 mm(W) x 1635 mm(H) x 770 mm(D); switching matrix, 406 mm(W) x 210 mm(H) x 380mm (D)

Weight: cabinet with instruments, approximately 200 kg; switching matrix, approximately 25.3 kg

Accessories Furnished

HP 16066A: Test Fixture Adapter

HP 16067A: 24 pin DIP Low Leakage Fixture

HP 16068A: 48 pin DIP Low Leakage Fixture

HP 16069A: Universal Low Leakage Fixture

HP 16070A: General Purpose Dip Fixture

HP 16071A: Universal Fixture

HP 16072A: Personality Board (for connecting probe card)

HP 16075A: Relay Test Adapter

HP 16076A: System Test Module

HP 16077A: Extension Cable Fixture

System Controller

Required Controller: HP 9000 Series 200 Model 236A, 236C, 236S or 236CS, or Series 300 Model 310

System Language: BASIC 3.0 for Series 200 or 4.0 for Series 300

Memory Size: ≥ 832 K byte

Interface: In addition to standard HP-IB, 2 HP-IB interface Cards (HP 98624A) are required.

Prober Interface

Automatic wafer probers used with the HP 4062B must be equipped with HP-IB capability. Hardware for mounting the switching matrix on the prober is also required. Contact the prober manufacturer for details concerning necessary mounting hardware.

Accessories Available

	Price
HP 16262B OPT. 502: EG 2001X Control Software	\$2,500
OPT. 521: TSK 6000A Control Software	\$2,500
HP 16262C OPT. 401: SPN Data File Creation Software	\$1,650

Ordering Information

HP 4062B Semiconductor Parametric Test System (does not include controller)	\$84,900
OPT. 050/060: For 50/60Hz Line Frequency ¹	N/C
OPT. 100/120/220/240: For 100/120/220/240 Line Voltage ²	N/C
OPT. 001: 12-pin Configuration (delete 36 pins)	\$-16,200
OPT. 002: 24-pin Configuration (delete 24 pins)	\$-10,800
OPT. 003: 36-pin Configuration (delete 12 pins)	\$-5,400
OPT. 004: Additional Pin Board	\$460
OPT. 011: SMU Board	\$1,200
OPT. 030: For HP 900 Model 310 Controller ⁴	N/C
OPT. 036: For HP 9000 Model 236 A/S/C/CS Controller ⁴	N/C
OPT. 102: Delete 4280A	\$-9,800
OPT. 110: Delete Test Fixtures for Packaged Devices	\$-3,900
OPT. 401: SPN Data File Creation Software	\$1,800
OPT. 501: EG 1034X Control Software ³	N/C
OPT. 502: EG 2001X Control Software ³	N/C
OPT. 521: TSK 6000A Control Software ³	N/C
OPT. 920: Extra System Library	\$320

¹Must select OPT. 050 or 060 according to the power line frequency used.

²Must select OPT. 100, 120, 220 or 240 according to the power line voltage used.

³Must select OPT. 501, 502 or 521.

⁴Must select OPT. 030 or 036 according to the system controller used.



SEMICONDUCTOR TEST EQUIPMENT

Semiconductor Parameter Analysis System

Model 4063A

- 1fA, 10 μ V and 1fF resolution through a wafer prober
- Wide variety of application programs

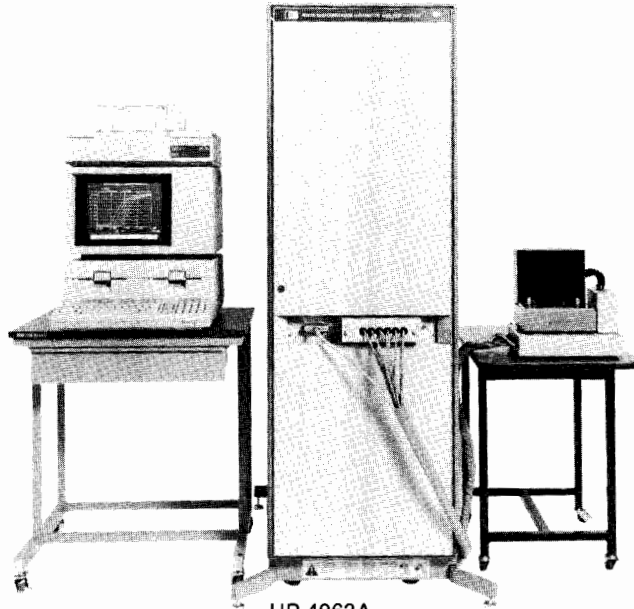

HP 4063A

(System controller, printer and tables are sold separately.)

Description

The HP 4063A offers plenty of advantages and benefits for applications in the semiconductor development lab. You can use the system to reduce your semiconductor development time and cost, ensure the accuracy and reliability of your measurements, and eliminate the long start-up times characteristic of other test systems.

The HP 4063A is the first semiconductor parameter analysis system capable of stable 1fA resolution measurements of wafer devices. Since precise measurements of wafer devices is possible, evaluation results can be fed back to control the semiconductor process. The result is that semiconductor development time and cost can be reduced.

Precise 1fA and 10 μ V DC measurements plus 1fF capacitance measurements at 1 MHz are performed through the HP 4063A switching matrix. All these measurements can be made at any one of the 6 (standard) or 12 (option) switching matrix DUT channels. That means you can make measurements with a single probing to ensure accuracy and reliability.

The entire system is controlled by menu-driven software. This simplifies operation so that you can become an expert operator quickly. The system includes a wide selection of application programs so that you can begin measurements as soon as the system is installed. This will virtually eliminate the long start-up time characteristic of other test systems.

System configuration

Digital Voltmeter (HP 3456A)
pA meter/DC Voltage Source (HP 4140B)
DC Source/Monitor (HP 4141B)
1 MHz C Meter/C-V Plotter (HP 4280A with OPT.001)
Switching Matrix
Switching Matrix Controller
Rack Cabinet (HP 29402C)

Application Package

The following programs are furnished with the 4063A. These are easy to execute with a few keystrokes.

MOSFET DC Characteristics
Bipolar Tr. DC Characteristics
MOS Diode Capacitance Characteristics
Junction Diode Capacitance Characteristics
DLTS (OPT. 301)
SPN Data File Creation (OPT. 401)
Wafer Measurement (OPT. 411)

Specifications

Switching Matrix

Number of DUT channels: 6 (standard) or 12 (optional)

- Easy menu-driven operation
- Powerful programming tools

Number of AUX terminals: 2

Connection method: guarded Kelvin connection

Maximum voltage between DUT Channels when switch is open: ± 200 Vdc

Maximum ground-referenced voltage at DUT Channel: ± 100 Vdc

Maximum current at DUT channel: 500 mA

DC Measurements

Source and Monitor: 4 units

Output Measurement Range: current, 0 A to ± 100 mA, 0.3% basic accuracy, 1 pA max resolution; voltage, 0 to ± 100 V, 0.1% basic accuracy, 1 mV max resolution.

Ground Unit

Output Voltage: 0 V ± 7 mV

Low Current Measurements

Measurement Range: 0 A to ± 19.99 mA, 0.5% basic accuracy, 1 fA max resolution

Voltage Source for Low Current Measurements

Output Modes:



Output Range: 0 to ± 100 V, 10 mV max resolution

High Resolution Voltage Measurements

Measurement Range: 0 V to ± 200 V, 0.0078% basic accuracy, 10 μ V max resolution

Voltage Source: 2 units

Output Range: 0V to ± 20 V, 0.5% basic accuracy, 1 mV max resolution

Capacitance-Conductance Measurements

Test Frequency: 1 MHz $\pm 0.01\%$

OSC Level: 30 mVrms $\pm 30\%$ and 10 mVrms $\pm 30\%$

Measurements Range:

C: to 1.2 nF, 0.35% basic accuracy, 1fF max resolution

G: to 11 mS, 0.55% basic accuracy, 10 nS max resolution

dc Bias Source: 0 to ± 100 V

General Specifications

Operating Temperature Range: 10°C to 40°C, $\leq 70\%$ RH at 40°C

Power Requirements: 750 VA max (standard system)

Dimensions: 535mm W x 1635mm H x 800mm D

Additional cabinet will be added for options 301, 302, 311.

Weight: approximately 230 kg (standard)

System Controller

Required Controller: HP 9000 Series 200 model 236C/236CS/236A/236S Personal Technical Computer

Ordering Information

HP 4063A Semiconductor Parameter Analysis System (does not include controller) \$102,100

Opt. 050/060:¹ for 50/60 Hz Line frequency N/C

Opt. 100/120/220/240:² for 100/120/220/240 V line voltage N/C

Opt. 301: DLTS measurement \$9,000

Opt. 302: Current bias for DLTS \$2,900

Opt. 311: 12-channel configuration \$31,000

Opt. 331: LF capacitance measurement (± 35 V DC Bias Operation) \$10,450

Opt. 332: LF capacitance measurement (± 100 V DC Bias Operation) \$10,400

Opt. 351: Add rack cabinet (for OPT.301, 302, 331, 332) \$4,000

Opt. 352: Add rack cabinet (for OPT.311) \$4,000

Opt. 401: SPN data file creation software \$1,900

Opt. 411: Wafer measurement software \$1,100

Opt. 501: Electroglas 1034X prober control software \$2,600

Opt. 502: Electroglas 2001X prober control software \$2,600

Opt. 521: TSK A-PM 6000 prober control software \$2,600

Opt. 611: SI 5500 temperature controller control software (for DLTS) \$650

Opt. 801: Extra SMU board \$1,200

Opt. 910: Extra system library \$200

1. Must select OPT. 050 or 060 according to the power line frequency used.

2. Must select OPT. 100, 120, 220 or 240 according to the power line voltage used.

SEMICONDUCTOR TEST EQUIPMENT

Semiconductor/Component Test System

Model 4061A

245



- Ready to use—supplied with 7 turn-key application pacs
- Reliable impedance and current measurements with one probing
- Productivity improvement through accurate and fast measurement over wide range

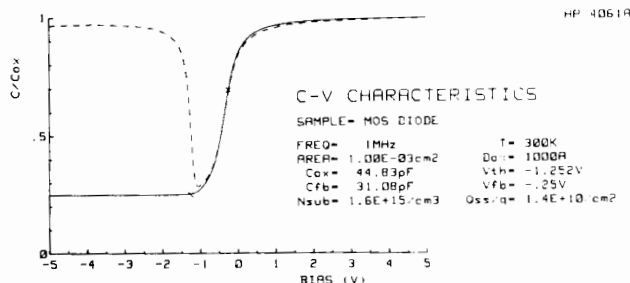

DESIGNED FOR
HP-IB
SYSTEMS

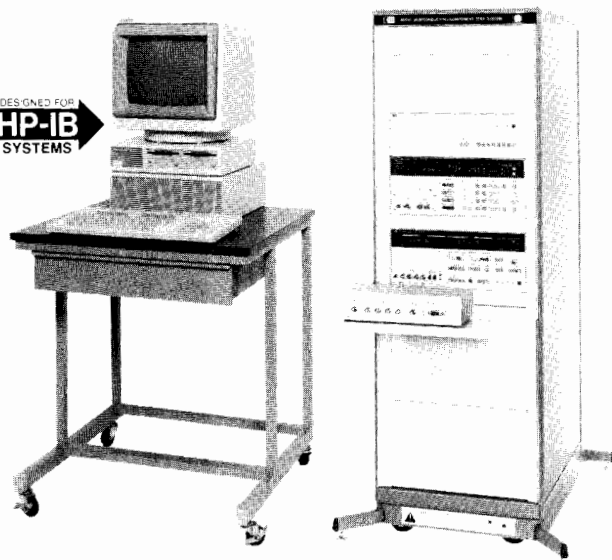

HP 4061A

System controller and table are sold separately

Specification

For detailed specifications on each of the instruments used in the HP 4061A, refer to the individual data sheets.

Switching Subsystem

The switching subsystem consists of a switch control module and switching module with interconnecting cables.

Function: Switches connection from DUT to either Multi-frequency LCR Meter or the pA Meter/DC Voltage source.

System Measurement Range (only deviations from individual instrument specifications are listed.)

Impedance Measurements (HP 4275A)

Frequency range: ≤ 1 MHz

Measurement parameters: C-G

Capacitance: ≤ 2000 pF (with $D \leq 0.1$)

***Accuracy:** (accuracy of HP 4275A) $\times 1.5 + \Delta C$ (at $23^\circ\text{C} \pm 5^\circ\text{C}$).

$$\Delta C = 1.4 \times 10^{-3} C \times f^2 \text{ (pF)} + 5 \text{ counts}$$

Conductance: ≤ 12 mS ($D \leq 0.1$)

***Accuracy:** (accuracy of 4275A) $\times 1.5 + \Delta G$ (at $23^\circ\text{C} \pm 5^\circ\text{C}$)

$$\Delta G = 6 \times 10^{-3} C \times f(S) + 5 \text{ counts}$$

* f: frequency in MHz

Cx: Measured capacitance value in pF

At 5°C to 40°C , ΔC and ΔG doubles. Example: Assuming $C_x = 1000$ pF and $f = 1$ MHz, $C = (1.4 \times 10^{-3} \cdot 10^3 \cdot (1)^2) \text{ pF} + 5$ counts = 1.4 pF + 5 counts

Current Measurements (HP 4140B)

Accuracy: (accuracy of HP 4140B) $\times 1.5 + 5$ counts

After one-hour warmup and at DUT terminal of switching module

Impedance Measuring Section (HP 4275A)

See the HP 4275A's page.

Current Measurement Section (HP 4140B)

See the HP 4140B's page.

General Information

Operating temperature: 5°C to 40°C , $\leq 70\%$ RH at 40°C

Power: 100, 120, 220, and 240V, $\pm 5\% - 10\%$, 48 to 66 Hz, 520 VA

Size: 535mm W x 1635 mm H x 770 mm D

Weight: Approximately 125 kg.

System Controller

HP 9000 Series 200 Model 226A, 226S, 236A or 236S, or Series 300 Model 310

Ordering Information

HP 4061A Semiconductor/Component Test System (does not include controller)

Price
\$38,300

Opt. 001: ± 100 V dc Bias for HP 4275A

N/C

Opt. 002: 1-3-5 Frequency Steps for HP 4275A

N/C

Opt. 026*: For HP 9000 Model 226 A/S controller

N/C

Opt. 031*: For HP 9000 Model 310 controller

N/C

Opt. 036*: For HP 9000 Model 236 A/S controller

N/C

*Must order either OPT. 026, 031 or 036.

Description

The HP 4061A Semiconductor/Component Test System is a dedicated system for making efficient, automatic evaluation of the fundamental characteristics of semiconductor and electronic components required in R & D and production areas. This system employs reliable, accurate measurements and high speed data processing to perform more reliable evaluations with speed and less manpower. The HP 4061A is supplied with 7 sophisticated applications programs and is flexible in both software and hardware. Thus, the system can output measurement results in nearly any required data format.

The switching subsystem, designed especially for use with the HP 4061A, allows both impedance and current measurement without changing DUT connection. Using this new switching subsystem, and by making impedance measurements, the HP 4061A performs evaluation of Doping profile, Oxide capacitance, Flat band condition, Threshold voltage, Surface charge, and Minority carrier life time/surface generation velocity. The HP 4061A also measures leakage current and reverse/forward current-voltage characteristics. Surface state density evaluation, using both high (e.g., 1 MHz) and low frequency (Quasi-static) C-V measurements and data processing are also possible by making modifications to system software.

The system offers significant improvement in both yield and quality in production through fast and reliable measurements and evaluations. It is also a valuable evaluation tool for the development of new materials and devices. The HP 4061A provides the flexibility to meet the future measurement requirements of the electronics industry.

System Configuration

- pA Meter/DC Voltage Source (4140B)
- Multi-frequency LCR Meter (4275A)
- Switching Subsystem
- Rack Cabinet (29402C)

Furnished Application Software

Semiconductor high/low frequency C-V characteristics, I-V characteristics, C-t characteristics and Zerst analysis, Impedance Frequency/Bias characteristics, Ideal C-V curve.



SEMICONDUCTOR TEST EQUIPMENT

Semiconductor Parameter Analyzer

Model 4145B

- Fully automatic, high-speed dc characterization of semiconductor devices.
- High resolution, wide range sourcing and measurement.
I: 50fA – 100mA, V: 1mV – 100V
- Maximum 1150 measurement and display points for precise measurement and analysis.
- Flexible graphic analysis functions for quick parameter extraction.
- Built-in micro flexible disc drive for storage of 240 user programs or 105 measurement results.

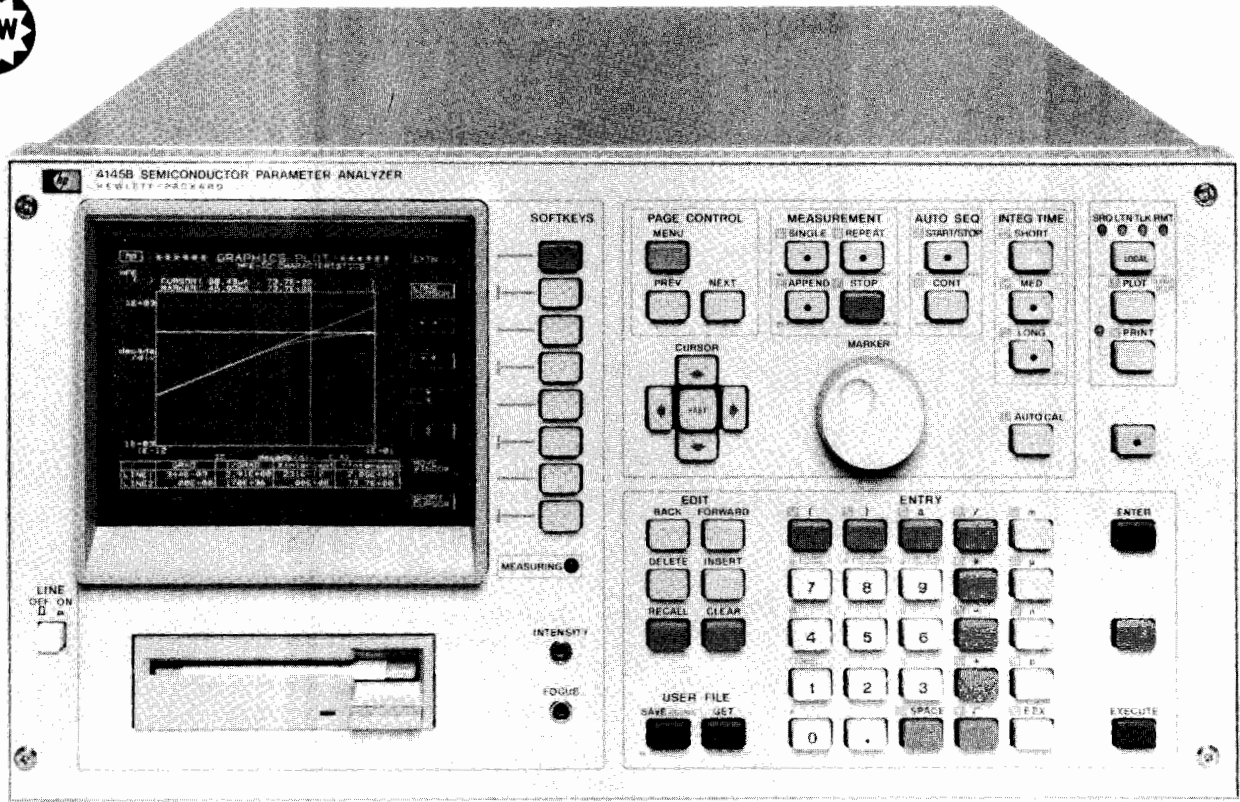

HP 4145B



Description

Designed for production line and laboratory use, the HP 4145B is the electronics industry's first stand-alone instrument capable of complete dc characterization of semiconductor devices and materials. It stimulates voltage and current sensitive devices, measures the resulting current and voltage responses, and displays the results in a user-selectable format (graph, list, matrix or schmo) on a built-in CRT display. An on-board programmable calculator provides real-time calculation of voltage/current dependent parameters, such as the current gain (h_{FE}) and transconductance (g_m) of transistors, which also can be displayed on the CRT. A number of powerful graphic analysis tools—marker, cursor, line function, interpolation—enhance the HP 4145B's basic capabilities and provide fast, accurate analysis of semiconductor devices, leading to increased production yields and improved device quality.

Four built-in source monitor units (SMUs) are the heart of the HP 4145B. Each SMU can be independently programmed to function as either a voltage source/current monitor or a current source/voltage monitor. Thus, a bipolar transistor, for example, can be completely characterized in common-base, common-emitter, and common-collector configurations without changing connections—only changing the SMUs' operating modes is required. The HP 4145B is also equipped with two voltage sources and two voltage monitors for measurements on devices having more than four terminals, such as ICs.

The HP 4145B can be controlled from the front panel, via the HP-IB (standard), or by measurement setups stored on micro flexible discs.

Displayed information—measurement setups, auto-sequence programs, measurement results—can be dumped directly onto an external graphics printer/plotter to obtain publication quality hard copies. Additionally, the built-in 3½" flexible disc drive enables you to store measurement setups and measured data, which can be accessed by another compatible HP disc drive for further processing.

Auto Sequence Programs

Measurement programs stored on a HP 4145B micro flexible disc can be linked by an auto sequence program, making it possible to perform a series of measurements with just one keystroke.

Four User-Selectable Display Formats to Suit the Evaluation

Measurement results can be displayed in one of four display formats: GRAPHICS, LIST, MATRIX or SCHMOO. After measurement has been made and the results displayed, the softkeys can be used to access various analysis functions for complete device evaluation. These functions include MARKER for numeric readout of measured value at any point along a plotted curve, CURSOR for numeric readout of value at any graphic point and for line positioning, STORE/RECALL for overlay comparisons, AUTO SCALE for optimum graphic scaling, and LINE FUNCTION for direct readout of line gradient and X-Y axes intercept values.



Specifications

Measurement

Source/Monitor unit (SMU): four SMUs are built into the HP 4145B. Each SMU can be programmed to source voltage and monitor current, or conversely to source current and monitor voltage. Each SMU can also be programmed to COM mode. This sets voltage at 0 volts and current compliance at 100 mA.

Output/measurement resolution: voltage, 4½ digits; current, 4 digits

Voltage measurement input resistance/current source output resistance: $\geq 10^{12}\Omega$

Maximum capacitive load: 1000 pF

SMU Voltage Range, Resolution and Accuracy

Voltage Range	Resolution	Accuracy ^{1,2}	Max. Current
±20V	1mV	$\pm(0.1\%+10\text{mV}+0.4\times I_o)$	100mA
±40V	2mV	$\pm(0.1\%+20\text{mV}+0.4\times I_o)$	50mA
±100V	5mV	$\pm(0.1\%+50\text{mV}+0.4\times I_o)$	20mA

* I_o -v is SMU output current in amps.

SMU Current Range, Resolution and Accuracy

Current Range	Resolution	Accuracy ^{1,2}	Max. Voltage
±100mA	100µA	$\pm(0.3\%+100\mu\text{A}+2\mu\text{A}\times V_o)$	20V(>50mA)
			40V(>20mA)
±10mA	10µA	$\pm(0.3\%+10\mu\text{A}+200\text{nA}\times V_o)$	100V(≤20mA)
±1000µA	1µA	$\pm(0.3\%+1\mu\text{A}+20\text{nA}\times V_o)$	
±100µA	100nA	$\pm(0.3\%+100\text{nA}+2\text{nA}\times V_o)$	
±10µA	10nA	$\pm(0.3\%+10\text{nA}+200\text{pA}\times V_o)$	
±1000nA	1nA	$\pm(0.5\%+1\text{nA}+20\text{pA}\times V_o)$	
±100nA	100pA	$\pm(0.5\%+100\text{pA}+2\text{pA}\times V_o)$	
±10nA	10pA	$\pm(1\%+15\text{pA}+200\text{fA}\times V_o)$	
±1000pA	1pA	$\pm(1\%+6\text{pA}+20\text{fA}\times V_o)$	

* V_o -v is SMU output voltage in volts.

**50 fA resolution in current monitor mode.

- Accuracy specifications are given as $\pm\%$ of reading or setting value $\pm\%$ of range.
- Accuracy tolerances are specified at 25°C $\pm 5^\circ\text{C}$, after a 40 minute warm-up time, with AUTO CAL on, and specified at the rear panel connector terminals referenced to SMU common. Tolerances are doubled for the extended temperature range of 10°C to 40°C.

SMU Voltage/Current Compliance

Maximum voltage compliance: 20 V, 40 V, or 100 V, depending on the output current range.

Maximum current compliance: 20 mA, 50 mA, or 100 mA, depending on the output voltage range.

Compliance setting resolution: same as current and voltage output/measurement resolution. Maximum current compliance resolution, however, is 50 pA.

Compliance accuracy: voltage compliance accuracy is the same as voltage output/measurement accuracy. Current compliance accuracy is current output/measurement accuracy \pm (1% of range + 10 pA).

Voltage/Current Sweep Characteristics

Output from up to three SMUs or voltage sources can be swept in one of three modes: VAR1, VAR2, or VAR1'.

VAR1: linear or logarithmic staircase sweep

VAR2: linear staircase sweep. Output from the VAR2 source is incremented after completion of each VAR1 sweep.

VAR1': output from the VAR1' source is synchronized with VAR1 but at levels proportional to a user-selectable ratio or offset relative to VAR1.

Ratio: ± 0.01 to ± 10

Offset: any value that will not cause VAR1' to exceed maximum allowable output.

Hold time: 0 to 650 seconds, $\pm(0.5\% + 9\text{ ms})$ with 10 ms resolution

Delay time: 0 to 6.5 seconds, $\pm(0.1\% + 5\text{ ms})$ with 1 ms resolution

No. of Measurement Steps: 1024 for a single VAR 1 sweep, 1150 for a multiple sweep

Voltage Sources (Vs) Characteristics

Number of sources: two

Output resistance: $\leq 0.2\Omega$

Maximum capacitive load: 1000 pF

Voltage Output Range, Resolution and Accuracy

Output Voltage Range	Resolution	Accuracy	Max. Output Current
±20 V	1 mV	$\pm(0.5\%$ of setting + 10 mV)	10 mA

Voltage Monitors (Vm) Characteristics

Number of monitors: two

Input resistance: 1 M Ω \pm 1% shunted by 100 pF \pm 10%

Voltage Measurement Range, Resolution and Accuracy

Measurement Voltage Range	Resolution	Accuracy
± 2 V	100 µV	$\pm(0.5\%$ of reading + 10 mV)
±20 V	1 mV	$\pm(0.2\%$ of reading + 10 mV)

Characteristics Common to SMUs, Voltage Sources & Voltage Monitors

Maximum allowable terminal voltage: 100 V peak across SMU and V_m input terminals, or SMU and V_S output terminals, or between those terminals and guard; and 42 V maximum from Common to Ground.

Display

CRT size and screen resolution: 152.4 mm (6 inch) diagonal; 2048 x 2048 points.

Display modes: Graphics, Schmo, List, Matrix, and Time Domain

External CRT analog output: X, Y and Z outputs of 0 to 1 Vdc into 330 Ω (X and Y) and 240 Ω (Z).

Analysis

Calculation: two user functions can be input and keyboard calculations can be done using the following 11 operators: +, -, *, /, $\sqrt{\quad}$, EXP, LOG, LN, ** (power), ABS (absolute) and Δ (differential).

Constants Available on the Keyboard

q: Electron charge (1.602189×10^{-19} coulomb)

k: Boltzmann's Constant (1.380662×10^{-23} J/ $^\circ\text{K}$)

e: Dielectric constant of vacuum (8.854185×10^{-12} F/m)

Analysis functions: overlay comparison with STORE/RECALL, Marker, Interpolate, Cursor, Auto scale, Zoom function (\leftrightarrow , \leftarrow , \rightarrow , \uparrow , \downarrow) Line and Move Window.

General Specifications

Operating temperature range: +10°C to +40°C; $\leq 70\%$ RH at 40°C, permissible temperature change $\leq 1^\circ\text{C}/5\text{ min}$.

Power requirements: 100/120/220 V $\pm 10\%$; 240 V - 10% + 5%; 48 to 66 Hz; 270 VA max.

Dimensions: 426 mm W x 235 mm H x 612 mm D (16.75" x 9.06" x 24.1").

Weight: 27 kg (59 lb) approximately.

Reference Data

SMU measurement time: measurement time = response time + ranging time + integration time.

SMU Response Time

Current Range	Setup/Settling Time	SMU Wait Time
100 nA to 100 mA	2.7 ms	0.2 ms
1 nA and 10 nA		47.5 ms

Ranging time: varies from 4 ms to 74 ms

Integration time: SHORT, MED and LONG

	SHORT	MED	LONG
50 Hz	3.6 ms	20 ms	320 ms
60 Hz		16.7 ms	267 ms

Accessories Furnished

HP 16058A Test Fixture

HP 04145-61501 Disc Set

HP 04145-60001 Connector Plate

HP 04145-61622 Triaxial Cable (3m), 4 ea.

HP 04145-61630 BNC Cable (3m), 4 ea.

HP 04145-61623 Shorting Connector

Ordering Information

HP 4145B Semiconductor Parameter Analyzer \$22,800

Opt. 050/060: 50Hz/60Hz Line Frequency

N/C



SEMICONDUCTOR TEST EQUIPMENT

Switching Matrix

Model 4085M

- 48 pins with 1pA resolution

- Easy programmable switching

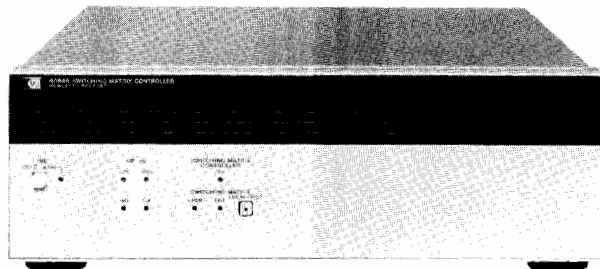

Switching Matrix Controller

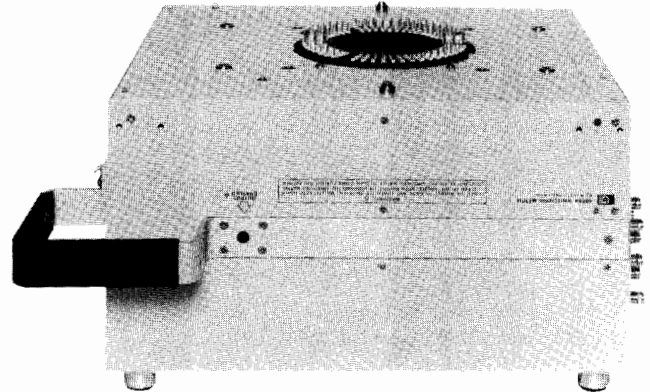

Switching Matrix

HP 4085M

HP 4085M Description

Combining the HP 4085M switching matrix with the HP 4145B Semiconductor Parameter Analyzer produces a 1 pA, 1 mV switching system capable of 48-pin high resolution semiconductor testing.

A design which minimizes both noise and leakage current means exceptional built-in dc measurement capabilities and the realization of 1 pA resolution measurements at any one of the 48 pins.

The software included with the system makes it possible to freely switch any one of the eight instrument ports to any one of the test pins from the system controller. A number of fixtures are available for wafer and various packaged device measurements. The HP 4085M retains the HP 4145B's full measurement capabilities to obtain highly reliable wide range dc parameter measurements.

Specifications

Switching Matrix

DUT Pins: From 12 to 48 pins can be installed.

Instrument Ports:* Eight instrument ports are included.

Low Leakage SMU Port: 1 ea. (Port 1)

SMU Ports : 3 ea. (Port 2 - 4)

Vs Ports : 2 ea. (Vs Port 1 and 2)

Vm Ports : 2 ea. (Vm Port 1 and 2)

*SMU: Stimulus Measurement Unit

Vs : Voltage Source

Vm : Voltage Monitor

Maximum Voltage between Instrument Ports: ± 220 Vdc

Maximum Current at each DUT Pin: ± 500 mA dc

General Specifications

Operating temperature: 10°C to 40 °C; $\leq 70\%$ RH at 40°C

Air cleanliness: class 100,000 or higher clean room required.

Power requirements: 100, 120, 220V $\pm 10\%$; 240V $+5\% - 10\%$; 48 to 66 Hz, 130VA max

Size: Switching Matrix, 406W \times 210H \times 380D mm; Switching Matrix Controller, 426W \times 134H \times 432D mm

Weight: Switching Matrix, approximately 25.3kg; Switching Matrix Controller, approximately 8kg

System Controller

Required Controller: HP 9000 Series 200 Model 216S, 236A or 236S, or Series 300 Model 310

System Language: Basic 2.0 or later version

Memory Size: ≥ 320 k byte

Ordering Information

HP 4085M Switching Matrix (does not include controller) **Price** \$41,900

Opt. 001: 12-pin system \$-16,200

Opt. 002: 24-pin system \$-10,800

Opt. 003: 36-pin system \$-5,400

Opt. 004: Add one pin \$460

Opt. 016:* For HP 9000 Model 216A/S controller N/C

Opt. 030:* For HP 9000 Model 310 controller N/C

Opt. 036:* For HP 9000 Model 236 A/S controller N/C

* Must select Opt. 016, 030 or 036 according to the system controller used.

System Configuration Example

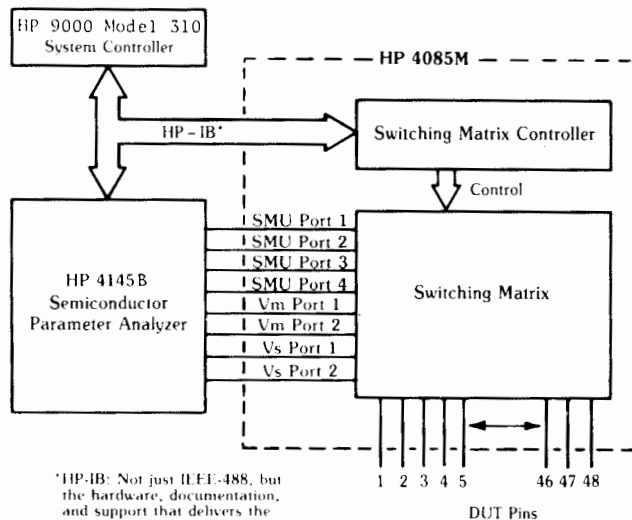

*HP-IB: Not just IEEE-488, but the hardware, documentation, and support that delivers the shortest path to a measurement system.

SEMICONDUCTOR TEST EQUIPMENT

pA Meter/DC Voltage Source

Model 4140B

249



- 3 basic semiconductor measurements: I, I-V and quasi-static C-V
- Two programmable voltage sources

- Basic accuracy: 0.5%
- High resolution: 0.001×10^{-12}
- HP-IB standard

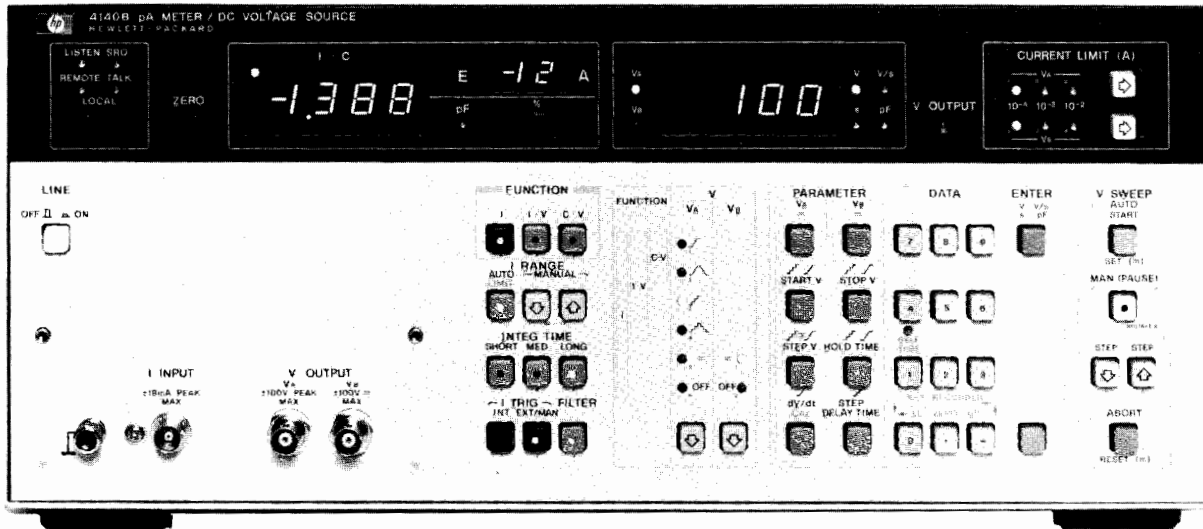

HP 4140B



Description

The HP 4140B pA Meter/DC Voltage Source is another in Hewlett-Packard's new generation of Component Measurement instrumentation. It consists of an extremely stable picoampere meter and two programmable dc voltage sources, one of which operates as a ramp and staircase generator as well as a dc source. These features make the HP 4140B ideal for making dc characteristic measurements such as leakage current, current-voltage characteristics and quasi-static C-V measurements required by the semiconductor industry for new product development and for improving production yields. It is equally useful in measurements of electronic components and materials to determine leakage currents or insulation resistances.

The HP 4140B can contribute to the development, production and quality control of semiconductor devices and to the improvement in the reliability of electronic components and equipment.

Stable pA Measurements

Stable picoampere measurements can be made with the HP 4140B with a maximum resolution of 10^{-15} A. This is made possible by a new measurement technique in conjunction with an offset current capability, low noise test leads, and an electrostatic and light shielded test fixture. These features provide both stable and fast picoampere measurements.

This measurement technique is very useful in making small leakage current measurements and determining dc parameters of semiconductor devices or measuring the insulation resistance and leakage current for dielectric absorption measurements necessary in the analysis of capacitors or insulation materials.

Synchronized I-V Measurements

The HP 4140B makes automatic, synchronized current-voltage measurements that have required a large instrumentation system in the past.

The two voltage sources in the HP 4140B operate over a range of -100 V to +100 V with a maximum resolution of 10 mV. One operates only as a stable dc source while the other generates a staircase voltage, a precise ramp or a stable dc level.

By adding precise, programmable timing capability, we can now make fast, accurate I-V and C-V measurements. Device stabilization times, (time between the applied voltage and the subsequent current

measurement) can now be programmed from the front panel of the HP 4140B or via the HP-IB bus.

Quasi-Static C-V Measurements

Automatic quasi-static C-V measurements are easily accomplished by the ramp voltage capability of the HP 4140B. This measurement is highly significant in evaluating basic semiconductor characteristics.

The HP 4140B operates over a capacitance range of 0.1 pF to 1999 pF with a dc voltage ramp rate of 1 mV/s to 1 V/s in 1 mV/s increments. Capacitance, which is calculated from the measured current divided by the ramp rate, can also be provided as a percent of the capacitance of the oxide film (C_{ox}) over a range of 0.0 to 199.9%. By providing the output voltage at each capacitance measurement point, we have the dc (quasi-static) C-V characteristics of the device under test.

HP-IB Capability

Interfacing the HP 4140B to an HP-IB system improves measurement efficiency and takes advantage of its high speed (approx 5 ms) measurement rate. Such a system will minimize measurement time of dc parameters of semiconductors and the insulation resistance and leakage current of electric components and materials. This allows rapid feedback to production for fast evaluation of a new device in the development stage.

Specifications

Measurement functions: I, I-V and C-V

Voltage sources: two separate sources (V_A and V_B)

V_A : ± 100 V programmable source/function generator

V_B : ± 100 V programmable dc voltage source

Measurement Function/Source Selection

Function	V_A	V_B
I		--- (DC)
I-V		--- (DC)
C-V		--- (DC)



SEMICONDUCTOR TEST EQUIPMENT

pA Meter/DC Voltage Source

Model 4140B (cont'd)

Voltage sweep: auto or manual (pause)

Current Measurements

Displays: current, 3½ digits with 2 character annunciator. Voltage, 3½ digits.

Measurement range: $\pm 0.001 \times 10^{-12} \text{A}$ to $1.000 \times 10^{-2} \text{A}$ full scale in 11 ranges.

Overrange capability: 99.9% on all ranges.

Range selection: auto (lowest current range is selectable) and manual

Measurement Accuracy/Integration Time

Range	Accuracy* ± (% of rdg. + counts)	Integration Time** (ms)		
		Short	Medium	Long
$10^{-2} - 10^{-9}$	0.5 + 2	20	80	320
10^{-10}	2 + 2			
10^{-11}	5 + 3	80	320	1280
10^{-12}	5 + 8	160	640	2560

* Accuracy for long integration time. 23°C ± 5°C. humidity ≤ 70%. For short and medium integration time, see reference data section.

** Integration times specified at 50 Hz. For 60 Hz operation, multiple time by 1.2.

Zero offset: cancels leakage current of test leads or test fixtures.

Offset range: 0 to $\pm 100 \times 10^{-15} \text{A}$.

Trigger: INT, EXT and HOLD/MAN

Input terminal: triaxial

Capacitance-Voltage (C-V) Measurement

Measurement ranges: 0.0 pF – 100.0 pF and 200 pF – 1000 pF full scale in two ranges; 99.9% overrange

Ranging: auto

% C: capacitance change of device under test is displayed as a percent of the set value of the oxide capacitance ($C_{ox} = 100\%$)

% C range: 0.0% – 199.9%

Cox setting ranges (2 ranges): 0.1 pF – 199.9 pF and 200 pF – 1999 pF

Capacitance calculation accuracy: accuracy is dependent on accuracy of both the current measurement and ramp voltage.

Zero offset: cancels stray capacitances of test fixtures and test leads.

Offset range: 0 to 100 pF

High speed I data output: available with HP-IB interface only. Outputs current measurement data at 4 ms intervals (max rate).

DC Voltage Sources

Output Modes, V_A and V_B

Function	V_A	V_B
I		--- (DC)
I-V		--- (DC)
C-V		--- (DC)

Voltage ranges (V_A and V_B): 0 to $\pm 10.00 \text{V}$ and 0 to $\pm 100.0 \text{V}$ in 2 ranges, auto range only.

Maximum current: 10 mA, both sources.

Voltage sweep: auto and manual (pause), up/down step in manual (pause) mode. Sweep abort standard.

Operating Parameter Setting Ranges

Start voltage and stop voltage: 0 – $\pm 10.00 \text{V}$, 0.01 V steps; 0 – $\pm 100.0 \text{V}$, 0.1 V steps

Step voltage: 0 – $\pm 10.00 \text{V}$, 0.01 V steps; 0 – $\pm 100.0 \text{V}$, 0.1 V steps

Hold time: 0 – 199.9 seconds in 0.1 s increments; 0 – 1999 seconds in 1.0 s increments

Step delay time: 0 – 10.00 seconds in 0.01 s increments; 0 – 100.0 seconds in 0.1 s increments

Ramp rate (dV/dt): 0.001 V/s – 1.000 V/s in 0.001 V/s increments

Accuracy (at 23°C ± 5°C)

Output voltage: $\pm 10 \text{V}$, $\pm(0.07\% + 11 \text{mV})$; $\pm 100 \text{V}$, $\pm(0.09\% + 110 \text{mV})$

Linearity: typically 0.5%, 0 – $\pm 10 \text{V}$; < 5%, > 10 V.

Current limit: 100 μA , 1 mA and 10 mA, $\pm 10\%$ (V_A and V_B)

Output terminals: BNC; L-GND

Reference Data

Current Measurement

Current Measurement Accuracy*

Range	Integration Time	
	Short	Medium
$10^{-2} - 10^{-8}$	0.5 + 3	0.5 + 2
10^{-9}	0.5 + 3	0.5 + 3
10^{-10}	2 + 4	2 + 3
10^{-11}	5 + 10	5 + 4
10^{-12}	5 + 20	5 + 10

* ± (% of rdg. + counts), 23°C

Current ranging times*: 20 ms to 7.76 s. (longer ranging time needed for large changes in input signal level, especially on lowest current ranges).

*When FILTER is on, current ranging time increases 60 ms (50 Hz power line) or 50 ms (60 Hz power line)

Warm-up time: ≥ 1 hour

Common mode rejection ratio: ≥ 120 dB (≤ 2 counts)

Analog Output I, C and V_A

Accuracy: $\pm(0.5\% + 20 \text{mV})$

Low pass filter: 3 position: OFF, 0.22 s ± 20% and 1 s ± 20% applied to both V_A and I/C data outputs

Pen lift output: TTL low level (≤ 0.8V) during sweep period in I-V and C-V functions

Recorder output scaling: pushbutton scaling of lower left and upper right limits of X-Y recorder

HP-IB Interface

Remote controlled functions: measurement function, current range, integration time, I data output trigger, voltage sweep controls, current limit, V_A and V_B voltages, zero (offset), self test and parameter settings (voltages, sweep/hold/delay times)

Data Output

Measured data (I, C and V_A),

Voltage setting (V_A and V_B),

Parameter settings

General Information

Power: 100, 120, 220, V ± 10%, 240 V + 5% – 10%; 48-66 Hz, 135 VA max

Size: 426 mm W x 177 mm H x 498 mm D (16.5" x 7" x 19.6").

Weight: 14.4 kg (31.7 lb)

Accessories Furnished

HP 16053A test leads: consists of one triaxial cable, two each BNC-BNC cables and one connection plate with mating female panel-mount connectors. Cables are one meter in length.

HP 16055A test fixture: for general device measurements. Provides electrostatic and light shielding for stable pA measurements.

Accessories Available

HP 16054A connection selector: provides a simple method to select appropriate connection of low lead for the pA meter section.

HP 16056A current divider (10:1): for use only on the 10 mA range to extend the measurement capability to 100 mA.

Ordering Information

Accessories

HP 16054A Connection Selector

\$350 ☞

HP 16056A Current Divider (10:1)

\$190 ☞

Options

Opt 907 Front Handle Kit (HP P/N 5061-0090)

\$65

Opt 908 Rack Flange Kit (HP P/N 5061-0078)

\$35

Opt 909 Rack & Handle Kit (HP P/N 5061-0084)

\$90

Opt 910 Extra Manual

\$47

HP 4140B pA Meter/DC Voltage Source

\$9,500

☞ Fast-Ship product — see page 766.

SEMICONDUCTOR TEST EQUIPMENT

DC SOURCE/MONITOR

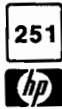

Model 4141B

- High speed measurements down to the pA range
- High reliability at low cost

- High accuracy and resolution
 $V: \pm 100\mu V - \pm 100V, 0.1\%$
 $I: \pm 50fA - \pm 100mA, 0.3\%$

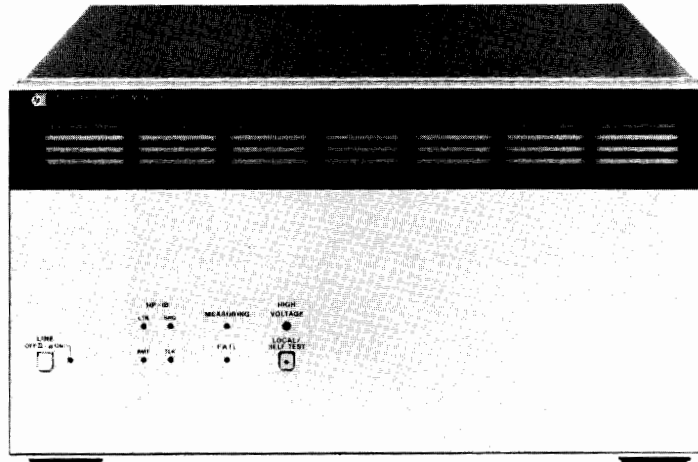

HP 4141B



Description

The HP 4141B DC Source/Monitor is designed for use as a system component in user-designed semiconductor I-V or DC parametric test systems. With its wide DC measurement range, high resolution, high-speed measurement capabilities, remote sensing, and high accuracy, the HP 4141B will contribute towards quality improvement and increased measurement throughput in the lab or on the production line.

High Speed Measurements with High Resolution

Four source/monitor units (SMU's) coupled with two voltage-source units (Vs's), two voltage monitor units (Vm's), and one ground unit (GNDU) make the HP 4141B equivalent to twenty one instruments. A stand-alone instrument capable of measuring dc parameters, the HP 4141B features high resolution measurements (50fA/100μV) and a built-in timing controller. Typical time for a current or voltage measurement, which includes data transfer, is approximately 25ms. A swept measurement (51 points) takes approximately 490ms. High accuracy and high speed measurements, especially in the low current range, are exclusive features of the HP 4141B.

High Reliability

The HP 4141B's high reliability significantly simplifies maintenance and reduces maintenance costs. To reduce system down time, the HP 4141B is designed for on-site service. Performance verification and diagnostics software for user troubleshooting is also available.

Specifications

Measurement Unit

Source and monitor units (SMU): 4 channels (Kelvin connection) Each SMU can be programmed to source voltage and monitor current, or conversely to source current and monitor voltage.

SMU Range, Resolution and Accuracy

Voltage range	Resolution	Accuracy	Max. Current
±20V	1mV	0.1% + 0.05%	100mA
±40V	2mV		50mA
±100V	5mV		20mA
Current Range	Resolution	Accuracy	Max. Voltage
±100mA	100μA	0.3% + (0.1 + 0.2 x Vout*/100)%	20V (I > 50mA)
			40V (20mA < I ≤ 50mA)
±10mA	10μA		100V (I ≤ 20mA)
±1000μA	1μA		
±100μA	100nA		
±10μA	10nA	0.5% + (0.1 + 0.2 x Vout*/100)%	
±1000nA	1nA		
±100nA	100pA		
±10nA	10pA	1% + (0.1 + 0.2 x Vout*/100)% + 5pA	
±1000pA	1pA **		

*Vout is the SMU output voltage, in volts.
 **Max. Measurement Resolution is 50fA.

1. Accuracy specifications are given as % of reading when measuring or % of setting when reading.
2. Accuracy tolerances are specified at 23°C ±5°C, after a 40-minute warm-up, with AUTO CAL on, and are specified at the rear panel connector terminals referenced to SMU common. Tolerances double for the extended temperature range of 10°C to 40°C.

Output/Measurement resolution: Voltage - 4½ digits
 Current - 4 digits

Voltage source units (Vs): 2 channels

Voltage Range, Resolution, and Accuracy

Output voltage range	Resolution	Accuracy	Max. Current
±20V	1mV	0.5% of setting + 10mV	10mA

Voltage monitor units (Vm): 2 channels

Voltage Range, Resolution and Accuracy

Measurement voltage range	Resolution	Accuracy
±2V	100μV	0.5% of reading + 10mV
±20V	1mV	0.2% of reading + 10mV

Ground Unit: 1 channel (kelvin connection)

Current range: ±500mA

General Specifications

Operating Temperature Range: +10°C to +40°C, ≤70%RH at 40°C. Permissible temperature change ≤1°C/5min, Maximum wet-bulb temperature is 29°C.

Power requirements: 100/120/220V ±10%, 240V-10%+5%, 48 to 66Hz, 240/VA max.

Dimensions: Approximately 426mm (16.77in)W x 235mm (9.25in)H x 612mm (24.1in)D

Weight: Approximately 19kg (41.5 lbs)

Accessories Furnished

HP 04085-61651 Interconnect Cable Assembly

HP 04141-60001 Connector Plate

HP 04145-61630 BNC Cable (3m) 4ea.

Accessories Available

HP 16058A Test Fixture

HP 16059A Adapter (Using with 16058A)

Price

\$2,450

\$600

Ordering Information

4141B DC Source/Monitor

Opt.001: Extra SMU Board

Opt.050/060: *50Hz/60Hz Line Frequency

*Must select Opt. 050 or 060 according to the power line frequency used.

Price

\$19,100

\$1,200

\$0



SEMICONDUCTOR TEST EQUIPMENT

1 MHz C Meter/C-V Plotter

Model 4280A

- Built-in sweepable dc bias source and timer for C-V (Capacitance-Voltage)/C-t (Capacitance-Time) measurements
- High speed C-t measurements with minimum measurement interval of 10 ms (10 μ s if an external pulse generator is used)
- Basic C measurement accuracy: 0.1%
- Test lead extension up to 5 m
- 5½-digit display resolution (option) for C measurement

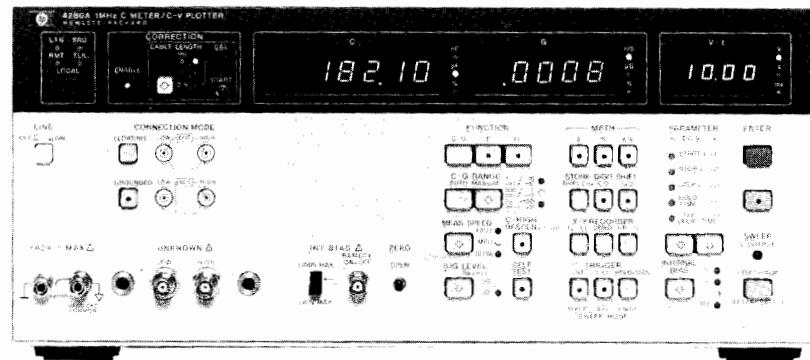

HP 4280A



Description

HP's 4280A 1 MHz C Meter/C-V Plotter measures the capacitance and conductance of semiconductor devices and materials as functions of applied voltage (C-V) or time (C-t). The HP 4280A consists of a precision 1 MHz C-G meter, a programmable dc bias source that can be swept in staircase fashion, and accurate timing control.

C-V and C-t Measurements

The HP 4280's internal dc bias source has a range of 0 V to ± 100 V with 1 mV resolution on the most sensitive range. Various measurement parameters for C-V and C-t measurements—hold time (bias pulse width) and delay time (measurement interval)—can be manually set from the front panel. Or these parameters can be set under program control via the HP-IB. Settable range for C-t measurement interval is 10 ms to 32s with a best case resolution of 10 μ s. If an external pulse generator is used, however, measurement intervals as short as 10 μ s can be set. Up to 9999 readings can be set for a C-t measurement. These capabilities make it possible for the HP 4280A to measure the C-t characteristics of virtually any device.

High Speed C-t Measurement

A special sampling integration technique employed in the HP 4280A provides measurement intervals as short as 10 μ s using an external pulse generator, such as the HP 8112A or HP 8160A, to provide the bias pulse. Short measurement interval makes the HP 4280A applicable to Deep Level Transient Spectroscopy (DLTS) measurements, which are commonly used to analyze the physical characteristics of semiconductors.

Precision, High Resolution Measurements

The HP 4280A measures capacitances up to 1.900 nF, over three ranges, with 0.001 pF resolution on the most sensitive range. Conductance up to 12 mS can be measured with a maximum resolution of 10 μ S.

C and G measurements are made at 1 MHz. AC signal level is selectable between 10 mVrms or 30 mVrms, suitable for semiconductor measurements. Basic measurement accuracy is 0.1%. Maximum display resolution is 4½ digits. With Option 001, however, display resolution for capacitance is 5½ digits.

The accuracy and resolution of the HP 4280A satisfy the stringent requirements of laboratory and R and D measurements, which require the detection of minute changes in device characteristics.

Probed Measurements On Wafers

HP's 4280A has an automatic error correction function that makes

it possible to use test leads up to 5 m long (HP P/N 8120-4195). The HP 4280A can measure either floating or grounded devices. Thus, the HP 4280A can be connected to a wafer prober and still provide stable, accurate C and G measurements.

Easy, Low Cost Systemization

HP-IB is standard on the HP 4280A. So, a process evaluation system or a lab automation system capable of evaluating the physical characteristics of semiconductor devices can be easily constructed.

The HP 4280A is equipped with analog outputs to allow users to plot device characteristics on an X-Y recorder or large screen display.

Specifications (refer to data sheet to complete specifications)

Measurement functions: C, C-V and C-t

Function		Available Internal dc Bias Function
Basic Function	Selection	
C	C only, G only C-G only	OFF, \equiv (DC)
C-V	C-V G-V C & G-V	
C-t	C-t G-t C & G-t	, \equiv (DC), OFF

C Measurement

Test Signal

Frequency: 1 MHz $\pm 0.01\%$

OSC level: 30 mVrms or 10 mVrms $\pm 10\%$

Measurement terminals: two-terminal-pair configuration (High, Low and Guard).

Connection mode: sets connection configuration between DUT (floating/grounded) and measurement circuit.

Ranging: auto or manual

Error Compensation

Cable length: 0 m, 1 m or 0-5 m. The standard cable (HP P/N 8120-4195) up to 5 m can be internally compensated.

Zero open: compensate stray capacitance and conductance at the test fixture.

External error compensation: compensate errors by external computer to eliminate other error factors not listed above.

Measurement speed: FAST, MED or SLOW

Trigger: Internal, External or Hold/Manual

Internal dc bias mode: OFF or \equiv (DC)



Measurement Range/Resolution/Accuracy

Range ¹	Resolution ²	Max. Display ³	Accuracy ⁴ ±(% of rdg + counts)	
			OSC: 30 mV	OSC: 10 mV
10 pF/100 μS	0.001 pF 0.01 μS	19,000 pF 120.00 μS	±(0.1% + 5) ±(0.2% + 5)	±(0.2% + 5) ±(0.3% + 5)
100 pF/1 mS	0.01 pF 0.1 μS	190.00 pF 1.2000 mS	±(0.1% + 3) ±(0.2% + 3)	±(0.2% + 3) ±(0.3% + 3)
1 nF/10 mS ⁵	0.1 pF 0.001 mS	1.9000 nF 12.0000 mS	±(0.1% + 3) ±(1.2% + 3)	±(0.2% + 3) ±(1.2% + 3)

¹ 100 pF/1 mS and 1 nF/10 mS ranges only in grounded measurement.

² When measurement speed is set to FAST (10 mV/30 mV) or MED (10 mV), resolution and Max. display become 1 digit less (3½ digit display).

³ Approx. 50 pF at 100 pF/1 mS range and 1.76 nF at 1 nF/10 mS range in grounded measurement. Error correction to offset residuals will reduce maximum value which can be measured.

⁴ Accuracy is specified at UNKNOWN terminals and at the end of HP 16082A Test Leads (1 m) after warm-up ≥30 min., at temperature 23°C ±5°C, zero open calibration is performed, and CORRECTION is enabled. Front panel settings are C-G, FLOATING and 0 m or 1 m (CABLE LENGTH). Some errors will be added at other settings (refer to data sheet). C accuracy is specified when D < 0.05 and G accuracy is specified when counts of C < 1/100 of range. Error double at 0°C-55°C.

⁵ Add 0.1% of rdg for C and 0.2% of rdg for G when HP 16082A is used.

C-V Measurement

Function: measures C-V, G-V or C & G-V characteristics using internal staircase bias.

Measurement speed: FAST, MED or SLOW

C-t Measurement

Function: measures C-t, G-t or C & G-t characteristics using internal and/or external pulse bias source.

Internal measurement mode: Burst or Sampling Mode automatically selected.

Burst mode: apply one pulse then make repetitive measurement with specified time interval between measurements.

Sampling mode: repeated pulse with single samples between pulses. Delay between application of measure voltage and sample can be specified.

Measurement speed: FAST or MED

DC Bias Source

Output Mode: , , ,  (DC) or OFF

Output Voltage Range/Resolution/Accuracy

Voltage Range	Resolution	Accuracy* ±(% of setting + volts)
±1.999 V	1 mV	±(0.2% + 0.01 V)
±19.99 V	10 mV	±(0.1% + 0.02 V)
±100.0 V	100 mV	±(0.1% + 0.1 V)

*at 23°C ±5°C, at 0°C -55°C error doubles

Staircase Sweep Parameter Settings (C-V Basic Function Only)

Start/stop voltage: 0 V-±100 V (max. 1 mV resolution)

Step voltage: 0 V-200 V (max. 1 mV resolution)

Hold/step delay time (th/td): 3 ms-650s (max. 1 ms resolution)

Pulse Bias Parameter Settings (C-t basic function only)

DC/pulse/measurement voltage: 0 V-±100 V (max. 1 mV resolution)

Number of readings: 1-9999

Hold time (th): max. 10 μs resolution

Internal bias: 10 ms-32 s

Ext bias slow: 50 μs-32 s

Ext bias fast: 10 μs-32 s

Delay time (td): 10 μs-32 s (max. 10 μs resolution)

Burst Mode

Function	Meas. Speed	Block Mode	Non Block Mode	
			Data Format	
			Binary	ASCII
C-t G-t	FAST	10 ms-32 s	20 ms-32 s	150 ms-32 s
	MED	50 ms-32 s		200 ms-32 s
C & G-t	FAST			100 ms-32 s
	MED			

Sampling Mode

Ext bias slow: 200 μs-5 s

Ext bias fast: 10 μs-5 s

Math functions: displays measured C/G values as differential values (Δ), % ratio (%) or differential % (Δ%) of the reference value.

Other

HP-IB: not just IEEE-488, but the hardware, documentation and support that delivers the shortest path to a measurement system.

Data output format: ASCII or Binary

Block mode output: can make C-V/t characteristics measurement and store measured data (C-V/t or G-V/t Function: 680 data, C & G-V/t Function: 400 data) into the internal data buffer. Then, packed data can be output.

Recorder Output

Output voltage: ±10 V for C, G and V/t data

Accuracy: ±(% of output voltage + V)

C or G: ±(0.5% + 20 mV)

V or t: ±(0.15% + 40 mV)

Self test: verifies normal measurement operations (not including calibration)

Options

Option 001: High Resolution Offset Capacitance Measurement

Function: increase C measurement resolutions by one digit with offset reference value.

C offset range: 0 pF-1023 pF (1 pF increment). C offset value can be set by measured data or numeric key.

General Specifications

Operating temperature range: 0°C to 55°C; 95% RH at 40°C

Power requirements: 100/120/220 V ±10%, 240 V + 5% - 10%; 48 to 66 Hz; 140 V A max.

Dimensions: 426 mm W x 177 mm H x 498 mm D (16.5" x 7" x 19.5")

Weight: 15.3 kg (33.7 lb)

Accessories Furnished

HP 16080A: Direct Coupled Test Fixture

Reference Data

Measurement Time

MEAS SPEED	Measurement Function					
	C-G		C		G	
FAST	30	(70)	10	(30)	10	(30)
MED	70	(110)	40	(60)	35	(55)
SLOW	400	(440)	270	(290)	220	(240)

When measured values are displayed on the front panel and the recorder outputs are used, measurement times in parentheses apply.

Residual L-R compensation: error compensation for residual L-R (max. 19 μH/190 Ω) is available using an external controller.

Internal DC Characteristics of High and Low Unknown Terminals (Without DC Bias)

Maximum offset voltage: ±1 mV

Maximum allowable current: 100 mA

Internal DC Bias

Settling time (99.9% of final value): 0.05 × voltage swing (V) + 1.7 (ms)

Maximum output current: ±6 mA

Hold time/step delay time/th/td: 0.02% (basic accuracy)

Response time of the EXT SLOW bias circuit (99.9% of final value): 100 μs

Option 001

C offset accuracy: ±(2% of reference value + 0.5 pF) can be compensated by CORRECTION ENABLE key.

Ordering Information

Opt 001 C-High Resolution (not field installable)

HP 16081A Test Leads, 2 m double shielded, BNC

HP 16082A Test Leads, 1 m, BNC

HP 16083A Pulse Bias Noise Clipper

Price

\$390

\$700

\$230

\$360

HP 4280A 1 MHz C Meter/C-V Plotter

\$9500

☎ Fast-Ship product — see page 766.



SEMICONDUCTOR TEST EQUIPMENT

Parameter Extraction Software

Model 94445A, 94401A

- Shortens IC design time
- Improves circuit designs
- Lowers chip costs
- Maximizes yields
- Accurate circuit simulations
- Device AC and DC measurements

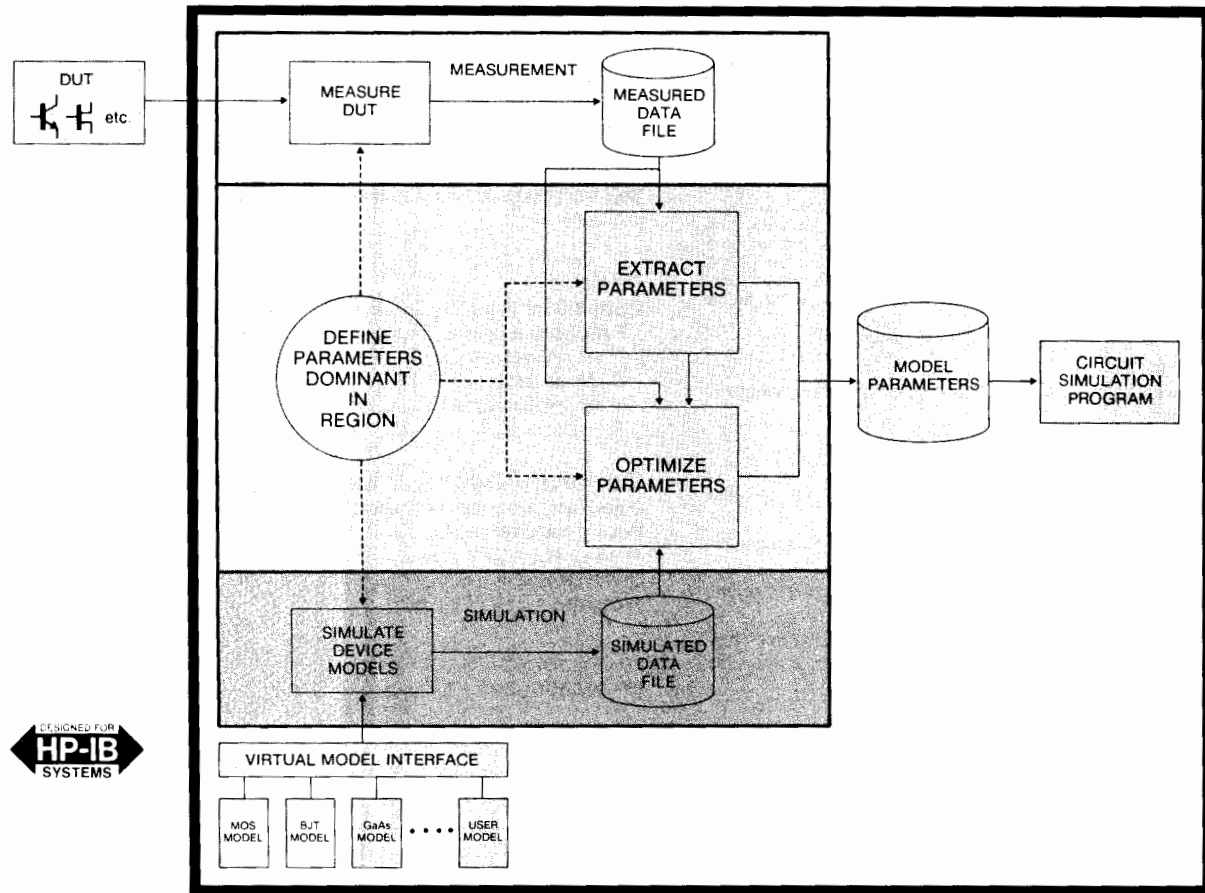

TECAP automatic parameter extraction methodology

TECAP Lets You Design New IC's in Less Time - With Less Cost

Hewlett-Packard's TECAP characterization System shortens your IC design runs and lowers design costs. TECAP - Transistor Electrical Characterization and Analysis Program - provides fast, reliable analysis of device behavior. Model parameters generated with the TECAP system will improve your circuit simulation and IC designs.

TECAP provides engineers with a complete system for device characterization. The easy-to-use display environment and extensive set of calibration and measurement drivers streamlines data collection. Simple commands allow you to quickly extract model parameters from measured data. Integrated, powerful simulation tools allow you to perform real-time analysis of your device performance.

Design IC's and New Devices Faster

TECAP lets you perform your design revisions using CAE analysis. Because this is more economical and much faster than multiple fabrication runs, you save valuable engineering and production resources. Accurate model parameters form the foundation for error-free circuit simulation and precise IC design. TECAP's integrated measurement, extraction, and simulation tools provide you with accurate model parameters in seconds. Because you can now begin wafer fabrication with a superior design, you minimize passes through the fab line, slash your design cycles, and deliver products to your customers in a timely manner.

Develop and Understand New Device Models

You can implement your own transistor models into TECAP to be completely compatible with proprietary circuit simulation programs or emerging new semiconductor technologies. You can use the versa-

tile simulation tools to develop and test new model equations. TECAP gives you the immediate feedback you need to evaluate and understand equation behavior. TECAP replaces pages of batch printouts with vivid, colorful graphics so you may clearly visualize the effects of model parameters and complex, multi-order equations.

Get Maximum Performance From Your Process

TECAP allows you to significantly improve the performance of your existing IC process. With TECAP, you can determine those parameters which have the greatest effects on performance measures such as speed, power, and logic levels. Using TECAP's statistical tools, you can accurately determine worst case performance of your process using those dominant parameters. TECAP gives you the vehicle to construct worst case models which will allow you to increase the performance of your process with minimal process development and lower cost.

TECAP Extracts Model Parameters in Seconds

TECAP can automatically extract UCB Level 2, 3 MOS and Gummel-Poon bipolar model parameters in seconds. These models, developed at the University of California, Berkeley, can simulate second-order effects such as channel-length modulation and offer direct compatibility with the UCB SPICE 2G.6 circuit simulator.

TECAP can also extract parameters for your new transistor models. Newly implemented models have the same parameter extraction, optimization, and simulation capabilities as standard TECAP models. You can even add a custom extraction module to the program to fully automate parameter extraction for your model.



TECAP is Easy to use

TECAP provides both ease-of-use for the occasional user and advanced features and capabilities for the expert user. You can access any TECAP command from one convenient menu - so don't get lost in menu hierarchies. The "main menu" always displays program status to keep you updated on program action. These human-engineering features have been designed into TECAP to automate the process of parameter extraction and new model development.

To measure a device, extract model parameters, or simulate device performance, you select the appropriate command. If the system needs more information from you, it will supply a diagram or table for you to edit. Every table is already furnished with default values or configurations. The table entry method allows you to have immediate access to all of your characterization routines - this lets you use the design tools more productively.

Integrated System Saves Time

TECAP's integrated environment lets you concentrate on evaluating results, so you don't waste time figuring out how to get them. You can measure devices, extract parameters, simulate device models, and plot results all with the same program.

TECAP minimizes setup preparation time so each user can immediately begin extracting parameters from their devices. For example, you can save a complete system environment on a disc and use it in seconds. You can retrieve instrument setups, extraction routines, and device models with a single command. You can create system configurations for every process in your company. You can quickly setup an environment to perform characterization on NMOS, CMOS, bipolar, or GaAs devices - using the SAME system.

You can operate the TECAP system without knowledge of the computer hardware, the computer operating system, or the measurement instruments. The system automatically adapts to handle all the instrument setups and measurements you need for device characterization. To give you maximum flexibility, the software lets you control a wide variety of measurement and computation hardware.

TECAP Specifications

Operating System: Pascal 3.1 Language System.

Media: 3.5 in. double-sided microfloppy or 5.25 in. minifloppy.

Memory Required: 3 Megabytes.

Data Space: up to 18,432 measured and simulated data points.

Measurement: voltage, current, capacitance, and 2-port AC parameters vs. bias and frequency.

Extraction: Interactive Parameter Extraction and Parameter

Optimization:

- Levenberg-Marquardt algorithm for non-linear, least-squares fit
- constrained optimization
- simultaneous optimization of up to 15 parameters for a set of 1024 data points, maximum
- compatible with user-defined models

Pre-Defined Parameter Extraction and Parameter Optimization:

- direct extraction from measured data
- automatic optimization of model parameters

UCB Level 2,3 MOSFET Models:

- classical parameters
- short-channel parameters
- narrow-width parameters
- saturation parameters
- external resistance
- junction capacitances

UCB Bipolar Model:

- external resistances
- forward and reverse Early voltages

- forward and reverse Gummel parameters
- junction capacitances
- AC parameters

Simulation: voltage, current, capacitance, and 2-port AC parameters vs. bias and frequency:

- eight nodes maximum (4 device terminals plus 4 series resistances) available models:

UCB MOS Level 1,2,3

UCB Bipolar

Curtice GaAs MESFET

Yaeger-Dutton GaAs HEMT

UCB JFET

Diode

PN Junction Capacitance

MOS Gate Capacitance

Classical MOS

compatible with user-defined models interactive simulation

User Customization:

User-Definable Models.....	6 max
User-Definable Instruments.....	8 max
User-Definable Switch Matrix.....	1 max
User-Definable Prober.....	1 max
User-Definable Commands.....	15 max
User-Definable Macros.....	14 max

Benchmark Data: ALL TIMES ARE TYPICAL USING HP 9000 Series 300, HP 4141B, HP 4280, and HP 8753A.
ALL TIMES ARE IN SECONDS.

		Measurement	Extraction	Extraction & Optimization
MOS (Level 2)	DC(1)	18.5	3	77
	CV(2)	11	1	4.5
MOS (Level 3)	DC(1)	18.5	3	50
	CV(2)	11	1	4.5
BJT	DC(3)	19.5	8.5	165
	CV(4)	32	3	15
	AC(5)	257	19	266
GaAs	DC	6	-	60
	CV	5	-	-

(1) extracting 13 DC parameters to model different geometry devices

(2) extracting 4 CV parameters

(3) extracting 16 DC parameters (forward & reverse)

(4) extracting 9 CV parameters

(5) extracting 9 AC parameters

For benchmark information on your process, contact your HP Field Sales Representative for details (see page 769)

Ordering Information

Please call your local HP Sales Office listed on page 769 for a data sheet or applications assistance.

TECAP Software

HP 94445A TECAP Software (DC & C-V Analysis) \$20,000

or

Opt 001 TECAP Software (AC Analysis) \$12,500

HP 94401A TECAP Software (AC Analysis ONLY - \$15,000
must have HP 94445A TECAP Software)

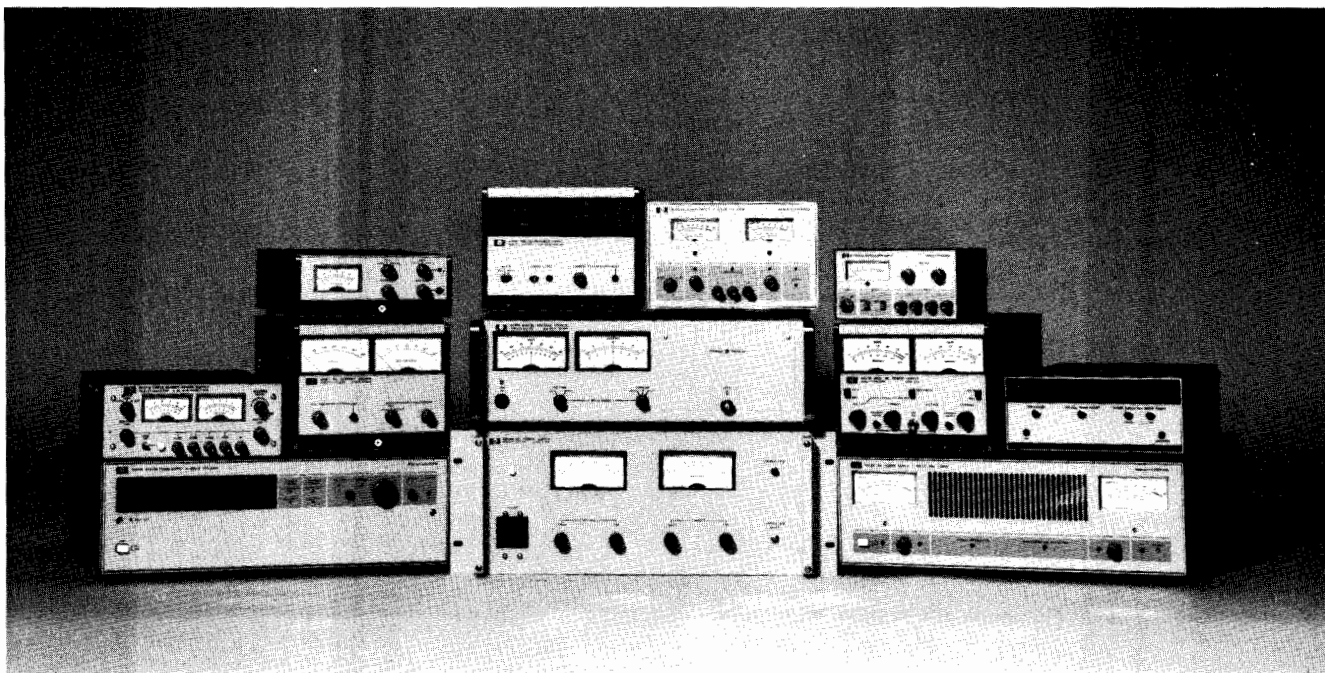

Introduction

Hewlett-Packard's extensive variety of power supplies serve a wide range of applications. For circuit and device development, there are laboratory supplies. For industrial needs, there are high power units. The HP-IB power sources manufactured by Hewlett-Packard are used in automated systems, and OEM Modular Power Supplies are designed for incorporation into other products. Through technological innovations, Hewlett-Packard strives to offer advanced capabilities, high reliability, and good value in both system and bench power supply families.

Regulation Techniques

The regulation technique used in a power supply defines its performance specifications, size, and efficiency. HP power supplies are designed using one of four proven regulation techniques: Series, SCR, SCR preregulator/series regulator, and switching.

Series regulation: this technique exhibits good regulation, low ripple and noise, and fast transient response. However, it is relatively inefficient. This results in greater power usage, large size, and more generated heat than the other methods. For this reason, series regulation is most useful for lower power units. These power supplies are used in laboratory and test applications, where stable, precise, dc power is needed.

SCR regulation: this technique is more efficient than series regulation, so the power supplies have lower power usage, smaller heat sinks, and less generated heat. However, the regulation (PARD ripple and noise) and transient response specifications are better with series regulation than with SCR regulation. Power supplies with SCR regulation are especially useful for high power industrial applications where fine regulation is not necessary and the lower cost/watt is important.

SCR preregulation/series regulator: this technique combines the best qualities of series and SCR regulation. As can be seen in the table, the operating specifications are much better than with SCR regulation. SCR preregulation does not detract from the excellent characteristic of series regulation, except for slower transient response. The efficiency is higher than that with series regulation, but not quite as high as with SCR regulation alone. These power supplies are used in laboratory and test applications similar to those of series regulated power supplies but at power levels greater than 75 watts.

Switching regulation: this technique provides high efficiency and operating specifications similar to series regulation (see table). These power supplies also tend to be small and lightweight.

Example Power Supply Comparison for a 40 V, 25 A, 1000 Watt Application

Regulation Technique	HP Model Number	PARD (ripple and noise) rms/p-p	Load Effect	Load Transient Recovery	Typical Efficiency
Series with SCR preregulation	6268B 40 V @ 30 A	1 mV/5 mV	.01% + 200 μ V (4.2 mV at 40 V)	50 μ s, 10 mV	60%
Switching (autoranging)	6012A 60 V @ 50 A	5 mV/50 mV	.01% + 5 mV (9 mV at 40 V)	2 ms, 100 mV	75%
SCR	6434B 40 V @ 25 A	40 mV/500 mV	40 mV	200 ms, 200 mV	70%

Selecting a Power Supply

The tables on the next few pages list the dc power supplies in this catalog in output voltage order. For manual power supply operation, simply find those power supplies that correspond to the appropriate voltage and current levels and turn to the listed page numbers for further information.

For operation in an automatic system, power supplies must be chosen which can be controlled by the method you intend to use in your system, following the information in the tables.

HP-IB control usually provides the greatest level of system capability. The HP 59501B (page 277) is a special, isolated DAC which is used to configure many models into HP-IB systems. The Multiprogrammer (page 172) is a computer-controllable instrument subsystem that can be configured to provide power supply programming and many other system functions, including digital inputs and outputs, A/Ds, DACs, and event sensing.

New 1986/87 Power Supply Catalog



For more details concerning Hewlett-Packard power supplies, ask your HP sales representative for a *DC Power Supply Catalog*, or fill in the card at the back of this catalog.





Voltage Rating Index with remote control selection guide*

Multiple Output Systems Power Supplies: HP-IB Controlled Output Ratings and Combinations

Output Channel		Model and Number of Outputs per Model			
Hi Range/ Low Range VOLTS	Hi Range/ Low Range AMPS	HP 6624A 4 OUTPUT	HP 6623A 3 OUTPUT	HP 6622A 2 OUTPUT	HP 6621A 2 OUTPUT
0-20 0-7	0-2 0-5	2	1	-	-
0-50 0-20	0-0.8 0-2	2	1	-	-
0-20 0-7	0-4 0-10	-	1	-	2
0-50 0-20	0-1.6 0-4	-	-	2	-

See page 272 for full description and specifications

Voltage Rating Index with remote control selection guide

Max. Volts (DC)	Max. Amperes (DC)	Type	HP Model	Page	GSA	Remote Control Methods*										Remote Readback Methods for Output Voltage Current and Status			
						for Output Voltage					for Output Current					Direct	Multiprogrammer*	HP-IB	
						Resistance	Voltage	HP 59501B*	Multiprogrammer*	HP-IB	Resistance	Voltage	HP 59501B*	Multiprogrammer*	HP-IB				
6	1	Triple Output (6, ±18 V)	6235A	262	•														
6	2.5	Triple Output (6, ±20 V)	6236B	262	•														
6.7	30	Autoranging	6023A	266		•	•	•	•		•	•	•	•		•	•		
6.7	30	HP-IB Autoranging	6033A	274		•	•	•		•	•	•	•		•			•	
7	120	Autoranging	6011A	266		•	•	•	•		•	•	•	•		•	•		
7	120	HP-IB Autoranging	6031A	274		•	•	•		•	•	•	•		•			•	
7.5	5	CV/CC	6281A	264	•	•	•	•	•		•	•	•	•					
8	1000	CV/CC	6464C	270	•	•	•	•	•		•	•	•	•					
±10	0.01	HP-IB DAC	59501B	277	•					•									
10	1	CV/CC	6214B	261	•														
10	10	CV/CC	6282A	264	•	•	•	•	•		•	•	•	•					
10	50	CV/CC	6259B	268	•	•	•	•	•		•	•	•	•					
10	100	CV/CC	6260B	268	•	•	•	•	•		•	•	•	•					
15	15.9	Autoranging	6023A	266		•	•	•	•		•	•	•	•		•	•		
15	15.9	HP-IB Autoranging	6033A	274		•	•	•		•	•	•	•		•			•	
15	71	Autoranging	6011A	266		•	•	•	•		•	•	•	•		•	•		
15	71	HP-IB Autoranging	6031A	274		•	•	•		•	•	•	•		•			•	
15	200	CV/CC	6453A	270	•	•	•	•	•		•	•	•	•					
16 or 18	600 or 500	CV/CC	6466C	270	•	•	•	•	•		•	•	•	•					

* An option may be required to program with the specified method.

POWER SUPPLIES

Voltage Rating Index with remote control selection guide* (Cont.)

Max. Volts (DC)	Max. Amperes (DC)	Type	HP Model	Page	GSA	Remote Control Methods*										Remote Readback Methods for Output Voltage Current and Status			
						for Output Voltage					for Output Current					Direct	Multiprogrammer*	HP-IB	
						Resistance	Voltage	HP 59501B*	Multiprogrammer*	HP-IB	Resistance	Voltage	HP 59501B*	Multiprogrammer*	HP-IB				
18	1	Triple Output (18, ±20 V)	6237B	262	•														
18	0.2	Triple Output (6, ±18 V)	6235A	262	•														
20	0.5	Triple Output (6, ±20 V)	6236B	262	•														
20	0.5	Triple Output (18, ±20 V)	6237B	262	•														
20	0.6	Dual Outut (20, 20 V)	6205C	262	•	•	•	•	•	•	•	•	•	•	•				
20	1.5	CV/CC	6200B	261	•	•	•	•	•		•	•	•						
±20	±2	Bipolar PSA	6825A	279	•	•	•	•	•		•	•	•						
20	2	Precision Voltage	6114A	280	•	•	•	•	•		•	•	•	•					
20	3	CV/CC	6284A	264	•	•	•	•	•		•	•	•	•					
20	3	Dual Output (20, 20 V)	6253A	264	•	•	•	•	•		•	•	•	•					
20	10	Autoranging	6023A	266		•	•	•	•		•	•	•	•		•	•		
20	10	HP-IB Autoranging	6033A	274		•	•	•	•	•	•	•	•	•				•	
20	10	Autoranging	6024A	266	•	•	•	•	•		•	•	•	•		•	•		
20	10	CV/CC	6263B	268	•	•	•	•	•		•	•	•	•					
20	10	CV/CC	6286A	264	•	•	•	•	•		•	•	•	•					
20	20	CV/CC	6264B	268	•	•	•	•	•		•	•	•	•					
20	50	Autoranging	6011A	266		•	•	•	•		•	•	•	•		•	•		
20	50	HP-IB Autoranging	6031A	274		•	•	•	•	•	•	•	•	•				•	
20	50	Autoranging	6012B	266	•	•	•	•	•		•	•	•	•		•	•		
20	50	HP-IB Autoranging	6032A	274		•	•	•	•	•	•	•	•	•				•	
20	50	CV/CC	6261B	268	•	•	•	•	•		•	•	•	•					
25	0.2	Dual Output (25,25 V)	6234A	261	•														
25	0.4	CV/CC	6216B	261	•														
25	2	Dual Output (25, 25 V)	6227B	264	•	•	•	•	•		•	•	•	•					
30	1	CV/CL	6206B	261	•	•	•	•	•										
36	100	CV/CC	6456B	270	•	•	•	•	•		•	•	•	•					
36	300	CV/CC	6469C	270	•	•	•	•	•		•	•	•	•					
40	0.3	Dual Output (40, 40 V)	6205C	262	•	•	•	•	•		•	•	•	•					
40	0.75	CV/CC	6200B	261	•	•	•	•	•		•	•	•	•					
40	1	Precision Voltage	6114A	280	•	•	•	•	•		•	•	•	•					
40	1.5	CV/CC	6289A	264	•	•	•	•	•		•	•	•	•					
40	1.5	Dual Output (40,40 V)	6255A	264	•	•	•	•	•		•	•	•	•					
40	5	CV/CC	6266B	268	•	•	•	•	•		•	•	•	•					
40	5	CV/CC	6291A	264	•	•	•	•	•		•	•	•	•					
40	5.7	Autoranging	6024A	266	•	•	•	•	•		•	•	•	•		•	•		
40	10	CV/CC	6267B	268	•	•	•	•	•		•	•	•	•					
40	25	CV/CC	6434B	270	•	•	•	•	•		•	•	•	•					
40	30	Autoranging	6012B	266		•	•	•	•		•	•	•	•		•	•		
40	30	HP-IB Autoranging	6032A	274		•	•	•	•	•	•	•	•	•				•	

* An option may be required to program with the specified method.



Max. Volts (DC)	Max. Amperes (DC)	Type	HP Model	Page	GSA	Remote Control Methods*										Remote Readback Methods for Output Voltage Current and Status		
						for Output Voltage					for Output Current					Direct	Multiprogrammer*	HP-IB
						Resistance	Voltage	HP 59501B*	Multiprogrammer*	HP-IB	Resistance	Voltage	HP 59501B*	Multiprogrammer*	HP-IB			
40	30	CV/CC	6268B	268	•	•	•	•	•		•	•	•	•				
40	50	CV/CC	6269B	268	•	•	•	•	•		•	•	•	•				
50	0.2	CV/CC	6218B	261	•													
50	0.5	Precision Current	6177C	281	•	•	•				•	•	•					
50	0.8	Precision Voltage	6115A	280	•	•	•	•	•		•	•	•	•				
50	1	Dual Output (50, 50 V)	6228B	264	•	•	•	•	•		•	•	•	•				
±50	±1	Bipolar PSA	6824A	279	•	•	•	•										
±50	±1	Bipolar PSA	6826A	279	•	•	•	•			•	•	•					
±50	±1	Precision Voltage**	6130C	278	•					•					•			
50	4	HP-IB Autoranging	6002A	276	•	•	•	•		•	•	•	•		•			
±50	±5	Precision Voltage**	6129C	278	•					•					•			
60	0.5	CV/CL	6206B	261	•	•	•	•										
60	1	CV/CC	6294A	264	•	•	•	•	•		•	•	•	•				
60	3.3	Autoranging	6024A	266	•	•	•	•	•		•	•	•	•		•	•	
60	3.3	HP-IB Autoranging	6038A	274	•	•	•	•		•	•	•	•		•			•
60	15	CV/CC	6274B	268	•	•	•	•	•		•	•	•	•				
60	17.5	Autoranging	6012B	266	•	•	•	•	•		•	•	•	•		•	•	
60	17.5	HP-IB Autoranging	6032A	274	•	•	•	•		•	•	•	•		•			•
64	50	CV/CC	6459A	270	•	•	•	•			•	•	•					
64	150	CV/CC	6472C	270	•	•	•	•	•		•	•	•	•				
±100	±0.016	Precision Current**	6140A	278	•					•					•			
100	0.1	CV/CC	6212B	261	•													
100	0.25	Precision Current	6181C	281	•	•	•				•	•	•					
100	0.4	Precision Voltage	6115A	280	•	•	•	•	•		•	•	•	•				
±100	±0.5	Precision Voltage**	6131C	278	•					•					•			
±100	±0.5	Bipolar PSA	6827A	279	•	•	•	•			•	•	•					
100	0.75	CV/CC	6299A	264	•	•	•	•	•		•	•	•	•				
110	100	CV/CC	6475C	270	•	•	•	•			•	•	•					
120	2.5	CV/CC	6443B	270	•	•	•	•			•	•	•					
200	5	Autoranging	6010A	266		•	•	•	•		•	•	•	•		•	•	
200	5	HP-IB Autoranging	6030A	274		•	•	•		•	•	•	•		•			•
220	50	CV/CC	6477C	270	•	•	•	•			•	•	•					
300	0.1	Precision Current	6186C	281	•	•	•				•	•	•					
300	35	CV/CC	6479C	270	•	•	•	•			•	•	•					
320	0.1	CV/CC	6209B	261	•	•	•	•			•	•	•					
440	25	CV/CC	6483C	270	•	•	•	•			•	•	•					
500	20	CV/CC	6483C	270	•	•	•	•			•	•	•					
600	1.5	CV/CC	6448B	270	•	•	•	•			•	•	•					
600	15	CV/CC	6483C	270	•	•	•	•			•	•	•					

* An option may be required to program with the specified method.

**An HP 59301A ASCII to parallel converter is required to operate this source on the HP-IB.

POWER SUPPLIES

Power Supply Terms and Specification Definitions

Power Supply Terms

Ambient temperature: the temperature of the air immediately surrounding the power supply.

Auto-parallel operation: a master-slave connection of the outputs of two or more supplies used for obtaining a current output greater than can be obtained from one supply.

Autoranging power supply: a power supply that can provide maximum rated power over a wide range of voltage and current without external intervention to change range.

Auto-series operation: a master-slave connection of the outputs of two or more supplies used for obtaining a voltage greater than can be obtained from one supply.

Auto-tracking operation: a master-slave connection of two or more supplies each of which has one of its output terminals in common with one of the output terminals of all of the other supplies.

Complementary tracking: a master-slave interconnection of two supplies in which the voltage of the slave is equal to or proportional to that of the master and of opposite polarity with respect to a common point.

Compliance voltage: the output voltage of a power supply operating in the constant-current mode.

Constant-current (CC) power supply: a power supply that stabilizes output current with respect to changes in influence quantities. Thus, for a change in load resistance, the output current remains constant while the output voltage changes by whatever amount necessary to accomplish this.

Constant-voltage (CV) power supply: a power supply that stabilizes output voltage with respect to changes in influence quantities. Thus, for a change in load resistance, the output voltage remains constant while the output current changes by whatever amount necessary to accomplish this.

Constant-voltage/constant-current (CV/CC) power supply: a power supply that operates as a constant voltage power supply or a constant-current power supply depending on load conditions. It acts as a constant-voltage source for comparatively large values of load resistance and as a constant-current source for comparatively small values of load resistance.

Constant-voltage/current-limiting (CV/CL) power supply: a power supply similar to a constant-voltage/constant-current supply except that at comparatively small values of load resistance, its output current is limited instead of being stabilized.

Crowbar: see overvoltage protection.

Current limiting: the action of limiting the output current of a constant-voltage supply to some predetermined maximum value (fixed or adjustable) and automatically restoring the output voltage to its normal value when the overload or short circuit is removed. There are three types of current limiting: 1) by constant-voltage/constant-current crossover, 2) by decreasing the output voltage as the current increases, 3) by decreasing both voltage and current as the load resistance decreases (referred to as foldback or cutback current limiting).

Drift: the maximum change of an output voltage or current during an 8-hour period following a 30-minute warmup, with all influence and control quantities maintained constant during the warm-up time and the period of drift measurement. Drift includes both periodic and random deviations over the bandwidth from zero frequency (dc) to a specified upper frequency limit (usually 20 Hz).

Load effect: formerly known as load regulation, load effect is the change in the steady-state value of the stabilized output voltage or current resulting from a full-load change in the load current of a constant-voltage supply or the load voltage of a constant-current supply, with all other influence quantities maintained constant.

Load effect transient recovery time: the time interval between a specified step change in the load current of a constant-voltage supply (usually a full-load or 5-ampere change, whichever is smaller) or in the load voltage of a constant-current supply and the instant when the stabilized output quantity returns to and stays within the specified transient recovery band.

Master-slave operation: a method of interconnecting two or more supplies such that one of them (the master) serves to control the others (the slaves). The outputs of the slave supplies always remain equal to or proportional to the output of the master. The outputs of

the master supply and of one or more slaves may be connected in series, in parallel, or with just their negative or positive output terminals in common. (See also complementary tracking.)

Nominal value: the value that exists "in name only," not the actual value. For example, in the case of a power supply with a calibrated output control, the nominal value is the value indicated by the control setting. For a supply with a fixed output, the nominal output is the output indicated on the nameplate. The nominal value of a 120-volt \pm 10% line voltage is 120 volts.

Output impedance: the complex ratio of a sinusoidal voltage and sinusoidal current at the output terminals, the one being caused by the other and being of external origin.

Overcurrent protection: protection of the power supply and/or connected equipment against excessive output current.

Overtemperature protection: protection of the power supply or parts of it against temperatures exceeding specified values.

Overvoltage protection: protection of the power supply and/or connected equipment against excessive output voltage. Overvoltage protection is usually by means of a crowbar protection circuit, which rapidly places a low resistance shunt across the supply's output terminals to reduce output voltage to a low value if a predetermined voltage is exceeded. A supply equipped with an overvoltage crowbar must also be protected by a means of limiting or interrupting output current.

PARD (acronym for periodic and random deviation): the term PARD replaces the former term ripple and noise. PARD is the periodic and random deviation of a dc output voltage or current from its average value, over a specified bandwidth (20 Hz to 20 MHz) and with all influence and control quantities maintained constant.

Programming speed: the maximum time required for the programmed output voltage or current to change from a specified initial value (usually zero or maximum output) to a value within a specified tolerance band of a specified newly programmed value (for most models 99.9% or 0.1% of maximum output, respectively; 99% and 1% for the HP 6114A, 6115A, 6177C-6186C, and HP 6434B-6483C) following the onset of a step change in an analog programming signal, or the gating of a digital signal.

Remote control: also referred to as remote programming, remote control is the setting of the power supply voltage, current, or other function by means of an external control quantity such as a variable resistance, voltage, or current, or a digital signal.

Remote sensing: remote sensing, or remote error sensing, is a means by which a power supply monitors the stabilized voltage directly at the load using extra sensing leads. The resulting circuit action compensates for voltage drops in the load leads (up to a specified limit).

Resolution: for a bench supply, the smallest change in output voltage or current that can be obtained using the front panel controls. For a system supply, the smallest change that can be obtained using either the front panel controls or a computer.

Reverse voltage protection: protection of the power supply against reverse voltage applied at the output terminals.

Slave operation: see master-slave operation.

Source effect: formerly known as line regulation, source effect is the change in the steady-state value of the stabilized output voltage on current resulting from any change in the source voltage within its specified range, with all other influence quantities maintained constant. Source effect may be measured at any output voltage and current within rating.

Temperature effect coefficient: the maximum steady-state change in a power supply's output voltage or current per degree Celsius following a change in the ambient temperature within specified limits, with all other influence quantities maintained constant.

Voltage limiting: the action of limiting the output voltage of a constant-current supply to some predetermined maximum value (fixed or adjustable) and automatically restoring the output current to its normal value when the load conditions are restored to normal. There are two types of voltage limiting: 1) by constant-voltage/constant-current crossover, 2) by decreasing the output current as the voltage increases.

Warm-up time: the time interval after switching on a power supply until it complies with all performance specifications.

POWER SUPPLIES

Laboratory: Single & Multiple Output, 10W to 38W
Models 6200B-6218B and 6234A-6237B

261



- HP 6212B-6218B . . . 10 watts output
- Compact, impact-resistant stackable case
- Short-circuit proof

- HP 6200B-6209B . . . 30 watts output
- Auto series, parallel, and tracking
- Remote sensing

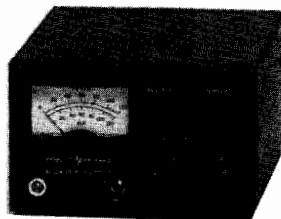

Single Output: HP 6212B-6218B



Single Output: HP 6200B-6209B

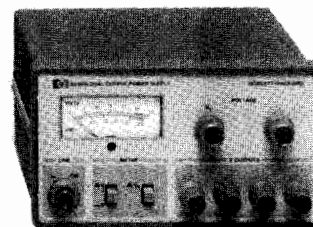

Dual Output: HP 6234A

Description—Single Output Models

Models 6212B-6218B

These popular low-cost CV/CC bench supplies are designed for general laboratory use and are equipped with front-panel mounted voltage and current controls, a combination volt/ammeter, and output binding posts. Output voltage and current are continuously variable, via coarse and fine controls from 0 to 15% above the maximum rated output. A switch selects either output voltage or current for display on the panel meter.

Load connections are made via three binding posts. Either the + or the - post may be grounded through an adjacent GND terminal or the supply may be operated floating at up to 300 volts above ground.

The supplies can also be operated as constant current sources with 500 μ A load regulation. All of these models can be connected in series or parallel.

The molded, impact-resistant case includes an interlocking feature for stacking several units vertically, thus minimizing bench space required for multiple supplies. Alternatively, up to three units can be mounted side by side in a 19" rack using Rack Mounting Kit HP 14521B. These supplies measure 86 H x 133 W x 368 mmD (3.40" x 5.25" x 8") and weigh 2 kg (4.4 lb).

Models 6200B-6209B

This series of low-cost bench supplies includes three models covering an output voltage range from 0–20 V to 0–320 V. All models are equipped with ten-turn voltage and current controls, (except the HP 6206B, which does not have a current control), volt/ampere meter, meter function/range switch, and front and rear output terminals. In addition, on the dual-range models (HP 6200B and 6206B), an output range switch permits the selection of either a high or a low output voltage range.

The constant voltage/current limiting supply, HP 6206B, is short-circuit protected by a fixed current limiting circuit which is activated at approximately 110% of rated load current. The current-limit point can be reduced by changing the value of a single internal resistor. For the constant voltage/constant current supplies, ten-turn current controls allow the current-limit point to be set to any value within the current rating. Using these controls the CV/CC supplies can also be operated as constant-current sources.

Units may be bench operated or rack mounted individually or in pairs using accessory rack mounting hardware.

All models in this group of supplies measure 89 H x 216 W x 317 mm D (3.50" x 8.50" x 12.50") and weigh 4.5 kg (10 lb).

Description—Dual Output Models

Model 6234A

Model 6234A is a low-cost, dual-output bench power supply with two independently adjustable and isolated power sources in one compact unit. Both of the dc power sources are of the constant voltage/current limit type with each output voltage being adjustable continuously over a 0 to 25 V range. The maximum current available per output is 0.2 A and is limited automatically to prevent overload.

The HP 6234A offers considerable flexibility to the user with output voltages that can be arranged to provide identical or different voltages in any polarity combination with respect to 0 or other common positive or negative voltage points. The outputs can also be connected in series to provide up to 50 V at 0.2 A. Both sources are fully isolated to permit either of the output terminals to be grounded.

With pushbutton switches, users can select either voltage or current for each output to be monitored on the unit's meter. Other features include two multiple-turn controls for precise voltage setting, regulation to 0.01%, and ripple and noise of less than 200 microvolts rms.

With dimensions of only 93 mm high, 157 mm wide and 210 mm deep (3.64" x 6.17" x 8.25"), the HP 6234A supply takes up a minimum amount of bench space. Its weight is 2.3 kg (5 lb). The unit can be powered from a 115 V or an optional 230 V, 47-63 Hz ac input, (Option 028).

Model 6205C

This low-cost bench supply is equipped with ten-turn output voltage controls, volt/ampere meter, meter function/ range switch, and front and rear output terminals. In addition, an output range switch permits the selection of either a high or a low output voltage range.

Model 6205C combines the versatility of a dual power supply with the flexibility of auto-parallel and auto-series operation to extend the output ratings of this supply to 20 V/1.2 A, 40 V/0.6 A, and 80 V/0.3 A. In addition, using the supply's auto-tracking capability, opposite



POWER SUPPLIES

Laboratory: Single & Multiple Output, 10W to 38W

Models 6200B-6218B and 6234A-6237B (cont.)

- Dual output to 24 watts
- Short-circuit proof
- Independent voltage controls

- Triple output to 38 watts
- Short circuit proof
- Tracking ± 20 volt outputs

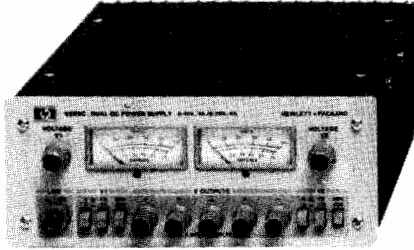

Dual Output: HP 6205C

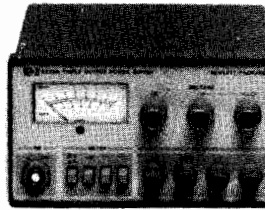

Triple Output: HP 6235A



Triple Output: HP 6236B, 6237B

polarity voltages (± 20 V, ± 40 V) can conveniently be obtained from this one supply.

This constant voltage/current limiting supply is short-circuit protected by a fixed current limiting circuit which is activated at approximately 110% of rated load current. The current-limit point can be reduced by changing the value of a single internal resistor. Units may be bench operated or rack mounted individually or in pairs using accessory rack mounting hardware.

Description—Triple Output Models

HP 6235A

This compact, low-cost, three-in-one power supply is a handy addition to the lab bench where single or multiple voltages are needed for designing and testing breadboards and prototypes. The HP 6235A delivers three adjustable dc output voltages: 0 to +6 V at 1 A, 0 to +18 V at 0.2 A, and 0 to -18 V at 0.2 A. A single 0 to 36 volt output at 0.2 A can also be obtained by connecting across the +18 V and -18 V terminals.

The controls, meter, and binding posts are conveniently arranged on the front panel. One voltage control simultaneously adjusts the +18 V and -18 V outputs, which track one another and can be used to power operational amplifiers and other circuits requiring balanced positive and negative voltages. The supply's dual outputs have added versatility with an adjustable tracking ratio control (TRACK) that can set the negative output to a lower voltage than the positive output. Once the tracking ratio control has established a voltage ratio between the positive and negative outputs, the ratio remains constant as the +18 V voltage control is adjusted. A third control sets the 0 to +6 V output voltage.

The supply is a constant voltage/current limit type with each output voltage continuously adjustable over its range, while the maximum current available is automatically limited to prevent overloading. The power supply's outputs share a common terminal and are isolated from chassis ground so that any output terminal can be grounded if desired. Each output voltage or current can be quickly selected and monitored with the push-button meter switches.

Model 6235A measures 89 H x 157 W x 210 mm D (3.5" x 6.17" x 8.25") and weighs 2.3 kg (5 lb).

HP 6236B and 6237B

Microprocessors, digital and linear integrated circuits, and displays used in lab development frequently require triple output power supplies for operating prototypes. The HP 6236B and 6237B are valued additions to the design bench due to their multiple output voltages, small size, ease of operation and application-related performance.

These compact constant voltage/current limiting supplies combine 0 to ± 20 V tracking outputs rated at 0.5 A with a single output rated at 0 to +6 volts at up to 2.5 A in the HP 6236B, and 0 to +18 volts at 1 A in the HP 6237B.

Controls, meters, and binding posts are logically arranged on a neatly laid out front panel. One voltage control simultaneously adjusts the 20 V and -20 V outputs, which track within 1% to power operational amplifiers and circuits requiring balanced voltages. A tracking ratio control can disable the 1:1 tracking feature and set the negative output to a lower voltage than that of the positive output. Once the tracking ratio control has established a voltage ratio between the positive and negative outputs, the ratio remains constant as the ± 20 V voltage control varies both outputs. Another voltage control sets the 0 to +6 V (HP 6236B) or 0 to +18 V (HP 6237B) output.

All outputs are protected against overload and short-circuit damage by fixed current limiting circuits. For any overload condition, the +20 V and -20 V outputs in both models are limited to 0.55 A and the +18 V output in the HP 6237B is limited to 1.1 A. The overload protection circuit for the +6 V output in the HP 6236B has a current foldback characteristic that reduces the maximum available current from about 2.75 A at a 6 V terminal voltage to 1 A at zero volts (or short circuited). This foldback limiting characteristic maximizes the available current in the important 5 to 6-volt range while minimizing dissipation during overloads.

Another protective feature safeguards sensitive load circuitry by preventing an output voltage overshoot when the supply is turned on or off.

Separate dual-range panel meters allow both the voltage and current of any output to be monitored simultaneously. A three-position switch selects the output which the meters will monitor.

Both models measure only 89 H x 216 W x 319 mm D (3.5" x 8.5" x 12.5") and weigh 4.3 kg (9.5 lb).



Specifications

RATINGS		PERFORMANCE							GENERAL	
DC Output		HP Model	Load Effect	Source Effect	PAR rms/p-p	Control Mode and Resolution	Remote Control Coefficients	Power 115 V ac ± 10%	Options	Price
Volts	Amps									
SINGLE OUTPUT—10 WATTS										
0-10	0-1	6214B	4 mV	4 mV	200 μV/1 mV	CV/CC 5mV/75μA	**	48-440 Hz 0.3 A, 28 W	28	\$370
0-25	0-0.4	6216B	4 mV	4 mV	200 μV/1 mV	CV/CC 5mV/20μA	**	48-440 Hz 0.3 A, 28 W	28	\$370
0-50	0-0.2	6218B	4 mV	4 mV	200 μV/1 mV	CV/CC 10mV/10μA	**	48-440 Hz 0.3 A, 28 W	28	\$370
0-100	0-0.1	6212B	8 mV	4 mV	200 μV/1 mV	CV/CC 20mV/10μA	**	48-440 Hz 0.3 A, 28 W	28	\$450
SINGLE OUTPUT—UP TO 30 WATTS										
Dual range 0-20 or 0-40	0-1.5 0-0.75	6200B	0.01% + 4 mV	0.01% + 4 mV	200 μV/1 mV	CV/CC 10 mV/2 mA	2000/V ± 1% 0.5 kΩ/A ± 10% or 1 kΩ/A ± 10%	48-440 Hz 0.9 A, 70 W	11, 28	\$650
Dual range 0-30 or 0-60	0-1 0-0.5	6206B	0.01% + 4 mV	0.01% + 4 mV	200 μV/1 mV	CV/CL 10 mV/*	3000/V ± 1%	48-440 Hz 1 A, 66 W	11, 28	\$650
0-320	0-0.1	6209B	0.02% + 2 mV	0.02% + 2 mV	1 mV/40 mV	CV/CC 40 mV/200 μA	3000/V ± 1% 150 kΩ/A ± 10%	48-63 Hz 1 A, 60 W	28	\$770
DUAL OUTPUT—10 WATTS										
Dual output 0-25 and 0-25	0.2 0.2	6234A	0.01% + 1 mV	0.01% + 1 mV	200 μV/1 mV	CV/CL	**	104-127 Vac 47-63 Hz 0.26A, 35 W	28	\$450
DUAL OUTPUT—24 WATTS										
Two dual ranges 0-20/0-40 and 0-20/0-40	0-0.6/0.3 0-0.6/0.3	6205C	0.01% + 4 mV	0.01% + 4 mV	200 μV/1 mV	CV/CL 10 mV/*	2000/V ± 1%	48-440 Hz 0.5 A, 50 W	11, 28 40	\$700
TRIPLE OUTPUT—13 WATTS										
Triple output 0 to 6 and 0 to 18 and 0 to -18	0-1 0-0.2 0-0.2	6235A	8 mV 10 mV 10 mV	8 mV 15 mV 15 mV	1 mV/5 mV 1 mV/5 mV 1 mV/5 mV	CV/CL	** ** **	47-63 Hz 0.26 A, 35 W	28	\$480
TRIPLE OUTPUT—35 WATTS*										
Triple output 0 to +6 and 0 to +20 and 0 to -20	2.5 0.5 0.5	6236B	0.01% + 2 mV	0.01% + 2 mV	350 μV/1.5 mV	CV/CL 70 mV/*	**	104-127 Vac 47-63 Hz 1.2 A, 112 W	100 120 220 240	\$700
TRIPLE OUTPUT—38 WATTS*										
Triple Output 0 to +18 and 0 to +20 and 0 to -20	1 0.5 0.5	6237B	0.01% + 2 mV	0.01% + 2 mV	350 μV/1.5 mV	CV/CL 70 mV/*	**	104-127 Vac 47-63 Hz 1.2 A, 112 W	100 120 220 240	\$700

*fixed current limit
**remote control not available
*ac input voltage option must be specified when ordering

Option Descriptions

011: internal overvoltage protection crowbar. Protects delicate loads against power supply failure or operator error. Dual output models have dual crowbars.

HP 6200B, 6206B
HP 6205C

add \$100
add \$200
NC

028: 230 Vac ± 10%, single phase input. Consists of reconnecting power transformer taps, and other components where necessary.

040: Multiprogrammer interface. Prepares HP 6205C power supplies for resistance programming by the HP 6940B or 6942A Multiprogrammer

add \$76

100: 87-106 Vac, 47-63 Hz, single phase input

NC

120: 104-127 Vac, 47-63 Hz, single phase input

NC

220: 191-233 Vac, 47-63 Hz, single phase input

NC

240: 208-250 Vac, 47-63 Hz, single phase input

NC

910: one additional operating and service manual is shipped with each power supply

HP 6200B-6237B

add \$5.10

Accessories

HP 14513A: rack kit for one HP 6200-6209B, 6236B, or 6237B supply

\$56

HP 14523A: rack kit for two of the above power supplies

\$30

HP 14521B: rack kit for one, two or three HP 6212B-6218B power supplies

\$85

☎ Fast-Ship product — see page 766.

POWER SUPPLIES

General Purpose: 25-200 W Output

Models 6227B-6299A

- Constant voltage/constant current operation
- Remote sensing and programming
- Auto-series, -parallel, & -tracking operation
- Front and rear output terminals
- Floating output—use as positive or negative source
- Bench or rack mounting

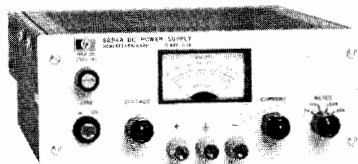

HP 6281A, 6284A, 6289A,
6294A, 6299A

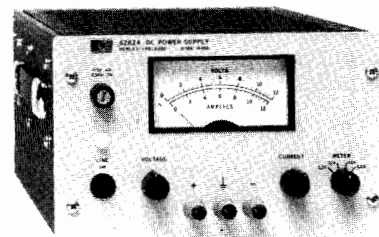

HP 6282A, 6286A,
6291A, 6296A

Description

HP 6281A-6299A Single Output

This series of medium-power constant voltage/constant current power supplies is available in two power ranges: 37-75 watts (packaged in 3½-inch high half-rack cases) and 100-200 watts (packaged in 5¼-inch high half-rack cases). All models except HP 6294A and 6299A have separate coarse and fine voltage and current controls that allow the voltage and current outputs to be varied from zero to the maximum rated values. The latter two models have ten-turn voltage controls. Crossover from constant voltage to constant current operation occurs automatically when the load current exceeds the value established by the current control settings. A four-position meter function switch selects either of two output voltage or output current ranges (X1, X0.1) for display on the panel meter.

The 37-75 watt models are of the series-regulated type. They have excellent regulation and ripple characteristics and include a special output-capacitor discharge circuit for improved programming speed. The 100-200 watt models employ a series-regulator/SCR-preregulator configuration to achieve the high efficiency necessary for a convection-cooled package of this size. They also have excellent regulation, low ripple and noise, and moderate programming speeds.

Specifications

RATINGS			PERFORMANCE							
DC Output		HP Model	Load Effect		Source Effect		PAR (rms/p-p)		Drift (stability)	
Volts	Amperes		Voltage	Current	Voltage	Current	Voltage	Current	Voltage	Current
0-7.5	0-5	6281A	5 mV	0.01% + 250 µA	0.01% + 2 mV	0.01% + 250 µA	200 µV/1 mV	4 mA rms	0.1% + 2.5 mV	0.1% + 12.5 mA
0-10	0-10	6282A	0.01% + 1 mV	0.05% + 1 mA	0.01% + 1 mV	0.05% + 1 mA	500 µV/25 mV	5 mA rms	0.1% + 2.5 mV	0.1% + 25 mA
0-20	0-3	6253A*	0.01% + 4 mV	0.01% + 250 µA	0.02% + 2 mV	0.01% + 250 µA	200 µV/1 mV	2 mA rms	0.1% + 2.5 mV	0.1% + 7.5 mA
0-20	0-3	6284A	0.01% + 4 mV	0.01% + 250 µA	0.01% + 2 mV	0.01% + 250 µA	200 µV/1 mV	2 mA rms	0.1% + 2.5 mV	0.1% + 7.5 mA
0-20	0-10	6286A	0.01% + 1 mV	0.05% + 1 mA	0.01% + 1 mV	0.05% + 1 mA	500 µV/25 mV	5 mA rms	0.1% + 2.5 mV	0.1% + 25 mA
0-25	0-2	6227B*	0.01% + 1 mV	0.01% + 250 µA	1 mV	100 µA	250 µV/4 mV	250 µA/2 mA	0.2% + 2 mV	0.2% + 3 mA
0-40	0-1.5	6255A*	0.01% + 2 mV	0.01% + 250 µA	0.01% + 2 mV	0.01% + 250 µA	200 µV/1 mV	500 µA rms	0.1% + 2.5 mV	0.1% + 4 mA
0-40	0-1.5	6289A	0.01% + 2 mV	0.01% + 250 µA	0.01% + 2 mV	0.01% + 250 µA	200 µV/1 mV	500 µA rms	0.1% + 2.5 mV	0.1% + 4 mA
0-40	0-5	6291A	0.01% + 1 mV	0.05% + 1 mA	0.01% + 1 mV	0.05% + 1 mA	500 µV/25 mV	3 mA rms	0.1% + 2.5 mV	0.1% + 12.5 mA
0-50	0-1	6228B*	0.01% + 1 mV	0.01% + 250 µA	1 mV	100 µA	250 µV/4 mV	250 µA/2 mA	0.2% + 2 mV	0.2% + 1.5 mA
0-60	0-1	6294A	0.01% + 2 mV	0.01% + 250 µA	0.01% + 2 mV	0.01% + 250 µA	200 µV/1 mV	500 µA rms	0.1% + 2.5 mV	0.1% + 2.5 mA
0-60	0-3	6296A	0.01% + 1 mV	0.05% + 1 mA	0.01% + 1 mV	0.05% + 1 mA	500 µV/25 mV	3 mA rms	0.1% + 2.5 mV	0.1% + 7.5 mA
0-100	0-0.75	6299A	0.01% + 2 mV	0.01% + 250 µA	0.01% + 2 mV	0.01% + 250 µA	200 µV/1 mV	500 µA rms	0.1% + 2.5 mV	0.1% + 2 mA

*Models 6227B, 6228B, 6253A, and 6255A contain two identical, independently-adjustable power supplies.

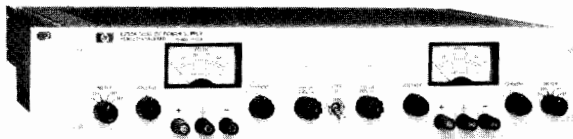

HP 6253A, 6255A



HP 6227B, 6228B

Each side of the dual supply can be operated as a constant voltage or constant current source, and each has its own crowbar for overvoltage protection. In the tracking mode, an overvoltage condition in either supply trips both crowbars. The power supply outputs are isolated up to 300 V from output to chassis or output to output.

Specifications—General

Load effect transient recovery: time, 50 μs; level, 15 mV.
Meter accuracy: 3% of full scale.
Power: standard input voltage is 115 V ac ± 10%. Order Option 028 for 230 V ac ± 10% operation. Input power frequency, maximum input current, maximum power consumption are:
 HP 6227B and 6228B, 48–63 Hz, 2.7 A, 260 W;
 HP 6253A, 48–440 Hz, 2.6 A, 235 W; HP 6255A, 48–440 Hz, 2.6 A, 235 W; HP 6281A, 48–440 Hz, 1.3 A, 118 W; HP 6282A, 57–63 Hz, 3.5 A, 200 W; HP 6284A, 48–440 Hz, 1.5 A, 128 W; HP 6286A, 57–63 Hz, 5.5 A, 320 W; HP 6289A, 48–440 Hz, 1.3 A, 110 W; HP 6291A, 57–63 Hz, 5.5 A, 280 W; HP 6294A, 48–440 Hz, 1.3 A, 114 W; HP 6296A, 57–63 Hz, 4.5 A, 250 W; HP 6299A, 48–440 Hz, 1.5 A, 135 W.
Size: 6227B, 6228B: 155 H x 197 W x 309.55 mm D (6³/₃₂" x 7²⁵/₃₂" x 12³/₁₆").
 HP 6253A, 6255A: 87 H x 483 W x 403 mm D (3⁷/₁₆" x 19" x 15⁷/₈").
 HP 6281A, 6284A, 6289A, 6294A, 6299A: 87 H x 209 W x 398 mm D (3⁷/₁₆" x 8⁷/₃₂" x 15⁵/₈").
 HP 6282A, 6286A, 6291A, 6296A: 131 H x 210 W x 435 mm D (5¹/₃₂" x 8¹/₄" x 17¹/₈").

Option Descriptions

005: 50 Hz ac input: optimizes power supplies that require adjustment/modification for 50 Hz operation. N/C
010: Chassis slides. Enable convenient access to rack-mounted power supply for maintenance. add \$160

011: Internal overvoltage protection crowbar. Protects sensitive loads against power supply failure or operator error. Monitors the output voltage and places a virtual short circuit (conducting SCR) across load after preset trip voltage is exceeded.

HP 6281A, 6284A, 6289A, 6294A, 6299A add \$125
 HP 6282A, 6286A, 6291A, 6296A add \$205
 HP 6253A, 6255A add \$205
028: 230 Vac ± 10%, single-phase input. Factory modification reconnects the multi-tap input power transformer for 230 V operation. N/C
040: Interfacing for Multiprogrammer operation. Prepares standard HP power supplies for resistance programming by the HP 6940B or 6942A. Price per output. add \$76
910: one additional operating and service manual shipped with the power supply
 HP 6253A, 6255A, 6227B, 6228B add \$7.50
 HP 6281A, 6282A, 6284A, 6286A, 6289A, 6291A, 6294A, 6296A, 6299A add \$5.10

Accessories

HP 14513A: 3.5 in. high rack kit for one HP 6281A, 6284A, 6289A, 6294A, 6299A \$56
HP 14523A: 3.5 in. high rack kit for two above supplies \$30
HP 14515A: 5.25 in. high rack kit for one HP 6282A, 6286A, 6291A, 6296A \$61
HP 14525A: 5.25 in. high rack kit for two above supplies \$35
HP 5060-8760: blank filler panel for HP 6227B, 6228B \$36 ☎
HP 5060-8762: adapter frame for rack mounting one or two HP 6227B, 6228B \$115 ☎

Specifications, continued

REMOTE CONTROL FEATURES								GENERAL					
Resistance Coefficient		Voltage Coefficient		Speed, UP*		Speed, DOWN*		Overvoltage		Weight			
Voltage	Current	Voltage	Current	NL	FL	NL	FL	Range	Margin	Net	Shipping	Options▲	Price
200 Ω/V ±1%	200 Ω/A ±10%	1 V/V ±1%	0.2 V/A ±10%	1 ms	2 ms	10 ms	6 ms	2.5-10 V	4% + 2 V	6.4 kg/14 lb	7.2 kg/16 lb	11, 28, 40	\$850
200 Ω/V ±1%	100 Ω/A ±10%	1 V/V ±1%	100 mV/A ±10%	70 ms	200 ms	9 s	40 ms	1-13 V	7% + 1 V	11.3 kg/25 lb	13.6 kg/30 lb	5, 11, 28, 40	\$1000
200 Ω/V ±1%	500 Ω/A ±10%	1 V/V ±1%	0.33 V/A ±10%	30 ms	80 ms	400 ms	100 ms	2.5-23 V	4% + 2 V	12.7 kg/28 lb	17.7 kg/39 lb	10, 11, 28, 40	\$1350
200 Ω/V ±1%	500 Ω/A ±10%	1 V/V ±1%	0.33 V/A ±10%	30 ms	80 ms	400 ms	100 ms	2.5-23 V	4% + 2 V	6.4 kg/14 lb	7.2 kg/16 lb	11, 28, 40	\$700
200 Ω/V ±1%	100 Ω/A ±10%	1 V/V ±1%	100 mV/A ±10%	150 ms	150 ms	9 s	70 ms	2-22 V	7% + 1 V	10.8 kg/26 lb	13.1 kg/29 lb	5, 11, 28	\$1050
200 Ω/V ±1%	500 Ω/A ±10%	1 V/V ±1%	.5 V/A ±10%	40 ms	200 ms	400 ms	75 ms	5-28 V	7% + 1.5 V	11 ka/24 lb	12.9 kg/28 lb	40	\$1650
200 Ω/V ±1%	500 Ω/A ±10%	1 V/V ±1%	0.66 V/A ±10%	15 ms	45 ms	200 ms	40 ms	2.5-44 V	4% + 2 V	12.7 kg/28 lb	17.7 kg/39 lb	10, 11, 28, 40	\$1350
200 Ω/V ±1%	500 Ω/A ±10%	1 V/V ±1%	0.66 V/A ±10%	15 ms	45 ms	200 ms	40 ms	2.5-44 V	4% + 2 V	6.4 kg/14 lb	7.2 kg/16 lb	11, 28, 40	\$700
200 Ω/V ±1%	200 Ω/A ±10%	1 V/V ±1%	200 mV/A ±10%	275 ms	275 ms	13 s	275 ms	6-43 V	7% + 1 V	11.3 kg/25 lb	12.7 kg/28 lb	5, 11, 28	\$1050
200 Ω/V ±1%	1 kΩ/A ±10%	1 V/V ±1%	1 V/A ±10%	50 ms	350 ms	1 s	50 ms	5-55 V	7% + 1.5 V	11 ka/24 lb	12.9 kg/28 lb	40	\$1650
300 Ω/V ±1%	1 kΩ/A ±10%	1 V/V ±1%	1 V/A ±10%	25 ms	80 ms	2 s	175 ms	5-65 V	4% + 2 V	5.9 kg/13 lb	6.8 kg/15 lb	11, 28, 40	\$750
300 Ω/V ±1%	500 Ω/A ±10%	1 V/V ±1%	333 mV/A ±10%	600 ms	600 ms	5 s	200 ms	9-66 V	7% + 1 V	11.3 kg/25 lb	12.7 kg/28 lb	5, 11, 28	\$1050
300 Ω/V ±1%	1 kΩ/A ±10%	1 V/V ±1%	1.3 V/A ±10%	25 ms	200 ms	1.5 s	200 ms	20-106 V	4% + 2 V	5.9 kg/13 lb	6.8 kg/15 lb	11, 28, 40	\$750

*UP = increasing output voltage. NL = No output load current. FL = Full rated output load current.



POWER SUPPLIES

Autoranging Power Supplies

Models 6010A, 6011A, 6012B, 6023A, and 6024A

- Complete front panel control/display
- Constant voltage/constant current operation
- Remote programming and sensing
- Autoranging output
- High efficiency, compact, and light weight
- Ten-turn voltage and current controls

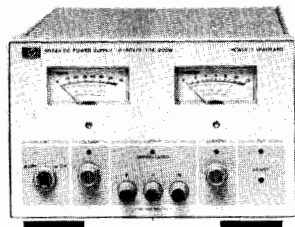

HP 6024A

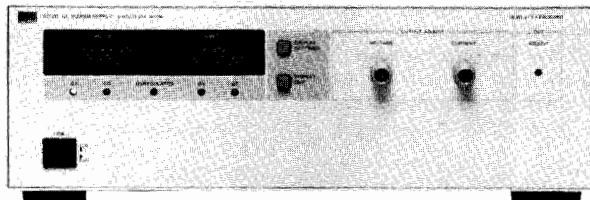

HP 6010A, 6011A, 6012B

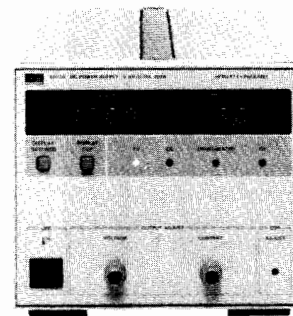

HP 6023A

Description

HP Models 6010A, 6011A, 6012B, and 6023A

This versatile family of dc power supplies provides laboratory grade performance along with many features to meet both laboratory and system needs.

Ten-turn front panel controls provide the means to precisely adjust the output voltage and current. The settings of these controls can be observed on the front panel meters by pressing the Display Settings button. This allows the current limit to be set when operating in the CV mode without shorting the output terminals and the voltage limit to be set when operating in the CC mode without opening the load leads.

Three and one-half digit front panel meters provide a convenient means for monitoring the output voltage and current. The accuracy of these meters allow them to replace external DVMs and monitor resistors in many applications that require monitoring of the power supply output.

The overvoltage protection (OVP) trip level can also be displayed on the front panel meters, allowing the trip level to be accurately adjusted without actually activating the OVP circuitry or disconnecting loads. In addition to the protection provided to the power supply and load by the OVP, these supplies also have protection against operating under excessive ac line or thermal conditions.

As autoranging power supplies, these units can operate at their maximum rated power over a wide and continuous range of voltage and current combinations. This often allows both present and future requirements to be satisfied with fewer supplies.

HP Model 6023A is stable when operating in the CC mode into inductive loads up to one henry. HP Models 6010A, 6011A and 6012B are stable when operating in the CC mode into inductive loads up to 100 mH, and a special modification is available for these three models to assure stability with loads up to ten henries.

System Features

The output voltage and current of these supplies can be remotely controlled with either 0-5 volt or 0-4000 ohm analog programming signals. The actual output levels can be monitored without complicated external circuitry by connecting DVMs to the buffered 0-5 volt monitor outputs. All programming and monitoring signals are referenced to the same common and are accessed through the rear panel barrier strip.

Either terminal may be grounded, or floated up to ± 240 volts from chassis ground for the HP 6011A, 6012B and 6023A, and ± 550 volts for the HP 6010A.

If more output voltage or current is needed than a single unit can provide, auto-series or auto-parallel configurations can be used. Up to four 1000-watt units, or up to two 200-watt units can be connected in auto-parallel, and any combination can be used in auto-series providing up to 240 volts total (550 Vdc for HP 6010A) from chassis ground including output voltage. Remote sensing can be used to maintain the CV load effect specification at the load with up to 0.5 volt drop per load lead and sense wires that are less than 0.2 ohm per lead. Operation is possible with up to 2.0 volts per lead; however, load effect specification may be degraded. For more system control and monitoring capabilities, see Option 002.

Specifications

Ratings*									Regulation				10% Change Transient Recovery
Volts	Amperes	Autoranging Output*						HP Model	Load Effect		Source Effect		
		V ₁	P ₁	V ₂	P ₂	V ₃	P ₃		Voltage	Current	Voltage	Current	
0-20	0-30	20V	200W	14V	242W	6.7V	200W	6023A	0.01% +2mV	0.01% +9mA	0.01% +1mV	0.01% +6mA	1ms 50mV
0-20	0-120	20V	1000W	14V	1064W	7V	840W	6011A	0.01% +3mV	0.01% +15mA	0.01% +2mV	0.01% +25mA	2ms 100mV
0-60	0-10	60V	200W	40V	240W	20V	200W	6024A	0.01% +3mV	0.01% +3mA	0.01% +5mV	0.01% +5mA	1ms 75mV
0-60	0-50	60V	1000W	40V	1200W	20V	1000W	6012B	0.01% +5mV	0.01% +10mA	0.01% +3mV	0.01% +10mA	2ms 100mV
0-200	0-17	200V	1000W	120V	1200W	60V	1020W	6010A	0.01% +5mV	0.01% +10mA	0.01% +5mV	0.01% +5mA	2ms 150mV

*See the generalized autoranging output characteristic curve.

HP Model 6024A

As an autoranging dc power supply, the HP 6024A can provide 200 watts over a wide and continuous range of voltage and current combinations, with maximums of 60 volts and 10 amperes. This provides greater flexibility than traditional power supplies that have only one maximum power point.

Ten-turn potentiometers provide precise control of the output voltage and current. The output levels can be observed on the separate front panel voltage and current meters. Terminals are available on both the front and rear panel for load connections.

The built-in OVP is adjustable from the front panel. Other protection features include over-temperature and high ac line detection.

The HP 6024A has many system oriented features. It can be remotely programmed with 0-5 volt or 0-2500 ohm analog signals. The output current can be easily monitored without an external shunt with the proportional 0-5 volt buffered monitor output. Remote sensing can be used to eliminate the effects of voltage drops in the load leads, and either terminal may be floated up to ± 240 volts from chassis ground. Several units can be combined in auto-series, auto-parallel, and auto-tracking configurations, further increasing the HP 6024A's flexibility.

For more system features, see Option 002.

General Specifications

Dimensions

HP 6010A, 6011A and 6012B: 132.6 mm H x 425.5 mm W x 516.4 mm D (5.2" x 16.75" x 20.33")

HP 6023A: 177.0 mm H x 212.3 mm W x 443.6 mm D (6.97" x 8.36" x 17.872")

HP 6024A: 133.4 mm H x 212.3 mm W x 415.33 D (5.25" x 8.36" x 16.35")

Ordering Information

Option Descriptions

002: provides extra programming and monitoring capabilities for system use. A card inserted into the power supply is accessible through a 37-pin connector on the rear panel. It provides easy access to the control and monitor signals available on standard units, as well as these additional features:

- OVP trip and reset
- power supply inhibit
- status bits indicating CV mode, CC mode, unregulated output, OVP tripped, overtemperature condition, and ac line drop-out
- remote programming via a 0-2 mA current sink
- bias supplies for your circuitry: +5 volts at 100 mA, +15 volts at 75 mA, and -15 volts at 75 mA.
- buffered 0-5 volt outputs representing both the output voltage and output current. (HP 6010A, 6011A, 6012B, and 6023A provide this feature standard, but HP 6024A only provides a scaled 0-5 volt output to represent the output current, not the output voltage.)
- programmable remote/local for use when programming with a current sink.

Price

\$330.00

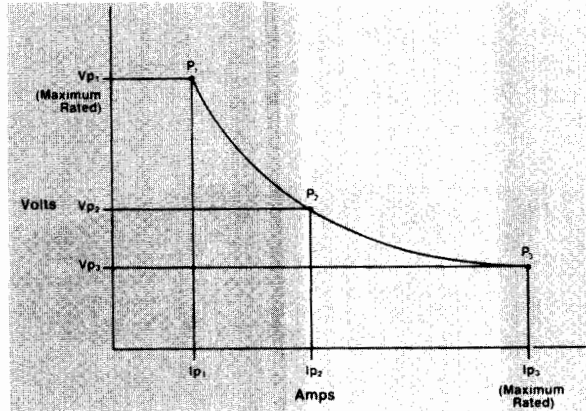

Generalized autoranging output characteristic curve

These features can all be taken advantage of with an HP 6940B or 6942A Multiprogrammer instrument sub-system configured with an HP 69520A or 69709A Power Supply Programming Card. The Multiprogrammer provides a cost-effective solution for controlling a group of power supplies, and also can provide many other digital and analog monitoring and control functions, all on the HP-IB. The voltage and current programming resolution available with either card is 1/1000th of full scale.

The features available with Option 002 can also be interfaced to your own external circuitry rather than an HP Multiprogrammer.

100: 87-106 Vac, 48-63 Hz. HP 6024A Only! This option is for use in Japan only. The power supply output power is 75% of the output power available with the other line voltage options. For HP 6024A only.

120: 104 to 127 Vac, 48-63 Hz.

220: 191 to 233 Vac, 48-63 Hz.

240: 208 to 250 Vac, 48-63 Hz.

800: Rack-mount kit for two units side by side. This applies to HP 6023A and 6024A only.

908: Rack-mount kit for a single unit. A blank filler panel is supplied when ordered for half rack width units.

910: One extra operating and service manual shipped with each power supply.

N/C
N/C
N/C
N/C

HP 6023A \$75.00
HP 6024A \$70.00

HP 6010A, 6011A, 6012B \$30.00
HP 6023A \$80.00
HP 6024A \$53.50

HP 6024A \$10.00
HP 6010A, 6011A, 6012B, 6023A \$20.00

PARD (rms/p-p) 20Hz-20MHz		Programming Response Time							General*					Price	
		UP			DOWN				AC Input Current				Weight kg (lbs)		
		Settling Band	Full Load	No Load	Full Load	Light Load		100 Vac	120 Vac	220 Vac	240 Vac	Net	Shipping		
3 mV 30 mV	15 mA —	5 mV	100 ms	100 ms	200 ms	500 ms	50 Ω	—	6.5 A	3.3 A	3.6 A	8.6 (19)	10.5 (23)	\$1650	
8 mV 50 mV	120 mA —	30 mV	300 ms	300 ms	500 ms	1.5 sec	50 Ω	—	24 A	15 A	14 A	16.8 (37)	22.2 (49)	\$2400	
3 mV 30 mV	5 mA —	60 mV	200 ms	200 ms	300 ms	600 ms	Open	5.3 A	5.3 A	2.9 A	2.7 A	5.4 (12)	7.3 (16)	\$1350	
8 mV 40 mV	25 mA —	90 mV	300 ms	300 ms	2.0 sec	3.0 sec	100 Ω	—	24 A	15 A	14 A	15.9 (35)	21.3 (47)	\$2400	
22mV 50mV	15mA —	300mV	300ms	300ms	600ms	3.5 sec	Open	—	24 A	15 A	14 A	16.3 (36)	21.7 (48)	\$2400	

* An ac input option must be specified when ordering.



POWER SUPPLIES

General Purpose: 120-2000 W Output

Models 6259B-6274B

- Built-in overvoltage protection
- Constant voltage/constant current operation
- Remote programming and sensing

- Remote sensing
- Auto-series, -parallel, and -tracking operation
- $\leq 50 \mu\text{s}$ load transient recovery

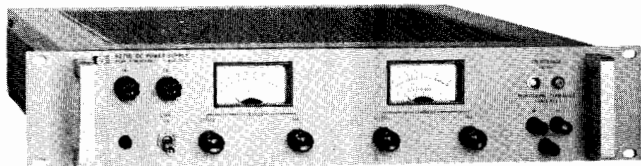

HP 6263B, 6266B, 6271B

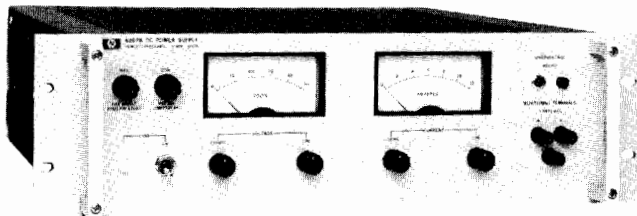

HP 6264B, 6267B

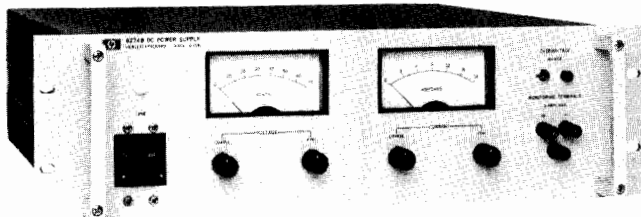

HP 6274B

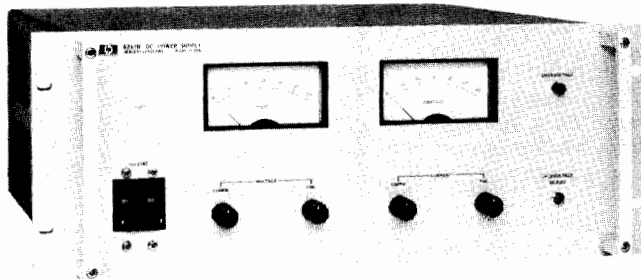

HP 6259B, 6260B, 6261B, 6268B, 6269B

Description

Models 6259B-6274B

This series of high-performance constant voltage/constant current supplies includes twelve models with output rating from 10 to 60 V. All models employ a transistor series-regulator/triac-preregulator circuit to achieve high efficiency, excellent regulation, low ripple and noise, and moderate programming speeds in a compact full-rack width package.

Separate coarse and fine voltage and current controls allow the voltage and current outputs to be varied from zero to the maximum rated value, crossover from constant voltage to constant current operation occurs automatically when the load current exceeds the value established by the current control settings.

Additional features include built-in overvoltage crowbar protection; remote error sensing; and auto-series, auto-parallel, and auto-tracking operation. The crowbar trip point adjustment and associated overvoltage indicator are conveniently located on the front panel.

Specifications†

RATINGS			PERFORMANCE							
DC Output		HP Model	Load Effect		Source Effect		PARD (rms/p-p)		Drift (stability)	
Volts	Amperes		Voltage	Current	Voltage	Current	Voltage	Current	Voltage	Current
0-10	0-50	6259B	0.01% + 200 μV	0.02% + 1 mA	0.01% + 200 μV	0.02% + 1 mA	500 $\mu\text{V}/5 \text{ mV}$	25 mA rms	0.03% + 2 mV	0.03% + 10 mA
0-10	0-100	6260B	0.01% + 200 μV	0.02% + 2 mA	0.01% + 200 μV	0.02% + 2 mA	500 $\mu\text{V}/5 \text{ mV}$	50 mA rms	0.03% + 2 mV	0.03% + 20 mA
0-20	0-10	6263B	0.01% + 200 μV	0.02% + 500 μA	0.01% + 200 μV	0.02% + 500 μA	200 $\mu\text{V}/10 \text{ mV}$	3 mA rms	0.03% + 500 μV	0.03% + 6 mA
0-20	0-20	6264B	0.01% + 200 μV	0.02% + 500 μA	0.01% + 200 μV	0.02% + 500 μA	200 $\mu\text{V}/10 \text{ mV}$	5 mA rms	0.03% + 500 μV	0.03% + 6 mA
0-20	0-50	6261B	0.01% + 200 μV	0.02% + 1 mA	0.01% + 200 μV	0.02% + 1 mA	500 $\mu\text{V}/5 \text{ mV}$	25 mA rms	0.03% + 2 mV	0.03% + 10 mA
0-40	0-5	6266B	0.01% + 200 μV	0.02% + 500 μA	0.01% + 200 μV	0.02% + 500 μA	200 $\mu\text{V}/10 \text{ mV}$	3 mA rms	0.03% + 500 μV	0.03% + 3 mA
0-40	0-10	6267B	0.01% + 200 μV	0.02% + 500 μA	0.01% + 200 μV	0.02% + 500 μA	200 $\mu\text{V}/10 \text{ mV}$	3 mA rms	0.03% + 2 mV	0.03% + 3 mA
0-40	0-30	6268B	0.01% + 200 μV	0.02% + 2 mA	0.01% + 200 μV	0.02% + 2 mA	1 mV/5 mV	20 mA rms	0.03% + 2 mV	0.03% + 5 mA
0-40	0-50	6269B	0.01% + 200 μV	0.02% + 2 mA	0.01% + 200 μV	0.02% + 2 mA	1 mV/5 mV	25 mA rms	0.03% + 2 mV	0.03% + 10 mA
0-60	0-15	6274B	0.01% + 200 μV	0.02% + 500 μA	0.01% + 200 μV	0.02% + 500 μA	200 $\mu\text{V}/20 \text{ mV}$	5 mA rms	0.03% + 2 mV	0.03% + 5 mA

†Refer to page 260 for complete specification definitions.



Auto-series, auto-parallel, and auto-tracking connections should ordinarily include no more than three supplies. If a specific application requires the use of more than three supplies in any of the three connections, consult your local HP Field Engineer for additional information.

All dc output, ac input, sensing, control, and programming connections are made to rear-panel terminals. Either the positive or negative output terminal may be grounded or the supplies may be operated floating at up to 300 volts above ground. Models 6263B, 6264B, 6266B and 6267B are convection cooled. All other models in this series employ cooling fans. Models which output more than 200 watts are equipped with terminal blocks for ac input and are not shipped with line cords.

Specification—General

Load effect transient recovery: time, 50 μ s; Level, 10 mV.

Resolution: voltage control, less than 0.02%; current control, less than 0.15%.

Temperature coefficient per °C: 0.01% of output plus 200 μ V.

Temperature ratings: operating, 0 to 55°C; storage, -40 to 75°C.

Remote control programming: these power supplies are capable of being programmed in constant voltage and constant current operation by using an external resistance or dc voltage with coefficients as shown in the table below.

Rear terminal wiring configurations for remote control operation are specified in the operating and service manual supplied with the power supply. For remote control programming procedures and timing considerations, contact your local HP field engineer.

Power: input voltage tolerance is $\pm 10\%$, 57-63 Hz. For other input voltage and frequency options available, see option listing in the specifications table below. Standard input voltage, maximum input current, and maximum power are:

HP 6259B, 230 V ac, 6 A, 850 W;
 HP 6260B, 230 V ac, 12 A, 1600 W;
 HP 6263B, 115 V ac, 4.5 A, 350 W;
 HP 6266B, 115 V ac, 4 A, 325 W;
 HP 6268B, 230 V ac, 12 A, 1600 W;
 HP 6261B, 230 V ac, 12 A 1500 W;
 HP 6264B, 115 V ac, 8 A, 600 W;
 HP 6267B, 115 V ac, 8 A, 550 W;
 HP 6269B, 230 V ac, 18 A, 2500 W;
 HP 6274B, 115 V ac, 15 A, 1200 W;

AC line connections: three wire, five foot ac power cord included—HP 6263B and 6266B.

Three-terminal barrier strip provided on power supply for ac power connections—HP 6259B, 6260B, 6261B, 6264B, 6267B, 6268B, 6269B and 6274B.

Size

HP 6263B, 6266B: 83.7 H x 483 W x 479.4 mm D (3.296" x 19" x 18.875").

HP 6264B, 6267B, 6274B: 127 H x 483 W x 479.4 mm D (5.00" x 19" x 18.875").

HP 6259B, 6260B, 6261B, 6268B, 6269B: 173 H x 483 W x 479.4 mm D; (6.812" x 19" x 18.875").

Option Descriptions

005: 50 Hz ac input: optimizes power supplies that require adjustment/modification for 50 Hz operation.

010: chassis slides. For access to rack mounted power supplies: HP 6263B, 6264B, 6266B, 6267B

HP 6274B, 6259B, 6260B, 6261B, 6268B, 6269B

016: Model 6260B only. 115 Vac $\pm 10\%$ single phase input. Consists of replacing power transformer and circuit breaker, and reconnecting bias transformer, RFI choke and fans.

022: voltage and current programming adjust. Allows the V and I programming coefficients and zero output to be conveniently adjusted to 0.1% accuracy via access holes in the rear panel. Consists of four potentiometers and resistors located inside the rear panel.

026: 115 Vac $\pm 10\%$, single phase input. Consists of replacing the input circuit breaker and reconnecting the power transformer, bias transformer, RFI choke, and fans. Models 6259B, 6261B and 6268B only.

027: 208 Vac, $\pm 10\%$, single phase input. Consists of reconnecting power transformer taps, and other components where necessary.

028: 230 Vac $\pm 10\%$, single phase input. Consists of reconnecting power transformer taps, and other components where necessary.

040: Multiprogrammer interface. Prepares standard HP power supplies for resistance programming by the HP 6942A or 6940B Multiprogrammers. This option includes Option 022, special calibration, and protection check-out procedures (where required).

910: one additional operating and service manual shipped with each power supply. HP 6259B-6274B

Price

N/C

add \$86

add \$160

add \$120

add \$61

N/C

N/C

N/C

add \$76

add \$7.50

Specifications, Continued

REMOTE CONTROL FEATURES								GENERAL					
Resistance Coeff.		Voltage Coeff.		Speed Up*		Speed Down*		Overvoltage		Weight		Options	Price
Voltage	Current	Voltage	Current	NL	FL	NL	FL	Range	Margin	Net	Shipping		
200 $\Omega/V \pm 1\%$	4 $\Omega/A \pm 10\%$	1 V/V $\pm 1\%$	10 mV/A $\pm 10\%$	70 ms	70 ms	200 ms	100 ms	2-12 V	5% + 2V	31.3 kg/69 lb	35.3 kg/78 lb	5, 10, 22, 26, 27, 40	\$1775
200 $\Omega/V \pm 1\%$	2 $\Omega/A \pm 10\%$	1 V/V $\pm 1\%$	5 mV/A $\pm 10\%$	70 ms	70 ms	200 ms	75 ms	2-12 V	5% + 2 V	43.9 kg/97 lb	48 kg/106 lb	5, 10, 16, 22, 27, 40	\$2105
200 $\Omega/V \pm 1\%$	100 $\Omega/A \pm 10\%$	1 V/V $\pm 1\%$	50 mV/A $\pm 10\%$	150 ms	150 ms	7 s	350 ms	2-23 V	5% + 1 V	15.4 kg/34 lb	18.6 kg/41 lb	5, 10, 22, 27, 28, 40	\$1450
200 $\Omega/V \pm 1\%$	10 $\Omega/A \pm 10\%$	1 V/V $\pm 1\%$	25 mV/A $\pm 10\%$	140 ms	140 ms	10 s	150 ms	2.5-23V	5% + 1 V	21.3 kg/47 lb	24.5 kg/54 lb	5, 10, 22, 27, 28, 40	\$1500
200 $\Omega/V \pm 1\%$	4 $\Omega/A \pm 10\%$	1 V/V $\pm 1\%$	10 m V/A $\pm 10\%$	150 ms	150 ms	250 ms	250 ms	2-23 V	5% + 2 V	35.3 kg/78 lb	39.4 kg/87 lb	5, 10, 22, 26, 27, 40	\$1880
200 $\Omega/V \pm 1\%$	200 $\Omega/A \pm 10\%$	1 V/V $\pm 1\%$	100 mV/A $\pm 10\%$	275 ms	275 ms	13 s	1.5 s	2.5-45 V	5% + 1 V	15.4 kg/34 lb	18.6 kg/41 lb	5, 10, 22, 27, 28, 40	\$1400
200 $\Omega/V \pm 1\%$	100 $\Omega/A \pm 10\%$	1 V/V $\pm 1\%$	50 mV/A $\pm 10\%$	275 ms	275 ms	13 s	750 ms	2.5-45 V	5% + 1 V	17.7 kg/39 lb	20.8 kg/46 lb	5, 10, 22, 27, 28, 40	\$1450
200 $\Omega/V \pm 1\%$	6 $\Omega/A \pm 10\%$	1 V/V $\pm 1\%$	16.7 mV/A $\pm 10\%$	300 ms	300 ms	1 s	650 ms	4-45 V	5% + 1 V	34.4 kg/76 lb	38.1 kg/84 lb	5, 10, 22, 26, 27, 40	\$1830
200 $\Omega/V \pm 1\%$	4 $\Omega/A \pm 10\%$	1 V/V $\pm 1\%$	10 mV/A $\pm 10\%$	350 ms	350 ms	1 s	600 ms	4-45 V	5% + 1 V	40.3 kg/89 lb	44 kg/98 lb	5, 10, 22, 27, 40	\$2000
300 $\Omega/V \pm 1\%$	67 $\Omega/A \pm 10\%$	1 V/V $\pm 1\%$	33.3 mV/A $\pm 10\%$	600 ms	600 ms	40 s	800 ms	6-66 V	5% + 1 V	21.7 kg/48 lb	24.5 kg/54 lb	5, 10, 22, 27, 28, 40	\$1600

*Up = increasing output voltage. NL = No output load current. FL = Full rated output load current



POWER SUPPLIES

General Purpose: 300—11,000 W Output

Models 6434B—6483C

- Outstanding value—low cost/watt
- Up to 75% efficiency at full output
- Constant voltage/constant current operation

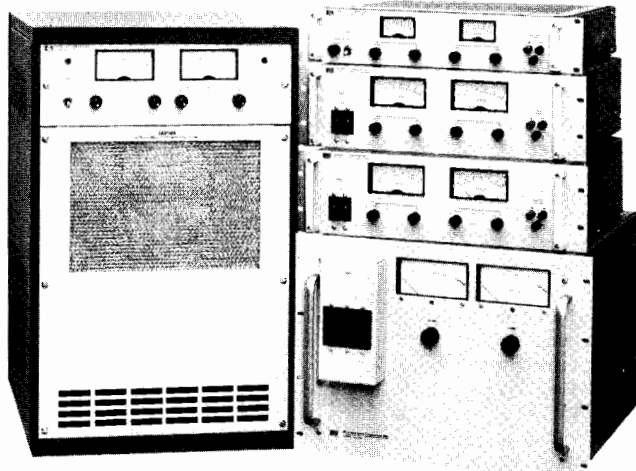

HP 6434B—6483C

Description

This series of SCR-regulated power supplies is designed for medium to high-power applications requiring a fixed or variable dc source with moderate regulation and ripple. For supplies with better regulation, faster response time, and lower ripple, see models HP 6259B—6274B on page 268.

Operating Features

All supplies in this series are of the constant voltage/constant current type. Large easy-to-read panel meters continuously monitor output voltage current.

Input and output power, remote sensing, remote programming, and auto-series, -parallel, and -tracking connections are made to bus bars and terminal blocks on the rear panel.

Protective Features

In addition to the overload protection inherent in constant voltage/constant current operation, there are many other built-in protective features included in these supplies. The features vary within the three model classifications as follows:

HP 6434B—6448B: (1) Reverse voltage protection. (2) Fused ac input.

HP 6453A, 6456B, 6459A: (1) AC line loss protection circuit monitors 3-phase input and cuts off SCR's and opens output bus if a phase drops out; operation resumes when ac input returns to normal. (2) 3-phase input circuit breaker. (3) Optional internal crowbar (Option 006) protects load from overvoltage condition.

HP 6464C—6483C: (1) High-temperature protection thermostat opens input to power transformer and lights front panel indicator if supply overheats. (2) Prolonged overload protection circuit is activated and lights front panel indicator if output current exceeds approximately 115% of maximum rating. (3) Optional internal crowbar (except on HP 6464C) protects load from overvoltage condition. (4) Turn-on circuit limits peak line current during start-up into low impedance loads. (5) Phase-balance circuit permits operation with line-to-line input voltage imbalance up to 8%. (6) Overcurrent and over-voltage circuits of master slave supplies used in auto-series, -parallel, or -tracking operation can be interlocked.

Auto-Series, -Parallel, -Tracking Operation

Supplies may be connected in auto-series, or auto-tracking (except HP 6448B and 6483C, which cannot be connected in auto-series).

Up to three lower-power models (HP 6434B—6448B) may be connected in any of the above configurations. Higher-power model (HP 6453A/6483C) interconnection should ordinarily include no more than two supplies.

Remote Programming

The voltage and current outputs of the supplies can be programmed by a remote resistance, or for most models, a remote voltage source. Programming speeds and coefficients are detailed in the specifications table.

AC Power Requirements

The ac power requirements vary with the three model classifications (see option listings). When powered from a 50 Hz source (possible with option 005), the rms ripple and transient response specifications increase by 50%. The p-p ripple specification is unchanged by line frequency.

Specifications†

RATINGS			PERFORMANCE						
DC Output		HP Model	Load Effect		Source Effect		PARD Δ rms/p-p	Temperature Coefficient	Drift
Volts‡	Ampere§		Voltage	Current	Voltage	Current			
0-8	0-1000	6464C	0.05% + 5 mV	0.1% + 1 A	0.05% + 5 mV	0.1% + 1 A	80 mV/1 V	0.03% + 100 μ V	0.03% + 1 mV
0-15	0-200	6453A	0.2% + 10 mV††	1% or 2 A††	0.2% + 10 mV††	1% or 2 A††	150 mV rms	0.05% + 2 mV	0.25% + 10 mV
0-16 or 18	0-600 or 500*	6466C	0.05% + 5 mV	0.1% + 0.6 A	0.05% + 5 mV	0.1% + 0.6 A	180 mV/1 V	0.03% + 200 μ V	0.2% + 1 mV
0-36	0-100	6456B	0.2% + 10 mV††	1% or 1 A††	0.2% + 10 mV††	1% or 1 A††	180 mV rms	0.05% + 2 mV	0.25% + 10 mV
0-36	0-300	6469C	0.05% + 5 mV	0.1% + 0.3 A	0.05% + 5 mV	0.1% + 0.3 A	180 mV/1 V	0.03% + 400 μ V	0.15% + 1 mV
0-40	0-25	6434B	40 mV	200 mA	18 mV	200 mA	40 mV/500 mV	0.03% + 5 mV	0.1% + 20 mV
0-64	0-50	6459A	0.2% + 10 mV††	1% or 0.5 A††	0.2% + 10 mV††	1% or 0.5 A††	160 mV rms	0.05% + 2 mV	0.25% + 10 mV
0-64	0-150	6472C	0.05% + 100 mV	0.1% + 0.15 A	0.05% + 100 mV	0.1% + 0.15 A	160 mV/2 V	0.03% + 4 mV	0.15% + 16 mV
0-110	0-100	6475C	0.05% + 100 mV	0.1% + 0.1 A	0.05% + 100 mV	0.1% + 0.1 A	200 mV/2 V	0.03% + 5 mV	0.15% + 20 mV
0-120	0-2.5	6443B	120 mV	25 mA	60 mV	25 mA	240 mV/400 mV	0.03% + 20 mV	0.1% + 60 mV
0-220	0-50	6477C	0.05% + 100 mV	0.1% + 50 mA	0.05% + 100 mV	0.1% + 50 mA	330 mV/2 V	0.03% + 8 mV	0.15% + 35 mV
0-300	0-35	6479C	0.05% + 100 mV	0.1% + 35 mA	0.05% + 100 mV	0.1% + 35 mA	330 mV/3 V	0.03% + 11 mV	0.15% + 45 mV
0-440, 500 or 600	0-25, 20, 15*	6483C	0.05% + 100 mV	0.1% + 35 mA	0.05% + 100 mV	0.1% + 35 mA	600 mV/5 V	0.03% + 20 mV	0.15% + 80 mV
1-600	5 mA-1.5 A	6448B	1 V	40 mA	600 mV	15 mA	600 mV/2 V	0.03% + 100 mV	0.1% + 300 mV

† Refer to page 260 for complete specification definitions.

†† Specified for combined line and load regulation.

Δ For operation with a 50 Hz input (possible only with Option 005), the rms ripple and transient response specifications are increased by 50%.

* The output current rating is given in the same order corresponding with the voltage rating.

§ Under light loading conditions, power supply may not meet all published specifications. The graph on the next page defines the permissible operating regions for CV and CC modes of operation.

For operation with a 50 Hz input (possible only with Option 005), output current is linearly derated from 100% at 40°C to 80% at 50°C.



POWER SUPPLY OUTPUT RESTRICTIONS AS A FUNCTION OF LOADING

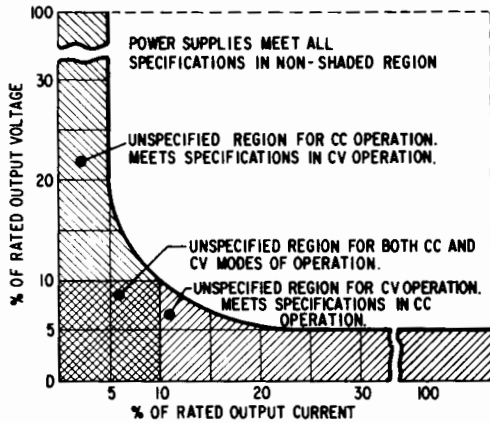

An ac input option must be specified when ordering.

Line Cords

Line cords are not supplied with models 6453A-6483C.

Size

- Model 6443B:** 89 H x 483 W x 445 mm D (3.5" x 19" x 17.5").
- Models 6434B, & 6448B:** 133 H x 483 W x 432 mm D (5.25" x 19" x 17").
- Models 6453A, 6456B, & 6459A:** 356 H x 483 W x 500 mm D (14" x 19" x 19.7").
- Models 6464C, 6466C, 6469C, 6472C, 6475C, 6477C, 6479C, & 6483C:** 705 H x 483 W x 715 mm D (27.75" x 19" x 28.12").

Option Descriptions

HP 6434B-6448B

- Std:** 115 V ac, ± 10%, single phase, 57-63 Hz
- 005:** realignment for 50 Hz operation
- 010:** chassis slides
- 027:** 208 V ac, ± 10%, single phase, 57-63 Hz
- 028:** 230 V ac, ± 10%, single phase, 57-63 Hz
- 910:** one extra operating and service manual shipped with each power supply

Price

- N/C
- N/C
- add \$160
- N/C
- N/C
- add \$10

HP 6453A, 6456B, 6459A

An ac input option must be specified when ordering.

- AC input connections are by means of a 4-conductor connector at rear of unit. A matching Hubbell No. 7413G plug (HP part number 1251-1570) is furnished.
- 001:** 208 V ac, ± 10%, 3-phase, 15.5 A/phase, 57-63 Hz N/C
- 002:** 230 V ac, ± 10%, 3-phase, 14 A/phase, 57-63 Hz N/C
- 003:** 460 V ac, ± 10%, 3-phase, 7 A/phase, 57-63 Hz add \$100
- 005:** realignment for 50 Hz operation N/C
- 006:** overvoltage protection crowbar add \$495
- HP 6453A, 6459A** add \$650
- HP 6456B** add \$255
- 010:** chassis slides add \$150
- 031:** 380 V ac, ± 10%, 3-phase, 8.5 A/phase, 57-63 Hz
- 032:** 400 V ac, ± 10%, 3-phase- 8.0 A/phase, 57-63 Hz \$150
- 910:** one extra operating and service manual shipped with each power supply. \$10

HP 6464C-6483C

An ac input option must be specified when ordering.

- AC input connections are by means of enclosed 4-wire terminal block
- 001:** 208 V ac, ± 10%, 3-phase, 55 A/phase, 57-63 Hz N/C
- 002:** 230 V ac, ± 10%, 3-phase, 50 A/phase, 57-63 Hz N/C
- 003:** 460 V ac, ± 10%, 3-phase, 25 A/phase, 57-63 Hz add \$255
- 005:** realignment for 50 Hz operation N/C
- 006:** internal overvoltage protection crowbar add \$395
- HP 6477C, 6479C, 6483C** add \$580
- HP 6466C** add \$515
- HP 6469C** add \$465
- HP 6472C, 6475C** add \$130
- 023:** rack mounting attachments for standard 19" rack add \$130
- 031:** 380 V ac, ± 10%, 3-phase, 30 A/phase, 57-63 Hz add \$255
- 032:** 400 V ac, ± 10%, 3-phase, 28.5 A/phase, 57-63 Hz add \$255
- 040:** prepares power supply to be programmed with resistance by an HP 6940B or 6942A. add \$100
- 910:** one extra operating and service manual shipped with each power supply. add \$15

Accessory

- 14545A:** casters for HP 6464C-6483C—set of four \$86

Specifications, continued

REMOTE CONTROL												GENERAL			
Resolution		Load Transient Recovery Δ	Resistance Coefficient		Voltage Coefficient \dagger		Up		Down		Net Weight		Options	Price	
V	C		Voltage	Current	Voltage	Current	NL	FL	NL	FL	Kg	lb			
8 mV	1 A	100 ms, 500 mV	200 $\Omega/V \pm 2\%$	1 $\Omega/A \pm 2\%$	1 V/V $\pm 1\%$	6.2 mV/A $\pm 7\%$	1.6 s	0.6 s	6 s	0.1 s	235	518	1, 2, 3, 5, 23, 31, 32, 40	\$8700*	
65 mV	1 A	50 ms, 150 mV	200 $\Omega/V \pm 2\%$	1 Ω/A	0.4 V/V	30 mV/A	1 s	0.5 s	20 s	0.2 s	108	238	1, 2, 3, 5, 6, 10, 31, 32	\$4400*	
18 mV	0.5 A	100 ms, 500 mV	200 $\Omega/V \pm 2\%$	1.66 $\Omega/A \pm 2\%$	1 V/V $\pm 1\%$	10.3 mV/A $\pm 7\%$	1.6 s	0.6 s	15 s	0.2 s	226	500	1, 2, 3, 5, 6, 23, 31, 32, 40	\$8600*	
90 mV	0.5 A	50 ms, 300 mV	200 $\Omega/V \pm 2\%$	2 Ω/A	166 mV/V	60 mV/A	1 s	0.5 s	60 s	0.5 s	108	238	1, 2, 3, 5, 6, 10, 31, 32	\$4000*	
36 mV	0.3 A	100 ms, 500 mV	200 $\Omega/V \pm 2\%$	3.33 $\Omega/A \pm 2\%$	1 V/V	20.6 mV/A $\pm 7\%$	1.6 s	3 s	20 s	0.5 s	226	500	1, 2, 3, 5, 6, 23, 31, 32, 40	\$8000*	
10 mV	12.5 mA	200 ms, 200 mV	200 $\Omega/V \pm 2\%$	12 Ω/A	1 V/V	**	0.3 s	1.2 s	75 s	1.2 s	30.4	67	5, 10, 27, 28	\$1800	
100 mV	0.25 A	50 ms, 600 mV	300 $\Omega/V \pm 2\%$	4 Ω/A	94 mV/V	120 mV/A	1 s	0.5 s	45 s	0.7 s	108	238	1, 2, 3, 5, 6, 10, 31, 32	\$4000*	
64 mV	0.15 mA	100 ms, 750 mV	300 $\Omega/V \pm 2\%$	6.7 $\Omega/A \pm 2\%$	1 V/V $\pm 3\%$	41.2 mV/A $\pm 7\%$	1.4 s	2.5 s	55 s	0.7 s	226	500	1, 2, 3, 5, 6, 23, 31, 32, 40	\$8000*	
22 mV	0.1 A	100 ms, 1 V	300 $\Omega/V \pm 2\%$	10 $\Omega/A \pm 2\%$	1 V/V $\pm 3\%$	62 mV/A $\pm 7\%$	1.5 s	2 s	80 s	0.7 s	226	500	1, 2, 3, 5, 6, 23, 31, 32	\$8000*	
30 mV	1.3 mA	200 ms, 600 mV	300 $\Omega/V \pm 2\%$	120 Ω/A	1 V/V	**	0.5 s	2 s	210 s	2 s	14	31	5, 10, 27, 28	\$1350	
44 mV	50 mA	100 ms, 2 V	300 $\Omega/V \pm 2\%$	20 $\Omega/V \pm 2\%$	1 V/V $\pm 3\%$	124 mV/A $\pm 7\%$	1.5 s	2 s	95 s	1 s	226	500	1, 2, 3, 5, 6, 23, 31, 32	\$8000*	
60 mV	35 mA	100 ms, 3 V	300 $\Omega/V \pm 2\%$	28.6 $\Omega/A \pm 2\%$	1 V/V $\pm 3\%$	177 mV/A $\pm 7\%$	1.5 s	2 s	75 s	1.6 s	226	500	1, 2, 3, 5, 6, 23, 31, 32	\$8000*	
60 mV	25 mA	100 ms, 5 V	300 $\Omega/V \pm 2\%$	40 $\Omega/A \pm 2\%$	1 V/V $\pm 3\%$	0.25 V/A $\pm 7\%$	1.5 s	2 s	120 s	2 s	226	500	1, 2, 3, 5, 6, 23, 31, 32	\$8400*	
60 mV	0.75 mA	200 ms, 3 V	300 $\Omega/V \pm 2\%$	600 Ω/A	1 V/V	**	0.2 s	1 s	45 s	2 s	27.6	61	5, 10, 27, 28	\$1750	

Δ For operation with a 50 Hz input (possible only with Option 005), the rms ripple and transient response specifications are increased by 50%.

**This feature is not available.

*An ac input option must be specified when ordering these 3-phase models.

\dagger Special Option J30 must be ordered with models 6434B-6448B and 6466C-6483C to be programmed with an HP 59501B Power Supply Programmer. Contact your local HP Field Engineer for ordering instructions.



POWER SUPPLIES

Multiple Output Linear System Power Supplies

Models 6621A, 6622A, 6623A and 6624A

- 2, 3 or 4 Independent Isolated Outputs per Model
- 160 Watts Total Output Power per Model
- HP-IB Programming of Voltage and Current

- HP-IB Measurement of Voltage and Current
- Full Local Control or Local Lockout
- Programmable Overvoltage and Overcurrent Protection

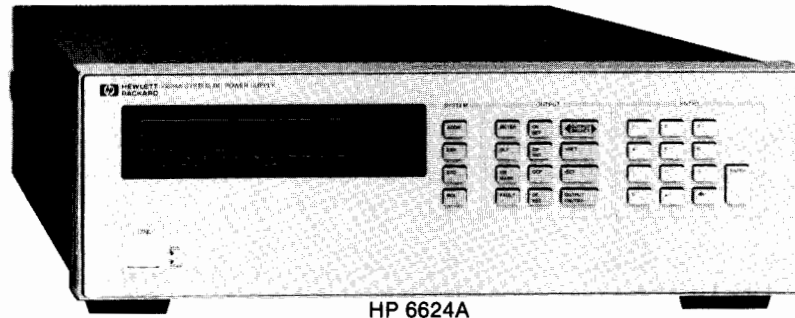

HP 6624A

Description

These HP-IB multiple output series regulated system power supplies feature a combination of intelligence, performance and low price which makes them the choice for power systems applications.

Four models, each offering a total of 160 watts output power, offer a variety of output combinations of 40 and 80 watts with voltages up to 50 volts and currents to 10 amps. Each output can produce power in two ranges (see fig. 1). For example, model 6622A has two 80 watt outputs. Each of these can produce 80 watts at either 20 volts or 50 volts. When operating below 20 volts, each output can source or sink up to 4 amps. When operating between 20 volts and 50 volts, it can source or sink up to 2 amps. Output combinations include:

- 6621A - 2 outputs at 80 watts, either 0-7 or 0-20 volts
- 6622A - 2 outputs at 80 watts, either 0-20 or 0-50 volts
- 6623A - 1 output at 80 watts, 0-7 or 0-20 volts; 1 at 40 watts, 0-20 or 0-50 volts; 1 at 40 watts, 0-7 or 0-20 volts
- 6624A - 4 outputs at 40 watts: two at 0-7 or 0-20 volts and two at 0-20 or 0-50 volts

The built-in interface is tailored to the power supply, resulting in simpler programming. Specifications supplied with these power supplies already take both the power supply and programming interface into account as a system. Self-contained measurement and readback capabilities eliminate the need for scanning the output or using a separate DVM.

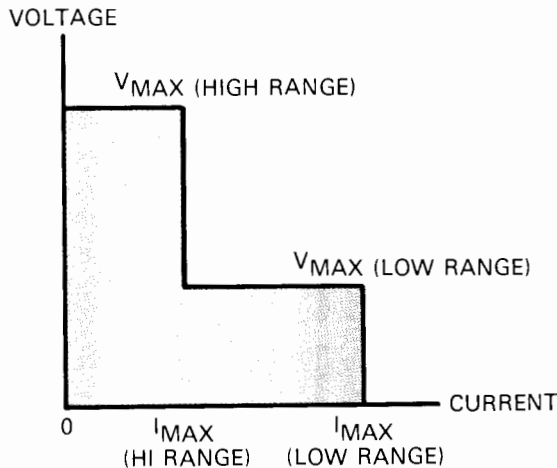

Fig 1. Output Characteristic Curve for HP 662X Series Power Supplies

Programming Capabilities

These power supplies share the programming command set of the higher power models 6030A-6038A programmable power supplies. (see page 274) The following functions are implemented:

- Output Voltage and Current Programming
- Output Voltage and Current Measurement and Readback Present and Accumulated Status Readback
- Programmable Service Request Mask
- Programmable Overcurrent Protection
- Programmable Overvoltage Protection
- Storage and Recall of Programmed Value Sets (all outputs)
- Echo Queries of Programmable Functions/Settings
- Output Channel Enable/Disable
- Programming Syntax Error Detection
- Reprogramming Delay Time for Service Request Mask

Operating voltage and current range is selected programmatically, with the last parameter programmed (voltage or current) determining the range. No separate command is required to switch output range.

Programmed command processing time is typically 7 milliseconds. Response time to within settling band is additional.

Protection Features

Local lockout capability enables the programmer to disable all front panel controls over the HP-IB except the channel select (to allow display of the output voltage and current of any channel.)

Protection against overcurrent conditions is provided by either the current limit or overcurrent protection. Current limit will prevent the output current from exceeding a programmed value, while overcurrent protection will disable the supply if that value of current is reached. Current limit is always active, while overcurrent protection can be enabled or disabled.

As an example of its use, consider testing PC board subassemblies with a programmable power supply. A shorted component would cause current to be drawn from the power supply at the current limit value, possibly burning the board. Enabling overcurrent protection would cause the power supply to disable itself when the current limit value is reached, thus minimizing damage.

Output Ratings And Combinations

OUTPUT	CHANNEL	NUMBER OF OUTPUTS PER MODEL			
		6624A (4 output)	6623A (3 output)	6622A (2 output)	6621A (2 output)
0-20/ 0-2	0-7/ 0-5	2	1	-	-
0-50/ 0-0.8	0-20/ 0-2	2	1	-	-
0-20/ 0-4	0-7/ 0-10	-	1	-	2
0-50/ 0-2	0-20/ 0-4	-	-	2	-

Protection against output overvoltage conditions is also provided. Normally, the power supply voltage will not exceed the programmed voltage setting. Programmable overvoltage protection guards your load against hardware faults by disabling and down-programming the power supply output if the programmed overvoltage setting is exceeded. A crowbar circuit is activated and shorts the output under these conditions.

This series also provides protection from unregulated output in the event of line voltage dropout and also guards against overtemperature conditions. The output is disabled when either of these conditions exists.

A service request can be generated to inform the controller in the event of any user-defined combination of overvoltage, overcurrent, overtemperature or mode change.

Fault trips which disable the output can be reset over the HP-IB.

Software Calibration And Selftest

With this series of power supplies, calibration is performed without removing the instrument's cover. All that is required is a shunt, a dvm, a controller and a few lines of code. Simple commands instruct the power supply to go to preset adjustment points, where voltages or currents are read with the dvm and shunt. Then the readings are sent to the power supply, which adjusts its calibration. Calibration is maintained through line voltage cycling.

Calibration integrity can be assured by using a jumper inside the box which, when removed, will prevent the supply from accepting calibration commands.

These supplies also have considerable selftest capability, which is exercised at power on and upon receipt of the selftest command over the HP-IB. Running selftests over the HP-IB will not cause the output to change.

System Configuration

This series of power supplies offers a number of significant benefits in the area of simplicity and flexibility of system configuration.

A convenient rear panel line voltage module allows switching of input line voltage without removing the covers. (The line voltage option determines line cord plug configuration.)

For applications which require different combinations of voltage and current for different loads, the dual range full power feature will be useful (see fig. 1). If this is not enough, two outputs can be combined in parallel or series combinations for more power at a given voltage or current level.

Where a precisely regulated voltage is required at the load, remote sensing at the load can be used. This capability will compensate for load lead IR drops of up to 1 volt per load lead. Add 1mV to the load effect specification for each 200 mV drop in the negative load lead when remote sensing.

All outputs of these power supplies are isolated for up to 240 volts dc from chassis ground and each other.

For applications which require a hardware trip signal separate from the HP-IB remote disable, terminals are provided on the rear panel barrier block of each output which provide bidirectional overvoltage protection trip capability. These terminals can be used to

monitor for an OVP trip signal, strapped together to disable all outputs when one OVP is tripped or used as a remote disable separate from the HP-IB.

These models can sink as well as source current. This means that downprogramming without a load takes the same time as upprogramming. Quick discharging of reactive loads is another benefit resulting from this capability.

Front Panel Control

To aid in system program development, the following capabilities of these power supplies are controllable from the front panel:

- Output Channel Select (Controls and Display)
- OVP Setting
- Overcurrent Protection Enable
- Storage and Recall of Programmed Settings
- Voltage Setting
- Current Setting
- SRQ Mask Delay Time
- Output Enable/Disable
- OVP, OCP Reset
- Local

The alphanumeric LCD display will normally display output voltage and current for the channel selected. When programming from the front panel, the function being programmed and the present value will be displayed. Fault conditions will be spelled out in alpha characters. Output channel is indicated by an annunciator.

Changing the HP-IB address is done from the front panel, using the address key and the numeric keypad.

General Specifications

HP-IB interface functions: SH1, AH1, T6, L4, SR1, RL1, PP1, DC1, DT0. For more information on these codes, refer to the HP-IB section of this catalog.

Safety agency compliance: This series of power supplies is designed to comply with the following regulatory standards: IEC 348, VDE 0411, UL 1244, ANSI C39.5, and CSA Electrical Bulletin 556B.

Dimensions (all models): 132.6 mm H x 425.5 mm W x 497.8 mm D. (5.22 in. H x 16.75 in. W x 19.6 in. D)

Input current: 100 VAC 120 VAC 220 VAC 240 VAC
(max.rms, all models) 6.3 A 5.4 A 3.0 A 3.0 A

Weights kg(lb) (all models): NET 17.4(38) SHIPPING 22.7(50)

Prices And Option Descriptions

- 6621A:** Dual output system power supply. \$2700
- 6622A:** Dual output system power supply. \$2700
- 6623A:** Triple output system power supply. \$3200
- 6624A:** Quad output system power supply. \$3700
- (NOTE: Line voltage option (100, 120, 220 or 240) must be specified)**
- 100:** 87- 106 Vac, 47-66 Hz. (for Japan only) N/C
- 120:** 104-127 Vac, 47-66 Hz. N/C
- 220:** 191-233 Vac, 47-66 Hz. N/C
- 240:** 209-250 Vac, 47-66 Hz. N/C
- 700:** CIIIL programming for MATE in place of HP-IB add \$500
- 908:** Rack Mount Kit for one unit (no handles) add \$30
- 909:** Rack kit with handles add \$80
- 910:** One each extra operating and service manuals. (Operating manual only is shipped with standard unit.) add \$30

Output Channel Specifications (READ ACROSS FROM PREVIOUS PAGE)

HP-IB OUTPUT SETTINGS				HP-IB MEASUREMENT READBACK ACCURACY		PARD (p-p/rms)		REGULATION				PROGRAMMING SPEED		
RESOLUTION		ACCURACY**		**				LOAD EFFECT		SOURCE EFFECT		TIME	RESPONSE	SETTLING
VOLTAGE	CURRENT	VOLTAGE	CURRENT	VOLTAGE	CURRENT	VOLTAGE	CURRENT	VOLTAGE	CURRENT	VOLTAGE	CURRENT	CONSTANT	TIME	BAND
6 mV	25 mA	19 mV + 0.06%*	50 mA + 0.16%*	20 mV + 0.05%*	10 mA + 0.1%*	3 mV/500 uV	1 mA rms	2 mV	1 mA	1 mV + 0.01%*	1 mA + 0.06%*	250 uS	2 mS	20 mV
15 mV	10 mA	50 mV + 0.06%*	20 mA + 0.16%*	50 mV + 0.05%*	4 mA + 0.1%*	3 mV/500 uV	1 mA rms	2 mV	0.5 mA	1 mV + 0.01%*	1 mA + 0.06%*	750 uS	6 mS	50 mV
6 mV	50 mA	19 mV + 0.06%*	100 mA + 0.16%*	20 mV + 0.05%*	20 mA + 0.1%*	3 mV/500 uV	1 mA rms	2 mV	2 mA	1 mV + 0.01%*	2 mA + 0.06%*	250 uS	2 mS	20 mV
15 mV	20 mA	50 mV + 0.06%*	40 mA + 0.16%*	50 mV + 0.05%*	8 mA + 0.1%*	3 mV/500 uV	1 mA rms	2 mV	1 mA	1 mV + 0.01%*	2 mA + 0.06%*	750 uS	6 mS	50 mV

*% of setting. ** For a ±5°C range about the calibration temperature

POWER SUPPLIES

Autoranging System Power Supplies

Models 6030A, 6031A, 6032A, 6033A, and 6038A

- HP-IB programming of voltage and current
- Readback of voltage, current and status
- Overvoltage and overcurrent protection

- Optional CILL programming
- Built-in self-test and diagnostics
- Up to 1200 watts output
- Full local control enable/disable

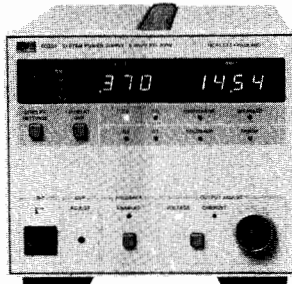

HP 6033A, 6038A

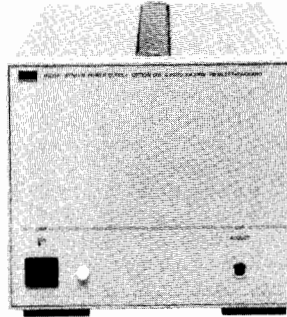

HP 6033A and 6038A with Opt 001

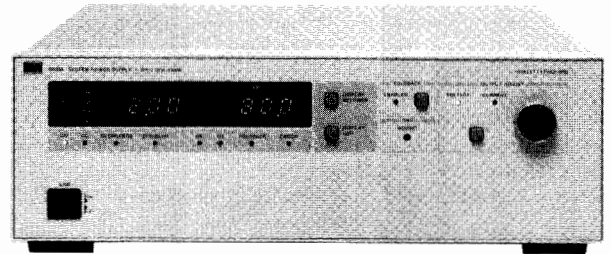

HP 6030A, 6031A and 6032A

Description

These HP-IB CV/CC dc power supplies have many productivity-oriented features which make them easy to program, integrate into systems and use.

A conventional power supply subsystem capable of monitoring and controlling power supply voltage and current requires a variety of hardware in addition to the actual supply. These new power supplies, however, have built-in capabilities which eliminate the need for D/A programmers, DVMs, and associated auxiliary circuitry. Fewer instruments mean less rack space, easier calculation of system specifications, quicker configurations, higher system reliability, more rapid troubleshooting, and simpler software. As autoranging power supplies, these models can provide a wide and continuous range of voltage and current combinations at the maximum rated power. This often allows both present and future requirements to be satisfied with fewer supplies, also reducing the number of instruments in the system.

Front Panel Control

Most of the extensive programmable instruction set can be simulated with front panel controls, thus facilitating design and debugging of system hardware and software. During system operation, if local control is not needed, the front panel controls can be disabled with a computer command. If operator interaction is required, a computer command can place limits on the output voltage and current available. Often, control and monitoring via the front panel is very useful during system development, but not needed afterwards. If the system is reproduced without further development, power supplies without front panel controls and meters (Option 001) can then be used. Ordering your power supplies with Option 001 significantly decreases the cost.

Protection Features

Because of the delicate nature of most loads, these system power supplies provide several different types of protection. Since they are CV/CC supplies, both the output voltage and current will be automatically limited to the programmed values. If reaching a programmed value indicates an undesirable condition, the power supply can be instructed to automatically down-program to zero output. For example, if the programmed current limit is reached while testing a PC board assembly, it may indicate a shorted component. In this case, the FOLDBACK feature, if enabled, would be able to serve as an overcurrent protection circuit and down-program the power supply automatically. FOLDBACK can be enabled and reset over the HP-IB.

The built-in overvoltage protection circuit is adjustable with a front panel control. The set trip level can be displayed on the front panel meter and also can be read back over the HP-IB, thus making adjusting the level easy. The OVP circuit, once tripped, can be reset over the HP-IB.

Production procedures sometimes require the operator to adjust the output voltage or current of a power supply locally with the front panel controls. If this is done, programmed levels can be set to limit the available adjustment range to a safe margin.

Potentially harmful conditions, such as overtemperature and high or low ac input, will trigger the power supply to automatically down-program to zero output. When these conditions occur, or the FOLDBACK or OVP circuits trip, LEDs on the front panel light to indicate the failure. This status can also be read back to the computer over the HP-IB and can be used to generate interrupts.

Specifications

Ratings		Autoranging Output*							Regulation				10% Change Transient Recovery
									Load Effect		Source Effect		
Volts	Amperes	V ₁	P ₁	V ₂	P ₂	V ₃	P ₃	HP Model	Voltage	Current	Voltage	Current	
0-20	0-30	20V	200W	14V	242W	6.7V	200W	6033A	0.01% +2mV	0.01% +9mA	0.01% +1mV	0.01% +6mA	1ms / 50mV
0-20	0-120	20V	1000W	14V	1064W	7V	840W	6031A	0.01% +3mV	0.01% +15mA	0.01% +2mV	0.01% +25mA	2ms / 100mV
0-60	0-10	60V	200W	40V	240W	20V	200W	6038A	0.01% +3mV	0.01% +5mA	0.01% +2mV	0.01% +2mA	1ms / 75mV
0-60	0-50	60V	1000W	40V	1200W	20V	1000W	6032A	0.01% +5mV	0.01% +10mA	0.01% +3mV	0.01% +10mA	2ms / 100mV
0-200	0-17	200V	1000W	120V	1200W	60V	1020W	6030A	0.01% +5mV	0.01% +10mA	0.01% +5mV	0.01% +5mA	2ms / 150mV

*See the generalized autoranging output characteristic curve.



Programmable Features

Below are the parameters which can be programmed on the HP 6030A — 6038A and the information which is available for readback over the HP-IB. All of these features are included with the standard user-friendly programming language.

Programmable Functions

- Output Voltage
- Output Current
- Output Disable/Enable
- Soft Voltage Limit
- Soft Current Limit
- Group Trigger
- Foldback Mode
- Device Clear
- Interrupt Mask
- Interrupt Delay
- Preset Power Supply States
- Self-Test
- Local Lockout

Readback Functions

- Programmed Voltage
- Programmed Current
- Actual Voltage
- Actual Current
- OVP Trip Level
- Soft Voltage Limit
- Soft Current Limit
- Foldback Mode
- Present Status
- Accumulated Status
- Interrupt Mask
- Programming Error Codes
- Self Test Error Codes
- Output Disable/Enable
- Device ID

For added flexibility now a CIIL programming language, Option 700, is available.

System Configuration

If your application requires more power than the output capability of a single unit, you can use an auto-series connection for greater output voltage or an auto-parallel connection for greater output current. Any combination of models is possible with two units used in auto-parallel or up to 240 volts (550 volts for the HP 6030A) total output for auto-series connections. In addition, up to four 1000 watt models may be connected in autoparallel. For example, if you need 200 amperes at 6 volts, a cost-effective solution would be to use an HP 6031A as the master power supply and an HP 6011A as the slave in an auto-parallel configuration. See page 266 for more information about the HP 6011A, a non-HP-IB dc power supply.

Remote sensing can be used to maintain the CV load effect specification at the load with up to 0.5 volt drop per load lead, and sense wires which are less than 0.2 ohm per lead. Operation is possible with up to 2.0 volts drop per lead; however, the load effect specification may be degraded.

Either terminal may be grounded, or may be floated up to ± 240 (± 550 volts for the HP 6030A) volts from chassis ground.

Analog programming inputs and monitoring terminals are provided on the rear panel in addition to the HP-IB programming capabilities. Zero to full scale voltage or current can be programmed with either 0-5 volt voltage signals, or 0-4000 ohm resistance signals. The monitoring terminals present 0-5 volt buffered signals which are proportional to the output voltage and current.

HP models 6030A, 6031A, 6032A, and 6038A are stable when operating in CC into inductive loads up to 100 mH, and the HP 6033A and 6038A can handle up to 1 H. A special modification is available for HP Models 6030A, 6031A and 6032A to ensure stable operation when operating into inductive loads up to 10 H.

General Specifications

HP-IB interface functions: SH1, T6, AH1, L4, SR1, RL1, PP1, DC1, DT1. For more on these codes, refer to the HP-IB section of this catalog.

Specifications cont.

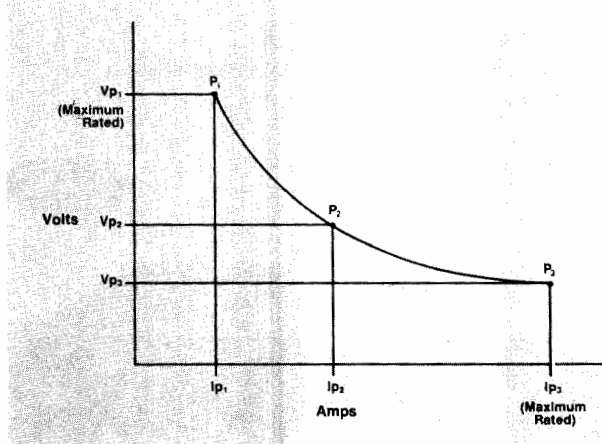

Generalized autoranging output characteristic curve

Dimensions: HP 6033A and 6038A: 177.0 mm H x 212.3 mm W x 443.6 mm D (6.97" x 8.36" x 17.872")
 HP 6030A, 6031A and 6032A: 132.6 mm H x 425.5 mm W x 503.7 mm D (5.2" x 16.75" x 19.83")

Option Descriptions

- 001:** Front panel which has only line switch, line indicator, and OVP adjust. less \$300
- 100:** 87-106 Vac, 48-63 Hz. This option is for use in Japan only. The power supply output power is 75% of the output power available with the other line voltage options. N/C
- 120:** 104-127 Vac, 48-63 Hz. N/C
- 220:** 191-233 Vac, 48-63 Hz. N/C
- 240:** 208-250 Vac, 48-63 Hz. N/C
- 700:** CIIL programming language add \$800
- 800:** Rack mount kit for two units side by side. This applies to HP 6033A and 6038A only. add \$ 75
- 908:** Rack mount kit for a single unit. A blank filler panel is supplied when this option is ordered with HP 6033A and 6038A.
 HP 6033A and 6038A add \$ 80
 HP 6030A, 6031A and 6032A add \$ 30
- 910:** One extra operating and service manual shipped with each power supply. add \$ 15

PARD (rms/p-p) 20 Hz-20 MHz	Remote Control						General					
	Resolution		Accuracy		AC Input Current				Weight - kg (lbs)		Price	
	Voltage	Current	Voltage	Current	100 Vac	120 Vac	220 Vac	240 Vac	Net	Shipping		
3mV/30mV	15mA/-	5mV	7.5mA	0.035% +9mV	0.15% +20mA	6.0A	6.5A	3.8A	3.6A	9.6(21)	11.4(25)	\$2400
8mV/50mV	120mA/-	5mV	30mA	0.035% +15mV	0.25% +250mA	24A	24A	15A	14A	17.2(38)	22.7(50)	\$3200
3mV/30mV	5mA/-	15mV	2.5mA	0.035% +40mV	0.085% +10mA	6.0A	6.5A	3.8A	3.6A	9.6(21)	11.4(25)	\$2400
8mV/40mV	25mA/-	15mV	12.5mA	0.035% +40mV	0.2% +85mA	24A	24A	15A	14A	16.3(36)	21.8(48)	\$3100
22mV/50mV	15mA/-	50mV	4.25mA	0.035% +145mV	0.2% +25mA	24A	24A	15A	14A	16.3(36)	21.7(48)	\$3200



POWER SUPPLIES

200 Watt System Power Supply

Model 6002A

- 200 watt autoranging dc output
- Constant-voltage/constant-current operation
- HP-IB programming option

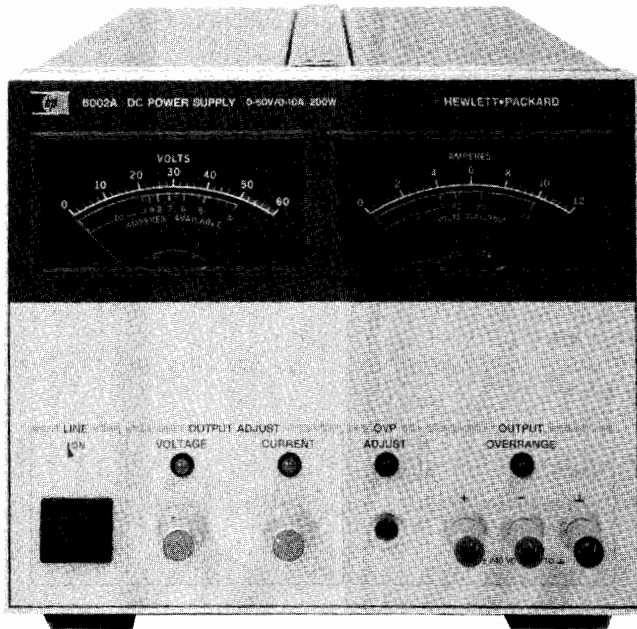

HP 6002A

Description

The HP 6002A dc power supply offers an exceptional combination of performance and flexibility. It employs a unique control concept which provides for an autoranging output with the performance characteristics of linear regulation. The HP 6002A is a 200 watt CV/CC power supply, which may be remotely programmed via the HP-IB when equipped with Option 001.

As an autoranging power supply, the HP 6002A can provide 200 watts over a wide range of voltage and currents without external intervention. This allows it to take the place of multiple conventional power supplies. For example, the HP 6002A can replace both a 50 volt, 4 ampere supply and a 20 volt, 10 ampere supply.

System Features/Remote Control

Analog programming of output voltages and current can be accomplished through the use of remotely controlled resistance or voltage applied to rear panel terminals. Additional control terminals are provided for remote load voltage sensing, auto-series or parallel operation, and for remotely activating the crowbar circuit. A pulse output from the crowbar terminal indicates the overvoltage circuit has been self-activated. A voltage step change appearing on terminal indicates a changeover to or from constant-current operation.

HP-IB Option

Digital programming via Option 001 permits control of output voltage or current by the Hewlett-Packard Interface Bus (HP-IB). Two programmable ranges allow better resolution below 10 volts or 2 amperes. The selection of HP-IB control of either voltage or current is done by rear panel switches. The IEEE 488 interface functions supported by the HP 6002A with Option 001 are basic listener (L2) and acceptor handshake (AH1). Complete explanation of these interface functions is available in the IEEE Std. 488-1978.

Specifications

DC output: voltage and current output can be adjusted over the ranges indicated by front panel controls, analog programming, or an optional HP-IB interface.

Voltage: 0-50 V. **Current:** 0-10 A.
Maximum 200 watts output from 20 V to 50 V.

- Built-in overvoltage protection crowbar
- CV/CC operating status indicators
- Remote analog programming and sensing

Autoranging Output Characteristic

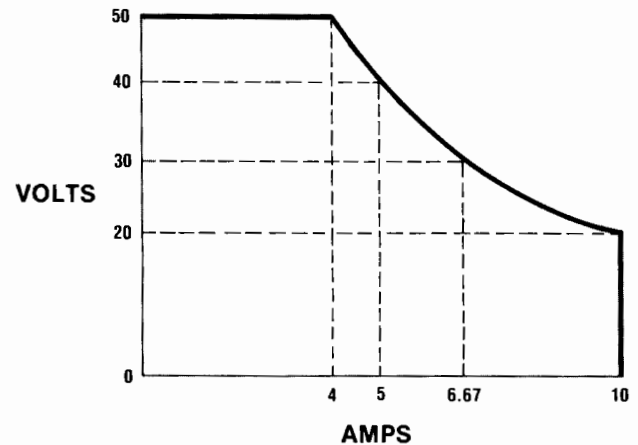

Load effect: constant-voltage, 0.01% +1 mV. Constant-current, 0.01% +1 mA.

Source effect: CV, 0.01% +1 mV; CC, 0.01% +1 mA.

PARD (ripple and noise): rms/p-p, 20 Hz to 20 MHz; CV, 1 mV/10 mV; CC, 5 mA rms.

Temperature coefficient: CV, 0.02% +200 μ V/ $^{\circ}$ C; CC 0.02% +5 mA/ $^{\circ}$ C.

Drift: CV, 0.05% +1 mV/8 h; CC, 0.05% +5 mA/8 h.

Load transient recovery: 100 μ s for output voltage to recover within 15 mV of nominal voltage setting following a load current change of 50% to 100% or 100% to 50% of full load current.

Response time: maximum time for output voltage to change between 0 to 99.9% or 100% to 0.1% of maximum rated output voltage. Up Programming: no load, 100 ms; full load, 100 ms. Down Programming: no load, 400 ms; full load, 200 ms.

Overvoltage protection: trip voltage adjustable from 2.5 V to 60 V.

DC output isolation: 150 V dc.

Power: 100, 120, 220, or 240 V ac (-13%, +6%), 48-63 Hz.

Temperature rating: 0 $^{\circ}$ C to 55 $^{\circ}$ C operating, -40 $^{\circ}$ C to +75 $^{\circ}$ C storage. Supply is cooled by built-in fan.

Size: 180 H x 212 W x 422 mm D (6.97" x 8.36" x 16.6").

Weight: net, 14.5 kg (32 lb); shipping, 15.9 kg (35 lb).

HP-IB Option

Programmable ranges: high: 0-50 V or 0-10 A,
low: 0-10 V or 0-2 A.

Programming speed: same as response time.

Accuracy: hi range: CV, 0.2% +25 mV; CC, 0.2% +25 mA.
lo range: CV, 0.2% +10 mV; CC, 0.2% +25 mA.

Resolution: hi range: CV, 50 mV; CC, 10 mA. (12 bit)
lo range: CV, 10 mV; CC, 2 mA. (12 bit)

Isolation: 250 volts dc from bus data lines to power supply.

Accessories

Accessories	Price
HP 5061-0060: rack mounting adapter kit for one HP 6002A	\$80.00
HP 5061-0094: cabinet lock-together kit to connect two HP 6002As	\$38.00
HP 5061-0078: rack flange kit to mount 2 locked HP 6002As	\$35.00

Options

Options	Price
001: HP-IB interface	add \$560.00
910: one extra operating and service manual	add \$7.50

HP 6002A Autoranging DC Power Supply **\$1950**

POWER SUPPLIES

Digital Programmable: HP-IB Programmer

Model 59501B



- HP-IB power supply control
- HP-IB-to-power-supply isolation
- Programmable range

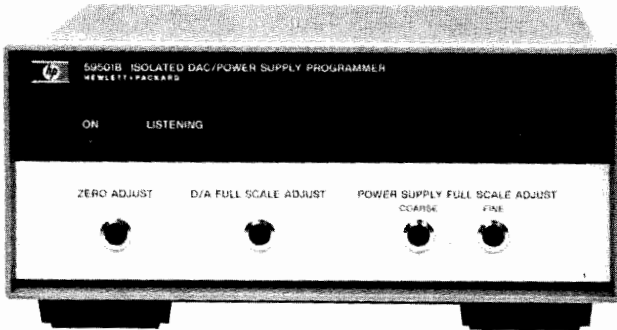

HP 59501B



Description

The HP 59501B is an isolated digital-to-analog converter designed to provide a convenient interface between the Hewlett-Packard Interface Bus and HP power supplies. With the HP 59501B, a wide range of dc voltages and currents becomes automatically controllable via the HP-IB. With proper wiring, the built-in isolation devices protect other instrumentation on the HP-IB from damage that could be caused by power supply outputs. In addition, an internal control circuit holds the output level near zero until programmed data is received. A programmable High/Low range control improves resolution by ten-to-one.

Power supply control is accomplished through the HP 59501B's programmable output voltage and programming network (see below). By making the appropriate connections between the 59501B's rear terminals and the remote programming terminals on the supply, the output voltage (or current) of the supply can be programmed from zero to its full rated output. The HP 59501B front panel controls provide fast and easy calibration of power supply outputs. The Zero Adjust enables the user to correct for small offsets in power supply response to programmed inputs. The Power Supply Full Scale Adjust (part of programming network) enables the user to set the maximum output desired from the power supply when the HP 59501B is programmed to its maximum value. For example, this adjustment would normally be used to calibrate the maximum programmable output of a 320Vdc power supply to 320 volts. However, it could also be used to set the maximum to 200 volts.

The HP 59501B also can be used directly as a low level dc signal source. Unipolar and bipolar output modes are available with output voltages programmable from zero to 9.99 volts, or minus 10.0 to plus 9.98 volts. Output current up to 10 milliamperes is available and is automatically limited to protect the HP 59501B and user equipment. The HP 59501B produces a full scale voltage change in approximately 250 μ s from the time the digital data is received.

- Programmable 10-volt dc output
- Unipolar/bipolar operation
- Fast digital to analog conversion

Specifications

Digital to Analog Converter

DC output voltage: programmable in high or low ranges within the voltage limits shown below. Output mode is unipolar or bipolar and is selected by a rear panel switch.

Unipolar: 0 to 9.99 V (low range, 0 to 0.999 V).

Bipolar: -10 to +9.98 V (low range, -1 to +0.998 V).

DC output current: 10 mA maximum.

PARD (ripple and noise): 2 mV rms/10 mV p-p.

Resolution: unipolar, 10 mV (low range, 1 mV). Bipolar, 20 mV (low range, 2 mV).

Accuracy: specified at 23°C $\pm 5^\circ$ C.

Unipolar: 0.1% + 5 mV (low range, 0.1% + 1 mV).

Bipolar: 0.1% + 10 mV (low range, 0.1% + 2 mV).

Stability: change in output over 8 hour interval under constant line, load, and ambient following a 30 minute warm-up. Stability is included in accuracy specification measurements over the temperature range indicated.

Unipolar: 0.04% + 0.5 mV (low range, 0.04% + 0.1 mV).

Bipolar: 0.04% + 1 mV (low range, 0.04% + 0.2 mV).

Temperature coefficient: unipolar, 0.01%/°C + 0.5 mV/°C (low range, 0.1%/°C + 0.1 mV/°C). Bipolar, 0.01%/°C + 0.5 mV/°C (low range, 0.01%/°C + 0.1 mV/°C).

Zero adjust: plus or minus 250 millivolts.

D/A full scale adjust: plus or minus 5%.

Programming speed: the time required for output to go from zero to 99% of programmed output change is 250 μ s (measured with resistive load connected to output terminals).

Power Supply Programming

Programming network specifications: in the following specifications, M represents the calibrated full scale value of the supply being programmed and P is the actual programmed output. The full scale value (M) can be any value within the supply's output range and is calibrated with the HP 59501B programmed to its maximum high range output.

Accuracy: specified at 23°C $\pm 5^\circ$ C.

Unipolar: 0.05% M + 0.25% P (low range, 0.01% M + 0.25% P).

Bipolar: 0.1% M + 0.25% P (low range, 0.02% M + 0.25% P).

Isolation: 600 V dc between HP-IB data lines and output terminals.

Temperature coefficient: 0.005% M/°C + 0.015% P/°C (low range, 0.01% M/°C + 0.015% P/°C).

Programming resolution: 0.1% M (low range, 0.01% M).

Programming speed: D/A programming speed plus the programming speed of the power supply.

General

Temperature range: operation, 0 to 55°C; storage, -40 to 75°C.

Power: 100, 120, 220, or 240 Vac (+6% -13%) 47-63 Hz, 10 VA (selectable on rear panel).

Size: 101.6 H x 212.9 W x 294.6 mm D (4" x 8.38" x 11.6").

Weight: net, 1.82 kg (4 lb); shipping, 2.27 kg (5 lb).

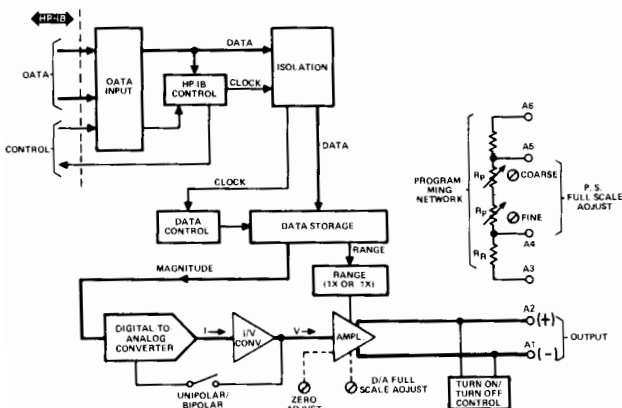

Several programming notes are available to assist in operating the HP 59501B Power Supply Programmer with the HP desktop computers. For more on free publications, see page 755.

Accessories

HP 5060-0173: rack mounting adapter kit for one HP 59501B

HP 5060-0174: rack mounting adapter kit to connect two HP 59501B's

Ordering Information

HP 59501B HP-IB Isolated D/A Power Supply Programmer

Price

\$52

\$52

Price

\$760



POWER SUPPLIES

Precision Bipolar System Supplies

Models 6129C-6131C & 6140A

- HP-IB compatible options P05 and J99 with HP 59301A
- Fast, accurate, high resolution programming
- Bipolar output

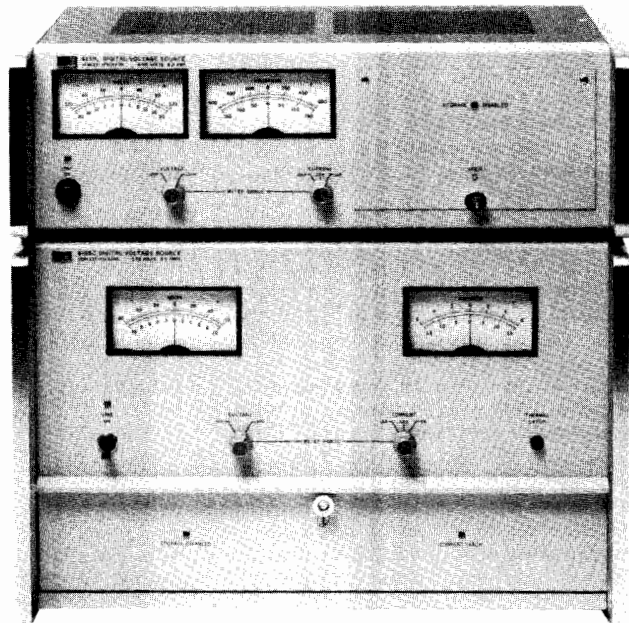

HP 6131C (top) & 6129C

The family of Precision Bipolar System Supplies consists of three voltage sources (HP 6129C, 6130C and 6131C) and one current source (HP 6140A). They provide easy, fast and accurate programming of their dc outputs, with many features oriented specifically towards efficient integration in automatic systems.

HP-IB

These system power supplies, when ordered with either option P05 or J99, may be programmed on the HP-IB via the HP 59301A ASCII to parallel converter.

Isolation

All digital inputs are completely isolated from the analog outputs.

Programmable Current Limit (Voltage Source)

Valuable loads can be protected by a user programmable current latch. Output power goes to zero when the latch circuit is tripped. The reaction time to the latch can be adjusted, if desired, to avoid tripping when reprogramming with a capacitive load. There is also a fixed current limit at 110% of rated current output.

Current Monitoring Terminals (Voltage Sources)

A voltage is available at the rear barrier strip which is proportional to the output current.

Analog Input

An ac signal may be injected into the output amplifier to simulate various noise and ripple conditions.

Precision Bipolar System Current Source

The HP 6140A Current Source has features which correspond to the voltage sources. It has a programmable voltage limit, voltage monitoring terminal, as well as isolation, HP-IB options, and analog input capabilities.

Accessories Furnished

HP 1251-0086 50-contact rear plug.
HP 5060-7948 Plug-in extender board for voltage source.
HP 5060-7948/5060-7982. Two plug-in extender boards for current source.

- Current sink or source
- Programmable current latch (on voltage sources) or voltage limit (on current sources)
- Isolated output

Specifications

	Binary Instruments Option J20 & P05		BCD Instruments Option J99	
	X1 Range	X10 Range	X1 Range	X10 Range
HP 6129C				
Output	±16.384 V, 5 A	±50.00 V, 5 A	±9.999 V, 5 A	±50.00 V, 5 A
Accuracy	1.5 mV	15 mV	1.5 mV	15 mV
Resolution	0.5 mV	5 mV	1 mV	10 mV
HP 6130C				
Output	±16.384 V, 1 A	±50.00 V, 1 A	±9.999 V, 1 A	±50.00 V, 1 A
Accuracy	1 mV	10 mV	1 mV	10 mV
Resolution	0.5 mV	5 mV	1 mV	10 mV
HP 6131C				
Output	±16.384 V, 0.5 A	±100.00 V, 0.5 A	±9.999 V, 0.5 A	±99.99 V, 0.5 A
Accuracy	1 mV	10 mV	1 mV	1 mV
Resolution	0.5 mV	5 mV	1 mV	10 mV
HP 6140A				
Output	±16.384 mA, 100 V	±163.84 mA, 100 V	±9.999 mA, 100 V	±99.99 mA, 100 V
Accuracy	1 µA ±0.01%	10 µA ±0.01%	10 µA ±0.01%	10 µA ±0.01%
Resolution	0.5 µA	5 µA	1 µA	10 µA

Options

AC Power Option

028: transformer tap change for 230 V ac ±10%, single-phase input on HP 6130C and 6131C. (HP 6129C and 6140A are 115/230 switch selectable.)

Price

N/C

Standard Interface Options*

P05: 16 bit binary programming format with modifications to interface to the HP 59301A and be programmed on the HP-IB. In addition to power supply modifications, a cable to connect the supply to the HP 59301A and programming documentation are included.

add \$150

J99: 4 digit BCD programming format, otherwise similar to Opt. P05. A cable, and programming documentation, are included.

add \$150

J20: 16 bit binary interface for HP 12661A I/O programmer card for Hewlett-Packard computers.

N/C

Accessories Available

HP 14533B: Pocket programmer permits manual programming of all input functions by switch closure.

\$395

HP 14534A: Pocket programmer extension cable (3 ft).

\$170

HP 14535A: HP computer interface kit includes HP 12661A computer I/O card, HP 14539A cable, verification software and RTE Driver. Up to eight PBSS's may be controlled from one HP 14535A.

\$1725

HP 14536A: Chaining cable connects an additional PBSS to the existing chain of PBSS's.

\$295

Ordering Information

An interface option must be ordered.

HP 6129C: Digital Voltage Source

\$7300

Opt 908: Rack Flange Kit

add \$50

HP 6130C, 6131C: Digital Voltage Source

\$4200

Opt 908: Rack Flange Kit

add \$37.50

HP 6140A: Digital Current Source

\$7300

Opt 908: Rack Flange Kit

add \$37.50

Opt 910: One extra operating and service manual shipped with each power supply

\$20

POWER SUPPLIES

Special Purpose: DC Power Supply/Amplifiers

Models 6824A-6827A

- High speed remote programming
- Overload protection
- Wide-band response

- Bipolar voltage
- Current sink or source

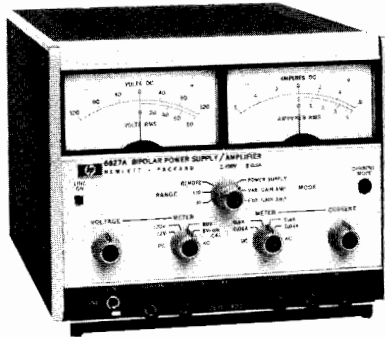

HP 6825A-6827A

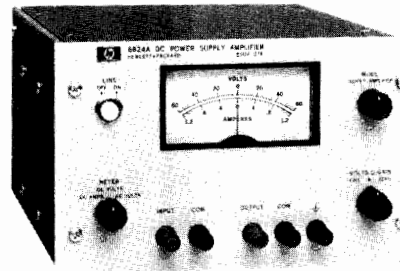

HP 6824A

Description

The Power Supply/Amplifier is a general-purpose instrument useful in any laboratory engaged in research and development of electronic systems, circuitry, or components. The unit can be operated in one of two basic operating modes: power supply or amplifier. Terminals at the rear permit access to various internal control points to further expand the operational capabilities of the instrument. The resulting flexibility lends the Power Supply/Amplifier to an almost unlimited number of applications.

Models 6825A Through 6827A

These models feature dual-range output and constant-voltage/constant-current operation. Output voltage and current as a dc supply, or gain as a power amplifier, are remotely controllable and are compatible with Hewlett-Packard Multiprogrammer Systems.

The unit can furnish a bipolar, constant-voltage or constant-current output. It can be remotely programmed with a resistance, voltage, or current and its high speed programming characteristics adapt it to a wide variety of laboratory and production testing applications. The unit can sink, as well as source, current permitting it to serve as a variable load device.

As a direct-coupled power amplifier, each unit offers a signal-to-noise ratio of approximately 80 dB at full output with low distortion and a frequency response up to 40 kHz in the fixed gain mode.

Model 6824A

Although this model does not provide quite the level of performance and flexibility of Models 6825A through 6827A, it is lower in cost and is suitable for many applications.

As a power supply, this unit offers constant-voltage/current-limiting operation, remote programming, and auto-series, auto-parallel operation.

As a power amplifier, the unit exhibits a high signal-to-noise ratio with a 20 dB gain from dc to 10 kHz. It is useful in servo systems, as a pulse or oscillator amplifier, for motor control, and a variety of other applications.

General Specifications

Temperature: operating, 0 to 55°C; storage, -40 to +75°C.

Power: HP 6824A, standard input voltage is 104-127 V ac, 48-63 Hz. Order Option 028 for 230 V ±10% operation. HP 6825A, 6826A, 6827A, switchable, 100, 120, 220, or 240 V ac, -13% +6%, 48-63 Hz, 150 W.

Size: HP 6824A, 131 H x 209 W x 303 mm D (5¹/₂" x 8⁷/₃₂" x 11¹/₁₆"). HP 6825A, 6826A & 6827A, 155 H x 198 W x 316 mm D (6³/₃₂" x 7²/₃₂" x 12⁷/₁₆").

Weight: HP 6824A, 7.7 kg (17 lb); 6825A, 6826A & 6827A, 8.2 kg (18 lb).

Specifications

RATINGS		POWER SUPPLY PERFORMANCE							POWER AMPLIFIER PERFORMANCE							
DC Output		HP Model	PAR (rms/p-p)		Transient Recovery		Resolution		Voltage Gain		Frequency Response, +1, -3 dB		Distortion at full output		Options	Price
Volts	Amperes		Voltage	Current	Time	Level	Voltage	Current	Fixed	Variable	Fixed Gain	Variable Gain	100 Hz	10 kHz		
-5 V to +5 V/ -20 V to +20 V	0-2.0 A Both Ranges	6825A	10/30 mV	5/15 mA	100 μs	20 mV	40 mV	6 mA	1X 4X	0-2X 0-8X	dc -40 kHz	dc -15 kHz	0.1% THD	0.5%	9	\$2100
-5 V to +5 V/ -50 V to +50 V	0-1.0 A Both Ranges	6826A	6/35 mV	0.8/5 mA	100 μs	50 mV	100 mV	3 mA	1X 10X	0-2X 0-20X	dc -40 kHz	dc -15 kHz	0.1% THD	0.5%	9	\$2100
-10 V to +10 V/ -100 V to +100 V	0-0.5 A Both Ranges	6827A	10/50 mV	0.4/5 mA	100 μs	100 mV	200 mV	1.5 mA	2X 20X	0-4X 0-40X	dc -30 kHz	dc -15 kHz	0.1% THD	1%	9	\$2100
-50 V to +50 V	0-1.0 A	6824A	10 mV rms	-	100 μs	0.02% +5 mV	-	-	-	0-10X	-	dc -10 kHz	0.1% THD	-	9.28	\$1300

Options Descriptions

028: 230 V ac ± 10%, single phase input

910: one additional manual shipped with each power supply

Prices

N/C

add \$5.10

add \$15

Accessories

HP 5060-8762: adapter frame for rack mounting one or two HP 6825A-6827A units \$115

HP 5060-8760: blank filler panel to be used with a above units \$36

HP 14515A: rack mounting kit for one HP 6824A \$61

HP 14525A: rack mounting kit for two HP 6824As \$35



POWER SUPPLIES

Special Purpose; Precision Voltage Sources

Models 6114A and 6115A

- 0.025% output voltage accuracy
- Pushbutton voltage control
- Five minute warm-up



HP 6114A & 6115A

Description

HP Models 6114A and 6115A

These 40-watt precision power supplies are high-accuracy instruments designed for use as low-cost calibrators, working voltage standards, systems reference supplies, or high-performance lab supplies. They are ideal for applications where an accurate, highly stable, and easy-to-use source of dc voltage is required.

Output Ratings

Both models feature automatic dual-range operation. For example, the HP 6114A can supply 0-20V at 0-2A, and 20-40V at 0-1A, without manual range switching. Automatic output current range cross-over occurs when the supply is providing greater than one-half of the maximum rated output voltage.

Output Voltage Controls

Pushbutton voltage controls allow the output voltage to be set rapidly and accurately. The setting is displayed in large, easy-to-read numerals. A four-digit pushbutton switch increases or decreases the output voltage in unit steps, and the switches go directly from "9" to "0" without backing down. A fifth digit, set via a separate front-panel control, provides output voltage resolution of 200 μ V.

The output voltage accuracy is 0.025% (250 ppm) plus 1 mV — for example, at 40 volts output, the output voltage of Model 6114A is accurate within ± 11 mV. This accuracy is attained after only five minutes' warmup, thus making these supplies especially suitable as portable calibrators.

Output Current Controls

A front-panel current control allows the maximum output current of these supplies to be set to any desired value within the maximum rating. Using this control, the supplies can be operated as constant-current sources with 0.01% current regulation. A current mode indicator (a light-emitting diode) immediately lights when the supply is operated in the gross current limit region or when the output current level established by the setting of the front-panel control is reached. When the indicator is lighted, the output voltage is uncalibrated, but the front panel voltmeter continues to indicate the output voltage with an accuracy of 2%. A ten-turn current control with a three-digit graduated dial provides 2 mA current resolution.

Remote Programming

Models 6114A and 6115A are designed to be programmed with either the HP Multiprogrammer or the HP-IB Isolated D/A Power Supply Programmer. Interfacing for Multiprogrammer operation is included as a standard feature in these models; therefore, the addition of Option 040 is not required. See pages 277 and 172 for additional information on digital programming interfaces for power supplies. Both supplies can also be remote programmed by means of an external voltage or resistance.

The output capacitor can be disconnected to reduce current surges, thereby improving the performance of the supply as a constant-current source; this also increases the programming speed by approximately an order of magnitude. Note, however, that some capacitance

- May be used with HP-IB Power Supply Programmer
- Overvoltage and overcurrent indicators
- Built-in overvoltage crowbar

at the load may be required to maintain power supply stability under all loading conditions when the output capacitor is disconnected.

Overvoltage Protection

A built-in overvoltage protection circuit (an SCR crowbar) monitors the output and reduces the output voltage and current to zero whenever a preset voltage limit (adjustable from the front panel) is exceeded. This feature provides a convenient method of limiting the maximum output voltage supplied to voltage-sensitive loads.

Specifications

DC Output: voltage and current output can be adjusted over the range indicated by front-panel controls or analog programming.

HP 6114A: 0-20 volts, 0-2 amperes

20-40 volts, 0-1 amperes

HP 6115A: 0- 50 volts, 0-0.8 amperes

50-100 volts, 0-0.4 amperes

Both models feature automatic dual-range operation, which eliminates manual range switching.

Load effect: constant-voltage deviation, 0.0005% + 100 μ V; constant-current deviation, 0.01% + 500 μ A.

Source effect: over the rated input voltage range: constant-voltage, 0.0005% + 100 μ V; constant-current, 0.005% + 40 μ A.

PAR (ripple and noise): rms/p-p, 20 Hz to 20 MHz; CV 40 μ V/200 μ V, CC 200 μ A/1 mA.

Temperature coefficient: CV, 0.0001% + 15 μ V/ $^{\circ}$ C; CC, 0.02% + 50 μ A/ $^{\circ}$ C.

Drift: CV, 0.0015% + 15 μ V per 8 hours, 0.0075% + 30 μ V per 90 days.

Output voltage accuracy: output voltage accuracy obtained from front-panel controls at $23 \pm 3^{\circ}$ C at any ac line voltage and load current within rating and following a five-minute warm-up: 0.025% + 1.0 mV.

Resolution: front-panel voltage control, 200 μ V; front-panel current control, 2 mA.

Output impedance: typical value is approximated by 0.05 m Ω in series with 3 mH.

Load transient recovery time: less than 50 μ s is required for output voltage (constant voltage operation) to recover within 50 mV of the nominal output level following a change in output current equal to the current rating of the supply.

Remote programming speed: up programming of voltage at full load: HP 6114A, 1.75s; HP 6115A, 4.5s. Down programming, no load: HP 6114A, 350 ms; HP 6115A, 500 ms.

Overvoltage protection crowbar: adjustable front-panel screwdriver control from 0.5 to 45 volts on the HP 6114A and 0.5 to 110 volts on the HP 6115A.

Power: 104-127 or 208-254 Vac (switchable), 48-440Hz, 150 VA max.

Temperature rating: operating, 0 to 50 $^{\circ}$ C; storage, -40 to +75 $^{\circ}$ C.

Size: 197 mm W x 165 mm H x 337mm D (7.75" x 6.5" x 13.25")

Weight: 7.7 kg (17 lb) net, 9.5 kg (21 lb) shipping.

Accessories

5060-8762: adapter frame for rack mounting one or two 1/2 rack width units. This frame applies to HP 6114A, 6115A

5060-8760: blank filler panel. This 1/2 rack width panel applies to HP 6114A, 6115A

Price

\$115

\$36

Ordering Information

HP 6114A Precision Power Supply

\$1650

HP 6115A Precision Power Supply

\$1650

Special Purpose: Precision Constant Current Sources Models 6177C, 6181C & 6186C

- Continuously variable voltage limit
- Output useful to micro-ampere region

- High output impedance—no output capacitor



HP 6177C, 6181C

HP 6186C

voltage to vary from zero to maximum.

Source effect (line regulation): less than 25 ppm of output + 5 ppm of range switch setting for any change in the line voltage between 104 and 127 V ac at any output current and voltage within rating.

Load effect transient recovery: less than 800 μ s for recovery to within 1% of nominal output current following a full load change in output voltage. (On HP 6186C, recovery time for 100 mA/10 mA/1 mA ranges is 1 ms/1.6 ms/4 ms, respectively.)

Temperature coefficient: output change per degree C is less than 75 ppm of output current +5 ppm of range switch setting.

Drift (stability): less than 100 ppm of output current +25 ppm of range switch setting. Stability is measured for eight hours after one hour warm-up under conditions of constant line, load, temperature, and output setting.

Resolution: 0.03% of range switch setting.

Temperature rating: operating 0, to 55°C; storage, -40 to +75°C.

Description

These solid-state constant-current sources are ideal for semiconductor circuit development, component testing, and precision electroplating applications.

Their high-speed remote programming characteristics make these supplies useful in testing and sorting semiconductors, resistors, relays, meters, etc. The ability to superimpose ac modulation on the dc output permits the supplies to be used for measurement of dynamic or incremental impedance of circuit components.

Accessories

HP 5060-8764: rack adapter for rack mounting one or two HP 6177C or 6181C supplies

HP 5060-8762: rack adapter for rack mounting one or two HP 6186C supplies

HP 5060-8530: filler panel for HP 6177C, 6181C

HP 5060-8760: filler panel for HP 6186C

Price

\$130

\$115.00

\$49

\$36

Options

028: 230 Vac \pm 10%, single-phase input.

910: one additional operating and service manual

N/C

add \$7.50

Specifications

Load effect (load regulation): less than 25 ppm of output + 5 ppm of range switch setting for a load change which causes the output

Ordering Information

HP 6177C, 6181C Constant Current Source

HP 6186C Constant Current Source

\$1450

\$2000

Model		HP 6177C	HP 6181C	HP 6186C
Output Current ††		0-500 mA	0-250 mA	0-100 mA
Voltage Compliance Δ		0-50 V dc	0-100 V dc	0-300 V dc
Output Ranges	A	0-5 mA	0-2.5 mA	0-1 mA
	B	0-50 mA	0-25 mA	0-10 mA
	C	0-500 mA	0-250 mA	0-100 mA
AC Input		115V ac \pm 10%, 48-63 Hz; 0.6 A, 55 W at 115 V ac For 230 V ac see Option 028	115 V ac \pm 10%, 48-63 Hz; 0.6 A, 55 W at 115 V ac For 230 V ac see Option 028	115/230 V ac, 48-63 Hz; 0.9 A, 90 W at 115 V ac 115/230 V ac switch
Constant Current	Voltage Control (accuracy: 0.5% of output current \pm 0.04% of range)	Range A	200 mV/mA	1 V/mA
		Range B	20 mV/mA	100 mV/mA
		Range C	2 mV/mA	10 mV/mA
Remote Programming	Resistance Control (accuracy: 1% of output current \pm 0.04% of range)	Range A	400 ohms/mA	2 k Ω /mA
		Range B	40 ohms/mA	200 ohms/mA
		Range C	4 ohms/mA	20 ohms/mA
Voltage Limit Remote Programming	Voltage Control (Accuracy: 20%)		1 V/V	1 V/V
		Resistance Control	870 ohms/V	435 ohms/V
		Accuracy	25%	25%
Typical Output Impedance (R in parallel with C)*	Range A	R = 330 Meg, C = 500 pF	R = 1330 Meg, C = 10 pF	R = 10,000 Meg, C = 900 pF
	Range B	R = 33 Meg, C = 0.005 μ F	R = 133 Meg, C = 100 pF	R = 1,000 Meg, C = 700 pF
	Range C	R = 3.3 Meg, C = 0.05 μ F	R = 13.3 Meg, C = 1000 pF	R = 100 Meg, C = 1500 pF
PARD (Ripple and Noise): rms/p-p (20 Hz to 20 MHz) with either output terminal grounded	Range A	1.6 μ A rms/40 μ A p-p	0.8 μ A rms/20 μ A p-p	0.2 μ A rms/5 μ A p-p
	Range B	16 μ A rms/200 μ A p-p	8 μ A rms/100 μ A p-p	2 μ A rms/50 μ A p-p
	Range C	160 μ A rms/1 mA p-p	80 μ A rms/500 μ A p-p	20 μ A rms/500 μ A p-p
Programming Speed: from 0 to 99% of range switch setting with a resistive load ** (Output Current Modulation)		6 ms	6 ms	10 ms
Dimensions:		7.75" (W) x 3.44" (H) x 12.38" (D) 197 mm (W) x 88 mm (H) x 315 mm (D)	7.75" (W) x 3.44" (H) x 12.38" (D) 197 mm (W) x 88 mm (H) x 315 mm (D)	7.75" (W) x 3.44" (H) x 12.38" (D) 197 mm (W) x 158 mm (H) x 315 mm (D)
Weight: (Net/Shipping)		4.53 kg (10 lb)/5.9 kg (13 lb)	4.53 kg (10 lb)/5.9 kg (13 lb)	5.9 kg (13 lb)/7.7 kg (17 lb)

* This network is a simplified representation of a complex network. The formula $Z = R\sqrt{1 + \omega^2 C^2} + X_c^2$ is used for frequencies up to 1 MHz by substituting the values given for R and C. Above 1 MHz, the output impedance is greater than the formula would indicate.

** Output current can be modulated 100% up to 50 Hz; percent modulation decreases

linearly to 10% at 500 Hz.

†† For operation above 40°C the maximum output current must be reduced linearly to 80% of rating at 55°C (maximum temperature).

Δ Minimum voltage obtainable with voltage limit control is 0.5 V.

DATA ACQUISITION SYSTEMS

General Information

- Reduce Manufacturing Costs
- Reduce Product Development Time
- On-Going Payback
- Improve Product Quality
- Higher Process Throughput
- More Process Up-Time

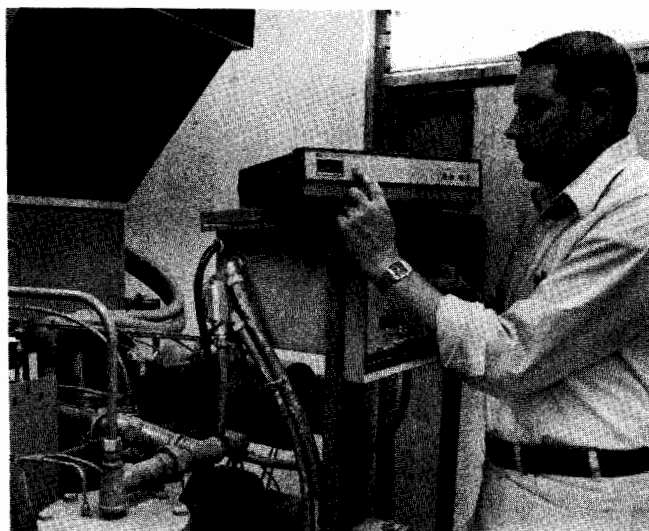

Data Acquisition is the generally accepted term for the procedure of characterizing a product or a process using electronic instruments. A "process" is defined as any procedure used to build a product or provide a service. A product or process is characterized by measuring it in minute detail so that all significant operating parameters are accurately known. Once characterized, improvements can be made that reduce costs and/or increase a product's performance/price ratio. A data acquisition system is a tool for increasing your bottom-line profitability.

Experience has shown that profit robbing inefficiencies are usually caused by many small errors rather than a few large ones. Today's modern electronic data acquisition systems can perform thousands of measurements per second, detect changes smaller than one part in one million and respond to those changes in less than 1/100th of a second. This high performance allows even large products and processes to be characterized in detail so that very high efficiencies can be attained.

The products and processes that can benefit from data acquisition are very broad. Producers of everything from automobiles to zucchini, research and development labs, utilities, educators, and the military services all have found that data acquisition is a cost effective technique.

The block diagram at the right shows how a typical data acquisition system is configured. A test program is stored in the computer. When executed, the program adjusts the product or process to a desired condition through the control functions in the data acquisition instrument. Then the computer directs the data acquisition instrument to take measurements. The measurements are analyzed and a report printed that describes the characteristics being tested. Based on the results, the product or process is modified to improve its performance. This cycle continues until optimization is achieved. Once the

critical control parameters and measurements are determined, the computer can be further programmed to automatically control the process or product at its optimum point.

Hewlett-Packard has been building electronic data acquisition systems for over 15 years. More than 55,000 systems have been installed worldwide. In addition to a broad

range of high quality computers and instruments, Hewlett-Packard has an ever-expanding offering of software and support services that provide a total data acquisition system solution. The following paragraphs describe data acquisition systems from Hewlett-Packard that can handle most applications in manufacturing, R&D, education, utilities and military/aerospace.

Product/Process Characterization Block Diagram

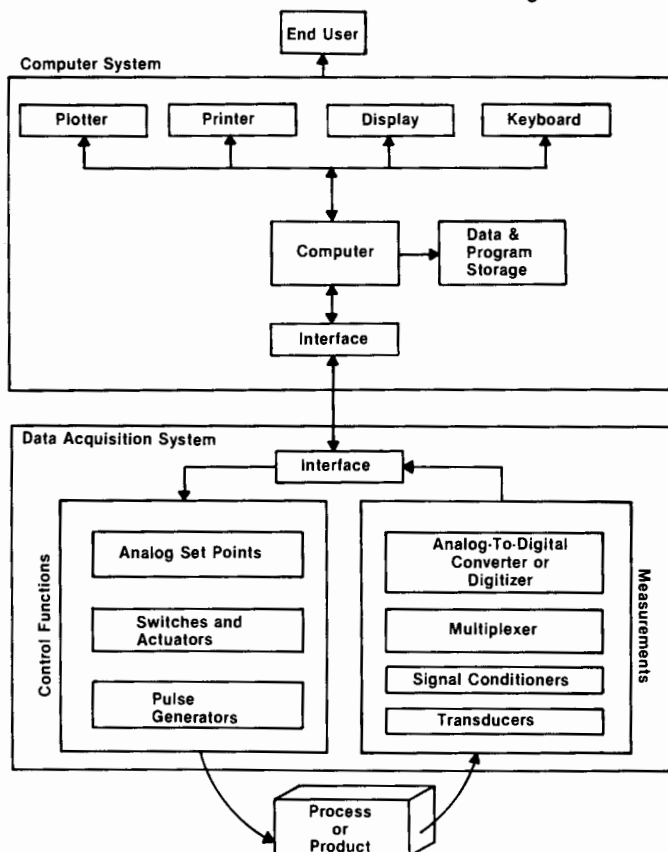

Portable Systems

- Total Battery Operation
- Easy Data Transfer to a Host Computer
- Unattended Operation
- Low Cost

Many applications, such as those in outdoor locations and moving vehicles, require that measurements be made where line voltage is not available or difficult to provide. Hewlett-Packard's portable data acquisition system is specifically designed for these situations. Built-in batteries power the computer, disc, printer and data acquisition instrument. Measurement, control and many analysis operations are performed by the data acquisition system itself. For more sophisticated analysis, data can be easily transferred to a PC or minicomputer. Remote unattended data logging can continue for very long periods of time by using the Remote Battery Charging Option and sleep mode. Low prices make these systems ideal for first time users too. See page 286 for further information.

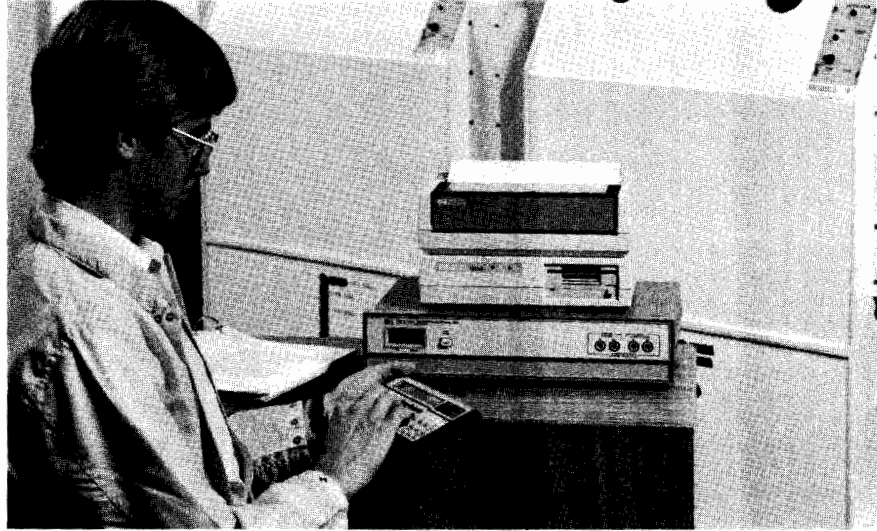

Personal Computer Based Systems

- Compatible with Industry Standard Operating Systems
- Easy-to-Use Menu Driven Software
- Choice of Data Acquisition Instruments

Many personal computer owners are discovering the benefits of data acquisition. Hewlett-Packard has data acquisition interfaces and software designed specially for use with PC's. Now you can use your personal computer for all of your computing needs. You have a choice of data acquisition instruments too so the total system can be customized to meet your individual requirements. The menu driven software makes the system easy to use regardless of which hardware is chosen. See page 288 for further information.

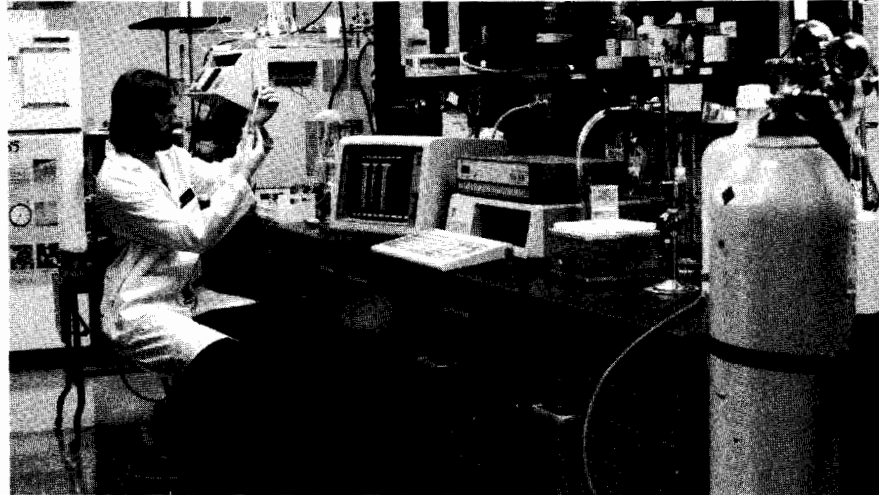

Remotely Locatable Systems

- Designed for Harsh Environments
- Local Intelligence
- Easy to Program
- Communications Flexibility

Applications like oil, gas and electrical distribution, wastewater treatment and facility monitoring often require that data acquisition systems be located far from their host computers in less than ideal environments. Hewlett-Packard's remotely locatable systems are designed specifically for these conditions. Extended operating temperature ranges and protection from electrical transients are standard features. Measurement and control modules are individually housed in aluminum enclosures to minimize contamination and provide maximum protection from physical damage. Lots of built-in computing power minimizes the need for data communication and keeps the system user friendly. When data communication is required, it can be done by dedicated wires, telephone lines or by radio links. See page 290 for further information.

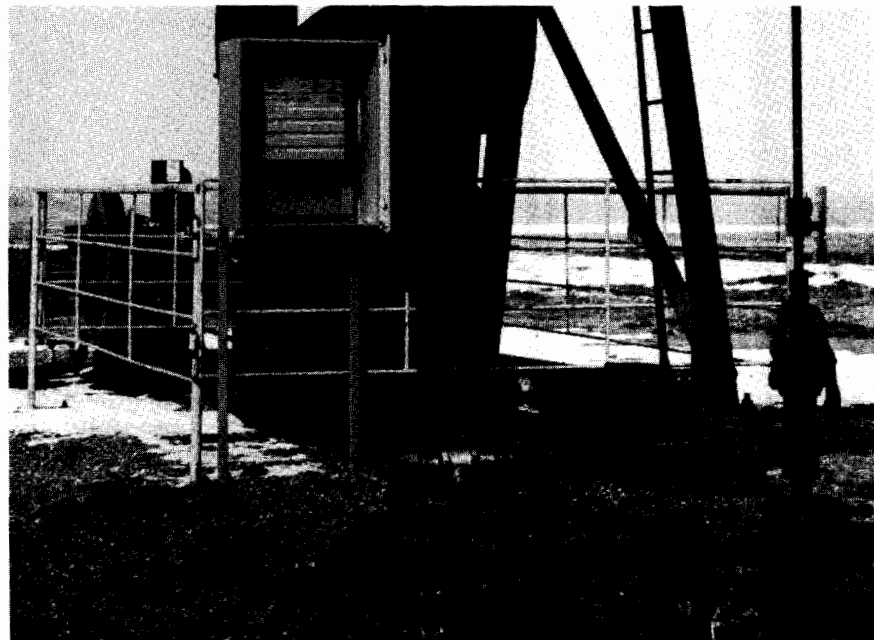



High Performance Systems

- High Data Throughput
- High Accuracy
- Large Measurement Point Count
- Many Control Functions
- Built-in Transducer Signal Conditioning

In many research, development and manufacturing applications, high accuracy and large numbers of measurements are required. Hewlett-Packard's high performance data acquisition systems are an excellent solution. Measurement data can be taken from over 1500 separate points and stored directly on disc at many thousands of readings per second. Measurement accuracy can be better than 0.01% of reading. High performance systems can offer a full range of control outputs including analog output, digital output and switching. Built-in signal conditioning is included in some systems for common transducers like thermocouples and strain gages. See pages 292 through 301 for further information.

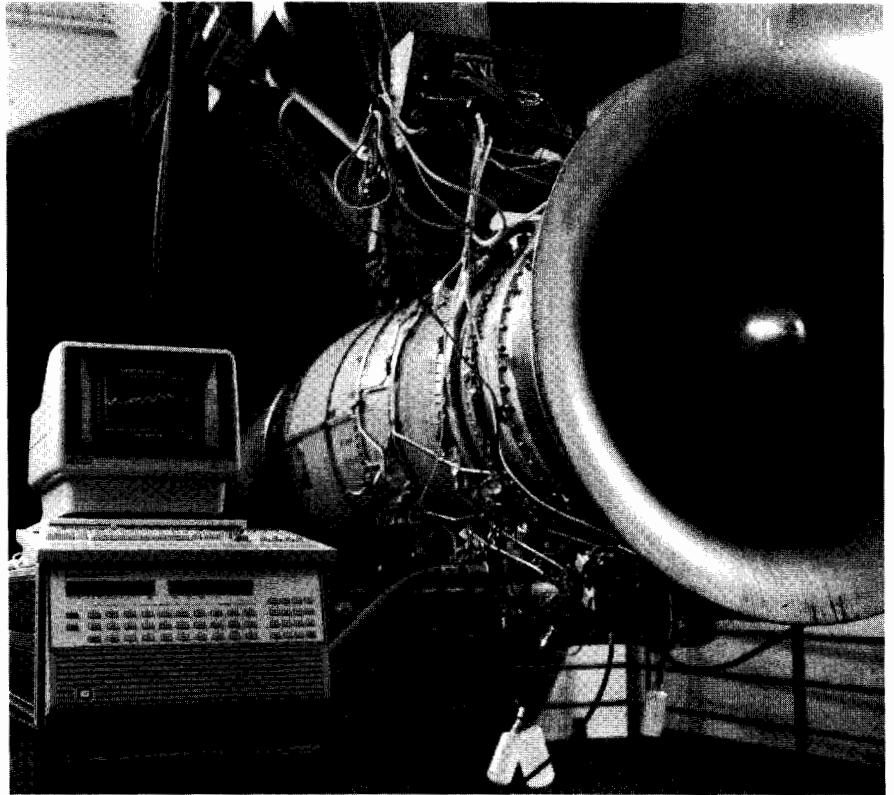

Software Solutions

- Significantly Reduces Programming Time
- Tools for Acquisition, Analysis, Presentation, and Distribution of Data

Software for data acquisition applications is as important as the computer and the data acquisition instrument and can cost as much as both of these combined. In a typical application, taking measurements and sending control commands is a small part of the job. Most of the application program is dedicated to manipulating and presenting data. Hewlett-Packard's data acquisition software solutions save many man-hours of programming by providing powerful software tools for performing many common data calculation, manipulation, and presentation tasks. See page 302 for more information.

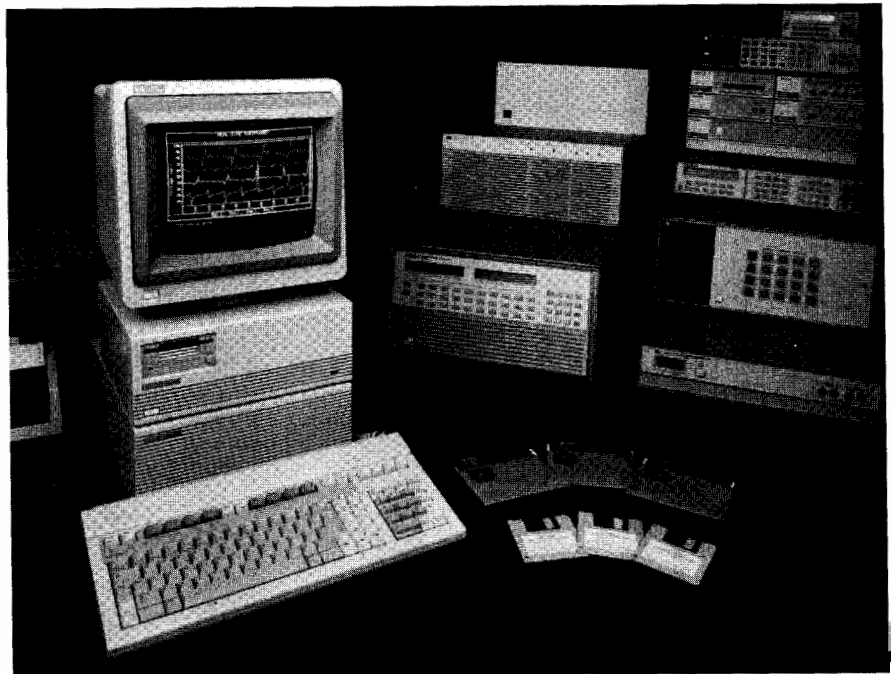

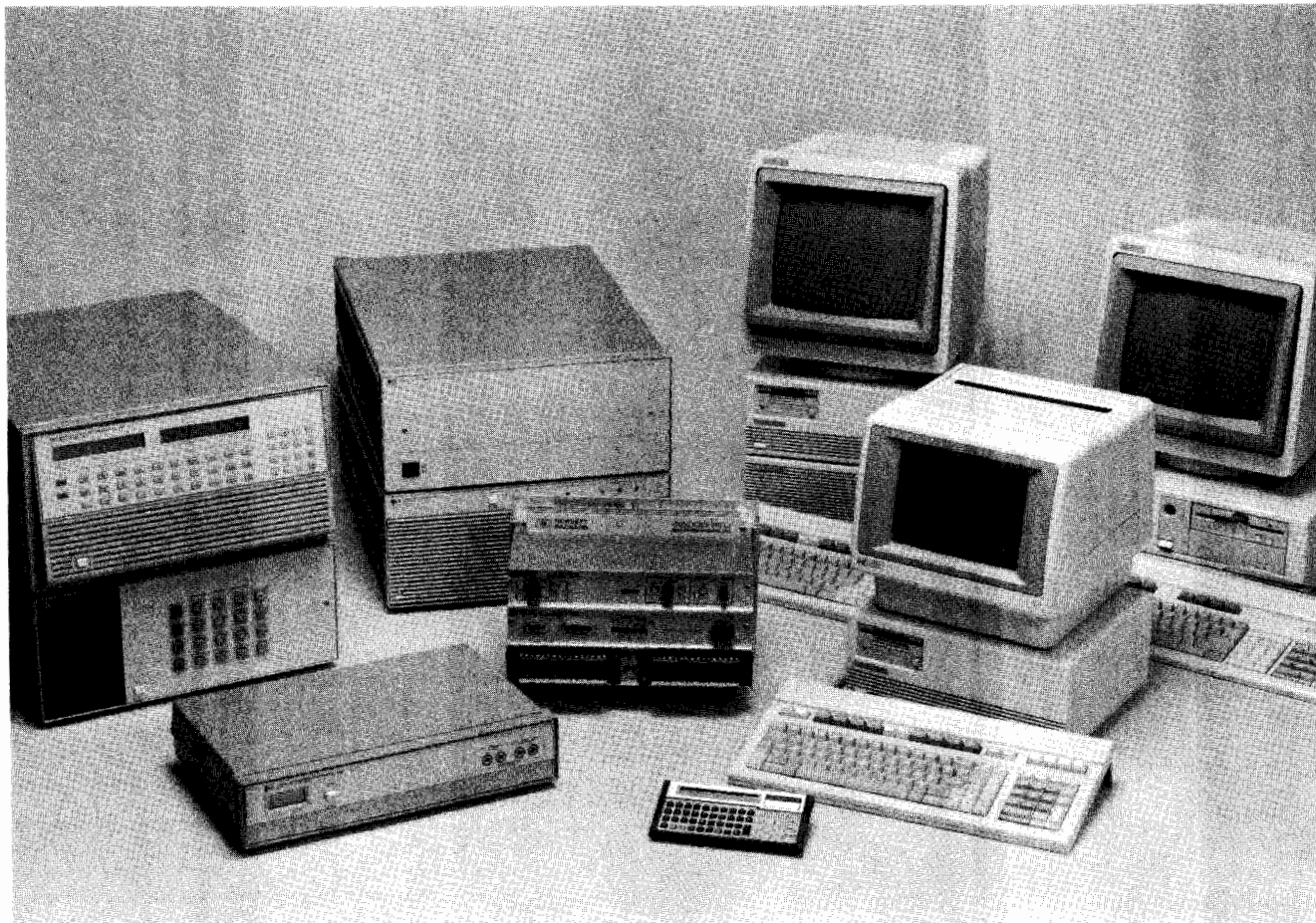

The Total Data Acquisition System Solution

- Computers
- Instruments
- Software Tools
- Custom Software
- Hardware and Software Support Services
- System Integration Programs

Every data acquisition system requires a combination of computers, instruments and software. The extent to which these pieces are packaged together is dependent upon

your individual needs. Whether its a completely integrated turnkey system, system components, plug-in board products or a customized in-house system, Hewlett-Packard can help. Turnkey solutions can be provided by HP's own Customer Support Group or through an expanding network of independent Systems Integrators and Software Suppliers. Contact your local HP sales office for more information about these programs.

Information on data acquisition plug-in board products for Series 1000 and Series

9000 computers can be found on pages 184 and 89 respectively. Information on instruments and computers for custom-built systems can be found under the headings for those products. The remainder of this section contains detailed information on data acquisition component systems. These systems provide solutions for a very broad range of applications. Contact your local Hewlett-Packard sales office for more information on how these systems can work for you.



DATA ACQUISITION SYSTEMS

Portable Systems

HP Model 3421A and HP 71B

- Up to 30 different channels, 56 single-ended channels
- Electronic calibration for repeatable answers
- Built-in 5½ digit A/D converter with 1µV sensitivity
- Optional 12 volt remote charging adapter
- "Sleep mode" for extended battery life in remote locations
- Front terminals for convenient DCV, ACV, 2- and 4-wire ohms, frequency and temperature

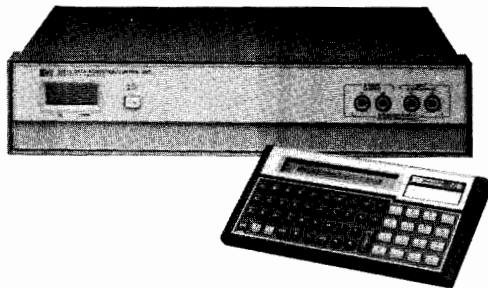

The System

Now you can justify that small data acquisition project with a system that will quickly pay its own way.

The HP 3421A and HP 71B, with an HP 82401A Interface Module and HP 82479A Data Acquisition Pac ROM, form a most versatile and powerful data acquisition system that is also portable.

A 96 kbyte RAM* and its non-volatile memory make the HP 71B the ideal controller for gathering data in remote locations. For increased mass memory capacity, the HP 9114B can be added. Massive amounts of data can now be collected remotely, taken to another location, then processed.

Add the HP 2225B printer to log or process the data into lists, graphs, or charts.

*Available from Handheld Products, Inc., Charlotte, NC.

The Instrument

The HP 3421A mainframe scans 30 channels, measures dc volts, ac volts, both 2- and 4-wire ohms, frequency and temperature. It also reads and writes digital information and stores up to 30 analog readings. The standard HP 3421A comes with an HP-IL interface, so it can be controlled by an HP 71B handheld computer or an HP 85B desktop computer.

The HP 3421A not only has the measurement integrity of more expensive data acquisition units, but it also is compact, battery powered and has a "sleep" mode for extended battery life.

When you are at the end of a long, intermittent power line, or 15 miles from the ranger station, you will appreciate the "powerdown" command in the HP 71B. This command tells the HP 3421A, and most HP-IL peripherals "go to sleep" until the internal timer module awakens them.

Electronic Calibration

The HP 3421A has no manual calibration adjustments—no pots that change value—no variable capacitors that move due to vibration inside the cab of a truck. All calibration constants are stored in a CMOS RAM and protected by a 10-year lithium iodide battery.

There are remote data logging applications where the battery life-time of the HP 3421A and HP-IL peripherals need to be extended. The HP 3421A option 214 enables the HP 3421A, the HP 9114B Portable Disc Drive, the HP 2225B Thinkjet Printer, HP 71B, and other loop devices to be charged by an external 12 volt dc source such as an automotive battery.

Battery-operational lifetime for the HP 3421A is dependent on those factors which essentially determine the drain on the battery, versus any charging of the battery. Among those factors are the type of measurement, number of channels per scan, and number of scans per time interval. Other devices have similar dependency factors.

Difficult remote site measurements like studies of large civil structures, measurements in open fields, remote weather stations, and tests in moving vehicles are examples of the applications that are possible on an extended duration using option 214.

The Controller

The HP 71B is a powerful handheld computer that comes standard with: 17.5 kbytes of user memory; a BASIC operating system with over 230 keywords built in; a clock, calendar and three timers; battery operation (continuous memory); user definable keyboard; built-in statistic functions; and CALC mode for powerful calculations.

The Software in ROM

Exceptional convenience for workstation and field use is provided by the HP 82479A ROM and key overlay for the HP 71B. Composed of independent software modules, the ROM implements a: (1) FRONT PANEL - more than a front panel, with 14 measurement functions, analog and digital channel controls, and linearization for popular thermocouples, thermistors and RTD's; (2) STRIP CHART-drive the HP 2225B printer as a 9-channel strip chart recorder, real time or post processing data; (3) MONITOR-large screen, near real-time display of up to 18 measured parameters numerically, and symbolically relative to preset limits; (4) DATA LOGGER-simplicity of menu-driven software for setting up routines to acquire, store and/or present data; and (5) REPORT-perform minimal statistical, graphical and tabular analysis on data; and (6) BASIC KEYWORDS-45 powerful statements added to the programming language designed for instrument control; (7) TRANSFER-formats and transfers data to both Series 200/300 and MS-DOS personal computers.

HP 3421A Mainframe Specifications

The HP 3421A mainframe comes with:

- A 5½, 4½, and 3½ digit integrating A/D converter
- Thermocouple compensation
- Type T thermocouple linearization built in
- HP-IL
- 30-reading storage buffer
- LCD 30 channel display with power and error indicators
- Electronic calibration
- Rechargeable battery
- High level command set

All specifications apply for relative humidity less than 85% at 30°C.



DC Voltage

Ranges: 300 mV, 3 V, 30 V, 300 V, Autorange
Basic accuracy: $\pm(0.009\%$ readings + 3 counts); 5½ digits
Reading rates: 2 to 35 readings/second

Resistance

Ranges: 300 Ω , 3 k Ω , 30 k Ω , 3 M Ω , 30 M Ω ; Autorange
Basic accuracy: $\pm(0.12\%$ reading + 3 counts); 5½ digits
Reading rates: 2 to 35 readings/second

AC Voltage

Ranges: 3 V, 30 V (300 V with HP 44469A divider)
Converter type: averaging
Resolution: 3½ to 4½ digits
Basic accuracy: 4½ digits: $\pm(0.5\%$ reading + 60 counts); 45 Hz to 500 Hz, $\pm(1\%$ reading + 60 counts), 30 Hz to 1 kHz; providing the input voltage is at least 10% of range.

Counter

The counter is part of the mainframe circuit, and is multiplexed through the channel relays.

Resolution: 65.535 counts
Frequency: 1 Hz to 10 kHz
Modes: frequency, totalize

Thermocouple Thermometer

Type T thermocouple linearization is built in. For other thermocouple types, the reference junction temperature is available on each multiplexer assembly.

Approximate Maximum Reading Rates (readings/second)

These rates assume 30 readings taken on a fixed range with no function change. Speeds are independent of channel sequence. Rates include scan time, A/D conversion time and the time to transfer the reading to the computer. Rates apply for either HP-IB or HP-IL.

HP 71B	DCV, Ω		ACV	Frequency	Type T Thermocouple
	Auto Zero On	Auto Zero Off			
5½ Digit	3	1.5	—	0.1	0.9
4½ Digit	7	6.8	0.3	0.8	0.9
3½ Digit	9	8.5	0.4	0.4	0.9

Option 020, 021, 022 Multiplexer/Actuator Assemblies

The configuration of multiplexer and actuators depends on the option you order. Option 020 has eight multiplexer/two actuator channels; Option 021 has nine multiplexer/one actuator channels; Option 022 has ten multiplexer channels. The actuators are capable of switching 252 Vac. One HP 3421A mainframe can hold up to three assemblies.

Option 040 Breadboard Assembly

The breadboard assembly is convenient for constructing custom circuitry. It comes complete with a manual describing the circuit that enables the HP 3421A to communicate directly with an eight-bit microprocessor.

Option 050 Digital I/O Assembly

Option 050 has eight isolated input lines and eight isolated output lines for both monitoring and controlling external digital devices.

Option 214 12 Volt Remote Charging Assembly

This optional assembly provides the necessary isolation and regulation for a 12 volt automotive battery or system to recharge or charge, while in use, the batteries of the HP 3421A, HP 71B Handheld Computer, and peripherals such as the HP 9114B Portable 3½" Disc Drive and HP 2225B Thinkjet Printer.

Ordering Information

Input and I/O Assembly Options

	Price
020: Eight Channel Multiplexer/Two Channel Actuator Assembly	\$375
021: Nine Channel Multiplexer/One Channel Actuator Assembly	\$375
022: Ten Channel Multiplexer Assembly	\$375
040: Breadboard Assembly with connector block	\$90
050: Eight bit in, eight bit out Digital I/O Assembly with connector block	\$375
214: add 12 volt power assembly. Cannot be added if opt 201 is specified.	\$400

Power and Frequency Options

315-346: Line power options from 100 V/50 Hz-240 V/60 Hz	N/C
---	-----

Rack Mount and Manual Options

401: Side Handle Kit	\$25
907: Front Handle Kit	\$50
908: Rack Mount Kit	\$30
909: Rack Mount with Handle	\$75
910: Extra Manuals	\$90

Field Installation Kits*

HP 44462A: Eight Channel Multiplexer/Two Channel Actuator Assembly with thermocouple compensation, connector block	\$375
HP 44463A: extra connector block for above	\$35
HP 44464A: Breadboard Assembly with connector block	\$90
HP 44465A: Eight bit in, eight bit out digital I/O assembly with connector block	\$375
HP 44466A: Extra connector block for digital or breadboard assembly	\$15
HP 44469A: Seven 10:1 dividers for measuring 300 Vac	\$15

Accessories

HP 2225B: Thinkjet Personal Printer (HP-IL)	\$495
HP 9114B: Portable Disc Drive (HP-IL)	\$795
HP 11340A: 20-metre HP-IL Cable	\$95
HP 11340B: 50-metre HP-IL Cable	\$175
HP 11340C: 100-metre HP-IL Cable	\$350
HP 82402A: Dual HP-IL Adapter	\$85
HP 82479A: HP 71 Data Acquisition Pac ROM	\$195

Related Products

HP 71B Handheld Computer	\$525
HP 3468A 5½ Digit Multimeter	\$750

HP 3421A Data Acquisition/Control Unit

\$1,625

*Field installation is recommended to be performed only by service trained personnel.



DATA ACQUISITION SYSTEMS

Personal Computer Based Systems

HP Model 3055S



HP Vectra with HP 3497A and HP 3421A



Description

The HP Model 3055S is a family of data acquisition products that brings Hewlett-Packard's measurement expertise to the Personal Computer market.

A comprehensive data acquisition system, the HP 3055S will run on the HP Vectra, IBM® PC, IBM PC/XT™ and IBM PC/AT™. The HP 3055S includes two data acquisition software packages for two popular HP data acquisition front ends.

The Hardware

The HP 3055S gives you a choice of two front ends to connect to your Personal Computer; either the HP 3497A or the HP 3421A.

The HP 3421A Data Acquisition/Control Unit is ideally suited for those small to medium channel applications that require accurate measurements at an affordable cost.

The HP 3421A has three slots that can hold any combination of three permanently installed optional assemblies; multiplexer/actuator, digital I/O, and breadboard. Each HP 3421A can be configured for up to 30 channels of voltage, resistance, frequency or thermocouple measurements.

The HP 3497A Data Acquisition/Control Unit is ideally suited for those medium to large channel applications that require versatility and ease of use. It has five slots that can hold any combination of 12 optional plug-in assemblies.

These assemblies plug into the HP 3497A card cage for quick and easy expansion and configuration changes, without removing the covers. Up to 100 analog channels can be installed in the HP 3497A, and each HP 3498A extender can hold another 200 analog channels.

Common HP 3421A and HP 3497A Features

Isolated inputs/outputs	Low thermal relays
Integrating A/D	DCV, Resistance
5½ digit resolution	Digital input/output
1 µV sensitivity	Thermocouple compensation
Autorangeing, autozero	Differential inputs
HP-IB	Actuators

The Software

Menu Operation

Use the HP 3055S's menu operation to quickly set up your experiment, acquire data, store and analyze the results with minimal effort. The HP 3055S menu operation supports either one HP 3497A or two HP 3421As.

Gather data on up to 100 channels, check limits, activate alarms, store, print and analyze the data—all by pressing softkeys on the CRT menu or entering alphanumeric responses.

Supported Functions include:

DCV	Resistance (2- or 4-wire)
Digital Read	Actuators
RTD (100 Ohm)	Thermocouples (J, K, T, E, R, S)
mX+B	Thermistors (2.2k Ohm)
BASIC subroutine	Polynomial (5th order)

Powerful analysis routines such as channel vs channel, channel vs time and statistics/histogram are available for analyzing the data you have gathered.

Subroutines:

The HP 3055S also provides temperature conversion subroutines that the user can call from a custom mainline program. This gives the advanced user the versatility to write a complex BASIC program using the HP 3055S subroutines as building blocks. The user can expand the system up to 1000 analog and 1360 digital channels and add other HP-IB instruments by writing a custom BASIC program.

DATA ACQUISITION SYSTEMS

Personal Computer Based Systems

HP Model 3055S

289



Link to LOTUS 1-2-3™:

A utility program is also provided for converting the HP 3055S data to LOTUS 1-2-3™ format for further analysis. This means you can add the data you have acquired from the HP 3055S with data from other sources into a spreadsheet for manipulation and graphical display.

Applications

Applications for the HP 3055S include product R & D, product test, process monitoring, energy management and scientific research.

The HP 3055S can be used for the design of new products such as solar collectors and batteries, and in controlling and recording the oven temperature vs time in product test applications. The HP 3055S can also monitor the temperature and pressure of a process, and actuate alarms when limits are exceeded.

Energy management applications in greenhouses and small buildings can be solved by the HP 3055S since it can monitor temperature and turn on heaters, blowers and fans by controlling external relays.

Scientific research applications in chemical labs, for example, can use the HP 3055S to eliminate manual data reduction and examine cause and effect relationships.



Data Acquisition Front End

(Order either one HP 3497A or up to two HP 3421As. The options listed are supported by the menu driven portion of the HP 3055S software. All other options can be accessed from a user written BASIC program.)

HP 3421A

Options

020: 8 Channel Multiplexer/2 Channel Actuator	\$ 350
021: 9 Channel Multiplexer/1 Channel Actuator	\$ 350
022: 10 Channel Multiplexer	\$ 350
050: 8 Channel Digital I/O	\$ 350
201: HP-IB (required)	\$ 250

HP 3497A

Options

001: DVM and Current Source (required)	\$1650
010: 20 Channel Relay Multiplexer	\$ 600
A20: Relay Multiplexer with T/C Compensation	\$ 750
050: 16 Channel Digital Input	\$ 550
110: 16 Channel Digital Output/Actuator	\$ 750
115: 8 Channel High Voltage Actuator	\$ 550

Price

\$1550

Data Acquisition Software

HP 44451B (HP 3421A/HP Vectra/IBM® PC software)	\$ 400
option 005 (add HP 61062 plus HP-IB cable)	\$ 480
HP 44457B (HP 3497A/HP Vectra/IBM® PC software)	\$ 500
option 005 (add HP 61062 plus an HP-IB cable)	\$ 480

Other Hardware

HP PC Instruments

HP PC Instruments link test and measurement devices to the HP Vectra PC, IBM PC, PC/XT, and PC/AT creating a more efficient cost-saving way to program and perform test procedures, analyze and compare data, and record and plot results. The PC Instrument system includes the following devices: digital multimeter, digitizing oscilloscope, function generator, universal counter, relay multiplexer, dual voltage digital-to-analog converter, digital input/output, and relay actuator.

See PC Instruments in the Test Section for more information.

Other Software

ASYST™ Scientific Software

ASYST Scientific Software is a programming language that integrates PC instruments and HP-IB instruments with powerful analysis statistics and graphics capabilities common to most engineering and scientific applications. ASYST provides you with the power, precision, and flexibility previously found only on mainframe and minicomputers.

ASYST programs execute quickly in both the interactive and compiled modes. Fast numeric calculations are performed by utilizing the optional co-processors in the HP Vectra PC, and the IBM PC, PC/XT or PC/AT. In addition, all commands co-reside in memory.

Built-in analysis functions, like FFT, and XY.AUTO.PLOT, reduce your application programming time by approximately 90%. These pre-programmed commands can be combined and modified to extend the system for custom applications.

See PC Instruments in the Test Section for more information.

MS™-DOS and GW-BASIC are U.S. trademarks of Microsoft, Inc.
IBM® is a registered trademark of International Business Machines, Inc.
ASYST™ is a trademark of Macmillan Software Company.

Ordering Information

For a complete system, order an HP 3055S and select an HP Personal Computer, a Data Acquisition Front End (either an HP 3421A or HP 3497A) and the appropriate Data Acquisition Software package.

The Computer

HP Vectra	IBM® PC, IBM® PC/XT, IBM® PC/AT
Requirements: 256k RAM Vectra DOS (HP 45951A) Vectra BASIC (HP 45952A) Dual 5½ inch disc drives or 5¼ inch with hard disc HP-IB card and library (HP 61062AA) Graphics Printer (HP 2225C)	Requirements: 256k RAM PC-DOS 2.1 or higher (with BASICA) Graphics Monitor Card Dual 5¼ inch disc drives or 5¼ inch with hard disc HP-IB card & library (HP 61062) Graphics Printer



DATA ACQUISITION SYSTEMS

Front Ends for Measurement and Control

HP Model 48000 RTU

- For Industrial Monitoring and Control
- Stand-Alone or System Operation
- Radio/Modem/Wireline Datacom

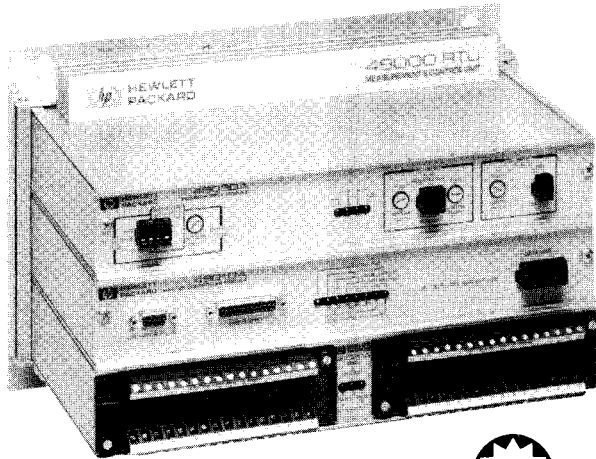

Description

The HP 48000 RTU Measurement and Control Unit is a microprocessor based front-end, designed for distributed monitoring and control in an industrial environment. Starting with as few as 16 I/O points, system designers can build and configure the HP 48000 RTU to address a broad range of applications.

These applications include:

- Oil and Gas Production Systems
- Pipeline SCADA Systems
- Electrical Utility SCADA Systems
- Machine Monitoring and Control
- Process Monitoring and Control
- Facility or Energy Management
- Wastewater Treatment
- Alarm Systems

The HP 48000 product family is a comprehensive line of modular hardware which can be easily configured to meet your application needs.

Intelligence and Ease of Programming

A User Configured Database and built-in BASIC compiler make it easy to implement intelligent processing with the HP 48000 RTU. The Application Development Software package is in a menu-driven format to easily configure the database and to access the BASIC programming mode. Database configurations can be done during runtime without disturbing the system operation. Similarly, BASIC programs can be initiated without disrupting the normal operating routine of the HP 48000 RTU.

User Configured Database

Over 60 signal processing functions are available at the HP 48000 RTU to off-load host computer processing. These functions include PID loop control, AGA flow calculations, engineering unit conversion, and alarm limit checking. Database configuration can be done using one of several HP personal computers or the HP 3081A Workstation Terminal. Database parameters can also be set by the host computer.

BASIC Programming

The HP 48000 contains a built in BASIC compiler used for more complex signal processing, or for custom control routines. The BASIC is incrementally compiled, providing fast program execution in a multi-tasking environment. Up to eight BASIC tasks may reside in a single HP 48000 RTU.

- Rugged Design for Harsh Environments
- Menu Driven Configuration
- Multi-Tasking BASIC



Application Development Software

The Application Development Software is in a menu-driven format allowing easy configuration of the database. Configuration is simply a matter of choosing an item from the display and assigning the appropriate value.

The Application Development Software also allows designers to:

- Load configurations and programs in the 48000 RTU
- Store configurations and programs on disc
- Print configurations and programs

Designed for Harsh Environments

The HP 48000 RTU is designed to withstand the harsh environmental conditions of the industrial world. Many of the features of the HP 48000 RTU exhibit the rugged standards to which it has been designed.

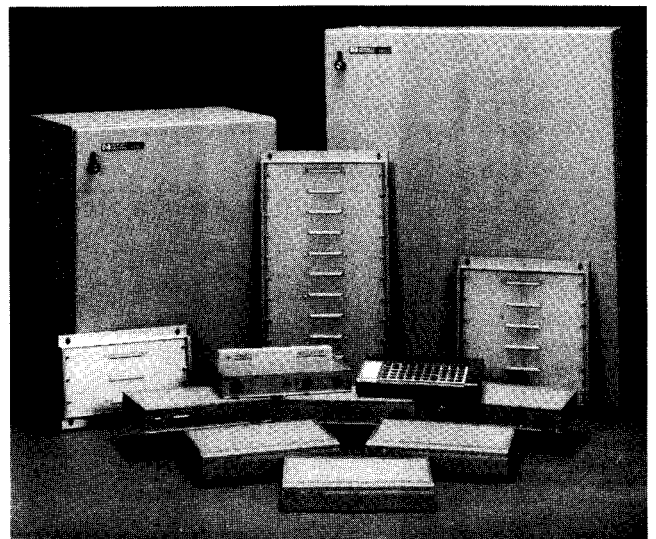

Some of these features include:

- -40°C to +65°C operating temperature range
- Pin and socket connectors provide reliable interconnection
- CMOS components ensure low power consumption
- Transient Voltage Suppressors protect the electronics from electrical transients
- Modules can be exchanged under power
- I/O modules are protected from field wiring shorts
- Low power-consumption allows sourcing from battery or solar power
- Power Miser Mode ensures that field sensors are powered only during measurement
- Database records and BASIC programs are held in Battery-backed RAM
- Aluminum module enclosures protect circuit boards
- Powered by 24 VAC/DC or 110/230 VAC with power transformer option
- Built-in diagnostics and visual status indicators
- Plug-in field expansion with minimum effort

Communications Flexibility

The diagram to the right illustrates some of the networking configurations supported by the HP 48000 RTU. Remote data acquisition and control systems are easily implemented using a twisted pair wireline, telephone compacy facilities or radio communication networks.

The host computer accesses data in a network of remote units in one of three modes:

- standard poll/response
- polled Report-By-Exception (RBX)
- Spontaneous Report-By Exception (SRBX)

By selecting the communication mode and choosing either HEX ASCII or Radix-64 ASCII protocols, users can optimize communication efficiency for their application.

Other data communication features of the HP 48000 RTU products include:

- A Modem Module meeting 202T or CCITT V.23 standards
- A RS232 C port that supports smart auto-dial modems
- A FCC and DOC approved Radio Datacom Module
- A data link Repeaters to extend wireline communications
- Communication Handler software for HP host computer interface
- Multi-drop networking capabilities of up to 90 RTUs over a maximum distance of 3.6 kilometers (using data link repeater)

General Module Specifications

Temperature Range: 40°C to +65°C (operating); -65°C to +85°C (storage)

Humidity Range: 5 to 95% non-condensing

RFI Susceptibility: 1 volt/meter from 14 KHz to 1 GHz

EMI Emissions: Meets VDE 0871 level B

Vibration: Random vibration. Power Spectral Density of 0.04 G²/Hz from 5 to 500 Hz (functional). Swept sine wave vibration of 1.0G from 5 to 600 Hz with five minutes resonant dwell (survival).

Shock: Half sine waveform impact of <3 ms duration with a velocity change of 175 cm/s (functional). Trapezoidal waveform impact of 30G with a velocity change of 742 cm/s (survival).

Transient Protection: Meets IEEE 472/ANSI-C37. 90a surge withstand capability in all communications and field wiring points. Normal operation with up to 15 kv electrostatic discharge.

Power Line Surge: Meets IEEE 587.

Dimensions: 330mm W x 215mm D x 55mm H (13" x 8.5" x 2.17")

Electrical Classification: General Non-Hazardous Area (CSA, FM & TUV approved).

Ordering Information

Hardware	Price
HP 48001A 3-Slot Backplane	\$200
HP 48002A 6-Slot Backplane	\$250
HP 48003A 11-Slot Backplane	\$350
HP 48004A System Enclosure (3 or 6 slot)	\$500
HP 48005A System Enclosure (11 slot)	\$500

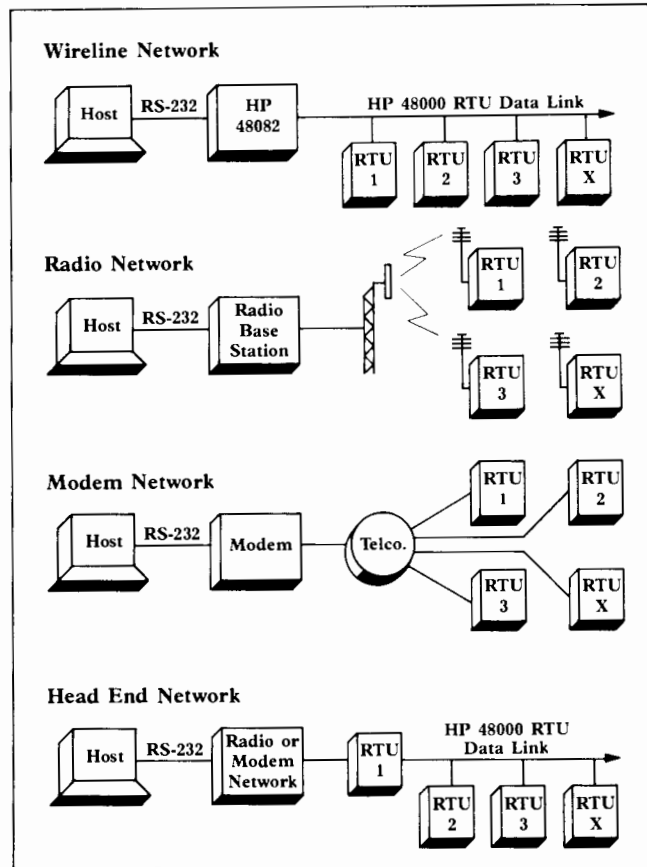

HP 48010A Master Controller Module	\$2550
HP 48020A Configurable I/O Module	\$1725
HP 48021A Analog Output Module	To be announced
HP 48022A Low Level Input Module with thermocouple compensation	To be announced
HP 48023A Digital Output Module	To be announced
HP 48024A Digital Input Module	\$1225
HP 48025A Isolated Digital Input Module	To be announced
HP 48030A Power Supply Module	\$1325
HP 48040A Radio Datacom Module	\$2300
Opt 001 150.8 to 174 MHz	N/C
Opt 002 450 to 475 MHz	N/C
Opt 003 928 to 960 MHz	To be announced
Opt 004 406 to 430 MHz	N/C
Opt 100 Constant carrier operation	N/C
Opt 101 CCITT Modulation Frequencies	N/C
HP 40041A Modem Module	\$850

Application Development Software

HP 40070A HP 150 based (3½" SS disc)	\$250
HP 40071A HP Portable Plus based (3½" SS disc)	\$250
HP 40072A HP Vectra based (5¼" DS disc)	\$250

Communication Handlers

HP 48073A HP 1000/A Series (CS 80 tape)	\$125
HP 48075A HP 9000/Series 200 & 300 (3½" SS disc)	\$75
HP 48076A HP Vectra (5¼" DS disc)	\$75

Accessories

HP 48032A Power Transformer	\$75
HP 48081A Repeater	\$725
HP 48083A Datacommunications Adapter	\$775
HP 48085A Complete Manual Set	\$600
HP 3081A/004 Workstation Terminal	\$850

48010-80020 Overlay for the HP 3081A/004 for use with the HP 48000 RTU To be announced

DATA ACQUISITION SYSTEMS

Front Ends for Measurement and Control

Model 3421A

- Up to 30 differential channels, 56 single-ended channels
- Electronic calibration for repeatable answers
- Built-in 5½ digit A/D converter with 1 μV sensitivity
- HP-IL (standard) and HP-IB (optional) with rear panel switch
- Optional 12 volt remote charging adapter



Description

If your measurement needs exceed the capabilities of plug-in cards but don't quite call for a top-of-the-line data acquisition unit, the HP 3421A is just what you are looking for. The HP 3421A is the instrument that beats the high cost of data logging. Use it for small data acquisition projects with the assurance that it will quickly pay its own way. The HP 3421A is configured with several different computers into a variety of systems designed for low to medium sized applications.

The HP 3421A with the HP 71B Handheld Computer

For low cost start-up or portable applications, the HP 3421A, HP 71B and HP 82479A ROM PAC form a surprisingly powerful system. See pages 286 and 287 for more information.

The HP 3421A with the HP 85B Personal Computer

The HP 3421A can be combined with the HP 85B Personal Computer for applications that require more computing power. Built-in CRT, printer, and mass storage combined with a powerful BASIC operating system make the HP 85B a very convenient computer for small laboratory, R&D and manufacturing situations. Dedicated software completes the system with menu programming, subroutine programming, instrument front panel emulation and graphics analysis.

The HP 3421A with Other Personal Computers

Even more computing power is available from today's modern PC's. The HP 3055S software, combined with an HP 3421A, adds data acquisition applications to the word processing and spreadsheet applications commonly available for PC's. Versions of the HP 3055S Data Acquisition Software are available for the HP Vectra, IBM PC, IBM PC/XT and IBM PC/AT. See pages 288 and 289 for more information on this product.

The Instrument

The HP 3421A scans up to 30 channels, measuring DCV, ACV, 2- and 4-wire Ohms, Frequency, and Temperature. It also reads and

- "Sleep mode" for extended battery life in remote locations
- Front terminals for convenient DCV, ACV, 2 & 4-wire ohms, frequency and temperature
- Display shows channels closed, digital states and self-test conditions

writes digital information and stores up to 30 analog readings. The standard HP 3421A comes with an HP-IL interface for battery-powered flexibility or optionally HP-IB for more computational power.

Up to three of the following assemblies may be added to the HP 3421A mainframe:

- 10-channel analog multiplexer/actuator assembly with thermocouple compensation,
- 8-bit input/8-bit output digital assembly,
- Breadboard assembly for custom circuitry.

Measurement Integrity

With its 5½, 4½, 3½ digit A/D converter, the HP 3421A can resolve 1 μV out of 300 mV to monitor thermocouples and other low-level transducers. Or it can read higher level signals by auto-ranging up to 300 volts dc.

System Versatility

Each HP 3421A can scan up to 30 differential channels or 56 single-ended channels of analog information. The HP 3421A is battery-powered with latching relays that will not change state when the ac line power is removed. Battery power gives the HP 3421A its own uninterruptible power supply.

All functions are remotely programmable via either HP-IL or HP-IB. Use HP-IL with the HP 71B handheld calculator as a self-contained battery-powered data logger, or use HP-IB with the HP 85B Personal Computer for more programming performance.

The HP 3421A is not limited to portable applications. It is equally useful in laboratory situations, where its 0.01% accuracy, 1 microvolt sensitivity and 5½ digit resolution assure you of reliable answers.

Digital inputs, actuator outputs and a breadboard assembly give the laboratory designer a great deal of instrument flexibility while HP-IB compatibility adds the option of a more powerful instrument controller.

System Specifications (with an HP 85B Computer)

These rates assume 30 readings taken on a fixed range with no function change. Speeds are independent of channel sequence. Rates include scan time, A/D conversion time and the time to transfer the reading to the computer. Rates apply for either HP-IB or HP-IL.

Approximate Maximum Reading Rates (readings/second)

HP 85B ¹	DCV, Ω		ACV	Frequency	Type T Thermocouple
	Auto Zero Off	Auto Zero On			
5½ Digit	3.2	1.8	-	0.1	0.9
4½ Digit	9	8	0.3	0.8	0.9
3½ Digit	11	10	0.4	5.8	0.9

¹Using Fast Handshake

HP 3421A Mainframe Specifications

The HP 3421A mainframe comes with:

- A 5½, 4½, and 3½ digit integrating A/D converter
- Thermocouple compensation
- Type T thermocouple linearization built in
- HP-IL
- 30-reading storage buffer
- LCD 30 channel display with power and error indicators
- Electronic calibration
- Rechargeable battery
- High level command set

All specifications apply for relative humidity less than 85% at 30 degrees C.



DC Voltage

Ranges: 300 mV, 3 V, 30 V, 300 V, Autorange

Basic accuracy: $\pm(.009\%$ reading + 3 counts); 5½ digits

Reading rates: 2 to 35 readings/second

Resistance

Ranges: 300 Ω , 3 k Ω , 30 k Ω , 300 k Ω , 3 M Ω , 30 M Ω ; Autorange

Basic accuracy: $\pm(.012\%$ reading + 3 counts); 5½ digits

Reading rates: 2 to 35 readings/second

AC Voltage

Ranges: 3 V, 30 V, (300 V with HP 44469A divider)

Converter type: averaging

Resolution: 3½ or 4½ digits

Basic accuracy: 4½ digits: $\pm(0.5\%$ reading + 60 counts), 45 Hz to 500 Hz; $\pm(1\%$ reading + 60 counts), 30 Hz to 1 kHz; providing the input voltage is at least 10% of range.

Counter

The counter is part of the mainframe circuit, and is multiplexed through the channel relays.

Resolution: 65,535 counts

Frequency: 1 Hz to 10 kHz

Modes: frequency, totalize

Thermocouple Thermometer

Type T thermocouple linearization is built in. For other thermocouple types, the reference junction temperature is available on each multiplexer assembly.

Temperature Errors

These errors include the linearization error of the HP 85B software, thermal offset voltages, A/D error and reference junction error. They do not include transducer errors.

J.E.T. Thermocouples

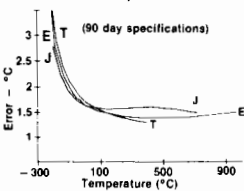

K.R.S. Thermocouples

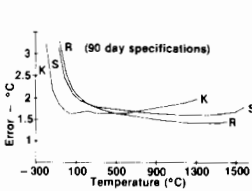

2.2 k Ω Thermistor

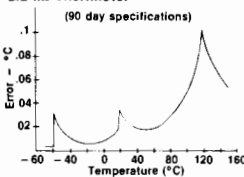

100 Ω Platinum RTD $\alpha = .00385$

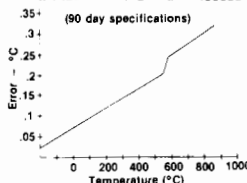

Option 020, 021, 022 Multiplexer/Actuator Assemblies

The configuration of multiplexer and actuators depends on the option you order. Option 020 has 8 multiplexer/2 actuator channels; Option 021 has 9 multiplexer/1 actuator channels; Option 022 has 10 multiplexer channels. The actuators are capable of switching 252 Vac. One HP 3421A mainframe can hold up to 3 assemblies.

Option 040 Breadboard Assembly

The breadboard assembly is convenient for constructing custom circuitry. It comes complete with a manual describing the circuit that enables the HP 3421A to communicate directly with an 8-bit microprocessor.

Option 050 Digital I/O Assembly

Option 050 has 8 isolated input lines and 8 isolated output lines for both monitoring and controlling external digital devices.

Option 201 HP-IB

The Option 201 adds an HP-IB interface to the HP 3421A. Interface functions: SH1, AH1, T6, TE0, LE0, L4, SR1, RL0, PP0, DC1, DT1, C0. For more on these codes, see the HP-IB section of this catalog.

Option 214 12 Volt Remote Charging Adapter

This optional assembly provides the necessary isolation and regulation for a 12 volt automotive battery or system to charge the batteries of the HP 3421A, HP 71B Handheld Computer, and peripherals such as the HP 9114B Portable 3½" Microfloppy and HP 2225B Thinkjet Personal Printer. Option 214 is mutually exclusive with Option 201 (HP-IB).

Ordering Information

Input and I/O Assembly Options

020: 8 Channel Multiplexer/2 Channel Actuator Assembly \$350

021: 9 Channel Multiplexer/1 Channel Actuator Assembly \$350

022: 10 Channel Multiplexer Assembly \$350

040: Breadboard Assembly with connector block \$90

050: 8 bit in, 8 bit out Digital I/O Assembly with connector block \$350

201: add HP-IB interface. Allows use of EITHER an HP-IB or HP-IL controller \$250

214: add 12 volt remote charging adapter. Cannot be added if opt 201 is specified \$400

Power and Frequency Options

315-346: Line power options from 100 V/50 Hz-240 V/60 Hz N/C

Rack Mount and Manual Options

401: Side Handle Kit \$20

907: Front Handle Kit \$50

908: Rack Mount Kit \$30

909: Rack Mount with Handle \$75

910: Extra Manuals \$75

Field Installation Kits*

HP 44461A: Add HP-IB interface. Allows use of either an HP-IB or HP-IL Controller \$300

HP 44462A: 8-Channel Multiplexer/2 Channel Actuator Assembly with thermocouple compensation, connector block \$350

HP 44463A: extra connector block for above \$35

HP 44464A: Breadboard Assembly with connector block \$90

HP 44465A: 8 bit in, 8 bit out digital I/O assembly with connector block \$350

HP 44466A: Extra connector block for digital or breadboard assembly \$15

HP 44469A: Seven 10:1 dividers for measuring 300 Vac \$15

Accessories

HP 2225B: Thinkjet Personal Printer (HP-IL) \$495

HP 9114B: Portable 3½" Microfloppy (HP-IL) \$795

HP 11340A: 20-metre HP-IL Cable \$75

HP 11340B: 50-metre HP-IL Cable \$150

HP 11340C: 100-metre HP-IL Cable \$300

HP 82161A: Digital Cassette Drive (HP-IL) \$550

HP 82162A: Printer/Plotter (HP-IL) \$450

HP 82402A: Dual HP-IL Adapter \$85

HP 82479A: HP-71 Data Acquisition Pac ROM \$195

HP 03056-90000: Software for the HP 85B \$250

Related Products

HP 71B Handheld Computer \$525

HP 3468A Digital Multimeter \$750

HP 3421A Data Acquisition/Control Unit \$1,550

* Field installation is recommended to be performed only by service trained personnel.

☎ Fast-ship product — see page 766.



DATA ACQUISITION SYSTEMS

Front Ends for Measurement and Control

HP Model 3497A

- Relay multiplexing
- DVM
- FET multiplexer
- Real time clock
- Bridge completion

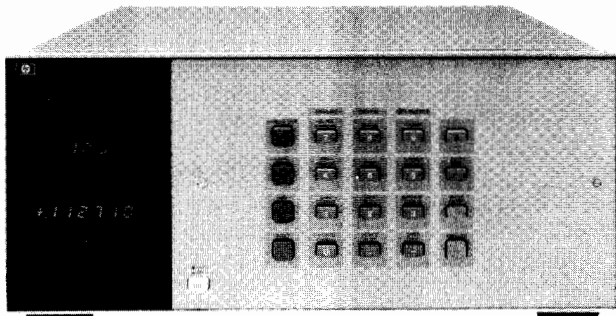

HP 3497A

Description

The HP 3497A Data Acquisition/Control Unit combines the capabilities of several instruments and is a basic building block of an automatic data acquisition and control system. The HP 3497A will be used in an HP-IB automated system and can be viewed as a precision measurement and control computer peripheral.

The HP 3497A has been designed to be a very versatile and very powerful instrument. A basic HP 3497A consists of a mainframe that includes a front panel keyboard and display, a non-volatile real time clock, and an HP-IB interface. Available as an option is a 5½ digit integrating digital voltmeter and current source that occupies a dedicated slot in the HP 3497A chassis. Capability is added to the HP 3497A by using any combination of plug-in assemblies. Available plug-in assemblies are:

- Relay Multiplexers with or without thermocouple compensation
- FET Multiplexer
- Digital Input/Interrupt
- Counters
- Strain gage/bridge completion
- Actuators
- Programmable voltage and current D/As
- Breadboard Assembly

Up to 5 assemblies can be added to a HP 3497A and the HP 3498A Extender chassis can hold up to 10 more plug-in assemblies.

High Performance

The HP 3497A DVM can resolve 1 microvolt signals and is ideal for the precise measurement of the outputs of thermocouples, strain gauges and other transducers. Included on the DVM is a programmable current source that allows four-terminal resistance measurements. The multiplexer assemblies switch 3 wires (Hi, Lo, and Guard) and add less than 2 microvolts of thermal offset to the measured signal.

Flexible Hardware Configuration

The HP 3497A card cage can hold 5 of any combination of the plug-in assemblies. This allows the multiplexing of up to 100 3-wire inputs to the DVM in a single HP 3497A or a single HP 3497A might contain 60 multiplexer channels, 16 digital inputs, 16 actuator outputs, and a DVM. By using the HP 3498A Extender, up to 1000 analog channels and 1360 digital channels can be controlled, all at a single bus address.

Ease of Use

The HP 3497A keyboard and display make the HP 3497A very easy to use and makes debugging of a HP 3497A based system easy. The calibration adjustments for the HP 3497A DVM are located behind a hinged front panel; this allows complete calibration of the DVM without removing it from the test rack. Connections to all of the HP 3497A assemblies are made using screw terminals, thereby eliminating the need for soldering.

Real Time Clock

The HP 3497A mainframe includes a quartz-referenced, non-volatile, real-time clock. In addition to providing timing data, the clock can mea-

- Digital inputs/outputs
- Counter
- Programmable D/As
- Optional RS-232C interface

sure elapsed time, interrupt at a presettable time, and output a programmable pulse train.

Clock Format

Month:Day:Hours:Minutes:Seconds (U.S. Format)

Day:Month:Hours:Minutes:Seconds (European Format)

Option 001—5½ Digit DVM and Current Source

The HP 3497A DVM assembly is a systems quality, 5½ digit, 1 microvolt sensitive dc voltmeter. The DVM is fully guarded and uses an integrating A/D conversion technique; this yields excellent common and normal mode noise rejection.

Included on the DVM assembly is a three level programmable current source. The current source, when used simultaneously with the DVM, can be used to make high accuracy four terminal resistance measurements with 1 milliohm resolution. Maximum speed is 300 readings per second in 3½ digit mode.

Buffer size: packed format: 100 readings; ASCII format: 60 readings

Scanning Speeds	Number of Digits Selected	85	Series 200/300	1000A*
Sequential Channels using external increment	5½ digits	39 (33)	39	39 (25)
	4½ digits	97 (88)	103	108 (79)
	3½ digits	112 (107)	123	127 (99)
Random Channels using software	5½ digits	13 (11)	27	24 (20)
	4½ digits	14 (11)	51	41 (34)
	3½ digits	14 (11)	55	43 (36)

*A600 + speeds in FORTRAN

Option 010—20 Channel Relay Multiplexer

This assembly uses reed relays to multiplex signals to the DVM or other instruments. Each assembly switches 20 channels, each channel consists of HI, Lo, and Guard lines. Two channels may be closed per assembly and relays may be closed in a random sequence or incremented between programmable limits. The low thermal offset of the relays make it suitable for measuring the outputs of strain gage and other transducers. Each channel can be configured with a filter or current shunt for additional flexibility.

Option 020—Relay Multiplexer with Thermocouple Compensation

The option 020 assembly uses the same relay multiplexer as option 010 but incorporates a special isothermal connector block to allow thermocouple compensation. Two types of compensation (selectable by the user) are available. A temperature-dependent voltage is generated for software compensation; this voltage is then used in a computer program to compensate the thermocouple voltage. Hardware compensation involves inserting a voltage in the measurement circuit that automatically compensates the thermocouple voltage.

Option 030—20 Channel FET Multiplexer Assembly

The option 030 assembly is used to multiplex input signals to a DVM in a manner similar to option 010. The option 030 assembly provides high speed, low level multiplexing. Maximum signal levels are 12 volts peak between any high, low or guard input and any other guard input, guard common or chassis ground.

Maximum sequential scanning rate: 4800 readings/s (at 60 Hz) using an HP 3437A Voltmeter and HP Series 200 computer (4000 readings/s at 50 Hz power).

Option 050—16 Channel Isolated Digital Input/Interrupt

The option 050 assembly can sense up to 16 channels of digital data. The first 8 channels can also be used as interrupt lines to detect transient signals. The assembly can accept inputs of 5, 12 or 24 volts and all functions and masks are fully programmable. A five-volt supply is provided for driving external contact closures and open collector outputs.



Option 060—100 kHz Reciprocal Counter

This option can be used to measure mechanical and low frequency electronic signals. The counter can measure the period of signals up to 100 kHz and the pulse width of signals down to 18 μ s. The counter can also count up or down from a programmable start point. It can accept inputs of 5, 12, or 24 volts including CMOS, open collector TTL and passive contact closures.

Option 070—120 Ohm Strain Gage/Bridge Completion Assembly

Option 071—350 Ohm Strain Gage/Bridge Completion Assembly

The option 070/071 assemblies may be used to provide bridge completion for measuring strain gages, RTDs pressure sensors and load cells. Each card uses an internal shared half bridge and can complete 10 channels of $\frac{1}{4}$ and $\frac{1}{2}$ and full bridges in any combination. When used with a +5 V excitation supply (such as the HP 6214A) and the HP 3497A DVM, the assembly provides 0.1 μ e sensitivity with 1 μ e accuracy. Provisions are made for shunt calibration and checking gage leakage and lead resistance.

Option 110—16 Channel Actuator

Option 115—8 Channel High Voltage Actuator

Option 110 consists of 16 mercury wetted form C (single pole-double throw) relays. Each relay can be individually closed and can switch 1 A at 100V. The actuator assembly can be used to switch test fixture power or to actuate alarm bells. This flexibility of this assembly allows it to be used as a digital output or matrix switch.

Option 115 is an 8 channel high voltage actuator assembly that can switch voltages up to 252 Vrms and currents up to 2 amperes. The Option 115 assembly is ideal for switching power line voltages to small motors, alarm bells and lights, motor starters and solenoids.

	Option 110	Option 115
Switch Form	C	A
Contact Type	Mercury Wetted	Dry
Number of channels	16	8
Maximum Voltage	100 V Peak	252 Vrms 48 Vdc
Maximum Current	1 A	2 Arms or dc
Maximum Power	100 VA	500 VA ac 60 VA dc

Option 120—Dual Voltage D/A

Option 130—Dual Current D/A

Option 120 consists of two 0 to ± 10 V programmable voltage sources. These sources can be used to provide a programmable test stimulus or to control voltage programmed devices like power supplies and VCOs.

Option 130 consists of two 0 to 20 mA or 4 to 20 mA programmable current sources. These sources, especially when using the 4 to 20 mA range, can be used as transmitters in industrial current loops and can drive up to 600 ohms of total loop resistance.

Option 120

Output: 13 bits including polarity

Least significant bit: 2.5 mV

Output range: -10.2375 V to +10.2375 V

Maximum output current: 15 mA (output within specifications)

Option 130

Output: 12 bits

Least significant bit: 5 μ A (0 to 20 mA range)

4 μ A (4 to 20 mA range)

Output range: 0 to 20.475 mA or 4 to 20.380 mA (each source jumper selectable)

Compliance voltage: 12.0 volts

Option 140 Breadboard Card

Option 140 is a breadboard card compatible with the HP 3497A cardage. Using this card, HP 3497A users can construct special purpose assemblies that communicate with the HP 3497A backplane.

Option 232—RS232C Interface

Option 232 to the HP 3497A deletes the standard HP-IB interface and adds an RS232C (CCITT/V.24) compatible interface allowing you to remotely locate the HP 3497A. The option 232 interface is also compatible with the new RS423 (CCITT/V.10) version of the RS449 interface.

Option 298—HP 3498A Extender

The HP 3498A Extender chassis allows low cost expansion of HP 3497A-based systems. Each HP 3498A can hold up to ten HP 3497A

plug-in assemblies. Use of one or more HP 3498As requires an HP 3497A (for control); all required connecting cables are supplied with the HP 3498A. Up to 13 HP 3498As can be controlled by a single HP 3497A.

Software

HP 3054A (HP 44453A): Menu-driven data logger for Series 300/200 (BASIC 3.0 and 4.0). Also, BASIC subroutines to program HP 3497A, perform temperature conversions, and graph results.

HP 3055S (HP 44457A/B): Menu-driven data logger software for HP 150, Vectra PC and IBM PC-XT/AT. Provides links to Lotus 1-2-3 for spreadsheet analysis of data.

HP DACQ/300 (HP 44458A/B): BASIC subroutines for Series 300/200 (BASIC 4.0) for use in capturing, storing, analyzing, and displaying data over HP-IB.

General

Size (HP 3497A or HP 3498A): 190.5 mm H x 428.6 mm W x 520.7 mm D (7 $\frac{1}{2}$ " x 16 $\frac{7}{8}$ " x 20 $\frac{1}{2}$ ").

Net weight: HP 3497A, 20.4 kg (45 lb) and 3498A, 20.4 kg (45 lb) with assemblies in all slots.

Shipping weight: HP 3497A and HP 3498A maximum with assemblies in all slots are 26.3 kg (58 lb.)

Operating temperature: 0°C to 55°C

Non-operating temperature: -40°C to 75°C

Humidity: to 95% at 40°C except as noted

Operating power: switch selection of 110, 120, 220 and 240 volts $\pm 10\%$, 48-66 Hz, 150 VA 3497A and 3498A.

Ordering Information

Price

Each HP 3497A can hold one DVM assembly (Opt 001) and up to 5 plug-in assemblies. Each HP 3498A (Opt 298) can hold 10 additional plug-ins. To order plug-ins without a mainframe, order as 444XXX Field Installation Kits as shown below.

Clock format and power line frequency and voltage will be determined at the factory based on the country from which the order was placed.

Opt 001 or 44420A: 5 $\frac{1}{2}$ Digit DVM and Current Source	\$1,650
Opt 010 or 44421A: 20 Channel Relay Multiplexer Assembly	\$650
Opt x20 or 44422x: Relay Multiplexer Assembly Substitute A in place of x for software compensation. For hardware compensation, substitute the thermocouple type B, E, J, K, R, S, or T for x.	\$750
Opt 030 or 44423A: 20 channel FET Multiplexer Assembly	\$750
Opt 050 or 44425A: 16 channel Isolated Digital Input/Interrupt Assembly	\$550
Opt 060 or 44426A: 100 kHz Reciprocal Counter	\$600
Opt 070 or 44427A: 120 Ohm Strain Gage/Bridge Completion Assembly	\$900
Opt 071 or 44427B: 350 Ohm Strain Gage/Bridge Completion Assembly	\$900
Opt 110 or 44428A: 16 Channel Actuator/Digital Output Assembly	\$750
Opt 115 or 44431A: 8 Channel High Voltage Actuator Assembly	\$550
Opt 120 or 44429A: Dual Output Voltage DAC Assembly	\$1,000
Opt 130 or 44430A: Dual Output Current DAC Assembly	\$1,000
Opt 140 or 44432A: Breadboard Card	\$130
Opt 232: Delete HP-IB Interface, add RS232C Interface	\$250
Opt 260: Delete Keyboard and Display	less \$360
Opt 298: Add HP 3498A Extender & connecting cables	\$2,100

HP 3497A Data Acquisition/Control Unit \$3,000



DATA ACQUISITION SYSTEMS

Front Ends for Measurement and Control

HP Model 3852S

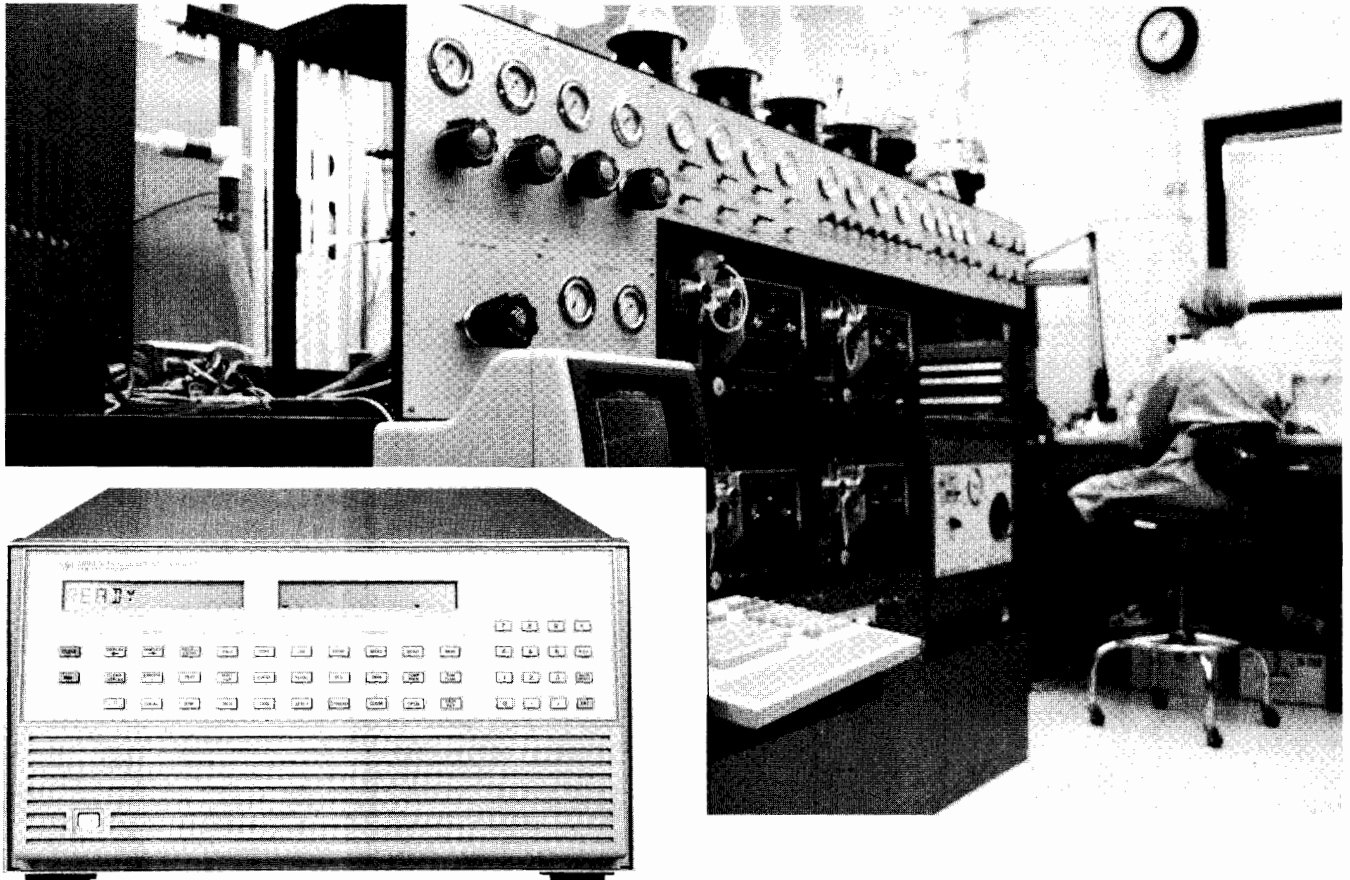

Configure the Capabilities You Need

You can easily configure an HP 3852S Data Acquisition and Control System to meet your needs for measuring physical parameters through transducers, and for providing control outputs. The HP 3852A Data Acquisition/Control Unit (mainframe) has eight slots for plug-in function modules. If more slots are needed, up to seven extenders can be added, each with ten additional slots. You can choose any combination of capabilities that include precision and high-speed plug-in voltmeters and a variety of analog and digital input/output functions.

A system clock and programmable pacer are built-in to drive your system. The clock — non-volatile for four years; 1 msec resolution—allows data to be time-stamped and events to be timed. The pacer—0.25 μ sec resolution—provides powerful capabilities to initiate and pace measurements, scans, or events.

Include High-Speed and Accurate Analog Measurements in One System

Choose from two digital voltmeters to meet your measurement needs. For applications that require sensitive, accurate measurements in the presence of noise (for example, thermocouples), use the 5½-Digit Integrating Voltmeter and Relay Multiplexers. If you need speed, the 13-Bit High-Speed Voltmeter and High-Speed FET Multiplexers are the answer, providing single-channel bursts, channel-to-channel, random channel, full auto-ranging, and direct DMA transfers to a hard disc at an honest 100,000 readings/sec. The system voltmeters can be used in the mainframe or any extender, and multiple voltmeters are allowed per card-cage.

Add Versatility and Expandability to Your System

With the HP 3852S Data Acquisition and Control System, you'll have available a complete set of input and output plug-in modules for interfacing to measurements and for controlling and sequencing your tests. Modules are available to handle physical measurements of temperature, flow, pressure, level, and strain.

Take Advantage of Extensive Front-End Intelligence

The HP 3852A mainframe has considerable built-in intelligence to increase the speed of collecting measurement and control data. Control decisions can be handled faster using subroutines running within the mainframe. This intelligence can be used to *return only significant data* to the computer, increasing its efficiency.

- Up to 5,500 readings can be stored in the standard HP 3852A mainframe. Expand this memory (used for storage of user routines as well as readings) to 256 kbytes, 1 Mbytes, 2 Mbytes, or 4 Mbytes with an Extended Memory board. Extended memory fits inside the mainframe controller module without using an I/O slot.

The power of this front-end intelligence in combination with an HP Series 300 Computer and the optional data acquisition software adapts easily to testing your complex product or characterizing your process. Of course, the mainframe can be also used with HP 1000 computers, other IEEE-488 controllers and instruments, and a variety of computer peripherals.

Reduce Your Test Development Investment

Optional data acquisition software for an HP Series 300/200 computer gets your application running quickly and easily by providing off-the-shelf solutions for:

- Data base management — store large amounts of data in files that are easy to identify and access later.
- Graphics presentations — display or plot color graphs, display a real-time strip chart, plot data with linear, log, semilog, or automatic axis scaling.

Data analysis — This software provides high-level subroutines as tools to be used in a test system program running with HP Series 300 BASIC. Ease-of-use is exemplified by:

- automatic creation of a data base for storing data using only one subroutine,
- fast access to a single data item or a block of data items using only one subroutine,
- manipulation and formatting of gathered data any way you wish.

Program development time is leveraged using this software, while allowing a powerful, highly customized system to be developed. Furthermore, the software can be used with any HP-IB instrument and HP Series 300/200 peripheral.

Data Acquisition and Control Unit — HP 3852A

Mainframe Supports:

- Eight Function Module Slots
- Data Acquisition Operating System
- System Timer
- Measurement Pacer
- Full Alphanumeric Keyboard, Command and Result Displays

Benefits

- **Make real-time decisions and reduce data without burdening your computer:**
 - Powerful HP 3852A command statements simplify complex measurements.
 - Execution speed of command sequences are enhanced by executing subroutines stored in the HP 3852A memory.
 - Built-in, easy-to-use transducer conversions are supported for thermocouples, thermistors, RTDs, and strain gages.
 - Post-processing and data reduction before transferring results to a computer are achievable by first storing data to the HP 3852A internal memory.
 - Limit checking of analog measurements is performed in real time or after the measurements have been stored in mainframe memory.
- **Optimize measurement timing and throughput to meet your needs:**
 - Asynchronous communication with a computer is achieved through input and output buffering.
 - Control can be timed using built-in clock and alarm capabilities (can cause an interrupt).
 - A built-in pacer simplifies measurement timing and triggering.
 - Multiple voltmeters can be used. The high-speed voltmeter can control scanning, timing, and triggering of its own high-speed FET multiplexer subsystem via ribbon cable. Several of these subsystems can run simultaneously.

Data Acquisition Operating System

Commands:

Powerful data acquisition commands are easy to remember and use. For example, "MEAS TEMPK <channel list>" performs K-type thermocouple measurements, cold-junction compensation, linearization, and channel scanning—ALL AUTOMATICALLY. In addition, <channel list> may be a short list of channels—or possibly the name of an array containing a much longer list.

Down-Loaded Subroutines:

FOR...NEXT, IF...THEN...ELSE, WHILE...ENDWHILE Enhanced BASIC language constructs are available.

User subroutines with variables can be called for execution by a computer, other subroutines, or conditional interrupts.

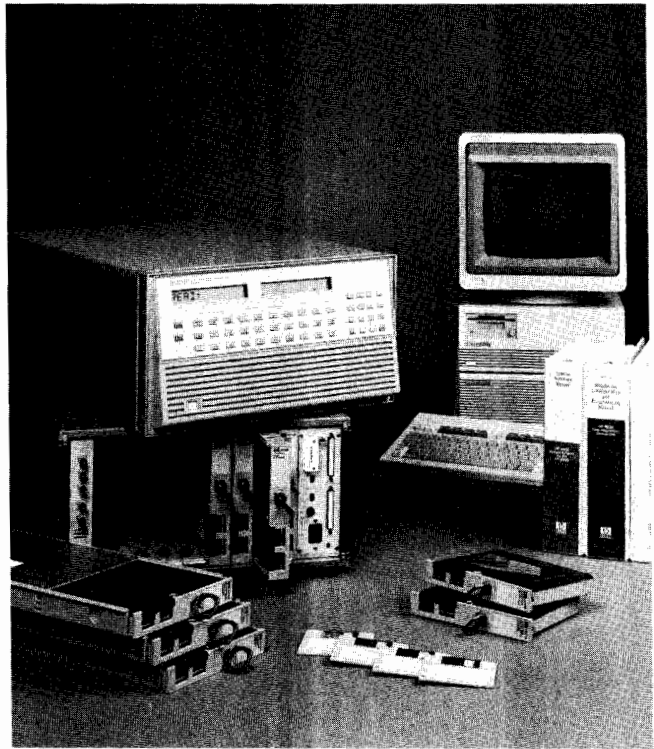

Transducer Conversions:

Transducer conversions have been optimized to support high system accuracy and speed for these transducers:

- * Thermocouples
- * Thermistors
- * Platinum RTDs
- * Strain Gages

Special Conversions:

A special function permits user-defined tables of X,Y pairs to be used for linear interpolation (at a small price in memory usage, this function will typically execute much faster than high-order polynomial calculations).

Limit Testing:

Perform limit testing in real-time (data is tested as it is measured) or as a post-process (data previously stored in arrays is tested). Limit test failures can cause an interrupt if enabled.

Interrupts:

Time alarms, events that have just occurred, or limit tests of measurements can cause an HP-IB Service Request or a call to a stored subroutine.

Math Operations:

+ , - , * , / , ATN , BINAND , BINCMP , BINEOR , BINIOR , BIT , COS , EXP , LOG , SIN , SQRT

Scaling:

Offset and scale factors ($mx + b$) can be performed on an entire array using just one command.

Statistics:

An easy-to-use function finds MIN, MAX, MEAN, and SIGMA (standard deviation) of the values stored in arrays.

Extender Chassis — HP 3853A

Extender Supports:

- Ten Function Module Slots

Benefit

- **Expand your system with no loss of functional capability:**
 - Up to seven extenders may be used with each HP 3852A mainframe.
 - Any slot can be used for any function module and multiple voltmeters can be used with parallel triggering.
 - All mainframe functions, including interrupts and triggering, are available through the extender control cable.

DATA ACQUISITION SYSTEMS

Front Ends for Measurement and Control

HP Model 3852S (Cont)

5½ to 3½ Digit Integrating Voltmeter -

HP 44701A

Directly Measures:

- DC Voltage
- Resistance
- AC Voltage

Benefits

- **Accurately measure small signal changes in noisy environments:**
 - Integrating A/D rejects normal mode noise at multiples of the power line frequency.
 - Guarded input maximizes common-mode rejection.
- **Choose the resolution, accuracy, and noise rejection needed, while maximizing measurement speed:**
 - Integration selection (number of power line cycles) is key to optimizing these performance parameters.
 - This voltmeter provides the fastest DC reading rates available with power line-related noise rejection.
- **Optimize resistance measurements to the accuracy you need:**
 - Use two-wire ohms for measurements where lead resistance is not critical.
 - Use four-wire ohms where inaccuracies due to measurement leads cannot be tolerated (*most accurate measurement technique for RTDs*).
 - Use offset-compensated ohms to correctly measure resistance in the presence of series voltages (often caused by thermocouple effects).

DC Voltage

Accuracy:

± (% of reading + volts), rear terminal input, one-hour warm-up, specified over time since last calibration, and operating temperature.

90 Days, 18 to 28°C, Auto-zero On

Integration Time in Number of Power Line Cycles (NPLC)

	1	0.1	0.005	0.0005
Range:				
30 mV	0.02% + 6 μV	0.02% + 8 μV	0.02% + 20 μV	0.02% + 60 μV
300 mV	0.008% + 6 μV	0.008% + 10 μV	0.008% + 40 μV	0.008% + 400 μV
3 μV	0.008% + 8 μV	0.008% + 40 μV	0.008% + 400 μV	0.008% + 4 mV
30 μV	0.008% + 300 μV	0.008% + 700 μV	0.008% + 4 mV	0.008% + 40 mV
300 μV	0.008% + 700 μV	0.008% + 4 mV	0.008% + 40 mV	0.008% + 400 mV

Reading Rate/Noise Rejection:

Integration Time in Number of Power Line Cycles (NPLC)

Integration Time 60 Hz (50 Hz)	1	0.1	0.005	0.0005
	16.7 (20.0) msec	1.67 (2.0) msec	100 (100) μsec	10 (10) μsec
Number of Converted Digits	6½	5½	4½	3½
Reading Rate (readings/sec) with auto-zero, auto-range off 60 Hz (50 Hz)	57 (48)	415 (360)	1350 (1350)	1600 (1600)
Min Noise Rejection (dB)				
Normal Mode Rejection at 50 or 60 Hz ± 0.09%	60	0	0	0
DC Common Mode Rejection with 1 kΩ in low lead	120	120	120	120
Effective Common Mode Rejection, at 50 or 60 Hz ± 0.09% with 1 kΩ in low lead	150	90	90	90

13-Bit High-Speed Voltmeter —

HP 44702A/B

Directly Measures:

- DC Voltage
- DC Resistance

Benefits

- **Collect data quickly:**
 - A measurement rate of 100,000 readings/sec with auto-ranging is achieved by directly controlling up to six (eight in an extender) High-Speed FET Multiplexers through a dedicated ribbon cable.
 - Multiple High-Speed Voltmeters can be triggered simultaneously.
- **Maximize your measurement throughput:**
 - On-board buffer is included for over 8,000 readings (HP 44702A) or over 64,000 readings (HP 44702B) that can be transferred to mainframe internal memory or to hard disc via GPIO and a DMA controller while taking measurements.
 - Dedicated triggering is achieved with on-board pacers.
 - Balanced input, equal impedance between high-to-chassis and low-to-chassis, gives good common mode noise rejection.

DC Voltage

Accuracy:

± (% of reading + volts), rear terminal input, one-hour warm-up, specified over time since last calibration, and operating temperature, with auto-zeroing performed within one minute of measurement.

90 Days, 18 to 28°C

	Accuracy	
Range:		
40 mV	0.05% + 68 μV	
320 mV	0.05% + 234 μV	
2.56 V	0.05% + 1.88 mV	
10.24 V	0.05% + 7.5 mV	

Reading Rates:

100,000 readings/sec with auto-ranging. Proper auto-ranging is ensured as long as a single-channel signal changes no more than 600 volts/sec during auto-ranging.

Noise Rejection:

Min effective common mode rejection specified in dB for DC to 60 Hz with 1 kΩ in low lead; maximum signal (high to low) + common mode voltage (low to chassis) for proper operation is ±10.24 volts.

ECMR

Range:		
40 mV		90
320 mV		80
2.56 V		70
10.24 V		70

Relay Multiplexers — HP 44705A/44706A/ 44708A/44717A/44718A

Directly Multiplexes:

- Voltage
- Resistance
- Thermocouples
- Strain Gages

Benefits

- **Reduce the effects of real-world measurement errors in a multi-channel system:**
 - Relay multiplexers minimize errors due to thermal DC offsets, crosstalk, and injected (bias) currents.
 - The relay multiplexers have high, low, and guard terminals to maximize common mode noise rejection.
 - A single-ended multiplexer (HP 44706A) lowers your cost per channel.
 - With shunt and series jumpers in each channel of the HP 44705A and 44708A multiplexers, you can easily install a one-pole low-pass filter for additional noise rejection, a voltage divider to extend relay lifetime, or a shunt resistor to measure current.
 - Scanning is break-before-make to prevent inadvertent connections of circuits being measured.
 - Each lead to the back-plane and common terminals has a 100 Ω resistor in series to prolong the lifetime of the relay contacts. Due to placement, these resistors contribute no error when measuring 2-wire ohms resistance using the HP 44701A Integrating Voltmeter. The resistor can be shorted, but this can seriously shorten relay contact life if relatively high voltages or currents are switched.
 - Tree switch relays automatically isolate each bank of relays from the back-plane to reduce crosstalk and improve settling time.
- **Optimize thermocouple measurement accuracy:**
 - Thermocouple types can be mixed on the HP 44708A multiplexer to optimize accuracy over the temperature ranges needed.
 - Thermocouple compensation is handled automatically with no extra wiring.
- **Measure strain accurately:**
 - Strain sensitivity can be optimized using finger-moveable jumpers to select between 1/4-, 1/2-, and full-bridge configurations. The HP 44717A and 44718A multiplexers each support 10 bridges for 120 Ω and 350 Ω strain gages.
 - No manual adjustments are required to balance the bridge.
 - Strain accuracy is independent of long-term bridge excitation voltage changes because the excitation voltage is automatically measured and included in the strain calculations.
 - The excitation voltage is always applied, never switched, reducing errors due to dynamic heating and cooling of the gages.
 - Connection to an available Wagner ground reduces errors due to gage leakage current.

FET Multiplexers — HP 44709A/44710A/ 44711A/44712A/44713A/44719A/44720A

Directly Multiplexes:

- Voltage
- Resistance
- Thermocouples
- Strain Gages

Benefits

- **Maximize your measurement throughput:**
 - A throughput rate of 100,000 readings/sec is realized using High-Speed FET Multiplexers (HP 44711A/44712A/44713A) directly controlled through a dedicated ribbon cable by the 13-Bit High-Speed Voltmeter.
 - Up to six (eight in an extender) High-Speed FET Multiplexers can be controlled through this ribbon cable.
 - The 24-channel multiplexers switch high and low only. Each floating input is balanced (that is, equal impedance between high-to-chassis and low-to-chassis) to provide good common mode noise rejection.
 - For lower costs per channel, single-ended multiplexing of 48 channels (HP 44712A) is also available (has no common mode noise rejection, however).
- **Increase system reliability:**
 - FETs have no mechanical limitations (no wear out due to switching).
 - Similar to their relay counterparts, the HP 44709A/44710A/44719A/44720A FET multiplexers have high, low, and guard connections for better common mode rejection than the high-speed FET multiplexers.

Digital to Analog Converters —

HP 44727A/44727B/44727C

Directly Outputs:

- DC Voltage
- DC Current

Benefit

- **Simplify your test system by providing test or control of devices with one data acquisition control system:**
 - Four channels are provided on each module.
 - Each channel can be configured using finger-movable jumpers to output either unipolar or bipolar voltage, or unipolar current. Reconfiguration may require recalibration of the changed channel. Recalibration consists of adjustments to zero offset and gain potentiometers, and can be performed with the HP 44701A Integrating Voltmeter or equivalent. Three configurations (4-Channel Voltage—HP 44727A; 4-Channel Current—HP 44727B; 2-Channel Voltage, 2-Channel Current—HP 44727C) are available to make reconfiguration unnecessary in most cases.
 - Channels are isolated and can be connected in parallel for current or in series for voltage to expand the usable ranges.
 - Each channel configured for voltage has remote sense capabilities to ensure accurate voltages at the device.

DC Voltage

Ranges: 0 to +10.235 V or -10.235 to +10.235 V

Resolution: 2.5 mV (12 bits plus a sign bit for bipolar range)

DC Current

Ranges: 0 to +20.16 mA or +4 to +20.16 mA

Resolution: 2.5 μ A (13 bits)

5-Channel Counter/Totalizer — HP 44715A

Directly Provides:

- Count Measurements
- Period Measurements
- Frequency Measurements
- Interrupts

Benefit

- **Reduce your costs by taking advantage of frequency counting versatility:**
 - The counter/totalizer accurately measures logic or RMS inputs with frequencies up to 200 kHz.
 - By multiplexing between five isolated channels and five non-isolated channels, a total of ten connected channels is possible (only five can operate simultaneously).
 - Each DC logic channel independently counts on either positive or negative signal transitions. Non-isolated, low-level RMS inputs are measured using a zero-crossing detector.
 - Any channel that is totalizing can be programmed to set an interrupt for a counter roll-over to zero.
 - For isolated DC inputs, nominal voltages are separately selected for each channel by finger-movable jumpers. For non-isolated inputs, either TTL or low-level RMS inputs are also separately selected for each channel by finger-movable jumpers.
 - Debounce times (common to all channels) can be programmed to prevent false counts.
 - With shunt and series jumpers in each channel, you can easily install a one-pole low-pass filter for rejection of unwanted signals.

Digital Inputs with Totalize and Interrupt -

HP 44721A/44722A

Directly Provides:

- Logic Readings
- Totalize Count Measurements
- Interrupts

Benefit

- **Conveniently read a variety of digital values in your system:**
 - Isolated inputs detect the presence of DC (HP 44721A 16-channel digital input) or AC (HP 44722A 8-channel digital input) inputs based on nominal voltages selected by finger-movable jumpers.
 - Each channel can independently totalize positive or negative (whichever is selected) logic transitions.
 - Voltage selection and function can be set independently on each channel.
 - Any channel can be programmed to set an interrupt for an edge occurrence (positive or negative) or a counter roll-over to zero.
 - Debounce circuitry that is common to all channels prevents erroneous readings on inputs that are still changing after a logic level transition.
 - For detecting whether switches are opened or closed, the HP 44721A has a non-isolated five volt supply at the terminal module with 9.4 kΩ ±10% pull-up resistors on each input.

16-Channel Digital Output — HP 44724A

Directly Provides:

- Open Drain Digital Outputs

Benefit

- **Conveniently control DC devices or logic levels:**
 - Open drain outputs are used to control DC devices with up to 55 V, or drive TTL logic levels. An external power supply and external pull-up resistors are required.

Characteristics

Max Input Voltage:

Between High and Low Terminal of Each Channel — 55 V DC
Between Channels or Between Any Terminal and Chassis — 354 V peak or 250 V DC

Max Sink Current: 500 mA DC per channel (1 A fuse protection)

Max Reverse Polarity Current: 500 mA DC per channel

TTL Compatibility: 200 mA per channel with $V_{out} \leq 0.4$ volts

Switching — HP 44725A/44728A/44729A

Directly Switches:

- Voltage
- Current
- Power

Benefit

- **Reliability switch the voltage, current, or power you need:**

- Both the HP 44725A and 44728A use single-pole double-throw (SPDT) Form-C relays that return to their normally closed positions at power down. The HP 44725A 16-channel general purpose relays are for switching low-level power or moderate voltages and currents in an experiment while minimizing errors due to cross talk and thermal DC offsets. More DC or AC power can be switched with the HP 44728A 8-channel relay actuator.
- The HP 44729A 8-channel AC power controller distributes AC power. It switches “on” at the zero voltage crossing and “off” at the zero current crossing for long device life and low transient generation. Each channel has a relay and solid state switch in parallel to provide an exceptional combination of switch life and low on-resistance.

Characteristics

	Module		
	HP 44725A	HP 44728A	HP 44729A
Max Input Voltage (Vmax) Per Channel	30 V DC or RMS, 42 V peak	300 V DC, 250 V RMS	— 250 V RMS, 354 V peak
Max Input Current Per Channel	1.5 A DC, 1.5 A RMS	2 A DC, 3 A RMS (5 A fuse protection)	2.5 A RMS (3 A RMS if module is limited to 16 A RMS total; 4 A fuse protection per channel)
Max Sum of the Squared RMS Currents in Each Channel (per module; for any load type)	24 A ²	26 A ²	—
Max On Resistance	175 mΩ	200 mΩ	125 mΩ @ 3 A RMS; 200 mΩ @ 100 mA RMS
Switch Life (on/off cycles) Full Load	10 ⁶ (≤2 switches per second)	10 ⁶	5•10 ⁶
Min Load	10 ⁶ (≤2 switches per second)	—	—
Max Wire Size	16 AWG	14 AWG	12 AWG (power in terminals); 14 AWG (power distribution terminals)

Ordering Information

To order, specify an HP 3852S System with the appropriate software, controller, mainframe, extenders, function modules, racks, and extra terminal modules. The HP 3852S itself has no cost—each component of the system is priced individually.

	Price
Data Acquisition Manager	
HP 44458A Data Acquisition and Control Software for Series 300/200 Computers on 3½" Flexible Discs (BASIC 4.0 or greater)	\$1950.00
HP 44458B Data Acquisition and Control Software for Series 200 Computers on 5¼" flexible Discs (BASIC 4.0 or greater)	\$1950.00
HP 44458R License to Reproduce HP 44458A or 44458B. Includes one set of software manuals.	\$1200.00
Mainframe	
HP 3852A Data Acquisition and Control Unit	\$3600.00
HP 44703A Mainframe Extended Memory Card—256 kbytes	600.00
HP 44703B Mainframe Extended Memory Card—1 Mbyte	1450.00

Extended memory cards for 2 Mbytes and 4 Mbytes can be ordered from Infotek Systems, 1400 N. Baxter Street, Anaheim, CA 92806-1201, as AM220B and AM244B, respectively. These products have been *functionally tested, but are not warranted or supported by HP* (no RFI or environmental tests were conducted). Warranty for two years and support of individual cards are provided by Infotek.

Extender	
HP 3853A Extender Chassis	\$2400.00
Analog Inputs	

Voltmeters	
HP 44701A 5½ to 3½-Digit Integrating Voltmeter	1500.00
HP 44702A 13-Bit High-Speed Voltmeter (100,000 readings/sec; buffer for over 8,000 readings)	2500.00
HP 44702B 13-Bit High-Speed Voltmeter (100,000 readings/sec; buffer for over 64,000 readings)	3000.00
High-Speed Extended Memory Card for Expanding HP 44702A Buffer to Over 64,000 Readings	550.00
HP 44703C High Speed Extended Memory	550.00

Relay Multiplexers	
HP 44705A 20-Channel Relay Multiplexer	750.00
HP 44706A 60-Channel Single-Ended Relay Multiplexer	900.00
HP 44708A 20-Channel Relay Multiplexer with Thermocouple Compensation	850.00
HP 44717A 10-Bridge 120 Ohm Static Strain Gage Relay Multiplexer	1000.00
HP 44718A 10-Bridge 350 Ohm Static Strain Gage Relay Multiplexer	1000.00

FET Multiplexers	
HP 44709A 20-Channel FET Multiplexer	800.00
HP 44710A 20-Channel FET Multiplexer with Thermocouple Compensation	900.00
HP 44719A 10-Bridge 120 Ohm Static Strain Gage FET Multiplexer	1050.00

HP 44720A 10-Bridge 350 Ohm Static Strain Gage FET Multiplexer	1050.00
HP 44711A 24-Channel High-Speed FET Multiplexer	900.00
HP 44712A 48-Channel High-Speed Single-Ended FET Multiplexer	1050.00
HP 44713A 24-Channel High-Speed FET Multiplexer with Thermocouple Compensation	1000.00

Analog Outputs

HP 44727A 4-Channel Voltage DAC	1200.00
HP 44727B 4-Channel Current DAC	1200.00
HP 44727C 2-Channel Voltage; 2-Channel Current DAC	1200.00

Counter

HP 44715A 5-Channel Counter/Totalizer (200 kHz)	950.00
--	--------

Digital Inputs/Outputs—Switching

HP 44721A 16-Channel Digital Input with Totalize and Interrupt	650.00
HP 44722A 8-Channel AC Digital Input with Totalize and Interrupt	650.00
HP 44724A 16-Channel Digital Output	650.00
HP 44725A 16-Channel General Purpose Switch	750.00
HP 44728A 8-Channel Relay Actuator	600.00
HP 44729A 8-Channel Power Controller	900.00

Breadboard

HP 44736A Breadboard	350.00
-----------------------------	--------

High-Speed Accessories

HP 98620B 2-Channel DMA Controller for HP Series 300/200 Computers	500.00
HP 98622A GPIO Interface for HP Series 300/200 Computers	355.00
HP 98625A High-Speed HP-IB Disc Interface for HP Series 300/200 controllers	605.00
HP 44744A 2-Meter GPIO Cable with Mating for HP 44702A/B and HP 98622A	250.00
HP 44744B 4-Meter GPIO Cable with Mating for HP 44702A/B and HP 98622A	300.00
HP 44745A 4-Meter GPIO Cable with Mating for HP 44702A/B and HP 12006A (GPIO interface for HP 1000 Computers)	300.00

Service and Support Products and Courses

HP 44743A Plug-In Module Service Module (back-plane extender)	255.00
HP 44743B Power Supply Service Module (back-plane extender)	460.00
HP 50011B HP-IB Course for HP Series 300/200 Computers	1200.00
HP 50015A Data Acquisition and Control Fundamentals Course	750.00
HP 50016E HP-IB Course for HP 1000 Computers	950.00
HP 50600B Instrument Application Services (Consulting)	1000.00
HP P/N 03852-88701 ROM Update Kit	250.00



DATA ACQUISITION SYSTEMS

DACQ/300 Data Acquisition Manager

HP 44458A/B

- Reduce Your Software Development Time
- Customize Your Data Management Needs

- Optimize Your Software Performance
- Use With Any HP-IB Instrument

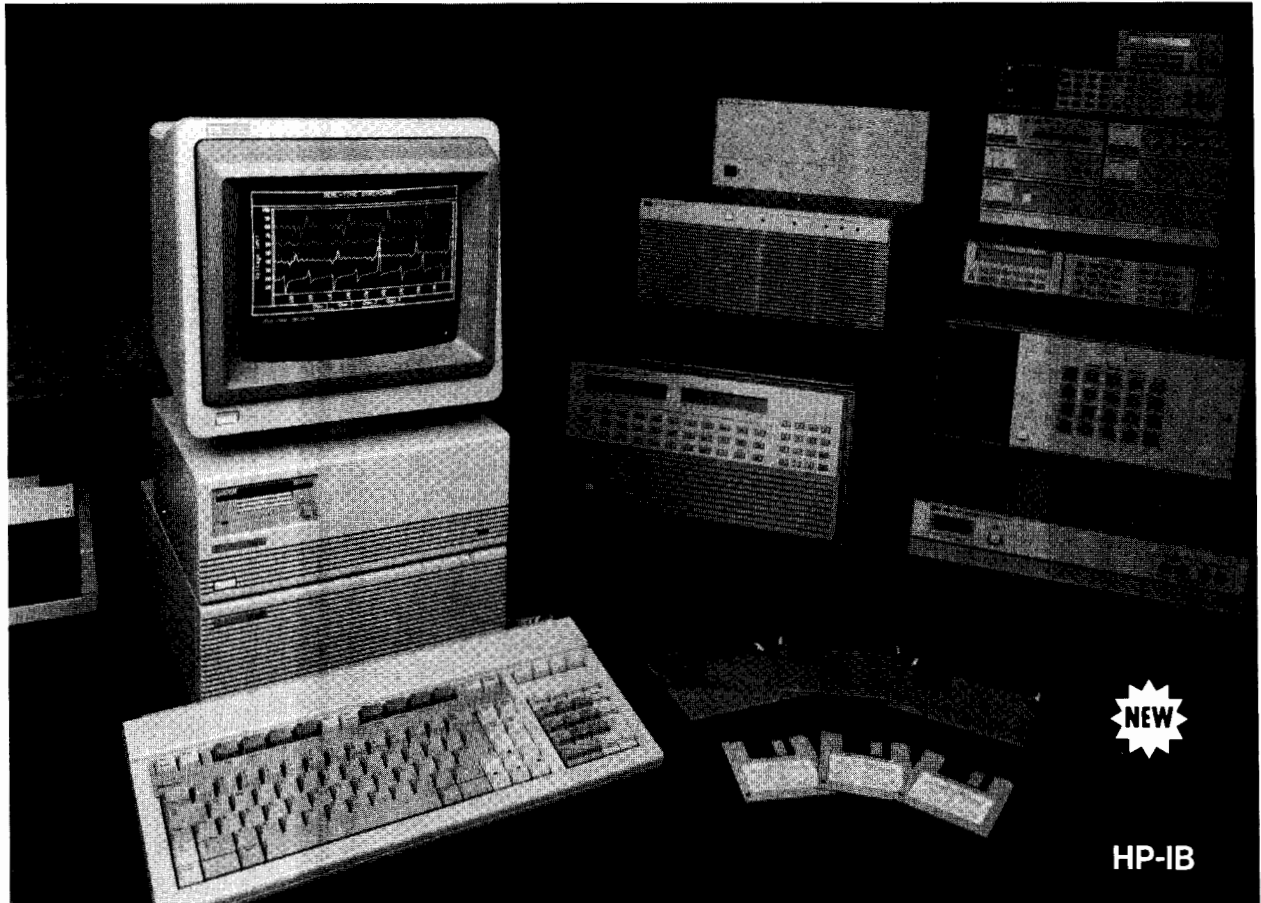

Description

HP DACQ/300 is a general-purpose Data Acquisition Manager for the HP 9000 Series 200/300 controllers. The software reduces your development time by providing you with software "tools" (subroutines written in BASIC and compiled Pascal) that you can add to your BASIC program to handle up to 90% of your data acquisition/control functions. Built-in error-handling routines speed up your software development and can be adjusted to match your final application needs. Customize your program by adding only those "tools" that you need. The software optimizes performance with compiled Pascal and Assembly subroutines which take advantage of the

controller's floating point hardware. Eliminate the need to have several software packages because HP DACQ/300 can be used with ANY HP-IB instrument and any Series 300 supported peripheral.

Software "tools" provide:

- Data capture
- Date base set-up
- Data base storage and retrieval
- Data analysis
- Data presentation
- Data transmission
- Process control
- Task scheduling

Data Management

Use HP DACQ/300 "tools" to:

- Set up a data base organized into archives, books, and pages
- Specify the format of books and pages
- Capture data over HP-IB, GPIO, the program, or the keyboard
- Time-stamp and store the data into the data base
- Document the data
- Retrieve the data from the data base to display, analyze, or transmit it elsewhere

Data Analysis

Entire arrays of data captured over HP-IB or retrieved from the data base can be analyzed quickly using these subroutines.

- Scaling ($mx + b$)
- Limit checking
- Statistics (high, low, mean, standard deviation)
- Math (+, -, *, /)
- FFT and inverse FFT
- Temperature conversions (thermocouples, thermistors, RTD's)
- Strain gage conversions
- User-defined look-up tables
- Unpacking packed readings

Data Presentation

Printing:

Captured data and sections of the data base can be printed on the Series 300/200 display or to a supported HP-IB printer.

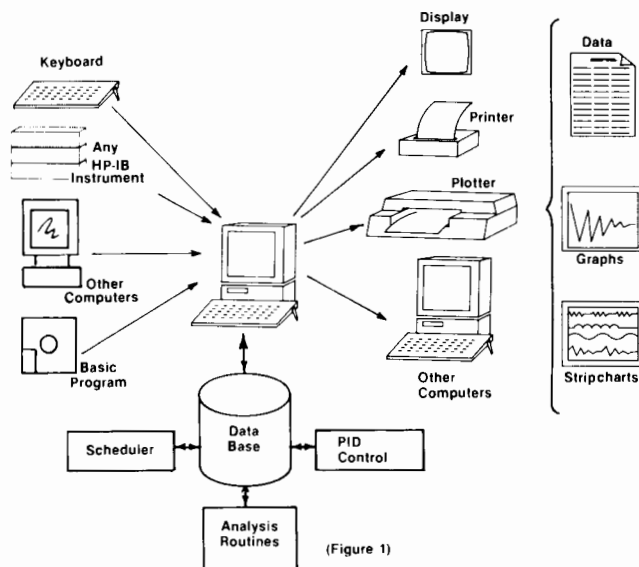

(Figure 1)

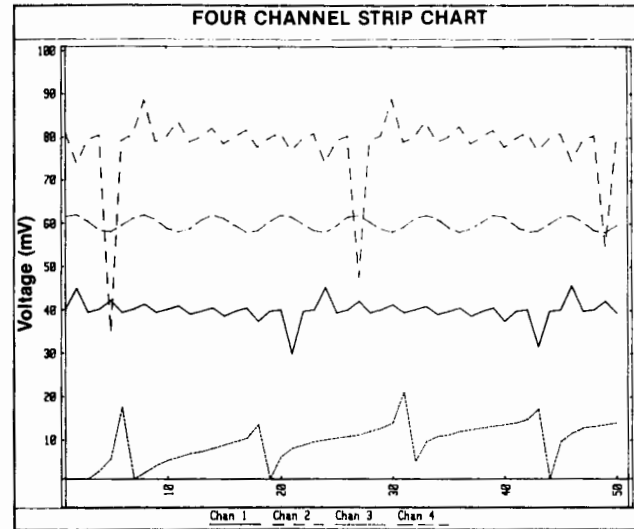
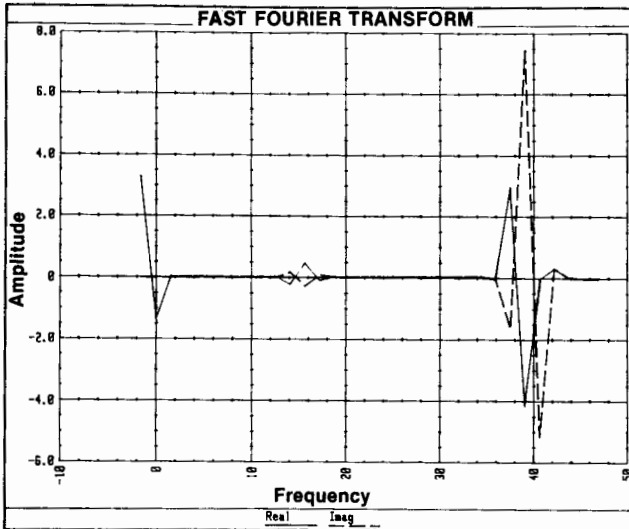

Plotting:

Plot subroutines allow you to plot up to eight traces per chart on either the Series 300/200 display or an HP plotter. The labels, size, location, color, and orientation of the chart is programmable, allowing you to have more than one chart per screen or page. Linear and logarithmic scaling (with or without grid lines) are available as well as auto-scaling of the entire chart.

Real-time Stripcharting:

The stripchart subroutines allow you to display up to four color traces on a chart as the readings are being received from the instrument. Once the screen is full, the data scrolls on the display. A file can be reserved to store values that scroll off the display. Data from the instrument can be plotted versus time or a user-defined array. If a hard copy of the stripchart is desired, the data can be saved and later sent to an HP plotter with the Plot subroutines.

Data Transmission

Transmit data from the data base to another computer over RS-232 using the data transmission subroutines. These subroutines can be used to set up the HP Series 300/200 Datacomm Card (HP 98628A) with the desired protocols. The ENQ/ACK and X-ON/X-OFF protocols, baud rate, handshaking, and the use of modems are all supported with these subroutines. Files of data can be formatted into ASCII or you can create your own format with these subroutines. When the default format (ASCII) is used, the files transmitted can be used by Lotus 1-2-3, Wordstar, and other popular spreadsheet and word processing programs.

Process Control

The PID subroutines provides you with a software tool for calculating up to 10 PID algorithms. You specify the PID constants and send the measured values from your process to this subroutine. The subroutine performs the PID calculation and returns the final values. "Bumpless" control allows a smooth transition from manual control of your process to automatic control (using the PID subroutines). You can cascade two or more of the PID loops and adjust the PID constants ("tune your process control loops") while the process is still under automatic control.

Task Scheduling

The scheduler subroutine assists you in scheduling tasks (subroutines) within your program. The software creates a table of up to 99 tasks and allows you to designate each task name and number, starting time, time interval between task runs, number of times the task is to be run, and its priority. When the scheduler subroutine is called, it returns the number of the task with the highest priority scheduled for

that time. Your program can then run that task by calling the appropriate subroutine.

Configuration/Verification

DACQ/300 contains a menu-driven program that you can use to help document your equipment set-up and application. The program allows you to write a description of your application and prompts you to list the peripherals and instruments attached. The program automatically reads the configuration (processor, memory, plug-in interface cards, operating system) of the Series 300/200 computer. When you are finished, the entire set-up and description will be saved in a file. The program even contains a routine to verify that the present configuration matches a configuration stored in a file.

Summary

HP DACQ/300 is a powerful software package that provides you with "tools" to handle up to 90% of your data acquisition/control program. This leaves you time to concentrate on other aspects of your application. Collecting, storing, analyzing, transmitting, and scheduling data and subroutines are all handled by this software. Add only the routines that you need to customize your program and allow DACQ/300 to optimize your software performance. Use HP DACQ/300 with ANY HP-IB instrument and Series 300 supported peripheral for ALL of your data acquisition data management needs.

Ordering Information

Hardware Requirements:

HP 9000 Series 300 Model 310 or 320
 HP 9000 Series 200 Models 216, 217, 220, 236*
 Operating System - BASIC 4.0 or higher
 Memory - 1 Megabyte or greater
 Peripherals - any Series 300 supported
 Instruments - any HP-IB instrument (no drivers)
 Interface cards (optional)
 - 98620B - 2 channel DMA
 - 98635A - Floating point Math
 - 98628A - Datacomm (RS-232C)
 - 98622A - GPIO

Prices:

HP 44458A: 3 1/2" flexible discs \$1950.00
 HP 44458B: 5 1/4" flexible discs \$1950.00
 HP 44458R: right to reproduce (includes certificate and documentation) \$1200.00

*No color support for HP 9836C



ELECTRONIC COUNTERS

General Information

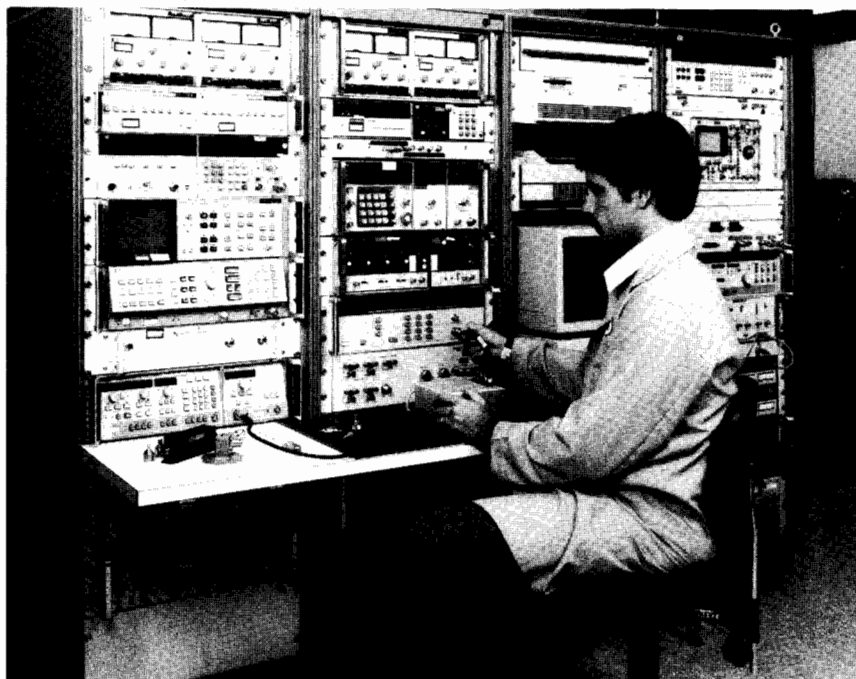

HP made-for-systems counters offer flexible solutions for automatic testing applications

The Strengths of a Counter

Save time and money

First, you get useful results, such as frequency, period and time interval without calculation. Then you get the lowest cost solution to frequency and time measurements. And finally, you get there with much less operator training.

Improve Manufacturing Productivity

The throughput, or rate of measuring, in a counter makes it the preferred choice in manufacturing. Hundreds, often thousands, of highly accurate measurements are provided each second.

A Counter for Your Needs

Choose from a wide range of cost-effective measurement solutions:

—Frequency counters from the 225 MHz HP 5384A to the 110 GHz HP 5355A/5356D.

—Universal counters, which add time interval measurement ability, from the 100 ns single shot HP 5314A to the 20 ps single shot HP 5370 B.

—Maximum flexibility with the high performance universal HP 5345A, and its pulsed microwave or millimeter plug-in companion 5355A with 5356A/B/C/D heads.

The Right Technique - Frequency Measurement

The traditional technique of counting the number of input cycles over a selected gate time gives you the advantage of a low cost at the expense of limited resolution at low frequencies - one hertz per second of gate time.

Reciprocal counting gives you the enhancement of significantly more useful digits of resolution at lower frequencies. For example, measuring 100 Hz with the HP 5384A, will give 8 digits in one second; a traditional counter would give only 3.

Interpolation gives you yet more useful digits of resolution. The HP 5370B will give at least 11 digits per second.

The Right Technique - Time Interval

Traditionally, time intervals have been measured by counting the instrument clock over the interval to be measured. With a 10 MHz clock, you would have 100 ns resolution. To get more resolution, you need a higher clock frequency, and so a more expensive counter. With a 500 MHz clock, you have 2 ns resolution.

Time interval averaging will give you greater resolution - 10 times for 100 measurements - at the expense of requiring a repetitive signal and much greater measurement time.

Interpolation gives you enhanced resolution at a lower cost, such as 2 ns single shot for only \$2800 in the HP 5334A. Interpolation can also emulate a 50 GHz clock to give you 20 ps single shot resolution, such as in the HP 5370B.

Let the Counter Give you More

Data reduction with built-in statistics and math functions, gives you useful information rapidly instead of inundating you with masses of raw data for later processing.

Pulse characterization, with built-in peak amplitude measurements and automatic trigger level setting, greatly speeds your analysis tasks. Math capabilities can then reduce the data to rise and fall times, slew rates, duty cycle or phase difference.

Reduced external circuitry results from built-in arming and gating, select the time interval of interest in complex waveforms, or profile a changing frequency.

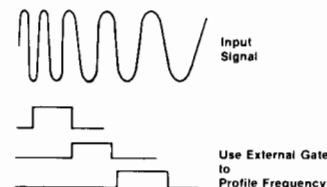

External gating of a frequency measurement lets you profile a signal with changing frequency.

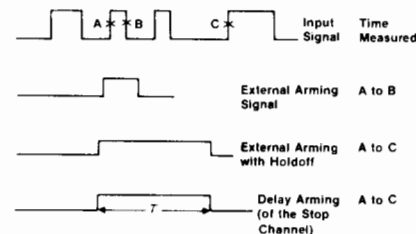

External arming, external arming with holdoff and built-in delay functions make it easy for you to pick out time intervals of interest.

Automatic Test Equipment

HP-IB is standard on many counters, and is an option on many others. Now you have accurate time and frequency information rapidly transferred to your system, thereby improving manufacturing productivity.

Here are some examples:

Counters such as the HP 5345A can provide frequency measurements to 500 MHz or single shot time interval measurements to 2 ns resolution at rates to 9000 measurements per second.

The HP 5370B can give you better than 100 ps accuracy at several hundred results per second, and 20 ps resolution measurements at up to 6000 measurements per second.

The HP 5334A offers you a systems solution of frequency or time interval to 2 ns resolution.

The HP 5316A gives universal counter capability.

The HP 5351B gives 26.5 GHz frequency measurements at 80 readings per second.

See the selection guide on next page for more systems choices.

HP-IL gives you low-cost, portable automatic frequency measurement capability with the HP 5384A 225 MHz counter, or the 5385A 1-GHz counter.

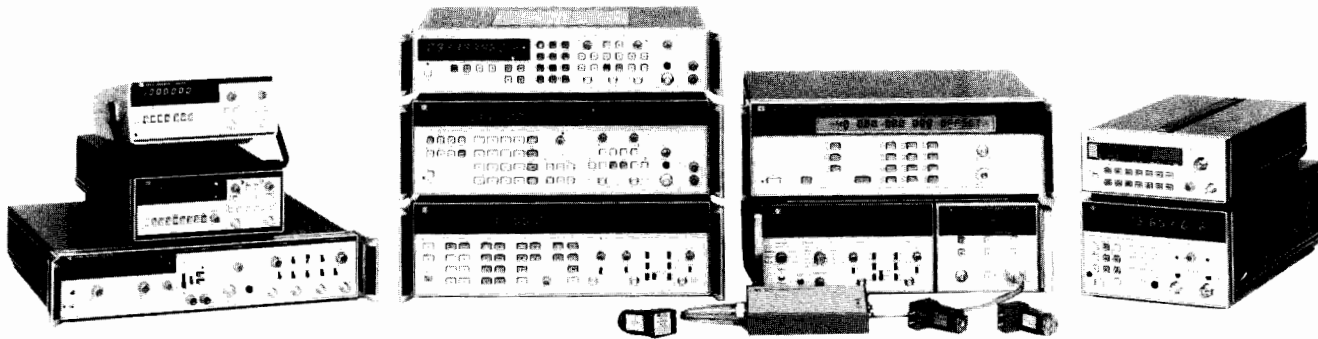

HP offers a wide selection of counters to fit your particular frequency and time measurement needs.

Counter Selection Guide

Model	Frequency A	Frequency B	Frequency C	Single Shot Time Interval	Display Digits	Resolution vs. Time	Sensitivity	HP-IB Readings/s	Enhanced Capabilities Available	Standard Price	Page
Basic Frequency Counters											
5384A	10 Hz-100 MHz	50 MHz-225 MHz			11	9 digits/s	10 mV	4	Oven time base, battery	\$1400	316
5385A	10 Hz-100 MHz	90 MHz-1 GHz			11	9 digits/s	10 mV	4	Oven time base, battery	\$1700	316
5386A	10 Hz-100 MHz	90 MHz-3 GHz			11	9 digits/s	10 mV	4	Oven time base	\$2900	316
Microwave And Millimeter CW Counters											
5386A	10 Hz-100 MHz	90 MHz-3 GHz			11	9 digits/s	-27 dBm	4	Oven time base	\$2900	316
5340A	10 Hz-18 GHz	10 Hz-250 MHz			8	varies	-35 dBm	10	Oven time base, limiter	\$13500	312
5342A	500 MHz-18 GHz	10 Hz-520 MHz			11	1 Hz/s	-25 dBm	10	Oven time base, limiter, amplitude	\$6500	309
5343A	500 MHz-26.5 GHz	10 Hz-520 MHz			11	1 Hz/s	-33 dBm	10	Limiter, offset, totalize	\$7800	309
5350B	500 MHz-20 GHz	10 Hz-525 MHz			11	1 Hz/s	-40 dBm	to 120	Oven time base, limiter, math, fast acquisition	\$5000	306
5351B	500 MHz-26.5 GHz	10 Hz-525 MHz			11	1 Hz/s	-40 dBm	to 120	Oven time base, limiter, math, fast acquisition	\$6000	306
5352B	500 MHz-40 GHz	10 Hz-525 MHz			11	1 Hz/s	-30 dBm	to 120	Oven time base, math, fast acquisition	\$10000	306
5356D		36 GHz-110 GHz			11	<2 Hz/s	-20/-3 dBm	to 9000	Frequency averaging	\$5000*	313
Microwave And Millimeter Pulse Counters											
5355A	400 MHz-1.4 GHz		0-500 MHz	2 ns	11	>8 digits/s	-15 dBm	to 9000	Frequency profile, pulse width	\$5100*	314
5356A	1.5 GHz-18 GHz	400 MHz-1.4 GHz	0-500 MHz	2 ns	11	1 Hz/s	-25 dBm	to 9000	Frequency profile, pulse width	\$1800*	313
5356B	1.5 GHz-26.5 GHz	400 MHz-1.4 GHz	0-500 MHz	2 ns	11	1 Hz/s	-20 dBm	to 9000	Frequency profile, pulse width	\$2000*	313
5356C	1.5 GHz-40 GHz	400 MHz-1.4 GHz	0-500 MHz	2 ns	11	<2 Hz/s	-15 dBm	to 9000	Frequency profile, pulse width	\$2500*	313
5356D	36 GHz-110 GHz	400 MHz-1.4 GHz	0-500 MHz	2 ns	11	<2 Hz/s	-20/-3 dBm	to 9000	Frequency profile, pulse width	\$5000*	313
Basic Universal Counters											
5314A	10 Hz-100 MHz			100 ns	7	10 or 1 Hz/s	25 mV		Period, ratio, totalize, battery	\$550	333
5315A	.1 Hz-100 MHz		50 MHz-1 GHz	100 ns	8	7 digits/s	10 mV		Period, ratio, totalize, battery, oven TB	\$1100	330
5315B	.1 Hz-100 MHz		50 MHz-1 GHz	100 ns	8	7 digits/s	10 mV		Period, ratio, totalize, oven time base	\$1500	330
5316A	.1 Hz-100 MHz		50 MHz-1 GHz	100 ns	8	7 digits/s	10 mV	10	Oven time base	\$1900	330
Performance Universal Counters											
5328B	0-100 MHz		90 MHz-1.3 GHz	10 ns	8	1 Hz/s	25 mV	to 500	DVM, oven time base	\$4400	329
5334A	.001 Hz-100 MHz	.001 Hz-100 MHz	90 MHz-1.3 GHz	2 ns	9	9 digits/s	35 mV	to 140	Auto pulse characterization	\$2800	324
5335A	.002 Hz-200 MHz		150 MHz-1.3 GHz	2 ns	12	9 digits/s	25 mV	15	Auto pulse characterization, statistics	\$3900	326
5345A	0-500 MHz		(see 5355A, 5356 A/B/C/D)	2 ns	11	>9 digits/s	25 mV	to 9000	External gate, frequency average	\$9000	322
Precision Time Interval Counter											
5370B	0-100 MHz			20 ps	12	>11 digits/s	35 mV	to 6000	Statistics, external gate	\$9900	318
Enhancement Products											
HP 5363B Time Interval High Impedance Probes										\$4200	321
HP 5344A/S Source Synchronizer										\$13500	311

*needs 5345A, 5355A and mixers



ELECTRONIC COUNTERS

Low-Cost, High-Performance CW Microwave Frequency Counters

Models 5350B, 5351B, 5352B

- Frequency coverage from 10 Hz to 40 GHz, direct inputs
- Exceptional sensitivity to -40 dBm
- 1 GHz/second tracking speed
- 60-millisecond acquisition time
- 100 measurements/second over HP-IB in automatic mode
- Two years of extended hardware support with Option W30

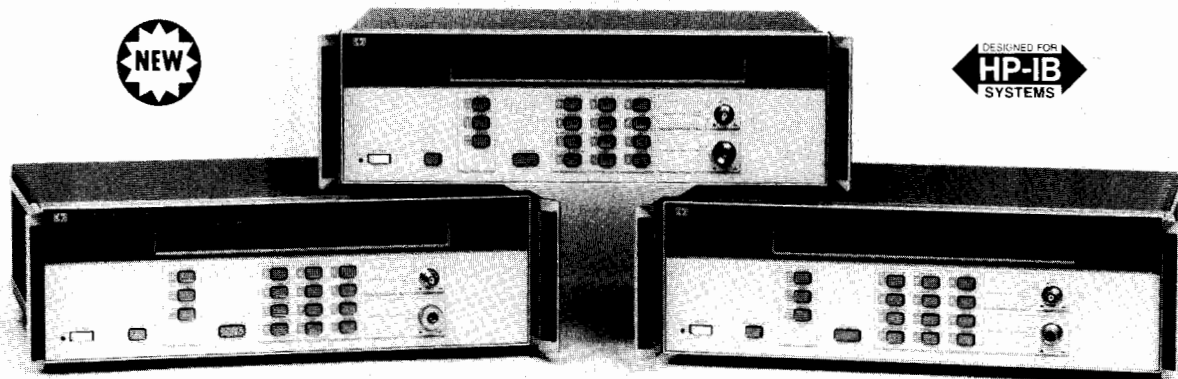

HP 5350B, HP 5351B, HP 5352B

HP 5350B/5351B/5352B Microwave Frequency Counters

The HP 5350B/5351B/5352B are automatic CW Microwave Frequency Counters that measure to 20, 26.5, and 40 GHz respectively. With resolution as fine as 1 Hz, these counters provide you with fast and precise frequency measurements.

By integrating all microwave components onto a single hybrid GaAs circuit, these counters offer you high performance at low prices. Wide frequency coverage, exceptional sensitivity, fast tracking speed, high measurement throughput, and wide FM tolerance are but a few of the high-performance features that you get with these low-cost counters.

With a built-in microprocessor, the HP 5350B/5351B/5352B also have math capabilities such as measurement scaling and offset. These functions are useful when you need indirect measurement results. Also, automatic amplitude discrimination automatically measures frequency of the highest-amplitude signal in a multi-signal environment. Other convenience features include diagnostic routines that let you perform tests on the counter for general information and troubleshooting.

The HP 5350B/5351B/5352B are ideal components for test systems. They are easy to program and their English-like commands simplify systems integration by reducing your programming effort. Their high measurement throughput also saves you money by reducing test time. In automatic test systems, the programmable alphanumeric liquid-crystal display (LCD) can serve as a message center; and if operational security is a concern, keyboard and display lockout can be activated. In noise-sensitive environments, you can put these counters in the SLEEP mode to reduce kickback noise to as low as -70 dBm.

Direct Inputs to 40 GHz, Providing Low-cost Solutions for your Expanding Needs

The HP 5350B/5351B/5352B provide a full range of high-performance, low-cost products to meet your expanding measurement needs. The HP 5350B and HP 5351B measure frequency from 10 Hz to 20 GHz and 26.5 GHz respectively. The HP 5352B, which extends input capability to 40 GHz, now lets you make measurements in the millimeter-wave range directly – without having to purchase expensive mixers.

Exceptional Sensitivity, Making Direct Measurement of Low-Level Signals Possible

As these counters have input sensitivity to -40 dBm (-30 dBm for HP 5352B), accurately measuring your low-energy signals becomes a simple task. For example, you no longer need expensive microwave amplifiers to make low-level measurements. Also, you no longer have to worry about signal attenuation by the probe when you make frequency measurements at different nodes within your circuit. These conveniences simplify measurements in applications such as receiver front-end testing.

Reduced Acquisition Time, Significantly Improving Your Measurement Throughput

With acquisition time reduced to 60 milliseconds in automatic, fast-acquisition tracking mode (20 milliseconds in manual mode), these high-speed microwave counters can significantly improve your measurement throughput.

In bench-top applications, this high-speed throughput gives you fast measurement response. The liquid-crystal display (LCD) will update measurements rapidly to shorten your evaluation time. For applications that require fast measurement response to source tuning, these counters are ideal solutions.

In systems environments, the counters' fast measurement throughput also contributes to your overall system efficiency. Delivering more than 100 measurements/second over HP-IB in automatic mode, the counters' systems performance saves you money by reducing test time.

1 GHz/second Tracking Speed, Accurately Measuring Your Fast-Moving Signals

Fast acquisition also offers you fast tracking speed. With acquisition time below 60 milliseconds, these counters can track source drift to 1 GHz/second effortlessly. For example, in measuring the response of a voltage-controlled oscillator (VCO) to voltage-source tuning, these counters will track the changing frequency rapidly to measure the transfer characteristics.

Option W30 Provides you with Convenient Service and Support For the Second and Third Year of Ownership

In addition to the one-year service that HP normally provides for all of its instruments, Option W30 gives you two additional years of support at the time of purchase. This optional support reflects HP's commitment to product reliability and customer satisfaction.

HP 5350B/5351B/5352B Specifications

Input 1

Frequency range: HP 5350B: 10 Hz to 20 GHz
 HP 5351B: 10 Hz to 26.5 GHz
 HP 5352B: 10 Hz to 40 GHz

Sensitivity

HP 5350B/5351B: 500 MHz to 12.4 GHz: -32 dBm (-40 dBm typical @ 25°C); Option 002: -39 dBm; Option 006: -37 dBm.
HP 5350B/5351B: 12.4 GHz to 20 GHz: -27 dBm (-35 dBm typical @ 25°C); Option 002: -33 dBm; Option 006: -31 dBm.
HP 5351B: 20 GHz to 26.5 GHz: -16 dBm (-28 dBm typical @ 25°C); Option 002: -25 dBm; Option 006: -23 dBm.
HP 5352B: 500 MHz to 26.5 GHz: -25 dBm (-30 dBm typical @ 25°C); 26.5 GHz to 40 GHz linear decrease to -15 dBm (-20 dBm @ 25°C).

Maximum input: +7 dBm.

Damage level: +25 dBm; HP 5350B/5351B Option 006: 500 MHz to 6 GHz + 39 dBm; 6 GHz to 18 GHz + 36 dBm; 18 GHz to 26.5 GHz + 34.8 dBm.

SWR (typical): 500 MHz to 10 GHz 2:1; Option 002/006 2.5:1.
 10 GHz to 26.5 GHz 3:1; Option 002/006 3.5:1.
 26.5 GHz to 40 GHz 3.5:1.

Coupling: dc to 50Ω termination, ac to instrument.

Accuracy: ± 1 LSD ± time-base error × frequency. (See Graphs 3 & 5).

Residual stability: when counter and source use common 10 MHz time base or counter uses external higher stability time base, .3 LSD rms typical for resolution 1 Hz - 1 kHz at 25°C; HP 5352B .7 LSD typical 26.5 - 40 GHz; LSD = least significant digit.

Resolution: selectable 1 Hz to 1 MHz.

FM Tolerance (see FM Tolerance Graph)

Maximum deviation: Auto: 20 MHz p-p (12 MHz 5350B).
 Manual: 60 MHz p-p (55 MHz 5352B).

Maximum FM rate: 10 MHz.

Tracking Speed

Fast-acquisition track: 1 GHz/s.
Normal FM rate: 1 MHz/s.
Low FM rate: 80 kHz/s.

AM tolerance: any modulation index provided the minimum signal level is not less than the sensitivity specification.

Modes of Operation

Automatic: counter automatically acquires and displays highest level signal within sensitivity range.

Manual: center frequency must be entered to within ± 20 MHz or input frequency; ± 3 MHz worst case below 1 GHz; increases measurement and data output rate.

Automatic amplitude discrimination: automatically measures the largest of all signals present, providing that signal is >6 dB (typical) above any signal within 500 MHz; >20 dB (typical) above any signal within 500 MHz to 20 (40) GHz.

Acquisition time

Automatic mode: fast-acquisition track: <60 ms.
 normal FM rate: <125 ms.
 low RM rate: <1.25 s
Manual mode: <20 ms.

	TCX0	Option 001	Option 010
Aging Rate	1 X 10 ⁻⁷ per month	5 X 10 ⁻¹⁰ per day	2 X 10 ⁻⁸ per year
Short Term	1 X 10 ⁻⁹ per s	1 X 10 ⁻¹⁰ per s	1 X 10 ⁻¹⁰ per s
Temperature 0 - 50	1 X 10 ⁻⁶	1 X 10 ⁻⁹	1 X 10 ⁻⁹
Line 10% change	1 X 10 ⁻⁷	1 X 10 ⁻¹⁰	1 X 10 ⁻¹⁰
Warm up to <5 X 10 ⁻⁹ @ 25°C		10 minutes	10 minutes

Figure 1. Time Base (10 MHz).

Input 2:

Frequency range: 10 Hz to 525 MHz.

Mode of Operation

50 Ω: 10 MHz to 525 MHz.

1M Ω: 10 Hz to 80 MHz.

Sensitivity: full operating environment:

50 Ω: 10 MHz to 525 MHz, 25 mV rms; 15 mV typical @ 25°C;

1M Ω: 10 Hz to 80 MHz, 25 mV rms; 15 mV typical @ 25°C;

Gate Time = 1/resolution: 1 ms minimum.

Resolution: selectable 1 Hz to 1 MHz.

High resolution: 1M Ω mode: 0.001 Hz for <100 kHz input; 0.01 Hz for <1 MHz input; 0.1 Hz for <10 MHz input; 1 Hz for >10MHz input; 1 second gate.

Accuracy: (See Graphs 4 & 5). ±1 LSD

$$\left(\frac{\pm 1.4 \times \text{Trigger Error}^{(1)} \pm \text{Time Base}}{\text{Gate Time}} \right) \times \text{Frequency}$$

Impedance: selectable 1M Ω nominal shunted by <70 pF or 50 Ω nominal.

Coupling: ac.

Connector: replaceable fuse, type BNC female.

Maximum input: 50 Ω: +10 dBm; 1M Ω: 1V rms.

Damage level: 50 Ω or 1M Ω dc - 5 kHz: 250 V (dc + ac peak); >5 kHz: 5.5 V rms (+ 28 dBm) + 1.25 X 10⁶ V rms/FREQ.

Panel label: 5.5 V rms (+ 28 dBm).

Time base output: 10 MHz and 1 MHz, 2.4 V square wave AC coupled into 1k Ω: 1.5V p-p into 50 Ω; available from rear panel BNC connectors whenever the instrument has AC power connected.

External time base: 1, 2, 5 or 10 MHz, 0.7 V min to 8 V max. p-p sine wave or square wave into > 1k Ω shunted by < 30 pF, via rear-panel BNC connector. External reference automatically selected when signal is present.

General

Display: segmented 24-character alphanumeric LCD (backlighted).

Keyboard: set-up stored in STBY mode.

Self-check: tests for correct circuit operation.

Diagnostics: front-panel or HP-IB selectable, Display and Keyboard Lockout, Service Diagnostics and User Information.

Data output: over HP-IB bus; varies with Frequency and Resolution.

Auto mode: >100 readings/s, 10 kHz resolution, no math functions, "DUMP" mode.

Manual mode: >120 readings per second formatted at 10 kHz resolution, no math functions "DUMP MODE".

Math functions: result = measurement x scale + offset.

Offset: measurement is offset by entered value.

Scale: measurement is multiplied by entered value.

Smooth: displayed resolution is determined using exponential averaging; displays only stable digits.

Sample rate: variable from less than 50 ms between measurements to HOLD, which holds the display indefinitely or until trigger occurs.

Display rate: 5/s, variable over HP-IB.

Overload indication: "OVRLOAD" A user message.

Sleep mode: input 1 emissions reduced to <-70 dBm typical when sleep mode or input 2 is selected.

IF output: rear panel BNC provides 30 - 110 MHz down-converted microwave signal at >-20 dBm into 50 Ω, ac coupled.

HP-IB interface functions: functions and diagnostics are programmable; address-set at front panel, default switches on rear panel; teach/learn programming; IEEE 728 compatible command structure; function subset SH1, AH1, T5, RF1, RL1, PP0, DC1, DT1, C0, E1 (see page 126).

Reset/local: returns to local control.

Operation temperature: 0° C to 50° C.

Power requirements: 100 VA max.

Line select: 100 V (90-105 VAC rms; 47.5 - 440 Hz).
 115/120 V (104/126 VAC rms; 47.5 - 440 Hz).
 220 V (198-231 VAC rms; 47.5 - 66 Hz).
 230/240 V (207-252 VAC rms; 47.5 - 66 Hz).

Accessories furnished: power cord, manual.

Size: 33mmH × 407 mmW × 358 mmD (5¼ in. H × 16 in. W × 14 in. D)

Weight: 11 kg (24 lb).

(1) Trigger Error $\sqrt{e_i^2 + e_n^2}$ s rms

Input Slew Rate in V/s at Trigger Point

Where e_i = effective rms noise of counter's input channel (100 μV typical)

e_n = rms noise of the input signal for a 500 MHz bandwidth

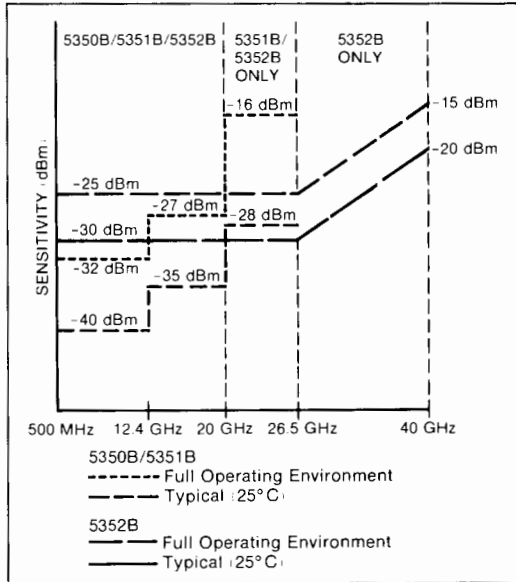

Graph 1. Sensitivity

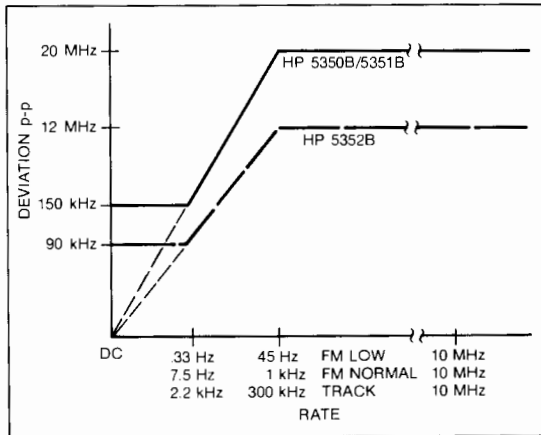

Graph 2. FM Rate Tolerance

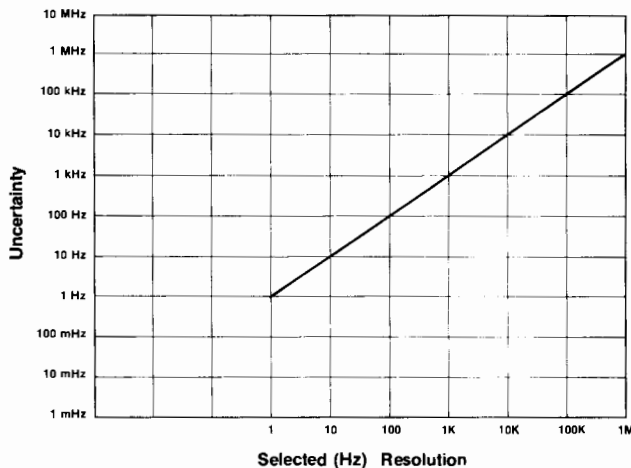

Graph 3. Input 1 uncertainty due to selected resolution

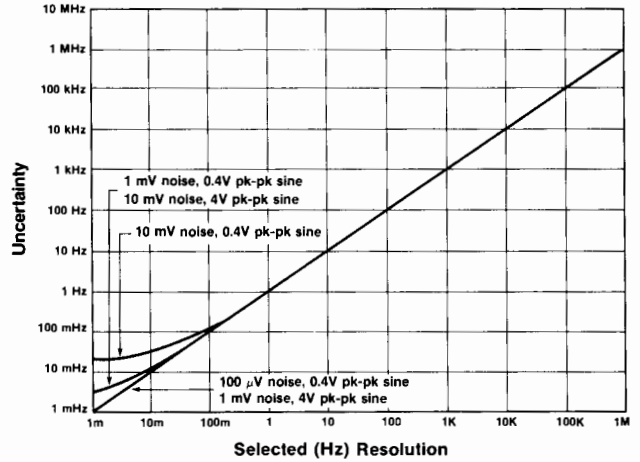

Graph 4. Input 2 uncertainty due to selected resolution and trigger error.

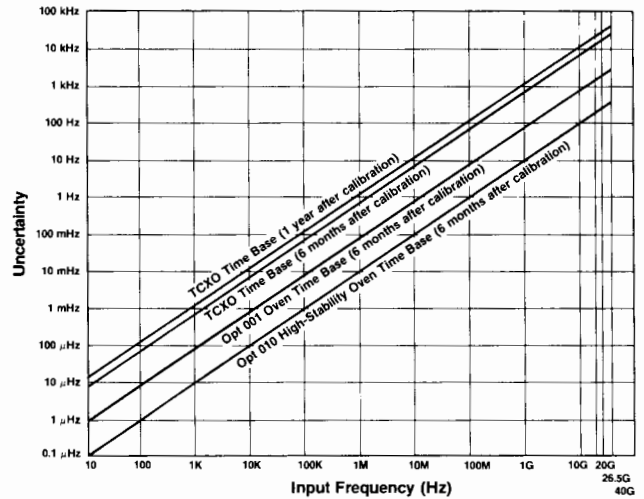

Graph 5. Uncertainty due to time-base error. Time-base error can be reduced by calibrating the time base more frequently, or by using a time base with a slower aging rate.

Ordering Information

	Price
HP 5350B 20 GHz Microwave Frequency Counter	\$ 5,000
HP 5351B 26.5 GHz Microwave Frequency Counter	\$ 6,000
HP 5352B 40 GHz Microwave Frequency Counter	\$10,000
Opt 001 Oven Time Base	+\$750
Opt 002 Rear Panel Inputs (HP 5350B/51B only)	+\$300
Opt 006 Microwave Level Limiter (HP 5350B/51B only)	+\$500
Opt 010 High Stability Oven Time Base	+\$1,500
Opt 910 Additional Operating & Service Manual	+\$40
Opt 908 Rack Mount Kit for use with front handles removed	+\$55
Opt 913 Rack Mount Kit for use with supplied front handles	+\$55
Opt W30 2-year extended hardware support	+\$160

Additional Equipment Available:

Transit Case	9211-2643
Waveguide (3" straight) adapter WR28-APC3.5	05356-20217
Waveguide (3" straight) to coaxial adapter WR42-APC3.5	05356-20216
Adapter - In series APC 3.5 Male to Male	1250-1748
Adapter - In series APC 3.5 Female to Female	1250-1749

ELECTRONIC COUNTERS

CW Microwave Frequency Counters

Models 5342A & 5343A



- Automatic measurements to 18 GHz/26.5 GHz
- Portability
- Wide FM tolerance

- Amplitude measurement in dBm (HP 5342A Option 002)
- High input sensitivity
- Digital-to-analog converter (Option 004)

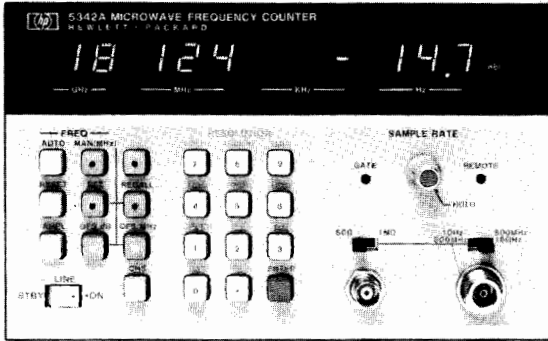

HP 5342A

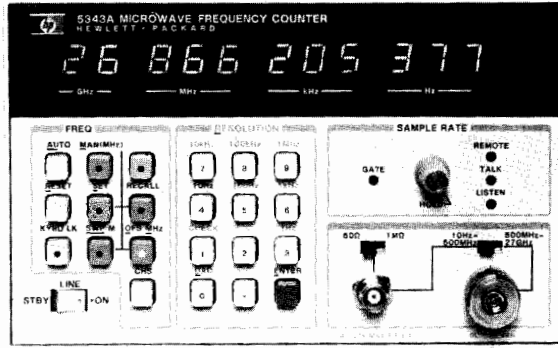

HP 5343A



HP 5342A & 5343A Microwave Counters

Portability

The HP 5342A and HP 5343A Microwave Counters provide automatic frequency measurement to 18 or 26.5 GHz in highly portable packages. The operating range of the HP 5342A can be extended to 24 GHz with Option 005.

Amplitude Measurements (Option 002, HP 5342A only)

Option 002 adds the ability to measure and display the power level of the input in dBm. The 11-digit LED display presents amplitude measurement to 0.1 dBm resolution. Also, the same option extends the instrument's dynamic range to enable frequency measurements to +22 dBm.

FM Tolerance

Measuring a carrier frequency while it is being frequency modulated has broad appeal in the communication industry and elsewhere. Both the HP 5342A and HP 5343A can tolerate peak-to-peak FM deviation to 50 MHz.

Digital-To-Analog Converter (Option 004)

Option 004 lets you convert any three consecutive displayed digits (frequency or amplitude) into an analog voltage output on the rear panel. This makes the monitoring of microwave-oscillator-frequency drift easy to make with only a stripchart recorder.

Scaling and Offset Functions

The versatility of the microprocessor-controlled keyboard allows you to perform math functions by means of a few key strokes. Frequency values to 1 Hz resolution can be added to or subtracted from the measured frequency for IF offset application. The HP 5343A also offers an $mx \pm b$ mode for both scaling and offset functions.

HP 5342A Specifications

Signal Input

Input 1

Frequency range: HP 5342A: 500 MHz to 18 GHz.

HP 5343A: 500 MHz to 26.5 GHz.

Sensitivity: HP 5342A: 500 MHz to 12.4 GHz: -25 dBm.
12.4 GHz to 18 GHz: -20 dBm.

HP 5343A: 500 MHz to 12.4 GHz: -33 dBm.
12.4 GHz to 18 GHz: -28 dBm.
18.0 GHz to 26.5 GHz: -23 dBm.

Maximum input: +7 dBm (See Option 002, 003 for higher levels).

Impedance: 50, nominal.

Connector: HP 5342A: Precision Type N female.

HP 5343A: APC 3.5 male with collar.

Damage level: +25 dBm, peak (See Option 006 for +39 dBm protection).

Coupling: dc to load, ac to instrument.

SWR: < 2:1, 500 MHz-10 GHz.

< 3:1, 10 GHz-18 GHz/26.5 GHz.

FM tolerance: switch selectable (rear panel)

Wide: 50 MHz p-p worst case.

Normal: 20 MHz p-p worst case.

Narrow: (HP 5343A only) 6 MHz p-p worst case.

For Modulation Rates from dc to 10 MHz.

AM tolerance: any modulation index provided the minimum signal level is not less than the sensitivity specification.

Automatic amplitude discrimination: automatically measures the largest of all signals present, providing that signal is 6 dB above any signal within 500 MHz; 20 dB above any signal, 500 MHz-18 /26.5 GHz.

Modes of Operation

Automatic: counter automatically acquires and displays highest level signal within sensitivity range.

Manual: center frequency entered to within ± 40 MHz of true value.

Acquisition Time

Automatic Mode

Narrow FM 200 ms worst case (HP 5343A only)

Normal FM 530 ms worst case

Wide FM 2.4 s worst case

Manual mode: 80 ms after frequency entered.

Input 2

Frequency range: 10 Hz to 520 MHz direct count.

Sensitivity: 50 Ω : 10 Hz to 520 MHz: 25 mV rms. 1 M Ω : 10 Hz to 25 MHz: 50 mV rms.

Impedance: selectable 1 M Ω , <50 pF or 50 Ω nominal.

Coupling: ac.

Connector: type BNC female.

Maximum input 50 Ω : 3.5 V rms (+24 dBm) or 5 V dc, fuse protected

1 M Ω : 200 V dc + 5 V rms.

Time Base

Crystal frequency: 10 MHz.

Stability

Aging rate: $< 1 \times 10^{-7}$ /month.

Temperature: $< \pm 1 \times 10^{-6}$ over the range 0°C to 50°C.

Short term: $< 1 \times 10^{-9}$ for 1 second averaging time.

Line variation: $< \pm 1 \times 10^{-7}$ for 10% change from nominal.

Output frequency: 10 MHz, ≥ 2.4 V square wave (TTL compatible) 1.5 p-p V into 50 Ω available from rear panel BNC.

External time base: requires 10 MHz, 3.0 V p-p sine wave or square wave into 1 k Ω via rear panel BNC connector. Switch selects either internal or external time base.

ELECTRONIC COUNTERS

Automatic Microwave Counters

Models 5342A & 5343A (cont.)

Optional Time Base (option 001)

Crystal frequency: 10 MHz.

Stability

- Aging rate:** $<5 \times 10^{-10}$ /day after 24-hour warmup.
- Temperature:** $<7 \times 10^{-9}$ over the range 0°C to 50°C.
- Short term:** $<1 \times 10^{-10}$ for 1 second averaging time.
- Line variation:** $<1 \times 10^{-10}$ for 10% change from nominal.
- Warm-up:** $<5 \times 10^{-9}$ of final value 20 minutes after turn-on, at 25°C.

Amplitude Measurement (opt 002) (HP 5342A only)

Input 1

Frequency range: 500 MHz–18 GHz.

Dynamic range (frequency and level)

- 22 dBm to +22 dBm 500 MHz to 12.4 GHz
- 15 dBm to +22 dBm 12.4 GHz to 18 GHz

Maximum operating level: +22 dBm.

Damage level: +25 dBm, peak.

Resolution: 0.1 dBm.

Accuracy: ± 1.5 dB (excluding mismatch uncertainty).

SWR: $<2:1$ (amplitude measurement).

$<5:1$ (frequency measurement).

Measurement time: 100 ms + frequency measurement time.

Display: simultaneously displays frequency to 1 MHz resolution and level. (Option 011 provides full frequency resolution on HP-IB).

Input 2 (50 Ω impedance only)

Frequency range: 10 MHz–520 MHz.

Dynamic range (frequency and level): –17 dBm to +20 dBm.

Damage level: +24 dBm.

Accuracy: ± 1.5 dB (excluding mismatch uncertainty).

SWR: $<1.8:1$.

Measurement time: 100 ms + frequency measurement time.

Display: simultaneously displays frequency and input level.

Extended Dynamic Range (opt 003) (HP 5342A only)

Frequency range: 500 MHz to 18 GHz.

Sensitivity: 500 MHz to 12.4 GHz: –22 dBm.
12.4 GHz to 18 GHz: –15 dBm.

Maximum operating level: +22 dBm.

Dynamic range: 500 MHz to 12.4 GHz: 44 dB.
12.4 GHz to 18 GHz: 37 dB.

Damage level: +25 dBm, peak.

SWR: $<5:1$.

Microwave Limiter (option 006)

Input 1

Frequency range: HP 5342A: 500 MHz – 18 GHz.
HP 5343A: 500 MHz – 26.5 GHz.

Sensitivity: HP 5342A: 500 MHz – 12.4 GHz: –21 dBm.
12.4 GHz – 18 GHz: –15 dBm.
HP 5343A: 500 MHz – 12.4 GHz: –30 dBm.
12.4 GHz – 18 GHz: –24 dBm.
18 GHz – 26.5 GHz: –18 dBm.

Maximum operating level: +7 dBm.

Damage level: 500 MHz – 6 GHz: +39 dBm (8W).

6 GHz – 18 GHz: +36 dBm (4W).

(HP 5343A only) 18 GHz – 26.5 GHz: +34.8 dBm (3W).

SWR: 2.5:1, 500 MHz – 10 GHz.

3.5:1, 10 GHz – 18 GHz/26.5 GHz.

Note: Option 006 is incompatible with Option 002, Option 003, and Option 005 for HP 5342A. Please consult factory special to combine Options 005 and 006.

General

Accuracy: ± 1 LSD \pm time-base error.

Resolution: front panel push buttons select 1 Hz to 1 MHz.

Display: 11 digit LED display, sectionalized to read GHz, MHz, kHz, and Hz.

Self-check: selected from front panel pushbuttons displays 75 MHz for resolution chosen.

Frequency offset: selected from front panel pushbuttons. Displayed frequency is offset by entered value to 1 Hz resolution.

Frequency multiply: (HP 5343A only) (mx \pm b) measured data is multiplied by any integer up to 99. Offset can then be added or subtracted. Front-panel selectable.

Totalize (HP 5343A only): input 2 can totalize at rates up to 520 MHz. Readout on the fly is controlled by front panel or HP-IB.

Sample rate: variable from less than 20 ms between measurements to HOLD which holds display indefinitely.

IF out: rear panel BNC connector provides 25 MHz to 125 MHz output of down-converted microwave signal.

Power requirements: 100/120/220/240 V rms, +5%, –10%, 48–66 Hz; 100 VA max.

Weight: net 9.1 kg (20 lb). Shipping 12.7 kg (28 lb).

Size: 133 mm H x 213 W x 498 mm D (5.25 in. H x 8.38 in. W x 19.6 in. D).

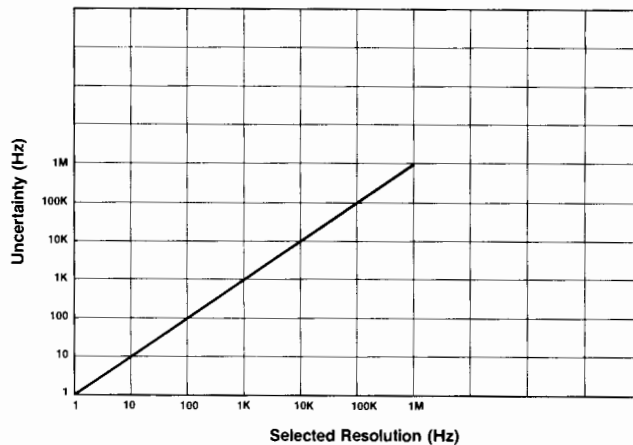

Graph 1. Uncertainty due to selected resolution.

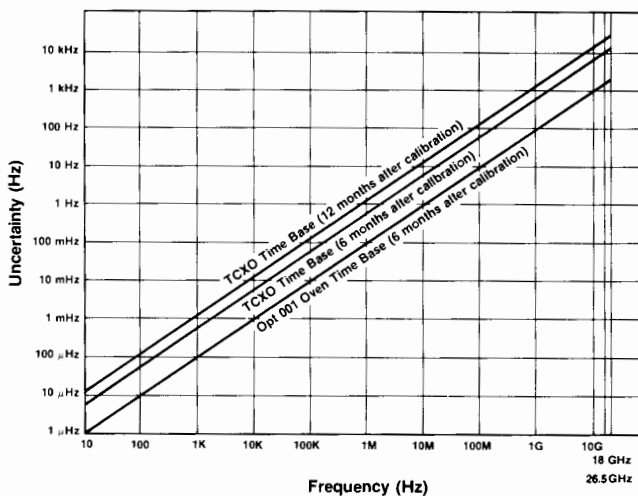

Graph 2. Uncertainty due to timebase error can be reduced by calibrating the timebase more frequently, or by using a timebase with a lower aging rate.

Ordering Information

HP 5342A Frequency Counter \$6500
HP 5343A Frequency Counter \$7500

Options and Accessories (both models)

Opt 001 High Stability Time Base + \$750
Opt 002 Amplitude Measurement (HP 5342A Only) + \$1600
Opt 003 Extended Dynamic Range (HP 5342A Only) + \$650
Opt 004 Digital-To-Analog Converter + \$400
Opt 005 Frequency Extension to 24 GHz (HP 5342A Only) + \$500
Opt 006 Limiter Input Protection (+39 dBm) + \$500
Opt 011 Digital Input/Output (HP-IB) (Cable Not Incl) + \$550
Opt 908 Rack Mounting Adapter Kit + \$45
HP K70-59992A: Rack Mounting Adapter Kit With Slot for access to front connectors from rear.
HP 10842A: Extender Board Kit \$500

ELECTRONIC COUNTERS

Microwave Source Synchronizer

Model 5344S

311



- Convenient CW lock
- High-performance microwave counter

- Narrow band locked sweeps
- Wideband lock and roll

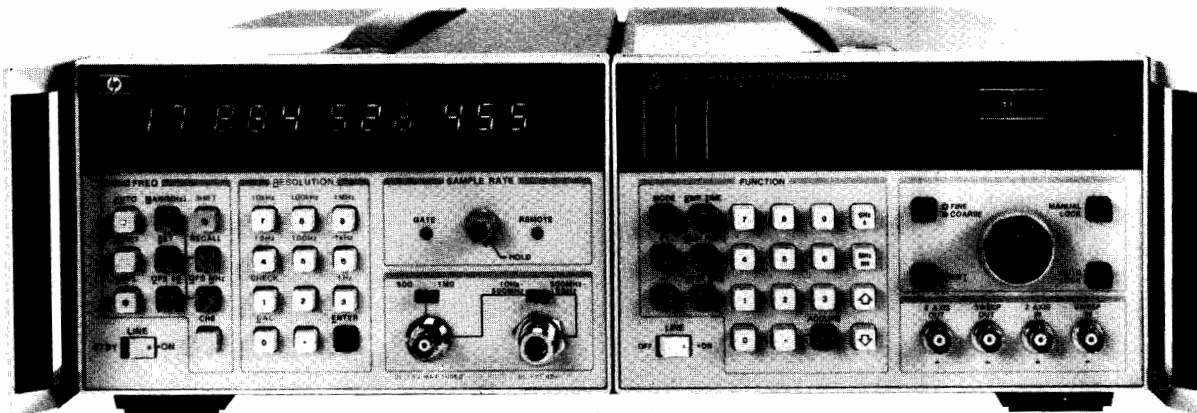

HP 5344S



HP 5344S Microwave Source Synchronizer

The HP 5344S Microwave Source Synchronizer phase locks your microwave signal to a high stability quartz oscillator in the HP 5344S. This greatly increases the frequency accuracy and repeatability of the microwave source in CW or swept operation. The long-term frequency stability (5×10^{-10} /day) of your source now becomes comparable to that of a microwave synthesizer, but at a much lower cost. The HP 5344S is a full-rack system consisting of the HP 5344A Source Synchronizer and the HP 5342A 18 GHz Microwave Counter with an Option 001 High Stability Timebase and Option 011 HP-IB Interface (HP's implementation of IEEE Standard 488). These two half-rack instruments are mechanically and electrically integrated at the factory.

For applications requiring direct phase-locked frequencies up to 26.5 GHz, the HP 5344S Option 043 is available which replaces the HP 5342A with the HP 5343A 26.5 GHz Microwave Counter.

HP 5344S Specifications

Lock Input

Frequency coverage: 500 MHz–18 GHz.
500 MHz–26.5 GHz (HP 5344S Option 043).

Resolution: 1 Hz.

Long-term stability: equal to timebase in counter.

	Standard (HP 5342A)	Option 043 (HP 5343A)
Minimum Lock Level		
500 MHz–12.4 GHz	–22 dBm	–30 dBm
12.4 GHz–18.0 GHz	–19 dBm	–25 dBm
18.0 GHz–26.5 GHz	—	–20 dBm

Lock time (typical): dependent on source. Typical times with HP 8350B/83592A source:

Manual Lock: 900 ms	Apply to CW or LOCK/ROLL modes.
Auto Lock: 1.5 s	For CF/ Δ F or START/STOP add 300 ms.

Option 043: all lock times reduced by 400 ms.

Accuracy (CW): equal to counter accuracy.

Capture Range (manual mode)

CW or LOCK/ROLL (start frequency): ± 25 MHz for sources with FM sensitivity greater than or equal to 5 MHz/V. Five volts \times FM sensitivity for sources less than 5 MHz/V sensitivity.

FM output connector: rear panel BNC female.

FM output drive: ± 10 V in series with 250.

Polarity: automatic selection.

Operating Modes

CW: Manual Lock—Source is manually tuned to within capture range of desired frequency.

Auto Lock—Source is tuned automatically by the HP 5344S via the HP-IB to bring it into lock.

CW/ Δ F sweep (manual lock or auto lock): performs a phase continuous locked sweep from $CF - \frac{1}{2}\Delta F$ to $CF + \frac{1}{2}\Delta F$ in a sweep time defined by the user. Sweeps up to 40 MHz are available.

START/STOP sweep (manual lock or auto lock): performs a phase continuous locked sweep from START frequency to STOP frequency over a sweep time defined by the user. Sweeps up to 40 MHz are available.

Accuracy—CF/ Δ F and START/STOP modes

Start or Stop Frequencies: 1 kHz typical.

Linearity: $\pm 0.05\%$ of sweep with respect to Sweep Out voltage (typical).

Resolution: 1 Hz for CF/ Δ F, START, and STOP frequencies.

Sweep time: available in CF/ Δ F and START/STOP modes. Continuously adjustable from 10 ms to 100 s.

Marker frequencies: available in CF/ Δ F and START/STOP modes. Up to four frequency markers are settable across the sweep band.

LOCK/ROLL (manual lock or auto lock): sweep is phase-locked by the HP 5344S to a precise start frequency and then control is transferred to the sweeper to complete the sweep. The source determines sweep time, marker frequencies, and stop frequency.

General

Microwave counter specifications: refer to HP 5342A or 5343A data.

HP-IB interface functions: SH1, AH1, T1, L2, SL1, RL1, PP0, DC1, DT1, C1, E1 (see page 126).

Operating temperature: 0°C to 50°C.

Power requirements: 100/120/220/240 V rms, +5%, –10% 48–66 Hz; 125 VA max (HP 5344A) plus 100 VA max (HP 5342A).

Size: 133 mm H \times 426 mm W \times 498 mm D (5¼ in. \times 16¾ in. \times 19¼ in.).

Weight: net, 18.7 kg (41 lb); shipping, 25.9 kg (57 lb).

Front handles: supplied with the instrument.

Ordering Information

HP 5344S Microwave Source Synchronizer (18 GHz)

Option 043 26.5 GHz operation (HP 5343A microwave counter replaces the HP 5342A in the system)

Option 142 Deletes HP 5342A Microwave Counter

Option 908 Rack mounting flange kit for use upon removal of supplied front handles

Option 913 Rack mounting flange kit for use with supplied front handles

Price

\$13,500

+ \$900

– \$7,600

+ \$25

+ \$31



ELECTRONIC COUNTERS

Automatic Microwave Counter

Model 5340A

- Single input 10 Hz to 18 GHz
- Automatic amplitude discrimination
- High sensitivity -35 dBm
- Optional extension to 23 GHz
- High AM and FM tolerance
- Exceptional reliability

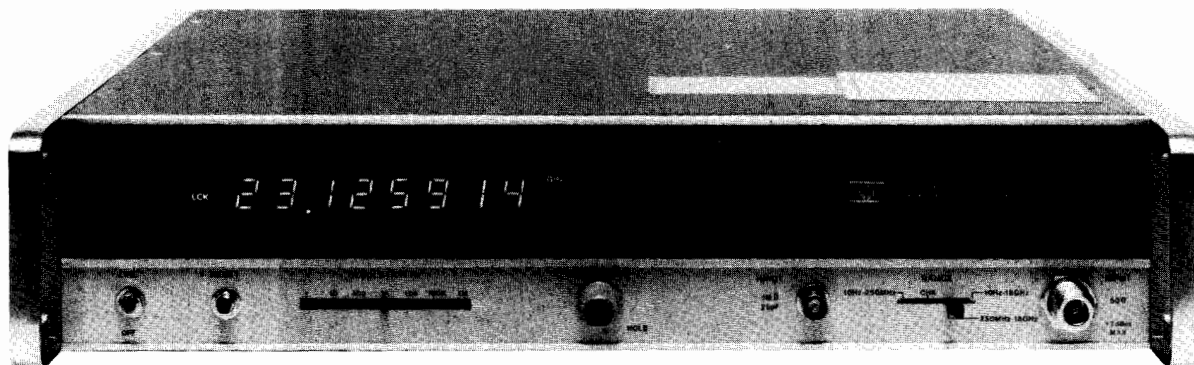

HP 5340A



HP 5340A Frequency Counter

The HP 5340A Frequency Counter is an easily used, versatile instrument for direct measurement of frequencies from 10 Hz through 18 GHz via a single input connector.

The exceptional sensitivity of this instrument enhances measurement in the microwave field, where signals are commonly low-level and connected via directional coupler or lossy devices.

Access to the HP Interface Bus via Option 011 provides a flexible systems interface. The ability to program octave range through this input reduces acquisition time to less than 40 ms (typical).

HP 5340A Specifications

Signal Input

Input 1

Range: 10 Hz to 18 GHz.

Symmetry: sinewave or squarewave input (40% duty factor, worst case).

Sensitivity: -30 dBm, 10 Hz to 500 MHz; -35 dBm, 500 MHz to 10 GHz; -25 dBm, 10 to 18 GHz.

Dynamic range: 37 dB, 10 Hz to 500 MHz; 42 dB, 500 MHz to 10 GHz; 32 dB, 10 GHz to 18 GHz.

Impedance: 50 Ω .

VSWR: $<2:1$, 10 Hz–12.4 GHz; $<3:1$, 12.4–18 GHz.

Connector: precision Type N.

Coupling: dc to load, ac to instrument.

Damage level: +30 dBm.

Total power (ac + dc) not to exceed 1 watt. See Option 006 for up to +39 dBm protection.

Acquisition time: <150 ms mean typical.

Input 2

Range: 10 Hz–250 MHz direct count.

Sensitivity: 50 mV rms, 150 mV p-p pulses to 0.1% duty factor; minimum pulse width 2 ns.

Impedance: 1 M Ω shunted by <25 pF.

Connector: type BNC female.

Coupling: ac.

Maximum input: 200 V rms, 10 Hz to 100 Hz; 20 V rms, 100 Hz to 100 kHz; 2 V rms, 100 kHz to 250 MHz.

Automatic amplitude discrimination: automatically selects the strongest of all signals present (within 250 MHz to 18 GHz phase-lock range), providing signal level is: 6 dB above any signal within 200 MHz; 10 dB above any signal within 500 MHz; 20 dB above any signal, 250 MHz–18 GHz (typical performance).

Maximum AM modulation: any modulation index as long as the minimum voltage of the signal is not less than the sensitivity specification.

Time Base

Crystal frequency: 10 MHz.

Stability

Aging rate: $<3 \times 10^{-7}$ per month.

Short term: $<5 \times 10^{-10}$ rms for 1 second averaging time.

Temperature: $<\pm 2 \times 10^{-6}$ over the range of 0°C to 50°C.

Line variation: $<\pm 1 \times 10^{-7}$ for 10% line variation from nominal.

Output frequency: 10 MHz, ≥ 2.4 V square wave (TTL compatible) available from rear panel BNC.

External time base: requires 10 MHz approximately 1.5 V p-p sine wave or square wave into 1 k Ω via rear panel BNC. Switch selects either internal or external time base.

Optional time base (opt 001) aging rate: $<5 \times 10^{-10}$ per day after 24-hour warm-up for less than 24 hour off-time.

General

Accuracy: ± 1 LSD \pm time-base error.

Resolution: front-panel switch selects 1 Hz to 1 MHz.

Display: eight digit LED with positioned decimal point and appropriate measurement units of kHz, MHz, or GHz.

Self check: counts and displays 10 MHz for resolution chosen.

Sample rate: controls time between measurements. Continuously adjustable from 50 ms typical to 5 seconds. HOLD position holds display indefinitely. RESET button resets display to zero and activates a new measurement.

HP-IB interface functions: SH1, AH1, T1, L2, SL1, RL2, PP0, DC1, DT1, C0, E1 (see page 126).

Operating temperature: 0°C to 50°C.

Power: 115 V or 230 V $\pm 5\%$, -10% , 48–66 Hz, 100 VA.

Weight: net, 11.3 kg (25 lb). Shipping, 14.1 kg (31 lb).

Size: 88.2 mm H x 425 mm W x 467 mm D (3.47 in. x 16.75 in. x 18.39 in.).

Ordering Information

HP 5340A Frequency Counter	Price
Opt 001 High Stability Time Base	+ \$750
Opt 002 Rear Panel Connectors	+ \$200
Opt 005 Frequency Extension to 23 GHz	+ \$600
Opt 006 Limiter Input Protection (+39 dBm)	+ \$600
Opt 011 Remote Programming-Digital Output (HP-IB)	+ \$550
Opt 908 Rack Flange Kit	+ \$30



- -25 dBm sensitivity
- 100 Hz measurement resolution
- 75 nanoseconds minimum pulse width

- 20 nanoseconds minimum external gate
- CHIRP profile or VCO post-tuning drift

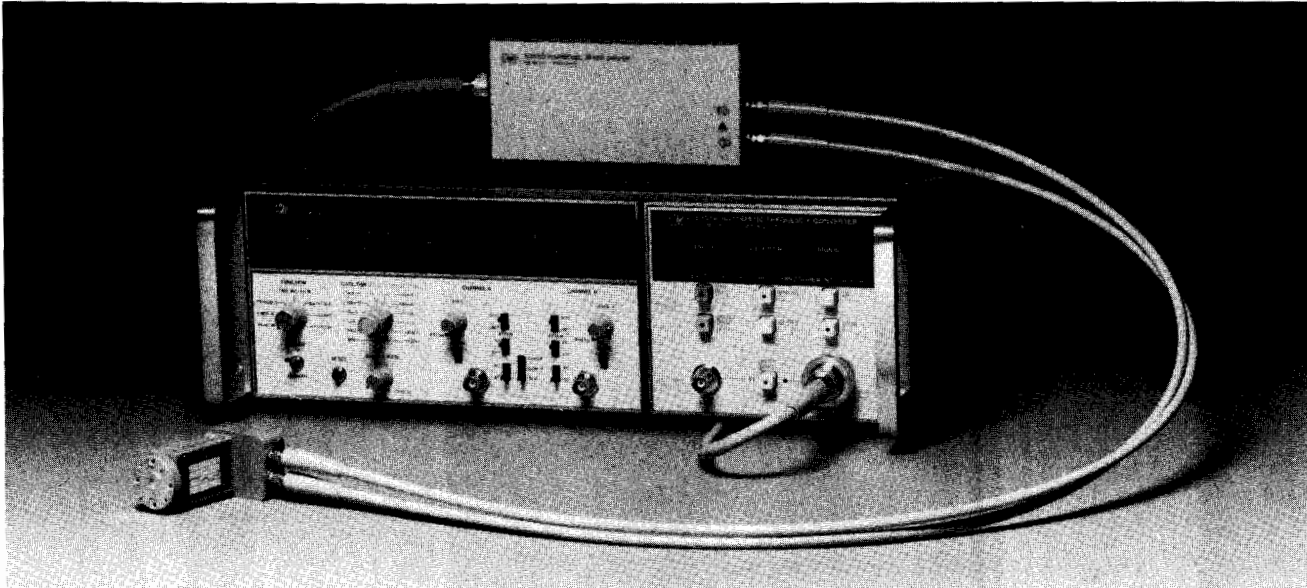

Extending the frequency range of CW and pulse measurements to 100 GHz.



Pulse and CW Measurements to 110 GHz

HP 5355A Automatic Frequency Converter/5345A Counter, together with the HP 5356A, 5356B, 5356C, 5356D Frequency Converter Heads, provide pulse and CW frequency measurement capability to 18, 26.5, 40, and 110 GHz respectively. The HP 5355A's internal microprocessor controls the measurement algorithm, computes the input microwave frequency, and displays the result on the HP 5345A with 11 digits of resolution.

Automatic Pulse Detection

This 110 GHz counter is a versatile tool for characterizing pulsed signals. Internal pulse-detection circuitry (Figure 1) can detect incoming RF bursts as short as 75 nanoseconds and generate a measurement gate for the counter. With this internally-generated detection gate, the counter can then measure the average frequency of the RF burst.

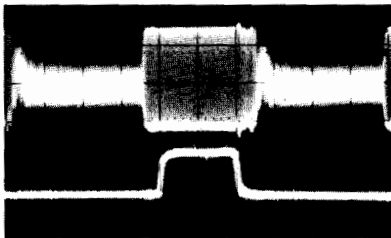

Figure 1. Automatic Pulse Detection

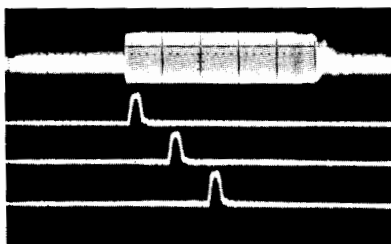

Figure 2. External gates as short as 20 ns

Pulse Frequency Profiling

If there is FM on the burst carrier, the counter can also accept external measurement gates as short as 20 nanoseconds (Figure 2) to perform dynamic frequency profilings. This external gating capability is useful in applications such as radar CHIRP characterization. (Figure 3) It can also help VCO manufacturers measure oscillator's post-tuning drift (Figure 4).

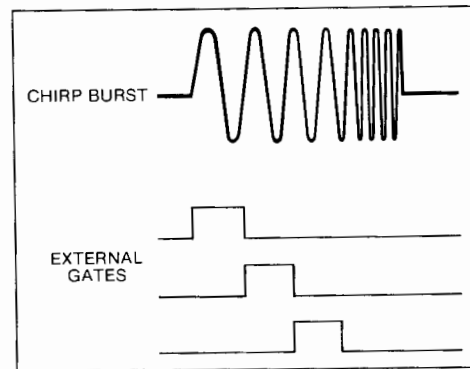

Figure 3. CHIRP radar characterization

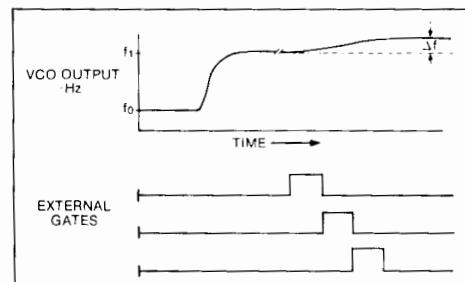

Figure 4. VCO post-tuning drift characterization



ELECTRONIC COUNTERS

Pulse and CW Microwave Frequency Counters

Models 5345A/5355A/5356 A, B, C, D (cont.)

Exceptional Resolution, High Accuracy

You can select the measurement gate time of this counter from 50 nanoseconds to 1000 seconds. Increasing the measurement gate time increases the resolution of measurement results. In fact, this counter can measure a 110 GHz signal with 100 Hz resolution and 3 kHz accuracy in pulse mode. This performance improves to 1 Hz in CW mode.

Even if your application requires narrow external gates, the counter can still achieve fine resolution through an automatic frequency averaging scheme (Figure 5). When the measurement gate is longer than the external gate, the counter will automatically take several measurements of the repetitive signal. It will then average the results to yield better resolution. The measurement process is completely automatic—making the counter easy to work with.

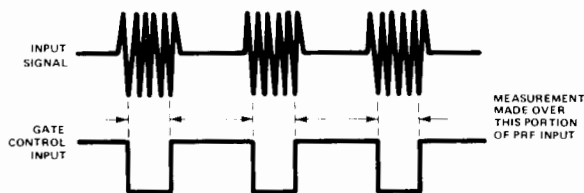

Figure 5. Frequency averaging to increase resolution

Sensitivity, FM Tolerance, Automatic Amplitude Discrimination

HP's pulse counters have sensitivity performance to -25 dBm, making measurement of low-level microwave and millimeter-wave signals reliable and accurate. For signals with frequency modulation, these counters also offer high peak-to-peak amplitude discrimination automatically measures the signal with the highest amplitude.

Systems Performance, 9000 Measurements/Second

These counters are fully programmable over HP-IB. Measurement throughput of 9000 measurements/second saves you money by reducing test time.

Input Specifications (pulse and CW mode)

	HP 5356A	HP 5356B	HP 5356C	HP 5356D
Frequency Range	1.5-18 GHz	1.5-26.5 GHz	1.5-40 GHz	36-110 GHz
Sensitivity:				
1.5-12.4 GHz	-20 dBm	-20 dBm	-25 dBm	---
12.4-18 GHz	+5 dBm	-15 dBm	-20 dBm	---
18-26.5 GHz	---	-15 dBm	-20 dBm	---
26.5-34 GHz	---	---	-15 dBm	---
34-40 GHz	---	---	-10 dBm	---
36-50 GHz	---	---	---	-20 dBm
40-60 GHz	---	---	---	-15 dBm
50-75 GHz	---	---	---	-10 dBm
75-95 GHz	---	---	---	-7 dBm
95-105 GHz	---	---	---	-5 dBm
105-110 GHz	---	---	---	-3 dBm
Maximum Input:				
1.5-12.4 GHz	+5 dBm	+5 dBm	+5 dBm	---
12.4-18 GHz	+5 dBm	+5 dBm	+15 dBm	---
18-26.5 GHz	---	+5 dBm	+15 dBm	---
26.5-40 GHz	---	---	+15 dBm	---
36-110 GHz	---	---	---	+5 dBm
① Damage Level	+25 dBm peak	+25 dBm peak	+25 dBm peak	+24 dBm peak +20 dBm CW
Impedance	50 Ω NOMINAL	50 Ω NOMINAL	50 Ω NOMINAL	Waveguide
SWR: (TYPICAL)				
1.5-10 GHz	<2.1	<2.1	<2.1	---
10-18 GHz	<3.1	<3.1	<3.1	---
18-26.5 GHz	---	<3.1	<3.1	---
26.5-34 GHz	---	---	<3.1	---
34-40 GHz	---	---	<5.1	---
36-110 GHz	---	---	---	<3.1
Connector	N Male	SMA Male	APC 3.5 Male	Waveguide

① HP 5356A/B. See Option 006 for higher damage protection to +39 dBm.

② 1.5-6 GHz, +0 dBm (+5 dBm, TYPICAL)
6-12.4 GHz, +5 dBm

CW Mode

	HP 5356A/B/C Auto Mode	HP 5356A/B/C/D Man Mode	HP 5356D Auto Mode
FM Tolerance	5356A/B: 15 MHz p-p (60 MHz p-p in special FM mode), rate: dc -10 MHz 5356C: 60 MHz p-p, rate: dc -10 MHz	80 MHz p-p rate: dc -10 MHz	Fig. 6
AM Tolerance	Any modulation index provided the minimum signal level is greater than the counter sensitivity		50%
Multiple Signal Discrimination	Automatic Amplitude Discrimination (AAD). Automatically measures largest signal provided signal is 8 dB (TYPICAL) greater than any signal within 500 MHz and 20 dB (TYPICAL) greater than any signal over the full frequency range of the head.		15 dB TYP
Acquisition Time (TYPICAL)	HP 5356A/B = 400 ms HP 5356C = 1.4 s	15 ms	① 100 ms
Measurement Time (TYPICAL)	Gate Time ≤ 100 ms: Acquisition time + 4 × HP 5345A GATE TIME + 5345A Sample Rate + 125 ms. Gate Time > 100 ms: Acquisition time + HP 5345A GATE TIME + HP 5345A Sample Rate + 35 ms		
Tracking Rate	---		100 MHz/s (TYPICAL)
LSD Displayed	1 Hz : HP 5345A Gate Time		
Resolution	±2 × LSD ±10 ⁻¹⁰ rms × FREQ		
Accuracy	±2 × LSD ±1 × 10 ⁻¹⁰ rms × FREQ ± time base error × FREQ		

① 100 ms (input level -5 to +5 dBm),
300 ms (input level -15 to -5 dBm),
400 ms (input level -20 to -15 dBm)

Pulse Mode

	HP 5356A/B/C/D Input Auto Mode	HP 5356A/B/C/D Input Man Mode
FM Tolerance (TYPICAL)	50 MHz p-p Chirp	80 MHz p-p Chirp
Acquisition Time (TYPICAL)	<ul style="list-style-type: none"> HP 5356A/B/C Input Man Mode: 0 HP 5356A/B Input Auto Mode: 100 μs : (EXT GATE WIDTH × PRF) + 650 ms (for EXT GATE ≤ 100 μs (2 × PRF) + 650 ms for EXT GATE > 100 μs) HP 5356C Input Auto Mode: (8 × PRF) + 1.55s + 100 μs : (EXT GATE WIDTH × PRF) for EXT GATE ≤ 100s (10 × PRF) + 1.55s for EXT GATE > 100 μs HP 5356D - 5 to +5 dBm: (X) = 2.5 HP 5356D - 15 to -5 dBm: (X) = 3.5 HP 5356D - 20 to -15 dBm: (X) = 4.5 $(X)s + 2 \left(\frac{100 \mu s}{EXT GATE WIDTH \times PRF} \right) \text{ For EXT GATE } \leq 100 \mu s$ $(X)s + \frac{2}{PRF} \text{ For EXT GATE } > 100 \mu s$ <ul style="list-style-type: none"> HP 5356D Limited Search: (X) = 1, Range: 1 to 6 GHz or ±3 GHz from center frequency 	
Calibration Time	$\left(\frac{HP 5345A GATE TIME}{EXT GATE WIDTH \times PRF} \right) + 75 \text{ ms}$ Performed during 10 consecutive measurements when PULSE Mode is selected, after any front panel change, or when the EXTERNAL GATE width changes by more than 12%. Only calibrates if External Gate is <100 μs	
Measurement Time (TYPICAL)	Acquisition Time + Calibration Time + HP 5345A SAMPLE RATE + HP 5345A GATE TIME or 100 μs (whichever is greater)	Acquisition Time + Calibration Time + HP 5345A SAMPLE RATE + 60 ms + (1 μs + HP 5345A GATE TIME)
Pulse Width Min.	100 ns (150 ns, HP 5356D with Opt. 110)	75 ns
Max.	20 ms	20 ms
Pulse Repetition Frequency Min.	50 Hz	50 Hz
Min. (HP 5356D only)	500 Hz	500 Hz
Max.	2 MHz	2 MHz
Minimum On/OFF RATIO	25 dB TYPICAL	
Maximum Video Feed-Through	15 mV p-p TYPICAL for 4 ns rise and fall times, > 10 ns for HP 5356A/B/C. No limitation for HP 5356D (Waveguide beyond cutoff)	
Minimum EXT GATE WIDTH	20 ns	
LSD Displayed	1 Hz : HP 5345A GATE TIME	
Resolution	±2 × LSD ±100 Hz rms +	
Accuracy	$\left(1 \pm \sqrt{\frac{HP 5345 GATE TIME \times EXT GATE TIME WIDTH}{EXT GATE TIME WIDTH}} \right) \pm 3 \text{ kHz}$ $\pm 2 \times LSD \pm 100 \text{ Hz rms} \pm$ $\pm \frac{0.4}{EXT GATE TIME WIDTH} \pm \text{Time base error} \times FREQ$	

① For (HP 5345 GATE TIME) > 10 ms and PULSE WIDTH > 10 μs, use

$$\left(3 \pm \sqrt{\frac{HP 5345 GATE TIME \times EXT GATE TIME WIDTH}{EXT GATE TIME WIDTH}} \right)$$

For EXT GATE signals generated by the HP 5355A, the EXT GATE WIDTH equals the input PULSE WIDTH minus 30 ns (TYPICAL) for the HP 5356A/B/C/D input and equals the input PULSE width minus 65 ns (TYPICAL) for the HP 5355A 0.4-1.5 GHz input.

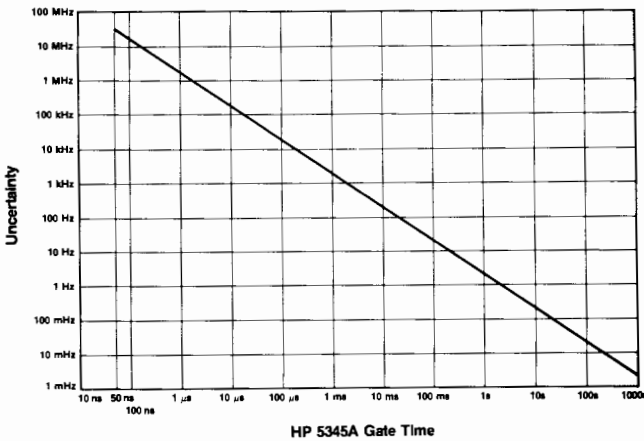

Graph 1. Uncertainty ($2 \times \text{LSD}$) due to selected 5345A gate time.

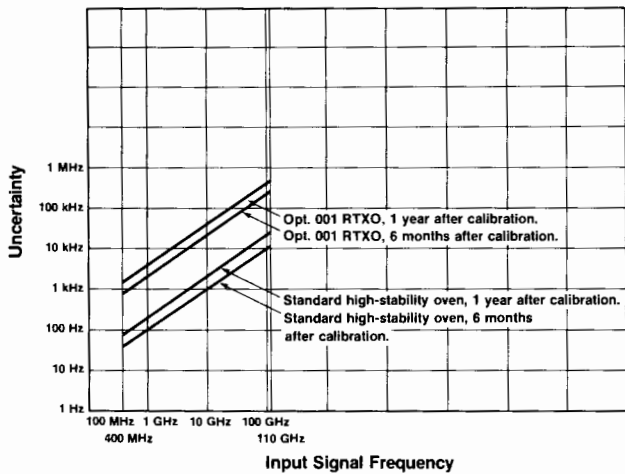

Graph 2. Uncertainty, due to time-base error. Time-base error can be reduced by calibrating the time base more frequently

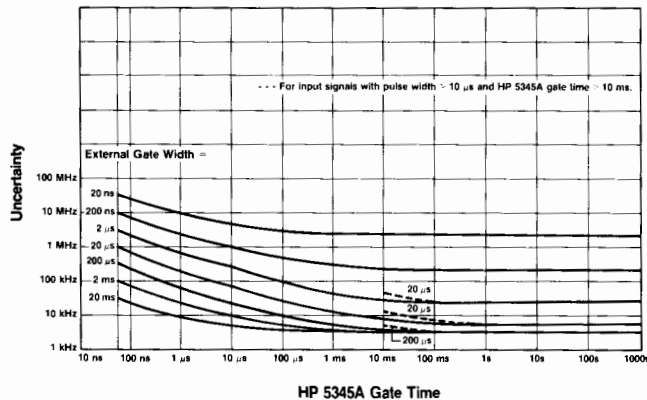

Graph 3. Uncertainty due to jitter (rms jitter) and gate error

$$\frac{.04}{\text{EXT GATE WIDTH}} \pm 3 \text{ kHz}$$

Input Specifications

- 5355A 0.4 - 1.6 GHz (condensed)
- Sensitivity:** -15 dBm.
- Maximum input:** +5 dBm.
- Impedance:** 50 Ω nominal.
- Damage level:** +24 dBm peak (fuse in BNC connector).
- Pulse width:** 150 ns to 1 s
- Pulse repetition rate:** 100 Hz to 2 MHz.

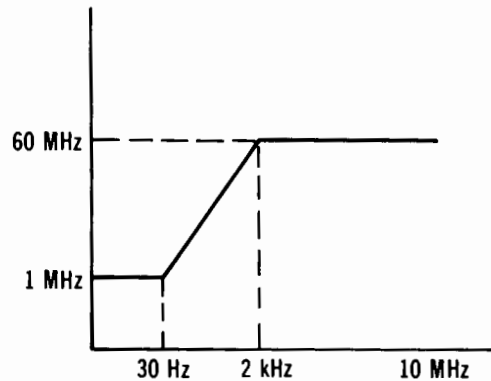

Figure 6 HP 5356D FM Tolerance

Ordering Information

HP 5345A Electronic Frequency Counter	\$8,000
HP 5355A Automatic Frequency Converter	\$6,100
HP 5356A 18 GHz Frequency Converter	\$1,800
HP 5356B 26.5 GHz Frequency Converter	\$2,000
HP 5356C 40 GHz Frequency Converter	\$2,500
HP 5356D 36-110 GHz Harmonic Mixer Driver	\$5,000

Options for HP 5345A

Opt 001 Room Temperature Time Base	-\$320
Opt 010 HP-IB Talk Only	+\$350
Opt 011 HP-IB includes remote programming	+\$950
Opt 012 HP-IB similar to Opt 011, but also includes slope and trigger level controls	+\$1,600
Opt 908 Rack Flange Kit, HP 5060-8740	+\$22 ☎

Options for HP 5356A

Opt 001 High Pass Filter	+\$200
Opt 006 Limiter	+\$400

Options for HP 5356B

Opt 001 18-26.5 GHz Waveguide (WR-42)	+\$850
Opt 006 Limiter	+\$400

Option for HP 5356C

Opt 001 26.5-40 GHz Waveguide (WR-28)	+\$750
--	--------

Options for HP 5356D (requires an HP 5355A with S/N prefix greater than 2620 - xxxxx and one of the following mixer options)

Opt 050 (HP 11970Q) 36-50 GHz Harmonic Mixer	+\$1,700
Opt 060 (HP 11970U) 40-60 GHz Harmonic Mixer	+\$1,850
Opt 075 (HP 11970V) 50-75 GHz Harmonic Mixer	+\$2,250
Opt 110 (HP 11970W) 75-110 GHz Harmonic Mixer	+\$2,250

Opt 005 (two HP 5061-5458 parts) 2 cables to connect HP 5356D to HP 11970Q/U/V or W

☎ Fast-Ship Product — see page 766



ELECTRONIC COUNTERS

Low Cost Counters for Frequency Measurements

Models 5384A, 5385A, 5386A

- Frequency measurements to 3 GHz (HP 5386A)
- Up to 11 digits of resolution, 9 digits per second
- -27 dBm sensitivity



HP 5386A: 10 Hz to 3 GHz (pictured above).
 HP 5385A: 10 Hz to 1 GHz (not shown).
 HP 5384A: 10 Hz to 225 MHz (not shown).

HP 5384A/5385A/5386A Frequency Counters

The HP 5384A/85A/86A are HP's lowest priced system counters. They provide outstanding measurement performance for bench, field, and systems applications. Combining wide frequency range, high resolution, high sensitivity, and HP-IB compatibility, these counters compare with instruments which cost much more.

Portable: The half-rack-width package makes the HP 5384A/85A/86A portable and saves rack or bench space.

Versatile Display: The twelve-digit, liquid-crystal display has larger characters than other LED displays and is easier to read in sunlight. The added feature of remote display extends the usefulness of these counters beyond that of simply making and displaying frequency measurements. User-friendly messages, prompts and measurement units can now be displayed.

Low Cost Of Ownership: Integrated design and extensive self-tests result in greater reliability, easier serviceability, and ultimately lower cost of ownership.

Performance

If your frequency measurement needs are below 3 GHz, the HP 5386A will provide you with the basic performance of traditional microwave counters, at about half the price. The HP 5386A measures frequencies from 10 Hz to 3 GHz with only two input ports, instead of the three ports found with other counters. The high-frequency input measures frequencies from 90 MHz to 3 GHz with -27 dBm sensitivity (10 mV rms). In addition, prescaling techniques offer peak-to-peak FM tolerance of at least 100 MHz for your communications applications. You can select the number of digits displayed from 3-to-11 to blank meaningless digits from an unstable signal source. The HP 5386A also solves your systems problems with full remote programmability (via HP-IB standard feature) and remote display capabilities. The high-stability timebase option will lengthen the required calibration period (for kHz accuracy at 3 GHz) from six months to a full year.

Applications

The HP 5386A fits well in the following application areas for local oscillator, IF, and radio transmitter frequency measurements:

- Military and private communications
- TACAN, DME, and Identify Friend or Foe
- Global Positioning System
- MDS Television

- HP-IB standard
- Systems performance and portability

Condensed Specifications

Input Channel A (HP 5384A/85A/86A): 1 M ohm // 25 pF.

Range: 10 Hz to 100 MHz.

Sensitivity: 15 mV rms sine wave 50 Hz (10 Hz for HP 5386A) to 100 MHz; HP 5384A/85A Only: 25 mV rms sine wave 10 Hz to 50 Hz; 45 mV peak-to-peak 5 ns minimum pulse width.

Dynamic Range: 45 mV to 4 V peak-to-peak X attenuator setting.

Attenuator: X1 or X20 nominal above 50 Hz input.

Low Pass Filter: 100 kHz nominal 3 dB point.

Manual Trigger Level: variable, -0.1 V to +0.1 V X attenuator.

Damage Level X1: 10 - 200 Hz 350 V (dc + ac peak).
 0.2 - 420 kHz 170 V (dc + ac peak).
 0.42 - 10 MHz (5 X 10⁷ V rms Hz)/FREQ.
 >10 MHz 5 V rms.

X20: <1 MHz, Same as X1: >1 MHz, 50 V rms.

Input Channel B (HP 5384A): 50 ohm.

Range: 50 to 225 MHz.

Sensitivity: 10 mV rms 50 to 200 MHz; 15 mV rms 200 to 225 MHz.

Dynamic Range: 10 mV to 1 V rms.

Manual Attenuator: variable, X1 to X5 (0 to 14 dB) nominal.

Damage Level: 350 V dc + 5 V rms ac.

Input Channel B (HP 5385A): 50 ohm, fused.

Range: 90 to 1000 MHz.

Sensitivity: 10 mV rms (-27 dBm) 100-1000 MHz; 15 mV rms (-33 dBm) 90 - 100 MHz.

Dynamic Range: 10 mV to 7 V rms (-27 to +30 dBm).

Manual Attenuator: variable, X1 to X18 (0 to 25 dB) nominal.

Damage Level: ac >1 MHz + 30 dBm (7 V rms).

ac <1 MHz 2 V rms, dc ± 5 V.

Input Channel B (HP 5386A): 50 ohm nominal, VSWR 2.5, typical.

Range: 90 MHz to 3 GHz, prescaled.

Coupling: ac.

Sensitivity: 10 mV rms (-27 dBm).

Dynamic Range: 10 mV rms to .5 V rms (-27 dBm to +7 dBm).

Damage Level: ac: +27 dBm, dc: ± 5 V.

NOTE: Manual attenuator not active for channel B.

Frequency A and B

Range Channel A: 10 Hz - 100 MHz.

Range Channel B: (HP 5384A) 50 MHz - 225 MHz; (HP 5385A) 90 MHz - 1.0 GHz; (HP 5386A) 90 MHz - 3 GHz.

LSD Displayed: 10 Hz to 1 MHz.

Accuracy: ± Resolution ± Timebase Error X Frequency (see Graphs 1 and 3).

Period A

Range: 10 ns to 0.1 s.

LSD Displayed: .001 fs to 10 ns.

Accuracy: ± Resolution ± Timebase Error X Period (see Graphs 2 and 3).

Timebase

Standard HP 5384A: 10 MHz.

Aging Rate: <3 X 10⁻⁷/mo.

Temperature: <5 X 10⁻⁶, 0° to 50°C, ref. 25°C.

Line Voltage: <1 X 10⁻⁷ for ± 10% variation.

Standard HP 5385A/86A, Option 001 (HP 5384A): TCXO, 10 MHz.

Aging Rate: <1 X 10⁻⁷/mo.

Temperature: <2 X 10⁻⁶, 0° to 40°C, ref. 25°C.

Line Voltage: <5 X 10⁻⁸ for ± 10% variation.

Oven Timebase (Option 004)

Frequency: 10 MHz.

Aging Rate: <3 X 10⁻⁸/mo. after 30 days continuous operation.

Temperature: <1 X 10⁻⁷, 0° to 50°C, ref. 25°C.

Line Voltage: <2 X 10⁻⁹ for ± 10% variation.

Battery Operation (HP 5384A/85A Only): the instrument operates for 3 hours (typ.) with Option 004. In STBY, the oven will operate continuously for 24 hours (typ.).

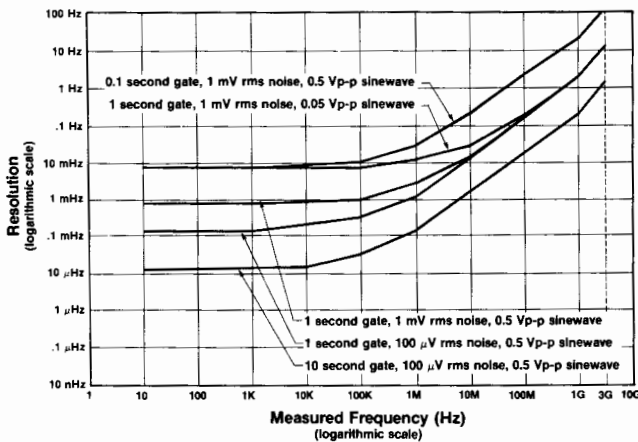

Graph 1. Frequency Resolution. Uncertainties which limit resolution can be reduced by increasing the gate time, reducing the noise on the input signal, or increasing the input signal amplitude.

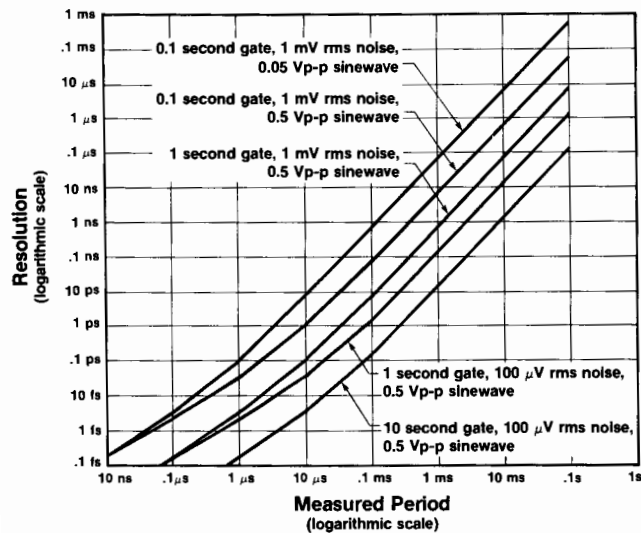

Graph 2. Period Resolution. Uncertainties which limit resolution can be reduced by increasing the gate time, reducing the noise on the input signal, or increasing the input signal amplitude.

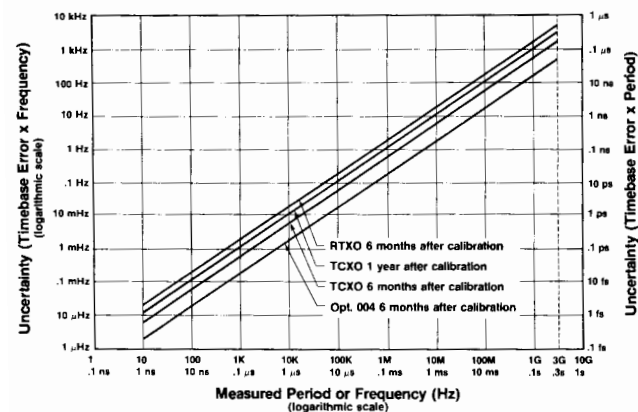

Graph 3. Frequency and Period Uncertainty due to Timebase Error. Timebase error can be reduced by calibrating the timebase more frequently, or by using a timebase with a better aging rate.

I/O Interface

HP-IB Standard

Programmable Functions: Frequency A, Frequency B, Period A.
Programmable Controls: ATTN A, FILTER A, MAN LEVEL A, MAN LEVEL A/B (HP 5384A/85A Only), Gate Time.

Display: Normal, Increment, Decrement (digits displayed); Remote, Local; any 12-character message can be displayed on the LCD via a system controller.

Data Output: output will be maximum resolution/gate time.

Format: 17 characters plus CR and LF.

Rate: 4 readings/s maximum at 0.1 s gate.

HP-IB Interface Functions: SH1, AH1, T5, TE0, L4, LE0, SR1, RL1, PP0, DC1, DT1, C0, E1 (see page 126).

Talk Only: Set with address switch = 31.

Battery Pack (Option 005 - HP 5384A/85A Only)

Battery Type: sealed lead-acid.

Capacity: 4 hours (typ.) at 25°C without Option 004.

Recharge Time: 16 hours (typ.) in the standby mode.

Battery Low Annunciator: enabled 20 minutes prior to instrument shutdown nominally.

Battery Save Switch (rear panel): prevents discharge of interval battery by the oven timebase, Option 004, during instrument standby (STBY).

Line Failure Protection: instrument automatically switches to battery in case of line failure.

Weight: Option 005 adds 1.4 kg (3 lb) to instrument weight.

General

Check: 10 MHz self-test.

Gate Times: 0.1, 1, or 10 seconds (nominal).

Display: 12-digit alphanumeric liquid crystal.

Display Digits (variable): frequency 3 to 11; period 3 to 8.

Timebase Output: 10 MHz, 25 mV p-p (nominal) into 50 ohm.

External Timebase Input: 10 MHz, 0.5 V rms into 500 ohm; 15 V (dc + ac peak) maximum.

Operating Temperature: 0° to 50°C.

Power Requirements

AC: selectable, 18 VA max. (30 VA max., HP 5386A) 115 V + 10%, -25%; 230 V + 10%, -15%; 48 - 66 Hz; 115 V ± 10%: 380 - 420 Hz.

DC: (HP 5384A/85A Only): 9 - 15 V dc, 1.0 A maximum.

Weight

HP 5384A/85A: net, 2.5 kg (4.5 lb). Shipping, 4.5 kg (9 lb).

HP 5386A: net, 3.5 kg (7.5 lb). Shipping 5.5 kg (11 lb).

Size:

HP 5384A/85A: 212 mmW x 98 mmH x 276 mmD (8 3/8 in. x 3 7/8 in. x 10 7/8 in.); **HP 5386A:** 212.3 mmW x 88.1 mmH x 421.6 mmD (8 1/2 in. x 3 1/2 in. x 16 1/2 in.).

Ordering Information

HP 5384A Frequency Counter 225 MHz \$1400

HP 5385A Frequency Counter 1.0 GHz \$1700

HP 5386A Frequency Counter 3.0 GHz \$2900

Opt 004 High Stability Ovenized Timebase + \$500

Opt 910 Additional Operating/Service Manual + \$20

HP 5384A/85A Only:

Opt 001 High Stability TCXO (HP 5384A)* + \$150

Opt 005 Battery Pack + \$300

HP 5061-1171 Slide Handle Kit \$19

HP 5060-0173 Rack Mount Kit (single) \$62

HP 5060-0174 Rack Mount Kit (dual) \$62.50

HP 34110A Vinyl Carrying/Operating Case \$40

*TCXO timebase is standard with HP 5385A/86A

HP 5386A only:

Side Handle Kit: HP P/N 5061-9688 \$50

Rack Mount Kit (single), HP P/N 5061-9672 \$50

Rack Mount Kit (dual), HP P/N's 5061-9674 and 5061-9694 \$55

☎ Fast-Ship product — see page 766.



ELECTRONIC COUNTERS

Universal Time Interval Counter

Model 5370B

- 20 ps single shot LSD
- ± 100 ps accuracy achievable
- 6000 measurements/s possible
- Built-in statistics functions
- Positive, zero and negative time
- Frequency and period to 100 MHz

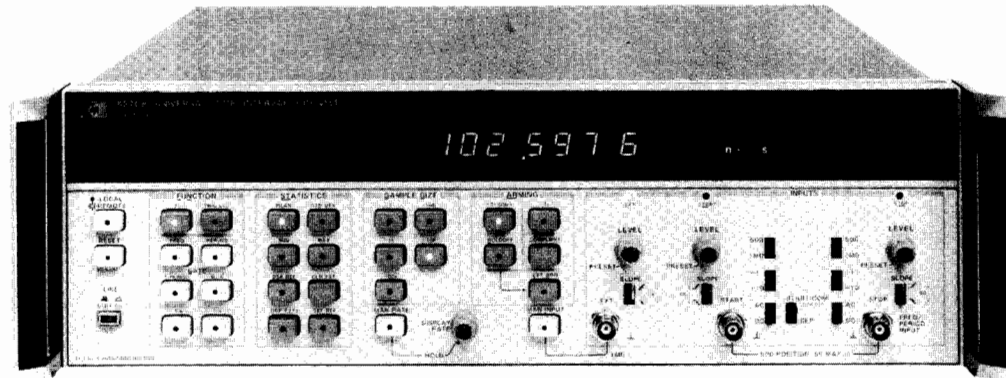

With the HP 5370B, you can make high-precision, time-interval measurements at up to 6000 measurements/s, making it ideal for your production applications.



Increase Productivity with the HP 5370B's Precision and Measurement Speed

- IC Tester performance verification
- Fast IC characterization
- Disc drive manufacture
- Digital communications - jitter analysis
- Radar/laser ranging calibration
- Nuclear systems
- Calibration Labs

Use the full range of functions

Time Interval: you can get 20 ps single shot LSD on time intervals from zero to 10 s, including negative time (where the STOP channel event occurs before the START channel event).

Frequency: measure up to 100 MHz with 11 digits of resolution in one second. Choose gate times down to one period; use one period with average mode and access the powerful STATISTICS capabilities.

Period: measure period average from one to 100k samples and use STATISTICS.

Statistics: will reduce your external computations, reduce random errors and improve measurement throughput.

Sample size: you can select 1, 10, 1K, 10k or 100k samples from the front panel, or 1 to 16,777,215 samples over HP-IB. For the selected sample size you can compute:

Mean
Standard Deviation
Minimum
Maximum

Select the time interval you want from complex waveforms: use the extremely flexible arming and gating to select: +TI or \pm TI with internal arming, external arming - no hold-off, or with external arming - external hold-off.

Program all major capabilities of the HP 5370B over HP-IB:

Data output rates:

- up to 6000 readings/second in fast binary mode - 165 μ s dead time.
- 10 to 20 readings/second fully formatted - 330 μ s dead time.

Condensed Specifications

Sensitivity: 100 mV p-p, 35 mV rms sine wave \times attenuator setting.

Impedance: selectable 1 M Ω //45 pF or 50 Ω nominal.

Trigger level: -2 V to +2 V, adjustable; 10 mV displayed resolution.

Trigger slope: independent selection of + or - slope.

Attenuators: $\div 1$ and $\div 10$ nominal.

Dynamic Range (preset)

50 Ω $\div 1$: 100 mV to 4 V p-p pulse; **$\div 10$:** 1 V to 7 V p-p pulse.

1 M Ω $\div 1$: 100 mV to 4 V p-p pulse; **$\div 10$:** 1 V to 10 V p-p pulse.

Dynamic range for rms sine wave is one-third of the above values.

Signal Operating Range

50 Ω $\div 1$: -4 V to +4 V; **$\div 10$:** -7 V to 7 V.

1 M Ω $\div 1$: -4 V to +4 V; **$\div 10$:** -25 V to 10 V.

Coupling: ac or dc switch selectable.

Minimum pulse width: 5 ns.

Maximum Input

50 Ω $\div 1$: ± 7 V dc
7 V rms below 5 MHz
3.5 V rms (+24 dBm) above 5 MHz.
 $\div 10$: ± 7 V dc, 7 V rms (+30 dBm).

1 M Ω $\div 1$: ± 350 V dc
250 V rms to 20 kHz decreasing to 3.5 V rms above 5 MHz.
 $\div 10$: ± 350 V dc
250 V rms to 20 kHz decreasing to 35 V rms above 5 MHz.

Common Input

All specifications are the same as for separate operation with the following differences:

Impedance: 1 M Ω becomes 500 k Ω shunted by < 80 pF.
50 Ω same as in separate.

Sensitivity (preset)

50 Ω $\div 1$: 200 mV p-p, 70 mV rms; **$\div 10$:** 2 V p-p, 700 mV rms.

1 M Ω : same as in separate.

Dynamic Range (preset)

50 Ω $\div 1$: 200 mV to 5 V p-p pulse; **$\div 10$:** 2 V to 5 V p-p pulse.

1 M Ω : same as in separate.

Maximum Input

50 Ω ± 5 V dc or 5 V rms.

1 M Ω same as in separate.

Attenuators: becomes $\div 2$ and $\div 20$ for 50 Ω .

DESIGNED FOR
HP-IB
SYSTEMS

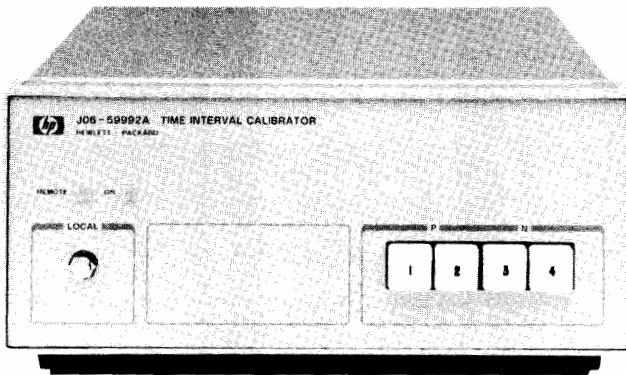

The JO6-59992A Time Interval Calibrator gives you the ability to remove systematic errors from your measurement system, so that the 5370B can measure with uncertainties of $< \pm 100$ ps.

Time Interval Measurement

Range

\pm TI: -10 to +10 s, including zero.

+TI: 10 ns to 10 s.

Accuracy

The accuracy (uncertainty) in a time interval measurement is influenced by:

- 1) internal systematic uncertainty;
- 2) trigger level timing error, for each edge;
- 3) crystal oscillator aging;
- 4) noise on the input signal; and
- 5) internal timing jitter.

Factors 1, 2 and 3 can be significantly reduced by calibration - 1 and 2 by using the JO6-59992A Time Interval Calibrator.

Factors 4 and 5 can be significantly reduced by averaging: (by \sqrt{N} , where N is the number of measurements averaged).

Total Uncertainty

Add together the following:

- 1) Systematic uncertainty is:
1 ns worst case, or
400 ps typical, or
20 ps typical after calibration.
- 2) Trigger level timing error is:
read from graph 1 for each edge, or
40 ps typical after calibration. Total error is the lower of the two.
- 3) Crystal aging influence is:
read from graph 2.
- 4) Input signal noise influence is:
read from graph 3 for each edge.
- 5) Internal timing jitter influence is:
100 ps for up to 1 s intervals.

Example

Measure a time interval of 500 ns, from a 1V, 10 ns rise time edge to a 1V, 10 ns edge. Input signal noise (in a 500 MHz bandwidth) is 1mV. It is 1 year since oscillator calibration. The measurement will be made single shot.

- 1) is typically 400 ps.
- 2) is 250 ps.
- 3) is negligible.
- 4) is 2×10 ps: 20 ps.
- 5) is 100 ps.

Total uncertainty is ± 770 ps.

Calibrate out systematic errors and you will reduce this to ± 180 ps.

Average 100 readings in addition to calibration, and reduce to ± 72 ps.

Calibration is a simple procedure, which can be automated with HP-IB.

The Time Interval Calibrator, in conjunction with a suitable pulse generator, provides the counter with signals which will let you measure the systematic errors. Once measured, you simply subtract them from your results to make Time Interval or Pulse Width measurements with uncertainties of $< \pm 100$ ps.

Calibrate to the probe tips of the HP 5363B Time Interval Probes

The calibration works equally well when high impedance probes are needed to make your measurement.

Frequency and Period Measurement

Frequency range: 0.1 Hz to 100 MHz.

Period range: 10 ns to 10 s.

Internal gate times: 1 period, 0.01, 0.1, 1 s.

External gate times: 20 ns to 10 s.

Accuracy

The accuracy (uncertainty) in a frequency measurement is influenced by:

- 1) crystal oscillator aging;
- 2) internal uncertainty; and
- 3) noise on the input signal.

Factor 1 can be reduced by calibration.

Factors 2 and 3 can be reduced by selecting longer gate times.

Total Uncertainty

Add together the following:

- 1) Crystal aging influence is:
read from graph 4.
- 2) Internal uncertainty is:
read from graph 5.
- 3) Input signal noise influence is:
read from graph 6.

Example

Measure a 1 MHz, 2V pk-pk sine wave. Input signal noise (in a 500 MHz bandwidth) is 1mV. It is 1 year since oscillator calibration. The selected gate time is 0.1 second.

- 1) is 180 mHz.
- 2) is 1 mHz.
- 3) is 3.2 mHz.

Total uncertainty is 184 mHz.

If you had calibrated the oscillator within the last month, this could be reduced to 19.2 mHz.

Select a one second gate time in addition to the recent calibration, and reduce this to 15.3 mHz.

ELECTRONIC COUNTERS

Universal Time Interval Counter

Model 5370B (cont.)

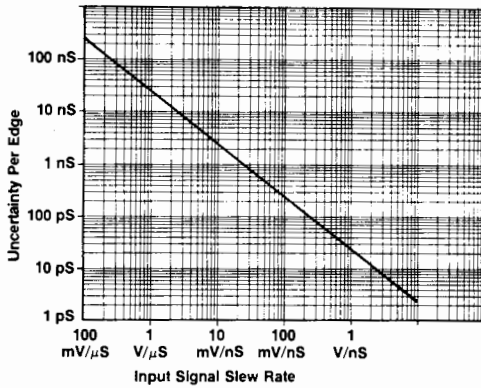

Graph 1. Trigger level timing error varies with input signal slew rate. Uncertainty is associated with both start and stop edges.

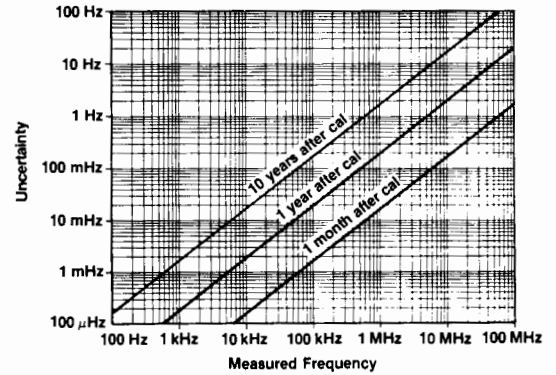

Graph 4. Time base crystal aging affects Frequency and Period measurements. You can further reduce the uncertainty by using an atomic frequency standard.

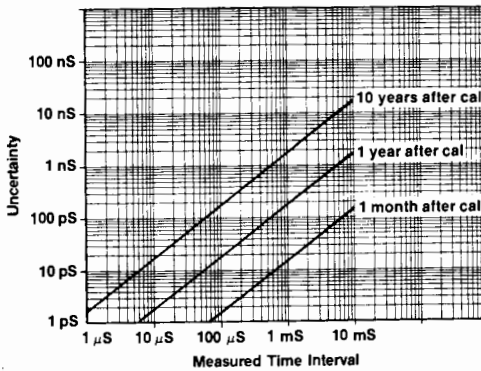

Graph 2. Time base crystal aging affects a time interval or pulse width measurement.

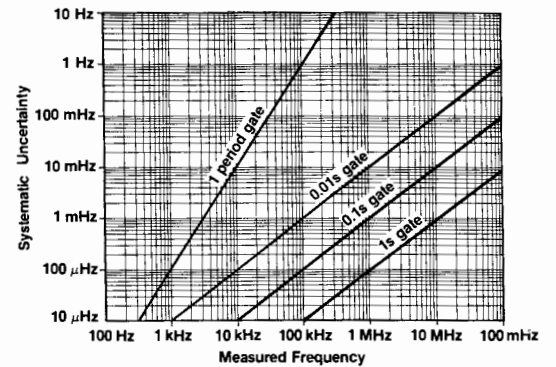

Graph 5. Internal uncertainties affect Frequency and Period measurements.

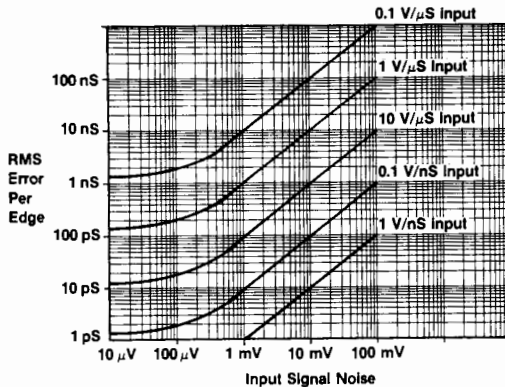

Graph 3. Noise on the input signal will add uncertainty to a time interval measurement. Averaging will reduce the effects of random noise.

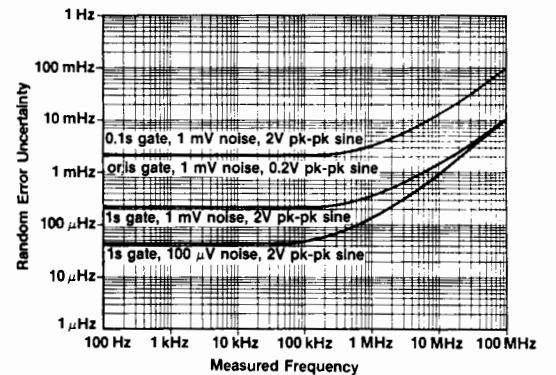

Graph 6. Noise on the input signal will add uncertainty to a Frequency or Period measurement. Longer gate times and averaging will reduce the effects of random noise.

General - 5370B

Display: 16 digits, suppressed leading zeros.
Size: 133 H x 426 W x 521 mm D (5.25 x 16.75 x 20.5).
Weight: 14.55 kg (32 lb.).
Power requirements: 100, 120, 220, or 240 V ac +5% -10%, 48 to 66 Hz, less than 250 VA.
Front handles: supplied with instrument.

General - J06-59992A

Size: 102 H x 213 W x 295 mm D (4.0 x 8.38 x 11.6).
Weight: 3.0 kg (6.6 lb).
Power requirements: 115 or 230 V ac +10% -15%, 48 to 66 Hz, 10 VA.

Ordering Information

Item	Price
HP 5370B Time Interval Counter	\$9900
J06-59992A Time Interval Calibrator	\$3000
Opt 913 (5370B Rack Flange Kit - use with supplied front handles)	+ \$30
Opt 908 (5370B Rack Flange Kit - without handles)	+ \$33
HP 10870A Service Kit Accessory	\$650

Note: Ask your local HP sales representative for Product Note 5370 B-2 for details on the HP J06-59992A Time Interval Calibrator (see page 769).



- Precise trigger level setting
- Wide input dynamic range

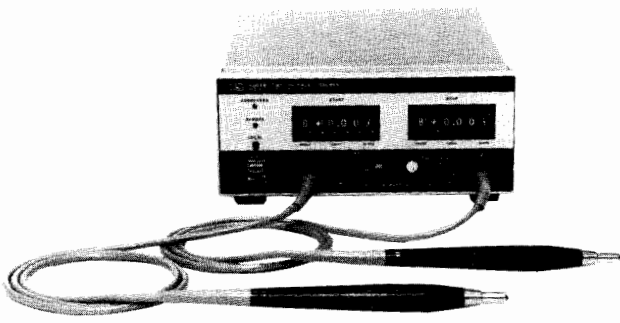

HP 5363B



HP 5363B Time Interval Probes

Enhanced Counter Measurements

The HP 5363B provides the necessary input signal conditioning to allow a universal counter to make highly accurate and repeatable time interval measurements. Counters such as the HP 5345A, 5370B, 5335A, 5334A, and 5328B when teamed up with the HP 5363B can now make more accurate rise time, fall time, slew rate, propagation delay, and other complex measurements.

Wide Dynamic Range, Fine Trigger Level Settability

Greatly improved dynamic range allows the trigger point to be selected in 10 mV increments from -9.99 V to +9.99 V.

Minimized Circuit Loading

High impedance, low capacitance active probes minimize circuit loading and pulse distortion. Each probe contains two measurement channels, start and stop, so timing measurements on one waveform are possible. As example, the input/output rise (propagation delay) of a device can be measured between the probes.

Eliminate Systematic Timing Errors

Delays through probes, cables and inherent differential delays between a counter's input channels limit the absolute accuracy of time interval measurements.

A calibration procedure using the HP 5363B can equalize such systematic delays to set the counter to read 0.0 ns. This is possible with counters that can measure down to 0 ns like the HP 5370B, 5334A, and HP 5335A. For counters with a minimum time interval specification (HP 5345A and 5328B have 10 ns minimum capability), the HP 5363B can add a fixed offset of 10 ns to permit measurements of zero time interval.

Condensed Specifications

Operating range: ±10 V.

Minimum input voltage: ±100 mV about trigger point.

Damage level: ±30 V.

Voltage resolution: 10 mV.

Impedance: 1 MΩ shunted by <20 pF.

Effective bandwidth: 350 MHz (1 ns rise time).

Minimum pulse width: 5 ns at ±100 mV about trigger point.

Output to counter: separate start/stop outputs; -0.5 V to +0.5 V into 50 Ω, slew rate through zero volts exceeds 0.25 V/ns.

Delay compensation range: 2 ns adjustable about 0 ns or 10 ns.

Power: 100, 120, 220, 240 Vac (+5-10%), 48-440 Hz; 40 VA max.

Weight: net 3.0 kg (6.5 lb). Shipping 5.5 kg (12 lb).

Dimensions: 88.1 H x 212 W x 295 mm D (3.5 in. x 8.4 in. x 11.6 in.).

Absolute Accuracy

$$\pm 1 \text{ ns} \pm \frac{\text{START TLA} + \text{START NTE}}{\text{START slew rate}} \pm \frac{\text{STOP TLA} + \text{STOP NTE}}{\text{STOP slew rate}}$$

where TLA denotes trigger accuracy and NTE denotes noise trigger error.

Noise trigger error: $\sqrt{(125 \mu\text{V})^2 + e_n^2}$ volts where 125 μV is the typical input noise on the HP 5363B and e_n is the input signal noise for a 350 MHz bandwidth.

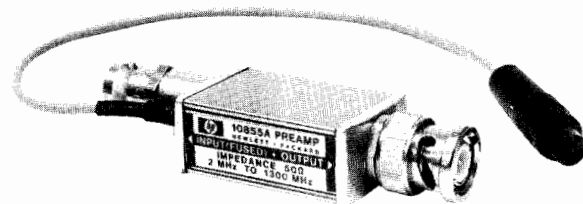

HP 10855A

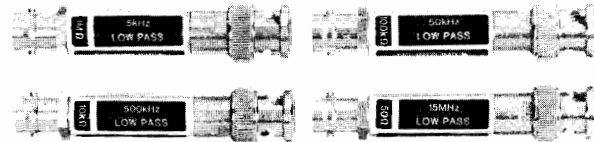

HP 10856A

HP 10855A 2-1300 MHz Preamp

The HP 10855A Preamp provides a minimum of 22 dB gain from 2 MHz to 1300 MHz to enhance measurements of very low-level signals. The ±1.5 dB flat response reduces distortion in non-sinusoidal waveforms. The HP 10855A operates conveniently with a variety of HP measuring instruments having probe power outlets, or will work with the HP 1122A Probe Power Supply. The HP 5334A/5335A Option 030 and HP 5328B Option 031 counters all measure frequency to 1300 MHz and are compatible for use with the HP 10855A.

HP 10855A Specifications

Frequency range: 2 MHz-1300 MHz.

Gain (minimum): 22 dB; 24 dB typical.

Gain flatness across full frequency range: ±1.5 dB.

Noise figure: <8.5 dB typical.

Output power for 1 dB gain compression: 0 dBm.

Harmonic distortion: -30 dB for -15 dBm output, typical.

Output for <-66 dB harmonic distortion: -25 dBm, typical.

VSWR: forward, <2.2; reverse, <2.8.

Impedance: 50 Ω nominal.

Reverse isolation: >45 dB.

Maximum input: 3.5 V rms (+24 dBm), fuse protected.

HP 10856A Low Pass Filter Kit

The four low pass filters of the HP 10856A filter kit are recommended for use with any HP frequency counter to reduce high frequency noise or unwanted signals that cause frequency or period measurement errors. Further applications for the kit include reducing noise (trace fuzz) in oscilloscope and spectrum analyzer displays.

HP 10856A Specifications

Cut Off Frequency (NOMINAL)	5 KHz	50 KHz	500 KHz	15 MHz
Input Impedance (NOMINAL)	1 MΩ	100 kΩ	10 kΩ	50 Ω
Signal Rejection, 100 MHz to 500 MHz	>40 dB	>40 dB	>40 dB	>20 dB

Roll-off: 20 dB per decade.

Attenuation: × 2, reduces signal voltage by a factor of 2.

Output impedance: for use with 1 MΩ input instruments.

Accessories Available

HP 10821A Probe Accessory Kit including 2 of each of the following: HP 10229A Hook Tip; HP 10218A BNC to Probe Adapter; HP 10100C 50 ohm Feedthrough termination; HP 1250-0655 BNC Tee to Probe Adapter; and HP 8710-0661 HP Probe tips (extra).

Price

\$160

Ordering Information

HP 5363B Time Interval Probes

\$4200

HP 10855A 2-1300 MHz Preamp

\$550

HP 10856A Low Pass Filter Kit

\$300

☎ Fast-Ship product — see page 766.



ELECTRONIC COUNTERS

Our Fastest Universal Systems Counter

Model 5345A

- 500 MHz Direct Count, Conversion Plug-Ins to 110 GHz
- 2 ns Single Shot Resolution, 2 ps Averaged
- 25 mV Sensitivity to 500 MHz
- Up to 9000 readings/second over HP-IB

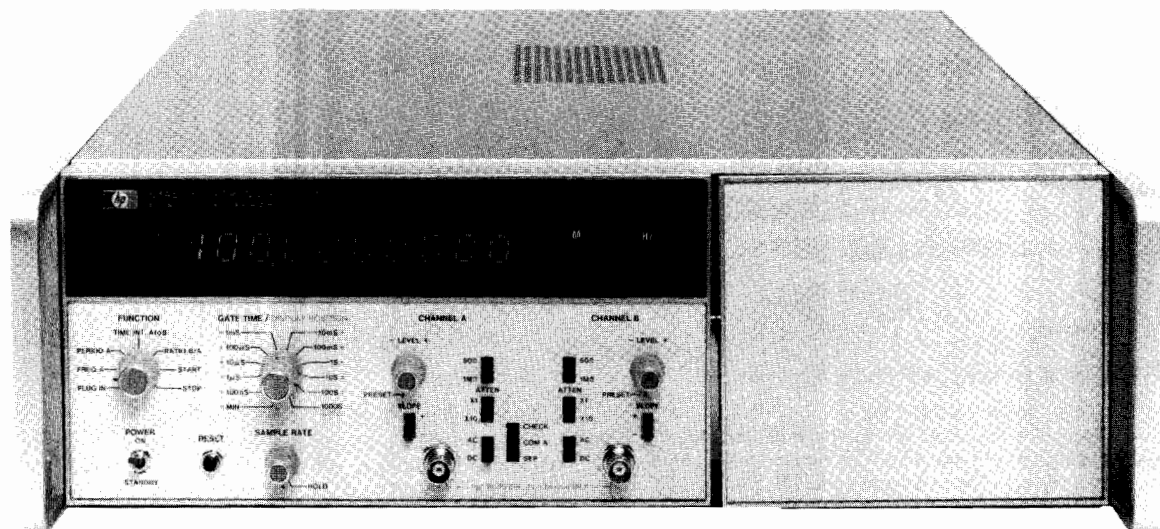

HP 5345A



Versatile, High-Speed Measurement Power

- High resolution pulsed Frequency measurements and pulse profiling to 110 GHz with the HP 5355A and HP 5356A/B/C/D.
- Rapid 2 ns resolution Time Interval measurements for jitter characterization.
- High throughput Frequency, Period, Radio, Totalize, and Scale measurements to 500 MHz.

HP 5345A Condensed Specifications

Input Channels A and B

Range: 0 to 500 MHz dc coupled 50 Ω and 1 M Ω ; 4 MHz to 500 MHz ac coupled, 50 Ω ; 200 Hz to 500 MHz ac coupled, 1 M Ω .

Impedance: selectable, 1 M Ω shunted by less than 45 pF or 50 Ω (nominal).

Sensitivity: $\times 1$, 25 mV rms sine wave and 75 mV peak-to-peak pulse; $\times 10$, 300 mV rms sine wave and 900 mV peak-to-peak pulse.

Dynamic range: 50 Ω & 1 M Ω : 25 mV to 300 mV rms sine wave ($\times 1$); 300 mV to 2.0 V rms ($\times 10$).

Trigger level: adjustable over ± 2.0 V dc.

Output: rear-panel BNC connectors bring out CHAN A TRIG LEVEL and CHAN B TRIG LEVEL for convenient DVM monitoring.

Common Input

Range: ac coupled 50 Ω , 4 MHz to 400 MHz; ac coupled 1 M Ω , 300 Hz to 400 MHz; dc coupled, 0 to 400 MHz.

Impedance: 50 Ω remains 50 Ω ; 1 M Ω becomes 500 k Ω shunted by <80 pF.

Sensitivity: 50 Ω : 50 mV rms; 1 M Ω : No change.

Dynamic range: 50 Ω : 50 mV to 600 mV rms ($\times 1$); 600 mV to 4 V rms ($\times 10$); 1 M Ω : No change.

Frequency A

Range: 0.00005 Hz to 500 MHz.

Resolution: See Graph 1.

Accuracy: \pm Resolution \pm Time-Base Error (Graph 2).

Period A

Range: 2 ns to 20,000 s.

Resolution and Accuracy: Δ Freq [Per]/Freq (Graphs 1 and 2).

Time Interval/Time Interval Average

Range: 10 ns to 20,000 s.

Minimum Dead Time: 10 ns.

Trigger Pulse Width: 1 ns minimum width input at minimum voltage input.

Resolution

Time Interval: 2 ns \pm Noise Trigger Error (Graph 3).

Time Interval Average: \pm T.I. Resolution \pm 2 picoseconds.
 $\sqrt{\text{intervals averaged}}$

Accuracy: \pm Resolution \pm Time Base Error (Graph 2) \pm Trigger Level Timing Error (Graph 4) \pm 700 ps.

Ratio B/A

Range: both channels accept dc to 500 MHz.

LSD: Ratio/[Freq B x Gate Time].

Resolution and Accuracy: \pm LSD \pm [A Trigger Error (Graph 3)/Gate time] x Ratio.

Start/Stop

Range: both inputs dc to 500 MHz.

Modes: A, A \pm B determined by rear-panel switch.

Scaling

Range: dc to 500 MHz.

Scaling Factor: selectable by GATE TIME setting. Scaling factor equals GATE TIME setting/ 10^{-9} seconds.

Input: input signal through channel A.

Output: output frequency equals input frequency divided by scaling factor.

Time Base

Standard High Stability Oven

Frequency: 10 MHz.

Aging rate: $< 5 \times 10^{-10}$ per day.

Short term: $< 1 \times 10^{-11}$ for 1 s average.

Temperature: $< 7 \times 10^{-9}$, 0°C to 55°C.

Opt 001

Frequency: 10 MHz.

Aging rate: $< 3 \times 10^{-7}$ per month.

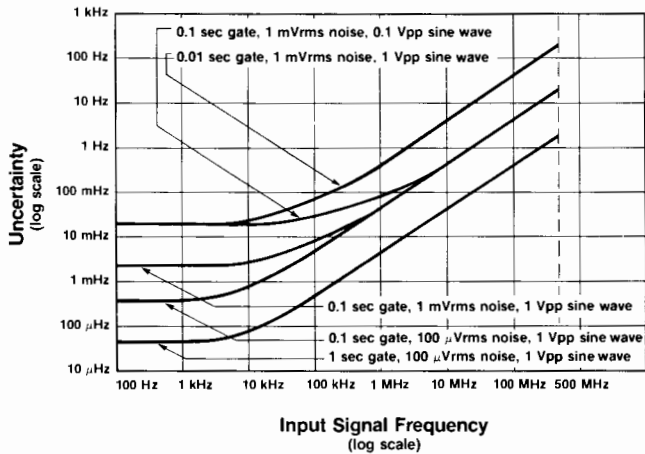

Graph 1, Frequency Resolution Error: Noise on the input signal and internal uncertainties affect Frequency and Period measurements. Longer gate times will reduce this error. (For Period, invert and find the $\Delta F/F$, then multiply by the Period. This yields Period Uncertainty (ΔP .)

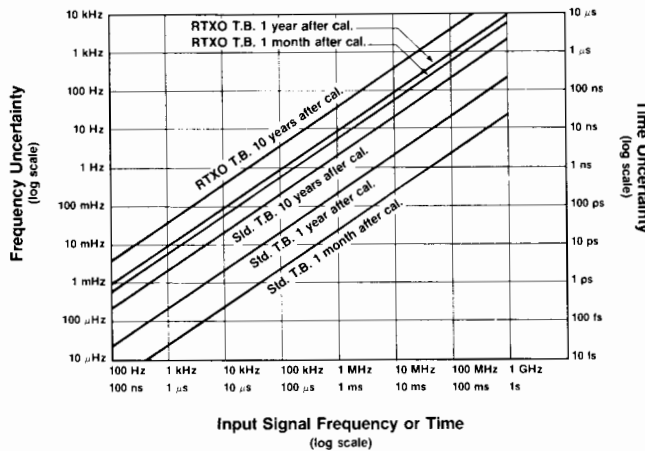

Graph 2, Time-Base Error: Environment and aging of the crystal affects all measurements. Frequent calibration and a better time base will reduce this error.

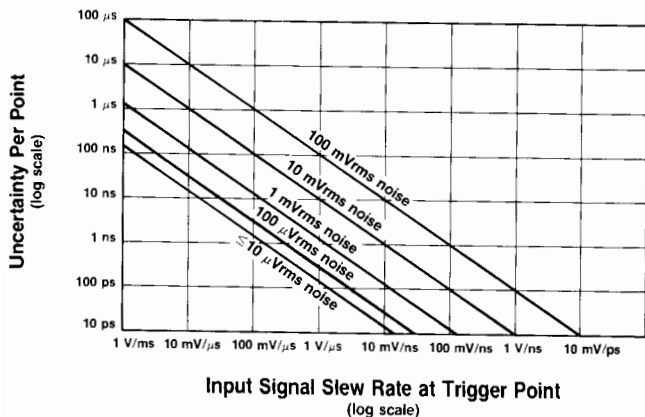

Graph 3, Input Noise Trigger Error: Noise on the input signal affects both the Start and Stop points of all time interval measurements. Averaging will reduce this error.

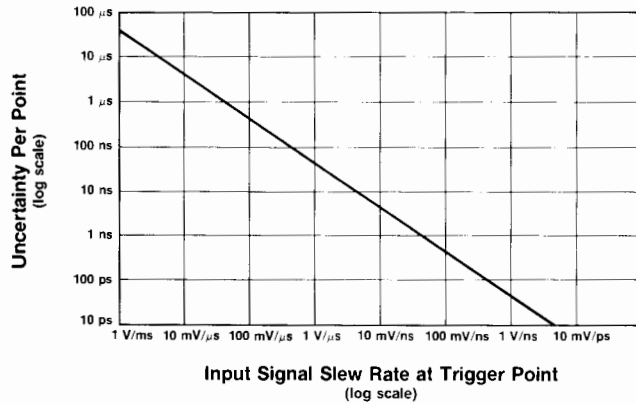

Graph 4, Trigger Level Timing Error: Affects the Start and Stop points, total error is the larger of the two. Input calibration will reduce this error.

Opt 001 (cont.)

Short term: $< 2 \times 10^{-9}$ rms for 1 s.
Temperature: $< 2 \times 10^{-6}$, 25°C to 35°C.
 $< 5 \times 10^{-6}$, 0°C to 55°C.

Line voltage: $< 1 \times 10^{-8}$, $\pm 10\%$ from nominal.

External frequency standard input: input voltage > 1.0 V rms into 1 k Ω required from source of 1, 2, 2.5, 5 or 10 MHz $\pm 5 \times 10^{-8}$ ($\pm 5 \times 10^{-6}$ for option 001).

Frequency standard output: > 1 V rms into 50 Ω at 10.0 MHz sine wave.

General

Display: 11-digit LED display and sign.

Gate time: 1000 s to 100 ns in decade steps; < 50 ns in MIN position.

Measurement speed

Mode of Operation	Readings per Second
Normal Operation (Max sample rate)	10
Externally armed	500
Externally gated	500
Computer dump	9,000

Overflow: asterisk is illuminated when display is overflowed.

Sample rate: continuously variable from < 0.1 s to > 5 s with front-panel control. In HOLD position the last reading is maintained until the counter is reset.

External arm input: counter can be armed by a -1.0 V signal applied to the rear panel 50 Ω input.

External gate input: same conditions as for EXT ARM.

Gate output: > 1 V into 50 Ω .

Operating temperature: 0°C to 55°C.

Power requirements: 100/120/220/240 V rms $+5\%$ -10% 48 to 66 Hz, maximum power 250 VA.

Weight: 17 kg (37 lb).
Size: 132.6 mmH x 425 mmW x 495 mmD (5.22 in x 16.75 in x 19.5 in).

HP 10590A Plug-In Adapter

The HP 10590A allows the user to interface any of the obsolete HP 5245 series of plug-ins (except the HP 5264A) to the HP 5345A counter.

Ordering Information

HP 5345A Plug-In Counter	\$9,000
Opt 001 Room Temperature Time Base	- \$320
Opt 010 HP-IB Talk Only	+ \$350
Opt 011 HP-IB includes remote programming	+ \$950
Opt 012 HP-IB similar to Opt 011, but also includes slope and trigger level controls	+ \$1,600
Opt 908 Rack Flange Kit, HP 5060-8740	+ \$22
HP 10590A Plug-In Adapter	\$1,500
HP 10595A Board Extender Kit: For troubleshooting	\$1,000
Fast-Ship product — see page 766.	



ELECTRONIC COUNTERS

100 MHz Universal Counters

Model 5334A

- Two matched 100 MHz input channels; optional C Channel to 1.3 GHz
- 9 digits per second resolution from .001 Hz to 1.3 GHz
- 2 ns single shot time interval resolution
- Automatic rise/fall time, pulse width and peak amplitude measurements
- Store/recall of up to 10 front-panel setups
- Complete HP-IB programmability

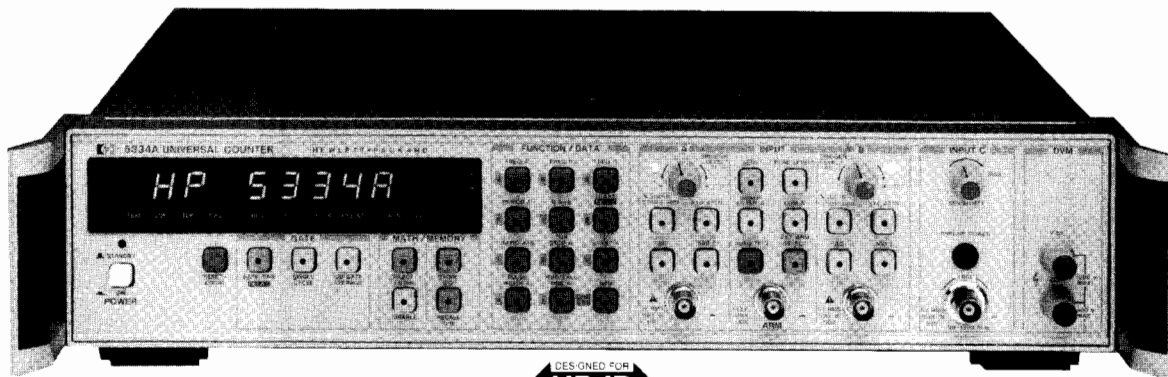

HP 5334A



Expanded Universal Counter Capability for Bench or System

- Rise/Fall Time and Pulse Width measurements at the push of a button.
- Measure the Peak Amplitude of the input signal to 20 MHz.
- Store up to 10 measurement setups in a nonvolatile memory for later recall.
- Offset, Normalize, and Average measurements for greater use ability of results.
- Auto Triggering and Auto Attenuation for user convenience.

As well as

- 100 MHz Frequency and Period measurements with resolution of 9 digits per second of gate time.
- Time Interval and Time Interval Delay to 2 ns resolution, 200 ps with averaging.
- Full HP-IB programmability standard with optional rear inputs for system applications. Make up to 140 readings per second.
- 1.3 GHz C Channel, ± 1000 V dc DVM, and High Stability Oven Time Base options.
- External Arming/Gating for synchronizing measurements to external events.

Condensed Specifications

Input Characteristics (channels A and B)

Range

DC coupled: 0 to 100 MHz.

AC coupled: 1 M Ω , 30 Hz to 100 MHz; 50 Ω , 1 MHz to 100 MHz.

Sensitivity

15 mV rms sine wave to 20 MHz, 35 mV rms sine wave to 100 MHz.

100 mV peak-to-peak at a minimum pulse width of 5 ns.

Dynamic Range (X1)

45 mV to 5 V peak-to-peak, to 20 MHz.

100 mV to 2.5 V peak-to-peak, to 100 MHz.

Trigger Level Range

Manual (auto trigger off): continuously adjustable over ± 5.1 V (\times ATTN), displayed in 20 mV steps (\times ATTN).

Preset: 0V NOMINAL in Sensitivity Mode.

Auto Trigger

DC coupled: 100 Hz to 100 MHz.

AC coupled: 1 M Ω , 100 Hz to 100 MHz; 50 Ω , 1 MHz to 100 MHz.

Trigger Slope: independent selection of + or - slope.

Impedance: 1 M Ω or 50 Ω , NOMINAL, switch selectable.

Attenuator

Manual: $\times 1$ or $\times 10$ NOMINAL, switch selectable.

Auto: attenuator automatically switched when in Auto Trigger.

Low Pass Filter: 100 kHz NOMINAL, Channel A, switchable.

External Arm

Sensitivity: 500 mV peak-to-peak at Min. pulse width of 50 ns.

Signal Operating Range: -5 V dc to +5 V dc.

Slope: independent selection of START and STOP ARM slopes: +, -, or OFF.

Frequency A and Frequency B

Range: .001 Hz to 100 MHz.

Resolution: See Graph 1.

Accuracy: \pm Resolution \pm Time Base Error (Graph 2).

Period A

Range: 10 ns to 10³ s (single gate), 10 s (100 GATE AVERAGE)

Resolution and Accuracy: Δ FREQ [PER]/FREQ (Graph 1 and 2)

Time Interval A to B

Range: -1 ns to 10³ (single shot), 10 s (100 GATE AVERAGE).

LSD: 1 ns (100 ps using 100 GATE AVERAGE).

Resolution: \pm LSD \pm Noise Trigger Error (Graph 3) \pm 1 ns rms.

Accuracy: \pm Resolution \pm Time Base Error (Graph 2) \pm Trig Level Timing Error (Graph 4) \pm Trig Level Setting Error (Graph 5) \pm 2 ns.

Time Interval Delay

Selectable delay can be inserted between START and STOP of Time Interval A to B. Inputs during delay are ignored. Delay Range is 1 ms to 99,999 s.

Ratio A/B

Range: .001 Hz to 100 MHz both channels.

LSD: $4 \times$ RATIO/[FREQ A \times GATE TIME].

Resolution and Accuracy: \pm LSD \pm [B Trig Error (Graph 3)/GATE TIME].

Totalize

Range: 0 to 10¹² -1.

Resolution and Accuracy: 1 count of input signal.

Pulse Width A

Range: 5 ns to 10 ms.

LSD, Resolution, Accuracy: same as Time Interval A to B except \pm 2 ns in Accuracy deleted.

Rise/Fall Time A

Range: 30 ns to 10 ms.

Minimum Amplitude: 500 mV peak-to-peak.

Dynamic Range: 500 mV to 40 V peak-to-peak.

LSD, Resolution, Accuracy: same as Time Interval A to B.

Read Peak Amplitudes

Max. and Min. peaks of Channel A or Channel B input are displayed.

Frequency Range: dc, 100 Hz to 20 MHz.

Dynamic Range: 0-40 V peak-to-peak.

Resolution: $\times 1$: 20 mV $\times 10$: 200 mV

Time Base

Frequency: 10 MHz.

Aging Rate: $< 3 \times 10^{-7}$ per month.

Math

Display = (Measurement/Normalize) + Offset.

Entry Range: $\pm 1 \times 10^{-10}$ to $\pm 9.999999999999 \times 10^9$.

Single Cycle: one measurement per push of RESET.

100 Gate Average: 100 measurements accumulated and average value displayed. Adds one digit of resolution to measurements and reduces resolution error by 10.

Gate Output: rear panel BNC drives TTL levels into 1 k Ω .

Hewlett-Packard Interface Bus

Programmable Controls: all front-panel controls and functions, except Option 030 Channel C sensitivity and power on/stby switch.

Trigger Level: set Channel A or B in 20 mV steps (\times ATTN).



Data Output

Normal Operation: ten readings/second, formatted.

High Speed Mode: up to 140 readings/second, unformatted.

HP-IB Interface Functions: SH1, AH1, T5, TE0, L4, LE0, SR1, RL1, PP0, DC1, C0, E2 (see page 126).

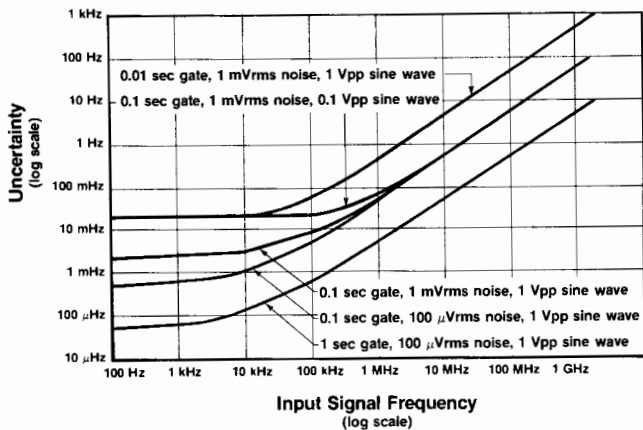

Graph 1, Frequency Resolution Error: Noise on the input signal and internal uncertainties affect Frequency and Period measurements.

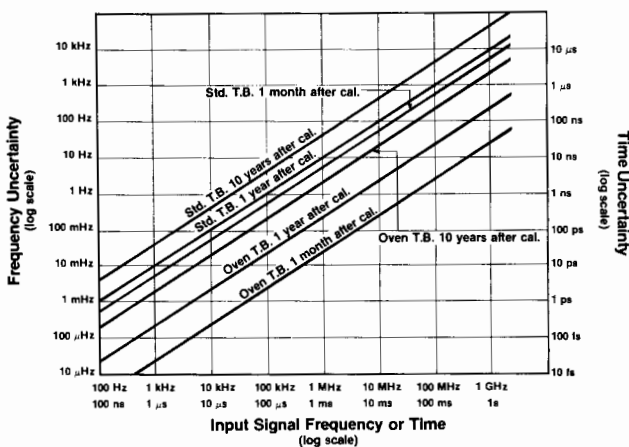

Graph 2, Time Base Error: Crystal environment and aging affects all measurements.

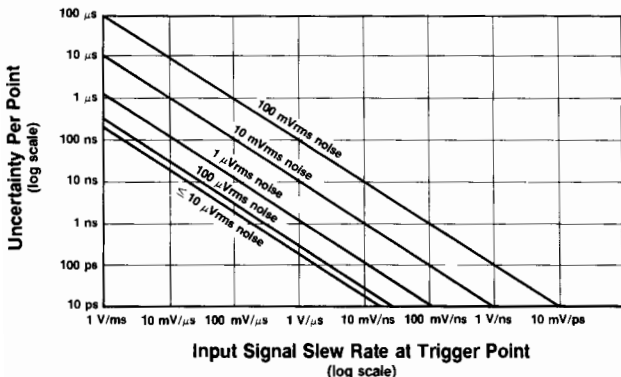

Graph 3, Input Noise Trigger Error: Noise on the input signal affects both the Start and Stop points of all time interval measurements.

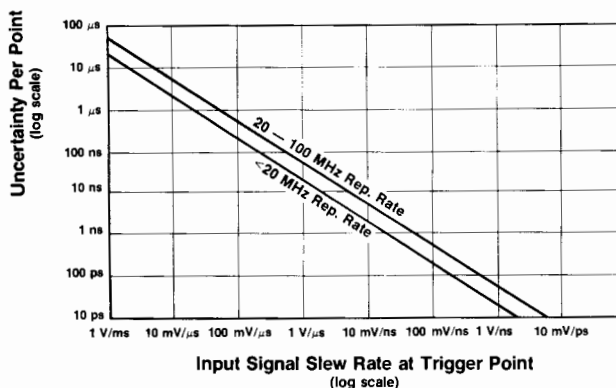

Graph 4, Trigger Level Timing Error: Affects the Start and Stop points of all time-interval measurements. Total error is the larger of the two trigger point errors.

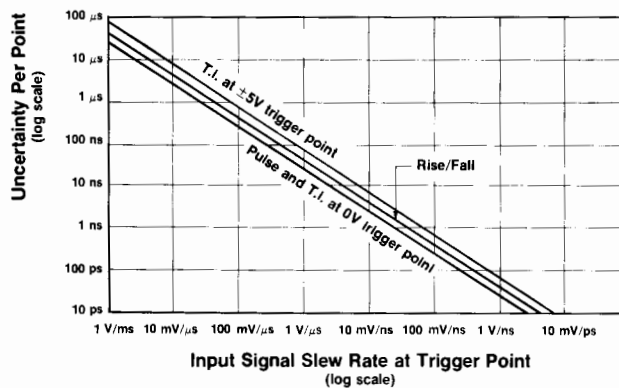

Graph 5, Trigger Level Setting Error: Affects both the Start and Stop points of all time interval measurements.

Options

Option 010 High Stability Time Base (Oven)

Frequency: 10 MHz.

Aging Rate: 5×10^{-10} /day after 24-hour warm up.

Option 020 DC Digital Voltmeter

Range: 4 digits, autopolarity, autoranging ($\pm 10, 100, 1000$ V).

Sensitivity and LSD: 100 μ V for ± 1 V readings, 1 mV for ± 10 V reading, 10 mV for ± 100 V reading, 100 mV for ± 1000 V reading.

Input: floating pair, 10 M Ω \pm 1%.

Option 030 1300 MHz C Channel

Range: 90 MHz to 1300 MHz.

Sensitivity: 15 mV rms (-23.5 dBm) sine wave, 90 MHz to 1000 MHz. 75 mV rms (-9.5 dBm) sine wave, 1000 MHz to 1300 MHz.

Resolution and Accuracy: same as Frequency A and B.

Ordering Information

HP 5334A Universal Counter

Opt 010 Oven Oscillator

Opt 020 DVM

Opt 030 Channel C

Opt 050 Both option 020 and 030 combined

Opt 060 Rear Terminals

Channel A,B and ARM in parallel with front inputs.

Options 020 and 030 at rear panel only.

Opt 908 No handles Rack Mount Kit

Opt 913 With handles Rack Mount Kit

Price

\$2800

+ \$800

+ \$500

+ \$755

+ \$1255

+ \$100

+ \$30

+ \$30

ELECTRONIC COUNTERS

Our Highest Performance Universal Systems Counter

Model 5335A

- A high performance 200 MHz/2 ns Universal Counter
- Built-in automatic rise time, duty cycle, pulse width, slew rate and phase measurements
- Advanced automatic triggering capabilities
- HP-IB plus math and statistics functions standard

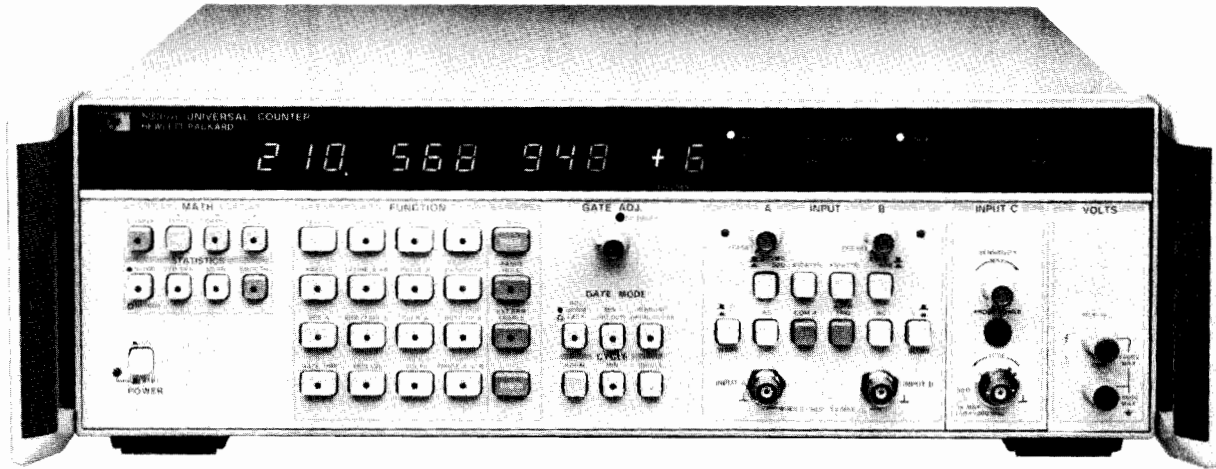

HP 5335A



Remarkable Automatic Measurement Power

The HP 5335A is an advanced universal counter with automatic measurement power built in. Designed either for bench or systems applications, the counter has 16 front-panel measurement functions, plus four "phantom" functions, all automatically selected by push button or by HP-IB. These twenty functions, plus greatly expanded arming and triggering capability, make the HP 5335A a most powerful universal counter. In addition, math and statistics features, matched Channel A and B input amplifiers, and HP-IB are all included in the standard unit, making the HP 5335A easily the most advanced universal counter available at its price.

Pulse Characterization Measurements

The HP 5335A possesses the expected universal measurements, and does them better than ever before. Beyond the expected measurement set, the HP 5335A has the ability to automatically measure waveform characteristics for various applications. Op amp characterization is one area where a number of measurements are needed to define the amplifier's performance. Using the HP 5335A and a signal source, rise and fall times, output slew rate, and propagation times can be measured with one test set-up. Also, duty cycle can be measured to see the distortion on a square wave through the amplifier due to different rising and falling slew rates. Phase measurements are also push-button selectable and automatically performed by the counter.

Complete Triggering Capability

To get good measurement results, a counter must properly trigger on the input signal. The HP 5335A employs both manual and automatic trigger modes to quickly and easily set the right trigger points.

Manual Triggering

The counter has a ± 5 Vdc range to help reduce input attenuator use for most input signals, including TTL.

Automatic Triggering

Two auto trigger modes help you trigger automatically. Just press *auto trig* or select auto trig on the HP-IB and the counter automatically selects 10%-90% rise/fall time trigger points, 50% phase trigger points, or the preset value of your choice. Then it tracks the signal's dc offset continuously to stay on the right trigger point. Option 040 allows programmability of trigger levels via HP-IB.

Trigger Level DVM

Built into the basic counter. Just press TRG LVL to see both input channel trigger levels displayed.

A Full Set of Universal Measurement Functions

In addition to waveform characterization features, the HP 5335A has an extremely wide set of measurement functions covering frequency, time, events and volts. These functions let you characterize signals quicker and more thoroughly than ever before possible.

Frequency

Frequency is the most common measurement performed by counters. The HP 5335A measures to 200 MHz in Channel A, 100 MHz in Channel B, and 1.3 GHz in its optional Channel C. Due to the counter's advanced design and reciprocal measurement technique, resolution is a constant 9 digits per second of gate time across its entire measurement range.

Time

In a universal counter, a time interval measurement equates to a stopwatch measurement started and stopped by unique events. Precision is dependent on the counter's circuitry.

To ensure precision, the HP 5335A has matched custom input amplifiers to greatly reduce trigger errors that might be produced if the start and stop signals were amplified differently. Further, the counter employs an analog interpolation technique that turns its 10 MHz clock into the equivalent of a 1 GHz time base. The HP 5335A is thus able to resolve single shot time interval measurements to better than 2 nanoseconds (100 ps with averaging). This analog interpolation eliminates the need found in some counters for a phase-modulated (jittered) time base for time interval average measurements.

Math and Statistics

Averaging techniques are often used to extend the resolution of a counter. For averaging, the HP 5335A provides sample sizes of $N = 100$ or $N = 1,000$. Best of all, averaging can be employed for all measurements except phase. In addition to mean, and selection of sample size, the counter takes standard deviations of the current measurement for the sample size selected.

Math functions are another built-in feature that provide operator convenience. These functions let you convert the display into direct indications of parameters like flow, speed, pressure, and temperature. Additionally, the counter remembers the offset, scale, and normalize factors for each measurement function.



Condensed Specifications

Input Characteristics (channel A and B)

Range

DC coupled, 0 to 100 MHz.

AC 1 M Ω , 30 Hz to 100 MHz.

AC 50 Ω , 200 kHz to 100 MHz.

NOTE: Channel A range 200 MHz when in Frequency A and Ratio modes.

Sensitivity ($\times 1$)

25 mV rms sinewave.

75 mV peak-to-peak pulse at minimum pulse width of 5 ns.

Dynamic Range ($\times 1$)

75 mV to 5 V peak-to-peak, to 100 MHz.

75 mV to 2.5 V peak-to-peak, >100 MHz.

Signal Operating Range ($\times 1$, DC)

-5 V dc to +5 V dc.

Trigger Level Range ($\times 1$)

Auto Trigger OFF

Preset: set to 0 V dc NOMINAL.

Adjustable: -5 V dc to +5 V dc.

Auto Trigger ON

Preset: set to nominal 50% point of input signal.

Adjustable: nominally between + and - peaks of input signal.

Auto Trigger ($\times 1$)

Range (50% duty cycle)

DC coupled, 30 Hz to 200 MHz.

AC 1 M Ω , 30 Hz to 200 MHz.

AC 50 Ω , 200 kHz to 200 MHz.

Minimum signal: 100 mV rms.

Duty cycle range: 10% to 90%.

Response time: 3 seconds, typical.

NOTE: Auto Trigger requires a repetitive signal.

Coupling: ac or dc, switchable.

Impedance: 1 M Ω , nominal, shunted by <35 pF or 50 Ω nominal, switchable. In COMMON A, 1 M Ω is shunted by <50 pF.

Attenuator: $\times 1$ or $\times 10$ nominal, switchable.

Slope: independent selection of + or - slope.

Channel input: SEPARATE or COMMON A, switchable.

Frequency A

Range: 0 to 200 MHz, prescaled by 2.

LSD Displayed

$\frac{1 \text{ ns}}{\text{Gate Time}} \times \text{FREQ.}$ (e.g. 9 digits in a second).

Resolution

$\pm (2 \times \text{LSD}) \pm 1.4 \times \frac{\text{Trigger Error}}{\text{Gate Time}} \times \text{FREQ.}$

Accuracy: $\pm (\text{Resolution}) \pm (\text{Time Base Error}) \times \text{FREQ.}$

Period A

Range: 10 ns to 10^7 s.

LSD Displayed

$\frac{1 \text{ ns}}{\text{Gate Time}} \times \text{PER.}$ (e.g. 9 digits in a second).

Period average: user selects MEAN function, and $n = 100$, or $n = 1,000$.

Time Interval A \rightarrow B

Range: 0 ns to 10^7 s.

LSD displayed: 1 ns (100 ps using MEAN).

Resolution: $\pm (2 \times \text{LSD}) \pm (\text{START Trigger Error}) \pm (\text{STOP Trigger Error})$.

Accuracy: $\pm (\text{Resolution}) \pm (\text{Time Base Error}) \times \text{TI} \pm (\text{Trigger Level Timing Error}) \pm (2 \text{ ns})$.

Gate mode: MIN only.

Time interval average: user selects MEAN function, and $n = 100$, or $n = 1,000$.

Time Interval Delay (holdoff)

Front panel Gate Adjust control inserts a variable delay between START and enabling of STOP. Electrical inputs during delay are ignored. Delay ranges are same as gate time ranges (100 μ s, to 4 s NOMINAL) for gate modes of Fast, Norm, and Manual.

Inverse Time Interval A \rightarrow B

Range: 10^{-7} to 10^9 units/second.

LSD Displayed, Resolution, and Accuracy are inverse of Time Interval A \rightarrow B specifications.

Rise and Fall Time A

Range: 20 ns to 10 ms transition with 50 Hz to 25 MHz repetition rates (50% duty cycle).

Minimum pulse height: 500 mV peak-to-peak.

Minimum pulse width: 20 ns.

Duty cycle range: 20% to 80%.

LSD Displayed and Resolution are same as Time Interval A \rightarrow B Specifications.

Pulse Width A

Range: 5 ns to 10^7 s.

Trigger point range: 40% to 60% of pulse height.

LSD Displayed and Resolution are same as Time Interval A \rightarrow B specifications.

Duty Cycle A

Range: 1% to 99%, 0 to 100 MHz.

Trigger point range: 40% to 60% of pulse height.

LSD displayed: $\frac{1 \text{ ns}}{\text{PER}} \times 100\%$



NOTE: Constant duty cycle required during measurement.

Slew Rate A

Range: 50 V/s to 10^8 V/s slew rate with 50 Hz to 25 MHz repetition rates (50% duty cycle). Minimum Pulse Height, Width, and Duty Cycle Range are same as Rise and Fall Time A.

Input mode: automatically set to COMMON A with 10% and 90% trigger levels.

Ratio A/B

Range: Channel A, 0 to 200 MHz (prescaled by 2).
Channel B, 0 to 100 MHz.

LSD displayed: $\frac{\text{RATIO}}{\text{FREQ} \times \text{Gate Time}}$ where FREQ is higher frequency after prescaling.

Totalize A

Range: 0 to 100 MHz.

LSD displayed: 1 count of input.

HP-IB output: at end of gate.

Manual

Count reset: via RESET key.

HP-IB output: totalize data on-the-fly sent if Cycle mode set to Single. Input frequency range in this mode is 0 to 50 Hz nominal.

Gated

Count reset: automatic after measurement.

Phase A Rel B

Range: -180° to 360° , Range Hold off, or 0° to 360° , Range Hold on, with signal repetition rates of 30 Hz to 1 MHz.

Minimum signal: 100 mV rms.

LSD displayed: 0.1° .

Gate Time

Range: 100 ns to 10^7 s.

LSD displayed: up to three digits with Ext. Arm Enable OFF, 100 ns when ON. MIN Gate Mode display zero.



ELECTRONIC COUNTERS

Our Highest Performance Universal Systems Counter (cont.)

Model 5335A

Trigger Level

Range: $\times 1$, +5 to -5 V; $\times 10$, +50 to -50 V.

Resolution: $\times 1$, 10 mV; $\times 10$, 100 mV.

Accuracy ($\times 1$): ± 20 mV, $\pm 0.5\%$ of reading.

Time Base

Standard Crystal

Frequency: 10 MHz.

Aging rate: $< 3 \times 10^{-7}$ /month.

Temperature: $< 4 \times 10^{-6}$, 0 to 50°C.

Line voltage: $< 1 \times 10^{-7}$ for 10% change.

High stability crystal: see Option 010.

External time base input: rear panel BNC accepts 5 or 10 MHz, 200 mV rms into 1 k Ω ; 5 V rms maximum.

Time base out: 10 MHz, > 1 V p-p into 50 Ω via rear panel.

Statistics

Sample size: selectable between either $n = 100$ or $n = 1,000$ samples.

Std. dev.: displays a standard deviation of selected sample size.

Mean: displays mean estimate of selected sample size.

Smooth: performs a weighted running average and truncates unstable least significant digits from display.

Math

All measurement functions, with exception of GATE TIME, Totalize in Scale Mode, and TRIG LVL, may be operated upon by Math functions. Offset, Normalize, and Scale may be used independently or together as follows:

$$\text{Display} = \frac{\text{Measurement} + \text{Offset}}{\text{Normalize}} \times \text{Scale.}$$

Number value range: $\pm 1 \times 10^{-9}$ to $\pm 9 \times 10^9$.

Last display: causes value of previous display to Offset (negative value), Normalize, or Scale all subsequent measurements.

Measurement t-1: causes each new measurement to be Offset (negative value), Normalized, or Scaled by each immediately preceding measurement.

Hewlett-Packard interface BUS

Programmable controls: all measurement functions, Math, Statistics, Reset, Range Hold, Ext. Arm Enable/Slope, Check, Gate Adj. (~ 1 ms to 1 s), Gate Open/Close (gate times to ∞), Gate Mode, Cycle, Preset, Slope, Common A, Auto Trigger.

Special functions: FREQ B, PULSE B, TIME B \rightarrow A, TOT A-B, LEARN, MIN, MAX, all internal diagnostic routines.

Interface functions: SH1, AH1, TS, TEQ, L4, SL1, RL1, PP0, DC1, DT1, C0, E1 (see page 126).

Data output: fixed output format consisting of 19 characters plus CR and LF output is typically 8 ms.

Option 040: adds complete systems programmability; see column at right.

General

Gate: minimum, manual, or continuously variable (NORM/FAST) via Gate Adj. control.

NORM: 20 ms to 4 s NOMINAL.

FAST: 100 μ s to 20 ms NOMINAL.

MIN: minimum gate time. Actual time depends on function.

MANUAL: each press opens or closes gate.

Cycle: determines delay between measurements.

NORM: no more than 4 readings per second, nominal.

MIN: updates display as rapidly as possible (~ 15 readings per second, depending on function).

SINGLE: one measurement taken with each press of button.

Arming: Ext. Arm Enable key allows rear panel input to determine Start and/or Stop point of a measurement. External gate defined by both Start and Stop armed. All measurements are armable except Manual Totalize, Phase, and Trigger Level.

Start arm: + or - slope of arm input signal starts measurement.

Stop arm: + or - slope of arm input signal stops measurement. When used, Start Arm must occur before Stop Arm.

Ext. arm input: rear panel BNC accepts TTL into 20 k Ω . Minimum Start To Stop Time: 200 ns.

Trigger level out: dc output into 1 M Ω via rear panel BNCs for Channel A and B; not adjusted for attenuators.

Accuracy at dc ($\times 1$): ± 15 mV $\pm 0.5\%$ of TRIG LVL reading.

Gate out: TTL level into 50 Ω ; goes low when gate open; rear panel BNC.

Range hold: freezes decimal point and exponent of display.

Reset: starts a new measurement cycle when pressed.

Check: performs internal self test and lamp test.

Display: 12-digit LED display in engineering format; exponent range of +18 to -18.

Operating temperature: 0 to 50°C.

Power requirements: 100, 120, 220, 240 VAC (+5%, -10%), 48-66 Hz; 130 VA max.

Weight: net, 8.8 kg (19 lb 8 oz). Shipping, 13.6 kg (30 lb).

Dimensions: 425.5 mm W x 132.6 mm H x 345.4 mm D (16 $\frac{3}{4}$ in. x 5 $\frac{1}{4}$ in. x 13 $\frac{1}{2}$ in.), not including removable handles.

Options

Option 010: High Stability Time Base (oven)

Frequency: 10 MHz.

Aging rate: $< 5 \times 10^{-10}$ /day after 24-hour warm up.

Short term: $< 1 \times 10^{-10}$ rms for 1s average.

Temperature: $< 7 \times 10^{-9}$, 0 to 50°C.

Line voltage: $< 1 \times 10^{-10}$ for 10% change.

Warm-up: within 5×10^{-9} of final value in 20 minutes.

Option 020: DC Digital Voltmeter

Range: 4 digits, autoranging, autopolarity, in ± 10 , ± 100 , ± 1000 V ranges.

Sensitivity: 100 μ V, 1 mV, 10 mV, 100 mV for ± 1 V, ± 10 V, ± 100 V, ± 1000 V readings.

LSD displayed: same as sensitivity.

Input type: floating pair.

Input impedance: 10 M Ω $\pm 1\%$.

Option 030: 1.3 GHz C Channel

Input Characteristics

Range: 150 MHz to 1.3 GHz.

Sensitivity: 10 mV rms sinewave (-27 dBm) to 1 GHz. 100 mV rms sinewave (-7 dBm) to 1.3 GHz.

Frequency C

Range: 150 MHz to 1.3 GHz, prescaled by 20. LSD Displayed, Resolution, and Accuracy are same as Frequency A.

Ratio C/A

Range: channel A, 0 to 200 MHz.

channel C, 150 to 1300 MHz.

Option 040: Complete Systems Programmability

Adds remote selection of low pass filter, ac/dc coupling, $\times 1$ - $\times 10$ attenuation, dc trigger level and input impedance for both Channel A and B.

Definitions

Duty cycle: percentage of time a signal is high or low, depending on Slope A setting. Trigger point is high/low dividing point.

$$\text{DUTY CY} = \frac{\text{PULSE}}{\text{PER}} \times 100\%.$$

Slew rate: effective slope between 10% and 90% points of rising or falling signal depending on Slope A setting.

$$\text{SLEW} = \frac{V_B - V_A}{T_I}$$

Phase: angle, with respect to B signal, between 50% points of channel A and B signals, trigger slopes selected by Channel A and B slope switches.

$$\text{PHASE} = \frac{(T_{I1} + T_{I2}) 360^\circ}{2 \text{ PER}}$$

T_{I1} is time between 50% points of A then B signals using slopes defined during Phase measurement.

T_{I2} is time between 50% points of A then B signals using complement slopes to T_{I1} .

Front handles: supplied with instrument.

Ordering Information

HP 5335A Universal Counter

Opt 010 Oven Oscillator

Opt 020 DVM

Opt 030 C Channel

Opt 040 Expanded HP-IB Control

Opt 908 Rack Flange Kit for use without handles.

Opt 913 Rack Flange Kit for use with supplied front handles.

Price

\$3900

+ \$800

+ \$550

+ \$800

+ \$750

+ \$32

+ \$35

ELECTRONIC COUNTERS

100 MHz Universal Counters

Model 5328B

329



- 100 MHz and 1300 MHz
- 10 ns Time Interval
- T.I. Averaging to 10 ps resolution

- "Armed" measurements
- DVM option
- HP-IB Interface standard

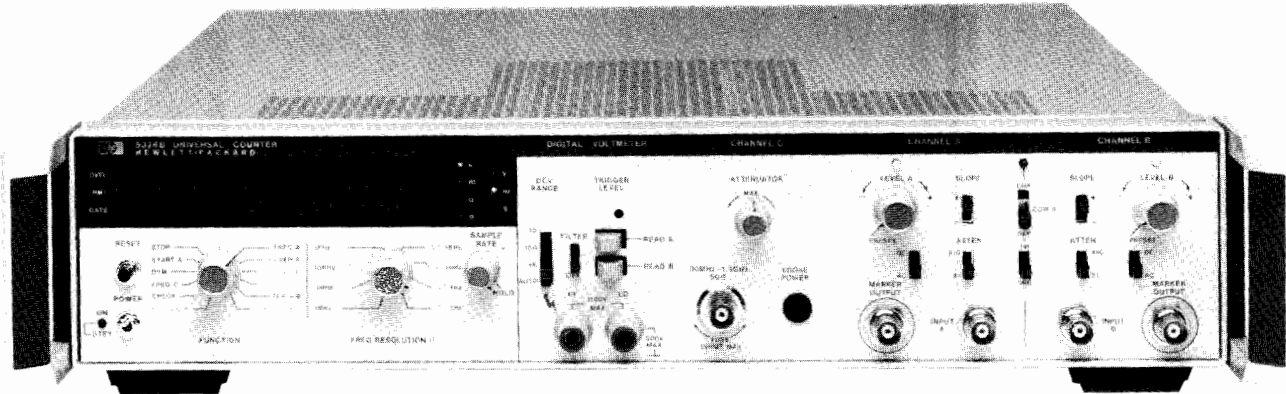

HP 5328B



Solid Universal Counter Performance for Bench or System

- Frequency measurements to 100 MHz, 1.3 GHz optional.
- 10 ns Time Interval resolution, 10 ps with averaging.
- 10 ns Period resolution, 1 fs with averaging.
- ± 1000 V dc DVM and High Stability Oven Time Base options.
- HP-IB programming and External Arming standard.

Condensed Specifications

Input Characteristics

Sensitivity: 25 mV rms, to 40 MHz; 50 mV rms, 40 MHz-100 MHz.
Attenuators (nominal): $\times 1$, $\times 10$ switch selectable.

Frequency A

Range: 0 to 100 MHz.

Period A

Range: 100 ns to 10^7 s with resolution to 10 ns.

Period Average A

Range: 100 ns to 10^7 s with resolution to 1 fs.

Time Interval A \rightarrow B

Range: 10 ns to 10^7 s with resolution to 10 ns.

Time Interval Average A \rightarrow B

Range: 0.1 ns to 1 s with resolution to 10 ps.

Minimum Dead Time: 40 ns.

Ratio B/A

Range: Channel A, 0 to 10 MHz; Channel B, 0 to 100 MHz.

HP-IB Interface Bus

Programmable functions: Functions, resolution, sample rate, (maximum or manual control), arming, display modes, measurement modes, output mode, and reset commands. Trigger level, trigger slope, input impedance, coupling, separate/common/check, invert A and B. Trigger level is programmable in 10 mV steps in $\times 1$; 100 mV in $\times 10$. Trigger level accuracy under remote control in $\times 1$: ± 35 mV.

Interface functions: SH1, AH1, T1, L2, SR1, RL1, PP0, DC1, DT1, C0, E1. (See page 126).

Service request (SRQ): if enabled, indicates end of measurement.

Maximum data output rate: 500 readings/s.

General

Display: 9-digit LED display.

Sample Rate: Variable from less than 2 ms between measurements to HOLD, which holds display indefinitely.

Gate Output: rear panel output; TTL levels.

Time Base Output: rear panel output; TTL levels.

Operating Temperature: 0° to 50° C.

Power Requirements: 100/120/240 V rms, +5%, -10% (switch selectable), 48-66 Hz; 150 VA max.

Time Base Oscillators

Standard Crystal Oscillator

Frequency: 10 MHz.

Aging Rate: $< 3 \times 10^{-7}$ /month.

Temperature: $< 2.5 \times 10^{-6}$, 0° to 50° C.

Line Voltage: $< 1 \times 10^{-7}$ for 10% change.

Option 010: Oven Oscillator

Frequency: 10 MHz.

Aging Rate: $< 5 \times 10^{-10}$ /day after 24-hour warm-up.

Short Term: $< 1 \times 10^{-10}$ rms/s.

Temperature: $< 7 \times 10^{-9}$, 0° to 50° C.

Line Voltage: $< 5 \times 10^{-9}$ for 10% variation.

Warm-Up: within 5×10^{-9} of final value in 20 minutes.

Option 021: High Performance Digital Voltmeter

Range: ± 10 , ± 100 , ± 1000 V dc and Autorange.

Sensitivity: 10 μ V, 100 μ V, 1 mV, 10 mV, 100 mV for measurement times of 10 s, 1 s 0.1 s, 10 ms, 1 ms respectively.

Input: floating pair, 10 M Ω nominal.

Maximum Input: hi to low: ± 1100 V all ranges; low to chassis ground: ± 500 V.

Trigger Level Measurements: 1 mV display resolution.

Option 031: 1300 MHz C-Channel

Input Characteristics

Sensitivity: 20 mV rms sine wave (-21 dBm).

Maximum Input: 5 V rms, ± 5 Vdc, fuse protected.

Frequency C

Range: 90 MHz to 1300 MHz, prescaled by 4 with resolution to 0.1 Hz.

Ratio C/A

Range: channel A, 0 to 10 MHz; channel C, 90 to 1300 MHz

Attenuation: continuously variable for optimum noise suppression.

Ordering Information

HP 5328B Universal Counter

Opt 010 High Stability Time Base

Opt 021 High Performance DVM

Opt 031 1300 MHz Channel C

Opt 050 DVM and Channel C

Opt 908 No Handles Rack Flange Kit

Opt 913 With Handles Rack Flange Kit

Price

\$4400

+ \$800

+ \$800

+ \$1000

+ \$1800

+ \$30

+ \$30



ELECTRONIC COUNTERS

Universal Counters

Models 5315A/B, 5316A

- Frequency, period, ratio, and totalize to 100 MHz
- Three versions: portable, rackable, or HP-IB
- 1 GHz capability available

- Uses reciprocal technique for full low-frequency resolution
- 100 ns time interval, 10 ps T.I. averaging
- Oven option for increased accuracy

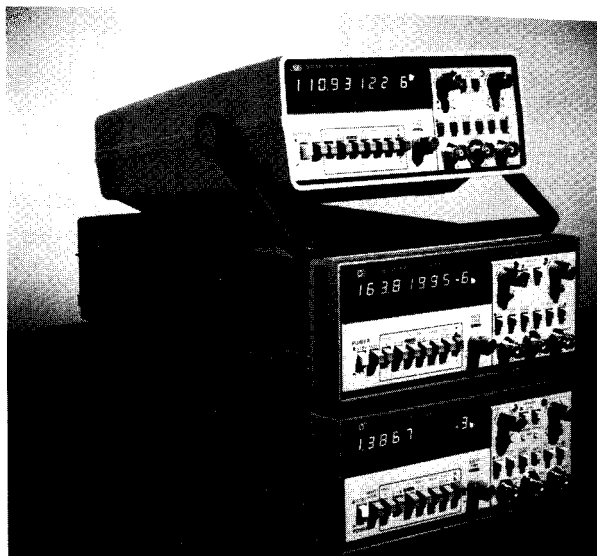

HP 5316A



HP 5315A/B and HP 5316A Universal Counters

A Quiet Revolution in Capability . . .

HP's economical HP 5315A/B, and HP 5316A counters provide all the universal counter capability you've come to expect at much higher prices. That's because they use a unique custom circuit called the MRC (Multiple Register Counter) which packs counting and computing power into this popular counter series. To a user, the differences in operation from conventional direct models can be listed quickly: low frequency resolution is an outstanding 7 digits per second of gate time and reliability is extremely good due to the counter's low chip count. Also, the continuously adjustable gate time allows automatic selection of sample size for easy trade-offs between measurement time and resolution.

Much of the counter's performance is based on reciprocal counting techniques first pioneered in HP's high-performance HP 5360A computing counter, and the current HP 5345A Universal Counter. The use of these techniques coupled with HP's MRC and a microprocessor provides a quiet but powerful revolution in counter performance within the HP 5315A/B and HP 5316A. For example, this counter gives you its full 7-digits/second resolution over the range from 1 Hz to 100 MHz. This, simply stated, shows the power of the MRC and reciprocal counting.

High Performance, Low Price

In addition to its economy, the MRC counter offers a full set of universal counter measurements, and there are very few limitations to this capability. Increased accuracy in low-cost portable and system counters is also available with the oven oscillator option through improved temperature stability and lower aging rates.

Frequency to 100 MHz, C-Channel to 1.0 GHz

The MRC counter measures frequency to 100 MHz. Additionally the optional C-Channel measures to 1.0 GHz for both CW and pulsed RF signals as narrow as 60 ms. The C-Channel option is particularly useful in navigation and communications equipment testing due to this pulsed RF measurement feature.

Time Interval to 100 ns, T.I. Averaging to 10 ps

The MRC counter provides three time measurement modes. Single-shot time interval allows measurements over a range of 100 ns to 100,000 seconds. This capability can be used to measure pulse width. Time interval averaging provides greater resolution for repetitive events. Finally, time interval delay avoids measurement of spurious signals by holding off the counter's trigger point by a precise, operator-selectable amount of time.

A Full Set of Measurements

Besides the frequency and time functions mentioned above, the MRC counter has other measurement functions that make it a truly impressive value:

Period A—allows single period measurements via Channel A.

Ratio A/B—allows frequencies to 100 MHz into both Channel A and B.

A By B—totalizes the A input between 2 events on B channel.

Totalize—a manually gated totalize mode of operation.

Input Signal Conditioning Versatility

A full complement of input signal conditioning controls are provided for both channels. These include \pm slope, ± 2.5 Vdc trigger level, and ac/dc coupling. Other controls are a Separate/Common switch, and a 100 kHz low-pass filter for Channel A.

A Choice of Three Models

The MRC counter is available in three different versions:

HP 5315A: a portable, light-weight unit best suited for field applications. This unit has a convenient carrying handle and optional battery power is available for up to 4 hours continuous operation. Despite its high impact plastic case, the HP 5315A possesses low RFI/EMC characteristics, making it equally suitable for bench use.



HP 5315B: a rackable, stackable counter that is designed to meet the most demanding RFI/EMC specs, the HP 5315B is intended primarily for rack mount use.

HP 5316A: this model possesses all the characteristics of both the HP 5315A and HP 5315B, and it has HP-IB capability built-in as standard equipment. It has low RFI, it is rackable, and it is functionally identical to the HP 5315A/B. In addition to programmable measurement functions, the user can also select dc trigger level and \pm slope under HP-IB control. Channel A and B trigger levels are brought out to the front panel on this unit for easy measurement with a DVM.

HP 5315A/B 5316A Condensed Specifications

Input Characteristics (channel A and channel B)

Range: dc coupled 0 to 100 MHz.

ac coupled 30 Hz to 100 MHz.

Sensitivity: 10 mV rms sine wave to 10 MHz.

25 mV rms sine wave to 100 MHz.

75 mV peak-to-peak pulse at minimum pulse width of 5 ns.

Sensitivity can be varied continuously up to 500 mV rms *NOMINALLY* by adjusting sensitivity control. In sensitivity mode, trigger level is automatically set to 0 V *NOMINAL*.

Dynamic Range

30 mV to 5 V peak-to-peak, 0 to 10 MHz.

75 mV to 5 V peak-to-peak, 10 to 100 MHz.

Coupling: ac or dc, switchable.

Filter: low pass, switchable in or out of Channel A. 3 dB point of 100 kHz *NOMINALLY*.

Impedance: 1 M Ω *NOMINAL* shunted by less than 40 pF.

Signal operating range: +2.5 Vdc to -2.5 Vdc.

Attenuator: $\times 1$ or $\times 20$ *NOMINAL*.

Trigger level: variable between +2.5 Vdc and -2.5 Vdc.

Slope: independent selection of + or - slope.

Common input: all specifications are the same for Common A except the following:

Sensitivity: 10 mV rms sine wave to 10 MHz; 25 mV rms sine wave to 50 MHz; 50 mV rms to 100 MHz; 150 mV peak-to-peak at a minimum pulse width of 5 ns.

Dynamic range: 30 mV to 5 V peak-to-peak to 10 MHz; 75 mV to 5 V peak-to-peak, 10-50 MHz; 150 mV to 5V peak-to-peak, 50-100 MHz.

Impedance: 500 k Ω *NOMINAL* shunted by less than 70 pF.

Damage Level

ac & dc $\times 1$:

dc to 2.4 kHz

2.4 kHz to 100 kHz

> 100 kHz

ac & dc $\times 20$:

dc to 28 kHz

28 kHz to 100 kHz

> 100 kHz

250 V (dc + ac rms)

6 $\times 10^5$ V rms Hz/FREQ

6 V rms

500 V (dc + ac peak)

1 $\times 10^7$ V rms Hz/FREQ

100 V rms

Frequency (channel A)

Range: 0.1 Hz to 100 MHz.

LSD displayed: 10 Hz to 1 nHz depending upon gate time and input signal. At least 7 digits displayed per second of gate time.

Period

Range: 10 ns to 10^5 s.

LSD displayed: 100 ns to 1 fs depending upon gate time and input signal. At least 7 digits displayed per second of gate time.

Time Interval

Range: 100 ns to 10^5 s.

LSD displayed: 100 ns.

Time Interval Average

Range: 0 ns to 10^5 s.

LSD displayed: 100 ns to 10 ps depending upon gate time and input signal.

Number of intervals averaged (N): N = Gate Time \times FREQ.

Minimum dead time (stop to start): 200 ns.

Time Interval Delay (holdoff)

Front panel gate time knob inserts a variable delay of *NOMINALLY* 500 μ s to 30 ms between START (Channel A) and enabling of STOP (Channel B). Electrical inputs during delay time are ignored. Delay time may be digitally measured by simultaneously pressing T.I. Averaging, T.I. Delay and blue key.

Ratio

Range: 0.1 Hz to 100 MHz, both channels.

LSD: $\frac{2.5 \times \text{Period A}}{\text{Gate Time}}$ \times Ratio (rounded to nearest decade).

Totalize

Manual

Range: 0 to 100 MHz.

A gated by B

Totalizes input A between two events of B. Instrument must be reset to make new measurement. Gate opens on A slope, closes on B slope. Range: 0 to 100 MHz.

General

Standard Time Base

Frequency: 10 MHz.

Aging rate: $< 3 \times 10^{-7}$ /mo.

Temperature: $\pm 5 \times 10^{-6}$, 0 $^\circ$ to 50 $^\circ$ C.

Line voltage: $< 1 \times 10^{-7}$ for a $\pm 10\%$ variation.

Check: counts internal 10 MHz reference frequency over gate time range *NOMINALLY* 500 μ s to 30 ms.

Error light: LED warning light activated if logic error is found during instrument turn-on self-check.

Display: 8-digit LED display, with engineering units annunciator.

Overflow: only frequency and totalize measurements will overflow. In case of overflow, eight least significant digits will be displayed and front panel overflow LED will be actuated. All other measurements which would theoretically cause a display of more than 8 digits will result in the display of the 8 most significant digits.

Gate time: continuously variable, *NOMINALLY* from 60 ms to 10 s or 1 period of the input, whichever is longer.

Sample rate: up to 7 readings per second *NOMINAL* except in time interval mode, where it is continuously variable *NOMINALLY* from 250 ms to 10 s via Gate Time Control.

Operating temperature: 0 $^\circ$ to 50 $^\circ$ C.

Power requirements: 100, 120, 220, 240 V (+5%, -10%) 48-66 Hz; 15 VA maximum or 30 VA maximum (HP 5316A).

Weight: net, 2.2 kg (4 lb 12 oz). Shipping, 4.1 kg (9 lb).

Dimensions: 238 mm W \times 98 mm H \times 276 mm D (9 $\frac{3}{8}$ in. \times 3 $\frac{3}{8}$ in. \times 10 $\frac{7}{8}$ in.).

Additional HP 5315B Specifications

Rack and stack metal case with rear panel, switchable ac power line module. Specifications same as HP 5315A except as follows:

Rack mount: HP 5061-9672 recommended.

Oscillator output: 10 MHz, 50 mV pk-pk into 50 Ω load, on rear panel.

External frequency standard input: 10 MHz, 1 V rms into 500 Ω , on rear panel.

Dimensions: 212 mm W \times 88 mm H \times 345 mm D (8 $\frac{3}{8}$ in. \times 3 $\frac{1}{2}$ in. \times 13 $\frac{3}{4}$ in.).

Weight: net, 3.2 kg (7 lb 2 oz). Shipping, 4.5 kg (10 lb).



ELECTRONIC COUNTERS

Universal Counters

Models 5315A/B, 5316A (cont.)

Additional HP 5316A Specifications

Rack and stack metal case with rear panel, switchable ac power line module, Specifications same as HP 5315A except as follows:

Rack mount kit: HP 5061-9672 recommended.

Oscillator output: 10 MHz, 50 mV p-p into 50 Ω load on rear panel.

External frequency standard input: 1, 5, 10 MHz, 1 V rms into 500 Ω , or rear panel.

Trigger level output: $\pm 5\%$, ± 15 mV, over ± 2.0 Vdc range at front panel connectors.

Dimensions: 212 mm W x 88 mm H x 415 mm D (8 3/8 in. x 3 1/2 in. x 16 1/2 in.).

Weight: net, 3.9 kg (8 lb 10 oz). Shipping, 6.3 kg (14 lb).

Hewlett-Packard interface Bus

Programmable functions: Frequency A, Frequency A Armed by B, Totalize, A Gated by B, Ratio A/B, Time Interval Average A \rightarrow B, Time Int. Delay, Read Gate Time, Display Test, 10 MHz Check, Interface Test, Initialize, Reset, Wait State ON/OFF.

Programmable controls: Gate Time Command which sets long (60 ms to 10 s) or short (500 μ s to 30 ms) range; Trigger Level Commands which set Channel A and/or B slope (\pm) and Channel A and/or B trigger from -2.50 Vdc to $+2.50$ Vdc in steps of .01V.

HP-IB Interface Functions: SH1, AH1, T1, L2, SR1, RL1, PP0, DC1, DT1, C0, E1 (see page 126).

Options

Opt. 001: High Stability Time Base (TCXO).

Frequency: 10 MHz.

Aging rate: $< 1 \times 10^{-7}$ /mo.

Temperature: $\pm 1 \times 10^{-6}$, 0° to 40°C.

Line voltage: $< 1 \times 10^{-8}$ for $\pm 10\%$ variation.

Opt. 002: battery (HP 5315A only).

Type: rechargeable lead-acid (sealed).

Capacity: TYPICALLY 4 hours of continuous operation at 25 °C.

Recharging time: TYPICALLY 16 hours to 98% of full charge, instrument non-operating. Charging circuitry included with Option. Batteries not charged during instrument operation.

Low voltage indicator: instrument turns itself off automatically when low battery condition exists. *Discharge* LED flashes slowly when this happens. *Discharge* LED is on whenever battery is supplying power to instrument. *Charge* LED indicates state of charge of battery during charging only and is on whenever battery is charged to 95% *NOMINAL* of capacity. *Charge* LED flashes when 90% *NOMINAL* of charge taken out is replaced. *Charge* LED is off if charge is less than 70% *NOMINAL* of capacity.

Line failure protection: instrument automatically switches to battery in case of line failure.

Weight: Opt 002 adds 1.4 kg (3 lb) to weight of instrument.

Option 003: C Channel.

Input Characteristics

Range: 50 to 1000 MHz, prescaled by 10.

Sensitivity: 15 mV rms sinewave (-23.5 dBm) to 650 MHz. 75 mV rms sinewave (-9.5 dBm) to 1000 MHz.

Sensitivity can be decreased continuously by up to 20 dB *NOMINAL*, 50 to 500 MHz and 10 dB *NOMINAL*, 500 to 1000 MHz by adjusting sensitivity control. Trigger level is fixed at 0 V *NOMINAL*.

Dynamic range: 15 mV to 1 V rms (36 dB), 50 to 650 MHz. 75 mV to 1 V rms (20 dB), 650 to 1000 MHz.

Signal operating range: $+5$ Vdc to -5 Vdc.

Coupling: ac.

Impedance: 50 Ω *NOMINAL* (VSWR, $< 2.5:1$ TYPICAL).

Damage level: ± 8 V (dc + ac peak), fuse protected. Fuse located in BNC connector.

Frequency (channel C) Range: 50 to 1000 MHz.

LSD displayed: 100 Hz to 1 Hz depending upon gate time. At least 7 digits per second of gate time.

Option 004: High Stability OVEN Time Base (HP 5315A only).

Frequency: 10 MHz.

Aging rate: $< 3 \times 10^{-8}$ /mo.*.

Temperature: $\pm 1 \times 10^{-7}$, 0° to 50°C.

Line voltage: $< 1 \times 10^{-8}$, for a 10% variation.

Oven will operate continuously off of a fully charged battery for > 24 hours, typically, when in standby mode (no power applied, instrument OFF, and Freq. A button depressed).

(HP 5315B and HP 5316A)

Frequency: 10 MHz.

Aging rate: $< 3 \times 10^{-8}$ /mo.**

Temperature: $\pm 2 \times 10^{-8}$, 0° to 50°C.

Line voltage: $< 1 \times 10^{-9}$, for a 10% variation.

Ordering Information

HP 5315A Universal Counter **\$1100** ☎

HP 5315B Universal Counter **\$1500** ☎

HP 5316A Universal Counter **\$1900**

		HP 5315A	HP 5315B	HP 5316A	Price
Opt 001	TCXO Time Base	X	X	X	+\$150
Opt 002	Battery Pack	X			+\$300
Opt 003	C-Channel (1.0 GHz)	X			+\$300
			X	X	-\$400
Opt 004	High Stability OVEN Time Base	X			+\$450
			X	X	+\$600

All HP 5315A orders must include one (1) of these line power options: **Price**

Opt 100 90-105 VAC N/C

Opt 120 108-126 VAC N/C

Opt 220 198-231 VAC N/C

Opt 240 216-252 VAC N/C

☎ Fast-Ship product—see page 766.

* After 30 days continuous operation (ac power applied, in OFF or ON position).

** After 30 days continuous operation.

$< 5 \times 10^{-9}$ /mo., after 7 days continuous operation.

ELECTRONIC COUNTERS

Low Cost Universal

Model 5314A

333



- 100 MHz
- 100 ns time interval
- Portable

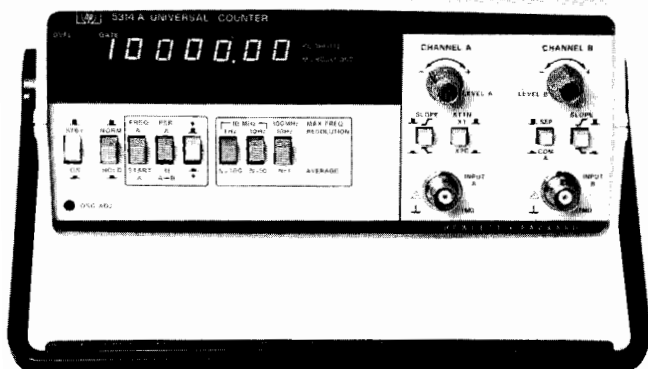

HP 5314A

HP 5314A Universal Counter

The HP 5314A Universal Counter combines excellent performance and traditional HP quality at a very attractive price. This counter is designed to deliver reliable, high quality operation in such areas as: Production Test, Frequency Monitoring, Education, Training, Service and Calibration. Additionally, the optional battery (option 002) makes the HP 5314A especially attractive for field and portable applications.

Input Characteristics (channels A and B)

Range: CHANNEL A: 10 Hz to 10 MHz Direct.
1 MHz to 100 MHz Prescaled.
CHANNEL B: 10 Hz to 2.5 MHz.

Sensitivity: CHANNEL A: 25 mV rms to 100 MHz.
75 mV peak-to-peak at minimum pulse width of 5 ns (100 MHz range).
CHANNEL B: 25 mV rms to 2.5 MHz.
75 mV peak-to-peak at minimum pulse width of 200 ns.

Coupling: ac.

Impedance: 1 MΩ NOMINAL shunted by less than 30 pF.

Attenuator: ×1 or ×20 NOMINAL (A channel only).

Trigger level: continuously variable ± 350 mV times attenuator setting around average value of signal.

Slope: independent selection of + or - slope.

Channel input: selectable SEPARATE OR COMMON A.

Dynamic range: 75 mV p-p to 4 V p-p.

Frequency

Range: 10 Hz to 10 MHz direct count.

1 MHz to 100 MHz prescaled by 10.

Least significant digit (LSD) displayed: direct count 0.1 Hz, 1 Hz, 10 Hz switch selectable. Prescaled 10 Hz, 100 Hz, 1 kHz switch selectable.

Resolution: ± LSD.

Accuracy: ± LSD ± (time base error) x Freq.

Period

Range: 10 Hz to 2.5 MHz.

LSD displayed: $\frac{100 \text{ ns}}{N}$ for N=1 to 1000 in decade steps of N.

Resolution: ± LSD ± $\frac{(1.4 \times \text{TRIGGER ERROR})}{N}$

Accuracy: ± LSD ± $\frac{(1.4 \times \text{TRIGGER ERROR})}{N}$

± (time base error) x Period.

Time Interval

Range: 250 ns to 1 s.

LSD displayed: 100 ns.

Resolution: ± LSD ± START trigger error ± STOP trigger error.

Accuracy: ± LSD ± START trigger error

± STOP trigger error ± (time base error) x TI.

External arming required for START/STOP channels.

Ratio (A to B)

Range: 10 Hz to 10 MHz CHANNEL A.

10 Hz to 2.5 MHz CHANNEL B.

LSD displayed: 1/N in decade steps of N for N = 1 to 1000.

Resolution: ± LSD ± (B trigger error x Frequency A)/N.

Accuracy: ± LSD ± (B trigger error x Frequency A)/N.

Totalize

Range: 10 Hz to 10 MHz.

Resolution: ± 1 count of input.

Totalize controlled by front panel switch.

General

Check: counts internal 10 MHz oscillator.

Display: 7 digit amber LED display with gate and overflow indication.

Max sample rate: 5 readings per second.

Operating temperature: 0° to 50 °C.

Power requirement: 115, +10%, -25%; 230 V, +9%, -17%; 48-66 Hz; 10 VA max.

Weight: 2.0 kg (4.4 lb).

Dimension: 238 mm W x 98 mm H x 276 mm D (9 3/8 in. x 3 7/8 in. x 10 7/8 in.).

Time Base

Frequency: 10 MHz.

Ageing rate: < 3 parts in 10⁷ per month.

Temperature: < ± 1 part in 10⁵, 0 to 50 °C.

Line voltage: < ± 1 part in 10⁷ for ± 10% variation.

Options

Option 001 TCXO

Frequency: 10 MHz.

Ageing rate: < 1 part in 10⁷ per month.

Temperature: < ± 1 part in 10⁶, 0 to 40 °C.

Line voltage: < ± 1 part in 10⁸ for ± 10% variation.

Option 002 Battery

Type: rechargeable lead-acid (sealed).

Capacity: typically 8 hours of continuous operation at 25 °C.

Recharging time: typically 16 hours to 98% of full charge, instrument non-operating. Charging circuitry included with option. Batteries not charged during instrument operation.

Battery voltage sensor: automatically shuts instrument off when low battery condition exists.

Line failure protection: instrument automatically switches to batteries in case of line failure.

Weight: Option 002 adds typically 1.5 kg (3.3 lb) to weight of instrument.

Definitions

Resolution: smallest discernible change of measurement result due to a minimum change in the input.

Accuracy: deviation from the actual value as fixed by universally accepted standards of frequency and time.

Trigger error:

$$\frac{\sqrt{(80 \mu\text{V})^2 + e_n^2}}{\text{input slew rate at trigger point } (\mu\text{V/s})} \text{ (rms)}$$

Where e_n is the RMS noise of the input for a 100 MHz bandwidth in CHANNEL A and 10 MHz bandwidth in CHANNEL B.

Ordering Information

HP 5314A 100 MHz/100 ns Universal Counter

Opt 001 High Stability Time Base

Opt 002 Battery

All orders must include one (1) of these line power options:

Opt 115 86-127 V

Opt 230 190-250 V

☎ Fast-Ship product — see page 750.

Price

HP 5314A \$550 ☎

Opt 001 \$150

Opt 002 \$150

Opt 115 N C

Opt 230 N C



FREQUENCY & TIME STANDARDS

General Information

Hewlett-Packard offers frequency standards and clocks which provide accurate frequency, time interval and timekeeping capabilities. Further, Hewlett-Packard standards provide means for comparing these quantities against national standards such as the National Bureau of Standards (NBS) and the U.S. Naval Observatory. Units of frequency or time cannot be kept in a vault for ready reference. They must be generated for each use, hence be regularly compared against recognized primary standards.

Frequency standards and clock systems manufactured by Hewlett-Packard are used for control and calibration at observatories, national centers for measurement standards, physical research laboratories, missile and satellite tracking stations, communication systems, radio navigation systems, manufacturing plants and radio monitoring and transmitting stations.

Types of Frequency Standards

At the present time, three types of frequency standards are in common use. These are:

1. The cesium atomic beam controlled oscillator.
2. The rubidium gas cell controlled oscillator, and
3. The quartz crystal oscillator.

Hewlett-Packard manufactures all three types of frequency standards. Of these three standards, the first is a primary frequency standard and the last two are secondary frequency standards. The distinction between a primary standard and a secondary standard is that the primary standard does not require any other reference for calibration; whereas the secondary standard requires calibrations both during manufacturing and at intervals during use depending on the accuracy desired.

Cesium Beam Frequency Standard

Cesium beam standards are in use wherever the goal is a very high accuracy primary frequency standard. In fact, the NBS frequency standard itself is of the cesium beam type. The cesium beam standard is an atomic resonance device which provides access to one of nature's invariant frequencies in accord with the principles of quantum mechanics. The cesium standard is a true primary standard and requires no other reference for calibration.

Rubidium Frequency Standard

Rubidium frequency standards feature a high order of both short-term and long-term frequency stability. These are both important in certain fields such as deep-space communications, satellite ranging, and doppler radar.

Rubidium standards are similar to cesium beam standards in that an atomic resonant element prevents drift of a quartz oscillator through a frequency lock-loop. Yet the rubidium gas cell is dependent upon gas mixture and gas pressure in the cell. It must be calibrated and then it is subject to a small degree of drift. The drift is typically 100 times less than the best quartz crystal standard.

TABLE 1 Comparison of Frequency Standards

Standard	Principal construction feature	Principal advantage
Cesium Atomic Beam Resonator Controlled Oscillator.	Beam of free cesium atoms, spatially state selected, is subjected to a microwave signal at resonance frequency.	High intrinsic reproducibility and long-term stability. Designated as primary standard for definition of time interval.
Rubidium Gas Cell Resonator Controlled Oscillator.	Gas buffered resonance cell with optically pumped state selection.	Compact and light weight. High degree of short-term stability.
Quartz Crystal Oscillator.	Piezoelectrically active quartz crystal with electronic stabilization.	Very compact, light and rugged. Inexpensive.

Quartz Crystal Oscillators

Quartz oscillators are used in virtually every frequency control application including atomic standards. The excellent short-term stability and spectral purity of the quartz oscillators used in Hewlett-Packard atomic standards contribute to the high quality of the output signal of these standards. For less demanding applications where some long-term drift can be tolerated, quartz oscillators are used as independent frequency sources.

Frequency Standards and Clocks

Frequency standards and clocks have no fundamental differences—they are based upon dual aspects of the same phenomenon. Time and frequency are intangible quantities which can be measured only with respect to some physical quantity. The basic unit of time, the second, is defined as the duration of 9,192,631,770 periods of transition within the cesium atom. Conversely an unknown frequency is determined by counting the number of cycles over the period of a second. The Master Clock at the U.S. Naval Observatory, one of the world's most accurate clocks, is made of an ensemble of more than a dozen Hewlett-Packard cesium beam frequency standards. The USNO directly controls the distribution of precise time and time interval (frequency) from Naval radio stations, Loran-C (operated by U.S. Coast Guard), Omega and Satellite Navigation Systems. Hewlett-Packard portable cesium standards, "flying clocks," are used to periodically check the synchronization between these stations and the Master Clock.

Hewlett-Packard cesium beam standards are widely used to drive precision clocks because of the extremely good long-term stability and reliability of this primary standard. If a quartz oscillator or other secondary standard is used, it must be evaluated for rate of drift and be corrected periodically.

Time Scale

The time interval of the atomic time scale is the International Second, defined in October 1967 by the Thirteenth General Conference of Weights and Measures. Since January 1972 the frequency offset between UTC and Atomic Time has been zero and the UTC time scale is kept in synchronism with the rotation of the earth to within ± 0.9 second by step-time adjustments of exactly 1 second, when needed (see Hewlett-Packard Application Note 52-2).

The U.S. National Bureau of Standards (NBS) and USNO provide the official basis for Standard Time for the United States. The UTC signal is broadcast from the NBS stations WWV and WWVB and by several other stations throughout the world. (See Hewlett-Packard Application Note 52-1, Fundamentals of Time and Frequency Standards, for a list of stations broadcasting time signals).

Standby Power Supplies

Minimum down-time, important for any system, is vital to a time standard. Its worth depends directly on continuity of operation. Noninterrupted operation is also important to ultra-precise quartz oscillators.

Hewlett-Packard standby power supplies ensure continued operation despite line interruptions, and operate over a range of ac line voltage to supply regulated dc to operate frequency standards and frequency dividers and clocks. The batteries in the supplies assume the full load immediately when ac power fails.

Hewlett-Packard Time and Frequency Standard

The Hewlett-Packard House Standard at the Santa Clara Division consists of an ensemble of five Hewlett-Packard Cesium Beam Standards each with the Option 004 High Performance Tube.

The standard is compared to the U.S. Naval Observatory Master Clock in Washington, D.C. by means of the Global Positioning (GPS) navigation system. It is also compared with the U.S. National Bureau of Standards Frequency Standard (NBS FS) at Boulder, Colorado by means of GPS through the Naval Observatory. The frequency uncertainty of the standard is within a few parts in 10^{13} with respect to the standards maintained by the NBS and the USNO.

Time is maintained relative to the Naval Observatory and the National Bureau of Standards master clocks to an accuracy of better than ± 1.0 microseconds. This accuracy is verified with flying clock trips from the Naval Observatory to both Hewlett-Packard Santa Clara Division and Hewlett-Packard Geneva. Both locations have been designated U.S. Naval Observatory Time Reference Stations.

FREQUENCY & TIME STANDARDS

Atomic Frequency Standards

Models 5061B

335



- HP 5061B
- Improved accuracy $\pm 6 \times 10^{-12}$
 - Primary standard
 - Proven reliability

- HP 5061B, Opt 004
- Accuracy $\pm 4 \times 10^{-12}$
 - Settability $\pm 1 \times 10^{-13}$
 - Time domain stability 5×10^{-12} (1 s avg)

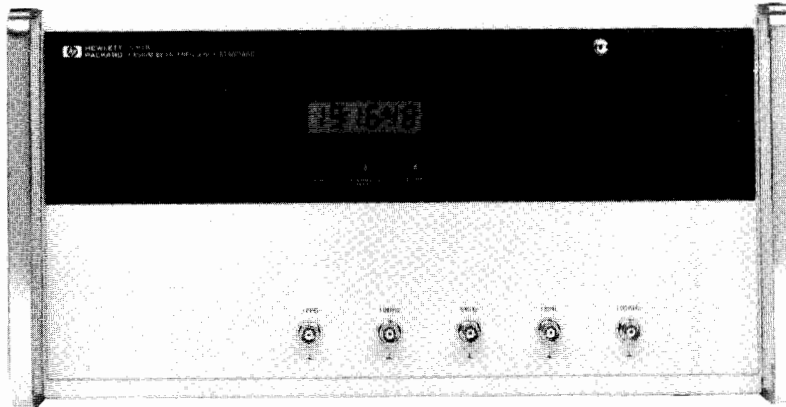

HP 5061B

HP 5061B Cesium Beam Standard

The first Hewlett-Packard Cesium Beam Standard, the HP 5060A, was introduced in 1964. This was followed in 1967 with the improved HP 5061A and in 1973 with the high performance beam tube option for the HP 5061A. Since this time the accuracy and reliability of Hewlett-Packard cesium beam standards has been demonstrated and these standards have become the world-wide standard for frequency and time keeping. The HP 5061B has provision for an optional digital divider and reliable, easy-to-read LED clock (Option 003) and for a battery with 3/4 hour standby power capacity with automatic charging.

Reliability and warranty: over 100 million operation hours have proven the performance and reliability of Hewlett-Packard cesium beam standards in various world-wide applications. The units have provided dependable microsecond accuracy in aircraft, ship and fixed environments.

A three-year warranty on the HP 5061B standard cesium beam tube is provided as a result of proven field reliability over an extended period. This warranty includes replacement of the cesium beam tube if it should fail within the warranty period.

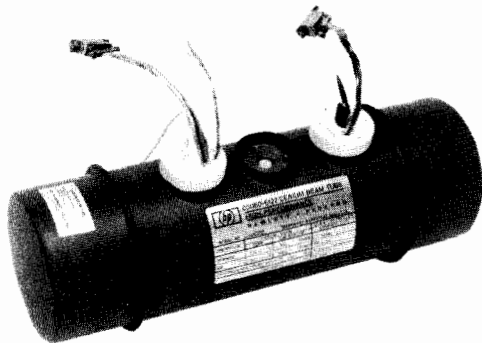

Option 004, High Performance Cesium Beam Tube

HP 5061B with Opt 004, High Performance Cesium Beam Tube

The Hewlett-Packard 5061B primary frequency standard with the Option 004 Cesium Beam Tube offers increased stability and accuracy in the instrument which has become the worldwide standard of frequency and time keeping since its introduction in 1967. Improvements in magnetic shielding, ruggedization and environmental performance permit improved performance and expansion of navigation

and communication systems that have been made practical by the HP Cesium Beam Frequency Standard.

The design concept of the high-performance beam tube includes unique HP designed dual-beam optics with higher beam intensity to accomplish better short-term stability and greater immunity to effects of shock and vibration. A 50 percent increase in resonance cavity length without change in the overall beam tube size contributes to better accuracy and settability because of the high Q of the narrower resonant line width. This tube retains the unique cesium standard feature of virtually no long term instability or aging.

The intrinsic accuracy is improved to $\pm 4 \times 10^{-12}$ which provides an excellent reference standard without need of calibration. If desired, as in many timekeeping applications, two or more units may be calibrated to determine the difference in rate or may be adjusted to the same frequency. With the improved settability specifications of 1×10^{-13} small changes in frequency are accomplished rapidly and accurately. A provision for degaussing the tube without adversely affecting the instrument operation allows removal of any residual magnetic field in the tube. This is important in achieving the settability performance.

The short term stability specification is improved by a factor of ten with this tube. The 5×10^{-12} (1 s avg.) performance compares very favorably with that of rubidium type standards which are noted for their excellent short term stability. An important advantage from the better short term stability is the capability to make measurements to 1 sigma precision of 1×10^{-12} in about one minute compared to the two hours required previously. The HP 5061B with the Option 004 High Performance Tube has the same high reliability as the HP 5061B with the standard tube. The new high performance tube is warranted for one year, but is designed to have the same long life as the standard tube.*

HP E21-5061B Flying Clock

The HP E21-5061B consists of a HP 5061B Cesium Beam Standard with Option 003 LED Clock and HP 5089A Power Supply joined together to make one portable unit. The power supply, which can be operated from 11 to 30 V dc, 85 to 255 V ac, will provide approximately 10 hours standby power (from sealed immobilized electrolyte lead calcium batteries) for the HP 5061B Cesium Beam Standard.

This wide range of operating power capabilities enable the HP E21-5061B to operate on local power in virtually any country in the world. The 10 hours standby capability make it possible to travel where there is no power available and, of course, allow the HP E21-5061B to conveniently be transported between power sources and operated in almost any air or surface vehicle as a "flying clock" (see Hewlett-Packard Journal, August 1966 and December 1967).

The Option 004 tube, because of the improved shielding, offers a significant increase in accuracy under the varying earth's magnetic field conditions experienced by flying clocks and is a desirable addition to the HP E21-5061B. In addition, the better short term stability permits more accurate and rapid comparison of standards.

*See page 340 for ordering information.

FREQUENCY & TIME STANDARDS

Atomic Frequency Standards

Model 5061B (cont.)



HP 10638A

HP 10638A Degausser

The HP 10638A Degausser is designed for use with the Option 004 High Performance Cesium Beam Tube without interrupting normal operation. The degausser removes residual magnetism in the shields of the beam tube which can build up over time, due to a changing magnetic environment, and can cause a frequency offset. Relaxation of the residual magnetism insures a settability of $\pm 1 \times 10^{-13}$, allowing stable precise changes in output frequency and a reproducibility of $\pm 3 \times 10^{-12}$. The degausser should be used when initially setting up the HP 5061B with Option 004 or after the instrument has been moved or adjusted.*

HP 5061B with Option 003, Time Standard and Standby Power Supply

The HP 5061B has provision for an optional digital divider and reliable, easy to read LCD, time-of-day, 24-hour digital clock (Option 003). By including this option, the number of applications and the versatility of the cesium standard is increased. The one-pulse-per-second output can simplify the comparison with other standards (such as portable and secondary standards) as well as GPS and Loran Systems. The techniques for such comparisons are described in Application Note AN-52. Option 003 also includes an internal battery power supply which will provide at least 45 minutes of standby power if the line power should fail. This will prevent phase and frequency interruptions due to intermittent or an extended power failure. Battery power also enables moving the cesium beam standard to locations of other secondary standards without losing time.*

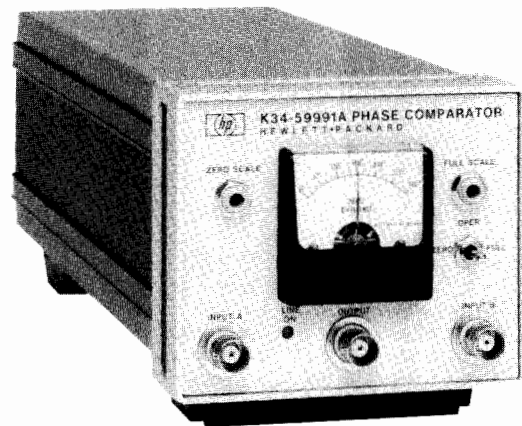

HP K34-59991A

HP K34-59991A Phase Comparator

The HP K34-59991A Broadband Linear Phase Comparator accurately compares the phase relationship of the output signals of two frequency standards having the same nominal frequency. This will enable resolving extremely small differences between precision frequency sources. The Phase Comparator operates over a frequency range of 10 kHz to 50 MHz and input levels between 100 mV and 10 V rms. A linear dc output voltage, proportional to the phase differences between the two standards, is available at both the front and rear panels. This voltage is also monitored on a front-panel meter and is suitable for driving a stripchart recorder, thus allowing longterm monitoring of the frequency standards. By using this comparator, very small frequency differences can be detected and adjustments can be made to frequency standards to correct for timekeeping errors.*

HP J45-5061 Certified Stability of 1×10^{-13}

The HP J45-5061B is a special option which will certify that the Model HP 5061B with standard Options 003 and 004 has stability performance of better than or equal to 1×10^{-13} in a day, when measured each day for any five consecutive days. This means that the cesium standards absolute deviation from the HP Santa Clara Division House Standard is less than or equal to 8.64 ns per day on each of the five consecutive days during the certification. The certification applies only to original shipments and is performed under calibration laboratory conditions with the cesium beam tube degaussed and operating in a stable magnetic environment and over a restricted temperature range of ± 2.5 degrees range at any temperature between 15 and 35 degrees C.*

* See page 340 for ordering information.

FREQUENCY & TIME STANDARDS

Atomic Frequency Standards

Model 5065A

337



- Compact, high reliability, proven performance
- Long term drift rate $< 1 \times 10^{-11}$ /month
- Time domain stability $< 5 \times 10^{-13}$ (100 s, avg)
- High reliability

- Proven performance
- Compact
- Long-term drift rate $< 1 \times 10^{-11}$ /month
- Time domain stability $< 5 \times 10^{-13}$ (100 s, avg.)

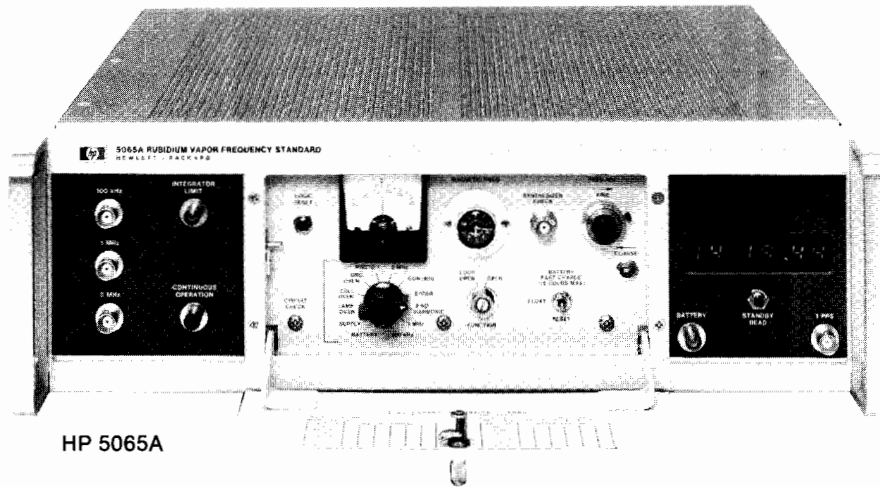

HP 5065A Rubidium Frequency Standard

The HP 5065A is an atomic-type secondary frequency standard which uses a rubidium vapor resonance cell as the stabilizing element. As a result, it has long-term stability of better than 1×10^{-11} per month which exceeds that of high quality quartz oscillator frequency standards by 50 to 100 times. Furthermore, it has excellent short-term stability. These features contribute to its desirability as a coherent signal source, as a master oscillator for radio and radar systems where special requirements for stability and/or narrow bandwidth must be met, as a precision time keeper where the better performance of a cesium beam primary standard is not required, and as a house frequency standard for improved accuracy with fewer NBS calibrations compared to that required with quartz standards.

Front panel controls and circuit check meter of the HP 5065A are protected by a panel door. The magnetic field control provides fine frequency adjustment with which the frequency can be set to a precision of better than 2×10^{-12} without reference to a chart. The low noise quartz oscillator is phase-locked to the atomic frequency and provides the standard 5 MHz, 1 MHz, and 100 kHz outputs. The circuit check meter with selector switch monitors key voltages and currents for routine maintenance readings, calibration procedures, and fault finding.

The HP 5065A is designed for assured operation—to give the user confidence that the standard output signals are correct and locked to the atomic frequency. Logic within the unit maintains power to a “continuous” operation light on the front panel. If operation is interrupted, even momentarily, for any reason the light goes out and stays out until manually reset. An integrator limit light warns when the frequency correcting servo loop is approaching the limit of its dynamic range.

The HP 5065A is contained in a small-size package and is lightweight in comparison to a cesium beam standard. Additionally the rubidium resonance cell is much more frequency stable than quartz oscillators while subjected to shock and vibration, EMC, humidity, and magnetic field effects.

Reliability and warranty: the most significant module in the HP 5065A in terms of performance is the Rubidium Vapor Frequency Reference (RVFR). This temperature controlled, magnetically shielded unit includes the Rb gas cell and a photo sensitive detector

designed for maximum possible reliability. Field experience, including several million hours of operation, have demonstrated this reliability and the RVFR is now warranted for a period of three years. This increased warranty protects the owner in the event of random failure.

The Option 001 Digital Clock has an easy to read LED time-of-day display. The olive black upper panel provides a dark background around the readout for excellent contrast and readability. Initial clock setting is accomplished by means of pushbuttons easily accessible by removing the top cover. The LED display offers high reliability, freedom from errors due to mechanical shock, and performance over the full environmental range of the HP 5065A. A sync button on the digital divider permits automatic synchronization of this 1 PPS pulse to an external pulse. The clock 1 PPS is adjustable in decade steps from $1 \mu\text{s}$ to 1 s, with respect to the synchronized reference, with 6 thumbwheel switches. A screwdriver adjustment allows fine continuous adjustment over a range of $1 \mu\text{s}$.

To conserve battery power, the display is not illuminated when ac power is not available. A STANDBY READ pushbutton below the display is used for readout when operating on the internal battery or external dc.

The Option 002 Standby Battery provides the HP 5065A with a minimum of 10 minutes standby power at 25°C . Switchover from line to battery is automatic so there is no interruption of operation if ac line power should fail. A front panel ac interruption light warns when ac power has failed or has been disconnected. Fast or float charging rates may be selected when ac power is available.

The Option 003 combines the Option 001 Clock and Option 002 Battery and should be specified if both Options 001 and 002 are required.

HP E21- 5065A Portable Time Standard

HP E21- 5065A Portable Time Standard is a complete system for precision timekeeping and for transporting time from one location to another. It consists of the HP 5065A Rubidium Standard with digital clock and divider (Option 001) and the HP 5089A Power Supply with 6 or more hours standby capability. The component units are held together by side bars, and the interconnecting cables are protected by a back cover.

FREQUENCY & TIME STANDARDS

Atomic Frequency Standards

Models 5061B, 5065A (cont.)

Specifications — Atomic Frequency Standards

Instrument:	HP 5061B Option 004		HP 5061B		HP 5065A
Type of Standard:	Cesium		Cesium		Rubidium
Accuracy: maintained in magnetic field to 2 gauss and over temperature range of:	$\pm 7 \times 10^{-12}$ 0 to 50°C	$\pm 4 \times 10^{-12}$ $\pm 2.5^\circ\text{C}$ in range of 15 to 35°C	$\pm 1 \times 10^{-11}$ 0 to 50°C	$\pm 6 \times 10^{-12}$ $\pm 2.5^\circ\text{C}$ in range of 15 to 35°C	
Stability: Long Term: Short Term 5 MHz ⁽²⁾ :	Averaging time: 10 ⁻³ 10 ⁻² 10 ⁻¹ 10 ⁰ 10 ¹ 10 ² 10 ³		10 ⁻³ 10 ⁻² 10 ⁻¹ 10 ⁰ 10 ¹ 10 ² 10 ³		10 ⁻³ 10 ⁻² 10 ⁻¹ 10 ⁰ 10 ¹ 10 ² 10 ³
SSB Phase Noise Signal (1 Hz BW) Offset from signal:	Hz: 10 ⁻³ 10 ⁻² 10 ⁻¹ 0 10 ¹ 10 ² 10 ³		-28 dB -48 dB -68 dB -96 dB -120 dB -125 dB -140 dB		-25 dB -52 dB -72 dB -93 dB -120 dB -126 dB -140 dB
Reproducibility ⁽⁴⁾	$\pm 3 \times 10^{-12(3)}$		$\pm 5 \times 10^{-12}$		
Settability (frequency) ⁽⁵⁾ :	$\pm 1 \times 10^{-13(3)}$		$\pm 7 \times 10^{-13}$		$\pm 2 \times 10^{-12}$
Warm-up:	At 25°C 30 Min.		At 25°C 45 Min.		At 25°C 1 x 10 ⁻¹⁰ 1 hr. 5 x 10 ⁻¹¹ 4 hrs.
Sinusoidal Outputs:	10 MHz, 5 MHz, 1 MHz, 100 kHz,				5 MHz, 1MHz, 100kHz
Output Voltage	Front & Rear BNC — 1 V into 50 ohms				
Harmonic Distortion: (below rated output) Non-Harmonic related output: (below rated output)	>40 dB >80 dB		>40 dB >80 dB		>40 dB >80 dB
DC Magnetic Field Stability: Temperature, operating	$< \pm 2 \times 10^{-13}$ 2 Gauss Field 0 to 50°C		$< \pm 2 \times 10^{-12}$ 2 Gauss Field 0 to 50°C		$< \pm 5 \times 10^{-12}$ 1 Gauss Field 0 to 50°C
Temperature, non-operating	-40°C to 75°C		-40°C to 75°C		-40°C to 75°C

NOTES:

- (1) For life of beam tube.
- (2) Short-term stability for the HP 5061B with both standard and high performance tubes is given for the normal loop time constant. For improved short-term stability in controlled environments the long time constant may be used.
- (3) With HP 10638A Degausser.
- (4) Degree to which an oscillator will produce the same frequency from one occasion to another without recalibration.
- (5) Degree to which frequency can be set to agree with a reference frequency.



Specifications - Atomic Frequency Standards

Instrument	HP 5061B Opt 004	HP 5061B	HP 5065A
Power: AC:	50, 60 or 400 Hz $\pm 10\%$, 115/230 V $\pm 10\%$		
DC:	44 W 22 to 30 V 30 W	44 W 22 to 30 V 30 W	49 W 23 to 30 V 35 W 10/7.5 W 6/0 W
Option 001: add (AC/DC) 002: add (AC/DC) 003: add (AC/DC)	16/5 W	16/5 W	
Dimensions (H x W x D): mm: inches:	221 x 425 x 416 8.7 x 16.7 x 16.4	221 x 425 x 416 8.7 x 16.7 x 16.4	133 x 425 x 416 5.2 x 16.7 x 16.4
Weight: (lb/kg) Option 001: add (lb/kg) 002: add (lb/kg) 003: add (lb/kg)	70/31.8 6/2.7	67/30.5 6/2.7	34/15.4 2/0.9 3.5/1.6
Time Standard (Clock)			
1 PPS Outputs: Master:	Front & Rear BNC	Front & Rear BNC	Front & Rear BNC
Clock:	± 10 V peak into 50 Ω load		
Amplitude:	20 μ s min	20 μ s min	20 μ s min
Width:	<50 ns	<50 ns	<50 ns
Rise Time:	<50 ns	<50 ns	<2 μ s
Fall Time:			
Jitter, pulse-to-pulse:	<1 ns, rms	<1 ns, rms	<5 ns, rms
Synchronization:	Automatic, 100 ns \pm 100 ns delay	Automatic, 100 ns \pm 100 ns delay	Auto., 10 \pm 1 μ s delay
Clock pulse adjustment range:	1 μ s to 1 s	1 μ s to 1 s	1 μ s to 1 s
Clock display:	Solid State Digital		
Standby Power Supply Capacity at 25°C with Clock:	45 Minutes	45 Minutes	10 Minutes
Recharge, Fast/Float:	Automatic, fast charge		Switch

Ordering Information

HP 5061B Cesium Beam Frequency Standard

HP 5065A Rubidium Frequency Standard

HP 10638A Degausser

Special Option HP E21-5061B Flying Clock

Consists of: HP 5061B with Opt 001 (not included in E21 price) and HP 5089A Standby Power Supply.
Weight: 64 kg (141 lb).

Size: 425 H x 405 W x 546 mm D (16.7 in. x 15.9 in. x 21.5 in.) (includes handles).

Special Option HP E21-5065A Portable Time Standard

Consists of: HP 5065A with Opt 001 (not included in E21 price) and HP 5089A Standby Power Supply

Price

\$32,200

\$21,500

\$ 1,300

+ \$ 6,275

+ \$ 6,350

Weight: 50 kg (110 lb).

Size: 425 H x 405 W x 546 mm D (16.7 in. x 15.9 in. x 21.5 in.) (includes handles).

Special Option HP K34-59991A Phase Comparator + \$1,150

Options for 5061B

Opt 003 Clock and Standby Power Supply + \$4,400

Opt 004 High Performance Beam Tube + \$5,200

Opt 908 Rack Flange Kit + \$ 45

Options for 5065A

Opt 001 Clock + \$3,000

Opt 002 Standby Power Supply + \$ 700

Opt 003 Clock and Standby Power Supply + \$3,700

Opt 908 Rack Flange Kit + \$ 37

FREQUENCY & TIME STANDARDS

Quartz Frequency Standard

Model 105B

- High spectral purity
- Well-buffered outputs
- Aging <math> < 5 \times 10^{-10}</math> per day
- Excellent stability
- High reliability
- Built-in 8-hour standby battery

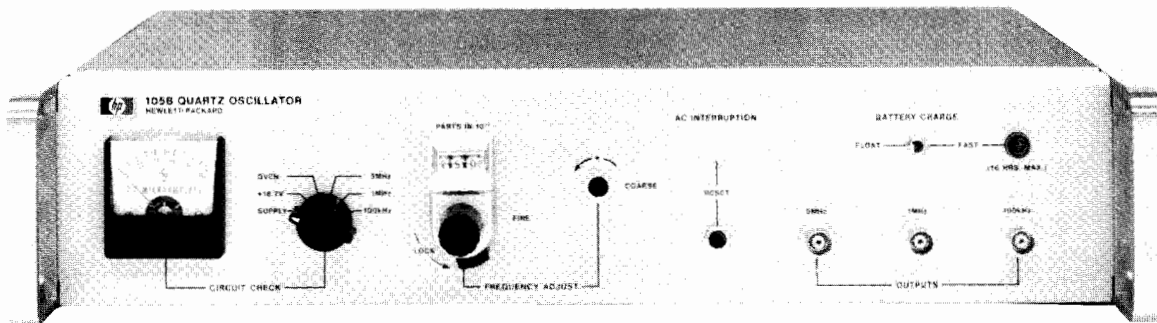

HP 105B

HP 105B Quartz Oscillator

The HP 105B Quartz Oscillator provides state-of-the-art performance in precision frequency and time systems because of its excellent long and short term stability characteristics, spectrally pure output, unexcelled reliability, and ability to operate under a wide range of environmental conditions. The HP 105B fills a need for a small and economical yet highly stable precision quartz oscillator for frequency and time standards. The HP 105B can be operated from the ac line. It also has a built-in 8-hour standby battery for uninterrupted operation should line power fail. The 5 MHz, 1 MHz and 100 kHz buffered sinusoidal outputs have excellent short term stability (5 parts in 10^{12} rms for 1 s averaging time) and aging rate (<math> < 5</math> parts in 10^{10} per day).

The HP 105B features rapid warm-up. Typically, the oscillator will be within 5 parts in 10^9 of the final frequency in 15 minutes after an "off" period of 24 hours. The basis of these oscillators is an extremely stable "SC" cut quartz crystal developed by Hewlett-Packard. New technologies in the crystal mounting and packaging have resulted in a cleaner crystal which in turn has a lower aging rate. The crystal, oscillator and AGC circuit are all enclosed in a proportional oven which reduces the temperature effects on these components and circuits.

Particular care was taken to provide a spectrally pure 5 MHz output which, when multiplied high into the microwave region, provides signals with spectra only a few cycles wide. Spectra less than 1 Hz wide can be obtained in X-band (8.2 to 12.4 GHz). The stability and purity of the 5 MHz output make it suitable for doppler measurements, microwave spectroscopy, and similar applications where the reference frequency must be multiplied by a large factor.

Specifications

Outputs: 5 MHz, 1 MHz, 100 kHz; 1 V rms into 50 Ω front and rear connectors.

Clock output: 1 MHz or 100 kHz; 0.5 V rms into 1 k Ω , rear connector. Normally supplied wired for 1 MHz output.

Frequency Stability

Aging rate: <math> < 5 \times 10^{-10}</math> per 24 hours.

Short-term stability: for 5 MHz output only.

$\tau(\text{sec})$	$\sigma\Delta f/f(2,\tau)$
10^{-2}	1.5×10^{-10}
10^{-1}	1.5×10^{-11}
10^0	5×10^{-12}

Temperature: <math> < 2.5 \times 10^{-9}</math> total change 0°C to 50°C .

Load: $\pm 1 \times 10^{-10}$ open to short circuit, 50 Ω R, L or C load change.

Supply voltage: $\pm 5 \times 10^{-11}$ for 22–30 V dc from 26 V dc reference and for 115/230 V $\pm 10\%$.

Warm-up (at 25°C): to within 5×10^{-9} of final frequency in 15 min.

Distortion (5 MHz, 1 MHz, 100 kHz) Below Rated Output

Harmonic: >40 dB.

Non-harmonic: >80 dB.

Frequency Adjustments

Fine: $\pm 5 \times 10^{-8}$ range with digital dial reading parts in 10^{10} .

Coarse: 1×10^{-6} front-panel screwdriver control.

Phase locking: external +5 V to –5 V allows $> 2 \times 10^{-8}$ frequency control for locking to external source.

Environmental

Temperature, operating: 0°C to $+50^\circ\text{C}$.

Temperature, storage: -40°C to $+50^\circ\text{C}$ ($+75^\circ\text{C}$ without standby battery).

Altitude: 15.24 km (50,000 ft.).

Standby supply capacity: 6 hours at 25°C ambient temperatures.

Power requirements: 115/230 V $\pm 10\%$, 50–400 Hz at 18 W (70 W warm-up) Add 1 W for float charge and 12 W for fast charge. 22–30 V dc at 8 W (16 W warm-up).

Size: 88 mm H x 425 mm W x 286 mm D (3 $\frac{1}{2}$ in. x 16 $\frac{3}{4}$ in. x 11 $\frac{1}{4}$ in.).

Weight: 105B—net, 11 kg (24 lb). Shipping, 14 kg (31 lb).

Ordering Information

HP 105B Quartz Oscillator

Opt 908 Rack Flange Kit

Opt 910 Extra manual

Price

\$6400

+ \$35

+ \$19

FREQUENCY & TIME STANDARDS

Distribution Amplifier

Model 5087A

341



- Versatile with 3 input and 12 output channels
- Low noise, high stability, and isolation

- Exceptional phase stability
- Plug-in modular construction

HP 5087A

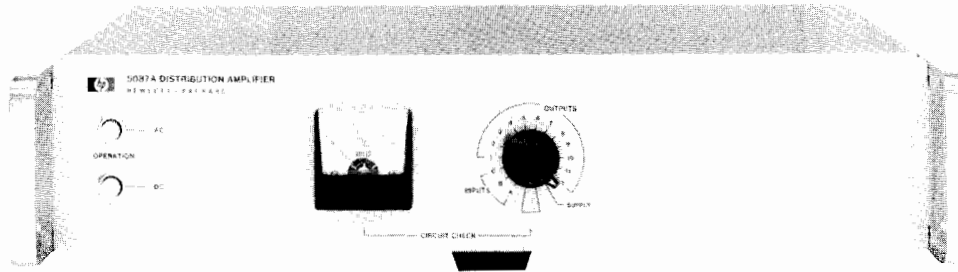

HP 5087A Distribution Amplifier

The Hewlett-Packard 5087A Distribution Amplifier provides the isolation and flexibility required for distribution of the output of high-quality frequency standards. Low distortion and excellent isolation make it ideal for providing multiple outputs from atomic or crystal frequency standards. The 3 input channels will accept 10 MHz, 5 MHz, 1 MHz or 100 kHz in any combination. The number of outputs for each channel is selectable up to a total of 12 outputs. The output levels are individually adjustable from 0 to 3 V rms. All input and output levels are monitored on a front-panel meter.

The Distribution Amplifier features plug-in modular construction, short circuit isolation, exceptional phase stability, low noise and cross-talk, and uninterrupted switchover to standby dc in event of ac power failure.

The shielding around each input and output plug-in amplifier assures minimum noise and crosstalk. The tuned output amplifiers provide clean signals and high channel-to-channel isolation.

The instrument is designed for maximum versatility and can be supplied to meet a wide variety of special requirements. The standard configuration of input and output amplifiers is shown in Figure 1.

Several other commonly used configurations are also available and special combinations of the various input and output modules can be supplied. Input and output amplifiers can be added or the configuration easily changed at any time.

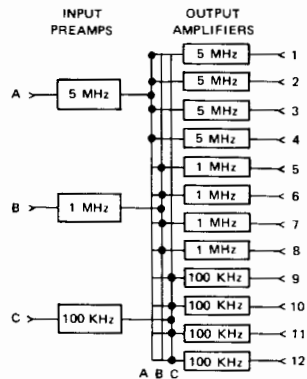

Figure 1. HP 5087A Distribution Amplifier with Option 031, Standard Configuration input and output amplifiers.

Specifications

Inputs: (up to three, rear panel BNC).

Frequencies: 10 MHz, 5 MHz, 1 MHz or 100 kHz.

Level: 0.3 to 3.0 V rms, 50 ohms.

Outputs (up to 12 rear panel BNC).

Frequencies: 10 MHz, 5 MHz, 1 MHz or 100 kHz.

Level: 0–3 V into 50 ohms (screwdriver adjustment).

Harmonic distortion: >40 dB below rated output.

Non-harmonic distortion: >80 dB below rated output.

Isolation

Load (open or short on any other channel)

Amplitude change: 0.1%.

Phase change: <0.1 ns at 5 or 10 MHz.

<0.5 ns at 1 MHz.

<5.0 ns at 100 kHz.

Injected signal: 1 V signal up to 50 MHz applied to any output except 10 MHz, will be down more than 60 dB in all other outputs; 10 MHz output channel will be down more than 50 dB.

SSB phase noise (5 MHz): >145 dB below signal in 1 Hz BW for frequencies > 1 kHz from carrier.

Short term stability degradation (5 MHz): < 1 x 10⁻¹² in 10 kHz band. (1 s average).

Environmental

Temperature: MIL-E-16400, Class 4.

Operating: 0–50°C; storage: –62° to +75°C.

Stability

Amplitude: ±0.5 dB, 0° to 50°C.

Phase: <0.1 ns/°C., 5 and 10 MHz.

Humidity: 95% at 40°C.

Altitude: up to 30,000 ft.

General

Power: 115 or 230 V ±10%, 48 to 440 Hz, 20 VA, max, or 22–30 V dc, 500 milliamperes, max.

Dimensions: 88 mm H x 425 mm W x 286 mm D (3.5 in. x 16.7 in. x 11.3 in.).

Weight: typical, Opt 031—Net 7 kg (15 lb).

Ordering Information

HP 5087A Distribution Amplifier Mainframe

Price

\$1800

Normal Configurations (input and output amplifiers)

Opt 031 5, 1 and 0.1 MHz inputs and 4 outputs at each frequency + \$2220

Opt 032 Single 5 MHz input and 12 outputs + \$2060

Opt 033 Single 10 MHz input and 12 outputs + \$2060

Opt 034 Single 5 MHz input, 4 each outputs at 5, 1 and 0.1 MHz + \$2060

Special Configurations

Input Preampifiers (up to 3 total)

Opt 004 Input Preamplifier (0.1 to 10 MHz) + \$80

Opt 005 5 to 1 MHz Input Divider + \$165

Opt 006 1 to 0.1 MHz Input Divider + \$220

Opt 011 5 to 10 MHz Input Doubler + \$250

Opt 013 10 to 5 MHz Input Divider + \$165

Opt 014 10 to 1 MHz Input Divider + \$275

Output Amplifiers (up to 12 total)

Opt 001 5 MHz Output Amplifier + \$165

Opt 002 1 MHz Output Amplifier + \$165

Opt 003 0.1 MHz Output Amplifier + \$165

Opt 012 10 MHz Output Amplifier + \$165

Opt 908 Rack Flange Kit + \$35



FREQUENCY & TIME STANDARDS

Standby Power Supply

Model 5089A

- 15 ampere-hour capacity
- Maintenance free lead-calcium batteries
- Used in "Flying Clocks"
- Automatic recharge

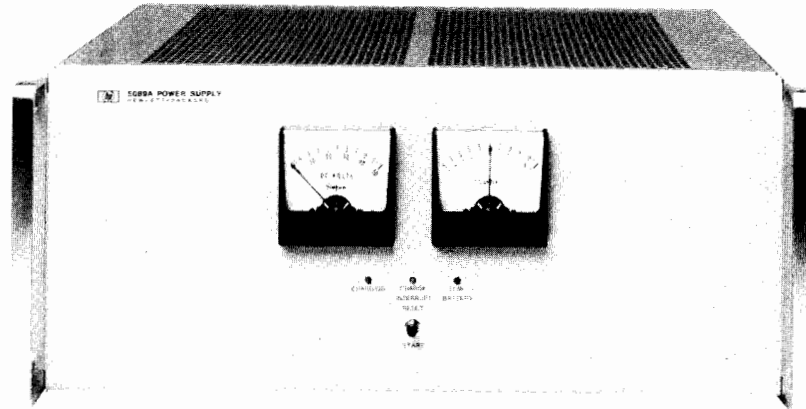

HP 5089A

HP 5089A Standby Power Supply

The HP 5089A Standby Power Supply furnishes dc power to keep frequency or time standard systems operating during extended interruptions of ac line power. For applications where it is essential to maintain continuous operation and avoid loss of precise time, the use of a standby power supply is an absolute necessity. This unit is designed for use with Hewlett-Packard Cesium Beam Standards, Rubidium Vapor Standards, Quartz Oscillators, and other equipment which will operate from 22 to 28 V dc. No switching is used in transferring power from line to battery operation and back again, thus assuring uninterrupted operation.

Versatility

The HP 5089A is an extremely versatile unit. It was designed both as a portable power supply for the HP 5061B and HP 5056A "flying clocks", and as a standby supply for stationary applications.

Portable Applications

Portable or "flying clock" applications require a power supply to operate from a wide range of power sources, along with the standby capability to maintain continuous operation where no external power is available. A special inverter permits operation from a 12 V dc automobile battery. In addition, the 85 to 255 V ac, and 11 to 30 V dc capability enables the HP 5089A to operate from almost any power source in the world. The 15 ampere-hour standby batteries are the double sealed lead-calcium type, and thus are virtually spillproof. Mounting hardware is available to attach the HP 5089A to either the HP 5061B or the HP 5065A standards to make a portable frequency time standard package. These portable packages are available from Hewlett-Packard under HP E21-5061B and HP E21-5065A.

Stationary Applications

Stationary applications require long periods of power supply operation in a float or standby mode. Then, when an ac supply failure occurs, the supply must provide full standby capability. The charging circuits inside the HP 5089A are designed to charge the batteries in such a way that they will provide both long, trouble-free, reliable operation, and full standby power. After use, when ac power is restored, the HP 5089A will fully recharge its batteries. The double sealed batteries will not leak or require maintenance of any kind. Thus, the HP 5089A allows you to add standby capability to your system with very little increase in maintenance costs.

Ease of Operation

In normal operation there is virtually no required operator intervention. The HP 5089A automatically maintains the batteries in a fully charged state, ready to supply standby power. Should regular line power fail, the HP 5089A will provide uninterrupted dc power (to the limit of its standby capacity) for your equipment. After normal operating power is restored, the HP 5089A will automatically recharge its batteries back to the standby level.

The HP 5089A tells you its operational status at a glance through three LED lamps: GREEN indicates the battery is being charged; YELLOW indicates there has been an ac line failure; a RED lamp lights when the battery is almost fully discharged. Two front-panel meters show battery voltage and charge/discharge current.

Batteries

The HP 5089A utilizes the "immobilized electrolyte" technology in its maintenance-free lead-calcium batteries. The lead-calcium grid gives these batteries longer life with better reliability than conventionally designed batteries. The batteries are double sealed to provide virtually leakproof, and thus maintenance-free operation.

HP 5089A Specifications

Input Voltage

AC charging: 85 V to 130 V ac rms, 48 to 440 Hz, 300 VA max.
85 V to 255 V ac rms, 48 to 66 Hz, 300 VA max.

DC operation: 11 V to 30 V dc, 110 W max.

Output voltage: 22 V to 28 V dc (nominal). 2 A maximum.

Standby capacity: 15 AH at +25°C when fully charged.

Recharge: complete recharge in 24 hours when operating from ac line.

External low battery voltage alarm: floating contact closure at rear-panel barrier block for external visible or audible "low battery" warning. Contact rating is 30 V dc at 2 amperes.

Operating Environment

Temperature: 0°C to 50°C.

Humidity: up to 95% at 40°C (with no internal condensation).

Altitude: 12,000 metres (40,000 feet).

Storage Environment

Temperature: -40°C to +65°C.

Humidity: up to 95% noncondensing.

Altitude: 15,000 metres (50,000 feet).

Dimensions: 177 mmH x 425 mmW x 416 mmD (7 in. x 16.7 in. x 16.4 in).

Weight: net weight 30.5 kg (67 lb).

Accessories Supplied

HP 05061-6091: AC Power Input Cable Assembly
HP 05089-60102: DC Power Input Cable Assembly
HP 05089-60101: DC Output Cable Assembly
HP 5060-0169: Extender Board Assy (Dual 25 Pin)

Ordering Information

Ordering Information	Price
HP 5089A Standby Power Supply	\$5500
Opt 001 Spare AI Board Assembly (HP 05089-60001)	+\$700
Opt 908 Rack Mounting Adapter Kit	+\$300
Opt 910 Extra Operating and Service Manual	+\$10



Signature Multimeter, Combines Counter and Multimeter Functions with Signature Analysis Model 5005A/B

- Digital and analog measurement capability optimized for digital troubleshooting
- Easy to use single probe measurement of logic signals, voltage, and frequency
- 25 MHz, multiple logic family signature analysis with qualified clocking mode
- Compact and portable (HP 5005A)

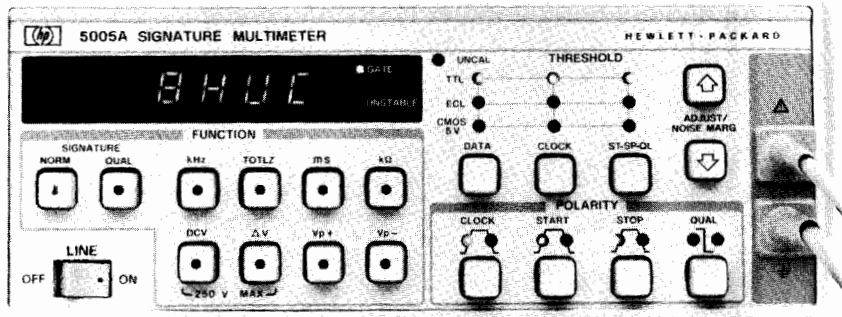

HP 5005A Signature Multimeter

HP 5005A/B

Total checkout of a digital system often requires characterizing both digital data activity and analog signal parameters. A typical troubleshooting procedure may specify a digital multimeter for checking power supplies and circuit board integrity (shorts and opens), a universal counter to measure clock frequencies and time intervals between signals, and a means to verify the analog integrity of active digital signals. The HP 5005 Signature Multimeter offers, in a single instrument, a measurement set optimized for these types of digital troubleshooting applications.

Two versions, the HP 5005A for manual applications and the HP 5005B for automatic test system applications, share common performance capabilities. Their feature set includes:

- Field proven Signature Analysis (for multiple logic families).
- Digital multimeter (DC volts, resistance and differential voltage).
- Frequency counter (frequency, totalize, time interval).
- Voltage threshold (upper voltage peak, lower voltage peak).
- Multifunction probe.

Signature Analysis

HP's patented Signature Analysis technique enables the HP 5005 to generate a compressed, four digit "fingerprint" or signature of the digital data stream at a logic node. Any fault associated with a device connected through the node will force a change in the data stream and, consequently, produce an erroneous signature.

Specific features of the HP 5005 Signature Analyzer include:

- Multiple logic family compatibility—preset threshold levels for TTL, CMOS, and ECL or adjustable thresholds (+12.5 V to -12.5 V) assure coverage of a wide variety of logic device types.
- 25 MHz clock frequency—extends Signature Analysis to high speed circuits such as CRT controllers.
- Qualified signature mode—speeds fault isolation in complex products by windowing signature collection to specific modules or devices without requiring major test setup changes. This simplifies the engineering involvement in hardware and software testability and accelerates test procedure preparation.

Digital Multimeter

Certain digital problems result from analog circuit failures: a low power supply voltage, an open or shorted circuit path, a faulty A/D or D/A converter. Each may contribute to a system failure. The HP 5005 contains a 4½ digit dc voltmeter, ohmmeter, and differential voltmeter, each with performance geared toward analog measurements necessary in digital troubleshooting.

The implementation of each multimeter function emphasizes simplicity and convenience. Automatic internal self calibration and auto-ranging maximize troubleshooting efficiency by eliminating unnecessary interaction with the instrument. Improvements in display interpretation also aid troubleshooting. The ohmmeter, for example, when measuring an open circuit, produces an "OPEN" indication on the display rather than the typical overload display.

Frequency Counter

The counter within the HP 5005 provides totalize and frequency measurements to 50 MHz, and time interval measurements to 100 nanosecond resolution. Intended to extend the digital troubleshooting capabilities of the Signature Analysis (synchronous measurements), the counter functions provide the ability to characterize one-shots and timers through time interval measurement; test interrupt lines, reset lines, and asynchronous communication interfaces (RS-232) through totalize; and verify clock and clock driver circuitry through frequency measurement.

Voltage Threshold

Logic level degradation is a common and troublesome malfunction in digital products. Isolating this failure typically requires displaying and interpreting the waveform. The HP 5005's peak voltage measurement mode provides a simple, direct method of measuring logic high and logic low voltage of active digital signals.

The peak voltage measurement mode allows the HP 5005 to characterize and display either the greatest (positive peak) or lowest (negative peak) voltage measured at the probe. Selection of either positive peak or negative peak mode displays the appropriate measured threshold for comparison against the specifications of the logic family.



DIGITAL CIRCUIT TESTERS

Signature Multimeter, Combines Counter and Multimeter Function with Signature Analysis

Model 5005A/B (cont.)

- Complete HP-IB programmability of every function
- Measurement trigger switch in probe
- Rack and stack enclosure (HP 5005B)
- Programmable audible beeper

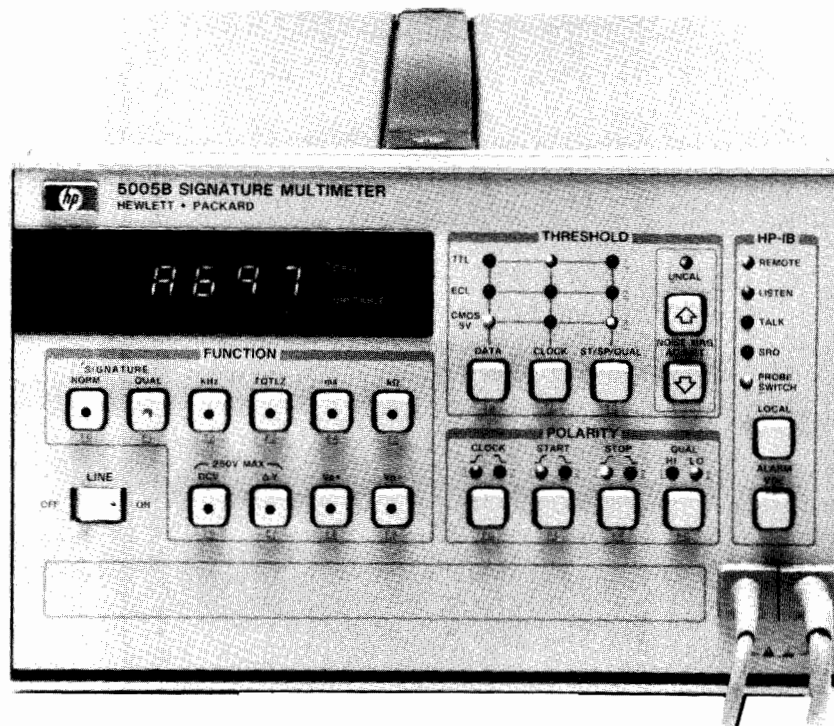

HP 5005B Programmable Signature Multimeter



Multifunction Probe

Several measurement functions incorporated into a single instrument can provide optimal troubleshooting efficiency only when each function is easy to use. The operator, when troubleshooting, must be able to measure the analog signal parameters and digital functional characteristics of a node without requiring time consuming and error-prone probe or instrument setup changes. The HP 5005 multifunction probe solves this problem by providing automatic access to the Signature Analyzer, multimeter, and counter functions through a single probe. All signal multiplexing to the appropriate measurement function is accomplished inside the HP 5005.

This efficient probing scheme becomes particularly important in automatic applications. The HP 5005B takes advantage of the several functions available in the multifunction probe. A switch, located on the side of the probe, allows the operator to trigger automatic measurement. The instrument controller can then characterize both the analog parameters and functional digital operation of a circuit node while the operator probes the same point. This greater automatic measurement efficiency translates into increased troubleshooting productivity.

HP-IB Programmability

Complete programmability makes the HP 5005B an ideal choice for automatic digital testing and troubleshooting. Every HP 5005B measurement and control function can be programmed through the HP-IB interface. This flexibility allows the automatic test system designer full access to the many measurement functions in the instrument.

Simplified programming enhances the automatic testing and troubleshooting productivity improvements inherent in the HP 5005B. Straightforward commands and data output formats aid in accelerating test program development. A measurement trigger switch located in the probe allows direct operator communication to the controller. Audible feedback, supplied by the beeper in the HP 5005B, can then indicate the completion of the measurement cycle. This closed-loop communication (controller-to-operator) aids in improving troubleshooting efficiency.

Portability

The HP 5005A offers a compact portable solution for manual troubleshooting of digitally based products. Its compact package, complete measurement capabilities, and multifunction probe make it invaluable as a bench or field service tool. This complete measurement set, combined into a single instrument, insures your always having the necessary troubleshooting capabilities in hand.

The identical feature set between the HP 5005A and HP 5005B also simplifies going from automatic to manual troubleshooting procedures. Consistent front panel function key arrangements and performance specifications allow direct translation of test or troubleshooting procedures. Your investment in an automatic procedure provides an additional return when expanding into a manual troubleshooting environment.



HP 5005A/B Specifications

Signature

Display: 4 digits. Characters 0-9, ACFHPU.

Fault detection accuracy: 100% probability of detecting single-bit errors; 99.998% probability of detecting multiple-bit errors.

Minimum gate length: 1 clock cycle (1 data bit) between START and STOP.

Maximum gate length: no limit.

Minimum timing between gates: 1 clock cycle between STOP and START.

Data Probe Timing

Setup time: 10 ns (data to be valid at least 10 ns before selected clock edge.)

Hold time: 0 ns (data to be held until occurrence of selected clock edge.)

START, STOP, QUAL Timing

Setup time: 20 ns (signals to be valid at least 20 ns before selected clock edge.)

Hold time: 0 ns (signals to be held until occurrence of selected clock edge.)

CLOCK Timing

Maximum clock frequency: 25 MHz.

Minimum pulse width: 15 ns in high or low state.

Quality mode: allows data clock qualification by an external signal. DATA probe input impedance ≈ 50 k Ω to the average value of "0" and "1" threshold settings (± 6 V max); 15 pF.

START, STOP, CLOCK, QUAL input impedance ≈ 100 k Ω ; 15 pF.

Front panel indicators: flashing GATE light indicates detection of valid START, STOP, CLOCK conditions. Flashing UNSTABLE light indicates a difference between 2 successive signatures, and possible intermittent faults.

Frequency

Display: 5 digits.

Ranges: 100 kHz, 1 MHz, 10 MHz, 50 MHz, autoranged.

Resolution: 1 LSD (1 Hz on 100 kHz range).

Accuracy: $\pm 0.01\%$ of reading ± 1 count.

Minimum pulse width ≈ 10 ns in high or low state.

Gate time ≈ 1 s, fixed.

Input impedance ≈ 50 k Ω to the average value of "0" and "1" threshold settings (± 6 V max); 15 pF.

Totalizing

Display: 5 digits.

Range: 0-99,999 counts.

Resolution: 1 count.

Maximum input frequency ≈ 50 MHz, with a minimum pulse width of 10 ns, and minimum pulse separation of 10 ns.

Minimum START/STOP pulse width ≈ 20 ns.

DATA input impedance ≈ 50 k Ω to the average value of "0" and "1" threshold settings (± 6 V max); 15 pF.

START, STOP input impedance ≈ 100 k Ω ; 15 pF.

Time Interval

Display: 5 digits.

Ranges: 10 ms, 100 ms, 1 s, 10 s, 100 s, autoranged.

Resolution: 1 count (100 ns on 10 ms range).

Accuracy $\pm 0.01\%$ of reading ± 2 counts.

Minimum START/STOP pulse width ≈ 20 ns.

START, STOP input impedance ≈ 100 k Ω ; 15 pF.

Resistance

Display: 4 or 5 digits, depending on range.

Ranges: 30 k Ω , 300 k Ω , 1 M Ω , 3 M Ω , 10 M Ω , autoranged.

Accuracy: (at 15°C–30°C).

RANGE	FULL SCALE	ACCURACY	DISPLAY RESOLUTION
30 k Ω	29.999 k Ω	$\pm 1\%$ of reading $\pm 2 \Omega$	1 Ω
300 k Ω	299.99 k Ω	$\pm 1\%$ of reading	10 Ω
1 M Ω	999.9 k Ω	$\pm 1\%$ of reading	100 Ω
3 M Ω	2999. k Ω	$\pm 10\%$ of reading	1 k Ω
10 M Ω	10000. k Ω	$\pm 10\%$ of reading	10 k Ω

Input impedance ≈ 20 k Ω to ± 2 V

DC Voltage

Display: $4\frac{1}{2}$ digits.

Ranges: ± 25 V, ± 250 V, autoranged; referenced to earth ground.

Accuracy: (at 15°C–30°C).

RANGE	ACCURACY	RESOLUTION
25 V	$\pm 0.1\%$ of reading ± 2 mV	1 mV
250 V (<100 V)	$\pm 0.25\%$ of reading ± 20 mV	10 mV
250 V (≥ 100 V)	$\pm 0.25\%$ of reading ± 20 mV	100 mV

Input impedance ≈ 10 M Ω .

Differential Voltage

Reading: reads input voltage present at the probe and displays difference between it and voltage at the time ΔV key was depressed.

Specifications: same as for DCV, above. Voltage range is determined by larger of 2 compared voltages.

Peak Voltage

Display: $3\frac{1}{2}$ digits.

Range: 0– ± 12 Vp.

Resolution: 50 mV.

Accuracy: $\pm 2\%$ of reading $\pm 5\%$ of p-p signal ± 100 mV.

Minimum peak duration ≈ 10 ns.

Maximum time between peaks ≈ 50 ms.

Input impedance ≈ 100 k Ω ; 15 pF.

Signature Analyzer Logic Thresholds

Preset thresholds: TTL, ECL, CMOS.

Adjustable thresholds: each preset threshold can be adjusted.

Range: ± 12.5 V, in 50 mV steps.

Accuracy: $\pm 2\%$ of setting, ± 2 V

Logic threshold circuitry is operative during NORM, QUAL, kHz, TOTLZ and ms measurements.

General

Data probe tip: acts as high-speed logic probe in the NORM, QUAL, kHz and TOTLZ modes. Lamp indicates high, low, bad-level and pulsing states.

Minimum detected pulse width is 10 ns.

Data Probe Protection

Continuous Overload

DCV, ΔV , k Ω modes only: ± 250 V ac/dc.

All other modes: ± 150 V ac/dc, 20 V rms at input frequencies > 2 MHz.

Intermittent overload: ± 250 V ac/dc, up to 1 min, for all modes.

Timing Pod Protection

Continuous overload: ± 100 V ac/dc, 20 V rms at input frequencies > 2 MHz.

Intermittent overload: ± 140 V ac/dc, up to 1 min.

Auxiliary power supply: three rear-panel connectors supply 5 V at 0.7A total for accessories (HP 5005A only)

Operating temperature: 0°C to +55°C.

Power: selectable 100 V, 120 V, 220 V or 240 V ac line ($+5\%$ – 10%), HP 5005A–48–440 Hz, 35 VA maximum.

HP 5005B–48–66 Hz, 35 VA maximum.

Weight: HP 5005A–Net: 3.5 kg (8.0 lb.) Shipping: 10 kg (22.5 lb.).

HP 5005B–Net: 5.5 kg (12.0 lb.) Shipping: 8.7 kg (19 lb.).

Size: HP 5005A–90 mm H x 215 mm W x 410 mm D ($3\frac{1}{2}$ " x $8\frac{1}{2}$ " x 16"), excluding handle.

HP 5005B–133 mm H x 212 mm W x 432 mm D ($5\frac{1}{4}$ " x $8\frac{3}{8}$ " x 17"), excluding handle.

Ordering Information

HP 5005A Signature Multimeter

Opt 910: Additional manual

HP 5005B Signature Multimeter

Opt 910: Additional Manual

Price

\$2,900

+ \$35

\$4,000

+ \$40

DIGITAL CIRCUIT TESTERS

Signature Analyzer, A Digital Troubleshooting Tool

Model 5006A

- Reduce warranty and service support costs
- Full at-speed testing of digital products
- Reduce comparisons to documentation with composite signature
- Compare signatures in groups with signature memory

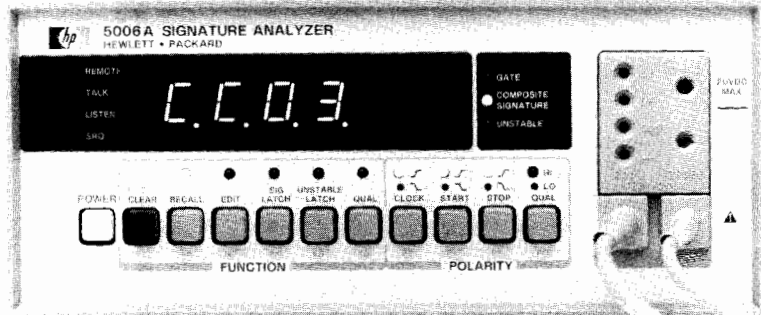

HP 5006A



HP 5006A Signature Analyzer

The Technique

Signature Analysis is a fast and accurate troubleshooting method for digital circuits. Fault finding is reduced to tracing signal flow and comparing measured signatures to those recorded on paper or in a computer. Troubleshoot with Signature Analysis by probing the circuit, reading the display and comparing to the known good signature. A signature is a cyclic redundancy code (CRC) used as an error detection check on blocks of data. Test patterns may be generated within a circuit or stimulated externally.

Programmability Means Efficiency

The HP 5006A is completely programmable using the optional HP-IB interface. Upgrade production test and troubleshooting systems to include digital troubleshooting by adding the HP-IB option.

Signatures compress the necessary troubleshooting information of a bit stream into 16 bits. Instead of entire bit streams, only signatures need be compared to detect bit errors in the unit under test.

Time Savers

Composite signature and signature memory save time for the troubleshooter who does not have a computer-aided system. Composite signature is the binary sum of individual signatures. The HP 5006A computes it for any grouping of digital signals (i.e., bus or IC). Only one "composite" signature need be compared to documentation if all signals for that group are good.

Signatures are stored in the HP 5006A memory after the probe switch is pushed. The memory stores the last 32 signatures probed. Individual signatures can now be compared in groups instead of after each probe by reviewing the memory in the RECALL mode.

HP 5006A Specifications

General

Display: 4 digits. Characters 0-9, ACFHPU.

Fault detection accuracy: 100% probability of detecting single-bit errors; 99.998% probability of detecting multiple-bit errors.

Composite signature: maximum number of signatures: No limit.

Sums all signatures, triggered by probe switch, following depression of CLEAR key, or power-up.

Signature memory: signatures recallable by probe switch: The last 32 signatures triggered by probe switch.

Timing

Clock: maximum frequency: 25 MHz. Minimum clock time: 15 ns in high or low state.

Probe: setup time: 10 ns with 0.2 V overdrive. (Data to be valid at least 10 ns before selected clock edge.) Hold time: 0 ns. (Data to be held after occurrence of selected clock edge.)

Start, stop, qualifier: setup time: 20 ns with 0.2 V overdrive. (Data to be valid at least 20 ns before selected clock edge.) Hold time: 0 ns. (Data to be held until occurrence of selected clock edge.) Minimum gate length: 1 clock cycle (1 data bit) between START and STOP.

Maximum gate length: no limit.

Minimum timing between gates: 1 clock cycle between STOP and START.

Input Impedance

Probe: 50 k Ω to ground nominal.

Pod: 100 k Ω to ground nominal.

Overload Protection

Probe: ± 150 V continuous.

± 250 V intermittent.

250 V ac for 1 minute.

Pod: ± 20 V continuous.

± 140 V intermittent.

± 140 V ac for 1 minute.

CMOS sense: 20 V dc maximum.

TTL Thresholds

Probe: Logic one: 2 V + .2-.3. Logic zero: 0.8 V +.3-.2

Pod: 1.4 V ± 6

CMOS Thresholds

Logic one: 70% of sensed voltage.

Logic zero: 30% of sensed voltage.

Display and Indicators

Signature: four seven-segment digits with decimal point.

Lamps: Key Status: Recall, edit, signature latch, unstable latch, qualify mode, timing polarities. Programmable: Remote, talk, listen, SRQ. (Option 040). Status: Composite signature, gate, unstable.

Probe: logic levels indicated: High, low, open and pulsing. Minimum pulse width: 10 ns.

Other

Selectable power: 115 V +10%–25% ac line, 48–440 Hz.

230 V +10–15% ac line, 48–66 Hz. 25 VA maximum.

Operating environment: temperature: 0–55°C. Humidity: 95% RH at +40°C. Altitude: 4600 m (15,000 ft).

Size: 89 mm H x 216 mm W 279 mm D (3-1/2 in. x 8-1/2 in. x 11 in.).

Net weight: 2.4 kg (5.3 lb). Shipping weight: 4.1 kg (9 lb).

Ordering Information

HP 5006A Signature Analyzer

Opt 40 HP-IB Interface

Opt 910 Additional Manual

HP 5060-0173 Half Rack Mount Kit

Price

\$1200

+\$300

+\$16.50

\$64

DIGITAL CIRCUIT TESTERS

Microprocessor Lab, Logic Probe

Models 5036A & 545A

347



- Covers hardware, software and troubleshooting in one course.

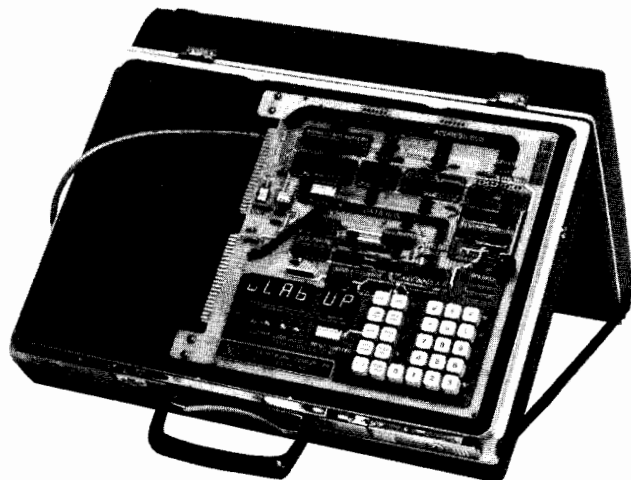

HP 5036A

HP 5036A Microprocessor Lab

Staying Current with Technology

The microprocessor presents a repair problem due to its complexity, and because it is used in so many diverse products. Little imagination is required to anticipate field repair problems with microprocessor-based products like traffic controllers, typesetters, POS terminals, medical instrumentation, etc.

There are scientists and engineers who can contribute to solving this problem by learning about both the hardware and software in microprocessor systems, and there is a virtual army of technicians who need to learn to troubleshoot them. The HP 5036A Microprocessor Lab provides both the hardware and software basics and vital troubleshooting information needed to solve the microprocessor puzzle.

The HP 5036A course book, *Practical Microprocessors*, covers both hardware and software in detail in separate chapters containing summaries, hands-on experiments and quizzes. Once these chapters are completed, the course builds up to a series of troubleshooting experiments employing recommended troubleshooting instruments that challenge the user and reinforce microprocessor operating concepts. The book also contains information on the use of oscilloscopes, signature analyzers, logic analyzers, and logic probes for troubleshooting microprocessor-based products.

HP 5036A Major Features

- Color PC board graphics illustrate system block diagrams to enhance learning.
- Multiple-experiment troubleshooting chapter highlights IC Troubleshooters such as HP 545A Probe, 546A Pulser, 547A Current Tracer and HP Signature Analyzers.
- Plug-in jumpers create real hardware faults that allow realistic troubleshooting practice.
- Complete resident software.
- Dual 5-volt power supplies, plus edge connectors for expandability.
- LED monitors on all data, address, status and output lines.

Accessories Available

HP 5024A Logic Troubleshooting Kit
HP 5006A Signature Analyzer

Price

\$770
\$1200

Ordering Information

HP 5036A Microprocessor Lab and Power Supply mounted in briefcase, plus *Practical Microprocessors* text and lab book, in English (German, French and Italian editions are available in those countries).

\$1250 ☎

☎ Fast-Ship product—See page 766.

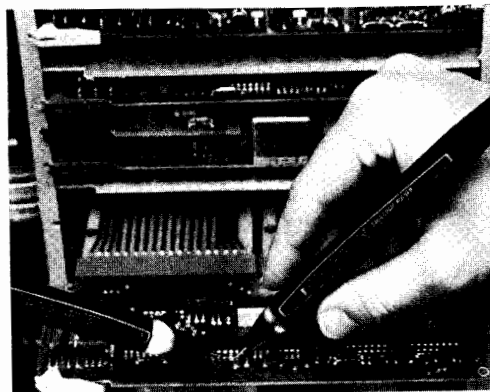

HP 545A

HP 545A TTL/CMOS Logic Probe

The HP 545A Logic Probe contains all the features built into other HP probes, plus switch-selectable, multi-family operation and built-in pulse memory. Employing straightforward one-lamp display the HP 545A operates from 3 to 18 volts in CMOS applications or from 4.5 to 15 V dc supplies in the TTL mode while maintaining standard TTL thresholds.

The probe's independent, built-in pulse memory and LED display help you capture hard to see, intermittent pulses. Just connect the probe tip to a circuit point, reset the memory, and wait for the probe to catch those hard to find glitches. The memory captures and retains a pulse until reset.

The hand-held HP 545A is light, rugged, overload protected, and very fast: 80 MHz in TTL, 40 MHz in CMOS. It also employs handy power supply connectors that enable you to easily hook up to supply voltage almost anywhere in the unit under test.

HP 545A Probe Specifications

Input current: $\leq 15 \mu\text{A}$ (source or sink).

Input capacitance: $\leq 15 \text{ pF}$.

Logic thresholds

***TTL:** Logic one $2.0 + 0.4$, -0.2 V . Logic zero $0.8 + 0.2$, -0.4 V .

CMOS: 3–10 V dc supply

Logic one: $0.7 \times V_{\text{supply}} \pm 0.5 \text{ V dc}$.

Logic zero: $0.3 \times V_{\text{supply}} \pm 0.5 \text{ V dc}$.

CMOS: ≥ 10 –18 V dc supply.

Logic one: $0.7 \times V_{\text{supply}} \pm 1.0 \text{ V dc}$.

Logic zero: $0.3 \times V_{\text{supply}} \pm 1.0 \text{ V dc}$.

Input minimum pulse width: 10 ns using ground lead (typically 20 ns without ground lead).

Input maximum pulse repetition frequency:

TTL, 80 MHz. CMOS, 40 MHz.

Input overload protection: $\pm 120 \text{ V}$ continuous (dc to 1 kHz); ± 250 for 15 seconds (dc to 1 kHz).

Pulse memory: indicates first entry into valid logic level; also indicates return to initial valid level from bad level for pulse $\geq 1 \mu\text{s}$ wide.

Power Requirements

TTL: 4.5 to 15 V dc*.

CMOS: 3 to 18 V dc.

Maximum current: 70 mA.

Overload protection: $\pm 25 \text{ V dc}$ for one minute.

Accessory included: ground clip.

* $\pm 5\%$ 10% V dc power supply; usable to +15 V dc with slightly increased logic low threshold.

Ordering Information

HP 545A Logic Probe

☎ Fast-Ship product—See page 766.

Price

\$180 ☎



DIGITAL CIRCUIT TESTERS

Logic Pulser, Digital Current Tracer

Models 546A, 547A

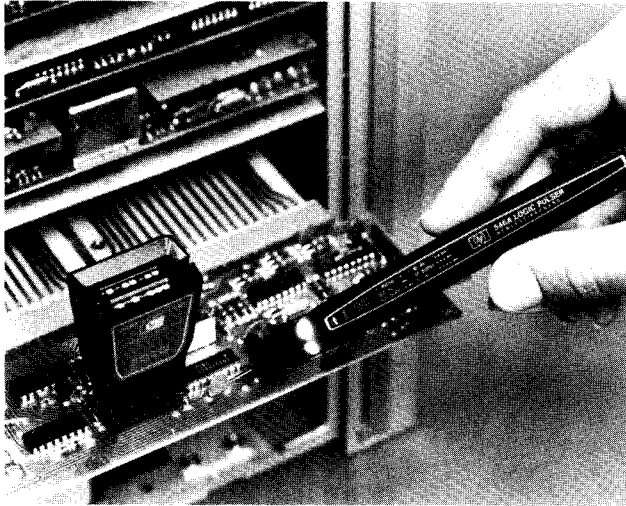

HP 548A/546A

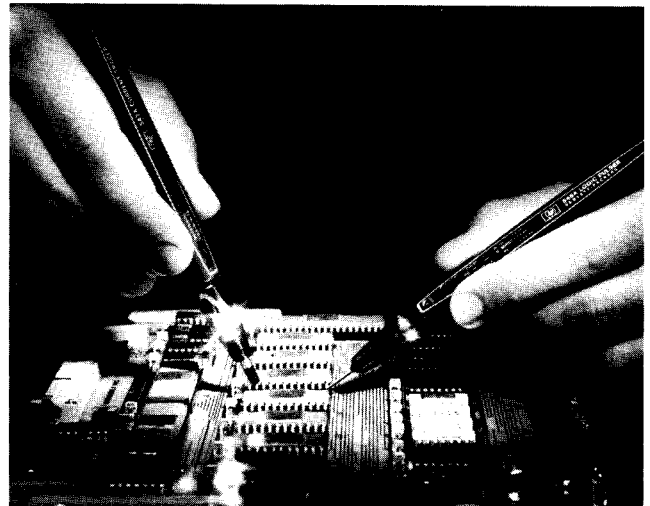

HP 547A/546A

Logic Pulser

The Logic Pulser solves the problem of how to pulse IC's in digital circuits. Merely touch the Pulser to the circuit under test, press the pulse button and all circuits connected to the node (outputs as well as inputs) are briefly driven to their opposite state. No unsoldering of IC outputs is required. Pulse injection is automatic, high nodes are pulsed low and low nodes, high, each time the button is pressed.

Ability to source or sink up to 0.65 amperes insures sufficient current to override IC outputs in either the high or low state. Output pulse width is limited so the amount of energy delivered to the device under test is never excessive. Additionally, the Pulser output is three-state so that the circuit under test is unaffected until the Pulser is activated.

HP 546A Logic Pulser

Automatic polarity pulse output, pulse width, and amplitude make for easy multi-family operation when you use the HP 546A Logic Pulser. But, the real surprise comes when you code in one of its six ROM-programmable output patterns (single pulses; pulse streams of either 1, 10, or 100 Hz; or bursts of 10 or 100 Hz; or bursts of 10 or 100 pulses). This feature allows you to continually pulse a circuit when necessary, or it also provides an easy means to put an exact number of pulses into counters and shift registers. Used with our multi-family IC Troubleshooters, the HP 546A acts as both a voltage and current source in digital troubleshooting applications.

HP 546A Pulser Specifications

Output

Family	Output Current	Pulse Width	Typical Output Voltage	
			HIGH	LOW
TTL/DTL	<650 mA	≥0.5 μs	≥3 V dc	≤0.8 V dc
CMOS	≤100 mA	≥5.0 μs	≥(V _{supply} - 1 V dc)	≤0.5 V dc

Power supply requirements: TTL; 4.5 to 5.5 V dc at 35 mA, CMOS; 3 to 18 V dc at 35 mA, protected to ±25 V dc for 1 min.

Digital Current Tracer

The HP 547A Current Tracer precisely locates low-impedance faults in digital circuits by locating current sources or sinks. For example, on a bad node the Tracer can verify that the driver is functioning and also show where the problem is by tracing current flow to the source or sink causing the node to be stuck. The Tracer is designed to troubleshoot circuits carrying fast rise-time current pulses. The Tracer senses the magnetic field generated by these signals in the circuit and displays transitions, single pulses, and pulse trains using a simple one-light indicator. Because it is not voltage sensitive, the Tracer operates on all logic families having current pulses exceeding 1 mA, including CMOS, where even lightly loaded outputs can have up to 2 to 3 mA of instantaneous charging current.

To use the Tracer, align the dot on its tip at a reference point, usually the output of a node driver. Set the sensitivity control to indicate the presence of ac current activity. As you probe from point to point or follow traces, the lamp will change intensity; when you find the fault the Tracer will indicate the same brightness found at the reference point.

HP 547A Current Tracer Specifications

Input

Sensitivity: 1 mA to 1 A.

Frequency response: light indicates single-step current transitions; single pulses ≥50 ns in width; pulse trains to 10 MHz (typically 20 MHz for current pulses ≥10 mA).

Risetime: light indicates current transitions with risetime ≤200 ns at 1 mA.

Power Supply Requirements

Voltage: 4.5 to 18 V dc.

Input current: ≤75 mA.

Maximum ripple: ±500 mV above 5 V dc.

Overvoltage protection: ±25 V dc for one minute.

Accessories Available

HP 00545-60104: Tip Kit for HP 546A Pulser, 545A Probe

HP 10526-60002: Multi-Pin Stimulus Kit

HP 1250-1948 Adapter, Coax Str.

Price

\$50 ☐

\$70 ☐

\$22

Ordering Information

HP 546A Logic Pulser

HP 547A Digital Current Tracer

☐ Fact-ship product—see page 766.

\$200 ☐

\$410 ☐

DIGITAL CIRCUIT TESTERS

Logic Clip, Logic Comparator

Models 548A & 10529A

349

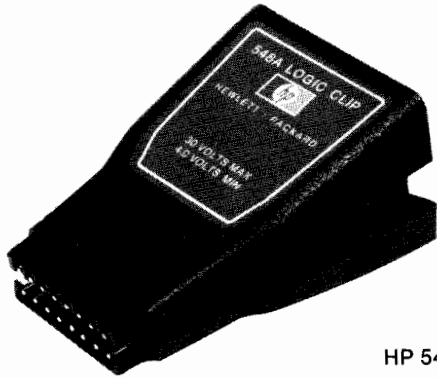

HP 548A

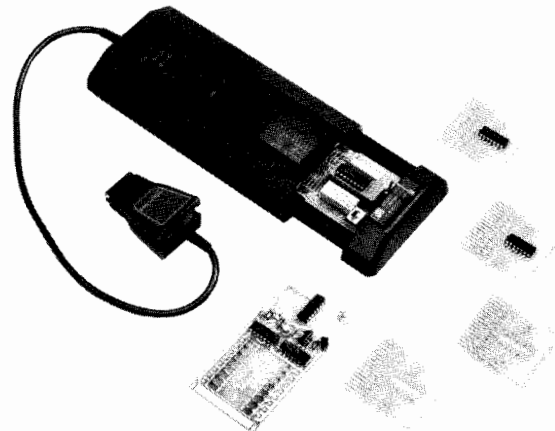

HP 10529A

HP 548A Logic Clip

The Logic Clip is an extremely handy service and design tool which clips onto dual-in-line package (DIP) ICs, instantly displaying the states of up to 16 pins. Each of the clip's 16 LEDs independently follows level changes at its associated pin. Lit diodes are logic High, extinguished diodes are Low.

The Logic Clips's real value is in its ease of use. It has no controls to set, needs no power connections, and requires practically no explanation as to how it is used. The clip has its own gating logic for locating ground and V_{CC} pins and its buffered inputs reduce circuit loading.

The Logic Clip is much easier to use than either an oscilloscope or a voltmeter when you are interested in whether a circuit is in the high or low state, rather than its actual voltage. The Clip, in effect, is 16 binary voltmeters, and the user does not have to shift his eyes away from his circuit to make the readings.

The intuitive relationship of the input to the output—lighted diode corresponding a high logic state—greatly simplifies the troubleshooting procedure. The user is free to concentrate his attention on his circuits, rather than on measurement techniques. Also, timing relationships become especially apparent when clock rates can be slowed to about 1 pulse per second.

When used in conjunction with the Logic Pulser, the Logic Clip offers unparalleled analysis capability for troubleshooting sequential used to inject pulses between gates allowing it to supply signals to the IC under test absolutely independent of gates connected to the IC. All outputs may then be observed simultaneously on the Logic Clip. Deviations from expected results are immediately apparent as the Pulser steps the IC through its truth table.

HP 548A Multi-Family Logic Clip

Fully automatic and protected to 30 V dc, and employing bright individual LEDs in its display, the HP 548A brings multi-family operation to the HP line of IC Troubleshooters. The Clip can be externally powered, if desired, using a simple power connector.

HP 548A Specifications

Input threshold: $(\geq 0.4 \pm 0.06 \times \text{Supply Voltage}) = \text{Logic High}$.

Input impedance: 1 CMOS load per input.

Input protection: 30 V dc for 1 minute.

Supply voltage: 4-18 V dc across any two pins.

Auxiliary supply input: 4.5 to 20 V dc applied via connector. Supply must be ≥ 1.5 V dc more positive than any pin of IC under test.

Supply current: < 55 mA.

HP 548A Logic Clip

☎ Fast-ship product—see page 766.

\$220 ☎

HP 10529A Logic Comparator

The HP 10529A Logic Comparator clips onto powered TTL or DTL ICs and detects functional failures by comparing the in-circuit test IC with a known good reference IC inserted in the Comparator. Outputs of the particular IC to be tested are selected via 16 miniature switches which tell the Comparator which pins of the reference IC are inputs and which are outputs. Any logic state difference between the test IC and reference IC is identified to the specific pin(s) on 14- or 16-pin dual in-line packages on the Comparator's display. A lighted LED corresponds to a logic difference. Intermittent errors as short as 300 nanoseconds (using the socket board) are detected, and the error indication on the Comparator's display is stretched for a visual indication. A failure on an input pin, such as an internal short, will appear as a failure on the IC driving the failed IC; thus a failure indication actually pinpoints a malfunctioning node. A test board is supplied to exercise all of the circuitry, test leads, and display elements to verify proper operation.

HP 10541A: twenty additional blank reference boards; identical to the 10 boards provided with the Logic Comparator.

HP 10541B: twenty preprogrammed reference boards. The 10541B includes the following ICs: 7400, 7402, 7404, 7408, 7410, 7420, 7430, 7440, 7451, 7454, 7473, 7474, 7475, 7476, 7483, 7486, 7490, 7493, 74121, 9601.

HP 10529A Specifications

Input threshold: 1.4 V nominal (1.8 V nominal with socket board), TTL or DTL compatible.

Test IC loading: outputs driving Test IC inputs are loaded by 5 low-power TTL loads plus input of Reference IC. Test IC outputs are loaded by 2 low-power TTL loads.

Input protection: voltages < -1 V or > 7 V must be current limited to 10 mA.

Supply voltage: 5 V $\pm 5\%$, at 300 mA.

Supply protection: supply voltage must be limited to 7 V.

Maximum current consumption: 300 mA.

Sensitivity

Error sensitivity: 200 ns with reference board or 300 ns with socket board. Errors greater than this are detected and stretched to at least 0.1 second.

Delayed variation immunity: 50 ns. Errors shorter than this value are considered spurious and ignored.

Frequency range: maximum operational frequency varies with duty cycle. An error existing for a full clock cycle will be detected if the cycle rate is less than 3 MHz.

Accessories included: 1 test board; 10 blank reference boards; 1 programmable socket board; 1 carrying case.

Accessories Available

HP 10541A: Twenty Blank Reference Boards

HP 10541B: Twenty Pre-programmed Boards

Price

\$100 ☎

\$300 ☎

HP 10529A Logic Comparator

☎ Fast-ship product—see page 766.

\$750 ☎

DIGITAL CIRCUIT TESTERS

Logic Troubleshooting Kits

Models 5011T, 5021A, 5022A, 5023A & 5024A

- Complete multi-family kits
- Stimulus-response capability
- In-circuit fault finding

- In-circuit analysis
- Dynamic and static testing
- Multi-pin testing



HP 5011T

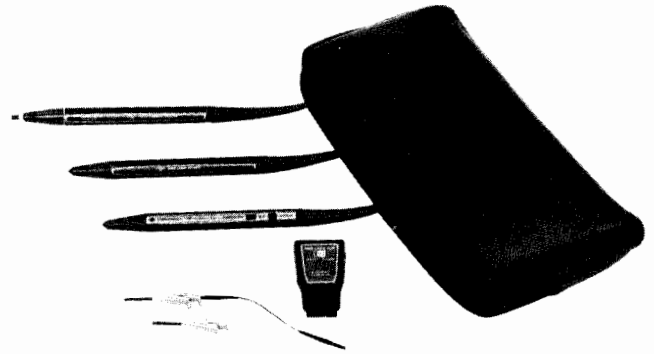

HP 5022A

FAULT	STIMULUS	RESPONSE	TEST METHOD
Shorted Node ¹	Pulser ²	Current Tracer	<ul style="list-style-type: none"> • Pulse shorted node • Follow current pulses to short
Stuck Data Bus	Pulser ²	Current Tracer	<ul style="list-style-type: none"> • Pulse bus line(s) • Trace current to device holding the bus in a stuck condition
Signal Line Short to Vcc or Ground	Pulser	Probe, Current Tracer	<ul style="list-style-type: none"> • Pulse and probe test point simultaneously • Short to Vcc or Ground cannot be overridden by pulsing • Pulse test point, and follow current pulses to the short
Supply to Ground Short	Pulser	Current Tracer	<ul style="list-style-type: none"> • Remove power from circuit under test • Disconnect electrolytic bypass capacitors • Pulse across Vcc and ground using accessory connectors provided • Trace current to fault
Internally Open IC	Pulser ²	Probe	<ul style="list-style-type: none"> • Pulse device input(s) • Probe output for response
Solder Bridge	Pulser ²	Current Tracer	<ul style="list-style-type: none"> • Pulse suspect line(s) • Trace current pulses to the fault • Light goes out when solder bridge passed
Sequential Logic Fault in Counter or Shift Register	Pulser	Clip	<ul style="list-style-type: none"> • Circuit clock de-activated • Use Pulser to enter desired number of pulses • Place Clip on counter or shift register and verify device truth table

1. A node is an interconnection between two or more IC's.
2. Use the Pulser to provide stimulus or use normal circuit signals, whichever is most convenient.

Used individually, each of HP's IC Troubleshooters provide their own unique and important troubleshooting function. Together they become invaluable stimulus-response testing partners that help pinpoint faults and ensure fast non-destructive repair of digital circuits.

To help you take advantage of the usefulness of the IC Troubleshooters, HP has packaged them into kits which offer both ordering convenience, and cost savings. Also, applications information is available, such as AN 163-2, "New Techniques of Digital Troubleshooting", to help users derive maximum benefit from these instruments.

The table shows a series of typical node and gate faults and the combination of tools used to troubleshoot the circuit. As with all sophisticated measuring instruments, operator skill and circuit knowledge are key factors once the various clues or "bits" of information are obtained using the IC Troubleshooters.

To accomplish troubleshooting at the node and gate level, both stimulus (Pulser) and response (Probe, Tracer, Clip and Comparator) instruments are needed. Moreover, instruments with both voltage and current troubleshooting capability help isolate electrical faults where the precise physical location is hard to identify.

The HP 547A Current Tracer, the latest and most sophisticated of these troubleshooters, lets you "see" current flow on nodes and buses that otherwise appear stuck at one voltage level. Used with the HP 546A Pulser, stimulus-response testing is now also possible in the current domain.

IC Troubleshooter Kits Ordering Information

Kit	H mm (in)	W mm (in)	D mm (in)	Net Wt kg (lbs, oz)	Ship Wt kg (lbs, oz)
HP 5011T	82.6 (3.25)	203 (8)	311 (12.25)	1.49 (3.5)	2.11 (4.11)
HP 5021A	64 (2.5)	146 (5.75)	298 (11.75)	0.51 (1.2)	0.62 (1.6)
HP 5022A	64 (2.5)	146 (5.75)	298 (11.75)	0.65 (1.7)	0.76 (1.11)
HP 5023A	225 (8.88)	200 (7.88)	337 (13.25)	1.63 (3.10)	2.19 (4.14)
HP 5024A	64 (2.5)	146 (5.75)	298 (11.75)	0.60 (1.5)	0.71 (1.9)

Accessories Available

HP 00545-60104: Tip Kit for HP 545A Probe, and 546A Pulser

Price \$50 ☎

HP 10526-60002: Multi-pin Stimulus Kit for Logic Pulser

\$70

HP 10529-60006: External Reference Kit for HP 10529A Comparator

\$420

HP 10541A: Twenty blank reference boards for HP 10529A Comparator

\$100 ☎

HP 10541B: Twenty pre-programmed reference boards for HP 10529A Comparator

\$300 ☎

☎ Fast-ship product—see page 766.

IC Troubleshooter Kits Selection Guide

HP MODEL	545A TTL/CMOS Probe	546A TTL/CMOS Pulser	547A TTL/CMOS Current Tracer	548A TTL/CMOS Clip	10529A TTL Comparator	PRICE \$
5011T Kit	X	X		X	X	1320 ☎
5021A Kit	X	X		X		590 ☎
5022A Kit	X	X	X	X		990 ☎
5023A Kit	X	X	X	X	X	1730 ☎
5024A Kit	X	X	X			770 ☎

☎ Fast-ship product—see page 766.



Technological advances and increased worldwide competition are placing new demands on production managers to cut costs, increase productivity and improve process quality. Automatic test equipment has become a key factor in achieving these goals. The implementation of a cost effective ATE solution requires careful assessment of the particular production environment in which it will be used.

Fault Identification

The cost of finding a fault or failure in electronic equipment increases by a factor of ten at each stage of the production process. While the quantifiable costs are high, intangible costs can be even greater. Defects at the board level cause bottlenecks, disrupting the smooth flow of the production process. Failures found at final test lead to late deliveries and non-linear shipments. If a failure reaches the field, it tends to undermine your company's reputation for quality.

Your real goal is high turn-on rates in final test. To achieve this goal requires boards that are defect free. High yield PC boards are a function of good parts, good processes, and good design.

Many defects can occur in the PC assembly process that cannot be detected by incoming inspection and bare board testing. Therefore, the best place for thorough testing is at the board level because it is the first opportunity to locate faults across the entire fault spectrum.

The Board Test Advantage

Automatic board test equipment will save you money by increasing productivity and improving process quality. Productivity is increased by replacing labor intensive manual testing with computer-aided testing. Component level diagnostics reduce re-work costs.

As production throughput increases, so does your plant capacity.

ATE will also help achieve your quality goals. Improved quality will lower warranty costs and preserve customer goodwill. Automatic testing provides feedback necessary to diagnose problems in your production process and correct them. This allows you to build quality into your product, not test it in.

Choosing a Circuit Board Tester

Your production operation is unique, so you must consider such factors as: production yield, process induced fault spectrum, production volume, board type, and anticipated new products. A major consideration is the level of support you will require from your ATE vendor.

Three general types of loaded board testers are being used in the electronics industry. They are in-circuit, functional and combinational testers.

Functional Board Testers

Functional test systems emulate the electrical environment of the board under test. The primary goal of the functional tester is to verify the dynamic performance of the complete circuit under test. Most are simulator-based and provide a fast go/no go decision on the board under test. Since most tests are performed at the board-edge connector, fault isolation is more difficult and time consuming than on an in-circuit tester. The same is true for programming the dedicated functional test system.

Combinational Test Systems

Individually, in-circuit and functional testers have advantages and disadvantages. Combining these measurement techniques provides a complimentary approach to board testing. Test systems that combine in-circuit

and functional test capability can not only check for shorts and component errors, but can verify the dynamic performance of the circuit under test. Analog functional testing comes standard with all HP test systems. Digital functional testing is optionally available on the HP 3065 Family of in-circuit board testers.

Computer Integrated Manufacturing (CIM)

Computer Integrated Manufacturing (CIM) is viewed as an overall strategy for linking existing production technologies to manage previously independent activities. The test workcell is one of the areas that, when linked to the CIM network, can improve the manufacturing process, productivity and the quality of your products and services.

The HP Q-STAR Network offers the foundation for implementing CIM in your manufacturing process, while providing the optimum solution for your test workcell needs. It provides the tools to implement quality management techniques, paperless repair, and test program management across the test workcell with a minimum investment. It also provides links to a factory-wide CIM network. The Q-STAR Network provides a modular approach for maximum flexibility in implementing CIM in your test workcell.

Is ATE the Answer?

Can automatic board test equipment save you money? Would CIM increase productivity and improve your manufacturing process and product quality? An HP Sales Representative can help you answer these questions and more. Ask about HP's 99% Guaranteed Uptime Services as well.



BOARD TEST SYSTEMS

Model 3065 Board Test Family



- Combinational Testers
- Guaranteed 99% Uptime Service

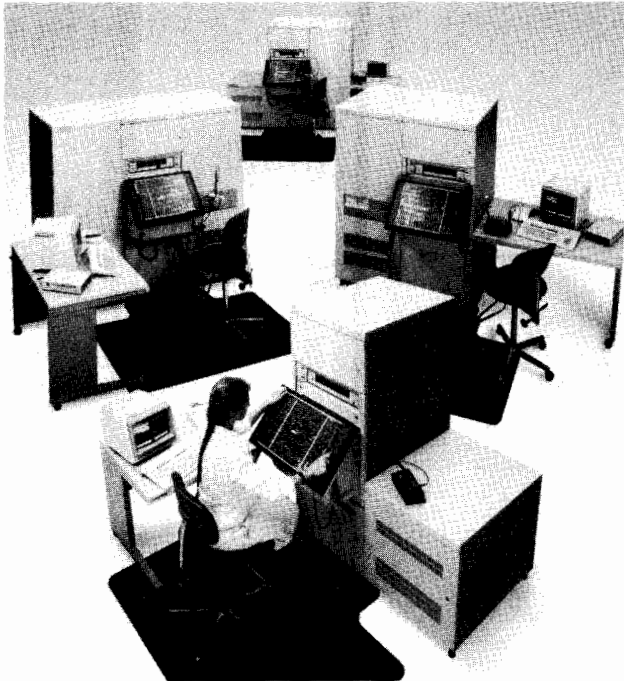

Description

The HP 3065 Board Test Family is the result of many years of experience in automatic testing and advanced computer technology. These combinational testers feature high speed digital in-circuit and digital functional testing with our proven 6-wire analog in-circuit and analog functional measurement capabilities. Their distributed intelligence architecture allows a single system controller to support multiple test stations, multiple programming and repair stations, and a variety of peripherals without sacrificing high throughput in production test.

Controller:

The HP 3065 Family has three system controllers providing a wide selection of price/performance combinations. All include specialized HP minicomputers, each with different operating speeds, memory capacity and peripheral handling capabilities.

The HP 3065C System Controller provides up to two megabytes of internal memory and a 132Mb fixed disc drive. A single controller can support up to three test stations and three programming/repair stations simultaneously.

The HP 3065CL uses an HP A600+ based controller with up to 4Mb of internal memory and a 55Mb fixed disc drive. It supports one test station and two additional terminals for programming. Up to 14 terminals can be added for use as repair stations. The test station must be located adjacent to the controller.

The HP 3065CX is an HP A900 based controller and has up to 9Mb of internal memory and a 132Mb fixed disc drive. It supports up to three test stations and up to 19 programming/repair stations simultaneously.

Digital/Analog Test Stations

Two test stations are available in the HP 3065 Board Test Family. Both the test stations provide state-of-the-art in-circuit and functional testing to isolate both component and process induced faults on PC

board assemblies. Each scanner has 22 slots for analog, digital, hybrid and general purpose relay cards providing up to 1408 analog or 1320 hybrid points.

The HP 3065HX test station provides digital and analog in-circuit and analog functional testing capabilities. Digital in-circuit tests use a distributed control structure to apply test patterns at programmable rates of up to 5 MHz on all hybrid pins; 2.5 MHz on dedicated digital pins. Analog in-circuit tests use 3-, 4-, 5-, or 6-wire guarding, phase synchronous detection, extra digit and enhanced modes to measure a wide range of components and component values. Analog functional tests are made using internal sources and detectors and a wide range of external instrumentation via the HP-IB (IEEE-488) interface. In addition to the measurement bay, an instrument bay is provided to allow the addition of up to eight programmable digital DUT power supplies and/or functional test instruments.

The HP 3065HL is a single bay test station with the same user interface as the HP 3065HX. It supports dedicated analog and digital cards as well as hybrid cards. The test station has four fixed DUT power supplies and the capability to support two additional programmable supplies. Digital pattern application rates are programmable up to 5 MHz on all hybrid card pins; 2.5 MHz on all dedicated digital pins. Analog functional testing capability is supported, but the equipment bay is not provided.

In-circuit Test Performance

The HP 3065 Family combines digital and analog test capabilities to provide high quality tests for exceptional test effectiveness. More components over a wider range of values can be tested, lowering your overall testing costs and increasing the quality of your products.

Digital In-circuit Testing

Digital in-circuit testing techniques are used to detect IC pin faults on the loaded PC board. Using a "Computer-behind-the-pins" that contains RAM storage, the HP 3065 can produce complex test signals to test MSI, LSI and VLSI parts. The RAM, using "keep" and "toggle" in addition to the traditional 1, 0, X and Z vector states, has essentially unlimited vector capability. Data compression of 150:1 and greater can be achieved using this technique.

Digital pattern application rates are programmable up to 5 MHz on all hybrid pins (2.5 MHz on dedicated digital pins). For signal purity and repeatability at these rates, the HP 3065 Family was designed with transmission line impedance-matching throughout the digital subsystem. Using the recommended twisted pair fixture wiring extends this controlled impedance to the board under test.

All driver/receiver pins can access two distinct reference sets of drive and receive thresholds, allowing multiple logic families to be tested in a single pass. For more than two logic families, the reference levels can be reprogrammed between tests to give unlimited logic family capability.

HP's extensive library of digital tests now contains over 4500 part numbers of SSI, MSI, LSI and VLSI devices. Since the library is continuously being updated, the HP 3065 Family keeps pace with advancing technology.

The HP 3065 Family features the standard Safeguard In-circuit analysis package which minimizes the risk of tester-caused damage to your digital devices. This package analyzes each digital test as it is created, taking into consideration device parameters such as package type, power dissipation, voltage overshoot and overdrive currents. If unsafe overdrive conditions are detected, the programmer is notified and can correct the problem. The Safeguard In-circuit analysis also automatically insures adequate cooling times for repeatedly over-driven devices like bussed microcomputer parts. Dual drive edge speeds protect against CMOS damage. The slow edge minimizes overshoot and ringing that cause latchup. The fast edge is used for testing TTL and ECL logic where fast rise times are required.

Advanced Analog In-circuit Testing

Advanced analog in-circuit testing is based on the proven analog techniques pioneered in the HP 3060A, 3061A and 3062A board test systems. The HP 3065 Family can perform 2-, 3-, 4-, 5-, and 6-wire measurements for testing critical components precisely in complex circuits. Phase synchronous detection is used to measure the value of individual components in parallel combinations.

Hybrid devices such as CODEC's, A-to-D's, DAC's and other complex circuits can easily be measured by simply synchronizing the digital and analog subsystem capabilities.

Combinational Test

The HP 3065 Family offers both analog and digital functional test capability to increase your final test yield. Functional testing increases test effectiveness by finding faults not found in in-circuit testing and allowing tuning and adjustments of circuits by the system operator.

Analog Functional Testing

The HP 3065 test system has standard sources and detectors to provide analog functional testing on the board under test. If additional capability is required, optional test instrumentation can be added via the standard HP-IB (IEEE-488) interface.

Digital Functional Testing

The HP 3065 Advanced Technologies Tester (HP 3065AT) is specifically designed for the enhanced testing of VLSI, ASIC, and SMD based PCBs. The HP 3065AT Tester features high speed data capture, clock speeds for testing 32-bit microprocessors, and advanced control line capability for bus emulation testing. These test features provide significant capability for improving detection and diagnostics of manufacturing defects and parts faults. This enhanced test capability provides yields of 98% to 99% on PCBs.

Test Advanced VLSI and ASIC Parts

The combination of in-circuit and advanced technology testing extends the capabilities of the HP 3065 to find defects caused by advanced VLSI devices used on the DUT. Increased use of VLSI devices such as 32-bit microprocessors and one Mbit memories has changed the test feature set needed to find manufacturing and parts faults. The HP 3065AT meets these test requirements by providing programmers with data application rates of 7.5M patterns/sec and clock rates to 16.67 MHz. DUTs with onboard clocks of up to 20 MHz can be synched directly to AT Tester hardware with the synch-to-clock capability.

High speed data rate application is backed by a virtually unlimited number of patterns for test purposes. The HP 3065AT uses a 64K deep sequence RAM for applying patterns and a 2K directory RAM to extend the pattern set to as many as 67 million possible patterns.

Advanced VLSI devices require extensive timing control capabilities for complex bus protocols. The HP 3065AT provides programmers with eight trigger inputs, eight clock waveform inputs and outputs, and twelve programmable waveform pins. A total of fifteen timing sets are available for controlling bus protocols. Different timing sets may be invoked for each vector application. Within these vector applications strobe times and states (1, 0, tristate, etc.) are modifiable on-the-fly. Up to 240 events can occur within a single timing set.

Application Specific Integrated Circuit (ASIC) parts such as PALs, gate arrays and standard cells are custom configured for a DUT. The HP 3065AT makes testing of these devices easier by providing a Pattern Capture Format for entering custom vector sets from a CAE system to the HP 3065AT test program. Given the capability

to use the ASIC custom vector sets and the system flexibility, complete tests can be easily formulated.

Test Unaccessible Circuits Through Cluster Testing

Often the physical layout (required by SMDs) or electrical limitations (testing PALs) make it difficult or impossible to automatically probe or backdrive a component or group of components. The HP 3065AT provides excellent fault detection in this situation. Then, by using the Backtrace Probe algorithms, programmers can obtain extremely accurate component diagnostics.

Diagnose Faulty Parts

The HP 3065AT backtrace algorithm is generated from fixture and library data to provide fault isolation within a circuit cluster. Internal circuit states can be measured automatically via the bed-of-nails fixture, or through an operator probe capability, to capture signals up to 25 MHz. Programmers can choose data capture (bit-by-bit) or CRC signatures for circuit measurements. The program can also branch during the algorithm to perform diagnostic tests using analog measurements. This is especially useful in hybrid signal circuit test.

Graphical Debug for Ease of Programming

The Graphical Debug package reduces the time required for programmers to prepare complicated tests. The programmer can view eight programmed waveforms or 16 ASCII representations at a time directly on the system terminal for any number of waveforms as required. This can be effectively used to insure that the waveform set is entered into the software as intended. Once the waveform set is verified, the actual waveforms can be viewed as they are applied to the DUT using 30nsec sampling intervals.

Protect Your Investment

In order to protect your investment in the production test area, many factors must be considered. Three of the most important considerations are the flexibility, compatibility and service of your ATE systems.

Keep Pace with Technology

The modularity and flexibility of the HP 3065 Family allow the user to keep pace with rapidly changing board test technology. An ongoing enhancement program in both the hardware and software areas has produced advances such as a new vector processor card, a new hybrid card, and the new Advanced Technologies test capability for digital functional testing.

The HP Q-STAR network has added new software packages that include HP PR PLUS, NS/3065, Q-STATS II, and BTL PLUS to link the test workcell into your facility-wide CIM structure.

System Compatibility

The HP 3065 family of testers provide perhaps the most important factor in protecting your investment . . . system compatibility. Test programs and fixtures developed on one system are easily transported to others within the family. Therefore, training, test programs and fixtures are not abandoned when additional testing capacity is needed.

99% Guaranteed Uptime Service

In the U.S., HP is offering a 99% Guaranteed Uptime Service program on the HP 3065 Board Test Family. This is made possible by the excellent reliability record of the HP 3065 and HP's outstanding support organization. HP offers a complete solution to your application, hardware and software support needs.

HP 3065 Board Test Family

For an informative brochure on the HP 3065 Board Test Family or more information on the 99% Guaranteed Uptime Service program, call 1-800-634-8378.

Prices start at \$148,000.



BOARD TEST SYSTEMS

Model 3061A/3062A Board Test Systems



Description

The HP 3061A and HP 3062A test systems combine excellent in-circuit fault isolation with functional testing capability to maximize PC board yields. Both incorporate advanced measurement and interface technology based on years of experience within HP and field proven in the HP 3060A.

The HP 3061A Board Test System has been optimized for analog PC board testing. It combines advanced analog in-circuit and analog functional test capabilities with high speed shorts/opens testing.

The HP 3062A Board Test System adds both digital static and digital functional testing to analog testing capabilities of the HP 3061A. You can choose the system that is right for your specific production test needs.

System Controllers

You may select from four system controllers, the HP Model 36, HP Model 26, HP Model 20, or HP Model 16. Software written on one model is directly compatible with the others. The HP Model 26 and 36 computers have built-in floppy disc drives for convenient programming. Additional hard disc drives can be added. The HP Model 16's low cost and small physical size makes it an ideal controller for dedicated test applications. The HP Model 20 Box Computer is rack mounted and offers a low cost alternative to the HP Model 26 and 36. It has a 15-slot card cage for additional interfaces and memory expansion.

Advanced Analog In-Circuit Testing

The HP 3061A/3062A advanced analog in-circuit testing finds faults over a wide variety of components, measurement values, and tolerances. Advanced six-wire guarding methods make accurate measurements possible, even in cases of severe parallel shunting. Programmers may select a variety of guarding methods to optimize throughput and/or accuracy for specific production requirements.

This test technique assures you of consistent measurement results from board-to-board and between systems. For example, you can off-load analog testing from one tester to another during peak production periods and get the same test results. HP analog in-circuit testing techniques mean flexible, consistent, and accurate measurements from your testers.

Analog Functional Testing for Higher Yields

Analog functional testing enhances the results of in-circuit testing and significantly increases PC board yields. Yields of 85-90% using analog in-circuit test methods may be increased to 95-98% with the addition of functional testing. The standard HP 3061A/3062A gives the user a wide range of measurement test tools for full functional testing. If additional functional test capability is required, HP-IB instrumentation from Hewlett-Packard may be easily added for your specific functional test needs.

Digital Functional Testing

The HP 3062A tests digital PC boards containing a wide range of logic devices including microprocessors. The testing of microprocessor-based circuits with bus-structured devices, large memories, and dynamic memory devices often presents difficult test problems. Functional testing of your microprocessor boards is reduced to a manageable task using Signature Analysis (SA).

Digital Static Pattern Testing tests circuits of medium complexity. This technique stimulates digital circuits and compares the measured response to an expected response. Using advanced analog testing and static pattern testing, hybrid circuits such as A to D's and phase lock loops can be thoroughly tested.

Software for Your Programmers

Test development times are reduced to a minimum through the use of HP's high-level languages and automatic program generator. The system software includes the following:

- **Board Test Language (BTL200)**-BTL200 controls complex system functions including setup, measurement, response and data evaluation. On-line editing and immediate execution makes the testing of complex circuit configurations a simple task.
- **In-Circuit Program Generator (IPG200)**-IPG200 automatically generates the analog in-circuit test program from the circuit description entered by the programmer. It analyzes the circuit for parallel paths and automatically selects optimum guarding locations. IPG200 then prints out a measurement analysis of each component, the test program, and fixture documentation. Once the fixture is built, verification software helps to check for construction errors.
- **Software Development Package (DFT200)**-DFT200 software development package aids the user in entering and debugging programs using the Signature Analysis (SA) technique. DFT200 combines stimulus and SA measurement routines into a final efficient test program. This means faster program execution and high PC board throughput.

HP Q-STAR Networking/Datalogging

HP BTL PLUS links the HP 3061/3062 into the HP Q-STAR Network via the HP-IB (IEEE-488) interface. The software package (HP 44582A) is an enhanced version of the standard HP 3061A/3062A system software, so compatibility with existing software is preserved. Networking the HP 3061A/3062A systems with the HP 3065 CL/CX controllers that have Network Services (NS/3065) allows these systems to become an integral part of your test workcell. HP BTL PLUS allows you to:

- Archive your test programs in one central location
- Monitor your production process by collecting data
- Analyze this production data with HP Q-STATS software
- Ensure data accuracy with automatic datalogging
- Create a centralized repair station for several testers
- Download current test programs from central disc storage
- Protect your data and programs with HP Q-STAR file security

HP Support

Qualified systems engineers are located near your facility to provide you with applications and programming support. Customer Engineers support your system on a worldwide basis through the use of locally-placed system service kits. But, that's still not the whole story. Complete user training courses are taught for each system. To enhance the learning process, these training courses are offered at 14 Hewlett-Packard training locations throughout the world.

Ordering Information

HP 3061A Board Test System
(depending on configuration)
HP 3062A Board Test System
(depending on configuration)

Price starts at \$78,000

Price starts at \$128,000



BOARD TEST SYSTEMS

HP Q-STAR Test Network Software System



Description

Automatic testing is not the total solution to productivity or product quality. Software applications must exist to form the framework for using board test data to improve product quality as well as provide timely feedback to improve the manufacturing process using Statistical Quality Control (SQC) techniques. There must also be an overall strategy for linking computer-aided solutions throughout the entire manufacturing facility. Hewlett-Packard offers Computer Integrated Manufacturing (CIM) products and services linking all areas within the facility. Timely communication among production, engineering and administration is essential if control of the manufacturing facility is to be maintained.

The HP Q-STAR Test Network offers the basis for implementing SQC and CIM in the manufacturing process while providing the optimum solution for your test workcell needs. It provides the tools to implement quality management techniques, paperless repair across the network, and test program management at minimal additional cost to you.

The modular structure of the applications software in the HP Q-STAR Network provides the flexibility to select only the capability you need now and then add others as your needs expand. Some of the basic applications (PRR, Q-STATS) are provided as a standard part of the system software. Then, as your needs increase, test management software (NS/3065 and BTL PLUS), network-wide paperless repair (PR PLUS), and more sophisticated quality management software (Q-STATS II) can be added.

Test Software Management

HP NS/3065 (HP 44670A) provides transparent network services for multiple HP 3065 board test systems and is built on an HP AdvanceNet foundation. HP NS/3065 gives you the flexibility to create a network that meets your needs today and expands to cover your board test needs in the future. Linking test systems together with HP NS/3065 gives you the advantages of:

- File sharing, for automatic program archiving and downloading
- Resource sharing, lowering your investment in peripherals
- File security, ensuring revision control of test programs, protection of proprietary programs, and prevention of accidental data loss
- Compatibility with existing programs, for shorter learning curves
- Distributed processing, for more uptime and unlimited expansion

In addition to linking board test systems, NS/3065 also provides high-speed connections to other computer systems for data processing and storage.

HP BTL PLUS links the HP 3061A/3062A into the HP Q-STAR Network via the HP-IB (IEEE-488) interface. The software package (HP 44582A) is an enhanced version of the standard HP 3061A/3062A system software, so compatibility with existing software is preserved. Networking the HP 3061A/3062A systems with the HP 3065CL/CX controllers that have Network Services (NS/3065) allows these systems to become an integral part of your test workcell.

HP BTL PLUS allows you to:

- Archive your test programs in one central location
- Monitor your production process by collecting data
- Analyze this production data with HP Q-STATS software
- Ensure data accuracy with automatic datalogging and bar code reader capability
- Create a centralized paperless repair station for several testers
- Download current test programs from central disc storage
- Protect your data and programs with HP Q-STAR file security

Paperless Repair Software

Two paperless repair software packages are available as a part of HP's Q-STAR Network. The first, Paperless Repair/Reporting (PRR), is a standard part of the HP 3065 Family software. HP PRR with its bar code capability automates the diagnostics flow between the test and repair areas of a board test cluster (test stations and systems tied to a single HP 3065 Controller) and provides board tracking through the test/repair cycle. Actual failure data from the board test cluster is collected and sent to the HP Q-STATS data base for analysis. Alarms are built in to alert the operator to repeated defects to minimize repair and scrap.

HP PR PLUS (HP 44671A) has all the benefits of PRR plus additional features to provide the most efficient use of available resources. It allows paperless repair across the entire board test network so boards can be repaired on any available terminal. Failure data is transferred into the HP Q-STATS II data base from any repair terminal on the network. In addition, HP PR PLUS supports local language screens to allow the repair operator to quickly understand the problem.

HP's paperless repair software streamlines the repair operation while providing timely feedback to improve production processes.

Quality Management Software

Analysis of data gathered in the test/repair loop is performed by HP Q-STATS, another standard feature of the HP 3065 Family software. Statistical analysis of raw data from a board test cluster provides useful information required by programmers, test engineers, and managers. For example, producibility reports provide a statistical measure of the quality and repeatability of a test. HP Q-STATS provides production management information in several different formats based on Statistical Quality Control concepts. Tabular reports high-tested, and the average test and repair times. Pareto charts give detailed information such as board failures by component designator.

HP Q-STATS II extends the SQC-analysis features across the entire test workcell that may include HP 3065's, 3061/62A's, and other automatic test systems. It integrates data from all these sources into one data base and analyzes all this data to produce useful SQC information. HP Q-STATS II contains reporting features that HP Q-STATS does not have, including presentation-quality graphical formats and new reports such as control charts, overview histograms, and various other production summaries.

Two additional features of HP Q-STATS II are SQL ad hoc queries of the data base and the use of an HP 9000 workstation with an HP-UX operating system as the host computer. The use of the separate workstation allows the data to be analyzed and reports generated without impacting the throughput of the test systems. Add NS/1000 and a link to HP QDM/1000 and the data in HP Q-STATS II can be integrated into a facility-wide quality data base.

Since HP Q-STATS II implements a turnkey data collection function, test managers will find it easier to implement SQC practices to improve quality and increase the productivity of the production processes.

Ordering Information

	Price
HP 44582A BTL PLUS Software for HP 3061/62A Systems	\$5,000
HP 44670A NS/3065 Software for HP 3065 Family	
Option 010 NS/3065 for HP 3065C Controller	\$4,500
Option 020 NS/3065 for HP 3065CL Controller	\$4,500
Option 030 NS/3065 for HP 3065CX Controller	\$7,500
HP 44671A PR PLUS Software	\$4,500-\$7,500
HP 44672A Q-STATS II Software	\$40,000

BOARD TEST SYSTEMS

Board Test Application Services

- Custom fixtures, board test software and library test software
- Fast turnaround
- High quality solutions
- Local installation

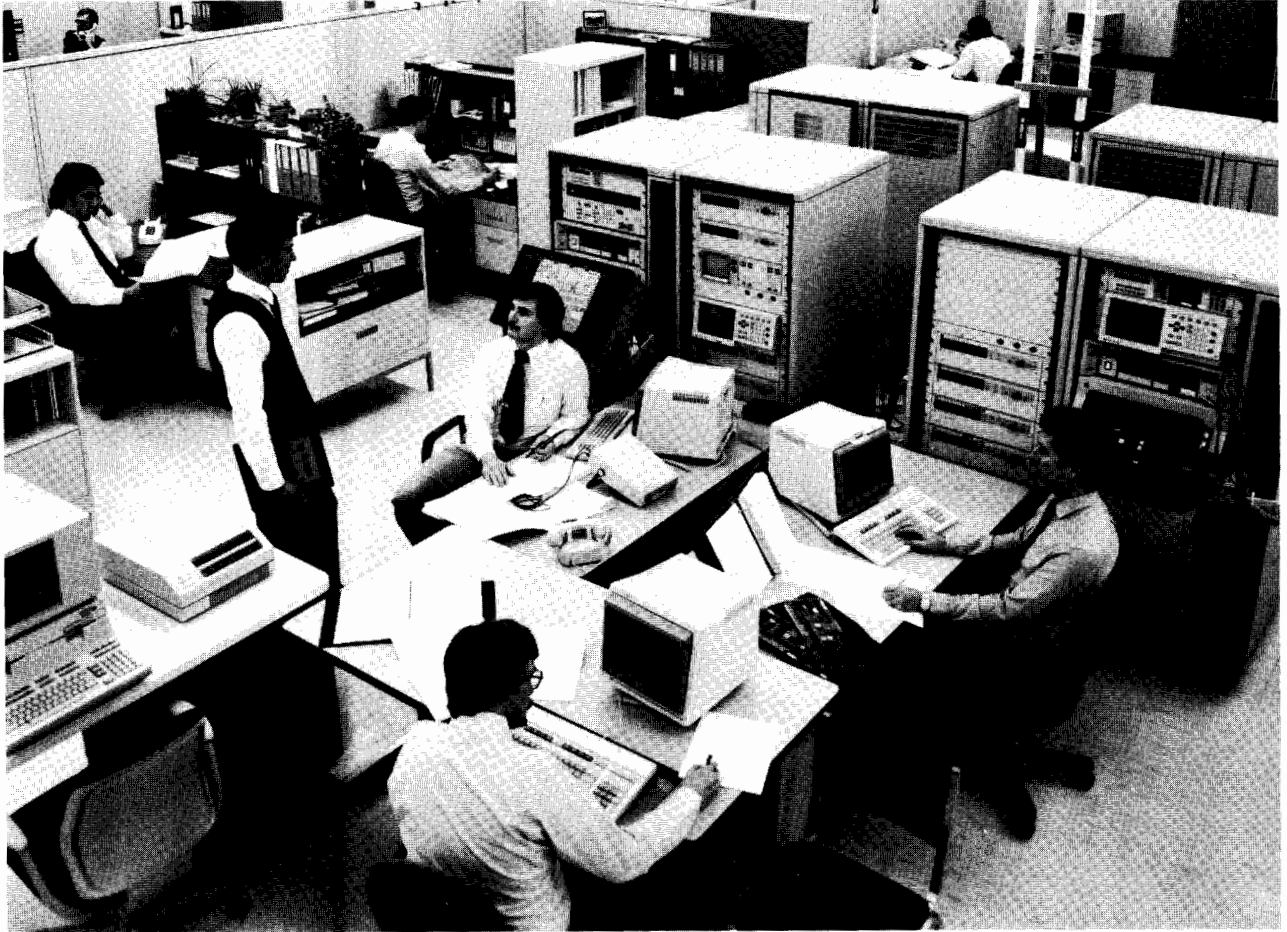

Custom board test application services are available through HP's SupportNet team of Application Centers and your local Application Engineer. By using the SupportNet team, you can benefit from the economies of scale provided by a centralized programming and fixturing staff in the Centers, and have the assistance of near-by Application Engineers to help define your requirements, and to install and support custom programs when they are completed.

The SupportNet team offers a broad range of custom fixtures and programs tailored to fit your exact needs. HP is able to offer these services at economical prices by taking advantage of the hundreds of man-years of experience of SupportNet personnel, combined with significant capital investments in automated assembly, programming stations and test equipment.

Custom Fixtures

Custom fixtures may be ordered for any of HP's board test systems. The fixtures can be built from one of HP's high-quality fixture kits, or from a kit brand of your choice. To provide a fixture built to your exact needs, you may select from a number of options including special probe types, unique fixture plate milling and special damming of the fixture vacuum. You may also choose to have specialized electronics built into the fixture or custom interfaces built for programmable instrumentation.

HP also maintains an on-going monitoring program for special fixtures developed by third parties including dual-access and dual-stage fixtures.

Custom Programs

Custom in-circuit board test software is available for the HP 3061A, 3062A, and 3065 board test systems. This software includes data entry, shorts and opens tests, in-circuit testing of digital ICs using the HP 3065 digital device library and specific functional tests for various circuit components. It may optionally include library test development of digital ICs—either commercial or custom—not yet in the HP 3065 device library, or these tests can be ordered separately.

These programs include a complete, personalized documentation package and on-site installation by your HP Application Engineer.

Ordering Information

HP 44810A Custom Fixture-Built from Small HP Kit
 HP 44811A Custom Fixture-Built from Large HP Kit
 HP 44812A Custom Fixture-Built from Dual HP Kit
 HP 44813A Custom Fixture-Special Design
 HP 44820A Custom In-Circuit Board Test Program
 HP 44830A In-Circuit Library Test Program

Price

Quote
 Quote
 Quote
 Quote
 Quote
 Quote

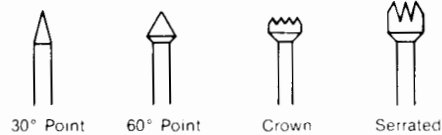
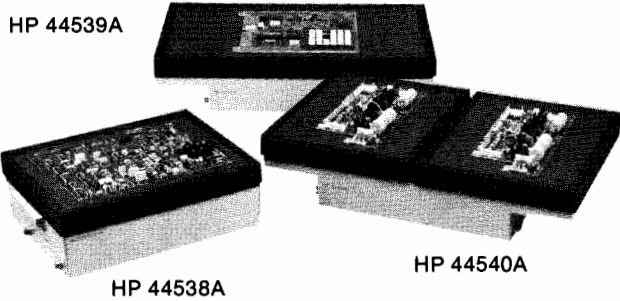

Fixturing Products

Description

The vacuum-actuated test fixtures have a dual vacuum plate design that creates a guided probe system. The spring probes are equipped to allow wire-wrap interconnections, and are easily replaceable. A patch panel interfaces the probes to HP 306X Board Test Systems' relay matrix. The entire lightweight fixture is enclosed by a molded plastic case, eliminating the possibility of accidental damage or contamination. An optional extender and breadboard kit allows you to add your own custom test circuitry to the fixture.

Performance

Special attention has been paid to the design of the fixturing products to ensure performance. The patch panel is made of a material that exhibits very high isolation resistance. This means leakage currents are kept low and will not significantly affect in-circuit measurements. In addition, the spring probes exhibit low series resistance and can handle up to three amperes of current.

Attention has been paid not only to electrical performance but to mechanical performance as well. For example, the fixture has been designed to significantly reduce vacuum requirements. Low leakage probe sockets together with an improved vacuum seal made of durable Poron help achieve an air-tight construction. The improved vacuum seal serves to muffle the acoustic noise level for smooth, quiet operation.

The fixture kits are designed for ease of assembly and modification. No adhesives are required at any point in the assembly process. The test head is hinged and can be locked in either the down position or the up position for easy access to wiring. Once assembly is completed, a fixture verification software package aids you in debugging the initial construction and is also useful for repairing and troubleshooting the kits already in production.

Test Fixture Available in Three Sizes

There is a kit for relatively small boards up to a size of 25.4 x 33 cm (10" x 13"). For larger boards, a kit that will accommodate sizes up to 33 x 55.9 cm (13" x 22") is available. In addition, a dual fixture kit is available which allows you to increase throughput by testing boards in tandem. Each side of the dual fixture will accept a small size PC board. All three of the fixturing products are fully compatible with HP 306X Board Test Systems, and are available as either options or accessories.

Fixture Kit Construction Parts

Probes

Four probe styles are available, each with two different ranges of spring tension. The probes can be ordered with sixty degree single-point tip (HP 44561L and 44561H), star or crown-point tip (HP 44563L and 44563H), serrated multi-point tip (HP 44562L and 44562H) and spear point tip (HP 44564L and 44564H). The high force (8 oz. spring tension) probes are recommended except for high pin density applications. In these applications, low force (4 oz. spring tension) probes should be used. Each option contains 100 probes.

Sockets

HP sockets (HP 44574A) are specially designed for low air leakage and reliability. The sockets have 0.54" diameter barrel which accepts most standard probes.

Patch Panel Plugs

Eight patch panel plugs are available to meet your specific fixture building needs. Single (HP 44589S and 44589SW) and dual plug (HP 44590D and 44590DW) versions are available pre-wired and with wirewrap posts or posts only. The pre-wired 5-plug (HP 44592A) is used for HP 3065 system's digital nodes. It features twisted pair wires for quick and easy wiring of 4 digital nodes. The hybrid driver/receiver 5-plug and ground plug (HP 44592H and 44592G) allow for convenient hybrid wiring. HP 44591A DUT PWR Pin plugs are required for HP 3065 digital pulser power wiring. These plugs are specially designed to fit the HP 3065 system scanner board.

Extenders

Height extenders are available for the standard fixture (HP 44560S) and for the large or dual fixture (HP 44560D). These extenders add 7.6 cm (3") of vertical height. A 12.7 cm x 17.8 cm (5" x 7") breadboard is available for either extender.

Assembly tool kit—HP 44572A option 003 contains the hardware and tools needed to assemble HP test fixtures. One tool kit is needed for each assembly station.

Spare parts kit—HP 44573A contains spare parts for constructing or modifying an HP test fixture.

Ordering Information

	Price
HP 44538A Standard Test Fixture Kit	\$655
HP 44539A Large Test Fixture Kit	\$830
HP 44540A Dual Test Fixture Kit	\$990
HP 44560S Standard Extender	\$170
HP 44560SA Standard Extender Angled to 45°	\$150
HP 44560D Large/Dual Extender	\$250
HP 44560DA Large/Dual Extender, Angled to 45°	\$150
HP 44572A Assembly Tool Kit	\$125
Option 001 Fixture Verification Software Package	\$225
HP 44573A Spare Parts Kit	\$90

Probes

HP 44561L LF Single (60°) point 100 per bag	\$150
HP 44561H HF Single (60°) point 100 per bag	\$150
HP 44562L LF Serrated Head 100 per bag	\$170
HP 44562H HF Serrated Head 100 per bag	\$170
HP 44563L LF Star 100 per bag	\$95
HP 44563H HF Star 100 per bag	\$95
HP 44564L LF Spear (30°) point 100 per bag	\$95
HP 44564H HF Spear (30°) point 100 per bag	\$95

Sockets

HP 44574A Socket (.054" dia. barrel)	\$60
--------------------------------------	------

Patch Panel Plugs

HP 44589S Single Plug w/wirewrap tail	\$60
HP 44589SW Single Plug pre-wired	\$115
HP 44590D Dual Plug w/wirewrap tail	\$160
HP 44590DW Dual Plug pre-wired	\$185
HP 44591A HP 3065 DUT Power Pin Kit	\$65
HP 44592A HP 3065 Dr/Rv 5-plug	\$505
HP 44592H Hybrid Dr/Rv 5-plug	\$605
HP 44592G Hybrid Ground Plug	\$80



VIDEO TEST EQUIPMENT

Video Measurement System & Set

Models 51810S, 51810 A/R

- High-throughput video testing
- Tasks separated for operator, test and QA managers
- Test results stored in database



The HP 51810S Video Measurement System

HP 51810S Video Measurement System

Over 60 parameters on NTSC baseband video signals are automatically measured using this computer-based test system. Signal-to-noise ratio, differential gain and phase, as well as other distortion measurements are among the tests it performs. Although intended primarily for production-testing of video products, the HP 51810S Video Measurement System will find applications in research and development, quality assurance, and broadcasting due to the wide variety of measurements it can make.

The HP 51810S is among the first high-volume manufacturing solutions available for final testing of video products. In keeping with the industry's growing demand for automatic test equipment, features like high test speed, ease of use, and a database for storing test results have been included. Separating tasks into test creation, test execution, and results evaluation, allows semi-skilled operators to run predefined tests easily, while providing full flexibility to quality assurance and test managers.

Along with advanced measurement software, the system combines new and existing hardware products. The new product, an HP 51810A or HP 51810R Video Measurement Set includes a Video Sync Separator and the Video Measurement Software. (The HP 51810R is a discounted version of the HP 51810A for multiple purchases.)

Powerful System Components

At the heart of the system is an HP 5180A Waveform Recorder, which captures and digitizes the video signal from the device under test. The HP 5180A is a high-fidelity, 10-bit digitizer, yielding chrominance amplitude resolutions up to 0.05 IRE. Combining digital interpolation schemes in software with a 20 MHz sampling rate, timing resolutions of 5 ns are obtained.

In addition to providing triggering signals to the waveform recorder, the Video Sync Separator (part of the Video Measurement Set) offers signal preprocessing on 1 volt, 75 ohm baseband video signals with a clamp, a subcarrier filter, an anti-aliasing filter and a times ten gain amplifier. The subcarrier filter is used for tests in which luminance information is not needed. Maximizing the voltage

resolution of the measurement, it allows the waveform recorder to capture the signal on the largest possible range. The gain amplifier is used for measuring noise on a quiet line. All of the functions of the sync separator are programmable via an HP-IB interface, and are changeable through the video-system-software menus.

The Video Measurement Software (also part of the Video Measurement Set) extracts gain, phase, timing, noise and distortion parameters from the digitized waveform, compares them to two preset limits - cautionary and alarm - and stores them for later analysis. Separating tasks in the software for three types of users - test manager, operator, and report manager - make the system quick to learn and easy to use.

Each of the hardware components in the system are powerful tools that can be used to solve other measurement problems. In addition to the Waveform Recorder and the Video Sync Separator, the system consists of an HP 9000 Model 310 computer with 3 megabytes of memory, an HP 9133H 20-megabyte Winchester disc drive, and optional printers and plotters. Other types of tests such as audio tests can be created using the same computer and waveform recorder by using leftover memory or adding additional memory to the system.

High-Throughput Testing

At typical production-test throughputs, this system automatically tests up to 250 products per hour. Contributing to its high speed are advanced assembly-coded, digital-signal-processing routines, which make single-line measurements throughout the video frame. Test speeds are also increased by incorporating an optimizer that orders and groups tests, eliminating redundant digitizing operations. Finally, high-speed data transfers to the computer are accomplished using a direct-memory-access (DMA) interface.

Within the software, "hooks" have been included for interfacing the system to other test equipment. Communication to a programmable generator, bar code reader, or a host computer are all possible. The system is conveniently equipped with both HP-IB and RS-232C interfacing abilities for these purposes.

Flexible, Yet Simple to Operate

To simplify operation, while retaining full flexibility, the three steps of testing - definition, execution, and evaluation - are structured for three types of users. The three users are the test manager, the operator, and the report manager. Each is provided with only the capabilities needed to perform their task.

- **The test manager** defines and orders tests, sets test limits and manages the database. Softkeys are used to select appropriate test definition information from menus. Data entry is checked to prevent entering inconsistent parameters. Most screens have HELP keys, informing the users what that screen is for and how to use it.
- **The operator** executes the tests defined by the test manager. After entering the serial number of the device to be tested, PASS or FAIL information is displayed on the screen. Two levels of test limits are reported: cautionary and alarm. (Limits are set by the test manager.) The operator can obtain quick, pre-formatted reports showing actual results or can proceed directly to testing the next unit.
- **The report manager** uses the database to analyze test results offline. Histograms, statistics and single or multiple device-test reports are all available with the standard software.

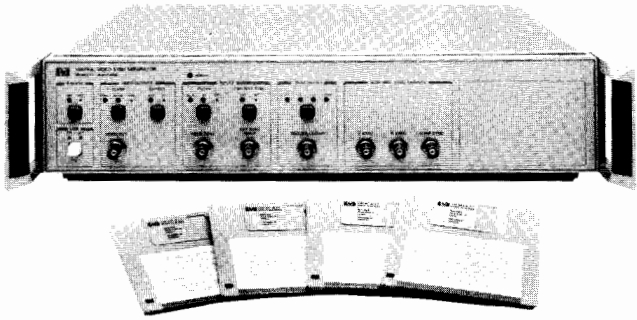

HP 51810A Video Measurement Set Convenient Modes Of Operation

Tests are selected by two methods. User-defined test groups are useful for manufacturing testing, and in device characterization where a well-thought-out test group is to be applied. "Quick Tests" are singly executed tests ideal for engineering applications. In both modes, tests can be programmed to run once, multiple times, or continuously. In addition, a delay between measurements is programmable for parameter trending over time. While running a user defined test group, the test manager has the choice of whether or not to store test results in the database.

Thousands of Test Results Stored

A database stores the HP 51810S test results for several thousand devices, depending on the length and number of the test groups defined. These results may be accessed easily for quality checking and process monitoring, by sorting on device serial number, date, failed parameter, and operator. Reports are defined by the report manager, which include histograms and statistics. Hard copies are easily obtained using any of several high quality HP plotters and printers.

Full Range of Standard Tests

All of the measurements that the system makes are based on standards set by the Electronic Industries Association (EIA RS-170-A and RS-250-B), the Network Transmission Committee (NTC-7) the Federal Communications Commission, and the International Radio Consultative Committee (CCIR). Below is a list of the tests performed. Several standard signals may be used for each test. An insertion gain test is performed at the user's request to calibrate out any system-gain errors.

• Differential Gain and Phase

While most test systems report only two answers for Differential Gain and Phase, the 51810S adds amplitude and phase measurements for each chrominance packet in the signal under test. Also included in this test are Burst-Amplitude, and Relative-Burst-Gain and Phase measurements.

• Gain-Frequency Distortion

By reporting the 6 packet amplitudes on an FCC multiburst or NTC-7 combination signal, the frequency response of the device under test can be obtained.

• Chrominance-Luminance Intermodulation

Both the reference luminance level, and the difference between the reference and each luminance level on a 3-level chrominance signal are reported.

• Chrominance-Luminance Gain/Delay Inequality

Also called "Relative Chroma Level and Relative Chroma Time" tests. Chrominance and luminance amplitudes and chroma delay are reported.

• Luminance Nonlinearity

Amplitude step differences for each level of a 5 or 10 step modulated staircase are reported.

• Chrominance Nonlinear Gain/Phase Distortion

Chroma amplitude of each of the 3 packets on a modulated pedestal or NTC-7 Combination signal are reported. Also, the normalized amplitude of the 20 IRE and 80 IRE packets are reported with the middle packet scaled to 40 IRE. The average phase of each packet is given relative to the color burst as well as the total phase deviation in absolute degrees.

• Color Bar Amplitude and Phase

All six color bar amplitudes and phases are reported for either the EIA, SMPTE, or FCC color bar signals.

• Dynamic Gain

Bar amplitude and sync amplitude in IRE are given, as well as sync amplitude as a percent of bar.

• Short/Line Time Waveform Distortion

Bar tilt and 2T pulse amplitude, and ringing amplitudes in 4 places are reported.

• Signal-to-Noise Ratio

Six different signal-to-noise ratio tests are available including SNR NTC-7, SNR CCIR, and four user-defined-weighting SNR measurements. Using the insertion gain test, noise is measured relative to actual signal power.

• Horizontal/Vertical Timing

Horizontal timing measurements (line 10 and above) include sync width, rise and fall times, front and back porch durations, blanking and breezeway width, sync to setup time, and color cycles. On lines 1-9, vertical sync, serration, and equalizing pulse widths are measured.

• Waveform Monitor

A selected line of video is captured and displayed on the computer screen. Relative or absolute amplitude and timing information at any point is displayed using cursors controlled with softkeys. Zooming is accomplished using digital interpolation.

Accessories Available

System Controller Accessories

	Price
HP 10833A HP-IB Cables, 1.0 m (2 needed)	\$80
HP 10833D HP-IB Cables, 0.5m (1 needed)	\$80
HP 10875B DMA Cable	\$180

Recommended Accessories

Plotter (choose at least one)	
HP 7475A Graphics Plotter, OPT 002	\$1,895
HP 7470A Graphics Plotter, OPT 002	\$1,095
Printer (choose at least one)	
HP 2225A Thinkjet Printer	\$495
HP 2934A Dual-Mode Printer	\$2,995

Ordering Information

This ordering guide lists the HP 51810S line items required for compatibility. It is not necessary to order any line item you already own. Contact an HP Sales Representative at your local HP Sales Office for assistance. (See page 769.)

System Reference

	Price
HP 51810S Video Measurement System	
This system model number ensures coordination of shipments and compatibility of instruments and software.	0

Video Measurement Set (includes Video Measurement Software and Sync Separator)

HP 51810A Video Measurement Set (first copy)	\$11,500
HP 51810R Video Measurement Set (copies 2-n)	\$9,100

Digitizer

HP 5180A Waveform Recorder	\$18,600
-----------------------------------	----------

Mass Storage

HP 9133H 20 MByte Winchester	\$2,740
-------------------------------------	---------

System Controller

HP 98580A Measurement Automation System	\$5,750
HP 98257A 1M Byte Ram Board (2 required)	\$1,450 each
HP 98622A GPIO Interface	\$355
HP 46084A HP-HIL Module	\$150

Fast-Ship product — see page 766.

DATA COMMUNICATIONS TEST EQUIPMENT

General Information: Protocol Analysis



HP Family of Datacomm Test Equipment

Hewlett-Packard and Data Communications Test Equipment

As a major supplier of computer equipment, Hewlett-Packard brings a unique perspective to datacomm testing. We understand your network and datacomm component support and test needs, because we have the same needs. In R & D, data center, or field service, we have the products and the experience to make you successful.

When you call HP, you'll talk to local datacomm test experts, much more than typical sales representatives. They can provide training, advice, and service quickly, from an HP office near you. And they will be there when you need them, weeks or years from now.

We know you don't want to invest effort in developing test equipment expertise. Keeping up with datacomm systems and technologies is enough of a challenge. You want equipment that lets you test quickly, with a minimum of effort, in any environment. In a recent survey, our customers told us their main reason for buying HP datacomm test equipment is that it's easy to use.

The growth of demands on datacomm systems is matched only by the burden of developing and maintaining them. Maximizing system availability and utility requires increasingly sophisticated testing. As just one example, consider the wasted time and expense of calling in the wrong vendor for service when testing can assure you of calling the right one. Clearly, your network's performance can only be as good as your ability to

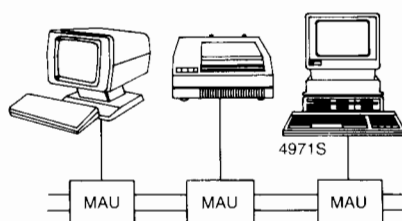

LAN Test

measure and test. Hewlett-Packard has a proud history of contributions to the datacomm test industry. This year we introduced three new protocol analyzers, including our first LAN protocol analyzer, and the first non-intrusive analog test set.

A datacomm network can be divided into protocol (user level) links between computers, terminals, printers, or other data terminating equipment (DTE). Two DTEs communicate across a digital link such as RS-232C/V.24, RS-449, V.35, or X.21 for wide area networks (WAN), or IEEE 802.3/Ethernet in the case of local area networks (LAN).

If the digital link is long, it may contain an analog link, such as a telephone line. Guaranteeing transparency of DTE to DTE communications is the function of protocol. This first section deals with protocol testing. Digital and analog testing are discussed in following sections. Test points in a typical WAN system for the three domains of datacomm testing are shown here.

Protocol Analysis

In data communications, protocol can be defined as "rules governing the exchange of information between two pieces of data processing equipment," plus control lead changes in a wide area network.

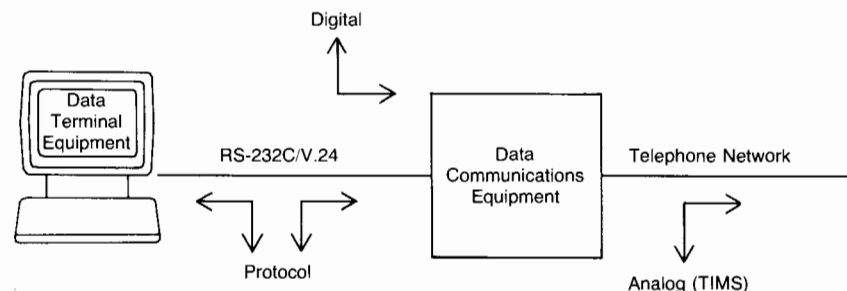

WAN Test

Protocol may take the form of characters or bit fields separate from or added at the beginning or end or in the midst of user data. It is needed for message:

- Framing and Synchronization
- Error Detection and Recovery
- Sequence Control
- Acknowledgement
- Link Initialization and Disconnection
- Addressing and Routing

With low speed, simple datacomm networks, an observer can watch data flow on a standard data monitor, visually searching for anomalies. This observer needs intimate knowledge of his network's protocol, as well as the capacity for inexhaustible attention to detail. Modern high-speed, complex, multi-level protocols and very complex networks, make real-time manual analysis (monitor mode) virtually impossible. A protocol analyzer can make complex automated testing easy and provide many other more sophisticated capabilities. In addition to the monitor mode, a protocol analyzer offers two other fundamental modes of operation: data analysis mode and simulate mode. In data analysis mode, as in monitor mode, the analyzer is non-intrusively connected at the digital interface, and the system functions as though no analyzer were present. In the analysis mode it:

- Stores selected data for future use
- Displays only selected data
- Triggers on selected events
- Interprets advanced protocols
- Counts or times events
- Verifies protocol function
- Evaluates system performance
- Detects protocol incompatibilities

Simulation opens a whole new dimension of datacomm support. In addition to these analysis tools, the analyzer can now replace elements of the network being tested. It can imitate the network to a DTE or node, and exercise segments of the network without loading down the system or risking system failure because of malfunction in the tested segment. The analyzer can simulate a DTE or node into the network for system troubleshooting or certification.

Protocol analyzers can be used for:

- Troubleshooting
- System integration
- System installation
- Fault isolation
- Software and hardware development
- Network performance optimization

Different test applications and environments require different protocol analyzers. For field service, key features are portability, ease-of-use and remote capability. Speed, power and large capture memory characterize needs of an EDP center. R & D and manufacturing require automation and programmability. In the fast changing world of protocol, versatility and power to add new capabilities are needed for any application.

The Hewlett-Packard Protocol Analyzer Family

HP offers a family of five powerful, general purpose protocol analyzers, with software and accessories to meet your special needs. While maintaining family compatibility, each analyzer is tailored for a different environment, with different features and characteristics. All have common operating, setup, remote transfer and display characteristics. If you have used one HP protocol analyzer, you can immediately use any other. An overview of differences and similarities is presented in the accompanying chart. Family features and individual highlights are discussed in the following pages.

Ease-of-Use

HP protocol analyzers use a softkey-driven menu, human interface to provide sophisticated testing capability without cryptic programming or long learning curves. With dynamic relabeling of the softkeys, only choices appropriate to the setup and menu level are presented. No special programming skills or obscure code words need to be learned. Complex tests can be written and run using only the softkeys. Complete setups and tests can be easily stored for reuse or distribution. All analyzers have typewriter quality, full ASCII keyboards. All WAN analyzer keyboards fold against the instrument fronts to protect the CRT, mass store devices and keyboard. The special displays make visual analysis of high level protocols or complex control lead handshaking quick, sure and easy, and they work equally well on real-time, buffered or stored data.

Power

In addition to capturing the character traffic on a channel, HP WAN protocol analyzers capture all control lead activity and mark each event with a unique time stamp. These time stamps remain with the data for event-to-event timing measurements and timing diagram displays. Timing and lead information allows complete analysis of traffic at a later time, in another analyzer, or at a remote location.

Relative time relationships are maintained without filling the buffer or mass storage with idle line time.



HP Protocol Test Family

Sophisticated triggering allows you to program the analyzer to take a variety of actions in response to different system events. Character strings, lead transitions, errors, complicated protocol activity, or any event on the interface can trigger the analyzer to send a message, increment a counter, start or stop a timer, start or stop display or storage, highlight, or take other actions. Triggering effectively automates protocol analysis. Most common protocols are built in to the HP analyzer family with specialized displays, instrument setup, and triggering and message mnemonics available as needed. User-defined character asynchronous/synchronous allows operation in most non-standard protocols. Many protocols and analysis capabilities not inherent in the analyzers are available as applications software.

Beyond the powerful analysis abilities in non-intrusive monitor mode, all family members provide powerful simulate capability. Softkey and menu programming allows easy stimulus/response testing of network components without tying up other network resources. All triggering and analysis capabilities are available while actively simulating networks or components. Simulation can be especially useful in isolating intermittent or infrequent problems, or for testing a new application or device before system connection.

Applications Packages

Software and/or hardware accessories extend the capabilities of your HP analyzer in new protocols or applications. Some currently available packages are listed in the family chart and discussed on the following product pages. Applications packages guarantee that

your HP protocol analyzer will not be obsoleted by your changing needs, or by changing technology and standards.

Remote

All HP protocol analyzers support the remote exchange of data, menus, setups, and applications software over RS-232/V.24. The HP 4953A, 4952A, and 4971A provide total remote operation over RS-232/V.24. Local or remote computer control of the analyzers is possible. Remote capability gives field service personnel access to central site expertise and central site experts direct access to remote sites without qualified service personnel.

Applications

Major applications involving protocol analyzers include field service; electronic data processing center support; network component research, development, manufacture, installation and service; and general network troubleshooting. HP's protocol analysis applications join the company's family of general purpose analyzers, special need accessories and extensive support services to provide complete solutions for HP customers.

Hewlett-Packard is your source for total datacomm network and component test and support. The following pages detail specific applications and operating characteristics for each analyzer. Beyond equipment, Hewlett-Packard provides the utmost in training and support for datacomm users. Your local HP field engineer will be happy to supply information about seminars or customer engineering services available in your area, as well as more detailed information or a demonstration of Hewlett-Packard protocol analyzer family members meeting your needs.



☆ = NEW

☆ **HP 4951C** ☆ **HP 4952A** **HP 4953A** **HP 4955A** ☆ **HP 4971S**

Size (HWD—cm) (HWD—Inches)	11.2x25.9x28.6 cm 4.4x10.2x11.3 in.	11.2x25.9x28.6 cm 4.4x10.2x11.3 in.	19.6x42.5x41.2 cm 7.8x16.8x16.3 in.	19.6x42.5x65.4 cm 7.9x16.8x25.7 in.	Configuration dependent
Net Weight	6.4 kg (14 lb)	6.8 kg (15 lb)	15.5 kg (34 lb)	22 kg (49 lb)	
Price (Typical)	\$4,000 US	\$7,000 US	\$14,000 US	\$19,880 US	\$22,000 US
Physical Interfaces	RS-232C/V.24, RS-449/422A/423A, MIL-188C, V.35	RS-232C/V.24, RS-449/422A/423A, MIL-188C, X.21, V.35	RS-232C/V.24, RS-449/422A/423A, MIL-188C, X.21, V.35	RS-232C/V.24, RS-449/422A/423A, MIL-188C, X.21, V.35	IEEE-802.3 (ETHERNET)
Protocols	Async, Sync, Bisync, SDLC, HDLC, SNA, DDCMP, X.25, IPARS	Async, Sync, Bisync, SDLC, HDLC, SNA, IPARS, X.25, X.21	Async, Sync, Bisync, SDLC, HDLC, SNA, DDCMP, X.25, X.21, Bisync-framed X.25, CCITT#7/CCS7	Async, Sync, Bisync, SDLC, HDLC, SNA, DDCMP, X.25, X.21, Bisync-framed X.25, CCITT#7	TCP/IP, DECNET, XNS User Defined
Data Rate	50 bps—19.2 kbps	50 bps—64 kbps	50 bps—72 kbps	50 bps—72 kbps	10 Mbps
Display	5 in. diagonal, 16 lines, 32 chars/line	5 in. diagonal, 16 lines, 32 chars/line	9 in. diagonal, 25 lines, 80 chars/line	9 in. diagonal, 25 lines, 80 chars/line	12 in. diagonal, 25 lines, 80 chars/line
Mass Store	3.5 in. Microfloppy	3.5 in. Microfloppy	500 Kbyte Tape 512 Kbyte NVRAM	Dual 500 Kbyte Tapes	Choice of Disc Drives 3.5 in. Microfloppy 10-40 Mbyte Winchesters
Video Out	RS-170	RS-170			Hi Resolution
Programming	Softkey Menus	Enhanced Softkey Menus	Softkey Menus, SNA Testing Language, X.21 State Simulator	Softkey Menus/opt BASIC	Enhanced Softkey Menus
Timers/Counters	5/5	5/5	5/5	5/5	16/16
Triggers	63 Simultaneous	63 Simultaneous	63 Simultaneous	63 Simultaneous	16 Filters with up to 62 characters each
Send String	1750 characters total 255 per message	1750 characters total 255 per message	1750 characters total 1350 per message	1750 characters total 255 per message	16 Messages of 2022 characters each
Auto Increment N(s),N(r),P(s),P(r)	No	No	Yes	Yes	Not Applicable
BERT	63, 511, 2047 PRBS	63, 511, 2047, 4095 PRBS	No	No	No
Autoconfigure	Yes	Yes	No	No	Node Map (Statistics Pac)
Cursor Timing	No	Yes	Yes	No	Yes
Data Capture Buffer	32 Kbyte NVRAM	32 Kbyte NVRAM opt 3/4 Mbyte	64 Kbyte (256 optional)	256 Kbyte RAM	1 Mbyte
Printer Output	Any RS-232C/V.24	Any RS-232C/V.24	Any RS-232C/V.24 Graphics with HP 2932A, 2934A, 2671G, 2673A, and 2225D ThinkJet	HP-IB Graphics with HP 2932A, 2934A, 2671G, 2673A	HP-IB HP 2225A ThinkJet
Remote Operation	Transfer data, menus via RS-232C/V.24	Transfer data, menus, SW applications via RS-232C/V.24 Total control via RS-232C/V.24	Transfer data, menus, SW applications via RS-232C/V.24 Total control via RS-232C/V.24	Transfer data, menus, SW applications via RS-232C/V.24 Total control via HP-IB	Transfer data, menus, SW applications via RS-232C/V.24 Total control via RS-232C/V.24
Other	Battery Backup of Menus, Data Terminal Emulator	Battery Backup of Menus, Data Autostart Disc file Terminal Emulator Data Filter	Autostart Tape file Data Filter	HP-IB Real-time Clock External Trigger In/Out	Real-time Clock



HP 4951C



HP 4953A



HP 4971S

DATA COMMUNICATIONS TEST EQUIPMENT

Protocol Analyzers

Models 4951C and 4952A

363

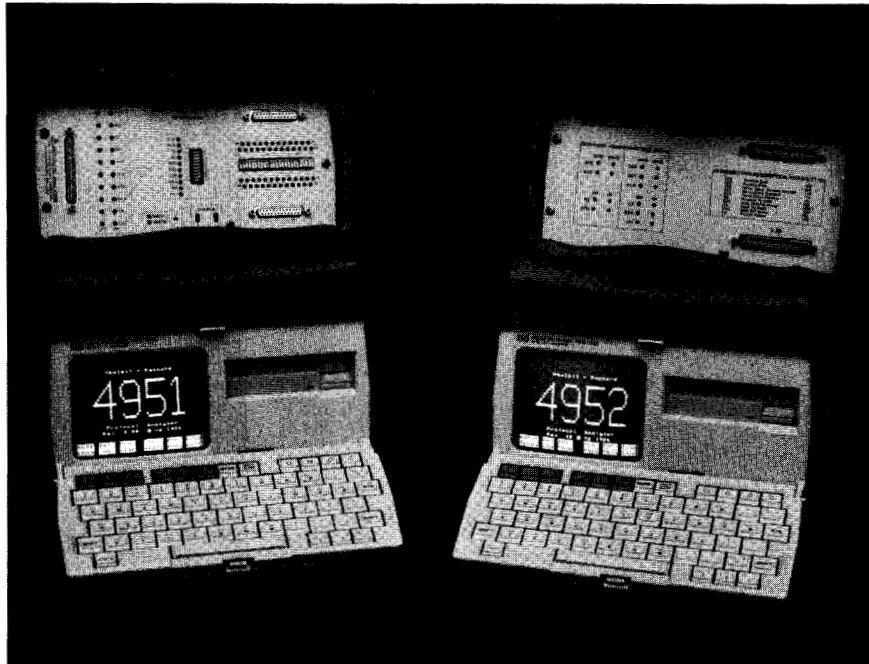

HP 4951C and HP 4952A Protocol Analyzers

The HP 4951C (19.2 kbps) and HP 4952A (64 kbps) are high performance portable data communications protocol analyzers used for the installation, maintenance, and design of data communications networks and equipment.

Applications

- Monitor and decode data transmissions.
- Simulate network components.
- Use as an asynchronous terminal.
- Install and maintain IBM* 3270 network components.
- Perform bit error tests.
- Test remote facilities from your facility.
- Decode 5, 6, 7, and 8 bit datacodes: ASCII, EBCDIC, Transcode, IPARS, Baudot, EBCD and Hex.
- Test many protocols standard with the HP 4951C and HP 4952A: Async, BSC, SDLC (NRZI), HDLC, X.25, user-defined async and sync protocols.
- Test additional protocols with software accessories:

	HP 4951C	HP 4952A
SNA	HP 18331D	HP 18261A
DDCMP	HP 18331D	—
X.25	HP 18331D*	Standard
X.21		HP 18260A

*Brings HP 4951C X.25 capabilities up to those of the HP 4952A.

Features to Make Your Job Easier

- With the push of a key, Auto Configure automatically determines line parameters and begins monitoring data.
- A 3 1/2" micro floppy disc stores 618 Kbytes of data, timing, lead status, programs and configurations.
- External viewing is supported via a standard RS-170 video port.
- Printouts to all RS-232C/V.24 printers via a separate port.

*IBM is a registered trade mark for International Business Machines.

- Nonvolatile memory stores data, programs, and configurations.
- 63 triggers for characters, errors, lead transitions, or timer values.
- 5 timers and 5 counters.

Additional Features of the HP 4952A

- 64 kbps
- 3/4 Mbyte extended capture buffer (Option 002)
- Nonvolatile application storage (Option 002)
- Unattended remote testing
- Cursor timing
- Enhanced programming features: Run time user comments, softkey triggering, subroutines
- Buffer data filtering to maximize capture buffer
- Selective store to disc

Ordering Information

HP 4951C Protocol Analyzer
(does not include interface pod or service manual)

Product	Option	Description	Price
HP 4951C		Protocol Analyzer	\$3450
	002	Deletes Integral Disc Drive	\$-400
	003	Katakana (JIS-7, JIS-8, EBCDIC, datacodes)	\$250
HP 18174A	101	RS-449/422A/423A Interface Pod	\$400
HP 18180A	102	Combination RS-232C/V.24 and RS-449/422A/423A Interface Pod	\$800
HP 18179A	103	RS-232C/V.24 Interface Pod with Full Breakout Box	\$550
HP 18177A	105	V.35 Interface Pod	\$700
	915	Service Manual	\$110
	916	Extra Operating Manual	\$30

HP 4953A	+N00	Software Notification Service	\$60/yr
HP 18190A		Soft Vinyl Carrying Case	\$125
HP 18331D		SNA Analysis, DDCMP, X.25 Analysis/Simulation Software	\$350
HP 18332D		3270 Installation and Maintenance Software	\$350
HP 18347A		HP 4951C Customer Training Course. See your local sales representative for location and availability.	*TBA
	W30	3-year extended hardware support. Provides 2 additional years of return-to-HP hardware service support (for 2nd and 3rd years).	\$170
HP 92192A		Set of 10 double sided discs	\$69 ☎
HP 2225D		RS-232C/V.24 ThinkJet Printer	\$495 ☎
9211-1290		Hard Transit Case	\$390

HP 4952A Protocol Analyzer

(does not include interface pod or service manual)

Product	Option	Description	Price
HP 4952A		Protocol Analyzer	\$6450
	002	Expanded Memory	\$1,500
	003	Katakana (JIS-7, JIS-8, EBCDIC data codes)	\$250
HP 18174A	101	RS-449/422A/423A Interface Pod	\$400
HP 18180A	102	Combination RS-232C/V.24 and RS-449/422A/423A Interface Pod	\$800
HP 18179A	103	RS-232C/V.24 Interface Pod with Full Breakout Box	\$550
HP 18260A	104	X.21/RS-232C/V.24 Interface Pod	*TBA
HP 18177A	105	V.35 Interface Pod	\$700
	916	Extra Operating Manual	\$40
HP 4953A	+N00	Software Notification Service	\$60/yr
HP 18190A		Soft Vinyl Carrying Case	\$125
HP 18261A		SNA Analysis	*TBA
HP 92192A		Set of 10 double sided discs	\$69 ☎
HP 2225D		RS-232C/V.24 ThinkJet Printer	\$495 ☎
9211-1290		Hard Transit Case	\$390
	W30	3-year extended hardware support. Provides 2 additional years of return to HP hardware service support	

☎ Fast-Ship product - See page 766

*To Be Announced



DATA COMMUNICATIONS TEST EQUIPMENT

Protocol Analyzer

Model 4953A



HP 4953A

HP 4953A Protocol Analyzer

The HP 4953A Protocol Analyzer is designed to aid you in:

- Decreasing the time for development of datacomm products and enhancing product quality with our protocol emulators and simulation tools.
- Minimizing downtime of your datacomm system by using our extensive applications software to quickly pinpoint network problems.
- Maintenance of datacomm networks and equipment.
- Unattended remote testing and complete remote site support through the transfer of data, menus, setups and applications from another analyzer or personal computer.

The HP 4953A is an easy-to-use, yet highly sophisticated tool for analyzing and simulating computer communications traffic. It effectively combines high-speed operation, multi-protocol versatility, large non-volatile mass storage, programming flexibility, hardware and software expandability, and ease-of-use.

High Speed

State-of-the-art multiprocessor design ensures reliable sophisticated analysis and simulation up to 72 kbps, and data capture of bit-oriented protocols up to 256 kbps. Our standard data filter allows for more efficient use of buffer memory. You can filter lead transitions, time stamps or received data.

As testing complexity and data link speeds increase, the HP 4953A will continue to provide the necessary flexibility and speed.

Multi-Protocol

Hewlett-Packard's commitment to popular complex protocols such as X.25, SNA, Bisync, X.21, X.75, DDCMP and CCITT#7/CCS7 means that the HP 4953A may be used to solve problems throughout the network, not just in one specialized area.

Non-Volatile RAM-disc Mass Storage

In addition to our 256 Kbytes of data capture buffer, the HP 4953A has 512 Kbytes of non-volatile RAM storage. All applications, captured data and program menus may be stored in this additional memory. At power-on any of the programs can be automatically loaded and can be run instantly.

Flexibility of Programming

High level protocol analysis and simulation is a standard capability of the HP 4953A. Simulation is fully softkey-driven and equipped with event triggers, timers and counters for actively testing stand-alone devices or network components. Real-time display of timers and counters in graphical form is also a standard feature on the HP 4953A. When performing conformance or margin testing, the HP 4953A will save time and increase productivity by providing a protocol testing standard. Additionally, selective capture of data to mass store saves time that would be wasted searching through volumes of captured data for events.

Ease-of-Use

HP's softkey-guided approach to operation helps bring you up to speed quickly while greatly increasing your efficiency.

Expandability

Extensive application software memory makes the HP 4953A one of the most expandable protocol analyzers available. Many software and hardware accessories are now available to broaden the HP 4953A's analysis and simulation capabilities. For example, our X.21 State Simulator Package allows you to completely analyze or simulate X.21 data traffic, and the SNA Emulation Language allows the development of SNA software products with efficiency and higher quality. As technologies and testing needs evolve, the HP 4953A customers can continue to meet their needs by purchasing low cost accessories rather than replacing protocol test equipment.

HP 18153A - SNA Analysis for the HP 4953A

The HP 18153A presents SNA data in clear, easy-to-read, high-level terms, showing the TH, RU and FMH for FID types 0, 1, 2, 3, 4 and F, plus the first 80 characters of data.

HP 18310A - NEW - SNA Emulation Language for the HP 4953A

The HP 18310A uses a programming language for developing and verifying operations of LU6.2 and 3270 SNA products. This programming environment contains SNA emulators and a softkey-driven programming language. In addition, pre-written test scenarios are also available to automatically verify operation of common IBM 3270-series and LU6.2 - compatible products. The HP 18310A requires Option 001 extended memory.

HP 18154A - X.21 Interface Kit for the HP 4953A

This interface kit complements the state-oriented HP 18198A. The HP 18154A strengths lie in the detailed Level I analysis of the X.21 physical interface and protocol.

HP 18198A - NEW - State Simulator for the HP 4953A

HP's top of the line X.21 testing solution, the HP 18198A, combines a state level decode, a protocol specific programming language, and ease-of-use to provide unequalled performance in an X.21 test tool. The HP 18290A is a set of X.21 analysis test programs written using the HP 18198A programming language. The HP 18198A requires Option 001 extended memory.

HP 18199A - CCITT#7/CCS7 Analysis for the HP 4953A

FISU and LSSU suppression, automatic network frame counts and inter-frame timing measurements. User-definable mnemonics and field segmentation for portions of Level 4 allow for on-going development of new fields and User Parts. Requires Option 001 extended memory.

HP 18155A - BSC-Framed X.25 Decode for the HP 4953A

Provides a clear, easy-to-read format of the link and packet level mnemonics of BSC-framed X.25 along with the first 80 characters of information.

Ordering Information

HP 4953A Protocol Analyzer

(does not include Interface Pod or Service Manual)

	Price
HP 4953A Protocol Analyzer	\$12000
Option 001: Adds Extended Memory	\$1000
Option 003: Adds Katakana Char.Set (JIS-8)	\$250
Option 100: Adds HP 18135A (RS-232C/V.24)	\$950
Option 101: Adds HP 18136A (RS-449/422A/423A)	\$950
Option 104: Adds HP 18137A (V.35)	\$1150
Option 105: Adds HP 18139A (MIL-188C)	\$950
Option 106: Adds HP 18136A and HP 18154A	\$2200
Option 908: Rack Mount (5061-9678)	\$35
Option 915: Service Manual	\$95
Option 916: Additional Operating Manual	\$55
Option +N00: Software Notification Service	\$60/yr.

DATA COMMUNICATIONS TEST EQUIPMENT

Protocol Analyzer

Model 4955A

365



Physical Interface Pods

HP 18135A: RS-232C/V.24 Interface Pod	\$950
HP 18136A: RS-449/422A/423A Interface Pod	\$950
HP 18137A: V.35 Interface Pod	\$1150
HP 18139A: MIL-188C Pod	\$950

Application Software

HP 18153A: SNA Analysis	
HP 18154A: X.21 Interface Kit*	\$1250
HP 18155A: BSC/X.25 Decode	\$450
HP 18198A: X.21 State Simulator	\$7010
HP 18199A: CCITT#7/CCS7 Analysis	\$1600
HP 18290A: X.21 DTE Analysis Pack (requires HP 18198A)	\$500
HP 18310A: SNA Emulation Language	\$2500
HP 18311A: SNA 3270 Device Exerciser	\$1000
HP 18312A: SNA LU6.2 Node Exerciser	\$2000

Other Accessories

HP 18140A: Breakout Box for all Interfaces	\$505
HP 98200A: Certified Blank Tape Cartridges, Set of 5	\$95 ☎
9211-2644: Transit Case	\$430

*Requires HP 18136A (RS-449/422A/423A) Pod



HP 4955A

HP 4955A Protocol Analyzer

The HP 4955A is a high level tool for R & D and manufacturing, as well as for network performance analysis. In addition to the standard capabilities provided within the protocol analyzer family, the HP 4955A offers optional BASIC programming, HP-IB control, a real-time clock, and dual tape drives. Troubleshooting is straightforward with the softkey-driven menus. The datacomm-enhanced BASIC (Option 001) programming language can be used for sophisticated analysis or for unique applications. BASIC uses many of the menu routines, maintaining softkey ease-of-use while giving you the capability to write your own programs as needed.

The HP 4955A, combined with the HP 18150JA X.25 Conformance Testing and Certification System, provides you with a very powerful tool for certifying equipment for use in X.25 networks. This package contains more than 700 individual test sequences for verifying conformance to the CCITT X.25 specification. These tests were designed in accordance with the National Bureau of Standards' X.25 verification procedure, FS 1041/FIPS 100. This package also contains a Link level DTE and DCE emulation program which allows easy packet level testing by automatically handling the link level. Together, the HP 4955A and the HP 18150JA offer an extremely powerful X.25 problem-solving system.

General Operating Characteristics

Protocols: X.25, HDLC, BSC, SDLC, user-defined character synchronous and asynchronous. Available software accessories supply custom display formats to decode SNA, BSC-framed X.25, DDCMP, X.21, and CCITT#7.

Data Transfer Rates: 50 bps to 72 kbps using internal clock. The HP 4955A can properly frame data at higher rates using an external clock.

Data Transmission Modes: Synchronous, asynchronous, and synchronous NRZI.

Capture Memory: 256 Kbytes for storing data, timing, and interface lead status.

Triggers: 63, using any combination of characters, errors, or interface lead transitions. External TTL, pulse trigger-in and trigger-out ports are provided. Bit and character masking, and "not" characters are supported. Trigger events can be selectively displayed and stored to tape. Data and time can also be stored for future reference.

Timers and Counters: 5 each.

Timers: 65535 ms max; 1 ms resolution and accuracy.

Counters: Up to 9999.

Date and Time Clock: Battery backup.

Dual Tape Drives: Cartridges store buffer data and timing information, menu configurations, custom data codes, application programs, and BASIC programs. The entire contents of the buffer memory may be stored on a single data cartridge.

Display: 23 cm (9 in.) diagonal, 25-line by 80-character display. Double size characters are selectable.

Keyboard: The full ASCII keyboard pivots and locks at any angle for convenient desk, bench, rack, or floor-standing operation.

HP-IB (IEEE-488-1978): As a controller, it allows for direct hard copy output of any display to an HP 2671G, HP 2673A, HP 2932A, or HP 2934A printer. In addressable mode, the HP 4955A can be operated remotely using an HP-IB controller.

Security: Simulation and data recording capabilities can be inhibited.

Ordering Information

HP 4955A Protocol Analyzer (includes HP 18135A)	Price
Option 001: BASIC Programming Language	Add \$1200
Option 002: Deletes HP 18135A	Less \$950
Option 003: Katakana Character Set (JIS-8)	Add \$250
Option 500: Japanese Operating Manual (04955-90026)	Add \$55
Option 908: Rack Mount Kit (HP 5061-9678)	Add \$35
Option 910: Extra Operating Manual (04955-90029)	Add \$55
Option 915: Service Manual (04955-90004)	Add \$95

Physical Interface Pods

HP 18135A: RS-232C/V.24 Interface Pod	\$950
HP 18136A: RS-449/422A/423A Interface Pod (Balanced RS-422A drivers)	\$950
HP 18137A: V.35 Interface Pod	\$1150
HP 18138A: X.21 Interface Kit (used with HP 18136A)	\$250
HP 18139A: MIL-188C Interface Pod	\$950

Software and other Accessories

HP 18140A: Breakout Box (for all interfaces)	\$505
HP 18141A: Service Kit	\$750
HP 18142A: BASIC Programming Language Field Retrofit Kit	\$1500
HP 18145A: Remote Testing Package	\$500
HP 18146A: CCITT#7 Decode Package	\$500
HP 18150JA: X.25 DTE and DCE Conformance Testing and Certification System	\$2500
HP 18151JA: X.25 DTE Conformance Testing and Certification System	\$1500
HP 98200A: Certified Blank Tape Cartridge (set of 5)	\$95 ☎
9211-2662: Transit Case	\$550
One day HP 4955A Training (+24A)	\$1475
HP 4953A +N00: Software notification service	\$60/yr.

☎ Fast-Ship product — See page 766



DATA COMMUNICATIONS TEST EQUIPMENT

LAN Protocol Analyzer

Model 4971S



HP 4971S LAN Protocol Analyzer

The HP 4971S is a LAN protocol analyzer for troubleshooting on local area networks employing Ethernet or IEEE 802.3 protocols on a 10 Mbps baseband coaxial medium or other mediums with Ethernet-compatible interfaces. This LAN protocol analyzer provides a comprehensive, easy-to-use, troubleshooting tool for fast problem isolation and maintenance of a local area network. It allows the user to monitor traffic on the network, generate data frames to test other nodes, and gather statistics to verify network performance. An HP 4971S can also download programs via an RS-232C/V.24 link to another HP 4971S for troubleshooting a LAN in a distant location.

Features

A View Into Your Entire LAN

The HP 4971S allows you to completely decode IEEE 802.3 and Ethernet data frames, as well as formatting the upper-layer protocols. You can actually see the content of the frames transmitted on the network.

Generation of Data Frames: Lets the user define up to 16 different messages for testing other nodes or for traffic load generation.

16 User-definable Filters: The powerful filtering process allows you to keep only the data of interest and to efficiently use the buffer memory. Filtering criteria includes addresses: type, length, and data fields; length of the frame; bad or good frame check sequence; misaligned frames; and runts.

Softkey-guided Programming For User-created Applications: Allows you to write your own application programs with the softkey-guided programming language to capture data based on your filtering specifications. Using these programs, you can also send messages to test other nodes, generate traffic load on the network and count collisions.

High Level Naming of Node Addresses: Supports user-definable names to associate with hex addresses. These high-level names on the node list are used throughout the tests for all defined addresses.

Flexible Display Formats: Allow you to examine all the frames or selected frames in a choice of formats such as ASCII, EBCDIC, Hex,

or various combinations of these. In addition, received frames can be displayed with frame header, protocol and filter information, and user data. Header information includes source and destination addresses, timestamps, filter specifications, and frame length.

Statistics Application Software: Allows you to measure network utilization, identify the busiest nodes, collect statistics for logical connections, and evaluate the traffic profile of your network.

Up to 40 Mbytes of Fixed Disc Storage: Store large amounts of data and programs for your testing needs.

Full Remote Operation: An HP 4971S can function as a master unit, fully controlling a slave unit over an RS-232C/V.24 link to diagnose a remote LAN.

Printer Output: Lets you print data and test configurations to an HP 2225A ThinkJet printer.

Softkey Guided Measurements: Easy-to-use even for first time users.

Self-guided Tutorial: Instructs you in using the analyzer so you can start solving problems immediately.



Maintaining and Troubleshooting Your Local Area Network

In the LAN environment where multiple vendors are usually attached to the same network, the HP 4971S provides an unbiased view of the activity on the network independent of any vendors' higher-level software. It allows you to monitor the network or selectively view any information transmitted. The HP 4971S is also a complementary tool for built-in network diagnostic software. When there is a failure in the network, the built-in diagnostic software reports the problem and gives you some clues as to what has taken place. Using that information, you can set up the HP 4971S to capture the events that take place before and during the time when the same failure occurs again. With both built-in network diagnostics software and the HP 4971S, you can now tackle those hard-to-find, intermittent problems. The HP 4971S lets you further analyze the captured data to prevent the same type of failure from occurring again. It is the perfect tool to integrate into your network support strategy.

Remote Operation

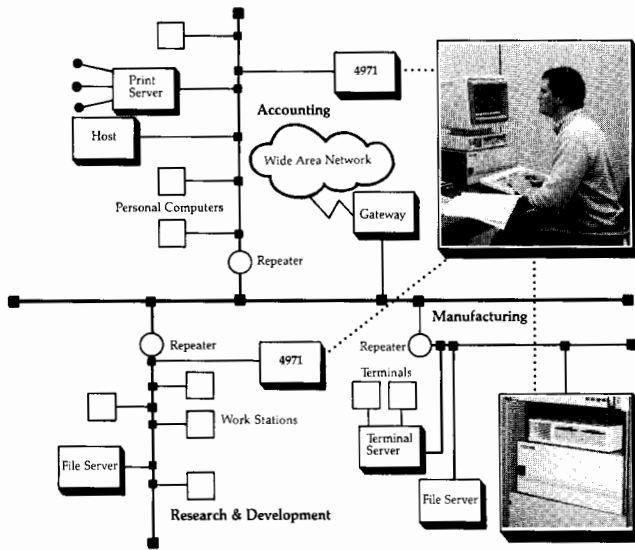

The master HP 4971S controls the slave unit via an RS-232C/V.24 link. The screen information, along with data collected at the slave site, is uploaded to the master unit. The master unit has control over every monitor, simulate, mass storage and printing function in the slave unit.

Operating Specifications

Protocols: IEEE 802.3, IEEE 802.2, Ethernet.

Interfaces: IEEE 802.3, Ethernet and other Ethernet compatible interfaces.

Data Transfer Rate: 10 Mbps.

Data Codes: ASCII, EBCDIC.

Data Formats: IEEE 802.2, 802.3, Ethernet and user definable frame formats.

Capture Buffer Memory: One Mbyte memory for incoming data that has passed the filtering process.

Mass Storage: Two 3-1/2" external microfloppy discs (1420 Kbytes) or a single 710 Kbyte 3-1/2" external floppy disc and up to 40 Mbyte on an external hard disc for storage of programs, data and configurations.

Node Names: User-definable names for up to 1000 network addresses

Filters: 16 Filters with 14 trigger bytes defined for addresses and type or length field and 47 non-contiguous user-definable trigger bytes.

Timers: Maximum 1.5 days for timestamping. For event timing, maximum 3 hours per interval, maximum accumulation to 1.5 days.

Counters: 16 each with a maximum count of 99,999,999.

Timestamping: Timestamp for each incoming frame. Displayed as time of day, time from start of monitor, time between frames, time from triggered event, and time from specified captured frame.

Transmitter Performance: Typically responds to an incoming frame within 10 milliseconds. Define and transmit messages from 5 to 2026 bytes including frame check sequence.

Receiver Performance: In monitor mode, captures and displays all frames within IEEE 802.3 specifications.

Traffic Generation: Using maximum legal frame length (1518 bytes), 90% network loading can be achieved.

Display: 12 in. external monochromatic display with 80 characters on 25 lines.

Printer Support: Supports HP 2225A Thinkjet printer via HP-IB interface.

Remote RS-232C/V.24 Interface: Supports data rates from 300 bps to 9600 bps in asynchronous mode.

Self-Test: Extensive self-test and functional verification routines isolate failures to the field-replaceable unit.

Physical Specifications

For a typical system consisting of HP 4971A, HP 9122D disc drive, HP 46021A keyboard, and HP 35731B display.

Electromagnetic Compatibility: Type tested for compliance with VDE 0871 Level A, radiated and conducted.

Operating Temperature: 10 degrees to 40 degrees C (50 degrees to 104 degrees F).

Storage Temperature: -40 degrees to 60 degrees C (-40 degrees to 140 degrees F).

Humidity (Operating): 20% to 80% (non-condensing 26 degrees C max. wet bulb temperature).

Humidity (Non-operating): 8% to 80% (non-condensing).

Altitude (Operating): 0 to 4572 m (0 to 15,000 ft).

Weight: 31.8 kg (70 lb).

Power Requirements: 90-125 Vac, 195-250 Vac; 48-66 Hz single phase.

Power Consumption: Typically 320 watts.

Configuration Examples

Stand-alone System

For a system to be used as a stand-alone instrument with floppy disc storage, the following should be ordered:

HP 4971S: LAN Protocol Analyzer System

HP 4971A: LAN Protocol Analyzer

Option 001: Video Interface & Cable

HP 35731BM: 12 in. Monochrome CRT w/tilt & swivel

HP 46021A: Keyboard

HP 9122D: Double-sided 3-1/2" Dual Microfloppy Disc Drive

HP 92254A: 6 m AUI Cable

HP 30241A: Media Access Unit & Cable Tap

HP 4971A + H45: Response Center Service

For Remote Operation

Master System Configuration

For a master system, with fixed disc storage, used for controlling a slave system to monitor a LAN at another location, the following should be ordered:

HP 4971S: LAN Protocol Analyzer System

HP 4971A: LAN Protocol Analyzer

Option 001: Video Interface & Cable

Option 002: RS-232C/V.24 Remote Communications Interface

HP 35731BM: 12 in. Monochrome CRT w/tilt & swivel

HP 46021A: Keyboard

HP 9133H: 20 Mbyte Hard Disc & 3-1/2" Microfloppy Disc Drive

HP 92254A: 6 m AUI cable

HP 30241A: Media Access Unit & cable tap

HP 4971A + H45: Response Center Service

Slave System Configuration

For a slave system, with fixed disc storage, for monitoring a LAN to be controlled by a master system, the following should be ordered:

HP 4971S: LAN Protocol Analyzer System

HP 4971A: LAN Protocol Analyzer

Option 002: RS-232C/V.24 Remote Communications Interface

Option 908: HP 4971A Rack Mount Adapter Kit

HP 9153A: 10 Mbyte Hard Disc & 3-1/2" Microfloppy Disc Drive

HP 92254A: 6 m AUI cable

HP 30241A: Media Access Unit & cable tap

HP 19500B: HP 9921D/33H/33L/53A Rack Mount Adapter Kit

Price

\$18,541

\$ 930

\$ 340

\$ 225

\$ 1390

\$ 135

\$ 400

\$75/mo.

\$18,541

\$ 930

\$ 655

\$ 340

\$ 225

\$2740

\$ 135

\$ 400

\$75/mo.

\$18,541

\$ 655

\$ 30

\$1940

\$ 135

\$ 400

\$ 85



DATA COMMUNICATIONS TEST EQUIPMENT

General Information: Data and Voice Testing

Data Network Testing

There are a wide variety of tests that can be made on a data communications system. Depending on the point in the system at which the tests are made, quite different philosophies and techniques apply.

Protocol analysis is usually concerned with overall network performance, determined through monitoring or simulating network software (protocol and/or data). Digital testing involves measuring modem-channel-modem efficiency in terms such as Bit Error Rate (BER) and Block Error Rate (BLER). Analog testing measures the tariffed and other key parameters of the transmission line itself.

The interrelationships of these measurement results are complicated and difficult to understand. For example, how is envelope delay distortion of the line related to the BER or the throughput of the system? Generally speaking, the three measurement techniques are related in a hierarchical fashion. Nonintrusive network monitoring by protocol analyzers gives an indication of overall performance and can often isolate problems to the component or section. When monitoring is insufficient, such as during software debugging or systems integration, protocol analyzers also can be used to simulate network components such as front-end processors or terminals. Once sectionalized, BER testers are used to verify and quantify the link dysfunction, and analog measurements determine which tariffed parameter is out of specification should the telephone line be the problem.

Combined protocol, digital, and analog tests can be used synergistically to restore the network quickly and efficiently. Protocol Analysis has been previously described. The next sections detail the analog and digital testing.

Digital Measurements

Data error analyzers are used to test the quality of both the modem and the transmission facility. They provide information about the modem and transmission line, but no information about the DTE they replace.

The overall quality of the link is indicated by its BER. A good link will have an error rate better than 1×10^{-5} per bit. This measurement will include the effect of both transmission line impairments and the modem's ability to overcome them. Modems vary widely in their sensitivity to line impairments. Low speed (less than 300 bps) and adaptively equalized modems are less sensitive than high speed (more than 4800 bps) and non-adaptively equalized modems.

Since data communications systems transmit data and control information in blocks, these instruments also measure BLER and Percent Error Free Seconds (%EFS). BER, BLER and %EFS can be used together to examine the statistics of the error mechanism.

If the BER and BLER are both high, and %EFS low, the impairment is random and probably due to noise. If the BER and %EFS are high but the BLER is low, the impairment is more bursty. This happens when lines are switched, synchronization is temporarily lost, or impulse noise is too high.

		Basic Testing							Conditioned Circuit Testing			Additional Testing for Complete Troubleshooting												
		In-Service Testing	Bell	CCITT	V.A.O.F	Loss Continuity	Noise, Loss vs. Freq.	Signal/Noise Ratio	Impulse Noise	Wideband Impulse Noise	P / AR	Envelope or Group Delay	Attenuation Distortion	NLD or Intermodulation Distortion	Phase Jitter	Amplitude Jitter	Hits Dropouts	Return Loss	Loop Holding	Signaling Testing	Digital Access	Auto End-To-End Testing		
Instruments	3551A																							
	4935A																							
	4937A																							
	4938A																							
	4947A																							
	3776B*																							
	4945A																							
	3552A																							
	4936A																							
	3776A*																							
4948A**																								
Private Line Access & Test System	37100S*																							

*Information about the HP 3776A, HP 3776B and HP 37100S can be found in the Telecommunications Test Equipment section.

**In-service Testing is discussed in the description of the HP 4948A in this section.

Error rates are quantitative checks of the data communications system that can be made in a few minutes. If the system is bad, diagnostic measurements are provided to help isolate the problem. Dropouts, clock slips, error skew, jitter, and total peak distortion indicate some of the problems that can occur with a modem or on a link. These measurements are made simultaneously with the error rate measurements and can be printed out in automatic unattended mode if desired.

Catastrophic failures can usually be found with self-tests and loop-back switches built into the modem. Data error analyzers can find failures that are not illuminated by internal self-tests.

Modem dynamics are another source of data transmission problems. Modern modems have automatic equalization circuits to compensate for telephone line distortions. It is important to let the equalization process settle, particularly with switched carrier modems, so data is not transmitted too soon.

Measurements that verify modem dynamics are RTS-CTS delay and modem start up tests such as ping-pong.

Analog Impairments Affect Performance

Analog impairments on the telephone line can significantly affect the efficiency of data communications. What the user notices is a slow down in throughput (because of frequent retransmission of blocks of data), garbled data or no data at all. These effects are a result of the line impairments distorting the

modem signal so that the receiving modem cannot make correct decisions. Data bits and blocks are received in error.

The various modem types are susceptible to each impairment in differing degrees. Low speed modems generally use simple modulation schemes and are mostly affected by problems of *continuity, loss, signal-to-noise ratio, and impulse noise.*

As modem speeds increase, the modulation schemes become more complex and so they are more susceptible to impairments. Automatic equalization helps take care of bandwidth reduction, and envelope (group) delay distortion problems. But to significantly reduce the impairing effects and improve error performance specially, selected and conditioned leased telephone lines are used.

A number of levels of conditioning are available to suit the circuit to the speed of the modem, each tariffed at a different rate. Conditioning can minimize noise, hits, dropouts, phase jitter, non-linear (inter-modulation) distortion, bandwidth reduction and envelope (group) delay distortion.

So there is a need for testing: by the circuit supplier, when he installs or repairs a conditioned circuit, to check if impairment levels are within the agreed limits; by the circuit user, to ensure he is getting the quality of circuit he is paying for.

DATA COMMUNICATIONS TEST EQUIPMENT

Data Error Analyzer, Bit Error Rate Test Set

369

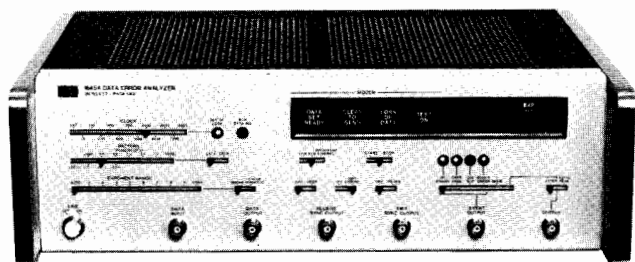

HP 1645A

HP 1645A Description

Hewlett-Packard's Model 1645A Data Error Analyzer quickly isolates data communications link problems through six simultaneous measurements. During test, the HP 1645A can be left totally unattended because it automatically maintains synchronization even in the presence of dropouts. For added convenience, the HP 1645A can be equipped with a printer for hard-copy recordings of long tests.

Bit-error and block-error rate tests are autoranged and displayed directly on an LED readout; there is no need to perform any calculation. Additionally, the HP 1645A measures jitter or total peak distortion (the sum effect of jitter and bias), counts the number of times carrier loss or dropouts occur, measures data error skew, and counts the number of clock slips resulting from phase hits or modem synchronization problems.

With all these measurements made during the same test interval, you'll be able to determine more precisely where your problem is.

HP 1645A Specifications

Transmitter and Receiver Bit Rate

Asynchronous Modem Operation: selectable 75, 150, 200, 300, 600, 1200, 1800, 2400, 3600, 4800, 7200, 9600 bps.

Synchronous Modem Operation: to 5 Mbps. (Modem supplies transmit and receive clocks).

Indicators

Out of lock; received data inverted; bit error; carrier loss; clock slip; block error; Data Set Ready (DSR); Clear To Send (CTS); loss of data; test on.

General

Power: 115 or 230 Vac, 48 to 440 Hz, 150 VA max.

Dimensions: 133 H x 425 W x 286 mm D (5.25 x 16.75 x 11.25 in.).

Weight: net, 8.2 kg (18 lb); shipping, 10.9 kg (24 lb).

Accessories Supplied: one 3 m (10 ft) RS-232C/V.24 interconnecting cable to connect the HP 1645A to the modem (HP P/N 01645-61605), one 2.3 m (7.5 ft) 3-wire power cord (HP P/N 8120-1378); one Operating and Service manual.

Ordering Information

HP 1645A Data Error Analyzer

Price
\$4465

Interfaces

HP 10387A: for Type 303 modems (with cable)

\$700

HP 10388A: for CCITT V.35 (with cable)

\$560

HP 10389A: Breakout Box (RS-232C/V.24) (with cable)

\$390

HP 18062B: MIL-STD-188C interface

\$285

HP 18063A: RS-449 interface (with cable)

\$355

Accessories

HP 10233A: Printer interconnecting cable connects HP 1645A to HP 5150A printer.

\$195

HP 4925B Description

More than a BERT

The HP 4925B is more than just a bit error rate test set. In addition to the standard bit and block error tests, the HP 4925B measures errored seconds, percent error-free seconds, timing delay, and parity errors over both RS-232C/V.24 and V.35. Now complete data testing to 72 kbps is available making the HP 4925B ideally suited for complete DDS testing.

Increased flexibility is afforded by a complete breakout box. You can manipulate and monitor individual signal lines on the RS-232C/V.24 interface or crosspatch any line from the DCE side of the interface to the DTE side of the interface.

In addition, the HP 4925B adds to its arsenal the ability to frame data for testing character-oriented systems. The HP 4925B also transmits the FOX message to terminals and printers. Three separate

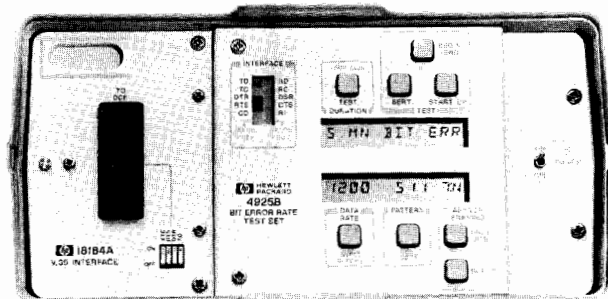

HP 4925B

startup tests enable dynamic testing of modems. This makes the unit extremely useful in isolating faults related to automatic equalization, receive carrier recovery, receive clock synchronization and initial recovery of received data. The startup tests include an end-to-end, half-duplex ping-pong test, a local modem loopback test and a test specifically designed to use the remote testing capabilities of the Bell 208B modem.

Intended primarily for field service installation and maintenance, the HP 4925B weighs only three pounds with batteries.

For operation with the V.35 interface, the HP 4925B is powered by a supplied AC power module accessory. This power module can also be used with the RS-232C/V.24 interface in fixed location or long term testing situations.

HP 4925B Specifications

Data Rates: 75, 110, 134.5, 150, 200, 300, 600, 1200, 1800, 2400, 3600, 4800, 7200, 9600, 14400, 19200 bps for asynchronous systems (framed and unframed) or synchronous systems where the HP 4925B provides the clock. Up to 72 kbps for synchronous systems.

Patterns: 63, 511, or 2047 bit pseudo-random binary sequence, FOX message.

Bit Error Testing: simultaneous detection of bit errors, block errors and errored seconds.

Parity Error Analysis: characters analyzed for odd or even parity errors.

FOX Message Transmission: use a 5-bit baudot code, 6-bit EBCDIC code, 7-bit ASCII code, or 8-bit EBCDIC code.

Character Oriented Network Testing

Data Levels: 5, 6, 7 or 8 bits per character.

Parity: Odd, Even, or None.

Detection and Annunciation of Dropouts and Clock Slips

RTS-CTS Delay Time

Resolution: 1 ms.

Accuracy: $\pm 4\%$ of reading.

Maximum Reading: 999 ms.

Startup Testing: end-to-end test, loopback test, Bell 208B modem test.

Power: six 9-volt alkaline transistor batteries; battery life exceeds 50 hours using RS-232C/V.24 only. AC module (HP 18185A) or (HP 18194A) recommended for use with V.35 interface.

Weight: 1.5 kg (3 lb) with batteries.

HP 18183A Interface/Breakout Box (RS-232C/V.24): hard-wired activity indicators for TD, RD, TC, RC, DTR, DSR, RTS, CTS, CD, RI; one non-dedicated mark/space tri-state activity monitor.

HP 18184A V.35: interface provides the physical level interface for data circuits operating to 72 kbps.

Ordering Information

HP 4925B Bit Error Rate Test Set (does not include interface)

Price
\$1195

Option 001: Adds HP 18192A carrying case

\$110

Option 101: Adds HP 18183A RS-232C/V.24 interface

\$390

Option 102: Adds HP 18184A V.35 interface and HP 18185A 115V power module

\$570

Option 104: Adds HP 18184A V.35 interface and HP 18194A 220V power module

\$615

Accessories

HP 18183A: RS-232C/V.24 interface

\$390

HP 18184A: V.35 interface

\$455

HP 18185A: 115V power module

\$115

HP 18191A: Rack mount

\$180

HP 18192A: Carrying case

\$110

HP 18194A: 220V power module

\$160

DATA COMMUNICATIONS TEST EQUIPMENT

Transmission Impairment Measuring Sets (TIMS)

Models HP 4935A/4936A HP 3551A/3552A

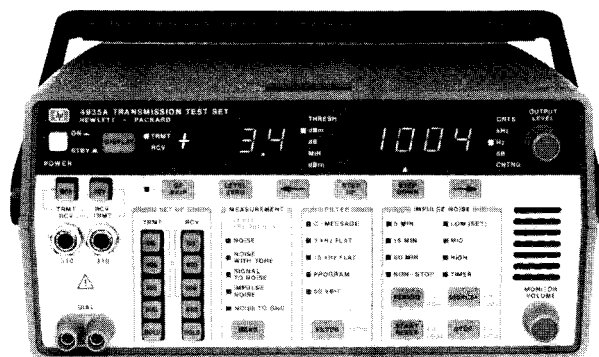

HP 4935A

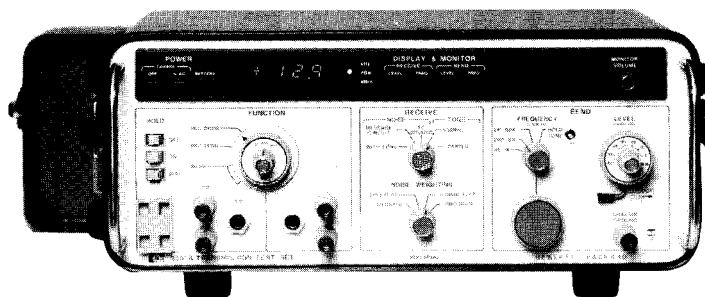

HP 3551A

Product Description

Quality Circuits for Voice, Data or Program

The HP 4935A/4936A Transmission Impairment Measuring Sets and the HP 3551A/3552A Transmission Test Sets are rugged, portable test sets that provide the basic analog tests to isolate faults and to qualify circuits for voice, data, and broadcast service. In addition, the HP 4935A, with its 110 kHz bandwidth, performs the required tests to qualify the local loop for Digital Data System (DDS) up to 56 kbps. The Peak-to-Average Ratio (P/AR) measurement option on the HP 4935A gives users a powerful, yet simple measure of the combined factors that affect the overall data transmission quality of the line.

Different Instruments for Different Standards

The HP 4935A and HP 3551A perform measurements compatible with the Bell standards (BSTR 41009) and IEEE standards (IEEE 743-1984). These standards are primarily used in North America. The HP 4936A and HP 3552A are compatible with the recommendations of the CCITT.

HP 4935S Data Transmission Test System

The HP 4935S combines the analog test power of the HP 4935A with the compact, yet powerful digital test abilities of the HP 4925B to form a complete data installation and maintenance tool. This is especially useful for those technicians who have both analog and BERT test needs. See page 369 for more information.

Capability Summary

HP 4935A/4936A

Measurements

Level

Frequency

Circuit Noise

Noise-with-Tone

Signal-to-Noise Ratio

3 Level Impulse Noise (quiet) ('36A)

3 Level Impulse Noise (with tone)

Noise-to-Ground ('35A)

P/AR (option '35A)

Ranges

Trans. Level: -40 to +13 dBm

Trans. Freq.: 10 Hz to 110 kHz

Rec. Level: -60 to +13 dBm

Rec. Freq.: 20 to 110 kHz

Message Circuit Noise: 0 to 100 ('35A)

-90 to +10 dBm ('36A)

Noise-with-Tone: 10 to 100 dBm ('35A)

-80 to +10 dBm ('36A)

Noise-to-Ground: 50 to 130 ('35A)

Signal-to-Noise Ratio: 10 to 45 dB

Impulse Noise Threshold:

30 to 109 dBm ('35A)

-60 to 16 dBm ('36A)

Impulse Noise Separation: 4 dB ('35A)

3 dB ('36A)

P/AR Range: 0 to 120 P/AR units ('35A)

General

Impedances: 135, 600, 900 ohms ('35A)

150, 600, 900 ohms ('36A)

Filters

4935A:

C-Message

3 kHz flat

Program

15 kHz flat

50 kbit

1010 Hz notch

4936A:

Psophometric (P.53)

272-3250 Hz flat (0.71 impulse noise)

Sound unweighted (J.16)

Sound weighted (J.16)

820 Hz notch

Size: 127 x 279 x 381 mm (5.0 x 11.0 x 15.0 in.)

Weight: 5.0 kg (11 lb), 6.5 kg (14 lb) with battery

3551A/3552A:

Measurements

Level

Frequency

Circuit Noise

Noise-with-Tone

Noise-to-Ground

Range

Trans. Level: -60 to +10 dBm

Trans. Freq.: 40 Hz to 60 kHz

Rec. Level: -70 to 15 dBm

Rec. Freq.: 40 Hz to 60 kHz

Message Circuit Noise:

0 to 85 dBm ('51A)

-90 to -5 dBm ('52A)

Noise-with-Tone: 10 to 85 dBm ('51A)

-80 to -5 dBm ('52A)

Noise-to-Ground: 40 to 125 dBm ('51A)

-50 to 35 dBm ('52A)

General

Impedances: 135, 600, 900 ohms ('51A)

150, 600, 900 ohms ('52A)

Filters

3551A:

C-Message

3 kHz flat

Program

15 kHz flat

3552A:

Psophometric

3 kHz flat

Program

15 kHz flat

Size: 133 mm H x 343 mm W x 354 mm D

(5.25 x 13.5 x 10.0 in.)

Weight: 6.6 kg (14.5 lb)

Ordering Information

HP 3551A Transmission Test Set \$3500

HP 3552A Transmission Test Set \$3800

(CCITT)

HP 4935A Transmission \$3295

Impairment Measuring Set

Option 001: Adds Rechargeable \$375

Battery Pack

Option 002: Adds P/AR \$300

Measurement in place of Noise-to-

Ground

Option 003: Adds both Battery \$430

Pack and P/AR, deletes Noise-to-

Ground

Option 910: Adds extra HP \$25

4935A Operating and Service

Manual

HP 4936A Transmission \$4010

Impairment Measuring Set

Option 001: Includes 820 Hz tone \$495

with rechargeable Battery Pack

Option 002: 1020 Hz tone \$0

Option 003: Includes 1020 Hz \$495

tone with rechargeable Battery

Pack

Option 910: Adds extra HP \$35

4936A Operating and Service

Manual

DATA COMMUNICATIONS TEST EQUIPMENT

Network Circuit Access Test Set, Transmission Impairment Measuring Set

Models 4938A/4937A

371



HP 4935S Data Transmission Test Set	\$4615
Option 001: Adds rechargeable Battery Pack to HP 4935A	\$375
Option 002: Adds P/AR measurement in place of Noise-to-Ground in HP 4935A	\$300
Option 003: Adds both battery Pack and P/AR to HP 4935A, deletes Noise-to-Ground	\$430
Option 101: Adds RS-232C/V.24 Interface to HP 4925B	\$390
Option 102: Adds V.35 Interface and HP 18184A Power Module (115V) to HP 4925B	\$570
Option 104: Adds V.35 Interface and HP 18194A Power Module (220V) to HP 4925B	\$605
Option 910: Adds extra HP 4935A and HP 4925B Operating and Service Manuals	\$60

Accessories

HP 18132A: 19 in. rack mount for HP 4935A	\$150
HP 18134A: Soft Vinyl Carrying Case for HP 4935A or HP 4935S	\$125
HP 18192A: Soft Vinyl Carrying Case for HP 4925B	\$85
HP 15512A: Cable 1 m length of 600 balanced cable with a 3-pin audio connector (Siemens type) at each end (for the HP 4936A)	\$75
HP 15513A: Cable 1 m length of 600 balanced cable with a WECO 310 jack plug at each end (for the HP 4935A)	\$60
HP 18161A: Ladder Bracket	\$25
HP 18185A: Power Module (115V) for HP 4925B	\$115
HP 18194A: Power Module (220V) for HP 4925B	\$160

HP 4937S

Network Access Transmission Test Set

HP 4937S = HP 4937A + HP 4938A

A Transmission Test Set With Signaling

The HP 4937S Network Access Transmission Test Set provides transmission tests, supervisory signaling simulation, and network access capabilities for installation and maintenance of networks and PBXs. It is a field-service, portable test set designed for craft-level use. All the transmission measurements are compatible with current Bell standards.

One Instrument for Installation/Maintenance of PBXs and Networks.



The HP 4937A contains a set of voiceband transmission tests — level/frequency measurement, noise, and 2- and 4-wire return loss measurements. It also has the ability to seize and hold three types of E/M lines. In addition, the HP 4937A simulates signaling both from the central office and from the PBX at the network interface.

The HP 4938A provides additional network access and margin testing capabilities. It includes access to 4-wire simplex leads, generating ringing signal, and providing access for loop current and ringing voltage measurement.

HP 4937A Specifications

Level/Frequency

Transmitter

Level: -40 dBm to +13 dBm

Frequency: 20 Hz to 9999 Hz

Receiver

Level: -60 dBm to +13 dBm

Frequency: 20 Hz to 9999 Hz

Noise Measurements

Noise: 0 to 99 Dbrn

Noise-with-Tone: 10 dBm to 99 dBm

Signal-to-Noise Ratio: 10 to 45 dB

Noise-to-Ground: 50 to 99 dBm

Filters: C-Message, 3 kHz flat, 1010 Hz notch

Return Loss

Impedance: 600 and 900 ohms

Signal Spectra: Echo return loss, singing return loss high, singing return loss low.

Return Loss, 2-Wire

Transmitter Level: -26 dBm to -2 dBm

Receiver Range: 0 to 40 dBm

Return Loss, 4-Wire

Transmitter Level: -26 dBm to -2 dBm

Receiver Range: 0 to 50 dB

Transhybrid Loss Compensation: -29.9 to +29.9 dB

Supervisory Signaling

E/M Signaling: Types I, II, III

Loop Signaling: Loop start, Ground start, Loop Reverse Battery

Battery: -48 Vdc current limited to 29 mA

Hold Circuit: 2 each drawing 20 mA at a minimum voltage of 8.5 Vdc

Wink: Idle state, 100 ms; off-hook state, 200 ms

General

Battery Supply (Optional): Typically 5 hours of continuous operation at +25°C. Complete recharging in 14 hours with unit in STBY

Dimensions: 27.9 W x 12.7 H x 38.0 cm (11.0 x 5.0 x 15.0 in.)

Weight: 5.3 kg (12 lb), 7.6 kg (17 lb) with batteries

HP 4938A Specifications

Ringing Voltage Generator

Output Level: 86 Vrms

Frequencies: 20 Hz and 30 Hz

Ring Trip Threshold: 17 mA typical

Ringing Termination: REN-3 load, ring trip closure

Loop Signaling Network: loop start, 430 ohms; ground start, 550 ohms from ring to ground

4-Wire Network Access: 2 dual center-trapped simplex transformers

Battery Simulator: 48 Vdc maximum current 100 mA

General

Dimensions: 9.1 H x 26.1 L x 12.6 cm W (3.6 x 10.3 x 4.9 in.)

Weight: 1.5 kg (3.2 lb)

Ordering Information

HP 4937S Network Access Transmission Test Set \$5200

Option 001: Rechargeable batteries \$250

Option 002: Replace 900 ohms with 150 ohms N/C

HP 4937A Transmission Impairment Measuring Set \$4250

Option 001: Rechargeable batteries \$250

Option 002: Replace 900 ohms with 150 ohms N/C

Option 910: Extra Operating and Service Manual \$27

HP 4938A Network Circuit Access Test Set \$1050





DATA COMMUNICATIONS TEST EQUIPMENT

Transmission Impairment Measuring Set (TIMS)

Model 4945A

- Compatible with North American standards
- Complete testing of:
 - Voice grade data channels
 - Program channels
 - High speed digital channels
- 110 kHz bandwidth
- Portable package for field use
- Versatile I/O for systems use
- Master/Slave capability for end-to-end testing
- Automatic gain slope measurement
- Programmable sweep
- 5x display for distant viewing

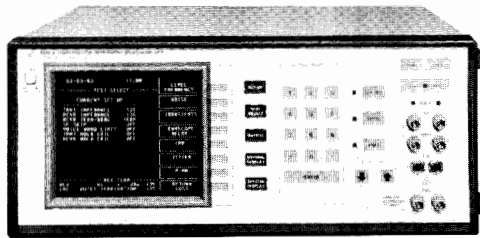

RS-232



HP 4945A Product Description

The HP 4945A Transmission Impairment Measuring Set provides the complete set of measurements needed to quickly isolate faults and qualify circuits for voice, data or broadcast transmission up to 110 kHz. All measurements are compatible with current Bell standards including the ability to test local distribution loops for Digital Data Systems (DDS) to 56 kbps.

The HP 4945A offers you all the measurements needed to install, troubleshoot, and maintain both voice and data circuits. These measurements are designed in accordance with Bell System Technical Reference 41009 and IEEE 743-1984. The list includes:

Loss	3 Level Impulse Noise
Attenuation Distortion	Gain Hits
Gain-Slope	Phase Hits
Message Circuit Noise	Dropouts
Notched Noise	Peak-to-Average Ratio (P/AR)
Signal-to-Noise Ratio	Envelope Delay Distortion
Noise-to-Ground	2-Wire Return Loss
Amplitude Jitter	4-Wire Return Loss
Phase Jitter	
Intermodulation Distortion*	

In addition to a complete measurement set, the HP 4945A has a CRT for displaying data, Master/Slave capability for remote control and data collection, and controllability over three different interfaces, HP-IB, RS-232C, or HP-IL.

The CRT allows you to see more information than conventional segmented displays. All set-up conditions and measurement results are presented in a logical, easy-to-understand format. The SPECIAL DISPLAY key enlarges the measurement results five times to allow for easy viewing from a distance.

Master/Slave saves time and money by allowing you to control the remote (Slave) TIMS from the local (Master) TIMS. This HP-pioneered and patented technique allows the Master unit to completely control and collect data from the remote Slave unit over the lines under test.

The HP 4945A can be controlled by a computer or controller over three different interfaces. For large systems, HP-IB provides the speed and versatility needed to tie together many test instruments. When the distance between the controller and the HP 4945A is great, RS-232C and a pair of asynchronous modems, provides a low-cost solution for control. HP-IL is used with handheld calculators when portable data collection is a must. Additionally, all measurement results are printed without the need for a controller.

Specifications

For details, ask your local HP sales Office for an HP 4945A TIMS data brochure.

General

Impedances: 135, 600, 900, 1200 ohms
Power: 115/230 Vac \pm 11%, 48 to 63 Hz, 150 W max
Dimensions: 184 H x 451 W x 489 mm D (7.25 x 17.75 x 19.25 in.)
Weight: 15 kg (33 lb)

Level and Frequency

Frequency Range: 20 Hz to 110 kHz
Level Range: -60 to 13 dBm

Noise Measurements

Transmitter: 1004 Hz fixed or quiet termination

Receiver Range:

Message circuit noise: 10 to 90 dBm
Noise-with-Tone: 10 to 90 dBm
Noise-to-Ground: 40 to 130 dBm
Signal-to-Noise Ratio: 10 to 45 dB
Filters: C-Message, 3 kHz flat, Program, 15 kHz flat, 50 kbit, 1010 Hz notch

Peak-to-Average Ratio

Per BSTR 41009 and IEEE 743-1984
P/AR Range: 0 to 120 P/AR units

Jitter

Amplitude Jitter: 0 to 30% peak-to-peak
Phase Jitter: 0 to 30 degrees peak-to-peak
Bandwidths: 20-300 Hz, 4 to 20 Hz, 4 to 300 Hz

Transients

Count Rate: 7, 8, 100 counts per second
Count Range: 0 to 9999
Timer: 1 to 9999 minutes, continuous
Phase Hit Threshold: 5° to 45° in 5° steps
Gain Hit Threshold: 2 to 10 dB in 1 dB steps
Dropout Threshold: - 12 dB
Impulse Noise Threshold Low: 30 to 110 dBm
Impulse Noise Threshold Mid: 2, 3, 4, 6 dB above low
Impulse Noise Threshold High: 2, 3, 4, 6 dB above mid

Envelope Delay

Range: -3000 to 9000 microseconds
Modulation: 83 $\frac{1}{3}$ Hz

Return Loss

2-Wire Range: 0 to 40 dB
4-wire Range: 0 to 50 dB
Transhybrid Loss Compensation: -10 to 30 dB

Ordering Information

HP 4945A TIMS

	Price
Option 001: 100/200 Volt Operation	\$14950
Option 101: Adds HP 18162A HP-IB Module	N/C
Option 102: Adds HP 18163A RS-232C Module	\$500
Option 103: Adds HP 18165A HP-IL Module	\$500
Option 104: Adds HP 18169A 19" Rack Mount	\$350
Option 105: Adds HP 18170A Soft Vinyl Carrying Case	\$75
	\$210

Accessories

HP 18162A: HP-IB Module	\$505
HP 18163A: RS-232C Module	\$505
HP 18165A: HP-IL Module	\$355
HP 18169A: 19" Rack Mount	\$80
HP 18170A: Soft Vinyl Carrying Case	\$210
HP 18176A: 23" Rack Mount	\$160
9211-2650: Hard Transit Case	\$480

*The Non-Linear Distortion Technique is licensed under Hekimian Laboratories, Inc., USA Patent No. 3862380.

DATA COMMUNICATIONS TEST EQUIPMENT

Transmission Impairment Measuring Set

Model 4947A

373



- Voice-grade circuit testing
- Compatible with North-American standards
- High performance at an affordable price

- Easy to use
- Automatic end-to-end and loopback testing
- Low-cost print/plot hardcopy

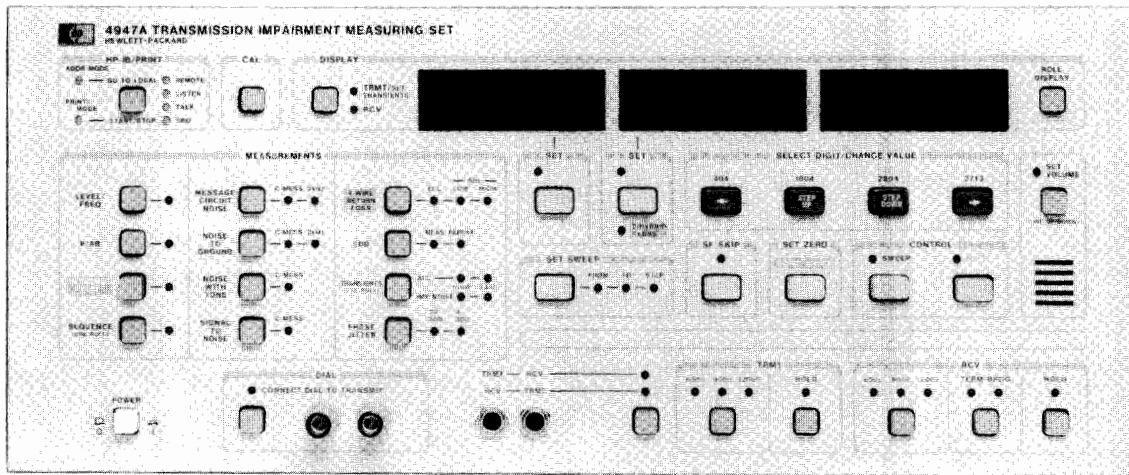

HP 4947A

HP 4947A Transmission Impairment Measuring Set

Description

The HP 4947A Transmission Impairment Measuring Set (TIMS) is a test set with the high measurement capability required to completely characterize a long-haul data network. In addition, it has many time- and labor-saving features which can lead to higher productivity in line testing. Its operation is modeled on the proven HP 4935A TIMS which makes it simple to use, particularly for those who have been trained on the HP 4935A.

Who Needs an HP 4947A?

If you are an end user or data-network operator you need high circuit availability. When trouble comes, you need to identify a line or modem problem quickly so you can contact the right vendor to clear the problem. To get the best response from the circuit providers you need a credible, comprehensive instrument which will let you indicate the problem area with confidence.

If you are a carrier or telephone company who provides voice-grade special-service circuits you need to clear reported troubles fast. To do this you need equipment you can trust - which lets you find any fault on the line.

Measurement Capability

Operating frequency range: 50 Hz to 5 kHz
Measurement methods are in accordance with IEEE 743-1984 Level

Frequency
Message circuit noise - C-message, 3 kHz flat
Noise-to-ground - C-message, 3 kHz flat
Noise-with-tone
Signal-to-noise
Envelope Delay Distortion
Dropouts
Phase hits
Gain hits
3-level impulse noise
4-wire return loss - ERL, SRL-LO, SRL-HI
Peak/Average Ratio
Phase jitter - 20 to 300 Hz, 4 to 300 Hz
Intermodulation distortion*

Line Access Facilities

Loudspeaker for monitoring the signal at either the transmit or receive port.

*The Intermodulation Distortion technique is licensed under Hekimian Laboratories, Inc.
US Patent No. 3862380.

Separate hold circuits for the transmit and receive ports; butt-in connection available to the transmit port.

DTMF dialing capability.

Plot to HP ThinkJet

The HP 4947A generates plots using the graphics mode of a regular ThinkJet printer, for really low-cost plotting capability. You can record graphs of EDD, level or attenuation vs frequency.

Print Capability

The HP 4947A can drive suitable 80-column printers with "Listen Only" mode, for example, the HP ThinkJet. You can document your test activity, record swept or sequence measurements, or produce a time-stamped printout of transients during a long-term test.

System Use

Using the HP-IB control interface you can remotely control all the front-panel features of the HP 4947A plus SF and MF dialing. You can build an automatic test system: for overnight testing in a network tech control center; or for production testing in PBX manufacture. You can even extend the control over long distances.

Easy End-to-end Testing

The HP 4947A has a simple solution for fast, trouble-free end-to-end testing. You only need to use two HP 4947As and the circuit under test. With a couple of keystrokes you can run a sequence of tests which measure all the key data transmission parameters. And the system is robust enough to support remote start-up and auto restart on power failure or signal loss. Each HP 4947A stores the results of its own measurements in non-volatile memory. Later, results can be dumped to a printer or controller, or read from the display.

The measurements made in the sequence are: P/AR, level at 1004 Hz, gain slope, noise-with-tone, S/N, idle channel noise, intermodulation distortion (both uncorrected and corrected for S/N), phase jitter, phase and gain hits, dropouts and impulse noise.

Fast Loopback Testing

Three keystrokes will activate a remote 2713 Hz loopback device and run the sequence. For extra speed there is a faster version of the sequence which runs without the transient measurements.

Ordering Information

HP 4947A Transmission Impairment Measuring Set	\$7900
Options 907 - Front handle kit	+ \$70
908 - Rack flange kit	+ \$40
910 - Extra set of manuals	+ \$50



DATA COMMUNICATIONS TEST EQUIPMENT

In-service Transmission Impairment Measuring Set

Model 4948A

- Voice-grade data circuit testing - without traffic interruption.
- True preventive maintenance.
- Network management information - without special modems.
- Suitable for North-American and CCITT environments.

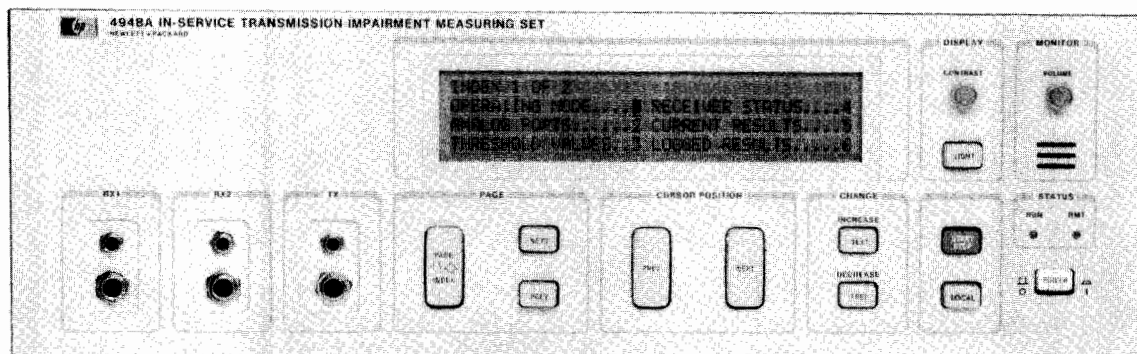

HP 4948A



HP 4948A In-service Transmission Impairment Measuring Set

Description

The HP 4948A is a unique transmission impairment measuring set (TIMS) which lets you test data circuits carrying voice-grade modem traffic while they are still in service.

A simple 2-wire connection to the data circuit carrying the modem signal, at a voice-frequency access point, is all that is required for the HP 4948A to measure the impairments that have been added between signal generation and the measurement point.

With one keystroke the HP 4948A can automatically identify the modem type and measure all the transmission impairments simultaneously. It remembers all the previous test conditions so no time need be wasted setting up a test.

The HP 4948A Simplifies Testing

The in-service capability of the HP 4948A opens up new test strategies. The HP 4948A lets you see if the analog signal is good where you are testing. Because you are measuring on the live modem signal, only one instrument need be used, which removes the problem of co-ordinating an end-to-end test. This speeds up the fingerpointing that helps you establish who has the responsibility to repair a fault in today's multi-vendor networks.

You can respond to trouble reports immediately without taking the line from service. All the impairments are measured at once so you can quickly and easily recognize the problem. The HP 4948A sees the line like a modem sees it (same bandwidth, same response) letting you identify the impairments that are really causing data errors. And with the HP 4948A's long-term data logging capabilities, you can even track down difficult, intermittent faults.

With the HP 4948A you can implement a preventive maintenance policy and routinely check lines against a benchmark. While the circuits are still operating, carrying traffic, you will see any degradations and be able to clear problems before they cause data errors. Testing can be done at convenient times, even when the circuits are being heavily used and the network is under most stress.

The HP 4948A is an economic means of producing data for private network management - even for small systems, or systems using a variety of modem types.

Compatible Modems

The HP 4948A has been designed to operate with many of the common high-speed modems in use today (see table).

When you don't know the type of modem connected to the circuit, the HP 4948A can be set to automatically identify the line signal before computing results. This simplifies the use of the HP 4948A, particularly in the middle of the network where records may be unavailable or difficult to access.

Networks

You can use the HP 4948A at any point along a datacommunications circuit. In multi-point circuits, testing the host-to-slave link is as easy as for point-to-point circuits. To test the slave-to-host link, only one slave modem must be transmitting data while the HP 4948A analyzes the signal.

Measurement Capability

Level	Dropouts	On modem signals only:
Frequency	Gain hits	Attenuation distortion
S/N	Phase hits	Delay distortion
Phase jitter	Impulse noise	
44-20Hz, 20-300Hz		
Amplitude jitter		
44-20Hz, 20-300Hz		

The results are all computed simultaneously.

Measuring Impairments on a Modem Signal

The conventional way of testing a telephone circuit is to send a signal through it, and at the far end compare the received signal with the signal that was transmitted. The differences are measured and results computed for the line-impairing effects. Typically a tone is used as the line stimulus, since it is a simple signal and relatively easy to reproduce.

The test signal available when testing in-service on voice-grade data circuits is the live analog modem signal. This signal is well defined, with a fixed baud rate, carrier frequency and data constellation. A receiver configured to detect a particular modem signal will see variations from the expected signal in the same way as the receiver measuring on a tone.

The HP 4948A measures the effects of the same line impairments that are measured by a conventional, intrusive TIMS. A TIMS measures the effects on the simple known signal (tone) but the HP 4948A measures the effects on the full bandwidth of the data signal with level and frequency properties dependent on the transmitting modem and the data. In addition, the HP 4948A measures impairments at its data detection point - as a modem would see them. From these measurements the HP 4948A predicts conditions on the line and presents its results in conventional form. In most practical situations, the results from the HP 4948A are very similar to those from a TIMS. However, they cannot be directly equated because of the different techniques involved.

Data Logging

Result data can be stored in the test set's own internal non-volatile memory for later interrogation. The HP 4948A can be left unattended for long periods babysitting a line. This lets you look back at intermittents after they have occurred, or comprehensively characterize a line's performance over a period of time. When characterizing a line the average, max and min values for each impairment are stored after the end of a preset period. A period can have a duration of 5, 15, 30 or 60 minutes and the instrument has the capacity to store the most recent 200 periods.

For routine monitoring, you can set thresholds on each impairment that will trigger when the signal is bad. These can be set high so that only the most severe impairments are recorded, or low so that every potential data-impairing effect is recorded.

If a power failure occurs while the test set is left unattended logging results, it will shut down in a controlled manner recording the time of the failure. When power returns, the time is again recorded and the test is continued. The statistical results for periods in which power failures occur are computed for the time that the test set was operational within each period.

Hard Copy of Results

You can get printouts of logged results and instrument status by connecting a printer directly to the HP 4948A (both HP-IB and RS 232 interfaces). This is a good way of analyzing all the result information that is accumulated during an extended test, and you can keep the circuit records to allow you to spot quality degradations.

Remote Control

A fully-automatic monitoring system can be built using HP-IB control from a desktop computer. By adding a suitable switch (for example, HP 3777A) a number of circuits can be automatically tested; and with the addition of HP-IB extenders and modems a complete network can be supervised.

Constellation Display Output

You can display the constellation pattern of the received modem signal plus the impairing effects by connecting an oscilloscope to the X-Y output of the HP 4948A.

Modem Signal Simulation

The HP 4948A can generate a modem signal simulating the analog properties of any of the compatible types of modems. With this you can test a newly-installed circuit using a signal similar to the one that will be used on the circuit when it is operational.

Single-tone Operation

The HP 4948A can send and receive tones, so you can use it to work with a distant tone source of any kind. Also, lines can be tested that have a level of impairments that prevents the transmission of a modem signal.

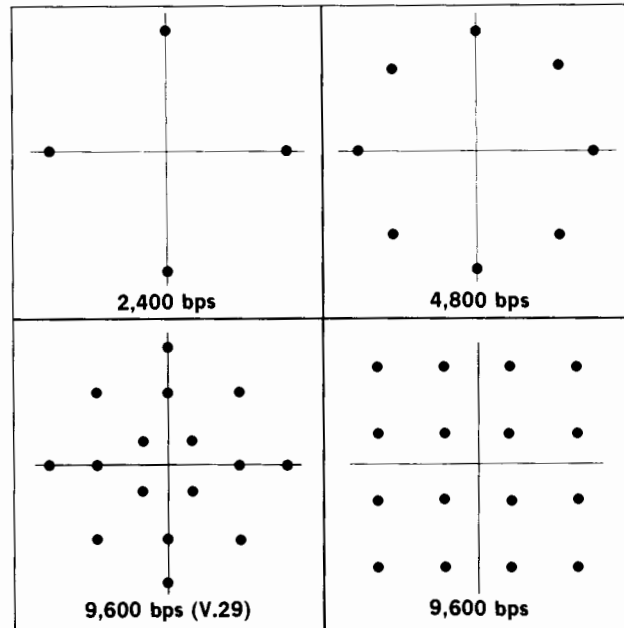

Constellation diagrams of common modem signals.

Compatible Modem Types	
Data Rate	Examples
9600 bps	CCITT V.29, AT&T 209, AT&T 2096, V.29 with 1800 Hz carrier
4800 bps	CCITT V.27, AT&T 208, AT&T 2048
2400 bps	CCITT V.26 A&B, AT&T 201 B&C

AT&T is a trademark of American Telephone and Telegraph Co.

General Specifications

Dimensions: 163 × 426 × 570 mm (6.4 × 17 × 23 in)

Weight: 14 kg (30 lb)

Ordering Information

	Transmit & Receive Connectors	
	WECO 310 and Bantam	Siemens 3-pin
Stand-alone Front connectors Adjustable legs	HP 4948A Standard	Option 003
For rack mounting Front connectors Flat base	Option 001	Option 004
For rack mounting Rear connectors Flat base	Option 002	Option 005

Option 907 - Front handle kit

Option 908 - Rack mounting flanges for 19" racks

Option 910 - Extra set of operating and service manuals

Transit case: HP part number 9211-2661

HP 4948A In-service Transmission Impairment

Measuring Set

Price
To be announced



DATA COMMUNICATIONS TEST EQUIPMENT

15 Hz to 50 kHz Selective Voltmeter

Model 3581C

- Voice grade testing
- Wideband data circuit testing
- Single frequency interference
- Spectrum analysis



HP 3581C

Description

The HP 3581C Selective Voltmeter has found wide application in testing special service circuits in both inside and outside plant maintenance. The HP 3581C is used to do spectrum analysis, measure non-linear distortion (harmonic distortion) and to locate and measure unwanted spurious and induced tones. The unit can be operated from ac line or from optional internal batteries.

Specifications

Frequency range: 15 Hz to 50 kHz.

Display: 5 digit LED readout. Resolution: 1 Hz. Accuracy: ± 3.5 Hz.

Typical stability: ± 10 Hz/h after 1 hour. ± 5 Hz/ $^{\circ}$ C.

Automatic frequency control (AFC), hold-in range: ± 800 Hz.

Pull-in range: $> 5 \times$ bandwidth for 3 Hz to 100 Hz bandwidth; > 800 Hz for 300 Hz bandwidth for full-scale signal.

Lock frequency: center of passband ± 1 Hz.

Amplitude

Instrument Range

Linear: 30 V to 100 nV full scale.

Log: +30 dBm or dBV to -150 dBm or dBV.

Amplitude Accuracy*

	Log	Linear
15 Hz–50 kHz, frequency response	± 0.4 dB	$\pm 4\%$
Switching between bandwidths (@ 25 $^{\circ}$ C)	± 0.5 dB	$\pm 5\%$
Amplitude display	± 2 dB	$\pm 2\%$
Input attenuator	± 0.3 dB	$\pm 3\%$
Amplitude reference level, Most sensitive range	± 1 dB	$\pm 10\%$
All other ranges	± 1 dB	$\pm 3\%$

Dynamic range: > 80 dB.

Noise sidebands: greater than 70 dB below CW signal. 10 bandwidths away from signal.

IF feedthrough: input level > 10 V: -60 dB; input level < 10 V: -70 dB.

Spurious responses: > 80 dB below input reference level.

Sweep

Scan width: 50 Hz to 50 kHz. These scans can be adjusted to cover a group of frequencies within the overall instrument range.

Sweep error light: this LED indicates a sweep that is too fast to capture full response.

*Note: these specifications cover the full temperature frequency and amplitude range, and represent worst case. Accuracy is significantly better for measurements not at the extremes.

External trigger: a short to ground stops normal sweep. Opening the short then enables a sweep.

Input

Unbalanced (UNBAL)

Impedance: 1 M Ω /40 pF.

Balanced/Bridged (BRDG)

Impedance: 10 k Ω .

Frequency response: 40 Hz–20 kHz, ± 0.5 dB for signals < 20 dBm.

Balanced/Terminated (TERM)

Impedance: 600 Ω /900 Ω balanced.

Frequency response: same as balanced/bridging.

Input connector: accepts WECO 310 plug.

Output Characteristics

Tracking generator output (also known as BFO or tracking oscillator output). Switchable on rear panel to restored output (HP 3581C acts as a narrow band amplifier).

Range: 0 to 2 V rms.

Frequency response: $\pm 3\%$ 15 Hz to 50 kHz.

LO output: 100 mV signal from 1 MHz to 1.5 MHz as input is tuned from 0 to 50 kHz.

Output connector: WECO 310, for connection to tracking generator output or restored output. In addition to monitoring restored output with headphones, an internal speaker also provides an audio indication of signal content.

Restored output: acts as a narrow band amplifier.

X-Y recorder analog outputs: 0 to +5V $\pm 2.5\%$.

General

Operating temperature range: 0 $^{\circ}$ C to 55 $^{\circ}$ C.

Humidity: 95% relative, maximum at 40 $^{\circ}$ C.

Power requirements: 100 V, 120 V, 220 V, 240 V +5% -10%, 10 VA typical, 48 Hz to 440 Hz.

Size: 412.8 mm H x 203.2 mm W x 285.8 mm D (16 $\frac{1}{4}$ " x 8" x 11 $\frac{1}{4}$ ").

Weight: 11.5 kg (23 lb); Option 001, 13.5 kg (30 lb).

Accessory available: HP 7090A Measurement Plotting System.

Option 001: rechargeable battery: used to make floating measurements; 12 hours to fully charge. Also includes front panel dust cover.

Ordering Information

HP 3581C Selective Voltmeter

Opt 001: Battery Pack, dust cover

Opt 003: Rack Mount

Price

\$6,800

add \$700

add \$330



Introduction

Digital networks have advanced rapidly from the early days when junction PCM systems were used to increase inter-exchange capacity between switching centers. Key to this has been the development of integrated digital switching and transmission systems and the impact of technology, particularly in the area of codecs and subscriber line interface circuits. This trend towards Integrated Digital Networks (IDNs) and Integrated Services Digital Networks (ISDNs) has resulted in new testing needs and increased emphasis on characterizing performance of PCM conversion equipment and digital transmission links.

PCM Conversion Measurements

Today's IDNs are almost exclusively based on 64 kb/s PCM voice channels to one of two coding standards, CEPT A-law or Bell μ -law, both of which are now standardized by the CCITT. These coding standards both use 8 kHz speech sampling and 8-bit PCM companding to achieve high quality digitized voice transmission through 64 kb/s circuit-switched digital exchanges. Circuits can also carry multiplexed low-speed or wideband high-speed data with the result that future networks will carry a mixture of voice and data services via digital transmission systems. Initially, the majority of data carried by IDNs will be "conventional" analog modulated data from modems at customers' premises which is then PCM encoded at the nearest serving exchange switching center. In addition to dial-up data circuits through digital switches, an increasing number of leased non-switched circuits are provided at least in part, if not completely, via PCM transmission systems between switching offices.

These developments have resulted in an increased demand for measurements in the PCM signal of parameters affecting both voice and data services. This is especially true for automatic remote test systems such as the checking of circuits provided via digital access and cross-connect systems. The key to testing these circuits is the ability to measure PCM voice and analog data transmission performance at both analog and digital access points i.e. in a mixed analog/

digital network. HP's 3776 PCM Terminal Test set can make both PCM voice and analog data measurements in both analog and digital domains.

The HP 3776 has also made significant advances in the field of PCM measuring technology by implementing most of the measurements using digital signal processing. This allows comprehensive measurement capability to be integrated into a smaller, lower cost, more portable package than previously possible. When coupled with HP's computational products, the HP 3776 becomes a powerful system component of automated remote access and test systems for monitoring and maintaining mixed analog/digital networks.

The HP 3779 Primary Multiplex Analyzer has a complementary focus. Its internal intelligence provides major benefits: an exceptionally friendly front panel, built-in automatic measurement sequencing with limit-testing, and channel scanner and printer control. The HP 3779 is therefore optimized for R&D, production test and commissioning of line cards and PCM multiplexers/channel banks.

TDM Transmission Measurements

Digital transmission over cable, radio, satellite and, more recently, optical fibre is becoming an increasingly large proportion of inter-exchange and long haul transmission. As IDNs evolve and other services are added into the ISDN concept, transmission measurements have shifted from basic measures of bit error ratio and peak-peak jitter towards more thorough analysis of systems in terms of error performance or distribution with time. There is an increasing emphasis on evaluating "availability" of digital circuits. This requires more powerful analysis capability to be built into test instrumentation and the possibility of collecting large amounts of data for evaluation off-line in computers. HP is uniquely placed with advanced measuring and computational technology to provide measurement solutions for

these needs. A comprehensive range of error and jitter performance test equipment is now available covering bit rates from 1 kb/s to 170 Mb/s. Many special features are included for the three principal IDN digital transmission hierarchies now standardized by the CCITT.

The latest and most powerful instrument is the HP 3764A Digital Transmission Analyzer which is specifically designed for error and jitter performance measurements on 140 Mb/s links. Built-in analysis of availability and error distribution with real time are provided together with a choice of printer or cassette data capture media. An option of the instrument provides error performance testing and interfacing at the four standard bit rates of the CEPT digital hierarchy. Full HP-IB control also makes this instrument a powerful tool in automated production testing or digital network maintenance.

Jitter and Digital Networks

The increasing interest in and significance of timing jitter in digital networks has made this parameter of key importance in PCM/TDM measurements. This phenomenon has not been well understood until relatively recently, but is now recognized to be a major source of errors and other transmission impairments. HP offers a comprehensive range of jitter testing capability based on the HP 3785 Jitter Generator & Receiver for bit rates up to 50 Mb/s, and the HP 3764A Digital Transmission Analyzer for 140 Mb/s. Ease-of-use features such as built-in jitter tolerance mask sweeping and full HP-IB control make these instruments powerful tools in production test and field trial situations. A loop timing measurement in the HP 3776 PCM Terminal Test Set provides a quick field check of the most common causes of digital switching machine malfunction when working to loop-timed PCM multiplexers/channel banks.

Read on for a more detailed look at the comprehensive range of HP products for digital communications applications.

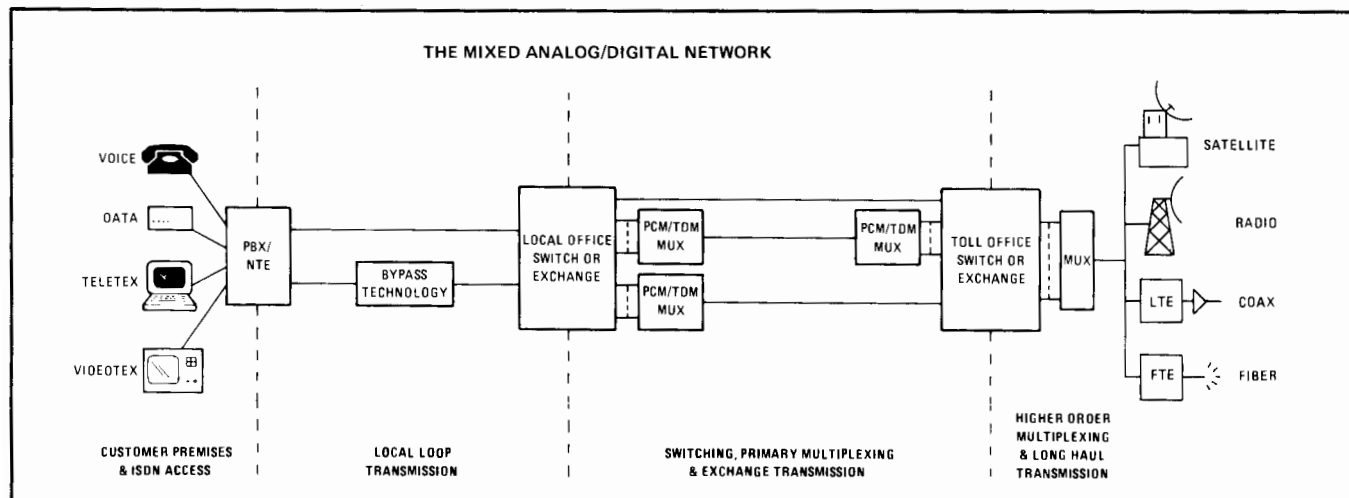



TELECOMMUNICATIONS TEST EQUIPMENT

PCM Terminal Test Set, Primary Multiplex Analyzer, HP-IB Controlled Channel Selector

Models 3776A, 3776B, 3779C, 3779D, 3777A

HP 3776A/B

- Network test of 4 kHz channels
- VF and 2/1.5 Mb/s interface as standard
- Voice, PCM and data (option 001) measurements in one portable instrument
- Direct output to printer or plotter
- Framing and signaling bits setting and monitoring

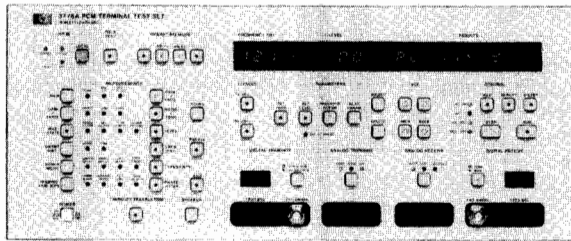

HP 3776B

HP 3779C/D

- Manufacturing/R&D test of digital line cards/channel banks
- VF interface standard, 2/1.5 Mb/s interface optional
- Comprehensive PCM in-band and out-of-band measurements (to 40 kHz)
- Direct control of printer and channel selector
- HP 3779C tests multiplex alignment and alarm functions (D-A mode)

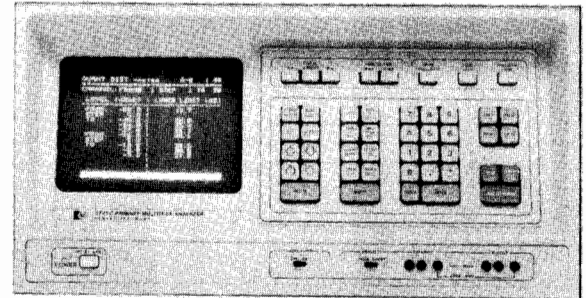

HP 3779C



HP 3776A/B PCM Terminal Test Set

The HP 3776A is designed for CEPT/CCITT compatible networks. Model 3776B is designed for Bell/Japanese/CCITT compatible networks. Full information and specifications are contained in the data sheet and specification booklet.

- HP 3776A has 30/31 channel voice testing capability
- HP 3776B has Bell extended superframe (ESF) & B8ZS line coding capability

HP 3776A Options

STD: analog connections are Siemens 3-pin; digital are 120 ohm bal Siemens 3-pin and 75 ohm unbal BNC

001: adds data measurements

002: BNC connectors replaced with 75 ohm unbal Siemens

HP 3776B Options

STD: connectors are WECO 310 and Bantam jack

001: adds data measurements

002: Japanese measurements/connectors

004: all connectors Trompeter triaxial type BJ77 located on the rear panel

HP 3777A Channel Selector

- DC to 110 kHz
- 2-wire/4-wire balanced switching
- Remote control only (HP-IB)

The HP 3777A is a 4-pole access switch for telecom applications. It may be configured as a single 4-wire switch or as two, independent, 2-wire switches. Channel capacity is arranged by adding standard modules. Unselected channels are switched to 600 ohm terminations.

HP 3777A Options

No. of Channels	Connectors	
	Siemens 3-Pin	WECO 310
6	Opt H07	Opt H16
12	Opt 002	Opt 003
18	Opt H13	Opt H17
24	Opt H14	Opt 001
30	Std	Opt H05

Ordering Information

HP 3776A PCM Terminal Test Set (CEPT)

HP 3776B PCM Terminal Test Set (Bell)

HP 3777A Channel Selector

Price

\$11150

\$11700

\$4450

HP 3779C/D Primary Multiplex Analyzer

The HP 3779C is designed for CEPT/CCITT compatible networks. Model 3779D is designed for Bell/Japanese/CCITT compatible networks. Full information and specifications are contained in the data sheet and specification booklet.

- Standard PMA provides A-A and E-E (end-to-end) measurements
- Options provide all measurement modes and a single-channel TTL-compatible interface for codec and line card testing

HP 3779C Options

STD: A-A and E-E; Siemens 3-pin

001: all modes; digital connectors 75 ohm unbal BNC

002: as 001 except digital connectors 75 ohm unbal Siemens

003: as 002 except PCM and co-directional clock connectors 120 ohm bal Siemens

3779D Options

STD: A-A and E-E; WECO 310 connectors

001: all modes; digital connectors WECO 310

002: digital option is Mu-law at 2 Mb/s via single channel interface only

003: as option 001 except digital connectors 75 ohm unbal BNC

Accessories

HP 15518A/B/C: dual-port loop-holding accessory for HP 3776A/B opt 002

HP 15515B: loop-holding unit, 24 mA current sink; WECO connectors

HP 15512A: 1m length 600 ohm bal cable; Siemens 3-pin connector both ends

HP 15513A: 1m length 600 ohm bal cable; WECO 310 jack plug both ends

Ordering Information

HP 3779C Primary Multiplex Analyzer (CEPT)

HP 3779D Primary Multiplex Analyzer (Bell)

HP 15512A Cable

HP 15513A Cable

HP 15515B Loop Holding Unit

HP 15518A/B/C Loop Holding Accessory

Price

\$20450

\$23750

\$75

\$60

\$290

\$430

TELECOMMUNICATIONS TEST EQUIPMENT

1 kb/s/50 Mb/s PCM/TDM Error Measuring Set for Field Use

Model 3780A

379



- Binary and code error measurements
- Internal crystal clocks and clock recovery
- Clock frequency offset generation and measurement
- Ternary coded and binary interfaces
- PRBS and WORD pattern generation and detection
- Printer and recorder outputs

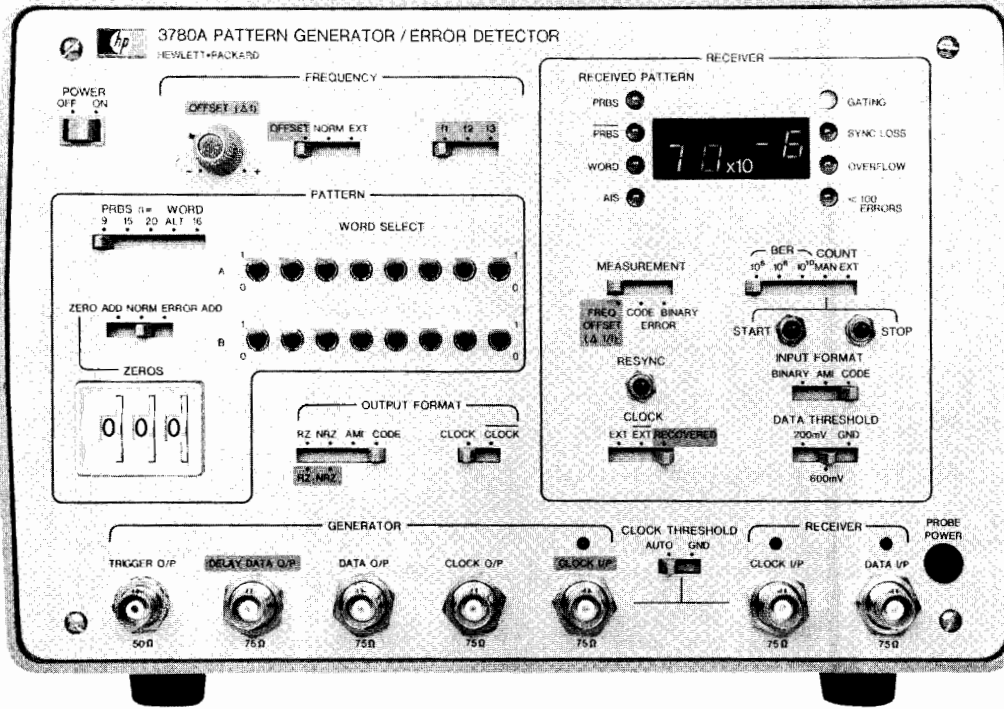

HP 3780A
Option 001

The HP 3780A Pattern Generator/Error Detector is a comprehensive error measuring set in one portable package. The instrument measures Binary Errors and Code Errors in digital transmission equipment operating at bit rates between 1 kb/s and 50 Mb/s. Frequency offset generation and measurement are also provided at the standard bit rates used in PCM/TDM transmission.

Binary errors are detected by stimulating the system with a test pattern and comparing the output bit-by-bit with a separate internally generated, error-free pattern. Code errors on interface or line coded information are detected during decoding into binary data. The errors can be counted over a chosen gating period and displayed directly as bit error ratio (BER) or total error count (COUNT).

Error measurements can be made with PRBS or WORD patterns and the receiver has automatic pattern recognition and synchronization. Alternatively, the reference pattern can be preset by the pattern switch which allows detection of systematic pattern errors. Zero add facilities allow investigation of regenerator clock recovery performance. This capability can be extended by the optional addition of programmable word and alternating word generation.

The clock frequency in the pattern generator can be offset and measured in the receiver. The offset is displayed as a fraction of the nominal crystal centre frequency. In addition, the offset of external clocks applied to the generator can be measured provided that the frequency is within 25 kHz of one of the installed crystal frequencies.

BER or COUNT results can be displayed directly by LED's on the front panel or monitored via a BCD printer and strip chart recorder. This makes the HP 3780A ideally suited for unattended long-term measurements. Monitoring, display, and recording of the Alarm Indication Signal (AIS) is now included.

The HP 3780A has been designed principally for use in field trials, commissioning, and maintenance of digital transmission terminal and link equipment. A new option has been added which provides 2²³-1 pattern capability and automatic equalization for in-station cabling for 2, 8 and 34 Mb/s systems.

Specifications

Measurements

Binary errors: closed loop bit-by-bit detection on any pattern produced by generator, excluding added zeros or alternating words.

Code errors: violations of coding rule detected on any pattern with AMI, HDB3, or HDB2 coding (optionally AMI, B6ZS, or B3ZS).

Frequency offset: measurement of fractional offset of generator clock output from installed crystal rates.

Options

Word/Connector Options

- | | Price |
|--|-----------|
| 001: all words replaced by a 16-bit front panel programmable word | +\$230.00 |
| 002: Siemens 1.6 mm connectors | + \$85.00 |
| 003: combination of 001 and 002 | +\$290.00 |

Frequency Offset Option

- | | |
|--|-----------|
| 099: frequency offset—measurement only; frequency offset generation deleted | +\$165.00 |
|--|-----------|

Frequency/Codec Options

- | | |
|---|-----------|
| Std: internal clock frequencies of 2048, 8448, and 1536 kHz; HDB3/HDB2 codec. | |
| 100: internal clock frequencies of 2048, 8448, and 34368 kHz; HDB3/HDB2 codec. | +\$235.00 |
| 101: internal clock frequencies of 1544, 6312, and 44736 kHz; B6ZS/B3ZS codec. | |
| 102: internal clock frequencies of 1544, 6312, and 3152 kHz; B6ZS/B3ZS codec. | |
| 103: internal clock frequencies of 2048, 8448, and 34368 kHz; 2 ²³ -1 pattern replaces 2 ⁹ -1; HDB3 codec. | +\$550.00 |
| 104: as option 103 but with Siemens 1.6 mm connectors | +\$600.00 |

HP 3780A Pattern Generator/Error Detector \$7400.00



TELECOMMUNICATIONS TEST EQUIPMENT

Dedicated PCM/TDM Error Measuring Sets

Models 3781A, 3782A, 3781B, 3782B

HP 3781A/E

- Versatile selection of test patterns
- Internal jitter modulation
- Additional delayed data output

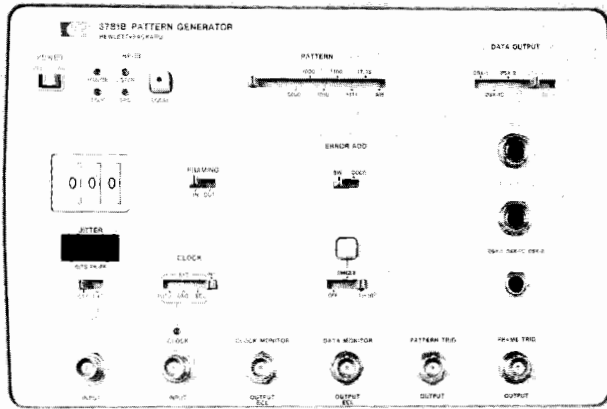

HP 3781B

HP 3782A/B

- Binary and code error measurements
- Error ratio, error count, error seconds and error-free seconds displayed
- Powerful error distribution analysis

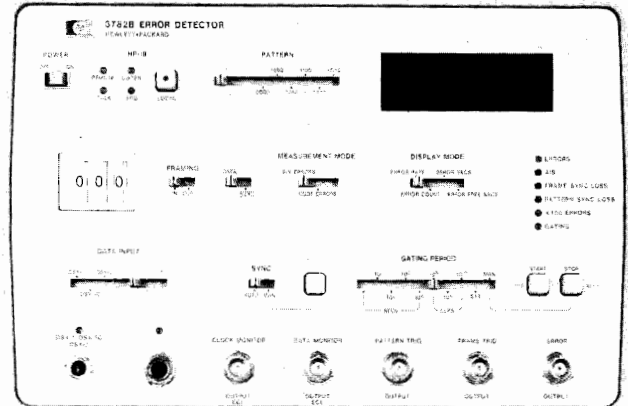

HP 3782B



The HP 3781A Pattern Generator and HP 3782A Error Detector form a high performance error measuring system which complements the existing HP 3780A Pattern Generator/Error Detector. Designed to conform with CEPT and CCITT standards, the HP 3781A/3782A provide four bit rates (up to 50 Mb/s) of the digital hierarchy in one compact system. Applications of the system are in R&D, field trial and production testing, especially where an automatic and remote measurement capability via the HP-IB is required.

In the HP 3781A, binary or code errors can be injected as single shot or at 10^{-3} or 10^{-5} rates into a wide range of PRBS and 16-bit WORD test patterns coded in AMI or HDB3. The test patterns provided include standard 2^9-1 , $2^{15}-1$, and $2^{23}-1$ bit PRBS to CCITT Recommendations, fully programmable 16-bit WORD, and two 8-bit WORDS which may be alternated under the control of an external signal. Zero substitution (up to 120 zeros) for PRBS patterns is included to examine, for example, the clock recovery performance of regenerators. 75 Ω unbalanced and 120 Ω balanced pseudo-ternary outputs and binary TTL monitor outputs are provided. A jitter modulation input facility is provided for simple oscillator connection, with direct LED display of pk-pk bits of jitter. This can be used to measure the input jitter tolerance of digital transmission equipment. A second data output with 12 bits delay provides adequate simulation of an independent sequence for thorough testing of 4 ϕ PSK digital radio systems. As an option, four extra data outputs coded in AMI or HDB3 can be included on the rear panel for driving adjacent radio channels.

The HP 3782A detects binary or code errors which can be displayed in the form of error ratio, error count, error seconds, and error-free seconds over a wide choice of gating periods. All four results are computed simultaneously over the same gating period. For ease of use there is a built-in automatic check for compatibility of switch position combinations. An error code flashes on the display if incompatibility is detected. When the monitor mode is used, the HP 3782A can be used for in-service monitoring of digital transmission links.

Measurement results are available on the HP-IB and a rear panel result threshold switch allows pre-selection of an error threshold above which results will be printed. This provides useful data reduction and a first order error distribution analysis. With a built-in real-time clock, results can be output with time, if required.

The HP 3781B Pattern Generator and HP 3782B Error Detector form a dedicated error measurement system for testing and evaluating the performance of Bell digital transmission terminal and link equipment, up to and including the DS-3 level in the digital hierarchy. The HP 3781B/3782B can be used in production testing, field installation, and maintenance of the Bell digital transmission system, including PCM/TDM transmission over cable, radio, satellite, and fibre optic links. The principal application is at the DS-3 level in the Bell digital hierarchy.

The HP 3781B/3782B are designed to interface at Bell System standard cross connect points with appropriate ternary coding and interface voltage levels at each hierarchical level. Interfacing at the DS-1C and DS-2 levels is limited to T1-C and T2 line systems. At the DS-3 level, a choice of four data formats is available. Alternatively, binary ECL interfaces can be used.

The HP 3781B Pattern Generator provides a selection of standard 2^9-1 , $2^{15}-1$, and $2^{20}-1$ bit PRBS and fixed WORD test patterns with a choice of single error or 1 in 10^5 error simulation on the digital data stream for normal measurements and troubleshooting. A pattern of 17 ones/15 zeros and zero substitution (up to 999 zeros) for PRBS patterns are included to examine phase sensitive circuitry such as clock recovery of regenerators. A jitter modulation input facility is provided for simple oscillator connection, with direct LED display of pk-pk bits of jitter. This can be used to measure the input jitter tolerance of digital transmission equipment. A second DS-3 output channel with 22 bits delay provides adequate simulation of an independent sequence for thorough testing of 4 ϕ PSK digital radio systems. As an optional extra, four DSX-3 BNC outputs on the rear panel can be included for driving adjacent radio channels.

The HP 3782B Error Detector detects any binary or code errors generated by the system under test. At the DS-3 level, it can perform in-service or out-of-service measurements of parity errors within the digital transmission system. The HP 3782B can measure simultaneously error rate, error count, error seconds, and error free seconds over a single gating period. When the DS-3 MON facility is used, in-service measurements (eg parity errors) of live traffic are possible. For ease of use, there is a built-in automatic check for compatibility of switch position combinations. An error code flashes on the display if incompatibility is detected. Hard copies of results can be obtained on a printer via HP-IB control, either in the "talk-only" or "addressable" modes. In addition, a preselectable error rate threshold and a real time clock allows selection for printing results which exceed a defined threshold (with local time, if required).

Ordering Information
HP 3781A Pattern Generator
HP 3782A Error Detector

Price
 \$7400
 \$6900

Ordering Information
HP 3781B Pattern Generator
HP 3782B Error Detector

Price
 \$8150
 \$7450

TELECOMMUNICATIONS TEST EQUIPMENT

Dedicated 150 Mb/s PCM/TDM Error Detection System

Models 3762A/3763A, 3764A

381



HP 3762A/3763A

- Binary bit-by-bit error detection
- Coded and binary operation
- Variable clock frequency offsets

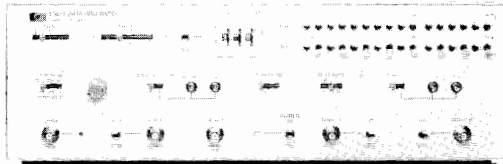

HP 3762A

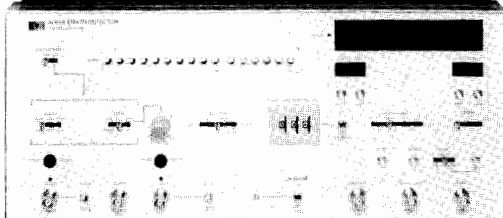

HP 3763A

HP 3762A Data Generator/3763A Error Detector

The HP 3762A Data Generator and HP 3763A Error Detector comprise a dedicated error rate measurement system for evaluating high-speed digital transmission equipment. Basically, there are two versions of the system available. One features CMI and binary data formats and is specifically intended for use in field commissioning and maintenance of digital radio (terrestrial microwave and TDMA satellite) systems. The other version, with CMI and ternary (HDB3 and B3ZS) data formats, is designed for digital multiplex and digital cable systems. Burst gating inputs allow the HP 3762A/3763A to be used in TDMA applications

Specifications Summary

HP 3762A Data Generator

Internal clock: two crystal clocks in the range 30 to 150 MHz; crystals fitted in standard unit are 139.264 and 141.040 MHz; offset continuously variable up to ± 60 ppm.

External clock input: 1 kHz to 150 MHz; 75 ohm.

Patterns: $2^{10}-1$, $2^{15}-1$, and $2^{23}-1$ PRBS; two 10- or 16-bit programmable words; two 1010 . . . repetitive patterns; two 8-bit words alternated by an external signal; PRBS patterns can be gated off for 1 to 999 clock periods after trigger pulse (zero substitution); error add facilities.

HP 3763A Error Detector

Data input: CMI, NRZ, or RZ formats; 75 ohm; DATA or $\overline{\text{DATA}}$; 12 dB fixed equalization at 70 MHz on CMI inputs with clock recovery.

External clock: as 3762A.

Patterns: all the patterns of the HP 3762A, including zero substitution, but excluding alternating words.

Count: totalizes errors over a selected gating period; internal period can be 10^6 , 10^8 , 10^{10} clock periods or 1 min to 24 h, repetitive or single shot, manual start/stop or external (ECL) control; result displayed as ABCD.

Measurement gating input: gates error and clock inputs to error counter, providing a measurement "window"; 50 ohm; ECL levels.

Frequency offset measurement: measures deviation of received bit rate from nominal rate; result displayed as $\pm \text{BCD} \times 10^{-6}$.

Printer output (rear panel): 8-4-2-1 BCD, 10-column output of result plus local time, if required, and flags; TTL print command pulse.

Recorder output (rear panel): constant current drive output of BER or COUNT result, with flags.

Ordering Information

HP 3762A Data Generator

HP 3763A Error Detector

Price

\$9,000

\$8,150

HP 3764A

- Error analysis at 2, 8, 34 & 139 Mbit/s based on latest G.821 Recommendation or error & jitter measurement and analysis at 139 Mbit/s only
- Powerful data logging facilities
- Single key measurement set-up using preset memory
- Portable single-unit construction

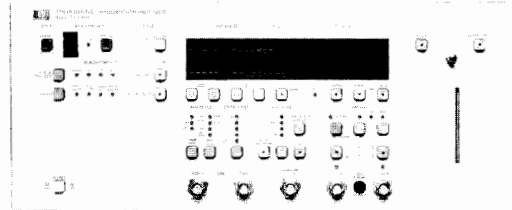

HP 3764A



HP 3764A Digital Transmission Analyzer

The HP 3764A Digital Transmission Analyzer is available in three versions. The standard instrument offers a low-cost solution to users who want to perform error measurements at 139 Mbit/s only. The option 001 instrument is a multirate error analyzer in a single, rugged, low-weight case particularly suited to field installation and maintenance applications. The option 002 instrument performs a full set of bit error and jitter measurements at 139 Mbit/s to match development or manufacturing requirements.

Specifications Summary

Generator Section

Clocks: Standard & Opt 002, 139.264 MHz with fixed frequency offsets; Opt 001, 139.264, 34.368, 8.448 & 2.048 MHz, with fixed frequency offsets available as Opt 005.

Data outputs: CMI format at 139 Mbit/s; HDB3 format at 34, 8 & 2 Mbit/s; binary-RZ from 1 to 150 Mbit/s, NRZ from 1 to 170 Mbit/s (using external clock source), ECL levels, 75 ohm unbalanced.

Data patterns: PRBS $2^{15}-1$ and $2^{23}-1$; word, programmable 16-bit or two alternating 8-bit words; errors, single error or fixed 1×10^{-3} rate.

Receiver Section

Recovered clock: 139.264 Mbit/s ± 3 Mbit/s; 34, 8, 2 Mbit/s ± 100 ppm.

Binary clock: 1 kHz to 170 MHz.

Data inputs: 75 ohm terminated; monitor (25 dB additional gain); binary, RZ or NRZ, ECL levels.

Error analysis: Error count, error ratio, error seconds, error-free seconds, % unavailability, % errored seconds, % severely-errored seconds, % degraded minutes. All measurements made simultaneously and in accordance with Recommendation G.821.

Jitter analysis: Peak-to-Peak, hit count, hit seconds, hit-free seconds. Further analysis possible using internal jitter filters and demodulated jitter output.

Internal printer: Any combination of analysis parameters can be selected for printing.

Ordering Information

HP 3764A Standard: Error analysis at 139 Mbit/s.

HP 3764A Option 003: Standard with 3 additional delayed outputs.

HP 3764A Option 002: Error & jitter analysis at 139 Mbit/s.

HP 3764A Option 001: Error analysis at 2, 8, 34 & 139 Mbit/s.

Option 005: Multirate fixed-frequency offsets for Option 001.

Option 010: Tape cartridge unit replaces the printer.

Price

\$10,050

\$800

\$2,700

\$800

\$1,400



TELECOMMUNICATIONS TEST EQUIPMENT

Dedicated PCM/TDM Jitter Generator and Receiver

Models 3785A, 3785B

- Jitter generation and measurement on data and clock
- Jitter specifications designed to CCITT recommendation 0.171
- Transient-free sweeping of internal CCITT defined jitter tolerance masks

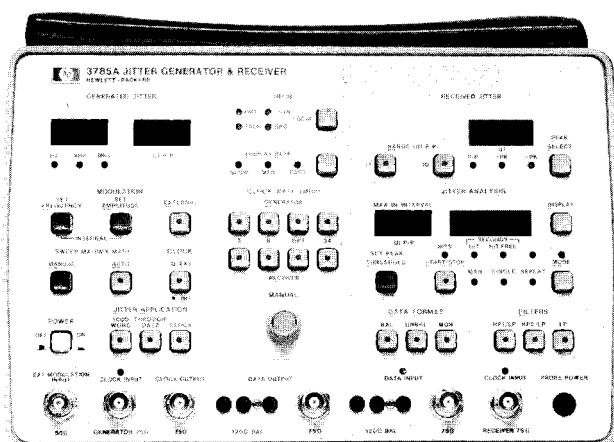

HP 3785A (2048, 8448, 34368 and, optionally, 25776 kHz)
CEPT

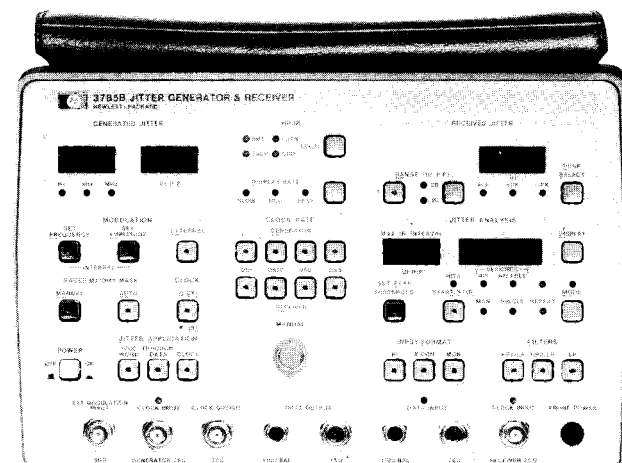

HP 3785B (DS-1, DS-1C, DS-2 and DS-3)
Bell



The HP 3785A/B Jitter Generator and Receiver is a dedicated jitter measurement system for testing and evaluating the performance of CEPT or Bell digital transmission terminal and link equipment up to and including the third level (34368 kb/s or DS-3) in the digital hierarchy. The HP 3785A/B can be used in production testing, field installation and maintenance of the CEPT or Bell digital transmission system including PCM/TDM transmission over cable, radio, satellite, and fiber optic links. The principal application is thorough testing to current CCITT Recommendations at each level in the digital hierarchy.

In addition to providing a comprehensive measurement capability which includes in-service jitter measurements, the microprocessor-controlled Jitter Generator and Receiver is easy to use with ergonomic layout of switches and connectors on the front panel. The instrument is designed to interface fully with the HP-IB, allowing bus-controlled operation and automatic measurement sequencing.

The Jitter Generator may be used to phase modulate an internally provided crystal clock, an externally applied clock (at a nominal digital hierarchy bit rate) or an externally applied data stream. Sinusoidal modulation is provided by an internal synthesizer whose amplitude and frequency can be set manually or swept, transient-free, through a CCITT shaped jitter tolerance mask programmed into the instrument. Alternatively, external modulating signals can be applied. The amplitude of generated jitter in unit intervals (U.I.) pk-pk and the frequency of internal modulation are in accordance with CCITT Recommendation 0.171 and are displayed on the front panel.

The modulated clock output can be applied to an external pattern generator such as the HP 3780A, 3762A, 3781A or 3782B. For jitter transfer function measurements, the CCITT standard 1000 repetitive pattern is provided within the HP 3785A/B. In addition, for demultiplexer jitter transfer function, jitter can be applied to an externally applied data stream which has the necessary framing and justification digits. Consult the data sheet for full technical specifications.

Consult the data sheet for full technical specifications.

Measurements

The Jitter Receiver offers six types of measurement:

- Absolute jitter amplitude in U.I. pk-pk
- Jitter peak, positive or negative
- Jitter hit count of the number of times received jitter exceeds a user-defined hit threshold in U.I. pk

- Single portable unit for up to 4 internal bit rates
- Built-in measurement filters to CCITT recommendations
- Comprehensive jitter analysis against real-time and jitter amplitude

- Jitter hit seconds count of the number of seconds in which one or more jitter hits occur
- Jitter hit-free seconds count of the number of seconds which are free of jitter hits
- Maximum absolute jitter amplitude in U.I. pk-pk is held during the jitter analysis gating period

Simultaneous measurement of all six parameters is possible with result display selection. In addition, the Receiver has a built-in interval timer and real-time clock to allow measurements of jitter distribution against time to be made.

The measurements can be made on clock or data inputs with or without internal filtering. Two high pass filters and one low pass filter as specified by CCITT are provided for each of the four bit rates. In addition, external filters can be connected between the demodulated jitter output and the measuring circuitry input. The demodulated jitter output can also be used to measure rms jitter amplitude on an external voltmeter or to display jitter spectrum on an external analyzer.

The clock reference for the jitter measurements can be internally derived from the applied data or clock via a narrow band phase-locked loop or externally derived from an applied reference.

The data input allows out-of-service or in-service measurements. The MON facility for in-service measurements has built-in additional gain to compensate for the flat loss at the protected monitor points.

HP-IB Operation

The capabilities of the HP 3785A/B can be enhanced by using the HP-IB to provide remote operation and automatic sequencing of results.

The HP-IB facility offers several principal features:

- Remote control of front panel switches and pushbuttons using programming codes
- Control codes which are set to default values on power-on and can be user-defined with the controller
- The ability to transfer all desired switch positions and masks onto a tape memory and reloaded back onto the instrument at a later time
- Output of the result data to a printer (eg HP 5150A Thermal Printer) or storage memory

Ordering Information

HP 3785A Jitter Generator and Receiver (CEPT)

Price

\$12450.00

HP 3785B Jitter Generator and Receiver (Bell)

\$14500.00



FDM System Measurements

Frequency Division Multiplex (FDM) systems are the traditional method of transmitting a number of telecommunications channels over a single wideband transmission medium such as coaxial cable or microwave radio, each channel being allocated a unique part of the frequency spectrum. In narrow satellite or radio channels there might be only 12 or 24 telephone channels, whereas in a high capacity 12 MHz or 18 MHz system 2700 or 3600 channels can be transmitted simultaneously.

Hewlett-Packard supplies a comprehensive range of manual and automatic test-equipment, summarized in the table below, for FDM baseband, microwave radio and satellite systems.

FDM Measurements

The HP 3586A/B Selective Level Meter (SLM) and its companion Synthesizer/Level Generator the HP 3336A/B are specifically designed for manual measurements in manufacture, installation and maintenance. Both instruments incorporate synthesizer tuning for stability and resolution and provide absolute level accuracy of ± 0.2 dB (SLM) and ± 0.15 dB (Generator). The HP 3586A/3336A combination is optimized for testing to CCITT standards and the HP 3586B/3336B to Bell or North American standards.

Both HP 3586A/B and HP 3336A/B are HP-IB programmable and can be combined into a low-cost system with the HP-85F Personal Computer. This system, the HP 3046A/B, is simple to use and enables automatic multiple measurements and sequences to be set up using the stored FDM plans. Up to four test points can be accessed by means of an HP 3755A Access Switch Controller and HP 3754A Access Switch.

The HP 3746A SLMS, developed from the HP 3586A/B, has been optimized for FDM maintenance measurements, particularly in automatic network monitoring systems.

The performance objectives for present day networks and customer expectations (particularly business customers and data

users) demand rapid fault location and analysis of system degradation. Hewlett-Packard offers two automatic FDM network monitoring systems designed around the HP 3746A SLMS: the HP 37051S based on the HP 9000 series 300 computer and the HP 37050S system based on the HP 1000 A-series computer. The 37051S is a low-cost measurement system for smaller networks providing control of up to 6 remote measurement subsystems. The system stores database information on the test points and allows an automatic measurement routine to be run continuously using sequence files. These can be interrupted at any time for demand measurements.

The HP 37050S system has all of these features and in addition can control up to 16 remote subsystems per computer. It provides comprehensive data reduction and results reporting - for the larger system this is essential. The computer utilizes powerful Real-Time Executive (RTE) operating system software, so (unlike the HP 37051S) can provide simultaneous measurements at multiple sites and an support several users at local or remote terminals. The HP 37050S can be readily extended to cover a very large network by linking computers using distributed system software.

Analog Radio Measurements

"Traditional" radio measurements divide into two categories: IF/RF transmission measurements and qualitative baseband measurements.

The HP 3711A/3712A Microwave Link Analyzer provides a comprehensive set of transmission measurements at 70/140 MHz IF. These measurements can be extended to RF interface points with the HP 8350B Up Conversion Simulator and the HP 3730B Down Converter.

Baseband qualitative measurements such as white-noise testing can be performed at IF interface points by using the HP 3717A 70 MHz Modulator/Demodulator.

Digital Radio Measurements

Digital radio systems require not only traditional measurements but also some new dedicated measurements: carrier-to-noise

(C/N) vs bit error ratio (BER) testing, and constellation analysis.

The overall performance measure of any digital transmission system is BER. A radio system is subject to fading phenomena which decrease the system C/N ratio, and reduce the BER performance. The HP 3708A Noise and Interference Test Set is designed to accurately and easily set up C/N conditions. HP produces a range of BER testers for different bit rates and data formats and these can be used along with the HP 3708A to perform the C/N vs BER test. The HP 3708S system operates on HP 9000 series 200 and 300 computers and controls both the HP 3708A and BER test sets to automate the C/N vs BER measurement process.

For in-service digital radio testing, the radio constellation pattern can be used to obtain a qualitative assessment of overall radio performance. Faults are found and identified quickly because each fault produces a characteristic constellation pattern. This powerful technique is harnessed by the new HP 3709A Constellation Display. Until now, general-purpose sampling oscilloscopes offered the only means to display a constellation pattern, but they are over-complex to operate in this specialist application. The HP 3709A is simple to operate, with dedicated graticules and an automatic timebase. A sample "impairment catalog" in the instrument training manual assists in troubleshooting and impairment identification.

In addition to displaying patterns, the HP 3709A can measure the constellation parameters of: closure, lock-angle error and quad-angle error. These assist visual interpretation of the display. The constellation pattern and associated measurement results can be dumped to a ThinkJet printer to provide a hard record of radio performance.

For more detailed analysis, constellation data can be transferred over HP-IB to a computer. A set of demonstration subroutines is available to assist in writing application programs.

		MAINTENANCE/ MONITORING	INSTALLATION	MANUFACTURE
FDM Measurements	Manual	HP 3586A/B, 3746A	HP 3586A/B, 3336A/B	HP 3586A/B, 3336A/B
	Automatic	HP 3046A/B, 3746A	HP 3046A/B, 3746A 3336A/B	HP 3046A/B
	Surveillance	HP 37050S, 37051S	—	—

TELECOMMUNICATIONS TEST EQUIPMENT

Selective Level Measuring Set, Access/Distribution Switches

Models 3746A, 3754A, 3755A, 3756A, 3757A

HP 3746A

- Fast, accurate measurements on frequency division multiplex (FDM) systems
- Selective filters for pilot, channel and (optionally) group power and weighted noise measurements
- Automatic tuning to stored frequency plans with comparison of measured level to stored limits

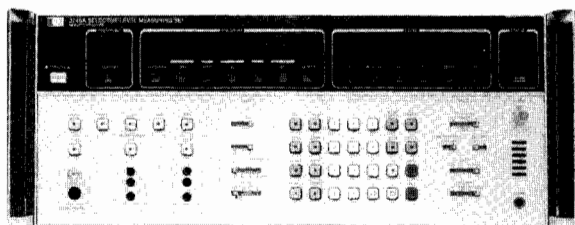

HP 3746A

HP 3746A Selective Level Measuring Set (SLMS) (50 Hz to 32 MHz)

The HP 3746A SLMS makes fast, accurate selective level measurements. A built-in synthesiser gives high tuning accuracy and 1 Hz resolution across the entire 50 Hz to 32 MHz frequency range. Tuning can be performed by: entering a single frequency, stepping between frequency limits, stepping through a set of unrelated frequencies, or by FDM plan description.

The instrument's measurement filters are purpose designed for FDM testing. The flat-topped 3.1 kHz channel filter extracts a voice channel while rejecting adjacent carriers, pilots and other traffic. The 38 Hz pilot filter is flat topped over 22 Hz so AFC is not required, but rejects adjacent tones so that carrier leak can be tested on an active system. A built-in counter can be used to check tone frequencies. Options include: group power, C-message or psophometric noise measurements, noise-with-tone, phase jitter and single-level impulse noise.

The SLMS is optimised for FDM maintenance measurements and network monitoring. It has built-in "intelligence" to allow scanning of FDM signals and limit checking of measured levels. Special hot-tone search routines can rapidly detect high-level signals (See Application Note AN 323). The SLMS can directly control access switches for system applications, and has a built-in real-time clock and printer drivers for data logging. It is fully HP-IB programmable, and can be used as the heart of a self-contained measurement system, or integrated into a computer-controlled system like the HP 37050S FDM Network Monitoring System.

Ordering Information

HP 15580A Active Probe	
HP 15581B Passive Probe	
HP 15582A Return Loss Kit	
HP 15589A Instrument Cart	

Price

\$460
\$375
\$670
\$780

HP 3746A Options

001: Siemens series 1.6/5.6 mm 75 ohm connectors	N/C
005: WECO 477B/223A (equivalent) connectors	\$65
011: 48 kHz group filter	\$850
012: tracking generator	\$279
014: high stability frequency reference	\$650
015: channel impairments - CCITT	\$375
016: channel impairments - North America	\$375

HP 3746A Selective Level Measuring Set

HP 3754A, 3755A, 3756A, 3757A

- Select 1 from a possible 10 RF inputs/outputs
- Cascade up to 111 switches to allow selection from 1000 inputs/outputs
- Mix different switches for the most cost-effective solution

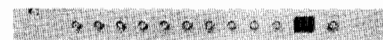

HP 3757A

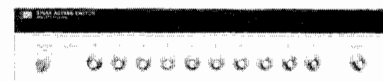

HP 3754A

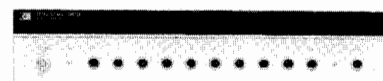

HP 3756A



HP 3755A

HP 3754A, HP 3756A, HP 3757A Switches and HP 3755A Switch Controller

The HP 3754A, 3756A and 3757A Switches and the HP 3755A Switch Controller have been developed to meet the requirements of four main areas:

1. Frequency division multiplex (FDM) system surveillance and maintenance - the switch arrangement is used in conjunction with a selective level measuring set (SLMS), such as the HP 3746A, to monitor pilot and traffic levels at various points in the multiplex. The HP 3746A SLMS can control the access switches directly without needing the HP 3755A Switch Controller.
2. Production testing - where automatic selection or distribution of RF signals is required.
3. IF access and distribution - 70 MHz IF signals can be switched using the HP 3756A for connection to the HP 3717A 70 MHz Modulator/Demodulator.
4. Access and distribution of digital communications signals up to 34 Mb/s (CEPT) or 44.7 Mb/s (DS-3).

Options: The standard versions of these switches have BNC connectors and 75 ohm terminations. Different connectors are available as options on some models and 50 ohm versions are available as options or specials on all models - see data sheet for full details.

Ordering Information

HP 3754A 25 MHz Access Switch	\$2450
HP 3755A Switch Controller	\$2400
HP 3756A 90 MHz Bi-directional Switch	\$3100
HP 3757A 8.5 MHz Access Switch	\$950

TELECOMMUNICATIONS TEST EQUIPMENT

Selective Level Meter and Synthesizer

Models 3586A/B & 3336A/B

385

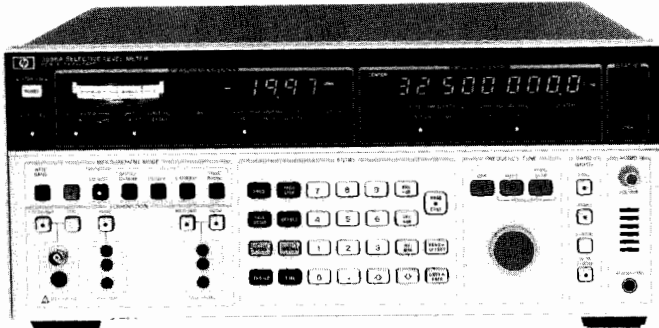

HP 3586A Selective Level Meter (CCITT)



General

The HP 3586A/B Selective Level Meters and HP 3336A/B Tracking Synthesizers offer the high performance necessary to meet the demanding requirements in the design, manufacture, commissioning and maintenance of Frequency Division Multiplex (FDM) systems. The HP 3586 and HP 3336 "A" models meet CCITT requirements, and the "B" models meet North American (Bell) standards. Both are fully programmable over the HP Interface Bus. The HP 3586A & B Selective Level Meter provides a unique combination of features, including wideband power and optional telephone impairment measurement of impulse noise, phase jitter, noise with tone, and signal-to-noise with tone ratio. The HP 3586A & B's wide frequency coverage to 32.5 MHz allows measurements to be made at both voice channel and carrier frequencies. Microprocessor control adds many ease-of-use features such as amplitude offset measurements of tone and noise level in units of dBmO, dBnCO, or dBpWO. Convenience features include simultaneous analog and digital level displays, precise frequency setting with HP's fractional N synthesized local oscillator, accurate frequency counter and tone measurements with automatic channel alignment for 800 Hz (CCITT) or 1004 Hz (Bell) test tone or carrier frequency reference.

The HP 3336 A/B Synthesizer/Level Generator is an excellent precision tracking signal source for the HP 3586A and B Selective Level Meter. When the Selective Level Meter and Synthesizer are in the tracking mode, the frequency of the synthesizer is automatically set to the frequency of the SLM. Frequency coverage is 10 Hz to 20.9 MHz, making the HP 3336 A and B useful for telephone circuit loop testing on most FDM systems, transfer function and distortion measurements in telecommunications manufacturing.

Carrier Frequency and Voice Channel

The HP 3586A & B can make both carrier frequency measurements to 32.5 MHz and voice channel measurements from 50 Hz to 100 kHz.

You can measure tone levels, idle channel noise or weighted noise at voice channel, then compare at carrier frequency.

Transmission Impairments

The Transmission Impairments capability permits phase jitter, weighted noise, noise-with-tone, signal-to-noise-with-tone ratio, and single level impulse noise measurements. The HP 3586A's capability to make these transmission impairment measurements at both FDM voice channel and carrier frequencies is unique.

Frequency and Amplitude Precision

The HP 3336 A/B provides frequency resolution of one microhertz (.000001 Hz) up to 100 kHz and one millihertz (.001 Hz) to 20.9 MHz. Level accuracy is ± 1.5 dB at full output over the full frequency range with ± 1.2 dB optional. Harmonic levels are more than 60 dB down up to 1 MHz and more than 50 dB down up to 20.9 MHz, performance not previously available in a synthesizer.

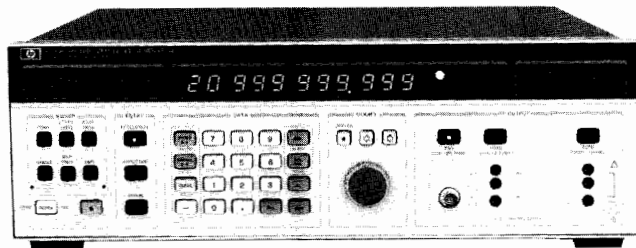

HP 3336A Synthesizer/Level Generator (CCITT)

FDM Testing

The flexible output section allows different connectors to be provided either by option or special request. Frequency entry is accomplished by keyboard or analog control for manual tuning or frequency stepping of any digit.

The Amplitude Blanking feature allows testing of operational FDM systems without disturbing adjacent channels while the frequency is changed. The output is blanked to less than -85 dBm until the next desired frequency is reached.

General Purpose Features

The HP 3336 A/B Synthesizer provides wide band sweep capability—sweep the full frequency range (or as little as two microhertz), log or linear, single or continuous. Single phase lock loop design means the sweep is phase continuous and you can modulate with AM to 50 kHz or PM to 5 kHz. Ten storage registers can be used to keep different test settings available for repetitive test. All necessary functions on the HP 3336 A/B can be remotely programmed by HP-IB control for automatic testing.

Designed-In Serviceability

The HP 3586 A/B Selective Level Meter and the HP 3336 A/B Synthesizer/Level Generator have been designed for reliable operation and excellent accessibility with many useful service features.

North American (Bell) and CCITT Requirements

The HP 3586A & B Selective Level Meter and HP 3336 A & B Synthesizer/Level Generator are designed to meet most world-wide connector and impedance requirements for both carrier and voice channel measurements. Special or regional connectors can be provided by option or special request.

Input Configuration

CCITT Requirements

HP 3586A SLM	75 Ω /10 k Ω Unbalanced 150 Ω , 600 Ω /10 k Ω Balanced
HP 3336A Synthesizer	75 Ω Unbalanced 150 Ω , 600 Ω Balanced

North American (Bell) Requirements

HP 3586B SLM	75 Ω /10 k Ω Unbalanced 124 Ω , 135 Ω , 600 Ω /10 k Ω Balanced
HP 3336B Synthesizer	75 Ω Unbalanced 124 Ω , 135 Ω , 600 Ω Balanced

Fully Programmable

HP-IB control is standard, allowing automatic operation to be controlled by a desktop calculator such as the HP Model 85B, HP 9816A, Series 200, or by a main frame computer, such as the HP 1000. FDM tests such as surveillance can be made from a remote location to reduce maintenance costs and increase troubleshooting efficiency. See page 388 for information on HP 3046 A/B selective level measuring system.

High Impedance Accessory Probes

Models HP 15580A and HP 15581B unbalanced high impedance probes and model HP 15576A balanced high impedance probe are available for use with the HP 3586A/B to facilitate bridging measurements.



TELECOMMUNICATIONS TEST EQUIPMENT

Selective Level Meter/Synthesizer

Models 3586A/B and 3336A/B (cont.)

Frequency

Signal Input	HP 3586A	HP 3586B
75 Ω Unbalanced	50 Hz to 32.5 MHz	
124 Ω Balanced		4 kHz to 10 MHz
135 Ω Balanced		4 kHz to 1 MHz
150 Ω Balanced	4 kHz to 1 MHz	
600 Ω Balanced	50 Hz to 108 kHz	

The 124 Ω , 135 Ω , 150 Ω and 600 Ω inputs are usable over wider frequency ranges, but are not specified in under and overrange operation.

Frequency resolution: 0.1 Hz.

Center frequency accuracy: $\pm 1 \times 10^{-5}$ /year ($\pm 2 \times 10^{-7}$ /year with option 004).

Counter accuracy: ± 1.0 Hz in addition to center frequency accuracy for signals within the 60 dB bandwidth of the IF filter chosen or greater than -100 dBm (largest signal measured).

Frequency display: 9 digit LED.

Selectivity

3 dB Bandwidth, $\pm 10\%$

HP 3586 (CCITT)	HP 3586B (N. American)
20 Hz	20 Hz
400 Hz	400 Hz
3100 Hz	3100 Hz
Psophometric	C-Message
Noise Weighting	Noise Weighting

Adjacent channel rejection: 75 dB minimum at ± 2850 Hz, 3100 Hz BW.

Passband flatness: ± 0.3 dB.

Amplitude

Measurement range: +20 to -130 dBm.

Amplitude resolution: .01 dB.

Level accuracy: 10 dB autorange, low distortion mode, after calibration. 20 Hz and 400 Hz BW below -80 dBm.

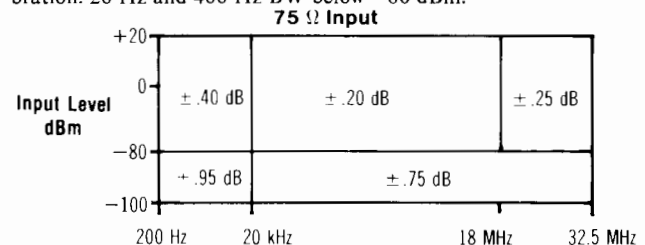

124 Ω input (HP 3586B): ± 0.6 dB, 4 kHz to 10 kHz; ± 0.35 dB, 50 kHz to 5 MHz; ± 0.50 dB, 10 kHz to 50 kHz, and 5 MHz to 10 MHz for +20 to -80 dBm.

135 Ω /150 Ω input (HP 3586A or B): ± 0.6 dB, 4 kHz to 10 kHz; ± 0.35 dB, 50 kHz to 1 MHz, ± 0.50 dB, 10 kHz to 50 kHz for +20 to -80 dBm.

600 Ω input (3586 A/B): ± 0.35 dB, 200 Hz to 108 kHz for +20 to -80 dBm.

Level accuracy: 100 dB range (after calibration): add correction to 10 dB auto-range accuracy for dB below full scale. (Not required when in 10 dB autorange).

dB Below Full Scale	Accuracy Correction
0 to -20 dB	± 0.25 dB
-20 to -40 dB	± 0.50 dB
-40 to -80 dB	± 2.0 dB

Dynamic Range

Spurious Responses

Image rejection (100-132 MHz): -80 dBc.

IF rejection: 15625 Hz, -80 dBc; 50 MHz, -60 dBc.

Non-harmonic spurious signals: >1600 Hz offset, -80 dBc; 300 Hz to 1600 Hz offset, -75 dBc.

Distortion

Harmonic distortion: -70 dB below full scale (>4 kHz on 75 Ω and 600 Ω inputs), low distortion mode.

Intermodulation distortion: 60 dB below full scale, 200 Hz to 50 kHz offset; 70 dB below full scale, 50 kHz to 1 MHz offset.

Wideband power accuracy: after calibration, 100 dB range, averaging on, -45 to +20 dBm.

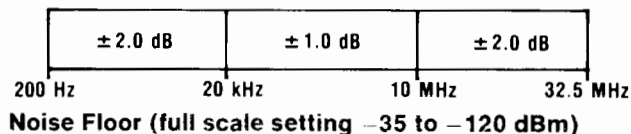

Frequency	Bandwidth	Noise Level
100 kHz to 32.5 MHz	3100, 1740, 2000 Hz	-116 dBm
	20 Hz, 400 Hz	-120 dBm
10 kHz to 100 kHz	All	-105 dBm

The noise floor for full scale settings of -30 to +24 dBm will be 80 dB below full scale for >100 kHz, or 60 dB below full scale for <100 kHz.

Signal Inputs

HP Model	Impedance	Frequency	Mating Connector
3586A	75 ohms unbalanced	50 Hz to 32.5 MHz	BNC
	150 ohms balanced	4 kHz to 1 MHz	Siemens 3-prong
	600 ohms balanced	50 Hz to 108 kHz	9 Rel 6 AC
3586B	75 ohms unbalanced	50 Hz to 32.5 MHz	WECO 439/440A
	124 ohms balanced	4 kHz to 10 MHz	WECO 443A
	135 ohms balanced	4 kHz to 1 MHz	WECO 241A
	600 ohms balanced	50 Hz to 108 kHz	WECO 310

Connector Options

Opt 001 (HP 3586A): 75 ohms mates with Siemens 1.6/5.6 mm coaxial.

Opt 001 (HP 3586B): 75 ohms mates with WECO 358A. 124 ohms mates with WECO 372A.

(Contact local sales office for other special connectors.)

Return loss: -30 dB (50/75 Ω); -25 dB (600 Ω).

Balance

Input	Frequency	Balance
124 Ω	10 kHz to 10 MHz	-36 dB
135 Ω or 150 Ω	10 kHz to 1 MHz	-36 dB
600 Ω	50 Hz to 108 kHz	-40 dB

Demodulated Audio Output

Output Level: 0 dBm into a 600 Ω load, adjustable.

Output Connector: mates with WECO 347A.

HP-IB Interface Functions: SH1, AH1, T6, TE0, L4, LE0, SR1, RL1, PP1, DC1, DT1, C1, C3, C28.

Additional Options

HP 3586A (CCITT)

Opt 001: 75 Ω input connector option. Siemens 1.6/5.6 mm coaxial connector replaces BNC.

Opt 004: High Stability Frequency reference 10 MHz oven stabilized reference oscillator improves frequency stability to $\pm 2 \times 10^{-7}$ /year.

HP 3586B (N. American)

Opt 001: 75 Ω and 124 Ω input connector option. Changes 75 Ω input connector to mate with WECO 358A and 124 Ω input to mate with WECO 372A.

Opt 004: High Stability Frequency reference. Same as Opt 004-HP 3586A.

Auxiliary Signal Inputs/Outputs

Tracking generator: 0 dBm rear panel tracking output.

External reference input: 1 MHz, 10 MHz or sub-harmonic input.

Reference output: 10 MHz, +8 dBm output.

Probe power: front panel dc output for HP active high impedance accessory probes.

HP-IB Interface Functions: rear panel interface meeting IEEE 488-1978 for remote operation. Used for tracking synthesizer interface. SH1, AH1, T6, L3, SR1, RL1, PP0, DC1, C0, E1.

Additional outputs: rear panel demodulated audio; phase jitter meter.

General

Operating Environment

Temperature: 0° to 55°C.

Relative humidity: 95%, 0° to 40°C.

Altitude: ≤15,000 ft; ≤4600 metres.

Storage Environment

Temperature: -40°C to 75°C.

Altitude: ≤50,000 ft; ≤15,240 metres.

Power: 100/120/220/240 V, +5%, -10% 48 to 66 Hz, 150 VA.

Weight: 23 kg (50 lb) net; 30 kg (65 lb) shipping.

Size: 177 mm H x 425.5 mm W x 466.7 mm D (7" x 16.75" x 18.38").

HP 3336 A & B Abbreviated Specifications

(See data sheet or manual for complete specifications)

Frequency

Frequency Range of Signal Outputs

Signal Output	HP 3336A	HP 3336B
75 Ω Unbalanced	10 Hz to 20.999 999 999 MHz	
124 Ω Balanced		10 kHz to 10.999 999 999 MHz
135 Ω Balanced		10 kHz to 2.099 999 999 MHz
150 Ω Balanced	10 kHz to 2.099 999 999 MHz	
600 Ω Balanced	200 Hz to 109.999 999 kHz	

All balanced outputs are usable over wider frequency ranges but are not specified in under and overrange operation.

Resolution: 1 μHz for frequencies < 100 kHz, 1 mHz for frequencies ≥ 100 kHz.

Aging rate (instruments without option 004): ±5 x 10⁻⁶/year (20° to 30°C).

Warm-up time: 30 minutes.

Amplitude

Range: 75 and 600 Ω outputs: -72.99 to +7.00 dBm.

124, 135 and 150 Ω outputs: -78.23 to +1.76 dBm.

Level accuracy, 20° to 30°C

75 Ω Output			75 Ω Output with Option 005*		
+7.00	±.15 dB		+7.00	±.12 dB	
-3.00	±.25 dB	±.30 dB	-3.00	±.16 dB	
-13.00	±.30 dB	±.35 dB	-13.00	±.18 dB	
-33.00	±.35 dB	±.40 dB	-33.00	±.22 dB	
-72.99	±.40 dB	±.45 dB	-72.99		
	10Hz	10MHz		10 Hz	20.9 MHz

*high accuracy attenuator

124 Ω output: 50 kHz to 10.9 MHz ±.15 dB -8.23 to 1.76 dBm, ±0.3 dB -18.23 to -8.24 dBm, ±.35 dB -38.23 to -18.24 dBm ±.4 dB -78.23 to -38.24 dBm.

135 Ω/150 Ω output: 10 kHz to 2.09 MHz, ±.17 dB -8.23 to +1.76 dBm, ±.32 dB -18.23 to -8.24 dBm, ±.37 dB -38.23 to -18.24 dBm, ±.42 dB -78.23 to -38.24 dBm.

600 Ω output: 200 Hz to 109.9 kHz, ±.30 dB -3.00 to +7.00 dBm/ ±.40 dB -13.00 to 2.99 dBm, ±.45 dB -33.00 to -12.99 dBm ±.50 dB -72.99 to -32.99 dBm.

1. Add ±.03 dB for 0° to 55°C operation.

2. Warm-up time is 30 minutes.

Amplitude blanking: <-85 dBm output during blanking

Spectral Purity

Phase noise: <-72 dB, HP 3336A and HP 3336B, for a 3 kHz band, 2 kHz either side of a 20 MHz carrier.

Harmonic level: -35 dB, 10 Hz to 30 Hz; -50 dB, 30 Hz to 50 Hz; -60 dB, 50 Hz to 1 MHz; -55 dB, 1 MHz to 5 MHz; -50 dB, 5 MHz to 20 MHz.

Spurious: all non-harmonically related signals will be more than 70 dB below the fundamental or -100 dBm (-115 dBm with option 005 except 150 or 600 Ω), whichever is greater.

Phase Offset

Range: ±719.9° with respect to arbitrary starting phase or assigned zero phase.

Resolution: 0.1°.

Increment accuracy: ±0.2°.

Ambient stability: ±1.0 degree of phase per degree C.

Frequency Sweep

Sweep time: linear sweep, 0.01 s to 99.99 s; single log sweep, 2 s to 99.99 s; continuous log sweep, 0.1 s to 99.99 s.

Maximum sweep width: specified frequency range of selected output.

Minimum sweep width: log sweep, 1 decade; linear sweep, minimum sweepwidth (Hz) = 0.1 (Hz/s) x sweep time(s).

Phase continuity: sweep is phase continuous over full frequency range.

Sweep flatness: ±0.15 dB, fast leveling, 10 kHz to 20 MHz, 0.03 s sweep time; ±0.15 dB, normal leveling, 50 Hz to 1 MHz, 0.5 s sweep time.

Amplitude modulation: modulation depth, 0 to 100%. Modulation frequency range, 50 Hz to 50 kHz.

Phase modulation: range, 0 to ±850°. Linearity, ±0.5% from best fit straight line. Modulation frequency range, dc to 5 kHz.

External leveling: input from an external voltage source to regulate the signal amplitude at a remote point.

HP-IB Interface Functions: rear panel interface meeting IEEE 488-1978 for remote operation. Used for tracking synthesizer interface. SH1, AH1, T6, L3, SR1, RL1, PP0, DC1, C0, E1.

Options

Option 001, HP 3336A/B Synthesizer/Level Generator

1.6/5.6 mm 75Ω input, (HP 3336A). 75Ω mates with WECO 358A, (HP 3336B). 124Ω connector mates with WECO 372A, (HP 3336B).

Option 004, High Stability Frequency Reference

Aging rate: ±5 x 10⁻⁸/week after 72 hours continuous operation ±1 x 10⁻⁷/month after 15 days continuous operation.

Ambient stability: ±5 x 10⁻⁷ maximum, 0° to 55°C.

Option 005, high accuracy attenuator: improves level accuracy and spurious level. See main specifications.

General

Operating Environment

Temperature: 0° to 55°C.

Relative humidity: ≤85%, 0° to 40°C.

Altitude: ≤15,000 ft., ≤4600 metres.

Storage Environment

Temperature: -50° to +65°C.

Altitude: ≤50,000 ft., ≤15,240 metres.

Power requirements: 100/120/220/240 V, +5%, -10%, 48 to 66 Hz, 60 VA, (100 VA with all options), 10 VA standby.

Size: 132.6 mm high x 425.5 mm wide x 425.5 mm deep (5¼" x 16¾" x 16¾").

Weight: Net wt., 10 kg (22 lb). Shipping wt., 15.5 kg (34 lb).

Ordering Information

HP 3586A Selective Level Meter (CCITT)

Opt 001: 1.6/5.6 mm 75 Ω Connector

Opt 004: High Stability Frequency Reference

HP 3586B Selective Level Meter (N. American)

Opt 001: 75 Ω Connector mates with WECO 358A

and 124 Ω Connector mates with WECO 372A

Opt 004: Same as HP 3586A

HP 3336A Synthesizer/Level Generator (CCITT)

Opt 001: 1.6/5.6 mm 75 Ω Connector

Opt 004: High Stability Frequency Reference

Opt 005: High Precision Attenuator

HP 3336B Synthesizer/Level Generator (N. American)

Opt 001: 75 Ω WECO 358A, 124 Ω WECO 372A

Opt 004, 005: Same as HP 3336A

Price

\$10,500

add \$100

add \$750

\$10,500

add \$100

add \$750

\$5,000

add \$100

add \$650

add \$650

\$5,000

add \$100



TELECOMMUNICATIONS TEST EQUIPMENT

Selective Level Measuring System

Model 3046A/B

- Low cost FDM surveillance
- Stored CCITT or Bell FDM plans
- Synthesizer frequency accuracy
- 0.2 dB amplitude accuracy
- Voice channel impairments
- Plotting and storage of data



HP 3046B



Introduction

The HP 3046A/B systems are designed to automate measurements made on Frequency Division Multiplex (FDM) systems. These include tests such as pilot levels, carrier leaks and slot noise. The system, with all of its measurement power, requires no computer background to operate. Surveillance programs are configured simply by making choices from a series of measurement menus. The HP 3046A is designed for CCITT applications, while the HP 3046B meets North American (Bell) requirements.

This system is ideal for automating surveillance and routine maintenance on a local basis for small to medium capacity systems. Hewlett-Packard also provides automatic test equipment for large capacity FDM systems, using a distributed approach. See page 85-9.14 for a description of these automatic test systems. With a distributed system, remote selective level meters (SLMs) can be monitored from a central computer. With a local system such as the HP 3046A/B, each SLM computer is independent, making installation and operation easier, and the system more mobile.

System Configuration

A standard HP 3046A/B consists of an HP 3586A/B Selective Level Meter with Transmission Impairments and two copies of the appropriate system software, contained on data cartridges. An HP-85 desktop computer is also required and may be ordered as part of the system. A minimum controller configuration includes the HP-85B, a 82936A ROM Drawer, an 00085-15004 Matrix ROM and the 82937A HP-IB interface.

System software consists of FDM surveillance programs with stored CCITT (HP 3046A) or Bell (HP 3046B) plans, and system test software. The system test software can be used to verify proper

system operation and to help identify the faulty component in case of a failure.

For applications requiring a precision signal source, an HP 3336A/B Synthesizer/Level Generator can be added to the system. A 0 dBm tracking source is standard with the HP 3586A/B.

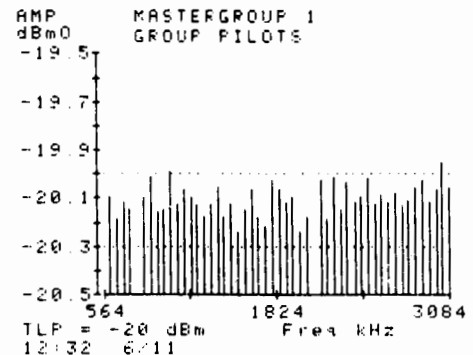

Tabular and Graphic Outputs

An automatic system will collect large amounts of data in a short time, making effective presentation of the results vital. In addition to a variety of tabular listing formats, the Selective Level Measuring

(SLM) System provides graphics—the ability to plot measured results. A plot of hundreds of data points can be analyzed in seconds, providing real insight into the condition of the system. With only a tabular listing, interpretation of hundreds of data points is difficult if not impossible. An active marker is provided to read the amplitude of any point on the graph to 0.01 dB resolution and to list FDM number and frequency.

Storage of Tests and Data

Tests are performed with an automatic system in much the same way they are done manually. First, the measurement parameters (frequency, bandwidth, etc.) are set, and then the measurement is made. The SLM System provides for storage of test parameters on the computer's built-in tape. With this feature often used test set-ups can simply be recalled from tape rather than having to be re-entered each time the test is run. In addition, a program can be stored in a file that will load and run when power to the computer is cycled. In this way a complicated series of tests can be run simply by turning the computer off and then on.

The system can also store measured data for future reference. Short term storage is automatic and has a capacity of 600 readings. This means that measured data can be retrieved any time after a test has been run. If an overnight test were run with only errors printed, this feature would allow printing or plotting of all the data in the morning.

Permanent storage on tape is also provided. This storage allows comparison of today's readings with those taken weeks or months earlier (limit is 600 readings). Data stored includes test limits, TLP, and the time of day and date when the measurement was made.

Timed Measurements

Every printout of test results includes time from turn on or time of day, and the date. The system also provides for delayed start of test and/or repetition of the test at timed intervals. This makes it easy to run a test at night or over a weekend and monitor system performance over time.

Provision for Custom Plans

An "array sweep" is available for testing of non-standard FDM plans. Each of four arrays has a capacity of 100 custom frequencies. Carrier tests can be performed at each test frequency, tested against limits and plotted or printed. Once an array of custom frequencies and the test at each is entered, it can be stored on tape for easy access.

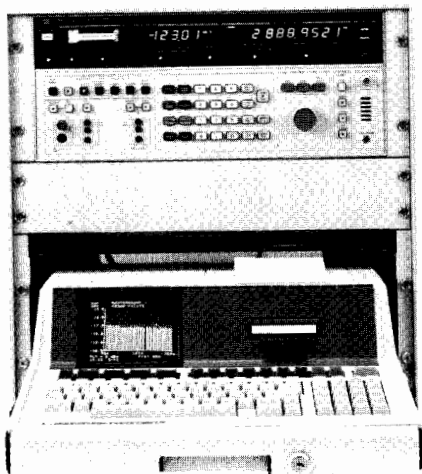

Option 400 cabinet with locking drawer

Recommended Accessories

Disk drive: A disk drive, such as the HP 82901M or HP 9121D provides much faster access to programs and data. This is highly recommended if the level of system interaction is expected to be high. These drives interface the system via HP-IB (HP-IB cable not supplied; ROM included with HP 85B computer only.)

Access switch: An access switch and switch controller can be added to the system with simple program modifications. The recommended controller is the HP 3755A, with several compatible switches available.

General

System Specifications

System accuracy specifications are identical to those of the HP 3586A/B and HP 3336A/B; see pages 386 and 387.

Measurement speed: 0.5 seconds/reading with no range change; 1.3 seconds/reading with range change; 3.3 seconds/reading with range change and Auto-cal.

System Performance

FDM Carrier Tests

Pilots

HP 3046A (CCITT): Group, Supergroup, Mastergroup, Super-mastergroup, and Hypergroup.

HP 3046B (North American): Group, Supergroup and Mastergroup pilots. Non-standard pilots can also be measured.

Carrier leaks: Channel, Group and Supergroup.

Test tones: 1010 Hz or 800 Hz (HP 3046A) or 1004 Hz (HP 3046B) and custom tones.

Signalling tones: 2600 Hz (HP 3046B)

Channel Noise and Slot Noise

HP 3046A: Flat or Psophometric weighting

HP 3046B: Flat or C-Message weighting

Other Tests

Transmission Impairments

Phase Jitter

Weighted Noise with 3100 Hz channel filter

Noise with Tone (notched noise)

Impulse noise can be measured and graphed over any period of time up to 90 minutes

Spot frequency: in the spot frequency mode, the HP 3046 can measure and print the level at a single frequency. The point to be measured can be defined by frequency or FDM number. Wide band power can also be measured and printed out in this mode.

System verification: the system verification program verifies operation of the HP 3586A/B and the HP 3336A/B, and can be used to locate the source of a hardware failure.

Physical Parameters

Temperature: 5 to 40°C

Relative humidity: 95%, 0 to 40°C

Altitude: ≤4600 metres, 15,000 feet

Ordering Information

	Price
HP 3046S Selective Level Measuring System	\$0
By ordering the system instrumentation and controller under this model number, total system compatibility is insured.	
HP 3046A SLM System Instrumentation and Software (CCITT)	\$11,355
HP 3046B SLM System Instrumentation and Software (Bell)	11,355
001: Special Connector (HP 3586A/B Option 001)	\$100
004: High Stability Frequency Reference (HP 3586A/B Option 004)	\$750
100: Add HP 3336A/B Synthesizer/Level Generator	\$5,000
101: Special Connector (HP 3336A/B Option 001)	\$100
104: High Stability Frequency Reference (HP 3336A/B Option 004)	\$650
105: High Accuracy Attenuator (HP 3336A/B Option 005)	\$650
400: Locking Cabinet for Standard System	\$1,725
450: Locking Cabinet for System with Synthesizer	\$1,975
480: 220 V Operation (For Opt. 400, 450)	\$0
HP 85B Controller configurations are priced beginning at	\$4,100
Consult the HP 3046S System Configuration Guide for further details.	



TELECOMMUNICATIONS TEST EQUIPMENT

Microwave Link Analyzer

Models 3711A/3712A, 3730B, 3717A, 8350B, 8620C, 86200 Series RF Plug-ins

- Comprehensive testing of microwave radio links and components.
- Baseband and IF (70/140 MHz) interface on MLA.
- Extension to RF (0.5 to 18 GHz) with up/down converter.
- Baseband qualitative measurements via 70 MHz modulator/demodulator.
- Test analog and digital radios.

70/140 MHz IF MLA System

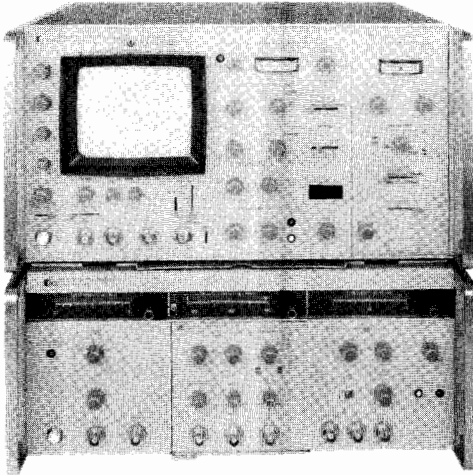

HP 3711A IF/BB Transmitter
 HP 3791B BB Transmitter (Plug-in)
 HP 3712A IF/BB Receiver
 HP 3793B Diff. Phase Detector (Plug-in)

70 MHz Modulator/Demodulator

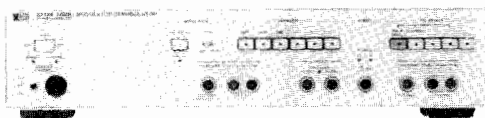

HP 3717A

HP 3711A/3712A Microwave Link Analyzer

The HP 3711A/3712A MLA system provides a comprehensive range of microwave radio measurements at baseband and IF (70 or 140 MHz) including: amplitude and group delay response, modulator/demodulator linearity and sensitivity, differential phase and gain, power and frequency. These measurements can be made on individual components of an analog or digital radio or over a radio link, without needing a reference channel.

The HP 8350B or HP 8620C Sweeper with HP 86200 series of MLA Upconverter Simulation Plug-ins upconverts the MLA transmitter signal to RF channels in the range 0.5 to 18 GHz. (The HP 11869A Adapter is required for HP 8350B.)

The HP 3730B RF Down Converter with plug-ins converts RF signals in the 1.7 to 14.5 GHz range to a 140 MHz or 70 MHz IF. (This range can be extended with external LOs.)

Together, the HP 8350B/HP 8620C and HP 3730B extend the MLA system to make measurements on RF channels and devices over bandwidths of up to 1 GHz.

At non-demodulating repeater stations, the HP 3717A 70MHz Modulator/Demodulator allows qualitative baseband tests such as white-noise loading, TV waveform testing and baseband-frequency response to complement the MLA swept IF measurements. The HP 3717A is a high-quality modem which can be substituted for operational equipment to isolate system faults.

RF to IF Down Conversion

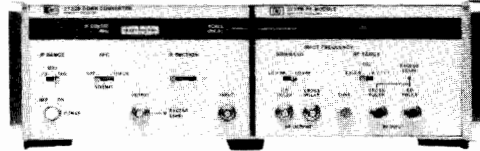

HP 3730B Mainframe Hp 3737B plug-in

MLA Upconverter Simulation

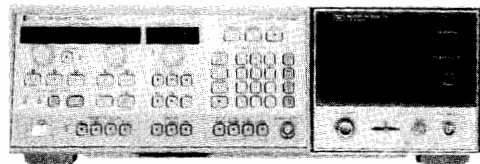

HP 8350B/86245A

Ordering Information

Price

MLA System:

HP 3711A IF/BB Transmitter	\$7,500
HP 3791B BB Transmitter (Plug-in)	\$1,700
HP 3712A IF/BB Receiver	\$9,250
HP 3793B Diff. Phase Detector (Plug-in)	\$1,750

See data sheet for details of connector, test tone and other options, and accessories.

HP 3730B Down Converter	\$4,350
HP 3736B RF Module 1.7 to 4.2 GHz	\$5,600
HP 3737B RF Module 3.7 to 8.5 GHz	\$6,700
HP 3738B RF Module 5.9 to 11.7 GHz	\$7,800
HP 3739B RF Module 10.7 to 14.5 GHz	\$11,150

See data sheet for details of options and accessories.

HP 8620C Sweeper Mainframe	\$3,850
HP 8350B Sweeper Mainframe	\$4,550
HP 11869A Adapter	\$400

HP 86200 MLA Upconverter Simulation Plug-ins

Plug-in Model Number	MLA Option Number	Freq Range (GHz)
86222A/B	H80	0.5 - 2.4
86235A	008	1.7 - 4.3
86240C	-	3.6 - 8.6
86242D	008	5.9 - 9.0
86245A	008	5.9 - 12.4
86250D	008	8.0 - 12.4
86260A	H82	12.0 - 18.0

HP 3717A 70 MHz Modulator/Demodulator \$12,600

See data sheet for details of connector, emphasis network and other options.

TELECOMMUNICATIONS TEST EQUIPMENT

RF Sweeper MLA Upconverter Simulation

Models 8350, 8620C, 86200 Series RF Plug-Ins

391



- MLA upconverter simulator options 0.5 to 18.0 GHz
- Use with MLA or as a general purpose sweeper
- Swept and CW RF source
- Test digital & analog microwave radio systems & components

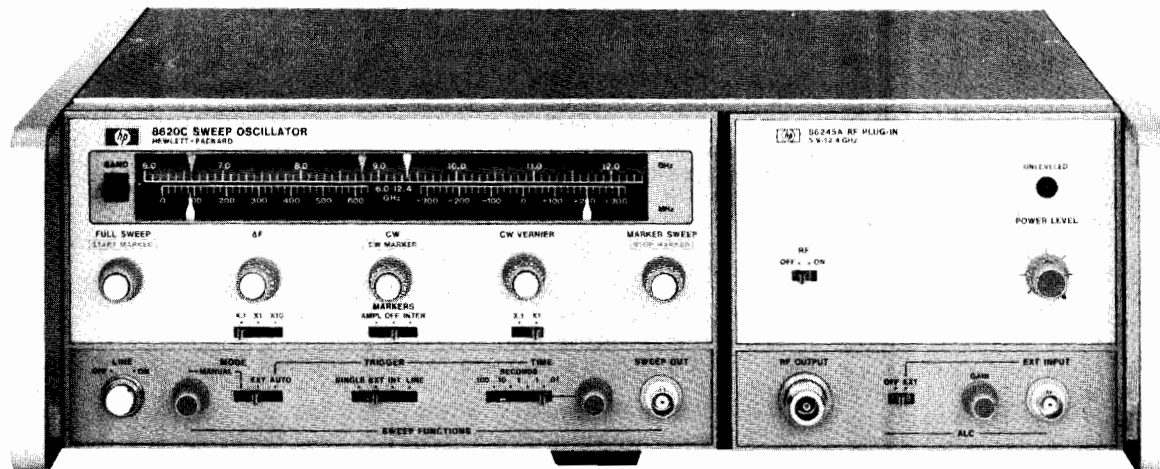

HP 8620C/86245A

Description

The HP 8620C Sweep Oscillator and HP 86200 Series of RF plug-ins provide a high performance, solid state source for Microwave Radio System tests via MLA Upconverter Simulation Options. These permit accurate RF-to-BB, RF-to-IF and RF-to-RF distortion measurements to be made with the HP 3700 Series MLA System. The plug-ins can also be used as standard sweeper plug-ins, with the only basic difference being modified FM circuitry. The RF-to-RF measurements must be made in conjunction with the HP 3730B RF Down Converter. This allows group delay, linearity, differential gain and phase measurements to be made on RF devices and components within the Microwave Radio System. The HP 8350 Sweep Oscillator Mainframe is also compatible with the HP 86200 series MLA option plug-ins through the use of the HP 11869A Adapter (see page 501).

Specifications

The HP 8620C/86200 Series MLA Upconverter Simulation Plug-ins are optimized for group delay, linearity, and differential gain and

phase over the specified frequency range. All plug-ins can be used with MLA sweep widths of 100 MHz (200 MHz with Option H42) or less. The following specifications supplement the standard HP 8620C system specifications (covered on pages 513-519).

Complementary Equipment

Equipment	Price
HP 8350 Sweeper Mainframe	\$4,565
HP 11869A Adapter	\$405
HP 8620C Sweeper Mainframe (required)	\$3,865
To properly interface the HP 8620C/86200 Series plug-in to the item under test, the following are recommended for optimal performance:	
HP 784C Directional Detector (1.7 - 12.4 GHz)	\$1,655
Flatness over any 30 MHz: $\leq \pm 0.1$ dB	
Equivalent source match: typically ≤ 1.5	
HP 11675B Leveling Cable Assembly (1.7 - 12.4 GHz)	\$655
Group delay: ≤ 0.25 ns p-p (with 1.25 SWR at each end)	

MLA Upconverter Simulation Plug-in Specifications (25°C)

HP Model Number ¹	MLA Option Number	MLA Freq. Range (GHz)	Group Delay (ns) p-p		Linearity (%)	Diff. Gain (%)	Diff. Phase (°)	FM Sens. (MHz/V)	Price W/MLA Option
			@ 277.7 kHz						
			Across Any 30 MHz BW			@ 5.6 MHz ²			
86222A/B	H80	0.5-2.4	<3	<2.5	<2.5	<2.5	<3	N/S	\$7,025/8,475
86235A	008	1.7-4.3	<2	<2.0	<2.0	<2.0	<2	+20	\$6,080
86240C	-	3.6-8.6	<1	<0.5	<0.5	<0.5	<1	+20	\$7,525
86242D	008	5.9-9.0	<1	<0.5	<0.5	<0.5	<1	+20	\$6,180
86245A	008	5.9-12.4	<1	<0.5	<0.5	<0.5	<1	+20	\$6,980
86250D	008	8.0-12.4	<1	<0.5	<0.5	<0.5	<1	+20	\$6,280
86260B	H82	10.0-15.5	<3	<3.5	<2.5	<2.5	<3	N/S	\$7,130
86260A	H82	12.0-18.0	<3	<2.5	<2.5	<2.5	<3	N/S	\$6,680

¹Internal leveling is standard on all HP 86200 series plug-ins.

²Except HP 86222A/B & 86260A which are tested @ 2.4 MHz.

For applications requiring better distortion specifications, HP also offers plug-in systems which include a leveling cable and directional coupler. These systems are available in the following bands: 5.8-6.5 GHz, 7.0-8.6 GHz, 10.7-11.7 GHz, and 12.2-12.7 GHz. The system specifications are as follows:

Group delay @ 500 kHz: < 0.5 ns p-p

Linearity @ 500 kHz: $< 0.25\%$

Flatness: $\leq \pm 0.1$ dB

For more information consult your local HP Field Engineer.

The options shown after each plug-in provide the special MLA interface capability. Refer to pages 513-519 for details on other RF Sweeper plug-in specifications and options.

TELECOMMUNICATIONS TEST EQUIPMENT

Radio System Testing

Measurements on Digital Radio Systems

Introduction

Digital microwave radio systems form part of many communications networks, being more cost effective and simpler to install, over long distances and difficult terrain, than either cable or fiber.

A digital radio carries a stream of digital information by modulating an RF carrier to a number of discrete amplitude and phase states. Each of these states corresponds to a unique digital pattern (symbol) and the set of possible modulation states is the radio constellation.

There are a number of modulation schemes in common use, which range from simple schemes like BPSK to more complex schemes such as 16QAM and 64QAM. The more complex schemes carry more data in a given RF bandwidth but are more difficult to implement and are more easily upset by impairments such as noise and interference, or degradations internal to the radio. However these schemes are gaining in popularity in line-of-sight applications, while simple but robust schemes are used extensively in satellite and military applications.

Constellation Pattern Analysis

The introduction of the HP 3709A provides digital radio operators with an easy-to-use, low-priced constellation pattern display.

The new HP 8980A Vector Analyzer and HP 8780A Signal Generator offer higher performance capabilities for those digital radio design and manufacture applications that require it.

Constellation pattern analysis is not new, but previously could only be achieved using a sampling oscilloscope. The high cost of this type of oscilloscope severely limited the number of applications, outside of radio manufacture and design, in which the technique could be used. The technique of analysing constellation patterns on digital radio systems offers operators a powerful, in-service method of trouble-shooting and diagnosing degradations on a digital radio system.

The HP 3709A Constellation Display is designed primarily for use in digital radio service and maintenance, though it will also

find many applications in the design, manufacture, installation and commissioning of digital radio systems.

All digital radios share a similar block diagram.

The HP 3709A connects to protected monitor points on the demodulator of the digital radio receiver which give access to the I (in-phase), Q (quadrature) and symbol timing clock signals. It is used to display the individual I and Q signals versus time (eye diagrams) or the I signal versus the Q signal in a phase plane diagram (constellation pattern). As the test is non-intrusive, it can be performed on a radio carrying live traffic with no interference to the traffic.

Timing for the HP 3709A is taken from the recovered symbol timing clock of the radio and an automatic timebase ensures that a two eye width eye diagram is displayed when either the I or Q signal is monitored.

Constellation Patterns

The constellation pattern reveals both amplitude and phase distortions of the digital radio signal.

During normal operation a digital radio will produce a characteristic constellation pattern which, for most modulation schemes, will be regular in shape and consist of small clusters (or clouds) - one cluster for each modulation state.

(The internal noise of the radio causes each modulation state to be a cluster rather than a pinpoint on the constellation pattern.)

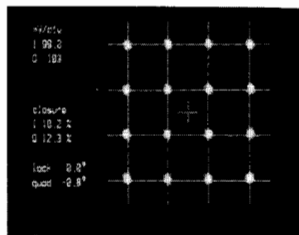

Constellation Pattern
(Normal - 16QAM radio)

Most digital radio impairments produce characteristic constellation patterns which make fault diagnosis straightforward.

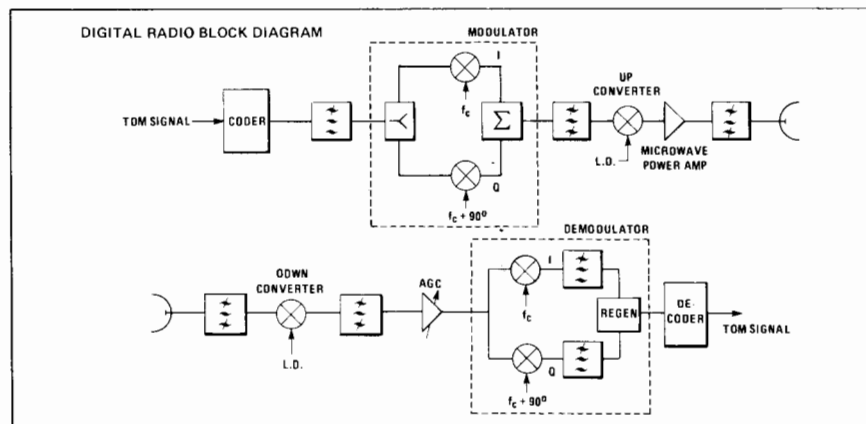

Digital Radio Block Diagram

The following examples, taken from a 16QAM radio system, illustrate how different impairments show different constellation patterns.

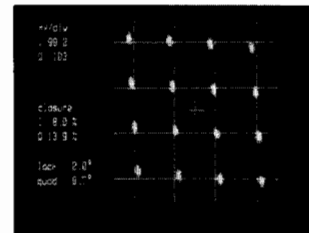

Quadrature Angle Error

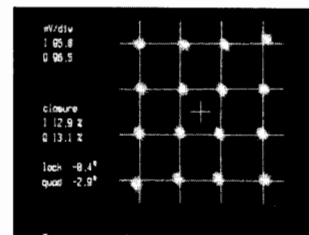

AM-AM / AM-PM

To assist the user in identifying problems on a digital radio, an example impairment "catalog" is provided in the HP 3709A training manual.

Constellation Measurements

The HP 3709A provides measurement routines and reference gratitudes for the most common modulation schemes used in digital radios: QPSK, 9PRS (3LPR), 16QAM, 49PRS (7LPR) and 64QAM.

Dedicated features of the HP 3709A include the measurement of signal level and the following key constellation parameters:

- Closure - ratio of rms cluster size to cluster separation.
- Lock angle error - the overall rotation of the constellation pattern.
- Quad angle error - the out-of-squareness of the measured constellation.

To calculate these parameters, the HP 3709A accumulates 600 (randomly taken) samples of the levels of the I and Q signals, then calculates the mean position and variance for each cluster of the constellation. It uses these intermediate results to calculate the final constellation parameters.

The raw values (I, Q pairs), estimates of mean positions and variances, or the final constellation parameters are available over the Hewlett-Packard Interface Bus (HP-IB).

A computer can therefore be used to interface with the display and retrieve any of the available levels of data. This permits more accurate or extensive analysis of the constellation to be made.

Radio System Testing

In R&D and manufacturing environments, many of the same measurement needs exist when designing, troubleshooting, and aligning digital radio systems. In addition, it is often necessary to further characterize performance using calibrated test signals and quantitative analysis.

A source such as the HP 8780A Vector Signal Generator can provide accurate, calibrated test signals that simulate normal radio operation in a lab setting. Complete control over modulation parameters and impairments such as quadrature error and AM-PM conversion not only allow testing with ideal signals, but also with precisely degraded signals for margin testing.

When combined with an analysis product such as the HP 8980A Vector Analyzer, completely automated stimulus-response testing is possible.

Precision measurements for radio characterization must rely on repeatable, known signal conditions. For example, the HP 8780A Vector Signal Generator could be used as shown in Figure 1 to provide a "perfect" test signal so that the demodulator quadrature alignment error could be read from the HP 8980A Vector Analyzer. Continuously updated readouts permit easy adjustment of the receiver.

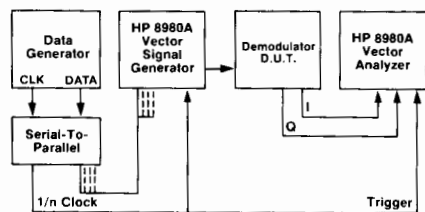

Figure 1.

Other problems such as gain imbalances and quadrature errors can be quickly identified using the constellation analysis technique.

Once the demodulator is calibrated, the same test system can be used to perform margin testing, i.e., to test the ability of the radio to operate properly under degraded conditions. For example, the HP 8780A Vector Signal Generator can generate signals with known amounts of phase rotation or quadrature error. Or, its I<Q function allows convenient simulation of modulator gain errors.

As shown in Figure 2, HPA distortion can be easily observed in the constellation diagram by varying the signal over a range of output levels. On-screen markers, provided on the HP 8980A, facilitate measurements of AM-PM conversion and other degradations.

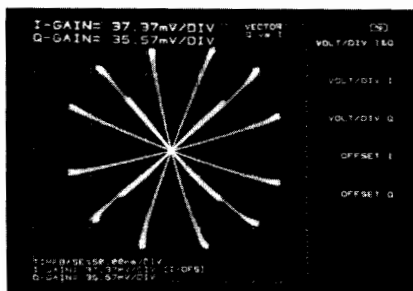
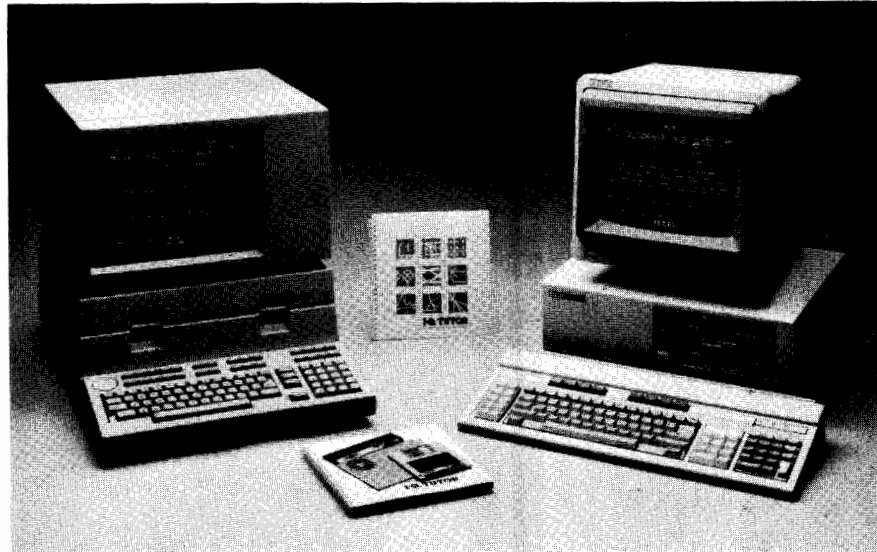

Figure 2.



I*Q Tutor is available on the HP 9000 Model 216, 217 or 236 computer, or on the HP Vectra or IBM PC, PC/XT, or PC/AT.

I*Q Tutor

Imagine a practice workbench which simulates a full digital communications system from voice channel through transmission and back to voice. I*Q Tutor is just that — it's an interactive software training package that simulates the major building blocks of a modern digital communications system. I*Q Tutor is for technical entrants to the field of digital communications, as well as for expanding insights of more senior engineers and engineering managers.

On the computer screen, the user selects the system node to be examined. (See Figure 3.) Time and frequency domain signals can be viewed, as well as vector signals. The notebook pages at the bottom represent on-screen explanations of what is happening to the signal.

The power and versatility of I*Q Tutor come from the ease of changing system parameters, and then viewing the effects of those changes. Figure 4 shows the different vector displays of a QPSK signal: the eye diagram, the vector diagram and the constellation diagram.

The user can also change the signal-to-noise ratio, or select from several data filters to examine how these changes affect the system symbol error rate and the transmission bandwidth. An advanced design screen is available for exploring multipath fades and AM-AM and AM-PM distortion effects.

Subjects covered in the training manual include:

Understanding Fundamental Concepts
Phase and Magnitude • Practical Digital Modulation Techniques • BPSK • QPSK • 16QAM • Offset QPSK and Offset 16QAM • Understanding the System Block Diagram

Real World Concerns
Multipath Fade • High Power Amplifier Nonlinearities • Advanced Design Mode

Experimental Exercises
P(e) vs. SNR • P(e) vs. Filter Bandwidth • Noise, Errors and the I*Q Vector Diagram • Multipath and "M" Curves • Distortion Caused by HPA Non-linearities

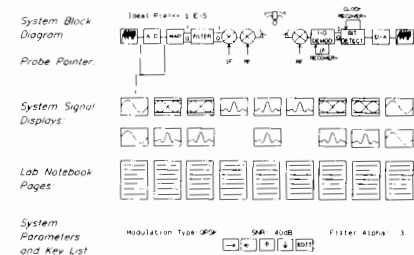

Figure 3. I*Q Tutor System Block Diagram

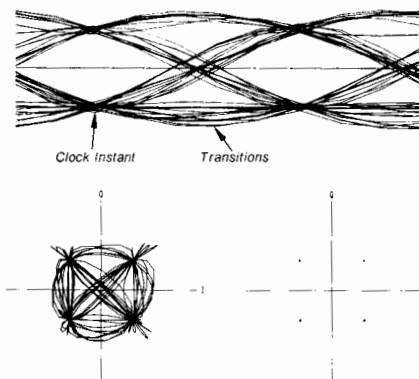

Figure 4. Eye Diagram, Vector Diagram, and Constellation Diagram of a QPSK Signal

Ordering Information:

HP 11736A Runs on HP9000 Model 216A, 217A, and 236A computers with 640 kbytes of memory, or the Model 236C with 896 kbytes. Requires BASIC 2.0 with Extensions 2.1, or BASIC 3.0 with Graph and GraphX extensions.

Price: \$95.00

HP 11736B Runs on HP Vectra and most IBM PC-compatible computers (PC/XT/AT) with a monochrome or color graphics card.

Price \$95.00



TELECOMMUNICATIONS TEST EQUIPMENT

Microwave Radio Noise and Interference Test Set and Measurement System; Digital Radio Constellation Display

Models 3708A, 3708S, 3709A

HP 3708A

- Highly accurate wideband noise source covers all common microwave link IFs
- Tracking mode maintains constant C/N ratio under carrier fading conditions
- Broadband interference facility, with or without noise injection, stresses the radio deterministically

HP 3708S

- Extensive graphics capability facilitates operation and measurement interpretation
- Complete range of Hewlett-Packard HP-IB compatible bit-error-ratio test sets supported

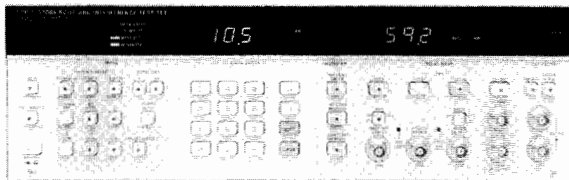

HP 3708A



HP 3708A Noise and Interference Test Set

The HP 3708A offers an accurate, yet simple, method of simulating flat-fade conditions on a digital or FM microwave radio. Designed for connection at the IF section, the HP 3708A adds calibrated levels of white noise and/or interference signals to the radio IF carrier. A built-in power meter and microprocessor control enable the radio IF carrier power to be sampled by the HP 3708A at the point of noise injection and the noise density (or interference level) to be adjusted automatically to maintain a constant carrier-to-noise (or interference) ratio even in the presence of receiver carrier level variations.

Additional capabilities within the instrument include:

- True RMS IF power meter
- High stability 0 dBm reference tone (can be used as interferer)
- Direct noise bandwidth measurement
- Entry is units of C/N_0 , E_b/N_0 or C/N (C/N in user-defined bandwidth)

Options

Std: Signal connectors impedance, 75 ohm nominal unbalanced to GND. Reference tone oscillator frequency is 70/140 MHz.

001: Signal connectors impedance, 50 ohm nominal unbalanced to GND.

Special options: Reference tone oscillator frequencies, other than the standard values, are available on a special order basis.

HP 3708A Noise and Interference Test Set \$14,450.00

HP 3708S Noise and Interference Measurement System

Using the HP 3708S system, automatic measurement of radio performance under flat-fade (and/or interference) conditions can be made with the HP 3708A, and a pattern generator and error detector to provide and monitor a known test pattern. The following measurements are supported: C/N vs BER (tracking/non-tracking, with/without interference) and C/I vs BER.

Versions of the HP 3708S system software (HP 37080) exist to support all current HP bit-error-ratio test sets with HP-IB capability.

HP 3709A

- Informative constellation measurements
- Simplified oscilloscope controls
- Partial HP-IB control allows data transfer

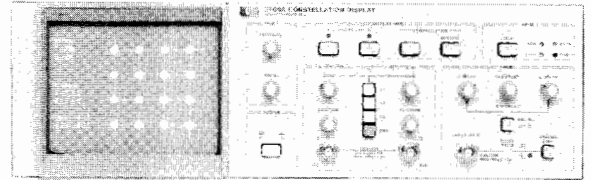

HP 3709A



HP 3709A Constellation Display

Designed primarily for service and maintenance in digital microwave radios, the HP 3709A is a dedicated display for characterizing radio performance and condition by analysis of constellation patterns. Since impairments on a digital radio produce distinctive constellation patterns, the HP 3709A can provide a fast, straightforward method of diagnosing impairments on both in-service and out-of-service systems.

The HP 3709A is capable of monitoring radio eye and constellation patterns, and measuring key constellation parameters such as closure, lock-angle error and quad-angle error. In addition, the HP 3709A can dump a formatted report of the constellation and constellation measurements to a ThinkJet printer.

The HP 3709A can be used for trouble-shooting, in-service performance assessment, radio adjustments and to obtain data for written reports.

Supported Radio Parameters

Modulation schemes: The HP 3709A has graticules and measurement routines to cover QPSK, 9PRS (3LPR), 16QAM, 49PRS (7LPR) and 64QAM radios (25PRS, 81PRS, 256QAM are available as special options).

Monitor points:

(1) I and Q signals: Any of the above schemes with signal levels in the range 100mv to 1V p-p across the constellation. (dc offsets must be no more than 0.5 x signal amplitude p-p)

(2) Clock: 1MHz to 80MHz (100mV to 1V p-p).

Symbol Clock Rate	Bit Rate (Mbit/s)		
	QPSK/ 9PRS	16QAM/ 49PRS	64QAM
Min 1 MHz	2	4	6
Max 80 MHz	160	320	480

Impedance level: All HP 3709A inputs are 75 ohm terminated.

Options: Versions of the HP 3709A offering higher sensitivity and 50 ohm terminations are available.

Accessories:

Transit case: HP Part No. 9211-2661 contains custom-moulded inserts which fit snugly around the instrument for maximum protection during transit.

HP 3709A Constellation Display

\$8,750

TELECOMMUNICATIONS TEST EQUIPMENT

Vector Signal Generator and Analyzer

Models 8780A, 8980A

395



- 10 MHz to 3 GHz IF testing
- BPSK, QPSK, 8PSK, 16QAM, 64QAM, and burst digital modulation

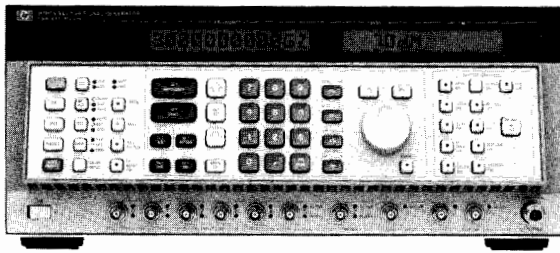

HP 8780A



- Analyzes coherent phase and amplitude modulation
- 350 MHz I vs. Q bandwidth
- Markers for measuring phase, amplitude, and time
- 12-bit digitizing for HP-IB measurements

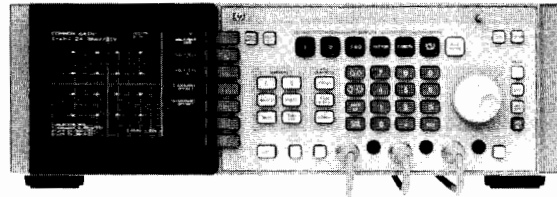

HP 8980A



HP 8780A Vector Signal Generator

The HP 8780A Vector Signal Generator is a synthesized source with exceptional modulation for modern digital microwave radio and satellite communications testing. The Vector Signal Generator offers a wide variety of modulation using both digital and analog inputs. It generates standard formats from QPSK to 64QAM, and traditional modulation like FM, AM and pulse, as well as sophisticated complex modulation.

Applications

The Vector Signal Generator is well-suited for receiver measurements where wideband or complex modulations are required. Its coherent carrier output makes it particularly valuable for systems employing vector demodulators. Its standard modulations—BPSK, QPSK, 8PSK, 16QAM, and 64QAM (with Opt. 064)—using digital inputs are easily programmed with standard data generators. Less common modulations, like TDMA, can be programmed using the Burst feature in conjunction with one of the PSK modulations.

Simultaneous modulations are available to simplify receiver and IF measurements. For example, the envelope of a digitally modulated signal can be varied to test receiver AGC performance. The I<Q feature can be used to simulate I<Q modulations or to evaluate the effect of amplitude imbalances. Similarly, the two-state feature allows digitally-controlled transitions between two I,Q states for margin testing of carrier recovery circuitry.

For more information about the HP 8780A, refer to the *Vector Modulation Generators and Analyzers* section of this catalog.

Performance Summary

Frequency: 10 MHz to 3 GHz; Resolution: 1 Hz

Output: +10 to -100 dBm; Resolution: 0.1 dB

Coherent Carrier Output: Unmodulated coherent carrier available at rear panel. Range: 10 MHz to 3 GHz; Level > -20 dBm (+10 dBm with Option 002)

Digital Modulation

Modulation types: BPSK, QPSK, 8PSK, 16QAM, 64QAM with Opt. 064, arbitrary 2-state, Burst.* Simultaneous burst* available with BPSK, QPSK, 8PSK, or CW

Alternate level: Available with BPSK, QPSK, Burst* BPSK, Burst* QPSK

I<Q: available with all digital modulations

Clock modes: Single, separate I and Q*, or asynchronous

Parallel data rates: 0 to 150 MHz clocked, 0 to 50 MHz asynchronous, 0 to 100 MHz clocked 64QAM w/Opt. 064

Data input levels: ECL, ground, or auto -2.5 V to 2.5 V

Data and clock input impedances: 50 ohms nominal

Burst Modulation: 0 to 150 MHz clocked, 0 to 50 MHz asynchronous

Scalar Modulation/AM:

Sensitivity: 0 to +1 volt for 0 to full scale envelope modulation

Frequency response: dc to 500 kHz (-3dB)

Input impedance: 10k ohms nominal

Traditional AM modulation requires a dc offset of 0.5 V to be added to the scalar input.

*Not available with Option 064

HP 8980A Vector Analyzer

The HP 8980A Vector Analyzer is a 350 MHz X-Y two-channel sampling oscilloscope. It is designed to analyze the in-phase (I) and quadrature-phase (Q) components of modern digital microwave radio signals such as QPSK, 16QAM, 256QAM, etc.

Applications

Measurable, repeatable results are important in monitoring and maintaining the quality of digital microwave or satellite systems over time. The HP 8980A constellation analysis feature gives non-intrusive direct measures of constellation closure, quadrature error, and lock angle error for a wide variety of modulation formats from QPSK to 256 QAM. Continuous or single I,Q voltage measurements are also possible, thus facilitating on-line adjustments of quadrature balance and minimum constellation closure. Front panel probe power and optional active probes permit easy troubleshooting of difficult circuit-level problems. For a permanent hardcopy output, an HP 2225A ThinkJet printer can provide paper copies of the display in seconds.

Auto Scope and Save/Recall features make the HP 8980A easy to use. Display markers help the user translate visual data into accurate, quantified data in seconds.

The 12-bit digitizing capability of the HP 8980A makes automated testing easy. All front panel settings are easily programmable over the HP-IB.

For more information about the HP 8980A, refer to the *Vector Modulation Generators and Analyzers* section of this catalog.

Performance Summary

I and Q Channel Inputs

Input Sensitivity: Volts/division range: 5 mV/div to 1 V/div in standard grid, in 1,2,5 sequence or fine resolution

Input impedance: 50 or 75 ohms, interchangeable

Maximum input voltage: DC Coupled: ± 5 V peak; AC Coupled: ± 25 Vdc, ± 5 V peak ac

Dynamic performance: Bandwidth (-3dB): dc to 350 MHz, including I vs. Q

Timing: Time/division range: 0.5 ns/div to 2 ms/div

Delay range: 0 to 1000 divisions, 20 ms max.

Skew I or Skew Q range: 0 to 5 divisions

External Trigger System:

ECL: 50 or 75 ohms to -2V, ECL threshold

TTL: 50 or 75 ohms to gnd, TTL threshold

VARIABLE: 50 or 75 ohms to gnd or -2 V threshold

AUTO-LEVEL: 50 or 75 ohms to gnd, 100 kHz to 150 MHz

Gate Input: (Rear Panel)

ECL: 50 ohms terminated to -2 V, ECL threshold

TTL: 50 ohms terminated to ground, TTL threshold

Gate Operation: Blanks display and disables measurements asynchronously with trigger rate.

Accessories

HP 1124A 100 MHz Active Probe

Price

\$325.00



TELECOMMUNICATIONS TEST EQUIPMENT

Operational Support Systems

Models 37050S, 37051S, 37100S

HP 37050S, HP 37051S

- Continually monitor FDM network performance
- Early identification of degradations allows effective preventative maintenance
- Collect performance statistics on leased facilities
- Minimise repair time through rapid fault identification

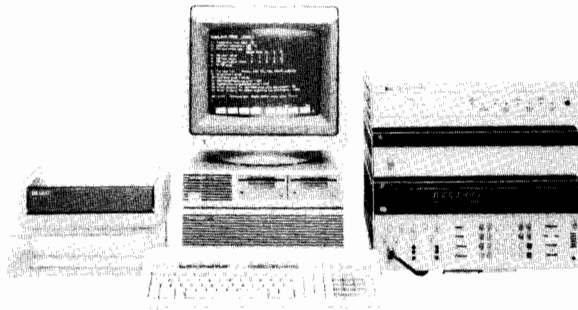

By continually monitoring the performance of an FDM transmission network, the HP 37050S and HP 37051S systems allow deteriorations or faults to be isolated and rectified in the shortest possible time. The HP 37050S has been designed to meet the demands of large, high-capacity FDM networks, whereas the HP 37051S provides a low-cost solution for small FDM networks.

Both systems combine the extensive measurement capability and built-in intelligence of HP 3746A Selective Level Measuring Sets (SLMSs) with access switches and dedicated control software to provide comprehensive measurements which include:

Pilots	Channel noise
Carrier leaks	Inter-supergroup slot noise
Power	Fast 'hot tone' searches

Automatic measurement sequences can be created for network monitoring. User-initiated measurements, temporarily interrupting any sequence, can be made to investigate a problem highlighted through monitoring.

HP 37050S FDM Network Monitoring System

The HP 37050S is a flexible, automatic measurement system designed for comprehensive performance monitoring of large FDM transmission networks.

The system operates under the direct control of an HP 1000 A-Series computer system which simultaneously gathers measurement data from up to 16 remote sites. Simultaneous access to system facilities by a number of users is accommodated. Specialized results modes are provided that reduce the mass of data available to only that which is relevant.

Two or more computer systems can be linked together enabling an HP 37050S system to be expanded beyond 16 sites.

HP 37051S FDM Measurement System

The HP 37051S is the ideal answer for the operator of a small FDM network who wishes to make measurements at several remote FDM installations and present the information obtained at one central location.

This system operates under the control of an HP 9000 Series 300 computer that provides control of up to 6 remote sites in succession.

HP 37051S operators can expand their monitoring system to the HP 37050S as their network grows or needs change.

HP 37100S

- Remotely test private circuits from a convenient central site without moving from the keyboard of a computer terminal
- Dramatically improve the productivity of telephone maintenance operations by reducing troubleshooting and technician-travel time
- User-friendly software means no special keyboard skills are required
- Software-generated reports and features which save time and effort

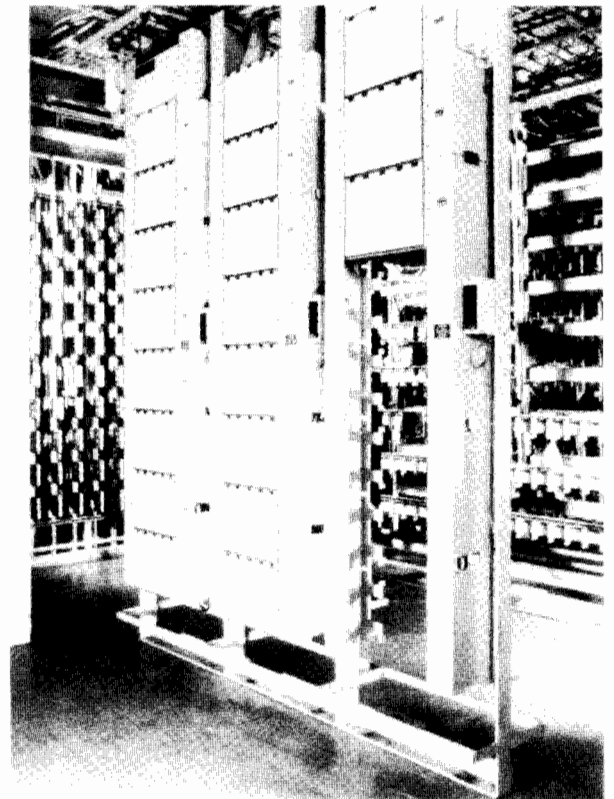

The HP 37100S Remote Access and Test System

The HP 37100S Remote Access and Test System (HP RATES) provides the hardware, software and support for nationwide testing and troubleshooting of special-service metallic telephone lines. Applications include testing of 2, 4, 6 or 8-wire private circuits which are permanently routed through the equipment and can be accessed and tested at a remote site under the control of a central-site operator.

The HP RATES system uses the well-proven HP 1000 A-Series computer as the system controller running applications software packages, controlling the remote site access and test equipment via modem connections over dedicated or dial-up telephone lines. An operator using a terminal connected to the central site computer, interacts with the applications software to verify circuit performance, accessing the circuit at a remote location and performing the tests from the central location. Extensive use is made of a graphics screen presentation to ensure a user-friendly man/machine interface which relates directly to the tests being performed.

The HP RATES system has been designed to be modular at all levels, providing solutions for the large and small telephone companies. The modularity allows expansion throughout: additional circuits, extra test features and more test personnel are all easily accommodated.

LOGIC ANALYZERS

State, Timing, Analog, And System Performance Analysis
Model 1631A/D, 1630A/D/G

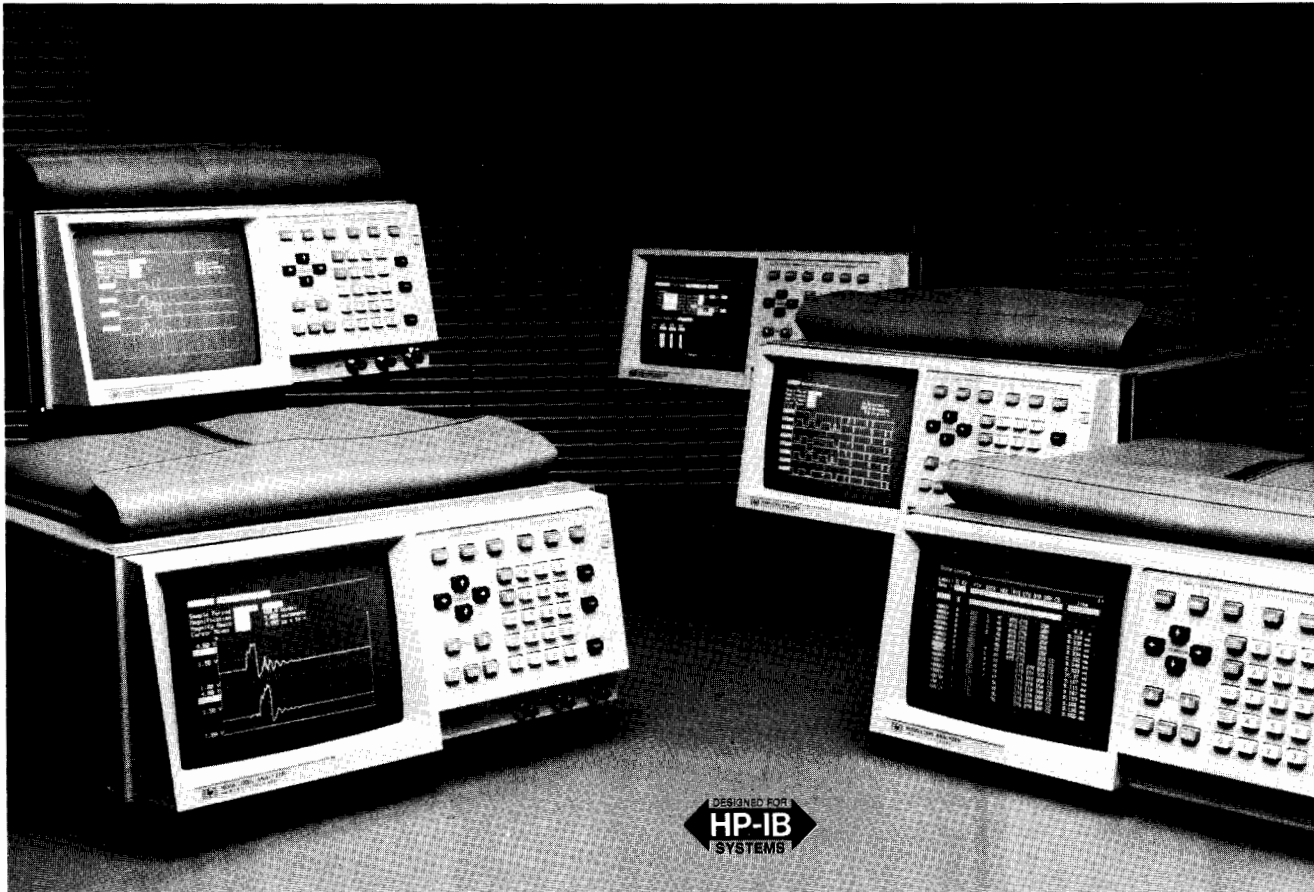

Hewlett-Packard provides a complete line of high-performance logic analyzers to help you design and troubleshoot today's systems.

Indispensable Tools For Digital Design And Test

Powerful

- Timing, state, analog (HP 1631A/D), and software performance analysis all in one low-cost instrument.
- Trigger measurements on combinations of glitches, edges, voltage levels (HP 1631A/D) and patterns so you can quickly track down hard-to-find problems.

Versatile

- Each instrument within the family can be upgraded, providing a range of price/performance solutions.
- Preprocessors and disassemblers tailor the HP 1630 and HP 1631 for a variety of microprocessors and communication buses.
- Built-in HP-IB and HP-IL interfaces allow for automatic testing applications and for sending data to an external printer or disc drive.

Easy to Use

- A menu architecture guides you through each step in the measurement process. All choices are clearly shown, and prompt and error messages help eliminate setup guesswork.
- Data can be displayed in eight different formats, including microprocessor mnemonics, relocatable addresses, and user-defined labels.

Multi-function Tool

Combining up to five logic analysis functions in one benchtop instrument, the HP 1630/1631 may be your single most important tool for digital-product design, development, and testing.

- Timing analysis at 100 MHz to check hardware and status signals.
- State analysis at 25 MHz to trace program and software flow.
- Analog analysis at 200 megasamples/second to verify data voltage and time parameters.
- Performance analysis to optimize code.
- Interactive state/timing/analog (HP 1631A/D) analysis to integrate systems, circuits and code.

Flexibility, high performance, and reliability make the HP 1630 and 1631 logic analyzers excellent values.

Preprocessor/Interface Modules

Because digital design and test involves more than just a logic analyzer, Hewlett-Packard provides a complete line of preprocessor and interface modules for HP 1630 and HP 1631 logic analyzers that simplify data interpretation and interconnections.

- Microprocessor preprocessors - direct connection to eight and 16-bit microprocessor systems. Please see page 403.
- Bus preprocessors - non-intrusive monitoring plus inverse assembly for easy interpretation of RS-232C/V.24, RS-449, and HP-IB data buses. Please see page 403.
- Minicomputer interfaces - eliminate loading, clocking, and demultiplexing problems. Please see page 403.

HP 1630A		HP 1630D		HP 1630G		HP 1631A			HP 1631D		
State	Timing	State	Timing	State	Timing	State	Timing	Analog	State	Timing	Analog
35	—	43	—	65	—	35	—	2	43	—	2
—	8	—	16	—	8	—	8	2	—	16	2
27	8	35	8	57	8	27	8	2	35	8	2
—	—	27	16	—	—	—	—	2	27	16	2



LOGIC ANALYZERS

Logic Analyzer With Scope

Models HP 1631A, and 1631D

- Built-in two-channel digitizing oscilloscope—50 MHz bandwidth and 200 M sample/second rate
- Up to 43 state channels and 16 timing channels



The HP 1631A/D logic analyzer has a built-in digitizing oscilloscope, enabling digital hardware designers to make the cross-domain measurements needed to troubleshoot and characterize systems.

Three Instruments in One Box: HP 1631D

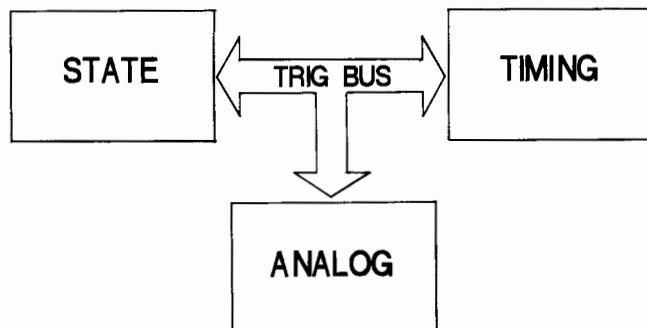

The HP 1631A/D provides three instruments in one, linked by an internal trigger bus. Interactive measurements allow you to trigger on the symptom with one instrument, and analyze the cause with another.

HP 1631A/D Logic Analyzer . . .

The HP 1631A/D provides a digitizing oscilloscope and a logic analyzer in one low-cost instrument. Its analog, timing, state, and system performance analysis capabilities function separately or interactively to serve the needs of digital design and test engineers.

The A and D models differ only in state/timing channel width. The HP 1631A provides up to 35 state channels, eight timing channels, and two analog channels. The HP 1631D provides up to 43 state channels, 16 timing channels, and two analog channels.

The One Tool For Every Phase Of Digital Design And Test

A 50 MHz digitizing oscilloscope

- 200 megasample/second digitizing rate for capturing single-shot waveforms
- Two simultaneous channels
- Single-shot time intervals to ± 1.5 ns

A complete logic analyzer

- 100 MHz timing analyzer
- Time-interval accuracy to ± 1.5 ns
- 25 MHz state analyzer

- Interactive measurements
- Automatic time-interval measurements

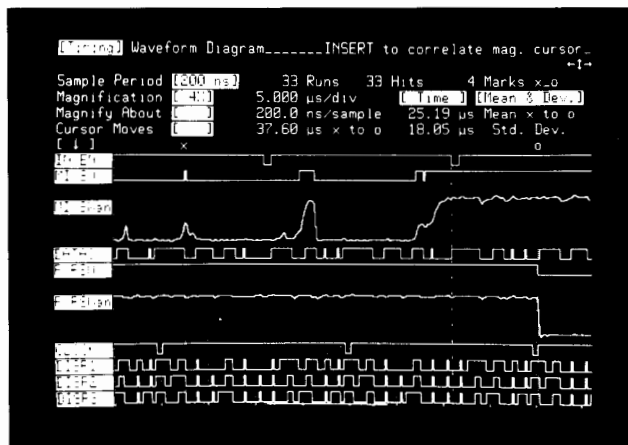

Interactive measurements allow you to use the timing analyzer to locate and trigger on a glitch, and then use the analog analyzer (with higher vertical resolution) to analyze the cause.

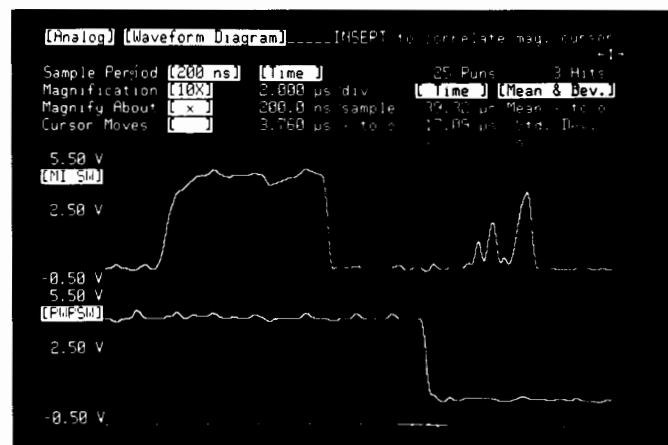

With a built-in oscilloscope, the HP 1631A/D provides two channels of analog analysis plus automatic time-interval measurements and statistics.

Interactive Analysis

You can use one of the HP 1631A/D's analyzers to capture the symptom and then use one of the other analyzers to analyze the cause. Depending on your measurement needs, you can select state, timing, or analog as master. The other two then become slave. When the master's trigger specification is met, it simultaneously triggers the slave—while maintaining time correlation between the analyzers.

Analog Waveform Analysis

Analog waveform analysis provides simultaneous display of up to two channels. User-definable labels, wide magnification range, and direct readout of time and voltage between cursors are available.

State Analysis

State listings and waveforms provide displays and windowing of address, data, status, and control line activity. Selectable display modes include binary, octal, decimal, hexadecimal, ASCII, relocation, user-defined mnemonics, and microprocessor-specific mnemonics. You can assign labels, and display and/or trigger on code in terms of relocatable or absolute addresses, or user-defined mnemonics.

Timing Analysis

Timing waveform diagrams provide simultaneous display of up to 16 channels, with user-definable labels. Wide magnification range, glitch display, and direct readout of time between cursors are available.

Three Analyzers In One

Analog Analysis

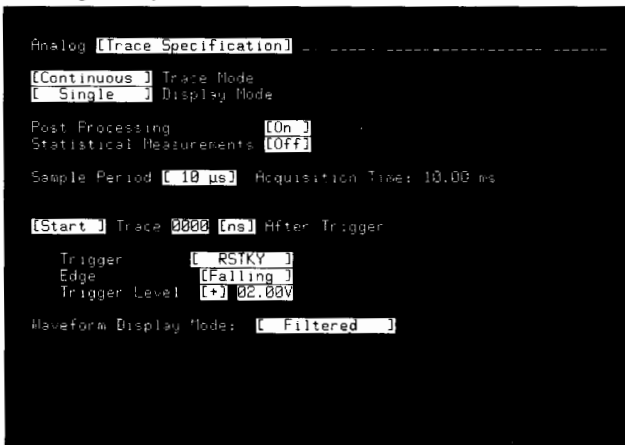

The analog analyzer triggers at +2.00 V on the falling edge of channel RSTKY.

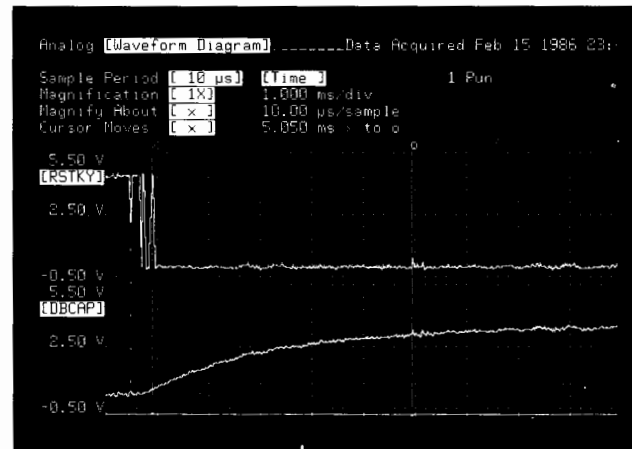

The X cursor shows that the analyzer triggered at +2.00 V on the falling edge of channel RSTKY.

Timing Analysis

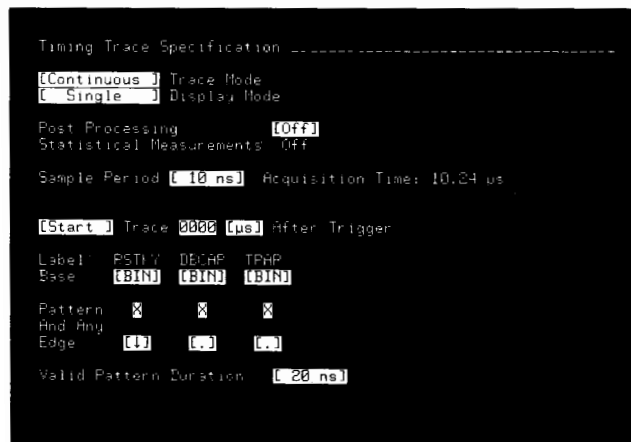

The timing analyzer triggers on a falling edge of RSTKY.

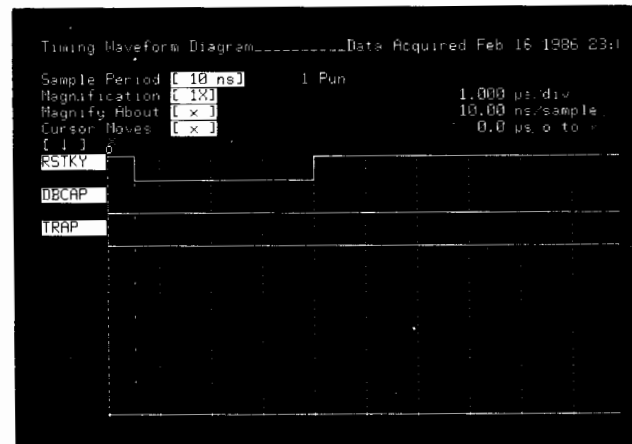

The dashed line on the left shows that the analyzer triggered on the falling edge of RSTDY.

State Analysis



The state analyzer triggers on the first occurrence of HEX address 24, and captures the next 1000 states.

Label	Base	8085 Mnemonic	STAT
[Mark]	XXXX	[Instructions]	[XXXXXX]
-0007+	0436	DCR D	opfch
-0006+	0437	JIS 0436	opfch
-0005+	0438	36 memory read	memrd
-0004+	0439	04 memory read	memrd
-0003+	0436	DCR D	opfch
-0002+	0B86	04 memory write	memwr
-0001+	0B85	37 memory write	memwr
+0000+	0024	JMP 0008	opfch
+0001+	0025	08 memory read	memrd
+0002+	0026	08 memory read	memrd
+0003+	0008	SHLD 0B03	opfch
+0004+	0009	D3 memory read	memrd
+0005+	000A	08 memory read	memrd
+0006+	0B03	FD memory write	memwr
+0007+	0B04	08 memory write	memwr
+0008+	000B	OUT 10	opfch

The highlighted area shows that the analyzer triggered at HEX address 24 and captured the subsequent states.

Trigger on the Error

Through post-processing, you can set the analyzer to trigger on an error condition. In the example below, the instrument triggers when either the analog analyzer detects a time interval less than 1 μ s or the timing analyzer detects a time interval greater than 43 μ s.

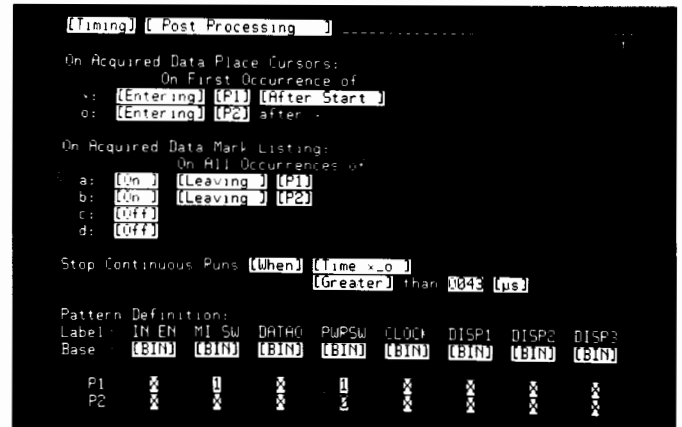

Automatic Time-interval Measurements with Statistics

Automatic time-interval measurements can be made by placing cursors. The measurements are updated and displayed on the CRT along with mean, standard deviation, and minimum and maximum values. With its analog capability, the HP 1631A/D also provides statistics on voltage values.

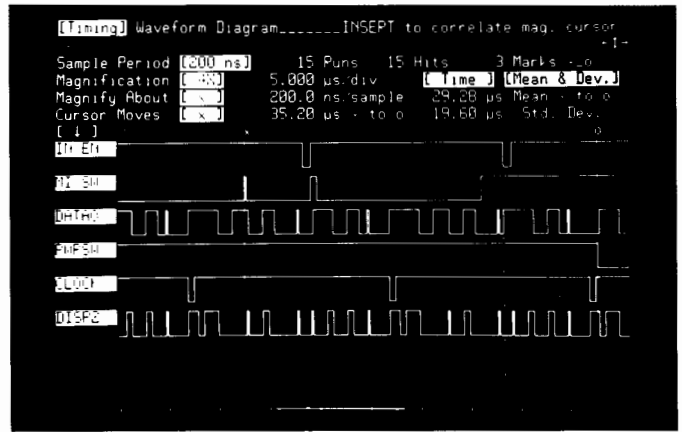
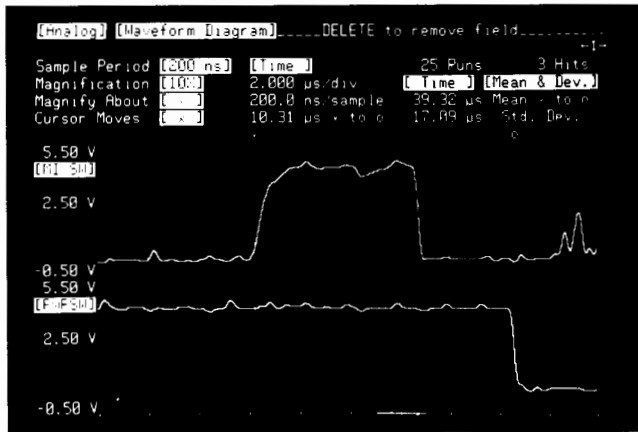

Inverse Assembly

Displaying program activity in inverse assembly can save many hours in test and debug. No more time-consuming or error-prone conversions from hex because measurement listings appear just as you wrote them, making them easy to compare to source-code listings.

Preprocessor/Interface Modules

HP provides a complete line of microprocessor preprocessors that tailor the HP 1631A/D to specific microprocessors. Preprocessor interface modules contain circuitry that properly formats data, and they provide connection via a microprocessor socket. Software supplied with preprocessors performs inverse assembly for state displays in the selected microprocessor's mnemonics.

A bus preprocessor available for analyzing RS-232C/V.24, RS-449, and HP-IB data bus, and minicomputer interface modules are also available for use with HP logic analyzers.

For more details on these preprocessor/interface modules, please refer to page 403.

LOGIC ANALYZERS

General-purpose Family

Models HP 1630A, 1630D, and 1630G

401



- Provides state, timing, and system performance analysis in one instrument
- Timing post-processing
- Interactive measurements
- Full compare mode (HP 1630G)

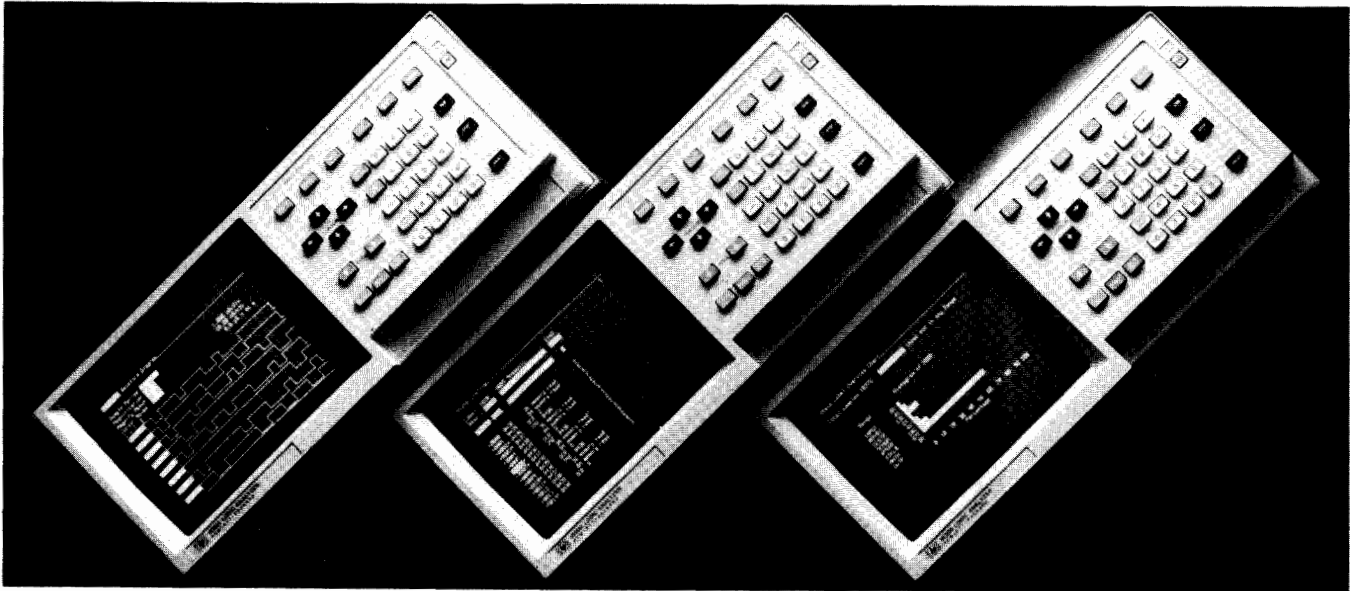

General-purpose Tool For The Modern Designer

The HP 1630 family of logic analyzers consists of three models designed to meet the needs of digital design and test engineers.

The A and D models differ only in channel width—the HP 1630A has 35 channels, and the HP 1630D has 43 channels. The HP 1630G has 65 channels, and additional system performance features for time tagging, time-positional charting, and module linkage histograms.

State Analysis

State listings and waveforms provide displays and windowing of address, data, status, and control line activity. Selectable display modes include binary, octal, decimal, hexadecimal, ASCII, relocation, user-defined mnemonics, and microprocessor-specific mnemonics. You can assign labels, and display and/or trigger on code in terms of relocatable or absolute addresses, or user-defined mnemonics.

- 25 MHz speed
- Up to 65 channels (HP 1630G)
- 1k memory
- Three clocks
- Demultiplexing
- Full compare mode (HP 1630G)

Timing Analysis

Timing waveform diagrams provide simultaneous display of up to 16 channels, with user-definable labels that speed and simplify data evaluation. Wide magnification range, unique glitch display, and direct readout of time between cursors let you quickly adjust parameters to match the application.

- Speeds to 100 MHz
- Up to 16 channels (HP 1630D)
- 1k memory
- Glitch triggering

Timing Post-processing

Automatic time-interval measurements are provided with X and O cursors, with statistical calculations to enhance accuracy. A search-and-then-stop mode, which is called post-processing, stops timing data acquisition if your system violates a timing or sequence condition.

System Performance Analysis

Meeting system throughput requirements often requires a global look at overall system activity. Time interval, event, and module linkage histograms let you view system hardware and software activity or specific modules of code for performance evaluation (HP 1630G only).

Out-of-spec conditions or bottlenecks stand out. The display shows measurement data, including the minimum, maximum, average, and total measurement time.

- Time-interval histogram - eight ranges, 1 μ s resolution
- State label histogram - eight labels, maximum count $2^{63}-1$
- Time-positional histogram - 1023 time buckets, 1.023 μ s to 205 μ s duration
- Module linkage histogram - eight definable events, eight links

Interactive Measurements

The HP 1630A/D/G's interactive measurement capability allows you to determine whether your system problems are software errors or hardware malfunctions.

- Trigger on state and view timing data
- Trigger on timing and view state data
- Time tags for real-time measurements between states (HP 1630G)

Preprocessors

A wide selection of preprocessors tailors the HP 1630 logic analyzers to specific microprocessors. Preprocessor interface modules contain circuitry that properly formats data, and they provide connection via a microprocessor socket. Software supplied with preprocessors performs inverse assembly for state displays in the selected microprocessor's mnemonics. For more details on HP's preprocessors and interface modules, please refer to page 403.

Inverse Assembly

Program activity displayed in inverse assembly can save many hours in test and debug. No more time-consuming or error-prone conversions from hex because now your measurement listings appear just as you wrote them, making them easy to compare to source-code listings.

Fast, Reliable Storage of Setups And Data

HP-IB and HP-IL are standard on the HP 1630A/D/G. These interfaces allow the logic analyzer to communicate with a variety of computers, test equipment, and peripherals. A small investment in an HP disc drive allows you to store setups and data. The HP 1630A/D/G can use the HP 9122S/D disc drive as the mass storage device.

Hardcopy Output Simplifies Documentation

With the HP 2225A ThinkJet printer, you can quickly obtain a copy of any HP 1630A/D/G display. Instead of time-consuming hand documentation or inconvenient photography, simply push the PRINT button. In seconds, you have a complete record for your lab notebook.



HP 1630A: For Eight-bit Analysis

With its 35 channels, the HP 1630A is an economical solution for designs involving eight-bit microprocessors, most of which require 24 channels for address and data.

The HP 1630A provides a cost-effective solution and uncompromised measurement performance. In addition to state and timing analysis, the HP 1630A also offers system performance analysis with complete time-interval histogramming, glitch triggering and capture, and post-processing.

Most state analyzers offer many levels of triggering, and require you to string the levels together to trigger on the precise term of interest. The HP 1630A provides four powerful resource terms (a, b, c, d) plus the \neq of each term, and NO STATE and ALL STATES triggering. You may assign an address, data, or status value to any combination of resource terms. Each time the HP 1630A captures a bus transaction, it automatically tests to see whether that term is to be stored, and whether it is a trigger point or a restart term. Therefore, the HP 1630A accomplishes in one level what most other analyzers require three or more levels to accomplish.

For designs requiring 16-bit microprocessors, you can easily upgrade your HP 1630A to either an HP 1630D or HP 1630G.

HP 1630D: 16-bit hardware analysis

The HP 1630D facilitates hardware analysis and debug of 16-bit microprocessors. The HP 1630A's measurement capability is also available in the HP 1630D, but with additional state and timing channels to meet the needs of 16-bit microprocessors. Total channel count is increased to 43, where eight or 16 of the channels can be used for high-speed timing analysis. Glitch triggering and capture are also increased to eight channels.

Finding hardware problems in complex digital systems requires a logic analyzer that has flexible triggering. The ability to trigger the timing analyzer from the state analyzer, or vice versa, is critical.

In addition to triggering on patterns from one to 16 channels wide, you can define a simultaneous occurrence of a pattern and a positive or negative edge to assure data registration precisely on entering or exiting the specified pattern. You can also specify a pattern and a glitch on one or more channels. You can trigger on just edges or glitches, and you can define the valid pattern duration.

X and O cursors can be moved anywhere on or off screen. You can magnify the trace around either cursor for greater visual resolution. Time intervals are displayed on-screen, independent of magnification and sample period.

HP 1630G: 16-bit software analysis

With up to 65 channels of state analysis, eight of which can be used for high-speed timing analysis, the HP 1630G is essential for engineers developing 16-bit microprocessor-based products. To verify state execution time, a real-time clock measures the actual time between states, the total time, or the number of unstored states between states in the state listing.

After the functional design is complete, the overall performance of the system must be evaluated to ensure that the system is operating efficiently. The HP 1630G's extensive system performance analysis provides qualified histogramming that shows all acquired states of just-executed instructions; module histograms that show the execution time of a subroutine or module; intermodule linkage histograms that show software traffic patterns to determine which module or subroutine is calling another; and time-positional measurements that produce a time-varying profile of system activity where the x-axis is time and the y-axis is the number of calls to a given routine.

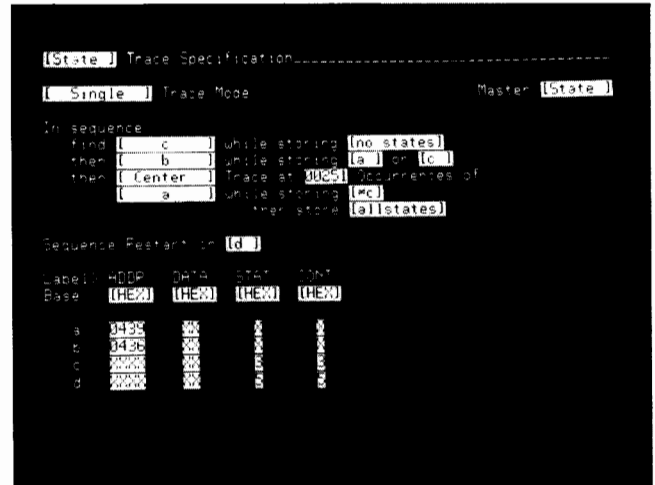

State trace specifications can be easily set up with the HP 1630A/D/G's flexible resource terms.

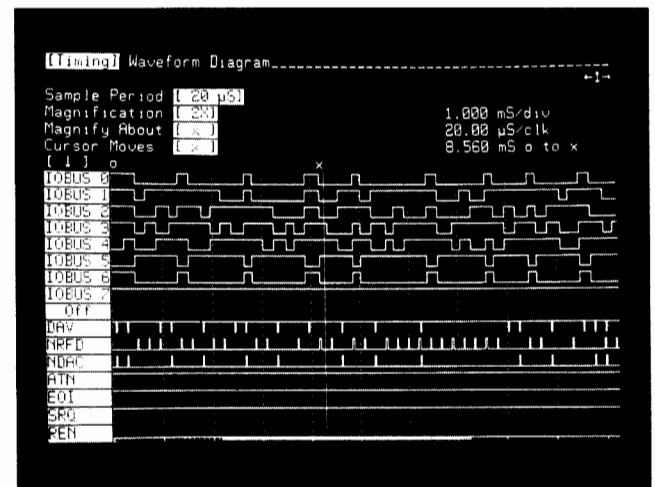

The HP 1630D captures and displays up to 16 channels of timing data with each having unique labels.

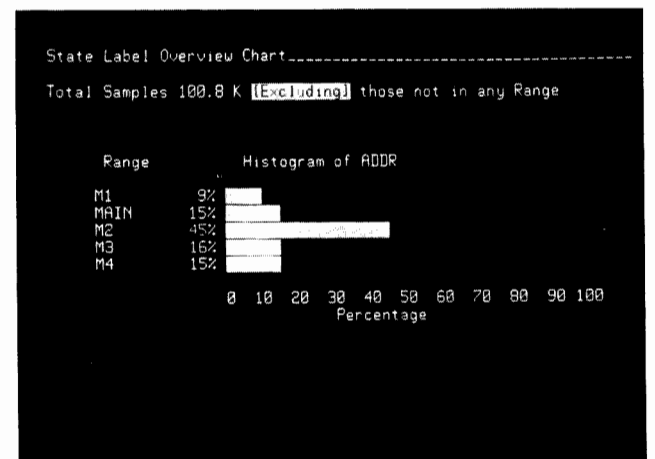

A variety of system analysis measurements assist in optimizing the performance of a microprocessor-based system.

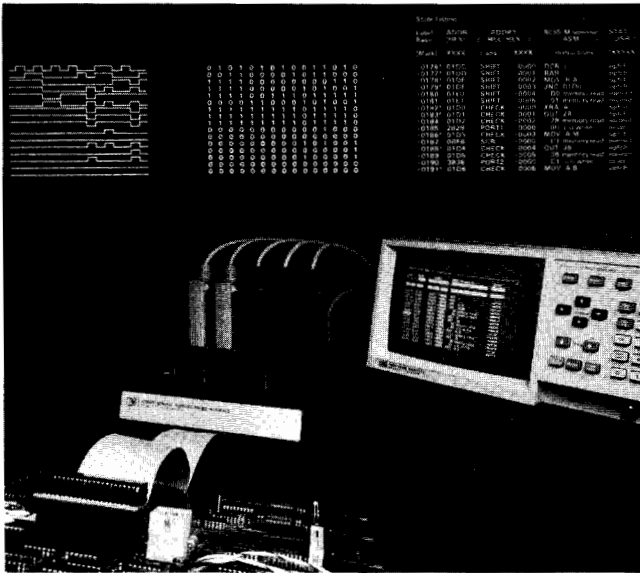

Because digital design and test involves more than just a logic analyzer, HP offers a wide selection of preprocessors and interface modules that simplify data interpretations and interconnections.

Preprocessors And Interfaces

Preprocessors and interface modules tailor the HP 1631A/D and HP 1630A/D/G logic analyzers for use with specific microprocessor systems. Preprocessors provide quick, convenient connections between target microprocessor systems and logic analyzers.

Inverse assemblers translate collected state events into the microprocessor mnemonic for easy reading and analysis. The interface software automatically sets formats for the logic analyzer to match inputs from the microprocessor under test.

General-purpose Interface Module

The HP 10269B general-purpose interface module provides the mechanical and electrical interface between HP logic analyzers and a microprocessor or bus preprocessor. Control software and inverse assemblers are provided on a 3 1/2-inch disc that is supplied with each preprocessor. This disc is compatible with the HP 9122S/D disc drive.

Microprocessor Preprocessors

Microprocessor	HP Preprocessor Model No.
8086/8088	10305B
8085	10304B
80286	10312B
80186/80188	10306B
6809/6809E	10308B
6800/6802	10307B
68008	10310B
68000/68010	10311B
Z8001	10301B
Z8002	10302B
Z80	10300B
NSC800	10303B
General purpose	10320A

User-definable Interfaces

For custom interfaces where no active components are required, the HP 10320A user-definable interface module provides a wire-wrapped printed-circuit board, wire-wrap pins, cable connectors, and a design manual.

For interfaces requiring active components, order both the HP 10320A and HP 10321A. The HP 10321A includes additional chip sockets, wire-wrapping pins, and an assortment of passive and active components for buffering and demultiplexing.

Connection between the HP 10320A or HP 10321A and the target system is accomplished by selecting one of the three dual in-line connectors shown below.

Dual In-line Connector	HP Model Number
40-pin	10322A
48-pin	10323A
64-pin	10324A

User convenience is enhanced by demultiplexing address and data signals on the interface board and with user labels in the logic analyzer. State, timing, and analog (HP 1631A/D) labels and symbols can be loaded into the logic analyzer to simplify data interpretation and reduce measurement errors.

Minicomputer Interfaces

Connecting HP logic analyzers to minicomputers is facilitated through minicomputer interfaces for three of the more popular minicomputer buses:

- HP 10275A PDP-11 UNIBUS Interface
- HP 10276A LSI Q-BUS Interface
- HP 52126A MULTIBUS Interface

The interface boards plug into the respective buses. A ribbon cable extending from the board must either be connected to the logic analyzer through the HP 10320A with an HP 10269B user-definable interface.

Switches on each interface board qualify information routed to the logic analyzer or preprocessor by the selected activity type. Any combination of monitored activities may be selected for a logic analysis measurement.

Computer Activity	HP 10275A	HP 10276A	HP 52126A
Reads	X	X	X
Writes	X	X	X
Interrupt vectors	X	X	
DMA transfers	X	X	
Refresh activity		X	
I/O transfers			X

Bus Preprocessors ... Non-intrusive Monitoring Plus Inverse Assembly

The HP 10342B bus preprocessor captures bus activity and provides inverse assembly for RS-232C/V.24, RS-449, and HP-IB buses. This bus analysis tool combines the power of a logic analyzer with the convenience of a preprocessor, yielding a truly easy-to-use instrument.

Simply select the appropriate operating modes from the front of the HP 10342B, press run on your logic analyzer, and you will obtain a listing of your bus activity. The inverse assembler configures and assigns labels to the lines used in the logic analyzer.

The HP 10342B, which is compatible with all HP logic analyzers, uses the timing analyzer to display the condition of the handshake lines when a character is received. Easy access to an oscilloscope for high-resolution timing measurements can be made by connecting any of the input signal lines to one of the three probe sockets located on the front panel of the HP 10342B.

Inverse Assembly

The HP 10342B is supplied with a 3 1/2-inch disc inverse assembler that converts data and status into standard text for easy interpretation.

In the HP-IB mode, all data, handshake, and status lines are monitored and states displayed. For RS-232C/V.24 and RS-449, data and five handshake lines are monitored and displayed. Four of the handshake lines are synchronous with the serial controller. The fifth is asynchronous with the carrier detect, but is sampled each time a character is sent to the analyzer.

Ordering Information

Please refer to page 406 for details.



LOGIC ANALYZERS

Specifications And Characteristics

Models 1631A/D, 1630A/D/G, 10342B

HP 1630A/D/G, 1631A/D Specifications

Memory

Data acquisition: 1024 words.

Compare: 16 words, HP 1630A/D, 1631A/D; 16 or 1024 words, HP 1630G.

Memory search: all patterns within a label set may be marked or separately displayed.

State Analysis Mode

Clocks

Clock edges: for each of three ORed clocks, select either or both edges; separate edges of one clock may be selected for multiplexed modes.

Repetition rate, single phase: 25 MHz for single edge of single clock; 20 MHz for any combinations of ORed clocks and edges.

Repetition rate, multiplexed: master clock must follow slave clock by at least 10 ns and precede next slave clock by at least 50 ns.

Pulse width: ≥ 10 ns at threshold.

Setup time: ≥ 20 ns.

Hold time: zero.

Data Indexing

Resources: four terms, including the Boolean NOT of each term, ALL patterns or NO pattern; terms may be used as often as needed.

Trigger: up to four resource terms in sequence; final sequence term may use up to four ORed resource terms.

Restart: up to four ORed terms to reinitiate sequence search.

Store qualifiers: up to four ORed resource terms; may be separately defined for each term in the trigger sequence.

Occurrence: to 59 999; applies to final sequence term only.

Compare: width of analyzer by 16 words; trace until "equal to" or "not equal to" with each compare word matched to all 1024 words in memory; compare words may contain "don't care" terms.

Full compare (HP 1630G only): the compare file is the full 1024 states of memory.

Timing Analysis Mode

Clock

Range: 10 ns to 500 ms in 1, 2, 5 sequence.

Accuracy: $\pm 0.01\%$.

Glitch: min detectable glitch, 5 ns width at threshold; with glitch detection on, number of timing channels is halved.

Data Indexing

Asynchronous pattern: 20 ns to 1 ms in 1, 2, 5 sequence with accuracy $\pm 20\%$ or 15 ns, whichever is greater; glitch or edge ANDed with asynchronous pattern.

Maximum time delay: approx 2^{18} times the sample period, to 9999 s max.

Cursors: time between dual cursors (x and o) displayed to accuracy of one sample period.

Expansion: X1 to X40 in 1, 2, 4 sequence; standard display shows entire 1k memory at X1.

Analog Analysis Mode (HP 1631A/D)

Channel 1 And 2 (Vertical)

Probe factors: 1:1, 10:1, or 50:1 probe attenuation factors may be entered to scale the HP 1631A/D to input voltages at the probe tip

Range: 40 mV to 2.5 V full-scale

Bandwidth (-3 dB) dc-coupled: dc to 50 MHz

Dc gain accuracy: $\pm 2.5\%$ of full-scale

Analog-to-digital conversion (ADC) resolution: ± 1 LSB, which is $\pm 1.6\%$ of full-scale

Transition time: ≤ 5.25 ns, 20% to 80% of full-scale

Trigger

Sources: channel 1, channel 2, or external trigger input

Edge: rising or falling edge may be selected for any source

Time Base (Horizontal)

Sample period: 5 ns to 500 ms in a 1-2-5 sequence

Range: 500 μ s to 500 s full-scale (10 divisions)

Time base accuracy

Sample period: $\pm 0.1\%$

Time-interval measurement accuracy (equal rise and fall times): single-shot, ± 1.5 ns for 5 ns sample period, ± 1 sample period for sample periods of 10 ns or greater; continuous, ± 1.5 times sample period, based on 100 averages

Delay tracepoint: equals trigger plus delay; tracepoint can be delayed from 0 to about 260k sample periods after the trigger

Analog Operating Conditions (HP 1631A/D)

Digitizer: two channels are digitized simultaneously

Digitizing technique (real-time digitizing): all data points are digitized at equal selectable increments in time on each acquisition

Digitizing rate: selectable, 2 samples/second to 200 megasamples/second

Voltage resolution: 6 bits, 1 part in 64

Acquisition memory: 1024 samples, 6 bits/channel, 2 channels; up to 1000 samples are used for display; magnifier allows full-screen display from 1000 samples to 25 samples; the entire 1024 sample record can be accessed via HP-IB and HP-IL.

Interactive State/Timing/Analog Analysis Mode

Acquisition: analog, timing, and state data acquisition occur simultaneously

Arming: either of the three analyzers can be master while the remaining two are slave

Master state: the waveform analyzer and the timing analyzer can be simultaneously armed by the full data indexing capability of the state analyzer

Master timing: the waveform analyzer and the state analyzer can be simultaneously armed by the full data indexing capability of the timing analyzer

Master analog (HP 1631A/D): the timing analyzer and the state analyzer can be simultaneously armed by the full analog indexing capability of the waveform analyzer.

Tracepoint alignment: analog, timing, and state acquisition data can be correlated in time

Mixed display: timing channels can be displayed on the same screen with analog channels; the tracepoint and time/div are common to timing and analog in this display mode, and set by the timing analyzer

Software Performance Analysis and Overview Modes

XY Chart: all 1024 events/samples for any label group can be displayed as a chart of order of occurrence by magnitude; max and min vertical limits are user-specified.

Time interval histogram: measures time between start and stop events defined for up to eight time ranges.

Time range: min size, 1 μ s.

Display: histogram; min, max, average, and last time reading; total elapsed time; number of samples.

Resolution: for four-bit label group, 250 ns or 0.1% of reading, whichever is greater.

State histogram: sampled occurrence count of events in a label group for up to eight total user-defined ranges or values.

Max count: $2^{63} - 1$.

Resolution: $\pm 0.01\%$.

Time-positional histogram (HP 1630G only): shows the number of occurrences of an event over time. A time unit is defined, and the analyzer counts the occurrences of a specified event in that time unit. The measurement can be repeated for up to 1023 equal-sized time units.

Typical accuracy of first time unit: -250 ns to +500 ns, $\pm 0.01\%$ of specified width.

Typical accuracy of subsequent time units: $\pm 0.01\%$ of specified width.

Linkage histogram (HP 1630G only): shows up to eight module links. A link is defined as a specific state followed immediately by another specific state with no intervening states. Store qualification can be used to acquire states selectively. The measurement can be started on completion of a sequence of up to three resource terms, with restart and occurrence capabilities such as state data indexing.

Max number of definable events: 8.

Max number of definable links: 8.

Max count: $2^{63} - 1$.



Measurement Aids

Cursors: two cursors (X and O) are provided for making voltage and time measurements on displayed waveforms. Both absolute and differential values are provided for voltage measurements. Dual cursor time measurements can be made between two points on the same waveform or between two points on different waveforms.

Cursor statistics: X to O cursor statistics are provided for continuous voltage and time measurements: max, min, mean and standard deviation. Single cursor voltage statistics can be obtained between two points on the same waveform or between two points on different waveforms (time only).

Cursor placement: both X and O cursors can be uniquely specified with respect to the tracepoint or acquisition start, by selection of channel 1 or 2, rising or falling edge, voltage level, hold or delay time.

State/Timing/Analog Inputs

State/Timing Probe Inputs

RC: 100k ohm, $\pm 2\%$ shunted by approximately 5 pF at probe body

Minimum swing: 600 mV p-p

Minimum input overdrive (above pod threshold): 250 mV or 30% of input amplitude, whichever is greater

Maximum voltage: ± 40 V, peak

Threshold voltage: -9.9 V to $+9.9$ V in 0.1 V increments

Accuracy: 2.5%, ± 120 mV

Dynamic range: ± 10 V about threshold

Analog Inputs (HP 1631A/D): channel 1, channel 2, external trigger

Input coupling: dc

Input RC: 1 megohm $\pm 2\%$, shunted by approximately 14 pF

Maximum safe input voltage: ± 40 V (dc + peak ac)

General Characteristics

Labels

Input channel labels: up to eight state, up to 16 timing, user-defined, five-character labels may be assigned bit patterns in any configuration up to 65 (HP 1630G) bits/label. Bits may be used in more than one label and need not be contiguous.

User field: all labels with four bits or less allow mnemonics to be assigned to specific patterns. Primary use is to identify such functions as read, write, opcode, etc.

Relocatable field: up to sixteen module starting locations may be specified, allowing trigger parameters to be based on module names, plus an offset value.

Time-of-day clock: a 24-hour clock prints out the time of data collection on all stored records.

Activity markers: provided in the format display for identifying active inputs.

Non-volatile memory (HP 1630G): the HP 1630G has 8k of EEPROM for internally storing a disassembler. One setup configuration of the instrument can also be stored.

HP-IB Outputs

An HP-IB connector, along with an eight-position switch, is located on the rear panel. Five positions on the switch are used to determine the address, two positions are used to determine "talk-only" for hardcopy and system controller modes.

HP-IL Outputs

An HP-IL connector is located on the rear panel for interfacing.

Programmability

All instrument configurations and acquisition data may be remotely programmed via the HP-IB (IEEE-488) or HP-IL.

Rear-panel BNC Outputs

One BNC output is located on the rear panel with a TTL output. High is ≥ 2 V into 50 ohms; low is 0.4 V into 50 ohms. The BNC can be programmed from the keyboard to provide the following signals: pulse on state tracepoint, high until state tracepoint, low until state tracepoint, high on last sequence, constant high, constant low, high on timing pattern, probe compensation (HP 1631A/D), and positive edge on analog trigger (HP 1631A/D). A second BNC is located on the rear panel to provide +5 V for the HP 10269B general-purpose probe interface.

Operating Environment

Temperature: 0° to 55° C ($+32^\circ$ to 131° F)

Humidity: up to 95% relative humidity at $+40^\circ$ C

Altitude: to 4600 m (15 000 ft)

Vibration: vibrated in three planes for 15 minutes each with 0.3 mm excursions, 5 to 55 Hz.

Weight: all models ~ 30 lbs (13.6 kg) net; all models ~ 40 lbs (18.1 kg) shipping

Power: 115/230 Vac, -22% to $+10\%$; 300 W max; 48–66 Hz

Size: 190 x 426 x 447 mm (7.5 x 16.8 x 17.6 in)

Product Support Package

HP 1630-68705: HP logic analyzer support package

HP 5957-7306: HP logic analyzer service training

Accessories Supplied

One operating manual, one 2.3 m (7.5 ft) power cord, plus the following probes:

HP Model #	10271A	10272A	10273A	10017A
1630A	3	1	—	—
1630D	3	2	—	—
1630G	3	1	3	—
1631A	3	1	—	2
1631D	3	2	—	2

HP 10342B Operating Characteristics

RS-232C (V.24)/449

Asynchronous

Data transfer rates (bits/second): 50, 75, 110, 134.5, 150, 300, 600, 1200, 1800, 2000, 2400, 3600, 4800, 7200, 9600 or 19 200

Parity: Odd, even, or none

Bits per character: 6-bit transcode
7-bit ASCII
8-bit ASCII
8-bit EBCDIC

Stop bits per character: 1, 1.5, 2

Synchronous

Data transfer rate: to 72k bits/second

Format: Bit-oriented protocols (BOP)

Synchronous data link control (SDLC)

High-level data link control (HDLC)

X.25 packet mode

Standard network access protocol (SNAP)

Hewlett-Packard data link control (HPDLC)

Burroughs data link control (BDLC)



LOGIC ANALYZERS

Specifications And Characteristics

Models 1631A/D, 1630A/D/G, 10342B (Cont.)

Advanced data communication control procedure (ADCCP)
 Character-oriented protocols (COP)
 Binary synchronous communication (BSC)
 Digital data communications message protocol (DDCMP)

Selectable: 6, 7, or 8 bits per character
 Transmit clock source: data terminal equipment (DTE) or data communications equipment (DCE). Internally selectable on pc-board.

General

Inputs: Three provided: RS-232C (V.24), RS-449, and HP-IB
Outputs: Three mini-probe sockets can be connected to any of the input lines via jumper wires
Signal line loading: RS-232C/449, 1 standard load; HP-IB, 1 LS load (loading at the end of the supplied ribbon cables)
Power requirement: +5 V at 0.65 A

HP 10269B Specifications

Channel width: HP 10269B, 9 probe sockets, 65 data channels, and 3 clock channels.

Qualified clock rate: 25 MHz max.

Input

Impedance: 100 k Ω < 20 pF at interface module connector.

Maximum: \pm 40 Vdc.

Dynamic range: threshold \pm 10 V in 0.1 V increments.

Minimum clock pulse width: 10 ns.

Setup and Hold Times

Setup time: 20 ns min.

Hold time: zero.

Power

Power available for interface module: 1.0 A max at +5 Vdc, supplied by HP 1630 Logic Analyzer.

Environmental

Temperature: operating, 0° to +55° C (+32° to +131° F); non-operating, -40° to +75° C (-40° to +167° F).

Humidity: to 90% at +40° C, noncondensing.

Altitude: operating, 4600 m (15 000 ft); nonoperating, 15 300 m (50 000 ft).

Ordering Information

Logic Analyzers

HP 1630A (35 channels)

Price

\$8600

HP 1630D (43 channels) \$10,630
HP 1630G (65 channels) \$12,100
HP 1631A (35 channels, plus two analog) \$11,000
HP 1631D (43 channels, plus two analog) \$13,000

Support Products

HP 10269B general-purpose probe interface \$460
HP 10331A HP 1630A/D to HP 1631A/D upgrade kit. \$3500
HP 10340A HP 1630A/D to HP 1630G upgrade kit \$3450

Preprocessors/Interfaces

Microprocessor Preprocessors - note, inverse assembly is provided on 3 1/2-inch disc

HP 10300B Z80 interface \$860
HP 10301B Z8001 interface \$960
HP 10302B Z8002 interface \$960
HP 10303B NSC800 interface \$1000
HP 10304B 8085 interface \$860
HP 10305B 8086/8088 interface \$1210
HP 10306B 80186/80188 interface \$2000
HP 10307B 6800/6802 interface \$1100
HP 10308B 6809/6809E interface \$1100
HP 10310B 68005 interface \$1100
HP 10311B 68000/68010 interface \$1300
HP 10312B 80286 interface \$2000

Bus Preprocessors

HP 10342B bus preprocessor (RS-232C/V.24, RS-449, HP-IB) including inverse assembly \$1200

Minicomputer Interfaces

HP 10275A PDP-11 UNIBUS interface board \$460
HP 10276A LSI-11 Q-BUS interface board \$510
HP 52126A MULTIBUS interface board \$350

User-definable Interfaces

HP 10320A user-definable interface module \$250
HP 10321A microprocessor interface kit for the HP 10320A \$225

Connectors

HP 10322A 40-pin dual in-line package connector and cable for the HP 10320A \$400
HP 10323A 48-pin dual in-line package connector and cable for the HP 10320A \$460
HP 10324A 64-pin dual in-line package connector and cable for the HP 10320A \$560

FREQUENCY, FUNCTION & WAVEFORM SYNTHESIZERS

General Information

407



Signal sources are described by various names: oscillators, audio signal generators, synthesizers, function generators, etc. The names are typically associated with the application area. A signal generator is an oscillator that has modulation capability. Synthesizers are sine-wave sources generated digitally, using a process known as "fractional N", which gives them excellent frequency stability. The term oscillator refers exclusively to a sinusoidal source while a function generator always provides additional wave shapes, most often square waves, triangle waves and, increasingly, arbitrary waveforms.

Technological progress has lowered the cost of digitally derived sources. Hence, synthesizers are increasingly being used in place of oscillators. Synthesizers offer the user two important benefits, the ability to digitally enter frequency very precisely and extremely stable frequency output. In addition, function generators and arbitrary waveform generators are becoming digitally derived, which has tended to blur the traditional definitions of these products.

Source Summary

Type	HP Model	Frequency Range	Page
Function Generator	3312A	100 Hz to 100 MHz	422
Function Generator	3314A	100 Hz to 100 MHz	423
Pulse/Function Generator	8111A	100 Hz to 100 MHz	473
Function Generator	8116A	100 Hz to 100 MHz	419
Arbitrary Waveform Generator	8770A (DC)	100 Hz to 100 MHz	410
Generator Opt. 002	8175A (DC)	100 Hz to 100 MHz	481
Synthesizer/Function Generator	3325A	100 Hz to 100 MHz	412
Function Generator	3326A (DC)	100 Hz to 100 MHz	414
Function Generator	8165A	100 Hz to 100 MHz	418
Synthesizer/Level Generator	3335A	100 Hz to 100 MHz	416
Level Generator	3336A/B/C	100 Hz to 100 MHz	417 & 385



FREQUENCY, FUNCTION & WAVEFORM SYNTHESIZERS

General Information (con't)

FUNCTION GENERATOR SUMMARY

	Function Generators	Arbitrary Waveform/Function Generators			Pulse/Function Generators		Synthesizer/Function Generators			
	HP Models	3312A	3314A	8175A	8770A	8111A	8116A	3325A	3326A	8165A
Frequency										
Min	0.1 Hz	1.0 mHz	DC	DC	1.0 Hz	1.0 mHz	1 μHz	DC	1 mHz	
Max	13 MHz	20 MHz	25 MHz	50 MHz	20 MHz	50 MHz	21 MHz-sine 11 MHz-square 11 kHz-triangle	13 MHz	50 MHz	20 MHz-pulse/ramp
Waveforms (symmetry)										
Sine	20-80%	5-95%	Full	Full	10-90%	10-90%	50%	50%	50%	
Square	20-80%	5-95%	Arbitrary	Arbitrary	10-90%	10-90%	50%	1-99%	20, 50, 80%	
Transition time	<20 ns	<9 ns	Waveform	Waveform	<10 ns	<6 ns	<20 ns	<15 ns	<5 ns	
Triangle	20-80%	5-95%			10-90%	10-90%	50% + ramp	—	20, 50, 80%	
Output (into 50 Ohms)										
Amplitude (p-p)	10 V	10 V	16 V	2 V	16 V	16 V	10 V	10 V	20 V	
DC Offset	±5 V	±5 V	±8 V	—	±8 V	±8 V	±5 V	±5 V	±5 V	
Output Impedance-Ω	50	50	50	50	50	50	50	50	50/1000	
Modes										
Counted Burst	—	1 to 1999			1 to 1999	1 to 1999	—	—	1 to 1999	
Gate	int/ext	int/ext	Full	Full	ext	ext	—	—	ext	
Phase Lock	—	±200 deg	Arbitrary	Arbitrary	—	—	—	—	ext	
Trigger	int/ext	int/ext	Waveform	Waveform	ext	int/ext	—	int/ext	ext	
Arbitrary	—	150 vectors			—	—	—	—	—	
Modulation/Sweep										
AM	int/ext	ext			—	ext	ext	int/ext	option	
FM	int/ext	ext	Full	Full	—	ext	PM	int/ext PM	ext	
PWM	—	—	Arbitrary	Arbitrary	—	ext	—	ext	—	
VCO	int/ext	ext	Waveform	Waveform	ext	ext	—	—	ext	
Lin Sweep	int/ext	int		HP 11775A	—	—	int	int	—	
Log Sweep	—	int			—	option	int	discrete	option	
Programmability	—	HP-IB	HP-IB	HP-IB	—	HP-IB	HP-IB	HP-IB	HP-IB	
Catalog page	422	423	480	410	421	419	412	414	418	
Notes	50% above 1 MHz	also 1/2 cycle bursts	2 analog outputs, dig./analog signals simultaneously	Requires HP Series 200 Controller	50% above 1 MHz	20-80% above 1 MHz	40 Vp-p to 1 MHz option	internal output combiner		

Function Generators

The function generator is a versatile, multi-waveform signal source capable of very wide frequency coverage.

The HP 3312A, HP 3314A, HP 3325A and HP 3326A offer a complete set of functions including sine, square, triangle, ramp and even arbitrary waveforms (HP 3314A). For extended pulse capabilities, the HP 8111A and HP 8116A Pulse/Function Generators include precise timing waveforms.

In addition to this complete set of waveforms, Function Generators include versatile modulation capabilities such as amplitude, frequency, phase, pulse width and VCO control.

The Function Generator is an indispensable, general-purpose signal source for production testing, instrument repair, and the electronics laboratory. Diverse fields of applications in which the function generator is being used include medical research, education, chemical, communications, geophysics, industrial control, military and aerospace.

Frequency Synthesizers

Today's measurement needs are placing increasingly stringent requirements on signal sources for greater frequency resolution and stability. Narrowband component testing, satellite and terrestrial communications, local oscillator and automatic test systems are only a few of the many applications that con-

tinually require higher precision sources.

Square waves, triangle waves, and pulses are signals typically associated with non-synthesized sources. This situation is changing. Precision signals of these types are finding important applications in mechanical, civil and environmental engineering.

Increased amplitude accuracy and resolution are also requirements in many applications. The telecommunications industry's Frequency Division Multiplex (FDM) systems require high amplitude accuracy and resolution (0.01 dB) as well as high frequency resolution and stability. These requirements are becoming commonplace in R&D and production test environments.

Frequency Synthesis Techniques

Traditional approaches to indirect synthesis techniques require a phase-locked loop for every decade of frequency resolution. This method provides adequate performance, but many component parts leads to an expensive product. However, a new technique has been developed by Hewlett-Packard that allows a single phase-locked loop to offer multidigit resolution. The process is called Fractional Frequency Synthesis or Fractional N—a method of relating the VCO frequency to the crystal reference by other than an integer N. Up to 11 digits of frequency resolution can be achieved from a single phase-locked loop with this new technique. Significant cost savings and increased reliability result.

Signal Quality

The common specifications that describe signal sources include frequency range and resolution, amplitude range and resolution, distortion and stability.

Additional specifications that are pertinent to the synthesizer are phase noise and spurious content. Phase noise describes the short-term frequency stability of a signal source. It is typically specified as single sideband spectral density or integrated (total) phase noise. Spurious signals are discrete, nonharmonically related signals appearing in the output.

Synthesizers

Hewlett-Packard offers a wide range of high quality frequency synthesizers and synthesized signal generators covering the frequency range of dc to 26 GHz. In addition to being high performance synthesized signal sources, they incorporate many additional features which allow them to fulfill the needs of either bench or programmable applications.

The combined frequency ranges of the HP 8656B, 8660A/C, 8662A, 8663A, 8672A and 8673B,C, and D Synthesized Signal Generators span 10 kHz to 26 GHz. These generators couple the frequency accuracy and stability of synthesizers with the modulation capability and precise, calibrated, wide-range level control of high quality signal generators. In addition, each of these



generators offers HP-IB remote control of frequency, level and modulation.

Synthesized Level Generators

The HP 3335A is a synthesized level generator covering the range of 200 Hz to 80 MHz. This instrument is ideal as a stand-alone generator with synthesizer stability or as a companion generator for the HP 3745A/B SLMS and HP 3586A/B/C Selective Level Meters. It offers the traditional range of connectors and output impedances, balanced and unbalanced, required by the telecommunications industry. The HP 3336A/B/C is a 21-MHz synthesized level generator with a similar set of telecommunications features. It, too, is ideal as a stand-alone generator or as a companion for HP's 3586A/B/C Selective Level Meters. For more information on these generators, refer to the Telecommunications section of this catalog.

Sweep Capability

The HP 3325A, 3326A, 3330B, 3335A, 3336A/B/C, 8660C, 8662A, 8663A, and 8673B, C and D are among the most linear

sweepers ever built. Keyboard control of microprocessors gives these instruments digital control of sweep start/stop frequencies and sweep times.

Synthesizer/Function Generator

The HP 3325A is a function generator whose functions are derived from a primary synthesized oscillator. It provides a high purity synthesized sine wave from 0.000001 Hz to 21 MHz, precision square waves to 11 MHz, linear ramps and triangle waveforms to 11 kHz, 11 digit resolution ($1 \mu\text{Hz} < 100 \text{ kHz}$), wideband phase-continuous sweep, and HP-IB programmability. The low price makes the HP 3325A an excellent choice for automatic test systems or bench applications.

The HP 3326A is a two-channel synthesizer with internal modulation, sine and square waves, and four operating modes including two-phase, two-tone, two-channel, and pulse. Discrete sweep and nonvolatile storage of instrument states make the HP 3326A an ideal choice for ATE applications, where high-performance and versatility are important.

Arbitrary Waveform Synthesizer

The new HP 8770A Arbitrary Waveform Synthesizer offers a significant advance in waveform generation for DC-50 MHz applications. Relying on state-of-the-art digital technology for its digital-to-analog output converter, the HP 8770A provides 125 million waveform samples per second (8 ns, i.e. 50 MHz bandwidth), with 12-bit amplitude resolution (0.025%). The completely arbitrary waveform is constructed mathematically using an HP 9000 Series 200 or 300 Desktop Computer and HP 11776A Waveform Generation Software. This powerful software uses the newly-developed Waveform Generation Language (WGL) which provides a flexible application-oriented tool to mathematically construct any user-required waveform. The available 128K word memory is further enhanced by memory conservation or "re-use" modes. The HP 8770A makes applications such as hard-disc signal simulation, ATE, and receiver video testing possible with just one generator.

HP Model	Frequency Range	Frequency Resolution	Frequency Stability	Level Range dBm - 50 Ω	Level Resolution	Remote Control	Other Features*	Page
3325A***	DC-21 MHz (sine) DC-11 MHz (square)	0.000001 Hz or 0.001 Hz (11 digits)	5×10^{-9} /yr	-56.02 to +23.98 (sine)	0.01 dB or 0.001 mV to 0.01 V (4 digits)	All functions	8, 11, 12, 13	412
3326A	DC-13 MHz	0.000001 Hz or 0.001 Hz (11 digits)	5×10^{-9} /yr	-56.02 dBm to +23.98 dBm	0.01 dB or 0.001 mV to 0.01V (4 digits)	All functions	8, 11, 12, 13, 18	414
8770A	DC to 50 MHz	-----	5×10^{-10} /day	-110 to +13	12-bit 1:4096	All functions	Fully Arbitrary Waveform	410
3335A	200 Hz-80 MHz	0.001 Hz	10^{-9} /day	-87 to +13	0.01 dB (4 digits)	All functions	2, 3, 8	416
3336A/B/C	10 Hz - 21 MHz	0.001 Hz or 11 digits	1.5×10^{-9} /day	-71 to +8	0.01 dB	All functions	8, 11, 12, 13	385, 417
8656B	100 kHz to 990 MHz	10 Hz	10^{-9} /day	-127 to +13	0.1 dB	Freq., ampl. & modulation	8, 14	409
8660A/C**	10 kHz to 2600 MHz	1 Hz or 2 Hz (10 digits)	3×10^{-9} /day	-146 to +13	Local: 10-dB steps plus Vernier remote: 1-dB steps	Freq., ampl. & modulation	HP 8660A 5, 7, 8 HP 8660C 3, 5, 7, 8	530
8642A/B	100 kHz to 1050 MHz (A) 100 kHz to 121 MHz (B)	1 Hz	2×10^{-9} /yr (1x10 ⁻⁹ /day opt.)	-140 to +20	0.1 dB	All functions	3, 4, 12, 13, 14	524
8662A**	10 kHz - 1280 MHz	0.1 Hz or 0.2 Hz (11 digits)	5×10^{-9} /day	-139.9 to +13	0.1 dB (4 digits)	Freq., ampl., modulation & sweep	3, 8, 14	527
8663A**	10 kHz to 2560 MHz	0.1 Hz or 0.2 Hz (11 digits)	5×10^{-9} /day	-129.9 to +16	0.1 dB	Freq., ampl., modulation & sweep	3, 8, 14, 15	527
8671B	2 to 18 GHz	1, 2, 3 kHz	5×10^{-9} /day	-120 to +8	—	Freq.	8	542
8672A	2 to 18 GHz	1, 2, 3 kHz	5×10^{-9} /day	-120 to +2 (+7 optional)	Local: 10-dB steps plus Vernier remote: 1-dB steps	Frequency, amplitude, and modulation	8, 10	546
8672S	10 MHz to 18 GHz	1, 2, 3 kHz	5×10^{-9} /day	-120 to +2 (+7 optional)	Local: 10-dB steps plus Vernier remote: 1-dB steps	Freq., amplitude, and modulation	8, 16	546
8673B	2 to 26.5 GHz	1, 2, 3, 4 kHz	5×10^{-9} /day	-100 to +8	Local: 10-dB steps plus Vernier remote: 1-dB steps	Freq., amplitude, and modulation	8, 16	544
8673E	2 to 18 GHz	1, 2, 3 kHz	5×10^{-9} /day	-120 to +8	Local: 10-dB steps plus Vernier remote: 1-dB steps	Freq., amplitude, and modulation	8, 16	543
8673C	50 MHz to 18 GHz	1, 2, 3 kHz	5×10^{-9} /day	-100 to +2	Local: 10-dB steps plus Vernier remote: 1-dB steps	Freq., amplitude, and modulation	8, 16, 17	544
8673D	50 MHz to 26.5 GHz	1, 2, 3, 4 kHz	5×10^{-9} /day	-100 to +5	Local: 10-dB steps plus Vernier remote: 1-dB steps	Freq., amplitude, and modulation	8, 16, 17	544
8165A	1 mHz to 50 MHz	4 digits	1×10^{-9} /day	10.0 mV to 20 Vp-p	3 digits	Modulation & trigger	3, 8, 10	418

*Other features: (1) 10^{-9} /day freq. stability optional, (2) 5×10^{-10} /day, (3) digital freq. sweep, (4) digital ampl. sweep, (5) internal AM/FM, Φ M, (6) external AM, (7) 3×10^{-9} /day stability Opt. 001, (8) HP-IB, (9) external FM, (10) external AM & FM, (11) 5×10^{-10} /week stability optional, (12) external AM & Φ M, (13) phase-continuous sweep, (14) internal & external AM & FM, (15) independent and simultaneous A, FM, PM and pulse modulation, (16) external AM, FM, and pulse modulation, (17) harmonically-related spurious $< -60 \text{ dBc}$, (18) The HP 3326A is a two-channel synthesizer with internal modulation, square waves, discrete (user-defined) frequency sweep, and four operating modes including two-phase, two-tone, pulse, and two-channel.

**The HP 8660A/C, 8662A, 8663A and 8672A are synthesized signal generators. They are discussed in detail in the section labeled "Signal Generators."

***The HP 3325A Synthesizer/Function Generator includes squarewaves, positive and negative ramps, and triangle waveforms in addition to sinewaves.



FREQUENCY, FUNCTION & WAVEFORM SYNTHESIZERS

Arbitrary Waveform Synthesizer System, DC-50 MHz

Models 8770S, 8770A, 11776A

- A new source of "real-life" signals to 50 MHz
- The standard for generating arbitrary waveforms
- Quick and easy "what if" testing
- Accurate margin tests with user-defined distortions
- 125 MHz sample rate
- 12 bit resolution, 128K word memory

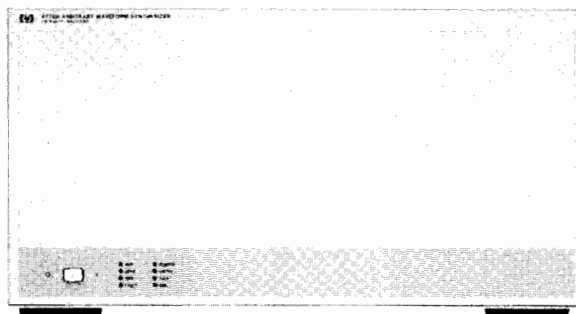
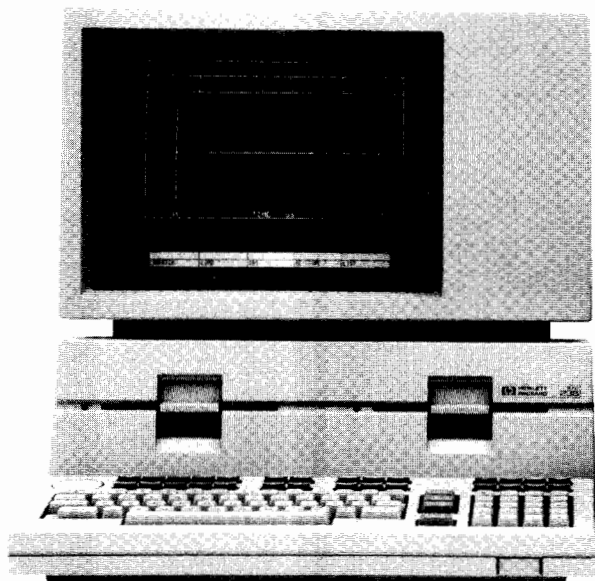

Providing Waveforms of Any Shape to 50 MHz

The HP 8770S Arbitrary Waveform Synthesizer System, consisting of the HP 8770A Arbitrary Waveform Synthesizer and an HP Series 200 or 300 Technical Computer running the HP 11776A Waveform Generation Software, is a complete system for the generating arbitrary waveforms from dc to 50 MHz. Waveforms created with the software and generated by the HP 8770A can represent not only ideal test signals, but "real-life" signals with precise amounts of distortion or noise added to represent true operating conditions. All signal parameters are under complete software control, allowing for quick changes to meet new test demands. Regardless of your application, the use of precise complex test signals will improve the evaluation of your circuits or systems.

Complete Waveform Generation/Capture/Modification Systems

The HP 8770S offers capabilities not previously available for accurate and efficient tests of rigid disc drive circuitry, high-speed serial logic systems, receiver video processing sections, and specialized television video developments. The system can also be expanded to become a complete waveform development station. Waveforms created with the HP 11776A and generated by the HP 8770A can be viewed and captured by other instruments. The waveform data can be brought back into the HP 11776A for modification of the original waveform. It becomes easy to perform "what if" testing quickly to more accurately determine a device's performance under actual signal conditions.

Complex Signals Made Easy

Previously, the more complex a signal was, the more costly and difficult it was to produce. Fortunately, this is not the case with the HP 8770S. The HP 8770S can generate complex signals as easily as a signal generator generates a sine wave. Multi-tone signals, exponentially growing/decaying signals, irregular signals, pulses with jitter or truly arbitrary waveforms are quickly generated when samples of the

desired waveforms are loaded into the HP 8770A memory. The HP 8770S can generate many signals without the need for external modulation sources, and at the same time you can add precise non-linearities or distortions to completely test a device's response and reduce development times. Now you can quickly identify faulty or marginal systems at an early stage with signals containing varying amounts of distortion to eliminate costly problems later on.

Complete Signal Control

The HP 8770A reproduces signals from waveform samples updated every 8 ns and thus allows changing of signal parameters very rapidly. The 12-bit words give the HP 8770A's output high amplitude resolution. The 125 MHz internal clock phase-locks to a crystal oscillator and provides a time-base with synthesizer accuracy. Special output circuits provide low harmonic and spurious signal levels to meet the needs of the most demanding application. A 110 dB RF attenuator allows signal power to be precisely set at any level desired.

Powerful Software Speeds Waveform Creation

The HP 11776A Waveform Generation Software operates on the HP 200 and 300-series technical computers. The HP 11776A is optimized for the easy creation and modification of waveform sample data defining the desired analog waves subsequently generated by the HP 8770A. Exact and precise waveforms can be quickly created using a command set that operates similar to a hand-held calculator. Glitches, noise or distortions can be added in precise amounts to waveforms to simulate real signal conditions for more accurate tests. Double your power by using the internal FFT routine to modify and create waveforms in the frequency domain. Create new, personalized commands out of existing commands to further increase waveform creation and modification efficiency.



Complete ATE Fit

Because of its versatility, the HP 8770S can simplify many of your test equipment requirements for providing complex signals. The HP 8770A has a complete HP-IB command set for full automatic control and easy downloading of waveform data previously defined by the HP 11776A software or by other means. Digital data representing waveform samples can be downloaded through either HP-IB, or through Direct-Memory-Access (DMA). Trigger outputs are also available to help waveform capture devices lock onto specific parts of test waveforms having special interest.

Build Waveform Libraries for Complete Tests

Any HP-IB computer can control the HP 8770A and download previously defined waveform data. Generate a library of test waveforms with the HP 11776A software and then download them to the HP 8770A from the computer in your ATE system for use in your applications.

Meet New Test Signal Requirements Quickly

The versatility of the HP 8770S assures that you will have the test signals needed to meet future needs. To generate new waveforms, waveform data need only be created with the software and then downloaded into the HP 8770A for immediate generation, or saved for later use and for distribution to multiple stations. The large 128K word memory of the HP 8770A ensures that even the most complex waveforms can be completely defined and generated.

Sequencing Stretches Memory

With most arbitrary waveforms, certain parts of the waveform often repeat themselves and quickly fill up even the largest arbitrary waveform generator memory. This leaves less memory to define the rest of the desired test signal. The HP 8770A avoids this problem by allowing programming of sections of memory (packets) to be repeated any number of times and in any order. This sequencer capability frees large amounts of memory to give greater flexibility when defining the rest of the desired test signal. Many test signals can also be stored simultaneously in the memory and accessed at any time with the sequencer.



The HP 8770S offers complex waveform synthesis up to 50 MHz bandwidths.

Performance Characteristics

Peak Output Signal: 2 V p—p into 50 ohms

Attenuator: 110 dB in 10 dB steps

DC Performance

Resolution: 12 bits per sample

Amplitude Drift (20-30° C): Typically $\leq \pm 2.5\%$ of full scale

Sine Wave Performance

Frequency Range: DC to 50 MHz

Time Base: Internal 10 MHz ($< 5 \times 10^{-10}$ /day aging rate after 24 hour warm-up)

Clock Rate: 125 MHz internal or 60 - 130 MHz external input

Harmonic Distortion: < -50 dBc for signals ≤ 10 MHz

< -40 dBc for signals from > 10 to 50 MHz

Spurious & Non-harmonic Distortion: < -50 dBc for signals ≤ 25 MHz

< -40 dBc for signals from > 25 to 50 MHz

Two-Tone Linearity (124 KHz separation): Typically < -60 dBc
SSB Phase Noise @ 10 MHz: < -120 dBc/Hz @ 10 kHz offset typical

Dynamic Range: 72 dB plus 110 dB step attenuator

Amplitude Flatness (without attenuation): Typically ± 0.8 dB

Amplitude Stability: ± 0.02 dB typical @ 20° C after 24 hour warm-up

Risetime: < 8 ns (10% to 90%) typical

Output Markers: Memory Scan Start

Packet Start

Sequence Start

Memory Address Equal

HP-IB Interface Codes: SH1, AH1, T5, TE0, LE0, L3, SR1, RL1, PP1, DC1, DT0, C0

General

Operating Temperature: 15 - 40° C

Power: 445 VA

Weight: Net, 23.6 kg (52 lb), Shipping, 29.5 kg (65 lb)

Size: 235 H x 425.5 W x 622 mm D (9.25" x 16.75" x 24.5")

Ordering Information

Price

HP 8770S Arbitrary Waveform Synthesizer System

\$0

To ensure coordination of shipments and compatibility of instruments, computers and software, use the system model number when ordering individual components. Obtain the HP 8770A and HP 11776A Data Sheet and an HP 8770S Ordering Guide from your local sales office.

HP 8770A Arbitrary Waveform Synthesizer

\$24,000

Option 002: 75 ohm Output Impedance

N/C

HP 11776A Waveform Generation Software

\$5,000

(5.25" Diskettes Standard)

Option 630: 3.5" Diskettes Only

N/C



FREQUENCY, FUNCTION & WAVEFORM SYNTHESIZERS

1 μ Hz to 21 MHz Synthesizer/Function Generator

Model 3325A

- Synthesizer
- Function generator
- Sweeper
- Programmable

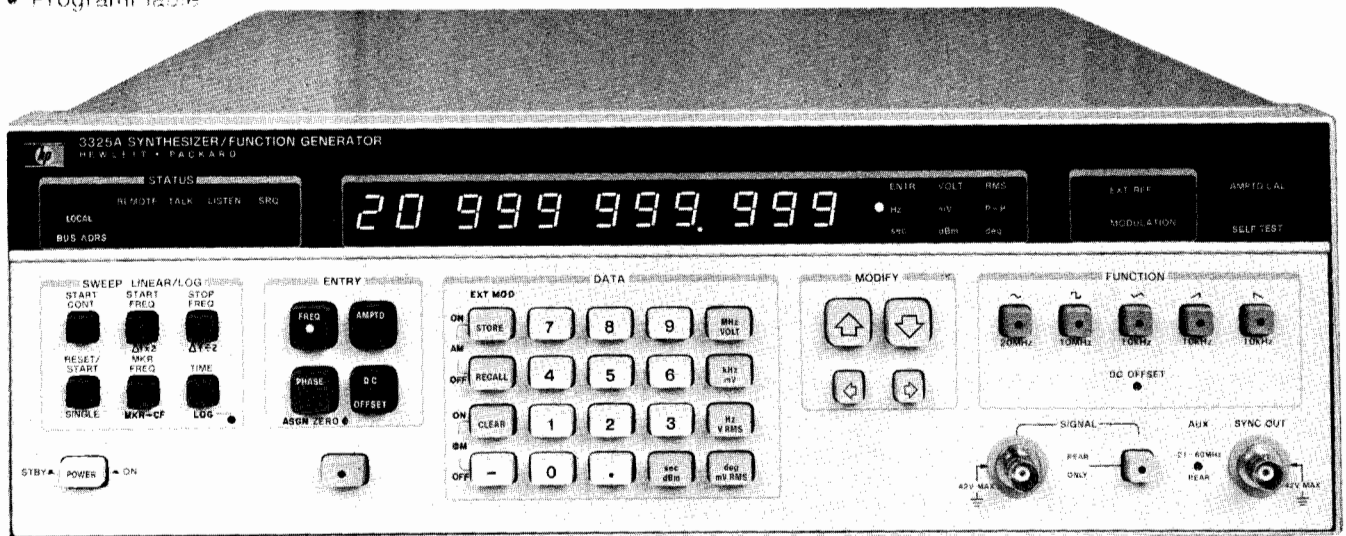

HP 3325A



Description

The HP 3325A Synthesizer/Function Generator is an uncompromising, high performance synthesizer with 11 digit resolution, a function generator with precision waveforms, a wideband sweeper, and a fully programmable systems instrument.

Synthesizer

The HP 3325A is first with microhertz resolution below 100 kHz along with frequency coverage from .000001 Hz to 20.999 999 999 MHz. Signal purity, accuracy and stability are as good or better than earlier stand-alone HP synthesizers. Harmonics are 65 dB down below 50 kHz and you can externally modulate with AM and PM.

Function Generator

The HP 3325A is also a high performance function generator providing precision waveforms with synthesizer accuracy and resolution. Squarewaves to 10.999 999 999 MHz have 20 ns rise and fall times. Triangles and ramps with .05% linearity are available up to 10.999 999 999 kHz. All waveforms can be dc and phase offset.

A Wideband Sweeper

A major contribution is wideband phase continuous sweep, covering up to the full frequency range of each waveform. Sweep log or linear, single or continuous without the phase discontinuities usually associated with synthesizers. Phase lock loop testing is made easier.

Make convenient swept frequency network measurement on filters, amplifiers or any passive or active network. Use the TTL marker to check the frequency of points of interest on a swept frequency display desired. Use the convenient "zoom" functions $\Delta F \times 2$ and $\Delta F + 2$ to quickly change the frequency span for the display desired.

Fully Programmable

All necessary functions are programmable on the HP-IB, including frequency, amplitude, all functions, phase and dc offset, modulation, all sweep parameters, amplitude cal and self-test, making the HP 3325A a very versatile and powerful addition to automatic test systems. The isolated interface combined with floating outputs and inputs and talk mode make the HP 3325A easy to use in Automatic Test Systems.

More Features

The phase of the output can be changed $\pm 719.9^\circ$ with 0.1° resolution. The phase is advanced (or retarded) with respect to the starting

phase. Two HP 3325A units can be phase locked together for dual phase output applications.

DC offset is capable of ± 4.5 Vdc on the standard instrument. The high voltage option (Opt 002) allows ac voltages up to 40 Vpp and ac + dc up to ± 18 V total (ac peak + dc).

Ten storage registers can be programmed with ten different combinations of function/parameter settings from the front panel, stored and then recalled.

The HP 3325A can display 11 digits of frequency and 4 digits of volts or millivolts from 1 mV to 10 volts peak to peak. Conversion to RMS or dBm is simple with the touch of a button.

New Technology

The HP 3325A provides unprecedented performance per dollar thanks to several major contributions from advances in HP technology. A single loop Fractional-N synthesis technique allows synthesizer accuracy with 11 digits of resolution and, as an added bonus, phase continuous frequency sweep. Fewer parts and integrated circuit technology make the difference. A unique method of triangle and ramp waveform generation provides excellent linearity. Add microprocessor control and Hewlett-Packard Interface Bus (HP-IB) operation and the result is more performance, flexibility and versatility on the bench or in automatic test systems than previously available, and at a lower cost.

Specifications

Refer to the HP 3325A data sheet for complete specifications.

Waveforms

Sine, Square, Triangle, negative and positive Ramps.

Frequency Range

Sine: 1 μ Hz to 20.999 999 999 MHz

Square: 1 μ Hz to 10.999 999 999 MHz

Triangle/ramps: 1 μ Hz to 10.999 999 999 kHz

Resolution: 1 μ Hz, < 100 kHz
1 mHz \geq 100 kHz

Aging rate: $\pm 5 \times 10^{-6}$ /year, 20° to 30° C

Warm-up time: 20 minutes to within specified accuracy



Main Signal Output (all waveforms)

Impedance: 50 Ω

Connector: BNC; switchable to front or rear panel, nonswitchable with option 002, except by internal cable change.

Amplitude

Range: 1 mV to 10 V p-p in 8 amplitude ranges, 1-3-10 sequence (10 dB steps), into 50 Ω load.

Function	Sine		Square		Triangle/Ramps	
	min	max	min	max	min	max
Units Displayed						
peak-peak	1.000 mV	10.00 V	1.000 mV	10.00 V	1.000 mV	10.00 V
rms	0.354 mV	3.536 V	0.500 mV	5.000 V	0.289 mV	2.887 V
dBm (50 Ω)	-56.02	+23.98	-53.01	+26.99	-57.78	+22.22

Resolution: 0.03% of full range or 0.01 dB (4 digits).

Amplitude Accuracy (without dc offset, relative to programmed amplitude and accuracy)

Sinewave Amplitude Accuracy

1 mHz to 100 kHz: ± 0.1 dB, ≥ 3 Vpp; ± 0.2 dB, < 3 Vpp

100 kHz to 20 MHz: ± 0.4 dB, ≥ 3 Vpp; ± 0.6 dB, 0.1 to 3 Vpp

Squarewave Amplitude Accuracy

1 mHz to 100 kHz: 1%, ≥ 3 Vpp; 2.2%, < 3 Vpp

100 kHz to 10 MHz: 11.1%, ≥ 3 Vpp; 13.6%, < 3 Vpp

Triangle Amplitude Accuracy

1 mHz to 2 kHz: 1.5%, ≥ 3 Vpp; 2.7%, < 3 Vpp

2 kHz to 10 kHz: 5%, ≥ 3 Vpp; 6.2%, < 3 Vpp

Sinewave Spectral Purity

Phase noise: -60 dB for a 30 kHz band centered on a 20 MHz carrier (excluding ± 1 Hz about the carrier) with high-stability option 001 installed.

Spurious: all non-harmonically related output signals will be more than 70 dB below the carrier (60 dB with dc offset), or less than -90 dBm, whichever is greater.

Sinewave harmonic distortion: harmonically related signals will be less than the following levels (relative to the fundamental) at full output for each range:

Frequency Range	Harmonic Level
0.1 Hz to 50 kHz	-65 dB
50 kHz to 200 kHz	-60 dB
200 kHz to 2 MHz	-40 dB
2 MHz to 15 MHz	-30 dB
15 MHz to 20 MHz	-25 dB

Squarewave Characteristics

Rise/fall time: ≤ 20 ns, 10% to 90% at full output

Overshoot: $\leq 5\%$ of peak to peak amplitude, at full output

Settling time: < 1 μ s to settle to within .05% of final value.

Phase Offset

Range: $\pm 719.9^\circ$ with respect to arbitrary starting phase or assigned zero phase

Resolution: 0.1 $^\circ$

Accuracy: $\pm 0.2^\circ$

DC Offset

Range: dc only (no ac signal): 0 to ± 5.0 V/50 Ω .

dc + ac: Maximum dc offset ± 4.5 V on highest range, decreasing to ± 4.5 mV on lowest range.

Resolution: 4 digits

Sinewave Amplitude Modulation

Modulation depth at full output for each range: 0-100%

Modulation frequency range: dc to 400 kHz (0-21. MHz carrier frequency)

Sensitivity: ± 5 V peak for 100% modulation

Sinewave Phase Modulation

Range: $\pm 850^\circ$, ± 5 V input

Modulation frequency range: dc -5 kHz

Frequency Sweep

Sweep Time

Linear: 0.01 s to 99.99 s

Logarithmic: 2 s to 99.99 s single, 0.1 s to 99.99 s continuous

Maximum sweep width: full frequency range of the main signal output for the waveform in use, except minimum log start frequency is 1 Hz.

Phase continuity: sweep is phase continuous over the full frequency range of the main output.

Auxiliary Inputs and Outputs

Reference input: for phase-locking HP 3325A to an external frequency reference signal from 0 dBm to +20 dBm into 50 Ω . Reference signal must be a subharmonic of 10 MHz from 1 MHz to 10 MHz.

Auxiliary frequency output: 21 MHz to 60.999 999 999 MHz, under range coverage to 19.000 000 001 MHz, frequency selection from front panel; 0 dBm; output impedance 50 Ω .

Sync output: square wave with V (high) ≥ 1.2 V, V (low) ≤ 0.2 V into 50 Ω .

X-Axis drive: 0 to $> +10$ V dc linear ramp proportional to sweep frequency, linearity, 10-90%, $\pm 0.1\%$ of final value.

Sweep marker output: high to low TTL compatible voltage transition at selected marker frequency.

Z-Axis blank output: TTL compatible voltage levels capable of sinking 200 mA from a positive source.

1 MHz reference output: 0 dBm output for phase-locking additional instruments to the HP 3325A.

10 MHz oven output: 0 dBm internal high stability frequency reference output for phase-locking HP 3325A. (Opt. 001 only)

HP-IB Interface Functions: SH1, AH1, T6, L3, SR1, RL1, PP0, DC1, DT0, C0, E1.

Recommended Accessory: HP 7090A Measurement Plotting System.

Option 001 High Stability Frequency Reference

Aging rate: $\pm 5 \times 10^{-8}$ /week (72-h warm up); $\pm 1 \times 10^{-7}$ /month (after 15 days continuous operation).

Ambient stability: $\pm 5 \times 10^{-8}$ (0 $^\circ$ to +55 $^\circ$ C).

Warm-up time: reference will be within $\pm 1 \times 10^{-7}$ of final value 15 minutes after turn-on for an off time of less than 24 hours.

Option 002 High Voltage Output

Frequency range: 1 μ Hz to 1 MHz

Amplitude

Range: 4.00 mVpp to 40.00 Vpp (500 Ω , < 500 pF load).

Accuracy and Flatness at Full Output

Sine, square, and triangle waves: $\pm 2\%$ at 2 kHz

Ramps: $\pm 2\%$ at 500 Hz

Flatness: $\pm 10\%$ relative to programmed amplitude

Sinewave distortion: harmonically related signals will be the same as the standard instrument to 1 MHz

Maximum output current: 80 mAapp.

Output impedance: < 2 Ω at dc, < 10 Ω at 1 MHz

DC offset range: 4 times the specified range of the standard instrument.

General

Operating environment

Temperature: 0 $^\circ$ C to 55 $^\circ$ C.

Relative humidity: 95%, 0 $^\circ$ C to 40 $^\circ$ C.

Altitude: $\leq 15,000$ ft.

Storage temperature: -40 $^\circ$ C to +75 $^\circ$ C.

Storage altitude: $\leq 50,000$ ft.

Power: 100/120/220/240 V, +5%, -10%, 48 to 66 Hz; 90 VA, 120 VA with all options; 10 VA standby.

Weight: 9 kg (20 lb) net; 14.5 kg (32 lb) shipping.

Size: 132.6 H x 425.5 W x 497.8 mm D (5.25" x 16.75" x 19.63").

Ordering Information*

HP 3325A Frequency Synthesizer \$4,500

Opt. 001 High Stability Frequency Reference add \$750

Opt. 002 High Voltage Output add \$250

Opt 907 Front Handle Kit (standalone orders P/N HP 5061-0089) \$55

Opt 908 Rack Flange Kit (standalone orders P/N HP 5061-0077) \$270

Opt 909 Rack Flange and Handle Combination Kit (standalone orders P/N HP 5061-0083) \$80

*HP-IB cable not supplied. See page 133.

Fast-Ship product—see page 133.

FREQUENCY, FUNCTION & WAVEFORM SYNTHESIZERS

Two-Channel Synthesizer, DC to 13 MHz

Model 3326A



HP 3326A



The HP 3326A Two-Channel Synthesizer combines two independent synthesizers, flexible modulation, and control circuitry into a single, powerful package. This single instrument can provide precise phase offset, two-tone sweep, fast frequency switching, internal modulation, and pulse signals for bench or systems use.

Complete Two-Phase Solution

The HP 3326A can provide two signals whose phase is adjustable and calibrated anywhere in its 13 MHz frequency range without an external phasemeter.

Self-calibration can be performed internally or externally and yields accuracy of ± 0.2 degrees below 100 kHz. Phase can be set with 0.01 degree resolution at all frequencies. Using its unique phase-calibration circuitry, calibrated multi-phase signals are easily achieved with two or more HP 3326As.

Powerful Two-Tone Capability

The HP 3326A is the single-source answer for producing a wide variety of broadband two-tone signals. It's two channels can be offset up to ± 100 kHz, either in the CW mode or while sweeping.

Channel amplitudes and functions (sine or square) can be selected independently and provided from separate outputs or through the built-in signal combiner. Low sinewave distortion (harmonics are at least -70 dBc below 100 kHz) makes low-distortion intermodulation measurements a simple task.

Versatile ATE Source

With two complete synthesizers in a single instrument, rack space and power are conserved. Features like internal amplitude and phase modulation, two-tone, and pulse modes allow this one instrument to do the job of several sources.

All functions, modes, and parameters of the HP 3326A are completely programmable over the HP-IB. Maximum accuracy is ensured with amplitude/phase calibrations that can be enabled, disabled and initiated under remote control.

High Performance Modulation and Pulses

Precise amplitude and phase modulation is easy with both channels of the HP 3326A. Each channel can be used with simultaneous AM and PM, or one channel can modulate the other. Amplitude modulation frequency is dc to 100 kHz and envelope distortion is better than -46 dB.

In the pulse mode both pulse and pulse-complement outputs are provided. Symmetry range is 1% to 99% and is settable in 0.1% increments. In addition, both pulse amplitudes and their offsets are independently controllable.

Other Features

The HP 3326A has a host of convenience features to speed and simplify signal generation. Nine complete setup states can be stored in nonvolatile memory, along with automatic storage of the power-off state. A discrete sweep mode is available to generate from 2 to 63

frequency pairs with dwell times individually selectable for each frequency and each channel. Several flexible triggering modes allow hardware or software triggers to initiate frequency, amplitude, or phase changes, and sweeps.

DC offset is available in all modes, and all outputs are floating. Frequency resolution is 11 digits, and all sweeps and frequency changes are phase-continuous.

Specifications

For complete specifications refer to the HP 3326A data sheet.

Operating Modes

Two Channel: Channels A and B are independent

Two-Phase: Channels A and B are the same frequency, with calibrated phase offset between the two signals

Two-Tone: Channel B frequency offset 0 to 100 kHz from channel A frequency

Pulse: Channel B is the complement of Channel A

Frequency (Waveforms are Sine, Square, Pulse, and DC)

Range: 0 Hz to 13 MHz

Resolution: 1 μ Hz below 100 kHz, 1 mHz at and above 100 kHz

Stability: $\pm 5 \times 10^{-6}$ /year, 20° to 30°C. See also option 001, High Stability Frequency Reference.

Accuracy: $\pm 5 \times 10^{-6}$ of selected value, 20° to 30°C, at time of calibration with standard frequency reference

Sinewave Spectral Purity

Harmonics: Harmonically related signals will be less than the following levels relative to the fundamental, or < -90 dBm, whichever is greater:

	10 Hz	50 kHz	100 kHz	1 MHz	13 MHz
+23.98 dBm	-80 dBc	-70 dBc	-55 dBc	-30 dBc	
+13.98 dBm	-80 dBc	-80 dBc	-65 dBc	-50 dBc	
-56.02 dBm					

Integrated Phase noise: -66 dBc (Option 001 only, for a 30 kHz band centered on a 10 MHz carrier excluding ± 1 Hz about the carrier)

Main Signal Outputs (Channels A & B, All Waveforms Unless Noted)

Connectors: Front panel BNC female

Impedance: 50 Ω ; output may be floated to ± 42 V peak

Sync A: TTL level squarewave at Channel A frequency.

Output Amplitude (Sine Mode)

Range: 1 mVpp to 10 Vpp in 8 ranges without DC offset. See also option 002 High Voltage Output

Units: Volts peak-peak, Volts rms, dBm (50 Ω), dBV



Resolution: 0.1% of full range for peak-peak entry
0.3% of full range for rms entry
0.01 dB for dBm or dBV entry

Accuracy: Relative to programmed value after self-calibration

	0.001 Hz	100 kHz	1 MHz	13 MHz
+23.98 dBm	-----	-----	-----	-----
	±0.1 dB	±0.3 dB	±0.6 dB	
+3.98 dBm	-----	-----	-----	-----
			±0.8 dB	
-36.02 dBm	±0.2 dB	±0.5 dB	-----	-----
			±1.0 dB	
-56.02 dBm	-----	-----	-----	-----

Squarewave and Pulse Characteristics
Rise/fall time: ≤15 ns, 10% to 90% at full output
Overshoot: ≤5% of peak-to-peak amplitude at full output
Pulse width range: 1% to 99% of period or 20 ns, whichever is greater
Pulse width resolution: 0.1% of period
Pulse width accuracy: ≤±1% of period ±20 ns
Amplitude accuracy: ±2%, 0.001 Hz to 100 kHz

DC Offset
Range: (See also option 002, high voltage output)
DC only: 0 to ±5 V
DC+AC: DC+AC peak ≤5V; Max. DC offset is affected by AC range, Maximum is 4.5 V decreasing to 4.5 mV on lowest range
Resolution: 3 digits
Accuracy: (After self-calibration)
DC only: ±75 mV
DC+AC: (Sinewave) 10 Hz to 1 MHz: ±2% of range
1 MHz to 13 MHz: ±5% of range

Phase Offset
 (Channel A vs B in Two-Phase mode)
Range: ±720 degrees
Resolution: 0.01 degree
Accuracy: After self-calibration, for equal-level sinewaves 1 V to 10 V peak-peak

0.1 Hz to 10 Hz	±0.5 degrees
10 Hz to 100 kHz	±0.2 degrees
100 kHz to 1 MHz	±0.3 degrees
1 MHz to 13 MHz	±2.0 degrees

Amplitude Modulation
 Specifications apply to Channel A and Channel B with external modulation or to Channel A internal modulation with Channel B as the modulation source. External modulation is allowed in all modes; internal modulation is allowed only in the two-channel mode.
Waveforms: Sine, square, or (external only) pulse
Frequency Range: Carrier: DC to 13 MHz
Modulation: DC to 100 kHz
Modulation Depth: 0 to 100%

Phase Modulation
 Specifications apply to Channel A and Channel B with external modulation or to Channel A internal modulation with Channel B as the modulation source. External modulation is allowed in all modes; internal modulation is allowed only in the two-channel mode.
Waveforms: Sine, square, or (external only) pulse
Frequency Range: Carrier: DC to 13 MHz
Modulation: DC to 5 kHz
Phase Deviation: 0° to 360°

Frequency Sweep
Sweep Types: Linear, discrete
Sweep Forms: Triangle, ramp
Sweep Time: 5 ms to 1000 s
Sweep Elements (Discrete): 2 to 63 frequency pairs and dwell times, user defined; dwell times = 5 ms to 1000 s/element
Maximum Sweep Width: 13 MHz

Output Combiner
 Channel A and B are combined on the Channel A output. B output is off. Combiner may be used in the two-channel, two-phase, and two-tone modes. DC offset is automatically set to 0 V.
Frequency Range: DC to 13 MHz
Return Loss: >20 dB

Auxiliary Outputs (All Connectors are Rear-Panel BNC)
10 MHz reference: +3 dBm output to phase lock other instruments to the HP 3326A
10 MHz oven output: +3 dBm oven-stabilized frequency reference (option 001 only)
X-axis drive: Linear ramp proportional to sweep time
Z-axis blank: TTL low during sweep
Sweep Marker: TTL low at selected marker frequency in sweep
20-33 MHz LO: >100 mV square wave output offset 20 MHz from Channel B output

Auxiliary Inputs (All Connectors are Rear-Panel BNC)
Reference Input: For phase-locking to an external frequency reference. Signal of 1, 2, 5, or 10 MHz, ±10 ppm, 0 to +20 dBm
External Trigger Input: TTL level to initiate linear or discrete sweep on high to low transition
Channel A and B external phase calibration inputs
Channel A and B external amplitude modulation inputs
Channel A and B external phase modulation inputs

HP-IB Remote Control
 Compatible with IEEE Standard 488-1978
Interface Functions:
 SH1,AH1,T6,L4,SR1,RL1,PP0,DC1,DT1,C0,E1

Option 001 High Stability Frequency Reference
Stability: ±5×10⁻⁸/week after 72 hours continuous operation
±1×10⁻⁷/month after 15 days continuous operation

Option 002 High Voltage Output
 Multiplies the output level by 4 and expands the allowable DC offset range. Specifications apply to both channels in all modes with the internal combiner off.
Frequency range: DC to 1 MHz
Output impedance: <2 Ω, DC to 50 kHz; <10 Ω, 50 kHz to 1 MHz
Amplitude range: 4 mV to 40 Vpp into >1k Ω, <200 pF load without DC offset (must be entered in peak-to-peak units only)
DC offset: ±20 V, independent of amplitude range. DC + AC peak must not exceed 20 V

Option 003 Rear Terminal Outputs
 Provides Channel A and B main outputs only on rear panel BNC's. Front panel main outputs are removed. Specifications unchanged.

General
Power: 100/120/220/240 V, +5%, -10%, 48 to 66 Hz; 120 VA, 150 VA with all options, 10 VA standby
Weight: 27 kg (60 lb) net, 37 kg (81 lb) shipping
Dimensions: 177 mm H x 425.5 mm W x 497.8 mm D (7" x 16 3/4" x 19 5/8")

Accessories Available
HP 15507A Isolator: For isolation of signal ground between frequency reference and instrument input/output
HP 9211-2656 transit case for protection in transportation and storage

Ordering Information	Price
HP 3326A Two-Channel Synthesizer	\$9,565
Option 001 High Stability Frequency Reference	add \$650
Option 002 High Voltage Output	add \$300
Option 003 Rear Terminal Outputs	N/C
Option 907 Front Handle Kit	\$60
Option 908 Rack Flange Kit	\$35
Option 909 Rack Flange and Handle Combination Kit	\$90
Option 910 Extra Operating Manual	add \$160
Option 914 Delete Service Manual	less \$115



FREQUENCY, FUNCTION & WAVEFORM SYNTHESIZERS

Synthesizer/Level Generator 200 Hz to 81 MHz

Model 3335A

- 1 mHz resolution
- High spectral purity
- Precision amplitude control
- Program storage
- HP-IB

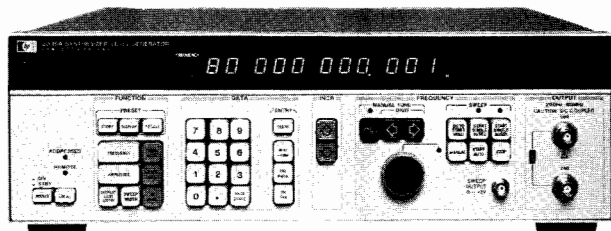

HP 3335A



Description

Covering a frequency range of 200 Hz–81 MHz, the HP 3335A Synthesizer/Level Generator has performance characteristics that make it ideally suited for the telecommunications industry, as well as for traditional synthesizer applications, including testing of Frequency Division Multiplex (FDM) equipment and R & D and production testing of communications systems. It features precision level control, millihertz resolution, high spectral purity, internal frequency sweep, HP-IB programmability and numerous user conveniences.

Internal Storage

Up to 10 different front panel settings (frequency, level, ϕ incr, etc.) can be stored in internal memory registers for later recall. The DISPLAY key allows viewing of register contents without altering the synthesizer output.

Precision Amplitude

Increasing channel capacity of Frequency Division Multiplex (FDM) systems is continually placing more stringent requirements on the testing of transmission parameters. To meet these performance standards, the HP 3335A incorporates a state-of-the-art attenuator resulting in attenuator accuracies of up to ± 0.025 dB over the 81 MHz frequency range.

HP-IB Programmability

IEEE STD 488-1978 Definition SH0, AH1, T0, L2, SR0, RL1, PP0, DC1, DT0, C0.

Frequency Stability

The HP 3335A synthesizes its output frequency from an internal temperature-controlled crystal oscillator which provides $\pm 1 \times 10^{-8}$ /day frequency stability ($\pm 5 \times 10^{-10}$ is optional). The HP 3335A can also be phase-locked to any external frequency standards.

Automatic Frequency Sweep

The HP 3335A combines the precision frequency accuracy and stability of a synthesizer with the time-saving convenience of a digital sweeper.

SLMS - Tracking Generator

The HP 3335A operates as a tracking generator with the HP 3746A/B Selective Level Measuring Set (SLMS), or the HP 3586A/B/C Selective Level Meter for automatic or semi-automatic testing of FDM systems. For closed-loop tracking where the HP 3335A and HP 3746A/B are in the same location, the frequency of the generator is controlled by the microprocessor in the SLMS.

Options

Standard: equipped with switch-selectable 50 Ω and 75 Ω outputs (BNC connectors).

001: High-stability frequency reference

002/004: Equipped with 75 Ω unbalanced and 124 Ω and 135 Ω balanced connectors per table.

	Option	Fits WECO Type	Spacing	Accepts WECO Type
75 Ω	002	477B	N/A	358A
	004	560A		439A/440A
124 Ω	002	477B	16 mm (.625")	372A
	004	560A	12.7 mm (0.5")	443A
135 Ω	002/004	223A	16 mm (.625")	241A

003: 75 Ω unbalanced BNC output and 150 Ω balanced output using a pair of BNC connectors at 20 mm (0.80 in.) spacings.

Abbreviated Specifications

(For complete specifications, refer to the HP 3335A data sheet.)

Frequency Range

Standard: 200 Hz–81 MHz;

Opt. 002/004: 75 Ω , 200 Hz–81 MHz; 124 Ω , 10 kHz–10 MHz; 135/150 Ω , 10 kHz–2 MHz.

Opt. 003: 75 Ω , 200 Hz–81 MHz; 150 Ω , 10 kHz–2 MHz

Frequency resolution: .001 Hz.

Stability, long term: $\pm 1 \times 10^{-8}$ /day; $\pm 1 \times 10^{-7}$ /month.

Opt. 001 (high stability frequency reference)

Aging rate: $\pm 5 \times 10^{-10}$ /day; $\pm 2 \times 10^{-8}$ /month; $\pm 1 \times 10^{-7}$ /year

Warmup: Within 5×10^{-9} of final value 20 minutes after turn-on at 25°C.

Spectral Purity

Harmonic distortion: 200 Hz–10 MHz: < -45 dBc; 10 MHz–81 MHz: < -40 dBc

Phase noise (30 kHz band, excluding ± 1 Hz, centered on the carrier): 9.9 MHz: < -63 dBc; 20 MHz: < -70 dBc; 40 MHz: < -64 dBc; 81 MHz: < -58 dBc

Spurious: nonharmonically related signals: the greater of -75 dBc or -125 dBm (50/75 Ω), -97 dBm (124 Ω), -68 dBm (135/150 Ω)

Amplitude Range

Standard: 50 Ω : +13.01 dBm to -86.98 dBm; 75 Ω : +11.25 dBm to -88.74 dBm.

Opt. 002/004: 75/124/135 Ω : +11.25 dBm to -88.74 dBm

Opt. 003: 75/150 Ω : +11.25 dBm to -88.74 dBm

Signal balance (124 Ω , 135 Ω , 150 Ω balanced outputs): > 60 dB at 100 kHz

Resolution: 0.01 dB

Absolute level accuracy (max. output at 100 kHz, 20°C to 30°C): 50/75 Ω ± 0.05 dB; 124/135/150 Ω : ± 0.1 dB

Flatness (relative to 100 kHz, full amplitude): 50/75 Ω : 1 kHz–25 MHz: ± 0.07 dB; 200 Hz–81 MHz: ± 0.15 dB. 124 Ω : 10 kHz–10 MHz: ± 0.15 dB, 10 kHz–10 MHz ± 0.4 dB; 135/150 Ω : 10 kHz–2 MHz: ± 0.18 dB

Attenuator:

Range: 0 to 98 dB in 2 dB steps

Accuracy: (1 year)

50 Ω :	ATTENUATION	FREQUENCY
	0 to 38 dB	± 0.25 dB
40 to 58 dB	± 0.3 dB	
60 to 98 dB	± 0.9 dB	

75 Ω :	ATTENUATION	FREQUENCY	
		200Hz	80 MHz
0 to 18 dB	± 0.4 dB	± 15 dB	
20 to 58 dB	± 0.9 dB	± 25 dB	
60 to 98 dB	± 2.0 dB	± 50 dB	

Options

001: Hi-stability reference $\pm 5 \times 10^{-10}$ /day

002: Connector option (75/124/135 Ω)

003: Connector option (75/150 Ω)

004: Connector option (75 Ω , miniature WECO on 124/135 Ω)

Price

add \$1210

add \$550

add \$350

add \$550

HP 3335A Synthesizer/Level Generator

\$11,100

FREQUENCY, FUNCTION & WAVEFORM SYNTHESIZERS

Synthesizer/Level Generator

Model 3336C

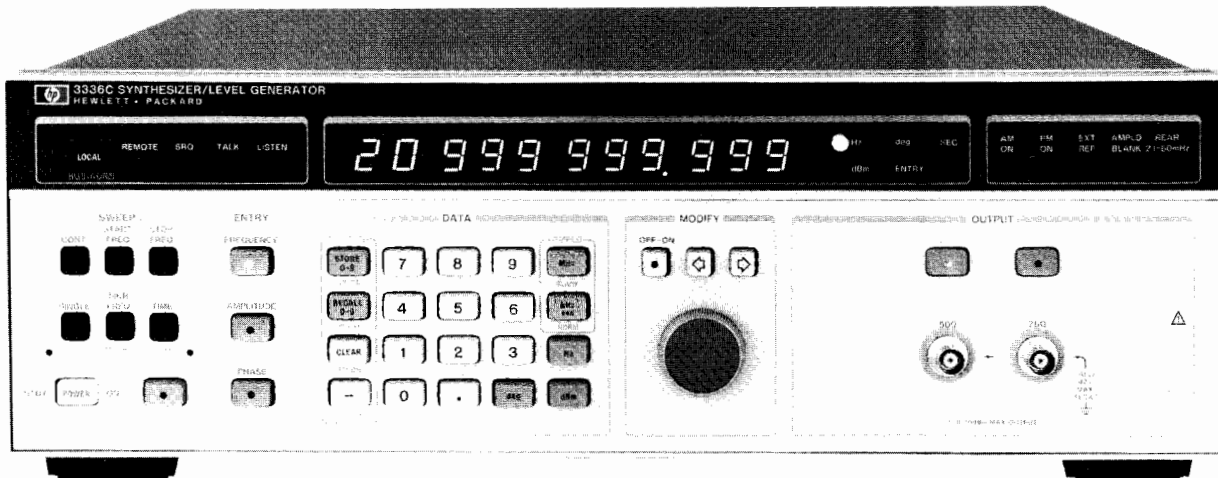

HP 3336C



Description

Covering a frequency range of 10 Hz to 20.999 MHz, the HP 3336C is designed for traditional synthesizer applications as well as R&D and production testing of systems or components. It features precision level control, high spectral purity, optional frequency stability of $\pm 5 \times 10^{-8}$ /week, internal frequency sweep and numerous user conveniences. All models include HP-IB.

Precision Frequency Measurements

Major advances in HP technology have provided a single loop, fractional-N synthesis technique which allows synthesizer accuracy with 11 digits of resolution, with completely phase continuous frequency sweep over any of the instrument's frequency ranges. Microhertz resolution below 100 kHz allows precise frequency measurements over a range of 10 Hz to 20.999 999 999 MHz. Harmonics are below -60 dBc over the range from 50 Hz to 1 MHz (-50 dBc to 20 MHz), with spurious signals below -70 dBc or -100 dBm in the standard instrument, -115 dBm with an option. Integrated Phase Noise is -64 dBc (30 kHz BW).

± 0.05 dB Amplitude Accuracy

New HP attenuator technology coupled with custom designs in leveling loops and thermal converters produce amplitude accuracies seen only in instruments at much greater cost. The fast leveling loop makes extremely flat sweeps possible at high sweep speeds. External leveling is also available for those custom applications where a control loop is desired.

Other Features

Models HP 3336 A & B are also available for the telecommunication industry. See page 385. All three models (the HP 3336A, B & C) have 10 storage registers; amplitude blanking capability during frequency switching; linear or logarithmic phase continuous sweep capabilities; RPG (rotary pulse generator) to simplify modification of any digit in the display; phase offset capability; output connector and impedance flexibility; AM and PM modulation; and many other features. Refer to the data sheet for complete information.

Abbreviated Specifications

Frequency

Range: 10 Hz to 20.999 999 999 MHz

Resolution: 1 μ Hz for frequencies < 100 kHz, 1 mHz for frequencies ≥ 100 kHz

Aging rate: $\pm 5 \times 10^{-6}$ /year (20° to 30°C)

Warm-up time: 30 minutes to within specified accuracy

Amplitude

Range: 50 Ω : -71.23 to +8.76 dBm; 75 Ω : -72.99 to 7.00 dBm

Absolute accuracy: ± 0.05 dB, 20° to 30°C (for the top 9.99 dB of amplitude range at 10 kHz), ± 0.08 dB, 0° to 55°C

Flatness: 50/75 Ω , ± 0.1 dB (± 0.07 dB with option 005) referenced to 10 kHz.

Attenuator Accuracy: (instruments without option 005)

10 Hz 1 MHz 10 MHz 20.9 MHz

10 to 19.99 dB	± 1 dB	± 15	± 2 dB
20 to 39.99 dB	± 15 dB	± 2 dB	± 25 dB
40 to 79.99 dB	± 2 dB	± 25 dB	± 3 dB

Note: Amplitude Accuracy is the sum of the Absolute Accuracy and, as necessary, Flatness and Attenuator Accuracy.

Phase Offset

Range: $\pm 719.9^\circ$ with respect to arbitrary reference phase.

Amplitude Modulation

Modulation depth: 0 to 100%

Modulation frequency range: 50 Hz to 50 kHz

Envelope distortion: < -30 dB to 80% modulation (1 kHz modulating freq.)

Phase Modulation

Range: 0° to $\pm 850^\circ$

Linearity: $\pm 0.5\%$ from best fit straight line

Modulation frequency range: dc to 5 kHz

Input sensitivity: ± 5 V peak for 850° phase shift (170°/volt)

Frequency Sweep

Sweep time: Linear; 0.01 s to 99.99 s. Single Log; 2 s to 99.99 s. Continuous Log; 0.1 s to 99.99 s.

Maximum sweep width: specified frequency range of selected output

Minimum sweep width: Log; 1 decade. Linear; minimum BW (Hz) = .1 (Hz/s) x Sweep Time (s)

Phase continuity: phase is continuous over full frequency range.

Sweep flatness: fast leveling ± 0.15 dB, 10 kHz to 20 MHz, .03 s

Sweep time: normal leveling; ± 0.15 dB, 50 Hz to 1 MHz, 0.5s sweep time.

HP-IB Interface Functions:

SH1, AH1, T6, L3, SR1, RL1, PP0, DC1, DT0, C0, E1.

General

Operating Environment

Temperature: 0° to 55°C

Relative humidity: $\leq 85\%$, 0° to 40°C

Altitude: $\leq 15,000$ ft, (4600 metres)

Storage temperatures: -50° to +65°C

Storage altitude: $\leq 50,000$ ft, (15,240 metres)

Power requirements: 100/120/220/240 V, +5%, -10%, 48 to 66 Hz, 60 VA, (100 VA with all options), 10 VA standby

Size: 132.6 mm H x 425.5 mm W x 497.8 mm D, (5.2" x 16.8" x 19.6")

Weight: net, 10 kg. (22 lb). Shipping, 15.5 kg. (34 lb)

Ordering Information

HP 3336C Synthesizer/Level Generator (General Purpose) \$4.800

Opt 004 High Stability Frequency Reference add \$650

Opt 005 High Accuracy Attenuator add \$650

Opt 907 Front Handle Kit add \$55

Opt 908 Rack Flange Kit add \$32.50

Opt 909 Rack Flange and Handle Kit add \$80

FREQUENCY, FUNCTION & WAVEFORM SYNTHESIZERS

50 MHz Programmable Signal Source Model 8165A

- Pulse/function capability
- Sine, triangle, square to 50 MHz
- Pulses and ramps to 20 MHz
- Trigger, gate and counted burst
- Synthesizer stability, precision amplitude
- Storage of operating parameters

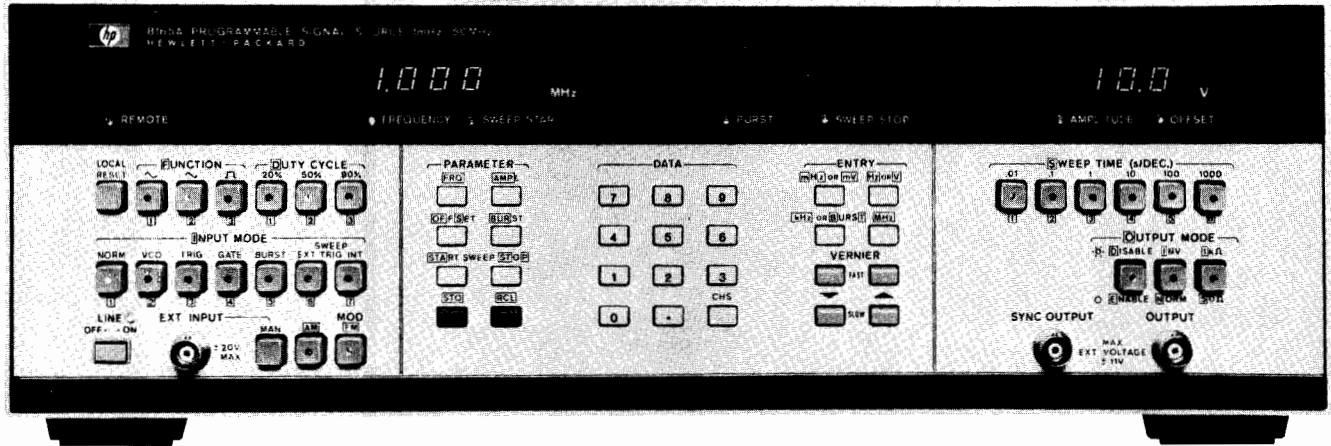

Picture shows 8165A with option 002, AM and Logarithmic Sweep.

Versatility and Simplicity for Systems and Bench

The HP 8165A Programmable Signal Source is a versatile function generator with good accuracy and many trigger features. Microprocessor control assures rapid, accurate setup whether programming locally or via HP-IB.

Operating Set Storage

Ten complete sets of operating information can be stored and recalled. In the event of power failure, battery back up retains all data plus the active settings.

Stability and Resolution

Stable frequency is ensured with an internal crystal. The four-digit frequency display provides a 1 μ Hz resolution in the 1 to 9.999 MHz range. In Normal mode, the accuracy is 0.001% with a stability of $\pm 1 \times 10^{-6}$.

Specifications

Waveforms and Frequency Range

Sine, square, triangle (50% duty cycle): 1.000 mHz to 50.00 MHz.

Pulse/ramp (20, 80% symmetry): 1.000 mHz to 19.99 MHz.

Haversine/havertriangle: please inquire for special option.

Output Characteristics

Range: amplitude and offset independently variable within ± 10 V window.

Source impedance: selectable 50 $\Omega \pm 1\%$ or 1 k $\Omega \pm 10\%$

Amplitude: 10.0 mVpp to 10.0 Vpp (50 Ω into 50 Ω)
2.00 Vpp to 20.0 Vpp (1 k Ω into 50 Ω)

Accuracy	Sine V Vrms	Square	Triangle (50%)	Ramp (20%–80%)	Pulse (20%–80%)
<1kHz	$\pm 3\%$	$\pm 2\%$	$\pm 3\%$	$\pm 3\%$	$\pm 2\%$
1kHz–4.99MHz	$\pm 3\%$	$\pm 2\%$	$\pm 3\%$	$\pm 5\%$	$\pm 2\%$
5 MHz–19.9MHz	$\pm 8\%$	$\pm 5\%$	$\pm 10\%$	$\pm 10\%$	$\pm 5\%$
20MHz–50MHz	$\pm 8\%$	$\pm 5\%$	+5% to –20%	–	–

Offset: 0 ± 10 mV to ± 5.00 V (50 Ω into 50 Ω)

0 ± 20 mV to ± 10.0 V (1 k Ω into 50 Ω)

Accuracy: $\pm 1\%$ programmed value $\pm 1\%$ signal Vpp ± 20 mV.

Sine Characteristics

Distortion: total harmonic distortion (THD) for fundamental up to 1 MHz: $\pm 1\%$.

Harmonic signals: (fundamental 1-10 MHz): ≤ -36 dB

Harmonic signals: (fundamental above 10 MHz): ≤ -30 dB.

Square/Pulse Characteristics

Transition times: (10% to 90%): ≤ 5 ns (50 Ω into 50 Ω), ≤ 7 ns (1 k Ω into 50 Ω)

Preshoot/Overshoot/ringing: $\leq \pm 5\%$ (50 Ω into 50 Ω), $\pm 10\%$ (1 k Ω into 50 Ω).

Triangle/Ramp Characteristics

Linearity: (10% to 90%): $\leq \pm 1\%$ ($\leq \pm 5\%$ above 5 MHz).

Operating Modes

Norm (continuous phase locked), **VCO** (external sweep voltage),

Trig (ext or man. one-shot), **Gate**, **Burst** (1-9999 counted cycles),

Frequency Modulation

HP-IB: control and learn capability for all modes and parameters.

Interface functions*: SH1, AH1, T6, L4, SR1, RL1, PP0, DC0, DT1, C0, E1.

General

Memory: non volatile. 10 addressable locations plus one for active operating state. Each location can store a complete set of operating parameters and modes.

Power: 100/120/220/240 Vrms; $\pm 5\%$, -10% ; 48 to 66 Hz, 200 V A max.

Operating temperature: 0° to 50° C

Weight: net 12 kg (26.5 lbs). Shipping 16 kg (35.3 lbs).

Size: 133 H x 426 W x 422 mm D (5.2" x 16.8" x 16.6").

Ordering Information

HP 8165A Programmable Signal Source** \$6790

Opt 002: AM and logarithmic sweep add \$850

Opt 003: Rear Panel Connectors N/C

Opt 907: Front Handle Kit (Part No HP 5061-0089) add \$55

Opt 908: Rack Mounting Kit (Part No HP 5061-0077) add \$32.50

Opt 909: Opt 907, 908 combined (Part No HP 5061-0083) add \$80

Opt 910: additional Operating and Service Manual add \$70

*For more on these codes refer to the HP-IB section of this catalog.

**HP-IB cables not supplied, see page 133.

☎ Fast-Ship product—see page 766

FREQUENCY, FUNCTION & WAVEFORM SYNTHESIZERS

1 mHz–50 MHz Pulse/Function Generator

Model 8116A

419



- Sine, triangle, square, haverfunctions and dc
- 1 mHz–50 MHz, 32 Vpp for all waveforms
- Variable (10 ns min) pulse width, 6 ns transitions
- Wide range of operating capability
- Self-prompting operating concept
- Error recognition and self test



Picture shows 8116A with Option 001, Burst and Logarithmic Sweep.

The fully programmable HP 8116A features pulse as well as function generator capabilities in one small unit. A broad 1 mHz–50 MHz band for all waveforms and a wide choice of operating and modulating modes assure high flexibility. These factors, plus good repeatability, make the HP 8116A a sound, long-term investment.

Unique Operating Concept Saves Engineering Time

HP's custom IC's have made it feasible to put the many HP 8116A capabilities into such a small volume. Handling is simplified by a unique, microprocessor-controlled, operating concept which ensures a clear overview of the compact front panel at all times. When the mode and waveform have been selected, illuminated labels show which parameters must be set. There's no clutter, no confusion.

Auto vernier. In normal mode, the HP 8116A's auto-vernier increments any desired parameter continuously until a stop signal is applied. This means that thresholds can be measured automatically, without a controller.

Level or amplitude programming. The HP 8116A's output can be programmed in terms of high and low levels or in terms of amplitude and offset. Consequently a direct, automatic, conversion is always feasible so that the HP 8116A can be programmed in the same terms as the device is specified.

Safe limit. Devices can be protected by the limit feature. This prevents the output from exceeding a given magnitude.

Rectangular Waveforms

For applications such as laser diodes or dc motors, square waves can be programmed for constant duty cycles from 10% to 90%. For digital test, or for simulating very low duty-cycle events, pulse width can be programmed down to 10 ns. Square wave and Pulse modes provide clean 6 ns edges that are ideal for many technologies. Pulse width modulation and pulse recovery capability are available in Pulse mode.

Sine and Triangle Functions

10% to 90% duty cycle, programmable in 1% steps, provides ramps and asymmetrical sine waves for testing VCO's, servos, amplifier linearity and industrial process control systems. Haverfunctions,

available in External Trigger, Gate and Burst modes, extend the applications to areas such as telephone line and vibration testing.

Modulation

All waveforms can be amplitude or frequency modulated. VCO operation allows frequency variation over two decades with an external voltage; consequently transducer output can be conditioned for mag tape recording, or frequency-shift keying or linear sweep can be carried out.

Option 001

10 1/2-decade log sweep. Sweep mode covers the wide 1 mHz – 50 MHz band in a single up sweep. Test setups require no more than an X-Y recorder or scope because all necessary control signals are available. The HP 8116A sweeps can be internally triggered, if desired.

Accurate, counted bursts. A preprogrammed number of cycles of any waveform can be generated in Burst mode. With sine, triangle and square functions, bursts can be triggered internally as well as externally.

Hold capability. For material stress testing, low frequency functions can be held at instantaneous levels. Hold is controlled by an external signal.

Low-Cost Automation for Bench and Systems

Powerful capability, small size and wide specified temperature range make the HP 8116A a good choice for automatic test systems. Also, the low cost means that it's now realistic to automate those routine bench jobs and leave more time for design. Comfortable software features such as easy syntax and flexible format contribute to rapid system design.

Operating Confidence

There's reliance in the HP 8116A's output because proper operation is always ensured by the instrument's error detector. This helps the user to recover from an incorrect front panel or programming operation by indicating the offending parameter. Also, the built-in test and diagnosis feature verifies correct function each time the instrument is switched on.

Specifications overleaf



FREQUENCY, FUNCTION & WAVEFORM SYNTHESIZERS

1 MHz–50 MHz Pulse/Function Generator

Model 8116A (cont.)

Specifications

Specifications apply with 50-ohm load and temperatures in the range 0°C to 55°C.

Functions

Sine, triangle, ramp, square, pulse, haversine, havertriangle, dc.

Timing

Frequency

Range: 1 mHz to 50 MHz (3-digit resolution).

Accuracy¹ (pulse mode, 50% d/c): $\pm 3\% \pm 0.3$ MHz below 100 kHz, $\pm 5\%$ above 100 kHz.

Jitter (pulse mode, 50% d/c): $< 0.1\% + 100$ ps.

Stability: $\pm 2\%$ (1 hour), $\pm 5\%$ (24 hours).

Duty cycle: (sine, triangle, square, haversine, havertriangle).

Range: 10% to 90% (20% to 80% above 1 MHz), 2-digit resolution.

Accuracy¹: ± 0.5 digits (± 3 digits above 1 MHz).

Pulse Width

Range: 10.0 ns to 999 ms (3-digit resolution).

Accuracy¹: $\pm 5\% \pm 2$ ns.

Jitter: $< 0.1\%$ ($0.2\% + 200$ ps for width ≤ 10 μ s).

Output Characteristics

(voltages double into high impedance).

Amplitude

Range: 10.0 mVpp to 16.0 Vpp (3-digit resolution).

Accuracy¹: $\pm 5\%$ (at 1 kHz for sine and triangle).

Flatness (sine): $\pm 3\%$ ($\pm 5\%$ above 1 MHz, $+5$ – -15% above 10 MHz).

Flatness (triangle): $\pm 3\%$ ($\pm 5\%$ above 1 MHz, $+5$ – -25% above 10 MHz).

Offset and dc Mode

Range: 0.00 to ± 7.95 V (0 to ± 795 V mV for amplitude < 100 mVpp).

Resolution: 3 digits.

Accuracy¹: 0.5% of setting $\pm 1\%$ of ampl ± 40 mV ($+2$ mV if ampl < 100 mVpp, ± 20 mV in dc mode).

Distortion (sine, normal mode, 50% duty cycle).

Total harmonic distortion (10 Hz–50 kHz): $< 1\%$ (-40 dB)*.

Harmonic related signals (50 kHz–1 MHz): < -34 dB,
(1 MHz–50 MHz): < -23 dB*.

*May increase by 3 dB below 10°C and above 45°C.

Non-linearity (triangle, ramp, 100 mHz–1 MHz): $< \pm 3\%$.

Pulse and Square Wave Characteristics

Transitions: < 7 ns.

Pulse perturbations: $< \pm 5\% \pm 2$ mV.

Output impedance: 50 ohm $\pm 5\%$.

Operating Modes

Normal, trigger*, gate*, external width.

Additional Modes in HP 8116A Option 001

Logarithmic Up Sweep (for all waveforms).

Range: Start and stop frequencies selectable up to full range (1 mHz–50 MHz).

Sweep time: selectable in 1-2-5 sequence from 10 ms to 500 seconds per decade.

Sweep repetition: continuous sweeps (internal sweep) or externally triggered.

Counted Burst* (for all waveforms).

Burst length: 1 to 1999 cycles.

Burst repetition: internally triggered at selectable intervals from 100 ns to 999 ms (except in Pulse mode), or externally triggered, up to 40 MHz.

*Selectable (-90°) start-phase for haversine, havertriangle.

Control Modes

Frequency modulation: $\pm 5\%$ max deviation.

Sensitivity: 1 V for 1% deviation.

Modulating frequency: dc to 20 kHz.

Amplitude Modulation

Sensitivity: ± 2.5 V for 100% mod. ($+2.5$ V to -7.5 V for DSBSC).

Modulating frequency: dc to 1 MHz.

¹Applies from 15°C to 35°C, %-error increases 0.05 per °C outside this range.

Pulse Width Modulation

Range: 10 ns to 1 s in 8 non-overlapping decade ranges.
Max. width ratio: 10:1.

Sensitivity: ± 9 V for 1:10 ratio.

Voltage-Controlled Oscillator

Range: 2 decades in range 1 MHz–50 MHz.

Sensitivity: 0.1 V to 10 V for 2 decades.

Modulating frequency: dc to 1 kHz.

Auxiliary Modes

Manual: simulates external input.

1 cycle (option 001): triggers single output cycle in Trigger, Gate and Ext Burst modes.

Auto vernier: continuous vernier which can be remotely or manually stopped.

Limit: programmable maximum output levels to protect DUT.

Complement: selectable normal/complement output.

Disable: relay disconnects output.

Auxiliary Inputs and Outputs

External Input

Threshold: ± 10 V adjustable.

Max input voltage: ± 20 V.

Sensitivity: 500 mVpp.

Min pulse width: 10 ns.

Input impedance: 10 k Ω typ.

Trigger slope: positive, negative and off.

Control Input

Max input voltage: ± 20 V.

Input impedance: 10 k Ω typ.

Trigger Output

Output levels: 0/2.4 V typ.

Output impedance: 50 ohm typ.

X-Output (Option 001) for sweep X-Y recording (rear panel).

Output levels: 0 V (= start frequency) to 10 V max.

Slope: 1.5 V per sweep decade.

Marker Output (Option 001) for sweep (rear panel).

Output levels: TTL

Leading edge: positive at selected marker frequency.

Hold Input (Option 001), rear panel.

Input levels: TTL

Leading edge: positive transition causes HP 8116A output ($f < 10$ Hz) to hold at instantaneous level. Output droop 0.01% per second.

Max input voltage: ± 20 V

HP-IB Capability

All manual key operations are programmable. Talk mode provides learn, status byte and error report capabilities.

Memory

Battery-backup RAM retains current operating state.

General

Repeatability: factor 4 better than accuracy.

Environmental

Storage temperature: -40°C to $+70^\circ\text{C}$.

Operating temperature: 0°C to 55°C .

Humidity: 95% RH, 0°C to 40°C .

Power: 100/120/220/240 V rms; $\pm 5\%$, -10% ; 48 to 440 Hz; 120 VA max.

Weight: net, 5.9 kg (13 lb). Shipping, 8.0 kg (18 lb).

Size: 89 H x 212.3 W x 422 mm D (3.5" x 8.36" x 16.6").

Ordering Information

HP 8116A Programmable Pulse/Function Generator* \$3500

Opt 001: Burst and Logarithmic Sweep add \$400

Opt 910: Extra Operating & Service Manual add \$40

HP 5061-9701: Bail Handle Kit \$38

HP 5061-9672: Rack Mount Kit (single HP 8116A) \$49

HP 5061-9674: Rack Mount Kit (two instruments) \$30

HP 5061-9694: Lock Link Kit (for use with \$25

HP 5061-0074)

*HP-IB cables not supplied, see page 133.

☎ Fast-Ship product — see page 766

Prices

\$3500

add \$400

add \$40

\$38

\$49

\$30

\$25

FREQUENCY, FUNCTION & WAVEFORM SYNTHESIZERS

1 Hz–20 MHz Pulse/Function Generator

Model 8111A

421



- Sine, triangle, square, haversine functions
- 20 MHz, 32 Vpp for all waveforms
- Variable duty cycle or pulse width

- Trigger, gate, VCO and optional burst
- Digital display for all parameters
- Error recognition

Picture shows 8111A with Option 001, Counted Burst.



The HP 8111A combines pulse generator and function generator capabilities in a single, compact unit. Triggered operation for all waveforms, and the ability to define rectangular waveforms in terms of pulse width or duty cycle, are examples of the HP 8111A's versatility.

Saves Space and Equipment

Small size and manifold capability make the HP 8111A an ideal source for service and bench. Digital display, error detector and good repeatability assure high operating confidence. This reduces the need for output monitoring and consequently saves equipment.

Flexible

Operating modes include VCO which permits frequency-shift keying and dc-to-frequency conversion as well as sweep and FM applications. Option 001's Burst mode simplifies tone burst generation and digital preconditioning by generating a precise number of waveform cycles. An "extra cycle" feature activated after a burst allows critical events to be examined.

Pulse mode's variable width down to 25 ns and clean 10 ns transitions provide useful digital test capability. High analog flexibility is assured because all waveforms can be generated in trigger, gate and burst modes. Adjustable duty cycle up to 999 kHz means that CRT sawtooth waveforms and rectangular signals for dc motor control can be simulated.

Specifications (50-ohm load resistance)

Waveforms

sine, triangle, ramp, square, pulse, haversine functions.

Timing

Frequency

Range: 1.00 Hz to 20.0 MHz (3-digit resolution).

Accuracy (50% duty cycle): 5% ($\pm 10\%$ below 10 Hz).

Jitter: $< 0.1\% + 50$ ps.

Stability: $\pm 0.2\%$ (1 hour), $\pm 0.5\%$ (24 hours).

Duty Cycle (sine, triangle, square, haversine functions):

	Calibrated	Variable (below 1 MHz)
Range:	50% nominal	10% to 90%
Resolution:	2 digits	2 digits
Accuracy:	± 1 digit	± 6 digits
		(± 3 in range 20 to 80%).

Pulse Width

Range: 25.0 ns to 100 ms (3-digit resolution).

Accuracy: $\pm 5\% \pm 2$ ns.

Output Characteristics

(voltages double into high impedance)

Amplitude

Range: 1.60 mVpp to 16.00 Vpp (3½ digit resolution).

Accuracy: $\pm 5\%$ (at 1 kHz for sine and triangle).

Flatness (sine, triangle): $\pm 3\%$ ($+10\%$, -15% above 1 MHz).

Offset

Range: 0.00 mV to ± 8.00 V (3-digit resolution).

Accuracy: $\pm 0.5\%$ setting $\pm 1\%$ ampl ± 20 mV
(ampl ≥ 160 mVpp),
 $\pm 0.5\%$ setting $\pm 1\%$ ampl ± 1 mV
(ampl < 160 mVpp).

Distortion: THD (1 Hz–1 MHz) $< 3\%$ (-30 dB); harmonics (1 MHz–20 MHz) < -26 dB. Distortion may increase by 3 dB below 10°C and above 45°C .

Linearity (triangle): $< \pm 3\%$ ($< \pm 1\%$ below 1 MHz)

Pulse and Squarewave Performance

Transitions: < 10 ns.

Perturbations: $< \pm 5\%$ ($< \pm 10\%$ below 0.16 Vpp).

Output impedance: ± 50 ohm $\pm 5\%$.

Modes

normal, trigger*, gate*, VCO and (Option 001) burst*.

*Adjustable start-phase for haversine, haversine

VCO range: 2 decades, ext. signal 0.1 V to 10 V (dc to 1 kHz).

Burst length: 1 to 1999 periods for all waveforms.

General

Repeatability: factor 2.5 better than accuracy.

Environmental

Storage temperature: -40°C to $+75^\circ\text{C}$.

Operating temperature: 0°C to 55°C .

Humidity: 95% RH, 0°C to 40°C .

Power: 100/120/220/240 V rms; $+5\% - 10\%$; 48 to 440 Hz; 70 VA max.

Weight: net, 4.6 kg (10 lb). Shipping, 6.6 kg (15 lb).

Size: 89 H x 212.3 W x 345 mm D (3.5" x 8.36" x 13.6").

Ordering Information

HP 8111A Pulse/Function Generator

Opt 001: Burst

Opt 910: Extra Operating and Service Manual

HP 5061-9701: Bail Handle Kit

HP 5061-9672 Rack Mount Kit (single HP 8111A)

HP 5061-9674 Rack Mount Kit (two instruments)

HP 5061-9694 Lock Link Kit (for use with HP 5061-0074)

☎ Fast-Ship product—see page 766

Price

\$1965 ☎

add \$370

add \$38

\$38 ☎

\$49 ☎

\$30 ☎

\$25 ☎



FREQUENCY, FUNCTION & WAVEFORM SYNTHESIZERS

Function Generator

Model 3312A

- Two function generators in one instrument
- AM-FM, sweep, trigger, gate and burst

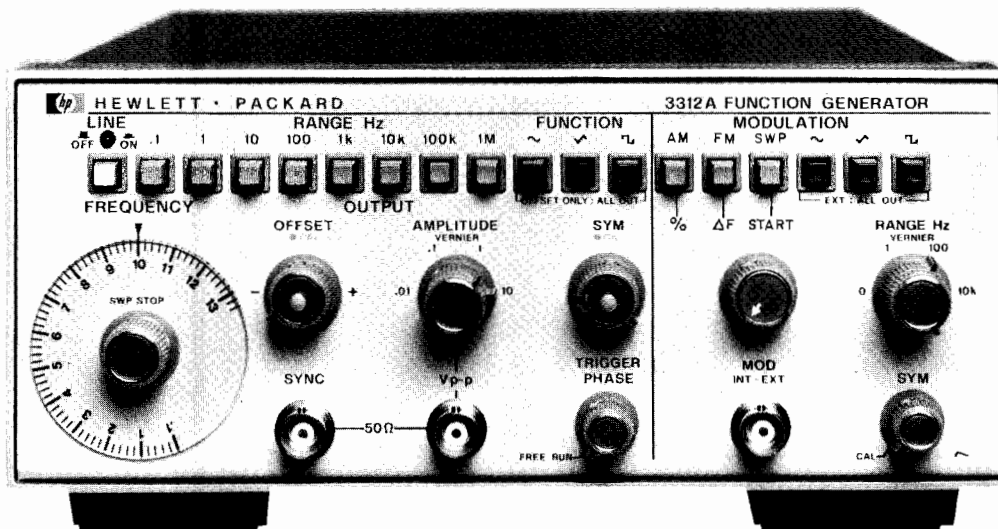

HP 3312A

Description

Hewlett-Packard's 3312 A Function Generator combines two separate, independent function generators with a modulator section in one compact instrument.

The main generator can—via pushbutton control—be triggered by the modulation generator to provide sweep functions, AM, FM or tone burst.

Ten V p-p into 50 Ω provides adequate power for most applications. The output attenuator has a range of more than 10,000:1 so clean low-level signals from 10 V to 1 mV p-p into 50 Ω can be obtained. The main generator includes dc offset up to 10 volts p-p into 50 Ω.

The HP 3312A is an effective low cost solution for generating a multitude of functions.

Specifications

Output waveforms: sine, square, triangle, ± ramp, pulse, AM, FM, sweep, triggered and gated.

Frequency Characteristics

Range: 0.1 Hz to 13 MHz in 8 decades ranges.

Dial accuracy: ±5% of full scale. Unspecified in Uncal Mode.

Square wave rise or fall time (10% to 90%): <20 ns.

Aberrations: <10%.

Triangle linearity error: <1% at 100 Hz.

Variable symmetry: 80:20:80 to 1 MHz.

Sine wave distortion: <0.5% (−46 dB) THD from 10 Hz to 50 kHz. (10 kHz range maximum). >30 dB below fundamental from 50 kHz to 13 MHz, at full-rated output.

Output Characteristics

Impedance: 50 Ω ± 10%.

Level: 20 V p-p into open circuit, >10 V p-p into 50 Ω at 1 kHz.

Level flatness (sine wave): <±3% from 10 Hz to 100 kHz at full rated output (1 kHz reference). <±10% from 100 kHz to 10 MHz.

Attenuator: 1:1, 10:1, 100:1, 1000:1 and >10:1 continuous control.

Attenuator error: <5%.

Sync output: impedance: 50 Ω ± 10%, >1 V p-p square wave into open circuit. Duty cycle varies with symmetry control.

DC offset: variable up to ± 10 volts. Instantaneous ac voltage + Vdc offset cannot exceed ± 10 V (open circuit) or ± 5 V (terminated 50 ohm).

Modulation Characteristics

Types: internal AM, FM, sweep, trigger, gate or burst; external AM, FM, sweep, trigger, gate or burst.

Waveforms: sine, square, triangle, ramp or variable symmetry pulse.

Frequency range: 0.01 Hz to 10 kHz.

Output level: >1.0 V p-p into 10 kΩ.

Amplitude Modulation

Depth: 0 to 100%.

Modulation frequency: 0.01 Hz to 10 kHz (internal), DC to >1 MHz (external).

Carrier 3 dB bandwidth: <100 Hz to >5 MHz.

Carrier envelope distortion: <2% at 70% sine wave modulation with $f_c = 1$ MHz, $f_m = 1$ kHz.

External sensitivity: <10 V p-p for 100% modulation.

Frequency Modulation

Deviation: 0 to ±5% (internal).

Modulation frequency: internal: 0.01 Hz to 10 kHz; external: DC to >50 kHz.

Distortion: <−35 dB at $f_c = 10$ MHz, $f_m = 1$ kHz, 400 KHz peak deviation.

Sweep Characteristics

Sweep width: >100:1 on any range.

Sweep rate: 0.01 Hz to 10 kHz, 90:10 ramp, and 0 Hz Range (provides manual setting of "Sweep Start" without modulation generator oscillating).

Sweep mode: repetitive linear sweep between start and stop frequency settings. Retrace time can be increased with symmetry -control.

Ramp output: 0 to >−4 p-p into 5 kΩ.

Gate Characteristics

Start/stop phase range: +90° to −80°.

Frequency range: 0.1 Hz to 1 MHz (useful to 10 MHz).

Gating signal frequency range (external): dc to 1 MHz, TTL compatible.

External Frequency Control

Range: 1000:1 on any range.

Input requirement: with dial set at 10, 0 to −2 V ±20% will linearly decrease frequency >1000:1. An ac voltage will FM the frequency about a dial setting within the limits (0.1 < f < 10) x range setting.

Linearity: 0.5% of Fmax for Fmax ≤ 1 MHz 5.0% of Fmax for Fmax > 1 MHz. Deviation is from a best fit straight line. VCO frequency span ≤ 100:1.

Input impedance: 2.8 kΩ ± 5%.

General

Operating temperature: 0°C to +55°C; specifications apply from 0°C to 40°C.

Storage temperature: −40°C to +75°C.

Power: 100 V, 120 V, 220 V, 240 V +5%, −10%, switchable; 48 Hz to 440 Hz; ≤25 VA.

Size: 102 mm H x 213 mm W x 377 mm D (4" x 8.4" x 14.8").

Weight: net, 3.8 kg (8.4 lb). Shipping, 5.9 kg (13 lb).

HP 3312A Function Generator

☎ Fast-Ship product — see page 766.

\$1,450

FREQUENCY, FUNCTION & WAVEFORM SYNTHESIZERS

1 MHz to 20 MHz Function Generator with Arbitrary Waveforms

Model 3314A

423



- Lin/Log sweeps
- AM/FM/VCO
- Phase lock xN and $\div N$

- Gate and counted burst
- 1/2 cycle mode
- Arbitrary waveform generator



HP 3314A



HP 3314A Multi-Waveform Generator

The HP 3314A is a Function/Waveform Generator with the precision and versatility to produce numerous waveforms. Its feature set includes accurate sine, square, and triangle waves, with ramps and pulses available using variable symmetry. Additional features include counted bursts, gate, lin/log sweeps, AM, FM/VCO, dc offset, and phase lock. For increased versatility, the Arbitrary waveform mode allows a countless number of user defined waveforms. Since complete programmability is provided, all of these capabilities are available for ATE systems, as well as bench applications.

Precise Functions

The HP 3314A provides sine, square, and triangle waveforms from 0.001 Hz to 19.99 MHz with an amplitude range of 0.01 mV to 10 Vp-p into 50 ohms, with optional 30 Vp-p into > 500 ohms.

Continuous waveforms are provided with high accuracy and low distortion, with frequency accuracy on the upper ranges of 0.01% and sine distortion < -55 dBc to 50 kHz.

Pulses and ramps are provided to 2 MHz using the variable symmetry control over the full 5% to 95% symmetry range. This provides narrow pulses with 9 ns rise/fall times for digital circuit testing, and positive or negative ramps for amplifier testing and process control.

Independent dc offset to ± 5 V (into 50 ohms) can be added to any ac signal. A post-attenuator summing technique is used providing large ac signals with small offsets and vice versa.

Burst and Gate

The HP 3314A's N Cycle burst mode generates an integer number of complete cycles at each trigger. Bursts of 1 to 1999 cycles are possible for use in applications ranging from sonar testing to digital circuits. Variable symmetry and start/stop phase can be used to produce single ramps and haversines.

Like burst mode, gate mode can be triggered internally or externally. In gate, the HP 3314A output consists of complete cycles, pulses or Arb's which start when the trigger is true, and stop after the trigger goes false. In gate and burst modes, the full frequency range applies for sine, square, triangle, pulse, and ramp waveforms.

New 1/2 Cycle and "Integer" Phase Lock Modes

The new 1/2 Cycle burst mode allows simulation of specialized signals found in electronics. At each trigger, alternating 1/2 cycles of sines or triangles are produced. With the addition of variable start/stop phase and symmetry, pulses with variable rise/fall time and overshoot can be produced. Repetition rate, 1/2 cycle frequency, symmetry, and phase can be set independently to produce a variety of waveforms.

The $\text{Fin} \times N$ $\text{Fin} \div N$ modes provide powerful phase locking capability. With "integer" phase lock, fractions or multiples of the reference signal can be provided, and ± 200 deg of phase offset is available. Since the HP 3314A phase locks to the plus or minus edge of the trigger signal, it can lock to a variety of signals such as sines, squares, pulses, ramps, and others—with complete control of output function, symmetry, N, phase, amplitude and offset.

Modulation and Sweep

Complete AM, FM/VCO modulation give the HP 3314A versatile signal modifying capabilities. With 100 kHz bandwidths, AM and FM/VCO can be used separately or simultaneously to produce a multitude of waveforms.

Multi-frequency measurements can be made with the HP 3314A's sweep capabilities. Linear, logarithmic, and manual sweep make measurements of filters, amplifiers, and other networks convenient and accurate. X drive, marker, and trigger output signals are also provided.

Arbitrary Waveforms

For specialized low frequency applications, the HP 3314A's Arbitrary (ARB) waveform mode lets you create custom waveforms as a series of voltage ramps or vectors. Values are easy to enter from the front panel using the modify knob as a "pencil" and an oscilloscope as a "pad". For remote programming, use a desktop or mainframe computer to calculate the values, then program them using the HP-IB. Arb waveforms are automatically stored in non-volatile memory for quick recall.

Two Sources in One

A square wave trigger source is included for generation of complex waveforms with a single HP 3314A. The 0.5 mHz to 500 kHz internal trigger is useful in gated, burst, and phase locked waveforms. This signal is provided as an output for synchronizing the HP 3314A to other devices.

Source for your System

Because all front panel controls are programmable, the HP 3314A's precision and versatility can be utilized in automated test systems.

System efficiency can be improved with standard features such as Service Request (SRQ) interrupt capability and buffered transfer mode.

In production test environments, the HP 3314A's Query commands can be used when an operator and computer are sharing control of the instrumentation. Parameters can be read from the HP 3314A into the computer where its computational capabilities can be utilized.



FREQUENCY, FUNCTION & WAVEFORM SYNTHESIZERS

1 MHz to 20 MHz Function Generator with Arbitrary Waveforms

Model 3314A (cont.)

Arbs Made Easy

With complete control of each vector, the modify knob is used as a "pencil" to draw the waveform on an oscilloscope.

1. After ~20 unit vectors have been inserted, use modify to set the marker, VMKR, to #1. Then set the height of #1 to 400.

2. Press V LEN and use modify to set the length to 3.

3. Press V HGT twice, and set the height of #2 to -190.

4. Continue to use V HGT and V LEN to create the desired waveform, and INS (insert) or DEL (delete) vectors as needed. Amplitude and frequency can now be set without affecting the vector values. Waveform parameters are automatically stored in non-volatile memory while they are being created.

5. Later, if a slightly different waveform is needed, just use the marker to select an individual vector, and modify its height and length without affecting the height and length of other vectors!

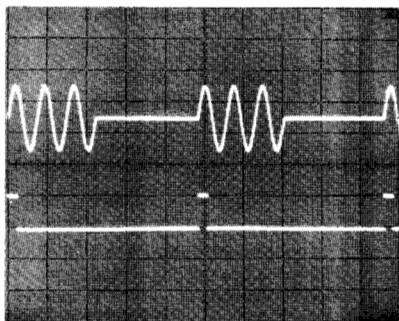
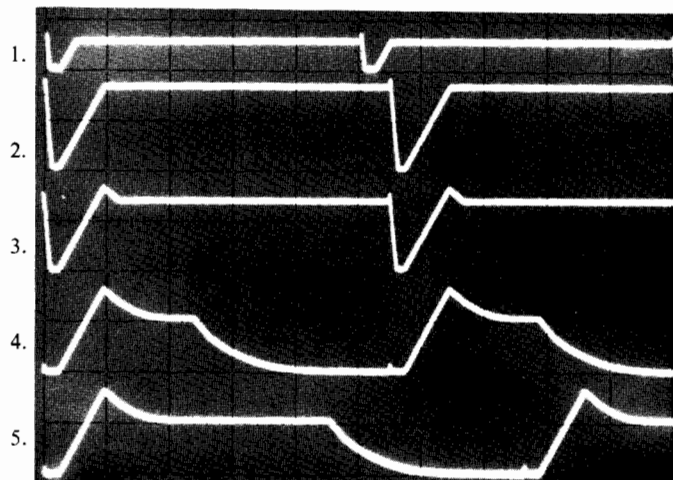

Counted burst with ext. trigger

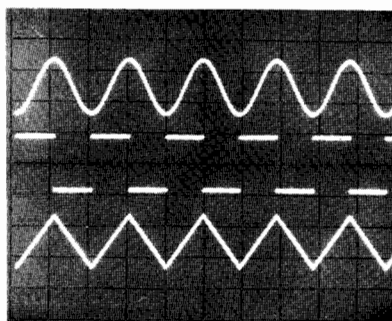

Sine, square, and triangle to 20 MHz

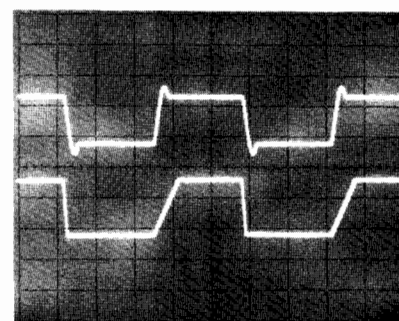

1/2 cycle mode simulating overshoot and variable rise/fall pulses

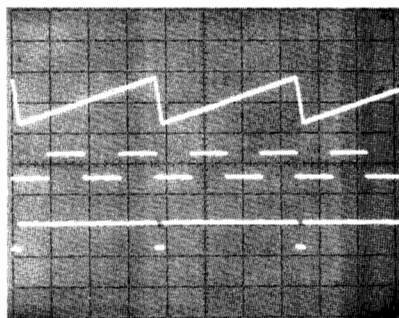

Ramp output phase locked to internal trigger. Shown with sync output.

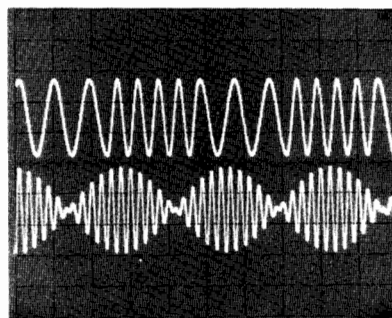

FM and AM (suppressed carrier)

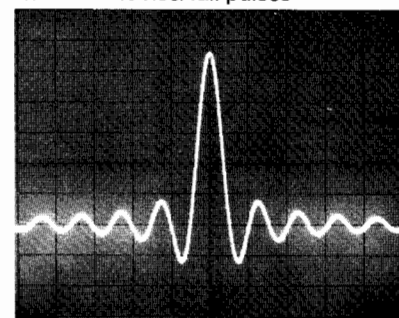

$\frac{\text{sine } x}{x}$ using ARB's

Specifications

Frequency

Frequency range: 0.001 Hz to 19.99 MHz—sine, square and triangle waveforms, 0.001 Hz through 2 MHz range when symmetry \neq 50%

Resolution: 3½ digits

Frequency Accuracy

HP-IB #	Range	Minimum Frequency		Maximum Frequency	Accuracy
		Range Hold	Autorange		
1	2 Hz	.001 Hz	.001 Hz	1.999 Hz	$\pm(0.4\%$ setting + 0.2% range)
2	20 Hz	0.01 Hz	1.50 Hz	19.99 Hz	
3	200 Hz	00.1 Hz	15.0 Hz	199.9 Hz	$\pm(0.2\%$ setting + 0.1% range)
4	2 kHz	001. kHz	150. kHz	1999. Hz	
5	20 kHz	0.01 kHz	1.50 kHz	19.99 kHz	
6	200 kHz	00.1 kHz	15.0 kHz	199.9 kHz	

Synthesized					
7	2 MHz	001. kHz	150. kHz	1999. kHz	$\pm(0.01\%$ setting +50 ppm/year)
8	20 MHz	0.01 MHz	1.50 MHz	19.99 MHz	

Accuracy applies in the Free Run mode, with VCO Off, and Symmetry = 50% (Fixed)

Amplitude

Amplitude range: 0.01 mVp-p to 10 Vp-p into 50 Ω

Resolution: 3½ digits

HP-IB #	Range	Minimum (Range Hold)	Minimum (Autorange)	Maximum	Step Attenuator
1	10 mV	0.01 mV	0.01 mV	10.00 mV	60 dB
2	100 mV	0.1 mV	10.00 mV	100.0 mV	40 dB
3	1 V	.001 mV	100.0 mV	1.000 V	20 dB
4	10 V	0.01 mV	1.000 V	10.00 V	0 dB

Absolute Amplitude Accuracy

$\pm(1\%$ of display + 0.035 Vp-p), sine and square wave
 $\pm(1\%$ of display + 0.06 Vp-p), triangle

Amplitudes: 1.00 Vp-p to 10.00 Vp-p (Range 4)

Frequency: 10 kHz, Autorange ON

Flatness-sine wave: relative to 10 kHz, 1.00 V to 10.0 V (Range 4)

20 Hz	50 kHz	1 MHz	19.99 MHz
.07 dB	.33 dB	1.5 dB	



Frequency Sweep

	Range (decades)	Start Freq	Stop Freq	Sweep Time
linear	0 to 2	≥.001 Hz	≤19.99 MHz	7.2 ms to 1999 s/sweep
log	1 to 7 (integer only)	≥0.2 Hz	≤19.99 MHz	40 ms to 1999 s/decade

Manual Sweep

Modify knob tunes between start and stop frequencies. X drive follows sweep.

X Drive Start/Stop Voltage

-5 V to +5 V into 1 kΩ load

Z Axis Output

Blanking Pulse, > +5 V

Baseline, 0V ± 1 V

Marker Pulse, < -5 V into 1 kΩ load

Modulation Inputs

	Bandwidth	Sensitivity	Range	Z
AM	dc to 100 kHz	2 Vp-p for 100% -1 Vdc for suppressed carrier	>100%	10 kΩ
FM	100 Hz to 100 kHz	±1 Vp for ±1% of range deviation	1% of Freq. range	10 kΩ
VCO	dc to 100 kHz	10%/volt	+1 to -10V	10 kΩ

Waveform Characteristics

Sine Harmonic Distortion

Individual harmonics will be below these levels, relative to the fundamental. Offset = 0V. Function Invert = OFF. Range Hold = OFF.

20 Hz	50 kHz	1490 kHz	19.99 MHz
	-55 dB*	-40 dB	-25 dB

*add 4 dB for ambient temperature 0 to 5°C and 45 to 55°C, 20 Hz to 50 kHz

Square Wave Rise/Fall Time

< 9 ns, 10% to 90% at 10 Vp-p output

N Integer

N = 1 to 1999, Preset to 1

For Phase-lock $Fin \div N$, $Fin \times N$

or N CYCLE (counted burst)

Function Invert

Inverts ac portion of signal outputs

Sine, square, triangle, ramp, pulse, and ARBs

Does not affect Sync and Trigger outputs or dc offset setting

Phase

Phase Offset—Phase Lock Modes

Resolution: 0.1°

Range: ±199.9°

Accuracy: ±2° (50 Hz to 15 kHz)

Phase Offset is Referenced to

signal output for $Fin \div N$

signal input for $Fin \times N$

Start/Stop Phase—Burst Modes

Resolution: 0.1°

Range: ±90.0° for frequencies to 19.99 MHz

Accuracy: ±3° (applies from .001 Hz to 1 kHz)

Trigger

Internal Trigger

Range: .002 ms (500 kHz) to 1999 s (0.5 mHz) square wave.

Period Accuracy:

± (0.01% + 50 ppm/year) of displayed interval (excluding sweep intervals)

Trigger output: low <0.5 V, high > 2.5 V; output resistance 1 kΩ

External Trigger

For Gate, N Cycle, ½ Cycle, $Fin \times N$, $Fin \div N$, and external sweep triggers

Frequency range: 50 Hz to 20 MHz

Trigger slope: selectable, positive or negative

Trigger level: Selectable to 0 V or +1 V

Trigger level hysteresis: ±0.15 V

Input resistance = 1 kΩ

Symmetry

Symmetry range: 5% to 95% of period

Frequency range: 2 Hz to 2 MHz ranges

Arbitrary Waveforms

Output consists of a series of voltage ramps called vectors. Arbitrary waveforms can be composed of 2 to 150 vectors. A maximum of 160 vectors can be stored in six available storage registers with a minimum of 2 vectors per waveform (#1 and return-to-start vectors).

Waveform Parameters

Key	Range	Description
Δt	0.2 ms to 19.99 ms	sets the time value for each unit of V LEN (length)
V HGT	0 to ±1999	sets the relative height of an individual vector
V LEN	1 to 127	sets the length in time of an individual vector in integral multiples of Δt
V MKR	1 to 150	marker is used to select an individual vector
INS		insert is used to add a vector before the marker location
DEL		deletes the vector at marker location
FREQ	.002 Hz to 2.5 kHz	$\text{Freq} = \frac{1}{\Delta t(VLEN_1 + VLEN_2 + \dots VLEN_n)}$
AMPTD	.01 mV to 10 Vp-p	sets amplitude window for ARB waveform
OFFSET	0 to ± 5 Vdc	offsets the ARB waveform independent of AMPTD setting
PHASE	+90° to -90°	sets wave start/stop voltage within the window defined by AMPTD

Marker output: located on Z axis rear panel connector

Sync output: low during the return-to-start vector

Gate mode: allows external gating of ARB output-complete ARB waveforms only

Option 001 - Voltage Multiplier

Simultaneous ×3 amplitude output on rear panel (into >500 Ω).

30 Vp-p max, dc to 1 MHz.

General

Specifications Apply When

Main signal output terminated into 50 ± 0.1 Ω

Warm-up > 30 minutes

Within ±5°C and 24 hours of last internal calibration

Temperature: 0 to 55°C

Relative humidity: <95% at 40°C

Altitude: <15,000 ft

Storage temperature: -40 to +75°C

Power

100/120/220/240 V + 5% -10%, 48 to 66 Hz

90 VA maximum

Weight: net, 7.3 kg (16 lb). Shipping, 10.5 kg (23 lb).

Dimensions: 132.6 mm (5.22 in.) H x 212.3 mm (8.36 in.) W x 419.0 mm (16.50 in.) D

HP-IB

IEEE Standard 488-1978 abbreviated definition

SH1 AH1 T6 TE0 L3 LE0 SR1 RL1 PP0 DC1 DT1 C0 E2

Accessories Included

HP 11048C 50 Ω feed-through termination

50 ±0.1 Ω

Accessories

Transit case for one HP 3314A

HP P/N9211-2677

Ordering Information

HP 3314A Function Generator

Option 001: simultaneous X3 output

Price

\$4,200

add \$250



OSCILLOSCOPES & WAVEFORM ANALYZERS

HP Digitizing Oscilloscopes

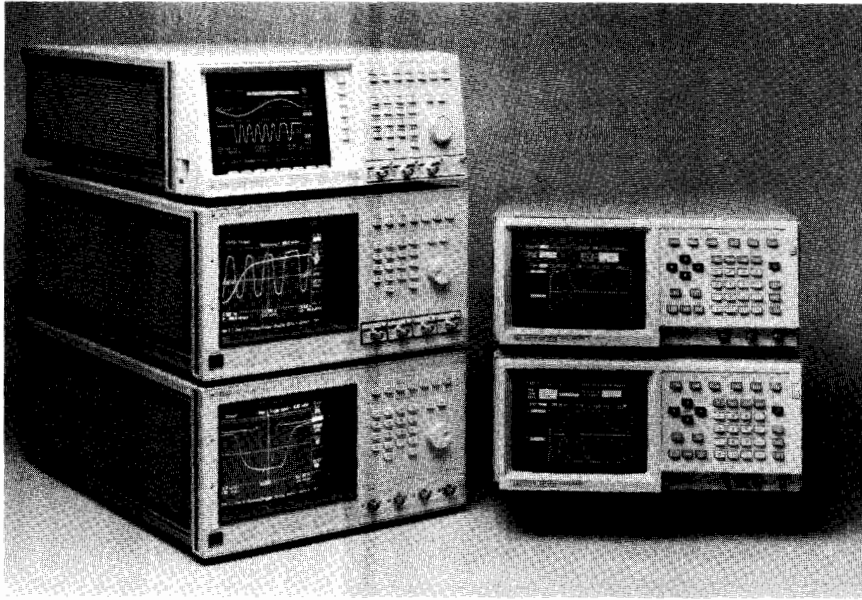

The HP 54100 and HP 54200 Series Digitizing Oscilloscopes . . . combining high bandwidth with high digitizing rates makes these general-purpose oscilloscopes useful for both analog and digital measurements.

Choose the Right Scope for Your Application

Selecting a digitizing oscilloscope is similar to selecting a conventional one; it involves asking whether the instrument can capture the waveform of interest, and, after storage, whether the data can be recalled and analyzed in the desired way.

Selection Criteria

Digitizing rate: for single-shot transient capture, digitizing rate is the key criteria for determining whether the oscilloscope can capture a one-time event. It is suggested that your scope have a digitizing rate of at least

two and a half to four times the bandwidth of the waveform you wish to capture for single-shot measurements. For repetitive waveforms, some scopes use repetitive sampling, for which digitizing rate is a less important criterion than bandwidth and vertical resolution.

Bandwidth: bandwidth is another fundamental selection criterion. It affects the accuracy of amplitude and timing measurements.

The bandwidth of an oscilloscope should exceed that of the signal; how much it exceeds it depends on the measurement accuracy needed. In general, the instrument's bandwidth should be three times the highest frequency component of the signal.

For pulse applications, the rise time is related to the maximum frequency content by:
frequency = $0.35/\text{rise time}$

This guideline suggests that you should choose an oscilloscope with a rise time less than one-third the rise time of your signals.

Resolution: voltage resolution and timing resolution are also important criteria when choosing an oscilloscope. Your particular application helps determine how much resolution you need. For single-shot acquisition, there is an inherent trade-off between timing resolution and vertical resolution. Obtaining higher vertical resolution means sacrificing digitizing rate.

The timing resolution of the scope is more important to the digital designer who measures propagation delay and setup and hold times.

If, however, the signal being measured is a complex, modulated-analog signal where frequency-domain analysis is desired in addition to time-domain analysis, then increased voltage resolution results in greater signal-to-noise measurement capability. A guideline is 6 dB signal-to-noise measurement capability per bit of resolution (ten bits gives you 60 dB). Bits of resolution are related to percentage resolution by:

$$\% = 100/2^n$$

where n is the number of bits.

Memory: the fourth selection criterion is the memory length of the oscilloscope. Memory length simply describes how long an event (i.e., how many samples can be captured, although there are a variety of techniques to capture long waveforms or non-continuous events using burst timebase or adaptive sample rate.

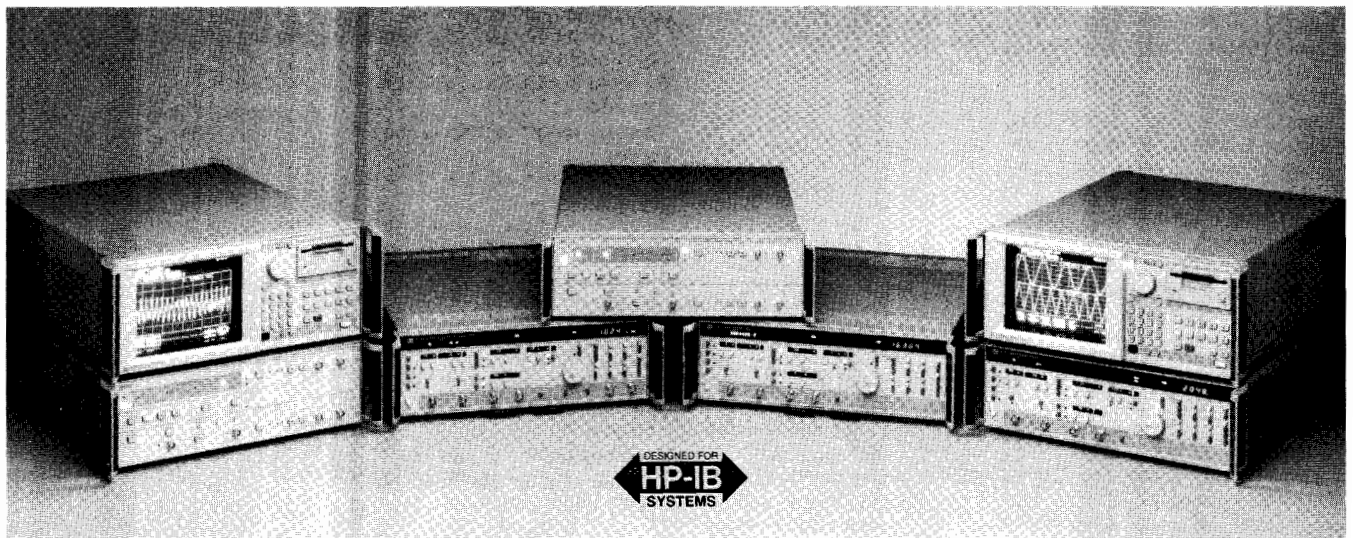

The HP 5180/83 Series Precision Digitizing Oscilloscopes . . . exceptional resolution and dynamic range plus built-in analysis features allow complete characterization of complex modulated signals.



Compare the Features . . .

Whether you need pinpoint vertical resolution or lightning-fast signal capture, Hewlett-Packard's digitizing oscilloscopes provide a powerful set of features and capabilities in an easy-to-use interface.

Here's a look at how the various models compare in terms of features, capabilities, and price.

HP Model #	54200A/D	54201A/D	54100A/D & 54110D	54111D	5180T/U	5183T/U
Bandwidth -Repetitive -Single-shot	50 MHz 50 MHz	300 MHz 50 MHz	1 GHz 10 MHz	500 MHz 250 MHz	10 MHz 10 MHz	1 MHz 1 MHz
Channels	2	2	2	2	2/4	2/4
Digitizing Rate	200 Msa/s	200 Msa/s	40 Msa/s	1 Gsa/s	20 Msa/s	4 Msa/s
Memory/Channel	1 k sa	1 k sa	1 k sa	8 k sa	8 k sa	64 k sa 256 k sa Option
Vertical Resolution	6 bits, 7 bits with avg.	6 bits, 7 bits with avg.	7 bits, 10 bits with avg.	8 bits to 25 MHz 7 bits to 100 MHz 6 bits to 500 MHz	10 bits	12 bits
Input Voltage Ranges	Cont. Variable 40 mV — 40 V full scale	Cont. Variable 40 mV — 16 V full scale	7 Ranges 80 mV — 8 V full scale	Cont. Variable 8 mV — 40 V full scale	7 Ranges 100 mV — 10 V full scale	9 Ranges 100 mV — 50V full scale
Input Coupling	1 M Ω /ac,dc	ac,dc, 50 Ω , 1 M Ω Internal	50 Ω , 10 k Ω 1 M Ω pods	ac, dc, 50 Ω , 1 M Ω Internal	ac, dc 1M Ω 50 Ω aux. ch.	ac, dc 1 M Ω
Effective Bits	—	—	—	—	7.8 Eff. Bits 60 dB	10.0 Eff Bits 72 dB
Pulse Parameter Measurements	yes	yes	yes	yes	yes	yes
Waveform Math	—	A + B, A - B	A + B, A - B, A vs B, Invert	A + B, A - B, Invert	A + B, A - B, AxB Integration, Differentiation	A + B, A - B, AxB Integration, Differentiation
Other Analysis Functions	Accumulate, Envelope, Averaging	Accumulate, Envelope, Averaging	Infinite Persistence, Averaging, Magnify	Infinite Persistence, Averaging	Event Crossings, Min/Max Hold, FFT	Event Crossings, Min/Max Hold, Inverse ASR, FTT
Waveform Storage	4 Waveform	4 Waveform	2 Pixel, 4 Waveform	2 Pixel, 4 Repet. Wfm, 4 SS Wfm.	250 - 1k Wfm to Optional Built-In Floppy Disc	250 - 1k Wfm to Optional Built-In Floppy Disc
Trigger Enhancements	27-bit State Trigger, Missing/Extra Bit, Digital Delay	27-bit State Trigger, Missing/Extra Bit, Digital Delay	Edge, Patterns, State, Digital Delay By Event and Time, Time Qualified Pattern	Edge, Pattern, State, Digital Delay By Event and Time, Time Qualified Pattern	Digital Trigger Variable sensitivity, Bi-trigger	Digital Trigger Variable sensitivity, Bi-trigger, Dropout Trigger, High Freq Trigger, Delay Trigger
Instant Hardcopy & Disc Support	HP Plotters HP Printers	HP Plotters HP Printers	HP Plotters HP Printers	HP Plotters HP Printers	HP 9122 Discs HP Plotters	HP 9122 Discs HP Plotters
Other	—	—	Color Display	Color Display	Optional Built in Floppy	Optional Built in Floppy
Price	\$5900/\$9800	\$7900/9800	\$17,600/19,300 \$21,100	\$23,900	\$29,100/\$47,700	\$19,900/\$29,900
Page Reference	428	428	434	436	442	438

* D Models Only



OSCILLOSCOPES & WAVEFORM ANALYZERS

200 Megasample/Second Digitizing Oscilloscopes

Models 54200A/D, 54201A/D

- Dual 200 megasample/second digitizers, allowing 50 MHz single-shot capture
- Pre-trigger viewing
- Automatic waveform measurements
- Up to 27 channels of state triggering
- Infinite variable persistence
- Instant hardcopy output
- 300 MHz repetitive bandwidth (HP 54201A/D only)

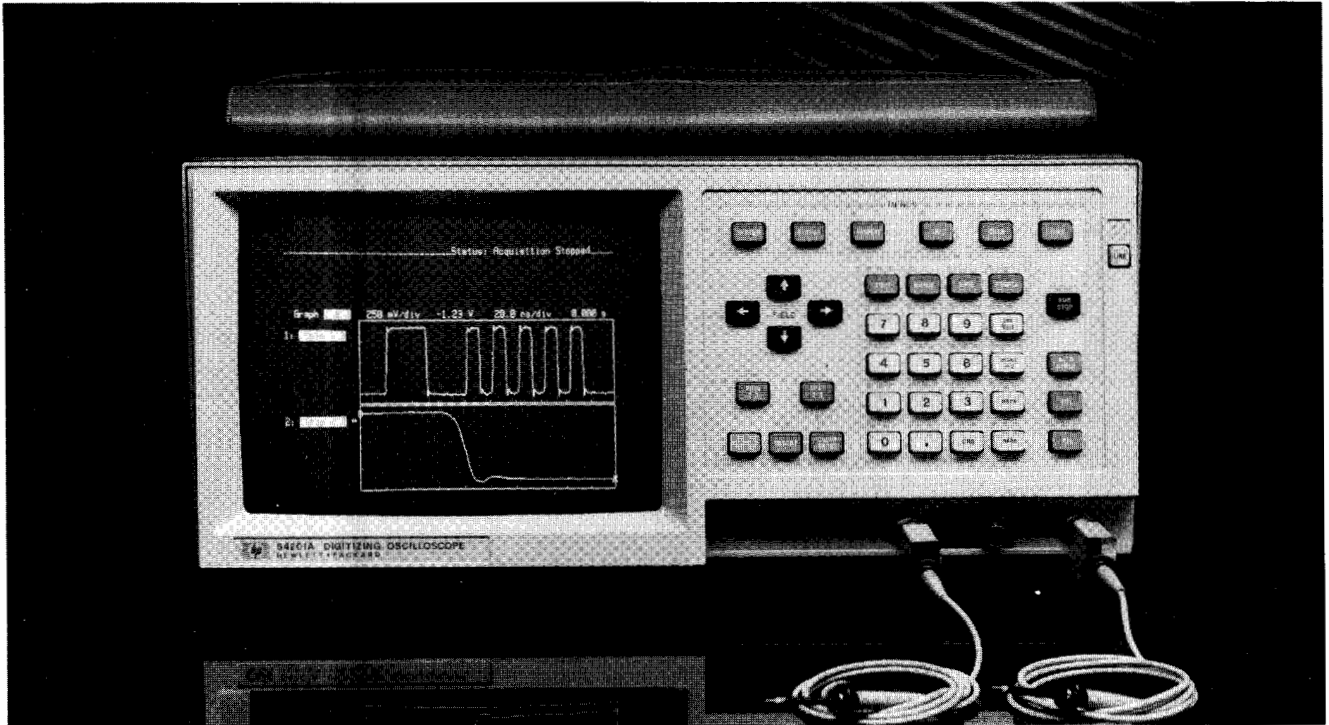

HP 54200A/D

- Dual 200 megasample/second digitizers
 - 50 MHz bandwidth
 - Pre-trigger display
 - Auto-scaling of input signal
 - Automatic measurements of waveform parameters
 - Infinite persistence display, plus envelope and average display modes
- The HP 54200D model adds:
- Up to 27 channels of state triggering
 - Missing bit triggering mode
 - Extra bit triggering mode

HP 54201A/D

- 300 MHz repetitive bandwidth
 - Dual 200 megasample/second digitizers
 - 50 MHz single-shot bandwidth
 - Pre-trigger display
 - Auto-scaling of input signal
 - Automatic measurements of waveform parameters
 - Infinite persistence display, plus envelope and average display modes
- The HP 54201D model adds:
- Up to 27 channels of state triggering
 - Missing bit triggering mode
 - Extra bit triggering mode

Simplify Waveform Capture and Analysis

Easy Instrument Setup

- Pressing the Auto-Scale button automatically provides a scaled display of a wide range of input signals.
- Save and recall your front panel setups for quick return to previous measurements.
- ECL and TTL preset keys automatically set up vertical range, offset, and trigger levels for viewing digital signals.
- Input and memory labels aid in signal and setup identification.
- "Configuration" menu gives instrument status in a single display to aid in instrument setup and measurement documentation.
- Built-in 50 ohm switchable inputs eliminate the need for external termination devices (HP 54201A/D only).

Digital Storage

- Bright, fade-free, non-blooming displays.
- Waveforms can be stored for comparison or analysis. Stored waveforms can be displayed concurrently with live waveforms and can be output directly to a printer or plotter.
- Time/voltage cursors enable measurements on or between live and stored waveforms.
- Average mode improves signal-to-noise ratio on repetitive signals.
- Envelope mode saves maximum and minimum values of repetitive events for worst-case analysis.
- Accumulate mode displays multi-valued waveforms.
- Connect-the-dots mode aids signal interpretation (HP 54201A/D).

High-performance Digitizing

- 200 megasample/second digitizing rate with 50 MHz single-shot capture.
- Dual analog-to-digital converters provide two-channel simultaneous acquisition without sacrificing digitizing rate.
- 300 MHz repetitive bandwidth (HP 54201A/D).
- 10 ps time resolution (HP 54201A/D).

Instant Documentation

- Quickly document live and stored waveforms, selected measurements, and instrument setup information.
- One-button hardcopy output to HP's 2225A ThinkJet printer and to the HP 7470A, HP 7475A, and HP 7550 plotters.

Simplified Programming

- Logical, structured programming mnemonics simplify writing, editing, and modifying test programs.
- Remote HP-IB operation includes instrument setups, automatic waveform measurements, and waveform data output.
- HELP, DEBUG, and QUERY help the programmer write effective programs.
- Follows the recommendations of IEEE standard 728-1982, "Recommended Practice for Code and Format Conventions."

Automatic Waveform Measurements

- Measure waveform parameters automatically without a controller using built-in measurement routines.
- Measurement results are continuously computed and updated to aid in circuit adjustments and analysis.
- Measurements can be made on both live and stored waveforms. Up to four waveforms may be analyzed at one time.
- Measurement threshold can be assigned for each graph in terms of percent, voltage, and TTL/ECL levels.
- Eliminate measurement errors associated with manually positioning the waveform and counting graticule lines.

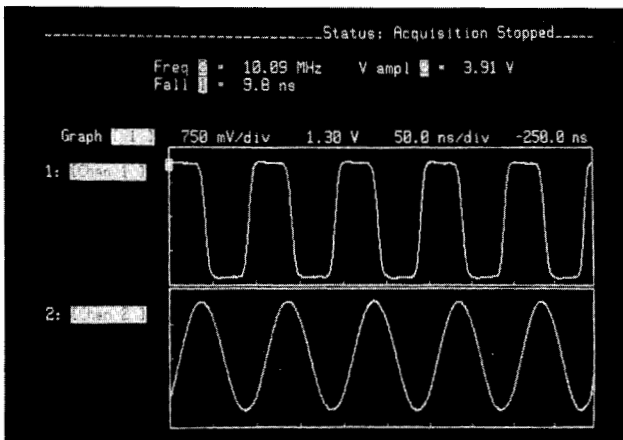

Built-in routines measure waveform parameters automatically.

The HP 54200/201D: Flexible Triggering For Today's Digital Systems

State Trigger Inputs

The HP 54200D and HP 54201D use three HP 10271A ten-channel probes to input 27 channels of state trigger and three clocks. These inputs can be used in a multiplexed configuration on microprocessor systems with multiplexed buses.

Normal

The normal mode provides state triggering that is similar to that in the HP 1630A/D logic analyzer. Up to four unique state patterns of up to 27 bits each may be qualified on in a user-defined sequence. The last state can be an ORed or ANDed combination of up to four state patterns and can be specified to occur from one to 59 999 times before

satisfying a complete state sequence. Up to four ORed sequence restart terms allow you to restart the complete sequence if the restart term occurs before the proper sequence is completed. Upon satisfying a sequence specification, the HP 54200/201D can be defined to trigger immediately, or trigger on the next valid analog trigger.

Qualified

The qualified mode enables the user to perform digital delay triggering, which is very useful for triggering on a serial bit string. One application involves triggering on the nth sector pulse on a disc after an index pulse. Simply qualify on the index pulse, and define the sequence to trigger after the nth occurrence of any state.

Missing Bit

The HP 54200/201D can detect a missing bit in a string of serial data, and trigger the acquisition. A reference clock provided by the user is compared to the input serial data. There must be one data bit transition in the serial data within each reference clock cycle. If the data bit is missing, the HP 54200/201D detects it and triggers the acquisition on the next reference clock edge. When in this mode, the last state in the sequence specification can be defined to search for up to 59 999 missing bits.

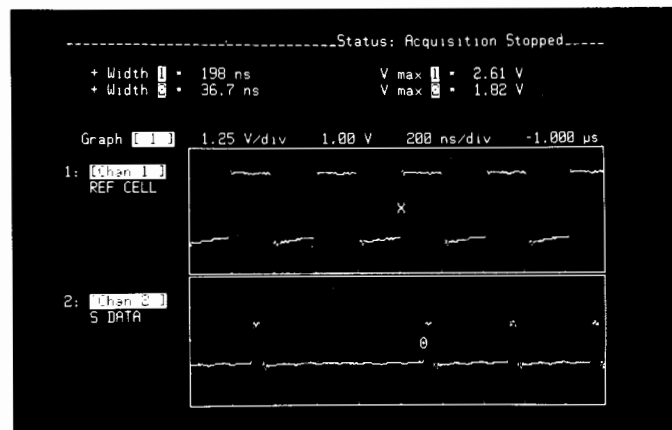

The missing-bit mode allows circuit faults to be captured quickly and easily.

Extra Bit

The extra bit mode operates similarly to the missing bit mode. If more than one data bit transition occurs within any reference clock cycle, the HP 54200/201D detects it and triggers the acquisition according to the state sequence specification.

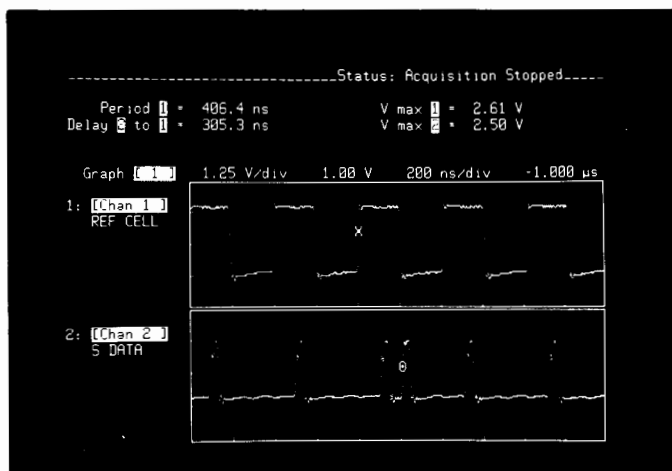

The extra-bit mode makes finding elusive glitches a snap.



OSCILLOSCOPES & WAVEFORM ANALYZERS

200 Megasample/Second Digitizing Oscilloscopes

Models 54200A/D, 54201A/D

Specifications

Channels 1 and 2 (Vertical)	HP 54200A/D		HP 54201A/D			
Acquisition Method	Real-time sampling	Real-time sampling	Repetitive sampling			
Bandwidth (-3 dB) dc-coupled ac-coupled	dc - 50 MHz 10 Hz - 50 MHz	dc - 50 MHz 10 Hz - 50 MHz	dc - 300 MHz 10 Hz - 300 MHz			
Transition Time (10-90%, calculated from: bandwidth x trans. time = 0.35)	7 ns	7 ns	1.2 ns			
Range (fs calibrated with 2-digit resolution)	40 mV to 40 V	40 mV to 16 V				
Gain Accuracy	±2% of full-scale*					
A/D Conversion (ADC) Accuracy	±1.6% of full-scale					
Dc Offset Acc. Chan. Range 40 mV to 390 mV 400 mV to 40 V 40 mV to 790 mV 800 mV to 16 V	±1% (offset) ±5mV ±1% (offset) ±50mV	±1% of offset ±5mV ±1% of offset ±100mV				
Voltage Meas. Accuracy (dc) Single cursor (X or 0) Dual cursor (X to 0 on same waveform)	Gain accuracy + ADC accuracy + offset accuracy Gain accuracy + 2 (ADC accuracy)					
Input Coupling	ac, dc					
Input Resist. (Nominal)	1 MΩ	1 MΩ; 50Ω dc coupling				
Input Cap. (Nominal)	14 pF	10 pF				
Maximum Safe Input Voltage	±40V (dc+pk ac)	1 MΩ: ±40V (dc+peak ac) 50Ω: 5 Vrms or ±40V (dc + peak ac), whichever is less				
Input (dc + pk ac) Operating Range Channel range 40 mV to 390 mV 400 mV to 40 V 40 mV to 16 V	±2 V ±20 V	±1 vertical range from center				
Dc Offset Range/resolution	Channel Range	Offset Range	Offset Res.	Channel Range	Offset Range	Offset Res.
	40 mV/ 390 mV	±2 V	~1.2 mV	40 mV/ 790 mV	±1.5 V	1 mV
	400 mV/ 40 V	±20 V	~12 mV	800 mV/ 16 V	±30 V	20 mV

*Specifications apply within ±10° C of auto-calibration temperature.

**Dual-cursor specs apply for measurements made on the same or simultaneously-acquired waveforms.

*** Provides 10:1, 1MΩ input at HP 10017A or HP 10018A probe tip.

Notes: specifications apply after a 30-minute warmup period. Single-shot reconstruction uncertainty equals ±1 ns (applies for time ranges of 50 ns through 2 μs).

Time Base (Horizontal)	HP 54200A/D			HP 54201A/D		
Acquisition Method	Real-time sampling		Real-time sampling	Repetitive sampling		
Range (10 div.), 1-2-5 sequence	50 ns - 10 s full-scale			10 ns - 20 μs full-scale		
Time Base Accuracy single/dual cursors	±2 ns or ±0.2% of time range, whichever is greater.**			±200 ps or ±2% of time range, whichever is greater.**		
Delay (Time Offset) Pre/Post-trigger range	Time Range	Pre-trigger Range	Post-trigger Range	Time Range	Pre-trigger Range	Post-trigger Range
	50 ns to 5μs	up to 5μs	up to 1 ms	Real-time Sampling Mode		
				50 ns to 5μs	up to 10μs	at least 200 screen dia.
	10μs to 10s	up to 1 screen diameter	up to 260 screen diameters	10 μs to 10s	up to 2 screen diameters	at least 200 screen diameters
				Repetitive Sampling Mode		
				10ns to 20μs	up to at 2 screen diameters	least 200 screen diameters
Pre/Post-trigger resolution	Adjustable in steps of 0.1 (coarse) and 0.004 (fine) screen diameters, or the LSB digit, whichever is greater.			Adjustable in steps of 0.1 (coarse) and 0.001 (fine) screen diameters, or the LSB digit, whichever is greater.		

Trigger (Analog)	HP 54200A/D		HP 54201A/D	
Acquisition Method	Real-time sampling		Real-time sampling	Repetitive sampling
Sources	Chan. 1, chan. 2, external trig. input		Chan. 1, chan. 2	External trigger input
Sensitivity	1/8 of full-scale (dc - 50 MHz)		1/8 of full-scale (dc-250MHz)	50Ω: 60 mV - 250 MHz .2MΩ: 1V (dc/100 MHz)***
Trig. Range Chan. range 40 mV - 390 mV 400 mV - 40 V 40 mV - 16 V	±2 V ±20 V		±1.5 x fs	±2 V
Resolution Chan. range 40 mV - 390 mV 400 mV - 40 V 40 mV - 16 V	~2.4 mV ~24 mV		.02 x fs	20 mV
Level Acc. Chan. range 40 mV - 390 mV 400 mV - 40 V 40 mV - 790 mV 800 mV - 16 V	±2% ±5 mV ±2% ±50 mV		±*3% ±5 mV ±3% ±100 mV	±3% ±30 mV
External Trig. Input	HP 54200A/D		HP 54201A/D	
Acquisition Method	Real-time sampling		Real-time sampling	Repetitive sampling
Input Resist. (Nominal)	1 MΩ		50 Ω	.2M Ω***
Input Coupling	ac, dc		dc	dc
Maximum Safe Input Voltage	±40V (dc+peak ac)		5 Vrms or ±40V (dc+pk ac), whichever is less.	±40V (dc + peak ac)
Input Oper. Range	Same as chan. 1 and chan. 2 inputs.		±5 V (dc + peak ac)	



State Trigger Mode

(HP 54200D and HP 54201D only)

Clock Repetition Rate

Single phase: 25 MHz max. with single clock and single edge; 20 MHz max. with any ORed combination of clocks and edges. Multiplexed: master/slave clock timing; master clock must follow slave clock by at least 10 ns and precede next slave clock by 50 ns or more.

Minimum Clock Pulse Width: 20 ns at threshold

Minimum Setup Time: 20 ns, the time data must be present before the clock transition.

Minimum Hold Time: 0 seconds, the time data must be present after the clock transition.

Probes (HP 10271A)

Input RC: 100 kΩ ±2% shunted by ~5 pF at the probe body.

Minimum Input: 600 mV peak-to-peak

Minimum Input Overdrive: 250 mV or 30% of input amplitude, whichever is greater.

Maximum Safe Input Voltage: ±40 V peak

Threshold Range: -9.9 V to +9.9 V in 0.1 V increments

Threshold Accuracy: ±2.5% ±120 mV

Dynamic Range: ±10 V about threshold

Digitizer

Digitizing Technique

Real-time digitizing: all data points are acquired on a single acquisition.

Random repetitive digitizing (HP 54201A/D): data points are acquired on multiple acquisitions.

Resolution: 6 bits; 1 part in 64. Effective resolution can be extended up to ~7 bits by using data filtering and averaging.

Acquisition Record Length: 1001 samples (1000 intervals).

Display

Data Display Formats: one, two, or four waveforms can be displayed at the same time. They can be live waveforms (channel 1 or 2 display) or stored waveforms (from waveform memories 0,1,2, or 3) in any combination.

Display/Store Modes

Normal: the display is repetitively updated with each new waveform acquisition.

Accumulate: all successive waveform acquisitions are displayed until erased. Erasure modes are manual, slow (after 64 acquisitions), and fast (after 16 acquisitions).

Envelope: provides a display of the running maximum and minimum voltage at each sample point for a repetitive input waveform.

Average: provides a display of the average voltage at each sample point for 4, 16, 64, or 256 user-defined waveform acquisitions. On each acquisition 1/n times, the new data is added to (n-1)/n of the previous value at each time coordinate. Operates in a continuous mode.

Connect-The-Dots (HP 54201A/D): provides a display of the sample points connected by straight lines.

Measurement Aids

Automatic Measurements: the following waveform measurements can be performed automatically on live or stored waveforms. The standard measurement thresholds are the 10%, 50%, and 90% points of the waveform. In the user-defined mode, voltages, percentages, or ECL/TTL presets can be used to define the upper and lower thresholds. Measurements are continuously updated with each new acquisition.

Frequency	Duty Cycle
Period	Delay
+ Pulse Width	Delay [Ave], [Max],
- Pulse Width	[Min], [Last] (HP 54201A/D)
Rise Time	Vampl
Fall Time	Vmax
	Vmin
	Vrms

Setup Aids

Auto-Scale: pressing the Auto-Scale key sets the vertical and horizontal ranges, offset, and trigger level to display the input signals. Period, positive pulse, negative pulse, rising edge, or falling edge may be selected as the horizontal display criterion. Requires a duty cycle of >1%, frequency >50 Hz, and amplitude >20 mV peak. Vertical, horizontal, and trigger auto-scaling functions may be selectively enabled or disabled. The HP 54201A/D requires a frequency between 50 Hz and 200 MHz.

Presets: scales the vertical range, offset, and trigger level to predetermined values for displaying ECL or TTL waveforms.

Setup Memories: four front-panel setups (0 through 3) may be saved in non-volatile memory. Labels may be assigned to each setup.

Ordering Information

	Price
HP 54200A 50 MHz digitizing oscilloscope	\$5900
HP 54200D 50 MHz, logic triggering digitizing oscilloscope	\$9800
HP 54201A 300 MHz digitizing oscilloscope	\$7900
HP 54201D 300 MHz, logic triggering digitizing oscilloscope	\$9800



OSCILLOSCOPES & WAVEFORM ANALYZERS

Digitizing Oscilloscopes

HP 54100-Series

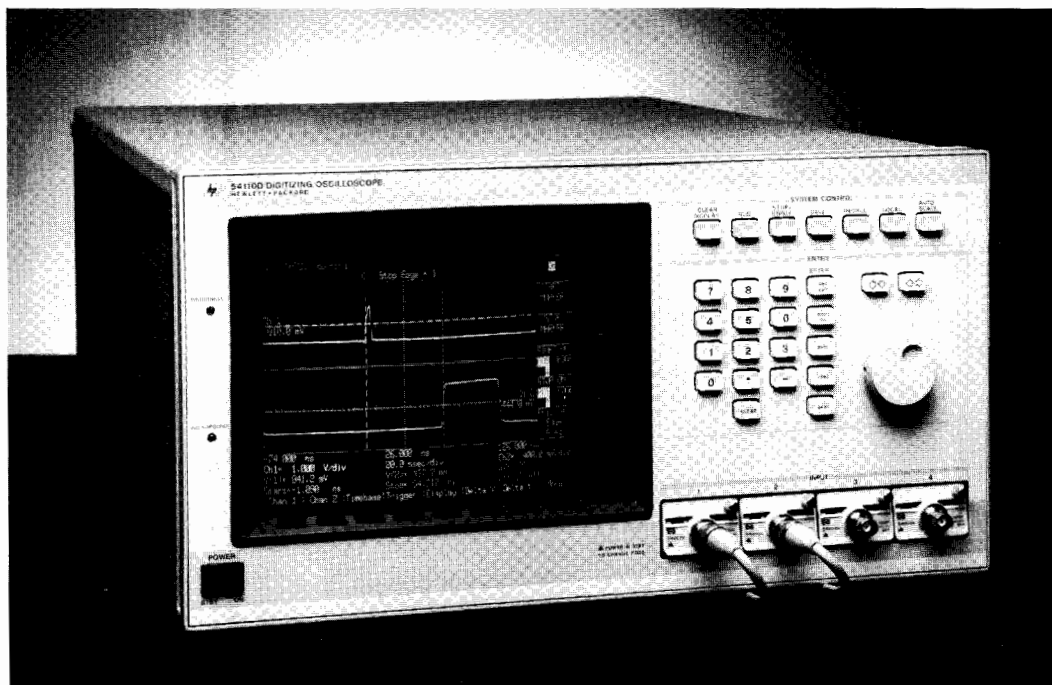

HP 54110D - Color 1 GHz Digitizing Oscilloscope



High-performance with an Easy-to-use Front Panel

In the HP 54100-series digitizing oscilloscopes, Hewlett-Packard combines an innovative oscilloscope architecture with state-of-the-art technologies, creating a general-purpose oscilloscope for engineers involved in analog as well as digital design and test. The HP 54100A/D, HP 54110D, and HP 54111D simplify analog time-domain measurements: they can make the measurements needed when working with the most recently developed logic families, and they can make standard measurements faster and more accurately than conventional oscilloscopes can.

HP 54100-Series Oscilloscopes

HP 54100A/D and HP 54110D

- 1 GHz bandwidth/10 ps resolution
- 40 megasample/second digitizing rate
- 10 bits vertical resolution with averaging
- 1k memory per channel

HP 54111D

- 1 gigasample/second digitizing rate
- 500 MHz repetitive bandwidth
- 250 MHz single-shot bandwidth
- 8 bits vertical resolution at reduced bandwidth
- 8k memory per channel

Whether you need fast single-shot performance with deep memory or high bandwidth with precise timing resolution, the HP 54100 series oscilloscopes are the easy-to-use, high-performance solution . . . with answers!

The HP 54100 series digitizing oscilloscopes produce more than graphical displays of waveforms . . . with automatic pulse parameter measurements, answers are only a key press away. Flexible display modes such as waveform averaging and infinite persistence give you

the analysis tool you need to extract noise or analyze worst case conditions. The HP 54100 series oscilloscopes provide total measurement solutions for the circuit designer or test engineer.

These oscilloscopes were designed with ease-of-use in mind. Automatic waveform scaling and save/recall setup registers make setting up the oscilloscope for your critical measurements a snap. A functional color display enhances interpretation multiple waveform displays and instant hardcopy output gives permanent documentation.

In Computer-aided Test . . .

Easily understood, English-like commands with a logical structure facilitate programming the 54100-series oscilloscopes in computer-aided test. Complete waveform data is available for analysis in a variety of formats. Acquire the data in the format you need and transmit it as a binary block quickly and efficiently.

In General-purpose, Digital Design . . .

Ease of use, automatic measurements, programmability, and precise time-interval measurements make the HP 54100-series scopes ideal for the designer's bench. By using special save/recall keys, you can step through a sequence of complex measurements, each having a different setup, without a controller.

In Data Communications . . .

Make eye-pattern and jitter measurements with the HP 54100-series scopes. Infinite persistence and waveform overlay simplify worst-case timing measurements. Different colors for the two vertical input channels, augmented by a third color where their traces overlap, add new clarity to these measurements (HP 54110D and HP 54111D only).

Crystal-controlled time-base stability ensures accuracy when making long-term measurements. Use averaging to view signals in noise, and use automatic waveform parameter measurements to check signal fidelity.



Digital Storage

- Bright, stable display of low duty-cycle signals.
- Retain waveforms as long as desired for worst-case analysis.
- Fade-free, non-blooming display.
- Store as many waveforms as needed for comparison or reference.
- Make measurements after signal is acquired. This is especially useful on single-shot signals or infrequent error conditions.
- Waveform data available over the HP-IB.
- Signal averaging for noise rejection and increased resolution.

Automatic Measurements

- Automatic edge finders save time, eliminate uncertainty, and reduce operator error in time-interval measurements.
- Measure pulse parameters automatically, without a controller.
- Markers indicate where the measurement was made, providing confidence in measurement results.

Pre-trigger Display

- Find causes of events.
- Displayed time can be any time before or after the trigger, and is not limited to one screen width before the trigger. Time intervals can be measured with a resolution of parts per million, before and after the trigger.

Store Waveforms for Comparison and Reference

- Pixel memories for overlaying multiple waveforms.
- Waveform memories for measurements and comparison of stored signals.

Easy-to-Use

- Pressing the Auto-Scale button automatically sets up the time base, sensitivity, offset, and trigger for a stable display over a wide range of input signals.
- Save up to ten front panel setups in non-volatile memory; simplify a sequence of repeated measurements quickly.
- Instant hardcopy with either a pen plotter or a graphics printer eliminates time-consuming, expensive photography.
- ECL and TTL presets scale the vertical gain, offset, and trigger levels for the selected logic family. This saves time in setting up for a measurement.

Simplified Programming

- Simple, logical, structured programming mnemonics make programs easy to edit, easy to understand, and easy to modify for new applications.
- Measurement-oriented, English-like mnemonics.

Triggering on Complex Digital Waveforms

- Logic pattern triggering allows you to trigger on the complex events found in typical digital systems.
- Trigger holdoff can be specified by events or by time for stable triggering on long, complex sequences of events.
- Independent trigger threshold adjustments for each channel. No need to reset the trigger level each time you switch from one trigger source to another.

Additional Triggering

The HP 54100/110/111D add the following triggering features to the basic capabilities of the HP 54100A.

Fourth Input

All D models have four inputs: two are vertical channels, and two are trigger inputs. The HP 54100A has three inputs; two vertical channels and one trigger input.

Pattern Trigger

In all D models' pattern trigger mode, each of the four inputs can be selected as high, low, or don't care. In the HP 54100A, the pattern selection is limited to the three inputs. The additional bit in the pattern specification extends the usefulness of pattern triggering to more complex data buses.

Time-Qualified Pattern

In addition to triggering on entering or exiting the specified pattern, the 54100/110/111D can be set to trigger when a specified pattern is present for less than or greater than a specified duration, from 10 ns to 5 seconds. Applications include glitch detection, triggering on timing violations, and capturing bus hangup conditions.

Pattern With Clock

All D models can be set to trigger on an edge of either polarity on any one of the four inputs, when a specified pattern exists at the other three inputs. This is useful when it is necessary to synchronize the display to a system clock and detect a system state.

Delayed Trigger

All D models can be set up to arm on an edge on any one of its four inputs, then trigger on an edge on any other input after a specified time or after a specified number of edges. The delay time can be varied from 20 ns to 5 seconds. The edge count can be set from 1 to 99999999. The delay-by-events mode is particularly useful in systems where the data rate fluctuates or jitters, as in a disc drive. You could use the delay-by-events mode to arm on the index pulse in a disc drive, then trigger on a data pulse anywhere around the track. This stabilizes the display on a particular pulse.

Document Results

Active as well as stored waveforms, setup conditions, and measurement results can be printed or plotted for instant, low-cost documentation. HP printers provide report-quality hardcopy for articles or printed reports at minimal cost, and without the delay of photographic reproduction.

Color as a Measurement Tool

The addition of color to an oscilloscope can make productivity improvements in applications performed manually as well as those involving automated measurements. Color can be combined with intensity, line types, and modulation to create easier, faster measurements with fewer errors than with a monochrome oscilloscope.

The HP 54110/111D can display a high-resolution, flicker-free color representation of rapidly changing data. With the nine-inch raster display, the user can work with as many as nine colors at one time, selecting these nine from a total of 4096 available. For convenience, a default nine-color palette was designed to provide optimum viewing for users in standard laboratory environments.

Adding color to an instrument such as an oscilloscope aids the user in four ways:

- it helps in differentiating between overlapping, superimposed, or similar waveforms;
- it helps in associating displayed information with corresponding data or waveforms;
- it can be used to emphasize displayed information; and
- the user can choose colors and their use to compensate for color blindness, ambient conditions, or special test requirements.



OSCILLOSCOPES & WAVEFORM ANALYZERS

Digitizing Oscilloscopes

Models 54100A/D, 54110D

- 1 GHz bandwidth
- Automatic pulse parameter and time interval measurements
- Digital storage

HP 54100A/D and HP 54110D

As the speeds of analog and digital logic continue to increase, board and system designers need to pay even closer attention to high-frequency and transmission-line characteristics of their circuits. Design requirements are rigorous. Subnanosecond technology creates narrow and elusive pulses.

High Bandwidth

The HP 54100/110 unite a powerful 1 GHz bandwidth with a random repetitive sampling technique for viewing rarely occurring narrow waveforms. With a 40 megasample/second single-shot digitizing rate and an effective digitizing rate of 100 gigasamples/second, these oscilloscopes yield 0.002% time base accuracy, 50 ps aperture jitter, and 10 ps resolution for confident measurements of critical timing parameters in high-speed circuitry.

With random repetitive sampling, you can capture waveforms that occur thousands of screen diameters before the trigger event. This gives an effective memory depth of millions of bytes for finding causes of failures that occur long before the trigger.

High Resolution

Analyze perturbations within a waveform with high resolution. With vertical magnification and waveform averaging, small signal details can be viewed and measured with 10 bits of effective resolution.

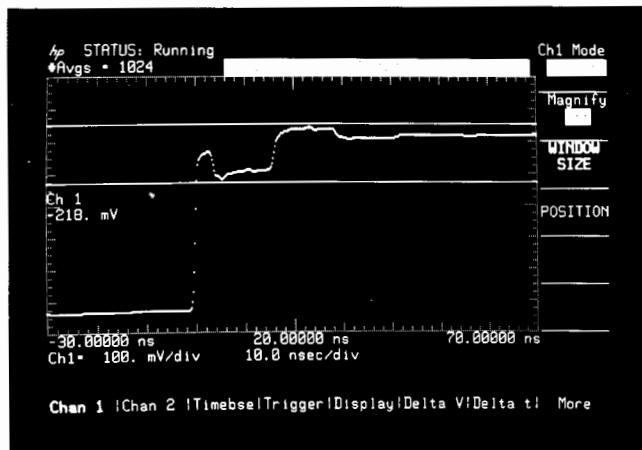

Without magnification, details of ringing, reflections and other distortions are lost.

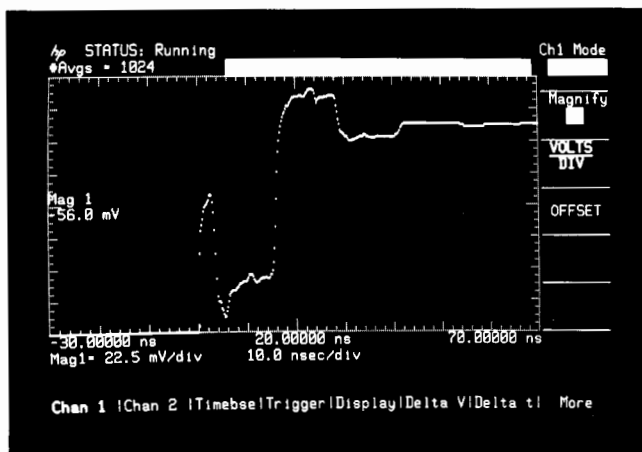

With vertical magnification, these distortions can be examined in detail.

- Available with color or monochrome display
- Flexible probing solution
- Pre-trigger viewing
- Logic triggering capability

Flexible Analysis

Only the HP 54100A/D and HP 54110D allow the display of either vertical channel versus the other. The 1 GHz bandwidth makes this feature valuable in measuring high-speed I-V device characteristics and transfer functions of high-speed converters.

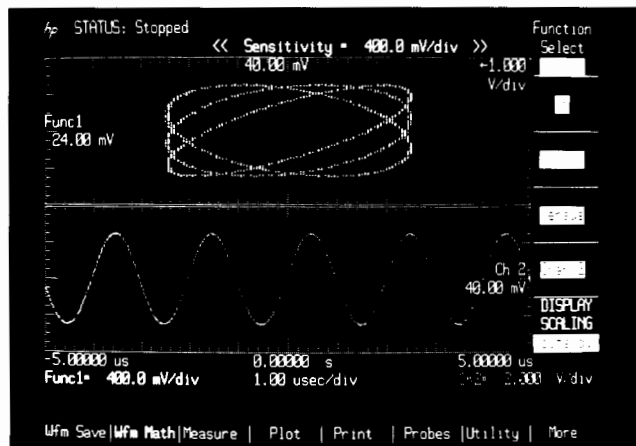

Channel versus channel display

The HP 54100A/D

When a monochrome display is preferred, for instance in a totally automatic test application, choose the HP 54100A or HP 54100D oscilloscope. These units require less rack height (7 in) than the HP 54110D (8 3/4 in) and have all of the same measurement features and specifications. The HP 54100A has one trigger input, while the HP 54100D and HP 54110D have two.

The HP 54100M

In non-commercial applications when compatibility with the U.S. Air Force MATE (Modular Automatic Test Equipment) program is needed, contact Hewlett-Packard for information concerning the HP 54100M oscilloscope. The HP 54100M implements automatic test features of the HP 54100A through an internal TMA (Test Module Adapter). The HP 54100M is CILL (Control Interface Intermediate Language) compatible and includes most of the same features as the HP 54100A.

A Choice of Input Pods and Probes

The HP 54100/110 inputs are configured with removable pods that can be chosen according to the application. Pods can be changed quickly and easily, and they occupy a minimum of storage space.

- 50 ohm inputs and probes for a wide variety of environments, without the expense of amplifier plug-ins.
- 1 GHz miniature active probes for densely-packed, high-speed 1 logic circuits.
- 1 Mohm probes for circuits sensitive to resistive loading.
- 50 ohm BNC inputs for measurements where terminated lines are important.
- 100:1 probes for extended dynamic range.

For more information on the HP 54100/110's probing system, please refer to page 448.

Specifications - HP 54100A/D, HP 54110D

Inputs

	HP 54002A	HP 54001A	HP 54003A
	50 Ω input	1 GHz miniature active probe	1 MΩ input, with 10:1 probe attached
Maximum input voltage	5 V rms	20 V peak	20 V peak
Coupling	dc	dc	dc
Input capacitance (nominal)	N/A	2 pF	8 pF
Input resistance (nominal)	50 Ω	10 kΩ	1 MΩ
Bandwidth (-3dB)	dc to 1 GHz	dc to 1 GHz	dc to 300 MHz
Transition time (10% to 90%)	≤350 ps	≤350 ps	≤1.2 ns
System bandwidth with HP 54100A/D, 54110D (-3 dB)	dc to 1 GHz	dc to 700 MHz	dc to 300 MHz
System transition time with HP 54100A/D, 54110D (10% to 90%)	≤350 ps	≤400 ps	≤1.2 ns
Division ratio	1:1	10:1 ±3%	10:1 ±3%

Vertical (Voltage)

The following apply when the HP 54100A/D is used with the HP 54002A 50 ohm input pod.

Bandwidth (-3 dB): dc to 1 GHz; these specifications apply over ambient temperature range of +15° C to +35° C.

Transition time (10% to 90%): ≤350 ps

Deflection factor (full-scale=8 divisions): 10 mV/div to 1 V/div in 1-2-5 steps.

DC accuracy, single voltage marker: ±3% of full-scale ±2% of offset; when driven from a 50 ohm source.

DC delta voltage accuracy using voltage markers on the same channel: ±1% of full-scale ±3% of reading, when driven from a 50 ohm source.

DC Offset

Range: ±1.5 × full-scale (referenced to center screen).

Magnifier: expands displayed signal vertically from 1 to 16 times; adjustable in 0.5% steps.

Inputs: two inputs, configurable with HP 54000-series pods.

Horizontal (Time)

Deflection Factor (full-scale is 10 divisions): 100 ps/div to 1 sec/div.

Delay (Time Offset)

Pre-trigger range: up to -200 ms or -10 divisions, whichever is greater.

Post-trigger range: up to +1 second or +10 divisions, whichever is greater.

Time Base Accuracy

Single-channel: (100 ps ±2 × 10⁻⁵ × delta T reading)

Channel-to-channel: (200 ps ±2 × 10⁻⁵ × delta T reading)

RMS Jitter: (50 ps + 5 × 10⁻⁷ × delay setting)

Trigger

The following apply when the HP 54100A/D, 54100D is used with the HP 54002A 50 ohm input pod.

Trigger Source	Vertical Channel 1 or 2	Trigger Input 3 (HP 54100D, 54110D: Trig In 3 or 4)
Trigger level range	±2 × full-scale	±2 V
Trigger sensitivity dc to 100 MHz	0.12 × full-scale	40 mV
100 to 500 MHz	0.24 × full-scale	50 mV

Trigger Source: channel 1, channel 2, trigger 3 input (HP 54100D/54110D, trigger 4 input).

Trigger 3 Input (HP 54100D, 54110D, trigger 4 input): configurable with HP 54000-series pods.

Operating Characteristics

Digitizer

Resolution: 7 bits (1 part in 128).

Effective resolution can be extended up to approx 10 bits by using magnification and averaging.

Digitizing rate: up to 40 megasamples/s. Vertical

Input protection: a relay opens when applied voltage exceeds rated input for input pod in use (see "Inputs").

Horizontal

Delay between channels: difference in delay between channels can be nulled out in 10 ps steps up to 10 ns to compensate for differences in input cables or probe length.

Reference location: the reference point can be located at the left edge, center, or right edge of the display. The reference point is that point where the time is offset from the trigger by the delay time.

Display

Data display resolution: 500 points horizontally by 256 points vertically.

Data display formats

Split screen: each channel display is four divisions high.

Full screen: the 2 channels are overlaid. Each channel display is eight div high.

Display modes

Variable persistence: the time that each data point is retained on the display can be varied from 200 ms to 10 seconds, or it can be displayed indefinitely.

Averaging: the number of averages can be varied from 1 to 2048 in powers of 2. On each acquisition, 1/n times the new data is added to (n-1)/n of the previous value at each time coordinate. Averaging operates continuously; the average does not converge to a final value after n acquisitions.

Graticules: full grid, axes with tic marks, or frame with tic marks.

Display colors (HP 54110D): a default color selection is set up in the instrument. Different colors are used for display background, channel 1/ function 1, channel 2/ function 2, background and high-lighted text, advisories, markers, and memories. If desired, the user may change the colors used from the front panel or over the HP-IB.

Ordering Information

	Price
HP 54100A	\$17,600
HP 54100D	\$19,300
HP 54110D color display	\$21,000

Input Pods And Probes

HP 54001A 1 GHz miniature active probe pod	\$750
HP 54002A 50 ohm BNC input pod	\$130
HP 54003A 1-megohm, 10:1 probe pod	\$550



OSCILLOSCOPES & WAVEFORM ANALYZERS

Digitizing Oscilloscopes

Models 54111D

- 1 Gigasample/second digitizing rate
- 500 MHz repetitive bandwidth
- 8k memory depth

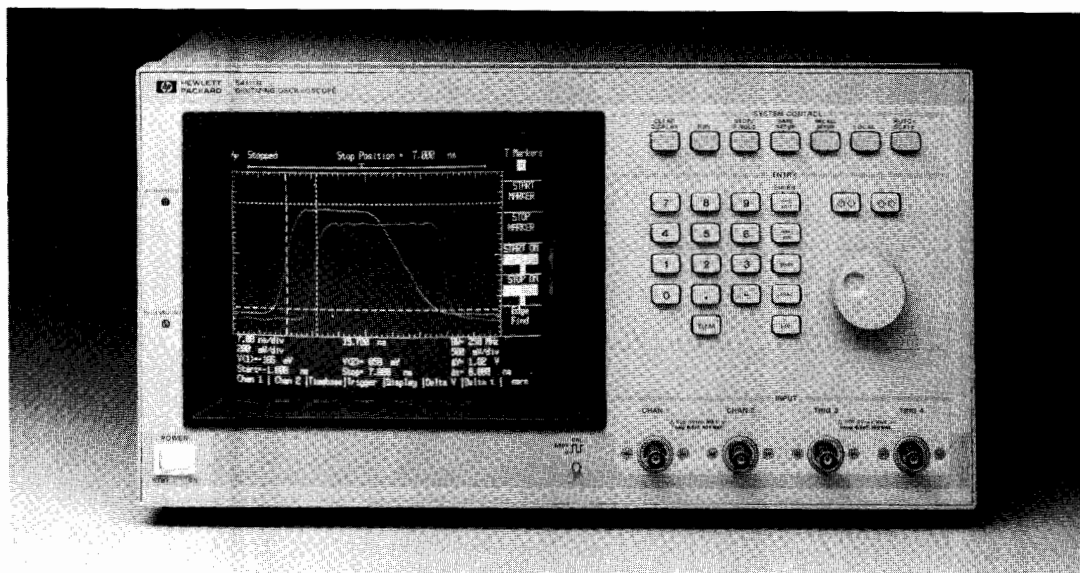

Introducing HP's newest scope . . . the HP 54111D features a 1 gigasample/second digitizing rate and a 500 MHz bandwidth.

HP 54111D: High-speed General-Purpose Scope

The HP 54111D is a 1 gigasample/second, two-channel digitizing oscilloscope with a memory depth of 8k samples per channel. The HP 54111D retains all of the key features and user friendliness of the HP 54100/110 oscilloscopes . . . such as automatic measurements, auto-scaling, cursors, and a functional color display. Plus, the HP 54111D adds features necessary for controlling and managing the added memory depth, such as scroll, zoom, and memory bar.

Key Contributions

- 1 gigasample/second digitizing rate (maximum)
- 500 MHz repetitive bandwidth
- 250 MHz single-shot bandwidth
- 8k memory per channel
- Up to eight bits of vertical resolution with bandwidth limits
- Two channels of simultaneous capture at the full digitizing rate
- Pre-trigger information
- Automatic measurements
- Fully HP-IB programmable with HP's oscilloscope language (HP-OL)
- Complex triggering capabilities
- Instant hardcopy output
- Flexible display modes

General-purpose to Special Applications

With a 1 gigasample/second digitizing rate, the HP 54111D gives you the fastest sampling rate available in a general-purpose digitizing oscilloscope. However, the HP 54111D is much more than an instrument for capturing fast single-shot transients. With random repetitive sampling, this instrument provides a bandwidth of 500 MHz for high-speed circuit design and test.

In addition to its single-shot and repetitive capabilities, the HP 54111D provides flexible input coupling with a side dynamic range for viewing and analyzing a variety of signals. Use this scope for just about any general-purpose application from very slow to very high-speed repetitive or non-repetitive waveforms.

Memory Bar Simplifies Data Viewing

The HP 54111D provides 8k samples of memory per channel. This results in 16 screens of waveform information in each real-time or single-shot acquisition cycle. To simplify management of all this data,

the HP 54111D displays a memory bar. The memory bar is displayed along the top edge of the graticule and shows the portion of memory being viewed relative to the entire memory record. In addition, the trigger point and cursor locations are also shown along the memory bar.

Ultra High Digitizing Rate

No longer do you need a manual analog storage oscilloscope to capture high-speed single-shot phenomena found in:

- high-speed pulse analysis
- nuclear test studies
- plasma discharge
- high voltage arcing
- high frequency bursts

All these single-shot events can be captured easily with two simultaneous digitizers running at 1 GHz, with 8 μ s of data stored for review and analysis.

High-speed ECL Design

Non-repetitive glitches appearing on the clock signal can be captured easily with the 250 MHz single-shot performance of the HP 54111D. Eight μ s of pre-trigger data is invaluable for determining the cause of the glitch.

High-speed Semiconductor Design

Single-shot performance of 250 Mhz permits you to measure the outputs from latches (i.e., one-time events for multiple clock periods in ECL circuits).

Laser and High Energy Research

Photo detector pulses can be measured via single-shot capture using the 1 GHz sampling rate and built-in automatic pulse parameters measurements. Infinite persistence can also be used to show and measure maximum variations of the waveform to 500 MHz repetitive bandwidth.

The HP 54111D's two simultaneous 1 gigasample/second channels give you the single-shot performance of the most advanced analog storage oscilloscopes, but with all the advantages and ease of use of a digitizing oscilloscope. And with a staggered over-sampling technique, the HP 54111D provides this single-shot performance with up to eight bits of non-blooming vertical resolution.

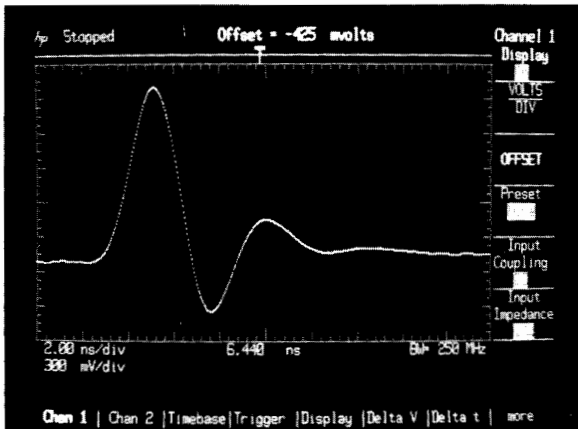

With its 1 gigasample/second digitizing rate, the HP 54111D was able to capture this laser pulse single-shot.

Data Communications

Combine 1 gigasample/second digitizing rate with eight kbytes of memory depth per channel, and you have an invaluable tool for analyzing high-speed serial waveforms such as data communications or radar testing.

High Bandwidth Applications

Not only is the HP 54111D digitizing oscilloscope useful for single-shot phenomena, but it also samples repetitively, giving you 500 MHz bandwidth with high signal fidelity. Use this scope for just about any general-purpose application from very slow to very high-speed repetitive or non-repetitive waveforms.

Computer-aided Test

The HP 54111D has many features that make it an excellent tool in computer-aided test. Its repetitive bandwidth and digitizing rate allow it to cover a wide range of automatic measurement applications. In addition, this instrument has many features that enhance test throughput time, such as built-in automatic measurements, fast acquisition cycles, and deep memory.

Input Range and Conditioning

The HP 54111D has the widest input dynamic range and coupling capabilities of any of our digitizing oscilloscopes. The input sensitivity can be set from 1 mV/div to 5 V/div. In addition, all input coupling is internal and programmable. The selections include: ac, dc, 1 megohm, 50 ohms, and GND. These input signal conditioning features make the HP 54111D more general-purpose for the circuit designer and test engineer.

HP 54111D Specifications

Vertical (Voltage)

Channels: 2

Bandwidth	Single-shot	Repetitive
dc-coupled	dc to 250 MHz	dc to 500 MHz
ac-coupled	10 Hz to 250 MHz	10 Hz to 500 MHz
Transition Time (10% to 90%)	1.4 ns	700 ps
Deflection Factor (full scale=8 div)	1 mV/div to 5 V/div continuous*	
Resolution	8 bits to 25 Mz, 7 bits to 100 MHz, 100 MHz, 6 bits to 250 MHz	6 bits, 8 bits with averaging to 500 MHz

Gain Accuracy: $\pm 2\%$ of full-scale**

Dc Offset Accuracy: $\pm 1.5\%$ of setting

Measurement Accuracy

single data point: \pm gain acc \pm offset acc \pm resolution between data points on the same waveform: \pm gain acc $\pm 2 \times$ resolution

Dc Offset Range: ± 200 mV (1 mV/div to 4.9 mV/div)

± 1 V (5 mV/div to 49 mV/div)

± 10 V (50 mV/div to .49 V/div)

± 100 V (.5 V/div to 5 V/div)

Input Coupling: ac/dc/dc-50 ohms/Gnd

Input Impedance: 1 Mohm at 6.5 pF or 50 ohm (dc)

Maximum Safe Input Voltage: ± 40 V at 1 Mohm (dc + peak ac), 5 V rms at 50 ohms

*Bandwidth for settings 1 mV/div to 4.9 mV/div is reduced to 150 MHz.

**When calibrated to probe tip using front panel calibration source. Applies to major ranges (5 mV/div, 10 mV/div, 20 mV/div, 50 mV/div, 100 mV/div, 200 mV/div, 500 mV/div, 1 V/div, and 2 V/div). All continuous settings between these ranges are $\pm 3\%$ of full-scale.

Horizontal (Time)

Digitizing Rate: 1 gigasamples/second to 50 samples/second

Deflection Factor: 500 ps/div to 1 s/div

Memory Depth Per Channel: 8k (8 μ s at 1 gigasample/second), single-shot only.

Pre-trigger Delay Range: -8μ s at timebase settings 50 us/div and less, increasing to -160 seconds at 1 s/div.

Post-trigger Delay Range: .16 seconds at timebase settings .5 μ s/div and less, increasing to 10k seconds at 1 s/div.

Time Measurement Accuracy	Single-shot	Repetitive
single channel	± 300 ps $\pm .03\%$ of reading	± 100 ps $\pm .03\%$ of reading
dual channel	± 600 ps $\pm .03\%$ of reading	± 200 ps $\pm .03\%$ of reading
Triggering Sources	Internal Chan 1,2	Ext. Inputs 3,4
Sensitivity		
single-shot	0.1 of full scale, dc to 200 MHz***	15 mV (1:1), dc to 200 MHz
repetitive	0.2 of full scale, 200 MHz to 500 MHz ***	45 mV (1:1), 200 MHz to 500 MHz
Trigger Level Range	$\pm 3 \times$ full scale	± 1 V (1:1)
Input Resistance	NA	1 Mohm
Maximum Input Safe Voltage	NA	± 10 V, dc + peak ac
Input Operating Range	NA	± 1 V(1:1), dc + peak ac

***Applies to settings 5 mV/div to 5 V/div only.

Ordering Information

HP 54111D 1 gigasample/second digitizing oscilloscope

Price

\$23,900



OSCILLOSCOPES & WAVEFORM ANALYZERS

Precision Digitizing Oscilloscopes

Models 5183T,U & 5180T,U

HP 5183T,U

- 12-bit resolution, 4 megasamples per second
- 2 differential channels, 72 dB dynamic range
- Up to 512k words memory, enhanced triggering
- Calibration to probe tip

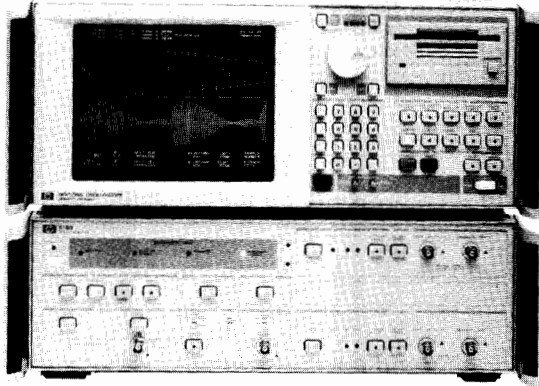

HP 5180T,U

- 10-bit resolution, 20 megasamples per second
- 2-channel operation, 60 dB dynamic range
- 16k words memory

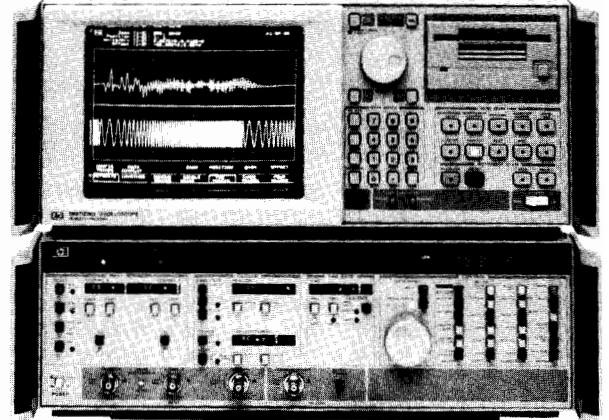

HP 5183T, 2 differential channels (HP 5183U, 4 differential channels—not shown)
(see page 441 for more information on the recorder section)

HP 5180T, 2 channels (HP 5180U, 4 channels—not shown)
(see page 442 for more information on the recorder section)

Precision Digitizing Oscilloscope

The oscilloscope has been one of the fundamental engineering tools for many decades. It is a general purpose instrument, which provides the same measurement answers as racks of instrumentation. Voltage, frequency, phase and many more parameters can be measured using an oscilloscope, but it usually involves laborious human intervention to count graticules and interpret data. Also, until the storage scope, most transient measurements could not be performed.

With the advent of digitizing oscilloscopes, the tedium involved in taking data from a waveform has been vanquished. The production line no longer needs the single, dedicated instruments, customized to take a voltage or time measurement. The digitizing scope can “capture” the waveform, and preprocess the signal to provide single number answers so that the technician or computer can make simple “go” or “no go” decisions. Waveforms can be stored enabling characterization and correlation between runs.

Accuracy unrealized by oscilloscopes is obtained by this new series of precision digitizing oscilloscopes. Measurements with standard analog oscilloscopes produce approximately 30 dB of dynamic range; the HP 5183T,U and 5180T,U precision digitizing oscilloscopes have 72 dB and 60 dB of dynamic range respectively.

Built-in Analysis Package

HP precision digitizing oscilloscopes provide many analysis features. These features give the designer or technician the information he needs in real time without resorting to the use of sophisticated external software to manipulate the data.

Precision Pulse Measurements

These oscilloscopes provide pulse measurements according to the IEEE-194 standard. The designers can also define their own pulse characterization environment. Risettime or falltime are provided with the touch of a finger in the analysis menu. Positive and negative

pulse widths along with duty cycle and amplitude are other statistics available. Also included at a single touch are overshoot and undershoot.

Real Time Conversion to Frequency Domain

With the introduction of the precision digitizing oscilloscope, the designer can now do some frequency domain analysis with the same instrument that does the time domain analysis. Both domains can be observed and characterized simultaneously. An FFT is performed on the time record using either a Hann, Uniform, Flat Top or user defined window. The magnitude and the phase spectrums can then be computed and displayed independently using the flexibility of the instruments.

Waveform Math and Calculus

Two waveforms can be manipulated mathematically by adding, subtracting or multiplying them together. This gives the designer the ability to experiment quickly with modulation, performing experiments on raw data before breadboarding is done. Afterwards, the data can be gathered from the actual circuit and compared against the theoretical data. All this is accomplished without the aid of external computational equipment.

Incoming signals, or waveforms in memory can be integrated or differentiated, resulting in a waveform that lets the designer bypass special purpose hardware or computer programming. The DC drift of a circuit is easily quantifiable using integration in the analysis feature set. High frequency components of a signal are easily identifiable by integrating an incoming signal and placing it either underneath the signal, or combining the two traces into one display.

Waveform Reconstruction means Readable Displays

A common complaint when using digitizing oscilloscopes, is that the representation of the data is not always optimum. The following two figures show the same waveform; the top waveform has used the waveform reconstruction algorithm, built into the HP 5183T,U and 5180T,U, and the bottom waveform shows the data with the recon-

struction feature turned off. The top graph is also the representation that would be viewed on a storage oscilloscope.

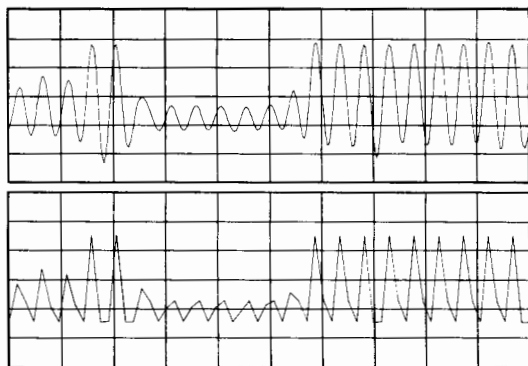

Reconstruction gives designers a truer representation of the data, allowing them to continue thinking in the analog time domain.

Flexibility in Data Presentation

These digitizing oscilloscopes are extremely friendly as bench top instruments. One to four traces can be displayed, with the designer determining what the traces consist of and how they are displayed. As with analog oscilloscopes, continuous or single-shot waveforms can be displayed. Here the similarity with analog scopes ends; the precision digitizing oscilloscope can also display waveforms stored in memory, or signals that have been processed using the analysis functions inside the scope. The HP 5183T,U and 5180T,U can display analyzed data and the original measurement continuously as the signals are digitized. Once the waveform has been digitized, the display can be manipulated by zooming in on an interesting section, or changing the gain and offset to show more fine details.

Permanent Copies of Waveforms

The HP 5183T,U and 5180T,U provide two ways to create permanent copies of waveforms or processed signals. With the optional internal floppy disc, up to 250 1K records can be stored. In addition to

storing captured and processed waveforms, the entire state of the instrument can be stored so that complex series of instrument setups can be recalled at a touch, leaving the designer or technician to concentrate on the device under test, and not setting up instruments. The waveforms are formatted in Hewlett-Packard's LIF directory, permitting the recorded disc to be used with any of the HP 9000 series 200 and 300 computers. In addition to storing the binary waveform, each file is time stamped.

Hardcopies of the display can also be created without the aid of a controller. This series of precision digitizing oscilloscopes operates most HP plotters (see the data sheet for a complete list of the supported plotters).

Precision Measurements with Cursors

Two cursors are provided for making accurate measurements. A reference level, settable by the operator, is used to make voltage measurements; timing measurements are taken with respect to the trigger point. The difference between two cursors is also available for voltage, timing, frequency and decibels. Measurements using the delta cursors feature can be made on a single trace, or between two different traces being displayed.

Quick timing, frequency, voltage and power analysis can be accomplished using a single cursor. Once the cursor is placed on the desired waveform, the minimum and maximum can be determined with a single touch. A single keystroke places the cursor on the next minimum, maximum, or zero crossing which reveals waveform details without the user having to perform a tedious search.

Battery Backed up Instrument Settings

Four instrument settings may be stored, but five can be recalled. The fifth memory location contains the instrument environment that was present before the last recall, which means that a complex instrument setting won't be overwritten by accident. This gives the designer or technician the ability to determine the exact instrument settings, and then auto-sequence through five different test setups. The ram that stores the front panel settings along with the internal clock is backed up by a lithium battery.

Common Analysis Features

Pulse characterization

Rise time, fall time, baseline, topline
+ width, - width, overshoot, period
frequency and duty cycle

Voltmeter

Peak to peak, rms and period rms

Frequency Domain

Power spectrum, phase spectrum and magnitude spectrum

Available windows

Uniform, Hann and Flat Top

Waveform math

Add, subtract and multiply

Calculus

Integrate and differentiate

Frequency Counter

Average frequency and event crossing

Miscellaneous functions

Minimum hold, maximum hold and extract

Cursor functions

Waveform maximum, waveform minimum, next maximum, next minimum, next crossing, next positive crossing and next negative crossing

Display functions

X zoom, X position, Y gain, Y offset,
reconstruction and dot or line mode

Plotting

Plot waveforms with most HP plotters

Mass storage

Using 3.5 inch floppy discs, when option 035 is installed

See next page for more information on the HP 5183T,U.
See pages 441 and 442 for more information on the recorder sections.
See page 442 for more information on the HP 5180T,U.



OSCILLOSCOPES & WAVEFORM ANALYZERS

Precision Digitizing Oscilloscope

Model 5183T,U

- Differential inputs
- Adaptive Sample Rate
- Dropout trigger
- 256K word per channel optional memory
- Complete calibration to probe tip
- Configurable as two or four channels

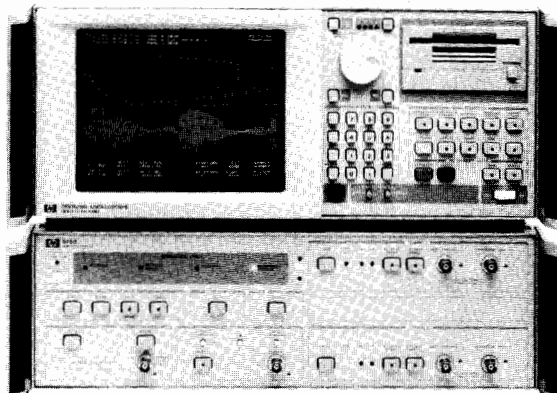

HP 5183T



Unbeatable measurement resolution & accuracy

The HP 5183T,U provides many features unavailable from any other digitizing oscilloscope. Trigger features allow data acquisition that was previously either impossible, or required complex external trigger circuitry. The optional 512K word memory allows long continuous records to be acquired. Adaptive Sample Rate gives the benefit of catching glitches that would ordinarily escape detection. The burst timebase feature allows samples to be gathered in packets of samples as small as 1 sample per trigger point. Calibration is now possible out to the probe tip providing greater absolute accuracy.

Enhanced trigger capability

As with the other Hewlett-Packard waveform recorders, post- and pre-triggering are available. This permits viewing of the trigger point, the events leading up to the trigger point, or events that occur long after the trigger has occurred. Dropout trigger provides the capability to trigger on the absence of a signal. This means that the HP 5183T,U can be used to monitor a signal source such as a power main. The recorder can be configured with auto advance to capture up to 256 1K records showing dropouts, when Option 512 is installed.

Sequential trigger is used in the following manner. A trigger event occurs at the external trigger input. Then, when a user defined delay elapses, the recorder will wait for the proper internal trigger and record in the operator defined environment. This can be used for recording signals such as a specific sector on a magnetic disc, using the index pulse as the external trigger, and the approximate delay to the proper sector.

Trigger-on-all allows the trigger circuitry to be or'ed together internally. This trigger scheme is also available in four channel operation, with two recorder sections being used together. This allows the designer to set up triggering conditions for the channels, and whichever event occurs first, will cause synchronous triggering and sampling in all channels.

High frequency trigger will cause the recorder to trigger on a glitch of sufficient amplitude or other large high frequency components in the waveform. This is only available with the optional Adaptive Sample Rate.

Adaptive Sample Rate (ASR)

ASR provides rapid sampling only when it is needed. With this option, the recorder will sample at a slow speed until high frequency energy is detected. As this occurs, the timebase will speed up to capture the high frequency signal, returning to the slower speed when the high frequency ceases. This means that for many input signals, the memory can appear to be up to 30 Mbytes, when the optional 512K word memory is used.

HP 5183T,U Specifications*

Channel A and B inputs

- Maximum sensitivity (nominal):** 50 μ V.
- Input attenuator ranges:** 100 mV to 50 V (Full scale).
- Input offset voltage:** $\pm 200\%$ of input attenuator range.
- Amplifier bandwidth (nominal):** (-1 dB) 1 MHz, (-2 dB) 3 MHz with filter (10 pole), (-4 dB) 1 MHz, (-65 dB) 3 MHz.
- Input impedance (nominal):** 1 M Ω in parallel with 45 pF.
- CMRR at 10 kHz:** 60 dB on 100 mV to 1 V ranges.
- Damage level:** ± 5 V dc plus peak ac on 100 mV to 1 V ranges 400% of range dc plus peak ac or 2 V to 50 V ranges.

Dynamic performance after calibration

- Harmonic and spurious distortion:** ≤ -65 dBc.
- Effective bits:** 10.0 bits.

Triggering

- Internal trigger:** level and sensitivity selectable over input voltage range.
- External trigger:** level selectable over ± 5 V.
- Internal source:** channel 1, channel 2, drop-out, sequential, trigger-on-all, or high frequency trigger (with Option 301).
- Measurement control:** auto, normal, single, manual trigger.
- Settable:** level, hysteresis, position, drop out delay, delay from external trigger (sequential trigger).
- Slope:** \pm and bittrigger (internal only).
- Trigger position:** - 100% to + 6400% of record length

Timebase

- Internal timebase:** 4 MHz internal timebase allows sample rates between 250 ns and 4 s, in 250 ns increments.
- External timebase:** 1, 4 or 10 MHz.
- External encode:** dc to 2.1 MHz or 1.9 MHz to 4 MHz

Memory

- Size:** 65,536 words per channel, or 262,144 words per channel when Option 512 is installed.
- Segmentation:** memory can be configured as a single 131,072 word record for channel A, or between 1 to 64 equal length records for channel A and B.
- When Option 512 is installed, memory can be configured as a single 524,288 word record for channel A, or between 1 and 256 equal length records for channel A and B.
- ASR (Adaptive Sample Rate):** Slows timebase by a 1:64 rate when high frequency energy is not present; Option 301.

*See HP 5183T,U Data Sheet for more information

OSCILLOSCOPES & WAVEFORM ANALYZERS

Waveform Recorder and Ordering Information

Models 5183A/T/U

441



- Flexibility in signal conditioning
- 72 dB of dynamic range for analysis
- Includes BASIC or Pascal software drivers

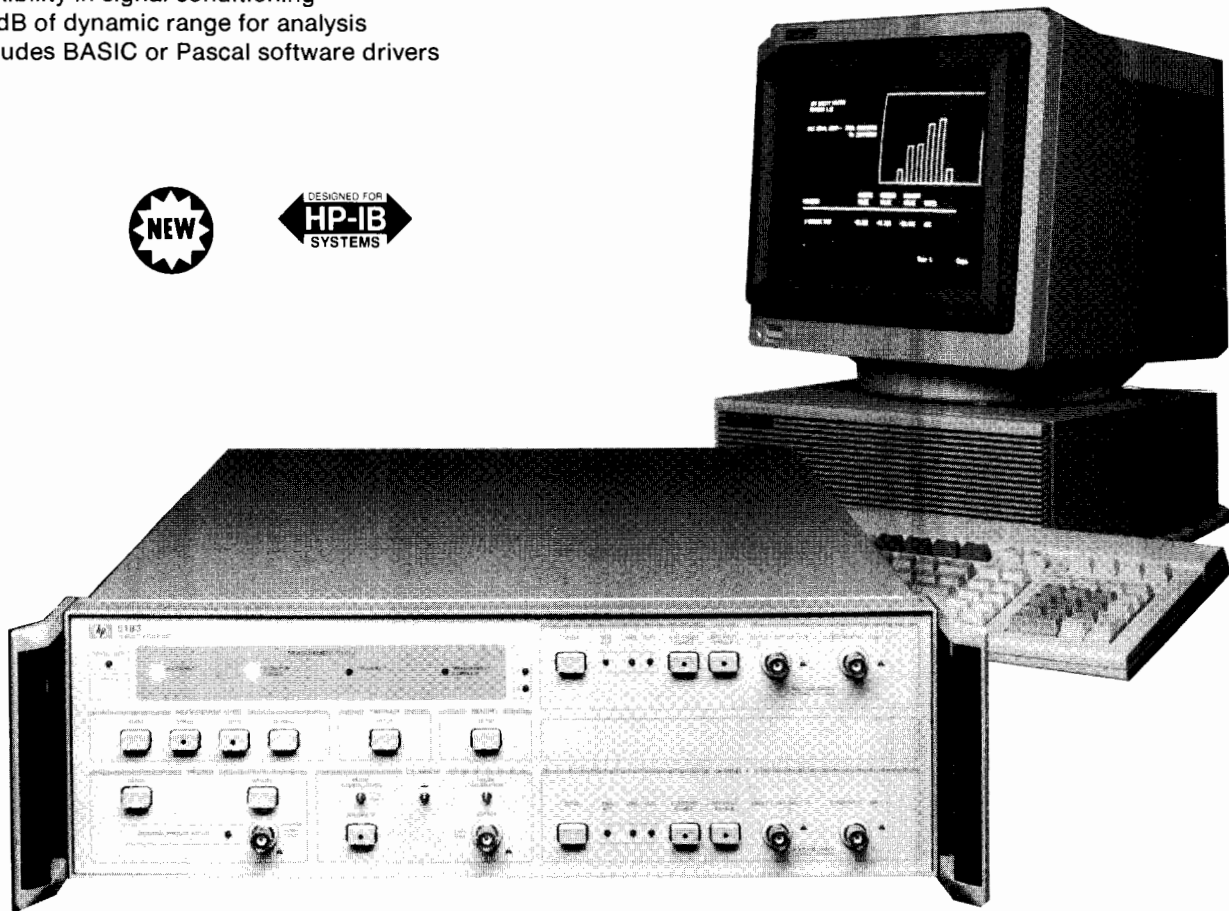

HP 5183A

HP 5183A Waveform Recorder

For those applications that require the superb fidelity of the HP 5183T, but not the packaged analysis routines, real time control or display, the HP 5183A is the ideal solution. It comes standard with software that enables control and data transfer in either BASIC or Pascal with the HP 200 and 300 series computer.

HP 5183A Condensed Specifications*

Channel A and B inputs

Maximum sensitivity (nominal): 50 μ V.

Input attenuator ranges: \pm 100 mV to \pm 50 V (full scale).

Input offset voltage: \pm 200% of input attenuator range.

Amplifier bandwidth (nominal): (-1 dB) 1 MHz, (-2 dB) 3 MHz with filter (10 pole), (-4 dB) 1 MHz, (-65 dB) 3 MHz.

Input impedance (nominal): 1M Ω in parallel with 45 pF.

CMRR at 10 kHz: 60 dB on 100 mV to 1 V ranges.

Damage level: \pm 5 V dc plus peak ac on 100 mV to 1 V ranges 400% of range dc plus peak ac or 2 V to 50 V ranges.

Dynamic Performance after Calibration

Harmonic and spurious distortion: \leq -65 dBc.

Effective bits: 10.0 bits.

Triggering

Internal trigger: level and sensitivity selectable over input voltage range.

External trigger: level selectable over \pm 5V.

Internal source: Channel 1, Channel 2.

Measurement control: auto, normal, single, manual trigger.

Settable: level, hysteresis, position.

Slope: \pm and bi-trigger (internal only).

Trigger position: -100% to +6400% of record length.

*See HP 5183A Recorder Data Sheet (Pub 5952-7824D) for more information.

Time Base

Internal time base: 4 MHz internal time base allows sample rates between 250 ns and 4 s, in 250 ns increments.

External time base: 1, 4 or 10 MHz.

External encode: dc to 2.1 MHz or 1.9 MHz to 4 MHz.

Memory

Size: 65,536 words per channel, or 262,144 words per channel when Option 512 is installed.

Ordering Information for the

HP 5183 A/T/U

HP 5183A Waveform Recorder 2-Channel (includes \$ 12,000

an interconnect cable and software for control and data transfer on the HP 200 and 300 series computers)

HP 5180A Waveform Recorder 2-Channel (see page \$ 18,600

for description and specifications)

HP 5183T Digitizing Oscilloscope 2-Channel (includes \$ 19,900

waveform analyzer, 2-channel recorder section, software and interconnect cables)

HP 5183U Digitizing Oscilloscope 4-Channel includes \$ 29,900

waveform analyzer, 2 two-channel recorder sections, software and interconnect cables.

Options for HP 5183T

Opt 010 Oven Oscillator +\$1,200

Opt 035 Floppy Disc +\$1,000

Opt 301 Adaptive Sample Rate +\$3,100

Opt 512 512K Word Memory +\$5,200

Options for HP 5183U

Opt 010 Oven Oscillator +\$1,200

Opt 035 Floppy Disc +\$1,000

Opt 301 Adaptive Sample Rate +\$6,200

Opt 512 512K Word Memory +\$10,400



OSCILLOSCOPES & WAVEFORM ANALYZERS

Digitizing Oscilloscope and Waveform Recorder/Measurement System

Models 5180T/U, 5180A, 5180S, 51800A

- High quality display
- Built-in analysis provides answer and raw data
- Utilizes the HP 5180A for quality digitization
- 16K memory records up to 32 waveforms
- High-speed signal acquisition
- Accurately digitizes transient signals
- Up to 1 million words/s data transfer

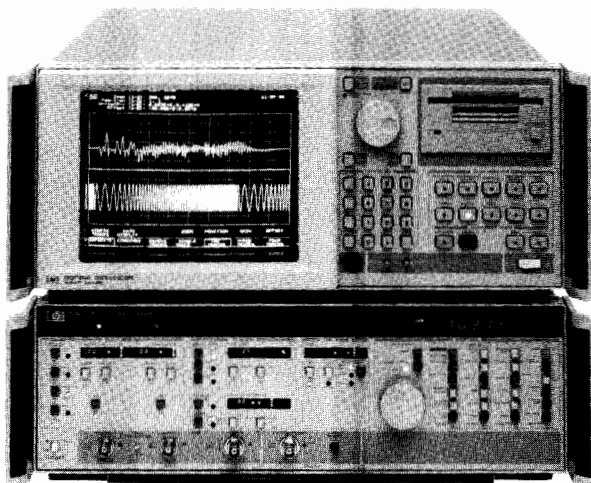

HP 5180T (HP 5180U not shown)

HP 5180T,U

Automatic Analysis

The HP 5180T/U delivers answers normally associated with other instruments such as time interval counters, voltmeters, spectrum analyzers, and storage oscilloscopes. Unlike other instruments, these digitizing oscilloscopes require only one waveform capture to get results. After you capture your signal, you can view it as you would with a storage oscilloscope; you can zoom in to view details, analyze pulses, view its frequency spectrum, and measure its rms or peak-to-peak amplitude - all using the same signal.

Dynamic Performance

Dynamic (ac) performance can mean the difference between just looking at a waveform or completely analyzing it. To help you analyze your signals thoroughly, the HP 5180T/U provides 10-bit resolution for waveform data while delivering full specified, high-fidelity dynamic performance.

Automatic Setup

The display provides many convenient features that enhance the system's waveform capture. For example, the AUTOSCOPE function acquires repetitive waveforms and automatically sets the input amplifier, trigger level, and time base to the appropriate values for optimum signal viewing. Existing front-panel settings are automatically saved in non-volatile RAM when AUTOSCOPE is pressed. You can also save up to four additional front-panel setups for recall at your convenience. An optional built-in floppy disc, which is compatible with those for the HP 9000 Series 200 and 300 Computers, lets you store both front-panel settings and captured waveforms. See page 443 for condensed specifications and ordering information.

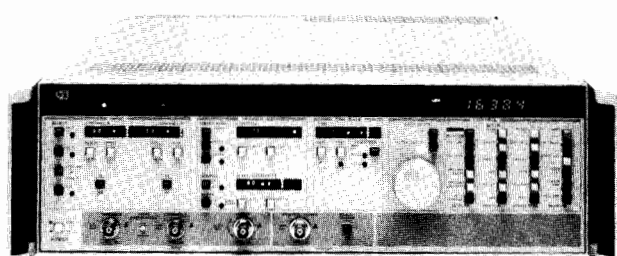

HP 5180A

HP 5180A

High Quality Samples Every 50 Nanoseconds

Signal processing requires high quality input data. Hewlett-Packard's 5180A Waveform Recorder digitizes and stores single-shot or repetitive signals. Voltage waveforms are digitized at sampling rates up to 20 M sa/s (50 ns/sample). Each voltage sample is encoded into a 10-bit word and stored into the memory. These precise voltages (and times) can be read from the front panel with cursors.

Excellent dynamic performance (please read HP Product Note 5180-2) means the ADC does not break up for higher input frequencies. Therefore, your signal is accurately represented for analysis (and replay; see the next pages for description of the HP 5182A Waveform Recorder/Generator).

Accurately Digitize Transients - The shape of fast attack and decay single-shot waveforms is preserved because the higher frequency components are accurately digitized. The digital trigger is precisely settable ensuring reliable triggering with no drift. Selectable hysteresis eliminates false triggering due to noise.

View Single-shot or Repetitive Signals Quickly

The HP 5180A controls external XYZ displays and hardcopy devices to show the contents of memory records without the need for a computer. Zoom and Gain features expand displayed waveforms horizontally or vertically to look in detail at a selected portion of a waveform. Dual trace capability puts two waveforms on an external display for visual comparison. Digital plotters and printers are controlled by HP-IB. There are two methods of transferring data from the HP 5180A to a computer for analysis: HP-IB and DMA. Direct Memory Access (DMA) can transfer data at a rate up to 1 million words/second, depending on the computer.

The HP 5180A can begin recording a signal at one sampling rate and then switch to another. The switch point is selectable. Set one timebase at a faster sample rate to record more detail, and set the other at a slower rate to conserve memory space. Two transients may be recorded simultaneously using the HP 5180A's input CHOP mode.

The HP 5180A is fully programmable over HP-IB for automated operations. See page 443 for condensed specifications and ordering information.

- Automatic measurements
- Universal measurement solutions
- Modular software

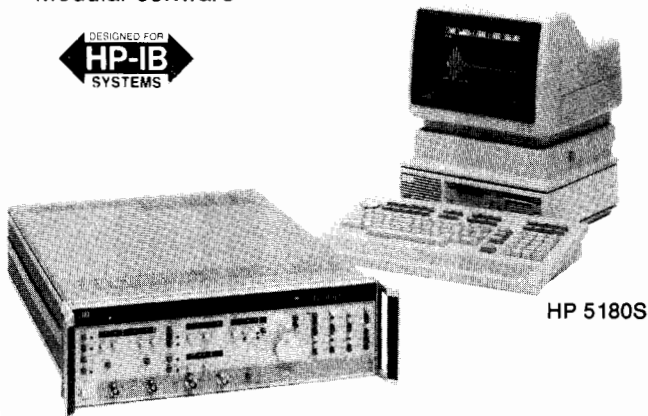

HP 5180S

HP 5180S and HP 51800A

Automatic Time Domain Measurements

Make time domain measurements on single-shot or repetitive waveforms with the HP Model 51800A Waveform Measurement Library. The library is a collection of programs designed to make measurements on signals captured by the HP 5180A Waveform Recorder and HP 5182A Waveform Recorder/Generator. Instruments are controlled by sub-programs. All you do is chain them together to make the measurements you need.

Realize the Power of a Waveform Recorder by Interfacing it to an HP Series 200 or 300 Technical Computer

The HP 5180S Waveform Measurement System allows you to configure a computer-controlled system based on the HP 5180A Waveform Controller. Because the signal has been digitized and stored, it can now be sent to a computer for analysis and then to a disc for permanent storage. Frequency, Period, Pulse Width, Rise/Fall Time, Volts rms and Volts p-p are some of the many standard measurement programs.

HP 5180A, T, U Specifications

See HP 5180A Waveform Recorder or HP 5180 T/U Digitizing Oscilloscope Data Sheet (Pub 5952-7722D & 5952-7835D) for more information.

Channel A and B Inputs

Maximum sensitivity: 200 μ V.

Input attenuator range: \pm 100 mV to \pm 10 V (full scale).

Input offset voltage: \pm selected Voltage Range.

Amplifier bandwidth (-3 dB): dc to 40 MHz (dc coupling).
10 Hz to 40 MHz (ac coupling).

Input impedance (NOMINAL): 1 M Ω || 40 pF (10 V range).
1 M Ω || 35 pF (other ranges).

Damage level: \pm 12 V above 1 kHz.

Dynamic Performance (at 1 MHz)

Harmonic and spurious distortion: -50 dBc

Effective bits: 7.8

Triggering

Internal trigger: level and sensitivity selectable over input voltage range.

External trigger: level selectable over \pm 2.5 V range.

Trigger position: -100% to +9999% of memory.

Timebase

Internal timebase: 20 MHz internal timebase allows sample rates between 50 ns and 50 ms in a 1-2-5 sequence.

External timebase: external timebase signals between 1 MHz and 20 MHz may be used. Internal divide ratio between 1 and 10⁶ in a 1, 2, 5 sequence.

- Increase test design productivity
- Choose standard measurements
- Add custom tests

Memory

Size: 16,384 10-bit words.

Segmentation: memory may be divided into 1, 2, 4, 8, 16, or 32 equal-length records.

Outputs

XYZ CRT monitor outputs: X, Y deflection voltages (NOMINAL) -1 to 0V into 50 Ω . X requires 1 MHz bandwidth input; Y requires 5 MHz bandwidth input. Z voltage (NOMINAL) is 0 to 2 V into 1 k Ω (0 to 1V into 50 Ω), selectable positive or negative going blanking pulse. Z requires 1.25 MHz bandwidth input.

HP-IB: all front panel function values selectable via HP-IB. Data I/O in ASCII or binary; maximum 3 Kbyte/second rate, depending on controller. "Talk only" to HP-GL plotters available even if no controller is used.

DMA: direct memory access allows fast parallel data transfer; maximum 1M word/second, depending on controller.

General

Operating temperature: 0°C to 55°C.

Power requirements: 100/120/220/240 volts +5%, -10%; 48 to 66 Hz. Max power dissipation 500 VA.

Weight: 22 kg (48 lb) net; 25 kg (53 lb) shipping.

Size: 142 mm H x 426 mm W x 574 mm D (5⁵/₈" x 16³/₄" x 23").

Ordering Information

HP 5180A Waveform Recorder

Price

\$18,600

HP 5180S Waveform Measurement System

N/C

To ensure coordination of shipments and compatibility of instruments, computers and software, use the system model number when ordering the individual components, including peripherals such as printers and plotters. Obtain an HP 51800A Data Sheet and HP 5180S Ordering Guide from your local sales office. See page 774.

HP 51800A Waveform Measurement Library

\$1,000

HP 5180T Digitizing Oscilloscope (2 Channel) includes waveform analyzer, two-channel recorder section, software and interconnect cables

\$29,100

HP 5180U Digitizing Oscilloscope (4 Channel) includes waveform analyzer, 2 two-channel recorder sections, software and interconnect cables

\$47,700

Accessories for HP 5180A

HP 10871B Service Kit

\$4,500

HP 10873A Rack Mount Kit

\$140

HP 10874A Slide Mount Kit

\$190

HP 10875A 4.8 m DMA Cable

\$180

HP 10875B 1.0 m DMA Cable

\$180

Opt 910 Additional Manuals

+\$170

Option for HP 5180T/U

Opt 035 Floppy Disc

+\$1,000

Accessories for HP 5180U

HP 1008A Testmobile

\$950

Opt 002 Storage Shelf and Lower Cabinet

+\$115

To ensure coordination of shipments and compatibility of instruments and peripherals such as printers, plotters, and disc drives, it is important that you request the appropriate Data Sheets and Ordering Guides from your local sales office. Please see page 769.



OSCILLOSCOPES & WAVEFORM ANALYZERS

Waveform Recorder/Generator, 20 MHz, 10 Bits, 16K Word Memory

Model 5182A

- 16K nonvolatile waveform memory
- Fully programmable via HP-IB
- Quickly transfer waveforms to/from computer

- Easily simulate complex, real signals
- Record single-shot, replay repetitively

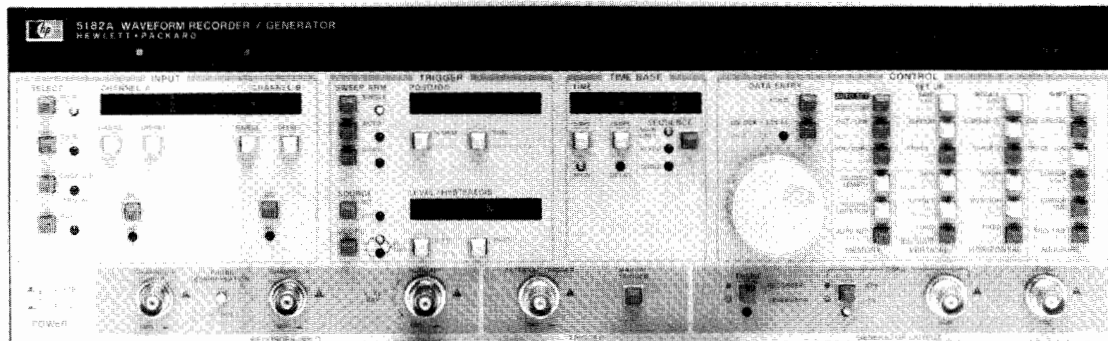

Duplicate Infrequent Waveforms Whenever You Need Them

Get an "instant replay" of your single shot signal when you buy a HP 5182A Waveform Recorder/Generator. Also create repetitive signals by playing back a single recording over and over again with no time gap between replays.

Now you can test your circuits with the actual signal you record rather than a theoretical one. "What if" testing can be done by adding a computer to modify and store the waveforms. An HP Series 200/300 Technical Computer, HP 9111A Graphics Tablet and an HP 5182A comprise the HP 5182S Waveform Generation System.

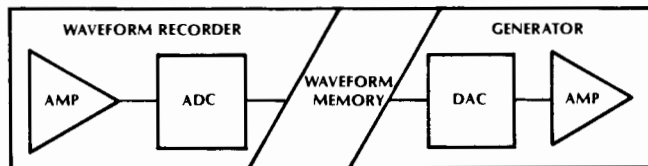

A Waveform Recorder/Generator is a High Speed Digital "Tape" Recorder

The "tape" is silicon memory. At 20 M samples per second, it can store 819 μ s, 819 seconds at 20 samples per second. This digitized waveform can be played back once, or over and over again with no time gap. For example, you can accurately store 16 separate lines of video, or a single sector of data from a floppy disc drive. The video signal can generate color bar patterns to test video circuits. The disc signal can be used to test read-recovery circuits.

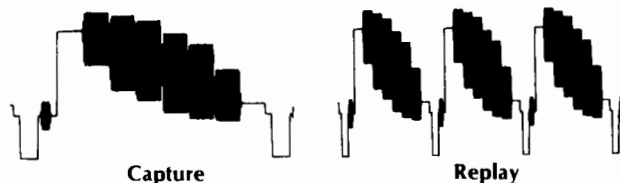

Capture and Save in the Field, Replay on the Bench

Continuous (battery backed up) waveform memory allows you to record up to 32 waveforms on site. Remove the power and carry the HP 5182A back to the lab. Now you can play them back to test your circuits or for further analysis. Attach the HP 5182A to an HP Series 200/300 Technical Computer and you can store the waveforms on disc, process them further and modify them for "what if" testing.

Simulate Expensive, Single-Shot Experiments

Some experiments can be very time consuming and expensive to repeat, for example: biomedical experiments, measurements of explosions, and propagation experiments such as radar and sonar. With the HP 5182A you can capture the signal accurately, when it occurs. Then, switch to generator mode, and you're ready to replay it, any time you need it.

A sync pulse is generated once per playback cycle for synchronizing other equipment.

Generator Section Specifications

For accessories and specifications of the recorder section, please see page 443.

Peak output voltage (for full-scale waveform) into 50 ohms

Range	Vernier Range		Vernier Step Size
	Min	Max	
5.12 V	520 mV	5.12 V	40 mV
512 mV	52 mV	512 mV	4 mV
51.2 mV	5.2 mV	51.2 mV	0.4 mV

Max. output voltage into open circuit: 10 V (NOMINAL).

Output offset: -5.12 V to +5.11 V in 10 mV steps into 50 ohms.

AC Performance: Noise: -65 dBc.

Harmonic distortion (dc to 1 MHz): -48 dBc.

Spurious (sample rate related): -40 dBc TYPICAL.

Output risetime: 100 ns max. (10% to 90%).

Amplifier bandwidth (-3dB): 10 MHz (NOMINAL)

DC performance (10 bits resolution per sample)

Differential nonlinearity: <1 LSB (Monotonic).

Integral nonlinearity: <3 LSB.

Offset accuracy: 100 mV (20-30°C).

Absolute accuracy: 1% of p-p full scale range (20-30°C).

Internal trigger: Output automatically triggered when armed.

External trigger: Slope, level, hysteresis, width, impedance, coupling and maximum input same as for Recorder. (See page 443).

Insertion delay: 250 ns max.

Time base modes

Main only: Available in Single, Auto, and Normal Sweep Arm modes.

Mixed (main, delay): Available in Single and Normal Sweep Arm modes.

Memory size: 16384 10-bit words; Segmentation: 1,2,4,8,16 or 32 equal length blocks. Generation: Data may be generated from any memory block. Within any one block, a portion of the waveform may be generated by setting the starting point and stopping point. An even number of points is always output.

Sync output: Voltage: 0 to -0.75 V NOMINAL into 50 ohms, Pulse Width: One sample interval with the falling (first) edge active (or approximately 100 μ s when the sync pulse is past the stop position, and Sweep Arm is Single or Normal). Position: Settable from first point in the record to the last point. If the sync position is set outside the limits of the Start and Stop Position markers, the output record is extended to include the Sync Position by assigning a dc voltage (equal to the nearest Start/Stop Position marker) to the waveform between the Start/Stop Position marker and the sync position.

Ordering Information

HP 5182 A Waveform Recorder/Generator

\$23,000

OSCILLOSCOPES & WAVEFORM ANALYZERS

Waveform Generation System

Models 5182S, 51820A

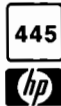

- Save time storing and recalling waveforms
- Quickly modify and utilize waveforms
- Save time when generating arbitrary waveforms
- No programming necessary

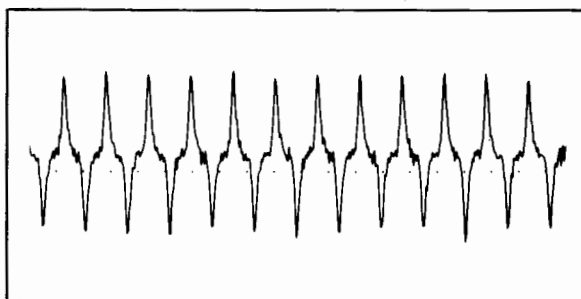
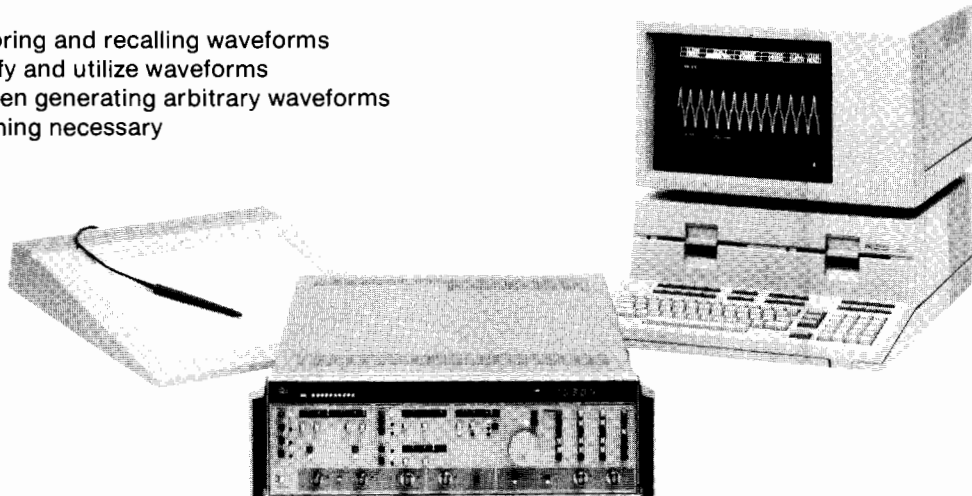

This signal was recorded from a floppy disc read head.

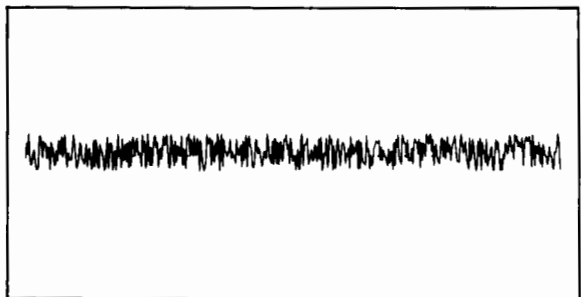

Combined with noise generated from built-in function . . .

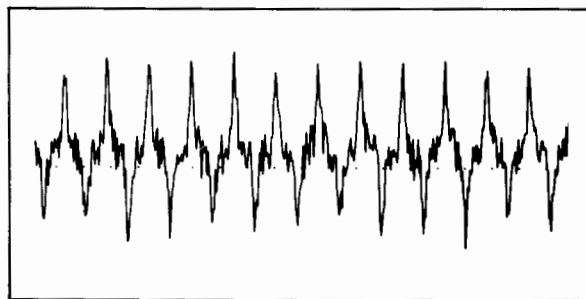

It is used to test the sensitivity of read recovery circuits.

Save Time Generating Specialized Waveforms

The HP 51820A Software is a powerful set of tools for creating specialized waveforms. Modify captured waveforms or define new ones with the HP 9111A graphics tablet (part of the HP 5182S system). Simply press a SOFTKEY to send waveforms to the HP 5182A for replay or disc for storage. Since the HP 51820A is a complete package (no programming is required), you are productive immediately.

The software is driven by a main menu and three submenus: draw, process and I/O. Because it's only two levels deep, you won't get lost in multiple levels of menus.

Waveform Capture, Modification and Playback

Modify waveforms you've captured and play them back into the device you are testing. Rather than waiting for a glitch to occur randomly, you can draw one and see the circuit response immediately.

Waveforms can also be modified by processing. Simple functions like offset and gain are built into the SOFTKEY MENU. There are also SOFTKEYS for adding or multiplying two waveforms together.

More complicated processing like calculus and convolution can be accomplished by modifying the user-equation subroutines. Four SOFTKEYS are reserved for your own equations. The Software comes with the equations programmed to generate sine waves, triangle waves, square waves and random noise.

Arbitrary Waveform Generation

There are three ways to create the waveforms you need. You can recall waveforms from the library, including sine waves, square waves, SIN (X)/X, Gaussian pulses, exponentials and more. You can calculate waveform samples with equations. Third, you can draw or trace waveforms with the graphics tablet. Choose the method that will get you the signal you need in the shortest time.

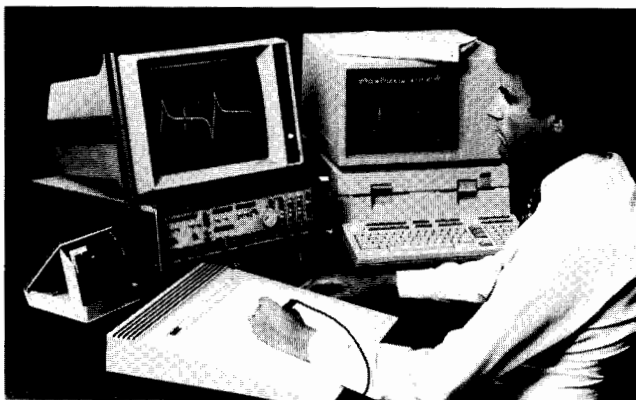

Draw, trace, or edit waveforms with friendly software and graphics tablet. Waveforms can also be generated by equations.

Ordering Information

HP 5182S Waveform Generation System

Price
N/C

To ensure coordination of shipments and compatibility of instruments, computers and software, use the system model number when ordering individual components including peripherals such as printers and plotters. Obtain HP 51820A and HP 51800A Data Sheets and a HP 5182S Ordering Guide from your local sales office. See page 769.

HP 51820A Waveform Generation Software

\$1000



OSCILLOSCOPES & WAVEFORM ANALYZERS

Three-Channel Recorder to 3 kHz, 12 Bits, 33.3 kHz Sample Rate

Model 7090A

- DC to 3 kHz bandwidth, 33.3 KHz sampling rate
- 3 Channels with simultaneous sampling
- 12-bit resolution, 1 k buffer/channel
- 6 trigger modes with up to 100% pre-trigger capture
- Full HP-IB programmability
- Annotation of set-up and trigger conditions and data points

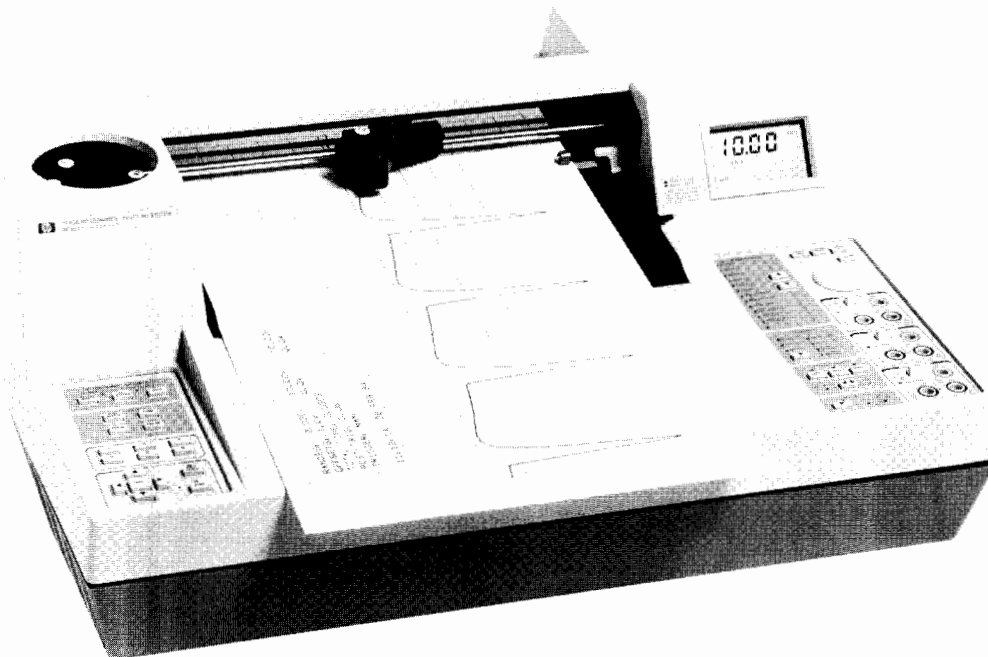

The HP 7090A is designed for low-frequency (<3 kHz) measurement, analysis, and documentation. The HP 7090A merges several technologies - waveform recording, digital plotting, analog recording, and automated measurement - to provide a powerful solution to a broad range of measurement applications. It significantly increases the ability to measure and display low-frequency phenomena and substantially improves real-time recording and digital plotting . . . all in one low-cost system.

Signal Capture

Simultaneous sampling on each of three channels, 12-bit resolution, bandwidth of dc to 3 kHz (33.3 k samples/s maximum), and 1000 word memory per channel allow high resolution measurement, storage, and display.

Flexible Triggering

The HP 7090A has six trigger modes which allow virtually any signal change to initiate signal capture, even decaying repetitive signals such as faults in a power line voltage, or in a transducer's carrier. Combined with pre-trigger capability, these trigger modes make the HP 7090A ideal for turn-on/off characterization, fault monitoring and mechanical motion analysis.

A System Component

All panel functions are programmable via the HP-IB interface. Data can be transferred from the internal 1 k-buffers or streamed in real time from the analog-to-digital converters at up to 500 points/s. In addition, the menu-driven HP 17090B Measurement Graphics Software package is available for HP 9000 Series 200 computers (BASIC 3.0 only). The software allows easy data manipulation, storage and retrieval, and system integration.

Versatile Capabilities

Uniquely, the HP 7090A is also a high performance analog/digital plotter. It is ideal for a graphics dump from a smart instrument or as part of an HP-IB system; you can also use the HP 7090A to take an X-Y dump from an analog instrument. With the HP 7090A, hand annotation is unnecessary. The 7090A annotates setup conditions, date and time, selected data points from memory, and trigger information. It draws user-defined axes and grids, eliminating the need for

pre-printed graph paper. The HP 7090A even lets you plot overhead transparencies for technical presentations using your current spreadsheet/graphics software.

Applications

Capturing Low Frequency Electrical Transients: General diagnostic monitoring (such as looking for relative timing sequences) and fault monitoring (capturing pre-trigger data for intermittent failure analysis) are natural applications for the HP 7090A.

Measuring Phase Relationships: The simultaneous sampling on all channels is ideal for measuring current/voltage phase relationships in power systems.

Analog Instrument/Digital System Link: The HP 7090A can integrate an analog instrument into an HP-IB system; the HP 7090A, with a controller can digitize output voltages from analog instruments for HP-IB system data entry.

Mechanical and Electromechanical Testing: Applications in which transducers convert velocity, acceleration, force, temperature or torque to voltage are a good fit for the HP 7090A. These applications have a maximum output frequency below 3 kHz. The HP 7090A's flexible trigger capabilities make it useful for one-shot electromechanical events such as clutch and mechanism engagements

Electromechanical Control Systems: The HP 7090A can measure the response of a system to a stimulus; a typical use would be exciting the system with a step function and using the measured response to determine damping ratio and the natural frequency of the control system.

Material Testing: The HP 7090A can record classic stress-strain curves, particularly those obtained from destructive testing. The data is stored in a buffer, so even though the sample has been destroyed, the data can be viewed and rescaled in several different ways.

Automatic Test: When linked to an HP 9000 Series 200 computer, the HP 7090A is a good, inexpensive learning tool for small companies considering automatic test systems. Applications include environmental and production line testing and proof of performance records.

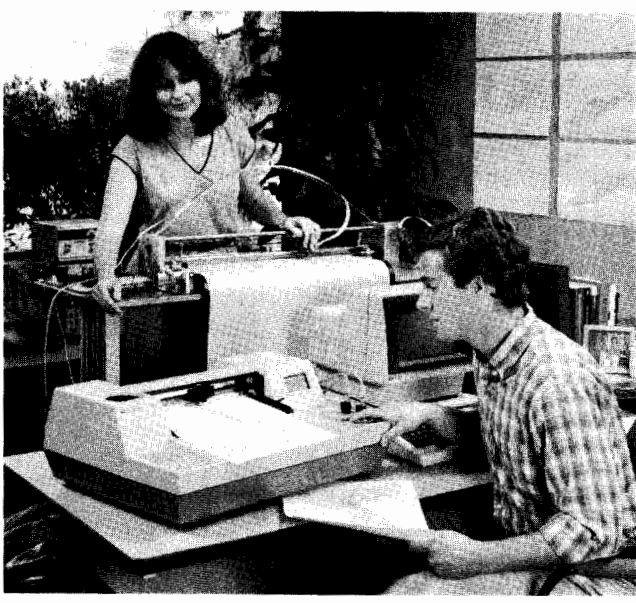
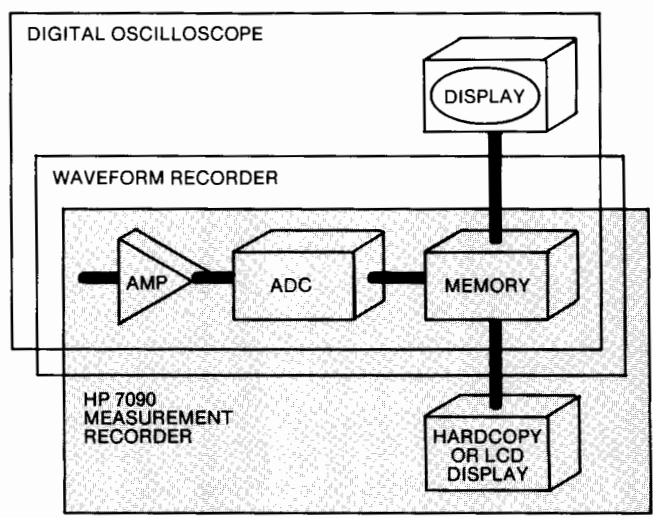

Measurement Graphics Software

Combining an HP 7090A, an HP 9000 Series 200 computer and the HP 17090B Measurement Graphics Software produces a powerful menu-driven system for measurement, data manipulation, and data storage and retrieval. The menu-driven software, written in BASIC 3.0 for Series 200 computers, takes advantage of the HP 7090A's capabilities as a system component. Data streaming is simplified, and can be done from each channel's A/D converter in real time or from each buffer after the data has been captured. All HP 7090A functions can be controlled by the computer.

Program Capabilities: There are six main functional areas of Measurement Graphics Software:

- Measurement Setup
- Measurement
- Display Annotation
- Data Manipulation
- Storage and Retrieval

The HP 17090B software helps you use the HP 7090's features easily and effectively plus, it provides storage, annotation and data transformation options not available on the HP 7090A unit alone.

Friendly, Menu-driven Interface: Each menu allows the user to view several parameters simultaneously. Series 200 softkeys and cursor-control knob minimize keyboard input. The "help" softkey displays the available choices and ranges for each parameter setting.

System Requirements: Measurement Graphics Software is written in BASIC 3.0 and requires a minimum of 216 K of RAM after the operating system is loaded; however, 433 K is recommended for optimum program speed. The software is designed for use with an HP 9000 Series 200 computer and an HP 7090A Measurement Plotting System. The software is supplied on two 3.5 inch microfloppy or 5.25 inch minifloppy discs and is accompanied by a user's manual.

Summary of HP 7090A Specifications*

Inputs

- Number of channels: 3
- Input alternator range: ± 5 mV to ± 100 V (full scale)
- Input offset voltage: ± 2 full scale or ± 100 V maximum
- Amplifier bandwidth (≥ 3 dB): dc to 3 kHz for all full scale ranges ≥ 20 mV, 2.6 kHz for all full scale ranges ≤ 20 mV
- Input impedance: 1 Mohm, shunted by 45 pf (Nominal)
- CMRR: 140 dBdc; 100 dBac @ 60 Hz with 1 kohm unbalance in LOW terminal and most sensitive range (at 25°C)

Dynamic Performance

- Slewing speed (Nominal)
 - Direct mode: 127 cm/s (50 in/s)
 - Plotting mode: 75 cm/s (30 in/s)
- Acceleration (Nominal): 2 g constant
- Peak capture: 250 μ s at fastest timebase range

Triggering

- Internal trigger:
 - Inside or outside window
 - Above or below level, selectable over the full-scale range in 1.0% increments (Nominal)
 - Source: channel 1
- External trigger:
 - BNC connector, TTL level or contact closure to ground
- Manual trigger:
 - Available from front panel controls
- Display: Up to 100% pre-trigger; up to 24 hour post-trigger delay after trigger before measurement start

Timebase

- Range:
 - Buffer mode: 30 milliseconds to 24 hours
 - Direct record mode: 1 second to 24 hours
- Accuracy: $\pm 0.1\%$

Memory

- Size: 1 K per channel
- Resolution: 12 bits

Supplemental Characteristics

Analog to Digital

- Maximum sampling rate: 33.3 k samples/s
- Maximum streaming rate over HP-IB:

	ASCII	Binary
1 channel	167/s	500/s
1 channel plus trigger	143/s	333/s
3 channels	59/s	167/s
3 channels plus trigger	59/s	167/s

Writing System

- 6-pen carousel with automatic pen capping
- Fiber-tip pens for paper or transparencies

Ordering Information

	Price
HP 10833A or 45529A HP-IB (IEEE-488) 1-meter cable	\$81 ☎
HP 10833B or 45529B HP-IB (IEEE-488) 2-meter cable	\$91 ☎
HP 17090B Measurement Graphics Software	
Option 630 (3.5 in. disc size)	\$700
Option 655 (5.25 in. disc size)	\$700
HP 7090A Measurement Plotting System	\$4,900

*Refer to page 455 for complete specifications.
☎ Fast-Ship product—see page 766



OSCILLOSCOPES & WAVEFORM ANALYZERS

Probe Multiplexer

HP 54300A, HP 54001A, HP 54002A, and HP 54003A

- Expand Input Capability Of 50 Ω Instrumentation
- Your choice 50 Ω , 10k Ω & 1 M Ω Input Pods

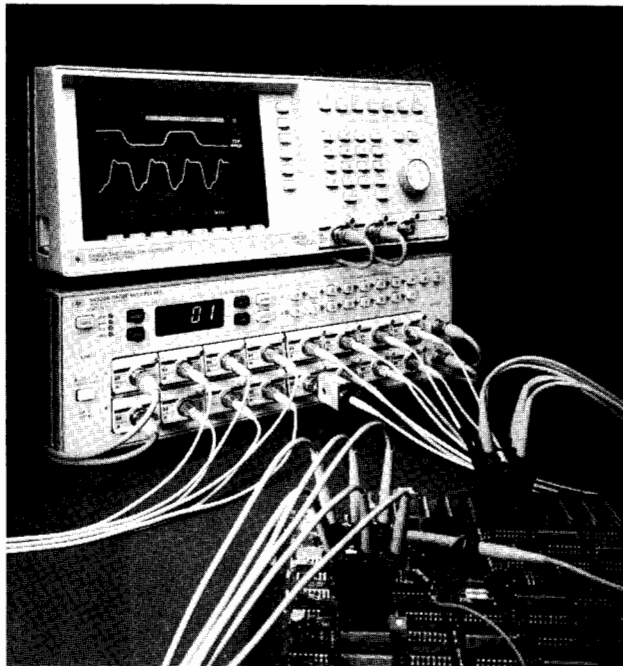

The HP 54300A probe multiplexer expands the input capability of the HP 54100A/D digitizing oscilloscope, or any 50 Ω input instrument, simplifying delicate high-frequency connections.

The Multi-Input Tool For 50 Ω Instrumentation

The HP 54300A is a programmable, dual eight-to-one probe multiplexer designed to expand the input capability of instrumentation with 50 Ω inputs. The unique strength of this multiplexer is its configurability. The user may select from three different input pods: two high-frequency, high-impedance probes, or a 50 Ω BNC input for terminated line applications.

The HP 54300A features full HP-IB programmability as well as simple front-panel control. It has internal non-volatile memory for storing lists of switching steps. Switch lists can be advanced step-by-step from a front-panel button, over the HP-IB (i.e., IEEE-488) or for data logging applications, through a TTL pulse entered at the rear panel.

Automate Complex Measurements

The HP 54300A is ideal for delicate situations where high-frequency connections must be maintained and probes cannot be conveniently moved from one connection to another. Complex measurements can be automated by using the multiplexer's 16 inputs, switching one or two of them at a time into the test instrument, under computer control. In situations requiring more than 16 inputs, HP 54300A multiplexers may be cascaded in series to give a total of 128 inputs.

Your Choice Of Inputs

Configurable inputs is one of the HP 54300A's strongest contributions. It accepts all of the input pods designed for the HP 54100/110 1 GHz digitizing oscilloscope.

- Fully HP-IB Programmable. Plus Convenient Front-panel Control
- Internal Non-volatile Memory

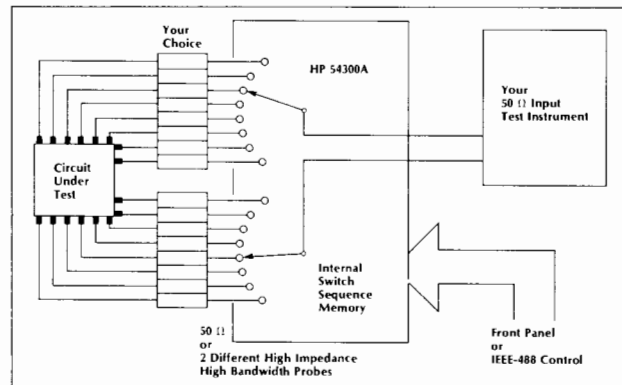

The HP 54300A's configurable inputs and HP-IB programmability make it a powerful addition to your bench or ATE system.

HP 54001A 1 GHz Active Mini-probe Pod

This pod, with its built-in probe, offers 1 GHz bandwidth with 10k Ω /2 pF input loading. It uses HP's mini-tip probe for easy access in compact circuits, and features both high-bandwidth and high-impedance at the probe tip. This probe is ideal for making high-speed logic measurements, where high bandwidth is needed and probe capacitance is a significant factor in loading the test circuit.

HP 54002A 50 Ω BNC Pod

This pod should be used with terminated 50 Ω systems. Output from the multiplexer using this pod is <2 dB down at >1 GHz. The 54002A is also useful with divider probes such as the HP 10020A.

HP 54003A 300 MHz 1 M Ω Probe Pod

This pod, with a 10:1 detachable mini-tip probe, has 1 M Ω resistive and 8 pF capacitive loading. It is valuable when resistance is a more significant loading factor than capacitance, such as in operational amplifier measurements. If desired, the probe may be removed from its pod to provide a 1 M Ω approximately 10 pF BNC input.

Fully Programmable For Automated Testing

All functions that can be controlled from the HP 54300A front panel can also be controlled over the HP-IB. Simple, English-like commands are used with an optional format that is compatible with the command language of the HP 3488A switch/control unit.

The HP 54300A command set is simple, but complete. Even information such as the type of input pod that is being used or the total number of switch closures that have occurred on a given switch pole may be obtained over the bus. This information is useful in determining whether the correct pods have been inserted for a particular automatic program, or to indicate when switch replacement is due. The HP 54300A is a powerful complement to other HP programmable instruments and HP computers for automated testing of high-frequency circuits.

Ordering Information

HP 54300A dual 8:1 probe multiplexer	Price \$6800
Includes one operating and programming manual. Each HP 54300 accepts up to 16 input pods in any combination. Pods must be ordered separately.	
Opt. 908 Rackmount flange kit	\$32.50
HP 54001A 1 GHz miniature active probe pod	\$750
HP 54002A 50 Ω BNC input pod	\$130
HP 54003A 1M Ω 10:1 probe pod	\$650

For information on other probes and probing accessories, please refer to the section on the HP 54100/110 digitizing oscilloscope, page 432.



Miniature Oscilloscope Probes

OSCILLOSCOPE/MINIATURE PROBE COMPATIBILITY AND PROBE CHARACTERISTICS								
HP Oscilloscope/ Logic Analyzer	HP Probe Model No.	Approx Overall Length in Metres (ft)	Division Ratio	Input R	Shunt Capacitance	Compensates Oscilloscope Input	Max dc Volts	Price
1725/27, 1631A/D, 54200/201	10017A	1 m (3.3)	10:1	1 MΩ	8 pF	9 to 14 pF	300	\$130
1725/27, 54200/201 1631A/D, 54100 series with 54003A	10018A	2 m (6.6)	10:1	1 MΩ	10 pF	9 to 14 pF	300	\$110
1740A, 1741A, 1744A, 1745A, 1746A	10040A	1 m (3.3)	10:1	1 MΩ	9 pF	20 to 30 pF	300	\$125
	10041A	2 m (6.6)	10:1	1 MΩ	12 pF	20 to 30 pF	300	\$125
	10042A	3 m (9.8)	10:1	1 MΩ	15 pF	20 to 30 pF	300	\$125
1950A, 1980B	10081A**	2 m (6.6)	10:1	1 MΩ	12 pF	12 to 20 pF	300	\$150
	10084A**	2 m (6.6)	1:1		68 pF		300	\$150
All scopes with high Z inputs (may reduce bandwidth)	10021A	1 m (3.3)	1:1		36 pF		300	\$75
	10022A	2 m (6.6)	1:1		62 pF		300	\$80
All scopes with 50 Ω inputs	10026A	1 m (3.3)	1:1	50 Ω			100	\$75
	10027A	2 m (6.6)	1:1	50 Ω			100	\$75

Accessories supplied with each probe: one retractable hook tip, one IC probe tip adapter, one alligator clip, one 20 cm (8 in) ground lead, eight color-coded indicator sleeves, one grounding spring, and one Operating Note.

*These miniature probes may be used with other oscilloscopes and test instruments with the proper input capacitance with no noticeable bandwidth degradation. However, due to variations of input characteristics, the probes may require recalibration for optimum performance.

**The HP 10080-series miniature probes include a Feature Enable pushbutton for exclusive use with the HP 1980 Oscilloscope Measurement System.

Standard Probes

Standard Probe/Instrument Compatibility

Scope/ Plug-in	1725/27 54200/201	1740A thru 1744A
Probe		
10002A		L
10004D		X
10005D		L
10006D		X
10014A	X	
10016B	X	
10020A	X	X
1124A	L	L

Notes:

X indicates that probe will maintain the bandwidth of the instrument.

L indicates that probe may limit the bandwidth of the instrument.

Standard Divider Probe Characteristics

HP Model No.	Division Ratio	Resistance (M Ω)	Shunt Capacitance (pF)	Compen- sates Scope Input C (pF)	Max dc Volts	Overall Length m (ft)	Price
10002A	50:1	9	2.5	15-55	1000	1.5(5)	\$200
10004D	10:1	10	10	20-30	500	1.1 (3.5)	\$125
10005D	10:1	10	17	20-30	500	3 (10)	\$150
10006D	10:1	10	14	20-30	500	1.8 (6)	\$117
10013A	10:1	10	13	24-45	500	1.8 (6)	\$90
10014A	10:1	10	10	9-13	500	1.1 (3.5)	\$140
10016B	10:1	10	14	9-13	500	1.8 (6)	\$150

HP 10020A Resistive Dividers

Division Ratio	Input R* (ohms)	Division Accuracy	Max V** (rms)	Input C (pF)
1:1	50	—	6	—
5:1	250	±3%	9	<0.7
10:1	500	±3%	12	<0.7
20:1	1000	±3%	15	<0.7
50:1	2500	±3%	25	<0.7
100:1	5000	±3%	35	<0.7

*When terminated in 50 ohms.

**Limited by power dissipation of resistive element.

HP 10020A Resistive Divider Probe Kit

Probe length (overall): ≈ 1.2 m (4 ft).

Weight: net, 0.45 kg (1 lb); shipping, 1.4 kg (3 lb).

Accessories supplied: blocking capacitor, BNC adapter tip, 6-32 adapter tip, alligator tip, probe handle, cable assy's 5.1 cm (2 in) & 15.2 cm (6 in) ground, spanner tip, insulating caps, colored sleeves.

HP 1124A 100 MHz Active Divider Probe

The HP 1124A active divider probe provides high voltage, general-purpose probing capabilities for instruments having 50 ohm inputs without selectable high impedance inputs. This 10 Mohm 10 pF probe allows direct measurements of 100 V, in the 100:1 division ratio mode, from dc to 100 MHz. In the 10:1 division ratio mode, input voltage range is ±10 V. Power is supplied by instruments with probe power jacks or the HP 1122A probe power supply.

HP 1124A Specifications

(Measured when connected to a 50 ohm load)

Bandwidth: (measured from a terminated 50 ohm source) dc-coupled, dc to 100 MHz; ac-coupled, 2 Hz to 100 MHz.

Pulse response: (measured from a terminated 50 ohm source) transition time, <3.5 ns; perturbations, 5% p-p. Measured with pulse transition time of >2.5 ns.

Attenuation ratio: 10:1 ±5%; 100:1 ±5%.

Dynamic range: x10, ±10 V; x100, ±100 V.

Input RC: 10 Mohm shunted by ~10 pF.

Maximum safe input

dc-coupled: x10, ±300 V (dc + peak ac) ≤100 MHz; x100, ±500 V (dc + peak ac) ≤100 MHz.

ac-coupled: x10, ±300 V (dc + peak ac) ≤100 MHz; dc component must not exceed ±200 V; x100, ±500 V (dc + peak ac) ≤100 MHz; dc component must not exceed ±200 V.

Accessories supplied: one 20.3 cm (8 in) ground lead, one retractable hook tip, and two probe tip insulating caps.

Power: supplied by instruments with probe power jacks or the HP 1122A probe power supply.

Weight: net, 0.2 kg (5 oz); shipping, 0.91 kg (2 lb).

Length: ~1.5 m (5 ft) overall.

Ordering Information

HP 10020A resistive divider probe kit

HP 1124A 100 MHz active probe

Price

\$375

\$325



OSCILLOSCOPES & WAVEFORM ANALYZERS

Probes and Other Oscilloscope Accessories

HP 1122A Probe Power Supply

The HP 1122A is a regulated power supply that provides all power requirements for simultaneous operation of up to four active probes.

HP 1122A Specifications

Probe driving capability: up to four HP active probes.
 Power output: -12.6 V and +15 V, $\pm 3\%$.
 Power input: 115 V or 230 V $\pm 10\%$, 48 to 440 Hz, 40 W (with four probes).
 Weight: net, 2.7 kg (6 lb); shipping 3.6 kg (8 lb).

Miniature Probe Accessories

HP 10017-67603 Coaxial Adapter Cable

HP P/N 10017-67603 is a 230 mm (9 in) 50 ohm slip-on adapter cable for miniature and standard HP probes. It provides a coaxial interface to 0.64 mm (0.025 in) square pin circuit nodes. The cable is ideal for probing computer back planes as well as wire wrap terminals. HP P/N 10017-67604 miniature-to-standard probe adapter allows the cable to slip directly onto the HP easy IC miniature probe tip with the insulating barrel removed.

HP 10017-67604 Miniature-to-Standard Probe Adapter

HP P/N 10017-67604 allows standard size slip-on probe tip accessories to be used with HP miniature probes. With the retractable insulating barrel removed from the miniature probe and replaced with the HP 10017-67604 adapter, the probe slides directly into the standard size probe tip accessories.

HP 10024A IC Test Clip

The HP 10024A IC test clip provides easy probing of dual in-line packages and includes four insulated circuit interface pins. Additional circuit interface pins are available (see Ordering Information) in packages of twelve pins. Each pin has a tip on each end so that probes such as those on HP logic analyzers can be connected for fast, functional checks of circuit operation.

Probe Accessories

Terminations

HP 10100C: 50 ohm $\pm 1\%$ BNC male to BNC female feedthrough termination.

Standard Probe Tip Adapters

HP 10229A hook tip adapter: retractable pincer tip provides firm connection to circuit nodes. Recommended accessory for HP 10020A resistive divider kit.

HP P/N 10004-69515 IC probe tip adapter: retractable pincers provide convenient connection to dual in-line packages for HP probes 10004D, 10005D, 10006D, 10007B, 10008B, 10013A, 10014A, 10016B, and 1124A. Supplied with HP probes 10004D, 10005D, 10006D, 10014A, and 10016B.

Light Filters

Blue light filter: HP P/N 01740-02701 for HP 1700-series scopes.

Testmobile

The HP 1008A provides a sturdy, lightweight, stable platform for your oscilloscope or instrumentation system (see specification chart). Large angled wheels with a wide track move quietly and smoothly over most surfaces. The top tray is table height and can be tilted to a convenient viewing angle between 30 degrees above and 30 degrees below the horizontal position with a total of seven detent positions in 10 degree increments. The caps on each side rail are designed to hold three probes to reduce the possibility of damaging probes not in use. A 01007-60017 power strip (U.S.) is included with each HP 1008A.

HP 1008A Option 006 adds a storage cabinet with a shelf on top and a drawer in the lower position to the basic HP 1008A. Load limit is 18 kg (40 lb) each on the shelf and in the cabinet, 11 kg (25 lb) in the drawer.

HP 1008A Specifications

		HP 1008A
Height		930 mm (36½ in)
Overall width		759 mm (29½ in)
Width of tray		473 mm (18½ in)
Tilt tray angle		$\pm 30^\circ$
Weight	net	13 kg (28 lb)
	shipping	22 kg (48 lb)
Max load on tilt tray		45 kg (100 lb)
Max load below tilt tray		see option description

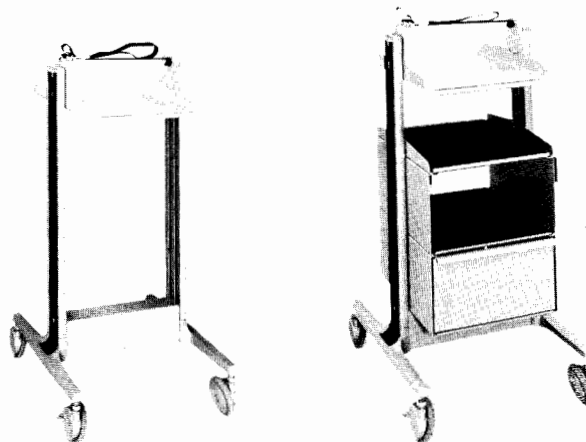

Basic Testmobile

Opt 006: storage cabinet with shelf on top and drawer in lower position; load limit 18 (40 lb) each on shelf and in cabinet, 11 kg (25 lb) in drawer.

Ordering Information

Ordering Information	Price
HP 1122A probe power supply	\$1050
HP 10017-67603 coaxial adapter cable	\$60
HP 10017-67604 miniature-to-standard probe adapter	\$40
HP 10024A IC test clip (with 4 circuit interface pins)	\$20
HP 10024-69501 interface pin kit for HP 10024A; includes 12 interface pins	\$39
HP 1250-1454 BNC-to-mini probe adapter	\$13.50
HP 10229A retractable hook tip adapter	\$15
HP 10004-69515 IC probe tip adapter	\$12
HP 10100C 50 ohm feedthrough termination	\$25
HP 5020-0530 amber plastic filter for 12.7 cm (5 in) rectangular CRT	\$28
HP 5020-0567 smoke-gray plastic filter for 12.7 cm (5 in) rectangular CRT	\$40
HP 5060-0548 blue plastic filter for 12.7 (5 in) rectangular CRT	\$12.50
HP 01740-02701 blue light filter for HP 1700-series oscilloscopes (8 x 10 division CRT)	\$11.50
HP 1490-0714 fixed slides for HP 180/81 scopes	\$160
HP 1490-0719 pivoted slides for HP 180/81 scopes	\$240
HP 1490-0768 slide adapter, required for securing slides to HP 180/81 rack-style oscilloscopes	\$215
HP 1008A testmobile	\$950
HP 1008A, option 006 added shelf and cabinet for 1008A	\$265
HP 01008-61207 probe pod holder holds three small logic analyzer probe pods such as HP 10230 and HP 10248	\$15
HP 01008-68703 rack mount kit for the HP 1008A; 13.3 cm (5¼ in) height for mounting under the tilt tray	\$75
HP 01007-60017 power strip kit; U.S. only five outlet power strip for the HP 1008A	\$85

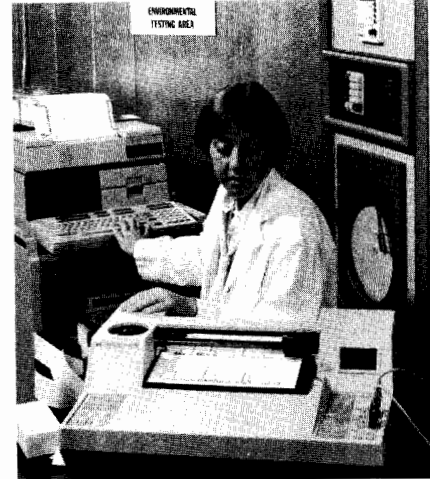
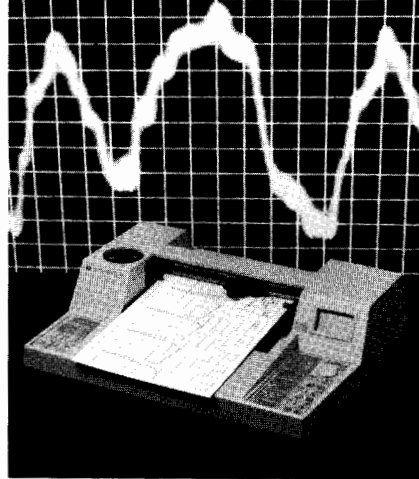
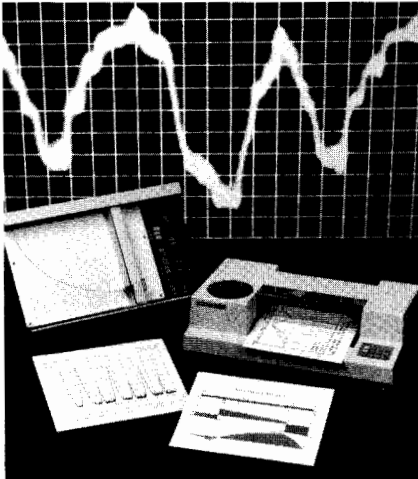

Introduction

Whenever you measure and collect data with accuracy and precision, you need precise hardcopy records of your results. A hardcopy graphics device can improve your measurement system: plots provide permanent post-test results for analysis and documentation purposes and can be filed and retrieved as needed; output can be presented on overhead transparencies for effective communication during training sessions or meetings; and plots take less time than manual graphing and less money than scope camera film.

Recording Analog Data

For measurements made from analog input signals, HP offers two solutions. HP offers a family of traditional X-Y recorders, plus the HP 7090A Measurement Plotting System, a versatile measurement graphics instrument. The HP 7090A is a recorder that captures signals up to 3 kHz and plots annotated results on paper.

Recording Digital Data

Hewlett-Packard has two solutions for obtaining hardcopy records from digital data input. Both the HP 7090A and HP's graphics plotters (HP ColorPro, 7475A and 7550A), with the appropriate hardware and software, can draw grids, annotate charts, and use many line types and colors to differentiate data.

Whether your application is manufacturing, engineering, education, or medicine, HP offers the products and performance features to meet your hardcopy requirements. Check the table on pages 460 through 462 to help choose the best device for your HP instrument.

X-Y Recorders

X-Y recorders plot graphs from low-frequency analog signals. There are three factors to consider in selecting an X-Y recorder:

static performance, dynamic performance, and specific features that are important for your particular application.

Measurement Plotting System

The HP 7090A Measurement Plotting System is a new concept that provides a significant measurement advantage as well as unparalleled flexibility in hardcopy graphics. Functionally, the HP 7090A can replace traditional analog recorders in most applications, and, in addition, add significant and unique measurement and graphics capabilities. With its three input channels, 3 kHz bandwidth, and HP-IB interface, the HP 7090A provides the advantages of analog recording and digital plotting in one product.

The HP 7090A replaces traditional analog recorders; it offers superior dynamic performance and accuracy; 41,000 calibrated ranges; a 30 msec to 24-hour time base; 6 triggering modes; the ability to annotate with date, time, and setup conditions; and the ability to draw axes and grids which correspond to the recorded data.

The HP 7090A is also a low frequency waveform/signal analyzer. It provides the signal capture functionality expected from a dedicated instrument at a fraction of the cost. Three channel 12 bit digitization, sampling rates of 33.3k samples/sec, and 6 trigger modes make the HP 7090A a perfect choice for applications requiring 3 kHz data acquisition and analysis.

Graphics Plotters

Graphics plotters provide multi-color, professional quality hardcopy for digital data input. Selection is based on line quality, speed, output size, intelligence features, available software, interface, and budget considerations. See pages 108 - 113 for more details on digital plotters.

Choosing Your Measurement Graphics Output Device

HP Model	Floating, guarded input(s)	Sensitivity	CMRR AC/DC	No. of Channels/pens	Paper Size		Slewing speed	Acceleration y-axis/x-axis	HP-IB interface	Overhead transparencies	Price
					A/ A4	B/ A3					
Analog Recording 7015		Medium	100 dB/ 90 dB	1	✓		50 cm/s	2.5g/1.3g/ (Peak)			\$2,300
7035	✓	Medium	130 dB/ 100 dB	1	✓		50 cm/s	not specified			\$2,800
7045	✓	High	110 dB/ 90 dB	1	✓	✓	97 cm/s	7.6g/5.1g (Peak)			\$3,800
7046	✓	High	110 dB/ 90 dB	2	✓	✓	97 cm/s	6.3g/3.8g (Peak)			\$4,800
Analog & Digital Recording 7090	✓	Very high	140 dB/ 100 dB	3 channels /6 pens	✓	✓	127 cm/s direct 75 cm/s plotting	2g constant (=8g peak)	✓	✓	\$4,900
Digital Recording 7440 (ColorPro)				8 pens	✓		40.0 cm/s	2g	✓	✓	\$1,295
7475				6 pens	✓	✓	38.1 cm/s	2g	✓	✓	\$1,895
7550				8 pens	✓	✓	80 cm/s	6g	✓	✓	\$3,900

PLOTTERS & RECORDERS

Measurement Plotting System

Model 7090A

- Floating and guarded inputs
- DC to 3 kHz bandwidth, 33.3 kHz sampling rate
- 3 channels with simultaneous sampling
- 12-bit resolution, 1 k buffer/channel
- 6 trigger modes with up to 100% pre-trigger capture
- Full programmability and data transfer over HP-IB



HP 7090A

The HP 7090A is designed for low-frequency (< 3 kHz) measurement, analysis, and documentation. The 7090A merges several technologies - waveform recording, digital plotting, analog recording, and automated measurement - to provide a powerful solution to a broad range of measurement applications. It significantly increases the ability to measure and display low-frequency phenomena and substantially improves real-time recording and digital plotting ... all in one low-cost system.

Signal Capture

Simultaneous sampling on each of three channels, 12-bit resolution, bandwidth of dc to 3 kHz (33.3 k samples/s maximum), and 1000 word memory per channel allow high resolution measurement, storage, and display.

Flexible Triggering

The HP 7090A has six trigger modes which allow virtually any signal change to initiate signal capture, even decaying repetitive signals such as faults in a power line voltage, or in a transducer's carrier. Combined with pre-trigger capability, these trigger modes make the HP 7090A Measurement Plotting System ideal for turn-on/off characterization, fault monitoring and mechanical motion analysis.

A System Component

All panel functions are programmable via the HP-IB interface. Data can be transferred from the internal 1 k-buffers or streamed in real time from the analog-to-digital converters at up to 500 points/s. In addition, the menu-driven HP 17090B Measurement Graphics Software package is available for HP 9000 Series 200

computers (BASIC 3.0 only). The software allows easy data manipulation, storage and retrieval, and system integration.

Versatile Capabilities

As the name implies, the HP 7090A Measurement Plotting System is also a high performance digital plotter. It is ideal for a graphics dump from a smart instrument (e.g. from an HP 8569B Spectrum Analyzer) or as part of an HP-IB system; you can also use the HP 7090A to take an X-Y dump from an analog instrument (e.g. from an HP 141T Spectrum Analyzer System). With the HP 7090A, hand annotation is unnecessary. The 7090A annotates setup conditions, date and time, selected data points from memory, and trigger information. It draws user-defined axes and grids, eliminating the need for pre-printed graph paper. The HP 7090A even lets you plot overhead transparencies for technical presentations.

Applications

Analog Recording: Electrical, chemical, mechanical and medical fields all benefit from recording real-time X-Y and Y-T relationships. As an analog recorder, the HP 7090A has sensitivity to 5 mV full scale and 41,000 calibrated ranges for easy and quick calibration to measurement units. The HP 7090A's superior dynamic performance and high sensitivity provide users the versatility and accuracy required in laboratory environments.

Capturing Low Frequency Electrical Transients: General diagnostic monitoring (such as looking for relative timing sequences) and fault monitoring (capturing pre-trigger data for intermittent

failure analysis) are natural applications for the HP 7090A.

Measuring Phase Relationships: The simultaneous sampling on all channels is ideal for measuring current/voltage phase relationships in power systems.

Analog Instrument/Digital System Link: The HP 7090A can integrate an analog instrument into an HP-IB system; the HP 7090A, with a controller can digitize output voltages from analog instruments for HP-IB system data entry.

Mechanical and Electromechanical Testing: Applications in which transducers convert velocity, acceleration, force, temperature or torque to voltage are a good fit for the HP 7090A. These applications have a maximum output frequency below 3 kHz. The HP 7090A's flexible trigger capabilities make it useful for one-shot electromechanical events such as clutch and mechanism engagements.

Electromechanical Control Systems: The HP 7090A can measure the response of a system to a stimulus; a typical use would be exciting the system with a step function and using the measured response to determine damping ratio and the natural frequency of the control system.

Material Testing: The HP 7090A can record classic stress-strain curves, particularly those obtained from destructive testing. The data is stored in a buffer, so even though the sample has been destroyed, the data can be viewed and rescaled in several different ways.

Automatic Test: When linked to an HP 9000 Series 200 computer, the HP 7090A is a good, inexpensive learning tool for small companies considering automatic test systems. Applications include environmental and production line testing and proof of performance records.

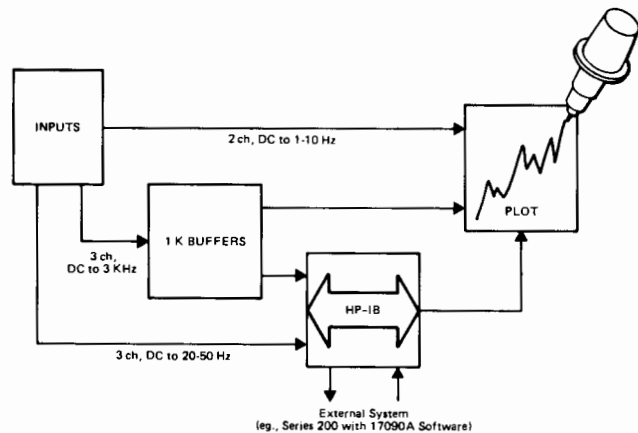

Possible data flow paths for the HP 7090A Measurement Plotting System.

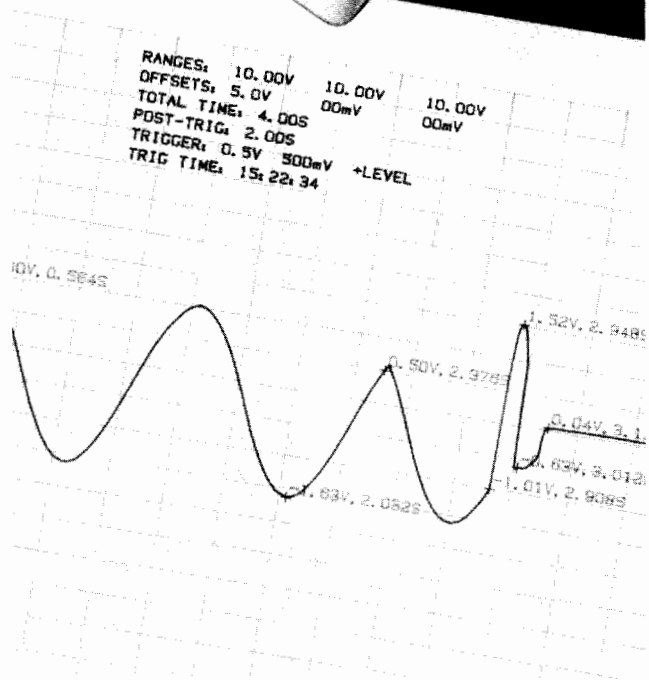
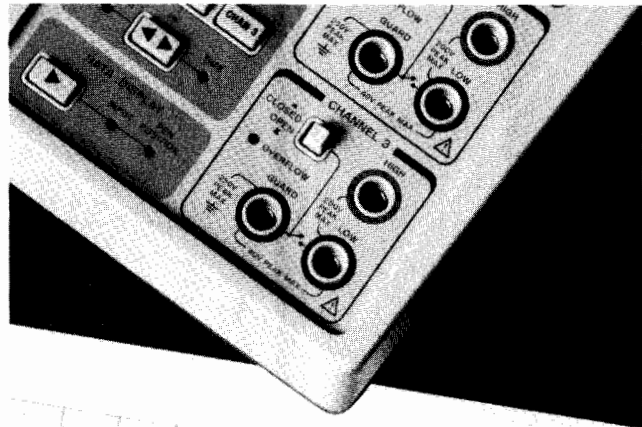

Measurement Graphics Software

Combining an HP 7090A, an HP 9000 Series 200 computer and the HP 17090B Measurement Graphics Software produces a powerful menu-driven system for measurement, data manipulation, and data storage and retrieval. The menu-driven software, written in BASIC 3.0 for Series 200 computers, takes advantage of the HP 7090A's capabilities as a system component. No programming is necessary; once the HP 7090A is loaded with paper and pens and connected to the controller using an HP-IB cable, just load the software. All HP 7090A functions can be controlled by the computer.

Program Capabilities: There are six main functional areas of Measurement Graphics Software:

- Measurement Setup
- Measurement
- Display
- Annotation
- Data Manipulation
- Storage and Retrieval

The HP 17090B software helps you use the HP 7090A's features easily and effectively plus, it provides storage, annotation and data transformation options not available on the HP 7090A unit alone.

Friendly, Menu-driven Interface: Each menu allows the user to view several parameters simultaneously. Series 200 softkeys and cursor-control knob minimize keyboard input. The "help" softkey displays the available choices and ranges for each parameter setting.

System Requirements: Measurement Graphics Software is written in BASIC 3.0 and requires a minimum of 216 K of RAM after the operating system is loaded; however, 433 K is recommended for optimum program speed. The software is designed for use with an HP 9000 Series 200 computer and an HP 7090A Measurement Plotting System. The software is supplied on two 3.5 in. microfloppy or 5.25 in. minifloppy discs and is accompanied by a user's manual.

PLOTTERS & RECORDERS

Measurement Plotting System

Model 7090A

HP 7090A Panel Controls



Easy-to-read controls provide accurate feedback of recording conditions.

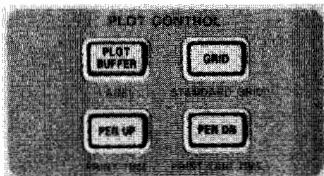

Annotation capability eliminates errors from hand annotation, and creates accurate hardcopy records.

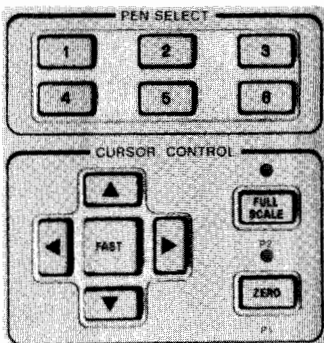

Controls allow the easy selection and movement of pens. Scaling capability allows you to design graphs to fit custom formats.

Ten thousand possible ranges eliminate guessing about exact set-up parameters. Ability to store set-up conditions decreases set-up time for repeated experiments.

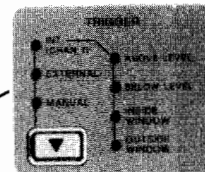
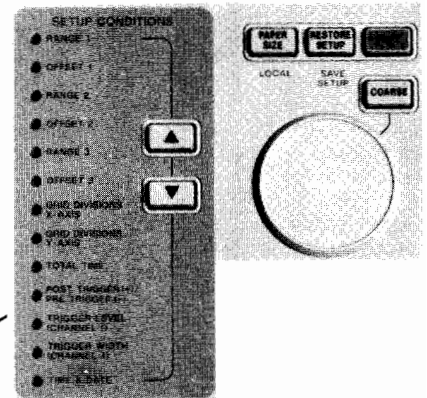

Multiple trigger modes make viewing transient and pre-trigger data easy; eliminates the search through strip chart/oscillographic output for an event.

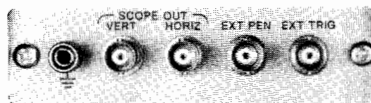

Three output channels allow you to measure and view low-frequency phenomena at a much lower cost than a traditional waveform recorder.

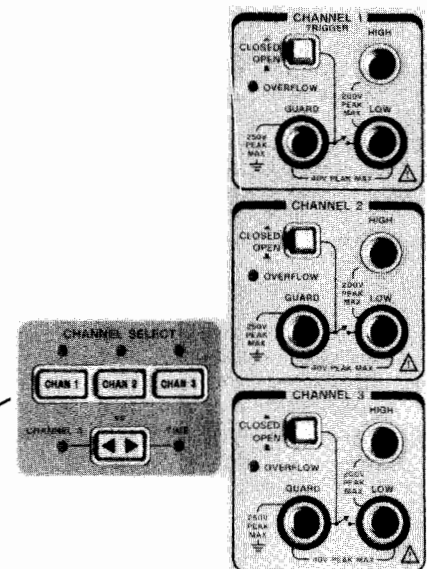

Data display capability allows you to scan the buffer, displaying current values on LCD or labeling datapoints on graph.



External connectors provide flexibility for configuring experiments to meet your varied measurement needs.

PLOTTERS & RECORDERS

Measurement Plotting System

Model 7090A (cont)

455



Specifications

Inputs

Number of channels	3
Type of input	floating, guarded
Sensitivity	5 mV to 100 V full scale
Sensitivity ranges	41,000
Zero offset	±2 full scale or ±100 V maximum
Zero offset ranges	approximately 5% or range steps
Input impedance	1 Mohm, shunted by 45 pf (Nominal)
Maximum input voltage	200 V, dc or peak
Maximum source resistance	10 kohm
Common mode rejection ratio	140 dB dc; 100 dB ac @ 60 Hz with 1 kohm unbalance in LOW terminal and most sensitive range (at 25 C)

Electrical accuracy (@ 25 C, ±1 scale offset maximum):

Constant inaccuracy	±0.15% of range
1 V to 100 V range	increases from ±0.15% of range
5 mV to 500 mV range	@ 500 mV to ±0.26% of range @ 5 mV
Reading inaccuracy	±0.055% of reading
Temperature coefficient	
Constant inaccuracy	
1 V to 100 V range	±0.012% of range/degree C
5 mV to 500 V range	increases from ±0.012% or range/degree C @ 500 mV to ±0.044% of range/degree C @ 5 mV
Reading inaccuracy	±0.01% of reading/degree C

Timebase

Buffer mode	
Range	30 milliseconds to 24 hours
Number of ranges	4,700
Direct mode	
Range	1 second to 24 hours
Number of ranges	3,700
Accuracy	±0.1%

Dynamic Performance

Slewing Speed (Nominal)	
Direct mode	127 cm/s (50 in./s)
Plotting mode	75 cm/s (30 in./s)
Acceleration (Nominal)	2 g constant
Bandwidth (≥3dB)	3 kHz for all full scale ranges
	≥ 20 mV
	2.6 kHz for all full-scale ranges
	<20 mV
Peak capture	250 μs at fastest timebase range

Memory per Channel

Size	1000 words
Resolution	12-bits

Trigger Characteristics

Internal Trigger	Inside or outside window to capture decaying repetitive signals, inside resets with each reverse transition; Above or below level, selectable over the full-scale range in 1.0% of range increments (NOMINAL); Source, channel 1
External Trigger	BNC connector, TTL level or contact closure to ground
Manual Trigger	Available from front-panel controls
Display	Up to 100% pre-trigger capture, up to 24 hour post-trigger delay before measurement start

Supplemental Characteristics

Writing System	6-pen carousel with automatic pen capping Fiber-tip pens for paper or transparencies
Digital Plotting	Intelligence: over 40 HP-GL instructions; five built in character sets including ANSI ASCII, HP 9825, French/German, Scandinavian,



Media

Programming

Scope Output

Digital Voltmeter (DVM) Mode

Pen Position Data Display

External Pen Lift Control

Analog-to-digital

Real-time Clock

Environmental Power Requirement

Size

Weight

Spanish/Latin America
Front-panel controls: P1, P2; pen position cursors; pen selection
Interface modes (user selectable): listen only; listen/talk
Types: paper, overhead transparency film
Sizes (switch-selectable): A4/A (210 x 297 mm, 8.5 x 11 in.); A3/B (297 x 420 mm, 11 x 17 in.)
HP-IB control of all recorder and plotter functions
Software lockable front panel
Allows use of X-Y oscilloscope to preview buffer contents
Connectors: 2 BNC, vertical and horizontal
Output: -10 V to 10 V (0 V corresponds to origin on chart); refreshed every 15 ms
Resolution: 10-bit
Allows panel display of dc voltage levels on selected channel input
Sampling rate: 1/sec (NOMINAL)
Allows cursor to move pen along plotted buffer data on selected channel, value shown on display, and coordinate pair can be printed at selected points.
BNC connector, TTL level or contact closure to ground
Max. sampling rate: 33.3 k samples/s
Max. streaming rate over HP-IB:

	ASCII	Binary
1 channel	167/s	500/s
1 channel plus trigger	143/s	333/s
3 channels	59/s	167/s
3 channels plus trigger	59/s	167/s

Functions: second, minute, hour, day, year
Controls: front-panel set, battery (lithium) backup
Accuracy: ±4 sec/day @ 25 C
Operating temperature: 0-55 C
Source: 100, 120, 220, 240 V ac -10%, +5%
Frequency: 48-66 Hz
Consumption: 140 W
Height: 205.5 mm (8.1 in.)
Weight: 575.0 (22.6 in.)
Depth: 465.0 (18.3 in.)
Net: 15.7 kg (34.5 lbs)
Shipping: 23.6 kg (18.3 lbs)

Accessories Supplied

Interfacing and Programming Manual
Operator's Manual
Pocket Guide

Part Number

07090-90001
07090-90002
07090-90004

An assortment of pens and media are also shipped with each HP 7090A unit sold. Paper size and power cord are determined by destination.

Ordering Information

HP 10833A or 45529A HP-IB (IEEE-488) 1-meter cable	\$81.00
HP 10833B or 45529B HP-IB (IEEE-488) 2-meter cable	\$91.00
HP 7090A Measurement Plotting System	\$4900.00
Option 910 (duplicate set of manuals)	\$100.00
HP 17090B Measurement Graphics Software	
Option 630 (3.5 in. disc size)	\$700.00
Option 655 (5.25 in. disc size)	\$700.00

Price



PLOTTERS & RECORDERS

Low-Cost, General Purpose X-Y Recorders, Time Base

Models 7015B, 7035B, 17108A

- Full capability

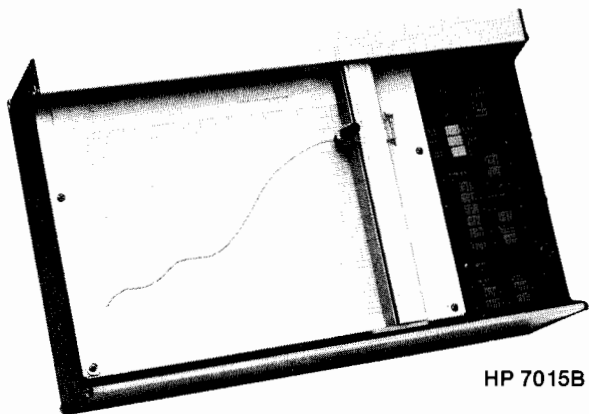

HP 7015B

- Precision recording

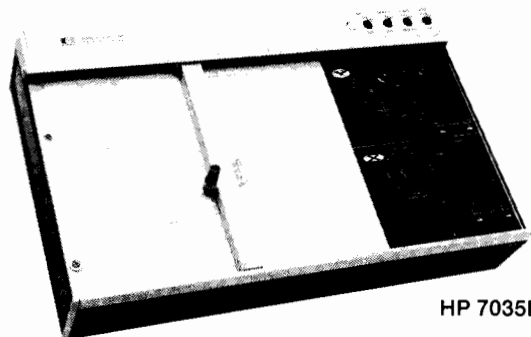

HP 7035B

For 35 years, the Hewlett-Packard family of X-Y recorders has been bringing performance, reliability, and service to lab environments all over the world. These recorders are manufactured in the HP tradition of quality, and designed to help you make recordings easily and accurately.

HP 7015B: a low-cost recorder for applications that require high dynamic performance, medium sensitivity, and A4/A-size output.

HP 7035B: a general purpose laboratory recorder for applications that require low dynamic performance, medium sensitivity, and A-size output.

HP 7045B and 7046B: high performance recorders for applications that require very high dynamic performance, high sensitivity, and A4/A- or A3/B-size output.

These HP X-Y recorders have electrostatic holddown for silent, trouble-free grip. And they use disposable pens for crisp, clean traces and one-step replacement of ink, tip, and color.

HP 7090A: a "next generation" recorder combining the highest performance in X-Y recorders with versatile digital plotting.

Model 7015B X-Y Recorder

The HP 7015B is a low-cost, one-pen X-Y recorder that allows charting on paper sizes up to ISO A/4 or 216 x 280 mm (8.5 x 11 in.). The unit is mounted in a sturdy case made from a single casting, assuring mechanical alignment and long life, even in rugged environments. The HP 7015B provides recording for a wide range of laboratory uses where there is a need for full capability at a reasonable cost.

The HP 7015B has a full complement of capabilities. The standard features include an internal time base with sweep selections from 5 seconds to 15 minutes. The time base provides automatic pen control and accepts remote triggering from sweep start and reset.

Also included are matched input filters, remote pen lift, and TTL-level remote control. The HP 7015B accepts TTL-level and low current (5mA) contact closure for easy interface with external equipment.

Model 7035B X-Y Recorder

The HP 7035B is an excellent recorder for general lab use. Compact in design, the HP 7035B is well adapted to rack mounting with

the addition of only two optional wing brackets. It features floating guarded inputs to help eliminate the common mode voltage effects that are troublesome when recording from low-level sources.

Input connectors on the HP 7035B accept both open wire and plug-type connectors. In addition, the recorder provides five calibrated ranges (0.4 mV/cm to 4 V/cm) for each axis; signal scaling for full-scale deflection, and high-impedance (1 megohm, except for the first two ranges).

Model 17108A Time Base

The HP 17108A is a self-contained time base that operates on either axis of the HP 7035B. By simply plugging in the HP 17108A, the HP 7035B is provided with five sweep seconds from 0.2 s/cm to 20 s/cm (0.5 to 50 s/in.). This module, powered by a single self-contained battery, is controlled by its own six-position range switch and three-position mode switch.



HP 17108A Option 002 mounted on recorder.

HP 17108A Specifications

Sweep seconds: 0.2, 0.4, 2, 4, 20 s/cm (0.5, 1, 5, 10, 50 s/in.)

Accuracy: 5% of recorder full scale

Linearity: 0.5% of full scale (20°C to 30°C)

Output voltage: 0 to 1.5 V

Power: replaceable mercury battery (100 h)

PLOTTERS & RECORDERS

Low Cost, General Use X-Y Recorder (cont'd)

Models 7015B, 7035B

457



HP 7015B and 7035B Specifications

Performance Specifications

	HP 7015B	HP 7035B
Type of input	Floating binding posts or circuit board rear connector	Floating guarded signal pair; rear connector
Input ranges	5, 50, 500 mV/cm (0.01, 0.1, 1 V/in.)	0.4, 4, 40, 400 mV/cm; 4 V/cm (1, 10, 100 mV/in.; 1 V/in.)
Input resistance	1 M Ω constant on all ranges	100 k Ω on 4 mV/cm (10 mV/in.) and potentiometric or essentially infinite at null on 0.4 mV/cm (1 mV/in.)
Source resistance	10 k Ω maximum on all ranges	20 k Ω maximum on most sensitive range; no restrictions on other ranges
Accuracy	$\pm 0.3\%$ of full scale on most sensitive range (includes linearity and resettability) plus $\pm 0.2\%$ of deflection when on other ranges; temp. coefficient $\pm 0.02\%$ per $^{\circ}\text{C}$	$\pm 0.2\%$ of full scale
Deadband Common mode rejection	$\pm 0.2\%$ of full scale 100 dB dc, 90 dB ac with 1 k unbalanced in HI terminal CMR decreases 20 dB per decade step in attenuation	130 dB dc, 100 dB ac with 1 k Ω between the negative input and guard connection CMR decreases 20 dB per decade step in attenuation
Normal mode rejection	Greater than 50 dB at 60 Hz (40 dB/decade rolloff above 60 Hz)	Greater than 30 dB at 60 Hz; then 18 dB/octave

Dynamic Performance Specifications

Slewing speed	Greater than 50 cm/s (20 in./s)	50 cm/s (20 in./s) nominal at 115V
Acceleration peak Y-axis X-axis	2.5 g's (2540 cm/s ² or 1000 in./s ²) 1.3 g's (1270 cm/s ² or 500 in./s ²) (with internal filters switched out)	Not specified
Maximum overshoot	2% of full scale	Not specified

Offset Specifications

Zero offset	Zero may be placed anywhere on the writing area or electrically off scale up to one full scale from zero index
-------------	--

Time Base Specifications

Time base	Six speeds: 0.1, 0.5, 1, 5, 10, 50 s/cm (0.5, 1, 5, 10, 50, 100s/in.) remote sweep start and reset via TTL level or contact closure	Optional external time base (HP 17108A)
TIME BASE ACCURACY	1.5% ± 0.1 per $^{\circ}\text{C}$	$\pm 5\%$ of recorder full scale

General Specifications

Power	Switch selectable for 100, 120, 220, 240 Vac $\pm 5 - 10\%$; 47.5 to 440 Hz; 70 VA maximum	115 or 230 V $\pm 10\%$; 50 to 60 Hz; approx. 45 VA
Pen lift	Electric (remote via TTL level or contact closure)	Electric pen lift capable of being remotely controlled
Writing area	18 x 25 cm (7 x 10 in.)	
Weight	Net 7.2 kg (16 lb)	Net 8 kg (18 lb)
Size	267 H x 432 W x 135 mm D (10.5 in. x 17 in. x 5 in.)	265 H x 445 W x 121 mm D (10.5 in. x 17.5 in. x 4.8 in.)

HP 7015B Options

001 Metric calibration
908 Rack Mount

Price

N/C
\$30

HP 17108A Options

002 HP 17108A Metric calibration

N/C

HP 7035B Options

001 Metric Calibration
908 Rack Mount

N/C
\$35

Ordering Information

HP 7015B Lab X-Y recorder
HP 7035B General Purpose X-Y recorder
HP 17108A Time base plug-in

\$2300
\$2700
\$490



PLOTTERS & RECORDERS

High Performance General Use X-Y Recorders

Models 7045B, 7046B

- Dynamic performance
- High sensitivity
- A4/A or A3/B paper size
- Choice of one-pen or two-pen models

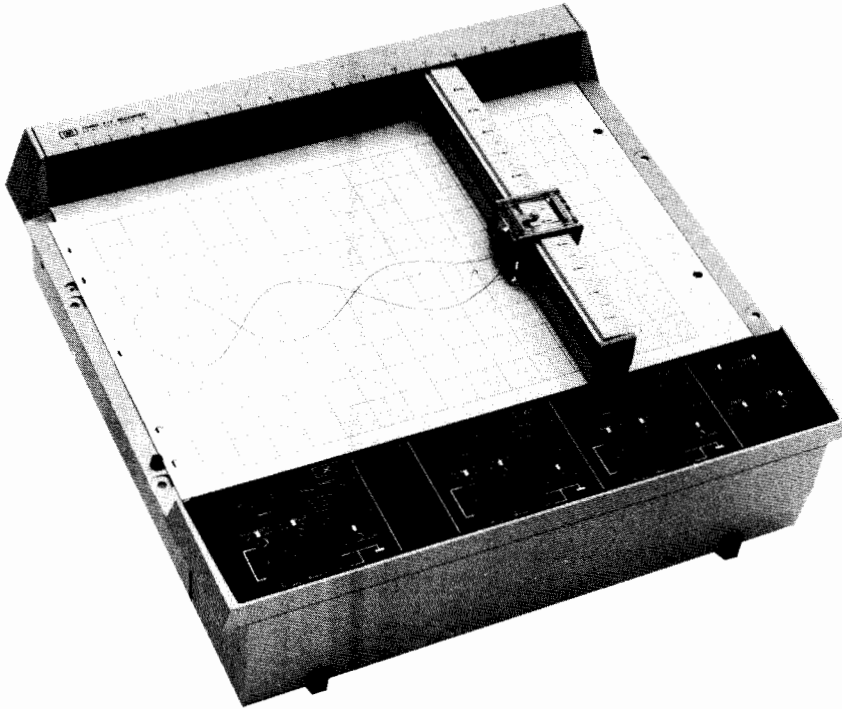

HP 7046B

The HP 7045B offers exceptional slewing speed and acceleration on both X- and Y-axes. This high dynamic performance allows the HP 7045B to faithfully reproduce a wide range of fast-changing signals.

The HP 7046B offers high dynamic performance in a two-pen model. And both Y-axes have virtually no overshoot, allowing accurate plotting of two variables against a third.

Both the one-pen (X or T vs Y) HP 7045B and the two-pen (X or T vs Y1 & Y2) HP 7046B offer the same quality features.

Very High Dynamic Performance

With a combination of high slewing speed and acceleration, these recorders can capture fast, changing signals that an ordinary recorder might miss. For example, the HP 7045B will, typically, record a signal from dc to 10 Hz at 2 cm peak-to-peak amplitude on either axis.

TTL Remote Control

With TTL or simple contact closure to ground, a rear connector offers easy interface to measurement systems. TTL provides remote control of sweep, start and reset, pen lift, servo mute, and chart hold. Pen lift, the most important action to be controlled remotely, is also available from a convenient rear-mounted banana jack connector.

Wide Chart Size Range

The HP 7045B and 7046B accept ISO A3, ISO A4, ANSI B, ANSI A, and any size under the maximum limit (A3/B-size). With this flexibility, these recorders can fill a variety of charting needs.



User-oriented Features

These recorders are precision instruments that are easy to use. The polarity reverse switch eliminates the need to reverse input leads. The response switch allows recorder response to be slowed to simplify setup. A separate rear connector provides a convenient remote pen lift control connection. And built-in hardware simplifies table or rack mounting.

PLOTTERS & RECORDERS

High Performance General Use X-Y Recorders

Models 7045B, 7046B (cont'd)

459



HP 7045B and 7046B Specifications

Performance Specifications

	HP 7045B	HP 7046B
Type of input	Front and rear input. Floating, guarded. Polarity reversal switch on front panel.	
Input ranges	0.25, 0.5, 1, 2.5, 5, 10, 25, 50, 100, 250, 500 mV/cm. 1, 2.5, 5 V/cm. (0.5, 1, 2, 5, 10, 20, 50, 100, 200, 500 mV/in. 1, 2, 5, 10 V/in.) Continuous vernier between ranges.	
Input resistance	1 megohm constant on all ranges	
Source resistance	10 kΩ maximum on all ranges	
Accuracy	±0.2% of full scale (includes linearity and deadband) at 25°C. Temp coefficient ±0.01% per °C	
Range Accuracy	±0.2% of full scale ±0.2% of deflection (includes linearity and deadband) at 25°C. Temp coefficient ±0.01% per °C.	
Deadband	0.1% of full scale	
Common mode rejection	110 dB and 90 dB ac (exceeds 130 dB dc and 110 dB ac under normal lab environmental conditions) with 1 k Ω between HI and LO terminals. CMV applied between ground and LO, and attenuator on most sensitive range. CMR decreases 20 dB per decade step in attenuation.	
Normal mode rejection	Internal filter not available	

Dynamic Performance Specifications

Slewing speed	97 cm/s (38 in./s) typical under normal lab conditions. 76 cm/s (30 in./s) minimum.	
Acceleration peak-Y axis	7620 cm/s ² (3000 in./s ²)	6350 cm/s ² (2500 in./s ²)
-X axis	5080 cm/s ² (2000 in./s ²)	3800 cm/s ² (1500 in./s ²)
Overshoot	1% of full scale maximum.	

Offset Specifications

Zero offset	Zero may be placed anywhere on the writing area or electrically off scale up to one full scale from zero index.
--------------------	---

Time Base Specifications

Time base	8 speeds: 0.25, 0.5, 1, 2, 5, 10, 25, 50 s/cm (0.5, 1, 2, 5, 10, 20, 50, 100 s/in.)
Time base accuracy	1.0% at 25°C. Temp coefficient at ±0.1%/C°

General Specifications

Power	100, 120, 220, 240 Vac +5 -10%; 48 to 440 Hz; 230 VA	100, 120, 220, 240 Vac +5 -10%; 48 to 440 Hz; 230 VA
Pen lift	Electric (remote via TTL level)	
Writing area	25 x 38 cm (10 x 15 in.)	
Weight	Net 13.7 kg (30 lb)	Net 16 kg (35 lb)
Size	400 H x 483 W x 165 mm D (15.8" x 19" x 6.5").	441 H x 483 W x 173 mm D (17.4" x 19" x 6.8").

HP 7045B Options

001 Time base	
002 Event marker	
006 Metric calibration	

Price

STD.
\$170
N/C

HP 7046B Options

001 Time base	
002 Event marker	
007 Metric calibration	

Price

STD.
\$170
N/C

Ordering Information

HP 7045B Very high speed recorder
HP 7046B 2-pen, very high speed recorder

Price

\$3800
\$4800



PLOTTERS & RECORDERS

Recorder/Plotter Selection Guide

The following pages list recommended graphics output devices for over 100 HP instruments. HP instruments designed with microprocessors can control plotting from front-panel buttons or menu-driven softkeys. If your instrument has this capability, it will be listed with a "direct to plotter" output capability.

Other HP instruments require the appropriate controller and software in order to send graphics output to the plotter. These devices are indicated by "indirect to plotter" output capability. If the system includes or requires a particular controller, that controller is indicated. Voltage and penlift for instruments with analog output are also listed.

(To order the ColorPro plotter ask for the HP 7440A.)

HP Instrument	Output Capability*	Plotter Software Support	X-Y Recorder Outputs		Recommended HP Models
			Voltage	Penlift	
PC Instruments	Indirect to plotter	Data Acquisition Software: HP 150, HP 14855A; IBM PC, HP 14856A			7475A ColorPro
141T Spectrum Analyzer System	Direct to recorder		X -5 to 5 V Y 0 to -.8 V	YES (14 V pen up, 0 V pen down)	7090A 7015B
415E SWR Meter	Direct to recorder		Y 0 to 1 V	NO	7090A 7045B
432A/B/C 436A/438A Power Meters	Direct to recorder		Y 0 to 1 V	NO	7090A 7045B
853A Spectrum Analyzer Display	Direct to recorder Direct to plotter (LO)	Front-panel controls select graticule and/or trace (no annotation)	X -5 to 5 V Y 0 to .8 V	YES (15 V pen up, 0 V pen down)	7090A 7475A 7550A ColorPro
1040A UV/VIS LC Detector	Indirect to plotter	HP 1040A opt. 631 software available			7475A ColorPro 7550A
1090A Liquid Chromatograph	Indirect to plotter. System includes HP 85B	HP software included			7475A 7550A ColorPro
3046A/B/S Selective Level Measuring Systems	Indirect to plotter	Customer software required			7475A 7090A
3047A/S Spectrum Analyzer Systems	Indirect to plotter	HP software included with 3047S			7475A 7550A
3054A/C/DL/S Data Acquisition Systems	Indirect to plotter	Customer software required for 3054C/DL			
3314A Function Generator	Direct to recorder		X -5 to 5 V	YES	7090A
3325A Synthesizer/Function Generator	Direct to recorder		X 0 to 10 V	YES TTL	7090A
3326A Two Channel Synthesizer	Direct to recorder		X 0 to 10 V	YES-TTL	7090A
3335A Synthesizer/Level Generator	Direct to recorder		X 0 to 10 V	NO	7090A
3336A/B/C Synthesizer/Level Generator	Direct to recorder		X 0 to 10 V	YES TTL	7090A
3350A/3357A/B Lab Automation System	Indirect to plotter. System includes HP 1000	HP 19135C C/PLOT/3350 software available			7475A 7550A
3421A Data Acquisition/ Control Unit	Indirect to plotter	Customer software required			7475A
3497A/S Data Acquisition/ Control System	Indirect to plotter	Customer software required			7475A
3561A/62A/65S Dynamic Signal Analyzer	Direct to plotter (05) or indirect to plotter	Front-panel control duplicates screen image to plotter. Software similar to 3577, also adds annotation			7475A 7550A ColorPro 7090A
3575A Gain/Phase Meter	Direct to recorder		Y1 10 mV/degree Y2 10 mV/dB	NO	7090A 7046B
3577A Network Analyzer	Direct to plotter (LO) or indirect to plotter	Front-panel control duplicates screen image to plotter. Menu-driven software provides selectable graticule, trace, annotation, pen number, line type.			7475A 7550A ColorPro 7090A
3580A Spectrum Analyzer	Direct to recorder		X 0 to 5 V Y 0 to 5 V	YES Contact closure to ground during sweep	7090A 7045B
3581A Wave Analyzer 3581C Selective Voltmeter	Direct to recorder		X 0 to 5 V Y 0 to 5 V	YES Contact closure to ground during sweep	7090A 7045B
3582A/S Spectrum Analyzer	Direct to recorder Indirect to plotter	Customer software required	X 0 to 5.25 V Y 0 to 5.25 V	YES Contact closure during sweep	7090A 7045B 7475A
3585A Spectrum Analyzer	Direct to recorder Indirect to plotter	HP software available	X 0 to 10 V Y 0 to 10 V	YES TTL	7090A 7045B 7475A

*"Indirect to plotter" requires an appropriate controller and software. "Direct to plotter" may require an address of 05 or L0 (listen only).



HP Instrument	Output Capability "Indirect to plotter" requires an appropriate controller and software.	Plotter Software Support	X-Y Recorder Outputs		Recom- mended HP Models
			Voltage	Penlift	
3586A/B/C Selective Level Meter	Indirect to plotter	Customer software required			7475A
3708S Noise and Interference Test System	Indirect to plotter	HP software available (HP 37080 A/B/C/R)			7475A 7090A ColorPro
3712A MLA Receiver	Direct to recorder		X -5 to 5 V Y -5 to 5 V	YES	7090A 7015B
3770B Telephone Analyzer	Direct to recorder (Special graph paper available)		X 0 to 5 V Y -5 to 5 V	NO	7090A
3776A/B PCM Terminal Test Set	Direct to recorder or Direct to plotter (LO)				7090A 7475A ColorPro 7550A
3780A Error Measuring Set	Direct to recorder		Y 0 to 1 mA into 10Kohm max	NO	7090A
3852A Data Acquisition/Control Unit	Indirect to plotter	HP 44458A software available			7475A
4061A/S Semiconductor Component Test System	Indirect to plotter	HP software included with 4061S			7475A
4062B/S Semiconductor Parametric Test System	Indirect to plotter	Customer software required			7475A
4063A/S Semiconductor Parametric Analysis System	Indirect to plotter	HP software included			7475A 7550A
4064A/S DLTS Analysis System	Indirect to plotter	HP software included			7475A 7550A
4140B pA Meter/DC Voltage Source	Direct to recorder Indirect to plotter	Customer software required	X -10 to 10 V Y -5 to 5 V	YES	7090A 7045B 7475A
4145A Semiconductor Parameter Analyzer	Direct to plotter (LO)	Front-panel controls select trace and/or graticule, fixed characters			7475A 7550A
4191A RF Impedance Analyzer (with Option 004)	Direct to recorder		X 0 to 1 V Y1 0 to 1 V Y2 0 to 1 V	NO	7090A 7046B
(Option 004 not required)	Indirect to plotter	Customer software required			7475A
4192A LF Impedance Analyzer	Direct to recorder		X -1 to 1 V Y -1 to 1 V	YES TTL (low level at pen down)	7090A 7045B
	Indirect to plotter	Customer software required			7475A
4193A Vector Impedance Meter	Direct to recorder		X 0 to 1 V Y1 0 to 1 V Y2 -1 to 1 V	YES	7090A 7046B
	Indirect to plotter	Customer software required			7475A
4194A Impedance Gain-Phase Analyzer	Direct to plotter	Front-panel control duplicates screen image to plotter. Graticule, traces are selectable			7475A 7550A ColorPro
4280A 1 MHz C Meter/C-V Plotter	Direct to recorder Indirect to plotter	HP software available	X -10 to 10 V Y -10 to 10 V	YES	7090A 7045B 7475A
5180A Waveform Recorder 5182A Waveform Recorder Generator	Direct to recorder	Front panel controls provide fixed graticule, trace, annotation; 51800A Waveform Measurement Library also available	X -1 to 0 V Y -1 to 0 V	YES (0 V and 5 V)	7090A 7045B
	Direct to plotter (LO) or Indirect to plotter				7475A 7550A
5180T/U 5183T/U Waveform Recorders	Direct to plotter Indirect to plotter	Front panel controls provide user selectable graticule, trace, and annotation. Waveform measurement library also available.			ColorPro 7475A 7550A 7090A
5390A Frequency Stability Analyzer	Indirect to plotter	HP software provides graticule, trace, and characters			7475A
54100A/D 54110D 6 Hz Digitizing Oscilloscope 54200A/D 54201A/D Digitizing Oscilloscope	Direct to plotter				7475A 7550A ColorPro 7090A
5427A Digital Vibration Test Control System	Direct to plotter (05)	Front-panel controls select fixed-format graticule, trace, and/or characters			7475A 7550A 7090A
55286S/88S Dimensional Metrology Analysis Systems	Indirect to plotter. System includes HP 85	Menu-driven software provides fixed-format plots with graticule and characters, selectable trace, title block, and vertical scale			7475A
5965A Infrared Detector	Indirect to plotter	HP 59965A software available for series 300.			ColorPro 7475A 7550A
5987A/5970B/95C/87A/88A GCMS Systems	Indirect to plotter. System includes HP 1000, Series 200 or Series 300.	59872A software available			7475A 7550A ColorPro
6901S Measurement and Analysis System	Direct to plotter (05)	Menu-driven software provides fixed-format plots with graticule and characters, selectable trace			7475A
6940B/42A Multiprogrammers	Indirect to plotter	Customer software required			7475A ColorPro
6942S Computer Aided Test System	Indirect to plotter	Customer software required			7475A ColorPro
6944A/S Multiprogrammer	Indirect to plotter	Customer software required			7475A ColorPro
71000 Series Modular Spectrum Analyzers	Direct to plotter				7475A 7550A ColorPro
8116A Pulse/Function Generator (with Option 001)	Direct to recorder		X 0 to 10 V (1.5 V/decade)	YES TTL	7090A 7045B
8165A Programmable Signal Source (with Option 002)	Direct to recorder		X 0 to 2.99 V (1 V/decade)	NO	7090A 7045B
8340A Synthesized Sweeper	Direct to recorder		X 0 to 10 V	YES	7090A 7045B
8350B Sweep Oscillator	Direct to recorder		X 0 to 10 V	YES	7090A 7045B

PLOTTERS & RECORDERS

Recorder/Plotter Selection Guide



HP Instrument	Output Capability "Indirect to plotter" requires an appropriate controller and software.	Plotter Software Support	X-Y Recorder Outputs		Recom- mended HP Models
			Voltage	Penlift	
8405A Vector Voltmeter	Direct to recorder		Y1 0 to 1 V Y2 -5 to 5 V	NO	7090A 7046B
8410B Network Analyzer System — The following plug-ins are part of the 8410B system:					
8412A Phase-Magnitude Display	Direct to recorder		Y1 50 mV/dB Y2 10 mV/degree	NO	7090A 7046B
8414A Polar Display	Direct to recorder		X -2.5 to 2.5 V Y -2.5 to 2.5 V	NO	7090A 7045B
8408B/S Automatic Network Analyzer	Indirect to plotter	HP software duplicates screen image onto plotter			7475A 7550A
8450/51A/52A Diode Array Spectrophotometers	Direct to plotter	Selectable graticule, trace, and characters			7475A 7550A
8452A Diode Array Spectrophotometer	Direct to plotter	Selectable graticule, trace, and characters.			ColorPro 7475A 7550A
8505A Network Analyzer	Direct to recorder Indirect to plotter	HP software provides graticule, trace, and characters	X 0 to 7.5 V Y -1.25 to 1.25V	YES 200 mA current sink	7090A 7045B 7475A 7550A ColorPro
8507D/S Automatic RF Network Analyzer System	Indirect to plotter	HP software provides graticule, trace, and characters			7475A 7550A ColorPro
8510A Network Analyzer	Direct to plotter	Front-panel controls select graticule, trace characters, pen and quadrant			7475A 7550A ColorPro
8557A/58B/59A Spectrum Analyzers	Direct to recorder		X -5 to 5 V Y 0 to .8 V (with 853A and 180 mainframes)	YES (15 V pen up, 0 V pen down)	7090A 7045B
With 853A Display	Direct to plotter				7475A
8565A Spectrum Analyzer	Direct to recorder		X -5 to 5 V Y 0 to .8 V	YES (15 V pen up, 0 V pen down)	7090A ColorPro 7045B
8566B/S/68B/S Spectrum Analyzers	Direct to recorder Direct to plotter	HP 85862/63 software packages available	X 0 to 10 V Y 0 to 10 V	YES (15 V pen up, 0 V pen down)	7090A ColorPro 7475A
8569B/8570A Spectrum Analyzers	Direct to recorder Direct to plotter	Front-panel controls select graticule, trace, and/or characters	X -5 to 5 V Y 0 to .8 V	YES (15 V pen up, 0 V pen down)	7090A 7045B 7475A 7550A ColorPro
8620C Sweep Oscillator	Direct to recorder		X 0 to 10 V	YES (5 V pen up)	7090A 7045B
8642A/B Synthesized Signal Generator	Direct to recorder		X 0 to 10 V	YES-TTL	7090A
8660C Synthesized Signal Generator	Direct to recorder		X 0 to 8 V	YES (with Option H24)	7090A 7045B
8662A/63A/73B/C/D Synthesized Signal Generators	Direct to recorder		X 0 to 10 V	YES TTL	7090A 7045B
8683A/B/D/84A/B/D Signal Generators	Direct to recorder		X 0 to 10 V	NO	7090A
8750A Storage-Normalizer	Direct to recorder		X 0 to 1 V Y -4 to 4 V	YES (open collector driver, 20 V max)	7090A 7045B
8753A Network Analyzer	Direct to plotter				ColorPro 7475A 7550A 7090A
8754A Network Analyzer	Direct to recorder		X 0 to 1 V Y -.4 to .4 V	YES (5 V pen up, 0 V pen down)	7090A 7045B
8755S Scalar Network Analyzer System	Direct to recorder		Y -4 to 4 V X 0 to 10 V	YES (open collector driver, 20 V max)	7090A 7045B
8757A/S Automatic Scalar Network Analyzer	Direct to plotter	HP 8757A has softkeys with custom plot capability. HP 8757S has menu-driven software.			7475A 7550A ColorPro 7090A
8756A/S Automatic Scalar Network Analyzer	Direct to plotter	8756A provides menu-driven softkeys, 8756S has menu-driven software to select graticule, trace, and/or characters (rev. 1 does not include 7550A in ID table)			7475A 7550A
8900C/D Peak Power Meter	Direct to recorder		Y 0 to 1 V	NO	7090A
8903B Audio Analyzer	Direct to recorder Indirect to plotter		X 0 to 10 V Y 0 to 10 V	YES	7090A 7015B ColorPro 7475A
8953A/S Transceiver Test System	Indirect to plotter	Customer software required*			7475A ColorPro
8955A/S RF Test System	Indirect to plotter	Customer software required*			7475A
8970A Noise Figure Meter	Direct to recorder Indirect to plotter		X 0 to 6 V Y 0 to 6 V	YES TTL	7090A 7045B ColorPro 7475A



Introduction

Instrumentation tape recorders (ITRs) are used to record, store, and reproduce test data for many and varied applications. The main reasons for using ITRs are economy, accurate data recording and reproduction, and long-term data storage. ITRs manufactured by Hewlett-Packard are 4 or 8-channel recorders using 1/4-inch tape. They are designed specifically for applications under 64 kHz. ITR recording provides nondestructive reproduction so data can be reproduced repeatedly without degrading the quality, and time-base can be contracted or expanded. Data is contracted by using faster tape speeds to reproduce slow-speed data or expanded by doing the reverse to produce, for example, lower frequency data for use on a graphics recorder.

ITR Characteristics

Direct record/reproduce electronics: direct electronics accept frequencies above 100 Hz (approximate) and record the amplitude of the input signal on the tape as a proportional magnetic flux intensity. Because direct electronics require a "linear" relationship, changing tape type generally necessitates the re-equalization of each direct channel. Direct electronics also require that each recorded tape be degaussed (erased) fully before being reused.

FM record/reproduce electronics: FM electronics accept very low frequencies, including dc. In FM, the amplitude of the input signal is recorded as a frequency deviation from a "center" frequency, the maximum input amplitude being recorded as a 40% deviation. Because amplitude is converted to a frequency, FM tends to be insensitive to tape drop-outs, but sensitive to speed irregularities such as flutter. With FM, tape types can be changed without re-equalizing the channel. Since FM records to saturation, tape can be reused without degaussing with only a small (10 to 15 dB) loss in signal-to-noise ratio.

Common frequency range: FM and direct have a common segment of the frequency range in which either type of electronics can function. On Hewlett-Packard's ITRs this range is approximately 100 Hz to 5 kHz. The advantages of using direct electronics in this range are high frequency response at slow tape speeds and a general insensitivity to flutter. The advantages of FM are dc response and a general insensitivity to tape drop-outs.

Tape speed control: the tape speed is usually controlled by a phase-lock servo system in one of two ways. The more common method uses the servo system to control the

rotational speed of the tape capstan, employing a tachometer mounted on the capstan's shaft to monitor the speed. With this method, tape speed control is limited to approximately $\pm 0.2\%$, because of capstan irregularities, tape slippage, and tape stretching. The less common but more precise method uses a frequency reference placed on one track during recording as the speed reference for the phase-lock servo during reproduce. Tape servo generates a reproduce speed that is virtually identical to the record speed; the time difference between events in record and reproduce is indicated by the time base error specification (which assumes continuous phase-lock operation). The time base error figure represents a short-term specification, because drop-outs, etc., may cause momentary loss of phase lock.

Flutter: this is a short-term tape speed variation. It produces time base perturbations in direct electronics and noise in FM.

Signal-to-noise ratio: this is the ratio of maximum to minimum recordable amplitude expressed as a voltage ratio in dB. Basically, it represents the usable dynamic range.

Tape selection: it is recommended that instrumentation tape such as Ampex 797 always be used. Use of other quality tape may adversely affect head wear, signal-to-noise ratio, etc.



PLOTTERS & RECORDERS

Instrumentation Tape Recorders and Degausser

Models 3964A, 3968A, and 13064A Degausser

- Continuing savings by recording on 1/4-inch tape
- Choice of 4 or 8-channel recorders
- Selection of FM or direct electronics
- Six tape speeds, including 15/32 ips
- Remote control (TTL or optional HP-IB)
- Switch selection of tach or tape servo

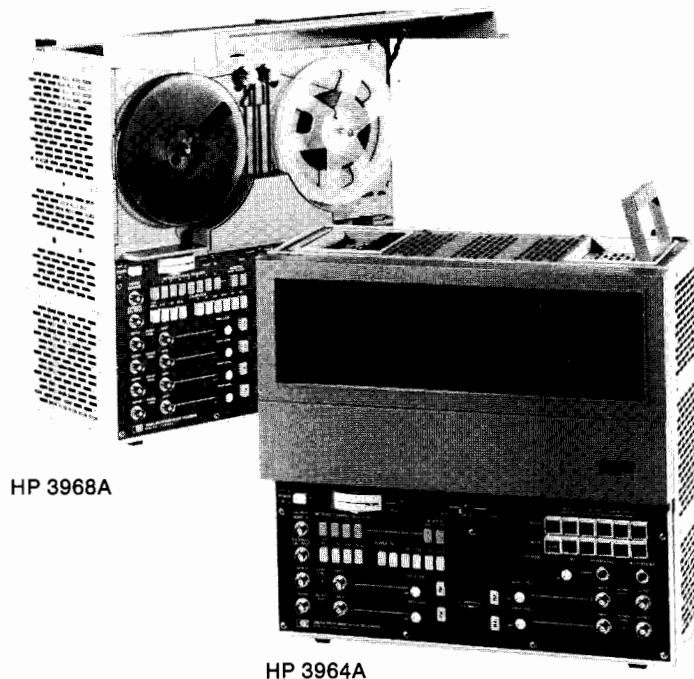

HP 3968A

HP 3964A

HP 3964A and 3968A ITRs, HP 13064A Degausser

The 4-channel HP 3964A and 8-channel HP 3968A are quality instrumentation tape recorders (ITRs) that provide cost-saving operation by using 1/4-inch tape for a wide variety of recordings. Medical versions of the HP 3964A and 3968A (Options 009 and 010) are available. These versions include a UL 544 medical listing making them useful in hospitals, medical offices, and research facilities.

The HP 13064A bulk tape degausser erases a complete roll of tape cleanly in seconds. A thoroughly clean tape is necessary to obtain maximum signal-to-noise ratio.

Both the HP 3964A and the HP 3968A are precision-built ITRs with features that cut costs, enhance the usefulness of the units, and simplify recording tasks in laboratory, medical, production, and field use.

HP 3964A, 3968A Features

Cost-saving 1/4-inch tape: provides continuing savings for the life of the recorder. By using 1/4-inch tape, rather than 1/2-inch tape, users can save over 50 percent on tape costs.

AC/DC calibrator: provides an internal voltage source that simplifies the set up of input and output levels for each data channel. Six voltages, ac or \pm dc, can be pushbutton selected, applied, and monitored to check out each channel. In addition, there is an external connector to allow the use of scopes or other monitoring devices.

Tach or tape servo control: tach-servo and tape-servo systems are switch selectable.

Flutter compensation: improves the signal-to-noise ratio in FM by up to 12 dB in a vibrating environment. When switched on, flutter-generated noise introduced during record and reproduce is subtracted from all FM data channels during reproduce to improve performance. One FM channel is used for flutter compensation; this same channel can also be used for tape servo control, saving a data channel for recording when both flutter compensation and tape servo are required.

Voice capability: provides voice annotation capability on the fourth channel of the HP 3964A or the eighth channel of the HP 3968A, using the press-to-talk microphone. The voice channel accepts data only, voice only, or data with a voice interrupt. Microphone, speaker, and headphone jack are provided with both recorders.

FM electronics-to-electronics (e-e) mode: transfers the input signal automatically to output, bypassing the record/reproduce heads. This occurs when tape is below record/reproduce speed or in Fast Forward, Rewind, or Stop mode. E-E allows the unit to be set and calibrated without using tape.

Instrumentation Tape Recorder Notes

These technical application notes are available, at no charge, from your Hewlett-Packard sales office:

Topic	Application Note No.	HP Part Number
Dropouts	213-1	5952-2841
Crosstalk	213-2	5952-2844
Interchannel Time Displacement Error	213-3	5952-2848
Magnetic Tape Recording Handbook	89	5952-2820

HP 3964A, 3968A Transport Specifications

Tape width: 1/4 inch (6.3 mm)

Reel size: standard 7-inch (18 cm) plastic reel, totally enclosed by reel cover

Heads

HP 3964A: One 4-track record and one 4-track reproduce

HP 3968A: One 8-track record and one 8-track reproduce

Tape Speed* (ips)	15	7 1/2	3 3/4	1 7/8	1 5/16	1 5/32
Flutter (% p-p)	0.35	0.35	0.40	0.50	0.70	1.5
Time base error (μ s)*	± 4	± 5	± 7.5	± 15	± 25	± 50
Start time (s) (typical)	3	1.5	0.9	0.5	0.5	0.5
Tape speed accuracy \pm %	0.2	0.2	0.2	0.2	0.2	0.2

*Tape servo operation

Tape motion controls: pushbutton selectable Forward Record, Reverse Record, Forward Play, Reverse Play, Fast Forward, Fast Rewind, and Stop

EOT sensing: tape drive stops automatically at the END of tape (EOT)

Reel revolution counter: 4-digit counter with pushbutton reset

FM Record/Reproduce Specifications¹

Tape Speed (ips)	Passband ² (Hz)	Signal-to-noise ³ Ratio	
		HP 3964A	HP 3968A
15	dc-5000	48	46
7 1/2	dc-2500	48	46
3 3/4	dc-1250	48	46
1 7/8	dc-625	46	46
1 5/16	dc-312	44	44
1 5/32	dc-156	40	40

- Based on use of Ampex 797 tape or equivalent
- Frequency response over passband is ± 1.0 dB referenced to 10% of upper band edge frequency
- Signal measured with carrier deviation $\pm 40\%$ of upper passband without flutter compensation. Output filters of reproduce amplifiers selected for constant amplitude response. May also be selected for linear phase (transient) response

Flutter compensation: can improve signal-to-noise by up to 4 dB under static conditions and as much as 12 dB under conditions of vibration. Selected by rear panel switch.

Distortion: total harmonic distortion $< 1.2\%$ @ 15 to 1 7/8 ips, $< 2\%$ @ 1 5/16 to 1 5/32 ips.

Linearity: $\pm 1.0\%$ of peak-to-peak output for best straight line through zero at $\pm 40\%$ deviation

DC drift: $\pm 0.1\%$ (max) of full scale output per $^{\circ}\text{C}$

Input level: 1 V to 30 V (peak-to-peak); continuously adjustable

Input impedance: 100 k Ω nominal, shunted by < 100 pF single-ended

Output level: 1 to 5 V (peak-to-peak); continuously adjustable

Load impedance: minimum load impedance 660 Ω

Direct Record/Reproduce Specifications¹

Tape Speed (ips)	Passband (± 3 dB) ²		S/N Ratio (dB) ³	
	HP 3964A	HP 3968A	HP 3964A	HP 3968A
15	70-64000 Hz	500-64000 Hz	38	36
7 1/2	50-32000 Hz	250-32000 Hz	38	36
3 3/4	50-16000 Hz	100-16000 Hz	38	36
1 7/8	50-8000 Hz	100-8000 Hz	38	36
1 5/16	50-4000 Hz	100-4000 Hz	38	35
1 5/32	50-2010 Hz	100-2000 Hz	37	35

- Based on the use of Ampex 797 tape or equivalent
- Reference to 10% of upper band edge
- Referenced to a 500 Hz sine wave with a maximum of 1% third harmonic distortion when reproduced at 3 3/4 ips

Input level: 1 V to 30 V (p-p); continuously adjustable

Input impedance: 100 k Ω nominal, single-ended

Output level: 0.5 to 5 V (p-p); continuously adjustable

Load impedance: minimum load impedance 600 Ω

Calibrator: internal signal source, peak ac and \pm dc levels of 0, 1.0, 1.414, 2.5, 5.0, and 10.0 volts $\pm 2\%$

Meter modes: peak ac or dc, input or output

HP 3964A, 3968A General Specifications

Size

HP 3964A: 400 H x 427 W x 256 mm D (15.7" x 16.8" x 10.1")

HP 3968A: 445 H x 427 W x 256 mm D (17.5" x 16.8" x 10.1")

Weight: HP 3964A, 29.5 kg (65 lb); HP 3968A, 31.3 kg (69 lb)

Power requirements: 100, 120, 220, or 240 V, $\pm 5\%$, -10% , 48-66 Hz; 110 W average

Temperature: storage, -40°C to 75°C ; operating, 0°C to 55°C ; tape limit, 10°C to 40°C

Altitude: storage, 15240 m (50000 ft); operating, 4500 m (15000 ft)

Humidity: the system, excluding tape limitations, will operate from 10% to 95% RH (25°C to 40°C), non-condensing

Shock: 30 g maximum (11 ms) non-operating

Mounting: rack mounting kit for equipment racks, 19-inch



HP 13064A

HP 13064A Tape Degausser Specifications

Tape size: 1/4-inch (6.33 mm) tape on reels up to 10 1/2 inch (266 mm) in diameter

Erase: 60 dB minimum

Duty cycle: one minute ON, three minutes OFF

Size: 67 H x 133 W x 171 mm D (2.6" x 5.25" x 6.75")

Weight: approximately 4.3 kg (9.5 lb)

Power requirements: 115 V ac $\pm 10\%$, 50-60 Hz (Opt 001); 230 V ac $\pm 10\%$, 50-60 Hz (Opt 002)

HP 3964A, 3968A Options

Price

Record/Reproduce Channel Data Card Options

Option provides one data card. Specify one option for each channel, up to 4 for HP 3964A, up to 8 for HP 3968A.

001 FM data card, standard \$480

030 FM data card, medical (must order Opt 009 or 010) \$480

002 Direct data card, standard \$450

031 Direct data card, medical (must order Opt 009 or 010) \$450

Medical ITR Options

009 Medical version with white paint \$500

010 Medical version with standard paint \$430

Other Options

Specify no more than one of each option per mainframe

003 Rear panel with BNC input/output connectors for each channel.

HP 3964A \$95

HP 3968A \$125

004 Locking knob set (screwdriver adjustable) \$50

005 Metric speed annotation on pushbuttons N/C

007 HP-IB remote control of speeds and mode \$470

024 Loop adapter (accommodates 5 to 30-ft loop) \$975

026 Slides for 19 in. racks \$135

027 Slides for HP cabinets \$195

041 IRIG servo reference frequency \$225

070 Overlap. For two units. Provides automatic play/record commands for second recorder when first unit tape is low \$380

Ordering Information

Price

HP 3964A 4-channel instrumentation tape recorder \$8065

HP 3968A 8-channel instrumentation tape recorder \$10,370

HP 13064A Tape degausser (specify Option 001 for 115 V ac or 002 for 230 Vac, N/C for options) \$155

HP 13107A Transit case for HP 3964A \$480

HP 13106A Transit case for HP 3968A \$480



PULSE GENERATORS

General Information

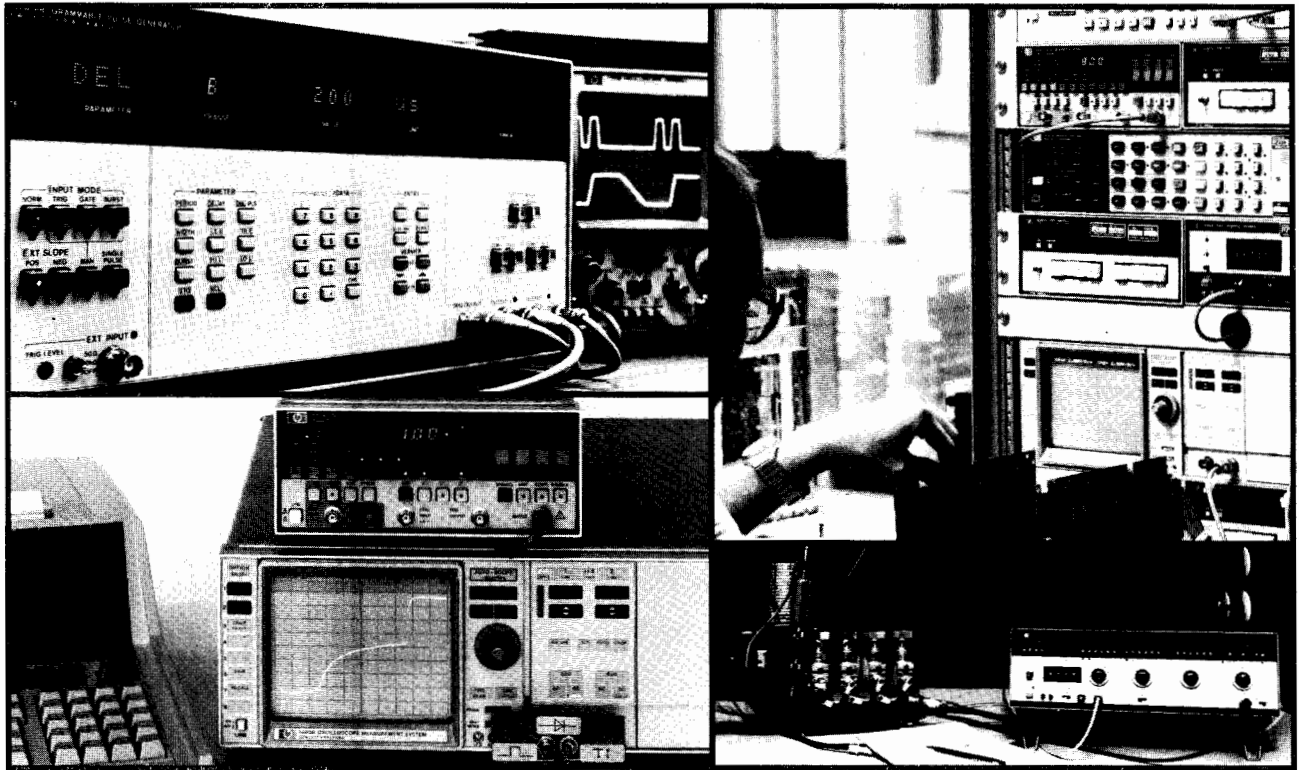

Analog and Digital Test

HP's *pulse generators* range from simple, inexpensive units to high performance, microprocessor-based instruments offering precision pulse generation. Depending on model, variable clock speeds to 1 GHz and variable amplitudes up to 100 V are available.

Pulse parameters are independently variable for thorough characterization and worst-case testing. Variable pulse transitions permit parametric analysis like trigger circuit hysteresis, and the fastest settings are ideal for at-speed logic test and amplifier transient investigations.

Pulse/function generators combine pulse capability with all features expected of a function generator. The benefits are high flexibility for analog requirements plus an entry into logic test.

Operating Comfort

Clear front panel layout, guided parameter selection, and error detection and recovery features, mean quick familiarization and rapid, error-free use. In addition, great emphasis is placed on ruggedness, reliability and serviceability. The generators are developed and produced using high quality standard components and custom-designed ICs. Resultant technical benefits are, for exam-

ple, broad operating temperature range and clean 50-Ohm output impedance.

Selectable polarity, complement and offset help make hook-up simpler and, for further flexibility, *inverters, adders and splitters* are available (page 477*).

Complex waveform capability allows glitches, ringing and multi-level signals to be simulated. Constant numbers of pulses, unaffected by other parameters are available in HP's counted burst mode.

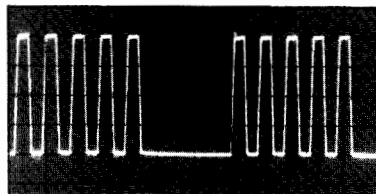

Bench and Automatic Test

A new generation of very versatile models offer good repeatability and high operating comfort for fast, accurate testing. These instruments also offer HP-IB which makes bench automation a reality for time-consuming tests. Setup time is a minimum because the syntax is simple and uses the same command sequence as the front panel.

Straight-forward syntax helps develop ATS software quickly; good repeatability and error reporting eliminate the need for software measurement loops. Specified performance over the entire 0°C to 55°C operating temperature range guarantees reliability in system racks.

Time Synthesis (page 478*)

Time Synthesizers are mainly used in radar and laser ranging, component and circuit testing, and precise triggering and calibrating applications. They give a precisely timed output pulse with an accurate, adjustable delay which may be incremented in steps as small as 50 pico-seconds. A fixed, virtually jitter-free insertion delay allows phase locking to equipment under test.

Logic Capability

CMOS: HP 8011A, 8015A, 8111A, 8112A, 8116A, 8160A

TTL: HP 8012B, 8013B, 8015A, 8111A, 8112A, 8116A, 8160A.

LS-TTL: HP 8082A, 8161A

ECL: HP 8082A (0.7 ns), 8080A (0.5 ns/0.2 ns, depending on configuration), HP 8161A (0.9 ns). Figures in brackets are the equivalent ECL switching time, 20% to 80% of amplitude.

Pulse Generator Selection Chart

HP Model Page	Pulse Generators											Pulse/Function Generators		
	214B 472	8005B 473	8011A 473	8012B 474	8013B 474	8015A 475	8082A 476	8080A 477	HP-IB 8112A 468	HP-IB 8160A 469	HP-IB 8161A 469	HP-IB 8111A 421	HP-IB 8116A 419	HP-IB 8165A 418
Timing														
Max frequency (MHz)	10	20	20	50	50	50	250	300/1000	50	50	100	20	50	50
Transition time (ns)	15	10 var	10	5 var	3.5	6 var	1 var	0.8/0.3	5 var	6 var	1.3 var	10	6	5
Var width (ns) min	25	25	25	10	10	10	2	Sp Opt	10	10	4	25	10	10
Square/duty cycle (%)	1-10	Sq	Sq	Sq	Sq	Sq	Sq	Sq	1-99			10-90	10-90	20/50/80
Variable delay	•	•	•	•	•	•	•	•	•	•	•	•	•	•
Output (max values are quoted: see specifications for conditions).														
Amplitude (V)	100	10	16	10	10	30	5	4/2.4	32	20	5	32	32	20
Offset/Window (V)		±4/±10		±2.5/±7.5	±2.5/±7.5	±28/±16	±2/±5	±2/±4	±16/±16	±20/±20	±5/±5	±16/±16	±16/±16	±10/±10
Format	+/-	•	•	•	•	•	•	•	•	•	•	•	•	•
• = positive, negative, symmetrical, normal and complement formats.														
Outputs	1	+ and -	1	1	+ and -	2	1	Configurable	1	2-chan option	2-chan option	1	1	1
Additional outputs		TTL				TTL	Compl				Compl			
Operating Modes														
Trigger	•	•	•	•	•	•	•	•	•	•	•	•	•	•
Ext width														
Gate	•	•		•	•	•	•	•	•	•	•	•	•	•
Ext burst	Option		Option			Option			•	•	•	Option	Option	•
Int burst													Option	
Double pulse	•	•		•	•	•	•	•	•	•	•			
Control (Modulation) Modes														

Pulse Generator Definitions

Time Reference Point: Median (50% amplitude point on pulse edge).

Pulse Period: The time interval between the leading edge medians of consecutive trigger output pulses.

Trigger Delay: Interval between trigger point of input signal and the trigger output pulse's leading edge median. Applies in trigger, external width, gate and burst modes.

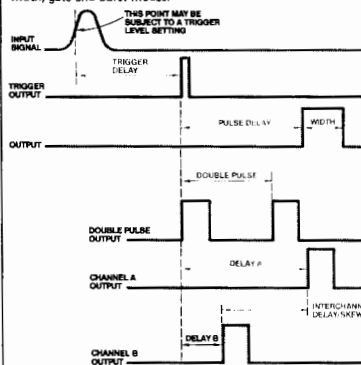

Pulse Delay: Interval between leading edge medians of trigger output pulse and output pulse.

Double Pulse: Interval between leading edge medians of the double pulse.

Interchannel Delay/Skew: Interval between corresponding leading edgemedians.

Pulse Width: Interval between leading- and trailing-edge medians.

Additional Information for Pulse Generators with Variable Transition Times

Pulse Width: The specified and displayed value is that obtained with fastest edges; essentially equal to the interval from the start of the leading edge to the start of the trailing edge.

By designing so that the pulse edges turn about their start points, the interval from leading edge start to trailing edge start stays unchanged* when transition times are varied. This is more convenient for programming and the width display is easy to interpret.

*In practice, start points may shift with change in transition time.

Delay: The specified and displayed value is that obtained with the fastest leading edge. For a slower edge, the actual delay exceeds the displayed delay by the combined shift of start-point and median.

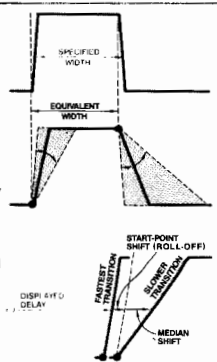

Transition Time: Interval between the 10% and 90% amplitude points on the leading/trailing edge.

Linearity: Peak deviation of an edge from a straight line through the 10% and 90% amplitude points, expressed as percentage of pulse amplitude.

Jitter: Short-term instability of one event with respect to another. Unless stated otherwise, value is p-p, expressed as a percentage of the main parameter.

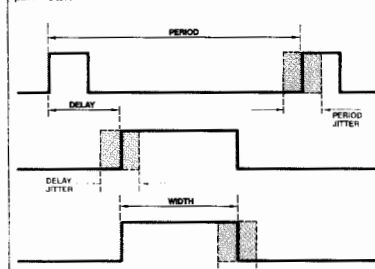

Stability: Long-term average instability, expressed as percentage of main parameter over a specific time duration, e.g. hour, year. Excludes jitter.

Pulse Level: High level and low level. Any limitation is expressed by an amplitude specification.

Pulse Amplitude (alternative to level definition): Pulse amplitude and offset* are specified. Any limitation is expressed by a window (max high level, min low level).

*Pulse generators use baseline offset. Function generator outputs are symmetrical and consequently use median offset.

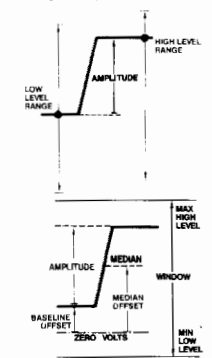

Preshoot, Overshoot, Ringing: Preshoot and overshoot are peak distortions preceding/following an edge. Ringing is the positive peak and negative peak distortion excluding overshoot, on pulse top or base. A combined preshoot overshoot, ringing specification of e.g. ± 5% implies:

- Overshoot/undershoot < 5%,
- Largest pulse-top oscillation < ± 5% of pulse amplitude.

Setting Time: Time taken for pulse levels to settle within level specification, measured from 90% point on leading edge.

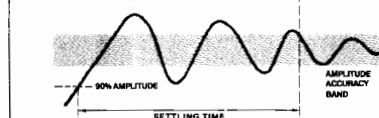

Duty Cycle: Percentage ratio of pulse width to period. In pulse/function generators, this term is also used to define sine and triangle symmetry.

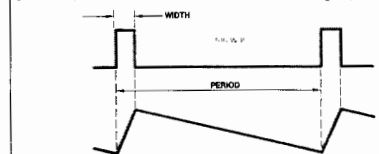

Output Impedance/Resistance: Effective pulse source impedance/dc resistance.

Reflection Coefficient: Reflection at pulse generator output expressed in percent of incident pulse amplitude. (Test pulse edges correspond to generator's fastest transitions).

Repeatability: When an instrument operates under the same environmental conditions, and with the same settings, the value of a parameter will lie within a band inside the accuracy window. Repeatability defines the width of this band.



HP-IB Programming Terminology

Listen Time: The time an instrument occupies the bus to receive and verify a message. The NRFD signal is active during this period.

Settling Time: The time taken by the instrument to execute an HP-IB message, and for the output to settle within the accuracy specification. NRFD inactive.

Execution Time: The sum of Listen Time and Settling Time.

Talk Time: The time an instrument occupies the bus to output a specified string. Output data is typically instrument error status, or current or stored parameters.



PULSE GENERATORS

Programmable Low Cost Pulse Generator

Model 8112A

- Full pulse capability
- Modulation
- Ramps and haversines
- Width/duty cycle
- Device protection
- Error recognition and self test

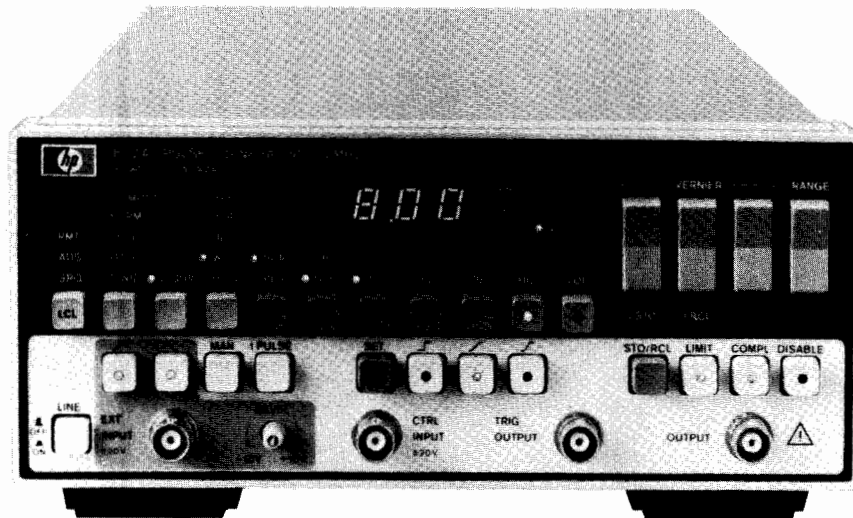

HP 8112A



The HP 8112A is fully programmable 50 MHz pulse generator with 5 ns transitions and 32 V_{pp} (into open circuit) max output amplitude. All pulse parameters are variable including delay and double pulse spacing.

Besides the comprehensive trigger modes, external modulation capabilities extend applicability. 3-level signals and upper level, width, period and delay-modulated signals are available. These can be combined with the trigger modes so that complex real-life signals like modulated bursts are simulated easily.

Step response and trigger hysteresis measurements require fast transitions or sawtooth signals as obtained in the HP 8112A's linear transition mode—either fixed 5 ns or variable from 6.5 ns. The new cosine transitions, also variable from 6.5 ns, mean that band-filtered signals are now just as simple to obtain.

Sensitive devices are protected by programming output limits and the upper level can be controlled by the device supply. Also, constant energy or constant width can be programmed.

Dual channel operation is feasible by operating HP 8112A's in a master/slave combination.

For really easy operation a green button gives error-free settings. A new softkey operating concept plus detailed error recognition make the HP 8112A's powerful versatility easy to handle.

Specifications

Specifications apply with 50-ohm load, and temperatures in the range 0°C to 55°C.

Timing (specifications apply for min transition times)

Period: 20.0 ns to 950 ms.

Delay: 65.0 ns to 950 ms.

Double pulse: 20.0 ns to 950 ms.

Width: 10.0 ns to 950 ms.

Accuracy: ± 5% of progr value ± 2 ns (delay: ± 4 ns).

Duty cycle: 1% to 99% (Min: 10 ns. Max: period -10 ns).

Accuracy: ± 10% of progr value.

Pulse Characteristics (voltages double when driving into open circuit)

Levels

High level: -7.90 V to 8.00 V.

Low level: -8.00 V to 7.90 V.

Accuracy: ± 1% of progr value ± 3% amplitude ± 40 mV.

Settling time: 100 ns + transition time.

Transition times

Fixed: 5 ns typical

Linear and Cosine: 6.5 ns to 95.0 ms (max edge ratio 1:20 within a 1.5-decade range. Ranges overlap by 0.5 decade).

Accuracy: ± 5% of programmed value ± 2 ns.

Preshoot, overshoot, ringing: ± 5% ± 10 mV (variable transitions), ± 10% ± 10 mV (fixed transitions).

Output resistance: 50 ohm ± 5%.

Operating modes: Normal, Trigger, Gate, Ext Width (pulse restoration), Ext Burst (1 to 1999 pulses).

Control (Modulation) Modes

Period, delay, width covered in 8 non-overlapping decades (max input frequency 8 kHz.).

High level: -8 V to +8 V, independent of progr low level (min input transition 200 μs).

General

HP-IB: all keys programmable. Learn, status and error reporting capability. Interface functions: SH1, AH1, T6, L4, SR1, RLL1, PPO, DC1, DT1.

Memory: retains current operating state. 9 store/recall locations, 1 fixed set of parameters.

Repeatability: factor 4 better than accuracy.

Environmental

Storage temperature: -40°C to +65°C.

Operating temperature: 0°C to 55°C.

Humidity: 95% RH, 0°C to 40°C.

Power: 100/120/220/240 V rms; +5%; -10%; 48 to 440 Hz; 120 VA max

Weight: net, 5.9 kg (13 lb). Shipping, 8.0 kg (18 lb).

Size: 89 H x 212.3 W x 450 mm D (3.5" x 8.36" x 17.7").

Ordering Information

HP 8112A Programmable Pulse Generator*

Opt 910 Extra Operating and Service Manual

HP 5061-9701 Bail Handle Kit

HP 5061-9672 Rack Mount Kit (single HP 8112A)

HP 5061-9674 Rack Mount Kit (two instruments)

HP 5061-9694 Lock Link Kit (for use with HP 5061-0074)

* HP-IB cables not supplied, see page 133

☎ Fast-Ship product—see page 766

Prices

\$4775

add \$48

\$38 ☎

\$49 ☎

\$30 ☎

\$25 ☎

PULSE GENERATORS

Programmable Precision Pulse Generators

Models 8160A, 8161A

469



- 50 MHz repetition rate
- 6.0 ns variable transition time
- 20 V output amplitude

- 1-3% pulse parameter accuracy
- Full dual channel capability (option 020)
- 1 year recalibration period

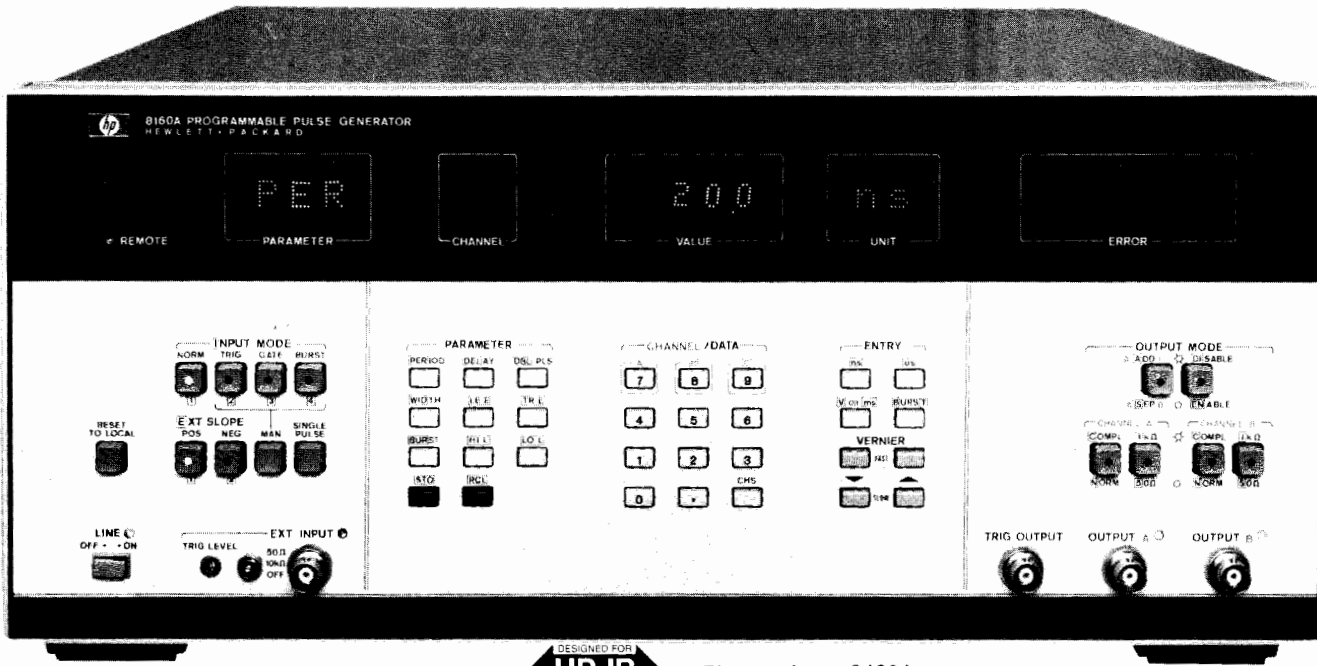

Designed For
MATE
Systems



Picture shows 8160A
with Option 020, Dual Channel
with Option 700, MATE/CIL compatibility

- 100 MHz repetition rate
- 1.3 ns variable transition time
- 5 V amplitude

- 1-3% basic timing accuracy
- Full dual channel capability (option 020)
- 1 year recalibration period

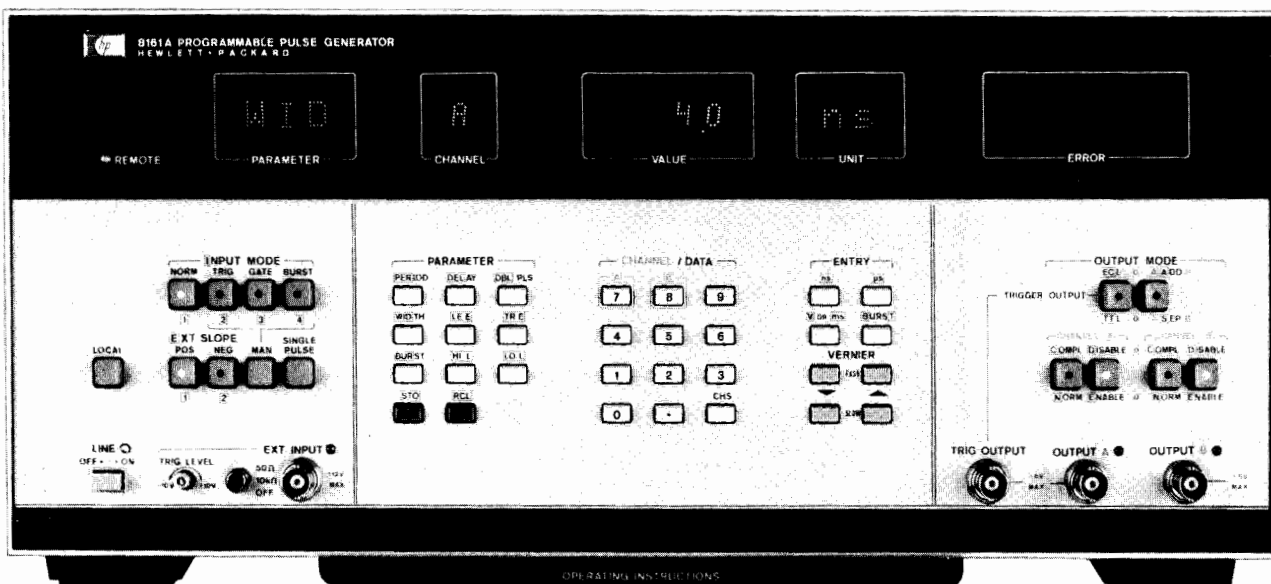

Designed For
MATE
Systems



Picture shows 8161A
with Option 020, Dual Channel
with Option 700, MATE/CIL compatibility

PULSE GENERATORS

Programmable Precision Pulse Generators

Models 8160A, 8161A (cont.)

The HP 8160A and 8161A are fully programmable pulse generators designed for high performance applications on the bench and in automatic test systems. Operation is made easy because the pulse parameters are controlled independently and do not inter-react. Dual channel options permit synchronous or complex waveforms to be generated. With its 50 MHz repetition rate, 20 V output, and 6 ns variable transition times, the HP 8160A is a general purpose pulse generator. The HP 8161A covers the high end of technology with its 100 MHz, 5 V and 1.3 ns variable transition times. Measured between the 20% to 80% amplitude points, these transitions are faster than 1 ns and meet ECL requirements.

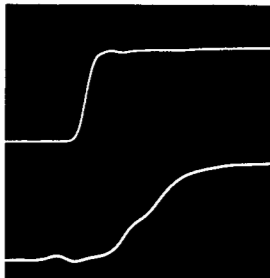

HP 8161A input pulse (upper) and ECL memory output pulse (lower).

Combining high programming accuracy with microprocessor-based control capabilities, pulses can be set up without a measuring instrument. Pulse parameters are entered and displayed numerically, and generated with a basic timing accuracy of 1-3%, depending upon parameter.

An easy-to-use HP-IB interface brings high-accuracy pulses to automatic test. All parameters and operating modes are remotely programmable using straight-forward command sequences. Faster, easier program generation and reduced software costs are direct benefits.

Precision Pulse Generation

Both models provide precision control over all parameters of their output pulses. The HP 8160A's leading and trailing edge transition times may be independently programmed down to 6 ns. The HP 8161A's transitions have a common control from 1.3 ns to 5 ns, and are independent above 5 ns. Variable transition times are indispensable when digital IC's need to be characterized: either the IC's data sheeted input transition time is required, or the IC's functioning range with various transitions needs to be evaluated.

Direct entry of the high and low levels of the output pulse enables easy adjustment to the logic levels concerned. Pulse width is variable from 4 ns (HP 8161A) or 10 ns (HP 8160A) to 1 s, giving a wide range of duty cycle programmability. Delay shifts the output pulse in relation to the trigger output or, in double pulse mode, defines the pulse spacing.

In the dual-channel versions, double pulse can be selected in either or both channels. This means, for example, that simultaneous clock and data signals can be generated.

Complex Signals

Independent pulse parameters plus individual programmability of the Option 020's dual outputs are augmented by the A ADD B mode. Summation allows complex signals to be precisely and easily set up. Here are some examples:

Applications such as radar coincidence circuits and special codes in communications require 3- and 4-level signals. These are conveniently generated by combining channel A and channel B pulses.

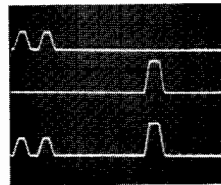
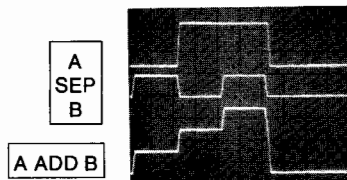

A
SEP
B

A ADD B

Transponder circuits need accurate delays, often with respect to a double-pulse interrogation signal. In the HP 8160A, this is arranged by operating one channel in double pulse mode and setting up the transponder delay in the other.

A critical test for digital circuits and IC's is its glitch and noise sensitivity, which can be easily performed with the A ADD B mode.

A
SEP
B

A ADD B

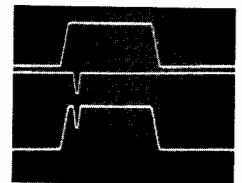

Counted Burst

Using Burst Mode, a predetermined number of pulses is generated independent of frequency. Bursts from 0 to 9999 pulses in length may be produced, and can be triggered via an external signal manually or with an HP-IB command.

Wide Temperature Range for System Reliability

The HP 8160A's and 8161A's 0-50°C operating range ensures calculable performance. Indeed, temperatures will generally be between 20-40°C where there is no derating factor.

User Features

Fast, Reliable Setup

Microprocessor control promotes highly accurate pulses. Parameters are directly entered via the instrument's keyboard, and are then displayed on numeric LED's with 3-digit resolution.

In bench applications, the vernier controls give a fine adjust capability to "tweak-in" any pulse parameter. You can increment or decrement the selected parameter either in single steps or at speed.

Error detection by the microprocessor further simplifies pulse setup by solving the old problem of incompatible settings. Should pulse width exceed pulse period, for example, the microprocessor indicates a TIMING error. All possible mis-settings are detected and the type of error is indicated to aid rapid correction.

HP-IB Programming

Microprocessor control over all interface functions makes remote programming as easy and straight-forward as manual control. The instruments employ keystroke programming so that data entry via the HP-IB is an exact simulation of manual entry. Bus commands for each front panel key simply replace manual keystrokes.

Parameter Storage

Complete parameter and mode information for 9 independent instrument set-ups can be stored. Waveforms may be stored and recalled either manually or via the HP-IB.

By utilizing a single command to recall an entire instrument set-up, controller time is saved. In simple repetitive testing applications, storage of test waveforms gives a high degree of user convenience without an external controller.



Learn Mode

When interrogated by the system controller, the instruments output a character string to the interface bus. This string completely describes the pulser's current set-up or any one of its stored parameter sets. Using Learn Mode, you can enter and try out waveforms manually and then automatically transfer them via the HP-IB to the controller for storage in a program.

Verification Software for the 8160A

Test system accuracy is guaranteed by accessory software which verifies the HP 8160A's performance standards. The software is fully documented and comes recorded on a cassette suitable for HP Model 9825A Desktop Computer.

In the event of a failure, downtime is minimized because the software also delivers diagnostic information to accelerate repair and calibration.

Specifications

(50-ohm source into 50-ohm load). Standard instruments are single channel. Option 020 provides independent dual channels with common pulse period.

Timing (with minimum transitions)	HP Model 8160A	HP Model 8161A
Period Range: Accuracy: Max Jitter:	20 ns to 999 ms. ±3% of progr value ±0.3 ns (period < 100 ns); ±2% of progr value (period ≥ 100 ns). 0.1% of progr value + 50 ps.	10 ns to 980 ms. ±3% of progr value ±0.5 ns (period < 100 ns); ±2% of progr value (period ≥ 100 ns). 0.1% of progr value + 50 ps.
Delay, Double Pulse, Width Delay Range: Double Pulse Range: Width Range: Accuracy: Max Jitter:	0.0 ns to 999 ms. 20.0 ns to 999 ms. 10.0 ns to 999 ms. ±1% of progr value ±1 ns. 0.1% + 50 ps (≤999 ns); 0.05% (999 ns < -≤9.99 μs); 0.005% (>9.99 μs).	0.0 ns to 990 ms. 8.0 ns to 990 ms. 4.0 ns to 990 ms. ±1% of progr value ±1 ns. 0.1% + 50 ps (≤999 ns); 0.05% (999 ns < -≤9.99 μs); 0.005% (>9.99 μs).
Output Characteristics Output levels High Level Range: Low Level Range: Amplitude: Level Accuracy: Settling Time:	50 Ω into 50 Ω -9.89 V to 9.99 V. -9.99 V to 9.89 V. 0.10 V min, 9.99 V max. ±1% of progr value ±1% of ampl ±50 mV. 40 ns.	50 Ω into open or 1 kΩ into 50 Ω -19.7 V to 19.9 V -19.9 V to 19.7 V 0.2 V min, 19.9 V max -4.95 V to 5.00 V. -5.00 V to 4.95 V. 0.06 V min, 5.00 V max. ±1% of progr value ±3% of ampl ±25 mV. 20 ns plus transition time.
Transition Times (10 - 90% amplitude) Leading Edge: Trailing Edge: Accuracy: Linearity:	6.0 ns to 9.99 ms. 6.0 ns to 9.99 ms. ±3% of progr value ±1 ns. ±3% for transitions > 30 ns.	1.3 ns to 900 μs. 1.3 ns to 900 μs. ±10% of progr value ±1 ns. ±5% for transitions > 30 ns.
Preshoot, Overshoot, Ringing:	±5% of ampl ±10 mV.	±5% of ampl ±10 mV (may increase to ±10% of ampl ±10 mV for transitions < 2.5 ns).
A ADD B:	Adds channel A and B outputs (Opt 020 only).	Adds channel A and B outputs (Opt 020 only).
Output Format:	Normal/Complement Selectable. (Independently selectable in each channel in Option 020.)	Simultaneous Normal and Complement Outputs. (Independently selectable in each channel in Option 020.)
Source Impedance:	50 ohm/1 kohm selectable.	50 ohm.

Operating modes: Normal, Trigger, Gate, Ext Burst (0-9999 pulses).

HP-IB capability: all modes and parameters can be programmed. Talk mode for status, error messages, stored parameters.

Memory: 9 programmable locations*,
1 location for active operating state*,
1 location with fixed parameter set.

Capacity: 1 complete operating state per location.

*Battery back-up for power-off storage

General

Recalibration period: 1 year.

Repeatability: factor 2 better than specified accuracy.

Operating temperature: 0°C to 50°C (Specifications apply from 20°C to 40°C. Accuracy derating factors for 0°C to 20°C and 40°C to 50°C).

Power: 115/230 V ac + 10%, -22%, 48-66 Hz; 675 VA max.

Weight: net 20.8 kg (46 lbs). Shipping 25 kg (55 lbs).

Size: 178 H x 426 x 530 mm D (7" x 16.8" x 20.9").

Ordering Information

Price

	HP 8160A	HP 8161A
HP 8160A/8161A Programmable Pulse Generator*	\$14,900	\$16,400
Opt 001: Rear panel inputs and outputs	N/C	N/C
Opt 020: Second channel (Rate common)	\$7,300	\$7,100
Opt 700: Built-in MATE/CIIL compatibility	\$3,000	\$3,000
Opt 907: Front handle kit (P/N HP 5061-0090)	\$65	\$65 ☎
Opt 908: Rack flange kit (P/N HP 5061-0078)	\$35	\$35 ☎
Opt 909: Opt 907, 908, combined (P/N HP 5061-0084)	\$90	\$90 ☎
Opt 910: Additional Operating Manual	\$120	\$150
08160-39910 Verification Software (HP 8160A only).	\$200	---

* HP-IB cables not supplied, see page 133

☎ Fast-Ship product—see page 766



PULSE GENERATORS

Fast, High Power Pulse Generator

Model 214B

- High power 100 V, 2 A output
- 10 MHz repetition rate
- Constant duty cycle
- Counted pulse burst option

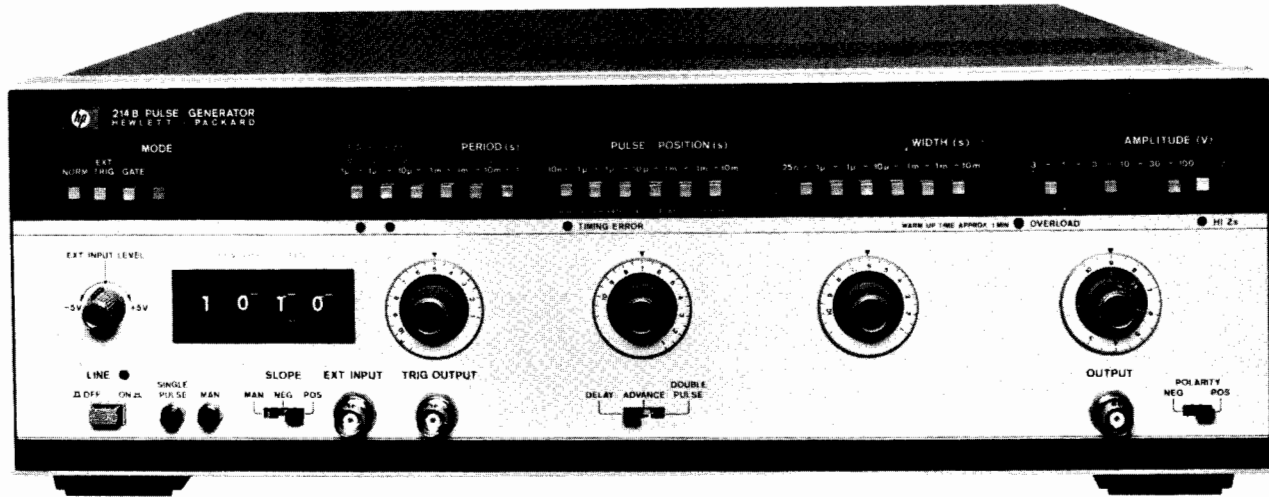

Picture shows 214B with Option 001, Counted Burst.

The HP 214B pulse generator employs semiconductor technology for high power pulse generation at up to 10 MHz repetition rate. Delivering 100 V pulses with 15 ns risetimes, the HP 214B meets the speed demands of today's applications.

State-of-the-art VMOS FETS used as current sources for the output amplifier tubes enable pulse width to be specified down to 25 ns. The HP 214B is thus well-equipped for low duty cycle applications such as laser diode pulsing or transient simulation.

Where changing duty cycle threatens destruction to the device under test, the HP 214B Constant Duty Cycle (CDC) mode provides device protection. In CDC operation the duty cycle, hence power, remains constant as frequency is varied. The HP 214B is itself protected against excessive duty cycles via an overload protect circuit.

Easy operation is assured by the timing error indication. Calibrated dials enable fast accurate adjustments. Operating into unmatched loads, clean pulse shape is guaranteed by the low reactance 50 Ω source impedance. Pulse distortions such as preshoot and overshoot are specified as 5% at all amplitudes.

Specifications

Timing

Repetition rate: 10 Hz to 10 MHz in 6 ranges. In 30 V - 100 V amplitude range, maximum rep. rate is 4 MHz. Calibrated vernier provides continuous adjustment within ranges. **Vernier accuracy:** $\pm(10\%$ of setting + 1% full scale). **Period Jitter:** $\leq 0.1\% + 300$ ps.

Pulse delay/advance: pulse can be delayed/advanced with respect to the trigger output from 10 ns to 10 ms (\pm fixed delay of 45 ns) in 5 ranges. Calibrated vernier provides continuous adjustment within ranges. **Vernier accuracy:** $\pm(10\%$ of setting + 1% full scale) + fixed delay. **Position Jitter:** $\leq 0.1\% + 500$ ps

Maximum pulse position duty cycle: $\geq 50\%$

Double pulse: 5 MHz maximum in all ranges except 30 V - 100 V range which is max. 2 MHz. Minimum separation is 100 ns.

Pulse width: 25 ns to 10 ms in 6 decade ranges. Calibrated vernier provides continuous adjustment within ranges. **Accuracy:** $\pm(10\%$ of setting + 1% full scale) + 5 ns. **Width Jitter:** $\leq 0.1\% + 500$ ps.

Max. duty cycle: $\geq 10\%$ for 30 - 100 V range. $\geq 50\%$ all other ranges. **Constant duty cycle mode (disabled in ext. trigger mode):** duty cycle of output pulse remains constant as the period is varied. The duty cycle limits in this mode are typically 8% fixed for the 10 M - 1 MHz range (max. 4 MHz); 2.5% to 10% for 1 MHz - .1 MHz range; .25% to 10% for .1 MHz - 10 kHz range; 0.1% for all other ranges. Calibrated vernier provides continuous adjustment within ranges.

Accuracy: $\pm(15\%$ of setting + 1% of full scale).

Trigger Output

Amplitude: $\geq +5$ V (50 ohm into open circuit).

Pulse width: 10 ns typical.

External Operating Modes

External Input (impedance 10 k ohm, dc coupled)

Repetition rate: dc to 10 MHz. **Sensitivity:** 500 mVpp, dc coupled.

Slope: pos. or neg. **Trigger level:** +5 V to -5 V adjustable.

Maximum input level: ± 100 V. **Trigger pulse width:** ≥ 10 ns.

EXT TRIG mode: an output pulse is generated for each input pulse.

GATE mode: gate signal turns on rep. rate generator synchronously. Last pulse always completed.

BURST mode (optional): preselected number of pulses generated on receipt of trigger signal. **Number of pulses:** 1 to 9999. Minimum spacing between bursts: 200 ns.

Manual: pushbutton can be used for triggering single pulses (EXT TRIG mode), generating gate signals (GATE mode) or triggering pulse bursts (BURST mode).

Output

Amplitude: 0.3 V to 100 V in 5 ranges. Calibrated vernier provides adjustment within ranges. **Vernier accuracy:** $\pm 10\%$ of setting.

Source impedance: fixed 50 Ω nominal on ranges up to 10 V. Selectable 50 Ω nominal or HI-Z on 10 - 30 - 100 V ranges (with 50 Ω / 50 Ω impedance, amplitude decreases to 5 - 15 - 50 V).

Polarity: pos. or neg. selectable.

Transition times: ≤ 15 ns for leading and trailing edges.

Pulse top perturbations: $\leq \pm 5\%$ of amplitude.

General

Operating temperature: 0°C to 55°C.

Power: 100/120/220/240 Vrms; +5%, -10%, 48 to 66 Hz, 360 VA max.

Size: 133 mm H x 426 mm W x 422 mm D (5.2" x 16.8" x 16.6").

Weight: net 13.6 kg (30 lb). Shipping 15.6 kg (34.3 lb).

Ordering Information

HP 214B Pulse Generator

Opt 001: Counted Burst

Opt 907: Front Handle Kit (part number HP 5061-0089).

Opt 908: Rack Mount Kit (part number HP 5061-0077).

Opt 909: Opt 907, 908 Combined (part number HP 5061-0083).

Opt 910: extra Operating and Service Manual

☎ Fast-Ship product—see page 766

Prices

\$3820

add \$475

add \$55 ☎

add \$32.50 ☎

add \$80 ☎

add \$33

PULSE GENERATORS

20 MHz Pulse Sources

Models 8005B, 8011A

473



- Dual outputs, +10 V and -10 V
- TTL output
- Gating, square wave, double pulse modes

- Repetition rate 0.1 Hz to 20 MHz
- Positive/negative/symmetrical output
- Normal/complement switch

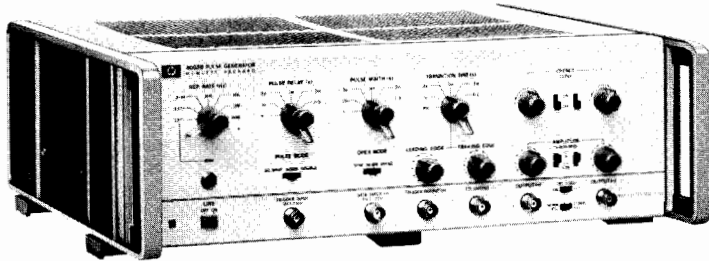

HP 8005B

The HP 8005B is a general purpose, triple output pulse generator. This instrument has all parameters variable and produces simultaneous pos. and neg. pulses. It also has a TTL output with all parameters variable except amplitude. This feature, together with the normal/complement facility, greatly improves the ease of operation.

HP 8005B Specifications

Pulse Characteristics

Transition times: ≤ 10 ns to 2 s. Edges independently variable.
Non-linearity: for transition times > 30 ns, $< 4\%$ of pulse amplitude.
Preshoot, overshoot, ringing: $< 5\%$ of pulse amplitude.
Pulse width: < 25 ns to 3 s. **Jitter:** $< 0.1\%$ of setting + 50 ps.
Max. duty cycle: $> 80\%$ (0.3 Hz - 1 MHz), $> 50\%$ (1-20 MHz).
Square wave: 0.15 Hz - 10 MHz.
Pulse delay: < 100 ns to 3 s. **Jitter:** $< 0.1\%$ of setting + 50 ps.
Pulse outputs: simultaneous pos., neg. and TTL outputs.
Pulse amplitude: 300 mV to 10 V.
Output protection: max. external voltage ± 10 V.
Source impedance: 50 ohms $\pm 10\%$ or high impedance selectable.
TTL compatible output: +4.6 V norm. or comp. 50 Ω impedance.

Repetition Rate and Trigger

Repetition rate: 0.3 Hz to 20 MHz in 5 ranges. **Jitter:** $< 0.1\%$ + 50 ps.
Double pulse: 10 MHz max. Simulates 20 MHz.
Trigger output: $> +2$ V ampl. across 50 ohms. **Width:** > 6 ns.

External Operating Modes

External Triggering (dc to 20 MHz)

Delay: approx. 35 ns trig. input to trig. output.
Maximum input: ± 10 V. **Sensitivity:** sine 2 Vpp.
Impedance: approx. 1k ohms, dc coupled. **Pulses:** ± 1 Vpeak.
Input pulse width: ≥ 10 ns.

Gating

Synchronous: gate signal turns on repetition rate. Last pulse is always completed.

Asynchronous: gate signal controls output of rate generator.

Gate Input (impedance 1 k ohms dc coupled)

Amplitude: 2 V to 20 V (max.). **Polarity:** negative.

General

Operating temperature: 0°C to 55°C.
Power: 115/230 V rms; +10%, -15%; 48 to 440 Hz, 180 VA max.
Weight: net 7 kg (15.5 lb). Shipping 9 kg (20 lb).
Size: 130 H x 426 W x 290 mm D (5.1" x 16.8" x 11.4").

Ordering Information HP 8005B, 8011A

HP 8011A Pulse Generator	Price
	\$1090
Opt 001: Pulse Burst	add \$370
Opt 910: extra Operating and Service Manual	add \$20
HP 15179A (for HP 8011A): Adapter frame, Rack mount for 1 or 2 units, includes blank panel for single-unit operation.	\$205
HP 8005B Pulse Generator.	\$2960
Opt 908: Rack Flange Kit (part number HP 5060-8740).	add \$37.50
Opt 910: extra Operating and Service Manual.	add \$28

☎ Fast-Ship product—see page 766



Picture shows 8011A with Option 001, Burst.

The HP 8011A is a versatile, reliable, low cost pulse generator. This compact instrument features an uncomplicated design using high quality components to ensure long, dependable service. Ease of operation results from the logical and simple front panel layout. These qualities and the many pulse formats available emphasize the HP Model 8011A's cost-effectiveness in a wide application range.

HP 8011A Specifications

Pulse Characteristics (50 ohm source/load impedances)

Transition times: < 10 ns fixed.
Overshoot, ringing and preshoot: $< \pm 5\%$ of pulse amplitude. May increase to 10% at counter-clock wise positions of amplitude vernier.
Pulse width: 25 ns to 100 ms in four ranges. Vernier provides continuous adjustment within each range.
Width jitter: $< 0.1\%$ + 50 ps on any width setting.
Maximum duty cycle: $> 50\%$ (100% using pulse complement)
Maximum output: 8 V. With internal 50 Ω and external Hi-Z or internal Hi-Z/external 50 Ω , then 16 V max.
Attenuator: 3-step attenuator provides the ranges 0.25 V - 1 V - 4 V - 16 V. Vernier provides continuous adjustment within each range.
Source impedance: 50 $\Omega \pm 10\%$ shunted by 30 pF, except in 4 V - 16 V range which is 50 Ω /Hi-Z, switch selectable.
Polarity/format: pos., neg., or sym./norm. or compl., switch select.

Repetition Rate and Trigger

0.1 Hz to 20 MHz in 5 ranges. Vernier provides continuous adjustment within each range. **Period jitter:** $< 0.1\%$ + 50 ps of per. setting.
Square Wave: 0.05 Hz to 10 MHz.
Trigger output: dc coupled 50 Ω (typ.) source delivering $\geq +1$ V into 50 Ω (can increase to +5 V). **Trigger pulse width:** 20 ns ± 10 ns.

External Operating Modes

Input impedance: 50 $\Omega \pm 10\%$. **Trigger polarity:** positive.
Maximum input: ± 5 V. **Sensitivity:** 1 V.
Manual: front panel pushbutton for generating single pulse.
Repetition rate: 0 to 20 MHz. In square wave, output frequency is half the input frequency.
Trigger source: manual or ext. signal. Min. ext. signal width 20 ns.
Pulse burst mode (option 001): preselected number of pulses generated on receipt of trigger.
Burst trigger source: man. or ext. signal. Min. signal width 25 ns.

General

Operating temperature: 0°C to 55°C.
Power: 100/120/220/240 V rms; +5%, -10%; 48 Hz to 440 Hz, 70 VA max.
Weight: net, 4 kg (9 lb). Shipping, 6.5 kg (14.6 lb).
Dimensions: 126 H x 200 W x 280 mm D (5" x 7.9" x 11").



PULSE GENERATORS

50 MHz Pulse Sources

Models 8012B & 8013B

- Variable transition times down to 5 ns
- ± 10 V amplitude; selectable source impedance
- Ideal for testing TTL

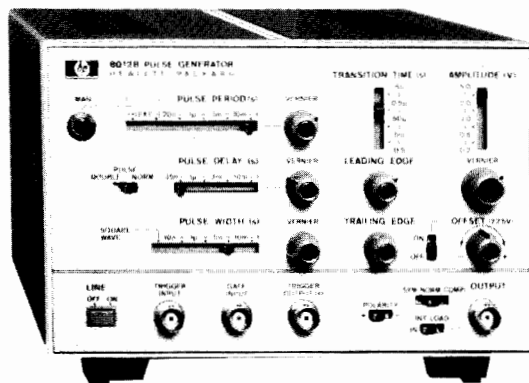

HP 8012B

- Fixed 3.5 ns transition times
- 10 V amplitude; selectable source impedance
- 2 outputs

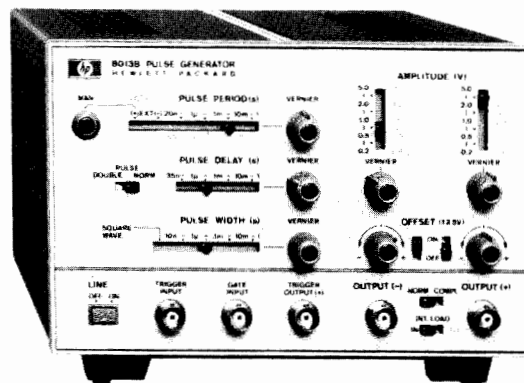

HP 8013B

The HP 8012B and 8013B are at the top of their class for versatility, ease of operation and wide range of application. They provide the ideal solution to almost all digital logic testing problems with fixed 3.5 ns transition times on the HP 8013B and variable transition times down to 5 ns on the HP 8012B. The well-composed layout of the front panel controls (horizontal controls for horizontal parameters, vertical controls for vertical parameters) enables output pulses to be set up quickly and accurately with minimum risk of incompatible settings. Both models feature normal and complement outputs and a switchable internal 50 ohm source.

Specifications

Pulse Characteristics

Parameter	HP Model 8012B		HP Model 8013B	
	Int. load IN	Int. load OUT	Int. load IN	Int. load OUT
Transition times	5 ns—0.5s 4 ranges, Verniers provide separate control of both edges within ranges up to max. ratios of 100:1 or 1:100.	6 ns—0.5s	3.5 ns fixed	5 ns fixed
Source impedance	50 ohms $\pm 10\%$ shunted by typically 20 pF	>50 ohms	50 ohms $\pm 3\%$ shunted by typically 20 pF	>50 ohms

Parameter	HP Models 8012B/8013B	
	Internal load IN	Internal load OUT
Overshoot ringing	$\pm 5\%$ of pulse amplitude	May increase to $\pm 10\%$ when amplitude is between 0.4—4 V
Maximum output	5 V across 50 ohms, 10 V across open circuit. Short cct. protection.	10 V across 50 ohms, Short cct. protection.
Attenuator	4-step, reduces output to 0.2 V.	4-step, reduces output to 0.4 V.
DC offset	± 2.5 V across 50 ohms. Independent of amplitude settings.	DC offset switched off.

Linearity (HP 8012B): for transition times > 30 ns, maximum straight line deviation is 5% of pulse amplitude.

Preshoot: $< \pm 5\%$ of pulse amplitude.

Pulse width: < 10 ns to 1 s in four ranges. Vernier provides continuous adjustment within ranges.

Width jitter: $< 0.1\% + 50$ ps on any width setting.

Maximum duty cycle: $> 75\%$ from 1 Hz to 10 MHz, decreasing to $\geq 40\%$ at 50 MHz. Up to 100% in COMPL mode.

Polarity: HP 8012B; positive or negative selectable, NORM/COMPL/SYM selectable; HP 8013B, one positive + one negative channel, NORM/COMPL selectable.

Pulse delay: < 35 ns to 1 s (with respect to trigger output) in four ranges; vernier provides continuous adjustment within ranges.

Delay jitter: $< 0.1\% + 50$ ps on any setting.

Repetition Rate and Trigger

1 Hz to 50 MHz in four ranges, continuous adjustment within ranges.

Period jitter: $< 0.1\% + 50$ ps on any rate setting.

Square wave: 0.5 Hz to 25 MHz in four ranges. Duty cycle 50% $\pm 5\%$ up to 1 MHz, tolerance increases to $\pm 15\%$ at 25 MHz.

Trigger output: $> +1$ V across 50 Ω , 16 ns ± 10 ns wide.

External Triggering

0 to 50 MHz; for square wave output, frequency divided by factor 2.

Trigger input: sine waves 1.5 V p-p (about zero) or pulses > 0.8 V either polarity, > 7 ns wide. Maximum input ± 7 V.

Impedance: 50 $\Omega \pm 10\%$, dc coupled.

Delay: 25 ns ± 8 ns leading edge trig. input to trig. output.

Manual: pushbutton for single pulse.

Gating

Synchronous gating: gating signal turns generator "on". Last pulse is completed even if the gate ends during pulse.

Gate input: dc-coupled; voltage at open connector approx. +1.8 V. Shorting current ≤ 12 mA. Input impedance $\approx 160 \Omega$

Gate input signal: voltage $> +1.5$ V or resistor > 1 k Ω to ground enables rep. rate generator. Voltage $< +0.8$ V or resistor $< 160 \Omega$ disables rep. rate generator. Input TTL compatible, max. ± 5 V.

External Width and RZ

External width: output pulse width determined by width of drive input signal. Amplitude, transition times selectable. Trigger output independent of external width input signal.

RZ mode: external drive input switched to delay generator. Period determined by period of drive input signal. Delay, amplitude and width selectable.

Input signal: $> +1$ V, > 7 ns wide. Max. ± 5 V. 50 Ω dc coupled.

General

Operating temperature: 0°C to 55°C .

Power: 100/120/220/240 V rms; $+5\%$, -10% ; 48 to 400 Hz, 100 VA max.

Weight: net, 4kg (8.8 lb). Shipping, 6.5 kg (14.6 lb).

Size: 126 H x 200 W x 280 mm D (5 x 7.9 x 11 in.)

Ordering Information

HP 8012B Pulse Generator

Opt 910: extra operating and service manual

HP 8013B Pulse Generator

Opt 910: extra operating and service manual

HP 15179A Adapter frame. Rack mounting for 1 or 2 units, includes blank panel for single-unit requirements

Prices

\$1750

add \$20

\$1650

add \$13

\$205



PULSE GENERATORS

50 MHz, Dual Output

Model 8015A



- Two independent ± 16 V outputs
- Additional TTL output

- Remote control and counted burst options
- Complex waveforms

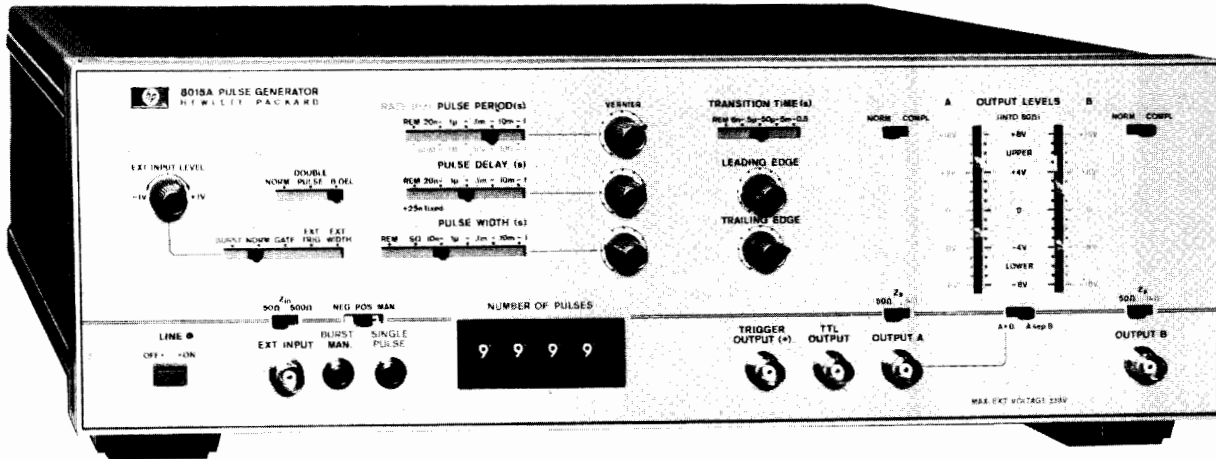

Picture shows 8015A with Option 002, Burst

Offering B Delay mode in addition to variability of all pulse parameters, the HP 8015A is ideal for analyzing critical timing conditions, or generating 2-phase clocks.

A + B mode gives a 30 V output within a ± 16 V window. Combined with B Delay mode, three-level signals, special codes or simulated biomedical signals can be generated.

Option 002 Burst mode generates an exact number of pulses by means of an internal counter.

Direct access to either or both output amplifiers (Option 007) converts to MOS/CMOS levels. Alternatively, high-level tracking capability ensures that clock and data signals follow the supply, and thus safeguards CMOS devices.

For use in automatic test, Option 003 allows all pulse parameters to be controlled remotely.

Specifications

Timing

Repetition rate: 1 Hz to 50 MHz (square wave and double pulse to 25 MHz, A + B mode to 40 MHz, B delay 20 MHz).

Width: 10 ns to 1 s or square wave.

Delay: 20 ns to 1 s (both channels, interchannel or double pulse).

Jitter: 0.1% + 50 ps.

Output (50 Ω Output Impedance into 50 Ω termination. Voltages double in 50 Ω / 1 k Ω or 1 k Ω / 50 Ω operation).

Magnitude: 1 V to 8 V amplitude (2 V to 16 V in A + B mode).

High level: -7 V to +8 V. **Low level:** -8 V to +7 V.

Transition times: 6 ns to 0.5 s in four ranges, independent leading/trailing vernier adjustment.

Non-linearity: 5% for transitions > 30 ns.

Preshoot, overshoot and ringing: 5%.

A + B mode: sum of channel A and channel B outputs.

Complement: independently selectable.

Impedance: 50 Ω / 1 k Ω , independently selectable.

Trigger Input

Impedance: 50 Ω / 500 Ω selectable.

Level: adjustable +1 V to -1 V (50 Ω), +10 V to -10 V (500 Ω).

Slope: + or - selectable.

Auxiliary Outputs

TTL: 50 Ω output impedance, timing as channel A.

Trigger output: 1 V, 50 Ω into 50 Ω .

Option 002 Burst Mode

Burst length: 1-9999 pulses, selectable.

Pulse repetition rate: 1 Hz to 40 MHz.

Burst trigger: trigger input.

Minimum burst separation: 200 ns.

Option 003 Remote Control

Timing ranges: TTL or contact closure.

Timing verniers: current, voltage or resistor programming.

Output levels: voltage programming.

Burst: BCD, TTL/contact closure.

Option 007 Amplifier and Tracking Modes

Dual Amplifier Mode

Gain: 0.8 to 6.4.

Frequency response (-3 dB): 0 to 80 MHz.

Upper Level Tracking Mode

Upper level: input voltage $\pm 5\%$.

Lower level: 0 V ± 250 mV.

Settling time: 400 μ s to $\pm 5\%$ of final value.

General

Operating temperature: 0°C to 55°C.

Power: 100/120/220/240 V rms; +5%, -10%; 48 to 440 Hz, 180 VA max.

Weight: net, 11 kg (24.26 lb). Shipping, 14.7 kg (32.4 lb).

Size: 133 H x 426 W x 346 mm D (5.2" x 16.75" x 13.6").

Ordering Information

HP 8015A Pulse Generator

Opt 002: Pulse Burst

Opt 003: Remote Control

Opt 007: Dual Amplifier and Level Tracking modes

Opt 907: Front Handle Kit (Part No. HP 5061-0089)

Opt 908: Rack Flange Kit (Part No. HP 5061-0077)

Opt 909: Opt. 907, 908 combined

(Part No. HP 5061-0083)

Opt 910: Additional Operating and Service Manual

Price

\$4450

add \$700

add \$1000

add \$470

add \$55

add \$32.50

add \$80

add \$38

☎ Fast-Ship product—see page 7



PULSE GENERATORS

250 MHz Fast Pulse Source

Model 8082A

- < 1 ns variable transition times
- Ultra-clean 50 ohm source

- Switch-selectable ECL levels
- Dual ± 5 V outputs

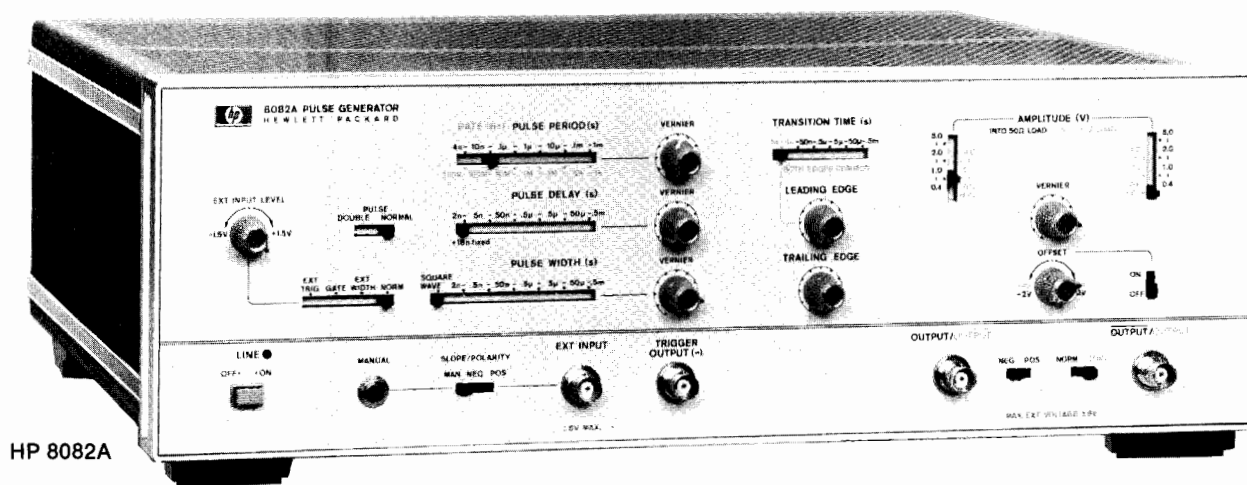

HP 8082A

The HP 8082A is Hewlett-Packard's fastest pulse generator with all pulse parameters variable. With repetition rates to 250 MHz, transition times down to 1 ns and amplitudes to 5 V, the HP 8082A is ideally suited for state-of-the-art TTL and ECL logic designs. Using the HP 8082A, you can rapidly test logic circuits under all operating conditions by simply varying pulse parameters. Although a highly sophisticated instrument, the HP 8082A is still easy to operate because of its logical front panel layout and switch selectable ECL output levels. Another feature that contributes to ease of operation is the square wave mode. You can, for example, carry out toggle rate tests in this mode up to 250 MHz without having to worry about pulse duty cycle.

Hybrid IC's, manufactured by Hewlett-Packard, are used extensively in the design of the HP 8082A. These ICs eliminate the need for fans, reduce power consumption and enable a low reactance 50 ohm source impedance to be used. This source impedance absorbs 98% of reflections from signals up to 4 V amplitude.

Specifications

Pulse Characteristics (50 Ω source and load impedance)

Transition times: (10% to 90%): 1 ns to 0.5 ms in 6 ranges at amplitudes >1.8 V and >4.5 V respectively in the two upper output ranges. Minimum value may increase to 1.2 ns at other amplitudes. Leading/trailing times are common on fastest range, and independently variable over 1:10 ratio on other ranges.

Overshoot and ringing: $\leq \pm 10\%$ of pulse amplitude may increase to $\pm 10\%$ with amplitude vernier CCW.

Preshoot: $\leq \pm 5\%$ of pulse amplitude.

Linearity: linearity aberration for both slopes $\leq 5\%$ for transition times >5 ns.

Output: maximum amplitude is 5 V from 50 Ω into 50 Ω . Maximum output voltage is ± 5 V (amplitude + offset).

Offset: ± 2 V, into 50 Ω .

DC-source impedance: 50 Ω +5% -10%.

Reflection coefficient: 5% in ECL setting, increasing to 15% in 5 V range.

Output protection: cannot be damaged by open or short circuits or application of ext. ≤ 6 V or ± 200 mA independent of control settings.

Attenuator: two separate three step-attenuators reduce the outputs to 1 V. Vernier is common for both outputs and reduces the output to 0.4 V minimum. A further position provides ECL-compatible outputs (-0.9 V to -1.7 V typ. open circuit).

Timing

Repetition rate: 250 MHz to 1 kHz in 6 ranges.

Period jitter: <0.1% of setting +50 ps.

Delay: 2 ns -0.5 ms in 6 ranges plus typ. 17 ns fxd. with respect to trigger output. Duty cycle >50%.

Delay jitter: <0.1% of setting +50 ps.

Double pulse: up to 125 MHz max. (simulates 250 MHz).

Pulse width: 2.4 ns to 0.5 ms in 6 ranges.

Width jitter: <0.1% of setting +50 ps.

Width duty cycle: >50%.

Square wave: delay and double pulse are disabled, max. Rep. Rate 250 MHz. Duty cycle is 50% $\pm 10\%$ up to 100 MHz, 50% $\pm 15\%$ for >100 MHz.

Trigger output: negative going Square Wave (50% duty cycle typ.) >500 mV from 50 Ω into 50 Ω . Internal 50 Ω can be switched off by slide-switch on PC-board. Amplitude up to 1 V into 50 Ω up to 200 MHz.

Trigger output protection: cannot be damaged by short circuit or application of external ± 200 mA.

External Operating Modes

External Input

Input impedance: 50 Ω $\pm 10\%$. dc coupled.

Maximum input: ± 6 V.

Trigger level: adjustable -1.5 V to +1.5 V.

Slope control: positive, negative or manual selectable. In the manual position all ext. functions can be controlled by push button. Button pushed in simulates an "on-signal."

Sensitivity: sine-wave >200 mV p-p pulses >200 mV.

Repetition rate: 0 to 250 MHz.

External-Controlled Modes

External trigger: there is approximately 7 ns delay between the external input and the trigger output. Rep. rate is externally controlled (is triggered by external signal). Trigger output provides the pulse-shaped input signal.

Synchronous gating: gating signal turns rep. rate generator on. Last pulse normal width even if gate ends during pulse.

External width: output pulse width determined by width of drive input. Rep. rate and delay are disabled. Trigger output provides shaped input signal.

General

Operating temperature: 0°C to 55°C.

Power: 100/120/220/240 Vrms; +5%, -10%; 48-440 Hz. 85 VA max.

Weight: net, 7.9 kg (17.44 lb). Shipping 8.9 kg (19.63 lb).

Size: 133 mm H x 426 W x 345 mm D (5.2" x 16.75" x 13.6").

Ordering Information

HP 8082A Pulse Generator

Price

\$4985

Opt 907: Front Handle Kit (part number HP 5061-0089).

add \$55

Opt 908: Rack Flange Kit (part number HP 5061-0077).

add \$32.50

Opt 909: Opt 907, 908 Combined (part number HP 5061-0083).

add \$80

Opt 910: Additional Operating and Service Manual

add \$28

☎ Fast-Ship product—see page 766

PULSE GENERATORS

Configurable Pulse/Data Stimuli

HP 8080A Series



Example: HP 8080A SO4

- 1 GHz, 300 ps transitions
- Interchannel delay

Example: HP 8080A DO1

- 300 MHz, 800 ps transitions
- Manually programmable data

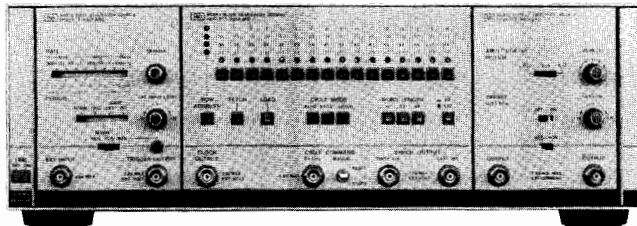
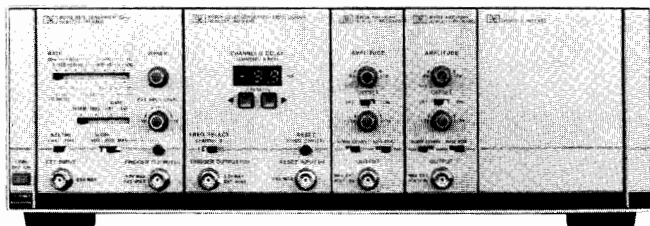

HP 8091A Rate Generator
 HP 8092A Delay Generator
 CHA HP 8093A Output Amplifiers
 CHB HP 8093A Output Amplifiers
 HP 15400A Blank Panel

HP 8081A Rate Generator
 HP 8084A Word Generator
 HP 8083A Output Amplifier

Research and development in advanced technologies such as subnanosecond ICs, fiber optics and nucleonics, require fast pulses for thorough characterization. The HP 8080A can, for example, generate simultaneous 1 GHz clock and simulated NRZ data for testing today's fastest memories, or complementary data with up to 64 bits and fast 300 ps edges for state-of-the-art communication devices. Cost-effectivity is promoted because the HP 8080A's modular structure allows performance and capability to be tailored to the requirement.

Two examples are shown here. Full details of these and all other factory-systemized configurations are in the data sheet. Individual modules are also available for special applications or for extending an existing configuration. Ask for the systemizing and adjustment guidelines.

Leading Characteristics (50-ohm load)

HP 8080A SO4

Timing

- Repetition rate:** 100 Hz - 1 GHz.
- Interchannel delay:** ± 9.9 ns in 0.1 ns steps.
- Channel B divider:** 0.5 f selectable for simulating NRZ data.
- Width:** Square wave.
- Modes:** Int, Ext Width, Gate, Manual.
- Independent 50-ohm Outputs**
 - Amplitude:** 0.6 V to 1.2 Vpp.
 - Offset:** ± 1.2 V.
 - Transitions times (10% to 90%):** <300 ps.
 - Polarity:** selectable
 - Format:** Normal/Complement selectable

HP 8080A DO1

Timing

- Repetition rate:** 10 Hz-300 MHz.
- Width:** square wave (RZ) or NRZ.
- Modes:** Int, Ext/Manual Width.
- Data cycle modes:** Ext/Man Single and Gated Cycle, Auto Cycle.
- Data:** Serial, 16/32/64 bit selectable.
- Simultaneous Normal and Complement 50-ohm Outputs**

- Amplitude:** 0.2 V to 2 V.
- Offset:** ± 1 V.
- Transition times (10% to 90%):** <800 ps.
- Polarity:** selectable.

General

- Operating temperatures:** 0°C to 55°C.
- Power:** 115/230 V rms; + 10%, -22%; 48 to 66 Hz, 200 VA max.
- Weight:** (typical, HP 8080A Mainframe plus full complement of modules) 9.4 kg (16.6 lbs) net; 19.7 kg (43.3 lbs) shipping.
- Size:** (HP 8080A Mainframe): 133 H x 426 W x 422 mm D (5.24" x 16.77" x 16.61").

Ordering Information

HP 8080A Mainframe	\$2,440
Opt 907: Front handle kit	add \$55
Opt 908: Rack flange kit	add \$32.50
Opt 909: Opt 907, 908 combined	add \$80
Opt S01: (HP 8081/83A, 2 x HP 15400A)	add \$3,080
Opt S02: (HP 8081/93A, 2 x HP 15400A, 15401A)	add \$4,090
Opt S03: (HP 8091/93A, 2 x HP 15400A, 15401A)	add \$7,220
Opt S04: (HP 8091/92A, 2 x HP 8093A, 15400A)	add \$13,100
Opt D01: (HP 8081/83/84A)	add \$6,575
Opt D02: (HP 8081/84/93A, 15401A)	add \$7,585
Opt D03: (HP 8081/84A, 2 x HP 8093A)	add \$9,970
HP 8081A 300 MHz Rate Generator module	\$1,485
HP 8083A 300 MHz Output Amplified module	\$1,485
HP 8084A 300 MHz Word Generator module	\$3,605
HP 8091A 1 GHz Rate Generator module	\$4,615
HP 8092A 1 GHz Delay Generator module	\$3,555
HP 8093A 1 GHz Output Amplifier module	\$2,440
Opt H01: Special Option for variable-width operation with HP 8092A	Price on inquiry
Additional manuals: Opt 910, per module	add \$28

Accessories Available

HP 15400A Blank Panel, 1/4 mainframe width	\$55
HP 15401A Blank Panel, 1/2 mainframe width	\$55
HP 15402A BNC Feedthru panel, 1/2 width	\$265

Pulse Generator Accessories



HP 15104A Pulse Adder/Splitter dc to 2 GHz	\$105
HP 15116A Pulse Inverter 3 MHz to 2 GHz	\$265
HP 15115A Pulse Splitter/Inverter 3 MHz to 2 GHz	\$210

PULSE GENERATORS

High Resolution Time Synthesizer

Model 5359A

- Precise digital delays 0- 160 ms
- 50 ps increments
- Jitter < 100 ps
- Programmable
- Fully synchronous to external trigger
- Automatic calibration

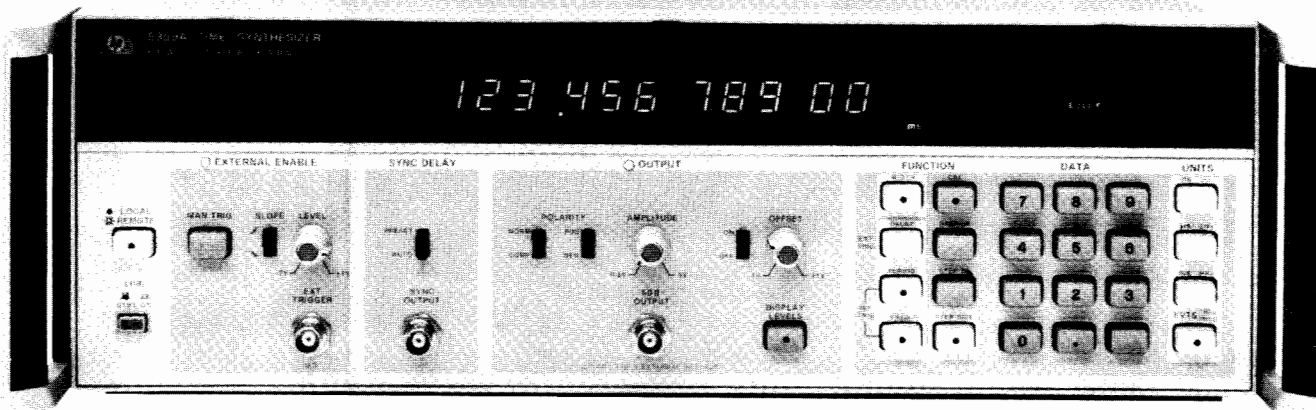

HP 5359A



HP 5359A Time Synthesizer

The HP 5359A Time Synthesizer produces two extremely precise, low jitter time delays. These delays, T_d and T_w , are individually selectable by means of the keyboard, in 50 ps or greater steps to generate delays of up to 160 ms.

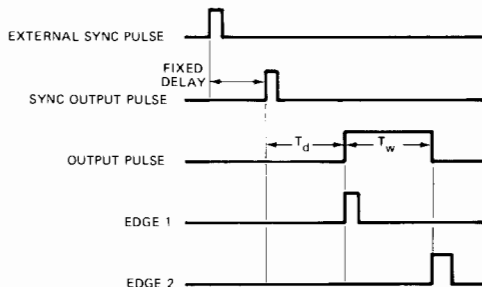

The HP 5359A has many applications and may be used for the calibration of Radar, Loran, DME and Tacan Systems, or for precision generation of delayed sweeps in oscilloscopes, and for extremely accurate "time positioning" control of external gates on frequency counters. In component and circuit test, the instrument may be used for extremely accurate delay line simulation.

Condensed Specifications

Modes

External trigger mode: the delays from the sync out to the beginning of the output pulse, and the width of the output pulse, are selected.

Internal trigger mode: the "period" or "frequency", and the width of the output pulse, are selected.

Range

Delay T_d : 0 ns to 160 ms.

Width T_w : 5 ns to 160 ms (width & delay \leq 160 ms).

Period: 100 ns min or width + 85 ns; 160 ms max.

Frequency: same as corresponding "period".

Repetition rate: 10 MHz max.

Accuracy: ± 1 ns \pm time base error (± 100 ps \pm time base error after external calibration).

Insertion delay: fixed at < 150 ns; selectable as < 50 ns for delays > 100 ns.

Jitter: typical 100 ps rms; maximum 200 ps rms (delays to 10 ms).

External trigger input: -2 V to + 2 V slope selectable.

Sync output: 1 V - 50 Ω ; 5 V - 1 M Ω . Width 35 ns nominal.

Output Pulse

Amplitude: 0.5 V to 5 V into 50 Ω .

Polarity: positive or negative.

Offset: -1 V to 1 V, or OFF.

Transition time: < 5 ns.

External voltage must not be applied. Offset and Amplitude voltage into 50 Ω may be displayed.

EDGE 1 OUTPUT (rear panel): occurs in Sync with leading edge of output pulse (same spec. as Sync out).

EDGE 2 OUTPUT (rear panel): occurs in Sync with falling edge of output pulse (same spec. as Sync out).

Events mode: substitutes external input (to 100 MHz) for the internally counted clock (delay and width must both be specified in terms of events instead of time).

Triggered frequency mode: the same as internal frequency mode except the output is a burst beginning in synchronism with an external trigger signal, and continues for the duration of this signal.

Calibrate mode: performs an internal calibration to remove the effects of internal delay differences.

External probes: provides outputs to control the HP 5363B probes and accepts inputs from the probes to include external devices in the calibration loop.

HP-IB: All controls except trigger levels are programmable as standard.

Time Base

High Stability Oven Oscillator

Frequency: 10 MHz.

Aging: $< 5 \times 10^{-10}$ /day.

Temperature: $< 2.5 \times 10^{-9}$, 0°C to 50°C.

Line voltage: $< 1 \times 10^{-10}$, $\pm 10\%$ from nominal.

Size: 133 H x 426 W x 521 mm D (5.25 in. x 16.75 in. x 20.50 in.).

Weight: 13.6 kg (30 lb).

Power requirements: 100, 120, 220, or 240 Vac +5% -10%, 48 to 66 Hz, less than 250 VA.

Front handles: supplied with instrument.

Ordering Information

HP 5359A Time Synthesizer

Opt 908 Rack Flange Kit for use without handles

Opt 913 Rack Flange Kit for use with supplied handles

HP 10870A Service Kit

Price

\$10,500

+ \$32.50

+ \$35

\$750

DATA GENERATORS & DATA ANALYZERS

General Information:

479

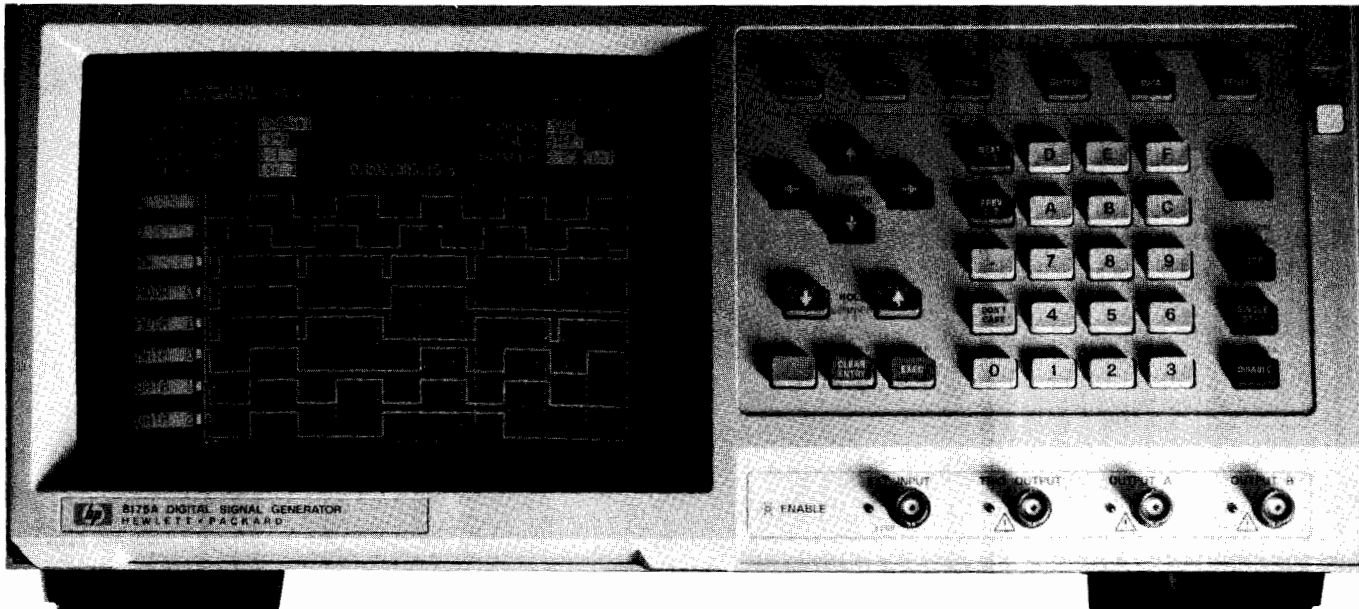

Data Generator Selection and Technical Data Chart

MODEL PARAMETER	8180A (8181A)	8016A	8175A	8080A D01, D02,D03	8018A	8170A
DATARATE (Mbit/s)	50	50	50 PARALLEL 100 SERIAL	300	50	2
NUMBER OF CHANNELS	8 PARALLEL (16 OPT.) (128 WITH EXTENSION)	8 PARALLEL	24 PARALLEL OR 2 SERIAL	1 SERIAL (2 SERIAL)	2 SERIAL	16 PARALLEL
MEMORY DEPTH (PATTERNS)	1024	32/8 CH., 64/4 CH., 128/2 CH., 256/1 CH.	1024 PARALLEL 8096 SERIAL	64 SERIAL	1024/2 CHANNEL 2048/1 CHANNEL	2048/16 CH, 4096/8 CH
VARIABLE DELAY AND WIDTH	0...999 ms (8 CH.)	0...1 us (4 CH.) DELAY 10 ns...1 us WIDTH POTENTIOMETER	20...40 ns, (4 CH.) DELAY ONLY	SPECIAL OPTION	NO	NO
RESOLUTION	100 ps		100 ps			
RZ/NRZ	RZ/NRZ	RZ/NRZ	NRZ	RZ/NRZ	RZ/NRZ	NRZ
PATTERN DURATION	NO	NO	20 ns...9.9 s	NO	NO	NO
RESOLUTION			10 ns			
OUTPUT LEVELS (HL=HIGH LEVEL, LL=LOW LEVEL)	TTL,ECL,VAR -1...+17 V (HL) -2...+16 V (LL) (HIGH IMPEDANCE)	TTL,ECL,VAR 1...2.5 V (HL TTL) -0.9...1.1 V (HL ECL) AMPLITUDE VAR. 0.3...1 V (ECL) POTENTIOMETER	TTL,ECL,TRI STATE VAR 2.4...9.9 V (HL)	D01: 0.2...2 V D02, D03: 0.6...1.2 V PEAK TO PEAK OFFS. D01: +/- 1.0 V, D02/03: +/- 1.2V POTENTIOMETER	ECL,VAR 1.25...15 V POTENTIOMETER	TTL,VAR 3...15 V (HL) -0.5...+0.4 V(LL) POTENTIOMETER
RESOLUTION	10 mV (50 OHM), 20 mV (10 KOHM)		100 mV			
50 OHM SOURCE IMPEDANCE	YES	YES	NO	YES	YES	NO

DATA GENERATORS & DATA ANALYZERS

50 MHz Digital Signal Generator

Model 8175A

- 24 channels / 1 kbit ea / 50 Mbit/s ea
2 channels / 8 kbit ea / 100 Mbit/s ea
- Virtual Memory Expansion 255 memory segments sequencing
- Programmable pattern Durations 20 ns to 9.99 s range / 10 ns res.

- Interaction with DUT
- Most logic families (TTL/CMOS/ECL)
- Manual and automated operation CRT, mass storage, hardcopy, HP-IB
- also, analog capability (see next page)

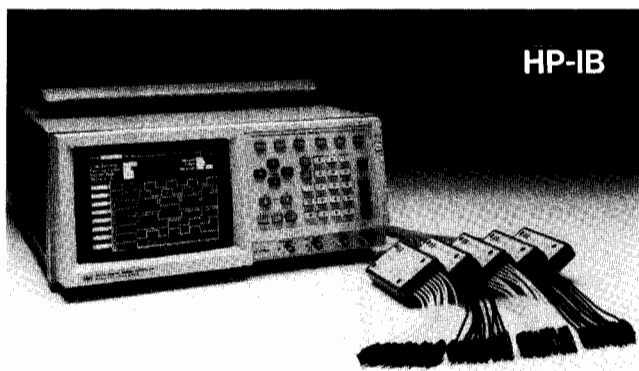

HP 8175A with output pods (15461A/15462A/15464A) and trigger pod (15463A)

HP 8175A Digital Signal Generator

The HP 8175A delivers high-speed parallel and serial data with programmable patterns, adequate for at-speed testing of most of present and future logic circuits. Individually Programmable Pattern Durations permit complex timing set-ups for simulation of extreme, asynchronous timings without wasting memory. Virtual Memory Expansion allows very long data sequences by branching to up to 255 user-definable memory segments. Interaction with a device under test provides for simulation of a wide range of data paths in digital systems. Output pods provide the appropriate levels for most logic families and flexible interface adapters ensure the specified signal quality at the probe tip, a precondition for reliable results.

A Fine Timing option (opt. 001) enhances the timing resolution provided with Programmable Pattern Durations in order to delay four channels with 100 ps.

Operational convenience is stressed through a large, menu driven CRT, a comprehensive data editor including waveform graphics and the capability to directly access (via HP-IB) a printer for documentation and a flexible disc drive for use as a test data library.

In Engineering Test, this versatile feature set provides early simulation of elements not yet available, speeding design cycles through reduced integration time at circuit, module and system level.

In Production Test and Incoming Inspection, automated at-speed testing at the module and system level results in early failure detection, thus reducing production cost and improving quality.

Combining the HP 8175A Digital Signal Generator with a HP 1630/31 family logic analyzer results in a complete Stimulus-Response measurement system. For more information on the HP 1630/31 family logic analyzers refer to the respective pages in this catalog.

Data Page (PAP) Setup

Address	Location	Name	POD 2	Used Format	Allocation	Duration
1022		000	00000000	00	0.00	us
1023		000	00000000	00	0.00	us
0000	START	000	00000011	00	0.00	us
0001		000	00000000	00	0.10	us
0002		000	00000001	00	0.10	us
0003		000	00000011	10	0.25	us
0004		000	00000011	11	0.25	us
0005		000	00000000	00	0.25	us
0006		000	00000011	01	0.10	us
0007		000	00000011	00	0.05	us
0008		000	00000000	00	0.10	us
0009		000	00000010	00	0.10	us
0010		000	00000010	12	0.25	us
0011	UP	000	00000010	11	0.25	us
0012		000	00000010	01	0.15	us
0013		000	00000010	01	0.10	us

Data Page: Pattern Set-Up

Data can be entered and displayed in various codings. Channels to be displayed can be selected. Comprehensive data editing support is provided. For instance, segments can be moved or copied to other memory addresses or data segments can be 'block modified'. Easy exchange of data between channels avoids having to rearrange probes at the test fixture. Also, fixed patterns such as up and down counters with selectable start and stop address are loaded with a few keystrokes. All codings from the pattern Set-Up page will be automatically converted into a timing diagram when switched to this page. Or, the data can be set-up from scratch or easily edited in terms of waveforms.

Program Page (PMP) Assignments

Available segments: 255 (max. 255 Segments)

Pod	Segment	Label or Time	Label or Address	Label or Address	Repetition Times
000	TEST0	from	00	to	100
001	TEST1	from	200	to	UP
002	TEST2	from	250	to	270
003	TEST3	from	300	to	300
004	TEST4	from	300	to	300
005	TEST5	from	300	to	300
006	TEST6	from	300	to	300
007	TEST7	from	300	to	300
008	TEST8	from	300	to	300
009	TEST9	from	300	to	300
010	TEST10	from	300	to	300
011	TEST11	from	300	to	300
012	TEST12	from	300	to	300
013	TEST13	from	300	to	300
014	TEST14	from	300	to	300
015	TEST15	from	300	to	300
016	TEST16	from	300	to	300
017	TEST17	from	300	to	300
018	TEST18	from	300	to	300
019	TEST19	from	300	to	300
020	TEST20	from	300	to	300
021	TEST21	from	300	to	300
022	TEST22	from	300	to	300
023	TEST23	from	300	to	300
024	TEST24	from	300	to	300
025	TEST25	from	300	to	300
026	TEST26	from	300	to	300
027	TEST27	from	300	to	300
028	TEST28	from	300	to	300
029	TEST29	from	300	to	300
030	TEST30	from	300	to	300
031	TEST31	from	300	to	300
032	TEST32	from	300	to	300
033	TEST33	from	300	to	300
034	TEST34	from	300	to	300
035	TEST35	from	300	to	300
036	TEST36	from	300	to	300
037	TEST37	from	300	to	300
038	TEST38	from	300	to	300
039	TEST39	from	300	to	300
040	TEST40	from	300	to	300
041	TEST41	from	300	to	300
042	TEST42	from	300	to	300
043	TEST43	from	300	to	300
044	TEST44	from	300	to	300
045	TEST45	from	300	to	300
046	TEST46	from	300	to	300
047	TEST47	from	300	to	300
048	TEST48	from	300	to	300
049	TEST49	from	300	to	300
050	TEST50	from	300	to	300

Program Page: Segment Assignment

This page gives an example of how pattern sequencing can be defined. Up to 255 segments of data memory can be defined by first and last addresses or labels in the 0000 to 1023 address range. During data execution the segments are real-time sequenced in the given order thus virtually expanding the memory depth far beyond the physical depth of 1024 patterns.

DATA GENERATORS & DATA ANALYZERS

50 MHz Digital Signal Generator

Model 8175A #002



- 2 analog channels / 1 kword ea / 50 MPoint/s
- up to 16 V output voltage (into 50 Ohm) separately programmable offset (max ±8 V)
- programmable data point durations 20 ns to 9.99 seconds / 10 ns resolution

- 4 waveform entry modes calculator, graphical editing, abs. and rel. levels, various codings
- digital and analog signals simultaneously
- 10 bit amplitude resolution

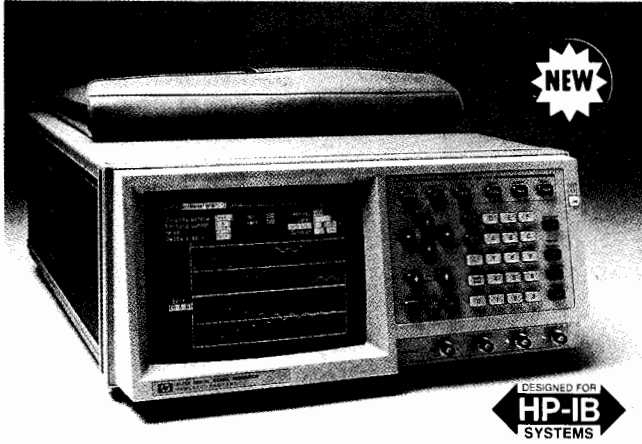

HP 8175A, Option 002; Data Page: Waveform Setup

With the Option 002, the Dual Arbitrary Waveform Generator, the HP 8175A offers the new Arbitrary Waveform mode in addition to the existing Parallel and Serial modes. In the Arbitrary Waveform mode, you have: Dual arbitrary waveform channels, and simultaneous equivalent digital signals. This means you have the ideal source for difficult applications, for example:

- simulation of two dependent variables, like force and distance, at the same time.
- digital and analog stimulation of devices like programmable filters.
- stimulus and compare signals at the same time for DACs or ADCs.

The arbitrary outputs are 50 Mpoints/s, synchronous, but independent in shape and amplitude (max 16 V p-p into 50 Ohm and max 32 V p-p into open), and the waveforms can be set up by means of: a) algorithms (a fundamental set of mathematical functions are available, including noise), b) interpolations (linear and spline), c) graphic or tabular entry of instantaneous level (or amplitude and offset), d) tabular entry of equivalent digital pattern. Additionally, any existing waveform can be modified. One way is simply by tabular or graphical editing. A more powerful alternative is the "Combine" feature. This allows you to combine an algorithm arithmetically with any desired part of the current waveform.

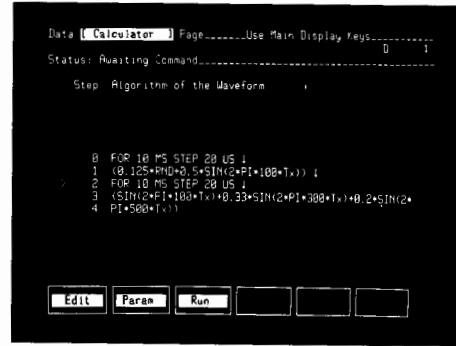

Data Page: Calculator

The built in Calculator provides a comfortable method of setting up very complex, mathematically-definable waveforms by simply entering the formula. Softkeys support most of the fundamental mathematical functions. The Combine capability allows any previously generated function to be combined with the current calculated function. By this means, noise can be introduced into any desired parts of the waveform.

Ordering Information

HP 8175A Digital Signal Generator

(excludes Pods, order Pods individually as required)

Note: HP 8175A must be ordered with at least one of the options #002, #003, #004, #005 or required pods

Options:

- Opt. 001 Fine Timing: 4 channels, 100 ps resolution add \$1100
- Opt. 002 Dual Arbitrary Waveform Generator add \$3200
- Opt. 003 Set of 4 ECL Pods Model HP 15461A and 1 Trigger Pod Model HP 15463A add \$3700
- Opt. 004 Set of 4 TTL Pods Model HP 15464A and 1 Trigger Pod Model HP 15463A add \$3100
- Opt. 005 Set of 4 TTL/CMOS Pods Model HP 15462A and 1 Trigger Pod Model HP 15463A add \$5700
- Opt. 908 Rack Flange Kit (PN 5061-9678) add \$800
- Opt. 910 Additional Operating/Programming/Service Manual add \$100
- Opt. 916 Additional Operating Programming Manual add \$50

Pods:

- HP 15461A ECL Pod (fixed ECL levels, includes 1 ea HP 15429A) \$800
- HP 15462A TTL/CMOS Pod (programmable High Level, incl. 1 ea HP 15429A) \$1300
- HP 15463A Trigger Pod (includes lead set and 10 ea probe tip) \$500
- HP 15464A TTL Pod (fixed TTL levels, includes 1 ea HP 15429A) \$800

Adaptors for HP 15461A, HP 15462A and HP 15464A:

- HP 15408A plug-on grabbers with ground leads 5 ea \$200
- HP 15409A plug-on BNC adaptors, 5 ea \$200
- HP 15410A plug-on SMB adaptors, 5 ea \$200
- HP 15411A plug-on coax open-end adaptors, 5 ea \$200
- HP 15415A plug-on miniprobe, usable with HP 10024A IC clip, 5 ea \$200
- HP 15429A solder-in receptacles (standard accessory, 5x2 ea) \$200

Adaptors for HP 15463A:

- HP PN 15463-63201 lead set \$600
- HP PN 10230-62101 probe tip, 1 ea (10 ea necessary per pod) \$100

Others:

- HP 15430A cable for synchronized master-slave operation of two ea HP 8175A \$200
- HP 10062A Protective Cover (for front panel) \$200

Fast-Ship product—see page 766

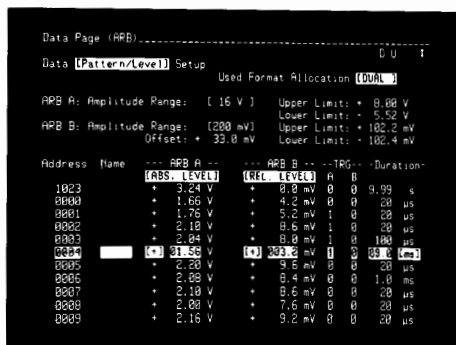

Data Page: Pattern/Level Set-Up

Data Points of a waveform can be entered and displayed in absolute or relative levels or in various codes. Comprehensive waveform editing support is provided. For instance, segments of data points can be moved or copied to other memory locations or waveform segments can easily be exchanged between the two analog channels. In this way it is easy to produce phase shifted signals. Graphical editing of the waveform, including interpolation between data points, is possible on this menu.



DATA GENERATORS & DATA ANALYZERS

50 MHz Digital Signal Generator

Model 8175A (cont.)

Specifications and Characteristics

Specifications apply for operating temperatures from 0 C to 55 C.

Parallel / Serial Data Generator

Number of channels: 24 parallel, 2 serial

Bits per channel: 1024 parallel, 8192 serial

Max. NRZ Bit rate per ch.: 50 Mbit/s parallel, 100 Mbit/s serial

Pattern Duration (with internal clock):

In *Parallel* mode the duration of each individual pattern is programmable. In *Serial* mode the duration of the data bits is programmable with successive bits always having the same duration. The duration is equal for all channels.

Range/Resolution: (10)*, 20 ns - 9.99 μ s / 10 ns
 10 μ s - 999 μ s / 1 μ s
 1 ms - 99.9 ms / 100 μ s
 0.1 s - 9.99 s / 10 ms

* 10 ns in serial mode with fixed timing

Accuracy: $\pm 0.05\%$ of progr. duration ± 2.5 ns
 (asynchronous start)
 $\pm 0.5\%$ of progr. duration ± 2.5 ns
 (synchr. start, clock calibration)
 $\pm 3.0\%$ of progr. duration ± 2.5 ns
 (synchr. start, no clock cal.)

Jitter (max.): 0.1% of progr. value + 150ps

Pattern Duration (with external clock):

Period of ext. clock x m
 m (Range) / Resolution:
 (1)2** to 999 / 1 period
 1 000 to 99 900 / 100 periods
 100 000 to 9 990 000 / 10 000 periods
 10 000 000 to 999 000 000 / 1 000 000 periods

**Min. Pattern duration in parallel mode 20ns, in serial mode 10ns.

Clock

The clock has a programmable period. It is available on line 7 of the pod for the output flags. In serial mode an additional Clock is available providing a pulse at every bit.

Period (with internal clock):

Range / Resolution: 20ns - 9.99 μ s / 10ns; 2 μ s - 999 μ s / 1 μ s

Accuracy: $\pm 0.05\%$ of progr. value $\pm 2.5\mu$ s
 (asynchronous start)
 $\pm 0.5\%$ of progr. value $\pm 2.5\mu$ s
 (synchr. start, clock cal.)
 $\pm 3\%$ of progr. value $\pm 2.5\mu$ s
 (synchr. start, no clock cal.)

Period (with external clock):

Period of external clock x m

Range: m = 2,3,4 . . . 999, 1000, 1100, 1200, . . . 99 900

Skew (maximum time difference between the leading or trailing data bit edges of the same memory address with Fine Timing off)

across ECL pods: ≤ 6 ns; typical ≤ 3 ns

across TTL/CMOS pods: ≤ 7 ns; typical ≤ 3 ns

Option 001 Fine Timing

(can be retrofitted in HP service office)

Parallel Data Generator

Channels: 0,1,2 and 3 of pod 0

Delay (Range/Resolution): 20 ns to 40 ns / 100 ps

Accuracy: $\pm 5\%$ of progr. value ± 1 ns

Serial Data Generator

Channels: 0 and 2 of pod 0

Delay (Range/Resolution): 0 ns to 20 ns / 100 ps

Accuracy: $\pm 5\%$ of progr. value ± 2 ns

Option 002 Dual Arbitrary Waveform Generator (can be retrofitted in HP service office)

Number of Analog Outputs: 2

Number of Bits: 10

Number of Data Points:

Horizontal: 1024 points

Vertical: 1000 points with additional 24 points override
 800 points for 16 V p-p Output Voltage Range
 640 points for 32 V p-p Output Voltage Range

Differential Non-Linearity: ≤ 1 LSB (monotonic)

Output Impedance: 50 Ohm $\pm 5\%$

Output Levels

Load Impedance: 50 Ohm:

7 Output Voltage Ranges: 0.2 V to 16 V, Res. 0.2 mV to 20 mV

2 Offset Ranges: ± 0.8 V and ± 8 V (Output Volt. Range > 1 V)

Load Impedance: ≥ 50 kOhm

7 Output Voltage Ranges: 0.5 V to 32 V, Res. 0.5 mV to 50 mV

2 Offset Ranges: ± 1.6 V and ± 16 V (Output Volt. R. > 2 V)

Accuracy (Output A and Output B)

Amplitude Accuracy: $\pm 4\% \pm 4$ LSB

Offset Accuracy: $\pm 1\%$ of programmed value

$\pm 2\%$ of (progr. High Level of p-p Output Volt. +
 progr. Low Level of p-p Output Volt.) (if High and
 Low Level are identical in magnitude, but opposite in sign, this error
 will be zero).

plus:

into 50 Ohm: ± 10 mV for 0.2 V, 0.5 V and 1 V ranges

or: ± 25 mV for 2 V and 5 V range

or: ± 50 mV for 10 V and 16 V range

into ≥ 50 kOhm: ± 20 mV for 0.5 V, 1 V and 2 V ranges

or: ± 50 mV for 5 V and 10 V range

or: ± 100 mV for 20 V and 32 V range

Timing (for Output A and B)

The maximum sample update rate is 50 MHz.

The Data Point Duration is 20 ns to 9.99 s.

Trigger Output Characteristics:

Number of Trigger Output Channels: 2

Trigger Output Impedance: 50 Ohm $\pm 5\%$

Trigger Output Levels: ECL into 50 Ohm

TTL into 50 Ohm and ≥ 50 kOhm

Trigger Pulse Width: The trigger can be set for each individual data point to High Level or Low Level. The trigger width depends on the programmed Data Point Duration.

External Input (BNC)

This connector can be used to start / stop datacycling with selectable transitions.

Impedance: 10 k Ω / 50 pF

Threshold (Range/Resolution): -9.9V to +9.9 V / 100 mV

Accuracy: $\pm 5\%$ of progr. value ± 250 mV

Min. swing: 600 mV pp

Min. overdrive: 250 mV or 30% of input amplitude

Max. input voltage: ± 20 V

External Clock (BNC)

Clock rate (Range): 8Hz to 100 MHz

All other specifications see External Input (BNC).

External Reference (BNC)

Input characteristics: LS TTL compatible

DATA GENERATORS & DATA ANALYZERS

Data Generator/Analyzer System

Models 8180A/B, 8181A/B, 8182A/B

483



- Digital ac parametric and functional evaluation
- 50MHz, 1kbit - 16kbit vector memory depth
- 100ps timing/ 10mV level resolution

- Variable sampling point in synchronous mode
- Real-time data comparison
- Transparent softkey operating/measurement concept

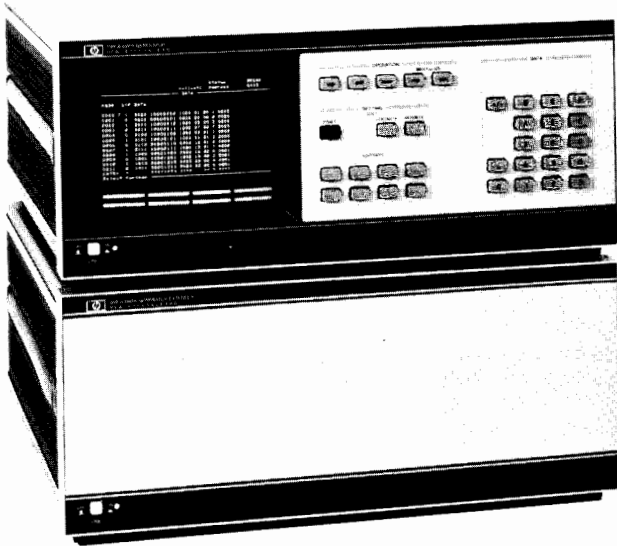

Upper: HP 8180A/B Data Generator
Lower: HP 8181A/B Data Generator Extender

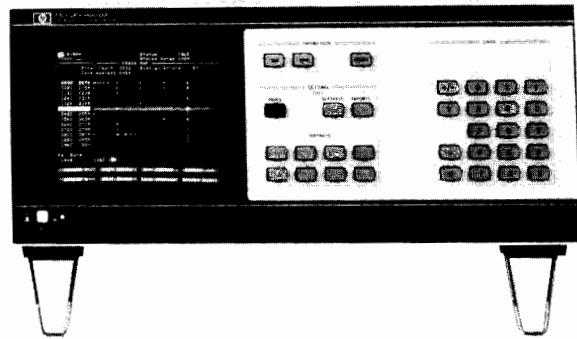

HP 8182A/B Data Analyzer

The Tool for At-Speed Evaluation of Digital IC's, Boards & Modules

The HP 8180A and 98180B are modular, high speed Data Generators for the stimulation of digital IC's and boards. For the analysis of a digital circuit's response the HP 8182A and the HP 8182B provide capabilities for data capture and comparison and for level and timing characteristics measurements. The Data Generators and Data Analyzers are matched in performance with regard to vector rates, vector memory depth and measurement accuracy and functionality. They can be used as stand-alone instruments, in Stimulus-Response Setups or as modules in complete IC Test Systems.

Modular Configurations - From Stand-Alone to Complete Systems

Stand-alone operation is supported by an autonomous operating and measurement concept. Stacking instruments expands the channel counts, thus enabling you to adapt the system size exactly to the individual test and budget requirements. The universal HP-IB interface makes the system open to the integration of other measurement equipment e.g. for DC measurement units etc. In addition, for IC Test applications, HP is offering complete Test Systems including mainframe (rack, power provisions etc.) Testhead and System Software. This provides the turn - key solution required in applications like IC Design Verification and Prototype Evaluation, Failure Analysis, Low- Volume Production and Incoming Inspection.

Applications that Reflect in Features

For at-speed functional verification of prototype circuits the Generators and Analyzers offer programmable digital patterns at clock rates up to 50 MHz. The linear vector memory depth of

1kbit/channel ("A" versions) and 16kbit/channel ("B" versions) allow you to generate and capture the immense number of testvectors required for testing most complex devices. Real-time comparison between "expected" data and captured data generates an "Error Map" which gives immediate feedback and increases throughput.

For thorough characterization of a circuits performance limits, timing edges can be positioned with a best resolution of 100 ps and level pairs can be programmed with a 10 mV resolution. On the Analyzer side, the sampling point can be swept in 100ps steps for measurements of set-up/hold time and propagation delays. "Window Comparison" simultaneously checks proper upper and lower logic level and timing conditions. This makes the equipment the ideal tool for Critical Path Analysis of prototype circuits and for in-depth analysis of circuits failing a test.

Operation - Interactive or under Software Control

On the bench the Data Generators and Analyzers are fully operational without an external controller due to a softkey - driven, interactive operating concept. This gives a quick access to each parameter while a large CRT provides a transparent overview of the current instrument settings.

For remote operation, all set-ups can be programmed with an external controller via the standard HP-IB interface. This enables interactive operation as well as full automation under program control. For IC Test System applications a software package provides a shell which enables the user to concentrate on the device under test rather than the test machine itself.

For a detailed description of IC Test System configurations, Testhead and software refer to the model HP 81810S in this catalog (page 239). HP-IB is Hewlett-Packards implementation of IEEE-488



DATA GENERATORS & DATA ANALYZERS

Data Generator/Analyzer System

Models 8180A/B, 8181A/B, 8182A/B (cont.)

Specifications

Specifications apply for operating temperatures from 0°C to 50°C.

HP 8180A/B, 8181A/B Data Generator/Extender

Memory and Channels

Memory depth: 1024 bit/channel ("A" version);
16384 bit/channel ("B" version)

Number of channels: up to 64 using HP 8180A/B with two HP 8181A/B Extenders. Up to 128 channels with 2 sets of equipment in parallel operation.

HP 8180A/B Channels

RZ (return-to-zero) channels: independent variable delay and width in each of up to 8 channels.

NRZ (non-return-zero) channels: Up to 16 channels minus the number of RZ channels. Fixed timing.

Strobe channel: NRZ data or clock. Fixed timing

Clock channels: independent delay and width in each of 2 channels. Clock 1 can be selected to run continuously in Break state (see 'Cycle modes').

HP 8181A Channels

NRZ: up to 24 channels. Fixed timing within an Extender, group delay with respect to HP 8180A/B.

Memory Loading

Codes: bin, oct, hex, dec (address codes: oct, hex, dec).

Entry: Keyboard or HP-IB.

Displayed channel order: user-defined.

Line edit: insert, delete, macro.

Channel edit: clear, set, copy, prbs, counts, entry mask.

Cycle Modes

Single, Auto, Initialization + Auto, Gated, Initialization + Gated. (Initialization data is output at the beginning of the first cycle only).

Break state: implemented by manual or external BREAK command or by strobe channel bit. Data is held at current address. Manual or external RUN command cause same cycle to continue.

Stop state: implemented by manual or external STOP command. Data is held at current address and the cycle is terminated. Manual or external RUN command trigger a new cycle.

Timing

Clock period: 20 ns to 950 ms (1.05 Hz to 50 MHz). Ext clock 0 to 50 MHz.

Delay

(relative to strobe channel): 0.0 ns to 950 ms, max 90% period - 18ns.

Width: 10.0 ns to 950 ms, max 90% period - 8ns.

Skew: ≤ 2 ns for NRZ channels and RZ channels programmed for zero delay.

Resolution: 3 digits (best case 100 ps).

Accuracy: $\pm 5\%$ of programmed value ± 1 ns.

Jitter: $\leq 0.2\% + 100$ ps (+ additional 50 ps for delay and width).

Outputs

Output impedance: 50 Ohm

Data and clock: 4 different high level / low level pairs can be defined and assigned to any number of individual outputs. Each channel has independent normal / complement switching. Common 'off'.

Read-out: can be selected for 50 Ohm or high impedance load (common selection for all channels).

	50 Ohm load	High-impedance load
High level:	-1.50 to +5.50 V	-1.00 to +17.0 V
Low level:	-2.00 to +5.00 V	-2.00 to +16.0 V
Resolution:	3 digits (10 mV)	3 digits (best case 20 mV)
Amplitude:	0.5 to 5.5 V	1.0 to 17 V

Transitions:

10% to 90% (3 + | 0.2 ampl) ns (3 + | 0.5 ampl) ns

20% to 80% at ECL levels: 1.5 ns

Strobe: ECL/TTL selectable

HP 8182A/B Data Analyzer

Memory and Channels

Memory depth: 1024 bit/channel ("A" version);
16384 bit/channel ("B" version)

Number of channels: up to 32. Can be doubled by parallel operation of two HP 8182A's.

Expected data memory: 1024 to 16384 bit/channel, segmentable.

Codes: bin, oct, hex (address code: dec).

Entry: Keyboard, HP-IB or read-in from DUT.

Displayed channel order: user-defined.

Line edit: word mask (don't care), insert, delete.

Channel edit: clear, set, copy, mask (don't care), exchange.

Modes

Analysis / store-and-compare: synchronous sampling with variable analog sampling point delay or asynchronous sampling. Comparison with expected data, if required.

Displays: state list, timing diagram, or error map.

Glitch detection: down to 5 ns. Memory depth is halved when glitch detection is selected.

Trigger condition: can be selected to start or stop analysis.

Real-time compare: comparison of actual with expected data throughout a time window. Window has variable analog delay and width. Real-time and latched error output signals are provided.

Display: error map.

Trigger conditions: starts comparison.

Timing

External clock: 0 to 50 MHz.

Delay

(relative to external clock): 0.0 ns to 1 s, max 95% period - 1 ns

Compare window width: 10.0 ns to 1 s, max 95% period - 9 ns

Channel skew: ≤ 2 ns

Resolution: 3 digits (best case 100 ps).

Accuracy: $\pm 5\%$ of programmed value ± 1 ns.

Internal clock: 1 Hz to 50 MHz (1-2-5) steps).

Inputs

Data: 6 different thresholds or dual threshold pairs can be defined and assigned to any number of individual inputs.

Clock: programmable threshold and selectable slope (positive, negative, both).

Input impedance: 1 MOhm, < 7 pF.

Control signals: (100 kOhm / 50 Ohm selectabel input impedance)

Trigger arm and ext stop signals: independent programmable thresholds and selectable slope (positive, negative, don't care).

Trigger qualifier and clock qualifier signals: independent programmable threshold and selectable levels (high, low, don't care).

Threshold range: -10.0 to +10.0 V.

Dynamic range: threshold ± 10 V.

Resolution: 3 digits (best case 10 mV).

Trigger

Trigger arm, word and qualifier, digital filter (1 to 16), clock and qualifier, delay (0 to 65535.)

Ordering and Literature

For Ordering Information (also on accessories) and detailed Technical Data Sheets and Application Notes on the products covered in this chapter, please contact your HP sales office.

DATA GENERATORS & DATA ANALYZERS

9-Bit Parallel, 32-Bit Serial, 50 MHz Word Generator

Model 8016A

485



- 2 complementary outputs per channel, RZ/NRZ formats
- Variable RZ width, 4 delay channels
- Channel serializer
- TTL/ECL output levels selectable

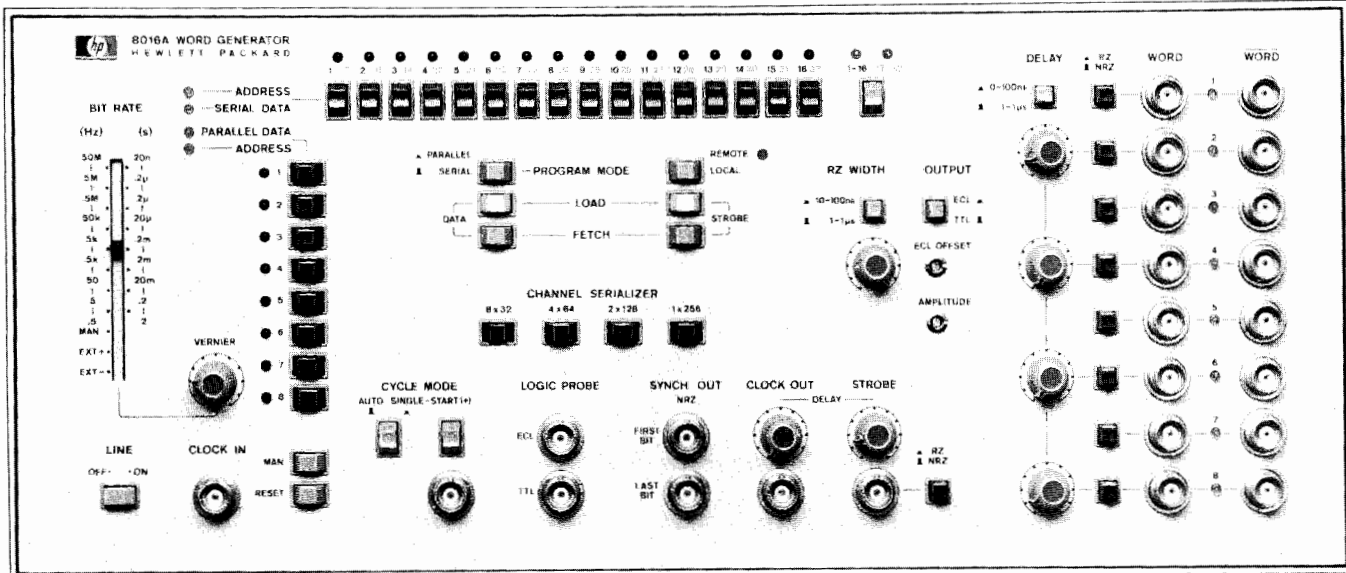

HP 8016A

with Option 001

The HP 8016A is a 9-channel data generator capable of serialization up to 256 bits. For the digital designer the HP 8016A is a natural companion to multichannel data display devices such as logic analyzers. As a bench or systems component, the HP 8016A provides programmable digital patterns plus adjustable timing parameters necessary for testing ICs and circuit boards.

Functional Test

Bit pattern programmability combined with fast cycle time (50 MHz clock) make the HP 8016A especially effective in simulating worst case conditions, e.g. high speed IC testing. The HP 8016A saves time in component evaluation environments because test setups can be rapidly built and reconfigured to meet the demands of testing small quantities of a wide variety of IC types.

Parametric Test

Complete testing of digital circuits and systems requires not only digital patterns for functional test but control of the analog parameters of the pulses as well. Adjustable pulse widths, levels, and interchannel delays contribute to measurements such as setup and hold times, clock pulse width sensitivities, and system sensitivity to propagation delay variations. To meet these testing requirements, the HP 8016A includes 6 independent delay circuits. Output levels of the HP 8016A's 50 Ω output amplifiers are selectable for ECL or TTL test specifications and can be adjusted. In addition, a choice of RZ or NRZ formats with variable RZ pulse width is provided.

Specifications

Data capacity: 8 data channels plus 1 strobe channel, each 32 bits. 8 data channels can be serialized as four 64-bit channels, two 128-bit channels or a single 256-bit channel.

Data loading: address channel, enter 32 serial bits in that channel. Alternatively, address parallel word, enter (max 8) bits in that word. Addressing/entry by pushbuttons/LEDs or via HP-IB (option 001).

Data Outputs: (50 Ω source into 50 Ω load).

Format: independent RZ/NRZ selection in each channel.

RZ width: single continuous adjustment in ranges 10-100 ns, 0.1-1 μ s.

Width jitter: $\leq 0.2\% + 50$ ps

Complement: simultaneous normal and complement outputs for each channel.

Delay: channels 2, 4, 6, 8 can be delayed independently within the ranges 0-100 ns, 0.1-1 μ s with respect to odd channels.

Jitter: $\leq 0.1\% + 5$ ps

Skew (undelayed): ± 1 ns

Levels: ECL/TTL selectable

Transition times: ≤ 3.0 ns (ECL ≤ 2.5 ns)

Bit Rate

Internal: 0.5 Hz to 50 MHz.

External: dc to 50 MHz, or manual.

Data Cycling

Auto: Sequence recycles continuously.

Single cycle: Sequence is triggered/gated by external pulse/level.

General

Operating temperature: 0°C to +50°C.

Power: 100/120/220/240 Vrms; +5%, -10%; 48 Hz to 66 Hz, 200 VA (maximum)

Weight: net, 14.5 kg (32 lb). Shipping 16 kg (35.3 lb).

Size: 177 H x 426 W x 422 mm D (7" x 16.8" x 16.6").

Ordering Information

HP 8016A Word Generator

Opt 001: HP-IB for data loading*

Opt 907: Front Handle Kit (Part No. HP 5061-0090)

Opt 908: Rack Flange (Part No. HP 5061-0078)

Opt 909: Opt 907, 908 combined (Part No. HP 5061-0084)

Opt 910: Additional Operating and Service Manual

Price

\$8 700

add \$800

add \$65

add \$35

add \$90

add \$48

*HP-IB cables: Refer to page 133.

☎ Fast-Ship product --- see page 766



DATA GENERATORS & DATA ANALYZERS

Logic Pattern Generator

Model 8170A

- 4k/2k memory depth
- 8 bit/16 bit parallel output
- 2 wire/3 wire handshake capability
- Internal and external addressing

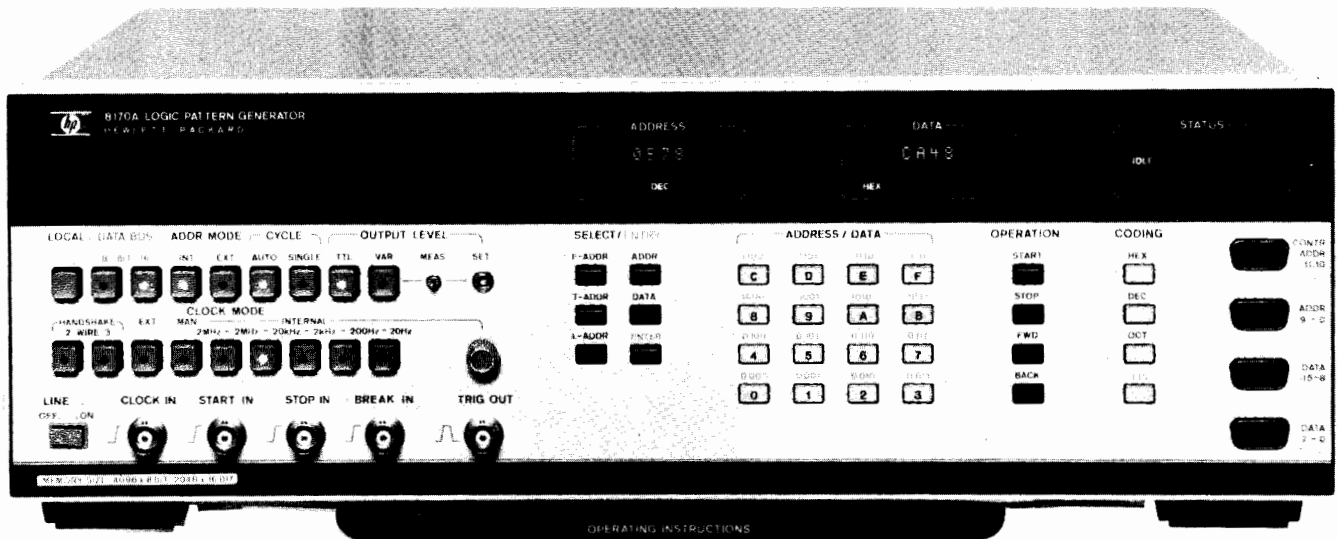

HP 8170A



Parts, memories and peripherals can be verified at all stages in design and production because the HP 8170A allows testing in isolation from the system. Busses or devices can be stimulated synchronously or asynchronously with data from the HP 8170A's memory. Address outputs (Option 002) allow writing into a RAM for subsequent comparison on e.g. a logic analyzer. In external address mode, software can be setup, verified and modified in the HP 8170A before committing ROM's.

The HP 8170A memory can be programmed manually, via HP-IB or by selecting one of the fixed patterns. User codes can be used directly because conversion is handled automatically.

Specifications

Memory: 4k/2k, 8- or 16- bit width, selectable. Freely programmable or selectable patterns (Set/reset/prbs/count up/down).

Address Modes

Internal: ascending sequence between user-defined addresses.

External: 10-line address plus 4 enable lines. Max rate 2 Mbit/s.

Clocking

Internal: 20 Hz to 2 MHz in 5 ranges.

External: dc to 2 MHz.

Manual: forward/backward data stepping.

Handshake: 2-wire/3-wire (IEEE 488) selectable.

Cycle Modes (applies to Int Address mode)

Auto cycle: data cycled continuously.

Single cycle: data is cycled once per Start In command.

Outputs

Data: 8 or 16 lines, selectable. Pos/neg true selectable.

Control: data Valid. Pos/neg true selectable.

Status: 2 lines indicate whether data is clocked, static or off.

Levels: TTL or adjustable +3 V to +15 V.

Address (via Opt 002 pod): 10 lines, +2.4 V true, +0.5 V false.

Inputs

Address: 10 lines (12 lines in Opt 001).

Control: ready for Data and data accepted lines.

Enable: 4 lines.

Levels: high +2.0 V, low +8.0 V.

Remote control: HP-IB, RS-232C (CCITT V.24).

HP-IB

Interface functions: SH1, AH1, L4, SR1, RL1, T5, PP0, DC0, DT0, C0.

General

Power: 100/120/220/240 V rms; +5%, -10%; 48-66 Hz, 110 VA max.

Operating temperature: 0°C to 55°C.

Weight: net 11 kg (24.3 lbs). Shipping 15 kg (33.2 lbs).

Dimensions: 133 H x 426 W x 422 mm D (5.2" x 16.8" x 16.6").

Ordering Information

	Price
HP 8170A Logic Pattern Generator**	\$6,700
Opt 002: Address Driver Pod (HP 15452A)	add \$470
Opt 907: Front Handle Kit (HP part number 5061-0089)	add \$55 ☎
Opt 908: Rack Mount Kit (HP part number 5061-0077)	add \$32.50 ☎
Opt 909: Opt 907, 908 combined (HP p/n 5061-0083)	add \$80 ☎
Opt 910: Extra Operating and Service Manual	add \$70
HP 15457A Pod Connector (Pods can be easily plugged into DUT when this accessory is wired in)	add \$65
HP 15459A 1.5 m pod extension cable	add \$190

Supplied Accessories

HP 15453A Address input pod	\$320
HP 15454A Control Pod	\$320
HP 15455A Data Pod (D0-D7)	\$320
HP 15456A Data Pod (D8-D15)	\$320
HP 15458A Snap-on Assembly (one per pod)	\$150
HP 10230-62101 Hook-on Clip	\$3

*For more on these codes refer to the HP-IB section of this catalog.

**HP-IB cables not furnished, see page 133.

☎ Fast-Ship product — see page 766

DATA GENERATORS & DATA ANALYZERS

50 MHz Serial Data/PRBS Generator

Model 8018A

487



- 2048 bit, dual channel memory
- Variable word and pattern length

- TTL, ECL, CMOS compatible
- Programmable, prbs and mixed data

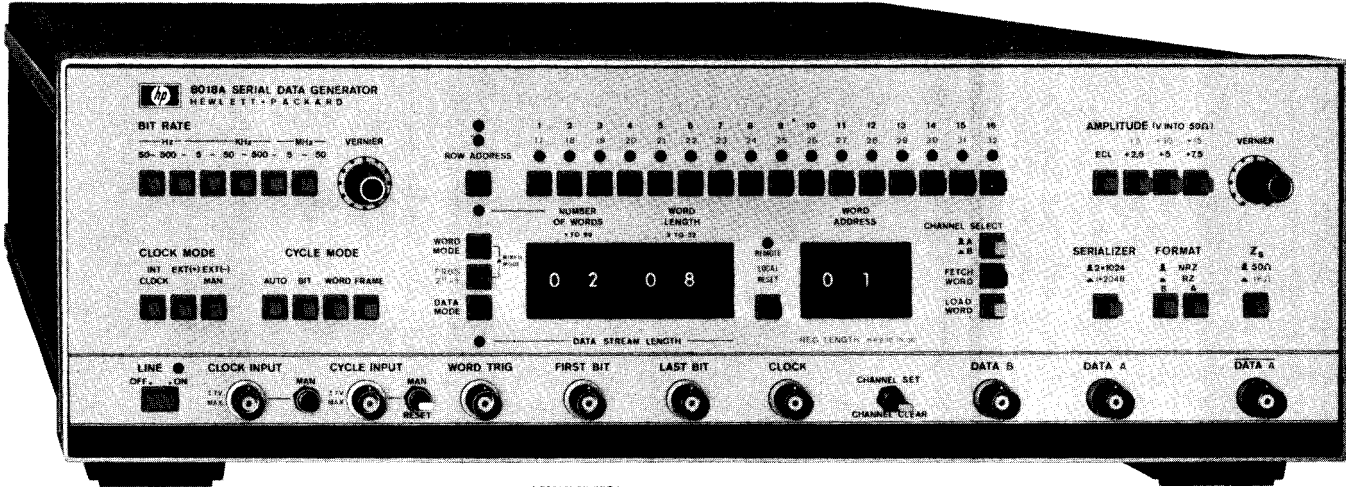

HP 8018A



with Option 001

With 2048 programmable bits, and a choice of pseudo-random binary sequences (prbs) ranging to over 1 Mbits, the HP 8018A is a powerful stimulator for serial digital systems and devices requiring high bit rate and fast pulses. Even preamble-data-post-amble data link patterns are feasible by combining prbs and programmed data. Useful synch outputs simplify testing by locking scope or analyzer to unique points in the data stream.

For data link patterns, mixed mode inserts a prbs after each odd word.

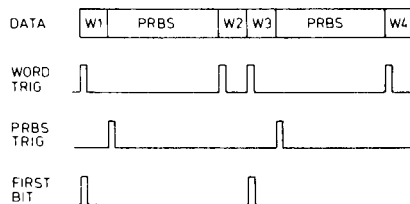

For dual-channel applications, the memory splits so that the outputs have independent 1 Kbits of data.

A high performance output amplifier adds to the HP 8018A's wide applicability. It delivers clean, 6 ns pulses with repetition rates from dc to 50 Mbits/s. Output amplitude is variable up to 15 volts into 50 Ω . This enables you to directly drive logic circuits ranging from TTL to CMOS. Output levels for emitter-coupled-logic (ECL) are also provided.

To handle patterns for repetitive tests more conveniently, data can be loaded via HP-IB (Option 001).

Specifications

Data Capacity and Modes

Programmable memory: 2 channels, each 1 kbit, serializable. Thumbwheel switches define data stream length or frame length (N words of Mbits), and set up synch signals accordingly.

Prbs: pseudo-random binary sequences of 511, 1023, 32767 and 1048575 bits. Synch pulse at beginning of sequence.

Mixed: prbs is inserted after every odd-numbered programmable word.

Data Outputs

Channel A: simultaneous normal and complement outputs. ECL levels or variable +15 V amplitude. Selectable 50 Ω /1 k Ω output impedance, RZ/NRZ format.

Data length: up to 1024 bit or (serialized with B data) 1025 to 2048 bit.

Transitions (50 Ω into 50 Ω): ≤ 6 ns (ECL ≤ 5 ns)

Preshoot, overshoot, ringing: $\leq 10\%$ (ECL $\leq 15\%$)

Channel B: normal output, 2.4 V (50 Ω into 50 Ω), up to 1024 bits, RZ/NRZ selectable.

Bit Rate

Internal: 50 Hz to 50 MHz (40 MHz in Mixed mode), jitter 0.2%

External: dc to 50 MHz (40 MHz in Mixed mode) or manual.

Data Cycling

Auto: sequence recycles continuously.

Bit: bits are triggered/gated by external pulses/level.

Word: words are triggered/gated by external pulses/level.

Frame: sequence is triggered/gated by external pulses/level.

Manual: switch triggers single bits/words/frame.

General

Power: 100/120/220/240 V rms; +5%, -10%; 48 to 440 Hz. 230 V A max.

Temperature range: 0°C to 50°C.

Weight: net 12 kg (26.5 lbs). Shipping 16 kg (35.3 lbs).

Size: 133 H x 426 W x 422 mm D (5.2" x 16.8" x 16.6").

Ordering Information

HP 8018A Serial Data Generator \$4700

Opt 001: HP-IB for data loading* add \$700

Opt 907: Front Handle Kit (Part No. HP 5061-0089) add \$55

Opt 908: Rack Flange Kit (Part No. HP 5061-0077) add \$32.50

Opt 909: Opt. 907, 908 combined add \$80

(Part No. HP 5061-0083)

Opt 910: Extra Operating and Service Manual add \$38

* HP-IB cables: refer to page 133.

☎ Fast-Ship product—see page 766



AMPLIFIERS

Microwave Amplifier

Model 11975A

- 2 GHz to 8 GHz wideband frequency coverage
- 40 milliwatts (+16 dBm) output power
- Adjustable, leveled power level

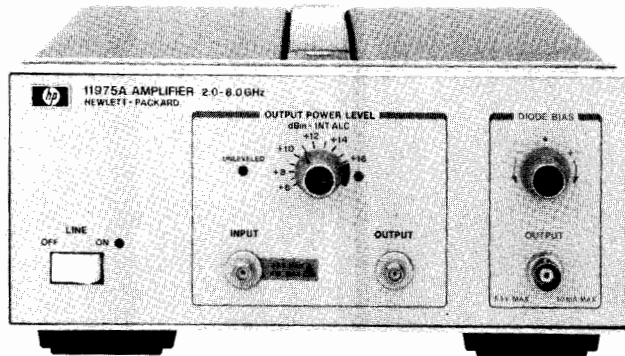

HP 11975A

Convenient Microwave Amplifier

The HP 11975A is a general purpose microwave amplifier that offers versatility, convenience, and reliability at an economical price. Combining state-of-the-art GaAs FET technology with a regulated power supply and control circuits makes this amplifier a complete tool for lab and production.

Broadband, Leveled Power

The amplifier delivers up to 40 milliwatts (+16 dBm) of leveled power for broadband input signals from 2 to 8 GHz. With ± 1 dB frequency response and ± 2 dB absolute power accuracy, the HP 11975A provides calibrated power for fixed or swept frequency needs.

Versatile Features

The HP 11975A has many features designed for general-purpose use:

- Automatic level control (ALC):** output power is normally leveled unless the ALC switch (rear panel) is OFF or less than the minimum input power required for leveling is available. An "unleveled" light indicates the non-ALC condition.
- Adjustable output power:** calibrated output power can be adjusted from +6 to +16 dBm. An "uncalibrated" light indicates when greater than +16 dBm is present at the output connector.
- Diode bias:** positive or negative bias current needed for some harmonic mixers is provided by a separate connector and control knob.

Applications

- The HP 11975A supports many general-purpose testing needs:
- As an LO booster and isolation amplifier, the HP 11975A improves mixer performance and testing.
- As a pre-amplifier, the HP 11975A increases counter sensitivity and improves spectrum analyzer noise figure.
- As an LO line driver for a harmonic mixer (such as an HP 11517A or HP 11970), the HP 11975A increases sensitivity, improves frequency response, and reduces gain compression.

Specifications

Frequency Specifications

Frequency range: 2.0 to 8.0 GHz in one band.

Output Specifications

Distortion

Harmonics (2nd and 3rd): < -20 dBc for $P_{out} \leq +16$ dBm.

Non-harmonics: < -60 dBc typical for $P_{out} \leq +16$ dBm.

Third order intercept (ALC OFF): +25 dBm typical.

1 dB gain compression (ALC OFF): +18 dBm typical.

Noise figure: 13 dB typical.

Output Power (ALC ON)

Power level control: single-turn knob with 11 calibrated divisions in 1 dB steps; spring-loaded detent for uncalibrated power above +16 dBm.

- Automatic level control (ALC)
- Diode bias supply for harmonic mixers

Power range: +6 dBm to +16 dBm.

Absolute power accuracy: ± 2.0 dB; ± 1.5 dB typical.

Frequency response: ± 1.0 dB; ± 0.5 dB typical.

Uncalibrated power range: +16.75 dBm to +19 dBm typical; uncalibrated light warns of high level.

Reverse isolation: > 40 dB typical at +16 dBm output.

Output Connection

Connector: SMA female.

Impedance: 50 ohm nominal.

SWR: 1.7:1, ALC ON; 2.5:1 typical, ALC OFF.

Short circuit protection: continuous.

Input Specifications

Minimum input power: minimum power for leveling.

Small signal gain: gain with less than minimum input for leveling or with ALC switch OFF (rear panel).

Frequency	Minimum Input	Gain
2.0 GHz to 4.5 GHz	+2 dBm	15 dB
4.5 GHz to 6.1 GHz	+5 dBm	11 dB
6.1 GHz to 8.0 GHz	+8 dBm	9 dB

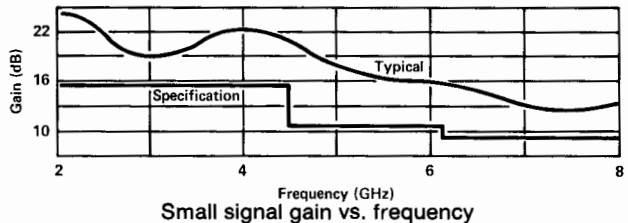

Input Connection

Connector: SMA female.

Impedance: 50 ohm nominal.

SWR (ALC OFF): 2.7:1 typical.

Maximum input: = +30 dBm (1 watt); ± 35 Vdc.

Diode Bias Specifications

Bias control: five-turn knob for positive and negative current adjustment with 10 μ A resolution.

Current range: 0 to ± 10 mA typical for single-diode load.

Output Connection

Connector: BNC female.

Maximum voltage: ± 3 Vdc typical.

Short circuit protection: ≤ 11 mA @ 25° C.

General Specifications

Power requirements: 100, 120, 220, or 240 Vac (user selectable), +5%, -10%; 48 to 440 Hz; less than 36 VA; convection cooled.

Environmental: per MIL-T-28800C, Type III, Class 5, Style E.

Temperature: operating 0° to +55°C; storage -40° to +75°C.

EMI: conducted and radiated interferences are in compliance with methods CEO3 and REO2 of MIL STD 461A and CISPR Pub. 11 (1975).

Weight: net, 3.04 kg (6.8 lb). Shipping, 5.45 kg (12.2 lb).

Size: 102 H \times 213 W \times 297 mm D (4.0" \times 8.4" \times 11.7").

Ordering Information

HP 11975A Amplifier

Opt 001: Type N Female Connectors

Opt 907: Front Handles

Opt 910: Extra Operating and Service Manual

Rack Mounting Kit: (HP P/N 5061-0072)

☎ Fast-Ship product—see page 166

Price

\$4,100

add \$100

add \$50

add \$5

add \$33 ☎



- Continuous 2 to 20 GHz coverage
- 15 dB gain to 18.6 GHz



HP 8349B

The HP 8349B Microwave Amplifier delivers increased microwave power performance across a 2 to 20 GHz frequency range. This general-purpose broadband power amplifier is designed for maximum reliability and configured for the greatest convenience in interfacing with Hewlett-Packard's microwave sources, namely the HP 8350 or HP 8620C sweep oscillators, the HP 8340B/8341B synthesized sweepers, and the HP 8672A or 8673 synthesized signal generators.

Providing 100 mW (+20 dBm) of unleveled output power from 2 to 18.6 GHz, 50 mW (+17 dBm) from 18.6 to 20.0, the HP 8349B offers one of the broadest operating bandwidths available from a solid-state power amplifier. This general-purpose, broadband power performance is achieved using a GaAs FET design of multiple stages. This multiple stage design provides more than 15 dB of gain from 2 to 18.6 GHz, and more than 12 dB of gain from 18.6 to 20.0 GHz.

The HP 8349B can also provide externally leveled output power without using an external coupler and detector, since these components are built-in and are compatible with Hewlett-Packard microwave sources. The HP 8349B is also equipped with an output power display. This display minimizes the need for an external power meter and enhances the amplifier's utility; for example the HP 8349B can be placed at the end of a long RF cable where the microwave output needs to be amplified, leveled and monitored.

Naturally, the versatile power control features of the microwave source (e.g., calibrated power, power sweep, power slope and remote power control via the Hewlett-Packard Interface Bus) can be accurately transmitted through the HP 8349B during external leveling operations.

The HP 8349B also has a built-in source module interface, enabling it to provide the HP 83550 series millimeter-wave source modules with the DC bias and control signals they need for proper operation. Using the HP 8349B and a millimeter source module extends the capabilities of any HP microwave source operating in the 11 to 20.0 GHz range to millimeter-wave frequencies.

Applications

The broadband power of the HP 8349B is ideal in a number of applications that require high power, whether in a versatile bench-top arrangement or in a dedicated rack-mount system. In antenna testing, the HP 8349B can be placed at the end of long RF cables, delivering high power right to the device under test. In EW/ECM systems, the HP 8349B can be combined with the HP 8340B/41B, or the HP 8673A synthesized signal generator to provide high power pulses with little degradation in pulse performance. The HP 8349B is also an excellent choice as a microwave driver for TWTs, high power amplifiers, or mixers. And with a typical noise figure of <13 dB, the HP 8349B is often used as a pre-amplifier for spectrum analyzers and frequency counters.

- 100 milliwatts across 2 to 18.6 GHz
- < 13 dB typical noise figure

The dynamic range of a scalar network analyzer measurement system is limited by the maximum output power of the microwave source and the sensitivity of the detectors. Using the illustrated configuration, the effective dynamic range of a scalar analyzer system is typically extended by >20 dB by combining the calibrated dynamic range of the reference detector (R) with that of the transmission detector (B) in a ratio measurement (B/R). The HP 8349B makes this possible by extending the external crystal leveling power control of the microwave source. Hewlett-Packard Application Note 327-1 discusses this application in detail, and shows how typically >80 dB of dynamic range can be achieved from 2 to 20 GHz using the HP 8349B amplifier, the HP 8350B/83592C sweep oscillator and the HP 8756A or HP 8757A scalar network analyzer.

RFI susceptibility tests can also greatly benefit from the high quality amplifying characteristics of the HP 8349B.

Frequency Specifications

Range: 2.0-20 GHz

Output and Input Specifications (25°C ±5°C)

Minimum Output Power (25°C ±5°C): +5dBm input

Frequency Range (GHz)	Output	
	Leveled	Unleveled
2.0 to 18.6	19 dBm (80mW)	20 dBm (100mW)
18.6 to 20.0	16 dBm (40mW)	17 dBm (50mW)

Power Flatness (Leveled): ±1.25 dB

1 dB Compression Point: +21 dBm, nominal

Minimum Small Signal Gain (at -5 dBm input): 15 dB, 2 to 18.6 GHz
12dB, 18.6 to 20 GHz

Noise Figure: <13 dB, typical

Impedance (Input and Output): 50 ohms, nominal
SWR

Frequency Range (GHz)	Input	Output	
		Leveled	Unleveled (typical)
2.0 to 5.0	≤2.8	≤2.5	≤4.8
5.0 to 11.0	≤2.8	≤2.5	≤3.8
11.0 to 18.0	≤2.8	≤2.5	≤3.2
18.0 to 20.0*	≤2.8	≤2.5	≤3.2

*SWR from 18.0 to 20.0 GHz is typical

Maximum Continuous Input, to the input or output ports:
+27 dBm (RF), ±10V (DC)

Spectral Purity

Harmonics: (at + 20 dBm output) <-20 dBc, 2.0 to <11.0 GHz.
<-30 dBc, 11.0 to 20.0 GHz typical.

Non-Harmonic Spurious: ≤-55 dBc.

Third Order Intercept: + 33 dBm, nominal.

Pulse Transmission Capability

Rise/Fall Time: Typically <10 ns.

Delay Time (input to output): Typically <8 ns.

General

Reverse Isolation: >50 dB, typical

RF Input/Output Connectors: Type N Female

Size: 133 H x 214 W x 366 mm D (5.2" x 8.36" x 13.6").

Weight: Net, 7 kg (15 lb); shipping, 14 kg (31 lb).

Ordering Information

HP 8349B 2 to 20 GHz Microwave Amplifier

Opt 001 Rear Panel RF Input/Output

Opt 002 Rear Panel RF Input with Front Panel RF Output

Opt 910 Extra Service Manual

Price

\$7,000

+\$1,500

+\$1,500

+\$1,500

+\$1,500

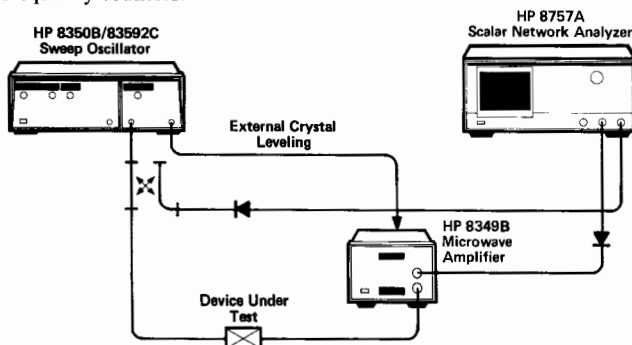

Extended Dynamic Range Configuration



AMPLIFIERS

RF Amplifiers

Models 8447A/D/E/F

- Wide band (multi-decade)
- Low noise
- Flat response

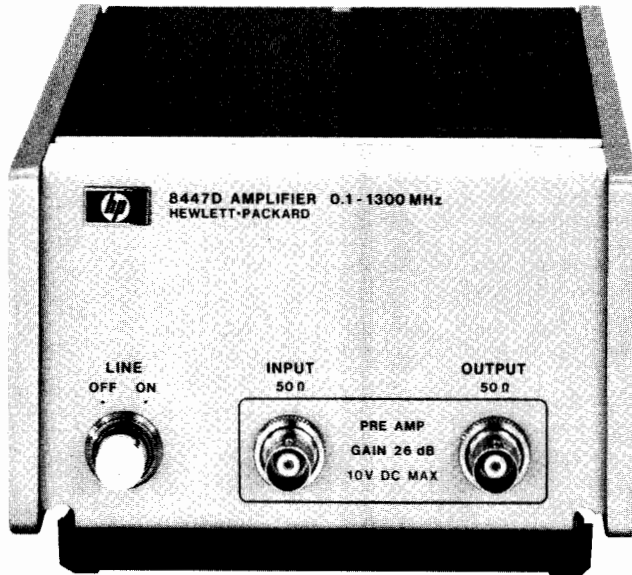

HP 8447D

The HP 8447 series of general-purpose amplifiers offers high reliability and the convenience of a small, lightweight package.

High Performance

These low noise, high gain amplifiers provide the flat frequency response and low distortion required for a wide range of uses. They can be used to improve the sensitivity of counters, spectrum analyzers,

RF voltmeters, EMI meters, power meters, and other devices; or to increase the maximum power available from a signal generator or sweeper.

Broadband Frequency Coverage

The HP 8447 series offers an amplifier for nearly every application in the 100 kHz to 1.3 GHz frequency range. The amplifiers' wide bandwidths are compatible with other wideband instruments used for making measurements involving broadband spectra.

Options

Standard connectors are BNC (f) on all amplifiers.
 Option 010 N (f) connectors on single channel amplifier.
 Option 001 Dual channel amplifier, BNC (f) connectors.
 Option 011 Dual channel amplifier, N (f) connectors.
Note: dual-channel amplifiers are ideal for dual-channel systems such as oscilloscopes or network analyzers. Channels may also be cascaded for increased small-signal gain.

General

Weight: net, 1.56 kg (3.4 lb). Shipping, 2.30 kg (5.1 lb).

Size: 85.8 H x 130 W x 216 mm D (3.4" x 5.1" x 8.5").

Power requirements: 110 or 230 V ac \pm 10%, 48-440 Hz, 15 watts.

Ordering Information

Price

HP 8447A Preamp	\$1075
Opt 910: Extra Operating and Service Manual (HP 8447A)	\$2
HP 8447D Preamp	\$1100
HP 8447E Power Amp	\$1225
HP 8447F Preamp-Power Amp	\$1875
Opt 910: Extra Operating and Service Manual (HP 8447D/E/F)	\$4

Specifications

	HP 8447A Preamp	HP 8447D Preamp	HP 8447E Power Amp	HP 8447F Preamp-Power Amp
Frequency Range	0.1-400 MHz	100 kHz-1.3 GHz	100 kHz-1.3 GHz	100 kHz-1.3 GHz
Typical 3 dB Bandwidth	50 kHz-700 MHz	75 kHz-1.7 GHz	75 kHz-2.0 GHz	50 kHz-1.4 GHz
Gain (Mean, per channel)	20 dB \pm 1.0 dB at 10 MHz	>26 dB (20°C-30°C)	22 dB \pm 1.5 dB (20°C-30°C)	
Gain Flatness Across Full Frequency Range	\pm 0.7 dB	\pm 1.5 dB	\pm 1.5 dB	↑ HP 8447D AND 8447E COMBINED IN A SINGLE PACKAGE ↓
Noise Figure	<6 dB	<8.5 dB	<11 dB typical	
Output Power for 1 dB Gain Compression	>+6 dBm	>+7 dBm typical	>+13.5 dBm <1 GHz	
Harmonic Distortion	-32 dB for 0 dBm output	-30 dB for 0 dBm output (typical)	-30 dB for +8 dBm output	
Typical Output for <-60 dB Harmonic Distortion	-25 dBm	-30 dBm	-20 dBm	
VSWR	<1.7	<2.0 input <2.5 output 1-1300 MHz	<2.2 input <2.5 output 1-1300 MHz	
Impedance	50 Ω	50 Ω	50 Ω	
Reverse Isolation	>30 dB	>40 dB	>40 dB	
Maximum DC Voltage Input	\pm 10 V	\pm 10 V	\pm 10 V	
Options Available	001	001, 010, 011	010	
Option Prices	add \$600	add \$650, \$100, \$1000	add \$100	add \$385

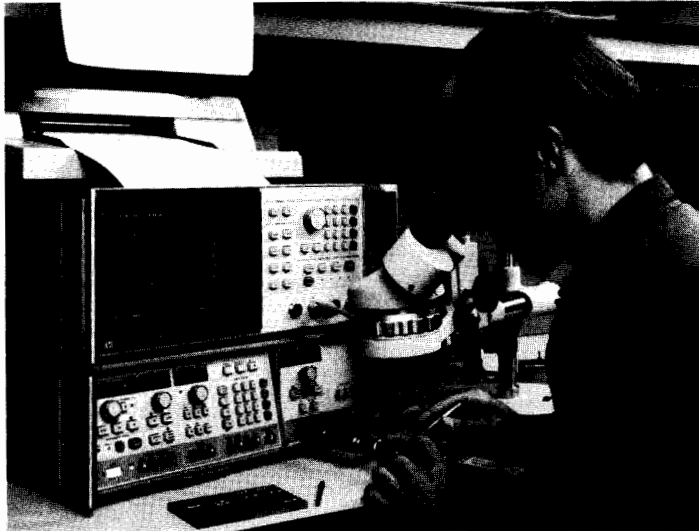

Sweep Oscillators

Sweep oscillators are important in a number of applications where the characteristics of a device or system must be determined over a continuous range of frequencies. By replacing laborious point-by-point techniques, swept measurements increase the speed and convenience of broadband testing. The continuous frequency characterization of the unknown device or system also eliminates the chance of missing important information between frequency points. Swept techniques are applicable in all phases of design, manufacture, and maintenance.

Hewlett-Packard Sweep Oscillators

Hewlett-Packard sweepers cover the entire frequency spectrum from dc to 60 GHz. Self-contained, multi-octave sweepers cover the frequency range to 110 MHz. The HP 8620 and HP 8350 family of solid state oscillators provide a versatile choice of configurations—single band, straddle band, or very wide band plug-ins. The HP 8340B (10 MHz to 26.5 GHz) and the HP 8341B (10 MHz to 20.0 GHz) are broadband synthesizers that combine the excellent stability, frequency accuracy, and phase noise of a synthesizer with the versatile characteristics of a sweep oscillator. And for coverage in the millimeter-wave frequency range, the HP 83550-series frequency multipliers effectively extend the excellent performance of Hewlett-Packard's sweep oscillator family to the 26.5-40 GHz (HP 83554A), 33-50 GHz (HP 83555A), and 40-60 (HP 83556A) millimeter-wave frequency ranges.

A chart of the complete frequency coverage of Hewlett-Packard's line of sweep oscillators is shown on page 493.

Sweep Oscillator Features

Sweep Flexibility

Every HP sweeper has several different sweep modes available for setting the frequency limits of the instrument. A full band or independently adjustable start/stop frequency sweep can be selected. Alternately, a marker sweep or a symmetrical F sweep about the desired center frequency can be chosen. And switching from one sweep mode to another is a simple pushbutton operation.

In the auto mode the sweep retriggers automatically. A manual sweep is also available, a real convenience for calibrating displays such as X-Y recorders. An external trigger is provided as well for applications where the sweeper must be synchronized to other instrumentation or remotely controlled. Sweep times from 0.01 to more than 100 seconds can be selected.

Marker capability, both Z-axis intensity dots and RF pips, are available on HP sweepers to note important measurement frequencies. Two or more independent markers are offered on all sweepers with up to five markers on the HP 8340B/41B as well as the HP 8350 mainframe. Crystal markers are also offered on the HP 86222B, 83522A, and 83525A/B RF plug-ins.

Another powerful feature available on the HP 8340B/41B and 8350 sweeper mainframe is Save/Recall Mode where up to nine complete front panel states can be stored in memory and later recalled when the measurement is repeated. This saves considerable time when repetitive tests are required.

Power Output and Leveling

Power output is continuously adjustable at the front panel over approximately a 10 dB range of all plug-ins. Built-in attenuators are also available on most plug-ins for greater power control. Internal or external leveling is employed to obtain (1) a constant power output and (2) a good source match (low VSWR). This ensures high accuracy when making swept measurements.

The HP 8340B/41B and 83500 series of plug-ins for the HP 8350 offer calibrated output power and internal leveling as standard features. Power is calibrated over a 15 dB range (40 dB for the HP 8340B/41B) with 0.1 dB resolution (programmable to 0.02 dB); with an internal step attenuator, the calibrated range is extended to 85 dB (130 dB on the HP 8340B/41B).

When higher output is required, the HP 8349B microwave amplifier can be driven by the RF output of the sweeper to provide a full +20 dBm of output power from 2 to 18.6 GHz, +17 dBm from 18.6 to 20.0 GHz. The amplifier is capable of at least 15 dB of gain

to 18.6 GHz, 12 dB of gain to 20 GHz, and can be easily leveled via its built-in directional detector and the automatic level control (ALC) circuitry of the sweeper.

Power as well as frequency can be swept with the HP 8340B/41B or the HP 8350 and 83500 series plug-ins using the Power Sweep function. This means that both the frequency response and power response of level sensitive devices like transistors and amplifiers can be measured using the same test set-up. Using the power sweep function the 1 dB gain compression can easily be measured at a CW frequency. Also, the ability to alternate between two successive sweeps allows a swept measurement of the 1 dB gain compression point.

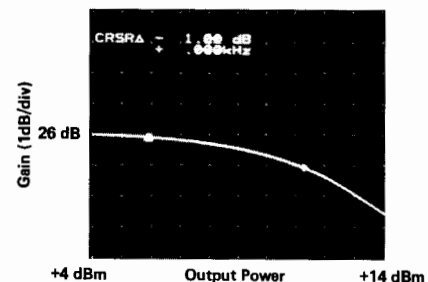

Power Sweep Measurement

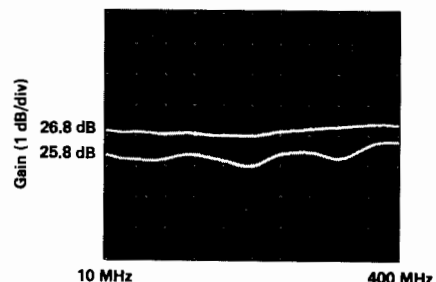

Alternate Sweep Measurement

Modulation

Modulation capabilities further extend the sweeper's usefulness both as a sweeper and a signal generator for signal simulations. Most Hewlett-Packard sweep oscillators offer versatile FM and AM capabilities which are



SWEEP OSCILLATORS

General Information (cont.)

useful for a variety of tests on communication receivers. The flexible FM capability allows remote analog frequency programming, important for many applications.

External pulse modulation is available on many of the HP 83500/86200 series plug-ins. These plug-ins also accept the 27.8 kHz square wave modulation required by the HP 8755, 8756A and 8757A scalar network analyzers directly, eliminating the need for an external modulator. The HP 8350 mainframe will supply the 27.8 kHz square wave modulation directly to the plug-in.

The HP 8340B and 8341B synthesized sweepers have extensive modulation capability, providing both internal pulse, AM, and FM modulation. The pulse modulation capability works for pulse widths as narrow as 100 ns, having rise and fall times less than 25 ns and an on/off ratio of greater than 80 dB. The AM is dc coupled and has a 3 dB bandwidth of 100 kHz. The maximum modulation depth varies with available output power but it is never less than 90%. FM modulation is available with peak frequency deviations to 10 MHz and modulation rates from 50 KHz to 10 MHz. In addition, all modulation features can be used simultaneously. For example, the HP 8340B and 8341B may simultaneously pulse and amplitude modulate the RF to simulate the effect of antenna scan on a pulse modulated signal.

MLA Compatibility

In communications applications where up-converter simulation is required in conjunction with the HP Microwave Link Analyzer, several of the plug-ins have been selected to provide this capability as an option in frequency ranges from 500 MHz to 18 GHz. Group delay of less than 1 nanosecond and linearity of better than 0.5% over 30 MHz across most of the frequency range permit very accurate RF to RF, RF to IF and RF to BB distortion measurements. See page 391 for more information.

Programming

The HP 8340B/41B, 8350 mainframe and 83500 series plug-ins offer total HP-IB control of all front panel functions. Not only CW frequencies, but sweeps, markers, power levels, etc., can be remotely programmed via the HP-IB. This means there are no limitations to designing customized automatic systems for either component or system testing. The HP 8620C solid state sweeper mainframe offers optional HP-IB programming capability.

In many applications a computer can be used to assimilate data from a network analyzer (HP 8756A/57A or 8510). With automatic systems the computer can completely set up the measurement, sweep width, markers, power level, etc., and then document the measurement results in a printed or plotted format. For operations requiring a minimum of user interactions specification comparisons can be made for automatic "go/no-go" testing.

An example of this computer-aided test is the HP 85015B system software for the HP 8756A/57A scalar network analyzers. This software package allows you to configure and

store complete measurements and measurement setups as well as customized output formats. The HP 85016B system software includes all the features of the HP 85015B and includes fault location capabilities that allow the automated scalar measurement system to locate faults in transmission media. Refer to page 610.

Covering Millimeter-wave Frequencies

The new HP 83550-series millimeter-wave source modules answer the growing need for high-performance sweep oscillators in the millimeter-wave frequency ranges. The source modules are frequency multipliers that effectively extend the excellent performance of HP sweep oscillators covering the 11 to 20 GHz range to the 26.5 to 40 GHz (HP 83554A), the 33 to 50 GHz (HP 83555A), and the 40 to 60 GHz (HP 83556A) millimeter-wave frequency ranges.

To use the HP 83550-series source modules with existing HP microwave sources, the HP 8349B amplifier is necessary to provide the +17 dBm of output power and, through a built-in source module interface, the DC bias and control signals the source modules need for proper operation. Another solution for a microwave driver in applications that incorporate the HP 8350B is the new HP 83550A, an 8 to 20 GHz RF plug-in that provides +20 dBm to 18.6 GHz and +18 dBm, 18.6 to 20 GHz. This plug-in also has a built-in source module interface to drive the millimeter-wave source modules directly.

Digital Sweeping Synthesizers

The HP 3325A/26A, 3330B, 3335A, 8642A/B, 8660C, 8662A/63A, and 8673B/C/D/E combine the precision frequency accuracy and stability of a synthesizer with the time saving convenience of a sweeper. Instead of analog sweeps, however, these units provide a digital sweep. The digital sweep is a progression of discrete CW frequencies that can be stepped through at a specified rate. Parameters such as start/stop/center frequencies, sweep width, frequency step and sweep time are entered and executed through a convenient keyboard or remote programming. Some additional features are phase-continuous linear/log sweep in the HP 3325A and amplitude sweeping in steps as small as 0.01 dB in the HP 3330B. This, in conjunction with frequency sweeping, can provide a comprehensive family of curves.

Sweeper Applications

Sweepers are an integral part of many kinds of test applications. Their versatility and extensive feature set make them the perfect choice for scalar/vector network analysis, noise figure measurements, frequency translation measurements, signal simulation and many other applications. The sweepers you will find in this book are designed to be compatible with all relevant measurement solution from HP.

Sweepers are used extensively with swept scalar network analyzers to characterize the amplitude responses of broadband devices or with vector network analyzers when the amplitude and phase characteristics of the device (i.e. s-parameters) are needed. Examples of such analyzers are the HP

8756A and HP 8757A scalar network analyzers and the HP 8510A vector network analyzer. The HP 8340B/41B and HP 8350B sweepers can be controlled by these analyzers via a private "system interface bus." This makes use of the sweepers full programmability and creates synergistic performance; for instance, the ability to save and recall complete system setups and not just one instrument's.

Some applications require special characteristic of a microwave sweep oscillators. For measurements requiring low harmonics, the HP 83592C RF plug-in for the HP 8350 sweep oscillator mainframe offers -55 dBc harmonic suppression from 3.5 to 20 GHz. For applications that require high power, the new HP 83550A offers +20 dBm of leveled output power to 18.6 GHz, +18 dBm from 18.6 to 20 GHz.

For scalar measurements requiring more dynamic range, the HP 8349B microwave amplifier can be used to extend the dynamic range from 76 dB to typically > 90 dB.

For measurements that require an entirely spurious-free environment and phase information, sweepers may be used with vector network analyzers such as the HP 8510A. Extremely high performance vector measurements can be made with the HP 8340B/41B and the HP 8510. For less demanding applications, the HP 8350B/83500 series sweepers can be used with the HP 8510. For instance, the HP 8350B/83522A can be used with the HP 8510 to make RF measurements with greater than 90 dB of dynamic range from 45 MHz to 2.4 GHz.

Noise figure measurements above 1500 MHz can be made using the HP 8970A noise figure meter with either the HP 8340B/8341B or the HP 8350 serving as the local oscillator. With this equipment noise figure and gain measurements can be made

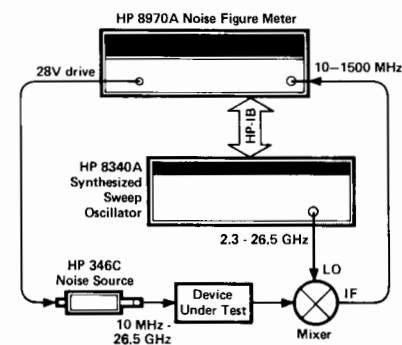

on microwave components such as amplifiers, transistors or mixers. The HP 8340B/41B can also be used as a microwave LO in an HP 8902S and 8952S measurement systems that makes several important measurements on microwave sources.

Two-tone sweep testing of devices such as mixers and receiver front ends requires two signals offset from each other by the IF. This is accomplished by phase-locking the difference frequency of two sweep oscillators to a very stable source. The sweepers may then be swept across the band of interest.

The modulation and built-in attenuator features of Hewlett-Packard sweep oscilla-



tors make them useful in many traditional CW signal generator applications. The excellent stability, phase noise, frequency range and modulation capability of the HP 8340B and 8341B make them well suited for most of these applications. In addition, accuracy, linearity, and flatness of the broadband plug-ins like the HP 83590A, 83594A, 83595A, 83592 A/B/C, 86290 B/C, 83525 A/B, 86222 A/B, and 83522A make them more than adequate in many applications requiring a general purpose CW generator.

For wideband applications these RF plug-ins feature performance that rivals octave band oscillators in the areas of frequency purity and accuracy, harmonics, flatness, and power.

For a complete discussion of swept frequency measurements the following application notes and others are available from your local Hewlett-Packard sales office.

- AN 155-2 "100 dB Dynamic Range Measurements Using the 8755 Frequency Response Test Set"
- AN 183 "High Frequency Swept Measurements"
- AN 187-6 "Frequency Performance of the 8620C Sweep Oscillator Under Remote Programming"
- AN 312-1 "Configuration of a Two-tone Sweeping Generator"
- AN 327-1 "Extending Dynamic Range of Scalar Transmission Measurements Using the HP 8756A or HP 8755C Scalar Network Analyzer"

- AN 329 "Performance Characteristics of HP Microwave Signal Sources-A Comparison"
- PN 8340A-1 "Increasing Frequency Switching Speed on the HP 8340A Synthesized Sweeper"
- PN 8340-2 "Generating Phase Coherent Signals with the HP 8340 and 8341 Synthesized Sweepers"
- PN 8340A-6 "Reduced Harmonic Distortion Using the Integra TMF-1800H Tracking Filter with the HP 8340A Synthesized Sweeper"
- PN 8340A-7 "Microwave Noise Figure Measurements Using the 8340A Synthesized Sweeper with the HP 8970A Noise Figure Meter"
- PN 8350-1 "Using the HP 8350A Sweep Oscillator with the Wiltron 560 Scalar Network Analyzer"
- PN 8350-2 "Improved Frequency Accuracy by Calibrating HP 83590 Series RF Plug-ins to HP 8350A Sweep Oscillator Mainframe"
- PN 8350-3 "A Penlift Dwell Circuit for the HP 8350 Sweep Oscillator"
- PN 8350-4 "Pulse Modulation Characteristics of the HP 83500 Series Sweep Oscillator RF Plug-ins"
- PN 8350-6 "Reduced Harmonic Distortion Using the Integra TMF-1800H Tracking Filter with the HP 8350 Sweep Oscillator"
- PN 8350-7 "Microwave Noise Figure Measurements Using the HP 8350A Sweep Oscillator with the HP 8970A Noise Figure Meter"
- PN 8350-8 "Leveling the HP 8350B Sweep Oscillator with an HP 430 Series Power Meter"
- PN 8350-9 "Improving the Output Power Flatness of the HP 8350 Sweep Oscillator"
- PN 8349-1 "Achieving Calibrated Output Power With The HP 8350 Sweep Oscillator/8349 Broadband Amplifier Combination"
- PN 8620C-1 "Using the HP 8620C Sweep Oscillator with the Wiltron 560 Scalar Network Analyzer"
- PN 8756A-1 "Automating the 8756A Scalar Network Analyzer"
- PN 8756-2 "Using the HP 11664C Detector Adapter to Make Millimeter-Wave Scalar Measurements"
- PN 8756A-3 "How to use the HP 5344S Source Synchronizer with the HP 8350B Sweep Oscillator and the HP 8756A Scalar Analyzer"
- PN 8756-4 "How to Automate the HP 5344S Source Synchronizer, the HP 8350B Sweep Oscillator, and the HP 8756A Scalar Analyzer with an HP Series 200 Computer"
- PN 8757-5 "Measuring Voltage-Controlled Devices with the HP 8757A Scalar Network Analyzer"

Sweep Oscillator—Summary Chart

Frequency Range*	Model Number			Frequency														
	8350 Series	8620 Series**	Other Sweepers	100 kHz	1 MHz	10 MHz	100 MHz	1 GHz	2 GHz	4 GHz	8 GHz	12 GHz	18 GHz	26 GHz	40 GHz	50 GHz	60 GHz	
DC-13MHz 0.1 Hz-13 MHz 10 Hz-21 MHz 1 μHz-21 MHz 1 mHz-50 MHz 200 Hz-80 MHz 10 kHz-1280 MHz 10 kHz-2600 MHz			3326A 3312A 3336A/B/C 3325A 8165A 3335A 8662A 8660C	←	←	←	←	←	←	←	←	←	←	←	←	←	←	←
100 kHz-1 GHz 100 kHz-2 GHz 100 kHz-2.56 GHz 10 MHz-1.3 GHz 10 MHz-2.4 GHz 10 MHz-8.4 GHz 10 MHz-20 GHz 10 MHz-26.5 GHz 50 MHz-18.6 GHz 50 MHz-26.5	83522A 83525A/B 83592A/B/C 83595A	86220A 86222A/B	8642A 8642B 8663A 8341B 8340B 8673C 8673D	←	←	←	←	←	←	←	←	←	←	←	←	←	←	←
1.7-4.3 GHz 2-8.4 GHz 3.6-8.6 GHz 2-18 GHz 2-18.6 GHz 2-20 GHz 2-22 GHz 2-26.5 GHz	83540A/B 83590A 83594A	86235A 86240A/B 86240C 86290B/C 86290B Opt H08	8673E 8673B	←	←	←	←	←	←	←	←	←	←	←	←	←	←	←
3.2-6.5 GHz		86241A		←	←	←	←	←	←	←	←	←	←	←	←	←	←	←
5.9-9.0 GHz 5.9-12.4 GHz 7-11 GHz 7.5-18.6 GHz 8-12.4 GHz 8-20 GHz	83545A 83550A	86242D 86245A 86250D Opt H08 86251A 86250D		←	←	←	←	←	←	←	←	←	←	←	←	←	←	←
10-15.5 GHz 12.4-18 GHz 17-22 GHz 18-26.5 GHz 26.5-40 GHz	83570A 83572A/B	86260B 86260A 86260C		←	←	←	←	←	←	←	←	←	←	←	←	←	←	←
26.5-40 GHz*** 33-50 GHz*** 40-60 GHz***			83554A 83555A 83556A	←	←	←	←	←	←	←	←	←	←	←	←	←	←	←

*Other Special Frequency Ranges Can Be Provided Upon Request.

**HP 86200 Series RF Plug-ins are usable with the HP 8350B Mainframe via the HP 11869A Adapter. HP 83500 Series Plug-ins are not usable in the HP 8620C Mainframe.

***The HP 83550-series millimeter-wave source modules are frequency multipliers that require a +17 dBm microwave input. See pages 510-512.



SWEEP OSCILLATORS

Synthesized Sweepers

Models 8340B, 8341B

- 1 to 4 Hz frequency resolution
- Low spurious and phase noise
- 100 ns pulse width capability
- +10 dBm to -110 dBm calibrated output

- Complete analog sweeper
- DC to 100 kHz amplitude modulation
- <-50 dBc harmonics 1.4 to 20 GHz, opt. 003 on HP 8341B

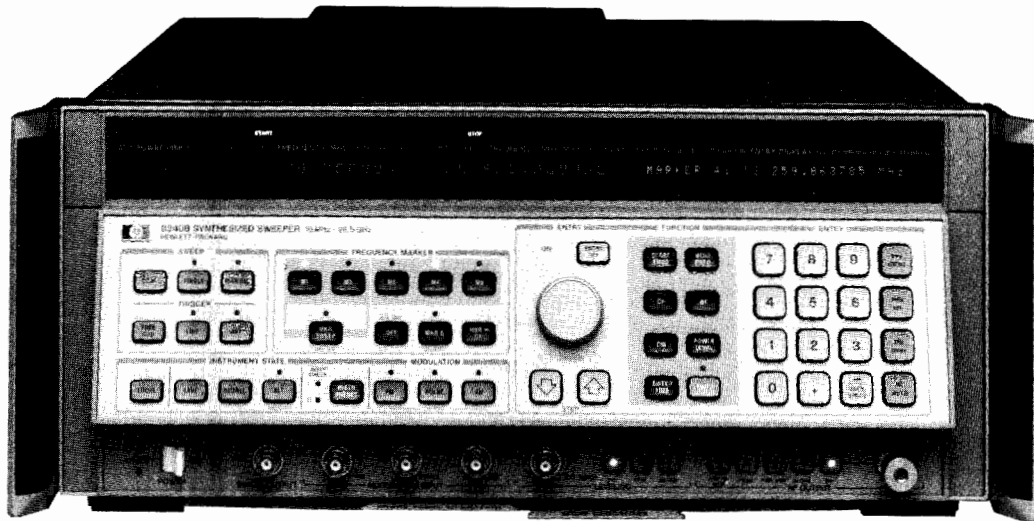

HP 8340B



HP 8340B/8341B Synthesized Sweepers

The HP 8340B and 8341B Synthesized Sweepers deliver the combined high-performance of a synthesizer and a broadband sweep oscillator in one instrument that is completely controllable via the Hewlett-Packard Interface Bus (HP-IB). This efficient combination of performance and versatility is ideal for manual or automatic test systems and in many cases enables the HP 8340B/41B to replace a sweep oscillator, a frequency counter, an RF synthesizer, and a microwave synthesizer.

Synthesizer Precision and Spectral Purity

The synthesized broadband frequency coverage (10 MHz to 26.5 GHz on the HP 8340B and 10 MHz to 20 GHz on the HP 8341B) and the precise 1 to 4 Hz frequency resolution (depending on the frequency band of the HP 8340B or 8341B) are generated by indirect synthesis techniques. These techniques enable the HP 8340B/41B to achieve the same low single-sideband phase-noise performance as the HP 8672A and HP 8673 series of Synthesized Signal Generators. The HP 8340B/41B long-term stability is also outstanding at 1×10^{-9} /day (see specification on following page for more information).

The HP 8340B/41B also feature CW switching times of better than 50 ms (typically <35 ms). Additionally, a "Fast Phase-lock" programming command can be used to reduce typical CW switching times to between 11 and 22 ms (depending on frequency step size and absolute frequency value).

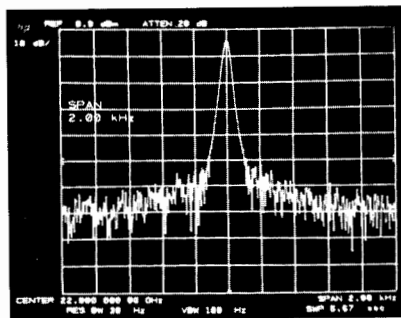

Spectrum Analyzer photo of HP 8340B signal at 22 GHz.

Swept Capability

Analog sweep widths as narrow as 100 Hz or as broad as the full frequency range of the HP 8340B or 8341B permit rapid and thorough testing of any device within their broad frequency ranges. To simplify swept measurements, five frequency markers are provided along with useful marker functions such as marker sweep, marker to center frequency (MKR-CF), and marker difference. Direct compatibility with the HP 8510, 8756A/57A, 8410 and 8755 Network Analyzers also enhances the HP 8340B/41B's swept capability.

Pulse, Amplitude, and Frequency Modulation

The HP 8340B/41B have a high-performance pulse modulator with an ON/OFF ratio >80 dB and rise and fall times <25 ns. Pulse amplitude is leveled and can be as narrow as 100 ns. The HP 8340B/41B also feature dc-coupled amplitude modulation with a 3 dB bandwidth of 100 kHz and a minimum depth of 90%. And with the HP 8340B/41B, pulse and amplitude modulation can be used simultaneously.

The HP 8340B/41B also offer new frequency modulation capabilities, with modulation rates from 50 kHz to 10 MHz and peak deviations to 10 MHz.

HP 8341B Option 003: <-50 dBc Harmonics

Option 003 on the HP 8341B delivers excellent harmonic performance with harmonics that are at least 50 dB below the carrier from 1.4 to 20.0 GHz.

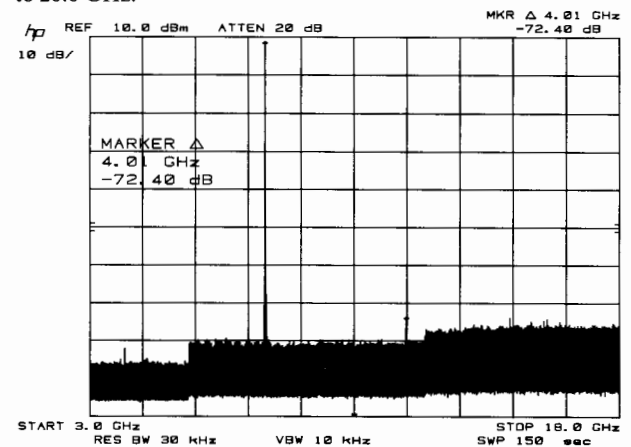

Harmonic Performance of the HP 8341B Opt. 003



Output Power

The HP 8340B/41B provide high output power which can be controlled down to -110 dBm with 0.05 dB resolution. High power resolution is complemented by outstanding accuracy and flatness, as shown on the following page of specifications. The HP 8340B/41B also feature power sweep capability with >20 dB dynamic range for complete characterization of level-sensitive devices.

Usability and Programmability

The ENTRY DISPLAYS of the HP 8340B/41B always show the active functions and their current values, which can be easily changed via the data entry keyboard, the step keys or the knob. This friendly and responsive interaction with the user makes the HP 8340B/41B very easy instruments to operate. Complete HP-IB programmability also enables the HP 8340B/41B to effectively interact with computers via simple-to-use programming codes (for example, a CW frequency of 5 GHz can be programmed by: CW 5 GZ). Other HP-IB enhanced features, such as the "Fast Phase-lock" command, let users easily and fully exploit the powerful capabilities of the HP 8340B/41B.

Network Analyzer Companions

Besides being excellent stand-alone general purpose sources, the HP 8340B and HP 8341B are also ideal sources for precision microwave network analysis. Examples of this are the HP 8340B/41B with the HP 8510 and HP 8756A/57A network analyzers. The HP 8510 vector network analyzer brings tremendous measurement capability to the microwave engineer that was never before available. A significant portion of this capability depends on the stability, signal purity and source/analyzer interface of the sweeper used. An example of this high performance is shown in Figure 1 where a single device under test was measured seven times with seven completely different HP 8510/8340B test systems. The repeatability (system to system) is remarkable. When the HP 8512A or 8514A 500 MHz to 18 GHz test sets are used with the HP 8510, the 10 MHz to 20 GHz HP 8341B is the recommended source and when the HP 8513A or 8515A 45 MHz to 26.5 GHz test sets are used, the 10 MHz to 26.5 GHz HP 8340B is recommended.

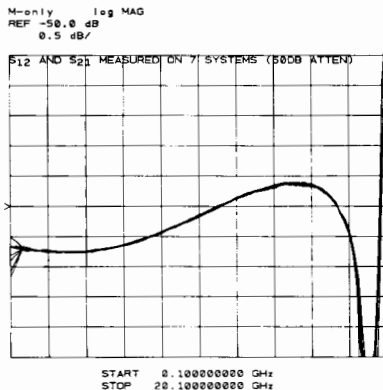

Both the HP 8340B and HP 8341B can also be teamed with the HP 8756A and HP 8757A scalar network analyzers for precision scalar analysis, for instance, magnitude-only applications where data at accurate frequencies is needed. In addition to this frequency accuracy, the HP 8340B/8341B have a "phase-locked sweep." For sweep widths of $n \times 5$ MHz or less (n = frequency band number), one of the phase-locked loops is swept producing synthesizer class frequency accuracy and stability in a continuous sweep. As an example, see Figure 2 where an 832 MHz SAW resonator is swept over a width of 400 kHz by the HP 8341B with less than 60 Hz of residual FM.

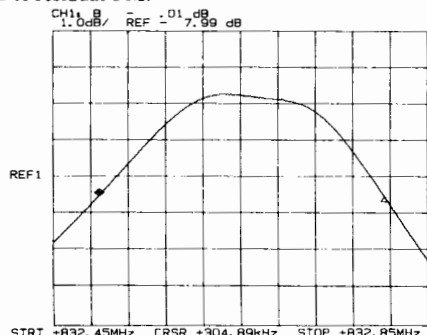

The HP 8341B is particularly well suited for scalar analysis because of its excellent performance for the price. Previously, if greater frequency

accuracy and stability was required of a swept source, the sweeper was combined with a source-locking counter or simply stopped and counted in CW mode. Now with the 10 MHz to 20 GHz HP 8341B, you can obtain the highest quality frequency accuracy, stability, and phase noise along with an analog sweeper. The HP 8341B has all this built into a single easy-to-use instrument at a price comparable to a broadband sweeper/source-locking counter combination.

HP 8340B/8341B Specifications

(see technical data sheet for complete specifications)

HP-IB Interface Functions

The following codes describe the HP-IB electrical capabilities of the HP 8340A/41A using IEEE Std 488-1978 mnemonics: SH1, AH1, T6, TE0, L4, LE0, SR1, RL1, PP0, DC1, DT1, C0, C1, C2, C3, C28, E1.

Frequency

CW Mode (and Manual Sweep)

Frequency Range: HP 8340B, 10 MHz to 26.5 GHz
HP 8341B, 10 MHz to 20.0 GHz

Frequency Resolution:

- 1 Hz, 0.01 to <7.0 GHz
- 2 Hz, 7.0 to <13.5 GHz
- 3 Hz, 13.5 to <20.0 GHz
- 4 Hz, 20.0 to 26.5 GHz (HP 8340B only)

Accuracy: Same as time base.

Time Base:

Internal 10 MHz time base.

Aging Rate: less than 1×10^{-9} /day and 2.5×10^{-7} /year after 30 day warm-up.

Temperature Effect: typically $<1 \times 10^{-5}$ SUP10/ $^{\circ}$ C.

Line Voltage Effect: typically $<1 \times 10^{-5}$ SUP11/ $\pm 10\%$ line voltage change.

Switching time: <50 ms to be within specified frequency resolution (PEAK function off).

(Fast Phase Lock Mode reduces typical switching time to <20 ms).

Frequency Bands: For bands 0 and 1, the output is derived from the fundamental frequency of the internal 2.3 to 7.0 GHz YIG-tuned oscillator ($n = 1$). For bands 2 (7.0-13.5 GHz), 3 (13.5-20 GHz), and 4 (20.0-26.5 GHz), the output is derived from the 2nd, 3rd, or 4th harmonic of the oscillator ($n = 2, 3, \text{ or } 4$).

Swept Mode

Center Frequency/Sweep Width (ΔF)

Range: HP 8340B: 10.00005 MHz to 26.4999995 GHz (**center frequency**): 100 Hz to 26.49 GHz (**sweep width**). HP 8341B: 10.00005 MHz to 19.9999995 GHz (**center frequency**). 100 Hz to 19.99 GHz (**sweep width**).

Resolution: approximately 0.1% of sweep width (ΔF).

Readout Accuracy: (sweep time > 100 ms)

$\Delta F \leq n \times 5$ MHz: $\pm 1\%$ of indicated sweep width (ΔF). \pm time base accuracy.

$n \times 5$ MHz $< \Delta F < n \times 100$ MHz: $\pm 2\%$ of indicated sweep width (ΔF).

$\Delta F \geq n \times 100$ MHz: $\pm 1\%$ of indicated sweep width (ΔF), or ± 50 MHz, whichever is less.

Where n = harmonic multiplication number (1 to 4). Refer to Frequency Bands description above.

Start/Stop Frequency

Range: HP 8340B: 10 MHz to 26.4999999 GHz (Start); 10.0001 MHz to 26.5 GHz (Stop) HP 8341B: 10 MHz to 19.9999999 GHz (Start)

10.0001 MHz to 20.0 GHz (Stop)

Resolution: same as Center Frequency/Sweep Width.

Readout Accuracy: with respect to sweep out voltage (sweep time > 100 ms): same as Center Frequency/Sweep Width Mode.

Frequency Markers

All 5 markers are independently variable and have the same specifications.

Range: HP 8340B: 10 MHz to 26.5 GHz.

HP 8341B: 10 MHz to 20.0 GHz.

Resolution: same as Center Frequency/Sweep Width.

Readout Accuracy: same as Center Frequency/Sweep Width.

Readout Accuracy in MKR Δ Mode: same as Center Frequency/Sweep Width.

Swept Frequency Accuracy (of any frequency covered by the sweep): same as Center Frequency/Sweep Width Mode.



SWEEP OSCILLATORS

Synthesized Sweepers (cont.)

Models 8340B, 8341B

Spectral Purity

Specifications apply to CW mode and all swept modes unless otherwise stated.

Spurious Signals (expressed in dB relative to the carrier level (dBc) at ALC level of 0 dBm).

Harmonics (up to 26.5 GHz) of output frequency: <-35 dBc

Subharmonics and Multiples Thereof (up to 26.5 GHz) of output frequency:

<-25 dBc, 7.0 to <20.0 GHz

<-20 dBc, 20.0 to 26.5 GHz (HP 8340B only)

HP 8341B Opt. 003 Harmonics and Subharmonics (up to 20.0 GHz)

<-35 dBc, 0.01 to 1.4 GHz

<-50 dBc, 1.4 to 20 GHz

Non-Harmonically related spurious (CW and Manual Sweep mode only):

<-50 dBc, 0.01 to < 2.3 GHz

<-70 dBc, 2.3 to < 7.0 GHz

<-64 dBc, 7.0 to <13.5 GHz

<-60 dBc, 13.5 to <20.0 GHz

<-58 dBc, 20.0 to 26.5 GHz (HP 8340B only)

HP 8340/41B Single-Sideband Phase Noise (dBc/1 Hz Noise BW, CW Mode, all power levels)

Frequency Range (GHz)	Offset from Carrier				
	30 Hz	100 Hz	1 kHz	10 kHz	100 kHz
0.01 to < 2.3	-64	-70	-78	-86	-107
2.3 to < 7.0	-64	-70	-78	-86	-107
7.0 to <13.5	-58	-64	-72	-80	-101
13.5 to <20.0	-54	-60	-68	-76	-97
20.0 to 26.5*	-52	-58	-66	-74	-95

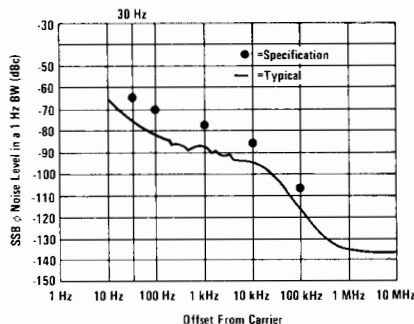

Typical HP 8340B/41B Phase Noise performance from 2.3 to 7.0 GHz.

Typical Residual FM in CW Mode: <n × 60 Hz rms

Typical Residual FM in Swept Mode:

ΔF >n × 5 MHz: <n × 25 kHz rms.

ΔF ≤n × 5 MHz: same as CW Mode.

Where n = harmonic multiplication number (1 to 4). Refer to Frequency Bands description above.

RF Output

Output Power Range

HP 8340B/41B Maximum Leveled Power (0°C to +35°C)

Frequency Range	Specified	Typical
0.01 to < 2.3 GHz	+10.0 dBm	+12 dBm
2.3 to < 7.0 GHz	+12.0 dBm	+16 dBm
7.0 to <13.5 GHz	+10.0 dBm	+12 dBm
13.5 to <20.0 GHz	+ 9.0 dBm	+11 dBm
20.0 to <23.0 GHz*	+ 3.0 dBm	+ 5 dBm
23.0 to 26.5 GHz*	+ 1.0 dBm	+ 3 dBm

Minimum Settable Power: HP 8340B/41B, -110 dBm, 0.01 to 26.5 GHz.

RF Off: When the RF key is turned off, the **POWER dBm** display will read **OFF** and a 0 dBm signal out of the RF connector will typically be attenuated to a level of <-100 dBm. Additional attenuation of the signal may be achieved by using the internal step attenuator.

Output Power Resolution

ENTRY DISPLAY: 0.05 dB

POWER dBm Display: 0.1 dB

HP 8340B/41B Output Power Accuracy (0°C to +55°C)

Output Level Range	Frequency Range (GHz)		
	0.01 to <2.3	2.3 to <20	20 to 26.5*
+20 to +10 dBm	-	±1.8 dB	±2.3 dB
+10 to -9.95 dBm	±0.9 dB	±1.5 dB	±2.0 dB
-10 to -19.95 dBm	±1.2 dB	±2.0 dB	±2.5 dB
-20 to -49.95 dBm	±1.5 dB	±2.3 dB	±2.8 dB
-50 to -79.95 dBm	±1.8 dB	±2.6 dB	±3.1 dB
-80 to -100 dBm	±2.1 dB	±2.9 dB	±3.4 dB
-100 to -110 dBm (typically)	±2.9 dB	±3.7 dB	±4.2 dB

Accuracy specifications include power level variations with frequency and temperature (i.e. flatness, which is given below).

HP 8340B/41B Flatness (Internally leveled)

Output Level Range	Frequency Range (GHz)		
	0.01 to <2.3	2.3 to <20	20 to 26.5*
+20 to +10 dBm	-	±1.2 dB	±1.7 dB
+10 to -9.95 dBm	±0.6 dB	±1.1 dB	±1.6 dB
-10 to -19.95 dBm	±0.9 dB	±1.6 dB	±2.1 dB
-20 to -49.95 dBm	±1.2 dB	±1.9 dB	±2.4 dB
-50 to -79.95 dBm	±1.4 dB	±2.2 dB	±2.7 dB
-80 to -100 dBm	±1.7 dB	±2.5 dB	±3.0 dB
-100 to -110 dBm (typically)	±1.9 dB	±3.1 dB	±3.6 dB

Output Level Switching Time: typically <10 ms to be within ±0.1 dB of final value with no attenuator change (internal leveling only).

Stability with Temperature: typically ±0.01 dB/°C.

Output Impedance: 50Ω nominal.

Source SWR (internal leveling only):

Typically <1.3:1, 0.01 to <2.6 GHz.

Typically <1.6:1, 2.3 to <18.0 GHz.

Typically <2.0:1, 18.0 to 26.5 GHz. (20.0 GHz for HP 8341B)

*HP 8340B only

Power Sweep

Range:

Displayed: 0 to 40 dB/sweep

Actual: At least 10 dB at any given frequency (at least 20 dB in DECOUPLED mode; see Figure 2 below).

Resolution: 0.05 dB/sweep

Accuracy:

Starting Power Level: Same as Output Power Accuracy Power Sweep Width and Linearity:

Resolution: 0.05 dB/sweep

Slope Compensation

Calibrated Range: 0 to 0.4 dB/GHz

Resolution: 0.001 dB/GHz

External Leveling

XTAL allows the HP 8340B/41B to be externally leveled by crystal detectors of positive or negative polarity.

METER allows power meter leveling with any HP power meter.

Range: 500 μ V (-66 dBV) to 2V (+6 dBV) for **XTAL** or **METER** modes.

Accuracy: leveled voltage is shown in **ENTRY DISPLAY** in dBV. Accuracy of actual voltage at EXT INPUT relative to the displayed value is as follows:

± 0.5 dB, ± 0.2 mV.

Loop bandwidth: nominally 80 kHz in **XTAL** mode, 0.7 Hz in **METER** mode.

Input Impedance: nominally 1 M Ω .

Pulse Modulation

Specifications apply only to CW frequencies.

ON/OFF Ratio: >80 dB.

Rise (T_R) and Fall (T_F) Times: ≤ 25 ns.

Minimum Internally Leveled RF Pulse Width (T_{RF}): ≤ 100 ns.

Minimum Unleveled RF Pulse Width: typically < 25 ns.

Pulse Repetition Frequency:

100 Hz to 5 MHz (when internally leveled)

Typically dc to 20 MHz in non-leveled operation

Maximum Peak Power: same as CW and swept modes. See **RF OUTPUT** specifications.

Accuracy of Internally Leveled RF Pulse (V_p) (relative to CW level)

Pulse Width	Frequency Range (GHz)		
	0.01 to 0.4	0.4 to <2.3	2.3 to 26.5*
100 to <200 ns	—	+3/-0.3 dB	+1.5/-0.3 dB
200 to <500 ns	—	+1.5/-0.3 dB	± 0.3 dB
≥ 500 ns	—	± 0.3 dB	± 0.3 dB
1 to <2 μ s (typically)	+3/-0.3 dB	—	—
2 to <5 μ s (typically)	+1.5/-0.3 dB	—	—
≥ 5 μ s (typically)	± 0.3 dB	—	—

*20.0 GHz for HP 8341B

Settling Time: Settling time states the typical amount of time needed for the internally leveled RF pulse amplitude to be within 10% of its final value after a change in the pulse amplitude has been initiated. In the HP 8340B/41B, for pulse widths < 10 μ s, settling time is the greater of 70 μ s or the time to generate 7 pulses. For pulse widths ≥ 10 μ s, settling time is 70 μ s divided by the duty cycle. Settling time can be reduced by pressing **SHIFT AM**, which effectively increases the ALC bandwidth. **SHIFT AM** also has the effect of causing some degradation in the pulse envelope as well as raising the minimum pulse repetition frequency from 100 Hz to 1 kHz.

Overshoot, Ringing (V_{OR}/V_p): $< 15\%$ typically.

Pulse Width Compression ($T_V - T_{RF}$): ± 5 ns typically.

Delay Time (T_D): 50 ns typically.

Video Feedthrough (V_F/V_p):

$< 5\%$, 0.01 to < 0.4 GHz typical (for output power levels $\leq +8$ dBm)

$< 5\%$, 0.4 to < 2.3 GHz (for output power levels $\leq +8$ dBm)

$< 0.2\%$, 2.3 to 26.5 GHz (20.0 GHz for HP 8341B)

Sidebands caused by a pulse input when PULSE is OFF: typically < -50 dBc with a 30 kHz squarewave input from .01 to 7.0 GHz.

Pulse Input: TTL compatible. (Open circuit is TTL high level and keeps RF on). Damage level +12V, -20V.

Pulse Definitions:

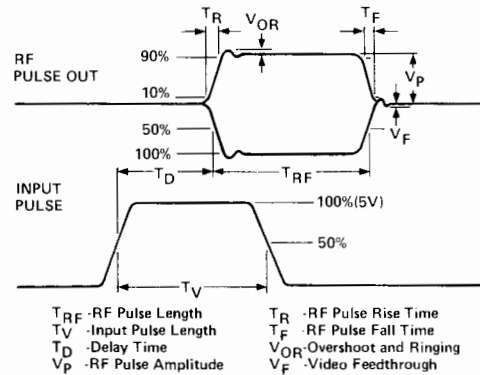

Amplitude Modulation

Specifications below apply when the HP 8340B/41B are internally leveled, for waveforms whose envelope peak is at least 1 dB below maximum specified power.

AM Depth: 0-90%. Actual available depth will be greater than this in many cases and is determined by the difference of the maximum leveled power available at frequency of interest and -30 dBm.

AM Sensitivity: (at a 1 kHz rate and 30% depth) 100%/V $\pm 5\%$. AM depth is linearly controlled by varying input level between 0 and ± 1 V peak. Nominal input impedance is 600 Ω .

AM Bandwidth (30% Depth, PULSE off): dc coupled, 3 dB point > 100 kHz.

AM Frequency Response (Flatness) Relative to a 1 kHz Rate at 30% depth (PULSE off): ± 0.20 dB, dc to 10 kHz.

Distortion: typical values are given in Figure 3 below.

Incidental ϕM in Peak Radians (Rates ≤ 10 kHz, 30% Depth): < 0.4 typically

Incidental FM: Incidental $\phi M \times$ Modulation Frequency.

AM Input Impedance: nominally 600 ohms.

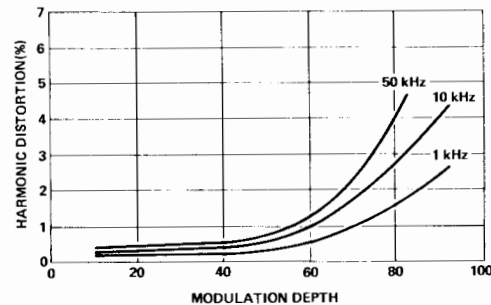

Figure 3. Typical HP 8340B/41B AM distortion for various modulation rates and depths.

Frequency Modulation

Frequency Modulation is standard on the HP 8340B/41B.

Modulation Rates: 50 kHz to 10 MHz

Peak Deviation: the lesser of 10 MHz or:

Band 0, 1: 5 X Mod Rate

Band 2: 10 X Mod Rate

Band 3: 15 X Mod Rate

Band 4: 20 X Mod Rate

Deviation Accuracy: $\pm 10\%$ (@ 100 kHz Rate).

Sensitivity: 1 MHz/Volt, 10 MHz/Volt, user selectable.

Ordering Information

HP 8340B Synthesized Sweeper	\$65,000
Option 001 Front Panel RF Output Without Attenuator	less \$2,000
Option 004 Rear Panel RF Output With Attenuator	add \$200
Option 005 Rear Panel RF Output Without Attenuator	less \$1,800
Option 006 Delete Pulse Modulation	less \$4,000
Option 007 Relaxed Phase Noise Specifications	less \$3,500
Option 915 Add Service Manual	add \$300
Option W30 2 Additional Years of Return-to-HP Warr.	add \$850
HP 8341B Synthesized Sweeper	\$39,500
Option 003 Low Harmonics	add \$1,500
Option 004 Rear Panel Output With Attenuator	add \$200
Option 915 Add Service Manual	add \$300
Option W30 2 Additional Years of Return-to-HP Warr.	add \$850



SWEEP OSCILLATORS

Model 8350 Series: 10 MHz to 40 GHz

Model 8350 Series

- Versatile microprocessor-controlled mainframe
- Single-band, straddle-band and broad band plug-ins
- 10 MHz to 40 GHz in two plug-ins
- 10 mW output power to 26.5 GHz
- Total HP-IB programmability

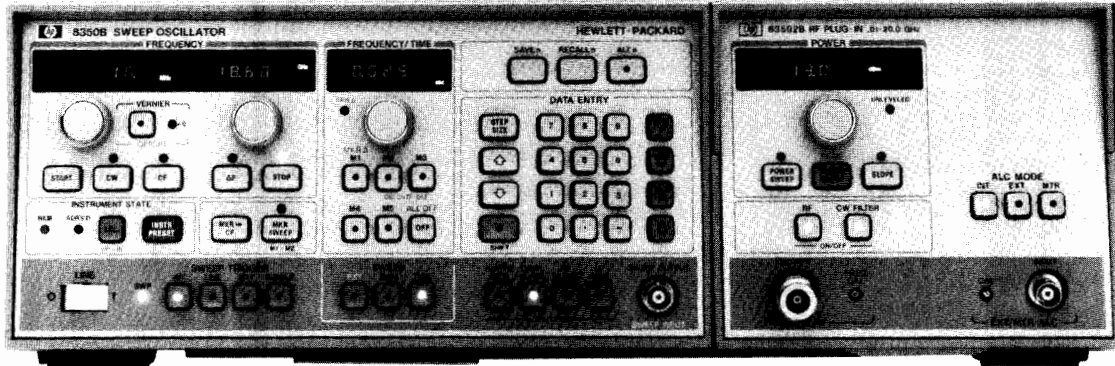

HP 8350B



HP 8350 System

The HP 8350 is a powerful general-purpose source for swept microwave measurements, wideband CW signal generation and automatic testing. It incorporates the efficiency of microprocessor control with state-of-the-art YIG-tuned oscillators and GaAs FET amplifiers to produce a high performance sweep oscillator system ideally suited for either manual or automatic measurements.

You can easily configure a source to meet your application's frequency coverage and power requirements. Just combine the versatile HP 8350 mainframe with any of the 33 standard RF plug-ins (see table at right) and you are ready to make measurements. Both the advanced HP 83500 series plug-ins and the existing HP 86200 series plug-ins (via the HP 11869A adapter) are accepted by the HP 8350 mainframe.

HP 8350 Mainframe

The HP 8350 has been designed to include many features that not only speed up and simplify measurements but also improve accuracy. In addition, it is compatible with HP network analyzers, counters, noise figure meters, power meters, and microwave link analyzers to provide complete solutions.

All function values (sweep limit frequencies, marker frequencies, etc.) are indicated on high resolution digital displays. Function values are easily modified using the appropriate knob, step keys, or data entry keyboard.

Five independent, continuously variable markers are available to note your measurement frequencies. The active marker frequency or the difference frequency between any two markers is read easily from high resolution digital display. You can also use marker sweep to zoom in on a particular frequency span while retaining your original sweep limits.

Another particularly useful feature in making repetitive measurements is the HP 8350's Save/Recall Mode. Once the sweeper has been set for a particular measurement, all front panel settings (HP 8350 and HP 83500 series plug-in) can be *Saved* and later *Recalled* to repeat the measurement by accessing one of nine internal storage registers.

In the past, HP-IB programming of sweepers was limited to a series of CW frequencies. With the HP 8350 all front panel functions, e.g. sweeps, markers, sweep time, even output power (HP 83500 series plug-ins) can be programmed. This means there are no limitations in designing your own customized test systems. Utilizing the Learn Mode function, the HP 8350 becomes a "talker" as well as "listener" on the bus, transferring all manually entered front panel controls to the computer.

Full compatibility with both the HP 8510 and the HP 8410C Network Analyzers, the HP 8756A and the HP 8757A Scalar Network Analyzers are provided for convenient vector and scalar measurements with the HP 8350. The HP 5343A Counter can be combined with the HP 8350 to measure Start, Stop, or marker frequencies with up to 100 kHz accuracy while sweeping. Improved frequency accuracy and stability may be achieved by using the HP 5344S Source Synchronizer with the HP 8350 to phase-lock the RF output. Microwave

noise figure measurements may be made using the HP 8350 with the HP 8970A Noise Figure Meter. In addition, the HP 8350B, with an appropriate plug-in driving the HP 8349B microwave amplifier, provides up to +20 dBm of output power across a 2 to 20 GHz range.

HP 83500 Series Plug-Ins

Broadband frequency coverage from 10 MHz to 40 GHz with high output power is provided in the HP 83500 series RF plug-ins. One plug-in, the HP 83595A, operates over the entire 10 MHz to 26.5 GHz range without sacrificing frequency accuracy (± 12 MHz at 26.5 GHz). The HP 83592C, 10 MHz to 20 GHz RF plug-in has -55 dBc harmonics and subharmonics from 2 to 20 GHz. The HP 83550A provides +20 dBm of output power from 8.0 to 18.6 GHz, +18 dBm from 18.6 to 20.0 GHz and also has a built-in source module interface to drive the HP 83550-series millimeter-wave source modules. The 18 GHz to 26.5 GHz band is filled by the HP 83570A RF plug-in and boasts a 10 mW power level (comparable to most BWOs). The millimeter-wave bands are covered by the HP 83550-series millimeter-wave source modules, frequency multipliers that provide coverage in the 26.5 to 40 GHz (HP 83554A), 33 to 50 GHz (HP 83555A), and 40 to 60 GHz (HP 83556A) bands by effectively extending the characteristics of an 11 to 20 GHz microwave source to the millimeter frequency range.

The HP 83500 series plug-ins offer output power level control previously unavailable on a swept source. Power level control is calibrated with 0.1 dB resolution and up to 80 dB range (with Opt 002 attenuator). Calibrated power sweeps are available for characterizing device performance as a function of power. Slope and internal leveling controls are standard on all units. The HP 83500 series plug-ins (except the HP 83572A/B) are also capable of power meter leveling with the HP 432A/B/C, 436A, and 438A power meters.

All HP 83500 series front panel functions are HP-IB programmable including power level. This means your automatic test systems can now characterize a device both as a function of frequency and input power level.

HP 86200 Series Plug-Ins

Simply combining the HP 86200 series plug-in (including the one you may already own) with an HP 11869A Adapter makes all the convenient digital controls, markers, and HP-IB capability of the HP 8350 immediately available to you. The HP 86200 series are a particularly attractive plug-in choice when economical single-band operation is desired with the HP 8350 mainframe. For measurements with HP Microwave Link Analyzers, specially characterized HP 86200 series plug-ins can be used with the HP 8350 to create an upconverter for communications distortion measurements.

The HP 86290B/C plug-ins cover the 2-18 GHz frequency range with 10 mW and 20 mW of output power respectively. Frequency accuracy at 18 GHz is 20 MHz, exceeding that available on most single-band plug-ins. Both HP 83500 series and HP 86200 series plug-ins compatible with the HP 8350 mainframe are summarized in the table below. Note that the HP 11869A Adapter is required with all HP 86200 series plug-ins.



HP 11869A

HP 83540A



HP 86290B

	HP Model number	Frequency range (GHz)	Leveled power output	Frequency accuracy (MHz)	Complete specifications on page
Broad-band Plug-ins	83595A	0.01-26.5	2.5 mW	±12	502
	83594A	2-26.5	2.5 mW	±12	502
	83592A/B	0.01-20	10 mW/20 mW*	±10	502
	83592C	0.01-20	4 mW	±10	502
	83590A	2-20	10 mW	±10	502
	83525A/B	0.01-8.4	20 mW/10 mW	±12	504
	83522A	0.01-2.4	20 mW	±5	504
	86222A/B	0.01-2.4	20 mW	±10	516
	86290B	2-18.6	10 mW	±30	515
86290C	2-18.6	20 mW	±30	515	
Straddle-band Plug-ins	83540A/B	2-8.4	40 mW/20 mW	±12	506
	86240A	2-8.4	40 mW	±20	517
	86240B	2-8.4	20 mW	±20	517
	86240C	3.6-8.6	40 mW	±20	517
	86251A	7.5-18.6	10 mW	±20	517
	83550A	8.0-20.0	100 mW/50 mW**	±20	506
Single-band Plug-ins	86220A	0.01-1.3	10 mW	±10	518
	86235A	1.7-4.3	40 mW	±20	518
	86241A	3.2-6.5	3.2 mW	±30	518
	86242D	5.9-9	10 mW	±35	518
	83545A	5.9-12.4	50 mW	±20	506
	86245A	5.9-12.4	50 mW	±40	518
	86250D	8.0-12.4	10 mW	±40	518
	86260B	10-15.5	10 mW	±50	518
	86260A	12.4-18	10 mW	±50	518
	86260C	17-22	10 mW	±50	518
	83570A	18-26.5	10 mW	±30	508
	83572A	26.5-40	1.6 mW (Opt 001)	±100	508
	83572B	26.5-40	4 mW (Opt 001)	±100	508

NOTE: The HP 11869A Adapter is required to interface HP 86200 series plug-ins with the HP 8350B mainframe.

*HP 83592B: 20 mW to 18.6 GHz.

**HP 83550A: 100 mW to 18.6 GHz.



SWEEP OSCILLATORS

Model 8350 Series: Mainframe

Model 8350B

- Accurate, high resolution, digital displays
- Five markers with marker Δ and marker sweep
- Save/recall 9 complete front panel states

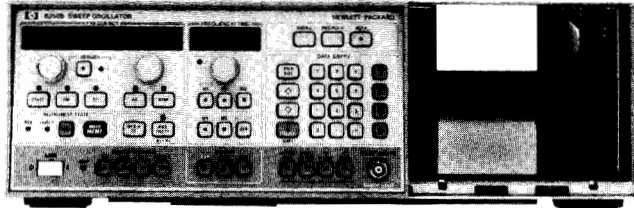

HP 8350B



HP 8350B

Sweep Oscillator applications are greatly enhanced by the features of the HP 8350B. Along with the traditional swept and CW frequency functions, the HP 8350B adds extensive marker capabilities, versatile data entry and complete HP-IB programmability. Besides the popular HP 83500-series RF plug-ins, the HP 8350B also accepts the HP 86200-series plug-ins via the HP 11869A adapter. And the HP 8350B is directly compatible with such measurement systems as the HP 8510A/8410C vector network analyzers and the HP 8756A/8757A scalar network analyzers. Frequency accuracy is easily enhanced by using the HP 5343A counter to count the START, STOP, or ACTIVE MARKER frequencies. For even more frequency accuracy and stability the HP 5344S source synchronizer may be used to phase-lock the RF output.

The HP 8350B has three methods of changing function values: control knobs, keyboard entry, or step key entry.

Five markers are available with the HP 8350B. These markers, combined with the high resolution digital readout, make the accurate location of important frequency responses easy. A key marker feature, marker Δ , computes the difference between any two markers. The markers can modify the center frequency (marker \rightarrow CF) or the START/STOP frequency (Marker Sweep). These expanded marker capabilities simplify sophisticated measurements.

A necessity in making repetitive measurements or automatic tests is the Save/Recall feature. Once the HP 8350B controls have been set for a particular measurement, all of the front panel controls can be "Saved" in a memory location and later "Recalled" when the measurement is repeated. This feature supplies nine memory locations, each storing a complete front panel set-up. Nonvolatile memory is included so that all memories are retained even when line power is removed.

The HP 8350B makes "simultaneous" comparison of two separate frequency ranges or power levels easy via the alternate sweep mode. When the alternate sweep mode is activated, the HP 8350B alternates between the current front panel setting and any stored memory setting on successive sweeps. The output from this function may be processed through a network analyzer such as the HP 8756A or the HP 8757A and viewed on a two channel display.

All front panel controls (except the ac line switch) may be programmed or controlled via the HP-IB. The HP 8350B may interact as a listener or as a talker on the HP-IB. As a talker the HP 8350B is capable of outputting the manually entered front panel information to a controller.

A self test is performed at turn on or whenever the instrument pre-set function is activated. This function verifies that the HP 8350B is functioning properly. If there is a problem, error codes are displayed on the front panel to help locate the problem quickly to the board and component level.

- Accepts all HP 83500 series plug-ins
- Total HP-IB programmability

HP 8350B Specifications

Instrument Control

Control knobs, step keys and data entry keyboard: all instrument parameters whether time, frequency or power may be set three ways: control knobs, keyboard entry, or step keys.

Frequency Control Functions

Range: determined by RF plug-in unit used.

Linearity: refer to RF unit specifications.

START/STOP sweep: sweeps up from the START frequency to the STOP frequency.

CF/ Δ F Sweep: sweeps symmetrically upward, centered on CF.

Δ F: frequency width of sweep continuously adjustable from zero to 100% of frequency range.

Δ F Accuracy: refer to RF unit specifications.

CF Accuracy: refer to RF unit specifications.

CF Resolution: 0.00038% (262,144 points across band).

Δ F Resolution: 0.1% of full band (1024 points across band)

0.012% of band for $1/8$ of band or less

0.0015% of band for $1/64$ of band or less.

Display resolution: 5 digits.

CW operation: single frequency RF output.

CW accuracy: refer to RF unit specifications.

CW resolution: same as CF.

Vernier: adjusts CW frequency or swept center frequency up to 0.05% of RF plug-in band being swept.

Vernier resolution: 4 ppm (64 points between each CW point; 262,144 points across band).

Offset: allows the CW frequency or center frequency to be offset by any amount up to the full range of the plug-in.

Resolution: same as CF.

Accuracy: refer to RF unit specifications.

Frequency markers: five frequency markers are independently adjustable and fully calibrated over the entire sweep range. Amplitude or intensity markers available.

Resolution: 0.4% of selected sweep width (256 points/sweep).

Accuracy: refer to frequency accuracy.

Marker output: rectangular pulse, typically -5 volts peak available from the POS Z BLANK connector on rear panel.

Marker sweep: RF output is swept between Marker 1 and Marker 2.

Marker \rightarrow CF: causes the CW or the swept center frequency to equal the frequency of the active marker.

Sweep and Trigger Modes

Internal: sweep recurs automatically.

Line: sweep triggered by ac power line frequency.

External trigger: sweep is actuated by external trigger signal.

Single: selects mode and triggers a single sweep.

Sweep time: continuously adjustable from 10 ms to 100 seconds.

Manual sweep: front panel controls provide continuous manual adjustment of frequency between end frequencies.

External sweep: sweep is controlled by external signal applied to front or rear panel SWP OUTPUT/SWP INPUT connector.

Sweep output: direct-coupled sawtooth, zero to approximately ± 10 volts, at front or rear panel concurrent with swept RF output.

Instrument State Storage

Save n/recall n: up to 9 different front panel settings can be stored in the HP 8350B via the Save n (n = 1 through 9) function. Settings can be recalled randomly or in sequence.

Alt n: causes the RF output to alternate on successive sweeps between the current front panel setting and a setting stored in memory.



Instrument State

Instrument preset: sets the front panel of the HP 8350B into a pre-determined state. It also causes an internal analog and digital self-test to occur. If internal errors or failures are detected they are indicated via error codes.

Modulation

External AM: refer to RF unit specifications.

Internal AM: square wave modulation available at all sweep speeds. Factory preset to 27.8 kHz although selectable to 1000 Hz or 27.8 kHz. On/off ratio, refer to RF unit specifications.

External FM: refer to RF unit specifications.

Phase-lock: refer to RF unit specifications.

Remote Programming (HP-IB)

The HP 8350B has both input and output capability. The HP-IB address can be displayed on the front panel and is selectable (any number from 0 to 31). All front panel controls except the ac line power switch are programmable.

Frequency resolution: same as CF/ΔF plus vernier.

Power resolution: see HP 83500 Series Plug-ins.

Output mode functions: the HP 8350B can output to a controller an instrument state message that describes the present instrument status.

HP-IB interface functions: SH1, AH1, T6, L4, SR1, RL1, PPO, DC1, DT1, CO, E1.

General Specifications

Nonvolatile memory: continuous memory that retains the contents of all instrument state storage registers, the HP-IB address, and current instrument state when ac line power is off.

Blanking

RF: when enabled, RF turns off during retrace and remains off until next sweep.

Display: POS Z BLANK; direct-coupled rectangular pulse approximately +5.0 volts during retrace and bandswitch points of sweep. NEG Z BLANK; direct-coupled rectangular pulse approximately -5.0 volts coincident in time with RF blanking.

Pen Lift: output to control the pen lift function of XY recorder at end point of sweep.

Counter trigger (CNTR TRIG): output for controlling the external trigger input of the HP 5343A Frequency Counter.

Stop sweep: input for stopping the progress of a forward sweep, used with HP 5343A Frequency Counter.

Program connector: additional control of and information on the HP 8350B instrument state is provided via a 25 pin rear panel connector.

HP 8410C interface cable: permits multi-octave operation of HP HP 8410C Network Analyzer with HP 8350B.

Operating temperature range: 0°C to +55°C.

Power: 100, 120, 220 or 240 volts ±10%, 50 to 60 Hz (Option 400, 60 to 400 Hz). Approximately 270 volt-amps including RF unit.

Weight (not including RF unit): Net 16.5 kg (36.4 lb). Shipping 22.7 kg (50 lb).

Dimensions: 425 mm wide, 133.3 mm high, 422 mm deep (16.75" x 5.25" x 16.6").

Ordering Information

HP 8350B Sweep Oscillator Mainframe²

Options

400: 400 Hz Power Line Frequency Operation	add \$200
803: HP 5343A Interface Cables	add \$60
850: HP 8410C Source Control Cables	add \$100
908: Rack Mount Kit	add \$32.50
910: Extra Manual	add \$80
913: Rack Flange Kit for Instruments with Front Handles	add \$35

Price

\$4,565

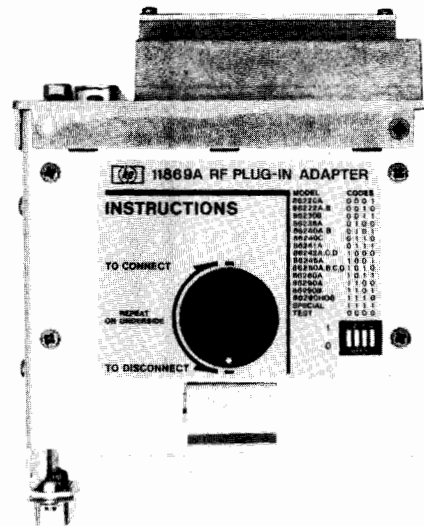

HP 11869A

HP 11869A Adapter

The HP 11869A adapter provides the electrical and mechanical interface between the HP 8350 and 86200 series plug-ins. All of the HP 8350's standard operating features, including HP-IB remote programming, are available. However, specific plug-in functions (output power level, RF on/off, etc.) cannot be controlled or remotely programmed by the HP 8350 mainframe.

Plug-ins With Rear Panel RF Output

Option 004 allows the adapter to be used with HP 86200-series plug-ins that are equipped with rear panel RF output.

Plug-ins Compatible With The HP 11869A Adapter

The HP 11869A adapter attaches to the back of the HP 86200 series plug-in and is equipped with a switch for setting the specific interface code for the plug-in being used.

The following plug-ins will operate in the HP 8350 by using the HP 11869A.

HP 86220A (0.01-1.3 GHz)	HP 86245A (5.9-12.4 GHz)
HP 86222A/B (0.01-2.4 GHz)	HP 86250A/B/C/D ¹ (8.0-12.4 GHz)
HP 86230B ¹ (1.8-4.2 GHz)	HP 86251A ³ (7.5-18.6 GHz)
HP 86235A (1.7-4.3 GHz)	HP 86260A (12.4-18.0 GHz)
HP 86240A/B (2.0-8.4 GHz)	HP 86260B (10.0-15.5 GHz)
HP 86240C (3.6-8.6 GHz)	HP 86260C (17.0-22.0 GHz)
HP 86241A (3.2-6.5 GHz)	HP 86290A ¹ (2.0-18.0 GHz)
HP 86242A/C/D ¹ (5.9-9.0 GHz)	HP 86290B/C (2.0-18.6 GHz)

HP 11869A Adapter

Options

\$405

004: Extension Cables for Plug-ins with Rear Panel RF Output add \$200

006: Type N Aux Out Interface Connector for HP 86251A and 86290A¹/B/C add \$200

¹Models 86230B, 86290A, 86250A/B/C, and 86242A/C are obsolete. However, existing models can interface to HP 8350B mainframe via the HP 11869A adapter.

²For transit cases see page 742

³Requires a special PROM for the HP 11869A, which is shipped with every HP 86251A.



SWEEP OSCILLATORS

Model 8350 Series: Broadband RF Plug-Ins

Models 83595A, 83592A/B/C, 83594A, 83590A

- Calibrated output power with 0.1 dB resolution
- -13 dBm from 0.01 to 18.6 GHz
- 12 MHz frequency accuracy at 26.5 GHz

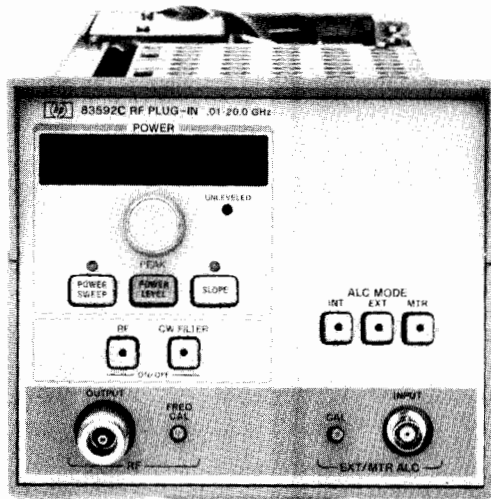

HP 83592C



The six HP 83590 series plug-ins feature wideband frequency coverage as exemplified by the HP 83595A which covers 0.01–26.5 GHz in a single sweep. While the HP 83590 series feature broadband sweeps, they still maintain narrowband precision. The frequency output exhibits excellent stability and accuracy. At 26.5 GHz the HP 83595A maintains an accuracy of ± 12 MHz. The HP 83592B does not sacrifice power for broadband high frequency coverage; the output power is internally leveled for a minimum +13 dBm (to 18.6 GHz) output with ± 0.9 dB flatness. The HP 83592C provides a clean test signal with -55 dBc harmonic and subharmonic levels to maximize dynamic range. Power output capabilities have been expanded to provide power sweep and slope control. In addition, the HP 83590 series plug-ins are completely HP-IB programmable.

The most outstanding feature of the HP 83590 series plug-ins is their broad frequency range. Innovative technology is used to create this precision frequency range. The principle behind this technology is the Switched YIG Tuned Multiplier circuit (SYTM). The YTM circuit uses the output of a fundamental oscillator to drive a high-efficiency multiplier that has been integrated with a tracking YIG filter in order to create and select high order harmonics to be used as output frequencies.

A figure of merit for the HP 83590 series is their flat output power over the entire frequency range. The output power is internally leveled within 0.9 dB for a minimum output power of 10 dBm, with a displayed resolution of 0.1 dB. The power level may be controlled to a minimum settable power level of -5 dBm. This level may be extended to -75 dBm on the HP 83592A/B and HP 83590A with Option 002 (70 dB Step Attenuator) or to -60 dBm on the HP 83592C, the HP 83595A and HP 83594A with Option 002 (55 dB Step Attenuator).

Since power parameters are critical to high frequency measurements, the HP 83590 Series (along with all HP 83500 series plug-ins) offer many modes of power output. In addition to a single power output, the HP 83590 Series offer a Power Sweep function. The Power Sweep function sweeps a power range for characterizing level sensitive devices like amplifiers and transistors. The Slope mode is supplied to provide compensation for cable or test set losses. In all these modes the power output is internally monitored and leveled. If preferred, the power may be externally leveled. The HP 83590 Series plug-ins are capable of power meter leveling with the HP 432A/B/C, 436A, and 438A power meters.

HP-IB programmability is an essential feature when one of the HP 83590 series is used in automatic test systems. For example, the automated tests of amplifiers for gain compression are possible. These plug-ins are completely programmable, which means the power mode may be selected and the power level may be set with .02 dB resolution.

- -55 dBc harmonics and subharmonics from 3.5 to 20 GHz
- Internal leveling and slope standard
- HP-IB

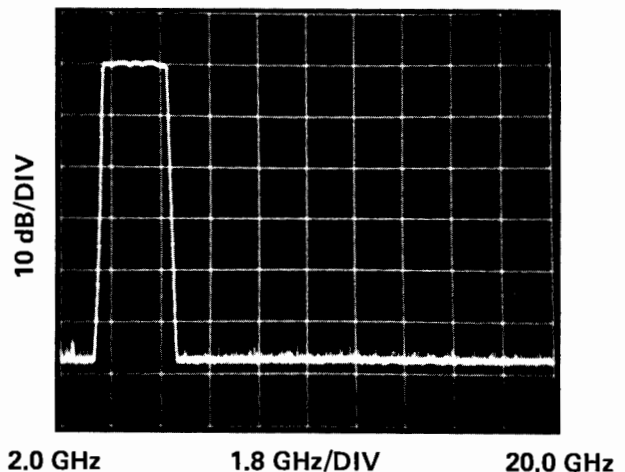

General Specifications

Sweep time (minimum): 10 ms for a single band (Bands 0, 1, 2, 3, 4). 25 ms for full band (HP 83590A, 83592A/B).

Switch points: HP 83595A, 83592A/B/C: Internal bands are 0.01–2.4 GHz, 2.3–7.0 GHz, 6.9–13.5 GHz, 13.4–20.0 GHz and 19.9–26.5 GHz (HP 83595A only). Broadband switch points are at approximately 2.4 GHz, 7.0 GHz, 13.5 GHz and 20.0 GHz (HP 83595A only). HP 83594A, 83590A: Internal bands are 2.0–7.0 GHz, 6.9–13.5 GHz, 13.4–20.0 GHz and 19.9–26.5 GHz (HP 83594A only). Broadband switch points are at approximately 7.0 GHz, 13.5 GHz and 20.0 GHz (HP 83594A only).

Auxiliary output: HP 83595A, 83592A/B/C: Rear panel 2.3–7.0 GHz fundamental oscillator output, nominally 0 dBm. HP 83594A, 83590A: Rear panel 2.0–7.0 GHz fundamental oscillator output, nominally 0 dBm.

Frequency reference output: (1 V/GHz or 0.5 V/GHz internal switch selectable, rear panel BNC output): HP 83595A, 83592A/B/C: nominal 1 V/GHz (0.01–19 GHz) ± 25 mV; nominal 0.5 V/GHz (full frequency coverage) ± 25 mV. HP 83594A, 83590A: nominal 1 V/GHz (2–19 GHz) ± 25 mV; nominal 0.5 V/GHz (full frequency coverage) ± 25 mV.

RF output connector: HP 83595A, 83594A: Type APC 3.5 male. HP 83592A/B/C, 83590A: Type N female.

Weight: net, 6.0 kg (13.2 lb); shipping, 9.2 kg (20 lb).

Improved Network Measurement Capabilities

These plug-ins are compatible with the:

- HP 8510 Network Analyzer
- HP 8410 Network Analyzer
- HP 8757A Scalar Network Analyzer
- HP 8756A Scalar Network Analyzer
- HP 8970A Noise Figure Meter
- HP 8709A Phase-Lock Synchronizer
- HP 5344S Source Synchronizer

Output Characteristics

Impedance: 50 Ω nominal.

VSWR: $< 1.9:1$

Power Sweep (with option 002 Power Sweep cannot cross an attenuator step)

Calibrated range: HP 83590A, 83592A/B/C: > 10 dB (15 dB typical); HP 83594A, 83595A: 9 dB.

Accuracy (including linearity): $< \pm 1.5$ dB typical.

Resolution: 0.1 dB.

Slope Compensation (with option 002 Slope cannot cross an attenuator step).

Calibrated range: up to 0.5 dB/GHz (10 dB over full range).

Linearity: <0.3 dB typical.

Resolution: 0.1 dB/GHz.

Attenuator Accuracy (\pm dB referenced from the 0 dB setting, HP 83590A, 83592A/B only).

Frequency Range (GHz)	Attenuator Setting (dB)						
	10	20	30	40	50	60	70
0.01-12.4	0.6	0.7	0.9	1.8	2.0	2.2	2.3
12.4-18.0	0.7	0.9	1.2	2.0	2.3	2.5	2.8
18.0-20.0	0.9	1.5	2.5	3.0	3.2	3.3	3.5

Modulation Characteristics

External AM

Frequency response: typically 100 kHz.

Input impedance: approximately 10 k Ω .

Range of amplitude control: typically 15 dB.

Sensitivity: 1 dB/V typical.

Maximum input: 15 V.

Pulse In (HP 83595A and 83592A/B/C only)

TTL Compatible: Logic high = RF on, logic low = RF off.

0.01 to 20.0 GHz: Squarewave modulation up to 30 kHz.

On/Off Ratio: \geq 30 dB below specified maximum leveled power.

0.01 to 2.5 GHz

Rise/Fall Time: typically 50 ns.

Minimum Pulse Width

Leveled: 1 μ sec.

Unleveled: typically 200 ns.

2.5 to 20 GHz

Rise/Fall Time: typically 10 ns.

Minimum Pulse Width

Leveled: typically 1 μ s.

Unleveled: typically 100 ns.

External FM

Maximum Deviations for Modulation Frequencies

DC to 100 Hz: \pm 75 MHz.

100 Hz to 1 MHz: \pm 7 MHz.

1 MHz to 2 MHz: \pm 5 MHz.

2 MHz to 10 MHz: \pm 1 MHz.

Sensitivity

FM Mode: -20 MHz/V typical.

Phase-lock mode: -6 MHz/V typical.

Input impedance: 2 k Ω nominal.

Frequency response (DC to 2 MHz): \pm 3 dB.



Ordering Information

Price

HP 83590A 2.0 to 20 GHz RF Plug-in	\$17,700
Option 002: 70 dB Step Attenuator	add \$1,305
Option 004: Rear Panel RF Output	add \$200
HP 83592A 0.01 to 20 GHz RF Plug-in	\$20,500
Option 002: 70 dB Step Attenuator	add \$1,305
Option 004: Rear Panel RF Output	add \$200
HP 83592B 0.01 to 20 GHz (13 dBm) RF Plug-in	\$23,500
Option 002: 70 dB Step Attenuator	add \$1,305
Option 004: Rear Panel RF Output	add \$200
HP 83592C 0.01 to 20 GHz (-55 dBc harmonics) RF Plug-in	\$22,000
Option 002: 55 dB Step Attenuator	\$1,305
Option 004: Rear Panel RF Output	\$200
HP 83594A 2.0 to 26.5 GHz RF Plug-in	\$22,820
Option 002: 55 dB Step Attenuator	add \$1,305
Option 004: Rear Panel RF Output	add \$200
HP 83595A 0.01 to 26.5 GHz RF Plug-in	\$26,000
Option 002: 55 dB Step Attenuator	add \$1,305
Option 004: Rear Panel RF Output	add \$200

	HP 83592A/B/C HP 83590A (excluding Band 0)					HP 83594A HP 83594A (excluding Band 0)					
	Band 0	Band 1	Band 2	Band 3	Full Band	Band 0	Band 1	Band 2	Band 3	Band 4	Full Band
	.01-2.4	2.4-7.0	7.0-13.5	13.5-20	.01-20	.01-2.4	2.4-7.0	7.0-13.5	13.5-20	20-26.5	.01-26.5
Frequency Characteristics											
Accuracy: (25°C \pm 5°C)											
CW Mode: (MHz)	\pm 5	\pm 5	\pm 10	\pm 10		\pm 5	\pm 5	\pm 10	\pm 10	\pm 12	
Typically: (MHz)	\pm 2	\pm 2	\pm 3	\pm 4		\pm 2	\pm 2	\pm 3	\pm 4	\pm 5	
All Sweep Modes (100ms Sweep Time): (MHz)	\pm 15	\pm 20	\pm 25	\pm 30	\pm 50	\pm 15	\pm 20	\pm 25	\pm 30	\pm 35	\pm 50
Linearity: Typ. (MHz)	\pm 2	\pm 2	\pm 4	\pm 6	\pm 10	\pm 2	\pm 2	\pm 4	\pm 6	\pm 10	\pm 15
Stability											
With Temperature: Typically (MHz/°C)	\pm 0.2	\pm 0.2	\pm 0.4	\pm 0.6	\pm 0.6	\pm 0.2	\pm 0.2	\pm 0.4	\pm 0.6	\pm 0.8	\pm 0.8
With 10% Line Voltage Change: (kHz)	\pm 50	\pm 50	\pm 100	\pm 150	\pm 150	\pm 50	\pm 50	\pm 100	\pm 150	\pm 200	\pm 200
With 10 Power Level Change: (kHz)	\pm 200	\pm 200	\pm 400	\pm 600	\pm 600	\pm 200	\pm 200	\pm 400	\pm 600	\pm 800	\pm 800
With 3:1 Load VSWR: (kHz)	\pm 100	\pm 100	\pm 200	\pm 300	\pm 300	\pm 100	\pm 100	\pm 200	\pm 300	\pm 400	\pm 400
With Time (after 1 hour warmup at the same frequency)											
Typically (kHz)	<100	<100	<200	<300	<300	<100	<100	<200	<300	<400	<400
Residual FM (20 Hz-15kHz bandwidth, peak): (kHz)	<8	<5	<7	<9		<5	<5	<7	<9	<12	
Output Characteristics											
Maximum Leveled Power ^D : (mW) (25°C)	10,(20) ^B	10,(20), ^A (4) ^C	10,(20), ^A (4) ^C	10,(2.5) ^C	10,(2.5) ^C	10	10	10	10	2.5	2.5
Opt 002	10,(16) ^B	7,(14) ^B , (3.2) ^C	6.3,(14) ^B , (2.5) ^C	5,(1.4) ^C	3.2,(1.4) ^C	10	7	6.3	5	1.25	1.25
Power Level Accuracy											
(Internally Leveled): (dB)	< \pm 1.5	< \pm 1.3	< \pm 1.3	< \pm 1.4	< \pm 1.5	< \pm 1.5	< \pm 1.3	< \pm 1.3	< \pm 1.4	< \pm 1.7	< \pm 1.8
Minimum Settable Power: (dBm)	-5	-5	-5	-5	-5	-5	-5	-5	-5	-5	-5
With Opt 002	-75,(-60) ^C	-75,(-60) ^C	-75,(-60) ^C	-75,(-60) ^C	-75,(-60) ^C	-60	-60	-60	-60	-60	-60
Remote Programming Resolution Displayed: (dB)	0.1	0.1	0.1	0.1	0.1	0.1	0.1	0.1	0.1	0.1	0.1
Settable (dB)	.02	.02	.02	.02	.02	.02	.02	.02	.02	.02	.02
Power Variation (Max. Rated Pwr)											
Internally Leveled: (dB)	< \pm 0.9	< \pm 0.7	< \pm 0.7	< \pm 0.8	< \pm 0.9	\pm 0.9	\pm 0.7	\pm 0.7	\pm 0.8	\pm 0.9	\pm 1.0
Externally Leveled (Excludes Coupler/Detector Variation)											
(For Negative Crystal Detector and Power Meter): (dB)	< \pm 2	< \pm 2	< \pm 2	< \pm 2	< \pm 2	< \pm 2	< \pm 2	< \pm 2	< \pm 2	< \pm 2	< \pm 2
With Temperature: (dB/°C)	0.1	0.1	0.1	0.1	0.1	0.1	0.1	0.1	0.1	0.1	0.1
Residual AM in 100 kHz Bandwidth: (dBc)	<-50	<-50	<-50	<-50	<-50	<-50	<-50	<-50	<-50	<-50	<-50
Spurious Signals											
Harmonically Related: (dBc)	<-25,(20) ^{B,E}	<-25,(<-55) ^F	<-25,(<-55) ^F	<-25,(<-55) ^F	<-25	<-25	<-25	<-25	<-25	<-20	<-20
Typically: (dBc)	<-35 ^F	<-40,(<-60) ^F	<-35,(<-60) ^F	<-35,(<-60) ^F	<-35	<-35	<-40	<-35	<-35	<-35	<-35
Non-Harmonics: (dBc)	<-25	<-50,(<-55) ^F	<-50,(<-55) ^F	<-50,(<-55) ^F	<-50 ^F	<-25	<-50	<-50	<-50	<-50	<-50

^A Band 1 on the HP 83590A and the HP 83594A covers 2.0-7.0 GHz, and Full Band on the HP 83590A and 83594A covers 2-20 GHz and 2-26.5 GHz.

^B HP 83592B only.

^C HP 83592C only.

^D 0.5 dB lower with Opt 004.

^E HP 83592C only; <-25 dBc (0.01-1.4 GHz)

<-45 dBc (1.4-2.4 GHz)

<-50 dBc (2.4-3.5 GHz)

<-55 dBc (3.5-7.0 GHz)

^F HP 83592C <-35 dBc (0.01-1.4 GHz); <-50 dBc (1.4-2.4 GHz)

^G With HP 83592 A/B/C (0.01 - 20GHz): -25 dBc



SWEEP OSCILLATORS

Model 8350 Series: Broadband RF Plug-Ins (cont.)

Models 83522A, 83525A and 83525B

- 10 MHz–2.4 GHz and 10 MHz–8.4 GHz in one continuous sweep
- Calibrated output power
- Power sweep

- 1, 10, and 50 MHz crystal markers
- HP 83525B with > -45 dBc harmonics from 2–8.4 GHz
- Complete HP-IB programmability

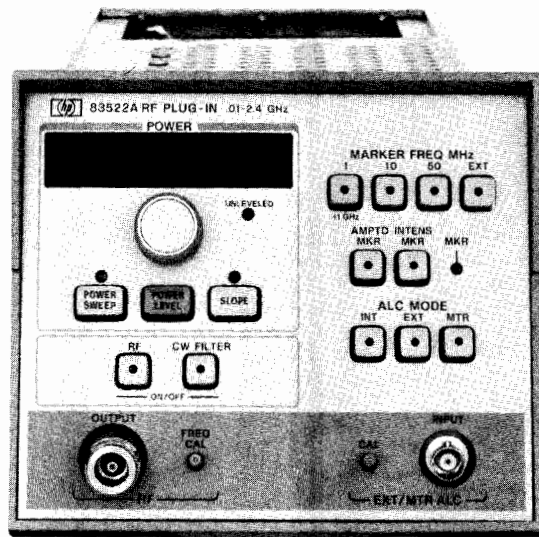

HP 83522A

Broadband frequency measurements may be made with the HP 83522A (10 MHz to 2.4 GHz) plug-in and the HP 83525A/B (10 MHz to 8.4 GHz) plug-in. These plug-ins have similar functions as well as individual merits which are described below.

HP 83522A

The HP 83522A uses a heterodyne circuit to provide high performance 10 MHz to 2.4 GHz frequency coverage. This frequency range is covered in one continuous sweep having excellent frequency characteristics. Frequency accuracy is maintained within 5 MHz and the linearity is within 1 MHz over the full band. The power output is internally leveled to ± 0.25 dB flatness over the entire 10 MHz to 2.4 GHz range while maintaining a power level ≥ 13 dBm.

HP 83525A/B

The HP 83525A/B cover the frequency range of 10 MHz to 8.4 GHz with excellent frequency stability, accuracy, and output power. This wide frequency range is created by automatically switching two bands together with a PIN diode switch. The lower frequency band covers 0.01–2.1 GHz which results from a heterodyne circuit. The upper frequency band is produced by a 2–8.4 GHz YIG oscillator. This 0.1 GHz frequency overlap is provided to enable smooth, narrowband sweeps around the switch point. On a full band sweep (10 MHz to 8.4 GHz) the band discontinuity at the switch point is typically < 8 MHz. The HP 83525A/B maintain excellent frequency parameters with a lower band accuracy within ± 5 MHz and an upper band accuracy within ± 12 MHz. Full band frequency linearity is ± 3 MHz while the lower band maintains a linearity of ± 2 MHz.

The HP 83525A plug-in, with its extremely broad frequency range, does not sacrifice power. This plug-in provides at least +13 dBm of output power while being internally leveled to a flatness of ± 1 dB.

The HP 83525B plug-in provides the same outstanding specifications as the HP 83525A plus 45 dBc harmonics for maximum dynamic range in RF component and system measurements.

HP 83522/83525 Common Features

Crystal Marker Capability

A powerful feature offered by the HP 83522A and the HP 83525A/B is Crystal Marker capability. This capability provides harmonic markers at 10 or 50 MHz intervals over the full range of the HP 83522A and below 2 GHz with the HP 83525A/B. In addition, 1 MHz harmonic markers are available below 1 GHz with all three

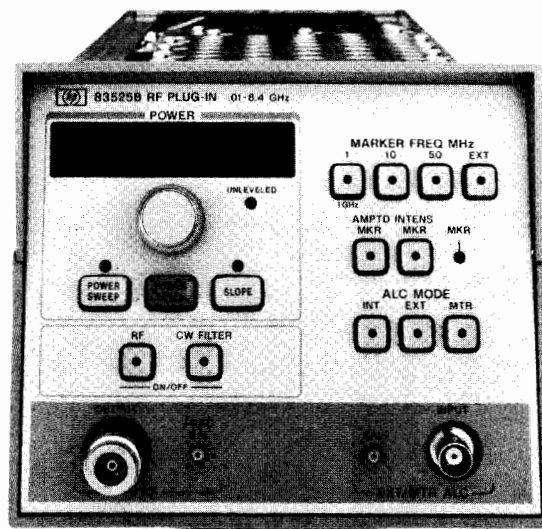

HP 83525B



plug-ins. These markers may be seen as either intensity spots or amplitude dips. The amplitude markers are compatible with the HP 8756A and 8757A Scalar Network Analyzers. These crystal markers simplify and speed up precision frequency measurements.

Power Output

The HP 83522A and the HP 83525A/B plug-ins have a calibrated output power range of typically 15 dB that may be extended to > 80 dB with Option 002 (70 dB attenuator). The output power level accuracy is within 1 dB on the HP 83522A and within 1.5 dB on the HP 83525A/B. The front panel digital resolution enables the power to be manually set to a 0.1 dB resolution. The power may be remotely HP-IB programmed to 0.02 dB resolution.

In addition to a single power output, these plug-ins offer a Power Sweep function. The Power Sweep function sweeps a power range for characterizing level sensitive devices like amplifiers and transistors. The Slope mode is supplied to provide compensation for cable or test set losses.

Programmability

The HP 83522A and the HP 83525A/B are completely programmable plug-ins. This infers that the power level, power mode (Power Sweep, Slope, etc.), crystal markers and other plug-in functions may be externally controlled via the HP-IB. Programmability is a key feature for automatic test systems or production environments requiring multiple, repetitive tests.

Network Measurements

Increased dynamic range scalar measurements can be made using either the HP 83522A or the 83525A with the HP 8756A or the HP 8757A Scalar Network Analyzer. In the AC detection mode, the dynamic range is increased by internally modulating the RF output with the required 27.8 kHz square wave (produced by the HP 8350). This causes the output to be modulated before it is passed through the output amplifier, thereby avoiding modulation of the amplifier noise. The advantage of increased dynamic range is complemented by the simple interface between the sweep oscillator and the HP 8756/8757A. In addition, these plug-ins are directly compatible with the HP 8510 and the HP 8410s' Network Analyzer, for vector and scalar measurements, the HP 8970A Noise Figure Meter for noise level analysis, and the HP 5344S Source Synchronizer for phase-lock applications.



Frequency Characteristics

Range	HP 83522A	HP 83525A/B	
	0.01-2.4 GHz	0.01-2 GHz	2-8.4 GHz
Accuracy* (25°C ±5°C) CW Mode: Typically: All Sweep Modes Linearity Typically:	±5 MHz ±1.5 MHz ±15 MHz ±1 MHz	±5 MHz ±1.5 MHz ±15 MHz ±2 MHz	±12 MHz ±3.5 MHz ±20 MHz ±3 MHz
Stability With Temperature: Typically With 10% Line Voltage Change: With 10 dB Power Level Change: With 3:1 Load SWR: With Time (in 10 minute period after one hour warmup at the same frequency setting): Typically Residual FM (20 Hz-15 KHz Bandwidth), peak:	±200 kHz/°C ±20 kHz ±100 kHz ±10 kHz ≤±100 kHz ≤5 kHz	±200 kHz/°C ±20 kHz ±100 kHz ±10 kHz ≤±100 kHz ≤5 kHz	±200 kHz/°C ±20 kHz ±1 MHz ±250 kHz ≤±200 kHz ≤7 kHz

Output Characteristics

	HP 83522A	HP 83525A/B	
	0.01-2.4 GHz	0.01-2 GHz	2-8.4 GHz
Maximum Leveled Output Power (25°C ± 5°C) With Option 002	+20 mW +20 mW	+20 mW +20 mW	+20 mW/10 mW +20 mW/10 mW
Power Level Accuracy (Internally Leveled): Attenuator Accuracy (per 10 dB step, typical): Calibrated Range: With Option 002: Resolution (displayed): Remote Programming (Settable):	±1 dB ±0.3 dB 15 dB 85 dB 0.1 dB ±0.01 dB	±1.5 dB ±0.3 dB 15 dB 85 dB 0.1 dB ±0.01 dB	±1.5 dB ±0.3 dB 15 dB 85 dB 0.1 dB ±0.01 dB
Power Variation (Max. Rated Pwr) Internally Leveled: Externally Leveled (Excludes Coupler/Detector Variation) For Negative Crystal Detector or Power Meter: With Temperature:	±0.25 dB ≤±0.1 dB ±0.02 dB/°C	±1 dB ≤±0.1 dB ±0.02 dB/°C	±1 dB ≤±0.1 dB ±0.02 dB/°C
Residual AM in 100 kHz Bandwidth:	<-50 dBc	<-50 dBc	<-50 dBc
Spurious Signals Harmonics (for 10 mW output pwr): Typical: Non-Harmonics: Typical:	<-25 dBc <-30 dBc <-25 dBc <-30 dBc	<-25 dBc** <-30 dBc <-30 dBc <-35 dBc	<-25 dBc/ 45 dBc <-30 dBc/50 dBc <-60 dBc <-60 dBc
Output VSWR (internally leveled)	<1.5	<2.0	<1.6

Unleveled indicator: lights when RF power level is set too high to permit leveling over sweep range selected.

Impedance: 50 Ω nominal

Power Sweep

Calibrated range: 15 dB

Accuracy (including linearity): <±1.5 dB typical

Resolution: 0.1 dB

Slope Compensation

Calibrated range: up to 5 dB/GHz (10 dB over full range, typically 15 dB)

Linearity: <0.2 dB typical

Resolution: 0.01 dB/GHz

Modulation Characteristics

External AM

Frequency response: 100 kHz typically

Input impedance: Approximately 10 kΩ

Range of amplitude control: 15 dB typically

Sensitivity: 1 dB/V typically

Maximum input: 15 V

Pulse modulation: (HP 83525A/B, 2-8.4 GHz)

Rise/fall time: 20 ns typically

Minimum pulse width: Leveled: 1 μs (HP 83525A), 5 μs (HP 83525B) typically
Unleveled: 100 ns typically

*When calibrated using internal crystal markers and FREQ CAL adjustment.

**83525A harmonics <- 20 dBc for 20 mW output power.

Internal AM

Selectable (by internal jumper in HP 8350) to 1 kHz or 27.8 kHz square-wave modulation. 27.8 kHz modulation guarantees operation with HP 8755 Frequency Response Test Set.

On/Off Ratio: ≥30 dB (>40 dB above 2 GHz)

External FM

Maximum Deviations for Modulation Frequencies

DC to 100 Hz: ±75 MHz

100 Hz to 1 MHz: ±7 MHz

1 MHz to 2 MHz: ±5 MHz

2 MHz to 10 MHz: ±1 MHz

Sensitivity

FM Mode: -20 MHz/V typical

Phase-lock mode: -6 MHz/V typical

Input impedance: 2 kΩ nominal

Frequency response (dc to 2 MHz): ±3 dB

Crystal Marker Capability

Internal crystal markers: Harmonic markers of 10 and 50 MHz are available over the full range of the HP 83522A and below 2 GHz with HP 83525A/B. 1 MHz harmonic markers are available below 1 GHz with the HP 83522A and 83525A/B. Markers are output as intensity spots through the POS Z BLANK connector on the HP 8350 or as amplitude dips on the RF output.

Accuracy of center frequencies (25°C): ±5 x 10⁻⁶

Typical Marker Width Around Center Frequency

1 MHz Markers: ±100 kHz

10 MHz Markers: ±200 kHz

50 MHz Markers: ±300 kHz

Temperature stability: ±2 x 10⁻⁶/°C typical

External marker input: generates amplitude or Z-axis marker when sweep frequency equals external input frequency.

Frequency range: .01 to 2.4 GHz (2.0 GHz for HP 83525A/B)

Marker width: ±300 kHz

Marker indicator light: LED lights when coincident with crystal or external marker for accurate CW calibration.

General Specifications

Sweep Time (minimum over full band)

HP 83522A (.01-2.4 GHz): 10 ms

HP 83525A/B (.01-8.4 GHz): 17 ms

Switch points (HP 83525A/B only): low band .01-2.1 GHz, high band 2.0-8.4 GHz. Internal band switch point at 2.0-2.1 GHz.

Frequency reference output: nominal 1 V/GHz (over full sweep range); ±10 mV rear panel BNC output.

RF Output connector: type N female

Weight: net, 4.5 kg (10 lb); shipping, 7.7 kg (17 lb)

Improved Network Measurement Capabilities

The HP 83522A and 83525A/B are compatible with the:

HP 8510 Network Analyzer

HP 8410 Network Analyzer

HP 8757A Scalar Network Analyzer

HP 8756A Scalar Network Analyzer

HP 8970A Noise Figure Meter (frequencies >2 GHz)

HP 8709A Phase-lock Synchronizer

HP 5344S Source Synchronizer

Ordering Information

HP 83522A (+13 dBm) .01-2.4 GHz RF Plug-in

Options

002: 70 dB Step Attenuator

004: Rear Panel RF Output

HP 83525A (+13 dBm) .01-8.4 GHz RF Plug-in

HP 83525B (+10 dBm) .01-8.4 GHz RF Plug-in

Options

002: 70 dB Step Attenuator

004: Rear Panel RF Output

Price

\$8,170

add \$1,005

add \$200

\$12,500

\$13,500

add \$1,105

add \$200



SWEEP OSCILLATORS

Model 8350 Series: RF Plug-Ins

Models 83540A, 83540B, 83545A, and 83550A

- HP 83540A: 40 mW internally leveled 2–8.4 GHz output
- HP 83545A: 50 mW internally leveled 5.9–12.4 GHz output
- HP 83540B: ± 45 dBc harmonics 2–8.4 GHz output
- HP 83550A: 100 mW internally leveled 8–18.6 GHz output, built in source module interface
- Calibrated output power with 0.1 dB resolution
- Power sweep
- Complete HP-IB programmability

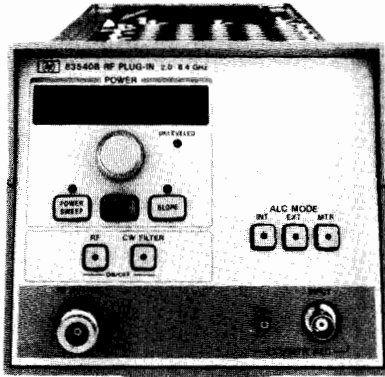

HP 83540B

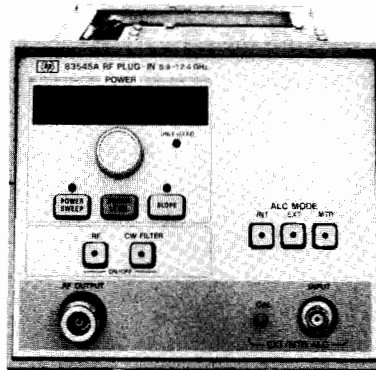

HP 83545A

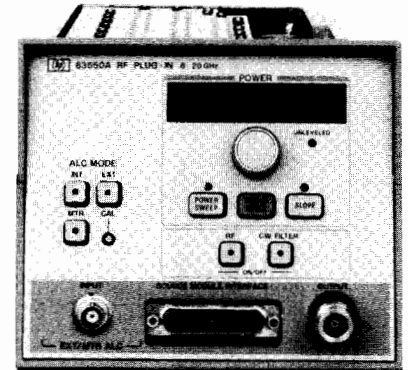

HP 83550A



HP 83540A/B

High power, high performance, straddle band frequency coverage from 2–8.4 GHz is provided by the HP 83540 plug-ins. The output power is leveled at a minimum of +16 dBm from the HP 83540A and +13 dBm from the HP 83540B with variations less than ± 1 dB. The calibrated power output range is 15 dB which may be extended to >80 dB with Option 002 (70 dB step attenuator). These plug-ins also feature power sweep which allows real time power response measurements to be made in a single test. Another power function is slope compensation which adjusts for high frequency cable or test set losses. All plug-in features are completely HP-IB programmable. The frequency outputs are accurate to $<\pm 15$ MHz while maintaining a full band linearity typically within 0.1%. In addition to its sweeper functions, the HP 83540 is also directly compatible with the HP 8756A and 8757A scalar network analyzers and the HP 8510 and HP 8410C vector network analyzers.

The HP 83540B gives emphasis to signal purity with 45 dBc harmonics for extended dynamic range in precision RF scalar measurement systems.

HP 83545A

The HP 83545A plug-in features high performance 5.9–12.4 GHz frequency coverage with exceptionally high output power. The output power is internally leveled to at least +17 dBm, with power variations less than ± 0.6 dB. The calibrated output power has a range of 15 dB that is expandable to >80 dB with option 002 (70 dB step attenuator). A power sweep function is available for power response measurements. In addition, the HP 83545 provides slope compensation and complete HP-IB programmability. The frequency output is accurate to ± 20 MHz with excellent stability and linearity (typically 0.1%). Network analysis is simplified since the HP 83545 provides 27.8 kHz internal modulation for direct compatibility with the HP 8756A and 8757A scalar network analyzers and it is also directly compatible with the HP 8510 and 8410C network analyzers.

HP 83550A

The HP 83550A is a new, high power 8.0–20.0 GHz plug-in that provides +20 dBm of output power to 18.6 GHz and +18 dBm of output power from 18.6 to 20.0 GHz. This high output power is internally leveled with variations of less than ± 1.25 dB. The output power has a range of at least 18 dB that is expandable to >68 dB with option 002 (50 dB step attenuator) and the frequency output is accurate to ± 20 MHz.

The HP 83550A is also equipped with a source module interface that allows it to be used as a microwave driver for the HP millimeter-wave source modules. These modules are frequency multipliers that effectively extend Hewlett-Packard's microwave sources like the HP 83550A to the millimeter-wave frequency range. Currently these source modules cover the 26.5–40.0 GHz (HP 83554A), the 33.0–50.0 GHz (HP 83555A), and the 40.0–60.0 GHz (HP 83556A) millimeter-wave frequency bands. The HP 83550A is the perfect microwave driver for these source modules as it can directly supply the +17 dBm of output power from 11 to 20 GHz these source modules need and also supplies the DC bias and control signals through the source module interface.

The HP 83550A is directly compatible with the HP 8756A and 8757A scalar network analyzers and the HP 8510A and 8410C vector network analyzers.

General Specifications

RF output connector: type N female

Sweep time (minimum over full band): 10 msec

Weight: HP 83540A/B, HP 83545A, HP 83550A: net, 4.5 kg (10 lb); shipping, 7.7 kg (17 lb)

Improved Network Measurement Capabilities

The HP 83540A/B, 83545A, and 83550A are compatible with the:

- HP 8510 Vector Network Analyzer
- HP 8410 Vector Network Analyzer
- HP 8755 Scalar Network Analyzer
- HP 8756A Scalar Network Analyzer
- HP 8757A Scalar Network Analyzer
- HP 8970A Noise Figure Meter
- HP 8709A Phase-lock Synchronizer
- HP 5344S Source Synchronizer



Frequency Characteristics

	HP 83540A	HP 83540B	HP 83545A	HP 83550A
Range:	2-8.4 GHz	2-8.4 GHz	5.9-12.4 GHz	8-20 GHz
Accuracy (25°C + 5°C) CW Mode: Typical: All Sweep Modes (for sweep times >100 msec):	±15 MHz ±3.5 MHz ±20 MHz	±12 MHz ±3.5 MHz ±20 MHz	±20 MHz ±10 MHz ±35 MHz	±20 MHz — ±50 MHz
Stability With Temperature: With 10% Line Voltage Change: With 10 dB Power Level Change: With 3:1 Load SWR Change: With Time: (in 10 minute time period after one hour warmup at the same frequency setting: Residual FM: (20 Hz-15 kHz bandwidth) peak	±200 kHz/°C ±20 kHz ±1 MHz ±250 kHz ±200 kHz <9 kHz	±200 kHz/°C ±20 kHz ±1 MHz ±250 kHz ±200 kHz <7 kHz	±1.2 MHz/°C ±40 kHz ±1.5 MHz ±250 kHz ±200 kHz <15 kHz	±1 MHz/°C ±150 kHz* ±500 kHz ±500 kHz ±1 MHz* <25 kHz

Output Characteristics

Maximum Levelled Power: (25°C+5°C) With Opt. 002	>40 mW >32 mW	>20 mW >16 mW	>50 mW >40 mW	>100 mW, 8-18.6 GHz >60 mW, 18.6-20 GHz >50 mW, 8-18.6 GHz >30 mW, 18.6-20 GHz
Power Variation (at max rated power) Internally Levelled: Unlevelled: Typically Externally Levelled (Excluding coupler and detector variations): Crystal Detector or Power Meter: Power Level Accuracy: Option 002: (at 0 dB attenuator step) Power Sweep Calibrated Range: Accuracy (including linearity): typical Resolution: Slope Compensation Calibrated Range (max): Maximum Allowable Power Difference: Linearity: Typical Resolution:	<±1 dB <±2 dB <±0.1 dB <±1.5 dB <±1.7 dB >15 dB ±1.5 dB 0.1 dB 5 dB/GHz 10 dB <0.2 dB 0.01 dB	<±1 dB <±2 dB <±0.1 dB <±1.5 dB <±1.7 dB >15 dB ±1.5 dB 0.1 dB 5 dB/GHz 10 dB <0.2 dB 0.01 dB	<±0.6 dB <±3 dB <±0.1 dB <±1 dB* <±1 dB* >15 dB ±1.5 dB 0.01 dB 5 dB/GHz 10 dB <0.2 dB 0.01 dB	<±1.25 dB — <±0.1 dB* <±1.5 dB <±1.7 dB >18 dB ±1.5 dB 0.1 dB 5 dB/GHz 18 dB — 0.01 dB
Spurious Signals: (Below fundamental at specified max power) Harmonically Related: Non-Harmonics: Source VSWR: 50 ohms nominal impedance Internally levelled: Unlevelled: Typically Residual AM in 100 kHz Bandwidth:	<-20 dBc <-60 dBc <1.6 <2.5 <-50 dBc	<-45 dBc <-60 dBc <1.6 <2.5 <-50 dBc	<-17 dBc, 5.9-7 GHz <-30 dBc, 7-12.4 GHz <-60 dBc <1.6 <2.5 <-50 dBc	<-15 dBc, 8-11 GHz <-20 dBc, 11-20 GHz <-50 dBc <2.5 <3.8, 8-11 GHz <3.2, 11-20 GHz <-50 dBc
Modulation Characteristics External FM Maximum Deviations DC to 100 Hz: 100 Hz to 1 MHz: 1 MHz to 2 MHz: 2 MHz to 6 MHz: 6 MHz to 10 MHz: Sensitivity: Nominal FM Mode: Phase-lock Mode:	±75 MHz ±7 MHz ±5 MHz ±1 MHz ±1 MHz -20 MHz/V -6 MHz/V	±75 MHz ±7 MHz ±5 MHz ±1 MHz ±1 MHz -20 MHz/V -6 MHz/V	±75 MHz ±7 MHz ±5 MHz ±1.5 MHz ±1.5 MHz -20 MHz/V -6 MHz/V	±75 MHz ±13.5 MHz ±13.5 MHz ±13.5 MHz — -20 MHz/V -6 MHz/V
External AM Input Impedance: nominal Frequency Response: Typical Range: Typical Pulse Modulation Rise/Fall Time: Typical Minimum Pulse Width Levelled: Typical Unlevelled: Typical Square Wave Response On/Off Ratio: Typical Symmetry: Typical	33 kohms 100 kHz 15 dB 20 nsec 1 usec 100 nsec >30 dB 40/60	33 kohms 100 kHz 15 dB 20 nsec 5 usec 100 nsec >30 dB 40/60	33 kohms 100 kHz 15 dB 15 nsec 1 usec 100 nsec >40 dB 40/60	35 kohms 100 kHz 20 dB 25 nsec 1 usec 100 nsec >30 dB 45/55
Internal AM Selectable to 1 kHz or 27.8 kHz square wave On/Off Ratio:	>30 dB	>30 dB	>30 dB	>30 dB

*Denotes typical values

Ordering Information

HP 83540A 2-8.4 GHz Plug-in
002: 70 dB Step Attenuator
004: Rear Panel RF Output
910: Extra Manual

Price
\$9,780
add \$1,105
add \$200
add \$40

HP 83540B 2-8.4 GHz Plug-in
002: 70 dB Step Attenuator
004: Rear Panel RF Output
910: Extra Manual

\$10,280
add \$1,105
add \$200
add \$40

HP 83545A 5.9-12.4 GHz Plug-in
002: 70 dB Step Attenuator
004: Rear Panel RF Output
910: Extra Manual

\$9,780
add \$1,105
add \$200
add \$40

HP 83550A 8-20 GHz Plug-in
002: 50 dB Step Attenuator
004: Rear Panel RF Output
006: Rear Panel AUX OUT
910: Extra Manual

\$13,000
add \$1,305
add \$200
add \$450
add \$40

SWEEP OSCILLATORS

Model 8350 Series: RF Plug-Ins (cont.)

Models 83570A, 83572A and 83572B

- HP 83572B offers 5 mW minimum unlevelled 26.5-40 GHz output
- HP 83570A offers 10 mW internally leveled 18-26.5 GHz output
- HP 83570A offers low frequency auxiliary output for easy counting and phase-locking
- Calibrated output power with 0.1 dB resolution
- Power sweep
- Complete HP-IB programmability

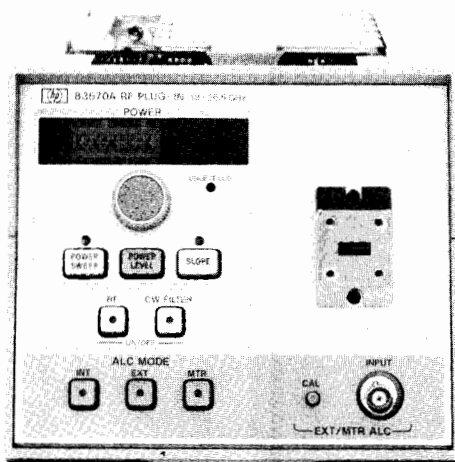

HP 83570A

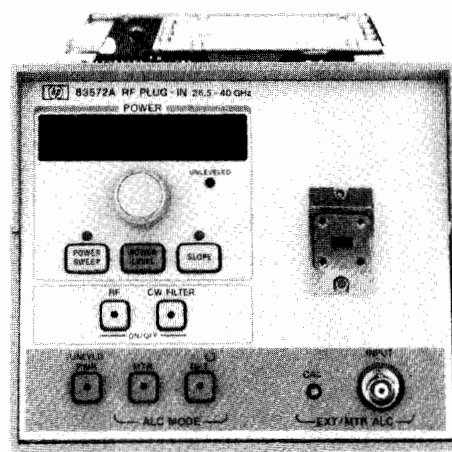

HP 83572A

HP 83570A

Now precision measurements to 26.5 GHz are possible with the solid state HP 83570A plug-in. The HP 83570A plug-in maintains a minimum leveled output power of 10 dBm which is comparable to the output power of Backward Wave Oscillators. Power is internally leveled to a flatness $< \pm 1.4$ dB. At the output, power losses are minimized with a waveguide output connector (a coaxial output connector may be made using the HP K281C adapter). Full range coverage of the HP 83570A extends from 18 GHz to 26.5 GHz. This frequency range maintains a 30 MHz frequency accuracy and 0.1% linearity. With high frequency coverage, complete HP-IB programmability and outstanding leveled output power, the HP 83570A plug-in, combined with the many features of the HP 8350 mainframe adds a new dimension to microwave measurements above 18 GHz.

The output power has a calibrated range of 11 dB which can be extended with external attenuators such as the HP 8495K. The power level may be manually set to a 0.1 dB resolution, or the power level may be remotely HP-IB programmed to a 0.02 dB resolution. In addition to a single output power, the HP 83570A also has a power sweep function. This function sweeps the power from one level to another. Another important feature that the HP 83570A offers is slope compensation. This compensates for high frequency power losses in external tests by attenuating the power at lower frequencies.

Scalar measurements at high frequencies may be easily made since the HP 83570A provides internal 27.8 kHz modulation required to interface with the HP 8756A or the HP 8757A Scalar Network Analyzer in the AC detection mode. In addition to simplifying the interface circuitry, internal modulation reduces connection losses which are critical at high frequencies.

The high output power and HP-IB programmability also make the HP 83570A ideal for use with the HP 8410 Network Analyzer and HP K8747A Test Set when making vector network measurements from 18 to 26.5 GHz. The +10 dBm output power is required for proper operation of HP K8747A mixers.

HP 83572A/B

The HP 83572A/B RF Plug-in extends the frequency coverage from 26.5 GHz to 40.0 GHz. The plug-ins offer minimum unlevelled output power of 7 dBm (HP 83572B), and 3 dBm (HP 83572A) for maximizing the dynamic range of passive device measurements. Option 001 provides 6 dBm (HP 83572B), and 2 dBm (HP 83572A) calibrated externally leveled output power for regulated power control during swept and CW operations. The HP 83572 offers 100 MHz frequency accuracy and 0.2% linearity. With high frequency coverage, complete HP-IB programmability and outstanding leveled output power, the HP 83572 plug-ins extend the HP 8350 mainframe capabilities above 26.5 GHz.

The output power has calibrated range of 7 dB (HP 83572A) and 11 dB (HP 83572B). The power level may be manually set to a 0.1 dB resolution, or it may be remotely HP-IB programmed to a 0.01 dB resolution. The HP 83572 also features Power Sweep which allows real time power response measurements of active devices. Another important feature is slope compensation which compensates for system/cable losses at high frequencies.

Scalar measurements at high frequencies may be easily made since the HP 83572 provides internal 27.8 kHz modulation (Option 006) required to interface with the HP 8756A or the HP 8757A Scalar Network Analyzer in the AC detection mode. In addition to amplifying the interface circuitry, internal modulation reduces connection losses which are critical at high frequencies.

The high output power and HP-IB programmability also make the HP 83572 ideal for use with the HP 8410 Network Analyzer and HP R8747B Test Unit when making vector network measurements from 26.5 to 40.0 GHz.



Output Characteristics

RF Power Leveling

Unleveled: selected by front panel switch; refer to chart for figures. Standard for HP 83572A/B.

Internal: selected by front panel switch; refer to chart for figures. Standard for HP 83570A.

External

Crystal detector: approximately -10 to -200 mV for specified leveling at rated output; for use with negative polarity detectors such as HP 422 Series Crystal Detectors.

Calibrated crystal detector (option 001): approximately -10 to -200 mV for specified leveling at rated output; for use with negative polarity detectors such as HP 422 Series Crystal Detectors. SHIFT DET switch selects internal calibration for an external coupler, a crystal detector, and a BNC cable, all included in Option 001 of HP 83572.

Power meter input: switch selects proper compensation for HP 432A/B/C Power Meters.

Indicator: front panel indicator lights when RF power becomes unleveled. Residual AM in 100 kHz Bandwidth: <-50 dBc.

Impedance: 50 Ω nominal

Power Sweep

Calibrated range

HP 83570A: ≥ 11 dB.

HP 83572A/B (option 001 only): ≥ 7 dB, typical.

Accuracy: ± 1.5 dB typical.

Resolution: 0.1 dB

Slope compensation

Calibrated range

HP 83570A: up to 5 dB/GHz (10 dB max, typically 11 dB).

HP 83572A/B (option 001 only): Up to 5 dB/GHz (7 dB max).

Linearity: <0.2 dB.

Resolution: 0.1 dB/GHz

Frequency Characteristics

	HP 83570A	HP 83572A/B
Range	18–26.5 GHz	26.5–40 GHz
Accuracy (25°C $\pm 5^\circ$ C)		
CW Mode:	± 30 MHz	± 100 MHz
Typical:	± 20 MHz	± 20 MHz
All Sweep Modes:	± 55 MHz	± 150 MHz
Linearity typically:	± 15 MHz	± 50 MHz
Stability		
With Temperature:	800 kHz/ $^\circ$ C	± 8 MHz/ $^\circ$ C
With 10% Line Voltage Change:	± 80 kHz	± 1 MHz
With 10 dB Power Level Change:	+1 MHz	± 200 kHz
With 3:1 Load SWR:	± 500 kHz	± 100 kHz
With Time: (in 10 minute time period after one hour warmup at the same frequency setting, typical)	± 400 kHz	± 4 MHz
Residual FM: (in 20 Hz–15 kHz bandwidth, CW mode):	<30 kHz	<60 kHz

Output Characteristics

Maximum Leveled Power (25°C $\pm 5^\circ$ C):	>10 mW	
Minimum Unleveled Power (25°C $\pm 5^\circ$ C):		>2 mW (5 mW)*
Opt. 001 (at output of external leveling coupler):		1.0 dB less
Opt. 006 (at waveguide output of plug-in):		1.5 dB less
Power Level Accuracy: Typical		
Internally leveled:	± 1.8 dB	
Externally Leveled (Opt. 001):		± 1.5 dB
Resolution (displayed):	0.1 dB	0.1 dB
Remote Programming (settable)	± 0.01 dB	± 0.01 dB
Power Variation (At max. rated power)		
Internally Leveled:	$<\pm 1.4$ dB	
Unleveled: Typically	$<\pm 2$ dB	$<\pm 3$ dB
Externally Leveled (Excluding coupler and detector variation):		
Crystal Detector or Power Meter	$<\pm 0.1$ dB	$<\pm 0.2$ dB
Spurious Signals: (Below fundamental at specified maximum power)		
Harmonically Related:	<-25 dBc	<-50 dBc
Non-Harmonics:	<-50 dBc	<-50 dBc
Source VSWR: 50 Ω nominal impedance		
Internally leveled:	<2.5	
Externally leveled (Opt. 001)		<1.5
Modulation Characteristics		
External FM		
Maximum Deviations for Modulation Frequencies		
DC to 100 Hz:	± 75 MHz	± 150 MHz
100 Hz to 200 kHz:		± 3.5 MHz
100 Hz to 1 MHz:	± 7 MHz	
1 MHz to 2 MHz:	± 5 MHz	
2 MHz to 10 MHz:	± 1.5 MHz	
Sensitivity: Nominal		
FM Mode:	-20 MHz/V	-20 MHz/V
Phase-lock Mode:	-6 MHz/V	-6 MHz/V
External AM		
Frequency Response:		
Typically	100 kHz	10 kHz
Range of Amplitude Control (typically)		
Internally Leveled:	11 dB	—
Option 001 (externally leveled):	—	7 dB (11 dB)*
Unleveled:	—	30 dB
Sensitivity:	1 dB/V	1 dB/V (Opt. 001)
Input Impedance: Approx.	30 k Ω	30 k Ω

Internal Square Wave Modulation (Option 006 of HP 83572A/B) 1 kHz or 27.8 kHz square wave modulation selectable by internal jumper in HP 8350B. The 27.8 kHz modulation ensures operation with Hewlett-Packard scalar network analyzers.

On/Off Ratio: >25 dB >20 dB
Symmetry: 40/60 45/55

External Pulse and Square Wave Modulation***		
Pulse Input: TTL compatible		
Rise/Fall Time:	20 ns	300/50 ns
Minimum RF Pulse: Width (Typically)		
Internally Leveled:	1 μ s	—
Unleveled:	100 ns	500 ns
Modulation Rate:	—	0.5–1 MHz
On/Off Ratio:	>25 dB	>26 dB

*HP 83572B only

**Requires HP 83572A/B Option 006

***HP 83572A/B Option 006, unleveled output

General Specifications

Sweep Time (minimum over full band)

HP 83570A (18–26.5 GHz): 10 ms

HP 83572A/B (26.5–40.0 GHz): 10 ms.

RF Output Connector

HP 83570A type WR42 waveguide.

HP 83572A/B type WR28 waveguide.

Auxiliary output: (HP 83570A) real panel 9–13.25 GHz fundamental oscillator output, nominally 0 dBm.

Weight: net 5.4 kg (12 lbs). Shipping 8.7 kg (19 lbs).

Improved Network Measurement Capabilities

The HP 83570A is Compatible with the

HP 8756A Scalar Network Analyzer**

HP 8757A Scalar Network Analyzer**

HP 5344S Source Synchronizer

HP 8410 Network Analyzer using the K8747A Test Set

The HP 83572A/B are Compatible with the

HP 8756A Scalar Network Analyzer**

HP 8757A Scalar Network Analyzer**

HP 8410 Network Analyzer using the R8747B Test Set

Ordering Information

Price

HP 83570A 18–26.5 GHz RF Plug-in (Internal leveling standard) \$11,985

HP 83572A 26.5–40.0 GHz RF Plug-In \$14,540

Opt 001: Calibrated External Leveling add \$1,605

Opt 006: Internal Pulse and Square Wave Modulation capability add \$1,805

HP 83572B 26.5–40.0 GHz RF Plug-in \$17,500

Opt 001: Calibrated External Leveling add \$1,600

Opt 006: Internal Pulse and Square Wave Modulation capability add \$1,800



SWEEP OSCILLATORS

Model 8350 Series: Millimeter-Wave Source Modules

Models 83554A, 83555A and 83556A

- 26.5 to 60 GHz frequency range
- Internally-leveled high output power
- Can be driven by many HP microwave sources
- Source module remotable up to a meter length
- Low entry cost

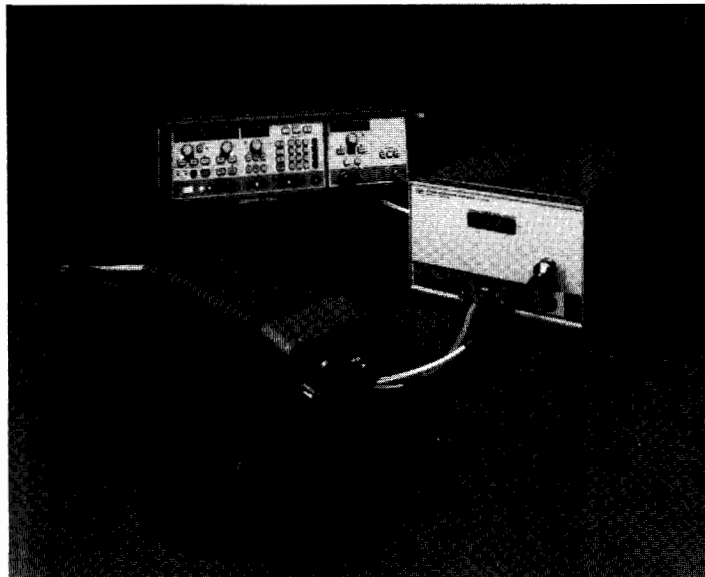

HP 83550 Series Millimeter-wave Source Modules

The three HP 83550 series millimeter-wave source modules provide a simple approach to extend the frequency range of 11 to 20 GHz sources to cover 26.5 to 40 GHz (HP 83554A), 33 to 50 GHz (HP 83555A) and 40 to 60 GHz (HP 83556A) bands. The HP 83550 series source modules offer internally-leveled high output power, full waveguide band frequency coverage, and the high frequency accuracy and resolution of the driving microwave source.

As shown in Figure 1, there are two basic ways of configuring a millimeter-wave source to best suit your specific needs. Your choice can range from a sweep oscillator (HP 8350B/83550A) to a sophisticated synthesized sweeper (HP 8341B/8349B).

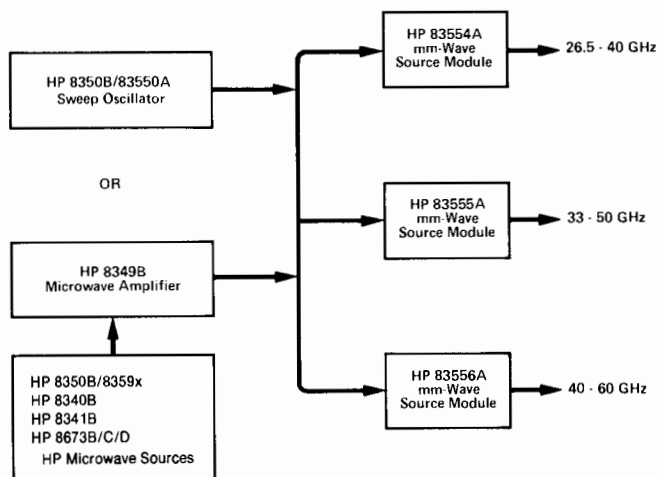

Frequency Precision and Spectral Purity

An advantage of using frequency multiplication to generate millimeter-wave signals is that the module output translates many of the capabilities and features of the microwave source driver. The frequency accuracy and resolution are multiplied by a factor of two

or three depending on whether the drive frequency is doubled or tripled. For example, a millimeter-wave source based on the HP 8341B/8349B will have frequency resolution of 6 Hz from 26.5 to 40 GHz, and 9 Hz from 33 to 50 GHz.

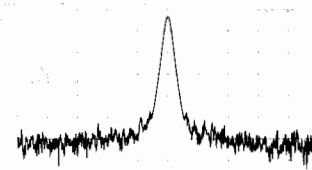

Spectrum Analyzer Photo of HP 8340B/8349B/83556A Signal at 50 GHz.

The HP 83550 series source modules offer harmonic and sub-harmonic suppression of <-25 dBc in the 26.5 to 40 GHz band and <-20 dBc from 33 to 50 GHz and 40 to 60 GHz bands. The high stability and low phase noise characteristics of the HP 8340B/41B or HP 8673B/C/D synthesizers (combined with the required HP 8349B amplifier) are also essentially translated through the source modules and are available for a variety of signal simulation applications.

High Output Power

Internally-leveled output power from the source modules is rated at +8 dBm for the HP 83554A, +3 dBm for the HP 83555A and +3 dBm for the HP 83556A. This high output power can permit the source module to serve as a mixer LO in some applications, and also expands the available dynamic range in frequency response measurements.

Pulse, AM and FM Modulation

The high performance pulse modulators of the HP synthesized sources offer >80 dB ON/OFF ratio and <50 ns rise and fall times. Pulse amplitudes are leveled for pulse widths as narrow as 1 μ s.

The HP 8340B/41B also feature dc-coupled AM with a 3 dB bandwidth of 50 kHz. Pulse and amplitude modulation can be used to simultaneously simulate antenna scan patterns.

HP 8340B/41B, 8673B/C/D Synthesizer Sources Related Specifications

Frequency

Resolution: 2 (HP 83554A) or 3 (HP 83555A, 83556A) times the resolution of the input frequency

Accuracy: Same as time base.

Time Base: Internal 10 MHz time base. Aging rate: less than 1×10^{-9} /day and 2.5×10^{-7} /year after 30 day warm-up (HP 8340B/41B only); less than 5×10^{-10} /day after a 24-hour warm-up (HP 8673B/C/D only).

Spectral Purity

Single-Sideband Phase Noise: Same as input signal plus 6 dB (HP 83554A) or 10 dB (HP 83555A, 83556A)

Pulse Modulation

ON/OFF Ratio: Typically >80 dB.

Minimum Leveled RF Pulse Width: Typically < 2 μ S

Minimum Unleveled RF Pulse Width: Typically <100 ns.

Amplitude Modulation

Rates (3 dB BW): Typically DC to 50 kHz (HP 8340B/41B only); Typically 20 Hz to 50 kHz (HP 8673B/C/D only).

Sensitivity: Typically 30%/V (HP 8673B/C/D only) and 100 %/V.

Frequency Modulation

Maximum Deviations: Follows input with 2 (HP 83554A) or 3 (HP 83555A, 83556A) times the deviation.

Output Sensitivity: 2 (HP 83554A) or 3 (HP 83555A, HP 83556A) times the input sensitivity.

HP 8350B/83550A, 8350B/83590-series Related Specifications

Frequency

Resolution: 2 (HP 83554A) or 3 (HP 83555A, 83556A) times the resolution of the input frequency

Accuracy and Stability: 2 (HP 83554A) or 3 (HP 83555A, 83556A) times the accuracy and stability of the input frequency

Pulse Modulation

ON/OFF Ratio (Typically): >60 dB (83550A).

Minimum Unleveled RF Pulse Width: Typically <100 ns.

Amplitude Modulation

Rates (3 dB BW): Typically DC to 100 kHz.

Sensitivity: Typically 1 dB/V.

Frequency Modulation

Maximum Deviations: Follows input with 2 (HP 83554A) or 3 (HP 83555A, 83556A) times the deviation.

Output Sensitivity: 2 (HP 83554A) or 3 (HP 83555A, HP 83556A) times the input sensitivity.

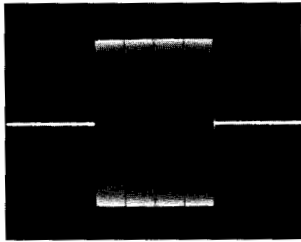

HP 8340B/8349B/83554A Pulse
Performance at 35 GHz. Pulse width = 5 μ S.

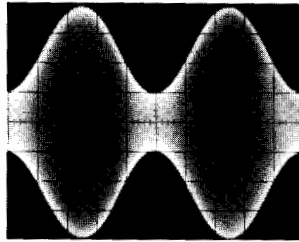

HP 8341B/8349B/83554A AM Performance
at 30 GHz. AM rate is 17 kHz and depth is
70%.

FM rates between 100 Hz and 10 MHz may be applied to the HP 8673B/C/D synthesizer input to achieve deviations up to 20 MHz (HP 83554A) and 30 MHz (HP 83555A, 83556A) at millimeter-wave frequencies.

Operational Simplicity

Simple front panel operations let you enter a display multiplier, so that the actual output frequency of the source module may be entered and displayed directly on the microwave source driver. The output power of the source module is displayed on the HP 83550A or the HP 8349B power display (depending on your millimeter-wave source configuration) and can be controlled again from the microwave driver.

In addition, the small size of the HP 83550-series source modules allows you to use them even on a crowded benchtop. Two flexible cables (a source module interface cable and an RF cable) are provided with the source modules to connect the microwave source driver to the source module. These cables permit you to place the source module up to 1 meter from the driving source. This allows you to bring your source to your test system instead of the other way around.

This combination of performance and versatility, plus total HP-IB programmability (via the microwave source driver), makes the HP millimeter-wave sources ideal in many automatic test or bench applications.

All at a Lower Cost

The HP 83550-series source modules combines performance and quality with a low cost of entry. This is possible because the source modules are backward-compatible with existing HP microwave sources. Thus, you can generate a full waveguide band of millimeter-wave frequencies for just the cost of the HP 8349B and a source module. Also, the cost of ownership to you is reduced even further by the two-year warranty on the microcircuits of the HP 83550-series source modules and the HP 8349B microwave amplifier.

HP 83554A Output Characteristics	HP 8350B/83550A	HP 8350B/ 83590 Series/8349B	HP 8340B/8349B, HP 8341B/8349B	HP 8673B/C/D/8349B
Maximum Leveled Power (25°C\pm5°C)	+8 dBm, 26.5-37.2 GHz +7 dBm, 37.2-40.0 GHz -5 dBm	+8 dBm, 26.5-37.2 GHz +7 dBm, 37.2-40.0 GHz -5 dBm	+8 dBm, 26.5-37.2 GHz +7 dBm, 37.2-40.0 GHz -5 dBm	+8 dBm, 26.5-37.2 GHz +7 dBm, 37.2-40.0 GHz -5 dBm
Minimum Settable Power:				
Power Level Accuracy¹ (25°C\pm5°C) Internally Leveled:	± 2.00 dB	± 2.00 dB	± 2.00 dB	± 2.00 dB
Power Flatness (at max leveled power) Internally Leveled:	± 1.50 dB	± 1.50 dB ²	± 1.50 dB ²	± 1.50 dB
Source Output SWR Internally Leveled: Unleveled: Typically	<2.0 <3.0	<2.0 <3.0	<2.0 <3.0	<2.0 <3.0
Spectral Purity Specifications Spurious Signals (expressed in dB relative to the carrier level (dBc)). Harmonically related spurious:	<-50 dBc, 26.5-39.75 GHz <-25 dBc, 39.75-40 GHz	<-20 dBc ³ , 26.5-39.75 GHz <-25 dBc, 39.75-40 GHz	<-20 dBc, 26.5-39.75 GHz <-25 dBc, 39.75-40 GHz	<-20 dBc ⁴ , 26.5-39.75 GHz <-25 dBc, 39.75-40 GHz

¹Specified with respect to HP 83550A or HP 8349B power display. Includes power level flatness.

²1V/GHz output must be changed to 0.5V/GHz on HP 83590 series plug-ins and HP 8340A/41A.

³Except for the HP 83592C which is -45 dBc.

⁴Except for the HP 8673C/D which are -50 dBc.



SWEEP OSCILLATORS

Model 8350 Series: Millimeter-Wave Source Modules (cont.)

Models 83554A, 83555A and 83556A

HP 83555A Output Characteristics	HP 8350B/83550A	HP 8350B/ 83590 Series/8349B	HP 8340B/8349B HP 8341B/8349B	HP 8673B/C/D/8349B
Maximum Leveled Power (25°C±5°C)	+3 dBm	+3 dBm	+3 dBm	+3 dBm
Minimum Settable Power:	-5 dBm	-5 dBm	-5 dBm	-5 dBm
Power Level Accuracy¹ (25°C±5°C)				
Internally Leveled:	±2.00 dB	±2.00 dB	±2.00 dB	±2.00 dB
Power Flatness (at max leveled power)				
Internally Leveled:	±1.50 dB	±1.50 dB ²	±1.50 dB ²	±1.50 dB
Source Output VSWR				
Internally Leveled:	<2.0	<2.0	<2.0	<2.0
Unleveled: Typically	<3.0	<3.0	<3.0	<3.0
Spectral Purity Specifications				
Spurious Signals (expressed in dB relative to the carrier level (dBc)).				
Harmonically related spurious:	<-50 dBc, 33-44 GHz <-20 dBc, 44-50 GHz	<-20 dBc ³ , 33-44 GHz <-20 dBc, 44-50 GHz	<-20 dBc	<-20 dBc ⁴ , 33-44 GHz <-20 dBc, 44-50 GHz

¹Specified with respect to HP 83550A or HP 8349B power display. Includes power level flatness.

²1V/GHz output must be changed to 0.5V/GHz on HP 83590 series plug-ins and HP 8340A/41A.

³Except for the HP 83592C which is -45 dBc.

⁴Except for the HP 8673C/D which are -50 dBc.

HP 83556A Output Characteristics	HP 8350B/83550A	HP 8350B/ 83590 Series/8349B	HP 8340B/8349B, HP 8341B/8349B	HP 8673B/C/D/8349B
Maximum Leveled Power (25°C±5°C)	+3 dBm	+3 dBm	+3 dBm	+3 dBm
Minimum Settable Power:	-5 dBm	-5 dBm	-5 dBm	-5 dBm
Power Level Accuracy¹ (25°C±5°C)				
Internally Leveled:	±2.25 dB	±2.25 dB	±2.25 dB	±2.25 dB
Power Flatness (at max leveled power)				
Internally Leveled:	±1.75 dB	±1.75 dB ²	±1.75 dB ²	±1.75 dB
Source Output VSWR				
Internally Leveled:	<2.0	<2.0	<2.0	<2.0
Unleveled: Typically	<3.0	<3.0	<3.0	<3.0
Spectral Purity Specifications				
Spurious Signals (expressed in dB relative to the carrier level (dBc)).				
Harmonically related spurious:	<-50 dBc, 40-53.3 GHz <-20 dBc, 53.3-60 GHz	<-20 dBc ³ , 40-53.3 GHz <-20 dBc, 53.3-60 GHz	<-20 dBc	<-20 dBc ⁴ , 40-53.3 GHz <-20 dBc, 53.3-60 GHz

¹Specified with respect to HP 83550A or HP 8349B power display. Includes power level flatness.

²1V/GHz output must be changed to 0.5V/GHz on HP 83590 series plug-in and HP 8340A/41A.

³Except for the HP 83592C which is -45 dBc.

⁴Except for the HP 8673C/D which are -50 dBc.

General Specifications

Minimum Input Power Level into RF Input Cable: +17 dBm (50 mW)

Maximum Input Power Level into RF Input Cable: +27 dBm.

Waveguide Output Connector

HP 83554A: EIA size WR 28 waveguide; JAN UG-599 flange.

HP 83555A: EIA size WR 22 waveguide; JAN UG-383 flange.

HP 83556A: EIA size WR 19 waveguide; JAN UG-383 flange.

Weight: Net, 1.7 kg (4 lb).

Dimensions

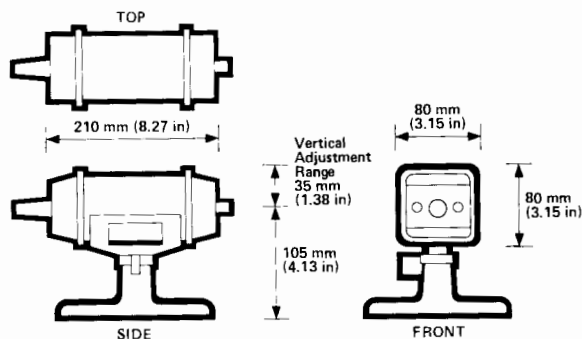

Furnished with Each Source Module: Operating and Service Manual, Modification Procedures for 0.5 V/GHz output, Type-N RF cable (also available as HP Part No. 5061-5359), Module Base Assembly (also available as HP Part No. 83556-60010).

Ordering Information

HP 83554A 26.5-40.0 GHz MM-Wave Source Module	\$8,000
Opt 910: Extra Manual	add \$20
HP 83555A 33.0-50.0 GHz MM-Wave Source Module	\$8,000
Opt 910: Extra Manual	add \$20
HP 83556A 40.0-60.0 GHz MM-Wave Source Module	\$8,000
Opt 910: Extra Manual	add \$20

SWEEP OSCILLATORS

Model 8620 Series: 10 MHz to 22 GHz

Model 8620 Series

513



- Single-band, straddle-band and broadband plug-ins
- External phase-lock capability
- > 10 mW to 22 GHz



HP 8620C with HP 86222B, 86290B



HP 8620 System

The Hewlett-Packard HP 8620 solid state sweeper system offers the flexibility of the HP 8620C mainframe in addition to a choice of singleband, multiband, straddle-band, and broadband plug-ins. The HP 8620 system also offers high output with solid state reliability—greater than 10 mW leveled to 22 GHz.

The fundamental oscillators used in the plug-ins and modules are YIG tuned transistor or bulk effect circuits. YIG tuning results in exceptional tuning linearity, low noise, and low spurious content; it also allows frequency modulation at high rates and wide deviations with low distortion.

HP 8620C Sweeper Mainframe

The HP 8620C has many features which are highly useful in stringent applications. With convenient functionally grouped controls and lighted pushbutton indicators the mainframe offers extreme ease of operation and flexibility. In addition, it can be a completely HP-IB programmable source, an indispensable feature for automatic systems and signal simulation applications.

HP 86222A/B and 86290B/C Broadband Plug-Ins

Now the 10 MHz to 18.6 GHz frequency range can be covered with just two plug-ins—the HP 86222A/B and 86290B/C. Besides their broad frequency range these plug-ins offer many special features including unique crystal markers in the HP 86222B and better than ± 30 MHz frequency accuracy in a HP 86290B/C even at 18 GHz.

HP 86240A/B/C and 86251A Straddle-Band Plug-Ins

Covering more than an octave of frequencies the HP 86240A/B span 2 to 8.4 GHz and the HP 86251A spans from 7.5 to 18.6 GHz with major advances in power output and signal purity. The HP 86240A offers more than 40 mW while the HP 86251A provides over 10 mW of leveled output across the full band. All three plug-ins deliver a high quality test signal of low harmonic content with the HP 86240B providing harmonics of > 45 dBc. This can be very important when making measurements across more than one octave.

HP 86200 Series Single-Band Plug-Ins

The HP 86200 series of plug-ins covers both ends of the frequency spectrum from 10 MHz to 22 GHz with a choice of nine plug-ins.

Plug-In Compatibility with HP 8350

The entire line of HP 86200 series plug-ins can be used in the HP 8350 Sweep Oscillator mainframe by using the HP 11869A Adapter.

TYPICAL UNLEVELED POWER OUTPUT

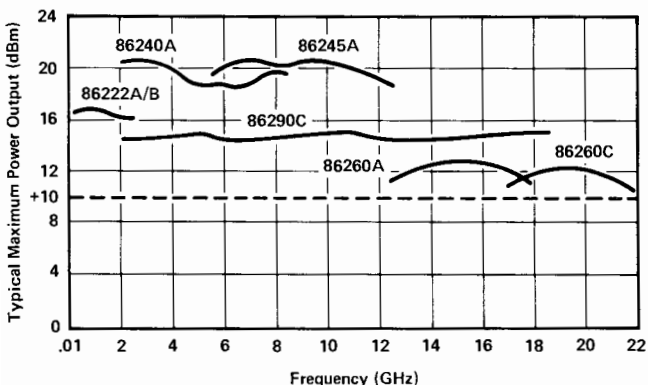



SWEEP OSCILLATORS

Model 8620 Series: Mainframe

Model 8620C

- Optional BCD or HP-IB programming
- 3 markers
- 100% ΔF capability, fully calibrated

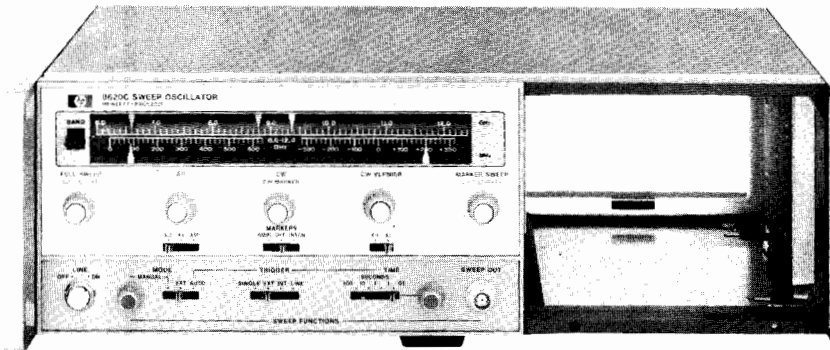

HP 8620C



The HP 8620C offers many features as standard equipment. For example, up to four separate bands and their respective frequency scales can be selected with a band select lever to the left of the dial scale. Pushbuttons, concentrically located in the frequency control knobs, light when actuated to indicate the sweep function in use. The sweep functions available are: FULL SWEEP, MARKER SWEEP, CW/ ΔF and CW. Three markers are available, controlled by the START MARKER, STOP MARKER, and CW MARKER knobs.

The HP 8620C is fully and continuously calibrated for any ΔF sweep width. The sweep is symmetrical about the CW MARKER setting and three continuously variable ΔF ranges are available by using the range switch below the ΔF knob. This allows calibrated sweep widths of up to 1%, 10% or 100% of full band.

When in CW/ ΔF or CW modes, the CW VERNIER knob allows for excellent frequency resolution. In terms of improved frequency resolution the vernier increases the effective length of the dial scale to 7.5 metres (300 inches).

Another feature is the capability to fully program the sweeper. The standard HP 8620C includes inputs for band selection, sweep function selection, and analog frequency control. In addition to this, a more flexible digital frequency programming option is available to control the HP 8620C via the HP-IB (Option 011).

8620C Specifications

Frequency

Frequency range accuracy and linearity: determined by band select lever and RF plug-in installed.

Sweep Functions

FULL SWEEP: sweeps the full band as determined by the plug-in and the band select lever.

MARKER SWEEP: sweeps from START MARKER to STOP MARKER frequency settings: up to the full range of the plug-in can be set to sweep either up or down in frequency.

ΔF Sweep: sweeps symmetrically upward in frequency, centered on CW setting, CW vernier can be activated for fine control of center frequency.

Width: continuously adjustable and calibrated from zero to 1%, zero to 10%, or zero to 100% of frequency band.

CW operations: single-frequency RF output controlled by CW MARKER knob selected by depressing pushbutton in CW MARKER control.

CW vernier: calibrated directly in MHz about CW setting. CW vernier activated by pushbutton in CW vernier control. Zero to $\pm 0.5\%$ or zero to $\pm 5\%$ of full bandwidth, selectable with front panel switch.

Frequency markers: three constant width frequency markers are fully calibrated and independently adjustable over the entire range in FULL SWEEP function, controlled by START MARKER, STOP MARKER, and CW MARKER controls. In ΔF sweep START and STOP MARKERS are available, and in MARKER SWEEP the CW MARKER is available. Front panel switch provides for the selection of either amplitude or intensity markers (amplitude modulating the RF output or Z-axis modulating the CRT display).

Marker output: rectangular pulse, typically -5 volts peak available from Z-axis BNC connector on rear panel. Source impedance, approximately 1000 ohms.

Sweep Modes: auto, manual and external

Sweep time: continuously adjustable from 0.01 to 100 seconds.

Sweep triggers: line, internal, external and single.

Sweep output: direct-coupled sawtooth, zero to approximately +10 volts, at front panel BNC connector, concurrent with swept RF output.

Modulation

External AM, FM and phase-lock capability; internal 1000 Hz square wave AM modulation available.

Remote Control

Remote band select: frequency range can be controlled remotely by three binary contact closure lines available at rear panel connector.

Remote Frequency Programming, Opt 011 (HP-IB)

Functions

Band: manual enable or remote control of up to four bands.

Mode: seven modes are selectable, including digital control in three modes with a resolution of 10,000 points.

HP-IB interface functions

SH0, AH1, T0, L2, SR0, RL2, PP0, DC0, DT0, C0, E1.

General

Blanking

RF: with blanking switch enabled, RF automatically turns off during retrace, and remains off until start of next sweep.

Display (Z-AXIS/MKR/PEN LIFT output): direct-coupled rectangular pulse approximately +5.0 volts coincident in time with RF blanking is on rear panel.

Negative (negative blanking output): direct-coupled rectangular pulse approximately -5.0 volts coincident in time with RF blanking.

Pen lift: for use with X-Y recorders having positive power supplies. Transistor-switch signal is available on Z-AXIS/MKR/PEN LIFT connector. This signal is also available on the programming connector.

Furnished: 2.29 m (7½-foot) power cable with NEMA plug and calibration scale. With Option 011, an HP-IB connector/adaptor are included.

Power: 100, 120, 220, or 240 volts $\pm 5 - 10\%$, 50 to 400 Hz. Approximately 140 watts.

Weight: (not including RF unit): Net, 11.1 kg (24 lb). Shipping 13.4 kg (30 lb).

Size: 132.6 mm H x 425 mm W x 337 mm D (5.29" x 16.75" x 13.25").

Ordering Information

HP 8620C Sweep Oscillator Mainframe

Opt 011: HP-IB Frequency Programming

Opt 007: Rear Sweep Out

Opt 820: 8410C Interface Cable

Opt 908: Rack Flange Kit

Price

\$3,865

add \$955

add \$75

add \$50

add \$37.50

SWEEP OSCILLATORS

Model 8620 Series: Broadband RF Plug-Ins

Models 86290B and 86290C

515



- +13 dBm 2 to 18.6 GHz with HP 86290C
- ± 30 MHz frequency accuracy at 18.6 GHz

- Compatible with HP 8350 mainframe via HP 11869A adapter

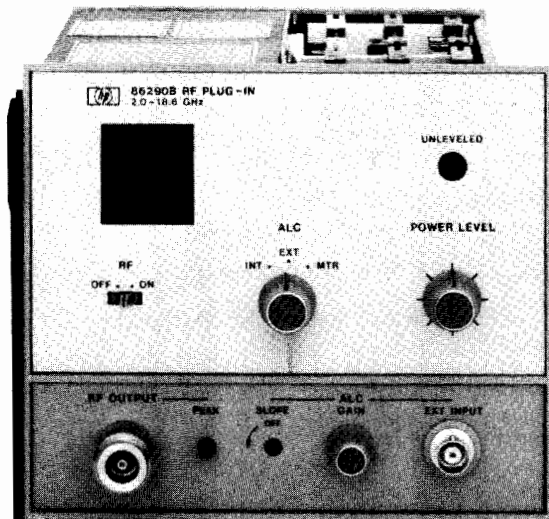

HP 86290B

The HP 86290B/C broadband plug-ins offer a continuous sweep from 2 to 18.6 GHz for broadband swept testing. In addition, higher frequency resolution is achieved by covering the 2 to 18.6 GHz range in three individual bands of 2 to 6.2, 6 to 12.4, 12 to 18.6. The HP 86290C offers outstanding electrical performance, producing >20 mW swept output over the 2 to 18.6 GHz range along with excellent linearity and low spurious and harmonic content. For scalar measurements in the AC detection mode, the 27.8 kHz square wave modulation from the HP 8756 or the HP 8757 Scalar Network Analyzers is accepted directly through the EXTERNAL AM input. When performing phase/amplitude network analysis the interfacing between the sweeper and the HP 8410C Network Analyzer permits the HP 8410C to automatically phase lock over multi-octave sweeps for continuous swept 2 to 18.6 GHz phase and amplitude measurements.

Specifications with Plug-In Installed in an HP 8620C Mainframe

Frequency Characteristics

	Band 1	Band 2	Band 3	Band 4
Range: (GHz) HP 86290B/C	2-6.2	6-12.4	12-18.6	2-18.6
Accuracy (25°C)				
CW mode (or >100 ms sweep time): (MHz)	± 20	± 30	± 30	± 100
Remote programming: (typ.)	± 2.5	± 2.5	± 3.5	—
All sweep modes: (MHz)	± 30	± 40	± 40	± 80
Marker: (MHz)	± 30	± 30	± 30	± 80
Linearity (MHz) typ.:	± 8	± 8	± 8	± 30
Frequency Stability				
With temperature: (MHz/°C)	± 0.5	± 1.0	± 1.5	± 2.0
With 10% line voltage change: (kHz)	± 100	± 100	± 100	± 100
With 10 dB power level change: (MHz)	± 0.6	± 1.2	± 1.8	± 1.8
With 3:1 load VSWR, all phases: (kHz)	± 100	± 200	± 300	± 300
With time (in 10 minute period after 30 minute warmup): typically (kHz)	± 300	± 600	± 900	± 900
Residual FM (20 Hz –15 kHz bandwidth CW mode: (kHz peak)	<10	<20	<30	<30

Output Characteristics

Maximum Levelled Power (25°C)

HP 86290B: +10 dBm, (Opt. 004: +9.5 dBm)

HP 86290C: +13 dBm, (Opt. 004: +12.5 dBm)

Power level control range: >10 dB

	Band 1	Band 2	Band 3	Band 4
Power Variation (Max Rated Pwr)				
Internally levelled: (dB)	± 0.7	± 0.7	± 0.8	± 0.9
Externally levelled (excluding coupler and detector variation)				
Crystal detector: –20 to –250 mV for specified leveling at rated output: (dB)	± 0.15	± 0.15	± 0.15	± 0.15
Power meter: internal leveling amplifier with compensation for HP models 432A/B/C provided: (dB)	± 0.15	± 0.15	± 0.15	± 0.15
With temperature, typically (dB/°C)	± 0.1	± 0.1	± 0.1	± 0.1

Residual AM in 100 kHz BW: <–55 dBc.

Spurious Signals

Harmonically related signals: <–25 dBc.

Non-harmonics: <–50 dBc.

Impedance: 50 Ω nominal.

SWR: <1.9 internally levelled.

RF output connector: type N female.

Modulation Characteristics

External AM

Input impedance: approximately 10k Ω .

Frequency response: typically 100 kHz levelled.

Square Wave Response

On/Off ratio: >30 dB.

Symmetry: 40/60.

Attenuation for +5V input: >30 dB.

Internal AM (1000 Hz)

Square-wave on/off ratio: >25 dB.

RF blanking on/off ratio: >30 dB.

External FM

Maximum Deviations for Modulation Frequencies

DC to 100 Hz: ± 75 MHz.

100 Hz to 2 MHz: ± 5 MHz.

Sensitivity (typically)

FM mode: –20 MHz/V.

Phase-lock mode: –6 MHz/V.

General

Sweep time (min): 10 ms single bands, 60 ms on 2 to 18.6 GHz band.

Auxiliary output: rear panel 2 to 6.2 GHz fundamental oscillator output, nominal –10 dBm.

Slope control: front panel control allowing compensation for frequency dependent test setup losses.

Peak control: front panel control for peaking power over desired frequency range.

Frequency reference output: nom. 1 V/GHz (2–18.6 volts) ± 35 mV rear panel BNC output.

Weight: net, 4.4 kg (9.6 lb); shipping, 5.9 kg (13 lb).

Ordering Information

HP 86290B 2 to 18.6 GHz +10 dBm (10 mW) plug-in (internal leveling standard)

HP 86290C 2 to 18.6 GHz +13 dBm (20 mW) plug-in (internal leveling standard)

Opt 004: rear panel RF output

Price

\$15,300

\$19,810

add \$100



SWEEP OSCILLATORS

Model 8620 Series: Broadband RF Plug-Ins (cont.)

Models 86222A and 86222B

- 10 MHz to 2.4 GHz in one, continuous sweep
- Internally leveled flatness ± 0.25 dB over full range

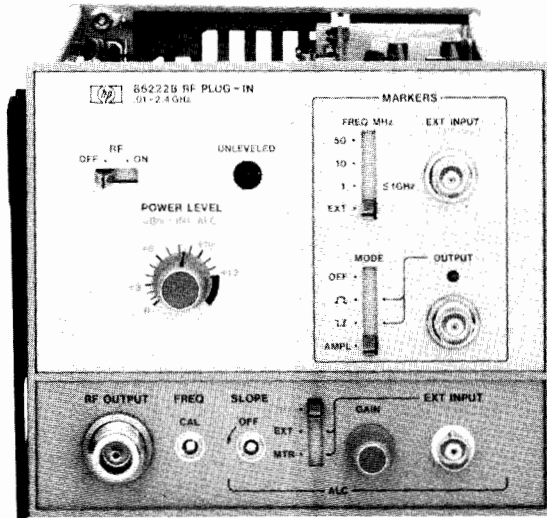

HP 86222B

The HP 86222A and 86222B RF plug-ins can provide CW or continuous swept 10 MHz to 2.4 GHz frequency coverage. Power output is calibrated from 0 to +13 dBm in 1 dB increments with ± 0.25 dB flatness and excellent linearity (2 MHz) over the entire 0.01 to 2.4 GHz range. For applications demanding precise frequency identification, the HP 86222B offers a crystal marker system which provides a comb of markers at 1, 10 or 50 MHz. Markers may be displayed as intensified spots on a CRT or as amplitude dips on the RF output (often useful for XY recordings). In addition, when the output frequency is coincident with a 50, 10 or 1 MHz comb of the internal crystal oscillator, a front panel LED lights for independent CW frequency calibration (75 kHz accuracy at 1 GHz). For scalar measurements in the AC detection mode, the 27.8 kHz square wave modulation from the HP 8756A or the HP 8757A Scalar Network Analyzer is accepted directly through the external AM input. For phase/magnitude network analysis the interfacing between the sweeper and the HP 8410C Network Analyzer permits the HP 8410C to automatically phase-lock over multi-octave sweeps.

Specifications with Plug-in Installed in an HP 8620C Mainframe

Frequency Characteristics

Range: 10 MHz to 2.4 GHz.

Accuracy (25°C)

CW mode: ± 10 MHz.

Remote programming: typically ± 1.5 MHz.

All sweep modes: ± 15 MHz (>100 ms sweep time). Accuracy of HP 86222B may be enhanced to better than ± 200 kHz through use of crystal markers.

Linearity: typically ± 2 MHz.

Stability

With temperature: ± 500 kHz/°C.

With 10% line voltage change: ± 20 kHz.

With 10 dB power level change: ± 100 kHz.

With 3:1 load SWR, all phases: ± 10 kHz.

With time (after 1-hour warm-up): typically ± 100 kHz/10 min.

Residual FM: (20 Hz ± 15 kHz bandwidth; FM switch in NORM; CW Mode): <5 kHz peak.

Output Characteristics

Maximum leveled power (25°C): >20 mW (+13 dBm); typically >+15 dBm.

Power level accuracy (internal leveling only): ± 1 dB.

Attenuator Opt 002: add ± 0.2 dB/10 dB step.

Power Variation (at max. rated power)

Internally Leveled

0.01 to 2.4 GHz: ± 0.25 dB.

Stability with temperature: typically ± 0.02 dB/°C.

- 1, 10, and 50 MHz crystal marker combs with HP 86222B
- Compatible with HP 8350 mainframe via HP 11869A adapter

Externally Leveled (excluding coupler and detector variation)

Crystal detector: (-10 to -100 mV at rated output): ± 0.1 dB.

Power meter (with HP 432A/B/C series power meters): ± 0.1 dB.

Residual AM in 100 kHz BW: <-50 dBc.

Spurious Signals (below fundamental)

Harmonics: <-25 dBc at +13 dBm; typically <-30 dBc at +10 dBm.

Non-Harmonics

0.01 to 2.3 GHz: <-30 dBc at +13 dBm; typically <-40 dBc at +10 dBm.

2.3 to 2.4 GHz: <-25 dBc at +13 dBm; typically <-35 dBc at +10 dBm.

Broadband noise in 100 kHz bandwidth: typically <-70 dBm.

Impedance: 50 Ω nominal.

SWR: <1.5 internally leveled.

Slope control: allows variable compensation for frequency dependent losses in test set-up.

RF output connector: type N female.

Modulation Characteristics

External AM

Input impedance: approximately 10 k Ω .

Frequency response: typically 150 kHz.

Square Wave Response

On/Off ratio: >30 dB.

Symmetry: 40/60, for > 10 dBm output power.

Attenuation for +6 V input: >30 dB.

Internal AM

1 kHz square-wave On/Off ratio: >30 dB.

RF blanking On/Off ratio: >30 dB.

External FM

Maximum Deviations for Modulation Frequencies

DC to 100 Hz: ± 75 MHz.

100 Hz to 1 MHz: ± 5 MHz.

1 MHz to 2 MHz: ± 2 MHz.

Sensitivity (typically)

FM mode: -20 MHz/V.

Phase-lock mode: -6 MHz/V.

Crystal Marker Capabilities (HP 86222B only)

Internal crystal markers: harmonic markers of 10 and 50 MHz usable over full 0.01 to 2.4 GHz range and 1 MHz markers usable 0.01 to 1 GHz. Positive (+) or negative (-) voltage output pulses can be selected to Z-axis intensify a scope trace; or RF amplitude pips can be selected (at maximum sweep speed, pulse width optimized for approximately 10 markers/sweep).

Accuracy of center frequencies (25°C): $\pm 5 \times 10^{-6}$.

Typical Marker Width Around Center Frequency

1 MHz markers: ± 75 kHz.

10 MHz markers: ± 200 kHz.

50 MHz markers: ± 300 kHz.

Temperature stability: typically $\pm 2 \times 10^{-6}$ /°C.

Marker output

Pos. intensity mode: nominally >3 V.

Neg. intensity mode: nominally -3 to -8 V, internally adjustable.

Amplitude mode: typically 0.5 dB, internally adjustable.

General

Weight: net, 2.5 kg (5.5 lb); shipping, 4 kg (9 lb).

Ordering Information

HP 86222A 0.01-2.4 GHz RF Plug-In (internal leveling standard)

Price

\$5,520

HP 86222B 0.01-2.4 GHz RF Plug-In with Crystal and External Markers (internal leveling standard)

\$6,970

Opt 002: 70 dB Step Attenuator (10 dB steps)

add \$750

Opt 004: Rear Panel RF Output

add \$200

SWEEP OSCILLATORS

Model 8620 Series: Straddle Band RF Plug-Ins

Models 86240A, 86240B, 86240C and 86251A



- 7.5–18.6 continuous sweep with HP 86251A
- <–45 dBc harmonics with HP 86240B
- Up to 40 mW output power with HP 86240A

- MLA compatibility with HP 86240C
- Usable in HP 8350 mainframe with HP 11869A plug-in adapter

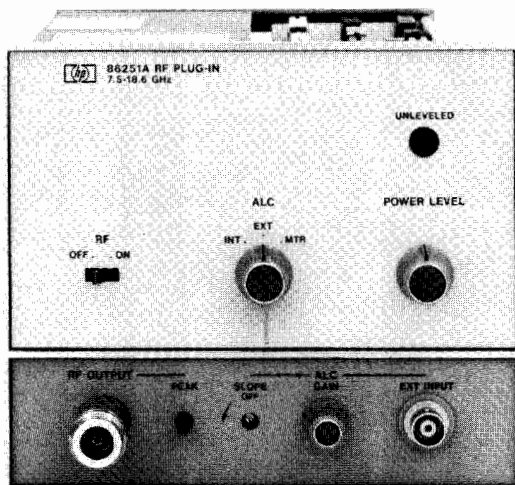

HP 86251A

HP 86251A: 7.5–18.6 GHz

The HP 86251A excels in meeting the most stringent of swept or CW source requirements for precise Radar and ECM component measurements. Covering the essential frequency bands with one continuous sweep, the HP 86251A is ideal for testing active devices like multioctave TWTs or RF memories as well as passive devices like filters or isolators.

HP 86240A/B: 2–8.4 GHz

The HP 86240A/B are designed for high power and superior performance with the HP 86240A delivering 40 mW of RF output power and the HP 86240B offering 45 dBc harmonics (typically <– 50 dBc). For precise RF power level control, internal leveling and slope control are also available.

HP 86240C RF Distortion Analysis of MW Links: 3.6-8.6 GHz

The HP 86240C can be used for MLA Upconverter Simulation as well as a general purpose sweeper. It is optimized for group delay of

less than 1 ns peak-to-peak over 30 MHz, linearity better than 0.5% and power output up to 40 mW. It has 10 MHz FM bandwidth, flat to ± 1.5 dB for noise loading applications, power control and internal leveling. For further information on MLA Upconverter Simulation refer to the Telecommunications Test Equipment section on page 391.

Specifications with Plug-In Installed in an HP 8620C Mainframe

Frequency Characteristics

Linearity: typically $\pm 0.1\%$.

Residual FM (in 20 Hz –15 kHz bandwidth, FM switch in NORM, CW Mode): <9 kHz peak, <30 kHz peak for HP 86251A.

Reference output: dc-coupled voltage proportional to RF frequency, voltage approximately 1 V/GHz.

Output Characteristics

Internal Leveling: selected by front panel switch; refer to RF plug-in specifications.

Source SWR: 50 Ω nominal impedance.

Internally leveled: <1.6 SWR for HP 86240. <1.9 SWR for HP 86251A.

Unleveled: typically 3 SWR.

RF output connector: type N female.

HP 86240C Modulation Characteristics

External FM (maximum deviation for modulation frequencies)

DC to 100 Hz: ± 100 MHz

90 kHz to 10 MHz: ± 1.5 MHz

Frequencies response, dc to 10 MHz: ± 1.5 dB

Nominal Sensitivity

FM mode: +20 MHz/volt

Upconverter mode: +20 MHz/volt

General

Weight: Net, 2.3 kg (5 lb); shipping, 3.2 kg (7 lb) for HP 86240A/B/C. Net, 4.4 kg (9.6 lb); shipping, 5.9 kg (13 lb) for HP 86251A.

Options

002: 70 dB Step Attenuator (HP 86240A/B/C only)

004: Rear Panel RF Output

Price

add \$905

add \$200

	HP 86240A	HP 86240B	HP 86240C	HP 86251A
FREQUENCY				
Frequency Range (GHz):	2.0–8.4	2.0–8.4	3.6–8.6	7.5–18.6
Frequency Accuracy: (25°C)				
CW Mode (MHz)	± 25	± 25	± 25	$\pm 60^1$
CW Remote Programming typically (MHz):	± 3.5	± 3.5	± 3.5	
All Sweep Modes (for sweep time >100 ms) (MHz):	± 40	± 50	± 35	± 60
POWER OUTPUT				
Maximum Leveled Power (25°C) (mW):	>40	>20	>40	>10
With Option 002 (mW):	>40	>20	>40	
Power Variation: (At Max Rated Power)				
Unleveled (Typically) (dB):	$< \pm 6$	$< \pm 6$	$< \pm 6$	$< \pm 5$
Internally Leveled:	$< \pm 2$	$< \pm 2$	$< \pm 2$	± 0.8
Externally Leveled (Excluding Coupler and Detector Variation) Crystal Detector and Power Meter (dB):	$< \pm 0.1$	$< \pm 0.1$	$< \pm 0.1$	± 0.15
Spurious Signals: (dB below fundamental at specified maximum power)				
Harmonics:	< -20 (@20 mW) < -16 (@40 mW)	< -45 (Typ < -50)	< -20 (@20 mW) < -16 (@40 mW)	< -35
Nonharmonics:	< -60	< -60	< -60	< -50
PRICE				
Plug-in:	\$6,575	\$7,720	\$7,525	\$10,780

¹CW mode installed in HP 8350 mainframe or remote programming in HP 8620C: ± 20 MHz.



SWEEP OSCILLATORS

Model 8620 Series: Single Band RF Plug-Ins

Model 86200 Series and 11869A Adapter

- 10 MHz to 22 GHz coverage
- >50 mW from 5.9 to 12.4 GHz
- Compatible with HP 8350 mainframe via HP 11869A adapter

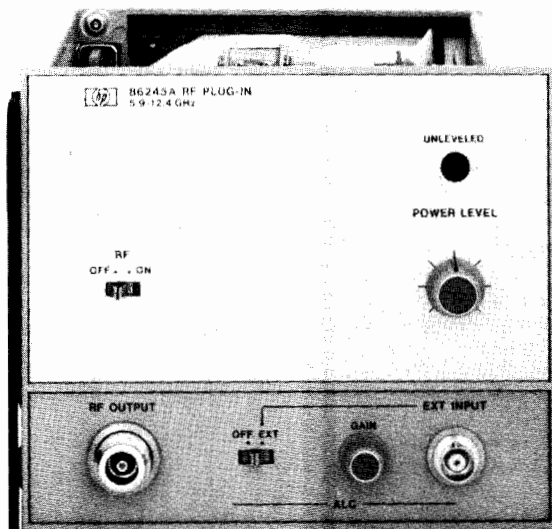

HP 86245A



HP 86260A

HP 86200 Series

The HP 86200 series plug-ins feature a wide choice of bandwidths and power specifications for covering the 10 MHz to 22 GHz frequency range. The HP 86222A/B 10 MHz to 2.4 GHz plug-ins, the HP 86240A/B/C 2 GHz to 8.6 GHz plug-ins, and the HP 86290B/C 2 GHz to 18.6 GHz plug-ins cover multi-octave frequency ranges with exceptional frequency precision and RF output characteristics. See preceding pages for specifications on these plug-ins. For octave band applications, smaller range plug-ins covering, for instance, 5.9 GHz to 12.4 GHz are available with optional capability to operate as up-converters for MLA measurements. Internal leveling is standard on all HP 86200 series plug-ins.

HP 11869A Adapter

The HP 86200 series can be used in the HP 8350 Sweep Oscillator mainframe with the addition of the HP 11869A Adapter. The HP 11869A provides the electrical and mechanical interface between the HP 86200 plug-in and the HP 8350 so that digital control of the plug-in is possible. All of the performance and features of the HP 8350 Sweep Oscillator mainframe are available when using the HP 86200 plug-ins and HP 11869A Adapter. For more information on the HP 11869A see page 501.

Specifications

With Plug-In Installed in an HP 8620C Mainframe

Frequency linearity: typically $\pm 1\%$.

Frequency reference output: typically 1 V/GHz dc-coupled voltage is available for referencing or phase-locking external equipment to the plug-in or for multi-octave operation with an HP 8410C.

RF power leveling: internal dc-coupled leveling amplifier and PIN modulator provided.

Internal, standard: selected by front panel switch; refer to RF plug-in specifications.

External

Crystal input: approximately -20 to 250 mV for specified leveling at rated output; for use with negative polarity detectors such as HP 780 Series Directional Detectors, HP 423A/B and 8470 Series Crystal Detectors.

Power meter input: leveling amplifier with compensation for HP 432A power meter included internally in all plug-ins except the HP 86241A.

Indicator: front panel indicator lights when RF power level is set too high to permit leveling over entire selected sweep range or when operating in unleveled mode.

Residual AM in 100 kHz bandwidth: < -50 dBc.

External AM

Frequency response: typically dc to 100 kHz unleveled, dc to 50 kHz leveled (at maximum leveled power).

Input impedance: approximately 5000 ohms.

RF output connector: type N Female.

HP 8350 Compatibility: the HP 11869A Adapter provides the electrical and mechanical interface so that the HP 86200 series plug-ins can be used in the HP 8350 Sweep Oscillator mainframe. For more information see the section on HP 11869A Adapter page 501.

Weight: net, 2.3 kg (5 lb); shipping, 3.2 kg (7 lb).

Options

002: 70 dB attenuator in 10 dB steps

004: rear panel RF output

Price

See model number
add \$200

Upconverter simulation options: options are available which guarantee compatibility with the HP Microwave Link Analyzer. For further information on these plug-ins refer to the Telecommunications Test Equipment Section beginning on page 391.



Single Band Plug-Ins

Refer also to Broadband Models 86222A/B (0.01-2.4 GHz), 86240A/B/C (2-8.4 GHz), 86251A (7.5-18.6 GHz), and 86290B/C (2-18.6 GHz)

Specifications with plug-in installed in HP 8620C	HP 86220A	HP 86235A	HP 86241A	HP 86242D	HP 86245A	HP 86250D	HP 86260B	HP 86260A	HP 86260C
Frequency range¹ (GHz):	0.01-1.3	1.7-4.3	3.2-6.5	5.9-9.0	5.9-12.4	8.0-12.4	10.0-15.5	12.4-18.0	17.0-22.0
Frequency accuracy CW mode (MHz): Remote programming typically (MHz): All sweep modes (sweep time >100 ms) (MHz):	±10 ±6.0 ±15	±20 ±2.5 ±30	±30 ±10.5 ±33	±35 ±5.0 ±40	±40 ±20 ±50	±40 ±20 ±50	±50 ±25 ±70	±50 ±25 ±70	±50 ±25 ±70
Stability: With Temperature: With 10% Line Voltage Change: With 10 dB Power Level Change: With 3:1 Load SWR Change, all Phases: With Time (after warm-up): Typ/10 min.	±600 kHz/°C ±20 kHz ±20 kHz ±250 kHz ± 200 kHz	±500 kHz/°C ±40 kHz ±1 MHz ±250 kHz ± 200 kHz	±650 kHz/°C ±30 kHz ±1 MHz ±250 kHz ± 200 kHz	±750 kHz/°C ±40 kHz ±1.5 MHz ±250 kHz ± 600 kHz	±1.2 MHz/°C ±40 kHz ±1.5 MHz ±250 kHz ± 600 kHz	±1.2 MHz/°C ±40 kHz ±1.5 MHz ±250 kHz ± 600 kHz	±5.4 MHz/°C ±180 kHz ±6 MHz ± 450 kHz	±5.4 MHz/°C ±180 kHz ±6 MHz ± 450 kHz	±5.4 MHz/°C ±180 kHz ±6 MHz ± 450 kHz
Residual FM (20 Hz -15 kHz BW, FM switch in NORM) CW mode (kHz peak):	<5	<7	<7	<15	<15	<15	<25	<25	<25
Maximum leveled power¹ (mW):	10	>40	>6.3(3.2-6 GHz) >5(6-6.5 GHz)	>10	>50	>10	>10	>10	>10
Power variation Internally leveled (dB): Externally leveled (dB) (excluding coupler & detector variation):	<±0.5 N/A	<±2 <±0.1	<±0.8 <±0.1	<±0.5 <±0.1	<±0.6 <±0.1	<±0.5 <±0.1	<±0.7 <±0.1	<±0.7 <±0.1	<±0.7 <±0.1
Spurious signals: (dB below fundamental, at specified max power) Harmonics: Nonharmonics:	<-25(10-750 MHz) <-30(750-1300 MHz) <-40	<-20 <-60	<-16(3.2-3.8 GHz) <-20(3.8-6.5 GHz) <-60	<-30 <-60	<-17(5.9-7 GHz) <-30(7-12.4 GHz) <-60	<-30 <-60	<-25 <-50	<-25 <-50	<-25 <-50
Source SWR: (50 Ω nom, Internally leveled)	<1.3	<1.6	<1.6	<1.6	<1.6	<1.6	<1.6	<1.6	<1.6
External FM: Max deviations (MHz) for modulation frequencies: DC-100 Hz: DC-1 MHz: Sensitivity (nom, MHz/V):	±15 ±0.5 +3.5	±75 ±5 -20/-6	±25 ±2 -6	±150 ±7 -20/-6	±150 ±7 -20/-6	±150 ±7 -20/-6	±150 (DC-200 kHz) ±5(200 Hz-200 kHz) -20/-6	±75 (DC-200 kHz) ±5(200 Hz-200 kHz) -20/-6	±75 (DC-200 kHz) ±5(200 Hz-200 kHz) -20/-6
AM: Internal 1 kHz Square wave On/Off ratio & EXT AM sensitivity To -10 V (dB): EXT AM Response compatible with 8756A/8757A Mod drive signal:	>35 No	>40 Yes	>25 No	>40 Yes	>40 Yes	>40 Yes	>25 No	>25 No	>25 No
Price: Plug-in: Opt 002 (70 dB Atten.)	\$3810 -\$750	\$5075 -\$850	\$4575 N/A	\$5175 N/A	\$7975 N/A	\$5275 N/A	\$6125 N/A	\$5675 N/A	\$9280 N/A

¹ Special frequency band and high power outputs available on request.



SIGNAL GENERATORS

Signal Generators to 60 GHz



Hewlett-Packard offers a complete line of signal generators from 10 kHz to 60 GHz. Each includes the following: 1) accurately calibrated variable frequency, 2) accurately calibrated variable output level, and 3) wide modulation capability.

New Generators for Complex Modulations

To simulate the complex modulation formats of modern microwave systems such as digital communications and radar/EW, HP introduces the HP 8780A Vector Signal Generator. It accepts digital data stream inputs and generates modulation formats such as QPSK, 16- and 64-QAM up to 150 Mbaud. Other wideband modulations include FM to 100 MHz deviation and pulsing with transition times as fast as 1 nanosecond. For more information, see the Vector Modulation Generators and Analyzers section.

The HP 8770A Arbitrary Waveform Synthesizer introduces ultra-high-speed digital technology for synthesizing fully-arbitrary waveforms with signal components up to 50 MHz. This capability gives you a highly-flexible method of precise signal generation for traditional VHF system tests on receivers as well as components.

In addition, the remarkable performance now available in generating arbitrary waveforms with 125 million sampling points per second and 12-bit amplitude resolution makes the generator ideal for many other important applications like computer disk signal simulations, EMP (Electro-Magnetic Pulse) simulations, and a highly-flexible signal source for automatic test systems. Signal fidelity exhibits typically < -60 dBc spurious and < -50 dBc harmonics. The 128K word memory provides for long, complex waveforms.

Synthesized Signal Generators

Collectively covering a frequency range from 10 kHz to 26.5 GHz, these versatile programmable signal generators are used in a wide variety of automated systems and high performance applications.

0.01 to 2560 MHz Low Close-in Noise Synthesized Signal Generators

The HP 8662A covers 10 kHz to 1280 MHz with calibrated output from +13 to -140 dBm. The HP 8663A shares the frequency synthesis circuitry of the HP 8662A and covers 100 kHz to 2560 MHz with calibrated levels from +16 to -130 dBm. Both generators feature extremely low phase noise and spurious while maintaining fast fre-

quency switching. The low phase noise close to the carrier (-112 dBc/Hz at a 100 Hz offset) optimizes the HP 8662A and 8663A for critical low noise applications like local oscillator substitution and multiplication to microwave frequencies. In addition, the low noise at typical channel spacings (-132 dBc/Hz at 10 kHz offset) allows both in-channel and out-of-channel measurements to be made under programmable control. The HP 8662A has AM and FM. The HP 8663A offers AM, FM, Φ M, and pulse modulation and a 10 Hz to 99.9 kHz modulation oscillator. Both the HP 8662A and 8663A feature precision digital sweep and full HP-IB programmability.

0.1 to 2115 MHz High Performance Synthesized Signal Generators

The HP 8642A (0.1 to 1057.5 MHz) and HP 8642B (0.1 to 2115 MHz) offer excellent spectral purity at carrier offsets beyond 10 kHz. Both share the same SAW resonator-based synthesis block diagram and differ primarily in frequency coverage. With SSB phase noise of -134 dBc/Hz at 20 kHz offset from a 1 GHz carrier and -100 dBc nonharmonic spurious, these generators are ideally suited to perform the most stringent of out-of-channel measurements on high performance RF communications receivers. Output levels from +20 dBm down to -140 dBm with ± 1 dB absolute level accuracy down to -127 dB allow these generators to drive high level mixers and pinpoint receiver sensitivity. RF leakage is specified at 0.5μ V for confidence in low level tests. AM, FM, Φ M and pulse modulation insure compatibility with most RF communications systems. AM is suited for avionics VOR and ILS systems and FM specifies 0.03% THD and typically 50 dB stereo separation. Frequency and amplitude sweep simplify device characterization.

The HP 8642A/B set a new standard for improved up-time in large ATE systems applications. A two-year recommended calibration interval, built-in diagnostic hardware and software and on-site repair and calibration contribute to improved ATE system productivity by keeping the HP 8642A/B up and running instead of out for repair.

0.1 to 990 MHz Low Cost Synthesized Signal Generator

The HP 8656B, an economical programmable RF signal generator, provides synthesized signals from 0.1 to 990 MHz. The HP

8656B offers a wide range of standard features, including 10 Hz resolution, full keyboard control, reverse power protection to 50W, and HP-IB programmability.

The HP 8656B features ± 1.0 dB level accuracy for increased measurement accuracy and repeatability. Its low RF leakage permits testing of RFI-susceptible devices and its phase adjustment feature allows characterization of phase sensitive devices. For communication receiver tests, the HP 8656B has flexible modulation, including simultaneous AM and FM rates from dc to 100 kHz. DCFM provides for testing with digital squelch tones. Separate increment keys provide rapid and easy setting of frequency, output and modulation. Because HP-IB is standard and frequency changes can be made in 150 ms, the HP 8656B is a cost-effective solution for in-channel measurements and an ideal general-purpose RF source for other applications.

0.01 kHz to 2600 MHz Synthesized Signal Generator with Plug-ins

The HP 8660A/C is a particularly versatile synthesized signal generator family, offering two mainframes and a variety of RF and modulation plug-ins. The HP 8660A mainframe utilizes thumbwheel switches for frequency selection. The HP 8660C has a more versatile keyboard control featuring synthesized digital sweep and frequency-step capability. Both HP-IB and BCD programming interfaces are available.

Three plug-in RF sections provide separate frequency ranges: 10 kHz to 110 MHz, 1 MHz to 1300 MHz, and 1 MHz to 2600 MHz. Output levels are calibrated over > 140 dB range. Five different modulation plug-ins provide versatile combinations of AM, FM, Φ M, and pulse modulation.

0.01 to 26.5 GHz Microwave Synthesized Signal Generators and mm-Wave Source Modules to 60 GHz

The HP 8340B (10 MHz to 26.5 GHz) and HP 8341B (10 MHz to 20 GHz) offer excellent CW performance. They also have a high-performance sweep oscillator, providing wide and narrow band continuous analog sweeps. Other features include 1 to 4 Hz frequency resolution, pulse frequency and amplitude modulation, and calibrated output power from +12 to -110 dBm.

The HP 8670 series of microwave synthesizers and the HP 8340B and HP 8341B Synthesized Sweepers cover five frequency ranges for measurement flexibility and broadband frequency coverage. They also feature good spectral purity and stability, versatile modulation, and full HP-IB programmability for signal simulation applications.

The HP 8671B Synthesized CW Generator is the economical solution for many applications from 2 to 18 GHz which require CW-only signals, such as LO substitution or for use in down-conversion for microwave noise figure measurements. Its output ranges from +8 to -120 dBm. The HP 8672A is a 2 to 18 GHz AM/FM generator with calibrated output from +3 to -120 dBm (+8 dBm with Option 008). The HP 8672S provides all the capability of the HP 8672A, plus extended frequency coverage from 10 MHz to 18 GHz and internal high-quality pulse modulation. Both the HP 8672A and S use knob-entry for frequency set.



The HP 8673B spans 2 to 26.5 GHz, with +8 to -100 dBm output level. Internal pulse modulation as well as external metered AM and FM allow complex signal simulation. Frequency and amplitude entry are digital keyboard entry.

The HP 8673E has all the features of the B-model except for frequency coverage of 2 to 18.0 GHz. Output range is +8 to -120 dBm.

The HP 8673D has all the performance of the HP 8673B, with extended frequency coverage from 50 MHz to 26.5 GHz, and harmonically related spurious outputs <-60 dBc from 2 to 26.5 GHz. Output power is >+5 dBm across the operating band. The HP 8673C offers the same performance from 50 MHz to 18.6 GHz.

Many of the microwave synthesizers and synthesized sweepers mentioned in this section are compatible with the HP 83554A/55A/56A mm-wave source modules for providing high-performance test signals to 60 GHz. Using power amplifiers and harmonic multipliers, the source modules also feature control interfaces which give direct frequency and output readout.

Solid-State, Mechanically Tuned Generators

Solid-state mechanically tuned generators combine fundamental oscillators with solid-state circuitry to yield excellent spectral purity for modern performance requirements.

2.3 to 18.0 GHz Solid-State Generators

The HP 8680 series solid-state signal generators are designed to meet the stringent requirements of modern microwave radar and communications testing. The HP 8683A and 8684A are optimized for communications receiver applications and feature low-distortion AM and FM, high spectral purity, and ± 2.5 dB output level accuracy.

The HP 8683B and 8684B add +10 dBm output power (standard) and high performance internal pulse modulation for radar/EW applications. An internal pulse generator provides wide ranges of rate, width and delay, and a custom pulse modulator yields >80 dB on/off ratio and <10 ns rise/fall times.

The HP 8683D and 8684D are extended-frequency versions of the HP 8683B and 8684B employing internal frequency doublers. Both are also capable of wideband FM for satellite communication applications.

Peak deviations of ± 10 MHz at dc to 10 MHz rates make these products suitable for DBS receiver testing.

0.5 to 1024 MHz, High Performance, Mechanically Tuned Generator

The performance leader of the RF mechanically tuned family is the HP 8640B signal generator, covering 450 kHz to 550 MHz. Frequency coverage can be extended to 1024 MHz with an internal doubler (Option 002), and an optional built-in audio oscillator extends the CW range down to 20 Hz (Option 001). The HP 8640B provides wide output level range from +19 to -145 dBm. High performance AM and FM and low phase noise at typical receiver channel spacings makes the HP 8640B an ideal generator for a wide variety of receiver measurements.

The HP 8640B with built-in counter has the ability to count external signals at frequencies up to 550 MHz and to phase-lock the generator's RF output to the counter time base for frequency stability of better than 5×10^{-8} /hour.

For avionics, navigation and communications applications, the HP 8640B Option 004 can be combined with suitable external modulation sources for testing ILS, VOR, and VHF communications receivers.

Signal Generator Summary

Frequency Range	HP Model	Characteristics	Page
0 to 50 MHz	8770A Arbitrary Waveform Synthesizer	Fully-arbitrary waveform. Output 125 million points per second (50 MHz). 12-Bit amplitude resolution (.025%). Operates from HP 200- or 300-Series Desktop Computer running HP 11776A Waveform Generation Software.	410
0.5 to 1024 MHz	8640B, 8640B Opt. 004 Signal Generators	Calibrated and leveled output from +19 to -145 dBm. AM, FM, and external pulse modulation. Built-in counter and phase lock capability. Avionics option available (Opt. 004).	533
0.1 to 1057.5 MHz 0.1 to 2115 MHz	8642A, 8642B Synthesized Signal Generators	High spectral purity. 1 Hz frequency resolution. ± 1 dB absolute output level accuracy. AM, FM, Φ M and pulse. Sweep 2 hour. On-site repair.	524
0.1 to 990 MHz	8656B Synthesized Signal Generator	± 1.0 dB absolute level accuracy from +13 to -127 dBm in 0.1 dB steps. Calibrated AM and FM. Frequency resolution of 10 Hz. Time base aging rate of ± 2 ppm/year.	522
0.01 to 1280 MHz	8662A Synthesized Signal Generator	Low close-in noise. 0.1 Hz frequency resolution, 5×10^{-19} /day stability. Calibrated and leveled output from +13 to -140 dBm. Digital sweep. Completely HP-IB programmable. AM/FM modulation. Fast switching.	527
0.1 to 2560 MHz	8663A Synthesized Signal Generator	Low close-in noise. 0.1 Hz frequency resolution, 5×10^{-19} /day stability. Calibrated and leveled output from +16 to -130 dBm. Digital sweep. Completely HP-IB programmable. AM, FM, Φ M, pulse modulation. Fast switching.	527
0.01 to 110 MHz 1 to 1300 MHz 1 to 2600 MHz	8660A, 8660C Synthesized Signal Generators	1 Hz frequency resolution, 3×10^{-19} /day stability. Calibrated and leveled output from +13 to -146 dBm. HP-IB and BCD programmable. AM, FM, Φ M, pulse modulation. Plug-ins determine frequency range and modulation capability.	531
50 to 3000 MHz	8780A Vector Signal Generator	Designed for complex modulation formats; QPSK, 16-QAM, 64-QAM, wideband FM to 50 MHz deviation, fast pulsing to 1 ns. Output range +10 to -100 dBm.	570
0.8 to 2.4 GHz 1.8 to 4.5 GHz	8614A, 8616A Signal Generators	Output +10 (HP 8616; +3 dBm above 3 GHz) to -127 dBm into 50 ohms, leveled below 0 dBm. Internal square-wave; external pulse, AM and FM. Auxiliary RF output.	540
2.3 to 6.5 GHz 5.4 to 12.5 GHz	8683/84 A,B Signal Generators	High spectral purity, stability. ± 2.5 dB absolute level accuracy from +10 to -110 dBm (0 dBm, A models). AM, FM standard. High perf. internal pulse modulator and pulse generator with B models. Portable, rugged (19.1 kg).	538
2.3 to 13 GHz 5.4 to 18 GHz	8683/84D Signal Generators	Same as B model except with wideband frequency coverage. DC coupled FM with ± 10 MHz deviations available. -3dBm standard output power in doubled frequency band. +10 dBm available with option 001.	538
2 to 18 GHz	8671B Synthesized CW Generator	1 to 3 kHz frequency resolution, 5×10^{-19} /day stability, +8 to -120 dBm output. Completely HP-IB programmable.	542
2 to 18 GHz	8673E Synthesized Signal Generator	1 to 3 kHz frequency resolution, 1.5×10^{-19} /day stability, +8 to -120 dBm output. Pulse, amplitude and frequency modulation. Digital sweep. Completely HP-IB programmable.	543
2 to 18 GHz	8672A Synthesized Signal Generator	1 to 3 kHz frequency resolution, 5×10^{-19} /day stability. Calibrated and leveled output from +3 to -120 dBm. Completely HP-IB programmable. Metered external AM and FM.	546
0.01 to 18 GHz	8672S Synthesized Signal Generator	1 to 3 kHz frequency resolution, 5×10^{-19} /day stability. Internal pulse modulator. Calibrated and leveled output from +2 to -120 dBm. Metered external AM and FM. Completely HP-IB programmable.	546
0.05 to 18.6 GHz 0.05 to 26.5 GHz	8673C, 8673D Synthesized Signal Generators	Harmonics and sub-harmonics <-60 dBc. 1 to 3 kHz resolution, C-model; 1 to 4 kHz, D-model; +2 to -100 dBm output. C-model; +5 to -100 dBm, D-model. Pulse amplitude and frequency modulation. Digital sweep. Completely HP-IB programmable.	544
0.01 to 20 GHz	8341B Synthesized Sweeper	1-3 Hz frequency resolution, 1×10^{-19} /day stability. +12 to -110 dBm output. Pulse, frequency and amplitude modulation. Continuous analog sweep with spans from 100 Hz to 19.99 GHz. Low harmonic option. Completely HP-IB programmable.	541
2 to 26.5 GHz	8673B Synthesized Signal Generator	1 to 4 kHz frequency resolution, 5×10^{-19} /day stability, +8 to -100 dBm output. Pulse, amplitude and frequency modulation. Digital sweep. Completely HP-IB programmable.	544
0.01 to 26.5 GHz	8340B Synthesized Sweeper	1 to 4 kHz frequency resolution, 1×10^{-19} /day stability. +12 to -110 dBm output. Pulse, frequency and amplitude modulation. Continuous analog sweep with spans from 100Hz to 26.49 GHz. Completely HP-IB programmable.	541
26.5 to 40 GHz 33 to 50 GHz 40 to 60 GHz	83554A, 83555A, 83556A Millimeter-Wave Source Modules	Effectively extends the performance of an 11 to 20 GHz microwave source (HP 8672A/S, 8673B/C/D, 8340A, 8341A, 8350B, 8620C) to the millimeter-wave frequency ranges.	510

SIGNAL GENERATORS

Synthesized Signal Generator

Model 8656B

- 100 kHz to 990 MHz
- ± 1.0 dB absolute level accuracy
- Amplitude offset and phase adjustment capability
- 150 millisecond frequency switching speed
- Versatile simultaneous modulation including dc FM
- Fully HP-IB programmable

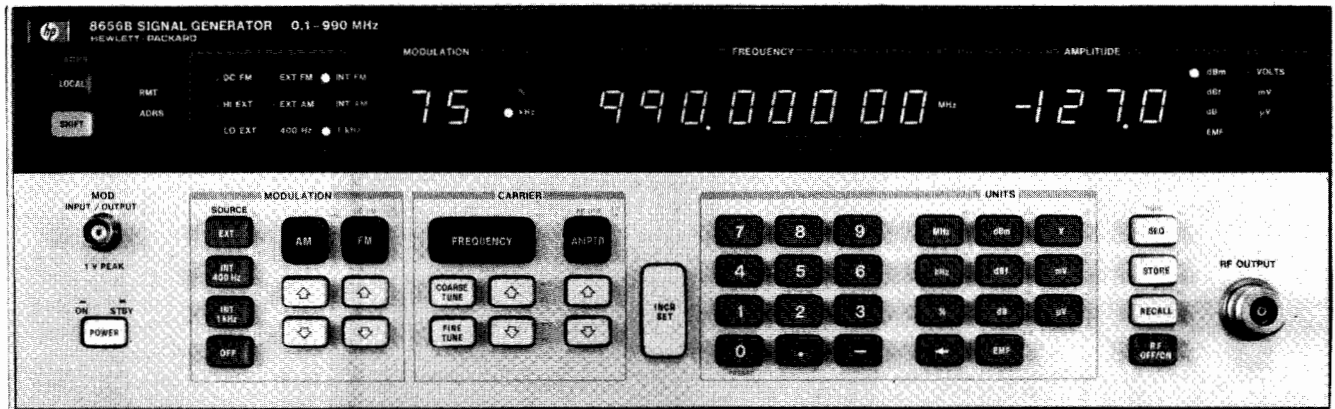

HP 8656B



Description

The HP 8656B is a programmable synthesized signal generator that offers exceptional value through a powerful combination of performance, quality and economy.

Frequency

The HP 8656B provides frequency coverage from 0.1 to 990 MHz (with under-range to 10 kHz). This wide range covers the IF and LO frequencies as well as the RF frequencies of most receivers. It also allows testing in a variety of communication systems including the 800 MHz FM mobile band and some telemetry bands. For automated testing, the 150 ms frequency switching speed of the HP 8656B (specified to be within 100 Hz of the final frequency) increases throughput. Frequency resolution of 10 Hz allows convenient setting of increments including narrow channel spacings, while characterization of phase sensitive devices is made easier with the help of the phase increment/decrement feature. The standard internal reference has an aging rate of 2 ppm/year. Improved stability and accuracy can be achieved by adding the optional 1×10^{-7} /day high stability time base (Option 001) or using an external reference of 1, 5 or 10 MHz.

Output

The output attenuator of the HP 8656B has been designed with high volume automatic test system use in mind. The 8656B also features ± 1.0 dB absolute level accuracy and 0.1 dB resolution for accurate receiver sensitivity tests, circuit characterization and R&D applications. The output levels are calibrated from +13 dBm (over-range to +17 dBm) to -127 dBm and may be set and displayed in any one of 14 convenient units including dBm, volts, dB μ V or Vemf. The output level can also be offset to compensate for cable and/or other losses external to the generator, or turned on or off with a dedicated key. Shielding keeps leakage at $< 1.0 \mu$ V for testing RFI susceptible devices, and standard resettable reverse power protection for up to 50 watts guards against accidental damage from transmitters.

Modulation

The HP 8656B's versatile modulation capabilities include simultaneous and mixed modulation modes (AM/AM, FM/FM and AM/FM) from internal (1 kHz and 400 Hz) and external sources. AM is ac coupled while FM can be either ac or dc coupled. The new, patented dc coupling technique used in the HP 8656B provides exceptional long term stability (< 10 Hz/hour) and center frequency accuracy (± 500 Hz) eliminating the need for retuning in the dc FM mode. For calibrated external modulation, a 1V peak signal is required, and HI/LO annunciators on the HP 8656B indicate when the external signal is within 5% of the correct amplitude.

Ease of Operation

A microprocessor-based controller provides a broad range of operating features for simple, but efficient control. Keyboard data entry uses a function/data/units format, and all function entries are made using a left-to-right keystroke sequence. All information entered is visible via LED displays and annunciators. Modulation, frequency, and level functions can be individually incremented by step sizes that are set by convenient keyboard entries. In addition, resolution control keys allow coarse and fine tuning of frequency in decade steps.

Up to ten front-panel setups can be stored and recalled. A sequence function allows you to cycle through stored setups at the touch of a key or via remote control. The microprocessor also makes troubleshooting aids available at the front panel, enhancing the serviceability of the HP 8656B.

HP-IB Programmability

Full HP-IB programmability is standard in the HP 8656B. Each programming command has an easy-to-remember, two-character, alpha-numeric HP-IB code that is also labeled next to each key. All functions are quickly and easily programmed using the same function/data/units format as in the manual mode.



HP 8656B Specifications

Frequency

Range: 100 kHz to 990 MHz (8 digit LED display).

Frequency underrange: 10 kHz with uncalibrated output (typical).

Resolution: 10 Hz.

Accuracy and stability: same as internal time base.

Time Base Characteristics

Typical Characteristics	Standard Time Base	Option 001 Time Base
Aging Rate	±2 ppm/year	1x10 ⁻⁷ /day
Frequency	50 MHz	10 MHz
External Reference Input (rear panel)	Accepts any 1, 5, or 10 MHz (±0.002%) frequency standard at a level >0.15 Vrms into 50 ohms.	

Frequency switching speed (to be within 100 Hz of final frequency): < 150 ms.

Phase Offset: adjustable via HP-IB or from the front panel in nominal 1 degree increments.

Spectral Purity

Spurious Signals (≤ +7 dBm output levels)

Harmonics: < -30 dBc.

Non-harmonic spurious (greater than 5 kHz from carrier in CW mode): < -60 dBc.

Sub-harmonics: none.

Residual FM

Post Detection Noise Bandwidth	Frequency Range (MHz)			
	0.1 to 123.5	123.5 to 247	237 to 494	494 to 990
0.3 to 3 kHz	<7 Hz rms	<2 Hz rms	<4 Hz rms	<7 Hz rms
0.05 to 15 kHz	<15 Hz rms	<4 Hz rms	<8 Hz rms	<15 Hz rms

Residual AM (0.05 to 15 kHz post detection noise bandwidth): 0.025%.

SSB Phase Noise (CW only)

Offset from Carrier	0.1 to 123.5 MHz (dBc/Hz)	123.5 to 247 MHz (dBc/Hz)	247 to 494 MHz (dBc/Hz)	494 to 990 MHz (dBc/Hz)
20 kHz	<-114	<-126	<-120	<-114

Typical SSB Phase Noise at 500 MHz

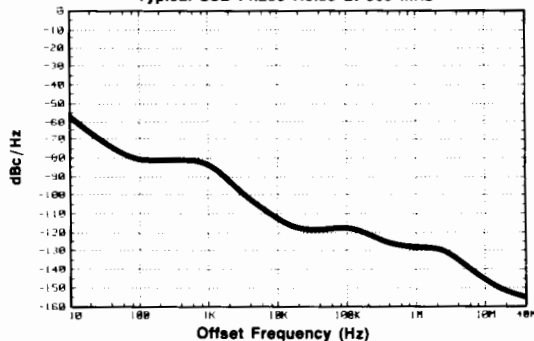

Output

Level range (into 50 ohms): 13 dBm to -127 dBm (3½ digit LED display; uncalibrated output to 17 dBm).

Resolution: 0.1 dB.

Absolute level accuracy: <±1.0 dB; 123.5 to 990 MHz <±1.5 dB; f_c < 123.5 MHz, levels > +7 dBm and <-124 dBm.

Level flatness (100 kHz to 990 MHz): ±1.0 dB at an output level setting of 0.0 dBm.

Reverse power protection: protects signal generator from application of up to 50 watts (from a 50Ω source) of RF power to 990 MHz into generator output; dc voltage cannot exceed 25V.

Amplitude Modulation (2 digit LED display)

AM depth¹: 0 to 99% to +7 dBm and 0 to 30% to +10 dBm.

Resolution: 1%.

AM rate: internal 400 Hz and 1 kHz, ±3%; external (1 dB bandwidth), 20 Hz to 40 kHz.

AM distortion (at internal rates): <1.5%, 0-30% AM; <3%, 31-70% AM; <4%, 71-90% AM.

Indicator accuracy (for depths <90% internal rates and levels < +7 dBm)¹: ≤±(2% + 4% of reading).

Incidental phase modulation (at 30% AM depth and internal rates): <0.3 radian peak.

Frequency Modulation (2 digit LED display)

FM Peak Deviation

Center Frequency	Maximum Peak Deviation	
	AC Mode	DC Mode
0.1 to 123.5 MHz	The lesser of 99 kHz or 4000 x rate (Hz)	99 kHz
123.5 to 247 MHz	50 kHz or 1000 x rate (Hz)	50 kHz
247 to 494 MHz	99 kHz or 2000 x rate (Hz)	99 kHz
494 to 990 MHz	99 kHz or 4000 x rate (Hz)	99 kHz

FM not specified for f_c - (Δf_{pk}) < 100 kHz

Resolution: 100 Hz for deviations less than 10 kHz; 1 kHz for deviations greater than 10 kHz.

FM rate: internal 400 Hz and 1 kHz, ±3%; external (1 dB BW), dc coupled, dc to 50 kHz; ac coupled, 20 Hz to 50 kHz.

Center frequency accuracy in dc FM mode: <±500 Hz.

Center frequency stability in dc FM mode: <10 Hz/hour.

FM distortion (internal rates and ≥3 kHz peak deviations): <0.5%.

Indicator accuracy¹: ±5% of reading at internal rates.

Incidental AM (for center frequency ≥500 kHz, peak deviation <20 kHz and internal rates): <0.1%.

Remote Programming

Interface: HP-IB (Hewlett-Packard's implementation of IEEE - 488).

Interface functions implemented: SH0, AH1, T0, L2, SR0, RL1, PP0, DC1, DT0, C0 and E1. (For more on these functions, refer to the HP-IB section of this catalog.)

General

Operating temperature range: 0° to +55° C.

Leakage: conducted and radiated interference is within the requirements of methods CE03 and RE02 of MIL STD 461B, FTZ 1115. Furthermore, RF leakage of less than 1.0 μV is induced in a two-turn loop, 2.5 cm in diameter, held 2.5 cm away from the front surface.

Power requirements: 100, 120, 220, or 240 Vac; +5%, -10%; 48 to 440 Hz, 125 VA maximum.

Weight: net, 18.2 kg (40 lb); shipping, 23.6 kg (52 lb).

Size: 133 H x 425 W x 520 D mm (5.25 x 16.75 x 20.5 inches). HP System II module size: 5/4 H x 1 MW x 17 D. For cabinet accessories, see page 748.

Rack slides and transit case: HP part numbers are: slide kit, 1494-0018; tilt slide kit, 1494-0025; full module transit case, 9211-2661.

Ordering Information

HP 8656B Signal Generator²

Option 001: High stability time base

Option 002: Rear panel input and output

Option 907: Front handle kit

Option 908: Rack flange kit

Option 909: Rack flange and front handle kit

Option 910: Extra operating & service manual

Price

\$6500

add \$850

add \$175

add \$55

add \$32.50

add \$80

add \$85

¹AM depth and FM deviation are further limited by Indicator Accuracy specifications.

²HP-IB cables not supplied, see page 133 for description and prices.



SIGNAL GENERATORS

Synthesized Signal Generators

Models 8642A and 8642B

- 100 kHz to 2.115 GHz
- < -147 dBc/Hz SSB phase noise at 20 kHz offset
- -100 dBc nonharmonic spurious
- $+20$ dBm maximum output level
- AM, FM, Φ M and pulse modulation
- On-site repair and calibration

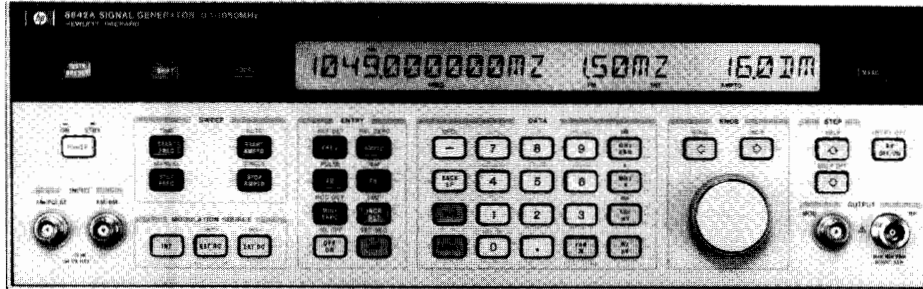

HP 8642A

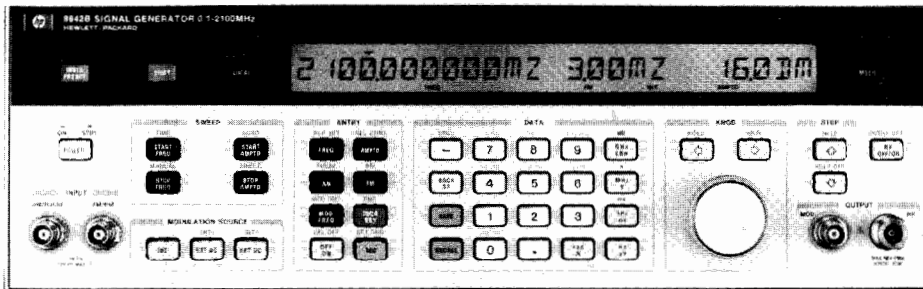

HP 8642B



HP 8642A/B Synthesized Signal Generators

The HP 8642A and HP 8642B synthesized signal generators are high performance programmable signal generators intended for the most demanding out-of-channel RF receiver measurements and other stringent RF applications. The HP 8642A covers the frequency range from 100 kHz to 1057.5 MHz and the HP 8642B covers the frequency range from 100 kHz to 2115 MHz. The two generators are otherwise very similar.

Low SSB Phase Noise

The HP 8642A/B improve the state-of-the-art in SSB phase noise at typical receiver adjacent channel spacings over the cavity tuned HP 8640B signal generator. This improvement is made possible through the use of high-Q Surface Acoustic Wave resonator oscillators operating near 800 MHz. SSB phase noise at 20 kHz offset from a 1 GHz carrier is -134 dBc/Hz, approximately 6 dB lower than the HP 8640B. The HP 8642A/B are an ideal choice to characterize selectivity on high performance receivers up to 1 GHz or 2 GHz. Furthermore, their advanced control features simplify measurements on the bench and in ATE systems.

-100 dBc Spurious

Nonharmonic spurious are held to below -100 dBc on the HP 8642A/B up to 1 GHz and to below -94 dBc on the HP 8642B above 1 GHz. These two generators allow receiver spurious rejection tests to be fully automated with the utmost confidence in test results. In the HP 8642A/B design, high performance mixers reduce typical synthesizer spurious, and rigid die castings with resilient RF gasketing provide up to 140 dB of circuit isolation to ensure low spurious content on the output.

± 1 dB Output Level Accuracy

Absolute output level accuracy is ± 1 dB down to -127 dBm (0.1 μ V). In R&D or on the production line, the HP 8642A/B will accurately measure receiver sensitivities. Excellent output level repeatability is obtained with a high reliability attenuator specifically

designed for continuous ATE system use. At any output level setting, the attenuator can be fixed and level varied up or down 10 dB in a transient free manner.

Up to $+20$ dBm Output Level

Up to $+20$ dBm is available from the HP 8642A/B to perform a variety of high level measurements, often eliminating the need for external amplifiers.

In ATE system use, this extra power is available to overcome cabling losses. Using the relative amplitude feature, the display can be offset to show correct output level at the end of the cable.

In receiver design, there is sufficient output power to drive high level mixers and perform receiver blocking tests. Intermodulation measurements can be made with high confidence since intermodulation distortion products on the HP 8642A/B are specified.

AM, FM, Φ M and Pulse Modulation

The HP 8642A/B offer AM, FM, Φ M and pulse modulation across their full frequency ranges with a unique dual output section to improve modulation characteristics at lower carrier frequencies.

The HP 8642A/B, like their predecessor the HP 8640B, use an RF divider output chain to obtain lower frequency coverage with improved spectral purity. However, the HP 8642A/B can, on demand, switch in a separate heterodyne (HET) output section below 132.2 MHz to obtain improved modulation performance over the divided output.

For testing FM mobile radios, the HP 8642A/B have built-in 750 μ s preemphasis (FM PRE) to simplify receiver audio flatness tests. Simultaneous modulation capability allows two-tone modulation tests.

A low distortion internal modulation oscillator can be used to modulate the HP 8642A/B up to 100 kHz rates or as a stand-alone audio source. The output, available at the front panel, is programmable both in frequency and level providing an independent audio oscillator.



Fit for ATE System Use

To improve instrument availability or "uptime", the HP 8642A/B have been designed to reduce failures and simplify the service procedure in the event of a failure. When used in ATE systems, the HP 8642A/B will improve overall system up-time, thus leading to increased productivity.

Extended Calibration Interval

The recommended calibration interval for the HP 8642A/B is two years, the result of a quality design, environmental-type testing and stringent production control. This means the HP 8642A/B will be more available for critical measurements, not out for calibration. When calibration is necessary, the HP 8952A Signal Generator Test System can automatically verify most warranted specifications for the HP 8642A/B in less than 20 minutes.

On-Site Repair and Calibration

The HP 8642A/B can be repaired and recalibrated on site in typically less than two hours. The fourteen internal modules that make up the HP 8642A/B all have rigid I/O specifications allowing a module-exchange repair strategy. Faulty modules can be quickly isolated using internal diagnostic hardware and software. A replacement module can be easily fitted and calibration data transferred to the instrument's main memory with a simple front-panel key sequence. Calibration and adjustments are primarily made electronically with ROM memory ICs and D/A converters.

A Unique Help Feature

Convenient control features help save time when putting the HP 8642A/B to work in systems. By using the "HELP" feature, special function codes and associated operational descriptions can be displayed by the alphanumeric back-lit liquid crystal display. It is easy to scroll through these descriptions with the knob or the UP/DOWN keys. The "HELP" feature eliminates the need to check manuals or pull-out cards by providing easy access to all special functions.

Through the LCD, messages in English clearly show instrument state and inform users of entry errors to help write programs that run smoothly from the start.

HP 8642A/B Specifications

Frequency

Range: 100 kHz to 1057.5 MHz, HP 8642A; 100 kHz to 2115 MHz, HP 8642B.

Bands: Both generators cover their ranges in one continuous span. However, many other specifications are dependent on carrier frequency. To simplify such specifications, the HP 8642A and 8642B carrier frequency ranges are divided into bands shown in the table below.

Band	Carrier Frequency (MHz)	Band	Carrier Frequency (MHz)
10	1057.500001-2115 (HP 8642B)	4	16.523438- 33.046875
9	528.750001-1057.5	3	8.261719- 16.523437
8	264.375001- 528.75	2	4.130860- 8.261718
7	132.187501- 264.375	1	0.1 - 4.130859
6	66.093751- 132.1875	HET	0.1 -132.1875
5	33.046876- 66.09375		

Resolution: 1 Hz, 0.1 Hz with special function.

Stability: same as reference oscillator.

Internal Reference Oscillator

Typical stability, standard: aging rate: ± 2 ppm/year.

Stability, option 001: $< 10^{-9}$ /day aging rate after 8 days warm-up.

Spectral Purity

Residual FM; CW, AM or Angle Modulation $\leq 1/3$ Maximum Peak Deviation:

Carrier Frequency	Post Detection Bandwidth, kHz	
	0.3 to 3 (Hz rms)	0.05 to 15 (Hz rms)
band 10 (HP 8642B)	<5	<9
band 9	<2	<5
band 8	<1.2	<2
bands 1 thru 7	<1	<1.2
band HET	<3.5	<5

SSB Phase Noise; CW, AM, or Angle Modulation $< 1/60$ Maximum Peak Deviation:

Carrier Frequency Band	SSB Phase Noise 20 kHz Offset dBc/Hz	SSB Phase Noise Floor 200 kHz Offset dBc/Hz
10	-125	-134
9	-134	-143
8	-137	-144
7	-141	-144
6	-144	-145
5	-145	-145
4	-146	-147
3	-147	-148
2	-148	-149
1	-137	-138
HET	-125	-137

Residual AM: $< 0.01\%$ AM rms, 0.3 to 3 kHz post-detection BW.

Spurious

Type of Spurious	HP 8642A/B Bands 1-9 and HET	HP 8642B Band 10
Harmonics		
Output Level $\leq +10$ dBm	-30 dBc	-25 dBc
Output Level $\leq +16$ dBm	-20 dBc	-20 dBc
Sub-harmonics	none	-45 dBc
Non-harmonics, > 10 kHz from the carrier	-100 dBc ¹	-94 dBc

Output

Level range: from maximum available to -140 dBm (0.023 μ V).

Maximum Level Available:

	HP 8642A	HP 8642B
+20 dBm (2.24V)	bands 1 thru 7	bands 1 thru 7
+19 dBm (2.00V)	n/a	band 8
+18 dBm (1.78V)	bands 8 & HET	HET
+17 dBm (1.58V)	n/a	band 9
+16 dBm (1.41V)	band 9	band 10

Resolution: 0.1 dB.

Absolute accuracy: ± 1 dB, output level ≥ -127 dBm.

Flatness: $\leq \pm 0.75$ dB, +10 dBm output level.

Impedance: 50 ohms nominal.

SWR: $< 1.5:1$ for output levels < 0 dBm;
 $< 2.0:1$ for output levels ≥ 0 dBm.

Reverse power protection: 50W, from a 50 Ω source 25 Vdc, HP 8642A;
25W, 50 Vdc, HP 8642B.

Third order intermodulation: < -50 dBc at +10 dBm, two generators 25 kHz apart into a resistive combiner. Typically decreases 10 dB for every 5 dB of combined level decrease.

Available calibration units: V, mV, μ V, dBm, and EMF. REL ZERO or REF SET can be used to obtain settings such as dB μ V, dBEMFV, dBf, etc.

Amplitude Modulation

AM depth: 0 to 99.9%, output level $\leq +10$ dBm.

AM resolution: 0.1%.

AM indicator accuracy at 1 kHz rate and up to 90% AM:
 $\pm (3.5\%$ of setting $+ 1\%$ AM), HP 8642A/B bands 1-8 and HET,
HP 8642B band 9.
 $\pm (5\%$ of setting $+ 1\%$ AM), HP 8642B band 9,
HP 8642B band 10.

AM distortion at 1 kHz rate:

Depth, %	Distortion	
	HP 8642A/B bands 1-8 HP 8642B band 9	HP 8642B band 9 HP8642B band 10 HP 8642A/B band HET
0 to 30	<1%	<2%
30 to 70	<2%	<4%
70 to 90	<4%	<6%

AM 3 dB bandwidth, depth $\leq 90\%$:

External dc/ac coupling: dc/20 Hz to 100 kHz, bands 1 and 5 thru 10; dc/20 Hz to 20 kHz, bands 2,3,4.

Internal: same as external ac.

Incidental phase modulation at 1 kHz rate and 30% AM: < 0.2 radians peak.

¹Not specified in HET band.



SIGNAL GENERATORS

Synthesized Signal Generators

Models 8642A and 8642B (cont.)

Frequency Modulation

Maximum FM deviation:

Carrier Frequency Band	Maximum Deviation DC Coupled	Maximum Deviation AC Coupled or Internal
10	3 MHz	(the smaller of) 3 MHz or $f_{\text{mod}} \times 2160$
9	1.5 MHz	1.5 MHz or $f_{\text{mod}} \times 1080$
8	750 kHz	750 kHz or $f_{\text{mod}} \times 540$
7	375 kHz	375 kHz or $f_{\text{mod}} \times 270$
6	187 kHz	187 kHz or $f_{\text{mod}} \times 135$
5	93.8 kHz	93.8 kHz or $f_{\text{mod}} \times 67.5$
4	46.9 kHz	46.9 kHz or $f_{\text{mod}} \times 33.75$
3	23.4 kHz	23.4 kHz or $f_{\text{mod}} \times 16.88$
2	11.7 kHz	11.7 kHz or $f_{\text{mod}} \times 8.44$
1	93.8 kHz	93.8 kHz or $f_{\text{mod}} \times 67.5$
HET	1.5 MHz	1.5 MHz or $f_{\text{mod}} \times 1080$

FM resolution: 0.7% of setting or 0.0004% of maximum deviation, whichever is larger.

FM indicator accuracy:

$\pm(5\%$ of setting + 10 Hz).

Rates dc to 100 kHz, external dc coupling.

Rates 20 Hz to 100 kHz, external ac and internal.

FM distortion: 4% for maximum dc coupled deviation, 2% for $1/2$ maximum dc deviation, 0.4% for $1/5$ maximum dc coupled deviation, rates 20 Hz to 100 kHz.

FM 3 dB bandwidth:

External dc/ac coupling: dc/20 Hz to 200 kHz.

Internal: dc/20 Hz to 200 kHz.

Incidental AM: 0.2%, 20 kHz peak deviation, 1 kHz rate, >400 kHz carrier frequency.

Carrier frequency offset when entering FM or phase modulation modes: AC and internal: none; DC: <500 Hz, HP 8642A/B; <1 kHz, HP 8642B band 10.

Phase Modulation

Maximum phase deviation:

Carrier Frequency Band	Maximum Deviation (Radians)
10	200
9	100
8	50
7	25
6	12.5
5	6.25
4	3.13
3	1.56
2	0.78
1	6.25
HET	100

Phase modulation accuracy: $\pm(5\%$ of setting + 0.09 radians), 1 kHz rate.

Phase modulation resolution: 0.7% of setting or 0.0004% of maximum deviation, whichever is greater.

Phase modulation distortion: <0.4%, 1 kHz rate.

Phase modulation 3 dB bandwidth: 20 Hz to 15 kHz, internal and external ac. DC to 15 kHz, external dc.

Pulse Modulation (for output levels $\leq +15$ dBm)

Pulse on/off ratio: >40 dB, HP 8642A/B; >80 dB, HP 8642B band 10.

Rise/fall time: <400 ns, 10% to 90%.

Maximum repetition frequency: 100 kHz.

Minimum pulse width: 2 μ s.

Nominal peak input threshold level: 1.5V.

Internal Modulation Oscillator

Rates: 20 Hz to 100 kHz.

Frequency resolution: 1% of setting.

Frequency accuracy: 2% of setting.

Output level range: 0 to 3V peak into 600 ohms.

Output level resolution: 4 mV.

Distortion: >0.5V peak: <0.02%, 0.02 kHz to 15.8 kHz; <0.15%, >15.8 kHz.

Output level accuracy: $\pm(4\%$ + 15 mV) within 1 second.

Output impedance: 600 ohms $\pm 10\%$.

Frequency Sweep

Digitally stepped sweep:

Start-stop sweep: sweeps between two selected endpoints in a linear step-wise manner. Endpoints can be anywhere within the frequency range of the instrument.

Phase continuous sweep:

Start-stop sweep: instrument sweeps between two selected endpoints in a linear, phase continuous manner.

Maximum span: up to 400 kHz, HP 8642A/B; up to 800 kHz, HP 8642B band 10.

X axis output: 0 to 10 Vdc, $\pm 10\%$.

Z axis output: TTL positive true for crt display blanking during retrace.

Remote Programming

Interface: HP-IB (Hewlett-Packard's implementation of IEEE-488-1978).

Functions controlled: all functions controlled from the front panel or over HP-IB from 00 to 30 (5 bit decimal equivalent).

Interface function: listener, talker, and controller.

HP-IB interface functions implemented: SH1, AH1, T5, TE0, L3, LE0, SR1, RL1, PP1, DC1, DT1, C1, C3, C28, E2.

General

Operating temperature range: 0° to 55° C.

Storage temperature: -55° C to +75° C.

Leakage: conducted and radiated interference is within the requirements of MIL STD 462B method CE03 and RE02. Interference is also within the standards set by FTZ 1115. Also, RF leakage of <0.5 μ V is induced in a two turn loop 2.5 cm in diameter, held 2.5 cm away from any surface for output levels ≤ 0 dBm.

Power requirements: 100V, 120V, 220V, or 240V; +5%, -10%; 48 to 440 Hz; 300 VA max.

Dimensions: 133H X 425W X 617D mm (5.25 X 16.75 X 24.3 inches).

HP System II module size: 5/8H X 1MW X 23D.

Weight: Net 32.7 kg (71.5 lb); shipping 43 kg (95 lb).

Supplemental Characteristics

Spectral Purity

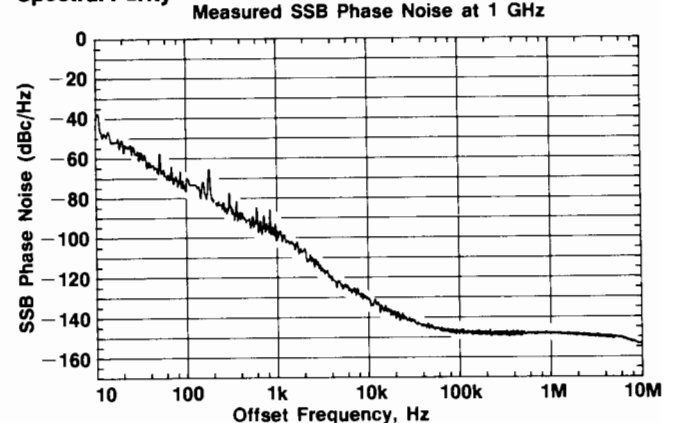

Ordering Information

	Price
HP 8642A Synthesized Signal Generator	\$22,500
HP 8642B Synthesized Signal Generator	\$29,500
Option 001: High stability time base	\$2,000
Option 002: Rear panel inputs and outputs	\$150
Option 710: On-site repair manual	\$72
Option 907: Front handle kit	\$55
Option 908: Rack flange kit	\$32.50
Option 909: Front handle kit & rack flange kit	\$80
Option 910: Extra manual	\$425
Option W03: 90 day on-site warranty conversion	\$0
Option W30: Three-year extended hardware support:	
HP 8642A	\$975
HP 8642B	\$1350
HP 11801A: On-site repair kit for HP 8642A	\$20,000
HP 11801B: On-site repair kit for HP 8642B	\$26,500
HP 11801C: On-site repair kit for HP 8642A and 8642B	\$28,000



SIGNAL GENERATORS

Synthesized Signal Generators

Models 8662A, 8663A

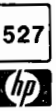

- 10 kHz to 1280 MHz frequency range
- <-147 dBc/Hz SSB phase noise at 10 kHz offset
- 0.1 Hz frequency resolution

- 100 kHz to 2560 MHz frequency range
- AM/FM/PM/pulse in one generator
- Internal variable modulation oscillator

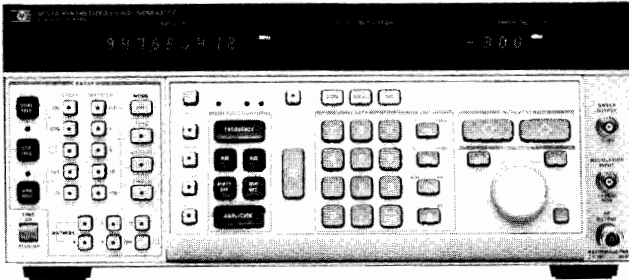

HP 8662A

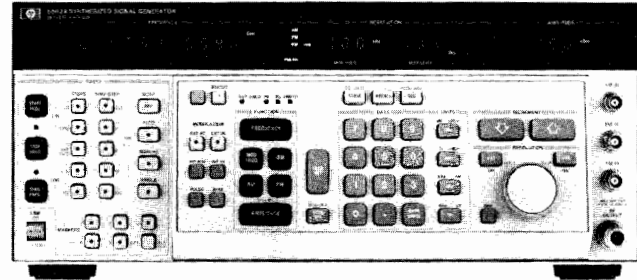

HP 8663A



HP 8662A Synthesized Signal Generator

The HP 8662A derives exceptional RF performance from an indirect frequency synthesis technique that results in frequency resolution of 0.1 Hz from 10 kHz to 640 MHz and 0.2 Hz from 640 MHz to 1280 MHz.

Output level accuracy is held to ± 1 dB using microprocessor correction. This makes the HP 8662A an ideal generator for performing precise receiver sensitivity tests either manually or in automated systems.

The HP 8662A offers versatile phase-locked AM/FM using either internal 400 Hz and 1 kHz rates or externally applied modulating signals, which can be either dc or ac coupled. Several different modes of simultaneous modulation (such as AM + FM or FM + FM) are possible.

Exceptional Spectral Purity

The key contribution of the HP 8662A is spectral purity. Fast-tuning, switched-inductance, voltage-controlled oscillators combined with a low noise reference multiplication chain result in very low SSB phase noise, especially at small offsets from the carrier. The phase noise at 20 kHz to 50 kHz offsets is comparable to that of the best cavity-tuned fundamental oscillators. Such excellent noise performance makes possible complete automation of receiver out-of-channel measurements.

With its excellent long and short-term frequency stability, high output power, fine frequency resolution, and broad frequency range the HP 8662A also meets the requirements of the most critical low noise local oscillator applications. In addition, its fast frequency switching and sweep capabilities also permit its use in many frequency agile and swept local oscillator applications.

An advanced microprocessor-based controller allows convenient keyboard control of all HP 8662A functions. For example, all functions can be incremented and decremented in any user-defined step size within the resolution of the synthesizer using the increment keys and the knob. Up to nine full front panel setups can be stored in the HP 8662A's memory and recalled for later use in any user-defined sequence at the touch of a pushbutton. This permits time-saving semi-automation of generator operation in production setups where the generator must perform many different tests.

Precision Digital Sweep

Fast frequency switching combined with microprocessor control gives the HP 8662A a powerful sweep capability. Automatic, single, and manual modes are available for both linear and logarithmic sweeps with user-selectable step size and number of steps. Five different sweep speeds can be chosen and up to five amplitude or Z-axis markers can be set. All sweep parameters can be controlled with full synthesizer resolution.

HP 8663A Synthesized Signal Generator

The HP 8663A provides all the features and the exceptional spectral purity of the HP 8662A with increased frequency range and modulation capability.

The HP 8663A also has U.S. Air Force MATE (Modular Automatic Test Equipment) system compatibility, Option 700. Option 700 is an external translator that provides the HP 8663A with the capability to be controlled by the MATE language CIIL (Control Interface Intermediate Language).

Broad Frequency Range

The HP 8663A utilizes the complete frequency synthesis portion of the HP 8662A with the addition of an internal frequency doubler to achieve a broad frequency range of 100 kHz to 2560 MHz in a single instrument. In the HP 8663A, the exceptional spectral purity of the HP 8662A is maintained up to 1280 MHz. Above this, phase noise is typically increased 6 dB to a level of -124 dBc/Hz at 10 kHz offset from a 2.5 GHz carrier. High output power of +16 dBm (with over-range to 19.9 dBm) is available for efficiently driving frequency translators when low noise microwave signals are needed. Combined with a microwave synthesizer such as the HP 8673A, full frequency coverage from 100 kHz to 26 GHz is possible.

Flexible Modulation

Complete modulation capability across a wide carrier frequency range is the key contribution of the HP 8663A. AM and FM characteristics are similar to those offered in the HP 8662A. The HP 8663A adds high performance pulse and biphase modulation with wide bandwidth linear phase modulation available with Option 002. For complete flexibility the HP 8663A Option 002 has the capability to simultaneously provide AM+FM+pulse+phase modulation across its entire frequency range. AM, FM, and linear phase are either AC or DC coupled while biphase and pulse are DC coupled. This modulation flexibility assures exact signal simulation when testing complex systems such as those involving pulsed doppler radar and electronic warfare. An internal 100 kHz sinusoidal modulation synthesizer phase locked to the 10 MHz time base is standard. Microprocessor flexibility allows the sweep functions to be applicable to the internal audio synthesizer, as well as the RF synthesizer, making applications involving swept modulation possible with a single instrument.

Similarity to the HP 8662A

Because the HP 8663A has been designed to be upward compatible with the HP 8662A, the two generators have identical control and performance characteristics for those functions that are common. Either generator can be combined with the HP 11729A Microwave Converter and the HP 3048A Phase Noise Measurement System to perform microwave phase noise measurements simply and quickly.



SIGNAL GENERATORS

Synthesized Signal Generators

Models 8662A, 8663A (cont.)

HP 8662A Specifications

Frequency

Range: 10 kHz to 1280 MHz (1279.999998 MHz).

Resolution: 0.1 Hz (0.2 Hz above 640 MHz).

Accuracy and stability: same as reference oscillator.

Internal reference oscillator: 10 MHz quartz oscillator. Aging rate $< 5 \times 10^{-10}$ /day after 10 day warm-up (typically 24 hrs in normal operating environment).

Spectral Purity

Residual SSB Phase Noise in 1 Hz BW ($320 \leq f_c < 640$ MHz)

Offset from Carrier				
10 Hz	100 Hz	1 kHz	10 kHz	100 kHz
-100 dBc	-112 dBc	-121 dBc	-131 dBc	-132 dBc

SSB broadband noise floor in 1 Hz BW at 3 MHz offset from carrier: < -146 dBc for f_c between 120 and 640 MHz at output levels above +10 dBm.

Spurious Signals

	Frequency Range (MHz)				
	0.01 to 120	120 to 160	160 to 320	320 to 640	640 to 1280
Spurious non-harmonically related ^{1,2}	-90 dBc	-100 dBc	-96 dBc	-90 dBc	-84 dBc
Sub-harmonically related ($\frac{1}{2}$, $\frac{3}{2}$, etc.)	none	none	none	none	-75 ³ dBc
Power line (60Hz) related or microphonically generated (within 300 Hz) ⁴ .	-90 dBc	-85 dBc	-80 dBc	-75 dBc	-70 dBc
Harmonics	< -30 dBc				

Output

Level range: +13 to -139.9 dBm (1V to $0.023 \mu V_{rms}$ into 50 Ω).

Resolution: 0.1 dB.

Absolute level accuracy (+15° to +45°C): ± 1 dB between +13 and -120 dBm, ± 3 dB between -120 and -130 dBm.

SWR: typically from 1.5 to 1.8 depending on output level and frequency.

Reverse power protection: typically up to 30W or ± 8 Vdc.

Amplitude Modulation

Depth: 0 to 95% at output levels of +8 dBm and below (+10 dBm in uncorrected mode). AM available above these output levels but not specified.

Resolution: 1%, 10 to 95% AM; 0.1%, 0 to 9.9% AM.

Incidental PM (at 30% AM): 0.15-640 MHz, < 0.12 radian peak; 640-1280 MHz, < 0.09 radian peak.

Incidental FM (at 30% AM): 0.15-640 MHz, $< 0.12 \times f_{mod}$; 640-1280 MHz, $< 0.09 \times f_{mod}$.

Indicated accuracy: $\pm 5\%$ of reading $\pm 1\%$ AM. Applies for rates given in table below, internal or external mode, for depths $\leq 90\%$.

Rates and Distortion with Internal or External Modulating Signal

Frequency range	AM rate	AM Distortion		
		0-30% AM	30-70% AM	70-90% AM
0.15-1 MHz	dc-1.5 kHz	2%	4%	5.75%
1-10 MHz	dc-5 kHz	2%	4%	5.75%
10-1280 MHz	dc-10 kHz	2%	4%	5.75%

Frequency Modulation

FM rates (1 dB bandwidth): external ac, 20 Hz to 100 kHz; external dc, dc to 100 kHz.

FM deviation: from 25 to 200 kHz depending on carrier frequency.

Indicated FM accuracy: $\pm 8\%$ of reading plus 10 Hz (50 Hz to 20 kHz).

FM resolution: 100 Hz for deviations < 10 kHz, 1 kHz for deviations ≥ 10 kHz.

Incidental AM (AM sidebands at 1 kHz rate and 20 kHz deviation): < -72 dBc, $f_c < 640$ MHz; < -65 dBc, $f_c \geq 640$ MHz.

FM distortion: $< 1.7\%$ for rates < 20 kHz, $< 1\%$ for rates < 1 kHz.

Center frequency accuracy and long term stability in AC mode: same as CW mode.

Supplemental Characteristics

Typical Absolute and Residual SSB Phase Noise, 639 MHz Carrier.

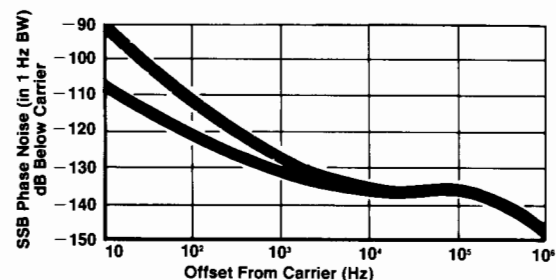

Frequency switching speed:⁵ From 420 μ sec to 12.5 msec, depending on the programming mode.

HP 8663A Specifications

The HP 8663A signal generator is related to the HP 8662A in both concept and structure. The HP 8662A concept of an extremely low phase noise signal source incorporating signal generator modulation capabilities and output characteristics is carried even further by the HP 8663A. While maintaining high spectral purity, the HP 8663A offers increased frequency range to 2560 MHz, increased output level to +16 dBm, and the addition of phase and pulse modulation. The result is a highly flexible and powerful signal generator that utilizes and extends the proven circuitry of the HP 8662A. Thus, the HP 8662A and HP 8663A share many of the same specifications as shown below:

Frequency

Range: 100 kHz to 2560 MHz (2559.999996 MHz)

Resolution: 0.1 Hz ($f_c < 640$ MHz)

0.2 Hz ($640 \text{ MHz} \leq f_c < 1280$ MHz)

0.4 Hz ($f_c \geq 1280$ MHz)

Accuracy, stability, and internal reference oscillator: identical to HP 8662A.

¹In the remote mode it is possible to have microprocessor clock related spurious signals spaced 3 MHz apart at an absolute level of typically less than -145 dBm.

²Spurious signals can be up to 3 dB higher in the dc FM mode.

³ $\frac{3}{2}$ spurs not specified for carrier frequencies above 850 MHz.

⁴At a 50 Hz line frequency, power line or microphonically related spurious signals may be up to 3 dB higher and appear at offsets as high as 1 kHz from the carrier.

⁵Due to automatic leveling loop bandwidth changes, brief (30 msec) level inaccuracies may occur when switching through 150 kHz and 1 MHz RF output frequencies.



Spectral Purity

Residual SSB phase noise in 1 Hz BW ($320 \leq f_c < 640$ MHz): identical to HP 8662A.

Typical SSB phase noise: identical to the HP 8662A for f_c between 100 kHz and 1280 MHz (see graph). For f_c between 1280 and 2560 MHz, the noise will be approximately 12 dB higher than the 639 MHz curve on the "typical SSB phase noise" graph.

Absolute SSB phase noise in a 1 Hz BW: identical to the HP 8662A for f_c between 100 kHz and 1280 MHz. For f_c between 1280 and 2560 MHz, the specified noise is 6 dB higher than the 640 to 1280 MHz specification in the table.

Spurious signals: identical to HP 8662A except for f_c between 1280 and 2560 MHz the spurious non-harmonics are -78 dBc, the subharmonically related ($f/2$, $3f/2$, etc.) between 640 and 1280 MHz are -70 dBc and between 1280 and 2560 MHz are -40 dBc, and the power line (60 Hz) or microphonically generated spurious are -65 dBc.

Harmonics: < -30 dBc, $\leq +13$ dBm output, < -25 dBc, $+13$ dBm to $+16$ dBm output, $f_c < 1280$ MHz; < -25 dBc, $f_c \geq 1280$ MHz

Output

Level range: +16 dBm to -129.9 dBm

Resolution: 0.1 dB

Absolute level accuracy ($+15^\circ$ to $+45^\circ$ C): ± 1 dB, +16 dBm to -119.9 dBm; ± 3 dB for -120 dBm and below.

SWR: < 1.5

Amplitude Modulation

Depth: 0 to 95% at levels of +10 dBm and below

Resolution: 0.1%

Incidental FM (at 30% AM): identical to HP 8662A except: $< 0.3 \times f_{\text{mod}}$ for $1280 \leq f_c < 2560$ MHz

Indicated accuracy: $\pm 6\%$ of reading $\pm 1\%$ AM (400 Hz and 1 kHz, depth 90%)

AM Bandwidth (1dB):

DC to > 1.5 kHz, 0.15 MHz $\leq f_c < 1$ MHz; DC to > 5 kHz, 1 MHz $\leq f_c \leq 10$ MHz; DC to > 10 kHz, $f_c > 10$ MHz: External dc coupling. External ac coupling or internal; low frequency coupling is 20 Hz.

Distortion (400 Hz and 1 kHz): $< 2\%$ (0-30% AM); $< 4\%$ (30-70% AM); $< 6\%$ (70-90% AM).

Frequency Modulation

FM rates (1 dB bandwidth): external ac, 20 Hz to 100 kHz, external dc, dc to 100 kHz.

Maximum allowable peak deviation: identical to HP 8662A for f_c between 100 kHz and 1280 MHz. Up to 400 kHz for f_c between 1280 and 2560 MHz.

Indicated FM accuracy (50 Hz to 20 kHz): $\pm 9\%$ of setting +10 Hz.

FM resolution: 100 Hz to 1 kHz depending on f_c and deviation setting.

Incidental AM (AM sidebands at 1 kHz rate and 20 kHz deviation): < -72 dBc ($10 \leq f_c < 640$ MHz); < -65 dBc ($640 \leq f_c < 2560$ MHz).

FM distortion: $< 1.25\%$ (400 Hz and 1 kHz rates); $< 1.75\%$ (rates less than 20 kHz).

Phase Modulation (Option 002)

Maximum peak phase deviation: from $\pm 25^\circ$ for f_c between 120 and 160 MHz up to $\pm 400^\circ$ for f_c between 1280 and 2560 MHz.

Maximum rate: from 10 kHz for f_c between 0.15 and 10 MHz up to 10 MHz for f_c between 250 and 2560 MHz.

Phase deviation resolution: 1° ($0.1 \leq f_c < 640$ MHz); 2° ($640 \leq f_c < 1280$ MHz); 4° ($1280 \leq f_c < 2560$ MHz).

Phase modulation distortion: 10% at maximum rate.

Biphase Modulation

Biphase modulation is available on the standard HP 8663A for f_c less than 640 MHz and available for all f_c with Option 002.

Deviation: $\pm 90^\circ$.

Carrier null when modulated with 1 MHz, 50% duty cycle square wave: > 25 dBc.

Modulation input required: TTL positive true. The internal modulation oscillator can be used for 50% duty cycle modulation. External input is on rear panel.

Pulse Modulation¹

Pulse on/off ratio: > 80 dB (50-2560 MHz).

Pulse rise/fall time: < 250 ns (50-120 MHz); < 780 ns (120-640 MHz); < 100 ns ($f_c \geq 640$ MHz).

Pulse Repetition Frequency (50% duty cycle):

Internal: 10 Hz to 99.9 kHz.

External: 10 Hz to 2 MHz, 50 MHz $< f_c < 640$ MHz; 10 Hz to 5 MHz, $f_c > 640$ MHz.

Internal Modulation Oscillator

Rates: 10 Hz to 99.9 kHz.

Frequency resolution: 3 digits.

Frequency accuracy: same as reference oscillator.

Output level (available on rear panel): 1 volt peak into 600 Ω .

Output impedance: 600 Ω .

Flatness (referenced to 1 kHz): $< \pm 1\%$.

Distortion: $< 1\%$.

Other HP 8662A and HP 8663A Information

Remote programming: the HP-IB interface is standard on the HP 8662A and HP 8663A signal generators. All functions controlled from the front panel with the exception of the line switch are programmable with the same accuracy and resolution as in manual mode.

Operating temperature range: 0° to $+55^\circ$ C.

Leakage: meets radiated and conducted limits of MIL STD 461A methods RE02 and CE03 as well as VDE 0871.

Power requirements: 115 (90-126) V or 230 (198-252) V; 48 to 66 Hz; 450 VA max.

Weight: HP 8662A: net 30 kg (65.5 lb.). Shipping 36 kg (80 lb.).

HP 8663A: net 33.8 (74 lb.). Shipping 40 kg (88 lb.).

Size: HP 8662A: 178 mm H x 425 mm W x 572 mm D (7" x 16.75" x 22.5"). HP 8663A: 178 mm H x 425 mm W x 642 mm D (7" x 16.75" x 25.3"). Note: depth includes front panel depth of 45 mm (1.75").

Ordering Information

	Price
HP 8662A 1280 MHz Signal Generator ²	\$32,500
Option 001: Rear panel RF output and mod input	add \$350
Option 003: Specified SSB phase noise for 640 MHz output	add \$500
Option 907: Front Handle kit	add \$65
Option 908: Rack flange kit	add \$35
Option 909: Rack flange & front handle kit	add \$90
Option 910: Extra operating & service manual	add \$135
HP 11721A External frequency doubler for operation to 2.56 GHz (HP 8662A only)	\$650
HP 8663A 2560 MHz Signal Generator ²	\$45,750
Option 001: Rear panel RF output and mod inputs	add \$350
Option 002: Wideband linear phase modulation	add \$5,250
Option 003: Specified SSB phase noise for 640 MHz output.	add \$500
Option 700: External MATE translator	add \$6,500
Option 907: Front handle kit	add \$65
Option 908: Rack flange kit	add \$35
Option 909: Rack flange & front handle kit	add \$90
Option 910: Extra operating & service manual	add \$200
HP 11714A Service Support Kit (required for servicing HP 8662A/8663A)	\$1250

¹Pulse modulation is available for $f_c < 50$ MHz but is unspecified.

²HP-IB cables not supplied, see page 133 for description and prices.

SIGNAL GENERATORS

Synthesized Signal Generators

Models 8660A and 8660C

- 10 kHz to 2600 MHz
- Synthesizer stability and accuracy
- 1 Hz resolution (2 Hz above 1300 MHz)

- Ten digit display
- Calibrated output over > 140 dB range
- AM, FM, Φ M, or pulse modulation

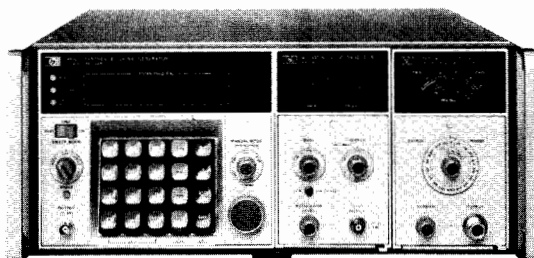

HP 8660C

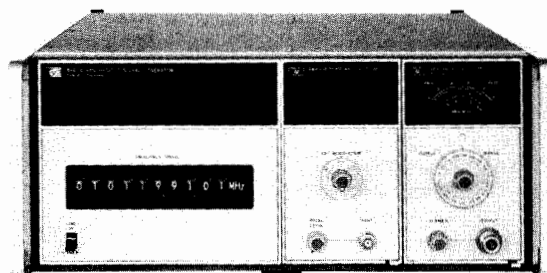

HP 8660A

HP 8660A, 8660C Synthesized Signal Generators

System Concept

The HP 8660 is a modular solid-state plug-in system. Each system includes: 1) a programmable synthesized signal generator mainframe, 2) an RF section plug-in, and 3) a modulation section. Synthesized accuracy and stability along with complete programmability make the HP 8660 ideal for most automated receiver and component testing situations.

Mainframes

There are two mainframes, the HP 8660A and HP 8660C which both offer a BCD or optional HP-IB interface and operation from an internal or external frequency reference. The HP 8660A mainframe uses thumbwheel switches to select CW output frequencies. The HP 8660C mainframe provides direct keyboard entry of CW frequencies. Added capabilities of the HP 8660C include digital sweep, frequency stepping, control of frequency with a tuning knob, and a ten-digit numerical display.

Plug-In RF Sections

The HP 86601A (0.01 – 110 MHz), HP 86602B (1 – 1300 MHz), and HP 86603A (1 – 2600 MHz) are the three RF section choices. The HP 11661B Frequency Extension Module (mainframe Option 100) must be used with the HP 86602B and HP 86603A and is installed internal to an HP 8660 mainframe. When using the HP 8660A mainframe, the HP 86603A plug-in must be ordered with Option 003.

Plug-In Modulation

There are five modulation sections to choose from. The HP 86631B Auxiliary Section provides external AM and pulse modulation. The HP 86632B offers AM and FM and utilizes a free-running VCO to provide high FM deviations and rates while the HP 86633B provides AM and phase locked FM. The HP 86634A offers high performance phase modulation with rates to 10 MHz while the HP 86635A provides both FM and phase modulation. (The HP 86634A and HP 86635A must be used with Option 002 RF Section.)

HP 8660A, 8660C Mainframe Specifications

Frequency accuracy and stability: CW frequency accuracy and long term stability are determined by internal reference oscillator (3×10^{-8} /day), or by external reference.

Reference Oscillator

Internal: 10 MHz quartz oscillator. Aging rate less than ± 3 parts in 10^8 per 24 hours after 72 hours warm-up (± 3 parts in 10^9 per 24 hours, Option 001).

External: rear panel switch allows operation from 5 MHz or 10 MHz frequency standard at a level between 0.5 and 2.5 Vrms into 170 ohms.

Reference output: rear panel BNC connector provides output of reference signal selected at level of at least 0.5 Vrms into 170 ohms.
Digital sweep (HP 8660C): auto, single, or manual. Selectable speeds 0.1, 1, or 50 seconds.

Remote Programming

Functions

HP 8660A: all front panel frequency and output level (and most modulation functions) are programmable.

HP 8660C: CW frequency, frequency stepping (STEP \uparrow , STEP \downarrow), output level, and most modulation functions are programmable. Note: digital sweep is NOT programmable.

Programming Input

Connector type: 36-pin Cinch type 57 (mating connector supplied). 24-pin Cinch type 57 for optional HP-IB interface (mating connector NOT supplied).

Logic: TTL compatible (negative true).

Switching time: less than 5 ms to be within 100 Hz of any new frequency selected. (Less than 100 ms to be within 10 Hz.)

General

Operating temperature range: 0 to +55°C.

Power: 100, 120, 220, or 240 volts +5%, -10%, 48-66 Hz; approximately 350 watts.

Weight (mainframe only): net 23.2 kg (51 lb). Shipping, 28.6 kg (63 lb).

Supplemental Characteristics

Typical Single Sideband Phase Noise

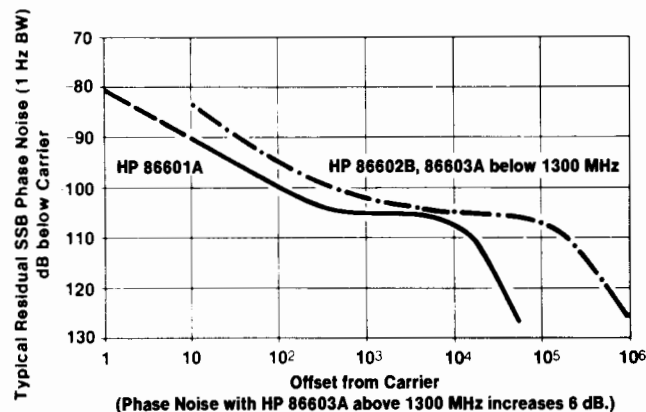

10 kHz to 110 MHz

1 MHz to 1300 MHz

1 MHz to 2600 MHz

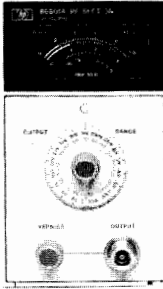

HP 86601A

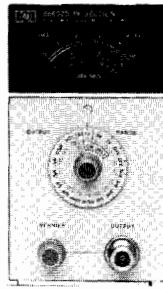

HP 86602B (HP 11661B required)

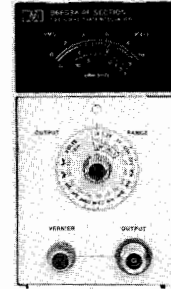

HP 86603A (HP 11661B required)

RF Section Specifications (installed in HP 8660A or HP 8660C mainframe)

		HP 86601A	HP 86602B (requires HP 11661B)	HP 86603A (requires HP 11661B)		
FREQUENCY CHARACTERISTICS	Frequency Range	0.01–110 MHz (109.999999 MHz)	1–1300 MHz (1299.999999 MHz)	1–2600 MHz (2599.999998 MHz)		
	Frequency Resolution	1 Hz	1 Hz	2 Hz		
	Harmonics	≤−40 dBc	≤−30 dBc (<−25 dBc above +3 dBm)	≤−20 dBc ¹		
	Spurious Non Harmonically Related	≤−80 dBc	≤−80 dBc below 700 MHz ≤−80 dBc above 700 MHz within 45 MHz of carrier ≤−70 dBc above 700 MHz >45 MHz from carrier ≤−50 dBc on +10 dBm range	≤−74 dBc within 40 MHz of carrier ¹ ≤−64 dBc >45 MHz from carrier ≤−64 dBc		
	Power Line Related (CW, AM, φM only) ²	≤−70 dBc	≤−70 dBc	≤−70 dBc		
Signal To Phase Noise Ratio (CW, AM, φM only) ²	>50 dB	>45 dB	>39 dB			
OUTPUT CHARACTERISTICS	Output Level (into 50Ω)	+13 dBm to −146 dBm	+10 to −146 dBm	+10 to −136 dBm		
	Output Accuracy (local and remote)	±1 dB, +13 to −66 dBm ±2 dB, −66 to −146 dBm	±1.5 to −76 dBm ±2.0 to −146 dBm	±2.5 dB to −76 dBm ³ ±3.5 dB to −136 dBm		
	Flatness (output level variation with frequency)	<±0.75 dB	<±1.0 dB	<±2.0 dB (1–2600 MHz)		
	Impedance	50Ω				
MODULATION CHARACTERISTICS	AM	AM Modulation Depth	0 to 95%	0 to 90% ⁴	0 to 50% ⁴	
		3 dB Bandwidth:	0–30%	200 Hz, CF<0.4 MHz 10 kHz, 0.4≤CF<4 MHz 100 kHz, CF>4 MHz	10 kHz, CF<10 MHz 100 kHz, CF≥10 MHz	10 kHz
			0–70%	125 Hz, CF<0.4 MHz 6 kHz, 0.4≤CF<4 MHz 60 kHz, CF>4 MHz	6 kHz, CF<10 MHz 60 kHz, CF≥10 MHz	N/A
			0–90%	100 Hz, CF<0.4 MHz 5 kHz, 0.4≤CF<4 MHz 50 kHz, CF≥4 MHz	5 kHz, CF<10 MHz 50 kHz, CF≥10 MHz	N/A
	Distortion, ⁵ THD at 30% AM at 70% AM at 90% AM	<1%, 0.4–110 MHz <3%, 0.4–110 MHz <5%, 0.4–110 MHz	<1% <3% <5%	<5% N/A N/A		
	FM	FM Rate	dc to 1 MHz with HP 86632B 20 Hz to 100 kHz with HP 86633B	dc to 200 kHz with HP 86632B and HP 86635A 20 Hz to 100 kHz with HP 86633B		
		Maximum Deviation (peak)	1 MHz with HP 86632B 100 kHz with HP 86633B	200 kHz with HP 86632B and HP 86635A 100 kHz with HP 86633B	400 kHz w/HP 86632B, 86635A 200 kHz w/HP 86633B	
		Distortion, THD (at rates up to 20 kHz)	<1% up to 200 kHz dev. <3% up to 1 MHz dev.	<1% up to 200 kHz dev.	<1% up to 400 kHz dev.	
	PULSE	Pulse Rise/Fall Time	200 ns	50 ns		
		ON/OFF Ratio (with pulse level control at max.)	>50 dB	>40 dB	>60 dB	
φM	φM Rate	N/A	dc to 1 MHz with HP 86635A dc to 1 MHz for CF <100 MHz dc to 10 MHz for CF ≥100 MHz with HP 86634A			
	Maximum Peak Deviation	N/A	0 to 100 degrees	0 to 200 degrees		
	Distortion, THD	N/A	<5% up to 1 MHz rates <7% up to 5 MHz rates <15% up to 10 MHz rates			
GENERAL	Weight	Net 5 kg (11 lb) Shipping 6.8 kg (15 lb)	Net 4.1 kg (9 lb) Shipping 5.5 kg (12 lb)	Net 5 kg (11 lb) Shipping 6.4 kg (14 lb)		
		HP 11661B: Net 2.3 kg (5 lb); shipping 2.7 kg (6 lb)				

¹For output levels +3 dBm and below; slightly higher +3 to +7 dBm.

²Measured in a 30 kHz band centered on the carrier excluding a 1 Hz band centered on the carrier.

³For +3 to +7 dBm output levels, output accuracy and flatness will be slightly degraded (above 1300 MHz only)

⁴For RF output level meter readings from +3 dB to −6 dB and only at +3 dBm and below.

⁵Applies only at 400 Hz and 1 kHz rates with output meter set between 0 and +3 dB. At −6 dB meter setting the distortion approximately doubles.

⁶Phase modulation is only possible with Option 002 RF Sections.

SIGNAL GENERATORS

Synthesized Signal Generators

Models 8660A & 8660C (cont.)

Pulse/AM

AM/High Deviation FM

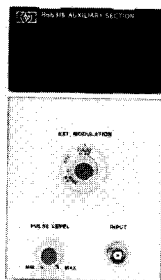
AM/ ϕ Locked FMHigh rate ϕ M ϕ M/FM

HP 86631B

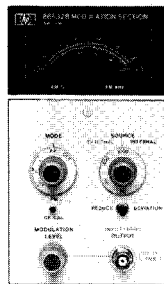

HP 86632B

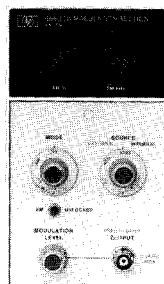

HP 86633B

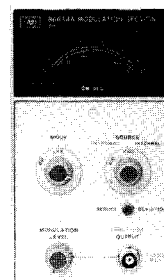

HP 86634A

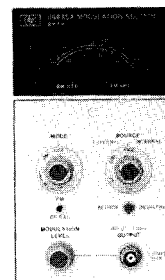

HP 86635A

Modulation Section Specifications

		HP 86631B	HP 86632B	HP 86633B	HP 86634A	HP 86635A
AM	Functions	Ext. Only	Int. and Ext.	Int. and Ext.	—	—
	Indicated Accuracy (at 400 and 1000 Hz rates)	—	±5% of full scale With HP 86601A RF Section: ±7%, center frequency ≥100 MHz. With HP 86603A RF Section: ±10%, center frequency ≥1300 MHz.		—	—
FM	Functions	—	Int. and Ext., FM CF CAL	Int. and Ext.	—	Int. and Ext., FM CF CAL
	Center Frequency Long Term Stability	—	Typically less than 200 Hz/hr	Same as in CW Mode (3×10^{-8} /day)	—	Typically less than 200 Hz/hr
	Indicated Accuracy (up to 20 kHz rates)	—	±5% of full scale		—	±5% of full scale
Pulse	Functions	Ext. Only	—	—	—	—
ϕ M	Functions	—	—	—	Int. and Ext.	Int. and Ext.
	Indicated Accuracy (15°C to 35°C)	—	—	—	±5% of full scale up to 100 kHz rates ±8% of full scale up to 2 MHz rates ±15% of full scale up to 10 MHz rates	
Meter		—	0–100% AM 0–10, 100, 1000 kHz FM Pk. Dev. (0–20, 200, 2000 kHz FM for CF ≥1300 MHz)	0–100% AM 0–10, 100 kHz FM Pk. dev. (0–20, 200 kHz FM for CF ≥1300 MHz)	0–100° Peak ϕ M (0–200° for CF ≥1300 MHz)	0–10, 100, 1000 kHz FM, 0–100° Pk. ϕ M (0–20, 200, 2000 kHz FM, 0–200° Pk. ϕ M for CF ≥1300 MHz)
Internal Modulation Source Output		None	400 Hz and 1 kHz ±5% 200 mV minimum into 10 k Ω . Available at front panel BNC connector			
Input Impedance		50 Ω Pulse 600 Ω AM	600 Ω	600 Ω	50 Ω	600 Ω
Weight		Net, 1.4 kg (3 lb) Shipping, 2.3 kg (5 lb)	Net, 2.7 kg (6 lb) Shipping, 4.1 kg (9 lb)	Net, 2.7 kg (6 lb) Shipping, 4.1 kg (9 lb)	Net, 1.8 kg (4 lb) Shipping, 3.2 kg (7 lb)	Net, 2.7 kg (6 lb) Shipping, 4.1 kg (9 lb)

Ordering Information

HP 8660A Synthesized Signal Generator mainframe \$12,000

HP 8660C Synthesized Signal Generator mainframe \$13,500

Options for HP 8660A, 8660C

Option 001: $\pm 3 \times 10^{-9}$ /day internal reference oscillator add \$210

Option 002: no internal reference oscillator less \$300

Option 003: operation from 50 to 400 Hz line add \$155

Option 004: 100 Hz frequency resolution (200 Hz above 1300 MHz) less \$350

Option 005: HP-IB programming interface \$250

Note: HP-IB cables not supplied, see page 133.

Option 009: (HP 8660A only) LED display indicates selected frequency in 1-2-4-8 BCD code add \$210

Option 100: HP 11661B factory installed inside main frame add \$5,400

Option 908: Rack Flange Kit \$40

HP 86601A 0.01–110 MHz RF Section \$7,000

Price

HP 86602B 1–1300 MHz RF Section \$7,600

HP 86603A 1–2600 MHz RF Section \$9,900

Note: HP 86602B and 86603A RF sections require an HP 11661B for operation.

Option 001: no RF output attenuator (all RF Sections) less \$600

Option 002: adds phase modulation capability (HP 86602B, 86603A only) add \$2,250

Option 003: allows operation of HP 86603A with HP 8660A mainframe add \$250

HP 11661B Frequency Extension Module \$5,400

HP 86631B Auxiliary Section \$600

HP 86632B AM/FM Modulation Section \$3,400

HP 86633B AM/FM Modulation Section \$3,400

HP 86634A ϕ M Modulation Section \$2,700

HP 86635A ϕ M/FM Modulation Section \$3,700

HP 11672A Service Accessory Kit \$1,250

HP 11707A Test Plug-in \$2,500

SIGNAL GENERATORS

Mechanically Tuned VHF Generator

Model 8640B

533



- 0.5 to 512 MHz frequency range with optional coverage to 1024 MHz
- +19 to -145 dBm output power range
- Low SSB phase noise
- Calibrated, metered AM, FM, and pulse modulation
- Internal phase lock/synchronizer, digital frequency readout, external count capability to 550 MHz

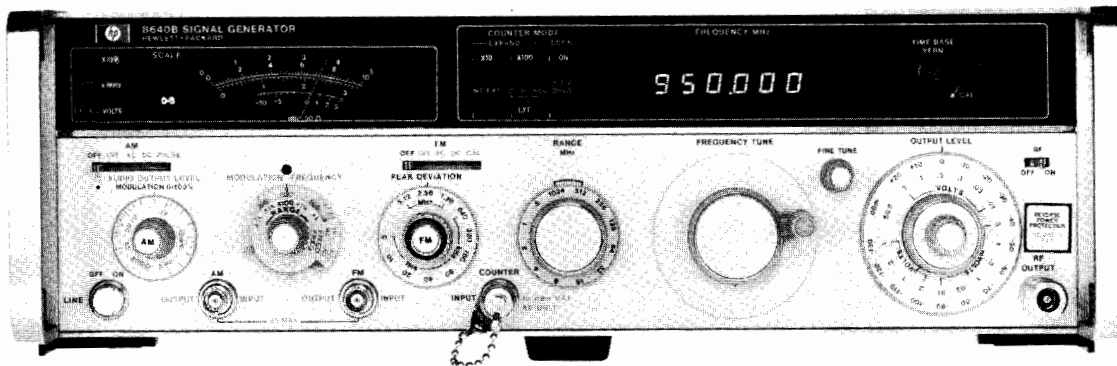

HP 8640B (with Option 001, 002, 003)

HP 8640B Signal Generator

The HP 8640B Signal Generator covers the frequency range 500 kHz to 512 MHz (450 kHz to 550 MHz with band overrange) and can be extended to 1024 MHz with an internal doubler (Opt. 002). Using the HP 11710B Down Converter, the HP 8640B frequency range can be extended down to 10 kHz. An optional audio oscillator (Opt. 001) is also available with a frequency range of 20 Hz to 600 kHz. This broad coverage, together with calibrated output and modulation, provides for complete RF and IF performance tests on virtually any type of HF, VHF, or UHF receiver.

A solid state generator, the HP 8640B has an output level range of +19 to -145 dBm (2V to 0.013 μ V) which is calibrated, metered, and leveled to within ± 0.5 dB across the full frequency range of the instrument.

The HP 8640B generator provides AM, FM, and pulse modulation for a wide range of receiver test applications. This modulation is calibrated and metered for direct readout under all operating conditions.

A reverse power protection option (Opt. 003) is available to eliminate instrument damage due to accidental transmitter keying. This module protects against up to 50 watts of applied power and automatically resets upon removal of the reverse power.

Spectrally Pure Output Signals

Noise performance of the HP 8640B is extremely low beyond 10 kHz offsets. The high-Q cavity oscillator has been optimized with use of a low-noise microwave transistor for spectrally pure output signals. At a 20 kHz offset from the carrier, SSB phase noise is < -130 dBc for carrier frequencies from 230 to 450 MHz, and rises to -122 dBc at 550 MHz. The SSB phase noise level decreases by approximately 6 dB for each division of the output frequency down to the

broadband noise floor of better than 140 dB/Hz. This exceptional noise performance is also preserved during FM modulation and in the phase-locked mode.

Built-in Counter

The internal 6-digit counter displays the output frequency and can also be used to count external input signals from 20 Hz to 550 MHz. This eliminates the need for a separate frequency counter in many measurement systems.

Internal Pushbutton Synchronizer

At the push of a button, the HP 8640B built-in phase lock synchronizer locks the RF output frequency to the crystal time base used in the counter. In this locked mode, the output stability is better than 5×10^{-8} /hr and the spectral purity and FM capability of the unlocked mode are preserved. For higher stability, it is possible to lock to an externally applied 5 MHz standard. Two HP 8640Bs can also be locked together for various 2-tone measurements.

In the phase locked mode, increased resolution is available by using the $\frac{1}{2}$ digit increment button. For example, 500 Hz resolution is possible for frequencies between 100 and 1000 MHz.

FM While Phase Locked

In the phase locked mode, full FM capability is preserved down to modulation rates of 50 Hz. The narrow bandwidth of the phase lock loop (< 5 Hz) provides for FM modulation up to 250 kHz rates and insures no degradation in noise from the unlocked mode. This crystal stability, coupled with the precision modulation and low noise, makes the HP 8640B ideal for testing narrowband FM or crystal-controlled receivers.



SIGNAL GENERATORS

Precision, High Stability, AM-FM VHF Signal Generator

Model 8640B (cont.)

HP 8640B Specifications

(See technical data sheet for complete specifications.) All specifications apply over the nominal frequency ranges and over the top 10 dB of the output level vernier range unless otherwise specified.

Frequency

Range: 500 kHz to 512 MHz in 10 octave ranges (to 1024 MHz with Option 002 internal frequency doubler).

Ranges and range overlap: ranges extend approximately 10% below and 7% above the nominal frequency ranges shown below.

Frequency ranges (MHz)		
0.5-1	8-16	128-256
1-2	16-32	256-512
2-4	32-64	512-1024
4-8	64-128	(Opt 002)

Fine Tuning

Unlocked: >1000 ppm total range.

Locked mode: >±20 ppm by varying internal time base vernier.

Internal Counter Resolution (unlocked)

Frequency Ranges (MHz)	Normal Mode	Expand X10	Expand X100
0.5-1	10 Hz	1 Hz	0.1 Hz
1-16	100 Hz	10 Hz	1 Hz
16-128	1 kHz	100 Hz	10 Hz
128-1024	10 kHz	1 kHz	100 Hz

Optimum Counter Resolution When Phase-Locked

Frequency Ranges (MHz)	With 6 Digits	+1/2 Digit
0.5-0.9999995	1 Hz	0.5 Hz
1.0-9.999995	10 Hz	5 Hz
10.0-99.99995	100 Hz	50 Hz
100.0-999.9995	1 kHz	500 Hz
1000-1024	10 kHz	5 kHz

Accuracy: 6½ digit LED display with X10 and X100 expand; accuracy depends on internal or external reference used.

Stability (after 2 hour warmup)

Normal: <10 ppm/10 min.

Locked: <0.05 ppm/hr.

Restabilization Time After Frequency Change

Normal: <15 min.

Locked: <1 min. after relocking to be within 0.1 ppm of steady state frequency.

Output

Range: 10 dB steps and 18 dB vernier provide the following output power settings into 50Ω.

Frequency Range (MHz)	HP 8640B	With Option(s)		
		002	003	002/003
0.5 to 512	+19 to -145 dBm	+18.5 to -145 dBm	+18.5 to -145 dBm	+18 to -145 dBm
512 to 1024 (Option 002)		+13 to -145 dBm		+12 to -145 dBm

Level Flatness (referred to output at 50 MHz and applies to 1V range and for top 10 dB of vernier range)

Frequency Range (MHz)	HP 8640B	With Option(s)		
		002	003	002/003
0.5 to 64	±0.5 dB	±0.75 dB	+0.75 dB -1.25 dB	+1.0 dB -2.0 dB
64 to 512		±1.0 dB		
512 to 1024 (Option 002)		±1.5 dB		±2.0 dB

Level accuracy: (worst case as indicated on level meter) ±1.5 dB to ±4.5 dB depending on level, frequency, and options installed.

Spectral Purity

Harmonics (at 1 volt, +10 dBm output range and below)

>30 dB below fundamental, 0.5 to 512 MHz.

>12 dB below fundamental, 512 to 1024 MHz (Option 002).

Spurious Output Signals (excluding frequencies within 15 kHz of the signal whose effects are specified in residual AM and FM)

Frequency Range (MHz)	Subharmonically Related	Non-harmonically Related
0.5 to 512	<-100 dBc	<-100 dBc
512 to 1024 (Option 002)	<-20 dBc	

¹dBc = dB below the carrier.

Residual AM (averaged rms): 0.3 to 3 kHz post-detection noise bandwidth <-85 dBc.

Residual FM (averaged rms): 0.3 to 3 kHz post-detection noise bandwidth. (CW and up to 1/8 maximum allowable peak deviation.)

0.5 to 512 MHz: <5 Hz.

512 to 1024 MHz: <10 Hz.

Measured SSB noise (typical): in graph below, triangular markers indicate specified limits.

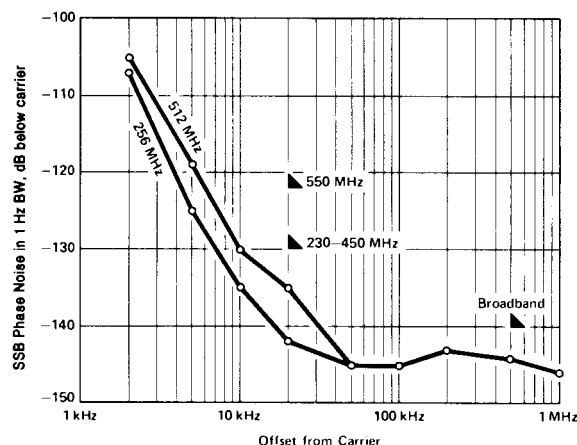



Modulation

General

Types: internal AM and FM; External AM, FM, and PULSE; simultaneous AM and FM or PULSE and FM.

Internal modulation sources (independently adjustable output level is available at front panel):

Standard:

Frequency: fixed 400 Hz and 1 kHz, $\pm 3\%$.

Output level: 10 mV to 1V rms into 600 Ω .

Optional (internal variable audio oscillator Option 001):

Frequency: variable 20 Hz to 600 kHz, $\pm 15\%$ plus fixed 400 Hz and 1 kHz $\pm 3\%$.

Output level: 1 mV to 3V rms into 600 Ω .

Amplitude Modulation

Depth

0.5 to 512 MHz: 0 to 100% for output levels from +13 dBm and below.

512 to 1024 MHz: 0 to 100% for output levels of +7 dBm and below, excluding the top 6 dB of output vernier range.

AM rates: INT and EXT ac, 20 Hz to AM 3 dB bandwidth; EXT dc, dc to AM 3 dB bandwidth.

AM 3 dB Bandwidth

Frequency Ranges	0 to 50% AM	50 to 90% AM
0.5 to 2 MHz	20 kHz	12.5 kHz
2 to 8 MHz	40 kHz	25 kHz
8 to 512 MHz	60 kHz	50 kHz
512 to 1024 MHz	60 kHz	50 kHz

AM Distortion (at 400 Hz and 1 kHz rates)

Frequency Ranges	0 to 30% AM	30 to 50% AM	50 to 90% AM
0.5 to 512 MHz		<1%	<3%
512 to 1024 MHz	<10%		<20%

External AM Sensitivity (400 Hz and 1 kHz rates)

0.5 to 512 MHz: (0.1 \pm 0.005)% AM per mV peak into 600 Ω with AM vernier at full clockwise position.

512 to 1024 MHz: nominal 0.1% AM per mV peak into 600 Ω with AM vernier at full clockwise position.

Indicated AM Accuracy (400 Hz and 1 kHz rates using internal meter)

0.5 to 512 MHz: \pm (5.5% of reading + 1.5% of full scale) from 0° to 50° C.

512 to 1024 MHz: not specified; each generator can be individually calibrated using operating manual procedure.

Peak Incidental Phase Modulation (at 30% AM)

0.5 to 128 MHz: <0.15 radian.

128 to 512 MHz: <0.3 radian.

512 to 1024 MHz: <0.6 radian.

Peak incidental frequency deviation: equals peak incidental phase deviation x modulation rate.

Pulse Modulation¹

	Frequency Ranges (MHz)					
	0.5-1	1-2	2-8	8-32	32-512	512-1024
Rise and Times Fall	<9 μ s	<4 μ s	<2 μ s	<1 μ s		<1 μ s (typical)
Pulse Repetition Rate	50 Hz to 50 kHz		50 Hz to 100 kHz	50 Hz to 250 kHz	50 Hz to 500 kHz	
Pulse Width Minimum ²	10 μ s		5 μ s	2 μ s		
Pulse ON/OFF ratio at max. vernier	>40 dB					>60 dB
Peak Input Required	Nominally +0.5V (5V max). Sinewave or pulse return to zero into 50 Ω					

¹Pulse performance degrades below 500 Hz repetition rates.

²For level accuracy within 1 dB of CW (>0.1% duty cycle).

Frequency Modulation

Deviation: maximum allowable deviation equals 1% of lowest frequency in each nominal output frequency range.

Frequency Range (MHz)	Maximum Peak Deviation (kHz)
0.5-1	5
1-2	10
2-4	20
4-8	40
8-16	80
16-32	160
32-64	320
64-128	640
128-256	1280
256-512	2560
512-1024	5120

FM 3 dB bandwidth: internal and external ac, 20 Hz to 250 kHz; external dc, dc to 250 kHz. (Locked mode: FM above 50 Hz only.)

FM Distortion (at 400 Hz and 1 kHz rates)

<1% for deviations up to 1/2 maximum allowable.

<3% up to maximum allowable deviation.

External FM sensitivity: 1 volt peak into 600 Ω yields maximum deviation indicated on PEAK DEVIATION switch with FM vernier at full clockwise position.

Indicated FM accuracy (400 Hz and 1 kHz rates from 15° to 35° C, using internal meter): \pm (7% of reading + 1.5% of full scale).

Incidental AM (at 400 Hz and 1 kHz rates)

0.5 to 512 MHz: <0.5% AM for FM up to 1/2 maximum allowable deviation; <1% AM for FM at maximum allowable deviation.

512 to 1024 MHz (Opt 002): <1% AM for FM up to 1/2 maximum allowable deviation; <7% AM for FM deviations up to maximum allowable.

Counter

Frequency range: 1 Hz to 550 MHz.

Sensitivity: \geq 100 mV rms into 50 Ω , ac only.

Resolution: 6-digit LED display.

Mode	Normal	Expand X10	Expand X100
0-10 MHz	100 Hz	10 Hz	1 Hz
10-550 MHz	10 kHz	1 kHz	100 Hz

External reference input: 5 MHz, nominally >0.5V p-p (5V maximum) into 1 k Ω .

Internal Reference (after 2 hr warm-up and calibration at 25° C)

Aging rate: <0.05 ppm/hr; <2 ppm/90 days.

Temperature Drift

< \pm 2 ppm from 15° to 35° C.

< \pm 10 ppm from 0° to 50° C.

Typical overall accuracy (within 3 months of calibration and from 15° to 35° C): \pm 2 ppm.

General

Operating temperature range: 0° to 55° C.

Power requirements: 100 or 120 volts (+5%, -10%) from 48 to 440 Hz; or 220 or 240 volts (+5%, -10%) from 48 to 66 Hz. 175 VA max (Option 002: 190 VA max).

Weight: net, 20.8 kg (46 lb). Shipping, 24.1 kg (53 lb).

Size: 140 H x 425 W x 476 mm D (5.5" x 16.75" x 18.75").

Ordering Information

8640B Signal Generator

Option 001: internal variable audio oscillator, 20 Hz to 600 kHz

Option 002: internal doubler 512-1024 MHz

Option 003: reverse power protection

Option 004: avionics option

Option 908: rack mount kit

Option 910: extra operating and service manual

Price

\$10,500

add \$500.00

add \$1005.00

add \$352.00

add \$1505.00

add \$37.50

add \$190



SIGNAL GENERATORS

Avionics VHF Signal Generator

Model 8640B Option 004

- Demodulated output from RF detector, ac and dc
- Phase shift less than 0.01° at 30 Hz

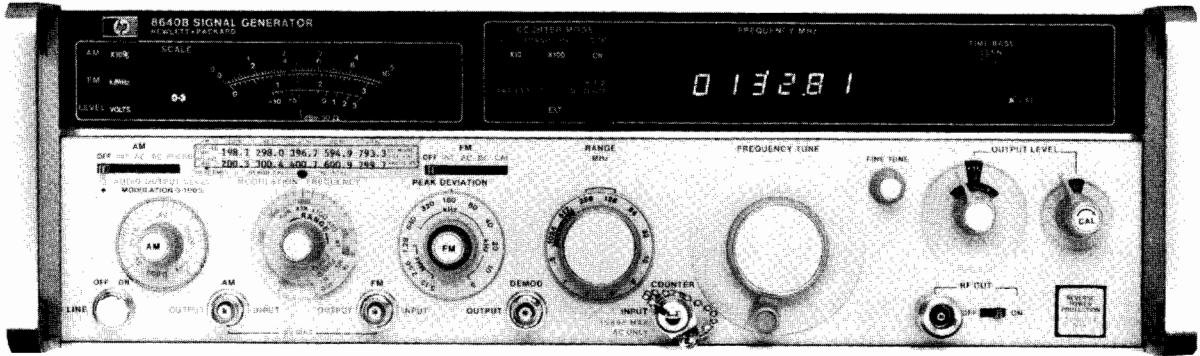

HP 8640B Option 004 (with Options 001, 003)

HP 8640B Avionics Option 004 Signal Generator

The Hewlett-Packard Model 8640B Option 004 NAV/COM Signal Generator is an HP 8640B AM/FM Signal Generator specially adapted for testing ILS (Marker Beacon, Localizer and Glide Slope), VOR and VHF communications receivers used throughout the aviation industry. VOR, LOCALIZER and VHF communications frequencies (108 to 136 MHz) are available on one frequency band for rapid channel selection. GLIDE SLOPE (329 to 335 MHz) and MARKER BEACON (75 MHz) frequencies are also easily set using the 6-digit LED display.

The HP 8640B Option 004 provides highly stable, spectrally pure RF signals for testing narrow-channel, crystal controlled receivers. For avionics testing, external audio generators are required to provide the composite modulation. Designed with versatile AM and FM modulation, Option 004 features low distortion modulation when used with suitable, external VOR/ILS Audio Generators.

Operation and specifications of the HP 8640B Option 004 are the same as the Standard HP 8640B AM/FM Signal Generator with the following additions:

Demodulated Output

One front panel BNC connector provides demodulated output from the RF peak detector for precise AM settings. A choice of combined ac/dc at 1V rms or ac only at 5V rms is provided.

Output Level Setting

To ensure the best possible demodulated output linearity, Option 004 combines a 10 dB step attenuator and a 1 dB step attenuator with a vernier. This provides output levels from +15 dBm to -142 dBm (1.3 V to 0.018 μ V). The output level can be read directly from the attenuator dial in 1 dB steps or from the front panel meter in dBm or volts.

External AM Input Impedance

External AM input impedance of 2 k Ω allows compatible operation with old and new generations of external audio generators.

Low Distortion Modulation

The HP 8640B Option 004 provides flat AM response and minimum phase shift at 30 Hz and 9960 Hz as well as constant group delay between 9 kHz and 11 kHz for accurate VOR and ILS testing.

HP 8640B Option 004 Specifications

(These specifications apply to HP 8640B Option 004 in addition to standard HP 8640B specifications. See HP 8640B AM/FM Signal Generator technical data for complete specifications.)

Spectral Purity

Noise: SSB broadband noise floor greater than 1 MHz offset from carrier: <-130 dBc.

Output Characteristics

Range: +15 dBm to -142 dBm (1.3V to 0.018 μ V).

Attenuators: a 10 dB step attenuator plus a 1 dB step attenuator with vernier allow selection of any output level over the full output level range.

Vernier: >2 dB continuously variable from a CAL detent position.

Level flatness (referred to 190 MHz and for +10 to -10 dBm without Option 003): < \pm 0.75 dB from 0.5 to 512 MHz; < \pm 0.5 dB from 108 to 336 MHz.

Level Accuracy

Output Level (dBm)	+15 to -10	-10 to -50	-50 to -142	With Option 003
Total Accuracy as Indicated on Level Meter	\pm 1.5 dB	\pm 2.0 dB	\pm 2.5 dB	Add \pm 0.5 dB except from 108 to 336 MHz

Modulation Characteristics

Demodulated output (output vernier in CAL position, 108 to 118 and 329 to 336 MHz and 20% - 80% AM): an internal selector switch allows selection of ac only or ac and dc at the demodulated output.

AC only output: directly proportional to AM depth (90 to 150 Hz modulation frequency).

% AM equals: (20 \pm 0.6)% per V rms, 0° to 55°C; (20 \pm 0.4)% per V rms, 20° to 30°C; (20 \pm 0.2)% per V rms (using the DEMOD CAL label provided).

AC and dc output: ac output voltage is directly proportional to AM depth (90 to 150 Hz modulation frequency). dc output equals (1.41 \pm 0.01) V dc with vernier in CAL position.

% AM equals: (100 \pm 3)% per V rms, 0° to 55°C; (100 \pm 2)% per V rms, 20° to 30°C; (100 \pm 1)% per V rms (using the DEMOD CAL label provided).

AM Characteristics (+10 dBm output and below)

External input impedance: nominally 2 k Ω .

Frequency response: < \pm 0.04 dB from 90 Hz through 150 Hz (108 to 118 and 329 to 335 MHz.); < \pm 0.1 dB, 9 kHz through 11 kHz (108 to 118 MHz).

Phase Shift from Audio Input to Demodulated Output (108 to 118 MHz, AM EXT DC mode)

30 Hz < \pm 0.01°; 30 Hz to 10 kHz < \pm 3°; 9 kHz to 11 kHz < \pm 2°.

Ordering Information

HP 8640B Signal Generator with Avionics Option 004	Price
Option 001: Internal variable audio oscillator, 20 Hz to 600 kHz	\$12,005 add \$500
Option 002: not available with Option 004	
Option 003: Reverse power protection	add \$352
Option 908: Rack mount kit	\$37.50
Option 910: Extra Operating and Service Manual	add \$190

SIGNAL GENERATORS

Accessories, Frequency Doublers

Models 11509A, 11687A, 11690A, 11710B, 11721A



- Additional capabilities for signal generators



HP 11687A



HP 11509A

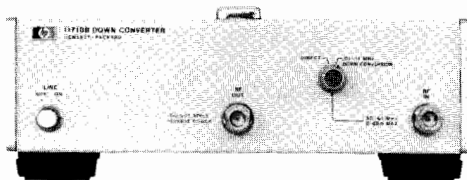

HP 11710B



HP 11690A



HP 11721A

HP 11509A Fuseholder

Accidental burnout of attenuators in HP 8640 and HP 8654 signal generators can be prevented by using this fuse element between the signal generator and a transceiver. The fuseholder has a frequency range of dc to 480 MHz, insertion loss of ≤ 1 dB, SWR of ≤ 1.35 (50 Ω load), and Type N connectors. Ten extra fuses are furnished.

HP 11687A 50-75 Ω Adapter

This 50-75 Ω adapter with Type N connectors is recommended for use with HP 8640, 8642, 8654, 8660, 8656, and 8662 signal generators for measurements in 75 Ω systems. The voltage calibration on the output level meter is unaffected by use of the adapter, but 1.76 dB must be subtracted from the dB scale on the meter to determine the output in dBm into 75 Ω . Frequency range is dc to 1300 MHz.

HP 11690A Frequency Doubler

The HP 11690A extends the frequency range of all HP 8640 series signal generators by doubling the 256-512 MHz frequency band up to 1024 MHz (to 110 MHz with band overrange). All HP 8640s indicate the correct doubled output frequency on a dial or counter when the 512-1024 MHz range is selected. The HP 11690A will also perform well with any source meeting the input requirements of 200-550 MHz at +10 to +19 dBm. Conversion loss is < 13 dB, output flatness has < 4 dB total variation, and the first and third input harmonics are suppressed > 20 dB. Connectors are BNC.

HP 11710B Down Converter

The HP 11710B Down Converter is an accessory for the HP 8640 and HP 8654 series signal generators. Frequency inputs from 50.01 to 61 MHz are down converted to the 10 kHz to 11 MHz range respectively. The output level and modulation functions of the HP 8640 and HP 8654 remain calibrated. A straight-through selection switch allows the input to pass through unchanged, and thus minimizes the necessity to move cables when testing. Option 001 provides rails and semi-rigid coax for combining the HP 11710B with an HP 8654A/B Signal Generator.

HP 11710B Specifications

Input

Down-conversion mode: 50.01 to 61.00 MHz at ≤ 0 dBm.

Straight-through mode: 0.01 to 1100 MHz (dc coupled).

Down-Converted Output

Frequency range: 10 kHz to 11 MHz.

Level range: 0 to -107 dBm

Level flatness: RF source flatness ± 0.5 dB (referred to 4.0 MHz).

Total level accuracy: ± 1 dB plus input level accuracy).

Harmonics: > 35 dB below the carrier (dBc).

Intermixing spurious: > 60 dBc.

Local oscillator feed-through (50 MHz): < -100 dBm.

Internal Reference Characteristics

Time base output: 1 MHz or 5 MHz selectable, nominally > 0.5 V p-p into 500 Ω . This will drive an HP 8640B external time base input.

Typical overall accuracy: (within 3 months of calibration and from 15 $^{\circ}$ C to 35 $^{\circ}$ C): ± 2 ppm.

General

Operating temperature range: 0 $^{\circ}$ to 55 $^{\circ}$ C.

Power requirements: 100, 120, 220, 240V (+5%, -10%), 48 to 440 Hz; 25 VA maximum.

Weight: net, 3.2 kg (7 lb); shipping, 4.5 kg (9 lb).

Size: 102 H \times 266 W \times 295 mm D (4" \times 10.5" \times 11.6"). $\frac{1}{2}$ MW \times 4 H \times 11 D System 1 Module.

HP 11721A Frequency Doubler

The HP 11721A Doubler is an ideal accessory for extending the usable frequency range of signal generators, frequency synthesizers, or other signal sources. Operating on input frequencies of 50 MHz to 1300 MHz, it provides a doubled output in the range of 100 MHz to 2600 MHz. The HP 11721A will work well with any RF source with an output in the range 50 to 1300 MHz.

The 50 Ω passive circuit of the HP 11721A offers low conversion loss, low spurious, and excellent flatness over its entire frequency range when operated above +10 dBm.

HP 11721A Specifications

Input frequency range: 50 to 1300 MHz.

Output frequency range: 100 to 2600 MHz.

Conversion loss (+13 dBm input, 50 to 1280 MHz): < 15 dB.

Spurious referenced to desired output frequency f (+13 dBm input with harmonics < -50 dBc, 50 to 1280 MHz): $f/2$, -15 dB; $3f/2$, -15 dB.

Input SWR: 1.5 typical.

Input/output impedance: 50 Ω nominal.

Operating temperature range: 0 $^{\circ}$ to +50 $^{\circ}$ C.

Connectors: input, type N male; output, type N female.

Size: 161 L \times 30 W \times 20.5 mm H (6 $\frac{3}{8}$ " \times 1 $\frac{3}{16}$ " \times 1 $\frac{3}{16}$ ").

Weight: net, .02 kg (0.5 lb); shipping, 0.4 kg (1 lb).

Ordering Information

	Price
HP 11509A Fuseholder	\$250.00
HP 11687A 50 Ω -75 Ω Adapter	\$195.00
HP 11690A Frequency Doubler	\$300.00
HP 11710B Down Converter	\$2650.00
Option 001: Combining Kit	add \$150.00
Option 910: Extra operating & service manual	add \$11.25
HP 11721A Frequency Doubler	\$650.00
☎ Fast ship product — see pg. 766	



SIGNAL GENERATORS

Solid-State Microwave Signal Generators

Models 8683/8684A,B,D

- Portable signal generators with high performance modulation
- Wide frequency ranges from 2.3-18 GHz
- Wideband FM for satellite video ± 10 MHz peak deviation
- dc-10 MHz rates

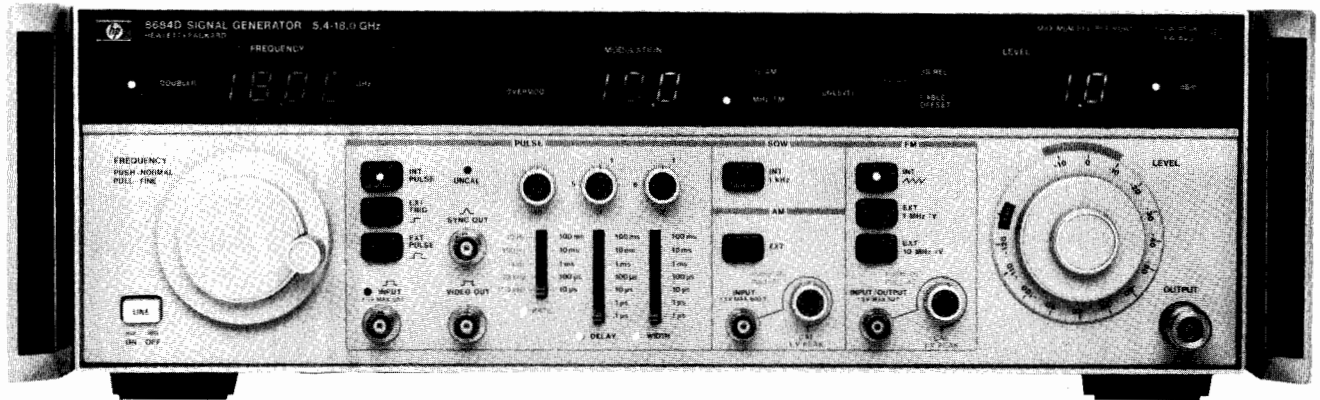

HP 8684D

HP 8683/8684 Microwave Signal Generators

The HP 8683 and 8684 are rugged portable signal generators designed for demanding benchtop and field maintenance environments. Operating in four overlapping frequency ranges, with a choice of features including a high performance internal pulse generator, the family provides a wide range of benefits for various radar, communications and electronic warfare applications.

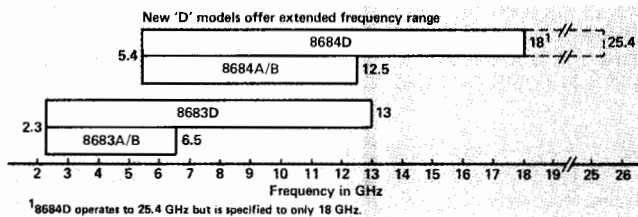

Clean, Stable, Cavity-Tuned Oscillator

At the heart of each signal generator is a mechanically tuned cavity oscillator. State-of-the-art electronics teamed with sophisticated mechanical design provide excellent frequency stability, spectral purity and quick warm-up times necessary for accurate measurements. With low spurious outputs and a low noise floor, the HP 8683 and 8684 are excellent for receiver sensitivity measurements and out-of-channel communications receiver measurements where high performance at low signal levels is required.

Microprocessor-Enhanced Measurement Accuracy

Characteristics of microwave components such as oscillators, amplifiers, and attenuators vary considerably with frequency and power level. An internal microprocessor effectively compensates for these variations, providing accurate output level in dBm, dB relative to a user-selected power level, or power level with a specified cable offset. These conveniences translate to faster measurements and reduced possibility of operator error in interpreting observations.

Reliability and Serviceability

The HP 8683 and 8684 were designed with high reliability and serviceability as major considerations. The instruments exceed rigorous military specifications (MIL-T-28800C Class V) for operating and non-operating temperature, humidity, condensation, shock and vibration, and EMI. The instruments success in these tests is an indication that they are rugged enough to provide accurate, reliable measurements in environments where many instruments would fail. For added reliability in the A and B models Option 002 may be selected for reverse power protection. With this option the possibility of instrument failure due to operator error is substantially reduced, allowing for as much as 10 watts average or 2000 watts peak reverse power with no

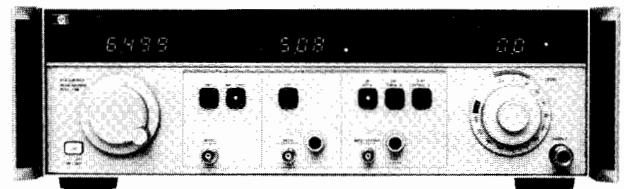

HP 8683A

damage to the instrument. The reliability of these generators is reflected in a demonstrated MTBF in excess of 20,000 hours.

Confidence in signal generator performance is provided by diagnostic tests which automatically execute at turn-on and monitor most critical nodes prior to entering the operation mode. If a failure is detected, in most cases it can be isolated to at least the circuit function level with the aid of the front panel display. The generators' open, accessible internal design and complete service manuals result in excellent serviceability, minimizing repair time if a failure should occur.

HP 8683/8684 A,B,D Features

A variety of modulation capabilities, frequency ranges, and power specifications are available in the HP 8683/8684 Microwave Signal Generator family.

Sharing the same rugged dependable design with the rest of the family, the A models provide AM and FM for conventional communications applications in an affordable package. All A models are specified to have maximum output power of 0 dBm throughout their frequency range; however, if required, Option 001 may be selected to provide +10 dBm output power.

The B and D models add a high performance pulse modulator and internal pulse generator for the simulation of a wide variety of sophisticated radar transmissions. Simultaneous FM and pulse allow chirping, while simultaneous AM and pulse allow simulation of antenna scan patterns. Of course, basic receiver sensitivity and AGC measurements can also be made easily.

For users with multi-band, broadband or general purpose applications, the D models, with twice the frequency coverage of the A and B models, offer exceptional performance, versatility and economy in a single box. Not only is frequency coverage increased, but in doubled mode, FM peak deviation is also doubled to 10 MHz at dc to 10 MHz rates making possible the direct test of satellite video receivers. If required, the high-power Option 001 may be selected to boost maximum output power in the frequency-doubled bands from -3 dBm to the +10 dBm level already provided in the main bands. By combining



proven, rugged, dependable design with the versatility of twice the frequency coverage and wideband FM, the D models offer cost-effective, high performance solutions to radar and communications receiver test problems.

Distinguishing features of the A, B, & D models			
	A	B	D
Output Power	0 dBm	+10 dBm	+10 dBm, -3 dBm ¹
Opt 001 Power	+10 dBm	N/A	+10 dBm ¹
Internal Pulse Generator/Modulator	No	Yes	Yes
FM Deviation (DC To 10MHz Rate)	5 MHz	5 MHz	10 MHz ¹

¹ These specifications for the doubled mode

HP 8683A/B/D, HP 8684A/B/D Specifications

Frequency Specifications

Range

HP 8683A/B: 2.3–6.5 GHz.

HP 8683D: 2.3–13.0 GHz.

HP 8684A/B: 5.4–12.5 GHz.

HP 8684D: 5.4–18.0 GHz.

Resolution: HP 8683, 5 MHz using a 4 digit LED display; HP 8684, 10 MHz using a 3 1/2 digit LED display.

Calibration accuracy: HP 8683A/B/D, $\pm 1.25\%$ <4.0 GHz, $\pm 0.75\%$ 4.0 to 6.5 GHz; HP 8683D x2 band, $\pm 1.25\%$ 6.5 to 8.0 GHz, $\pm 0.75\%$ >8 GHz; HP 8684A/B/D, $\pm 1.25\%$ 5.4 to 9.0 GHz, $\pm 0.75\%$ 9.0 to 12.5 GHz; HP 8684D x2 band, $\pm 1.25\%$ 12.5 to 18.0 GHz.

Stability (typical)

vs. time (20 min. after turn-on): <30 kHz/min.

vs. time (60 min. after turn-on): <100 kHz/hr.

vs. temperature (0 to 55°C): HP 8683, <15 MHz; HP 8684, <30 MHz.

vs. line voltage (transients of +5%/-10%): <20 ppm.

Spectral Purity

Harmonics (<18GHz, at specified max output): <-25 dBc.

HP 8683/84D harmonics are unspecified in x2 frequency band.

Fundamental feedthrough (at specified max. output): HP 8683D, <-25 dBc 6.5–9.5 GHz; HP 8684D, <-25 dBc 12.5–18.0 GHz. Not specified for D models with Option 001.

Spurious (non-harmonically related): <-80 dBc; typ, <-90 dBc.

Residual FM (50 Hz to 15 kHz post detection BW): <5 kHz peak. HP 8683/84D in doubled band: <10 kHz peak.

Single-sideband phase noise (avg. rms, 1 Hz BW, 10 kHz offset from carrier, typical): HP 8683A/B, <-72 dBc; HP 8683D, <-66 dBc; HP 8684A/B, <-65 dBc; HP 8684D, <-59 dBc.

Residual AM (avg. rms, 300 Hz to 15 kHz post detection BW): <0.15%.

Output Specifications

Range (leveled into 50Ω): HP 8683/84A, 0 to -130 dBm; HP 8683/84A opt. 001 and HP 8683/84B, +10 to -130 dBm; HP 8683/84D, +10 to -130 dBm (main band), -3 to -130 dBm (x2 band), +10 dBm in x2 bands available with Option 001.

Resolution: 0.1 dB using a 3 1/2 digit LED display.

Accuracy: ± 2.5 dB from maximum specified output power to -110 dBm (to -100 dBm in x2 bands); ± 3.5 dB to -120 dB. Typ. ± 0.9 dB at -100 dBm. Option 002 affects level accuracy ± 0.5 dB.

Flatness (power level > -10 dBm): ± 1.0 dB.

Reverse power protection: the standard models typically accept 1 watt avg. or 100 watts peak power with no damage resulting. Option 002 (on A and B models only) increases this protection to 10 watts avg. or 2kW peak.

Auxiliary output: rear panel, typically >-15 dBm into 50Ω, prior to AM, pulse, or frequency doubling; source impedance approx. 50Ω.

Modulation Specifications

Types: internal and external AM, FM, and Pulse (except HP 8683/84A). Simultaneous AM, FM, Pulse.

Metering: 3-digit LED, selectable for % AM or FM deviation.

Amplitude Modulation

Depth (1 kHz rate): 0-70%.

Rates (3 dB BW at 40% depth): dc to 10 kHz (dc coupled); 50 Hz to 10 kHz (ac coupled).

Distortion (THD): <10% at 40% depth and 1 kHz rate.

Indicated AM accuracy (depth 50%, 1 kHz rate): $\pm 5\%$ of full scale.

Incidental FM (30% AM depth): <15 kHz peak to peak. (<30 kHz p-p in doubled band, HP 8683/84D.)

Internal AM: fixed 1 kHz nom. square wave with 50 $\pm 5\%$ duty cycle.

Frequency Modulation

Peak deviation: HP 8683/84 A/B, ± 5 MHz; HP 8683/84D, ± 5 MHz (main); ± 10 MHz (x2 band).

Rates (3 dB BW): dc to 10 MHz, 100 Hz to 10 MHz (ac coupled).

Distortion: <5% at 100 kHz rate and <1 MHz peak deviation.

Indicated accuracy (typ., 10 MHz/V range): $\pm 10\%$ of full scale, deviations <5 MHz, 100 kHz rate.

Incidental AM (rate <100 kHz, peak deviation <1 MHz): <6%.

Internal FM: FM sawtooth with a fixed sweep rate of 1 kHz nom. and variable deviation up to ± 5 MHz (± 10 MHz for D models, x2 bands).

Phase lock input: typical sensitivity of -5 MHz/V.

Pulse Modulation

HP 8683/84 B/D Internal Pulse Generator

Rate: 10 Hz to 1 MHz continuously adjustable in 5 ranges.

Width: 50 ns to 100 ms continuously adjustable in 7 ranges.

Delay (time between sync out and video out): <50 ns to 100 ms in 7 ranges with continuous adjustment within ranges.

Accuracy: calibration accuracy is 20% of full scale.

HP 8683/84 B/D External Pulse Input Requirements

Rate: 0 to 1 MHz.

Width: >100 ns.

Level: on >+1.0 V peak; off <+0.4 V peak.

HP 8683/84 B/D RF Pulse Specifications

Rise/fall time: <10 ns.

On/off ratio: >80 dB.

Minimum pulse width: <100 ns.

Maximum pulse repetition frequency: >1 MHz.

Peak pulse power: ± 0.5 dB of level set in CW mode.

General

Operating temperature range: 0° to 55°C.

EMI: MIL-STD-461, VDE0871, CISPR Pub. 11.

Safety: meets the requirements of IEC 348.

Power: 100, 120, 220 or 240V, +5%, -10%; 48 to 66 Hz; (Opt. 003 adds 400 Hz operation at 100 or 120 V); <200 VA max.

Dimensions: 145 H x 457 W x 472 mm D (5.7" x 18" x 18.6").

Weight: HP 8683, 17.9kg (39 lb) net, 23.4 kg (51 lb) shipping; HP 8684, 16.5 kg (36 lb) net, 22.0 kg (48 lb) shipping.

Ordering Information

	Price
HP 8683A Microwave Signal Generator	\$12,030
HP 8684A Microwave Signal Generator	\$12,030
Option 001: +10 dBm output power, HP 8683/84 A	add \$1500
HP 8683B Microwave Signal Generator	\$15,030
HP 8684B Microwave Signal Generator	\$15,030
HP 8683D Microwave Signal Generator	\$19,000
Option 001 +10 dBm in x2 band, HP 8683D	add \$3000
HP 8684D Microwave Signal Generator	\$19,000
Option 001: +10 dBm in x2 band, HP 8684D	add \$5000
Option 002: Reverse power protection (except D models)	add \$725
Option 003: 400 Hz line frequency operation (all models)	add \$180
Option 910: Extra operating and service manual	add \$25
Option 913: Rack mounting flange kit	add \$35
HP 11727A Support kit	\$475



SIGNAL GENERATORS

UHF Signal Generators, Pulse Modulator

Models 8614A, 8616A, 11720A

- 800-2400MHz, 1800-4500MHz

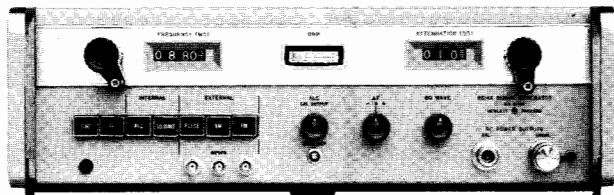

HP 8614A

HP 8614A, 8616A Signal Generators

The HP 8614A and 8616A Signal Generators provide stable, accurate signals from 800 to 2400 MHz (HP 8614A) and from 1800 to 4500 MHz (HP 8616A). Both frequency and attenuation are set on direct-reading digital dials. Selectable functions include CW, leveled output, square-wave modulation, and external AM, FM and pulse modulation. Modulation can be accomplished simultaneously with or without leveling.

The HP 8614A and 8616A can also be used with companion modulators, HP 8403A modulators and HP 8730-series PIN modulators to provide 80 dB pulse on/off ratio (see last page, this section). In addition, TWT amplifiers can be used with these generators to provide high power levels.

HP 8614A, 8616A Specifications

Frequency range: direct reading within 2 MHz, 800 to 2400 MHz (HP 8614A), 1800 to 4500 MHz (HP 8616A)

Vernier: ΔF control has a minimum range of 1.0 MHz for fine tuning.

Frequency calibration accuracy (0 dBm & below): ± 10 MHz (8616A). ± 5 MHz (8614A).

Frequency stability: approximately 50 ppm/ $^{\circ}$ C change in ambient temperature, less than 2500 Hz peak residual FM; 30 ppm change for line voltage variation of $\pm 10\%$.

RF output power: +10 dBm (0.707 V) to -127 dBm into 50 Ω load, (+3 dBm to -127 dBm from 3000 to 4500 MHz). Output attenuation dial directly calibrated in dBm from 0 to -127 dBm. A second uncalibrated output (approximately -3 dBm) is provided on front panel.

Output impedance: 50 Ω ; SWR <2.0.

Internal square wave: 950 to 1050 Hz. Square wave can be synchronized with a +1 to +10 V signal at PULSE input.

External pulse: 50 Hz to 50 kHz; 2 μ s rise time, +20 to +100 V peak input.

External AM: dc to 1 MHz, >20 dB range.

External FM: front-panel connector capacity-coupled to repeller of klystron; four-terminal rear-panel connector (Cinch-Jones type S304AB) is dc-coupled to repeller of klystron.

Power source: 115 or 230 V $\pm 10\%$, 50 to 60 Hz, approximately 130 W.

Size: cabinet, 141 H x 425 W x 467 mm D (5.5" x 16.75" x 18.4"); rack mount, 133 H x 416 W x 483 mm D (5.2" x 16.4" x 19").

Weight: net, 19.5 kg (43 lb). Shipping, 22.7 kg (50 lb).

Accessory furnished: HP 11500A Cable Assembly.

Ordering Information

HP 8614A Signal Generator (800-2400 MHz) \$7600

HP 8616A Signal Generator (1800-4500 MHz) \$7600

HP 8614A and 8616A Options

Option 001: External modulation input connectors on rear panel in parallel with front-panel connectors; RF connectors on rear panel only. add \$25

Option 908: Rack mounting flange kit add \$37.50

Option 910: Extra operating and service manual add \$7.50

2 to 18 GHz Pulse Modulator

- < 10 ns rise and fall times
- > 80 dB ON/OFF ratio

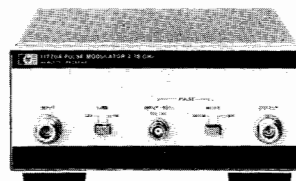

HP 11720A

HP 11720A Pulse Modulator

The HP 11720A Pulse Modulator is a high performance microwave pulse modulator covering the range of 2 to 18 GHz. Because of this wide frequency coverage, it can be used to increase the modulation capabilities of many microwave sources (sweepers or signal generators) and eliminate the need for several individual modulators in broadband applications.

In addition to wide frequency coverage, the HP 11720A features extremely short rise and fall times (<10 ns) and a high on/off ratio (>80 dB), making it suitable for almost any pulsed RF application.

The modulator used in the HP 11720A is a unique series-shunt PIN diode switch offering superior performance to that of a simple shunt-diode switch which reflects the input power back to the source in the "off" state. In the HP 11720A the series components reduce this reflection without significantly increasing the insertion loss.

The HP 11720A contains all the necessary modulator drive circuitry to achieve specified performance so that a standard pulse generator, or any other source that can deliver >3 V peak into 50 ohms, can supply the input. In addition, a normal/complement function is provided to adapt the HP 11720A to positive-true or negative-true logic inputs.

HP 11720A Specifications

Frequency range: 2 to 18 GHz.

ON/OFF ratio: >80 dB.

Rise and fall times: <10 ns.

Insertion loss: <6 dB, 2 to 12.4 GHz; <10 dB, 2 to 18 GHz.

Maximum RF input power: +20 dBm.

Maximum repetition rate: >5 MHz.

Minimum RF pulse width: <50 ns.

Video feedthrough: <60 mV peak-to-peak.

Pulse Input

Normal mode: >3 V (on), <0.5 V (off).

Complement mode: <0.5 V (on), >3 V (off).

Impedance: 50 Ω nominal.

Operating temperature: 0 $^{\circ}$ C to +55 $^{\circ}$ C.

Power: 100, 120, 220, 240 V +5, -10%; 48-400 Hz; 25 VA max.

Weight: net, 2.6 kg (5 lb 12 oz); shipping, 3.6 kg (8 lb).

Size: 101 mm H x 212 mm W x 290 mm D (4.0" x 8.4" x 11.4").

1/2 MW x 3 1/2 H x 11 D System II Module.

Ordering Information

HP 11720A Pulse Modulator

Option 910: Extra manual

Price

\$3250

add \$5.00

SIGNAL GENERATORS

Synthesized Sweepers

Models 8340B, 8341B

541



- 1 to 4 Hz frequency resolution
- Low spurious and phase noise
- 100 ns pulse width capability
- +10 dBm to -110 dBm calibrated output

- Complete analog sweeper
- DC to 100 kHz amplitude modulation
- <-50 dBc harmonics 1.4 to 20 GHz, opt. 003 on HP 8341B

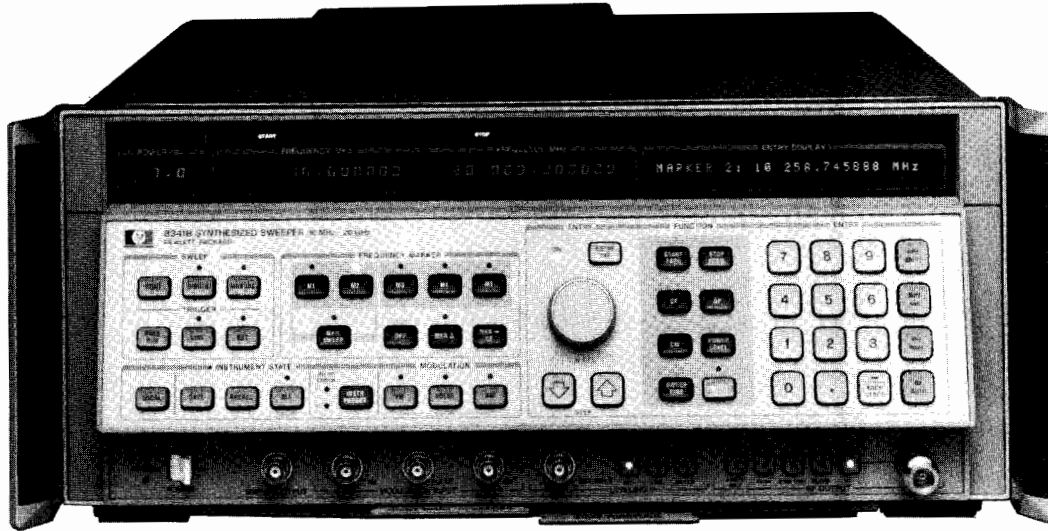

HP 8341B



HP 8340B/41B Synthesized Sweepers

The HP 8340B/41B Synthesized Sweepers deliver the combined high-performance of a synthesizer and a broadband sweep oscillator in one efficient instrument that is completely controllable via the Hewlett-Packard Interface Bus (HP-IB). This efficient combination of performance and versatility is ideal for manual or automatic test systems and enables the HP 8340B/41B to replace a sweep oscillator, a frequency counter, an RF synthesizer, and a microwave synthesizer.

Frequency Precision and Spectral Purity

The synthesized broadband frequency coverage and the precise 1 to 4 Hz frequency resolution (depending on the frequency band of the HP 8340B/41B) are generated by indirect synthesis techniques. These techniques enable the HP 8340B/41B to achieve the same low single-sideband phase noise performance as the HP 8672A and 8673 series Synthesized Signal Generators.

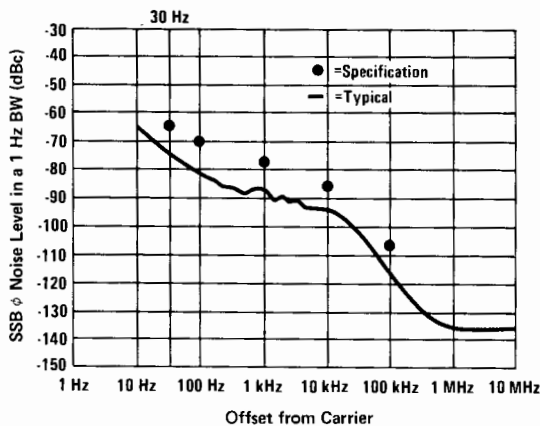

Typical HP 8340B Phase Noise performance from 2.3 to 7.0 GHz.

Stepped CW Switching Times

The HP 8340B/41B feature CW switching times of better than 50 ms (typically <35 ms). Additionally, a Fast Phase-lock programming command can be used to reduce typical CW switching times to between 11 and 22 ms (depending on frequency step size and absolute frequency value).

Output Power

The HP 8340B and the HP 8341B provide high output power which can be varied all the way down to the minimum level (-110 dBm) with .05 dB resolution.

The HP 8340B/41B also feature power sweep capability with >20 dB dynamic range for complete characterization of level-sensitive devices.

Pulse, Amplitude, and Frequency Modulation

The HP 8340B/41B have a high-performance pulse modulator with an ON/OFF ratio >80 dB and rise and fall times <25 ns. Pulse amplitude is leveled and can be as narrow as 100 ns. The HP 8340B/41B also feature dc-coupled amplitude modulation with a 3 dB bandwidth of 100 kHz and a minimum depth of 90%. And with the HP 8340B/41B, pulse and amplitude modulation can be used simultaneously.

The HP 8340B/41B also offer new frequency modulation capabilities, with the modulation rates from 50 kHz to 10 MHz and peak deviations to 10 MHz.

HP 8341B Option 003: <-50 dBc Harmonics

Option 003 on the HP 8341B delivers excellent harmonic performance with harmonics that are at least 50 dB below the carrier from 1.4 to 20.0 GHz.

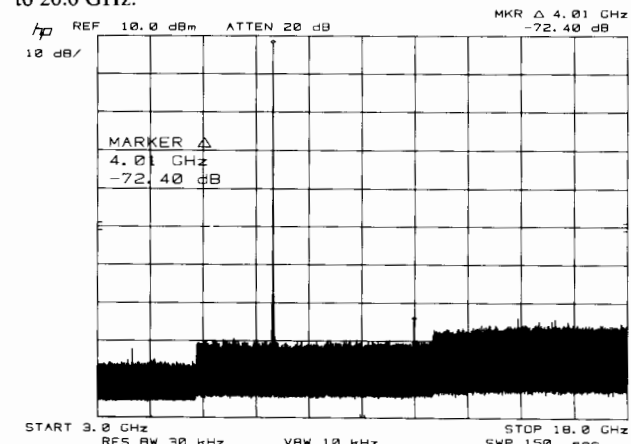

Harmonic Performance of the HP 8341B Opt. 003

For additional ordering and performance information about the HP 8340B and 8341B, refer to page 494.

SIGNAL GENERATORS

Synthesized CW Generator

Model 8671B

- 2 to 18 GHz frequency range
- +8 dBm calibrated output power
- Low spurious signals
- Low phase noise range
- 128 dB dynamic
- 1 to 3 kHz frequency resolution

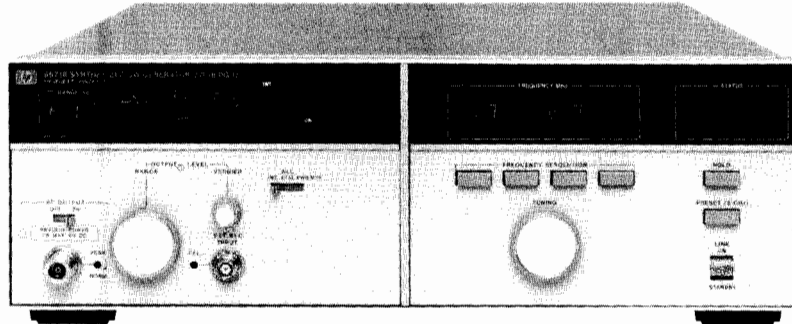

HP 8671B

HP 8671B Synthesized CW Generator

The HP 8671B is a new, streamlined 2.0 to 18.0 GHz synthesized CW generator. It meets all the requirements for a clean CW source. It features synthesized output with 1, 2 or 3 kHz resolution, 128 dB dynamic range, +8dBm calibrated output power, full programmability, low phase noise, plus low spurious signals.

General Purpose Measurements

For applications requiring a microwave local oscillator, the HP 8671B is the ideal solution. A simple, uncluttered, easy to use generator, the HP 8671B provides accurate, clean signals to upconvert and downconvert signals into the desired measurement frequency range.

The +8dBm output capability (with plenty of reserve) is just what you need to drive mixers. You can now take full advantage of the entire 2.0 to 18.0 GHz frequency range from a single instrument. The HP 8671B provides broadband synthesizer capability for the price of a non-synthesized source.

As a microwave source for downconversion, important measurements like noise figure and modulation analysis become more affordable. The HP 8671B with an external mixer allows you to make these measurements at an IF with the HP 8970A and 8970B Noise Figure Meters and the HP 8901A/B Modulation Analyzers. Other down-converted measurements may include network, spectrum, and waveform analysis.

ATE Systems

The +8dBm output capability of the HP 8671B provides the extra margin you need for automated systems. Higher power at the source means adequate power at the unit under test, even after losses through cables and switches. For automated systems, the requirements for low phase noise, low spurious signals, and precise frequency settability are easily accommodated by the HP 8671B.

HP 8671B Specifications

Frequency Characteristics

Frequency range: 2.0–18.0 GHz (18.6 GHz overrange).

Frequency bands and resolution: band 1: 2.0 to 6.2 GHz 1 kHz
band 2: 6.2 to 12.4 GHz 2 kHz
band 3: 12.4 to 18.0 GHz 3 kHz

Time base: internal 10 MHz ($<5 \times 10^{-10}$ /day aging rate) or external 5 or 10 MHz.

Frequency switching time: <15 ms to be within specified resolution, all bands.

Spectral Purity

Single-sideband phase noise (1 Hz BW, CW mode):

F _c	Offset from F _c				
	10 Hz	100 Hz	1 kHz	10 kHz	100 kHz
Band 1	-58 dBc	-70 dBc	-78 dBc	-86 dBc	-110 dBc
Band 2	-52 dBc	-64 dBc	-72 dBc	-80 dBc	-104 dBc
Band 3	-48 dBc	-60 dBc	-68 dBc	-76 dBc	-100 dBc

Harmonics (up to maximum frequency, output level meter readings <0 dB on 0 dBm range and below): <-25 dBc.

Sub-harmonics and multiples thereof: <-25 dBc.

Spurious

Non-harmonically related: <-70 dBc, Band 1; <-64 dBc, Band 2; <-60 dBc, Band 3.

Power line related and fan rotation related within 5 Hz below line frequency and multiples thereof:

F _c	Offset from F _c		
	<300 Hz	300 Hz to 1 kHz	>1 kHz
Band 1	-50 dBc	-60 dBc	-65 dBc
Band 2	-44 dBc	-54 dBc	-59 dBc
Band 3	-40 dBc	-50 dBc	-55 dBc

Output Characteristics

Output level (+15°C to +35°C): +8 to -120 dBm

Flatness (0 dBm range, +15°C to +35°C): ±0.75 dB, Band 1, ±1.00 dB, Band 2, ±1.25 dB, Band 3.

Output level switching time: <20 ms, internally leveled

<10 ms, typical within one output level range

Source impedance: 50 ohms nominal.

Remote Operation

Frequency: Programmable over full range with same resolution as manual mode

Output Level: Programmable in 1 dB steps

RF: Choice of either ON or OFF

ALC: Choice of either internal leveling, diode leveling, or power meter leveling

Interface functions:

HP 8673B: SH1, AH1, T5, TE0, L3, LE0, SR1, RL1, PP1, DC1, DT1, C0, E1.

HP 8672A: SH1, AH1, T6, TE0, L4, LE0, SR1, RL0, PP2, DC1, DT0, C0, E1.

General

Operating temperature range: 0°C to +55°C.

Power: 100, 120, 220, 240 V, +5%, -10%, 48-66 Hz; 300 VA max.

Weight: net, 27 kg (60 lb). Shipping, 32.5 kg (72 lb).

Size: 133 mm H x 425 mm W x 603 mm D (5.25" x 16.75" x 23.75").

Ordering Information

HP 8671B Synthesized CW Generator

Price
\$23,500

Option 907: Front panel handle kit +\$55

Option 908: Rack mounting flange kit +\$33

Option 909: Front panel handle kit plus rack mounting flange kit +\$80

Option 910: Extra operating and service manual +\$60

SIGNAL GENERATORS

Synthesized Signal Generators

Model 8673E

543



- 2 to 18 GHz
- +8 to -120 dBm calibrated output
- 0.1 dB resolution, digitally displayed

- AM/FM/Pulse Modulation
- Low spurious and phase noise
- 1 to 3 kHz frequency resolution



HP 8673E



HP 8673E Synthesized Signal Generator

The HP 8673E is a synthesized signal generator that delivers value-oriented performance in precise microwave signal simulation. It is optimized for applications requiring high performance signal generation in the 2.0 to 18.0 GHz frequency range while also providing 128 dB dynamic output range. The HP 8673E includes the necessary modulation features required in a full performance microwave synthesizer.

Exceptional Output Performance

The HP 8673E provides frequency coverage from 2.0 to 18.0 GHz with resolution of 1, 2, or 3 kHz depending upon frequency band. Optimized for output level flexibility, power is internally (or externally) leveled and calibrated from -120 dBm to +8 dBm. Adding to your measurement convenience, the output level is displayed on the front panel with 0.1 dB resolution with a digital display.

Flexible Modulation

As a full performance synthesized signal generator, the HP 8673E includes amplitude, frequency, and pulse modulation capability. AM depth up to 75% at rates up to 10 kHz is ideal for most applications. The HP 8673E features two types of FM: locked and unlocked operation. In the locked mode, operation is like other synthesizers providing up to 3 MHz deviation that is dependent upon modulation index. The unlocked mode allows up to 10 MHz deviation at rates as low as 50 Hz. Internally leveled pulse modulation over the entire 2 to 18 GHz range with ON/OFF ratios >70 dB is available with any externally supplied TTL-level input signals. Output pulses will have rise/fall times typically less than 50 ns.

Many More Features

The HP 8673E includes many more features including excellent spectral purity and a YIG-tuned oscillator phase-locked to a 10 MHz quartz crystal reference. Full HP-IB and digital sweep capability identical to the HP 8673B/C/D is also included. Listed below is a brief summary of specifications.

HP 8673E Specifications

Frequency Characteristics

Frequency range: 2.0 - 18.0 GHz (1.95 - 18.6 GHz overrange)
Resolution: 1 kHz, 2.0 - 6.6 GHz
 2 kHz, 6.6 - 12.3 GHz
 3 kHz, 12.3 - 18.0 GHz

Spectral Purity

Single-sideband phase noise (1 Hz BW, 1 kHz offset, CW mode): ≤ -60 dBc
Harmonics: ≤ -40 dBc at +3 dBm
Subharmonics and multiples thereof: -35 dBc at +3 dBm

Output Characteristics

Output level (+15°C to +35°C): +8 to -120 dBm
Resolution: 0.1 dB, digital display

Pulse Modulation

ON/OFF ratio: ≥ 70 dB
Rise/fall times: < 50 ns, typical
Pulse repetition frequency: 50 Hz to 1 MHz
Minimum duty cycle: < 0.0001 for leveled performance

Amplitude Modulation

Depth: 0 to 75%, at 0 dBm maximum carrier level, 15°C to 35°C
Rate (30% depth): 10 Hz - 10 kHz, ± 3 dB
Sensitivity: 30%/V and 100%/V ranges

Frequency Modulation

Deviation Range	Rate (±3 dB BW)	Maximum Peak Deviation
30 kHz/V	100 Hz - 2 MHz	the smaller of 3 MHz or: $f_{mod} \times 5, 2.0 - 6.6 \text{ GHz}$ $f_{mod} \times 10, 6.6 - 12.3 \text{ GHz}$ $f_{mod} \times 15, 12.3 - 18.0 \text{ GHz}$
100 kHz/V	100 Hz - 2 MHz	
300 kHz/V	3 kHz - 2 MHz	
1 MHz/V	3 kHz - 2 MHz	
3 MHz/V	3 kHz - 2 MHz	
10 MHz/V (unlocked)	50 Hz - 2 MHz, (typical)	10 MHz

Digital Sweep Characteristics

Identical to HP 8673B/C/D

Remote Programming

All functions HP-IB programmable except line switch.
Interface functions: SH1, AH1, T5, TE0, L3, LE0, SR1, RL1, PP1, DC1, DT1, C0, E1

General

Operating temperature range: 0°C to +55°C
Power: 100, 120, 220, 240V, +5%, -10%; 48-66Hz; 400 VA max
Weight: 29 kg (64 lb.) net
Size: 620mm D x 425mm W x 146mm H (24.4" x 16.8" x 5.7")

Ordering Information

HP 8673E Synthesized Signal Generator	\$36,500
Option 907: Front panel handle kit	55
Option 908: Rack mounting flange kit	33
Option 909: Front panel handle with rack mounting flange kit	80
Option 910: Extra manual	65



SIGNAL GENERATORS

Synthesized Signal Generators

Models 8673B, 8673C, and 8673D

- 10 MHz to 26.5 GHz frequency range
- < -60 dBc harmonics/subharmonics
- Low spurious and phase noise

- +8 to -100 dBm calibrated output
- Internally leveled AM/FM/pulse modulation
- Frequency extension capability to 60 GHz

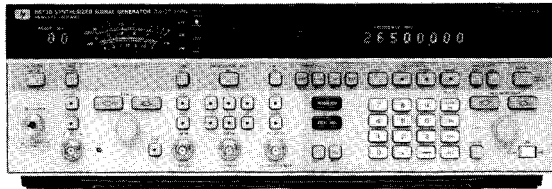

HP 8673B

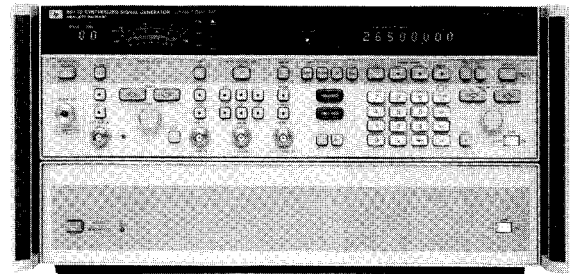

HP 8673D



HP 8673B, 8673C, and 8673D Synthesized Signal Generators

The HP 8673B/C/D Synthesized Signal Generators are full performance synthesizers designed to generate precise microwave signals over the 50 MHz to 26.5 GHz frequency range. These generators offer calibrated and leveled power, AM, FM, pulse modulation, digital sweep, programmability, and frequency extension capability to 60 GHz. The HP 8673B covers the 2.0 to 26.5 GHz range, while the HP 8673C/D pair cover from 50 MHz to 18.6 GHz and 26.5 GHz respectively.

Excellent Spectral Purity

A variety of applications ranging from microwave radar to communications systems require the frequency stability available from the HP 8673B/C/D. The broadband frequency coverage is derived from multiplying a fundamental 2.0 to 6.6 GHz YIG-tuned oscillator. This technique provides the widest possible frequency coverage from a single instrument. Indirect synthesis phase-locks the YIG-tuned oscillator to a 10 MHz quartz crystal reference to provide excellent long term and short term stability (frequency drift $< 5 \times 10^{-10}$ per day). Phase locked loops are optimized for lowest possible single-sideband phase noise. The HP 8673C and HP 8673D include an internal tracking YIG-filter to further reduce unwanted harmonic, subharmonic, and nonharmonic spurious signals above 1.2 GHz to < -60 dBc.

Wide Dynamic Output Range

For broadband component and receiver testing applications, the HP 8673B/C/D delivers exceptionally flat power output across the full frequency ranges. For receiver sensitivity measurements, power is internally (or externally) leveled to -100 dBm. Maximum available power varies with frequency as shown in Figure 1.

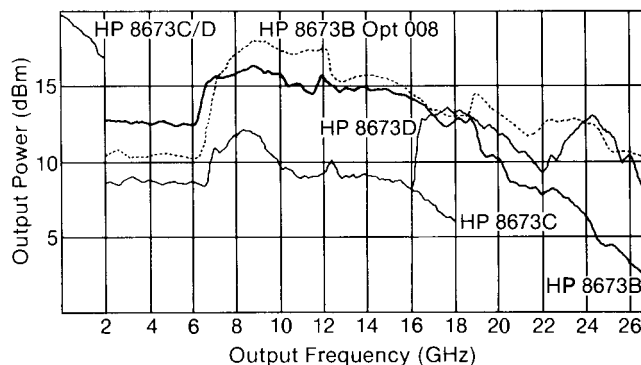

Figure 1. Maximum power typically available from HP 8673D, 8673C, 8673B, and 8673B Option 008 at 25°C

Internally Leveled Pulse Modulation

The HP 8673B/C/D features an internal pulse modulator that provides high-quality pulse modulation over the entire 50 MHz - 26.5 GHz range. Since the modulation is done before the frequency multiplication, the peak pulsed power can be leveled and calibrated to within typically ± 1 dBm of the set level referenced to CW. External TTL level pulse rates up to 1 MHz and pulse widths as narrow as 100 ns can be easily accommodated by the HP 8673B/C/D to provide ON/OFF ratios in excess of 80dB.

Calibrated AM/FM Modulation

AM and FM capability is included in the HP 8673B/C/D to expand the versatility in receiver testing applications. AM depth at rates up to 100 kHz can be accurately set using the front panel meter. Six ranges of metered FM are available at rates and peak deviations up to 10 MHz. Both AM depth and FM deviation are linearly controlled by varying the externally supplied modulating input voltage up to 1V peak. Simultaneous modulation of AM, FM, and pulse is possible to simulate complex environments.

Frequency Extension to 60 GHz

The HP 8673B/C/D can be used as microwave drivers for the HP 83550-series millimeter wave source modules. This combination (with the addition of the HP 8349B Microwave Amplifier) can provide leveled output signals up to 60 GHz with the "System Leveling" mode. The resultant output frequency can be displayed on the HP 8673B/C/D front panel by entering the multiplication factor of the source module.

Full Programmability and Digital Sweep

The HP 8673B/C/D provides full programmability of all front panel functions for automatic test applications. Output level can be controlled in steps as fine as 0.1dB. An internal microprocessor is used to simplify HP-IB program code generation and follow front-panel keystroke sequences. This design allows the implementation of digital sweep. Sweep spans can be set over the entire frequency range with variable rates, step sizes, and selectable markers available.



HP 8673B/C/D Specifications

Frequency Characteristics

Frequency Range: HP 8673B: 2.0–26.0 GHz (to 26.5 GHz in over-range).

HP 8673C: 0.05–18.6 GHz (0.01–18.6 GHz in overrange).

HP 8673D: 0.05–26.0 GHz (0.01–26.5 GHz in overrange).

Frequency Bands: Band 0: 0.05–2.0 GHz

Band 1: 2.0–6.6 GHz

Band 2: 6.6–12.3 GHz

Band 3: 12.3–18.6 GHz

Band 4: 18.6–26.0 GHz

Frequency Resolution: 1 kHz Band 0 and 1 3 kHz Band 3
2 kHz Band 2 4 kHz Band 4

Time base: internal 10 MHz ($<5 \times 10^{-10}$ /day aging rate) or external 5 or 10 MHz.

Frequency switching time: <20 ms (HP 8673B) and <50 ms (HP 8673C/D) to be within specified resolution, all bands.

Spectral Purity

Single-sideband phase noise (1 Hz BW, CW mode):

F _c	Offset from F _c				
	10 Hz	100 Hz	1 kHz	10 kHz	100 kHz
Band 0	-64 dBc	-70 dBc	-78 dBc	-86 dBc	-105 dBc
Band 1	-58 dBc	-70 dBc	-78 dBc	-86 dBc	-110 dBc
Band 2	-52 dBc	-64 dBc	-72 dBc	-80 dBc	-104 dBc
Band 3	-48 dBc	-60 dBc	-68 dBc	-76 dBc	-100 dBc
Band 4	-46 dBc	-58 dBc	-66 dBc	-74 dBc	-98 dBc

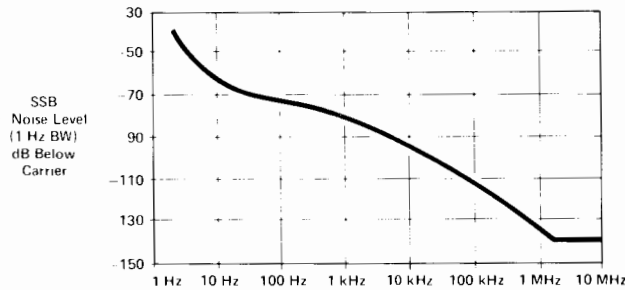

Figure 2. Typical HP 8673B/C/D single-sideband phase noise performance using the internal standard, Band 1.

Harmonics (up to maximum frequency, output level meter readings <0 dB on 0 dBm range and below): <-40 dBc (HP 8673B). <-40 dBc, 50MHz–1.2GHz, <-60 dBc, 1.2–26.0 GHz (HP 8673C/D).

Sub-harmonics and multiples thereof: <-60 dBc (HP 8673C/D) <-25 dBc, Bands 1–3; <-20 dBc, Band 4 (HP 8673B).

Spurious (CW and AM modes)

Non-harmonically related: <-60 dBc, Band 0; <-70 dBc, Band 1; <-64 dBc, Band 2; <-60 dBc, Band 3; <-58 dBc, Band 4.

Power line related and fan rotation related within 5 Hz below line frequency and multiples thereof:

F _c	Offset from F _c		
	<300 Hz	300 Hz to 1 kHz	>1 kHz
Band 0	-50 dBc	-60 dBc	-65 dBc
Band 1	-50 dBc	-60 dBc	-65 dBc
Band 2	-44 dBc	-54 dBc	-59 dBc
Band 3	-40 dBc	-50 dBc	-55 dBc
Band 4	-38 dBc	-48 dBc	-53 dBc

Output Characteristics

Output level (+15°C to +35°C):

8673B		8673C		8673D	
Level (dBm)	Freq. (GHz)	Level (dBm)	Freq. (GHz)	Level (dBm)	Freq.(GHz)
+8 to -100	2-18	+11 to -100	.05-2.0	+11 to -100	.05-2.0
+4 to -100	18-22	+5 to -100	2-16	+5 to -100	2-22
0 to -100	22-26	+2 to -100	16-18.6	+6 to -100	22-26

Flatness (0 dBm range, +15°C to +35°C): ± 0.5 dB through Band 0, ± 0.75 dB through Band 1, ± 1.0 dB through Band 2, ± 1.25 dB through Band 3, ± 1.75 dB through Band 4.

Remote programming output level resolution: 0.1 dB.

Source impedance: 50 ohms nominal.

Pulse Modulation

ON/OFF ratio: >80 dB.

Rise/fall times: <20 ns, Band 0; <35 ns, Bands 1–4.

Minimum leveled pulse width: <100 ns.

Pulse repetition frequency: dc–1 MHz.

Maximum peak power: same as in CW mode.

Peak level accuracy (relative to CW, +15°C to +35°C): ± 1.5 dB.

Pulse modulation input requirements: normal mode, positive-true TTL levels; complement mode, negative-true TTL levels.

Video feedthrough: typically <-50 dBc.

Amplitude Modulation

Rates (3 dB BW, 30% depth): 20 Hz–100 kHz.

Sensitivity: 30%/V, 100%/V ranges. Max. input 1 V peak into 600 Ω .

Frequency Modulation

Sensitivity	Rate (3 dB BW, typical)	Maximum Peak Deviation the smaller of 10 MHz or: fmod x 5, Band 0 fmod x 5, Band 1 fmod x 10, Band 2 fmod x 15, Band 3 fmod x 20, Band 4
30 kHz/V	50 Hz to 10 MHz	
100 kHz/V	50 Hz to 10 MHz	
300 kHz/V	1 kHz to 10 MHz	
1 MHz/V	1 kHz to 10 MHz	
3 MHz/V	1 kHz to 10 MHz	
10 MHz/V	1 kHz to 10 MHz	

Digital Sweep Characteristics

Sweep function: start/stop or ΔF (span) sweep.

Sweep modes: manual, auto, or single sweep.

Step size: maximum of 9999 frequency points per sweep; minimum step size equals frequency resolution.

Dwell time: set from 1 to 255 ms per frequency.

Markers: 5 independent, settable frequency markers.

Sweep outputs: 0 to +10 V ramp start to stop; 1 V/GHz ramp (18 V maximum); Z-axis blanking/markers; tone marker; penlift.

Remote Programming

All functions HP-IB programmable except line switch. The HP 8673B/C/D can output over the interface frequency and output level settings, error/malfunction codes, and operational status codes.

Interface functions:

SH1, AH1, T5, TE0, L3, LE0, SR1, RL1, PP1, DC1, DT1, C0, E1.

General

Operating temperature range: 0°C to +55°C.

Power: 100, 120, 220, 240 V, +5%, -10%, 48–66 Hz; 400 VA max. (HP 8673B), 500 VA max. (HP 8673C/D)

Weight: HP 8673B: net 29 kg (64 lb); shipping 34.5 kg (76 lb).

HP 8673C/D: net 42.4 kg (94 lb.); shipping 46.5 kg (103 lb).

Size: HP 8673B: 133 mm x 425 mm x 603 mm (5.25" x 16.75" x 23.75") HxWxD. HP 8673C/D: 234 mm x 425 mm x 613 mm (9.2" x 16.8" x 24.1") HxWxD.

Ordering Information

HP 8673B Synthesized Signal Generator

Option 001: Delete RF output attenuator

Option 002: Delete reference oscillator

Option 003: Operation at 400 Hz line

Option 004: Rear panel RF output

Option 005: Rear panel RF output without RF attenuator

Option 006: Chassis slide kit

Option 008: +7 dBm output level

Option 907: Front panel handle kit

Option 908: Rack mounting flange kit

Option 909: Front panel handle kit plus rack mounting flange kit

Option 910: Extra operating and service manual

HP 8673C Synthesized Signal Generator

Options 001, 002, 003, 004, 005, and 006: same as HP 8673B

Option 908: Rack mounting flange kit

Option 913: Rack flanges for standard front handles

Option 910: Service and extra operating manual

Option 915: Service manual

Option 916: Extra operating manual

HP 8673D Synthesized Signal Generator

Options 001, 002, 003, 004, 005, 006, 908, 913, 910, 915, and 916: Same as HP 8673C

HP 11726A Support Kit (for HP 8673B)

Price

\$45,000

less \$600

less \$735

add \$460

add \$75

less \$525

add \$75

add \$7,000

add \$55

add \$33

add \$80

add \$65

\$43,500

add \$55

add \$45

add \$85

add \$20

add \$65

\$52,000

\$1,005

SIGNAL GENERATORS

Synthesized Signal Generators

Models 8672A and 8672S

- 2 to 18 GHz frequency range
- Low spurious and phase noise
- Metered AM/FM

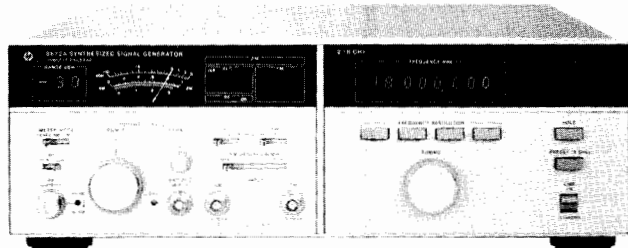

HP 8672A



- 10 MHz-18 GHz frequency range
- Internal pulse modulator
- HP-IB programmability

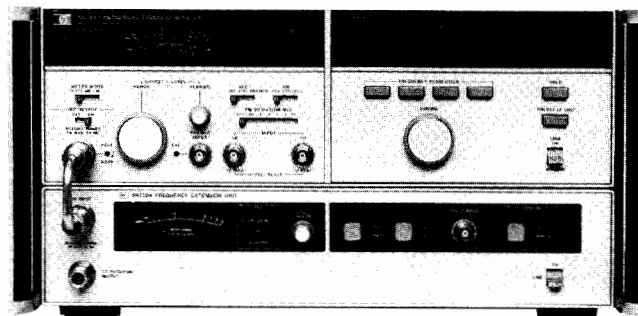

HP 8672S



HP8672A and 8672S Synthesized Signal Generators

The HP 8672A Synthesized Signal Generator delivers precise microwave signals over the 2.0 to 18.0 GHz frequency range. It features calibrated and leveled output power, AM/FM modulation capability, and full HP-IB programmability.

The HP 8672A delivers exceptionally flat power across the full frequency range. For receiver sensitivity measurements, power is internally (or externally) leveled and calibrated to -120 dBm. The option 008 raises the guaranteed maximum output to +8 dBm from a standard +3 dBm.

The HP 8672S consists of an HP 8672A and an HP 86720A frequency extension unit. This unit uses a heterodyne technique to extend the frequency coverage down to 10 MHz. It also adds pulse modulation capability over the entire 10 MHz to 18.0 GHz frequency range. Calibrated output level in this mode is available up to 2 GHz, while >80 dB ON/OFF ratio is available across the entire 18 GHz frequency range.

Specifications for the HP 8672S are identical to those of a standard HP 8672A for the 2 to 18 GHz frequency range with the exception of 1 dB less maximum output power and no AM modulation below 2 GHz.

Existing HP 8672A Signal Generators can be retrofitted to the HP 8672S configuration by ordering the HP 86720A Frequency Extension Unit and an HP 11731A or 11732A Frequency Extension Retrofit Kit.

HP 8672A and 8672S Specifications

Frequency Characteristics

Frequency range: HP 8672A: 2.0-18.0 GHz (18.6 GHz overrange)
HP 8672S: 0.01-18.0 GHz (18.6 GHz overrange)

Frequency bands and resolution:

Band 0:	0.01 - 2.0 GHz	1 kHz
Band 1:	2.0 - 6.2 GHz	1 kHz
Band 2:	6.2 - 12.4 GHz	2 kHz
Band 3:	12.4 - 18.0 GHz	3 kHz

Time base: internal 10 MHz ($<5 \times 10^{-10}$ /day aging rate) or external 5 or 10 MHz.

Frequency switching time: <15 ms to be within specified resolution, all bands.

Spectral Purity

Single-sideband phase noise: same as HP 8673B/C/D
Harmonics (up to maximum frequency, output level meter readings <0 dB on 0 dBm range and below): <-25 dBc.
Sub-harmonics and multiples thereof: <-25 dBc, Bands 1-3.
Spurious (CW and AM modes): Same as HP 8673B/C/D

Output Characteristics

Output level (+15°C to +35°C): HP 8672A: +3 to -120 dBm
HP 8672S: +13 dBm to -120 dBm, 0.01-2.0 GHz; +2 dBm to -120 dBm, 2.0-18.0 GHz

Flatness (0 dBm range, +15°C to +35°C):

HP 8672A: same as HP 8673B/C/D

HP 8672S: same as HP 8672A degraded by ± 0.25 dB

Remote programming output level resolution: 1.0 dB.

Source impedance: 50 ohms nominal.

Modulation Characteristics

Amplitude Modulation: same as HP 8673B/C/D (2-18 GHz)

Frequency Modulation: same as HP 8673B/C/D

Pulse Modulation: HP 8672S only

>80 dB ON/OFF ratio; <15 ns rise/fall times; peak pulsed power within 1.0 dB of level selected in CW mode for 0.01-2 GHz, uncalibrated for 2.0-18.0 GHz.

General

Programming: all functions HP-IB programmable except line switches and meter mode.

Interface functions: SH1, AH1, T6, TE0, L4, LE0, SRI, RL0, PP2, DC1, DT0, C0, E1.

Operating temperature range: 0 to +55°C.

Power: 100, 120, 220, 240V, +5%, -10%, 48-66 Hz; 400 VA max.

Weight: HP 8672A: net 27 kg (60 lb); shipping 32.5 kg (72 lb).

HP 8672S: net 39.5 kg (87 lb); shipping 43.6 kg (96 lb).

Size: HP 8672A: 133 mm \times 425 mm \times 603 mm (5.25" \times 16.75" \times 23.75") H \times W \times D

HP 8672S: 222 mm \times 425 mm \times 620 mm (8.8" \times 16.8" \times 24.4") H \times W \times D

Ordering Information

	Price
HP 8672A Synthesized Signal Generator	\$38,030
Option 001: Delete RF output attenuator	less \$600
Option 002: Delete reference oscillator	less \$550
Option 003: Operation at 50/60/400 Hz line	add \$250
Option 004: Rear panel RF output	add \$75
Option 005: Rear panel RF output without RF attenuator	less \$525
Option 006: Chassis slide kit	add \$45
Option 008: +8 dBm output level	add \$4,100
Option 907: Front panel handle kit	add \$55
Option 908: Rack mounting flange kit	add \$33
Option 909: Front panel handle plus rack mounting flange kit	add \$80
Option 910: Extra operating and service manual	add \$60
HP 8672S Synthesized Signal Generator	\$55,000
Options 001 and 002: same as HP 8672A	
Option 004: Rear panel RF output	add \$150
Option 005: Rear panel RF output w/o RF attenuator	less \$450
Option 006: Chassis slide kit	add \$80
Option 008: +7 dBm output level	add \$4,100
Option 009: Delete internal pulse modulator	less \$1,100
Option 010: Delete pulse modulator and step attenuator	less \$1,700
Option 908: Rack flange kit	add \$55
Option 913: Rack flanges for standard front panel handles	add \$45
Option 910: Extra operating and service manuals	add \$80
HP 86720A Frequency Extension Unit	\$17,000
HP 11731A Frequency Extension Retrofit Kit	\$1,000
HP 11732A Frequency Extension Retrofit Kit	No Charge
HP 11712A Support Kit	\$800

SIGNAL GENERATORS

PIN Modulators, Pulse Driver

Models 8730 Series, 8403A

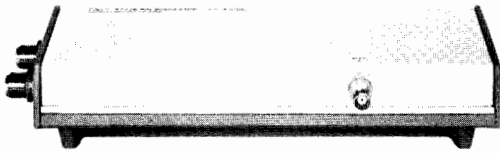

HP 8730B Series

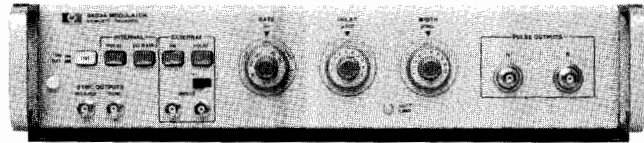

HP 8403A

HP 8730 Series PIN Modulators

With HP 8730 series PIN Modulators, signal sources, including klystrons, can be pulse-modulated, leveled or amplitude-modulated with sinusoidal and complex waveforms. Fast rise times, low incidental FM and a nearly constant impedance match to source and load are typical of these absorption-type modulators.

HP 8403A Modulator

The HP 8403A provides complete control of the PIN modulators, supplying the appropriate modulation wave shapes and bias levels for fast rise times, rated on/off ratios and amplitude modulation. An internal square-wave and pulse modulator with PRF of 50 Hz to 50 kHz and adjustable pulse width and delay also provide square wave and pulses for general pulse applications. For applications requiring an absorption-type modulator plus controls in a single unit, a PIN modulator can be installed inside the HP 8403A, for any specified frequency range.

HP 8403A Specifications

Output Characteristics (available separately at front panel).

For driving HP 8730 PIN modulators: AM and pulse output, pulse output specially shaped for optimum RF rise and decay times.

For general pulse applications: positive dc-coupled pulse 25 to 30 volts in amplitude, approximately symmetrical about 0 volt; no AM signal.

Modulation

Internal Square Wave

Frequency: variable from 50 Hz to 50 kHz.

Symmetry: better than 45/55%.

Internal Pulse

Repetition rate: variable from 50 Hz to 50 kHz.

Delay: variable from 0.1 μ s to 100 μ s, between sync out pulse and RF output pulse.

Width: variable from 0.1 μ s to 100 μ s.

HP 8730 Series Specifications

	HP 8731B	HP 8732B	HP 8733B	HP 8734B	HP 8731B-H10 ⁵
Frequency range (GHz)	0.8-2.4	1.8-4.5	3.7-8.3	7.0-12.4	0.4-1.2
Dynamic range (dB)	80	80	80	80	35
Max. residual atten. (dB) ¹	<2.0	<3.5 ²	<3.0	<5.0	<2.0
Typical rise time (ns) ³	30	30	30	30	40
Typical decay time (ns) ³	20	20	20	20	30
SWR, min. attenuation	1.6	1.6 ⁴	2.0	2.0	1.5 ⁵
SWR, max. attenuation	2.0	2.0	2.2	2.2	2.0 ⁶
Forward bias input resistance (ohms)	100	100	100	100	300
RF connector type	N(f)	N(f)	N(f)	N(f)	N(f)
Weight, net kg (lb)	2.5 (5.5)	2.7 (6.0)	1.4 (3.0)	1.4 (3.0)	2.5 (5.5)
shipping kg (lb)	3.3 (7.3)	3.5 (7.8)	1.9 (4.2)	1.9 (4.2)	3.3 (7.3)
Dimensions					
Height, mm (in)	57 (2.25)	57 (2.25)	57 (2.25)	57 (2.25)	57 (2.25)
Width, mm (in)	124 (4.9)	124 (4.9)	83 (3.25)	83 (3.25)	124 (4.9)
Depth, mm (in)	289 (11.4)	289 (11.4)	311 (12.3)	311 (12.3)	289 (11.4)
Prices	\$1625	\$1710	\$1850	\$1850	\$1625

Maximum ratings: maximum input power, peak or CW: 1 W; bias limits: +20 V, -10 V.
Bias polarity: negative voltage increases attenuation.
RFI: radiated leakage limits are below those specified in MIL-I-6181D at input levels <1 mW; at all input levels radiated interference is sufficiently low to obtain rated attenuation.

1. With +5 V bias.
2. 4 dB, 4 to 4.5 GHz.
3. Driven by HP 8403A Modulator.
4. 2.0 SWR, 4 to 4.5 GHz.

5. External high-pass filters required.
6. Excluding high-pass filters.

External Sync

Signal: 5 to 20 volts peak, + or -, pulse or sine wave.

Input impedance: approximately 2000 ohms, dc-coupled.

Trigger Out

Sync out: simultaneous with or 0.1 to 100 μ s in advance of RF pulse, as set by delay control.

Delayed sync out: simultaneous with output pulse.

Amplitude: approximately -2 volts.

Source impedance: approximately 330 ohms.

External Pulse

Amplitude and polarity: 5 volts to 20 volts peak, + or -.

Repetition rate: maximum average PRF, 500 kHz/s.

Input impedance: approximately 2000 ohms, dc-coupled.

Width: minimum 0.1 μ s; maximum 1/PRF - 0.4 μ s.

Amplitude Modulation (with HP 8730 series)

Frequency response: dc to approximately 10 MHz (3 dB).

Sensitivity: approximately 10 dB/volt with HP 8730A series; approximately 20 dB/volt with HP 8730B series.

Input impedance: approximately 1000 ohms.

General

Power: 115 or 230 volts \pm 10%, 50 to 400 Hz, approximately 10 watts.

Size: 96 H x 425 W x 467 mm D (3.75" x 16.73" x 18.4").

Weight: net, 7.4 kg (16.5 lb). Shipping, 9 kg (20 lb).

Ordering Information

HP 8403A Modulator

Price

\$2570

Options

002: HP 8731B PIN Modulator installed in HP 8403A add \$1525

004: HP 8732B PIN Modulator installed in HP 8403A add \$1600

006: HP 8733B PIN Modulator installed in HP 8403A add \$1725

008: HP 8734B PIN Modulator installed in HP 8403A add \$1725

009: Input and Output Connectors on rear panel add \$50

908: Rack flange kit add \$35.00

910: Extra Manual add \$7.50

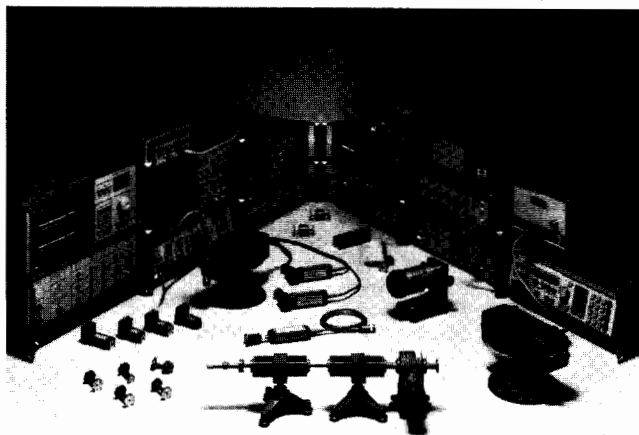

Figure 1. New HP millimeter-wave product line includes spectrum analyzers, scalar and vector network analyzers, frequency counters, power meters, sweepers and synthesizers, and a full line of waveguide measurement accessories.

Introduction

Hewlett-Packard now addresses measurements to 60 GHz and beyond with an offering of spectrum analyzers, vector and scalar network analyzers, signal sources, power meters, frequency counters, and a complete line of waveguide measurement accessories. In most cases, this new millimeter-wave test equipment is based around an existing piece of HP microwave test equipment.

HEWLETT-PACKARD MILLIMETER-WAVE PRODUCT LINE

FREQUENCY RANGE	26.5 to 40 GHz	33 to 50 GHz	40 to 60 GHz	50 to 75 GHz	75 to 110 GHz
Signal Sources					
Signal Analysis					
Vector Network Analysis					
Scalar Network Analysis					
mm Wave Measurement Accessories					
Power Measurements					
Frequency Counting					

Available Now

In Development

Figure 2. Synopsis of HP's mm-wave product line, including frequency extensions currently under development.

As shown in Figure 2, HP's new line of millimeter-wave test equipment includes power meters to 50 GHz, scalar network analyzers, sweepers, and synthesizers to 60 GHz, vector network analyzers to 100 GHz, measurement accessories, spectrum analyzers and frequency counters to 110 GHz. Also indicated is the commitment to extend the entire line to 110 GHz.

Millimeter-Wave Signal Sources

Hewlett-Packard offers three millimeter-wave source modules (see Figure 3) that produce high power, high quality signals covering the full waveguide bands of 26.5 to 40 GHz, 33 to 50 GHz, and 40 to 60 GHz. These source modules are efficient frequency multipliers that translate 50 mW microwave signals in the 11 to 20 GHz range to millimeter-wave signals. The source for the microwave input signal can be either the new HP 83550A 8 to 20 GHz, +20 dBm RF plug-in for the HP 8350B sweep oscillator, or any other HP 11 to 20 GHz microwave source driving the new HP 8349B 2 to 20 GHz power amplifier.

Convenience and Economy

Because the source module is small, light in weight, and connected to the microwave driver via flexible cables, it can be placed right at the waveguide input (rather than requiring that the waveguide be run to the source).

Also, since the module is an extension of a lower frequency microwave source, its cost is quite low relative to other source alternatives. And of course, the microwave driving source can be productively used for other microwave applications when not in use with the module.

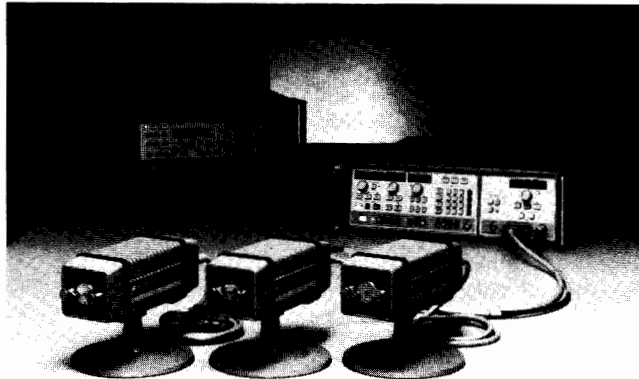

Figure 3. HP millimeter-wave source modules include the HP 83554A (26.5 to 40 GHz), HP 83555A (33 to 50 GHz), and HP 83556A (40 to 60 GHz).

Translate the High Performance of Your Microwave Source

With the source modules, the characteristics of your microwave source are translated to millimeter-wave frequencies. For millimeter-wave swept testing, the features of the HP 8350-series sweep oscillator including all sweep modes, calibrated leveled power and, full programmability, are all available.

When highest frequency accuracy, stability, and spectral purity are needed, a microwave synthesizer can be used as the driving source. For instance, with the HP 8341B synthesized sweeper, you can achieve 9 Hz of frequency resolution at 60 GHz, and typically -70 dBc/Hz SSB phase noise at 35 GHz (in a 1 Hz BW 10 kHz away from the carrier). Similarly, the sophisticated (AM, FM or pulse) modulation of a synthesized signal generator like the HP 8673 series or the HP 8341B/40B can be translated up to millimeter-wave frequencies.

Signal Analysis

To extend your millimeter-wave signal analysis capability to 110 GHz, HP offers a line of external harmonic mixers. The mixers, along with the multi-band millimeter-wave capability of the new HP 71000 spectrum analyzer (see Figure 4), the high performance of the HP 8566B and economy of the HP 8569B spectrum analyzers offer a wide range of millimeter-wave signal analysis capability.

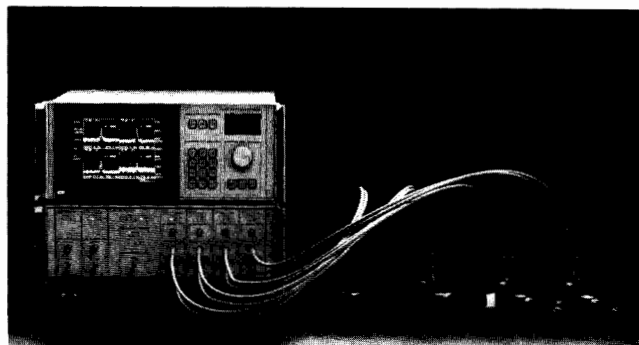

Figure 4. HP 71000 millimeter-wave spectrum analyzer with four HP 11970 series mixers measuring 26.5 to 110 GHz on four simultaneous displays.

Easy to Use

Because the HP 11970 and 11971 series mixers do not require DC bias and its associated adjustments, measurements can be made quickly and easily. Signal frequencies are easy to determine using these mixers with the high-performance signal identification functions in both the HP 8566B and new HP 71000 spectrum analyzers, providing fast, reliable results.

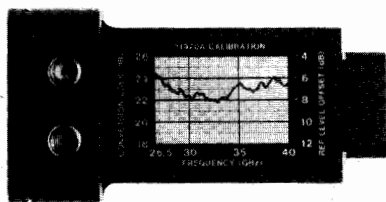

Figure 5. Each harmonic mixer's conversion loss is plotted versus frequency and mounted on the body of the unit.

High Performance

Each individual mixer is characterized by a plot of conversion loss versus frequency which is mounted on the body of the unit (see Figure 5). By removing the conversion loss characteristics of the mixer from the amplitude measurement (using a simple down-loadable program in the HP 71000 or 8566B or a manual IF gain adjustment on the HP 8569B), calibrated amplitude measurements are possible with a spectrum analyzer at millimeter-wave frequencies. In addition, these harmonic mixers have excellent sensitivity, offering typically -104 dBm at 44 GHz and -93 dBm at 94 GHz (HP 11970 series in a 1 kHz resolution BW).

Vector Network Analysis

Now the powerful HP 8510 microwave vector network analyzer can be extended to operate at millimeter-wave frequencies (see Figure 6). All of the HP 8510 system measurement capabilities available at microwave frequencies are now obtainable to 100 GHz. Optionally, the ability to view the response of a test device as a function of time is also available.

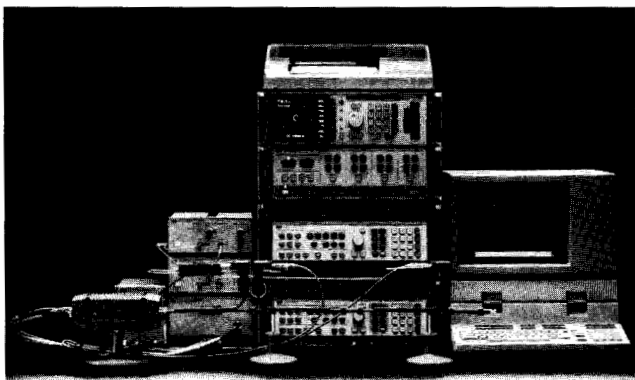

Figure 6. HP 8510 millimeter-wave network analyzer for the 26.5 to 40 GHz frequency band.

Wide Dynamic Range

With 80 to 100 dB of dynamic range, measuring the transmission loss of a high rejection filter or the return loss of a small signal device isn't limited by the test system.

Simple to Use

An HP 8510 millimeter-wave system provides a new level of measurement convenience. The mobility of the test ports means you can quickly connect and measure your device rather than spend time adapting to the requirements of the test system.

Precision with Speed

Using the HP 85129A millimeter-wave system software pac, the HP 8510 millimeter-wave system is capable of measurements with speed and accuracy. Measurement speeds range from 7 seconds for 51 synthesized frequency points to just under a minute for a full 401 points of error-corrected measurements. Meaningful resolutions of 0.05 dB and 0.1 degrees phase are easily achieved. Accuracy enhancement further improves measurement uncertainty by reducing the level of systematic errors. Effective directivity and source match are typically 38 to 45 dB and 35 to 40 dB, respectively.

Configuration Summary

All of the details for configuring and operating an HP 8510 millimeter-wave system are thoroughly documented in HP Product Note 8510-1A. For ordering convenience, kits of the components necessary to configure the test set portion of the system are offered. System software and a complete line of calibration devices are also available.

Scalar Network Analysis

Scalar network measurement systems covering 26.5 to 60 GHz include calibrated detectors, analyzers, sources, and millimeter-wave accessories and take advantage of all the capability and productivity enhancements built into the systems for microwave use.

Choose from two HP scalar network analyzers—the HP 8756A or the HP 8757A. The HP 8757A is the ideal choice for most millimeter-wave measurements. Using the R, Q, and U85026A detectors, the HP 8757A can measure in either AC or DC detection modes, allowing you to optimize your measurement dynamic range for each device. For multi-port devices, use the optional fourth detector input to measure four independent device parameters simultaneously. In addition, the HP 8757A, with its 9 inch diagonal vector display, can generate limit lines that permit pass/fail testing—ideal for the production environment. For measurements above 60 GHz, use the HP 85025C (HP 8757A only) and 11664C detector adapters with your millimeter-wave detectors and source.

Frequency Counters

Hewlett-Packard extends its frequency measuring capability to millimeter-wave frequencies with the addition of the HP 5352A 40 GHz CW counter and the HP 5356D harmonic mixer driver (which translates the HP 5345/55/56 series CW and pulse microwave counter to millimeter-wave frequencies via the HP 11970 series harmonic mixers) for frequency coverage to 110 GHz.

The HP 5352A 10 Hz to 40 GHz CW counter provides reliable performance and ease of use at a low price for microwave and millimeter-wave frequency measurements. A rugged APC-3.5 male input connector is used to cover a broad 500 MHz to 40 GHz range. Alternatively, a 3.5 mm coax to WR-28 waveguide adapter could be used for measurements in 26.5 to 40 GHz waveguide. Dynamic range at 40 GHz is 22 dB and resolution is 1 Hz. Operation is enhanced by data manipulation features (e.g. math functions and offset capability), and full programmability.

The HP 5356D harmonic mixer driver extends the line of HP 5345A/5355A/5356 series microwave frequency counters to 110 GHz. With this extension comes the capability to measure both CW and pulsed millimeter-wave signals. Using the 36 to 50 GHz band as an example, 25 dB dynamic range with 48 MHz FM tolerance (at rates of dc to 10 MHz) is available in CW mode. An RF chirp burst of 75 ns minimum pulse width can be profiled using 20 ns external gating capability.

Power Meters

The accuracy in power measurements at microwave frequencies has now been extended into the millimeter-wave region. Paired with the HP 438A, 436A, or 435B power meters, the new HP R8486A and Q8486A thermocouple waveguide power sensors exhibit stable, well-matched performance allowing you to accurately measure power in the frequency ranges of 26.5 to 40 GHz and 33 to 50 GHz respectively.

These millimeter-wave power sensors have the capability to normalize the sensor/meter combination to the 50 MHz, 1mW reference signal contained within the power meters. The accuracy of your power measurements is further assured by traceability to NBS standards.

Millimeter-Wave Measurement Waveguide Accessories

Accompanying HP's broad range of millimeter-wave instrumentation is a full line of millimeter-wave measurement accessories. These accessories make up the components necessary to configure practical millimeter-wave measurement systems in the 26.5 to 40 GHz, 33 to 50 GHz, 40 to 60 GHz, 50 to 75 GHz, and 75 to 110 GHz waveguide bands. Accessories in the line include variable attenuators, frequency meters, couplers, isolators, detectors, terminations, fixed attenuators and assorted adapters, bends, twists and straights.

MICROWAVE TEST EQUIPMENT

Microwave Measurements and Products



Microwave measuring techniques

Hewlett-Packard offers a complete line of microwave coaxial and waveguide measuring equipment. Measuring systems can be assembled from this equipment to make accurate reflection and transmission measurements on other components such as filters, mixers, cables, etc. Signal characteristics such as frequency, power, or spectral content may be measured using other associated equipment.

HP equipment capability ranges from inexpensive systems for point-by-point, narrow-band work to powerful analyzers which furnish dynamic displays of error-corrected network scattering parameters across wide frequency bands. Equipment selection and measuring techniques depend primarily on the accuracy, speed, and cost requirements of the application.

Some applications require complete phase and amplitude characterization of microwave components. These vector measurements are usually made in design labs to aid in component design or in evaluating performance to phase specifications. Such phase measurements require relatively sophisticated equipment and techniques.

But the majority of microwave measurements made in production, test, maintenance, and calibration require only amplitude (scalar) characteristics. Scalar test procedures are popular because they are straightforward, easy-to-use, and low cost, yet yield an excellent measure of the quality of the test part.

More detailed information is available in the Coaxial & Waveguide Measurement Accessories Catalog & Microwave Measurement Handbook, literature number 5954-6401.

Confidence in Component Performance

The performance of every unit manufactured is verified on an error-correcting automatic network analyzer that has been calibrated with standards that are directly or indirectly traceable to the National Bureau of Standards. This means you can be assured that the product you receive has been properly tested and meets the specifications you expect.

MICROWAVE TEST EQUIPMENT

Coaxial Switches

Models 8761A/B, 33311B/C, 33312B/C, 33313B/C

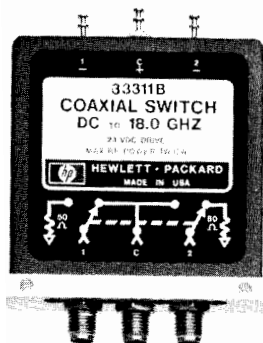

HP 33311B

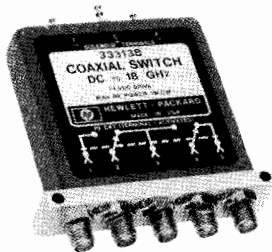

HP 33313B

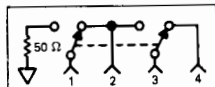

HP 33312B/C

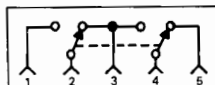

HP 33313B/C
Wiring Diagrams

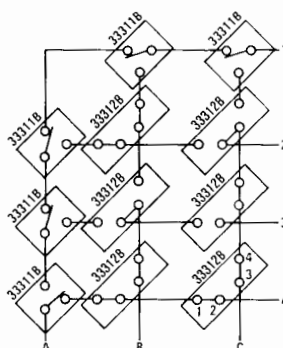

Typical Matrix Application

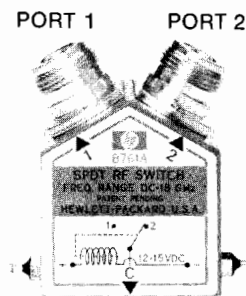

PORT C
HP 8761A Option 001

HP 8761A/B, 33311B/C, 33312B/C, 33313B/C Coaxial Switches

HP coaxial switches all feature low SWR, low insertion loss, and excellent isolation. The HP 8761A/B is an SPDT switch for dc to 18 GHz. It is controlled by latching solenoids and is break-before-make. Six connector options plus a 50-ohm termination may be specified for each port, making switch "trees" possible.

The HP 33311B (dc - 18 GHz) and 33311C (dc - 26.5 GHz) switches are also SPDT type. They feature exceptional isolation of 90 dB to 18 GHz, as well as internally-switched 50-ohm loads resulting in all ports maintaining a 50-ohm match. They use latching solenoids and the switching current is automatically cut off when switching is complete. Their compact size and high repeatability and reliability make them very suitable for OEM use.

HP 33312B/C (4-port) and 33313B/C (5-port) serve a variety of uses such as "transfer" switches to insert or remove a component from a signal path. They can also be used as the intersection switching element in a larger microwave matrix as shown above. HP 33312B/C features one internal 50-ohm switched load while HP 33313B/C brings all 5 ports to 5 connectors. B-models cover dc - 18 GHz and C-models, dc - 26.5 GHz. Ask for Application Note 332 for more information on microwave switching.

HP-IB Compatible

The HP 33311B/C, 33312B/C, 33313B/C, and the 8761A/B Switches can be remotely controlled by the HP-IB with either the HP 11713A Attenuator/Switch Driver or the HP 59306A Relay Actuator. See the catalog index for page reference.

HP 33311B/C, 33312B/C, 33313B/C, 8761A/B Specifications

HP Models	Freq. Range (GHz)	SWR 50 ohm nominal	Insertion Loss	Isolation	Switching Speed	RF Connector	Dimensions H * W * D (mm)	Shipping Weight (grms)	Price
33311B	dc - 18	1.25: to 12.4 GHz 1.5: to 18.0 GHz	< 0.5 dB @ 18 GHz	>90 dB to 18 GHz	30 msec	SMA (f)	54 * 53 * 14	220	\$ 570
33311C	dc - 26.5	1.3: to 10 GHz 1.5: to 16 GHz 2.3: to 26.5 GHz	< 1.4 dB @ 26.5 GHz	>90 dB to 12.4 GHz >85 dB to 18 GHz >50 dB to 26.5 GHz	30 msec	APC-3.5 (f)	54 * 53 * 14	220	\$ 750
33312B	dc - 18	1.25: to 12.4 GHz 1.4: to 18 GHz	< 0.5 dB @ 18 GHz	>90 dB to 18 GHz	30 msec	SMA (f)	54 * 53 * 14	220	\$ 615
33312C	dc 26.5	1.5: to 16 GHz 1.9: to 26.5 GHz	< 1.4 dB @ 26.5 GHz	>85 dB to 18 GHz >50 dB to 26.5 GHz	30 msec	APC-3.5 (f)	54 * 53 * 14	220	\$ 795
33313B	dc - 18	1.25: to 12.4 GHz 1.5: to 18 GHz	< 0.5 dB @ 18 GHz	>90 dB to 18 GHz	30 msec	SMA (f)	54 * 53 * 14	220	\$ 655
33313C	dc - 26.5	1.5: to 16 GHz 1.9: to 26.5 GHz	< 1.4 dB @ 26.5 GHz	>85 dB to 18 GHz >50 dB to 26.5 GHz	30 msec	APC-3.5 (f)	54 * 53 * 14	220	\$ 835
8761A	dc - 18	1.2: to 12.4 GHz 1.25: to 18GHz	0.8 dB @ 18 GHz	>50 dB to 12.4 GHz >45 dB to 18 GHz	35-50 msec	See table: How to Order the HP 8761A/B	41 * 38 * 38	300	\$ 295
8761B	dc - 18	1.2: to 12.4 GHz 1.25: to 18 GHz	0.8 dB @ 18 GHz	>50 dB to 12.4 GHz >45 dB to 18 GHz	35-50 msec		41 * 38 * 38	300	\$ 295

SPECIFICATIONS COMMON TO ALL MODEL NUMBERS

Life: > 1,000,000 switchings
Max Power Input: 1 W average, or 100 W Peak (Max. 10 μsec P.Width) Except HP 8761A/B, 10 W average, 5kW peak

How to Order HP 8761A/B Switches

Specify solenoid voltage and connectors (including built-in 50-ohm termination) by the alphabetic suffix on the switch model number and the appropriate three-digit option number.

A Model: 12-15 V Connector Option Number 0 0 1
B Model: 24-30 V (See table) Port 1 Port 2 Port C

Option Code	Connector Type	Option Code	Connector Type
0	N (f)	4	APC-7 for UT-250 Coax
1	N (m)	5	SMA (f)
2	APC-7 w/Threaded sleeve	6	SMA (m)
3	APC-7 w/Coupling nut	7	50Ω Termination

Solenoid voltage (dc or pulsed): 24 volts for HP 33311B/C;12B/C;13B/C (diode protected to reduce transients)
12 to 15 volts for HP 8761A
24 to 30 volts for HP 8761B
15 volt solenoid voltage: Option 015 for HP 33311B/C; 12B/C; 13B/C



MICROWAVE TEST EQUIPMENT

Coaxial Fixed Attenuators

Models 8491A/B, 8492A, 8493A/B/C, 8498A, 11581/2/3A/3C, 33340A/B/C

- Flat frequency response
- Low SWR
- Specifications traceable to NBS

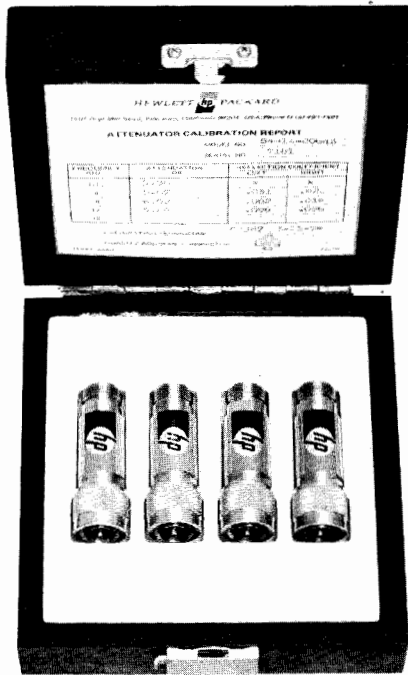

HP 11581A

HP 8491A/B, 8492A, 8493A/B/C Fixed Attenuators

Hewlett-Packard coaxial fixed attenuators provide precision attenuation, flat frequency response, low SWR over broad frequency ranges at low prices. Attenuators are available in nominal attenuations of 3-dB and 6-dB, also 10-dB increments from 10 dB to 60 dB. These attenuators are swept-frequency tested to ensure meeting specifications at all frequencies. Calibration points are provided on a nameplate chart attached to each unit.

HP 11581A, 11582A, 11583A/C Attenuator Sets

A set of four Hewlett-Packard attenuators—3, 6, 10 and 20 dB—are furnished in a handsome walnut accessory case. The HP 11581A set consists of HP 8491A Attenuators; the HP 11582A set, HP 8491B Attenuators; the HP 11583A set, HP 8492A Attenuators; and the HP 11583C set, HP 8493C Attenuators. The set includes calibration reports certified traceable to the National Bureau of Standards, containing both the attenuation and the reflection coefficients for each attenuator at four frequencies for the HP 11581A (dc, 4, 8, 12.4 GHz) and five frequencies for the HP 11582A and HP 11583A (dc, 4, 8, 12.4, 18 GHz). By specifying option 890, calibration data is given at 26 frequencies (HP 11581A) or 42 frequencies (HP 11582A and 11583A). The HP 11583C set includes option 890 calibration data. See next page for exact frequency lists.

These sets are ideal for calibration labs or where precise knowledge of attenuation and SWR is desired.

HP 8498A High Power Attenuator

The HP 8498A Option 030 is designed to meet the needs of high power attenuation applications in the RF and microwave frequency range. It is specified from dc to 18 GHz at 25 watts average, 500 watts peak, from dc to 5.8 GHz and 125 watts peak from 5.8 to 18 GHz. Available only in a 30 dB model (option 030), the unit offers low SWR (<1.30 at 18 GHz) and good accuracy (± 1 dB at 18 GHz). The unit also features 'human engineered' cooling fins that prevent operator burns even under continuous maximum input power conditions.

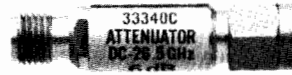

HP 33340C

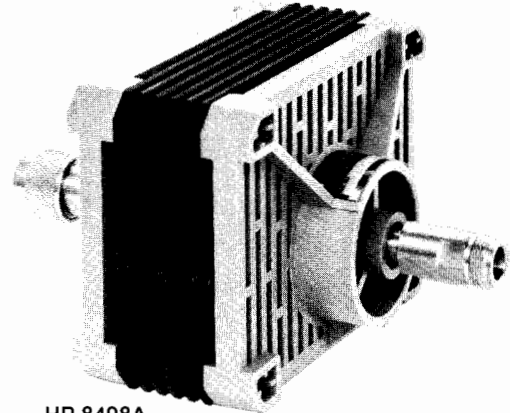

HP 8498A
Option 030

Option 890 Calibration Data

Extensive calibration data is available on HP attenuators at low cost. When option 890 is specified for the fixed attenuators or microwave step attenuators, standardized calibration data in frequency steps no larger than 500 MHz is provided over the frequency range of the units. This data is generated from measurements made on an HP 8542 Automatic Network Analyzer and features excellent accuracy (traceable to NBS) and low cost. Data is given for attenuation and the SWR (reflection coefficient for the HP 8493C) of each port and is provided in a protective plastic envelope.

Calibration data has important uses in applications such as RF substitution measurements and test system verification. Using the actual calibration data rather than data sheet specifications allows the attenuation uncertainty to be reduced 60% or more. Also, the calculated mismatch uncertainty for a test system is lower if the actual SWR data for the attenuators is used. Similar calibration data is used in HP production areas to verify the performance of manual and automated test systems. For automated system checkout, the calibrated unit is tested and the results are compared to the previously stored calibration data. If the differences are within the measurement uncertainty, proper operation is ensured. For step attenuators, the calibration data can be used in automated test systems to more accurately characterize a device's characteristics. By storing the calibration data for the individual steps, the measurement results can be adjusted by the actual amount of attenuation (for example, when a nominal 10 dB step is actually 9.6 dB).

The calibration data frequencies, prices, and ordering information for fixed attenuators are on the next page, and the same information for step attenuators is on page 554.

HP 33340A/B/C Fixed Attenuators

The HP 33340A, 33340B and 33340C are Coaxial Fixed Attenuators intended for OEM and systems use. Frequency range specifications are dc—12.4 GHz, dc—18 GHz and dc—26.5 GHz respectively. These OEM attenuators are similar to the HP 8493 series Attenuators.

For more information regarding the HP 33340 series refer to the data sheet (5952-8279).

Ordering Information

HP 33340A Coaxial Fixed Attenuator
Option 890
HP 33340B Coaxial Fixed Attenuator
Option 890
HP 33340C Coaxial Fixed Attenuator
Option 890

Price
\$85
add \$20
\$110
add \$25
\$238
add \$40



HP 8491A/B series



HP 8492 series



HP 8493A/B/C series

Ordering Example

Include appropriate frequency range/connector and attenuation designations from the ordering example below with every attenuator order.

Calibration Data

Include "Option 890" or "Option 894" in addition to attenuation option when ordering calibration data.

HEWLETT PACKARD
CALIBRATION REPORT

MODEL: 8493B OPT 896/898 SER NO: 02521
DATE: 11-06-83 TECHNICIAN: 33886
MEAS SYSTEM: 8542E SYSTEM A
PORT IDENTIFICATION: With the label facing the user, PORT 1 is on the left and PORT 2 is on the right.

FREQUENCY (MHz)	ATTENUATION (dB)	SWR PORT 1	SWR PORT 2
100.00	5.64	1.004	1.009
300.00	5.85	1.005	1.009
500.00	5.86	1.005	1.009
700.00	5.85	1.005	1.010
900.00	5.87	1.006	
1000.00	5.86		
1250.00	5.89		
1500.00	5.91		
1750.00			
2000.00			

Option 890 Example

8491B Option 010 Option 890 or 894

Connectors and Frequency Range

- 1A:** Type N (m,f), dc-12.4 GHz
- 1B:** Type N (m,f), dc-18 GHz
- 2A:** APC-7, dc-18 GHz
- 3A:** SMA (m,f), dc-12.4 GHz
- 3B:** SMA (m,f), dc-18 GHz
- 3C:** APC 3.5 (m,f), dc-26.5 GHz
- 8A:** Type N (m,f), dc-18 GHz

8498 is available in a 30 dB model only

* Not available for HP 8493A/B ** Not available for HP 8493C

Attenuation

- 003:** 3 dB
- 006:** 6 dB
- 010:** 10 dB
- 020:** 20 dB
- 030:** 30 dB
- 040:** 40 dB*
- 050:** 50 dB**
- 060:** 60 dB**

Ordering Information

- HP 11581A** 3, 6, 10, 20 dB HP 8491A set
- Option 890** Calibration Data
- HP 11582A** 3, 6, 10, 20 dB HP 8491B set
- Option 890** Calibration Data
- HP 11583A** 3, 6, 10, 20 dB HP 8492A set
- Option 890** Calibration Data
- HP 11583C** 3, 6, 10, 20 dB HP 8493C set
- Option 890** Calibration Data

Price

- \$525
- Add \$90
- \$650
- Add \$110
- \$1,200
- Add \$100
- \$1,320
- Incl.

HP 8491A/B, 8492A, 8493A/B/C, 8498A, Option 890 Specifications

HP Model	Frequency Range GHz	SWR Maximum	Maximum input Power	Attenuation Accuracy								Connector	Price (Specify option)
				3 dB (Option 003)	6 dB (Option 006)	10 dB (Option 010)	20 dB (Option 020)	30 dB (Option 030)	40 dB (Option 040)	50 dB (Option 050)	60 dB (Option 060)		
8491A 3-30 dB	dc-12.4	dc-8 GHz: 1.2 8-12.4 GHz: 1.3	2 W Avg. 100 W Peak	±0.3 dB	±0.4 dB	±0.6 dB	±0.6 dB	±1 dB	—	—	—	N(m,f)	\$115
				—	—	—	—	—	±1.5 dB	±1.5 dB	±2 dB		\$165
8491B 3-30 dB	dc-18	dc-8 GHz: 1.2 8-12.4 GHz: 1.3 12.4-18 GHz: 1.5	2 W Avg. 100 W Peak	±0.3 dB dc-12.4 GHz ±0.4 dB 12.4-18 GHz	±0.4 dB dc-12.4 GHz ±0.5 dB 12.4-18 GHz	±0.6 dB	±0.6 dB dc-12.4 GHz ±1.0 dB 12.4-18 GHz	±1 dB	—	—	—	N(m,f)	\$140
				—	—	—	—	±1.5 dB	±1.5 dB	±2 dB	\$200		
8492A 3-30 dB	dc-18	dc-8 GHz: 1.15 dc-12.4 GHz: 1.25 12.4-18 GHz: 1.35	2 W Avg. 100 W Peak	±0.3 dB dc-12.4 GHz ±0.4 dB 12.4-18 GHz	±0.4 dB dc-12.4 GHz ±0.5 dB 12.4-18 GHz	±0.6 dB	±0.6 dB dc-12.4 GHz ±1.0 dB 12.4-18 GHz	±1 dB	—	—	—	APC-7	\$265
				—	—	—	—	±1.5 dB	±1.5 dB	±2 dB	\$330		
8493A 3-20 dB	dc-12.4	dc-8 GHz: 1.2 8-12.4 GHz: 1.3	2 W Avg. 100 W Peak	±0.3 dB	±0.4 dB	±0.6 dB	±0.6 dB	—	—	—	—	SMA (m,f)	\$115
				—	—	—	—	±1 dB	—	—	—		\$140
8493B 3-20 dB	dc-18	dc-8 GHz: 1.2 8-12.4 GHz: 1.3 12.4-18 GHz: 1.5	2 W Avg. 100 W Peak	±0.3 dB dc-12.4 GHz ±0.4 dB 12.4-18 GHz	±0.4 dB dc-12.4 GHz ±0.5 dB 12.4-18 GHz	±0.6 dB	±0.6 dB dc-12.4 GHz ±1.0 dB 12.4-18 GHz	—	—	—	—	SMA(m,f)	\$140
				—	—	—	—	±1 dB	—	—	—		\$275
8493C	dc-26.5	dc-8 GHz: 1.1 8-12.4 GHz: 1.15 12.4-26.5 GHz: 1.25(1.27 Opt. 006)	2 W Avg. 100 W Peak	±0.5 dB dc-18 GHz ±1.0 dB 18-26.5 GHz	±0.6 dB ±0.6 dB	±0.3 dB ±0.5 dB	±0.5 dB ±0.6 dB	±0.7 dB ±1.0 dB	±1.0 dB ±1.3 dB	—	—	APC 3.5 (m,f)	\$275
				—	—	—	—	±1 dB	—	—	—		\$950
8498A Option 030	dc-18	dc-2 GHz: 1.1 2-12.4 GHz: 1.2 12.4-18 GHz: 1.35	25 W Avg. 500 W Peak (dc-7 GHz) 125 W Peak (7-18 GHz) 500 watt-µs max. per pulse	—	—	—	—	±1 dB	—	—	—	N(m,f)	\$950
Option 890 Calibration Data	HP Models		Calibration Frequencies (MHz)								Option 890 Price		
	8491A, 8493A		100, 500, 1000, every 500 MHz to 12000, 12400. (26 frequencies)								add \$20		
	8491B, 8492A, 8493B, 8498A 8493C		Same as above plus 12500 to 16000 8493B, 8498A in 500 MHz steps, 16000 to 18000 in 250 MHz steps. (42 frequencies)								add \$25		
Option 894 Calibration Data	8492A 8493C		Same as HP 8492A Option 890 plus 110, 580, 1050 and 1520 MHz. Same as HP 8493C Option 890 plus 100, 110, 500, 580, 1000, 1050, 1500 and 1520 MHz.								add \$30 add \$50		

MICROWAVE TEST EQUIPMENT

Coaxial Step Attenuators

Models 355 Series, 8494/5/6/7 Series, 11713A, 11716A/B, 11717A

- Excellent repeatability
- Manual and programmable
- Calibration data available

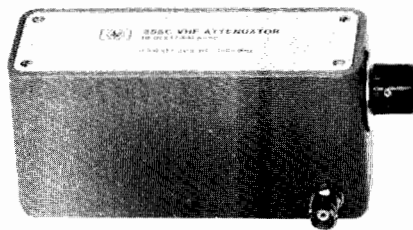

HP 355C

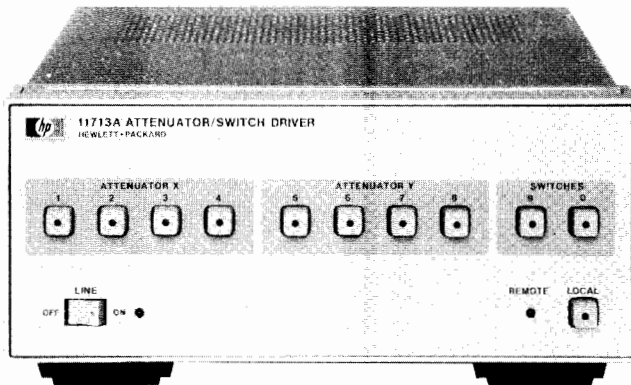

HP 11713A



HP 355C/D/E/F Manual and Programmable Step Attenuators, dc to 1000 MHz

Precision attenuation from dc to 1000 MHz is available with these Hewlett-Packard attenuators. HP 355C/E provide 0 to 12 dB in 1-dB steps and HP 355D/F provide 0 to 120 dB in 10-dB steps. For the HP 355E and 355F models, attenuation programming is done through a 7-pin connector. All standard models are equipped with BNC connectors.

HP 8494A/B/G/H, 8495A/B/D/G/H/K, 8496A/B/G/H, 8497K Manual and Programmable Step Attenuators, dc to 26.5 GHz

Four attenuation ranges are available: 0 to 11 dB in 1-dB steps (HP 8494), 0 to 70 dB in 10-dB steps (HP 8495), 0 to 110 dB in 10-dB steps (HP 8496) and 0 to 90 dB in 10 dB steps (HP 8497). There is choice of three connectors: Type N (f), SMA (f), and APC-7 (APC-3.5 on HP 8495D/K and 8497K only). Manual and programmable versions are available as well as coverage of three frequency ranges (dc-4 GHz, dc-18 GHz, and dc-26.5 GHz). Calibration data (SWR and attenuation) is available on the HP 8494/5/6/7 models as option 890. The data is generated by an automatic network analyzer test system and is given for each step of the attenuator at 14 frequencies (dc-4 GHz models), 47 frequencies (dc-18 GHz models), or 72 frequencies (dc-26.5 GHz); see frequency lists on next page. This data is very useful for improving measurement accuracy in manual and automated test systems.

Each attenuator consists of three or four attenuation sections connected in cascade. Attenuator sections are inserted and removed by cam-actuated "edge line" contacts. These contacts are gold-plated leaf-springs that ensure long life (over a million steps) and high repeatability (typically 0.03 dB).

The G, H, and K programmable models offer the same high performance as the manual models with the addition of fast switching solenoids. Attenuation programming is done through a 12-pin con-

- New, 5-million-cycle-per-section reliability

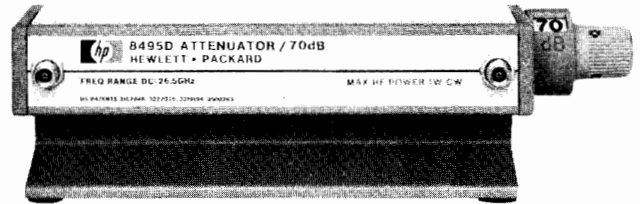

HP 8495D option 004

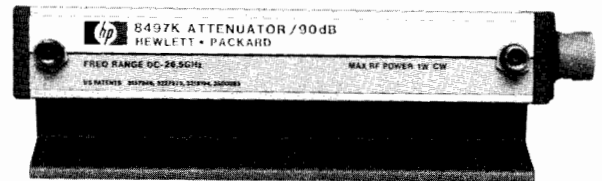

HP 8497K option 004

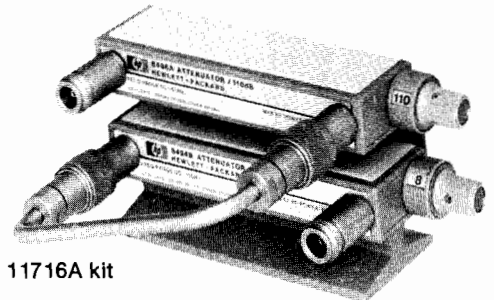

HP 11716A kit

ductor. For ease of connection to the driving circuit, each attenuator is provided with a five-foot cable assembly that includes the mating connector. With the HP 11713A Attenuator Driver, the attenuators are easily integrated into a Hewlett-Packard Interface Bus (HP-IB) automated system.

HP 11716A/B Interconnection Kit

Convenient interconnection of 1-dB and 10-dB models is provided with the HP 11716A/B. These kits provide a rigid RF cable, mounting bracket, and screws to connect any pair of HP 8494/5/6 attenuators in series (see picture above). Attenuators must be ordered separately.

Equivalent versions of these attenuators for incorporation in equipment (i.e., "OEM") are available under model numbers HP 33320, 33321, 33322 and 33323. See following pages.

HP 11713A Attenuator/Switch Driver

This instrument has all of the necessary features to provide HP-IB control of up to two programmable attenuators of the HP 8494/5/6/7 or HP 33320/1/2/3 series and concurrently up to two electro-mechanical switches (e.g., HP 8761B or 33311 series). Alternatively, the HP 11713A can be used to supply +24 V common and ten pairs of transistor switches (total current less than 1.25A) to control up to ten relays. The HP 11713A includes an integral power supply with short circuit protection that can simultaneously provide 125 milliamps at 24 volts to all contacts for control of the attenuators and switches, so no external power supply is needed. For convenience in connecting HP 8490 or HP 33320-series Attenuators, two 5-foot cables with appropriate connectors are supplied.

A local mode and front-panel push buttons allow switches and attenuator sections to be operated manually. Switching time for the drivers is less than 10 milliseconds.

Ordering Information

	Price
HP 11713A Attenuator/Switch Driver	\$1610
HP 11716A Interconnection Kit for Type N (f) Connectors	\$190
HP 11716B Interconnection Kit for APC-7 Connectors	\$270
HP 11717A Attenuator/Switch Rack Mount Support Kit	\$45



How to Order the HP 8494/5/6/7 Series Attenuators

Each order must include basic model number, suffix letter, and connector option.

HP 8494 A Option 001 Option 890

Optional calibration data.

- 4 (1dB step, 11 dB max)
- 5 (10 dB step, 70 dB max)
- 6 (10 dB step, 110 dB max)
- 7 (10 dB step, 90 dB max)

- A (Manual, dc—4 GHz)
- B (Manual, dc—18 GHz)
- D (Manual, dc—26.5 GHz)*
- G (Programmable, dc—4 GHz)
- H (Programmable, dc—18 GHz)
- K (Programmable, dc—26.5 GHz)*

- 001 (N-Female)
- 002 (SMA Female)
- 003 (APC-7)
- 004 (APC-3.5 Female)*

* Option 004 is only available on 'D' and 'K' models.

HP 355 Series, 8494/5/6/7 Series Specifications

HP Model and (Switching Mode)	Frequency Range (GHz)	Incremental Attenuation (dB)	SWR Maximum (50 Ω Nominal)	Insertion Loss (0 dB setting)	Attenuation Accuracy	Power Rating, Minimum Life	Solenoid Voltage Speed Power	Size, Shipping Weight	Connector Options Available	Price	
355C (Manual)	dc—1	0—12 1 dB steps	dc—0.25 GHz: 1.2 dc—0.5 GHz: 1.3 dc—1.0 GHz: 1.5	0.11 dB + 1.39 dB/GHz	±0.1 dB @ 1000 Hz ±0.25 dB: dc—0.5 GHz ±0.35 dB: dc—1.0 GHz	0.5 W avg 350 W peak 0.3 million cycles per section	— 15—18 V <65 ms 3.0 W	67 H × 70 W × 152 mm D (2.6" × 2.75" × 6") 1.4 kg (3 lb)	BNC (f) See Note 1	\$350 \$645	
355E (Programmable)											
355D (Manual)	dc—1	0—120 10 dB steps	dc—0.25 GHz: 1.2 dc—0.5 GHz: 1.3 dc—1.0 GHz: 1.5	0.11 dB + 1.39 dB/GHz	±0.3 dB @ 1000 Hz ±1.5 dB to 90 dB, and ±3 dB to 120 dB @ 1 GHz	0.5 W avg 350 W peak 0.3 million cycles per section	— 15—18 V <65 ms 3.0 W	67 H × 70 W × 152 mm D (2.6" × 2.75" × 6") 1.4 kg (3 lb)	BNC (f) See Note 1	\$350 \$645	
355F (Programmable)											
8494A (Manual)	dc—4	0—11 1 dB Steps	1.5	0.6 dB + 0.09 dB/GHz	±0.2 dB: 1—2 dB ±0.3 dB: 3—6 dB ±0.4 dB: 7—10 dB ±0.5 dB: 11 dB	1 W avg 100 W peak 10 μs max. 5 million cycles per section	— 20—30 V <20 ms 2.7 W	43 H × 73 W × 159 mm D (1.7" × 2.9" × 6.2") 0.9 kg (2 lb) 43 H × 73 W × 142 mm D (1.7" × 2.9" × 5.6")	001 002 003 See Note 2	\$700 \$1,070	
8494G (Programmable)											
8494B (Manual)	dc—18	0—11 1 dB steps	dc—8 GHz: 1.5 dc—12.4 GHz: 1.6 dc—18 GHz: 1.9	0.6 dB + 0.09 dB/GHz	dc—12.4 GHz ±0.3 dB: 1—2 dB ±0.4 dB: 3—4 dB ±0.5 dB: 5—6 dB ±0.6 dB: 7—10 dB ±0.7 dB: 11 dB dc—18 GHz ±0.7 dB: 1—5 dB ±0.8 dB: 6—9 dB ±0.9 dB: 10—11 dB	1 W avg 100 W peak 10 μs max. 5 million cycles per section	— 20—30 V <20 ms 2.7 W	43 H × 73 W × 159 mm D (1.7" × 2.9" × 6.2") 0.9 kg (2 lb) 43 H × 73 W × 142 mm D (1.7" × 2.9" × 5.6")	001 002 003 See Note 2	\$890 \$1,365	
8494H (Programmable)											
8495A (Manual)	dc—4	0—70 10 dB steps	1.35	0.4 dB + 0.07 dB/GHz	±1.7% of setting or ±0.4 dB, whichever is greater	1 W avg 100 W peak 10 μs max. 5 million cycles per section	— 20—30 V <20 ms 2.7 W	43 H × 73 W × 130 mm D (1.7" × 2.9" × 5.1") 0.9 kg (2 lb) 43 H × 73 W × 114 mm D (1.7" × 2.9" × 4.5")	001 002 003 See Note 2	\$500 \$895	
8495G (Programmable)											
8495B (Manual)	dc—18	0—70 10 dB steps	dc—8 GHz: 1.35 dc—12.4 GHz: 1.5 dc—18 GHz: 1.7	0.4 dB + 0.07 dB/GHz	±3%: dc—12.4 GHz ±4%: dc—18 GHz % in dB from Atten. Setting	1 W avg 100 W peak 10 μs max. 5 million cycles per section	— 20—30 V <20 ms 2.7 W	43 H × 73 W × 130 mm D (1.7" × 2.9" × 5.1") 0.9 kg (2 lb) 43 H × 73 W × 114 mm D (1.7" × 2.9" × 4.5")	001 002 003 See Note 2	\$655 \$1,000	
8495H (Programmable)											
8495D (Manual)	dc—26.5	0—70 10 dB steps	dc—12.4 GHz: 1.6 12.4—18 GHz: 1.9 18—26.5 GHz: 2.2	0.5 dB + 0.13 dB/GHz	±3%: dc—12.4 GHz ±4%: dc—18 GHz ±7%: dc—26.5 GHz % in dB from Atten. Setting	1 W avg 100 W peak 10 μs max. 5 million cycles per section	— 20-30 V <20 ms 2.7 W	43 H × 52 W × 159 mm D (1.7" × 2.1" × 6.2") 0.9 kg (2 lb) 43 H × 52 W × 168 mm D (1.7" × 2.1" × 6.6")	004 APC-3.5 See Note 2	\$980 \$1,445	
8495K (Programmable)											
8496A (Manual)	dc—4	0—110 10 dB steps	1.5	0.6 dB + 0.09 dB/GHz	±1.7% of setting or ±0.4 dB, whichever is greater	1 W avg 100 W peak 10 μs max. 5 million cycles per section	— 20—30 V <20 ms 2.7 W	43 H × 73 W × 159 mm D (1.7" × 2.9" × 6.2") 0.9 kg (2 lb) 43 H × 73 W × 142 mm D (1.7" × 2.9" × 5.6")	001 002 003 See Note 2	\$700 \$1,070	
8496G (Programmable)											
8496B (Manual)	dc—18	0—110 10 dB steps	dc—8 GHz: 1.5 dc—12.4 GHz: 1.6 dc—18 GHz: 1.9	0.6 dB + 0.09 dB/GHz	±3%: dc—12.4 GHz ±4%: dc—18 GHz % in dB from Atten. Setting	1 W avg 100 W peak 10 μs max. 5 million cycles per section	— 20—30 V <20 ms 2.7 W	43 H × 73 W × 159 mm D (1.7" × 2.9" × 6.2") 0.9 kg (2 lb) 43 H × 73 W × 142 mm D (1.7" × 2.9" × 5.6")	001 002 003 See Note 2	\$890 \$1,365	
8496H (Programmable)											
8497K (Programmable)	dc—26.5	0—90 10 dB steps	dc—6 GHz: 1.25 6—12.4 GHz: 1.45 12.4—18.0 GHz: 1.6 18.0—26.5 GHz: 1.8	0.6 dB + 0.09 dB/GHz	±0.3 dB at 6 GHz 10 dB attenuation to ±2.8 dB at 26.5 GHz 90 dB atten- uation. See Data Sheet 5952-8278 for details.	1 W avg 100 W peak 10 μs max. 5 million cycles per section	5 V or 24V	43 H × 52 W × 143 mm D (1.7" × 2.1" × 5.6") 0.9 kg (2 lb)	004 APC-3.5 See Note 2	\$1800	
Option 890 Calibration Data		Option 890 Frequency List (MHz)			Models			Option 890 Price			
DC to 4 GHz Models: 100, 300, 500, 700, 900, 1000, 1250, 1500, 1750, 2000, 2500, 3000, 3500, 4000		DC to 26.5 GHz Models every 500 MHz 2 to 16 GHz every 250 MHz 16 to 26.5 GHz			8494A/G, 8496A/G, 33320A/G, 33322A/G 8495A/G, 33321A/G			add \$130 add \$110			
DC to 18 GHz Models: Same as above to 4000 MHz, every 500 MHz to 16000 (plus 12400 MHz), every 250 MHz from 16000 to 18000.					8494B/H, 8496B/H, 33320B/H, 33322B/H 8495B/H, 33321B/H 8495D/K, 8497K			add \$170 add \$150 add \$250			
Note 1: 355C/D/E/F connector options (BNC (f) standard) Option 001 N(f) Option 005 TNC(f) Option 007 Transistor protection (355E/F only)				Price add \$25 add \$10 add \$55		Note 2: 8494/5/6/7 orders must specify connector option. See ordering example above. Option 001 N(f) Option 002 SMA(f) Option 003 APC-7 Option 004 APC-3.5 (HP 8495D/K, 8497K only)				N/C N/C add \$50 N/C	



MICROWAVE TEST EQUIPMENT

Variable Attenuators and OEM Step Attenuators

Models 370, 382 Series, 33300 Series, 33320 Series

HP Q382A

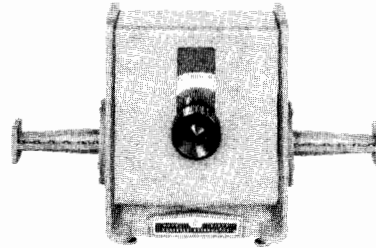
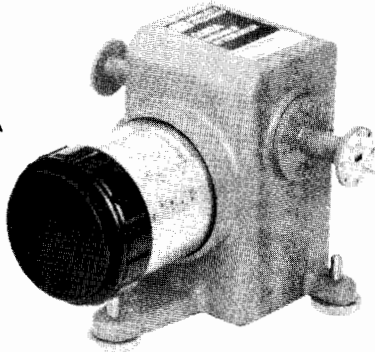

HP P382A

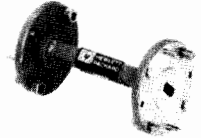

HP Q370A



HP 33300A



HP 33321H

HP 33300 Series, 33320 Series OEM Step Attenuators

HP 33300 Series Step Attenuators provide wideband programmable signal level control. Magnetic latching solenoids switch individual attenuating elements into and out of contact with a 50-ohm transmission line. C/D models have separate indicator contacts and A/B models have no indicator contacts. Three three-digit connector options (0XY) must be specified. X is the input connector, Y is the output connector, first digit is always 0. See specifications table for option numbers.

HP 33320 series Step Attenuators are compact versions of the HP 8494/5/6/7 bench Attenuators on page 554 (same specifications) and are configured for designing into microwave systems and instruments. Manual or electrically-actuated versions are available. The manual models take less than 1.5 square inches of panel space. OEM quantity discounts are available for HP 33300 and 33320 series. HP 33320 series now have 5-million-step reliability specification.

HP 33300 Series, 33320 Series Specifications

HP Model	Freq Range (GHz)	Mode	Range	Remarks	Price
33300 A/B C/D	dc-18	Prog.	0-70 dB 10 dB steps	A&C models 12-15 V	\$1200 \$1250
33301 A/B C/D	dc-18	Prog.	0-42 dB 6 dB steps	B&D models 24-30 V	\$1200 \$1250
33304 A/B C/D	dc-18	Prog.	0-11 dB 1 dB steps	Connector options available:	\$1575 \$1635
33305 A/B C/D	dc-18	Prog.	0-110 dB 10 dB steps	0: N(f), 1: N(m) 2: 7mm(f), 3: 7mm(m) 5: SMA(f), 6: SMA(m)	\$1585 \$1635
33320A B	dc-4 dc-18	Manual	1-11 dB 1dB steps	Specifications identical to 8494 series page 554	\$ 680 \$ 870
33320G H	dc-4 dc-18	Prog.			\$1050 \$1345
33321A B D	dc-4 dc-18 dc-26.5	Manual	0-70 dB 10 dB steps	Specifications identical to 8495 series page 554	\$ 480 \$ 635 \$ 975
33321G H K	dc-4 dc-18 dc-26.5	Prog.			\$ 875 \$ 980 \$1425
33322A B	dc-4 dc-18	Manual	0-110 dB 10 db steps	Specifications identical to 8496 series page 554	\$ 680 \$ 870
33322G H	dc-4 dc-18	Prog.			\$1050 \$1345
33323K	dc-26.5	Prog.	0-90 dB 10 dB steps	Specifications identical to 8497K page 554 APC-3.5 only	\$1785

HP 370A/B/C Millimetre-Wave Fixed Attenuators

The HP Q and U 370 Fixed Attenuators offer precise attenuation, flat frequency response, and low SWR. Their ruggedness, reliability, and small size make them ideal for bench systems applications. They are also useful for general purpose applications, like the reduction of power levels to sensitive components and systems.

HP 370A/B/C Fixed Attenuator Specifications

HP Model	Frequency Range (GHz)	SWR (Max)	Max. Input Power	Attenuation	Attenuation Accuracy	Waveguide & Equivalent Flange	Price
Q370A	33-50	1.2	5W Avg. 100W Peak	3dB	±0.3dB	WR-22	\$440
Q370B				6dB	±0.6dB		
Q370C				10dB	±0.3dB		
U370A	40-60	1.2	5W Avg. 100W Peak	3dB	±0.3dB	WR-19	\$460
U370B				6dB	±0.6dB	UG-383/U (Mod.)	
U370C				10dB	±0.6dB		

HP 382 Series Waveguide Attenuators

Operation of these HP 382 series rotary-vane, continuously-variable attenuators depends on a mathematical law rather than on the resistivity of the attenuator card. They are direct-reading and provide accurate attenuation from 0 to 50 dB (60 dB for S382C) regardless of temperature and humidity.

HP 382 Series Specifications

HP Model	Frequency Range (GHz)	Accuracy	Attenuation Range (dB)	Waveguide & Equivalent Flange	Price
S382C	2.6-3.95	±1% of reading or 0.1 dB whichever greater ±2% above 50 dB	0-60	WR 284 UG-584/U	\$4375
G382A	3.95-5.85	±2% of reading or 0.1 dB whichever greater	0-50	WR 187 UG-407/U	\$3080
J382A	5.3-8.2	±2% of reading or 0.1 dB whichever greater	0-50	WR 137 UG-441/U	\$2475
H382A	7.05-10.0	±2% of reading or 0.1 dB whichever greater	0-50	WR 112 UG-138/U	\$2475
X382A	8.2-12.4	±2% of reading or 0.1 dB whichever greater	0-50	WR 90 UG-135/U	\$1485
P382A	12.4-18.0	±2% of reading or 0.1 dB whichever greater	0-50	WR 62 UG-419/U	\$1485
K382A	18.0-26.5	±2% of reading or 0.1 dB whichever greater	0-50	WR 42 UG-597/U	\$2475
R382A	26.5-40.0	±2% of reading or 0.1 dB whichever greater	0-50	WR 28 UG-599/U	\$2470
Q382A	33.0-50.0	±2% of reading or 0.1dB (whichever greater)	0-50	WR-22 UG-383/U	\$2025
U382A	40.0-60.0			WR-19 UG-383/U (Mod.)	\$2075

MICROWAVE TEST EQUIPMENT

Transmission Reflection Test Sets, Power Splitters, Power Dividers

Models 8721A, 85044A/B, 11850C/D, 11667A/B, 11636A/B



HP 85044A

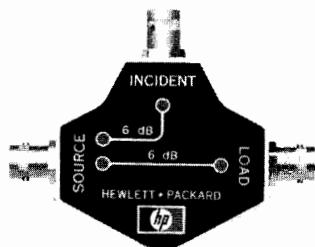

HP 8721A

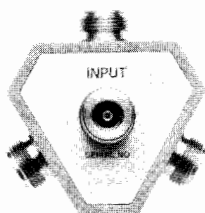

HP 11850C

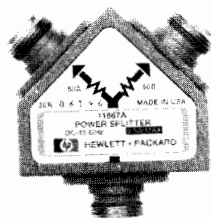

HP 11667A



HP 11636A

HP 11667A Power Splitter (Type N) HP 11667B Power Splitter (APC-3.5)

These two-way, two-resistor splitters provide good input and output source match in ratio measurement and source leveling applications. The HP 11667A operates from dc to 18 GHz with output match >17 dB and tracking <0.25 dB. The HP 11667B operates from dc to 26.5 GHz and has output source match >18 dB and tracking <0.4 dB. Detailed specifications are on page 607.

HP 11636A/B Power Dividers/Combiners

The HP 11636A/B are two-way, three-resistor power dividers for use in non-ratio measurements. They can also be used as power combiners for combining two independent signals. They are ideal for fault location measurements made with the HP 8757S and the HP 85016A software.

Frequency Range

HP 11636A: DC to 18 GHz.

HP 11636B: DC to 26.5 GHz.

Impedance: 50 ohms nominal.

Insertion loss: 6 dB nominal.

	DC-10 GHz	DC-18 GHz	DC-26.5 GHz
Input SWR			
HP 11636A	<1.25	<1.35	
HP 11636B	<1.22	<1.29	<1.29
Output SWR (non-ratio measurements)			
HP 11636A	<1.25	<1.35	
HP 11636B	<1.22	<1.29	<1.29
Output Tracking (between output arms)			
HP 11636A	<0.4 dB	<0.5 dB	
HP 11636B	<0.25 dB	<0.25 dB	<0.5 dB
Typical Phase Tracking (between output arms)			
HP 11636A	2°	2°	
HP 11636B	2°	2.5°	3°
Maximum Input Power			
HP 11636A +30 dBm			
HP 11636B +27 dBm			
Connectors			
HP 11636A: Type N male input port, female output ports.			
HP 11636B: APC-3.5 female on all ports.			
Dimensions			
HP 11636A: 42 H x 45 W x 18 mm D (1.64 x 1.75 x 0.69 in.)			
HP 11636B: 40 H x 47 W x 10 mm D (1.6 x 1.9 x 0.4 in.)			
Weight			
HP 11636A: net, 0.14 kg (0.31 lb); shipping, 0.45 kg (1 lb)			
HP 11636B: net, 0.06 kg (0.13 lb); shipping, 0.14 kg (0.3 lb)			

Description

Accurate broadband measurements of transmission and reflection parameters are highly dependent on the device used to separate signals for the measurement. Some devices separate the reflected and transmitted signals and some split power for ratio and comparison measurements.

HP 8721A Directional Bridge

HP 8721A Option 008 75 Ohm Version

Frequency range: 0.1 - 110 MHz.

Directivity: >40 dB, 1 - 110 MHz, typically >30 dB, 0.1 - 1 MHz.

Load port match: >30 dB (VSWR <1.07).

Transmission arm: Nominal loss, 6 dB. Frequency response, <0.2 dB.

Coupling arm: Nominal coupling, 6 dB. Frequency response, <0.6 dB.

Maximum input power: +20 dBm.

Weight: net, 0.55 kg (0.25 lb); shipping, 1.1 kg (0.5 lb).

Size: 59 H x 39 W x 123 mm D (1.5 x 1 x 3.13 in.).

HP 85044A 50 Ohm Transmission Reflection Test Set

HP 85044B 75 Ohm Transmission Reflection Test Set

The HP 85044 contains a power splitter and directional bridge that permits simultaneous transmission and reflection measurements with over 30 dB directivity from 300 kHz to 3.0 GHz. Detailed specifications on the HP 85044A and HP 85044B appear on page 625.

HP 11850C 50 Ohm Power Splitter

HP 11850D 75 Ohm Power Splitter

These three-way power splitters are designed for ratio measurements from dc to 3.0 GHz (11850C) or 2 GHz (11850D). One output port provides the reference and the other two output ports can be used for independent transmission measurements. They provide 0.25 dB tracking and >20 dB output match. Detailed specifications are on page 627.

Ordering Information

	Price
HP 8721 Directional Bridge	\$320
Option 008: 75 Ohm Version	add \$50
HP 85044A 50 Ohm Transmission Reflection Test Set	\$2,990
HP 85044B 75 Ohm Transmission Reflection Test Set	\$3,490
HP 11850C 50 Ohm Power Splitter	\$895
HP 11850D 75 Ohm Power Splitter	\$1,395
HP 11667A Power Splitter (DC - 18GHz)	\$925
Option 001: Type N Male Input, Type N Female Outputs	N/C
Option 002: Type N Female Input, APC-7 On Outputs	add \$75
HP 11667B Power Splitter (DC - 26.5 GHz)	\$945
HP 11636A Power Divider (DC - 18 GHz)	\$395
HP 11636B Power Divider (DC - 26.5 GHz)	\$945

MICROWAVE TEST EQUIPMENT

Coaxial Single and Dual-Directional Couplers

Models 770 Series, 11691D, 11692D

- Broadband coverage
- High directivity
- Close tracking

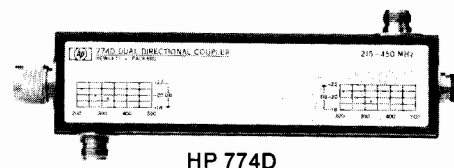
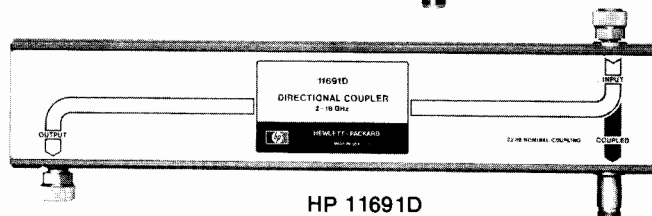
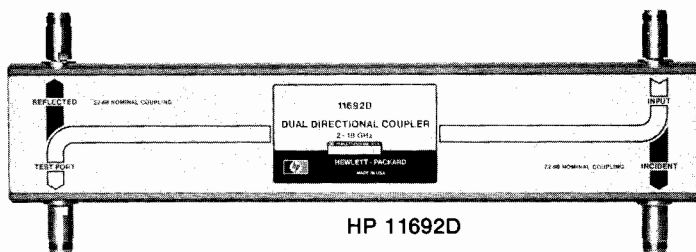

HP 779D Directional Coupler

The HP 779D spans more than two octaves from 1.7 to 12.4 GHz with excellent directivity. With increased coupling factors (typically 24 dB), the HP 779 is useful down to 500 MHz. Upper frequency usefulness extends to 18 GHz with directivity reduced to about 15 dB. Various connector options are available.

HP 11691D Directional Coupler

The HP 11691D is an ultra-wide-band single directional coupler covering 2 to 18 GHz with high directivity. It is useful as a power monitoring or leveling coupler, or for making reflection measurements. Couplers are preferred over broadband bridges in reflectometer applications in situations where the power level of the source is limited, or where simultaneous measurement of return loss and insertion loss is desired.

HP 774D-777D Dual-Directional Couplers (octave bands)

The economical HP 774D-777D Couplers cover frequency spreads of more than two-to-one, each centered on one of the important VHF/UHF bands. With their high directivity and a mean coupling accuracy of ± 0.5 dB, these couplers are ideal for reflectometer applications. Furthermore, the close tracking of the auxiliary arms makes these couplers particularly useful for reflectometers driven by sweep oscillators such as the HP 8350B with its appropriate plug-in. Power ratings are 50 W average, 500 W peak.

HP 778D, 11692D Dual-Directional Couplers (multi-octave bands)

These couplers are ideal for swept-frequency reflectometer testing of broadband coaxial components. The HP 778D covers 100 MHz to 2 GHz and the HP 11692D covers 2 to 18 GHz. High directivity and close tracking of the auxiliary arms are featured. Various connector options are available. Both couplers handle 50 W average power. Peak power: HP 778D, 500 W; HP 11692D, 250 W.

HP 779D, 11691D Specifications

HP Model	Frequency Range (GHz)	Mean Output Coupling (dB)	Output Coupling Variation (dB)	Minimum Directivity (dB)	Equivalent ¹ Source Match	Price
779D	1.7-12.4	20 \pm 0.5	\pm 0.75	1.7-4 GHz: 30 4-12.4 GHz: 26	1.2	\$1075
11691D	2-18	22 Nominal	\pm 1.0	2-8 GHz: 30 dB 8-18 GHz: 26 dB	1.2	\$1530
HP 779D Standard connectors Primary Line N(m) input, N(f) output; auxiliary arm N(f) Option 010: Primary Line N(f) input, N(m) output; auxiliary output N(f) N/C Other options: APC-7 on any or all ports Contact HP						
HP 11691D Standard connectors Primary line: APC-7, APC-7; Auxiliary Arm: N(f) Option 001: All N(f) less \$30 Option 005: All APC-7 add \$25						
¹ Apparent SWR at the output port of a coupler when used in a closed-loop leveling system.						

HP 774D, 775D, 776D, 777D, 778D, 11692D Specifications

HP Model	Frequency Range (GHz)	Nominal Coupling (dB)	Maximum Coupling Variation (dB)	Minimum Directivity (dB)	SWR Primary Line Maximum (50% Nom.)	Price
774D	0.215-0.450	20	\pm 1	40	1.15	\$800
775D ¹	0.450-0.940	20	\pm 1	40	1.15	\$800
776D ¹	0.940-1.90	20	\pm 1	40	1.15	\$800
777D	1.90-4.0	20	\pm 0.4	30	1.2	\$950
778D	0.10-2.0	20	\pm 1.5	0.1-1 GHz: 36 ² 1-2 GHz: 32	1.1	\$950
11692D	2.0-18.0	22	\pm 1 incident to test port	2-8 GHz: 30 8-18 GHz: 26 ³	2-12.4 GHz: 1.3 12.4-18 GHz: 1.4	\$2730
HP 774D-777D Standard connectors Primary Line: N(m), N(f) Auxiliary Arm: N(f), N(f)						
HP 778D Standard connectors Primary Line: N(m), N(f); Auxiliary Arms: N(f), N(f) Option 011: Primary Line, APC-7, N(f) add \$25 Option 012: Primary Line, N(m), N(f) N/C						
HP 11692D Standard connectors Primary line: N(f), APC-7; Auxiliary Arms: N(f), N(f) Option 001: Primary Line, N(f), N(f) less \$15 Option 002: Primary Line, N(f), N(m) less \$15						
¹ Maximum auxiliary arm tracking: 0.3 dB for HP 776D; 0.5 dB for HP 777D ² 30 dB, 0.1 to 2 GHz, input port. ³ 24 dB with Type N connector on the test port.						

MICROWAVE TEST EQUIPMENT

Frequency Meters and Waveguide Directional Couplers

Models 532 Series, 536A, 537A, 752 Series

559

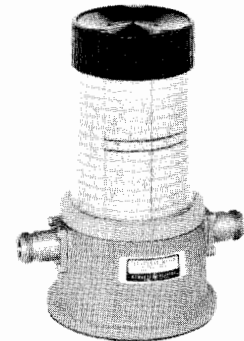
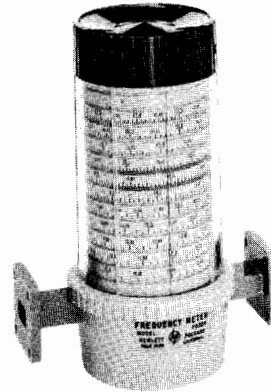
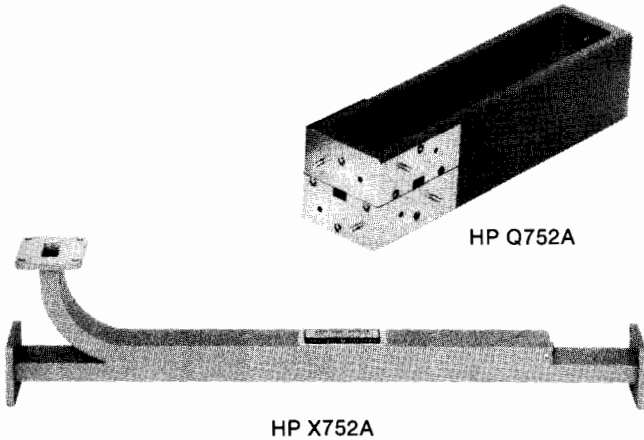

HP 752 Series Waveguide Directional Couplers

The HP 752 series Couplers are specified to meet a wide variety of microwave applications. Every coupler has a minimum directivity of 40 dB over its entire frequency range. Each coupler is swept-frequency tested to ensure that the main guide SWR and directivity specifications are accurate. Performance characteristics are unaffected by humidity, temperature, and time, making these units especially useful in microwave "standards" measurements.

The HP 752 Couplers are an essential part of many waveguide measurement systems. Attenuation measurements, reflectometer setups, power measurements, source leveling and network analysis are just a few areas in which these couplers are used.

HP 752 Series Specifications

HP Model	Frequency Range (GHz)	Nominal Coupling (dB)	Mean Coupling Accuracy (dB)	Maximum Coupling Variation (dB)	Minimum Directivity (dB)	Waveguide & Flange	Price
X752A	8.2-12.4	3	±0.4	±0.5	40	WR90 UG-135/U	\$680
X752C		10					
X752D		20					
P752A	12.4-18.0	3	±0.4	±0.5	40	WR62 UG-419/U	\$680
P752C		10					
P752D		20					
K752A	18.0-26.5	3	±0.7	±0.5	40	WR42 UG-595/U	\$825
K752C		10					
K752D		20					
R752A	26.5-40.0	3	±0.7	±0.5	40	WR28 UG-599/U	\$890
R752C		10					
R752D		20					
Q752A	33.0-50.0	3	±0.7 dB	±0.7	36	WR-22 UG-383/U	\$1150
Q752C		10					
Q752D		20					
U752A	40.0-60.0	3	±0.7 dB	±0.7	36	WR-19 UG-383/U (Mod.)	\$1150
U752C		10					
U752D		20					
V752C	50.0-75.0	10	±1.0	±1.0	33	WR 15 UG-381/U	\$1250
V752D		20					
W752C	75.0-110.0	10	±1.0	±1.0	30	WR 18 UG-387/U (Mod.)	\$1325
W752D		20					

HP 532 Series, 536A, 537A Frequency Meters

These direct-reading frequency meters measure frequencies from 8.2 to 40 GHz in waveguide and from 960 MHz to 12.4 GHz in coax quickly and accurately. Their long scales and numerous calibration marks provide high resolution which is particularly useful when measuring frequency differences or small frequency changes. Frequency is read directly in GHz so neither interpolation nor charts are required.

The instruments comprise a special transmission section with a high-Q resonant cavity which is tuned by a choke plunger. A 1 dB or greater dip in output indicates resonance; virtually full power is transmitted off resonance. Overall accuracy of each frequency meter includes allowance for 0 to 100 percent relative humidity and temperature variation from 13 to 33°C.

HP 532 Series, 536A and 537A Specifications

HP Model	Frequency Range (GHz)	Overall Accuracy (%)	Calibration Increment (MHz)	W/G-Coax Equivalent Flange (Connector)	Price
536A	0.96-4.20	0.96 to 1 GHz: 0.22 1 to 4.2 GHz: 0.17	2	Coax Type N(f)	\$1600
537A	3.7-12.4	0.170	10	Coax Type N(f)	\$1200
X532B	8.20-12.4	0.080	5	WR90 UG-39/U	\$1155
P532A	12.4-18.0	0.100	5	WR62 UG-419/U	\$1155
K532A	18.0-26.5	0.110	10	WR42 UG-595/U	\$1540
R532A	26.5-40.0	0.120	10	WR28 UG-599/U	\$1540
Q532A	33.0-50.0	0.12	20	WR-22 UG-383/U	\$1975
U532A	40.0-60.0	0.15		WR-19 UG-383/U (Mod.)	\$2075



MICROWAVE TEST EQUIPMENT

Coaxial Crystal Detectors

Models 420C, 423B, 8470B, 8471A, 8472B, 8473B/C/D, 33330B/C/D

- 10 MHz to 33 GHz
- Flat frequency response
- High burnout protection
- Low SWR
- Field replaceable detector elements



HP 33330B



HP 8470B Opt 012



HP 423B



HP 8473D

Coaxial Crystal Detector Specifications

HP Model	Frequency Range (GHz)	Frequency Response (dB)	SWR Maximum (50Ω Nom.)	Low Level Sensitivity	Maximum Input (Peak or Average)	Short-Term Maximum Input (<1 min.)	Option 001 Matched Pair (order 2 units for each pair)	Options Available	Input Connector	Output Connector	Price
420C (note 1)	0.01-12.4 Point Contact	±2	2.0	>0.15 mV/μW	100 mW	0.1 watt	±1 dB	001 003	N (m)	BNC (f)	\$140
423B	0.01-12.4 LBSD	±0.2/octave to 8 GHz ±0.3 overall	<1.15 to 4 GHz <1.3 to 12.4 GHz	>0.5 mV/μW	200 mW	1 watt	±0.2 dB to 12.4 GHz	001 002 003	N (m)	BNC (f)	\$270
8470B	0.01-18.0 LBSD	±0.2/octave to 8 GHz ±0.3 to 12.4 GHz ±0.6 to 18 GHz	<1.15 to 4 GHz <1.3 to 15 GHz <1.4 to 18 GHz	>0.5 mV/μW	200 mW	1 watt	±0.2 dB to 12.4 GHz ±0.3 dB to 18 GHz	001 002 003	APC-7	BNC (f)	\$330
8470B Opt 012									N (m)		
8471A (note 1)	100 kHz-1.2 GHz Point Contact	±0.6 (typical) ±0.1/100 MHz	1.3 (typical) 50Ω	>0.35 mV/μW	3 Vrms	3 Vrms	N/A	004 005 006	BNC (m)	BNC (f)	\$100
8472B	.01-18 LBSD	±0.3 to 12.4 GHz ±0.5 to 15 GHz ±0.6 to 18 GHz	<1.20 to 4.5 GHz <1.35 to 7 GHz <1.50 to 12.4 GHz <1.70 to 18 GHz	>0.5 mV/μW	200 mW	1 watt	±0.2 dB to 12.4 GHz ±0.3 dB to 18 GHz	002 003	SMA (m)	BNC (f)	\$330
8473B	0.01-18.0 LBSD	±0.2/octave to 8 GHz ±0.6 to 18 GHz	<1.2 to 4.0 GHz <1.5 to 18 GHz	>0.5 mV/μW	200 mW	1 watt	±0.2 dB to 12.4 GHz ±0.3 dB to 18 GHz	001 003	APC-3.5 (m)	BNC (f)	\$310
8473C	0.01-26.5 LBSD	±0.6 to 20 GHz ±1.5 with a -3.5 dB slope, 20 to 26.5 GHz	<1.2 to 4 GHz <1.5 to 18 GHz <2.2 to 26.5 GHz	>0.5 mV/μW to 18 GHz >0.18 mV/μW to 26.5 GHz	200 mW	1 watt	±0.2 dB to 12.4 GHz ±0.3 dB to 18 GHz ±0.5 dB to 26.5 GHz	001 003	APC-3.5 (m)	BNC (f)	\$360
8473D	0.01-33.0 PDB	±0.25 to 14 GHz ±0.4 to 26.5 GHz ±1.25 to 33 GHz	<1.20 to 14 GHz <1.36 to 26.5 GHz <2.96 to 33 GHz	>0.5 mV/μW	200 mW	1 watt	N/A	003	APC-3.5 (m)	BNC (f)	\$430
33330B	0.01-18.0 LBSD	±0.6	<1.2 to 4.0 GHz <1.5 to 18 GHz	>0.5 mV/μW	200 mW	1 watt	±0.2 dB to 12.4 GHz ±0.3 dB to 18 GHz	001 003	APC-3.5 (m)	SMC (m)	\$302
33330C	0.01-26.5 LBSD	±0.6 to 20 GHz ±1.5 with a -3.5 dB slope, 20 to 26.5 GHz	<1.5 to 18 GHz <2.2 to 26.5 GHz	>0.5 mV/μW to 18 GHz Degrades to 0.18 mV/μW at 26.5 GHz	200 mW	1 watt	±0.3 dB to 18 GHz ±0.5 dB to 26.5 GHz	001 003	APC-3.5 (m)	SMC (m)	\$337
33330D	0.01-33.0 PDB	±0.35 to 14 GHz ±0.4 to 26.5 GHz ±1.25 to 33 GHz	<1.20 to 14 GHz <1.36 to 26.5 GHz <2.96 to 33 GHz	>0.5 mV/μW	200 mW	1 watt	N/A	003	APC-3.5 (m)	SMC (m)	\$395

Options

Option 001: Matched response. Must order two (2) option 001s for a pair of detectors with matched frequency response. add \$25

Option 002: Optimum square law load. add \$25

Option 003: Positive polarity output. add \$35

HP 420C

001: matched response (must order 2) add \$20

003: positive polarity output N/C

HP 8471A

004: positive output N/C

005: 75 ohm negative output add \$10

006: 75 ohm positive output add \$10

HP 423B, 8470B, 8472B, 8473B/C, 33330B/C Low Barrier Schottky Diode (LBSD) Detectors

The low-barrier Schottky diode (LBSD) detectors are a state-of-the-art addition to the HP family of high performance detectors. Various models provide coverage to 12.4, 18, and 26.5 GHz and input connectors are Type N, APC-7, or APC-3.5 depending on frequency range. Output connector is BNC (f) except for the HP 33330B/C (SMC).

Matched pairs (Opt 001), square-law load (Opt 002), and positive polarity output (Opt 003) are available for most models.

HP 8473D, 33330D Planar Doped Barrier (PDB) Detectors

These detectors are the newest addition to HP's family of high performance detectors. They feature a broadband, very flat frequency response (±1.25 dB from .01 to 33 GHz) as well as superior SWR performance (<1.36 to 26.5 GHz, <2.96 to 33 GHz).

Positive polarity output (Opt 003) is available for both models. Due to their exceptional frequency response, any two standard 8473D's or 33330D's are a matched pair (the matched pair option, Opt 001, is not needed).

Planar Doped Barrier Diodes		Low Barrier Schottky Diodes			
HP Model	Opt. 003	HP Model	Opt. 001	Opt. 002	Opt. 003
8473D	add \$35	423B	add \$25	add \$25	add \$35
33330D	add \$30	8470B	add \$25	add \$25	add \$35
		8472B	add \$25	n/a	add \$35
		8473B	add \$25	n/a	add \$35
		8473C	add \$25	n/a	add \$35
		33330B	add \$20	n/a	add \$50
		33330C	add \$20	n/a	add \$30

note 1: These point-contact detectors have been widely used for many years and provide good performance at an economical price.

☎ Fast-ship product --- see page 766.

MICROWAVE TEST EQUIPMENT

Waveguide Crystal Detectors, Mixers

Models 422A/C, 424A, 11970/11971 Series, 10514/34A

561



HP K422C



HP 10514A

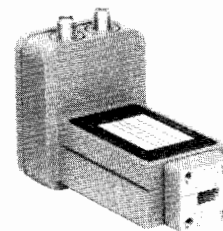

HP 11970/11971 Series

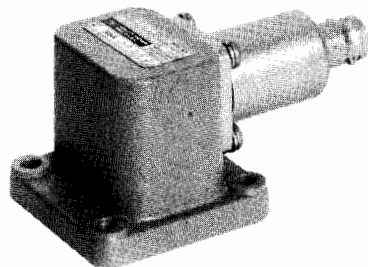

HP X424A

HP 422 Series, 424 Series Crystal Detectors

The HP 422A/C and 424A families of Crystal Detectors combine high sensitivity with flat frequency response and low SWR to provide waveguide band coverage from 8.2 to 60 GHz. They deliver between 0.2 and 0.5 mV/μW output at low level and handle 100 mW peak input. SWR ranges from 1.35 at X-band to 3 at R-band.

The HP K422C detector uses a planar doped barrier (PDB) diode. This superior diode technology results in a frequency response 5 times better than the former HP K422A (± 0.4 dB vs. ± 2.0 dB).

HP Q/U422 Series millimetre-wave detectors use Low-Barrier Schottky diodes for low video impedance and low junction capacitance. Their SWR is below 2.0, low-level sensitivity is 0.2 mV/μW.

For reflectometer applications in which both flat frequency response and square-law characteristics are important, these models can be supplied as matched pairs (Option 001) and with optimum square-law loads (Option 002). Due to its exceptionally flat frequency response, and any two standard HP K422Cs become a matched pair, and therefore the matched pair option, Option 001, is not needed.

HP 422 Series, 424 Series Waveguide Crystal Detector Specifications

HP Model	Frequency Range (GHz)	Frequency Response (dB)	Option 001 Matched Response (dB)	LowLevel Sensitivity mV/μW	SWR	Waveguide & Equivalent Flange	Price
X424A	8.2-12.4	± 0.3	± 0.3 dB	>0.4	1.35	WR90 UG-135/U	\$300
P424A	12.4-18.0	± 0.5	± 0.5 dB	>0.3	1.5	WR62 UG-419/U	\$340
K422C	18.0-26.5	± 0.4	N/A	>0.5	1.36	WR42 UG-595/U	\$800
R422A	26.5-40.0	± 2	± 1 dB	>0.3	3.0	WR28 UG-599/U	\$800
Q422A	33.0-50.0	± 1.5	N/A	>0.25	2.0	WR-22 UG-383/U	\$1150
U422A	40.0-60.0	± 1.5	N/A	>0.20	2.0	WR-19 UG-383/U (mod)	\$1350

Option 001: Matched response. Must order two (2) option 001's for a pair of detectors with matched frequency response.

Option 002: optimum square-law load.

Option 003: positive polarity output. (available with X/P424A and Q/U422A)

Option Prices

HP Model	Opt. 001	Opt. 002	Opt. 003
K422C	N/A	add \$20	N/A
P424A	add \$20	add \$20	N/C
R422A	add \$45	add \$20	N/A
X424A	add \$20	add \$20	N/C
Q422A	N/A	N/A	N/C
U422A	N/A	N/A	N/C

HP 10514A, 10534A Double Balanced Mixers

These mixers are excellent in a variety of mixing applications as well as AM, pulse, and square-wave modulation applications. The careful balancing of the hot carrier diodes in the HP 10514A and 10534A provides excellent output suppression of the local oscillator and input frequencies. Frequency ranges are 0.2-500 MHz for the HP 10514A and 0.05-150 MHz for the HP 10534A. Connectors are BNC.

HP 11970 and 11971 Series Harmonic Mixers

Although designed for operation with HP spectrum analyzers, these broadband mixers also serve a wide variety of general-purpose uses for the frequency bands from 18 to 110 GHz. Such uses include down-conversion for noise figure and network analysis measurements.

As down-conversion mixers for test receivers, the HP 11970 and 11971 offer flat response, low SWR, and low conversion loss without requiring bias. These mixers can also serve as harmonic generators with input signals from 2 to 6.1 GHz (depending on the model). Outputs are at the band specified, and each mixer is individually calibrated for conversion loss over its complete band. See page 693 for more technical performance information.

Ordering Information

HP 10514A Double Balanced Mixer (0.2-500 MHz)	\$185
HP 10534A Double Balanced Mixer (0.05-150 MHz)	\$133

HP 11970/11971 Series Specifications

HP Models	Frequency Range (GHz)	Freq. Response (dB)	Waveguide and Equivalent Flange	Price
11970K	18 - 26.5	± 1.9	WR-42	\$1500
11971K		± 2.1	UG-595/U	\$1350
11970A	26.5 - 40	± 1.9	WR-28	\$1550
11971A		± 2.1	UG-599/U	\$1400
11970Q	33 - 50	± 1.9	WR-22	\$1700
11971Q		$\pm 2/3$	UG-383/U	\$1600
11970U	40 - 60	± 1.9	WR-19	\$1850
11971U		± 2.3	UG-383/U (mod)	\$1800
11970V	50 - 75	± 2.1	WR-15	\$2250
11971V		± 2.5	UG-385/U	\$2000
11970W	75 - 110	± 3.0	WR-10	\$2550
			UG-385/U (mod)	

MICROWAVE TEST EQUIPMENT

Slotted Lines, Carriage, Probes, SWR Meter

Models 415E, 442B, 447B, 809C, 816A

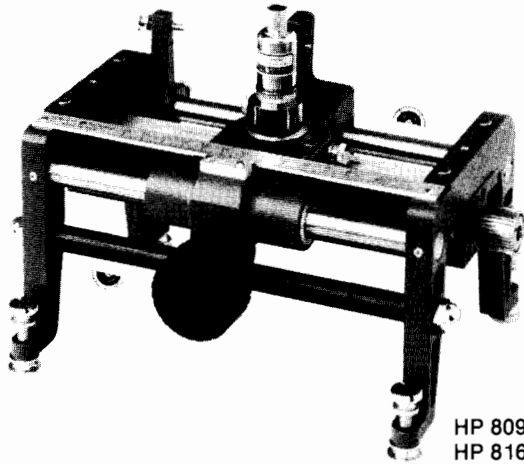

HP 809C
HP 816A Opt 011

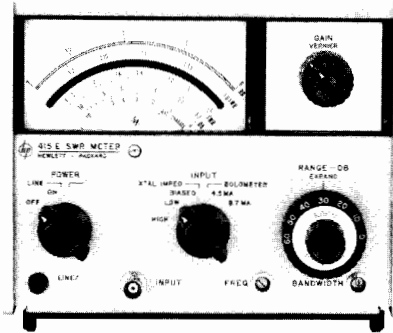

HP 415E



HP 442B



HP 447B

HP 415E SWR Meter

HP 415E SWR Meter is a low noise, 1000 Hz tuned amplifier and voltmeter, calibrated in dB and SWR. Designed for use with square law detectors, it measures SWR, attenuation, and gain directly from metered scales, or drives an X-Y recorder for RF substitution measurements. Front panel INPUT switch selects unbiased low (50-200 Ω) or high (2500-10,000 Ω) impedance crystal, biased crystal (1 V into 1 kΩ), or low or high current bolometer (4.5 or 8.7 mA ± 3% into 200 Ω).

An internal precision 60 dB attenuator allows the HP 415E to operate over a 70 dB range in 10 or 2 dB steps, with ±0.05 dB accuracy for a 10 dB step; maximum cumulative error between any two 10 dB steps is ±0.1 dB. Sensitivity is 0.15 μV rms for full scale deflection at maximum bandwidth (1 μV rms on high impedance crystal input).

Continuously adjustable bandwidth can be adjusted from 15 Hz for maximum sensitivity at CW frequencies to 130 Hz for swept frequency uses. An optional rechargeable battery pack provides up to 36 hours of continuous operation for portable use.

Weight: Net 4 kg (9 lb); shipping 5.8 kg (13 lb).

Power: 115-230 V ±10%, 50-400 Hz, 1 VA.

Dimensions: 155Hx190Wx279mm D(6³/₃₂x7²⁵/₃₂x11in.)

HP 809C Slotted Line Carriage

The HP 809C carriage operates with the HP 816A coaxial slotted section. It is compatible with the HP 442B, and 447B coaxial probes. The carriage has a centimeter scale with a vernier reading to 0.1 mm, and provision is also made for mounting a dial gauge if more accurate probe position reading is required.

HP 816A Slotted Section

The HP 816A coaxial slotted section is used with the HP 809C carriage. The HP 816A coaxial line accepts the HP 447B probe.

HP 816A Specifications

HP Model	Frequency Range (GHz)	SWR Residual	WG & Flange or Coax Conn.	Remarks	Price
816A	1.8-18.0	1.02-1.04 (APC-7)	Coaxial APC-7 N(f)	11512A N (m) Short 11565A APC-7 Short	\$1070
Opt 011			Both APC-7	furnished. Use with	Add \$25
Opt 022		1.04-1.06 N(f)	N(m), N(f)	HP 809C Carriage HP 447B Probe	Less \$15

HP 442B, 447B Probes/Adapters

The HP 442B fits the HP 809C carriage and provides sampled RF at a Type N jack.

HP 447B is similarly used with the HP 809C and the HP 816A coaxial section for 1.8 to 18 GHz.

Ordering Information

HP 442B RF probe	\$300
HP 447B Detector probe	\$415
HP 809C Slotted line carriage	\$980
HP 415E SWR Meter	\$2105
Opt 001: rechargeable battery installed	add \$105
Opt 002: rear panel input connector	add \$25

MICROWAVE TEST EQUIPMENT

2.4 mm Coaxial Connector Family Adapters and Standards

Models HP 11900-11902, 11904, 85138, 85140, 85141

- DC-50 GHz frequency range
- Rugged instrument and metrology grades

- Adapters to all common connector types
- Standards for reflection calibration

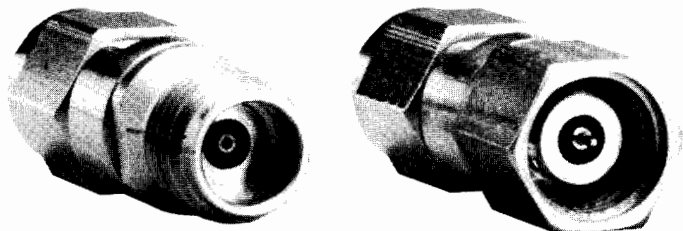

HP 11900A/B/C

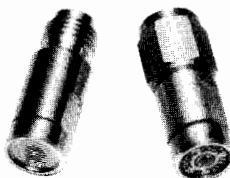

HP 85138 A/B

The 2.4 mm connector permits microwave components and systems to operate with coaxial interconnections at frequencies up to 50 GHz. Such systems need no longer be restricted to waveguide. Using the 2.4 mm connector, broadband devices operating from DC to 50 GHz are possible, simplifying and speeding the design and manufacture of components and systems.

The 2.4 mm connector interface was conceived by Hewlett-Packard and has been jointly developed by HP, Amphenol Products, and M/A-COM Omni Spectra. Supporting this development are products from HP, Amphenol Products, M/A-COM Omni Spectra and Maury Microwave.

Design goals for this connector included: a rugged interface with excellent return loss characteristics, a connector with very repeatable performance, and reasonable connector cost in systems applications. By foregoing compatibility with existing connector types, a design was achieved that optimizes performance over the entire DC to 50 GHz range, not just at the higher frequencies.

Implementation of the 2.4 mm connector concept is in the form of three levels or grades of the connector series, each of which is totally compatible with the others because each conforms to the connector interface dimensions. Three connector grades permit best application fit, with trade-offs in performance versus cost. M/A-COM Omni Spectra offers the "production-grade" OS-50 series for use in components, cabling and microstrip. Its design emphasizes economy and assembly simplicity. The "instrument-grade" APC-2.4 series from Amphenol Products is intended for use with test and measurement equipment where the connector must withstand many connect/disconnect cycles. Designed for traceability to national measurement standards, the "metrology-grade" connector will be used by HP on calibration standards.

HP 11900A/B/C, 11901A/B/C/D, 11902A/B, 11904A/B/C/D Between-Series Adapters

The HP 11900 series of 2.4 mm connector adapters allow 2.4 mm connectors of either sex to be mated to other types of connectors. These metrology-grade adapters are recommended for use where high precision and repeatability are required. The electrical lengths of the adapters are matched within the same adapter families (e.g., all 2.4 mm to APC-3.5), allowing accurate non-insertable device measurements. For information on 2.4 mm coax to R- and Q-band waveguide adapters, refer to page 564.

HP 11900A/B/C, 11901A/B/C/D, 11902A/B, 11904A/B/C/D Specifications

HP Model	Type	Sex ¹		Sex ¹	Frequency (GHz)	Return Loss	Repeat-ability ^{2,3} (Min.)	U.S. Price
11900A	2.4 mm	(m)	/2.4 mm	(m)	DC-50	>26 dB	-44 dB	\$450
11900B	2.4 mm	(f)	/2.4 mm	(f)	DC-50	>26 dB	-44 dB	450
11900C	2.4 mm	(m)	/2.4 mm	(f)	DC-50	>26 dB	-44 dB	450
11901A	2.4 mm	(m)	/APC-3.5	(m)	DC-26.5	>32 dB	-54 dB	375
11901B	2.4 mm	(f)	/APC-3.5	(f)	DC-26.5	>32 dB	-54 dB	375
11901C	2.4 mm	(m)	/APC-3.5	(f)	DC-26.5	>32 dB	-54 dB	375
11901D	2.4 mm	(f)	/APC-3.5	(m)	DC-26.5	>32 dB	-54 dB	375
11902A	2.4 mm	(m)	/APC-7	-	DC-18	>32 dB	-56 dB	325
11902B	2.4 mm	(f)	/APC-7	-	DC-18	>32 dB	-56 dB	325
11904A	2.4 mm	(m)	/K Conn.**	(m)	DC-40	>24 dB	-40 dB	500
11904B	2.4 mm	(f)	/K Conn.**	(f)	DC-40	>24 dB	-40 dB	500
11904C	2.4 mm	(m)	/K Conn.**	(f)	DC-40	>24 dB	-40 dB	500
11904D	2.4 mm	(f)	/K Conn.**	(m)	DC-40	>24 dB	-40 dB	500

HP 85138A/B, 85140A/B, 85141A/B Calibration Accessories

The HP 85138A/B terminations are instrument-grade, 50 ohm loads designed for device termination and reference calibration where high performance is important. The HP 85140A/B and HP 85141A/B are metrology-grade, precision shielded open and short circuits for maximum reflection calibration accuracy for vector and scalar network analyzers. The open circuit utilizes a specially designed plastic center conductor support, to provide the proper center pin setback and uniform open circuit capacitance required for a high level of performance.

HP 85138A/B, 85140A/B, 85141A/B Specifications

HP Model	Type	Sex ¹	Return Loss (dB)	Repeatability ² (Min.)	U.S. Price
85140A	2.4 mm Short	(m)	N/A	-50 dB	\$250
85140B	2.4 mm Short	(f)	N/A	-50 dB	275
85141A	2.4 mm Open	(m)	N/A	-44 dB	275
85141B	2.4 mm Open	(f)	N/A	-44 dB	300
85138A	2.4 mm 50 ohm Termination*	(m)	>30 (DC-26.5 GHz) >25 (26.5-40 GHz) >20 (40-50 GHz)	-40 dB	475
85138B	2.4 mm 50 ohm Termination*	(f)	>30 (DC-26.5 GHz) >25 (26.5-40 GHz) >20 (40-50 GHz)	-40 dB	525

¹f=jack, m=plug

²at the 2.4mm port

³Repeatability = $20 \log |\Delta \Gamma|$, where $|\Delta \Gamma| = |\Gamma_{m1} - \Gamma_{m2}|$, i.e., the difference between two measurements Γ_{m1} and Γ_{m2} , before and after one disconnect/connect cycle.

APC-7* is a U.S. registered trademark of the Bunker Ramo corporation.

*Instrument-grade.

**The K connector is developed and manufactured by the Wiltron company (Morgan Hill, CA).



MICROWAVE TEST EQUIPMENT

Adapters, Waveguide/Coax, Waveguide/Waveguide

Models 281A/B/C, 292A/B, 11515/6A, 897A/B, 898A/B, 899A/B

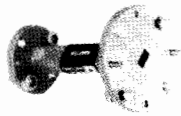

HP UV292A

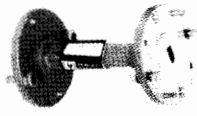

HP Q898A



HP Q899A

HP 281A/B/C, 292A/B, 11515A/6A Coax and Waveguide Adapters

HP 281A/B Adapters transform waveguide transmission line into 50-ohm coaxial line. The HP 281C family has improved SWR. HP R/Q281 Adapters use the new 2.4 mm coaxial connector capable of non-modulating performance all the way to 50 GHz.

HP 292A/B Waveguide-to-Waveguide Adapters connect two different waveguide sizes with overlapping frequency ranges. HP 11515A/16A adapt circular to rectangular flanges in K-band and R-band.

HP 281A/B/C Specifications

HP Model	SWR	Frequency Range (GHz)	Waveguide Size EIA	Coaxial Connector	W/G Flange UG(-) U	Price
S281A	1.25	2.60-3.95	WR284	N (f)	584	\$210
G281A	1.25	3.95-5.85	WR187	N (f)	407	\$190
J281A	1.25	5.30-8.20	WR137	N (f)	441	\$160
H281A	1.25	7.05-10.0	WR112	N (f)	138	\$140
X281A	1.25	8.20-12.4	WR90	N (f)	135	\$120
X281B	1.25	8.20-12.4	WR90	APC-7	135	\$285
Option 013				N (f)		less \$15
X281C	1.05	8.20-12.4	WR90	APC-7	135	\$335
Option 012				N (m)		less \$15
Option 013				N (f)		less \$15
P281B	1.25	12.4-18.0	WR62	APC-7	419	\$230
Option 013				N (f)		less \$15
P281C	1.06	12.4-18.0	WR62	APC-7	419	\$360
Option 012				N (m)		less \$15
Option 013				N (f)		less \$15
K281C	1.07	18.0-26.5	WR42	APC-3.5 (f)	597	\$400
Option 012				APC-3.5 (m)		N/C
R281A				2.4 mm (f)	381	\$850
R281B	1.1	26.5 - 40.0	WR-28	2.4 mm (m)		\$800
Q281A				2.4 mm (f)	383	\$850
Q281B	1.1	33.0 - 50.0	WR-22	2.4 mm (m)		\$800

HP 292A/B, 11515A, 11516A Specifications

HP Model	Frequency Range (GHz)	SWR	W/G Size Flange	to	W/G Size Flange	Price
HX292B	8.2-10.0	1.05	WR 112 UG-51/U		WR 90 UG-39/U	\$210
MX292B	10.0-12.4	1.05	WR 75 Cover		WR 90 UG-39/U	\$270
MP292B	12.4-15.0	1.05	WR 75 Cover		WR 62 UG-419/U	\$210
NP292A	15.0-18.0	1.05	WR 51 Cover		WR 62 UG-419/U	\$210
NK292A	18.0-22.0	1.05	WR 51 Cover		WR 42 UG-595/U	\$210
RQ292A	33.0-40.0	1.15	WR-28 UG-381/U		WR-22 UG-383/U	\$450
QU292A	40.0-50.0	1.15	WR-22 UG-383/U		WR-19 UG-383/U(mod.)	\$460
UV292A	50.0-60.0	1.15	WR-19 UG-383/U(mod.)		WR-15 UG-385/U	\$470
11515A	18.0-26.5	-	WR 42 UG-425/U		WR 42 UG-595/U	\$210
11516A	26.5-40.0	-	WR 28 UG-381/U		WR 28 UG-599/U	\$210

HP Q281B

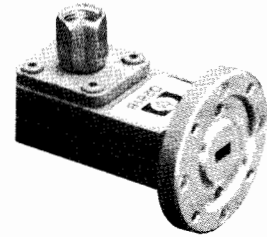

HP X281A

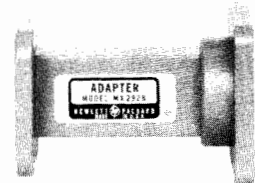

HP MX292B



HP 11515A

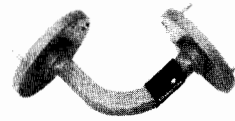

HP Q897A

HP 897A/B, 898A/B, 899A/B Millimetre-Wave Waveguide Accessories

HP offers a number of E- and H-Plane bends, twists, and straight sections necessary for assembling waveguide measurement systems. HP 897A/B are 90 degree bends with the A model being H-Plane and the B model being E-Plane. HP 898A/B twists can be specified for either right-hand rotation (A model) or left rotation (B model) of 90 degrees. HP 899A/B are straight sections available in 2.5 cm (A model) and 5 cm (B model) lengths.

HP 897A/B, 898A/B, 899A/B Waveguide Accessories Specifications

Frequency Range (GHz)	Description and HP Model	SWR	W/G	Equiv. Flange	Price
	Bends				
	H-Plane				
33 - 50	Q897A	1.1	WR-22	UG-383/U	145
40 - 60	U897A	1.1	WR-19	UG-383/U(mod)	145
50 - 75	V897A	1.1	WR-15	UG-385/U	145
75 - 110	W897A	1.1	WR-10	UG-387/U(mod)	145
	E-Plane				
33 - 50	Q897B	1.1	WR-22	UG-383/U	145
40 - 60	U897B	1.1	WR-19	UG-383/U(mod)	145
50 - 75	V897B	1.1	WR-15	UG-385/U	145
75 - 110	W897B	1.1	WR-10	UG-387/U(mod)	145
	Twists				
	90°R.H.				
33 - 50	Q898A	1.1	WR-22	UG-383/U	150
40 - 60	U898A	1.1	WR-19	UG-383/U(mod)	150
50 - 75	V898A	1.1	WR-15	UG-385/U	150
75 - 110	W898A	1.1	WR-10	UG-387/U(mod)	150
	90°L.H.				
33 - 50	Q898B	1.1	WR-22	UG-383/U	150
40 - 60	U898B	1.1	WR-19	UG-383/U(mod)	150
50 - 75	V898B	1.1	WR-15	UG-385/U	150
75 - 110	W898B	1.1	WR-10	UG-387/U(mod)	150
	Straights				
	2.5cm				
33 - 50	Q899A	1.1	WR-22	UG-383/U	140
40 - 60	U899A	1.1	WR-19	UG-383/U(mod)	140
50 - 75	V899A	1.1	WR-15	UG-385/U	140
75 - 110	W899A	1.1	WR-10	UG-387/U(mod)	140
	5cm				
33 - 50	Q899B	1.1	WR-22	UG-383/U	140
40 - 60	U899B	1.1	WR-19	UG-383/U(mod)	140
50 - 75	V899B	1.1	WR-15	UG-385/U	140
75 - 110	W899B	1.1	WR-10	UG-387/U(mod)	140

MICROWAVE TEST EQUIPMENT

Filters, Isolators, and Tuners

Models 360 Series, 362 Series, 365A Series, 870A

565



- Effective elimination of undesirable signals
- Low insertion loss through passband



HP X362A

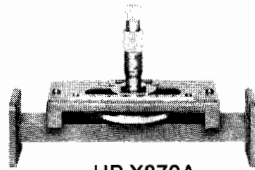

HP X870A



HP Q365A



HP 360D

HP 360 Series Coaxial Low Pass Filters, HP 362 Series Waveguide Low Pass Filters

These Hewlett-Packard low-pass filters facilitate microwave measurements by eliminating undesirable signals (such as harmonics) from the measurement system. Suppression of such signals is particularly important in applications such as broadband reflection and transmission measurements or slotted line measurements where harmonics generated by the signal source could otherwise impair measurement accuracy.

HP X870A, P870A Waveguide Slide-Screw Tuners

Waveguide slide-screw tuners are used primarily for correcting discontinuities or for "matching" waveguide systems. HP X870A covers 8.2-12.4 GHz in WR 90 waveguide and HP P870A covers 12.4-18.0 GHz in WR 62 waveguide. Both can correct a SWR of 20 to a value of 1.02, with a maximum loss of 2 dB.

Ordering Information

HP X870A Waveguide tuner
HP P870A Waveguide tuner

Price

\$800
\$830

HP 365A Millimetre-Wave Waveguide Isolators

The HP Q and U365A Isolators use a Faraday-rotation-type design consisting of a section of waveguide containing low-loss ferrite material and impedance matching elements. A permanent magnet supplies the external magnetic bias field to the ferrite core. This results in excellent broadband isolation ratios of at least 25 dB along with low SWR and insertion loss.

HP 365A Waveguide Isolator Specifications

HP Model	Frequency Range (GHz)	SWR (Max.)	Maximum Insertion Loss (dB)	Minimum Isolation (dB)	Maximum Input Power (Avg)	Waveguide & Equivalent Flange	Price
R365A	26.5-40.0	1.4	1.5	25	1.5W	WR-28 UG-599/U	\$775
Q365A	33-50	1.4	1.5			WR-22 UG-383/U	\$990
U365A	40-60	1.4	1.8			WR-19 UG-383/U(Mod)	\$1190
V365A	50-75	2.0	3.0			WR-15 UG-381/U	\$1475
W365A	75-110	2.0	3.0			WR-10 UG-387/U(Mod)	\$1925

HP 360 Series Coaxial Filter Specifications

HP Model	Cut-off Frequency (MHz)	Insertion Loss	Rejection	Impedance	SWR Maximum	Connectors	Overall Length mm (in)	Shipping Weight kg (lb)	Price
360A	700	<1 dB below 0.9 times cut-off frequency	>50 dB at 1.25 times cut-off frequency	50 Ω	<1.6 to within 100 MHz of cut-off	N (m,f)	276 (10.9)	0.9 (2)	\$400
360B	1200			50 Ω		N (m,f)	183 (7.2)	0.9 (2)	\$400
360C	2200			50 Ω	<1.6 to within 200 MHz of cut-off	N (m,f)	274 (10.8)	0.9 (2)	\$330
360D	4100			50 Ω	<1.6 to within 300 MHz of cut-off	N (m,f)	187 (7.4)	0.45 (1)	\$330

HP 362 Waveguide Low Pass Filter Specifications

HP Model	Passband (GHz)	Stopband (GHz)	Passband Insertion Loss	Stopband Rejection	SWR Maximum	Waveguide Size	Equivalent Flange	Length mm (in)	Shipping Weight kg (lb)	Price
X362A	8.2-12.4	16-37.5	<1 dB	At least 40dB	1.5	WR 90	UG-39/U	136 (5.4)	0.9 (2)	\$1150
P362A	12.4-18.0	23-54			1.5	WR 62	UG-419/U	94 (3.7)	0.37 (13 oz)	\$1150
K362A ¹	18.0-26.5	31-80			1.5	WR 42	UG-595/U	64 (2.5)	0.15 (5.3 oz)	\$975
R362A ¹	26.5-40.0	47-120	<2 dB	>35 dB	1.8	WR 28	UG-599/U	42 (1.7)	0.11 (4 oz)	\$975
¹ Circular Flange Adapters: For K-Band, specify HP 11515A (UG-425/U). For R-Band, specify HP 11516A (UG-381/U).										\$210

MICROWAVE TEST EQUIPMENT

Waveguide Stands, Air Lines, Coaxial Terminations

Models 11540 Series, 11566/7/A, 11588A, 11606A, 908A, 909 Series



HP 11566A



HP 11606A

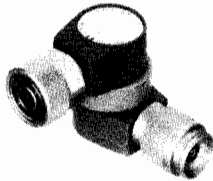

HP 11588A

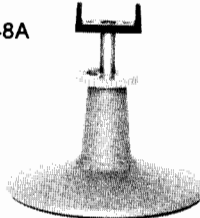

HP 11540A

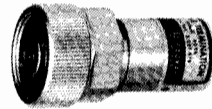

HP 909A



HP 909D

HP 11588A Swivel Adapter, 11606A Rotary Air Line

The HP 11606A Rotary Air Line and the HP 11588A Swivel Adapter are capable of a full 360° of rotation. A combination of the air line and the adapter permits rigid coax movement in three dimensions. Even the most awkwardly shaped devices can be easily connected or disconnected in a coax system with the aid of these components. Insertion loss is <0.5 dB and uncertainty due to rotation is -57 dB.

HP 11566A, 11567A Air Line Extension

Impedance: 50 ohms.
Frequency: dc-18 GHz.
Reflection coefficient: 0.018 + (0.001 x frequency in GHz).
Connector: APC-7.
Length: 11566A, 102.5 mm (4 in.); 11567A, 202.5 mm (8 in.).
Shipping weight: 0.45 kg (1 lb).

HP 11540 Series Waveguide Stand, Waveguide Holders

The HP 11540A Waveguide Stand locks HP waveguide holders at any height from 70 to 133 mm (2.75 in. to 5.25 in.). The waveguide holders are offered in five sizes to hold waveguide covering frequencies from 22 to 40 GHz.

HP 11588A, 11606A Specifications

HP Model	Frequency Range GHz	SWR	Connectors	Dimensions mm (in)	Shipping Weight kg (lb)	Price
11588A	DC-12.4	1.1	APC-7(m)(f)	42 x 59 x 30 (1 7/8 x 2 3/16 x 1 1/16)	0.28 (10 oz.)	\$550
11606A	DC-12.4	1.1	APC-7(f)	100 x 19 (4 x 3/4)	0.45 (1 lb)	\$450

Ordering Information

HP 11566A Air line extension \$275
 HP 11567A Air line extension \$320
 HP 11540A Waveguide stand \$60
 HP 11545A X-Band, each \$40
 HP 11546A P-Band, 11547A K-Band, 11548A R-Band Waveguide holders each \$40

Price

HP 908A, 909A/C/D/E Coaxial Fixed Terminations (50 and 75 Ω)

The HP 908A, 909A and 909D Terminations are low reflection loads for terminating 50 Ω coaxial systems in their characteristic impedance. The HP909C (50 Ω) and HP909E (75 Ω) are precision ultra low reflection terminations intended for use as calibration standards.

HP 908A, 909A/C/D Specifications

HP Model	Frequency Range (GHz)	Impedance (ohms)	SWR	Power Rating	Connector	Price
908A	dc-4	50	1.05	1/2 W avg. 1 kW pk	N (m)	\$100
909A	dc-18	50	1.05: 0-4 GHz 1.1: 4-12.4 GHz 1.25: 12.4-18 GHz	2 W avg. 300 W pk	APC-7	\$175
909A Option 012 Option 013			1.06: 0-4 GHz 1.11: 4-12.4 GHz 1.3: 12.4-18 GHz		Opt. 012 N (m) Opt. 013 N (f)	Less \$15
909C	dc-2	50	1.005	1/2 W avg. 100 W pk	APC-7	\$302
909C Option 012 Option 013			1.01		Opt. 012 N (m) Opt. 013 N (f)	Less \$25
909C Option 200	dc-0.2	50	1.005	1/2 W avg. 100 W pk.	Must be ordered with Opt. 012 N (m) or Opt. 013 N(f)	N.C.
909C Option 201			1.01		Must be ordered with Opt. 012 N(m)	Less \$20
909D	dc-26.5	50	1.07: dc-4 GHz 1.12: 4-12.4 GHz 1.22: 12.4-26.5 GHz	2 W avg. 100 W pk	APC-3.5 (m)	\$250
909D Option 011					Opt. 011 APC-3.5 (f)	N.C.
909D Option 040			1.02: dc-4GHz 1.12: 4-12.4GHz 1.22: 12.4-26.5GHz		APC-3.5 (m) Opt. 011 APC-3.5 (f)	add \$15
909E Option 201	dc-0.2	75	1.01	1/2 W avg. 100 W pk.	N(m)	\$257
85138A	dc-50	50	1.22	1/2 W	2.4 mm (m)	\$300
85138B	dc-50	50	1.22	1/2 W	2.4 mm (f)	\$350

MICROWAVE TEST EQUIPMENT

Coaxial and Waveguide Terminations

Models HP 905, 910, 911, 914, 920, 923

567



- Precision loads and shorts for measurements to 60 GHz



HP 11512A



HP Q914C



HP X914B



HP 911C



HP X910B

HP 905A, 911A, 911C Coaxial Sliding Loads

The HP 905A, and 911A are movable, low reflection 50 Ω loads for precision measurements. The HP 905A is supplied with three interchangeable connectors, N-male, N-female and APC-7. The HP 911A is supplied with SMA male and female.

The HP 911C is a sliding load designed for 3.5 mm coaxial transmission lines and uses the APC-3.5 connector. This permits mode-free operation to 26.5 GHz. The HP 911C is furnished with interchangeable male and female connectors in a carrying case.

HP 905A, 911A, 911C Specifications

HP Model	Frequency Range (GHz)	Load SWR	Power Rating	Length (mm) in.	Shipping Weight	Price
905A	1.8-18	1.05	1 W avg. 5 kW pk	(440) 17.25	(1.4 kg) 3 lb	\$635
911A	2-18	1.1, 2-4 GHz; 1.05, 4-18 GHz	1 W avg. 5 kW pk	(380) 14.87	(1.4 kg) 3 lb	\$620
911C	2-26.5	1.2, 2-10 GHz; 1.07, 10-26.5 GHz	1 W avg. 5 kW pk	(266) 10.5	(1.7 kg) 3.8 lb	\$1130

HP 11511A, 11512A, 11565A Coaxial Shorts and Opens

These shorts and opens are used for establishing measurement planes for known reflection phase and magnitude in 50 Ω and 75 Ω coaxial systems for various connectors.

Ordering Information

HP 11511A N-(f) short (50 ohm)	\$50 ☎
HP 1250-1531 N-(f) short (75 ohm)	\$19 ☎
HP 11512A N-(m) short (50 ohm)	\$50 ☎
HP 1250-1530 N-(m) short (75 ohm)	\$32 ☎
HP 11565A APC-7 short (50 ohm)	\$100 ☎
HP 0960-0054 SMA-(f) short (50 ohm)	\$25 ☎
HP 0960-0055 SMA-(m) short (50 ohm)	\$21 ☎
HP 85140A 2.4mm (m) short	\$250 ☎
HP 85140B 2.4mm (f) short	\$300 ☎
HP 85141A 2.4mm (m) open	\$275 ☎
HP 85141B 2.4mm (f) open	\$325 ☎

☎ Fast-Ship product—see page 766.

HP 920A/B, X923A Waveguide Shorts

The HP 920A/B is a movable short, adjustable through at least half a wavelength at the low end of the band. The HP X923A is also a movable short, but is adjustable through about two wavelengths at 8.2 GHz. HP Q/U920A use micrometer adjustment.

HP 920A/B, X923A Specifications

HP Model	Frequency Range (GHz)	Type	Waveguide Size EIA	Price
X923A	8.2-12.4	movable	WR90	\$510
P920B	12.4-18.0	movable	WR62	\$560
K920B	18.0-26.5	movable	WR42	\$765
R920B	26.5-40.0	movable	WR28	\$700
Q920A	33.0-50.0	movable	WR22	\$550
U920A	40.0-60.0	movable	WR19	\$550

HP 910A/B, 914B/C Waveguide Fixed and Movable Terminations

The HP 910A/B are fixed terminations for waveguide systems. The HP 914A/B are similar to the HP 910A/B, except that their absorptive elements are movable and locking plungers control the position of the elements. HP 914C models use micrometer adjustment.

HP 910A/B, 914A/B/C Specifications

HP Model	Frequency Range (GHz)	SWR	Power Rating	Type	Waveguide Size (EIA)	Price
X910B	8.2-12.4	1.015	1 watt	fixed	WR90	\$235
P910A	12.4-18.0	1.02	1 watt	fixed	WR62	\$225
R910A	26.5-40.0	1.03	1 watt	fixed	WR42	\$225
Q910A	33.0-50.0	1.03	1 watt	fixed	WR22	\$245
U910A	40.0-60.0	1.04	1 watt	fixed	WR19	\$245
X914B	8.2-12.4	1.01	1 watt	sliding	WR90	\$535
P914A	12.4-18.0	1.01	½ watt	sliding	WR62	\$535
K914B	18.0-26.5	1.01	½ watt	sliding	WR42	\$765
R914C	26.5-40.0	1.01	½ watt	sliding	WR28	\$700
Q914C	33.0-50.0	1.01	½ watt	sliding	WR22	\$750
U914C	40.0-60.0	1.01	½ watt	sliding	WR19	\$800

VECTOR MODULATION GENERATORS & ANALYZERS

General Information

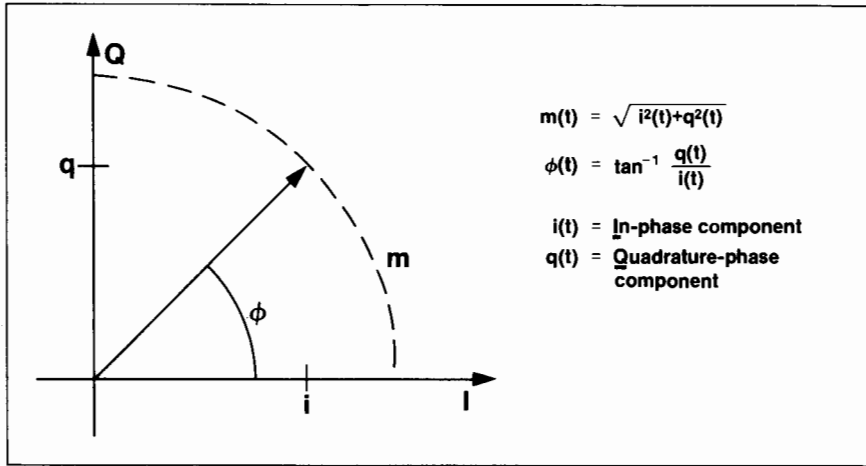

Figure 1. A signal's magnitude and phase can be represented by a vector with rectangular coordinates I and Q.

Why vector techniques

Modern communication and defense electronic systems are continually pushed to do more for less: carry more information in smaller bandwidths, find out more about potential threats in shorter time, and achieve previously unheard-of levels of efficiency and cost effectiveness. Some of the techniques used to reach such performance advances are vector modulation, demodulation and analysis. Vector techniques use two separate orthogonal signals to describe any modulation in terms of its in-phase and quadrature-phase components.

In defense applications, vector techniques have long been used to determine range and velocity information with the aid of signal processing. Vector modulation is also used in phase-coded radars for pulse compression and decreased range ambiguity.

In communications, vector modulation and demodulation improve the quality of microwave communications by transmitting voice and data as digitally encoded levels and phases. Vector modulation and demodulation in these applications provide better signal quality, reliability and economic advantages over analog transmission schemes.

With the introduction of HP's vector products, exceptional vector measurement capability no longer has to be custom-built; costly design and support problems can be avoided.

What's a vector?

A vector is a way of describing a signal in terms of its instantaneous phase and amplitude with respect to some reference, typically the CW carrier. The reference is necessary to determine 0 degrees phase. For the simple case of a CW signal, its vector representation (Fig. 1) clearly shows its phase and amplitude.

Another way to represent the same vector is in terms of its rectangular components. These would be the in-phase (I) and quadrature-phase (Q) components. This is important because it is easier to build hardware to get the I and Q information directly from a modulated signal than it is to get the phase and amplitude information.

For modulated signals, the vector representation will vary with time. This is often what we want to see: not just the instantaneous phase and amplitude of a signal, but also

how it changes with time. One example of this would be the characterization of a pulse during turn-on and turn-off. Fig. 2 shows a vector diagram of the output of a pulse modulator that has some phase and amplitude transients. We can clearly see that as the pulse turns on it lags in phase and when it turns off it leads. This type of characterization can be used to measure pulse modulator performance or when combining parallel transmitter outputs.

A signal's vector representation tells a lot about a signal: its phase, amplitude, modulation type, and even something about the hardware that generated it. But how do we get a signal's I and Q components, and how do we look at them once we have them?

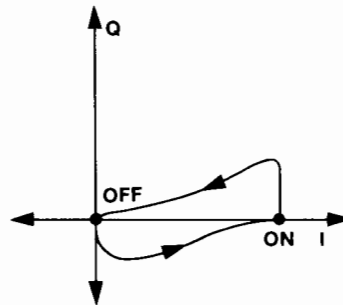

Figure 2. Vector diagram of a pulse with transients.

Vector Demodulation

To derive a signal's I and Q components for vector representation, a vector demodulator like the one in Fig. 3 is used. The vector demodulator uses a local oscillator tuned to a reference frequency (usually the same frequency as the modulated RF) and a quadrature hybrid to form I and Q reference signals for demodulation of the input. The input signal mixes against the two reference phases to get the baseband I and Q components. After the sum frequency components are filtered out, the I and Q components are ready to be displayed.

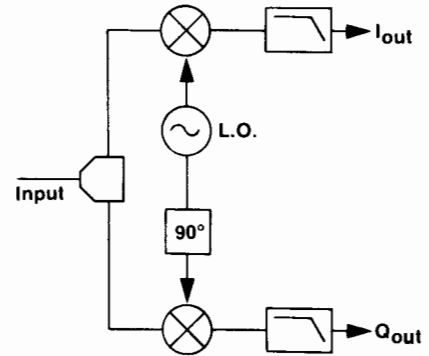

Figure 3. Vector Demodulator

To see the phase-amplitude relationship that is contained in the I and Q signals, they must be displayed on an X versus Y display like the HP 8980A Vector Analyzer. Once the vector representation is displayed, several typical demodulator errors will be easy to spot. For example, gain imbalances and quadrature errors can be seen in Fig. 4.

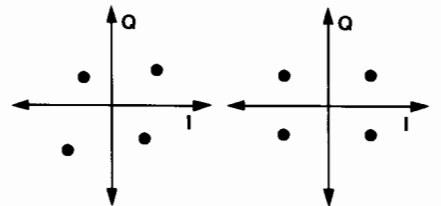

Figure 4. The effects of demodulator quadrature error (l.) and amplitude imbalance (r.) on a 4 phase (QPSK) signal.

Vector Modulation

Vector modulation provides a way to modulate a signal in terms of I and Q. It is especially useful when the modulated signal is to be analyzed by a vector demodulator. All of the benefits associated with vector demodulators also apply to modulators. The baseband I and Q modulating signals only need half the final modulation bandwidth, and they completely define the modulated signal's amplitude and phase.

The way a vector modulator works is practically identical to the demodulator

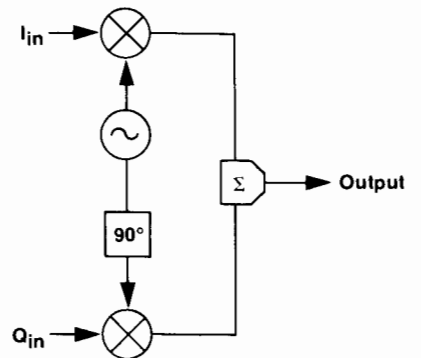

Figure 5. Vector Modulator

(see Fig. 5). An L.O. is divided into in-phase and quadrature-phase signals and then mixed against the modulating I and Q signals. Filters are usually not required after the mixing since there should be no spurious signals. Finally, the I and Q modulated signals are added at the output.

Some Typical Modulations

Vector techniques have been simultaneously pioneered in several fields. In each of these different fields there are different concerns that dictate the modulation and demodulation techniques used.

In radar/EW applications, vector modulators and demodulators are often used to generate and analyze phase-coded pulses.

A typical example of phase-coding a pulse involves using a Barker code to bi-phase modulate the pulse during the pulse on-time. Fig. 6 shows the time and vector diagrams of this kind of a phase-coded pulse. In this case a short 5 bit Barker code is imbedded in the pulse using bi-phase-shift-keying (BPSK).

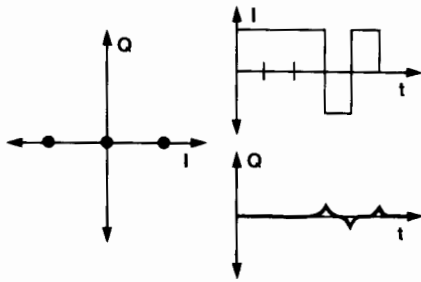

Figure 6. Vector and time I/Q diagrams of a phase-coded pulse.

In digital communications, many different vector modulations are used — each with its own advantages and disadvantages (see Fig. 7). In general, the types of modulation used for digital microwave radio can be divided into two classes: phase-shift-keying (PSK), and

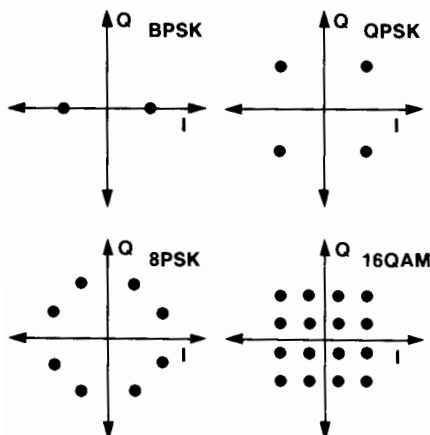

Figure 7. Some standard digital modulations used in communications.

quadrature-amplitude-modulation (QAM). These different modulation formats can be thought of as different "alphabets" for communicating digital information. The higher the number of different symbols or "states", the more information can be communicated with a single character (phase-amplitude state).

HP's Solution

With the introduction of the vector modulation products from HP, vector techniques are no longer out of reach for those who don't want to "build their own". For those who have taken the time to pioneer vector signal generation and analysis, off-the-shelf instruments represent state-of-the-art performance at a level of convenience previously unavailable.

The HP 8780A Vector Signal Generator is a synthesized 10 MHz to 3 GHz source with unprecedented modulation capabilities. At the heart of the Vector Signal Generator is a wideband vector modulator that makes it an excellent source for testing receivers that use vector demodulation. To simplify digital modulation, the Vector Signal Generator has digital inputs that control the generation of common modulation formats.

In addition to its vector and digital modulation capabilities, the Vector Signal Generator has wideband traditional FM and AM modulation. Frequency modulated signals can be generated at rates to 12 MHz and peak-to-peak deviations greater than 50 MHz.

The HP 8980A Vector Analyzer is a powerful modulation analysis tool when connected to the outputs of a vector demodulator. It is much more than a wideband X versus Y display. It offers time, vector, and constellation displays, plus internal data analysis and markers.

Together, the Vector Signal Generator and Vector Analyzer offer unprecedented convenience and accuracy for wideband modulation generation and analysis. And the fact that they share a foundation built on vector modulation techniques makes them well suited to many of today's receiver, component and system measurements.

Literature

This has been a very brief description of what vector techniques are and how they are used. For more detailed information on specific applications or hands-on learning experiences there are a variety of resources available from HP.

I*Q Tutor: The Hewlett-Packard Digital Communications Tutorial.

Sometimes it's best to start at the beginning. HP 11736A/B I*Q Tutor is a tutorial manual and computer program which simulates many of the signals in real digital mi-

crowave radios to help develop an understanding of the fundamental concepts of digital communication. The computer program runs on Hewlett-Packard 200 series and Vectra computers as well as IBM PCs and compatibles. (See also page 393)

AN 343-1 Measurement Applications In Digital Microwave Radio.

Digital microwave radios are increasingly chosen for both satellite and terrestrial applications. This Application Note outlines some of the measurements and test procedures critical to measuring the analog signals in DMR systems. It provides a good starting point for the engineer or technician called upon to design measurements for these applications.

AN 343-2 Dynamic Component Tests Using Vector Modulation Analysis.

As modern communications and defense electronic applications grow more complex, testing of components under dynamic signal conditions (pulses, bursts of data, etc.) is emerging as the critical measurement for device and system performance verification. Vector modulation analysis techniques address tests made under dynamic conditions. Understanding the advantages and disadvantages of each is an important first step in deciding whether vector modulation analysis will meet your particular measurement needs.

AN 343-3 Coherent Pulsed Tests of Radar and Electronic Warfare Systems.

Almost all radars and electronic warfare equipment now coherently transmit and detect their signals. This Application Note describes methods of testing the microwave portion of radar and EW equipment using a vector measurement system.

PN 8780A-1 The Introductory Operating Guide to The HP 8780A Vector Signal Generator.

This Product Note describes the Vector Signal Generator in detail with an emphasis on applications. Several examples are discussed including the generation of TDMA communications signals, phase-coded radar pulses and wideband chirps.

PN 8980A-1 The HP 8980A Vector Analyzer Product Note.

The Vector Analyzer is a wideband analysis instrument optimized for the display and measurement of I and Q vector modulation signals. The HP 8980A Product Note contains information necessary to understand its use and evaluate its suitability for specific measurements.



VECTOR MODULATION GENERATORS & ANALYZERS

Vector Signal Generator

Model 8780A

- 700 MHz of arbitrary modulation using vector inputs
- 10 MHz to 3 GHz IF testing
- Pulse modulation with 1 ns rise times

- BPSK, QPSK, 8PSK, 16QAM digital modulation and Pulse
- Wideband FM: over 50 MHz p-p deviations
- Linear amplitude modulation with >50 dB dynamic range and 350 MHz bandwidth

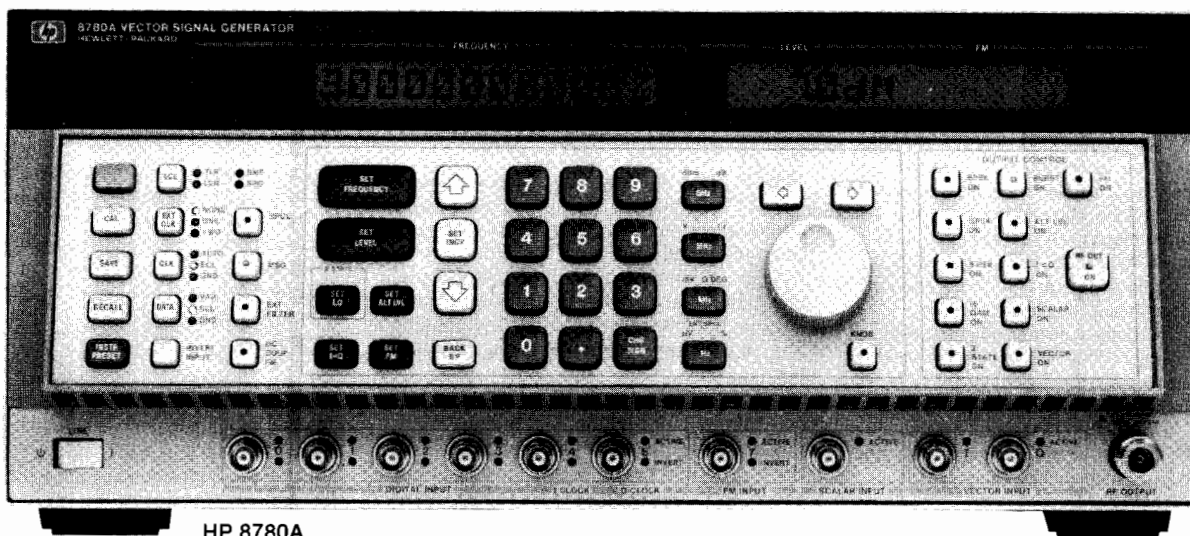

HP 8780A

Description

The HP 8780A Vector Signal Generator is a synthesized IF source with exceptional modulation for modern receiver and component testing. It is capable of modulation bandwidths almost 100 times wider than previous synthesizers, and has built-in DACs (digital-to-analog-converters) to simplify generation of common digital modulations. Its extra-wide modulation bandwidth comes from a vector modulator that effectively doubles baseband modulation bandwidths for 700 MHz of output modulation. The Vector Signal Generator's wideband modulation is complemented with an unmodulated coherent carrier output for demodulation of test signals.

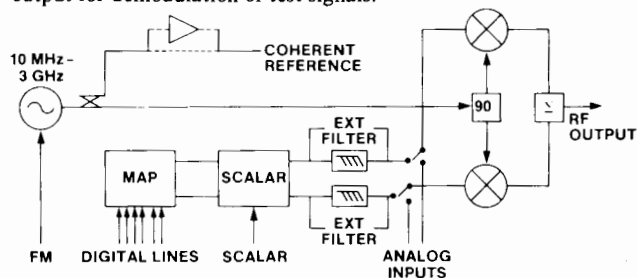

HP 8780A Block Diagram

The Vector Signal Generator offers a wide variety of modulation using both digital and analog inputs. It generates many standard digital modulations like QPSK and 16QAM and traditional modulations like FM, AM and pulse. By combining the different modulation types, signals as diverse as Barker-coded radar pulses and doppler-shifted satellite signals can be simulated.

Applications

The Vector Signal Generator is well suited to receiver measurements where wideband or complex modulations are required. Its coherent carrier output makes it particularly valuable for systems employing vector demodulators and for pulsed phase measurements of components.

Modulation

The Vector Signal Generator vector modulation capabilities are some of its most valuable. The 350 MHz I and Q (In-phase and Quadrature-phase) inputs combine to generate arbitrary phase and amplitude modulation within a 700 MHz output bandwidth. With the

proper I and Q signals, the Vector Signal Generator can generate an infinite variety of modulations. Some of the most likely sources for I and Q driving signals are two HP 8770A Arbitrary Waveform Synthesizers, the output of a signal generator and quadrature hybrid or other baseband waveform generators.

The HP 8780A generates extremely wideband AM (350 MHz) with typical dynamic range and accuracy of 50 dB and 2% respectively. A variety of amplitude-only modulations like gaussian-shaped pulses and pulse trains of different amplitudes can be easily generated using this technique.

Digital modulation

HP 8780A offers a more convenient way to generate modulations using only digital inputs. The Vector Signal Generator generates several standard modulations (BPSK, QPSK, 8PSK, 16QAM, and 64QAM with Opt. 064) using digital inputs, and other common modulations can be generated by combining the Vector Signal Generator modulations. For example, the HP 8780A can generate TDMA (time-division-multiple-access) modulation by combining Burst modulation with one of the PSK modulations. Radar Barker codes and spread spectrum modulations can be generated in similar ways.

The Vector Signal Generator frequency modulation capabilities are also wideband with peak-to-peak deviations up to 50 MHz and rates up to 12 MHz. The FM performance has low distortion and good low frequency response for satellite video applications. If wider deviations are required, the FM input can be safely overdriven for typical deviations of >200 MHz p-p.

The Vector Signal Generator also generates simultaneous modulations to simplify receiver tests and IF measurements. For example, the envelope of a digitally modulated signal can be varied to test receiver AGC performance, or a Barker-coded radar modulation can be simultaneously frequency modulated to simulate doppler shifts. The table below shows which modulations can be combined and some applications for the combinations.

	FM	Scalar
Digital	Receiver carrier recovery loop characterization	Receiver AGC testing and compression measurements
Vector	Simulating doppler shifts	N/A
FM	N/A	Receiver AGC testing
Scalar	Receiver AGC testing	N/A



HP 8780A Specifications

Frequency

Range: 10 MHz to 3 GHz.

Resolution: 1 Hz.

Switching speed: <200 ms normally

Accuracy and stability: Same as reference oscillator (<5 × 10⁻¹⁰/day after 10 day warm up for internal reference).

Output

Level range: +10 to -100 dBm <2.5 GHz,
+4 to -100 dBm ≥2.5 GHz.

Resolution: 0.1 dB.

Accuracy: ±2 dB for levels >-30 dBm,
±3.5 dB for levels ≤-30 dBm and ≥-100 dBm).

SWR: typically < 1.3:1.

Flatness: ±1dB.

Coherent Carrier Output

Unmodulated (except for FM) coherent carrier available at rear panel.

Frequency range: 10 MHz to 3 GHz.

Output level: typically >-20 dBm (+10 dBm with Opt. 002)

Spectral Purity

Residual phase noise

Offset from carrier	CW* specified at 1 GHz	CW* typical 10 MHz-3 GHz	DCFM typical 10 MHz-3 GHz	ACFM typical 10 MHz-3 GHz
100 Hz	-84dBc	-86dBc	-75dBc	
1 KHz	-100dBc	-100dBc	-95dBc	-55dBc
100 KHz	-107dBc	-110dBc	-110dBc	-106dBc
1 MHz	-108dBc	-112dBc	-112dBc	-112dBc
10 MHz (>+7dBm)	-130dBc	-132dBc	-132dBc	-132dBc

*Digital, vector, and scalar residual phase noise is the same as CW.

Harmonics: <-35dBc for output levels ≤+7dBm.

Non-harmonically related spurious for CW, digital, vector, and scalar modulated signals >-40dBm:

<-60 dBc for 10 MHz to 3 GHz, ≥20 MHz from carrier

<-55 dBc for 10 MHz to 3 GHz, <20 MHz from carrier

<-55 dBc for <10 MHz & >3 GHz to 18 GHz.

Residual FM for CW, digital, vector or scalar modulated signals:

<4 Hz rms for 300 Hz to 3 kHz detection BW at 50 MHz.

AC Coupled Frequency Modulation

Rates (3 dB frequencies): 20 Hz to 12 MHz.

Deviation ranges: 50 kHz to 50 MHz peak-to-peak (typically >200 MHz p-p possible with slightly higher distortion by overdriving FM input).

Sensitivity: 1V peak-to-peak for maximum deviation.

Sensitivity Accuracy: ±5% for rates 50 Hz to 10 MHz and deviations <30 MHz p-p.

Input impedance: 50 ohms nominal.

Residual FM for 300 Hz to 3 kHz BW and 50kHz deviation range: <250 Hz rms.

Supplemental Characteristics

Distortion to 3 MHz rates at 10 MHz p-p: <.75%.

Carrier spurious responses (>20 kHz offset): <-60 dBc.

Frequency flatness (50 Hz to 10 MHz): <±0.5dB.

Differential gain at 27.6 MHz p-p: <2%.

Differential phase at 27.6 MHz p-p: <1 degree.

Field time distortion: <1%.

Luminance-to-chrominance delay: <20 ns.

DC Coupled Frequency Modulation

Maximum rate (3 dB frequency): 10 kHz.

Deviation ranges: 150 Hz to 150 kHz peak-to-peak.

Sensitivity: 1V peak-to-peak for maximum deviation.

Sensitivity Accuracy: ±10% for rates <1 kHz and deviations <150 kHz p-p.

Distortion at 1kHz rate and 150 kHz p-p deviation: <5%

Input impedance: 50 ohms nominal.

Residual FM for 300 Hz to 3 kHz BW and 150kHz deviation range: <8 Hz rms.

Supplemental Characteristics

Carrier spurious responses: <-60 dBc for >1 kHz offsets,
<-50 dBc for 100 Hz - 1 kHz offsets.

Digital Modulation

Modulation types: BPSK, QPSK, 8PSK, 16QAM (64QAM with Opt. 064).

Arbitrary 2-state, Burst (except with Opt. 064).

Simultaneous burst: Available with BPSK, QPSK, 8PSK, or CW (8PSK not available with Opt. 064).

Alternate level: Available with BPSK, QPSK, BPSK and burst, QPSK and burst.

I<Q: Available with all digital modulations.

Clock modes: Single, separate I and Q (except with Opt. 064), or asynchronous.

Parallel data rates: 0 to 150 MHz clocked,
0 to 100 MHz clocked 64QAM w/Opt. 064,
0 to 50 MHz asynchronous.

Serial data rates (only with Opt. 064): 0 to 150 MHz clock and data line for 0 to 2.5 MHz 64QAM clock rate.

Data input levels: ECL (-2V termination), ground, or variable -2.5V to 2.5V.

Baseband filters: Three internal; external ports supplied.

Data and clock input impedances: 50 ohms nominal.

Data and clock drive requirements: 0.3 to 3.0 Vp-p.

Data dc accuracy at 140 MHz carrier and ≤+7dBm levels:

±1.2% of full scale for BPSK, QPSK, 8PSK,

±2% of full scale for 16QAM, 2-state, alt-lvl, I<Q.

Burst dc on/off ratio: >50 dB for 140 MHz carrier.

Supplemental Characteristics 10 MHz to 3 GHz

Data asymmetry: <1 ns for clocked modes.

Data skew: <1 ns for single clock operation.

Pulse Modulation (Burst)

Pulse rates: 0 to 150 MHz clocked, 0 to 50 MHz asynchronous.

Pulse dc on/off ratio: >50 dB for 140 MHz carrier.

Pulse rise/fall times: ≤ 1ns

Scalar Modulation/AM

Traditional AM modulation requires a dc offset of 0.5 V to be added to the scalar input.

Sensitivity: 0 to +1 volt for 0 to full scale envelope modulation

DC accuracy: ±3% of full scale for 140 MHz carrier and for ≤ +7 dBm levels.

DC offsets: <1% of full scale

Frequency response: dc to 500 kHz (-3dB).

Input impedance: 10k ohms nominal.

Vector Modulation (using analog I/Q inputs)

Frequency response: dc to 350 MHz (-3dB) at 1 GHz carrier frequency.

DC accuracy: ±2% of full scale for 140 MHz carrier at <+7 dBm and $\sqrt{I^2 + Q^2} \leq 0.5V$.

DC offsets: <1% of full scale for 140 MHz carrier.

Sensitivity: ±0.5V into 50 ohms for ±100% I and Q.

Supplemental Characteristics over 10 MHz to 3 GHz frequency range

Input impedance: 50 ohms.

SWR: <1.5:1 dc to 350 MHz.

Frequency Response: dc to 350 MHz for carriers 400 MHz to 3 GHz.

Frequency Flatness: ±0.3 dB.

Remote Programming

All functions HP-1B programmable except line switch. The HP 8780A can output over the interface frequency and output level settings, error/malfunction codes, and operational status codes.

Interface Functions: SH1, AH1, T5, TEU, L4, LE0, SR1, RL1, PP1, DC1, DT0, C0.

General

Operating temperature range: 0 degrees C to +55 degrees C.

Power: 100, 120, 220, 240 V, +5%, -10%, 48-440 Hz; 500 VA max.

Weight: net, 31.5 kg (70 lb). Shipping, 35.5 kg (78 lb).

Size: 184 mm H × 425 mm W × 637 mm D (7.3" × 16.7" × 25.1").

Ordering Information

HP 8780A Vector Signal Generator

Option 001: Rear panel output and modulation inputs

Option 002: +10 dBm Coherent Carrier output

Option 064: 64 QAM modulation

Option 907: Front Panel Handles

Option 908: Rack Mount Flanges

Option 909: Handles and Flanges

Option 915: Service Manual

Option 916: Extra Operating Manual

Price

55,000

450

Contact HP

Contact HP

65

35

90

45

25



VECTOR MODULATION GENERATORS & ANALYZERS

Vector Analyzer

Model 8980A

- Analyzes coherent phase and amplitude modulation
- 350 MHz I vs. Q bandwidth
- Markers for measuring phase, amplitude, and time
- 12 bit digitizing for HP-IB measurements

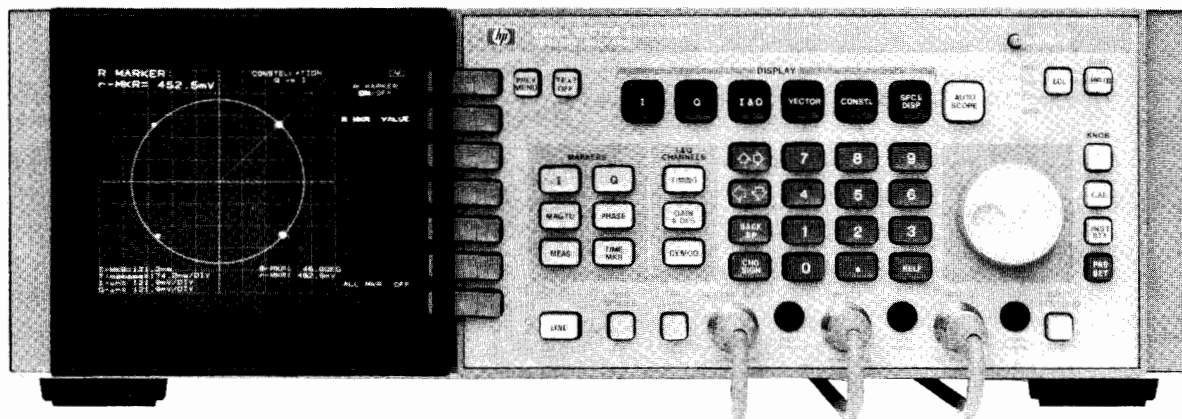

HP 8980A



Description

Traditional tools for analyzing wideband modulated carriers do not provide phase information, a critical parameter in measuring the performance of wideband coherent modulation. The new HP 8980A Vector Analyzer is a 350 MHz X-Y two-channel sampling oscilloscope designed to characterize the In-phase and Quadrature-phase signals of modern communications and radar/EW signals.

Markers for Precise Magnitude, Phase, and Time Measurements

The HP 8980A markers help the user translate visual data into accurate quantified data in just seconds. Selecting the I, Q, Magnitude, Phase, or Time Marker keys prompts the user with a softkey menu for activating the marker, entering a marker value, or choosing the Delta function. The Delta function is especially useful in checking whether a signal parameter is within a given tolerance, or to check how closely the signal through one device matches that through another.

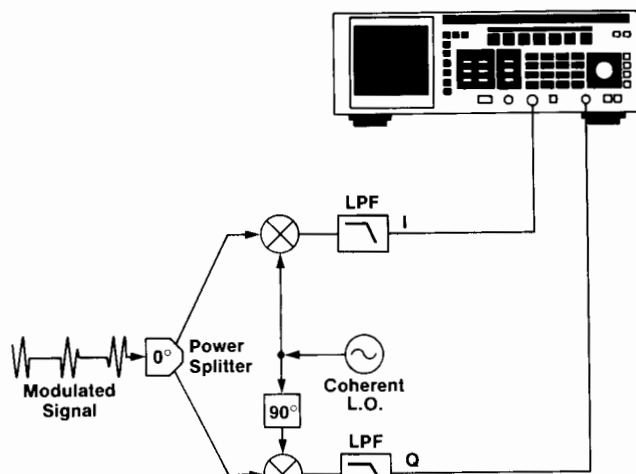

The HP 8980A analyzes the in-phase (I) and quadrature-phase (Q) components of a vector demodulated signal

The HP 8980A Vector analyzer teams up with the HP 8780A Vector Signal Generator and a vector demodulator to provide complete solutions for most vector test applications. From the traditional "eye" diagram of a digital microwave radio to the phase diagram of a complex radar signal, the HP 8980A gives both visual and quantitative measures of system performance.

High-Speed Vector Diagrams

The HP 8980A's accurate vector diagrams and internal data analysis functions speed the identification and measurement of demodulator quadrature errors, offsets, and gain imbalances. Instantaneous phase information is easily obtained from the front panel using the display markers, while conventional time-domain measurements of the I and Q channels are possible with the Vector Analyzer's familiar oscilloscope features.

Automatic Constellation Measurements

Measurable, repeatable results are important in monitoring and maintaining the quality of digital microwave or satellite systems over time. The HP 8980A constellation analysis feature gives non-intrusive direct measures of constellation closure, quadrature error, and lock angle error for a wide variety of modulation formats from QPSK to 256 QAM. Continuous or single I,Q voltage measurements are also possible, thus facilitating on-line adjustments of quadrature balance and minimum eye closure. Front panel probe power and optional active probes give maximum flexibility for troubleshooting difficult circuit-level problems. For a permanent hardcopy output, an HP 2225A ThinkJet printer can provide paper copies of the display in seconds, at the push of a button.

VECTOR MODULATION GENERATORS & ANALYZERS

Vector Analyzer

Model 8980A

573



High Resolution Digitizing of Repetitive Waveforms

The 12-bit digitizing capability of the HP 8980A facilitates applications that call for statistical analysis, frequency domain analysis, or other computer processing. The design engineer can capture up to 1024 points of the I,Q time waveforms over the HP-IB bus at subnanosecond intervals if desired. Possibilities including calculating and smoothing the magnitude and phase, performing an FFT for frequency domain analysis, computing the frequency shift of a Doppler signal, or calculating the frequency characteristics of a chirp signal.

Precise, Flexible Timing and Triggering

The HP 8980A has timing control from 1/2 ns to 2 ms/div that is easily controlled in steps or fine-tuned with a knob. I and Q can be delayed 1000 screen widths, or 20 ms, whichever is smaller. And the skew function allows the user to compensate for cable length differences between the I and Q channels, or to display modulations for which the two channels are purposely offset, such as in offset QPSK.

In addition to triggering internally on I, Q or line, the HP 8980A allows a range of external triggering options, including TTL, ECL, variable, or auto levels.

Operating Ease

Engineering productivity increases when test equipment is easy to use and taking measurements is fast. The HP 8980A was designed for intuitive, self-guided use, and minimum keystroke setup. Front panel clarity and one-button function selection allow easy switching among the time, vector and constellation displays. The ability to store and recall up to ten instrument states speeds repetitive measurements, especially in a manufacturing test environment. Additional convenience features like Auto Scope and Preset help the user find the signal or get the instrument into a known state.

Convenience in Automated or Production Line Testing

Automation of vector measurements for benchtop or manufacturing test environments minimizes setup time and measurement time and boosts productivity for extensive and repetitive tests. All HP 8980A front panel controls are easily programmed via the HP-IB. For more information about operating the HP 8980A, ask for Product Note 8980A-1 *Introductory Operating Guide to the HP 8980A Vector Analyzer*.

Specifications

I and Q Channel Inputs

Input Sensitivity

Volts/division range: 5 mV/div to 1 V/div in standard grid, in 1,2,5 sequence or fine resolution using 50 ohm termination.

Input impedance: 50 or 75 ohms, interchangeable with screw-in adaptors.

Maximum input voltage: dc Coupled: ± 5 V peak; ac Coupled: ± 25 Vdc, ± 5 V peak ac

DC measurement accuracy. Measurements with internal A/D converter.

I or Q measurement accuracy: \pm the greater of (1%-of-full-scale or 2mV) $\pm 1\%$ of offset

I vs. Q differential gain: $\pm 1\%$ measured at 100 mV full scale.

Dynamic performance

Transition time: ≤ 1.0 ns (10% to 90%) for an 80%-of-full-scale step measured at 10 mV/div, typical all ranges.

Bandwidth (-3 dB): dc to 350 MHz, including I vs. Q

Timing

Timing is specified for delays less than 100 divisions (100*time/div)

Time/division range: 0.5 ns/div to 2 ms/div in 1,2,5 sequence or fine resolution.

Delay range: 0 to 1000 divisions, 20 ms max.

Skew I or Skew Q range: 0 to 5 divisions

Delta time accuracy: $\pm 3\%$ for delta time > 6 ns or 2 divisions, after the greater of (1 division or 20 ns)

I vs. Q timing accuracy: \pm the greater of: (1 ns or .2 div) at Skew I = Skew Q = 0

Triggering

Internal

Minimum signal, dc to 150 MHz with pulse width > 3 ns: 2 divisions p-p

External

Minimum signal dc to 80 MHz: 100 mV p-p

Minimum signal 80 MHz to 150 MHz: 200 mV p-p

Supplemental Characteristics

I and Q Channel Inputs

DC Display and Marker Accuracy

Deflection factor accuracy: $\pm 1\%$

Display offset accuracy: \pm the greater of 1%-of-full-scale or 2 mV. (Offset=0, center screen voltage)

Measurements

A/D resolution: 12 bits

Measurement noise: 4 counts RMS

Dynamic performance

I-to-Q or Q-to-I crosstalk: -50 dB or 1% of full scale peak, whichever is greater, dc to 200 MHz

Time Base

Time/division accuracy: $\pm 3\%$

Delay reference accuracy: less than the greater of 5 ns or 4.2 divisions (internal trigger only); leading edge of pulse is visible (external or internal trigger)

Time base jitter: the greater of 100 ps or .2 div (specified for delay less than 200 divisions)

Triggering

External Trigger System

ECL: 50 or 75 ohms to -2 V, ECL threshold

TTL: 50 or 75 ohms to gnd, TTL threshold

VARIABLE: 50 or 75 ohms to gnd or -2 V, threshold adjustable as specified

AUTO-LEVEL: 50 or 75 ohms to gnd, threshold continuously adjusted to halfway between high and low input levels (100 kHz to 150 MHz)

External trigger maximum input: ± 5 V peak dc+ac, 5 V peak-to-peak ac

Internal variable trigger levels

Range: anywhere on screen

Resolution: 2% of full scale

Accuracy: $\pm 5\%$ of full scale

External variable trigger levels

Range: ± 5 V

Resolution: 40 mV

Accuracy: ± 100 mV

Gate Input: (Rear Panel)

ECL: 50 ohms terminated to -2 V, ECL threshold

TTL: 50 ohms terminated to ground, TTL threshold

Gate Operation: Blanks display and disables measurements asynchronously with trigger rate.

Minimum pulse width (On or Off): 100 ns

Gate timing uncertainty: ± 2 ns

Ordering Information

HP 8980A Vector Analyzer

Accessories

HP 1124A Active Probe

Price

Contact HP

\$325.00



FIBER OPTIC TEST EQUIPMENT

General Information

Probably the most remarkable fact about the evolution of fiber optics has been their rapid market growth. Design work began some twenty years ago, with trial projects carrying live telephone traffic being installed ten years later. Today, optical fibers are mass-produced for many applications worldwide.

Technical Background

In general, all fiber optic systems incorporate the following elements: transmitters, fibers, repeaters, and receivers, all of which are linked by connectors and/or splices.

Today, size, lifetime, reliability and ruggedness are major factors in the choice of sources and receivers for optical communication links.

Sources employ LED's or LD's (laser diodes) to generate the optical output, while APD's or PIN diodes are used to detect the incident optical power on the receiving side.

Optical Sources

LED's are primarily used in short distance systems (<10km) with data rates below 100MHz. A limiting factor is their broad spectral width and the low coupling efficiency compared with an LD. Advantages are their simpler drive electronics, a higher reliability, and the lower price.

LD's, on the other hand, feature a small spectral width, an excellent coupling efficiency, and reach data rates up to 2 GHz. Thus LD's enable repeaterless data transmission over great distances (40km).

Optical Fibers

Inside the fiber, light is guided by total reflection at the core/cladding boundary due to corresponding differences in the refractive indices. Fibers employed as transmission media fall into three categories:

Step Index Fiber. Nowadays this type is of less importance due to its low bandwidth (<5MHz), high multimode dispersion, and high attenuation. Mainly used in industrial applications (in avionics, vessels, or automobiles).

Graded Index Fiber. This type features higher data rates (up to 800MHz x km), a lower dispersion and attenuation. This fiber is frequently used in datacom or LAN applications.

Single-Mode Fiber. This fiber is preferred when highest data rates are required. Based on data rates up to 100GHz x km and low dispersion and attenuation, this fiber is the ideal transmission media in long-haul telecommunication systems.

Optical Receivers

To convert light back into an electrical signal for further processing PIN, diodes serve as receiving detectors when high data rates are required. This property is combined with favorable linearity and high stability. When increased sensitivity is of major concern, APD's are preferred. Due to their non-linearity, APD's are used only for purely digital applications, while PIN diodes can be used in both analog and digital systems.

Fiber Optic Test Environments

HP's line of fiber optic test equipment offers new measurement capabilities for design and production engineers in a number of different application areas.

Computers

The increasing sophistication of computers and their distributed services, prompted by the need for greater data handling capabilities and higher memory densities, has resulted in a demand for fiber optic systems. Major application areas include the mutual interfacing of central processors, the linking of them to peripheral devices, and data transmission within the mainframe. Reduced bit error rates — free from environmental interference — are assured.

Local Area Networks

The development of Local Area Networks has been stimulated by the availability of low-cost, intelligent, digital terminal hardware and the trend towards distributed data acquisition and processing. Here also, optical fibers often serve as the transmission medium in networks which may be configured as ring, star or bus structures. Such systems are primarily installed in business environments to support office operations, manufacturing facilities or private automatic branch exchanges; they all take advantage of the absence of crosstalk, electromagnetic interference or echoes — often a problem in twisted pair and coax systems.

Industrial Electronics

Industrial environments represent an ideal market for numerous fiber optic applications. Examples include power plants, railroad networks and the metal industry, where data acquisition, control and process signals need to be transmitted, without being affected by strong electromagnetic fields.

Some automobile and avionics manufacturers have begun to install optical fibers instead of copper cables to increase safety and reliability, and to save weight.

Fiber optic sensors are gaining importance in hazardous environments to monitor chemical, biological, and physical processes.

Telecommunications

The telecommunications industry has traditionally been the sphere of greatest interest and highest investment for fiber optics technology. The majority of resources are employed to investigate, design and install new information transfer and processing equipment; long-haul transmission systems (submarine fiber optic cables linking continents, for example), and networks in high traffic environments.

Measurement Problems and Solutions

Designers, manufacturers and end-users of fiber optic components, modules or systems face a large variety of measurement tasks. These tasks range from physical measurements, such as fiber geometry or numerical aperture, to system performance tests in the time or frequency domain.

HP offers two powerful lines of fiber optic test instruments. The first line consists of the HP 8150A Optical Signal Source, the HP 8151A Pulse Power Meter, and the HP 81511/81512A Optical Heads. This test equipment offers new ways to perform parametric tests with reliable and repeatable results in the 850 and 1300nm wavelength range.

Testing the sensitivity or defining the pulse response of a receiver demands a stimulus such as the HP 8150A. With the help of this instrument, it is an easy task to perform parametric tests at calibrated levels, under fully-specified and precisely-controlled conditions.

Its counterpart the HP 8151A, together with the HP 81511/81512A, provides technicians and engineers with an ideal tool for verifying analog and digital power level parameters in terms of peak and average power.

The second line consists of the new HP 8152A Optical Average Power Meter, the HP 8154B LED Source, the HP 8158B Optical Attenuator, and the HP 8159A Optical Switch. This line aims at applications in the 1300nm and 1550nm wavelength range.

A major criterium for data transmission is the bit error rate of the transmission line. With the HP 8158B Optical Attenuator and the HP 8152A Optical Average Power Meter, it will be possible to precisely determine that power level at which the bit error rate increases.

Whenever reference measurements are performed, the HP 8154B will serve as the appropriate stimulus on the one hand, and the HP 8159A as switching element that truly automates these reference measurements on the other.

FIBER OPTIC TEST EQUIPMENT

Optical Signal Source

Model 8150A



- E/O transducer capability with 250 MHz bandwidth
- Calibrated output power levels from 1 nW to 2 mW

- Built-in modulator (50 MHz)
- Wavelength 850 nm \pm 15 nm

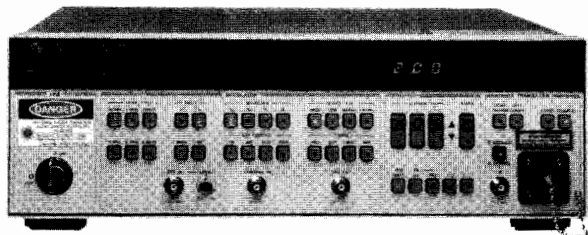

HP 8150A



The HP 8150A is a universal light stimulus for the parametric testing of fiber optic components and systems employing an LD with an 850 nm center-wavelength. The instrument's transducer permits the conversion of both digital and analog electrical signals up to 250 MHz (-3 dBm) into their optical equivalents. The internal modulator features additional capabilities which allow the HP 8150A to function as pulse/function generator with an optical output. All specifications refer directly to the open end of the 2m pigtail fiber and provides the user with well-defined signal conditions at his device under test.

Transducer

In the transducer operating mode, the HP 8150A can be adapted to the user's absolute power level requirements with an adjustable gain from 1.80 nW/V to 1.80 mW/V. Transition times of less than 2 ns ensure the generation of clean, high-speed digital signals up to 250 MHz. Its large bandwidth and optical power range make the HP 8150A a suitable tool for testing large optical systems.

Modulator

The modulator operating mode offers a straightforward method for generating accurate, calibrated, repeatable power levels, by simply programming high or low power values at the frontpanel, or via the HP-IB. In addition, the mesial power level (50% amplitude level) and extinction ratio values (high/low power) of signals are selectable, allowing the user to simulate attenuation effects of fiber optic systems. A rearpanel monitor output allows the permanent control of the electrical signal responsible for modulating the transducer. The internal modulator also offers the choice of various waveforms with adjustable duty cycles or true pulses with variable width. A host of other features, such as FM, AM, PWM and VCO, can be externally and internally activated and contribute to the versatility of the HP 8150A as a stimulus for fiber optic system and automated bench applications.

Traceability and safety

The specifications of the HP 8150A are traceable to the NBS in the USA and other national standard bureaus, such as the PTB in Germany.

A set of safety features are provided in order to meet international safety regulations. The ON/OFF safety key, remote interlock facility and appropriate safety labeling are other standard HP 8150A features which help eliminate hazards to the operator.

HP 8150A Specifications

Optical characteristics

Wavelength: 850nm \pm 15nm

Output: 50/125 μ m graded index, multimode; NA=0.2

Transducer mode

Conversion range: 1.80nW/V to 1.80mW/V

Absolute accuracy: \pm 1dB of setting

Relative accuracy: \pm 0.5dB of setting

Stability: \pm 0.05dB (12 hours, T \leq 2°C)

Electrical input swing: 0.1 Vpp to 1.0Vpp

Electrical input window: \pm 0.5V

Input impedance: 50 Ohm

Offset compensation range: \pm 1.2V

Bandwidth: DC to 170MHz @ -1.5 dB,
to 250MHz @ -3.0 dB

Flatness: \pm 0.25dB (1Hz to 99.9kHz),
 \pm 0.5dB (100kHz to 9.99MHz),
 \pm 1.5dB (10MHz to 170MHz)

Pulse response: $<$ 2.0ns; perturbations: $<$ 15% of amplitude

Modulator mode (using internal pulse/function generator)

Output power

High level: 1.18nW to 2.00mw; **Low level:** 1.00nW to 1.01mW

Mesial level: 1.09nW to 1.10mW;

Extinction ratio: 1.18 to 10.0

Accuracy High/Low/Mesial level (at 30Hz): \pm 1.0 dBopt

Accuracy Extinction ratio (at 30Hz): \pm 20%

Timing parameters of internal modulator

Frequency Range: 1mHz to 50MHz (3 digit resolution)

Operating modes: Normal, Ext. Trigger*/Gate*/Width, Int. Trigger*/Gate*

*Selectable (-90°) start phase for haversine/havertriangle

Control Modes: FM, AM, PWM and VCO

General

HP-IB capability

Interface functions: SH1, AH1, T6, L4, SR1, RL1, PP0, DC1, DT1, C0

Recalibration period: 1 year

Environmental

Storage temperature: -40° C to $+65^\circ$ C

Operating temperature: 0° C to $+55^\circ$ C

Humidity: 95% R.H. from 0° C to $+40^\circ$ C

Power: 100/120/220/240 Vrms; $+5\%$, -10% , 48 - 66 Hz, 140 VA max

Weight: net 12.5kg (27lbs), shipping 16.5kg (36.3lbs)

Size: 133mm(H) x 426mm(W) x 422mm(D) (5.2" x 16.8" x 16.6")

Ordering information

HP 8150A Optical Signal Source

Opt 907: Front handle kit

HP P/N 5061-0089

Opt 908: Rack mount kit

HP P/N 5061-0077

Opt 909: Rack flange and handle combination kit

HP P/N 5061-0083

Opt 910: Extra operating and service manual

HP 81501BC*: FO Cable Diamond HMS-10/HP/
pigtail (supplied with instrument)

HP 15475A: Cleaning kit (supplied with instrument)

*For other fiber optic cables, see 'Fiber Optic Test Accessories' on page 581.

Prices

\$15,400

\$55

\$32.50

\$60

\$60

\$250

\$100

Fast-Ship product—see page 76



FIBER OPTIC TEST EQUIPMENT

Optical Pulse Power Meter

Model 8151A with 81511A/81512A

- Peak and average power measurements
- Accuracy $\pm 2.5\%$
- O/E transducer capability

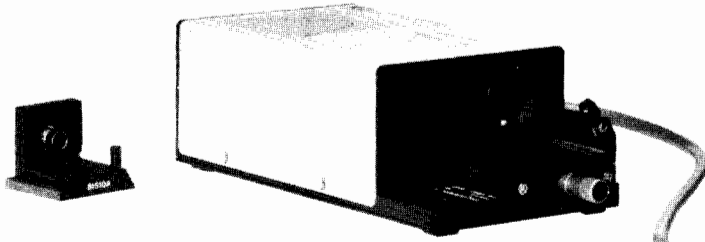

HP 81510A

HP 81511A

The HP 8151A, in combination with the HP 81511A/81512A Optical Heads, is a response measuring instrument for the level characterization of fiber optic components, modules and systems. In addition to performing average power measurements, the HP 8151A enables the user to accurately determine upper and lower peak power levels - important in digital applications. This feature is also useful for applications where non-repetitive signals need to be evaluated, or where threshold levels are to be determined. The instrument's versatility is further enhanced by capabilities which allow the user to measure the amplitude, mesial power and extinction ratio of a signal.

The instrument's transducer has a frequency range of 250MHz, and outputs an electrical signal which corresponds directly to the optical input waveform. The transducer output can be applied to other instruments for further processing, or displayed on an oscilloscope. By using the transducer, timing related measurements as functions of optical power (e.g. propagation delay versus power) are possible.

HP-IB programmability is a standard feature of this instrument, thereby giving the user total remote control of all power meter functions.

HP 81511A and HP 81512A Optical Heads

These products complement the operation of the HP 8151A Optical Pulse Power Meter. The HP 81511A Optical Head is for use at operating wavelengths between 550 and 950nm (calibrated for 850nm), and the HP 81512A for use between 900 and 1725nm (calibrated for 1300nm). The HP 8151A cannot be operated without an optical head. All heads carry interface adapters for fiber connectors (Standard 'Diamond HMS-10', optional NEC/D3 (FC), and others) and bare fibers. The manual z-microdrive facilitates the optimum coupling of the fiber end to the PIN diode in the head. The HP 8151A's frontpanel trend meter assists in determining the coupling efficiency.

A calibration grid on top of each optical head indicates typ. correction factors to be entered into the HP 8151A for operating wavelengths other than that for which the head is calibrated. Thus, the HP 8151A can be adapted to operate at any wavelength in the 550 to 1725nm range.

HP 8151A Specifications

Optical characteristics of HP 81511A/81512A Optical Heads

Wavelength range HP 81511A: 550 to 950nm, cal for 850nm
 HP 81512A: 900 to 1725nm, cal for 1300nm
Maximum core diameter: HP 81511A: 200 μ m
 HP 81512A: 100 μ m

Optical power measurements

Parameters measured: high, low, and mesial power levels, amplitude, extinction ratio, average power
Measurement range: HP 81511A: +10dBm to -60dBm
 HP 81512A: 0dBm to -50dBm
Resolution: 3 digits (Watts), 1pW min.
 4 digits (dB), 0.01dB min.



HP 8151A



Accuracy: (applies to linear display in Watt, rel. to calibration):

Range [dBm]	\pm (of read + counts)	Hi/Low Peak Power Flatness	Average Power \pm (of read + counts)
+10 ¹	0.3dB + 5	200Hz - 9.99MHz: ± 0.4 dB of ampl. ² 10MHz - 99.9MHz: ± 0.6 dB of ampl. ²	0.1dB + 5
0	0.3dB + 30 ²		0.1dB + 5
-10	0.35dB + 50		0.1dB + 5
Bandwidth			
-20	0.2dB + 10	10kHz	0.1dB + 5
-30	0.2dB + 10	6kHz	0.1dB + 5
-40	0.2dB + 20 ²	1kHz ²	0.15dB + 10 ²
-50	0.2dB + 50 ²	1kHz ²	0.2dB + 50 ²
-60 ²	0.3dB + 80 ²	4kHz ²	0.2dB + 50 ²

1) not valid for HP 81512A 2) better specifications for HP 81511A

Transducer (opto-electric conversion)

Actual waveform depends on measurement range. Calibrated for 850nm (HP 81511A)/1300nm (HP 81512A).

Conversion Accuracy (for 30Hz squarewave):

Range [dBm]	Conversion Factor DC	Accuracy of Conversion	Bandwidth w/o Lowpass	rms Noise [dBm]
+10 ¹	1V/10mW ¹	± 0.3 dB ± 10 mV ¹	DC-250MHz ¹	-20 ¹
0	1V/1mW	± 0.3 dB ± 10 mV	DC-250MHz ²	-20 ³
-10	1V/1mW	± 0.35 dB ± 20 mV	DC-250MHz ²	-30
-20	1V/10 μ W	± 0.35 dB ± 20 mV	DC-10kHz ²	-40 ³
-30	1V/1 μ W	± 0.3 dB ± 20 mV	DC-6kHz ²	-50 ³
-40	1V/1 μ W	± 0.3 dB ± 20 mV	DC-1kHz ²	-60 ³
-50	1V/10nW	± 0.3 dB ± 50 mV ³	DC-1kHz ²	-60 ³
-60 ³	1V/1nW ¹	± 0.3 dB ± 20 mV ¹	DC-4kHz ²	-70 ³

1) for HP 81511A only 2) 150MHz for HP 81512A 3) better specifications for HP 81511A

Pulse response

Transition time: ≤ 2 ns full b/w (≤ 3 ns for HP 81512A)

Perturbations: $\leq 10\%$ of amplitude

General

HP-IB capability

Interface functions: SH1, AH1, T6, L4, SR1, RL1, PP0, DC1, DT1, C0

Recalibration period: 1 year

Environmental

Storage temperature: -40°C to +70°C

Operating temperature: 0°C to +55°C.

Humidity: 95% R.H. from 0°C to +40°C

Power: 100/120/220/240 Vrms; +5%, -10%, 48 to 66Hz, 100VA max.

Weight: HP 8151A: net 8kg (17.5lbs), shipping 10kg (22lbs)

HP 81511A: net 1.3kg (2.9lbs), shipping 2kg (4.4lbs)

HP 81512A: same as for HP 81511A

Size: HP 8151A: 140mm(H) x 220mm(W) x 530mm(D) (5.7" x 9" x 21.6")

HP 81511A: 60mm(H) x 96mm(W) x 200mm(D) (2.5" x 3.9" x 8.2")

HP 81512A: same as for HP 81511A

Ordering information

HP 8151A Optical Pulse Power Meter

Opt 907: Front handle kit

HP P/N 5061-0089

Opt 908: Rack mount kit

HP P/N 5061-0057

Opt 910: Extra operating and service manual

HP P/N 08151-90001

HP 81511A Optical Head 550 to 950nm

HP 81512A Optical Head 900 to 1725 nm

Note: The HP 8151A cannot be used without an optical head and connector adapter. For connector adapters and cleaning kit, see 'Fiber Optic Test Accessories' on page 581

Fast-Ship product—see page 766.

Price

\$7500

\$ 55

\$32.50

\$ 60

\$3500

\$4800

FIBER OPTIC TEST EQUIPMENT

Optical Receiver, Optical Switch

Model 81519A, 8159A

577



- Calibrated O/E conversion
- DC to 400 MHz bandwidth
- ± 0.3 dB conversion accuracy



HP 81519A

The HP 81519A is a linear transducer which converts optical signals into their electrical equivalents. The instrument is designed as a front-end interface to conventional electronic test equipment and as a general purpose receiving device for testing fiber optic modules and systems.

A PIN diode, calibrated at 850nm, serves as opto/electric converter in the range between 550 and 950nm. The characteristic curve on top of the instrument indicates the transducer gain in this range.

With the wide demodulation frequency band of DC to 400 MHz and an intrinsic transition time of less than 1.1 ns, the HP 81519A is a valuable tool for testing fiber optic devices in computer, local area network and aerospace applications. When operating in conjunction with other equipment, measurements such as pulse response and bandwidth in the time and frequency domains can be performed accurately.

With the adjustable offset, the conversion window can be conveniently shifted between 0 and 1 mW in accordance with the optical input power.

HP 81519A Specifications

Optical characteristics

Wavelength range: 550 to 950 nm, cal for 850 nm

Input: Adapts to core diameters up to 80 μ m; N.A. ≤ 0.2

Input swing: 1 mW (min. low level 0mW, max. high 1.5 mW)

Input connector: Diamond HMS-10/HP

connector uncertainty: ± 0.1 dB

Transducer characteristics

Conversion, opto/electric

Conversion gain: -1 V/mW; **Accuracy:** ± 0.3 dB $\pm 10\mu$ W

Small signal bandwidth: DC to 400 MHz (@ -3.0 dB)

Flatness of conversion: ± 0.3 dB (DC to 150 MHz)

NEP: < 700 nW (rms); **Distortion:** typ. 20dB (40dBel.)

Output (into 50 Ohm)

Range: ± 0.5 V; Output impedance: 50 Ohm $\pm 2\%$

Response

Transition time: ≤ 1.1 ns; Perturbations: $< 10\%$ of ampl.

General

Environmental

Storage temperature: -40°C to $+70^\circ\text{C}$

Operating temperature: 0°C to $+55^\circ\text{C}$

Humidity: 95% R.H. from 0°C to $+40^\circ\text{C}$

Power: 115/230 Vrms, $+10\%$, -22% , 48 to 66 Hz, 16VA max.

Weight: net 1.7 kg (3.6 lbs), shipping 2.4 kg (5 lbs)

Size: 95mm(H) x 105mm(W) x 345mm(D) (3.8" x 4.3" x 13.6")

Ordering information

HP 81519A Optical Receiver

Opt 910: Extra operating and service manual

Price

\$3000

\$ 20

- Insertion loss < 3.5 dB incl. two connectors
- Crosstalk attenuation > 50 dB
- Repeatability 0.2dB

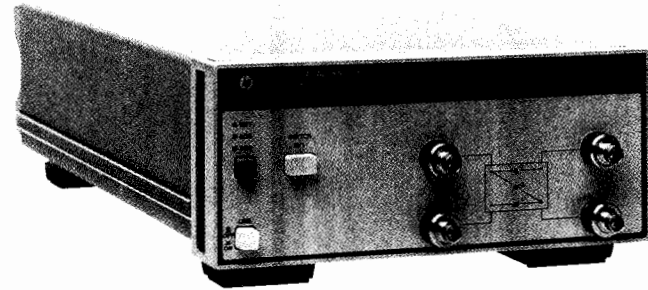

HP 8159A



The HP 8159A Optical Switch features two optical inputs, A_{in} and B_{in} , and two outputs, A_{out} and B_{out} . The following switch combinations can be chosen either manually or via HP-IB: A_{in} to A_{out} , B_{in} to B_{out} or A_{in} to B_{out} .

In areas where reference measurements are of great interest, e.g. in production environments, the HP 8159A helps to save valuable test time, formerly spent for time-consuming re-connections between the device under test and the reference power meter. Full programmability permits R&D or production engineers to truly automate their measurements.

The highly switching rate of 20Hz shortens the measuring time, thus increasing the throughput. With excellent switching repeatability of 0.2dB and high performance Diamond/Interoptics connectors, the HP 8159A specifically assists the user in performing accurate, reliable and repeatable measurements.

For critical tests, immersion oil can be used to decrease the insertion loss as the HP 8159A features easily cleanable connectors.

HP 8159A Specifications

Optical characteristics

Fiber type: 50/125 μ m, G.I.

Numerical aperture: 0.2 ± 0.02

Input/Output connector: Diamond HMS-10/HP

Insertion loss (incl. 2 connectors, for all switching paths): < 3.5 dB

Typical: < 2.8 dB

Switch repeatability (1000 cycles, $\pm 2^\circ\text{C}$ window): 0.2dB window

Crosstalk attenuation: > 50 dB

Supplementary Performance Characteristics

Wavelength range: 780 - 1350nm

Switching rate: 20 Hz

Settling time: < 25 ms

Lifetime: 10^6 cycles

General

HP-IB capability

Interface function: SH1, AH1, T6, L4, SR1, RL1, PP0, DC1, DT0, C0

Environmental

Storage temperature: -40°C to $+75^\circ\text{C}$

Operating temperature: 0°C to $+55^\circ\text{C}$

Humidity: $< 95\%$ R.H. from 0°C to $+40^\circ\text{C}$

Power: 100/120/220/240Vrms, 48 - 400Hz, $+5\%$, -10% , 35VA max

Weight: net 3.75kg (8.3lbs), shipping 7.8kg (17.2lbs)

Size: 89mm(H) x 212,3mm(W) x 345mm(D) (3.5" x 8.36" x 13.6")

Ordering information

HP 8159A Optical Switch

Opt 907: Front handle kit

HP P/N 5061-9688

Opt 908: Rack flange kit

HP P/N 5061-9672

Opt 910: Add. operating and service manual

P/N 5061-9701 Bail handle kit

Price

\$4100

\$50 ☎

\$50 ☎

\$40

\$38 ☎

☎ Fast-Ship product—see page 766



FIBER OPTIC TEST EQUIPMENT

Optical Average Power Meter

Model 8152A

- Two optical inputs
- Optical heads individually calibrated from 850 to 1700nm
- Multi- and single-mode
- 3.7% accuracy

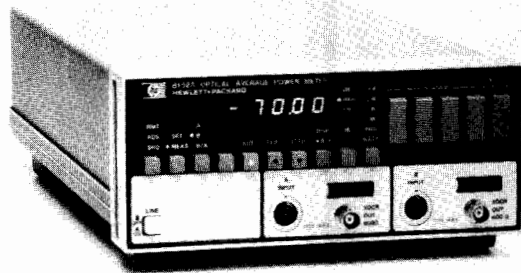

HP 8152A



The HP 8152A Optical Average Power Meter and its optical heads provide the accuracy and versatility for absolute and relative power measurements in a fiber optic test environment. Applications range from output power measurement of active optical components, or loss/attenuation measurement of passive optical components, to ratio measurement of power splitters.

Individually calibrated optical heads ensure highly precise measurement results over the entire wavelength range from 850 to 1700nm. After entering the operating wavelength, the appropriate sensitivity correction factor will automatically be taken into account to ensure the correct measurement value is displayed.

The combination of 2 independent optical inputs, the capability to perform ratio measurements, plus the new HP 81000BS Optical Power Splitter provides a fast, easy solution to determine the power ratio of an optical splitter or eliminating the instabilities of an optical source.

All functions can be set manually via front panel controls, or programmed via HP-IB for complete remote control. The HP 8152A is therefore an ideal tool for departments such as R&D, production and incoming evaluation.

HP 81521B Optical Head

It is the standard optical head for the HP 8152A. The HP 81521B covers almost all common applications in the wavelength range from 850 to 1700nm.

Each optical head is individually calibrated and features a non volatile memory for storage of wavelengths other than 1300nm, therefore, simple entry of the wavelength at the power meter ensures accurate measurements.

HP 8152A Specifications

Optical characteristics of the 81521B Optical Head

Wavelength range: 850 to 1700nm
Sensor element: Cooled Ge PIN diode
Sensor diameter: 5mm
Maximum power density: 10mW/mm²

Optical power measurements

Measurement range: +3 to -80dBm
Resolution: 4½ digits, 0.01dB, 10pW best case
Traceable calibration accuracy: ±5%

Accuracy

(rel. to calibration at 1300nm and -20dBm, log. reading, 0 to 40°C ambient temp., 10 to 100% full scale, -50dBm range 100pW to 100%):

Range [dBm]	Average power ± (of read + Watts)
0	0.15dB
-10	0.15dB
-20	0.15dB
-30	0.15dB
-40	0.15dB
-50	0.15dB + 100pW

General

HP-IB capability

Interface function: SH1, AH1, T6, L4, SR1, RL1, PP0, DC1, DT1, C0

Recalibration period: 1 year

Warm-up time: 15 minutes

Environmental

Storage temperature: -40°C to +75°C

Operating temperature: 0°C to +55°C

Humidity: <95% R.H. from 0°C to +40°C

Power: 100/120/220/240Vrms, +5%, -10%, 90VA max., 48-400Hz

Weight: **HP 8152A:** net 4.3kg (9.5lbs), shipping 8.6kg (19lbs)

HP 81521B: net 0.45kg (1lbs), shipping 1kg (2.2lbs)

Size: **HP 8152A:** 89mm(H) x 2123mm(W) x 345mm(D) (3.5" x 8.36" x 13.6")

HP 81521B: 37.7 diameter, 140mm length (1.5" x 5.5")

Ordering information

	Price
HP 8152A Optical Average Power Meter	\$2900
Opt 907: Front handle kit (HP P/N 5061-9688)	\$50
Opt 908: Rack flange kit (HP P/N 5061-9672)	\$50
Opt 916: Additional operating manual	\$40
P/N 5061-9701: Bail handle kit	\$38
HP 81521B Optical Head 850 to 1700nm	\$1750
HP 81010BL Lens for 9/125um, 1300 to 1550nm	\$90
HP 81050BL Lens for 50/125um, 1300 to 1550nm	\$130
HP 81000AF Filterholder	\$35
HP 81000BS Optical Power Splitter 1300 to 1550nm	\$1800

Note: The HP 8152A cannot be used without an optical head, appropriate connector adapter and optical lens. For additional information, see "Fiber Optic Test Accessories" on page 581.

Fast-Ship product—see page 766.

FIBER OPTIC TEST EQUIPMENT

LED Source 1300NM

Model 8154B

579



- Stability $\pm 0.02\text{dB}/1\text{h}$ and $\pm 0.04\text{dB}/12\text{h}$
- Internal 270Hz chopper generator
- External modulation up to 1MHz

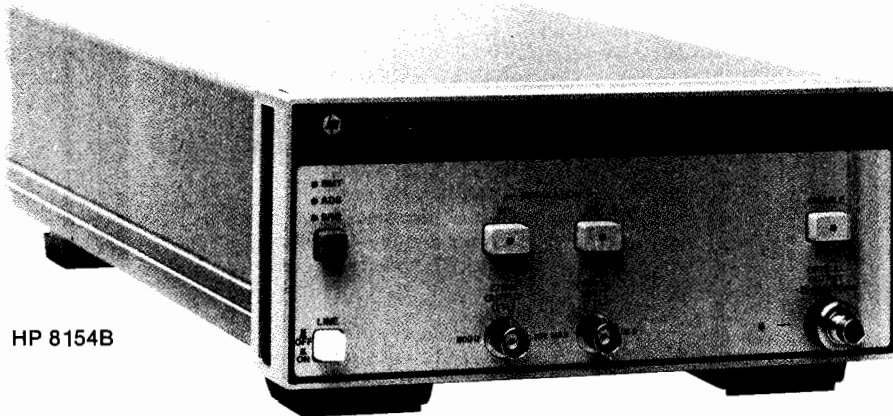

HP 8154B



The HP 8154B is a high performance 1300nm LED source. Whether the insertion loss of connectors, attenuation of cables or the splice loss of optical links needs to be evaluated, the HP 8154B provides the required power level stability.

Even for month-long environmental tests, as often performed by connector and fiber/cable manufacturers, the HP 8154B ensures accurate measurements due to its long-term stability of less than 0.04dB within 12h, and 0.3dB over one year within the specified temperature range.

The HP 8154B outputs CW or 270Hz chopped light. External modulation (TTL levels) up to 1MHz is also possible, and allows signal performance tests on short distance links when low data rates are required.

HP 8154B Specifications

Optical characteristics

Wavelength range: 1300nm $\pm 40\text{nm}$

Half spectral bandwidth: 50 to 90nm

Fiber type: 50/125 μm , G.I.

Numerical aperture: 0.2

Output connector: Diamond HMS-10/HP

Output power

Optical power out of 50/125 μm fiber: 10 μW (-20dBm)

Optical power out of 62.5/125 μm fiber: 10 μW (-20dBm)

Accuracy (incl. stability, power degradation over time, cross-mateability of connectors, variation over temperature and absolute calibration accuracy): $< \pm 1.0\text{dB}$

Stability over 1h and $\pm 2^\circ\text{C}$ env. temp. window: $< \pm 0.02\text{dB}$

Stability over 12h and $\pm 2^\circ\text{C}$ env. temp. window: $< \pm 0.04\text{dB}$

Stability within recal. period and 0 to 55 $^\circ\text{C}$ (with respect to 25 $^\circ\text{C}$): $< \pm 0.3\text{dB}$

Add. degradation over 1000h of operation: $< 0.1\text{dB}$

Supplementary Performance Characteristics

Digital Input

Input levels: TTL

Max. input voltage: $\pm 10\text{V}$

Input impedance: 10 kOhm

Input frequency: 0 to 1MHz

270Hz Output TTL

Output levels: TTL

Max. input voltage: $\pm 10\text{V}$

Output impedance: 600 Ohm

Output frequency: 270Hz (derived from internal quartz oscillator)

Optical Output

Output power out of 9/125 μm single-mode fiber: 0.3 μW (-35dBm)

Operating Modes

Output disable: LED switched off

Digital input enable: Activates the digital input

Internal modulation enable: Activates internal 270Hz generator

General

Recalibration period: 1 year

Warm-up time: 30 minutes

HP-IB Capability

Listen

Output/modulation disable/enable: $< 50\text{ms}$

Receive time: $< 1\text{ms}/\text{character}$

Talk

Query commands: $< 0.5\text{ms}/\text{character}$

HP-IB interface function code: SH1, AH1, T6, L4, SR1, RL1, PP0, DC1, DT0, C0

Environmental

Storage Temperature: -40°C to $+75^\circ\text{C}$

Operating Temperature: 0°C to $+55^\circ\text{C}$

Humidity: $< 95\%$ R.H. from 0°C to $+40^\circ\text{C}$

Power: 100/120/220/240Vrms, $+5\%$, -10% , 48-400Hz, 35VA max.

After being switched off the instrument will come up with the output and digital input disabled.

Dimensions: 89mm(H) x 212.3mm(W) x 345mm(D)
(3.5"x8.36"x13.6")

Weight: net 3.75kg (8.3lbs), shipping 7.8kg (17.2lbs)

Ordering Information

HP 8154B LED Source 1300nm

Price

\$4900

Opt. 907: Front handle kit (HP P/N 5061-9688) \$50

Opt. 908: Rack flange kit (HP P/N 5061-9672) \$50

Opt. 916: Additional operating manual \$40

P/N 5061-9701 Bail handle kit \$38

For adapters, cables and other accessories see 'Fiber Optic Test Accessories' on page 581

☎ Fast-Ship product—see page 766.



FIBER OPTIC TEST EQUIPMENT

Optical Attenuator

Model 8158B

- Suited for multimode and single-mode fibers
- Calibrated at 1300nm and 1550nm
- High resolution of 0.01dB



HP 8158B



The HP 8158B Optical Attenuator is a fully programmable and highly flexible test instrument. Due to its state-of-the-art fiberless design, all applications employing fibers with core diameters up to 85 μ m are covered with one instrument. Multimode and single-mode measurements can be performed by simply pressing the respective key.

Even when the present application switches from 1300nm to 1550nm, no upgrade is necessary for the HP 8158B. Individual calibration at 1300nm and 1550nm and stored correction factors for other wavelengths in a non-volatile memory obsolete look-up tables and ensures easy and straightforward operation.

HP 8158B Specifications

Optical Characteristics

Specifications are measured at 1300nm and 1550nm using a CW laser diode source with constant output power and fibers with 50/125 μ m (NA=0.2, G.I.) and 9/125 μ m (NA=0.1)

Wavelength Range: 1200nm to 1650nm

Connector Type: Diamond HMS-10/HP

Applicable Fiber Type: all fiber types with a NA \leq 0.3

Attenuation Range: **Single-mode** (9/125 μ m fiber): 0 to 60.00dB
Multimode (50/125 μ m G.I. fiber): 0 to 60.00dB

Insertion loss (incl. both connectors)

	single-mode 9 μ m	multimode 50 μ m
worst case	<4.8dB	<3.0dB
typical	3.0dB	1.0dB

Accuracy

Linearity (connector uncertainty not incl.): $\leq \pm 0.4$ dB

Repeatability (of attenuation after any parameter has been changed and reset): $\leq \pm 0.04$ dB

Display

Display Range: 0.00 to 64.00dB

Display resolution: 0.01dB (min. step size)

Supplementary Performance Characteristics

Repeatability (of attenuation after a max. of 6 matings with same connector):

single-mode (9 μ m): <0.2dB

multimode (50 μ m): <0.1dB

Return loss: >27dB

Operating Modes

Output disable: Optical signal path interrupted

Single: Single-mode selected

Multi: Multimode selected

λ : Entering of wavelength between 1200nm and 1650nm for automatic correction of attenuation using typical correction values (measured and specified at 1300nm and 1550nm)

Att: Attenuation is displayed and can be varied

Cal: Entry of calibration factor to adjust display so that displayed value indicates actual power level at output connector of attenuator. Range: ± 99.99 dB

General

HP-IB Capability

All modes and parameters can be programmed

Listen (time to receive, verify and set up parameter)

Output disable/enable, attenuation, λ : <20 to 600ms (depending on actual setting/programmed parameter)

Cal: <5ms

HP-IB Interface Function Code: SH1, AH1, T6, L4, SR1, RL1, PPO, DC1, DT0, C0

Recalibration period: 1 year

No warm-up time required if previously stored within operating temperature range.

Environmental

Storage Temperature: -40°C to $+75^{\circ}\text{C}$

Operating Temperature: 0°C to $+55^{\circ}\text{C}$

Humidity: <95% R.H. from 0°C to $+40^{\circ}\text{C}$

Power: 100/120/220/240Vrms, +5%, -10%, 48-400Hz, 90VA max.

Battery back up (for non-volatile memory): with instrument switched off all current modes and data will be maintained for at least 10 years after instrument delivery

Dimensions: 89mm(H) x 212.3mm(W) x 345mm(D) (3.5" x 8.36" x 13.6")

Weight: net 6.3kg (13.9lbs), shipping 10.6kg (23.4lbs)

Ordering Information

HP 8158B Optical Attenuator

Opt. 907: Front handle kit (HP P/N 5061-9688)

Opt. 908: Rack flange kit (HP P/N 5061-9672)

Opt. 916: Additional operating manual

P/N 5061-9701 Bail handle kit

Price

\$6100

\$50

\$50

\$30

\$38

For adapters, cables and accessories see 'Fiber Optic Test Accessories' on page 581.

☎ Fast-Ship product—see page 766.



Fiber optic test accessories for HP 8150A, HP8151A, HP81511A/81512A and HP 81519A

Interface cables (50/125μm, G.I.)

One end of the 2m optical cable is terminated with the standard Diamond HFS1/KV connector. The other end can be selected from the following:

Cable Configuration	Model No.	Price
Diamond to HFS1/KV	HP 81500A	\$450
Diamond to NEC D4	HP 81500B	\$550
Diamond to pigtail	HP 81500C*	\$250
Diamond to Amphenol 906	HP 81500E	\$550
Diamond to HFS-24 (SMA)	HP 81500F	\$450
Diamond to NTT,FC	HP 81500G	\$550
Diamond to F&G 3702	HP 81500J	\$450
Diamond to Stratos	HP 81500K	\$550
Diamond to AMP-SMA	HP 81500N	\$550

*supplied with HP 8150A

Connector adapters

The table below indicates adapter types (opt. base plate) presently available for use with HP 81511A/81512A Optical Heads.

Adapter Configuration	Model No.	Price
Diamond HFS1	HP 81510A	\$250
NEC D4	HP 81510B	\$200
For pigtail 50/125μm	HP 81510C*	\$200
For pigtail 200/250μm	HP 81510D	\$200
Amphenol 906	HP 81510E	\$200
HP SMA	HP 81510F	\$200
NEC D3(FC)	HP 81510G	\$200
Western Electric	HP 81510H	\$200
F&G 3702	HP 81510J	\$200
Stratos 430	HP 81510K	\$200
AMP-SMA	HP 81510N	\$200
Optical Base Plate	HP 81510Q	\$100
Parallel Beam Adapter	HP 81510R	\$350
Blank Adapter (Can be customized by user)	HP 81510Z	\$ 95

*Supplied with HP 81511A/81512A

HP 5040-9036 Connector Adapter Case \$95

The case conveniently holds up to six connector adapters for safe storage. The wooden box is lined with foam cushion which is customformed to fit the adapter dimensions.

HP 9300-1094 Safety Glasses \$430

For eye protection from possible ocular hazards resulting from exposure to high intensity, short wavelength laser emissions.

Fiber optic test accessories for HP 8152A, HP 8154B, HP 8158B, HP 8159A and HP 81521B

Interface cables:

One end of the 2m optical cables are terminated with a Diamond HMS-10/HP connector with a 2.5mm ferrule. The other end can be selected from the following:

Multimode Fibers (62.5/125μm, G.I.)

Cable Configuration	Model No.	Price
Diamond HMS-10/HP to Diamond HMS-10/HP	HP 81621AC	\$470
Diamond HMS-10/HP to Bare Fiber	HP 81621BC	\$270
Diamond HMS-10/HP to Western Electric ST	HP 81621VC	\$470

Multimode Fibers (50/125μm, G.I.):

Cable Configuration	Model No.	Price
Diamond HMS-10/HP to Diamond HMS-10/HP	HP 81501AC	\$470
Diamond HMS-10/HP to Bare Fiber	HP 81501BC	\$270
Diamond HMS-10/HP to FC	HP 81501FC	\$470
Diamond HMS-10/HP to NEC D4	HP 81501GC	\$470
Diamond HMS-10/HP to Amphenol 906	HP 81501HC	\$470
Diamond HMS-10/HP to AMP-SMA	HP 81501JC	\$470
Diamond HMS-10/HP to F&G 3702	HP 81501LC	\$470
Diamond HMS-10/HP to Stratos 430	HP 81501NC	\$470
Diamond HMS-10/HP to Western Electric ST	HP 81501VC	\$470
Diamond HMS-10/HP to Biconic (WE)	HP 81501WC	\$300
Diamond HMS-10/HP to Diamond HFS-1	HP 81501YC	\$600

Single-mode Fibers (9/125μm):

Cable Configuration	Model No.	Price
Diamond HMS-10/HP to Diamond HMS-10/HP	HP 81101AC	\$470
Diamond HMS-10/HP to Bare Fiber	HP 81101BC	\$270
Diamond HMS-10/HP to FC	HP 81101FC	\$550
Diamond HMS-10/HP to NEC D4	HP 81101GC	\$600
Diamond HMS-10/HP to PC/NTT	HP 81101PC	\$850
Diamond HMS-10/HP to Biconic (WE)	HP 81101WC	\$650

Connector adapters

The table below indicates adapter types presently available for use with the HP 81521B Optical Head.

Adapter Configuration	Model No.	Price
Diamond HMS-10	HP 81000AA	\$130
Bare Fiber Adapter 125μm cladding	HP 81000BA	\$340
FC/NEC D3	HP 81000FA	\$ 90
NEC D4	HP 81000GA	\$130
SMA	HP 81000JA	\$ 90
F&G 3702	HP 81000LA	\$ 90
Stratos 430	HP 81000NA	\$ 90
Biconic (WE)	HP 81000WA	\$ 90
Diamond HFS-1	HP 81000YA	\$130
Blank Adapter (can be customized by user)	HP 81000ZA	\$ 35

Lenses

If the optical power out of a fiber shall be measured an appropriate lens for the optical head has to be used.

Wavelength	Core/Cladding Diameter	Model No.	Price
1300nm, 1550nm	9/125μm, 10/125μm	HP 81010BL	\$ 90
1300nm, 1550nm	50/125μm, 62/125μm	HP 81050BL	\$130

HP 81000AF Filterholder \$35

This filterholder picks up all presently available standard filters with a diameter up to 1".

Optical Power Splitter

The currently available optical power splitter features both mode- and polarization independence. The power splitter has to be used with an optical head such as the HP 81521B.

Wavelength	Fiber core diameter	Model No.	Price
1300nm, 1550nm	9 to 85μm	HP 81000BS	\$1800

HP 15475A Cleaning Kit \$100

The kit consists of cleaning brush, tissue and tape etc. to clean the optical surfaces of fibers and lenses. It is supplied in a plastic carrying case. This kit is supplied with the HP 8150A Optical Signal Source.



POWER METERS

Power Measurements

Average Power Measurements

At microwave frequencies, power is the best measure of signal amplitude because, unlike voltage and current, power remains constant along a lossless transmission line. For this reason, power meters are almost indispensable for microwave measurements. Typical applications include monitoring transmitter power levels, calibrating signal generators, leveling signal sources, and measuring transmission characteristics of unknown devices.

To satisfy the requirements of this broad range of applications Hewlett-Packard has developed a family of general purpose microwave power meters and power sensors. The power sensors use a diode, thermocouple, or thermistor as the power sensing element, and it is important to understand the merits of each of these sensors before choosing a particular power meter.

Power Meters and Sensors

Hewlett-Packard makes five average-reading power meters. The HP 438A is a dual channel power meter designed for ATE systems applications. The HP 435B and the 436A are analog and digital meters, which are designed to operate with HP's line of thermocouple and diode power sensors. The HP 432 power meters are designed to operate with HP's line of thermistor mounts: the HP 432A is an analog power meter, and the HP 432B is digital with BCD output.

Thermocouple power sensors are generally preferred for measuring power because they exhibit lower SWR and wider dynamic range than previously used thermistor elements. Low SWR is directly responsible for superior accuracy since mismatch errors are lower.

Thermocouple sensors (HP 8481, 8482, 8483, 8485A, R8486A, Q8486A) are available from 100 kHz to 50 GHz and range from -30 dBm to +44 dBm. The HP 8484A diode sensor operates with the same meters and extends the input level down to -70 dBm. This sensor uses a Low-Barrier Schottky Diode to achieve exceptional 100 pW (-70 dBm) sensitivity and low noise and drift. Because the diode is always operated in its square law region (voltage out \propto power in), the HP 8484A can be used to measure the true power of complex as well as CW waveforms.

Thermistor power sensors (HP 478A, 486A series) operate with the HP 432A and 432B power meters. Since these power meters are based on balanced bridge principles, they are used whenever a direct dc-substitution technique is required. In addition, waveguide thermistor mounts are available from 8.20 to 40 GHz.

Peak Power Measurements

A frequent requirement in microwave work is the measurement of peak power in a periodic pulse. Rather than calculate peak power from an average power measurement, it would be more convenient to measure peak power directly. Hewlett-Packard produces two versatile instruments that accurately and conveniently measure peak power from 50 MHz to 18 GHz, and from 0 dBm to + 20

dBm on pulses with widths from 100 nanoseconds to CW.

The HP 8900C is an economical analog power meter calibrated in watts and dBm. The HP 8900D has an easy to read 3½ digit display calibrated in watts. Both of these peak power meters work with the HP 84811A peak power sensor that conveniently detaches from the meters for storage, recalibration, or replacement.

The HP 8900C/D meters feature two modes of operation, Direct and Compare. In the Direct mode, the meter automatically measures and displays the maximum RF power. In the Compare mode, an oscilloscope and a meter front panel control are used to measure power at arbitrary points on the pulsed waveform. In this mode, the detected pulse train and an accurate reference line, supplied by the HP 8900C/D, can be simultaneously displayed on the oscilloscope CRT. The front panel control moves the reference line up or down with respect to the detected waveform. The user can then measure power at any desired point on the waveform by simply moving the reference line to that point.

Automatic Systems to Calibrate Power Sensors and Attenuators

Power sensors and attenuators, in most cases, are the standards against which signal levels are compared. For this reason, it is essential that they be periodically recalibrated to maintain measurement integrity. Power sensors and attenuators are calibrated by either a highly accurate and fast, but expensive automatic network analyzer or by an economical, manual, but slow and tedious system. There is very little calibration capability offered in between. But now, HP offers an automatic power sensor and attenuator calibra-

tion system, the HP 436A-E40. The heart of this system is a power meter based reflectometer controlled by the HP-85 computer.

Calibration systems similar to the HP 436A-E40 have been in use for several years at key Hewlett-Packard calibration laboratories throughout the world.

Figure 1 shows the system configuration. In operation, for power meter calibration, test signals are standardized against a specially calibrated power sensor standard. The sensor to be calibrated is compared against the standardized signals and a calibration chart is plotted or table printed.

The system is also ideal for attenuation calibration. The accuracy and linearity of power meters plus the low SWR of power sensors offer attenuation accuracy surpassed only by error correcting automatic network analyzers.

The reports for Cal Factor and attenuation are printed in either tabular or graph form and they include the calibration uncertainty. Coaxial power sensors and attenuators can be calibrated from 100 MHz to 26.5 GHz in 3 bands, 100 MHz to 2 GHz, 2 to 18 GHz, and 18 to 26.5 GHz. Waveguide thermistor sensors can be calibrated in X, P, and K bands.

Literature

Application Note 64-1, Fundamentals of RF and Microwave Power Measurements, deals with the general theory of microwave power measurements. It covers the basic principals of measurement, calculation of measurement uncertainty, traceability, etc.

Application Note 64-2, Extended Applications of Automatic Power Meters, discusses an automatic power meter system for measuring attenuation, gain saturation and the calibration factor of power sensors.

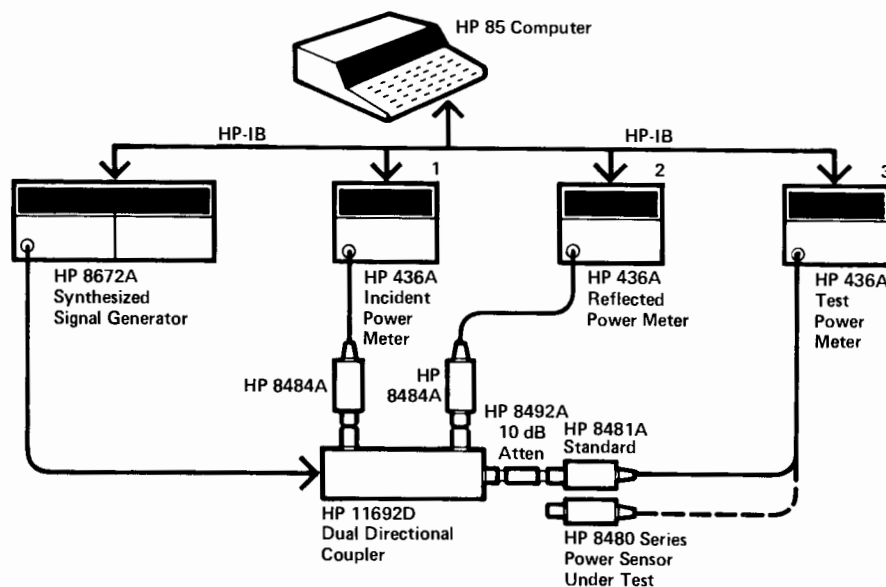

Figure 1. Power sensors and attenuators calibration system.

POWER METERS

Power Meter

Model HP 438A

583



- Ideal for ATE applications
- Dual power sensors
- Innovative ratio & difference measurements



HP 438A

DESIGNED FOR
MATE
SYSTEMS



The HP 438A Power Meter is a dual channel power meter designed specifically for ATE systems. The compact front panel is designed to save space in rack mounted systems, while the dual channel design allows simple measurements of the ratio and difference of power levels from two separate sensors. Compatible with the HP 8480 series of thermocouple and diode sensors, the power and frequency range of the meter extends from -70 dBm to 44 dBm and from 100 kHz to 50 GHz.

Important measurement contributions are a programmable digital filter for optimizing resolution and measurement speed, independent offset (in dB) values for each channel, 0.001 dB resolution available, and a power difference mode for displaying absorbed power in transmission lines. Up to 19 different operating states of the meter can be stored into non-volatile memory for later recall.

The programmable digital averaging filter gives the user control over the inherent tradeoff between speed and accuracy. The AUTO filter mode is usually adequate for fully settled readings with 0.01 dB resolution. Less digital averaging leads to faster but noisier readings, if speed is the critical issue.

The Hewlett-Packard Interface Bus (HP-IB) capability is standard on the HP 438A with programming codes printed on the front panel for easy reference. For U.S. Air Force MATE (Modular Automatic Test Equipment) system applications, Option 700 provides the HP 438A with the internal capability to be controlled by the MATE language CIIL (Control Interface Intermediate Language). All measurement modes are programmable including zeroing, calibration, and Cal Factor. Complete interrupt capability with flexible SRQ operation optimizes the efficiency of program execution in automatic systems.

HP 438A Specifications

Frequency range: 100 kHz to 50 GHz (depending on power sensor used).

Power range: -70 dBm to $+44$ dBm (100 pW to 25 W), sensor dependent. Uses HP 8480 series power sensors; see sensor specs for details.

Operating temperature range: 0 -55° C.

Instrumentation Accuracy

Single channel, linear mode: $\pm 0.5\%$.

Log mode: ± 0.02 dB.

Dual channel, linear mode: $\pm 1\%$.

Log mode: ± 0.04 dB.

Zeroing: automatic, $\pm 0.5\%$ full scale on most sensitive range.

Power Reference

Power output: 1.00 mW. Factory set to $\pm 0.7\%$, traceable to the U.S. National Bureau of Standards.

Accuracy: $\pm 1.2\%$ worst case ($\pm 0.9\%$ rss) for 1 year.

Connector: front panel type N female (also on rear panel, Opt 002).

Meter Adjustments

Cal factor: values from 1% to 150% in 0.1% steps can be entered to account for sensor frequency response. Sensor calibration: automatic self calibration to 1.00 mW.

General

Display: four digit display (five digits in high resolution mode) with 20% over-range capability on all ranges. Annunciators to indicate measurement mode, Cal Factor, offset value, fixed or automatic range and filter values, and error conditions.

Recorder output: linearly proportional to power in watts. One volt corresponds to full scale; $1\text{ k}\Omega$ output impedance, BNC rear panel female connector.

Line voltage: 100, 120, 220 or 240 Vac $+5\%$ -10% . 100 and 120 volts, 48 to 66 Hz and 300 to 440 Hz. 220 and 240 volts, 48 to 66 Hz only.

Power requirements: 65 VA, 35 watts, maximum.

Weight: net, 5.9 kg (13 lb). Shipping, 9.1 kg (20 lb).

Dimensions: 89 mmH x 213 mmW x 418 mmD (3.5 x 8.4 x 16.8 in).

HP-IB interface codes: SH1, AH1, T5, TE0, L4, LE0, SR1, RL1, PP1, DC1, DT1, C0.

Accessories

Furnished: HP 11730A, 2 each, 1.5 metre (5 ft) power sensor cables. Power cable, 1 each, 2.4 metres (7.5 ft). Mains plug matches destination requirements.

Available: To select non-standard lengths for power sensor cables, select option 004 (delete sensor cables) and order as required from HP 11730A-F, power sensor cables. Lengths are available from 1.5 metres (5 ft) to 61 metres (200 ft).

HP 11730A-F Power Sensor Cables

The HP 11730 series power sensor cables are for use with the HP 435B, 436A, and 438A power meters and the HP 8480 series thermocouple and diode power sensors. These cables are designed to reduce RFI effects on low power readings with an improved shielding design in the cable itself. Cables may be ordered individually or in pairs in any combination desired for single and dual channel measurements.

The HP 11730A cable is the standard cable for the HP 435B, 436A, and 438A (2 cables shipped) meters. To order a non-standard cable, select Option 004 for the meter in question, and order the desired cable from below.

Ordering Information

	Price
HP 438A Dual Channel Power Meter	\$4900
Option 002: Rear panel sensor connectors (in parallel with front panel) and additional reference oscillator with rear panel output.	+\$325
Option 700: Internal MATE programming	+1000
Option 004: Delete power sensor cables	-\$146
Option 910: Additional manual	\$25
HP 11730A 1.5 metre (5 ft) sensor cable	\$75
HP 11730B 3.0 metre (10 ft) sensor cable	\$85
HP 11730C 6.1 metre (20 ft) sensor cable	\$105
HP 11730D 15.2 metre (50 ft) sensor cable	\$165
HP 11730E 30.5 metre (100 ft) sensor cable	\$215
HP 11730F 61.0 metre (200 ft) sensor cable	\$355

☛ Fast-ship product—see page 766.



POWER METERS

Thermocouple Power Meter

Model 436A

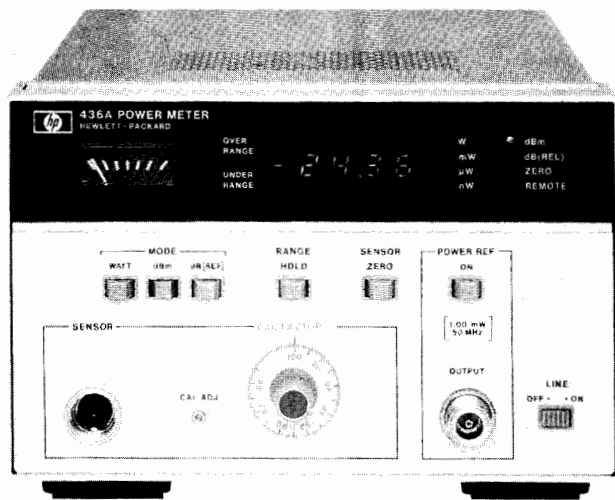

HP 436A Power Meter

The HP 436A Power Meter is a general purpose digital power meter intended for manual and automatic RF and microwave power measurements. It is compatible with the entire series of HP 8480 Power Sensors. Depending on which power sensor is used, the HP 436A can measure power from -70 dBm (100 pW) to $+44$ dBm (25W) at frequencies up to 50 GHz.

The logically organized and uncluttered front panel, and the convenience of push-button operation and digital display make the HP 436A both easy to interpret and easy to use in any application. The auto ranging capability allows for "hands-off" operation.

The HP 436A measures either absolute or relative power. It displays absolute power in either watts or dBm, and relative power in dB.

The HP 436A Power Meter also features optional programmability; the Hewlett-Packard Interface Bus (HP-IB) interface is available. This interface allows full remote control of all power meter functions (CAL function can be programmed to either 100 percent or the CAL factor which has been manually set on the front panel). This option may be added by the user at a later time.

HP 436A Specifications

Frequency range: 100 kHz to 50 GHz (depending on power sensor used).

Temperature range: 0–55°C.

Power Range (display calibrated in watts, dBm, and dB relative to reference power level).

With HP 8481A, 8482A, 8483A, 8485A, R8486A, Q8486A sensors: 50 dB with 5 full-scale ranges of -20 , -10 , 0 , 10 , and 20 dBm ($10 \mu\text{W}$ to 100 mW).

With HP 8481B or 8482B sensors: 44 dB with 5 full-scale ranges of 10 , 20 , 30 , 40 , and 44 dBm (10 mW to 25 W).

With HP 8481H or 8482H sensors: 45 dB with 5 full-scale ranges of 0 , 10 , 20 , 30 and 35 dBm (1 mW to 3 W).

With HP 8484A sensor: 50 dB with 5 full-scale ranges of -60 , -50 , -40 , -30 , and -20 dBm (1 nW to $10 \mu\text{W}$).

Accuracy

Instrumentation

Watt mode: $\pm 0.5\%$.

dBm mode: $\pm 0.02 \text{ dB} \pm 0.001 \text{ dB}/^\circ\text{C}$.

dB (REL) mode¹: $\pm 0.02 \text{ dB} \pm 0.001 \text{ dB}/^\circ\text{C}$.

¹ Specifications are for within range measurements. For range-to-range accuracy add another $\pm 0.02 \text{ dB}$.

Zero: automatic, operated by a front-panel switch.

Zero set: $\pm 0.5\%$ of full scale on most sensitive range, typical; ± 1 count on other ranges.

Zero carry over: $\pm 0.2\%$ of full scale when zeroed on the most sensitive range.

Power reference: internal 50 MHz oscillator with Type N female connector on front panel (or rear panel, Option 003 only).

Power output: 1.0 mW. Factory set to $\pm 0.7\%$ traceable to the National Bureau of Standards.

Accuracy: $\pm 1.2\%$ worst case ($\pm 0.9\%$ rss) for one year.

Supplemental Characteristics

Noise (typical, at constant temperature, peak change over any one-minute interval): 20 pW (HP 8484A); 40 nW (HP 8481A, 8482A, 8483A, 8485A, R8486A, Q8486A); 40 μW (HP 8481B, 8482B); 4 μW (HP 8481H, 8482H).

Drift (1 hour, typical, at constant temperature after 24-hour warm-up): 20 pW (HP 8484A); 10 nW (HP 8481A, 8482A, 8483A, 8485A, R8486A, Q8486A); 10 μW (HP 8481B, 8482B); 1 μW (HP 8481H, 8482H).

Response time typical, measured at recorder output, 0 to 99% of reading:

Range 1 (most sensitive range) < 10 seconds.

Range 2 < 1 second.

Ranges 3 through 5 < 100 milliseconds.

Cal factor: 16-position switch normalizes meter reading to account for calibration factor. Range 85% to 100% in 1% steps.

Cal adj: front-panel adjustment provides capability to adjust gain in meter to match power sensor in use.

Recorder output: linearly proportional to indicated power with 1 volt corresponding to full scale and 0.316 volts to -5 dB ; 1 k Ω output impedance, BNC connector.

RF blanking: open collector TTL; pulls low during meter zeroing. Useful for turning off RF input to sensor during auto-zeroing. BNC connector.

Display: four-digit display with 20% over-range capability on all ranges; analog uncalibrated peaking meter to show fast changes.

Power consumption: 100, 120, 220, or 240 V ($+5\%$, -10%), 48 to 66 Hz, and 360 to 440 Hz; $< 20 \text{ V} \cdot \text{A}$ ($< 23 \text{ V} \cdot \text{A}$ with option 022).

HP-IB Function codes: AH1, C0, DC2, DT0, LE0, PP0, RL2, SH1, SR0, T3, TE0. (For more on these codes refer to the HP-IB section in this catalog.)

Weight: net, 4.5 kg (10 lb). Shipping, 5.5 kg (12 lb).

Size: 134 H x 213 W x 279 mm D (5.2" x 8.4" x 11.0").

Accessories

Furnished: HP 11730A, 1.5 m (5 ft) cable for power sensor; 2.3 m (7.5 ft) power cable. Mains plug shipped to match destination requirements.

Available: To select non-standard lengths for power sensor cables, select option 004 (delete sensor cables) and order as required from HP 11730A-F, power sensor cables. Lengths are available from 1.5 metres (5 ft) to 61 metres (200 ft). To rack mount one HP 436A by itself, order HP 5061-9657 Rack Mount Adapter Kit.

Ordering Information

HP 436A Power Meter Price
\$2900

Option 003: Reference oscillator output on rear panel no charge
only.

Option 004: Delete power sensor cable less \$73

Option 022: Digital input/output, fully compatible add \$500
with HP Interface Bus (HP-IB)

Option 908: Kit for rack mounting one HP 436A \$35

Option 910: Extra operating and service manual add \$25



HP 435B

HP 435B Power Meter

The HP 435B Power Meter is an analog power meter, compatible with the entire series of HP 8480 Power Sensors. Depending on which sensor is used, the HP 435B can measure power from -65 dBm to $+44$ dBm, full scale, at frequencies from 100 kHz to 50 GHz. This versatile instrument also features $<1\%$ instrumentation uncertainty, low noise and drift, auto-zero, recorder output, optional battery operation, and long cable options up to 61 m (200 ft).

HP 11683A Range Calibrator

The HP 11683A Calibrator is specifically designed for use with the HP 435B, 436A and 438A Power Meters. It allows verification of full-scale meter readings on all ranges, as well as meter tracking. Simply connect the cable between the power meter and calibrator. The CAL ADJ control on the power meter is used to set the meter to full scale on the 1 mW range. The calibrator and meter are then stepped through the other ranges verifying accuracy within $\pm 1\%$ plus noise and drift. The HP 11683A also has a polarity switch which tests the Auto-Zero circuit.

HP 435B Specifications

Frequency range: 100 kHz to 50 GHz (depending on power sensor used).

Temperature range: 0 -55° C.

Power Range (calibrated in watts and dB in 5 dB steps).

With HP 8481A, 8482A, 8483A, 8485A, R8486A or Q8486A: -25 dBm (3μ W) to $+20$ dBm (100 mW) full scale.

With HP 8481B or 8482B: $+5$ dBm (3 mW) to $+44$ dBm (25 W) full scale.

With HP 8481H or 8482H: -5 dBm (0.3 mW) to $+35$ dBm (3 W) full scale.

With HP 8484A: -65 dBm (300 pW) to -20 dBm (10 μ W) full scale.

Accuracy

Instrumentation: $\pm 1\%$ of full scale on all ranges.

Zero: automatic, operated by front-panel switch.

Zero set: $\pm 0.5\%$ of full scale on most sensitive range, typical.

Zero carryover: $\pm 0.5\%$ of full scale when zeroed on the most sensitive range.

Power reference: internal 50 MHz oscillator with Type N female connector on front panel (or rear panel, Option 003 only).

Power output: 1.00 mW. Factory set to $\pm 0.7\%$ traceable to the National Bureau of Standards.

Accuracy: $\pm 1.2\%$ worst case ($\pm 0.9\%$ rss) for one year.

Supplemental Characteristics

Noise (typical, at constant temperature, peak change over any one-minute interval): 20 pW (HP 8484A); 40 nW (HP 8481A, 8482A, 8483A, 8485A, R8486A, Q8486A); 40 μ W (HP 8481B, 8482B); 4 μ W (HP 8481H, 8482H).

Drift (1 hour, typical, at constant temperature after 24-hour warm-up): 40 pW (HP 8484A); 15 nW (HP 8481A, 8482A, 8483A, 8485A, R8486A, Q8486A); 15 μ W (HP 8481B, 8482B); 1.5 μ W (HP 8481H, 8482H).

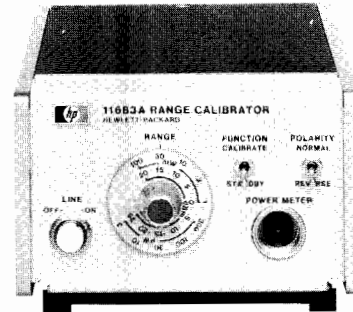

HP 11683A

Response Time (typical, measured at recorder output, 0 to 99% of reading):

Range 1 (most sensitive range) <10.0 seconds

Range 2 <3.8 seconds

Range 3 <1.3 seconds

Ranges 4 to 5 <500 milliseconds.

Cal factor: 16-position switch normalizes meter reading to account for calibration factor; range 85% to 100% in 1% steps.

Recorder output: linearly proportional to indicated power with 1 volt corresponding to full scale; 1 k Ω output impedance, BNC connector.

RF blanking output: provides a contact closure to ground. Used for turning off RF input to sensor during auto-zeroing. BNC connector.

Cal adj: front-panel adjustment provides capability to adjust gain of meter to match power sensor in use.

Power consumption: 110 or 120 V ($+5\%$, -10%), 48 to 66 Hz and 360 to 440 Hz; also 220 or 240 V ($+5\%$, -10%), 48 to 66 Hz only; <20 V \cdot A.

Weight: net, 2.7 kg (5.9 lb). Shipping, 4.2 kg (9.2 lb).

Size: 155 H x 130 W x 279 mm D (6.3" x 5.1" x 11").

Accessories

Furnished: HP 11730A, 1.52 m (5 ft) cable for the power sensor; 2.3 m (7.5 ft) power cable (mains plug shipped to match destination requirements).

Available (See page 583).

To select non-standard lengths for power sensor cables, select option 004 (delete sensor cables) and order as required from HP 11730A-F, power sensor cables. Lengths are available from 1.5 metres (5 ft) to 61 metres (200 ft).

HP 11076A: Carrying case.

HP 5060-8762: Rack adapter frame (holds three instruments the size of the HP 435B).

Combining Cases (See page 752).

HP 1051A: 286 mm (11.25 in.) deep.

HP 1052A: 416 mm (16.4 in.) deep.

These combining cases accept $1/3$ -module Hewlett-Packard instruments for bench use or rack mounting.

HP 11683A Range Calibrator

Calibration functions: outputs corresponding to meter readings of 3, 10, 30, 100 and 300 μ W; 1, 3, 10, 30, and 100 mW.

Calibration uncertainty: $\pm 0.25\%$ in all ranges.

Power: 100, 120, 220, or 240 Vac $+5\%$, -10% , 48 -440 Hz, less than 10 V \cdot A.

Weight: net, 1.13 kg (2.5 lb). Shipping, 1.9 kg (4.2 lb).

Size: 89 H x 133 W x 216 mm D (3.5" x 5.25" x 8.5").

Ordering Information

HP 11683A Range Calibrator

HP 435B Power Meter

HP 435B Options

001: Rechargeable battery installed provides up to 16 hours of continuous operation add \$100

002: Input connector placed on rear panel in parallel with front add \$25

003: Parallel sensor inputs front and rear panels, reference oscillator output on rear panel. add \$25

004: Delete power sensor cable less \$73

910: Extra operating and service manual add \$7.50



POWER METERS

Power Sensors

Models 8481A/B, 8481H, 8482A/B, 8482H, 8483A, 8484A, 8485A, R/Q 8486A, 11708A

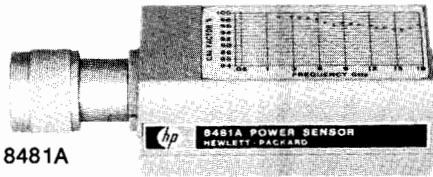

HP 8481A

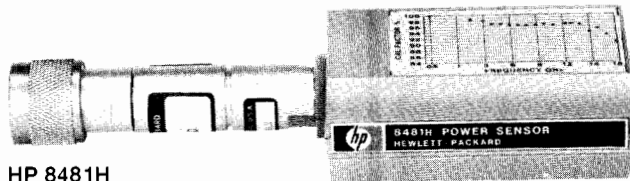

HP 8481H

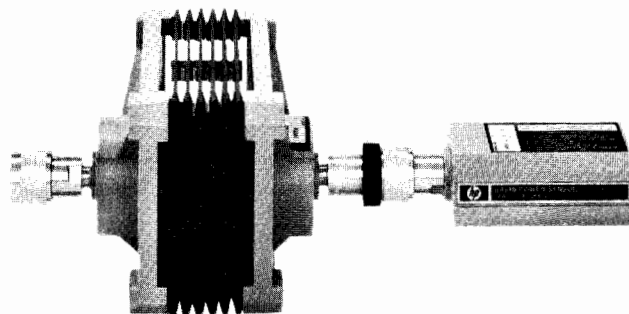

HP 8481B

HP 8480 Series Power Sensors

The HP 8480 series of Power Sensors have been designed for use with the HP 435B, 436A, and 438A Power Meters. They feature wide frequency and power ranges in addition to very low SWR.

The power measurement range of these sensors is from 0.1 nW to 25 watts. With just three sensors a power measurement range of 114 dB can be achieved.

Wide Frequency Range for Many Applications

Power measurements can be made over a frequency range of 100 kHz to 50 GHz. The six frequency ranges covered with these units are 10 MHz to 18 GHz, 100 kHz to 4.2 GHz, and 50 MHz to 26.5 GHz, in 50 Ω sensors and 100 kHz to 2 GHz, with the 75-ohm sensor, and 26.5 to 40 GHz and 33 to 50 GHz in Waveguide.

Low SWR for Low Measurement Uncertainty

The HP 8481/82/83/85/86 series of sensors use a silicon monolithic thermocouple as the sensing element. The small physical size of the thermocouple enables the sensors to have a very low SWR even at 50 GHz. A low SWR reduces mismatch uncertainty error, typically the largest single source of error in power measurements. The HP 8484A sensor uses a crystal detector for higher sensitivity and low SWR.

Individually Calibrated for More Confidence in Results

Each sensor is individually calibrated, traceable to the National Bureau of Standards. A control on the meter compensates for power sensor Cal Factor at any frequency. A precise automatic network analyzer printout for Cal Factor and reflection coefficient is supplied with the HP 8481A/B/H, 8484A, 8485A and R/Q8486A. This means you can significantly reduce mismatch uncertainty by calculating the mismatch error.

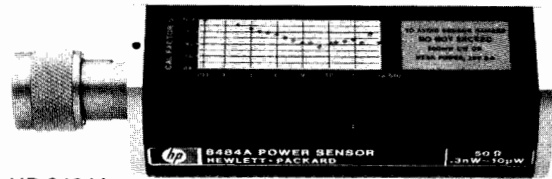

HP 8484A

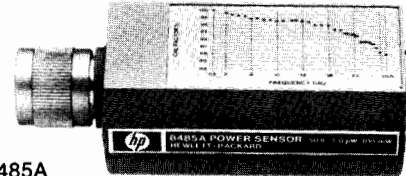

HP 8485A

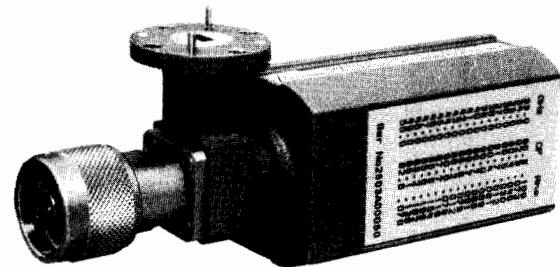

HP Q8486A

High Power Sensors to 25 Watts

The HP 8481B and 8482B High Power Sensors both have a power range of 1 mW to 25 watts. The HP 8481B covers a frequency range of 10 MHz to 18 GHz and the HP 8482B has a frequency range of 100 kHz to 4.2 GHz.

Previous methods of measuring high power levels usually required adding a separate attenuator in front of a low power sensor. With the HP 8481/82B power sensors, the attenuator and sensor are combined into one unit. This reduces mismatch uncertainty error and improves accuracy by including the attenuator in the measured Calibration Factor curves. In addition, light-weight, heat-dissipating fins on the attenuator prevent burns.

Medium Power Sensors to 3 Watts

The HP 8481H measures power from 100 μ W to 3 watts over a frequency range of 10 MHz to 18 GHz. The HP 8482H measures power from 10 μ W to 3 watts over a frequency range of 100 kHz to 4.2 GHz.

Standard Sensors to 100 mW

The HP 8481A, 8482A, 8483A, and 8485A Power Sensors all measure power over a range of 1 μ W to 100 mW. The HP 8481A is a 50-ohm sensor with a frequency range of 10 MHz to 18 GHz. The HP 8482A is a 50-ohm sensor with a frequency range of 100 kHz to 4.2 GHz. The HP 8485A is a 50-ohm sensor with a frequency range of 50 MHz to 26.5 GHz. The HP 8483A is a 75-ohm sensor and covers a frequency range of 100 kHz to 2 GHz.

High Sensitivity Sensors

The HP 8484A measures power from 0.1 nW to 10 μ W over a frequency range of 10 MHz to 18 GHz. It is furnished with the HP 11708A 50 MHz reference attenuator for precise calibration with 1 mW power meter reference oscillator. Noise and drift have been reduced to less than 5% of full scale on the 300 pW range (only 15 pW) when it is used with the HP 435B power meter. Noise and drift are even less with the HP 436A and 438A power meters.

Millimeter-Wave Power Sensors

The HP R8486A and Q8486A Thermocouple Waveguide Power Sensors measure true, average power from 1 μ W to 100 mW over the frequency ranges of 26.5 to 40 GHz (R-band) and 33 to 50 GHz (Q-band).



HP 8480 Series Specifications

HP Model (Nominal Impedance)	Frequency Range	Power Range	Maximum Power	Power Linearity ²	Maximum SWR (Reflection Coefficient)	Size mm (in.)	RF Connector	Price
						Shipping Weight kg (lb)		
8481A (50 Ω)	10 MHz-18 GHz	1 μW to 100 mW	300 mW avg. 15 W peak 30 W • μs (per pulse)	+10 to +20 dBm +2, -4%	10 MHz - 30 MHz: 1.40 (0.166) 30 MHz - 50 MHz: 1.18 (0.083) 50 MHz - 2 GHz: 1.10 (0.048) 2 - 12.4 GHz: 1.18 (0.083) 12.4 - 18 GHz: 1.28 (0.123)	30 x 38 x 105 (1.2 x 1.5 x 4.1)	N(m)	\$630
Option 001						0.5 (1)	APC-7	add \$25
8481B (50 Ω)	10 MHz-18 GHz	1 mW to 25W	0-35°C: 30 W avg. 1 35°C-55°C: 25 W avg. 10 MHz-5.8 GHz 500 W peak 5.8-18 GHz 125 W peak 500 W • μs (per pulse)	+35 to +44 dBm ±4%	10 MHz - 2 GHz: 1.10 (0.048) 2-12.4 GHz: 1.18 (0.083) 12.4-18 GHz: 1.28 (0.123)	83 x 114 x 248 (3.25 x 4.5 x 9.75)	N(m)	\$1402
8481H (50 Ω)	10 MHz-18 GHz	100 μW to 3W	3.5 W avg. 100 W peak 100W • μs (per pulse)	+25 to +35 dBm ±5%	10 MHz - 8 GHz: 1.20 (0.091) 8-12.4 GHz: 1.25 (0.110) 12.4 - 18 GHz: 1.30 (0.130)	30 x 38 x 149 (1.2 x 1.5 x 5.9)	N(m)	\$770
8482A (50 Ω)	100 kHz-4.2 GHz	1.0 μW to 100 mW	300 mW avg. 15 W peak 30 W • μs (per pulse)	+10 to +20 dBm +2, -4%	100-300 kHz: 1.60 (0.231) 300 kHz - 1 MHz: 1.20 (0.091) 1 MHz - 2 GHz: 1.10 (0.048) 2-4.2 GHz: 1.30 (0.130)	30 x 38 x 105 (1.2 x 1.5 x 4.1)	N(m)	\$580
8482B (50 Ω)	100 kHz-4.2 GHz	1 mW to 25W	0-35°C: 30 W avg. 1 35°C-55°C: 25 W avg. 500 W peak 500 W • μs (per pulse)	+35 to +44 dBm ±4%	100 kHz - 2 GHz: 1.10 (0.048) 2 GHz - 4.2 GHz: 1.18 (0.083)	83 x 114 x 248 (3.2 x 4.5 x 9.7)	N(m)	\$1352
8482H (50 Ω)	100 kHz-4.2 GHz	100 μW to 3W	3.5 W avg. 100 W peak 100 W • μs (per pulse)	+25 to +35 dBm ±5%	100 kHz-4.2 GHz: 1.20 (0.091)	30 x 38 x 149 (1.2 x 1.5 x 5.9)	N(m)	\$740
8483A ³ (75 Ω)	100 kHz-2 GHz	1.0 μW to 100 mW	300 mW avg. 10 W peak 30 W • μs (per pulse)	+10 to +20 dBm +2, -4%	100-600 kHz: 1.80 (0.286) 600 kHz - 2 GHz: 1.18 (0.083)	30 x 38 x 105 (1.2 x 1.5 x 4.1)	N(m) 75 Ω	\$580
8484A ⁴ (50 Ω)	10 MHz-18 GHz	0.1 nW to 10 μW	200 mW avg. 200 mW peak	-30 to -20 dBm ±1%	10-30 MHz: 1.40 (0.166) 30 MHz - 4 GHz: 1.15 (0.070) 4-10 GHz: 1.20 (0.091) 10-15 GHz: 1.30 (0.130) 15-18 GHz: 1.35 (0.149)	36 x 44 x 133 (1.4 x 1.7 x 5.2)	N(m)	\$880
8485A (50 Ω)	50 MHz-26.5 GHz	1 μW to 100 mW	300 mW avg. 15 W peak 30 W • μs (per pulse)	+10 to +20 dBm +2, -4%	50 MHz-100 MHz: 1.15 (0.070) 100 MHz-2 GHz: 1.10 (0.048) 2-12.4 GHz: 1.15 (0.070) 12.4-18 GHz: 1.20 (0.091) 18-26.5 GHz: 1.25 (0.111)	30 x 38 x 95 (1.2 x 1.5 x 3.7)	APC-3.5(m)	\$900
R8486A (Waveguide)	26.5-40 GHz	1 μW to 100 mW	300 mW avg. 15 W peak 30W • μs pulse	+10 to +20 dBm +2, -4%	1.4 (0.167)	30 x 38 x 126 (1.2 x 1.5 x 5.0)	Waveguide Flange UG-599/U	\$1500
Q8486A (Waveguide)	33-50 GHz	1 μW to 100 mW	300 mW avg. 15 W peak 30W • μs pulse	+10 to +20 dBm +2, -4%	1.5 (0.200)	30 x 38 x 126 (1.2 x 1.5 x 5.0)	Waveguide Flange UG-383/U	\$1750

¹For pulses greater than 30 W the maximum average power (Pa) is limited by the energy per pulse (E) in W • μs according to Pa = 30-0.02E.

²Negligible deviation except for those power ranges noted.

³Includes HP 1250-0597 adapter from 75 Ω type N to 50 Ω type N for calibration.

⁴Includes HP 11708A 30 dB attenuator for calibrating against a 0 dBm, 50 MHz power reference.

Uncertainty of Calibration Factor Data for HP 8482A and 8483A

Frequency (MHz)	Sum of Uncertainties (%) ¹				Probable Uncertainties (%) ²			
	HP Model				HP Model			
	8482A	8482B	8482H	8483A	8482A	8482B	8482H	8483A
0.1	+2.3	+5.7	+3.3	+2.6	+1.3	+2.8	+1.6	+1.5
0.3	2.2	5.7	3.2	2.5	1.2	2.8	1.6	1.4
1.0	2.2	5.7	3.2	2.5	1.2	2.8	1.6	1.4
3.0	2.2	5.7	3.2	2.5	1.2	2.8	1.6	1.4
10.0	2.5	5.7	3.5	3.0	1.3	2.8	1.6	1.6
30.0	2.6	5.7	3.6	3.1	1.4	2.8	1.7	1.6
50.0	0(ref)	2.7	0(ref)	0(ref)	0(ref)	2.7	0(ref)	0(ref)
100.0	3.1	5.6	4.1	3.9	1.6	3.3	1.9	2.0
300.0	3.1	5.6	4.1	3.9	1.6	3.3	1.9	2.0
1000.0	2.7	5.7	3.7	3.7	1.4	3.3	1.7	2.0
2000.0	2.7	5.5	3.7	3.9	1.4	3.1	1.7	2.1
4000.0	2.8	5.5	3.8	—	1.5	3.1	1.8	—

Uncertainty of Calibration Factor Data for HP 8481A/B, 8484A 8485A³

Frequency (GHz)	Sum of Uncertainties (%) ¹				Probable Uncertainties (%) ²			
	HP Model				HP Model			
	8481A	8481B	8481H	8484A 8485A	8481A	8481B	8481H	8484A 8485A
0.1	+3.1	+6.4	+4.1	+4.4	+1.6	+3.0	+1.9	+1.9
2	2.7	5.8	3.7	4.0	+3.6	1.4	3.1	1.7
4	2.8	5.8	3.8	4.1	—	1.5	3.1	1.8
6	2.8	5.8	3.8	4.1	4.0	1.5	3.1	1.8
8	3.2	6.0	4.2	4.6	—	1.7	3.2	2.0
10	3.6	6.2	4.6	5.1	4.7	1.9	3.3	2.2
12	3.9	7.8	4.9	6.5	—	2.1	4.1	2.4
14	4.8	7.9	5.8	7.4	5.6	2.6	4.1	2.8
16	5.2	8.0	6.2	7.8	—	2.9	4.2	3.0
18	5.8	8.3	6.8	8.4	5.9	3.2	4.3	3.4
22	—	—	—	—	—	—	—	—
26.5	—	—	—	7.3	—	—	—	—

¹Includes uncertainty of reference standard and transfer uncertainty. Directly traceable to NBS.

²Square root of sum of the individual uncertainties squared (RSS).

³For R/Q8486A uncertainty data see the data sheet (5953-6482).

☎ Fast-Ship product—see page 766.

POWER METERS

Thermistor Power Meters & Power Meter Calibrator

Models 432A/B, 8477A

- Automatic zero
- High accuracy

- Recorder outputs, analog & digital
- Long cable options

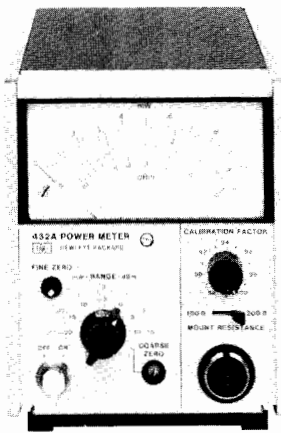

HP 432A

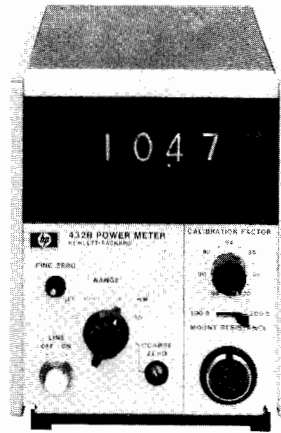

HP 432B

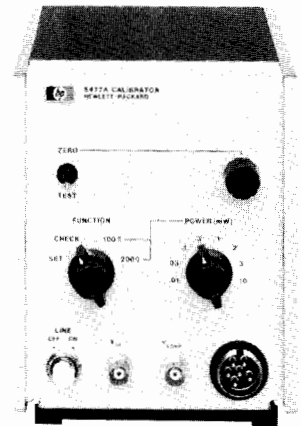

HP 8477A

HP 432A/B Power Meters

High accuracy—no thermoelectric error: high accuracy over a wide temperature range is featured on the HP 432 Power Meters. By measuring the output voltage of the thermistor bridges, and computing the corresponding power, even higher accuracy of $\pm 0.2\% \pm 0.5 \mu W$ can be obtained.

Accuracy can be maintained on even the most sensitive range because the error due to thermoelectric effect is reduced to a negligible level.

Calibrated mounts: each thermistor mount is furnished with data stating the Calibration Factor* and Effective Efficiency* at various frequencies across the operating range. For easy and accurate power measurements, the front panel of the HP 432 contains a calibration factor control, calibrated in 1% steps from 88% to 100%, that compensates for losses in the mount and eliminates the need for calculation.

Instrument type: automatic, self-balancing power meter for use with temperature-compensated thermistor sensor.

*"Calibration Factor" and "Effective Efficiency" are figures of merit expressing the ratio of the substituted signal measured by the power meter to the microwave power incident on and absorbed by the sensor.

Specifications (partial)

Power Range

HP 432A: seven ranges with full-scale readings of 10, 30, 100, and 300 μW , 1, 3, and 10 mW; also calibrated in dBm from -20 dBm to +10 dBm full scale in 5 dB steps.

HP 432B: four ranges with full-scale readings of 10 and 100 μW , and 1 and 10 mW.

Noise: less than 0.25% of full scale peak (typical).

Response time: at recorder output, 35 ms time constant (typical).

Fine zero: automatic, operated by front panel switch.

Zero carryover: less than 0.50% of full scale when zeroed on most sensitive range.

Meter

HP 432A: taut-band suspension, individually calibrated, mirror-backed scales. Milliwatt scale more than 108 mm (4.25 in.) long.

HP 432B: three digits with one digit overrange. 20% overrange capability on all ranges.

Calibration factor control: 13-position switch normalizes meter reading to account for thermistor sensor calibration factor. Range 100% to 88% in 1% steps.

Thermistor sensor: thermistor sensors are required for operation of the HP 432A/B. For microwave sensors HP 478B, 8478B and 486 series see page 589.

Recorder output: proportional to indicated power with 1 volt corresponding to full scale. 1 k Ω output impedance.

BCD output: 8, 4, 2, 1 code: "1" positive. TTL compatible logic. Operates with HP 5150A, Opt 002 (BCD) Digital Recorder. "Print" and "Inhibit" lines available. (HP 432B only.)

Power Consumption

HP 432A: 115 or 230 Vac $\pm 10\%$, 50 to 400 Hz, 1.5 watts.

HP 432B: 115 or 230 Vac $\pm 10\%$, 50 to 400 Hz, 10 watts.

Weight

HP 432A: net, 2.3 kg (5.5 lb). Shipping, 4.6 kg (10 lb).

HP 432B: net, 3 kg (6.5 lb). Shipping, 4.8 kg (10.5 lb).

Size: 130 W x 155 H x 279 mm D (5.2" x 6.1" x 11.0").

HP 8477A Power Meter Calibrator

The HP 8477A Calibrator is specifically designed for use with the HP 432 Power Meter. It allows you to verify full-scale meter readings on all ranges, and meter tracking. Simply connect three cables between the power meter and calibrator; no charts or additional instruments are required.

Power: 115 or 230 Vac $\pm 10\%$, 50 to 400 Hz, 3 watts.

Ordering Information

	Price
HP 432A Power meter	\$1225
HP 432B Power meter	\$2100
HP 432A/B Options	
001: rechargeable battery installed, provides up to 20 hours continuous operation (HP 432A only)	add \$105
002: input connector placed on rear panel in parallel with front	add \$25
003: input connector on rear panel only	add \$10
009: 3.1 m (10 ft) cable for 110- Ω or 200- Ω sensor	add \$30
010: 6.1 m (20 ft) cable for 100- Ω or 200- Ω sensor	add \$55
011: 15.2 m (50 ft) cable for 100- Ω or 200- Ω sensor	add \$105
012: 30.5 m (100 ft) cable for 100- Ω or 200- Ω sensor	add \$155
013: 61 m (200 ft) cable for 100- Ω or 200- Ω sensor	add \$260
100: 100 Vac operation, 48-66 Hz	no charge
910: extra operating and service manual	add \$5
HP 8477A Power Meter Calibrator	\$830



Thermistor Mounts, Peak Power Sensor & Peak Power Meters

Models 478A, 8478B, 486 Series, 8900C/D, 84811A

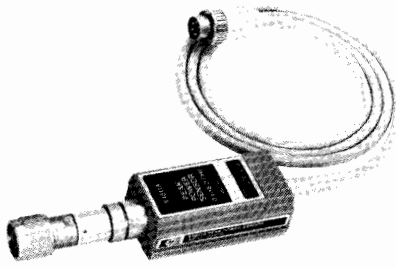

HP 84811A



HP 478A

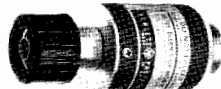

HP 8478B

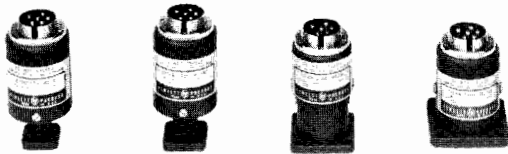

HP 486 Series

Temperature Compensated Thermistor Mounts

High efficiency and good RF match are characteristic of the HP 478A and 8478B coaxial and 486A series waveguide Thermistor Mounts. Used in conjunction with the HP 432 Power Meter they provide high accuracy even in routine power measurements. These thermistor mounts are temperature-compensated for low drift, even in the presence of thermal shocks, permitting measurement of microwave power as low as one microwatt. Each mount contains data showing Calibration Factor and Effective Efficiency at six frequencies, directly traceable to the National Bureau of Standards at those frequencies where NBS provides calibration service.

HP 486, 478, 8478B Specifications

HP Model	Frequency range, GHz	Maximum SWR	Operating Resistance (Ohms)	Price
478A	10 MHz to 10 GHz	1.75, 10 to 25 MHz 1.3, 25 MHz to 7 GHz 1.5, 7 to 10 GHz	200	\$325
8478B ¹	10 MHz to 18 GHz	1.75, 10 to 30 MHz 1.35, 30 to 100 MHz 1.1, 0.1 to 1 GHz 1.35, 1 to 12.4 GHz 1.6, 12.4 to 18 GHz	200	\$530
X486A	8.20 to 12.4	1.5	100	\$420
P486A	12.4 to 18.0	1.5	100	\$460
K486A ²	18.0 to 26.5	2.0	200	\$580
R486A ²	26.5 to 40.0	2.0	200	\$640

¹Option 011: furnished with APC-7 RF connector add \$25
²Circular flange adapters:
 K-band (UG-425/U) HP 11515A \$210
 R-band (UG-381/U) HP 11516A \$210

HP 84811A Peak Power Sensor

The HP 84811A Peak Power Sensor works with the HP 8900C/D Peak Power Meters to measure the peak power of RF pulses. It is supplied with a 4 foot flexible cable to easily reach the pulse source being measured. The HP 84811A also conveniently detaches from the meter for storage, recalibration or replacement.

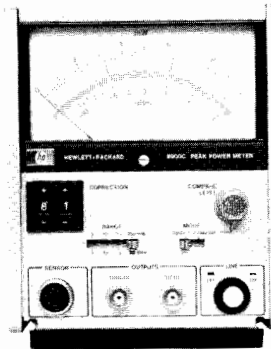

HP 8900C

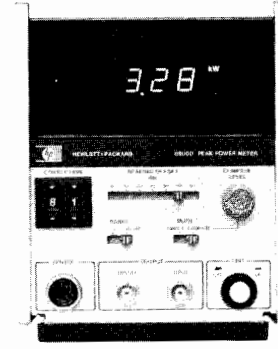

HP 8900D

HP 8900C/D Peak Power Meters

The HP 8900C and 8900D Peak Power Meters directly display the peak power of RF pulses over a 100 MHz to 18 GHz frequency range. Measurements can be made on pulses with widths from 1 μ s (100 ns in Compare mode) to CW, and repetition rates from 100 Hz (0 Hz in Compare mode) to 100 kHz.

The HP 8900C is an economical analog meter calibrated in watts and dBm. The analog display with its large, easy-to-read scale makes it simple to peak or null pulsed power systems. The HP 8900D has a high resolution 3 1/2 digit digital display calibrated in watts. The direct reading display and range annunciators make the digital version a good choice for production and field applications where unambiguous or frequent readings are required.

HP 8900C/D Peak Power Meters Specifications

Frequency range: 100 MHz to 18 GHz.

Dynamic range: 20 dB (0 to +20 dBm).

HP 8900C: 4 ranges of 3, 10, 30 and 100 mW full scale.

HP 8900D: 2 ranges of 10 and 100 mW full scale.

Pulse Response

Direct Mode

Pulse width: 1 μ s to CW.

Repetition rate: 100 Hz to 100 kHz.

Compare Mode

Pulse width: 100 ns (typical) limited by rise time specification.

Repetition rate: 0 to 100 kHz.

Rise time: 75 ns.

Fall time: 125 ns (as measured on video output).

Power consumption: 100 and 120 Vac +5, -10%, 48 -66 Hz and 360-440 Hz; 220 and 240 Vac +5, -10%, 48 -66 Hz.

Meter Accuracy	CW	Pulse	Transfer Accuracy CW to Pulse
Direct	± 0.2 dB	± 0.35 dB	± 0.2 dB
Compare	± 0.2 dB	± 0.25 dB	± 0.1 dB

HP 84811A Peak Power Sensor Specifications

Power range: 0 to +20 dBm (1 mW to 100 mW).

Frequency range: 100 MHz to 18 GHz.

SWR: 100 MHz to 12 GHz < 1.5. 12 GHz to 18 GHz < 2.0.

Maximum peak power: +24 dBm (250 mW) for 5 minutes.

Connector type: N (male).

Calibration: every 2 GHz from 2 to 10 GHz. Every 1 GHz from 11 to 18 GHz.

Operating temperature: 0 to +55°C.

Calibration accuracy: (+10 to +40°C), ± 0.7 dB 0.1 to 12 GHz. ± 1.0 dB to 18 GHz. 0-10°C and 40-55°C: add ± 0.2 dB.

Ordering Information

HP 8900C Analog peak power meter

HP 8900D Digital peak power meter

HP 84811A Peak power sensor

☎ Fast-Ship product—see page 766.

Price

\$1950

\$2450

\$750 ☎

NOISE FIGURE METER

Noise Measurements

Noise Figure

Modern receiving systems must often process very weak signals, and noise added by the receiving system components often determines whether or not an input signal can be processed properly. Noise figure is the figure of merit used to express how well a system and its components can process weak signals. It expresses the degradation in the S/N ratio as the signal passes through the system. Noise figure is unique and universal; it may be determined for transistors, amplifiers, mixers and entire systems. Considering the S/N ratio, it is often more economical to reduce the noise figure of the receiving system components than it is to increase the signal by increasing transmitted power or antenna gain.

Noise figure may also be expressed as the ratio of total output noise power (at a source temperature of 290K) compared to the output noise power if there were no noise added by the device under test (DUT), that is, a noise-free DUT. Consider the representation of the noise power at the output of a DUT vs. the temperature of the source impedance at the DUT input.

$$N_p = N_a + kGBT_s$$

Figure 1 is a graph of the equation. In the equation, N_a is the noise added by the DUT, k is Boltzmann's constant, G is the gain of the DUT, B is bandwidth in Hz, and T_s is the temperature of the source termination in Kelvins. Thermal agitation energy of the source impedance causes movement of the free-charge in that impedance. Energy of the moving charge that occurs within the bandwidth of the DUT masquerades as input signal, gets processed by the DUT, and contributes to power output. As the source temperature increases, the power output increases in accordance with the gain-bandwidth product and with Boltzmann's constant (which can be thought of as a conversion factor between two expressions for energy — Kelvin temperature and joules).

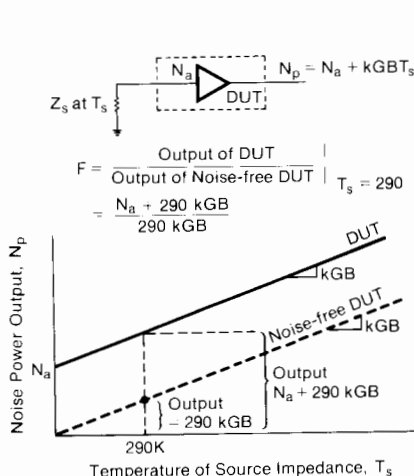

Figure 1. Available noise power and noise figure.

Noise figure is concerned with the behavior of the DUT compared to a noise-free DUT for a source temperature of 290K as shown in Figure 2. Noise figure is often expressed in dB by

$$F(\text{dB}) = 10 \log F$$

Effective Input Noise Temperature — (T_e)

Another figure of merit, the effective input noise temperature T_e , gives the noise performance without reference to a standard source temperature (290K). It is therefore commonly used for satellite system work where source temperatures are usually much lower than 290K.

Noise Figure Measurement

Noise figure meters measure two points along the straight-line for the DUT (Figure 3), and then display the corresponding noise figure. The two source temperatures correspond to the noise source being turned on (for T_h) and off (for T_c). The cold temperature of a noise source usually corresponds to the ambient temperature. The hot temperature of a noise source is specified indirectly by its excess noise ratio (ENR), which is given by

$$\text{ENR} = 10 \log \frac{T_h - 290}{290}$$

Noise Figure Measurement Applications

Hewlett-Packard's noise figure measurement equipment is exceptional in a variety of applications. It exhibits the following benefits in these applications.

Amplifiers: 1) Simultaneous noise figure and gain measurement, 2) Results automatically corrected for ENR variations, ambient temperature, and mixer, LO, and IF noise contributions, 3) Real-time, swept, corrected output to oscilloscope for easy tuning (display is digitally stored), 4) Automatic control of an external LO for measurements above 1600 MHz without a separate computer.

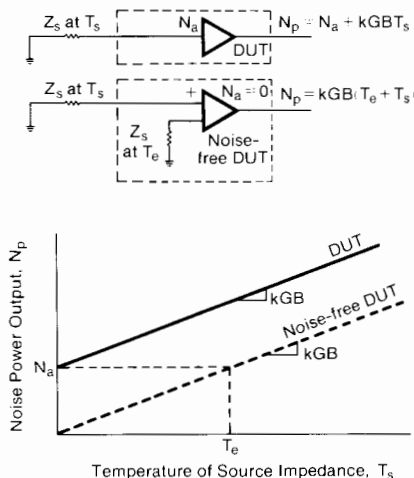

Figure 2. Available noise power & effective input noise temperature.

Transistors: the above benefits, plus: 1) Easy real-time tuning for best noise figure and gain, 2) Real-time tuning to actual transistor F_{min} without second stage effects, 3) Easy single-sideband measurement (high HP 8970A IF makes filtering easy), 4) Low mismatch effects (the HP 346A features virtually identical impedance for T_h and T_c), 5) Easy to program for automatic systems.

Receivers and mixers: 1) Simultaneous measurement of gain (conversion loss) and noise figure, 2) Tunable and swept IF from 10 to 1600 MHz, 3) No external IF gain needed, 4) Automatic ENR correction, even for broadband sweeps, 5) Effects of LO power, IF power, and IF frequency changes on noise figure are easily observed, 6) Easy to program.

Literature

Product Note 8970B-2, Applications and Operation of the HP 8970B Noise Figure Meter, describes the HP 8970B and many of its applications in more detail. It is both an introduction to the HP 8970B and a summary reference manual.

Product Note 8350A-7, Microwave Noise Figure Measurements Using the HP 8350A Sweep Oscillator with the HP 8970A Noise Figure Meter, describes measurements with this popular combination of equipment.

Programming Note 8970A/HP 85-1, Introductory Operating Guide for the HP 8970A Noise Figure Meter with the HP-85 Personal Computer, shows the ease of programming the noise figure meter, local oscillator, and computer for automatic system using BASIC.

Application Note 57-1, Fundamentals of RF and Microwave Noise Figure Measurements, explains the theory behind noise figure and its measurement. This note includes an extensive glossary of noise related terms.

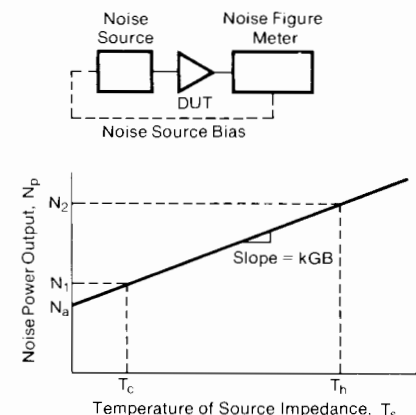
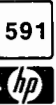

Figure 3. Available noise power and noise figure measurement.

NOISE FIGURE METER

Automatic Noise Figure Meter

Model 8970B



- 10 MHz to 1600 MHz.
- Accurate and simple, swept or CW measurements.
- Second stage correction.

- Display of both noise figure and gain
- Calibrated display on oscilloscope or recorder.
- Powerful special function enhancements

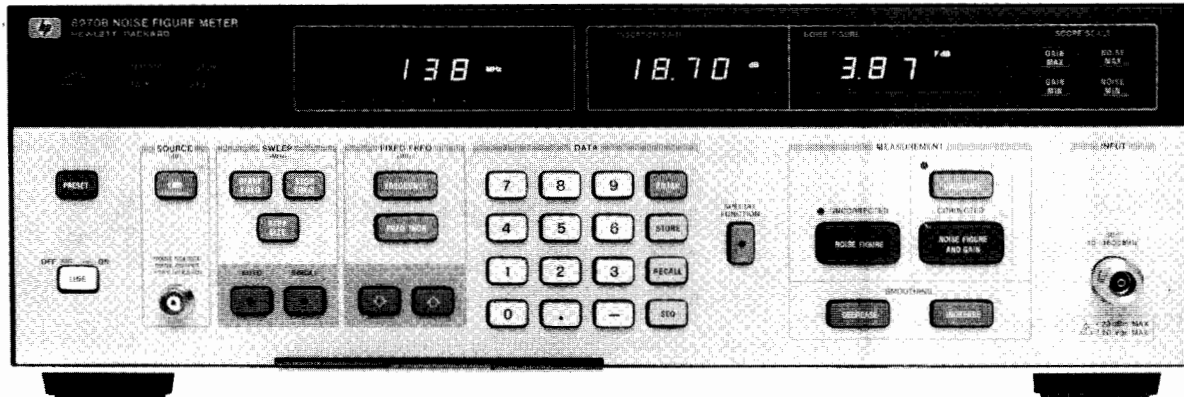

HP 8970B



HP 8970B Noise Figure Meter

With the HP 8970B noise figure meter, noise figure measurements are easy, accurate, and repeatable. The stand-alone meter has an input frequency range of 10 to 1600 MHz. When used with the HP 8971B Noise Figure Test Set and an external local oscillator, measurements from 10 MHz to 18 GHz are just as easy. The ENR (Excess Noise Ratio) calibration table of the noise source can be stored in the HP 8970B, and a properly interpolated value is automatically used at each measurement frequency. Automatic second stage correction makes accurate noise figure readings possible even for low gain devices. The HP 8970B's dynamic range allows gain measurements of up to at least 40 dB (higher in some cases) or loss measurements to -20 dB, with no external attenuation or amplification.

Microprocessor and Controller Functions

The HP 8970B takes the mystery out of noise figure measurements. It uses a microprocessor to make the calculations and corrections necessary for truly accurate, convenient, and flexible noise figure measurements. The meter also acts as a controller for external local oscillators (such as the HP 8670 series synthesizers, HP 8340 series synthesized sweepers, or the HP 8350 sweep oscillator) and the HP 8971B Noise Figure Test Set, making swept, broad-band microwave measurements of amplifiers, mixers, and transistors as simple as RF measurements.

The HP 8970B is fully programmable. Virtually all front panel keys and functions are accessible over HP-IB, Hewlett Packard's enhanced version of IEEE-488. The meter uses an independent System Interface Bus to control the HP 8971B and local oscillator. This additional bus gives the meter pass-through capability allowing other instrument controllers to send messages through the meter to any other instrument on the system interface bus.

Simple Calibration and Second Stage Correction

Noise figure measurement accuracy is enhanced because the meter measures its own noise figure (and that of the rest of the measurement system) at up to 181 points. It stores this information, interpolates if necessary, and corrects for it to remove second stage (measurement system) effects. The HP 8970B also measures the gain of the test device.

Display

The HP 8970B has an LED digital front panel display. Rear panel BNC connectors allow swept display of noise figure and gain versus frequency on an oscilloscope or x-y recorder. Either display mode is easily and accurately scaled to the desired resolution from the meter's front panel. The swept oscilloscope display allows the user to optimize the test device in real time for both corrected noise figure and gain. The noise figure display is easily changed from noise figure to effective noise temperature (T_e) or Y factor if desired. The HP 8970B also plots the noise figure and gain data without an external controller.

Front Panel and Special Functions

The HP 8970B front panel keys control the number entry, calibration, and measurement functions. STORE, RECALL, and SEQ keys allow up to 9 front panel settings to be stored and sequenced automatically or manually to save set-up time. Smoothing INCREASE and DECREASE keys are used to average up to 512 readings before display, which eliminates flicker and increases accuracy.

The simple front panel control of the HP 8970B satisfies many noise figure measurement needs. In addition, for those who may need even greater measurement power, there are more than 150 special functions that can be selected by using a numerical code and the special function key. Two examples are hot-cold measurements and automatic compensation for losses at the input of the test device. One of the special functions is a catalog that quickly indicates the current special function status. Three pull-out cards serve as a mini-reference manual for the instrument, including most of the special functions, the HP-IB formats and codes, and typical measurement set-ups. A complete set of service oriented special functions can also be accessed.



NOISE FIGURE METER

Noise Figure Test Set

Model 8971B

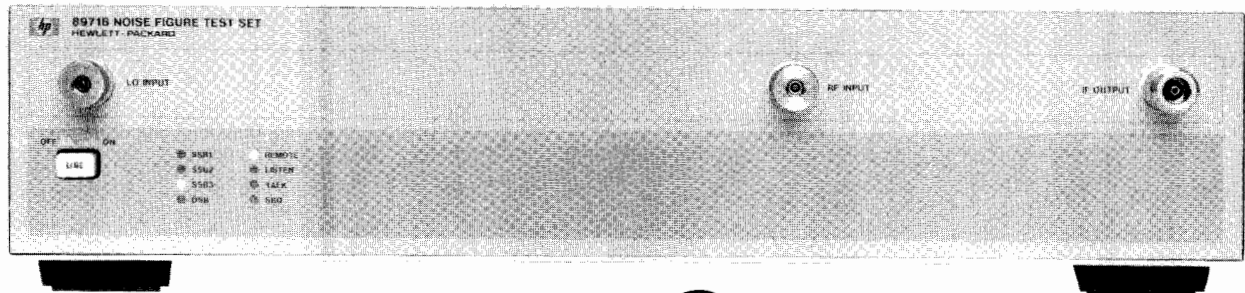

HP 8971B



HP 8971B Noise Figure Test Set

The HP 8971B Noise Figure Test Set, used with the HP 8970B Noise Figure Meter and an external local oscillator, brings the convenience and repeatability of RF noise figure measurements to microwave frequencies. The HP 8970B Noise Figure Meter's input frequency range is 10 to 1600 MHz. To make noise figure measurements at higher frequencies, the test device signal must first be down-converted to the below 1600 MHz frequency range of the noise figure meter. The HP 8971B Noise Figure Test Set combines all of the components necessary for microwave down-conversion into one easy-to-use package. Careful design and high performance components, including a stable YIG filter allow broad-band single sideband measurements from 10 MHz to 18 GHz with a single calibration and sweep. The noise figure test set is capable of both double and single sideband downconversion.

Double Sideband Measurements

Double sideband microwave measurements are the simplest. The most basic set-up requires only a mixer and local oscillator, but what is gained in simplicity can be lost in measurement accuracy. The measurement is an average of the device performance at the upper and lower sideband frequencies. Measurement errors may result if the noise figure and gain of the device differ significantly between the upper and lower sideband frequencies. This can present problems in measurements where a tuner is used to adjust the impedance at the input to the test device. Tuner impedance can vary rapidly with frequency which means that the performance of input-impedance-sensitive test devices performance will also vary rapidly with frequency.

Additional measurement errors are caused by harmonics generated in the mixing process. The 3rd harmonic of the LO is commonly down only 10 dB. If a broadband noise source is used, this will result in two additional 3rd harmonic noise sidebands at the output of the mixer. These sidebands are also detected and averaged into the final measurement. Thus, the displayed measurement is actually a combination of the performance of the test device at the LO frequency and at the frequency of the LO 3rd harmonic.

Single Sideband Measurements

Double sideband measurement difficulties are eliminated in single sideband measurements, but the measurement set-up is more complex. SSB measurements are made by pre-selecting one of the noise sidebands before it is down-converted by the mixer. Fixed frequency filters are inconvenient if measurements are to be made over a broad frequency range. Broadband single sideband measurements can be made using a tunable bandpass filter such as a YIG filter. In this type of measurement set-up, much care must be taken to tune the filter accurately and repeatably.

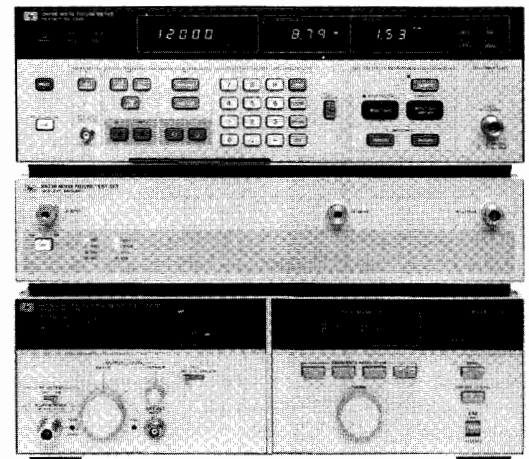

HP 8970B, 8971B, 8671B



Noise Figure Test Set Convenience

The HP 8971B Noise Figure Test Set, used in single sideband mode, brings the simplicity of double sideband measurements and the accuracy of single sideband measurements together in one package. Controlled by the HP 8970B Noise Figure Meter and used with an external LO, single sideband measurements can be made from 10 MHz to 18 GHz with the push of one key. The test set's internal configurations are totally transparent to the user. No more frustrations with measurements that crossover from RF to microwave frequencies. No more hassles with multiple bandpass filters to make single sideband measurements over broad frequency ranges.

New measurement modes in the HP 8970B allow for double down-conversion using the HP 8971B as the second downconverter. These new modes can be used for millimeter-wave measurements and other applications where the test device output frequency is above 18 GHz.

The use of an isolator and preamplifier between the test device and measurement system is strongly recommended to reduce mismatch uncertainty and second stage noise figure, two of the largest sources of noise figure measurement uncertainty.

NOISE FIGURE METER

Noise Sources
Models HP 346 A/B/C

593

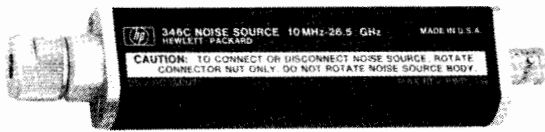

HP 346C

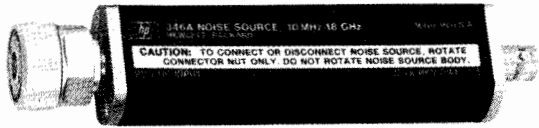

HP 346A (option 002)

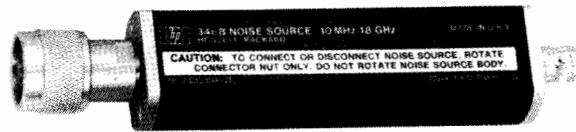

HP 346B (option 001)

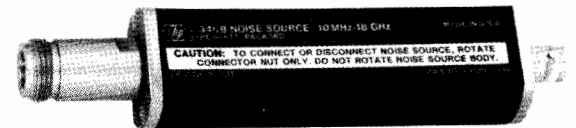

HP 346B (option 004)

HP 346A/B/C Broadband Noise Sources

The ideal companion to the HP 8970B is the HP 346 family of noise sources. These noise sources, covering the microwave frequency range up to 26.5 GHz as well as the UHF and IF ranges, make it unnecessary to maintain a different noise source for each frequency band. Each source has individually calibrated values of ENR at cardinal frequencies printed on its label (see illustration) for easy loading into the HP 8970B. The low SWR of each noise source reduces a major source of measurement uncertainty—re-reflections of test signals. The variety of connectors available reduces the need for degrading accuracy with connector adapters.

The HP 346 family of noise sources are designed for a broad range of measurement applications. The HP 346C covers the broadest frequency range, 10 MHz to 26.5 GHz. The HP 346B has a high excess noise ratio, low SWR, and a variety of connectors to make it a general purpose noise source. The HP 346A is especially designed for accurately characterizing the noise figure of DUTs which do not include an isolator at the input, such as GaAsFETs and many UHF amplifiers. Without an isolator such devices can change gain during the noise figure measurement and thereby cause large errors in measuring noise figure. The HP 346A has a very small change in reflection coefficient (<0.01) from ON to OFF to minimize the gain changes. The ENR is small enough (~ 5.2 dB) to accurately measure noise figures of low noise GaAsFETs and UHF amplifiers.

FREQ GHz	ENR dB	FREQ GHz	ENR dB	FREQ GHz	ENR dB
0.01	5.31	0.01	15.18	0.01	13.35
0.10	5.57	0.10	15.49	1.0	13.49
1.0	5.36	1.0	15.26	2.0	13.52
2.0	5.17	2.0	15.17	3.0	13.25
3.0	5.02	3.0	14.93	4.0	13.58
4.0	4.98	4.0	14.86	5.0	13.67
5.0	4.97	5.0	14.91	6.0	13.80
6.0	4.94	6.0	14.83	7.0	14.04
7.0	4.99	7.0	14.90	8.0	14.33
8.0	5.09	8.0	15.05	9.0	14.55
9.0	5.26	9.0	15.26	10.0	14.77
10.0	5.36	10.0	15.39	11.0	15.04
11.0	5.28	11.0	15.43	12.0	15.16
12.0	5.21	12.0	15.50	13.0	15.37
13.0	5.02	13.0	15.41	14.0	15.42
14.0	4.93	14.0	14.93	15.0	15.66
15.0	4.96	15.0	15.51	16.0	15.46
16.0	4.99	16.0	15.55	17.0	15.56
17.0	5.04	17.0	15.62	18.0	15.60
18.0	5.05	18.0	15.66	19.0	15.62
				20.0	15.91
				21.0	15.90
				22.0	16.13
				23.0	16.28
				24.0	16.22
				25.0	16.17
				26.0	16.16
				26.5	15.60
SERIAL NO. 1077A0798 OPT 002	SERIAL NO. 2037A00428	SERIAL NO. 2048A00320			

HP 346A HP 346B HP 346C

Example labels of 346 Noise Sources

HP 346 A/B/C Partial Specifications

(See technical data sheet for complete specifications.)

Frequency range: 10 MHz to 18 GHz for HP 346A/B; 10 MHz to 26.5 GHz for HP 346C.

Excess noise ratio (ENR) limits: HP 346A: 4.5 to 6.5 dB; HP 346B: 14 to 16 dB; HP 346C: 12 to 16 dB (10 MHz to 12 GHz) and 14 to 17 dB (12.0 to 26.5 GHz).

Maximum SWR (reflection coefficient) on and off:

HP 346A/B: 10 to 30 MHz — 1.3 (0.13); 30 to 5000 MHz — 1.15 (0.07); 5 to 18 GHz — 1.25 (0.11).

HP 346C: 10 MHz to 18 GHz — 1.25 (0.11); 18 to 26.5 GHz — 1.35 (0.15).

Power required: 28 ± 1 Vdc.

Dimensions: 140 H x 21 W x 30 mm D (5.5" x 0.8 x 1.2").

Weight: net, 0.108 kg (3.5 oz). Shipping, 0.5 kg (1 lb).

HP 8970B Partial Specifications

(See technical data sheet for complete specifications.)

Noise figure measurement range: 0 to 30 dB.

Noise figure instrumentation uncertainty: ± 0.1 dB for 0 to 55°C.

Noise figure resolution: 0.01 dB (0.001 dB over HP-IB).

Gain measurement range: -20 to at least 40 dB.

Gain instrumentation uncertainty: ± 0.15 dB.

Gain resolution: 0.01 dB (0.001 dB over HP-IB).

Frequency range: tunable from 10 to 1600 MHz.

Tuning accuracy: (from 10 to 40°C) $\pm (1 \text{ MHz} + 0.01 \times \text{freq.})$, 6 MHz maximum.

Frequency resolution: 1 MHz.

Noise figure: (for input power levels below -60 dBm) $<7 \text{ dB} + 0.003 \text{ dB/MHz}$.

Maximum operating input power: -10 dBm.

Maximum net external gain: 80 dB between noise source and HP 8970A RF input.

Noise source drive: 28.0 ± 0.1 volt.

HP-IB capability: SH1, AH1, T5, L4, SR1, RL1, PP0, DC1, DT1, C1, C3, C28, E1.

Operating temperature: 0°C to 55°C.

Storage temperature: -55°C to 75°C.

Power: 100, 120, 220, or 240 V (+5, -10%); 48-66 Hz; 150 VA maximum.

Dimensions: 146 H x 425 W x 476 mm D (5.75" x 16.8" x 18.8").

Weight: net, 15.5 kg (34 lb). Shipping, 18.5 kg (40 lb).

HP 8971B Partial Specifications

(See technical data sheet for complete specifications.)

Frequency range: 10 MHz to 18 GHz

Gain/noise figure repeatability: ± 0.2 dB

Image and odd-harmonic rejection: 25 dB

Ordering Information

HP 8970B Noise Figure Meter

Option 907: Front panel handle kit

Option 908: Rack mounting flange kit

Option 909: Both options 907 and 908

Option 910: Extra operating and service manual

HP 8971B Noise Figure Test Set

HP 346A Noise Source

HP 346B Noise Source

HP 346C Noise Source

Option 001 (HP 346A/B only): Type N (male)

connector

Option 002 (HP 346A/B only): APC-7 connector

Option 004 (HP 346A/B only): Type N (female)

connector

Price

Contact HP

add \$43

add \$25

add \$65

add \$25

Contact HP

\$1,500

\$1,400

\$1,900

N/C

Add \$25

N/C



NETWORK ANALYZERS

Complete Characterization of Linear Networks

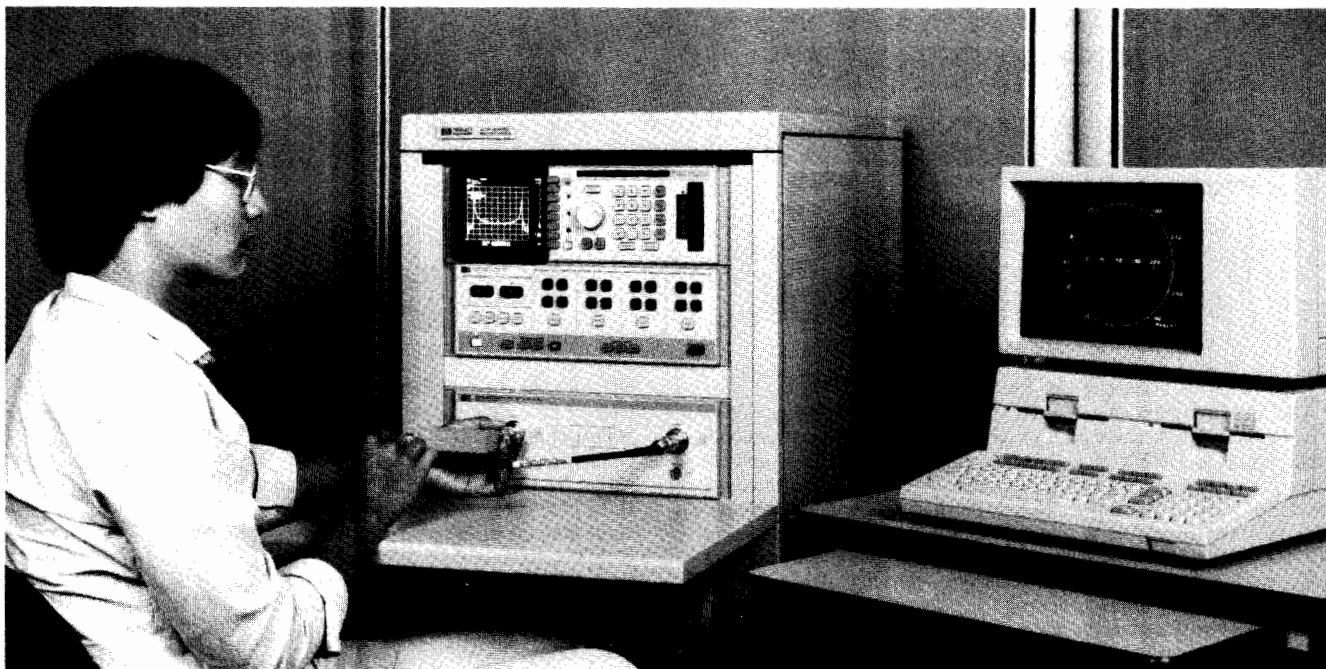

Why Network Analysis?

Characterizing the behavior of linear networks that will be stimulated by arbitrary signals and interfaced with a variety of other networks is a fundamental problem in both synthesis and test processes. For example, the engineer designing a multi-component network must predict with some certainty the final network performances from knowledge of the individual components. Similarly, a production manager must know allowable tolerances on the products manufactured and whether the final products meet the specified tolerances. Network analysis offers a solution to these problems through complete description of linear network behavior in the frequency domain. Additionally, some network analyzers offer the capability to transform measurement data, taken in the frequency domain, to the time domain providing further insight into the behavior of linear networks.

Network analysis accomplishes the description of both active and passive networks by creating a data model of such component parameters as impedances and transfer functions. However, these parameters not only vary as a function of frequency but are also complex variables in that they have both magnitude and phase. Until the advent of the modern network analyzer, phase was difficult to measure at CW frequencies and often involved laborious calculations; these measurements were accomplished by conventional oscilloscopes at lower frequencies and slotted lines at microwave frequencies. However, swept network analyzers now measure magnitude and phase (the total complex quantity) as a function of frequency with less difficulty than conventional CW measurements. Impedance and transfer functions can then be conveniently displayed on a swept CRT, as in Figure 1, X-Y recorder, or computer controlled peripherals such as a printer and/or a plotter. HP computers also combine with network analyzers to give new levels of speed and accuracy in swept measurements that could only be attained previously by long calculations at CW frequencies.

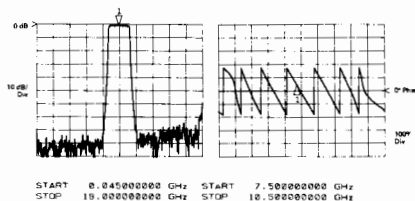

Figure 1. 45 MHz to 18 GHz measurement of magnitude and phase in a single sweep.

Thus, network analysis satisfies the engineering need to characterize the behavior of linear networks quickly, accurately, and completely over broad frequency ranges. In design situations, this minimizes the time required to test new designs and components, allowing more time to be spent on the design itself. Likewise, production test times may be minimized while reducing the uncertainties surrounding the test. Hewlett-Packard manufactures a full line of scalar network analyzers (magnitude only) and vector network analyzers (both magnitude and phase).

What is Network Analysis?

Network analysis is the process of creating a data model of the transfer and/or impedance characteristics of a linear network through stimulus-response testing over the frequency range of interest. All network analyzers in the HP product line operate according to this definition.

Creating a data model is important in that actual circuit performance often varies considerably from the performance predicted by calculations. This occurs because the perfect circuit element doesn't exist and because some of the electrical characteristics of a circuit may vary with frequency.

At frequencies above 1 MHz lumped elements actually become "circuits" consisting of the basic elements plus parasitics like stray capacitance, lead inductance, and unknown absorptive losses. Since parasitics depend on the individual device and its construction they are almost impossible to predict. Above

1 GHz component geometries are comparable to a signal wavelength, intensifying the variance in circuit behavior due to device construction. Further, lumped-element circuit theory is useless at these frequencies and distributed-element (or transmission-line) parameters are required to completely characterize a circuit.

Data models of both transfer and impedance functions must be obtained to completely describe the linear behavior of a circuit under test. At lower frequencies, h , y , and z -parameters are examples of transfer and/or impedance functions used in network description; at higher frequencies, S -parameters are used to characterize input-output impedances and transfer functions. Therefore, a network analyzer must measure some form of a circuit's transfer and impedance functions to achieve its objective of complete network characterization. Figure 2 shows an example of a swept impedance measurement.

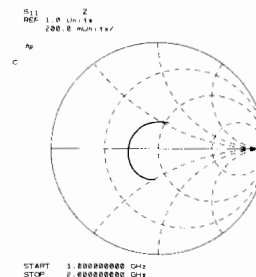

Figure 2. Input impedance of microcircuit amplifier is read directly with Smith Chart overlay for Polar Display.

Network analysis is generally limited to the definition of linear networks. Since linearity constrains networks stimulated by a

sine wave to produce a sine wave output, sine wave testing is an ideal method for characterizing magnitude and phase response as a function of frequency. In non-linear measurements phase is often meaningless and amplitude has to be defined with respect to individual frequency components. For non-linear measurements, refer to the sections on spectrum analyzers, wave analyzers (signal analyzers) and vector modulation products in this catalog.

Network Analyzers

Hewlett-Packard network analyzers are instruments that measure transfer and/or impedance functions of linear networks through sine wave testing. A network analyzer system accomplishes these measurements by configuring its various components around the device under test. The first requirement of the measurement system is a sine wave signal source to stimulate the device under test. Since transfer and impedance functions are ratios of various voltages and currents, a means of separating the appropriate signals from the measurement ports of the device under test is required. Finally, the network analyzer itself must detect the separated signals, form the desired signal ratios, and display the results.

Signal Sources and Signal Separation

In the general case, any sine wave source meeting the network analyzer's specifications can be used to stimulate the device under test. For CW measurements a simple oscillator may suffice; for greater CW frequency accuracy a signal generator or synthesizer may also be desirable. If the analyzer is capable of swept measurements, great economies in time can be achieved by stimulating the device under test with a sweep oscillator or synthesized sweeper. This allows quick and easy characterization of devices over broad frequency ranges. Some network analyzers will operate only with a companion source that both stimulates the device under test and acts as the analyzer's local oscillator.

At low frequencies it is not particularly difficult to separate the appropriate voltages and currents required for transfer and impedance function measurements. Signal separation is merely the process of establishing the proper shorts, opens, and connections at the measurement ports of the device under test. As frequencies increase, the problem of signal separation usually involves traveling waves on transmission lines and becomes correspondingly more difficult. Hewlett-Packard manufactures test sets (often called "transducers") applicable for separating the appropriate traveling waves in a variety of high frequency measurements.

Broadband and Narrowband Detection

After the desired signals have been obtained from the test set (or transducer) they must be detected by the network analyzer; HP network analyzers can use one of two detection methods. Broadband detection accepts the full frequency spectrum of the input signal while narrowband detection involves

tuned receivers that convert CW or swept RF signals to a constant IF signal. There are certain advantages to each detection scheme.

Scalar network analyzers usually employ broadband detection techniques. Broadband detection reduces instrument cost by eliminating the IF section required by narrowband analyzers but sacrifices noise and harmonic rejection. However, noise is not a factor in many applications, and careful measurement techniques, using filters, can eliminate harmonic signals that would otherwise preclude accurate measurements. Broadband systems are generally source independent while some narrowband systems require companion tracking sources. Finally, broadband systems can make measurements where the input and output signals are not of the same frequency, as in the measurement of the insertion loss of mixers and frequency doublers. Narrowband systems cannot make these measurements.

Vector network analyzers normally employ narrowband detection techniques. Narrowband detection makes a more sensitive low noise detection of the constant IF possible. This allows increased accuracy and dynamic range for frequency selective measurements (as compared to broadband systems) and high resolution through IF substitution using precision IF attenuators. Source dependent narrowband systems utilize a companion tracking source not only to stimulate the device under test, but also to produce a signal offset from the RF by a fixed frequency for tuning the analyzer's constant IF.

Signal Processing and Display

Once the RF has been detected, the network analyzer must process the detected signals and display the measured quantities. All HP network analyzers are multi-channel receivers utilizing a reference channel and at least one test channel; absolute signal levels in the channels, relative signal levels (ratios) between the channels, or relative phase difference between channels can be measured depending on the analyzer. Using these measured quantities, it is possible to either display directly as shown in Figure 3, or compute the magnitude and phase of transfer or impedance functions.

Magnitude measurements fall into two categories, relative and absolute; absolute measurements involve the exact signal level in each channel while relative measurements involve the ratios of the two signal channels. Absolute measurements are usually expressed in voltage (dBV) or in power (dBm). The units dBV are derived by taking the log ratio of an unknown signal in volts to a one volt reference. Similarly, dBm is the log ratio of unknown signal power to a one milliwatt reference.

Relative ratio measurements are usually made in dB, which is the log ratio of an unknown signal (Test Channel) with a chosen reference signal (Reference Channel). This allows the full dynamic range of the instrumentation to be used in measuring variations of both high and low level circuit responses. For example, 0 dB implies the two signal levels have a ratio of unity while ± 20 dB im-

plies a 10:1 voltage ratio between two signals.

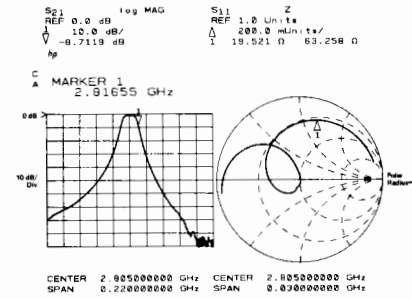

Figure 3. Simultaneous measurement of transmission response and passband reflection coefficient.

All network analyzer phase measurements are relative measurements with the reference channel signal considered to have zero phase. The analyzer then measures the phase difference of the test channel with respect to the reference channel.

Measurement results at CW frequencies may be displayed on analog meters, LEDs or computer controlled printers. Swept frequency measurements of amplitude and phase may be displayed versus frequency on CRTs, digital plotters or X-Y recorders. Insertion Loss is displayed in two different ways in Figure 4. The addition of digital storage and normalization to network analyzer CRTs ensures flicker-free traces and removal of frequency response errors for fast, real-time displays of test device responses versus frequency.

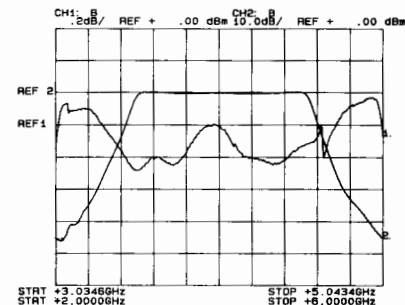

Figure 4. Simultaneous measurement of filter passband and skirts using alternate sweep.

Low Frequency Network Analysis

Networks operating at frequencies below 10 MHz are generally characterized by measuring the gain and phase changes through the network and the associated input and output impedances; h, y, and z-parameters as well as other lumped-component models are typical analytical and computational tools used to represent these measurements. The first derivative of phase with respect to frequency, group delay, is an important measurement of distortion in communication systems. Hewlett-Packard produces a broad line of instrumentation capable of measuring all of these parameters.

Phase information complements amplitude data in the measurement of low frequency parameters. Phase is more sensitive to



NETWORK ANALYZERS

Complete Characterization of Linear Networks (cont.)

network behavior and it is a required component of complex impedance and transfer functions. For instance, phase is required to determine the frequency of network resonances (poles) and anti-resonances (zeros). This is because the phase shift of a network transfer function is exactly zero at the frequency of resonance. Phase information is also vital in circuit design, particularly loop design, where phase margins are critical.

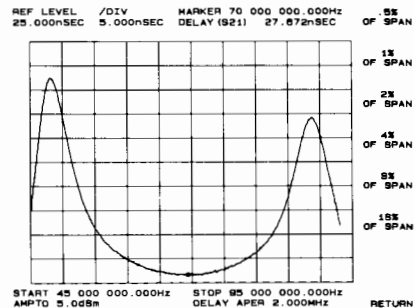

Figure 5. Direct measurement of group delay with digital readout at marker.

Phase data is also required to measure delay distortion or group delay of networks. Delay distortion occurs when different frequency components of a complex waveform experience nonlinear phase shifts as they are transmitted through a network. Group delay is a measure of this distortion and is defined as:

$$T_g = - \frac{d\theta}{d\omega}$$

There are several techniques for measuring group delay; the most common techniques are phase slope, amplitude modulation, frequency modulation, and frequency deviation. Most HP network analyzers can make measurements with at least one of these techniques while several analyzers measure and display group delay directly. Choice of a group delay measurement technique is dependent on the particular device under test and the resolution required.

An alternative method for measuring phase distortion is deviation from linear phase or differential phase. Deviations from linear phase can be measured by introducing enough electrical length in the network analyzer's reference channel to linearize a device's phase shift. Once this has been accomplished it is possible to observe any variations in phase shift linearity at high resolution. Since group delay is the derivative of phase ($d\theta/d\omega$), nonlinearities in phase shift correspond directly to changes in a device's group delay. Figure 6 shows deviation from linear phase and group delay. Introduction of electrical length in the measurement channel may be accomplished by physically adding cable, or it may be accomplished electronically on some network analyzers.

At lower frequency (typically ≤ 50 kHz) digital signal analysis using Fast Fourier Transformations (FFT) can also be used to determine the magnitude and phase of transfer characteristics. This subject is treated in the signal analyzers section of this catalog.

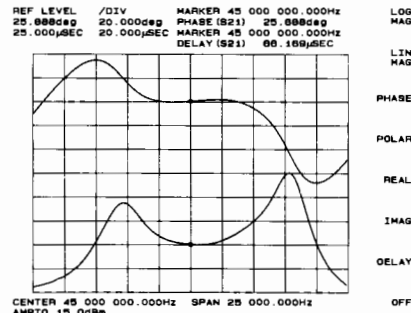

Figure 6. Two independent techniques for measuring filter phase distortion.

High Frequency Network Analysis

Measurements of voltages and currents become more and more difficult as frequency increases. Consequently, h, y, and z parameters lose their usefulness at high frequencies. High frequency network behavior can be better described using transmission line theory in terms of forward and reverse travelling waves. Thus, travelling waves make a logical replacement for voltages and currents in high frequency measurements.

Scattering parameters or S-parameters were developed to characterize linear networks at high frequencies. S-parameters define the ratios of reflected and transmitted traveling waves measured at the network ports. A two-port device is modeled with S-parameters in Figure 7. S_{11} is the complex re-

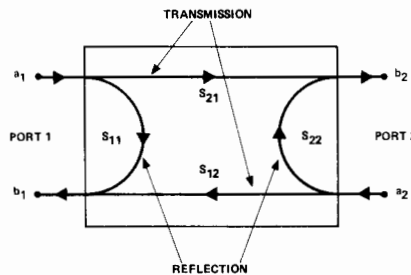

Figure 7. S-parameter model for a two-port linear network.

reflection coefficient at port 1 and is the ratio of b_1/a_1 , if $a_2 = 0$ (port 2 terminated in its characteristic impedance). S_{21} is the complex transmission coefficient from port 1 to port 2, b_2/a_1 , if $a_2 = 0$. The "a" and "b" signals represent the amplitude and phase of the incident and emerging or reflected traveling waves. By reversing the ports and terminating port 1 in its characteristic impedance, S_{22} and S_{12} can be similarly defined. From these definitions, the following equations can be derived:

$$\begin{aligned} E_{r1} &= S_{11}E_{i1} + S_{12}E_{i2} \\ E_{r2} &= S_{21}E_{i1} + S_{22}E_{i2} \end{aligned}$$

where incident signals act as independent variables determining the signals leaving the network. The definition of an S-parameter can be easily extended to multiport networks; measurement is also easily accomplished by terminating additional ports in their characteristic impedances. Thus, S-parameters completely describe linear network behavior in the same manner as low frequency parameters.

S-parameters offer numerous advantages to the microwave engineer because they are

both easy to use and easy to measure. They are easy to measure because the device is terminated in its characteristic impedance, allowing swept broadband frequency measurement without tuning, enhancing the stability of active devices, and permitting a test set up to be used for different devices. The design process is simplified because S-parameters are directly applicable to flow graph analysis. HP network analyzers and the appropriate test sets will measure and directly display S_{21} or S_{12} as gain or attenuation and S_{11} or S_{22} as reflection coefficient, return loss or impedance. Figure 8 shows measurements of both S_{21} and S_{11} . Also, S-parameters may be directly related to h, y, and z-parameters through algebraic transformations.

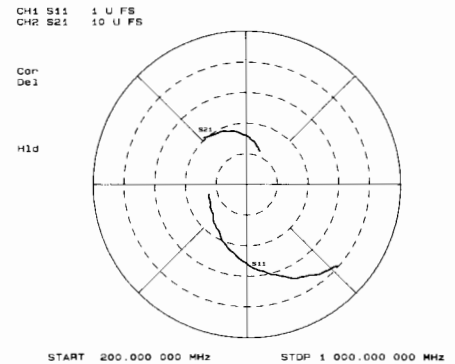

Figure 8. Simultaneous measurement of transistor S-parameters.

Additional Capabilities

Precision design work and manufacturing tolerances demand highly accurate measurements, but most errors in network measurements are complex quantities that vary as a function of frequency. By characterizing and virtually removing these systematic errors, measurement accuracies are improved by several orders of magnitude. Hewlett-Packard now offers network analyzers with built-in, high-speed computational hardware that can perform the complex mathematics required for sophisticated error correction. In many cases, this improvement in accuracy is provided in real time, permitting operator adjustment to the network being characterized while maintaining a high level of measurement accuracy. Other network analyzers, when combined with HP desktop computers into measurement systems, also offer accuracy enhancement through error correction.

Adding the computational capabilities of a digital computer can complement the network analyzer's versatility through simplifying and speeding measurements, data processing, and accuracy enhancement. Hewlett-Packard has combined network analyzers and computers into measurement systems and now offers some analyzers that may be easily interfaced with HP desktop computers through the Hewlett-Packard Interface Bus.

Computer controlled network analyzers can be programmed to set up and make many measurements automatically. The measurement process is further accelerated by the computer's ability to store, transform, sum-



marize, and output data in a variety of formats to a number of peripherals. These capabilities make the computer controlled network analyzer ideal for both computer aided design or automatic production testing.

Network Analyzer Product Line

Hewlett-Packard offers a complete line of network analyzers capable of measurements through the 1 Hz to 100 GHz frequency range. Further information and detailed specifications on individual network analyzers are available on the following pages (see matrix on page 599 for specific page numbers).

HP 3575A

The HP 3575A measures phase and amplitude or gain. With the HP 3575A, the complete response picture is available at a reasonable cost from a single instrument, over an 80 dB range, from 1 Hz to 13 MHz. The HP 3575A uses a broadband measurement technique, which is attractive because the measurement is not constrained by internal tracking source or dedicated external device. The HP 3575A is not dependent on the wave shape, thus measurements can be made on a variety of waveforms such as triangle and square waves.

HP 3577A/3577S

HP Model 3577A is a high-performance vector network analyzer for audio, video, baseband, and IF applications from 5 Hz to 200 MHz. The HP 3577A makes precision measurements of filters, amplifiers, crystal devices, cables, electronic components, and subsystems used in communications, telecommunications, consumer electronics, and general purpose testing.

The HP 3577A directly measures transfer functions, S-parameters, complex impedance, and user-defined functions. Convenient display modes include linear or log magnitude, real, imaginary, phase, polar, Smith charts, and group delay.

The dynamic range of the HP 3577A is greater than 100 dB, with 0.02 dB magnitude accuracy and 0.2 degree phase accuracy. Input sensitivity is -130 dBm with a resolution bandwidth of 1 Hz, making critical low-level measurements possible.

An internal swept source covers the entire 5 Hz to 200 MHz frequency range with 0.001 Hz resolution and settability. Linear logarithmic sweep and CW modes are built in; discrete sweep is easily added using an external computer and HP-IB programming. An alternate sweep mode allows two different frequency spans to be observed simultaneously.

Simultaneous reflection and transmission measurements can be made from 100 kHz to 200 MHz with the optional HP 35677A/B S-Parameter Test Set. In addition to splitters and directional couplers, the test set contains relays that allow both forward and reverse measurements to be made without having to reconnect the device under test. The low-cost HP 35676A/B Reflection/Transmission Test Kit allows unidirectional reflection and transmission measurements to be made between 5 Hz and 200 MHz.

The HP 3577S Network Analyzer System includes the HP 3577A, HP 35677A/B, HP 9000 Series 200 or 300 Computer, HP 35678A/B Calibration Kit, and HP 35675A Accuracy Enhancement Software. HP 3577S offers partial 8- or full 12-term error correction for all S-parameter measurements; conversion from S-parameters to h, y, or z parameters; and convenient computer disk storage of instrument, calibration, and measurement data. Auto-sequencing, user-defined subroutines, and HP-IB programming allow HP 3577S to be integrated with other Hewlett-Packard instruments to automate complicated measurement setups.

HP 8405A

The HP 8405A vector voltmeter is a dual-channel RF millivoltmeter and phasemeter. It reads the absolute voltages on either of two channels and simultaneously determines the phase relationship between them. CW measurements can be made over the frequency range 1 MHz to 1 GHz.

Besides its use as a voltmeter, applications of the HP 8405A include:

- 1) Transmission measurements (gain, loss, phase shift and return loss) in 50 Ω systems.
- 2) Group delay and amplitude modulation index.
- 3) In-circuit probing.
- 4) S-parameters in 50 Ω systems.

Application Notes 77-3, 77-4, and 91 are available for more detail on the above measurements.

HP 8754A

The HP 8754A is a completely integrated stimulus/response system for testing a wide variety of networks (such as filters, amplifiers, and attenuators) in the 4 to 1300 MHz frequency range. By combining a swept source, three channel tuned receiver, and polar/rectilinear CRT display into a single compact package, outstanding performance can be achieved at an economical price. Magnitude, phase, polar reflection coefficient and impedance are all measured directly over 80 dB of spurious free dynamic range. Frequency accuracy is provided by a crystal marker system and, since three receiver inputs are available, network transmission and reflection parameters can be measured simultaneously. Additionally, a complete line of 50 Ω and 75 Ω power splitters, transmission/reflection test sets, and S-parameter test sets, is available. A high impedance probe can also be used if necessary, and an external signal generator can be used directly to characterize narrowband devices such as crystal filters.

HP 8753A

The HP 8753A is a high performance/low cost RF vector network analyzer for laboratory or production measurement of devices and modules. It integrates a high resolution synthesized source and a three input receiver to measure and display magnitude, phase and group delay responses of RF networks. Simultaneous reflection and transmission measurements can be made with 1 Hz frequency resolution from 300 kHz to 3.0 GHz with 100 dB of dynamic range.

In addition to regular sweep modes, up to 30 arbitrary CW frequency points can be

measured with one sweep for more efficient and productive measurements. Improve measurement throughput in high volume applications by defining test limit lines in the network analyzer and letting the analyzer make the pass/fail limit test decision during the testing process. Two independent display channels and a large screen CRT make it easy to view measured results, either independently or simultaneously, in rectangular or polar/Smith chart formats.

Digital signal processing and microprocessor controls combine to provide easy operation and measurement improvement. Trace math, data averaging, trace smoothing, electrical delay, and accuracy enhancement provide performance improvement and flexibility. Measurement results may be printed or plotted directly to a compatible peripheral without the use of an external computer. Save instrument states, calibration sets, and memory trace data in internal non-volatile memory for more than three days or transfer information directly to a compatible external flexible disc without the use of a computer. The HP 8753A is also completely programmable through the Hewlett-Packard Interface Bus.

Optional capabilities include the transformation of measured data from the frequency domain to the time domain, providing the ability to view the response of a test device as a function of time (or distance), permitting identification of specific discontinuities within the test device or simulating transient testing of a DUT.

A complete set of measurement accessories for 50 or 75 ohm measurements such as test sets, calibration kits, verification kits, test port return cables, and adapters are available.

HP 8410C

The HP 8410C network analyzer system measures the transmission and reflection characteristics of linear networks in the form of gain, attenuation phase shift, reflection coefficient, normalized impedance and S-parameters in the frequency range of 110 MHz to 18 GHz.

The HP 8410C is a ratiometer using both reference and test signal inputs; consequently, the sweeper output must be divided into channels. This is accomplished by a "Test Set" whose other major function can be to provide the switching required for making transmission and reflection measurements with minimum or no changes in the measurement setup. Hewlett-Packard offers test sets covering various frequency ranges and switching functions.

Another major instrument required in the HP 8410 measurement system is a unit for the detection and display of the IF amplitude and phase. Two plug-in displays (for the HP 8410C mainframe) are available for this purpose: a phase-gain display for displaying log amplitude and phase versus frequency; and a polar display for displaying amplitude and phase in polar coordinates.

The HP 8410C is capable of swept measurements over multi-octave bands through 18 GHz. Measurements of more than 60 dB of attenuation and 40 dB of gain are possible.



NETWORK ANALYZERS

Complete Characterization of Linear Networks (cont.)

HP 8510A/8510T

The HP 8510 series microwave vector network analyzers provide complete measurement capability for characterization of linear networks from 45 MHz to 26.5 GHz. Full feature systems operating to 100 GHz can be configured. Two independent, yet identical, display channels can be used to view the log/linear magnitude, phase, or group delay response of a test device. The display channels may be viewed individually or simultaneously with measurement results presented in either a rectangular or polar/smith chart format. Powerful trace math, data averaging, smoothing, and electrical delay functions provide performance improvement and measurement flexibility. Internal, non-volatile, storage of instrument front panel states, calibration sets, and measurement data is available. A built-in tape cassette unit extends the storage capacity. Measurement results may be printed or plotted directly to a compatible peripheral without the need of an external computer. The system is completely programmable through the Hewlett-Packard Interface Bus.

An internal, high-speed computer controls all aspects of system operation and data processing, and provides the powerful capability to perform the complex mathematics required for vector error correction. Frequency response, one port, and full two port measurement calibrations are available. System speed is such that measured data is error-corrected, yet displayed in virtual real time, allowing for operator adjustment of the test device while retaining a high level of measurement accuracy.

Optionally, transformation of measured data from the frequency domain to the time domain is available, providing the ability to view the response of a test device as a function of time. The time domain response presents the individual responses of a network as a function of time (or distance), permitting identification of specific discontinuities within the test device. Individual responses can be isolated within settable "gates," and viewed in the frequency domain without the effect of the responses outside the gate.

A total measurement system comprises a source (either the HP 8350B series sweep oscillators or HP 8340B/8341B synthesized sweepers) and one of four broadband test sets. The test sets provide either reflection/transmission or full s-parameter measurement capability. The s-parameter test sets include test channel attenuators and bias networks for application in active device characterization. All four test sets include an integrated three- or four-channel frequency converter. The HP 8511A is a four-channel frequency converter covering the 45 MHz to 26.5 GHz frequency range, and it can be combined with a customer supplied test setup for customized test requirements. Additionally, a complete line of calibration/verification kits, test port return cables,

and other measurement accessories are available.

The HP 8510T network analyzer system provides, under one model number, the highest performance network measurement system available. Covering 45 MHz to 26.5 GHz, it includes the HP 8515A S-parameter test set and HP 8340B synthesized sweeper in a four foot high mobile rack along with a comprehensive array of standards, verification kits, and accessories. Also, included are system installation and one year on-site warranty.

Scalar Network Analyzers

Scalar (magnitude only) network analyzers use economical broadband diode detectors for swept frequency measurements. These detectors, along with broadband bridges, permit transmission and reflection measurements from 10 MHz to 26.5 GHz with one system. Because many devices can be sufficiently characterized by magnitude versus frequency measurements, the need for complex, costly phase measuring circuitry in the network analyzer is eliminated. A scalar measurement system usually consists of a scalar network analyzer, sweep oscillator, detectors and a signal separation device (such as a directional coupler or bridge). In addition, many scalar systems utilize computers for automatic testing and data collection. Scalar network analyzers have enjoyed wide acceptance in research and development, manufacturing and field service testing applications.

HP 8757A/8757S

The HP 8757A is Hewlett-Packard's highest performance scalar network analyzer. It can make swept frequency transmission and reflection measurements from 10 MHz to 60 GHz. Each of the three (or optionally four) detector inputs can be displayed independently in an absolute power measurement mode (A, B, C or R) or in a ratio measurement mode (A/R, B/R, C/R or any other combination). A built-in trace memory for each channel enables normalized measurements that can be saved with the front panel settings in the SAVE/RECALL registers.

Alongside the CRT are several keys whose functions are defined in the HP 8757A internal memory. These "soft keys" make a large number of measurement functions available without adding front panel complexity. For example, the "open/short cal" soft key guides the user through the steps involved in an open/short calibration for reflection measurements. The plot soft key allows the user to plot the output to an HP-IB plotter of the CRT trace, graticule and annotation.

Soft keys allow the user to make any measurements that have previously required a computer. For example, the cursor soft keys enable the user to measure the 3 dB (or any other value) frequencies of a band limited device. Another soft key allows the user to specify limit lines that appear on the CRT for

simple pass/fail testing. After the device under test has been adjusted, measurement results can be plotted and titled using the plot soft keys.

Add a computer for fully automated transmission and reflection testing. All functions and front panel controls are programmable via the HP-IB with simple 3 letter codes. In addition to complete programmability, the HP 8757A can output data back to a computer very fast. A 401 point trace of measurement data can be transmitted in 25 milliseconds.

The HP 8757S automatic scalar network analyzer system is an ordering convenience that consists of all the instruments and accessories needed for automated measurements of insertion loss or gain, return loss, SWR, and power. The system is based on the HP 8757A scalar network analyzer and is controlled by an HP 9000 series 200 or 300 computer over the HP-IB. Also included in the system are a sweep oscillator, a high directivity (40 dB) directional bridge, detectors, accessories, and the HP 85015B or HP 85016B system software.

The HP 85015B system software allows the user to configure and run automatic scalar measurements with simple menu selections. No programming is needed to perform, display, plot or print scalar measurements.

The HP 85016B transmission line test software enables the user to completely characterize coaxial cables and waveguide runs. Measure insertion and return loss of the transmission line, then plot return loss versus distance to locate bad connections and faults.

HP 8756A/8756S

The HP 8756A is also a microprocessor based scalar analyzer that measures swept frequency transmission and reflection. Its "soft keys" offer a subset of the functions defined for the HP 8757A described above. The 3 detector inputs can be displayed on either of two display channel in a power measurement mode or ratio measurement mode. A built-in trace memory for each channel enables normalized measurements to be made at any resolution or offset. A fully annotated graphics CRT displays the measurement trace, scale per division, input being measured, and start and stop frequencies (when using an HP 8350B, 8341B or 8340B sweep oscillator).

The HP 8756A uses an ac detection scheme to reduce the effects of RFI, noise, and time and temperature drift.

All functions and front panel controls of the HP 8756A are programmable via the HP-IB. With an HP 9000 series 200 or 300 computer, the HP 8756S automatic scalar network analyzer can make fully automated transmission and reflection measurements. The HP 85015B and HP 85016B software products are completely compatible with the HP 8756S.



Network Analyzer Product Line Summary

HP Model	Frequency Range	Source	Measurement Capabilities
3577A Network Analyzer Page 612	5 Hz to 200 MHz	Synthesized Source	Transfer functions, magnitude/phase, insertion loss/gain, attenuation, electrical length, gain compression, Group Delay, Deviation from Linear Phase HP-IB Programmable
3577S Network Analyzer System Page 617	100 KHz to 200 MHz	Synthesized Source	All the capabilities of the HP 3577A, in addition to full 12-term vector error correction, conversion from s-parameters to h, y, or z parameters, and convenient disc storage of device data, calibration data, and instrument states.
3562A Dual Channel Dynamic Signal Analyzer	64 uHz-100 kHz	Band-limited random noise, burst random, sine chirp, burst chirp, swept and fixed sine. DC offset is user selectable.	Network and spectrum analysis, FFT-based time, frequency, and amplitude domain measurements, waveform recording, 40-pole/40-zero Curve Fitter, Frequency Response Synthesis, Waveform Math.
3582A Spectrum Analyzer Page 697	20 mHz to 25.599 kHz	Built-in source that is selectable as either random or pseudorandom. The noise signal is automatically band-limited and band-translated to match the analysis.	Transfer function amplitude and phase. Coherence function. Transient capture and analysis.
3575A Gain Phase Meter Page 618	1 Hz-13 MHz	None	Gain, Phase and Amplitude Low Frequency Analysis
8405A Vector Voltmeter Page 622	1 MHz-1 GHz (CW)	HP 3200B Oscillator, VHF Signal Generators, HP 8654 (UHF), and HP 8640 A/B	Voltmeter Transfer Functions, Impedance in 50 Ω systems Group Delay, Amplitude Modulation Index S-parameters in 50 Ω systems
8754A Network Analyzer Page 621	4-1300 MHz	Swept source included external source usable.	Magnitude and phase transmission coefficient reflection coefficient and return loss S-parameters, impedance.
8753A Network Analyzer Page 623	300 kHz-3 GHz	Swept Synthesized Source Included	Transfer functions - magnitude/phase insertion loss/gain, attenuation, gain compression, s-parameters, electrical length, group delay, deviation from linear phase. Impedance - magnitude/phase - Return Loss, r+jx Full Accuracy Enhancement Time Domain Capability Full HP-IB programmability
8756A Scalar Network Analyzer Page 609	10 MHz-60 GHz	HP 8350 or 8620 Series Sweep Oscillators, HP 8340B/8341B Synthesized Sweeper	Scalar Transmission/Reflection Measurements 50 Ω Coax Measurements 10 MHz-26.5 GHz 75 Ω Coax Measurements 10 MHz-2.4 GHz Waveguide Measurements 26.5 GHz-60 GHz Open/Short Averaging, Normalization, Averaging Storage Registers, HP-IB Programmable
8756S Automatic Scalar Network Analyzer Page 609	10 MHz-60 GHz	HP 8350 Series Sweep Oscillators, HP 8340B/8341B Synthesized Sweeper	Automatic Scalar Transmission/Reflection Measurements Custom configurable test sequences Automatic data collection and storage HP 9816, 9817, 9826 or 9836 Computer
8757A Scalar Network Network Analyzer page 603	10 MHz-60 GHz	HP 8350 or 8620 Series Sweep Oscillators, HP 8340B or 8341B Synthesized Sweepers	Scalar Transmission/Reflection Measurements 50 Ω Coax Measurements 10 MHz-26.5 GHz 75 Ω Coax Measurements 10 MHz-2.4 GHz Waveguide Measurements 26.5 GHz-60 GHz Open/Short Averaging, Normalization, Averaging, Limit Testing Storage Registers, HP-IB Programmable
8757S Automatic Scalar Network Analyzer Page 600	10 MHz-60 GHz	HP 8350 or 8620 Series Sweep Oscillators, HP 8340B or 8341B Synthesized Sweepers	Automatic Scalar Transmission/Reflection Measurements Custom configurable test sequences Transmission line testing with fault location HP 9816, 9817, 9826 or 9836 Computer
8410C Network Analyzer Page 636	110 MHz-18 GHz	HP 8350, 8620 Series Sweep Oscillators HP 8340B or 8341B Synthesized Sweepers	Transmission/Reflection Characteristics, S-parameters 50 Ω Coax Measurements 110 MHz to 18 GHz Continuous Multi-octave Measurements with HP 8620 and 8350 Series Sweepers DC Bias for Semiconductor Measurements
8510 Series Network Analyzer Page 629	45 MHz to 100 GHz	HP 8350 Series Sweep Oscillators HP 8340B, 8341B Synthesized Sweepers	Transmission/Reflection Characteristics S-parameters Active device characterization Full error correction in real time Time domain capability Full HP-IB programmability

600



NETWORK ANALYZERS

Automatic Scalar Network Analyzer System (10 MHz to 60 GHz)

Model 8757S

- Measure insertion loss or gain, VSWR, and power
- Plot and display data
- Customize automatic tests without programming
- Troubleshoot waveguide and coax

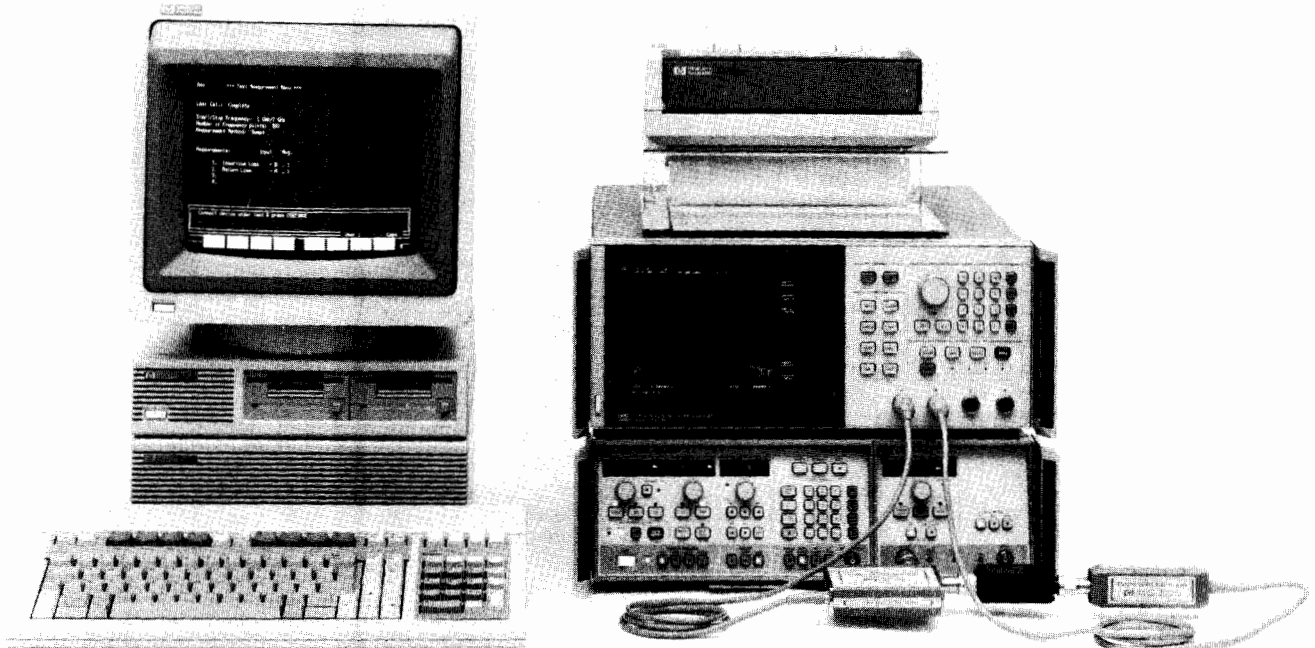

HP 8757S

The HP 8757S is a complete automatic scalar network analyzer for measurements of insertion loss or gain, return loss, and power from 10 MHz to 60 GHz. The system is based on the HP 8757A scalar network analyzer and is controlled by an HP 9000 series 200 or 300 computer over the Hewlett-Packard Interface Bus (HP-IB). Also included in the system are a swept source (HP 8350B sweep oscillator with RF plug-in or HP 8340B/8341B synthesized sweeper), a high directivity (40 dB) directional bridge, detectors, accessories, and the HP 85015B or 85016B system software. All analyzer and source controls are completely programmable.

Increase Productivity

The HP 85015B system software saves time and money in scalar measurements, and allows you to increase throughput without any programming. The simple menus and soft keys guide you through the measurement process. Informative "help" messages are always available for extra guidance. Frequently performed measurements may be saved for future use on the computer disc. When these test configurations are later recalled, the system is completely programmed with frequency limits, measurement channels, calibration data . . . everything you need to perform and display scalar measurements. The chances for operator error are greatly reduced, and repeatable, accurate data is ensured.

Troubleshoot Transmission Lines

The HP 85016B transmission line test software adds accurate fault location to the system. In addition to the frequency response of waveguide runs and coaxial cables, plot return loss data as a function of distance along the line. Locate bad connections and faults that cause reflections in the frequency range of interest.

Flexible Plot and Print Formats

Plot or print data and CRT graphics in your choice of formats without any programming. Select automatic scaling of either the vertical or horizontal axes (or both). Customize your own plot configuration with or without labels, grid lines, limit lines, and out-of-spec indicators. Plot up to four plots on a single page or print the data in the format you find most useful.

Easy to Use

In either manual or automatic operation, the HP 8757S is easy to operate. The fully annotated HP 8757A CRT is the system's control center with convenient display of frequency, power, and scaling parameters. Manual measurements can be easily controlled with the front panel function keys. With the system software and the entire HP 8757S system, even complex scalar measurements can be performed with ease.

High Performance

Each component of the HP 8757S is a high performance instrument in its own right. Together they form a very high performance automatic scalar network analyzer.

The HP 8757A scalar network analyzer offers 76 dB of dynamic range (+16 to -60 dBm) in three (or optionally four) independent inputs (A, B, (C), and R) when used with the HP 11664A/E detectors. Single inputs or ratio combinations of the inputs can be displayed on any of four independent display channels. Using AC modulation and detection, the HP 8757A provides excellent performance in the presence of unmodulated noise and spurious signals. The HP 11664 detectors cover the range from 10 MHz to 40 GHz and the HP 11664C detector adapter can be used with waveguide detectors for higher frequency operation. The HP 85025 and 85026 series detectors cover the range from 10 MHz to 60 GHz and offer the choice between AC and DC detection. In DC mode, the HP 85025 detectors can be used to provide excellent swept power measurements (dBm).

Test signals are provided by the HP 8350B sweep oscillator with an RF plug-in or by the HP 8340B/8341B synthesized sweepers. All source front panel functions are fully programmable via HP-IB and are also easy to use in manual applications. Frequency and power entries can be made with a knob, a numeric keypad, or with increment and decrement keys. Up to nine independent front panel settings may be saved or recalled at the touch of a key or through HP-IB.



System Specifications

ACCURACY

Transmission Loss or Gain Measurement Accuracy: Transmission loss or gain measurements are made relative to a 0 dB reference point established at calibration. The measurement accuracy is equal to the uncertainty due to the change in power level, called dynamic accuracy, plus mismatch uncertainty. The frequency response errors of the source, detectors, bridge and power splitter may be removed via calibration.

Dynamic Power Accuracy ($25 \pm 5^\circ\text{C}$, 0 dBm reference):

Coax Detectors* (50 MHz)

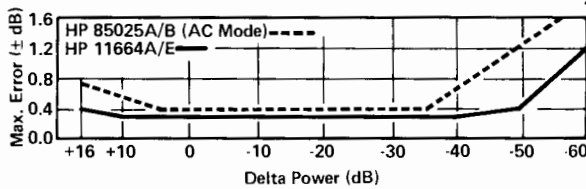

*For ≤ 20 dB change of power within +10 to -40 dBm, the specification for the HP 8757A with the HP 11664A/E is $\pm(0.1 \text{ dB} + 0.01 \text{ dB/dB})$.

Waveguide Detectors

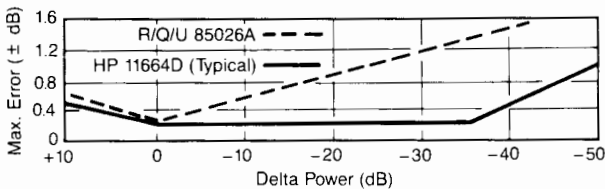

Absolute Power Measurement Accuracy: This specification is useful for determining the accuracy of power measurements in dBm when using the HP 85025A/B detectors in the DC mode. The total uncertainty is the sum of the detector frequency response, power accuracy, and mismatch uncertainties.

Absolute Power Accuracy (HP 85025A/B detectors in DC mode, detector offsets removed via power meter cal, $25 \pm 5^\circ\text{C}$):

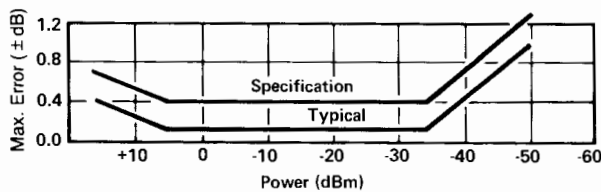

Detector Frequency Response (HP 85025A/B detectors, -10 dBm, $25 \pm 5^\circ\text{C}$):

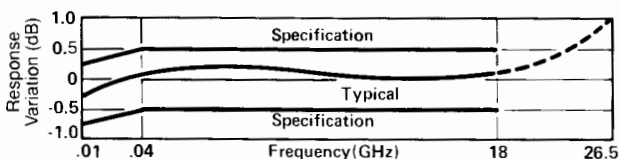

DYNAMIC RANGE (on all HP 8757A detector inputs):

Detector	AC Mode	DC Mode
HP 11664A/E	+16 to -60 dBm	
HP 11664D	+10 to -50 dBm	
HP 85025A/B	+16 to -55 dBm	+16 to -50 dBm
HP R/Q/U85026A	+10 to -50 dBm	+10 to -45 dBm

Reflection Measurement Accuracy: Uncertainties due to calibration error and the frequency response of the source, detectors and bridge are removed via open/short averaging. The remaining uncertainties are primarily the sum of directivity uncertainty, effective source match uncertainty, and dynamic power accuracy. As shown in the graphs below, directivity is the dominant error term when measuring small reflected signals (high return loss) and source match is dominant when measuring large reflected signals (low return loss).

The Effect of Effective Source Match on Reflection Uncertainty:

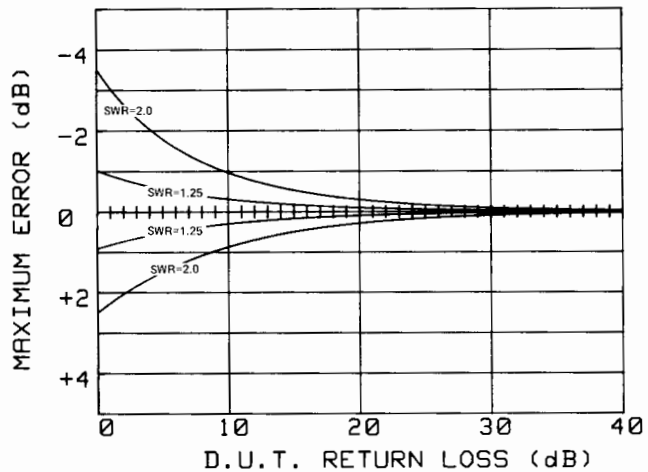

The Effect of Directivity on Reflection Uncertainty:

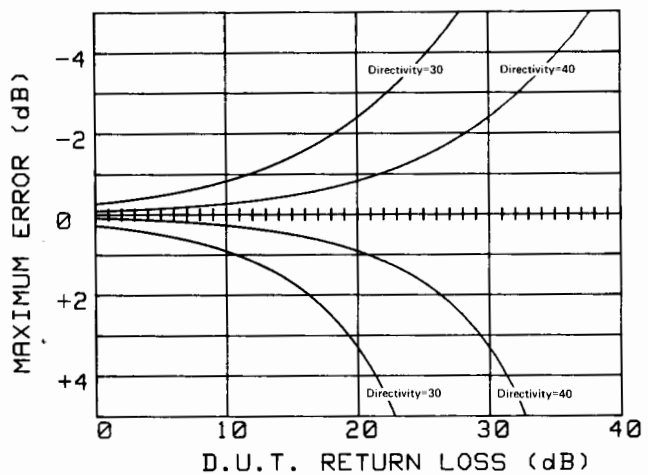

Dynamic Power Accuracy (HP 85027/20 bridges, 50 MHz, $25 \pm 5^\circ\text{C}$, +7 dBm input):

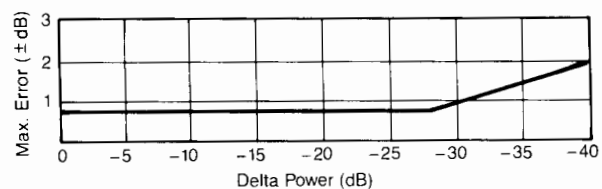



NETWORK ANALYZERS

Scalar Network Analyzer, 10 MHz to 60 GHz

Model 8757A

- 76 dB dynamic range
- Accurate swept power measurements (dBm)
- 40 dB directivity bridges
- Four independent display channels
- Limit testing built in
- Save/recall setup and cal data
- Direct plotter or printer output

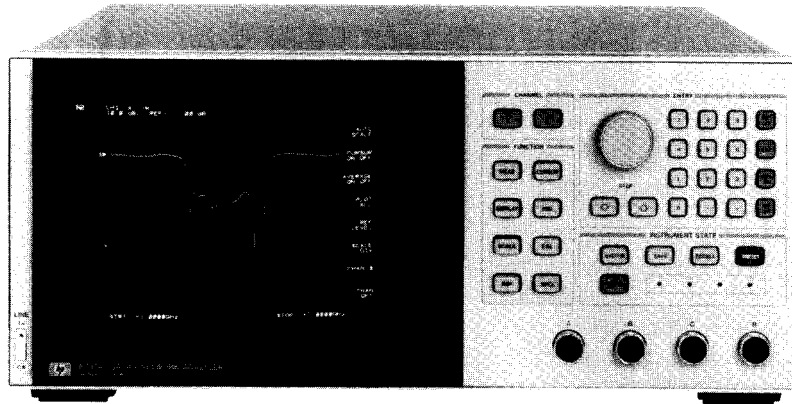

HP 8757A Option 001

Description

Measure insertion loss or gain, return loss, SWR, and power quickly and accurately with the HP 8757A scalar network analyzer. With high performance detectors and directional bridges and a companion HP source and digital plotter, the HP 8757A becomes the basis of a complete measurement system with superb performance.

Performance

The HP 8757A features 76 dB of dynamic range (-60 dBm to $+16$ dBm) when used with the HP 11664A/E detectors. With square wave modulation and detection (AC), the HP 11664 detectors enable reliable, drift-free measurements from 10 MHz to 40 GHz. With the HP 85025 and 85026 AC/DC detectors, make scalar measurements with or without modulation to 60 GHz. In DC mode (no modulation), use the HP 85025A/B to make accurate swept-frequency measurements of power (dBm).

High directivity bridges (>40 dB) covering RF and microwave frequencies help produce excellent measurement results. Using the HP 85020A/B and 85027A/B/C directional bridges, make accurate measurements of reflection and transmission parameters simultaneously.

Calibrate your test system, and make normalized measurements with 0.01 dB vertical resolution. Select the optimum horizontal resolution for your application, by choosing 101, 201, 401, 801, or 1601 data points. Lower resolution allows faster sweep times. Calibrate with full 1601 point resolution over your frequency range. Then zoom in on a narrower frequency span and retain calibration. The HP 8757A interpolates the calibration data automatically.

Easy to Use

With a combination of simple front panel keys and powerful menu-driven soft keys, the HP 8757A allows you to set up the system and make accurate measurements fast. Menus appear on the display, and you control them with the front panel soft keys. The soft keys give you powerful capabilities without adding front panel complexity. Press "Cal" and let the menu guide you through calibration procedures. Press "Autoscale" to bring your measurement into view quickly. Activate the "Cursor" and dial it to any point on your data trace for an accurate high resolution reading of magnitude (and frequency with the HP 8350B/8340B/8341B). Measurements are fast and easy.

Productivity Without a Controller

The HP 8757A increases productivity in scalar measurements even without a controller. Decrease the time it takes you to set up and make measurements, while improving the quality of the results.

Enter your own limit lines for easy comparison of measurement results to upper and lower specification limits. Or use these lines as

your own reference calibration and remove the frequency responses of devices that are inserted after calibration.

Four independent display channels add new capabilities to the system. Each channel can display the data taken from any of the three (or optionally four) detector inputs. Each channel can display a single input (A, B, (C), R) or a ratio combination of two inputs (A/R, B/R, A/B, etc.). With four inputs, measure multi-port devices or characterize several devices simultaneously. Or compare the response of the test device to the stored response of your "reference" device.

When used with the HP 8350B sweep oscillator or the HP 8340B/8341B synthesized sweepers, the HP 8757A acts as a system controller by managing the source via the "8757 System Interface." Using this interface the HP 8757A can extract frequency information and annotate the display. When used alone, the HP 8757A can save and recall up to nine front panel states in non-volatile memory, complete with calibration or measurement data, limit lines, and plot labels. With the system interface and a companion HP source, the HP 8757A can save and recall not only its own front panel state, but the source's as well. Configure often repeated measurements only once. Then just recall that set-up and connect your device.

Combining the HP 8757A with an HP 8350B/8340B/8341B also enables the useful "alternate sweep" function, which allows you to sweep different frequency ranges or power levels and display them both in real time.

The HP 8757A can adapt to any sweep ramp input in the 0-10 V range, such as a 2-5 V ramp. Test voltage-controlled oscillators and attenuators, using your test voltage ramp to drive the HP 8757A display. Plot output power or attenuation versus tuning voltage.

Document Your Results

The HP 8757A also uses the "8757 System Interface" to drive an HP-IB digital plotter or "ThinkJet" printer. Plot what appears on the CRT or define your own plot and plot size. Get crisp, permanent, annotated plots without a controller. Print graphics or tabular data listings on the HP "ThinkJet" printer.

Millimeter Wave Measurements

Extend scalar measurements to millimeter-wave frequencies with the HP 8757A and the waveguide detector for your frequency range. The HP R, Q, and U85026A detectors offer fully calibrated scalar measurements in the frequency bands 26.5-40 GHz (Ka) 33-50 GHz (Q) and 40-60 GHz (U). Add an HP millimeter-wave source and waveguide coupler for a complete scalar measurement system to 60 GHz. Above 60 GHz use your own waveguide detector with either the HP 85025C (AC/DC) or 11664C (AC only) detector adapters.

NETWORK ANALYZERS

8757/8756 System Accessories

Models 8757A, 85027A/B/C, 85020A/B

603



HP 8757A Specifications

Amplitude Characteristics

Independently controlled for each channel.

Reference offset: offset level adjustable in 0.01 dB increments from -70 to +20 dBm (power measurement) or -90 to +90 dB (ratio measurement).

Display characteristics

Resolution

Vertical: 0.003 dB (power measurement)
0.006 dB (ratio measurement)
0.01 dB for "Display Cursor"

Horizontal: 101, 201, 401, 801, or 1601 data points

#Points Minimum Sweep Time (ms) (log magnitude format only)

	1 Trace	2 Traces	3 Traces	4 Traces
101	40	50	60	70
201	50	75	90	100
401	100	100	150	200
801	200	250	NA	NA
1601	400	NA	NA	NA

Modulation Requirements (for HP 11664 detectors and HP 85025/26 detectors in AC mode):

Square-wave amplitude modulation

Frequency 27,778 ± 20 Hz

≥ 30 dB on/off ratio

45% to 55% symmetry

Averaging: 2, 4, 8, 16, 32, 64, 128, or 256 traces may be averaged.

Normalization: traces are stored and normalized with the highest resolution, independent of display scale/division or offset. Calibration data can be saved and recalled with the first four instrument states, and is interpolated when the frequency span is decreased.

HP-IB Characteristics

Transfer formats: Data may be transferred either as ASCII strings (nominally six characters per reading) or as 16 bit integers (most significant byte first). Readings may be taken at a single point, or an entire trace may be transferred at once.

Transfer speed:

ASCII format, 401 point trace: 800 ms typical.

ASCII format, point: 10 ms typical.

Binary format, 401 point trace: 24 ms typical.

Binary format, point: 5 ms typical.

System Interface

Description: the HP 8757A system interface is a dedicated HP-IB port used exclusively by the HP 8757A to control and extract information from a swept source and a digital plotter or "Thinkjet" printer.

Swept sources: HP 8350B with RF plug-in, HP 8340B/8341B synthesized sweeper, or any source that provides a sweep ramp in the range of 0-10 volts.

Plotters: HP 7440A, 7475A, 7550A, 7090A

Printers: HP 2225A

General Specifications

Power requirements: 48 to 62 Hz, 115/230 V ± 10%, typically 100 watts.

Dimensions: 178 H x 425 W x 482 mm D (7.0 x 16.75 x 19.0 in.).

Weight: net, 21 kg (46 lb); shipping, 26 kg (57.5 lb).

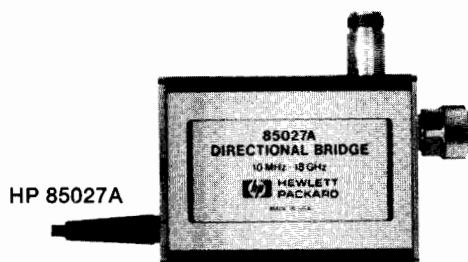

HP 85027A

• 40 dB Directivity

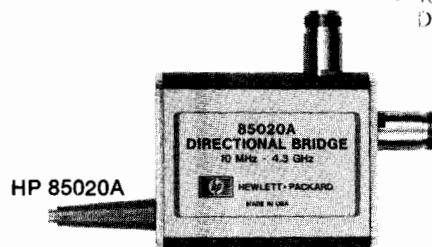

HP 85020A

Directional Bridges

The HP 85020A/B and HP 85027A/B/C are directional bridges designed especially for the HP 8757A, 8756A and 8755C scalar network analyzers. Each bridge features outstanding directivity and test port match in a compact, rugged package.

Within each bridge, one zero-bias Schottky diode detector measures the return loss of the test device. Ratio measurements can be made by adding a power splitter (HP 11667A/B) and detector (HP 11664 series or HP 85025 series).

HP 85027A/B/C Directional Bridges

The HP 85027 series directional bridges are designed to operate with the HP 8757, 8756 and 8755 scalar network analyzers for reflection measurements from 10 MHz to 26.5 GHz. A switch on the HP 85027 series bridges allows the user to configure them for operation with the HP 8757 or the HP 8756 and 8755 scalar network analyzers.

When used with the HP 8757A scalar network analyzer, the HP 85027 series bridges allow the user to choose the measurement mode that best suits the application. Use the bridge's AC mode (modulated RF) for measurements in the presence of undesired signals such as broadband noise or electromagnetic interference. Or choose the bridge's DC mode (unmodulated RF) to measure the return loss of modulation sensitive devices such as amplifiers with gain control circuits. Use the companion HP 85025 series detectors for AC and DC measurement versatility or the HP 11664 series detectors for AC only measurements.

High (40 dB) directivity and excellent test port match ensure accurate reflection measurements over a broad swept frequency range. The HP 85027B bridge operates from 10 MHz to 26.5 GHz and has an SMA compatible, precision APC-3.5 test port connector. The HP 85027A/C bridges operate from 10 MHz to 18 GHz. The HP 85027A has a rugged APC-7® test port connector and the HP 85027C has a precision Type-N connector.

Measuring SMA devices

Hewlett-Packard recommends using the HP 85027A bridge and an APC-7 to APC-3.5 adapter for measuring SMA devices from 10 MHz to 18 GHz. For SMA measurements to 26.5 GHz, HP recommends using APC-3.5 to APC-3.5 adapters (included with the HP 85027B bridge) to preserve the HP 85027B output connector.

HP 85020A/B Directional Bridges

The economical HP 85020A/B directional bridges also offer high (40 dB) directivity and excellent port match at RF (to 4.3 GHz) frequencies. For 50 ohm measurements choose the HP 85020A. The HP 85020B is designed for 75 ohm environments. Both RF bridges have Type-N connectors.

*APC-7 is a U.S. registered trademark of the Bunker Ramo corporation



NETWORK ANALYZERS

8757/8756 System Accessories (con't)

Model 85027 A/B/C, 85020 A/B, 85025 A/B, R/Q/U 85026A, 11664 A/D/E

DIRECTIONAL BRIDGE SUMMARY

For use with the HP 8757A, 8756A, or 8755C in AC detection mode only:								
Bridge	Freq. Range (GHz)	Nominal Impedance	Connector		Directivity (dB)	Test Port Match (SWR)	Weight	
			Input	Test port			Net	Shipping
85020A	.01-4.3 GHz	50 ohms	Type-N (f)	Type-N (f)	.01-3 GHz: 40 dB 3-4.3 GHz: 34 dB	.01-3 GHz: <1.22 3-4.3 GHz: <1.25	0.5 kg (1.2 lb)	2.3 kg (5 lb)
85020B	.01-2.4 GHz	75 ohms	Type-N (f)	Type-N (f)	40 dB	.01-1.3 GHz: <1.25 1.3-2.4 GHz: <1.43	"	"

For use with the HP 8756A, or 8755C in AC detection mode or with the HP 8757A in either AC or DC detection modes								
85027A	.01-18 GHz	50 ohms	Type-N (f)	APC-7	40 dB	.01-8.4 GHz: <1.15 8.4-12.4 GHz: <1.25 12.4-18 GHz: <1.43	0.5 kg (1.2 lb)	2.3 kg (5 lb)
85027B	.01-26.5 GHz	50 ohms	APC-3.5 (f)	APC-3.5 (f)	.01-20 GHz: 40 dB 20-26.5 GHz: 36 dB	.01-8.4 GHz: <1.15 8.4-20 GHz: <1.43 20-26.5 GHz: <1.75	"	"
85027C	.01-18 GHz	50 ohms	Type-N (f)	Type-N (f)	.01-12.4 GHz: 36dB 12.4-18 GHz: 34 dB	.01-8.4 GHz: <1.15 8.4-12.4 GHz: <1.25 12.4-18 GHz: <1.43	"	"

Detectors

Two types of detectors are available for use with HP scalar network analyzers for measurements up to 60 GHz. All detectors provide excellent impedance match, and therefore minimize mismatch uncertainty in scalar measurements.

HP 85025 and 85026 Series Detectors (AC/DC)

The HP 85025 and 85026 series detectors are designed specifically for operation with the HP 8757A Scalar Network Analyzer and are not compatible with either the HP 8756 or the 8755. The HP 85025/26 detectors detect either a modulated (AC) or an unmodulated (DC) microwave signal. In AC mode, the HP 85025/26 series detect the envelope of the 27.8 kHz modulated microwave signal,

provided internally by the HP 8350B Sweep Oscillator with RF plug-in or externally with the HP 8340/41 synthesized sweepers. In DC mode, the HP 85025/26 series detectors measure the microwave power directly without modulation. The user can change detection modes from the HP 8757A front panel.

HP 11664 Series Detectors (AC Only)

The HP 11664 series detectors are designed to operate with the HP 8757A, 8756A and 8755C scalar analyzers in AC mode only. The HP 11664A/E cover the 10 MHz to 26.5 GHz range, and the HP 11664D covers from 26.5 to 40 GHz.

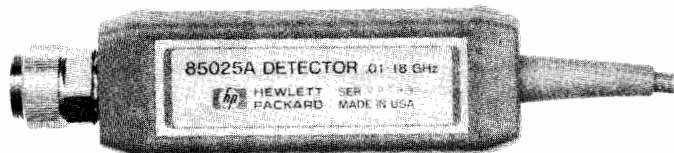

HP 85025A

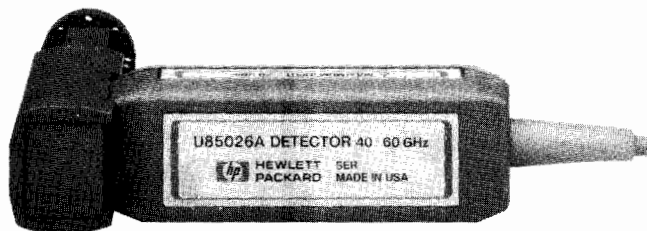

HP U85026A



HP 11664A



HP 85025C

Detector Adapters

The HP 85025C and the HP 11664C Detector Adapters match the scalar analyzer display to most standard crystal, silicon, and gallium arsenide detectors. This enables the user to operate in any frequency band, such as above 60 GHz with the HP 8757A, and above 40 GHz with the HP 8756A.

The HP 85025C Detector Adapter is designed for use with the HP 8757A only, and can operate in either AC or DC detection modes. A softkey calibration sequence calibrates the HP 8757A display to your particular detector for an accurate display of power level. The analyzer can then account for the voltage versus input power characteristics

of the detector in use. This calibration requires two known calibration inputs, one at a high level (linear operating region, above 0 dBm) and one at a low level (square law region, below -20 dBm).

The HP 11664C Detector Adapter is designed for use with the HP 8757A, 8756A, and 8755C scalar analyzers. The HP 11664C is matched to the particular diode used via two screwdriver adjustments. One adjustment sets the adapter's amplifier gain to the correct power level indication on the scalar network analyzer. The second adjustment matches the input impedance of the adapter to the load impedance of the detector. Together, the voltage versus power characteristics of the detector are calibrated for the scalar analyzer display.

Detector Summary

For use with the HP 8757A, 8756A, or 8755C in AC detection mode only:

Detector	Freq. Range (GHz)	Connector Type	Return Loss (dB)	Dynamic Range		Weight	
				8757	8756	Net	Shipping
11664A ¹	.01-18	Type-N (M)	.01-.04 GHz: 10 dB .04-4 GHz: 20 dB 4-12 GHz: 18 dB 12-18 GHz: 16 dB	+16 to -60 dBm	+10 to -50 dBm	0.17 kg (0.4 lb)	0.9 kg (2 lb)
11664E	.01-26.5	APC-3.5 (M)	.01-.04 GHz: 10 dB .04-6 GHz: 20 dB 6-20 GHz: 16 dB 20-26.5 GHz: 12 dB	+16 to -60 dBm	+10 to -50 dBm	"	"
11664D	26.5-40	WR-28	12 dB	+10 to -50 dBm	+10 to -50 dBm	0.24 kg (0.5 lb)	1.0 kg (2.2 lb)
11664C	³	SMA (M)	³	³	³	0.17 kg (0.4 lb)	0.9 kg (2 lb)

For use with HP 8757A only in either AC or DC detection modes:

Detector	Freq. Range (GHz)	Connector Type	Return Loss (dB)	AC mode	DC mode	Net	Shipping
85025A ¹	.01-18	Type-N (M)	.01-.04 GHz: 10 dB .04-4 GHz: 20 dB 4-18 GHz: 17 dB	+16 to -55 dBm	+16 to -50 dBm	0.24 kg (0.5 lb)	1.0 kg (2.2 kg)
85025B	.01-26.5	APC-3.5 (M)	.01-18 GHz: Same as 85025A 18-26.5 GHz: 12 dB	+16 to -55 dBm	+16 to -50 dBm	"	"
R85026A ² Q85026A ² U85026A ² 85025C ²	26.5-40 33-50 40-60 ³	WR-28 WR-22 WR-19 SMA (M)	12 dB 12 dB 12 dB ³	+10 to -50 dBm +10 to -50 dBm +10 to -50 dBm ³	+10 to -45 dBm +10 to -45 dBm +10 to -45 dBm ³	" " " "	" " " "

- Option 001 changes to APC-7 connector.
- The HP 85026 series detectors and the HP 85025C require HP 8757A firmware revision 2.0 or higher. To upgrade previous revisions order the HP 11614A Firmware Enhancement.
- Depends on the particular external detector used.



NETWORK ANALYZERS

8757/8756 System Accessories (con't)

Models 11679A/B, 85023A/B/C/D, 85022A, 85015B, 85016B, 11668A, 11678A

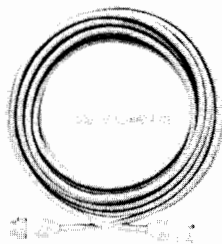

HP 11679A



HP 85023C

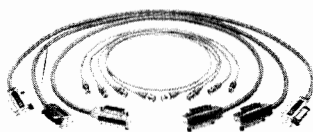

HP 85022A



HP 11668A



HP 11678A

HP 11679A/B Extension Cables

Function: These cables extend the distance between the scalar network analyzer and the detector or bridge to a maximum of 200 feet without degradation of performance.

HP 11679A: 7.6 m (25 ft) extension cable

HP 11679B: 61 m (200 ft) extension cable

HP 85023A/B/C/D Verification Kits

The HP 85023A/B/C/D system verification kits each contain a set of precision components used to perform a system verification procedure for the HP 8757S/56S scalar network analyzer system. This procedure, which is in the HP 8757A/56A Operating and Service Manuals, checks system installation and can be used as a daily functional test.

Choose a system verification kit to match your device under test. For APC-7 applications, select the HP 85023A. If you are measuring SMA or APC-3.5 devices, choose the HP 85023B. For 50 ohm, Type-N applications, select the HP 85023C. These kits (HP 85023A/B/C) all include an open, short, 10 dB fixed attenuator, 50 ohm termination, and a source to directional bridge adapter of the corresponding connector type. The HP 85023D verification kit, for 75 ohm Type-N measurements, consists of a short, a 75 ohm termination, a 50 ohm 10 dB fixed attenuator and two HP 11852A 50 to 75 ohm minimum loss pads (for 50/75 ohm impedance conversion).

Frequency range: HP 85023A/C, dc to 18 GHz.

HP 85023D, dc to 1.3 GHz.

HP 85023B, dc to 26.5 GHz.

Connector type: HP 85023A, APC-7.

HP 85023B, APC-3.5.

HP 85023C, Type-N, 50 ohm.

HP 85023D, Type-N, 75 ohm.

Characteristic impedance: HP 85023A/B/C, 50 ohm.

HP 85023D, 75 ohm.

Weight: net, 0.5 kg (1.2 lb); shipping, 1.2 kg (2.9 lb).

HP 85022A System Cable Kit

The HP 85022A contains all the BNC and HP-IB cables to connect an HP 8350B sweep oscillator (or HP 8340B synthesized sweeper), an HP Series 200 computer, and a printer to the HP 8757A or 8756A. This kit contains 3 one-metre HP-IB cables (HP 10833A), 3 two-foot BNC cables (HP 11170B), and 1 four-foot BNC cable (HP 11170C).

BNC connectors: N-Male, N-Male.

BNC impedance: 50 ohm.

Weight: net, 0.5 kg (1.2 lb); shipping, 1.2 kg (2.9 lb).

HP 85015B System Software for HP 8757S/8756S

Save frequently performed measurement procedures and calibration data for future use. Measure insertion loss, gain, power and reflection coefficient. The HP 85015 allows you to customize your test sequence and then print or plot the output in your choice of formats. The HP 85015 includes four system discs and a data disc for either 5.25 inch or 3.5 inch disc drives. Choose the option that corresponds to your computer configuration.

Weight: net, 0.5 kg (1.2 lb); shipping, 1.2 kg (2.9 lb).

For further information see page 610.

HP 85016B Transmission Line Test Software for HP 8757S/8756S

Add accurate transmission line fault location to the HP 85015A/B system software. In addition to frequency response, plot return loss of cables and waveguides as a function of distance. The HP 85016B includes four system discs and one data disc for either 5.25 inch or 3.5 inch disc drives. Choose the option that corresponds to your computer configuration.

Weight: net, 0.5 kg (1.2 lb); shipping, 1.2 kg (2.9 lb).

For further information see page 610.

HP 11668A High Pass Filter

The HP 11668A high pass filter accessory is recommended when making measurements on active devices that have gain below 50 MHz. Use of the HP 11668A, placed after the HP 11665B, reduces the modulator drive feedthrough from 8 mV to 1 mV and prevents possible amplifier saturation. Use of the HP 11668A filter is not necessary for passive measurements since the feedthrough from the HP 11665B is -65 dBm and causes no degradation in system performance.

Frequency range: 50 MHz to 18 GHz.

	Insertion Loss	Return Loss
50-100 MHz	≤2.5 dB	≥12 dB
100 MHz-8 GHz	≤1.0 dB	≥16 dB
8-12 GHz	≤1.0 dB	≥14 dB
12-18 GHz	≤1.5 dB	≥14 dB

Maximum input: +27 dBm.

Connectors: N-female, N-male.

Weight: net, 0.13 kg (5 oz); shipping, 0.28 kg (10 oz).

HP 11678A Low Pass Filter Kit

Description: the HP 11678A low pass filter kit contains five filters. Low pass filters reduce harmonics generated by the RF source when making precision measurements.

Frequency Range (low pass filters, cutoff frequency f_c)

HP 11688A: 2.8 GHz.

HP 11689A: 4.4 GHz.

HP 11684A: 6.8 GHz.

HP 11685A: 9.5 GHz.

HP 11686A: 13.0 GHz.

Insertion loss: <1.1 dB at 0.95 f_c .

Rejection (at 1.25 f_c): greater than 40 dB.

Impedance: 50 ohm normal.

Connectors: N-Female, N-Male.

Weight: net, 0.44 kg (1 lb); shipping, 1.2 kg (2.9 lb).

Service Products

HP 8757+23N/8756+23N Onsite Installation (where available)

Be sure your HP 8757S or 8756S automatic scalar network analyzer system is operating from the start by having an HP Customer Engineer configure your system at your site. After you have unpacked the equipment the HP Customer Engineer will assemble and verify the operation of your system.

HP 8757+02B/8756+02B Onsite Service (where available)

Increase your total system uptime by ordering onsite service. An HP Customer Engineer will come to your site to perform all repairs for one year.

NETWORK ANALYZERS

8757/8756 System Accessories (cont.)

Models 11613A, 11667A/B, 11636A/B, 11665B, 11679A/B, 11852A

607



HP 11613A Calibrator

HP 8757A verification/calibration is recommended every 12 months. This can be accomplished at an HP service center or on-site using the HP 11613A calibrator and an HP 9000 series 200 or series 300 computer.

The HP 11613A is a dedicated transfer standard for calibration of the HP 8757A. The HP 11613A provides the standard a 27.778 kHz source and a series of precision attenuators. The calibrator includes software (both 3.5 and 5.25 inch formats) that operates on an HP 9000 series 200 or series 300 computer and the BASIC operating system (BASIC 2.0, 2.1, 3.0 or 4.0). The software verifies (and adjusts if necessary) the internal calibration parameters stored in the non-volatile memory of the HP 8757A. All HP 8757A detector inputs can be calibrated in a matter of minutes. Re-calibration of the HP 11613A is recommended every two years.

Memory Requirement: 1/2M byte, including BASIC.

Dimensions: 40 H x 185 W x 203 mm D (1.5 x 7.3 x 8.0 in).

Cable length: 1.22 m (48 in).

Weight: Net 0.91 kg (2 lbs). Shipping 1.4 kg (3 lbs).

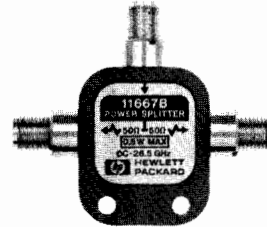

HP 11667B

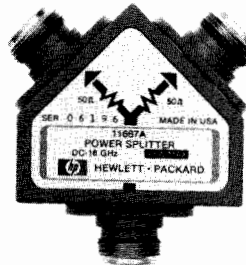

HP 11667A



HP 11665B

HP 11667A/B Power Splitter

The HP 11667A/B power splitters are recommended when making wideband ratio measurements using the HP 8757A, 8756A or 8755C scalar network analyzer. These two-resistor type splitters provide excellent output SWR at the auxiliary arm when used for source leveling or ratio measurement applications. The tracking between output arms over a frequency range from dc to 18 GHz allows wideband measurements to be made with a minimum of uncertainty.

Frequency Range:

HP 11667A: DC to 18 GHz.

HP 11667B: DC to 26.5 GHz.

Impedance: 50 ohms nominal.

Insertion Loss: 6 dB nominal.

	DC to 4 GHz	DC to 8 GHz	DC to 18 GHz	DC to 26.5 GHz
--	----------------	----------------	-----------------	-------------------

Input SWR:

HP 11667A: ≤ 1.15 ≤ 1.25 ≤ 1.45

HP 11667B: ≤ 1.22 ≤ 1.22 ≤ 1.22 ≤ 1.29

Equivalent Output SWR: (leveling or ratio measurements)

HP 11667A: ≤ 1.10 ≤ 1.20 ≤ 1.33

HP 11667B: ≤ 1.22 ≤ 1.22 ≤ 1.22 ≤ 1.22

Output Tracking: (between output arms)

HP 11667A: ≤ 0.15 dB ≤ 0.20 dB ≤ 0.25 dB

HP 11667B: ≤ 0.20 dB ≤ 0.20 dB ≤ 0.20 dB ≤ 0.25 dB

Typical Phase Tracking: (between output arms)

HP 11667A: 0.5 deg 1.5 deg 3.0 deg

HP 11667B: 1.5 deg 1.5 deg 1.5 deg 2.5 deg

Maximum Input Power: +27 dBm.

Connectors:

HP 11667A: N-female on all ports.

HP 11667B: APC-3.5 female on all ports.

Dimensions:

HP 11667A: 46 H x 52 W x 19 mm D (1.8 x 2.0 x 0.7 in).

HP 11667B: 40 H x 47 W x 10 mm D (1.6 x 1.9 x 0.4 in).

Weight:

HP 11667A: net, 0.14 kg (0.31 lb); shipping, 0.22 kg (0.5 lb).

HP 11667B: net, 0.06 kg (0.13 lb); shipping, 0.14 kg (0.3 lb).

HP 11636A/B Power Dividers

The HP 11636A/B power dividers/combiners are recommended when making wideband comparison measurements without ratiating, and in fault location measurements with the HP 8757S/85016. Detailed specifications are on page 557.

Other Signal Separation Devices

Many other signal separation devices are available from HP for use with the HP 8757A, 8756A and 8755C. Coaxial couplers from 0.1 to 18 GHz are available with the HP 770 series, the 790 series, and the HP 11692. Higher directivity HP 752 series waveguide couplers can also be used with the HP 8757A, 8756A or 8755C with the addition of appropriate HP 281 series waveguide-to-coax adapters.

11665B Modulator

Function: absorptive on-off modulator designed for and powered by the HP 8757A, 8756A or 8755C scalar network analyzers.

Frequency Range	Return Loss On and Off	Insertion Loss On Off
15-40 MHz	≥ 10 dB	≤ 7.0 dB ≥ 35 dB
40 MHz-4 GHz	≥ 15 dB	≤ 3.2 dB ≥ 35 dB
4-8 GHz	≥ 12 dB	≤ 3.8 dB ≥ 40 dB
8-12.4 GHz	≥ 8 dB	≤ 4.3 dB ≥ 45 dB
12.4-18 GHz	≥ 8 dB	≤ 5.0 dB ≥ 45 dB

Modulator drive feedthrough: ≤ 8 mV (peak) at 27.8 kHz at either port when powered by the HP 8757A, 8756A or 8755C. Reduced to ≤ 1 mV (peak) using the HP 11668A. (See HP 11668A High Pass Filter).

Drive current: nominally +50 mA in On condition, -50 mA Off condition.

Weight: net, 0.17 kg (6 oz); shipping, 0.9 kg (2 lb).

HP 11852B 50 ohm/75 ohm Minimum Loss Pad

The HP 11852A is a low SWR minimum loss pad required between 75 ohm devices and 50 ohm sources and detectors. For more information, see page 625.



NETWORK ANALYZERS

Ordering Information

Models 8757/8756

Ordering Information

The HP 8757S Automatic Scalar Network Analyzer is ordered with multiple line items to give you maximum flexibility in specifying a system that meets your needs. This ordering guide lists the HP 8757S line items required for software compatibility. It is not necessary to order any line item you already own. Consult your local HP Sales Office if you would like assistance.

HP 8757S Scalar Network Analyzer System Price \$0

This system model number ensures coordination of shipments and compatibility of instruments and software.

Analyzer

HP 8757A Scalar Network Analyzer	\$11,000
Opt. 001 Fourth detector input	\$1,500

Sweep Oscillators (choose either HP 8350B with an RF Plug-in 8340A or 8341A)

HP 8350B Sweep Oscillator Mainframe	\$4,565
HP 83522A 0.01-2.4 GHz RF Plug-in	\$8,170
HP 83592A 0.01-20 GHz RF Plug-in	\$20,500
HP 83595A 0.01-26.5 GHz RF Plug-in	\$26,000

Other RF Plug-in (see HP 8350B catalog entry for model and options)

HP 8341B 0.01-20 GHz Synthesized Sweeper	\$39,500
--	----------

Directional Bridges (choose at least one)

HP 85027A 0.01-18 GHz, APC-7, 50 ohm	\$2,500
HP 85027B 0.01-26.5 GHz, APC-3.5 female, 50 ohm	\$2,800
HP 85027C 0.01-18 GHz, Type-N female, 50 ohm	\$2,500
HP 85020A 0.01-4.3 GHz, Type-N female, 50 ohm	\$950
HP 85020B 0.01-2.4 GHz, Type-N female, 75 ohm	\$1,050

Detectors (choose at least one)

HP 11664A 0.01-18 GHz, Type-N male	\$430
Opt. 001 APC-7 connector	add \$25
HP 11664E 0.01-26.5 GHz, APC-3.5 male	\$680
HP 11664D 26.5-40 GHz, WR-28 waveguide	\$1,100
HP 11664C Detector Adapter	\$255
HP 85025A 0.01-18 GHz, Type-N male	\$850
Opt. 001 APC-7 connector	add \$50
HP 85025B 0.01-26.5 GHz, APC-3.5 male	\$950
HP R85026A 26.5-40 GHz, WR-28 waveguide	\$1,500
HP Q85026A 33-50 GHz, WR-22 waveguide	\$1,700
HP U85026A 40-60 GHz, WR-19 waveguide	\$1,700
HP 85025C Detector Adapter	\$500

System Verification Kits (choose at least one)

HP 85023A APC-7, 50 ohm	\$520
HP 85023B APC-3.5, 50 ohm	\$655
HP 85023C Type-N, 50 ohm	\$415
HP 85023D Type-N, 75 ohm	\$685

Filter Kits

HP 11668 High Pass Filter Kit	\$555
HP 11678 Low Pass Filter Kit	\$1,380

System Cable Kit

HP 85022A System Cable Kit	\$355
----------------------------	-------

Computer (choose one)

HP 9826S Series 200, Model 26S Computer	\$11,555
HP 9836S Series 200, Model 36S Computer	\$14,420
HP 98257A 1M byte Memory Board	\$1,450

Disc Drives (one required for HP 9816S)

HP 9122D 3.5 inch Dual Flexible Disc Drive	\$1,390
--	---------

Software (choose one option)

HP 85015B System Software for HP 8757S	\$2,000
Opt. 630 for Computer with HP 9121D/22D Disc Drive	N/C
Opt. 655 for either HP 9826S or 9836S Computer	N/C
HP 85016B Transmission Line Test Software for HP 8757S	\$4,500
Opt. 630: for Computer with HP 9121D/22D Disc Drive	N/C
Opt. 655: for either HP 9826S or 9836S Computer	N/C

Recommended Accessories

Printer (choose at least one)

HP 2225A ThinkJet Printer	\$495
HP 2673A Intelligent Graphics Printer	\$2,240
HP 2932A Opt 046 Impact Graphics Printer	\$2,645

Plotter (choose at least one)

HP 7440A Opt. 002 Eight-pen Graphics Plotter (8.5" x 11")	\$1,295
HP 7550 Eight-pen Vector Plotter (11" x 17")	\$3,900

Optional Accessories (for ratio and/or modulation measurements)

HP 11636A Power Divider DC to 18 GHz	\$400
HP 11636B Power Divider DC to 26.5 GHz	\$950
HP 11665B Modulator	\$605
HP 11667A Power Splitter DC to 18 GHz	\$930
Opt. 001 N-male on input port; N-female on output ports:	N/C
Opt. 002 N-female on input port; APC-7 on output ports:	add \$75

HP 11667B Power Splitter DC to 26.5 GHz	\$950
HP 11852A 50 to 75 ohm Minimum Loss Pad	\$205

Service and Support Products

HP 8757S+23N Onsite Installation (where available)	
HP 8757S+02B Onsite Service (where available)	

Compatible HP 8350B Plug-Ins

(HP 86200 series plug-ins require the HP 11869A adapter for use with the HP 8350)

HP Model Number	Frequency Range (GHz)	Power Out (mW)	Price
83595A	0.01-26.5	2.5	\$26,000
83592A	0.01-20.0	10	20,500
83592B	0.01-20.0	20	23,500
83592C	0.01-20.0	4	22,000
83525A	0.01-8.4	20	12,500
83525B	0.01-8.4	10	13,500
83522A	0.01-2.4	20	8,170
83594A	2.0-26.5	2.5	22,820
83590A	2.0-20.0	10	17,700
83550A	8.0-20.0	60	15,000
83540A	2.0-8.4	40	9,780
83540B	2.0-8.4	20	10,280
83545A	5.9-12.4	50	9,780
83570A	18.0-26.5	10	11,985
83572A ²	26.5-40.0	2	14,540
83572B ²	26.5-40.0	5	17,500
83554A ³	26.5-40.0	5	8,000
83555A ³	33.0-50.0	3.2	8,000
83556A ³	40.0-60.0	2	8,000
86222A	0.01-2.4	20	5,520
86222B	0.01-2.4	20	6,970
86220A ¹	0.01-1.3	10	3,810
86235A	1.7-4.3	40	5,075
86290B	2.0-18.6	10	15,300
86290C	2.0-18.6	20	19,810
86240A	2.0-8.4	40	6,575
86240B	2.0-8.4	20	7,720
86240C	3.6-8.6	40	7,525
86241A ¹	3.2-6.5	3.2	4,575
86245A	5.9-12.4	50	7,975
86242D	5.9-9.0	10	5,175
86250D	8.0-12.4	10	5,275
86251A	7.5-18.6	10	10,780
86260B ¹	10.0-18.6	10	6,125
86260A ¹	12.4-18.0	10	5,675
86260C ¹	17.0-22.0	10	9,280
8620C sweep oscillator mainframe			3,865
8350B sweep oscillator mainframe			4,565
11869A adapter for HP 86200 plug-in			280

¹Requires HP 11665B modulator.

²Requires Option 006 for internal 27.8 kHz modulator.

³Source module, requires a 11-20 GHz swept source.

NETWORK ANALYZERS

Scalar Network Analyzer, 10 MHz to 60 GHz

Model 8756A/S

609



- High (40 dB) directivity bridges
- "Autoscale" for fast measurements
- Full HP-IB programmability

- Fully annotated digital display
- Nine "Save/Recall" registers
- Direct digital plot capability

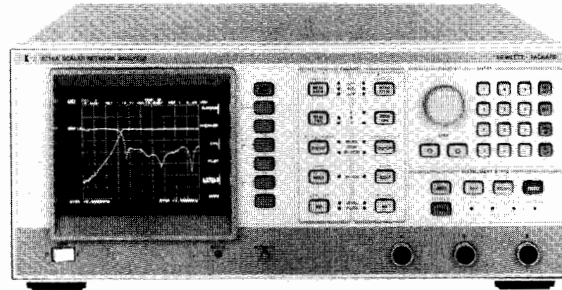

HP 8756A



Description

Measure insertion loss and gain, return loss, and absolute power quickly and accurately with the HP 8756A scalar network analyzer. These scalar measurements can be performed over a broad 10 MHz to 60 GHz frequency range. The HP 11664 diode detectors and AC modulation make accurate, reliable, and drift-free measurements. High-directivity directional bridges covering RF and microwave frequencies produce excellent reflection measurements. The HP 85020 and 85027 bridges, HP 11664 detectors and other scalar accessories are described on pages 603 through 606.

Easy-to-Use

The HP 8756A features two independent display channels with separate controls. Complete measurements can be performed using only five control keys for each channel.

Make even faster measurements with one key—the "Autoscale" key. Press it and the built-in microprocessor chooses the optimum scale and reference level to display your measurement. Use the convenient display cursor to read out magnitude and frequency at each data point.

For Automatic or Manual Systems

When used with the HP 8350B sweep oscillator or HP 8341B/8340B synthesized sweepers, the HP 8756A acts as a system controller by managing the other instruments through the "8756 System Interface." Using the system interface, the HP 8756A extracts frequency information from the sweeper and uses it to annotate the digital display.

When used alone, the HP 8756A can save and recall up to nine front-panel states. With the HP 8350B or 8340B/41B, it saves and recalls not only its own front-panel state, but the sweeper's as well.

Another benefit of the HP 8756A/8350B combination is "Alternate Sweep"; the ability to sweep two different frequency ranges or power levels and display them simultaneously.

System control also extends to an HP-IB digital plotter. The HP 8756A can directly plot the CRT's image onto a plotter such as the HP 7475A or 7440A. Crisp, permanent, annotated plots can be created just by selecting the Plot soft key. Adjustable horizontal resolution (101, 201 or 401 points) is available as Option H20.

Programmability Features

Since all of the controls of the HP 8756A are completely programmable, computer-controlled automatic systems can make full use of the HP 8756A and its built-in features. Order the HP 8756S automatic scalar network analyzer system and choose the configuration of source, analyzer, computer, and peripherals for your needs. Add the HP 85015B system software for custom testing and storage of data and measurement configurations. The HP 85016B transmission line test software adds accurate fault location to the capabilities of the HP 85015B system software.

Specifications

Function: The HP 8756A processes and displays the demodulated 27.8 kHz signals from the HP 11664 detectors and the HP 85020 or 85027 bridges.

Dynamic range: +10 dBm to -50 dBm in all three inputs (A, B, and R).

Dynamic accuracy: dynamic accuracy of a single channel measurement using HP 11664A/D/E Detector. Measurement taken over +10 to -50 dBm at 25°C and at 50 MHz.

±(0.1 dB + 0.01 dB/dB) from +10 to -40 dBm.

±(0.2 dB + 0.02 dB/dB) from -40 to -50 dBm.

Scale resolution: 0.1, 0.2, 0.5, 1, 2, 5, 10, or 20 dB per division. Independently controlled for each measurement channel.

Reference offset: offset level adjustable in 0.01 dB increments from -70.00 to +20.00 dBm (absolute) or -90.00 to +90.00 dB (ratio).

Resolution

Vertical: 0.006 dB for display.

0.01 dB for "Display Cursor."

Horizontal: 401 points.

Sweep time: minimum sweep time ≥ 150 ms (50 ms with Opt. H20).

Averaging: 2, 4, 8, 16, 32, 64, 128, or 256 traces may be averaged. Independent control of each display channel.

Normalization: traces are stored and normalized to 0.006 dB resolution, independent of scale/division or offset. The horizontal resolution is 401 points.

Transfer formats: data may be transferred as either ASCII strings (nominally 6 characters per reading) or as 16 bit integers. Readings may be taken at a single point or as an entire 401 point measurement trace.

Transfer Speed

ASCII format, trace: 800 ms typical.

ASCII format, point: 10 ms typical.

Binary format, trace: 35 ms typical.

Binary format, point: 5 ms typical.

Description: the HP 8756A System Interface is an HP-IB port used exclusively by the HP 8756A to control and extract information from a sweep oscillator and a digital plotter.

Sweep oscillators: HP 8350B with RF plug-in, HP 8340B/8341B synthesized sweep oscillators.

Plotters: HP 7440A Opt. 002, HP 7475A Opt. 002, HP 7550A Opt. 002, HP 9872C.

Power requirements: 48 to 62 Hz, 115/230V ±10%, typically 100 watts.

Dimensions: 178 H x 425.5 W x 451 mm D (7.0 x 16.75 x 17.75 in.).

Weight: Net, 15 kg (33 lb). Shipping, 20 kg (44 lb).

Ordering Information

HP 8756A scalar network analyzer

Option W30 two-year extended service contract

Price

\$8,500

\$250

NETWORK ANALYZERS

Scalar Network Analyzer Software for the HP 8757S/8756S

Models 85015B, 85016B

- Custom tests without programming
- Friendly menu operation
- Measure insertion and return loss

- Plot or store data
- Test coax and waveguide
- Locate faults in transmission lines

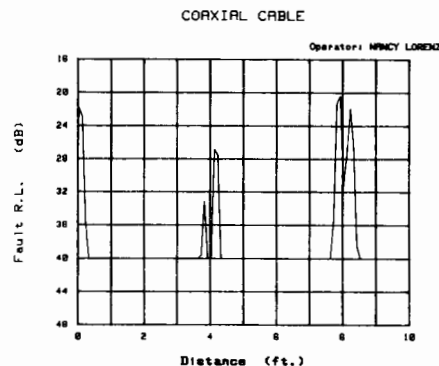
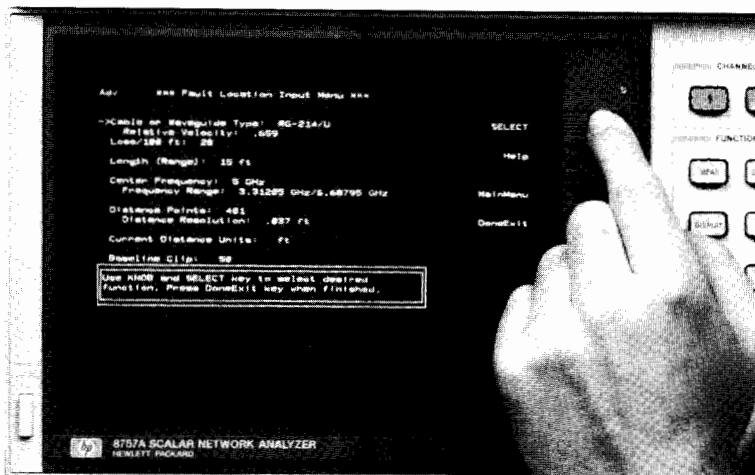

MISMATCH SUMMARY
 Cable or Waveguide Type: Coax
 Relative Velocity: 695
 Loss/100 ft: 50
 Length (Range): 10 ft
 Center Frequency: 5 GHz
 Frequency Range: 3.32295 GHz/5.68795 GHz
 Distance Points: 48
 Distance Resolution: .027 ft
 Current Distance Units: ft
 Baseline Clip: 50

Measurement 1:
 Operator: NANCY LORENZ

COAXIAL CABLE		
Distance (ft)	FLT. R.L. A (dB)	% OF TOTAL MISMATCH
.020	21.91	36.347
4.120	26.84	20.607
7.920	20.44	43.046

Using the HP 85015B system software for the HP 8757S/8756S, you can create and run complete scalar measurements without programming. The software guides you all the way from setup to output. Just make your selections using the computer's knob and softkeys. The software makes all the necessary settings on the scalar analyzer and source to provide fast, accurate measurements that can be stored for later reference.

Easy To Learn

Use the BASIC mode to get up to speed quickly on the software's operation. It prompts you with a few simple questions, then sets up your source and analyzer automatically. The software prompts you to make all the connections necessary for calibration and measurement sequences, then automatically plots the data on the CRT display. For a permanent record, send the plot to a graphics plotter with a single keystroke.

Use The Analyzer CRT

With the HP 8757, use the scalar analyzer as the control center for your measurements. The analyzer knob and softkeys control the software menus which appear on the CRT of the HP 8757A, instead of the computer's.

Customized Measurement Setups

Use the GENERAL and ADVANCED modes to access more of the software's powerful features. Define up to 4 measurements in one sequence. Specify particular power levels for your test device and enter your specification limits as point, line, or sloped limits. These limit lines allow simple pass/fail testing, or real time adjustment to within the spec limits.

Then output the data using your own customized format with labels, limit lines and "out-of spec" indicators. Make up to 4 plots on a single page. Store the data on computer disc for archival purposes, then recall it later for further analysis.

The software makes it easy to save your configuration, complete with all the parameters you've specified and the calibration data. When you want to run this test later, just recall the configuration and connect the device. The software recalls cal data, plot formats, labels, limit lines . . . everything you need to run complete automated tests.

Test Transmission Lines

The HP 85016B transmission line test software provides all the capability of the HP 85015B plus fault location for complete testing of coax and waveguide transmission lines. Test frequency response (insertion and return loss), then find faults (mismatches) that affect the signals in your frequency range. Troubleshoot your ECM, radar or communication system quickly and without guesswork.

Fault location is accomplished using frequency domain reflectometry, a technique that uses frequency domain reflection data and the inverse Fast Fourier Transform to characterize reflection as a function of distance. This enables you to locate impedance mismatches resulting from bad connections or faulty cables.

Ordering Information

Each software package comes with 5 discs, including a data disc. Order the option that corresponds to your computer configuration. The HP 85015B/16B can run on BASIC 2.0 or greater and requires 1 1/2 Mbytes of RAM memory.

	Price
HP 85015B system software	\$2000
Opt. 630: 3.5 inch discs	N/C
Opt. 655: 5.25 inch discs	N/C
Opt. 100: upgrade from HP 85015A	less \$500
HP 85016B transmission line test software	\$4500
Opt. 630: 3.5 inch discs	N/C
Opt. 655: 5.25 inch discs	N/C
Opt. 100: Upgrade from HP 85015A	less \$1500

NETWORK ANALYZERS

Transmission Line Test System

Model HP 8328A

611



- High resolution - 0.25%
- Fast computation
- Three user levels

- Automatic data correction
- Completely self-contained
- Pass/fail and limit testing



HP 8328A

The HP 8328A Transmission Line Test System tests the performance of waveguide runs and coaxial cables with swept frequency measurements of insertion loss and return loss. Additionally, the HP 8328A system can make fault location tests to find impedance mismatches as a function of distance, quickly and without guesswork.

The HP 8328A is a dedicated transmission line test system for tests from 10 MHz to 18 GHz. It is configured in a rugged, transportable container. The system is self-contained for ease of use and is ideal for accessing transmission lines in difficult-to-reach installations such as aircraft. Although all testing can be done automatically, full manual capability is retained.

The HP 8328A contains the HP 8757A Scalar Network Analyzer, the HP 8350B Sweep Oscillator with the HP 83592A RF Plug-In for coverage from 10 MHz to 18 GHz, the powerful HP 9000 Model 310 computer, the HP 85016B Transmission Line Test Software, and scalar analyzer accessories. The software is accessed from the front panel softkeys and knob of the HP 8757A. Complete measurements including pass/fail and limit testing can be configured and run easily like the HP 85016B software.

It is recommended that the HP 8328A Option 100, an HP 35731A monitor, an HP 46021A keyboard, and an HP 9122D dual disc drive be included for system diagnostics and disc backup for long-term data storage and retrieval.

Swept Distance Capability

Measurements vs. distance: Return loss (dB), SWR, or reflection coefficient.

Resolution (distance between data points as a percentage of the transmission line length):

1% (101 pts), 0.5% (201 pts), 0.25% (401 pts).

Data correction: Data is normalized to the response with a 50 ohm load at the test port. Data is also completely corrected for line losses and preceding mismatches. If waveguide is tested, the effects of phase dispersion are automatically removed from the response. The correction data for the coaxial cable or waveguide run is contained in a lookup table with over 100 entries stored in the program. This table can be modified to improve entries or updated with new cables.

Range and resolution (vs. frequency): The standard RF plug-in for the system is an HP 83592A, with a span from 10 MHz to 18 GHz. This span allows a minimum test range of 2 ft. and a resolution of 0.01 ft. (for 201 distance points and 0.5% resolution). Maximum test range is 500 ft. with a resolution of 2.5 ft.

Swept Frequency Capability

Measurements vs. frequency: Insertion loss, gain, return loss, VSWR, reflection coefficient, and power in dBm, dBW, or mW.

Frequency range: 10 MHz to 18 GHz with HP 83592A plug-in; Option 001, 10 MHz to 8.4 GHz with HP 83525B plug-in

Resolution: User selectable up to 1024 pts. for swept measurements, or stepped CW measurements.

Dynamic range (HP 11664A detectors and HP 8757A): 76 dB (+16 to -60 dBm)

General

User modes: BASIC, GENERAL, and ADVANCED. These user levels vary the level of sophistication to match the experience level of the user and the requirements of the measurement.

Measurement and data storage:

Configurations per data volume (typical): 99

Measurements per configuration: 4

Measurement data sets per data volume: 99

Additional storage can be obtained with the HP 8328A option 100 and the recommended optional equipment.

Ordering Information

HP 8328A Transmission Line Test System

Opt 001: 10 MHz to 8.4 GHz only

Opt 100: Adds support software

Price

\$64,000

less \$7,000

add \$250

NETWORK ANALYZERS

Audio/Video/Baseband/IF Network Analyzer, 5 Hz to 200 MHz

Model HP 3577A

- High speed/high accuracy measurements
- .001 dB, .005 degree, 1 ps, .001 Hz resolution
- Built-in three-term error correction plus normalization
- Magnitude, phase, polar, real, imaginary, and group delay display modes
- Convenience features including direct plotter control and vector math functions

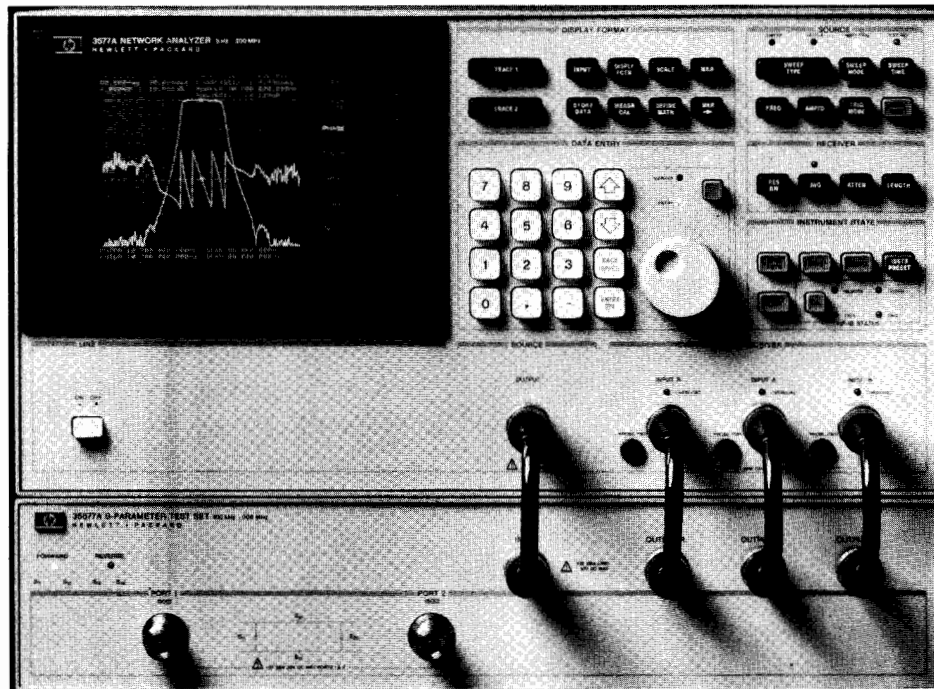

HP 3577A



Introduction

HP Model 3577A is a high performance network analyzer for audio, video, baseband and IF applications from 5Hz to 200MHz. The 3577A makes precision measurements to characterize filters, amplifiers, crystal devices, cables, and subsystems used in communications, telecommunications, consumer electronics, components and general purpose testing.

Convenient soft-key selection of measurement functions allows you to quickly measure transfer functions, magnitude/phase, insertion loss/gain, attenuation, electrical length and gain compression. In addition, measurement of phase distortion parameters such as group delay and deviation from linear phase can be made with high resolution. With the HP 3577A's flexible receiver input impedances, you can measure in either 50- Ω or high impedance (1 M Ω) environments. Use the HP 35677A/B S-Parameter Test Sets or the HP 35676A/B Reflection/Transmission Test Kits with the HP 3577A to make reflection measurements such as return loss, reflection coefficient and impedance in 50- Ω or 75- Ω systems, while simultaneously displaying transmission parameters.

With the addition of an HP 9000 Series 200 or 300 Computer and appropriate system software, the HP 3577A becomes the hub of a powerful network measurement solution, the HP 3577S Network Analyzer System. A full description of the HP 3577S begins on page 616.

Unprecedented Measurement Precision

Precision measurements can be made to characterize both wide-band and narrowband devices with high accuracy and resolution. Dynamic magnitude and phase accuracy is 0.02 dB and 0.2 deg, respectively. Device responses can be examined in fine detail with 0.001 dB, 0.005 deg, and 1 ps resolution. A built-in synthesized LO and tracking generator assure superb frequency accuracy with 0.001 Hz resolution. Dynamic range is 100 dB and the noise floor is -130 dBm for the most demanding measurements.

Versatility and Convenience

User-defined Vector Math functions operate on measured data, constants and functions to present measurement results in the form you need. Multiple Display Formats with electronic graticules provide accurate display in rectangular, polar or Smith chart coordinates. Frequency Sweep (Logarithmic, Linear or Alternate) and Amplitude Sweep capabilities meet measurement needs in a wide range of applications. Accessories such as S-Parameter Test Sets, Power Splitters, Minimum Loss Pad, Cables, Calibration Kits, Transistor Fixtures, Adapters, and Current and Voltage Probes ensure a complete solution to your measurement needs.

The built-in autoscale functions put the measurement on the screen quickly with a full scale display. Digital Display Markers with Marker → Min or Max and Marker Offset capabilities provide accurate, high resolution readout of data points on a fully annotated dual trace display. Direct Digital Plot (using an HP graphics plotter without a computer) of displayed traces, graticule, annotation and marker data provides quick, cost-effective hard copy of measurement results. Non-volatile Save/Recall Memory of five front panel instrument states is convenient for making rapid and repeatable measurements.

Similarly, trace data can be stored in magnitude and phase format in any one of four data registers. Since data is stored with full accuracy and resolution, it can be rescaled as needed.

Measurement Display Modes

Magnitude, phase, polar, real, imaginary, and delay modes are directly accessible from the soft key display menu. Input data, stored data and user-defined constants can then be combined using built-in vector math functions (+, -, *, /) to create arbitrary measurement display modes. As an example, a feedback amplifier can be mathematically analyzed by measuring its open loop gain, storing the data, and then adjusting a complex variable which represents the amount of feedback in the closed-loop gain equation.

High-Performance Group Delay Measurements

The HP 3577A measures group delay directly by dividing the measured phase changes across a selected frequency aperture by the aperture value. The frequency aperture can be set from 0.5% to 16% of span with annotation directly in Hertz, thus allowing the user to change span and still retain the same effective smoothing.

Sophisticated measurements of both magnitude and phase distortion in communication systems can be made.

Cables and transmission lines can be tested for maximally flat delay with a resolution of up to 1 psec.

Vector Noise Averaging

Noise reduction in the HP 3577A is accomplished by Vector Noise Averaging and/or selectable Resolution Bandwidth filters. With the proper use of these two noise reduction methods, greater than 130 dB dynamic range can typically be achieved.

Built-in Error Correction

Three-term Vector Error Correction in the HP 3577A is used to remove the effects of directivity, frequency response, and source mismatch from one-port measurements. Similarly, vector normalization enhances the accuracy of two-port measurements at the push of a button. These powerful accuracy enhancement routines can be used to cancel the repeatable error introduced by cable and test fixtures. Moreover, the HP 3577A can be easily upgraded to an HP 3577S Network Analyzer System with full twelve-term Vector Error Correction, as the need for uncompromising measurement accuracy arises.

HP-IB Programmability

The HP 3577A is fully programmable over the Hewlett-Packard Interface Bus. Simple programming codes minimize the time it takes to develop control software for automatic measurements. Quickly access a single point or an entire 401-point trace in either fast binary or ASCII modes. Customize the built-in vector display via the HP-IB to draw test limit lines, operator instructions or connection diagrams.

HP 3577A Network Analyzer Abbreviated Specifications

Source

Frequency

Range: 5 Hz to 200 MHz

Resolution: 0.001 Hz

Stability: $\pm 5 \times 10^{-8}$ /day, 0 to 55°C

Amplitude

Range: +15 dBm to -49 dBm (1.26Vrms to 793 μ Vrms; 2dBV to -62 dBV) into a 50 Ω load

Resolution: 0.1 dB

Accuracy: ± 1 dB at +15 dBm and 100 kHz. Below +15 dBm, add the greater of ± 0.02 dB/dB or 0.2 dB

Flatness: 1.5 dBp-p from 5 Hz to 200 MHz

Impedance: 50 Ω ; >20 dB return loss at all levels

RF Output Connector: 50 Ω Type N female

Sweep Types: Linear, alternate, cw and log frequency; log amplitude

Sweep Time: 100 ms/span to 200 ms/span for frequency sweep; 1 ms/step to 16 s/step for amplitude sweep.

Sweep Modes: Continuous, single, manual

Trigger Modes: Free run, immediate, line, external

Input Characteristics

Frequency Range: 5 Hz to 200 MHz

Inputs: Three receiver inputs (A, B and R)

Input Impedance: Selectable 50 Ω with > 25 dB return loss, or 1 M Ω in parallel with approximately 30 pF

Input Connectors: 50 Ω Type N female

Full Scale Input Level: -13 dBV from 10 kHz to 200 MHz with internal 20 dB attenuators ON (0dBm at 50 Ω)

Resolution Bandwidth: Selectable 1 kHz, 100 Hz, 10 Hz, or 1 Hz
Sensitivity (Due to noise and internal crosstalk between source and receiver inputs):

Resolution Bandwidth	30 kHz - 200 MHz (50 Ω) 30 kHz - 20 MHz (1 M Ω)	
	Internal 20 dB Attenuator ON	Internal 20 dB Attenuator OFF
1 Hz	-110 dBm	-130 dBm
10 Hz	-110 dBm	-130 dBm
100 Hz	-105 dBm	-125 dBm
1 kHz	-95 dBm	-115 dBm

Crosstalk: >100 dB isolation between inputs.

Electrical Length/Reference Plane Extension: Provides equivalent electrical line length, or delay at inputs A, B and R.
Range: -3×10^9 m to $+3 \times 10^6$ m or +1 s to -1 s

Resolution: 5 digits or 0.1 cm (3.3 ps) whichever is greater

Accuracy: ± 0.1 cm or $\pm 0.02\%$ whichever is greater.



NETWORK ANALYZERS

Audio/Video/Baseband/IF Network Analyzer, 5 Hz to 200 MHz

HP Model 3577A (cont.)

Magnitude Characteristics

Range: Full Scale Input to Sensitivity

Resolution

Marker: 0.001 dB (log); 5 digits (linear)

Display: 0.01 dB/div to 20 dB/div (log absolute); 0.01 dB/div to 200 dB/div (log ratio); 0.1 nV/div to 10 V/div (linear absolute); 10^{-10} /div to 10^{20} /div (linear ratio)

Display Units: dB, dBm, dBV, V, and linear ratio.

Accuracy (at 100 kHz, 25°C, and Full Scale Input)

Absolute (A, B, R): ± 0.2 dB

Ratio (A/R, B/R, A/B): ± 0.15 dB (50 Ω); ± 0.2 dB (1 M Ω).

Dynamic Accuracy:

Error		Input Level Relative to Full Scale Input
Resolution Bandwidth		
1 kHz, 100 Hz, 10 Hz	1 Hz	
± 0.4 dB	± 0.4 dB	0 dB to -10 dB
± 0.2 dB	± 0.2 dB	-10 dB to -50 dB
± 0.5 dB	± 0.5 dB	-50 dB to -60 dB
± 1.5 dB	± 2.5 dB	-60 dB to -80 dB
± 7.5 dB	± 7.5 dB	-80 dB to -90 dB
± 7.5 dB	± 3.00 dB	-90 dB to -100 dB

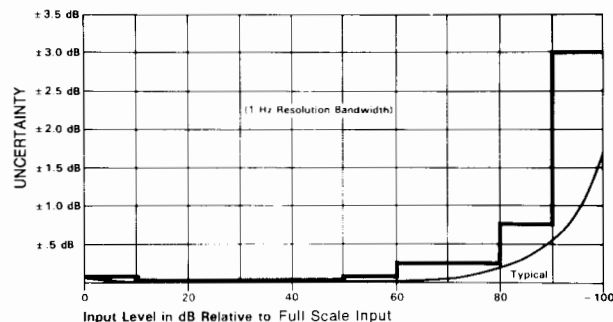
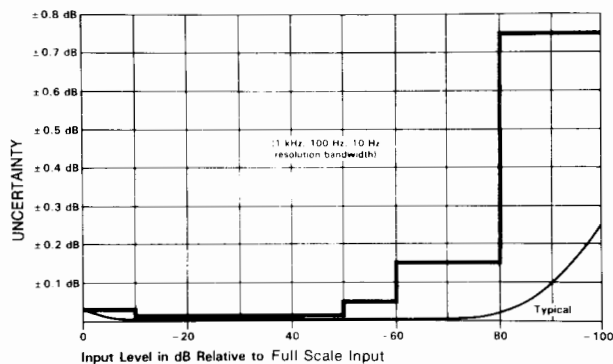

Frequency Response (when driven from a 50 Ω source and with 50 Ω receiver input impedance)

Absolute (A,B,R): 0.3 dBpp from 20 Hz to 20 MHz; 0.6 dBpp from 5 Hz to 200 MHz

Ratio (A/R, B/R, A/B): 0.3 dBpp from 20 Hz to 20 MHz; 0.4 dB from 5 Hz to 200 MHz

Reference Level

Range: -207 dBm to +33 dBm (-220 dBV to +20 dBV) (Log absolute); -400 dB to +400 dB (log ratio); 0 V to 10 V (linear absolute); 0 to 10^{20} (linear ratio)

Resolution: 0.001 dB (log); 5 digits (linear)

Stability

Temperature: Typically $\leq \pm 0.02$ dB/ $^{\circ}$ C

Time: Typically $\leq \pm 0.05$ dB/hour at 25 $^{\circ}$ C

Phase Characteristics (A/R, B/R, A/B)

Range ± 180 deg.

Resolution

Marker: 0.005 deg (0.001 rad)

Display: 0.01 deg/div to 200 deg/div (0.00018 rad/div to 3.49 rad/div)

Accuracy (at 100 kHz, 25 $^{\circ}$ C, and Full Scale Input: $\pm 2.0^{\circ}$)

Dynamic Accuracy:

Error	Input Level Relative to Full Scale Input
± 4 deg	0 dB to -10 dB
± 2 deg	-10 dB to -50 dB
± 5 deg	-50 dB to -60 dB
± 1.5 deg	-60 dB to -80 dB
± 7.5 deg	-80 dB to -100 dB

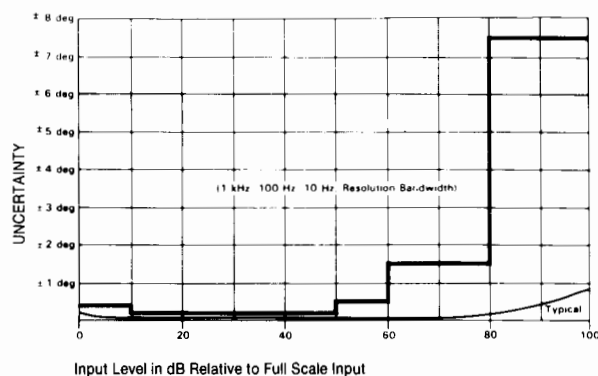

Reference Level Resolution: 0.01 deg.

Temperature Stability: Typically $\leq \pm 0.05$ deg/ $^{\circ}$ C.

Time Stability: Typically $\leq \pm 0.05$ deg/hr at 25 $^{\circ}$ C

Delay Characteristics

Range: 1ps to 20,000s

Resolution: .01ns/div to 1000s/div

Normalized Accuracy: $\frac{\text{Dynamic Phase Accuracy}}{360 \times \text{Aperture [Hz]}} + 2\text{nS}$

Aperture Range: 0.5% to 16% of frequency span.

Reference Level: $\pm 10^3\text{S}$

General Display Characteristics

Traces

No. Traces: Two simultaneous traces may be present with a rectangular graticule. One trace with polar or Smith graticules.

Markers: Each trace has one main marker and an offset marker. Markers indicate data at corresponding trace coordinates in the same units as used to set the Reference Level. Markers can be used to modify certain display parameters. Marker resolution is the same as horizontal display resolution.

Graticules

Rectangular Graticule: 0% to 100% full scale deflection in 0.05% increments. Logarithmic and Linear.

Polar/Smith Chart Graticule: ± 500 deg in 0.001 deg increments.

Noise Averaging

Type: Exponentially weighted vector averaging on successive sweep data.

Averaging Factor: Selectable 1 (off), 4, 8, 16, 32, 64, 128, 256.

Linear Phase Slope Compensation: Provides linear phase slope offset of -72,000 deg/span to +72,000 deg/span.

Calibration

Transmission: Both traces can be normalized to measured data with full accuracy and resolution.

Reflection: Corrects for directivity, frequency response and source match errors.



Programming Characteristics

Capability: Remote programming via the Hewlett-Packard Interface Bus (HP-IB). The HP 35677A/B S-Parameter Test Sets are programmable through the HP 3577A interface only.

Interface Functions: SH1, AH1, T5, TE0, L4, LE0, SR1, RL1, PP1, DC1, DT1, C0, E1. For more on these codes refer to the HP-IB section of this catalog.

Output Data Transfer Time: 401 data points (single parameter) can be transferred directly to an HP 200 series computer in Basic language as follows:

ASCII mode: Typically 1500 ms.

Binary-floating point mode: Typically 160 ms.

Graphics Capabilities: 12 lines of text with 40 alphanumeric characters per line, and high resolution line vectors can be displayed through HP-IB commands.

General Characteristics

External Reference Frequency Input

Frequency: 10 MHz/N. N is an integer from 1 to 100.

Level: 0 dBm \pm 10 dB, nominal.

Impedance: 50 Ω , nominal.

Connector: BNC female, rear panel.

Reference Frequency Output

Frequency: 10 MHz.

Level: Typically 0 dBm.

Impedance: 50 Ω , nominal.

Connector: BNC female, rear panel.

External Trigger: Triggers on negative TTL transition or contact closure to ground.

Connector: BNC female, rear panel.

Plotter Control: Directly compatible with HP-IB graphics plotters that use Hewlett-Packard Graphics Language (HP-GL) with listen only capability: HP 7470A, HP 7475A, HP 7550A, HP 7090A.

Save/Recall: Front-panel setups can be stored in non-volatile memory locations 1 through 5. Last state is saved when power is removed.

Operating Conditions

Temperature: 0°C to +55°C.

Relative Humidity: <95% at 40°C.

Altitude: <4,572m (15,000 ft).

Non-Operating Conditions

Temperature: -40°C to +75°C.

Altitude: <15,240m (50,000 ft).

Power: 115V \pm 10%, -25% (47 Hz to 440 Hz), or 230 V \pm 10%, -15% (47 Hz to 66Hz), 450 VA maximum.

Weight: 31 kg (67 lb) net; 41 kg (90 lb) shipping.

Dimensions: 222 mm H x 426 mm W x 578 mm D (8.75 in. x 16.75 in. x 22.75 in.).

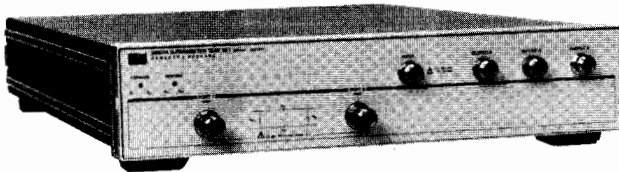

HP 35677A/B S-Parameter Test Sets

While test setups can be constructed from discrete RF components such as power dividers, directional bridges, cables, pads, etc., it is much easier to use a fully integrated test set such as the HP Model 35677A/B.

The test set contains the hardware required to make transmission and reflection measurements in both the forward and reverse directions. The only setup required is to connect the device under test to the two measurement ports; the HP 3577A Network Analyzer controls the switching functions, so that even reverse measurements can be made without changing device connections. The HP 35677A is used for 50 Ω systems and the HP 35677B is used for 75 Ω systems.

HP 35677A/B S-Parameter Test Set Specifications

Frequency Range: 100 kHz to 200 MHz.

Test Port Impedance

HP 35677A: 50 Ω .

HP 35677B: 75 Ω .

Directivity: >40 dB.

Frequency Response

Transmission (S_{21} , S_{12}): \pm 1 dB, \pm 5 degrees.

Reflection (S_{11} , S_{22}): \pm 1 dB, \pm 5 degrees.

Port Match

Test Ports 1, 2: HP 35677A, >26 dB; HP 35677B, >24 dB.

Test Ports 1, 2 Open/Short Ratio: HP 35677A, \pm 0.75 dB magnitude and \pm 5 degrees phase; HP 35677B, \pm 1 dB magnitude and \pm 7.5 degrees phase.

Input Port: >20 dB return loss.

Output Ports A, B, and R: >26 dB return loss.

Test Port Isolation: >100 dB.

Insertion Loss

RF Input to Test port 1 or 2: HP 35677A, typically 13 dB; HP 35677B, typically 19 dB.

RF Input to Output Ports A, B, or R: HP 35677A, typically 19 dB; HP 35677B, typically 31 dB.

Test Port Reciprocity

Transmission (S_{21} , S_{22}): Typically \pm 0.5 dB magnitude and \pm 5 degrees phase.

Reflection (S_{11} , S_{22}): Typically \pm 0.5 dB magnitude and \pm 5 degrees phase.

Incident Power Ratio (Test Port 1 to Test Port 2): Typically \pm 1.5 dB.

RF Input Maximum Operating Level: +25 dBm or \pm 30 Vdc.

RF Input Damage Level: \pm 27 dBm or \pm 30 Vdc.

Port 1 or 2 Damage Level: +27 dBm or \pm 30 Vdc.

Connectors

Input Port and Output Ports A, B, and R: 50 Ω Type N female.

Test Ports 1 and 2: HP 35677A, 50 Ω Type N female; HP 35677B, 75 Ω Type N female.

DC Bias Inputs: BNC female, rear panel.

DC Bias Range: Typically \pm 30 Vdc and \pm 20 mA with some degradation of RF specifications; 200 mA damage level.

Accessories Supplied

4 ea. 190 mm (7.5 in.) 50 Ω cables with Type N male connectors for connection to HP 3577A (HP Part No. 8120-4387).

1 ea. Test Set interconnect cable to HP 3577A (HP Part No. 35677-61620).

1 ea. Rear Panel Lock Foot Kit (HP Part No. 5061-0099).

1 ea. Service Manual (HP Part No. 35677-90010).

General Characteristics

Power: All power is obtained through the HP 35677A interconnect cable.

Weight: 6 kg (13 lb) net; 122 kg (25 lb) shipping.

Dimensions: 90mm H x 425mm W x 584mm D (3.5 in. x 16.75 in. x 22.75 in.). Add 1 $\frac{1}{8}$ inch to depth to include front panel connectors.

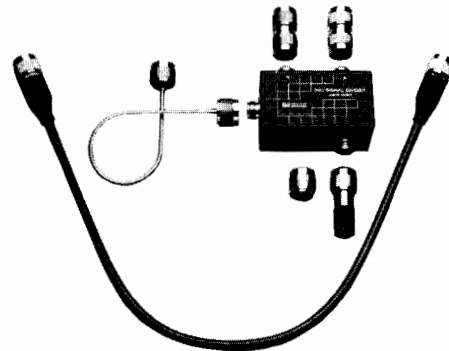

HP 35676A/B Reflection/Transmission Test Kits

Low frequency and broadband measurements with the HP 3577A are greatly simplified with the HP 35676A/B Reflection/Transmission Test Kits. Operating in conjunction with internal calibration routines in the HP 3577A, the test kits provide all the measurement capabilities required for reflection, transmission, and impedance measurements throughout the entire 5 Hz to 200 MHz frequency range. Separate versions are available for 50 Ω (HP 35676A) or 75 Ω (HP 35676B) environments. Each HP 35676A/B Reflection/Transmission Test Kit contains a precision resistive divider, 50 Ω (HP 35676A) or 75 Ω (HP 35676B) reference load, coaxial short, carrying case, and all cables and hardware necessary for basic measurements with the HP 3577A Network Analyzer.

HP 35676A/B Operating Characteristics*

Freq. Range: 5Hz to 200 MHz

Test Port Impedance: 50 \pm 2% typical (HP 35676A)
75 \pm 2% typical (HP 35676B)

Insertion Loss (Source Input to Test Output): 10 \pm 1 dB typical

Equivalent Directivity: 40 dB typical.

Equivalent Source Match: 30 dB typical (HP 35676A)
25 dB typical (HP 35676B).

Ordering Information

See page 617 for Ordering Information.

*Typical, assuming proper calibration with accessories supplied.

NETWORK ANALYZERS



Model HP 3577S Network Analyzer System

Model HP 35675A Accuracy Enhancement Software

- Twelve-term error correction
- Conversion from S-Parameters to H, Y, or Z-Parameters
- Convenient disc storage/recall of device, setup, and calibration data

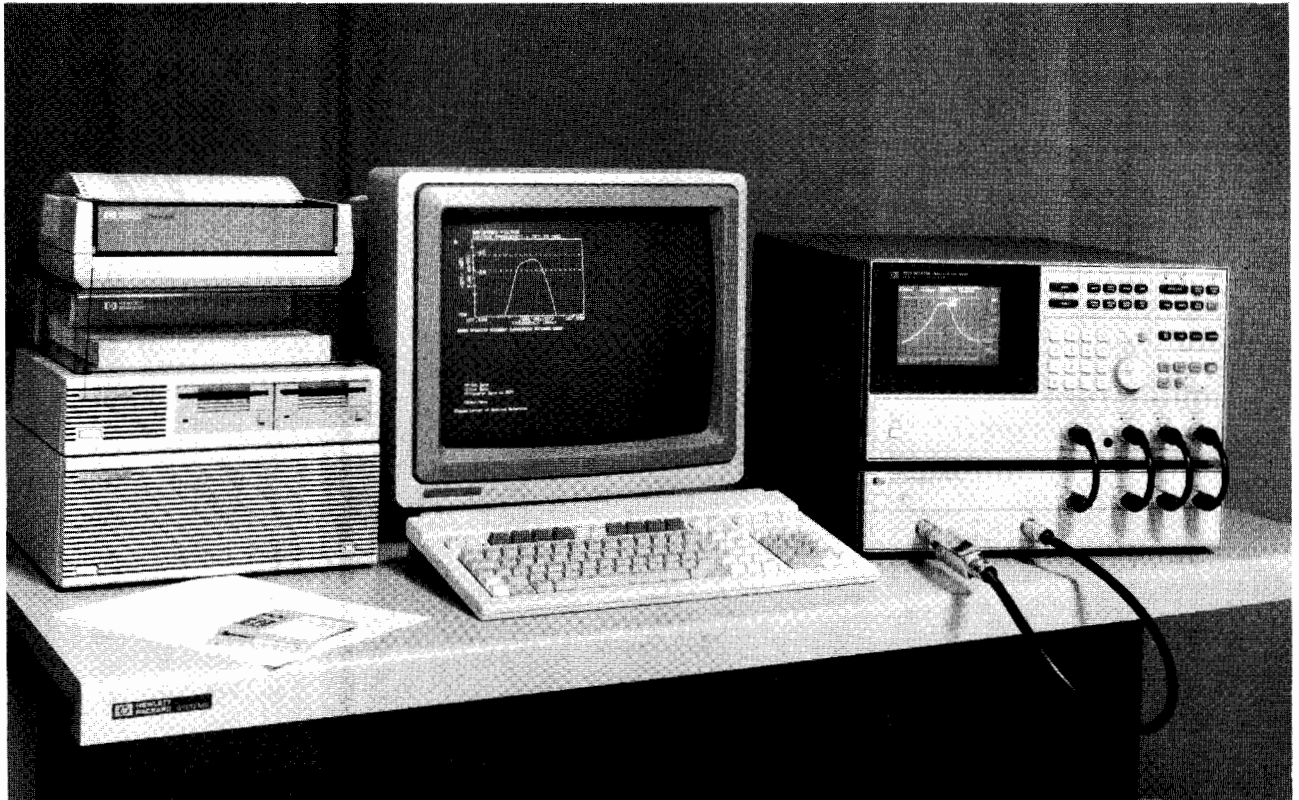

Introduction

The HP 3577S Network Analyzer System combines the HP 3577A Network Analyzer, HP 9000 Series 200 or 300 Computer, HP 35677A/B S-Parameter Test Set, HP 35678A/B Calibration Kit, and HP 35675A Accuracy Enhancement Software to form a powerful automated network measurement solution. Using HP-IB programming, HP 3577S can be integrated with other Hewlett Packard instruments to solve difficult measurement problems.

HP 35675A Accuracy Enhancement Software

At the heart of the system, HP 35675A Accuracy Enhancement Software expands the measurement capabilities of the HP 3577A Network Analyzer. First, it adds full two-port, twelve-term error correction capability. Second, it adds conversion from s-parameters to h, y, or z parameters. Finally, it adds convenient transfer of instrument, calibration, and measurement data between the HP 3577A and HP 9000 Series 200 or 300 computers.

Two-port, Twelve-term Error Correction

Repeatable errors due to the effects of cables and connectors are removed from reflection and transmission measurements by a 2-port, 12-term error correction algorithm. Fast, 8-term partial error correction is also available for measuring transmission parameters of well-

matched devices. Accurate measurements can be made inside environmental chambers and at remote or custom test fixtures. The entire test setup is characterized by measuring its response to open-circuit, short-circuit, thru, and reference terminations furnished with the HP 35678A/B Calibration Kit, from which the error coefficients are calculated.

Parameter Conversion

Error-corrected s-parameters can be converted to hybrid (h), admittance (y), or impedance (z) parameters, allowing device or network behavior to be expressed in the most appropriate form. For example, semiconductor h-parameters can be derived from s-parameter measurements and outputted directly to an HP printer, plotter, computer monitor, or HP 3577A display; all with only a few keystrokes.

Computer Disc Storage of Entire Test Setups

Entire test setups can be labelled and stored in computer disc memory for later use, allowing complicated measurements to be repeated simply by recalling previously stored instrument setup and calibration data. Actual measured data can be transferred to disc memory for storage, processing, or further mathematical analysis.



Friendly Operator Interface

The software guides the operator through easy-to-understand menus, automatically "remembering" every keystroke in an autosequence buffer. When a complicated measurement sequence has been completed, simply give it a name and store it in computer disk memory for later use. Because the most recent instrument state is also remembered, the operator needs only to redefine those variables of interest for each measurement, and on the entire setup. This feature is especially helpful when linking a series of frequency sweeps together to increase resolution.

The entire HP 3577S Network Analyzer System can be controlled from the computer keyboard, eliminating the need for an in-depth understanding of the HP 3577A. A mastery of computer programming is not necessary either.

Program Modifications

Although program modification is not required, Hewlett Packard encourages the experienced operator to tailor the HP 35675A Accuracy Enhancement Software to their specific application. An entire section of the operating manual is devoted to a detailed description of every subroutine and function used by the program; including format, purpose, pass parameter, common variables, error messages, and other required subroutines. Another section describes all program variables and labels. A custom subroutine written in HP Basic can be "installed" in system software and accessed from the menu with a single keystroke.

HP 3577S Network Analyzer System Characteristics

Frequency Range: 100 KHz to 200 MHz

System Impedance: 50Ω (with HP 35677A)
75Ω (with HP 35677B)

Error Correction: One and two port 8- or 12-term

Typical Performance (401 point, 12 term mode):

Calibration: 2 minutes including time to connect devices

Measurement plus corrections: 30 seconds

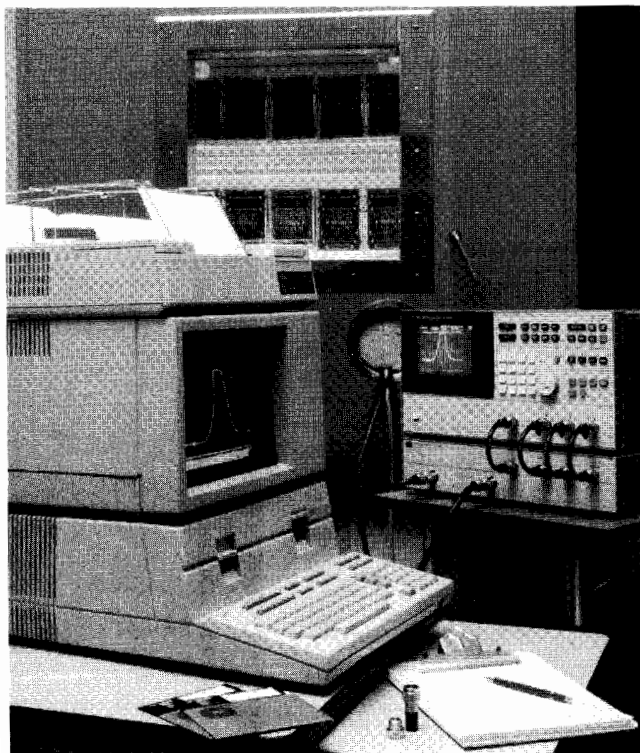

HP 9000 Series 200 Computers

HP 35675A Accuracy Enhancement Software and HP 3577S will run on any properly configured Series 200 Computer, including HP 9816A, 9826A, 9836A, 9836C, and 9920A. One Mbyte RAM is recommended, and up to 1.3 Mbytes may be required when an SRM and additional Basic extensions are used. The HP 35675A software will run on Series 200 Basic versions 2.0, 3.0, and 4.0. Basic 4.0 is included with all Series 200 Computers. Please consult the HP 3577A/S Configuration Guide (# 5953-5184) for more information.

HP 9000 Series 300 Computers

HP 35676A Accuracy Enhancement Software and HP 3577S will run on any properly configured Series 300 Modular Computer System. A properly configured system includes one each: System Processor Unit (SPU), video board, video monitor, keyboard, mass storage device, and Basic 4.0 operating system. Either specify option 008 (Display Compatibility Interface), or create a system from individual components. Please consult the HP 9000 Series 300 Hardware Technical Data Guide (# 5953-9572) and Pricing Information Guide (# 5953-9573) to ensure proper coordination of systems and components.

HP Printers and Plotters

Permanent documentation of test results can be obtained from a number of different HP graphics printers and plotters including HP ThinkJet 2225A, 7470A, 7475A, and 7550A.

HP 3577A/3577S

Ordering Information

	Price
HP 3577S Network Analyzer System	\$0
Specify this system reference number to ensure coordination of shipments and guarantee compatibility of instruments and software.	
A complete HP 3577S Network Analyzer System includes HP 3577A, HP 35675A, HP 35677A/B, HP 35678A/B, and a properly configured HP 9000 Series 200 or 300 Computer. IT IS NOT NECESSARY TO ORDER COMPONENTS ALREADY OWNED.	
HP 3577A Network Analyzer	\$24,000
Option 907: Front Handle Kit	add \$75
Option 908: Rack Mount Kit	add \$40
Option 909: Rack Mount and Front Handle Kit	add \$100
Option 910: Extra Operating and Service Manuals	add \$240
03577-84401: Service Accessory Kit for HP 3577A	\$250
HP 35675A Accuracy Enhancement Software	
Option 042: software on 5.25" disks	\$1,500
Option 044: software on 3.5" disks	\$1,500
HP 35676A 50Ω Reflection/Transmission Test Kit	\$1,250
HP 35676B 75Ω Reflection/Transmission Test Kit	\$1,500
HP 35677A 50Ω S-Parameter Test Set	\$3,600
HP 35677B 75Ω S-Parameter Test Set	\$3,600
Option 907: Front Handle Kit	add \$49
Option 908: Rack Mount Kit	add \$25
Option 909: Rack Mount and Front Handle Kit	add \$60
Option 910: Extra Operating and Service Manuals	add \$45
HP 35678A 50Ω Type N Calibration Kit	\$750
HP 35678B 75Ω Type N Calibration Kit	\$1,400
HP 35679A 50Ω Type N Port Extension Cables	\$500
HP 35679B 75Ω Type N Port Extension Cables	\$1,650

☛ Fast-Ship product — see page 766.



NETWORK ANALYZERS

Gain/Phase Meter

Model 3575A

- dBV, dB ratio and degrees from 1 Hz to 13 MHz

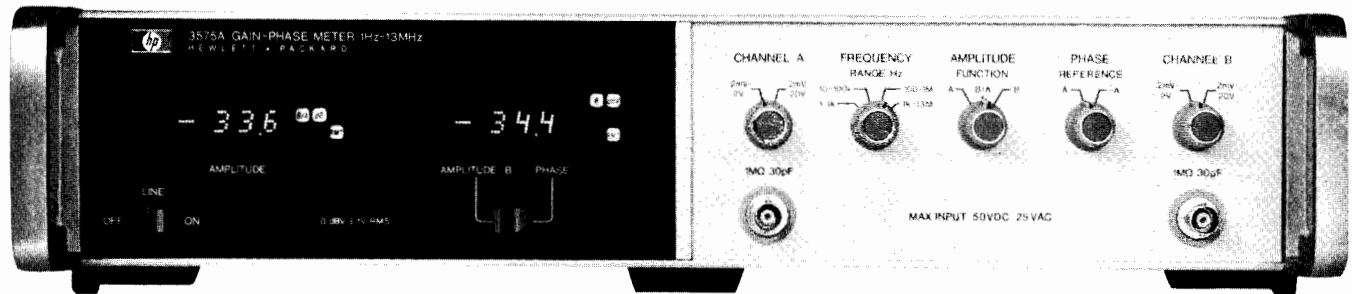

HP 3575A Option 001 dual panel meters

Description

The HP 3575A Gain-Phase Meter is a versatile two-channel analyzer which can measure and display the absolute amplitude level or amplitude ratio of signals present at the inputs. In addition, the HP 3575A can measure the phase relationship of the two signals. This analyzer is a broadband detector, which is easy to use because no frequency tuning is required.

Since a dedicated tracking source is not required to operate with the HP 3575A, a wide selection of stimuli is possible. This flexibility coupled with a variety of possible amplitude, gain and phase outputs (LED display, analog outputs, and optional BCD) gives you a wide choice of cost/results tradeoffs. For example, you may wish to manually plot your network response data on a Bode diagram in which case a low cost sine wave oscillator stimulus may be used. For easier, quicker results you may select the HP 7090A plotter and let the instruments plot your response. You may use a calculator or computer to control a programmable stimulus source and the HP 3575A to provide automatic measurements. Here you have a wide range of computation and output possibilities.

Phase

The phase relationship of two signals is indicated over a range of ± 192 degrees with 0.1 degree resolution. A unique logic circuit (patent) design allows the HP 3575A to make stable phase measurements in the presence of noise. This feature minimizes the error to less than two degrees for a signal-to-noise ratio of 30 dB. One of three band limiting filters may be selected to get further noise rejection.

The HP 3575A is also capable of measuring the phase relationship of a variety of waveforms, such as square waves and triangle waves. Even harmonic and in-phase odd harmonic components of these signals cause no phase measurement error. For out-of-phase odd harmonic signal-to-harmonic ratios of 40 dB, measurement errors are less than 0.6 degree as shown in Figure 1.

Amplitude

The amplitude of either channel or the ratio of the two can be measured over an 80 dB dynamic range and 100 dB measurement range. Resolution is 0.1 dB. Results are displayed in dBV for channel amplitude and dB for ratio measurements. Digit blanking and channel overload annunciators will turn on if the maximum allowable signal level at either channel input is exceeded.

Readout

The standard three-digit LED display may be selected by the operator to indicate the amplitude of channel A or B, gain or phase. A second three-digit LED display is optionally available for simultaneous display of amplitude and phase readings. Lighted annunciators identify the measurement function, units and remote status.

Programmable

Two programmable options both offer full control of front panel functions and BCD output of information (amplitude, ratio or phase) contained in both digital displays. The two options give the user a choice of negative true or positive true outputs.

Applications

The HP 3575A can solve network analysis problems in the 1 Hz to 13 MHz frequency range where complex measurements (gain or phase or both) are required. A few of the many measurements it can make are gain and phase response of feedback systems, envelope delay and return loss of transmission lines, complex impedance of components, and insertion loss of mixers and frequency doublers. Bode plots and Nichols charts are useful graphical tools for analyzing many of these response data.

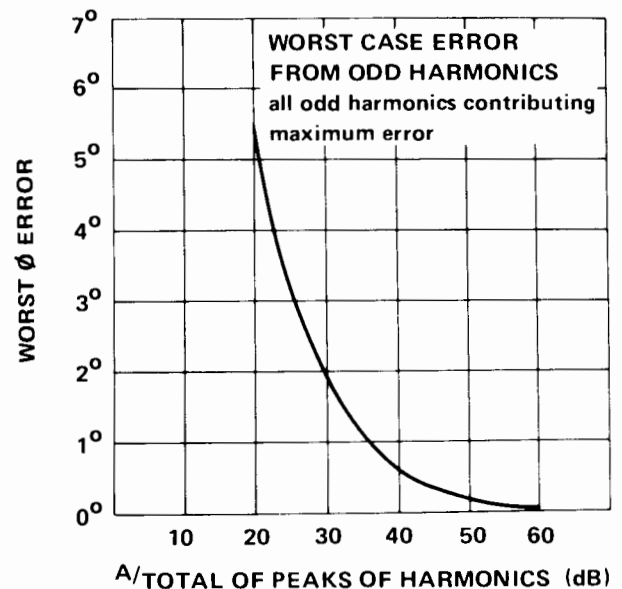
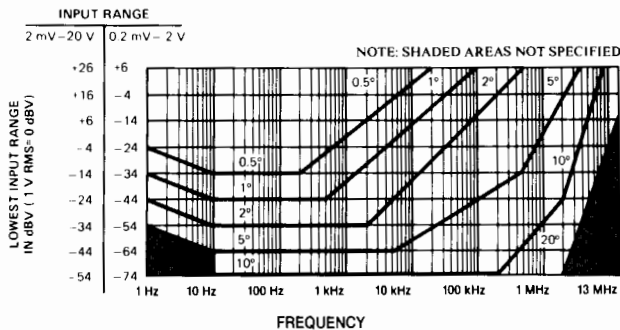

Figure 1. Worst case error from odd harmonics.



Specifications

Phase Accuracy*



*Conditions: Temperature: 25°C ±10°C; Frequency range switch on lowest applicable range; Analog Output accuracy (rear panel).

Input signal range: 200 μV rms to 20 V rms.

Harmonic Rejection

Even harmonics: no error.

Odd harmonics: (in phase) no error.

Odd harmonics: (out of phase) 0.57° worst case error when total odd harmonic distortion is 40 dB below the fundamental.

Noise tolerance: 2° error for a 10 kHz, 1 V sine wave on one channel. One volt sine wave added to Gaussian noise (limited to a 1 MHz bandwidth and 30 dB S/N ratio) on the other channel. The 100 Hz to 1 MHz frequency range was used.

Display

Range: ±180° with 12° of overrange.

Resolution: 0.1°.

Panel meter accuracy: ±3 counts (0.3 degrees/dB/dBV). The panel meter error must be added to the phase and amplitude errors to obtain the display error.

Inputs

Impedance: 1 MΩ 30 pF.

Protection: ±40 V dc, 20 V rms.

Response Time to Achieve 95% of Final Reading

Frequency Range	Time
1 Hz to 1 kHz	20 s
10 Hz to 100 kHz	2 s
100 Hz to 1 MHz	0.2 s
1 kHz to 13 MHz	20 ms

Rear terminal inputs are available as a special (HP 3575A-C09). Digital (Opt. 002). 0, +5 V; ground true. Twelve lines to fully program all functions.

Outputs

Analog

Phase: 10 mV/degree.

Amplitude: 10 mV/dB or dBV.

Output impedance: 1 kΩ

Digital (Opt 002): 0, +5 V; ground true. 31 output lines (1-2-4-8 BCD).

Digital readout: 3½ digits with sign and annunciators. Two readings per second, fixed.

Amplitude Accuracy*

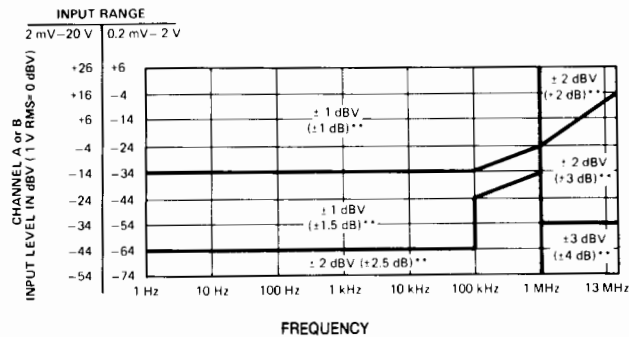

*Conditions: Temperature: 25°C ±10°C; accuracy applies to dB V and ratio measurements with the same frequency on both channels; for ratio measurements, the lowest level channel determines accuracy; analog output accuracy (rear panel).

**Ratio (B/A) tolerances

Amplitude functions: A dBV, B dBV or B/A dB.

Amplitude reference: (A dBV, B dBV) 1 V rms = 0 dBV.

Display

Range: A dBV, B dBV: -74 dBV to +26 dBV (in two ranges). B/A dB: -100 to +100 dB. (Both input signals must be within the range of 0.2 mV rms to 20 V rms)

Resolution: 0.1 dBV, 0.1 dB.

General

Power: 115 V/230 V ±10%, 48 Hz to 440 Hz, 40 VA.

Weight: net, 8.3 kg (18.4 lb). Shipping, 11.3 kg (25.8 lb).

Size: 88 H x 425 W x 337 mm D (3.47" x 16.75" x 13.25").

Accessories furnished: extender boards, line cable and 50-pin connector (Opt 002 and 003 only).

Recommended Accessories: HP 7090A Measurement Plotting System.

Options

001 Dual panel meters: HP's 3575A Opt 001 is equipped with two digital readouts and two analog outputs for simultaneous amplitude and phase readings. This option has no additional measurement capability over the standard instrument.

Dual analog outputs: rear panel BNC connectors provide dc output voltages that correspond to the respective panel meter readings.

001: Dual Readout add \$630

002/003 Programmable: HP 3575A Opt 002 and Opt 003 are equipped with dual panel meters and dual analog outputs (same as Opt 001) plus BCD outputs and complete remote control capability. Opt 002 has negative true output levels and Opt 003 has positive true output levels. BCD information from the HP 3575A (Opt 002) can be read by the HP 9800 series HP Desktop Computers with appropriate interfacing.

002: Programmable (negative true output levels) add \$1100

003: Programmable (positive true output levels) add \$1100

908: Rack Flange Kit add \$35

910: Extra Product Manual add \$50

HP 3575A Gain/Phase Meter

\$5,400

NETWORK ANALYZERS

RF Network Analyzer, 4 MHz to 1300 MHz

Model 8754A

- Integrated source, receiver, and display
- Lock to external source

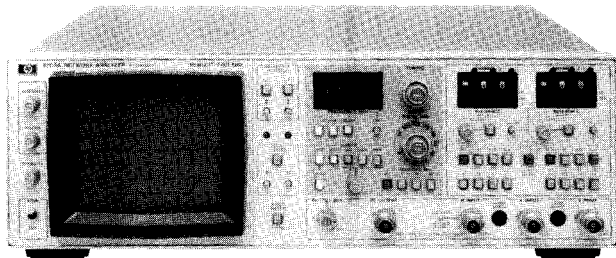

HP 8754A

Description

The HP 8754A is a complete stimulus/response test system which combines a 4-1300 MHz swept source, three-input narrowband, tuned receiver, and both rectilinear and polar displays in a compact package. The convenient built-in source incorporates digital display of the start or center frequency, the ability to sweep all or any portion of the 4-1300 MHz range, and crystal markers at 1, 10, or 50 MHz intervals to enable accurate frequency calibration and measurement. The receiver provides 80 dB dynamic range in two independent measurement channels to allow simultaneous measurement of any two transmission or reflection parameters using a single test setup. Measurements of absolute power, magnitude ratio, phase angle, and reflection coefficient (or return loss) are displayed on the fully calibrated CRT with resolutions up to 0.25 dB and 2.5 degrees per major division. With these features the HP 8754A offers a high level of operating convenience and technical performance to swept magnitude and phase measurements in laboratory, production, and field testing applications at an economical price.

A comprehensive line of 50-ohm and 75-ohm test sets allow you to tailor your test setup for a specific measurement using the minimum of equipment, or to provide the maximum in versatility for a wide range of applications. Signal separation devices include the HP 11850 Power Splitter for precision transmission measurements, the HP 85044 Transmission/Reflection Test Set for simultaneous transmission and reflection measurements, the HP 8748A S-Parameter Test Set to measure both forward and reverse S-Parameters. Matched cable sets, precision adapters, and transistor fixtures provide convenient, reliable connections to the test device. Adding the HP 8750A Storage Normalizer provides flicker-free rectilinear displays regardless of sweep rate. The HP 8750A will automatically store and subtract out the frequency response of a test set or cable if necessary, eliminating the need to use a grease pencil when making normalized measurements. For applications that require exceptional frequency accuracy and stability, the HP 8754A may be used with external sources such as the HP 8660, 8662A, 8663A, 8556B, or 8642A Signal Generators.

HP 8754A Network Analyzer Specifications

Frequency range: 4 to 1300 MHz.

Sweep modes: linear full sweep (4 to 1300 MHz) and calibrated sweep widths with variable start or center frequency.

Sweep widths: selectable sweep width ranges from 1 to 1000 MHz in a 1, 2, 5 sequence, plus CW. A vernier allows continuous adjustment of sweep width within each range and calibration to internal crystal markers.

Spectral Purity (+10 dBm RF output level)

Residual FM (swept and CW): ≤ 7 kHz rms (10 kHz bandwidth).

Harmonics: -28 dBc.

Output power range: 0 to +13 dBm typical, ± 0.5 dB flatness. Residual FM (swept or CW): ≤ 14 kHz rms (10 kHz bandwidth). Harmonics: Second typically -15 dBc, Third typically -25 dBc.

Output power range: 0 to +13 dBm typical, ± 0.5 dB flatness.

- Three inputs, two measurement channels
- 80 dB dynamic range

Receiver

Frequency: 4 MHz to 1300 MHz.

Input channel: two test inputs (A and B) and one reference (R) input.

Input connectors: type-N Female, 50 ohms nominal impedance.

Input port match: ≥ 20 dB Return Loss (1.22 SWR).

Maximum input level: 0 dBm at R, A, B inputs.

Damage level: +20 dBm (50 Vdc).

Noise level: < -80 dBm at A and B inputs.

Minimum R input level: -40 dBm (≥ -40 dBm required to operate R input phase-lock).

Crosstalk between channels: > 83 dB.

Error Limits:

Magnitude frequency response (flatness)

Absolute (A,B): $\leq \pm 1$ dB.

Ratio (A/R, B/R): $\leq +0.3$ dB.

Magnitude dynamic accuracy: ± 0.3 dB from 0 to -50 dBm, ± 0.5 dB from -50 to -60 dBm, ± 1 dBm from -60 to -70 dBm, ± 2.5 dB from -70 to -80 dBm.

Magnitude reference offset range: ± 199 dB in 1 dB steps. Vernier provides variable offset for calibration.

Absolute power measurements (A, B, and R): typically ± 0.5 dBm at 0 dBm, 50 MHz input.

Phase frequency response: $\pm 2.5^\circ$ (typically $\pm 1^\circ$);

Phase range: $\pm 180^\circ$.

Phase dynamic accuracy: $\pm 2^\circ$ from 0 to -50 dBm, $\pm 4^\circ$ from -50 to -70 dBm.

Phase reference offset range: $\pm 199^\circ$ in 1° steps. Vernier provides variable offset for calibration.

Electrical length adjustment range: typically 0 to 16 cm length for transmission phase; typically 0 to 8 cm reference plane extension for reflection measurements.

Display

Measurement functions: CRT displays either polar trace or Channel 1 and Channel 2 rectilinear traces.

Reference position: independent reference lines for Channel 1 and Channel 2 and polar center can be set to any position for calibration.

Video filter: typically 100 Hz (10 kHz without filter).

Graticule size: rectilinear 10 cm by 8 cm; polar 8 cm in diameter.

Smith chart overlays: 2, 1, 0.2 and 0.1 full scale (furnished).

CRT photography: Tektronix C-5B Oscilloscope Camera is recommended (UV illumination will not excite P39 CRT phosphor for graticule exposure).

Resolution: 10, 2.5, 1, 0.25 dB magnitude per major division. 90, 45, 10, 2.5 degrees phase per major division.

Accuracy: $\pm 2\%$ ± 0.05 division for rectilinear trace. Within 2.5 mm for polar trace.

General

Sweep output: -5 V to $+5$ V.

External sweep inputs: 0 to 10 V nominal.

X-Y Recorder/External CRT Output

Horizontal and vertical: 0.1 V/div.

Penlift/blanking: +5 V Blanking and Penlift.

External marker input: typically -13 dBm RF signal produce a marker at the frequency of the RF signal.

Magnitude/phase output: -10 mV/degree and -100 mV/dB.

Probe power: Two +15 Vdc and -12.6 Vdc.

Storage-Normalizer interfaces: directly compatible with the HP 8750A Storage-Normalizer. HP 8501A Storage-Normalizer requires a single internal adjustment for compatibility.

Programming connector: outputs include magnitude/phase and sweep outputs and inputs described above as well as measurement mode selection by TTL levels or contact closures.

External source: the HP 8754A sweep-out voltage is provided to frequency modulate (sweep) an external signal generator for narrowband measurement applications. A sweep input is provided to synchronize the CRT display for use with an externally swept source (HP 8620 and 8350 series).

Temperature

Operating: 0° to 55° C except where noted.

Storage: -40° C to $+75^\circ$ C.

NETWORK ANALYZERS

RF Network Analyzer

Model 8754A (cont.)

621



HP 85044A

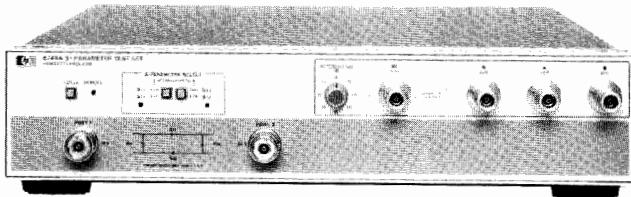

HP 8748A

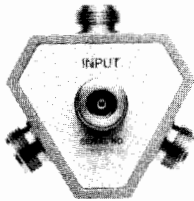

HP 11850C

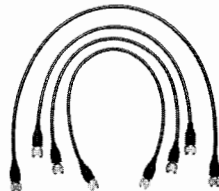

HP 11851B

EMI: VDE 0871/0875 and CISPR publication 11.

Safety: conforms to the requirements of IEC 348.

Power: selection of 100, 120, 220 and 240 V +5% -10%. 48 to 66 Hz, 20 VA max.

Size: 425.5 mm W x 133 mm H x 505 mm D (16 3/4" x 5 1/4" x 19 7/8").

Weight: net, 16.8 kg (37 lb); shipping, 19 kg (42 lb).

HP 8748A 50 Ohm S-Parameter Test Set Specifications

Frequency Range: 4 to 1300 MHz.

Directivity: ≥ 40 dB.

Frequency Response¹:

Transmission (S_{21} , S_{12}): ± 1 dB, $\pm 8^\circ$.

Reflection (S_{11} , S_{22}): ± 2 dB, $\pm 15^\circ$.

Port Match²:

Test Port 1 and 2: ≥ 26 dB Return Loss (≤ 1.11 SWR).

Test Port 1 and 2 open/short ratio: ± 0.75 dB and $\pm 6^\circ$ from 4 to 1000 MHz, ± 0.9 dB and $\pm 7.5^\circ$ from 1000 to 1300 MHz.

Insertion Loss:

Input to Test Port 1 or 2: 13 dB nominal.

Input to Port A, B or R: 19 dB nominal.

Maximum Operating Level: +20 dBm.

RF Attenuator Range: 0 to 70 dB in 10 dB steps.

Test Port Connectors: APC-7.

DC Bias Input Range: ± 30 Vdc, ± 200 mA.

Includes: cables for connection to HP 8754 and Reference Plane Extension Cable Kit.

Recommended Accessory: HP 11857D Test Port Extension Cables, HP 11608A Transistor Fixture, or HP 11600B, 11602B Transistor Fixtures.

Power: 20Vdc, supplied from HP 8754 via interface cable (included).

Size: 432mmW x 90mmH x 495mmD (17" x 3 1/2" x 19 1/2").

Weight: net, 9.1 kg (20 lb); shipping, 11.3 kg (25 lb).

HP 85044A 50 Ohm Transmission/Reflection Test Set

HP 85044B 75 Ohm Transmission/Reflection Test Set

General: the HP 85044 contains a power splitter and directional bridge that permits simultaneous transmission and reflection measure-

ments. Detailed specifications on the HP 85044A and 85044B appear on page 557. For interconnections from the HP 85044A to the HP 8754A use the HP 11851B RF Cable Set. The major specifications of the HP 85044A and 85044B are:

	HP 85044A	HP 85044B
Impedance:	50 ohm	75 ohm
Frequency Range:	300 kHz - 3 GHz	300 kHz - 2 GHz
Directivity:	35 dB to 1.3 GHz 30 dB to 3.0 GHz	35 dB to 1.3 GHz 30 dB to 2.0 GHz

Typical Tracking:

Transmission Magnitude, Phase:

.3 MHz to 2.0 MHz	± 1.0 dB, $+10^\circ$	± 1.0 dB, $\pm 10^\circ$
2.0 MHz to F_{max}	± 1.0 dB, $\pm 5^\circ$	± 1.0 dB, $\pm 5^\circ$

Reflection Magnitude, Phase:

.3 MHz to 2.0 MHz	± 1.0 dB, $\pm 25^\circ$	± 1.0 dB, $\pm 25^\circ$
2.0 MHz to F_{max}	± 1.0 dB, $\pm 5^\circ$	± 1.0 dB, $\pm 5^\circ$

Effective Source Match:

Test Port:

.3 MHz to 2.0 MHz	15 dB	15 dB
2.0 MHz to 1.3 GHz	20 dB	17 dB
1.3 GHz to F_{max}	16 dB	16 dB

Port Match:

Incident and Refl:

.3 MHz to 1.3 GHz	18 dB	18 dB
1.3 GHz to F_{max}	13 dB	13 dB

RF Input:

.3 MHz to 1.3 GHz	17 dB	17 dB
1.3 GHz to F_{max}	12 dB	12 dB

HP 11850C 50 Ω Three-Way Power Splitter

HP 11850D 75 Ω Three-Way Power Splitter

General: one output port provides the reference output and the other two output ports can be used for independent transmission measurements. Use the HP 11851B RF Cable Set for interconnections. Detailed specifications on page 626.

HP 11851B RF Cable Set

General: three 61 cm (24 in.) 50 Ω cables, phase matched to $\pm 2^\circ$ and one 86 cm (34 in.) 50 Ω cable. Used with HP 85044A/B and 11850C/D. Detailed specifications on page 626.

HP 11857D APC-7 Test Port Extension Cables

General: two precision 50 Ω cables phase matched to $\pm 2^\circ$ to connect text device between HP 8748A test ports. Detailed specifications on page 627.

Transistor Fixtures

General: three transistor fixtures can be used with the HP 8748A. The HP 11600B and 11602B require use of the HP 11858A Transistor Fixture Adapter. The HP 11608A transistor fixture connects directly to the HP 8748A. Detailed specifications on page 627.

Adapter Kits

General: the HP 11853A, 11854A, 11855A, and 11856A accessory kits are available to provide precision Type N and BNC adapters and calibration standards for use with the HP 11850C/D, 85044A/B, and 8748A test setups. Detailed specifications on page 626.

¹ \pm degrees, specified as deviation from linear phase.

² Effective port match for ratio measurements.

Ordering Information

	Price
HP 8754A Network Analyzer	\$15,500
Opt 908: Rack Flange Kit	add \$32
Opt 910: Extra Manual	\$75
Opt 913: Rack Mount Kit	add \$35
HP 11850C 50 Ω Three-Way Power Splitter	\$895
HP 11850B 75 Ω Three-Way Power Splitter	\$1,395
HP 85044A 50 Ω Transmission/Reflection Test Set	\$2,990
HP 85044B 75 Ω Transmission/Reflection Test Set	\$3,490
HP 11851B RF Cable Set	\$795
HP 11857D Test Port Extension Cables	\$1,045
HP 8748A 50 Ω S-Parameter Test Set	\$8,150
Opt 907: Front Handle Kit	add \$50
Opt 908: Rack Flange Kit	add \$30
Opt 909: Rack Mount Flange/Front Handle Kit	add \$72



NETWORK ANALYZERS

Vector Voltmeter

Model 8405A

- Accurate voltage and phase measurement
- 1 to 1000 MHz
- 50/75 Ω coaxial measurements

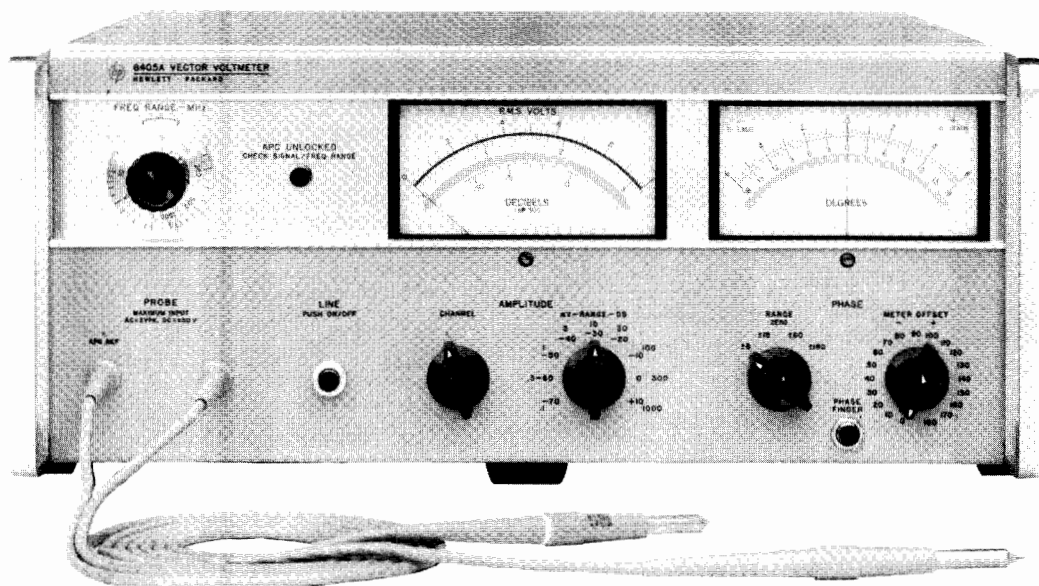

HP 8405A

The HP 8405A Vector Voltmeter measures voltage vectors described by both magnitude and phase. This capability makes the HP 8405A a unique instrument for about any design and test application in the frequency range 1 to 1000 MHz.

In addition to absolute voltage measurements, capabilities include insertion loss and computed group delay of bandpass filters and other transmission devices, gain and phase margin of amplifiers, complex impedance of mixers, antennas, matching the electrical lengths of cables, s-parameters of transistors, amplitude modulation index, RF distortion measurements and in-circuit probing. Simultaneous 50/75 ohm coaxial transmission and reflection measurements can be made using the HP 85044A/B transmission/reflection test set, and 50/75 ohm coaxial high resolution transmission comparison measurements can be made using the HP 11850C/D three-way power splitter. The HP 11852B 50-to-75 ohm minimum loss pad can be used to adapt the HP 11536A 50 ohm tee to a 75 ohm environment.

The HP 8405A achieves this measurement versatility through its two-channel capability enabling voltage magnitude measurements in either channel, thus allowing ratio measurements and phase difference measurements between the two channels. Gain or loss in excess of 90 dB and phase measurements with 0.1° resolution over a 360° phase range are possible.

Accuracy is achieved through the 1 kHz bandwidth entailing response only to the fundamental frequency of the input signal. Also, phase-locked coherent sampling to translate 1 to 1000 MHz RF signals to 20 kHz IF signals enables accurate detection of voltage magnitude and phase. Automatic phase-locked tuning makes it possible to select the one of 21 overlapping octave ranges which contains the input signal frequency by simply rotating a switch.

Specifications

Frequency range: 1 MHz to 1 GHz in 21 overlapping octave bands; tuning automatic within each band.

Isolation between channels: 1 to 300 MHz, >100 dB; 300 to 1,000 MHz >80 dB.

Maximum input: ac, 2 V peak; dc, ± 50 V.

Input impedance (nominal): 0.1 M Ω shunted by 2.5 pF; 1 M Ω shunted by 2 pF when HP 11576A 10:1 Divider is used; 0.1 M Ω shunted by 5 pF when HP 10216A Isolator is used. AC coupled.

Voltage Range (rms)

Channel	1 - 10 MHz	10 - 500 MHz	500 - 1000 MHz
A	1.5 mV - 1.0 V	300 μ V - 1.0 V	500 μ V - 1.0 V
B	<100 μ V - 1.0 V	<100 μ V - 1.0 V	<100 μ V - 1.0 V

Voltmeter ranges: 100 μ V to 1 V rms full scale in 10 dB steps.

Voltage ratio accuracy: 1-200 MHz, 0.2 dB for -60 to 0 dB ranges and 0.5 dB for -70 dB and +10 dB ranges; 200-1000 MHz, 0.2 dB for -60 to -10 dB ranges, 0.5 dB for -70 dB and 0 dB ranges and 1.5 dB for +10 dB range.

Phase range: 360° indicated on zero-center meter with end-scale ranges of $\pm 180^\circ$, $\pm 60^\circ$, $\pm 18^\circ$, and $\pm 6^\circ$.

Phase resolution: 0.1° at any phase angle.

Phase meter offset: $\pm 180^\circ$ in 10° steps.

Phase accuracy: $\pm 1.5^\circ$ (equal voltage Channel A and B).

Accessories furnished: two HP 11576A 10:1 Dividers, two HP 10216A Isolators, two HP 10218A BNC Adapters, six ground clips for HP 11576A or 10216A; six replacement probe tips.

Bandwidth: 1 kHz.

Power: 115 or 230 V $\pm 10\%$, 50 to 60 Hz, 35 W.

Weight: net, 13.9 kg (31 lb); shipping, 16.3 kg (36 lb).

Size: 177 H x 425 W x 467 mm D (7.0" x 16.75" x 18.38").

HP 11570A Accessory Kit

50 Ω Tee: HP 11536A: for monitoring signals on 50 Ω transmission lines without terminating line. Kit contains two with type N RF fittings.

50 Ω Power splitter: HP 11549A: all connectors Type N female.

50 Ω Termination: HP 908A: for terminating 50 Ω coaxial systems in their characteristic impedance.

Shorting plug: HP 11512A: Shorting Plug, Type N male.

Ordering Information

HP 8405A Vector Voltmeter

Opt 002: linear dB scale

HP 11570A Accessory Kit (measurement in 50 Ω systems only)

Price

\$5,670

add \$25

\$950

NETWORK ANALYZERS

RF Network Analyzer, 300 kHz to 3 GHz

Model 8753A



- 300 kHz to 3 GHz
- Integrated 1 Hz resolution synthesized source
- Direct save/recall to an external disc drive
- Time domain analysis

- 100 dB of dynamic range
- Group delay and deviation from linear phase
- 0.001 dB, 0.01 deg, 0.01 nanosec marker resolution
- Built-in accuracy enhancement

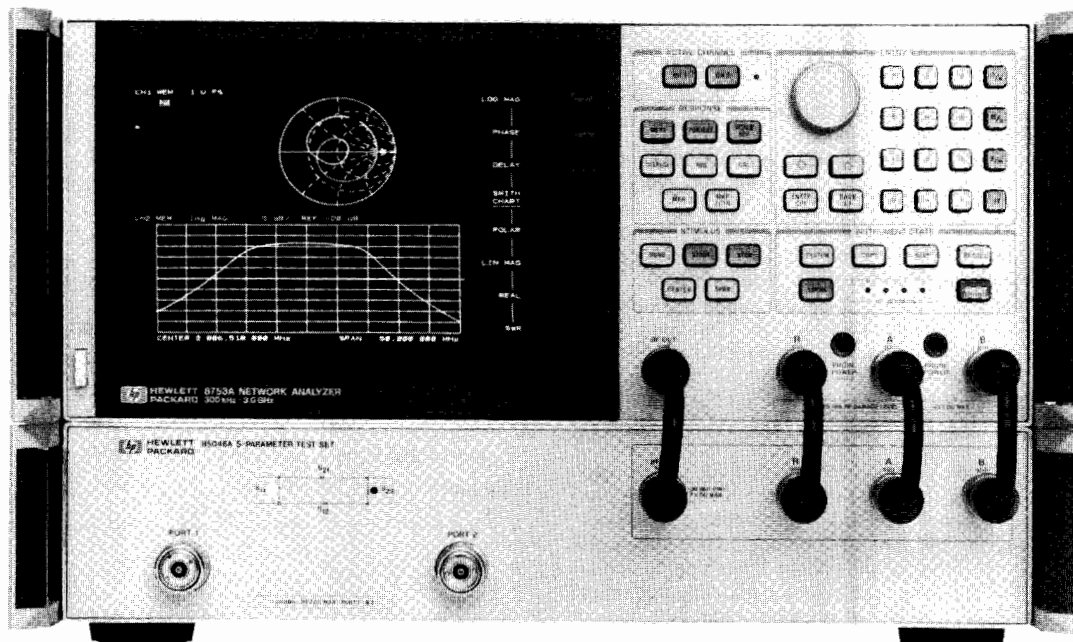

HP 8753A



Description

The HP 8753A provides excellent RF network measurements for the lab and production test areas. When combined with a test set, it yields a complete solution for characterizing the linear behavior of either active or passive networks, devices, or components from 300 kHz to 3 GHz. With two independent display channels available, you can simultaneously measure and display the reflection and transmission characteristics of the device under test. The easy-to-use soft-key selection of measurement functions allows you to quickly measure the magnitude, the phase, or group delay characteristics of your device under test. Directly measure the electrical length of a single device or phase match multiple devices. Data can be displayed in log magnitude, linear magnitude, SWR, phase, group delay, polar, real, or Smith Chart formats. The two independent display channels can be viewed separately or simultaneously in overlay or split screen formats.

The HP 8753A's integrated synthesized source provides >100 mw of output power, 1 Hz frequency resolution, and linear or logarithmic frequency sweeps.

All of the functions of the HP 8753A are completely programmable from an external computer through the Hewlett-Packard Interface Bus. Draw/label custom graphics onto the CRT of the HP 8753A using Hewlett-Packard Graphics Language commands. The entire CRT display - including the custom graphics - can be copied to a compatible HP-GL plotter or printer.

Excellent Performance

Digital signal processing allows the HP 8753A to measure signals over a wide 100 dB of dynamic range over the entire 300 kHz to 3 GHz frequency range. The tuned receiver yields a spurious free minimum sensitivity of -100 dBm. The HP 8753A also provides marker resolutions of 0.001 dB, 0.01 degree, and 0.01 nanoseconds. The IF processing and detection system contribute as little as ± 0.05 dB and ± 0.5 degree of dynamic accuracy uncertainty over a 50 dB measurement range.

Accuracy enhancement provides a means of reducing systematic residual errors (directivity, mismatch, frequency response, etc.) for the best measurement accuracy. By characterizing these systematic errors through the measurement of known standards, their effect on actual measurements can be minimized. Various levels of accuracy enhancement are possible—from a simple frequency response calibration to a full two-port calibration. Residual directivity can be improved to >50 dB, residual source and load match to >40 dB, and residual frequency response to <0.05 dB.

Hewlett-Packard supplies kits of measurement calibration standards for precision 7 mm, precision 3.5 mm, 50 Ω type N, and 75 Ω type N connector interfaces. The HP 8753A also provides the capability of measuring devices in other coaxial interfaces, given the proper calibration standards.

Outstanding Measurement Productivity

The HP 8753A provides the capability of substantially increasing measurement productivity. Reduce test times in high volume applications by defining test limits and letting the HP 8753A make the pass/fail decision when testing your devices. Limit lines can be completely defined from the front panel of the network analyzer and limit test conditions (pass or fail) are displayed on the CRT or can be determined over the HP-IB or from an accessible TTL output.

In addition, you can test your devices at only those frequencies at which you need data. Customize measurements by defining up to 30 different arbitrary CW frequencies or frequency sweep segments from the front panel of the network analyzer. Measured data can be displayed in either a swept format or listed on the CRT for easy viewing.

A full set of marker functions provide you with measurement information during your device adjustment cycle. Search for and track the maximum, the minimum, or a defined target value of the trace data. Directly measure and display a filter's center frequency, bandwidth, and Q through the use of a bandwidth function and internal processing.



NETWORK ANALYZERS

RF Network Analyzer, 300 kHz to 3 GHz

Model 8753A (con't.)

Obtain annotated hardcopies of measured data quickly on compatible Hewlett-Packard Graphics Language plotters and printers without the use of external computers. Save and recall instrument configurations including limit lines, frequency lists, and calibration data in internal memory or directly to a compatible external disc drive providing you with a quick return of your instrument state to previously defined measurement configurations.

Time Domain Analysis

The HP 8753A (with Option 010) has the capability of displaying the time domain response of a network, obtained by computing the Inverse Fourier Transform of the frequency domain response. The time domain response displays the reflection coefficient versus time, yielding the magnitude and location of each individual discontinuity of the network. It can also display the transmission coefficient versus time, yielding simulated transient response analysis of the network.

The HP 8753A offers two time domain modes. The Low Pass mode provides the traditional Time Domain Reflectometer (TDR) measurement capability and gives the response of the network to a (mathematically-simulated) step or impulse response. This mode gives information of the type of impedance (R, L, C) present at the discontinuity. The Band Pass time domain mode, which has only the impulse stimulus, may be used over any frequency range to give the time domain response of frequency selective devices such as SAW filters or antennas.

Gating is another powerful time domain feature that may be used to selectively isolate a single response in time and then convert just that response back to the frequency domain. For reflection measurements, this provides the capability to view the return loss of individual portions of a high frequency component without disturbing the actual circuit. For transmission measurements, one can view the frequency and time domain responses of individual transmission paths.

The HP 8753A time domain capability can give great insight into the design of high frequency components. Simulated linear impulse analysis can provide useful information such as the step response of a linear amplifier or the multiple spurious signal paths associated with SAW devices. Another useful application is coax cable fault location. Locate the position and magnitude of a single fault to within mm's and resolve multiple responses to within cm's. Gating can be used in a variety of applications such as removing the effects of multi-path and ground clutter in antenna measurements.

HP 8753A Specifications Summary

Source

Frequency Characteristics

Frequency Range: 300 kHz to 3 GHz

Frequency Resolution: 1 Hz

Frequency Accuracy (25 C): ± 10 ppm

Output Characteristics

Power Range: -5 to +20 dBm

Power Accuracy (50 MHz, +10 dBm): ± 0.5 dB

Power Linearity (relative to +10 dBm, 25 \pm 5 C):

-5 to +15 dBm: ± 0.2 dB

+15 to +20 dBm: ± 0.5 dB

Impedance: 50

Harmonics: ≤ -25 dBc (20 dBm output level)

typically ≤ -50 dBc (0 dBm output level)

Nonharmonics:

Mixer Related: ≤ -32 dBc (20 dBm output level)

typically ≤ -55 dBc (0 dBm output level)

Other Spurious:

$f < 135$ MHz: -60 dBc

$f \geq 135$ MHz: -60 dBc + $20 \cdot \log(f/135 \text{ MHz})$

Phase Noise (0 kHz offset in 1 Hz BW):

$f < 135$ MHz: -90 dBc

$f \geq 135$ MHz: -90 dBc + $20 \cdot \log(f/135 \text{ MHz})$

Receiver

Frequency Range: 300 kHz to 3 GHz

Inputs: A, B 100 dB dynamic range

Sensitivity (noise level):

3 kHz BW: -90 dBm

10 Hz BW: -100 dBm (typically -110 dBm)

Maximum Input Level: 0 dBm

Impedance: 50

Input Crosstalk:

300 kHz to 1 GHz: -100 dB

1 GHz to 3 GHz: -90 dB

Dynamic Accuracy: ± 0.05 dB, ± 0.5 deg over a 50 dB input range

Delay Characteristics:

Range: $1/2^*$ (1/minimum aperture)

Aperture: selectable (frequency span)/(# points - 1) to 20% of the frequency span

Resolution: $27.8/(\text{aperture in Hz})$

typically 0.01 nanoseconds

Accuracy: (phase accuracy)/($360^* \text{aperture in Hz}$)

Measurement Uncertainty

The following curves show the typical measurement uncertainty for devices with 7 mm connectors when using the HP 8753A with the HP 85046A s-parameter test set after full Accuracy Enhancement. The measurement uncertainty curves utilize an RSS model for the contribution of random errors such as noise and connector repeatability, and a worse case model for the contribution of dynamic accuracy and residual systematic errors.

Typical Reflection Uncertainty of One-Port Device

Ref power level = -20 dBm

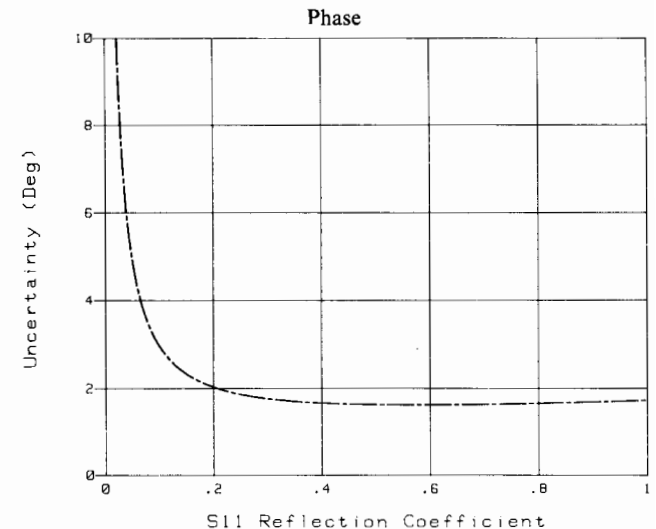
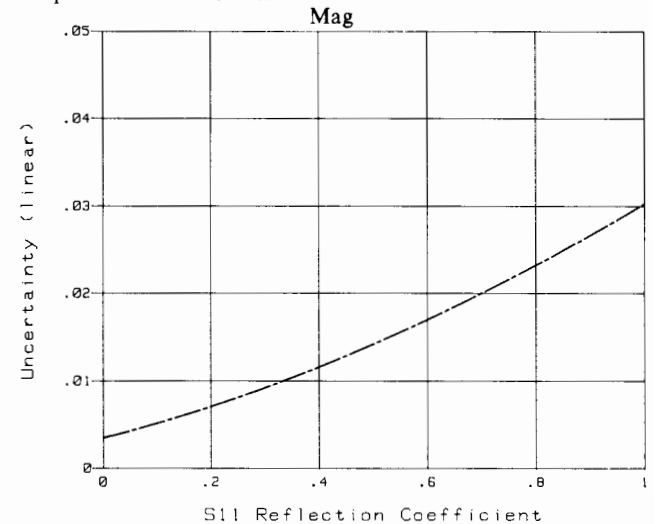

NETWORK ANALYZERS

Accessories
8753A Series



Typical Transmission Uncertainty of a Low Loss Device Ref power level = -10 dBm

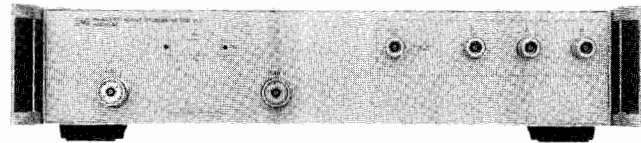
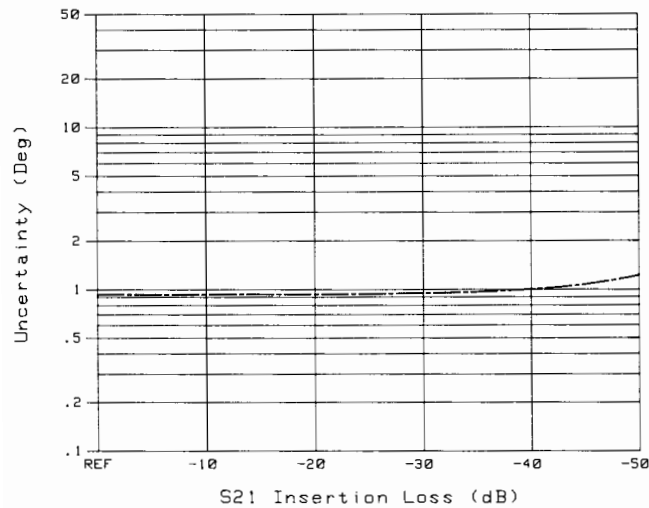
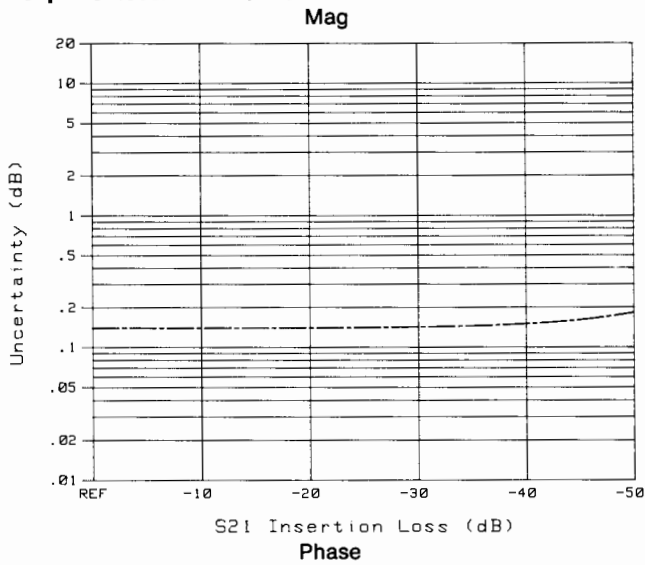

HP 85046A



HP 85044A

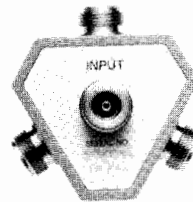

HP 11850C



HP 11851B

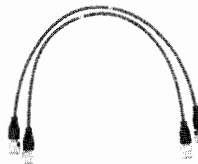

HP 11857D



HP 11852B

HP 8753A Accessories

HP 85044A 50 Ohm Transmission/Reflection Test Set HP 85044B 75 Ohm Transmission/Reflection Test Set

The HP 85044 A/B Transmission/Reflection test sets provide the capability to simultaneously measure the impedance and transmission characteristics of 50 and 75 ohm devices. Two-port devices must be physically turned around to measure their reverse direction characteristics. Test port connectors are precision 7 mm and 75 ohm type N (f), respectively.

Specifications	HP 85044A	HP 85044B
Impedance:	50 ohms	75 ohms
Frequency Range:	300 kHz to 3 GHz	300 kHz to 2 GHz
Directivity:	35 dB to 1.3 GHz 30 dB to 3.0 GHz	35 dB to 1.3 GHz 30 dB to 2.0 GHz

Typical Tracking:

Transmission Magnitude, Phase¹:

.3 MHz to 2.0 MHz	±1.5 dB, ±10°	±1.5 dB, ±10°
2.0 MHz to F _{max} ²	±1.5 dB, ±10°	±1.5 dB, ±10°

Reflection Magnitude, Phase¹:

.3 MHz to 2.0 MHz	±1.5 dB, ±25°	±1.0 dB, ±25°
2.0 MHz to F _{max}	±1.5 dB, ±10°	±1.0 dB, ±10°

Effective Source Match:

(Test Ports):

.3 MHz to 2.0 MHz	14 dB	14 dB
2.0 MHz to 1.3 GHz	20 dB	17 dB
1.3 GHz to F _{max}	16 dB	16 dB

Port Match:

Incident and Refl:
.3 MHz to 1.3 GHz
1.3 GHz to F_{max}

HP 85044A HP 85046A

18 dB 18 dB
13 dB 13 dB

RF Input:

.3 MHz to 1.3 GHz
1.3 GHz to F_{max}

17 dB 17 dB
12 dB 12 dB

RF Connectors:

Test Port:

All others:

Includes:

precision 7 mm 75 ohm type N (f)
50 ohm type N (f) 50 ohm type N (f)
HP 85044A—one precision 7 mm to
50 ohm type N (f) adapter;
HP 85044B—one HP 11852B
minimum loss pad.

Recommended

Accessories:

Dimensions:

HP 11851B RF cable kit
615H x 101 W x 204 mm D
(2.44 x 7.5 x 8.0 in)
net 1.7 kg (3.8 lb)

Weight:

¹Degrees, specified as deviation from linear phase.

²F_{max} is the upper frequency limit of the associated test set.



NETWORK ANALYZERS

Accessories (con't.)

8753A Series

HP 85046A/B S-Parameter Test Set

The HP 85046A/B s-parameter test sets provide the capability to measure impedance and transmission characteristics (including s-parameters) of 2 port devices in either direction with a single connection. The test sets are controlled from the HP 8753A and include a programmable step attenuator. Test port connectors are precision 7 mm and 75 ohm type N (f) respectively. Both connectors can be adapted to other interfaces with the appropriate precision adapters.

Specifications

	HP 85046A	HP 85046B
Impedance:	50 ohms	75 ohms
Frequency Range:	300 kHz to 3 GHz	300 kHz to 2 GHz
Directivity:	35 dB to 1.3 GHz 30 dB to 3.0 GHz	35 dB to 1.3 GHz 30 dB to 2.0 GHz

Typical Tracking:

Transmission Magnitude, Phase¹:

.3 MHz to 2.0 MHz	±1.5 dB, ±20°	±1.5 dB, ±20°
2.0 MHz to F _{max} ²	±1.5 dB, ±10°	±1.5 dB, ±10°

Reflection Magnitude, Phase¹:

.3 MHz to 2.0 MHz	±1.5 dB, ±25°	±1.5 dB, ±25°
2.0 MHz to F _{max}	±1.5 dB, ±10°	±1.5 dB, ±10°

Effective Source Match:

(Test Ports):

.3 MHz to 2.0 MHz	14 dB	14 dB
2.0 MHz to 1.3 GHz	20 dB	17 dB
1.3 GHz to F _{max}	16 dB	16 dB

Port Match:

R, A, B:

.3 MHz to 1.3 GHz	18 dB	18 dB
1.3 GHz to F _{max}	13 dB	13 dB

RF Input:

.3 MHz to 1.3 GHz	17 dB	17 dB
1.3 GHz to F _{max}	12 dB	12 dB

RF Connectors:

Port 1, 2:

precision 7 mm 75 ohm type N (f)

All others:

50 ohm type N (f) 50 ohm type N (f)

Includes:

Four 190 mm (7.5") cables with type N (m) connectors for connection to the HP 8753A. One HP 8753A test set interconnect cable.

Recommended

Accessories:

HP 11857D cables HP 11857B cables

Dimensions:

90 H x 426 W x 553 mm D
(3.5 x 16.75 x 21.5 in.)

Weight:

9.1 kg (20 lb)

¹Degrees, specified as deviation from linear phase.

²F_{max} is the upper frequency limit of the associated test set.

HP 11850C/D Three-Way Power Splitters

Specifications

	HP 11850C	HP 11850D
Impedance:	50 ohms	75 ohms
Frequency Range:	DC to 3 GHz	DC to 2 GHz
Tracking:	±2.5 dB, +3°	±2 dB, ±2.5°
Equivalent Source Match (ratio or leveling)	30 dB @ 1.3 GHz 20 dB @ 3 GHz	30 dB @ 1.3 GHz 20 dB @ 3 GHz
Nominal Insertion Loss:	9.5 dB +1 dB/GHz	7.8 dB

Input Port Match:

DC to 1.3 GHz	20 dB	20 dB
1.3 GHz to F _{max} ¹	10 dB	10 dB

Maximum Operating

Level:	+20 dBm	+20 dBm
Damage Level:	+30 dBm	+30 dBm

RF Connectors:

RF Input:	50 ohm type N (f)	50 ohm type N (f)
All Others:	50 ohm type N (f)	75 ohm type N (f)

Includes:

3 ea HP 11852B
50 to 75 ohm
min. loss pads

Recommended

HP 11851B RF Cable Kit

Accessories:

¹F_{max} is the upper frequency limit of the associated power splitter.

HP 11851B RF Cable Kit

General: three 610 mm (24 in.) 50 Ω cables phase matched to 4° at 1.3 GHz and one cable 860 mm (34 in.). Connectors are Type N Male. Recommended for use with HP 85044A/B Transmission/Reflection Test Set and HP 11850C/D Power Splitter.

Weight: net, 0.91 kg (2 lb); shipping, 1.36 kg (3 lb).

HP 11852B 50 Ω/75 Ω Minimum Loss Pad

General: the HP 11852B is a low SWR minimum loss pad required for transmission measurements on 75 Ω devices with HP 8753A receiver (50 Ω).

Frequency range: dc to 2.0 GHz.

Insertion loss: 5.7 dB.

Return loss: 75 Ω typically ≥30 dB. 50 Ω typically ≥26 dB.

Maximum input power: 250 mW (+24 dBm).

Connectors: 50 Ω Type N female and 75 Ω Type N male.

Size: 14 D x 70 mm L (0.56" x 2.75").

Weight: net, 0.11 kg (4 oz); shipping, 0.26 kg (9 oz).

HP 11853A 50 Ω Type N Accessory Kit

General: the HP 11853A furnishes the RF components required for measurement of devices with 50 Ω Type N Connectors using the HP 11850C, 85044A, or 85046A. Kit contains a Type N Female short, a Type N Male short, two Type N Male barrels, two Type N Female barrels and storage case.

Weight: net, 0.91 kg (2 lb); shipping, 1.36 kg (3 lb).

HP 11854A 50 Ω BNC Accessory Kit

General: the HP 11854A furnishes the RF components required for measurement of devices with 50 Ω BNC Connectors using the HP 11850C, 85044A, or 85046A. Kit contains two Type N Male to BNC Female adapters, two Type N Male to BNC Male adapters, two Type N Female to BNC Female adapters, two Type N Female to BNC Male adapters, a BNC Male short and storage case.

Weight: net, 1.13 kg (2½ lb).

HP 11855A 75 Ω Type N Accessory Kit

General: the HP 11855A provides the RF connecting hardware generally required for measurement of devices with 75 Ω Type N connectors using the HP 85044B, 85046B or 11850D. Kit contains two 75 Ω Type N Male barrels, two Type N Female barrels, a 75 Ω Type N Female short, a 75 Ω Type N Male short, a 75 Ω Type N Male termination, and storage case.

Weight: net, 0.91 kg (2 lb); shipping, 1.36 kg (3 lb).

HP 11856A 75 Ω BNC Accessory Kit

General: the HP 11856A provides the RF connecting hardware generally required for measurement of devices with 75 Ω BNC connectors using the HP 85044B, 11850D, or 85046B. Kit contains two Type N Male to BNC Female adapters, two Type N Male to BNC Male adapters, two Type N Female to BNC Female adapters, two Type N Female to BNC Male adapters, a BNC Male short, a 75 Ω BNC Male termination, and storage case.

Weight: net, 0.91 kg (2 lb); shipping, 1.36 kg (3 lb).

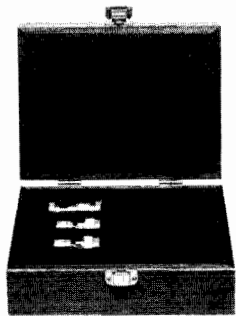

HP 85031B

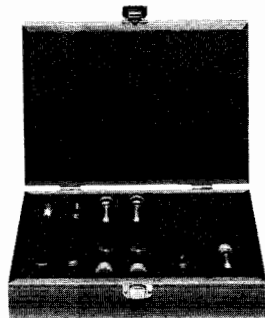

HP 85032B

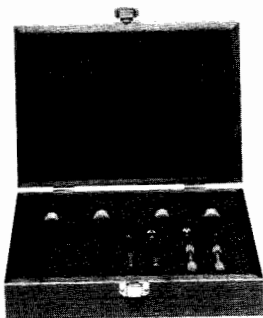

HP 85033C

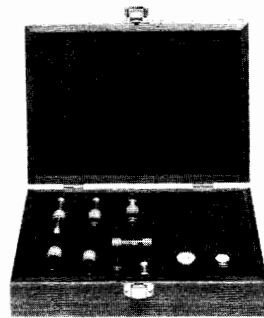

HP 85036B

HP 11857D 50 Ω APC-7 Test Port Extension Cables

General: two precision 61 cm (24 in.) cables, phase matched to 2° at 1.3 GHz for use with HP 85046B S-parameter test set. Connectors are 50 Ω APC-7.

Weight: net, 0.91 kg (2 lb); shipping, 2.3 kg (5 lb).

HP 11857B 75 Ω Type N Test Port Extension Cables

General: two precision 61 cm (24 in.) cables, phase matched to 2° at 1.3 GHz for use with HP 85046B S-parameter test set. One cable has 75 Ω Type N Male connectors on both ends; the other has one Type N Male and one Type N Female connector.

Weight: net, 0.91 kg (2 lb); shipping, 2.3 kg (5 lb).

HP 11858A Transistor Fixture Adapter

General: the HP 11858A adapts the HP 11600B and 11602B transistor fixtures (vertical test port configuration) to the HP 85046A S-parameter test set. Connectors are APC-7.

Weight: net, 0.91 kg (2 lb); shipping, 1.36 kg (3 lb).

Calibration Kits

Accuracy enhancement procedures characterize the systematic errors of the measurement system by measuring known devices (standards) on the system over the frequency range of interest. The calibration kits in the HP 8753A family contain precision standards with which to characterize the systematic errors of a HP 8753A measurement system. These standards have been optimized for the 300 kHz to 3 GHz frequency range and are available in various connector types that are compatible with the HP 8753A.

HP 85031B 7 mm Calibration Kit

The HP 85031B 7 mm calibration kit contains a set of precision 7 mm fixed terminations, an open circuit, and a short circuit used to calibrate the HP 8753A and its 50 ohm test sets for measurement of devices with precision 7 mm connectors.

HP 85032B 50 Ω Type N Calibration Kit

The HP 85032B Calibration Kit contains precision 50 Ω type N standards used to calibrate the HP 8753A and its 50 Ω test sets for measurement of devices with 50 Ω type N connectors. Precision phase-matched 7 mm to 50 Ω type N adapters are included for accurate measurements of non-insertable devices. Standards include fixed terminations, open circuits, and short circuits.

HP 85033C 3.5 mm Calibration Kit

The HP 85033C Calibration Kit contains precision 3.5 mm standards used to calibrate the HP 8753A and its 50 Ω test sets for measurement of devices with 3.5 mm and SMA connectors. Standards include fixed terminations, open circuits, and short circuits. Precision 7 mm to 3.5 mm adapters are included for accurate measurements of non-insertable devices.

HP 85036B 75 Ω type N Calibration Kit

The HP 85036B Calibration Kit contains precision 75 Ω type N standards used to calibrate the HP 8753A and its 75 Ω test sets for measurement of devices with 75 Ω type N connectors. Standards include fixed terminations, open circuits, and short circuits. Precision phase-matched adapters are included for accurate measurements of non-insertable devices.

Verification Kits

Measuring known devices, other than the calibration standards, is a convenient way of verifying that the HP 8753A measurement system is operating properly.

HP 85029A 7 mm Verification Kit

The HP 85029A Verification Kit contains a set of precision 7 mm devices, with data traceable to NBS, used to verify the calibrated performance of an HP 8753A measurement system. The devices have precision 7 mm connectors and include a 20 dB pad, a 50 dB pad and a mismatch attenuator. Verification process requires only an HP 85031B calibration kit, an HP 85029A verification kits and an external 3.5" disc (HP 9122S or HP 9122D) connected to the HP 8753A.

HP 85043B

The HP 85043B systems cabinet has been ergonomically designed specifically for the HP 8753A and the HP 85046A/B s-parameter test sets. The 122 cm (48-inch) system cabinet includes a bookcase, a drawer, and a convenient work surface.



NETWORK ANALYZERS

Accessories (con't.)

8753A Series

Service and Support Products

Service and support products are available for HP 8753A measurement systems. These on-site support products require a specific 50 ohm two-port measurement configuration.¹ Additional on-site support products and return-to-HP support products are available for this and other system configurations. Contact your local HP sales office for availability and price.

HP 8753A System On-Site Service

+23N Support Product

On-Site Installation and System Verification

Have your HP 8753A system¹ installed and certified NBS traceable by a qualified HP Customer Engineer at your location.

+02B Support Product

On-Site Service and System Verification

A qualified HP Customer Engineer will provide next day on-site response service for your HP 8753A system.¹ Two PM's and two system verifications (certified NBS traceable) are included. Option W03 for each product in the system¹ must be specified for this service.

+23G Support Product

On-Site System Verification

A qualified HP Customer Engineer will verify your HP 8753A system¹ operation and will provide you with a "Certificate of Traceability" with data traceable to NBS.

Option W03 On-Site Warranty

Converts the standard one-year return-to-HP warranty of the system¹ component to 90 days of on-site warranty. On-site service is available only on the specific 50 ohm two-port measurement system,¹ thus to convert warranty, each system component must be ordered with Option W03.

HP 8753A Return-to-HP Service

HP 8753A Option W30 3-Year Extended Return-to-HP Support

Adds two additional years of return-to-HP support to your normal one year return-to-HP warranty for the HP 8753A network analyzer (does not include test sets, cables, or calibration kits). Return-to-HP support does not include annual maintenance or calibrations of the network analyzer.

Ordering Information

	Price
HP 8753A Network Analyzer	\$23,500
Option 010 Time Domain	\$4,500
Option 908 Rack Mounting Kit (without handles)	\$40
Option 910 Extra Manuals	\$75
Option 913 Rack Mounting Kit	\$40
Option W03 On-Site Warranty Conversion	\$0
Option W30 Three-Year Extended Return-to-HP Support	\$600
HP 85046A 50Ω S-Parameter Test Set	\$7,000
Option 908 Rack Mounting Kit (without handles)	\$40
Option 913 Rack Mounting Kit	\$40
Option W03 On-Site Warranty Conversion	\$0
Option W30 Three-Year Extended Return-to-HP Support	\$250
HP 85046B 75Ω S-Parameter Test Set	\$7,500
Option 908 Rack Mounting Kit (without handles)	\$40
Option 913 Rack Mounting Kit	\$40
Option W30 Three-Year Extended Return-to-HP Support	\$250
HP 85044A 50Ω Transmission/Reflection Test Set	\$3,000
Option W30 Three-Year Extended Return-to-HP Support	\$60
HP 85044B 75Ω Transmission/Reflection Test Set	\$3,500
Option W30 Three-Year Extended Return-to-HP Support	\$60
HP 85029A Precision 7 mm Verification Kit	\$1,500
HP 85031B Precision 7 mm Calibration Kit	\$1,000
HP 85032B 50Ω type N Calibration Kit	\$1,500
HP 85033C Precision 3.5 mm Calibration Kit	\$2,500
HP 85036B 75Ω type N Calibration Kit	\$1,650
HP 85043B Systems Rack	\$2,300
HP 85033A SMA Kit	\$755
HP 11850C 50Ω Power Splitter	\$900
HP 11850D 75Ω Power Splitter	\$1,400
HP 11851B type N RF Cable Kit	\$800
HP 11852B 50 to 75Ω Minimum Loss Pad	\$250
HP 11853A 50Ω type N Accessory Kit	\$305
HP 11854A 50Ω BNC Accessory Kit	\$265
HP 11855A 75Ω type N Accessory Kit	\$305
HP 11856A 75Ω BNC Accessory Kit	\$365
HP 11857B 75Ω type N Test Port Extension Cables	\$1,455
HP 11857D 50Ω APC-7 Test Port Extension Cables	\$1,050
HP 11858A Transistor Fixture Adapter	\$980

¹The specific 50 ohm two-port measurement system includes the HP 8753A, the HP 85046A S-parameter test set, the HP 85031B 7 mm calibration kit, and the HP 11857D 7 mm test port extension cable set. This is a minimum configuration required for on-site verification.

NETWORK ANALYZERS

Microwave Network Analyzers, 45 MHz to 100 GHz

8510 Series

629



- 45 MHz to 100 GHz frequency range
- "Real Time" error-corrected measurements
- 50 dB effective directivity, 40 dB effective source and load match
- 70 dB to 100 dB dynamic range
- 0.001 dB, 0.01 degree, 0.01 nanosecond measurement resolution
- Time domain analysis

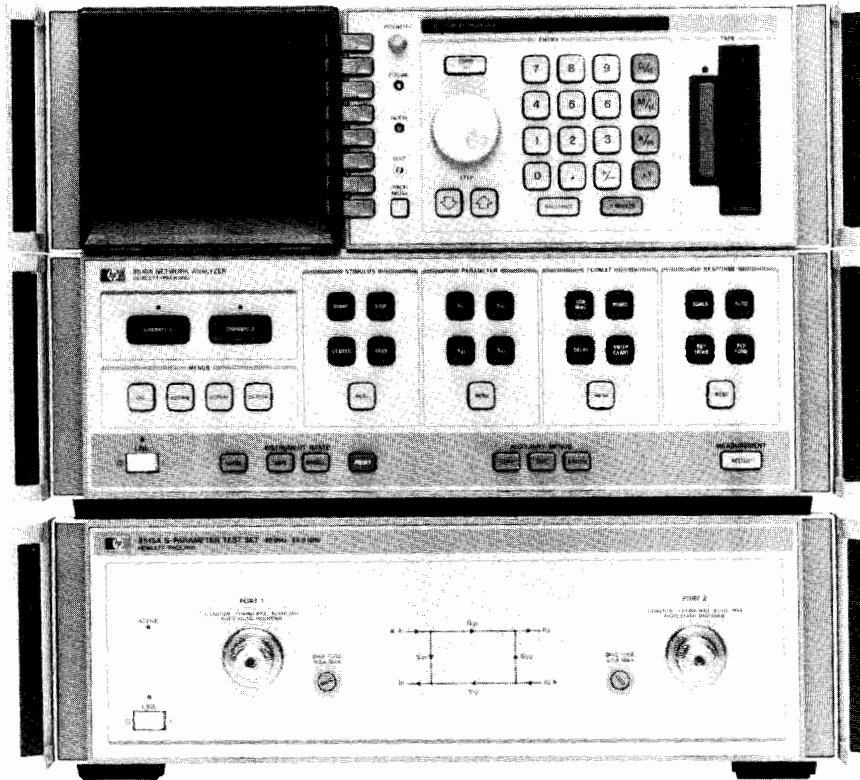

HP 8510



Description

The HP 8510 series microwave vector network analyzers provide a complete solution for characterizing the linear behavior of either active or passive networks over the 45 MHz to 26.5 GHz frequency range. A complete system comprises the HP 8510A network analyzer, one of four HP 851XA broadband test sets, and a compatible RF source. For millimeter-wave measurement needs, complete systems operating to 100 GHz can be configured.

The test sets are offered in one of two measurement test setup configurations. The reflection/transmission test sets provide the capability to simultaneously measure the complex reflection and transmission characteristics of a test device. The S-parameter test sets offer a single test setup solution for complete characterization of two-port devices. Each measurement presented on the CRT display consists of 51, 101, 201, or 401 discrete points of data, and when the system source is a synthesizer, the frequency of each data point is synthesized.

Measurement results can be displayed on one of two independent, yet identical, channels. The channels may be displayed individually, or simultaneously, with results presented in either logarithmic/linear magnitude, phase, or group delay format on rectangular or polar coordinates. Direct measurement of normalized impedance is possible with the Smith chart format. The value and frequency of any one data point can be read with one of five independent markers. The entire measurement trace can be copied directly to a plotter, such as the HP 7474A, 7475A, or 7550A without the need of an external computer. Also, a list of the trace values can be sent to a printer such as the 2225A.

Powerful measurement enhancement functions are also available. Data averaging can be employed to narrow the effective receiver IF

bandwidth, extending dynamic range and increasing signal-to-noise ratio. Trace smoothing aids in the interpretation of measurement results and is used to control the aperture of group delay measurements. The equivalent of an electronic line stretcher is available with the electrical delay function.

Built-in storage provides the capability to save and recall up to eight different front panel states, eight separate measurement calibrations, and four separate measurements in nonvolatile memory. Extension of the internal storage capacity is practically limitless via the built-in tape cassette unit.

All the functions of the HP 8510 system are completely programmable from an external computer through the Hewlett-Packard Interface Bus. Also, measurements can be transferred to a computer in one of four data transfer formats. CRT graphics, such as limit lines, can be written to the HP 8510 display to aid in test procedures. The built-in tape drive can, as well, be used to provide permanent storage of CRT graphics.

High Performance

Along with the capability to completely characterize a microwave network with a single connection over the extremely broad 45 MHz to 26.5 GHz frequency range, the HP 8510 system offers wide dynamic range. Depending on the test set used, 80 dB to 100 dB of dynamic range is available. The precision IF processing and detection system contributes as little as ± 0.05 dB and ± 0.5 degree measurement uncertainty at a level of 50 dB below the reference. Meaningful resolutions of 0.001 dB, 0.01 degree, and 0.01 nanosecond are easily achievable.

NETWORK ANALYZERS

Microwave Network Analyzers, 45 MHz to 100 GHz

8510 Series (cont.)

"Real Time" Error Correction

The fundamental accuracy limitations in most microwave measurements are due primarily to uncertainties associated with systematic errors in the microwave hardware (directivity, mismatch, frequency response, etc.). The HP 8510's built-in, high speed computer provides the capability to characterize and effectively remove the impact of systematic errors through accuracy enhancement techniques. Effective directivity is improved to 50 dB, and effective source and load match to better than 40 dB. The data processing speed of the system is such that a fully error-corrected, 401 point trace of data is updated in under one second. This virtual "real time" display of error-corrected data means that you can easily adjust your test device while it's being measured, with the assurance that you are viewing the data at the highest possible accuracy.

Hewlett-Packard supplies kits of measurement calibration standards for precision 7 mm, precision 3.5 mm, and Type N connector interfaces. The HP 8510 system, also, provides the capability to measure devices in other coaxial interfaces, and waveguide, given the proper calibration standards.

Time Domain Analysis

The HP 8510 (with option 010) has the capability of displaying the time domain response of a network, obtained by computing the Inverse Fourier Transform of the frequency domain response. The time domain response displays the reflection coefficient of the network versus time, which displays the magnitude and location of each individual discontinuity, or else the transmission coefficient versus time, which displays each individual transmission path.

The HP 8510 offers two time domain modes. The low pass mode provides traditional Time Domain Reflectometer (TDR) measurement capability and gives the response of the network to a (mathematically simulated) step or impulse stimulus. This mode gives information about the type of impedance (R, L, or C) present at a discontinuity. The band pass time domain mode, which has only the impulse stimulus, may be used over any frequency range to give the time domain response of frequency-selective devices (such as waveguide).

Gating is another powerful time domain feature that may be used to selectively isolate a single response in time and then convert just that response back to the frequency domain. For reflection measurements, this provides the capability to view the return loss of individual portions of a microwave component without disturbing the actual circuit. For transmission measurements, one can view the frequency and time domain responses of individual transmission paths.

The HP 8510 time domain capability can give great insight into the design of microwave components. Another useful application is cable fault location. Gating can be used in a variety of applications such as removing fixturing residuals or removing the effects of multipath and ground clutter in antenna measurements.

Compatible Sources

The HP 8340B and 8341B synthesized sweepers with the HP 8510 provide the best, most accurate measurements, regardless of the parameter selected. They combine a high resolution synthesizer with a broadband sweeper to cover the full frequency range of the HP 8510. With the HP 8340B you obtain 4 Hz resolution at 26.5 GHz for CW frequencies, phase locked narrowband (<5 MHz) sweeps, and fully synthesized start frequencies for broadband sweeps.

The HP 8350B sweep oscillator family is also fully compatible with the HP 8510. Coupled with this versatile sweeper mainframe, you can choose from a wide variety of RF plug-ins.

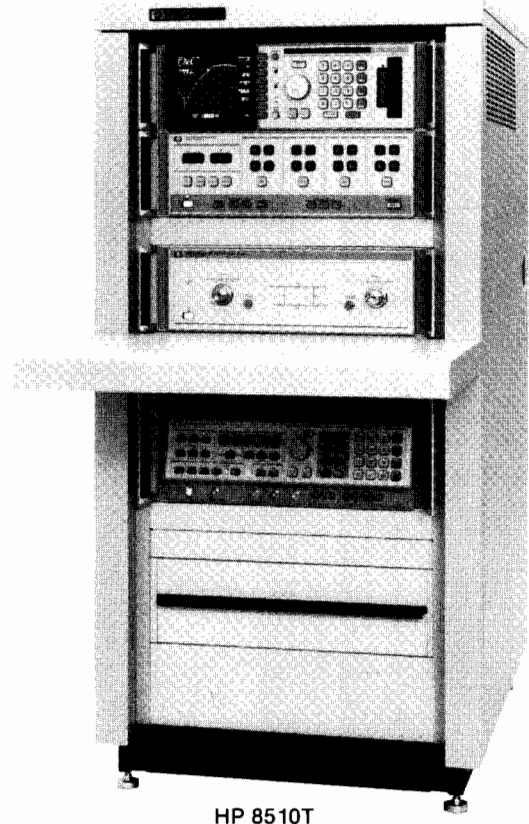

HP 8510T

HP 8510T Network Analyzer System

The HP 8510T is the highest performance system in the HP 8510 series. It provides, under one model number, everything needed to make precision measurements in the 45 MHz to 26.5 GHz frequency range. The system includes the HP 8510A with option 010, the 8515A S-Parameter Test Set, and an HP 8340B Synthesized Sweeper with option 005. A comprehensive array of test and measurement accessories including the HP 85050A 7 mm Calibration Kit, HP 85051A 7 mm Verification Kit, HP 85052A 3.5 mm Calibration Kit, along with RF return cables and adapters, are supplied. The instruments are installed in the portable HP 85043A system rack.

When you purchase HP 8510T you not only obtain a high performance network measurement system, you are also provided with the total solution. Included with the HP 8510T are an impressive array of support products including on-site maintenance for one year, installation, and calibration at no extra charge.

HP 85043A System Rack

The HP 85043A system rack is a rack standing only 123.7 cm (48.7") high with a width of 60.0 cm (23.6") and a depth of 80.0 cm (31.5"). Complete with support rails and ac power distribution (suitable for 50 to 60 Hz, 100-240 Vac), it includes rack mounting hardware for all instruments. Thermal design is such that no rack fan is needed.

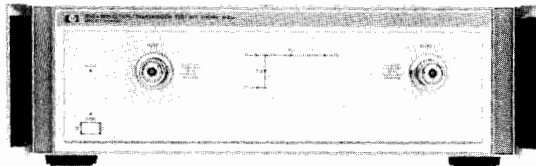

HP 8512A

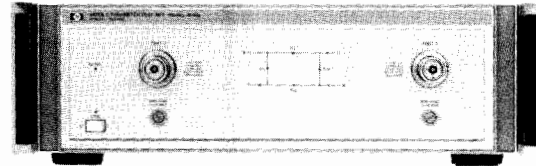

HP 8514A

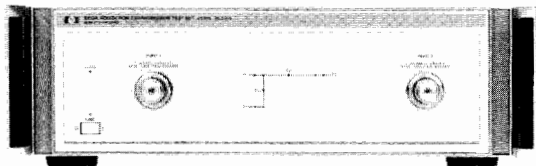

HP 8513A

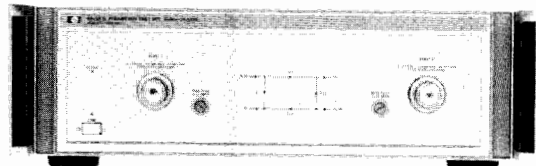

HP 8515A

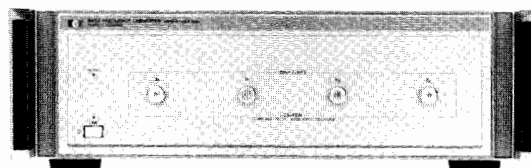

HP 8511A

HP 8512A Reflection/Transmission Test Set

The HP 8512A Reflection/Transmission Test Set provides the capability to simultaneously measure the complex reflection and transmission characteristics of a test device from 45 MHz to 18 GHz in transmission and 500 MHz to 18 GHz in reflection. Reflection measurements to 45 MHz are achievable with some loss (about 30dB) in dynamic range. An HP 8512A-based system offers very broad dynamic range with the highest accuracy available. The test ports have rugged precision 7-mm connectors and may be adapted to other interfaces with the appropriate precision adapters. The test set includes an integrated three-channel frequency converter.

HP 8513A Reflection/Transmission Test Set

The HP 8513A Reflection/Transmission Test Set provides the capability to simultaneously measure the complex reflection and transmission characteristics of a test device over the 45 MHz to 26.5 GHz frequency range. An HP 8513A-based system offers the capability to measure a network across an extremely wide frequency range with just one connection, over a wide dynamic range with high accuracy. The test ports are a special, ruggedized, version of the precision 3.5-mm connector interface that is completely compatible with any connector in the 3.5 mm family. The test set includes an integrated three-channel frequency converter.

HP 8514A S-Parameter Test Set

The HP 8514A S-Parameter Test Set provides the capability to measure all four S-parameters of a two port device with a single connection over the 500 MHz to 18 GHz frequency range. Measurements to 45 MHz are achievable with some loss (about 30 dB) in dynamic range. The S-parameter test set architecture is ideal for measuring two-port devices where it is not convenient to physically reverse the device to measure the reverse parameters, or for networks that need to be adjusted while being measured with full error-correction employed. The test ports have rugged precision 7-mm connectors

and may be adapted to other connector interfaces with the appropriate precision adapters. Along with an integrated, four-channel frequency converter, the test set includes two 90-dB step attenuators for changing the incident power level at the test port and two bias networks for applying dc bias to the test port center conductor in active device test applications.

HP 8515A S-Parameter Test Set

The HP 8515A S-Parameter Test Set provides the capability to measure all four S-parameters of a two-port device with a single connection over the 45 MHz to 26.5 GHz frequency range. The S-parameter test set architecture is ideal for measuring two port devices where it is not convenient to reverse the device to measure the reverse parameters, or for networks that need to be adjusted while being measured with full error-correction employed. The test ports are a special, ruggedized, version of the precision 3.5 mm interface that is completely compatible with any connector in the 3.5 mm family. Along with an integrated, four-channel frequency converter, the test set includes two 90-dB step attenuators for changing the incident power level at the test port and two bias networks for applying dc bias to the test port center conductor in active device test applications.

HP 8511A Frequency Converter

The HP 8511A is a four-channel frequency converter covering the 45 MHz to 26.5 GHz frequency range. An HP 8510/8511A combination results in a system that can be customized to unique test requirements with the addition of customer-supplied test setup hardware. Examples include multi-port device measurements, antenna characterization and radar cross section measurements. Each of the four inputs operates over the full dynamic range of the system, from 85 dB to 100 dB. Isolation between channels is typically greater than 100 dB. Dynamic accuracy is better than ± 0.05 dB and ± 0.2 degree at a test channel level of -50 dBm.



NETWORK ANALYZERS

Accessories

8510 Series

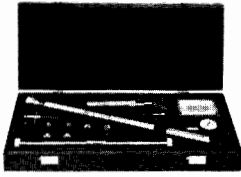

HP 85050A

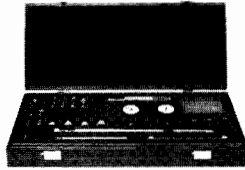

HP 85052A

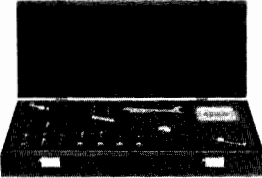

HP 85054A

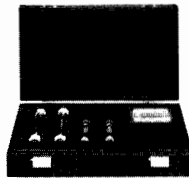

HP 85051A



HP 85053A



HP 85130A

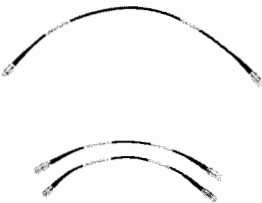

HP 85131A/B

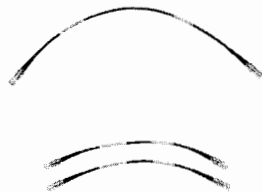

HP 85132A/B

Calibration Kits

Error-correction procedures require that the systematic errors in the measurement system be characterized by measuring known devices (standards) on the system over the frequency range of interest. The calibration kits in the HP 8510 family contain precision standard devices to characterize the systematic errors of the HP 8510 system. Hewlett-Packard offers several calibration kits in various connector interfaces that are compatible with the HP 8510.

HP 85050A 7 mm Calibration Kit

The HP 85050A 7 mm calibration kit contains a set of precision calibration standards used to calibrate the HP 8510 system for measurements of devices with precision 7 mm connectors. The calibration standards include open and short circuits, and fixed and sliding terminations. Also included are a precision 7 mm connector gage and tools for verifying and maintaining the connector interfaces.

Option 010: Adds a precision 30 cm beadless airline that is useful in time domain applications.

Option 020: Deletes precision 7 mm connector gage and tools.

HP 85052A 3.5 mm Calibration Kit

The HP 85052A 3.5 mm calibration kit contains a set of precision calibration standards used to calibrate the HP 8510 system for measurements of devices with 3.5 mm connectors (precision 3.5 mm or SMA). The calibration standards include open and short circuits, and fixed and sliding terminations. Also included are precision 7 mm to 3.5 mm adapters. Connector gages are supplied for verifying critical mechanical tolerances of the 3.5 mm connector interface.

Option 010: Adds precision 15 cm beadless airline that is useful in time domain applications.

Option 020: Deletes precision 3.5 mm connector gages.

HP 85054A Type N Calibration Kit

The HP 85054A Type N calibration kit contains a set of precision calibration standards used to calibrate the HP 8510 system for measurements of devices with Type N connectors. The calibration standards include open and short circuits, and fixed and sliding terminations. Also included are precision 7 mm to Type N adapters.

Verification Kits

Measuring known devices, other than the calibration standards, is a straightforward way of verifying that the HP 8510 system is operating properly. Hewlett-Packard offers verification kits that include standard devices, with data, for verifying the error-corrected measurement performance of the HP 8510 system.

HP 85051A 7 mm Verification Kit

The HP 85051A 7 mm verification kit contains a set of precision devices, with data, used to verify the error-corrected performance of the HP 8510 system. The devices have precision 7 mm connectors and include 20 dB and 50 dB attenuators, a 10 cm beadless airline, and a 10 cm beadless stepped impedance airline (25 ohms nominal).

HP 85053A 3.5 mm Verification Kit

The HP 85053A 3.5 mm verification kit contains a set of precision devices, with data, used to verify the error-corrected performance of the HP 8510 system. The devices have precision 3.5 mm connectors and include 20 dB and 40 dB attenuators, a 7.5 cm beadless airline, and a 7.5 cm beadless stepped impedance airline (25 ohms nominal).

Test Port Return Cables

Hewlett-Packard offers a variety of high quality RF cables that are used to return the transmitted signal to the test set when measuring two-port devices.

HP 85131A 3.5 mm Test Port Return Cable

The HP 85131A is a single test port return cable for use with either the HP 8513A or 8515A test sets (when connecting the device directly to Port 1).

Frequency Range: dc to 26.5 GHz

Length: 91 cm (36 in.)

VSWR: 1.22:1, typical

Connectors: Special 3.5 mm, and precision 3.5 mm (female)

HP 85131B 3.5 mm Test Port Return Cable Set

The HP 85131B is a pair of test port return cables for use with the HP 8515A test set. The device is connected between the cables during measurement.

Frequency Range: dc to 26.5 GHz

Length: 66 cm (24 in.) each

VSWR: 1.22:1, typical

Connectors: Special 3.5 mm, and precision 3.5 mm (one male, or female)

HP 85132A 7 mm Test Port Return Cable

The HP 85132A is a single test port return cable for use with either HP 8512A or 8414A test sets (when connecting the device directly to Port 1). When used with the HP 85130A adapter set, the HP 85132A can also be used with the HP 8513A and HP 8515A test sets when measuring devices with precision 7 mm connectors.

Frequency Range: dc to 18 GHz

Length: 91 cm (86 in.)

VSWR: 1.2:1, typical

Connectors: Precision 7 mm

HP 85132B Test Port Return Cable Set

The HP 85132B is a pair of test port return cables for use with the HP 8514A test set. The device is connected between the cables during measurement. When used with the HP 85130A adapter set, the HP 85132A set can also be used with the HP 8515A set when measuring devices with precision 7 mm connectors.

Frequency Range: dc to 18 GHz

Length: 66 cm (24 in.) each

VSWR: 1.2:1, typical

Connectors: Precision 7 mm

HP 85130A Special 3.5 mm to 7 mm Adapter Set

The HP 85130A kit contains a set of precision special 3.5 mm to 7 mm adapters used for converting the test ports of the HP 8513A and 8515A test sets to a precision 7 mm interface. The HP 85132A or 85132B cables are used as the test port return cables when the HP 85130A adapters are connected to the test set.

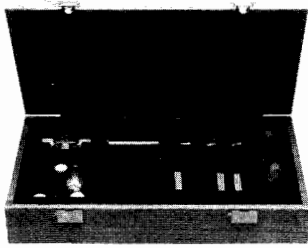

HP 85041A



HP 8717B

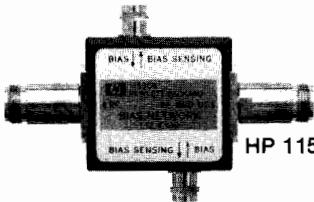

HP 11590B

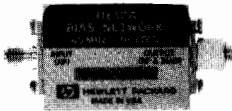

HP 11612A



HP 11635A

HP 8717B Transistor Bias Supply

The HP 8717B transistor bias supply provides manual or automatic biasing for transistor testing. This supply 8717B has two meters for independently monitoring current and voltage. Bias connections are conveniently selected for all transistor configurations with a front panel switch.

Voltage Ranges: 1,3,10,30,100 V

Current Ranges: 0.1,0.3,1,3,10,30,100,300,1000 mA

Accuracy: 4% of full scale for both current and voltage

Option 001: programmable D/A converter

Option 011: programming cable for HP Series 200/300 computers

HP 11590B Bias Network

The HP 11590B is a rugged, broadband bias network. This bias network provides dc bias to the center conductor of a coaxial line which can be connected to the device under test while blocking DC bias from the RF circuit.

Frequency Range: 0.1 to 12.4 GHz (Option 001, 1.0 to 18.0 GHz)

Maximum insertion loss: 1.0 dB, 0.1 - 1.0 GHz

0.8 dB, 1.0 - 12.4 GHz

1.2 dB, 12.4 - 18.0 GHz (Option 001)

Minimum return loss: 16 dB, 0.1 - 1.0 GHz

19 dB, 1.0 - 12.4 GHz

14 dB, 12.4 - 18.0 GHz (Option 001)

Maximum Bias Current: 0.5 A, each bias port

Maximum Bias Voltage: 100 V

Connectors: BNC for dc bias; Type N female for RF (Option 001, precision 7 mm)

HP 11612A Bias Network

The HP 11612A is an insertable, extremely broadband bias network with excellent port match and low insertion loss. This bias network provides dc bias to the center conductor of a coaxial line which can be connected to the device under test while blocking DC bias from the RF circuit.

Frequency Range: 45 MHz to 26.5 GHz

Insertion loss: 0.8 dB, 45 MHz - 12.4 GHz

(max) 1.3 dB, 12.4 - 26.5 GHz

Minimum return loss: 20 dB, 45 MHz - 8.0 GHz

18 dB, 8.0 - 18.0 GHz

14 dB, 18.0 - 26.5 GHz

Maximum Bias Current: 0.5 A

Maximum Bias Voltage: 40 V

Connectors: SMB snap-on for dc bias; precision 3.5 mm for RF

HP 11635A Bias Decoupling Network

The HP 11635A bias decoupling network is a recommended accessory for prevention of bias oscillations when biasing microwave bipolar transistors with any HP bias network or s-parameter test set. Installing the HP 11635A between the bias supply and the base bias network prevents low frequency oscillations.

Application Software

Hewlett-Packard offers several application software packages that compliment the HP 8510 system providing automated calibration and measurement capability. Software is available for HP Series 200/300 desktop computers using BASIC 2.0, 3.0, or 4.0 operating systems on both 3 1/2" and 5 1/4" disc media.

HP 85014A Active Device Measurement Application Pac

The HP 85014A software pac provides the capability to the HP 8510 system for measurement of RF and microwave transistors. Features include automated device biasing with the HP 8717B bias supply, system calibration, and de-embedding of s-parameters when using the HP 85041A transistor test fixture. It is also usable with other HP transistor fixtures as well as user-designed fixtures. Plotted and listed output of device S, H, Y, and Z parameters, as well as the device amplifier summary and termination summary are provided. Also available is the capability to store and retrieve s-parameter data in formats suitable for computer aided design applications.

HP 85013A Basic Measurements Application Pac

The HP 85013A software pac provides the capability to automate the HP 8510 system for applications where the system is required to emulate the user interface of the HP 8409 series automatic network analyzers. All the features of the HP 8409 series operating system are provided for including the capability to measure up to 401 related (Start/Stop/Step) or unrelated (individual CW) frequency points.

Active Device Test

Hewlett-Packard offers an extensive array of accessories designed for the needs of active device test and measurement, including fixtures, bias supplies, bias networks, and application software.

HP 85041A Transistor Test Fixture Kit

The HP 85041A transistor test fixture (TTF) kit is a comprehensive measurement system for testing and characterizing stripline packaged microwave transistors. Only useful when used with the HP 85014A active device measurement software.

Frequency Range: dc to 18 GHz

Transistor Package Inserts: 70 mil and 100 mil

Verification Devices: Short and through circuits

Connectors: precision 7 mm

Accessories Supplied: fixture stand, torque tool, tweezers, and lid opening tool

NETWORK ANALYZERS

Millimeter-wave Measurement Accessories

8510 Series

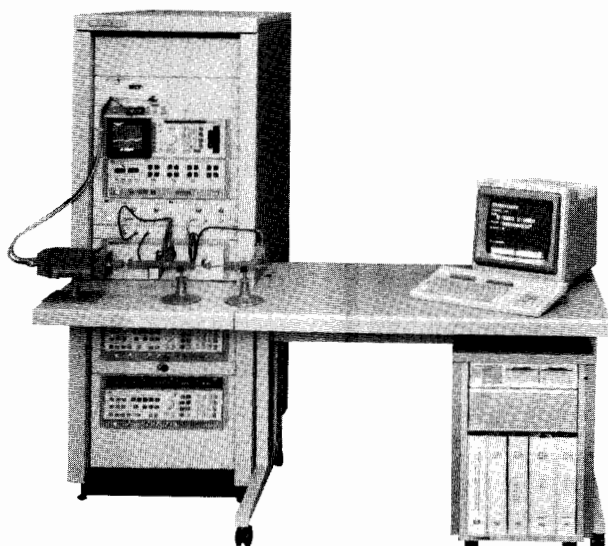

HP 8510 Millimeter-wave Network Analyzer System

The HP 8510 network analyzer is the solution for your vector measurement needs at millimeter-wave frequencies. With a variety of standard Hewlett-Packard products, you can configure a complete network analyzer system that provides vector measurement capability in the 26.5 GHz to 40 GHz, 33 GHz to 50 GHz, 40 GHz to 60 GHz, 50 GHz to 75 GHz, or 75 GHz to 100 GHz waveguide bands. Because the architecture uses two HP 834xB-series synthesized sources, utilizing one to provide the RF stimulus and the other to act as LO for frequency conversion to the HP 8510 IF frequency of 20 MHz, 70 dB to 80 dB of dynamic range is easily achieved. Increased IF averaging extends dynamic range up to from 15 to 20 dB by reducing random noise while increasing the measurement time per point.

The HP 85129A measurement software automates system operation but leaves all the powerful features of the HP 8510 accessible at the front panel, including built-in error correction and optional time domain capability.

For ordering convenience, Hewlett-Packard offers fully integrated racked system configurations which include all of the band-independent hardware necessary to configure a millimeter-wave HP 8510 system. A complete line of test set kits and calibration kits are also available.

HP 85100A LO/IF Kit

The HP 85100A combines the LO and IF amplifiers, a power divider, waveguide stands, and the interconnect cables that are part of the HP 8510 millimeter-wave system under one model number for ordering convenience.

Kit Includes:¹

Quantity	Model Part Number	Description
2	11975A	2-8 GHz LO Amplifier
1	8447A	IF Amplifier
1	8447A	
	Option 001	Dual IF Amplifier
1	0955-0264	2-8 GHz Power Divider
1	08510-60105	IF Interconnect Cable
4	11540A	Waveguide Stand
	Option E85	

¹ Also includes miscellaneous interconnect hardware.

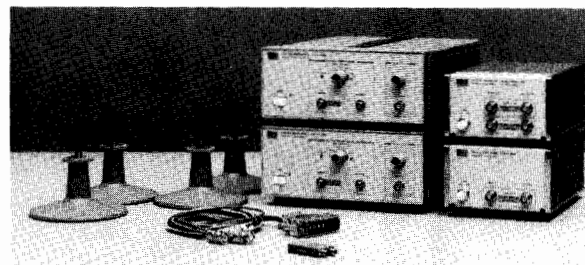

HP 85100A LO/IF Kit

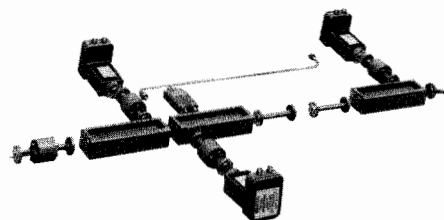

HP V11643A V-Band Test Set Kit



HP R11644A R-Band Calibration Kit

HP 11643A-Series Test Set Kits

The millimeter-wave test set kits contain the band-dependent hardware necessary to assemble a reflection/transmission test set for use with the HP 8510 millimeter-wave system. The kit includes directional couplers, harmonic mixers, isolators, a fixed termination, a power divider, and miscellaneous connecting hardware.

Kit includes:¹

Quantity	Model Part Number	Description
3	752D-series	20 dB ² Directional Coupler
3	11970A-series	Harmonic Mixer
4	365A-series	Isolator
1	910A-series	Fixed Termination
1	0955-0264	2-8 GHz Power Divider
2	898A-series	Waveguide Twist

¹ Also includes miscellaneous interconnect hardware.

² The V-band and W-band test set kits consist of two 20 dB couplers and one 10 dB coupler.

Precision Calibration Kits

Each calibration kit contains two straight waveguide test port sections with precision flanges, a flush short circuit, a precision shim of appropriate thickness used to make the quarter-wavelength offset short, and a sliding or fixed load termination. These standards allow full use of internal HP 8510 vector accuracy enhancement, offering fully error-corrected, high resolution, wide dynamic range magnitude and phase measurements with accuracy and speed comparable to the microwave HP 8510 system.



Support Products

Hewlett-Packard offers a complete group of support products specifically tailored to achieve maximum HP 8510 productivity. Several of these products are described below.

HP 8510A + 24D Basic Measurements Using the HP 8510 Network Analyzer System

With two enrollments included in the purchase price of the HP 8510A, this three day, lab intensive training course introduces students to the operation of the HP 8510 system including error-correction and time domain fundamentals. The training course provides the opportunity for users to accelerate on the basic operation learning curve, allowing maximum utilization of the system to be achieved in a shorter time.

HP 8510T + 23N On-Site System Installation (where available)

The HP 8510T+23N provides for complete installation of the HP 8510 system in either table top or racked configurations. Included are pre-installation inspection, on-site installation, and verification. Also included is a retrofit of one customer owned HP 8350 series sweep oscillator for HP 8510 compatibility.

HP 8510T + 23A Basic System Maintenance and Calibration (where available)

The HP 8510T+23A provides complete on-site maintenance and calibration support for an HP 8510 system. Included are next-day on-site response when repairs are needed, preventive maintenance, and on-site calibration performed twice a year with NBS (or other standard agency) traceable devices.

Ordering Information Analyzer

	Price
HP 8510A Network Analyzer	\$33,500
Option 010 Time Domain Capability	add \$9,500

Test Sets (choose at least one)

HP 8512A R/T Test Set (0.5 to 18.0 GHz)	\$17,300
HP 8513A R/T Test Set (45 MHz to 26.5 GHz)	\$25,000
HP 8514A S-Parameter Test Set (0.5 to 18.0 GHz)	\$28,000
HP 8515A S-Parameter Test Set (45 MHz to 26.5 GHz)	\$37,200
HP 8511A Frequency Converter (45 MHz to 26.5 GHz)	\$17,300

Sources (choose either the HP 8340B/8341B or the HP 8350B with an RF Plug-in)

HP 8340B 0.01 to 26.5 GHz Synthesized Sweeper (with option 005)	\$54,800
HP 8341B 0.01 to 20.0 GHz Synthesized Sweeper (with option 004)	\$39,700
HP 8350B Sweep Oscillator (choose one of these recommended plug-ins)	\$ 4,565
HP 83592A 0.01 to 20.0 GHz (with option 004)	\$20,700
HP 83595A 0.01 to 26.5 GHz (with option 004)	\$26,200

Calibration Kits (choose one for each connector type to be used)

HP 85050A 7 mm Calibration Kit	\$3,000
Opt. 010 30 cm beadless airline	add \$1,100
Opt. 020 delete connector tools	less \$750
HP 85052A 3.5 mm Calibration Kit	\$4,850
Opt. 010 15 cm beadless airline	add \$1,100
Opt. 020 delete connector tools	less \$750
HP 85054A Type N Calibration Kit	\$1,950

Verification Kits

HP 85051A 7 mm Verification Kit	\$2,400
HP 85053A 3.5 mm Verification Kit	\$2,600

Test Port Return Cables (choose at least one)

HP 85131A 3.5 mm Test Port Return Cable	\$850
HP 85131B 3.5 mm Test Port Return Cable Set	\$1,600
HP 85132A 7 mm Test Port Return Cable	\$700
HP 85132B 7 mm Test Port Return Cable Set	\$1,350
HP 85130A Special 3.5 mm to 7 mm Adapter Kit	\$575

Transistor Test Accessories

HP 85041A Transistor Test Fixture Kit	\$5,000
HP 8717B Transistor Bias Supply	\$4,415
(when used with HP 85014A software must order)	
Opt. 001 Programming Capability	add \$670
Opt. 011 Programming Cable	add \$250
HP 98622A GPIO Interface	\$355
HP 11590B Bias Network	\$775
HP 11612A Bias Network	\$700
HP 11635A Bias Decoupling Network	\$275

Millimeter-Wave Network Analyzer Kits

HP 85100A LO/IF Interface Kit	\$13,000
HP R11643A WR-28 Test Set Kit	14,000
HP Q11643A WR-22 Test Set Kit	15,000
HP U11643A WR-19 Test Set Kit	16,500
HP V11643A WR-15 Test Set Kit	17,500
HP W11643A WR-10 Test Set Kit	20,500
HP R11644A WR-28 Calibration Kit	\$3,600
HP Q11644A WR-22 Calibration Kit	3,850
HP U11644A WR-19 Calibration Kit	4,200
HP V11644A WR-15 Calibration Kit	4,200
HP W11644A WR-10 Calibration Kit	4,400

System Rack

HP 85043A System Rack	\$2,300
-----------------------	---------

Software (choose one option)

HP 85013A Basic Measurements Application Pac	\$950
Opt. 630 3 1/2" disc	N/C
Opt. 655 5 1/4" disc	N/C
HP 85014A Active Device Measurements Application Pac	\$3,000
Opt. 630 3 1/2" disc	N/C
Opt. 655 5 1/4" disc	N/C
HP 85129A 8510A Millimeter-wave Measurement Software	\$800

Support Products

HP 8510A + 24D User Course	\$1,100/student
HP 8510T + 23N On-site Installation (where available)	\$600
HP 8510T + 23A On-site Service (where available)	Contact Sales Office

Systems

HP 8510T Network Analyzer System	\$157,900
----------------------------------	-----------



NETWORK ANALYZERS

Microwave Network Analyzer, 110 MHz to 18 GHz

Model 8410 Series

- Economical vector performance
- Measures all network parameters
- Multioctave swept frequency measurements
- Eliminate harmonic and spurious responses

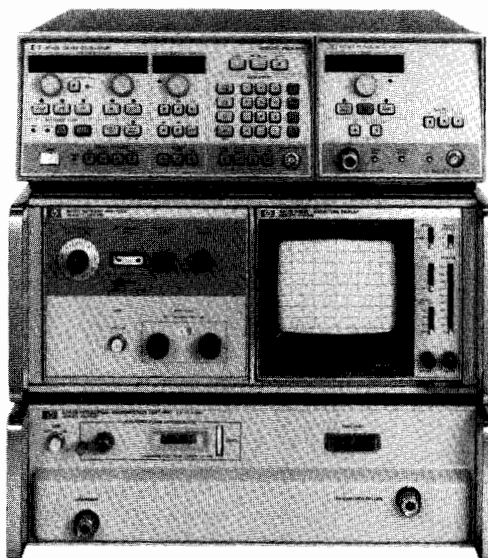

Receiver

The HP 8410C network analyzer and HP 8411A harmonic frequency converter comprise the nucleus of the swept-frequency system which provides magnitude and phase measurement capability from 110 MHz to 18 GHz in coax. Automatic frequency locking allows continuous multioctave sweeps. Frequency conversion from RF to IF gives high sensitivity and greater than 60 dB dynamic range, free of spurious and harmonic responses. Calibrated IF substitution makes possible accurate gain or insertion loss measurements.

Displays

The HP 8412B Phase/Magnitude Display displays magnitude and phase versus frequency. The HP 8414B Polar Display provides a polar plot of magnitude and phase. These displays are interchangeable plug-ins for the HP 8410C mainframe. The HP 8418B Auxiliary Display Unit can be added to provide simultaneous rectilinear and polar display capability.

Sources

Although the HP 8410C can produce octave-width sweeps using any swept source, continuous multi-octave sweeps limited only by the frequency range of the test set are possible with the HP 8620C or 8350B Sweep Oscillators.

Test Sets

The HP 8745A, 8743B, and 8746B test sets contain all the necessary splitters and couplers required to provide stimulus to the device under test and route the reference and reflected or transmitted signals to the receiver. Accessories allow the test sets to be configured for active and passive coaxial measurements as well as for semiconductor measurement applications.

System Ordering Convenience

HP 8410S systems enable ordering a complete network analyzer system, except for source, using a single model number. Each option has been configured for making general measurements on coaxial or semiconductor devices. The HP 8410S systems enable the operator to view a real time CRT display over octave or multioctave bands with a dynamic range of 60 dB amplitude and 360° phase. Multioctave, continuous network measurements over the frequency range of 2 to 18 GHz are possible when the HP 8410C is used with the HP 8620C or 8350B Sweep Oscillator.

The HP 8410S systems' upper frequency limit for coaxial and semiconductor measurements is 12.4 GHz; however, individual instruments may be ordered that will expand coaxial measurement capability to 18 GHz (option 018 instruments).

HP 8410S Network Analyzer Systems

GENERAL PURPOSE MEASUREMENTS			All HP 8410S Systems Include the Following Instrument Model Numbers: HP 8410C, 8411A, 8412B, 8414B, 11609A, and 8750A opt. 003										
Frequency Range	Option No.	Measurement Port Configuration	HP 8743B	HP 8745A	HP 8746B	HP 8717B	HP 11600B	HP 11602B	HP 11608A	HP 11604A	HP 11610B	HP 11650A	Price
0.11 to 2 GHz	110	Coaxial (APC-7)		X						X		X	\$35.510
0.11 to 12.4 GHz	310	Coaxial (APC-7)	X	X						X	X	X	\$45.830
2 to 12.4 GHz	210	Coaxial (APC-7)	X								X	X	\$35.850
SEMICONDUCTOR CHARACTERIZATION													
0.11 to 2 GHz	400	T018/T072 Packages		X		X	X						\$38.775
0.11 to 2 GHz	401	T05/T012 Packages		X		X		X					\$38.775
0.5 to 12.4 GHz	500	Stripline			X	X			X				\$42.785

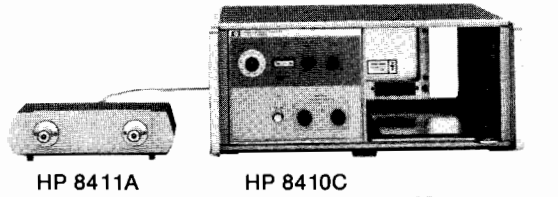

HP 8411A

HP 8410C

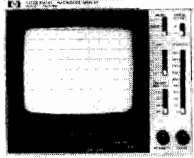

HP 8412B

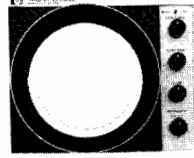

HP 8414B

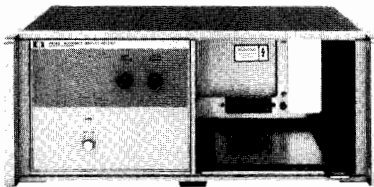

HP 8418B

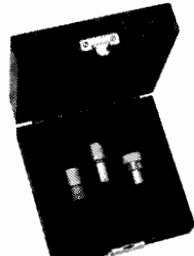

HP 11866A



HP 11650A

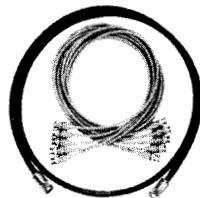

HP 11609A

Specifications

HP 8410C/8411A Network Analyzer

Function: HP 8411A converts RF signals to IF signals for processing in HP 8410C mainframe. HP 8410C is the mainframe for display plug-in units. Mainframe includes tuning circuits (octave bands or multioctave bands when used with HP 8620C or 8350B sweep oscillator), IF amplifiers and precision IF attenuator. HP 8410C allows injection of an external local oscillator used in automatic applications to lock the HP 8410C receiver to an external source such as the HP 3335A.

HP 8410C frequency range: 0.11 to 18 GHz.

HP 8411A frequency range: 0.11 to 12.4 GHz.

Opt 018: 0.11 to 18 GHz.

HP 8411A input impedance: 50 ohms nominal. SWR <1.5, 0.11 to 2.0 GHz; <2.0, 2.0 to 16.0 GHz; 3, 6.0 to 18.0 GHz.

Channel isolation: >65 dB, 0.1 to 6 GHz; >60 dB, 6 to 12.4 GHz; >50 dB, 12.4 to 18 GHz.

Magnitude Range

Reference channel: -18 to -35 dBm, 0.11 to 12.4 GHz; -18 to -25 dBm from 12.4 to 18.0 GHz.

Test channel: -10 to -75 dBm from 0.11 to 12.4 GHz; -10 to -68 dBm from 12.4 to 18 GHz.

Maximum RF input to either channel: 50 mW.

IF gain control: 69 dB range in 10 dB and 1 dB steps with a maximum cumulative error of ± 0.2 dB.

Phase

Phase range: 0 to 360°

Control: vernier control $\leq 90^\circ$

Connectors (HP 8411A): APC-7.

Power: 115 or 230 V $\pm 10\%$, 50-60 Hz, 70 watts (includes HP 8411A).

Weight

HP 8410C: net, 14.9 kg (33 lb); shipping, 18.5 kg (41 lb).

HP 8411A: net, 3.2 kg (7 lb); shipping, 4.5 kg (10 lb).

Size

HP 8410C: 191 H x 425 W x 467 mm D (7.5" x 16.75" x 18.38").

HP 8411A: 67 x 228 W x 143 mm D (2.63" x 9" x 5.63") exclusive of connectors and cable.

HP 8412B Phase-Magnitude Display

Function: plug-in CRT display unit for HP 8410C. Displays relative amplitude in dB and/or relative phase in degrees between reference and test channel inputs versus frequency. Programmable 180° phase offset by ground closure.

Amplitude

Range: 80 dB display range with selectable resolutions of 10, 2.5, 1 and 0.25 dB/division.

Accuracy: 0.08 dB/dB from midscreen.

Phase

Range: $\pm 180^\circ$ display range with selectable resolutions of 90, 45, 10, and 1°/division.

Accuracy: 0.065°/degree from midscreen.

Phase offset: 0.3°/20° step cumulative <3°.

Power: 23 watts supplied by mainframe.

Weight: net, 7.8 kg (17 lb); shipping, 10 kg (22 lb).

Size: 152 H x 186 W x 395 mm D (6" x 7.28" x 15.56") excluding front panel knobs.

HP 8414B Polar Display

Function: plug-in CRT display unit for HP 8410C. Displays amplitude and phase data in polar coordinates on 5-in. cathode ray tube.

Range: normalized polar coordinate display; magnitude calibration 20% of full scale per division. Scale factor is a function of IF setting on HP 8410C. The beam center function is controllable by an external contact closure.

Accuracy: error circle on CRT ± 3 mm.

Power: 35 watts supplied by mainframe.

Weight: net, 5.8 kg (13 lb); shipping, 8.1 kg (18 lb).

Size: 152 H x 186 W x 395 mm D (6" x 7.28" x 15.56") excluding front panel knobs.

HP 8418B Auxiliary Display Holder

Function: the HP 8418B auxiliary display holder provides power for operating of the HP 8412B or the 8414B display units. Used in conjunction with the HP 8410C network analyzer, it provides the capability of viewing amplitude and phase readout in both rectangular and polar coordinates simultaneously. Includes a remotely programmable 0-70 dB IF attenuator required for autoranging in automatic applications.

Weight: net, 11.2 kg (25 lb); shipping, 19.7 kg (44 lb).

Size: 177 H x 483 W x 450 mm D (6.97" x 19" x 17.13").

HP 11650A Accessory Kit

Function: accessories normally used for transmission and reflection tests with the HP 8745A and 8743B.

Weight: net, 1.34 kg (3 lb); shipping, 2.23 kg (5 lb).

HP 11866A APC-7 Calibration Kit

Function: a 50 Ω (>52 dB return loss 2 GHz) termination, a short circuit and a shielded open circuit are used with automatic network analyzers to quantify directivity, source math, and frequency tracking errors.

Weight: net 0.57 kg (1.25 lb); shipping, 0.91 kg (2.0 lb).

Size: 50.8 H x 127 W x 127 mm D (2.0" x 5.0" x 5.0").

HP 11609A Cable Kit

Function: interconnecting cables normally required for network measurements using the HP 8410C network analyzer.

Weight: net, 0.9 kg (2 lb); shipping 1.36 kg (3 lb).

Ordering Information

HP 8410C mainframe	\$7,775
Opt 908: Rack Flange Kit	add \$25
HP 8411A Frequency Converter	\$5,520
Opt 018: 0.11 to 18 GHz	add \$550
HP 8412B Phase-Magnitude Display	\$4,110
HP 8414B Polar Display	\$3,865
HP 8418B Auxiliary Display Holder	\$3,710
Opt 908: Rack Flange Kit	add \$25
HP 11650A Accessory Kit	\$1,605
HP 11866A APC-7 Calibration Kit	\$440
HP 11609A Cable Kit	\$150

NETWORK ANALYZERS

Test Sets and Accessories

Model 8410 Series



HP 8745A



HP 11857D

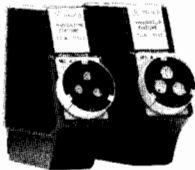

HP 11602B HP 11600B

HP 8745A S-Parameter Test Set

Function: wideband RF power splitter and reflectometer with calibrated line stretcher. Pushbutton operated for either forward or reverse transmission or reflection measurements with network analyzer.

Frequency range: 100 MHz to 2 GHz.

Impedance: 50 ohms nominal.

Source reflection coefficient: ≤ 0.057 , 0.11 to 2.0 GHz.

Termination reflection coefficient: < 0.10 , 100, to 200 MHz; < 0.063 , 200 MHz to 2.0 GHz.

Directivity: ≥ 36 dB, below 1 GHz; ≥ 32 dB, 1 to 2 GHz.

Reference plane extension: 0 to 15 cm for reflection; 0 to 30 cm for transmission.

Maximum RF power: 2 watts.

Connectors: RF input type N female; all other connectors APC-7; Option 001, type N female.

Remote programming: ground closure.

Power: 115 or 120 V $\pm 10\%$, 50 to 400 Hz, 40 watts.

Weight: net, 15.4 kg (34.25 lb); shipping, 18.0 kg (40 lb).

Size: 140 H x 425 W x 654 mm D (5.50" x 16.75" x 25.75").

HP 11600B/11602B Transistor Fixtures

Function: mounts on front of HP 8745A S-Parameter Test Set; holds devices for s-parameter measurements in a 50 ohm, coax circuit. Other devices also fit the fixture (tunnel diodes, etc.).

Transistor Base Patterns

Model 11600B: accepts TO-18/TO-72 packages.

Model 11602B: accepts TO-5/TO-12 packages.

Calibration references: short circuit termination and a 50 ohm through-section.

Frequency ranges: dc to 2 GHz.

Impedance: 50 ohms nominal.

Reflection coefficient: < 0.05 , 100 MHz to 1.0 GHz; < 0.09 , 1.0 to 2 GHz.

Connectors: hybrid APC-7; Option 001, type N female.

Weight: net 1.1 kg (2.38 lb); shipping, 1.8 kg (4 lb).

Size: 152 H x 44 W x 229 mm D (6" x 1.75" x 9").

HP 11857D 50 Ohm APC-7 Test Port Extension Cables

General: two precision 61 cm (24 in.) cables, for use with HP 8745A S-Parameter Test Set. Connectors are 50 Ohm APC-7.

Weight: net, 0.91 kg (2 lb); shipping, 2.3 kg (5 lb.)

HP 8410S Opt 110 Specifications

Function: the HP 8410S option 110 measurement system configuration is described on page 636. Following are specifications describing measurement capabilities of the HP 8410C/8411A when used with

the HP 8745A/11604A over the frequency range of 110 MHz to 2 GHz.

Frequency range: 0.11 to 2.0 GHz.

RF input: 20 dB range between +5 dBm and -12 dBm.

Source reflection coefficient: ≤ 0.067 , 0.11-2.0 GHz.

Termination reflection coefficient: ≤ 0.11 , 100-200 MHz; ≤ 0.07 , 200-2000 MHz.

Directivity: ≥ 28 dB 0.11-1.0 GHz; ≥ 27 dB 1.0-2.0 GHz.

Insertion loss, RF input to test port: 4 dB nominal.

Frequency Response

Transmission: typically $< \pm 0.35$ dB amplitude and $< \pm 5^\circ$ phase.

Reflection: typically $< \pm 0.06$ magnitude and $\pm 5^\circ$ phase with a short on the test port.

Transmission measurement accuracy: (see common performance specifications).

Reflection measurement accuracy (using HP 8414B): sources of error included in the accuracy equations are directivity, source match, and polar display accuracy.

Magnitude Accuracy

$\rho_u = \pm (0.0398 + 0.03 \rho_L + 0.067 \rho_L^2)$ 0.11-1.0 GHz.

$\rho_u = \pm (0.0447 + 0.03 \rho_L + 0.067 \rho_L^2)$ 1.0-2.0 GHz.

ρ_u = magnitude uncertainty.

ρ_L = measured reflection coefficient magnitude.

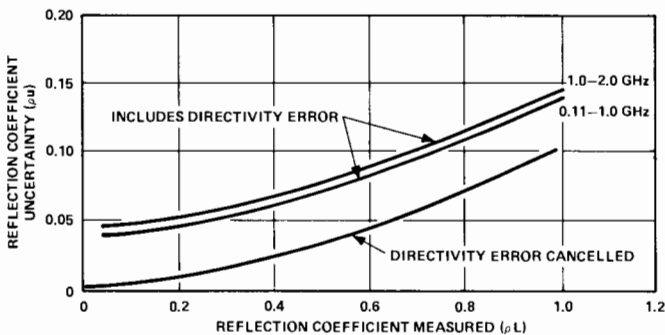

Phase Accuracy

$\Phi_u = \sin^{-1} \rho_u / \rho_L$ for $\Phi_u < 90^\circ$.

Φ_u = phase uncertainty.

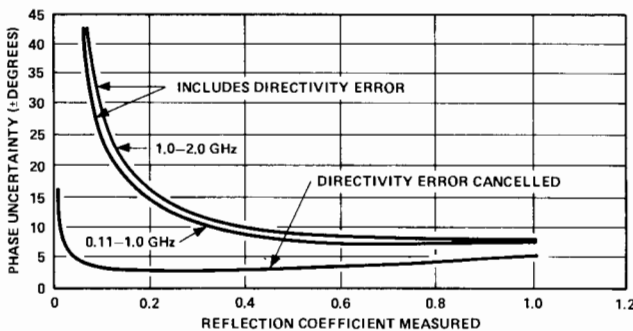

See HP 8410S network analyzer systems table for price and instrument breakdown.

Ordering Information

	Price
HP 8745A Test Set	\$8,930
Opt 001: Type N Test Port Connectors	N/C
Opt 908: Rack Flange Kit	\$25
HP 11604A Universal Arm Extension	\$2,710
HP 11600B/11602B Transistor Fixtures	\$1,505
Opt 001: Type N Female Connectors	less \$30
HP 11857A 50 Ohm APC-7 Test Port Extension Cables	\$1,005

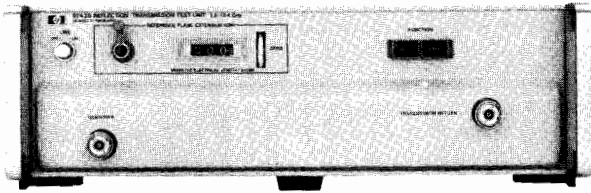

HP 8743B

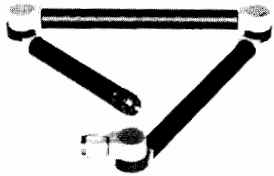

HP 11605A

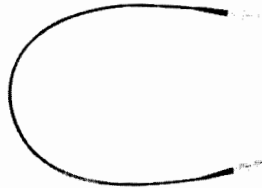

HP 11610B

HP 8743B Reflection/Transmission Test Unit

Function: wideband RF power splitter and reflectometer with calibrated line stretcher. Pushbutton operated for either transmission or reflection measurement with network analyzer. Designed for use with the HP 11610B test port extension cable.

Frequency range: 2 to 12.4 GHz (Opt 018: 2 to 18 GHz).

Impedance: 50 ohms nominal.

Source reflection coefficient: ≤ 0.09 , 2.0 to 8.0 GHz; ≤ 0.13 , 8.0 to 12.4 GHz; < 0.2 , 12.4 to 18 GHz.

Termination reflection coefficient: ≤ 0.13 in reflection mode, 2.0 to 12.4 GHz; ≤ 0.2 in transmission mode, 2.0 to 12.4 GHz; typically < 0.2 , 12.4 to 18 GHz.

Directivity: ≥ 30 dB, 2.0 to 12.4 GHz; ≥ 18 dB, 12.4 to 18 GHz.

Reference plane extension: 0 to 15 cm for reflection; 0 to 30 cm for transmission.

Connectors: RF input, type N female; all other connectors APC-7.

Remote programming: ground closure.

Power: 115 or 230 V $\pm 10\%$, 50-400 Hz, 15 W.

Weight: net, 12.1 kg (29 lb); shipping, 15.3 kg (34 lb).

Size: 140 H x 425 W x 467 mm D (5.50" x 16.75" x 18.38").

HP 11610B Microwave Cable

Function: a high quality semirigid coaxial cable used with the network analyzer at frequencies up to 18 GHz. It is designed for applications which require excellent magnitude and phase repeatability from connection to connection. The cable exhibits minimum change in transmission characteristics when flexed during normal use. The HP 11610B is the recommended transmission return cable for use with the HP 8743B and the HP 8746B.

Frequency range: dc to 18 GHz.

Impedance: 50 ohms nominal. Reflection coefficient of ports < 0.14 .

Insertion loss: < 0.7 dB + 0.12 dB/GHz.

Stability with three repeated flexings: < 0.3 dB, < 0.5 degrees +0.12 degrees/GHz change.

Connectors: APC-7.

Length: 1.07 m (42 inches).

HP 11605A Flexible Arm

Function: mounts on front of HP 8743B test set; connects to device under test. Rotary air-lines and rotary joints connect to any two-port geometry. Primarily intended for use with existing HP 8743As but can be used with HP 8743B (HP 11610B recommended for use with HP 8743B).

Frequency range: dc to 18 GHz.

Impedance: 50 ohms nominal. Reflection coefficient of ports: ≤ 0.11 , dc to 2.0; ≤ 0.23 , 2.0 to 12.4 GHz; ≤ 0.31 , 12.4 to 18 GHz.

Connectors: APC-7.

Weight: net, 1.8 kg (4 lb); shipping, 2.7 kg (6 lb).

Length: 257 mm (10.09") closed; 648 mm (25.50") extended.

HP 8410S Opt 210 Specifications

Function: the HP 8410S Option 210 measurement system configuration is described on page 636. Following are specifications describing measurement capabilities of the HP 8410C/8411A when used with the HP 8743B/11610B over the frequency range of 2 GHz to 12.4 GHz.

Frequency range: 2.0 to 12.4 GHz.

RF input: 20 dB range between +12 dBm and -5 dBm.

Source reflection coefficient: ≤ 0.09 , 2-8 GHz; ≤ 0.13 , 8-12.4 GHz.

Termination reflection coefficient: ≤ 0.09 , 2-8 GHz; ≤ 0.13 , 8-12.4 GHz.

Directivity: ≥ 30 dB, 2-12.4 GHz.

Insertion loss, RF input to test port: 20 dB nominal.

Frequency Response

Transmission: typically $< \pm 0.5$ dB amplitude and $< \pm 5^\circ$ phase.

Reflection: typically $< \pm 0.09$ magnitude and $< \pm 6^\circ$ phase, with a short on the unknown port.

Transmission Measurement accuracy (see Common Performance Specifications).

Reflection measurement accuracy (using HP 8414B): sources of error included in the accuracy equations are directivity, source match, and polar display accuracy.

Magnitude Accuracy

$\rho_u = \pm(0.0316 + 0.03 \rho_L + 0.09 \rho_L^2)$ 2-8 GHz.

$\rho_u = \pm(0.0316 + 0.03 \rho_L + 0.13 \rho_L^2)$ 8-12.4 GHz.

ρ_u = magnitude uncertainty.

ρ_u = measured reflection coefficient magnitude.

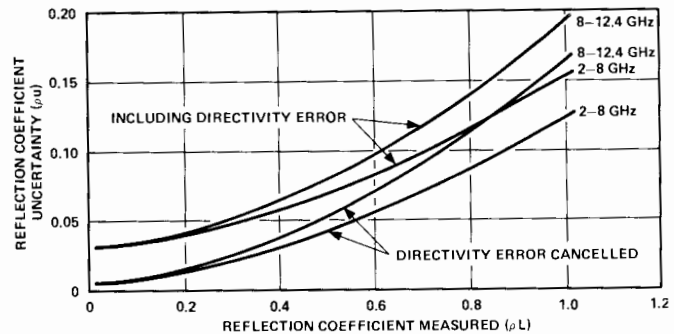

Phase Accuracy

$\Phi_u = \sin^{-1} \rho_u / \rho_L$ for $\Phi_u < \pm 90^\circ$.

Φ_u = phase uncertainty.

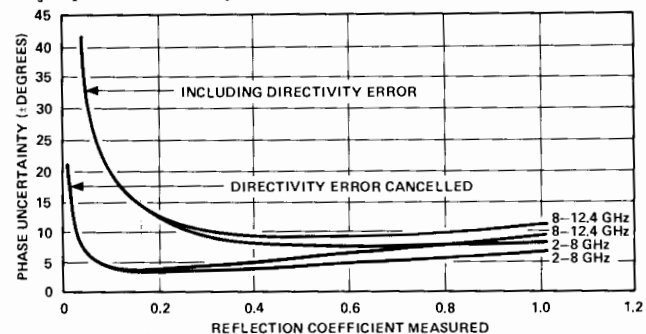

See HP 8410S network analyzer systems table for price and instrument breakdown.

Ordering Information

HP 8743B Reflection/Transmission Test Unit

Opt 018: 2 to 18 GHz

Opt 908: Rack Flange Kit

HP 11610B Microwave Cable

HP 11605A Flexible Arm

Price

\$7,320

add \$800

add \$25

\$655

\$3,015

NETWORK ANALYZERS

Test Sets and Accessories (cont.)

Model 8410 Series

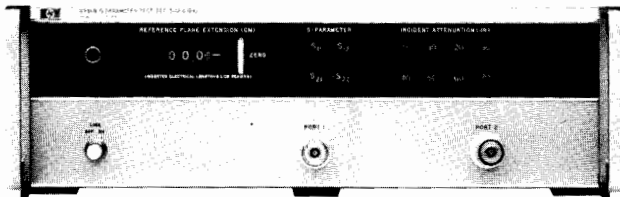

HP 8746B



HP 11608A

HP 8746B S-Parameter Test Set

Function: wideband RF power divider and reflectometer with calibrated line stretcher and a selectable 0-70 dB incident signal attenuator. Provides internal bias for completely characterizing two port active devices.

Frequency range: 0.5 to 12.4 GHz.

Source and termination reflection coefficient: ≤ 0.13 .

Directivity: ≥ 30 dB, 0.5 to 4.0 GHz; ≥ 26 dB, 4.0 to 12.4 GHz.

Incident attenuation: 0-70 dB in 10 dB steps $\pm 5\%$.

Reference plane extension: adds 0 to 15 cm for reflection, 0 to 30 cm for transmission.

Remote programming: ground closure.

Transistor biasing: via 36-pin connector.

Connectors: input type N female, test ports APC-7.

Opt 001: provides 10 dB higher power level at the test port.

Power: 115 or 230 V $\pm 10\%$, 48 to 440 Hz, 110 VA max.

Weight: net, 16.1 kg (35 lb); shipping, 19.1 kg (42 lb).

Size: 140 H x 425 W x 467 mm D (5.5" x 16.75" x 18.38").

HP 11608A Transistor Fixture

Function: provides the capability of completely characterizing stripline transistors. A through-line microstrip and bolt-in grounding structure machineable by customer is included.

Frequency range: dc to 12.4 GHz.

Reflection coefficient: < 0.05 , dc to 4 GHz; < 0.07 , 4.0 to 8.0 GHz; > 0.15 , 8 to 12.4 GHz.

Package Styles

Opt 003: 0.205 inch diameter packages.

Calibration references: option 003 only, short circuit termination and a 50-ohm through-section.

Connectors: APC-7 hybrid.

Weight: net, 0.9 kg (2 lb); shipping, 1.4 kg (3 lb).

Size: 25 H x 143 W x 89 mm D (1" x 5.63" x 3.5").

HP 8410S Opt 500 Specifications

Function: the HP 8410S option 500 measurement system configuration is described on page 632. Following are specifications describing measurement capabilities of the HP 8410C/8411A when used with the HP 8746B/11608A over the frequency range of 500 MHz to 12.4 GHz.

Frequency range: 0.5 to 12.4 GHz.

Transistor dc bias selection: front panel slide switches establish proper dc biasing for both Bi-polar and FET transistors. The voltage and current controls operate independently and are continuously adjustable over a current range of 0 to 500 mA and a voltage range of 0 to 30 Vdc.

RF input: 20 dB range between +12 and -5 dBm.

Incident attenuation range: 0 to 70 dB in 10 dB steps.

Source reflection coefficient: (typically) ≤ 0.132 , 0.5 to 4.0 GHz; ≤ 0.135 , 4.0 to 8.0 GHz; ± 0.141 , 8.0 to 12.4 GHz.

Termination reflection coefficient: (typically) < 0.139 , 0.5 to 4.0 GHz; < 0.148 , 4.0 to 8.0 GHz; GHz; ± 0.170 , 8.0 to 12.4 GHz.

Directivity: ≥ 28 dB, 0.5 to 4.0 GHz; ≥ 24 dB, 4 to 8.0 GHz; ≥ 23 dB, 8.0 to 12.4 GHz.

Frequency response: (typically) < 0.5 dB, ± 7 degrees, 0.05 to 4.0 GHz; < 0.75 dB, ± 7 degrees, 4.0 to 8.0 GHz; < 1.25 dB, ± 7 degrees, 8.0 to 12.4 GHz.

Transmission measurement accuracy: (see Common Performance Specifications).

Reflection measurement accuracy: sources of error included in the accuracy equation are directivity and source match.

Magnitude Accuracy

$$\rho_u = \pm(0.04 + 0.08 \rho_L + 0.13 \rho_L^2) \text{ 0.5 to 4.0 GHz.}$$

$$\rho_u = \pm(0.06 + 0.09 \rho_L + 0.135 \rho_L^2) \text{ 4.0 to 8.0 GHz.}$$

$$\rho_u = \pm(0.074 + 0.098 \rho_L + 0.14 \rho_L^2) \text{ 8.0 to 12.4 GHz.}$$

ρ_u = magnitude uncertainty.

ρ_L = measured reflection coefficient magnitude.

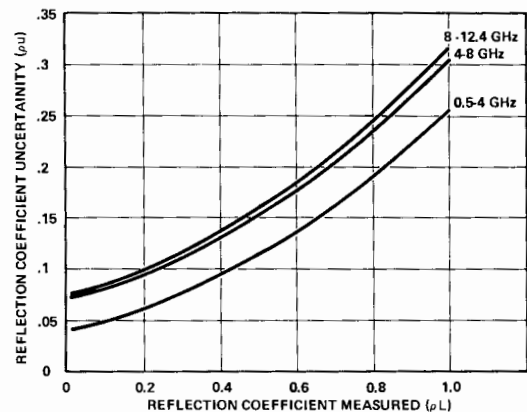

Phase Accuracy

$$\Phi_u = \sin^{-1} \rho_u / \rho_L \text{ for } \Phi_u < 90^\circ.$$

Φ_u = phase uncertainty.

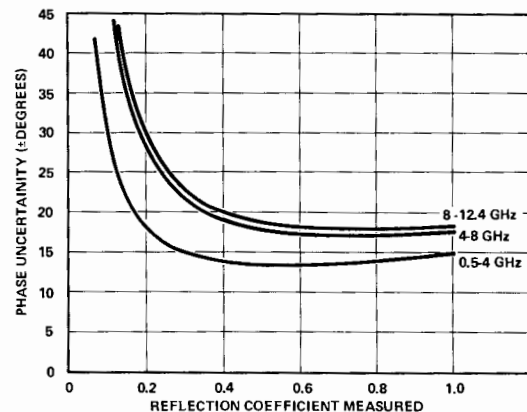

See HP 8410S network analyzer systems table for price and instrument breakdown.

Ordering Information

HP 8746B Test Unit

Opt 001: Large Signal

Opt 908: Rack Flange Kit

HP 11608A Transistor Fixture Customer Machineable

Opt 003: 0.205 inch diameter package style

Price

\$12,740

N/C

add \$25

\$1,705

add \$450

NETWORK ANALYZERS

Storage-Normalizer

Model 8750A



- Digital storage and normalization
- Simple CRT photos and x-y recordings
- Use with HP network and spectrum analyzers

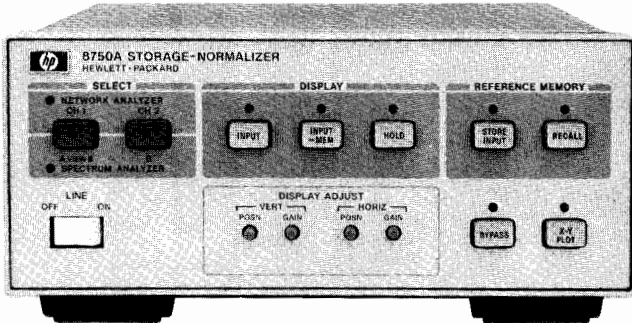

HP 8750A

With HP's versatile 8750A Storage-Normalizer, you can make your network analyzer or spectrum analyzer measurements faster, easier, and more accurately through the simple addition of digital storage and normalization. This useful instrument accessory is directly compatible via a single interface cable with the following Hewlett-Packard instruments; the HP 8755 Scalar Network Analyzer, the HP 8410/8412B, the HP 8754A and the HP 8505A Networks Analyzers and HP 8557A, 8558B, 8565A and 8559A Spectrum Analyzers. A special I/O adapter (opt 001 or opt 002) is available for interfacing instruments (like HP 140 Series Spectrum Analyzers) that are not directly compatible with the HP 8750A. An external oscilloscope can then be used for digitally stored and normalized displays. (The HP 8750A is not compatible with the HP 8414B Polar Display or the polar mode of the HP 8505A or the HP 8754A.)

In network analyzer applications, digital storage always yields a flicker-free display of the complete device response, facilitating easy adjustment of test devices under slow sweep conditions. Measurement accuracy is also improved since frequency response errors can be automatically removed through digital normalization. This effectively eliminates the need to manually record calibration traces on a CRT or x-y recorder and allows high resolution measurements of attenuator, amplifier, or filter passband flatness.

In spectrum analyzer applications, the HP 8750A's digital storage feature simplifies many difficult tests requiring slow scan times such as high resolution modulation measurements. Drift tests are also easy since two traces, a stored reference and the current input, can be displayed simultaneously.

Hard copy documentation can be obtained quickly and easily since data can be frozen on the CRT for straightforward CRT photography or output to an x-y recorder at a constant 30 second sweep rate.

Supplemental Performance Characteristics

Display

Horizontal memory resolution: two display channels, 256 points per channel (0.4% of full scale, 8 bit word)

Vertical memory resolution: 512 points displayed full scale (0.2% of full scale, 10 bit word) plus a 50% overrange (256 points) both above and below full screen.

Horizontal input sweep rates: 100 s max./10 ms min.

Display refresh rate: 6 ms.

Video Detection

Network analyzer: average detection (20 kHz).

Spectrum analyzer: peak detection.

Input/Output

A/D Horizontal Input

Network analyzer: 0 to 10 V nominal. Offset ± 0.5 V and Gain Adjust for 6 to 15 V sweep.

Spectrum analyzers: ± 5 V nominal. Offset ± 0.5 V and Gain Adjust for ± 4.5 to ± 5.5 V.

A/D Vertical Input

Network analyzer: ± 1 V min. and ± 2 V max, with continuous gain adjustment. Offset ± 0.3 V.

Spectrum analyzer: 0 to 0.8 V or 0 to -0.8 V. Offset ± 0.1 V and Gain Adjust $\pm 10\%$.

D/A Horizontal Output

Network analyzer: gain adjustment for 1 to 3 V peak. Offset adjustment $+0.5$ to -1.5 V.

Spectrum analyzer: gain adjustment for 1 to 3 V peak. Offset $+0.5$ to -1.5 V.

D/A Vertical Output

Network analyzer: same as Vertical Input with $\pm 10\%$ adjustment range.

Spectrum analyzer: same as Vertical Input with $\pm 10\%$ adjustment range.

X-Y Recorder Outputs

Horizontal range and accuracy: 0 ± 20 mV to 1 V nominal, settable within $\pm 3\%$ of full scale. BNC female output (rear panel).

Vertical range and accuracy: ± 4 V $\pm 3\%$ BNC female output (rear panel).

Sweep time: 30 s per displayed trace.

Penlift output: BNC female (rear panel with open collector -driver 20 V maximum.)

Controls

Select: LED display indicates network or spectrum analyzer operation depending on the plug-in interface card.

Display

Input: initiates digital storage.

Input-mem (input minus memory): stored Reference trace is subtracted from input data (normalization).

Hold: freezes display for CRT photos or further analysis.

Reference Memory

Store input: current input trace is stored as Reference.

Recall: displays stored Reference trace.

Bypass: bypasses HP 8750A so display is returned to conventional analog operation.

X-Y Plot: initiates X-Y plots.

General

Interface cards: the HP 8750A is supplied with two general plug-in interface cards, one for use with the HP Spectrum Analyzers listed above and one for use with the HP 8407A/8412B and 8505A Network Analyzer. When the HP 8750A is to be used primarily with an 8755C Scalar Network Analyzer, HP 8350B/8620C sweep oscillator, HP 8410C/8412B Network Analyzer, or the HP 8754A Network Analyzer, calibration and adjustment of the HP 8750A to these instruments can be greatly simplified by ordering one of the plug-in interface cards dedicated to these instruments (Opt. 003 and 004). All offset and gain adjustments are significantly reduced. When Opt. 003 or 004 are ordered, the two general interface cards are also included, so you have the flexibility to change your test set-up at any time.

Power: selection 100, 120, 220, or 240 V $+5\%$ -10% . 48 to 440 Hz and <20 VA (<20 watts).

Size: 102 H x 212 W x 280 mm D (4" x 8.4" x 11.2").

Weight: net, 2.72 kg (6.1 lbs); shipping, 5.0 kg (11 lbs).

Ordering Information

HP 8750A Storage-Normalizer

Price
\$2,355

Opt 001: BNC Interface Adapter (Deletes direct interface cable)

N/C

Opt 002: BNC Interface Adapter (Retains direct interface cable)

add \$180

Opt 003: HP 8755C or 8412B/8620C Plug-in Interface Card

add \$150

Opt 004: HP 8754A Plug-in Interface Card

add \$150

SIGNAL ANALYZERS

Wave, Distortion, Modulation, Spectrum and Fourier Analyzers



Analysis of signals in the frequency domain is an important measurement concept which is widely used for providing electrical and physical system performance information. Several examples will illustrate some important applications where signal analyzers are useful.

Mechanical Measurements

Noise and vibration levels are of major concern to manufacturers and users of mechanical structures such as aircraft, automobiles, and bridges. With an appropriate motion-to-electrical signal transducer the spectrum analyzer or the Fourier analyzer can examine vibration signals in the frequency domain. This makes it possible to monitor and analyze vibration components of rotating machines associated with unbalance, worn bearings or worn gears, and to identify a structure's natural modes of vibration.

Communications

In the fields of telecommunications, the spectrum, modulation, wave and audio analyzers provide vital operational performance verification of transceivers and multiplex systems. Unwanted signals such as carrier leak signals, out-of-band emissions, and cross

modulation products must be identified. System gain, loss, distortion and pilot tone measurements must also be made. These measurements are discussed in more detail in the Telecommunications Test Equipment section of this catalog.

Electronic Testing

Finally, in the general field of electronics, there are four primary uses for the signal analyzer. First, the analyzer is used to identify and measure signals which result from nonlinear effects in the process of amplification, filtering, and mixing. Second, the purity of signal sources is commonly observed. Third, the modulation analyzer serves a special purpose in analyzing modulated communication signals by measuring and displaying RF power, frequency and modulation characteristics. Fourth, the signal analyzer with a companion tracking generator is used as an amplitude-only network analyzer for frequency response measurements of filters, amplifiers, and many other types of networks.

Basic Analyzers

This section discusses the definition and use of several types of instruments for fre-

quency response signal analysis: spectrum analyzers, digital Fourier analyzers, wave analyzers, distortion analyzers, audio analyzers, modulation analyzers and measuring receivers.

Each of these instruments measures basic properties of a signal in the frequency domain, but each uses a different technique. The spectrum analyzer is a swept receiver that provides a visual display of amplitude versus frequency. It shows on a single display how energy is distributed as a function of frequency, displaying the absolute value of Fourier components of a given waveform. The Fourier analyzer uses digital sampling and transformation techniques to form a Fourier spectrum display that has phase as well as amplitude information. The wave analyzer is the true tuned voltmeter, showing on a meter the amplitude of the energy in a specific frequency window which is tunable over a specific frequency range. The distortion analyzer performs an almost reciprocal function to that of the wave analyzer. It collectively measures the energy outside a specific bandwidth tuning out the fundamental signal and displaying the energy of the har-

Wave, Distortion, Modulation, Spectrum and Fourier Analyzers (cont.)

monics and other distortion products on a meter. The audio analyzer performs the same measurement function as a distortion analyzer but also includes the additional measurement functions of SINAD, signal to noise ratio, frequency count, true rms DVM and dc DVM. The modulation analyzer tunes to the desired signal and recovers the entire modulation envelope of AM, FM and phase modulation for processing and display. The measuring receiver adds to the capabilities of the modulation analyzer the ability to very accurately measure signals down to -127 dBm.

Different Views

Figure 1 shows a graphical representation of the way five of the analyzers view a signal and one harmonic. The time domain scan of the signal is presented in Figure 1a. $A(t)$ is the complex voltage waveform as it would be viewed on an oscilloscope. The dashed lines represent the vector components of the signal: $A_1(t)$, the fundamental and $A_2(t)$ the second harmonic. In Figure 1b the spectrum analyzer displays the frequency spectrum showing both vector components and their amplitude relationship.

The Fourier analyzer uses digital signal processing techniques to extract both the amplitude and phase information about each spectral component. Conceptually the Fourier analyzer can be viewed as measuring a large number (up to 2048) of parallel filters as shown in Figure 1c. These filters are actually very specialized digital filters so that precise, repeatable results can be obtained. With this arrangement of parallel filters the complete display is generated in the time that it takes to analyze the lowest frequency component. HP Fourier analyzers presently cover the range of dc to 100 kHz.

The wave analyzer in Figure 1d measures the amplitude and frequency of the signal in the frequency window to which it is tuned. This window can be moved to measure the amplitude of the second harmonic, thereby making a precise comparison with the fundamental. This technique is practical from 15 Hz to above 32 MHz.

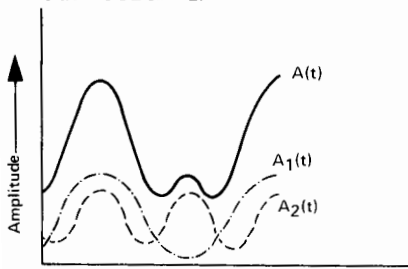

Figure 1a. Waveform

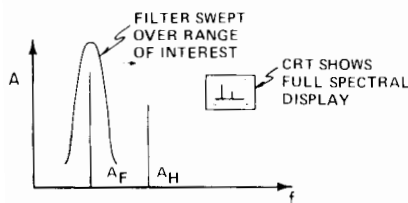

Figure 1b. Spectrum analyzer

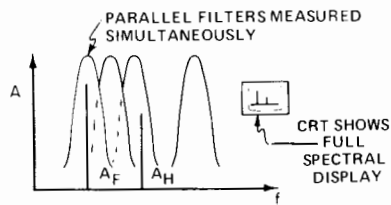

Figure 1c. Fourier analyzer

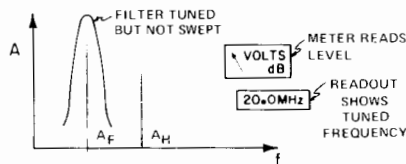

Figure 1d. Wave analyzer

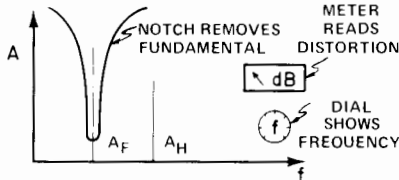

Figure 1e. Distortion analyzer

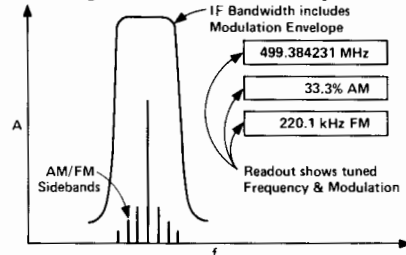

Figure 1f. Modulation analyzer

The distortion analyzer as pictured in Figure 1e rejects the fundamental to which it has been tuned and measures the energy everywhere else within the instrument's frequency spectrum. Distortion, as a percentage or in dB down from the fundamental, is displayed directly on a meter. Hewlett-Packard distortion analyzers cover 5 Hz to 600 kHz.

The modulation analyzer of Figure 1f and the measuring receiver tune to a desired frequency just as the wave analyzer does. Their IF bandwidths and detection systems are designed to pass the entire modulation envelope so that percent modulation, distortion, residual and peak deviation measurements can be made. All close-in spectral components are combined in the measurement.

The following section considers each instrument technique, showing the particular strength and flexibility of each.

Hardcopy Records

Signals and harmonics can be reproduced on printers and plotters for analysis, comparisons, and documentation. Report quality hard copy saves time and money when graphical representations are needed for reports or presentations. For more information, see the X-Y Recorder and Graphics Plotter Selection Guide for HP Instruments in the Recorders, Plotters & Printers section of this catalog.

Spectrum Analyzers

To display useful information about a frequency scan, a spectrum analyzer must be sensitive, frequency stable, free of spurious

responses over a wide band, and have calibrated accuracy in the CRT display. The examples which follow best demonstrate the wide variety of information which can be measured on the spectrum analyzer.

Measurements with the Spectrum Analyzer

CW signal: the most basic spectrum analysis measurement is the single CW signal.

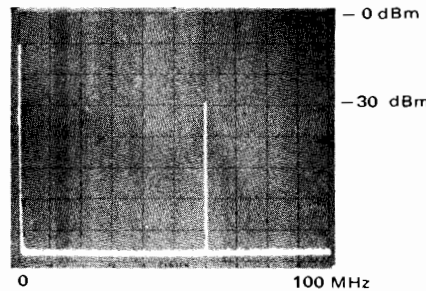

Pictured is a -30 dBm signal at 60 MHz. The zero frequency indicator is at the far left graticule line.

Spectral purity of a CW signal: one very important oscillator signal measurement is spectral purity. This 70 MHz carrier has power line related sidebands (± 60 Hz) which are 65 dB down.

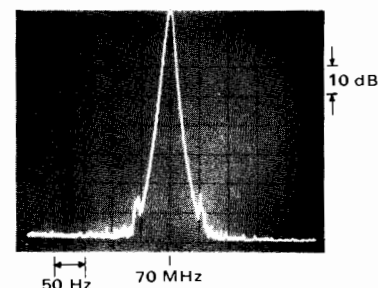

Such sidebands may result from power supply ripple. The 50 Hz/division spectrum analyzer scan and the 10 Hz analyzer bandwidth provide the high degree of resolution required to see these sidebands.

Frequency conversion products: the spectrum analyzer is well suited for frequency conversion measurements such as the output of a balanced mixer as shown.

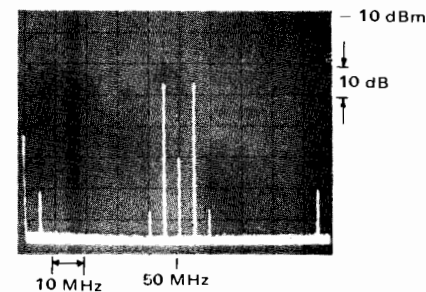

With the 50 MHz local oscillator input at 0 dBm and a 5 MHz, -30 dBm mixer signal, two sidebands at 45 MHz and 55 MHz result. The sidebands are -36 dBm, giving the mixer a 6 dB conversion loss. The local oscillator has 60 dB isolation and the 5 MHz signal has 41 dB isolation. Second order distortion products at 40 and 60 MHz are 40 dB below the desired mixer outputs.

SIGNAL ANALYZERS

Wave, Distortion, Modulation, Spectrum and Fourier Analyzers (cont.)

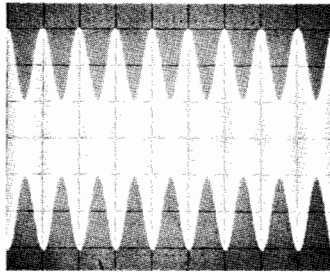

Oscilloscope

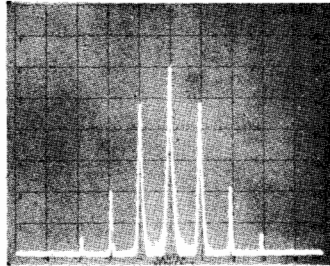

Spectrum Analyzer

Amplitude modulation: percent amplitude modulation is often more easily measured with the spectrum analyzer than it is with the oscilloscope. This is especially true for low level modulation.

With the oscilloscope time display, percent modulation, M , is measured as a ratio of the signal's dimensions: $M=100(6-2)/(6+2)=50\%$. In the spectrum analyzer display, whose vertical calibration is 10 dB/division, the carrier and sidebands differ by 12 dB, the voltages in the sidebands are $1/4$ of that of the carrier and again, $M=50\%$. At the same time the second and third harmonic distortion of the sidebands can be measured at 28 and 44 dB respectively.

Frequency modulation: information transmitted by FM can be characterized by the spectrum analyzer.

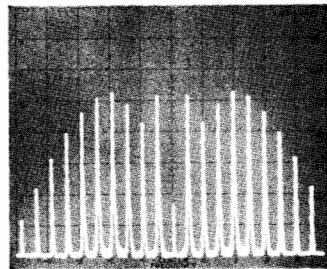

20 kHz Low Deviation FM

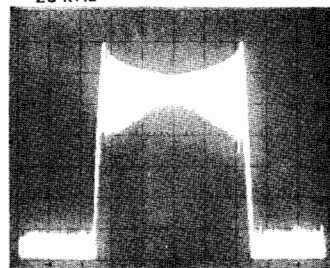

0.5 MHz High Deviation FM

Low deviation FM is applied to a 60 MHz carrier in the first photo. The deviation has been adjusted for the second carrier null ($M=5.52$). The sideband spacing is 10 kHz, the modulation frequency; therefore, Δf peak =

$$5.52 \times 10 \text{ kHz} = 55.2 \text{ kHz.}$$

The second photo is an example of a high deviation FM. The transmission bandwidth is 2.5 MHz.

Pulsed CW power: by viewing the spectra of a repetitive RF pulse on the spectrum analyzer, pulse width, average and peak power, occupied bandwidth, and duty cycle can be determined.

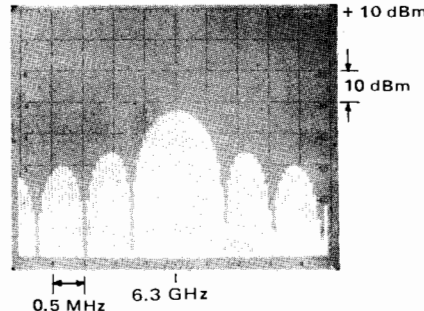

From the spectral output shown the pulse's complete characteristics are determined: 6.3 GHz RF at 0 dBm, pulsed at 50 kHz rate. The pulse width is 1.3 μ s.

EMI: Spectrum analyzers have long been a useful tool in the evaluation of electromagnetic interference (EMI). They are valuable for preliminary design troubleshooting and qualification testing. The spectrum analyzer's ability to display wide frequency spans provides "quick look" capability for locating EMI "hot spots." The high performance spectrum analyzers (HP 8566B, 8567A, and 8568B) offer full programmability, allowing automatic EMI measurements. With the addition of the Quasi-Peak Adapter (HP 85650A), these analyzers can make quasi-peak measurements used in commercial EMI tests.

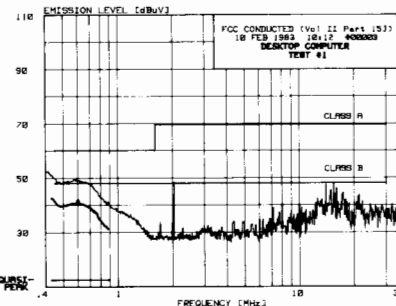

Plot of FCC conducted emissions test using peak and quasi-peak detection

Noise: spectrum analysis is effective in measuring impulse noise, random noise, carrier to noise ratio, and amplifier noise figure.

Phase noise: the short term frequency fluctuations of a sine wave source can be measured directly as phase modulation sidebands. Hewlett-Packard spectrum analyzers with narrow resolution and synthesized internal frequency sources can make many phase noise measurements directly. Bandwidth corrections, analyzer corrections, data averaging and setup calibration factors can be accounted for by Hewlett-Packard microprocessor-controlled spectrum analyzers. All instrument controls, data transfer and data reduction can be handled by easy-to-write software for Automatic Spectrum Analyzers.

Frequency response: using a tracking signal source and a spectrum analyzer the frequency response of filters can be displayed with ease.

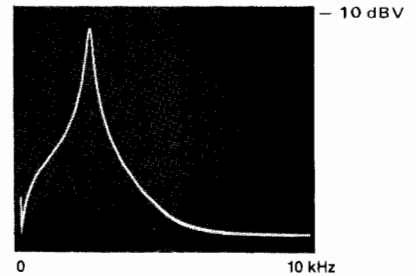

In this case, an audio filter used in a communications system is being measured. Since the input reference level to the filter is -13 dBV, the insertion loss at 2.4 kHz is 4 dB. Extremely high Q devices can be measured with this system.

Spectrum Analyzer Capabilities

To be useful in making measurements in the frequency domain, the analyzer must be capable of making quantitative measurements. Specifically, an analyzer must:

1. make absolute *frequency* measurements
2. make absolute *amplitude* measurements
3. operate over a *large amplitude dynamic range*
4. have *high resolution* of frequency and amplitude
5. have *high sensitivity*
6. provide means of *observing, preserving, and recording* its output in a convenient and rapid manner by using variable persistence, digital storage and adaptive sweep. Hewlett-Packard spectrum analyzers excel in these six measures of performance. Let us consider each of these performance standards in greater detail.

Absolute frequency measurements: frequency readout accuracy depends upon the tuning and readout techniques employed, as well as the stability of the spectrum analyzer's frequency reference. The absolute frequency accuracy read off the slide-rule type of frequency dial is approximately 1% of full scale. Synthesized local oscillators allow accuracies to ± 4 Hz at 1500 MHz in narrow frequency spans. When the spectrum analyzer is used in conjunction with a tracking generator (a source whose frequency is the same as the analyzer tuning frequency) accuracy much better than 1% can be achieved by counting the generator output.

Extended frequency capabilities: the frequency range of microwave spectrum analyzers can be extended to the millimeter frequency bands where waveguide transmission lines are required. This frequency extension is accomplished by using external harmonic mixers to convert the millimeter signal frequency down into the range of the spectrum analyzer. Hewlett-Packard Harmonic Mixers provide a high level of performance for measurements in these millimeter frequency bands from 18 to 60 GHz. Their characteristics include excellent absolute amplitude accuracy and low conversion loss, the latter providing high sensitivity. In addition, no mixer bias is required, allowing full waveguide band measurements to

be made easily and accurately. The non-biased feature also makes these mixers highly suitable for fully automatic systems, since there is no need to adjust a bias current over the frequency range to achieve the best flatness. For more information on millimeter measurements, refer to page 693.

Absolute amplitude measurements: all Hewlett-Packard spectrum analyzers are absolutely calibrated for amplitude measurements. This means the spectrum analyzer indicates to the user what the log/reference level or linear sensitivity is regardless of control settings. Either a warning light or CRT message indicates an uncalibrated condition, making operation of the analyzer easy and foolproof.

Microprocessor controlled analyzers feature built-in calibration routines which account for changes in analyzer controls such as the resolution bandwidth and RF attenuator.

Dynamic range: the dynamic range of a spectrum analyzer is defined as the difference between the input signal level and the average noise level or distortion products, whichever is greater. Hence, dynamic range can be either distortion limited, noise limited or display limited. Hewlett-Packard micro-processor controlled analyzers can be set to ensure that distortion products of on-screen signals will be below a certain level.

Frequency and amplitude resolution: frequency resolution is the ability of the analyzer to separate signals closely spaced in frequency. The frequency resolution of an analyzer is a function of three factors: 1) minimum IF bandwidth, 2) IF filter shape factor, 3) spectrum analyzer stability.

The minimum IF bandwidth ranges down to 1 Hz on Hewlett-Packard spectrum analyzers.

One way to define IF filter shape factor is the ratio of 60 dB bandwidth to 3 dB bandwidth. Filter shape factor specifies the selectivity of the IF filter. Hewlett-Packard spectrum analyzers have IF filter shape factors as low as 5:1.

Analyzer frequency stability also limits resolution. The residual FM (short term stability) should be less than the narrowest IF bandwidth. If not, the signal would drift in and out of the IF pass band. Hewlett-Packard analyzers have excellent stability. Low frequency and microwave frequency models are available with residual FM <1 Hz, enabling the measurement of noise sidebands. The stabilization circuitry is completely automatic and foolproof. No signal recentering, manual search, or checking is required.

Amplitude resolution is a function of the vertical scale calibration. Hewlett-Packard analyzers offer both log calibration for observing large amplitude variations (10, 5, 2 and 1 dB/div) and linear calibration for observing small amplitude variations.

Sensitivity: sensitivity is a measure of an analyzer's ability to detect small signals, and is often defined as the point where the signal level is equal to the noise level or $(S+N)/N=2$. Since noise level decreases as the bandwidth is decreased, sensitivity is a function of bandwidth. The maximum attainable sensitivity ranges from -150 dBm to -125 dBm with Hewlett-Packard analyzers.

Variable persistence, digital storage, and adaptive sweep: high resolution and sensitivity both require narrow bandwidths and consequently slow sweep rates. Because of these slow sweeps, both digital display and variable persistence are virtually indispensable in providing a bright, steady flicker-free trace.

The digital storage feature on Hewlett-Packard analyzers covering audio to microwave frequency ranges make measurements and CRT photography simple. It gives the CRT display a dot matrix connected by line generators for an unbroken and uniform intensity scan. In addition, the microprocessor controlled analyzers feature CRT annotation to completely describe the data characteristics displayed.

On low frequency analyzers, adaptive sweep effectively speeds the measurement times. On the very slow sweep times (required when using the 1 Hz bandwidth), adaptive sweep allows the scan to sweep rapidly when no signals occur and slow down when a signal is above a preset level. The measurement time savings can be greater than 20:1.

Tracking Preselector

The only way to simultaneously avoid spurious, multiple, harmonic and image responses is to filter the RF signal through a tracking preselector. This is an electronically tuned bandpass filter that automatically tracks the analyzer's tuning. A preselector can improve the spurious-free range of the analyzer from 70 dB to 100 dB.

Tracking Generator

A tracking generator expands the measurement capability of the spectrum analyzer by providing a signal source which tracks the tuning frequency of the analyzer. The source/receiver combination can be used to measure insertion loss, frequency response, return loss and allow precision frequency counting.

It helps make these additional measurements with increased distortion-free dynamic range, sensitivity and selectivity. The tracking generator is also an excellent stable sweeping generator. The residual FM varies from <1 Hz to <200 Hz for Hewlett-Packard tracking generators.

Automatic Spectrum Analyzers

The measurement capability of a spectrum analyzer can be greatly enhanced by allowing a desktop computer to control instrument functions and record frequency and amplitude information. Data can be gathered and processed into a variety of formats at a very rapid rate. Through comprehensive self-calibration, automatic spectrum analysis offers amplitude accuracy of up to ± 0.4 dB with 0.01 dB resolution. User cost savings are realized through faster measurements, lower operator skill requirements, and unattended operation capability.

Further discussion of computer based automatic spectrum analysis can be found on page 669.

Frequency Stability Analysis

Frequency stability and spectral purity are important parameters when characterizing most signal sources. Long term stability or

frequency drift due to aging or temperature effects is generally measured with a precision frequency counter such as the HP 5345A; random fluctuations in frequency or period can also be measured in the time domain, using an electronic counter and the Allan Variance technique.

Another measure of frequency stability is the phase spectral density. The most common method of making this measurement is to phase-lock the unknown to a clean reference source, mixing the two signals together in a phase detector and analyzing the low frequency output on a wave or spectrum analyzer. This technique allows the phase noise sidebands to be measured in the absence of the carrier, and can result in measurement sensitivities of -170 dBc or better.

Analog spectrum analyzers are required for noise measurement at high offset frequencies (above 100 kHz). However, at lower offsets (below approximately 100 Hz), their bandwidths become large in comparison to the frequencies being measured. In these cases, the use of FFT-based spectrum analyzers becomes necessary.

Insuring the accuracy of a phase noise measurement can be quite a problem. Non-ideal phase detectors and amplifiers will introduce measurement errors, and the phase-locked loop used to control the reference source will attenuate the noise signal at certain frequencies.

The HP 3048A Phase Noise Measurement System contains an FFT spectrum analyzer and uses optional, conventional spectrum analyzers to measure phase noise sidebands over the offset frequency range 0.02 to 40 MHz. Phase detectors are included for carriers from 5 MHz to 18 GHz and a variety of reference sources such as the HP 8662A or HP 8642A are optional to the system. An extensive software package manages the entire measurement process, including the operator's interface, system calibration, data gathering, graphics and data storage. Amplitude accuracy is ± 2 dB and measurement sensitivity is limited only by the reference source used. Most measurements are completed in less than three minutes. The HP 3048A Phase Noise Measurement System is completely described on page 707.

Fourier Analyzers

The Fourier analyzer uses digital signal processing techniques to provide measurement capability over and above that of a swept spectrum analyzer. Some of these include the precise measurement of random signals obscured by noise, measurement of the joint properties or relationships of two or more signals, measurements of statistical properties of signals, and measurements of very low frequency (e.g. below 5 Hz) or very closely spaced (e.g. less than 1 Hz) signals.

Fourier analyzers are based on the calculation of the Discrete Fourier Transform using a highly efficient algorithm known as the Fast Fourier Transform. As shown in Figure 2, this algorithm calculates the magnitude and phase of each frequency component from a block of time domain samples of the input signal.

The block diagram that is involved is shown in Figure 3. First, the input signal is filtered to remove out-of-band components. Next, the input is sampled and digitized at



SIGNAL ANALYZERS

Wave, Distortion, Modulation, Spectrum and Fourier Analyzers (cont.)

regular Δt intervals until a full block of samples called a time record has been collected. The processor then executes the desired series of computations on the time data to produce the frequency domain results. These results, which are stored in memory, can be analyzed on a CRT display, plotted, or processed further to provide the user additional useful information.

$$X(k \Delta f) = \sum x(n \Delta t) e^{-j2\pi(n)k/N}$$

EACH FREQUENCY POINT IS COMPOSED OF A MAGNITUDE AND PHASE VALUE

EACH FREQUENCY POINT CONTAINS INFORMATION FROM ALL TIME DOMAIN SAMPLES

COMPLEX FACTOR

Figure 2

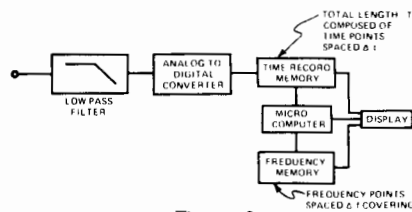

Figure 3

When two or more input channels are provided, signals can be sampled simultaneously. The processor can then additionally compute joint properties of the signals. This is useful for characterizing the transfer function of a linear device and for investigating cause/effect relationships.

The digital nature of Fourier analysis insures *high accuracy, stability and repeatability*. In addition, there are several specific advantages that are achieved.

Low Frequency Coverage

The Fourier transform calculates equally spaced frequency components from DC to the maximum frequency. By simply varying the sample rate it is possible to make measurements down to a few micro Hertz. For such low frequency measurements, the laws of physics dictate a long observation time. Since the Fourier transform simultaneously calculates all frequency points from one set of observation points, a one to two order of magnitude speed improvement over a swept measurement is possible.

High Frequency Resolution

By digitally translating a band of frequencies down to DC it is possible to provide very high frequency resolution over the entire range. This technique, known as Band Selectable Fourier Analysis, can provide resolution of a few millihertz as shown in Figure 4. Here a 5 Hz band of frequency located at 3 kHz is analyzed showing 0.48 Hz sidebands over 20 dB down.

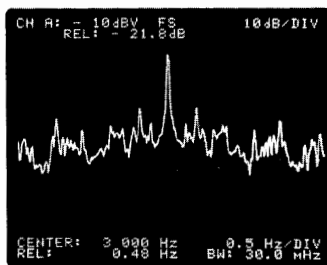

Figure 4

Direct Transfer Function Measurements

With simultaneous sampling of both the input and output of an electrical, mechanical, or acoustical system, it is possible to directly characterize transfer functions. Since the Fourier analyzer measures the frequency components simultaneously, energy must also be provided at these frequencies. This can be done with a broadband white noise signal, a pseudorandom noise signal or an impulse. Results presented in magnitude/phase or real/imaginary format help quickly illustrate the performance characteristics of a system.

The measurement of the coherence function can additionally provide a measure of the validity of a transfer function. It can distinguish portions of the output power that are not directly caused by the input, but may instead be due to additive noise, distortion products, or unmeasured inputs.

Systems Compatibility

Since the Fourier analyzer is basically all digital, interfacing to a computing controller or other digital peripherals is relatively simple. Remote programming and data input/output can considerably expand the range of potential applications.

Fourier Analyzer Applications

The versatility and performance of the Fourier analyzer make it an ideal tool for a variety of applications as a few specific examples will illustrate.

In the general area of electronics, the Fourier analyzer functions as a very high performance spectrum and network analyzer. It can be very useful for measuring phase noise or for characterizing filters.

In the field of communications, the Fourier analyzer can be very useful for characterizing audio signals, such as modems and touch tone signals.

When combined with a microphone the Fourier analyzer can be useful in characterizing acoustic devices, such as loud speakers.

With a motion transducer the Fourier analyzer can be used to analyze the vibration signatures of rotating machines. This can be very useful in helping to establish scientific maintenance policies.

The transfer function of a mechanical structure can illustrate how the structure responds to vibration inputs. This is extremely important in optimizing the design of structures that will be subjected to substantial vibration.

Wave Analyzers/SLMs

Wave analyzers are known by several different names: frequency selective voltmeter, carrier frequency voltmeter, and selective level meter. These names describe the instrument's function rather well.

As mentioned in the introduction to this section, a wave analyzer can be thought of as a finite bandwidth window filter which can be tuned throughout a particular frequency range.

Signals will be selectively measured as they are framed by the frequency window. Thus, for a particular signal, the wave analyzer can indicate its frequency (window position) and amplitude. Amplitude is read on an analog meter; frequency is read on either a mechanical or electronic readout.

The uses of wave analyzers can be categorized into three broad areas: 1) amplitude measurement of a single component of a complex frequency system, 2) amplitude measurement in the presence of noise and interfering signals, and 3) measurement of signal energy appearing in a specified, well defined bandwidth.

Wave Analyzer/SLM Considerations

Frequency Characteristics

Range: should be selected with the future in mind as well as present requirements.

Accuracy and resolution: should be consistent with available bandwidths. Narrow bandwidths require frequency dial accuracy to place the narrow window in the proper position for measurement. Accuracy of instruments with selectable bandwidths is determined by the basic center frequency accuracy of the IF bandwidth filters in addition to the local oscillator frequency accuracy.

Readout: usually an LED display.

Stability: frequency stability is important when using narrow bandwidths and for long term signal monitoring. Stability is best achieved with automatic frequency control (AFC) or frequency synthesis. AFC locks the local oscillator to the incoming signal and eliminates any relative drift between the two. A frequency synthesized local oscillator allows frequency accuracy of $<1 \times 10^{-5}$ with 0.1 Hz resolution.

Sweep: some instruments are equipped with sweep to allow use as a spectrum analyzer. Readout is a CRT or X-Y recorder.

Amplitude Characteristics

Range: the amplitude range is determined by the input attenuator and the internal noise of the instrument. Sensitivity is defined as the lowest measurable signal equal to the noise level for a unity signal-to-noise ratio (often called tangential sensitivity). Sensitivity will vary with bandwidth and input impedance.

Dynamic range: defined as the dB ratio of the largest and smallest signals that can be simultaneously accommodated without causing an error in the measurement.

Attenuators: the amplitude range switch is an attenuator in the input and IF stages. Intermodulation distortion is lowest when the input amplifier has the minimum signal applied and the IF gain is greatest. Conversely the internal noise, important when making sensitive measurements, is lowest with maximum input signal and lowest IF gain. Newer instruments use auto-ranging techniques.

Accuracy: amplitude accuracy is a function of frequency, input attenuator response, IF attenuator performance, calibration oscillator stability and accuracy, and meter tracking. Often specifications are expanded to separately describe each contributor.

Readout: amplitude readout is usually a meter calibrated in dB and/or volts or a LED digital display. Linear voltage meters are used to allow the user to see down into the noise at the bottom of the scale. Digital readouts are often used with an analog meter to aid in tuning to signals. Expanded scale meters allowing expansion of any 1 or 2 dB portion of the scale into a full scale presentation allow resolution of input level changes of a few hundredths of a dB while LED displays

allow 0.01 dB resolution. This is useful when the wave analyzer is used as a sensitive indicator in bridge or comparison measurements. The expanded scale meter is included in some instruments and is an optional accessory on others.

Input Characteristics

Impedance: may be high impedance bridging input or terminating impedance to match standard transmission lines. High frequency measurements require matched systems to avoid error-producing standing waves on interconnecting cables. The measure of impedance accuracy is usually return loss or reflection coefficient ($RL=20 \log \rho$). In low frequency instruments, percent accuracy is used. High input impedance instruments are usually poorer in high frequency and noise performance and are usually low frequency instruments. High impedance at high frequencies is accomplished by using a bridging probe to place the impedance at the point of measurement. The probe may be active with unity gain or passive with 20-30 dB insertion loss.

Input arrangement: input may be balanced to ground or unbalanced. Communications system usage typically requires balanced input. Standard 600 and 135/150 Ω balanced inputs are limited in frequency to less than 1 MHz and 124 Ω balanced to less than 10 MHz in most instruments. The impedance may be balanced to ground with the center point grounded or may be completely isolated from ground. Unbalanced inputs do not have frequency range limitations.

Network Analysis Application

Frequency response testing: with its tracking generator output, the wave analyzer is particularly useful for measuring filter and amplifier frequency responses. If a notch filter is being measured, for example, a narrow band measurement like that provided by a wave analyzer is essential for obtaining acceptable accuracy. A broadband technique will lead to some misleading results. For example, a notch filter may be driven with a flat oscillator and the response measured with a broadband voltmeter. The notch filter will reject the oscillator's fundamental tone, but pass its harmonics which are in the voltmeter's measurement range. Thus, an error results. If the voltmeter were frequency selective, like a wave analyzer, the harmonics would be rejected and the true level of the notch would be measured. Accurate and fast measurements can be made because Hewlett-Packard wave analyzers track and detect on the tracking generator frequency.

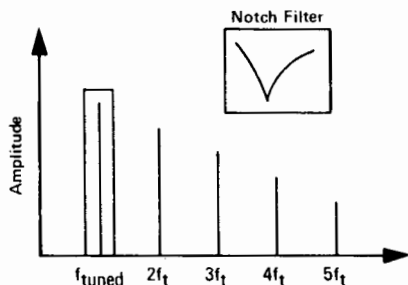

Only signal detected by wave analyzer. For example, the notch of a filter can be accurately measured to its full depth.

Distortion, Audio Analyzers

Harmonic distortion is one of many types of distortion created in communications equipment, audio and ultrasonic sound systems. Nonlinear elements in amplifiers cause harmonic related frequencies from a pure tone stimulus to be created at the output. Hence, to a listener, a poor reproduction quality becomes apparent. The total of these frequency components present in a signal, in addition to the fundamental frequency, can be measured quickly and easily with Hewlett-Packard distortion and audio analyzers.

The ratio of these frequency components to the amplitude of the fundamental is the total harmonic distortion (THD) as defined by the following equation (1):

$$THD = \frac{\sqrt{\Sigma (\text{harmonics})^2}}{\text{fundamental}}$$

The Hewlett-Packard distortion and audio analyzers consist of a narrow band rejection filter and broadband detector. Before the fundamental is rejected, the analyzer first measures the amplitude of the fundamental, all the harmonic components, and noise. Then the rejection filter is employed to remove the fundamental. The ratio of the two measurements is an approximation of equation (1) above and is defined by the following equation (2):

$$THD = \frac{\sqrt{\Sigma [(\text{harmonics})^2 + (\text{noise})^2]}}{\sqrt{\Sigma [(\text{fundamental})^2 + (\text{harmonics})^2 + (\text{noise})^2]}}$$

An approximation error of 1/2% can be expected for the THD levels of 10%. However, distortion levels as high as 10% are seldom encountered in most measurement situations. The harmonic content of the stimulus source must not be more than a third of the distortion expected to be caused by the system under test.

Audio Analyzers

The Audio Analyzer performs several basic low frequency measurements in addition to distortion, making it a general purpose audio test set. The audio analyzer includes the SINAD function for testing mobile radio receiver sensitivity. It contains a low distortion audio oscillator for stimulus response testing in combination with its distortion analyzer. It contains a true rms voltmeter and dc voltmeter for accurate measurement of complex waveform levels. Swept ac level and swept distortion measurements can be made when using the audio analyzer with a suitable X-Y recorder. Signal/noise ratio measurements are performed automatically when using the internal source and rms voltmeter. A reciprocal frequency counter is also included that continuously counts the frequency of the input signal.

These basic capabilities provide a general purpose instrument that represents high value in three major applications areas: 1) General audio component characterization, 2) radio transceiver audio measurements, 3) HP-IB systems. The Audio Analyzer provides sophisticated measurement capabilities with significantly reduced operator interaction.

True Harmonic Distortion Measurements

The Hewlett-Packard desktop computer controlled automatic spectrum analyzers provides a rapid means of measuring true harmonic distortion levels. The fundamental and its harmonic components are rapidly measured one at a time and the distortion is computed by applying equation (1). In production test situations, distortion calculations can be stored on tape for future reference and/or plotted for hard copy needs. Limit testing can also be applied.

Modulation Analyzers/Measuring Receivers

A modulation analyzer is a precision receiver designed to detect the entire modulation envelope of a signal under test. It can measure and display the carrier characteristics of RF frequency and power as well as AM, FM and phase modulation characteristics such as AM depth, peak deviation, residual modulation, and various ratios associated with them. The modulation analyzer also faithfully recovers the actual modulating signal for further analysis such as distortion testing.

Applications for modulation analyzers and measuring receivers include transmitter testing, signal generator calibration and RF signal characterization. The precision receiver capability allows comprehensive testing of the transmitter. All phases of design, production test, and maintenance of transmitters and their modules and subassemblies are applications for the modulation analyzer and measuring receiver. Because the measuring receiver can measure very low RF signal levels (to -127 dBm) as well as modulation and RF frequency, it is ideal for metrology and calibration labs for signal generator and attenuator calibration.

Capabilities

The unique measurement capabilities of modulation analyzers are easily shown on system tests with multiple-mode modulations such as simultaneous AM and FM. For example, if both amplitude and frequency modulation are present on a signal, a complex modulation spectrum is produced. To demonstrate this, an HP 8640B Signal Generator was 46.5% amplitude modulated with a 5 kHz triangular wave and 4.5 kHz peak frequency modulated with a 5 kHz sine wave simultaneously. The picture below shows the resulting signal as seen on a spectrum analyzer.

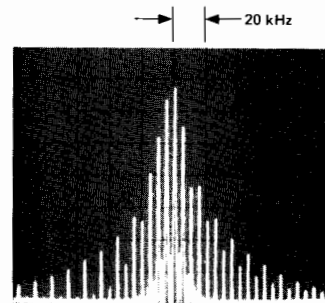

Spectrum Analyzer display of simultaneous AM (46.5%) and FM (4.5 kHz peak deviation) modulation.



SIGNAL ANALYZERS

Unequal, complex sidebands result and little data can be deduced. However, since a modulation analyzer faithfully recovers both modulation signals in independent detection systems insensitive to each other, it is easy to separate and read directly the various modulation components involved.

500.00 184 MHz

46.5 %AM

9.942 -3 Watts

4.49 kHz FM

Modulation Analyzer displays of RF signal parameters.

In addition, since the modulation analyzer handles the full complex modulation envelope, it measures and displays RF power and average frequency of the entire signal. The readings are all available at the push of a button.

The independent detection systems demodulate the waveforms. If further analysis is desired, the modulation analyzer characterizes audio signal level, frequency and dis-

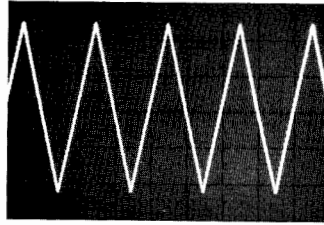

Recovered 5 kHz AM input signal viewed on oscilloscope.

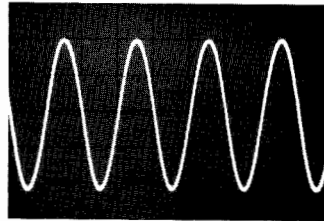

Recovered 5 kHz FM input signal.

ortion of both internally demodulated audio signals and external audio signals.

Since the AM and FM detection systems are independent and highly insensitive to each other, incidental modulation measurements can be made with high precision. For example, even with 90% amplitude modulation, the FM demodulator will accurately in-

dicating incidental FM. Such capability is valuable for design of oscillators, modulators, mixers and other components. It is very difficult to separate multiple modulation effects on spectrum analyzer displays because the effects are combined.

The HP 8901A/B Modulation Analyzers contain selectable filters to provide commonly used system characteristics for low-pass and high-pass filtering and FM de-emphasis. Thus measurement of transmitter modulation frequency response doesn't require additional equipment. Selectable detectors, including peak hold, allow measurements such as transmitter modulation limiting to be made very easily.

The measuring receiver can also serve as a high sensitivity, selective frequency counter and power meter. Since the superheterodyne design allows high sensitivity amplification of low level modulated signals, frequency counting of signals as low as -100 dBm is possible with good rejection of other signals.

Display and computational conveniences speed typical transmitter measurements and improve confidence in results. For example, ratio keys allow any measurement to be expressed in % or dB relative to any other measured or key-entered value. Such computations are valuable in applications such as mobile FM measurements, where hum and noise is expressed relative to an industry standard of 60% of maximum allowable deviation.

Signal Analyzers Selection Guide Spectrum Analyzers

Frequency Range	Amplitude Calibration Range	Bandwidths		HP Model Description	HP Companion Instruments	Page
		Min	Max			
0.02 Hz-25.6 kHz	-120 to +30 dBV	0.02 Hz	363 Hz	3582A Spectrum Analyzer		697
0.02 Hz-40 MHz (Offset from Carrier) 5 MHz to 18 GHz (Carrier Range)	-170 dBc	0.02 Hz	30 kHz	3048A Phase Noise Measurement System	8662A/8663A Synthesized Signal Generator 8642A/B Synthesized Signal Generator 11729B Carrier Noise Test Set	707
5 Hz-50 kHz	-150 to +30 dBm	1 Hz	300 Hz	3580A Spectrum Analyzer		695
20 Hz-300 kHz	-142 to +10 dBm	10 Hz	10 kHz	8556A Tuning Section Plug-In ¹		685
20 Hz to 40.1 MHz	-137 dB to +30 dBm	3 Hz	30 kHz	3585A Spectrum Analyzer		650
1 kHz-110 MHz	-140 to +10 dBm	10 Hz	300 kHz	8553B Tuning Section Plug-In ¹	8443A Tracking Generator	685
10 kHz-350 MHz	-117 to +20 dBm	1 kHz	3 MHz	8557A Spectrum Analyzer Plug-In ²		681
100 kHz-1250 MHz	-122 to +10 dBm	100 Hz	300 kHz	8554B Tuning Section Plug-In ¹	8444A Tracking Generator (500 kHz-1250 MHz)	685
100 kHz-1500 MHz	-117 to +30 dBm	1 kHz	3 MHz	8558B Spectrum Analyzer Plug-In ²	8444A Opt. 059 Tracking Generator (500 kHz-1500 MHz)	681
10 kHz-1.5 GHz	-113 to +30 dBm	1 kHz	3 MHz	8590A Spectrum Analyzer		678
100 Hz-1500 MHz	-137 dBm to +30 dBm	10 Hz	3 MHz	8568B Spectrum Analyzer and 8568S Automatic Spectrum Analyzer	8444A Opt. 059 Tracking Generator 85650A Quasi-Peak Adapter, 85865A RF Preselector	664 669
10 kHz-1500 MHz	-115 dBm to +30 dBm	1 kHz	3 MHz	8567A Spectrum Analyzer		670
10 MHz-21 GHz	-111 dBm to +30 dBm	1 kHz	3 MHz	8559A Spectrum Analyzer ²		681
100 Hz-2.9 GHz	-135 dBm to +30 dBm	10 Hz	3 MHz	71100A Modular Spectrum Analyzer	70300A Tracking Generator	655
100 Hz-22 GHz ³ (Extendable to 300 GHz)	-134 dBm to +30 dBm	10 Hz	3 MHz	8566B Spectrum Analyzer and 8566S Automatic Spectrum Analyzer	85650A Quasi-Peak Adapter, 85865A RF Preselector 11970K/A/Q/U/V/W Harmonic Mixers	666 669
100 Hz-26.5 GHz	-133 dBm to +30 dBm	10 Hz	3 MHz	71200A Modular Spectrum Analyzer	70300A Tracking Generator	655
10 MHz-22 GHz (Extendable to 40 GHz and above)	-122 dBm to +30 dBm	100 Hz	3 MHz	8565A Spectrum Analyzer	8750A Storage-Normalizer 8444A Opt. 059 Tracking Generator 11517A Harmonic Mixer	691
10 MHz-22 GHz ⁴ (Extendable to 115 GHz and above)	-123 to +30 dBm	100 Hz	3 MHz	8569B Spectrum Analyzer	8444A Opt. 059 Tracking Generator 11971K/A/Q/U/V/W Harmonic Mixers	689
10 MHz-22 GHz	-110 to +30 dBm	1 kHz	3 MHz	8570A Spectrum Analyzer		687
10 MHz-18 GHz (Extendable to 40 GHz and above)	-127 to +10 dBm	100 Hz	300 kHz	8555A Tuning Section Plug-In ¹	8444A Opt. 059 Tracking Generator 8445B Automatic Preselector (10 MHz-18 GHz) 11517A Harmonic Mixer	685
18 GHz-110 GHz (Extendable from 2.7 to 325 GHz)	-130 dBm to -3 dBm	10 Hz	3 MHz	71300A Modular Spectrum Analyzer	11970K/A/Q/U/V/W Harmonic Mixers	655

NOTE 1: For use in display mainframe HP 141T with IF section plug-ins HP 8552A or 8552B (page 685).

NOTE 2: For use in display mainframe HP 853A.

NOTE 3: Frequency range extendable to 110 GHz through the use of the HP 11970 series Harmonic Mixers. For higher frequency coverage, other external mixers are commercially available.

NOTE 4: Frequency range extendable to 71 GHz through the use of the HP 11971 series Harmonic Mixers. For higher frequency coverage, other external mixers are commercially available.



Modulation Analyzers/Measuring Receivers

Frequency Range	Modulation Measurements	Amplitude Measurement Range	Audio Frequency Count + Distortion Measurement	HP Model Number	Page
150 kHz-1300 MHz	AM, FM, ϕ M	+30 to 0 dBm	No	8901A	716
150 kHz-1300 MHz	AM, FM, ϕ M	+30 to -20 dBm	Yes	8901B	716
150 kHz-1300 MHz	AM, FM, ϕ M	+30 to -127 dBm	Yes	8902A	712
150 kHz - 18 GHz or 26.5 GHz	AM, FM, ϕ M	+30 to -105 dBm	Yes	8902S	714

Dynamic Signal Analyzers

Frequency Range	Amplitude Calibration Range	Resolution Points	HP Model Description	Functions Available		Page
		Max				
0.02 Hz-25.6 kHz	9 steps from 3 mV to 30 V RMS	256 VS 128 TF	3582A Spectrum Analyzer	Voltage Spectrum (VS) Phase Spectrum Transfer Function (TF)	Coherence Function Digital Averaging	697
0.0001 Hz - 100 kHz	78 steps from 3 mV to 22 V RMS	400	3561A Dynamic Signal Analyzer	Voltage Spectrum Phase Spectrum	1/3 V and 1/1 Octave Spectrum Time Domain Waveform	699
64 μ Hz to 100 kHz	78 steps from +3.972 mV to +31.547 V	801	3562A Dynamic Signal Analyzer	Power Spectrum Linear Spectrum Frequency Response Coherence Function Histogram Correlation	Impulse Response Waveform Recording Data Throughput Demodulation Vector Averaging Orbit Diagram	702

Distortion/Audio Analyzers

Fundamental Frequency Range	Minimum Distortion	Auto Set Level	Auto Nulling	True RMS	AM Detector	Filters	HP Model No.	Internal Source	HP-IB	Page
5 Hz to 600 kHz	0.03% (-70 dB)		•	•	•	•	334A			723
10 Hz-110 kHz	0.0018% (-95 dB)	•	•	•	•	•	334A Opt 002			723
20 Hz-100 kHz	0.01% (-80 dB)	•	•	•	Note 1	•	8903B*	•	•	719
20 Hz-100 kHz	0.01% (-80dB)	•	•	•	Note 1	•	8903E**		•	719

*The HP 8903B also performs Frequency Count, Signal/Noise, SINAD, watts, ac/dc voltage measurements.

NOTE 1: The HP 8901A Modulation Analyzer (page 716) provides complete demodulation of AM, FM, and ϕ M signals. **The HP 8903E also performs Frequency Count, SINAD, and ac/dc voltage measurements.

Wave Analyzers/Selective Level Meters

Frequency Range	Selective Bandpass	Dynamic Range		Freq. Readouts	Type of Inputs	Type of Outputs	Modes of Operation	HP Model Number	Page
		Absolute	Relative						
15 Hz to 50 kHz	3 Hz 10 Hz 30 Hz 100 Hz 300 Hz	0.1 μ V-300 V full scale	>85 dB	5-place digital	Banana Jacks	rec: 5 V full scale, with pen lift BFO, Local Oscillator, tuning loudspeaker, and headphone jack	AFC, normal, BFO	3581A/ 3581C	724 376
50 Hz to 32.5 MHz	20 Hz 400 Hz 3100 Hz	-130 to +20 dBm	>80 dB	LED, 0.1 Hz Resolution	50/75 Ω , BNC 600 Ω Banana Jacks	Tracking Generator Audio/Loud Speaker 1 MHz Ref.	Wideband Selective USB/LSB	3586C (3336C*)	653 417
50 Hz to 32.5 MHz	20 Hz 400 Hz 1740/2000 Hz Optional 3100 Hz WTD	-130 to +20 dBm	>70 dB	LED 0.1 Hz Resolution	75 Ω BNC/WECO 124 Ω WECO 135 Ω WECO 150 Ω Siemens 600 Ω WECO/ Siemens	Tracking Generator Audio/Loud Speaker 1 MHz Ref.	Wideband Selective SSB	3586A/B (3336A/B*) (3335A)	385 385 416

*Tracking Synthesizers.

Carrier Phase Noise Analysis

Frequency Range	HP Model Number	Maximum Sensitivity dBc/Hz (depends on offset & method)	Functions Available	Page
5 MHz-18 GHz	3048A Phase Noise Measurement System	-170 dBc/Hz (Requires external reference source of equivalent performance)	Fully documented Software with specified Phase Detector, Frequency Discriminator, AM and Two Port Measurements	707
5 MHz-18 GHz	11729C Carrier Noise Test Set	-126 dBc/Hz (Including HP 8662A Reference Source)	Phase Detector Mode Frequency Discriminator Mode AM Noise Option, Pulsed Carrier	709
5 MHz-18 GHz	11740A/S Microwave Phase Noise Measurement System	-126 dBc/Hz (Including HP 8662A Reference Source)	Fully documented Software supporting: Phase Detector Mode, Frequency Discriminator Mode, Two Port Measurements	711

650



SIGNAL ANALYZERS

20 Hz to 40 MHz Spectrum Analyzer

Model 3585A

- 80 dB dynamic range
- 3 Hz resolution bandwidth
- ± 0.4 dB amplitude accuracy
- 1001×1024 Digital Storage Display

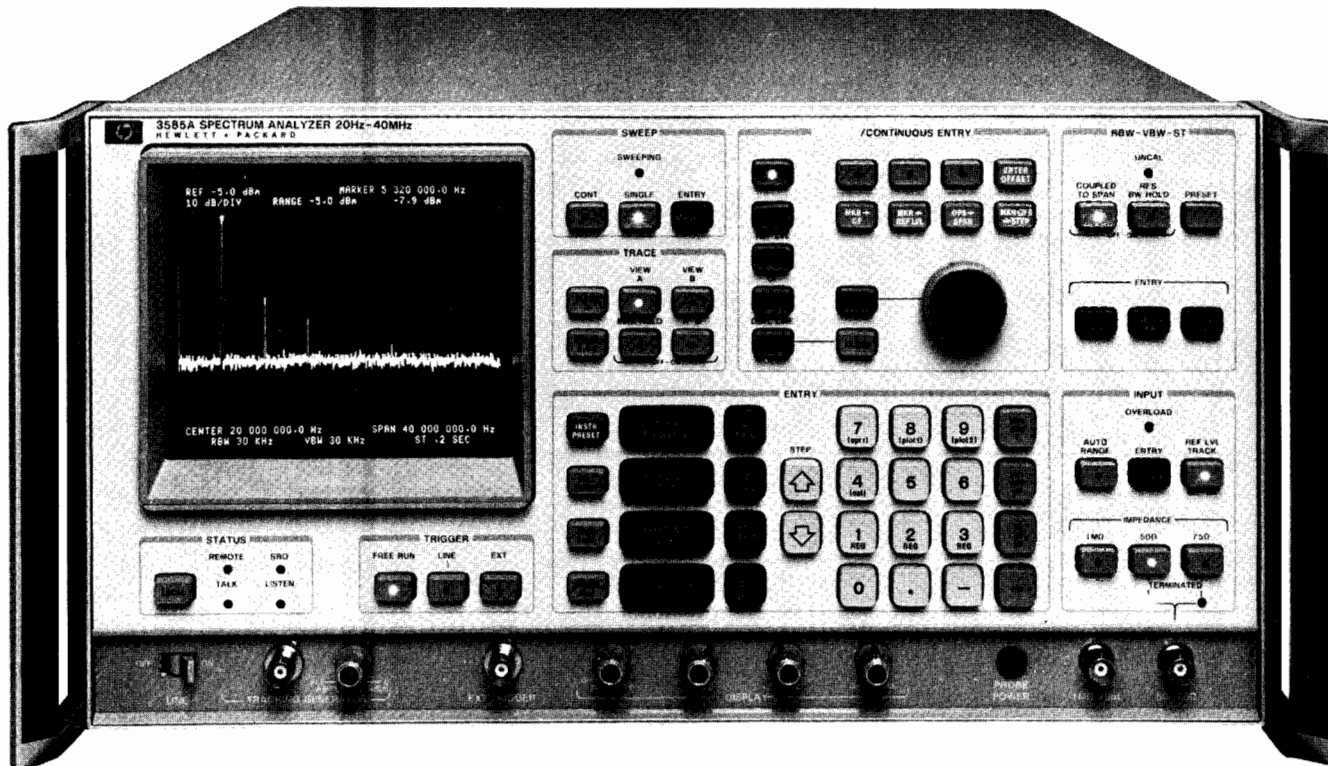

HP 3585A
(Shown with Opt. 907)



Uncompromising Baseband Signal Analysis

The HP 3585A Spectrum Analyzer delivers high performance where it counts - at baseband frequencies. With unmatched accuracy, resolution, and dynamic range, the 3585A is HP's best solution for signal analysis at the critical frequencies comprising voice, picture, or digital information.

In today's high speed, high density information processing systems, maintaining the integrity of data signals requires more measurement performance than ever before. The 3585A provides 80 dB of spurious-free dynamic range, a sharp 3 Hz resolution bandwidth, and fully synthesized tuning. Its 20 Hz - 40.1 MHz frequency range is more than adequate to cover most information bandwidths.

Measurement performance is critically important at baseband frequencies, because signal degradation occurring here is typically not recoverable elsewhere in the system. As a result, test requirements for baseband signals and circuits often demand a level of performance that only a high-performance, low-frequency signal analyzer such as the HP 3585A can provide.

Inside the HP 3585A

The HP 3585A is a swept heterodyne, triple conversion circuit with several major improvements. Frequency tuning is accomplished by a fully synthesized, phase continuous local oscillator, assuring excellent frequency stability for narrowband analysis across the entire frequency range. Internal microprocessors manage several functions including front panel operation, 1001-point digital vector storage display,

and periodic calibration of amplitude and frequency offsets. An accurate internal narrowband frequency counter can discriminate between the frequencies of closely spaced sinusoids with 0.1 Hz resolution. Finally, the HP 3585A contains fast-settling narrow resolution bandwidth filters that are among the best in the industry.

Fast, Flexible Frequency Sweeps

Well-designed filters and the phase-continuous, synthesized local oscillator team up to give the HP 3585A very fast sweep speeds. A 40-MHz sweep using the 30-kHz resolution bandwidth takes only 200 milliseconds, fast enough for high-resolution spectrum surveillance. A 1-MHz sweep using a 1-kHz bandwidth takes only 2 seconds.

Sweep width can be set to any arbitrary span between 0 and 40.1 MHz, or adjusted from 100 Hz to 40 MHz in a 1,2,5 step format. Resolution bandwidth and sweep time automatically track the selected frequency span to ensure optimum performance, or can be manually controlled.

1001 \times 1024 Digital Storage Display

The high performance of the HP 3585A is further complemented by a built-in 1001 \times 1024-point display. Measured analog signals are converted to 1001 digital data points prior to storage and display, allowing each point to be accessed individually using the display marker.

Front Panel Convenience

The HP 3585A's microprocessor-controlled front panel and CRT readout simplify complicated measurements. Frequency and amplitude settings may be entered directly using the keypad, incrementally stepped, or varied continuously using the rotary pulse generator.

An autoranging input attenuator eliminates the task of manually adjusting attenuation to achieve the correct mixer level. The input Range can also be manually adjusted from -25 dBm to $+30$ dBm in 5-dB steps.

With its primary marker set to a signal peak or other point of interest, the HP 3585A displays amplitude and frequency numerically on the CRT. A second marker numerically displays amplitude and frequency offsets between the two markers. Programmable Offset Step allows an operator to move easily between harmonically-related signals or evenly-spaced communication channels.

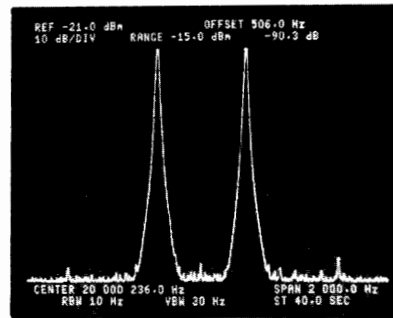

Offset Marker indicates a spurious sideband at -90.3 dBc, 506.0 Hz away from the carrier.

Versatile Noise and Distortion Analysis

Quiet and rock-stable, the HP 3585A excels as a noise and distortion analyzer. Its own uncompromising sensitivity and spectral purity are assured by its advanced front end design, synthesized local oscillator and built-in, oven-stabilized reference.

The HP 3585A can measure spurious, harmonic, and intermodulation products at levels typically 100 dB or more below the fundamental. Using its 3 Hz resolution bandwidth, power line sidebands below -95 dBc can typically be measured at frequency offsets of only 50 or 60 Hz. Total harmonic distortion and intermodulation distortion measurements can be automated using HP-IB programming.

A built-in noise level key displays RMS noise density normalized to a 1 Hz bandwidth at the marker position, allowing easy comparison of measurements made with different resolution bandwidths.

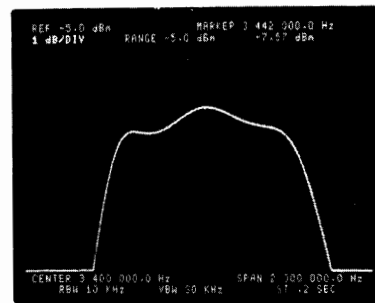

1 dB/div. frequency response for a bandpass amplifier centered at 3.442 MHz. Because this 2 MHz sweep takes only 0.2 seconds, the operator can observe circuit adjustments almost instantly.

Frequency Response Measurements

With its built-in tracking generator, digital trace storage, and narrowband frequency counter, the HP 3585A Spectrum Analyzer can accurately measure the frequency response of crystals, filters, and amplifiers. Small amplitude variations are resolved to 0.01 dB using the marker readout and the 1 dB/division expanded amplitude scale. Unwanted effects of test fixtures and cables are removed simply by storing the frequency response of the test setup in Trace B and subtracting it from measured data in Trace A.

With its wide dynamic range capability and high-resolution display, the HP 3585A is ideal for measuring and viewing the analog portions of 14 or 16-bit digital audio systems. It can also measure the frequency response of digital modem filters with better than ± 0.4 dB accuracy.

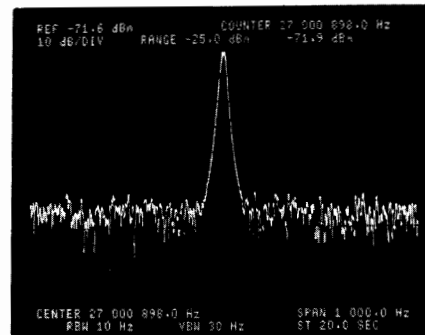

Built-in counter allows a 27 MHz carrier to be displayed with 0.1 Hz resolution and 1×10^{-7} / mo. stability

HF Radio Applications

In addition to its many uses as a baseband signal analyzer, the HP 3585A finds a home in HF radio applications as well. Synthesized tuning and high-resolution display make wideband surveillance of the entire 30-MHz HF radio spectrum easy. Fast-settling resolution bandwidth filters speed the analysis of modulated HF carriers.

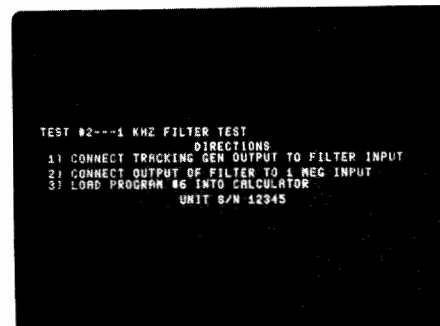

HP 3585A displays detailed instructions for an automatic filter test downloaded from an external computer.



SIGNAL ANALYZERS

20 Hz to 40 MHz Spectrum Analyzer (cont.)

Specifications

Frequency

Measurement range: 20 Hz to 40.1 MHz

Displayed Frequency Span

Range: 0 Hz to 40.1 MHz variable with 0.1 Hz resolution or 10 Hz to 40 MHz in 1, 2, 5 steps

Accuracy: $-0\% + 0.2\%$ of frequency span setting

Displayed Center, Start/Stop, and Manual Frequency

Range: 0 Hz to 40.1 MHz with 0.1 Hz resolution

Accuracy: 1×10^{-7} /month of frequency

Marker

Readout accuracy: $\pm 0.2\%$ of frequency span \pm resolution bandwidth

Counter accuracy: ± 0.3 Hz $\pm 1 \times 10^{-7}$ /month of counted frequency for a signal 20 dB greater than other signals and noise in the resolution bandwidth setting

Resolution Bandwidths

Range: 3 dB bandwidths of 3 Hz to 30 kHz in a 1, 3, 10 sequence

Accuracy: $\pm 20\%$ at the 3 dB points

Selectivity: 60 dB/3 dB <11:1

Amplitude

Measurement range:

1 M Ω input: -31 nVrms to $+7.08$ Vrms

50/75 Ω input: -137 dBm to $+30$ dBm

All receiver inputs can be overdriven by up to 12.3 dB above the range setting, with some degradation in distortion performance.

Displayed Range

Scale: 10 division CRT vertical axis with Reference Level at the top graticule line

Calibration: 10, 5, 2 and 1 dB/division from the Reference Level

Input range: -25 dBm to $+30$ dBm in 5 dB steps

Reference Level Range (relative to input range): -100 dB to $+10$ dB

Reference level accuracy (using 1 or 2 dB/div., at midscreen with sweep rate reduced by 4 or at the manual frequency)

50/75 Ω Input

+10 dB -50 dB -70 dB -90 dB

± 0.4 dB	± 0.7 dB	± 1.5 dB
--------------	--------------	--------------

1 M Ω Input - add to above

20 Hz 10 MHz 40.1 MHz

± 0.7 dB	± 1.5 dB
--------------	--------------

Amplitude Linearity (referred to reference level)

0 dB -20 dB -50 dB -80 dB -95 dB

± 0.3 dB	± 0.6 dB	± 1.0 dB	± 2.0 dB
--------------	--------------	--------------	--------------

Frequency Response (referred to center of span)

50/75 Ω input: ± 0.5 dB

1 M Ω Input

20 Hz 10 MHz 40.1 MHz

± 0.7 dB	± 1.5 dB
--------------	--------------

Marker Amplitude Accuracy

Midscreen at the reference level: use Reference Level accuracy from $+30$ dBm to -115 dBm, add Amplitude Linearity below -115 dBm.

Anywhere on screen: add Reference Level Accuracy, Amplitude Linearity and Frequency Response.

Dynamic Range

Spurious Responses (image, out of band, and harmonic distortion)

50/75 Ω input: < -80 dB referred to a single signal equal to or less than Input Range

1 M Ω input: < -80 dB except second harmonic distortion < -70 dB

Intermodulation Distortion

50/75 Ω input: < -80 dB referred to the larger of two signals each ≥ 6 dB below Input Range except 2nd order IM from 10 MHz to 40 MHz < -70 dB

1 M Ω input: < -70 dB

Residual responses (no signal at input): < -120 dBm using -25 dBm range

Residual phase noise (typical at 40 MHz, -10 dBm input):

5 KHz offset: -112 dBc/Hz

100 KHz offset: -120 dBc/Hz

Average Noise Level

50/75 Ω Input

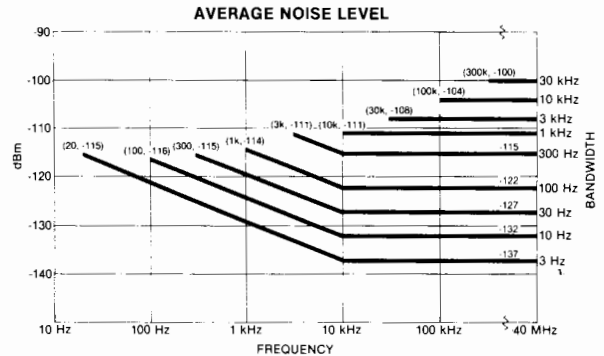

1 M Ω input: Below 500 kHz add 12 dB to above

Sweep

Modes: continuous, single or manual

Trigger: free Run, Line, or External

Time: 0.2 s full sweep to 200 s/Hz of Frequency Span (swept time excluding auto calibration cycles)

Input

Signal Inputs

50/75 Ω : > 26 dB return loss, BNC connector

1 M Ω : $\pm 3\%$ shunted by < 30 pF, BNC connector

Maximum Input Level

50/75 Ω : 13 V peak ac plus dc relay protected against overloads to 42 V peak.

1 M Ω input: 42 V peak ac plus dc (derate by factor of two for each octave above 5 MHz).

External trigger input: negative going TTL level or contact closure required to initiate sweep.

External reference input: 10 MHz (or subharmonic to 1 MHz), 0 dBm minimum level

Output

Tracking Generator

Level: 0 dBm to -11 dBm with a single turn knob

Frequency accuracy: ± 1 Hz relative to analyzer tuning

Frequency response: ± 0.7 dB

Impedance: 50 Ω ; > 14 dB return loss

Probe power: $+15$ Vdc, -12.6 Vdc; 150 mA max.

IF: 350 kHz, -11 dBV to -15 dBV at the reference level

Video: 10 V at the reference level

Frequency reference: 10.000 MHz $\pm 1 \times 10^{-7}$ /month, $+10$ dBm into 50 Ω

HP-IB Interface Functions

Sh1, An1, T6, L4, SR1, RL1, TP0, DC1, DT1, C0

General

Environmental

Temperature: operating 0°C to 55°C

Humidity: $< 95\%$ RH except 300 Hz BW $< 40\%$ RH

Warm-up time: 20 minutes at ambient temperature

Power requirements: 115 V ($+11\%$ -25%), 48-440 Hz

230V ($+11\%$ -18%), 48-66 Hz

180 watts 3A max

Weight: 39.9 kg (88 lb)

Size: 229 mm (9") H \times 426 mm (16.75") W \times 635 mm (25") D

Ordering Information

Opt. 907: Front Handle Kit

Opt. 908: Rack Flange Kit

Opt. 909: Combined Opt. 907 and 908

Opt. 910: Extra Manual

add \$75

add \$40

add \$105

add \$200

HP 3585A Signal Analyzer

\$23,700

SIGNAL ANALYZERS

50 Hz to 32.5 MHz Selective Level Meter

Model 3586C

653

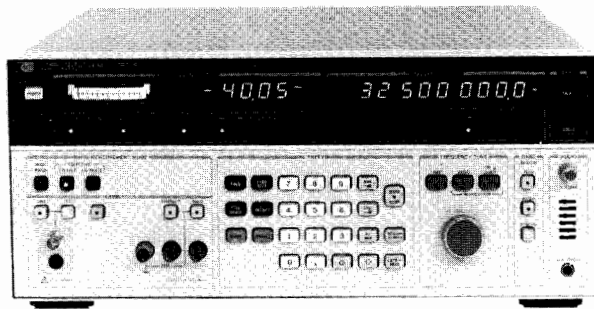

HP 3586C



Description

The HP 3586C selective Level Meter is designed for general purpose wave analysis applications in the design, manufacture, and maintenance of electronic systems.

Microprocessor control and HP-developed fractional-N synthesis provides precise frequency setting and time saving ease-of-use features, and the HP 3586C is fully HP-IB programmable.

The HP 3586C Selective Level Meter covers the frequency range from 50 Hz to 32.5 MHz, allowing measurement of audio, sonar, and other low frequency systems as well as high frequency communications and subsystems. Input impedances of 50, 75, or 600 Ω with 10 k Ω bridging adds measurement flexibility for a wide variety of applications.

Wideband power measurements can be made up to 32.5 MHz and down to -45 dBm. Measure selectively in LO distortion or LO noise modes or use USB or LSB for single sideband demodulation of a carrier.

Measurement Precision

Signal levels are measured with up to ± 0.2 dB accuracy down to -80 dBm with .01 dB resolution and bandwidth choices of 20, 400, or 3100 Hz. Automatic level calibration eliminates the need for manual calibration operations prior to critical level measurements. Frequency can be set precisely with 0.1 Hz resolution and $\pm 1 \times 10^{-5}$ stability ($\pm 2 \times 10^{-7}$ optional). The built-in frequency counter allows you to measure the frequency of a signal greater than -100 dBm within the filter bandwidth chosen and then tune the center of the filter passband precisely to that signal with one keystroke.

Selective Measurements

Make measurements on signals as close as 80 Hz spacing with 50 dB rejection using the 20 Hz filter. Use the extremely selective 3100 Hz filter for telecommunications channel level or noise measurements with 60 dB carrier rejection and 75 dB adjacent channel rejection, or demodulate the upper or lower sideband signal for further processing and listen to it with the speaker output.

Digital or Analog Frequency Control

Frequencies may be entered directly on the keyboard with 0.1 Hz resolution and then changed by entering any step size and stepping up or down in frequency, or use the analog frequency tune control. The analog frequency tune control will change frequency in automatically chosen steps proportional to the bandwidth chosen, or in the step size entered.

Tracking Synthesizer

The HP 3586C will operate in the frequency tracking mode with either the HP 3336C Synthesizer (see page 417) for measurements up to 20.9 MHz, or the HP 3335A Synthesizer (see page 416) for full frequency coverage up to 32.5 MHz. The tracking synthesizer will automatically tune to the frequency programmed on the HP 3586C in the tracking mode when their HP-IB interfaces are connected together with a bus cable.

Use the tracking mode to save time in amplitude-only network analysis or for loop-around measurements in telecommunications systems.

Frequency Response Measurements

The HP 3586C includes a rear panel tracking output of approximately 0 dBm amplitude and $\pm .5$ dB flatness at the same frequency as the passband center frequency. The tracking output has the same accuracy, stability and resolution as the HP 3586C center frequency specifications. This means the tracking output can be used for frequency response testing of high-Q filters and other selective networks. External attenuators can be used to adjust the input and output levels of the device under test to acceptable ranges.

For applications requiring improved amplitude accuracy and flatness, full amplitude range control without external attenuators, or better signal purity, use the HP 3336C or HP 3335A tracking synthesizer in place of the HP 3586C tracking output. By automatically tracking the frequency of the HP 3586C, the tracking synthesizers improve the accuracy and flexibility of frequency response measurements without increasing the measurement time.

Distortion Measurements

The front panel convenience features of the HP 3586C allow fast, accurate measurement of individual harmonic levels. To measure harmonic levels relative to the fundamental, first measure the fundamental signal level, and enter that level as an offset. Then, enter a frequency step size equal to the fundamental frequency. Now you can quickly step to the harmonic frequencies and measure the harmonic distortion directly without time-consuming calculations. When the exact fundamental frequency is unknown, the built-in counter can be used to measure the fundamental frequency, thereby ensuring precise tuning and accurate measurement.

Intermodulation distortion can also be measured quickly by storing the intermod frequencies and front panel settings in the non-volatile storage registers of the HP 3586C.

Verifying the total harmonic distortion specifications of sources and amplifiers is a laborious measurement unless a special purpose distortion analyzer is used. With a simple routine in a controller such as the HP 85B Personal Computer, the HP 3586C can be used to quickly measure total harmonic distortion as well as individual harmonic levels.

TOTAL HARMONIC DISTORTION TEST			
FUNDAMENTAL FREQ		ABSOLUTE AMP	
10.895.1 Hz		1.18 dBm	
HARMONIC FREQ		RELATIVE AMP	
2	21.610.2 Hz	-50.65 dB	
3	32.415.3 Hz	-50.36 dB	
4	43.220.4 Hz	-72.35 dB	
5	54.025.5 Hz	-50.55 dB	
6	64.830.6 Hz	-67.73 dB	
THD = -46.89 dB OR @ 45 %			

The HP 3586C and an HP computer were used to characterize a function generator for total harmonic distortion as well as harmonic level.

SIGNAL ANALYZERS

50 Hz to 32.5 MHz Selective Level Meter

Model 3586C (con't)

HP 3586C Specifications

Frequency

Frequency range: 50/75 Ω unbalanced input, 50 Hz to 32.5 MHz; 600 Ω Balanced Input, 50 Hz to 108 kHz

Frequency resolution: 0.1 Hz

Center frequency accuracy: $\pm 1 \times 10^{-5}$ /year, ($\pm 2 \times 10^{-7}$ /year with option 004).

Counter accuracy: ± 1.0 Hz in addition to center frequency accuracy for signals within the 60 dB bandwidth of the IF filter chosen or greater than -100 dBm (largest signal is measured).

Frequency display: 9 digit LED

Selectivity

3 dB bandwidth,* $\pm 10\%$: 20 Hz, 400 Hz, 3100 Hz

*Noise bandwidth is the same as the 3 dB bandwidth

60 dB bandwidth: 3100 Hz BW, ± 1850 Hz; 400 Hz BW, ± 1100 Hz; 20 Hz BW, ± 90 Hz

Adjacent channel rejection: 75 dB minimum at ± 2850 Hz, 3100 Hz BW

Passband flatness ± 0.3 dB

Passband Flatness

Bandwidth	Flatness Range	Flatness
3100 Hz	± 1000 Hz	
400 Hz	± 50 Hz	± 0.3
20 Hz	± 3 Hz	dB

Amplitude

Measurement range: +20 to -120 dBm

Amplitude resolution: .01 dB

Level accuracy: 10 dB auto range, low distortion mode, after calibration, signal at ± 1 Hz from center frequency.

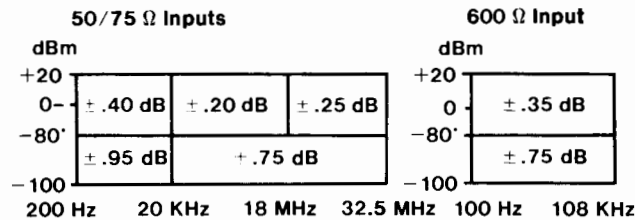

*20 Hz & 400 Hz BW below -90 dBm

Level accuracy: 100 dB range (after calibration), add correction to 10 dB auto-range accuracy for dB below full scale. (Not required when in 10 dB auto-range.)

dB Below Full Scale	Accuracy Correction
0 to -20 dB	$\pm .25$ dB
-20 to -40 dB	$\pm .50$ dB
-40 to -80 dB	± 2.0 dB

Wideband power accuracy: after calibration, 100 dB range, average on, -45 to +20 dBm.

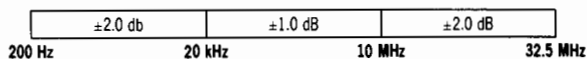

Dynamic Range

Spurious Responses

-110 dBm maximum or the following, whichever is greater:

Image rejection (100-132 MHz): -80 dBc

IF rejection: 15625 Hz, -80 dBc; 50 MHz, -60 dBc

Spurious signals: >1600 Hz offset, >-80 dBc; 300 Hz to 1600 Hz, >-75 dBc

Residual spurious: -110 dBm maximum; <350 Hz, -95 dBm

Distortion

Harmonic distortion: -75 dB below full scale, low distortion mode, above 4 kHz.

Intermodulation distortion: two-tone second and third order, separation 10 kHz to 1 MHz, -78 dB below full scale. Either tone ≥ 10 MHz, -70 dB.

Noise Floor (full scale setting -35 to -120 dBm)

Frequency	Bandwidth	Noise Level
100 kHz to 32.5 MHz	3100	-114 dBm
	20 Hz, 400 Hz	-120 dBm
2 kHz to 100 kHz	All	-105 dBm

The noise floor for full scale settings of -30 to +25 dBm will be 75 dB below full scale for >100 kHz, or 55 dB below full scale for <100 kHz.

Signal Inputs

Impedance	Frequency	Mating Connector
50/75 ohms unbalanced 600 ohms balanced	50 Hz to 32.5 MHz 50 Hz to 108 kHz	BNC Dual Banana Plug 0.75 inch Spacing

Return loss: 50/75 Ω , 30 dB; 600 Ω , 25 dB

Balance: 600 Ω ; 40 dB

Demodulated Audio Output

Output level: 0 dBm into a 600 Ω load

Output connector: 1/4" jack, mates with WECO 347.

Auxiliary Signal Inputs/Outputs

Tracking output: 0 dBm rear panel tracking output

Ext. reference input: 1 MHz to 10 MHz or sub-harmonic input.

Reference output: 10 MHz at 8 dBm output (also 10 MHz oven oscillator on instruments with option 004).

Probe power: front panel dc output for HP active high impedance accessory probes, (+15, -12 Vdc)

HP-IB Interface Functions: SH1, AH1, T6, L4, SR1, RL1, PP1, DC1, DT1, C1, C3, C28

Additional outputs: audio, phase jitter and meter output.

Options

Option 004: High stability frequency reference: 10 MHz oven stabilized reference oscillator improves frequency stability to $\pm 2 \times 10^{-7}$ /year.

General

Operating Environment

Temperature: 0° to 55°C

Relative humidity: 95%, 0° to 40°C

Altitude: $\leq 15,000$ ft., ≤ 4600 metres

Storage environment temperature: -40°C to 75°C

Storage altitude: $\leq 50,000$ ft., $\leq 15,240$ metres

Power: 100/120/220/240 V, +5%, -10%, 48 to 66 Hz, 150 VA

Weight: 23 kg. (50 lb) net; 30 kg. (65 lb) shipping

Size: 177 mm H x 425.5 mm W x 475.5 mm D (7" x 16.75" x 16.75")

HP 3586C Selective Level Meter*

Opt 004: High Stability Frequency Reference

Opt 907: Front Panel Handles

Opt 908: Rack Flange Kit

Opt 909: Rack Flange & Handle Combination Kit

\$10,200

add \$750

add \$65

add \$35

add \$90

Accessories

HP 1124A: High Impedance Probe

\$325

*HP-IB cables not supplied, see page 133

SIGNAL ANALYZERS

HP 71000 Modular Spectrum Analyzers

655

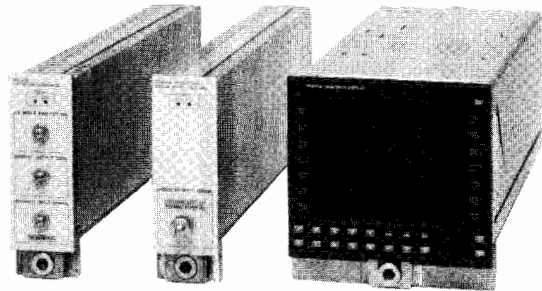

HP 71000 Modular Spectrum Analyzers

The HP 70000 Measurement System offers powerful new modular test instruments that make fast, precise measurements. Select just those components needed to match your measurement requirements, and as your needs change, expand or upgrade your system by adding new or different modules.

A rugged, reliable mainframe and two high-performance display/control units form the core of the HP 70000 System. These system building blocks combine with a variety of spectrum analyzer modules to create the HP 71000 Modular Spectrum Analyzers.

Choose Small or Large, Standard or Custom Systems

Put together the spectrum analyzer that best meets your needs by choosing from standard or custom systems, shipped from the factory ready for use.

Three standard HP 71000 Spectrum Analyzer systems cover RF, microwave, and millimetre frequency ranges. Each standard system consists of the HP 70001A Mainframe, 70205A Graphics Display, 70900A Local Oscillator, 70902A IF Section, and an RF section covering the frequency range of the analyzer. Options allow you to select the large, stand-alone 70206A System Graphics Display, the 70903A IF Section, and extended warranty coverage.

To assemble a custom system, use the HP 71000S System Reference Number which ensures the instrument will be sent ready for use. In addition, order HP Series 200 and 300 computers and peripherals using the HP 71000S System Reference number. Modules, displays, and mainframes can also be ordered individually.

HP 71100A RF Spectrum Analyzer: 100 Hz-2.9 GHz

The HP 71100A RF Spectrum Analyzer combines the power of the HP 70000 System with the superb performance of the RF Spectrum Analyzer modules to provide outstanding RF measurement capability. Its wide frequency range of 100 Hz to 2.9 GHz allows signal measurements from audio to microwave. The HP 70300A Tracking Generator, when combined with either the HP 71100A or 71200A Spectrum Analyzers, has a 125 dB dynamic range for making stimulus-response measurements easily.

HP 71200A Microwave Spectrum Analyzer:

50 kHz-22/26.5 GHz

The HP 71200A Microwave Spectrum Analyzer gives you low-cost spectrum analysis from 50 kHz to 22 GHz or from 50 kHz to 26.5 GHz. This unpreselected spectrum analyzer has automatic signal identification routines that directly read out the frequency of a displayed response at the touch of a single key. It provides excellent amplitude accuracy and sensitivity, and makes most signal measurements easily.

HP 71300A Millimetre Spectrum Analyzer: 2.7-325 GHz

The HP 71300A Millimetre Spectrum Analyzer offers a variety of new millimetre capabilities at an attractive price. Used with the HP 11970 series of mixers from 18 to 110 GHz, the HP 71300A provides excellent sensitivity and amplitude accuracy and permits quick measurements through push-button signal identification and elimination of bias adjustments. For improved amplitude accuracy the analyzer can remove mixer frequency response variations without operator intervention. Flexibility in configuration is easily accomplished; you can, for example, add other HP 70907A interface modules to sequentially measure multiple frequency bands. And the HP 71300A can be used with existing mixers over a wide 2.7 to 325 GHz frequency range. (Also see page 548.)

Custom Spectrum Analyzer Systems

For work requiring specialized equipment, small or large custom spectrum analyzer systems can be assembled.

A small spectrum analyzer might consist of a standard spectrum analyzer system without a display. In certain Automatic Test Systems (ATS), the display can be omitted: a computer can control the HP 70000 Measurement System, read and interpret the data, and display the results.

A large spectrum analyzer system might consist of two or more spectrum analyzers operating with the same display. One of the analyzers could be a microwave spectrum analyzer with four External Mixer Interface Modules installed. This combination would allow coverage of 50 kHz to 110 GHz with a single spectrum analyzer. The second analyzer might be an RF spectrum analyzer with a tracking generator attached to make reflection and transmission stimulus-response measurements. The HP 70000 Measurement System can expand to fill many test instrument needs by the addition of new or different modules.



SIGNAL ANALYZERS

HP 71000 Modular Spectrum Analyzers (con't)



The modular HP 70000 System allows you to select just the right capability for every application.



The modular system can be expanded to meet your future needs.

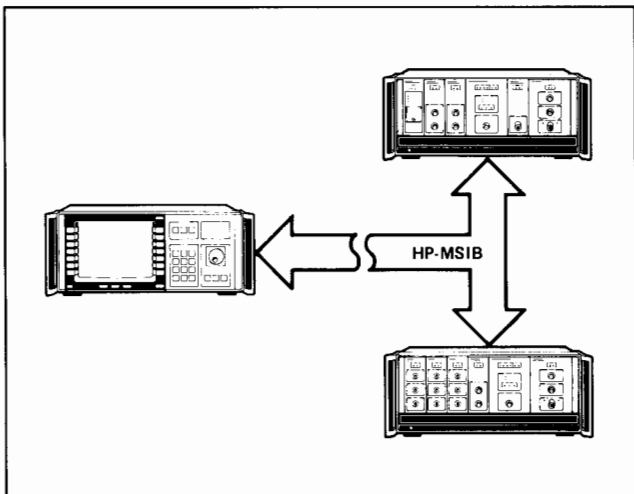

A single display can control multiple instruments separated up to 2 kilometres.

Adapts to Meet Your Needs

Just the Right Capability

The new HP 70000 Modular Measurement System lets you choose the capability you need, without the extra expense of unnecessary features. Select the frequency range you require: RF (100 Hz - 2.9 GHz), microwave (50 kHz - 22 or 26.5 GHz), or millimetre wave (18 - 110 GHz and beyond). Get the frequency resolution you want by choosing from two separate IF sections with resolution bandwidths of 10 Hz to 300 kHz or 100 kHz to 3 MHz.

If your measurements call for more than just a standard spectrum analyzer, include other modules to provide the right capability. Add the HP 70310A Precision Frequency Reference module to achieve the best absolute frequency accuracy Hewlett-Packard offers in an RF or microwave spectrum analyzer. For automatic stimulus-response capability to 2.9 GHz, include the HP 70300A Tracking Generator to your RF or microwave system. Or, add complete millimetre wave coverage to any system by using one or more HP 70907A External Mixer Interface modules.

Expandable

As your needs change, expand your HP 70000 System by adding modules, rather than replacing your entire instrument. For example, purchase a standard RF analyzer now, and you have the option of increasing capability for microwave or millimetre wave coverage, reflection and transmission measurements, or high-precision absolute frequency accuracy. For an independent synthesized signal source, add a second local oscillator and tracking generator.

The central components of the system, the HP 70001A Mainframe and HP 70205A and 70206A Displays, are designed to accommodate a broad range of future modules. As the HP 70000 Measurement System product line continues to grow, it will meet your requirements for years to come. And, because changes are incremental, the HP 70000 System eliminates the hidden costs of replacing an instrument: installation time, operating and service training time, and reprogramming.

Centralized System Control

One HP 70000 Measurement System can contain many spectrum analyzers. A single HP 70206A or 70205A Display can control any of these analyzers using a simple set of softkey menus. This central display can present the outputs from up to four instruments at once. For example, a single spectrum analyzer can sequentially switch between four different inputs, and the four outputs can be displayed simultaneously. Or, for faster operation, several spectrum analyzers can sweep independently and show their results on a single display screen.

Like individual instruments, the displays and spectrum analyzers can be physically separated by up to 2 kilometres while linked by the HP 70000 System's own high-speed data bus. The display can be placed at a convenient location for the operator, and the analyzer can be placed at the measurement site. The display controls each instrument over HP-MSIB (Modular System Interface Bus), while the individual instruments execute their own measurement procedures without a computer.

Powerful, Yet Easy to Use

Easy, Even for Occasional Users

Three keys on the display (USER, MENU, and DISPLAY) let you control all instrument functions. These "hardkeys" access "softkey" menus on the display screen. Softkeys give you complete control of the powerful commands and functions incorporated into the system.

Although the menu-driven softkey structure is flexible and powerful, manual measurements are still made easily, even by first-time operators. Most spectrum analyzer measurements can be made using basic controls like center frequency, span, and the marker functions.

The most frequently used softkeys are immediately available by pressing the USER hardkey. The USER key calls up 14 commonly used keys such as CENTER FREQ, SPAN, MARKER DELTA, HIGHEST PEAK, and NEXT PEAK. For example, the harmonic distortion measurement at right was made quickly and accurately using only those softkeys.

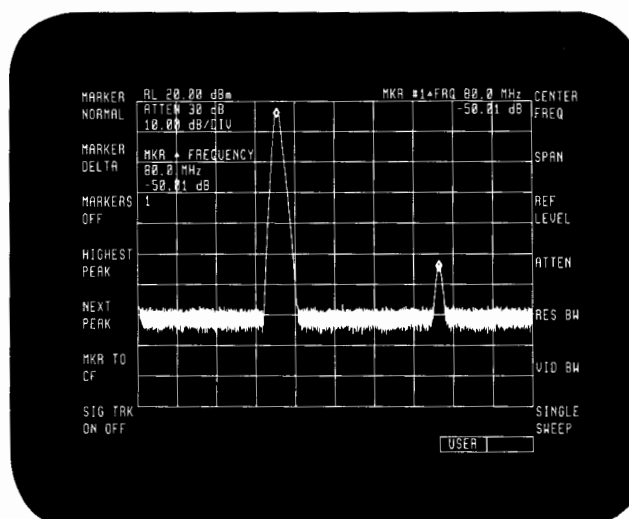

The fourteen most frequently used softkeys appear when the USER key is pressed.

Customized Softkeys

You can replace the softkeys found under the USER key with softkeys of your own choosing to create a customized keyboard. Over 180 softkeys under the MENU key are available for you to choose from.

By customizing the USER softkeys, any of the HP 71000 Spectrum Analyzer functions can be made available at the touch of a single key. For instance, if your measurements call for capturing and viewing single-shot spectra, you can make the SINGLE SWEEP softkey immediately available under USER. This is shown at right for a commercial broadcast FM band monitoring application. Note that CENTER FREQ and SPAN have been replaced by START FREQ and STOP FREQ.

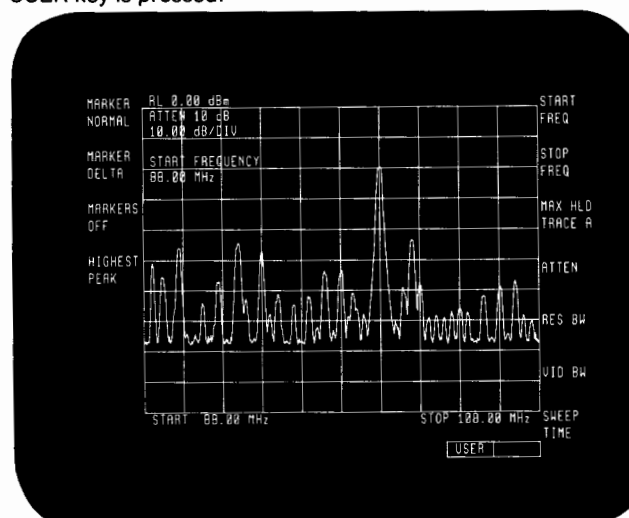

Replace softkeys under USER with keys such as START FREQ and STOP FREQ to create a customized keyboard.

One-Button Solutions

For complex measurements that are made routinely, one-button solutions are available to everybody, even first-time operators, by using the downloadable programming capability of the HP 71000 Series. An automatic procedure is created on a computer, downloaded into the non-volatile memory of the analyzer, and activated either manually or remotely.

All functions of the spectrum analyzer can be used in a downloadable program. You can create unique softkey labels for your programs and place these softkeys on the screen under the USER key.

Downloadable programs simplify manually performed tasks in many areas, ranging from field measurements to high-speed ATE systems. Programs can be used to compare measurement results against pre-set test limits, branch to other operations, prompt the user for input, and act as an HP-IB controller. For example, the screen at right is the result of a radar misfire measurement procedure called MISFIRE RATE.

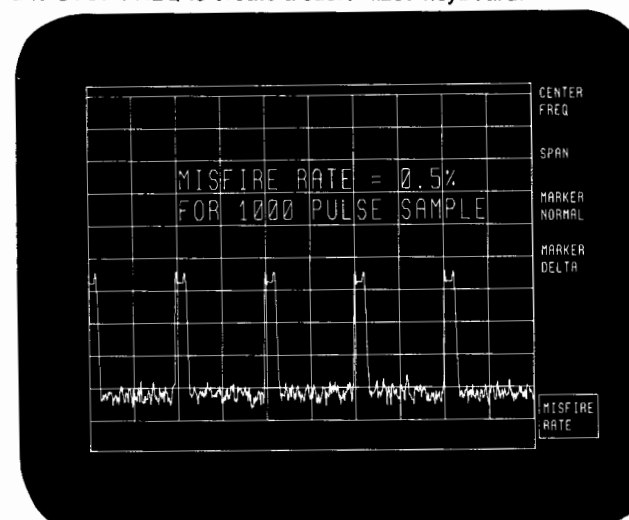

One-button solutions, such as MISFIRE RATE, can be created with downloadable programs to simplify manually performed tasks.



SIGNAL ANALYZERS

HP 71000 Modular Spectrum Analyzers (con't)

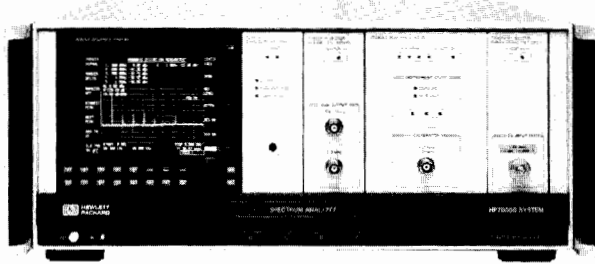

HP 71000 Standard Spectrum Analyzer Systems

Three standard factory-configured systems are offered for RF, microwave, and millimetre frequency ranges. Each system is assembled at the factory (with rear panel cabling and blank panels) and shipped with modules loaded into the mainframe ready to use. All standard systems use 7/8 of the mainframe capacity. A one-year, return-to-HP warranty is included with each standard or custom system.

HP 71100A RF Spectrum Analyzer

(100 Hz - 2.9 GHz)

HP 70001A	Mainframe
HP 70205A	Graphics Display
HP 70900A	Local Oscillator
HP 70902A	IF Section (Res BW 10 Hz - 300 kHz)
HP 70904A	RF Section (100 Hz - 2.9 GHz)

Price
\$33,000

HP 71200A Microwave Spectrum Analyzer

(50 kHz - 22 GHz)

HP 70001A	Mainframe
HP 70205A	Graphics Display
HP 70900A	Local Oscillator
HP 70902A	IF Section (Res BW 10 Hz - 300 kHz)
HP 70905A	RF Section (50 kHz - 22 GHz)

\$36,000

HP 71300A Millimetre Spectrum Analyzer

HP 70001A	Mainframe
HP 70205A	Graphics Display
HP 70900A	Local Oscillator
HP 70902A	IF Section (Res BW 10 Hz - 300 kHz)
HP 70907A	External Mixer Interface

\$34,000

System Options

(Except as noted, the options below apply to all standard systems)

Option 001 Delete HP 70905A RF Section, add HP 70906A RF Section (50 kHz - 26.5 GHz) (HP 71200A only) (7/8 of mainframe used)	\$1,600
Option 002 Delete HP 70205A Graphics Display, add HP 70206A System Graphics Display (50/60 Hz Operation) (400 Hz operation requires Option 401) (4/8 of mainframe used)	\$1,800
Option 004 Add HP 70903A IF Section (Res BW 100 kHz - 3 MHz) (8/8 of mainframe used)	\$2,600
Option 005 Delete HP 70902A IF Section, add HP 70903A IF Section (Res BW 100 kHz - 3 MHz) (7/8 of mainframe used)	-\$700
Option 010 Rack Mount Slide Kit for mainframe	\$450
Option 011 Rack Mount Slide Kit for HP 70206A Display	\$200
Option 400 Add 400 Hz Power Line Frequency Operation to the HP 70001A Mainframe	\$750
Option 401 Add 400 Hz Power Line Frequency Operation to the HP 70001A Mainframe and HP 70206A System Graphics Display	\$1,850
Option 908 Rack Flange Kit for mainframe or HP 70206A Display without handles	\$35
Option 913 Rack Flange Kit for mainframe or HP 70206A Display with handles	\$40
Option 910 Duplicate Manual Set	\$250

System Support Options

The Option W30 (where available) provides an additional two years "return-to-HP" service support, commencing at the end of the standard one-year warranty. (For information on availability and terms of on-site service, contact your HP sales representative.)

71100A Option W30	\$2,150
71200A Option W30	\$2,325
71300A Option W30	\$2,150

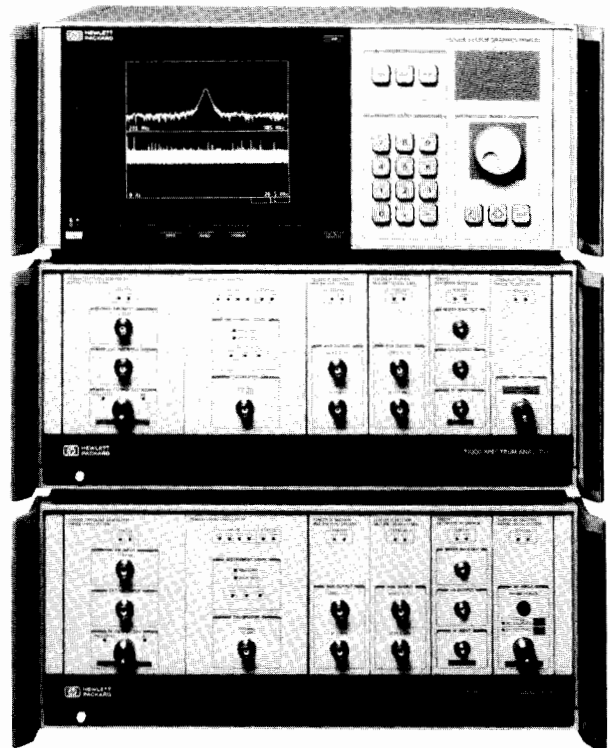

HP 71000 Custom Spectrum Analyzer Systems

Custom systems can be made up of a variety of the HP 70000 components listed on the facing page. You can start with a standard system including desired options and add modules and accessories or select all parts individually.

The HP 71000S System Reference Program is used to create custom systems. This model number ensures factory configuration of the spectrum analyzer and coordinated shipment of computers and peripherals. The HP 71000S systems are configured by the factory, supplied with necessary cabling and blank panels, and are loaded into mainframes at the factory. A one-year return-to-HP warranty is included with each system. HP 71000S Systems are shipped ready to use.

To order a custom system, follow the steps below:

1. Choose the HP 71000S System Reference.
2. Select one Standard Spectrum Analyzer System (optional).
3. Choose a display (optional).
4. Select those modules needed to complete your system. (One 70900A LO, one IF module, and one RF or 70907 module is required for each spectrum analyzer.)
5. Select as many mainframes as required to accommodate the modules selected. One mainframe is included with a standard system. Each mainframe accommodates eight 1/8-width modules.
6. Select desired Harmonic Mixers (optional).
7. Select desired support options.
8. Contact your local HP sales office.

(Ordering information is detailed in the HP 71000 Modular Spectrum Analyzer Ordering Guide, available from your local sales office.)

HP 71000 Automatic Spectrum Analyzer Systems

Automatic spectrum analyzer systems can also be ordered by using the HP 71000S System Reference Program, selecting a standard or custom spectrum analyzer system from the HP 71000S equipment list, and adding desired computers and peripherals.

To meet your automatic system needs, Hewlett-Packard offers a wide range of personal technical computers and peripherals. HP 9000 Series 200 and 300 Personal Technical Computers such as the 9816S, 9836S, and 98580A are recommended for the HP 71000 Modular Spectrum Analyzers. Peripherals such as disc drives (9121D and 82901M), printers (2225A, 2673A, and 9876A), and plotters (7475A and ColorPro) are also recommended.

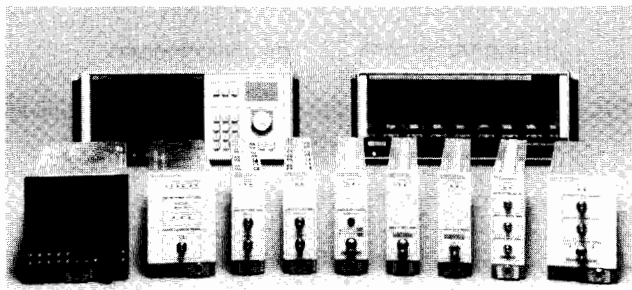

Components Of The HP 70000 Measurement System

The HP 71000 Modular Spectrum Analyzer family includes the components listed below. These components can be ordered individually to create or supplement a spectrum analyzer. (See the preceding page for standard HP 71000 Spectrum Analyzer Systems.)

HP 70001A System Mainframe \$4,100

The HP 70001A System Mainframe provides the structural environment for plug-in instrument modules along with cooling, power, and digital communication interface buses. It is compatible with 1/8-, 1/4-, 3/8- and 1/2-width modules and has a maximum capacity of eight 1/8 modules. Sliding a module in place automatically connects the module to power and digital interface and supplies it with forced-air cooling. Standard EIA rack compatibility is provided and benchtop use is facilitated with integral bails and handles.

The Hewlett-Packard Interface Bus (HP-IB) provides communication between controllers and other HP-IB instruments and the Modular System Interface Bus (HP-MSIB) supports high speed digital communication between instrument modules.

Good EMC performance and rugged structural design make the mainframe suitable for sensitive measurements in tough industrial environments.

HP 70206A System Graphics Display \$6,000

The HP 70206A System Graphics Display is a free-standing, menu-driven human interface for the HP 70000 Modular Measurement System. It displays configuration information and measurement results and has high resolution graphics, trace, text, and marker capability. Softkeys are used to establish an interactive front panel for any modular instrument.

A 9-inch CRT, easy-to-use menus, data and control keys, and an analog control knob make system operation friendly. The display may be stacked or racked with the HP 70001A System Mainframe or located up to 2 km away from the analyzer without slowing operation.

HP 70205A Graphics Display \$4,200

The HP 70205A Graphics Display is a 3/8-width module that provides a menu-driven human interface for the HP 70000 Measurement System. Its control and display capabilities are identical to those of the HP 70206A System Graphics Display.

HP 70900A Local Oscillator \$14,100

The HP 70900A Local Oscillator is a 3/8-width module that performs three essential functions in spectrum analyzer systems, supplying a swept synthesized local oscillator signal of 3.0 - 6.6 GHz for RF modules, tracking generator modules, external mixer interface modules, and any other modules or devices requiring the LO signal. For spans of 10 MHz*N or less (N = harmonic mixing number) the signal is fully synthesized, while for spans greater than 10 MHz*N, lock-and-roll tuning is used. It serves as a video processor for the video signal received from an IF section, and it operates as the master controller for spectrum analyzer systems. In addition, the LO contains the system firmware, enabling it to control and coordinate measurements, and to output data to the display or to a computer.

HP 70902A IF Section (Res BW 10 Hz - 300 kHz) \$3,300

HP 70903A IF Section (Res BW 100 kHz - 3 MHz) \$2,600

The HP 70902A and HP 70903A IF Sections are each 1/8-width modules that process a 21.4 MHz IF signal received from a spectrum analyzer RF section or an external mixer interface module. A detected video signal is produced and routed to the video processor in the HP 70900A Local Oscillator. The modules contain resolution bandwidth filters, log amplifiers, detection circuitry, and video filters. Both IF sections may be used in a single system to provide resolution bandwidths of 10 Hz to 3 MHz.

HP 70904A RF Section (100 Hz - 2.9 GHz) \$7,300

HP 70905A RF Section (50 kHz - 22 GHz) \$10,300

HP 70906A RF Section (50 kHz - 26.5 GHz) \$11,900

The HP 70904A, 70905A, and 70906A RF Sections are 1/8-width modules that serve as the front ends for RF and microwave spectrum analyzer systems. Each module contains an input attenuator and converts the incoming signal to a 21.4 MHz IF. All three front ends are unpreselected.

HP 70310A Precision Frequency Reference \$4,200

Option 002 Delete Ovenized Oscillator -\$2,400

The HP 70310A is a 1/8-width module that provides precision reference signals for HP 70000 instruments. Signals are phase-locked to an internal ovenized oscillator and are available at 10MHz and 100MHz. With the HP 70310A, the HP 71000 Spectrum Analyzer's frequency reference accuracy is improved from 13ppm (after 1 year) to 0.1ppm. An external reference input on the HP 70310A allows HP 71000 analyzers to be referenced to house standards or other external references at 1, 2, 5, or 10MHz.

HP 70300A Tracking Generator \$9,950

Option 001 Attenuator (70dB) \$1,200

The HP 70300A Tracking Generator is a 3/8-width module whose output signal tracks the tuned frequency of the spectrum analyzer. Stimulus-response measurements with a dynamic range of 125 dB can be made using this module in combination with the HP 71100A RF or HP 71200A Microwave Spectrum Analyzers. OPEN/SHORT and THRU normalization functions allow amplitude-normalized measurements to be made rapidly.

When the HP 70300A is added to the HP 70900A Local Oscillator, a swept synthesized source with a frequency range of 20 Hz - 2.9 GHz is created. Like the other modules in the system, the 70300A is fully automatic and easy to program and configure.

HP 70907A External Mixer Interface \$8,300

The HP 70907A External Mixer Interface is a 1/8-width module that provides a friendly interface between external mixers and spectrum analyzer systems. It contains an LO amplifier, programmable diode bias supply, and down-conversion circuitry to convert the 321.4 MHz input IF signal to a 21.4 MHz IF signal which it routes to one of the IF modules.

The frequency range of an HP 71000 spectrum analyzer can be extended to 110 GHz using this module with mixers from the HP 11970 series and to 325 GHz using it with mixers from other manufacturers. Applications requiring high sensitivity down to 2.7 GHz can also be addressed using this module with external mixers.

Harmonic Mixers

- HP 11970K** Harmonic Mixer (18 GHz - 26.5 GHz) \$1,500
- HP 11970A** Harmonic Mixer (26.5 GHz - 40 GHz) \$1,550
- HP 11970Q** Harmonic Mixer (33 GHz - 50 GHz) \$1,700
- HP 11970U** Harmonic Mixer (40 GHz - 60 GHz) \$1,850
- HP 11970T** Mixer Package (18 GHz - 40 GHz) \$3,100
- HP 11970V** Harmonic Mixer (50 GHz - 75 GHz) \$2,250
- HP 11970W** Harmonic Mixer (75 GHz - 110 GHz) \$2,550

Accessories

- HP 70800A/B/C/D/E HP-MSIB Cables**

SIGNAL ANALYZERS

HP 71000 Modular Spectrum Analyzers (con't)

Specifications

Amplitude	HP 71100A	HP 71200A	HP 71300A
Total Amplitude Range	-134 to +30 dBm	-132 to +30 dBm	-130 to -3 dBm
Maximum Safe Input Power AC Average Continuous	+30dBm	+15dBm (0 dB attn.) +25dBm (10 dB attn.) +30dBm (>10 dB attn.)	+20dBm with HP 11970 Mixers
Pulse Power	100 watts, 10 microsec pulse (≥20dB attenuation)	100 watts, 10 microsec pulse (≥40dB attenuation)	250 mW peak pulse power with <1 microsec pulse (+20 dBm ave. power) with HP 11970 mixers
DC	0 volts (dc coupled) ± 25 volts (ac coupled)	0 volts	N/A
Gain Compression Level	<-0.5 dB for signals ≤-10 dBm at input mixer		Depends on External Mixer Used
Displayed Average Noise Level HP 70902A IF 10 Hz Res BW, 0dB attn.	10MHz-2.0GHz -134dBm 2.0GHz-2.9GHz -132dBm	10MHz-2.9GHz <-129dBm 2.7-6.2GHz <-132dBm 6.0-12.7GHz <-125dBm 12.5-19.9GHz <-120dBm 19.7-22GHz <-116dBm	18-26.5GHz <-130dBm 26.5-40GHz <-128dBm 33-50GHz <-124dBm 40-60GHz <-124dBm
HP 70903A IF 100kHz Res BW, 0dB attn.	For frequencies >3MHz, displayed average noise level is 40dB higher than the above values.		
Display Range Calibration: Log Linear	Scale: 10 Division CRT .01 - 20 dB/div in increments of 0.5% 10% of Reference Level Per Division		
Spurious Responses For mixer levels ≤-40dBm, except as listed below (10dB attn)	Input Spurious 100Hz-10MHz <-60dBc 10MHz-2.9GHz <-70dBc	Input Spurious 50kHz-10MHz <-60dBc 10MHz-22/26.5GHz <-70dBc	Depends on External Mixer Used
Second Harmonic Distortion for input at mixer ≤-40dBm (10dB attn)	Band Second Harmon. 100Hz-10MHz <-60dBc 10MHz-2.9GHz <-70dBc	Band Second Harmon. 50kHz-10MHz <-60dBc 10MHz-6.2GHz <-70dBc 6GHz-12.7GHz <-60dBc 12.5-19.9GHz <-55dBc 19.7-22/26.5GHz <-50dBc	Depends on External Mixer Used
Third-Order Intermodulation Distortion with HP 70902A IF Section. For two signals, each ≤-30dBm at mixer (10 dB attn)	Center Intermod Equiv Frequency Products TOI 100Hz-10MHz <-66dBc +3dBm 10MHz-2.9GHz <-70dBc +5dBc	Center Intermod Equiv Frequency Products TOI 50kHz-10MHz <-66dBc +3dBm 10MHz-6.2GHz <-74dBc +7dBm 6.0-22/26.5GHz <-76dBc +8dBm	Depends on External Mixer Used (TOI of system at 321.4MHz input = -10dBm)
Amplitude Accuracy			
Frequency Response (10 dB Input Attenuation)	Band 100 Hz - 2.5 GHz ±1dB 100 Hz - 2.9 GHz ±1.5 dB	Band 400 kHz - 2.9 GHz ±1 dB 50 kHz - 2.9 GHz ±2.3 dB 2.7 GHz - 6.2 GHz ±1 dB 6.0 GHz - 12.7 GHz ±1.5 dB 12.5 Hz - 19.9 GHz ±2 dB 19.7 GHz - 22/26.5 GHz ±2.5 dB	11970 Band (GHz) 18-26.5 ±1.9 dB 26.5-40 ±1.9 dB 33-50 ±1.9 dB 40-60 ±1.9 dB
Frequency Response Ref. to 300MHz, -10dBm Calibrator (10dB Attn)	Band 100 Hz - 2.5 GHz ±1.3 dB 100 Hz - 2.9 GHz ±1.8 dB	Band 50 kHz - 29. GHz +1.3, -3.9 dB 400 kHz - 2.9 GHz ±1.3 dB 400 kHz - 6.2 GHz ±2.3 dB 400 kHz - 12.7 GHz ±2.8 dB 400 kHz - 19.9 GHz ±3.3 dB 400 kHz - 22/26.5 GHz ±3.8 dB	
Calibrator Uncertainty	±0.3 dB (-10 dBm, 300 MHz)		Internal ±0.4dB (-35dBm, 321.4MHz)
Amplitude Temperature Drift	For -10 dBm reference level (-35 dBm for HP 71300A), 10 dB input attenuation, 100 Hz resolution bandwidth (HP 70902A IF) or 300 kHz resolution bandwidth (HP 70903A IF) drift is ±0.05 dB/°C (accumulated error eliminated by recalibration)		
Resolution Bandwidth	±0.2 dB Corrected (1, 3, 10 Bandwidths)		HP 70902IF 110Hz-100kHz +0.2,-0.1dB
Switching Uncertainty	±3 dB Uncorrected		
Log Scale Switching Uncertainty	±0.3 dB		
IF Gain Uncertainty	10 dB ±0.1 dB 20 dB ±0.1 dB	30 dB ±0.1 dB 40 dB ±0.2 dB	50 dB ±0.2 dB
Scale Fidelity HP 70902A IF	Bandwidths ≥30 Hz and ≤100 kHz (Corrected): ±0.5 dB over 0 to 90 dB display Bandwidths <30 Hz or >100 kHz (Corrected): ±0.7 dB over 0 to 90 dB display		
HP 70903A IF	Bandwidths ≤1 MHz (Corrected): ±0.5 dB over 0 to 80 dB display (0 to 75dB in 71200A) Bandwidths >1 MHz (Corrected): ±0.7 dB over 0 to 80 dB display (0 to 75dB in 71200A)		
HP 70902A & 70903A IF	All Bandwidths: ±3 dB over 80 dB display (Uncorrected) ±0.1 dB/dB incremental accuracy (Corrected)		
Linear	±7.5% of Reference Level		



Specifications

Frequency	HP 71100A	HP 71200A	HP 71300A
Frequency Range	100Hz-2.9GHz (DC Coupled) 100kHz-2.9GHz (AC Coupled)	50kHz-22GHz 50kHz-26.5GHz (Option 001)	18-110GHz with HP 11970 Mixers (2.7-325GHz with other mixers)
Noise Sidebands (dBc/Hz)	Offset 100 Hz-2.9GHz >1kHz -85 (dBc/Hz) >30kHz -97 >1MHz -128	Offset 50kHz-6.2GHz >1kHz -85 (dBc/Hz) >30kHz -97 >1MHz -129	(dBc/Hz) Using HP 11970A >1kHz -67 (characteristic) >30kHz -79 (characteristic) >1MHz -111 (characteristic)
Frequency Readout Accuracy (N=Harmonic mixing band number)	Span <10MHz x N: \pm [(Frequency Readout x Frequency Reference Accuracy) + 1% of Span + 10Hz] Span >10MHz x N: \pm [(Frequency Readout x Frequency Reference Accuracy) + 2% of Span + 10Hz] Aging < 3 x 10 ⁻⁴ /year; Temperature Drift < 1 x 10 ⁻⁵ over 0° - 55 °C (With HP 70310A, Aging is < 1 x 10 ⁻⁷ /year; Temperature Drift < 7 x 10 ⁻⁹ over 0° - 55 °C)		
Frequency Span Accuracy	Span <10MHz x N: \pm [1% of span + (span x Frequency Reference Accuracy)] Span >10MHz x N: \pm (2% of span)		
Frequency Drift	For spans >10 MHz x N, frequency drift during one sweep is +1kHz per second and \pm 150kHz per °C. Errors resulting from drift are not cumulative from sweep to sweep.		
Resolution Bandwidths (-3dB)	Range 10Hz - 300kHz; 10 Hz-3MHz (Option 004) Adjustable in 1,3,10 sequence and 10% increments (except from 3kHz-10kHz) Accuracy \pm 20% Selectivity (-60dB/-3dB) 10 Hz - 3kHz Bandwidths <12:1 10kHz - 3MHz Bandwidths <16:1 Shape Synchronously tuned, 5 poles (10 Hz - 3kHz), 4 poles (10kHz - 3MHz) Approximately Gaussian shape.		
Video Bandwidth Range	3Hz-300kHz in 1,3,10 increments (3Hz-3MHz with Option 004); Accuracy (characteristic) \pm 20%		
Residual FM	Span >10MHz x N: <25 kHz x N p-p in 0.1 seconds (measurement BW=100kHz) Span \leq 10MHz x N: In synthesized spans residual FM is determined by noise sidebands		
Sweep Time	Range 50 ms to 1000s in 500us increments Accuracy Sweep times as low as 187us are available when traces with less than 801 points are defined \pm 2%		
Trigger	Free Run, Line, Video, External		

I/O Common to HP 71100A, 71200A, 71300A Systems

70902A IF Section: Auxiliary Video Output, 3 MHz IF Output, 21.4 MHz Auxiliary Output, 3 MHz Limited IF Output

70903A IF Section: Auxiliary Video Output, 21.4 MHz IF Output, 21.4 MHz Log IF Output

70900A LO Section: 300 MHz Calibrator Output, External Frequency Reference Input, Sweep Output/Input, Tune + Span Output, HSWP Output/Input

70205A/70206A Graphics Displays: Composite Video Output

Environmental

Temperature: Operation 0 to +55 C; Storage -40 to +75 C

Humidity: Operation 0 to 95% Relative Humidity at 40 C

EMI: Radiated interference is within the requirements of MIL-STD 461B, Class Alc, RE02

Warm-Up Time

One hour warm-up for cold start (0-55 C)

Weight (characteristics)

Systems

HP 71100A RF Analyzer	30.9 Kg (68.1 lb)
HP 71200A MW Analyzer	30.6 Kg (67.5 lb)
HP 71300A MM Analyzer	30.5 Kg (67.2 lb)

System Components

HP 70001A Mainframe	14.5 Kg (31.9 lb)
HP 70205A Graphics Display	5.1 Kg (11.2 lb)
HP 70206A System Graphics Display	18.6 Kg (41 lb)

Modules

HP 70900A Local Oscillator	5.7 Kg (12.6 lb)
HP 70902A IF Section	2.4 Kg (5.3 lb)
HP 70903A IF Section	2.3 Kg (5.1 lb)
HP 70904A RF Section	3.2 Kg (7.1 lb)
HP 70905A RF Section	2.9 Kg (6.4 lb)
HP 70906A RF Section	2.9 Kg (6.4 lb)
HP 70907A External Mixer Interface	2.8 Kg (6.2 lb)
HP 70300A Tracking Generator	5.0 Kg (11.0 lb)
HP 70310A Precision Freq. Ref.	3.0 Kg (6.6 lb)

Dimensions

HP 70001A Mainframe: 177.0 mm high, 425.4 mm wide, 526.0mm long

HP 70206A Display: 177.0 mm high, 425.4 mm wide, 502.0 mm long

Power Requirements

HP 70001A Mainframe: 100, 120, 220, and 240 VAC (+5%, -10%) 47-66 Hz (400 Hz operation is available with standard Option 400.)

650 VA Maximum

Modules: All power is supplied by the mainframe.

HP 70206A Display: 100, 120, 220, 240 VAC (+5%, -10%) 47-66 Hz (400 Hz operation is available with standard Option 400.)
300 VA Maximum

HP 70300A Tracking Generator

Frequency Range: 20Hz - 2.9GHz swept and CW

100Hz - 2.9GHz (71100A); 50kHz - 2.9GHz (71200A)

Resolution: < 1 Hz

Accuracy: \leq 10MHz span; \pm [(Output Freq x 13 x 10⁻⁶ + 1%span + 15Hz)]
>10MHz span; \pm [(Output Freq x 13 x 10⁻⁶ + 2%span + 15Hz)]

Tracking Accuracy: Tracking drift (typical) 5Hz/Hr (1 Hr warm-up)

Output Amplitude: -10dBm to -21dBm (0.01 dB resolution)

Absolute Accuracy: 300MHz @ -10dBm; \pm 0.5dB @ 25°C \pm 10°C

Level Flatness: 10MHz to 2.9GHz (relative to 300MHz) \pm 0.5dB
20Hz to 10MHz (relative to 1MHz) -0.7dB, +1.2dB

Dynamic Range: >125dB, 10Hz ResBW, 0dB Atten; 10MHz-2.0GHz 71100A

AM Rates: Internal 400Hz & 1kHz (\pm 3%)

External 20Hz-20kHz (3dB BW @ 30% AM)

Dimension: $\frac{3}{8}$ width module

HP 70310A Precision Frequency Reference

Aging: < 5 x 10⁻¹⁰/day (7-day average), < 1 x 10⁻⁷/year
Temperature Stability: < 7 x 10⁻⁹ over 0° to 55°C (25°C reference)

100 MHz Output Power: 0 dBm (typical)

10 MHz Output Power: 0 dBm (typical)

External Reference Input:

Input Frequencies: 1, 2, 5, or 10 MHz

Input Power Range: -5 to +21 dBm

Dimension: $\frac{1}{8}$ width module



SIGNAL ANALYZERS

Spectrum Analyzers, 100 Hz to 300 GHz

Models 8568B, 8567A & 8566B

- 100 Hz to 1.5 GHz coverage with counter accuracy
- 10 kHz to 1.5 GHz coverage at a lower price
- 100 Hz to 300 GHz coverage with synthesizer accuracy
- 2 to 22 GHz preselected range
- 10 Hz resolution bandwidth
- Trace markers with amplitude and frequency readout
- 16K bytes of RAM for trace data or custom routines
- Create and run routines without controller
- Plot results with or without controller



HP 8566B



HP 8568B



The HP 8568B and 8566B are high performance spectrum analyzers for bench and HP-IB system use. The HP 8568B operates over a 100 Hz to 1500 MHz frequency range. The HP 8567A operates over the 10 kHz to 1500 MHz frequency range. It is identical to the HP 8568B in all respects but lower price and reduced RF performance. The HP 8566B operates over a 100 Hz to 22 GHz range, and has preselection from 2 to 22 GHz. The HP 8566B frequency range may be extended to 300 GHz with commercially available mixers. (For external-mixing information, refer to Product Note 8566A-2 or contact your local HP field engineer.)

Each analyzer is designed around its own internal bus and controlled by its own microcomputer to yield significant improvements in operational and data processing features, and flexibility under program control. Each analyzer contains 16K bytes of RAM for storing measurement and data processing routines, which can be created and stored with or without a controller. The performance specifications for the HP 8568B, 8567A and 8566B are on pages 664, 670, and 666 respectively.

Performance

Exceptional frequency stability in both the HP 8568B and 8566B makes measurements with 10 Hz resolution bandwidths possible. Superior spectral purity and narrow resolution let you measure clean oscillators directly at RF frequencies. The 10 Hz resolution bandwidth also yields sensitivities to -135 dBm, which makes greater than 85 dB spurious-free dynamic range achievable. A frequency reference error of 2.5×10^{-7} /year together with the analyzer resolution and sensitivity allow measurements of unequal accuracy of small signals in the presence of large signals.

For applications that don't require the high performance of the 8568B, the 8567A offers the same speed, versatility, and automatic capability as the 8568B, at a lower price. Resolution bandwidths from 1 kHz to 3 MHz give sensitivities to -115 dBm and more than 75 dB of spurious-free dynamic range. A frequency reference error of 5×10^{-6} /year gives the frequency accuracy necessary for many ATE systems. Close-in AM measurements (0.5 Hz - 25 kHz sideband resolution) are made accurately using the Fast Fourier Transform (FFT) function available on the HP 8566B, 8568B, and 8567A.

Usability

Control settings are conveniently notated on the CRT. To activate a function, press a front-panel key, then select the function value using the knob, step keys, or numeric keyboard.

Make measurements following conventional "zoom" techniques, using the center frequency, frequency span, and reference level controls. Use the preset function to set all analyzer controls to a convenient starting point. Since certain functions are coupled, a calibrated display is easily maintained. For example, resolution bandwidth and sweep time change automatically when frequency span is reduced.

Use the four tunable markers to measure a signal, or to examine closely a portion of the spectrum. Set a marker at a signal peak to measure the signal amplitude and frequency, which are displayed on the CRT. Two markers make relative measurements, such as modulation or distortion measurements, by displaying the amplitude and frequency difference between the markers. Marker information lets you step between evenly spaced portions of the spectrum, like communication channels or signal harmonics, or "zoom-in" on a portion of the spectrum. Other marker functions include converting the noise level at the marker to the RMS noise density normalized to a 1 Hz bandwidth.

Once analyzer controls are set, their configuration can be saved in memory and later recalled to repeat measurements. An internal battery protects memory contents if power fails.

Versatile CRT Display and Plotting Capabilities

All displayed information resides in digital memory, which refreshes the CRT at a flicker-free rate. Display multiple traces to measure residual FM or drift, or to conduct real-time surveillance of a wide frequency range. The number of traces displayed is limited by the size of the CRT only. Display titles may be added.

By adding a graphics plotter, system measurements can be plotted for analysis, documentation, and presentation. Recommended HP-IB plotters include the 8-pen HP 7550A, the 6-pen 7475A, the 7440 ColorPro, and the 7090A Measurement Plotting System, which records and annotates analog measurements as well as digital. Plot with or without a controller.

Softkey Programming Lets you Create the Spectrum Analyzer Measurement "Personality"

Softkey programming lets you create measurement routines tailored to your needs. Stored in the analyzer, they can be executed when needed as easily as the analyzer's built-in functions. By defining custom softkeys in the spectrum analyzer, you can create a measurement "personality" that makes the analyzer more efficient for your types of measurements.

Load a keystroke sequence into a softkey from the front panel, using the title function (**SHIFT E**), or load a keystroke sequence into a softkey from a computer:

```
10 OUTPUT 718;"FUNCDEF ZOOM,";
20 OUTPUT 718;"@IP;CF 100MHZ;SP 10MHZ@";
30 OUTPUT 718;"KEYDEF 100,ZOOM,";
40 END
```

Execute the stored routine pressing three keys:

SHIFT, 100 Hz

Because the HP 8566B, 8567A, and 8568B contain built-in, flow-of-control functions (**REPEAT**, **UNTIL**, **IF**, **THEN**, **ELSE**, and **ENDIF**), measurement routines can be created and stored without the use of a computer. This frees computer time for handling other system components or data processing.

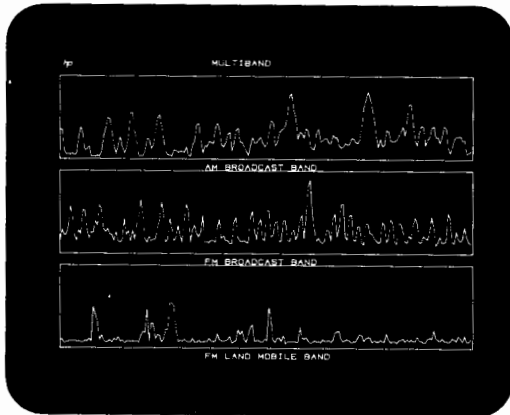

Surveillance Measurement of Multiple Bands Displayed Simultaneously

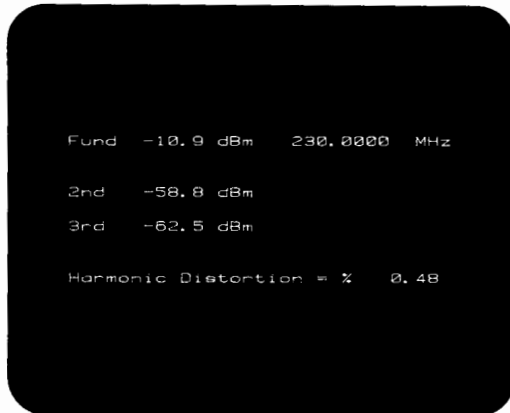

Harmonic Distortion Measurement

The HP 8568B, 8567A and 8566B are able to control HP-IB instruments without a computer connected through the use of softkey programming. See page 672 for more information on this capability.

Automatic Measurement Capability

Operate the HP 8566B, 8567A and 8568B via the HP Interface Bus (IEEE Standard 488-1975) to control all front-panel functions, or manipulate or store trace information. The display is accessible for annotation and graphing purposes.

Analyzer and HP-IB commands are easy to understand. For example, CF 20 MZ sets the analyzer center frequency to 20 MHz. Built-in firmware features, such as instrument preset, peak search, and automatic zoom, and flow-of-control commands further simplify writing software.

New signal processing commands include PWRBW, which calculates power bandwidth of a signal, and PEAKS, which identifies all responses on the display. The RMS function finds the RMS value of trace data; MPY multiplies two traces point-by-point.

Flow-of-control functions let you implement your own routines. Since the analyzer can make more decisions and process more data, a system controller can devote more time to handling other measurement or processing tasks.

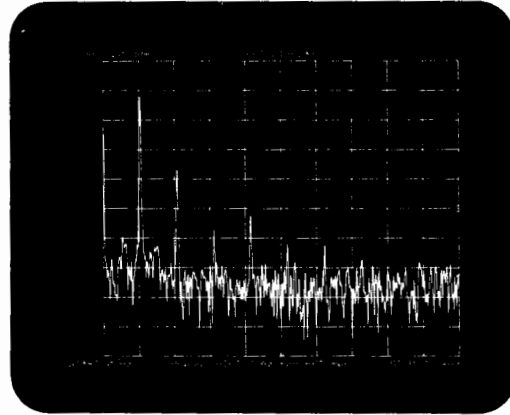

FFT. Performs a Fast-Fourier Transform on the analyzer video signal.

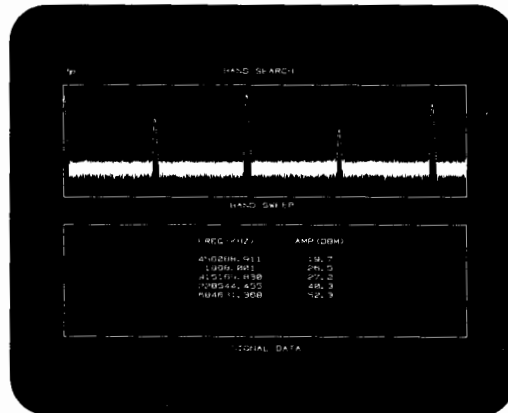

PEAKS. Identifies all responses on the display

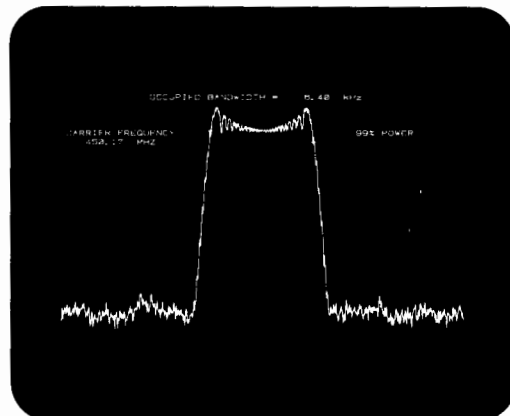

PWRBW. Returns the power bandwidth of a signal.



SIGNAL ANALYZERS

Spectrum Analyzer, 100 Hz to 1500 MHz

Model 8568B

- 100 Hz to 1.5 GHz frequency range
- Frequency counter accuracy
- Powerful firmware feature set
- Direct plot capability
- Enhanced signal processing power
- 16K bytes of user definable RAM

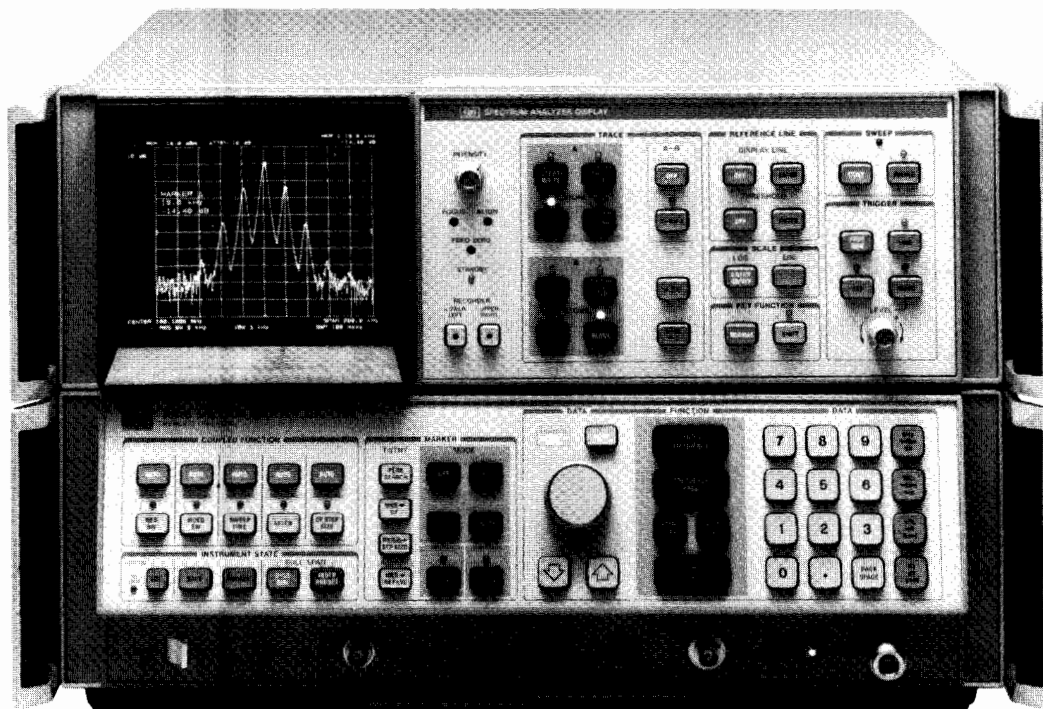

HP 8568B

The HP 8568B Spectrum Analyzer is a high performance spectrum analyzer for bench and remote operation which covers the 100 Hz to 1.5 GHz frequency range. Frequency-stabilized local oscillators and an internal counter bring unequalled measurement precision to RF spectrum analysis. Exceptional frequency stability and local oscillator spectral purity enable the use of a 10 Hz resolution bandwidth to make difficult, close-in sideband measurements on RF signals.

The HP 8568B offers 16K bytes of RAM for user-defined routines, which are accessible via HP-IB or from the front panel. This softkey programming opens new horizons of operator convenience features by allowing the operator to create measurement routines tailored to his or her particular application without the need for a controller. The HP 8568B can also control other HP-IB devices such as printers, signal generators, and power meters via softkey programming. See page 672.

All HP 8568B functions are programmable via HP-IB (IEEE 488-1975). Many high-level functions are internally available and return results instead of data to the controller. This allows the controller to perform other tasks; thus, execution time can be decreased. Friendly programming codes and easily recognizable mnemonics facilitate learning the analyzer language.

If you have an HP 8566A or 8568A and would like to enhance your analyzer by adding the capabilities of the "B" version, retrofit kits are available.

HP 8568B Specifications

Frequency

Displayed Range

Frequency span: 100 Hz to 1500 MHz.

Frequency span accuracy: for spans >1 MHz, $\pm(2\%$ of the indicated frequency separation between two points +0.5% span); for spans ≤ 1 MHz, $\pm(5\%$ of frequency separation +0.5% span).

Center frequency: 0 Hz to 1500 MHz.

Readout accuracy: span ≥ 100 Hz: $\pm(2\%$ of frequency span + frequency reference error \times tune frequency +10 Hz) after adjusting freq zero at stabilized temperature.

Start-stop frequency: permissible values must be consistent with those for center frequency and frequency span.

Readout accuracy: center frequency accuracy + $\frac{1}{2}$ frequency span accuracy.

Marker

Normal: frequency at the horizontal position of the tunable marker.

Accuracy: center frequency accuracy + frequency span accuracy between the marker and center frequencies.

Frequency count: displays the frequency signal on whose response the marker is positioned.

Accuracy: for span ≤ 100 kHz: frequency reference error \times displayed frequency $\pm 2 \times$ frequency counter resolution. For span >100 kHz but ≤ 1 MHz: freq. ref. error \times displayed frequency $\pm(10$ Hz + $2 \times$ frequency counter resolution). For span >1 MHz: $\pm(10$ kHz + frequency counter resolution).

Frequency reference error: aging rate $< 1 \times 10^{-9}$ /day; temp stability $< 7 \times 10^{-9}$, 0° to 55°C (after 30 day warm-up).

Δ : frequency difference between the stationary and tunable markers.

Accuracy: same as frequency span accuracy; in the FREQUENCY COUNT mode, twice the frequency count uncertainty plus drift during the period of the sweep (typically < 10 Hz/minute).

Resolution

Resolution bandwidth: 3 dB bandwidths of 10 Hz to 3 MHz in a 1, 3, 10 sequence.

Bandwidth accuracy: $\pm 10\%$, 1 MHz to 3 kHz; $\pm 20\%$, 1 kHz to 10 Hz, 3 MHz bandwidths.

Bandwidth selectivity: 60 dB/3 dB bandwidth ratio: $< 15:1$, 3 MHz to 100 kHz; $< 13:1$, 30 kHz to 10 kHz; $< 11:1$, 3 kHz to 30 Hz. 60 dB points on 10 Hz bandwidth are separated by < 100 Hz.

Stability

Residual FM: < 3 Hz peak-to-peak for sweep time ≤ 10 sec; span < 100 kHz, res. bandwidth ≤ 30 Hz, video bandwidth ≤ 30 Hz.

Drift: after 1 hr. warmup, < 10 Hz/min. of sweep time for spans ≤ 100 kHz; < 100 Hz/min. of sweep time for 100 kHz $<$ span ≤ 1 MHz; < 300 kHz/min. of sweep time for spans > 1 MHz.

Spectral Purity

Noise sidebands: > 80 dB at frequency offsets $\geq 30 \times$ res. bandwidth, for res. bandwidths ≤ 1 kHz.

Line related sidebands: > 85 dB below the peak of a CW signal.

Amplitude

Measurement range: -135 dBm to $+30$ dBm.

Displayed Range

Scale: over a 10 division CRT vertical axis.

Calibration

Log: 10 dB, 5 dB, 2 dB and 1 dB/division.

Linear: 10% of Reference Level/div when calibrated in voltage.

Fidelity

Log: (over 0 to 90 dB display)

Incremental accuracy: ± 0.1 dB/DB

Maximum cumulative error: (from the reference level)
 $\leq \pm 1.0$ dB; ≥ 30 Hz resolution bandwidth
 $\leq \pm 2.1$ dB; 10 Hz resolution bandwidth

Linear: $\pm 3\%$ of Reference Level.

Reference Level Range

Log
+60.0¹ to -139.9 dBm or equivalent in dBmV, dB μ V, volts.

Linear
228.6¹ volts to 0.22 μ volts full scale.

Accuracy: the sum of the following factors determines the reference-level accuracy. Depending upon the measurement technique followed after calibration, various of these sources of uncertainty may not be applicable. An internal error-correction function calibrates and reduces the uncertainty introduced by analyzer control changes from the error-calibration state.

Calibrator uncertainty: ± 0.2 dB.
Frequency response (flatness) uncertainty: (with ≥ 10 dB of RF attenuation) input #1: ± 1 dB, 100 Hz to 500 MHz; ± 1.5 dB 100 Hz to 1500 MHz; input #2: ± 1 dB, 100 kHz to 1500 MHz.

Amplitude temperature drift: at -10 dBm reference level with 10 dB input attenuation and 1 MHz resolution bandwidth, ± 0.05 dB/ $^{\circ}$ C (eliminated by recalibration).

Input connector switching uncertainty: ± 0.5 dB.

Input attenuation switching uncertainty: ± 1.0 dB.

Resolution bandwidth switching uncertainty:² (referred to 1 MHz bandwidth)—corrected (uncorrected)

Resolution BW	20-30 $^{\circ}$ C	0-55 $^{\circ}$ C
10 Hz	± 1.1 dB (± 2.0 dB)	(± 4.0 dB)
30 Hz	± 0.4 dB (± 0.8 dB)	(± 2.3 dB)
100 Hz to 1 MHz	± 0.2 dB (± 0.5 dB)	(± 2.0 dB)
3 MHz	± 0.2 dB (± 1.0 dB)	(± 2.0 dB)

Log scale switching uncertainty: ± 0.1 dB corrected (± 0.5 dB uncorrected).

IF Gain uncertainty: corrected (uncorrected). Assuming reference level calibrated to -10 dBm and 10 dB input attenuation, changes in reference level will contribute the following uncertainty.

Reference Level	20-30 $^{\circ}$ C	0-55 $^{\circ}$ C
0 to -55.9 dBm		
10 Hz Res BW	± 1.0 dB (± 1.6 dB)	(± 2.0 dB)
≥ 30 Hz Res BW	± 0.1 dB (± 0.6 dB)	(± 1.0 dB)
-56.0 to -129.9 dBm		
10 Hz Res BW	(± 2.0 dB) ³	(± 2.5 dB)
≥ 30 Hz Res BW	(± 1.0 dB) ³	(± 1.5 dB)

RF Gain uncertainty (due to 2nd LO shift): ± 0.1 dB corrected (± 1.0 dB uncorrected)

Error correction accuracy: ± 0.4 dB.

Marker

Normal: amplitude at the vertical position of the tunable marker.

Accuracy: sum of calibrator uncertainty, reference level uncertainty, and scale fidelity between the reference level and marker position.

Δ : amplitude difference between the stationary and tunable markers.

Accuracy: sum of scale fidelity and frequency between the two markers.

Reference Lines (display line and threshold)

Accuracy: sum of calibrator uncertainty, reference-level uncertainty, and scale fidelity between the reference level and reference line.

Dynamic Range

Spurious responses: for a total signal power ≤ -40 dBm at the input mixer, all image and out-of-band mixing responses, harmonic and intermodulation distortion products are > 75 dB below the total signal power for inputs 10 MHz to 1500 MHz; > 70 dB below the total signal power for input signals 100 Hz to 10 MHz.

Average noise level: (displayed) < -135 dBm for frequencies > 1 MHz with 10 Hz resolution bandwidth, 0 dB input attenuation, 1 Hz video filter.

Video bandwidth: variable from 1 Hz to 3 MHz in a 1, 3, 10 sequence.

Gain compression: < 0.5 dB for signal levels ≤ -10 dBm at the input mixer.

Sweep

Continuous

20 msec to 1500 sec in 1, 1.5, 3, 5, 7.5, 10 sequence.

Accuracy: sweep time ≤ 100 sec, $\pm 10\%$; > 100 sec, $\pm 20\%$.

Zero frequency span: 1 μ sec full sweep (10 divisions) to 10 msec full sweep in 1, 2, 5 sequence; 20 msec full sweep to 1500 sec full sweep in 1, 1.5, 2, 3, 5, 7.5, 10 sequence.

Accuracy: same as continuous.

Single: sweep ≥ 20 msec only.

¹Maximum input must not exceed +30 dBm (damage level).
²30 kHz and 100 kHz bandwidth switching uncertainty figures only applicable $\leq 90\%$ relative humidity.
³Correction only applies over the 0 dBm to -55.9 dBm range.

Input

RF Inputs

Input #1: 100 Hz to 1500 MHz, 50 Ω , BNC connector (Fused); dc coupled.

Reflection coefficient: typically < 0.20 (1.5 SWR) to 500 MHz, < 0.33 (2.0 SWR) 500 MHz to 1500 MHz; ≥ 10 dB input attenuation.

Input #2: 100 kHz to 1500 MHz, 50 Ω , Type N connector; ac coupled.

Reflection coefficient: typically < 0.20 (1.5 SWR); ≥ 10 dB input attenuation.

LO emission: typically < -75 dBm (0 dB RF Atten).

Isolation: > 85 dB between inputs.

Also available: input #1, 100 kHz to 1500 MHz, 75 Ω , BNC connector, ac coupled (Opt 001).

Maximum Input Level

AC: continuous power, +30 dBm (1 watt); 100 watts, 10 μ sec pulse into ≥ 50 dB attenuation.

DC: Input 1, 0 volts; Input 2, ± 50 volts.

Input attenuator: 70 dB range in 10 dB steps.

Accuracy: ± 1.0 dB over 10-70 dB range.

External frequency reference input (rear panel)

Must equal 10 MHz ± 100 Hz, 0 dBm (+10 dBm max.), 50 Ω nominal input impedance.

Quasi-peak (rear panel; nominal values)

Video input: 0-2 volts. 139 Ω input impedance.

21.4 MHz input: input is nominally -11 dBm (with spectrum analyzer input attenuator set to 10 dB). 50 Ω input impedance.

External sweep trigger input: > 2.4 volts.

Output

Calibrator: 20 MHz ± 20 MHz x frequency reference error (1 x 10^{-9} /Day), -10 dBm ± 0.2 dB; 50 Ω .

Probe power: +15 V, -12.6 V; 150 mA max.

Auxiliary (rear panel; nominal values)

Display: X, Y and Z outputs for auxiliary CRT displays. X, Y: 1 volt full deflection; Z: 0 to 1 V intensity modulation, -1 V blank.

Recorder

Horizontal sweep output (x axis): 0 V for left edge to +10 V for right edge.

Video output (y axis): Increases 100 mV/div from 0 to 1 V. Output impedance ≤ 475 Ω .

Penlight output (z axis): 15 V blanking output during retrace.

21.4 MHz IF: 50 Ω , nominally -20 dBm for a signal at the reference level.

1st LO: 2-3.7 GHz, $> +4$ dBm; 50 Ω output impedance.

Frequency reference: 10.000 MHz, 0 dBm; 50 Ω output impedance.

Quasi-peak (rear panel; nominal values)

Video output: 0-2 volts. Output impedance < 139 Ω .

21.4 MHz output: output is nominally -11 dBm (with spectrum analyzer input attenuator set to 10 dB). 50 Ω output impedance.

HP-IB Interface Functions

SH1, AH1, T6, L4, SR1, RL1, PP0, DC1, DT1, C1, C2, C3, C27. For more on these codes, refer to the HP-IB section of this catalog.

General

Environmental

Temperature: operating 0 $^{\circ}$ C to 55 $^{\circ}$ C, storage -40 $^{\circ}$ C to +75 $^{\circ}$ C.

Humidity: operating $< 95\%$ R.H., 0 $^{\circ}$ C to 40 $^{\circ}$ C except as noted.

EMI: 8568B conducted and radiated interference is within the requirements of CE03 and RE02 of MIL STD 461A, VDE 0871, and CISPR publication 11.

Power requirements: 50 to 60 Hz; 100, 120, 220 or 240 volts (+5%, -10%); approximately 450 VA (40 VA in standby). 400 Hz operation is available as Opt 400.

Weight: total net, 45 kg (100 lb); Display/IF Section, 21 kg (46 lb); RF Section, 24 kg (54 lb). Shipping net, 72 kg (158 lb); Display/IF Section, 27 kg (60 lb); RF Section, 32 kg (70 lb); Manuals and Accessories, 13 kg (28 lb).

Size: 267 H x 425.5 W x 558.8 mm D (10.5" x 16.75" x 22").

Ordering Information

	Price
HP 8568B Spectrum Analyzer	\$34,600
Opt 001: 75 Ω (BNC), 100 kHz to 1500 MHz RF Input #1	add \$200
Opt 010: Rack Slide Kit	add \$450
Opt 400: 400 Hz Power Line Frequency Operation	add \$400
Opt 462: Impulse BWs for MIL-STD EMI Measurements	add \$2000
Opt 908: Rack Flange Kit	add \$60
Opt 910: Extra Manual	add \$350
Opt 913: Rack Flange Kit to Mount Instruments With Handles	add \$70
HP 8568A + 01K Retrofit Kit	add \$2500



SIGNAL ANALYZERS

Spectrum Analyzer, 100 Hz to 300 GHz

Model 8566B

- 100 Hz to 22 GHz, external mixing to 300 GHz
- Synthesizer frequency accuracy
- Direct plot capability
- Expanded firmware feature set
- Enhanced signal processing power
- 16K bytes of user RAM

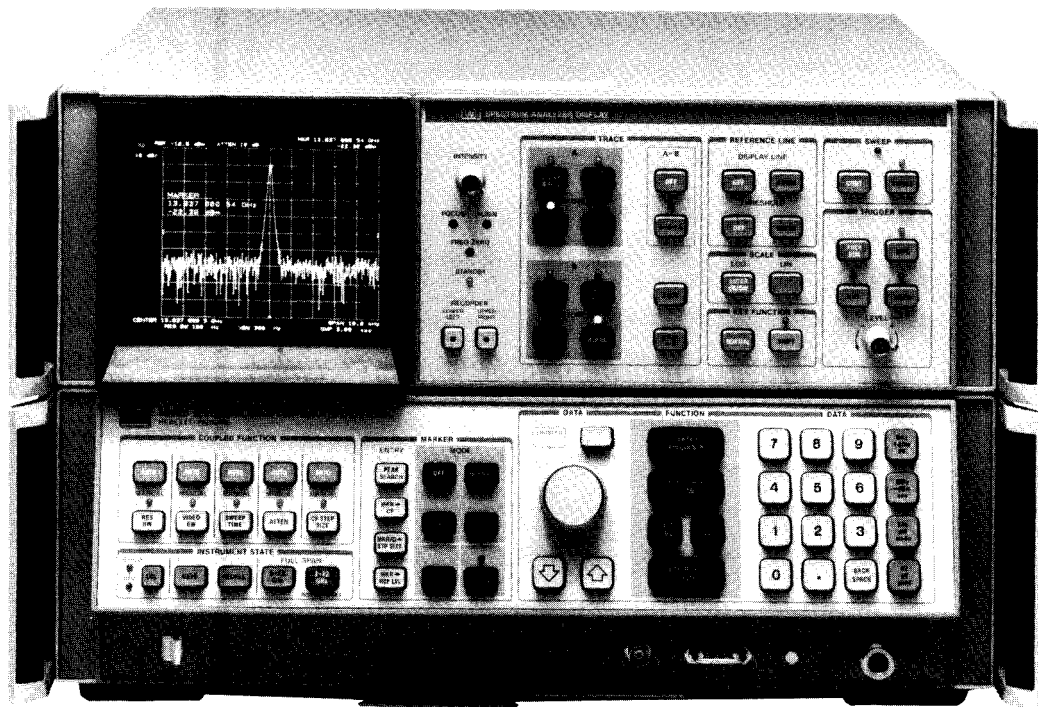

HP 8566B

The HP 8566B Spectrum Analyzer is a high performance spectrum analyzer for bench and remote operation which operates from 100 Hz to 22 GHz using internal mixing. The frequency range may be extended to 110 GHz with the 11970 series external mixers and to 300 GHz with commercially available mixers. (For more information on external mixing, see Product Note 8566A-2 or contact your local HP field engineer). A synthesized local oscillator yields counter-like accuracy at microwave and millimeter wave frequencies. 10 Hz resolution bandwidth and superior frequency stability allow difficult measurements such as line-related sideband characterization at 22 GHz.

The HP 8566B offers 16K bytes of RAM for user defined routines which are accessible via HP-IB or from the front panel. This softkey programming opens new horizons of operator convenience features by allowing the operator to create measurement routines tailored to his or her particular application without the need for a controller. The HP 8566B can also control other HP-IB devices such as printers, signal generators and power meters via softkey programming. See page 672.

All HP 8566B functions are programmable via HP-IB (IEEE 488-1975). Many high level functions are internally available and return results instead of data to the controller. This allows the controller to perform other tasks, thus execution time can be decreased. Friendly programming codes and easily recognizable mnemonics facilitate learning the analyzer language.

A unique integrated preselector/mixer provides high sensitivity with preselection from 2 GHz to 22 GHz. For example, in a 10 Hz resolution bandwidth, the sensitivity at 18 GHz is < -119 dBm. If you have an HP 8566A or 8568A and would like to enhance your analyzer by adding the capabilities of the "B", retrofit kits are available.

HP 8566B Specifications

Frequency

Measurement range: 100 Hz to 22 GHz with internal mixer, dc coupled input; 18.6 GHz to 110 GHz with the 11970 series external mixer set; 110 GHz to 300 GHz with commercially available external mixers.

Displayed Values

Center frequency: 0 Hz to 300 GHz.

Readout accuracy: (AUTO resolution bandwidth after adjusting frequency zero at stabilized temperature, and using the error correction function, SHIFT W and SHIFT X) spans $\leq n \times 5$ MHz: $\pm(2\%$ of frequency span + frequency reference error \times center frequency + 10 Hz); spans $> n \times 5$ MHz: $\pm(2\%$ of frequency span + $n \times 100$ kHz + frequency reference error \times center frequency) where n is the harmonic number, depending on center frequency:

n	Center Frequency (internal mixing)	n	Center Frequency (external mixing)
1	0 Hz to 5.8 GHz	6	18.6 GHz to 26.5 GHz
2	5.8 GHz to 12.5 GHz	8	26.5 GHz to 40.0 GHz
3	12.5 GHz to 18.6 GHz	10	40.0 GHz to 60.0 GHz
4	18.6 GHz to 22 GHz	14	50.0 GHz to 75.0 GHz
		18	75.0 GHz to 110.0 GHz

Frequency span: 0 Hz to 22 GHz over 10 division CRT horizontal axis; variable in approximately 1% increments.

Full span: 0 to 2.5 GHz or 2 to 22 GHz. 2 to 22 GHz is selected with INSTR PRESET.

Readout accuracy: spans ≤ 5 MHz: $\pm(2\%$ of frequency span + (frequency reference accuracy \times center frequency) + 10 Hz) after adjusting FREQ ZERO at stabilized temperature. spans > 5 MHz: $\pm(2\%$ of frequency span + ($n \times 100$ kHz) + (frequency reference accuracy \times center frequency)) where n is the harmonic mixing number, depending upon center frequency.



Start/stop frequency:

Readout accuracy: same as center frequency.

Frequency reference error: $<1 \times 10^{-9}$ /day and $<2.5 \times 10^{-7}$ /year.

Resolution

Resolution bandwidth: 3 dB bandwidths of 10 Hz to 3 MHz in a 1, 3, 10 sequence. Bandwidth may be selected manually or coupled to frequency span.

Bandwidth accuracy: calibrated to: $\pm 20\%$, 10 Hz to 3 MHz; $\pm 10\%$, 3 kHz to 1 MHz.

Bandwidth selectivity: 60 dB/3 dB bandwidth ratio: $<15:1$, 3 MHz to 100 kHz; $<13:1$, 30 kHz to 10 kHz; $<11:1$, 3 kHz to 30 Hz. 60 dB points on 10 Hz bandwidth are separated by <100 Hz.

Stability

Residual FM (typical): for fundamental mixing ($n = 1$); <50 kHz peak-to-peak, frequency span ≥ 5 MHz; <200 Hz peak-to-peak, frequency span ≤ 5 MHz; <5 Hz peak-to-peak, frequency span <100 kHz; <0.2 Hz peak-to-peak, frequency span <5 kHz.

Drift (typical): after 1 hour warm-up at stabilized temperature. COUPLED FUNCTION not required.

Frequency Span

<100 kHz
100 kHz to 5 MHz
 ≥ 5 MHz

Center Frequency Drift

<10 Hz/minute of sweep time
 <500 Hz/minute of sweep time
 <5 kHz/minute of sweep time

Because the analyzer is phase locked at the beginning of each sweep, drift occurs only during the time of one sweep.

Spectral Purity

Noise sidebands: >85 dB below the peak of a 5.8 GHz CW signal at 1 kHz offset; >79 dB typical for 12.5 GHz signal; >75 dB typical for 18.6 GHz signal; >73 dB typical for 22 GHz signal; all for resolution bandwidth ≤ 100 Hz.

Power line related sidebands: >80 dB below the peak of a 5.8 GHz CW signal, <360 Hz offset.

Amplitude

Measurement range: -134 dBm to $+30$ dBm.

Display Range:

Scale: over a 10 division CRT vertical axis with the Reference Level at the top graticule line.

Calibration

Log: 10 dB/div for 90 dB display from Reference Level.

5 dB/div for 50 dB display

2 dB/div for 20 dB display

1 dB/div for 10 dB display

expanded from
Reference Level

Linear: 10% of Reference Level/div when calibrated in voltage.

Fidelity

Log

Incremental

± 0.1 dB/dB over
0 to 80 dB display

Cumulative

$< \pm 1.0$ dB max over 0 to 80
dB display, 20–30°C.
 $< \pm 1.5$ dB max over 0 to 90
dB display.

Linear: $\pm 3\%$ of Reference Level

Reference Level

Range

Log: $+30.0$ to -99.9 dBm or equivalent in dBmV, dB μ V, Volts
Readout expandable to $+60.0^1$ volts to -119.9 dBm (-139.9 dBm for <1 kHz resolution bandwidth) using SHIFT I.

Linear: 7.07 volts to 2.2 μ volts full scale. Readout expandable to 223.6¹ volts to 2.2 μ volts (0.22 μ volts for <1 kHz resolution bandwidth) using SHIFT I.

Accuracy: the sum of the following factors determines the accuracy of the reference level readout. Depending upon the measurement technique followed after calibration with the CAL signal, various of these sources of uncertainty may not be applicable. Specifications are with the

preselector tracking optimized with MARKER PRESELECTOR PEAK function.

An internal error correction function calibrates and reduces the uncertainty introduced by analyzer control changes from the error calibration state (-7 dBm reference level, and 100 MHz center frequency) when SHIFT W and SHIFT X are executed just prior to the signal measurement (i.e. at the same temperature) within 20–30°C. range.

Calibration uncertainty: ± 0.3 dB.

Frequency response (flatness) uncertainty: ± 0.6 dB, 100 Hz to 2.5 GHz; ± 1.7 dB, 2.0 GHz to 12.5 GHz; ± 2.2 dB, 12.5 GHz to 20 GHz; ± 3.0 dB, 20 GHz to 22 GHz; for 10 dB attenuator setting. Cumulative flatness ± 2.2 dB, 100 Hz to 20 GHz. COUPLED FUNCTION not required as long as display remains calibrated.

Amplitude temperature drift: at -10 dBm reference level with 10 dB input attenuation and 1 MHz resolution bandwidth. ± 0.03 dB/°C (eliminated after recalibration).

Scale Fidelity

Log

Incremental

± 0.1 dB/dB

Cumulative

over 0 to 90 dB display
 ± 1.0 dB ≥ 30 Hz Resolution BW
 ± 2.1 dB 10 Hz Resolution BW

Linear: $\pm 3\%$ of reference level

Resolution bandwidth switching uncertainty²: referenced to 1 MHz bandwidth, corrected (uncorrected).³

Resolution BW

10 Hz

30 Hz

100 Hz to 1 MHz

3 MHz

Uncertainty

± 1.1 dB (± 2.0 dB)

± 0.4 dB (± 0.8 dB)

± 0.2 dB (± 0.5 dB)

± 0.5 dB (± 1.0 dB)

Log scale switching uncertainty: corrected (uncorrected). ± 0.1 dB (± 0.5 dB).

IF gain uncertainty: corrected (uncorrected). Assuming the internal calibration signal is used to calibrate the reference level at -10 dBm and the input attenuator is fixed at 10 dB, any changes to the reference level function value from -10 dBm will contribute IF gain uncertainty.

Range

0 to -55.9 dBm

10 Hz Resolution BW

≥ 30 Hz Resolution BW

-56.0 to -129.9 dBm⁴

10 Hz Resolution BW

≥ 30 Hz Resolution BW

Uncertainty

± 1.0 dB (± 1.6 dB)

0 dB (± 0.6 dB)

± 2.0 dB (± 2.0 dB)

± 1.0 dB (± 1.0 dB)

The range values change with different input attenuator settings. Each 10 dB decrease (or increase) in the amount of input attenuation at the time of calibration and measurement will cause a corresponding 10 dB decrease (increase) in absolute reference level settings described above.

RF gain uncertainty: corrected (uncorrected) 0 dB (± 0.2 dB). The gain change between preselected and non-preselected bands.

Error correction: ± 0.4 dB

When the error correction function is used (SHIFT W and SHIFT X), amplitude uncertainty is introduced because additional IF gain is used to offset errors in the switching of resolution BW, amplitude scales and RF gain.

Dynamic Range

Spurious responses: (signals generated by the analyzer due to input signals). For signals ≤ -40 dBm all harmonic and intermodulation distortion >70 dB below input signal.

Second order harmonic distortion: for mixer levels ≤ -40 dBm:

< -70 dBc, 100 Hz to 50 MHz; < -80 dBc, 50 MHz to 700 MHz;

< -70 dBc, 700 MHz to 2.5 GHz. For mixer levels ≤ -10 dBm:

< -100 dBc, 2 to 22 GHz.

¹Maximum input must not exceed $+30$ dBm (damage level).

²Accounted for under Error Correction Accuracy.

³Uncorrected values apply over 20–30°C range.

⁴Correction only applies over the 0 dBm to -55.9 dBm range.



SIGNAL ANALYZERS

Spectrum Analyzer, 100 Hz to 300 GHz

Model 8566B (cont.)

Third order intermodulation distortion: third order intercept (TOI): $>+5$ dBm, 100 Hz to 5 MHz; $>+7$ dBm, 5 MHz to 5.8 GHz; $>+5$ dBm, 5.8 to 18.6 GHz; $>+5$ dBm (typical), 18.6 GHz to 22 GHz; $>+5$ dBm (typical), 2 to 22 GHz for >100 MHz signal separation.

Image responses: (due to input signals 642.8 MHz above or below the tuned frequency) <-70 dBc, 100 Hz to 18.6 GHz; <-60 dBc, 18.6 GHz to 22 GHz.

Multiple responses: (due to the input signal mixing with more than one L.O. harmonic) <-70 dBc, 100 Hz to 22 GHz.

Out-of-band responses: (due to input signals outside the preselector's frequency span) <-60 dBc, 2 to 22 GHz.

Residual responses: (signals displayed by the analyzer independent of input signals) With 0 dB input attenuation and no input signal: <-100 dBm, 100 Hz to 5.8 GHz; <-95 dBm, 5.8 GHz to 12.5 GHz; <-85 dBm, 12.5 GHz to 18.6 GHz; <-80 dBm, 18.6 GHz to 22 GHz.

Gain compression: <1.0 dB, 100 Hz to 22 GHz with ≤-5 dBm at input mixer.

Average noise level: with 0 dB input attenuation and 10 Hz resolution bandwidth. <-95 dBm, 100 Hz to 50 kHz; <-112 dBm, 50 kHz to 1.0 MHz; <-134 dBm, 1.0 MHz to 2.5 GHz; <-132 dBm, 2.0 GHz to 5.8 GHz; <-125 dBm, 5.8 GHz to 12.5 GHz; <-119 dBm, 12.5 GHz to 18.6 GHz; <-114 dBm, 18.6 GHz to 22 GHz.

Video bandwidth: post detection low pass filter used to average displayed noise bandwidth variable from 1 Hz to 3 MHz in a 1,3,10 sequence. Video bandwidth may be selected manually or coupled to resolution bandwidth.

Reference Lines

Display line: movable horizontal line with amplitude readout.

Threshold: movable horizontal trace threshold with amplitude readout.

Accuracy: equals the sum of calibrator uncertainty, and scale fidelity between the reference level and reference line.

Marker

Marker functions are the same as the HP 8568B with the exception of frequency count. (Page 664).

Preselector peak: with the marker at the peak of a displayed input signal, preselector peak automatically adjusts preselector tracking for maximum response.

Sweep

Trigger, continuous and single are the same as the HP 8568B, pages 664 and 665.

Sweptime

Zero Frequency Span

With digital storage: 20 msec full sweep to 1500 sec full sweep $n \sim 1\%$ increments.

Without digital storage: 1 μ sec full sweep to 10 msec in 1, 2, 5 sequence.

Marker (sweeps >20 msec only)

Normal: displays time from beginning of sweep to marker position.

Δ : displays time difference between stationary and tunable marker.

Input

RF input: 100 Hz to 22 GHz, precision female type N connector, dc coupled.

SWR (typical): 1.2:1, 100 Hz to 2.5 GHz; 1.5:1, 2 GHz to 5.8 GHz; 1.9:1, 5.8 GHz to 22 GHz; with 10 dB input attenuation.

LO emission (typical): <-80 dBm when preselected; <-90 dBm when not preselected.

Maximum Input Level

AC: $+30$ dBm (1 watt), continuous power.

DC: <100 mA current damage level.

Input attenuator: 70 dB range in 10 dB steps.

Accuracy: ± 1.0 dB over 10–70 dB range.

IF Input

Maximum Input Level

External Sweep Trigger: input >2.4 volts (5 volts max.)

AC: $+10$ dBm, continuous power, from 50 Ω source.

DC: 20 volts with rise time of <1 volt/ μ sec.

Sensitivity: -30 dBm at 321.4 MHz produces full-scale CRT deflection ± 1.0 dB when KSU has been executed.

Quasi-Peak (rear panel; nominal values)

Video input: 0–2 Volts. 139 Ω input impedance.

21.4 MHz input: input is nominally -11 dBm (with spectrum analyzer input attenuator set to 10 dB). 50 Ω input impedance.

Output

Calibrator: 100 MHz \pm (frequency reference error). -10 dBm ± 0.3 dB, 50 Ω impedance.

Auxiliary

Auxiliary outputs are the same as the HP 8568B, page 665.

21.4 MHz IF (rear panel): a 50 Ω , 21.4 MHz output related to the RF input to the analyzer. In log scales, the IF output is logarithmically related to the RF input signal; in linear, the output is linearly related. The output is nominally -20 dBm for a signal at the reference level. Bandwidth is controlled by the analyzer's resolution bandwidth setting; amplitude controlled by the input attenuator, and IF step gain positions.

IF Output (front panel)

Maximum Input Level

AC: $+10$ dBm, continuous power, from 50 Ω source.

DC: 20 volts with rise time of <1 volt/ μ sec.

1st LO output (front panel): 2.3 to 6.2 GHz, $>+5$ dBm, 50 Ω output impedance (nominal).

Frequency reference (rear panel): >-5 dBm, 50 Ω output impedance

Sweep plus tune output (rear panel): -1 volt per GHz into a 10 k Ω minimum load.

10 MHz output (rear panel): >-5 dBm, 50 Ω output impedance.

Sweep plus tune output (rear panel): -1.0 volt per GHz of tune frequency, >10 k Ω load.

Accuracy: -1 V/GHz $\pm 20\% \pm 10$ mV.

Quasi-Peak (rear panel; nominal values)

Video output: 0–2 volts. Output impedance >10 Ω .

21.4 MHz output: output is nominally -11 dBm (with spectrum analyzer input attenuator set to 10 dB). 50 Ω input impedance.

HP-IB Interface Functions

SH1, AH1, T6, L4, SR1, RL1, PP0, DC1, DT1, C1, C2, C3, C28. For more on these codes, refer to the HP-IB section of this catalog.

General

Environmental

Temperature: operating 0°C to 55°C, storage -40 °C to $+75$ °C.

Humidity: operating $<95\%$ R.H., 0°C to 40°C except as noted.

EMI: conducted and radiated interference is within the requirements of CE03 and RE02 of MIL STD 461A, VDE 0871, and CISPR pub'n 11.

Power requirements: 50 to 60 Hz; 100, 120, 220, or 240 volts ($+5\%$, -10%); approximately 650 VA (40 VA in standby). 400 Hz operation is available as Opt 400.

Weight: total net 50 kg (112 lb); Display/IF Section, 21 kg (47 lb); RF Section, 24 kg (53 lb). Shipping, Display/IF Section 31 kg (69 lb); RF Section 39 kg (87 lb).

Size: 267 H x 425.5 W x 598.5 mm D (10.5" x 16.75" x 23.56").

Ordering Information

Ordering Information	Price
HP 8566B Spectrum Analyzer	\$55,000
Opt 010: Rack Slide Kit	add \$450
Opt 400: 400 Hz Power Line Frequency Operation	add \$400
Opt 462: Impulse BWs for MIL-STD EMI Measurements	add \$2000
Opt 908: Rack Flange Kit	add \$60
Opt 910: Extra Manual	add \$350
Opt 913: Rack Flange Kit to Mount Instruments with Handles	add \$70
HP 8566A+01K Retrofit Kit	\$2500

SIGNAL ANALYZERS

Automatic Spectrum Analyzers, 100 Hz to 22 GHz

Models 8566S, 8567S & 8568S



- HP 9000 Series 200 and 300 computers for powerful computer capability
- Assortment of printers and plotters to choose from
- Software to minimize program development time
- Ease of operation via HP-IB
- 16K bytes of analyzer RAM for user-defined routines

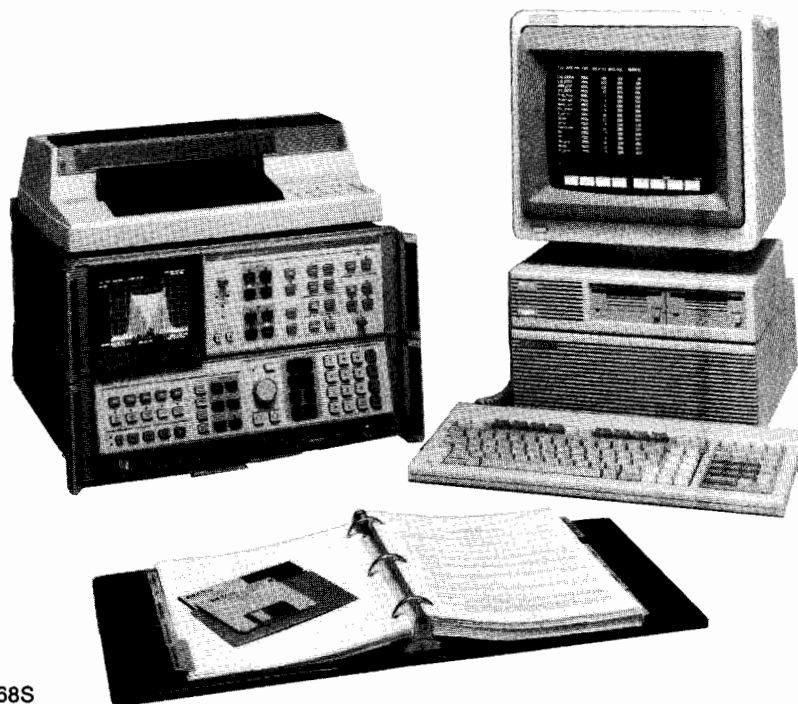

HP 8568S

The HP 8566S, 8567S and 8568S Automatic Spectrum Analyzers are systems based on the HP 8566B, 8567A and 8568B Spectrum Analyzers respectively. They are ideal for automatic systems applications due to their synthesized local oscillators, full programmability, direct and indirect plotter output, high level firmware function set, and 16,000 bytes of non-volatile memory for user-defined routines. Each system has an HP 9000 Series 200 or 300 Desktop Computer, both of which have a powerful Motorola 16-bit microprocessor. System Software is available in BASIC language. A wide variety of HP-IB printers and plotters are available for this system to provide the user with a great deal of flexibility to tailor the system for his or her needs. Operator training is available through the HP 8566A +24D or 8568A +24D Spectrum Analyzer Operation Course which is an intensive 4-day course that illustrates basic programming techniques for remote operation of these two spectrum analyzers. Course size is purposely kept small and hands-on operation is emphasized to facilitate getting the full benefits of the course. The frequency range of the HP 8566S can be extended above 22 GHz by using external mixers. (See page 693 for more information on the HP 11970 series mixers.)

System Software

System software is available for the HP 8566B and 8568B in BASIC (HP 85863B Software Library) for maximum flexibility. This software pack supplies high level routines (subprograms) to aid the system programmer in developing custom programs for specific applications. In effect, the software library acts as extensions of the spectrum analyzer's built-in firmware, thus enabling a user to write on a more conceptual level. For example, many measurements require the maximum amount of dynamic range available on the spectrum analyzer, given its current settings of center frequency, resolution bandwidth, and the maximum input level expected. Choosing the correct value of input attenuation which will result in the greatest dynamic range normally requires knowledge of the spectrum analyzer's

distortion and sensitivity characteristics. Subprogram *OPT-RANGE will automatically compute the optimum value of attenuation and set the spectrum analyzer's attenuator accordingly. Thus, by including *OPT-RANGE as part of the program, a user no longer needs to be concerned with the details of this aspect of the measurement. The system software comes on a 5 1/4 inch flexible disc (3 1/2-inch discs are also available) for use with an HP Series 200 or 300 computer. Also included is a manual which provides extensive documentation and line-by-line annotation of each program.

Major System Components

Spectrum Analyzer:	HP 8566B, 8567A, or 8568B
Desktop Computer:	HP Series 200, Model 216, 226, or 236; HP Series 300 Model 310 or 320
Printer:	HP 2671A, 2671G, or 2673A
Plotter:	HP 7090A, ColorPro, 7475A, or 7550A
Software:	85863B (BASIC) for HP 8566B and 8568B only
Operation Training Course:	HP 8566A +24D or 8568A +24D

Ordering Information

	Price
HP 8566S Automatic Spectrum Analyzer (HP 8566B based system)	\$0
HP 8567S Automatic Spectrum Analyzer (HP 8567A based system)	\$0
HP 8568S Automatic Spectrum Analyzer (HP 8568B based system)	\$0

For complete ordering information, prices, delivery, and available options, contact your local HP field engineer.

SIGNAL ANALYZERS

Spectrum Analyzer, 10 kHz to 1500 MHz

Model 8567A

- EMI measurement capability
- Close-in, accurate AM analysis
- Automatic signal monitoring
- Accurate, cost-effective component testing
- Direct plot capability
- Counter-like synthesis
- Powerful signal and trace processing functions
- Storage and execution of custom measurement routines

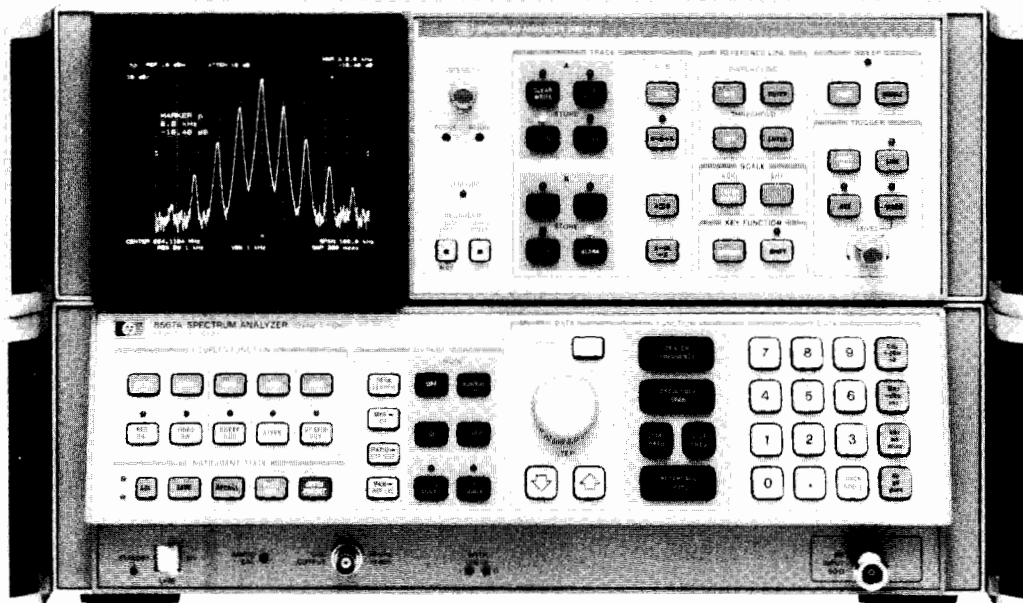

HP 8567A

The HP 8567A RF Spectrum Analyzer offers the performance and speed necessary for most bench and ATE uses at an affordable price. It covers the 10 kHz to 1.5 GHz frequency range. Difficult, close-in amplitude modulation measurements (0.5 Hz to 25 kHz) are made accurately, even in the presence of angle modulation, by using the Fast Fourier Transform (FFT) function, one of the many powerful HP 8567A firmware features.

Custom measurement routines are stored in the HP 8567A's 16K bytes of RAM and executed via HP-IB or from the front panel. These custom routines open a new horizon of operator convenience, allowing the operator to create measurement routines tailored to his or her particular application; routines that can be run without a computer.

The HP 8567A fits into many application areas. This cost-effective spectrum analyzer is ideal for EMI testing, and you can turn the HP 8567A into a CISPR* receiver by combining it with the HP 85650A Quasi-Peak Adapter and 85685A RF Preselector. Automate MIL-STD and commercial EMI measurements with the HP 85864C EMI Measurement Software. Perform spectrum monitoring and broadband surveillance automatically by using the HP 8567A with the HP 85865B Signal Monitoring Software. Add scalar measurement capability to the HP 8567A at minimal cost using the HP 8444A Option 059 Tracking Generator.

HP 8567A Specifications

Frequency

Frequency range: 10 kHz to 1500 MHz

Frequency readout accuracy: $\pm(2\%$ of frequency span + frequency reference error \times tuned frequency + 10 Hz) in AUTO resolution bandwidth at stabilized temperature using the error correction function.

*C.I.S.P.R. is a specification for radio interference measuring apparatus and measurement methods.

Frequency reference accuracy: Aging rate $< 5 \times 10^{-6}$ /year; temperature stability $< 1 \times 10^{-5}$ over $5^\circ - 55^\circ\text{C}$

Frequency span: Range 100 Hz to 1500 MHz in approximately 1% increments

Accuracy: spans > 1 MHz, $\pm(2\%$ of frequency separation between two points + 0.5% span); spans ≤ 1 MHz, $\pm(5\%$ of frequency separation + 0.5% span)

Markers

Normal: same as HP 8568B (page 664)

Frequency count: displays the frequency signal on whose response the marker is positioned.

Accuracy: spans ≤ 1 MHz, \pm (frequency reference error \times displayed frequency) $\pm(10$ Hz + 2 \times frequency counter resolution); spans > 1 MHz, $\pm(10$ kHz + frequency counter resolution)

Delta: same as HP 8568B (page 664)

Resolution bandwidths: (-3 dB) Range 1 kHz to 3 MHz adjustable in a 1, 3, 10 sequence. AM sideband resolution is typically 0.5 Hz-25 kHz using the FFT function.

Accuracy: $\pm 20\%$

Selectivity: (60dB/3dB) 1 kHz to 30 kHz, $< 13:1$; 100 kHz to 3 MHz, 15:1

Video bandwidth: Range 1 Hz to 3 MHz in 1, 3, 10 increments

Stability

Residual FM: 100 Hz peak-to-peak for sweep time ≤ 10 seconds, span < 100 kHz, resolution bandwidth 1 kHz, video bandwidth ≤ 30 Hz.

Frequency drift (after 1 hr. warmup at stabilized temperature): spans ≤ 1 kHz, < 100 Hz per minute of sweep time; 1 kHz $<$ span ≤ 1 MHz, < 1 kHz per minute of sweep time; spans > 1 MHz, < 300 kHz per minute of sweep time

Spectral purity: > 75 dBc, 30 kHz offset, 1 kHz resolution bandwidth



Amplitude

Total amplitude range: -115 dBm to +30 dBm

Maximum safe input power: AC Average Continuous, +30 dBm (+137 dBμV, 1 watt); pulse power, 100 watts for 10 μsec pulse, ≥50 dB attenuation; DC 0 volts (DC coupled)

Displayed average noise level: -115 dBm for frequencies >1 MHz, -92 dBm for frequencies < 1 MHz but > 50 kHz. (1 kHz res. bandwidth, 0 dB input attenuation, 1 Hz video filter)

Gain compression level: <1.0 dB for signal levels ≤-10 dBm at input mixer.

Display: 10-division CRT vertical axis.

Calibration: Log 10, 5, 2 and 1 dB/division; Linear 10% of reference level/division when calibrated in voltage.

Spurious responses: >70 dB below total signal power for mixer levels ≤-40 dBm

Reference level range: Log, +60.0 to -119.9 dBm; Linear 223.6 Volts to 2.2 μVolts full scale (maximum input must not exceed +30 dBm.)

Amplitude accuracy: The sum of the following factors determines the accuracy of the reference level readout. Depending upon the measurement technique followed after calibration, some of these sources of uncertainty may not be applicable. An internal error correction function reduces the uncertainty introduced by analyzer control changes from a state defined during the calibration of the instrument. Uncorrected values given in parentheses are typical values.

Frequency response: ±1 dB (≥10 dB RF attenuation)

Calibrator uncertainty: ±0.2 dB

Amplitude temperature drift: ±0.5 dB/°C (eliminated by recalibration) with -10 dBm reference level, 10 dB input attenuation, 1 MHz resolution bandwidth

Resolution bandwidth switching uncertainty¹: ±0.2 dB, (±1.0 dB uncorrected) Reference bandwidth is 1 MHz, 20° - 30°C

Log scale switching uncertainty: ±0.1 dB, (±1.0 dB uncorrected)

IF gain uncertainty: Assuming the internal calibration signal is used to calibrate the reference level at -10 dBm and the input attenuator is fixed at 10 dB, any changes in reference level in the following ranges will contribute to IF gain uncertainty: corrected (uncorrected)

Reference Level	20° - 30°C	5° - 55°C
0 to -55.9 dBm	±0.1 dB (±0.7 dB)	(±1.1 dB)
-56.0 to -119 dBm	±1.0 dB (±1.1 dB)	(±1.6 dB)

RF attenuator switching uncertainty: ±1.0 over 10 to 70 dB range
Scale fidelity

Log:

Incremental accuracy: ±0.1 dB/dB over 0 to 80 display

Maximum cumulative error: ±1.0 dB over 0 to 80 dB display, 20° to 30°C; ±1.5 dB over 0 to 90 dB display

Linear: ±3% of Reference Level

Error correction accuracy: ±0.4 dB (applicable when controls are changed from the calibration state)

Markers: same as HP 8568B (page 665).

Reference lines: same as HP 8568B (page 665).

Sweep

Sweep time: same as HP 8568B (page 665).

Inputs

RF input: 10 kHz to 1500 MHz, 50 ohm, Type N connector, dc coupled

Reflection coefficient: <0.20 (1.5:1SWR) (typical value, ≥10 dB input attenuation)

Also available: 10 kHz to 1500 MHz, 75 ohm, BNC connector, dc coupled (Option 001)

Maximum input level: AC, Continuous power, +30 dBm (1 watt); Pulsed power (10 μsec pulse into ≥50 dB input attenuation), 100 watts; DC, 0 volts

Input attenuator: Range, 10 dB to 70 dB in 10 dB steps

Accuracy: ±1.0 dB

Damage level: +30 dBm

External sweep trigger input: 2.4 to 5 volts (rear panel); input impedance (nominal) 139 Ω

¹30 kHz and 100 kHz bandwidth switching uncertainty is only applicable ≤90% relative humidity.

External frequency reference input: 10 MHz ±100 Hz, 0 dBm to +10 dBm (rear panel); input impedance (nominal) 50 Ω

Quasi-peak: (rear panel, nominal values)

Video input: 0 to 2 volts, 139 Ω input impedance

21.4 MHz IF input: -11 dBm with 10 dB input attenuation, 50 Ω input impedance

Outputs

Calibrator: 20 MHz ±(frequency reference error x days since calibration), -10 dBm ±0.2 dB, 50 Ω

Auxiliary: same as HP 8568B (page 665)

Direct plot output: Plots trace, graticule, and annotation shown on the CRT to an HP-IB plotter. Plotter must be set to address 705 and a computer should not be connected.

21.4 MHz IF: -20 dBm for a signal at the reference level

1st LO: 2 - 3.7 GHz, > +4 dBm, output impedance 50 Ω

Frequency reference output: 10 MHz, 0 dBm (nominal), output impedance 50 Ω

Quasi-peak: (rear panel, nominal values)

Video output: 0 - 2 Volts, output impedance <139 Ω

21.4 MHz IF output: -11 dBm with 10 dB input attenuation, output impedance 50 Ω

General

Environmental

Temperature: Operating 5°C to 55°C, storage -40°C to +75°C

EMI: Conducted and radiated interference is within the requirements of Class A1c, RE02 of MIL STD 461B, VDE 0871, and CISPR publication 11.

Warm-up time

Operation: Requires 30-minute warm-up from cold start, 5° - 55°C.

Frequency reference: Aging rate attained after 1 hr. from cold start at 25°C. Frequency is within 5 x 10⁻⁵ of final stabilized frequency within 30 minutes.

Power requirements: 50 - 60 Hz; 100, 120, 220 or 240 volts (+5%, -10%), 450 VA (approximately), 40 VA in standby. 400 Hz available as Option 400

Battery storage: Lithium battery holds information in RAM for typically 1 year.

Physical size characteristics

Net weight: Total, 45 kg (100 lb.); IF-Display Section, 21 kg (47 lb.); RF Section 24 kg (53 lb.)

Shipping: IF-Display Section, 27 kg (60 lb.); RF Section 32 kg (70 lb.)

Outside dimensions: 267 mm high x 425.5 mm wide x 558.8 mm deep (10.5" x 16.75" x 22")

Interface codes: SH1, AH1, T6, L4, SR1, RL1, PP0, DC1, DT1, C1, C2, C3, C27

Ordering Information

HP 8567A Spectrum Analyzer \$27,000

Opt 001: 75 Ohm (BNC), 10 kHz to 1500 MHz \$200

Opt 400: 400 Hz Power Line Frequency Operation \$400

Opt 908: Rack Flange Kit \$60

Opt 913: Rack Flange Kit to Mount Instruments with Handles \$70

Opt 010: Rack Mount Slide Kit \$450

Opt 910: Extra Manual \$350

Accessories

HP 85650A Quasi-Peak Adapter \$4,980

HP 85685A RF Preselector \$20,035

HP 8444A Option 059 Tracking Generator \$4,760

HP 8447D Preamplifier (0.1 to 1300 MHz) \$1,100

Transit Case

RF section P/N 9211-2655 \$520

IF section P/N 9211-2655 \$520

Software

HP 85864C EMI Software \$3,020

HP 85865B Signal Monitoring Software TBA



SIGNAL ANALYZERS

Downloadable Programming Capability

Models 8566B, 8567A, 8568B, and 71000 Series

- Expand your measurement capability
- Simplify your measurement tasks

The HP 8566B, 8567A, 8568B, and 71000 Series spectrum analyzers give you built-in capability to store and run programs and to control other instruments over the HP-IB. Programs written on a computer are "downloaded" into the analyzer, which stores them in its battery-backed, continuous memory. The computer can then be disconnected, freeing it for other uses, because the spectrum analyzer alone executes the downloaded programs (DLPs). Complex tests can be made, even by a non-expert operator, with immediate results. You now have an easy-to-use, customized instrument that provides accurate, repeatable measurements and whose manual operation is friendlier than ever before.

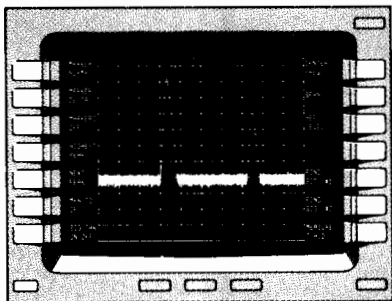

Customized Menus

Create your own softkey menus for one-button solutions to complicated measurement problems. A label on the CRT of an HP 71000 series modular spectrum analyzer indicates what downloaded function or test routine will be executed when the adjacent key is pressed.

Or, develop a menu of measurement routines and load it into the memory of an HP 8566B, 8567A, or 8568B Spectrum Analyzer. Then only the shift and number keys are needed to access each downloaded measurement routine contained in the downloaded menu.

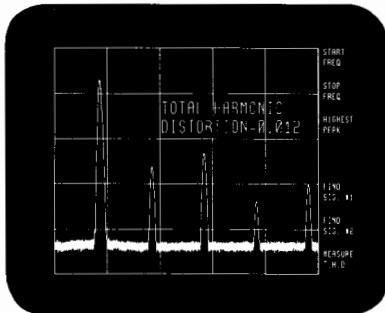

Programmed Efficiency

The following program excerpt directs the spectrum analyzer to measure Total Harmonic Distortion. A downloaded program like this executes a complete measurement routine in one easy step. The operator no longer has to manually perform a complex series of measurements and computations; the DLP provides repeatable results automatically.

```

REPEAT
  CF UP:TS:MKPK HI
  ADD THD,THD,MKA
  ADD N,N,1
  UNTIL N,GE,5
  DIV THD,THD,FUNDAMENTAL
  TEXT#TOTAL HARMONIC DISTORTION = $
  DSPLY THD,G,3
  
```

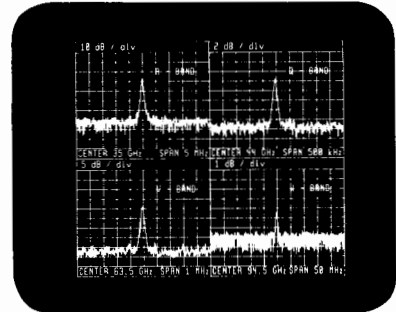

Automatic Multi-band Coverage

Under the control of a downloaded program, a single HP 71000 spectrum analyzer system can collect data and display results of multi-band coverage. By switching alternately between an RF section and three external mixer interface inputs, one analyzer can span the frequency range from 50 kHz to 75 GHz in just four broad-band sweeps. The DLP lets you view results from all bands in a single window or use multiple windows to display close-up sections of interest.

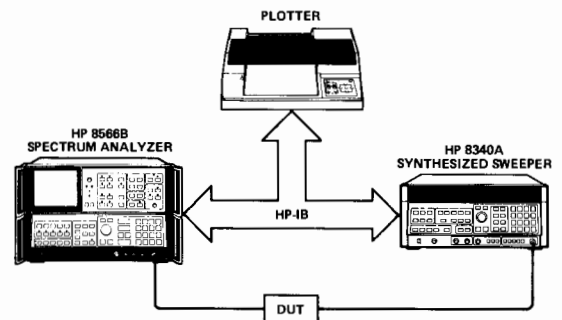

HP-IB Control

A downloaded program can automate stimulus-response testing by using a spectrum analyzer as the HP-IB controller. The DLP directs the analyzer to set the start and stop frequencies of a synthesized sweeper, via the HP-IB, to those of the spectrum analyzer. The downloaded program also regulates the collection and storage of data by the spectrum analyzer and the transmission of results over the HP-IB directly to a plotter.

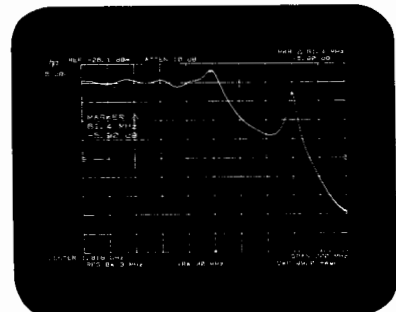

SIGNAL ANALYZERS

Signal Monitoring Software

Model 85865B

673



Automates the HP 8566B, 8567A and 8568B Spectrum Analyzers for

- Operator-controlled or unattended long-term signal monitoring
- Broadband surveillance and signal intelligence
- Communication system testing and maintenance

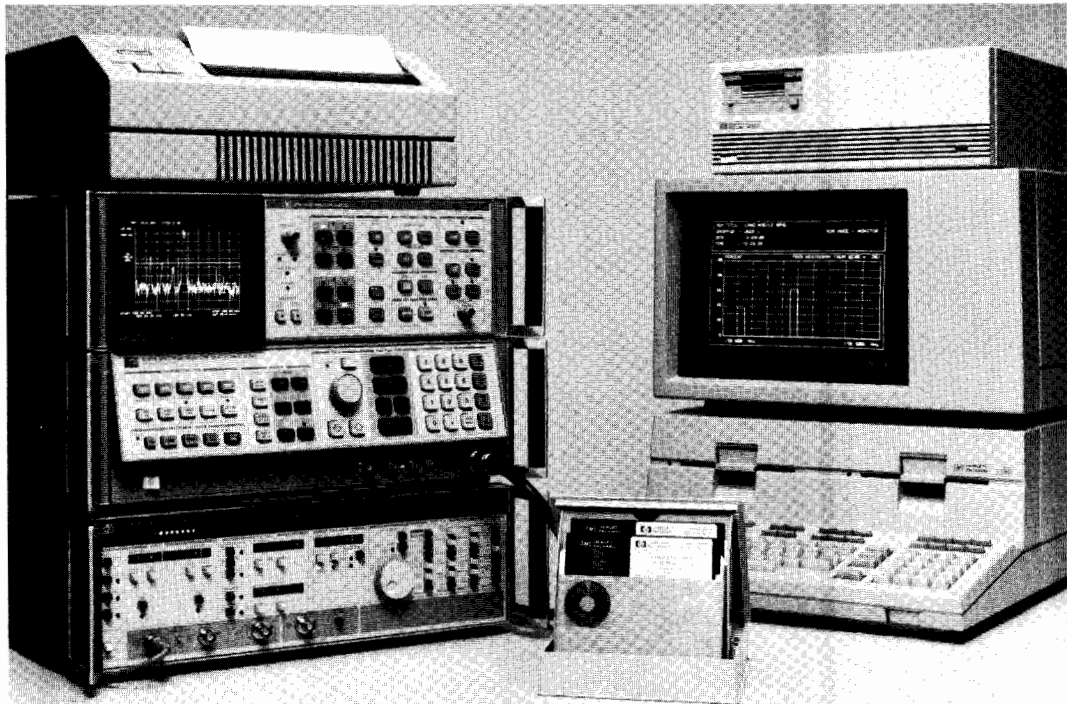

Typical system configuration using HP 85865B Signal Monitoring Software

Increase the power and flexibility of your HP 8566B, 8567A, or 8568B Spectrum Analyzer for signal monitoring and broadband surveillance. The HP 85865B Signal Monitoring Software automates your system for site surveillance applications and long-term attended or unattended monitoring operations. Menu options allow you to store command sequences and set the time of program execution. Monitor up to 32 frequency bands of interest and measure percent occupancy using the software's frequency histogram display. A multiband display option lets you view four selected bands at one time on the analyzer's CRT, and you can easily obtain hard copy of statistical information on band usage and transmission length using your system's printer or plotter. Signal data, collected continuously or at intervals over long periods of time, are stored with date and time included to provide comprehensive reports on ambient signal activity.

Diverse Applications

The HP 85865B Signal Monitoring Software offers advantages in areas requiring long-term monitoring of signal environments. For example, to maintain quality over the lifetime of a communication system, the program provides information on current band usage for management of the frequency spectrum, and on signal parameters to assure that transmissions meet specified tolerances. A "task scheduler" directs the spectrum analyzer to execute a file of commands at a given time, enabling completely automatic, unattended testing. Large blocks of data are stored and retrieved easily with a Hewlett-Packard Winchester disc drive added to your system.

For surveillance operations, the software's run-mode options permit the spectrum analyzer to automatically "search" a defined band, tune to a signal, measure frequency and amplitude, and determine modulation format. Data can be reported selectively: set an "alarm" to notify you when signals meet pre-determined characteristics, or construct a "signal mask" to prevent unwanted signals from being reported. Adding the HP 5180A Waveform Recorder to your system lets you measure pulse parameters including pulse width, pulse repetition interval, peak power, and average power for use in radar detection and system testing.

Powerful Graphics

Powerful display formats transform your system's console into an effective tool to analyze and manipulate data. View multiple bands—up to four at one time—in the frequency as well as the time domain. A "parameter summary" displays such measured signal parameters as pulse width, modulation format, pulse repetition interval, amplitude, and frequency. For a time profile of a particular band, use the three dimensional "raster" display of frequency, amplitude, and time. The "histogram" options provide information on band usage, and the "timegram" reports signal data as a function of time. The "timegram summary" displays statistics on percent occupancy, maximum frequency and amplitude, and average message length of two-way communication signals at specific frequencies. Transfer all display formats directly to an HP-IB X-Y plotter or HP-IB printer for customized hard-copy output.

The HP 85865B Signal Monitoring Software, written in Pascal 3.1, requires an HP 8566B (100 Hz to 22 GHz), HP 8567A (10kHz to 1.5 GHz), or HP 8568B (100 Hz to 1.5 GHz) Spectrum Analyzer and a compatible computer. For pulse analysis, a waveform recorder must be added to the system, and it is recommended that your computer contain at least 2 Mbytes of memory. Contact your nearest HP field representative for a complete list of accessories, including mass-storage devices, printers, and plotters. Hardware can be ordered as a single shipment using the "S" system. See page 669.

Minimum System Components:

Spectrum Analyzer	HP 8566B, 8567A or 8568B
Computer	HP Series 200, Models 236A/C/S/CS Technical or 220A Modular HP Series 300, Models 310 or 320

Ordering Information

HP 85865B Signal Monitoring Software

Price

(TBA)



SIGNAL ANALYZERS

Spectrum Analyzer/CISPR EMI Receiver 10kHz to 1.5GHz

Models 8573A, 8574A

- Meets CISPR Publication 16* requirements
- Performs VDE and FCC Compliance Tests

- Makes diagnostic EMI measurements
- Automates VDE, FCC, and MIL-STD EMI tests

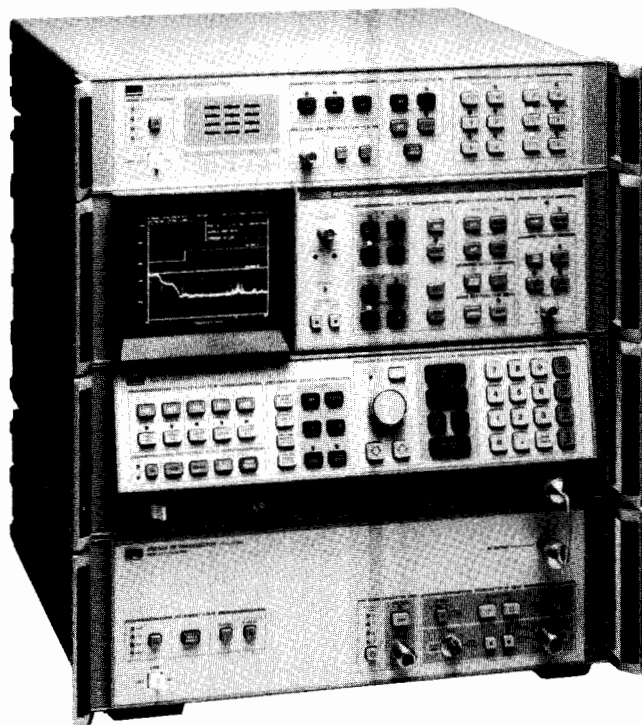

Typical HP 8573A Configuration with additional Controller



The HP 8573A and 8574A Spectrum Analyzer/CISPR EMI Receivers are designed for making fast, accurate EMI measurements. With improved sensitivity and overload protection, these powerful receivers meet CISPR Publication 16* recommendations as well as requirements of the FCC and VDE. And, because a versatile HP 8567A or 8568B Spectrum Analyzer forms the heart of each system, full EMI diagnostic capabilities aid you throughout a product's evolution, from design stages to completion of final commercial and MIL-STD qualification tests.

CISPR/EMI Receiver Features and More

To meet CISPR Publication 16 specifications, the HP 85650A Quasi-Peak Adapter provides the Spectrum Analyzer/CISPR EMI Receivers with required bandwidths and quasi-peak detection. The HP 85685A RF Preselector adds input overload protection and increased measurement sensitivity, and its built-in absolute amplitude calibration ensures ± 2 dB amplitude accuracy. The preselector automatically tracks the spectrum analyzer during manual and remote operation. A low-frequency RF input tolerates large impulses and Line Impedance Stabilization Network (LISN) transients. Both the low-frequency and high-frequency inputs allow the use of CISPR calibration pulses.

Automatic Control for Remote Operations

The HP 8573A and 8574A Spectrum Analyzer/CISPR EMI Receivers let you automate emission measurements via the HP-IB for conducted or radiated tests using a variety of compatible system controllers, EMI accessories, and peripherals. You can write your own programs or elect HP software: the HP 85864C EMI Measurement

software or HP 85870A Open-Site EMI Measurement System Software. Both feature easy-to-use menu structures that lead you through EMI measurements from initial setup to final results. Choose from libraries of FCC, VDE, and MIL-STD emission tests, or design your own. Results can be annotated and notes generated as part of your test documentation, and subroutines can be added to the software for automatic control of your EMI accessories.

EMI accessories available for FCC, VDE, and MIL-STD tests feature a LISN for commercial conducted measurements and current probes for MIL-STD conducted emission requirements. Transducer kits contain magnetic and electric field antennas for radiated emission testing from 10 kHz to 10 GHz. Other EMI accessories include preamplifiers, printers, plotters, and a system cabinet. See page 677.

Ordering Information

	Price
HP 8573A Spectrum Analyzer/CISPR EMI Receiver	\$51,980
HP 8574A Spectrum Analyzer/CISPR EMI Receiver	\$59,615
Option 001 HP 85900 System Cabinet (includes Option 913)	add \$2,850
Option 630 HP 85684C EMI Measurement Software (3 1/2" discs)	add \$3,020
Option 655 HP 85684C EMI Measurement Software (5 1/4" discs)	add \$3,020
Option 908 Rack mounting kit without handles	add \$122.50
Option 910 Extra set of operating manuals	add \$410
Option 913 Rack mounting kit with handles	add \$135

*CISPR Publication 16 is the Comite International Special des Perturbations Radioelectrique specification for radio interference measuring apparatus and measurement methods.

SIGNAL ANALYZERS

RF Preselector, 20 Hz to 2 GHz/Quasi-Peak Adapter

Models 85685A, 85650A

675



- Automatic filter tracking
- Input overload protection
- Low system noise

- Quasi-peak detection
- CISPR-specified bandwidths
- Bypass for regular spectrum analyzer operation

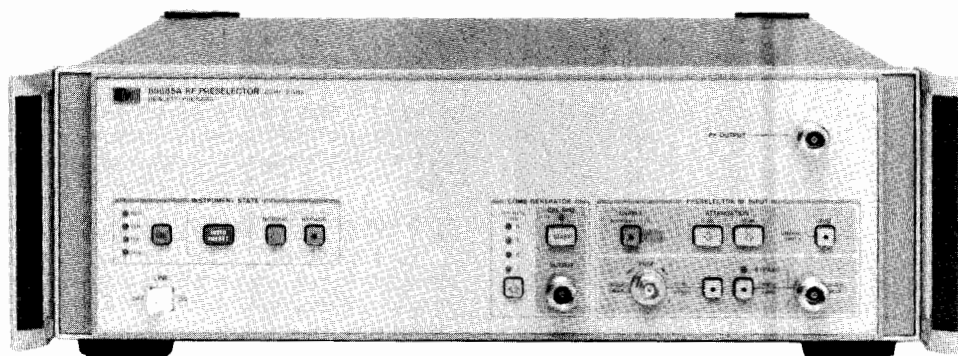

HP 85685A

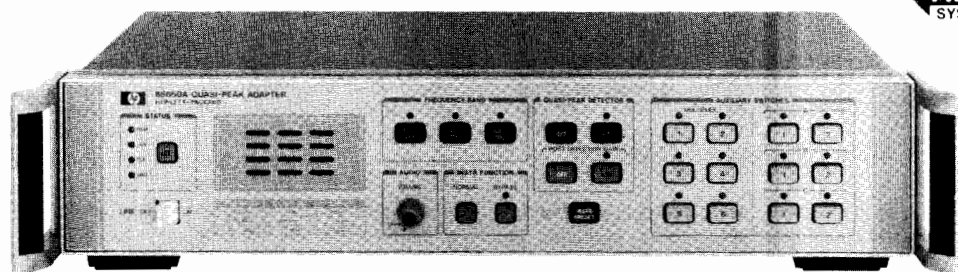

HP 85650A



HP 85685A RF Preselector

The HP 85685A RF Preselector makes a multi-purpose test receiver of an HP 8566B, 8567A, or 8568B Spectrum Analyzer. In addition to an instrument for general-purpose spectrum analysis, you now have a test receiver for specialized applications. The RF preselector, with tracking filters and preamplifiers covering the 20 Hz to 2 GHz range, improves spectrum analyzer measurement sensitivity while providing overload protection from out-of-band signals. The resulting test receiver system operating in the presence of high-level interference, has a measurement range 30 dB greater than that of a spectrum analyzer alone.

The spectrum analyzer/test receiver measures signals within the preselector filter passband and rejects out-of-band interference by 40 dB. This enables low-level signals to be monitored in the presence of high-level ambients. The preselector decreases input overload from out-of-band signals, thereby increasing the range for measuring low-level signals. Fast, wideband measurements mean a reduction in measurement time.

Combining the HP 85685A RF Preselector with an HP 8566B, 8567A, or 8568B Spectrum Analyzer and the HP 85650A Quasi-Peak Adapter gives you an EMI receiver that meets the recommendations of CISPR Publication 16*.

The RF preselector adds the measurement sensitivity and overload protection needed for FCC and VDE radiated emission testing at open sites. For commercial and MIL-STD conducted EMI tests, the low-frequency input tolerates large impulses and Line Impedance Stabilization Network (LISN) transients. A built-in calibrator ensures ± 2.0 dB absolute-amplitude accuracy as required by the FCC and VDE, and a convenient linearity check tests for system overload.

Operating the test receiver is easy. Use only the spectrum analyzer controls—the RF preselector automatically adjusts input-filter tracking, and the spectrum analyzer reports preselector operating conditions on the CRT. The receiver system is fully HP-IB programmable, and the HP 85685A comes equipped with the hardware needed to connect it to any compatible spectrum analyzer.

HP 85650A Quasi-peak Adapter

The HP 85650A Quasi-peak Adapter works with the HP 8566B, 8567A, and 8568B Spectrum Analyzers and with the 85685A RF Preselector to complete an EMI test receiver system. The quasi-peak adapter adds the special bandwidth filters and quasi-peak detection capability specified in CISPR Publication 16*. These bandwidth filters (200 Hz, 9 kHz, and 120 kHz) have 6 dB resolution and may be selected using either peak or quasi-peak detection.

A bypass switch enables the spectrum analyzer to bypass the quasi-peak adapter, and a Normal mode makes the three CISPR bandwidths available whether the quasi-peak adapter is on or off. The HP 85650A is fully programmable over the HP-IB for automated measurements, and it has both an internal speaker and an audio output jack (for external headphones) for monitoring signals.

Ordering Information

	Price
HP 85685A RF Preselector	\$20,035.00
Option 010, Rack mount slide kit	add \$385.00
Option 908, Rack flange kit without handles	add \$32.50
Option 910, Extra manual	add \$50.00
Option 913, Rack flange kit with handles	add \$35.00
HP 85650A Quasi-peak Adapter	\$4,980.00
Option 908, Rack flange kit without handles	add \$32.50
Option 910, Extra manual	add \$50.00
Option 913, Rack flange kit with handles	add \$35.00

*CISPR Publication 16 is the Comite International Special des Perturbations Radioelectrique specification for radio interference measuring apparatus and measurement methods.



SIGNAL ANALYZERS

EMI Measurement Software

Models 85864C, 85870A, 85874A

- Locate EMI "hot spots" quickly
- Increase EMI measurement repeatability
- Utilize powerful analysis aids



HP 85870A Open-Site EMI Measurement System Software

The HP 85870A Open-site EMI Measurement System (OEMS) Software is specially designed to automate and simplify commercial EMI, radiated-emission compliance measurements. EMI measurements made at open sites, due to ambient signals present in the measurement environment, are inherently more complex than measurements made in shielded enclosures. The HP 85870A helps EMI engineers and technicians quickly obtain repeatable, accurate, and completely documented measurement results using the HP 8573A and 8574A Spectrum Analyzer/EMI Receivers.

Identify and record ambients

The OEMS Software allows you to identify and categorize ambients by automatically (or manually) generating a list of the frequencies and amplitudes of ambient signals that are present when the equipment under test (EUT) is off. The ambient list is incorporated into a user-defined frequency-band table, which allows you to segment the entire range of interest and categorize the ambients in each band. For example, you can specify and label the 6-meter ham, FM radio, and land mobile bands in the frequency-band table. Methods are provided to generate and maintain complex ambient signal lists for repeated use. The spectrum analyzer screen is marked where the ambient signals occur for simplified identification of suspect EUT emissions.

Identify and maximize EUT emissions

With a complete ambient list and a remote AC power switch, the software can automatically turn on the EUT and find suspect emissions, even in the presence of impulsive or noisy environments. The EMC engineer or technician can then select from a number of features such as Tune & Listen, EUT On/Off, and Zoom Local to determine which signals are coming from the EUT. Confirmed emissions are assigned to a final list of signals. Each emission's amplitude is then determined by automatically controlling a turntable and antenna mast using a signal characterization routine of your choice. EUT emissions can be manually maximized using the SIG PEAK function, which controls an HP-IB antenna mast and turntable or allows manual positioning. The OEMS records information on each signal such as frequency and amplitude deviation from the limit, as well as the antenna height, turntable position, and user comments.

Generate complete reports in desired formats

Complete measurement results are documented in the format of your choice using the OEMS Software Report Generator. You can design your own test report using combinations of fixed text and

- Begin testing at system turn-on
- Test to standard or internal limits
- Automatically correct data for transducer and system gain/loss

updateable variable fields for the date and time of test, equipment name and serial number, or any other information. Ambient, suspect, or final signal lists and log frequency plots of the final data can be integrated with your text for concise, professional-looking reports. A library is provided to store these report formats. CRT data and signal lists can also be sent to a printer or plotter from virtually any point in the software.

HP 85864C EMI Measurement Software

The HP 85864C EMI Measurement Software is a general-purpose program for making automatic commercial and military emission measurements using an HP 8566B, 8567A, or 8568B Spectrum Analyzer. The friendly menu structure of the program leads you through an EMI measurement from initial setup to the final plotting of the test results. The HP 85864C has an easy start-up procedure, so you are "ready to run" even if you have never programmed before.

Automate MIL-STD and commercial EMI measurements

The HP 85864C EMI Measurement Software automates military and commercial EMI emission measurements. It is designed to automate EMI measurements made in a shielded enclosure. The HP 85864C takes advantage of the spectrum analyzer's ability to quickly measure wide frequency spans and locate EMI "hot spots" using peak detection. For commercial measurements, quasi-peak data need be taken only at these "hot spots." Save time and effort in your MIL-STD measurements by letting the software take narrowband and broadband data in the same test.

Design your own tests

Design your own tests or choose from the examples given in the software. These examples reside in the test library and include MIL-STD, FCC, and VDE/FTZ emission tests. Transducer factors, test limits, and receiver parameters are easily changed and stored in libraries. Once your test is designed, it is stored away and can be executed repeatedly at the push of a key.

Compatibility

The HP 85864C and 85870A are compatible with the following equipment:

Spectrum Analyzer*	HP 8566B, 8567A, 8568B
RF Preselector	HP 85685A
Quasi-Peak Adapter	HP 85650A
Spectrum Analyzer/EMI Receiver	HP 8573A, 8574A
Computer*	HP 9000 Series 300 Model 310, 320 (medium-resolution monitor only) HP 9000 Series 200 Model 216, 236 2 Mbytes (HP 85870A); 1.5 Mbytes (HP 85864C)
Memory Requirements*	HP 9122S/D, 9133H, 9153A
Mass Storage*	HP 7440A, 7475A, 7550A
Plotters	HP 2225A, 82906A, 2671G, 2673A
Printers	HP 98620B
DMA Controller	HP 98635A
Floating Point Card	HP 98635A
SRM Interface	HP 50962A

*Minimum equipment required

Ordering Information

	Price
HP 85864C EMI Measurement Software	\$0
Opt. 630 3½-inch media	\$3020
Opt. 655 5¼-inch media	\$3020
HP 85874A OEMS Software	\$0
Opt. 630 3½-inch media	\$5000
Opt. 655 5¼-inch media	\$5000
HP 85874A Bundled EMI Software	
Includes HP 85864C and 85870A	\$0
Opt. 630 3½-inch media	\$7000
Opt. 655 5¼-inch media	\$7000

SIGNAL ANALYZERS

Close-Field Probe/EMI Receiver Functions/EMI Accessories and Transducers

Models 11940A, 85867A, 85685A

677

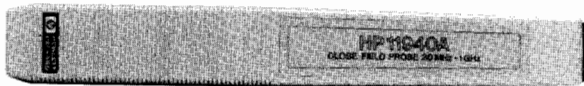

HP 11940A

HP 11940A Close-Field Probe

This small, hand-held, electromagnetic field sensor is used with a spectrum analyzer for electromagnetic interference (EMI) diagnostic and troubleshooting applications. A dual-loop configuration and balun structure enable it to make repeatable, absolute magnetic-field measurements over a 30 MHz to 1 GHz frequency range. Especially designed to measure radiation from surface currents, slots, and cables, this probe is an ideal tool for diagnostic testing of printed circuit boards, cabling, and shielded enclosures. It is calibrated to within +2 dB in a 377-ohm field impedance, and when attached to a source, it will generate a localized magnetic field for susceptibility testing.

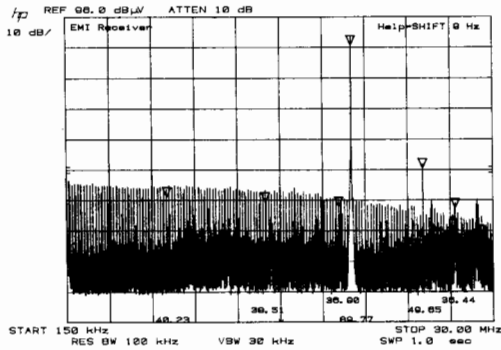

HP 85867A



HP 85867A EMI Receiver Functions

This set of softkey programs simplifies commercial EMI measurements performed manually using an HP spectrum analyzer/EMI receiver (see page 674). An external computer is not needed after the softkeys are downloaded in spectrum analyzer non-volatile RAM. You can select a CISPR* band, make automatic quasi-peak measurements at up to six discrete frequencies, and directly print or plot measurement data using front-panel softkeys.

Features of the EMI Receiver Functions include a quasi-peak softkey that automatically chooses correct analyzer resolution bandwidths, video bandwidths, CISPR bandwidths, and sweeptimes for fast, accurate quasi-peak measurements. Up to six quasi-peak markers and numeric values can be displayed at the same time. This lets you simultaneously view a wide frequency span and the quasi-peak values of up to six signals. A numeric keypad overlay for the spectrum analyzer is included to help you select the right softkey, and a help function gives the purpose of each softkey. Spectrum analyzer options are available for factory installation of this product.

Ordering Information

Item	Price
HP 11940A Close-Field Probe	\$500
Opt. 001 Rotary Joint	\$375
Opt. 002 RG 223 Cable and Adapters	\$83
HP 85867A EMI Receiver Functions	\$0
Opt. 630 3½-inch media	\$250
Opt. 655 5¼-inch media	\$250

Price

EMI Accessories

Turntable for Radiated Emission Testing

- Equipment Testing Turntable with HP-IB control.
- HP 85685A Option K40: 50-60 Hz, 100-120 volt
- HP 85685A Option K41: 50-60 Hz, 220-240 volt

Tower for Radiated Emission Testing

- Antenna Positioning Tower with HP-IB and polarization control.
- HP 85685A Option K42: 50-60 Hz, 100-120 volt
- HP 85685A Option K43: 50-60 Hz, 220-240 volt

*CISPR Publication 16 is the Comite International Special des Perturbations Radioelectrique specification for radio interference measuring apparatus and measurement methods.

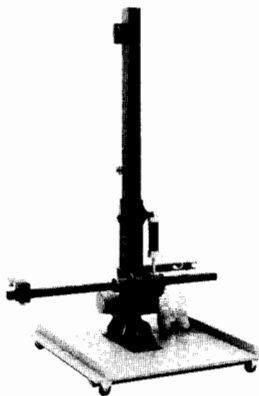

Antenna Positioning Tower



Log Periodic Antenna

Recommended EMI Transducer Kits:

Commercial			MIL-STD		
Test	Freq. Range	HP 85685A Option	Test	Freq. Range	HP 85685A Option
VDE 0871 FCC PART 15J FCC PART 15J (only).	Radiated	10 kHz-30 MHz	MIL-STD 461B/462	Radiated RE-02	14 kHz-1 GHz
		10 kHz-1 GHz			1-10 GHz
		10 kHz-30 MHz			10 kHz-30 MHz
	30 MHz-1 GHz			10 kHz-30 MHz	
		10 kHz-30 MHz			10 kHz-30 MHz



SIGNAL ANALYZERS

Spectrum Analyzer

Model 8590A

- Powerful features at a new, low cost
- Lightweight and portable
- Programmable via HP-IB, HP-IL, or RS232C
- Direct printer and plotter output



HP 8590A



HP 8590A Portable RF Spectrum Analyzer

This compact, portable RF spectrum analyzer offers many features of a high-performance model for a low, affordable price. With a wide frequency range (10 kHz to 1.5 GHz), large amplitude range (-115 dBm to +30 dBm), and 50- or optional 75-ohm input, the new HP 8590A has the versatility to make most RF signal measurements. Lightweight and sturdy, the analyzer goes where you need it—from the bench into the field. Over 100 functions are programmable from an optional computer interface, and many accessories are available to expand basic spectrum analyzer capabilities. Whatever the application, from automatic testing on the production line to servicing equipment in the field, the HP 8590A fits the job.

Digital Display

The raster-scan display of this spectrum analyzer gives a flicker-free and parallax-free graticule. Display menus simplify operation and reduce the number of front-panel controls. Easy-to-read control settings surround the graticule, and a 50-character label can be added to the top of the screen. Expanded display size and remote viewing of the screen are possible using the HP 82913A video monitor.

Simple Operation

Special training is not required to run the HP 8590A. Use the three main control keys and the data entry knob or keypad to measure any signal. Center the signal with FREQUENCY; resolve the signal with SPAN; move the signal up and down with AMPLITUDE. The analyzer automatically adjusts internal parameters such as resolution bandwidth, sweep time, IF gain, and input attenuation. Commonly used functions are built into dedicated keys. These include markers for reading out amplitude and frequency values, and PLOT and PRINT keys for recording test results easily on ordinary typing paper. Display-menu softkeys access nearly 100 additional time-saving functions.

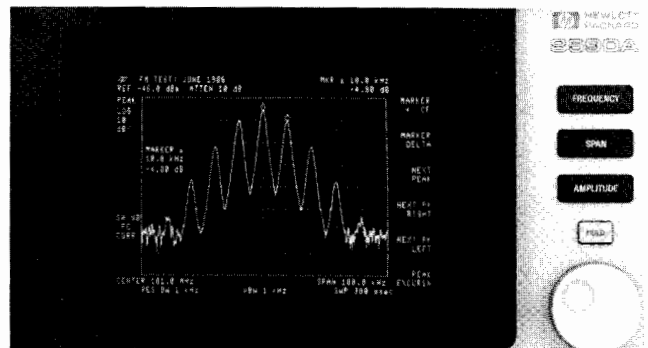

Hardworking Functions

The many built-in functions make complex measurements much easier. SIGNAL TRACK captures a signal in a crowded spectrum and holds it at center screen, thus allowing the operator to "zoom in" by changing frequency span. Marker functions display signal amplitude with 0.05 dB resolution. PEAK SEARCH places a marker on the highest signal displayed; NEXT PEAK moves the marker to the next highest signal. Other marker keys measure amplitude and frequency differences between signals and pause the analyzer at a marker while a demodulated signal is monitored.

The spectrum analyzer uses trace storage, two active traces, and trace math to eliminate frequency response variations caused by the analyzer and an external source. The screen displays the frequency response of the input signal alone (see below). Related functions are MAX HOLD, which displays a signal's peak amplitude and frequency drift, and VIDEO AVERAGE, which smooths displayed-noise peaks.

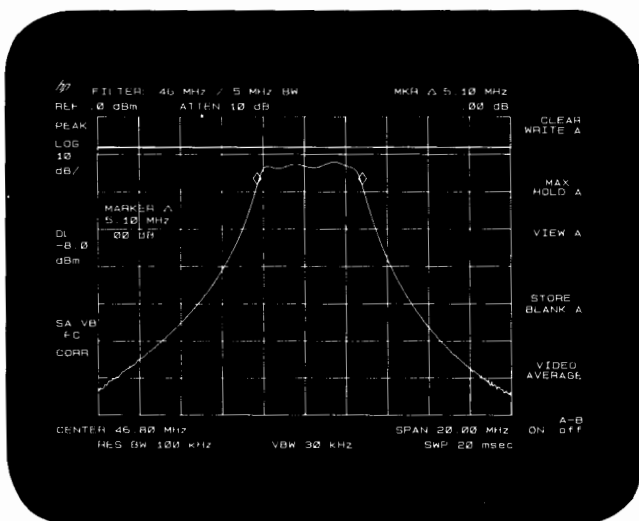

Special functions perform measurements such as %AM, 99% power bandwidth, and signal-to-noise. The 3 dB POINTS and 6 dB POINTS softkeys determine filter bandwidth. An FFT (Fast Fourier Transform) measures AM sidebands. Even though the analyzer's minimum IF bandwidth is 1 kHz, the FFT detects sub-Hz signals and transforms the RF display into a low-frequency display (see below).

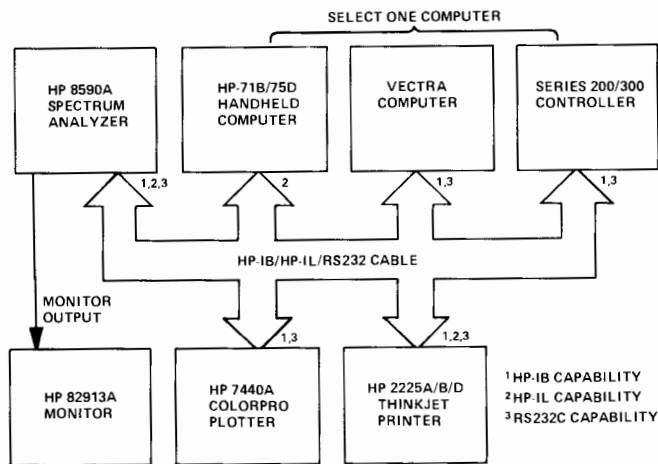
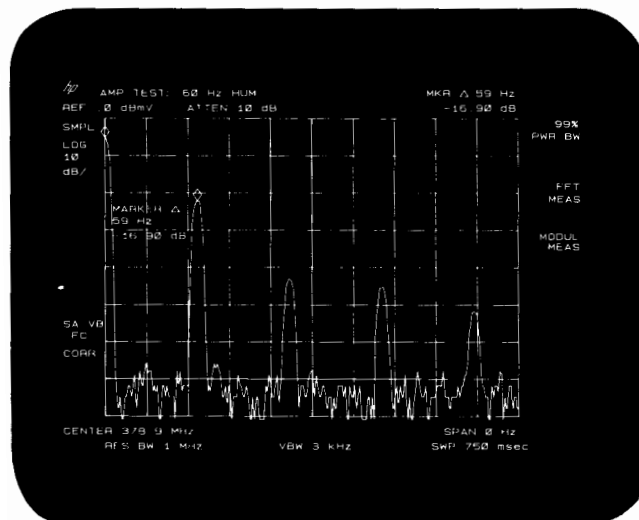

EQUIPMENT CONFIGURATION FOR AUTOMATIC TESTING

Automatic Control

Three computer-interface options are available to automate the spectrum analyzer's many functions: HP-IB¹, HP-IL², and RS232C. Programs can be written using a desktop or handheld computer. With over 80 programming commands built into the analyzer, any front-panel measurement can be automated and results can be stored as well. Even without a computer, the interface will send display data to a printer or plotter. The HP 8590A improves your efficiency with fast, repeatable, automatic measurements.

Portability and Performance

With this analyzer you can get the same quality test results in the field that you get in the factory. The analyzer weighs only 30 pounds and has a "briefcase" handle to make carrying easy, and it's small enough to slip under an airline seat. It can be taken anywhere—from isolating electromagnetic emissions in a mainframe computer to troubleshooting signal interference in the field. Automatic tests can be made using the HP-71B handheld computer, which fits into the analyzer's optional front cover. Wherever you need performance, you can depend on the HP 8590A.

Add-on Features

For specialized test needs, the portable spectrum analyzer is compatible with accessories such as computers, multi-pen plotters, a video monitor, and more. The HP 8444A Tracking Generator turns the HP 8590A into a stimulus-response system that makes frequency-response and insertion-loss measurements on RF components. Use a preamplifier and the HP 11940A Close Field Probe with the analyzer and tracking generator for a swept, broadband system that does EMI troubleshooting. To record important test results, use the HP ThinkJet Printer or the HP-71B Handheld Computer (a program is available for storing up to 30 display traces along with analyzer control settings).

¹HP-IB is Hewlett-Packard's hardware, software, documentation, and support for IEEE-488 and IEC-625 worldwide standards for interfacing instruments.

²HP-IL is the Hewlett-Packard Interface Loop for serial-interfacing instrument systems.



HP 8590A Specifications

Frequency

Frequency range: 10 kHz to 1.5 GHz with 4-digit resolution

Readout accuracy: $\pm(5 \text{ MHz} + 1\% \text{ of span})$ (50- Ω termination on 1st LO Out)

Frequency stability

Drift: <50 kHz/5 min. after 2-hour warmup and 5 min. after setting center frequency

Signal track: signal held at display center compensates for drift

Noise sidebands: <-65 dBc at 30 kHz offset (1 kHz RBW, 30 Hz VBW)

Frequency span range: zero and 50 kHz to 1.5 GHz with 4-digit resolution

Readout accuracy: $\pm 3\%$ of indicated frequency span

Bandwidth (-3 dB nominal)

Resolution BW (RBW): 1 kHz to 3 MHz in 1,3 sequence (Gaussian shape)

Video BW (VBW): 30 Hz to 3 MHz in 1,3 sequence

Sweep time range: 20 ms to 100 s

Readout accuracy: $\leq -10\%$ of indicated setting

Amplitude

Amplitude range (1 MHz to 1.3 GHz)³

50- Ω calibration: -115 dBm to +30 dBm

75- Ω calibration (Opt. 001): -63 dBmV to +77 dBmV

Readout resolution (with markers): <0.05 dB for log scale; <0.05% of Ref. Level for linear scale

Amplitude units: dBm, dBmV, dBuV, volt, watt

Amplitude scale: 1-20 dB/div. in 1 dB steps and linear

Maximum input power: +30 dBm (1 W) continuous; 0 V dc

Maximum dynamic range: 70 dB for on-screen viewing; 70 dB for signal-to-distortion; 95 dB for IF compression-to-noise

Displayed average noise: 1 MHz to 1.3 GHz (0 dB input attenuation, 1 kHz RBW, 30 Hz VBW)³

50- Ω calibration: <-115 dBm

75- Ω calibration (Opt. 001): <-63 dBmV

Gain compression

RF input: <1 dB for -10 dBm total power at input mixer

Internal IF: <1 dB when signals are higher than Ref. Level and total power at input mixer is -20 dBm

Spurious responses

Second Harmonic: <-70 dBc for -45 dBm at input mixer, input >5 MHz³

Third-order intermod.: <-70 dBc for two -30 dBm signals at input mixer, >50 kHz signal separation

Residual responses: <-95 dBm for no input signal (0 dB input atten. and 50- Ω termination on RF Input and 1st LO Out)

Amplitude Accuracy

Frequency response

Absolute variation: ± 1.5 dB referenced to Cal Out signal (10 dB atten.)

Peak variation: ± 1 dB referenced to mid-point between highest and lowest peak excursions

Calibrator accuracy (for 299.9 MHz \pm 300 kHz Cal Out signal)

50- Ω calibration: ± 1 dB for -20 dBm level

75- Ω calibration (Opt. 001): ± 1 dB for +27 dBmV level

Reference level setting (log scale)

0-60 dB atten.: ± 1.75 dB for +30 to -120 dBm range

10 dB atten.: ± 1.25 dB for 0 to -120 dBm range; ± 0.5 dB for 0 to -59 dBm range

Resolution BW switching: ± 0.25 dB for 3 kHz to 3 MHz RBW range

Log scale switching: no significant error for 1-20 dB/div. scale range

Log scale fidelity: ± 0.1 dB/dB change over 70 dB range with ± 0.75 dB max. over -60 dB range from Ref. Level; ± 1.0 dB max. over -70 dB range from Ref. Level

Linear scale fidelity: $\pm 3\%$ of Reference Level setting

Input/Output Characteristics

Front-panel connectors

RF input: 50- Ω BNC (standard); 75- Ω BNC (Opt. 001)

Probe power output: +15 V, -12.6 V, GND, 150 mA max.

Cal output

50- Ω BNC (standard): -20 dBm, 299.9 MHz

75- Ω BNC (Opt. 001): +27 dBmV, 299.9 MHz

1st LO output: 50- Ω BNC, +10 dBm, 2.05 to 3.55 GHz

Rear-panel connectors

Aux video output: 50- Ω BNC, 0 to 1 V

Monitor output: 50- Ω BNC, NTSC format, 19.2 kHz horiz. sync.

High sweep in/Out: BNC, high TTL = sweep, low TTL = retrace

Sweep output: BNC, 5 k- Ω , 0 to +10 V ramp

Aux IF output: 50- Ω BNC, -10 to -60 dBm, 21.4 MHz

Ext. trigger input: BNC, TTL levels, positive edge trigger

Interface connector: HP-IB (Opt. 021), HP-IL (Opt. 022), or RS232C (Opt. 023)

HP-IB codes: SH1, AH1, T6, L4, SR1, RL1, PP0, DC1, DT1, C1, C2, C3, C28

General

Temperature: 0° to 55°C operating; -40° to +75°C storage

Temperature stability: 2 hours after storage at a constant temp. between 0° and +55°C and 30 minutes after analyzer turn-on at the same constant temperature

EMI compatibility: CISPR pub. 11 (1985) and FTZ 526/527/79

Audible noise: <37.5 dBA pressure and <5.0 Bels power (ISO DP7779)

Power requirements: 86-127 or 195-253 V RMS; 47-66 Hz; 120 VA max.

Weight (characteristic): 13.5 kg (29.8 lb)

Size (characteristic): 213 mm (8.4") H \times 366 mm (14.4") W \times 460 mm (18.1") D

Warranty: One year limited warranty for materials and workmanship

Recommended Accessories

HP 2225A/B/D ThinkJet Printer

HP 7440A ColorPro Plotter

HP-71B/HP-75D Handheld Computer

HP 8444A Opt. 059 Tracking Generator

HP 82913A Monitor

HP 10855A Broadband Preamplifier

HP 11940A Close Field Probe

HP 11867A RF Limiter

HP 11694A 50-75 Ω Matching Transformer

HP 11852A 50-75 Ω Minimum Loss Pad

Rack Slide: P/N 1494-0060 (for HP 8590A Options 908/909)

Transit Case: P/N 9211-5604

Ordering Information

HP 8590A Portable RF Spectrum Analyzer	Price
Option 001: 75- Ω Input Impedance	\$9500
Option 021: HP-IB Interface	\$0
Option 022: HP-IL Interface	\$450
Option 023: RS232C Interface	\$450
Option 040: Front Panel Cover	\$200
Option 908: Rack Mount Without Handles	\$250
Option 909: Rack Mount With Handles	\$300
Option 910: Extra Operating and Installation Manuals	\$24
Option 915: Support Manual and Extra Operating and Installation Manuals	\$110

³Refer to Installation Manual (08590-90003) and Operation Manual (08590-90005) for more information.

- Rugged portability
- Simple three-knob operation
- Direct plotter control

- Display annotation and storage accessories
- Digital display with trace arithmetic
- Resolution bandwidths from 1kHz to 3MHz

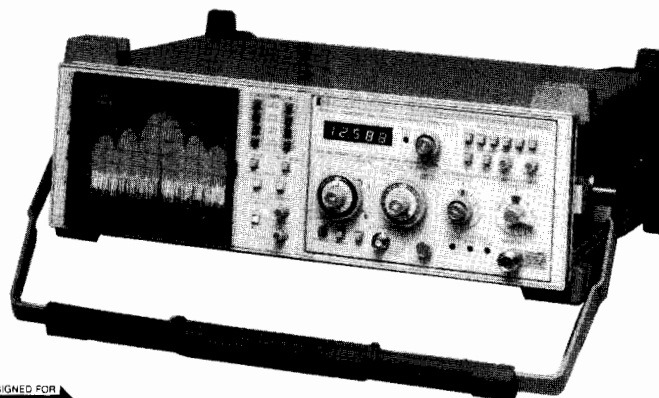

HP 8557A, 8558B, and 8559A Spectrum Analyzer Plug-Ins

Performance Plus Economy

The HP 8557A (10 KHz to 350 MHz), 8558B (100 KHz to 1500 MHz), and 8559A (10 MHz to 21 GHz) are spectrum analyzer plug-ins for use with the HP 853A Spectrum Analyzer Display. The excellent performance and convenient operation of these economical units make them ideal for a variety of applications in production, R&D, and field-service measurements.

Simple 3-Knob Operation

Preset these spectrum analyzers to color-coded, "basic-operation" settings, and use the coupled controls to make most measurements in three easy steps. Tune to a signal; the LED readout displays its frequency. Zoom in on the signal by reducing span width; the resolution bandwidth, video filter, and sweeptime automatically change to an optimum value for a calibrated display. Then, adjust the reference level to bring the peak of the signal to the top of the screen for the most accurate amplitude measurement.

Absolute Amplitude Calibration

Signal levels can be read directly from the CRT in dBm (in dBmV with Option 002 for the HP 8557A and 8558B) without the use of external standards or calculations. The signal level represented by the top graticule line on the CRT is always indicated by the reference-level control, and vertical scale factors of 10 dB/div, 1 dB/div, or linear can be selected.

HP 8557A Options

75-Ohm Input

Two options are available that allow measurements in 75-ohm systems. Option 001 has 75-ohm impedance, but retains the dBm power calibration. Option 002 also has 75-ohm impedance, but the amplitude is calibrated in dBmV for measurements on systems such as CATV.

HP 8558B Options

75-Ohm Input

Options 001 and 002, as described for the HP 8557A, are also available for the HP 8558B.

EMI Option H98

A hardware modification to the HP 8558B extends low-frequency coverage to 10 KHz, calibrates the display in dBuV, and provides resolution filters with 6 dB bandwidths of 9 and 120 kHz. With the enhancements, the HP 8558B is useful for FCC and VDE emission testing.

EMI Measurement System Option 98

A portable, semi-automatic EMI measurement system is provided by combining Option E98 (described above) with HP 853A computer accessories and software (see "Software," page 682). The system consists of HP 8558B Option E98, 853A Display, 75D Portable Computer, 82700A Memory Module, 82169A Interface, 82161A Cassette Drive, 82176A Cassettes, 82715A Card Holders, and Solid State Camera Software with user's manual (part number 75-00853).

HP 8444A Option 059 Tracking Generator (0.5-1500 MHz)

This option enables swept frequency measurements from 0.5 to 1500 MHz with greater than 90 dB of dynamic range. The output is calibrated absolutely at 0 dBm and is continuously variable to -10 dBm. Frequency of an unknown signal, as well as any point on a frequency-response curve, can be measured using the external counter output and a frequency counter such as the HP 5300B/5305B.

HP 8559A Accessory

HP 11870A Low Pass Filter

For RF measurement applications needing extended coverage to 2.6 GHz, the HP 11870A Low Pass Filter rejects signals above 3 GHz by more than 60 dB for image-free measurements over the entire 10 MHz to 2.6 GHz range.



SIGNAL ANALYZERS

Spectrum Analyzer Plug-ins

Models 8557A/8558B/8559A and 853A

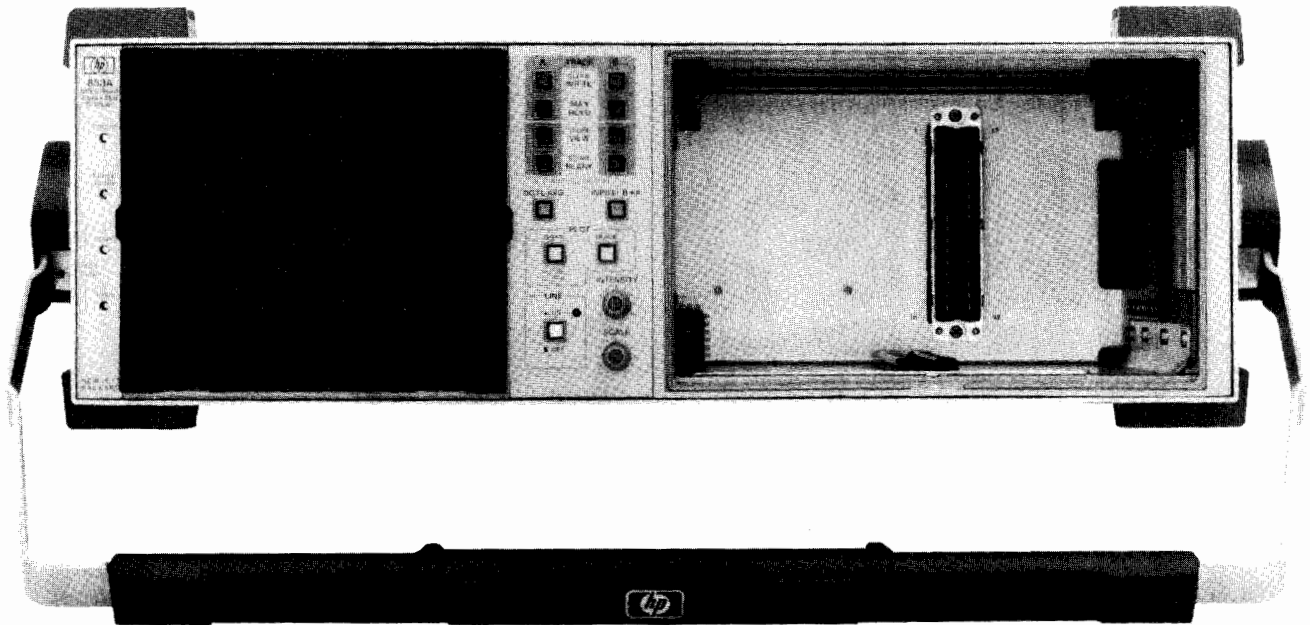

HP 853A



HP 853A Spectrum Analyzer Display

Digital Display

The HP 853A is a digital display mainframe for use with the HP 8557A, 8558B, and 8559A spectrum analyzer plug-ins. Signals are displayed on either of two independently stored digital traces. Display processing capabilities include maximum hold, digital averaging, and trace normalization for extended measurement capability. A built-in microprocessor manages the display operation and provides access (via the front panel) to built-in test routines for display calibration and testing.

HP-IB Capability Includes Direct Plotter Control

A hard-copy record of the displayed traces and graticule can be made on a digital plotter via HP-IB using the front-panel buttons of the HP 853A. A controller is not required. Although analyzer controls are not themselves programmable, the HP-IB can be used for applications that include using a controller to record trace data and to prompt the operator on the HP 853A CRT. The digital display and processing functions can be remotely programmed, and analyzer sweeps can be initiated over the HP-IB.

Two Configurations

The display is offered in two styles. The HP 853A (pictured) is a ruggedized, portable mainframe complete with tilt-bail handle and drip-proof, protective front cover. The HP 853A is ideally suited for rugged field environments and any areas where system mobility is required. The HP 853A Option 001 offers the digital display in a full module bench or rack-mount configuration.

Software

The Solid State Camera Software offers a low-cost, portable alternative to CRT photos. Its "Camera" program lets you annotate the display with a title and analyzer settings; permanently store traces and annotation in computer memory, on magnetic cards, or on magnetic cassette; and retrieve stored information for viewing or for making plotted hard copy. The "Limitgen" program allows test limit lines to be drawn on the HP 853A display.

The software adds measurement capability to many spectrum analyzer applications. Generating limit lines on the display aids EMI measurements, and FCC digital radio masks can be drawn. Recording spectrum analyzer display data is useful in proof-of-performance testing, electric field strength measurements, remote location testing, and communication band occupancy monitoring. Production measurements are enhanced by display comparison testing to specification lines or to ideal response shapes.

The Solid State Camera Software for the HP 853A display runs on an HP 75D Portable Computer and uses an HP 82700A 8k-Byte Memory Module and 82169A HP-IB Interface. Recommended options include the HP 7440 ColorPro and 7475A Plotters, as well as the HP 82161A Cassette Drive and 82176A Cassettes.

HP 853A Characteristics

Digital Display

Traces: dual trace, digitally stored display with resolution of 481 horizontal by 801 vertical points per trace.

Signal processing: maximum hold, digital averaging, and trace normalization.

Internal service routines: front-panel buttons access test routines for maintenance of digital hardware.

HP-IB

Direct plotter control: all displayed information transferable to HP-IB plotter using front-panel buttons.

Controller interface functions:

Trace data transfer: all trace data values are transferable to or from HP 853A with controller.

Input messages: controller input instructions or annotation can be displayed on either of two 60-character lines.

Display control: all trace-processing functions can be remotely controlled.

Sweep control: analyzer sweeps can be initiated and monitored.

HP-IB interface functions: SH1, AH1, T5, L4, SR1, RL1, PP0, DC1, DT1, C0, and E2.

Output Characteristics (Rear Panel)

Vertical output, AUX A: BNC output (50 ohms) provides detected video from 0 to 0.8 V for 8 divisions deflection on CRT display.

Penlift/blanking, AUX B: BNC output provides 0 V pendown/blanking signal at low impedance; 15 V penlift/unblanking at 10 k-ohm impedance.

21.4 MHz IF output, AUX C: BNC output (50 ohms) provides signal proportional to RF input. Level is about -10 dBm (into 50 ohms) with signal displayed at Reference Level. Output controlled by settings of RES BW, Input Atten, and Ref Level.

Horizontal output, AUX D: BNC output (5 k-ohms) provides horizontal sweep from -5 V to $+5$ V for full 10 division CRT horizontal deflection.

HP-IB interface port: 24-pin connector provides digital interface for IEE 488-1978 standard parallel bus.



HP 8557A Specifications

Frequency Specifications

Frequency range: 0.01 to 350 MHz.

Frequency Spans

Full band: displays entire spectrum, 0.01 to 350 MHz.

Per division: 5 kHz to 20 MHz/div in a 1,2,5 sequence.

Zero Span: analyzer functions as a manually-tuned receiver.

Frequency Accuracy

Tuning Accuracy: $\pm(3 \text{ MHz} + 10\% \text{ of frequency span per division})$.

Frequency span accuracy: $\pm 10\%$ of displayed frequency separation.

Spectral Resolution

Resolution Bandwidths: 8 selectable, 3-dB resolution bandwidths from 1 kHz to 3 MHz in 1,3 sequence; BW and frequency span are independently variable or may be coupled for optimum display when control markers aligned.

Resolution bandwidth accuracy: 3-dB points are $\pm 20\%$ ($+10^\circ$ to $+40^\circ\text{C}$).

Selectivity: (60-dB/3-dB bandwidth ratio) $< 15:1$.

Spectral Stability

Residual FM: $< 1 \text{ kHz p-p}$ in 0.1 second.

Noise sidebands: $\geq 75 \text{ dB}$ down, $> 50 \text{ kHz}$ from center of CW signal with 1 kHz Res. BW and full video filtering.

Amplitude Specifications

Amplitude range: -117 dBm to $+20 \text{ dBm}$.

Maximum Input (Safe) Levels

Total power: $+20 \text{ dBm}$ (100mW, 2.24 V RMS).

Voltage: $\pm 30 \text{ V dc}$ or 30 V RMS ($< 100 \text{ Hz}$).

Gain compression: typically $< 1 \text{ dB}$ for -10 dBm signal, 0 dB input attenuation.

Average noise level: $< -107 \text{ dBm}$ with 10 kHz resolution bandwidth, 0 dB input attenuation, and maximum (MAX) video filtering.

Calibrated Display Range

Log: 70 dB with 10 dB/div scale; 8 dB with 1 dB/div scale.

Linear: 8 divisions with linear (LIN) amplitude scale.

Amplitude Accuracy

Calibrator: $-30 \text{ dBm} \pm 1 \text{ dB}$ (into 50 ohms), 250 MHz $\pm 50 \text{ kHz}$.

Reference level: 10-dB steps and 12-dB vernier for calibrated adjustment from -112 dBm to $+40 \text{ dBm}^1$.

Step accuracy (with 0 dB input attenuation): -10 to -80 dBm , $\pm 0.5 \text{ dB}$; -10 to -100 dBm , $\pm 1.0 \text{ dBm}$.

Vernier accuracy: $\pm 0.5 \text{ dB}$.

Frequency Response: $\leq \pm 0.75 \text{ dB}$ with 10 dB input attenuation (includes input attenuator and mixer flatness).

Input attenuator: 0 to 50 dB, selectable in 10 dB steps.

Step accuracy: $< \pm 1.0 \text{ dB}$ per 10 dB step.

Maximum cumulative error: $< \pm 1.0 \text{ dB}$.

Bandwidth Switching (Amplitude Variation)

3 MHz to 300 kHz: $< \pm 0.5 \text{ dB}$.

3 MHz to 1 kHz: $< \pm 1.0 \text{ dB}$.

Display Fidelity

Log incremental accuracy: $\pm 0.1 \text{ dB/dB}$ from Reference Level.

Log maximum cumulative error: $\leq \pm 1.5 \text{ dB}$ over 70 dB range.

Linear accuracy: $\pm 3\%$ of Reference Level.

Spurious Responses

Second harmonic distortion: $> 70 \text{ dB}$ below a -40 dBm signal ($> 1 \text{ MHz}$) with 0 dB input attenuation; $> 60 \text{ dB}$ below for signals 20 kHz to 1 MHz.

Third-order intermodulation distortion: $> 70 \text{ dB}$ below to -40 dBm input signals ($> 1 \text{ MHz}$) separated by $\geq 50 \text{ kHz}$ and with 0 dB input attenuation; $> 60 \text{ dB}$ below for signals 10 kHz to 1 MHz.

Image and multiple responses: $> 70 \text{ dB}$ below a -40 dBm input signal ($> 1 \text{ MHz}$) with 0 dB input attenuation; $> 60 \text{ dB}$ below for signals 20 kHz to 1 MHz.

Residual responses: $< -100 \text{ dBm}$ with 0 dB input attenuation and no signal present at input.

Sweep Characteristics

Sweep Time

Automatic: sweep time is automatically adjusted to maintain absolute-amplitude calibration for any combination of frequency span, resolution bandwidth, and video filter bandwidth.

Calibrated sweep times: 0.1 msec to 10 sec/div in 1,2,5 sequence with $\pm 10\%$ typical accuracy.

Manual sweep: spectrum analyzer may be swept manually in either direction with front-panel control.

Signal Input Characteristics

Input Impedance: 50 ohm nominal; type BNC female connector.

Input SWR: typically < 1.5 with $\geq 10 \text{ dB}$ input attenuation.

Output Characteristics:

Probe power: $+15 \text{ V}$, -12.6 V , and GND (150 mA max).

HP 8558B Specifications

Frequency Specifications

Frequency range: 0.1 to 1500 MHz.

Frequency Spans

Per division: 5 kHz to 100 MHz/div in a 1,2,5 sequence.

Zero span: analyzer functions as a manually-tuned receiver.

Frequency Accuracy

Tuning accuracy: ($+10^\circ\text{C}$ to $+40^\circ\text{C}$)

0-195 MHz: $\pm(1 \text{ MHz} + 20\% \text{ frequency span per division})$.

195-1500 MHz: $\pm(5 \text{ MHz} + 20\% \text{ frequency span per division})$.

Frequency span accuracy: $\pm 5\%$ of displayed frequency separation.

Spectral Resolution

Resolution bandwidths: 8 selectable 3-dB resolution bandwidths from 1 kHz to 3 MHz in a 1,3 sequence. Bandwidth and frequency span are independently variable or may be coupled for optimum display when control markers are aligned.

Resolution bandwidth accuracy: 3-dB points are $\pm 20\%$ ($+10^\circ$ to 40°C).

Selectivity: (60-dB/3-dB bandwidth ratio) $< 15:1$.

Spectral Stability

Residual FM: $< 1 \text{ kHz p-p}$ in 0.1 second.

Noise sidebands: $\geq 65 \text{ dB}$ down, $\geq 50 \text{ kHz}$ from center of CW signal with 1 kHz resolution bandwidth and full video filtering.

Amplitude Specifications

Amplitude range: -117 to $+30 \text{ dBm}$.

Maximum Input (Safe) Levels

Total power: $+30 \text{ dBm}$ (1 W, 7.1 V RMS).

Voltage: $\pm 50 \text{ V dc}$ or 50 V RMS ($< 100 \text{ Hz}$).

Peak pulse power: $+50 \text{ dBm}$ (100 W, $< 10 \mu\text{s}$ pulse width, 0.01% duty cycle) with $\geq 20 \text{ dB}$ input attenuation.

Gain compression: typically $< 1 \text{ dB}$ for -10 dBm signal, 0 dB input attenuation.

Average noise level: $< -107 \text{ dBm}$ with 10 kHz resolution bandwidth, 0 dB input attenuation, and video filter at MAX.

Calibrated Display Range:

Log: 70 dB with 10 dB/div scale; 8 dB with 1 dB/div scale.

Linear: 8 divisions with linear (LIN) amplitude scale.

Amplitude Accuracy

Calibrator: $-30 \text{ dBm} \pm 1 \text{ dB}$ (into 50 ohms), 280 MHz $\pm 300 \text{ kHz}$.

Reference level: 10 dB steps and 12 dB vernier for calibrated adjustment from -112 dBm to $+60 \text{ dBm}^1$.

Step accuracy (with 0 dB input attenuation): -10 to -80 dBm ; $\pm 0.5 \text{ dB}$; -10 to -100 dBm ; $\pm 1.0 \text{ dB}$.

Vernier accuracy: $\pm 0.5 \text{ dB}$.

Frequency response: $\leq \pm 1.0 \text{ dB}$ with 10 dB input attenuation (includes input attenuator, mixer flatness, and internal limiter).

Input attenuator: 0 to 70 dB, selectable in 10 dB steps.

Step accuracy: $< \pm 0.5 \text{ dB}$ per 10 dB steps.

Maximum cumulative error: $< \pm 1.0 \text{ dB}$.

Bandwidth Switching (Amplitude Variation)

3 MHz to 300 kHz: $< \pm 0.5 \text{ dB}$.

3 MHz to 1 kHz: $< \pm 1.0 \text{ dB}$.

Display Fidelity

Log incremental accuracy: $\pm 0.1 \text{ dB/dB}$ from Reference Level.

Log maximum cumulative error: $\leq \pm 1.5 \text{ dB}$ over 70 dB range.

Linear accuracy: $\pm 3\%$ of Reference Level.

Spurious Responses

Second harmonic distortion: $> 70 \text{ dB}$ below two -40 dBm input signal with 0 dB input attenuation; $> 60 \text{ dB}$ below for signals 100 kHz to 5 MHz.

Third order intermodulation distortion: $> 70 \text{ dB}$ below two -30 dBm input signals ($> 5 \text{ MHz}$) separated by $\geq 50 \text{ kHz}$ and with 0 dB input attenuation; $> 60 \text{ dB}$ below for signals 100 kHz to 5 MHz.

Image and multiple responses: $> 70 \text{ dB}$ below a -40 dBm input signal ($> 5 \text{ MHz}$) with 0 dB input attenuation; $> 60 \text{ dB}$ below for signals 100 kHz to 5 MHz.

Residual responses: $< -100 \text{ dBm}$ with 0 dB input attenuation and no signal present at input.

¹Input not to exceed maximum levels.



SIGNAL ANALYZERS

Spectrum Analyzer Plug-ins

Models 8557A/8558B/8559A and 853A

Sweep Characteristics

Sweep Time

Automatic: sweep time is automatically adjusted to maintain absolute amplitude calibration for any combination of frequency span, resolution bandwidth, and video filter bandwidth.

Calibrated sweep times: 0.1 ms to 10 sec/div in 1,2,5 sequence with $\pm 10\%$ typical accuracy.

Manual sweep: spectrum analyzer may be swept manually in either direction with front-panel control.

Signal Input Characteristics

Input impedance: 50 ohms nominal; precision type-N female connector.

Input SWR: typically < 1.5 with ≥ 10 dB input attenuation.

Output Characteristics

First LO output: BNC output provides +10 dBm nominal signal (into 50 ohms), 2.05 to 3.55 GHz.

Probe power: +15 V, -12.6 V, and GND (150 mA max).

HP 8559A Specifications

Frequency Specifications

Frequency range: 0.01 to 21 GHz in six selectable ranges.

Frequency Spans

Fullband: displays entire spectrum of selected band.

Per division: 10 kHz to 200 MHz/div in a 1,2,5 sequence.

Zero span: analyzer functions as a manually-tuned receiver.

Frequency Accuracy

Tuning accuracy: 0.01 to 3 GHz, $< \pm(1 \text{ MHz} + 0.3\%$ of center frequency); 3 to 21 GHz, $< \pm(5 \text{ MHz} + 0.2\%$ of center frequency).

Frequency span accuracy: $< \pm 5\%$ of displayed frequency separation.

Spectral Resolution

Resolution bandwidths: 8 selectable, 3-dB resolution bandwidths from 1 kHz to 3 MHz in a 1,3 sequence. Bandwidth and frequency span are independently variable or may be coupled for optimum display when control markers are aligned.

Resolution bandwidth accuracy: 3-dB points are $< \pm 15\%$ (except for 3 MHz bandwidth, $< \pm 30\%$).

Selectivity: (60-dB/3-dB bandwidth ratio) $< 15:1$.

Spectral Stability (fundamental mixing, bands 0.01-3 GHz and 6-9 GHz)

Residual FM: < 2 kHz p-p in 0.1 second.

Noise sidebands: ≥ 70 dB down, ≥ 30 kHz from center of CW signal with 1 kHz resolution bandwidth and video filter at MAX.

Amplitude Specifications

Amplitude range: -111 to +30 dBm.

Maximum Input (Safe) Levels

Total power: +20 dBm (100 mW, 2.2 V RMS) with 0 dB input attenuation; +30 dBm (1 W, 7.1 V RMS) with ≥ 10 dB input attenuation.

Voltage: ± 7.1 V dc or 7.1 V RMS (< 100 Hz).

Peak pulse power: +50 dBm (100 W, 10 μ sec pulse width, 0.01% duty cycle) with ≥ 30 dB input attenuation.

Gain compression: < 0.5 dB for a -10 dBm input level, with 0 dB input attenuation.

Average noise level: see table below for maximum average noise level with 1 kHz resolution bandwidth, 0 dB input attenuation, and video filtering at MAX.

Frequency Range (GHz)	Avg. Noise Level (dBm/1 kHz)	Frequency Response (\pm dB max.)	Amplitude Accuracy ¹ (\pm dB max.)
0.01-3	-111	1.0	2.3
6.0-9	-108	1.0	2.3
3.0-9	-103	1.5	2.8
9.0-15	-98	1.8	3.1
6.0-15	-93	2.1	3.4
12.1-18	-92	2.3	3.6
18.0-21	-90	3.0	4.3

Alternate IF: regular IF at 3.0075 GHz; alternate IF available at 2.9925 GHz for all frequency bands (minimum frequency is 25 MHz).

Calibrated Display Range

Log: 70 dB with 10 dB/div scale; 8 dB with 1 dB/div scale.

Linear: 8 divisions with linear (LIN) amplitude scale.

Amplitude Accuracy

Calibrator: -10 dBm ± 0.3 dB (into 50 ohms), 35 MHz ± 400 kHz.

Reference level: 10 dB steps and 12 dB vernier for calibrated adjustment from -112 dBm to +60 dBm².

Step accuracy (with 0 dB input attenuation): -10 to -80 dBm, ± 0.5 dB; -10 to -100 dBm, ± 1.0 dB.

Vernier accuracy: ± 0.5 dB.

Frequency Response: see table above; includes input attenuator, mixer flatness, and mixer-mode gain variation (band-to-band) with 0 or 10 dB input attenuation.

Input attenuator: 0 to 70 dB, selectable in 10 dB steps.

Step accuracy: $< \pm 1.0$ dB per 10 dB step (0 to 60 dB, 0.01 to 18 GHz).

Maximum cumulative error: $< \pm 2.4$ dB (0 to 60 dB, 0.01 to 18 GHz).

Bandwidth Switching (Amplitude Variation)

3 MHz to 300 kHz: $< \pm 0.5$ dB.

3 MHz to 1 kHz: $< \pm 1.0$ dB.

Display Fidelity

Log incremental accuracy: ± 0.1 dB/dB from Reference Level.

Log maximum cumulative error: $\leq \pm 1.5$ dB over 70 dB range.

Linear accuracy: $\pm 3\%$ of Reference Level.

Spurious Responses

Second harmonic distortion: typically > 70 dB below a -40 dBm signal with 0 dB input attenuation.

Third order intermodulation distortion: typically > 70 dB below two -30 dBm input signals separated by ≥ 50 kHz with 0 dB input attenuation.

Residual responses: < -90 dBm with 0 dB input attenuation and no signal present at input (0.01³-3 GHz, 6-9 GHz).

Signal identifier: available in all frequency bands and spans, usable from 10 MHz to 100 kHz/div.

Sweep Characteristics

Sweep Time

Automatic: sweep time is automatically adjusted to maintain absolute amplitude calibration for any combination of frequency span, resolution bandwidth, and video filter bandwidth.

Calibrated sweep times: 2 usec to 10 sec/div in a 1,2,5 sequence (except 2 sec/div), $\pm 10\%$ accuracy ($\pm 20\%$ for 5/10 sec/div).

Manual sweep: analyzer may be swept manually in either direction with front-panel control.

Signal Input Characteristics

Input impedance: 50 ohm nominal, precision type-N female connector.

Input SWR: typically < 2.0 , 0 dB input attenuation; < 1.3 , 10 dB input attenuation.

General Specifications, HP 8557A, 8558B, and 8559A

Temperature Range: operating, 0° to +55°C; storage, -40° to +75°C.

EMI: conducted and radiated interference is within requirements of Methods CE03 and RE02 of MIL-STD 461A, CISPR Publication 11 (1975), and Messemfaenger Postverfuegung 526/527/79 (Kennzeichnung Mit F-Nummer/Funkschutzzeichen).

Power: < 200 VA with display, 48 to 440 Hz (48 to 66 Hz at 220 or 240 Vac); with HP 853A: 100, 120, 220, or 240 Vac, +5%, -10%.

Weight

HP 8557A: net, 5.0 kg (10 lb). Shipping, 8.5 kg (18 lb).

HP 8558B: net, 5.5 kg (12 lb). Shipping, 10.5 kg (23 lb).

HP 8559A: net, 5.5 kg (12 lb). Shipping, 9.1 kg (20 lb).

HP 853A: net, 15.9 kg (35 lb). Shipping, 18.6 kg (41 lb).

HP 853A Opt. 001: net, 14.5 kg (32 lb). Shipping, 17.3 kg (38 lb).

Size

HP 853A/Plug-in: 158.8mm H x 501.7mm W x 524.5mm D (6.25" x 19.75" x 20.65").

HP 853A Opt. 011/Plug-in: 133mm H x 425.5mm W x 473.3mm D (5.25" x 16.75" x 18.65").

Ordering Information

HP 8557A Spectrum Analyzer

Opt. 001: 75-ohm input, dBm calibration add \$100

Opt. 002: 75-ohm input, dBmV calibration add \$100

Opt. 910: extra Operating and Service Manual add \$17

HP 8558B Spectrum Analyzer

Opt. 001: 75-ohm input, dBm calibration add \$100

Opt. 002: 75-ohm input, dBmV calibration add \$100

Opt. 910: extra Operating and Service Manual add \$20

Opt. E98: EMI Measurement System add \$9,545

Opt. H17: extended coverage to 1700 MHz add \$550

Opt. H36: 6 MHz BW for CATV/LAN demodulation add \$315

Opt. H98: EMI Option add \$1,190

HP 8559A Spectrum Analyzer

Opt. 910: extra Operating and Service Manual \$11,825

Opt. 910: extra Operating and Service Manual add \$20

HP 853A Portable Spectrum Analyzer Display

Opt. 001: full module bench/rack configuration less \$200

Opt. 910: extra Operating and Service Manual \$10

Solid State Camera Software: HP part no. 75-00853

\$50

¹Using IF substitution, total accuracy is sum of frequency response, calibration, and reference level errors.

²Input level not to exceed maximum levels.

³25 MHz with Alternate IF ON.

SIGNAL ANALYZERS

HP 141T Spectrum Analyzer System

Model 141T System



- 20 Hz to 18 GHz, external mixing to 40 GHz
- Absolute amplitude calibration

- Tracking generators for component test
- Tracking preselector for simpler measurements

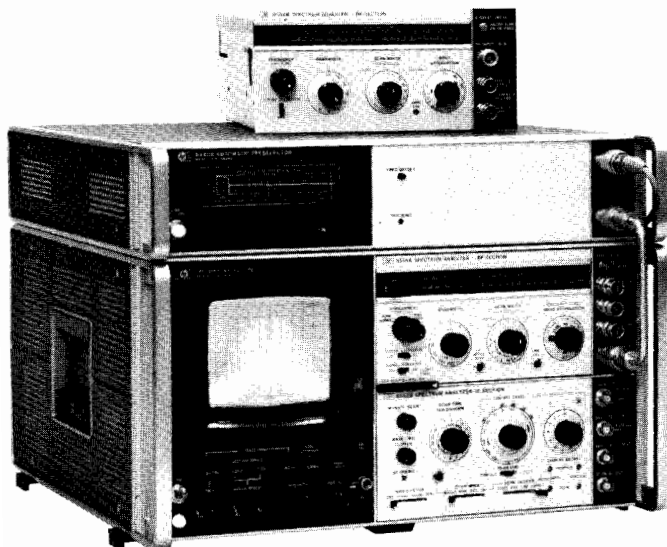

HP 141T Spectrum Analyzer System

HP 141T Spectrum Analyzer System

Hewlett-Packard's 141T Spectrum Analyzer System permits measurements at frequencies ranging from 20 Hz to 18 GHz by means of four plug-in tuning sections. For measurements in the 18 to 40 GHz region, an accessory external mixer may be used with the microwave tuning section. The modularity of this system allows you to keep pace with changing measurement requirements.

An HP 141T Spectrum Analyzer System is comprised of a main-frame/display, one tuning section, and one IF section. Each tuning section covers a different frequency range, allowing you to purchase those which best meet your current requirements. The HP 8556A covers from 20 Hz to 300 kHz, the HP 8553B from 1 kHz to 110 MHz, the 8554B from 100 kHz to 1250 MHz, and the HP 8555A from 10 MHz to 18 GHz. The HP 8552B IF section provides bandwidth/gain selection and detection.

For swept frequency testing of components, the HP 8443A or 8444A Opt 059 Tracking Generator can function as a swept signal source that, through locking, accurately tracks the frequency to which the analyzer is tuned. A microwave tracking preselector, the HP 8445B, simplifies measurements and improves the dynamic range of the HP 8555A Tuning Section for use in dense signal environments.

Calibrated frequency and amplitude measurements can be made over the entire frequency range. Logarithmic and linear scaling allow display of amplitude in dBm and voltage, respectively. A warning light indicates uncalibrated conditions due to improper control settings.

HP 141T Characteristics

Plug-ins: accepts Models 8552B, 8553B, 8554B, 8555A, and 8556A. Power requirements: 100, 120, 220, or 240V + 5%, - 10%; 50 to 60 Hz, normally less than 225W (includes plug-ins used).

Weight

Model 8552B IF section: net, 4.1 kg (9 lb). Shipping, 6.4 kg (14 lb).

Model 141T display section: net, 19.2 kg (43 lb). Shipping, 26 kg (57 lb).

HP 8556A Specifications

Frequency Specifications

Frequency range: 20 Hz to 300 kHz. Tuning dial ranges of 0-30 kHz and 0-300 kHz.

Scan width: (on a 10-division CRT horizontal axis)

Per division: 10 calibrated scan widths from 20 Hz/div to 20 kHz/div in a 1,2,5 sequence.

Frequency Accuracy

Center frequency accuracy: 0-30 kHz range, ± 500 Hz; 0-300 kHz range, ± 3 kHz.

Resolution

Bandwidth ranges: IF bandwidths of 10 Hz to 10 kHz are provided in a 1,3,10 sequence.

Amplitude Specifications

Amplitude measurement accuracy: ± 0.95 dB with proper technique.

Tracking Generator Specifications

Frequency range: tracks the analyzer tuning, 20 Hz to 300 kHz.

HP 8553A & 8443A Specifications

Frequency Specifications

Frequency range: 1 kHz-110 MHz (0-11 MHz and 0-110 MHz tuning ranges).

Scan Width (on 10-division CRT horizontal axis)

Per division: 18 calibrated scan widths from 20 Hz/div to 10 MHz/div in a 1,2,5 sequence.

Frequency Accuracy

Center frequency accuracy: the dial indicates the display center frequency within ± 1 MHz on the 0-110 MHz tuning range; ± 200 kHz on the 0-11 MHz tuning range with FINE TUNE centered and temperature range of 20°C to 30°C.

Resolution

Bandwidth: IF bandwidths of 10 Hz to 300 kHz are provided in a 1,3,10 sequence.



SIGNAL ANALYZERS

HP 141T Spectrum Analyzer System

Model 141T System

Amplitude Specifications

Absolute Amplitude Calibration Range

Log: from -130 to +10 dBm; 10 dB/div on a 70-dB display or 2 dB/div on a 16-dB display.

Dynamic Range

Average noise level: <-110 dBm with 10 kHz IF bandwidth.

Tracking Generator-Counter (HP 8443A)

Frequency range: 100 kHz to 110 MHz.

Amplitude range: <-120 dBm to +10 dBm in 10 and 1 dB steps with a continuous 1.2 dB vernier.

Counter

Display: 7 digits with 1 digit over-range. Reads to +10 Hz increments.

Accuracy: ±1 count ± time-base accuracy.

Time-base aging rate: <3 × 10⁻⁷/day (0.3 Hz/day) after warm-up.

HP 8554B Specifications

Frequency Specifications

Frequency range: 100 kHz to 1250 MHz.

Scan Width (on 10-division CRT horizontal axis)

Per division: 15 calibrated scan widths from 100 MHz/div to 2 kHz/div in a 1,2,5 sequence.

Frequency Accuracy

Center frequency accuracy: the dial indicates the display center frequency within 10 MHz.

Resolution

Bandwidth: IF bandwidths of 0.1 to 300 kHz provided in a 1,3,10 sequence.

Amplitude Specifications

Absolute Amplitude Calibration Range

Log: from -122 to +10 dBm; 10 dB/div on a 70-dB display, or 2 dB/div on a 16-dB display.

Linear: from 0.1 μV/div to 100 mV/div in a 1,2 sequence on an 8-division display.

Dynamic Range

Average noise level: <-102 dBm with 10 kHz IF bandwidth.

Amplitude measurement accuracy: ±1.75 dB with proper technique.

HP 8444A Opt 059 Tracking Generator Specifications

Frequency range: 0.5 MHz to 1500 MHz.

Frequency resolution: 1 kHz.

Residual FM (peak-to-peak): 200 Hz (stabilized).

Amplitude Range

Spectrum analyzer display: from -130 dBm to +10 dBm, 10 dB/div on a 70-dB display or 2 dB/div on a 16-dB display.

Tracking generator (drive level to test device): 0 to -10 dBm continuously variable.

Amplitude Accuracy

Absolute Amplitude Calibration Range

System frequency response: ±2.7 dB.

Tracking generator calibration: 0 dBm at 30 MHz to ±0.5 dB.

Dynamic range: >90 dB.

Counter output: typically 0.1V rms.

HP 8555A & 8445B Specifications

Frequency Specifications

Frequency range: 0.01-40 GHz.

Tuning Range

With internal mixer: 0.01-18.0 GHz.

With external mixer: 12.4-40 GHz.

Scan Width

Per division: 16 calibrated scan widths from 2 kHz/div to 200 MHz/div in a 2,5,10 sequence.

Frequency Accuracy

Dial accuracy: n × (±15 MHz) where n is the mixing mode.

Resolution

Bandwidth range: selectable 3 dB bandwidths from 100 Hz to 300 kHz in a 1,3,10 sequence.

Amplitude Specifications

Measurement Range

Log reference level: from -60 dBm to +10 dBm.

Linear sensitivity: from 0.1 μV/div to 100 mV/div.

Sensitivity and frequency response with internal coaxial mixer noise level: specified for 1 kHz bandwidth.

Frequency response with 10 dB input attenuator setting

Frequency Range (GHz)	Mixing Mode (n)	Average Noise Level (dBm max.)	Frequency Response* (dB max.)
0.01-2.05	1-	-115	±1.0
1.50-3.55	1-	-117	±1.0
2.07-6.15	2-	-108	±1.3
2.60-4.65	1+	-117	±1.0
4.11-6.15	1+	-115	±1.0
4.13-10.25	3-	-103	±1.5
6.17-10.25	2+	-105	±1.5
6.19-14.35	4-	-95	±2.0
8.23-14.35	3+	-100	±2.0
10.29-18.00	4+	-90	±2.0

*Includes mixer frequency response, RF attenuator frequency response, mixing mode gain variation, RF input VSWR.

HP 8445B Tracking Preselector

Frequency Specifications

Frequency range: dc-1.8 GHz low-pass filter; 1.8-18 GHz tracking filter.

Ordering Information

	Price
HP 141T Variable Persistence Display	\$4650
Opt 908: Rack flange kit	add \$27
HP 8552B High Resolution IF Section	\$5320
HP 8556A RF Section	\$3395
Opt 001: Balanced input	add \$220
Opt 002: Balanced input	add \$220
HP 8553B RF Section	\$4120
HP 8443A Tracking Generator-Counter	\$7450
HP 8554B RF Section	\$6970
Opt 003: Internal limiter	add \$170
HP 8444A Opt 059 Tracking Generator	\$4760
HP 8555A Tuning Section	\$10,920
Opt 001: APC-7 connectors	add \$40
Opt 002: Internal limiter	add \$210
Opt 005: Video tape	add \$105
HP 8445B Tracking Preselector, dc-18 GHz	\$5980
Opt 001: APC-7 connectors	add \$155
Opt 002: Add manual controls	add \$80
Opt 003: Add digital frequency readout	add \$670
Opt 004: Delete low-pass filter	less \$425
Opt 005: Delete interconnect rigid coax	less \$50
HP 11517A External Mixer (taper section req'd)	\$500
HP 11518A Taper Section, 12.4 to 18 GHz	\$375
HP 11519A Taper Section, 18 to 26.5 GHz	\$375
HP 11520A Taper Section, 26.5 to 40 GHz	\$375

SIGNAL ANALYZERS

Microwave Spectrum Analyzer, 10 MHz to 22 GHz

Model 8570A



- Internal preselection, 1.7 to 22 GHz
- Wide dynamic range, 103 dB
- Broad resolution selection, 1 kHz to 3 MHz

- Simple three-knob operation
- Digital display, dual traces & CRT annotation
- Direct-to-plotter output

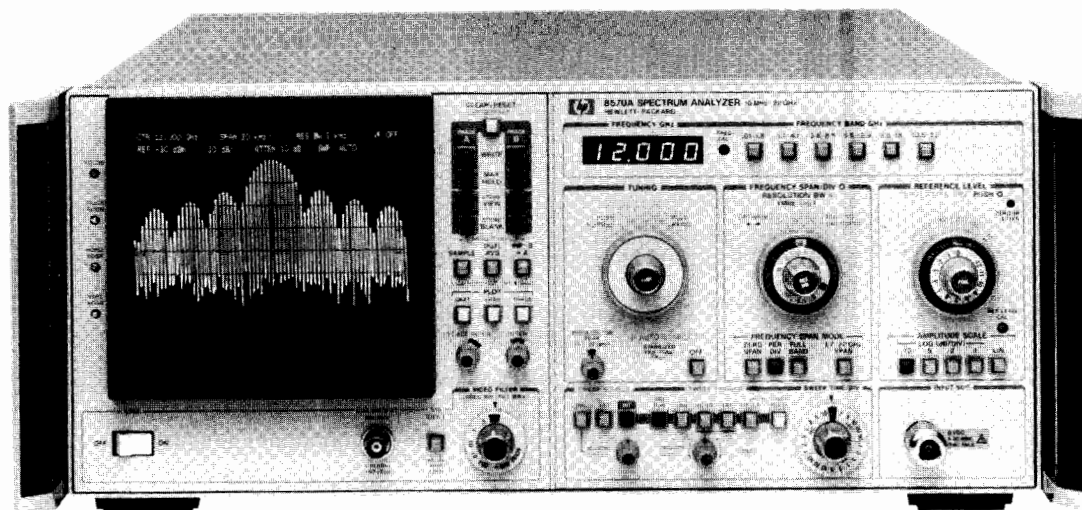

HP 8570A

HP 8570A Spectrum Analyzer

The performance and ease-of-use of the HP 8570A make it an ideal choice for lab, production, and field uses. The internal preselector provides wide dynamic range necessary for many applications while it simplifies signal identification. Precise measurements are made quickly and easily with features such as three-knob operation and digital display. Documented results are conveniently obtained with the direct-to-plotter HP-IB output.

Capable Performance

Measurements of signals from +30 to -110 dBm are possible with the HP 8570A. The internal preselector produces a wide 97 dB dynamic range for harmonic and widely-spaced intermodulation distortion measurements over its 1.7 to 22 GHz frequency range. Protection of the first mixer is provided by the built-in limiter to 1.8 GHz and by the preselector to 22 GHz.

Amplitude accuracies of ± 1.5 dB are possible over a 90 dB range using the reference level control (IF substitution), or over a 70 dB range reading directly from the CRT display. Frequency accuracies of 70 ppm (0.007 %) are possible using the Option 001 Internal Comb Generator.

A broad selection of resolution bandwidths allows a diversity of signals to be measured. Broadband pulsed signals, such as pulsed RF radar or electromagnetic interference (EMI) noise signals, are easily measured with wide resolution bandwidths to 3 MHz. These synchronously-tuned filters, resulting in their Gaussian shape, ensure a repeatable pulse response for accurate amplitude measurements. Narrower bandwidths to 1 kHz provide resolution and sensitivity to satisfy most measurement needs, such as measuring closely-spaced or low-power signals, or both. Bandwidths available in a 1, 3, 10 sequence save measurement time by providing flexibility while maintaining fast sweep times.

Ease of Operation

Engineered with the user in mind, the HP 8570A Spectrum Analyzer is easy to operate. This reduces measurement time and errors. Color-coded and logically grouped controls simplify normal operation. Most measurements can be made in three steps: (1) Display all of the signals in the band using the FULL SPAN control and measure any signal frequency by moving the marker to the signal with the TUNE control. (2) Zoom in on the signal for close-in analysis using the FREQ SPAN control. The coupled functions—Resolution Bandwidth, Video Bandwidth, and Sweep Time—are all automatically adjusted to ensure calibrated results. (3) Measure the signal amplitude using the REF LEVEL control.

The digital display adds flexibility and convenience to every measurement. Dual traces facilitate signal comparisons. Traces can be updated and stored separately for analysis later. Trace processing functions such as maximum hold, digital averaging, peak or sample detection, and trace subtraction provide capability for special applications. The digital display simplifies measurements requiring slow sweep times since adjustments of CRT intensity and persistence are not required.

Measurement results are conveniently converted into hard-copy form using a HP-IB graphics plotter. The direct-to-plotter feature of the HP 8570A outputs the CRT traces, graticule, and annotation information to a plotter using front-panel buttons, eliminating the necessity for a computer.

Automatic Measurements

Add a computer to your measurement system to increase speed and reduce errors. Operator efficiency can be enhanced using the semi-automatic capabilities of the HP 8570A. For example, a procedure with test limits can be written on the CRT to swiftly guide an operator through simple or complex measurements. Control settings can be monitored to ensure compliance with test requirements. Completely automatic measurements use the computer to initiate sweeps and input trace information for immediate analysis or for record keeping. Programs use two-letter mnemonics that are easy to remember and understand.

HP 8570A Specifications

Frequency Specifications

Frequency Range: 10 MHz to 22 GHz

Center Frequency

Readout Resolution: ± 1 MHz

Accuracy: $\pm (9 \text{ MHz or } 0.3 \% \text{ of center frequency, whichever is greater, plus } 20 \% \text{ of frequency span per division})$

Stability (for fundamental mixing, 0.01 to 4.1 GHz)

Total Residual FM:

Stabilized mode: < 200 Hz peak-to-peak in 0.1 second

Unstabilized mode: < 20 kHz peak-to-peak in 0.1 second

Noise Sidebands: (1 kHz bandwidth and 10 Hz video bandwidth) < -70 dBc at ≥ 30 kHz offset from a CW signal

Frequency Span

Setting Range: 1 kHz to 500 MHz/div in a 1, 2, 5, 10 sequence

Accuracy:

Unstabilized Mode: $\pm 5 \%$ for spans ≥ 20 kHz/div

Stabilized Mode: $\pm 20 \%$ for spans ≤ 100 kHz/div

Resolution Bandwidth (-3 dB)

Setting Range: 1 kHz to 3 MHz in a 1, 3, 10 sequence



Accuracy: $\leq \pm 20\%$

Selectivity: (60 dB/3 dB) $\leq 15:1$, approx. Gaussian shape

Video Bandwidth Characteristic

Setting Range: 1 MHz to 3 Hz in a 1, 3, 10 sequence

Noise Averaging: 1 Hz nominal NOISE AVG setting

Accuracy: Typically $\pm 20\%$

Amplitude Specifications

Maximum Amplitude Range: +30 dBm to -110 dBm

Maximum Safe Input Power

Total Average Continuous Power: +30 dBm (1 watt)

Peak Pulse Power: +50 dBm with ≥ 20 dB input attenuation (< 10 us pulse width, 0.01 % duty cycle)

DC or AC Power: (<< 50 ohms source impedance)

0 dB input attenuation: 0 volts, 1 ampere

≥ 10 dB input attenuation: ± 7 volts, 0.14 ampere

Input Mixer Protection:

0.01 to 1.8 GHz: Internal diode limiter

1.7 to 22 GHz: Saturation of YIG filter (preselector)

Display Range

Scale Size: 8 x 10 division internally etched CRT graticule

Scale Calibration: 10, 5, 2, and 1 dB/div and Linear

Reference Level Range: +60 to -112 dBm in 10 dB steps and continuous 0 to -12 dB calibrated vernier

Input Attenuator Range: 0 to 70 dB in 10 dB steps

Dynamic Range

Maximum Dynamic Range

Gain Compression to Noise: > 103 dB

Signal to Intermod Distortion: > 97 dB

Displayed Average Noise Level: (1 kHz RBW, 3 Hz VBW, 0 dB atten.)

Frequency (GHz)	Average Noise (dBm)
0.01 - 1.8	-110
1.7 - 4.1	-105
3.8 - 8.5	-100
5.8 - 12.9	-95
8.5 - 18	-90
10.5 - 22	-85

Gain Compression Level: ≤ -7 dBm at mixer for <1 dB compression

Spurious Response Characteristics

All Spurious Responses: < -70 dBc (except as noted below)

Second Harmonic Distortion:

Frequency Range (GHz)	Input Power at Mixer	Second Harmonic
0.01 - 1.8	-40 dBm	< -60 dBc
1.7 - 22	-10 dBm	< -100 dBc

Third-order Intermodulation Distortion:

Frequency Range (GHz)	Total Power at Mixer	Signal Spacing	Intermod Products	Equiv. TOI
0.01 - 22	-30 dBm	≥ 50 kHz	< -70 dBc	+5 dBm
1.7 - 12.9	-10 dBm	≥ 70 MHz	< -100 dBc	+40 dBm
1.7 - 22	-10 dBm	≥ 100 MHz	< -100 dBc	+40 dBm

Image and Multiple Responses:

0.01 to 1.8 GHz: < -70 dBc

1.7 to 22 GHz: < -60 dBc

Residual Responses: < -90 dBm with 0 dB input attenuation (no signal at input and fundamental mixing, 0.01 to 4.1 GHz)

Amplitude Accuracy

Frequency Response: (Ref. to 100 MHz, -10 dBm with 10 dB atten.)

Frequency (GHz)	Frequency Response (\pm dB max)
0.01 - 1.8	1.5
0.01 - 4.1	2.0
0.01 - 12.9	3.0
0.01 - 18	3.5
0.01 - 22	5.5

Internal Calibrator: $< \pm 0.3$ dB

Reference Level Accuracy: (0 dB input attenuation)

IF Step Gain: $< \pm 1.5$ dB over -10 to -100 dBm range

Vernier: $< \pm 1.0$ dB over 0 to -12 dB range when read from the vernier control

Input Attenuator Accuracy:

0.01 to 18 GHz: $\leq \pm 1.0$ dB/step, ± 2.4 dB max, 0 to 60 dB

0.01 to 22 GHz: $\leq \pm 1.5$ dB/step, ± 2.5 dB max, 0 to 40 dB

Resolution Bandwidth Switching: $< \pm 1.5$ dB from the 3 MHz RBW

Scale Fidelity

Log: $< \pm 0.1$ dB/dB to ± 1.5 dB max, 0 to 70 dB range

Linear: $< \pm 5$ % of reference level

Sweep Specifications

Sweep Time

Setting Range: 2 us to 10 s/div in a 1, 2, 5, 10 sequence

Accuracy:

2 us to 1 second: $\pm 15\%$

2 to 10 seconds: $\pm 20\%$

Sweep Trigger: Free Run, Line, Video, Single, or External

Input Output Characteristics

RF Input

Connector Type: Precision type N female

Input Impedance: 50 ohms nominal

SWR: (with ≥ 10 dB atten.) Typically < 2.0 to 18 GHz

LO Emission: (2.0 to 4.46 GHz)

Frequency (GHz)	Power (dBm)
0.01 - 1.8	< -60
1.7 - 22	< -80

Calibrator Signal: 100 MHz ± 10 kHz, -10 dBm ± 0.3 dB

HP-IB Interface: Compatibility with IEEE STD 488-1978

Function Codes: AH1, CO, DC1, DT0, E2, L4, PP0, RL0, SH1, SR0 & T7

Auxiliary Inputs: Blanking, External Sweep and Trigger, Retrace

Auxiliary Outputs: Blanking, Horiz. Sweep, 21.4 MHz IF, Vertical

General Specifications

Environmental

Temperature Range:

Operating: 0 to +45°C

Storage: -40 to +75°C

Warm-Up Time: 1 hour

EMI: Conducted and radiated interference is in compliance with MIL-STD 461A methods CE03 and RE02, CISPR Publication 11 (1975), and Messempefaenger-Postverfuergung 526/527/79 (Kennzeichnung Mit F-Nummer/Funkschutzzeichen).

Power-Line Requirements

Operating Voltage: 100, 120, 220, or 240 (+5%, -10%) VAC

Operating Frequency: 48 to 66 Hz

Maximum Power: 280 VA

Net Weight: 26.8 kg (59 lb.)

Shipping Weight: 38.6 kg (85 lb.)

Size: 188 mm H x 426 mm W x 552 mm D (7.0 " x 16.8 " x 21.8 ")

Standard Options Available

Option 001, Internal Comb Generator: Enhances frequency accuracy.

Frequency Range: 0.1 to 22 GHz

Comb Frequency: 100 MHz

Frequency Accuracy: $\leq \pm 0.007\%$

Option 400, 400 Hz Power Line Operation: Extends line frequency.

Operating Frequency Range:

100 & 120 VAC lines: 48 to 440 Hz

100, 120, 220 & 240 VAC lines: 48 to 66 Hz

Ordering Information

HP 8570A Spectrum Analyzer

Option 001: Internal Comb Generator

Option 400: 50 to 400 Hz Power Line Operation

Option 908: Rack Flange Kit without handles

Option 910: Extra Technical Reference Manuals

Option 913: Rack Flange Kit with handles

Price

\$25,000

\$1,425

\$350

\$35

\$50

\$40

SIGNAL ANALYZERS

Microwave Spectrum Analyzer, 10 MHz to 115 GHz

Model 8569B

689



- 0.01 to 22 GHz, external mixing to 115 GHz & above
- Internal preselection, 1.7 to 22 GHz
- Wide resolution range, 100 Hz to 3 MHz
- Simple three knob operation
- Digital display of dual traces and control settings
- Direct plotter output - no controller needed

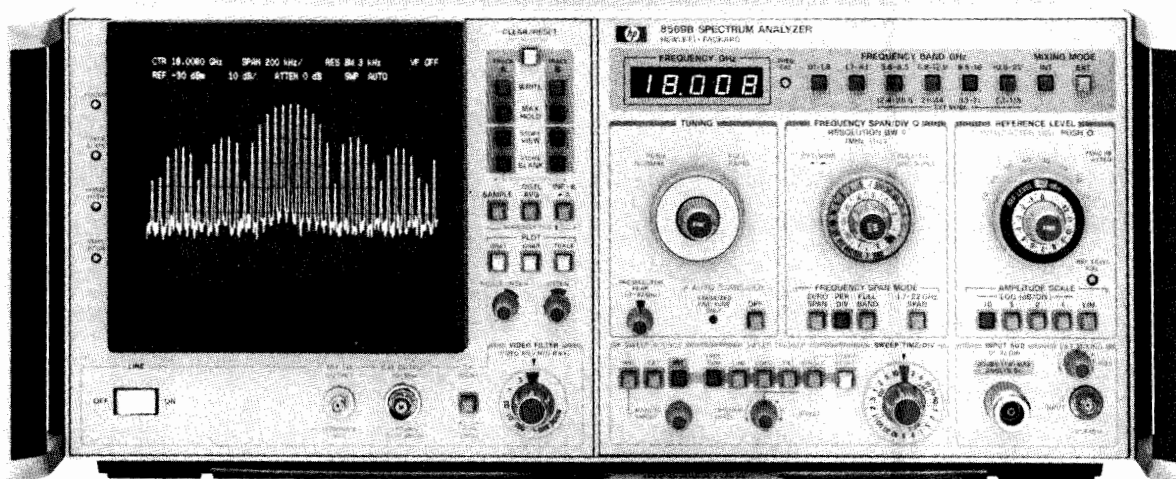

HP 8569B



HP 8569B Spectrum Analyzer

High performance and simple operation are combined with unique microprocessor-controlled capabilities in the HP 8569B Microwave Spectrum Analyzer. Excellent sensitivity and internal preselection assure the wide, spurious-free measurement range necessary for production applications, while the digital display and coupled controls speed measurement routines. The internal frequency range of 10 MHz to 22 GHz is extended using external mixers: to 40 GHz in two bands with the HP 8569B Option E02; to 71 GHz with other new HP 11971 series mixers; and to 115 GHz with other commercially available mixers. For more information on external harmonic mixers see page 693. For semi-automatic operation, connect a desktop computer to the HP 8569B via HP-IB to allow access to the displayed trace data and the control settings necessary to analyze or record measurements, or display operator messages and prompts on the CRT. Direct, hard copy output to a digital plotter is possible without the need of a controller or any programming.

Wide Range of Signal Resolution

Optimum resolution is possible for a wide range of signal characteristics with ten IF filters available from 100 Hz to 3 MHz. Fully automatic stabilization in narrow spans reduces residual FM to allow accurate measurements of closely spaced signals using the narrow bandwidths. The wide 1 and 3 MHz resolution bandwidths allow fast sweeps in wide spans and increased dynamic range for pulsed RF applications. All resolution filters are Gaussian-shaped for repeatable measurements, faster undistorted sweeps, and best pulse response.

High Accuracy and Wide Dynamic Range

Absolute signal levels from -123 to $+30$ dBm are easily and accurately measured using IF substitution because the HP 8569B displays the reference level value directly on the graticule. Damage to the mixer is prevented for signal levels of $+30$ dBm with a built-in limiter below 1.8 GHz and a preselector from 1.7 to 22 GHz. The internal preselector also ensures maximum use of this wide measurement range by reducing internal distortion products as much as 120 dB. In addition, flat frequency response ensures accuracy for relative as well as absolute power measurements.

Convenient Operation with Digital Display

Preset the HP 8569B to the color-coded, "basic operation" settings and use the coupled controls to make most measurements in three

easy steps: tune to the signal, select a span and raise it to the reference level. While in the AUTO sweptime position, a calibrated amplitude display is ensured. However, the microprocessor also monitors manually-selected sweep times and displays a warning if the sweep speed chosen is too fast for calibrated measurements. Signals are displayed on either of two independent digitally stored traces with all major control settings annotated above the graticule area. Display processing capabilities include Max Hold, digital averaging and trace normalization for extended measurement capability.

HP-IB Includes Direct Plotter Control

A hard-copy record of the displayed traces, control settings and graticule can be made on a digital plotter via HP-IB quickly and simply using the HP 8569B's front-panel pushbuttons without need for a controller. For maximum capability, attach a controller to the HP 8569B to read the trace data and control settings for a measurement analysis or recording on tape. Also, you can illustrate the test parameters for each measurement with display lines and instruct the operator with messages on the analyzer CRT. The controller can verify correct control settings before taking the test data or going on to the next step.

HP 8444A Option 059 Tracking Generator

Characterize the frequency response of devices up to 1500 MHz by using the HP 8444A Option 059 Tracking Generator with the HP 8569B. Dynamic range is greater than 90 dB and system response errors can be removed using trace normalization. In addition, increase the analyzer's frequency accuracy to ± 10 kHz using a counter with the tracking generator.

HP 8569B Specifications

Frequency Specifications

Frequency range: 0.01 to 22 GHz with internal mixer. 18 to 40 GHz with HP 8569B Option E02. Extendable to 71 GHz with new HP 11971 Q/U/V Mixers. Extendable to 115 GHz with commercially available mixers. See page 693 for more information on external mixers.

Tuning Accuracy (digital frequency readout in any span mode)

10 MHz to 115 GHz: $\pm(5$ MHz or 0.2% of center frequency, whichever is greater, $+20\%$ of Frequency Span/Div).



Frequency Spans

1.7 to 22 GHz: multiband span from 1.7 to 22 GHz in one sweep.

Full band: displays spectrum of entire band selected.

Per division: 1 kHz to 500 MHz/div in a 1, 2, 5 sequence.

Span width accuracy: $\pm 5\%$, 500 MHz to 20 kHz/div unstabilized; $\pm 15\%$, 100 kHz to 1 kHz/div, stabilized.

Zero span: analyzer becomes a manually tuned receiver.

Spectral Resolution and Stability

Resolution bandwidths: resolution (3 dB) bandwidths from 100 Hz to 3 MHz in 1, 3, sequence. Bandwidth and span width are independently variable or may be coupled for optimum display when control markers are aligned (▶◀).

Resolution bandwidth accuracy: 3 dB points are $\pm 15\%$.

Selectivity: (60 dB/3 dB bandwidth ratio): $< 11:1$, 100 Hz to 1 kHz; $< 15:1$, 3 kHz to 3 MHz.

Total residual FM: (fundamental mixing 0.01 to 4.1 GHz): < 100 Hz p-p in 0.1 second. First LO automatically stabilized for frequency spans ≤ 100 kHz/div.

Noise sidebands: > 75 dB down, ≥ 30 kHz from signal in a 1 kHz Res. Bandwidth and a 10 Hz (0.01) Video Filter.

Amplitude Specifications

Amplitude Range—Internal Mixer

Total power: +30 dBm, +137 dB μ V (1 watt).

Damage levels: (50 ohm nominal source impedance):

dc: 0 V with 0 dB input attenuation (1 A), ± 7 V with ≥ 10 dB input attenuation (0.14 A).

Peak pulse power: +50 dBm (< 10 μ s pulse width, 0.01% duty cycle with ≥ 20 dB input attenuation).

Gain compression: < 1 dB for -7 dBm signal, 0 dB input atten.

Average noise level: see table below for max. avg. noise level with 1 kHz res. bandwidth (0 dB atten. and 3 Hz video filter).

Frequency Band (GHz)	First IF in MHz	Harmonic Mode	Noise Level (dBm)	Frequency Response* (\pm dB max)
0.01-1.8	2050	1-	-113	1.2
1.7-4.1	321.4	1-	-110	1.5
3.8-8.5	321.4	2-	-107	2.5
5.8-12.9	321.4	3-	-100	2.5
8.5-18	321.4	4+	-95	3.0
10.5-22	321.4	5+	-90	4.5
12.4-26.5	321.4	6+	Use HP 11971 Series Mixers to 71 GHz and commercially available mixers to 115 GHz. Refer to page 693.	
21-44	321.4	10+		
33-71	321.4	16+		
53-115	321.4	26+		

*Frequency response includes input attenuator, preselector and mixer frequency response plus mixing mode gain variation (band to band).

Reference Level

Reference level range: +60 dBm (+30 dBm max. input) to -112 dBm in 10 dB steps and continuous 0 to -12 dB calibrated vernier.

Reference level accuracy: auto Sweep setting of Sweep Time/Div control insures a calibrated display within these limits:

Calibrator output: (100 MHz ± 10 kHz): -10 dBm ± 0.3 dB.

Reference level variation: (input atten. at 0 dB, 20° to 30°C): -10 to -70 dBm: ± 0.5 dB; -80 to -100 dBm: ± 1.0 dB.

Vernier: (0 to -12 dB continuous); maximum error ± 0.5 dB.

Input attenuator: 0-70 dB in 10 dB steps.

Step size variation: ± 1.0 dB, 0.01 to 18 GHz; ± 1.5 dB, 0.01 to 22 GHz. Maximum cumulative error: ± 2.5 dB.

Frequency response: see table above.

Switching between bandwidths: 3 MHz to 100 Hz, ± 1.0 dB.

Calibrated Display Range

Log: 1, 2, 5, and 10 dB/div over 8 divisions.

Linear: 0.56 μ V to 224 V in 50 ohm.

Display Accuracy

Log: ± 0.1 dB/dB; maximum cumulative error ± 1.5 dB.

Linear: $< \pm 3\%$ over full 8 division deflection.

Residual responses (no signal present at input): < -90 dBm.

Signal identifier: available from 10 MHz to 115 GHz.

Signal Input/Output Characteristics

Input SWR (input impedance 50 ohm nominal)

Input atten. at 0 dB: < 1.5 , 0.01-1.8 GHz; < 2.0 , 1.7-22 GHz.

Input atten. at ≥ 10 dB: < 1.3 , 0.01-1.8 GHz; < 2.0 , 1.7-22 GHz.

LO emission from RF input (1.4 to 5.2 GHz): < -60 dBm, 0.01 to 1.8 GHz; < -80 dBm, 1.7 to 22 GHz.

Input Protection (for input signals from 0.01 to 22 GHz)

0.01 to 1.8 GHz: internal diode limiter.

1.7 to 22 GHz: preselector protects mixer to +30 dBm.

321.4 MHz IF input: SMA female connector is a port for bias current output (± 5 mA) and IF return from an external mixer.

LO output: 2 to 4.46 GHz with minimum power of +8 dBm.

Sweep Specifications

Sweep Time

Auto: sweep time is automatically controlled by Frequency Span/Div, Resolution Bandwidth and Video Filter controls to maintain an absolute amplitude calibrated display.

Calibrated sweep times: 2 μ s to 10 s/div in 1, 2, 5 sequence.

Digital Display

Traces: dual trace, digitally stored display with a resolution of 481 horizontal by 801 vertical points for each trace.

Control readout: major control settings annotated on the CRT include Center or Marker frequency, Frequency Span/Div, Resolution BW, Video Filter, Reference Level, Scale Factor, RF Input Attenuator and Sweep Time/Div.

Signal processing: Max Hold, trace normalization, sample detection mode, digital avg. and dB μ V Reference Level readout.

Internal service routines: front-panel pushbuttons access test patterns to perform maintenance of digital hardware.

HP-IB

Direct plotter control: all displayed information can be transferred to an HP-IB plotter by using only front-panel pushbuttons.

Controller Interface Functions

Trace data transfer: all trace data values can be transferred to or from an HP 8569B with a controller.

Control readout: all displayed control settings can be transferred to a controller to check measurement conditions.

Input messages: controller-input instructions or annotation can be displayed within two 63-character lines on the analyzer CRT.

Sweep control: sweeps can be initiated and monitored.

Note: HP-IB cables are not supplied with the HP 8569B.

HP-IB Interface Functions

AH1, DC1, L4, SH1, T7. For more information on these codes, refer to the HP-IB section of this catalog.

General Specifications

Temperature range: operating 0° to +55°C, storage -40° to +75°C.

Humidity range (operating): 95% R.H., 0°C to 40°C.

EMI: conducted and radiated interference is in compliance with MIL-STD 461A Methods CE03 and RE02, CISPR Publication 11 (1975), and Messemphaenger-Postverfuegung 526/527/79 (Kennzeichnung Mit F-Nummer/Funkschutzzeichen).

Power requirements: 48-66 Hz; 100, 120, 220 or 240 volts (-10% to +5%); 280 VA max (400 Hz operation available as Opt 400).

Size: 188 H x 426 W x 552 mm D (7" x 16.8" x 21.8").

Weight: net 29.2 kg (64 lb). Shipping 41 kg (90 lb).

Standard Options Available

Opt 001, Internal Comb Generator: 100 MHz comb signals visible through 22 GHz for increased frequency accuracy (error $< 0.007\%$, typically ± 1 MHz at 22 GHz), and preselector peaking verification.

Opt 002, Delete 100, 300 Hz Bandwidths: standard specifications apply except minimum resolution bandwidth is 1 kHz with 15:1 shape factor, residual FM < 200 Hz when stabilized.

Opt 003, High Power LO: provides $\geq +14$ dBm for direct use with mixer (e.g. HP 11971 series).

Opt 400, 50 to 400 Hz Power Supply

HP Part No. 1450-0654—Transit Case: Order HP Part No. 1490-0913 also for castors.

Ordering Information

HP 8569B Spectrum Analyzer \$31,000

Opt 001: Internal Comb Generator add \$1,425

Opt 002: Delete 100, 300 Hz Bandwidths less \$800

Opt 003: High Power LO Output add \$1,000

Opt 400: 50 to 400 Hz Power Line Operation add \$350

Opt 908: Rack Flange Kit Without Handles add \$35

Opt 910: Extra Operating & Service Manual add \$50

Opt 913: Rack Flange Kit with Handles add \$40

Opt E02: Extend frequency range to 40 GHz add \$4,200

HP 8444A Opt 059 Tracking Generator \$4,760

HP 11971 Series Mixers extend frequency range to 71 GHz. See page 693.

Price

SIGNAL ANALYZERS

Spectrum Analyzer, 10 MHz to 40 GHz

Model 8565A



- 0.01 to 22 GHz, external mixing to 40 GHz
- Internal preselection, 1.7 to 22 GHz
- Wide resolution range, 1 kHz to 3 MHz standard

- Simple three knob operation
- CRT bezel readout displays control settings

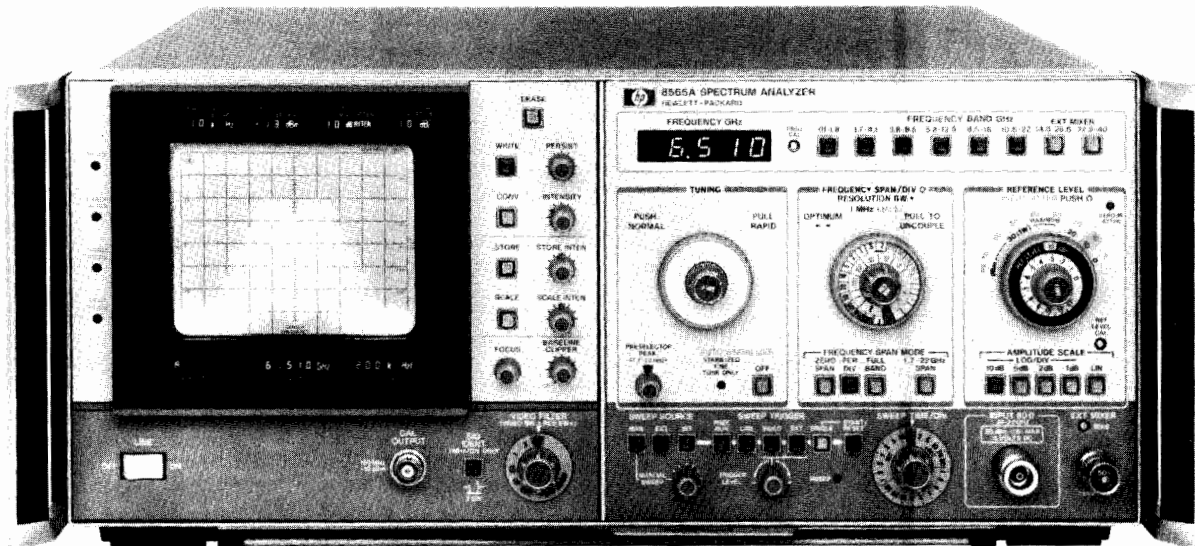

HP 8565A

HP 8565A Spectrum Analyzer

Covering from 0.01 to 22 GHz with its internal mixer, the HP 8565A has built-in preselection and brings accuracy plus convenience to microwave spectrum analysis. The wide range, spurious-free display, compact design and ease of use make it well suited for lab, production, or field applications requiring accurate measurement from IF through microwave frequencies. The HP 8565A can cover 0.01 to 22 GHz in just two spans for rapid location of signals prior to close-in analysis in one of six bands. Coverage is easily extended up to 40 GHz with the HP 11517A External Mixer.

High Resolution

Fully automatic stabilization in narrow spans reduces residual FM and drift. Standard resolution bandwidths range from 1 kHz to 3 MHz. The 1 and 3 MHz bandwidths allow fast sweeps in wide spans and increased dynamic range for pulsed RF; the narrow bandwidths allow measurement of closely spaced signals. Option 100 provides additional 100 Hz and 300 Hz IF bandwidth filters, and residual FM is < 100 Hz when stabilized. This 100 Hz resolution is usable up to 8.5 GHz and the 300 Hz resolution bandwidth to 22 GHz. All resolution filters are Gaussian-shaped for repeatable measurements, faster undistorted sweeps and best pulse response.

Absolute Amplitude Calibration

Absolute signal levels from -112 dBm to +30 dBm are easily measured because the HP 8565A always displays the value of the reference line with LEDs in the CRT bezel and at the reference level control. Changes in RF, IF gain, and preselector loss are automatically included. In addition, flat frequency response ensures accuracy for relative as well as absolute power measurements.

Wide Dynamic Range

Internal preselection (1.7 to 22 GHz) enables you to measure distortion products as much as 100 dB down. Even for closely spaced signals or measurements below 1.7 GHz, all distortion products are more than 70 dB down. In either case, maximum dynamic range is ensured even for 1 watt signals with the 70 dB input attenuator. An input limiter (0.01 to 1.8 GHz) and the internal preselector (1.7 to 22 GHz) enable the HP 8565A to withstand RF signals up to +30 dBm for all input attenuator settings.

Designed for Convenience

Coupled controls allow you to make most measurements in 3 simple steps. Green color coded keys preset the HP 8565A for normal operation so a measurement only requires that you tune to a signal, select a desired span, and raise it to the reference level. Automatically selected sweep times ensure a calibrated display for all combinations of frequency span, resolution bandwidth and video filtering.

The CRT bezel LEDs display all pertinent control settings to give you all the information needed for signal evaluations in one central location. These data are also captured in CRT photos.

HP 8444A Option 059 Tracking Generator

Make swept frequency response measurements to ± 1.7 dB from 10 to 1300 MHz (± 2.7 dB up to 1500 MHz) with greater than 90 dB of dynamic range. The output is absolutely calibrated at 0 dBm and continuously variable to < -10 dBm. The frequency of unknown signals as well as the frequency of any point on the frequency response curve can be measured from the external counter output using the low-cost HP 5300/5305B Counter.

HP 8750A Storage-Normalizer

The analyzer is made even easier to use with the digital storage of the HP 8750A because there is no need to re-adjust intensity or persistence as the sweep time changes. With the push of a button, a signal can be frozen on the CRT and then compared directly to the current input signal. Traces can also be compared arithmetically (i.e., normalized) to automatically remove frequency response variations. This is especially useful when used with the HP 8444A Opt. 059 Tracking Generator.

HP 8565A Specifications

Frequency Specifications

Frequency range: 0.01 to 22 GHz with internal mixer, 14.5 to 40 GHz with HP 11517A External Mixer. Extendable to 220 GHz with other commercially available mixers and using signal ID as in Application Note 150-14.

Tuning Accuracy (digital frequency readout in any span mode)

Internal mixing: 0.01 to 2.5 GHz $< \pm(5 \text{ MHz} + 20\%$ of Frequency Span/Div.); 2.5 to 22 GHz $< \pm(0.2\%$ of center frequency + 20% of Frequency Span/Div.).

External mixing: 14.5 to 40 GHz $< \pm(0.7\%$ of center frequency + 20% of Frequency Span/Div.).

Frequency Spans

1.7 to 22 GHz: multiband span from 1.7 to 22 GHz in one sweep.

Full band: displays spectrum of entire band selected.

Per division: eighteen calibrated spans from 1 kHz per div. to 500 MHz per div. in a 1, 2, 5 sequence, plus a full band span, "F".

Span width accuracy: the frequency error for any two points on the display for spans from 500 MHz/div to 20 kHz/div (un-stabilized) is less than $\pm 5\%$ of the indicated separation; for stabilized spans 100 kHz/div and less, the error is less than $\pm 15\%$.

Zero span: analyzer becomes a manually tuned receiver.



SIGNAL ANALYZERS

Signal Analyzer, 10 MHz to 40 GHz

Model 8565A (cont.)

Spectral Resolution and Stability

Resolution bandwidths: resolution (3 dB) bandwidths from 1 kHz to 3 MHz in 1, 3 sequence. Bandwidth and span width are independently variable or may be coupled for optimum display when control markers are aligned (▶◀).

Resolution bandwidth accuracy: 3 dB points $\leq \pm 15\%$.

Selectivity (60 dB/3 dB bandwidth ratio): $< 15:1$.

Stability: total residual FM (fundamental mixing 0.01 to 4.1 GHz): stabilized, < 200 Hz p-p in 0.1 s; unstabilized < 10 kHz p-p in 0.1 s.

Stabilization range: first LO automatically stabilized for frequency spans 100 kHz/div or less. First LO residual FM typically 30 Hz p-p when stabilized.

Noise sidebands: > 70 dB down, > 30 kHz from center of CW signal in a 1 kHz Res. Bandwidth and a 10 Hz (0.01 x) Video Filter.

Amplitude Specifications

Amplitude Range - Internal Mixer

Measurement Range

Total power: +30 dBm (1 watt).

Damage levels (50 Ω nominal source impedance):

dc: 0 V with 0 dB input atten, ± 7 V with ≥ 10 dB input atten.

ac: 0 V with 0 dB input atten, 10 V peak with ≥ 10 dB input atten.

RF (signals above 10 MHz): +30 dBm for any attenuator setting.

Gain compression: < 1 dB for 0 dBm input level with 0 dB attenuation.

Average noise level: see table below for max. avg. noise level with 1 kHz Res. Bandwidth (0 dB atten and 3 Hz video filter).

Frequency Band (GHz)	First IF in MHz	Harmonic Mode	Noise Level (dBm)	Frequency Response* (\pm dB MAX)
0.01-1.8	2050	1-	-112	1.2
1.7-4.1	321.4	1-	-109	1.7
3.8-8.5	321.4	2-	-103	2.5
5.8-12.9	321.4	3-	-94	2.5
8.5-18	321.4	4+	-87	3.5
10.5-22	321.4	5+	-75	4.5

*Frequency response includes input attenuator, preselector and mixer frequency response plus mixing mode gain variation (band to band).

Amplitude Range - HP 11517A External Mixer

Measurement range: saturation (gain compression < 1 dB), -15 dBm. Damage level $> +10$ dBm.

Sensitivity (average noise level in a 10 kHz IF bandwidth):

14.5-18 GHz < -80 dBm, 18-26.5 GHz < -70 dBm, 26.5-40 GHz < -60 dBm. Typical sensitivity is 10 dB better for each band.

> 40 GHz: for signal analysis above 40 GHz with commercially available mixers see Application Note 150-14.

Reference Level

Reference level range: +70 dBm (+30 dBm max. input) to -102 dBm in 10 dB steps and continuous 0 to -12 dB calibrated vernier.

Reference level accuracy: the Auto Sweep setting of the sweep time/div control insures a calibrated display within these limits:

Calibrator output (100 MHz \pm 10 kHz): -10 dBm ± 0.3 dB.

Reference level variation (input attenuator at 0 dB, 20° to 30° C): 10 dB steps $\leq \pm 0.5$ dB (0 to -70 dBm); $\leq \pm 1.0$ dB (0 to -90 dBm).

Vernier (0 to -12 dB) continuous: maximum error < 0.5 dB.

Input attenuator: (at preselector input, 0-70 dB in 10 dB steps).

Step size variation: $\leq \pm 1.0$ dB, 0.01 to 18 GHz; $\leq \pm 1.5$ dB, 0.01 to 22 GHz.

Maximum cumulative error over the 0 to 60 dB range: $\leq \pm 2.4$ dB, 0.01 to 18 GHz, 0 to 60 dB; $\leq \pm 2.5$ dB, 0.01 to 22 GHz, 0 to 40 dB.

Frequency response: see table above.

Switching between bandwidths: 3 MHz to 1 kHz, ± 1.0 dB

Calibrated Display Range

Log: (expanded from reference level down): 70 dB 10 dB/div, 40 dB 5 dB/div, 16 dB 2 dB/div and 8 dB 1 dB/div.

Linear: full scale from 1.8 μ V (-102 dBm in 50 Ω to 707 volts (+70 dBm) in 10 dB steps and continuous 0 to -12 dB vernier.

Display Accuracy

Log: $\leq \pm 0.1$ dB/dB, but $\leq \pm 1.5$ dB over full 70 dB display range.

Linear: $\leq \pm 3\%$ of reference level.

Residual responses (no signal present at input): with 0 dB input atten, fundamental mixing (0.01 to 4.1 GHz) < -90 dBm.

Signal identifier: available from 10 MHz to 40 GHz and in all Freq. Span/Div settings for signal identification.

Signal Input Characteristics

Input impedance: 50 ohm nominal, 0.01 to 22 GHz.

Input connector: precision Type N female.

Input SWR

Input attenuator at 0 dB: < 1.5 , 0.01 to 1.8 GHz; < 2.0 , 1.7 to 22 GHz.

Input attenuator at ≥ 10 dB: < 1.3 , 0.01 to 1.8 GHz; < 2.0 , 1.7 to 22 GHz.

LO Emission (2.00 to 4.46 GHz): -50 dBm, 0.01 to 1.8 GHz; -85 dBm, 1.7 to 22 GHz.

Input Protection (for input signals from 0.01 to 22 GHz)

0.01 to 1.8 GHz frequency band: internal diode limiter.

1.7 to 22 GHz frequency bands: saturation of YIG filter (pre-selector) occurs at total input signal power levels below input mixer damage.

External mixer input: BNC female connector is a port for LO power transfer, bias current and IF return.

Sweep Specifications

Sweep Time

Auto: sweep time is automatically controlled by Frequency Span/Div, Resolution Bandwidth and Video Filter controls to maintain an absolute amplitude calibrated display.

Calibrated sweep times: 21 internal sweep times from 2 μ s/div to 10 s/div in 1, 2, 5 sequence.

Display Characteristics

Cathode Ray Tube (aluminized P31 phosphor, 8 x 10 div internal graticule)

Persistence

Conventional: natural persistence of P31 phosphor.

Write: continuously adjustable from 0.2 s to full storage.

Storage time: continuously adjustable from 1 minute (full brightness) to > 30 minutes (minimum brightness).

Write speed: continuously adjustable to vary CRT sensitivity to capture large signal deflections in fast sweeps.

CRT Bezel readout: bezel LEDs display the following measurement data (included in CRT photographs taken with the HP 197B Opt 001, 006 Oscilloscope Camera): Ampl. Scale Factor, Ref. Level, Input Atten., Res. Bandwidth, Sweeptime/Div., Freq., Freq. Span/Div.

General Specifications

Temperature range: operating 0°C to 55°C, storage -40° to $+75^\circ$ C.

Humidity range (operating): $< 95\%$ R.H. 0°C to 40°C.

EMI: Conducted and radiated interference is in compliance with MIL-STD 461A Methods CE03 and RE02, CISPR publication 11 (1975), and Messemphaenger-Postverfuegung 526/527/79 (Kennzeichnung Mit F-Nummer/Funkschutzzeichen).

Power requirements: 48-66 Hz; 100, 120, 200 or 240 volts (-10% to $+5\%$); 220 VA max (400 Hz operation available as Opt 400).

Size: 188 H x 426 W x 552 mm D (7" x 16.8" x 21.8").

Weight: net 29.5 kg (64 lb). Shipping 39 kg (85 lb).

Standard Options Available

Opt 100, 100 and 300 Hz resolution bandwidths: adds 100 Hz and 300 Hz resolution bandwidths with 11:1 shape factor, residual FM < 100 Hz when stabilized and improves sensitivity by 10 dB.

Opt 200—Calibration in dB μ V

Opt 400—400 Hz Power Supply

HP Part No. 1540-0654 - Transit Case. Order HP Part No. 1490-0913 also for castors.

Ordering Information

Ordering Information	Price
HP 8565A Spectrum Analyzer	\$29,000
Opt 100: 100 Hz and 300 Hz Resolution Bandwidths	\$1,500
Opt 200: Calibration in dB μ V	\$100
Opt 400: Internal 50 to 400 Hz Power Supply	\$250
Opt 908: Rack Flange Kit	\$35
Opt 910: Extra Operating and Service Manual	\$50
Opt 913: Rack Flange Kit for instruments with handles	\$60
HP 11517A External Mixer (taper section req'd)	\$500
HP 11518A Taper Section, 12.4 to 18 GHz	\$375
HP 11519A Taper Section, 18 to 26.5 GHz	\$375
HP 11520A Taper Section, 26.5 to 40 GHz	\$375
HP 8444A Opt 059 Tracking Generator, 10 to 1500 MHz	\$4,760
HP 8750A Storage-Normalizer	\$2,355

SIGNAL ANALYZERS

Harmonic Mixers, 18 to 110 GHz

Models 11970 Series, 11971 Series & 11517A



- Low conversion loss
- Individually amplitude calibrated

- No bias or tuning adjustments
- High 100 mW safe input level

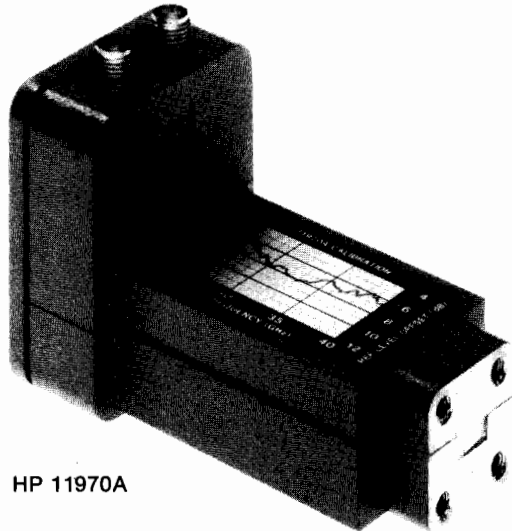

HP 11970A

Bias requirements: None

Typical odd order harmonic suppression: >20dB

Maximum CW RF input level: +20 dBm (100 mW)

Maximum peak pulse power: 24 dBm (250 mW) with <1 usec pulse (avg. Power: +20 dBm)

Environmental: Meets MIL-T-28800C, Type III, Class 3, Style C.

IF/LO connectors: SMA female

LO Range: HP 11970 Series, 3.0 to 6.1 GHz

HP 11971 Series, 2.0 to 4.5 GHz

HP Model	Frequency Range	LO Harm. Number	Conversion Loss (dB)	Noise Level (dB) / kHz (RBW)	Freq. ¹ Response (dB)	Gain Compression (dBm)
11970K	18-26.5	6+	24	-110	±1.9	-3
11970A	26.5-40	8+	26	-108	±1.9	-5
11970Q	33-50	10+	28	-104	±1.9	-7
11970U	40-60	10+	28	-104	±1.9	-7
11970V	50-75	14+	40	-92	±2.1	-3
11970W	75-110	18+	46	-85	±3.0	-1
11971K	18-26.5	6+	24	-110	±2.1	-3
11971A	26.5-40	10+	28	-106	±2.1	-7
11971Q	33-50	16+	40	-92	±2.3	-3
11971U	40-60	16+	40	-92	±2.3	-3
11971V	50-75 ²	16+	42	-89	±2.5	-3

HP 11970 and 11971: Exceptional Performance

The HP 11970 and 11971 series of waveguide Mixers are general purpose harmonic mixers employing state-of-the-art, dual diode design to achieve flat frequency response and low conversion loss. These mixers are available in six bands from 18 GHz through 110 GHz.

Easy to Use

The excellent frequency response and low conversion loss of the HP 11970 and 11971 series Harmonic Mixers are achieved without external dc bias or tuning stubs. Manual operation as well as computer controlled operation of hardware is simplified because no mixer adjustments are required.

HP 11517A Harmonic Mixer

This low-cost, wide-frequency-range harmonic mixer provides an economical solution for measurements not requiring amplitude calibration in the frequency range covering 12.4 to 40 GHz. Waveguide adapters are available to make measurements in more than one waveguide band.

The HP 11517A has an IF range of DC to 2 GHz and an LO range of 2 to 6 GHz, which makes this biased mixer compatible with a wide range of instruments.

Extends Spectrum Analysis Frequency

The HP 11970 and 11971 series Harmonic Mixers extend the frequency range of the HP 8566B, 8569B, and 71000 series microwave Spectrum Analyzers. The HP 11975A Amplifier provides the optimum LO power to the mixers when using the HP 8566B or 88569B Spectrum Analyzers. The HP 11517A external Harmonic Mixer extends the frequency range of the HP 8555A and 8565A Spectrum Analyzers.

Harmonic Mixer Selection Guide

HP Spectrum Analyzer	HP Compatible Mixer Series	HP LO Drive Amplifier
8566B	11970	11975A
71000	11970	70907A
8569B	11971	11975A
8569B Opt. 003	11971	internal ¹
8555A	11517A with adapters	11975A (optional)
8565A	11517A with adapters	11975A (optional)

HP 11970 and 11971 Series Specifications

IF range: DC to 1300 MHz

LO amplitude range: +14 to +18 dBm, +16 dBm optimum

Calibration accuracy: ±2.0dB with optimum LO amplitude

Typical RF input SWR: <2.2:1

HP 11517A Characteristics

IF range: DC to 2 GHz

LO frequency range: 2.1 to 6.1 GHz

LO amplitude range: 0 to +10 dBm (+10 dBm optimum)³

Typical flatness: ±3 dB over a 1 GHz span with biased peaked

Typical DC bias range: 0 to 3.5mA

Maximum CW RF input level: +10 dBm

Typical 3 dBm gain compression: -15 dBm

Typical noise level: -85 dBm (using HP 8555A or 8565A with 1 kHz RBW)

12.4 to 18 GHz, -80 dBm 18 to 26.5 GHz, -70 dBm 26.5 to 40 GHz

Waveguide adapters:

12.4 to 18 GHz, HP 11518A; 18 to 26.5 GHz, HP 11519A; 26.5 to 40 GHz, HP 11520A

Ordering Information

Model	Description	Price
HP 11970K	18 to 26.5 GHz Mixer	\$1500
HP 11970A	26.5 to 40 GHz Mixer	\$1550
HP 11970Q	33 to 50 GHz Mixer	\$1700
HP 11970U	40 to 60 GHz Mixer	\$1850
HP 11970V	50 to 75 GHz Mixer	\$2250
HP 11970W	75 to 110 GHz Mixer	\$2550
HP 11970T	18 to 40 GHz Mixers and Case	\$3100
Opt 001:	Adds 40 to 60 GHz Mixer to 11970T	add \$1850
Opt 002:	Adds 33 to 50 GHz Mixer to 11970T	add \$1700
HP 11971K	18 to 26.5 GHz	\$1350
HP 11971A	26.5 to 40 GHz	\$1400
HP 11971Q	33 to 50 GHz	\$1600
HP 11971U	40 to 60 GHz	\$1800
HP 11971V	50 to 75 GHz	\$2000
HP 11971T	18 to 40 GHz Mixer Set and Case	\$2700
Opt 009:	Mixer Connection Set contains three 1 meter low-loss SMA cables, a wrench, and an allen driver for use with any of the mixers listed above. Space is provided in carrying case for cables and tools.	\$250

HP 11969A Carrying Case for one to five mixers, SMA cables and tools \$565

HP 11517A Harmonic Mixer (Waveguide Adapter required) \$500

HP 11518A 12.4 to 18 GHz Waveguide Adapter \$375

HP 11519A 18 to 26.5 GHz Waveguide Adapter \$375

HP 11520A 26.5 to 40 GHz Waveguide Adapter \$375

HP 11975A 2 to 8 GHz Amplifier \$4100

¹Frequency response of the mixers is reduced by 1 dB for LO range of 14 to 18 dBm.

²Operates to 71 GHz with the HP 8569B.

³The HP 11975A Amplifier can be used to provide sufficient LO power to the mixers.

SIGNAL ANALYZERS

Spectrum Analyzer Accessories

Models 11975A, 8447 Series

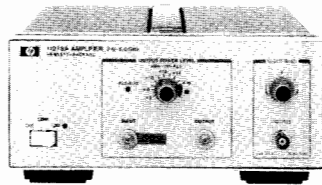

HP 11975A

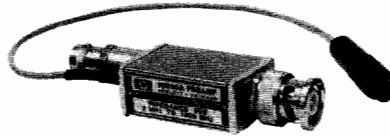

HP 10855A

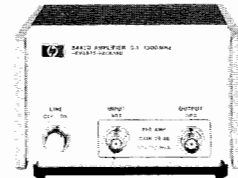

HP 8447 Series



HP 11693A



HP 11867A



HP 11694A

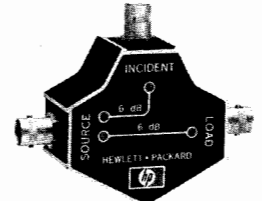

HP 8721A



HP 8406A



HP 11940A

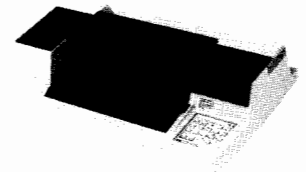

HP 7475A

HP 8447 Series Amplifiers (0.1 to 1300 MHz)

The HP 8447 Series Amplifiers feature low noise and wide bandwidth. This makes them ideal for improving spectrum analyzer sensitivity and noise figure while providing input isolation. Accurate measurements over a wide frequency range are assured due to the broad frequency coverage, flat frequency response, and low distortion of these amplifiers. (See page 490.)

HP 11975A Amplifier (2 to 8 GHz)

A wide variety of sources can be leveled to ± 1 dB and amplitude calibrated up to +16 dBm using the HP 11975A in a stimulus response system. As a preamp, the small signal gain of the HP 11975A varies between 9 and 15 dB depending on the frequency. For measurements above 18 GHz, the HP 11975A is ideal for amplifying the local oscillator signal from a spectrum analyzer or network analyzer to drive a waveguide mixer like the HP 11970 or 11971 Series Harmonic Mixers. (See page 488.)

HP 10855A 2-1300 MHz Preamp

The HP 10855A provides a minimum of 22 dB gain from 2 to 1300 MHz to enhance the measurement of very low-level signals. The ± 1.5 dB flat response reduces distortion in non-sinusoidal waveforms. This preamp operates conveniently with several spectrum analyzers that have probe power outlets. (See page 321.)

HP 11867A and 11693A Limiters

The input circuits of spectrum analyzers, counters, amplifiers, and other instrumentation is protected against high power levels with minimum effect on measurement performance. The HP 11867A RF Limiter (dc-1800 MHz) begins reflecting signal levels over 1 milliwatt without damage up to 10 watts avg. power and 100 watts peak power. Insertion loss is < 0.75 dB. The HP 11693A Microwave Limiter (0.1-12.4 GHz, useable to 18 GHz) guards against input signals over 1 milliwatt up to 1 watt avg. power and 10 watts peak power.

HP 11694A 75 Ω Matching Transformer (3 to 500 MHz)

Allows measurements in 75 Ω systems while retaining amplitude calibration. VSWR is < 1.2 , and insertion loss is < 0.75 dB. See Options 001 and 002 for 75 Ω versions of the HP 8557A and 8558B.

HP 8721A Directional Bridge (100 kHz to 100 MHz)

Used for return-loss measurements made with a swept source such as the HP 8443A Tracking Generator and a spectrum analyzer. 6dB insertion loss and 6dB coupled to auxiliary arm. Frequency response ± 0.5 dB (0.1-110MHz). Directivity > 40 dB (1 to 110 MHz). Load part return loss < 0.03 . Max input power +20 dBm. 50 Ω ; Option 008: 75 Ω . (See page 557.)

HP 11940A Close-Field Probe

This small, hand-held, electromagnetic-field sensor is used with a spectrum analyzer for electromagnetic interference (EMI) diagnostic and troubleshooting applications. Repeatable, absolute magnetic-field measurements at the probe's tip are provided over a 30 MHz to 1 GHz frequency range. The probe is calibrated for emission measurements to within ± 2 dB in a 377-ohm field impedance. The HP 11940A can also be used for localized susceptibility testing. (See page 677.)

HP 8406A Frequency Comb Generator

Produces frequency markers at 1, 10, and 100 MHz increments accurate to $\pm 0.01\%$ and useable to beyond 5 GHz. An external oscillator can be used to generate precision interpolation sidebands. For an internal comb generator option to the HP 8569B, see page 690.

HP Plotters and Printers

Hard-copy records of measurement data can be produced under the direction of either a computer or the measuring instrument itself. Many HP spectrum analyzers can send (without requiring an attached computer) displayed information to a variety of plotters and printers, including the HP ColorPro and 7475A Plotters and the HP Thinkjet Printer. Refer to individual spectrum analyzer models for compatibility information.

Ordering Information

	Price
HP 8447A 0.1 to 400 MHz Preamp	\$1075
HP 8447D 0.1 to 1300 MHz Preamp	\$1100
HP 8447E 0.1 to 1300 MHz Power Amplifier	\$1225
HP 8447F 0.1 to 1300 MHz Preamp and Power Amplifier	\$1875
HP 11975A 2 to 8 GHz Amplifier	\$4100
HP 10855A Preamp	\$550
HP 11867A RF Limiter	\$410
HP 11693A Microwave Limiter	\$460
HP 11694A 75 Ω Matching Transformer	\$205
HP 8721A Directional Bridge	\$325
HP 11940A Close-Field Probe	\$500
HP 8406A Frequency Comb Generator	\$2175

SIGNAL ANALYZERS

5 Hz to 50 kHz Spectrum Analyzer

Model 3580A

695

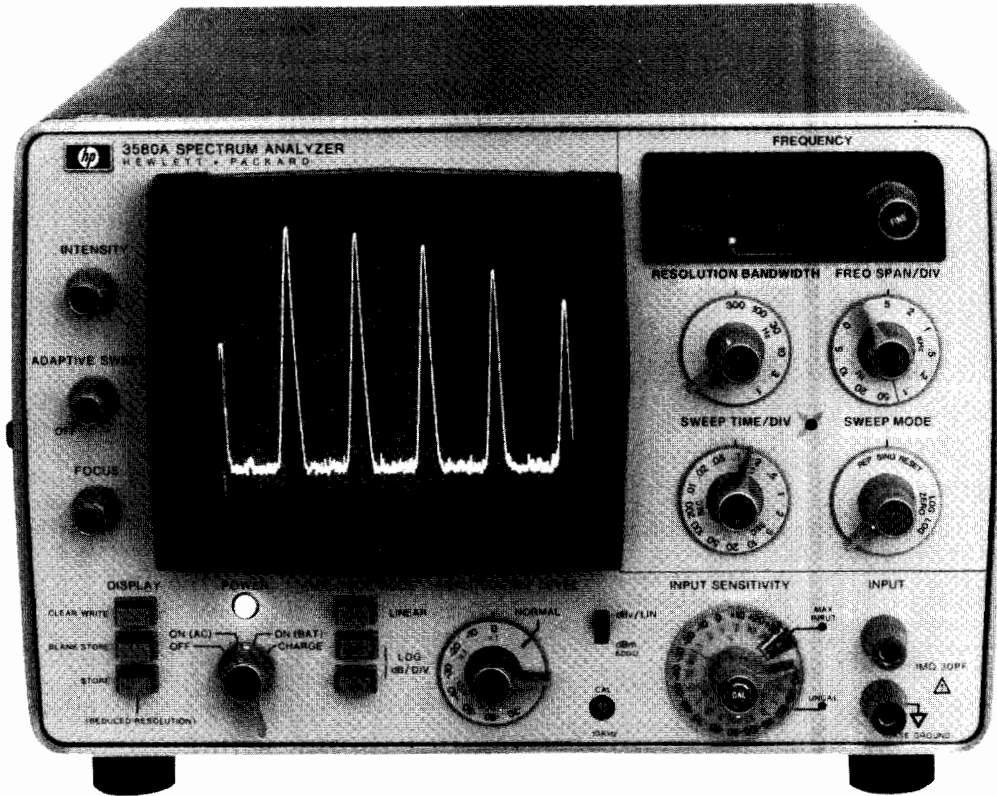

HP 3580A

Description

Hewlett-Packard's 3580A Spectrum Analyzer is a low frequency high performance analyzer. Its 1 Hz bandwidth allows the user to examine noise and extraneous signal content close in to a signal of interest.

For low frequency applications where sweep speeds can be slow and time-consuming, a special feature, adaptive sweep, allows the user to set a threshold above which only the spectra of interest are observed. In this mode, the CRT is rapidly swept. When a signal is encountered, the sweep slows down to reproduce full response. A factor of ten speed gain is possible.

Digital storage is another important feature which enhances the display for slowly swept low frequency signals. The analyzed signals are digitized and stored in memory. Trace information is then read from memory at a rate appropriate for obtaining an analog-like display.

Digital Storage for Spectra Comparison

Digital storage makes it possible to store one or two traces. When two are stored, both may be simultaneously displayed for easy comparison as shown below.

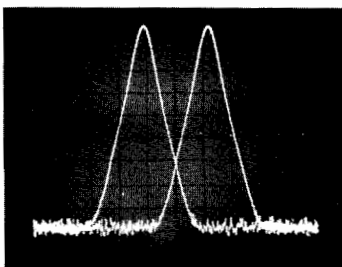

Adaptive Sweep

A tremendous savings in sweep time can be achieved by using adaptive sweep. In the left trace below, over 80 dB of dynamic range is used to look at low level signals and noise. Two hundred seconds were required to make the sweep. In the right trace, the baseline is raised to give 50 dB of dynamic range. Noise and other responses are not analyzed, so the sweep now takes only 14 seconds.

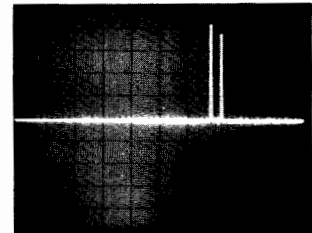
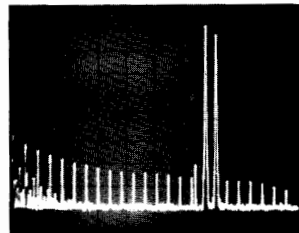

1 Hz Bandwidth

When using a 1 Hz bandwidth 60 Hz line related spectra are clearly exposed as shown in the left trace. An analysis of the same signal with a 10 Hz bandwidth will not resolve the line related spectra as shown on the right.

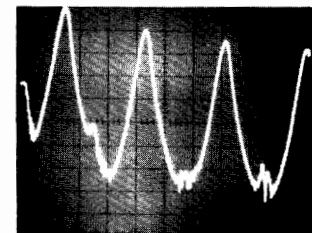
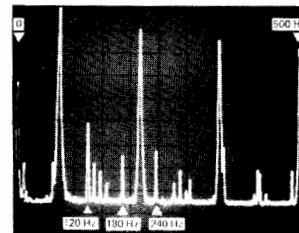



SIGNAL ANALYZERS

5 Hz to 50 kHz Spectrum Analyzer

Model 3580A (Cont.)

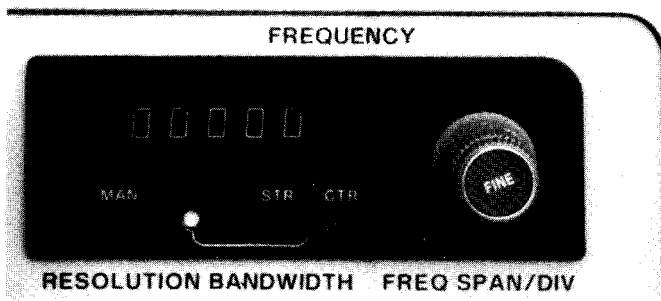

Digital Frequency Display

This display provides 1 Hz resolution for setting analysis range and for determining tuned frequency. In the automatic sweep modes, the sweep start or center frequency is displayed. In the manual sweep mode, actual tuned frequency is indicated. This mode effectively provides a cursor function for easy and accurate determination of the frequency at any point on the screen.

Internal Calibration Signal

A 10 kHz pulse derived from a crystal can be used to compensate for internal errors. A 10 kHz calibration potentiometer is provided so the 10 kHz fundamental can be adjusted to fall on the top line of the display. With this feature, operation and calibration can be verified for most of the instrument.

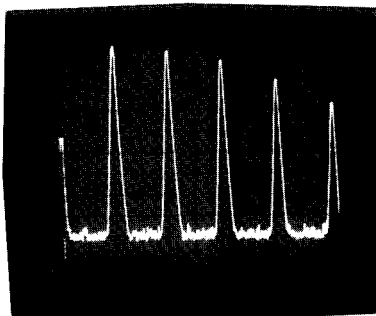

Specifications

Frequency Characteristics

Range: 5 Hz to 50 kHz.

Digital Frequency Display

Resolution: 1 Hz

Accuracy: ± 3.5 Hz, 0 to 55°C.

Typical stability: ± 10 Hz/hr after 1 hour; ± 5 Hz/°C.

Bandwidths:
(accuracy $\pm 15\%$)

Shape factor:

1 Hz (25°C ± 5 C)	3 Hz	10 Hz	30 Hz	100 Hz	300Hz
10					8

Out of range blank: if controls are set so portions of displayed signal lie below 0 Hz or above 50 kHz, the baseline is displayed.

Amplitude Characteristics

Overall Instrument Range

Linear: 20 V –100 nV full scale

Log: +30 dBm or dB V;

–150 dBm or dB V

Amplitude Accuracy

Frequency response:

20 Hz–20 kHz

5 Hz–50 kHz

Log Linear

± 3 dB $\pm 3\%$

± 5 dB $\pm 5\%$

Switching between bandwidths (25°C):

3 Hz–300 Hz

1 Hz–300 Hz

± 5 dB $\pm 5\%$

± 1 dB $\pm 10\%$

Amplitude display

Input attenuator

± 2 dB $\pm 2\%$

± 3 dB $\pm 3\%$

Amplitude reference level:

(IF attenuator)

Most sensitive range

± 1 dB $\pm 10\%$

All other ranges

± 1 dB $\pm 3\%$

Dynamic range: 80 dB

IF feedthru: input level > 10 V, –60 dB; < 10 V, –70 dB.

Spurious responses: >80 dB below input reference level.

Smoothing: 3 positions, rolloff is a function of bandwidth.

Overload indicator: this LED indicator warns of possible input amplifier overloading. Without this indication it would be possible to introduce spurious responses without knowing it.

Sweep Characteristics

Scan width: 50 Hz to 50 kHz.

Log sweep: 20 Hz to 43 kHz $\pm 20\%$ after 3 sweeps.

Sweep times: 0.1 s to 2000 s.

Rep: repetitive sweeps over the specified band.

Reset: resets to the beginning of the sweep—used to adjust start or center frequency.

Manual: in combination with the concentric knob, manual sweep fully duplicates the span of the electronic sweep.

Adaptive sweep: when in adaptive sweep below the threshold level, scan speed is 20 to 25 times faster. Threshold is adjustable to cover 0–60% of screen. Signals greater than about 6 dB above threshold are detected and swept slowly.

Sweep error light: this LED indicates a sweep that is too fast to capture full response. When the light is on, response can be >5% lower than it should.

Zero scan: to look at the time varying signal at the center or start frequency within the bandwidth selected, the zero scan is used.

Output Characteristics

Tracking generator output: (also known as BFO or tracking oscillator output).

Range: 0 to 1 V rms into 600 Ω .

Frequency response: $\pm 3\%$, 5 Hz to 50 kHz.

Impedance: 600 Ω .

Total harmonic and spurious content: 40 dB below 1 volt signal level.

X-Y Recorder Analog Outputs

Vertical: 0 to +5 V $\pm 2.5\%$.

Horizontal: 0 to +5 V $\pm 2.5\%$.

Impedance: 1 k Ω .

Pen lift: contact closure to ground during sweep.

Recommended Accessory: HP 7090A Measurement Plotting System.

Size: 203.2mm H x 285.8mm W x 412.8mm D (8" x 11¼" x 16¼").

Weight: net, 12.25 kg (27 lb); HP 3580A Opt 001: net, 15.88 kg (35 lb).

Temperature range: 0°C to 55°C.

Power: 100 V, 120 V, 220 V, or 240 V +5% – 10%; 48 to 440 Hz; 35 VA max.

Opt 001 battery: 5 hours from full charge. 14 hours to fully recharge. The internal battery is protected from deep discharge by an automatic turn off. Useful life of batteries is over 100 cycles.

Ordering Information

HP 3580A Spectrum Analyzer

Opt 001: internal rechargeable battery

Opt 002: balanced input

Opt 003: rack mount

Price

\$8,200

add \$700

add \$250

add \$330

SIGNAL ANALYZERS

Dual-Channel, Dynamic Signal Analyzer 0.02 Hz to 25.5 kHz

Model 3582A



- Transfer function magnitude and phase measurements
- Coherence function measurement
- Phase spectrum measurement
- Transient capture and frequency domain analysis
- Internal periodic and random noise source
- Band selectable analysis for 0.02 Hz resolution
- Alphanumeric CRT annotation and marker readout

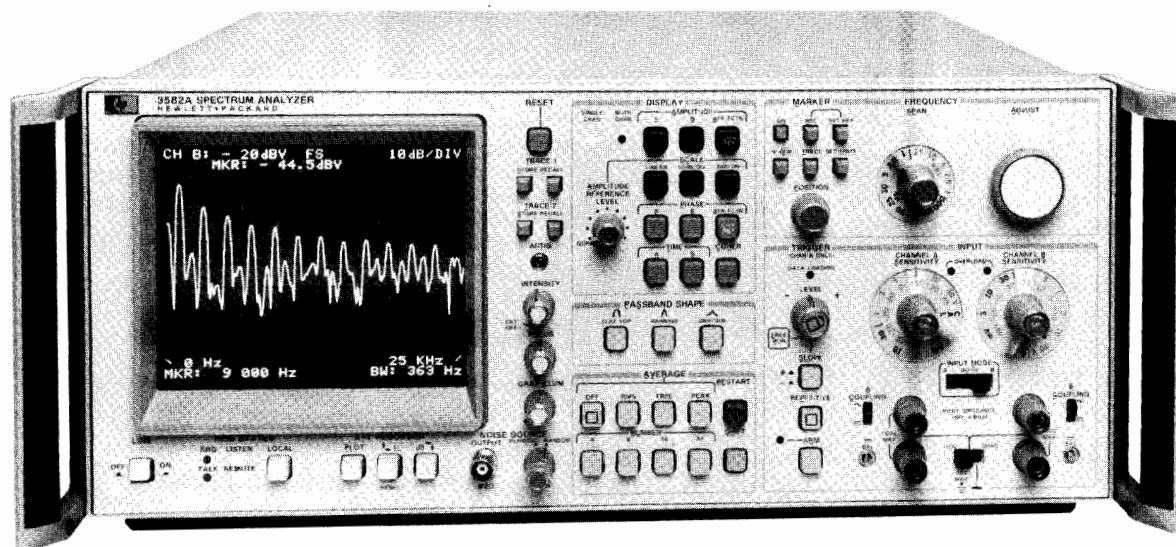

HP 3582A



Description

The HP 3582A offers outstanding value in a dual-channel, real-time spectrum analyzer that solves bench and systems measurement problems in the frequency range of 0.02 Hz to 25.599 kHz. Sophisticated LSI digital filtering combined with microcomputer execution of the Fast Fourier Transform (FFT) provides exceptional measurement capability and performance.

Exceptional Frequency Resolution

The ability to resolve closely spaced spectral components is often critical in the study of subtle phenomena such as structural transfer functions. Unlike conventional dynamic signal analysis which extends from dc to some maximum frequency, the HP 3582A can "zoom in" to analyze any selected band of frequencies with dramatically improved resolution. The start or center frequency of the 5 Hz to 25 kHz band analysis spans can be adjusted in 1 Hz increments to cover the entire frequency range of the instrument. This provides resolution down to 20 mHz across the entire range for spectrum analysis or 40 mHz for transfer functions, representing as much as 5000 to 1 improvement over conventional "baseband" analysis.

Excellent Low Frequency Coverage

Many electrical and physical measurements have significant spectral information in the audio and sub-audio range. With frequency ranges from 25 kHz down to 1 Hz full scale, the HP 3582A is extremely well suited to these types of measurements.

Real Time Measurement Speed

Long measurement times can be a major limitation of swept low frequency spectrum analyzers. In high volume testing or in applications requiring substantial on-line tuning these long measurement times are both expensive and inconvenient. Since the HP 3582A uses an advanced microcomputer to execute the Fast Fourier Transform (FFT), it can perform equivalent measurements as much as one to two orders of magnitude faster than a swept analyzer.

Wide Dynamic Range

In many applications the information of interest is contained not in the high amplitude fundamental, but rather in the low amplitude components. For a spectrum analyzer to provide useful information about these low level components in the presence of a large signal, it must offer wide dynamic range. The HP 3582A dynamic range is specified as 70 dB.

Phase Spectrum Measurement

Most spectrum analyzers can measure only the amplitude spectrum of a signal, yet complete characterization in the frequency domain also requires phase information. Signals with identical amplitude spectra, but different phase spectra can differ significantly. The advanced digital signal processing techniques incorporated in the HP 3582A provides direct measurement of phase spectra.

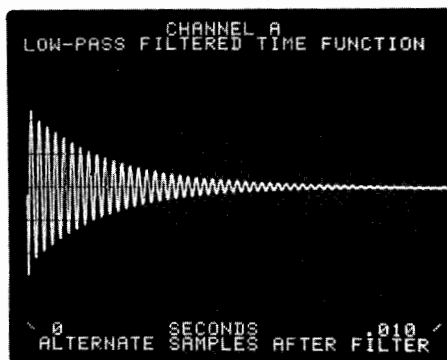

Figure 1: Captured transients can be measured in either the time or the frequency domain.

Transient Capture and Analysis

Many signals such as mechanical shocks and electrical transients may occur infrequently and spontaneously and may last only for a brief period of time. Swept spectrum analyzers generally cannot handle these transient signals. By using digital processing techniques, the HP 3582A can capture and analyze transients as short as a few milliseconds. This means that spectrum analysis and transfer function analysis are no longer limited to stable, time invariant signals.

Transfer Function Measurement with the Internal Noise Source

Many electrical circuits and mechanical systems can be treated as linear networks and can be characterized by the magnitude and phase of their transfer functions.

Most spectrum analyzers can measure only the magnitude portion of the transfer function—and even then only by assuming a flat drive signal. The HP 3582A directly measures the complete transfer function, both magnitude and phase. With dual channels analysis of



SIGNAL ANALYZERS

Dual-Channel, Dynamic Signal Analyzers 0.02 Hz to 25.5 kHz

Model 3582A

linear and non-linear networks, respectively. In addition, the sources are bandlimited to concentrate all stimulus energy in the analysis range.

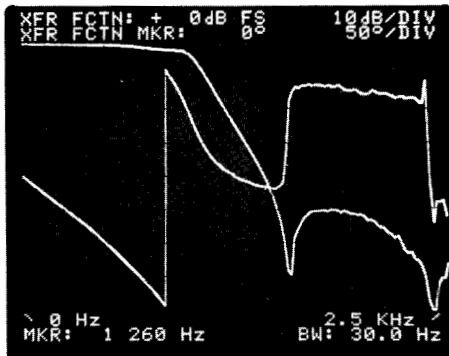

Figure 2: Transfer function amplitude and phase are measured with real time speed.

Coherence Function Measurement

The measurement of a device transfer function assumes that the device under test is linear and that no portion of the output is caused by noise or extraneous signal sources. In active electronic circuits or mechanical structures these conditions can easily be violated - yet such violations are very difficult to identify. The HP 3582A coherence function simplifies this problem by indicating the probability for causality between the two input signals at each frequency. If the coherence between input and measured output is low, the output signal contains a large amount of energy that is not related to the input. Thus, the transfer function measured at that frequency is not reliable.

Digital Averaging Capability

Many spectral measurements contain both discrete signals and random noise components. Obtaining proper amplitude readings can be difficult if the random components are really the ones of interest or are of nearly the same amplitude as the discrete signals.

The digital averaging techniques incorporated in the HP 3582A help solve these problems. The RMS averaging mode takes the power average of 4 to 256 successive spectra in order to reduce the uncertainty of the estimate of random spectral components.

When a synchronizing trigger signal is available, the TIME average can enhance the signal-to-noise ratio by as much as 24 dB. Since it involves the averaging of successive time records before transformation, it is also significantly faster than other types of averaging.

Powerful HF-IB Capability

All major front panel controls with the exception of the verniers are fully programmable via the HP-IB. The programming codes are simple and are logically derived from the front panel control labels.

From the HP-IB it is a simple matter to command the HP 3582A to output results in a usable form. Not only can the various control settings be retrieved, but numeric marker data can be extracted. More importantly, the full display can be read in ASCII format along with complete annotation.

HP 3582A Specifications

Frequency

Range: 0.02 Hz to 25.5 kHz with the low frequency limit the result of dc response.

Spans: 1 Hz to 25 kHz in a 1-2.5-5-10 sequence. The 1 Hz and 2.5 Hz spans are usable only in the 0-start mode.

Accuracy: $\pm 0.003\%$ of display center frequency.

Resolution: 0.4% of the frequency span for single channel or 0.8% of the frequency span for dual channels.

Filter Passband Shape

	Flat Top	Hanning	Uniform
3 dB Bandwidth (single channel)	$1.4 \pm 0.1\%$ of span)	$(0.58 \pm 0.05\%$ of span)	$(0.35 \pm 0.02\%$ of span)
Shape Factor	2.6 ± 0.1	9.1 ± 0.2	716 ± 20

Amplitude

Display Modes

Log: 10 dB/division or 2 dB/division

Linear: constant voltage/division

Measurement Range

Log: +30 dBV to -120 dBV noise floor

Linear: +30 V to 1 μ V noise floor

Dynamic range: 70 dB

DC response: adjustable to >40 dB below maximum input level

Accuracy

Accuracy at the ± 0.5 dB

Passband Center

Flat top filter: +0, -0.1 dB

Hanning filter: +0, -1.5 dB

Uniform filter: +0, -4.0 dB

Note: overall accuracy is the sum of the accuracy at the passband center plus the selected filter accuracy.

Resolution

Log: 0.1 dB

Linear: 3 digits

Phase

Display range: +200° to -200°

Accuracy: $\pm 10^\circ$

Resolution: 1°

Transfer Function

Measurement Range

Log: +160 dB full scale to -80 dB full scale

Linear: 4×10^8 full scale to 4×10^{-8} full scale

Phase display range: +200 degrees to -200 degrees

Accuracy

Amplitude	0.4 dB	0.8 dB	
ϕ	$\pm 2^\circ$	$\pm 5^\circ$	
	.02 Hz	5 kHz	25.5 kHz

Coherence: Range 0.0 to 1.0 with 0.01 resolution

Input

Impedance: $10^6 \Omega \pm 5\%$ shunted by <60 pF from input high to low (for less than 75% relative humidity)

Isolation: input low may be floated up to 30V

Coupling: switch selection of ac or dc coupling. The low frequency 3 dB roll off is <1 Hz.

Common Mode Rejection: >58 dB

Output

X-Y Recorder Level: 0 V to 5.25 V $\pm 5\%$

Noise Source Level: From <10 mV to >500 mV RMS into >50 Ω .

General

Environmental

Temperature: 0° C to 55° C operating; -40° C to +75° C storage

Humidity: <95% R.H. 0° C to 40° C

Power Requirements: 100, 120, 220 or 240 volts (+5%, -10%); 48-66 Hz; less than 150 VA

Dimensions

Size: 425.5 W x 552.5 D x 188 mmH (16.75" x 21.75" x 7.4")

Weight: net, 24.5 kg (54 lb); shipping, 29 kg (63 lb)

HP 3582A Spectrum Analyzer

\$11,600

SIGNAL ANALYZERS

Single Channel, Dynamic Signal Analyzer 0.000125 Hz to 100 kHz

Model 3561A

699



- Spectrum and network analysis, waveform recording, $\frac{1}{3}$ and $\frac{1}{1}$ octave analysis
- High accuracy, ± 0.15 dB
- 80 dB dynamic range and full alias protection
- High speed (7.5 kHz Real Time Rate)
- Band selectable zoom analysis for 640 μ Hz resolution
- Full CRT annotation and softkey ease-of-use
- Auto-ranging, auto-calibration, auto-scaling
- Internal non-volatile memory stores 2 traces and 6 states. Optional bubble (non-volatile) memory stores 127 traces and states.

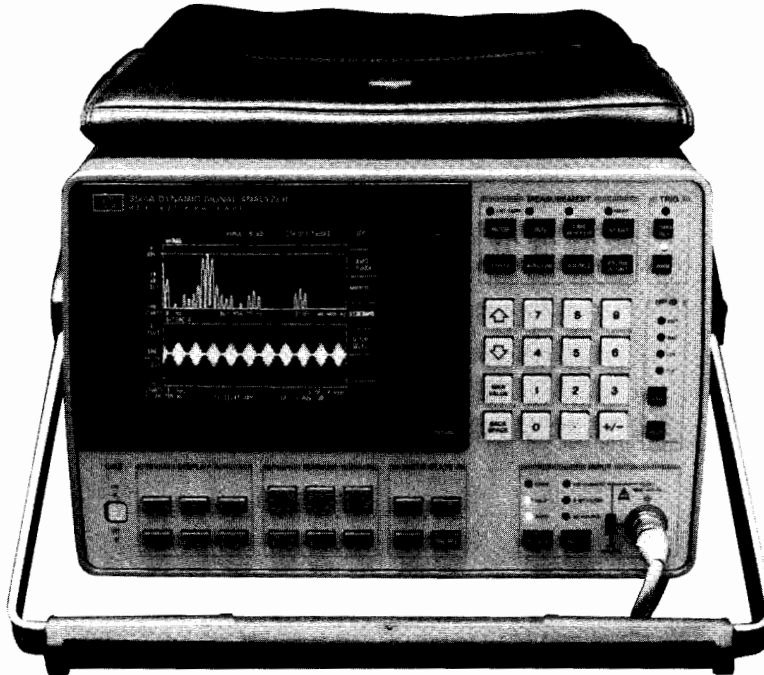

HP 3561A



Description

The HP 3561A is a versatile, single channel, real time spectrum analyzer with applications in electronics, vibration analysis, and acoustics. It is actually several instruments in one, operating in both the frequency domain and the time domain. In the frequency domain it serves as a spectrum analyzer with ± 0.15 dB amplitude accuracy and 2 degrees triggered phase accuracy. Utilizing the built-in tracking noise source, it also can serve as a network analyzer. (Trace math can be used when phase response or high accuracy is desired.) Digital signal processing allows the HP 3561A to digitally synthesize $\frac{1}{3}$ or $\frac{1}{1}$ octave filters, providing a high accuracy, drift free octave analyzer. Operating in the time domain the HP 3561A can be used as a low frequency digital storage oscilloscope. The HP 3561A contains a 40k-sample time buffer and complete triggering flexibility, so waveform recording is easy. Time or frequency measurements can be stored in an optional non-volatile "bubble" memory for later analysis. Annotated hardcopy is easily obtained by pressing "plot" ... the HP 3561A will control HP-GL plotters and raster dump printers directly. All of these capabilities in one portable instrument make the HP 3561A a powerful addition to any bench, and with a standard HP-IB interface, the HP 3561A makes an excellent systems instrument as well.

Spectrum Analysis

The HP 3561A offers swept analyzer performance with FFT speed. Up to two orders of magnitude speed improvement can be realized, especially in measurements requiring 1 Hz or better frequency resolution. The HP 3561A delivers 158 dB of automatically calibrated measurement range, from +27 dBV (22.4 volts RMS) to -131 dBV (0.28 microvolts RMS). Dynamic range is 80 dB, and amplitude accuracy is ± 0.15 dB on the +27 dBV to -40 dBV ranges (± 0.25 dB on the -41 dBV to -51 dBV ranges). Signals can be read in RMS volts, volts squared, milliwatts, dBV, dBm (with user-selected impedance), and user-defined engineering units. Band, harmonic and sideband

power can be computed directly using the built-in special marker functions. Frequencies spaced as narrow as 640 μ Hz can be resolved throughout the 100 kHz range, with frequency accuracy $\pm 0.003\%$ of display center frequency. Phase spectra relative to a trigger signal can be measured with up to 2 degrees phase accuracy, useful for machinery balancing.

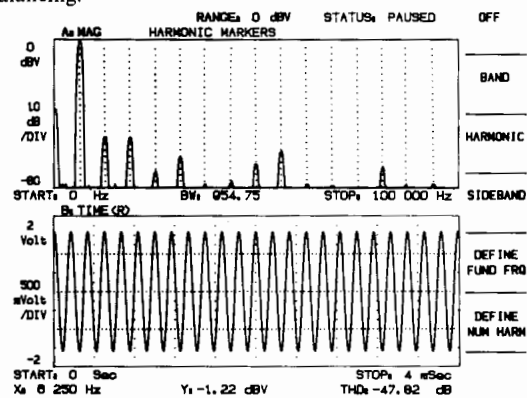

Harmonic marker function computes total harmonic distortion (THD) directly in dB or percent.

Network Analysis

A band-limited, band-translated noise source allows the HP 3561A to make amplitude and phase frequency response measurements. To make a network measurement, connect the internal noise source to the device under test, adjust the source amplitude, and measure the input spectrum. Store the input spectrum in memory and measure the response spectrum. A simple trace math operation produces the desired frequency response. Amplitude resolution is 0.01 dB and phase resolution is 0.1 degree.

SIGNAL ANALYZERS

Single Channel, Dynamic Signal Analyzer 0.000125 Hz to 100 kHz

Model 3561A (con't)

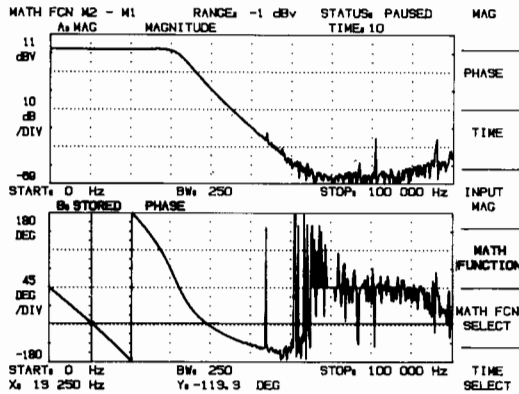

Figure 2: Network amplitude and phase response are measured using the unique internal noise source and trace math.

Waveform Recording

A high linearity 13 bit analog-to-digital converter makes the HP 3561A a natural for waveform recording. Forty-three sample rates ranging from 256 kHz to 0.026 Hz can be selected. If other sample rates are required, the analyzer can be made to sample on an external TTL clock signal. Up to 40k samples of time data can be stored internally in buffer memory, with complete trigger control. Trigger on an analog level with positive or negative slope and variable level. In either mode you can specify pre- or post-trigger values from 40k samples pre-trigger to 1023k samples of post-trigger delay. Data collected in the time domain is easily analyzed in the frequency domain, making the HP 3561A extremely useful in analyzing transients and other non-steady-state signals.

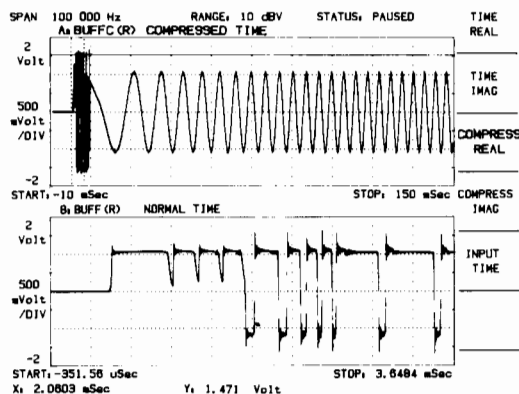

Figure 3: Up to 40,000 samples of a transient waveform can be captured, with analysis in either the time domain or the frequency domain.

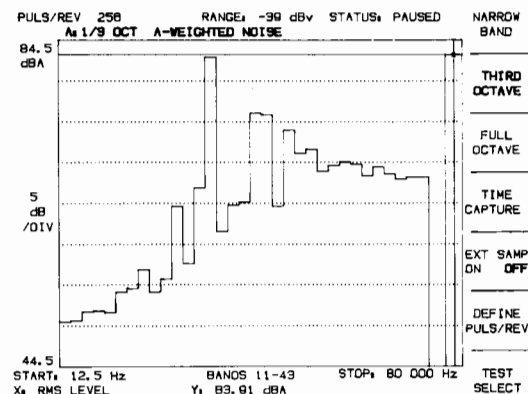

Figure 4: The combination of octave and narrowband analysis makes the HP 3561A a powerful instrument for noise and vibration analysis.

1/3 and 1/1 Octave Analysis

Octave analysis is often used in acoustic and vibration work for analyzing signals that are "proportional bandwidth". That is, they exhibit bandwidths that are proportional to their center frequencies. The HP 3561A digitally synthesizes a series of parallel bandpass filters, each with

bandwidth proportional to center frequency. The advantage of the digital technique is better stability and accuracy — there are no analog components to drift, age, or respond to temperature. A built-in hardware A-weight filter can be switched in for acoustic signals where the effects of the human ear must be taken into account.

Digital Averaging

Digital averaging is provided for improving a measurement in the presence of noise. RMS, RMS exponential, time and peak averaging are provided. Automatic overload signal rejection can be invoked to prevent an otherwise valid reading from being contaminated by one overloaded spectrum. A fast average display mode can be selected which speeds up the averaging process by turning off the display refresh during intermediate averages. This can result in a factor of 3 speed improvement over normal averaging mode. Coupled with its high real time rate, the HP 3561A can make averaged measurements in the same amount of time it formerly took to make an unaveraged measurement!

Flexible Display Formats and Complete Annotation

Display a single trace, two traces in upper/lower format, or two traces overlaid in front/back format. When several traces must be viewed at once, use the "spectral map" format which can display up to 60 separate traces stacked onto one display. Choose log or linear frequency spacing and log or linear amplitude units. Define your own units, give them a name, and the analyzer will read out in your units! Each trace is completely annotated and can be labelled with your own alphanumeric trace label. A view state display function is provided to quickly give you a summary of the analyzer's current setup state.

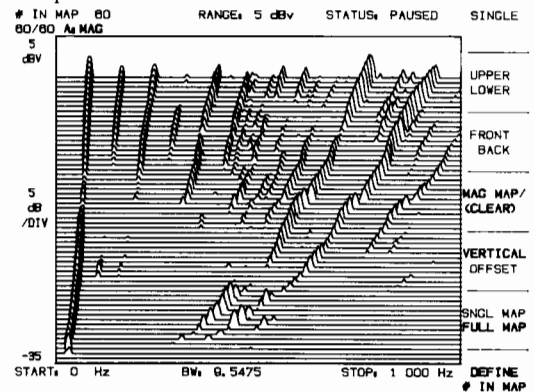

Figure 5: Spectral maps greatly reduce the time required to analyze changes in up to 60 successive measurements.

Internal Mass Storage

The standard HP 3561A contains 2 traces and 6 setup states of nonvolatile memory. When more storage is required, such as when you wish to store a 40,000-sample waveform captured in waveform recording mode, the "bubble memory" option can be installed. This non-volatile memory allows you to store any combination of 127 traces and states internally. Data stored in internal memory can be transferred via HP-IB to a computer for further analysis or archiving.

FILENAME	INDEX	TYPE	SIZE	DEFINE FILENAME
SWEET		BUFFERED	7	USE CAT FILENAME
AMP-ACC		SETUP	1	STORE BUFFER
SWEETTEST		SETUP	1	
TEST-01		SETUP	1	
XFER		SETUP	1	
J1L 0		TRACE	1	RECALL BUFFER
J1L 2		TRACE	1	
J1L 4		TRACE	1	
J1L 6		TRACE	1	DELETE
				ABORT

BUBBLE RECORDS AVAILABLE FOR NEW STORES: 112 CATALOG ON OFF

Figure 6: Traces and setups are stored in bubble memory by file name. The bubble memory catalog makes recall of stored files easy.

Annotated Hardcopy

You can obtain fast hardcopy of any display just by pressing the plot button. The HP 3561A controls HP-GL plotters and HP raster dump printers directly. A "marker plot" key allows you to annotate several locations on a plot with amplitude and frequency, or amplitude and time. Simply tune the cursor to the point of interest, press marker plot and the

analyzer annotates the location of interest. Do this as many times as you wish for complete, accurate documentation of measurements.

```

--DELAY 10 Sec      RANGE: 2 dBV      STATUS: PAUSED      SLOPE
                                POS NEG
NARROW BAND MODE      EXT SAMPLE OFF
FREQUENCY:
BASEBAND              CENTER: 250 Hz      DEFINE
                        SPAN: 500 Hz        % OF RNG
                        TIME: 800 nSec
TRIGGER:
INTERNAL              DELAY: 10 Sec      DELAY
AUTO ARM              ON OFF
AVERAGE:
OFF
WINDOW:
FLAT TOP              BW: 4.77375 Hz
SOURCE:
OFF
INPUT:
DC COUPLING          ICP CURRENT OFF      A WEIGHT FLTR OFF
UNITS:
X: Hz
Y: dBV
    
```

Figure 7: Plots of the view state display provide quick hard copy of instrument setup for complete measurement documentation.

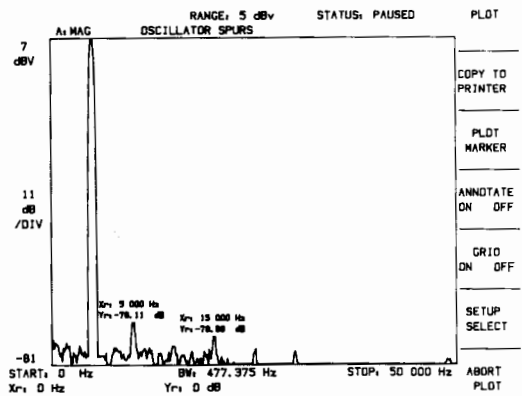

Figure 8: The marker plot function prints x and y marker values for any number of points on the plot.

Other Features

In most noise and vibration measurements, a transducer is used to convert the physical phenomena to voltage. These transducers generally require some type of signal conditioning. The HP 3561A contains an internal power supply for ICP type (integrated circuit piezoelectric) transducers. This eliminates an extra piece of equipment, which enhances portability and saves money. Trace math operations are provided that allow you to manipulate traces like numbers on a calculator. This is useful for converting units, compensating for systematic errors, and displaying spectra as a percentage of some reference value.

HP 3561A Specifications

Frequency

Range: 0.000125 Hz to 100 kHz
Spans: 0.01024 Hz to 100 kHz in a 1, 2, 2.5, 5, 10 sequence. Other spans are available but are too numerous to list here.
Accuracy: $\pm 0.003\%$ of display center frequency.
Resolution: 0.25% of frequency span.
Window: Flat Top, Hann, Uniform, and Exponential.
Bandwidth

	Flat Top	Hann	Uniform
3 dB Bandwidth (% of frequency span)	0.90%	0.36%	0.22%

Real Time Bandwidth: (Typical) Single display, 3.0 kHz. Fast average display, 7.5 kHz.

Amplitude

Measurement Range: +27 to -120 dBV noise floor (22.4 VRMS to 1 μ V noise floor.) Input range is selected in 1-dB steps from +27 to -51 dBV. Optimum range is determined automatically in the autorange mode.
Dynamic range: 80 dB

Accuracy at the Passband

Center: ± 0.15 dB +27 to -40 dBV input ranges
 ± 0.25 dB -41 to -51 dBV input ranges

Flat Top window: +0, -0.01 dB

Hann window: +0, -1.5 dB

Uniform window: +0, -4.0 dB

Note: Overall accuracy is the sum of the accuracy at the passband center plus the selected window accuracy.

Resolution

Log: 0.01 dB

Linear: 4 digits

Phase

Accuracy: ± 2 degrees, dc-10 kHz; ± 10 degrees, 10-100 kHz (signals no more than 40 dB below full range).

Resolution: 0.1 degree.

Input

Impedance: 1X10⁶ ohms $\pm 5\%$ shunted by 95 pF maximum.

Isolation: Input low may be connected to chassis ground or floated up to 30 volts RMS (42 volts peak) above ground.

Coupling: signal by be ac or dc coupled. Low frequency 3-dB point <1 Hz in ac mode.

A-weighting: Hardware A-weighting filter conforms to ANSI standard S1.4-1971 (R1976).

ICP current: Nominal 4 mA current source provided, compatible with integrated circuit piezoelectric accelerometers.

Output

Source: Band-limited, band-translated, pseudo-random, random, or impulse, or TTL "synch" signals are available on rear panel. Level is selectable between 0.7 and 0.007 volts RMS, nominal. Impedance 50 Ω $\pm 5\Omega$.

Print/Plot: Controls HP-GL plotters and HP raster dump printers directly.

Display

General: Magnitude, phase, time and math traces may be selected. Units available are; Horizontal: Hz, seconds, RPM, orders; linear or log spacing. Vertical: dBV, dBm (selectable Z), volts, volts squared, and user-defined units.

Scale: Linear or log magnitude scales may be selected. Full scale, dB/division, and degrees/division are user definable. Center scale user definable in phase or time traces.

Math: Arithmetic operations can be performed on new or recalled frequency spectra. Add, subtract, multiply, divide, integrate, differentiate and user-defined constants are provided. 1/BW is provided for Power Spectral Density (PSD) computations.

Internal Memory

	Non-volatile	Volatile
Standard:	2 traces, 6 states	40 time records
Optional:	Traces + states + (1 + 2* time capture records) = 127 40 time records	

Marker

Single, relative, harmonic, sideband, and power cursors are provided. THD can be calculated from up to 20 harmonics. Sideband power relative to specified carrier can be calculated from up to 10 sidebands. MKR to peak, MKR to center, MKR to full scale and marker peak track are provided.

General

Power: 100/120 Vac +5%, -10%, 48-440 Hz; 220/240 Vac +5%, -10%, 48-66 Hz.

Weight: 15 kg (33 lb) net, 21.6 kg (47.5 lb) shipping.

Dimensions: 335 mm W x 595 mm D x 197 mm H (13.2" x 23.4" x 7.8")

***HP -IB Interface Functions:** Implementation of IEEE Std. 488-1978 SH1, AH1, T5, TE0, L4, LE0, SR1, RLI, PP0, DC1, DT1, C0.

Ordering Information

	Price
HP 3561A Dynamic Signal Analyzer	\$ 10,500
Option 001 Extended Non-volatile Memory	add \$ 1,460

SIGNAL ANALYZERS

Dual-Channel, Dynamic Signal Analyzer 64 μ Hz to 100 kHz

Model 3562A

- Network analysis
- Spectrum analysis
- Transient analysis
- Waveform recording
- Frequency response analyzer
- Modulation analysis
- Direct control of disc drives
- Direct control of HP-GL plotters

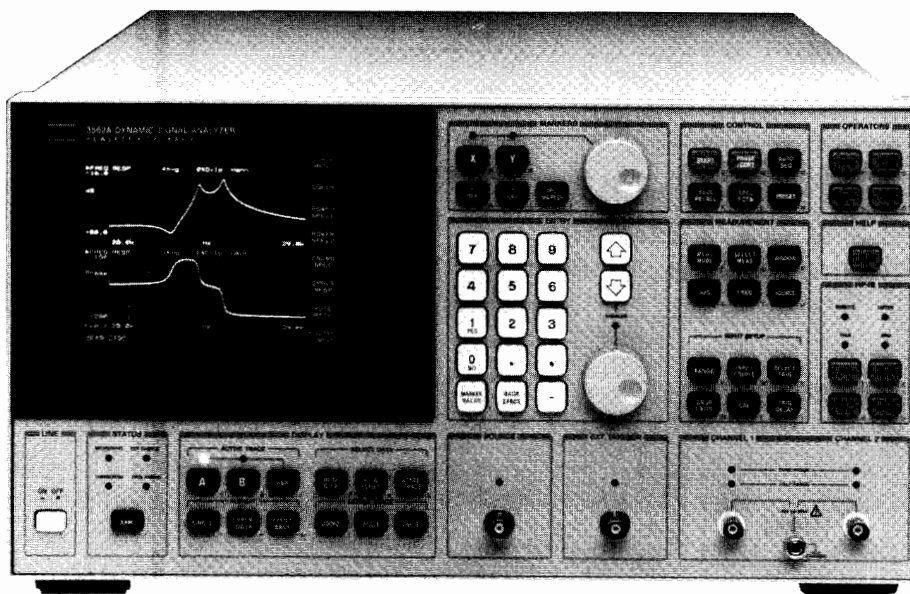

HP 3562A

The HP 3562A Dynamic Signal Analyzer is a dual-channel fast-Fourier transform-based network, spectrum and waveform analyzer which provides analysis capabilities in both the time and frequency domains. The dc-to-100 kHz frequency range, 150 dB measurement range and 80 dB dynamic range of the analyzer makes it a powerful solution for testing and analysis in electronics, mechanics and electro-mechanical control systems.

Two high performance input channels and a built-in signal source (noise and sine signals) address network analysis on the bench or in a test system. Zoom analysis with frequency resolution to 25.6 μ Hz plus a powerful AM, FM and PM demodulation function makes the HP 3562A a versatile spectrum analyzer. For transient or waveform analysis, signals can be sampled, digitized then stored in an internal memory, or directed via HP-IB to an external disc drive (without a computer). The stored waveforms can be recalled and analyzed in the time, frequency and amplitude domains (baseband and zoom analysis).

Additional features include a full range of data analysis capabilities such as vector averaging, block-operation Waveform Math, a 40-pole/40-zero Curve Fitter and Frequency Response Synthesis. Front panel operations can be automated without a computer with built-in Auto Sequence programming, or with computers through complete HP-IB programmability. For documentation of results with hardcopy or mass storage, the HP 3562A can control digital plotters and external disc drives directly via HP-IB.

Network Analysis

Accurate, high resolution frequency response measurements of electronic and mechanical systems can be performed with Linear Resolution FFT, Logarithmic Resolution and Swept Sine analysis. A built-in signal source provides a variety of random noise and sinewave signals to meet the requirements of the system under test.

Linear Resolution is the measurement technique common to all Dynamic Signal Analyzers. In the HP 3562A, 2048-point time

records are Fourier-transformed into 801-line frequency spectra. For network analysis, frequency response magnitude and phase, as well as input and output power spectra, can be measured with 801 lines of resolution. Accuracy for the frequency response magnitude and phase is ± 0.1 dB and $\pm 0.5^\circ$.

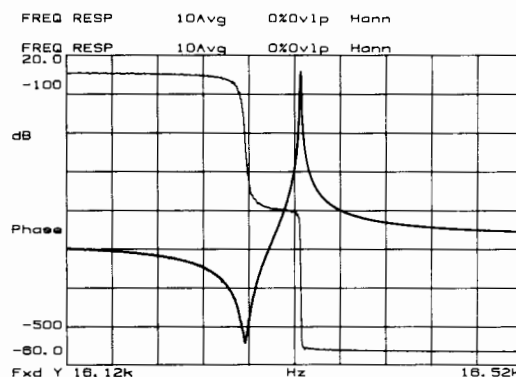

Logarithmic Resolution uses the speed of Linear Resolution FFT measurements to create frequency responses similar to a log-sweep swept sine test. Linear Resolution points are combined internally (rather than just reformatted), on the fly, to create 80-point-per-decade measurements over 1 to 5 decades. Start and stop frequencies can be selected in a 1-2-5 sequence from 0.1 Hz to 100 kHz (for a 0.1 Hz start frequency the maximum stop frequency is 10 kHz — 5 decades).

The Swept Sine mode reconfigures the HP 3562A as a powerful swept sine frequency response analyzer. The source can generate linear or logarithmic sweeps with increasing or decreasing frequency; user-selectable sweep rate and resolution are also standard source



functions. Input channel functions include user-selectable averaging and integration time; automatic input ranging can be activated to provide over 130 dB of dynamic range for measurements of high performance systems.

Spectrum Analysis

On-line analysis of distortion, drift, modulation and phase noise can benefit from the speed and accuracy of the HP 3562A. High resolution measurements are typically 100 times faster than tuned spectrum analyzers — and, since the HP 3562A is an FFT-based analyzer, you can see transient events that a tuned analyzer would probably miss.

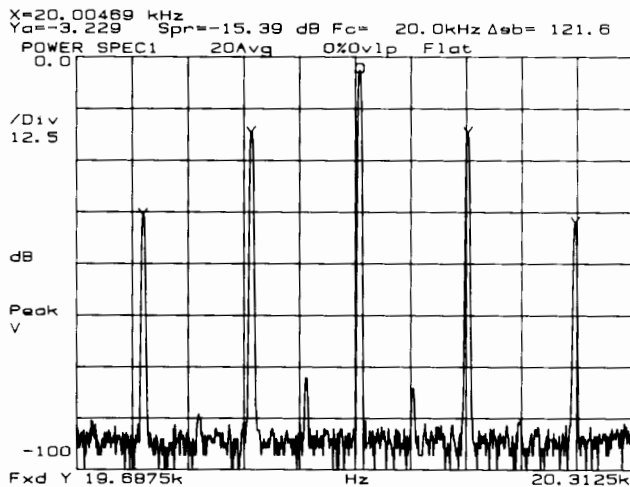

The HP 3562A is essentially a dual-channel spectrum analyzer which provides resolution to 25.6 μ Hz anywhere within the dc-to-100 kHz measurement range. Single channel accuracy is ± 0.15 dB with 80 dB of dynamic range. Modulation analysis can be performed on either or both channels with harmonic and sideband markers as well as with the built-in demodulation capability: zoom measurements can be AM, FM or PM demodulated with carrier frequencies up to 99.9 kHz.

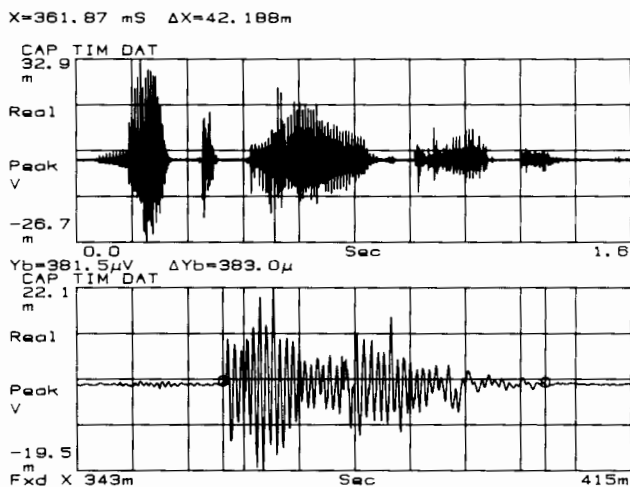

Waveform and Transient Analysis

Perform complete analysis of waveforms and transients in the time and frequency domains. Sampled and digitized waveforms can be

stored in internal memory (single-channel Time Capture) or on disc in an external disc drive (single- or dual-channel Time Throughput). Data can be recalled for time domain analysis as single time records or as a compressed display of up to 10 time records (Time Capture mode). Data can also be recalled for baseband and zoom analysis in the frequency domain, with vector averaging if needed.

A complete array of triggering capabilities are included to enhance both waveform recording modes. Pre- and post-trigger delays can be specified to capture the rising edge of a transient or to compensate for delays in the system under test.

Data Throughput to a Disc Drive

When access to prototypes is limited, make your test time more efficient with the Time Throughput capability: through direct control of external disc drives, the HP 3562A can store time data directly to disc without a computer. Set up a measurement and specify the quantity of single- or dual-channel data to be collected. Time data will be sampled, digitized and stored on disc for later analysis as individual time records or as baseband and zoom frequency spectra.

Hardcopy and Mass Storage with Plotters and Disc Drives

To speed and simplify documentation of results, direct control of plotters and disc drives via HP-IB is a standard feature in the HP 3562A. Literally anything displayed on the analyzer screen can be plotted or saved on disc: measurement results, setup state tables, synthesis tables, curve fit tables and Auto Sequence or Auto Math program listings. Plotting is enhanced with user-selectable line types, pens and paging controls. For mass storage operations, files can be given 8-letter user-defined names; and disc catalog can be recalled and displayed to show file name, type (data, setup, etc.) and date and time of storage.

Automation for Improved Productivity

Versatile automation capabilities and a wide range of response-only or stimulus/response measurement functions in the HP 3562A help you create productive solutions for your automated testing needs. As a standalone solution, the analyzer can "learn" a series of keystrokes and then perform them on command (Auto Sequence programming). Up to five Auto Sequence programs can be stored internally, with additional programs stored in an external disc drive.

For networked HP-IB systems, the HP 3562A provides complete HP-IB programmability. Custom display graphics and messages can be created through direct programming of the high resolution vector display — user-defined softkey menus can also be created to simplify interactive testing. Rear-panel outputs for large screen displays are also standard.

HP 3562A Specifications

Frequency

Measurement Range: 64 μ Hz to 100 kHz, both channels, single- or dual-channel operation

Accuracy: $\pm 0.004\%$ of frequency reading

Resolution: Span/800, both channels, single- or dual-channel operation

Spans:

Number of spans

Min span

Max span

Time record (seconds)

Window Functions: Hann, Flat Top, Uniform, Force, Exponential, and User Defined

Window Parameters:

3 dB BW (% of span)

Typical Real Time Bandwidth: 10 kHz single-channel, 5 kHz dual-channel, with fast averaging on.

Baseband

66

10.24 mHz

100 kHz

800/span

Zoom

64

20.48 mHz

100 kHz

800/span

Flat Top

0.45%

Hann

0.18%

Uniform

0.11%



SIGNAL ANALYZERS

Dual-Channel, Dynamic Signal Analyzer 64 μ Hz to 100 kHz

Model 3562A (cont.)

Amplitude

Accuracy (Linear Resolution)

Defined as Full Scale Accuracy at any of the 800 calculated frequency points. Overall accuracy is the sum of absolute accuracy, window flatness and noise level.

Absolute Accuracy

Single Channel (Channel 1 or Channel 2) ± 0.15 dB $\pm 0.015\%$ of input range (+27 dBV to -40 dBV)

± 0.25 dB $\pm 0.025\%$ of input range (-41 dBV to -51 dBV)

Frequency Response Channel Match:

± 0.1 dB, ± 0.5 degree

Window Flatness

Flat Top: +0, -0.01 dB

Hann: +0, -1.5 dB

Uniform: +0, -4.0

Noise Floor: (Flat top window, 50 Ω source, 50 Ω input termination)

20 Hz to 1 kHz (1 kHz span) < -126 dBV (-134 dBV/ $\sqrt{\text{Hz}}$)

1 kHz to 100 kHz (100 kHz span) < -116 dBV (-144 dBV/ $\sqrt{\text{Hz}}$)

Dynamic Range: All distortion (intermodulation and harmonic), spurious and alias products ≥ 80 dB below full scale input range

Phase

Accuracy: Single channel, referenced to the trigger point.

< 10 kHz $\pm 2.5^\circ$

10 kHz to 100 kHz $\pm 12.0^\circ$

Inputs

Input Impedance: 1 M $\Omega \pm 5\%$ shunted by 100 pF maximum

Input Coupling: The inputs may be ac or dc coupled; ac rolloff is < 3 dB at 1 Hz

Crosstalk: -140 dB (50 Ω source, 50 Ω input termination, input connectors shielded)

Common Mode Rejection:

0 Hz to 66 Hz 80 dB

66 Hz to 500 Hz 65 dB

Common Mode Voltage:

 dc to 500 Hz

Input Range (dBV rms) Maximum (ac + dc)

+27 to -12 ± 42.0 Vpeak

-13 to -51 ± 18.0 Vpeak*

*For the -43 to -51 dBV input ranges, common mode signal levels cannot exceed ± 18 Vpeak or (Input Range) + (Common Mode Rejection), whichever is the lesser level.

Common Mode Voltage: 500 Hz to 100kHz. The ac part of the signal is limited to 42 Vpeak or (Input Range) + (10dB), whichever is the lesser level.

Common Mode Distortion: For the levels specified, distortion of common mode signals will be less than the level of the rejected common mode signal.

External Trigger Input Impedance: Typically 50 k $\Omega \pm 5\%$

External Sampling Input: TTL compatible input for signals ≤ 256 kHz (nominal maximum sample rate).

External Reference Input

Input Frequencies: 1, 2, 5 or 10 MHz $\pm 0.01\%$

Amplitude Range: 0 dBm to +20 dBm (50 Ω)

Trigger

Trigger Modes: Free Run, Input Channel 1, Input Channel 2, Source and External Trigger. Free Run applies to all Measurement Modes; Input Channel 1, Input Channel 2, Source and External Trigger apply to the Linear Resolution, Time Capture and Time Throughput measurement modes.

Trigger Conditions

Free Run: A new measurement is initiated by the completion of the previous measurement.

Input: A new measurement is initiated when the input signal to either Channel 1 or Channel 2 meets the specified trigger conditions. Trigger Level range is $\pm 110\%$ of Full Scale Input Range; Trigger Level is user-selected in steps proportional to the input range.

Source: Measurements are synchronized with the periodic signal types (burst random, sine chirp and burst chirp).

External: A new measurement is initiated by a signal applied to the front panel External Trigger input. Trigger Level range is ± 10 V peak; Trigger Level is user selected in 80 mV steps.

Trigger Delay

Pre-Trigger: The measurement can be based on data from 1 to 4096 samples (1/2048 to 2 time records) prior to trigger conditions being met. Resolution is 1 sample (1/2048 of a time record).

Post-Trigger: The measurement is initiated from 1 to 65 536 samples (1/2048 to 32 time records) after the trigger conditions are met. Resolution is 1 sample (1/2048 of a time record).

Source

Source Types: Band limited, band translated random noise, burst random, sine chirp, and burst chirp, as well as fixed sine and swept sine signals are available from the front panel Source output. DC Offset is also user-selectable.

Output Impedance: 50 $\Omega \pm 5\Omega$

Output Level: between -10 and +10 V peak (ac + dc) into a ≥ 10 k Ω , < 1000 pF load. Maximum current = 20 mA.

AC Level: ± 5 V peak (≥ 10 k Ω , < 1000 pF load)

DC Offset: ± 10 V peak in 100 mV steps. Residual offset at 0 V offset ≤ 10 mV.

% In-Band Energy (1 kHz span, 5 kHz center frequency)

Random Noise: 70%

Sine Chirp: 85%

Accuracy and Purity: Fixed or Swept Sine

Flatness: ± 1 dB

Distortion (including subharmonics):

dc to 10 kHz -60 dB

10 kHz to 100 kHz -40 dB

General

Specifications apply within 5°C and 2 hrs of last internal calibration.

Ambient temperature: 0° to 55° C.

Relative Humidity: $\leq 95\%$ at 40° C.

Altitude: $\leq 4,572$ m (15,000 ft.)

Storage

Temperature: -40° to +75° C.

Altitude: $\leq 15,240$ m (50,000 ft)

Power:

115 VAC +10%, -25%, 48 to 440 Hz

230 VAC +10%, -15%, 48 to 66 Hz

450 VA maximum

Weight:

26 kg (56 lb) net

35 kg (77 lb) shipping

Dimensions:

222 mm (8.75 in) high

426 mm (16.75 in) wide

578 mm (22.75 in) deep

HP-IB

Implementation of IEEE Std 488-1978

HP-IB Interface Functions¹: SH1 AH1 T5 TE0 L4 LE0 SR1 RL1 PP0 DC1 DT1 C0. Supports the 91XX and 794X families of HP disc drives, as well as Hewlett-Packard Graphic Language (HP-GL) digital plotters.

Accessories Supplied

Operating, Programming and Service Manuals

Accessories Available

Transit Case for one HP 3562A: HP P/N 9211-2663

Ordering Information

HP 3562A Dynamic Signal Analyzer \$24,400

Option 907 Front Handle Kit \$ 75

Option 908 Rack Mount Kit \$ 40

Option 909 Rack Mount and Front Handle Kit \$ 100

Option 910 Extra Operating Manuals \$ 175

Option 914 Delete Service Manuals less \$ 100

¹For more on these codes refer to the HP-IB section of this catalog.



HP 3565S Signal Processing System

The HP 3565S is an expandable, off-the-shelf multi-channel signal processing system with applications in low frequency electronics, vibration analysis, control system testing and general signal analysis from 61 uHz to 51.2 kHz.

The system is based on the HP 9000 Series 300 technical computer, HP 35650A Series measurement hardware and HP VISTA Signal Processing Software. The system can be configured initially with as few as one input and one source module and expanded to a maximum of 62 modules, in any combination of inputs and sources. High channel-count systems required for large tests can be partitioned into a number of smaller ones by simply adding additional computers, software packages and interface modules.



Applications

The HP 3565S addresses a diversity of applications requiring low frequency spectrum analysis or stimulus/response testing. The development and testing of feedback control systems is enhanced by using multi-point frequency response measurements to completely characterize system behavior.

Monitoring the vibration levels of operating machinery yields useful, important information that can be used to predict failures before they occur. Maintenance can be planned and scheduled and downtime minimized. Multi-channel analysis allows continuous monitoring of large, complex installations.

Environmental vibration testing yields information critical in the design of components that will be exposed to high levels of shock and vibration. Acoustic testing is important in designing quieter products and pinpointing the sources of noise in systems.

The HP 3565S's simultaneous data collection from/up to 62 input channels is well suited to such applications as surveillance, production testing and signature analysis.

For users with needs in structural testing, the HP META family of software packages links to HP VISTA provides modal analysis, structural modifications simulation, and forced response simulation. (See page 161.)

System Computer

An HP 9000 Series 300 workstation is the system host for the HP 3565S, running application software under the HP-UX operating system. The measurement hardware can also be programmed standalone with HP-IB programming from a number of HP computers, including the Series 200/300 and members of the 9000 and 1000 families of computers.

Measurement Hardware

The 35650A Series measurement hardware consists of the HP 35650A Mainframe, HP 35651A HP-IB/Signal Processing Module, HP 35652A Input Module and the HP 35653A Source Module.

The HP 35650A Mainframe houses the modules and provides power and cooling in addition to triggering and sampling synchronization. A mainframe that holds up to eight modules and up to eight mainframes can be connected together.

The HP 35651A HP-IB/Signal Processor Module controls and manages the other modules and is the link to the host computer. The HP 35651A has dedicated processors to perform signal processing functions such as fast Fourier transforms and windowing operations. It can control disc drives directly, allowing ADC throughput of samples data at rates in excess of 500K Bytes per second. All of this adds up to high speed processing and reduction of the computational burden on the host computer.

The HP 35652A Input module digitizes signals at a 262 kHz sample rate and has the necessary hardware to provide very accurate frequency domain analysis up to 51.2 kHz. It has fully functional signal conditioning built in that provides complete compatibility with voltage, charge and ICP-type signal transducers. The module supports features such as auto-ranging, overload counting and DC offset subtraction to ensure high quality results.

The HP 35653A Source module provides the excitation signals necessary to stimulate devices under test. Random noise and fixed sine wave signals are available in both continuous and gated formats. Multiple uncorrelated noise sources, along with the analysis capability of the HP VISTA Signal Processing Software, provide multiple input, multiple output system testing.

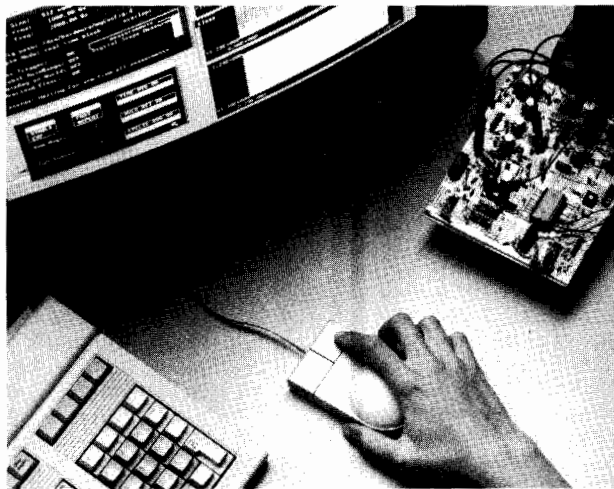

HP VISTA Signal Processing Software

The HP VISTA Signal Processing Software provides the capability to produce all the time, frequency and amplitude domain results used in the analysis of dynamic signals. Data can be analyzed on-line or from time domain data stored on a disc. The software is designed to work with the measurement hardware to produce accurate, calibrated results.

HP VISTA has an easy-to-understand user interface based on windows, pop-up memos and a mouse. It is as direct as a benchtop instrument and as friendly as a personal computer. A complete help feature provides operating information for both beginner and expert users.

Features of the software provide for powerful data analysis functions. The display can be formatted to provide optimum analysis of specific data, including user-defined two dimensional views and spectral maps. Post-processing functions include data editing and block math operations. The system can be customized with the user programming capability.

Brief Technical Specifications

35650 Measurement Hardware

35651A HP-IB/Signal Processing Module

FFT Computation Time: 1024-point complex transform in approximately 67 ms

Maximum throughput rate to disc: > 500 K bytes/second

35652A Input Module

Frequency Range: 61 μ Hz to 51.2 kHz

Time Record Block Sizes: 64 to 8192 in powers of two

Frequency Lines of Resolution: 39% of Time Record Block Size (nominal)

Full Scale Voltage Range: 1.26 mVp (-58 dBVp) to 39.8 Vp ($+32$ dBVp) in increasing steps of 25% (2 dB)

Full Scale Charge Range: -18 dBpCp to $+72$ dBpCp in 2 dB steps

Dynamic Range: <-80 dB relative to full scale ($R_s = 50$ ohms, $C_s = 1000$ pG, 16 averages, internal sampling)

35653A Source Module

Signal Types: Random, Sine, Burst Random, Fixed Sine, Variable Pulse

AC Output Level: 1.26 mVp (-58 dBVp) to 10.00 Vp ($+20$ dBVp) in 0.375 dB steps

HP VISTA Signal Processing Software

Time Domain Measurements: Time record, averaged time record, auto and cross correlation, impulse response and convolution

Frequency Domain Measurements: Frequency response function (multiple input, multiple output), auto and cross power spectrum, power and energy spectral density, linear spectrum, coherence (ordinary, multiple and partial) and convolution

Amplitude Domain Measurements: histogram, probability density function, joint probability density function, cumulative density function

Number of Frequency Spans: 19 baseband and 17 zoom

Windows: Hann, flat top, force and response, exponential, P301, P310, user-specified and smoothing

Ordering/Configuration Information

Price

Measurement Hardware

HP 35650A Mainframe	\$2,950
HP 35651A HP-IB/Signal Processing Module	\$3,250
HP 35652A Input Module	\$3,150
HP 35653A Source Module	\$1,750
HP 35605A 720 mm Rack	\$1,500
HP 35606A 1500 mm Rack	\$2,000

Software

HP 35630A VISTA	\$7,000
HP 74796D META-MODAL	\$10,000
HP 74796E META-MODS	\$10,000
HP 74796F META-FORCE	\$3,000
HP 74796G Bundled META	\$18,500

SIGNAL ANALYZERS

Automated Spectrum Analysis

Model 3048A Phase Noise Measurement System

707



Calibrated, Automated Phase Noise Measurements with

- Specified amplitude accuracy of ± 2 dB
- Offset frequency range of 0.01 Hz to 40 MHz
- Carrier frequency range from 5 MHz to beyond 18 GHz
- Spurs separated from noise spectra
- Optimization for several measurement techniques

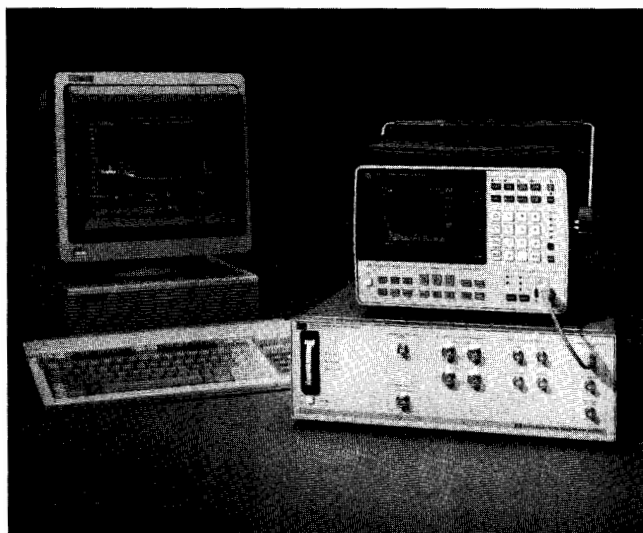

HP 3048A Phase Noise Measurement System controlled by an HP 98580A Desktop Computer.

The HP 3048A Phase Noise Measurement System uses the power of a flexible software program to automate the measurement of the phase noise of a carrier signal. The basic HP 3048A system includes the HP 11848A Phase Noise Interface containing the phase detectors and phase lock loop circuitry, the HP 3561A Dynamic Signal Analyzer, measurement software, and a comprehensive operator training course that teaches measurement procedures. Using an HP 98580A Desktop Computer, this basic system will accept the input of two sources at the same frequency in the range of 5 MHz to 18 GHz and characterize the demodulated phase noise over an offset range of 0.01 Hz to 100 kHz. Adding other HP spectrum analyzers such as the HP 8566B, 8567A, 8568B, or 3585A provides automated measurements to offsets of 40 MHz. A variety of signal generators such as the HP 8662A, 8663A, 8642A or 8642B can also be added to the system to provide a low-noise reference signal up to a frequency of 2.56 GHz. Adding an HP 11729C Carrier Noise Test Set in combination with an HP 8662A or HP 8663A provides a low-noise reference signal for measuring carrier signals up to 18 GHz.

The HP 3048A system software uses the HP 11848A interface to demodulate the phase noise of a carrier in the frequency range of 5 MHz to 18 GHz (and beyond with external, user-supplied mixers) and measures the resulting baseband signal with the spectrum analyzers. Measurement menus allow the operator to specify the measurement to be made and the system software controls the measurement process, including the calibration of the system. Several output formats are available to the user, including plots of the single sideband phase noise power of a signal, integrated noise power, or the calculated Allen variance. A real-time measurement mode is available to monitor the level of phase noise and discrete spurs as changes are made to the device under test.

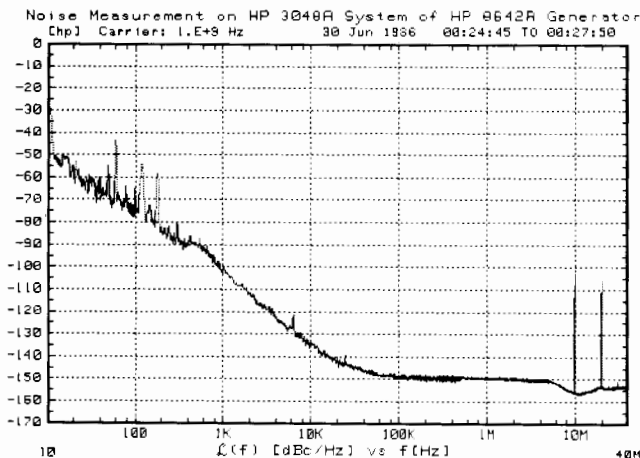

Typical single sideband phase noise measurement by the HP 3048A Phase Noise Measurement System.

As measured by the HP 3048A, the term "phase noise" includes all forms of a signal's frequency and phase instabilities. Randomly occurring frequency and phase noise modulation, as well as discrete sidebands resulting from power-line phase modulation and phase jitter, are detected and accurately measured. Coherent signals are displayed at the power level that was detected while random phase signals are normalized for a 1 Hz bandwidth. The HP 3048A system is optimized for several measurement techniques that are chosen based on the stability and tuning capability of the signal to be measured and the availability of comparable reference oscillators. The two primary techniques for demodulating the phase noise of a signal use either a phase detector or a frequency discriminator as the following diagrams illustrate.

Operation with a Phase Detector

This measurement technique uses a double-balanced mixer included in the HP 11848A interface as a phase detector and a separate reference oscillator to demodulate the phase noise from the carrier being tested. With the two signals in quadrature, the phase detector offers excellent sensitivity to reveal very low level phase noise sidebands of the carrier. Based on the tuning range of the source under control, the system automatically sets up a phase lock loop to hold the two signals in quadrature. An offset range of 0.01 Hz to 40 MHz can be measured regardless of the bandwidth of the phase lock loop as the software measures the loop's bandwidth and removes its effects from the measured phase noise. Due to this combination of excellent sensitivity and broadband operation, the HP 3048A system can provide calibrated (± 2 dB) phase noise plots of almost any type of source ranging from frequency standards to free-running VCOs.

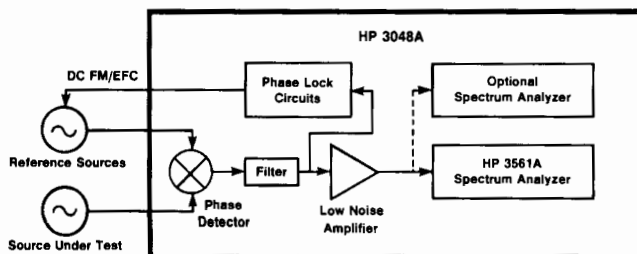

Typical test set-up for measuring the phase noise of relatively stable oscillators.



Operation with a Frequency Discriminator

With the HP 3048A, fully calibrated phase noise measurements of drifting or less stable signals are possible with user-supplied frequency discriminators. The HP 3048A software calibrates the system for the discriminator that is used to maintain the ± 2 dB amplitude accuracy of the measurement. Although the frequency discriminator limits the system's sensitivity close-in to the carrier, it does allow measurement of noisy or drifting sources that cannot be phase locked to a reference oscillator. It is also a very simple technique to implement.

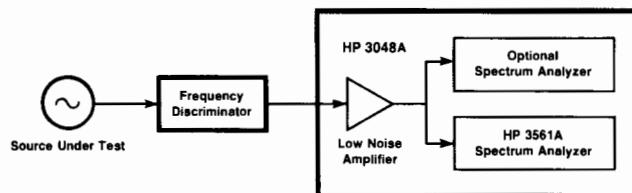

Typical test set-up for measuring the phase noise of drifting and less stable sources.

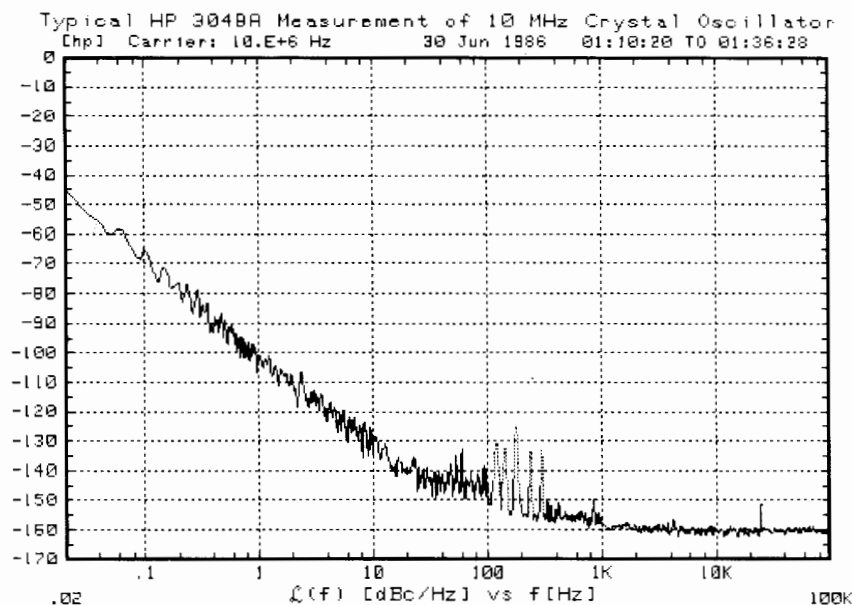

Typical HP 3048A system measurement results for a 10 MHz crystal oscillator.

Specifications Summary

Sensitivity:

The system's sensitivity is a function of the measurement technique that is used. The following graph indicates the sensitivity of the system as limited by its own internally-generated noise for a signal under test of +15 dBm. Also plotted is the specified phase noise that would limit the measurement sensitivity for a 1 GHz signal using several HP signal generators as reference sources.

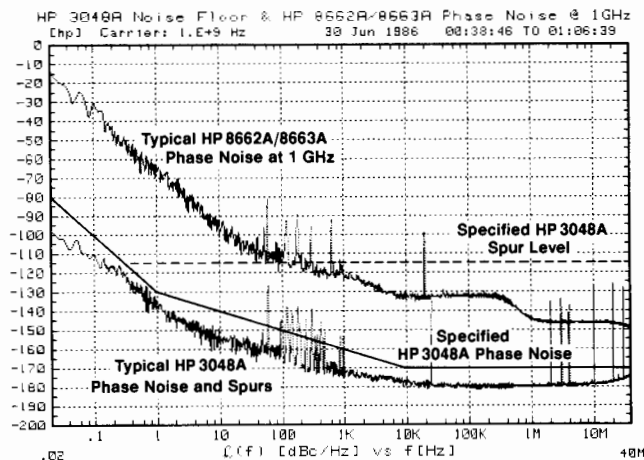

Carrier Frequency Range

Internal Mixer: 5 MHz to 1.6 GHz, optional to 18 GHz.

External (user-supplied) Mixer: The frequency range of the carrier is limited only by the frequency range of the external mixer or the frequency discriminator that is used.

Offset Frequency Range: 0.01 Hz to 100 kHz, extended to 40 MHz with an optional spectrum analyzer such as the HP 3585A.

Amplitude Accuracy: ± 2 dB to 1 MHz offset; ± 4 dB for offsets greater than 1 MHz. This accuracy is verified by the system at the time of the measurement. The system advises the user of any potential accuracy degradations detected during measurement set-up.

Ordering Information

HP 3048A Phase Noise Measurement System

Includes the **HP 11848A Phase Noise Interface**,
HP 3561A Dynamic Signal Analyzer, measurement software and operator training

Reference oscillator options:

Option	Description	Price
Option 001	Adds HP 8662A Opt. 003 Synthesized Signal Generator (0.01 to 1280 MHz)	\$33,000
Option 002	Adds HP 8663A Opt. 003 Synthesized Signal Generator (0.01 to 2560 MHz)	\$46,250
Option 003	Adds HP 11729C Carrier Noise Test Set (5 MHz to 18 GHz)	\$21,500
Option 005	Adds HP 8642A Opt. 001 Synthesized Signal Generator (0.1 to 1057 MHz)	\$24,500
Option 006	Adds HP 8642B Opt. 001 Synthesized Signal Generator (0.1 to 2114 MHz)	\$31,500

System Computer: HP 98580A Opt. 008 Desktop Computer with 2 megabytes of memory and HP-HIL knob.

For full details on available system options and ordering information, see the HP 3048A Phase Noise Measurement System Ordering Information Guide.

- 10 MHz to 18 GHz
- Phase noise and AM noise measurements
- Low system noise floor

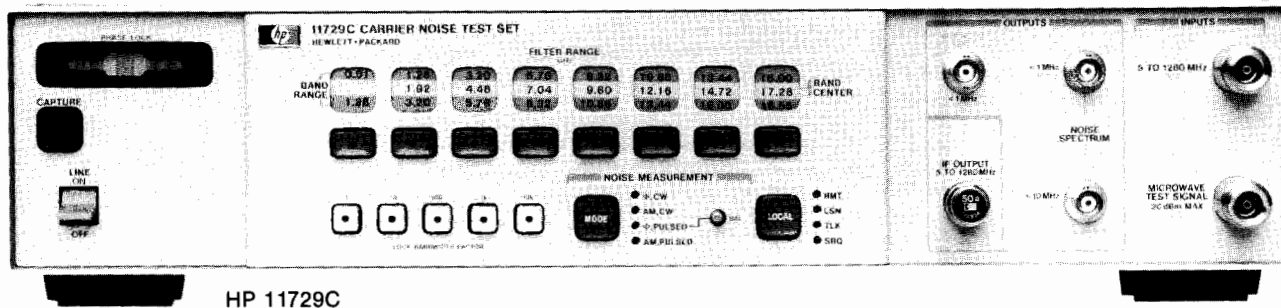

HP 11729C Carrier Noise Test Set Versatile Noise Measurements

The HP 11729C, combined with an HP 8662A synthesized signal generator and a baseband spectrum analyzer, form a complete broadband measurement system for phase noise and AM noise testing of microwave oscillators, 10 MHz to 18 GHz. With one versatile measurement system, direct AM noise measurements and two methods of phase noise measurements can be made, at offsets from the carrier of <1 Hz to 10 MHz. These three operating modes allow a wide variety of sources, from low noise stabilized sources to free-running sources with high drift to be measured. The HP 11729C may be ordered with either full frequency coverage, or in a number of band configurations to better match the application.

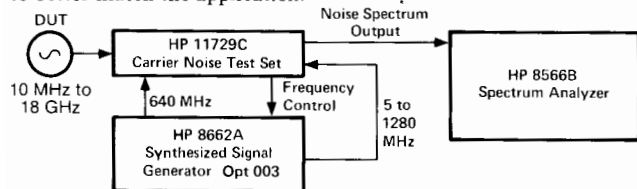

Complete carrier noise characterization system can be assembled from standard instruments.

Built-in Low Noise Reference

The HP 11729C/8662A combination includes the critical low noise microwave reference signal (which determines the system noise floor). The wide frequency range and low system noise floor of the HP 11729C/8662A enable a single system to be used on a broad range of sources. Typical system noise for a 10 GHz source is less than -123 dBc/Hz at a 10 kHz offset, allowing characterization of most high-performance sources.

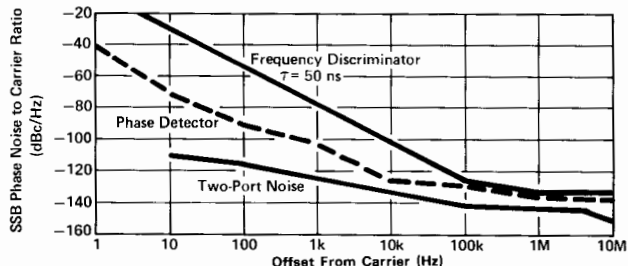

Figure 1. Typical HP 11729C/8662A system sensitivity using the phase detector and frequency discriminator methods at X-Band. Typical HP 11729C two-port noise.

Self-oscillator Mode

The HP 11729C features a new Surface-Acoustic-Wave (SAW) filter, which can be configured into an internal SAW oscillator. This built-in oscillator allows the HP 11729C to be used as a low-cost frequency discriminator system for measurements on free-running oscillators. This discriminator mode uses the HP 11729C in a "stand-alone" configuration, combined with a simple length of external delay line (such as RG 223 cable) and an available baseband analyzer (such as the HP 8566A/B or HP 3561A), as shown in Figure 2. For the

lowest cost solution for band-oriented applications, the HP 11729C can be ordered with a choice of several 2.56 GHz wide bands (see HP 11729B Ordering Information in the Technical Data Sheet).

The maximum sensitivity of the HP 11729C in the frequency discriminator mode is determined by the noise floor of the SAW oscillator; actual operating sensitivity is dependent on the delay time and attenuation of the delay line used. Figure 3 shows the typical absolute phase noise of the SAW oscillator translated to 10 GHz. Actual measurement sensitivity using a 100 ns delay line (with attenuation less than 12 dB at 1200 MHz) is also shown. At some IF frequencies and with low loss cable, longer delays can improve the close-in sensitivity closer to the noise floor limit set by the SAW oscillator.

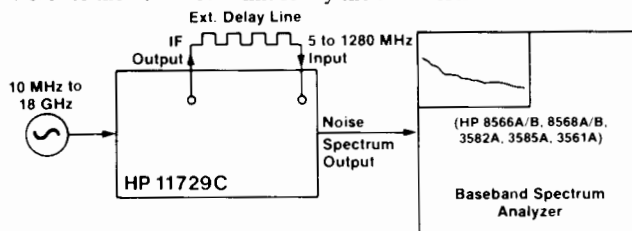

Figure 2. An HP 11729C, configured with an external delay line and a baseband spectrum analyzer, is a cost-effective solution for phase noise measurement on free-running sources.

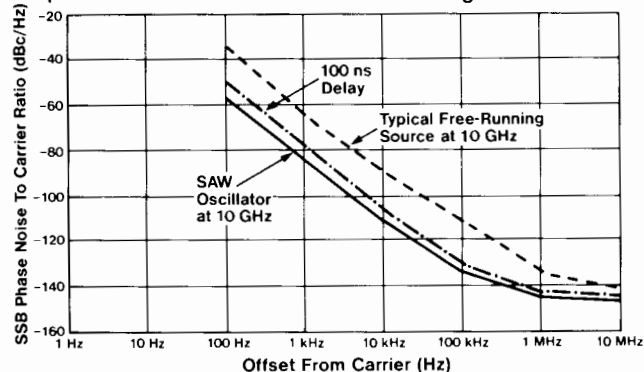

Figure 3. The HP 11729C in the stand-alone discriminator mode has the needed sensitivity for phase noise measurements on free-running sources.

Pulsed AM and Phase Noise Measurement Capability

The HP 11729C also features new circuitry to aid in making phase noise measurements on pulsed sources using the phase detector method. Selecting pulse mode switches in a user-supplied external low pass filter (LPF) used to remove the pulse repetition frequency (PRF) feedthrough. The LPF is necessary to prevent overloading of the low noise amplifier or phase-lock-loop. This same switching occurs when pulsed AM is selected, placing an external LPF following the AM detector for PRF rejection.



SIGNAL ANALYZERS

Carrier Noise Test Set (cont.)

Model 11729C

Two Phase Noise Measurement Modes

A choice of two phase noise measurement methods optimizes the measurement to the type of oscillator being measured. The phase detector method is ideal for synthesizers or stable free-running sources. The HP 11729C/8662A simplifies the phase detector method by providing all the necessary circuitry, including the low noise microwave reference source, the loop VCO, and a variable bandwidth phase-lock-loop.

The frequency discriminator method is best suited for sources with high level, low-rate phase noise such as free-running sources. The HP 11729C/8662A implements a convenient frequency discriminator (delay line/mixer technique), allowing sources to 18 GHz to be tested with a discriminator operating at an IF frequency less than 1.3 GHz. The HP 11729C/8662A contain all necessary hardware to implement the frequency discriminator method, except a simple user-supplied delay element that can be as simple as a length of inexpensive 50-ohm coaxial cable.

Direct AM Noise Measurements

The HP 11729C Option 130 offers convenient, direct AM noise measurements with typical sensitivity of less than -165 dBc/Hz. The HP 8662A provides a convenient calibration signal, and the same baseband analyzer used for phase noise measurements can be used for AM noise measurements.

Full Programmability for Easy System Configuration

The HP 11729C Carrier Noise Test Set is a fully programmable instrument all of whose functions can be automatically controlled via HP-Interface Bus. The HP 11729C/8662A/63A with an appropriate programmable baseband spectrum analyzer can be easily integrated into an automatic system using a software package called EASY_L. EASY_L is a modular, user-friendly program that allows automatic operation of the HP 11729C, along with the necessary spectrum analyzers (HP 8566/68 A/B) and local oscillator (HP 8662A/63A).

EASY_L implements both the Phase Detector and the Frequency Discriminator Method, and provides a plot of the phase noise data in units of script L(f). The software coordinates the instruments during the measurement and makes the necessary calibrations to improve the accuracy of the results. For more information on this software package refer to HP Product Note 11729C-3 "A User's Guide for Automatic Phase Noise Measurements".

Abbreviated HP 11729C/8662A Specifications

Frequency Range: 10 MHz to 18 GHz in 8 bands.

Absolute System Noise Floor, Phase Detector Method

System noise is specified only when the HP 11729C is used with an HP 8662A Option 003. (The HP 8663A Option 003, operated below 1280 MHz, may be used in place of the HP 8662A with no change in system performance.) These system noise specifications apply for the phase detector method, locking via the EFC of the HP 8662A crystal oscillator. Locking via the HP 8662A dc FM changes the noise on the tunable HP 8662A signal, and therefore total system noise. See the HP 11729C data sheet for more information.

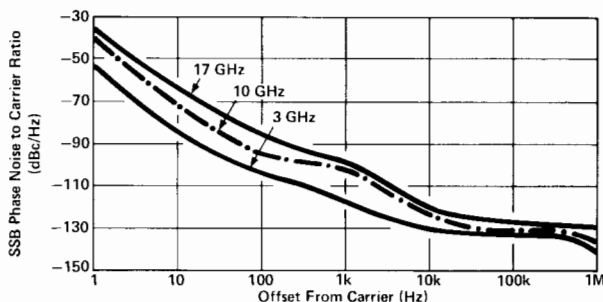

Typical HP 11729C/8662A System Noise (phase detector method, locking via EFC).

Test Signal Requirements

Amplitude: +7 dBm minimum to +18 dBm maximum (typically useable to -15 dBm with noise floor degradation).

RF Source Requirements

HP 8662A or 8663A Option 003.

HP 11729C Outputs

IF Output

Bandwidth: 5 to 1280 MHz.

Level: +7 dBm minimum.

Noise Spectrum Outputs

- 1) Noise Spectrum Output <1 MHz: dc coupled, 600 Ω nominal.
- 2) Noise Spectrum Output <10 MHz: 10 Hz to 10 MHz, 50 Ω nominal, nominal 40 dB of gain over <1 MHz output.
- 3) Auxiliary Noise Spectrum Output: dc coupled, 600 Ω nominal.

Phase Lock Loop Function

Frequency Control Outputs

To crystal oscillator: ± 10 V.

To dc FM: ± 1 V.

Lock bandwidth factor: nominal 1, 10, 100, 1k, 10k selectable.

Loop characteristics: dependent on method of phase lock chosen; typical loop bandwidths can range from 0.5 Hz to 100 kHz.

Remote Programming

All front panel functions are HP-IB programmable. In addition, the HP 11729C can output current settings and out-of-lock indication.

Interface functions: AH1, SH1, T5, L3, TE0, LE0, SR1, RL1, PP1, DC1, DT0, C0.

AM Noise Detection (Option 130)

Frequency: 10 MHz to 18 GHz.

Input level: 0 dBm minimum to +18 dBm maximum.

AM noise floor (at +10 dBm input level, dBc/Hz):

Offset from Carrier (Hz)	Typical	Specified
1k	-147	-138
10k	-152	-145
100k	-161	-155
1M	-165	-160

General

Operating temperature range: 0° to +55°C.

Power: 100, 120, 220, 240 V, +5%, -10%; 48 to 66 Hz; <75 VA max.

Weight: net, 10.4 kg (23 lb); shipping, 13.2 kg (29 lb).

Size: 425 W x 99 H x 551 mm D (21.7 x 16.8 x 3.9 in.). 1 MW x 3 1/2 H x 20 D System II module.

Ordering Information

HP 11729C Carrier Noise Test Set (10 MHz to 18 GHz) \$21,500

Note: Each of options 003 to 027 (only one may be ordered) also includes 0.005 to 1.28 GHz coverage

Option 003 (1.28 to 3.2 GHz) less \$8500

Option 007 (3.2 to 5.76 GHz) less \$8500

Option 011 (5.76 to 8.32 GHz) less \$8500

Option 015 (8.32 to 10.88 GHz) less \$8500

Option 019 (10.88 to 13.44 GHz) less \$8500

Option 023 (13.44 to 16.0 GHz) less \$8500

Option 027 (16.0 to 18.0 GHz) less \$8500

Option 130: AM noise detection \$1100

Option 140: Rear panel connectors \$500

Option 907: Front panel handle kit \$43

Option 908: Rack mounting flange kit \$25

Option 909: Front panel handle plus rack mounting flange kit \$65

Option 910: Extra operating and service manual \$35

SIGNAL ANALYZERS

Automated Phase Noise Analysis

Model 11740A/S

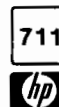

- Fully automated
- Built-in low noise reference
- High accuracy

- Powerful measurement software
- Absolute and two-port phase noise measurements

DESIGNED FOR
HP-IB
SYSTEMS

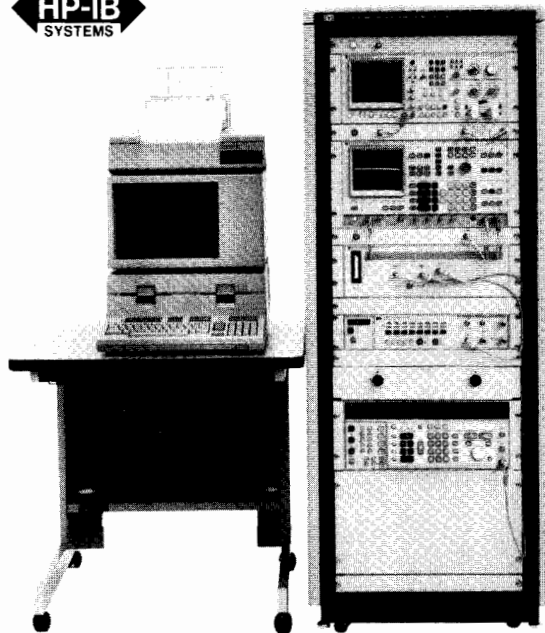

HP 11740S

HP 11740A Microwave Phase Noise Measurement System

The HP 11740A Microwave Phase Noise Measurement System is a complete, automatic system for phase noise measurements on carriers from 5 MHz to 18 GHz. The HP 11740A system includes the HP 3582A and HP 3585A Spectrum Analyzers, an interface for containing phase detectors and phase lock loop circuitry, the HP 11729C Carrier Noise Test Set, and the HP 8662A Synthesized Signal Generator. The integrated HP 11729C/8662A is used as a low noise reference and downconverter, translating the input signal to an intermediate frequency (IF). This IF signal is phase detected against the tunable HP 8662A front panel signal using the HP 35601A Spectrum Analyzer Interface. The detected baseband signal is then measured automatically by the spectrum analyzers.

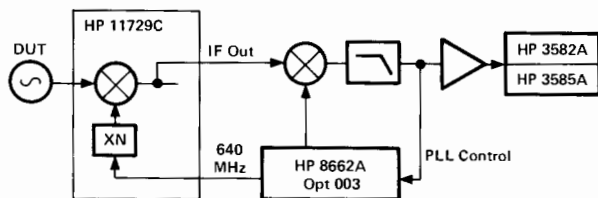

HP 11740A simplified block diagram.

Integrated Low Noise Reference

When used as a fully automatic system in the phase detector method of phase noise measurement, the software automatically controls the HP 11729C/8662A as the critical reference oscillator for sources > 1.28 GHz, or the HP 8662A (or HP 8663A) is controlled for measurements on sources less than 1.28 GHz (2.56 GHz). The HP 11729C/8662A provides the lowest noise floor for a microwave reference offered by HP. Typical system noise for a 10 GHz source is less than -123 dBc/Hz at a 10 kHz offset, allowing characterization of most high-performance sources. If desired, a user-supplied reference source can be set manually.

System Accuracy

The HP 11740A has specified system noise floor and excellent specified system accuracy (measurement of all phase noise present at the input to the phase detector) of ± 2 dB. (If the phase noise of the test source is >10 dB higher than the noise of the HP 11729C/8662A, then the noise of the test source alone can be measured with typically +2.5/-2.0 dB accuracy.) This complete system includes automatic characterization of the phase lock loop, allowing phase noise measurements to be made at offsets from <1 Hz to 40 MHz from the carrier, on synthesized or free-running oscillators.

Powerful Measurement Software

The HP 11740A is a software driven measurement system. The system software package consists of six discs, providing the necessary operating system, program, subroutines, and automated system check-out. Three methods of making phase noise measurements are supported by the system: the phase detector method, the frequency discriminator method and the two-port measurement technique. The powerful data manipulations of the HP 11740A allow the data to be displayed as $S\Phi(f)$, $\Delta(f)$, $S\Delta f(f)$ or $Sy(f)$.

Absolute and Two-Port Phase Noise

As well as providing a complete solution for automatic absolute phase noise measurements on sources, the HP 11740A can also be used for two-port phase noise measurements on devices. The built-in HP 8662A (8663A) can be used as a reference for devices to 1.28 (2.56) GHz.

Abbreviated Specifications

(Phase Noise Mode, phase detector method, using the integrated HP 11729C/8662A as the reference source.)

Test Signal Input

Frequency range: 5 MHz to 18 GHz.

Amplitude: for test frequencies >1.28 GHz; +7 dBm minimum to +20 dBm maximum. For test frequencies <1.28 GHz; -5 dBm minimum to +23 dBm maximum.

System Specifications

Accuracy: the system will measure the combined noise output of the phase detector with ± 2 dB accuracy for offsets from 0.02 Hz to 1 MHz, and ± 4 dB accuracy for offsets from 1 MHz to 40 MHz.

Absolute system noise floor:

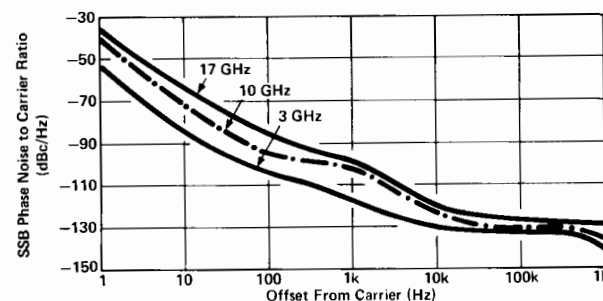

Typical HP 11729C/8662A system noise (phase detector method, locking via EFC).

Ordering Information

HP 11740S Microwave Phase Noise Measurement System

Price

\$0

HP 11740A System Instrumentation

\$118,810

Includes HP 11729C Carrier Noise Test Set, HP 8662A Synthesized Signal Generator, HP 3582A and 3585A Spectrum Analyzers, HP 35601A Spectrum Analyzer Interface, system software, and system rack with all associated power and signal cabling.

Requires HP Series 200 Model 36 or Model 16 Technical Computer or HP Series 300 Model 310 or 320, appropriately configured. Full details are available from your local HP sales office.



SIGNAL ANALYZERS

Measuring Receiver, 150 kHz to 1300 MHz
Model 8902A

- RF power: digital power meter accuracy
- Tuned RF level: 0 dBm to -127 dBm dynamic range
- Carrier Noise: AM and phase noise measurements to -140 dBc/Hz
- AM and FM, 1% accuracy; \emptyset M, 3% accuracy
- RF frequency: 10 Hz resolution
- Audio: frequency, level and distortion

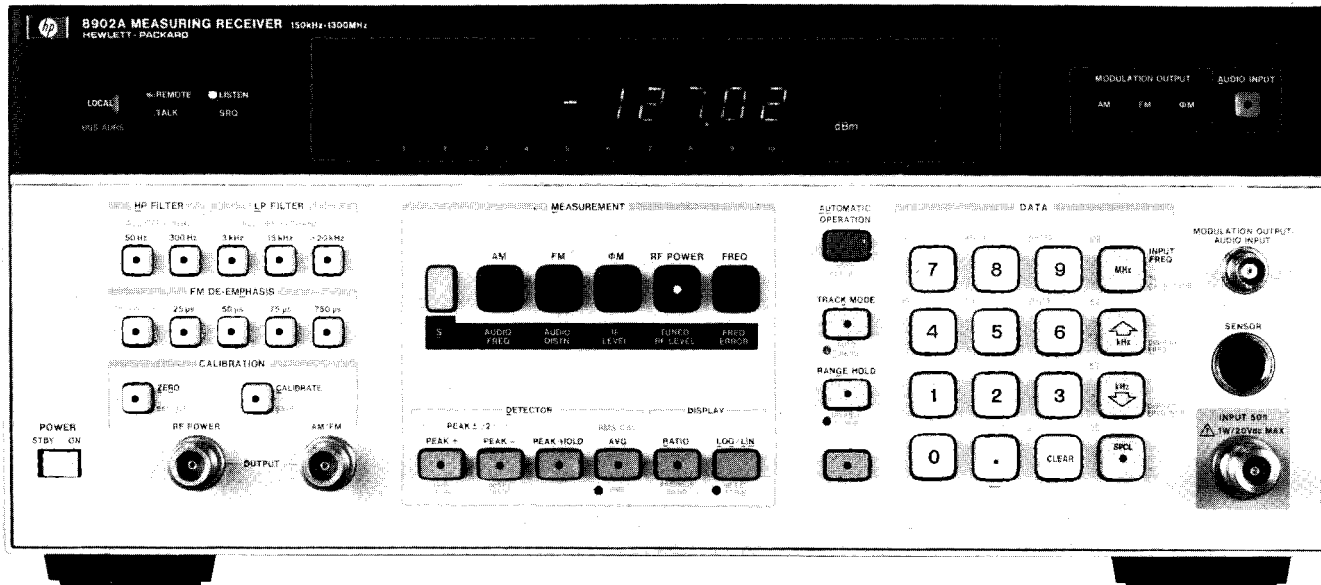

HP 8902A

HP 8902A Measuring Receiver

The HP 8902A Measuring Receiver combines six precise measurement functions into one fully automatic, HP-IB programmable instrument. It accurately measures RF power, tuned RF level, carrier noise/adjacent channel power, modulation and RF frequency, and characterizes audio signals. For precise signal analysis, the HP 8902A Measuring Receiver provides the performance you need.

RF Power delivers the accuracy and resolution of a high performance power meter. The HP 8902A with the HP 11722A Sensor Module measures power from $+30$ dBm to -20 dBm at frequencies from 100 kHz to 2.6 GHz. The HP 8902A also accepts all HP 8480 series power sensors for extended measurement capability.

Tuned RF Level's minimum sensitivity of -127 dBm with exceptional accuracy is a major contribution of the HP 8902A. You can make relative level measurements with accuracy you would only expect from a transfer standard: ± 0.02 dB ± 1 digit (worst case) for up to 10 dB step, increasing to ± 0.30 dB ± 1 digit at 110 dB step.

Carrier noise, phase noise and adjacent channel power measurements are simple, fast and accurate with the HP 8902A's high selectivity options (030-037). You select the noise filter bandwidth, measure the source under test's carrier power, tune the analyzer to the frequency offset desired (5 kHz to 1300 MHz) and measure the noise in seconds. The analyzer's measurement accuracy is better than ± 0.5 dB to -129 dBc/Hz, typically better than ± 1 dB to -140 dBc/Hz. The noise floor is -150 dBc/Hz.

AM and FM measurements offer 1% accuracy (3% accuracy for \emptyset M) and fast one-key operation. The HP 8902A has extremely low internal noise, and very low AM/ \emptyset M and \emptyset M/AM conversion, for accurately measuring residual and incidental AM, FM and \emptyset M on a wide range of simple and complex modulated signals.

RF frequency of complex modulated signals can be difficult to measure, but not with the HP 8902A. It tunes to the largest input signal or to any user specified frequency. The HP 8902A counts signals with 1 Hz resolution.

Audio distortion, frequency and level measurements provide comprehensive characterization of the modulation signal.

Metrology and Calibration

The HP 8902A Measuring Receiver makes signal generator and attenuator calibration easier than ever before.

The HP 8902A quickly and accurately measures your signal generator's RF frequency, RF level flatness, output level accuracy to -127 dBm, incidental and residual AM, FM and phase modulation, phase noise to < -140 dBc/Hz and characterizes the demodulated audio signals.

For attenuator calibration and other relative measurements, the HP 8902A gives you the accuracy and dynamic range you need. Tuned RF Level makes relative measurements with 127 dB dynamic range and 0.001 dB resolution. The combined dynamic range of Tuned RF Level and RF Power is 157 dB.

RF Signal Characterization

The HP 8902A Measuring Receiver is an excellent lab and production tool for accurately characterizing RF signals from 150 kHz to 1300 MHz.

Level measurements down to -127 dBm with superb accuracy make the HP 8902A ideal for testing devices such as antennas, multiplexers, log/linear amplifiers, filters and mixers. Unlike diode detectors, the HP 8902A's power meter accurately measures signals with harmonics and spurious.

The HP 8902A makes accurate AM to \emptyset M and AM to AM conversion measurements of phase and amplitude sensitive devices such as bandpass filters and multiple channel receivers. Excellent isolation between AM and FM makes it simple to separate the AM and \emptyset M of AM stereo, incidental AM of FM transmitters and the AM, FM and \emptyset M components of complex signals.

Automatic Test Systems

The HP 8902A is an important component of automatic RF test systems. All functions — power, level, frequency count, carrier noise, modulation, audio analysis — are fully automatic and easily programmed. With these measurements combined into one instrument, interfacing requirements, hardware costs, and software development time are reduced.

The HP 8902A's excellent measurement accuracy and dynamic range also make it a valuable tool for calibrating automatic test systems.

HP 8902A Specifications

RF Power (with HP 11722A Sensor Module)

Range: +30 dBm (1W) to -20 dBm (10 μ W).

Frequency range: 0.1 MHz to 2.6 GHz.

Linearity: ± 0.02 dB (within range) ± 0.02 dB per range change from reference range ± 1 count LSD.

Input SWR: <1.15.

Tuned RF Level

Range: 0 dBm to -127 dBm.

Frequency range: 2.5 MHz to 1300 MHz.

Relative accuracy: ± 0.02 dB ± 0.02 dB per IF range change ± 0.04 dB per RF range change ± 1 digit.

Selective power measurements (carrier noise, options 030-037)

Frequency range: 10 MHz to 1300 MHz

Carrier power range:

+30 dBm to -20 dBm; 12.5 kHz, 25 kHz and 30 kHz filters.

+30 dBm to -10 dBm; carrier noise filter.

Relative measurement accuracy:

± 0.5 dB; levels > -95 dBc; 12.5 kHz, 25 kHz and 30 kHz filters.

± 0.5 dB; levels > -129 dBc/Hz; carrier noise filter.

Filter bandwidths: 2.5 kHz, Carrier Noise filter; 8.0 kHz, 12.5 kHz filter; 16.0 kHz, 25 kHz filter; 30.0 kHz, Cellular Radio filter.

RF Frequency

Range: 150 kHz to 1300 MHz.

Maximum resolution: 1 Hz.

Amplitude Modulation

Rates: 20 Hz to 100 kHz.

Depths: to 99%.

Accuracy: $\pm 1\%$ of reading ± 1 digit, for rates 50 Hz to 50 kHz and depths $\geq 5\%$.

Frequency Modulation

Rates: 20 Hz to 200 kHz.

Deviations: to 400 kHz.

Accuracy: $\pm 1\%$ of reading ± 1 digit, for rates 50 Hz to 100 kHz.

Phase Modulation

Rates: 200 Hz to 20 kHz.

Deviations: to 400 radians.

Accuracy: $\pm 3\%$ of reading ± 1 digit.

Audio Level, Frequency and Distortion Capability

Audio Level

Accuracy: $\pm 4\%$ of reading, 100 mV to 3V.

Audio Frequency

Display resolution: 6 digits, to 250 kHz.

Audio Distortion

Accuracy: ± 1 dB, 400 Hz and 1 kHz.

Ordering Information

HP 8902A Measuring Receiver \$22,000

Option 001: rear panel instead of front panel connections for input, modulation output, and calibrators add \$200

Option 002: 1×10^{-9} /day internal reference oscillator add \$650

Option 003: Rear panel connections which allow use with an external local oscillator add \$400

Option 004: Operation from 48 Hz to 400 Hz power line (temp. <40°C) add \$275

Option 021: Add HP 11722A Sensor Module add \$1900

Option 030: High selectivity (select only two filter options) \$2400

(Options 032-037 require Option 030. Option 030 includes Option 003 connections for external local oscillator.)

Option 032: 12.5 kHz filter N/C

Option 033: 25.0 kHz filter N/C

Option 035: Cellular Radio filter N/C

Option 037: Carrier Noise filter N/C

Option 907: Front panel handle kit add \$65

Option 908: Rack mounting flange kit add \$35

Option 909: Front panel handle plus rack mounting flange kit add \$90

Option 910: Add manuals add \$275

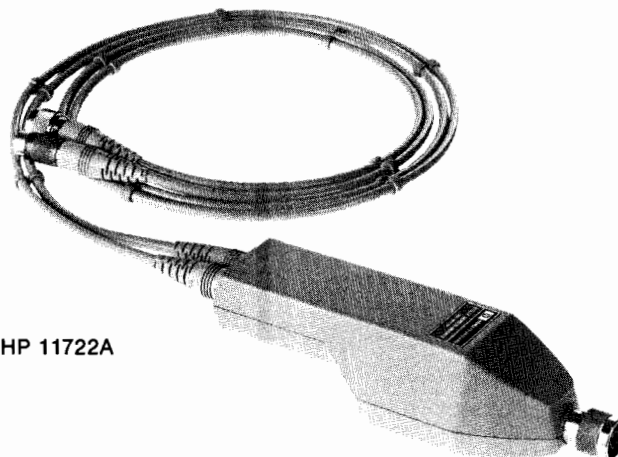

HP 11722A

HP 11722A Sensor Module

The HP 11722A Sensor Module was designed for use with the HP 8901B Modulation Analyzer and HP 8902A Measuring Receiver. The HP 11722A contains a silicon monolithic thermocouple as a power sensing element.

With the HP 11722A Sensor Module, you get all the performance of the HP 8901B or HP 8902A, plus superb power measurement accuracy, at a single connector. You can characterize a signal without switching back and forth between the power sensor and the analyzer's RF input.

Each HP 11722A Sensor Module is individually calibrated, traceable to the U.S. National Bureau of Standards. The calibration factors are printed on the sensor module for easy reference. Enter these factors into the HP 8901B or 8902A's non-volatile memory and the instrument automatically compensates for the power sensor's efficiency and mismatch loss at each frequency.

HP 11722A Specifications

Frequency range: 100 kHz to 2.6 GHz.

Power range: +30 dBm (1 watt) to -20 dBm (10 μ W).

Input SWR (Connected to an HP 8901B or 8902A): <1.15, for RF power measurements.

Power sensor linearity: +2%, -4%; +30 dBm to +20 dBm. Negligible deviation, levels <+20 dBm.

Calibration factors: each HP 11722A Sensor Module is individually calibrated. The calibration factors are printed on the HP 11722A Sensor Module for easy reference.

Cal Factor Uncertainty

Frequency	RSS Uncertainty	Worst Case Uncertainty
0.1 MHz	0.7%	1.6%
0.3 MHz	0.7%	1.6%
1.0 MHz	0.8%	1.7%
3.0 MHz	0.8%	1.7%
10.0 MHz	0.9%	2.0%
30.0 MHz	0.9%	2.0%
50.0 MHz	0.0% (ref.)	0.0% (ref.)
100.0 MHz	1.1%	2.2%
300.0 MHz	1.1%	2.2%
1000.0 MHz	1.1%	2.2%
2600.0 MHz	1.2%	2.3%

Ordering Information
HP 11722A Sensor Module
Option 910: Extra manual

Price
\$1900
add \$15



SIGNAL ANALYZERS

150 kHz to 26.5 GHz

Models 8902S, 11792A, 11793A, 11794A

- RF power: digital power meter accuracy
- Tuned RF level: 0 dBm to -105 dBm dynamic range
- AM and FM: 1% accuracy. Φ M: 3% accuracy
- Carrier Noise (AM and phase noise measurements): ± 0.5 dB accuracy
- RF frequency: 10 Hz resolution
- Audio: frequency, level and distortion

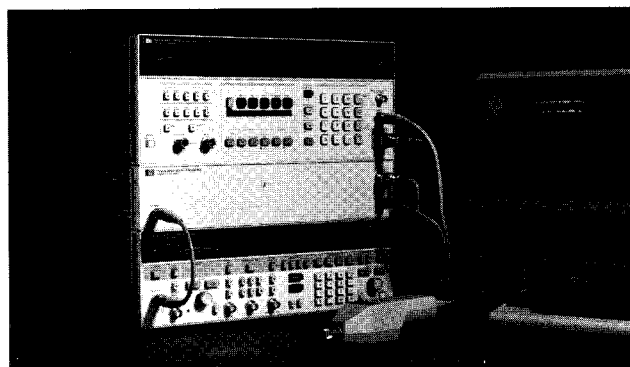

HP 8902S



HP 8902S Microwave Measurement System

The HP 8902S Microwave Measurement System extends the superb measurement performance of the HP 8902A Measuring Receiver to microwave frequencies. The HP 8902S system delivers the accuracy and resolution of a high performance power meter at frequencies from 50 MHz to 26.5 GHz and levels from +30 dBm to -105 dBm. It accurately measures AM, FM and Φ M, including residuals and incidentals, with a single keystroke. Adding options 030-037 to the HP 8902A extends the system's capability to include carrier noise measurements (AM and phase noise) with ± 0.5 dB accuracy to 26.5 GHz and down to the noise floor of the system's local oscillator. The HP 8902S counts signals to 26.5 GHz with 10 Hz resolution and excellent long-term frequency stability.

The HP 8902S Microwave Measurement System consists of the HP 8902A Measuring Receiver, HP 11793A Microwave Converter, HP 11792A Sensor Module, an instrument controller, HP 11794A Software Pac and a choice of microwave local oscillators. You can choose from the HP 8671B, 8672A and 8673B/D/E Synthesized Signal Generators and the HP 8340A and 8341A Sweep Oscillators.

Improves Quality

The HP 8902S minimizes measurement errors. The system's high performance instruments deliver superb accuracy: AM and FM, $\pm 1\%$; level and power, ± 0.02 dB ± 0.02 dB/10 dB; and carrier frequency, 10 Hz resolution.

Special care is taken to minimize the HP 8902S's input SWR, RFI susceptibility and insertion loss. 26.5 GHz hardware and a specially-designed flexible RF input cable with extremely stable insertion loss and input SWR help make your measurements repeatable.

Increases Confidence and Saves Time

The HP 8902S performs fast, accurate and repeatable microwave measurements traceable to the U.S. National Bureau of Standards.

Even difficult tasks such as measuring levels down to -105 dBm, residual FM down to <17 Hz and incidental Φ M of <0.03 radians in the presence of 50% AM, are performed in just a few seconds.

The HP 8902S can be assembled and running in minutes. For critical down-time applications, move the HP 8902S to the device-under-test and test it in place. Since the HP 8902S consists of general purpose HP-IB programmable equipment, it can also be used for other applications.

System Software

Under the control of the HP 11794A Software Pac, the HP 8902S Microwave measurement System functions as a single instrument. You select the frequency and measurement from the front panel of the HP 8902A. The software then calculates and sets the local oscillator frequency, then releases the HP 8902A to make the measurement

and display the results. Entering power sensor calibration factors is also fast and easy using the Cal Factor Manager function.

For automatic attenuator calibration, add the HP 11806A Attenuator Calibration Software Pac and an RF or microwave source to drive the attenuator. The HP 11806A adds the efficiency and repeatability of automation to the outstanding accuracy of the HP 8902A Measuring Receiver. By entering a table of frequencies, levels and specification limits, you can test any RF or microwave attenuator - fixed, manual or programmable - quickly and accurately. Adding an SWR bridge and 50 ohm termination will allow the system to test the SWR of the DUT. Flexible system configuration, various output formats and multiple test frequencies make the HP 11806A the ideal software pac for all your attenuator calibration needs.

Add the HP 8903B Audio Analyzer and HP 11795A Software Pac and the system expands to become an HP 8952S RF or Microwave Signal Generator Test System. (See next page for more information on the HP 8952S.)

HP 11793A Microwave Converter

The HP 11793A Microwave Converter down converts microwave signals to the frequency range of the HP 8902A Measuring Receiver. When you want to make a tuned RF level, modulation or frequency measurement above 1.3 GHz, the HP 11793A Microwave Converter routes the signal through its internal mixer. Below 1.3 GHz, signals are routed directly to the input of the HP 8902A.

The HP 11793A requires +8 dBm leveled output from the local oscillator. For LOs with insufficient power above 18 GHz, the HP 11793A offers an optional 18 to 26.5 GHz amplifier.

HP 11792A Sensor Module (50 MHz to 26.5 GHz)

When used with the HP 11793A Microwave Converter, the HP 11792A Sensor Module gives you all the performance of the HP 8902S system, plus superb power measurement accuracy, at a single connector. You can characterize a signal without manually switching back and forth between the power sensor and the receiver input.

Each HP 11792A Sensor Module is individually calibrated, traceable to the U.S. National Bureau of Standards. The calibration factors are printed on the sensor module for easy reference. Enter these factors into the HP 8902A's non-volatile memory and the instrument automatically compensates for the power sensor's efficiency and mismatch loss at each frequency. The 11792A is available with either a 3.5 mm precision or Type-N connector.

SIGNAL ANALYZERS

Microwave Measurement System, Signal Generator Test Set

Models 8902S, 8952S, 11795A

715



HP 8952S

HP 8902S Specifications

RF Power (with HP 11792A Sensor Module)

Range: +30 dBm (1W) to -20 dBm (10 μ W).

Frequency range: 50 MHz to 26.5 GHz.

Linearity: ± 0.02 dB (within range) ± 0.02 dB per range change from reference range ± 1 digit.

Input SWR: <1.10, $f_c \leq 2.0$ GHz.

<1.28, 2.0 GHz < $f_c \leq 18$ GHz.

<1.40, 18.0 GHz < $f_c \leq 26.5$ GHz.



Tuned RF Level¹

Frequency range²: 2.5 MHz to 26.5 GHz.

Range:

+10 dBm to -116 dBm, 2.5 MHz $\leq f_c \leq 1300$ MHz.

0 dBm to -100 dBm, 1300 MHz < $f_c \leq 18.0$ GHz.

0 dBm to -95 dBm, 18.0 GHz < $f_c \leq 26.5$ GHz.

Relative accuracy: ± 0.02 dB ± 0.02 dB per IF range change ± 0.04 dB per RF range change ± 1 digit.

RF Frequency

Range: 150 kHz to 26.5 GHz.

Maximum resolution: 10 Hz.

Time base aging rate: <5X10⁻¹⁰/day, for HP 8672A, HP 8673B/D/E; <1X10⁻⁹/day, for HP 8340A, HP 8341A.

Amplitude Modulation

Frequency range: 150 kHz to 26.5 GHz.

Rates: 20 Hz to 100 kHz.

Depths: to 99%.

Accuracy: $\pm 1\%$ of reading ± 1 digit, for rates 50 Hz to 50 kHz and depths $\geq 5\%$.

Frequency Modulation

Frequency range: 150 kHz to 26.5 GHz.

Rates: 20 Hz to 200 kHz.

Deviations: to 400 kHz.

Accuracy: $\pm 1\%$ of reading ± 1 digit, for rates 50 Hz to 100 kHz.

Phase Modulation

Frequency range: 150 kHz to 26.5 GHz.

Rates: 200 Hz to 20 kHz.

Deviations: to 400 radians.

Accuracy: $\pm 3\%$ of reading ± 1 digit.

General

Temperature: Operating, 15° C to 35° C; storage, -25° C to 60° C.

Power: 100, 120, 220, or 240V (+5%, -10%); 48-66 Hz; 1300 VA maximum (worst case).

Weight: Net 122.3 kg (270 lb); shipping, 153.3 kg (338.3 lb) worst case.

Ordering Information

HP 8902S Microwave Measurement System

The HP 8902S system consists of an HP 8902A Measuring Receiver, HP 11792A Sensor Module, HP 11793A Microwave Converter, a controller, two HP 10833 HP-IB cables, three accessory cables (included with HP 11793A) and a choice of synthesized microwave local oscillators. For complete ordering information, see the "HP 8902S Microwave Measurement System Ordering Information" guide, or call your HP sales office.

HP 11794A Software Pac \$250

HP 11806A Software Pac \$2,000

HP 8952S Signal Generator Test System

The HP 8952S Signal Generator Test System eases your signal generator calibration workload, performing automatic performance verification for incoming inspection, maintenance, and calibration.

The HP 8952S includes the HP 8902A Measuring Receiver, the HP 8903B Audio Analyzer, a printer, and your choice of HP 9000 controllers: Model 216S, 220S, 226S, 236S or Series 300 controller (Basic 3.0 or 4.0 operating systems). The frequency range of the HP 8952S can be extended from 1.3 GHz to 26.5 GHz by adding the HP 11792A Sensor Module, the HP 11793A Microwave Converter and a synthesized microwave signal generator. With these instruments you can perform 80% of all tests typically required to verify both RF and microwave signal generator performance.

The HP 8952S Test System makes fast, accurate and repeatable measurements and provides you with a hardcopy output of the results. The system is easy to use and is easily expanded to include additional instruments.

To test your HP signal generators, select from the HP 11795A Software Pac series. Each Software Pac follows the verification procedures called out by the appropriate signal generator service manual.

The HP 11795A Performance Verification Option 209 (HP 8656B) uses either the HP 8658A/B or HP 8656A/B Spectrum Analyzer to perform harmonic, spurious and, with an HP 8952A-K01 Phase Noise Demodulator and another HP 8656B, phase noise measurements. Option 204 (HP 8640B) now uses the HP 8116A Pulse/Function Generator and HP 1980B Oscilloscope Measurement System to characterize pulse modulation. Future software pacs will use these new instruments to perform complete testing of signal generator performance.

Ordering Information

HP 8952A Signal Generator Test Set \$30,750

HP 11795A Software Pac N/C

(Must order one option in addition to one disc media option)

Option 101, User Interface

(Required to run Performance Verification software options) \$1000

Performance Verification Options (select one or more):

204, HP 8640B Performance Verification software \$500

205, HP 8642A/B Performance Verification software \$750

208, HP 8656A Performance Verification software \$500

209, HP 8656B Performance Verification software \$500

214, HP 8662A Performance Verification software \$500

216, HP 8663A Performance Verification software \$500

317, HP 8672A Performance Verification software \$750

319, 8673A/B/C/D/E/M Performance Verification software \$1000

Disc Medium Options (select only one)

630, 3.5 inch disc medium for HP 9121D or

HP 9122D or HP 9133D N/C

650, 5.25 inch disc medium for HP 9125S N/C

655, 5.25 inch disc medium for HP 9826S/9836S N/C

¹An HP 11722A Sensor Module may be used with the HP 8902S to make tuned RF level measurements from 2.5 MHz to 1300 MHz at levels from 0 dBm to -127 dBm.

²Frequency range may be limited by the frequency range of the LO.

SIGNAL ANALYZERS

Modulation Analyzer, 150 kHz to 1300 MHz

Models 8901A, 8901B

- Measures AM and FM to 1% accuracy
- Measures RF frequency
- Measures RF Power

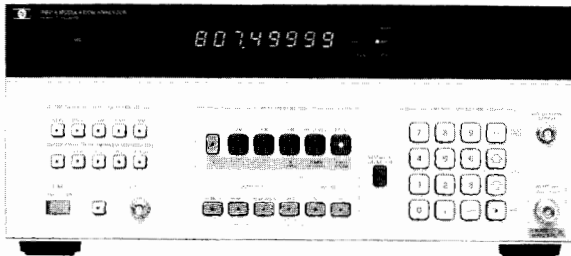

HP 8901A

HP 8901A and HP 8901B Modulation Analyzers

The HP 8901A and HP 8901B modulation analyzers combine the capabilities of several RF instruments to give complete, accurate characterization of modulated signals in the 150 kHz to 1300 MHz frequency range. Both instruments very accurately measure modulation and recover the modulation signal. They determine RF frequency and measure RF power. The major additional capabilities of the HP 8901B are its improved power meter accuracy, its ability to use external power sensors, to make adjacent channel power measurements or carrier noise measurements (with options 030-037) and its ability to count audio frequencies and measure distortion on 400 Hz and 1 kHz signals. Both instruments are fully automatic and make all major measurements with the push of a key or under HP-IB control.

Modulation Measurement Accuracy

Very accurate modulation measurements along with very low internal noise enable the HP 8901A/B to characterize even high performance signal sources. Their detection systems are configured for wideband recovery of the entire modulation spectrum so that highly precise measurements such as signal-to-noise or distortion can be made on the modulation signal. Modulation depth and deviation accuracy is generally $\pm 1\%$ of reading. Residual AM noise in a 50 Hz to 3 kHz bandwidth is $< 0.01\%$ while FM noise is < 8 Hz for 1300 MHz carrier frequencies, decreasing linearly to < 1 Hz below 100 MHz. Because the AM and FM demodulators are independent and highly insensitive to each other and because the analyzer has very low residual AM and FM, accurate incidental AM and FM measurements can be made.

Three detectors are available for depth and deviation measurements: positive peak, negative peak, and an average-responding detector with rms (sinewave) calibration. A PEAK HOLD function captures and displays the maximum peak modulation of a signal and is ideal for making transient measurements such as modulation limiting on mobile radios. The HP 8901B also has a true rms detector and the ability to measure peak to peak divided by two.

For measuring convenience, two high-pass (50 Hz and 300 Hz) and three low-pass (3 kHz, 5 kHz and > 20 kHz) post-detection filters are included for filtering the recovered modulation. The > 20 kHz Bessel filter minimizes overshoot on square-wave modulation. This allows accurate measurement of signals which are digitally modulated, such as FSK. Four de-emphasis networks commonly used in FM systems (25, 50, 75, and 750 μ s) are also provided.

A modulation output provides calibrated signal levels relative to the displayed modulation reading. The HP 8901B can make measurements on this demodulated signal such as frequency and distortion level.

Modulation calibrators (standard on the HP 8901B, Option 010 on the HP 8901A) provide two precision modulation standards. One is an amplitude modulated signal whose depth is calibrated to better than 0.1% accuracy. The second standard is a frequency modulated signal with peak deviation calibrated to 0.1% accuracy. The HP 11715A AM/FM Test Source is necessary to fully test and calibrate other modulation parameters.

- Low internal noise
- Completely automatic

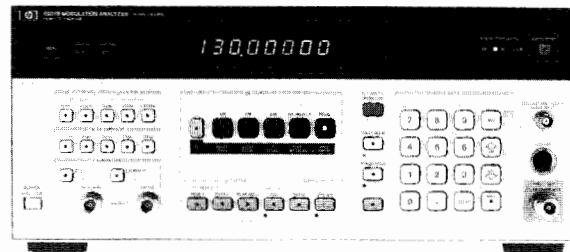

HP 8901B

Frequency Measurements

The HP 8901A/B modulation analyzers are more than just high quality modulation meters. They also perform as frequency counters. Resolution for the HP 8901A's 150 kHz to 1300 MHz frequency counter is 10 Hz below 1000 MHz, and 100 Hz above 1000 MHz. Resolution is 1 Hz for the HP 8901B. Sensitivity is -25 dBm (12 mV rms) below 650 MHz, and -20 dBm (22 mV rms) above 650 MHz. The standard instrument's time base stability is 1×10^{-6} /month, or an optional time base is available with 1×10^{-9} /day stability.

RF Power Measurements

The HP 8901A uses a diode detection circuit to measure RF input power. This technique measures peak voltage and is calibrated from 1 mW to 1W for sinewave inputs. The RF level measurement accuracy is ± 1.5 dB from 150 MHz to 1300 MHz.

The HP 8901B delivers the accuracy and resolution of a high performance power meter. The HP 8901B, with the HP 11722A Sensor Module, measures power from $+30$ dBm to -20 dBm at frequencies from 100 kHz to 2.6 GHz. The HP 8901B also accepts all HP 8480 series power sensors for extended measurement capability.

Adjacent Channel Power and Direct Spectrum Noise Measurements

The HP 8901B offers optional selective power measurement capability (options 030-037). With this capability you can quickly and accurately make adjacent channel power measurements to CEPT standards. The HP 8901B provides a choice of selectable filters for testing transceivers with 12.5, 25 and 30 kHz channel spacings.

To meet the CEPT standard at frequencies greater than 300 MHz, the HP 8901B requires an external local oscillator (LO) such as the HP 8656B Synthesized Signal Generator. Dedicating a signal generator as the external LO is not necessary. When not being used as the LO, a built-in RF switch in the HP 8901B routes the signal generator's output out the back panel.

Used with a low-phase-noise external LO, the HP 8901B also makes single-sideband (SSB) noise measurements to 1.3 GHz. To make the noise measurement, you just select the carrier noise filter and the frequency offset from the carrier (5 kHz to 1300 MHz). The HP 8901B then makes a selective power measurement (2.5 kHz BW) and converts the power to a 1 Hz bandwidth. The noise floor of the HP 8901B is -150 dBc/Hz. The HP 8901B's measurement accuracy is better than ± 0.5 dB down to -139 dBc.

Phase noise usually dominates the carrier-noise measurement at most offsets of interest, so direct-spectrum noise measurements provide a convenient and simple way to measure phase noise of many sources. Adding the HP 11793A Microwave Converter and a low-phase-noise microwave source such as the HP 8673B Synthesized Signal Generator extends this measurement to 26.5 GHz.

HP 8901A and HP 8901B Specifications

RF Input

Frequency range: 150 kHz to 1300 MHz

Operating Level:

12 mVrms to 7 Vrms, 150 kHz to 650 MHz.

22 mVrms to 7 Vrms, 650 MHz to 1300 MHz.

Input impedance: 50Ω nominal.

Tuning: manual frequency entry, automatic, or track (frequencies >10 MHz only).

Acquisition time (automatic operation): ~1.5 seconds.

Maximum safe input level (typical): 35 Vrms (25W for source SWR <4), ac; 40V, dc.

Frequency Modulation

Rates:

20 Hz to 10 kHz, 150 MHz to 10 MHz.

20 Hz to 200 kHz, 10 MHz to 1300 MHz.

20 Hz to 20 kHz with 750 μs filter, 10 MHz to 1300 MHz.

Deviations:

40 kHz peak maximum, 150 kHz to 10 MHz.

400 kHz peak maximum, 10 MHz to 1300 MHz.

40 kHz peak maximum with 750 μs filter, 10 MHz to 1300 MHz.

Accuracy^{1,2}:

±2% of reading ±1 digit, 20 Hz to 10 kHz rates, 250 kHz to 10 MHz.

±1% of reading ±1 digit, 50 Hz to 100 kHz rates; ±5% of reading ±1 digit, 20 Hz to 200 kHz rates, 10 MHz to 1300 MHz.

Demodulated Output Distortion³:

<0.1% THD, deviations <10 kHz, 400 kHz to 10 MHz.

<0.1% THD, rates and deviations <100 kHz, 10 MHz to 1300 MHz.

AM rejection (for 50% AM at 400 Hz and 1 kHz rates)¹: <20 Hz peak deviation measured in a 50 Hz to 3 kHz BW.

Residual FM (50 Hz to 3 kHz BW): <8 Hz rms @ 1300 MHz, decreasing linearly with frequency to <1 Hz rms for 100 MHz and below.

Maximum Deviation Resolution:

0.1 Hz (rms detector on HP 8901B only), <4 kHz peak deviation.

1 Hz, <4 kHz peak deviation.

10 Hz, 4 kHz to 40 kHz peak deviation.

100 Hz, 40 kHz to 400 kHz peak deviation.

Resolution is increased one digit with 750 μs de-emphasis and pre-display "on" and with rms detector.

Stereo separation (50 Hz to 15 kHz): >47 dB typical.

Phase Modulation

Carrier frequency: 10 MHz to 1300 MHz.

Rates: 200 Hz to 20 kHz; typically usable from 20 Hz to 100 kHz with degraded performance.

Deviation and Maximum Resolution:

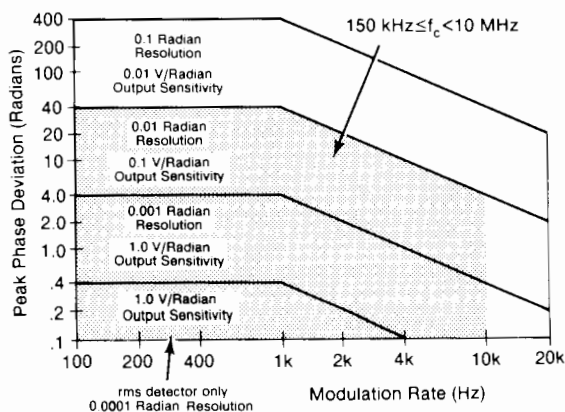

Accuracy¹: ±3% of reading ±1 digit.

Demodulated output distortion: <0.1% THD.

AM rejection (for 50% AM at 1 kHz rate)¹: <0.03 radian peak deviation (50 Hz to 3 kHz BW).

Amplitude Modulation

Rates:

20 Hz to 10 kHz, 150 kHz to 10 MHz.

20 Hz to 100 kHz, 10 MHz to 1300 MHz.

Depth: to 99%.

Accuracy^{1,2,4}:

±2% of reading ±1 digit, 50 Hz to 10 kHz rates, >5% depth; ±3% of reading ±1 digit, 20 Hz to 10 kHz rates, 150 kHz to 10 MHz.

±1% of reading ±1 digit, 50 Hz to 50 kHz rates, >5% depth; ±3% of reading ±1 digit, 20 Hz to 100 kHz rates, 10 MHz to 1300 MHz.

Flatness (variation in indicated AM depth for constant depth on input signal): ±0.3% of reading ±1 digit, 90 Hz to 10 kHz rates, 20% to 80% depth, 10 MHz to 1300 MHz.

Demodulated output distortion: <0.3% THD for ≤50% depth; <0.6% THD for >50% depth.

FM Rejection (at 400 Hz and 1 kHz rates, 50 Hz to 3 kHz BW)¹:

<0.2% AM for <5 kHz peak deviation, 250 kHz to 10 MHz.

<0.2% AM for <50 kHz peak deviation, 10 MHz to 1300 MHz.

Residual AM (50 Hz to 3 kHz BW): <0.01% rms.

Maximum Depth Resolution

0.01% for depths ≤39.99%; 0.1% for depths ≥40%. Resolution increases 1 digit with rms detector (HP 8901B only).

Frequency Counter

Range: 150 kHz-1300 MHz.

Accuracy: ±3 counts of least significant digit ± reference accuracy.

Internal Reference:

Frequency: 10 MHz.

Aging rate: <1×10⁻⁶/month (optional⁵: 1×10⁻⁹/day).

Maximum Resolution:

HP 8901A: 10 Hz for frequencies <1 GHz; 100 Hz for frequencies ≥1 GHz.

HP 8901B: 1 Hz.

HP 8901A RF Level (Peak Voltage Responding, RMS Sine Wave Power Calibrated)

Range: 1 mW to 1W.

Instrumentation accuracy: ±1.5 dB (150 kHz to 1300 MHz); 0.7 dB typical.

SWR: ≤1.3, 150kHz to 650 MHz; ≤1.5, 650 MHz to 1300 MHz.

Resolution: 0.1 mW for levels 0.1W to 1W; 0.01 mW for levels 0.01W to 0.1W; 0.001 mW for levels <0.01W.

HP 8901B RF Level (True RMS)

Frequency range with HP 11722A: 100 kHz to 2.6 GHz.

Power range: -20 dBm to +30 dBm.

RF Range Linearity (Using Recorder Output):

±0.02 dB, RF ranges 2 - 5.

±0.03 dB, RF range 1.

Using front-panel display, add ±1 count of least-significant digit.

RF Range-to-Range Change Error:

±0.02 dB/RF range change from reference range.

Input SWR: <1.15, using HP 11722A Sensor Module.

Zero Set (Digital Settability of Zero):

±0.07% of full scale on lowest range.

Decrease by a factor of 10 for each high range.

RF Power Resolution:

0.1% of full scale in watts or volts mode.

0.01 in dBm or dB relative mode.

¹ Peak residuals must be accounted for in peak readings.

² But not to exceed: 50 Hz to 40 kHz rates for stated accuracy with rms detector (HP 8901B only).

³ With 750 μs de-emphasis and pre-display "off", distortion is not specified for modulation outputs >4V peak. This can occur near maximum deviation for a measurement range at rates <2 kHz.

⁴ For peak measurements only, AM accuracy may be affected by distortion generated by the Modulation Analyzer. In the worst case, this can decrease accuracy by 0.1% of reading for each 0.1% of distortion.

⁵ After 30 day warm-up.



SIGNAL ANALYZERS

Modulation Analyzer, 150 kHz to 1300 MHz; AM/FM Test Source

Models 8901A, 8901B, 11715A

HP 8901B Selective Power Measurements (options 030-037)

Frequency range: 10 MHz to 1.3 GHz.

Carrier power range: +30 dBm to -20 dBm, 12.5, 25 and 30 kHz filters; +30 dBm to -10 dBm, Carrier Noise Filter.

Dynamic range: 115 dB.

Carrier rejection (temp. $\leq 35^\circ\text{C}$): >90 dB, for offsets ≥ 1 channel spacing or 5 kHz, whichever is larger.

Relative accuracy: ± 0.5 dB, levels ≥ -95 dBc or levels ≥ -129 dBc/Hz.

Filter bandwidths:

2.5 kHz, Carrier Noise Filter

8.5 kHz, 12.5 kHz Filter

16.0 kHz, 25 kHz Filter

30.0 kHz, Cellular Radio Filter

Power Reference

Power output: 1.00 mW. Factory set to $\pm 0.7\%$, traceable to the U.S. National Bureau of Standards.

Accuracy: $\pm 1.2\%$ worst case ($\pm 0.9\%$ rss) for one year (0°C to 55°C).

Audio Filters

High pass (3 dB cutoff frequency): 50 Hz and 300 Hz

Low pass (3 dB cutoff frequency except >20 kHz filter): 3 kHz, 15 kHz, >20 kHz.

De-emphasis filters: 25 μs , 50 μs , 75 μs , and 750 μs .

Calibrators (Standard HP 8901B, Option 010

HP 8901A)

AM calibrator depth and accuracy: 33.33% depth, nominal; internally calibrated to an accuracy of $\pm 0.1\%$.

FM calibrator deviation and accuracy: 34 kHz peak deviation, nominal; internally calibrated to an accuracy of $\pm 0.1\%$.

General Characteristics

Operating temperature range: 0° to 55°C .

Power requirements: 100, 120, 220, or 240V (+5, -10%); 48-66 Hz; 200 VA max.

Weight: HP 8901A—net 20 kg (44 lb), shipping 25 kg (55 lb); HP 8901B—net 23 kg (52 lb), shipping 31 kg (69 lb).

Size: HP 8901A, 190 mm H x 425 mm W x 468 mm D (7.5 in. x 16.8 in. x 18.4 in.); HP 8901B, 190 mm H x 425 mm W x 551 mm D (7.5 in. x 16.8 in. x 21.7 in.).

Ordering Information

HP 8901A Modulation Analyzer

Option 001: Rear panel connectors \$100

Option 002: 1×10^{-9} /day internal reference \$650

Option 003: Connections for external local oscillator \$400

Option 004: Operation from 48 to 440 Hz power (Temp. $< 40^\circ\text{C}$) \$275

Option 010: AM and FM calibrators \$625

HP 8901B Modulation Analyzer \$13000

Option 001: Rear panel connectors \$200

Option 002: 1×10^{-9} /day internal reference \$650

Option 003: Connections for external local oscillator \$400

Option 004: Operation from 48 to 440 Hz power (Temp. $< 40^\circ\text{C}$) \$275

Option 021: Add 11722 Sensor Module \$1900

Option 030: High selectivity (select only 2 filter options) \$2400

(Options 032-037 require Option 030; Option 030 includes Option 003 connections for external local oscillators.)

Option 032: 12.5 kHz filter N/C

Option 033: 20.0/25.0 kHz filter N/C

Option 035: Cellular Radio Filter N/C

Option 037: Carrier Noise Filter N/C

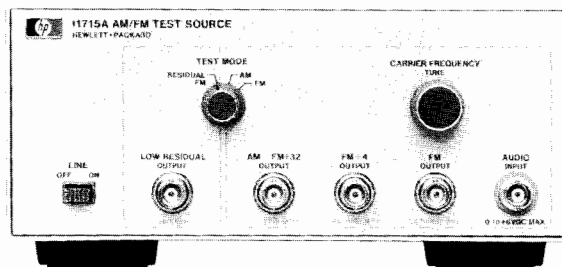

HP 11715A

HP 11715A AM/FM Test Source

The HP 11715A AM/FM Test Source provides very flat, wide-bandwidth, and low distortion amplitude or frequency modulated RF signals. Designed primarily for performance tests and adjustments of the HP 8901A/B Modulation Analyzer and HP 8902A Measuring Receiver, it will also serve as a high quality modulated test oscillator where its frequency ranges apply.

The major components of the HP 11715A are a low-noise voltage controlled oscillator (VCO), two digital dividers, and a double-balanced mixer. The VCO is the primary signal source, with a typical frequency range of 330 to 470 MHz at the FM OUTPUT. FM is produced by directly coupling the external modulation source to the VCO's tune input, providing very wide bandwidth modulation with low phase shift. This design also ensures very little incidental AM.

The HP 11715A can also be used in conjunction with an HP 8901A/B and an HP 8902A as a calibrated signal source for special applications. In particular, the U.S. commercial FM broadcast band of 88 to 108 MHz is covered by the FM $\div 4$ OUTPUT of the HP 11715A.

HP 11715A Specifications

FM Outputs

Frequency Range:

11 to 13.5 MHz, AM FM $\div 32$ output.

88 to 108 MHz, FM $\div 4$ output.

352 to 432 MHz, FM output.

Peak Deviation:

>12.5 kHz, 11 to 13.5 MHz carrier.

>100 kHz, 88 to 108 MHz carrier.

>400 kHz, 352 to 432 MHz carrier.

Distortion:

<0.025% THD (< -72 dB) for

Carrier frequency	Peak deviation	Modulation rate
12.5 MHz	12.5 kHz	<10 kHz
100 MHz	100 kHz	<100 kHz
400 MHz	400 kHz	<100 kHz

Flatness:

$\pm 0.1\%$, dc to 100 kHz rates.

$\pm 0.25\%$, dc to 200 kHz rates.

Stereo separation (88 to 108 MHz carrier, 75 kHz peak deviation, 1 kHz rate): >60 dB typical.

AM Output

Frequency range (AM FM $\div 32$ output): 11 to 13.5 MHz.

Depth: to 99%.

Distortion:

<0.05% THD (< -66 dB), 50% AM, 20 Hz to 100 kHz rates.

<0.1% THD (< -60 dB), 95% AM, 20 Hz to 100 kHz rates.

Flatness: $\pm 0.1\%$, 50 Hz to 50 kHz rates;

$\pm 0.25\%$, 20 Hz to 100 kHz rates.

Linearity: $\pm 0.1\%$, <95% AM; $\pm 0.2\%$, <99%.

Ordering Information

HP 11715A AM/FM Test Source

Price

\$2300

Audio Analyzer, 20 Hz to 100 kHz; Distortion Analyzer, 20 Hz to 100 kHz

Models 8903B, 8903E

- Measures distortion, SINAD, signal-to-noise
- Measures true-rms ac volts, dc volts, frequency
- Low-distortion programmable source
- RMS and average detection

- Measures distortion, SINAD
- Measures true-rms ac volts, dc volts, frequency
- RMS and average detection

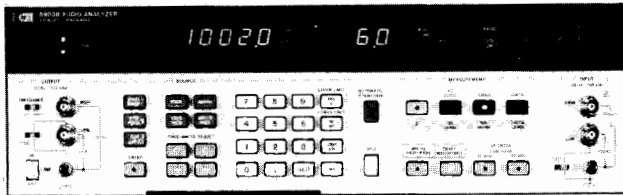

HP 8903B

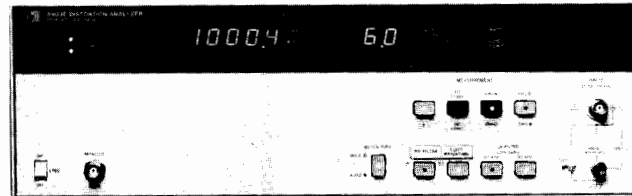

HP 8903E

HP 8903B Audio Analyzer

The HP 8903B Audio Analyzer provides unparalleled versatility and performance for audio measurements from 20 Hz to 100 kHz. The HP 8903B combines the functionality of a low-distortion audio source, high-performance distortion analyzer, frequency counter, ac voltmeter, dc voltmeter and SINAD meter into one compact package. With microprocessor control of source and analyzer, the HP 8903B can perform stimulus-response measurements, such as signal-to-noise ratio and swept distortion, automatically with no additional equipment.

For ease of use, most measurements are made with only one or two keystrokes. The HP 8903B automatically tunes and autoranges for maximum accuracy and resolution. For quick identification of input signals, the analyzer counts and displays the input frequency in all ac measurement modes. Stand alone swept measurement capability and simple HP-IB programming make the HP 8903B an extremely versatile tool for general audio and system applications.

The HP 8903B uses true-rms detection for accurate measurement of complex waveforms and noise. Average (rms-calibrated) detection is also available via front panel control. Accurate distortion measurements typically can be made down to less than -90 dB (0.003%) from 20 Hz to 20 kHz.

Audio Applications

The HP 8903B has many features which make difficult audio measurements easy. These include flexible data display formats, fully balanced analyzer input, plug-in filters, automatic notch filter tuning, convenient audio oscillator controls and swept measurements. With the ratio key, you can establish a reference in % or dB and directly make frequency response and 3 dB bandwidth measurements without computation. Fully balanced analyzer input allows testing of bridged power amplifiers found in many radios and car stereos as well as professional balanced audio equipment.

With two internal plug-in filter slots and six optional filters to choose from, the HP 8903B simplifies your audio measurements by providing the filter networks required by international standards (see next page for list of filters). The standard HP 8903B includes 30 kHz and 80 kHz low-pass filters to remove unwanted signals and noise. Fully-automatic notch-filter tuning coupled with automatic input ranging reduce operator workload while ensuring accurate distortion measurements. Distortion measurements down to <-90 dB (0.003%) typically can be made from 20 Hz to 20 kHz. In conjunction with an X-Y recorder, the HP 8903B can generate hard copy records of swept measurements such as frequency response and swept distortion.

Transmitter and Receiver Tests

Many features of the HP 8903B have been optimized for transmitter and receiver testing. These include SINAD measurements, optional plug-in weighting filters for testing to CEPT, EIA, CCIR, and Bell standards, rms detection for accurate noise readings and signal-to-noise ratio measurements. SINAD measurements, which are one of the most common FM receiver tests, must be made repeatedly when checking receiver sensitivity or adjacent-channel selectivity. In order to smooth out the noisy signals found in receiver testing, SINAD measurements in the HP 8903B employ extra filtering and parallel detection for high speed (>2 readings per second) and excellent repeatability. The HP 8903B overcomes the tendency of many automatic analyzers to become unlocked in SINAD mode by tuning its notch filter to the source frequency.

The HP 8903B uses true-rms detection (for all signals with crest factor <3) for accurate measurement of complex signals. Average detection is also available via front panel control. Just as SINAD measurements are most often performed on FM receivers, signal-to-noise ratio measurements are usually employed as a measure of signal quality on AM receivers. The HP 8903B automatically makes signal-to-noise ratio measurements by monitoring the ac level while turning its source on and off.

HP 8903E Distortion Analyzer

The HP 8903E Distortion Analyzer is a high performance tool for audio signal analysis from 20 Hz to 100 kHz. The HP 8903E Distortion Analyzer is the ANALYZER portion of an HP 8903B Audio Analyzer (HP 8903E has no source). Automatic distortion, SINAD, ac voltage, frequency, and dc voltage measurements are available on the HP 8903E.

The HP 8903E is simple to use. Fully automatic tuning and autoranging, coupled with single keystroke measurement selection, make accurate measurements easy to obtain with the HP 8903E. Many audio measurements either require a separate audio source or are made on playback-only systems. For such applications, the HP 8903E is the ideal, lower-cost solution.

With a selectable balanced or unbalanced input, the HP 8903E Distortion Analyzer can be used to characterize most types of audio equipment. True rms and average detectors allow the HP 8903E to make ac voltage measurements to most international standards. For receiver testing, a front-panel key allows the operator to lock the notch filter at any given input frequency in the distortion and SINAD modes. This feature ensures that the HP 8903E will not become unlocked when measuring receiver sensitivity and selectivity. For rejection of unwanted signals and noise, the HP 8903E has 30 kHz and 80 kHz low-pass filters. Floating the input (balanced operation), can help break insidious ground loops, typically providing over 75 dB of common mode rejection at the line frequency.



SIGNAL ANALYZERS

Audio Analyzer, 20 Hz to 100 kHz; Distortion Analyzer, 20 Hz to 100 kHz (cont.)

Models 8903B, 8903E

Internal Plug-in Filter Options

Both the HP 8903B and HP 8903E have TWO internal plug-in filter slots, each of which will accept one of six optional filters. The standard HP 8903B and HP 8903E come with 30 kHz and 80 kHz low-pass filters, but with NO PLUG-IN FILTERS. The appropriate filter options must be ORDERED for the analyzers to have any of the filters listed below. Each filter option has TWO option numbers: the 010 series for the left filter slot and the 050 series for the right filter slot. Each filter option ordered (maximum of two) adds additional cost to the instrument.

Filters	Option Numbers Filter Position	
	Left Slot	Right slot
400 Hz High-Pass	010	050
CCITT Weighting Filter	011	051
CCIR Weighting Filter	012	052
C-MESSAGE Weighting Filter	013	053
CCIR/ARM Weighting Filter	014	054
"A" Weighting Filter	015	055

HP 8903B and HP 8903E Specifications

System Specifications

(HP 8903B only, source and analyzer combined)

Distortion

Residual Distortion and Noise (the higher of):

80 kHz BW: -80 dB (0.01%) or 17 μ V, 20 Hz to 20 kHz.

500 kHz BW: -70 dB (0.032%) or 50 μ V, 20 Hz to 50 kHz.
-65 dB (0.056%) or 50 μ V, 50 kHz to 100 kHz.

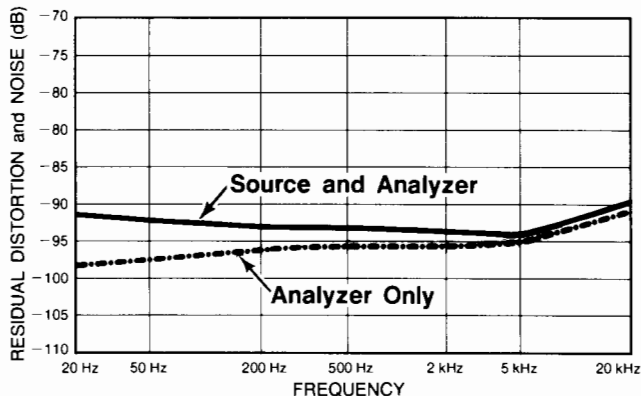

Typical residual THD + noise of source and analyzer combined (source voltage set to 1.5V, 80 kHz BW). Dashed line represents typical residual THD + noise for the analyzer only.

Signal-to-Noise

Frequency range: 50 Hz to 100 kHz.

Display range: 0 to 99.99 dB.

Accuracy: ± 1 dB.

Input voltage range: 50 mV to 300V.

Residual noise (the higher of): -85 dB or 17 μ V, 80 kHz BW; -70 dB or 50 μ V, 500 kHz BW.

Resolution: same as listed under SINAD.

Operation: the analyzer displays the ratio of the input voltages as the internal source is automatically switched on and off.

Source Specifications (HP 8903B only)

Frequency

Range: 20 Hz to 100 kHz.

Resolution: 0.3%.

Accuracy: 0.3% of setting.

Output Level

Range: 0.6 mV to 6V open circuit.

Resolution: 0.3% or better.

Accuracy (open circuit): 2% of setting 60 mV to 6V, 20 Hz to 50 kHz; 3% of setting 6 mV to 6V, 20 Hz to 100 kHz; 5% of setting 0.6 mV to 6 mV, 20 Hz to 100 kHz.

Flatness (1 kHz reference): $\pm 0.7\%$ (± 0.06 dB), 20 Hz to 20 kHz; $\pm 2.5\%$ (± 0.22 dB), 20 Hz to 100 kHz.

Distortion and noise (the higher of):

80 kHz BW: -80 dB (0.01%) or 15 μ V, 20 Hz to 20 kHz.

500 kHz BW: -70 dB (0.032%) or 38 μ V, 20 Hz to 50 kHz.
-65 dB (0.056%) or 38 μ V, 50 kHz to 100 kHz.

Impedance: 600 Ω $\pm 1\%$ or 50 Ω $\pm 2\%$, Front panel switchable. (Not HP-IB programmable.)

Sweep mode: log sweep with up to 500 points per decade or 255 points total between entered start and stop frequencies.

HP 8903B and HP 8903E Analyzer Specifications

Distortion

Fundamental frequency range: 20 Hz to 100 kHz.

Display range: 0.001% to 100% (-99.99 to 0 dB).

Accuracy: ± 1 dB, 20 Hz to 20 kHz; ± 2 dB, 20 kHz to 100 kHz.

Input voltage range: 50 mV to 300V.

Residual distortion and noise (the higher of):

80 kHz BW: -80 dB (0.01%) or 15 μ V, 20 Hz to 20 kHz.

500 kHz BW: -70 dB (0.032%) or 45 μ V, 20 Hz to 50 kHz.

-65 dB (0.056%) or 45 μ V, 50 kHz to 100 kHz.

3 dB measurement bandwidth: 10 Hz to 500 kHz.

Detection: true rms or rms calibrated average.

Displayed resolution: 0.0001%, for <0.1% distortion; 0.001%, 0.1% to 3% distortion; 0.01%, 3% to 30% distortion; 0.1%, >30% distortion.

Sinad

Fundamental frequency range: 20 Hz to 100 kHz.

Display range: 0 to 99.99 dB.

Residual distortion and noise: same as listed under Distortion.

Accuracy: ± 1 dB, 20 Hz to 20 kHz; ± 2 dB, 20 kHz to 100 kHz.

Input voltage range: 50 mV to 300V.

Detection: true rms or rms-calibrated average.

Resolution: HP 8903B: 0.01 dB for SINAD ratios >25 dB. For ratios <25 dB the display is rounded to the nearest 0.5 dB to reduce digit flickering of noisy signals (full resolution is available via special function 16.1). HP 8903E: powers up with special function 16.1 active for 0.01 dB resolution at all SINAD ratios.

Analog meter (HP 8903B only): Active in SINAD mode and for SINAD ratios ≤ 18 dB (≤ 24 dB using special function 7.1).

Tuning: HP 8903B: notch filter is tuned to the internal source frequency. HP 8903E: notch filter is tuned to the counted input frequency. Notch filter hold function available on front panel.

AC Level

Full range display: 300.0V, 30.00V, 3.000V, .3000V, 30.00 mV, 3.000 mV, 0.3000 mV.

Overrange: 33%, except on 300V range.

Accuracy: $\pm 2\%$, 50 mV to 300V, 20 Hz to 20 kHz; $\pm 4\%$, 0.3 mV to 50 mV, 20 Hz to 100 kHz; $\pm 4\%$, 50 mV to 300V, 20 kHz to 100 kHz.

AC converter: true-rms responding for signals with crest factor up to 3 and rms-calibrated average detection.

3 dB measurement bandwidth: >500 kHz.

DC Level

Full range display: 300.0V, 48.00V, 16.00V, 4.000V.

Overrange: 33%, except on 300V range.

Accuracy: $\pm 1.0\%$ of reading, 600 mV to 300V.
 ± 6 mV, $V_{in} < 600$ mV.

Frequency Measurement

Measurement range: 20 Hz to 150 kHz. (20 Hz to 100 kHz in distortion and SINAD modes.)

Resolution: 5 digits (0.01 Hz for input frequencies <100 Hz).

Accuracy: $\pm (0.004\% + 1 \text{ digit})$.

Sensitivity: 50 mV in distortion and SINAD modes, 5.0 mV in ac level and signal-to-noise (HP 8903B only) modes.

Counting technique: reciprocal with 2 MHz timebase.



Standard Audio Filters

30 kHz Low-Pass Filter

3 dB cutoff frequency: 30 kHz \pm 2 kHz.

Rolloff: third-order Butterworth; 18 dB/octave or 60 dB/decade.

80 kHz Low-Pass Filter

3 dB cutoff frequency: 80 kHz \pm 4 kHz.

Rolloff: third-order Butterworth; 18 dB/octave or 60 dB/decade.

Plug-in Audio Filters (optional)

400 Hz High-Pass Filter

3 dB cutoff frequency: 400 Hz \pm 40 Hz.

Rolloff: seventh-order Butterworth; 42 dB/octave or 140 dB/decade.

CCITT Weighting Filter (CCITT rec. P53)

Deviation from ideal response: \pm 0.2 dB at 800 Hz; \pm 1.0 dB, 300 Hz to 3 kHz; \pm 2.0 dB, 50 Hz to 3.5 kHz; \pm 3.0 dB, 3.5 kHz to 5 kHz.

CCIR Weighting Filter (CCIR rec. 468-2)

Deviation from ideal response: \pm 0.1 dB at 6.3 kHz; \pm 0.2 dB, 6.3 kHz to 7.1 kHz; \pm 0.4 dB, 7.1 kHz to 10 kHz; \pm 0.5 dB, 200 Hz to 6.3 kHz; \pm 1.0 dB, 31.5 Hz to 200 Hz, 10 kHz to 20 kHz; \pm 2.0 dB, 20 kHz to 31.5 kHz.

C-Message Weighting Filter (Per BSTM 41004)

Deviation from ideal response: \pm 0.1 dB at 1 kHz; \pm 1.0 dB, 60 Hz to 5 kHz.

CCIR/ARM Weighting Filter (CCIR rec. 468-2, average-responding meter, Dolby Labs bulletin No. 19/4)

Deviation from ideal response: same as listed under CCIR Filter.

"A" Weighting Filter (IEC rec. 179 and ANSI S1.4)

Deviation from ideal response: \pm 0.1 dB at 1 kHz; \pm 0.5 dB, 20 Hz to 10 kHz; \pm 1.0 dB, 10 kHz to 20 kHz.

Front/Rear-Panel Outputs

Recorder outputs (HP 8903B only):

X-axis: 0-10 Vdc corresponding to log of oscillator frequency. Output resistance 1 k Ω .

Y-axis: 0-10 Vdc corresponding to displayed value and entered plot limits. Output resistance 1 k Ω .

Pen lift: TTL output.

Monitor output: In ac level mode provides a scaled output of the input signal. In SINAD, distortion, and distortion-level modes provides scaled output of input signal with the fundamental removed.

Analyzer Input

Input type: Balanced (full differential).

Input impedance: 100 k Ω \pm 1% shunted by <300 pF, each side to ground. (In dc-level mode the input resistance is 101 k Ω \pm 1%).

Max input (maximum peak input voltage, any combination of ac/dc):

HP 8903B: 425 volts peak, applied differentially or between either input to ground.

HP 8903E: 42 volts peak, Low side to ground.

425 volts peak, differentially or High side to ground.

CMRR: >60 dB, 20 Hz to 1 kHz, V_{in} <2V; >45 dB, 20 Hz to 1 kHz; >30 dB, 20 Hz to 20 kHz.

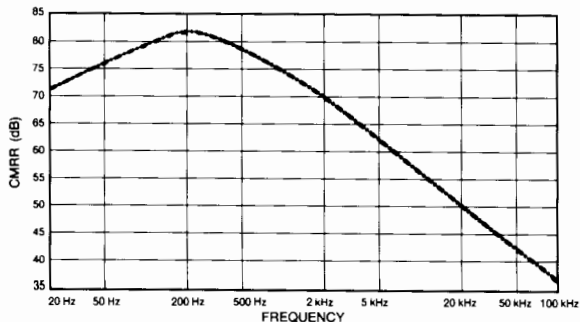

Typical CMRR from 20 Hz to 100 kHz with input voltage of 6 volts.

General

Temperature: operating, 0°C to 55°C; storage, -55°C to 75°C.

Remote operation: HP-IB, all functions except line switch, low-terminal ground switches, source output-impedance switch (HP 8903B only), and the X10 and \div 10 increment keys (HP 8903B only), are remotely controllable. The HP 8903E has many special functions which can only be accessed via HP-IB commands.

HP-IB compatibility: SH1, AH1, T5, TE0, L3, LE0, SR1, RL1, PP0, DC1, DTI, C0, E1.

Power: 100, 120, 220, or 240V (+5, -10%); 48-66 Hz. 100 or 120V +5, -10%); 48-440 Hz. 100 VA maximum.

Weight: HP 8903B: net 12.3 kg (27 lb.); shipping 16.4 kg (36 lb.) HP 8903E: net 11.8 kg (26 lb.); shipping 15.9 kg (35 lb.)

Dimensions: 146 mm H x 425 mm W x 462 mm D. (5.75 x 16.8 x 18.2 in.)

HP system II size: 5/4 H x 1 MW x 17 D.

EMI: conducted and radiated interference is within the requirement of methods CE03 and RE02 of MIL STD 461B and FTZ 526/527.

Conducted and radiated susceptibility: meets the requirements of methods CS01, CS02, and RS03 (1 V/m) of MIL STD 461B dated 1980.

Ordering Information

Analyzer Mainframes

HP 8903B Audio Analyzer

\$5800.00

Option 001: moves OUTPUT and INPUT

add \$100.00

connectors to rear panel

Option 915: add service manual

add \$34.00

Option 910: extra operating and service manual

add \$50.00

HP 8903E Distortion Analyzer

\$3900.00

Option 001: moves OUTPUT and INPUT

add \$200.00

connectors to rear panel

Option 915: add service manual

add \$34.00

Option 910: extra operating and service manual

add \$35.00

Options for both HP 8903B and HP 8903E

Option 010 or 050: 400 Hz High-Pass filter

add \$200.00

Option 011 or 051: CCITT Weighting filter

add \$200.00

Option 012 or 052: CCIR Weighting filter

add \$200.00

Option 013 or 053: C-Message Weighting filter

add \$200.00

Option 014 or 054: CCIR/ARM Weighting filter

add \$200.00

Option 015 or 055: "A" Weighting filter

add \$200.00

Option 907: front panel handle kit

add \$55.00

Option 908: rack mounting flange kit

add \$32.50

Option 909: front panel handle plus rack flange kit

add \$80.00

SIGNAL ANALYZERS

Distortion Measurement Set

Model 339A

- Ultra low distortion measurements
- Built-in low distortion oscillator
- Automatic
- True RMS detection

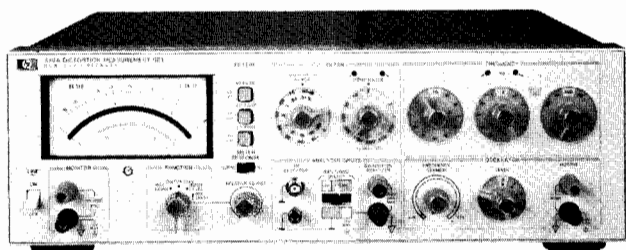

HP 339A

Description

Hewlett-Packard's Model 339A Distortion Measurement Set is an ultra low distortion measuring system complete with total harmonic distortion (THD) analyzer, true-rms voltmeter, and sinewave oscillator. This small, lightweight bench measurement set allows you to make THD distortion measurements as low as 0.0018% over a 10 Hz to 110 kHz frequency band including harmonics to 330 kHz.

For fast and easy THD measurements the built-in tracking oscillator in HP's 339A saves test time because you tune one instrument instead of two. Frequency and level measurements are easy to do with HP's 339A's voltmeter, which offers you a 1 mV to 300 V measurement range. The Relative Level mode has been included to further simplify frequency response measurements. Just set a 0 dBm reference at any frequency from 10 Hz to 110 kHz. Gain measurements can be read directly from the easy-to-read meter.

Operation Simplicity

Automatic frequency tuning and set-level features allow you to make rapid, error free THD measurements. The HP 339A's built-in tracking oscillator eliminates the need to find the fundamental frequency and tune the analyzer for a null. Just select your oscillator frequency and the rest is automatic. Automatic set-level saves time by automatically setting 0 dB (100%) reference in the distortion measuring mode. Front panel directional indicators light when the input range setting is improper insuring accurate and repeatable measurements. Automatic set-level also greatly simplifies measurements where distortion as a function of level (SINAD¹, for example) is desired. Without this feature, measurements are very time consuming and tedious.

When an external stimulus is used, analyzer tuning is simplified by directional indicator lights for reaching the fundamental null quickly and easily.

¹SINAD is a sensitivity measurement computed from the ratio of signal plus noise and distortion to noise and distortion.

Specifications

Distortion

Fundamental frequency range: 10 Hz to 110 kHz continuous frequency coverage in 4 decade ranges with 2-digit resolution. Distortion analyzer and oscillator are simultaneously tuned.

Distortion measurement range: 0.01% full scale to 100% full scale (-80 dB to 0 dB) in 9 ranges.

Detection and meter indication: true rms detection for waveforms with crest factor ≤ 3 . Meter reads dB and % THD (Total Harmonic Distortion). Meter response can be changed from NORMAL to VU ballistics with a front panel switch.

Distortion Measurement Accuracy

- 20 Hz to 20 kHz: ± 1 dB
- 10 Hz to 50 kHz: +1, -2 dB
- 50 kHz to 110 kHz: +1.5, -4 dB

Note: the above specifications apply for harmonics ≤ 330 kHz.

Fundamental Rejection (3 V scale or above)

- 10 Hz to 20 kHz: > 100 dB
- 20 kHz to 50 kHz: > 90 dB
- 50 kHz to 110 kHz: > 83 dB

Distortion Introduced by Instrument (input > 1V rms)

- 10 Hz to 10 kHz: < -95 dB (0.0018%) THD
- 10 kHz to 20 kHz: < -92 dB (0.0035%) THD
- 20 kHz to 30 kHz: < -90 dB (0.0056%) THD
- 30 kHz to 50 kHz: < -85 dB (0.01%) THD
- 50 kHz to 110 kHz: < -70 dB (0.032%) THD

Residual noise (fundamental frequency settings < 20 kHz, 80 kHz filter IN, source resistance ≤ 1 k Ω shielded): < -92 dB referenced to 1V.

Input level for distortion measurements: 30 mV to 300 V rms (100 mV range minimum).

Input impedance: 100 k Ω \pm 1% shunted by < 100 pF input High to Low.

Monitor: provides scaled presentation of input signal after fundamental is removed for further analysis using oscilloscope or low frequency spectrum analyzer. Output voltage: 1V rms \pm 5% open circuit for full scale meter indication, proportional to meter deflection. Output resistance: 1k Ω \pm 5%.

Auto set level: no set level adjustment required. Distortion measurements are made directly over 10 dB range selected by input range switch. Two LED annunciators provide a fast visual indication to change input range for valid distortion measurement. Correct range is indicated when both annunciators are extinguished.

Automatic fine tuning: using internal oscillator: No separate analyzer tuning necessary when using internal oscillator as signal source. Oscillator frequency controls simultaneously tune the analyzer. Using external frequency source: Two LED annunciators provide a quick visual indication for the operator to increase or decrease the frequency. When the analyzer is rough tuned to within one least significant digit of the fundamental frequency, the indicator lights are extinguished and the HP 339A auto-null circuitry takes over to provide a fast, accurate null without tedious operator tuning.

Input filters (usable on all functions): low pass: 30 kHz -3 dB point at 30 kHz, + 2.6 kHz, -3 kHz with 60 dB/decade rolloff. Provides band limiting required by FCC for proof-of-performance broadcast testing. 80 kHz -3 dB point at 80 kHz, + 7 kHz, -7.9 kHz with 60 dB/decade rolloff. Normally used with fundamental frequencies < 20 kHz to reduce the effect of higher frequency noise present in the measured signal. High Pass: 400 Hz -3 dB point at 400 Hz, + 35 Hz, -40 Hz with 60 dB/decade rolloff. Normally used with fundamental frequencies > 1 kHz to reduce the effect of hum components in the input signal.

DC isolation: input low may be connected to chassis ground or floated to 30 V to reduce the effects of ground loops on the measurement.

Relative Input Level Mode

Provides a ratio measurement relative to an operator selected reference level with readout directly in dBV or dBm (600 Ω). Voltage range, frequency range, accuracy specifications, and monitor are the same as in Voltmeter mode. (Accuracy is relative to 0 dB set level input.)

Oscillator

Frequency range: 10 Hz to 100 kHz in 4 overlapping decade ranges with 2 digit resolution. Frequency vernier provides continuous frequency tuning between 2nd digit switch settings.

Output level: variable from < 1 mV to > 3 V rms into 600 Ω with 10 dB/step Level control and > 10 dB Vernier adjustment. OSC Level position on function switch allows a quick check of oscillator level without disconnecting leads to device under test. Off position on Oscillator Level control provides fast signal-to-noise measurement capability. Oscillator output terminals remain terminated in 600Ω.

Frequency accuracy: ± 2% of selected frequency (with Frequency Vernier in Cal position).

Level flatness: 20 Hz to 20 kHz: ≤ ± 0.1 dB
10 Hz to 110 kHz: ≤ ± 0.2 dB

Distortion (≥ 600Ω load, ≤ 3V output)

10 Hz to 20 kHz: < -93 dB (0.0022%) THD
20 kHz to 30 kHz: < -85 dB (0.0056%) THD
30 kHz to 50 kHz: < -80 dB (0.01%) THD
50 kHz to 80 kHz: < -70 dB (0.032%) THD
80 kHz to 110 kHz: < -65 dB (0.056%) THD

Output resistance: 600Ω ± 5%

Voltmeter

Voltage range: 1 mV rms full scale to 300 V rms full scale (-60 dB to + 50 dB full scale, meter calibrated in dBV and dBm into 600Ω).

Detection and meter indication: true rms detection for waveforms with crest factor ≤ 3. Meter reads true rms volts, dBm into 600Ω, and dBV.

Accuracy (% of range setting)

20 Hz to 20 kHz: ± 2%

10 Hz to 110 kHz: ± 4%

Frequency range: 10 Hz to 110 kHz.

Input impedance: 100 kΩ ± 1% shunted by < 100 pF between input High to Low.

Monitor: provides scaled presentation of input signal for further analysis using oscilloscope or low frequency spectrum analyzer. Output voltage: 1V rms ± 5% open circuit for full scale meter indication, proportional to meter deflection. Output resistance: 1 kΩ ± 5%.

Option 001

Voltage range: 0.1 mV rms full scale to 300 V rms full scale (-80 dBV to +50 dBV full scale); (.1 mV and .3 mV ranges—external source resistance must be < 10 kΩ.)

Accuracy: 1 mV to 300 V Ranges

20 Hz to 20 kHz ±2%

10 Hz to 110 kHz

.1 mV and .3 mV Ranges

20 Hz to 20 kHz: ±2%

10 Hz to 30 kHz: ±4%

30 kHz to 80 kHz: +10/-30%

Noise Floor (600Ω source impedance)

30 kHz filter < 6 μV

80 kHz filter < 8 μV

AM Detector

Frequency range: carrier frequencies: 550 kHz to 1.6 MHz. Modulation frequencies: 20 Hz to 20 kHz.

Distortion introduced by AM detector (with 30 kHz filter switched IN): up to 85% Modulation: < -36 dB (1.6%) THD
85% to 95% Modulation: < -30 dB (3%) THD

Input level: maximum: 60V peak. Modulation signal level: 2V rms minimum; 10V rms maximum.

Monitor (with modulated RF carrier applied to AM detector input).

Distortion mode: provides scaled presentation of demodulated input signal after fundamental is removed.

Voltmeter and relative input mode: provides scaled presentation of demodulated input signal. Output voltage and output resistance are the same as in Distortion mode.

General

Power: 100/120/220/240 V + 5%, - 10% 48 Hz to 66 Hz line operation, 200 mA maximum.

Size: 146 mm H x 426 mm W x 375 mm D (5.75" x 16.75" x 14.75").

Weight: net 8.2 kg (18 lb). Shipping 11.3 kg (25 lb).

HP 339A Distortion Measurement Set \$3,600
Option 001 add \$275

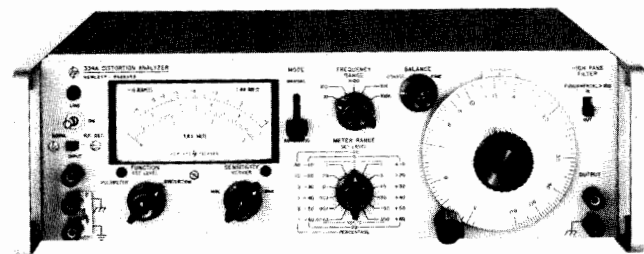

HP 334A

Description

Hewlett-Packard's model HP 334A Distortion Analyzer measures total distortion down to 0.1% full scale at any fundamental frequency between 5 Hz and 600 kHz; harmonics are indicated up to 3 MHz. Noise levels as low as 25 microvolts can be measured. The HP 334A includes automatic fundamental nulling and amplitude modulation detector. A Meter with VU ballistic characteristics and a 30 kHz low pass filter are optional.

HP 334A Specifications

Input level for distortion measurements: 0.3 V rms for 100% set level or 0.245 V for 0 dB set level (up to 300 V may be attenuated to set level reference).

Harmonic Measurement Accuracy (full scale)

Fundamental Input Less Than 30 V

Range	±3%	±6%	±12%
100%-0.3%	10 Hz-1 MHz	10 Hz-3 MHz	
0.1%	30 Hz-300 kHz	20 Hz-500 kHz	10 Hz-1.2 MHz

Fundamental rejection: > 80 dB

Residual distortion: > -70 dB (0.03%) from 5 Hz to 200 kHz; > -64 dB (0.06%) from 200 kHz to 600 kHz. Meter indication is proportional to average value of a sine wave.

Frequency calibration accuracy: better than ±5% from 5 Hz to 300 kHz. Better than ±10% from 300 to 600 kHz.

Input impedance: distortion mode: 1 MΩ ± 5% shunted by < 70 pF.

DC isolation: signal ground may be ±400 V dc from external chassis
Voltmeter range: 300 μV to 300 V rms full scale (13 ranges) 10 dB per range. Average responding calibrated in rms.

Noise measurements: voltmeter residual noise on the 300 μV range: < 25 μV rms, when terminated in 600 (shielded) ohms.

Output: 0.1 ± 0.01 V rms open circuit.

Output impedance: 2 kΩ

Automatic nulling mode: set level: at least 0.2 V rms

Frequency ranges: X1, manual null tuned to less than 3% set level: total frequency hold-in ±0.5% about true manual null. X10 through X10k, manual null tuned to less than 10% of set level; total frequency hold-in ±1% about true manual null.

Automatic null accuracy: 5 Hz to 100 Hz: meter reading within 0 to +3 dB of manual null. 100 Hz to 600 kHz: meter reading within 0 to +1.5 dB of manual null.

High pass filter: 3 dB point at 400 Hz with 18 dB per octave roll off.

AM detector: 550 kHz to 65 MHz; 40 Vp-p max input.

Distortion introduced by detector: carrier frequency: 550 kHz-1.6 MHz: < 50 dB (0.3%) for 3-8 V rms carriers modulated 30%. 1.6 MHz-65 MHz: < 40 dB (1%) for 3-8 V rms carriers modulated 30%.

General

Power: 115 or 230 V ±10%. 48 to 66 Hz.

Size: 426 mm W x 126 mm H x 337 mm D (16.75" x 5" x 13.25").

Weight: net 7.89 kg (17.75 lb). Shipping 10.35 kg (23 lb).

	Price
HP 334A Distortion Analyzer	\$3,100
Opt 001 VU Characteristics	\$25
Opt 002 30 kHz low pass filter	\$125
Opt 003 (combined 001 and 002)	\$150



SIGNAL ANALYZERS

15 Hz to 50 kHz Wave Analyzer

Model 3581A

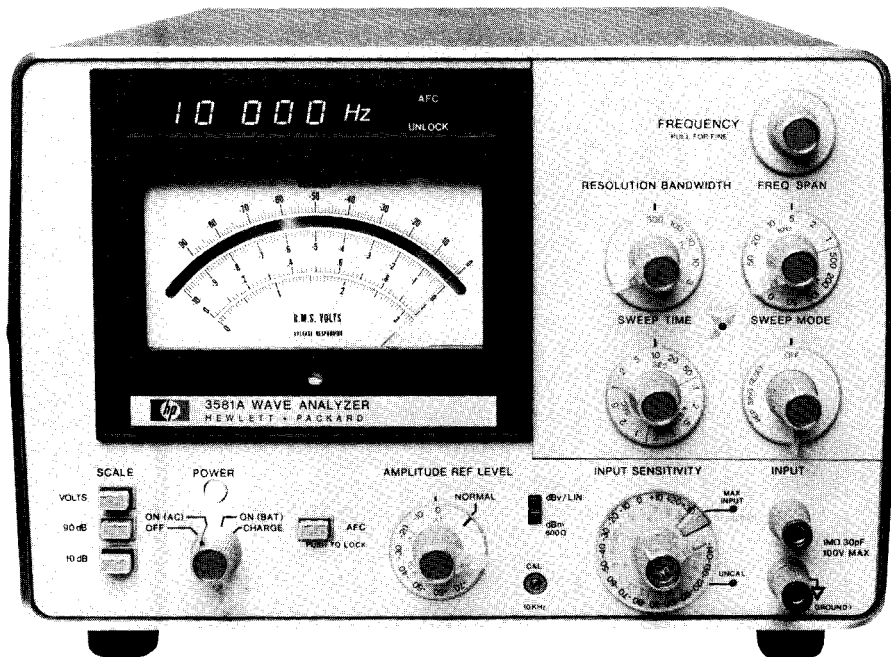

HP 3581A

Description

Hewlett-Packard's 3581A Wave Analyzer resolves and measures the amplitude and frequency of spectral components. This instrument offers accurate amplitude and good frequency resolution in the form of a portable, easy-to-use measuring tool. Since not all signals originate from a stable frequency source, the HP 3581A incorporates an AFC circuit which locks to a drifting signal for stable, accurate measurements.

The HP 3581A has other important features that are necessary when making measurements of small voltages from transducers and harmonic signals. Its 30 nV sensitivity becomes important for these measurements. Battery operation can be used to reduce the line related interference common in low level measurements so only the real spectrum is measured.

Digital readout of tuned frequency is located above the analog meter. It has been grouped with the meter for ease of reading. Resolution of the digital readout is 1 Hz for any frequency between 15 Hz and 50 kHz. Readout is updated five times per second so delay between tuning and reading is minimized.

Four meter scales are used to provide a wide range of displays. Two scales are used for linear voltage readings. Two log scales provide either a 90 dB or 10 dB display. In any case, the large meter with its mirror backing can present readings in dBV, dBm or volts. A meter was specifically chosen for amplitude display rather than digital readout because it is easier to peak a meter reading and because it's much easier to get a feel for noise or other amplitude variations by watching the meter. The same voltage used to drive the meter is also available on the rear panel for driving X-Y recorders.

Specifications

Frequency Characteristics

Range: 15 Hz to 50 kHz.

Display: 5 digit LED readout.

Resolution: 1Hz.

Accuracy: ± 3 Hz., 0 to 55°C.

Typical stability: ± 10 Hz/hour after 1 hour and ± 5 Hz/°C.

Automatic frequency control (AFC) hold-in range: ± 800 Hz.

Amplitude Characteristics

Instrument Range

Linear: 30 V to 100 nV full scale.

Log: +30 dBm or dBV to -150 dBm or dBV.

Amplitude Accuracy

Frequency response,
15 Hz-50 kHz

Log

± 0.4 dB

Linear

$\pm 4\%$

Dynamic range: >80 dB.

Noise sidebands: greater than 70 dB below CW signal. 10 bandwidths away from signal.

Spurious responses: >80 dB below input reference level.

Sweep Characteristics

Scan width: 50 Hz to 50 kHz, adjustable in a 1-2-5 sequence from 50 Hz to the full frequency range.

Sweep error light: this LED indicates a sweep that is too fast to capture full response. When the light is on, response will be lower than it should be.

External trigger: a short to ground stops the normal sweep. Opening the short then enables a sweep.

Input Characteristics

Impedance: 1 M Ω , 30 pF.

Maximum input level: 100 V rms, ± 100 V dc.

Output Characteristics

Tracking generator output: (also known as BFO or tracking oscillator output).

Range: 0 to >1 V rms into 600 Ω .

Frequency response: $\pm 3\%$ 15 Hz to 50 kHz.

X-Y Recorder Analog Outputs

Vertical: 0 to +5 V $\pm 2.5\%$.

Horizontal: 0 to +5 V $\pm 2.5\%$.

Impedance: 1 k Ω .

Recommended Accessory: HP 7090A Measurement Plotting System.

Pen lift: contact closure to ground during sweep.

Restored output: acts as a narrow band amplifier.

General

Power requirements: 100 V, 120 V, 220 V, or 240 V +5% -10%, 48 Hz to 440 Hz, 10 VA typical.

Size: 412.8 mm H x 203.2 mm W x 285.8 mm D (16 $\frac{1}{4}$ " x 8" x 11 $\frac{1}{4}$ ").

Weight: 11.5 kg (23 lb). Opt 001: 13.5 kg (30 lb).

Options

HP 3581A Wave Analyzer

001: Internal battery 12 hours from full charge. Internal battery is protected from deep discharge by an automatic turnoff. Useful battery life is over 100 cycles.

003: Rack Mount

910: Extra set manuals

Price

\$6,000

add \$700

\$330

add \$35

TRANSCIVER TEST EQUIPMENT

Automated Test Systems

Models 8953A, 8955A, 8957S

725

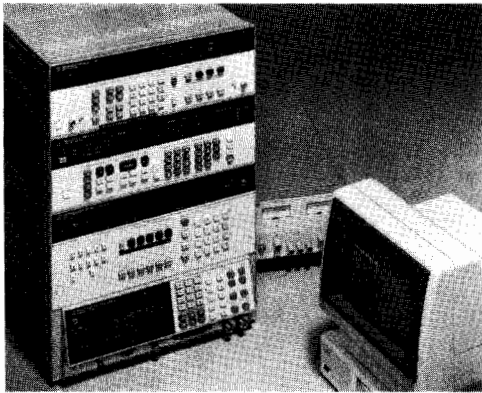

Transceiver Test Systems

Hewlett-Packard's transceiver test systems are flexible combinations of instrumentation and software for automatically testing radio transmitters and receivers. This approach to transceiver test gives you comprehensive, expandable solutions for a wide range of applications. You can choose the right combination of hardware and software to fit your needs today and in the future.

Simplifies Workflow

The diagram below illustrates a typical workflow using manual test equipment. In this case, a technician must manually test each radio and repair it if there is a problem. Then, he checks the radio again to verify that the fault was corrected. Because these tests are tedious and time-consuming, often only a cursory check is performed. The second diagram illustrates the effect of an automatic test system. This system quickly and completely tests the radio. If a fault is found, the technician makes the necessary repairs and the system verifies proper operation. Often, the system finds that an incoming radio is operating properly, saving the technician valuable time.

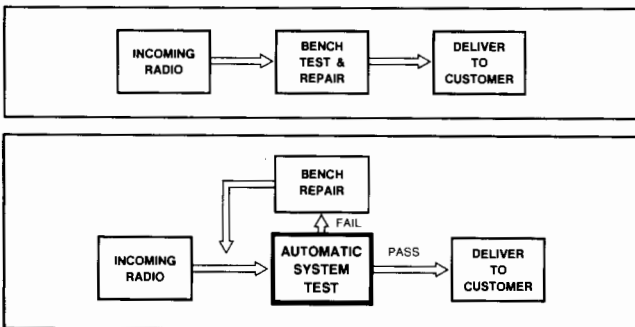

Ensures Quality

An automatic test system can make a thorough test of every radio, helping to find latent problems. An HP Transceiver Test System lets you make more measurements at more data points in less time than with manual testing. And it follows the same procedure every time, eliminating operator errors while maintaining consistent testing.

Improves Productivity

You can save time with an automatic test system. It frees highly skilled technicians for more productive work and allows for expansion to meet the growing demand for mobile radio products and services. Because they perform the tedious and repetitive tasks, automatic test systems help to increase job satisfaction as well.

Automated Transceiver Test

Hewlett-Packard's transceiver test product line was designed to offer maximum flexibility, modularity, and expandability to the mobile communication market. All systems consist of three basic measurement instruments which were designed with transceiver test in mind: the HP 8656B Synthesized Signal Generator, the HP 8903B Audio Analyzer, and the HP 8901A/B Modulation Analyzer. In addition, HP transceiver test systems incorporate a programmable system interface to provide flexible system integration. Three interfaces are

available to meet the wide range of measurement needs. These systems can then be automated using one of the many software packages available for the HP 85, Series 200 and Series 300 computers.

Based on the three basic measurement instruments and the system interface product line, Hewlett-Packard has developed three separate test systems:

HP 8953A

The HP 8953A Transceiver Test Set performs automatic and manual testing of AM, FM and SSB receivers and transmitters. It combines the measurement power of the three basic measurement instruments with the HP 8954A Transceiver Interface and all necessary cabling.

Ordering Information

	Price
HP 8953A Transceiver Test System (consisting of:)	\$28,500
HP 8901A Modulation Analyzer	
Option 001 rear panel connections	
Option 002 high stability time base	
HP 8656B Synthesized Signal Generator	
Option 002 rear panel connections	
HP 8903B Audio Analyzer	
Option 001 rear panel connections	
Option 010 400 Hz high pass filter	
Option 051 CCITT weighting filter	
HP 8954A Transceiver Interface	
HP 8498A Option 030 attenuator, 25 watt, 30 dB cables	

HP 8955A

The HP 8955A RF Test System utilizes the power of the HP 8956A System Interface for increased flexibility and adds the HP 436A Power Meter to increase power measurement accuracy. The system offers a variety of instrumentation options designed to accommodate all levels of AM, FM, and SSB testing. All instruments are mounted in a cabinet and a table is mounted off one side.

Ordering Information

	Price
HP 8955A RF Test System (consisting of:)	\$52,350
HP 8901A Modulation Analyzer	
Option 001 rear panel connections	
Option 002 high stability time base	
HP 8656B Synthesized Signal Generator	
Option 002 rear panel connections	
HP 8903B Audio Analyzer	
Option 001 rear panel connections	
Option 010 400 Hz high pass filter	
Option 051 CCITT weighting filter	
HP 8956A System Interface	
HP 436A Power Meter	
HP 8482A Power Sensor	
Cabinet	
Cables	

HP 8957S

The HP 8957S Cellular Radio Test System combines the three basic measurement instruments with the HP 8958A Cellular Radio Interface. This system will perform all signaling necessary to test AMPS and TACS compatible cellular radios.

Ordering Information

	Price
HP 8957S Cellular Radio Test System	N/C
(consisting of:)	
HP 8901B Modulation Analyzer	\$13,000
Option 001 rear panel connections	\$200
Option 002 high stability time base	\$650
HP 8656B Synthesized Signal Generator	\$6,500
Option 002 rear panel connections	\$175
HP 8903B Audio Analyzer	\$5,800
Option 001 rear panel connections	\$100
Option 010 400 Hz high pass filter	\$200
Option 051 CCITT weighting filter or	\$200
Option 053 C-message weighting filter	\$200
HP 8958A Cellular Radio Interface	\$11,000
HP 6024A Power Supply	\$1,300
HP 11804A Accessory Kit	\$2,400

TRANSCIVER TEST EQUIPMENT

System Software



System Software

An integral part of Hewlett-Packard's Transceiver Test product line is the wide variety of software application packages available. Designed to meet your testing needs, these packages offer a broad spectrum of solutions ranging from basic in-channel measurements to full radio characterization. With test times typically measured in seconds, these packages will quickly and accurately measure your transceiver's performance.

Simple Low-Priced Solution

The HP 11723B application program is Hewlett-Packard's lowest-priced solution for automatically testing radios. Designed to run on the HP 85B controller, the software offers a single program that performs the most common tests on AM and FM receivers and transmitters. The HP 11723B offers a solution to the testing needs of many small service repair facilities and users of land mobile communications equipment. All measurement routines are derived from the EIA-AM, EIA-FM and CEPT standards.

Testing your radios with the HP 11723B software is simplified with a single path execution sequence and helpful screen prompts. The test results are printed in a concise format which includes an audio frequency response plot. The software is written in BASIC language and can be customized to your application, adding tests and features you need.

Expandable Starter Software

The HP 11790A/B application packages were designed to meet the testing needs of small service repair facilities and users of land mobile communications equipment. Each software package includes three separate programs capable of performing most in-channel AM and FM test routines. The software is written in BASIC language, creating an excellent solution that is easily customized. All test routines are derived from the EIA-AM, EIA-FM and CEPT standards.

Using the HP 11790A/B to test radios is simplified with a single path execution sequence and helpful screen prompts. The test results are printed in an easy-to-read format which includes audio frequency response plots. Written in BASIC language, it can be easily customized to most applications.

Comprehensive Radio Characterization

The HP 11791A application package is an extensive, comprehensive software package for automatically testing AM and FM receivers and transmitters. Providing over 60 measurement routines and 37 separate hardware options, the software is capable of fully characterizing your receivers and transmitters. The HP 11791A meets the demanding requirements found in quality assurance, type testing and research and development applications. All measurement routines are derived from EIA-AM, EIA-FM and CEPT standards.

Using the HP 11791A application package, you create your own test packages with an automatic program generator (AUTOGEN). AUTOGEN pulls the tests you choose together into a test package and customizes each in a special Query mode. Also included in the HP 11791A application package is a special hardware verification utility. This utility performs interconnection verification checks and instrument level functional checks, giving the user added confidence that the system is properly interconnected and fully operational.

Exceptional Flexibility and Expandability

The HP 11805A application package represents a new standard in flexibility, modularity, and ease of use. The software consists of a main executive program coupled with a series of measurement test packages. With this format, you only purchase the measurement capability you need, with the ability to expand with full compatibility at a later date. This new approach to software development allows the HP 11805A to fit into any testing environment, dependent only on the measurement capability purchased. For specialized applications, the software is written in BASIC language and can be modified easily.

The HP 11805A can test multiple channel radios, and has the ability to encode and decode Continuous Tone Controlled Squelch (CTCSS) and Digital Coded Squelch (DCS) tones automatically. In addition, the test packages allow you to perform all tests on all channels, selected prime channels, or to select any test/channel combination you desire.

Pass/Fail limit testing allows you to quickly verify your radio's performance. Optimized for speed and repeatability, the HP 11805A increases productivity and efficiency. With the optional bar code reader, radio parameters can be entered in seconds and stored on disc for future use. In addition, a manual mode allows you to manually control test instrument settings through the computer without leaving the program. Clear instructions, easy-to-read graphics and helpful program prompts guide you through every step of the program.

Utility programs are also among the powerful capabilities of the HP 11805A software package. The System Interconnection Verification program is designed to insure that all instruments are connected properly and are responding to the computer controller. The System Calibration program accounts for all path losses from the radio through the interface. These path losses are then accounted for in the measurement test routines, increasing the accuracy and repeatability of the test results.

AMPS/TACS Cellular Radio Software

The HP 11797A cellular radio test software provides the comprehensive RF and signaling tests required to test cellular radios to the Advanced Mobile Phone Service (AMPS) and Total Access Communications System (TACS) specifications. For incoming inspection, quality control, and final test applications, the software performs complete over-the-air testing.

A flexible operating system allows you to select and run the measurement routines you want, in the order you want. These routines include call processing functions such as origination, origination re-order, paging, handoffs and error detection/correction (using three of five voting and BCH parity coding). The results are then displayed in a concise format with Pass/Fail limits, allowing you to quickly verify your radio's performance. THE HP 11797A will fully test a cellular radio in eight to nine minutes.

Ordering Information

HP 11723B Software Application Pac	\$100
HP 11790A Software Application Pac	\$250
HP 11790B Software Application Pac	\$350
HP 11805A Software Application Pac	
Option 001 Operating System Executive	\$1500
Option 100 North American FM Tests	\$500
Option 200 European ØM Tests	\$500
Option 400 SSB-SC Tests	\$750
HP 11791A Software Application Pac	\$5000
HP 11797A Software Application Pac	\$1000
HP 11798A Software Application Pac	\$1100

Both 3.5 in. and 5.25 in. disc mediums are shipped with each application package.

NMT Cellular Radio Software

The HP 11798A software package provides the comprehensive RF and signaling tests required for "over the air" testing of cellular mobile radios conforming to the 450 and 900 MHz standards of the Nordic Mobile Telephone system (NMT DOC.3.). With user-written software, the system is also capable of simulating a mobile station for base station signaling tests.



HP Model No.s	HP 11805A Options						11797A	11798A
	11723B	11790A/B	11791A	100	200	400		
Type	AM FM	AM FM	AM FM	ØM	FM	SSB-SC	AMPS TACS	NMT
Controllers	85F	216 226 236 310/320	216 236 310/320	216 236 310/320	216 236 310/320	216 236 310/320	216 236 310/320	216 236 310/320
BASIC	80 Series	3.0 4.0	4.0	4.0	4.0	4.0	3.0 4.0	3.0 4.0
Memory	32k	750k	1.25M	1.25M	1.25M	1.25M	1.0M	1.0M
Interfaces 8954A 8956A 8958A 8954A-H03 11799A	X	X (11790A) X (11790B)	X	X X X X	X X X X	X X X	X	X X X
Limit Testing	NO	NO	NO	Pass/ Fail	Pass/ Fail	Pass/ Fail	Pass/ Fail	Pass/ Fail
Out of Channel Tests	LMTD	LMTD	YES	LMTD	LMTD	LMTD	YES	LMTD
Ability to Select Tests	NO	NO	YES	YES	YES	YES	YES	YES
Measure Squelch	CTCSS	CTCSS	CTCSS	CTCSS DCS	CTCSS DCS		N/A	N/A
Generate Squelch	CTCSS	CTCSS	NO	CTCSS DCS	CTCSS DCS	NO	N/A	N/A
Bar Code Reader	NO	NO	NO	YES	YES	YES	NO	NO



TRANSCIVER TEST EQUIPMENT

RF Interfaces

Models 8954A, 8956A

HP 8954A

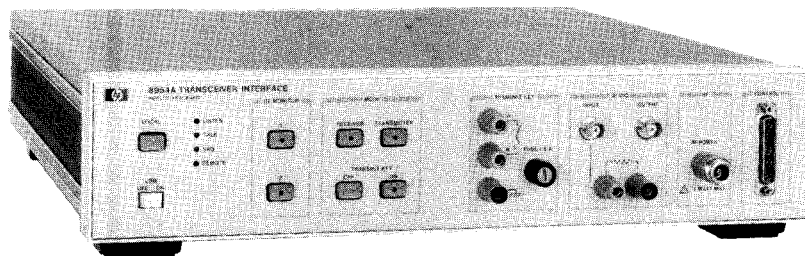

HP 8956A

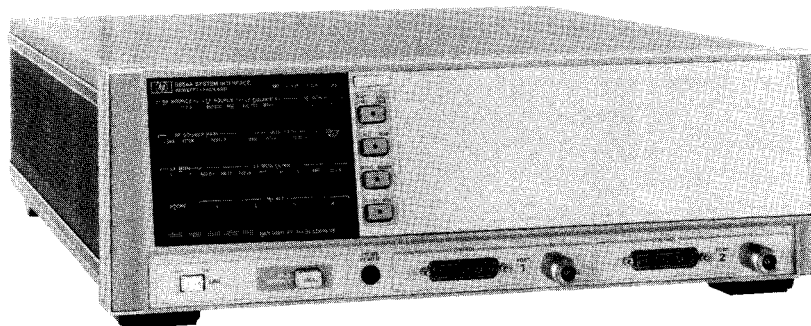

HP 8954A Transceiver Interface

The HP 8954A is Hewlett-Packard's lowest priced transceiver test interface. With this interface, signals can be routed between the measurement instruments and the transceiver under test. It is fully programmable and uses microwave switches and hardware in all RF paths. Designed for dc to 18 GHz measurements, the HP 8954A maintains low RF insertion loss and SWR.

The HP 8954A interface has connections that can integrate up to two RF signal sources, two RF monitors, an audio source, and an audio analyzer. You can also route a power supply's output through the interface to the front-panel transceiver control connector. External devices may be controlled with the HP 8954A's sixteen programmable Form A contact relays.

Using the annunciator front panel keys, you can manually control the Receive/Transmit signal path, select either RF monitor, or key the transmitter. The HP 8954A Transceiver Interface provides the flexibility needed for most AM, FM and SSB receiver and transmitter testing.

HP 8954A-H03 Transceiver Interface

The HP 8954A Option H03 Transceiver Interface is a full-duplex version of the standard HP 8954A. The standard RF switching hardware is replaced with a power divider network, adding the capability to test duplex radios. The HP 8954A-H03 can also be used with the HP 11799A Signaling Unit for testing NMT (Nordic Mobile Telephone) cellular radios.

HP 8954A Specifications

RF frequency range: 100 kHz to 1300 MHz (usable dc to 18 GHz).

VSWR (RF Port to RF Monitor): 1.15.

VSWR (RF Source to RF Port): 1.15.

RF insertion loss (RF Port to RF Monitor): 0.5 dB.

RF insertion loss (RF Source to RF Port): 6.0 dB + 0.45 dB - 0.35 dB.

Audio frequency range: 20 Hz to 100 kHz (dc coupled).

Audio insertion loss: 0.03 dB, 20 Hz to 20 kHz; 0.3 dB, 20 kHz to 100 kHz.

HP 8954A-H03 Specifications

RF frequency range: 10 MHz to 1500 MHz

VSWR: 1.5

RF insertion loss:

RF Port to RF Monitor 1: 25 dB

RF Port to RF Monitor 2: 34 dB

RF Source to RF Port: 34 dB

Ordering Information

HP 8954A Transceiver Interface

HP 8954A-H03 Transceiver Interface

Price

\$3,700

4,570

HP 8956A System Interface

The HP 8956A System Interface, with its multiple paths and connections, provides flexibility in the designing of systems in the frequency range from dc to 1000 MHz. It can integrate up to three RF signal sources, three RF monitors, two audio sources, two audio analyzers and a dc power supply.

A front panel keyboard simplifies control of all switching operations, making it a valuable component in system integration. The ability to Store and Recall front panel settings gives extra versatility in manual operation.

The HP 8956A System Interface has two RF test ports for duplex testing, stimulus/response testing or for connect/unconnect of one radio while another is being tested. Next to each RF port is a control connector that contains all the audio and power signals for simplifying test connections.

Additional functions of the HP 8956A include current drain and timing measurements.

HP 8956A Specifications

Frequency range: dc to 1000 MHz.

Maximum input power to RF ports

With the 30 dB attenuator: 120W CW;

Without the 30 dB attenuator: 0.5W CW.

VSWR

RF ports (instrument connections terminated in 50 ohms):

With the 30 dB attenuator: dc to 1000 MHz: 1.2.

Audio frequency range: dc to 100 kHz.

Ordering Information

HP 8956A System Interface

Price

\$13,000

TRANSCEIVER TEST EQUIPMENT

Cellular Interfaces

Models 8958A, 11799A

729



HP 8958A

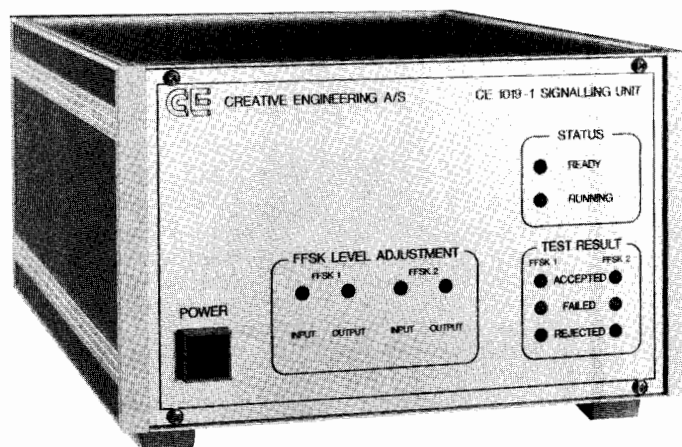

HP 11799A

HP 8958A Cellular Radio Interface

The HP 8958A Cellular Radio Interface gives your system the capability to fully test a cellular radio. With the flexible Channel Simulator, you can simulate cell-site operation, verify signaling protocol, or perform highly complex and sophisticated tests using an external controller to generate and analyze data content.

The HP 8958A controls the audio and dc paths between the test instrumentation and the radio. Functions include audio source and analyzer paths, dc power to the radio, access to the audio test points in the AMPS Test Bus Interface, and a power supply programmer.

Connections are provided for up to six RF signal sources and monitors (one of these ports is a low-SWR, controlled-loss path intended for high-accuracy power measurements). Option 002 adds a second antenna connection and RF switch for diversity testing. Option 003 provides one 4 GHz, low-loss path for conducted spurious tests.

HP 8958A Specifications

Frequency range: 10 to 1500 MHz.

Maximum input power: 20W.

VSWR:

RF Port 1: 1.2.

RF Ports 2-6: 1.5.

RCV-XMT: 1.2

Ordering Information

HP 8958A Cellular Radio Interface

Price

\$11,000

HP 11799A Signaling Unit

For testing cellular radios compatible with the 450 and 900 MHz protocols of the Nordic Mobile Telephone (NMT) system, Hewlett-Packard recommends and supplies the Creative Engineering CE1019-1 Signaling Unit. The CE1019-1 can be ordered from Hewlett-Packard as HP Model 11799A.

When used with the three basic transceiver test instruments and a duplex interface, the HP 11799A simulates a base station and mobile exchange for over-the-air RF and signaling tests of cellular mobile radios.

Ordering Information

HP 11799A Signaling Unit

Price

\$14,000

DIMENSIONAL MEASUREMENTS

Laser Position Transducer

Model 5527A

- High slew rate with high precision
- Improved reliability

- Easy system integration and programming

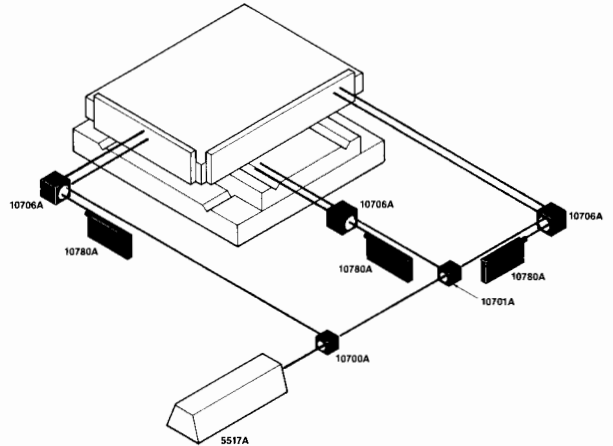
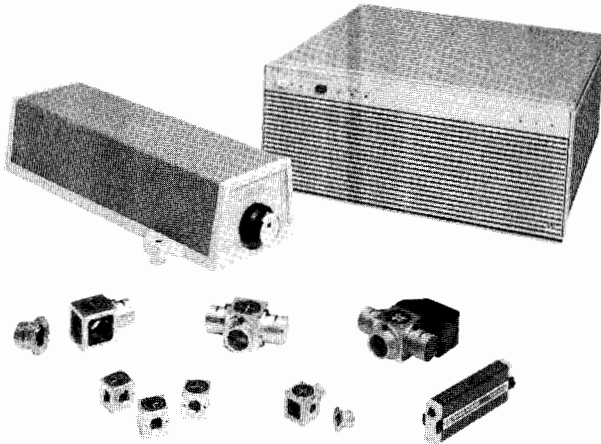

HP 5527A

Three axes X-Y stage application

HP 5527A Laser Position Transducer

The HP 5527A Laser Position Transducer is a system that measures linear displacements for improved sub-micron position measurement and control of precision equipment. It is ideal for closed-loop systems, and is also used for open-loop systems.

Combining new electronics with proven laser sources and optics, this system offers better resolution, greater measurement velocity, higher reliability, and is easier to use compared to previous systems. Applications in closed-loop feed-back systems can be found in:

- Integrated Circuit Manufacturing (wafer steppers, electron beam machines, inspection systems); and,
- Disc Manufacturing (magnetic and optical track writers).

Laser Source

The proven HP 5517A Laser Head is the source for the HP 5527A Laser Position Transducer. This laser head is accurate to better than 0.1 part per million. With a single laser head, up to four axes of motion may be monitored simultaneously.

Optics

The greatest possible flexibility for optical layout is available with four types of interferometers and their reflectors:

- HP 10702A Linear Interferometer and HP 10703A Linear Retroreflector - used in general applications;
- HP 10705A Single Beam Interferometer and the HP 10704A Single Beam Retroreflector - used where space is severely limited;
- HP 10706A Plane Mirror Interferometer - ideal for monitoring the position of an X-Y stage; and,
- HP 10715A Differential Interferometer - used in place of the HP 10706A where the most accurate positioning is required.

Both the HP 10706A Plane Mirror Interferometer and the HP 10715A Differential Interferometer are used with plane (flat) mirrors supplied by the user. Bending and splitting optics for all configurations are available.

Electronics

The all new HP 5507A Laser Position Transducer Electronics combine superior performance with greatly simplified operation. The HP 5507A takes the signal from one to four receivers and translates these into position-error information for each axis.

It does this with a resolution of 10 nm for Linear optics with 40.6 cm/s (16 in./s) slew rate and 5 nm for Plane Mirror optics 20.3 cm/s (8 in./s) slew rate.

The HP 5507A is HP-IB controlled to simplify programming, while maintaining high-speed position-error output through a 32-bit parallel bus to servo electronics. Also available is the HP 10941A Prototyping Kit on which you can build your own servo electronics that are electrically and mechanically compatible with the HP 5507A mainframe.

The HP 5507A offers a noise-free environment (RF and ground-loop noise) with an integral power supply for all the electronics. You can choose from one to four axes by ordering the HP 5507A with one to four Option 032s. You can also order Option 046 for automatic compensation with the HP 10751A Air Sensor and from one to three HP 10757A Material Temperature Sensors. When ordered with the options the entire subsystem is tested and shipped as ordered.

HP 5527A Specifications

The following is a partial list of system specifications. Please refer to the technical data sheets (02-5952-7818 & 02-5952-7819) for a complete list.

Laser: Helium-Neon. Continuous wave. Two frequency 1.0 mW output maximum.

Accuracy: ± 0.1 part per million in a vacuum.

Resolution: Linear or Single Beam optics $\lambda/64$ (10 nm or 0.4 μ in.). Plane or Differential optics $\lambda/128$ (5 nm or 0.2 μ in.).

Measurement range: ± 10.6 m (34.8 ft) per axis, closed loop.
 ± 40 m (130 ft) open loop, one axis only.

Number of axes: 4 maximum, depending on system configuration and environment.

Measurement velocity (optic dependent)

Linear or Single Beam: ± 40.6 cm/s (16 in./s).

Plane Mirror or Differential: ± 20.3 cm/s (8 in./s).

Maximum data-transfer rate (available for hardware)

32-bit parallel output position or position-error output 1.5 - 2.0 MHz. HP-IB Interface available through controller input (destination and commands) 75 - 350 Hz dependent on data format. Output (position): 80 - 1500 Hz, dependent on software and configuration.

Ordering Information

For complete ordering information, please contact your local Hewlett-Packard sales office (see page 769). System prices range from \$16,000 to \$50,000.

DIMENSIONAL MEASUREMENTS

Laser Transducer and Laser Measurement Systems

Models 5501A, 5528A

731



- Proven reliability
- High precision measurements

- Lowers production costs
- Improves production and parts quality

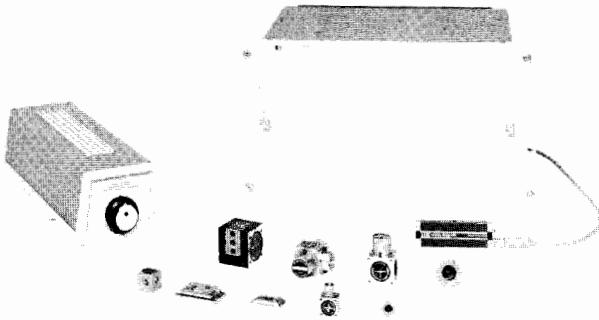

HP 5501A

HP 5501A Laser Transducer System

The HP 5501A Laser Transducer System is a linear-displacement measuring system that delivers the accuracy of laser interferometry to builders and users of precision-positioning equipment. Applications can be found in precision machining and precision measuring equipment as well as other applications that use on-the-fly readout.

Laser Source and Optics

You have a choice of two laser heads (the HP 5517A or the HP 5501B) and the same four interferometers that the HP 5507A offers (the HP 10702A Linear Interferometer, HP 10705A Single Beam Interferometer, the HP 10706A Plane Mirror Interferometer, and the HP 10715A Differential Interferometer).

Electronics

All signal processing and interfacing to a controller are performed by a series of printed-circuit boards which are housed in the HP 10740A Coupler. You can choose plug-ins for from one to four axes to get English/Metric output to an industrial controller (which you supply). These plug-ins are the HP 10760A Counter, HP 10761A Multiplier and the HP 10763A English/Metric Pulse Output. Compensation for air-density changes are provided by the HP 10756A Manual Compensator or the HP 5501A Automatic Compensator.

HP 5501A Specifications

The following is a partial list of system specifications. Please refer to the technical data sheets (02-5952-7751, 02-5952-7749, & 02-5952-7754) for a complete list.

Laser: Helium-Neon. Continuous wave. Two frequency. 1.0 mW output maximum.

Accuracy: ± 0.5 part per million in a vacuum.

Resolution: From $0.16 \mu\text{m}$ ($6.0 \mu\text{in.}$) to $0.005 \mu\text{m}$ ($0.2 \mu\text{in.}$), depending on electronics and optics being used.

Measurement range: 40 m (130 ft) maximum, depending on system configuration and environment for sum of all axes for multi-axis system.

Axes: 4 max., depending on system configuration and environment.

Measurement velocity: 18.3 m/min (720 in./min) maximum. The maximum measurement velocity depends on resolution extension and optics being used.

Maximum data-transfer rate: 700 Hz - 300 kHz, depending on number of axes, type of electronics and type of controller used.

Power: HP 6331F Power Supply is recommended for all configurations of the HP 5501A Laser Transducer System.

Ordering Information

For complete ordering information, please contact your local Hewlett-Packard sales office (see page 769).

System prices range from \$15,000 to \$45,000.

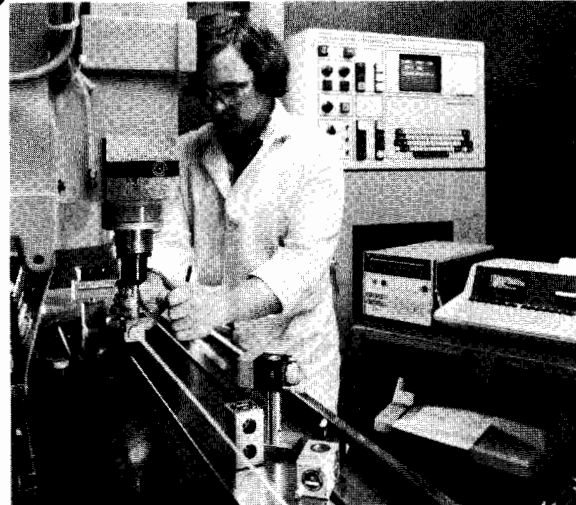

HP 5528A

HP 5528A Laser Measurement System

The HP 5528A Laser Measurement System fundamentally measures distance with resolutions up to $0.01 \mu\text{m}$ ($1.0 \mu\text{in.}$) - over distances up to 40 m (130 ft). The same basic principles are used to measure pitch, yaw, flatness, straightness, squareness, parallelism, and velocity to calibrate machine tools as well as other equipment such as printed-circuit board drilling machines.

Modular Design

The basic system consists of the HP 5508A Measurement Display, the HP 5518A Laser Head and the HP 10753A Laser Tripod. Optical components and their mounting fixtures are available in five convenient kits:

- HP 55280A Linear Measurement Kit (distance and velocity);
- HP 55281A Angular Optics Kit (pitch and yaw);
- HP 55282A Flatness Accessory Kit (flatness);
- HP 55283A Straightness Measurement Kit (straightness and parallelism); and
- HP 10777A Optical Square (squareness).

Also available are the HP 10751A Air Sensor and the HP 10757A Material Temperature Sensor for automatic compensation of position data for wavelength errors due to changes in air density and error due to changes in material length, respectively. Also available is the HP 55288S Dimensional Metrology Analysis System for the collection, analysis, and graphic presentation of data collected from the HP 5528S system. The HP 55288S includes software and the HP 85B Computer with appropriate interfaces and plug-ins.

HP 5528A Specifications

The following specifications are for distance measurement at 15 - 25 degrees Celsius. Please refer to the technical data sheet (02-5952-7864) for complete specifications.

Accuracy: ± 0.1 part per million in a vacuum.

± 1.7 parts per million using the HP 10751A Air Sensor.

Resolution: $0.01 \mu\text{m}$ ($1.0 \mu\text{in.}$).

Measurement range: 40 m (130 ft).

Measurement velocity: 18.3 m/min (720 in./min) maximum.

Display update rate: 40/s nominal.

Power: 100, 120, 220, 240 V ac (+5%, -10%), 48-66 Hz, 175 VA max.

Ordering Information

For complete specifications and ordering information, please contact your local Hewlett-Packard sales office (see page 769).

System prices range from \$17,500 to 49,500.



PRESSURE & TEMPERATURE

Quartz Pressure Probe, Quartz Pressure Set, & Pressure Signal Processor

Models 2813C/D, 2816A

- 0.001 psi resolution (6.9 Pa)
- High performance

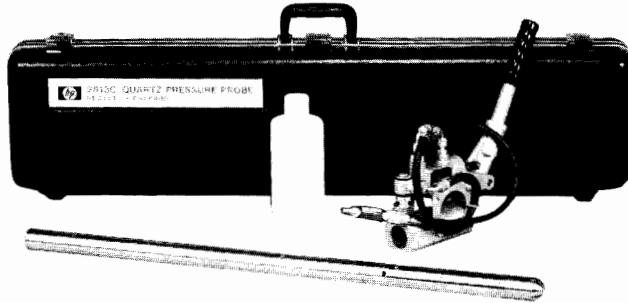

HP 2813C Quartz Pressure Probe

HP 2813C/D Quartz Pressure Probe and Pressure Set

The quartz technology that Hewlett-Packard first introduced to the oil- and gas-well industry in 1970 is still the standard for pressure measurement applications requiring extremely high accuracy, resolution and repeatability. These features, combined with its rugged construction, make the probe ideally suited for petroleum applications, oceanographic research and subterranean hydrodynamic studies.

High Precision, Resolution and Repeatability

Capable of sensing wellbore pressure changes as small as 0.001 psi, the probe's measurements can be instantly observed and recorded on the surface. With an accuracy better than ± 1.0 psi and $\pm 0.01\%$ of the pressure reading, the HP 2813C/D gives you confidence in the precision of your measurements. Also, with a repeatability of 0.4 psi over the full calibrated pressure range (200 - 11,000 psia) at constant temperature, you can be confident that changes in successive measurements are due to changes in the well, not probe measurement error.

Advanced Calibration Procedures

Advanced calibration procedures also contribute to the probe's high performance, with each probe being checked at 105 discrete calibration points over its full operating pressure and temperature range. The calibration data is processed by computer to yield coefficients of an equation that describe the relationship between frequency output, applied pressure and temperature.

Faster Thermal Restabilization

Based on the earlier Model HP 2813B, the HP 2813C thermally restabilizes two to five times faster than the HP 2813B. This improvement, due to a redesigned mechanical package, shortens costly test time.

Higher Temperature Range

Improvements in the sensor crystal's processing have increased the probe's temperature range from 302°F to 350°F.

Rugged and Reliable

Though a precision instrument, the HP 2813C is rugged and reliable in an oil field environment. Housed in a 1 $\frac{7}{16}$ inch OD case made of 17-4PH stainless steel, the probe can withstand pressures of up to 12,000 psia and temperatures of up to 350°F.

Easy to Use and Service

The simplicity of the HP 2813C's mechanical design makes it easy to use and service in the field.

Quick Factory Service

Your probe receives immediate attention when we receive it. An exchange set of the reference crystal, sensor crystal and electronics pc board is available, reducing repair time to one week. Standard recalibrations and repairs take four weeks or less.

- Rugged and reliable
- Simple operation



HP 2813D Quartz Pressure Set

Adapt to Your Own Instrumentation System

The reference crystal, sensor crystal and electronics pc board are available as matched components in the HP 2813D Quartz Pressure Set. This enables designing the essential pressure-measuring components of the HP 2813C into your own downhole instrumentation package.

How It Works

The essential pressure-measuring components of the HP 2813C Quartz Pressure Probe are its sensor crystal, reference crystal and electronics pc board. The sensor crystal, which is in direct fluid communication with the well, changes the frequency of its oscillations in response to pressure. The reference crystal, which is protected from applied pressure, subtracts the effects of temperature changes from the sensor crystal's frequency.

The resulting frequency is then transmitted by the electronics pc board through a center conductor, armored-electric line to an HP 2816A Signal Processor on the surface. This processor conditions the pressure-related signal to drive a frequency counter. The counter's signal can then be converted to a pressure reading when processed with the calibration data in a desktop computer.

The sensor crystal's high resolution is essentially constant and independent of operating pressure and temperature. Its stability minimizes hysteresis and zero drift, thus eliminating the need for frequent recalibration.

HP 2816A Signal Processor

Specifically designed to process the pressure-related signal from the HP 2813C/D, this processor conditions the signal to drive a frequency counter. The processed output frequency changes about 105 Hz/psi, allowing a resolution of 0.001 psi. It also supplies dc operating power to the probe through a center conductor, armored-electric line.

HP 2813C/D Specifications

Operating Environment

Calibrated pressure range: 200-11,000 psi (1,38-75,8 MPa).

Calibrated temperature range: 95-350°F (35-177°C).

Static Measurement (pressure and temperature are constant)

Accuracy: $\pm [1.0$ psi (6,9 kPa) (due to curve fit error) + 0.01% of actual pressure (due to calibration system error)].

Repeatability: ± 1.0 psi (6,9 kPa) over the entire calibrated pressure and temperature range; or, ± 0.4 psi (2,76 kPa) over the entire calibrated pressure range with temperature held to a single value.

Aging: Error due to aging of sensor and reference crystal pair is typically less than ± 0.5 psi (3,45 kPa) per year.

Temperature uncertainty error: $(\Delta T) * (0.28$ psi + 0.02% of actual pressure in psi) for temperature in degrees F.

Resolution: 0.001 psi (6,9 Pa) when sampling for 1-second.

Sensitivity: 105 Hz/psi (15,2 Hz/kPa) nominal at output of HP 2816A Signal Processor. The HP 2816A multiplies the incoming signal from the HP 2813C/D by 72 as part of the signal processing.

Non-Operating Characteristics (HP 2813C)

Outside diameter: 37 mm. (1 $\frac{7}{16}$ in.).

Length: 865 mm. (34 in.).

Weight: 5 kg (11 lb).

Static Tensile Pull Strength: 3175 kg (7,000 lb).

Steel Case Material: 17-4PH stainless steel, condition H1150.

HP 2813C Quartz Pressure Probe	\$20,900
HP 2813D Quartz Pressure Set	17,900
HP 2816A Signal Processor	2,100

PRESSURE & TEMPERATURE

Quartz Thermometer

Model 2804A

733

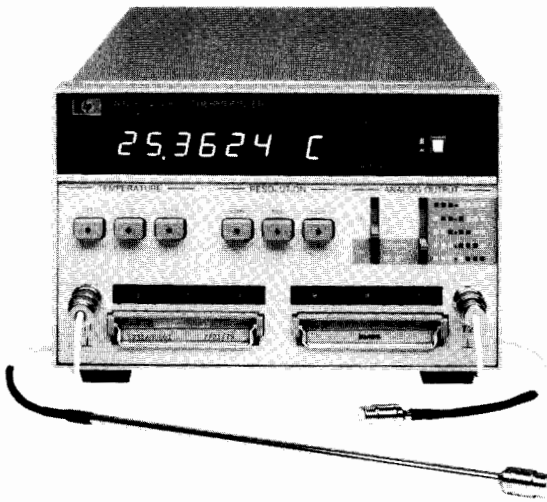

HP 2804A

- $\pm 0.04^{\circ}\text{C}$ absolute accuracy
- 0.0001°C or 0.001°F resolution
- -80° to $+250^{\circ}\text{C}$ range
- Display of absolute or differential temperature
- Flexible HP-IB system interface
- Variable resolution analog output
- Easy ice-point or triple-point adjustment



HP 2804A Quartz Thermometer

The HP 2804A Quartz Thermometer allows you to easily measure temperature with exceptionally high accuracy and resolution. Absolute accuracy is ± 40 millidegrees Celsius over the range of -50°C to 150°C , NBS traceable to IPTS-68. The useable resolution of 0.0001°C allows you to measure temperature changes that could not be detected by other digital thermometers.

The HP 2804A can be used with one or two temperature sensing probes. The temperature of either probe, or their difference, can be measured and displayed under pushbutton control. Display resolution is selectable from 0.01 to 0.0001°C (0.1 to 0.001°F) by pushbuttons. An internal switch allows you to easily select measurement in the Celsius or Fahrenheit temperature scale.

Temperature is measured and displayed automatically with the microprocessor and electronics provided in the HP 2804A package. There is no need to balance a bridge, perform calculations using resistance- or voltage-temperature tables or curves, or to use calibration correction tables. The only adjustment necessary to remove effects of thermal history on the sensor is a simple ice point or triple point calibration adjustment using the front panel thumbwheel switches.

How It Works

The HP 2804A temperature sensor is a quartz crystal whose precise angle of cut gives a stable and repeatable relationship between resonant frequency and temperature. Each quartz sensor is individually calibrated at the factory over the full temperature range. The calibration data for each sensor is processed and stored in a calibration module which is supplied with the probe.

In operation, a microprocessor in the thermometer performs the complex control and calculation operations to accurately measure temperature from the quartz sensor frequency and probe calibration information in the calibration module. The microprocessor also performs self-checks to detect fault conditions. If a problem occurs that would give an improper measurement, an error message is displayed to indicate the source of the problem.

System Oriented Design

The HP-IB (standard) offers you a simple, yet flexible, way to connect the Quartz Thermometer to either an HP computing controller or printer. Temperature data can easily be sent to a computer for processing and recording. All front-panel controls can be operated automatically by commands sent on the bus.

The analog output (standard) converts any three consecutive digits to a voltage between 0 and +10 volts to drive a chart recorder. Front-panel controls allow easy adjustment of pen zero and full scale as well as normal or offset (center-zero) operation. Any three digits can be selected for conversion, allowing you to change the full scale value on the recorder.

HP 2804A Specifications

Performance

Range: -80 to 250°C .

Absolute accuracy: HP 2804A with HP 18110A, or HP 18111A Quartz Probe —

$\pm 0.040^{\circ}\text{C}$ from -50 to 150°C

$\pm 0.075^{\circ}\text{C}$ from -80 to 250°C

NBS traceable to IPTS-68

Resolution: three levels can be selected:

Level of selection	Resolution		Nominal time between readings in seconds	
	$^{\circ}\text{C}$	$^{\circ}\text{F}$	T1 or T2	T1 - T2
Low	0.01	0.1	0.1	0.2
Medium	0.001	0.01	1	2
High	0.0001	0.001	10	20

General

Display: 7-digit LED with polarity, decimal, and degree C or F annunciator.

Probes: laboratory probes are available for use with the HP 2804A. Refer to the data sheet for specifications and sheath configurations.

Power Required

100, 120, 220, or 240 Vac, +5%–10%, 48 to 66 Hz, <30 VA.

Accessories and Probes

	Price
HP 18107A External Oscillator	\$400
HP 18110A Laboratory Probe and cal module, 25 mm (1 in.)	\$1750
HP 18111A Laboratory Probe and cal module, 230 mm (9.1 in.)	\$1750

HP 2804A Quartz Thermometer

\$4600

ANALYTICAL INSTRUMENTS FOR CHEMISTRY



HP 7690A Portable Bar-code System

Automated chemistry systems. To-date, HP automated chemistry products include the HP 7673A automated sampler and the HP 7690A portable barcode reader. Through an OEM relationship with Zymark Corporation, we are also involved in bringing robotic solutions to the analytical laboratory.

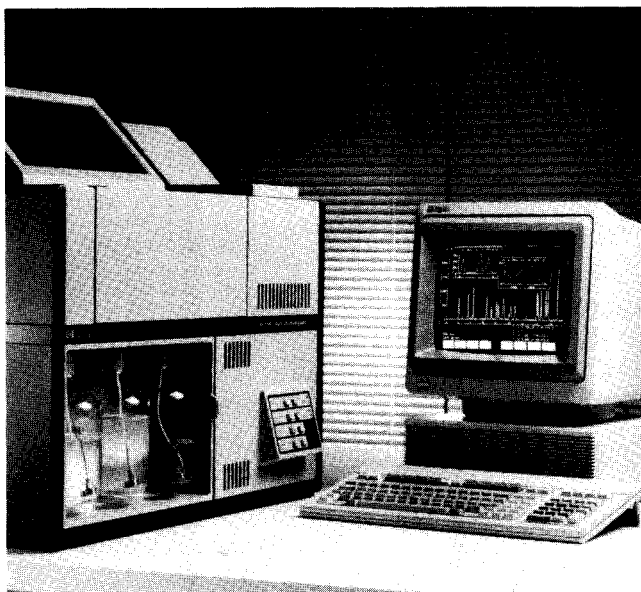

HP 1090 Series M Liquid Chromatograph with HP LC ChemStation

Liquid chromatographs. The HP 1090 family of HPLC systems splits into two major groups based on the type of system controller used. The HP 1090 Series L systems incorporate a system control panel and handle routine and high-volume analyses with ease. For more demanding applications, HP offers the HP 1090 Series M, which employs the HP LC ChemStation analytical workstation.

Increased confidence in results can be obtained by connecting a sensitive detector to an LC. LC detector options from HP include the HP 1040A diode-array detector and the HP 1046A fluorescence detector.



HP 5890A Gas Chromatograph with HP GC ChemStation

Gas chromatographs. The broad line of HP GCs includes the HP 5890A GC for routine analysis, which is fast becoming the standard of the industry. When combined with the HP GC ChemStation analytical workstation for data analysis, the HP 5890A serves as a powerful tool for research and development. Finally, the HP 5880A GC is available in a variety of configurations for special analyses, including simulated distillation and natural gas.

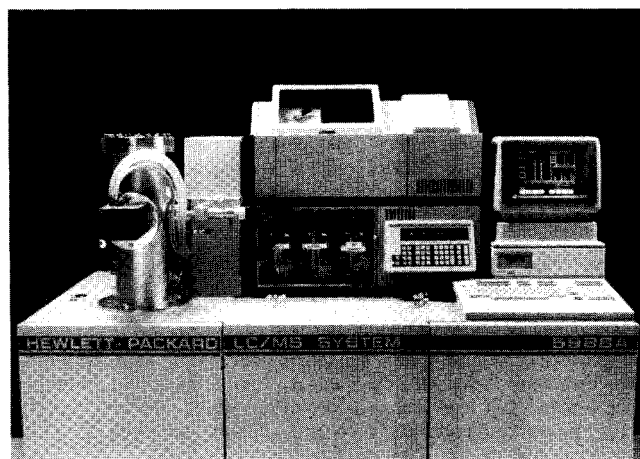

HP 5988A Thermospray LC/Mass Spectrometer

GC/MS and LC/MS. You may choose the appropriate mass spectrometer for your needs from among a number of alternatives. In each case, the HP MS ChemStation analytical workstation is available to control the system and process data.

The HP 5970B mass selective detector (MSD) allows gas chromatographers to extend their GC capabilities into the realm of GC/MS. The MSD connects to GCs from many manufacturers. For more capability, HP offers the HP 5995C benchtop GC/MS. At the top of the HP line is the research-grade HP 5988A GC/MS, also available as an LC/MS system.



HP 5965A Infrared Detector for GC/FTIR

GC/FTIR. In June 1986 HP introduced the HP 5965A infrared detector, the first and only FTIR designed and built specifically for capillary gas chromatography. The system, which includes an HP IRD ChemStation analytical workstation, allows scientists to combine data from both GC/FTIR and GC/MS for better compound identification. The IRD occupies fewer than eight linear inches of bench space and is available for a fraction of the cost of other FTIR systems that work with GC.

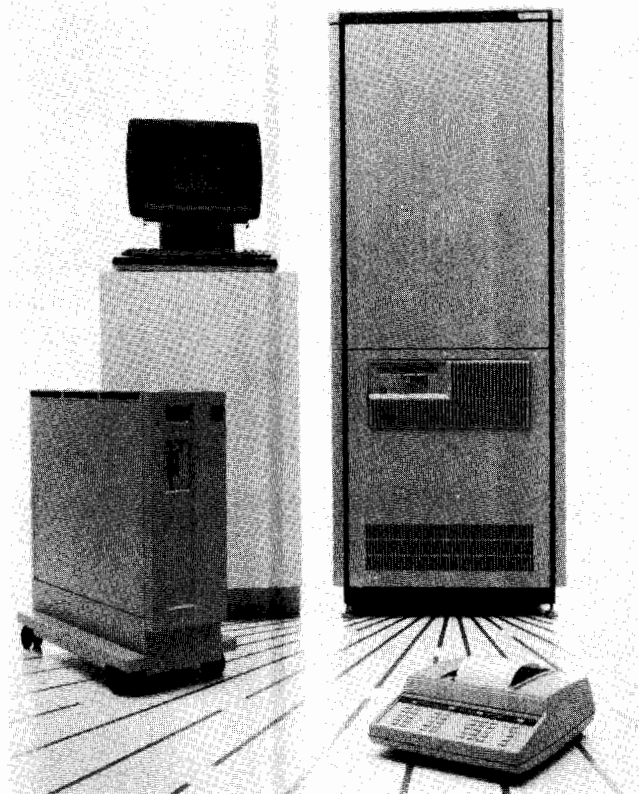

HP Lab Automation Systems

Laboratory Automation Systems. Whatever size your laboratory, HP integrators and systems for laboratory information management can help increase your productivity. The HP multi-user, multi-instrument data acquisition and laboratory information management system software products are based on the HP 1000 computer system. They provide easy-to-use, yet sophisticated data reduction and manage the flow of samples, information and materials throughout the lab. The HP family of integrators covers a wide range of capability and includes the HP 3390A reporting integrator, the HP 3392A networking integrator, and the HP 3393A computing integrator.

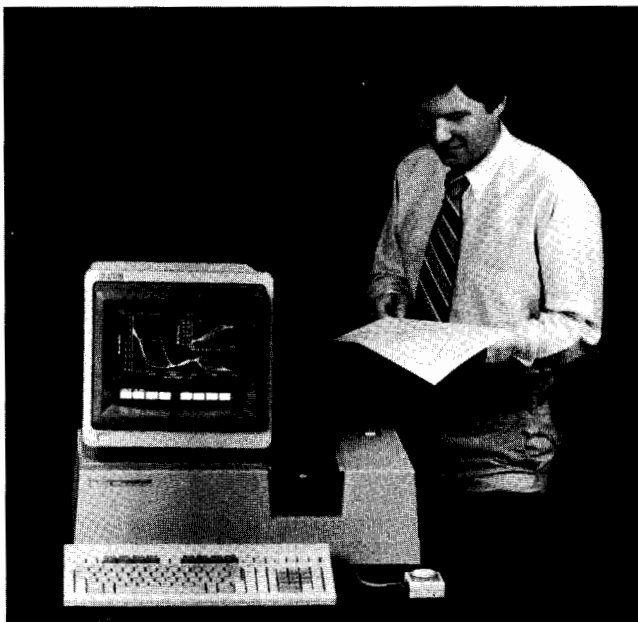

HP 8452A UV/Vis Diode-array Spectrophotometer

UV/Vis spectrophotometry. The HP 8451A UV/Vis spectrophotometer is the basis of a growing number of applications packages including simulated dissolution testing for pharmaceuticals. The HP 8452A UV/Vis spectrophotometer, which was introduced in March 1986, makes diode-array technology accessible to laboratories in industry and education where budgets are tight. The HP 8452A works with a variety of controllers, including the HP UV/Vis ChemStation analytical workstation, the HP Vectra PC, and the IBM PC, XT or AT.

For further information write to Hewlett-Packard Company, Analytical Products, 1820 Embarcadero Road, Palo Alto, CA 94303.

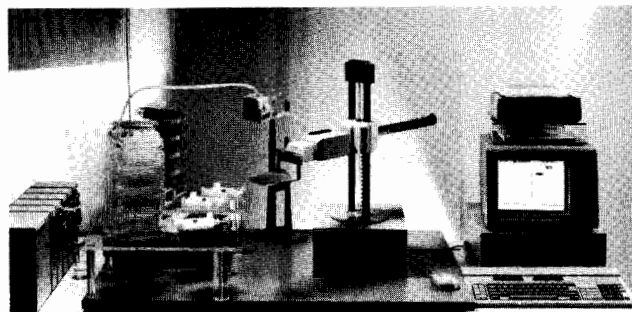

HP Genenchem Automated Microassay System

Innovative products for bioscience from HP Genenchem.

HP Genenchem's first product line is an automated microassay system that delivers reproducibility to the microassay process, a common bioscience procedure. The system employs the HP Vectra personal computer and robotic technology to provide automation from sample introduction to final report.

HP Genenchem, which is a joint venture between HP and Genentech, Inc., has also introduced a family of HPLC columns to meet the separation needs of bioscience labs.

SOLID STATE DEVICES

Components

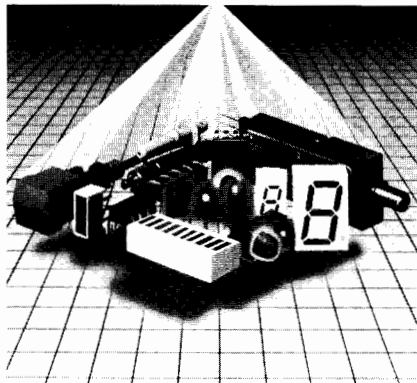

HP's Growing Optoelectronic Family

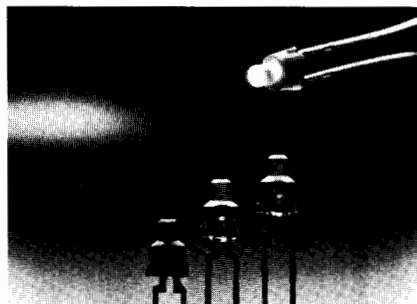

LED Lamps

LED Solid State Lamps, Light Bars & Arrays

Hewlett-Packard is a world leader in the area of LED technology, and offers a broad variety of LED indicator products available in red, high efficiency red, yellow and high performance green. Emphasizing high brightness and superior reliability, Hewlett-Packard's most recent product introductions include a family of high-performance green indicators, ultrabright LED lamps (125 mcd at 20mA), and LED bar graph arrays of 10- and 101-elements. Recent advancements in the fundamental semiconductor material have generated new areas of contribution, particularly in sunlight viewability, low power consumption, and brightness.

Solid State Displays

Hewlett-Packard offers a complete line of seven-segment displays in red, high efficiency red, yellow and high performance green and in a wide variety of package sizes. The newest member is the micro-bright display which has a 0.3-inch character height in a 0.5-inch by 0.3-inch package.

LED alphanumeric displays in monolithic and dot matrix versions are also available. Some of these rugged displays are screened and tested for use in military applications and harsh environments.

The aesthetic appearance and reliable performance of LED displays make them appropriate for use in instruments, point-of-sale,



Fiber Optic Family

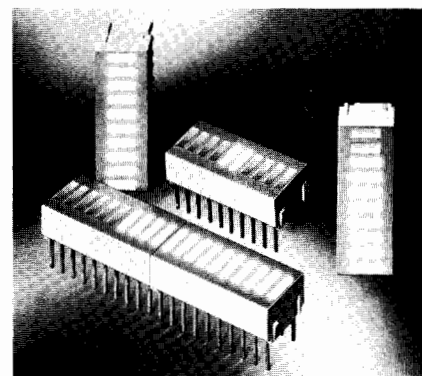

Light Bars

appliance, automobile, telephone and other high-ambient light front-panel displays.

Optocouplers

Hewlett-Packard's family of logic compatible, high-performance optocouplers provides solutions to problems caused by ground loops and induced common mode noise for both analog and digital applications in commercial, industrial and military products.

Types of optocouplers available include high-speed and high-gain devices ac/dc to logic interface optocouplers, and optocouplers which interface directly with microprocessors.

Fiber Optic Components

Hewlett-Packard offers three families of fiber optic components which include transmitters, receivers, cable, connectors and connector assembly tools.

Plastic Snap-In Link Components

Low cost and ease of use make this family of link components well-suited for applications connecting computers to terminals, printers, plotters and industrial-control equipment. These links use rugged, 1 millimetre diameter plastic fiber cable. Assembling the plastic snap-in connectors onto the cable is extremely easy. The HFBR-0500 evaluation kit contains a complete working link including transmitter, receiver, 5 metres of connected cable, extra connectors, polishing kit and technical literature.

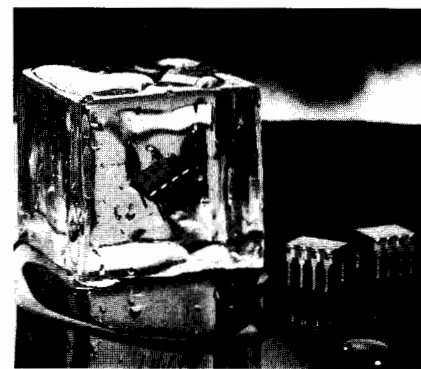

Hermetic Optocouplers

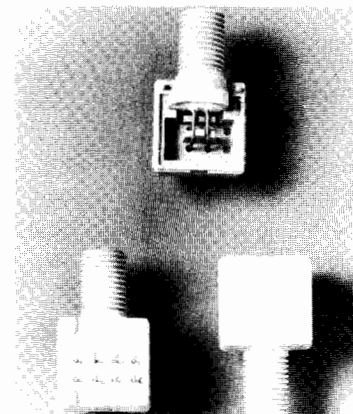

Low-Price Miniature Fiber Optic Components

Miniature Link Components

This family offers a wide range of price/performance choices for computer, industrial-control and military applications. The unique design of the lensed optical coupling system makes this family of components very reliable. The low cost miniature line (HFBR-0400 series) features a Dual-in-line package which requires no mounting hardware or receptacle for use with SMA-style connectors. The standard miniature line (HFBR-0200 series) features a precision metal package for rugged applications. Both HP-style and SMA-style connectors are available for this line. An evaluation kit is available for sampling purposes. The HFBR-0200 kit contains transmitter, receiver, 10 metres of cable and technical literature.

High Performance Modules

Transparent TTL-TTL link capability and independence from data format restrictions make this family of modules easy to use in a variety of applications. A link monitor on the receiver provides a digital indication of link continuity, independent of the presence of data. The modules are compatible with HP-style connectors and small-diameter glass fiber cable. A transmitter, receiver, 10 metres of connected cable and technical literature are contained in the HFBR-0010 evaluation kit.

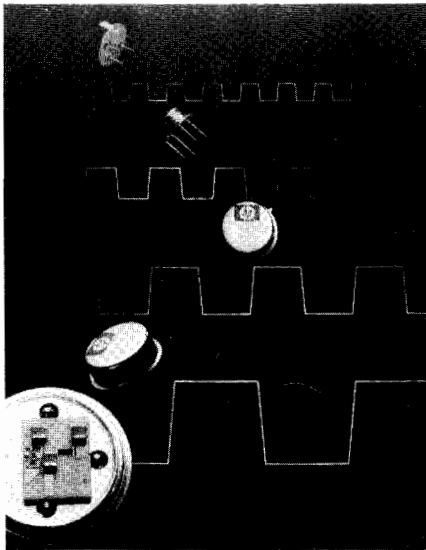

Hybrid Cascadable Amplifiers

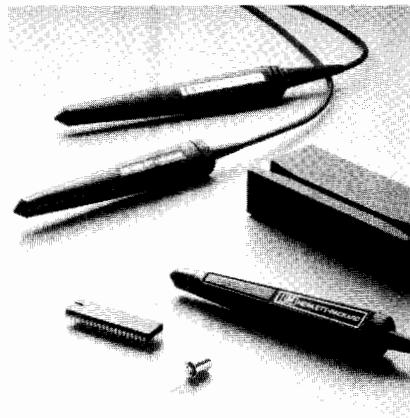

Bar Code Components

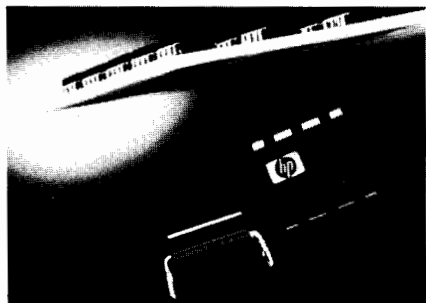

Surface Mount Optocouplers



Bipolar Transistors

Silicon Bipolar Transistors

Device-to-device uniformity and superior performance are combined in the HXTR series of microwave transistors which have been individually designed for low noise (HXTR-6000 series), high gain (HXTR-2000 series), low distortion linear power (HXTR-5000 series). With guaranteed RF performance specifications from 1000 to 4000 MHz, these devices are well suited for high-reliability, space military, and industrial applications at frequencies up to 6000 MHz.

Diodes

Schottky Barrier Diodes combine extremely high rectification efficiency with picosecond switching speeds, low series resistance, and low noise characteristics. This combination makes the Schottky an excellent mixer/detector diode.

PIN Diodes: PIN diodes function as variable resistors at microwave frequencies. By controlling the dc bias, the RF resistance of a PIN diode can be varied from 1 ohm to about 10 ohms. This property of the PIN diode

makes it extremely useful as a switch attenuator, modulator, phase shifter, limiter or AGC element at all frequencies from 1 MHz to 18 GHz and above.

Step Recovery Diodes: The step recovery diode is most graphically described as a charge-controlled switch. That is, a forward bias stores charge, a reverse bias depletes this stored charge, and when fully depleted the SRD ceases to conduct current.

Diodes for Hybrid Integrated Circuits: These circuits are used to achieve circuits with light weight, small size, operation to high frequencies, repeatable characteristics and lower end-product costs. HP offers a wide range of PIN, Schottky and SRD single diodes in beam lead and chip configurations as well as Schottky lead pair and quad diodes.

Integrated Products: Hewlett-Packard manufactures a broad line of components for the control, conversion, and generation of RF and microwave signals. This line of integrated products (combinations of chip and beam lead diodes with hybrid thin film circuit technology) includes SPST switches, absorptive

modulators, attenuators, limiters, comb generators, double-balanced mixers, and mixer/detectors.

High Reliability Testing

Many Hewlett-Packard components are space qualified. The reliability of these devices is established by one of the finest high reliability testing facilities in the microwave component industry. Hewlett-Packard's High Reliability Test Group maintains military approved JAN and JANTX parts in stock and can recommend HP standard screening programs, patterned after MIL-S-19500, for any HP component.

Write For More Information

Specifications of Hewlett-Packard's component products are available in individual data sheets or complete designer catalogs. These are available free of charge from your local HP sales office or authorized distributor, or return the Information Request Card located at the back of this catalog.

MEDICAL INSTRUMENTATION

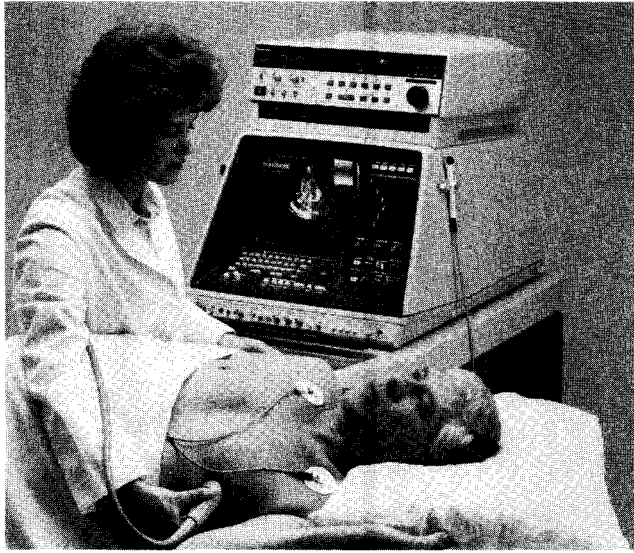

Ultrasound Imaging

- Real-time phased array systems—totally mobile
- Doppler option with advanced analysis capabilities
- Color flow mapping option
- HP 77020AC configured for the cardiologist
- HP 77020AR configured for radiology and shared services: abdominal, ob/gyn, neonatal, peripheral vascular



Cardiology Instrumentation

- New HP 4760A PageWriter Interpretive Cardiograph
- ECG Management Systems for computer-aided interpretation of electrocardiograms

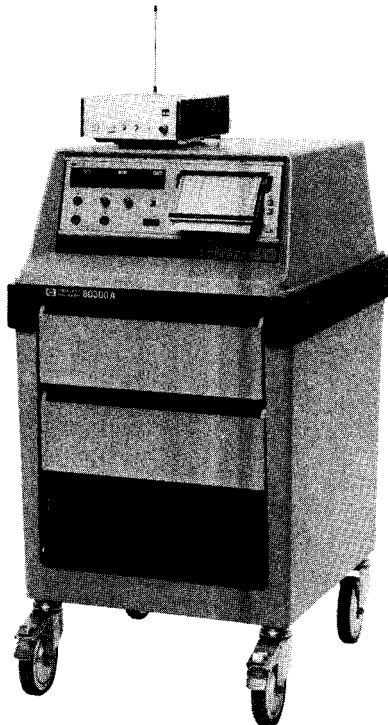

Obstetrical and Neonatal Instrumentation

- Fetal/maternal monitoring equipment includes antepartum and intrapartum fetal monitors, and central stations
- Telemetry for birthing centers
- Neonatal monitoring includes heart rate, temperature, respiration, ambient oxygen

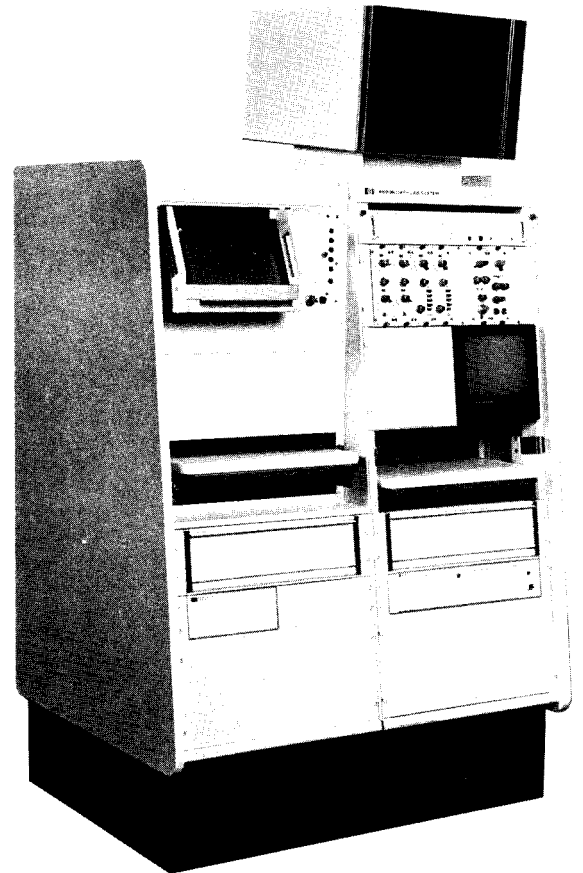

Cardiovascular Instrumentation

- Computerized catheterization data analysis system automates on-line data collection analysis
- Complete choice of plug-in signal conditioners and transducers



Arrhythmia Monitoring

- Detection and classification by algorithm
- Advanced information management capabilities
- Patient Information Centers
- Telemetry

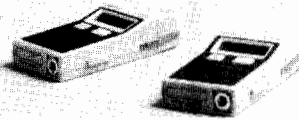
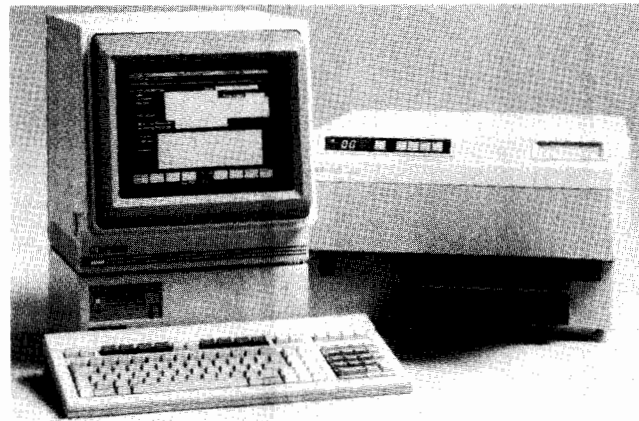

Ambulatory ECG

- True two-channel analysis and ST-segment measurement
- PC-based system includes two patient analyzers with HP LaserJet PLUS printer for reporting

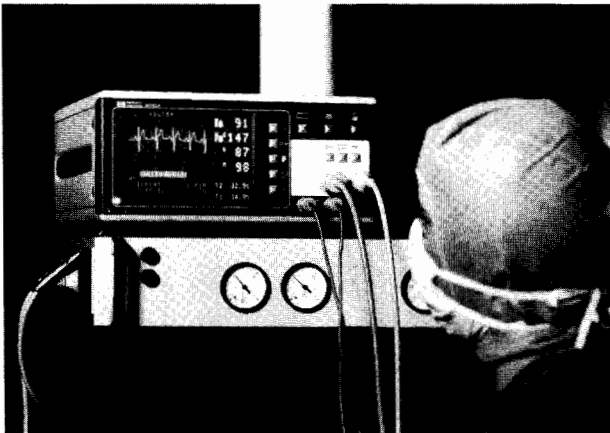

Basic Monitoring

- Compact, inexpensive bedside monitoring for surgi-center, operating room, ICU
- Four parameter combinations plus networking capability

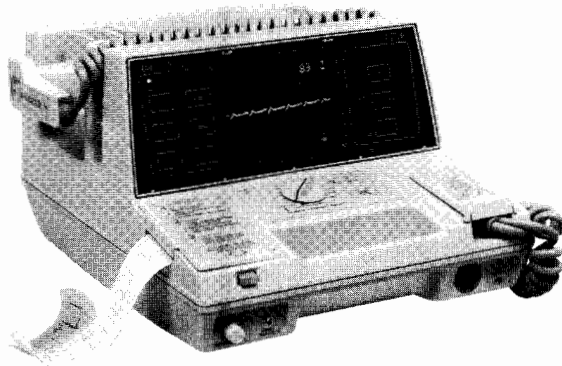

Resuscitation

- Easy to use - 3 step operation
- Lightweight - 25 lbs.; low-cost; 5-year guarantee



Patient Monitoring

- Monitor/Terminal with Overview feature
- Data management

For Additional Information on HP Medical instrumentation, request literature in one or more of the following categories:

- Patient Monitoring
 - Ultrasound Imaging
 - Cardiography Instrumentation
 - Cardiovascular Instrumentation
 - Obstetrical and Neonatal Instrumentation
 - Arrhythmia Monitoring
 - Patient Data Management
 - OR Monitoring
 - Resuscitation
 - Healthcare Information Systems
 - Healthcare Personal Computers
 - Supplies, Consumables, Pressure Transducers
- Please use request card at back of catalog.

An Invitation for you to become a subscriber to **ADVANCES FOR MEDICINE**, the Hewlett-Packard medical products magazine. To receive **ADVANCES** free of charge, simply fill in and return the request card at the back of this catalog.

CABLES & ADAPTERS

Cables, Adapters & Typical SWR Performance

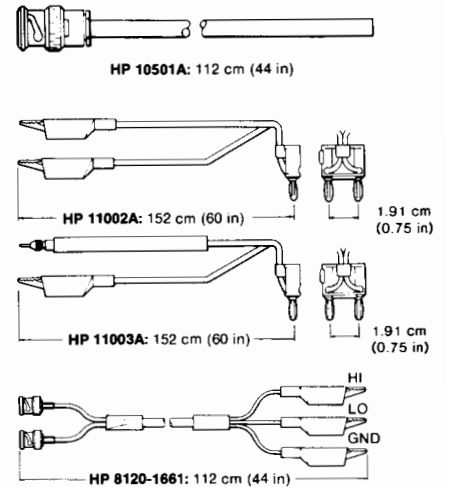
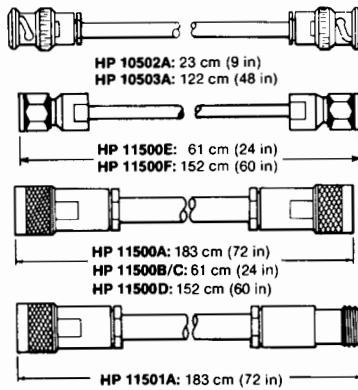
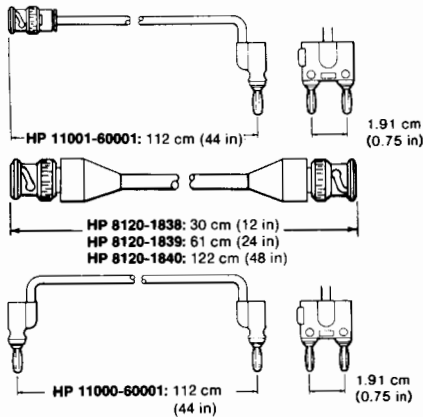

- HP 1250-0780
- HP 1250-1535
- HP 1250-1476
- HP 1250-0882
- HP 1250-1533
- HP 1250-1473
- HP 1250-0077
- HP 1250-1534
- HP 1250-1477
- HP 1250-0778
- HP 1250-1528
- HP 1250-1475
- HP 1250-0777
- HP 1250-1529
- HP 1250-1472
- HP 1250-0597
- HP 1250-1158
- HP 1250-0781
- HP 1250-0781
- HP 1250-0076
- HP 1250-1286
- HP 1250-0069
- HP 1250-0071
- HP 1250-0595
- HP 1250-1830
- HP 1250-1332
- HP 1250-0591
- HP 1250-0832
- HP 1250-1159
- HP 1250-1746
- HP 1250-1747
- HP 1250-1748
- HP 11900A
- HP 11901A
- HP 11904A
- HP 1250-1749
- HP 11900B
- HP 11901B
- HP 11904B
- HP 11900C
- HP 11901C/D
- HP 11904C/D
- HP 1250-0216
- HP 1250-1288
- HP 1250-0080
- HP 1250-1287
- HP 1250-0831
- HP 1250-1023
- HP 1250-1153
- HP 1250-1236
- HP 1250-1237
- HP 1250-1263
- HP 1250-1264
- HP 1251-2816
- HP 10110B
- HP 10111A
- HP 1251-2277
- HP 1250-1474
- HP 1250-1536
- HP 1250-1152

Coaxial Connector & Adapter Performance

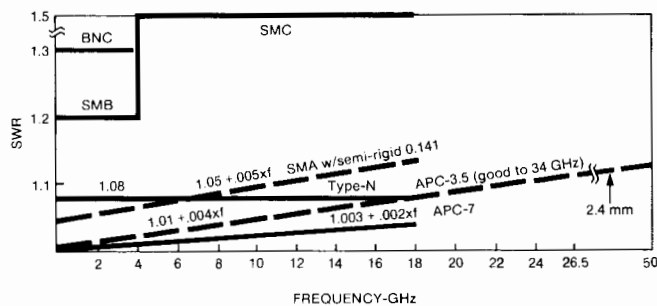

Typical SWR for connector pairs.

The performance curves in the graph will help you in choosing and applying HP cables, connectors and adapters. SWR curves show design specifications for mated pairs of connectors of the type indicated. You can expect typical performance in that range.

For cross-series adapters, use the curve with the highest SWR in each case. For applications of Tee-adapters such as HP 1250-0559, 1250-0846 and 1250-0781, be sure to consider the extra shunt capacitance of the Tee.

Of course when HP mounts various connectors onto RF and microwave products, the product specification predominates and SWR is often far superior to that shown in these utility curves. For example, the HP "precision" Type-N adapters shown on these pages are for high accuracy use dc-1.3 GHz where SWR < 1.03.

For more information on history and performance of various coax connectors, see HP's *Coaxial & Waveguide Measurement Accessories Catalog*. (Lit # 5954-6401).



HP Part Number

Cable Assemblies

HP 10501A: 112 cm 50Ω coax with one UG-88C/U BNC (m) connector

HP 10502A: 23 cm 50Ω coax with UG-88C/U BNC (m) connectors

HP 10503A: like HP 10503A, but 122 cm

HP 8120-1838: 30 cm 50Ω coax with two BNC (m) connectors

HP 8120-1839: like HP 8120-1838, but 61 cm

HP 8120-1840: like HP 8120-1838, but 122 cm

HP 11000-60001: 112 cm 50Ω coax with dual banana plugs

HP 11001-60001: 112 cm 50Ω coax, UG-88C/U BNC (m) to dual banana plug

HP 11002A Test Leads: 152 cm, alligator clips to dual banana plug

HP 11003A Test Leads: 152 cm, probe and alligator clip to dual banana plug

HP 8120-1661: 112 cm, dual BNC (m) to alligator clips

Price

\$13.00 📦

\$18.00 📦

\$20.00 📦

\$19.50 📦

\$20.00 📦

\$23.50 📦

\$29.00 📦

\$26.00 📦

\$20.00 📦

\$20.00 📦

\$90.00 📦

HP Model	Frequency Range (GHz)	Length cm (in)	Connectors	SWR	Ins. Loss (dB)	Price
11500A	dc - 18	183 (72)	N(m) (2)	—	—	\$100 📦
11500B	dc - 18	61 (24)	N(f) (2)	—	—	100 📦
11501A	dc - 18	183 (72)	N(m)-N(f)	—	—	100 📦
11500C	dc - 18	61 (24)	Precision N(m) (2)	1.4	1.5	250 📦
11500D	dc - 18	152 (60)	Precision N(m) (2)	1.4	3.0	300 📦
11500E	dc - 26.5	61 (24)	APC-3.5 (2)	1.4	2.0	400 📦
11500F	dc - 26.5	152 (60)	APC-3.5 (2)	1.4	4.0	450 📦

Adapters, 2.4 mm

(See page 563 for technical description and performance)

11900A 2.4 mm (m) to 2.4 (m) \$450.00

11900B 2.4 mm (f) to 2.4 (f) \$450.00

11900C 2.4 mm (m) to 2.4 (f) \$450.00

11901A 2.4 mm (m) to APC-3.5 (m) \$375.00

11901B 2.4 mm (f) to APC-3.5 (f) \$375.00

11901C 2.4 mm (m) to APC-3.5 (f) \$375.00

11901D 2.4 mm (f) to APC-3.5 (m) \$375.00

11902A 2.4 mm (m) to APC-7 \$325.00

11902B 2.4 mm (f) to APC-7 \$325.00

11904A 2.4 mm (m) to K (m)^[5] \$500.00

11904B 2.4 mm (f) to K (f)^[5] \$500.00

11904C 2.4 mm (m) to K (f) \$500.00

11904D 2.4 mm (f) to K (m) \$500.00

Adapters Type N, Standard 50 Ω

1250-0077 N(f) to BNC(m) \$12.00 📦

1250-0082 N(m) to BNC(m) \$13.50 📦

1250-0176 N(m) to N(f) right angle (use below 12 GHz) \$21.00 📦

1250-0559 N tee, (m)(f)(f) \$38.00 📦

1250-0777 N(f) to N(f) \$12.00 📦

1250-0778 N(m) to N(m) \$11.00 📦

1250-0780 N(m) to BNC(f) \$13.00 📦

1250-0846 N tee (f)(f)(f) \$18.50 📦

1250-1250 N(m) to SMA(f) \$35.00 📦

1250-1562 N(f) to SMA(m) \$50.00 📦

1250-1636 N(m) to SMA(m) \$125.00 📦

1250-1772 N(f) to SMA(f) \$67.50 📦

Adapters Type N, Precision 50 Ω^[1]

1250-1472 N(f) to N(f) \$33.00 📦

1250-1473 N(m) to BNC(m) \$35.00 📦

1250-1474 N(f) to BNC(f) \$23.00 📦

1250-1475 N(m) to N(m) \$52.00 📦

1250-1476 N(m) to BNC(f) \$30.00 📦

1250-1477 N(f) to BNC(m) \$29.00 📦

HP Part Number

Adapters Type N, Standard 75 Ω^[2]

1250-0597 N(m) (50Ω) to N(f)(75Ω) \$16.00 📦

1250-1528 N(m) to N(m) \$55.00 📦

1250-1529 N(f) to N(f) \$35.00 📦

1250-1533 N(m) to BNC(m) \$36.00 📦

1250-1534 N(f) to BNC(m) \$27.00 📦

1250-1535 N(m) to BNC(f) \$32.00 📦

1250-1536 N(f) to BNC(f) \$23.00 📦



Adapters APC-3.5

1250-1743 APC-3.5(m) to N(m) \$120.00 📦

1250-1744 APC-3.5(f) to N(m) \$160.00 📦

1250-1745 APC-3.5(f) to N(f) \$115.00 📦

1250-1746 APC-3.5(m) to APC-7 \$160.00 📦

1250-1747 APC-3.5(f) to APC-7 \$180.00 📦

1250-1748 APC-3.5(m) to APC-3.5(m) \$145.00 📦

1250-1749 APC-3.5(f) to APC-3.5(f) \$175.00 📦

1250-1750 APC-3.5(m) to N(f) \$135.00 📦

Adapters SMA

1250-1158 SMA(f) to SMA(f) \$18.00 📦

1250-1159 SMA(m) to SMA(m) \$16.50 📦

Adapters APC-7[®]

11524A APC-7 to N(f) \$160.00 📦

11525A APC-7 to N(m) \$160.00 📦

11533A APC-7 to SMA (m) \$225.00 📦

11534A APC-7 to SMA (f) \$225.00 📦

Adapter Banana Plug

1251-2816 Dual banana plug \$5.50 📦

Adapters BNC, Standard 50 Ω

1250-0069 BNC(m) to UHF(f) \$24.50 📦

1250-0071 BNC(f) to UHF(m) \$12.50 📦

1250-0076 Right angle BNC(UG-306/D) \$9.75 📦

1250-0080 BNC(f) to BNC(f) (UG-914/U) \$6.00 📦

1250-0216 BNC(m) to BNC(m) \$9.50 📦

1250-0591 BNC(f) to WECO Video (m) \$23.50 📦

1250-0595 BNC(f) to BNC Triaxial (m) \$15.00 📦

1250-0781 BNC tee(m)(f)(f) \$11.00 📦

1250-1263 BNC(m) to single banana plug \$16.50 📦

1250-1264 BNC(m) to dual banana plug \$27.00 📦

1250-1332 BNC (f) to TNC (m) \$38.00 📦

1250-1830 BNC (f) to BNC Triaxial (f) \$75.00 📦

1251-2277 BNC(f) to dual banana plug \$14.00 📦

10110B BNC(m) to dual banana plug \$77.00 📦

10111A BNC(f) to shielded banana plug \$40.00 📦

Adapters BNC, Standard 75 Ω^[3]

1250-1286 Right angle BNC \$18.50 📦

1250-1287 BNC(f) to BNC(f) \$9.25 📦

1250-1288 BNC(m) to BNC(m) \$12.00 📦

Adapters SMB, SMC^[4]

1250-0831 SMC(m) to BNC(m) \$26.00 📦

1250-0832 SMC(f) to BNC(f) \$30.00 📦

1250-1023 SMC(m) to N(m) \$37.00 📦

1250-1152 SMC(f) to N(m) \$55.00 📦

1250-1153 SMC(f) to N(f) \$60.00 📦

1250-1236 SMB(f) to BNC(f) \$32.00 📦

1250-1237 SMB(m) to BNC(f) \$34.00 📦

[1] "Precision": typically ≥36 dB return loss to 1.3 GHz.

[2] Type N outer conductor; center pin sized for 75 Ω characteristic.

[3] BNC outer conductor; center pin sized for 75 Ω characteristic.

[4] SMB & SMC are used often inside HP instruments for inter-module RF connections.

[5] The K-connector is developed & manufactured by the Wiltron Co, Morgan Hill, CA.

SMB is Snap-on configuration

SMC is Screw-on configuration

© APC-7 is a registered trademark of the Bunker Ramo Corporation

📦 Fast-Ship product—see page 766.



TRANSIT CASES

Rugged Protection for Instruments

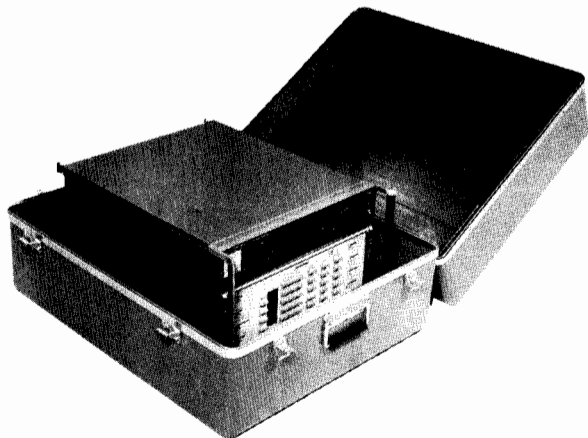

Typical System II Transit Case

Hewlett-Packard transit cases are rugged protective outer shells for use when instruments must be frequently transported or used away from laboratory conditions. HP cases protect your instruments from hostile environments, shock, vibration, moisture, and impact while providing a secure enclosure for shipping. The cases are molded from a structural composite which is 65% lighter than aluminum, yet which provides excellent strength and durability. Tests of the composite show tensile and compressive strength exceeding 33,000 PSI and flexural strength exceeding 45,000 PSI.

Typical Uses

Transit cases are a necessity whenever equipment is frequently transported from one operating location or test site to another, or is shipped for testing and calibration. Transit cases are particularly valuable for instruments used by service and repair personnel. For example, telephone companies frequently use transit cases for the

instruments they use to repair line faults. Transit cases are also valuable when instruments must be transported over rough roads, or are used in dusty environments or outdoors.

Product Detail

HP transit cases are pressure molded of an extremely strong and light fiberglass and resin laminate which provides an excellent strength to weight ratio. All cases seal tightly with O-ring gaskets and clamping latches. They are rainproof under the test conditions of MIL-STD-108. Carrying handles are conveniently placed, and fold flat when not in use.

Transit cases are typically provided with foam cushions that are designed to cradle the instrument securely. Maximum protection is provided against damage from handling, dropping, or crushing. The cushion inserts are typically molded polyurethane, or are fabricated from slabs of polyurethane or polyethylene flexible foams. Each case/cushion unit is designed as its own shock and vibration damping system.

Hewlett-Packard's standard transit cases provide effective protection from all but the most abusive treatment. To ensure maximum protection for your instrument, transit cases are also available in versions that meet the specified requirements of MIL-STD-108, MIL-T-21200, MIL-T-28800, MIL-T-4734, and MIL-C-4150.

Removable swivel casters are available as an option on certain HP transit cases. These cases are identified with an asterisk (*) in the case selection tables on pages 744 and 745.

How to Select the Proper Transit Case

Transit cases are available for almost all HP instruments. If you are ordering a case for one of HP's 80 most popular instruments and computation products, you can use the quick cross-reference table below. To order a case for any other instrument, please refer to "Accurate Measurements Assure Proper Fit" and use the tables for ordering System I and System II style cases.

HP Product Number to Transit Case Number Cross Reference

Product	Transit Case	Product	Transit Case	Product	Transit Case	Product	Transit Case	Product	Transit Case
141T	9211-1294	3577A	9211-2663	4191A	9211-2663	8341A/B	9211-2662	8654B	9211-1290
853A	9211-5439	3582A	9211-2656	4192A	9211-2663	8349A/B	9211-2667	8656B	9211-2661
11713A	9211-2671	3585A	9211-2663	4328A	9211-1318	8350B	9211-2649	8660A/C	9211-2662
11729C	9211-2654	3586A/B/C	9211-2650	4935A	9211-1290	8403A	9211-1292	8662A	9211-2662
1630A	9211-1294	3708A	9211-2655	4937A	9211-1289	8405A	9211-1293	8663A	9211-2662
1645A	9211-1289	3708A(Opt.1)	9211-2661	4945A	9211-2650	8445B	9211-1292	8671A/B	9211-2661
1725A	9211-2459	3709A	9211-2661	4951B	9211-1290	85B	9211-4120	8672A	9211-2661
1740A	9211-2459	3711A	9211-1293	4953A	9211-2644	8501A	9211-2660	8673B/E	9211-2661
1741A	9211-2459	3712A	9211-1294	4955A	9211-2663	8505A	9211-2665	8673C/D	9211-2663
197B	9211-2675	3717A	9211-2654	5061A	9211-1294	8510A ³	9211-2661	8683A/B/C/D	9211-2649
262X Series	9211-4677	3730B	9211-0839	5065A	9211-0839	8511A-8515A	9211-2661	8684A/B/C/D	9211-2649
264X Series	9211-4676	3746A	9211-2656	5150A	9211-2673	8555A	9211-2671	8753A	9211-2656
2671G	9211-2649	37461A	9211-2678	5316A	9211-2681	8562A/B	9211-2604	8754A	9211-2661
2673G	9211-2649	3762A	9211-2655	5328A	9211-2648	8565A	9211-2656	8756A	9211-2656
2816A	9211-1315	3763A	9211-2656	5334A	9211-2642	8566A/B ¹	9211-2655	8757A	9211-2656
334A	9211-1289	3764A	9211-2650	5335A	9211-2643	8566A/B ²	9211-2656	8770A	9211-2661
339A	9211-2643	3776A/B	9211-2650	5340A	9211-1292	8567A	9211-2665	8780A	9211-2662
3325A	9211-2655	3777A	9211-2644	5342A	9211-2682	8568A/B	9211-2655	8901A/B	9211-1293
3336A/B/C	9211-2655	3852A	9211-2657	5343A	9211-2682	8569B	9211-5603	8970A/B	9211-2649
3421A	9211-2642	3964A	9211-2557	5423A	9211-2661	8570A/	9211-2656	8971B	9211-2648
3455A	9211-2654	3968A	9211-2557	59306A	9211-2667	8614A	9211-0839	8980A	9211-2661
3456A	9211-2654	432A/B	9211-1318	59313A	9211-2671	8616A	9211-0839	8901A/B	9211-1293
3457A	9211-2642	435B	9211-1318	59401A	9211-2682	8620C	9211-1289	9826A	9211-2662
3478A	9211-2676	436A	9211-2667	7475A	9211-2655	8640B	9211-0839	9836A ¹	9211-2652
3488A	9211-2642	438A	9211-2676	82509B	9211-4684	8642A/B	9211-2661	9836A ²	9211-2662
3561A	9211-2459	4145A	9211-2663	8340A/B	9211-2662	8654A	9211-1895	9876A	9211-4679
3562A	9211-2663								

¹Top half ²Bottom half ³Instrument requires 2 cases

Instrument Cabinet System Styles

Hewlett-Packard produces two styles of cabinet systems: System I and System II. The most visible difference is handle configuration; the handles on System I instruments are a part of the instrument side frame, and project at 90 degrees from the instrument face. The handles on System II modules also project at 90 degrees from the instrument face, but are not a part of the instrument frame, are easily removable, and are turned outward at the handle grip. Each of the cabinet styles requires a different cushion insert configuration. This difference makes it important to order your case from the correct selection table.

Transit Case Styles

Each transit case is coded according to its style in the following tables: Valise (V), hinged with the handle opposite the hinge; Transit (T), a completely removable cover with a handle at each end; and Valise Transit (VT), a hinged transit case with a handle opposite the hinge and a handle at each end. Each case is designed and manufactured in the style which best suits the configuration of its instrument. If a style other than the standard is more appropriate for your application, a special case can be ordered.

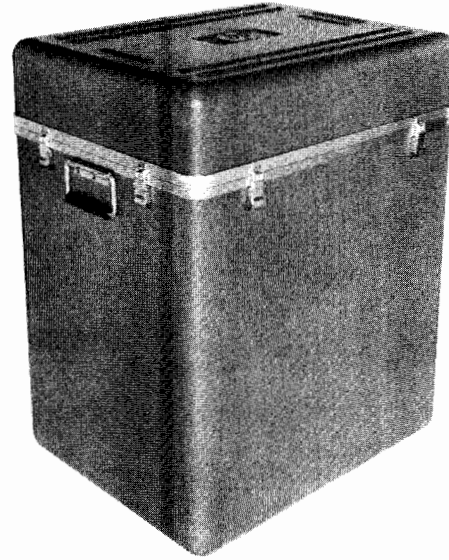

Typical transit (T) style case

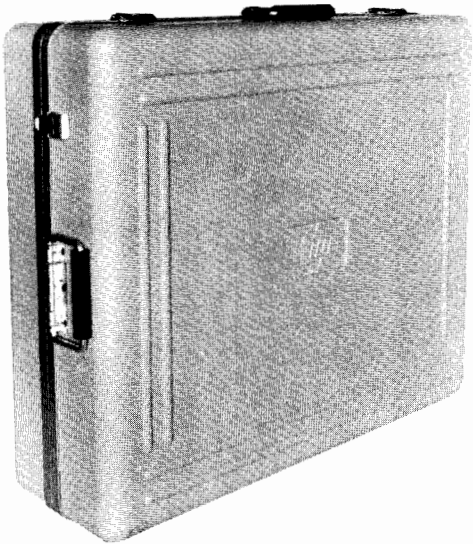

Typical valise transit (VT) style case



Typical valise (V) style case

Special or Custom Transit Cases

When HP began providing standardized cases, it was understood that there would be certain instruments that would not fit into the standard cases. For that reason, special or custom cases are available.

Proper fit is very important in protecting your instrument, and the dimensional measurements of your instrument are critical. It is recommended that when ordering a custom case you provide your Hewlett-Packard sales office with the instrument's exact height, width, and depth, the serial and model number, and any other pertinent information that may affect the design of the case or cushions. In designing your own case, you may wish to have additional space available for the protected storage of materials necessary for your instrument's on-site operation. Space can be provided for storing power/data cables, operating supplies, accessories, additional printed circuit boards, and documentation or manuals. All specifications and measurements should be on hand when discussing your needs with a representative from your local HP sales office.

Colors

HP transit cases are produced in "Hewlett-Packard Pearl Gray Cabinet," a standard color used in whole or in part on a majority of the instruments HP produces. Transit cases in any other color must be a special order at additional cost.

Accurate Measurements Assure Proper Fit

To assure proper fit, each instrument must be measured carefully. The three measurements necessary are:

WIDTH: The distance across the entire body of the instrument, not including rack mounting accessories. Instruments set up to be rack mounted require special cushion designs (custom transit cases).

DEPTH: The depth of the instrument from the front panel face to the rearmost projection at the back of the instrument. On a System II instrument add two inches if the instrument has handles.

HEIGHT: The actual instrument height from the base to the top of the cabinet.

The selection tables include American standard and metric measurements. The addition of any options, accessories, or standoff devices will affect the instrument's overall configuration and must be taken into consideration when ordering a transit case.

TRANSIT CASES

Rugged Protection for Instruments

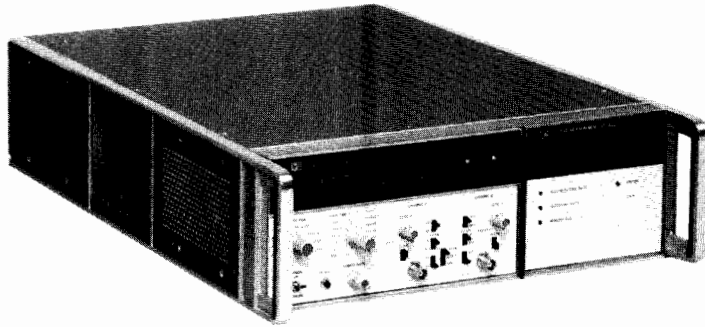

Typical full module System I style cabinet

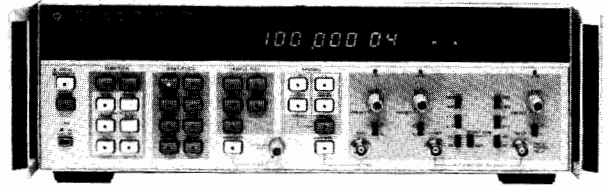

Typical full module System II style cabinet

System I Cabinet Style Transit Cases

Full Module Width Instruments					
Instrument Width - 16.75 in. 425.5 mm					
Instrument Depth - 11.25 in. 285.8 mm					
Inst. Height		Style	HP Part Number	Price	
in.	mm			1-4	5-49
3.50	88.9	VT*	9211-1288	\$370	330
5.25	133.4	VT*	9211-1289	\$380	340
7.00	177.8	VT*	9211-1290	\$390	360
8.75	222.3	T*	9211-1291	\$420	380
Instrument Depth - 16.25 in. 412.8 mm					
Inst. Height		Style	HP Part Number	Price	
in.	mm			1-4	5-49
3.50	88.9	VT*	9211-1292	\$400	370
5.25	133.4	VT*	9211-0839	\$420	380
7.00	177.8	VT*	9211-1293	\$430	390
8.75	222.8	VT*	9211-1294	\$430	390
10.50	266.7	T*	9211-1295	\$430	390
12.25	311.2	T*	9211-1313	\$450	410
Instrument Depth - 19.25 in. 489.0 mm					
Inst. Height		Style	HP Part Number	Price	
in.	mm			1-4	5-49
5.25	133.4	VT*	9211-1296	\$440	400
7.00	177.8	VT*	9211-1735	\$450	410
Instrument Depth - 22.25 in. 565.2 mm					
Inst. Height		Style	HP Part Number	Price	
in.	mm			1-4	5-49
12.25	311.2	T	9211-1297	\$480	430

*Removable casters are an option.

Two-thirds Module Width Instruments					
Instrument Width - 10.50 in. 266.7 mm					
Instrument Depth - 11.00 in. 270.4 mm					
Inst. Height		Style	HP Part Number	Price	
in.	mm			1-4	5-49
6.5	165.1	V	9211-1895	\$330	300

Half Module Width Instruments					
Instrument Width - 7.75 in. 196.9 mm					
Instrument Depth - 8.00 in. 203.2 mm					
Inst. Height		Style	HP Part Number	Price	
in.	mm			1-4	5-49
6.5	165.1	V	9211-1316	\$300	270
Instrument Depth - 11.00 in. 279.4 mm					
Inst. Height		Style	HP Part Number	Price	
in.	mm			1-4	5-49
6.5	165.1	V	9211-1315	\$310	280
Instrument Depth - 16.00 in. 406.4 mm					
Inst. Height		Style	HP Part Number	Price	
in.	mm			1-4	5-49
6.5	165.1	V	9211-1734	\$330	300

One-third Module Width Instruments					
Instrument Width - 5.125 in. 130.2 mm					
Instrument Depth - 8.00 in.1 203.2 mm					
Inst. Height		Style	HP Part Number	Price	
in.	mm			1-4	5-49
6.5	165.1	V	9211-1317	\$290	260
Instrument Depth - 11.00 in. 279.4 mm					
Inst. Height		Style	HP Part Number	Price	
in.	mm			1-4	5-49
6.5	165.1	V	9211-1318	\$300	270

System II Cabinet Style Transit Cases

Full Module Width Instruments					
Instrument Width - 16.75 in. 425.5 mm					
Instrument Depth - 15.25 in. 387.4 mm					
Inst. Height		Style	HP Part Number	Price	
in.	mm			1-4	5-49
3.50	88.9	VT	9211-2642	\$430	390
5.25	133.4	VT	9211-2643	\$430	390
7.00	177.8	VT	9211-2644	\$430	390
8.75	222.3	VT	9211-2645	\$430	390
10.50	266.7	T*	9211-2646	\$430	390
12.25	311.2	T*	9211-2647	\$430	390
Instrument Depth - 18.25 in. 463.6 mm					
Inst. Height		Style	HP Part Number	Price	
in.	mm			1-4	5-49
3.50	88.9	VT	9211-2648	\$480	430
5.25	133.4	VT	9211-2649	\$480	430
7.00	177.8	VT	9211-2650	\$480	430
8.75	222.3	T*	9211-2651	\$480	430
10.50	266.7	T*	9211-2652	\$480	430
12.25	311.2	T*	9211-2653	\$480	430
Instrument Depth - 21.50 in. 546.1 mm					
Inst. Height		Style	HP Part Number	Price	
in.	mm			1-4	5-49
3.50	88.9	VT	9211-2654	\$520	470
5.25	133.4	VT	9211-2655	\$520	470
7.00	177.8	VT	9211-2656	\$520	470
8.75	222.3	T*	9211-2657	\$520	470
10.50	266.7	T*	9211-2658	\$520	470
12.25	311.2	T*	9211-2659	\$520	470
Instrument Depth - 24.50 in. 622.3 mm					
Inst. Height		Style	HP Part Number	Price	
in.	mm			1-4	5-49
3.50	88.9	VT	9211-2660	\$550	500
5.25	133.4	VT	9211-2661	\$550	500
7.00	177.8	T*	9211-2662	\$550	500
8.75	222.3	T*	9211-2663	\$550	500
10.50	266.7	T*	9211-2664	\$550	500
12.25	311.2	T*	9211-2665	\$550	500

*Removable casters are an option.



Typical System II half module instrument

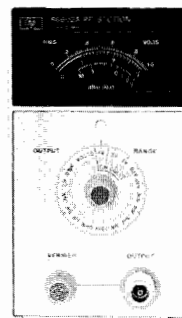

Typical System II quarter module instrument

System II Cabinet Style Transit Cases (Continued)

Half Module Width Instruments					
Instrument Width – 8.50 in. 215.9 mm					
Instrument Depth – 9.75 in. 247.7 mm					
Inst. Height in.	mm	Style	HP Part Number	Price	
				1-4	5-49
3.50	88.9	V	9211-2666	\$330	300
5.25	133.4	V	9211-2667	\$330	300
7.00	177.8	V	9211-2668	\$330	300
8.75	222.3	V	9211-2669	\$330	300
10.50	266.7	V*	9211-2670	\$330	300
Instrument Depth – 12.75 in. 323.9 mm					
Inst. Height in.	mm	Style	HP Part Number	Price	
				1-4	5-49
3.50	88.9	V	9211-2671	\$390	350
5.25	133.4	V	9211-2672	\$390	350
7.00	177.8	V	9211-2673	\$390	350
8.75	222.3	V	9211-2674	\$390	350
10.50	266.7	V	9211-2675	\$390	350
Instrument Depth – 15.75 in. 400.1 mm					
Inst. Height in.	mm	Style	HP Part Number	Price	
				1-4	5-49
3.50	88.9	V	9211-2676	\$400	360
5.25	133.4	V	9211-2677	\$400	360
7.00	177.8	V	9211-2678	\$400	360
8.75	222.3	V	9211-2679	\$400	360
10.50	266.7	V	9211-2680	\$400	360
Instrument Depth – 18.75 in. 476.3 mm					
Inst. Height in.	mm	Style	HP Part Number	Price	
				1-4	5-49
3.50	88.9	V	9211-2681	\$400	360
5.25	133.4	V	9211-2682	\$400	360
7.00	177.8	V	9211-2683	\$400	360
8.75	222.3	V	9211-2684	\$400	360
10.50	266.7	V	9211-2685	\$400	360

* Removable casters are an option.

Quarter Module Width Instruments					
Instrument Width – 4.125 in. 104.8 mm					
Instrument Depth – 9.75 in. 247.7 mm					
Inst. Height in.	mm	Style	HP Part Number	Price	
				1-4	5-49
3.50	88.9	V	9211-2686	\$280	250
5.25	133.4	V	9211-2687	\$280	250
7.00	177.8	V	9211-2688	\$280	250
Instrument Depth – 12.75 in. 323.9 mm					
Inst. Height in.	mm	Style	HP Part Number	Price	
				1-4	5-49
3.50	88.9	V	9211-2689	\$290	260
5.25	133.4	V	9211-2690	\$290	260
7.00	177.8	V	9211-2691	\$290	260
Instrument Depth – 15.75 in. 400.1 mm					
Inst. Height in.	mm	Style	HP Part Number	Price	
				1-4	5-49
3.50	88.9	V	9211-2692	\$350	310
5.25	133.4	V	9211-2693	\$350	310
7.00	177.8	V	9211-2694	\$350	310

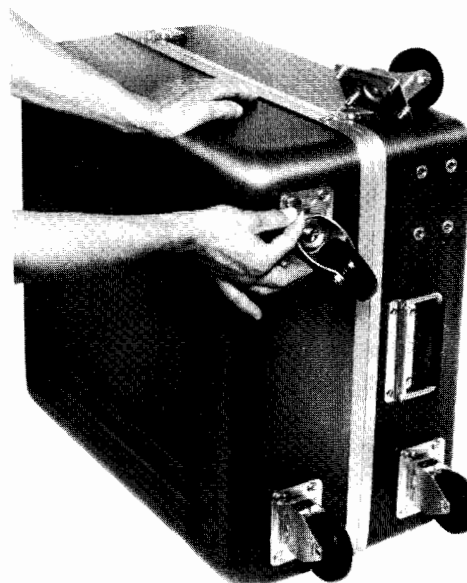

Field installed swivel caster kit. HP part number 1490-0913

OPERATING CASES

Rugged Protection for Instruments

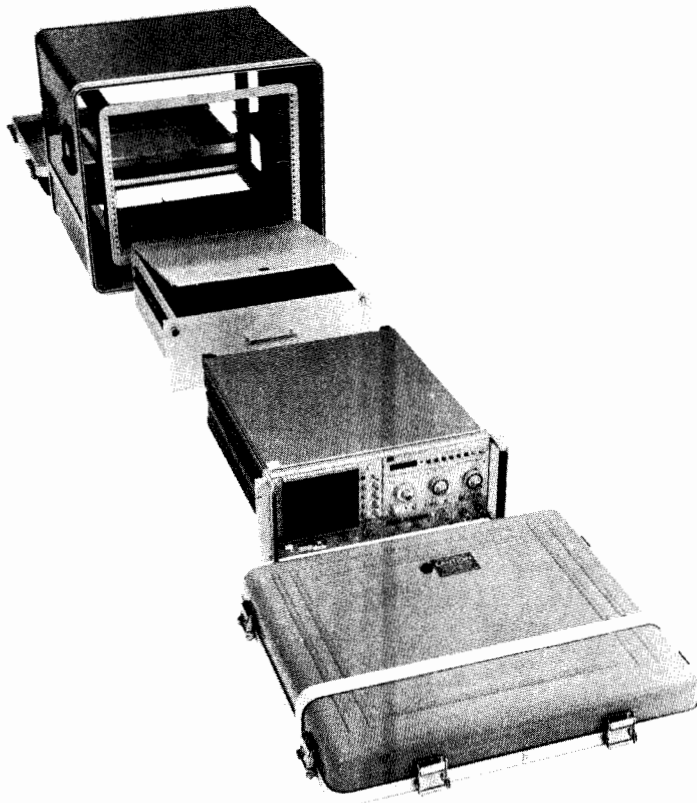

Exploded view of an Operating Case with an instrument and drawer ready for mounting.

Operating Cases

Hewlett-Packard operating cases are rugged protective enclosures, used when instruments are transported and used on-site. They are constructed of the same pressure molded fiberglass/resin laminate as Hewlett-Packard transit cases. Hewlett-Packard's standard hardware provides excellent protection from damage and the elements. Conveniently placed handles fold flat when not in use. Front and back covers seal with O-ring gaskets and clamping latches. All transit cases are rainproof under MIL-STD-108.

Interior Configuration

Operating cases are equipped with shock mounted aluminum frames that accept any standard 19-inch rack mounting instrument (EIA-RETMA standard), up to the height of the frames. Most full sized instruments and modular combinations of instruments can be rack mounted in one of our operating cases. The frame arrangement and the ability to remove the front and back covers allows the convenience of operation without removing the instrument. As a result, the instrument can be set up for operation with a minimum of delay. At the same time, environmental protection is afforded. Both Hewlett-Packard System I and System II cabinet styles can be mounted in operating cases (including System I module combining cases).

Rack mounting offers a number of conveniences. Total systems configured of individual instruments and accessories can be combined in one or more operating cases. Patch cable, HP-IB, and HP-IL connections can be left in place within the case, so that instruments are ready to be put into use with a minimum of delay.

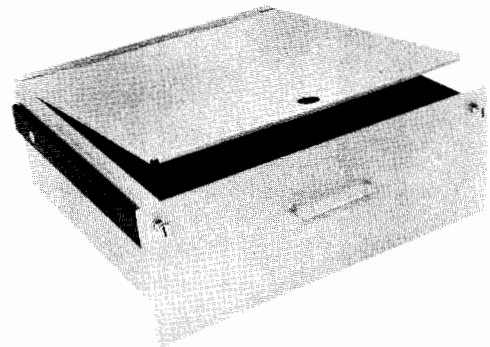

Sturdy drawers that accommodate various HP accessories and operating supplies are available in three sizes, and come with smooth operating ball bearing slides.

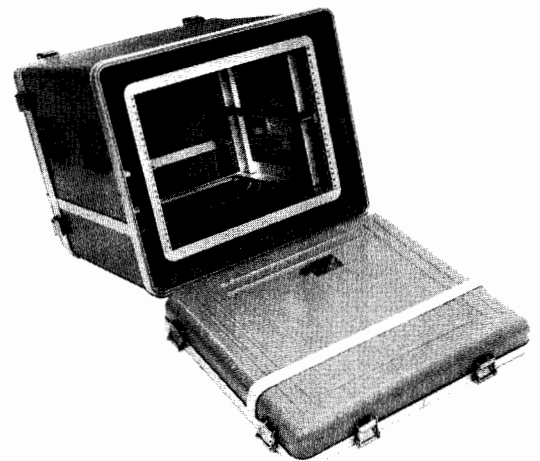

Elastomeric shock mounted frames provide outstanding shock and vibration attenuation. A set of standard shock mounts can be provided for any equipment weight and fragility.

Accessories and Options

A number of accessories and options are available to provide maximum flexibility. Drawers are available in three heights so that small accessories, supplies, and tools can be kept inside the case with the instrument (cut foam cushions can be designed to accommodate any of these items). Aluminum skids, stacking feet, internal power receptacles, and many other items are available as options on special orders, or as accessories for customer installation when ordered separately.

How to Order

Operating cases, like transit cases, are ordered through your local HP sales office. Because of the wide variety of options available and the number of configurations possible, it is recommended that you discuss your needs with an HP representative before you order.

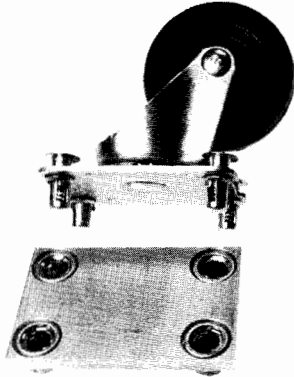

Heavy duty removable caster and mounting plate

Operating Case Selection Guide

Case Width = 24.00 in./609.6 mm (standard)
Case Depth = 28.50 in./723.9 mm (standard)

Nominal Rack Height in. ISO	Instrument Weight				Case Height		HP Part Number	Price	
	maximum lbs	minimum lbs	maximum kg	minimum kg	in.	mm		1-4	5-49
5.25 3U	75	20	34.0	9.1	10.75	273.1	9211-1302	\$1,350	1,080
8.75 5U	75	20	34.0	9.1	15.20	386.1	9211-1303	\$1,450	1,160
10.50 6U	130	30	59.0	13.6	17.00	431.8	9211-2635	\$1,650	1,320
12.25 7U	130	30	59.0	13.6	18.87	479.3	9211-1163	\$1,750	1,400
14.00 8U	130	30	59.0	13.6	20.50	520.7	9211-1241	\$1,800	1,450
15.75 9U	130	30	59.0	13.6	22.25	565.2	9211-1242	\$1,800	1,450
17.50 10U	130	30	59.0	13.6	24.00	612.1	9211-1243	\$1,800	1,450
19.25 11U	130	30	59.0	13.6	25.75	654.1	9211-1244	\$1,800	1,450
21.00 12U	250	50	113.4	22.7	28.00	711.2	9211-1245	\$1,800	1,450
22.75 13U	250	50	113.4	22.7	29.75	755.7	9211-2636	\$1,800	1,450
24.50 14U	250	50	113.4	22.7	31.50	800.1	9211-1911	\$2,200	1,750
26.25 15U	250	50	113.4	22.7	33.25	844.6	9211-2637	\$2,200	1,750
28.00 16U	250	50	113.4	22.7	35.00	889.0	9211-2638	\$2,200	1,750
29.75 17U	250	50	113.4	22.7	36.75	933.5	9211-2639	\$2,200	1,750
31.50 18U	250	50	113.4	22.7	38.50	977.9	9211-2640	\$2,200	1,750
33.25 19U	250	50	113.4	22.7	40.25	1022.4	9211-1713	\$2,200	1,750
47.25 27U	320	70	145.2	31.8	53.88	1368.6	9211-2641	\$2,700	2,150

Standard Features

Inner rack frame with provision for infinitely adjustable T-bar instrument support bracket. Standard 20" depth.

Inner rack frame with RETMA hole pattern drilled in rear rails.

Standard color: pearl grey cabinet.

Manual pressure relief valve.

Special Features Available

- A. Mating feet for stacking one case on top of another. \$50
- B. Special color. Please specify. \$40
- C. Modified inner rack frame depth. Standard depth 20" from front panel mounting surface to rear surface of frame. This option includes an appropriate change in the overall depth of the enclosure. Please specify desired inner frame depth. Maximum 23", minimum 12". \$300
- D. Instrument slide pair to mount on either side of inner frame using RETMA hole pattern drilled in front and rear rails. \$90
- E. Special shock mounts for unusual instrument weights. Please specify weights. \$40
- F. Increased front cover depth. Maximum depth 6". Please specify. \$250
- G. Increased rear cover depth. Maximum depth 6". Please specify. \$250
- H. Latches recessed into the surface of the case. \$250
- I. Handles recessed into the surface of the case. \$90
- J. Hermetically sealed case tested by the hot water method. \$90
- K. MIL-C-4150 certification with the exception of design and preproduction testing. Case will have increased wall thickness, hardware anodized to military specification, and will be hermetically tested using the hot water method. \$290
- L. Automatic pressure relief valve. \$50
- M. Addition of four permanently mounted, 3½" diameter swivel casters. \$120
- N. Addition of four removable, 3½" diameter swivel casters. Also available in kit form. \$250
- O. Addition of two aluminum hat-section skids to the case bottom. \$120
- P. Addition of lift rings to either side of the case. \$50
- Q. 3½ H (88.9 mm) Drawer with ball bearing slides. \$330
- R. 5¼ H (133.4 mm) Drawer with ball bearing slides. \$350
- S. 7 H (177.8 mm) Drawer with ball bearing slides. \$370
- T. Pair of T-Bar instrument support brackets. \$30
- U. AC power receptacle strip with four outlets mounted on bottom rear of inner rack frame. Power cord 1 meter (3' 3") long. NEMA connectors. \$50

Accessories (when ordered separately)

- 9211-1164** 3½ H (88.9 mm) Drawer with ball bearing slides. \$380
- 9211-1165** 5¼ H (133.4 mm) Drawer with ball bearing slides. \$400
- 9211-1166** 7 H (177.8 mm) Drawer with ball bearing slides. \$480
- 0950-0122** AC power receptacle strip with four outlets mounted on bottom rear of inner rack frame. Power cord 1 m (3.3') long, NEMA connectors. \$50
- 9211-1173** Pair T-Bar instrument support brackets. \$46
- 1490-0913** Caster kit, four removable 3½" (88.9 mm) swivel casters. For transit cases only. Recommended to be removed before transit. \$210
- 5081-5831** Operating Case Latch \$7.75 each
- 5081-5832** Aluminum hat section skids (2) for case bottom \$155
- 5081-5834** Caster kit, four removable 3½" (88.9 mm) swivel casters. Heavy duty for Transit or Operating Cases. Recommended to be removed before transit. \$300

On request, cases can be fabricated that meet the environmental requirements of Military Specifications. Specifications other than military are subject to change without notice.



CABINET ACCESSORIES

System II—Handles and Rack Flanges, Bail Handle Kit

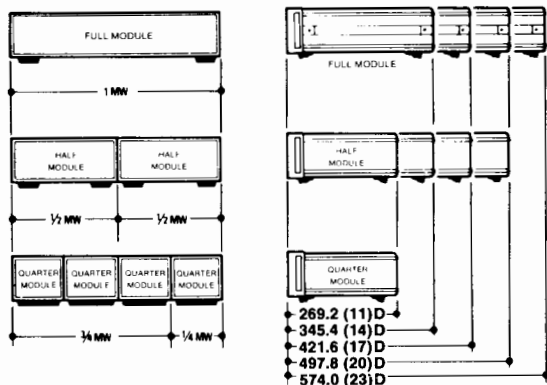
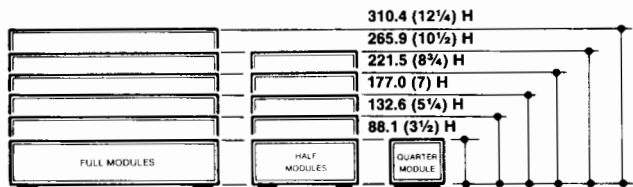

System II Cabinet Design

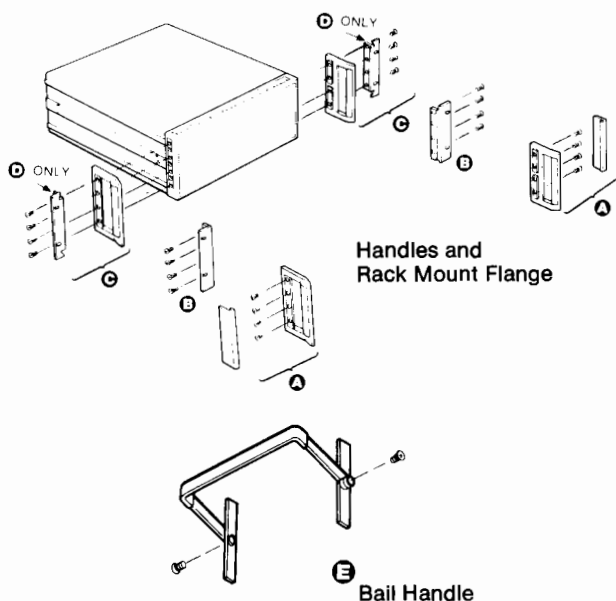

NOTICE—Most of the cabinet accessory kits shown on these pages include both inch and metric fasteners to make them compatible with the new metric-fastener-cabinets, as well as the older inch-fastener-cabinets which are still in service. It is most important for the user to be aware of these different fasteners to avoid thread damage when attaching the accessory kits. Metric-fastener-cabinets are identified with a yellow label on the rear which reads "Caution—metric and inch hardware", a "metric" embossment in the front bezel casting under the plastic trim strip, and on the middle of the rear bezel casting.

System II Cabinet Design

HP's modular cabinet system offers bench-stacking and rack mounting versatility. Many of HP's newer instruments are packaged in this System II frame, easily recognized by the cast aluminum front and rear frames. System II uses optional front corner handles characterized by a slight outward flare.

The family of System II modules is designed for compatibility with EIA and IEC racking standards, both in width and height. Each HP instrument specification contains dimensional information to tell you which module size is used.

Handles and Rack Mount Flanges

Handles and rack flanges are available for all System II cabinets, although they find most use on full width modules or combinations of narrower modules locked together to form 1 MW (module width).

Certain instruments are supplied with front handles as part of the selling price. Handles and rack flanges can be supplied with most instruments by specifying the appropriate option from the following list, at the time of order. The extra cost of each option is usually specified on the instrument data sheet.

- Option 907 Front Handles
- Option 908 Rack Mount Flanges
- Option 909 Handles with Rack Flanges
- Option 913 Rack Mount Flanges (If handles already furnished) (HP 5061-9769 Version)

The table below describes kits available for use after receipt of equipment. Field installation is very straight-forward. A plastic trim strip is easily removed and the handle or flange attached with screws supplied in the kit. Before rack mounting, bottom feet must be removed.

Bail Handle Kit

For 1/2 MW cabinets, you can attach this front bail handle for easy portability. Attaching hardware furnished.

HP Part No.	Name	Price
5061-9701	Bail Handle Kit for 88.1 (3 1/2) Module	\$38.00
5061-9702	Bail Handle Kit for 132.6 (5 1/4) Module	35.00
5061-9703	Bail Handle Kit for 177.0 (7) Module	33.00

Handle and Rack Flanges

Instrument Module Height mm (inch)	A Front Handle Kit		B Rack Mount Flange Kit [3]		C Rack Mount Flange Kits with Handles		D Rack Mount Flange Kit for Instruments With Previously Supplied Handles	
	HP Part No.	Price	HP Part No.	Price	HP Part No.	Price	HP Part No.	Price
88.1 (3 1/2)H	5061-9688	\$ 50.00	5061-9674[1]	\$30.00	5061-9675[1]	\$ 72.50	5061-9769[1]	\$21.00[4]
88.1 (3 1/2)H	—	—	5061-9676[2]	30.00	5061-9682[2]	72.50	5061-9770[2]	36.00[4]
132.6 (5 1/4)H	5061-9689	55.00	5061-9677	32.50	5061-9683	80.00	5061-9771	28.00
177.0 (7)H	5061-9690	65.00	5061-9678	35.00	5061-9684	90.00	5061-9772	32.00
221.5 (8 3/4)H	5061-9691	75.00	5061-9679	40.00	5061-9685	105.00	5061-9773	36.00
265.9 (10 1/2)H	5061-9692	95.00	5061-9680	45.00	5061-9686	120.00	5061-9774	40.00
310.4 (12 1/4)H	5061-9693	140.00	5061-9681	50.00	5061-9687	160.00	5061-9775	49.00
Kit includes	2 Handles + 2 Trim Strips + Mtg. Screws		2 Flanges + Mtg. Screws		2 Handles + 2 Flanges + Mtg. Screws		2 Flanges + Mtg. Screws	

[1] HP 5061-9674/9675/9769 Kits use standard flanges with 1.75" hole spacing.
 [2] HP 5061-9676/9682/9770 Kits use special flange with 3.00" hole spacing.

[3] Will not fit onto instruments with previously supplied handles.
 [4] Option 913 ordered on instruments supplies HP 5061-9769. For 3.00" spacing order HP 5061-9770 instead of Opt. 913.

CABINET ACCESSORIES

System II—Support Shelves, Filler Panels

NOTICE—Most of the cabinet accessory kits shown on these pages include both inch and metric fasteners to make them compatible with the new metric-fastener-cabinets, as well as the older inch-fastener-cabinets which are still in service. It is most important for the user to be aware of these different fasteners to avoid thread damage when attaching the accessory kits. Metric-fastener-cabinets are identified with a yellow label on the rear which reads “Caution—metric and inch hardware”, a “metric” embossment in the front bezel casting under the plastic trim strip, and on the middle of the rear bezel casting.

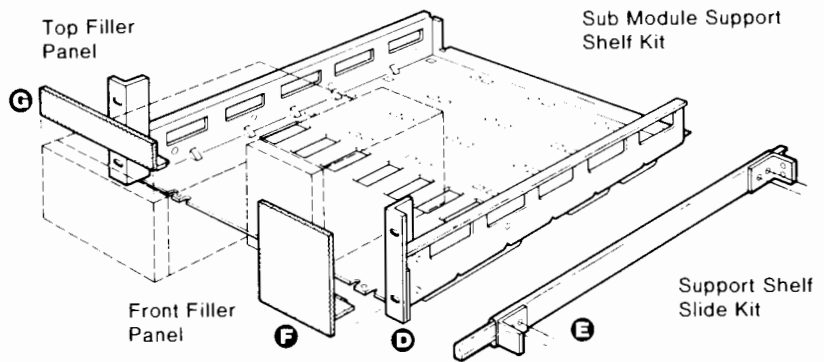
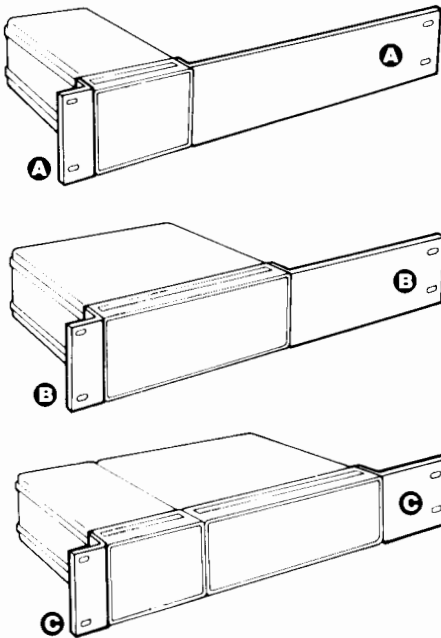

Rack Mount Adapter Kits

Modules of less than 1 MW can be rack mounted using these kits. Individual 1/4 MW or 1/2 MW modules use the kits shown below directly. Combinations of 1/4 MW and 1/2 MW (of equal depth) are first joined side-by-side with the Lock Link Kit (HP 5061-9694) (following page), then have end flanges applied. Combinations adding to 1 MW use regular rack flange kit (previous page). Kits include attaching screws but not front panel rack mounting screws. Hole patterns conform to EIA and IEC standards.

Rack Mount Adapter Kits

Module Height mm (inch)	A Mounts 1/4 MW Module		B Mounts 1/2 MW or 2 ea. 1/4 MW(2) Modules		C Mounts 3/4 MW (3 ea. 1/4 MW)(1) or 1/4 & 1/2 MW side-by-side(2)	
	HP Part No.	Price	HP Part No.	Price	HP Part No.	Price
88.1 (3 1/2)H	5061-9673	\$56.00	5061-9672	\$49.00	5061-9671	\$43.00
132.6 (5 1/4)H	—	—	5061-9657	60.00	5061-9658	50.00
177.0 (7)H	—	—	5061-9660	65.00	5061-9661	70.00
265.9 (10 1/2)H	—	—	5061-9666	77.50	5061-9667	72.50
Kit includes	1 ea. rack flange 1 ea. 1/4 MW extension adapter flange and screws		1 ea. rack flange 1 ea. 1/2 MW extension adapter flange and screws		1 ea. rack flange 1 ea. 1/4 MW extension adapter flange and screws	

[1] 1/2 MW can be center mounted using 2 of these kits.
[2] Side-by-side modules of equal depth require lock link kit (HP 5061-9694).

Support Shelf, Slide, and Filler Panels

Submodules of differing heights, widths, and depths (up to 20 D) may be rack-mounted using these support shelves. Any combination of 1/4 MW and 1/2 MW will fit side-by-side up to 1 MW. Filler panels close up vacant spaces either on top of short modules or side-by-side. The slide kit provides ready access to internal shelf areas and is designed for HP racks with 24-inch depth vertical support rails. Slide kit includes brackets and mounting screws.

HP Part No.	Name	Price
5061-9696	D Support Shelf for 88.1 (3 1/2)H Modules	\$195.00
5061-9697	D Support Shelf for 132.6 (5 1/4)H Modules	195.00
5061-9698	D Support Shelf for 177.0 (7)H Modules	210.00
1494-0015	E Slide Kit (2 ea slides, brackets, hardware)	120.00

Filler Panels

Description	Size	HP Part No.	Price
F For 88.1 (3 1/2) H support shelf partially filled with instruments, and having the following front panel space to fill:	1/4 MW to fill	5061-9721	\$67.50
	1/2 MW to fill	5061-9722	80.00
	3/4 MW to fill	5061-9723	92.50
F For 132.6 (5 1/4) H support shelf, and having the following front panel space to fill:	1/4 MW to fill	5061-9724	\$80.00
	1/2 MW to fill	5061-9725	87.50
F For 177.0 (7) H support shelf, and having the following front panel space to fill:	1/4 MW to fill	5061-9766	\$75.00
	1/2 MW to fill	5061-9727	110.00
G For 1/4 MW and having the following vertical space to fill:	43.2 (1 3/4)H	5061-2035	\$50.00
	87.6 (3 1/2)H	5061-2036	50.00
G For 1/2 MW and having the following vertical space to fill:	43.2 (1 3/4) H	5061-2037	\$50.00
	87.6 (3 1/2) H	5061-2038	50.00



CABINET ACCESSORIES

System II—Lock Link Kits, Rack Mount Slide Kits

NOTICE—Some of the cabinet accessory kits shown on these pages include both inch and metric fasteners to make them compatible with the new metric-fastener-cabinets, as well as the older inch-fastener-cabinets which are still in service. It is most important for the user to be aware of these different fasteners to avoid thread damage when attaching the accessory kits. Metric-fastener-cabinets are identified with a yellow label on the rear which reads “Caution—metric and inch hardware”, a “metric” embossment in the front bezel casting under the plastic trim strip, and on the middle of the rear bezel casting. Due to design considerations, the slide-mount kits shown on this page are offered in both inch and metric fastener versions.

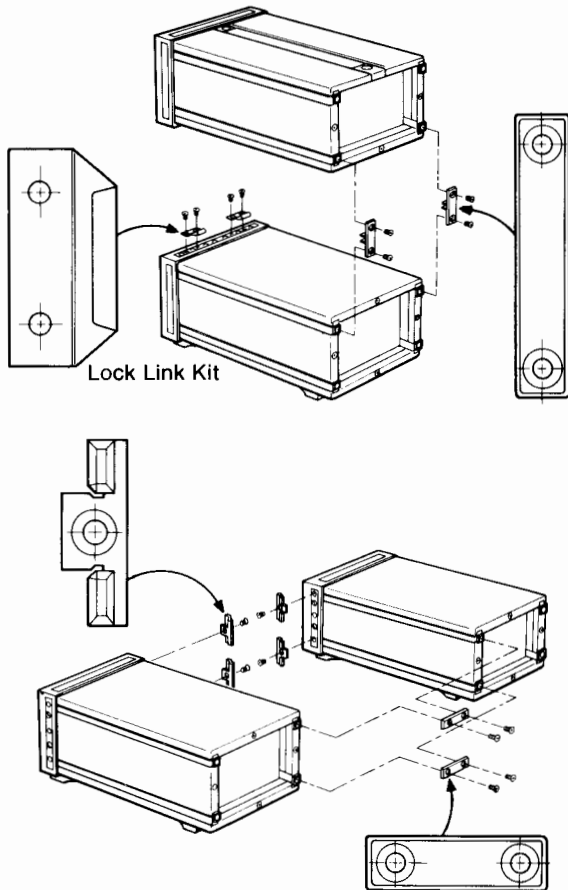

Lock Link Kit

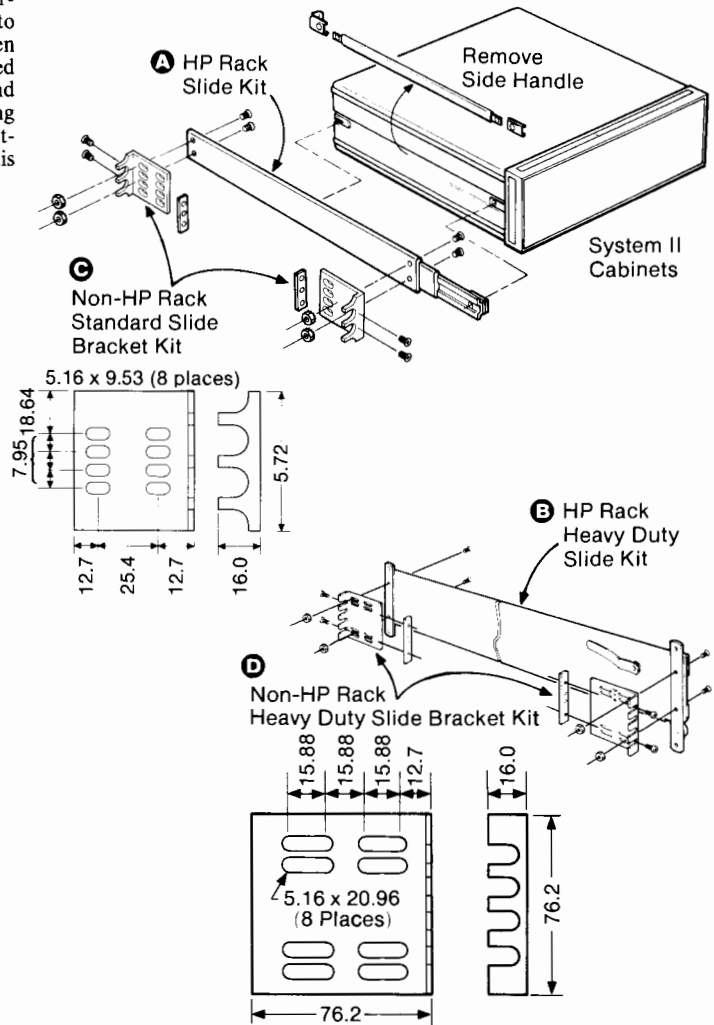

Lock Link Kits HP 5061-9694 (includes inch screws)

All sub-module cabinets of *equal depths* can be linked together over-under or side-by-side with hardware in the lock link kit. Cabinet frames are already pre-threaded to allow quick assembly. For side-by-side connections the kit contains 12 front hooks and six rear links, enough for 3 side-by-side joints. For vertical connections, the kit also contains four front hooks and four rear links enough for two over-under joints. Kit includes screws. Locking cabinets together horizontally in a configuration wider than 1 MW is not recommended.

If the over-under linked combination is to include rear standoff feet (HP 5061-9709), then the over-under locking feet kit HP 5061-9699 (next page) should be used for over-under connection.

The HP 5061-9694 Lock Link Kit is not recommended for full module over/under combinations. Use Kit HP 5061-9699 Locking Feet Kit (next page) to handle those larger weights.

Slide Kits and Rack Brackets

Rack slides are available for full-width System II cabinets to permit easy access to internal spaces. Each kit consists of two slides which mount directly to System II cabinet side handle recess spaces (after removing side handles). The slides also mount directly to vertical support rails in HP-racks. HP 1494-0060 mounts 345.4D and 421.6D depth System II cabinets. HP 1494-0059; 497.8D and 574.0D.

Standard weight slides carry 38.6 kg (85 lbs) max. load. Tilting versions are available in standard duty only. (HP 1494-0062 and 1494-0063.)

For non-HP-racks, end bracket kits are available for both standard and heavy duty slide kits. Slotted hole arrays in the brackets provide for front-to-back rack rail spacing of 24, 26, and 28-inch nominal centers. They also allow choice of two vertical positions. Each kit of four brackets includes screws and four bar nuts. These general purpose mounting brackets fit most common non-HP-racks such as GE, Honeywell, etc.

HP Part No.	Name	Price
Metric (Inch) 5061-9694	Lock Link Kit	\$ 25.00
1494-0060 (1494-0018)	A Non-Tilting, Std. Slide Kit, Fits 345.4D & 421.6D Cabinets	100.00
1494-0059 (1494-0017)	A Non-Tilting, Std. Slide Kit, Fits 497.8D & 574.0D Cabinets	100.00
1494-0062 (1494-0025)	Tilting, Std. Slide Kit, Fits 345.4D & 421.6D Cabinets	190.00
1494-0063 (1494-0026)	Tilting, Std. Slide Kit, Fits 497.8D & 574.0D Cabinets	190.00
1494-0058 (1494-0016)	B Non-Tilting, Heavy Duty Slide Kits (497.8D & 574.0D Cabinets Only)	290.00
1494-0061 (1494-0023)	C (4) End Brackets for Non-HP Racks, Std. Slides	46.00
1494-0064 (1494-0042)	D (4) End Brackets for Non-HP Racks, Heavy Duty Slides	70.00



NOTICE—Most of the cabinet accessory kits shown on these pages include both inch and metric fasteners to make them compatible with the new metric-fastener-cabinets, as well as the older inch-fastener-cabinets which are still in service. It is most important for the user to be aware of these different fasteners to avoid thread damage when attaching the accessory kits. Metric-fastener-cabinets are identified with a yellow label on the rear which reads "Caution—metric and inch hardware", a "metric" embossment in the front bezel casting under the plastic trim strip, and on the middle of the rear bezel casting.

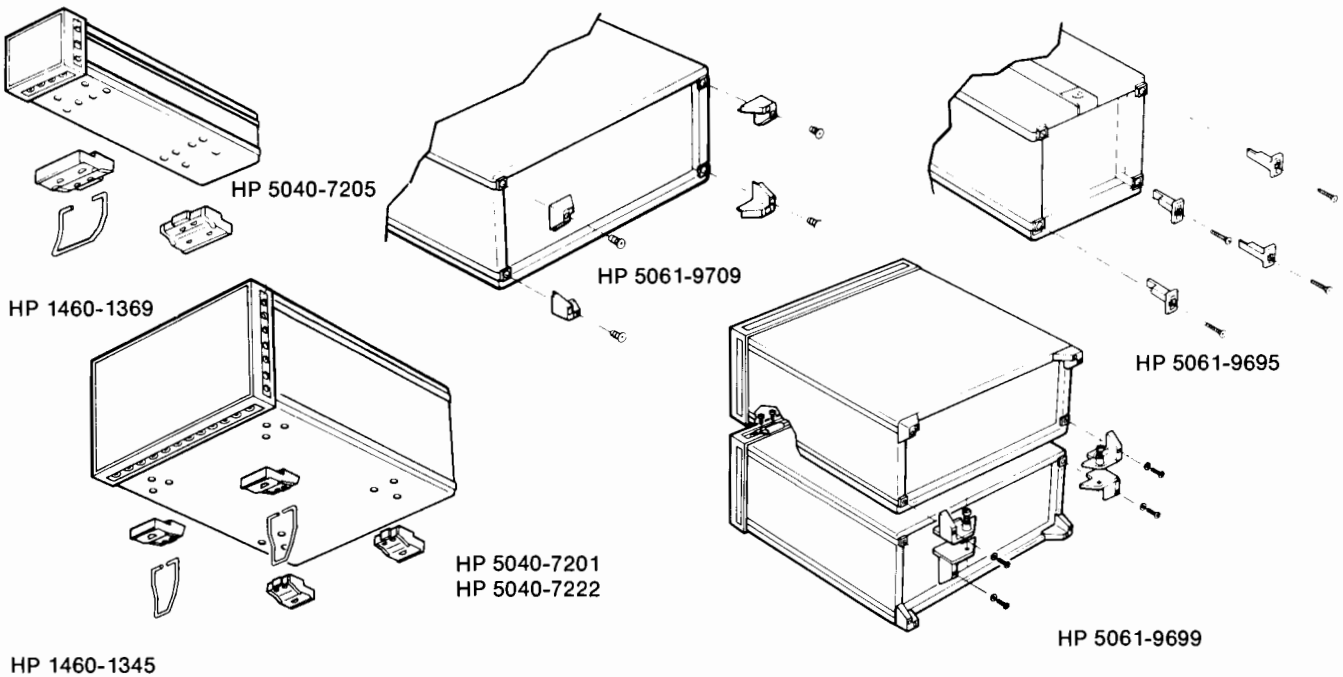

Bottom and Rear Cabinet Feet

Cabinet Rear Standoff Feet HP 5061-9709 (includes inch screws)

Kit HP 5061-9709 provides four corner feet which give 25.4 mm (1-in.) stand-off protection to the rear panel of instruments. It is used when instruments are to be operated or stored vertically on their rear panels. (Fits all but 1/4 MW by (88.1) 3/2H). Includes mounting screws.

Cord Wrap Feet Kit HP 5061-9695 (includes inch screws)

Kit HP 5061-9695 contains four ribbed corner posts on which you can wrap power cords or signal cables for transport or storage. (Recommended for 1/4 MW and 1/2 MW cabinets weighing less than 11 kg, (24 lbs). Includes mounting screws.

Cabinet Bottom Feet and Tilt Stands

The standard foot HP 5040-7201 fits the bottom of full width and 1/2 MW cabinets. It fits front or rear and four are required. HP 5040-7222 foot is a non-skid version. Used in pairs it can prevent bench-top creeping. Tilt-stand HP 1460-1345 fits into the standard or non-skid foot and is used in pairs (front or rear) to tilt the instrument up or down for better viewing.

For 1/4 MW cabinets, foot HP 5040-7205 fits front or rear (two required). Tilt stand HP 1460-1369 fits the standard 1/4 MW foot and can be used front or rear depending on whether you want an upward or downward display.

Rear Panel Locking Foot Kit

When full module cabinets are to be linked vertically, and rear standoff feet are planned, use this kit. It consists of right and left foot linking pairs and 2 front hooks, enough for one over-under joint.

Also requires one HP 5061-9709 foot kit to supply the remaining 4 corner feet.

HP Part No.	Name	Price
5061-9709	Rear Standoff Feet Kit (4 Feet)	\$8.75
5061-9695	Cord Wrap Feet Kit (4 Feet)	25.00
5040-7201	Standard Foot	1.50 ea.
5040-7222	Non-Skid Foot	4.00 ea.
1460-1345	Tilt Stand	1.00 ea.
5040-7205	1/4 MW Foot	6.00 ea.
1460-1369	1/4 MW Tilt Stand	10.00 ea.
5061-9699	1 MW Cabinet Lock-Foot Kit	60.00

CABINET ACCESSORIES

SYSTEM 1—Rack Hardware and Accessories

System 1 Cabinet Design

System 1 Cabinets are still used on older HP instruments. System 1 can be identified by its front handles being integral with the side casting frame. These two pages describe accessories for use with System 1 Cabinets and small modular instruments.

HP 1051A

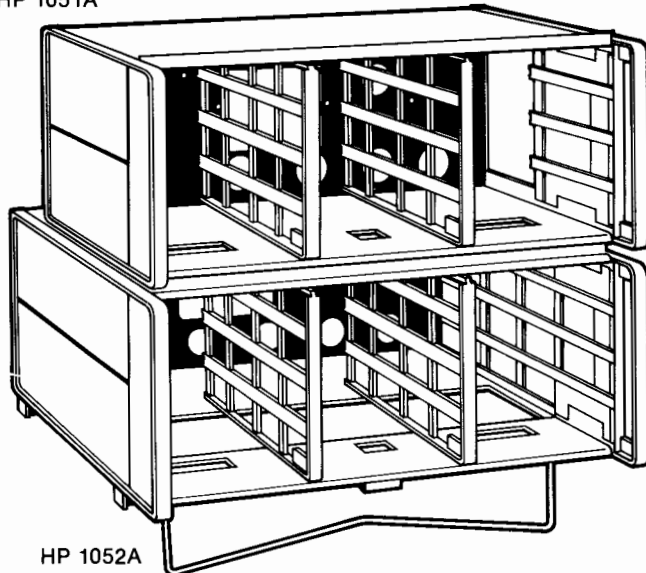

HP 1052A

Combining Cases, HP 1051A, 1052A

HP 1051A and HP 1052A combining cases conveniently rack or bench mount combinations of small modular Hewlett-Packard SYSTEM 1 instruments. Both cases accept 1/3 or 1/2 instrument modules, 130mm or 198 mm wide (5 1/8 or 7 7/8 inches). The basic difference is that the HP 1052A is 130 mm (5 1/8 in.) deeper and will accept modules up to 416mm deep (16 3/8 in.). The HP 1051A accepts instruments up to 286mm deep (11 1/4 in.). Each case is furnished with two dividers.

Accessory drawer HP 5060-8756 supplies storage space 1/3 width and 77 mm (3-1/32") high. Use an HP 5060-8758 filler panel above or below.

HP 1051A, 1052A, 5060-8756 Specifications

Size	Price
HP 1051A: 178 H x 482.6 W x 337 mm D (7" x 19" x 13 1/4).	\$570.00
HP 1052A: 178 H x 482.6 W x 467 mm D (7" x 19" x 18 3/8).	\$570.00

Weight

HP 1051A: net, 4.5 kg (10 lb). Shipping, 6.7 kg (15 lb).

HP 1052A: net, 5.4 kg (12 lb). Shipping, 8.1 kg (18 lb).

Opt 908: Rack Mount Kit \$40.00

Opt 910: Extra Manual \$1.00

HP 5060-8756 Accessory Drawer \$215.00

Rack Mounting Kits, HP 5060-8739 to 5060-8744

With these kits all Hewlett-Packard products in full rack-width cabinets of the integral side frame-handle style (see HP 1051A, 1052A, Combining Cases above) can be easily prepared for rack mounting. Each kit contains two flanges, a filler strip, and mounting screws.

Rack Mounting Kit Ordering Information

HP Part Number	Nominal Cabinet Height		Price
	Millimetres	Inches	
5060-8739	88.1	3 1/2	\$40.00
5060-8740	132.6	5 1/4	\$40.00
5060-8741*	177	7	\$40.00
5060-8742	221.5	8 3/4	\$45.00
5060-8743	265.9	10 1/2	\$45.00
5060-8744	310.4	12 1/4	\$50.00

*Also used to rack mount Combining Kits HP 1051A & 1052A shown above.

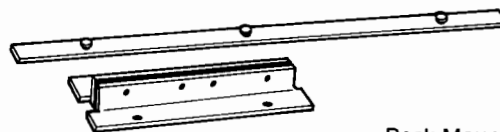

Rack Mounting Kits (HP 5060-8739 To 5060-8744)

HP 5040-6678 HP 5060-8764

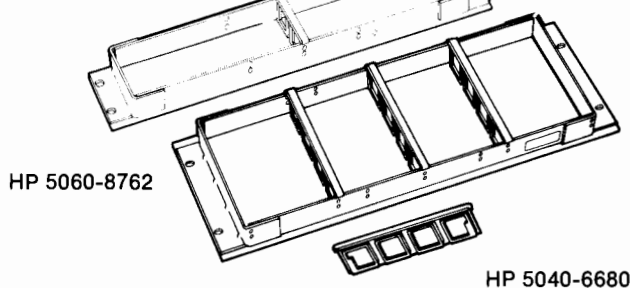

HP 5060-8762

HP 5040-6680

Rack Adapter Frames, HP 5060-8762, 5060-8764

These frames can be used to hold combinations of 1/3 and 1/2 module-width HP instruments. Each frame is furnished with mounting hardware and three dividers. Two models are available for different instrument heights. Adapter frames are for permanent or semi-permanent rack mounting. Where quick removal and reinstallation of instruments is desirable, the HP 1051A and HP 1052A should be used.

HP 5060-8762 is 178 mm (7 in.) high and accepts instruments heights of 1/4H, 1/2H, and 1H. HP 5060-8764 is 89 mm (3 1/2 in.) high and accepts instruments of 1/4H and 1/2H.

HP Part No.	Name	Price
5060-8762	Rack Adapter 178mm (7-in)	\$150.00
5060-8764	Rack Adapter 89mm (3 1/2-in)	\$150.00
5040-6678	Extra Vertical Dividers for 5060-8764	\$28.00
5040-6680	Extra Vertical Dividers for 5060-8762	\$12.00

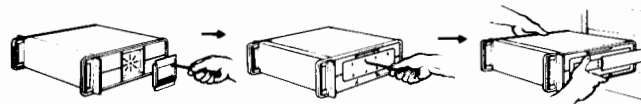

Remove Handles and Feet

Attach Adapter

Mount Slides

Rack Mount Slide Kits and Cabinet Adapters

By removing the side handle of full width system 1 cabinets, rack mount slides can be attached for easy access to internal space. Both tilting and non-tilt are available, while max. load factor is 31.7 kg (70 lb). The cabinet adapter plate attaches to the handle recess then to the slide. Slide kits include four angle brackets which mount to rack rails with front-to-back nominal spacings of 24, 26 and 28-inches.

Cabinet Adapters

HP Part No.	Name	Price
1490-0722	Adapter plate for 88.9mm H(3 1/2 in.) cabinets	\$135.00
1490-0721	Adapter plate for 133mm H(5 1/4 in.) and higher cabinets	\$260.00

Rack Mount Slide Kits, HP 1490-0713 to 1490-0720

HP Part Number ¹	Slide Type	Cabinet Depth	Extension Length	Price
1490-0713	fixed	All Sizes	482.6 (19) ²	\$140.00
1490-0714	fixed	All Sizes	635.0 (25) ³	\$160.00
1490-0715	tilting	279.4 (11)	482.6 (19) ²	\$220.00
1490-0716	tilting	406.4 (16)	482.6 (19) ²	\$230.00
1490-0717	tilting	279.4 (11)	533.4 (21) ³	\$240.00
1490-0718	tilting	406.4 (16)	558.8 (22) ³	\$240.00
1490-0719	tilting	482.6 (19)	635.0 (25) ³	\$240.00
1490-0720	tilting	558.8 (22)	635.0 (25) ³	\$240.00

1. Cabinet Adapters, below, must be added to slides
 2. Slide's stationary mounting depth: 406.4 (16)
 3. Slide's stationary mounting depth: 558.8 (22)

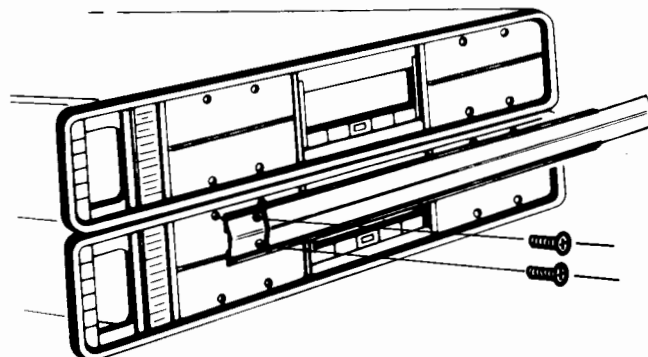

Joining Bracket Kits, HP 5060-8541 to 5060-8545

These kits join HP System 1 instruments of the same width and length into easily handled single stacks. Each kit consists of two brackets, mounting hardware and trim. They are available to fit the three most common instrument depths:

HP Part Number		Price
5060-8541:	279 mm (11 in.) EIA panel depth	\$160.00
5060-8543:	406 mm (16 in.) EIA panel depth	\$180.00
5060-8545:	480 mm (19 in.) EIA panel depth	\$190.00

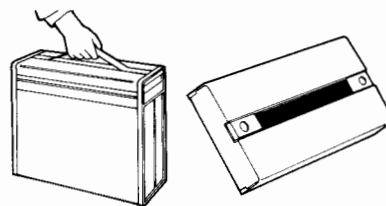
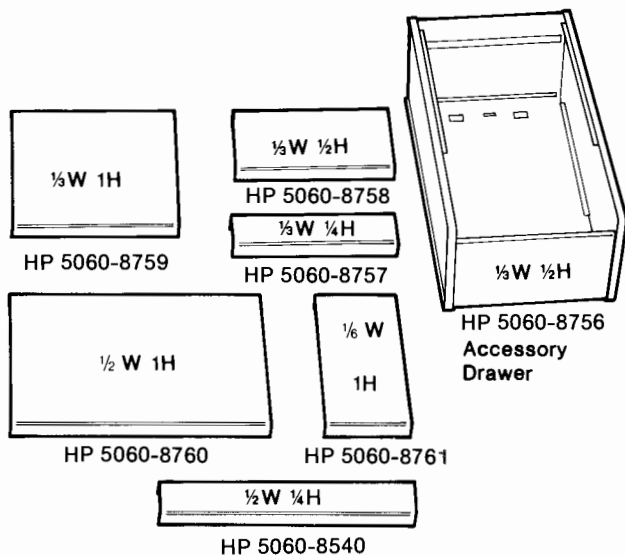

Control Panel Covers, HP 5060-8766 to 5060-8771

A series of control panel covers equipped with carrying handles are available for full rack width instruments. These covers protect instrument front panels and make rack mounted instruments tamper-proof.

One of these covers, the HP 5060-8768, fits both the HP 1051A and the HP 1052A Combining Case (previous page). Other covers are available to fit the six modular enclosures with front panel heights ranging from 88.1 to 310.4 mm (3 1/2 to 12 1/4 in.). Cover locks securely to front handles.

HP Part Number		Price
5060-8766:	88.1 mm (3 1/2 in.) EIA panel height	\$280.00
5060-8767:	132.6 mm (5 1/4 in.) EIA panel height	\$235.00
5060-8768:	177 mm (7 in.) EIA panel height	\$250.00
5060-8769:	221.5 mm (8 3/4 in.) EIA panel height	\$310.00
5060-8770:	265.9 mm (10 1/2 in.) EIA panel height	\$360.00
5060-8771:	310.4 mm (12 1/4 in.) EIA panel height	\$400.00

Filler Panels, HP 5060-8540, 5060-8757 to 5060-8761

Filler panels can be used to close off any leftover space after instruments are mounted in combining cases (left) or adapter frames (below). Panels are available in a variety of widths and heights.

HP Part No.	Module Case Height x Width	Filler Panel Dimensions		Price
		Millimetres	Inches	
5060-8540	1/4 x 1/2	38 x 198	1 1/2 x 7 25/32	\$54.00
5060-8757	1/4 x 1/3	38 x 130	1 1/2 x 5 1/8	\$75.00
5060-8758	1/2 x 1/3	77 x 130	3 1/32 x 5 1/8	\$43.00
5060-8759	full x 1/3	155 x 130	6 3/32 x 5 1/8	\$43.00
5060-8760	full x 1/2	155 x 198	6 3/32 x 7 25/32	\$44.00
5060-8761	full x 1/6	155 x 63	6 3/32 x 2 31/64	\$70.00

X-RAY EQUIPMENT

Scientific and Industrial X-Ray Systems

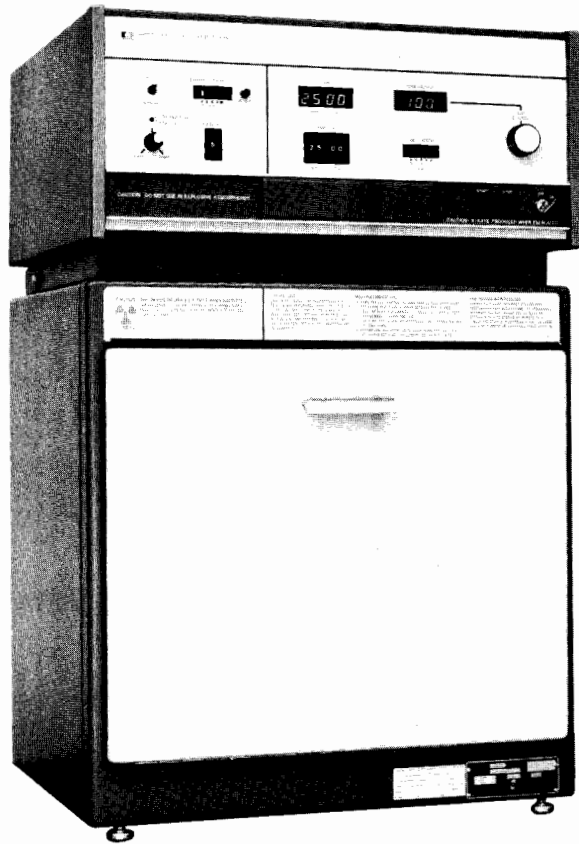

Model 43855A Option A02

Faxitron® Cabinet Systems

Radiography, the art and science of making pictures with X-rays, has an important place in modern technology. It is one of the major nondestructive test methods available to industry, provides an indispensable tool in scientific investigations and is a valuable aid to law enforcement agencies. Hewlett-Packard makes a major contribution to these activities with X-ray equipment that offers a "better way" through advanced technology and design. This equipment makes radiographs easier and safer to take.

Industrial Inspection

Industrial quality control and inspection procedures, especially in the field of electronics, benefit from nondestructive testing by radiography. The advantages of a testing method which does not harm the test objects are obvious. Radiography, therefore, offers benefits in design engineering, incoming inspection, production quality control, product reliability and failure analysis. X-rays are used to detect misregistration or plate-thru problems in multi-layer P.C. boards; porosity, poor substrate bonding and wiring or lead location in transistors and integrated circuits; voids and other encapsulation problems in potted components; and solder balls or other defects in sealed relays.

Die casting is another industry that benefits from the nondestructive aspects and ability to "see inside" provided by radiography. Porosity, gas voids, tramp metal inclusion and other common defects can be easily detected and the cause determined. Expensive machining time can be avoided for castings found to be defective through X-ray inspection. The integrity of welds, alignment of connectors, inspection for proper assembly and mechanical defects are further examples of tests which radiography performs for industry. The benefits of X-ray testing are reduced production costs, better quality assurance and product safety. The results are increased profits.

Medical Applications

HP Faxitron Cabinet X-ray Systems are used by the medical profession for specimen radiography in support of diagnostic surgical procedures and in biological research. Specimen radiographs of biopsy samples are correlated with preoperative mammograms, for example, and in the evaluation of mastectomy specimens. Typical research applications include microradiography of thin bone specimens and microangiographic studies of vasculature.

Scientific Applications

Oceanography, geology, marine biology, paleontology, pathology, botany, forestry and agricultural research are a few examples of scientific disciplines that use X-rays. Applications range from the study of the interior anatomy of fossils to determining the viability of seeds.

These are among the many applications served by HP Faxitron Cabinet X-ray Systems. They offer a unique combination of high quality radiographic capability, simplicity of operation and convenience of use which is expanding the capabilities of scientific and industrial concerns throughout the world.

HP 43700 Series Flash X-Ray Systems

High-speed (flash) radiography is used to record and study dynamic events where interposed material, smoke, flame, debris, or pressure variations exclude the use of high-speed cameras. Typical events include ballistics, shaped charges, explosives, behind-armor studies, shock waves in solids, aerospace phenomena, and crash-injury studies.

The basic performance requirement of a flash X-ray system used for the study of transient mechanisms is to provide high resolution radiographs with exposure times short enough to eliminate motion blur. HP series 43700 flash X-ray systems produce X-ray pulses of sub-microsecond duration and are designed specifically for "stop motion" radiographic applications. All HP 43700 series systems utilize the same basic components, the same electrical theory, and are modular in concept. Standard systems include 150 kV, 300 kV, 450 kV, 1 MV, and 2.3 MV models.

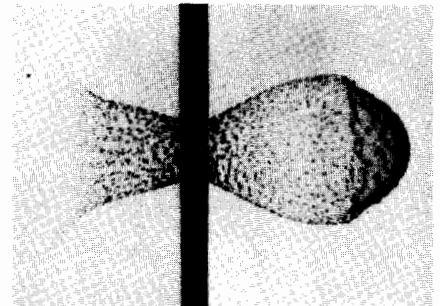

An HP basic single "channel" flash X-ray system, composed of a pulse generator, high-voltage power supply, cold-cathode field emission X-ray tube, and associated controls, provides a single radiograph per event. Additional pulser/X-ray tube sets (add-on channels) may be combined with the initial single-channel system to provide multiple-channel "systems." Multiple channel systems may be of identical output voltage or may use varied output voltage pulser/tube combinations.

For specific information and consultation regarding HP X-ray systems, contact Hewlett-Packard, 1700 S. Baker Street, McMinnville, Oregon 97128. US Telephone (800) 952-2212 see page 769.

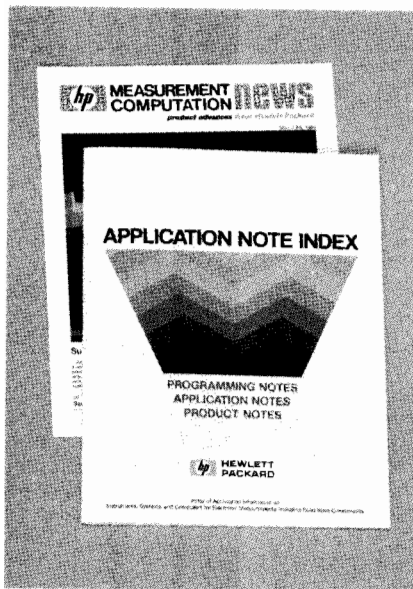

Free aids to selecting, using and maintaining HP products

HP offers a variety of free publications to help you choose the HP products that best fill your needs, to help you benefit from applications knowledge acquired by users inside and outside of HP, and to help you maintain your HP products. These publications range from new-product announcements, catalogs, product family brochures, and single-product technical data through application notes, product notes, and programming aids to service notes and general maintenance periodicals. Since the number and types of publications vary with product type, an outline of available publications organized by product type is provided below for your convenience.

Instruments and Systems

Product Information

Measurement/Computation News

Data sheets and brochures

Catalogs

Instruments Direct

DC Power Supplies

Recorder Supplies

Coaxial & Waveguide Measurement

Accessories

Digital IC Tester Program

DesignCenter magazine

HP Journal

Application Information

Application Notes

Product Notes

Programming Notes

Service Information

Service Notes

Bench Briefs

Computers, Peripherals & Calculators

Product Information

Measurement/Computation News

Data sheets & brochures

Selection guides

Catalogs

Computer Users Catalog

Personal Computer Users Catalog

Drafting Supplies

LaserJet Printer Font Catalog

Computer Users Documentation Index

HP Technical Software

Software Directory for Graphics Plotters

LaserJet Printer Family Software and

Hardware Solutions

Software and Accessories Guide for the

Vectra PC

Software and Accessories Guide for the

Touchscreen PC

HP Journal

Application Information

Application Notes

Application Briefs

Plotter Notes

Set-Up Instructions (for plotters)

Components

Product Information

Catalogs

Diode and Transistor Designer's Catalog

Optoelectronics Designer's Catalog

Microwave Integrated Products

Data Sheets

HP Journal

Application Information

Application Handbooks

Application Bulletins

Measurement/Computation News

Six times a year M/C News brings you announcements of HP's latest electronic measuring instruments and their accessories; personal, desktop, and larger computers, their software, peripherals, and accessories; opto-electronic and semiconductor components; and new no-charge literature such as catalogs and application notes.

DesignCenter

DesignCenter is published quarterly for users of HP 64000 Logic Development System products. This full-color magazine features customer application stories, announcements of new HP 64000 products, and interesting research projects from the University Associates Program.

Application Briefs, Bulletins, and Notes

These aids to solving your measurement, computation, and design problems offer the benefit of the applications research and experience of both HP customers and HP engineers. Some are tutorial, others describe how-to procedures.

Product Notes

Product Notes augment the Operating and Service Manuals supplied with HP electronic instruments by providing information on various topics that include specifications and characteristics, operation and use, applications and performance.

Programming Notes

Programming Notes provide product-specific information on the use and operation of instruments in HP-IB systems. Some notes address the needs of inexperienced users and cover basic operation of an HP-IB instrument using a specific HP desktop computer. Others address the needs of experienced users.

Application Note Index

The AN index lists and describes the contents of all Application Notes, Programming Notes, and Product Notes on electronic instruments, instrument systems, and solid-state components.

Hewlett-Packard Journal

Published monthly to communicate technical information from the laboratories of HP to all of the fields served by HP, the Journal contains descriptions of current hardware and software products as well as more general information such as advances in technology.

Service Notes

Service Notes contain product-specific service information for HP's electronic products. Subjects include product improvements, modifications, and procedures for troubleshooting, maintenance, and repair. Service Notes are published as appropriate throughout the life of a product. All new Notes are announced in Bench Briefs.

Bench Briefs

Bench Briefs provides those who maintain HP instruments with timely information that has both specific and general application. Subjects include troubleshooting tips and descriptions of new technologies, components, tools, and equipment. Also, new Service Notes are listed in Bench Briefs as they become available.

How to Obtain Free Publications

To obtain any of the publications described on this page, contact your nearest Hewlett-Packard office. Locations of HP offices are listed on the back pages of this catalog.

HP offices are also your best source of current information on the topics covered by Application Briefs, Application Bulletins, Application Notes, Product Notes, and Programming Notes.



ORDERING INFORMATION

Shipping, Prices, and Terms of Sale



Customer Service Offices

Hewlett-Packard is committed to providing convenient local support and the best possible attention to customer needs on a worldwide basis. There are more than 100 sales and support offices in the U.S. and some 275 sales and support offices and distributorships in 75 other countries; a listing of these offices starts on page 769.

Your entry point to the resources of Hewlett-Packard is through the local HP office nearest you. Our sales representatives and order support specialists there are well-equipped to provide you with pre-sale assistance in product selection, as well as related business information such as current product availability and price delivered to your location.

Most HP sales offices are tied into a sophisticated intra-company communications system. This not only means prompt transmission of orders to any HP product responsible division—it also speeds the flow of regular messages among HP sales offices and factories. The objective, of course, is to provide the fastest possible response to your product interests.

Price Information

Price information which may be supplied with this catalog provides you with helpful budgetary guidance.

Please call your nearby Hewlett-Packard sales office to determine a product's delivered price.

Prices furnished with this catalog are U.S. list prices prevailing at the time of printing. Hewlett-Packard reserves the right to change prices, and those prices prevailing at the time an order is received will apply.

Quotations and Pro Forma Invoices

Destination prices and other details you may need to know before ordering can be quickly obtained via telephone. Just call your nearest HP office.

If you are an international customer requiring formal paperwork such as pro forma invoices or quotations, please contact the Hewlett-Packard office or representative serving your area. Exportation or importation assistance is also available.

Placing Your Order

Hewlett-Packard people at the sales office nearest you will be pleased to provide assistance in selecting the HP equipment most appropriate to your needs, and to help you prepare your order.

The information in this catalog will, in many cases, be sufficient for you to decide to buy a particular HP product. In those instances, a telephone call to the nearest HP office will provide you with information on the product's availability and price.

To ensure maximum satisfaction with HP's products and services we ask that you order in the country of end use. Orders for end use inside the USA may be placed with your nearest U.S. sales office. Orders for end use outside the USA should be placed with an HP sales office in the country of end use. More information on placing such orders is available from the HP headquarters offices listed on page 769.

HP wants to be sure the product delivered to you is exactly the one you want. Therefore, when placing your order, please specify the product's catalog (model, accessory, or part) number, as well as the product's name. Be as

complete as possible in specifying exactly what you'd like, including standard options.

If you want special features or capabilities, such as different color or a non-standard power line voltage, ask your HP sales representative about availability and cost of these "specials" first—and then, to prevent misunderstandings, include special instructions and specification details with your order.

Terms of Sale

Inside the USA: Hewlett-Packard's standard credit terms for established customers in the USA are net 30 days from invoice date.

Leasing and extended financial terms are available. However, the associated costs are not included in any product prices furnished with this catalog. Your nearby HP office will be pleased to discuss your requirements and work with you in setting up an appropriate program.

Outside the USA: terms for orders placed on Hewlett-Packard Company by customers outside the USA are irrevocable letters of credit or cash in advance—unless other terms have been previously arranged. Please contact authorized Hewlett-Packard international subsidiaries or distributors regarding terms for orders placed with them.

U.S. Government Sales

Some products in this catalog are covered on GSA federal supply schedule multi-award contracts.

Product Changes

Although product information and illustrations in this catalog were current at the time it was approved for printing, Hewlett-Packard, in a continuing effort to offer excellent products at a fair value, reserves the right to change specifications, designs, and models without notice.

Shipping Methods

Inside the USA: shipments to destinations in the USA are made directly from factories or local warehouses. All prices include HP standard transportation and routing to any U.S. destination. If a different shipping method is needed, we will gladly ship to satisfy your requirements. In this case, the shipment will typically be sent freight collect.

Outside the USA: shipments to destinations outside the USA are made from the appropriate Hewlett-Packard facility by either surface or air, as requested. Sea shipments usually require commercial export packaging at a nominal extra charge.

Introduction

When Performance is Measured by Results . . .

Success in today's business environment depends on obtaining high productivity from both people and equipment. Selecting the right measurement and/or computer system is essential to achieving proper results.

. . . Results can be assured by Support

Achieving the best results from a measurement or computer solution involves more than just purchasing the right equipment. It also involves support of that equipment. Hewlett-Packard is a world leader in customer support and satisfaction.

HP's Complete Solution for Your Success

We want you to be successful with your HP solution. So we've designed flexible support that can be tailored to meet your individual productivity needs.

HP support helps you to quickly realize the full potential of your HP solution:

*Customer Education provides you with the expertise to take full advantage of your system's advanced technology and capabilities so you can become more productive faster.

*Application Consulting helps you implement your HP solution quickly and smoothly, and to customize systems solutions to meet your own unique needs.

*Hardware support helps minimize productivity interruption for maintenance and calibration so that you can prolong your system's useful life.

*Software support ensures that your system software is as current and productive as possible so you can maintain your competitive edge.

When you purchase HP equipment and support together, you are purchasing a complete productivity solution.

Make HP Your Partner in Productivity

Hewlett-Packard can be your partner in success. From your first consideration of an application solution through the entire life cycle of your system's implementation and use, HP stands behind your success with a complete range of worldwide support services. Choose Hewlett-Packard as your partner in success and you are assured of state-of-the-art hardware, software and support productivity.

Ordering Support is Easy

If you wish to design your own support program you may select the services you need from the product descriptions which follow. Or, if you prefer HP to configure a support plan for you, just contact your local HP sales office.

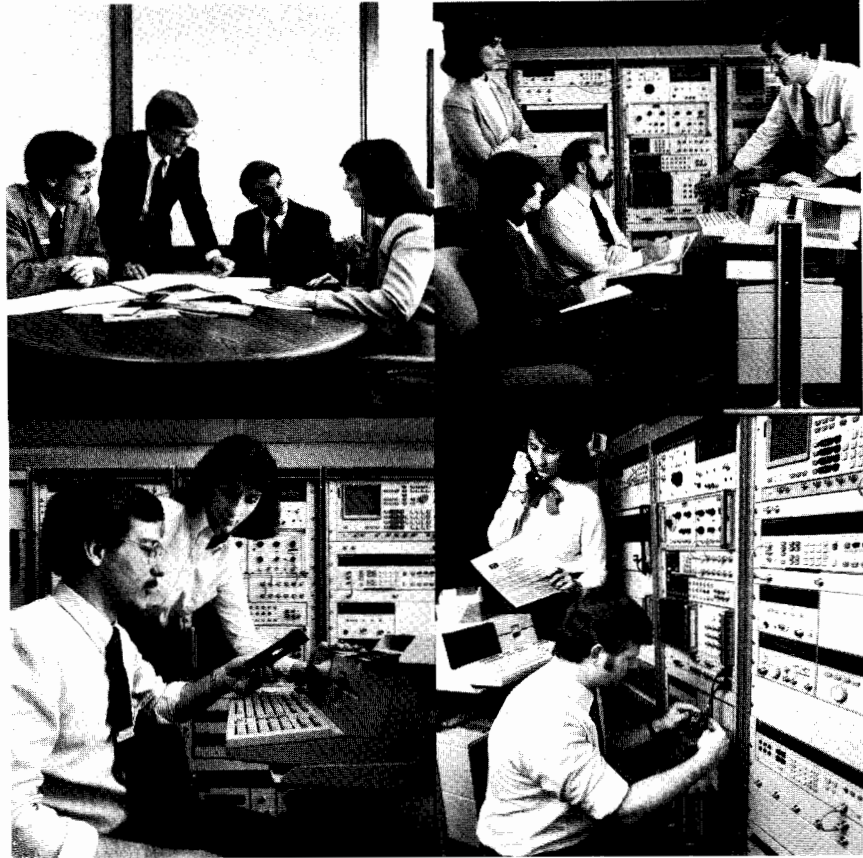

Your HP system implementation can be viewed as an application "life cycle". Each step of this cycle provides an opportunity to improve the use of your instruments or computers to increase productivity. Whether you are in the decision, implementation or sustained operation phase of your application life cycle, HP can provide the tools, knowledge, experience and support to ensure success.

THE APPLICATION LIFE CYCLE

Planning and Evaluation

- Needs Analysis and Requirements Definition • Authorization and Financing • System and Support Specifications
- Cost of Ownership Analysis
- Vendor Selection
- Equipment Order

Getting Ready

- Implementation Planning
- Application and Operator Training • Site Survey and Preparation • Information Gathering

When the System Arrives

- Hardware & Software Delivery • Racking, Cabling and Installation • Functional Test Design and Coding

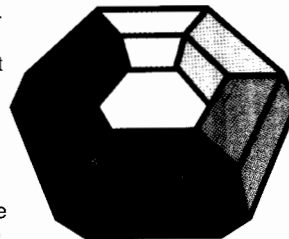

Extending System Life

- System Expansion or Reconfiguration • Hardware Upgrades and Refurbishment • System Software Upgrades • Application Software Performance Improvement • System Replacement

Keeping the System Productive

- System Calibration & Preventative Maintenance
- Remedial Maintenance
- System Software Updates and Support • Supplies Availability

Putting the System to Productive Use

- Application & Test Design
- Program Coding • Program and Test Documentation
- Fixture Installation • Staff Training

CUSTOMER SUPPORT

Customer Education



Training For Your Success

Hewlett-Packard offers training classes in hardware operation, applications, software and hardware maintenance for both HP computer and instrument products.

Learn More . . .

HP Customer Education provides you with an in-depth understanding of advanced technology and operating techniques. Students will learn more in an HP class than they could reasonably expect to learn by spending the same amount of time teaching themselves.

Learn Faster . . .

HP Customer Education is an intensive learning experience. Courses are designed to teach you quickly and efficiently how to use your equipment in new and productive ways.

Course material is presented in a logical and businesslike manner so that students can quickly assimilate vital information. No time is wasted on "salesy" presentations - the student's time is fully devoted to learning.

Learn Better . . .

The structured learning environment provided in an HP training course allows for full retention of course materials. A student will find that he or she can more quickly apply principles learned in a class, instead of trying to constantly learn through hit-or-miss experimentation.

The courses introduce key concepts and principles through illustrated study materials and lectures. Students then apply what they have learned through hands-on exercises and labs. In this way principles are immediately reinforced through actual use.

. . . For Your Success

In today's fast-paced business environment, gaining the most productivity from your people and equipment is essential to your success.

HP Customer Education can help you achieve this success. Choose from the computer and/or instrument courses described below, or contact your local HP Sales Office and ask for a copy of our free course catalog.

HP-IB Systems-Oriented Courses

The courses described below will help you integrate various HP instruments into your own HP-IB configured system, and then help you gain maximum value from their operation.

HP-IB Theory

This one-day course teaches the basics of HP-IB theory: the concepts of an interface, the objectives and key specifications of ANSI/IEEE Std. 488-1978, "IEEE Standard Digital Interface for Programmable Instrumentation" and the HP implementation of the IEEE Std. 488. *Ask for HP 51409A.*

HP-IB with MS-DOS

A one-day course which familiarizes students with the HP-IB Command Library for MS-DOS, and how it can be used to control HP-IB instruments and peripheral devices. The HP-IB Theory Course is prerequisite. For HP-IB with MS-DOS, *ask for HP 51412A.*

HP-IB Instrument Control Using Series 200/300 BASIC

This five-day lab-oriented course will enable you to set up and customize an HP-IB system to do various automatic test or measurement/control tasks. You will learn to create and document HP-IB programs by applying structured programming techniques using HP Series 200 Desktop Computers. To attend this course, *ask for HP 50011B.*

HP 6944A Multiprogrammer User's Course

This three-day course teaches you how to make measurements and perform stimulus/response or control for automation applications using the HP 6944A and the HP 85 computer. The course emphasizes practical applications and extensive hands-on experience with this important system component. *Ask for HP 6944A+24D.*

Logic-Related Courses

Today's microprocessor technology demands high logic development and analysis skills. To meet your needs in this important technology, HP offers the courses described below.

HP 64000 Logic Development Concepts and Measurements

To increase your productivity with the HP 64000 System, HP offers a group of courses.

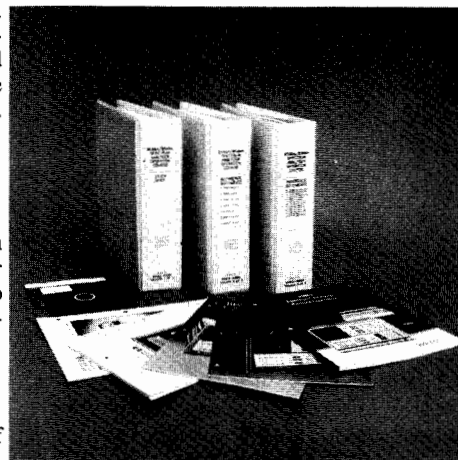

The HP 64000 System Concepts and Measurements course teaches general system operation and capabilities including emulation. *Ask for HP 64100A+24D.*

HP 64000 System Pascal Programming

HP offers two courses to help you use Pascal on your HP 64000 System: HP 64000 System Pascal Programming Course is a three-day introduction to the language using HOST Pascal. HP 64000 Pascal Microprocessors Course is a two-day applications-oriented session designed to improve your microprocessor productivity using Pascal. If you are a software engineer, *ask for HP 64000 System Pascal Programming Course.* Also ask about HP 64000 Pascal training for specific microprocessors.

Advanced Timing/Hardware Analysis Training

This one-day course teaches the concepts, applications and configurations of timing analysis using an HP 64600S 8-channel timing analyzer. You will learn to identify and solve timing-related problems, understand the interaction of the timing and state modules, and theories and effects of skew and asynchronous triggering. *Ask for HP 64600S+24F.*

Software Performance Analysis Training

This one-day course will help you simplify your complex software development process using the HP 64310A Software Performance Analyzer. You will learn to measure memory activity and evaluate program activity, as well as determine time distribution of a module's execution and transitions, and evaluate Intermodule Bus measurements.

This course will help streamline all phases of your software development. *Ask for HP 64310A+24A.*

HP 1631 Logic Analysis Measurement Techniques

This two-day lab-intensive course offers a systematic approach to problem solving. You will learn to match appropriate measurement techniques to specific problems using the interactive state and timing capabilities of the HP 1631. *Ask for HP 1631A/D+24A.*



eration, maintenance and self-test, as well as error correction, time domain and advanced operating techniques. This training will allow you to quickly take full advantage of the advanced capabilities of the HP 8510 Network Analyzer. *Ask for HP 8510+24D Training.*

HP 8566A/8568A Spectrum Analyzer Operation

This four-day program will help accelerate the integration of your HP 8566A or HP 8568A into automatic test systems. You will learn to effectively use signal acquisition and process capabilities; as well as how to analyze and optimize accuracy, sensitivity, dynamic range and resolution in a system environment. To attend this training, *ask for HP 8566A/8568A+24D.*



Board Test Courses

The accurate testing of IC boards is crucial to the productivity of many businesses. HP offers a variety of board test courses designed to enhance your use of HP board test equipment.

HP 3060A, 3061A, 3062A User's Course

This is a ten-day course which will teach you how to test analog and hybrid circuits with HP board test systems. *Ask for HP 3060A/61A/62A Board Test Systems User's Course.*

HP 3065 Board Test System User Training

This two-week course provides detailed programming and operating instruction for the HP 3065 board test system. Topics covered include system software and program development, board test topology, in-circuit testing digital scanner hardware, test language and test structure. Also included are reviews of BT BASIC, test optimization, fixturing, data logging, networking links and IPG II. *Ask for HP 3065C+24D Training.*

HP 3065 Advanced User Class

HP 3065 Advanced User Training is a one-week class covering advanced topics in the use of HP 3065 board test system, including writing digital tests using HP's Vector Control Language (VCL), internals of the safeguard pulsing protection analysis software, analog functional testing, testing hybrid devices and advanced features of BT-Basic.

Class time is hands-on laboratory exercises, lecture and class discussions. Prerequisite is Course 3065C+24D. *Ask for HP 44850A.*

RF & Microwave Related Courses

HP's RF & Microwave related courses provide you with practical training for your measurement applications:

Basic Measurements Using the HP 8510 Network Analyzer System

This three-day, lab-intensive training will allow you to better apply the HP 8510 to your needs. You will learn microwave and network analyzer fundamentals, system op-

Additional Instrumentation Courses

HP offers a number of other courses to help you understand instrumentation applications and to help you use your HP equipment more effectively:

Data Acquisition and Control Fundamentals

This three-day course is a hands-on introduction to the basic principles and concepts of data acquisition and control. After an overview of various system types, you will learn the techniques needed to measure various physical phenomena such as temperature and pressure. To gain a deeper understanding of what data acquisition and control automation can do for you, *ask for HP 50015A.*

HP 4955A Protocol Analyzer User Training

This is a one-day lab-intensive course on troubleshooting techniques, reinforced with hands-on experience. *Ask for HP 4955A+24A Training.*

HP 8180A/8182A Operating and Programming Techniques

These courses will teach you how to use and program the HP 8180A Data Generator and HP 8182A Data Analyzer to perform basic propagation delay, set-up and hold time measurements for devices under test. This on-site course allows for maximum hands-on activities so that you will gain real-time practice in operating the instruments and developing programs. *Ask for HP 8180A+24A.*

Other Test & Measurement System Courses

HP offers many more courses for electronic instrumentation, and others are being developed all the time. If you are using HP Semiconductor Test Equipment, look for *HP 4062B Operating and Programming Train-*

ing and HP 9430A Memory Test System Training. Other useful courses include *HP 8409C Automatic Network Analyzer User's Course* and *HP 55280A Basic*, and *HP 55283A Advanced Laser Measurement System Training.*

Computer Systems Customer Education

HP also offers a comprehensive range of training courses for the HP 3000, HP 1000, HP 9000 and HP Series 100 and HP Series 80 computers. These courses cover a variety of application and operation subjects so that you can use your computer systems as efficiently as possible.

Of particular interest to engineering oriented applications are:

- *HP-UX curriculum for UNIX™ users, programmers and system administrators

- *Engineering applications on the HP 9000 Series, including Fundamentals of EGS/200 and Advanced EGS/200

- *HP 1000 Series process monitoring and control, statistical quality control and automatic test systems programming courses

In addition, HP's computer systems curriculum includes a wide variety of software courses designed to help your business - from data base management and quality decision management to advanced graphics and financial analysis.

Also available are fundamental and advanced computer system maintenance courses to help your inhouse maintenance team sharpen their technical skills.

Ordering Information

HP's flexible computer and instrument systems training courses allow you to create a customized training plan. To help you meet your training needs, your HP representative will work with you to develop the proper training curriculum for your particular situation.

To enroll in any of the courses listed here, or to obtain more information on these and the many other courses HP offers, just contact your local HP Sales Office. They will provide you with complete course details, local class schedules and registration information.

™ UNIX is a US trademark of Bell Laboratories



CUSTOMER SUPPORT

Application Consulting

- Customized Training
- Application Support

- Extensive Experience
- One-Vendor Solution

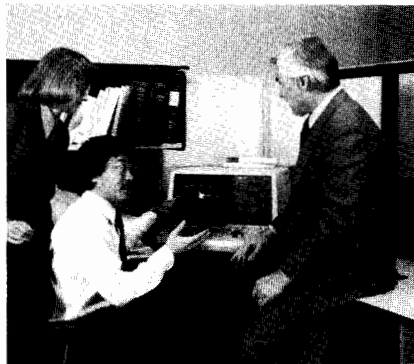

Hewlett-Packard's applications consulting experience can be yours. Trained systems and applications experts are available to work with you to develop customized solutions to your unique needs. Choose from among the programs described below for test and measurement and data processing/computing solutions to your application requirements.

Instrument Consulting Services for Maximum Productivity

When you purchase a test or measurement system, you want to make sure that the payback starts quickly. HP's Consulting Services provide assistance in developing your staff to ensure the most effective use of your system. Instrument Consulting Services feature the expertise of an HP Systems Engineer trained in your application area who can tailor the assistance to meet your own specific needs.

Customized Training Improves Utilization

If your application requires training that falls outside the scope of HP's formal training courses, our Systems Engineer (SE) can provide customized training to fit the demands of your particular application.

An HP SE skilled in your application area will work with you to determine the topics to be covered and the structure of the material to be presented. The training can cover basic system startup and operational techniques or can include more advanced material on your application. Each day of SE training could save your staff several days of startup time and could improve your overall capabilities and operating efficiency.

Application Support Speeds Solutions

Even if you require assistance beyond training, IAS can help. Under IAS, an HP SE can provide application support designed to help you achieve the highest possible level of success with your HP ATE, data acquisition board test, logic development, or other system.

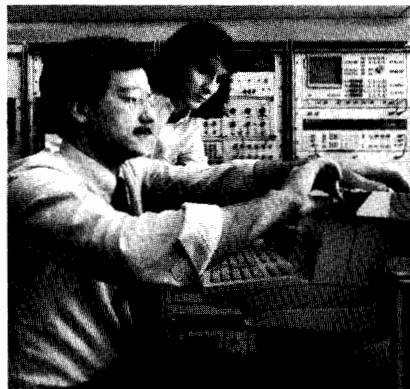

System Level Expertise Increases Productivity

If you have an existing measurement or test system and have partially or fully developed software or fixturing, IAS can help you fine tune the final implementation. An SE will travel to your site and work with you to analyze system performance parameters and make recommendations to help optimize performance.

Interactive Help

The interactive nature of IAS allows for maximum flexibility to improve your productivity. Since your needs determine the best mix of training, application advice or performance evaluation, an initial discussion with your HP representative will help define how IAS can benefit you. Our SE will then perform any research and preparation necessary.

The services provided by IAS are flexible and can be purchased in increments of one day (plus preparation time) or in larger blocks spaced out over longer periods.

Application Project Centers for Computer and Instrument Applications

Application Project Centers represent HP's commitment to ensuring that all your unique business requirements are met. They provide you with a comprehensive range of project services.

From Idea to Solution

When combined with HP products and support services, your ideas are transformed into quality solutions. HP can provide the hardware and application software and, through an Application Project Center, provide many services to assist in your system's implementation.

The Project Center Approach to Quality Solutions

The Definition Stage incorporates system analysis, functional and design specifications, and HP's consulting resources. A written proposal includes hardware, software,



training, and support issues. The Software Development Stage integrates HP's experience, use standards, and productivity tools with subcontract management. This results in custom software development which interfaces to computers and instrumentation. This is especially important to customers who want to augment HP standard application products while maintaining a single vendor approach to implement the project.

A detailed Custom Implementation Plan is then created which pulls together all the preceding work with HP's special support services. It incorporates HP's implementation services for software products and addresses all the customer's training and support needs. It may include customized education which is specific both to the application and to the environment in which it is being implemented.

Through a Working Partnership

HP's project team is a unique combination of people, expertise, equipment, and systems. The HP team works with your project team to develop and implement a quality solution.

Application Project Center services, coupled with HP's hardware and application software, gives HP the ability to provide the high-quality, single-source vendor that your company deserves.

Project Services for Custom Measurement Systems

Whether you are a small test lab or a large production facility, start-up time can be unproductive time. All new system installations have associated set-up and application programming time. HP wants you to quickly obtain use of your HP-IB, data acquisition, circuit test, or other HP products. HP's Project Services for Custom Measurement Systems offers you the most rapid and cost-effective method of getting your system into production. It provides all or part of initial application development and program coding for your system.



Problem-Solving Experts

HP's System Engineers are experienced with test and measurement systems and in solving application problems. Our SE will work with you to identify the procedures needed for your initial application. The SE can also develop the software and prepare your staff to maintain the package upon implementation.

Flexible to Meet Your Needs

The service is flexible and tailored to meet your needs. Applications problems are solved using an incremental approach which helps in the development of clear project checkpoints and division of responsibility for each phase.

The project specification is structured so that both HP and you are ensured of success upon completion. The SE will work with you to design and specify your system's application software. You benefit from the SE's experience in software development and receive a detailed document including:

- a flow chart of the system controller application package
- a description of how the subsystems interact and combine to meet overall requirements
- fixturing specification
- acceptance test procedure specification for each of the tasks, software sub-systems, and the completed system

Substantial Benefits

With the Project Specification, the customer knows exactly what is being purchased. And mutually agreed-upon acceptance criteria assures project completion with a minimum of "hassles". With Project Services, you get minimized and controlled project costs, increased in-house expertise, and decreased future maintenance costs for customer configured systems. And the quality of your applications implementation is maximized.

HP-ASSIST for Computer Applications

Helping your people use computer applications successfully is the goal of HP-ASSIST. Implementation of application software requires good planning, training, and a systematic approach to project management. At all these stages, HP-ASSIST helps your people obtain results.

More than Just Installation

To integrate application software into your daily operations, your people must understand how to use the system to its fullest capabilities. HP-ASSIST helps people adjust to changes in their computerized environment.

Saves You Time and Money

HP-ASSIST uses a systematic approach to implementation. You can reduce application software integration time. Your people learn the most efficient operating procedures from the start, which helps avoid problems once the system is in operation.

Teamwork Works

Successful implementation requires teamwork. Your project team provides a clear understanding of how your business functions. We add our specialized skills. This combination results in productive solutions.



Planning for Success

HP-ASSIST consists of three phases. Implementation Analysis, Implementation Team Training and Project Implementation Assistance.

- Implementation Analysis is the key to the rest of your project because it helps you define a clear set of goals and develop your plan of action. HP provides you with a written report which documents the scope, activities, timeframes and resources needed for your project.
- Implementation Team Training. An HP project manager will provide your Project Team with an overview in planning and project management. Once a solution is agreed upon, HP will work with you to implement the solution.
- Project Implementation Assistance. A detailed Implementation Plan will be devel-

oped, HP will monitor the effective execution of the Plan, and end users will be trained.

Some HP-ASSIST applications have simpler implementations so that certain steps may be combined or eliminated.

On-going Support

After your application is implemented, HP's on-going hardware and software support services make sure your computer system continues to operate smoothly and effectively.

Solutions

HP is committed to high quality solutions backed by high quality implementation services.

How to

To learn more about application support services, contact the nearest HP sales office or talk with your HP Sales Representative.



Software Support

- Broad Range of Services World-wide
- Flexible Options to Suit your Budget
- Assured Lasting Value for your HP Computer Products

Software Support

Your investment in system software doesn't end with the purchase of an instrument or computer system. It continues as you develop or improve programs specific to your application needs. Through HP's software support services (available for computers and specific instrument systems), you will gain valuable tools to keep your system software and programmers operating at peak efficiency.

Real Benefits

Software support allows you to stay current with changes in system software. Access to an HP Systems Engineer means that programmers save time during test development. Above all, software support can help you stay competitive. Because software support keeps you constantly informed of software changes, additions and enhancements, your system's operation cannot become out-moded.

Flexible Services

Because we realize that individual needs vary between users as well as over time, HP offers several types of software. We offer training courses, predefined and unstructured consulting assistance, and a variety of support agreements as well as assistance on a time-and-material basis.

Software Support Agreements

Our software support agreements provide the initial and ongoing technical information your staff requires. The assistance provided can range from documentation updates to personalized technical assistance, depending on the urgency and complexity of your needs. You can adapt your selection of services to meet the changing requirements of your computer system.

Account Management Support (Computers Only)

This service provides the expertise of an account-assigned support representative who gets to know you and your system. This in-depth knowledge of your situation allows our representative to make recommendations for managing your software with maximum effectiveness. It also contributes to prompt remedial action when necessary.

Telephone access to the Response Center is an integral part of this service. The Response Center provides an almost immediate response to urgent questions and a response within two hours to all others.

If on-site assistance is needed to identify a problem or develop a workaround, it is also included in this level of support. Additionally, you receive all support materials necessary to stay current with changes and improvements in HP software.



Response Center Support (Computers and Selected Instruments)

Response Center Support provides help from experienced professionals via the telephone. Teams of support engineers respond to urgent questions almost immediately and answer other questions within two hours. If on-site assistance is needed, it is available on a time-and-material basis. With Response Center Support, all of the software support materials necessary to maintain your system at current levels are included.

Software Materials Subscription (Computers and Selected Instruments)

If you want to stay current with developments in your system's software and are experienced on the use and operation of the software, then Software Materials Subscription (SMS) is for you. With SMS you will automatically receive Software Updates. These include improvements to software performance, additional software elements, resolution of specific anomalies, and increases in software capabilities.

You will receive Reference Manual Updates, Software Status Bulletins, and a User's Newsletter—all of which contain information on the use, application, configuration, and developments in HP software. For computers, this subscription is an integral part of both Account Management Support and Response Center Support, but is also

available separately. On-site assistance can be obtained on a time-and-material basis.

Custom Support Plan (Computers Only)

For additional assistance beyond the level provided by Account Management Support, we offer our Custom Support Plan. You work with your support representative to define the exact combination of services which will meet your needs. For consulting, reviewing or coordinating on a regular basis, this plan allows you to project all your software support needs in advance.

Support to Cover Multiple Systems

If you have several systems under a single System Manager, various optional services can be added to your support program to provide coverage for them at a significant cost savings.

Time-And-Material Service

HP software support assistance is also available on a time-and-material basis as needed.

How to Order

When expert technical support is important to the ongoing success of your application, consider HP's software support services. Contact your HP Sales Representative for details.



Hardware Support

- Flexible and Comprehensive Service Plans
- Personalized Service
- Factory Trained Service Personnel

Hardware Support for Your Productivity

You gain a powerful tool when you invest in the engineering quality of Hewlett-Packard's products. Yet simply choosing advanced technology HP products is often not enough to *maintain* your increased productivity. High performance equipment demands high performance maintenance in order to sustain your productivity.

At HP, we use our more than 40 years of engineering experience to design hardware support services that match the quality and performance of our measurement and computation systems.

A Wide Range of Hardware Support Services

HP offers a complete spectrum of support products for you. If you need cost-effective maintenance agreements that offer insurance-like protection, or per-incident service at low standardized prices, we have a plan for you. If you need on-site service for your systems or fast return-to-HP service for your system components, HP offers a plan for you. If you need instrument repair only or calibration backup for your cal lab, or both, there's a plan which fits your needs.

System Support Services

All HP computer and measurement system products can be covered by one of our maintenance agreement services, or, services can be obtained on a per-incident basis. You can choose from a variety of service levels depending upon your requirements for response time, coverage hours and cost.

Our cost-effective maintenance agreements provide the assurance of a known, specified response time, and save you the risk of having to finance unusually costly repairs. In addition, the periodic charge gives you a known, budgetable service cost for your equipment.

Basic System Maintenance Service

This service agreement provides next-day on-site service coverage from 8 am to 5 pm during the normal workweek (excluding HP holidays). Service includes an account-assigned CE who becomes familiar with your environment and takes personal responsibility for managing your system's maintenance program.

Also, your CE will perform preventive maintenance on a regular basis, scheduled in advance, to maintain your system at its optimal performance specifications.

Desktop computers configured with system peripherals gain the account management and system support essential for these

configurations (stand-alone desktop computers can be covered under workstation services - see "Workstation Services").

Standard System Maintenance Service

This agreement provides coverage from 8 am to 9 pm, Monday through Friday (excluding HP holidays). This coverage allows all scheduled maintenance services to be performed after normal working hours. Customers within 100 miles of an HP Support Responsible Office will receive an on-site visit within 4 hours. Extended coverage options can provide service up to 7 days per week, 24 hours per day.

Measurement System Calibration Service

For HP instrument products configured into measurement systems, calibration systems can be added to the Standard or Basic System Maintenance agreements. Some products can be calibrated at your site, while others will need to be returned to an HP Customer Service Center by your CE. Customer Service Centers will calibrate your equipment so it is traceable to the U.S. National Bureau of Standards (or other international standards organization, where applicable).

System Installation Services

When you purchase an HP computer or measurement system, support services begin even before your system is installed. A Customer Engineer routinely provides site planning, site environmental survey, and installation services. This advance planning ensures the sustained, reliable operation of your system.

Stand-alone Instrument Support Services

Customer Service Center Agreement

HP Customer Service Center agreements provide many of the same budgeting and convenience benefits of our other agreements, but for return-to-HP service. Agreements are available to provide repair, calibration or both for your single HP instruments, or for measurement system components that do not require on-site service.

When your instruments are covered by a Service Center Agreement, they receive priority response by a skilled HP technician. All labor and parts are included in the cost of the agreement, and your instrument is quickly processed and speedily returned to you.

Per-incident Service

If you prefer to handle your maintenance requirements as they arise, HP offers cost-effective per-incident instrument repair and calibration. Standard service prices have been established for over 750 HP instrument products, so barring unusual problems or misuse, you will know up-front what your service cost is.

CUSTOMER SUPPORT

Hardware Support

Other Support Services

Workstation Services

Refer to the Personal Computer section for information on maintenance services designed for terminal, personal computers, plotters, and printers used with your system. While some of these products can be covered under your system maintenance agreement, it is usually more economical to obtain workstation coverage for them.

Per-Incident Maintenance

Time-and-Material Service is available for HP computer systems not covered by a maintenance agreement. When you purchase this service, you receive a three-day response during coverage hours of 8 a.m. to 5 p.m., Monday through Friday, excluding HP holidays. You will be billed for all travel, parts, and labor involved in the service call.

Cooperative Support Services For Computers and Selected Instruments

Self-support is an expensive support solution. However, you may have the very large installed base of HP computer equipment and the technical expertise needed to make it cost-effective. If you meet these qualifications, HP has several services under the Cooperative Support Program to meet your needs:

Hardware Maintenance Training is available for many HP computer and instrument products. A balance of theory and practical experience provides customers with the skills needed to troubleshoot, repair, and maintain these products to the major subassembly level.

Hardware Subscription Service furnishes current service information for products covered by Cooperative Support. It includes a monthly newsletter for prompt notification of changes to maintenance procedures, periodic bulletins for procedural changes not yet included in manual updates, service manual updates and revisions, and a quarterly newsletter for current schedules and other information of HP's maintenance training program.

Technical Assistance Service provides access to the HP Customer Engineering Organization through phone-in consulting. It also includes all the features of Hardware Subscription Service to keep you current on procedures and training schedules. In addition, this service provides an account-assigned Customer Engineer to ensure that you are making the most effective use of all HP hardware services.

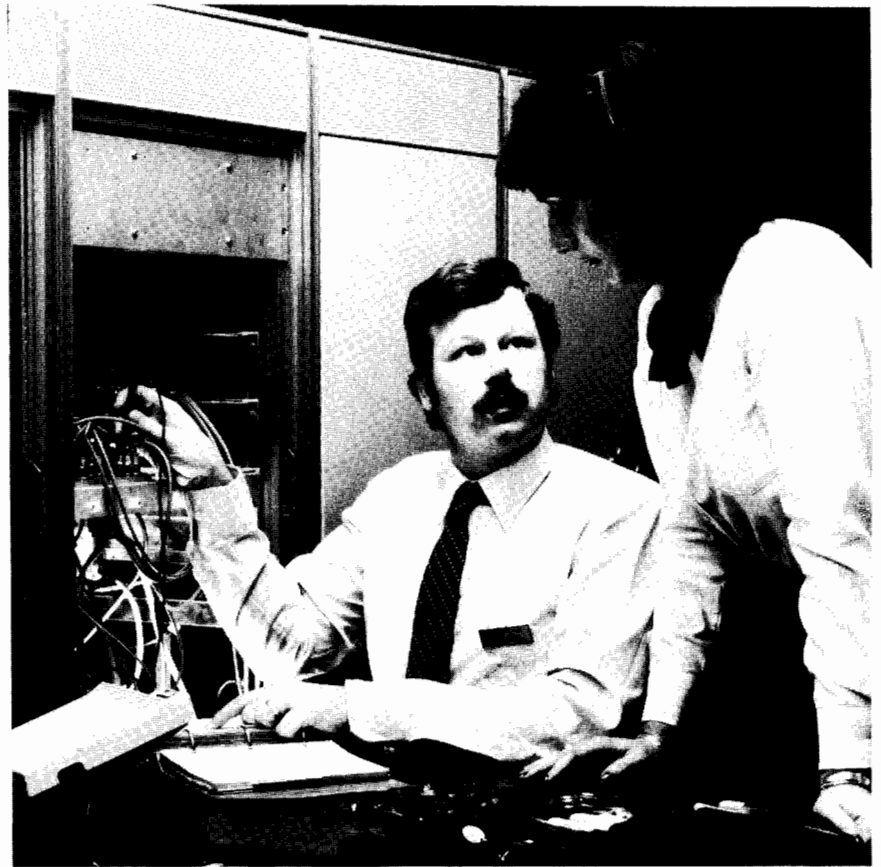

The Assembly Exchange Program offers customers who perform their own maintenance a fast, economical method of exchanging defective assemblies for refurbished ones. The modular design of our products enables the easy removal of the defective assembly and the easy installation of its replacement. In addition, the refurbished assembly is automatically updated to the latest revision level.

HP Service Locations Worldwide

HP maintains computer sales and support offices in more than 30 countries around the world. Refer to the listing of addresses at the back of this catalog for specific information. Selection is easy!

Whatever your level of need, our hardware support program offers you an appropriate level of service. For your computer service needs use the convenient Service Selection Guide on the next page to compare features and benefits. Then contact your local HP sales office for additional information on the service you require. Your HP sales representative can likewise help you choose the proper service level for your instrument and instrument system needs.

Fast, Cost-effective Hardware Support

Hewlett-Packard makes every effort to ensure your long-term productive use of our products. Take advantage of our flexible hardware support programs and you can be confident of continued productivity from your HP equipment.



* Within range of service center

Computer Service Selection Guide

SUMMARY FEATURES	SERVICE							
	GUS	STANDARD	BASIC	PRIORITY ON-SITE SERVICE	NEXT DAY ON-SITE SERVICE	SCHEDULED ON-SITE SERVICE	COURIER RETURN SERVICE	CUSTOMER RETURN SERVICE
Response time (or total turnaround time)	4 Hours	4 Hours ²	1 Day ²	4 Hours ²	1 Day ²	3 Days Average (scheduled weekly visit)	4 - 6 Days ³	≥5 Days Total ⁴
Coverage Hours	24 Hours/Day (7 Days/Week)	8 AM - 9 PM ¹ (5-7 Days/Week)	8 AM - 5 PM (5 Days/Week)	8 AM - 5 PM (5 Days/Week)	8 AM - 5 PM (5 Days/Week)	8 AM - 5 PM	8 AM - 5 PM	-
Relative Cost	1.6	1.0	0.8	0.8	0.5	.33	.40	.33
Commercial Systems	Available only on new & current HP 3000 products Recommended only for critical applications							
Small Business Systems								
Technical Systems		Good for manufacturing systems needing multiple shift coverage						
System- Workstations Personal Computers & Terminals		Recommended only on System Console	Recommended only on System Console	Recommended only on System Console		Recommended with purchase of spare units for backup	Recommended for maximum economy	Recommended for maximum economy
Standalone Workstations Personal & Desktop Computers				Recommended in critical applications			Recommended for maximum economy	Recommended for maximum economy



NOT AVAILABLE



NOT RECOMMENDED



RECOMMENDED

¹Extended hours are available

²Within 100 miles of a Primary SRO

³Within coverage zones specified. Call HP for coverage and availability.

⁴Total time varies according to your proximity to an HP Customer Service Center. Total time estimated here includes shipping time.

CUSTOMER SUPPORT

Fast-Ship Service

- Convenient catalog shopping
- Computer supplies/accessories
- Test & measurement accessories (U.S. only)
- Quick, easy telephone ordering
- Fast shipment



Refer to opposite page for full descriptions of all Fast-Ship catalogs. Note that the Instruments Direct Catalog has been renamed the Test and Measurement Accessories Catalog to more accurately reflect its content.

What Is Fast Ship Service?

Fast-Ship Service is the quick way for you to choose from thousands of HP products, order them by phone and receive expedited delivery. Four catalogs offer an array of supplies and accessories, add-on peripheral devices and test instruments.

Now, with **Fast-Ship Service**, you can call **HP DIRECT** distribution centers (see opposite page) and receive fast shipment from our complete stock of supplies, accessories and add-on products.

Computer Users Catalog (Worldwide)

This biannual publication provides a fast, easy way for HP customers to shop for nearly 2,000, supplies, accessories and add-on products. These products are HP manufactured, tested or approved to operate at maximum efficiency with HP equipment. Detailed descriptions, charts, full-color photographs and equipment guides provide all the information necessary to select the best products for your application.

Information is easily accessible, with new products grouped together in front and four convenient indexes for easy referencing.

To Get A Catalog

In the U.S.: Call 800-538-8787 (in CA, AK call 408-738-4133) or call your local HP Sales Office and request publication #5953-2450D.

Outside the U.S.: In the following countries, call the listed phone number (see below) and request the appropriate publication:

- U.K. 5953-2450UK
- Germany 5953-2450GE
- France 5953-2450FR
- Italy 5953-2450IT

In Japan request publication #9320-0761 from your local HP Sales Office. In all other countries, call HP DIRECT or ask your local HP Sales Office for publication #5953-2450.

Personal Computer Users Catalog (U.S. only)

Created specially for personal computer and office automation customers, this biannual catalog contains hundreds of products: magnetic media, supplies, accessories, peripherals and other items of special interest to the office and home computer user. Detailed descriptions, charts, full-color photographs and equipment specifications provide all the information necessary to select the best products for your computer needs.

New-product information is grouped conveniently together in front and a quick index helps you quickly find what you need.

To Get a Catalog (available in the U.S. only)

Call 800-538-8787 or contact your local HP Sales Office and request publication #5953-2461D.

HP Direct Order Phones (Worldwide)

In the U.S. call:

800-538-8787, (in CA, AK call (408) 738-4133).

Outside the U.S. call:

Australia	895-2895
Austria	(022) 25 00615/616
Belgium	(02) 761 3111
Canada	(416) 671-8383
Denmark	(02) 816640
Finland	(80) 4550211
France	(06) 928 3264
German Federal Republic	01 30 3322
Italy	(02) 92369 437-478
Netherlands	(020) 470639
Norway	(02) 171180
South Africa	802-5111
Spain	(01) 6374013
Sweden	(08) 7502028
Switzerland	(057) 312254/59
United Kingdom	(0734) 697 201

In countries where HP DIRECT is not yet available, order from your HP Sales Office.

Computer Users Documentation Index (Worldwide)

More than 2500 manuals, binders, books and guides for HP computer systems and peripherals are listed in this annual publication. For ease of use, the index is conveniently divided into three sections. You can find a manual easily — even if you don't know the part number — because the first two sections list the publication under the computer or peripheral to which they belong. The third section lists the publications in numerical order and includes the title, latest print date and the latest update (if this information is available).

To Get an Index

In the U.S.: Call 800-538-8787 (in CA, AK, HI call 408-738-4133) or contact your local HP Sales Office and request publication #5953-2460D.

Outside the U.S.: Call your local HP Sales Office. Request publication #5953-2460.

Test & Measurement Accessories Catalog (U.S. only)

This catalog features a broad line of electronic test and measurement accessories, such as oscilloscope probes, rack mount hardware, logic probes, and microwave power sensors, detectors and attenuators.

It is designed to make selection of accessories as easy as possible and features full-color photographs, detailed descriptions, and selection guides. Three different indexes make products easy to find.

The catalog also contains a selection of HP's most popular test instruments — all available off-the-shelf and shipped the same day if your order is received by 1 PM.

To Get a Catalog (available in U.S. only)

Call 800-523-2121 or contact your local HP Sales Office and request publication #5954-0193D.

Fast-Ship Service In the U.S.

Throughout the pages of this catalog you will notice the telephone symbol. This symbol identifies a wide variety of products available to you through the U.S. **Fast-Ship Service**, as well as through your local HP Sales Office:

- Test and Measurement Accessories
- Cables and adapters
- Microwave Accessories
- Basic Instruments
- PC Instruments
- Data communications
- Handheld calculators and computers
- Personal computers and software
- Peripherals and terminals
- Furniture and accessories
- Printers
- Plotters and their supplies
- Magentic media.

What Makes Fast-Ship Convenient?

When you call our HP Direct Phone Order Service weekdays between 6 AM and 5 PM Pacific Time, from anywhere in the U.S., you receive immediate confirmation of product availability, pricing and delivery. And remember, our prices include regular UPS or truck delivery. Expedited air service is also available. We usually can charge your order with an HP DIRECT Open Account (P.O.'s), or with your VISA, MasterCard or American Express credit card. We want you to be absolutely satisfied with our products. All supplies and accessories are designed and tested to meet the high quality standards you expect from Hewlett-Packard. All products in our catalog come with our guarantee of satisfaction. Any product in our catalogs not meeting your expectations can be returned — no questions asked.



CUSTOMER SUPPORT

Support Life Service Publications, Warranty and Certification

Support Life - Maintaining Your Productivity

Hewlett-Packard fully supports all products for a minimum of five years after production ceases, with selected products being supported for a minimum of ten years. After the expiration of the specified support period, HP will continue to offer support on a best-effort basis. In this way HP can help assure your ability to use your equipment productively for as long as possible.

Service Publications - Help You Maintain Your Instruments

The *Operating and Service Manual* supplied with Hewlett-Packard instrumentation contains maintenance, calibration, diagnostic and repair procedures, with troubleshooting charts, circuit diagrams and replacement parts lists. Most operating and service manuals, manual updates, and Service Notes are now available on COSATI standard, positive microfiche.

Bench Briefs, a periodic newsletter, has information to help repair and maintenance personnel get maximum performance from Hewlett-Packard instruments. It describes new Service Notes and other company publications as they become available. To become a regular subscriber, ask your local HP office to place your name on the mailing list.

Warranty - Confidence in Quality and Reliability

As an expression of confidence that our products will continue to meet the high standards of reliability and performance that our customers expect, Hewlett-Packard products carry the following warranty:

HP hardware products are warranted against defects in materials and workmanship. If HP receives notice of such defects during the warranty period, HP shall, at its option, either repair or replace hardware products which prove to be defective.

HP software and firmware products which are designated by HP for use with a hardware product, when properly installed on that hardware product, are warranted not to fail to execute their programming instructions due to defects in materials and workmanship. If HP receives notice of such defects during the warranty period, HP shall repair or replace software media and firmware which do not execute their programming instructions due to such defects. HP does not warrant that the operation of the software, firmware or hardware shall be uninterrupted or error free.

If HP is unable, within a reasonable time, to repair or replace any product to a condition as warranted, Buyer shall be entitled to a refund of the purchase price upon return of the product to HP.

a. **SUPPLEMENTAL STATEMENT:** Supplemental statements setting forth the duration and implementation of warranty and installation are available for most product types. These statements, if applicable to purchased products, are attached hereto and incorporated herein.

b. **DURATION AND COMMENCEMENT OF WARRANTY PERIOD:** The warranty period for each product is specified in the supplemental statement of warranty and installation attached hereto and incorporated herein. The warranty period begins either on the date of shipment or, where the purchase price includes installation by HP, on the date of installation. If Buyer schedules or delays installation more than thirty (30) days after delivery, the warranty period begins on the thirty first (31st) day from the date of shipment.

c. **PLACE OF PERFORMANCE:** Within HP service travel areas, warranty and installation services for products installed by HP and

certain other products designated by HP will be performed at Buyer's facility at no charge. Outside HP's service travel areas, warranty and installation services will be performed at Buyer's facility only upon HP's prior agreement and Buyer shall pay HP's round trip travel expenses and applicable additional expenses for such services.

On-site warranty services are provided only at the initial installation point. If products eligible for on-site warranty and installation services are moved from the initial installation point, the warranty will remain in effect only if Buyer purchases additional inspection or installation services at the new site.

Installation and on-site warranty services are available outside the country of initial purchase only if Buyer pays HP international prices. If Buyer transports a product from the country of initial purchase without having paid HP international prices, any remaining warranty covers parts and labor only and applies only if the product is returned to HP. However, Buyer may obtain on-site warranty service if the location is one where HP can normally provide on-site service for the product and the Buyer pays HP established travel charges. Service outside the country of initial purchase is subject to the conditions regarding HP service travel areas and initial installation point described above.

For product warranties requiring return to HP, products must be returned to a service facility designated by HP. Warranties requiring return to HP are not limited to the country of purchase. Buyer shall prepay shipping charges (and shall pay all duties and taxes) for products returned to HP for warranty service. Except for products returned to Buyer from another country, HP shall pay for return of products to Buyer.

d. **LIMITATION OF WARRANTY:** The foregoing warranty shall not apply to defects resulting from:

1. Improper or inadequate maintenance by Buyer;
2. Buyer-supplied software or interfacing;
3. Unauthorized modification or misuse;
4. Operation outside of the environmental specifications of the product; or
5. Improper site preparation and maintenance.

THE WARRANTY SET FORTH ABOVE IS EXCLUSIVE AND NO OTHER WARRANTY, WHETHER WRITTEN OR ORAL, IS EXPRESSED OR IMPLIED. HP SPECIFICALLY DISCLAIMS THE IMPLIED WARRANTIES OF MERCHANTABILITY AND FITNESS FOR A PARTICULAR PURPOSE.

EXCLUSIVE REMEDIES

The remedies provided herein are Buyer's sole and exclusive remedies. In no event shall HP be liable for direct, indirect, special, incidental or consequential damages (including loss of profits) whether based on contract, tort, or any other legal theory.

Certification—Traceability of Measurements to Known Standards

Products provided by Hewlett-Packard are thoroughly tested to meet their published specifications. A letter of Conformance (certifying that the product meets its published specifications to the extent possible) is available upon request at the time of purchase.

Hewlett-Packard's calibration measurements are traceable to National Standards—the National Bureau of Standards in the United States—and to comparable standards authorities in other countries, where applicable.

SALES & SUPPORT OFFICES

Arranged alphabetically by country

769



Product Line Sales/Support Key

Key Product Line

A Analytical

CM Components

C Computer Systems

E Electronic Instruments & Measurement Systems

M Medical Products

P Personal Computation Products

* Sales only for specific product line

** Support only for specific product line

IMPORTANT: These symbols designate general product line capability. They do not insure sales or support availability for all products within a line, at all locations. Contact your local sales office for information regarding locations where HP support is available for specific products.

HEADQUARTERS OFFICES

If there is no sales office listed for your area, contact one of these headquarters offices.

NORTH/CENTRAL AFRICA

Hewlett-Packard S.A.
7, rue du Bois-du-Lan
CH-1217 MEYRIN 1, Switzerland
Tel: (022) 83 12 12
Telex: 27835 hmea
Cable: HEWPACKSA Geneva

ASIA

Hewlett-Packard Asia Ltd.
47/F, 26 Harbour Rd.,
Wanchai, HONG KONG
G.P.O. Box 863, Hong Kong
Tel: 5-8330833
Telex: 76793 HPA HX
Cable: HPASIAL TD

CANADA

Hewlett-Packard (Canada) Ltd.
6877 Goreway Drive
MISSISSAUGA, Ontario L4V 1M8
Tel: (416) 678-9430
Telex: 069-8644

EASTERN EUROPE

Hewlett-Packard Ges.m.b.h.
Lieblgasse 1
P.O.Box 72
A-1222 VIENNA, Austria
Tel: (222) 2500-0
Telex: 13 4425 HEPA A

NORTHERN EUROPE

Hewlett-Packard S.A.
V. D. Hooplaan 241
P.O.Box 999
NL-1183 AG AMSTELVEEN
The Netherlands
Tel: 20 547999
Telex: 18 919 hpner

SOUTH EAST EUROPE

Hewlett-Packard S.A.
World Trade Center
110 Avenue Louis Casai
1215 Cointrin, GENEVA, Switzerland
Tel: (022) 98 96 51
Telex: 27225 hpser

MEDITERRANEAN AND MIDDLE EAST

Hewlett-Packard S.A.
Mediterranean and Middle East
Operations
Atrina Centre
32 Kifissias Ave.
Paradissos-Amarousion, ATHENS
Greece
Tel: 682 88 11
Telex: 21-6588 HPAT GR
Cable: HEWPACKSA Athens

UNITED KINGDOM

Hewlett-Packard Ltd.
Nine Mile Ride
Easthampstead, WOKINGHAM
Berkshire, IRGII 3LL
Tel: 0344 773100
Telex: 848805

EASTERN USA

Hewlett-Packard Co.
4 Choke Cherry Road
ROCKVILLE, MD 20850
Tel: (301) 948-6370

MIDWESTERN USA

Hewlett-Packard Co.
5201 Tollview Drive
ROLLING MEADOWS, IL 60008
Tel: (312) 255-9800

SOUTHERN USA

Hewlett-Packard Co.
2000 South Park Place
ATLANTA, GA 30339
Tel: (404) 955-1500

WESTERN USA

Hewlett-Packard Co.
5161 Lankershim Blvd.
NORTH HOLLYWOOD, CA 91601
Tel: (818) 505-5600

OTHER INTERNATIONAL AREAS

Hewlett-Packard Co.
Intercontinental Headquarters
3495 Deer Creek Road
PALO ALTO, CA 94304
Tel: (415) 857-1501
Telex: 034-8300
Cable: HEWPACK

ALGERIA

Bureau de Liaison
Hewlett-Packard Alger
Villa des Lions
9, Hai Galloul
DZ-BORDJ EL BAHRI
Tel: 76 03 36
Telex: 51260 dliondz

ANGOLA

Telectra Angola LDA
Empresa Técnica de Equipamentos
Rua Barbosa Rodrigues, 41-1 DT.
Caixa Postal 6487

LUANDA

Tel: 35515,35516
Telex: 3134
E,P

ARGENTINA

Hewlett-Packard Argentina S.A.
Montanases 2140/50
1428 BUENOS AIRES
Tel: 781-4059/69
Cable: HEWPACKARG
A,C,E,P
Biotron S.A.C.I.M.e.I.
Av. Paso Colon 221, Piso 9
1399 BUENOS AIRES
Tel: 541-333-490,
541-322-587
Telex: 17595 BIONAR

M

Laboratorio Rodriguez
Corswant S.R.L.
Misiones, 1156 - 1876
Bernal, Oeste
BUENOS AIRES

Tel: 252-3958, 252-4991

A

Argentina Esanco S.R.L.
A/ASCO 2328

1416 BUENOS AIRES

Tel: 541-58-1981, 541-59-2767
Telex: c/o 9400 HPARGENTINA
A

AUSTRALIA

Adelaide, South Australia Office

Hewlett-Packard Australia Ltd.
153 Greenhill Road
PARKSIDE, S.A. 5063
Tel: 272-5911
Telex: 82536
Cable: HEWPARD Adelaide
A*,C,CM,E,P

Brisbane, Queensland Office

Hewlett-Packard Australia Ltd.
10 Payne Road
THE GAP, Queensland 4061
Tel: 30-4133
Telex: 42133
Cable: HEWPARD Brisbane
A,C,CM,E,M,P

Canberra, Australia

Capital Territory

Office

Hewlett-Packard Australia Ltd.
Thynne Street, Fern Hill Park
BRUCE, A.C.T. 2617
P.O. Box 257,
JAMISON, A.C.T. 2614
Tel: 51 6999
Telex: 62650
Cable: HEWPARD Canberra
C,CM,E,P

Melbourne, Victoria

Office

Hewlett-Packard Australia Ltd.
31-41 Joseph Street
P.O. Box 221
BLACKBURN, Victoria 3130
Tel: 895-2895
Telex: 31-024
Cable: HEWPARD Melbourne
A,C,CM,E,M,P

Perth, Western Australia Office

Hewlett-Packard Australia Ltd.
261 Stirling Highway
CLAREMONT, W.A. 6010
Tel: 383-2188
Telex: 93859
Cable: HEWPARD Perth
C,CM,E,P

Sydney, New South Wales Office

Hewlett-Packard Australia Ltd.
17-23 Talavera Road
P.O. Box 308
NORTH RYDE, N.S.W. 2113
Tel: 888-4444
Telex: 21561
Cable: HEWPARD Sydney
A,C,CM,E,M,P

AUSTRIA

Hewlett-Packard Ges.m.b.h.
Verkaufsbuero Graz
Grottenhofstrasse 94
A-8052 GRAZ
Tel: (0316) 28-30-66
Telex: 312375
C,E

Hewlett-Packard Ges.m.b.h.

Lieblgasse 1
P.O. Box 72
A-1222 VIENNA
Tel: (0222) 2500-0
Telex: 134425 HEPA A
A,C,CM,E,M,P

BAHRAIN

Green Salon
P.O. Box 557
MANAMA
Tel: 255503-250950
Telex: 84419
P

Wael Pharmacy
P.O. Box 648

MANAMA

Tel: 256123
Telex: 8550 WAEI BN
E,M



SALES & SUPPORT OFFICES

Arranged alphabetically by country

BAHRAIN (Cont'd)

Zayani Computer Systems
218 Shaik Mubarak Building
Government Avenue
P.O. Box 5918

MANAMA

Tel: 276278
Telex: 9015 plans bn
P

BELGIUM

Hewlett-Packard Belgium S.A./N.V.
Blvd de la Woluwe, 100
Woluwedal
B-1200 BRUSSELS
Tel: (02) 762-32-00
Telex: 23-494 paloben bru
A,C,CM,E,M,P

BERMUDA

Applied Computer Technologies
Atlantic House Building
Par-La-Ville Road
HAMILTON 5
Tel: 295-1816
Telex: 380 3589/ACT BA
P

BOLIVIA

Arrellano Ltda
Av. 20 de Octubre #2125
Casilla 1383

LA PAZ

Tel: 368541
M

BRAZIL

Hewlett-Packard do Brasil
I.e.C. Ltda.

Alameda Rio Negro, 750

ALPHAVILLE

06400 Barueri SP
Tel: (011) 421.1311
Telex: (011) 33872 HPBR-BR
Cable: HEWPACK Sao Paulo
A,C,CM,E,M,P

Hewlett-Packard do Brasil
I.e.C. Ltda.

Praia de Botafogo 228

6° Andar-conj 614

Edificio Argentina - Ala A

22250 RIO DE JANEIRO, RJ

Tel: (021) 552-6422

Telex: 21905 HPBR-BR

Cable: HEWPACK Rio de Janeiro

A,C,CM,E,P*

Convex/Van Den

Rua Jose Bonifacio

458 Todos Os Santos

CEP 20771

RIO DE JANEIRO, RJ

Tel: 591-0197

Telex: 33487 EGLB BR

A

ANAMED I.C.E.I. Ltda.

Rua Bage, 103

04012 SAO PAULO, SP

Tel: (011) 572-6537

Telex: 24720 HPBR-BR

M

Datatronix Electronica Ltda.

Av. Pacaembu 746-C11

SAO PAULO, SP

Tel: (118) 260111

CM

BRUNEI

Komputer Wisman Sdn Bhd
Room 1
3rd Floor, Tumasek Plaza
Jalan Tutong

BANDAR SERI BEGAWAN

Tel: 23918,25603
C,E,P

CAMEROON

Beriac

B. P. 23

DOUALA

Tel: 420153

Telex: 5351

C,P

CANADA

Alberta

Hewlett-Packard (Canada) Ltd.
3030 3rd Avenue N.E.

CALGARY, Alberta T2A 6T7

Tel: (403) 235-3100

A,C,CM,E*,M,P*

Hewlett-Packard (Canada) Ltd.
11120-178th Street

EDMONTON, Alberta T5S 1P2

Tel: (403) 486-6666

A,C,CM,E,M,P

British Columbia

Hewlett-Packard (Canada) Ltd.
10691 Shellbridge Way

RICHMOND,

British Columbia V6X 2W8

Tel: (604) 270-2277

Telex: 610-922-5059

A,C,CM,E*,M,P*

Hewlett-Packard (Canada) Ltd.

121 - 3350 Douglas Street

VICTORIA, British Columbia V8Z 3L1

Tel: (604) 381-6616

C

Manitoba

Hewlett-Packard (Canada) Ltd.
1825 Inkster Blvd.

WINNIPEG, Manitoba R2X 1R3

Tel: (204) 694-2777

A,C,CM,E,M,P*

New Brunswick

Hewlett-Packard (Canada) Ltd.
814 Main Street

MONCTON, New Brunswick E1C 1E6

Tel: (506) 855-2841

C

Nova Scotia

Hewlett-Packard (Canada) Ltd.
Suite 111

900 Windmill Road

DARTMOUTH, Nova Scotia B3B 1P7

Tel: (902) 469-7820

C,CM,E*,M,P*

Ontario

Hewlett-Packard (Canada) Ltd.
3325 N. Service Rd., Unit W03

BURLINGTON, Ontario L7N 3G2

Tel: (416) 335-8644

C,M*

Hewlett-Packard (Canada) Ltd.

496 Days Road

KINGSTON, Ontario K7M 5R4

Tel: (613) 384-2088

C

Hewlett-Packard (Canada) Ltd.

552 Newbold Street

LONDON, Ontario N6E 2S5

Tel: (519) 686-9181

A,C,CM,E*,M,P*

Hewlett-Packard (Canada) Ltd.

6877 Goreway Drive

MISSISSAUGA, Ontario L4V 1M8

Tel: (416) 678-9430

Telex: 069-8644

A,C,CM,E,M,P

Hewlett-Packard (Canada) Ltd.

2670 Queensview Dr.

OTTAWA, Ontario K2B 8K1

Tel: (613) 820-6483

A,C,CM,E*,M,P*

Hewlett-Packard (Canada) Ltd.

The Oaks Plaza, Unit #9

2140 Regent Street

SUDBURY, Ontario, P3E 5S8

Tel: (705) 522-0202

C

Hewlett-Packard (Canada) Ltd.

3790 Victoria Park Ave.

WILLOWDALE, Ontario M2H 3H7

Tel: (416) 499-2550

C,E

Quebec

Hewlett-Packard (Canada) Ltd.

17500 Trans Canada Highway

South Service Road

KIRKLAND, Quebec H9J 2X8

Tel: (514) 697-4232

Telex: 058-21521

A,C,CM,E,M,P*

Hewlett-Packard (Canada) Ltd.

1150 rue Claire Fontaine

QUEBEC CITY, Quebec G1R 5G4

Tel: (418) 648-0726

C

Hewlett-Packard (Canada) Ltd.

130 Robin Crescent

SASKATOON, Saskatchewan S7L 6M7

Tel: (306) 242-3702

C

CHILE

ASC Ltda.

Austria 2041

SANTIAGO

Tel: 223-5946, 223-6148

Telex: 340192 ASC CK

C,P

Jorge Calcagni y Cia

Av. Italia 634 Santiago

Casilla 16475

SANTIAGO 9

Tel: 222-0222

Telex: 440283 JCYCL CZ

CM,E,M

Metrolab S.A.

Monjitas 454 of. 206

SANTIAGO

Tel: 395752, 398296

Telex: 340866 METLAB CK

A

Olympia (Chile) Ltda.

Av. Rodrigo de Araya 1045

Casilla 256-V

SANTIAGO 21

Tel: 225-5044

Telex: 340892 OLYMP

Cable: Olympiachile Santiagochile

C,P

CHINA, People's

Republic of

China Hewlett-Packard Co., Ltd.

47/F China Resources Bldg.

26 Harbour Road

HONG KONG

Tel: 5-8330833

Telex: 76793 HPA HX

Cable: HP ASIA LTD

A*,M*

China Hewlett-Packard Co., Ltd.

P.O. Box 9610, Beijing

4th Floor, 2nd Watch Factory Main

Bldg.

Shuang Yu Shou, Bei San Huan Road

Hai Dian District

BEIJING

Tel: 28-0567

Telex: 22601 CTSHP CN

Cable: 1920 Beijing

A,C,CM,E,M,P

China Hewlett-Packard Co., Ltd.

CHP Shanghai Branch

23/F Shanghai Union Building

100 Yan An dong Lu

SHANG-HAI

Tel: 265550

Telex: 33571 CHPSB CN

Cable: 3416 Shanghai

A,C,CM,E,M,P

COLOMBIA

Instrumentación

H. A. Langebaek & Kier S.A.

Carrera 4A No. 52A-26

Apartado Aereo 6287

BOGOTA 1, D.E.

Tel: 212-1466

Telex: 44400 INST CO

Cable: AARIS Bogota

CM,E,M

Nefromedicas Ltda.

Calle 123 No. 9B-31

Apartado Aereo 100-958

BOGOTA D.E., 10

Tel: 213-5267, 213-1615

Telex: 43415 HEGAS CO

A

Compumundo

Avenida 15 # 107-80

BOGOTA D.E.

Tel: 214-4458

Telex: 45466 SUMA CO

P

Carvajal, S.A.

Calle 29 Norte No. 6A-40

Apartado Aereo 46

CALI

Tel: 368-1111

Telex: 55650

C,E,P

**CONGO**

Seric-Congo
B. P. 2105

BRAZZAVILLE

Tel: 815034
Telex: 5262

COSTA RICA

Cientifica Costarricense S.A.
Avenida 2, Calle 5
San Pedro de Montes de Oca
Apartado 10159

SAN JOSÉ

Tel: 24-38-20, 24-08-19
Telex: 2367 GALGUR CR

CM,E,M

O. Fischel R. Y. Cia. S.A.
Apartados 434-10174

SAN JOSE

Tel: 23-72-44
Telex: 2379

Cable: OFIR
A

CYPRUS

Telerexa Ltd.
P.O. Box 1152
7 A Afroditis Avenue

NICOSIA

Tel: 45 628, 62 698
Telex: 2894 LEVIDO CY
E,M,P

DENMARK

Hewlett-Packard A/S
Kongevejen 25
DK-3460 **BIRKERØED**
Tel: (02) 81-66-40
Telex: 37409 hpas dk
A,C,CM,E,M,P
Hewlett-Packard A/S
Rolighedsvej 32
DK-8240 **RISSKOV**, Aarhus
Tel: (06) 17-60-00
Telex: 37409 hpas dk
C,E

DOMINICAN REPUBLIC

Microprog S.A.
Juan Tomás Mejía y Cotes No. 60
Arroyo Hondo
SANTO DOMINGO
Tel: 565-6268
Telex: 4510 ARENTA DR (RCA)
P

ECUADOR

CYEDE Cia. Ltda.
Avenida Eloy Alfaro 1749
y Belgica
Casilla 6423 CCI

QUITO

Tel: 245-0975, 243-052
Telex: 22548 CYEDE ED
E,P

Medtronics

Valladolid 524 Madrid
P.O. 9171, **QUITO**

Tel: 2-238-951
Telex: 2298 ECUAME ED
A

Hospitalar S.A.

Robles 625
Casilla 3590
QUITO
Tel: 545-250, 545-122
Telex: 2485 HOSPTL ED
Cable: HOSPITALAR-Quito
M

Ecuador Overseas Agencies C.A.

Calle 9 de Octubre #818
P.O. Box 1296, Guayaquil
QUITO
Tel: 306022
Telex: 3361 PBCGYE ED
M

EGYPT

Sakrco Enterprises
P.O. Box 259
ALEXANDRIA
Tel: 802908, 808020, 805302
Telex: 54333
C

International Engineering Associates

24 Hussein Hegazi Street
Kasr-el-Aini

CAIRO

Tel: 23829, 21641
Telex: 93830 IEA UN
Cable: INTEGASSO
E

Sakrco Enterprises
70 Mossadak Street
Dokki, Giza
CAIRO
Tel: 706 440, 701 087
Telex: 9337
C

S.S.C. Medical
40 Gezerat El Arab Street
Mohandessin
CAIRO
Tel: 803844, 805998, 810263
Telex: 20503 SSC UN
M*

EL SALVADOR

IPESA de El Salvador S.A.
29 Avenida Norte 1223
SAN SALVADOR
Tel: 26-6858, 26-6868
Telex: 301 20539 IPESA SAL
A,C,CM,E,P

ETHIOPIA

Seric-Ethiopia
P.O. Box 2764

ADDIS ABABA

Tel: 185114
Telex: 21150
C,P

FINLAND

Hewlett-Packard Oy
Piispankalliontie 17
02200 **ESPOO**
Tel: 00358-0-88721
Telex: 121563 HEWPA SF
C,CM,P

FRANCE

Hewlett-Packard France
Z.I. Mercure B
Rue Berthelot
13763 Les Milles Cedex

AIX-EN-PROVENCE

Tel: (42) 59-41-02
Telex: 410770F
A,C,E,M

Hewlett-Packard France
64, Rue Marchand Saillant
61000 **ALENCON**
Tel: (33) 29 04 42
C**

Hewlett-Packard France
Batiment Levitan
2585, route de Grasse
Bretelle Autoroute
06600 **ANTIBES**
Tel: (93) 74-59-19
C

Hewlett-Packard France
28 Rue de la République
Boite Postale 503
25026 **BESANÇON**
Tel: (81) 83-16-22
Telex: 361157
C,E*

Hewlett-Packard France
13 Place Napoléon III
29000 **BREST**
Tel: (98) 41-87-90
E

Hewlett-Packard France
Chemin des Mouilles
Boite Postale 162
69131 **ECULLY** Cedex (Lyon)
Tel: (78) 133-81-25
Telex: 310617F
A,C,E,M,P*

Hewlett-Packard France
Parc d'activités du Bois Briard
Avenue du Lac
91040 **EVRY** Cedex
Tel: (60) 77-83-83
Telex: 692315F
C

Hewlett-Packard France
5, avenue Raymond Chanas
38320 **EYBENS** (Grenoble)
Tel: (76) 62-57-98
Telex: 980124 HP GRENOB EYBE
C

Hewlett-Packard France
Rue Fernand. Forest
Z.A. Kergaradec
29239 **GOUESNOU**
Tel: (98) 41-87-90

Hewlett-Packard France
Parc Club des Tanneries
Batiment B4
4, Rue de la Faisanderie
67380 **LINCOLSHEIM**
(Strasbourg)
Tel: (88) 76-15-00
Telex: 890141F
C,E*,M*,P*

Hewlett-Packard France
Centre d'affaires Paris-Nord
Bâtiment Ampère
Rue de la Commune de Paris
Boite Postale 300

93 153 LE BLANC-MESNIL

Tel: (1) 865-44-52
Telex: 211032F
C,E,M

Hewlett-Packard France
Parc d'activités Cadéra
Quartier Jean-Mermoz
Avenue du Président JF Kennedy
33700 **MÉRIGNAC** (Bordeaux)
Tel: (56) 34-00-84
Telex: 550105F
C,E,M

Hewlett-Packard France
3, Rue Graham Bell
BP 5149
57074 **METZ** Cedex

Tel: (87) 36-13-31
Telex: 860602F
C,E

Hewlett-Packard France
Miniparc-ZIRST
Chemin du Vieux Chêne
38240 **MEYLAN** (Grenoble)
Tel: (76) 90-38-40
C

Hewlett-Packard France
Bat.A l'Erable
Bureau vert du Bois Briand
44085 **NANTES** Cedex
Tel: (40) 50-32-22
Telex: 711085F
A,C,E,CM*,P

Hewlett-Packard France
125, Rue du Faubourg Bannier
45000 **ORLÉANS**
Tel: (38) 62-20-31
E,P*

Hewlett-Packard France
Zone Industrielle de Courtaboeuf
Avenue des Tropiques
91947 **LES ULIS** Cedex (Orsay)
Tel: (69) 07-78-25
Telex: 600048F
A,C,CM,E,M,P**

Hewlett-Packard France
15, Avenue de L'Amiral-Bruix
75782 **PARIS** Cedex 16
Tel: (1) 45-02-75-00
Telex: 613663F
C,P*

Hewlett-Packard France
124, Boulevard Tourasse
64000 **PAU**
Tel: (59) 80-38-02
Telex: 550365F
C,E*

Hewlett-Packard France
6, Place Sainte Croix
86000 **POITIERS**
Tel: (49) 41-27-07
Telex: 792335F
C, E*



SALES & SUPPORT OFFICES

Arranged alphabetically by country

FRANCE (Cont'd)

Hewlett-Packard France
47, Rue de Chativesle
51100 **REIMS**
Tel: (26) 88-69-79
C, P*

Hewlett-Packard France
Parc d'activités de la Poterie
Rue Louis Kerautel-Botmel
35000 **RENNES**
Tel: (99) 51-42-44
Telex: 740912F
A*, C, E, M, P*

Hewlett-Packard France
98 Avenue de Bretagne
76100 **ROUEN**
Tel: (35) 63-57-66
Telex: 770035F
C, E

Hewlett-Packard France
4, Rue Thomas-Mann
Boite Postale 56
67033 **STRASBOURG** Cedex
Tel: (88) 28-56-46
Telex: 890141F
C, E, M, P*

Hewlett-Packard France
Le Péripole
3, Chemin du Pigeonnier de la Cèpière
3108 **TOULOUSE** Cedex
Tel: (61) 40-11-12
Telex: 531639F
A, C, E, M, P*

Hewlett-Packard France
Les Cardoulines
Batiment B2
Route des Dolines
Parc d'activite de Valbonne
Sophia Antipolis
06560 **VALBONNE** (Nice)
Tel: (93) 65-39-40
C

Hewlett-Packard France
9, Rue Baudin
26000 **VALENCE**
Tel: (75) 42-76-16
C**

Hewlett-Packard France
Carolor
ZAC de Bois Briand
57640 **VIGY** (Metz)
Tel: (8) 771 20 22
C

Hewlett-Packard France
Parc d'activité des Prés
1, Rue Papin
59658 **VILLENEUVE D'ASCQ** Cedex
Tel: (20) 47 78 78
Telex: 160124F
C, E, M, P

Hewlett-Packard France
Parc d'activités Paris-Nord 11
45, Rue des 3 Soeurs
93420 **VILLEPINTE**
Tel: (1) 48 63 80 80
Telex: 211032F
C, E, M, P*

GABON

Sho Gabon
P.O. Box 89
LIBREVILLE
Tel: 721 484
Telex: 5230

GERMAN FEDERAL REPUBLIC

Hewlett-Packard GmbH
Vertriebszentrum Mitte
Hewlett-Packard-Strasse
D-6380 **BAD HOMBURG**
Tel: (06172) 400-0
Telex: 410 844 hpbhg
A, C, E, M, P

Hewlett-Packard GmbH
Geschäftsstelle
Keithstrasse 2-4
D-1000 **BERLIN** 30
Tel: (030) 21 99 04-0
Telex: 0 18 3405 hpbld
A, C, E, M, P

Hewlett-Packard GmbH
Vertriebszentrum Südwest
Schickardstrasse 2
D-7030 **BÖBLINGEN**
Tel: (07031) 645-0
Telex: 7265 743 hep
A, C, CM, E, M, P

Hewlett-Packard GmbH
Geschäftsstelle
Schleefstr. 28a
D-4600 **DORTMUND**-41
Tel: (0231) 45001
Telex: 822858 hepdad
A, C, E

Hewlett-Packard GmbH
Vertriebszentrum Nord
Kapstadtring 5
D-2000 **HAMBURG** 60
Tel: (040) 63804-1
Telex: 021 63 032 hphd
A, C, E, M, P

Hewlett-Packard GmbH
Geschäftsstelle
Heidering 37-39
D-3000 **HANNOVER** 61
Tel: (0511) 5706-0
Telex: 092 3259
A, C, CM, E, M, P

Hewlett-Packard GmbH
Geschäftsstelle
Rosslauer Weg 2-4
D-6800 **MANNHEIM**
Tel: (0621) 70 05-0
Telex: 0462105
A, C, E

Hewlett-Packard GmbH
Geschäftsstelle
Messerschmittstrasse 7
D-7910 **NEU ULM**
Tel: (0731) 70 73-0
Telex: 0712816 HP ULM-D
A, C, E*

Hewlett-Packard GmbH
Geschäftsstelle
Emmericher Strasse 13
D-8500 **NÜRNBERG** 10
Tel: (0911) 5205-0
Telex: 0623 860 hpnbg
C, CM, E, M, P

Hewlett-Packard GmbH
Vertriebszentrum West
Berliner Strasse 111
D-4030 **RATINGEN** 3
Tel: (02102) 494-0
Telex: 589 070 hprad
A, C, E, M, P

Hewlett-Packard GmbH
Vertriebszentrum Süd
Eschenstrasse 5
D-8028 **TAUFKIRCHEN**
Tel: (089) 61 20 7-0
Telex: 0524985
A, C, CM, E, M, P
Hewlett-Packard GmbH
Geschäftsstelle
Ermisallee
7517 **WALDBRONN** 2
Tel: (07243) 602-0
Telex: 782 838 hepk
A, C, E

GREAT BRITAIN

See United Kingdom

GREECE
Hewlett-Packard A.E.
178, Kifissias Avenue
6th Floor
Halandri-**ATHENS**
Greece
Tel: 6471543, 6471673, 6472971
Telex: 221 286 HPHLGR
A, C, CM*, E, M, P

Kostas Karayannis S.A.
8, Omirou Street
ATHENS 133
Tel: 32 30 303, 32 37 371
Telex: 215962 RKAR GR
A, C*, CM, E
Impexin
Intellect Div.
209 Mesogion
11525 **ATHENS**
Tel: 6474481/2
Telex: 216286
P

Haril Company
38, Mihalakopoulou
ATHENS 612
Tel: 7236071
Telex: 218767
M*

Hellamco
P.O. Box 87528
18507 **PIRAEUS**
Tel: 4827049
Telex: 241441
A

GUATEMALA
IPESA
Avenida Reforma 3-48, Zona 9
GUATEMALA CITY
Tel: 316627, 317853, 66471/5
Telex: 3055765 IPESA GU
A, C, CM, E, M, P

HONG KONG

Hewlett-Packard Hong Kong, Ltd.
G.P.O. Box 795
5th Floor, Sun Hung Kai Centre
30 Harbour Road

HONG KONG
Tel: 5-8323211
Telex: 66678 HEWPA HX
Cable: HEWPACK HONG KONG
E, C, P

CET Ltd.
10th Floor, Hua Asia Bldg.
64-66 Gloucester Road
HONG KONG
Tel: (5) 200922
Telex: 85148 CET HX
CM

Schmidt & Co. (Hong Kong) Ltd.
18th Floor, Great Eagle Centre
23 Harbour Road, Wanchai

HONG KONG
Tel: 5-8330222
Telex: 74766 SCHMC HX
A, M

ICELAND

Hewlett-Packard Iceland
Hoefdabakka 9
110 **REYKJAVIK**
Tel: (1) 67 1000
A, C, CM, E, M, P

INDIA

Computer products are sold through
Blue Star Ltd. All computer repairs and
maintenance service is done through
Computer Maintenance Corp.

Blue Star Ltd.
B. D. Patel House
Near Sardar Patel Colony
AHMEDABAD 380 014
Tel: 403531, 403532
Telex: 0121-234
Cable: BLUE FROST
A, C, CM, E

Blue Star Ltd.
40/4 Lavelle Road
BANGALORE 560 001
Tel: 57881, 567780
Telex: 0845-430
Cable: BLUESTAR
A, C*, CM, E

Blue Star Ltd.
Band Box House
Prabhadevi
BOMBAY 400 025
Tel: 4933101, 4933222
Telex: 011-71051
Cable: BLUESTAR
A, M

Blue Star Ltd.
Sahas
414/2 Vir Savarkar Marg
Prabhadevi
BOMBAY 400 025
Tel: 430-6155, 430-6556
Telex: 011-71193 BSSS IN
Cable: FROSTBLUE
A, CM, E, M



Blue Star Ltd.
Kalyan, 19 Vishwas Colony
Alkapuri, **BORODA**, 390 005
Tel: 65235, 65236
Cable: BLUE STAR
A

Blue Star Ltd.
7 Hare Street
CALCUTTA 700 001
Tel: 230 131, 230132
Telex: 031-61120 BSNF IN
Cable: BLUESTAR
A,M,C,E

Blue Star Ltd.
133 Kodambakkam High Road
MADRAS 600 034
Tel: 472056, 470238
Telex: 041-379
Cable: BLUESTAR
A,M

Blue Star Ltd.
13 Community Center
New Friends Colony
NEW DELHI 110 065
Tel: 633 182, 636674
Telex: 031-61120
Cable: BLUEFROST
A,C*,CM,E,M

Blue Star Ltd.
15/16 C Wellesley Rd.
PUNE 411 011
Tel: 22775
Cable: BLUE STAR
A

Blue Star Ltd.
2-2-47/1108 Bolarum Rd.
SECUNDERABAD 500 003
Tel: 72057, 72058
Telex: 0155-459
Cable: BLUEFROST
A,C,E

Blue Star Ltd.
T.C. 7/603 Poornima
Maruthunkuzhi
TRIVANDRUM 695 013
Tel: 65799, 65820
Telex: 0884-259
Cable: BLUESTAR
E

Computer Maintenance Corporation
Ltd.
115, Sarojini Devi Road
SECUNDERABAD 500 003
Tel: 310-184, 345-774
Telex: 031-2960
C**

INDONESIA
BERCA Indonesia P.T.
P.O.Box 496/Jkt.
Jl. Abdul Muis 62
JAKARTA
Tel: 21-373009
Telex: 46748 BERSAL IA
Cable: BERSAL JAKARTA
P

BERCA Indonesia P.T.
P.O.Box 2497/Jkt
Antara Bldg., 11th Floor
Jl. Medan Merdeka Selatan 17
JAKARTA-PUSAT
Tel: 343989

Telex: 46748 BERSAL IA
A,C,E,M,P

BERCA Indonesia P.T.
Jalan Kutai 24

SURABAYA
Tel: 67118

Telex: 31146 BERSAL SB
Cable: BERSAL-SURABAYA
A*,E,M,P

IRAQ

Hewlett-Packard Trading S.A.
Service Operation
Al Mansoor City 9B/3/7

BAGHDAD

Tel: 551-49-73
Telex: 212-455 HEPAIRAQ IK
C

IRELAND

Hewlett-Packard Ireland Ltd.
82/83 Lower Leeson Street

DUBLIN 2

Tel: 0001 608800
Telex: 30439
C,E,P

Cardiac Services Ltd.
125 Dublin Industrial Estate

DUBLIN 11

Tel: (01) 307499
Telex: 32254
M

ISRAEL

Eldan Electronic Instrument Ltd.
P.O.Box 1270

JERUSALEM 91000
16, Ohaliav St.

JERUSALEM 94467

Tel: 533 221, 553 242
Telex: 25231 AB/PAKRD IL
A,M

Computation and Measurement
Systems (CMS) Ltd.
11 Masad Street
67060

TEL-AVIV

Tel: 388 388
Telex: 33569 Motil IL
C,CM,E,P

ITALY

Hewlett-Packard Italiana S.p.A.
Traversa 99C

Via Giulio Petroni, 19
I-70124 **BARI**

Tel: (080) 41-07-44
C,M

Hewlett-Packard Italiana S.p.A.
Via Emilia, 51/C
I-40011 **BOLOGNA** Anzola Dell'Emilia
Tel: (051) 731061
Telex: 511630
C,E,M

Hewlett-Packard Italiana S.p.A.
Via Principe Nicola 43G/C

I-95126 **CATANIA**

Tel: (095) 37-10-87
Telex: 970291
C

Hewlett-Packard Italiana S.p.A.
Via G. di Vittorio 9

20094 **CORSICO** (Milano)
Tel: (02) 448351

Hewlett-Packard Italiana S.p.A.
Viale Brigata Bisagno 2

16129 **GENOVA**

Tel: (010) 541141

Hewlett-Packard Italiana S.p.A.
Viale G. Modugno 33

I-16156 **GENOVA PEGLI**

Tel: (010) 68-37-07

Telex: 215238

C,E

Hewlett-Packard Italiana S.p.A.
Via G. di Vittorio 9

I-20063 **CERNUSCO SUL**

NAVIGLIO

(Milano)

Tel: (02) 923691

Telex: 334632

A,C,CM,E,M,P

Hewlett-Packard Italiana S.p.A.
Via Nuova Rivoltana 95

20090 **LIMITO** (Milano)

Tel: (02) 92761

Hewlett-Packard Italiana S.p.A.
Via Nuova San Rocco a

Capodimonte, 62/A

I-80131 **NAPOLI**

Tel: (081) 74 13544

Telex: 710698

A**,C,E,M

Hewlett-Packard Italiana S.p.A.
Via Orazio 16

80122 **NAPOLI**

Tel: (081) 7611444

Hewlett-Packard Italiana S.p.A.
Via Pellizzo 15

35128 **PADOVA**

Tel: (049) 8070166

Telex: 430315

A,C,E,M

Hewlett-Packard Italiana S.p.A.
Viale C. Pavese 340

I-00144 **ROMA EUR**

Tel: (06) 54831

Telex: 610514

A,C,E,M,P*

Hewlett-Packard Italiana S.p.A.
Via di Casellina 57/C

I-50018 **SCANDICCI-FIRENZE**

Tel: (055) 753863

C,E,M

Hewlett-Packard Italiana S.p.A.
Corso Svizzera, 185

I-10144 **TORINO**

Tel: (011) 74 4044

Telex: 221079

A*,C,E

IVORY COAST

S.I.T.E.L.

Societe Ivoirienne de

Telecommunications

Bd. Giscard d'Estaing

Carrefour Marcory

Zone 4.A.

Boite postale 2580

ABIDJAN 01

Tel: 353600

Telex: 43175

E

S.I.T.I.

Immeuble "Le General"

Av. du General de Gaulle

01 BP 161

ABIDJAN 01

Tel: 321227

C,P

JAPAN

Yokogawa-Hewlett-Packard Ltd.

152-1, Onna

ATSUGI, Kanagawa, 243

Tel: (0462) 25-0031

C,CM,E

Yokogawa-Hewlett-Packard Ltd.

Meiji-Seimei Chiba Bldg.

3-1 Hon Chiba-Cho

CHIBA, 280

Tel: (0472) 25 7701

C,E

Yokogawa-Hewlett-Packard Ltd.

Yasuda-Seimei Hiroshima Bldg.

6-11, Hon-dori, Naka-ku

HIROSHIMA, 730

Tel: (082) 241-0611

Yokogawa-Hewlett-Packard Ltd.

Towa Building

2-3, Kaigan-dori, 2 Chome Chuo-ku

KOBE, 650

Tel: (078) 392-4791

C,E

Yokogawa-Hewlett-Packard Ltd.

Kumagaya Asahi 82 Bldg.

3-4 Tsukuba

KUMAGAYA, Saitama 360

Tel: (0485) 24-6563

C,CM,E

Yokogawa-Hewlett-Packard Ltd.

Asahi Shinbun Daiichi Seimei Bldg.

4-7, Hanabata-cho

KUMAMOTO, 860

Tel: (0963) 54-7311

C,E

Yokogawa-Hewlett-Packard Ltd.

Shin-Kyoto Center Bldg.

614, Higashi-Shiokoji-cho

Karasuma-Nishiiru

Shiokoji-dori, Shimogyo-ku

KYOTO, 600

Tel: 075-343-0921

C,E

Yokogawa-Hewlett-Packard Ltd.

Mito Mitsui Bldg.

4-73, Sanno-maru, 1 Chome

MITO, Ibaraki 310

Tel: (0292) 25-7470

C,CM,E

SALES & SUPPORT OFFICES

Arranged alphabetically by country

JAPAN (Cont'd)

Yokogawa-Hewlett-Packard Ltd.
Meiji-Seimei Kokubun Bldg.
7-8 Kokubun, 1 Chome, Sendai
MIYAGI, 980
Tel: (0222) 25-1011
C,E

Yokogawa-Hewlett-Packard Ltd.
Gohda Bldg. 2F
2-10 Gohda 1 Chome
Okaya-Shi
NAGANO, 394
Tel: (0266) 23 0851
C,E

Yokogawa-Hewlett-Packard Ltd.
Nagoya Kokusai Center Building
47-1, Nagono, 1 Chome
Nakamura-ku
NAGOYA, 450
Tel: (052) 571-5171
C,CM,E,M

Yokogawa-Hewlett-Packard Ltd.
Sai-Kyo-Ren Building
1-2 Dote-cho
OHMIYA OHMIYA, Saitama 330
Tel: (0486) 45-8031

Yokogawa-Hewlett-Packard Ltd.
Chuo Bldg.,
4-20 Nishinakajima, 5 Chome
Yodogawa-ku
OSAKA, 532
Tel: (06) 304-6021
Telex: YHPOSA 523-3624
C,CM,E,M,P*

Yokogawa-Hewlett-Packard Ltd.
27-15, Yabe, 1 Chome
SAGAMIHARA Kanagawa, 229
Tel: 0427 59-1311
Yokogawa-Hewlett-Packard Ltd.
Motomuro-cho Dai-ich Seimei Bldg. 1F
219-21 Motomuro-cho,
Hamamatsu-shi
SHIZUOKA, 430
Tel: (0534) 56 1771
C,E

Yokogawa-Hewlett-Packard Ltd.
Daiichi Seimei Bldg.
7-1, Nishi Shinjuku, 2 Chome
Shinjuku-ku, **TOKYO** 160
Tel: 03-348-4611
C,E,M

Yokogawa Hewlett-Packard Ltd.
9-1, Takakura-cho
Hachioji-shi, **TOKYO**, 192
Tel: 0426-42-1261
C,E

Yokogawa-Hewlett-Packard Ltd.
29-21 Takaide-Higashi, 3 Chome
Suginami-ku **TOKYO** 168
Tel: (03) 331-6111
Telex: 232-2024 YHPTOK
C,CM,E,P*

Yokogawa Hokushin Electric
Corporation
Shinjuku-NS Bldg. 10F
4-1 Nishi-Shinjuku 2-Chome
Shinjuku-ku
TOKYO, 163
Tel: (03) 349-1859
Telex: J27584
A

Yokogawa Hokushin Electric Corp.
9-32 Nokacho 2 Chome
2 Chome Musashino-shi
TOKYO, 180
Tel: (0422) 54-1111
Telex: 02822-421 YEW MTK J
A

Yokogawa-Hewlett-Packard Ltd.
Meiji-Seimei
Utsunomiya Oodori Building
1-5 Oodori, 2 Chome
UTSUNOMIYA, Tochigi 320
Tel: (0286) 33-1153
C,E

Yokogawa-Hewlett-Packard Ltd.
Yasuda Seimei Nishiguchi Bldg.
30-4 Tsuruya-cho, 3 Chome
Kanagawa-ku, **YOKOHAMA** 221
Tel: (045) 312-1252
C,CM,E

JORDAN

Scientific and Medical Supplies Co.
P.O. Box 1387

AMMAN
Tel: 24907, 39907
Telex: 21456 SABCO JO
C,E,M,P

KENYA

ADCOM Ltd., Inc., Kenya
P.O.Box 30070
NAIROBI
Tel: 331955
Telex: 22639
E,M

KOREA

Samsung Hewlett-Packard Co. Ltd.
Dongbang Yeoeuido Building
12-16th Floors
36-1 Yeoeuido-Dong
Youngdeungpo-Ku
SEOUL

Tel: 784-4666, 784-2666
Telex: 25166 SAMSAN K
C,CM,E,M,P
Young In Scientific Co., Ltd.
Youngwha Building
547 Shinsa Dong, Kangnam-Ku
SEOUL 135
Tel: 546-7771
Telex: K23457 GINSCO
A

Dongbang Healthcare
Products Co. Ltd.
Suite 301 Medical Supply Center
Bldg. 1-31 Dongsungdong
Jong Ro-gu, **SEOUL**
Tel: 764-1171, 741-1641
Telex: K25706 TKBKO
Cable: TKBEEPKO
M

KUWAIT

Al-Khaldiya Trading & Contracting
P.O. Box 830
SAFAT
Tel: 4249 10, 411726
Telex: 22481 AREEG KT
Cable: VISCOUNT
E,M,A

Gulf Computing Systems
P.O. Box 25125
SAFAT
Tel: 435969
Telex: 23648
P

Photo & Cine Equipment
P.O. Box 270
SAFAT
Tel: 2445111
Telex: 22247 MATIN KT
Cable: MATIN KUWAIT
P

W.J. Towell Computer Services
P.O. Box 5897
SAFAT
Tel: 2462640/1
Telex: 30336 TOWELL KT
C

LEBANON

Computer Information Systems S.A.L.
Chammas Building
P.O. Box 11-6274 Dora
BEIRUT
Tel: 89 40 73
Telex: 42309
C,E,M,P

LIBERIA

Unichemicals Inc.
P.O. Box 4509
MONROVIA
Tel: 224282
Telex: 4509
E

MADAGASCAR

Technique et Precision
12, rue de Nice
P.O. Box 1227
101 **ANTANANARIVO**
Tel: 22090
Telex: 22255
P

LUXEMBOURG

Hewlett-Packard Belgium S.A./N.V.
Blvd de la Woluwe, 100
Woluwedal
B-1200 **BRUSSELS**
Tel: (02) 762-32-00
Telex: 23-494 paloben bru
A,C,CM,E,M,P

MALAYSIA

Hewlett-Packard Sales (Malaysia)
Sdn. Bhd.
9th Floor
Chung Khiaw Bank Building
46, Jalan Raja Laut
50350 **KUALA LUMPUR**
Tel: 2986555
Telex: 31011 HPSM MA
A,C,E,M,P*
Protel Engineering
P.O.Box 1917
Lot 6624, Section 64
23/4 Pending Road
Kuching, **SARAWAK**
Tel: 36299
Telex: 70904 PROMAL MA
Cable: PROTELENG
A,E,M

MALTA

Philip Toledo Ltd.
Birkirkara P.O. Box 11
Notabile Rd.
MRIEHEL
Tel: 447 47, 455 66, 4915 25
Telex: Media MW 649
E,M,P

MAURITIUS

Blanche Birger Co. Ltd.
18, Jules Koenig Street
PORT LOUIS
Tel: 20828
Telex: 4296
P

MEXICO

Hewlett-Packard de Mexico,
S.A. de C.V.
Rio Nio No. 4049 Desp. 12
Fracc. Cordoba
JUAREZ
Tel: 161-3-15-62
P
Hewlett-Packard de Mexico,
S.A. de C.V.
Condominio Kadereyta
Circuito del Mezon No. 186 Desp. 6
COL DEL PRADO - 76030 Qro.
Tel: 463-6-02-71
P
Hewlett-Packard de Mexico,
S.A. de C.V.
Monti Morelos No. 299
Fraccionamiento Loma Bonita 45060
GUADALAJARA, Jalisco
Tel: 36-31-48-00
Telex: 0684 186 ECOME
P
Microcomputadoras Hewlett-Packard,
S.A.
Monti Pelvoux 115
LOS LOMAS, Mexico, D.F.
Tel: 520-9127
P
Microcomputadoras Hewlett-Packard,
S.A. de C.V.
Monte Pelvoux No. 115
Lomas de Chapultepec, 11000
MEXICO, D.F.
Tel: 520-9127
P
Hewlett-Packard de Mexico,
S.A. de C.V.
Monte Pelvoux No. 111
Lomas de Chapultepec
11000 **MEXICO, D.F.**
Tel: 5-40-62-28, 72-66, 50-25
Telex: 17-74-507 HEWPACK MEX
A,C,CM,E,M,P
Hewlett-Packard De Mexico (Polanco)
Avenida Ejercito Nacional #579
2day3er piso
Colonia Granada 11560
MEXICO D.F.
Tel: 254-4433
P



Hewlett-Packard de Mexico,
S.A. de C.V.
Czda. del Valle
409 Ote. 4th Piso
Colonia del Valle
Municipio de Garza Garcia Nuevo Leon
66220 **MONTERREY**, Nuevo León
Tel: 83-78-42-40
Telex: 382410 HPMY
C

Infograficas y Sistemas del Noreste,
S.A.
Rio Orinoco #171 Oriente
Despacho 2001
Colonia Del Valle
MONTERREY
Tel: 559-4415, 575-3837
Telex: 483164
A,E

Hewlett-Packard de Mexico,
S.A. de C.V.
Blvd. Independencia No. 2000 Ote.
Col. Estrella
TORREON, COAH.
Tel: 171-18-21-99
P

MOROCCO

Etablissement Hubert Dolbeau & Fils
81 rue Karatchi
B.P. 11133

CASABLANCA
Tel: 3041-82, 3068-38
Telex: 23051, 22822
E

Gerep
2, rue Agadir
Boite Postale 156
CASABLANCA 01
Tel: 272093, 272095
Telex: 23 739
P

Sema-Maroc
Dept. Seric
6, rue Lapebie
CASABLANCA
Tel: 260980
Telex: 21641
C,P

NETHERLANDS

Hewlett-Packard Nederland B.V.
Startbaan 16
NL-1187 XR **AMSTELVEEN**
P.O. Box 667
NL-1180 AR **AMSTELVEEN**
Tel: (020) 547-6911
Telex: 13 216 HEPA NL
A,C,CM,E,M,P

Hewlett-Packard Nederland B.V.
Bonger 2
NL 2906VK **CAPELLE A/D IJSSEL**
P.O. Box 41
NL 2900AA **CAPELLE A/D IJSSEL**
Tel: (10) 51-64-44
Telex: 21261 HEPAC NL
C,E

Hewlett-Packard Nederland B.V.
Pastoor Petersstraat 134-136
NL 5612 LV **EINDHOVEN**
P.O. Box 2342
NL 5600 CH **EINDHOVEN**
Tel: (040) 326911
Telex: 51484 hepae nl
C,E,P

NEW ZEALAND

Hewlett-Packard (N.Z.) Ltd.
5 Owens Road
P.O. Box 26-189
Epsom, **AUCKLAND**
Tel: 687-159
Cable: HEWPAK Auckland
C,CM,E,P*
Hewlett-Packard (N.Z.) Ltd.
184-190 Willis Street
WELLINGTON
P.O. Box 9443
Courtenay Place, **WELLINGTON 3**
Tel: 877-199
Cable: HEWPAK Wellington
C,CM,E,P

Northrop Instruments & Systems Ltd.
369 Khyber Pass Road
P.O. Box 8602
AUCKLAND
Tel: 794-091
Telex: 60605
A,M
Northrop Instruments & Systems Ltd.
110 Mandeville St.
P.O. Box 8388
CHRISTCHURCH
Tel: 488-873
Telex: 4203
A,M
Northrop Instruments & Systems Ltd.
Sturdee House
85-87 Ghuznee Street
P.O. Box 2406
WELLINGTON
Tel: 850-091
Telex: NZ 3380
A,M

LAGOS

NIGERIA
Elmeco Nigeria Ltd.
46, Calcutta Crescent Apapa
P.O. Box 244and
LAGOS
E
NORTHERN IRELAND
See United Kingdom
NORWAY
Hewlett-Packard Norge A/S
Folke Bernadottes vei 50
P.O. Box 3558
N-5033 **FYLLINGSDALEN** (Bergen)
Tel: 0047/5/16 55 40
Telex: 76621 hpnas n
C,E,M
Hewlett-Packard Norge A/S
Osterndalen 16-18
P.O. Box 34
N-1345 **OEËSTERAAS**
Tel: 0047/2/24 60 90
Telex: 76621 hpnas n
A,C,CM,E,M,P

Hewlett-Packard Norge A/S
Boehmergt. 42
Box 2470
N-5037 **SOLHEIMSVIK**
Tel: 0047/5/29 00 90

OMAN

Khimjil Ramdas
P.O. Box 19
MUSCAT/SULTANATE OF OMAN
Tel: 795 901
Telex: 3489 BROKER MB MUSCAT
P

Suhail & Saud Bahwan
P.O.Box 169
MUSCAT/SULTANATE OF OMAN
Tel: 734 201-3
Telex: 5274 BAHWAN MB
E

Imtac LLC
P.O. Box 9196
MINA AL FAHAL/SULTANATE OF OMAN
Tel: 561 695, 5602078, 561010
Telex: 5298 Tawoos On
A,C,M

PAKISTAN

Mushko & Company Ltd.
House No. 16, Street No. 16
Sector F-6/3
ISLAMABAD
Tel: 824545
Cable: FEMUS Islamabad
A,E,P*

Mushko & Company Ltd.
Oosman Chambers
Abdullah Haroon Road
KARACHI 0302
Tel: 524131, 524132
Telex: 2894 MUSKO PK
Cable: COOPERATOR Karachi
A,E,P*

PANAMA

Electronico Balboa, S.A.
Calle Samuel Lewis, Ed. Alfa
Apartado 4929
PANAMA 5
Tel: 64-2700
Telex: 3483 ELECTRON PG
CM,E,M,P

PERU

Cía Electro Médica S.A.
Los Flamencos 145
San Isidro
Casilla 1030
LIMA 1
Tel: 41-4325, 41-3705
Telex: Pub. Booth 25306 PEC PISIDR
CM,E,M,P

SAMS S.A.
Arenida Republica de Panama 3534
San Isidro, **LIMA**
Tel: 419928/417108
Telex: 20450 PE LIBERTAD
A,C,P

PHILIPPINES

The Online Advanced Systems Corp.
2nd Floor, Electra House
115-117 Esteban Street
Legaspi Village, Makati
Metro **MANILA**
Tel: 815-38-10 (up to 16)
Telex: 63274 ONLINE PN
A,C,E,M,P

PORTUGAL

Mundinter Intercambio
Mundial de Comércio S.A.R.L.
Av. Antonio Augusto Aguiar 138
Apartado 2761

LISBON

Tel: (19) 53-21-31, 53-21-37
Telex: 16691 munter p
M

Soquimica
Av. da Liberdade, 220-2
1298 **LISBOA** Codex
Tel: 56-21-82
Telex: 13316 SABASA
A

Telectra-Empresa Técnica de
Equipamentos Eléctricos S.A.R.L.
Rua Rodrigo da Fonseca 103
P.O. Box 2531

LISBON 1

Tel: (19) 68-60-72
Telex: 12598
CM,E

C.P.C.S.I.
Rua de Costa Cabral 575
4200 **PORTO**
Tel: 499174/495173
Telex: 26054
C,P

PUERTO RICO

Hewlett-Packard Puerto Rico
101 Muñoz Rivera Av
Esu. Calle Ochoa
HATO REY, Puerto Rico 00918
Tel: (809) 754-7800
A,C,CM,M,E,P

QATAR

Computer Arabia
P.O. Box 2750

DOHA

Tel: 428555
Telex: 4806 CHPARB
P

Nasser Trading & Contracting
P.O.Box 1563

DOHA

Tel: 422170
Telex: 4439 NASSER DH
M

SAUDI ARABIA

Modern Electronics Establishment
Hewlett-Packard Division
P.O. Box 281
Thuobah
AL-KHOBAR 31952
Tel: 895-1760, 895-1764
Telex: 671 106 HPMEEK SJ
Cable: ELECTA AL-KHOBAR
C,E,M



SALES & SUPPORT OFFICES

Arranged alphabetically by country

SAUDI ARABIA (Continued)

Modern Electronics Establishment
Hewlett-Packard Division
P.O. Box 1228
Redec Plaza, 6th Floor
JEDDAH

Tel: 644 96 28
Telex: 4027 12 FARNAS SJ
Cable: ELECTA JEDDAH
A,C,CM,E,M,P

Modern Electronics Establishment
Hewlett-Packard Division
P.O. Box 22015
RIYADH 11495

Tel: 491-97 15, 491-63 87
Telex: 202049 MEERYD SJ
C,E,M

Abdul Ghani El Ajou Corp.
P.O. Box 78

RIYADH
Tel: 40 41 717
Telex: 200 932 EL AJOU
P

SCOTLAND

See United Kingdom

SENEGAL

Societe Hussein Ayad & Cie.
76, Avenue Georges Pompidou
B.P. 305

DAKAR
Tel: 32339
Cable: AYAD-Dakar
E

Moneger Distribution S.A.
1, Rue Parent
B.P. 148

DAKAR
Tel: 215 671
Telex: 587
P

Systeme Service Conseil (SSC)
14, Avenue du Parachois

DAKAR ETOILE
Tel: 219976
Telex: 577
C,P

SINGAPORE

Hewlett-Packard Singapore (Sales)
Pte. Ltd.

#08-00 Inchcape House
450-2 Alexandra Road
Alexandra P.O. Box 58

SINGAPORE, 9115
Tel: 473 1788
Telex: 34209 HPSGSO RS
Cable: HEWPACK, Singapore
A,C,E,M,P

Dynamar International Ltd.
Unit 05-11 Block 6

Kolam Ayer Industrial Estate
SINGAPORE 1334
Tel: 747-6188
Telex: 26283 RS
CM

SOUTH AFRICA

Hewlett-Packard So Africa (Pty.) Ltd.
P.O. Box 120
Howard Place **CAPE PROVINCE 7430**
Pine Park Center, Forest Drive
Pinelands

CAPE PROVINCE 7405
Tel: (021) 53 7954
Telex: 57-20006
A,C,CM,E,M,P

Hewlett-Packard So Africa (Pty.) Ltd.
2nd Floor Juniper House
92 Overport Drive
DURBAN 4067

Tel: (031) 28-4178
Telex: 6-22954
C

Hewlett-Packard So Africa (Pty.) Ltd.
6 Linton Arcade
511 Cape Road
Linton Grange

PORT ELIZABETH 6001
Tel: 041-301201
Telex: 24-2916
C

Hewlett-Packard So Africa (Pty.) Ltd.
Fountain Center
Kalkoen Str.
Monument Park Ext 2

PRETORIA 0105
Tel: (012) 45 5725
Telex: 32163
C,E

Hewlett-Packard So Africa (Pty.) Ltd.
9 Eastern Service Road
Eastgate Ext. 3
SANDTON 2144

Tel: 802-5111, 802-5125
Telex: 4-20877 SA
Cable: HEWPACK Johannesburg
A,C,CM,E,M,P

SPAIN

Hewlett-Packard Española, S.A.
Calle Entenza, 321
08029 **BARCELONA**

Tel: 3/322 24 51, 321 73 54
Telex: 52603 hpbee
A,C,E,M,P

Hewlett-Packard Española, S.A.
Calle San Vicente S/N
Edificio Albia II-7B
48001 **BILBAO**
Tel: 4/423 83 06
A,C,E,M

Hewlett-Packard Española, S.A.
Crta. de la Coruña, Km. 16, 400
Las Rozas
E-MADRID

Tel: (1) 637.00.11
Telex: 23515 HPE
C,M

Hewlett-Packard Española, S.A.
Avda. S. Francisco Javier, S/N
Planta 10. Edificio Sevilla 2
41005 **SEVILLA**
Tel: 54/64 44 54
Telex: 72933
A,C,M,P

Hewlett-Packard Española, S.A.
Isabel La Católica, 8
46004 **VALENCIA**
Tel: (96) 351 59 44
Telex: 63435
C,P

Hewlett-Packard Española, S.A.
Av. de Zugazarte, 8
Edificio El Abra 4
Las Arenas-Guecho
VIZCAYA

Tel: (94) 464 3255, 464 2933
Telex: 33032

SWEDEN

Hewlett-Packard Sverige AB
Östra Tullgatan 3
S-20011 **MALMÖ**
Box 6132
Tel: (040) 70270
Telex: (854) 17886 (via Spånga
office)
C,P

Hewlett-Packard Sverige AB
Västra Vintergatan 9
S-70344 **ÖREBRO**
Tel: (19) 10-48-80
Telex: (854) 17886 (via Spånga office)
C

Hewlett-Packard Sverige AB
Skalholtsgatan 9, Kista
Box 19
S-16393 **SPÅNGA**
Tel: (08) 750-2000
Telex: (854) 17886
Telefax: (08) 7527781
A,C,CM,E,M,P

Hewlett-Packard Sverige AB
Box 266
Topasgatan 1A
S-42123 **VÄSTRA-FRÖLUNDA**
(Gothenburg)
Tel: (031) 89-10-00
Telex: (854) 17886 (via Spånga
office)
A,C,CM,E,M,P

SUDAN

Mediterranean Engineering & Trading
Co. Ltd.
P.O. Box 1025
KHARTOUM
Tel: 41184
Telex: 24052
C,P

SWITZERLAND

Hewlett-Packard (Schweiz) AG
Clarastrasse 12
CH-4058 **BASEL**
Tel: (61) 33-59-20
A,C,E,P

Hewlett-Packard (Schweiz) AG
7, rue du Bois-du-Lan
Case postale 365
CH-1217 **MEYRIN 1**
Tel: (0041) 22-83-11-11
Telex: 27333 HPAG CH
A,C,CM,E,M,P

Hewlett-Packard (Schweiz) AG
Allmend 2
CH-8967 **WIDEN**
Tel: (0041) 57 31 21 11
Telex: 53933 hpag ch
Cable: HPAG CH
A,C,CM,E,M,P

Hewlett-Packard (Schweiz) AG
Schwamendingenstrasse 10
8050 **ZURICH**
Tel: (0041) 1 315 81 81
Telex: 823 537 HPAG CH
C,P

TAIPEI

General Electronic Inc.
Nuri Basha Ahnaf Ebn Kays Street
P.O. Box 5781
DAMASCUS
Tel: 33-24-87
Telex: 411 215
Cable: ELECTROBOR DAMASCUS
E

Middle East Electronics
P.O. Box 2308
Abu Rumaneh
DAMASCUS
Tel: 33 45 92
Telex: 411 771
M

TAIPEI

Hewlett-Packard Taiwan Ltd.
THM Office
2, Huan Nan Road
CHUNG LI, Taoyuan
Tel: (034) 929-666
C

Hewlett-Packard Taiwan Ltd.
Kaohsiung Office
11/F, 456, Chung Hsiao 1st Road
KAOHSIUNG
Tel: (07) 2412318
C,E

Hewlett-Packard Taiwan Ltd.
8th Floor, Hewlett-Packard Building
337 Fu Hsing North Road
TAIPEI

Tel: (02) 712-0404
Telex: 24439 HEWPACK
Cable: HEWPACK Taipei
A,C,CM,E,M,P

Ing Lih Trading Co.
6th Floor, 112, Sec. 1,
Chung Hsiao East Road
TAIPEI 100
Tel: (02) 394-8191
Telex: 22894 SANKWANG
A

THAILAND

Unimesa Co. Ltd.
30 Patpong Ave., Suriwong
BANGKOK 10500
Tel: 235-5727, 234-0991/3
Telex: 84439 Simonco TH
Cable: UNIMESA Bangkok
A,C,E,M

Bangkok Business Equipment Ltd.
5/5-6 Dejo Road
BANGKOK
Tel: 234-8670, 234-8671
Telex: 87699-BEQUIPT TH
Cable: BUSIQUIPT Bangkok
P

TUNISIA
Societe Africaine De Promotion
B.P. 12271

LOME
Tel: 21-62-88
Telex: 5304
P

TRINIDAD & TOBAGO
Caribbean Telecoms Ltd.
Corner McAllister Street &
Eastern Main Road, Laventille
P.O. Box 732
PORT-OF-SPAIN
Tel: 624-4213
Telex: 22561 CARTEL WG
Cable: CARTEL, PORT OF SPAIN
C,M,E,M,P

Computer and Controls Ltd.
P.O. Box 51
66 Independence Square
PORT-OF-SPAIN
Tel: 623-4472
Telex: 3000 POSTLX WG, ACCT
LOGO AGENCY 1264
A,P

Feral Assoc.
8 Fitzgerald Lane
PORT-OF-SPAIN
Tel: 62-36864, 62-39255
Telex: 22432 FERALCO
Cable: FERALCO
M

TUNISIA
Tunisie Electronique S.A.R.L.
31 Avenue de la Liberte
TUNIS
Tel: 280-144
C,E,P

Tunisie Electronique S.A.R.L.
94, Av. Jugurtha, Mutuelleville
1002 **TUNIS-BELVEDERE**
Tel: 280144
Telex: 13238
C,E,P

Corema S.A.
1 ter. Av. de Carthage
TUNIS
Tel: 253-821
Telex: 12319 CABAM TN
M

TURKEY
E.M.A
Mediha Eldem Sokak No. 41/6
Yenisehir
ANKARA
Tel: 319175
Telex: 42321 KTX TR
Cable: EMATRADE ANKARA
M

Teknim Company Ltd.
Iran Caddesi No. 7
Karaklidere
ANKARA
Tel: 275800
Telex: 42155 TKNM TR
C,E
Kurt & Kurt A.S.
Mithatpasa Caddesi No. 75
Kat 4 Kizilay
ANKARA
Tel: 318875/6/7/8
Telex: 42490 MESR TR
A

Saniva Bilgisayar Sistemleri A.S.
Buyukdere Caddesi 103/6
Gayrettepe
ISTANBUL
Tel: 1673180
Telex: 26345 SANI TR
C,P
Best Inc.
Esentepe, Gazeteciler Sitesi
Keskin Kalem
Sokak 6/3, Gayrettepe
ISTANBUL
Tel: 172 1328, 173 3344
Telex: 42490
A

UNITED ARAB EMIRATES
Emitac Ltd.
P.O. Box 1641
SHARJAH
Tel: 591181
Telex: 68136 EMITAC EM
Cable: EMITAC SHARJAH
E,C,M,P,A
Emitac Ltd.
P.O. Box 2711

ABU DHABI
Tel: 820419-20
Cable: EMITACH ABUDHABI
Emitac Ltd.
P.O. Box 8391
DUBAI
Tel: 377591
Emitac Ltd.
P.O. Box 473
RAS AL KHAIMAH
Tel: 28133, 21270

UNITED KINGDOM
ENGLAND

Hewlett-Packard Ltd.
Miller House
The Ring, **BRACKNELL**
Berks RG12 1XN
Tel: 0344 424898
Telex: 848733
E
Hewlett-Packard Ltd.
Elstree House, Elstree Way
BOREHAMWOOD, Herts WD6 1SG
Tel: 01 207 5000
Telex: 8952716
C,E

Hewlett-Packard Ltd.
Oakfield House, Oakfield Grove
Clifton **BRISTOL**, Avon BS8 2BN
Tel: 0272 736806
Telex: 444302
C,E,P
Hewlett-Packard Ltd.
9 Bridewell Place
LONDON EC4V 6BS
Tel: 01 583 6565
Telex: 298163
C,P
Hewlett-Packard Ltd.
Pontefract Road
NORMANTON, West Yorkshire WF6 1RN
Tel: 0924 895566
Telex: 557355
C,P

Hewlett-Packard Ltd.
The Quadrangle
106-118 Station Road
REDHILL, Surrey RH1 1PS
Tel: 0737 68655
Telex: 947234
C,E,P

Hewlett-Packard Ltd.
Avon House
435 Stratford Road
Shirley, **SOLIHULL**, West Midlands
B90 4BL
Tel: 021 745 8800
Telex: 339105
C,E,P

Hewlett-Packard Ltd.
Heathside Park Road
Cheadle Heath
STOCKPORT
Cheshire
SK3 ORB
Tel: 061-428-0828
Telex: 668068
A,C,E,M,P

Hewlett-Packard Ltd.
Harmon House
No. 1 George Street
UXBRIDGE, Middlesex UX8 1YN
Tel: 895 720 20
Telex: 893134/5
C,CM,E,M,P
Hewlett-Packard Ltd.
King Street Lane
Winnersh, **WOKINGHAM**
Berkshire RG11 5AR
Tel: 0734 784774
Telex: 847178
A,C,E,M,P

NORTHERN IRELAND
Hewlett-Packard (Ireland) Ltd.
Carrickfergus Industrial Centre
75 Belfast Road, Carrickfergus
CO. ANTRIM BT38 8PM
Tel: 09603 67333
C,E
Cardiac Services Company
95A Finaghy Road South
BELFAST, BT10 OBY
Tel: 0232-625566
Telex: 747626
M

SCOTLAND
Hewlett-Packard Ltd.
1/3 Springburn Place
College Milton North
EAST KILBRIDE, G74 3NU
Tel: 03552-49261
Telex: 779615
C,E

Hewlett-Packard Ltd.
SOUTH QUEENSFERRY
West Lothian, EH30 9TG
Tel: 031 331 1188
Telex: 72682
C,CM,E,M,P

UNITED STATES

Alabama
Hewlett-Packard Co.
2100 Riverchase Center
Building 100 - Suite 118
BIRMINGHAM, AL 35244
Tel: (205) 988-0547
A,C,M,P*
Hewlett-Packard Co.
420 Wynn Drive
HUNTSVILLE, AL 35805
Tel: (205) 830-2000
C,CM,E,M*

Alaska
Hewlett-Packard Co.
3601 C St., Suite 1416
ANCHORAGE, AK 99503
Tel: (907) 563-8855
C,E

Arizona
Hewlett-Packard Co.
8080 Pointe Parkway West
PHOENIX, AZ 85044
Tel: (602) 273-8000
A,C,CM,E,M,P
Hewlett-Packard Co.
3400 East Britannia Dr.
Bldg. C, Suite 124
TUCSON, AZ 85706
Tel: (602) 573-7400
C,E,M**

California
Hewlett-Packard Co.
99 South Hill Dr.
BRISBANE, CA 94005
Tel: (415) 330-2500
C
Hewlett-Packard Co.
5060 E. Clinton Avenue, Suite 102
FRESNO, CA 93727
Tel: (209) 252-9652
C,M

Hewlett-Packard Co.
1421 S. Manhattan Av.
FULLERTON, CA 92631
Tel: (714) 999-6700
C,CM,E,M
Hewlett-Packard Co.
7408 Hollister Ave. #A
GOLETA, CA 93117
Tel: (805) 685-6100
C,E



SALES & SUPPORT OFFICES

Arranged alphabetically by country

UNITED STATES (Cont'd)

Hewlett-Packard Co.
2525 Grand Avenue
LONG BEACH, CA 90815
Tel: (213) 498-1111
C

Hewlett-Packard Co.
5651 West Manchester Ave.
LOS ANGELES, CA 90045
Tel: (213) 337-8000
Telex: 910-325-6608
C,M

Hewlett-Packard Co.
3155 Porter Drive
PALO ALTO, CA 94304
Tel: (415) 857-8000
C,E

Hewlett-Packard Co.
4244 So. Market Court, Suite A
SACRAMENTO, CA 95834
Tel: (916) 929-7222
A*,C,E,M

Hewlett-Packard Co.
9606 Aero Drive
SAN DIEGO, CA 92123
Tel: (619) 279-3200
C,CM,E,M

Hewlett-Packard Co.
5725 W. Las Positas Blvd.
PLEASANTON, CA 94566
Tel: (415) 460-0282
C

Hewlett-Packard Co.
3003 Scott Boulevard
SANTA CLARA, CA 95054
Tel: (408) 988-7000
Telex: 910-338-0586
A,C,CM,E

Hewlett-Packard Co.
2150 W. Hillcrest Dr.
THOUSAND OAKS, CA 91320
(805) 373-7000
C,CM,E

Colorado
Hewlett-Packard Co.
2945 Center Green Court South
Suite A
BOULDER, CO 80301
Tel: (303) 499-6655
A,C,E

Hewlett-Packard Co.
24 Inverness Place, East
ENGLEWOOD, CO 80112
Tel: (303) 649-5000
A,C,CM,E,M

Connecticut
Hewlett-Packard Co.
500 Sylvan Av.
BRIDGEPORT, CT 06606
Tel: (203) 371-6454
C,E

Hewlett-Packard Co.
47 Barnes Industrial Road South
WALLINGFORD, CT 06492
Tel: (203) 265-7801
A,C,CM,E,M

Florida

Hewlett-Packard Co.
2901 N.W. 62nd Street
FORT LAUDERDALE, FL 33309
Tel: (305) 973-2600
C,E,M,P*

Hewlett-Packard Co.
6800 South Point Parkway
Suite 301
JACKSONVILLE, FL 32216
Tel: (904) 636-9955
C*,M**

Hewlett-Packard Co.
255 East Drive, Suite B
MELBOURNE, FL 32901
Tel: (305) 729-0704
CM,E

Hewlett-Packard Co.
6177 Lake Ellenor Drive
ORLANDO, FL 32809
Tel: (305) 859-2900
A,C,CM,E,P*

Hewlett-Packard Co.
4700 Bayou Blvd.
Building 5
PENSACOLA, FL 32503
Tel: (904) 476-8422
A,C,M

Hewlett-Packard Co.
5550 W. Idlewild, #150
TAMPA, FL 33614
Tel: (813) 884-3282
C,E,M,P

Georgia
Hewlett-Packard Co.
2000 South Park Place
ATLANTA, GA 30339
Tel: (404) 955-1500
Telex: 810-766-4890
A,C,CM,E,M,P*

Hewlett-Packard Co.
3607 Parkway Lane
Suite 300
NORCROSS, GA 30092
Tel: (404) 448-1894
C,E,P

Hawaii
Hewlett-Packard Co.
Kawaiahao Plaza, Suite 190
567 South King Street
HONOLULU, HI 96813
Tel: (808) 526-1555
A,C,E,M

Idaho
Hewlett-Packard Co.
11309 Chinden Blvd.
BOISE, ID 83707
Tel: (208) 323-2700
C

Illinois
Hewlett-Packard Co.
304 Eldorado Road
P.O. Box 1607
BLOOMINGTON, IL 61701
Tel: (309) 662-9411
A,C,E,M**

Hewlett-Packard Co.
525 W. Monroe, #1308
CHICAGO, IL 60606
Tel: (312) 930-0010
C

Hewlett-Packard Co.
1200 East Diehl Road
NAPERVILLE, IL 60566
Tel: (312) 357-8800
C

Hewlett-Packard Co.
5201 Tollview Drive
ROLLING MEADOWS, IL 60008
Tel: (312) 255-9800
Telex: 910-687-1066
A,C,CM,E,M

Indiana

Hewlett-Packard Co.
11911 N. Meridian St.
CARMEL, IN 46032
Tel: (317) 844-4100
A,C,CM,E,M

Hewlett-Packard Co.
111 E. Ludwig Road
Suite 108
FT. WAYNE, IN 46825
Tel: (219) 482-4283
C,E

Iowa
Hewlett-Packard Co.
4070 22nd Av. SW
CEDAR RAPIDS, IA 52404
Tel: (319) 390-4250
C,E,M

Hewlett-Packard Co.
4201 Corporate Dr.
WEST DES MOINES, IA 50265
Tel: (515) 224-1435
A**,C,M**

Kansas

Hewlett-Packard Co.
7804 East Funston Road, Suite 203
WICHITA, KS 67207
Tel: (316) 684-8491
C,E

Kentucky

Hewlett-Packard Co.
10300 Linn Station Road, Suite 100
LOUISVILLE, KY 40223
Tel: (502) 426-0100
A,C,M

Louisiana

Hewlett-Packard Co.
160 James Drive East
ST. ROSE, LA 70087
P.O. Box 1449
KENNER, LA 70063
Tel: (504) 467-4100
A,C,E,M,P

Maryland

Hewlett-Packard Co.
3701 Coppens Street
BALTIMORE, MD 21227
Tel: (301) 644-5800
Telex: 710-862-1943
A,C,CM,E,M

Hewlett-Packard Co.
2 Choke Cherry Road
ROCKVILLE, MD 20850
Tel: (301) 948-6370
A,C,CM,E,M

Massachusetts

Hewlett-Packard Co.
1775 Minuteman Road
ANDOVER, MA 01810
Tel: (617) 682-1500
A,C,CM,E,M,P*

Hewlett-Packard Co.
32 Hartwell Avenue
LEXINGTON, MA 02173
Tel: (617) 861-8960
C,E

Michigan

Hewlett-Packard Co.
4326 Cascade Road S.E.
GRAND RAPIDS, MI 49506
Tel: (616) 957-1970
C,M

Hewlett-Packard Co.
39550 Orchard Hill Place Drive
NOVI, MI 48050
Tel: (313) 349-9200
A,C,E,M

Hewlett-Packard Co.
1771 W. Big Beaver Road
TROY, MI 48084
Tel: (313) 643-6474
C

Minnesota

Hewlett-Packard Co.
2025 W. Larpenteur Ave.
ST. PAUL, MN 55113
Tel: (612) 644-1100
A,C,CM,E,M

Missouri

Hewlett-Packard Co.
1001 E. 101st Terrace Suite 120
KANSAS CITY, MO 64131-3368
Tel: (816) 941-0411
A,C,CM,E,M

Hewlett-Packard Co.
13001 Hollenberg Drive
BRIDGETON, MO 63044
Tel: (314) 344-5100
A,C,E,M

Nebraska

Hewlett-Packard
11626 Nicholas St.
OMAHA, NE 68154
Tel: (402) 493-0300
C,E,M

New Jersey

Hewlett-Packard Co.
120 W. Century Road
PARAMUS, NJ 07653
Tel: (201) 265-5000
A,C,CM,E,M

Hewlett-Packard Co.
20 New England Av. West
PISCATAWAY, NJ 08854
Tel: (201) 562-6100
A,C,CM,E

New Mexico

Hewlett-Packard Co.
7801 Jefferson N.E.
ALBUQUERQUE, NM 87109
Tel: (505) 823-6100
C,E,M

Hewlett-Packard Co.
1460 Trinity Dr., Suite 3
LOS ALAMOS, NM
Tel: (505) 662-6700
C,E

New York

Hewlett-Packard Co.
5 Computer Drive South
ALBANY, NY 12205
Tel: (518) 458-1550
A,C,E,M

Hewlett-Packard Co.
9600 Main Street
CLARENCE, NY 14031
Tel: (716) 759-8621
C,E

Hewlett-Packard Co.
200 Cross Keys Office Park
FAIRPORT, NY 14450
Tel: (716) 223-9950
A,C,CM,E,M

Hewlett-Packard Co.
7641 Henry Clay Blvd.
LIVERPOOL, NY 13088
Tel: (315) 451-1820
A,C,CM,E,M

Hewlett-Packard Co.
No. 1 Pennsylvania Plaza
55th Floor
34th Street & 8th Avenue
MANHATTAN NY 10119
Tel: (212) 971-0800
C,M*

Hewlett-Packard Co.
15 Myers Corner Rd.
Hollowbrook Park, Suite 20
WAPPINGER FALLS, NY 12590
Tel: (914) 298-9125
CM,E

Hewlett-Packard Co.
2975 Westchester Avenue
Purchase, NY 10577-2590
Tel: (914) 935-6300
C,CM,E

Hewlett-Packard Co.
3 Crossways Park West
WOODBURY, NY 11797
Tel: (516) 682-7800
A,C,CM,E,M

North Carolina

Hewlett-Packard Co.
305 Gregson Dr.
CARY, NC 27511
Tel: (919) 467-6600
C,CM,E,M,P*

Hewlett-Packard Co.
9600-H Southern Pine Blvd.
CHARLOTTE, NC 28210
Tel: (704) 527-8780
C*

Hewlett-Packard Co.
5605 Roanne Way
GREENSBORO, NC 27420
Tel: (919) 852-1800
A,C,CM,E,M,P*

Ohio

Hewlett-Packard Co.
2717 S. Arlington Road
AKRON, OH 44312
Tel: (216) 644-2270
C,E

Hewlett-Packard Co.
4501 Erskine Road
CINCINNATI, OH 45242
Tel: (513) 891-9870
C,M

Hewlett-Packard Co.
15885 Sprague Road
CLEVELAND, OH 44136
Tel: (216) 243-7300
A,C,CM,E,M

Hewlett-Packard Co.
9080 Springboro Pike
MIAMISBURG, OH 45342
Tel: (513) 433-2223
A,C,CM,E*,M

Hewlett-Packard Co.
One Maritime Plaza, 5th Floor
720 Water Street
TOLEDO, OH 43604
Tel: (419) 242-2200
C

Hewlett-Packard Co.
675 Brookside Blvd.
WESTERVILLE, OH 43081
Tel: (614) 891-3344
C,CM,E*

Oklahoma

Hewlett-Packard Co.
3525 N.W. 56th St.
Suite C-100
OKLAHOMA CITY, OK 73112
Tel: (405) 946-9499
C,E*,M

Hewlett-Packard Co.
3840 S. 103rd E. Ave., #100
TULSA, OK 74146
Tel: (918) 665-3300
A*,C,E,M*,P*

Oregon

Hewlett-Packard Co.
9255 S. W. Pioneer Court
WILSONVILLE, OR 97070
Tel: (503) 682-8000
A,C,E*,M

Pennsylvania

Hewlett-Packard Co.
50 Dorchester Rd.
HARRISBURG, PA 17112
Tel: (717) 657-5900
C

Hewlett-Packard Co.
111 Zeta Drive
PITTSBURGH, PA 15238
Tel: (412) 782-0400
A,C,E,M

Hewlett-Packard Co.
2750 Monroe Boulevard
VALLEY FORGE, PA 19482
Tel: (215) 666-9000
A,C,CM,E,M

South Carolina

Hewlett-Packard Co.
Brookside Park, Suite 122
1 Harbison Way
COLUMBIA, SC 29210
Tel: (803) 732-0400
C,M

Hewlett-Packard Co.
545 N. Pleasantburg Dr.
Suite 100
GREENVILLE, SC 29607
Tel: (803) 232-8002
C

Tennessee

Hewlett-Packard Co.
One Energy Centr. Suite 200
Pellissippi Pkwy.
KNOXVILLE, TN 37932
Tel: (615) 966-4747
A,C,M

Hewlett-Packard Co.
3070 Directors Row
Directors Square
MEMPHIS, TN 38131
Tel: (901) 346-8370
A,C,M

Hewlett-Packard Co.
220 Great Circle Road, Suite 116
NASHVILLE, TN 37228
Tel: (615) 255-1271
A,C,E,M,P

Texas

Hewlett-Packard Co.
1826-P Kramer Lane
AUSTIN, TX 78758
Tel: (512) 835-6771
C,E,P*

Hewlett-Packard Co.
5700 Cromo Dr
EL PASO, TX 79912
Tel: (915) 833-4400
C,E*,M**

Hewlett-Packard Co.
3952 Sandshell Drive
FORT WORTH, TX 76137
Tel: (817) 232-9500
C

Hewlett-Packard Co.
10535 Harwin Drive
HOUSTON, TX 77036
Tel: (713) 776-6400
A,C,E,M,P*

Hewlett-Packard Co.
3301 Royal Lane
IRVING, TX 75063
Tel: (214) 869-3377
C,E

Hewlett-Packard Co.
109 E. Toronto, Suite 100
McALLEN, TX 78503
Tel: (512) 630-3030
C

Hewlett-Packard Co.
930 E. Campbell Rd.
RICHARDSON, TX 75081
Tel: (214) 231-6101
A,C,CM,E,M,P*
Hewlett-Packard Co.
1020 Central Parkway South
SAN ANTONIO, TX 78232
Tel: (512) 494-9336
A,C,E,M,P*

Utah

Hewlett-Packard Co.
3530 W. 2100 South
SALT LAKE CITY, UT 84119
Tel: (801) 974-1700
A,C,E,M

Virginia

Hewlett-Packard Co.
840 Greenbrier Circle
Suite 101
CHESAPEAKE, VA 23320
Tel: (804) 424-7105
C,E,M

Hewlett-Packard Co.
4305 Cox Road
GLEN ALLEN, VA 23060
Tel: (804) 747-7750
A,C,E,M,P*

Hewlett-Packard Co.
Tanglewood West Bldg.
Suite 240
3959 Electric Road
ROANOKE, VA 24018
Tel: (703) 774-3444
C,E,P

Washington

Hewlett-Packard Co.
15815 S.E. 37th Street
BELLEVUE, WA 98006
Tel: (206) 643-4000
A,C,CM,E,M
Hewlett-Packard Co.
North 708 Argonne Road
SPOKANE, WA 99212-2793
Tel: (509) 922-7000
C

West Virginia

Hewlett-Packard Co.
501 56th
CHARLESTON, WV 25304
Tel: (304) 925-0492
A,C,M

Wisconsin

Hewlett-Packard Co.
275 N. Corporate Dr.
BROOKFIELD, WI 53005
Tel: (414) 784-8800
A,C,E*,M
URUGUAY
Pablo Ferrando S.A.C. e I.
Avenida Italia 2877
Casilla de Correo 370
MONTEVIDEO
Tel: 80-3805
Telex: Public Booth 901
A,CM,E,M



SALES & SUPPORT OFFICES

Arranged alphabetically by country

URUGUAY (Cont'd)

Olympia de Uruguay S.A.
Maquinas de Oficina
Avda. del Libertador 1997
Casilla de Correos 6644

MONTEVIDEO

Tel: 91-1809, 98-3807
Telex: 6342 OROU UY
P

VENEZUELA

Hewlett-Packard de Venezuela C.A.
3A Transversal Los Ruices Norte
Edificio Segre 2 & 3
Apartado 50933

CARACAS 1050

Tel: (582) 239-4133
Telex: 25 1046 HEWPACK
A,C,CM,E,M,P

Hewlett-Packard de Venezuela, C.A.
Centro Ciudad Comercial Tamanaco
Nivel C-2 (Nueva Etapa)
Local 53H05

Chuao, CARACAS

Tel: 928291
P

Albis Venezolana S.R.L.
Av. Las Marias, Ota. Alix,
El Pedregal
Apartado 81025

CARACAS 1080A

Tel: 747984, 742146
Telex: 24009 ALBIS VC

A

Tecnologica Medica del Caribe, C.A.
Multicentro Empresarial del Este
Ave. Libertador
Edif. Libertador

Nucleo "C" - Oficina 51-52

CARACAS

Tel: 339867/333780
M

Hewlett-Packard de Venezuela C.A.
Residencias Tia Betty Local 1
Avenida 3 y con Calle 75

MARACAIBO, Estado Zulia

Apartado 2646

Tel: (5861) 80304

Telex: 62464 HPMAR

C,E*

Hewlett-Packard de Venezuela C.A.
Urb. Lomas de Este
Torre Trebol — Piso 11

VALENCIA, Estado Carabobo

Apartado 3347

Tel: (5841) 222992

C,P

YUGOSLAVIA

Do Hermes

General Zdanova 4

YU-11000 **BEOGRAD**

Tel: (011) 342 641

Telex: 11433

A,C,E,M,P

Do Hermes

Celovska 73

YU-61000 **LJUBLJANA**

Tel: (06 1) 553 170

Telex: 31583

A,C,E,M,P

Elektrotehna

Titova 51

YU-61000 **LJUBLJANA**

CM

Do Hermes

Kralja Tomislava 1

YU-71000 **SARAJEVO**

Tel: (071) 35 859

Telex: 41634

C**,P

ZAIRE

Computer & Industrial Engineering

25, Avenue de la Justice

B.P. 12797

KINSHASA, Gombe

Tel: 32063

Telex: 21552

C,P

ZAMBIA

R.J. Tilbury (Zambia) Ltd.

P.O. Box 32792

LUSAKA

Tel: 215590

Telex: 40128

E

ZIMBABWE

Field Technical Sales (Private) Limited

45, Kelvin Road North

P.O. Box 3458

SALISBURY

Tel: 705 231

Telex: 4-122 RH

E,P

August 1986

