

Shaping the Future
of the **Electrical**
PLM and **CAD**

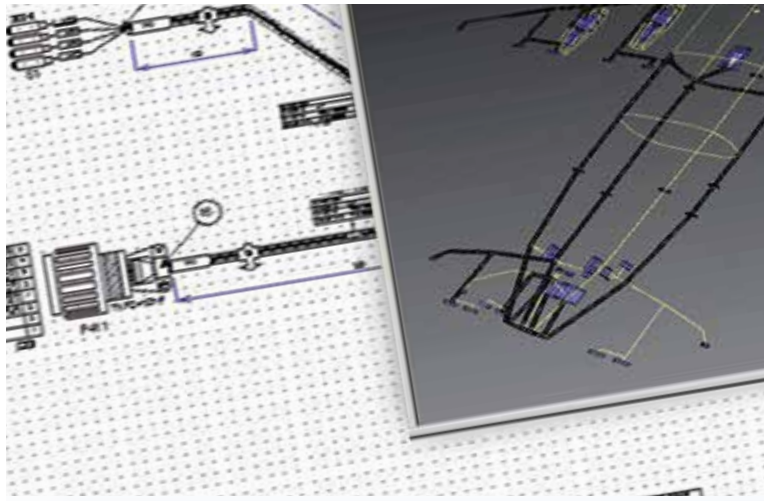

www.ige-xao.com

IGE+XAO GROUP
CORPORATED DOCUMENTATION



www.ige-xao.com



Providing clients with innovative software applications to increase the productivity and quality of electrical installation design, manufacturing and maintenance processes...

... this is the main mission the IGE+XAO Group set out to achieve through our range of software and services. Since our creation in 1986, the IGE+XAO Group has implemented a strong and ambitious strategy focusing on Marketing and Innovation to ensure we meet our clients' needs.

Through our Marketing strategy, we are constantly striving to increase our market share in France, as well as overseas. We have achieved this up to now, not only through our subsidiaries and offices across 17 countries, but also through our network of professional partners based in 33 countries. Today, IGE+XAO has sold over 67,400 licences across the globe and our clients range from craftsmen to multinational corporations in all industrial and service areas.

Our Innovation strategy has been implemented through a Research & Development investment representing 24% of our annual revenue.

With more than 150 engineers and technicians throughout the world, our development teams are constantly creating and improving our products and technologies.

In 2013, our Research and Development engineers will be working on the life cycle of electrical installation (electrical PLM), collaborative tools, automated cabling (2D and 3D) and system engineering with a view to improving productivity and quality. Supporting our commercial success, the Group has a strong financial structure with significant cash reserves and minimal liabilities.

I am extremely confident in our Group's capacity to expand within its field in years to come.

I trust you will enjoy reading about the IGE+XAO Group and finding out more about us and I would like to take this opportunity to thank, most sincerely, our clients and partners who have made us what we are today.

Alain Di Crescenzo
Chairman and CEO



© David Bocus



“26 years of experience

Over **67,400 licences** sold

26 locations in **17 countries**

More than **370 employees**

Listed on **Euronext** since

March 1997 ”

Shaping the Future of the **Electrical** **PLM** and **CAD**

Historically, the Group began by developing, selling and maintaining CAD (Computer Aided Design) software dedicated to the electrical industry. Electrical CAD software applications are used to design and maintain the electrical side of manufacturing processes and end products.

Today, CAD is the main business of the Group and represents 70% of its revenue.

From the late 90's, the IGE+XAO Group has started the development of a software suite covering the overall requirements of the "Harness Design" market, from the design to the manufacturing of electrical harnesses. This new market has led the Group to build a complete PLM (Product Lifecycle Management) software range. These solutions have attracted numerous global players in aeronautics and transportation such as Airbus, Eurocopter, Embraer or Alstom.

In 2005, IGE+XAO penetrated a new market: the Construction market. The strategy is twofold: the development of new products with prestigious partners such as Schneider Electric and Moeller Eaton Group and the launching of SEE Electrical Building a proprietary package targeting electrical installers.



© David Bécous

Alain Di Crescenzo
Chairman and CEO



Robert Grezes
Vice president
CAD R&D Director



Charles Baudron
Vice president
PLM R&D Director



- Subsidiaries
- Distributors

HISTORY OF THE GROUP

HISTORY OF THE GROUP

- 1986/1987:** Creation of **IGE**.
- 1988/1989:** Creation of a development and commercial subsidiary in **Poland**.
- 1991/1992:** Acquisition of **XAO Industrie** and Creation of the **IGE+XAO Group**.
- 1992/1993:** Creation of a commercial subsidiary in **Italy**.
- 1993/1994:** Creation of a commercial subsidiary in **Spain**.
- 1994/1995:** Creation of a commercial agency in **Germany**.
Creation of a development subsidiary in **Bulgaria**.
- 1997/1998:** Introduction of the **IGE+XAO Group** on the **Paris Stock Exchange**.
Creation of a commercial subsidiary in **Canada**.
Acquisition of **Schneider Electric's** Electrical CAD activity (called Handel).
- 1998/1999:** Creation of a commercial subsidiary in the **United Kingdom**.
- 1999/2000:** Creation of a commercial subsidiary in **Germany**.
- 2000/2001:** Acquisition of **Ingedata Développement** (France), **Tessdata BV** (Netherlands), **CAE Development ApS** (51%) & **CADdy Denmark A/S** (Denmark).
- 2001/2002:** Acquisition of a 19% stake of **Anyware Technologies**.
- 2002/2003:** Creation of a second commercial agency in **Germany**.
- 2004/2005:** Acquisition of **CAE Development ApS**.
- 2005/2006:** Creation of a commercial subsidiary in the **USA**.
Creation of a commercial agency in **China**.
Buy-out of **HIBATEC - Switzerland**.
- 2006/2007:** Creation of **EHMS** with the Labinal Group.
Creation of **S2E CONSULTING** with the **Sogeclair Group**.
Acquisition of **Compodata**.
- 2007/2008:** Creation of subsidiaries in **China** and **Tunisia**.
- 2008/2009:** Creation of a subsidiary in **Morocco**.
- 2009/2010:** Creation of a subsidiary in **Madagascar**.
- 2010/2011:** Launching of a wide **Chinese** sales network based on 3 IGE+XAO commercial agencies and 14 business partners.
Creation of a new office in Wadowice, **Poland**.
- 2011/2012:** Creation of a subsidiary in **Turkey**.
Creation of a new office in **Tarnow, Poland**.

Significant customers:

ABB, AgustaWestland SPA, Air France KLM, Airbus, AKKA, Akyapak, Alestis Aerospace, Alpatron, Alstom, ANURAG, Arcelormittal, AREVA Group, Aries Estructuras Aeroespaciales, Assystem, Astrium SAS, ATEL Netz Ag, BAM, Bauer GmbH, BBR GmbH, BE Aerospace Ltd, Beghin-Say, Beijing zhong xin xing ye keji, Benteler, Bosal, Bouygues, Brembo SPA, CABS, Carrier, CEA, Cegelec, Cermex, Chengdu Xinzhu Road & Bridge Machinery Co. Ltd, Coca Cola, COMAU (Fiat), Composite Engineering Inc., ContiTech Vibration Control, Cote SAS, Daf-Trucks, Dalkia, Danone, DCNS, DFM ZANAM-LEGMET Sp. z o.o., DHL, DRASS ENERGY SRL, Dredging International, Dunlop, Eaton Leonard Europe, EC Engineering, ECL, EDF, Eiffage Energie, ELV SPA, Embraer, Endurance Wind Power, Enexis, Euchner GmbH, Eurocopter, European Space Agency (ESA) , Fabricom, FAdeA SA, Faiveley, Faurecia, Fokker Elmo, Footlocker, Fromagerie BEL, Fuji Seal Group, Galileo Avionica, GDF Suez, General de Ingeniería INHISSET, General Dynamics European Land Systems- Germany, GPI, GSU/Eneco, Guérin Systèmes (Tetra Pack Group), Guinault, Hager, Haribo, Helibras, Hellenic Air Force, Henniez, Heuliez, Honda Aircraft Co., Honeywell, Houdijk Holland bv, Hydro Quebec, IMAC inc, Ineo, ITER, JSC ISS-Reshetnev Company, Kestrel Aerospace, Kocher Plastik GmbH, Kraft Foods, Labinal, Latelec, Legrand, Leroy Somer, Lindt, Lotus Bakeries, LVMH, Mairie de Paris, Manitowoc Crane Group, MBDA, Metso Brasil Indústria e Comércio Ltda, Michelin, Microturbo (Groupe Safran), Moëller Electric (Eaton) , Motorflug Baden-Baden GmbH, Motorola, Mühlenberg Interiors (EDAG Group) , NATO, Nestlé, Neu Railways, Nexans, NMBS/SNCB, Nomos Systems, Northrop Grumman, Panasonic, Perrier, PESA Bydgoszcz SA Holding, Philips, Prinoth, Potez Aeronautique, Priva, PSA Peugeot Citroën, Qi Qi Ha Er, RATP, Reel, Reims Aviation, Renault, Renault Trucks, Renson, Rio Tinto Alcan, Rolls-Royce Marine, RUAG AVIATION SA, S.A.B.C.A, Safran, Sagem, Saint Yorre, Samson AG, Saur, SCAM SPA, Schlumberger, Schneider Electric, SELEX SPA, SENER Ingeniería y Sistemas, S.A., Sepro, Shanghai Electric, Shanghai Rail Traffic, Sidel-Cermex, Siemens, Siemens Windpower, Sierra Nevada Corporation, Smurfit Kappa, SNCB, SNCF, Socata, SOGETI HT, Spie, Srbijagas, Sterela, Suez, Swedish Match Cigars NV, TEMSA, Thales, Toyota forklifts, Trakcja Polska S.A., Unilever, Valeo, Vallourec Talc de Luzenac, Van der Leun, Veolia Environnement, Vestas, Vesuvius, Vinci Energies, Volkswagen Group, VOSSLOH, Vulcanair SPA, Wabco GmbH, Wago, Wenzel Elektronik GmbH, Whirlpool Europe SRL, Wienerberger, Xella, ZF Sachs...

AN IMPORTANT CUSTOMER BASE

As of July 31st, 2012 the IGE+XAO Group has delivered over 67,400 licences and serves as many as 33,700 customers throughout the world.

These customers belong to a wide range of industries including:

- Automotive
- Transportation
- Power generation
- Electrical and electronic equipment
- Food, chemical and steel industries
- Building and public works
- Engineering companies
- Machine building
- Automation
- Etc.

Number of licences sold

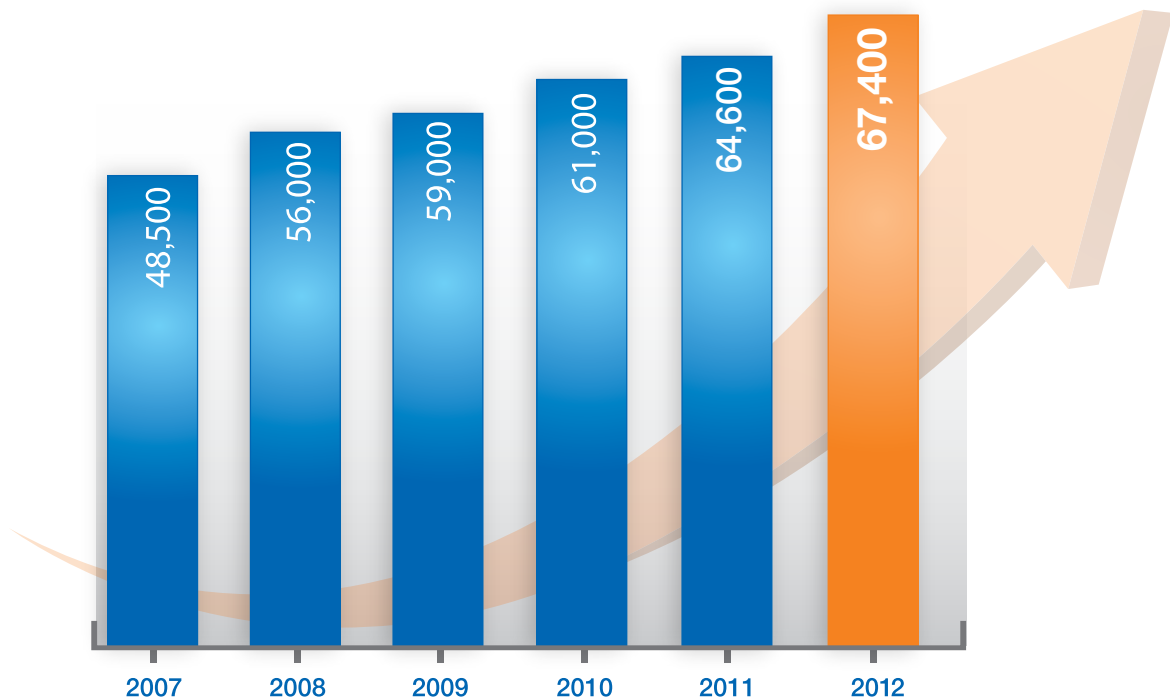

*International
openness*

Boldness

Dynamism



STRONG VALUES

Strong and shared values are key to the Group success.

All employees and managers carry daily the Group values to new employees, partners and suppliers.

PROFESSIONALISM

Consideration
for customers
and staff



A CLEAR STRATEGY

The Group strategy relies on **5 key points:**

▶ **A strong presence in 8 industries**

On each identified industry, IGE+XAO covers all requirements with a complete range of modular products...

- Aerospace
- Automotive
- Railway
- Shipbuilding
- Equipment & Machinery
- Automation & Plant
- Power generation & Energy
- Construction



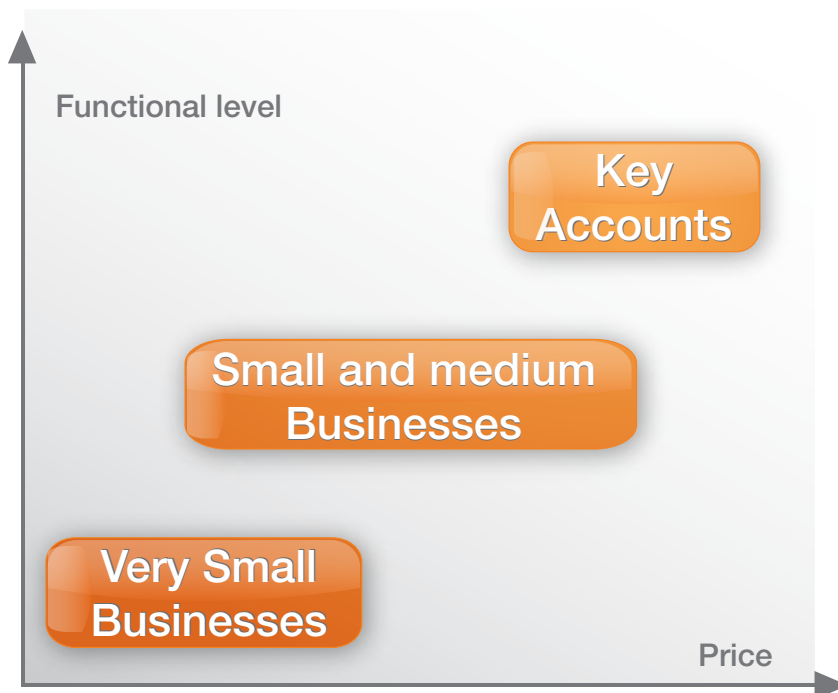

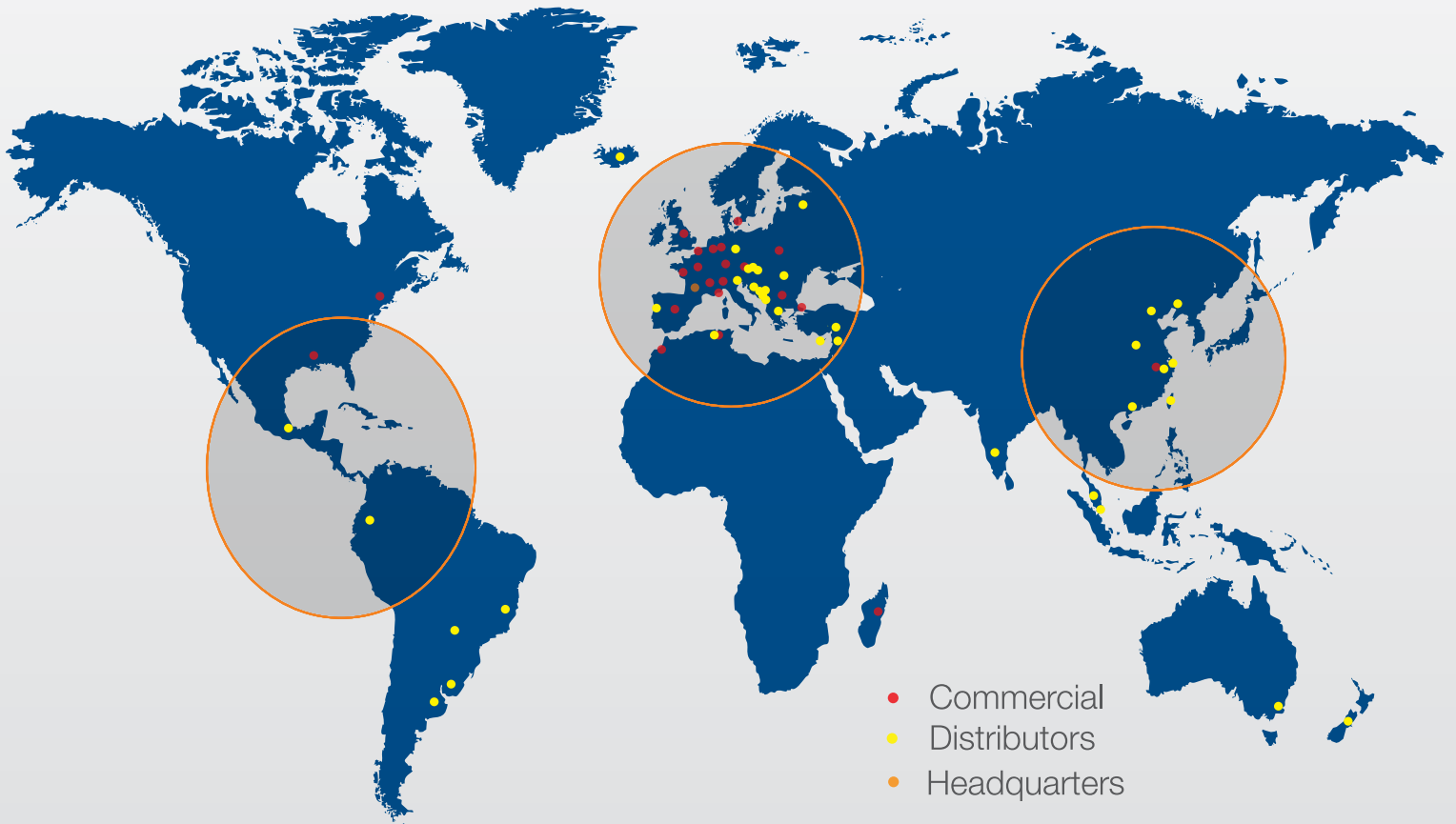











... with the ambition to be the partner for all companies whatever their size.





► A strong commercial international presence

The IGE+XAO Group is present in **17 countries** through its **26 offices**:

- | | |
|--|--|
|  Bulgaria |  Poland |
|  Canada |  Spain |
|  China |  Switzerland |
|  Denmark |  Tunisia |
|  France |  Turkey |
|  Germany |  United Kingdom |
|  Italy |  USA |
|  Madagascar | |
|  Morocco | |
|  Netherlands (The) | |

A network of **32 distributors/partners** represents the Group in **33 countries**:

- | | | |
|---|---|---|
|  Argentina |  Greece |  Romania |
|  Austria |  Hungary |  Russia |
|  Australia |  Iceland |  Serbia |
|  Bosnia and Herzegovina |  India |  Singapore |
|  Brazil |  Lebanon |  Slovakia |
|  China |  Macedonia |  Slovenia |
|  Colombia |  Malaysia |  Syria |
|  Croatia |  Mexico |  Taiwan |
|  Cyprus |  Montenegro |  Tunisia |
|  Czech Republic |  New Zealand |  Uruguay |
|  Faroe Islands |  Paraguay | |
| |  Portugal | |



► An efficient global R&D organization

Development teams are located all over the world.



► Innovation

The IGE+XAO Group invests in innovation as a top priority.

During the 2011/2012 tax year, the Research and Development activity represented 5,6 million euros, or 24% of the revenue.

Our Research and Development program is focused on two key areas:

- **Business** – dealing with automatic generation of schematics, automatic cabling, system engineering, dimensioning and simulation.
- **Technology** – dealing with concurrent engineering, product lifecycle management (PLM), product data management (PDM) and Internet applications.

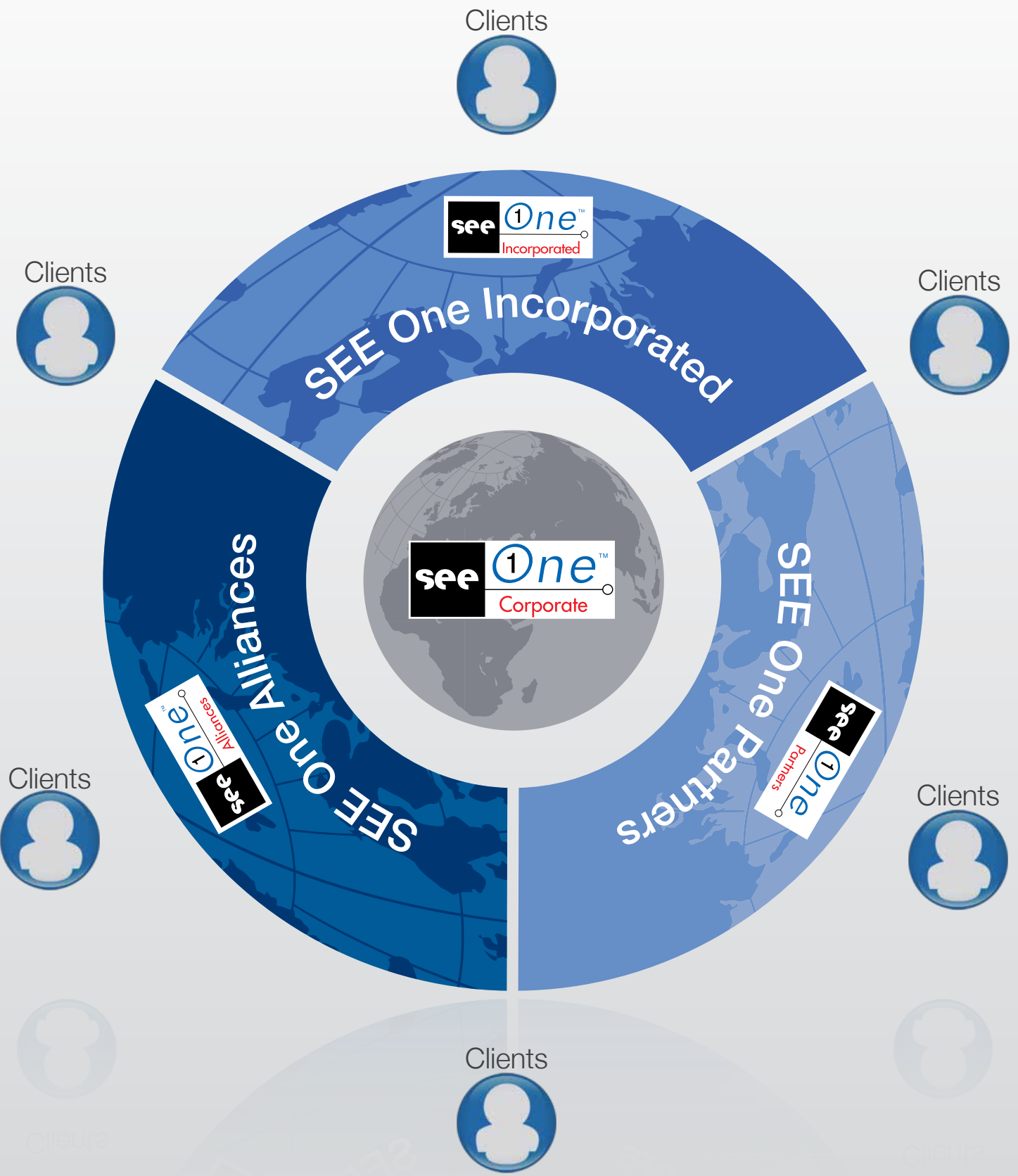

AN ORGANIZATION BUILT AROUND OUR CLIENTS

In response to the market fast-moving needs, the IGE+XAO Group has put in place an «extended enterprise» organization.

The organizational structure consists of the following entities:

SEE One Corporate consists of "R&D", commercial support, sales management, HR, finance, international support and global key accounts management.

SEE One Incorporated embraces the Group's consolidated commercial subsidiaries.

SEE One Alliances includes jointly owned companies (50% or lower stake):

- EHMS (created with Labinal).
- S2E Consulting (created with Sogclair).
- IGE+XAO Denmark (created with CAE Development ApS).



SEE One Partners comprises the IGE+XAO Group's technological and commercial partners.

Technological partners: Labinal, Dassault Systèmes, SolidWorks...

Commercial partners: Weidmüller, Schneider Electric, Moeller Electric Eaton, Labinal, Sogclair, as well as all the companies distributing the Group's products in countries where IGE+XAO is not represented.



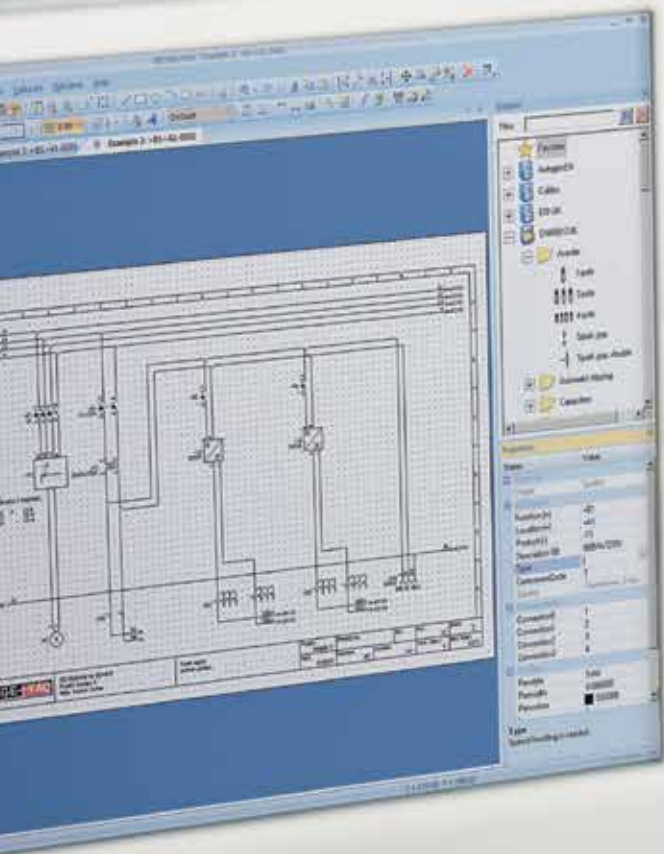
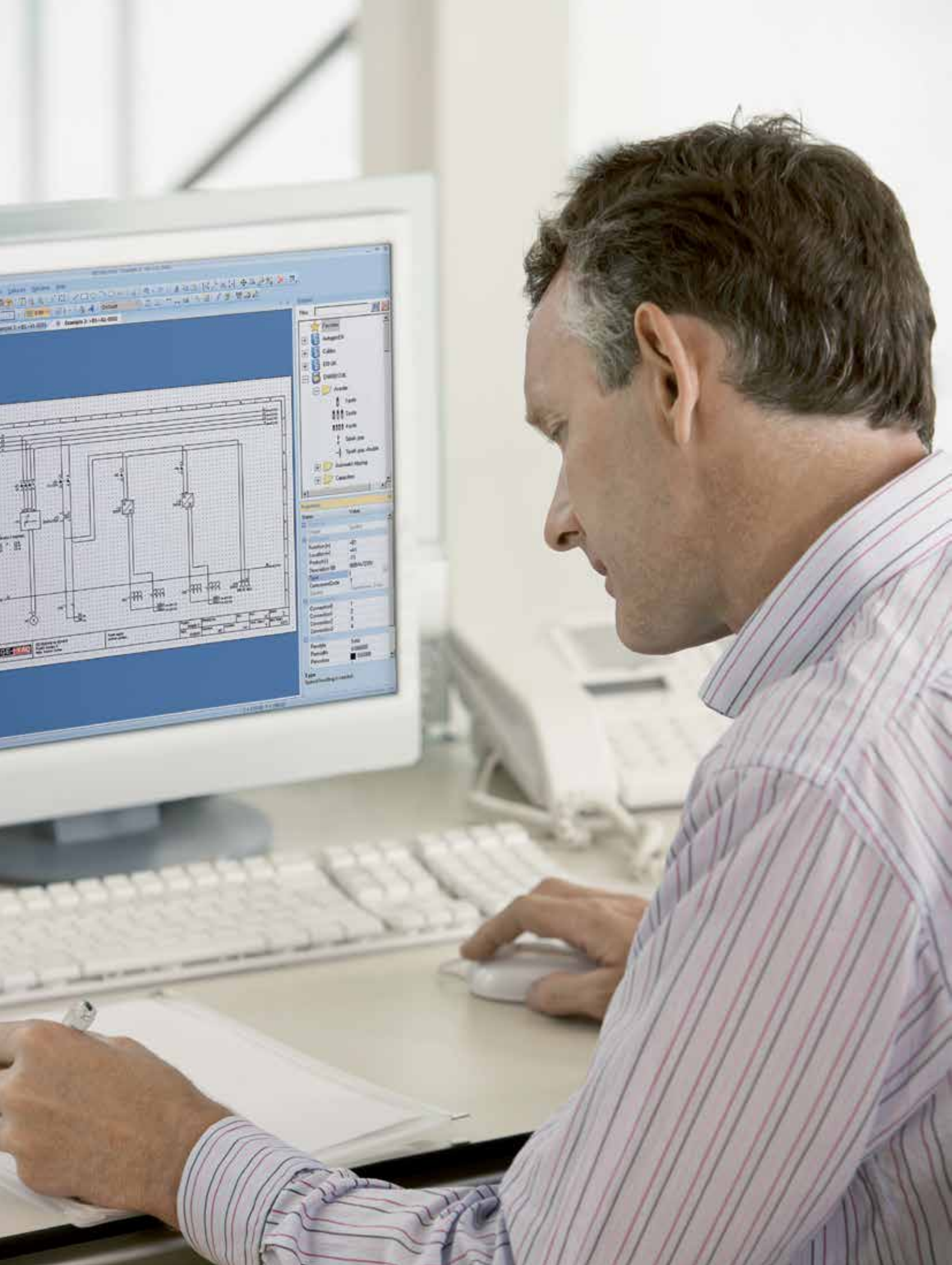

VALUE-ADDED SERVICES

IGE+XAO service portfolio: 4 levels of added-value services.

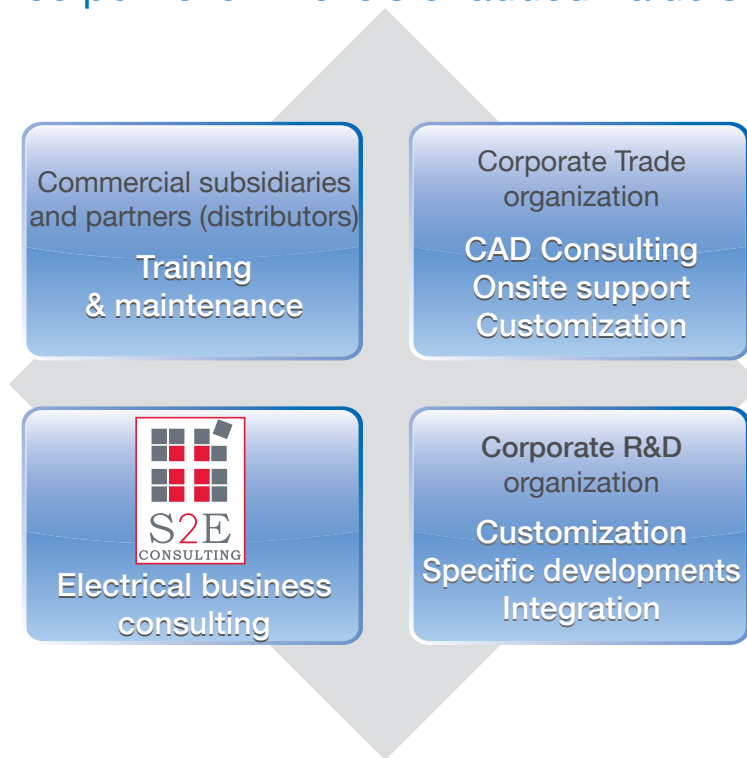

Fully aware that our clients' needs go beyond the software package, our Group offers value-added services.

Training sessions adapted to clients' needs and worldwide telephone helpline.

Over 70 experts are available to our clients for:

- Training worldwide.
- Assisting clients in more than 12 languages throughout the world.

Dedicated team to customize the software to our clients' needs.

The "Assistance +" team supports our clients in implementing and integrating IGE+XAO solutions. Services include CAD consulting, onsite support and customization.

Our R&D team also provides specific developments as well as integration services.

Value-added consulting.

Created in collaboration with the SOGECLAIR Group, S2E Consulting offers assistance and consulting services dedicated to system engineering and optimization of electrical design processes.



A SOLID PRESENCE IN 8 INDUSTRIES

14 products, 5 functional domains and 8 strategic industries

The IGE+XAO Group targets 8 strategic industries:



Aerospace



Equipment & Machinery



Automotive



Automation & Plant



Railway



Power generation & Energy



Shipbuilding



Construction

The Group objective is to provide software packages precisely tailored to each industry. Solutions cover requirements that go from simple electrical schematics to PLM (Product Lifecycle Management).

For each industry, the offer has been segmented in 5 domains:

- Electrical design (the core business of IGE+XAO)
- System design
- Electrical manufacturing
- Data management
- Communication

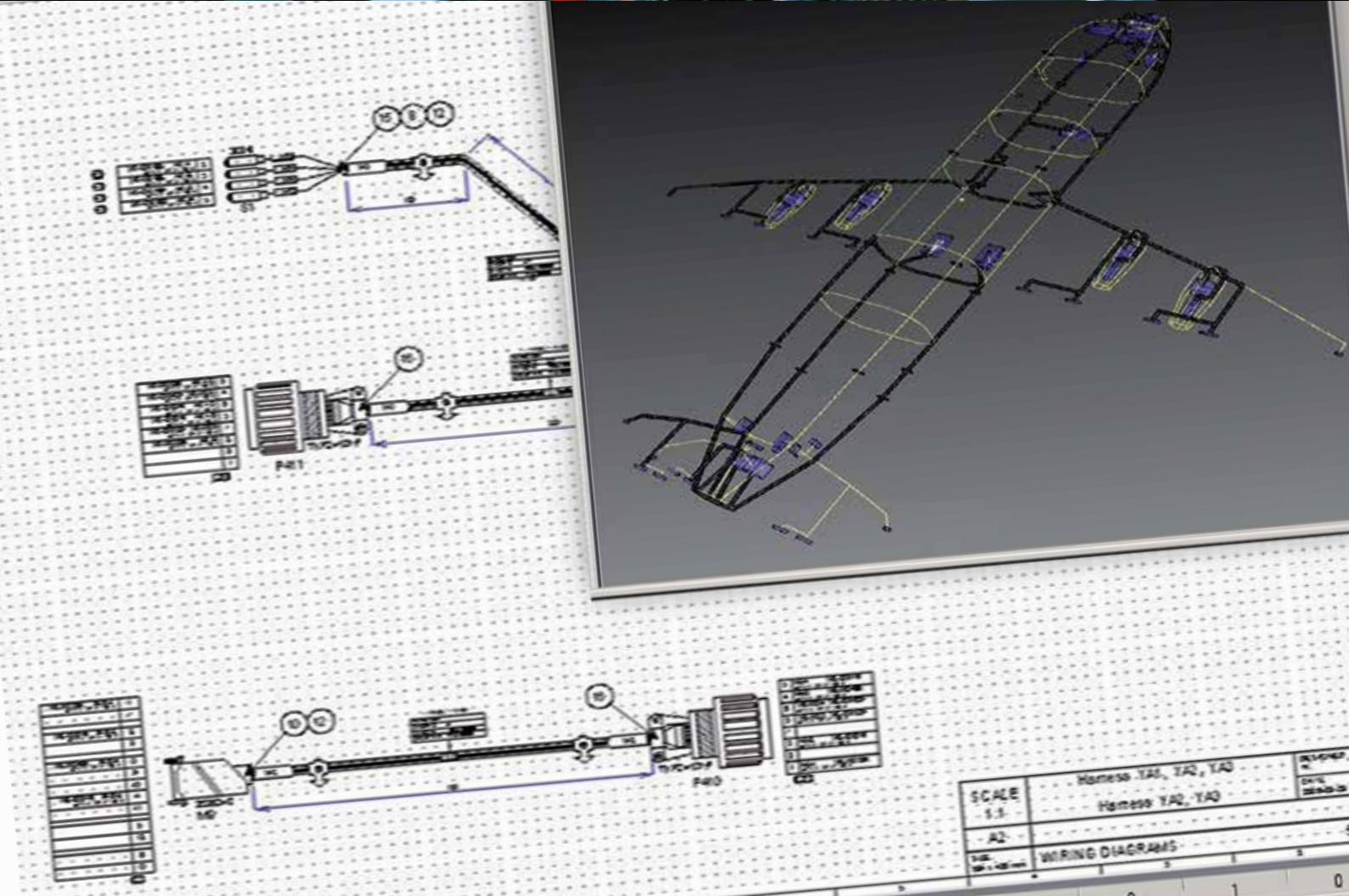



A powerful offer for the Aerospace Industry!

The Aerospace Industry is facing stiff challenges:

- An increasing number of equipment
- More and more complex cabling
- Heterogeneous software tools

To meet these challenges, the IGE+XAO Group has developed a complete software range with strong competitive advantages:

- Powerful PLM (Product Lifecycle Management) suite
- Complete offer that goes from design to manufacturing
- Strong information system integration
- Scalable solutions (from stand alone to PLM)

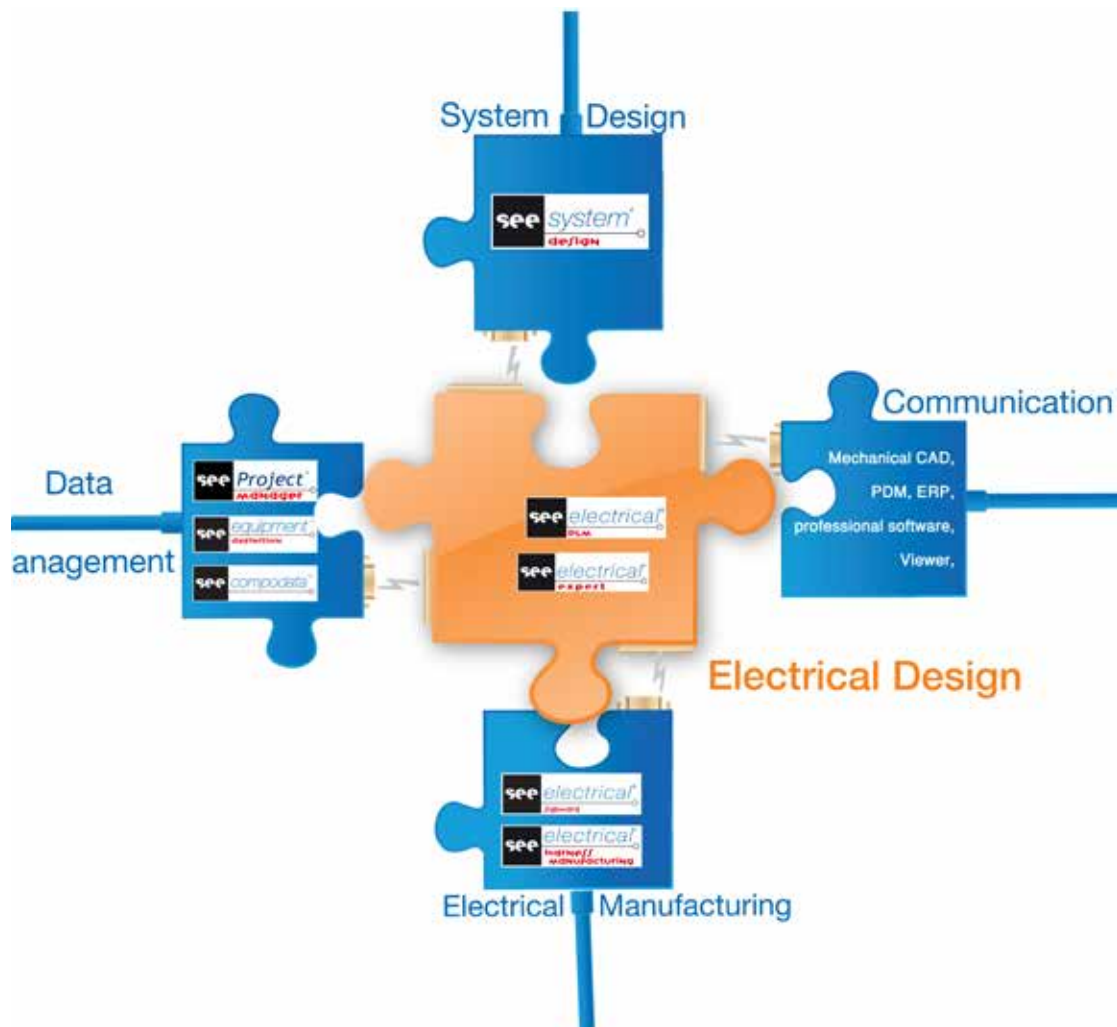

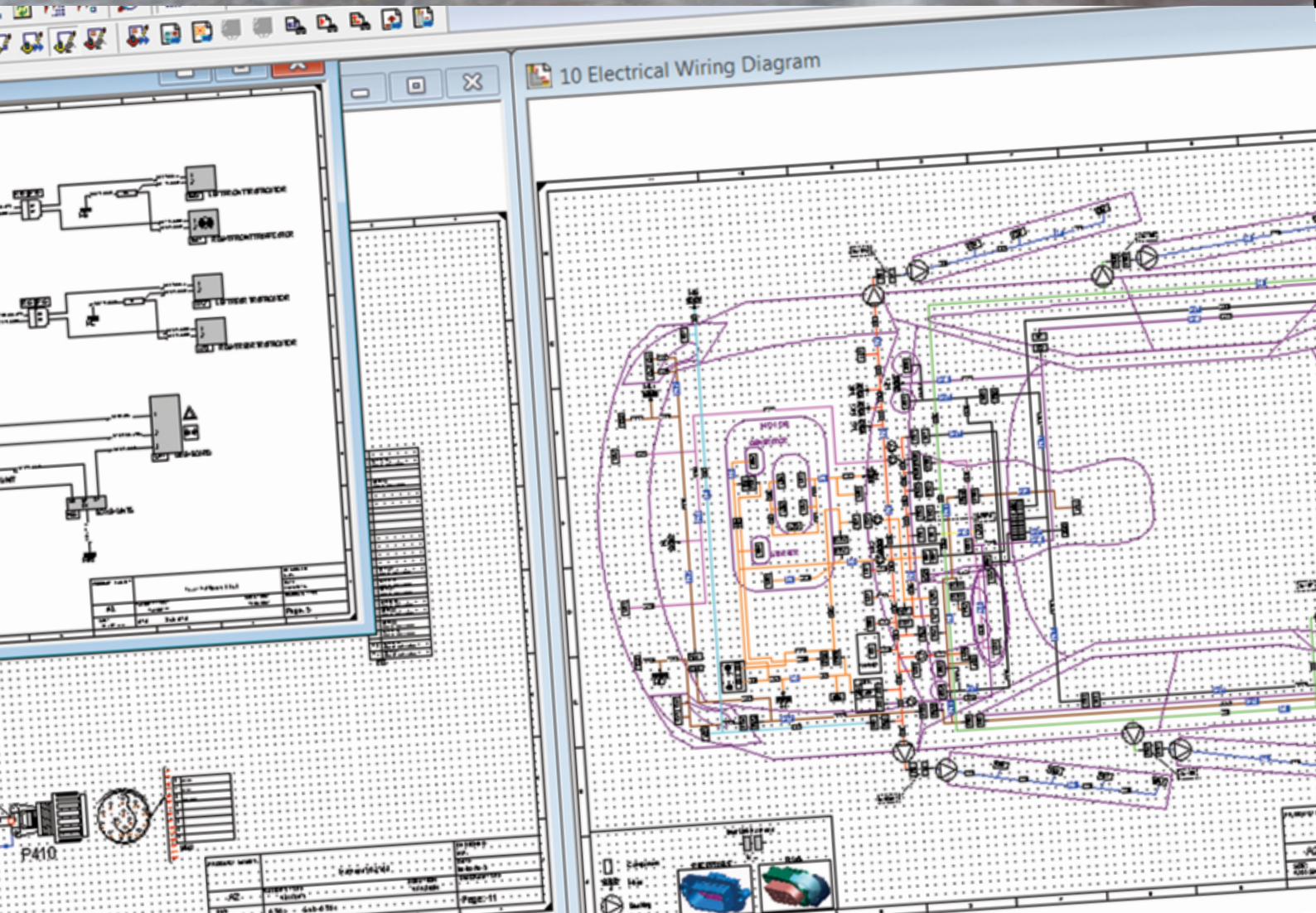

10 Electrical Wiring Diagram

Part No.	Description	Quantity	Unit
1	Battery	1	PCB
2	Resistor	10	PCB
3	Capacitor	5	PCB
4	Motor	1	PCB
5	Relay	1	PCB
6	Diode	2	PCB
7	LED	3	PCB
8	Switch	1	PCB
9	Transistor	1	PCB
10	IC	1	PCB





A strong offer for the Automotive Industry!

- CO² reduction
- Shorter development time
- Option management
- Increasingly complex electronic content...

... are some of the challenges that engineers in the Automotive Industry have to solve daily.

To assist them, the IGE+XAO Group has developed a complete software range with strong competitive advantages:

- Powerful PLM (Product Lifecycle Management) suite
- Automotive specific functions
- Strong information system integration
- Configuration management (options and variants)

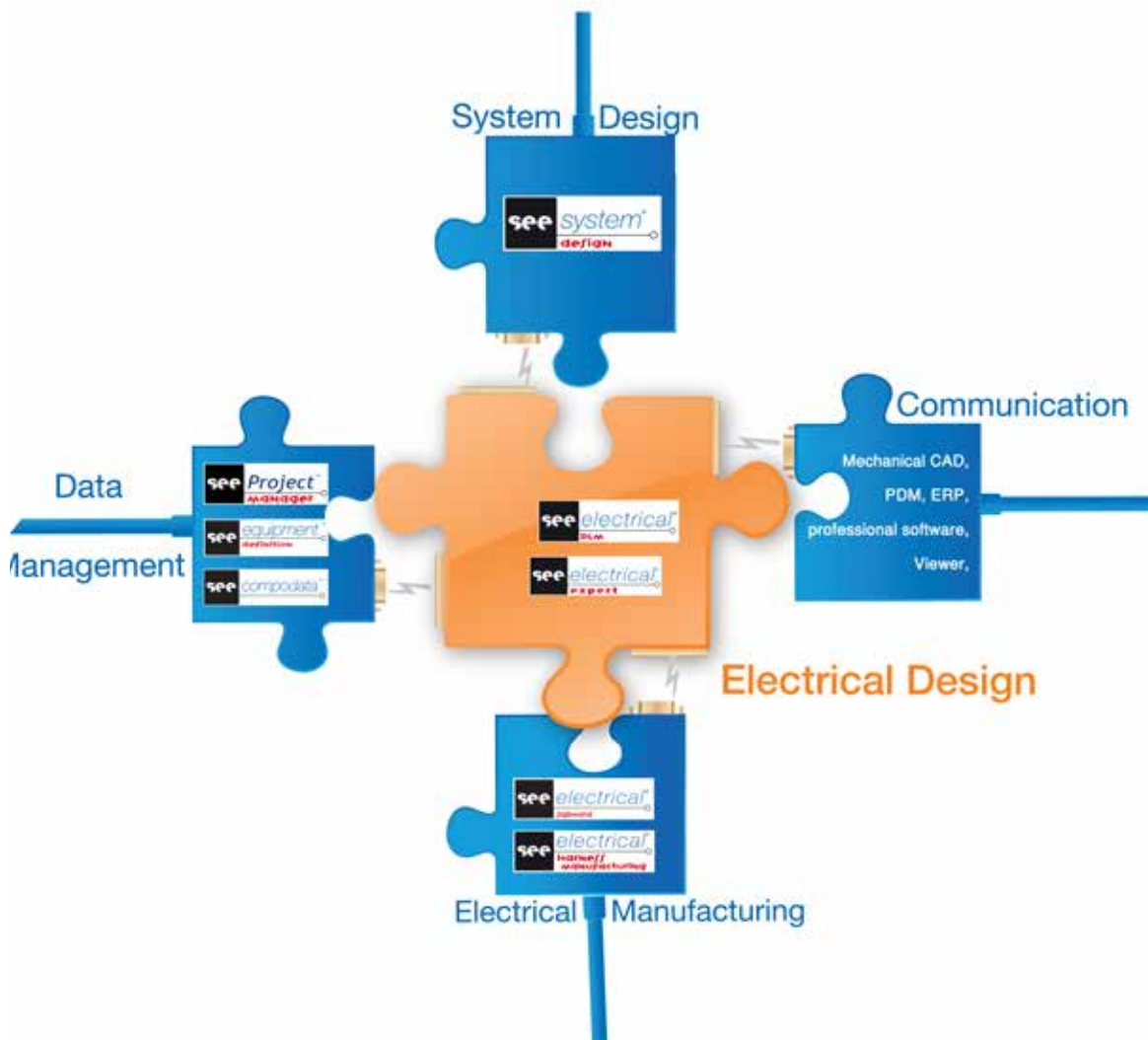

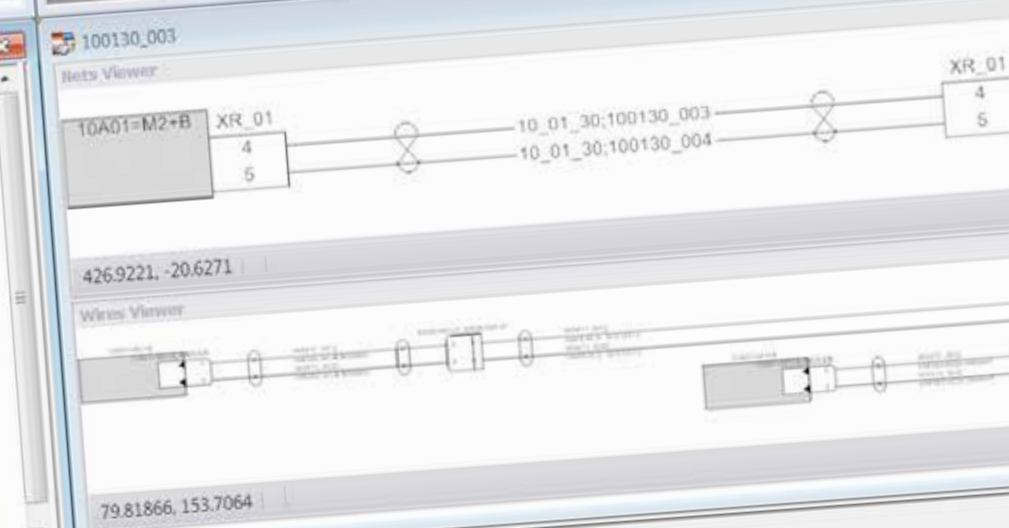
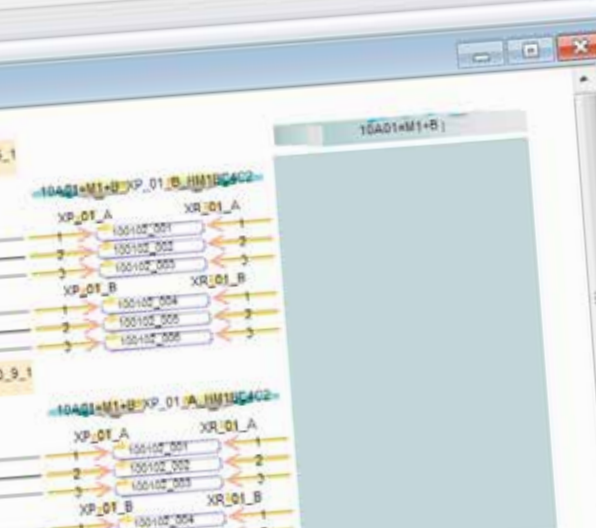
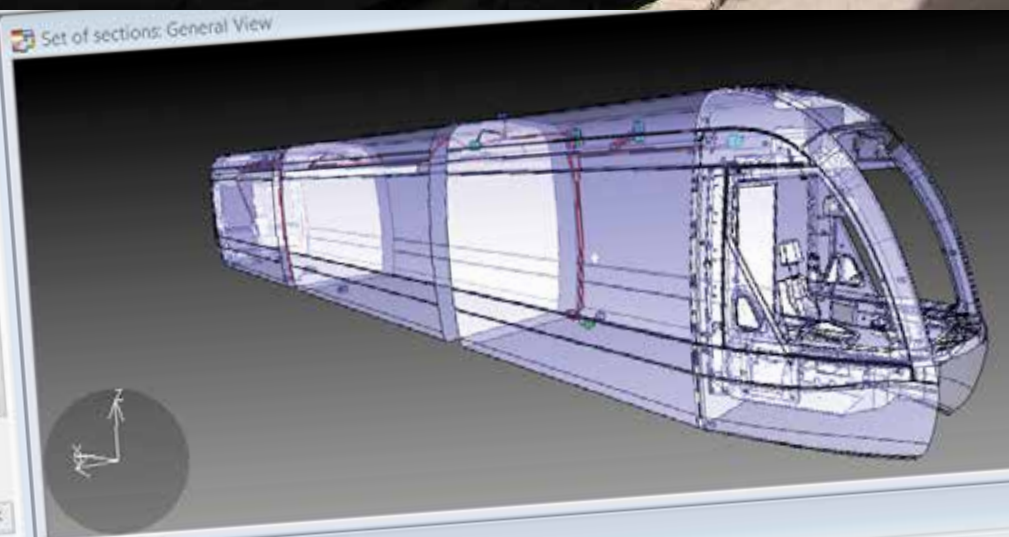
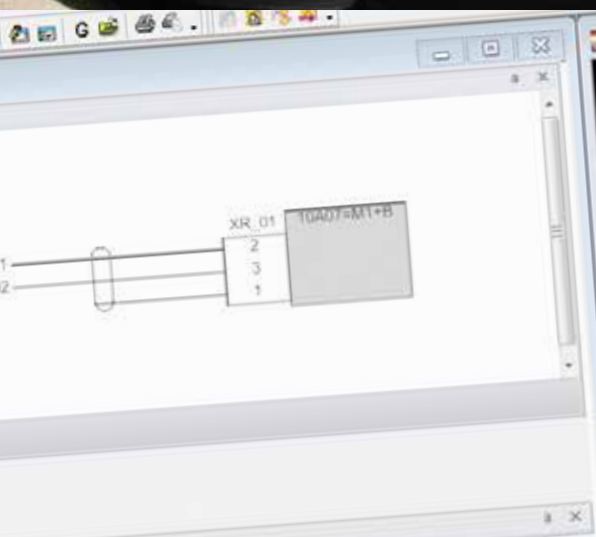



An innovative offer for the Railway Industry!

Railway design engineers work daily on key issues such as “intelligent train”, equipment reliability, safety, eco efficiency, additional comfort and services.

To cope with these issues, the IGE+XAO Group has developed an innovative and complete software range offering competitive advantages:

- Powerful PLM (Product Lifecycle Management) suite
- Railway specific functions
- Strong information system integration
- Traceability

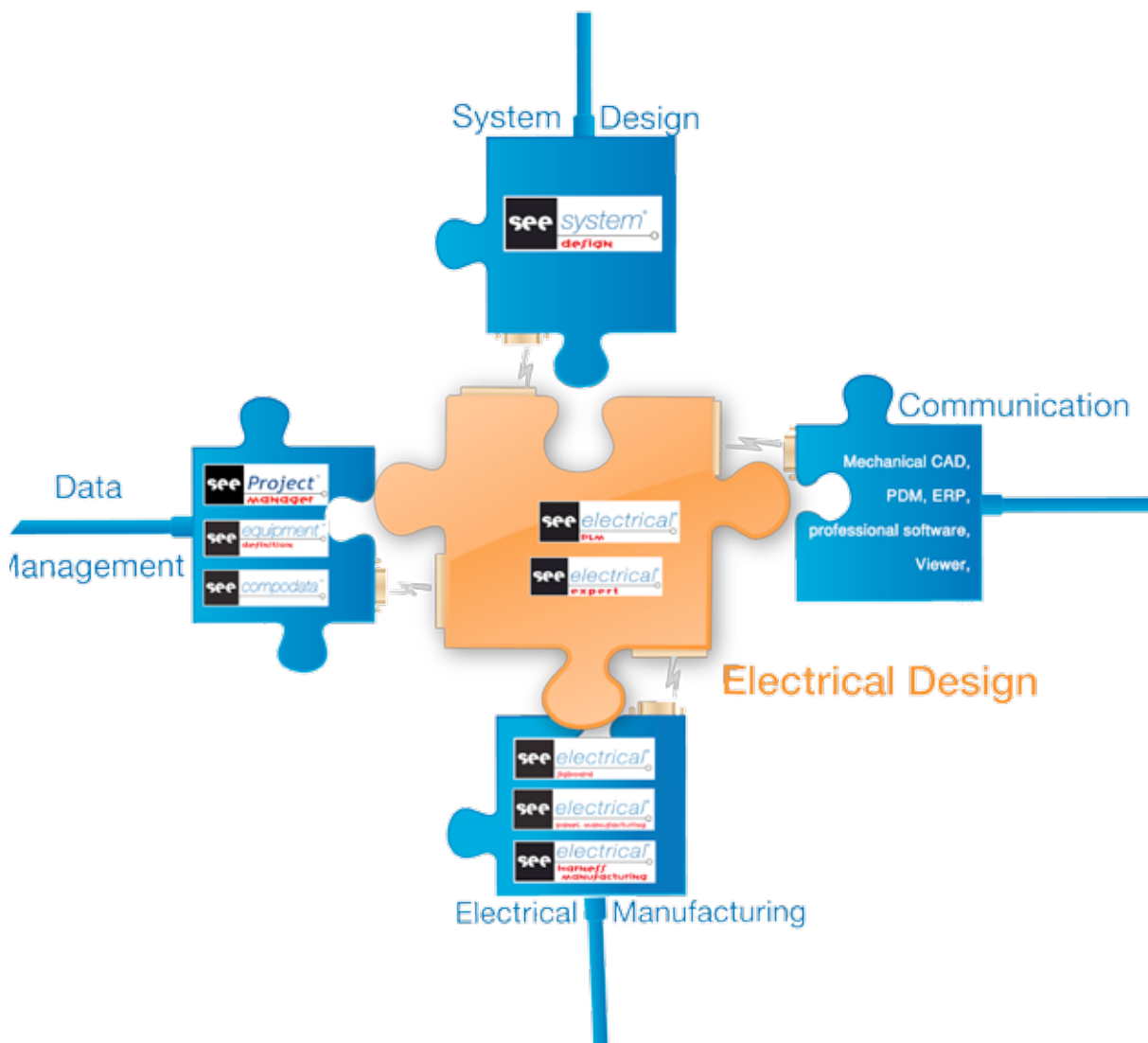



Window <> French (France) Empty

electrique 12v DC (Eclairage 4&5)

F10 Cabin overview

electrique 12v DC (Eclairage 2)

H1 Main cabin harness

The image displays a software interface for electrical design, showing four panels. The top panel is a software window with a menu bar and toolbar. Below it are four panels: 1. 'electrique 12v DC (Eclairage 4&5)': A circuit diagram on a grid background showing a power source connected to several parallel branches, each containing a switch and a light bulb. 2. 'F10 Cabin overview': A schematic diagram of a cabin layout with various electrical components and wiring paths. 3. 'electrique 12v DC (Eclairage 2)': Another circuit diagram similar to the first one, but with a different configuration of components. 4. 'H1 Main cabin harness': A detailed wiring diagram showing a complex network of electrical connections, including a legend table on the right side.

Code	Description
1.000.0	1.000.0
1.000.1	1.000.1
1.000.2	1.000.2
1.000.3	1.000.3
1.000.4	1.000.4
1.000.5	1.000.5
1.000.6	1.000.6
1.000.7	1.000.7
1.000.8	1.000.8
1.000.9	1.000.9
1.000.10	1.000.10



A competitive offer for the Shipbuilding Industry!

- “Smart” ship
 - Increasing number of equipment
 - Operational condition guarantee
 - Ship lifelong evolutions
 - Cost optimization
- ... are some of the trends that engineers in the Shipbuilding Industry have to work on everyday.

To answer these trends, the IGE+XAO Group has developed a complete software range with strong competitive advantages:

- Complete Visio-based offer that goes from functional design to schematics and cabling generation
- Communication capabilities (PLM and CAD integration)
- Collaborative design
- Multi function (hydraulics...)
- Configuration management (options and variants, versioning/maturity)

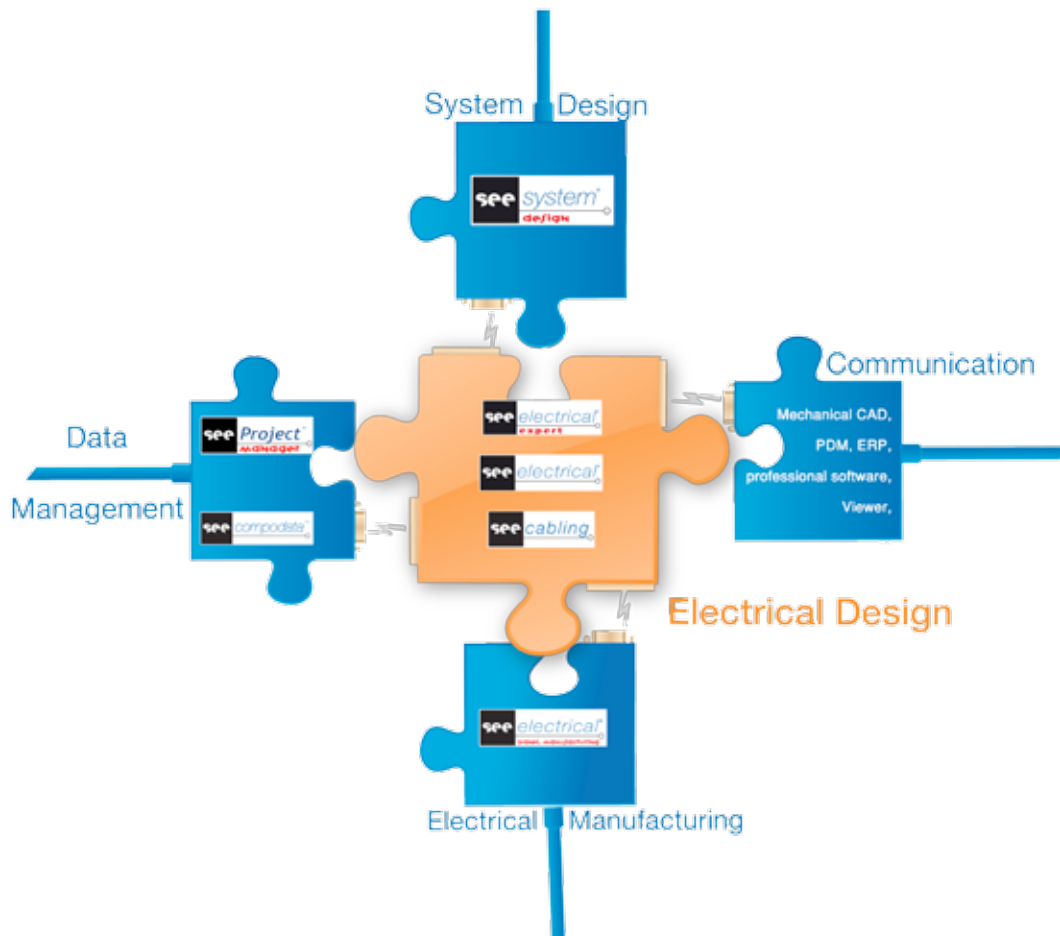



indow <>

Anglais (Royaum)

4 Power

3~400V/50Hz

L1 0V -X1 1

L2 BK 2

L3 BK 3

PE PE PE

-Q4 -U1 -Q5

-Q2 +0.2A 18A NO56 ..

-Q3 +0.2A 18A NO56 ..

Front motor

MANUFACTURER: SCHNEIDER ELECTRIC
CARD: TSX DSY 6R5

STATION: A1

Q01.1 Q01.2 Q01.3 Q01.4

Q01.1 Q01.2

SolidWorks

File Edit View SEE-3D Insert Simulation Tools Window Help

Edit Component Insert Components Mate Linear Compon... Smart Fasteners Move Component Show Hidden Components Assembly Features Reference Geometry New Motion Study Bill of Materials Exploded View Explode Line Sketch Intersect3D

Assembly Layout Sketch Evaluate Office Products CE AddIn Simulation

Function	Location	Descrip...	Product
+B1	+A1	T102030	-X11-1
Inserted	Equipment	Descri...	
	T102030	Generic term...	
+B1	+A1	T102030	-X11-2
Inserted	Equipment	Descri...	
	T102030	Generic term...	
+B1	+A1	T102030	-X11-3



A complete offer for the Equipment & Machinery Industry!

The Equipment & Machinery Industry has to meet several challenges:

- More and more complex equipment
- Customization
- Reliability
- More & more wire harnesses

The IGE+XAO Group has developed a complete software range with strong competitive advantages:

- One solution for every company size
- One of the most complete offer on the market
- Communication capabilities
- Customizable and scalable solutions
- Expertise from large customer base
- Strong partnership with key electrical equipment players
- Wire harnesses expertise
- Automatic schematic generation

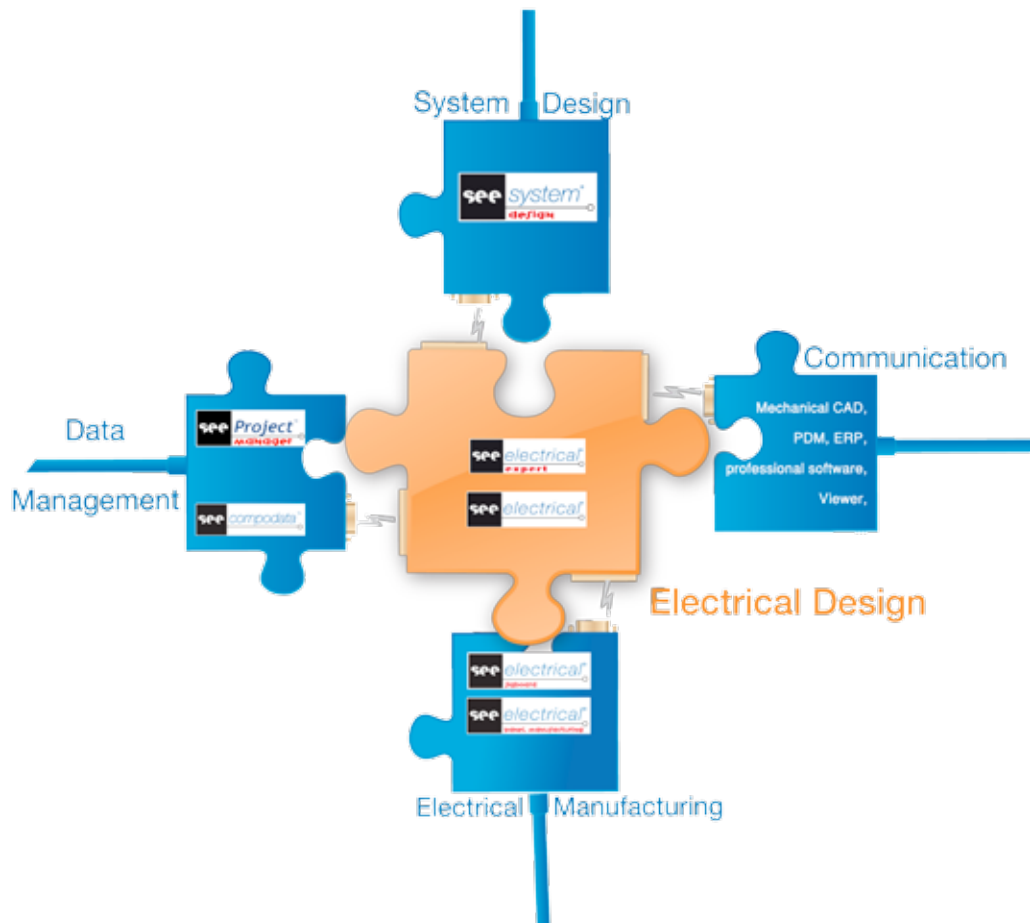

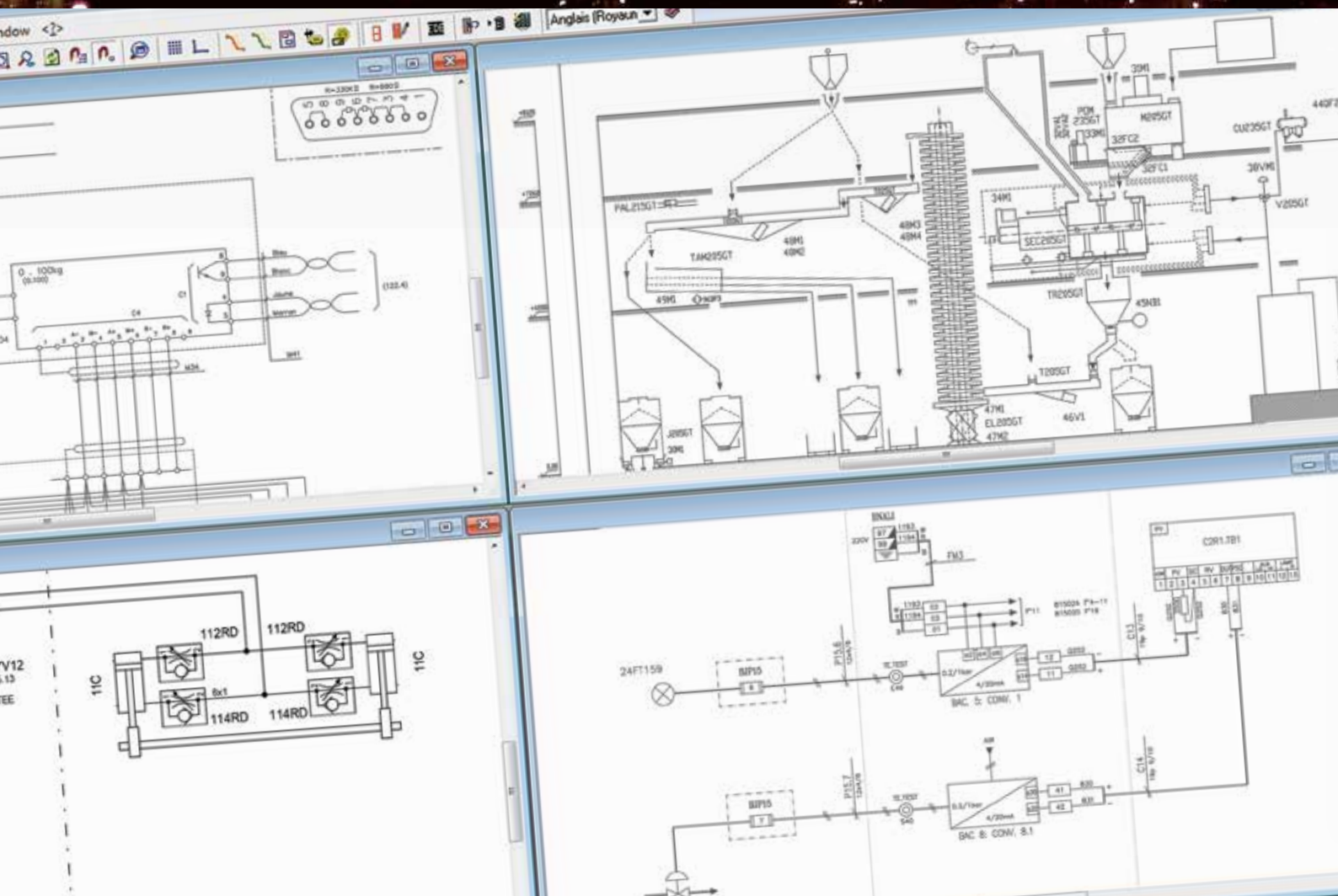



An extended offer for the Automation & Plant Industry!

The Automation & Plant Industry is the historical market of IGE+XAO and the Group has over 26 years of experience on this market.

The Group's solutions enable the user to:

- Design and maintain electrical and fluid installations
- Create the documentation and attached instructions, as well as associated maintenance documents.

Over 20,000 clients worldwide in the manufacturing market are using our solutions on a daily basis and benefiting from reduced costs, more efficient timing and improved quality.

The IGE+XAO Group has developed a complete software range with strong competitive advantages:

- One Solution for every company size
- One of the most complete offer on the market
- Communication capabilities
- Customizable and scalable solutions
- Complete environment (CEI, IEC, symbols...)
- "Easy to use" packages
- Large customer base
- Quality verification functions

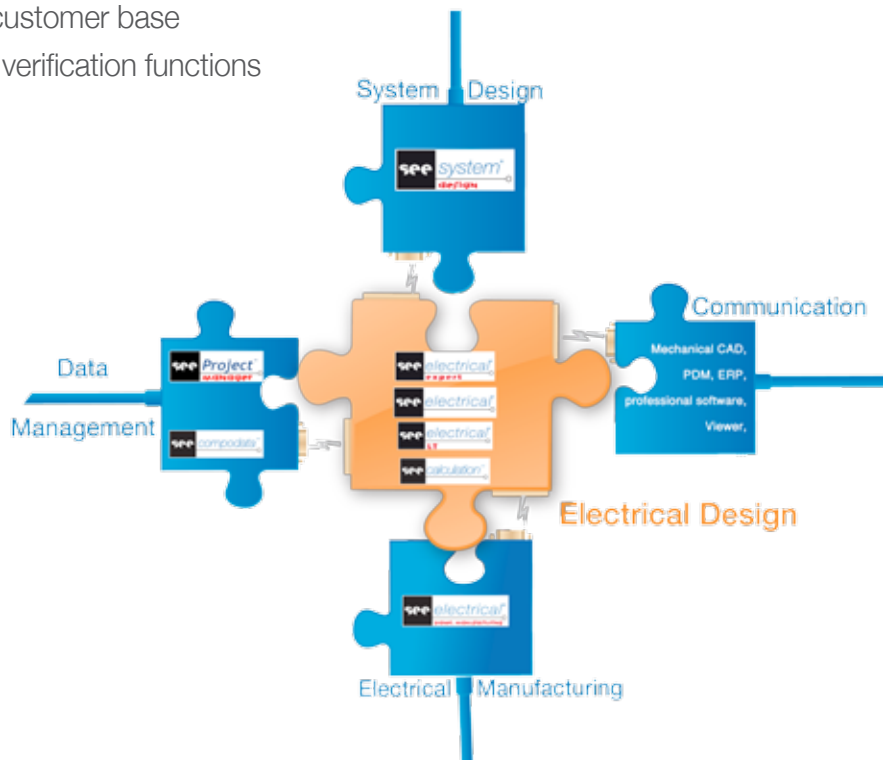

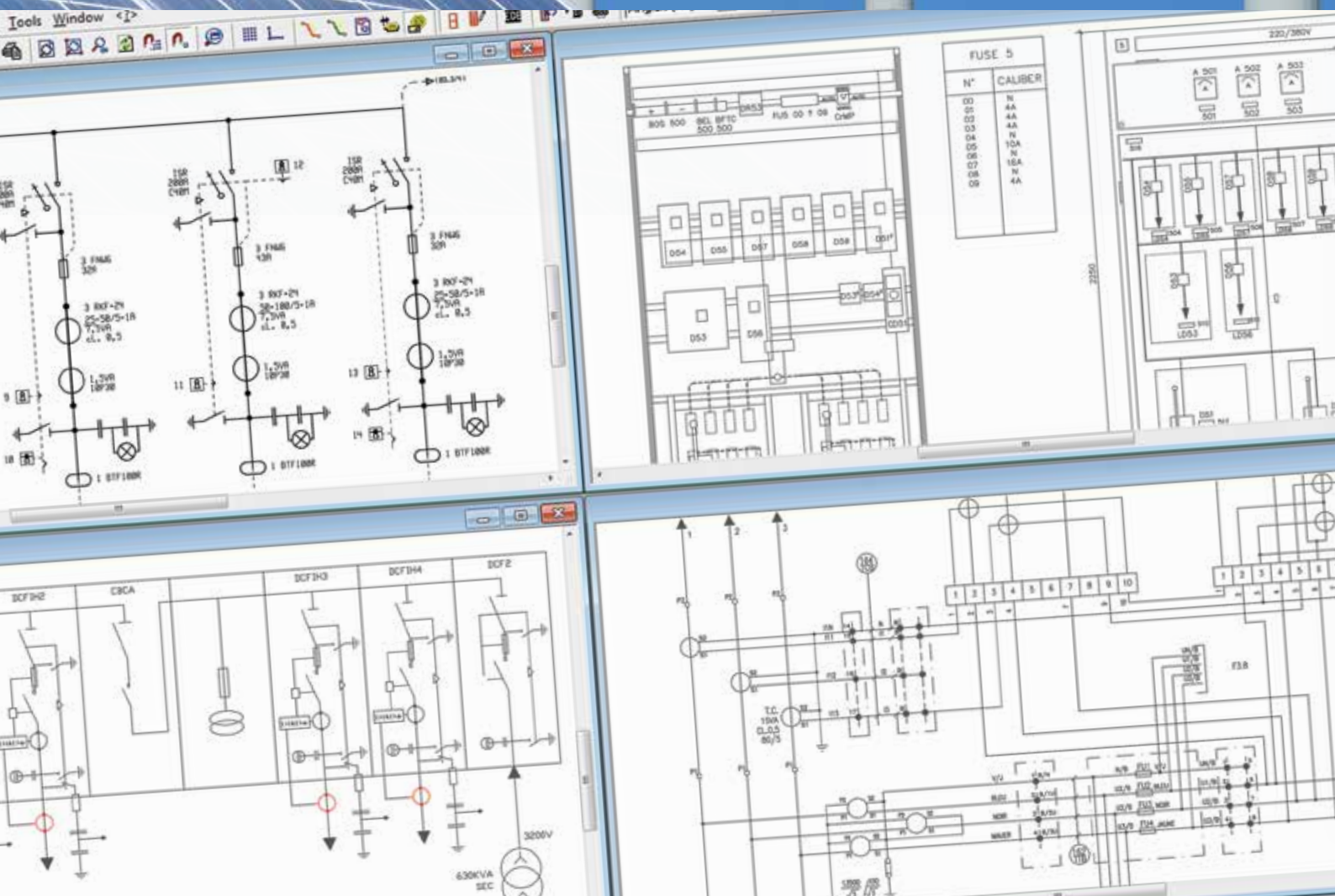



A compelling offer for the Power Generation & Energy Industry!

- Safety
- Alternative & sustainable energies
- Smart supply and demand
- Smart grid
- 24/7 operations
- Environmental regulations

... are some of the problems engineers in the Power Generation & Energy Industry have to cope with.

The IGE+XAO Group has developed a complete software range with strong competitive advantages:

- Complete offer from a powerful Visio-based offer to “on-the-shelf” easy to use packages
- Communication capabilities
- Very large project management
- Collaborative solution
- Customizable and scalable solutions

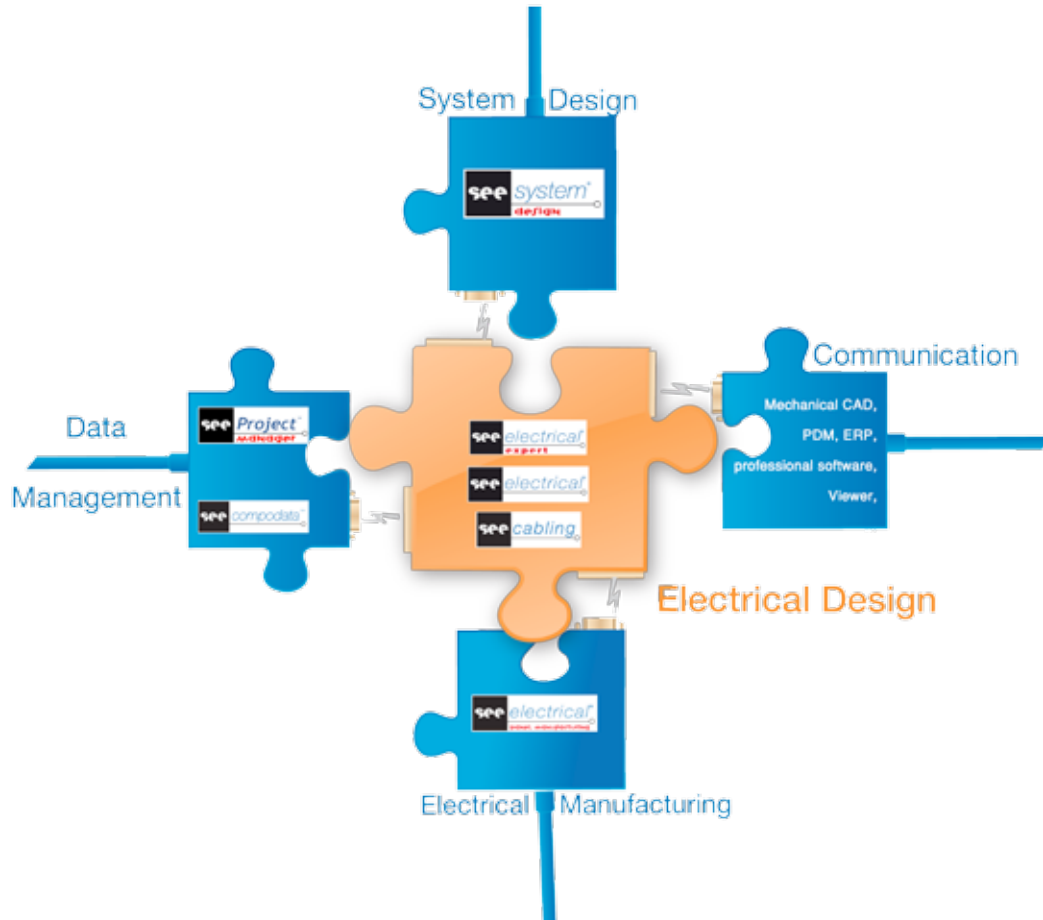



Zoom In Zoom Out Zoom Pan

Insert Equipment Favorites Equipments

Change Configure

Align Rotate Group Modify

Route Cabling

Insert Background Graphics

Origin Room

Measure Tools

Design Rule Check Proofing

Installation Drawings - Installation

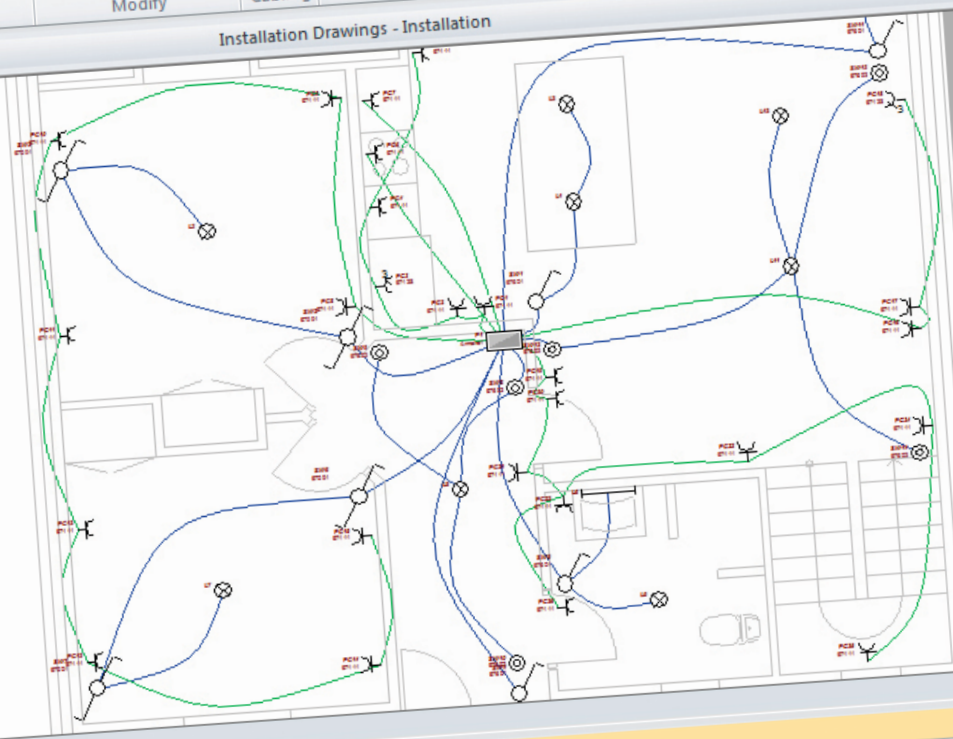

Properties

Property	Value
General Information	
Name	Folio1
Page Number	1
Number Of Pages	1
Viewpoint	Default
Size Of Paper	22704.43mm, 160.
Printing Scale	
Grid Information	
Grid	On
Size Of Grid	50.00mm, 50.00mm
Grid Factor	5
Snap Distance	50.00mm
Origin	0.00mm, 0.00mm
Visibility Information	
Consumers	On
Trunking	On
Cables	On
Rooms	On
Buildings	On
Tags	On
Guides	Off
Trackers	On
Graphics	On
Dimming	On

Socket Outlet with Protective Shutter

Two Multiple Socket Outlets

Three Multiple Socket Outlets

Four Multiple Socket Outlets

Socket Outlet with Isolating Transfo...

Socket Outlet with Interlocked Switch

Socket Outlet with Single Pole Switch

Socket Outlet with Multi Pole Switch



An effective offer for the Construction Industry!

IGE+XAO software range covers all professional electrical requirements in the Building Industry, making it possible to create automatically the documentation for the design and maintenance of electrical installations with optimal productivity.

The Group has developed a complete software range with strong competitive advantages:

- Automatic schematic generation
- "All in one" and "easy to use" product
- Strong calculation package
- Communication capabilities
- Price competitive solutions

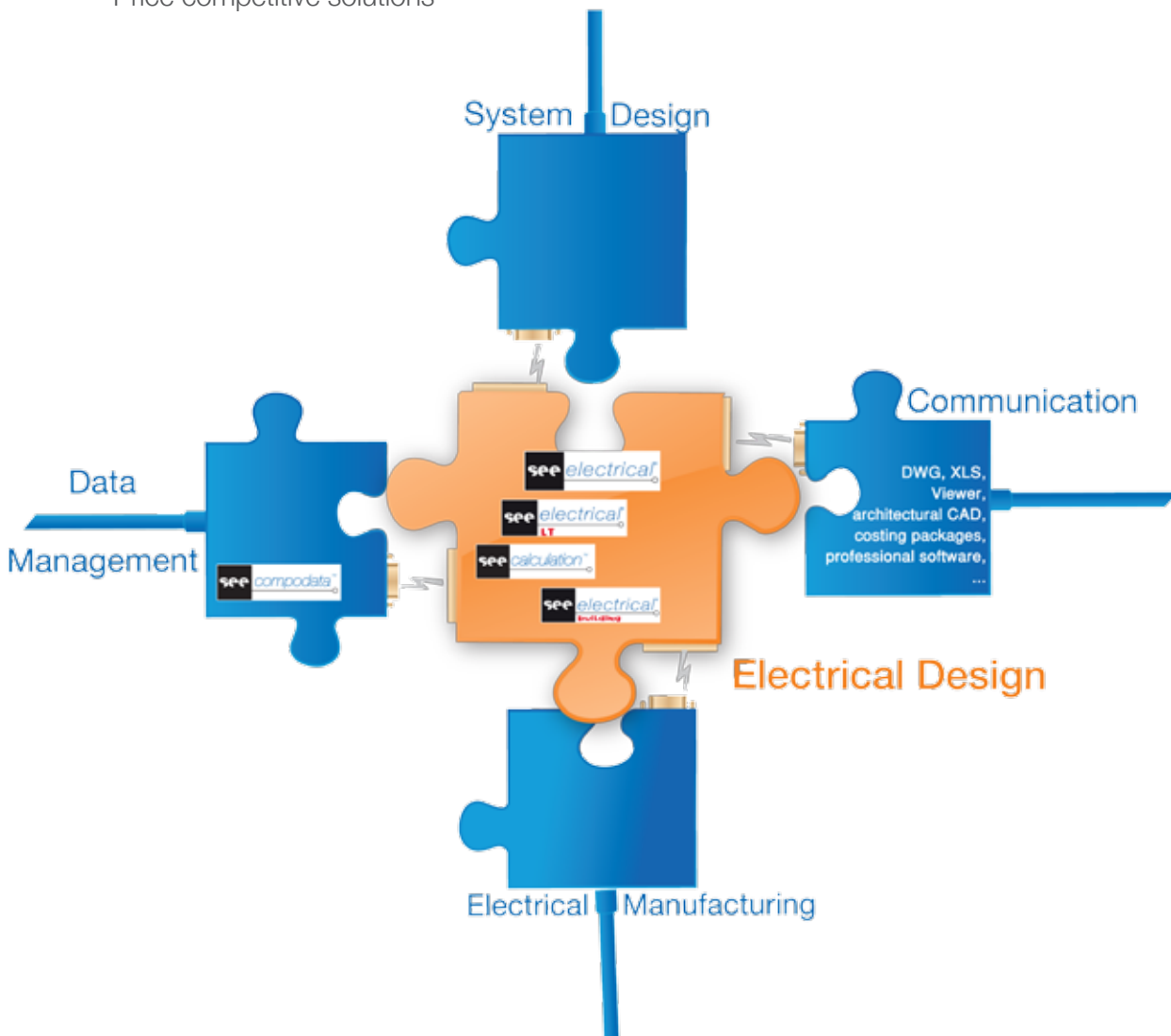

IGE+XAO LOCATIONS

Headquarters

www.ige-xao.com

25 boulevard Victor Hugo
BP 90312
31 773 COLOMIERS CEDEX
FRANCE
Ph: +33 (0)5 62 74 36 36
Fax: +33 (0)5 62 74 36 37

IGE+XAO Bulgaria

www.ige-xao.bg

205 Stanboliski Blvd.
1309 SOFIA
Ph: +359 2 8101 145
Fax: +359 2 8101 117

IGE+XAO Canada

www.ige-xao.ca

7777, Boul. Louis-H. Lafontaine
suite 201 - Montréal (Anjou)
Québec H1K 4E4
CANADA
Ph: 1-514-353-3445
Fax: 1-514-353-6857

IGE+XAO China

www.ige-xao.cn

Room 801, Block B,
Jun Lin Guo Ji
No.5 Guangzhou Road
NANJING, postcode : 210008
Ph : +86(0)25-8689 0716
Fax : +86(0)25-8465 0564

IGE+XAO Denmark

www.ige-xao.dk

Bistrupvej, 22
DK 3460 BIRKERØD
Ph: +45 45 94 21 00
Fax: +45 45 94 21 01

IGE+XAO France

www.ige-xao.fr

72, avenue de la République
92 320 CHÂTILLON
Ph: +33 (0)1 55 48 17 77
Fax: +33 (0)1 55 48 17 90

106, rue de la Liberté
38 180 SEYSSINS
Ph: +33 (0)4 76 70 16 42
Fax: +33 (0)4 76 70 16 09

3, rue de Lorraine
44240 LA CHAPELLE SUR ERDRE
Ph: +33 (0)2 51 89 72 12
Fax: +33 (0)2 51 89 14 72

Centre Etoile Valentine 5
Traverse de la Montre - Bât. B4
13 011 MARSEILLE
Ph: +33 (0)4 91 44 89 06
Fax: +33 (0)4 91 87 60 53

Synergie Club - Synergie Park
10 rue Louis Neel
59 260 LEZENNES
Ph: +33 (0)3 59 57 77 20
Fax: +33 (0)3 59 57 77 66

IGE+XAO Germany

www.ige-xao.de

Marie-Bernays-Ring 19a
D-41199 MÖNCHENGLADBACH
Ph: +49 (0)2166 13 39 10
Fax: +49 (0)2166 13 39 110

Lochfeldstr. 28c
D-76437 RASTATT
Ph: +49 (0)7222 77 47 3
Fax : +49 (0)7222 77 47 59

IGE+XAO Italy

www.ige-xao.it

Via delle Canovine, 46
I-24126 BERGAMO
Ph: +39 0354 596 167
Fax: +39 0354 243 793

IGE+XAO Madagascar

www.ige-xao.com

Immeuble SANTA, Antanimena,
24 rue Naka Rabemanantsoa,
101 ANTANANARIVO
Ph: +261 20 22 249 19

IGE+XAO Morocco

www.ige-xao.com

140 Boulevard Anfa
2ème étage
20100 CASABLANCA
Ph/Fax : +212 522 39 73 93

IGE+XAO Netherlands

www.ige-xao.nl

Beersdalweg 84 A
6412 PE HEERLEN
Ph: +31 (0)45 561 16 36
Fax : +31 (0)45 572 74 73

IGE+XAO Poland

www.ige-xao.com.pl

Pl. Na Stawach 3
30-107 KRAKÓW
Ph: +48 (0)12 630 30 30
Fax : +48 (0)12 630 30 37

ul. Lwowska 34
34-100 WADOWICE

ul. Strusińska 2
33-100 TARNÓW

IGE+XAO Spain

www.ige-xao.es

Parque Empresarial Neisa Sur
Edif. N°7
Av. andalucia Km 10,5
E-28021 MADRID
Ph: +34 91 797 90 71
Fax : +34 91 505 34 68

IGE+XAO Switzerland

www.ige-xao.ch

Paul-Emile-Brandt Str. 4
CH-2502 BIEL/BIENNE
Ph: +41 (0) 32-365 93 93
Fax: +41 (0) 32-365 93 69

IGE+XAO Tunisia

Cité El Ghazala
Pôle Technologique
Rte de Raoued km 3,5
Bloc B 22
2088 ARIANA
Ph: +216 70 83 45 45
Fax : +216 71 85 63 24

IGE+XAO Turkey

Ataşehir Bulvarı
Gardenya Plaza 3 K:4 N:22,
34758 Ataşehir
İSTANBUL
Ph: 90-530-498-91 76

BUTTİM B5 Blok No:1426,
16250 Osmangazi
BURSA
Ph: 90-530-498 91 77

IGE+XAO UK

www.ige-xao.co.uk

Unit 308
15 Paternoster Row,
SHEFFIELD
S1 2BX
Ph: +44(0)114 273 1155
Fax : +44(0)114 273 1166

IGE+XAO USA

www.ige-xao.us

2540 King Arthur Blvd.
Suite 209-M
Lewisville, TX 75056
Ph: +1 (972) 410-3610
Fax: +1 (972) 410-3611



www.ige-xao.com