

# DEWALT®



**POWERTOOLS AND ACCESSORIES CATALOGUE  
GUARANTEED TOUGH.®**

**2011**

**DEWALT**

# DEWALT®

## ENGINEERING EXCELLENCE

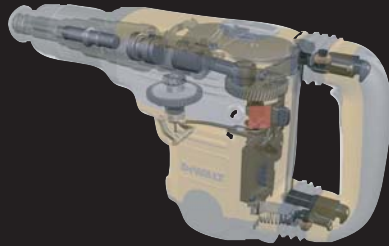

reddot



**Years of experience in engineering professional construction power tools at our in-house facility in Idstein, Germany**



**Years of experience in designing and manufacturing world class drilling solutions for the construction industry at our in-house facility in Buchberg, Germany**

- Simulation software developed in partnership with the automotive industry
- Industry leading application-based testing facilities
- Cutting edge drilling accessories manufacture
- Award winning design



**In-house design and manufacture ensures that the quality of DEWALT drilling solutions exceeds the requirements of the most demanding professional applications**



## IN STORE MERCHANDISING AND DISPLAY SYSTEM

- **FLEXIBLE, MODULAR SYSTEM**
- **CLEAR PRODUCT DIFFERENTIATION AND COMMUNICATION**
- **STRONG DEWALT BRANDING**

Products sold as per dealer's valid price list. Please refer to price list for stock availability.

All products shown are in compliance with the appropriate European regulations.

DeWALT is a member of EPTA

Dual voltage - all DeWALT power tools are supplied in both 230 Volts and 115 Volts options unless otherwise stated. Please contact your local dealer for availability.

DeWALT reserves the right to revise product specifications at any time without notice.

All measurements are in millimetres (mm) unless otherwise stated.

**WARNING:** all warranties are country/region specific. Tools purchased e.g. in the USA or via the internet, and imported into Europe, which are not CE approved, not only violate EU legislation, but will not be supported/served in Europe by DeWALT as a result.

Only European tools are covered by a European warranty.

**GUARANTEED TOUGH, ROBUSTESSE GARANTIE, DeWALT EXTREME, DeWALT, EXTREME DeWALT, DeWALT EXTREME IMPACT, DeWALT GUARANTEED TOUGH, SERIES 20, SERIES 30, SERIES 40, SERIES 60, AVC, XRP, XPC, XLR, and ALLIGATOR** are registered trademarks of The Black and Decker Corporation. The yellow and black colour scheme is used on DeWALT power tools and accessories as a trademark.

GORE Wet/Dry Filter is a trademark of W.L Gore & Associates Inc.



Registered Trade Marks of Robert Bosch GmbH. Torx® is a Registered Trade Mark of Acument Intellectual Properties, LLC.

# WHY DEWALT?



## END USER RESEARCH

- On average, we speak to 20,000 users every year as part of the product development process
- A comprehensive understanding of the real applications that our users perform enables us to generate product features that are a genuine benefit to our users



## INNOVATIVE PRODUCTS

- To support our users and drive our industry forward, DeWALT consistently develop truly innovative products, across multiple categories
- This technical strength is regularly recognised by international design awards



## COMPLETE PROFESSIONAL QUALITY PRODUCT RANGE

- DeWALT is a full range power tool and accessories supplier for the building contractor and professional tradesman



## USER LOYALTY

- The cast-iron DeWALT guarantee and premium service network ensure that our users have faith in the quality of our products. First-time buyers will become loyal DeWALT users
- DeWALT is heavily involved in end-user events across Europe - building our brand reputation, and generating huge excitement around our diverse product portfolio



**GUARANTEED TOUGH.®**

<b>FEATURES QUICK REFERENCE</b>	<b>4</b>
<b>PRODUCT QUICK REFERENCE</b>	<b>5</b>
<b>PRODUCT INNOVATIONS</b>	
Heavy Duty Cordless .....	6
Compact Cordless .....	8
The 10.8 Volt System .....	10
Construction Instruments .....	12
Heavy Duty Construction .....	14
Dust And Vibration Management .....	16
Mitre Saws .....	18
Portable Woodworking .....	20
Jobsite Saws .....	22
<b>WARRANTY AND SERVICE</b>	<b>24</b>

## POWER TOOLS & ATTACHMENTS

### CORDESS

The 36 Volt System .....	26
24 Volt SDS-Hammers .....	28
The 18 Volt System .....	28
The 14.4 Volt System .....	37
The 12 Volt System .....	41
The 7.2 Volt System .....	44
The 3.6 Volt System .....	45
Area Light, Radio and Vacuum .....	45
The 10.8 Volt System .....	46
Battery and Charger Systems .....	47

### CONSTRUCTION INSTRUMENTS

Laser Level Kit, Self Levelling Lasers .....	48
Laser Pointer & Plumb Bob, Distance Measurer & Auto Level Package .....	49
Tile Laser, Laser Level Attachments .....	50

### SCREWDRIVERS

Drywall Screwdrivers .....	51
Versaclutch Screwdrivers .....	51
Screwdrivers for Self Drilling Screws .....	52
Impact Wrenches .....	52

### DRILLS

Drill/ Mixers .....	53
Percussion Drills .....	53
Rotary Drills .....	55
Magnetic Drill Press .....	57

### DIAMOND DRILLS

Diamond Drilling System .....	58
Diamond Drills .....	60
Drilling Stands for Diamond Drills .....	60
Wet Tile Saw .....	61
Diamond Drill Attachments .....	61

### HAMMERS

Rotary & Combination Hammers .....	62
Dust Extraction .....	63
Chipping & Demolition Hammers .....	65

### METAL WORKING

Small Angle Grinders .....	67
Medium Angle Grinders .....	70
Large Angle Grinders .....	71
Die Grinders .....	74
Chop Saws .....	75
Sander .....	75
Polisher .....	75

### NAILERS

Staplers .....	76
Roofing Nailers .....	76
Framing Nailers .....	76
Palm Nailer .....	77
Finish Nailers .....	77
Cordless Nailers .....	78

### WOODWORKING

Routers .....	79
Dovetail Jigs .....	80
Router Attachments .....	81
Trimmers .....	83
Jointers .....	83
Planers .....	84
Orbital Sanders .....	85
Detail Sanders .....	85
Random Orbital Sanders .....	86
Belt Sanders .....	86
Finishing/ Grinding Machines .....	87
Heatgun .....	87

### SAWING

Plunge Saw .....	88
Jigsaws .....	89
Circular Saws .....	90
Reciprocating Saws .....	91
Alligator® Saws .....	92

### MITRE SAWS

Crosscut Mitre Saws .....	93
Compound Mitre Saws .....	93
Slide Compound Mitre Saws .....	94
Mitre Saw Attachments .....	95
Table Top Mitre Saws .....	96

### MACHINERY

Table Saws .....	97
Rolling Stand .....	97
Jobsite Saws .....	98
Radial Arm Saws .....	100
Bandsaws .....	100
Thicknessers .....	101
Dust Extraction .....	102

### BRUSH PAIRS

**103**

### ACCESSORIES

#### MASONRY DRILLING

EXTREME DeWALT® Masonry Drill Bits .....	105
Masonry Drill Bits .....	105
Multi-Material Drill Bits .....	106
SDS-Plus EXTREME DeWALT® 2 Drill Bits .....	106
EXTREME DeWALT® XLR Full Head Carbide Drill Bits .....	109
SDS-Plus 4-Cutter Drill Bits .....	110
SDS-Max Hammer Drill Bits .....	110
SDS-Plus Chisels .....	111
EXTREME DeWALT® Chisels .....	111
SDS-Max Chisels .....	112
19mm Hexagon Chisels .....	112
Pavement Breaker Chisels .....	112
Light Duty SDS-Plus Core Drills .....	113
Heavy Duty SDS-Max Core Drills .....	113
Single Piece Cores .....	113
Through Drilling Bits .....	114
Drive Adaptors & Adaptor - SDS-Plus .....	114

## METAL DRILLING

HSS-CO EXTREME DeWALT® Cobalt Metal Drill Bits .....	115
EXTREME DeWALT® 2 Metal Drill Bits .....	116
HSS-G DIN 338 Jobber Metal Drill Bits .....	117
HSS-G DIN 340 Long Series Metal Drill Bits .....	118
EXTREME DeWALT® Impact Step Bits .....	119
Step Drills .....	119
EXTREME DeWALT® Impact Drill Bits .....	120

## WOOD DRILLING

Brad Point Wood Drill Bits .....	120
Frame Drill Bits .....	121
TCT Hinge Boring Bits .....	121
Wood Auger Drill Bits .....	121
Self Feed Drill Bits .....	122
EXTREME DeWALT® Flat Wood Drill Bits .....	122
EXTREME DeWALT® Long Flat Wood Drill Bits .....	122
Flatwood Drill Bits .....	123

## HOLESAWS

EXTREME DeWALT® Impact Holesaws .....	124
Bi-Metal Deep Cut Holesaws .....	124
Bi-Metal Holesaw Sets .....	125
Carbide Grit Holesaws .....	125
Carbide Grit Holesaw Sets .....	125
EXTREME DeWALT® Quick Change Mandrels .....	126
Holesaw Mandrels and Accessories .....	126

## DRILLING ACCESSORIES

Mixer Tools .....	126
Chucks & Keys .....	127

## SCREWDRIVING

Screwdriving Accessories .....	128
EXTREME DeWALT® Impact Sets .....	130
DeWALT 'Flip & Drive' Units .....	131
EXTREME DeWALT® Impact Rated Socket Sets .....	131

## DRILLING & SCREWDRIVING SETS

Drilling Accessory Sets .....	132
Mag Box Magnetic Sets .....	133
Tough Case Storage .....	133
Modular Accessory Cases .....	134
Mini Mac Case Sets .....	134

## CIRCULAR SAW BLADES

EXTREME DeWALT® Stationary Circular Saw Blades .....	135
Stationary Circular Saw Blade Guide .....	137
EXTREME DeWALT® Portable Circular Saw Blades .....	138
Cordless Circular Saw Blades .....	139
Portable Circular Saw Blades .....	139
Portable Circular Saw Blade Guide .....	140
Insert Rings .....	142

## JIGSAW BLADES

XPC Wood Cutting Blades .....	143
Wood Cutting Blades .....	144
EXTREME DeWALT® Bi-Metal Cutting Blades T-Shank .....	145
Metal Cutting Blades .....	145
Wood & Metal Cutting Blades .....	146
EXTREME DeWALT® Special Material Blades .....	146
Wood & Metal Cutting Blade Kits .....	146

## RECIPROCATING SAW BLADES

Wood Cutting Blades .....	147
Metal Cutting Blades .....	147
General Purpose Blades .....	148
Demolition Blades .....	148
Reciprocating Blade Sets .....	148
Specialist Blades .....	149

## ALLIGATOR® SAW BLADES

149

## SPECIALIST WOODWORKING ACCESSORIES

Bandsaw Blades .....	150
Planer Blades & Jointer Accessories .....	150

## ROUTER BITS

151

## COATED ABRASIVES

Full Sheet .....	153
Hand Sanding Block .....	153
Half Sheet .....	154
Third Sheet .....	154
Quarter Sheet .....	155
Detail .....	156
Rolls .....	156
Belts .....	157
Grinding Belts .....	158
Honing Belts .....	158
Nylon Loop Discs .....	159
Extreme DeWALT® Fibre Discs .....	160
Flap Discs .....	160

## PADS & BONNETS

'Quick Fit' Platens .....	161
Backing Pads & Bonnets .....	161
Angle Grinder Polishing Bonnets .....	161

## BONDED ABRASIVES

Metal Cutting & Grinding Discs .....	162
Chop Saw Wheel .....	162
Stainless Steel & Thin Metal Cutting & Grinding Discs .....	163
Aluminium Cutting Discs .....	163
High Speed Stone Cutting Discs .....	163
Stone Cutting & Grinding Discs .....	164
Grinding Wheels & Honing Wheels .....	164
Grinding Cups .....	164
Wire Brushes .....	165

## DIAMOND DISCS

Diamond Disc Guide .....	166
High Performance Diamond Discs .....	167
Dry Diamond Discs .....	168
Wet & Dry Diamond Tile Saw Blade .....	168

## DIAMOND DRILLS

Dry Diamond Core Drills & Dosensenker .....	169
Wet Diamond Core Bits .....	170
Adaptors, Extension Rods & Pilot Bits .....	171
Diamond Tile Drill Bits .....	171

## NAILER ACCESSORIES

Nails .....	172
Staples .....	173

## DeWALT SERVICE

5 Star Service .....	174
Service Agent Network .....	175

The icons under each tool indicate the product features. Check details for information.



**DRILLING/CHISELLING MODES**  
Single mode for chiselling only



**TWO MODE**  
For rotary and hammer drilling



**THREE MODE**  
For rotary, hammer drilling and chiselling



**IMPACT MECHANISM**  
Uses rotary impacts to generate extremely high torque



**TWO AND THREE SPEED SELECTOR**  
Many DeWALT tools are available with multiple speeds to offer greater control in a variety of applications



**XRP®**  
The range of XRP® cordless power tools have extreme run-time and power



**CONSTANT SPEED**  
A constant speed is maintained under operational load



**ELECTRONIC VARIABLE SPEED CONTROL**  
The speed can be adjusted from low to high giving greater control in each application



**SOFT START**  
Electronic soft start to limit start-up current and reduce kick reaction which could misalign the accessory



**LOW VIBRATION SIDE HANDLE**  
Low-Vibration side handle with a damped mechanism



**ANTI-MASS**  
Anti-Mass Counter-balance system helps reduce vibration



**SUSPENDED HANDLES**  
Suspended handles dramatically reduce vibration, increasing productivity and end user comfort



**ANTI-VIBRATION FLOATING HANDLE**  
No matter where it is pressed, the whole handle is completely damped from top to bottom reducing the vibration to the user



**WET & DRY**  
Tool is designed to work with water feed



**3-POSITION KEYLESS SHOE**  
To maximise blade life



**4-POSITION KEYLESS BLADE CLAMP**  
Allows quick blade change, flush cutting and versatility



**PLUNGE ACTION**  
Parallel plunge action for accuracy and cut finish



**GUIDE RAIL COMPATIBLE**  
Tool can be used with DeWALT guide rail system



**COMPLETE TORQUE CONTROL**  
The Complete Torque Control offers a patented two step clutch system. On the pre-set lowest torque the user can complete 80% of his applications in a safer way. The highest torque setting is perfect for core drilling and big diameter applications with solid bits



**CLUTCH**  
Clutch protects the operator against kick back and the tool against overload should the accessory jam



**TOOL FREE ADJUSTMENT**  
The accessory in use, guard or shoe of the tool can be changed or adjusted without the need of a screwdriver, key or spanner



**KEYLESS CHUCK**



**QUICK CHANGE CHUCK**  
Ideal solution to change easily between SDS and 3 jaw chuck systems



**SPINDLE LOCK**  
Spindle is locked by pushing a button allowing quick and easy change of accessories



**FORWARD AND REVERSE**  
Forward and reverse action for screwdriving applications



**PENDULUM BLADE ACTION**  
Adjustable pendulum blade action provides improved cutting performance in comparison to a conventional blade action



**DUST EXTRACTION**  
Dust Extraction into either a dust bag on the tool or through an attachment to a dust extraction unit



**EASILY ACCESSIBLE BRUSHES**  
Brushes accessible for easy servicing reducing down time



**ELECTRONIC BRUSH WEAR INDICATOR**  
Service light in the tool handle indicates when the brushes require changing.



**DUST EJECTION SYSTEM**  
Rejects the majority of dust sucked into a grinder leaving clean air only to pass over the motor, resulting in increased durability



**HOOK & LOOP**  
Hook & Loop bases allow easy attachment of sand paper



**PALM GRIP**  
Tool designed for single-handed operation



**BATTERIES**  
Cordless tools (with the exception of bare units) come with either one or two batteries as standard equipment. The battery chemistry can be Nickel Cadmium (NiCd), Nickel Metal Hydride (NiMH) or Lithium-Ion (Li-Ion). Please refer to individual tool specifications for clarification of which battery or batteries come with your selected tool



**COMPACT BATTERY**  
Compact batteries are smaller and lighter than standard batteries, and require less charging time



**CORDED/CORDLESS**  
Tool can be powered by mains electricity source, or by DeWALT batteries



**CARRYING CASE**  
Supplied with heavy duty carrying case



Cat. No.	Page	Cat. No.	Page	Cat. No.	Page	Cat. No.	Page	Cat. No.	Page
D21160	57	D26500/ D26500K	84	DC235KL	26	DC840KB	43	DW630	75
D21441	56	D26501K	84	DC300KL/ DC300KN	27	DC845KB	43	DW650/ DW650E	86
D21510	53	D27107/ D27107V	98	DC305KL/ DC305KN	27	DC901KL/ DC901KN	26	DW670	83
D21520	53	D27111/ D27112	96	DC308KL/ DC308KN	27	DCD710S2	46	DW677	84
D21570K	55	D27300/ D27300T	101	DC330KB/ DC330KA/		DCD920B2	30	DW680/ DW680K	84
D21580K	60	D27900	102	DC330N	35	DCD920L2	30	DW682K	83
D215821	60	D27901	102	DC330KL	34	DCD925B2	29	DW685K	83
D21582K	60	D27902	129	DC352KBR/ DC352KN	35	DCD925L2	29	DW711	96
D215831	61	D28065	70	DC385KB/ DC385N	34	DCD930B2	38	DW712/ DW712N	93
D21583K	60	D28111	67	DC385KL	34	DCD930L2	38	DW713XPS/ DW713	93
D21585	60	D28113/ D28113K	67	DC390KB/ DC390KA/		DCD935B2	37	DW716EXPS/ DW716	94
D215851	61	D28116	67	DC390N	35	DCD935L2	37	DW717XPS	94
D21620K	57	D28117	67	DC390KL	35	DCD940B2	42	DW718XPS/ DW718	94
D21717K/ D21716/		D28130	68	DC411KB/ DC411KA/		DCD945B2	41	DW721KN/ DW722KN	100
D21716K	53	D28132C	68	DC411N	34	DCF610S2	46	DW728KN/ DW729KN	100
D21721K/ D21720K/	54	D28133	69	DC411KL	34	DCF815S2	46	DW733	102
D21720		D28134	68	DC415KL/ DC415KN	27	DCK210S2	47	DW738	100
D21805/ D21805K/		D28135/ D28135K	69	DC500	45	DCK211S2	47	DW739	101
D21805KS	54	D28136	69	DC509	27	DCL510N	46	DW743N	99
D23550	90	D28137	69	DC515N	36	DE7400	97	DW744XP	97
D23551	90	D28139	68	DC520KA/ DC520N	32	DW030P	49	DW745	97
D23620/ D23620K	90	D28141	70	DC527N	36	DW059K2H/ DW059K2	32	DW753	87
D23650K	90	D28142	68	DC528N	44	DW060K	50	DW754	87
D23651K	90	D28400	72	DC540K/ DC540	44	DW074K	48	DW755	87
D23700	91	D28401	72	DC542K/ DC542	43	DW075PK	48	DW777/ DW771	93
D24000S	61	D28413	71	DC547K/ DC547	36	DW079KH	48	DW831	70
D25012K/ D25012N	62	D28414	73	DC600KA	45	DW079PKH	48	DW840	70
D25013K/ D25013C/		D28415	74	DC602KB	43, 78	DW082K	49	DW849	75
D25013N	62	D28421	73	DC608KB	33, 78	DW084K	49	DW872	75
D25123K	62	D28422	71	DC616KB	33, 78	DW087K	49	DW876	101
D25124K	62	D28423	73	DC618KB/DC618KN	33, 78	DW096PK	49	DW882	74
D25223K	62	D28432C	73	DC721KB/ DC721KA/		DW152	53	DW904	44
D25301D	63	D28490	72	DC720KA	31	DW217	56	DW906	41
D25302DH	26	D28491	71	DC722C2	30	DW221	56	DW908	36
D25323K	63	D28492/ D28492K	72	DC722KL/ DC722N	30	DW2361	56	DW915	44
D25324K	63	D28493	71	DC725KB/ DC725KA	30	DW246	57	DW918	41
D25325K	63	D28495	71	DC727C2	29	DW263K	52	DW919	36
D25330K	65	D28498	74	DC727KL/ DC727N	29	DW264K	52	DW920K	44
D25404K	64	D28700	75	DC731KB/ DC731KA/		DW268K	51	DW934K2H/	
D25405K	64	D28715	75	DC730KA	38	DW269K	51	DW934K2/ DW934	35
D25501K	64	D28750	73	DC732C2	38	DW274K/ DW274KN	51	DW941K	41
D25601K	64	D28885	74	DC732KL/ DC732N	38	DW275K/ DW275KN	51	DW960	31
D25602K	64	D51180	77	DC733C2	39	DW292	52	DW965K	42
D25711K	65	D51238K	77	DC733K2/ DC733KB/		DW294	52	DW966K	40
D25712K	65	D51257K	77	DC733KA/ DC733KN	39	DW304PK	91	DW979K2	43
D25762K	65	D51276K	78	DC733KL	39	DW310K	91	DWC410	61
D25831K	65	D51321	76	DC735KB/ DC735KA	37	DW311K	91	DWD014/ DWD014S	55
D25870K	66	D51430	76	DC737C2	37	DW331K	89	DWD024/ DWD024K/	
D25899K	66	D51431	76	DC737KL/ DC737KN	37	DW333K	89	DWD024S/ DWD024KS	53
D25901K	66	D51825	76	DC740KA/ DC740K2	42	DW341K	89	DWD112/ DWD112S	55
D25941K	66	D51850	76	DC743KB/ DC742KA	42	DW343K	89	DWD115KS	56
D25980/ D25980K	66	D51855	77	DC745KB/ DC745KA	42	DW390/ DW391	92	DWD221	57
D26200	79	D51856	77	DC800KL/ DC800KN	26	DW392	92	DWD522KS	54
D26203	79	DC013	45	DC820KB	32	DW393	92	DWD524KS	54
D26204K	79	DC019	45	DC822KL/ DC822N	32	DW394	92	DWD525KS	55
D26410	86	DC020	45	DC825KB	32	DW432/ DW433	86	DWD530KS	55
D26411	87	DC212KA/ DC212N	29	DC827C2	31	DW443	86	DWS520K	88
D26420/ D26421	85	DC213KB	28	DC827KL/ DC827N	31	DW609	83	DWS520KR	88
D26422/ D26423	85	DC213KL	28	DC830KB	41	DW615	79		
D26430	85	DC222KA	28	DC832KL/ DC832N	40	DW621K/ DW621	79		
D26441	85	DC223KA	28	DC835KB	40	DW624	80		
D26453	86	DC224KA/ DC224KB	28	DC837C2	40	DW625EK/ DW625E	80		
D26480	85	DC234KL	26	DC837KL/ DC837N	40	DW626	80		



**DEWALT heavy duty cordless products offer  
SPEED, POWER & PRODUCTIVITY - what else do  
you need?**

**ALL NEW**



**DCD925L2**

## ➤ Other heavy duty cordless products from DEWALT



**DC213KL - 18V 3 MODE SDS-PLUS**



**DC390KL - 18V 165MM CIRC SAW**



**DC305KL - 36V RECIP SAW**



**DC020 - 12V-18V AREA LIGHT**

# 4

## reasons to buy DEWALT XRP



- **DURABILITY** - Robust all metal transmission provides reliability and longer tool life
- **APPLICATION SPEED** - DEWALT innovative 3 speed gear box provides optimal torque to speed ratio for the most common jobsite applications
- **EFFICIENCY** - Exclusive self-tightening chuck prevents bit slippage and is easy to apply
- **POWERFUL** - Frameless Motor and efficient power delivery system ensure tasks are completed easily and quickly

### 18V PLATFORM

DEWALT long life lithium ion batteries provide up to 2X the number of recharges of NiCd and NiMH

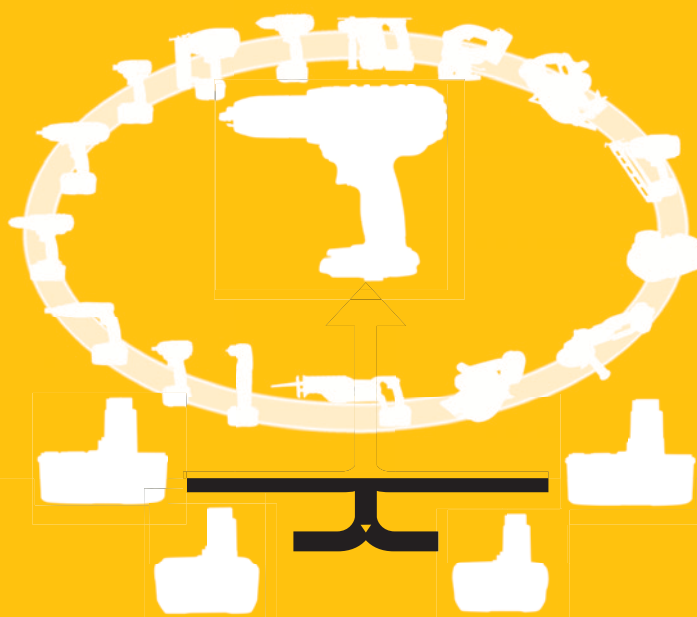

All DEWALT Lithium Ion power tools have been designed to maximise your productivity - perfectly combining **POWER** and **USER COMFORT**

# GUARANTEED TOUGH.®

**DEWALT compact cordless products offer superior task efficiency for repetitive applications and better access to confined work spaces**



DC837KL

## ➤ Other compact cordless products from DEWALT



DC822KL - 18V IMPACT WRENCH



DC727KL - 18V 2SP COMBI



DW965K - 12V RIGHT ANGLE DRILL



DC500 - 18V CORDLESS VAC



## 4 reasons to buy DeWALT Compact Impact Tools

- **POWER VS SIZE** - DeWALT Impact Drivers deliver incredible power, whilst retaining an extremely compact profile
- **CONTROL** - Ergonomic design, full variable speed switch and electronic motor brake for complete control
- **DURABILITY** - Rugged Aluminium front housing provides greater heat dispersion for longer tool life
- **DO MORE WITH 1 TOOL** - DeWALT has the most comprehensive range of Impact Accessories on the market, including:

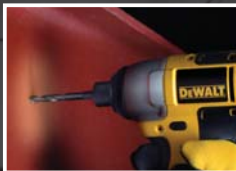

Extreme Impact Drill Bits



Extreme Impact Screwdriver bits



Extreme Impact Holesaws



Extreme Impact Sockets

### MAXIMISE YOUR EFFICIENCY!

Now Available - DeWALT COMPACT Lithium Ion Batteries

**COMPACT**  
**LITHIUM ION**



- **SMALLER** - more versatile
- **LIGHTER** - less user fatigue
- **FASTER** - less charge time

**BACKWARDS  
COMPATIBLE  
IN OVER 40 TOOLS**



## 10.8V range delivers total control optimising user efficiency



DCF610S2

### ➤ Other 10.8V Cordless products from DEWALT



DCD710S2 - 10.8V DRILL DRIVER



DCF815 - 10.8V IMPACT DRIVER



DCL510 - 10.8V TORCH



DT7965 - MAG BOX



# 4

## reasons to buy DeWALT 10.8V Screwdriver

- **ERGONOMICS** - Designed for comfort, the soft grip fits perfectly into the palm of your hand - pick up the tool and try for yourself!
- **DELIVERY OF POWER** - Optimized control and power over full range of jobsite applications
- **BIT RETENTION** - Innovative chuck holds 25mm hex bits securely, without the need for a holder and allows for single-handed operation
- **BALANCE** - The tool foot design and slide pack battery system mean that the tool will stand upright, so the user can always keep it close to hand

Coming in 2011...

## 10.8V INFRA RED THERMOMETER

Measures the temperature of an object from a distance!



DCT414S1

- Find leaks / hot spots
- Evaluate sealing / insulation
- Confirm water / pipe temperatures
- Inspect equipment

- User adjustable colour change indicator for hot / cold spots
- Adjustable emissivity - precise temperature measurement for different materials
- -30°C - 500°C temperature range



The result of thousands of hours of user research  
- DEWALT Lasers are exactly what you asked us to  
build



DW087

## ➤ Other laser products from DEWALT



DW079KH - SELF LEVELLING LASER



DW084 - 4 BEAM LASER POINTER



DW096 - X26 AUTO LEVEL



DW060 - TILE LASER

# 4

## reasons to buy the DeWALT Cross-Line Laser



- **INDUSTRY BENCHMARK** - The DeWALT Cross-Line Laser is trusted on over 100,000 jobsites across Europe\*
- **EASE OF USE** - Each button performs 1 function, DeWALT removes all unnecessary complexity
- **VERSATILITY** - Built in pivot mechanism, can be easily mounted on any common work surface
- **DURABILITY** - Designed specifically to maintain accuracy and withstand tough jobsite conditions (internal shock-absorbing mechanism/ full rubber over-mould)

### HAVE YOU ALSO TRIED ...



#### DeWALT Laser Distance Measure

Designed specifically to withstand tough construction site conditions

- **Accurate**
- **Easy to Use**
- **Jobsite tough**

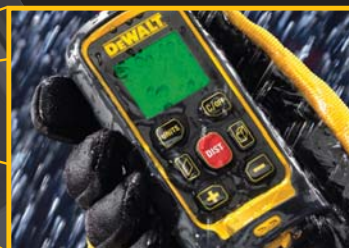

\*estimate based on DeWALT annual sales figures and product lifespan

# GUARANTEED TOUGH.®



## DEWALT SDS-MAX commercial construction hammers offer both performance and protection. No Compromise



D25602K

### ➤ Other Heavy Duty Construction products from DEWALT



D25980 - 30KG BREAKER



D25762K - 9KG SDS-MAX HAMMER



D28498 - 9 INCH GRINDER



# 4

## reasons to buy DeWALT 40-45mm Combination Hammer



- **COMFORT** - Shock absorbing rear and side handles for increased user comfort
- **DURABLE** - Heat resistant mechanism due to oil filled gearbox. Chain driven gearbox for longer tool life
- **Performance** - Oversized mechanism mechanism for more impact energy. Variable speed for optimal control
- **TECHNOLOGY** - Complete Torque Control system offers the user a low setting for standard applications, but a higher 'overdrive' setting for heavier tasks such as core drilling and large diameter bits

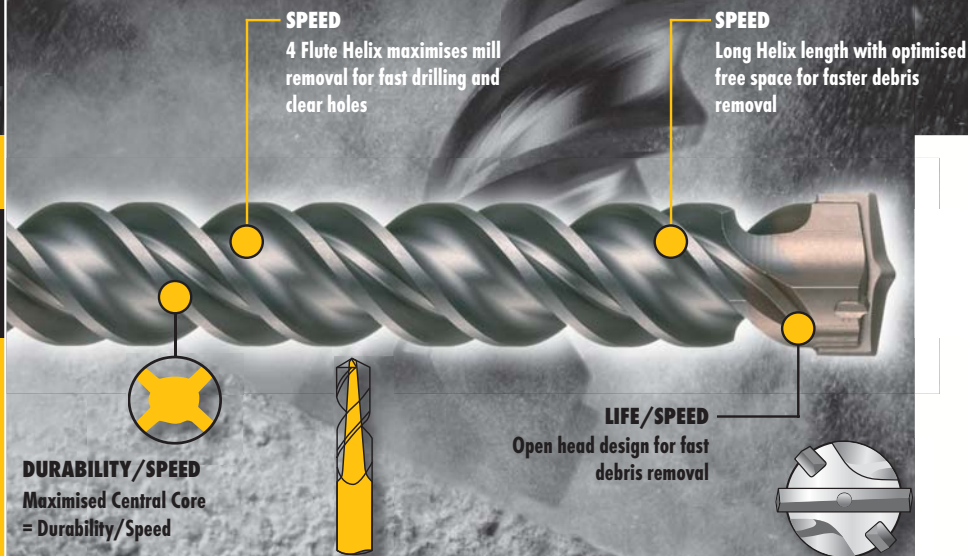

## DEWALT has developed efficient dust and vibration management products for improved user safety and comfort



D25324

### ➤ Other construction products from DEWALT



D25124K - HEAVY DUTY 3 MODE SDS-PLUS



D25223 - LOW VIBRATION 3 MODE SDS-PLUS



D25013 - TRADESMAN 3 MODE SDS-PLUS



D28113 - 115MM GRINDER

# 4

## reasons to buy DeWALT 26mm Low Vibration L-Shape Hammer



- **ACTIVE VIBRATION CONTROL SYSTEM** - AVC system and **FULLY FLOATING** rear handle dramatically reduce vibration, while the working end of the tool delivers the full force of the hammer to ensure maximum productivity
- **IMPROVED ERGONOMIC DESIGN** - Combined with AVC means the user can work for longer without tiring, and with reduced exposure to vibration
- **TOOL LIFE** - Optimised seals and robust design prevent dust ingress and prolong the life of the tool in a tough jobsite conditions
- **USER HEALTH** - Optional dust extraction system protects the user from harmful dust and supports a safe working environment

**XLR™**

**EXTREME**  
DeWALT  
**SDS-Plus**



**LONG LIFE**

**SDS-plus**



- 1** 2x more carbide than SDS-Plus 2-cutters for long life & extreme durability
- 2** Unique tip geometry for cleaner, concentric holes
- 3** Four flute spiral design for optimum debris removal and fast drilling

[www.DeWALT.co.uk/safety/vibration/calculator](http://www.DeWALT.co.uk/safety/vibration/calculator)

# GUARANTEED TOUGH.®

DEWALT manufactures precision engineered mitre saws which offer accuracy, performance and durability



DW717XPS

**XPS**  
CROSS CUT POSITIONING SYSTEM

**THE NEW  
SHADOW  
CUT-LINE  
SYSTEM**



## ➤ Other mitre saws from DEWALT



DW712 - 216MM SLIDE MITRE SAW



DW713XPS - 250MM MITRE SAW



DW716XPS - 305MM MITRE SAW



DW718XPS - 305MM SLIDE MITRE SAW



# 4

## reasons to buy DW717XPS



- **REPEATABLE ACCURACY** - Impressive specification, outstanding build quality and exclusive precision mitre and bevel adjustment system
- **BUILT FOR DURABILITY AND LONG-LIFE** - Powerful 1675 Watt motor delivers extended power and durability. Superior design ensures DeWALT mitre saws are tough enough to withstand the jobsite environment
- **XPS CUT-LINE** - Unlike lasers, the XPS system requires no adjustment, the shadow of the blade shows exactly where the cut will be
- **GREATER PRODUCTIVITY** - Illuminated work surface and fast accurate alignment



## DeWALT's best selling compact mitre saw

- Ultra-compact
- Easy to carry
- Reliable
- Repeatable accuracy
- Easy to slide



DW777

**DEWALT manufacture class leading wood working tools to provide professional tradesmen and craftsmen with a full range of high quality products**



DWS520KR

## ➤ Other portable wood working products from DEWALT



DW625EK - 2000 WATT 1/2" ROUTER



DW331K - 701 WATT JIGSAW



D26453 - 125MM RANDOM ORBIT SANDER



D26501K - 4MM PLANER

# 4

## reasons to buy the DeWALT Plunge Saw



➤ **ACCURACY** - Superior tooth design and excellent rail system with fixed rail adjusters to eliminate deflection during a cut

➤ **QUALITY OF FINISH**

- 48 tooth blade gives fine finish and very little breakout in laminates
- DeWALT guide rail system offers anti-splinter strips on both sides of the rail

➤ **SPEED AND PRODUCTIVITY** - Rapid adjustment and fast, accurate cuts

➤ **SAFETY** - Anti kickback function stops the saw from moving backwards along the rail



### The DeWALT Guide Rail System



SPEED



PRODUCTIVITY



ACCURACY

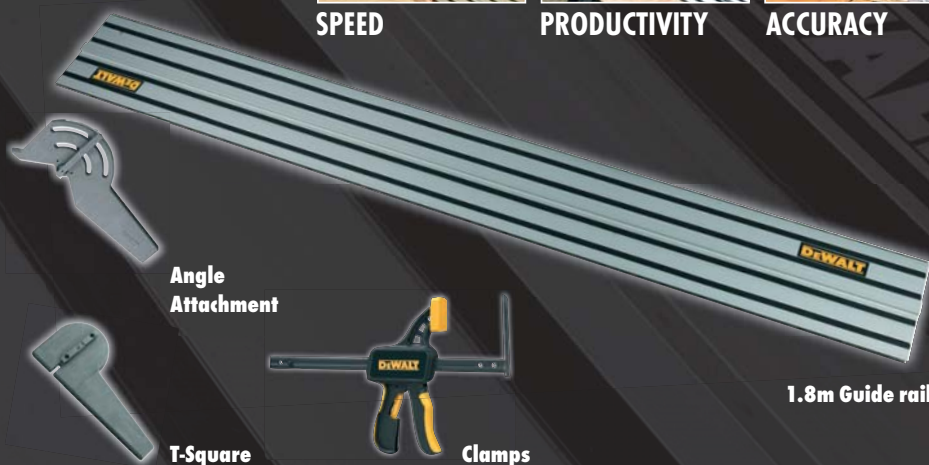

Angle Attachment

T-Square

Clamps

1.8m Guide rail

# GUARANTEED TOUGH.®



**DEWALT Jobsite Saws are designed for durability and provide class-leading functionality - without compromising on accuracy**



D27107

## ➤ Other jobsite saws from DEWALT



D23620K - 62MM CIRC SAW



DW311K - 1200 WATT RECIP SAW



D27111 - TABLE TOP MITRE SAW



DW745 - 250MM TABLE SAW



# 4

## reasons to buy DeWALT Combination Saws

- **ACCURACY** - Workshop accuracy - this machine has been designed for the needs of kitchen fitters to roofers. Ideal for cutting anything from cornice to roof joists - Giving you quality cuts every time
- **VERSATILITY** - Large accurate mitre saw combined with an accurate table saw in a mobile compact design - improving productivity
- **POWER** - Outstanding power to meet the most demanding site & workshop applications - Designed for tough environments
- **CAPACITY** - 305mm Blade delivers a capacity to suit the vast majority of applications with 81mm depth of cut and a cross cut of 205mm. You only need one machine which saves space, time and money

### Outstanding Portability

**Purpose built rolling stand dedicated to DW745 and DW744 table saws**

- **Lightweight**
- **Robust**
- **Easy set-up**



# GUARANTEED TOUGH.®

## DEWALT®

### 30

**DAY NO RISK SATISFACTION GUARANTEE**

### 1

**YEAR FREE SERVICE CONTRACT**

### 1

**YEAR WARRANTY**

**GUARANTEED TOUGH®**

# DEWALT offers an outstanding guarantee for professional users of our products

### 30

**DAY NO RISK SATISFACTION GUARANTEE**

If you are not completely satisfied with the performance of your DeWALT product, simply return it to the point of purchase within 30 days for a full refund or exchange. Product must be complete as purchased and proof of purchase must be produced. Spare parts and Accessories are excluded unless failed under warranty.

### 1

**YEAR FREE SERVICE CONTRACT**

If you require maintenance or service for your DeWALT product within 12 months of purchase, you are entitled to one service free of charge, undertaken at an authorised DeWALT repair agent. Proof of purchase must be produced. Includes labour. Spare parts and Accessories are excluded, unless failed under warranty.

### 1

**YEAR FULL WARRANTY**

In the unlikely event that your DeWALT product becomes defective due to faulty materials or workmanship within 12 months of purchase, DeWALT guarantees to replace all defective parts free of charge or - at our discretion - replace the unit free of charge.

This is provided that:

- The product has not been misused
- The product has been subject to fair wear and tear
- Repairs have not been attempted by unauthorised persons
- Proof of purchase is produced



In order to make a claim, you will need to submit proof of purchase to the vendor or an authorised repair agent.



This guarantee statement is in addition to and in no way prejudices your contractual rights as a professional user or your statutory rights as a private non-professional user. The guarantee is valid within the territories of the Member States of the European Union and the European Free Trade Area. A list of authorised DeWALT repair agents and full details of our after-sales service and contacts are available on pages 174-176, or online at:

[www.DEWALT.eu](http://www.DEWALT.eu)



# DEWALT® TOTAL SERVICE



## PROVIDING EXTRA PEACE OF MIND

**TOTAL SERVICE IS THE HAMMER PROTECTION PLAN THAT OFFERS COMPLETE PEACE OF MIND WITH NO UNEXPECTED SERVICE COSTS**

If your hammer drill breaks down simply deliver it to any authorised DeWALT repair agent, and it will be repaired and returned to you quickly and efficiently.



### WHAT DOES TOTAL SERVICE COVER?

- Wear & Tear
- Manufacturing defects
- Brush Change
- DeWALT Parts & retest



### PLUS

- Transportation of hammer, to and from site.



### WHERE CAN I BUY A TOTAL SERVICE PLAN?

DeWALT Total Service is not available at all DeWALT distributors. Please ask your DeWALT representative.



AVAILABLE AS EITHER

**2** OR **4**  
YEAR PLAN

You can also find a full list of the Terms & Conditions on the website.

[www.DEWALT.eu](http://www.DEWALT.eu)

# GUARANTEED TOUGH.®

**36 Volt Dedicated Cordless Hammer with Integrated Dust Extraction System**

**DC235KL\***



Ideal for drilling anchors and fixing holes into concrete, brick and masonry from 4 mm to 26 mm, with Dust Extraction System up to 16 mm in diameter  
 Rotation stop for light chiselling applications in plaster, tiles and render  
 Internal mechanism connected to external housings via spring dampeners meaning significantly lower vibration, reduced user fatigue allowing longer operating periods  
 Includes D25302DH Dust Extraction System with quick-fit system for easy tool free assembly and release

**Standard Equipment:** Integrated D25302DH dust extraction system with Hepa filter, 1 hour charger, 2 batteries Li-Ion, Side handle with dust extraction adaptation, Quick release SDS-Plus toolholder, Quick release 13mm 3 jaw chuck, Grease, Heavy duty carrying case

Battery Capacity	Li-Ion 2.2 Ah
Power Output	450 Watts
No Load Speed	0-1150 rpm
Impact Energy	2.5 J
Blows per Minute	0-4300 bpm
Tool Holder	SDS-Plus
Max. Drilling Capacity [Wood]	30 mm
Max. Drilling Capacity [Metal]	13 mm
Max. Drilling Capacity [Concrete]	26 mm
Weight	5.6 kg
Length	502 mm



\*DC235KL not available in the UK

**36 Volt Heavy Duty 3 Mode Quick Change Chuck Dedicated Cordless Hammer**

**DC234KL**



Ideal for drilling anchors and fixing holes into concrete, brick and masonry from 4 mm to 26 mm  
 Rotation stop for light chiselling applications in tiles and plaster and impact stop mode for rotary drilling only in wood and steel  
 Internal mechanism connected to external housings via spring dampeners meaning significantly lower vibration, reduced user fatigue allowing longer operating periods  
 Quick Release SDS-Plus Toolholder and 3 jaw chuck supplied for easy switching between hammer/rotary hammer and rotary only applications

**Standard Equipment:** 1 hour charger, 2 batteries, Multi-position side handle, 13 mm diameter 3 jaw keyless quick change chuck, Grease, Heavy duty carrying case

Battery Capacity	Li-Ion 2.2 Ah
Power Output	450 Watts
No Load Speed	0-1150 rpm
Impact Energy	2.5 J
Blows per Minute	0-4300 bpm
Tool Holder	SDS-Plus
Max. Drilling Capacity [Wood]	30 mm
Max. Drilling Capacity [Metal]	13 mm
Max. Drilling Capacity [Concrete]	26 mm
Weight	3.8 kg
Length x Height	320 x 230 mm



**Cordless Dust Extraction System**

**D25302DH**



Ideal for dust free drilling up to 16 mm in diameter with any DEWALT 28V or 36V SDS-Plus hammer  
 Powered by an independent motor maintaining maximum hammer performance with no decrease in durability  
 High quality washable HEPA filter capable of achieving 99.5% efficiency with dust particles as small as 0.3 microns  
 Quick-fit system for easy tool free assembly and release

**Standard Equipment:** Cordless dust extraction system, Side handle with dust extraction adaptation, Telescope, extraction head and depth rod, Connector pipe, Large kit box

Fits	Any DEWALT 28V or 36V SDS-Plus Hammer
Collar Diameter	54 mm
Max. Drill Bit Diameter	16 mm
Max. Drill Bit Length	210 mm
Max. Drilling Depth	150 mm
Hose Length	215 mm
Hose Diameter	32 mm
Weight	1.8 kg
Length x Height	502 x 360 mm



**36 Volt 13 mm Heavy Duty Hammer Drill**

**DC901KL/ DC901KN\***



Powerful 36 Volt combination tool for heavy duty hammer drilling and screwdriving applications  
 Three speed settings for optimum performance in high torque, normal use and high speed applications  
 22 position adjustable torque control for uniform results and optimised precision when screwdriving

**Standard Equipment:** 1 hour charger, 2 batteries, Multi position side handle, Heavy duty carrying case

Battery Capacity	Li-Ion 2.2 Ah
Chuck Capacity	1.5-13 mm
Power Output	750 Watts
No Load Speed	0-400 / 0-1200 / 0-1600 rpm
Beats per Minute	0-6800 / 0-20400 / 0-27200 bpm
Max Torque	42 Nm
Max. Drilling Capacity [Wood]	65 mm
Max. Drilling Capacity [Metal]	13 mm
Max. Drilling Capacity [Masonry]	16 mm
Weight	3 kg
Length x Height	267 x 260 mm



\*N version sold as bare unit

**36 Volt Heavy Duty High Torque Impact Wrench**

**DC800KL/ DC800KN**



Powerful fan cooled motor delivers up to 440 Nm of max torque and up to 2500 impacts per minute for heavy duty fastening applications  
 All metal gearing for efficient power transmission and long tool life  
 Aluminium front housing for better weight and balance  
 Modular component design for easy access and fast service

**Standard Equipment:** 1 hour charger, 2 batteries, Heavy duty carrying case

Battery Capacity	Li-Ion 2.2 Ah
Bit Holder	1/2"
Power Output	800 Watts
No Load Speed	1400 rpm
Impacts per Minute	2500 ipm
Max. Torque	440 Nm
Max. Bolt Diameter	M20
Weight	3.4 kg
Length x Height	273 x 275 mm



**36 Volt Heavy Duty Cordless Finishing Grinder**

**DC415KL/ DC415KN\***



Powerful DeWALT fan cooled motor delivers maximum power and durability 6,500 rpm provides high power for cutting and grinding applications  
Battery pack produces 36 Volt power at equivalent weight to 18 Volt NiCd/ NiMH pack weight

**Standard Equipment:** 1 hour charger, 2 batteries, Keyless protective guard, 2 position anti vibration side handle, Wrench, Heavy duty carrying case

Battery Capacity	Li-Ion 2.2 Ah
Max. Disc Diameter	125 mm
Power Output	815 Watts
No Load Speed	6500 rpm
Spindle Thread	M14
Weight	3.5 kg
Length x Height	340 x 150 mm

**LITHIUM ION**

\*N version sold as bare unit

**36 Volt Heavy Duty Cordless Reciprocating Saw**

**DC305KL/ DC305KN\***



Powerful DeWALT fan cooled motor with replaceable brushes and variable speed delivers fast cutting action up to 3000 strokes per minute and 29 mm stroke length  
4-position keyless blade clamp allows quick blade change, flush cutting, and versatility  
Battery pack produces 36 Volt power at equivalent weight to 18 Volt NiCd/ NiMH pack weight

**Standard Equipment:** 1 hour charger, 2 batteries, Wood cutting blade, Heavy duty carrying case

Battery Capacity	Li-Ion 2.2 Ah
Power Output	710 Watts
No Load Stroke Rate	0-3000 spm
Stroke Length	29 mm
Weight	3.81 kg
Length x Height	440 x 200 mm

**LITHIUM ION**

\*N version sold as bare unit

**36 Volt Heavy Duty Cordless Circular Saw**

**DC300KL/ DC300KN\***



184 mm, 24 tooth carbide tipped blade allows for efficient run-time and fast, smooth cut finish at maximum 62 mm depth of cut  
0-50° bevel capacity with lever-action detents at 22.5° and 45° allows for aggressive bevel cuts while allowing users to locate common angles quickly  
Battery pack produces 36 Volt power at equivalent weight to 18 Volt NiCd/ NiMH pack weight

**Standard Equipment:** 1 hour charger, 2 batteries, 184 mm 24 tooth carbide blade, Rip fence, Heavy duty carrying case

Battery Capacity	Li-Ion 2.2 Ah
Blade Diameter	184 mm
Power Output	940 Watts
No Load Speed	4000 rpm
Bevel Capacity	50 °
Weight	4.49 kg
Length x Height	406 x 255 mm

**LITHIUM ION**

\*N version sold as bare unit

**36 Volt Heavy Duty Cordless Jigsaw**

**DC308KL/ DC308KN\***



Powerful DeWALT fan cooled motor with replaceable brushes and variable speed delivers fast cutting action up to 2,700 strokes per minute  
Dust blower keeps line of cut clear of chips  
Battery pack produces 36 Volt power at equivalent weight to 18 Volt NiCd/ NiMH pack weight

**Standard Equipment:** 1 hour charger, 2 batteries, Anti-splinter shoe insert, Anti-scratch shoe cover, Dust extraction adaptor, 4 blades, Heavy duty carrying case

Battery Capacity	Li-Ion 2.2 Ah
Power Output	550 Watts
No Load Stroke Rate	0-2700 spm
Stroke Length	26 mm
Bevel Capacity	45 °
Max. Depth of Cut [Wood]	130 mm
Max. Depth of Cut [Metal]	10 mm
Weight	3.4 kg
Length x Height	300 x 215 mm

**LITHIUM ION**

\*N version sold as bare unit

**36V Heavy Duty Flashlight**

**DC509\***



Lockable head clip offers versatility and convenience of a lantern  
Flashlight with flexible neck for multi-directional hands-free lighting  
Compact, lightweight design with impact resistant housing  
8 hours continuous run time with the 36V Li-Ion battery pack

Bulb Type	Xenon
Battery Type	Li-Ion 36 V
Weight	0.52 kg
Length x Height	200 x 130 mm

**LITHIUM ION**

\*Batteries and charger sold separately

**24 Volt Heavy Duty SDS-Plus 3 Mode Quick Change Chuck Dedicated Cordless Hammer** **DC224KA / DC224KB\***



Ideal for drilling anchors and fixing holes into concrete, brick and masonry from 4 mm to 22 mm  
 Rotation stop for light chiselling applications in plaster, tiles and render and Impact stop mode for rotary drilling only in wood and steel  
 Internal mechanism connected to external housings via spring dampeners meaning significantly lower vibration, reduced user fatigue allowing longer operating periods  
 Quick Release SDS-Plus Toolholder and 3 Jaw Chuck supplied for easy switching between hammer/rotary hammer and rotary only applications

**Standard Equipment:** 1 hour charger, 2 batteries, Multi-position side handle, 13 mm diameter 3 jaw keyless quick change chuck, Grease, Heavy duty carrying case

Battery Capacity	NiCd 2.0 Ah
Power Output	300 Watts
No Load Speed	0-1100 rpm
Impact Energy	2.1 J
Blows per Minute	0-4200 bpm
Tool Holder	SDS-Plus
Max. Drilling Capacity [Wood]	30 mm
Max. Drilling Capacity [Metal]	13 mm
Max. Drilling Capacity [Concrete]	22 mm
Weight	4.0 kg
Length x Height	310 x 240 mm

\*Available with 3.0 NiMH batteries as B-version, DC224KB not available in the UK



**24 Volt Heavy Duty SDS-Plus 3 Mode Dedicated Cordless Hammer** **DC223KA**



Ideal for drilling anchors and fixing holes into concrete, brick and masonry from 4 mm to 22 mm  
 Rotation stop for light chiselling applications in plaster, tiles and render and Impact stop mode for rotary drilling only in wood and steel  
 Internal mechanism connected to external housings via spring dampeners meaning significantly lower vibration, reduced user fatigue allowing longer operating periods  
 Large 19 mm optimised hammer mechanism delivers corded drilling performance

**Standard Equipment:** 1 hour charger, 2 batteries, Multi-position side handle, Grease, Heavy duty carrying case

Battery Capacity	NiCd 2.0 Ah
Power Output	300 Watts
No Load Speed	0-1100 rpm
Impact Energy	2.1 J
Blows per Minute	0-4200 bpm
Tool Holder	SDS-Plus
Max. Drilling Capacity [Wood]	30 mm
Max. Drilling Capacity [Metal]	13 mm
Max. Drilling Capacity [Concrete]	22 mm
Weight	3.9 kg
Length x Height	290 x 240 mm



**24 Volt Heavy Duty SDS-Plus 2 Mode Dedicated Cordless Hammer** **DC222KA**



Ideal for drilling anchors and fixing holes into concrete, brick and masonry from 4 mm to 22 mm  
 Impact stop mode for rotary drilling only in wood, ceramic, steel  
 Internal mechanism connected to external housings via spring dampeners meaning significantly lower vibration, reduced user fatigue allowing longer operating periods  
 Large 19 mm optimised mechanism delivers corded drilling performance

**Standard Equipment:** 1 hour charger, 2 batteries, Multi-position side handle, Grease, Heavy duty carrying case

Battery Capacity	NiCd 2.0 Ah
Power Output	300 Watts
No Load Speed	0-1100 rpm
Impact Energy	2.1 J
Blows per Minute	4200 bpm
Tool Holder	SDS-Plus
Max. Drilling Capacity [Wood]	30 mm
Max. Drilling Capacity [Metal]	13 mm
Max. Drilling Capacity [Concrete]	22 mm
Weight	3.8 kg
Length x Height	290 x 240 mm



**18 Volt Heavy Duty SDS-Plus 3 Mode Dedicated Cordless Hammer** **DC213KL**



Ideal for drilling anchors and fixing holes into concrete, brick and masonry from 4 mm to 20 mm  
 Rotation stop for light chiselling applications in plaster, tiles and render and Impact stop mode for rotary drilling only in wood and steel  
 Internal mechanism connected to external housings via spring dampeners meaning significantly lower vibration, reduced user fatigue allowing longer operating periods  
 New 2.0Ah 18 Volt Lithium Ion battery, delivers higher performance and durability with 25 percent smaller battery and 200grams lighter. Overall unit weight less than 3kg

**Standard Equipment:** 40 minute charger, 2 batteries, Multi-position side handle, Grease, Heavy duty carrying case

Battery Capacity	2.0 Li-Ion Ah
Power Output	300 Watts
No Load Speed	0-1100 rpm
Impact Energy	2.1 J
Blows per Minute	0-4200 bpm
Tool Holder	SDS-Plus
Max. Drilling Capacity [Wood]	26 mm
Max. Drilling Capacity [Metal]	13 mm
Max. Drilling Capacity [Concrete]	20 mm
Weight	2.9 kg
Length x Height	270 x 192 mm



**18 Volt Heavy Duty SDS-Plus 3 Mode Dedicated Cordless Hammer** **DC213KB**



Ideal for drilling anchors and fixing holes into concrete, brick and masonry from 4 mm to 20 mm  
 Rotation stop for light chiselling applications in plaster, tiles and render and Impact stop mode for rotary drilling only in wood and steel  
 Internal mechanism connected to external housings via spring dampeners meaning significantly lower vibration, reduced user fatigue allowing longer operating periods  
 Large 19 mm optimised hammer mechanism delivers corded drilling performance

**Standard Equipment:** 40 minute charger, 2 batteries, Multi-position side handle, Grease, Heavy duty carrying case

Battery Capacity	NiMH 2.6 Ah
Power Output	300 Watts
No Load Speed	0-1100 rpm
Impact Energy	2.1 J
Blows per Minute	0-4200 bpm
Tool Holder	SDS-Plus
Max. Drilling Capacity [Wood]	26 mm
Max. Drilling Capacity [Metal]	13 mm
Max. Drilling Capacity [Concrete]	20 mm
Weight	3.1 kg
Length x Height	295 x 192 mm



## 18 Volt SDS-Plus 2 Mode Dedicated Hammer

DC212KA/ DC212N\*



Ideal for drilling anchors and fixing holes into concrete, brick and masonry from 4 mm to 20 mm  
Large 19 mm optimised hammer mechanism delivers corded drilling performance  
Efficient and compact gearbox for longer runtime and lighter weight  
Extremely compact design and rear mounted battery for excellent balance and optimum comfort

**Standard Equipment:** 1 hour charger, 2 batteries, Multi-position side handle, Grease tube, Heavy duty carrying case

Battery Capacity	NiCd 2.0 Ah
Power Output	300 Watts
No Load Speed	0-1100 rpm
Impact Energy	2.1 J
Blows per Minute	0-4200 bpm
Tool Holder	SDS-Plus
Max. Drilling Capacity [Wood]	26 mm
Max. Drilling Capacity [Metal]	13 mm
Max. Drilling Capacity [Concrete]	20 mm
Weight	3.1 kg
Length x Height	295 x 195 mm



\*Available as bare unit, without batteries and charger as N-version, DC212KA not available in the UK

## 18 Volt 13 mm XRP Li-Ion Heavy Duty Hammer Drill

DCD92512



Powerful 18 Volt XRP combination tool for heavy duty drilling and screwdriving applications  
DeWALT built frameless motor reduces size and increases efficiency producing excellent runtime  
22 position adjustable torque control for uniform results and optimised precision when screwdriving

**Standard Equipment:** 40 minute charger, 2 batteries, Multi position side handle, Heavy duty carrying case

Battery Capacity	Li-Ion 2.0 Ah
Chuck Capacity	1.5-13 mm
Power Output	450 Watts
No Load Speed	0-500/0-1250/0-2000 rpm
Beats per Minute	0-8500/0-21250/0-34000 bpm
Max Torque	55 Nm
Max. Drilling Capacity [Wood]	50 mm
Max. Drilling Capacity [Metal]	13 mm
Max. Drilling Capacity [Masonry]	16 mm
Weight	2.5 kg
Length x Height	247 x 252 mm



## 18 Volt 13 mm XRP Heavy Duty Hammer Drill

DCD925B2



Powerful 18 Volt XRP Combi tool for heavy duty drilling and screwdriving applications  
DeWALT built frameless motor reduces size and increases efficiency producing excellent runtime  
Ultra smooth 3 speed selector for optimum performance in high torque, normal use and high speed applications.  
22 position adjustable torque control for uniform results and optimised precision when screwdriving

**Standard Equipment:** 40 min multi chemistry charger, 2 batteries, Multi position side handle, Heavy duty carrying case

Battery Capacity	2.6 NiMH Ah
Chuck Capacity	1.5-13 mm
Power Output	450 Watts
No Load Speed	0-500/0-1250/0-2000 rpm
Beats per Minute	0-8500/0-21250/0-34000 bpm
Max Torque	55 Nm
Max. Drilling Capacity [Wood]	50 mm
Max. Drilling Capacity [Metal]	13 mm
Max. Drilling Capacity [Masonry]	16 mm
Weight	2.9 kg
Length x Height	247 x 248 mm



## 18 Volt 13 mm Compact Hammer Drill

DC727KL/ DC727N\*



Powerful 18 Volt combination tool for hammer drilling and screwdriving applications  
17 position adjustable torque control for consistent screwdriving into a variety of materials with different screw sizes  
13 mm single sleeve keyless chuck with automatic spindle lock for quick and easy bit change with one hand

**Standard Equipment:** 40 minute charger, 2 batteries, Heavy duty carrying case

Battery Capacity	Li-Ion 2.0 Ah
Chuck Capacity	1.5-13 mm
Power Output	375 Watts
No Load Speed	0-500 / 0-1700 rpm
Beats per Minute	0-8500/ 0-29000 bpm
Max Torque	41 Nm
Max. Drilling Capacity [Wood]	38 mm
Max. Drilling Capacity [Metal]	13 mm
Max. Drilling Capacity [Masonry]	13 mm
Weight	2.2 kg
Length x Height	225 x 239 mm



\*Available as bare unit, without batteries and charger as N-version

## 18 Volt 13mm Compact Hammer Drill

DC727C2\*



Powerful 18 Volt combination tool for hammer drilling and screwdriving applications  
13 mm single sleeve keyless chuck with automatic spindle lock for quick and easy bit change with one hand  
17 position adjustable torque control for consistent screwdriving into a variety of materials with different screw sizes  
Provided with Compact Li-Ion battery

**Standard Equipment:** 40 minute charger, 2 x 1.1Ah Compact Lithium batteries, Heavy duty carrying case

Battery Capacity	Li-Ion 1.1 Ah
Chuck Capacity	1.5-13 mm
Power Output	350 Watts
No Load Speed	0-500 / 0-1700 rpm
Beats per Minute	0-8500/ 0-29000 bpm
Max Torque	41 Nm
Max. Drilling Capacity [Wood]	38 mm
Max. Drilling Capacity [Metal]	13 mm
Max. Drilling Capacity [Masonry]	13 mm
Weight	1.84 kg
Length x Height	225 x 225 mm



\*DC727C2 not available in the UK



**18 Volt 13mm Compact Hammer Drill**

**DC725KB / DC725KA\***



Powerful 18 Volt combination tool for hammer drilling and screwdriving applications  
 13 mm single sleeve keyless chuck with automatic spindle lock for quick and easy bit change with one hand  
 17 position adjustable torque control for consistent screwdriving into a variety of materials with different screw sizes  
 All metal gearing for efficient power transmission and longer tool life

**Standard Equipment:** 1 hour charger, 2 batteries, Heavy duty carrying case

Battery Capacity	NiMH 2.6 Ah
Chuck Capacity	1.5-13 mm
Power Output	400 Watts
No Load Speed	0-500/ 0-1700 rpm
Beats per Minute	0-8500/ 0-29000 bpm
Max Torque	44 Nm
Max. Drilling Capacity [Wood]	38 mm
Max. Drilling Capacity [Metal]	13 mm
Max. Drilling Capacity [Masonry]	13 mm
Weight	2.4 kg
Length x Height	225 x 239 mm

\*Available as bare unit, without batteries and charger as N-version



**18 Volt 13 mm XRP Li-Ion Heavy Duty Cordless Drill Driver**

**DCD920L2\***



Powerful 18 Volt drill driver for heavy duty drilling and screwing applications  
 DeWALT built frameless motor reduces size and increases efficiency producing excellent runtime.  
 22 position adjustable torque control for uniform results and optimised precision when screwdriving

**Standard Equipment:** 40 Minute Charger, 2 batteries, Multi position side handle, Heavy duty carry case

Battery	2.0 Li-Ion
Chuck Capacity	1.5-13 mm
Power Output	450 Watts
No Load Speed	0-500/0-1250/0-2000 rpm
Max. Torque	55 Nm
Max. Drilling Capacity [Wood]	50 mm
Max. Drilling Capacity [Metal]	13 mm
Weight	2.4 kg
Length x Height	240 x 252 mm

\*DCD920L2 not available in the UK



**18 Volt 13 mm XRP Heavy Duty Drill Driver**

**DCD920B2**



Powerful 18 Volt XRP Drill Driver for heavy duty drilling and screwdriving applications  
 DeWALT built frameless motor reduces size and increases efficiency producing excellent runtime  
 Ultra smooth 3 speed selector for optimum performance in high torque, normal use and high speed applications.  
 22 position adjustable torque control for uniform results and optimised precision when screwdriving

**Standard Equipment:** 40 min multi chemistry charger, 2 batteries, Multi position side handle, Heavy duty carrying case

Battery	NiMH 2.6 Ah
Chuck Capacity	1.5-13 mm
Power Output	450 Watts
No Load Speed	0-500/0-1250/0-2000 rpm
Max. Torque	55 Nm
Max. Drilling Capacity [Wood]	50 mm
Max. Drilling Capacity [Metal]	13 mm
Weight	2.8 kg
Length x Height	240 x 248 mm



**18 Volt 13 mm Compact Drill Driver**

**DC722KL / DC722N\***



Powerful 18 Volt drill driver for drilling and screwdriving applications  
 13mm single sleeve keyless chuck with automatic spindle lock for quick and easy bit change with one hand  
 Battery pack produces 18 Volt power at less than 12 Volt NiCd/NiMH pack weight providing the ultimate ergonomic solution

**Standard Equipment:** 40 minute charger, 2 batteries, Heavy duty carrying case

Battery Capacity	2.0 Li-Ion Ah
Chuck Capacity	1.5-13 mm
Power Output	375 Watts
No Load Speed	0-500 / 0-1700 rpm
Max Torque	41 Nm
Max. Drilling Capacity [Wood]	38 mm
Max. Drilling Capacity [Metal]	13 mm
Weight	2.1 kg
Length x Height	210 x 239 mm

\*Available as bare unit, without batteries and charger as N-version, DC722KL, DC722N not available in the UK



**18 Volt 13mm Compact Drill Driver**

**DC722C2\***



Powerful 18 Volt drill driver for drilling and screwdriving applications  
 13mm single sleeve keyless chuck with automatic spindle lock for quick and easy bit change with one hand  
 17 position adjustable torque control for consistent screwdriving into a variety of materials with different screw sizes  
 Compatible with all DeWALT 18V battery packs

**Standard Equipment:** 40 minute charger, 2 x 1.1Ah Compact Lithium batteries, Heavy duty carrying case

Battery Capacity	1.1 Li-Ion Ah
Chuck Capacity	1.5-13 mm
Power Output	350 Watts
No Load Speed	0-500 / 0-1700 rpm
Max Torque	41 Nm
Max. Drilling Capacity [Wood]	38 mm
Max. Drilling Capacity [Metal]	13 mm
Weight	1.74 kg
Length x Height	210 x 225 mm

\*DC722C2 not available in the UK



**18 Volt 13 mm Compact Drill Driver**

**DC721KB / DC721KA / DC720KA\***



Powerful 18 Volt drill driver for drilling and screwdriving applications  
 13mm single sleeve keyless chuck with automatic spindle lock for quick and easy bit change with one hand  
 17 position adjustable torque control for consistent screwdriving into a variety of materials with different screw sizes  
 All metal gearing for efficient power transmission and longer tool life

**Standard Equipment:** 1 hour charger, 2 batteries, Heavy duty carrying case

Battery Capacity	NiMH 2.6 Ah
Chuck Capacity	1.5-13 mm
Power Output	400 Watts
No Load Speed	0-500 / 0-1700 rpm
Max Torque	44 Nm
Max. Drilling Capacity [Wood]	38 mm
Max. Drilling Capacity [Metal]	13 mm
Weight	2.3 kg
Length x Height	210 x 239 mm



\*DC721KA, DC720KA not available in the UK

**18 Volt 10mm Right Angle Drill - Bare Unit**

**DW960**



Powerful fan cooled motor delivers up to 33 Nm of sustained torque for turning large drill bits and fasteners  
 2 speed ranges 0-475/0-1500 rpm for increased user flexibility to achieve a wide range of applications  
 Forward, reverse, variable speed and electronic motor brake for total control  
 Durable, right angle transmission with sealed ball bearings and cut-steel gears for a longer tool life

Battery Capacity	fits 2.0, 2.4, 2.6, 3.0 Ah
Chuck Capacity	1.0-10 mm
Power Output	300 Watts
No Load Speed	0-475 / 0-1500 rpm
Max Torque	33 Nm
Max. Drilling Capacity [Wood]	28 mm
Max. Drilling Capacity [Metal]	10 mm
Weight	1.2 (2.2) kg
Length x Height	323 x 125 mm



**18 Volt Compact Impact Driver**

**DC827KL / DC827N**



Durable frameless high speed motor delivers up to 150 Nm of torque  
 All metal gearing for efficient power transmission and long tool life  
 Aluminium front housing provides greater heat dispersion increasing motor life  
 Improved variable speed switch and electronic motor brake for complete control for both setting and removing fasteners

**Standard Equipment:** 40 minute charger, 2 batteries, Heavy duty carrying case

Battery Capacity	2.0 Li-Ion Ah
Bit Holder	1/4"
Power Output	250 Watts
No Load Speed	0-2400 rpm
Impacts per Minute	0-2700 ipm
Max Torque	150 Nm
Max. Bolt Diameter	M12
Weight	1.7 kg
Length x Height	146 x 231 mm



**18 Volt Compact Impact Driver**

**DC827C2\***



Durable frameless high speed motor delivers up to 150 Nm of torque  
 All metal gearing for efficient power transmission and long tool life  
 Aluminium front housing provides greater heat dispersion increasing motor life  
 Improved variable speed switch and electronic motor brake for complete control for both setting and removing fasteners

**Standard Equipment:** 40 minute charger, 2 x 1.1Ah Compact Lithium batteries, Heavy duty carrying case

Battery Capacity	1.1 Li-Ion Ah
Bit Holder	1/4"
Power Output	250 Watts
No Load Speed	0-2400 rpm
Impacts per Minute	0-2700 ipm
Max Torque	150 Nm
Max. Bolt Diameter	M12
Weight	1.4 kg
Length x Height	146 x 230 mm



\*DC827C2 not available in the UK

**DEWALT IMPACT DRILLING AND SCREWDRIVING**



**The DEWALT EXTREME Impact range allows the user to perform more applications using the same tool.**

DEWALT supplies Impact Rated:

- Screw-driving bits
- Drill bits
- Hole-saws
- Flat-wood Bits

All these fastening and drilling bits have been designed to withstand the high torque generated by DEWALT Impact drivers.

For the complete range of IMPACT drilling and screwdriving accessories see pages 119, 120, 122, 123, 128

**18 Volt Compact Impact Driver**

**DC825KB**



Durable frameless high speed motor delivers up to 150 Nm of torque  
All metal gearing for efficient power transmission and long tool life  
Aluminium front housing provides greater heat dispersion increasing motor life  
Improved variable speed switch and electronic motor brake for complete control for both setting and removing fasteners

**Standard Equipment:** 40 minute charger, 2 batteries, Heavy duty carrying case

Battery Capacity	NiMH 2.6 Ah
Bit Holder	1/4"
Power Output	250 Watts
No Load Speed	0-2400 rpm
Impacts per Minute	0-2700 ipm
Max Torque	150 Nm
Max. Bolt Diameter	M12
Weight	2.0 kg
Length x Height	146 x 231 mm



**18 Volt High Torque Impact Wrench**

**DW059K2H/ DW059K2**



Powerful fan cooled motor delivers up to 418 Nm of sustained torque and up to 2600 impacts per minute for heavy duty fastening applications  
All metal gearing for efficient power transmission and long tool life  
Magnesium front housing for better weight and balance  
Modular component design for easy access and fast service

**Standard Equipment:** 1 hour charger, 2 batteries, Heavy duty carrying case

Battery Capacity	NiMH, 2.6 Ah
Bit Holder	1/2"
Power Output	365 Watts
No Load Speed	1650 rpm
Impacts per Minute	2600 ipm
Max. Torque	418 Nm
Max. Bolt Diameter	M20
Weight	3.4 kg
Length x Height	264 x 260 mm



**18 Volt Compact Impact Wrench**

**DC822KL/ DC822N\***



Durable Frameless high speed motor delivers up to 195 Nm of torque  
All metal gearing for efficient power transmission and long tool life  
Aluminium front housing provides greater heat dispersion increasing motor life  
Improved variable speed switch and electronic motor brake for complete control for both setting and removing fasteners

**Standard Equipment:** 40 minute charger, 2 batteries, Heavy duty carrying case

Battery Capacity	2.0 Li-Ion Ah
Bit Holder	1/2"
Power Output	250 Watts
No Load Speed	0-2400 rpm
Impacts per Minute	0-2700 ipm
Max. Torque	195 Nm
Max. Bolt Diameter	M16
Weight	1.7 kg
Length x Height	146 x 231 mm

**LITHIUM ION**

\*DC822KL not available in the UK

**18 Volt Compact Impact Wrench**

**DC820KB**



Durable frameless high speed motor delivers up to 195 Nm of torque  
All metal gearing for efficient power transmission and long tool life  
Aluminium front housing provides greater heat dispersion increasing motor life  
Improved variable speed switch and electronic motor brake for complete control for both setting and removing fasteners

**Standard Equipment:** 40 minute charger, 2 batteries, Heavy duty carrying case

Battery Capacity	NiMH, 2.6 Ah
Bit Holder	1/2"
Power Output	250 Watts
No Load Speed	0-2400 rpm
Impacts per Minute	0-2700 ipm
Max. Torque	195 Nm
Max. Bolt Diameter	M16
Weight	2.0 kg
Length x Height	146 x 231 mm



**18 Volt Drywall Screwdriver**

**DC520KA/ DC520N**



Removable depth sensitive "set and forget" nosepiece for consistent fastener depth  
Two speed settings, variable speed and reverse switch for maximum user control  
Up to 20 Nm of sustainable torque for maximum performance  
High performance fan cooled motor with replaceable brushes for maximum power and durability

**Standard Equipment:** 1 hour charger, 2 batteries, Magnetic bit holder, Screwdriver bit, Drywall nosepiece, Heavy duty carrying case

Battery Capacity	NiCd 2.0 Ah
Tool Holder	(Hex) 6.35 mm
Power Output	360 Watts
No Load Speed	0-900/0-2900 rpm
Max Torque	20 Nm
Weight	2.2 kg
Length x Height	307 x 231 mm



## 18 Volt Heavy Duty 16 Gauge Cordless Nail Gun

DC618KB / DC618KN



Versatility in the loading and unloading of fasteners - 20 degree angled magazine 120 nail capacity  
The tool works as fast as you do with consistent nail penetration  
The sequential operating mode allows for precision placement and the bump operating mode provides the user with production speed  
Depths can be easily referenced utilising numbered dial and user does not sacrifice performance when changing depths

**Standard Equipment:** 1 hour charger, 2 batteries, DeWALT safety glasses, Reversible belt hook, No-mark tip, Heavy duty carrying case

Nail Diameter	1.6 mm
Battery Capacity	NiMH 2.6 Ah
Magazine angle	20 °
Nail Length	32-63 mm
Magazine capacity	Up to 120 Nails
Magazine loading	Rear - load
Firing mode	Bump & Sequential
Height x Length	320 x 330 mm
Weight	3.9 kg
Nailer Operating Mode	Selective
Integrated Belt Hook	Yes
Jam Clearing	Yes
Features	LED Headlights



## 18 Volt 18 Gauge Cordless Nailer

DC608KB



The tool works as fast as you do with consistent nail penetration  
The sequential operating mode allows for precision placement and the bump operating mode provides the user with production speed  
Depths can be easily referenced utilising numbered dial and user does not sacrifice performance when changing depths

Provides easy access to the nosepiece for the simple removal of a jammed fastener without the use of screwdrivers or tool wrenches

**Standard Equipment:** 1 hour charger, 2 batteries, Heavy duty carrying case

Nail Diameter	1.2 mm
Battery Capacity	NiMH 2.6 Ah
Magazine angle	0 °
Nail Length	16-50 mm
Magazine capacity	110 Nails
Magazine loading	Side Load
Firing mode	Bump & Sequential
Length x Height	295 x 290 mm
Weight	3.4 kg
Nailer Operating Mode	Selective
Integrated Belt Hook	Yes
Jam Clearing	Yes



## 18 Volt Heavy Duty 16 Gauge Straight Cordless Nailer

DC616KB



Versatility in the loading and unloading of fasteners - straight magazine 110 nail capacity

The tool works as fast as you do with consistent nail penetration  
The sequential operating mode allows for precision placement and the bump operating mode provides the user with production speed  
Depths can be easily referenced utilising numbered dial and user does not sacrifice performance when changing depths

**Standard Equipment:** 1 hour charger, 2 batteries, DeWALT safety glasses, Reversible belt hook, No-mark tip, Heavy duty carrying case

Nail Diameter	1.6 mm
Battery Capacity	NiMH 2.6 Ah
Magazine angle	0 °
Nail Length	32-63 mm
Magazine capacity	110 Nails
Magazine loading	Rear - load
Firing mode	Bump & Sequential
Length x Height	330 x 320 mm
Weight	3.9 kg
Nailer Operating Mode	Selective
Integrated Belt Hook	Yes
Jam Clearing	Yes
Features	LED indicators



**18 Volt Finishing Grinder**

**DC411KL**



Powerful DEWALT fan cooled motor delivers maximum power and durability 6,500 rpm provides high power for cutting and grinding applications Battery pack produces 18 Volt power at less than 12 Volt NiCd / NiMH pack weight providing the ultimate ergonomic solution

**Standard Equipment:** 40 Min Charger, 2 batteries, Keyless protective guard, 2 position side handle, Heavy duty carrying case

Battery Capacity	Li-Ion 2.0 Ah
Max. Disc Diameter	125 mm
Power Output	405 Watts
No Load Speed	6500 rpm
Spindle Thread	M14
Weight	2.9 kg
Length x Height	375 x 147 mm



**18 Volt Finishing Grinder**

**DC411KB/ DC411KA/ DC411N**



Powerful DEWALT fan-cooled motor delivers maximum power and durability 6,500 rpm provides high power for cutting and grinding applications Steel cut spiral bevel gears provide highest level of durability and low vibration increasing user productivity Convenient trigger switch with lock-off button for easier gripping

**Standard Equipment:** 1 hour charger, 2 batteries, Keyless protective guard, 2 position side handle, Heavy duty carrying case

Battery Capacity	NiMH 2.6 Ah
Max. Disc Diameter	125 mm
Power Output	405 Watts
No Load Speed	6500 rpm
Spindle Thread	M14
Weight	3.2 kg
Length x Height	375 x 147 mm



**18 Volt Heavy Duty Reciprocating Saw**

**DC385KL**



Powerful DEWALT fan cooled motor with replaceable brushes and variable speed delivers fast cutting action up to 3,000 strokes per minute and 28.6 mm stroke length

Four-position blade clamp allows for flush cutting and increased versatility Battery pack produces 18 Volt power at less than 12 Volt NiCd / NiMH battery pack weight providing the ultimate ergonomic solution

**Standard Equipment:** 40 Min Charger, 2 batteries, Wood and metal blade, Heavy duty carrying case

Battery Capacity	Li-Ion 2.0 Ah
Power Output	390 Watts
No Load Stroke Rate	0-3000 spm
Stroke Length	28.6 mm
Weight	3.4 kg
Length x Height	435 x 188 mm



**18 Volt Heavy Duty Reciprocating Saw**

**DC385KB/ DC385N**



Powerful DEWALT fan cooled motor with replaceable brushes and variable speed delivers fast cutting action up to 3,000 strokes per minute and 28.6 mm stroke length

4-position blade clamp allows for flush cutting and increased versatility Lever-action keyless blade clamp for quick and easy blade changes Variable speed trigger, lock-off switch and electronic motor brake for quick controlled cuts and enhanced work safety

**Standard Equipment:** 40 Min Charger, 2 batteries, Wood and metal blade, Heavy duty carrying case

Battery Capacity	2.6 NiMH Ah
Power Output	390 Watts
No Load Stroke Rate	0-3000 spm
Stroke Length	28.6 mm
Weight	3.70 kg
Length x Height	435 x 188 mm



**18 Volt Heavy Duty Jigsaw**

**DC330KL**



Powerful DEWALT fan-cooled motor with replaceable brushes and variable speed. Fast cutting action up to 3000 strokes per minute Dust blower keeps line of cut clear of dust and debris Battery pack produces 18 Volt power at less than 12 Volt NiCd / NiMH battery pack weight providing the ultimate ergonomic solution

**Standard Equipment:** 40 minute charger, 2 batteries, Anti-scratch shoe cover, 1 XPC Wood blade, Heavy duty carrying case

Battery Capacity	Li-Ion 2.0 Ah
Power Output	400 Watts
No Load Stroke Rate	0-3000 spm
Stroke Length	26 mm
Bevel Capacity	45 °
Max. Depth of Cut [Wood]	135 mm
Max. Depth of Cut [Metal]	10 mm
Weight	3.1 kg
Length x Height	285 x 213 mm



**18 Volt Heavy Duty Jigsaw**

**DC330KB/ DC330KA/ DC330N**



Powerful DeWalt fan cooled motor with replaceable brushes and variable speed delivers fast cutting action up to 3000 strokes per minute  
 Dust blower keeps line of cut clear of chips  
 Tool free adjustable shoe with anti-scratch cover bevels 45 degrees in both directions  
 Quick and easy patented keyless blade change system accepts t-shank blades

**Standard Equipment:** 1 hour charger, 2 batteries, Anti-scratch shoe cover, 1 XPC Wood blade, Heavy duty carrying case

Battery Capacity	NiMH 2.6 Ah
Power Output	400 Watts
No Load Stroke Rate	0-3000 spm
Stroke Length	26 mm
Bevel Capacity	45 °
Max. Depth of Cut [Wood]	135 mm
Max. Depth of Cut [Metal]	10 mm
Weight	3.4 kg
Length x Height	285 x 213 mm



**18 Volt Heavy Duty Circular Saw**

**DC390KL**



Ultra thin kerf 165 mm, 24 tooth carbide-tipped blade allows for efficient run time and fast, smooth cut finish at maximum 55 mm depth of cut  
 Powerful DeWalt fan cooled motor with replaceable brushes delivers up to 3700 rotation per minute for fast cutting action  
 Battery pack produces 18 Volt power at less than 12 Volt NiCd / NiMH pack weight providing the ultimate ergonomic solution

**Standard Equipment:** 40 Min Charger, 2 batteries, 165 mm carbide blade, Rip fence, Hex key, Heavy duty carrying case

Battery Capacity	Li-Ion 2.0 Ah
Blade Diameter	165 mm
Power Output	390 Watts
No Load Speed	3700 rpm
Bevel Capacity	50 °
Weight	3.9 kg
Length x Height	406 x 259 mm



**18 Volt Heavy Duty Circular Saw**

**DC390KB/ DC390KA/ DC390N**



Ultra thin kerf 165 mm, 24 tooth carbide tipped blade allows for efficient run-time and fast, smooth cut finish at maximum 55 mm depth of cut  
 Powerful DeWalt fan cooled motor with replaceable brushes delivers up to 3700 rotation per minute for fast cutting action  
 Keyless bevel angle and depth of cut adjustment with easy to read scale for maximum cordless versatility  
 Extremely durable design offering a cast magnesium shoe and full metal guarding to withstand rough job site conditions

**Standard Equipment:** 1 hour charger, 2 batteries, 165 mm carbide blade, Rip fence, Hex key, Heavy duty carrying case

Battery Capacity	NiMH 2.6 Ah
Blade Diameter	165 mm
Power Output	390 Watts
No Load Speed	3700 rpm
Bevel Capacity	50 °
Weight	4.2 kg
Length x Height	406 x 259 mm



**18 Volt Heavy Duty Plunge Saw with 1.5m Rail**

**DC352KBR/ DC352KN\***



Parallel plunge allows the user to maintain a smooth and constant hand position while cutting  
 A 24 tooth blade gives a fine and accurate cut and maximises runtime and power  
 Rail adjustment allows the saw to be adjusted to accurately move along the rail  
 The anti kickback function stops the saw from moving backwards along the rail and helps stop the saw climbing out of the work piece when making plunge cuts

**Standard Equipment:** 1 hour charger, 2 batteries, 24 tooth precision circular saw blade, Heavy duty carrying case, 1.5m rail

Battery Capacity	NiMH 2.6 Ah
Power Output	390 Watts
No Load Speed	3200 rpm
Blade Diameter	165 mm
Blade Bore	20 mm
Bevel Capacity	47 °
Max. Depth of Cut at 90°[with guide rails]	55 mm
Max. Depth of Cut at 45°[with guide rails]	40 mm
Weight	5.6 kg
Length x Height	349 x 264 mm

\*N version sold as bare unit and does not include guide rail, DC352KBR not available in the UK



**18 Volt Heavy Duty Metal Cutting Circular Saw**

**DW934K2H/ DW934K2/ DW934\***



Robust cool-running 173mm, 40 tooth tungsten carbide tipped blade for burr-free cuts at constant 61mm cutting depth throughout the life of the blade  
 Powerful DeWalt fan cooled motor with replaceable brushes and new transmission design  
 Left side blade design, the new gun-sight line of cut indicator and the unique chemically treated glass window for enhanced line of cut visibility  
 Extremely durable design offering an anti-magnetic stainless shoe and full metal guarding to withstand rough job site conditions

**Standard Equipment:** 1 hour charger, 2 batteries, 173mm tungsten carbide blade, Hex key, Heavy duty carrying case

Battery Capacity	NiMH 2.6 Ah
Blade Diameter	173 mm
Power Output	315 Watts
No Load Speed	3100 rpm
Bevel Capacity	-
Weight	3.8 kg
Length x Height	365 x 195 mm

\*DW934 version sold as bare unit, DW934K2 not available in the UK



**18 Volt 600 ml Satchet and 310 ml Cartridge Sealant Gun DC547K/ DC547\***



2900 N push force suitable for high viscosity urethanes and adhesives  
 Variable speed control dial for pre-selection of dispensing speed  
 Electronic trigger with variable speed and automatic overload protection  
 Ergonomic T-handle design with rubber grip for extra comfort

**Standard Equipment:** 1 hour charger, 1 battery, Cartridge holder, Satchet barrel, Conversion kit

Battery Capacity	NiMH 2.6 Ah
Carrier Size	310-600 ml
Applicator	Cartridge & Satchet
Push Force	2900 N (295kg)
Push Speed	635 mm/min
Weight	3.3/2.3* kg
Length x Height	734 x 322 mm



\*DC547 sold as bare unit, DC547K, DC547 not available in the UK

**18 Volt Handheld Wet /Dry Vacuum - Bare Unit DC515N**



Runs off current 18 Volt battery platform allowing quick and easy change between different tools with a single battery  
 High efficiency filter traps 99.7% of dust as small as drywall and cement dust  
 1.9 Litre tank capacity allows for the cleaning up of larger amounts of material  
 The rubber hose is extendable to 1 metre for added flexibility for a wide range of applications

**Standard Equipment:** No batteries included, 1 metre heavy duty rubber hose, Crevice tool, Wide nozzle

Voltage	18 V
Battery	Not included
Power Input	180 Watts
Max. Airflow	15.9 l/sec
Tank volume	1.9 l
Power Source	DC
Hose Nozzle Outside Diameter	32 mm
Blower	No
Weight	1.2 (2.2) kg
Length x Height	460 x 200 mm

**18 Volt Fluorescent Light - Bare Unit DC527N\***



Compact, lightweight design with impact resistant housing  
 Battery and charger sold separately  
 Rubber overmold for increased durability  
 4 prong bulb for added bulb stability

Bulb Type	Fluorescent
Battery Type	18 V
Weight	0.5 kg
Length x Height	155 x 0 mm

\*Spare bulb available - DE5273

**18 Volt Heavy Duty Flexible Flashlight - Bare Unit DW919\***



Wide angle beam with metal reflector and Xenon bulbs for greater brightness  
 Lockable head clip offers versatility and convenience of a lantern.  
 Flashlight with flexible neck for multi-directional hands-free lighting  
 Compact, lightweight design with impact resistant housing

Bulb Type	Xenon
Battery Type	18 V V
Weight	0.45 kg
Length x Height	130 x 180 mm

\*Spare bulb available - DE9083

**18 Volt Flashlight - Bare Unit DW908\***



Wide angle beam with metal reflector and Xenon bulbs for greater brightness  
 Flashlight with 90 degree pivoting head and 5 set positions for multi directional lighting (including horizontal and vertical lighting)  
 Compact, lightweight design with impact resistant housing  
 On board spare bulb storage

Bulb Type	Xenon
Battery Type	18 V V
Weight	0.34 kg
Length x Height	85 x 240 mm

\*Spare bulb available - DE9083

## 14.4 Volt 13 mm XRP Li-Ion Heavy Duty Hammer Drill

DCD935L2



Powerful 14.4 Volt combination tool for heavy duty drilling and screwdriving applications  
DeWALT built frameless motor reduces size and increases efficiency producing excellent runtime  
22 position adjustable torque control for uniform results and optimised precision when screwdriving

**Standard Equipment:** 40 min multi chemistry charger, 2 batteries, Multi position side handle, Heavy duty carrying case

Battery Capacity	Li-Ion 2.0 Ah
Chuck Capacity	1.5-13 mm
Power Output	325 Watts
No Load Speed	0-425/0-1200/0-1800 rpm
Beats per Minute	0-7225/0-20400/0-30600 bpm
Max Torque	50 Nm
Max. Drilling Capacity [Wood]	45 mm
Max. Drilling Capacity [Metal]	13 mm
Max. Drilling Capacity [Masonry]	14 mm
Weight	2.4 kg
Length x Height	247 x 252 mm



## 14.4 Volt 13mm XRP Heavy Duty Hammer Drill

DCD935B2



Powerful 14.4 Volt XRP Combi tool for heavy duty drilling and screwdriving applications  
DeWALT built frameless motor reduces size and increases efficiency producing excellent runtime  
22 position adjustable torque control for uniform results and optimised precision when screwdriving  
Dual Collar design for quick and easy changing between hammer, drill and screw modes

**Standard Equipment:** 40 minute multi chemistry charger, 2 batteries, Multi position side handle, Heavy duty carrying case

Battery Capacity	NiMH 2.6 Ah
Chuck Capacity	1.5-13 mm
Power Output	325 Watts
No Load Speed	0-425/0-1200/0-1800 rpm
Beats per Minute	0-7225/0-20400/0-30600 bpm
Max Torque	50 Nm
Max. Drilling Capacity [Wood]	45 mm
Max. Drilling Capacity [Metal]	13 mm
Max. Drilling Capacity [Masonry]	14 mm
Weight	2.7 kg
Length x Height	247 x 248 mm



## 14.4 Volt 13mm Compact Hammer Drill

DC737KL/ DC737KN



Powerful 14.4 Volt combination tool for hammer-drilling and screw-driving applications  
Compact, lightweight design  
17 position adjustable torque control for consistent screwdriving into a variety of materials with different screw sizes  
Two speed settings, variable speed and reverse switch for controllable use

**Standard Equipment:** 40 minute charger, 2 batteries, Heavy duty carrying case

Battery Capacity	Li-Ion 2.0 Ah
Chuck Capacity	1.5-13 mm
Power Output	270 Watts
No Load Speed	0-400 / 0-1450 rpm
Beats per Minute	0-6,800 / 0-25,000 bpm
Max Torque	37 Nm
Max. Drilling Capacity [Wood]	35 mm
Max. Drilling Capacity [Metal]	13 mm
Max. Drilling Capacity [Masonry]	13 mm
Weight	2.1 kg
Length x Height	225 x 239 mm



\*DC737KL, DC737KN not available in the UK

## 14.4 Volt 13mm Compact Hammer Drill

DC737C2\*



Powerful 14.4 Volt combination tool for hammer-drilling and screw-driving applications  
Compact, lightweight design  
17 position adjustable torque control for consistent screwdriving into a variety of materials with different screw sizes  
Two speed settings, variable speed and reverse switch for controllable use

**Standard Equipment:** 40 minute charger, 2 x 1.1Ah Compact Lithium batteries, Heavy duty carrying case

Battery Capacity	Li-Ion 1.1 Ah
Chuck Capacity	1.5-13 mm
Power Output	250 Watts
No Load Speed	0-400 / 0-1450 rpm
Beats per Minute	0-6,800 / 0-25,000 bpm
Max Torque	37 Nm
Max. Drilling Capacity [Wood]	35 mm
Max. Drilling Capacity [Metal]	13 mm
Max. Drilling Capacity [Masonry]	13 mm
Weight	1.7 kg
Length x Height	225 x 240 mm



\*DC737C2 not available in the UK

## 14.4 Volt 13mm Compact Hammer Drill

DC735KB/ DC735KA



Powerful 14.4 Volt combination tool for hammer drilling and screwdriving applications  
13 mm single sleeve keyless chuck with automatic spindle lock for quick and easy bit change with one hand  
17 position adjustable torque control for consistent screwdriving into a variety of materials with different screw sizes  
All metal gearing for efficient power transmission and longer tool life

**Standard Equipment:** 1 hour charger, 2 batteries, Heavy duty carrying case

Battery Capacity	NiMH 2.6 Ah
Chuck Capacity	1.5-13 mm
Power Output	295 Watts
No Load Speed	0-400/ 0-1450 rpm
Beats per Minute	0-6800/ 0-25000 bpm
Max Torque	40 Nm
Max. Drilling Capacity [Wood]	35 mm
Max. Drilling Capacity [Metal]	13 mm
Max. Drilling Capacity [Masonry]	13 mm
Weight	2.2 kg
Length x Height	225 x 239 mm





**14.4 Volt 13mm XRP Li-Ion Heavy Duty Drill Driver**

**DCD930L2\***



Powerful 14.4 Volt XRP drill driver for heavy duty drilling and screwdriving applications  
 DeWALT built frameless motor reduces size and increases efficiency producing excellent runtime  
 Ultra smooth 3 speed selector for optimum performance in high torque, normal use and high speed applications

**Standard Equipment:** 40 min multi chemistry charger, 2 batteries, Heavy duty carry case, Multi position side handle

Battery	2.0 Li-Ion
Chuck Capacity	1.5-13 mm
Power Output	325 Watts
No Load Speed	0-425/0-1200/0-1800 rpm
Max. Torque	50 Nm
Max. Drilling Capacity [Wood]	45 mm
Max. Drilling Capacity [Metal]	13 mm
Weight	2.3 kg
Length x Height	240 x 252 mm

\*DCD930L2 not available in the UK



**14.4 Volt 13mm XRP Heavy Duty Drill Driver**

**DCD930B2\***



Powerful 14.4 Volt XRP drill driver for heavy duty drilling and screwdriving applications  
 DeWALT built frameless motor reduces size and increases efficiency producing excellent runtime  
 Ultra smooth 3 speed selector for optimum performance in high torque, normal use and high speed applications.  
 22 position adjustable torque control for uniform results and optimised precision when screwdriving

**Standard Equipment:** 40 minute multi chemistry charger, 2 batteries, Multi position side handle, Heavy duty carrying case

Battery	NiMH 2.6 Ah
Chuck Capacity	1.5-13 mm
Power Output	325 Watts
No Load Speed	0-425/0-1200/0-1800 rpm
Max. Torque	50 Nm
Max. Drilling Capacity [Wood]	45 mm
Max. Drilling Capacity [Metal]	13 mm
Weight	2.6 kg
Length x Height	240 x 248 mm

\*DCD930B2 not available in the UK



**14.4 Volt 13mm Compact Drill Driver**

**DC732KL/ DC732N\***



Powerful 14.4 Volt drill driver for drilling and screwdriving applications  
 13mm single sleeve keyless chuck with automatic spindle lock for quick and easy bit change with one hand  
 Battery pack produces 14.4 Volt power at less than 9.6 Volt NiCd/NiMH pack weight providing the ultimate ergonomic solution

**Standard Equipment:** 40 minute charger, 2 batteries, Heavy duty carrying case

Battery Capacity	2.0 Li-Ion Ah
Chuck Capacity	1.5-13 mm
Power Output	270 Watts
No Load Speed	0-400 / 0-1450 rpm
Max Torque	37 Nm
Max. Drilling Capacity [Wood]	35 mm
Max. Drilling Capacity [Metal]	13 mm
Weight	2 kg
Length x Height	210 x 239 mm

\*DC732KL not available in the UK



**14.4V 13mm Compact Drill Driver**

**DC732C2\***



Powerful 14.4 Volt drill driver for drilling and screwdriving applications  
 Compact, lightweight design  
 17 position adjustable torque control for consistent screwdriving into a variety of materials with different screw sizes  
 Two speed settings, variable speed and reverse switch for controllable use

**Standard Equipment:** 40 minute charger, 2 x 1.1Ah Compact Lithium batteries, Heavy duty carrying case

Battery Capacity	1.1 Li-Ion Ah
Chuck Capacity	1.5-13 mm
Power Output	250 Watts
No Load Speed	0-400 / 0-1450 rpm
Max Torque	37 Nm
Max. Drilling Capacity [Wood]	35 mm
Max. Drilling Capacity [Metal]	13 mm
Weight	1.7 kg
Length x Height	210 x 240 mm

\*DC732C2 not available in the UK



**14.4 Volt 13mm Compact Drill Driver**

**DC731KB/ DC731KA/ DC730KA\***



Powerful 14.4 Volt drill driver for drilling and screwdriving applications  
 13mm single sleeve keyless chuck with automatic spindle lock for quick and easy bit change with one hand  
 17 position adjustable torque control for consistent screwdriving into a variety of materials with different screw sizes  
 All metal gearing for efficient power transmission and longer tool life

**Standard Equipment:** 1 hour charger, 2 x 2.6Ah NiMH batteries, Heavy duty carrying case

Battery Capacity	NiMH 2.6 Ah
Chuck Capacity	1.5-13 mm
Power Output	295 Watts
No Load Speed	0-400 / 0-1450 rpm
Max Torque	40 Nm
Max. Drilling Capacity [Wood]	35 mm
Max. Drilling Capacity [Metal]	13 mm
Weight	2.1 kg
Length x Height	210 x 239 mm

\*DC730KA has 10mm chuck, DC731KA, DC730KA not available in the UK



## 14.4V 10mm Cordless Li-Ion Drill Driver

DC733KL\*



Powerful 14.4 Volt drill driver for drilling and screwdriving applications  
 10 mm single sleeve chuck and spindle lock for quick and easy bit change with one hand  
 Two speed settings, variable speed and reverse switch for maximum control  
 14 position adjustable torque control for consistent screwdriving into a variety of materials with different screw sizes

**Standard Equipment:** 40min Multi Chemistry Charger, 2 x 2.0Ah Li-Ion batteries, Heavy duty carrying case

Battery Capacity	Li-Ion 2.0 Ah
Chuck Capacity	1-10mm mm
Power Output	195 Watts
No Load Speed	0-400 / 0-1300 rpm
Max Torque	30 Nm
Max. Drilling Capacity [Wood]	30 mm
Max. Drilling Capacity [Metal]	10 mm
Weight	1.8 kg
Length x Height	220 x 240 mm

**LITHIUM ION**

\*DC733KL not available in the UK

## 14.4 Volt 10mm Drill Driver

DC733K2 / DC733KB / DC733KA / DC733KN



Powerful 14.4 Volt drill driver for drilling and screwdriving applications  
 10 mm single sleeve chuck and spindle lock for quick and easy bit change with one hand  
 Two speed settings, variable speed and reverse switch for maximum control  
 14 Position adjustable torque control for consistent screwdriving into a variety of materials with different screw sizes

**Standard Equipment:** 1 hour charger, 2 batteries, heavy duty carrying case

Battery Capacity	NiCd 2.0 Ah
Chuck Capacity	1-10 mm
Power Output	195 Watts
No Load Speed	0-400/0-1300 rpm
Max Torque	30 Nm
Max. Drilling Capacity [Wood]	30 mm
Max. Drilling Capacity [Metal]	10 mm
Weight	2.0 kg
Length x Height	220 x 235 mm



## 14.4 Volt 10mm Compact Drill Driver

DC733C2\*



Powerful 14.4 Volt drill driver for drilling and screwdriving applications  
 10 mm single sleeve chuck and spindle lock for quick and easy bit change with one hand  
 Two speed settings, variable speed and reverse switch for maximum control  
 14 position adjustable torque control for consistent screwdriving into a variety of materials with different screw sizes

**Standard Equipment:** 40min Multi Chemistry Charger, 2 x 1.1Ah Compact Li-Ion batteries, Heavy duty carrying case

Battery Capacity	Li-Ion 1.1 Ah
Chuck Capacity	1-10mm mm
Power Output	195 Watts
No Load Speed	0-400 / 0-1300 rpm
Max Torque	30 Nm
Max. Drilling Capacity [Wood]	30 mm
Max. Drilling Capacity [Metal]	10 mm
Weight	1.5 kg
Length x Height	220 x 220 mm



\*DC733C2 not available in the UK

## DEWALT EXTREME 2 METAL™



**DEWALT Extreme 2 Metal drill bits are ideal for fast, accurate, burr-free drilling.**

- Up to 4x faster than standard HSS-R bits, and up to 50% stronger
- The DEWALT twin tip design eliminates 'walking' allowing for accurate hole positioning and more efficient drilling
- Gold Ferrous Oxide coating prevents over-heating for longer bit life

For the complete range of EXTREME 2 METAL drill bits see page 116

**14.4 Volt 10mm Compact Right Angle Drill**

**DW966K**



Powerful fan cooled motor delivers up to 24 Nm of sustained torque for turning large drill bits and fasteners  
2 speed ranges 0-400/0-1,250 rpm for increased user flexibility to achieve a wide range of applications  
Forward, reverse, variable speed and electronic motor brake for total control  
Multi-grip trigger provides comfort and convenience by allowing the user to get into tighter spaces while still having access to the trigger

**Standard Equipment:** 1 hour charger, 1 battery, Heavy duty carrying case

Battery Capacity	NiCd 2.0 Ah
Chuck Capacity	1.0-10 mm
Power Output	220 Watts
No Load Speed	0-400/0-1,250 rpm
Max Torque	24 Nm
Max. Drilling Capacity [Wood]	28 mm
Max. Drilling Capacity [Metal]	10 mm
Weight	2.1 kg
Length x Height	323 x 125 mm



**14.4 Volt Compact Impact Driver**

**DC837KL/ DC837N\***



Durable frameless high speed motor delivers up to 140 Nm of torque  
All metal gearing for efficient power transmission and long tool life  
Aluminium front housing provides greater heat dispersion increasing motor life  
Improved variable speed switch and electronic motor brake for complete control for both setting and removing fasteners

**Standard Equipment:** 40 minute fast charger, 2 batteries, Heavy duty carrying case.

Battery Capacity	Li-Ion, 2.0 Ah
Bit Holder	1/4"
Power Output	240 Watts
No Load Speed	0-2400 rpm
Impacts per Minute	0-2700 ipm
Max Torque	140 Nm
Max. Bolt Diameter	M12
Weight	1.6 kg
Length x Height	146 x 231 mm

\*DC837KL, DC837N not available in the UK



**14.4 Volt Compact Impact Driver**

**DC837C2\***



Durable frameless high speed motor delivers up to 140 Nm of torque  
All metal gearing for efficient power transmission and long tool life  
Aluminium front housing provides greater heat dispersion increasing motor life  
Improved variable speed switch and electronic motor brake for complete control for both setting and removing fasteners

**Standard Equipment:** 40 minute fast charger, 2 x 1.1Ahr Compact Lithium batteries, Heavy duty carrying case.

Battery Capacity	Li-Ion, 1.1 Ah
Bit Holder	1/4"
Power Output	240 Watts
No Load Speed	0-2400 rpm
Impacts per Minute	0-2700 ipm
Max Torque	140 Nm
Max. Bolt Diameter	M12
Weight	1.4 kg
Length x Height	146 x 230 mm

\*DC837C2 not available in the UK



**14.4 Volt Compact Impact Driver**

**DC835KB**



Durable frameless high speed motor delivers up to 140 Nm of torque  
All metal gearing for efficient power transmission and long tool life  
Aluminium front housing provides greater heat dispersion increasing motor life  
Improved variable speed switch and electronic motor brake for complete control for both setting and removing fasteners

**Standard Equipment:** 40 minute fast charger, 2 batteries, Heavy duty carrying case

Battery Capacity	NiMH 2.6 Ah
Bit Holder	1/4"
Power Output	240 Watts
No Load Speed	0-2400 rpm
Impacts per Minute	0-2700 ipm
Max Torque	140 Nm
Max. Bolt Diameter	M12
Weight	1.8 kg
Length x Height	146 x 231 mm



**14.4 Volt Compact Impact Wrench**

**DC832KL/ DC832N\***



Durable frameless high speed motor delivers up to 180 Nm of torque  
All metal gearing for efficient power transmission and increased tool life  
Aluminium front housing provides greater heat dispersion increasing motor life  
Improved variable speed switch and electronic motor brake for complete control for both setting and removing fasteners

**Standard Equipment:** 40 minute fast charger, 2 batteries, Heavy duty carrying case.

Battery Capacity	Li-Ion, 2.0 Ah
Bit Holder	1/2"
Power Output	240 Watts
No Load Speed	0-2400 rpm
Impacts per Minute	0-2700 ipm
Max. Torque	180 Nm
Max. Bolt Diameter	M16
Weight	1.6 kg
Length x Height	146 x 231 mm

\*DC832KL, DC832N not available in the UK



**14.4 Volt Compact Impact Wrench**

**DC830KB**



Durable frameless high speed motor delivers up to 180 Nm of torque  
All metal gearing for efficient power transmission and long tool life  
Aluminium front housing provides greater heat dispersion increasing motor life  
Improved variable speed switch and electronic motor brake for complete control for both setting and removing fasteners

**Standard Equipment:** 40 minute fast charger, 2 batteries, Heavy duty carrying case

Battery Capacity	NiMH 2.6 Ah
Bit Holder	1/2"
Power Output	240 Watts
No Load Speed	0-2400 rpm
Impacts per Minute	0-2700 ipm
Max. Torque	180 Nm
Max. Bolt Diameter	M16
Weight	1.8 kg
Length x Height	146 x 231 mm



**14.4 Volt Shear**

**DW941K**



Powerful DeWALT fan cooled motor with replaceable brushes delivers high speed cutting in 1.2 mm sheet metal at 4.4 m/min  
Head swivels 360° which allows user to access tight quarters while maintaining comfort  
Variable speed and electronic brake for greater control and user safety  
42.7 m maximum length of cut per charge in 1.2 mm sheet metal

**Standard Equipment:** 1 hour charger, 1 battery, Allen key, Heavy duty carrying case

Battery Capacity	NiCd 2.0 Ah
Power Output	295 Watts
No Load Stroke Rate	0-2300 spm
Max. Depth of Cut [Metal]	1.2 mm
Weight	2.4 kg
Length x Height	336 x 230 mm



**14.4 Volt Heavy Duty Flexible Flashlight - Bare Unit**

**DW918\***



Wide angle beam with metal reflector and Xenon bulbs for greater brightness  
Flashlight with flexible neck for multi - directional, hands free lighting  
Lockable head clip offers versatility and convenience of a lantern.  
Compact, lightweight design with impact resistant housing

Bulb Type	Xenon
Battery Type	14.4 V V
Weight	0.45 kg
Length x Height	130 x 180 mm

\*Spare bulb available - DE9043

**14.4 Volt Flashlight - Bare Unit**

**DW906\***



Wide angle beam with metal reflector and Xenon bulbs for greater brightness  
Flashlight with 90 degree pivoting head and 5 set positions for multi directional lighting (including horizontal and vertical lighting)  
Compact, lightweight design with impact resistant housing  
On board spare bulb storage

Bulb Type	Xenon
Battery Type	14.4 V V
Weight	0.34 kg
Length x Height	85 x 240 mm

\*Spare bulb available - DE9043

**12 Volt 13mm XRP Heavy Duty Hammer Drill**

**DCD945B2**



Powerful 12 Volt XRP Combi tool for heavy duty drilling and screwdriving applications  
DeWALT built frameless motor reduces size and increases efficiency producing excellent runtime  
Ultra smooth 3 speed selector for optimum performance in high torque, normal use and high speed applications.  
22 position adjustable torque control for uniform results and optimised precision when screwdriving

**Standard Equipment:** 40 min multi chemistry charger, 2 batteries, Multi position side handle, Heavy duty carrying case

Battery Capacity	NiMH 2.6 Ah
Chuck Capacity	1.5-13 mm
Power Output	285 Watts
No Load Speed	0-425/0-1200/0-1800 rpm
Beats per Minute	0-7225/0-20400/0-30600 bpm
Max Torque	44 Nm
Max. Drilling Capacity [Wood]	38 mm
Max. Drilling Capacity [Metal]	13 mm
Max. Drilling Capacity [Masonry]	13 mm
Weight	2.5 kg
Length x Height	247 x 248 mm



**12 Volt 13mm Compact Hammer Drill**

**DC745KB / DC745KA\***



Powerful 12 Volt combination tool for hammer drilling and screwdriving applications  
 13 mm single sleeve keyless chuck with automatic spindle lock for quick and easy bit change with one hand  
 17 position adjustable torque control for consistent screwdriving into a variety of materials with different screw sizes  
 All metal gearing for efficient power transmission and longer tool life

**Standard Equipment:** 1 hour charger, 2 batteries, Heavy duty carrying case

Battery Capacity	NiMH 2.6 Ah
Chuck Capacity	1.5mm-13 mm
Power Output	240 Watts
No Load Speed	0-400 / 0-1450 rpm
Beats per Minute	0-6800 / 0-25000 bpm
Max Torque	35 Nm
Max. Drilling Capacity [Wood]	28 mm
Max. Drilling Capacity [Metal]	13 mm
Max. Drilling Capacity [Masonry]	13 mm
Weight	2.1 kg
Length x Height	225 x 239 mm

\*DC745KB not available in the UK



**12 Volt 13mm XRP Heavy Duty Drill Driver**

**DCD940B2\***



Powerful 12 Volt XRP Drill Driver for heavy duty drilling and screwdriving applications  
 DEWALT built frameless motor reduces size and increases efficiency producing excellent runtime  
 Ultra smooth 3 speed selector for optimum performance in high torque, normal use and high speed applications.  
 22 position adjustable torque control for uniform results and optimised precision when screwdriving

**Standard Equipment:** 40 minute multi chemistry charger, 2 batteries, Multi position side handle, Heavy duty carrying case

Battery	NiMH 2.6 Ah
Chuck Capacity	1.5-13 mm
Power Output	285 Watts
No Load Speed	0-425 / 0-1200 / 0-1800 rpm
Max. Torque	44 Nm
Max. Drilling Capacity [Wood]	38 mm
Max. Drilling Capacity [Metal]	13 mm
Weight	2.4 kg
Length x Height	240 x 248 mm

\*DCD940B2 not available in the UK



**12 Volt 13mm Compact Drill Driver**

**DC743KB / DC742KA\***



Powerful 12.0 Volt drill driver for drilling and screwdriving applications  
 13mm single sleeve keyless chuck with automatic spindle lock for quick and easy bit change with one hand  
 17 position adjustable torque control for consistent screwdriving into a variety of materials with different screw sizes  
 All metal gearing for efficient power transmission and longer tool life

**Standard Equipment:** 1 hour charger, 2 x 2.6Ah NiMH batteries, Heavy duty carrying case

Battery Capacity	NiMH 2.6 Ah
Chuck Capacity	1.5-13 mm
Power Output	240 Watts
No Load Speed	0-400 / 0-1450 rpm
Max Torque	35 Nm
Max. Drilling Capacity [Wood]	28 mm
Max. Drilling Capacity [Metal]	13 mm
Weight	2.0 kg
Length x Height	210 x 239 mm

\*DC742KA has 10mm chuck, DC743KB, DC742KA not available in the UK



**12 Volt 10mm Drill Driver**

**DC740KA / DC740K2\***



Powerful 12 Volt drill driver for drilling and screwdriving applications  
 10 mm single sleeve chuck and spindle lock for quick and easy bit change with one hand  
 14 Position adjustable torque control for consistent screwdriving into a variety of materials with different screw sizes  
 Removable Belt Clip

**Standard Equipment:** 1 hour charger, 2 batteries, Heavy duty carrying case

Battery Capacity	NiCd 1.3 Ah
Chuck Capacity	1-10 mm
Power Output	190 Watts
No Load Speed	0-350 / 0-1200 rpm
Max Torque	26 Nm
Max. Drilling Capacity [Wood]	25 mm
Max. Drilling Capacity [Metal]	10 mm
Weight	1.7 kg
Length x Height	220 x 225 mm

\*DC740K2 not available in the UK



**12 Volt 10mm Compact Right Angle Drill**

**DW965K**



Powerful fan cooled motor delivers up to 20 Nm of sustained torque for turning large bits and fasteners  
 2 speed ranges 0-400/0-1200 rpm for increased user flexibility providing a wide range of applications  
 Multi-grip trigger provides comfort and convenience by allowing the user to get into tighter spaces while still having access to the trigger  
 Forward, reverse, variable speed and electronic motor brake for total control

**Standard Equipment:** 1 hour charger, 1 battery, Heavy duty carrying case

Battery Capacity	NiCd 2.0 Ah
Chuck Capacity	1.0-10 mm
Power Output	190 Watts
No Load Speed	0-400 / 0-1200 rpm
Max Torque	20 Nm
Max. Drilling Capacity [Wood]	25 mm
Max. Drilling Capacity [Metal]	10 mm
Weight	2.0 kg
Length x Height	323 x 125 mm



## 12 Volt Compact Impact Driver

DC845KB



Durable frameless high speed motor delivers up to 130 Nm of torque  
All metal gearing for efficient power transmission and long tool life  
Aluminium front housing provides greater heat dispersion increasing motor life  
Improved variable speed switch and electronic motor brake for complete control for both setting and removing fasteners

**Standard Equipment:** 40 minute charger, 2 batteries, Heavy duty carrying case

Battery Capacity	NiMH 2.6 Ah
Bit Holder	1/4"
Power Output	220 Watts
No Load Speed	0-2400 rpm
Impacts per Minute	0-2700 ipm
Max Torque	130 Nm
Max. Bolt Diameter	M12
Weight	1.7 kg
Length x Height	146 x 231 mm



## 12 Volt Compact Impact Wrench

DC840KB



Durable frameless high speed motor delivers up to 160 Nm of torque  
All metal gearing for efficient power transmission and long tool life  
Aluminium front housing provides greater heat dispersion increasing motor life  
Improved variable speed switch and electronic motor brake for complete control for both setting and removing fasteners

**Standard Equipment:** 40 minute charger, 2 batteries, Heavy duty carrying case

Battery Capacity	NiMH 2.6 Ah
Bit Holder	1/2"
Power Output	220 Watts
No Load Speed	0-2400 rpm
Impacts per Minute	0-2700 ipm
Max. Torque	160 Nm
Max. Bolt Diameter	M16
Weight	1.7 kg
Length x Height	146 x 231 mm



## 12 Volt Drywall Screwdriver

DW979K2



Removable depth sensitive "set and forget" nosepiece for consistent fastener depth  
6.35 mm hex shank magnetic tool holder  
Up to 8.5 Nm of sustainable torque for maximum performance  
Two speed settings, variable speed and reverse switch for maximum control

**Standard Equipment:** 1 hour charger, 2 batteries, Magnetic bit holder, Screwdriver bit, Heavy duty carrying case

Battery Capacity	NiCd 2.0 Ah
Tool Holder	(Hex) 6.35 mm
Power Output	220 Watts
No Load Speed	0-800 / 0-2300 rpm
Max Torque	8.5 Nm
Weight	1.9 kg
Length x Height	307 x 231 mm



## 12 Volt 18 Gauge Cordless Nailer

DC602KB\*



The tool works as fast as you do with consistent nail penetration  
The sequential operating mode allows for precision placement and the bump operating mode provides the user with production speed  
Depths can be easily referenced utilising numbered dial and user does not sacrifice performance when changing depths  
Provides easy access to the nosepiece for the simple removal of a jammed fastener without the use of screwdrivers or tool wrenches

**Standard Equipment:** 30 minute charger, 2 batteries, Heavy duty carrying case

Nail Diameter	1.2 mm
Battery Capacity	NiMH 2.6 Ah
Magazine angle	0°
Nail Length	16-50 mm
Magazine capacity	110 Nails
Magazine loading	Side Load
Firing mode	Bump & Sequential
Length x Width x Height	295 x 95 x 290 mm
Weight	3.0 kg
Nailer Operating Mode	Selective
Integrated Belt Hook	Yes
Jam Clearing	Yes



\*DC602KB not available in the UK

## 12 Volt 600 ml Satchet and 310 ml Cartridge Cordless Sealant Gun

DC542K/ DC542\*



2900 N push force suitable for high viscosity urethanes and adhesives  
Variable speed control dial for pre-selection of dispensing speed  
Electronic trigger with variable speed & automatic overload protection  
Ergonomic T-handle design with rubber grip for extra comfort

**Standard Equipment:** 1 hour charger, 1 battery, Satchet barrel, Cartridge holder, Conversion kit

Battery Capacity	2.6 Ah
Carrier Size	310-600 ml
Applicator	Cartridge & Satchet
Push Force	2900 N (295Kg)
Push Speed	584 mm/min
Weight	3.1/2.4* kg
Length x Height	734 x 322 mm



\*DC542 sold as bare unit, DC542K, DC542 not available in the UK

**12 Volt 310 ml Cartridge Sealant Gun**

**DC540K/ DC540\***



2900 N push force suitable for high viscosity urethanes and adhesives  
 Variable speed control dial for pre-selection of dispensing speed  
 Electronic trigger with variable speed & automatic overload protection  
 Ergonomic T-handle design with rubber grip for extra comfort

**Standard Equipment:** 1 hour charger, 1 battery, Cartridge holder

Battery Capacity	2.6 Ah
Carrier Size	310 ml
Applicator	Cartridge
Push Force	2900 N (295Kg)
Push Speed	584 mm/min
Weight	2.8/2.1 kg
Length x Height	472 x 322 mm



\*DC540K, DC540 not available in the UK

**12 Volt Heavy Duty Flexible Flashlight - Bare Unit**

**DW915\***



Wide angle beam with metal reflector and Xenon bulbs for greater brightness  
 Spare extra-bright xenon bulb inside lens cover so a replacement is always on-hand.  
 Flashlight with flexible neck for multi-directional hands-free lighting  
 Lockable head clip offers versatility and convenience of a lantern

Bulb Type	Xenon
Battery Type	12 V V
Weight	0.45 kg
Length x Height	130 x 180 mm

\*Spare bulb available - DE9043

**12 Volt Flashlight - Bare Unit**

**DW904\***



Wide angle beam with metal reflector and Xenon bulbs for greater brightness  
 Flashlight with 90 degree pivoting head and 5 set positions for multi directional lighting (including horizontal and vertical lighting)  
 Compact, lightweight design with impact resistant housing  
 On board spare bulb storage

Bulb Type	Xenon
Battery Type	12 V V
Weight	0.34 kg
Length x Height	85 x 240 mm

\*Spare bulb available - DE9043

**12 / 14.4 Volt Fluorescent Light - Bare Unit**

**DC528N\***



Compact, lightweight design with impact resistant housing  
 Battery and charger sold separately  
 Rubber overmold for increased durability  
 4 prong bulb for added bulb stability

Bulb Type	Fluorescent
Battery Type	12 / 14.4 V
Weight	0.5 kg
Length x Height	155 x 370 mm

\*Spare bulb available - DE5273

**7.2 Volt Two Position Screwdriver**

**DW920K**



Hinged handle with position lock for two grip positions (in-line and pistol grip)  
 15 position adjustable torque control for consistent screwdriving into a variety of materials with different screw sizes  
 Variable speed and reverse switch for added versatility  
 Electronic motor brake for better control

**Standard Equipment:** 1 hour charger, 1 battery, Heavy duty carrying case

Battery Capacity	NiCd 1.3 Ah
Tool Holder	(Hex) 6.35 mm
Power Output	125 Watts
No Load Speed	0-500 rpm
Max Torque	10 Nm
Weight	1 kg
Length x Height	355 x NA mm



3.6 Volt Compact 3 Position Screwdriver

DC600KA



A 3 position locking pivot operated from left or right and a gearbox diameter of only 40 mm for easy access to the tightest of working spaces with maximum user control  
Two speed control and 8 torque settings ideal for screwdriving applications and pilot drilling  
Pistol grip, soft grip handle and a rapid actuation switch for superior ergonomics and maximum user control in any working position  
Quick release 6.35 mm magnetic collet for ease of use and convenience

**Standard Equipment:** 1 hour charger, 2 batteries, Screwdriver bit, Heavy duty carrying case

Battery Capacity	NiCd 1.2 Ah
Tool Holder	(Hex) 6.35 mm
No Load Speed	200/600 rpm
Max Torque	6 Nm
Weight	0.7 kg
Length x Height	300 x 65 mm



Multi Chemistry Corded/Cordless Radio Charger

DC013



Runs off mains and 7.2 Volt to 18 Volt Li-ION/NiCd/NiMH batteries  
Blow molded protective roll cage with 6 impact resistance points for maximum job site durability  
Charges DEWALT 7.2 Volt to 18 Volt Li-ION/NiCd/NiMH batteries  
High efficiency weather resistant speakers with bass ports and bass boost for maximum job site listening experience

**Standard Equipment:** No batteries included

Battery	Li-ION/NiMH/NiCd
Radio Power Source	AC - DC
Radio Frequencies	AM- FM Stereo
Charging Time	30-70 min
Length x Height	490 x 290 mm
Weight	6.7 kg

LITHIUM ION NIMH NiCd

Cordless or Corded Wet/Dry Vacuum

DC500



Runs off of 12-18 Volt DeWALT battery packs or mains supply  
High efficiency filter traps 99.7% of dust as fine as 0.3 Microns  
Vacuums Wet or Dry without the need to change the filter  
Heavy Duty Washable Filter

**Standard Equipment:** No batteries included, 2 metre heavy duty rubber hose, Crevice tool, Wide nozzle, Dust extraction adaptor

Voltage	12-18 V
Battery	Not included
Power Input	300 Watts
Max. Airflow	15.9 l/sec
Tank volume	7.5 l
Power Source	AC/DC
Hose Nozzle Outside Diameter	32 mm
Blower	Yes
Length x Height	390 x 360 mm
Weight	4.6 kg

LITHIUM ION NIMH NiCd

Cordless / Corded Area Flashlight

DC019\*



Runs off mains and 12 Volt to 18 Volt DeWALT LiIon / NiCd / NiMH batteries  
Compact and lightweight design provides quick and easy transport and storage  
Spring-loaded battery holder keeps battery in place when transporting from place to place

**Standard Equipment:** No batteries included

Power Source	12 - 18 V DC - AC
Voltage	12 - 18 V
Battery	Not included
Bulb Type	Fluorescent
Brightness	2700 Lumens
Charge time	NA hr
Weight	2.2 kg
Length x Height	165 x 159 mm

LITHIUM ION NIMH NiCd

\*DC019 not available in the UK

Cordless / Corded Area Light

DC020\*



Runs off of mains and 12 Volt to 18 Volt DEWALT Li-Ion / NiCd / NiMH battery packs  
2 power outlets offer more versatility for jobsite power  
Compact, lightweight design provides quick and easy fold up, transport and storage  
Spring loaded battery hold down keeps batteries in place when transporting around the jobsite

**Standard Equipment:** No batteries included

Power Source	12 - 18V DC - AC
Voltage	12 - 18 V
Battery	Not included
Bulb Type	Fluorescent
Brightness	2700 Lumens
Charge time	NA hr
Weight	2.4 kg
Length x Height	165 x 159 mm

LITHIUM ION NIMH NiCd

\* Battery and charger sold separately



**10.8 Volt 10mm Compact Drill Driver** **DCD710S2**



Powerful 10.8V drill driver for drilling and screwdriving applications  
 15 Position adjustable torque control for consistent screwdriving into a variety of materials with different screw sizes  
 Ergonomic handle and rubber overmold to provide ultimate end user comfort  
 Parabolic switch profile allowing for greater control over speed of application

**Standard Equipment:** 40 min charger, 2 Batteries, Kit box

Battery Capacity	1.3 Ah
Chuck Capacity	1.5 - 10 mm
Power Output	180 (MWO) Watts
No Load Speed	0-400/0-1500 rpm
Max Torque	25 Nm
Max. Drilling Capacity [Wood]	19 mm
Max. Drilling Capacity [Metal]	10 mm
Weight	1.1 kg
Length x Height	185 x 195 mm



**10.8 Volt Screwdriver** **DCF610S2**



Powerful 10.8V Screwdriver for screwdriving & drilling applications  
 15 Position adjustable torque control for consistent screwdriving into a variety of materials with different screw sizes  
 6.35mm 'drop in' keyless hex driver allows for quick, one handed fitment  
 3 LED 'Halo' ring provides maximum illumination to work piece

**Standard Equipment:** 40 min charger, 2 x 10.8V 1.3Ah Li-Ion batteries, Kit box

Battery Capacity	1.3 Ah
Bit Holder	6.35mm
Power Output	154 Watts
No Load Speed	0-1050 rpm
Max Torque	8 Nm
Weight	0.96 kg
Length x Height	158 x 190 mm



**10.8 Volt Compact Impact Driver** **DCF815S2**



Compact, durable design delivers 107Nm of torque  
 Parabolic switch profile allowing for greater control over speed  
 6.35mm 'drop in' keyless hex driver allows for quick, one handed fitment  
 3 LED 'Halo' ring provides maximum illumination to work piece

**Standard Equipment:** 40 min charger, 2 Batteries, Kit Box

Battery Capacity	1.3 Ah
Bit Holder	1/4" (6.35mm)
Power Output	147 Watts
No Load Speed	0-2450 rpm
Impacts per Minute	3400 ipm
Max Torque	107 Nm
Max. Bolt Diameter	6mm
Weight	1.04 kg
Length x Height	158 x 195 mm



**10.8 Volt Compact LED Flashlight - Bare Unit** **DCL510N\***



Compact, lightweight design with impact resistant housing  
 Flashlight head can rotate 180 degrees horizontally  
 Flashlight head also rotates 180 degrees vertically with ratchet lock  
 Flashlight has belt clip, magnetic mount or can be free standing.

Bulb Type	LED
Battery chemistry	Li-Ion
Height x Length	123 x 52 mm
Weight	0.15 kg
Battery Type	10.8 V



\*Battery and charger sold separately

10.8 Volt Compact Impact Driver/Screwdriver Twin Pack

DCK210S2\*



DCF815 10.8V Impact driver delivering 107Nm torque, 2450 RPM with 3400 BPM.  
 DCF610 10.8V Screwdriver delivering 0 - 1050 rpm.  
 Both tools feature 6.35mm 'drop in' hex retention, allowing 25mm bits to be inserted directly.  
 3 LED 'Halo' ring provides maximum illumination to work piece

**Standard Equipment:** 1 x DCF815 10.8V Compact Cordless Impact Driver, 1 x DCF610 10.8V Compact Cordless Screwdriver, 2 x 10.8V 1.3Ah Li-Ion batteries, 1 x 10.8V 40min charger, 1 x Heavy Duty Kit Bag

Voltage	10.8 V
Battery Capacity	1.3 Ah



\*DCK210S2 not available in the UK

10.8 Volt Compact Drill Driver/Impact Driver Twin Pack

DCK211S2



DCF815 10.8V Impact driver delivering 107Nm torque, 0-2450 RPM with 3400 BPM.  
 DCD710 10.8V Drill driver with 10mm chuck and 0-450/1500 RPM  
 DCD710 features 15+1 position adjustable torque control  
 DCF815 features 3 LED 'Halo' ring, providing maximum illumination to work piece.

**Standard Equipment:** 1 x DCD710 10.8V 10mm Compact cordless drill driver, 1 x DCF815 10.8V Compact Cordless Impact Driver, 2 x 10.8V 1.3Ah Li-Ion batteries, 1 x 10.8V 40min charger, 1 x Heavy Duty Kit Bag

Voltage	10.8 V
Battery Capacity	1.3 Ah



DEWALT Cordless Battery System

			Amp Hours	1 hour	1 hour	40 minutes	1 hour	1 hour	1 hour	1 hour	1 hour	40 minutes
NiCd			DE9000	DE0246	DE9135	DE9136	DC013	DE9116	DE9216	DCB100		
	<b>NiCd</b>	7.2V DE9057 1.3 Ah			✓	✓	✓	✓	✓			
		9.6V DE9062 1.3 Ah	9.6V DE9061 2.0 Ah			✓	✓	✓	✓	✓		
		12V DE9074 1.3 Ah	12V DE9071 2.0 Ah			✓	✓	✓	✓	✓		
		14.4V DE9094 1.3 Ah	14.4V DE9091 2.0 Ah			✓	✓	✓	✓	✓		
		18V DE9098 1.3 Ah	18V DE9095 2.0 Ah			✓	✓	✓	✓	✓		
		24V DE0243 2.0 Ah	24V DE0242 2.4 Ah		✓							
					DE9000	DE0246	DE9135	DE9136	DC013	DE9116	DE9216	DCB100
							✓	✓	✓	✓	✓	
	<b>NiMH</b>	12V DE9501 2.6 Ah			✓	✓	✓	✓	✓			
		14.4V DE9502 2.6 Ah			✓	✓	✓	✓	✓			
		18V DE9503 2.6 Ah			✓	✓	✓	✓	✓			
		24V DE0241 3.0Ah		✓								
			DE9000	DE0246	DE9135	DE9136	DC013	DE9116	DE9216	DCB100		
					✓	✓	✓					
	<b>COMPACT LITHIUM ION</b>	14.4V DE9141 1.1Ah			✓	✓	✓					
		18V DE9181 1.1Ah			✓	✓	✓					
			DE9000	DE0246	DE9135	DE9136	DC013	DE9116	DE9216	DCB100		
	<b>LITHIUM ION</b>	18V DE9180 2.0 Ah			✓	✓	✓					
		14V DE9140 2.0Ah			✓	✓	✓					
		28V DE9280 2.2Ah	✓									
		36V DE9360 2.2Ah	✓									
			DE9000	DE0246	DE9135	DE9136	DC013	DE9116	DE9216	DCB100		
	<b>10.8V LITHIUM ION</b>	10.8V DCB121 1.3 Ah								✓		

**Horizontal and Vertical Rotary Laser Kit**

**DW079PKH**



Fully self-levelling horizontal and vertical rotary laser for internal and external applications  
 Levelling accuracy of 0.1 mm/m combined with DeWALT durability  
 Built in beam-splitting prism allows easy 90° lay out and plumb up applications  
 The remote control features a manual button to allow the user to tilt the laser plane in the X and Y axis

**Standard Equipment:** DW079KH, Digital Detector (DE0772-XJ), Combi grade rod (DE0737-XJ), Heavy duty telescopic tripod (DE0735-XJ), Gradient bracket (DE0738-XJ), Wireless (IR) remote control, 18 Volt 2.6Ah NiMH battery, 1 hour charger, Laser target card, Wall mount, Laser enhancement glasses, Heavy duty carrying case

Laser class	3R, <5mW
Levelling accuracy	+/- 0.1 mm/m
Self-levelling range	+/- 5°
Indoor visibility range	30 m
Max. Working Range with Receiver	300 m
Rotation speed	0, 10, 50, 200, 600 rpm
Sloping range in X and Y axis	+/- 5°
Power Source	9.6V - 18V, NiCd/NiMH/Li-ion DeWALT batteries
Tripod connection	5/8"
Weight	2.0 kg
Length x Height	305 x 190 mm



**Horizontal and Vertical Self-Levelling Rotary Laser**

**DW079KH\***



Fully self-levelling horizontal and vertical rotary laser for internal and external applications  
 Levelling accuracy of 0.1 mm/m combined with DeWALT durability  
 Built in beam-splitting prism allows easy squaring and plumb bob applications  
 The remote control features a manual button to allow the user to tilt the laser plane in both X and Y axis

**Standard Equipment:** Wireless (IR) remote control, 18 Volt 2.6Ah NiMH battery, 1 hour charger, Wall mount, Laser target card, Laser enhancement glasses, Digital detector (DE0772-XJ), Heavy duty carrying case

Laser class	3R, <5mW
Levelling accuracy	+/- 0.1 mm/m
Self-levelling range	+/- 5°
Indoor visibility range	30 m
Max. Working Range with Receiver	300 m
Rotation speed	0, 10, 50, 200, 600 rpm
Sloping range in X and Y axis	+/- 5°
Power Source	9.6V - 18V, NiCd/NiMH/Li-ion DeWALT batteries
Tripod connection	5/8"
Weight	2.0 kg
Length x Height	305 x 190 mm

\*DW079KH not available in the UK



**Self-Levelling Horizontal and Vertical Rotary Laser Kit**

**DW075PK**



Fully automatic horizontal and vertical rotary laser  
 Levelling accuracy of 0.2mm/m  
 Wireless (IR) remote control operated scan mode generates a line between two points for an extremely bright beam over long distances which can then be moved by the user leaving hands free  
 Built in beam splitting prism allows easy squaring applications

**Standard Equipment:** DW075 transmitter, Laser Detector, Wall mount, Laser target card, Laser enhancement glasses, Heavy duty carrying case, Construction grade rod, Construction tripod

Laser class	3R, <5mW
Levelling accuracy	+/- 0.2 mm/m
Self-levelling range	+/- 5°
Indoor visibility range	15 m
Max. Working Range with Receiver	100 m
Rotation speed	0, 60, 600 rpm
Power Source	2 x D
Tripod connection	5/8"



**Self-Levelling Horizontal Rotary Laser**

**DW074K**



Fully automatic horizontal laser  
 Vertical manual levelling via easy to operate adjustment buttons, no dials for faster set up  
 Levelling accuracy of 0.2mm/m  
 Protected rotary head and weather proof design deliver class-leading exterior jobsite durability

**Standard Equipment:** DW074 transmitter, Laser Detector, Wall mount, Laser target card, Laser enhancement glasses, Heavy duty carrying case

Laser class	3R, <5mW
Levelling accuracy	+/- 0.2 mm/m
Self-levelling range	+/- 5°
Indoor visibility range	15 m
Max. Working Range with Receiver	100 m
Rotation speed	0, 60, 600 rpm
Power Source	2 x D
Tripod connection	5/8"



Laser Plumb Bob

DW082K



Self-levelling plumb bob is accurate to  $\pm 0.2$  mm/m  
 Self-levelling up to 4 degrees surface angle, finds plumb in seconds - no vials or knobs to adjust  
 One button operation is fast and easy to use  
 Focused laser beam keeps dot small even over long distances for improved accuracy and visibility

**Standard Equipment:** 4 x AA size alkaline batteries, Heavy duty carrying case

Laser class	2, <1mW
Levelling Accuracy	+/- 0.2 mm/m
Self-levelling range	+/- 4 °
Number of beams	2
Direction of beams	up/down
Indoor visibility range	15 m
Power Source	6V - 4x AA
Tripod connection	1/4"
Weight	0.46 kg
Length x Height	108 x 125 mm



Self Levelling Plumb, Level and Square 4 Beam Laser Pointer

DW084K



Self levelling 4 beam laser is accurate to  $\pm 0.2$  mm/m  
 Self levelling up to 4 degrees surface angle, finds plumb in seconds - no vials or knobs to adjust  
 One button operation is fast and easy to use  
 Focused laser beam keeps dots small even over long distances for improved accuracy and visibility

**Standard Equipment:** 4 x AA size alkaline batteries, Heavy duty carrying case

Laser class	2, <1mW
Levelling Accuracy	+/- 0.2 mm/m
Self-levelling range	+/- 4 °
Number of beams	4
Direction of beams	up/down/level/square
Indoor visibility range	25 m
Power Source	6V - 4x AA
Tripod connection	1/4"
Weight	0.55 kg
Length x Height	128 x 100 mm



Laser Distance Measurer

DW030P



Laser distance measurer (LDM) manufactured to withstand the inevitable drops, falls and knocks on the Job site  
 It has a range of up to 30m and at this distance the unit will have an accuracy variance no greater than 3mm  
 The unit has raised, oversized buttons to avoid miss measures  
 'One button, one function' when selecting the unit to give linear meter readings, square meter calculations and cubic metre calculations. It will add or subtract readings and calculate distance in Metric and Imperial.

**Standard Equipment:** 2 x 1.5v dc LR03 (AAA-size) batteries, Horizontal Belt Pouch, Wrist Lanyard

Laser class	Class 2
Levelling Accuracy	3mm @ 30m
Number of beams	1
Indoor visibility range	30m m
Power Source	2 x 1.5v dc LR03 (AAA-size) batteries
Weight	0.15 with batteries kg
Length x Height	115mm x 26mm mm

26 x Auto Level Package

DW096PK



26 x magnification for 100 m+ range  
 360° horizontal circle for precise measuring of horizontal angles  
 Vial set-up with final 1° self levelling capability for extra ease of use  
 Magnetically dampened compensator that maintains compensation over product life and for easy setup with optimum range and accuracy

**Standard Equipment:** Heavy duty 2.44 m aluminum grade rod, Aluminium construction tripod, String plumb bob, Heavy duty carrying case

Levelling Type	Auto
Magnification	26x
Accuracy	2 mm
Range	100 m
Stadia Ratio	1:100
Horizontal Circle Type	Continuous Drive
Weight	1.72 kg
Length x Height	207 x 145 mm



Self-Levelling Line Laser (Horizontal and Vertical)

DW087K



Self-levelling cross line laser is accurate to  $\pm 0.3$  mm/m in levelling applications  
 Self-levelling up to 4 degrees surface angle with automatic out of level indication, marks a levelled line in seconds  
 2 button operation and low battery indication for ease of use  
 Built in magnetic pivot bracket mounts easily on metal surfaces

**Standard Equipment:** 3 x AA size alkaline batteries, Wall mount bracket, Heavy duty carrying case

Laser class	2, <1mW
Accuracy	+/- 0.3 mm/m
Number of beams	2
Direction of beams	vertical/level
Indoor visibility range	15 m
Self-Levelling Range	+/- 4°
Power Supply	4.5V - 3x AA
Tripod connection	1/4"
Weight	0.46 kg
Length x Height	112 x 113 mm



**Tile Laser**

**DW060K**



Beams cross at 90 degrees for precision set out.  
Thin narrow beams aid alignment and increase accuracy.  
One button operation for easy of use.  
Cast Aluminium Body for increased accuracy and job site durability.

**Standard Equipment:** 2 x C-size alkaline batteries, Target card, Heavy duty carrying case

Laser class	2, <1mW
Accuracy	+/- 0.2 mm/m
Number of beams	2
Direction of beams	Forward
Indoor visibility range	15 m
Power Supply	3v - 2 x C
Tripod connection	No
Weight	1.26 kg
Length x Height	285 x 95 mm



**Laser Level Attachments**

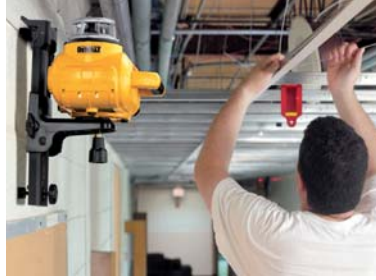

DE0735



DE0736



DE0842



DE0841



DE0734



DE0737



DE0772



DE0738



DE0730



DE0731



Cat. No.	Description
DE0730	Laser Target Card
DE0734	Aluminium Construction Grade Rod
DE0735	Elevated Laser Construction Tripod
DE0736	Aluminium Construction Tripod
DE0737	2.4m Construction Grade Rod
DE0738	Gradient Setting Bracket
DE0772	Waterproof Digital Laser Detector with Clamp
DE0841	Lightweight 1/4 inch Mini Tripod
DE0842	Floor to Ceiling 1/4 inch Laser Pole
DE0731	5/8" to 1/4" tripod adaptor

**Drywall Screwdriver**

**DW274K / DW274KN\***



Ideal for fastening drywall and panels to wooden or metal studs  
Removable depth sensitive "set and forget" nosepiece for consistent fastener depth  
Lightweight and compact design to reduce user fatigue and increase productivity  
Soft grip surface on handle and switch to reduce vibration and enhance user comfort

**Standard Equipment:** Depth sensitive nose, Screwdriver bit holder & Ph2 screwdriver bit, Belt clip, Heavy duty carrying case

Max Torque	10 Nm
Power Input	540 Watts
Power Output	295 Watts
No Load Speed	0-4000 rpm
Max. Screw Diameter	4.8 mm
Tool Holder	(Hex) 6.35 mm
Weight	1.3 kg
Length x Height	306 x 186 mm



\*Available with silent clutch as N version, DW274KN not available in the UK

**High Speed Drywall Screwdriver**

**DW275K / DW275KN\***



Ideal for fastening drywall and panels to wooden or metal studs  
Removable depth sensitive "set and forget" nosepiece for consistent fastener depth  
High speed for increased productivity  
Lightweight and compact design to reduce user fatigue and increase productivity

**Standard Equipment:** Depth sensitive nose, Screwdriver bit holder & Ph2 screwdriver bit, Belt clip, Heavy duty carrying case

Max Torque	10 Nm
Power Input	540 Watts
Power Output	295 Watts
No Load Speed	0-5300 rpm
Max. Screw Diameter	4.8 mm
Tool Holder	(Hex) 6.35 mm
Weight	1.3 kg
Length x Height	306 x 186 mm



\*Available with silent clutch as N version, DW275K, DW275KN not available in the UK

**Versaclutch Screwdriver**

**DW268K\***



Ideal for screwdriving applications in wood, plastic and metal  
Versatile tool with torque control up to 26 Nm  
Unique Versa Clutch Torque Control System allows a torque level to be set whilst maintaining an override capability for driving screws into material of inconsistent density such as wood  
Lightweight and compact design to reduce user fatigue and increase productivity

**Standard Equipment:** Heavy duty carrying case

Max Torque	4-26 Nm
Power Input	540 Watts
Power Output	295 Watts
No Load Speed	0-2500 rpm
Max. Screw Diameter	6.3 mm
Tool Holder	(Hex) 6.35 mm
Weight	1.3 kg
Length x Height	301 x 187 mm



\*DW268K not available in the UK

**High Torque Versaclutch Screwdriver**

**DW269K\***



Ideal for screwdriving applications in wood, plastic and metal  
Versatile tool with torque control up to 42 Nm  
Unique Versa Clutch Torque Control System allows a torque level to be set whilst maintaining an override capability for driving screws into material of inconsistent density such as wood  
Lightweight and compact design to reduce user fatigue and increase productivity

**Standard Equipment:** Heavy duty carrying case

Max Torque	4-42 Nm
Power Input	540 Watts
Power Output	295 Watts
No Load Speed	0-1000 rpm
Max. Screw Diameter	6.3 mm
Tool Holder	(Hex) 6.35 mm
Weight	1.3 kg
Length x Height	301 x 187 mm



\*DW269K not available in the UK

**Screwdriver for Self Drilling Screws**

**DW263K\***



Ideal for fascia, cladding and roofing applications  
Specially designed for working with self-drilling screws  
Removable depth sensitive "set and forget" nosepiece for consistent fastener depth  
Lightweight and compact design to reduce user fatigue and increase productivity

**Standard Equipment:** 8 mm magnetic bit holder for self drilling screws, nose adaptors (13 mm, 15 mm), Depth sensitive nose, Heavy duty carrying case

Max Torque	14.5 Nm
Power Input	540 Watts
Power Output	295 Watts
No Load Speed	0.2500 rpm
Max. Screw Diameter	6.3 mm
Tool Holder	(Hex) 6.35 mm
Weight	1.3 kg
Length x Height	301 x 186 mm



\*DW263K not available in the UK

**High Torque Screwdriver for Self Drilling Screws**

**DW264K\***



Ideal for fascia, cladding and roofing applications  
Specially designed for working with self-drilling screws  
Removable depth sensitive "set and forget" nosepiece for consistent fastener depth  
Lightweight and compact design to reduce user fatigue and increase productivity

**Standard Equipment:** 8 mm magnetic bit holder for self drilling screws, nose adaptors (13 mm, 15 mm), Depth sensitive nose, Heavy duty carrying case

Max Torque	18 Nm
Power Input	540 Watts
Power Output	295 Watts
No Load Speed	0.2000 rpm
Max. Screw Diameter	6.3 mm
Tool Holder	(Hex) 6.35 mm
Weight	1.3 kg
Length x Height	301 x 186 mm



\*DW264K not available in the UK

**Heavy Duty Impact Wrench 1/2"**

**DW292**



440 Nm of deliverable torque in forward and reverse  
Higher torque and faster speed increased productivity  
Soft grip handle to reduce vibrations and to enhance user comfort  
Robust design for increased durability

**Standard Equipment:** 1/2 inch ring retainer

Max Torque	440 Nm
Power Input	710 Watts
Power Output	370 Watts
No Load Speed	2200 rpm
Impacts per Minute	2700 ipm
Max. Bolt Diameter	M20
Bit Holder	1/2"
Weight	3.2 kg
Length x Height	292 x 216 mm



**Heavy Duty Impact Wrench 3/4"**

**DW294**



440 Nm of deliverable torque in forward and reverse  
Robust 3/4" anvil  
Compact and light weight to reduce user fatigue  
Soft grip handle to reduce vibrations and to enhance user comfort

**Standard Equipment:** 3/4 inch ring retainer

Max Torque	440 Nm
Power Input	710 Watts
Power Output	370 Watts
No Load Speed	2200 rpm
Impacts per Minute	2700 ipm
Max. Bolt Diameter	M20
Bit Holder	3/4"
Weight	3.2 kg
Length x Height	292 x 216 mm



**IMPACT SOCKETS**



**DEWALT Extreme Impact Rated sockets provide maximum durability.**

- Manufactured to the highest standards to ensure long life and durability
- Clear, laser etched diameter markings on each socket
- Designed for use with 1/2" drive wrenches, but also comes with 1/4" to 1/2" adaptor

For the complete range of Impact Sockets see page 131

13 mm Mixer and Rotary Drill

D21520



Variable speed reversing switch offers greater control for a wider range of applications  
 550 RPM provides increased torque for heavy duty drilling and mixing  
 Robust design and metal gear case for greater durability  
 2-position rear spade handle and 3-position side handle gives greater control

**Standard Equipment:** 3-position side handle, 2-position rear handle, Chuck key with holder

Chuck Capacity	2.0-13 mm
Spindle Thread	5/8" x 16 U.N.F.
Tool Holder	Keyed Chuck
Power Input	710 Watts
Power Output	560 Watts
Max Torque	50 Nm
No Load Speed	0-550 rpm
Max. Capacity	160 mm
Weight	3.4 kg
Length x Height	400 x 215 mm



Mixer with M14 Fitment

D21510



Ideal for mixing viscous materials like paints, mortar, drywall compound, etc.  
 Forward operation only  
 550 RPM provides increased torque for heavy duty mixing  
 Uses mixer baskets up to 160mm (M14 thread)

**Standard Equipment:** 3-position side handle, 2-position rear handle, M14 connector

Spindle Thread	5/8" x 16 U.N.F.
Tool Holder	M14
Power Input	710 Watts
Power Output	560 Watts
Max Torque	50 Nm
No Load Speed	0-550 rpm
Max. Capacity	160 mm
Weight	3.0 kg
Length x Height	420 x 215 mm



Heavy Duty Morse Taper (No 2) Mixer and Rotary Drill

DW152



Drilling large holes up to 23 mm diameter in metal  
 Two speed and high torque for continuous drilling even through hard materials  
 Ergonomic breast plate and two side handles for adjustment of the working position  
 No.2 Morse Taper tool holder for heavy duty applications

**Standard Equipment:** 2 side handles, Breast plate, Morse taper-M14 adaptor, Drift key

Tool Holder	No. 2 morse taper
Power Input	1050 Watts
Power Output	680 Watts
Max Torque	118/58 Nm
No Load Speed	400/800 rpm
Max. Capacity	53 mm
Weight	7.5 kg
Length x Height	435 x 605 mm



650W 13mm Percussion Drill

DWD024/ DWD024K/ DWD024S/ DWD024KS\*



Low weight ensures the drill is easy to use and it reduces user fatigue  
 Compact design enables comfortable use and allows access to tight spaces  
 An excellent power to size ratio results in a powerful, durable drill in a compact size  
 Trigger sensitive variable speed switch allows a user to drill slowly for precision accuracy when starting to drill a hole

**Standard Equipment:** Chuck key, Multi-position side handle, Depth stop

Chuck Capacity	1.5-13 mm
Power Input	650 Watts
Power Output	302 Watts
Max Torque	8.6 Nm
No Load Speed	0-2800 rpm
Blows per Minute	47600 bpm
Max. Drilling Capacity [Wood]	25 mm
Max. Drilling Capacity [Steel]	13 mm
Max. Drilling Capacity [Concrete]	16 mm
Spindle Thread	1/2" x 20 U.N.F.
Weight	1.82 kg
Length x Height	255 x 180 mm

\*Available with heavy duty carrying case as K version and with keyless chuck as S version, DWD024, DWD024S, DWD024KS not available in the UK

701 Watt single speed Percussion Drill

D21717K/ D21716/ D21716K\*



More powerful for heavy duty applications  
 Soft grip to enhance user comfort  
 Jampat construction design for added durability and ease of service  
 Variable speed control with forward and reverse mode to suit different materials

**Standard Equipment:** keyless chuck, multi-position side handle, depth stop, kitbox

Chuck Capacity	1.5-13 mm
Power Input	701 Watts
Power Output	360 Watts
Max Torque	12 Nm
No Load Speed	0-2600 rpm
Blows per Minute	0-44200 bpm
Max. Drilling Capacity [Wood]	30 mm
Max. Drilling Capacity [Steel]	13 mm
Max. Drilling Capacity [Concrete]	16 mm
Spindle Thread	1/2" x 20 U.N.F.
Weight	1.8 kg
Length x Height	280 x 185 mm

\*Available with heavy duty carrying case as K version and with keyless chuck as D21716, D21717K not available in the UK





**650 W - 2 Speed Percussion Drill**

**D21721K / D21720K / D21720\***



Very compact and lightweight to enhance user comfort  
Two speed gearbox for increased torque and more versatility  
Variable speed control with forward and reverse mode to suit different materials  
Dust sealed switch for added durability

**Standard Equipment:** Keyless Chuck, kitbox, multi position side-handle, depth stop



Chuck Capacity	1.5-13 mm
Power Input	650 Watts
Power Output	325W Watts
Max Torque	30/12 Nm
No Load Speed	0-1100 / 0-2600 rpm
Blows per Minute	0-19000 / 0-44200 bpm
Max. Drilling Capacity [Wood]	40/25 mm
Max. Drilling Capacity [Steel]	13 mm
Max. Drilling Capacity [Concrete]	16 mm
Spindle Thread	1/2" x20 U.N.F.
Weight	2.1 kg
Length x Height	330 x 199 mm

\*Available with heavy duty carrying case as K version and with keyed chuck as D21720, D21720K, D21720 not available in the UK

**770 W - 2 Speed Percussion Drill**

**D21805 / D21805K / D21805KS\***



Two speed gearbox for increased torque  
Improved drilling performance due to new motor wind  
Improved ergonomics with new polymer gear case  
New gear design to give improved life

**Standard Equipment:** Keyed chuck, Chuck key, Multi-position side handle, Depth stop



Chuck Capacity	1.5-13 mm
Power Input	770 Watts
Power Output	425 Watts
Max Torque	40/20 Nm
No Load Speed	0-1100 / 0-2700 rpm
Blows per Minute	0-18700 / 0-45900 bpm
Max. Drilling Capacity [Wood]	35 mm
Max. Drilling Capacity [Steel]	13 mm
Max. Drilling Capacity [Concrete]	20 mm
Spindle Thread	1/2" X 20 U.N.F.
Weight	2.3 kg
Length x Height	352 x 199 mm

\*Available with heavy duty carrying case as K version and with keyless chuck as S version, D21805, D21805K not available in the UK

**950 W - 2 Speed Percussion Drill**

**DWD522KS\***



Improved drilling performance from powerful new motor gives improved performance in heavy duty applications  
Innovative mode selection collar allows intuitive control for optimal performance  
Two speed gearbox for increased versatility  
Mechanical clutch increases user control and protection

**Standard Equipment:** multi-position side handle, depth stop, Heavy Duty Carrying Case.



Chuck Capacity	1.5-13 mm
Power Input	950 Watts
Power Output	415 Watts
Max Torque	40/20 Nm
No Load Speed	0-1250 0-3500 rpm
Blows per Minute	0-56000 bpm
Max. Drilling Capacity [Wood]	40 mm
Max. Drilling Capacity [Steel]	13 mm
Max. Drilling Capacity [Concrete]	20 mm
Spindle Thread	1/2" X 20 U.N.F.
Weight	2.8 kg
Length x Height	370 x 210 mm

\*DWD522KS not available in the UK

**1100 W - 2 Speed Pistol Percussion Drill**

**DWD524KS**



Improved drilling performance from powerful new motor gives improved performance in heavy duty applications  
Innovative mode selection collar allows intuitive control for optimal performance  
Two speed gearbox for increased versatility  
Mechanical clutch increases user control and protection

**Standard Equipment:** multi-position side handle, depth stop, Heavy Duty Carrying Case.



Chuck Capacity	1.5-13 mm
Power Input	1100 Watts
Power Output	540 Watts
Max Torque	40/20 Nm
No Load Speed	0-1200 0-3500 rpm
Blows per Minute	0-5600 bpm
Max. Drilling Capacity [Wood]	40 mm
Max. Drilling Capacity [Steel]	13 mm
Max. Drilling Capacity [Concrete]	20 mm
Spindle Thread	1/2" X 20 U.N.F.
Weight	2.8 kg
Length x Height	370 x 210 mm

**EXTREME MASONRY DRILL BITS**



**Extreme DeWalt Masonry Drill Bits offer class-leading percussion drilling performance:**

- Last up to 2x longer than a standard masonry bit
- Optimum carbide grade maximizes durability
- Ideal for drilling for anchors, plastic fixings, and pipe-work clearance holes

For the complete range of EXTREME Masonry drill bits see page 105

1100 W - 2 Speed Mid-Handle Percussion Drill

DWD525KS



Improved drilling performance from powerful new motor gives improved performance in heavy duty applications  
Two speed gearbox for increased versatility  
Mechanical clutch increases user control and protection  
Innovative mode selection collar allows intuitive control for optimal performance

**Standard Equipment:** multi-position side handle, depth stop, Heavy Duty Carrying Case.

Chuck Capacity	1.5-13 mm
Power Input	1100 Watts
Power Output	540 Watts
Max Torque	40/20 Nm
No Load Speed	0-1250 0-3500 rpm
Blows per Minute	0-56000 bpm
Max. Drilling Capacity [Wood]	40 mm
Max. Drilling Capacity [Steel]	13 mm
Max. Drilling Capacity [Concrete]	20 mm
Spindle Thread	1/2" X 20 U.N.F
Weight	2.8 kg
Length x Height	345 x 225 mm



1300 W - 2 Speed Percussion Drill

DWD530KS\*



Improved drilling performance from powerful new motor gives improved performance in heavy duty applications  
Two speed gearbox for increased versatility  
Electro-Mechanical clutch increases user control and protection  
Innovative mode selection collar allows intuitive control for optimal performance

**Standard Equipment:** multi-position side handle, depth stop, Heavy Duty Carrying Case.

Chuck Capacity	1.5-13 mm
Power Input	1300 Watts
Power Output	680 Watts
Max Torque	40/20 Nm
No Load Speed	0-1100 0-2700 rpm
Blows per Minute	0-56000 bpm
Max. Drilling Capacity [Wood]	40 mm
Max. Drilling Capacity [Steel]	13 mm
Max. Drilling Capacity [Concrete]	20 mm
Spindle Thread	1/2" X 20 U.N.F
Weight	2.8 kg
Length x Height	370 x 215 mm



\*DWD530KS not available in the UK

2 Speed Dry Diamond Drill with 16mm Keyed Chuck

D21570K



New motor gives improved performance in applications with dry core bits up to 127 mm in bricks or soft masonry  
Two speed gearbox for increased versatility when drilling in wood, metal and concrete with standard drill bits  
Heavy duty 16mm keyless steel chuck allows quick bit change whilst offering excellent bit retention  
Innovative mode selection collar allows intuitive control for optimal performance

**Standard Equipment:** Multi-Position side handle, Depth Stop, Heavy Duty Carrying Case

Spindle Thread	1/2" X 20 U.N.F
Power Input	1300 Watts
Power Output	680 Watts
No Load Speed	0-1100 0-2700 rpm
Max. Drilling Capacity [Masonry]	100 mm
Weight	2.4 kg
Length x Height	352 x 215 mm



10mm 0-2800rpm Rotary Drill

DWD014/ DWD014S\*



Compact design enables comfortable one handed use and allows access to tight spaces  
Low weight ensures the drill is easy to use and it reduces user fatigue  
Variable speed dial switch ensures control to suit different hole sizes in different materials  
Trigger sensitive variable speed switch allows a user to drill slowly for precision accuracy when starting to drill a hole

**Standard Equipment:** Chuck key

Chuck Capacity	1.0-10 mm
Power Input	550 Watts
Power Output	269 Watts
Max Torque	7.9 Nm
No Load Speed	0-2800 rpm
Max. Drilling Capacity [Wood]	25 mm
Max. Drilling Capacity [Steel]	10 mm
Spindle Thread	1/2" X 20 U.N.F
Weight	1.34 kg
Length x Height	225 x 170 mm



\*Available with keyless chuck as S version, DWD014, DWD014S not available in the UK

10 mm Rotary Drill with Keyed Chuck

DWD112/ DWD112S\*



Rubber grip gives maximum comfort to the user while drilling  
Ideal for use in a woodworking or light metal fabrication workshop to drill small holes into wood or sheet metal  
Size, balance and weight designed for one handed operation  
Variable speed switch control to suit different materials

Chuck Capacity	1.0-10 mm
Power Input	701 Watts
Power Output	358 Watts
Max Torque	10.9 Nm
No Load Speed	0-2500 rpm
Max. Drilling Capacity [Wood]	25 mm
Max. Drilling Capacity [Steel]	10 mm
Spindle Thread	1/2" X 20 U.N.F
Weight	1.8 kg
Length x Height	230 x 190 mm

\*Available with keyless chuck as S version, DWD112, DWD112S not available in the UK

**10 mm Mid-Handle Rotary Drill**

**DWD115KS\***



Rubber grip gives maximum comfort to the user while drilling  
 Ideal for use in a woodworking or light metal-fabrication workshop to drill small holes into wood or sheet metal  
 All metal 10 mm keyless chuck for quick and easy bit change  
 Well balanced mid-handle design similar to a cordless drill

**Standard Equipment:** Kitbox

Chuck Capacity	1.0-10 mm
Power Input	701 Watts
Power Output	358 Watts
Max Torque	10.9 Nm
No Load Speed	0-2500 rpm
Max. Drilling Capacity [Wood]	25 mm
Max. Drilling Capacity [Steel]	10 mm
Spindle Thread	1/2" X 20 U.N.F
Weight	1.9 kg
Length x Height	230 x 190 mm

\*DWD115KS not available in the UK



**High Speed Rotary Drill**

**DW217\***



Ideal for high speed drilling of small, precise holes in metal or wood  
 High overload capacity motor prevents failure in heavy duty applications  
 10 mm keyless chuck for quick and easy bit change with one hand to aid productivity  
 Heavy duty metal gear box for added durability

**Standard Equipment:** None

Chuck Capacity	0.5-10 mm
Power Input	675 Watts
Power Output	340 Watts
Max Torque	8.2 Nm
No Load Speed	0-4000 rpm
Max. Drilling Capacity [Wood]	20 mm
Max. Drilling Capacity [Steel]	8 mm
Spindle Thread	3/8" x 24 U.N.F
Weight	1.2 kg
Length x Height	247 x 177 mm

\*DW217 not available in the UK



**Rotary Drill**

**DW221\***



Ideal for drilling applications in wood, aluminium, soft steel and alloys  
 High overload capacity motor prevents failure in heavy duty applications  
 10 mm keyless chuck with innovative spindle lock system for quick and easy bit change with one hand to aid productivity  
 Heavy duty metal gear box for added durability

**Standard Equipment:** None

Chuck Capacity	1.5-10 mm
Power Input	701 Watts
Power Output	385 Watts
Max Torque	13.8 Nm
No Load Speed	0-2500 rpm
Max. Drilling Capacity [Wood]	25 mm
Max. Drilling Capacity [Steel]	10 mm
Spindle Thread	1/2" x 20 U.N.F
Weight	1.3 kg
Length x Height	275 x 190 mm

\*DW221 not available in the UK



**Rotary Drill for Stainless Steel**

**DW236i\***



Ideal for drilling large holes in stainless steel  
 High overload capacity motor prevents failure in heavy duty applications  
 13 mm keyless chuck with innovative spindle lock system for quick and easy bit change with one hand to aid productivity  
 Heavy duty metal gear box for added durability

**Standard Equipment:** Multi-position side handle, 6 piece cobalt drill bit set

Chuck Capacity	1.5-13 mm
Power Input	701 Watts
Power Output	385 Watts
Max Torque	35.8 Nm
No Load Speed	0-850 rpm
Max. Drilling Capacity [Wood]	30 mm
Max. Drilling Capacity [Steel]	13 mm
Spindle Thread	1/2" x 20 U.N.F
Weight	1.6 kg
Length x Height	295 x 198 mm

\*DW236i not available in the UK



**770 W - 2 Speed Rotary Drill with Clutch**

**D21441\***



Ideal for use in heavy steel fabrication  
 Two speed gearbox for increased torque  
 Improved drilling performance due to new motor wind  
 New patented ball clutch to give greater user control

**Standard Equipment:** Multi-position side handle, Depth stop

Chuck Capacity	1.5-13 mm
Power Input	770 Watts
Power Output	425 Watts
Max Torque	40/20 Nm
No Load Speed	0-1100 / 0-2700 rpm
Max. Drilling Capacity [Wood]	35 mm
Max. Drilling Capacity [Steel]	13 mm
Spindle Thread	1/2" x 20 U.N.F
Weight	2.2 kg
Length x Height	352 x 199 mm

\*D21441 not available in the UK



**High Torque Rotary Drill**

**DW246\***



Ideal for use in steel fabrication and construction industry  
 High overload capacity motor prevents failure in heavy duty applications  
 13 mm keyless chuck with innovative spindle lock system for quick and easy bit change with one hand to aid productivity  
 High torque for easy conversion to light duty mixer supported by a triple gear reduction

**Standard Equipment:** Multi-position side handle

Chuck Capacity	1.5-13 mm
Power Input	701 Watts
Power Output	385 Watts
Max Torque	57.3 Nm
No Load Speed	0-600 rpm
Max. Drilling Capacity [Wood]	35 mm
Max. Drilling Capacity [Steel]	13 mm
Spindle Thread	1/2" x 20 U.N.F
Weight	1.6 kg
Length x Height	310 x 195 mm



\*DW246 not available in the UK

**Low Speed Electronic Rotary Drill**

**DWD221\***



Ideal for use in steel fabrication and construction industry  
 High overload capacity motor prevents failure in heavy duty applications  
 13 mm keyless chuck with innovative spindle lock system for quick and easy bit change with one hand to aid productivity  
 e-clutch feature automatically switches off the unit in case of jammed drill bits to prevent motor overload and increase user protection

**Standard Equipment:** Multi-position side handle

Chuck Capacity	1.5-13 mm
Power Input	800 Watts
Power Output	385 Watts
Max Torque	57.3 Nm
No Load Speed	0-650 rpm
Max. Drilling Capacity [Wood]	38 mm
Max. Drilling Capacity [Steel]	13 mm
Spindle Thread	1/2" x 20 U.N.F
Weight	2.3 kg
Length x Height	310 x 215 mm



\*DWD221 not available in the UK

**10 mm Right Angle Rotary Drill**

**D21160\***



Ideal for working in tight or narrow spaces  
 Compact and lightweight design for easy handling  
 The full body paddle switch supports the natural shape of your hand and ensures less user fatigue for prolonged use  
 High torque to enable larger diameter hole drilling

**Standard Equipment:** Chuck keys

Chuck Capacity	1.0-10 mm
Power Input	350 Watts
Power Output	180 Watts
Max Torque	9.2 Nm
No Load Speed	0-1200 rpm
Max. Drilling Capacity [Wood]	20 mm
Max. Drilling Capacity [Steel]	10 mm
Spindle Thread	3/8" x 24 U.N.F
Weight	1.7 kg
Length x Height	262 x 50 mm

\*230V only

**2 Speed Magnetic Drill Press - 50 mm**

**D21620K\***



Delivers high level of performance for fast, clean and accurate drilling into steel  
 Compact and light weight unit which is both easy to transport and easy to position for drilling.  
 The universal quick release cutter holder is quick and easy to operate : no Allen key needed. It accepts any annular cutter with 19 mm round shank (Weldon) with one or more flats.  
 No volt switch prevents inadvertent restart after power failure

**Standard Equipment:** Quick release cutter holder, Gravity fed cutting fluid tank, Reversible press handle, Drilling guard, Safety strap, Heavy duty carrying case

Power Input	1150 Watts
Spindle Thread	1/2" x 20 UNF
No Load Speed	350/650 rpm
Cutter holder	19mm Weldon shank (3/4")
Max cutting depth with cutters	50 mm
Max cutting diameter with cutters	50 mm
Drill point pressure	317 Kg
Clamping force	10000 N
Length of drill stroke	147 mm
Weight	13 kg
Magnetic base dimensions	180 x 84 mm



\*D21620K not available in the UK

**HSS-G JOBBER METAL DRILL BITS**



**DEWALT HSS-G Jobber Metal Drill Bits offer rapid drilling, long life and excellent hole concentricity.**

- Precision ground from solid stock to 118 degree point angle
- Diameter tolerance to h8
- Suitable for portable or stationary drilling in steel cast steel, alloyed and non-alloyed, grey cast iron etc... up to 900N/mm<sup>2</sup>

For the complete range of HSS-G JOBBER metal drill bits see pages 117/118

**DRY**

Do you drill only into soft materials such as bricks, Poroton blocks, light breezeblock or limestone?

You need a Dry Drilling System

**NO**  
See below

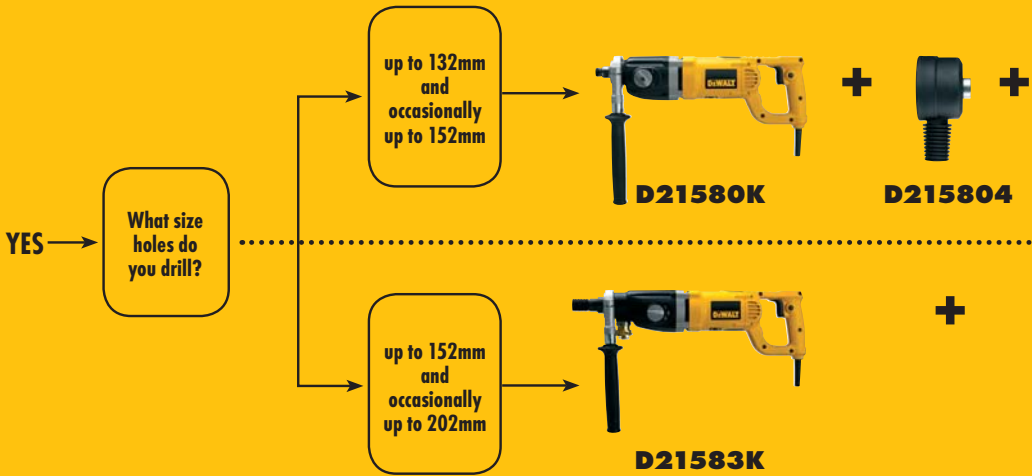

**WET**

Do you drill into hard materials such as reinforced concrete, natural stones or engineering bricks?

You need a Wet Drilling System

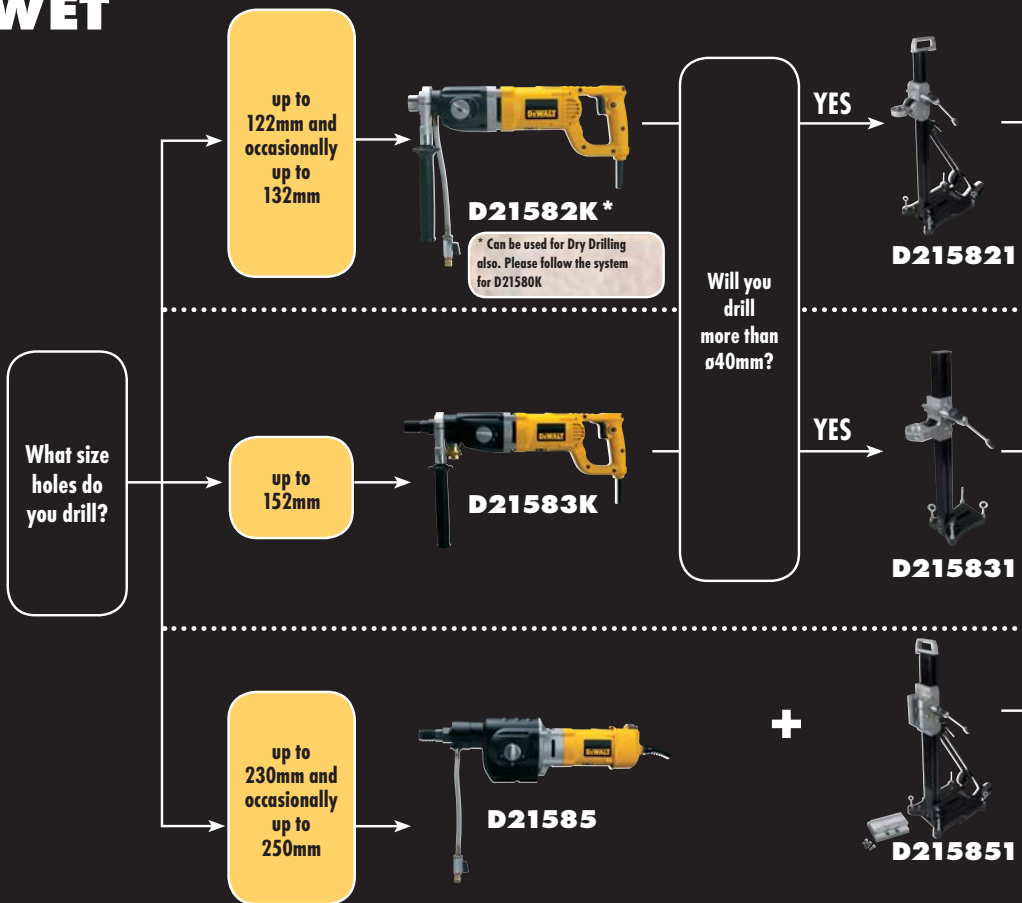



**D27902**



**D27902**

Will you drill more than  $\phi 100\text{mm}$ ?

NO



**D215821**

YES



**D215831**

YES

NO

ADAPTOR/PILOT BIT REQUIRED



**DT3823 & DT3848/9\***

OPTIONAL EXTENSION



**DT3844 (250mm)**



**DT3844 (250mm)**



**DT3844 (250mm)**



**DT3857 & DT3823 & DT3848**



**DT3844 (250mm)**

Go to page 169 to select your core

\*Longer pilot drill bit (DT3849) required when using D215804 dust extraction adaptor

Have you got mains water supply?

NO



**D215824**

NO



**D215824**

NO



**D215824**

Do you need to collect water afterwards to keep the working area clean?

YES



**D215822**

YES



**D215832**

YES



**D215852**



**D27902**



**D27902**



**D27902**

OPTIONAL EXTENSION



**DT3846 (150mm) or DT3847 (300mm)**



**1/2" BSP cores: DT3846 (150mm) or DT3847 (300mm)**

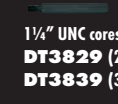

**1/4" UNC cores: DT3829 (200mm) or DT3839 (300mm)**

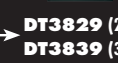

**DT3829 (200mm) or DT3839 (300mm)**

Go to 1/2" BSP fitment cores on page 170

This drill will accept either 1/2" BSP or 1/4" UNC cores please go to page 170

Go to 1/4" UNC fitment cores on page 170

**1705 W - 2 Speed Dry Diamond Drill**

**D21580K**



Ideal tool for electrical, plumbing or HVAC applications when drilling only into masonry and bricks  
Quick and accurate core drilling into brick and masonry up to 152 mm  
Increased power makes the job easier and faster  
Overload and thermal protection increase the life of the tool

**Standard Equipment:** Multi-position side handle, Heavy duty carrying case

Spindle Thread	1/2" Male BSP
Power Input	1705 Watts
Power Output	1150 Watts
No Load Speed	0-1100/0-2350 rpm
Max. Drilling Capacity [Masonry]	152 mm
Collar Diameter	53 mm
Weight	5.4 kg
Length x Height	480 x 165 mm



**1705 W - 2 Speed Wet & Dry Diamond Drill**

**D21582K\***



Ideal tool for electrical, plumbing or HVAC applications when drilling into masonry and concrete  
Quick and accurate dry drilling into bricks and masonry up to 152 mm  
Integrated water swivel for core drilling into harder material up to 132 mm such as natural stone, concrete, engineering bricks and reinforced concrete  
Increased power makes the job easier and faster

**Standard Equipment:** Multi-Position side handle, PRCD (in-line circuit breaker), Water supply hose with integrated tap, Heavy duty carrying case

Spindle Thread	1/2" Female BSP
Power Input	1705 Watts
Power Output	1150 Watts
No Load Speed	0-1100 / 0-2350 rpm
Max. Drilling Capacity [Concrete]	132 mm
Max. Drilling Capacity [Masonry]	152 mm
Collar Diameter	53 mm
Weight	5.9 kg
Length x Height	480 x 165 mm

\*110V only



**1910 W - Heavy Duty 3 Speed Wet & Dry Diamond Drill**

**D21583K\***



Ideal tool for heavy duty electrical, plumbing or HVAC applications when drilling predominantly into concrete  
Integrated water swivel for core drilling into the hardest material up to 152 mm such as natural stone, concrete, engineering brick and reinforced concrete  
Quick and accurate core drilling into brick and masonry up to 202 mm  
When dry drilling, a dust extractor can be plugged directly onto the drill to increase drilling performance

**Standard Equipment:** Multi-position side handle, PRCD (in-line circuit breaker), Connector for water supply, Connector for dust extraction, Heavy duty carrying case

Spindle Thread	1 1/4" Male UNC & 1/2" Female BSP
Power Input	1910 Watts
Power Output	1300 Watts
No Load Speed	0-1000 / 0-2400 / 0-4600 rpm
Max. Drilling Capacity [Concrete]	152 mm
Max. Drilling Capacity [Masonry]	202 mm
Collar Diameter	60 mm
Weight	6.4 kg
Length x Height	550 x 165 mm

\*110V only



**2500 W - Heavy Duty 3 Speed Wet Diamond Drilling Motor**

**D21585\***



Ideal tool for heavy duty electrical, plumbing, HVAC or general construction applications when drilling into concrete  
Integrated water swivel for core drilling into any material up to 250 mm  
High powered motor delivers best in class performance for frequent Heavy duty drilling  
3 Mechanical speeds deliver optimum drilling speed

**Standard Equipment:** PRCD (in-line circuit breaker), Water supply hose with integrated tap

Spindle Thread	1 1/4" Male UNC
Power Input	2500 Watts
Power Output	1500 Watts
No Load Speed	500 / 1200 / 2000 rpm
Max. Drilling Capacity [Concrete]	250 mm
Max. Drilling Capacity [Masonry]	300 mm
Collar Diameter	N/A mm
Weight	11.2 kg
Length x Height	570 x 160 mm

\*D21585 not available in the UK



**Small Drilling Stand - 53 mm Collar**

**D215821**



Ideal for occasional drilling of large holes into concrete or masonry  
Small and compact for easy transport to the job site  
Smooth sliding carriage delivers best in class drilling accuracy  
Reversible press handle offers tool-free handle set-up

Column Length	680 mm
Collar Diameter	53 mm
Max Drilling Diameter with Water Collector	102 mm
Max Drilling Diameter without Water Collector	152 mm
Weight	7 kg

Medium Drilling Stand with integrated vacuum base - 60 mm Collar

D215831



For heavy duty drilling into masonry and concrete  
Quick release tool holder allows a quick set up on the jobsite  
Support brackets increase the rigidity of the column  
Integrated vacuum base for an even quicker set up (vacuum pump required)

Column Length	995 mm
Collar Diameter	60 mm
Max Drilling Diameter with Water Collector	152 mm
Max Drilling Diameter without Water Collector	172 mm
Inclinable	45 °
Weight	16 kg

Stand for Drilling Motor (D21585)

D215851



For heavy duty drilling into masonry and concrete with D21585 drilling motor  
Large base delivers higher stability and improved drilling accuracy  
Integrated vacuum base for an even quicker set up (vacuum pump required)  
Support brackets increase the rigidity of the column

Column Length	995 mm
Collar Diameter	-
Max Drilling Diameter with Water Collector	250 mm
Max Drilling Diameter without Water Collector	300 mm
Inclinable	45 °
Weight	22 kg

250mm Slide Table Wet Tile Saw & Leg Stand

D24000S



Stainless steel rail system is integrated into the tile saw frame, ensuring accurate cuts  
Cantilevering rail / cart system allows for 610 mm ripping capacity  
Low weight allows one person to transport and set up saw  
Plunge feature allows the user to make quick plunge cuts for electrical outlets together with an integrated 45 / 22.5 degree feature for quick angle cuts

Power Input	1600 Watts
Wheel Diameter	250 mm
No Load Speed	4200 rpm
Depth of cut	95 mm
Width x Length	690 x 860 mm
Weight	32 kg

Standard Equipment: D240001 leg stand, DT3734 cutting disc, Extension table, Side and rear water collector, Hex key



110 mm Hand Held Wet Tile Saw

DWC410\*



1300 W motor delivers the cutting power to cut through granite, porcelain, concrete and other stone materials  
Premium 110 mm diameter continuous rim blade allows the user to cut a variety of different materials from ceramics to concrete up to 34 mm deep - wet or dry  
Water line and adjustable nozzle feeds water to the blade decreasing dust and increasing blade performance and life  
Bevels to 45 degrees for quick angled cuts

Power Input	1300 Watts
Power Output	800 Watts
Wheel Diameter	110 mm
No Load Speed	13000 rpm
Depth of cut	34 mm
Length x Height	252 x 166 mm
Weight	3.0 kg

Standard Equipment: 110 mm wet / dry continuous rim diamond blade, Water feed line, Tools for blade change



\*For information on Diamond Blades - see page 168

Mechanical Anchoring for Diamond Drill Stands

Vacuum Pump and Attachments for Diamond Drills

Diamond Drill Attachments



D215826



D215825



D215837

D215839



D215834



D215854

Cat. No.	Description	Fits
D215825	Fastening set for concrete	D215821 / D215831 / D215851
D215826	Fastening set for masonry	D215821 / D215831 / D215851
D215827	10 x spare dowels for concrete	D215825
D215828	Spare dowel for masonry	D215826

Cat. No.	Description	Fits
D215837	Vacuum pump	D215831 / D215851
D215838	Spare 3 m vacuum hose	D215837
D215839	Vacuum set (seal and valve)	D215831
D215859	Vacuum set (seal and valve)	D215851

Cat. No.	Description	Fits
D215834	Reduction ring 60 to 53 mm collar	D215831
D215835	Quick action bracing bracket	D215821 / D215831 / D215851
D215854	5 Copper ring for 1 1/4" core bits	D21583K / D21585



**22 mm SDS-Plus Rotary Hammer**

**D25012K/ D25012N\***



Drilling 4-22mm diameter anchor holes into concrete and masonry  
Impact stop for drilling in wood, steel, plastic and screwdriving applications  
Variable speed switch and full power in forward and reverse for total control  
Very compact design and low weight

**Standard Equipment:** Multi-position side handle, Depth stop, Heavy duty carrying case

Power Input	650 Watts
Power Output	300 Watts
No Load Speed	0-1550 rpm
Blows per Minute	0-4150 bpm
Impact Energy	0-2.4 J
Tool Holder	SDS-Plus
Max. Drilling Capacity [Wood]	30 mm
Max. Drilling Capacity [Metal]	13 mm
Max. Drilling Capacity [Concrete]	22 mm
Max. Drilling Capacity [Core bit]	50 mm
Weight	2.3 kg
Length x Height	325 x 210 mm

\*D25012K, D25012N not available in the UK



**22 mm SDS-Plus Combination Hammer**

**D25013K/ D25013C/ D25013N\***



Drilling 4-22mm diameter anchor holes into concrete and masonry...  
Impact stop for drilling in wood, steel, plastic and screwdriving applications  
Rotation stop for light chiselling in concrete and masonry  
Variable speed switch and full power in forward and reverse for total control

**Standard Equipment:** Multi-position side handle, Depth stop, Heavy duty carrying case

Power Input	650 Watts
Power Output	300 Watts
No Load Speed	0-1550 rpm
Blows per Minute	0-4550 bpm
Impact Energy	0-2.4 J
Tool Holder	SDS-Plus
Max. Drilling Capacity [Wood]	30 mm
Max. Drilling Capacity [Metal]	13 mm
Max. Drilling Capacity [Concrete]	22 mm
Max. Drilling Capacity [Core bit]	50 mm
Weight	2.3 kg
Length x Height	325 x 210 mm

\*Available with 3 jaws keyed chuck and SDS-Plus adaptor as C version, D25013C, D25013N not available in the UK



**26mm Heavy Duty SDS-Plus Combination Hammer**

**D25123K**



Ideal for drilling anchor and fixing holes into concrete and masonry from 4 to 26 mm in diameter  
Impact-stop for drilling in wood, steel, ceramic and screwdriving applications  
Rotation-stop for light chiselling applications in brick, soft masonry and occasionally concrete  
Large 22 mm hammer mechanism delivers high performance with low stress to the critical components resulting in better durability

**Standard Equipment:** Multi position side handle, Depth stop, Heavy duty carrying case

Power Input	800 Watts
Power Output	395 Watts
No Load Speed	0-1150 rpm
Blows per Minute	0-4300 bpm
Impact Energy	0-3.4 J
Tool Holder	SDS-Plus
Max. Drilling Capacity [Wood]	30 mm
Max. Drilling Capacity [Metal]	13 mm
Max. Drilling Capacity [Concrete]	26 mm
Max. Drilling Capacity [Core bit]	65 mm
Weight	2.9 kg
Length x Height	352 x 200 mm



**26mm Heavy Duty SDS-Plus Combination Hammer with Quick Change Chuck**

**D25124K**



Ideal for drilling anchor and fixing holes into concrete and masonry from 4 to 26 mm in diameter  
Rotation-stop for light chiselling applications in brick, soft masonry and occasionally concrete  
Impact-stop and Quick Change Removable Chuck for drilling in wood, steel, ceramic and screwdriving applications  
Large 22 mm hammer mechanism delivers high performance with low stress to the critical components resulting in better durability

**Standard Equipment:** "Quick Change" 13 mm 3-jaw keyless chuck, Multi-Position side handle, Depth stop, Heavy duty carrying case

Power Input	800 Watts
Power Output	395 Watts
No Load Speed	0-1150 rpm
Blows per Minute	0-4300 bpm
Impact Energy	0-3.4 J
Tool Holder	SDS-Plus
Max. Drilling Capacity [Wood]	30 mm
Max. Drilling Capacity [Metal]	13 mm
Max. Drilling Capacity [Concrete]	26 mm
Max. Drilling Capacity [Core bit]	65 mm
Weight	2.9 kg
Length x Height	352 x 200 mm



**26mm SDS-Plus Combination Hammer D-Handle Low Vibration**

**D25223K**



Ideal for drilling holes and fixing anchors into concrete and masonry from 4 to 26 mm in diameter  
The "D-handle" design makes it particularly suitable for vertical down drilling  
Active Vibration Control system with floating handle delivers extremely low vibration and more comfort  
Rotation-stop for light chiselling applications in soft masonry and occasionally concrete and impact-stop for drilling in wood, steel and screwdriving applications

**Standard Equipment:** Multi-position side handle, Depth stop, Heavy duty carrying case

Power Input	800 Watts
Power Output	395 Watts
No Load Speed	0-1150 rpm
Blows per Minute	0-4300 bpm
Tool Holder	SDS-Plus
Max. Drilling Capacity [Wood]	30 mm
Max. Drilling Capacity [Metal]	13 mm
Max. Drilling Capacity [Concrete]	26 mm
Max. Drilling Capacity [Core bit]	65 mm
Weight	3.2 kg
Length x Height	450 x 200 mm



**26mm L-Shape SDS-Plus Combination Hammer Low Vibration** **D25323K**



Ideal for drilling holes and fixing anchors into concrete and masonry from 4 to 26 mm in diameter  
Active Vibration Control system with floating handle delivers extremely low vibration and more comfort  
Rotation-stop for light chiselling applications in soft masonry and occasionally concrete and impact-stop for drilling in wood, steel and screwdriving applications  
Large 22 mm hammer mechanism delivers high performance with low stress to the critical components

**Standard Equipment:** Multi-position side handle, Depth stop, Heavy duty carrying case

Power Input	800 Watts
Power Output	395 Watts
No Load Speed	0-1150 rpm
Blows per Minute	0-4300 bpm
Impact Energy	0-3.4 J
Tool Holder	SDS-Plus
Max. Drilling Capacity [Wood]	30 mm
Max. Drilling Capacity [Metal]	13 mm
Max. Drilling Capacity [Concrete]	26 mm
Max. Drilling Capacity [Core bit]	65 mm
Weight	3.4 kg
Length x Height	314 x 225 mm



**26mm L-Shape SDS-Plus Combination Hammer with 3 jaw Quick Change Chuck Low Vibration** **D25324K**



Ideal for drilling holes and fixing anchors into concrete and masonry from 4 to 26 mm in diameter  
Active Vibration Control system with floating handle delivers extremely low vibration and more comfort  
Rotation-stop for light chiselling applications in soft masonry and occasionally concrete  
Impact stop and Quick Change Removable Chuck for precise drilling in wood and steel and screwdriving applications

**Standard Equipment:** Multi position side handle, Quick Adjustment depth stop, Quick Change 13 mm 3 Jaw Keyless Chuck for rotary drilling, Heavy duty carrying case

Power Input	800 Watts
Power Output	395 Watts
No Load Speed	0-1150 rpm
Blows per Minute	0-4300 bpm
Impact Energy	0-3.4 J
Tool Holder	SDS-Plus
Max. Drilling Capacity [Wood]	30 mm
Max. Drilling Capacity [Metal]	13 mm
Max. Drilling Capacity [Concrete]	26 mm
Max. Drilling Capacity [Core bit]	65 mm
Weight	3.5 kg
Length x Height	329 x 225 mm



**26mm L-Shape SDS-Plus Combination Hammer Integrated Dust Extraction Low Vibration** **D25325K**



Ideal for drilling holes and fixing anchors into concrete and masonry from 4 to 26 mm in diameter, and up to 16 mm with Dust Extraction System  
Rotation-stop for light chiselling in soft masonry and occasionally concrete and Impact-stop with Quick Change Removal Chuck for precise drilling in wood, steel and screwdriving applications

Active Vibration Control system with floating handle delivers extremely low vibration  
Hepa filter improves dust filtering ensuring minimum dust levels emitted into atmosphere

**Standard Equipment:** Integrated dust extraction system with Hepa filter, Multi position side handle, Quick adjustment depth stop, Quick change 13 mm 3 jaw keyless chuck for rotary drilling, Heavy duty carrying case

Power Input	800 Watts
Power Output	395 Watts
No Load Speed	0-1150 rpm
Blows per Minute	0-4300 bpm
Impact Energy	0-3.4 J
Tool Holder	SDS-Plus
Max. Drilling Capacity [Wood]	30 mm
Max. Drilling Capacity [Metal]	13 mm
Max. Drilling Capacity [Concrete]	26 mm
Max. Drilling Capacity [Core bit]	65 mm
Weight	5.1 kg
Length x Height	462 x 291 mm



**SDS-Plus Dust Extraction Telescope** **D25301D\***



For use with DEWALT corded and cordless SDS-Plus hammers  
Ideal for dust free drilling up to 16 mm in diameter  
Quick-fit system for easy tool free assembly and release  
Tough and versatile to meet the needs of the most demanding applications with a compact design to maintain visibility and extremely light weight to minimise user fatigue

**Standard Equipment:** Side handle with dust extraction adaptation, Telescope and extraction head, Rubber hose, 43mm adaptor, Carton box

Fits	Corded and Cordless SDS-Plus
Collar Diameter	43 / 54 mm
Max. Drill Bit Diameter	16 mm
Max. Drill Bit Length	224 mm
Max. Drilling Depth	150 mm
Hose Length	1500 mm
Hose Diameter	35 mm
Weight	1.2 kg



\*For dust extraction vacuums see page 102

**XLR ACCESSORIES**





**Our ultimate SDS-Plus Concrete drilling solution**

- SOLID CARBIDE head provides long life and extreme durability
- 4 cutter tip geometry provides cleaner, more concentric holes for supreme fixing retention
- 4 flute spiral gives optimum debris removal - for the hardest hitting hammers

For the complete range of XLR drill bits see page 109



**32 mm Heavy Duty SDS-Plus Combination Hammer**

**D25404K**



Ideal for drilling large anchor, fixing and through holes in concrete and masonry from 6 to 32 mm in diameter  
 Rotation-stop for light chiselling applications, render and tile removal  
 Impact-stop for drilling in wood, ceramic, steel and screwdriving applications  
 Large hammer mechanism construction guarantees longer tool life and superior performance

**Standard Equipment:** Quick release removable tool holder, Multi-position side handle, Heavy duty carrying case

Power Input	900 Watts
Power Output	550 Watts
No Load Speed	0-730 rpm
Blows per Minute	0-4100 bpm
Impact Energy	0.4-8 J
Tool Holder	SDS-Plus
Max. Drilling Capacity [Wood]	40 mm
Max. Drilling Capacity [Metal]	16 mm
Max. Drilling Capacity [Concrete]	6-32 mm
Max. Drilling Capacity [Core bit]	90 mm
Weight	4.9 kg
Length x Height	385 x 230 mm



**32mm Heavy Duty SDS-Plus Combination Hammer QCC and Accessory Pack**

**D25405K**



Ideal for drilling large anchor, fixing and through holes in concrete and masonry from 6 to 32mm in diameter  
 Rotation-stop for light chiselling applications, render and tile removal  
 Impact-stop for drilling in wood, ceramic, steel and screwdriving application  
 Large hammer mechanism construction guarantees longer tool life and superior performance

**Standard Equipment:** heavy duty carrying case, multi-position side handle, quick release removable tool holder, quick change 3 jaw chuck, 2 x SDS-Plus drill bits, 20mm flat SDS-Plus chisel, 4 x HSS drill bits, 4 x brad point wood drill bits, 20mm flatwood drill bit, 25mm flatwood drill bit, toughcase accessory organiser, safety glasses, workgloves

Power Input	900 Watts
Power Output	550 Watts
No Load Speed	0-730 rpm
Blows per Minute	0-4100 bpm
Impact Energy	0.4-8 J
Tool Holder	SDS-Plus
Max. Drilling Capacity [Wood]	40 mm
Max. Drilling Capacity [Metal]	16 mm
Max. Drilling Capacity [Concrete]	6-32 mm
Max. Drilling Capacity [Core bit]	90 mm
Weight	4.9 kg
Length x Height	385 x . mm



**40 mm SDS-Max Combination Hammer**

**D25501K**



Ideal for drilling anchor fixing and through holes in concrete and masonry from 12 to 40 mm in diameter. Core drilling up to 90 mm  
 Chain drive improves durability and increases efficiency together with an oil filled gearbox to ensure total component lubrication and superior heat dissipation  
 Ergonomic, compact and slim line design maximises control and offers easy access to confined spaces  
 Excellent power to weight ratio: 11 Joules of impact energy delivered by a 6 kg hammer

**Standard Equipment:** Multi-position side handle with depth stop, Heavy duty carrying case

Power Input	1100 Watts
Power Output	500 Watts
Load Speed	400 rpm
Blows per Minute	2740 bpm
Impact Energy	11 J
Tool Holder	SDS-Max
Max. Drilling Capacity [Concrete]	40 mm
Max. Drilling Capacity [Breakthrough bit]	55 mm
Max. Drilling Capacity [Core bit]	90 mm
Weight	6.15 kg
Length x Height	457 x 245 mm



**45mm SDS-Max Combination Hammer**

**D25601K**



Ideal for drilling anchor fixing and through holes in concrete and masonry from 12 to 45 mm in diameter. Core drilling up to 100 mm  
 Chain drive improves durability and increases efficiency together with an oil filled gearbox to ensure total component lubrication and superior heat dissipation  
 Ergonomic, compact and slim line design maximises control and offers easy access to confined spaces  
 Active Vibration Control system incorporating a floating rear handle and damped side handle to reduce vibration

**Standard Equipment:** Multi-position anti-vibration side handle with depth stop, Heavy duty carrying case

Power Input	1250 Watts
Power Output	615 Watts
Load Speed	210-415 rpm
Blows per Minute	1430-2840 bpm
Impact Energy	2-12 J
Tool Holder	SDS-Max
Max. Drilling Capacity [Concrete]	45 mm
Max. Drilling Capacity [Breakthrough bit]	65 mm
Max. Drilling Capacity [Core bit]	100 mm
Weight	6.8 kg
Length x Height	477 x 245 mm



**45 mm SDS-Max Combination Hammer**

**D25602K**



Ideal for drilling anchor fixing and through holes in concrete and masonry from 12 to 45 mm in diameter. Core drilling up to 100 mm  
 Chain drive improves durability and increases efficiency together with an oil filled gearbox to ensure total component lubrication and superior heat dissipation  
 Active Vibration Control system incorporating a floating rear handle and damped side handle to reduce vibration  
 Complete Torque Control. A patented 2 step clutch allows the user to select one of two settings for different diameter drill and core bits providing the maximum level of protection in all drilling applications

**Standard Equipment:** Multi-position anti-vibration side handle with depth stop, Heavy duty carrying case

Power Input	1250 Watts
Power Output	615 Watts
Load Speed	210-415 rpm
Blows per Minute	1430-2840 bpm
Impact Energy	2-12 J
Tool Holder	SDS-Max
Max. Drilling Capacity [Concrete]	45 mm
Max. Drilling Capacity [Breakthrough bit]	65 mm
Max. Drilling Capacity [Core bit]	100 mm
Weight	6.9 kg
Length x Height	477 x 245 mm



**48 mm SDS-Max Combination Hammer**

**D25711K**



Ideal for drilling anchor fixing and through holes in concrete and masonry from 12 to 48 mm in diameter. Core drilling up to 115 mm  
Active Vibration Control system incorporating a floating handle delivers extremely low vibration  
Electronic variable speed and impact energy control  
Lock-on switch for chipping

**Standard Equipment:** Multi-position side handle, Heavy duty carrying case

Power Input	1250 Watts
Power Output	840 Watts
Load Speed	132-265 rpm
Blows per Minute	1225-2450 bpm
Impact Energy	1.5-13 J
Tool Holder	SDS-Max
Max. Drilling Capacity [Concrete]	48 mm
Max. Drilling Capacity [Breakthrough bit]	80 mm
Max. Drilling Capacity [Core bit]	115 mm
Weight	8.7 kg
Length x Height	528 x 268 mm



**48 mm SDS-Max Combination Hammer**

**D25712K**



Ideal for drilling anchor fixing and through holes in concrete and masonry from 12 to 48 mm in diameter. Core drilling up to 125 mm  
Active Vibration Control system incorporating a counterbalance mass and floating handle delivers extremely low vibration  
Complete Torque Control. A patented 2 step clutch allows the user to select one of two settings for different diameter drill and core bits providing the maximum level of protection in all drilling applications  
Electronic variable speed and impact energy control

**Standard Equipment:** Multi-position side handle, Heavy duty carrying case

Power Input	1300 Watts
Power Output	840 Watts
Load Speed	137-275 rpm
Blows per Minute	1260-2520 bpm
Impact Energy	2.14 J
Tool Holder	SDS-Max
Max. Drilling Capacity [Concrete]	48 mm
Max. Drilling Capacity [Breakthrough bit]	80 mm
Max. Drilling Capacity [Core bit]	125 mm
Weight	9.1 kg
Length x Height	528 x 268 mm



**52 mm SDS-Max Combination Hammer**

**D25762K**



Ideal for drilling anchor fixing and through holes in concrete and masonry from 12 to 52 mm in diameter. Core drilling up to 150 mm  
Active Vibration Control system incorporating a counterbalance mass and floating handle delivers extremely low vibration  
Electronic variable speed and impact energy control  
Complete Torque Control. A patented 2 step clutch allows the user to select one of two settings for different diameter drill and core bits providing the maximum level of protection in all drilling applications

**Standard Equipment:** Multi-position side handle, Heavy duty carrying case

Power Input	1500 Watts
Power Output	980 Watts
Load Speed	125-250 rpm
Blows per Minute	1150-2300 bpm
Impact Energy	3-18 J
Tool Holder	SDS-Max
Max. Drilling Capacity [Concrete]	52 mm
Max. Drilling Capacity [Breakthrough bit]	80 mm
Max. Drilling Capacity [Core bit]	150 mm
Weight	9.9 kg
Length x Height	561 x 272 mm



**3 kg Heavy Duty SDS-Plus L-Shaped Dedicated Chipping Hammer**

**D25330K\***



Ideal for light chiselling applications in brick, light masonry and occasionally concrete  
Quick change chisel adjustment allows fast orientation of the chisel through 12 preset positions  
Large 22 mm hammer mechanism delivers high performance with low stress to the critical components  
Improved sealing for maximum protection from dust ingress ensuring long tool life

**Standard Equipment:** Multi position side handle, Heavy duty carrying case

Power Input	650 Watts
Power Output	400 Watts
Blows per Minute	0-4100 bpm
Impact Energy	0-3.1 J
Tool Holder	SDS-Plus
Weight	3.0 kg
Length x Height	296 x 225 mm



\*D25330K not available in the UK

**SDS-Max Dedicated Chipping Hammer**

**D25831K**



Ideal for light demolition, surface preparation or chiseling grooves and channel openings in brick, masonry and light concrete  
Chain drive improves durability and increases efficiency together with an oil filled gearbox to ensure total component lubrication and superior heat dissipation  
Ergonomic, compact and slim line design maximises control and offers easy access to confined spaces  
Electronic variable speed and impact energy control

**Standard Equipment:** Multi-position side handle, Heavy duty carrying case

Power Input	1250 Watts
Power Output	615 Watts
Blows per Minute	1430-2840 bpm
Impact Energy	2.12 J
Tool Holder	SDS-Max
Weight	6.1 kg
Length x Height	477 x 245 mm



**SDS-Max Dedicated Demolition Hammer**

**D25870K**



Ideal for demolition and surface preparation in brick, masonry and concrete  
Active Vibration Control system incorporating a counterbalance mass and floating handle delivers extremely low vibration  
Variable chisel locking at 24 positions to provide the perfect approach for all applications  
Electronic variable impact energy/speed for total control

**Standard Equipment:** Multi-position side handle, 1 point chisel, Heavy duty carrying case

Power Input	1300 Watts
Power Output	840 Watts
Blows per Minute	1260-2520 bpm
Impact Energy	2-14 J
Tool Holder	SDS-Max
Weight	8.0 kg
Length x Height	528 x 268 mm



**10 kg Demolition Hammer**

**D25899K**



Powerful and durable 1500 Watt motor delivers outstanding concrete breaking performance  
In line design for better handling and quick change chisel adjustment allows fast orientation of the chisel through 12 preset positions  
Magnesium housings ensure maximum durability and minimum weight  
Compact, streamlined design allows access in confined areas

**Standard Equipment:** Multi position side handle, Heavy duty carrying case

Power Input	1500 Watts
Power Output	750 Watts
Blows per Minute	2040 bpm
Impact Energy	25 J
Tool Holder	SDS-Max
Weight	9.6 kg
Length x Height	650 x 250 mm



**10 kg Demolition Hammer**

**D25901K**



Powerful and durable 1500 Watt motor delivers outstanding concrete breaking performance  
Active Vibration Control system incorporating a counterbalance mass and floating handle delivers extremely low vibration  
In line design for better handling and quick change chisel adjustment allows fast orientation of the chisel through 12 preset positions  
Magnesium housings ensure maximum durability and minimum weight

**Standard Equipment:** Multi position side handle, Chisel, Grease, Cloth, Heavy duty carrying case

Power Input	1500 Watts
Power Output	750 Watts
Blows per Minute	1020-2040 bpm
Impact Energy	5-25 J
Tool Holder	SDS-Max
Weight	10.6 kg
Length x Height	690 x 250 mm



**12 kg Demolition Hammer**

**D25941K**



Powerful and durable 1600 Watt motor delivers outstanding concrete breaking performance  
Active Vibration Control system incorporating a counterbalance mass and floating handle delivers extremely low vibration  
In line design for better handling and quick change chisel adjustment allows fast orientation of the chisel through 12 preset positions  
Magnesium housings ensure maximum durability and minimum weight

**Standard Equipment:** Multi position side handle, Pointed chisel, Grease, Cloth, Heavy duty carrying case

Power Input	1600 Watts
Power Output	790 Watts
Blows per Minute	1620 bpm
Impact Energy	30.6 J
Tool Holder	19mm Hex
Weight	13.1 kg
Length x Height	750 x 250 mm



**30 kg Pavement Breaker**

**D25980 / D25980K\***



Large oversize mechanism delivers extreme durability and excellent breaking performance  
2000 Watt motor delivers outstanding efficiency and durability  
Active Vibration Control offers safer, more comfortable use and more productivity  
Suspended Handle System absorbs the rebound and, working with the AVC, delivers the lowest vibration on the market

Power Input	2000 Watts
Power Output	986 Watts
Blows per Minute	870 bpm
Impact Energy	68 J
Tool Holder	28 mm Hex
Weight	31 kg
Length x Height	780 x 620 mm



\*K version comes with trolley (D259801)

For more information on vibration and to calculate the vibration exposure from your power tool visit: [www.DEWALT.co.uk/safety/vibration/calculator](http://www.DEWALT.co.uk/safety/vibration/calculator)

**900 W - 115 mm Small Angle Grinder**

**D28113/ D28113K**



Dust ejection system removes majority of debris from the air which passes over the motor, preventing abrasion and tracking  
 Small girth allow comfortable gripping resulting in superior ergonomics  
 The low profile gear case allows access in confined areas  
 Anti vibration side handle to improve user comfort

**Standard Equipment:** Protective keyless guard, Multi-position anti vibration side handle, Inner and outer disc flange, Spanner

Power Input	900 Watts
No Load Speed	10000 rpm
Max. Disc Diameter	115 mm
Spindle Thread	M14
Weight	2.1 kg
Length x Height	285 x 80 mm



**850 W - 115 mm Small Angle Grinder**

**D28111\***



Small girth allows comfortable gripping resulting in superior ergonomics  
 The low profile gear case allows access in confined areas  
 Abrasion protected motor for increased durability  
 Anti lock flange prevents flanges from permanently locking up and locking the disc on

**Standard Equipment:** Protective guard, Multi-position side handle, Inner and outer disc flange, Spanner

Power Input	850 Watts
No Load Speed	10000 rpm
Max. Disc Diameter	115 mm
Spindle Thread	M14
Weight	2.1 kg
Length x Height	270 x 80 mm



\*D28111 not available in the UK

**1100 W - 115 mm Variable Speed Small Angle Grinder**

**D28116\***



The electronic variable speed control offers added tool control and enables the tool to be used at optimum conditions to suit the accessory and material  
 Electro-mechanical clutch reduces the "kickback" transmitted to the operator if the cutting disc jams  
 No volt release switch will prevent the unit starting when plugged in, even if the switch is in the on position. Switch must be consciously reset before power is delivered  
 Overload protection will prevent the unit over heating by shutting the unit off until the unit has cooled down

**Standard Equipment:** Protective keyless guard, Multi-position anti vibration side handle, Inner and outer disc flanges, Spanner

Power Input	1100 Watts
No Load Speed	2800 - 10000 rpm
Max. Disc Diameter	115 mm
Spindle Thread	M14
Weight	2.3 kg
Length x Height	315 x 80 mm



\*D28116 not available in the UK

**1100 W - 115 mm Variable Speed Autobalancer Small Angle Grinder**

**D28117**



Autobalancer reduces vibration resulting in greater comfort  
 The electronic variable speed control offers added tool control and enables the tool to be used at optimum conditions to suit the accessory and material  
 Electro-mechanical clutch reduces the "kickback" transmitted to the operator if the cutting disc jams  
 No volt release switch will prevent the unit starting when plugged in, even if the switch is in the on position. Switch must be consciously reset before power is delivered

**Standard Equipment:** Protective keyless guard, Multi position anti vibration side handle, Inner and outer disc flanges, Spanner

Power Input	1100 Watts
No Load Speed	2800 - 10000 rpm
Max. Disc Diameter	115 mm
Spindle Thread	M14
Weight	2.5 kg
Length x Height	315 x 90 mm



**850 W - 125 mm Small Angle Grinder**

**D28139\***



Small girth allows comfortable gripping resulting in superior ergonomics  
 The low profile gear case allows access in confined areas  
 Abrasion protected motor for increased durability  
 Anti lock flange prevents flanges from permanently locking up and locking the disc on

**Standard Equipment:** Protective guard, Multi-position side handle, Inner and outer disc flange, Spanner



Power Input	850 Watts
No Load Speed	10000 rpm
Max. Disc Diameter	125 mm
Spindle Thread	M14
Weight	2.1 kg
Length x Height	270 x 80 mm

\*D28139 not available in the UK

**900 W - 125 mm Small Angle Grinder**

**D28130\***



Dust ejection system removes majority of debris from the air which passes over the motor, preventing abrasion and tracking  
 Small girth allow comfortable gripping resulting in superior ergonomics  
 The low profile gear case allows access in confined areas  
 Anti vibration side handle to improve user comfort

**Standard Equipment:** Protective guard, Multi-position anti vibration side handle, Inner and outer disc flange, Spanner



Power Input	900 Watts
No Load Speed	10000 rpm
Max. Disc Diameter	125 mm
Spindle Thread	M14
Weight	2.2 kg
Length x Height	285 x 80 mm

\*D28130 not available in the UK

**1100 W - 125 mm Small Angle Grinder**

**D28134\***



Dust ejection system removes majority of debris from the air which passes over the motor, preventing abrasion and tracking  
 Small girth allow comfortable gripping resulting in superior ergonomics  
 The low profile gear case allows access in confined areas  
 New guard design allows guard fitment, adjustment or removal without the use of tools, for increased flexibility

**Standard Equipment:** Protective keyless guard, Multi-position side handle, Inner and outer disc flange, Spanner



Power Input	1100 Watts
No Load Speed	10000 rpm
Max. Disc Diameter	125 mm
Spindle Thread	M14
Weight	2.2 kg
Length x Height	285 x 80 mm

\*D28134 not available in the UK

**125mm / 115mm Paddle Switch Grinder**

**D28142\***



A non locking paddle switch ensures the grinder switches off automatically when the unit is released  
 Dust ejection system removes majority of debris from the air which passes over the motor, preventing abrasion and tracking  
 Small girth allows user to maintain a comfortable grip, resulting in superior ergonomics  
 Anti-vibration side handle to improve user comfort

**Standard Equipment:** 115mm Protective guard, 125mm Protective guard, Inner and outer disc flange, Spanner, Multi positioned anti vibration side handle



Power Input	1100 Watts
No Load Speed	10000 rpm
Max. Disc Diameter	125 / 115 mm
Spindle Thread	M14
Weight	2.2 kg
Length x Height	285 x 80 mm

\*D28142 not available in the UK

**1200 W - 125 mm Small Angle Grinder**

**D28132C\***



Dust ejection system removes majority of debris from the air which passes over the motor, preventing abrasion and tracking  
 Anti lock flange prevents flanges from permanently locking up  
 Abrasion protected motor for increased durability  
 New guard design allows guard fitment, adjustment or removal without the use of tools, for increased flexibility

**Standard Equipment:** Protective keyless guard, Multi-position anti vibration side handle, Inner and outer disc flange, Spanner



Power Input	1200 Watts
No Load Speed	10000 rpm
Max. Disc Diameter	125 mm
Spindle Thread	M14
Weight	2.5 kg
Length x Height	300 x 80 mm

\*D28132C not available in the UK

## 1500 W - 125 mm Variable Speed Small Angle Grinder

D28136\*



The electronic variable speed control offers added tool control and enables the tool to be used at optimum conditions to suit the accessory and material  
 Electro-mechanical clutch reduces the "kickback" transmitted to the operator if the cutting disc jams  
 No volt release switch will prevent the unit starting when plugged in, even if the switch is in the on position. Switch must be consciously reset before power is delivered  
 Overload protection will prevent the unit over heating by shutting the unit off until the unit has cooled down

**Standard Equipment:** Protective keyless guard, Multi position anti vibration side handle, Inner and outer disc flanges, Spanner

Power Input	1500 Watts
No Load Speed	2800 - 10000 rpm
Max. Disc Diameter	125 mm
Spindle Thread	M14
Weight	2.6 kg
Length x Height	315 x 90 mm



\*D28136 not available in the UK

## 1100 W - 125 mm Electronic Small Angle Grinder

D28133\*



Electro-mechanical clutch reduces the "kickback" transmitted to the operator if the cutting disc jams

No volt release switch will prevent the unit starting when plugged in, even if the switch is in the on position. Switch must be consciously reset before power is delivered

Overload protection will prevent the unit over heating by shutting the unit off until the unit has cooled down

Dust ejection system removes majority of debris from the air which passes over the motor, preventing abrasion and tracking

**Standard Equipment:** Protective keyless guard, Multi position anti vibration side handle, Inner and outer disc flanges, Spanner

Power Input	1100 Watts
No Load Speed	10000 rpm
Max. Disc Diameter	125 mm
Spindle Thread	M14
Weight	2.3 kg
Length x Height	315 x 80 mm



\*D28133 not available in the UK

## 1400 W - 125 mm Small Angle Grinder

D28135 / D28135K\*



Dust ejection system removes majority of debris from the air which passes over the motor, preventing abrasion and tracking

Anti lock flange prevents flanges from permanently locking up and locking the disc on

Abrasion protected motor for increased durability

New guard design allows guard fitment, adjustment or removal without the use of tools, for increased flexibility

**Standard Equipment:** Protective keyless guard, Multi-position anti vibration side handle, Inner and outer disc flanges, Spanner

Power Input	1400 Watts
No Load Speed	10000 rpm
Max. Disc Diameter	125 mm
Spindle Thread	M14
Weight	2.5 kg
Length x Height	300 x 80 mm



\*K version comes with kitbox, D28135 not available in the UK

## 1500 W - 125 mm Variable Speed Autobalancer Small Angle Grinder

D28137\*



Autobalancer reduces vibration resulting in greater comfort

The electronic variable speed control offers added tool control and enables the tool to be used at optimum conditions to suit the accessory and material

Electro-mechanical clutch reduces the "kickback" transmitted to the operator if the cutting disc jams

No volt release switch will prevent the unit starting when plugged in, even if the switch is in the on position. Switch must be consciously reset before power is delivered

**Standard Equipment:** Protective keyless guard, Multi positioned anti vibration side handle, Inner and outer disc flanges, Spanner

Power Input	1500 Watts
No Load Speed	2800 - 10000 rpm
Max. Disc Diameter	125 mm
Spindle Thread	M14
Weight	2.7 kg
Length x Height	315 x 90 mm



\*D28137 not available in the UK



**1400 W - 125 mm Medium Angle Grinder**

**DW831**



Large diameter high power motor for superior performance  
 High temperature resin coated field for increased durability  
 Special air channels designed into field case to optimise motor cooling  
 Spindle lock for quick wheel changes

**Standard Equipment:** Protective guard, Side handle, Inner and outer disc flanges, Spanner

Power Input	1400 Watts
Power Output	900 Watts
No Load Speed	10000 rpm
Max. Disc Diameter	125 mm
Spindle Thread	M14
Weight	3.1 kg
Length x Height	385 x 115 mm



**1250 W - 125 mm Small Angle Grinder**

**D28065**



Dust ejection system removes majority of debris from the air which passes over the motor, preventing abrasion and tracking  
 Ergonomic main handle with rubber grip allows for maximum comfort when grinding for long periods of time  
 Abrasion protected motor for increased durability  
 New guard design allows guard fitment, adjustment or removal without the use of tools, for increased flexibility

**Standard Equipment:** Protective keyless guard, Multi-position anti vibration side handle, Inner and outer disc flanges, Spanner

Power Input	1250 Watts
Power Output	680 Watts
No Load Speed	9000 rpm
Max. Disc Diameter	125 mm
Spindle Thread	M14
Weight	2.6 kg
Length x Height	385 x 110 mm



**1400 W - 150 mm Small Angle Grinder**

**D28141\***



Dust ejection system removes majority of debris from the air which passes over the motor, preventing abrasion and tracking  
 Anti lock flange prevents flanges from permanently locking up and locking the disc on  
 Abrasion protected motor for increased durability  
 New guard design allows guard fitment, adjustment or removal without the use of tools, for increased flexibility

**Standard Equipment:** Protective keyless guard, Multi-position anti vibration side handle, Inner and outer disc flanges, Spanner

Power Input	1400W Watts
No Load Speed	9000 rpm
Max. Disc Diameter	150 mm
Spindle Thread	M14
Weight	2.6 kg
Length x Height	300 x 80 mm



\*D28141 not available in the UK

**1800 W - 180 mm Angle Grinder**

**DW840**



High temperature resin coated field for increased durability  
 Large diameter high power motor for excellent performance  
 Maximum power to weight ratio and superior tool balance  
 Special air channels designed into field case to optimise motor cooling

**Standard Equipment:** Protective guard, Side handle, Inner and outer disc flanges, Spanner

Power Input	1800 Watts
Power Output	1180 Watts
No Load Speed	8000 rpm
Max. Disc Diameter	180 mm
Spindle Thread	M14
Weight	4.0 kg
Length x Height	405 x 120 mm



**DEWALT DIAMOND BLADES**



**The DeWalt Laser range of Diamond Blades is designed to offer the right blade for the right task.**

- Diamond blades containing a high concentration of top quality diamonds for excellent cutting performance in extremely hard materials
- Segments Laser Welded to the core for use in tougher applications
- High quality, low carbon steel core reduces core distortion at high temperatures

For the complete range of diamond blades see page 166-168

2000 W - 180 mm Angle Grinder

D28491\*



Abrasion protected motor for increased durability  
Two position side handle allows the user to optimise handle position to give maximum comfort.  
Spindle lock for quick wheel changes  
Brush window allows quick brush replacement

**Standard Equipment:** Protective guard, Side handle, Inner and outer disc flanges, Spanner

Power Input	2000 Watts
Power Output	1054 Watts
No Load Speed	8500 rpm
Max. Disc Diameter	180 mm
Spindle Thread	M14
Weight	5.5 kg
Length x Height	490 x 151 mm



\*D28491 not available in the UK

2200 W - 180 mm Angle Grinder

D28493\*



Abrasion protected motor for increased durability  
Two position side handle allows the user to optimise handle position to give maximum comfort  
Spindle lock for quick wheel changes  
Brush window allows quick brush replacement

**Standard Equipment:** Protective guard, Side handle, Inner and outer disc flanges, Spanner

Power Input	2200 Watts
Power Output	1246 Watts
No Load Speed	8500 rpm
Max. Disc Diameter	180 mm
Spindle Thread	M14
Weight	5.5 kg
Length x Height	490 x 151 mm



\*D28493 not available in the UK

2200 W - 180 mm Heavy Duty Angle Grinder

D28413\*



Soft start to limit start up current and reduce kick back  
Anti vibration side handle  
Quick adjustment tool free guard  
Abrasion protected high power motor for increased motor durability

**Standard Equipment:** Protective tool free guard, Anti vibration side handle, Inner and outer flange set, Spanner

Power Input	2200 Watts
Power Output	1540 Watts
No Load Speed	8500 rpm
Max. Disc Diameter	180 mm
Spindle Thread	M14
Weight	5.9 kg
Length x Height	450 x 145 mm



\*D28413 not available in the UK

2400 W - 180 mm Heavy Duty Angle Grinder

D28422\*



Soft start to limit start up current and reduce kick back  
Anti vibration side handle  
Quick adjustment tool free guard  
Abrasion protected high power motor for increased motor durability

**Standard Equipment:** Protective tool free guard, Anti vibration side handle, Inner and outer flange set, Spanner

Power Input	2400 Watts
Power Output	1680 Watts
No Load Speed	8500 rpm
Max. Disc Diameter	180 mm
Spindle Thread	M14
Weight	6.5 kg
Length x Height	470 x 145 mm



\*D28422 not available in the UK

2400 W - 180 mm Heavy Duty Angle Grinder with No Volt Release Switch

D28495\*



No volt release switch prevents the unit starting when plugged in, even if the switch is lock on. Switch must consciously reset before power is delivered  
Torque limiting clutch reduces the maximum torque reaction transmitted to the operator if the disc jams  
Overload protection will prevent the motor overheating by shutting off the unit until the unit cools down  
Soft start to limit start-up current and reduce kick back

**Standard Equipment:** Protective keyless guard, Anti vibration side handle, Inner and outer disc flanges, Spanner

Power Input	2400 Watts
Power Output	1246 Watts
No Load Speed	8500 rpm
Max. Disc Diameter	180 mm
Spindle Thread	M14
Weight	5.5 kg
Length x Height	490 x 151 mm



\*D28495 not available in the UK

**2200 W - 230 mm Angle Grinder**

**D28492 / D28492K\***



Abrasion protected motor for increased durability  
 Two position side handle allows the user to optimise handle position to give maximum comfort  
 Spindle lock for quick wheel changes  
 Brush window allows quick brush replacement

**Standard Equipment:** Protective guard, Side handle, Inner and outer disc flanges, Spanner

Power Input	2200 Watts
Power Output	1246 Watts
No Load Speed	6500 rpm
Max. Disc Diameter	230 mm
Spindle Thread	M14
Weight	5.5 kg
Length x Height	490 x 151 mm



\*D28492 not available in the UK

**2000 W - 230 mm Angle Grinder**

**D28490**



Abrasion protected motor for increased durability  
 Two position side handle allows the user to optimise handle position to give maximum comfort  
 Spindle lock for quick wheel changes  
 Brush window allows quick brush replacement

**Standard Equipment:** Protective guard, Side handle, Inner and outer disc flanges, Spanner

Power Input	2000 Watts
Power Output	1054 Watts
No Load Speed	6500 rpm
Max. Disc Diameter	230 mm
Spindle Thread	M14
Weight	5.5 kg
Length x Height	490 x 151 mm



**2000 W - 230 mm Heavy Duty Angle Grinder**

**D28401\***



Quick adjustment tool free guard  
 Abrasion protected high power motor for increased motor durability  
 Five position side handle for improved balance in cutting and grinding applications  
 Cut off brushes to prolong motor life

**Standard Equipment:** Protective tool free guard, Side handle, Inner and outer flange set, Spanner

Power Input	2000 Watts
Power Output	1400 Watts
No Load Speed	6500 rpm
Max. Disc Diameter	230 mm
Spindle Thread	M14
Weight	5.8 kg
Length x Height	450 x 145 mm



\*D28401 not available in the UK

**2000 W - 230 mm Heavy Duty Angle Grinder**

**D28400\***



Soft start to limit start-up current and reduce kick back  
 Quick Adjustment tool free guard  
 Abrasion protected high power motor for increased motor durability  
 Five position side handle for improved balance in cutting and grinding applications

**Standard Equipment:** Protective tool free guard, Side handle, Inner and outer flange set, Spanner

Power Input	2000 Watts
Power Output	1400 Watts
No Load Speed	6500 rpm
Max. Disc Diameter	230 mm
Spindle Thread	M14
Weight	5.9 kg
Length x Height	450 x 145 mm



\*D28400 not available in the UK

2200 W - 230 mm Heavy Duty Angle Grinder

D28414



- Soft start to limit start-up current and reduce kick back
- Anti vibration side handle
- Quick adjustment tool free guard
- Abrasion protected high power motor for increased motor durability

**Standard Equipment:** Protective tool free guard, Anti vibration side handle, Inner and outer flange set, Spanner

Power Input	2200 Watts
Power Output	1540 Watts
No Load Speed	6500 rpm
Max. Disc Diameter	230 mm
Spindle Thread	M14
Weight	6.0 kg
Length x Height	450 x 145 mm



2300 W - 230 mm Heavy Duty Angle Grinder

D28421\*



- Anti vibration side handle
- Quick adjustment tool free guard
- Abrasion protected high power motor for increased motor durability
- Five position side handle for improved balance in cutting and grinding applications

**Standard Equipment:** Protective tool free guard, Anti vibration side handle, Inner and outer flange set, Spanner

Power Input	2300 Watts
Power Output	1610 Watts
No Load Speed	6500 rpm
Max. Disc Diameter	230 mm
Spindle Thread	M14
Weight	6.6 kg
Length x Height	470 x 145 mm



\*D28421 not available in the UK

2400 W - 230 mm Heavy Duty Angle Grinder

D28423\*



- Soft start to limit start-up current and reduce kick back
- Anti vibration side handle
- Seven position rotating back handle
- Quick adjustment tool free guard

**Standard Equipment:** Protective tool free guard, Anti vibration side handle, Inner and outer flange set, Spanner

Power Input	2400 Watts
Power Output	1680 Watts
No Load Speed	6500 rpm
Max. Disc Diameter	230 mm
Spindle Thread	M14
Weight	6.6 kg
Length x Height	490 x 145 mm



\*D28423 not available in the UK

2600 W - 230 mm Heavy Duty Angle Grinder

D28432C\*



- Soft start to limit start-up current and reduce kick back
- Anti vibration side handle
- Seven position rotating back handle
- Quick adjustment tool free guard

**Standard Equipment:** Protective tool free guard, Anti vibration side handle, Inner and outer flange set, Spanner

Power Input	2600 Watts
Power Output	1820 Watts
No Load Speed	6500 rpm
Max. Disc Diameter	230 mm
Spindle Thread	M14
Weight	6.6 kg
Length x Height	490 x 145 mm



\*D28432C not available in the UK

2400 W - 230 mm Heavy Duty Angle Grinder

D28750\*



- Soft start to limit start-up current and reduce kick back
- Anti vibration side handle
- Seven position rotating back handle
- Quick adjustment tool free guard

**Standard Equipment:** Protective tool free guard, Anti vibration side handle, Inner and outer flange set, Spanner

Power Input	2400 Watts
Power Output	1680 Watts
No Load Speed	5000 rpm
Max. Disc Diameter	230 mm
Spindle Thread	M14
Weight	6.6 kg
Length x Height	490 x 145 mm



\*D28750 not available in the UK

**2200 W - 230 mm Low Vibration Heavy Duty Angle Grinder D28415**



Autobalancer gives low vibration (4.1m/s<sup>2</sup> triaxially) resulting in greater end user comfort  
 Soft start to limit start-up current and reduce kick back  
 Anti vibration side handle  
 Quick adjustment tool free guard

**Standard Equipment:** Protective tool free guard, Anti vibration side handle, Inner and outer flange set, Spanner

Power Input	2200 Watts
Power Output	1540 Watts
No Load Speed	6500 rpm
Max. Disc Diameter	230 mm
Spindle Thread	M14
Weight	6.1 kg
Length x Height	450 x 145 mm



**230mm No volt release switch LAG D28498\***



No volt release switch prevents the unit starting when plugged in, even if the switch is lock on. Switch must consciously reset before power is delivered  
 Torque limiting clutch reduces the maximum torque reaction transmitted to the operator if the disc jams  
 Overload protection will prevent the motor overheating by shutting off the unit until the unit cools down  
 Soft start to limit start-up current and reduce kick back

**Standard Equipment:** Protective keyless guard, Anti vibration side handle, Inner and outer disc flanges, Spanner

Power Input	2400 Watts
Power Output	1246 Watts
No Load Speed	6500 rpm
Max. Disc Diameter	230 mm
Spindle Thread	M14
Weight	5.5 kg
Length x Height	490 x 151 mm



\*D28498 not available in the UK

**1800 W - 150 mm Straight Angle Grinder DW882**



Abrasion protected high power motor for increased durability  
 Rubberized front grip for better control  
 Brush access window for better serviceability  
 Cut-off brushes to prolong motor life

**Standard Equipment:** Protective guard, Inner and outer disc flanges, Abrasive 150 mm disc, Spanner

Power Input	1800 Watts
Power Output	1200 Watts
No Load Speed	5600 rpm
Max. Disc Diameter	150 mm
Spindle Thread	M16
Weight	6.7 kg
Length x Height	650 x 155 mm



**500 W - Single Speed Die Grinder D28885\***



Short body allows access when grinding in confined spaces  
 Hardened, precision-ground collet ensures that all attachments run perfectly true and concentrically  
 Cut-off brushes to prolong motor life  
 Ergonomic design results in user comfort allowing strain free grinding

**Standard Equipment:** 6 mm collet, Spanner

Power Input	500 Watts
Power Output	300 Watts
No Load Speed	27000 rpm
Collet Size	6 mm
Weight	1.4 kg
Length x Height	250 x 70 mm
Spindle lock	No



\*D28885 not available in the UK

**Collets**



Cat. No.	Description
D288861	3 mm Collet
D288862	1/8" Collet
D288863	6 mm Collet
D288864	1/4" Collet
D288865	8 mm Collet

2200 Watt 355 mm Abrasive Chop Saw

D28700



Horizontal handle for superior ergonomics and less user fatigue  
Quick release clamp results in less time in changing the work piece  
High power abrasion protected motor delivers high overload capabilities for greater durability  
Spindle lock for quick and easy wheel change

**Standard Equipment:** Metal cutting disc, Hex key

Power Input	2200 Watts
Power Output	1350 Watts
No Load Speed	3800 rpm
Wheel Diameter	355 mm
Max. Cutting Capacity at 90° [Square Profile]	119 x 119 mm
Max. Cutting Capacity at 90° [Rectangular Profile]	115 x 130 mm
Max. Cutting Capacity at 90° [L-Shape Profile]	137 x 137 mm
Max. Cutting Capacity at 90° [Rounded Profile]	115 mm
Max. Cutting Capacity at 45° [Square Profile]	98 x 98 mm
Max. Cutting Capacity at 45° [Rectangular Profile]	115 x 98 mm
Max. Cutting Capacity at 45° [L-Shape Profile]	98 x 98 mm
Max. Cutting Capacity at 45° [Rounded Profile]	98 mm
Weight	16 kg
Length x Height	486 x 378 mm



2200 Watt 355 mm High Performance Chopsaw

D28715



Keyless blade clamp allows quick, hassle free blade change  
Electronic soft start to limit start-up current and kick back reaction  
High power abrasion protected motor delivers high overload capabilities for greater durability  
Keyless mitre adjustments for quick and simple operations

**Standard Equipment:** Metal cutting disc, Hex key, Keyless blade clamp

Power Input	2200 Watts
Power Output	1350 Watts
No Load Speed	4000 rpm
Wheel Diameter	355 x 2.5 mm
Max. Cutting Capacity at 90° [Square Profile]	120 x 120 mm
Max. Cutting Capacity at 90° [Rectangular Profile]	100 x 200 mm
Max. Cutting Capacity at 90° [L-Shape Profile]	140 x 140 mm
Max. Cutting Capacity at 90° [Rounded Profile]	130 mm
Max. Cutting Capacity at 45° [Square Profile]	113 x 113 mm
Max. Cutting Capacity at 45° [Rectangular Profile]	100 x 140 mm
Max. Cutting Capacity at 45° [L-Shape Profile]	120 x 120 mm
Max. Cutting Capacity at 45° [Rounded Profile]	130 mm
Weight	18 kg
Length x Height	520 x 435 mm



2200 Watt 355 mm Tungsten Carbide Tipped Metal Cutting Chopsaw

DW872



Burr-free cuts at constant cutting depth throughout the life of the blade  
High power 2200 Watt motor with electronic soft start for metal cutting  
Robust cool-running 355 mm, 70 tooth tungsten carbide tipped blade  
Extra wide steel base for larger working area and increased stability

**Standard Equipment:** 355 mm metal carbide blade, Hex key, Auxiliary clamp

Power Input	2200 Watts
Power Output	1350 Watts
No Load Speed	1300 rpm
Wheel Diameter	355 mm
Max. Cutting Capacity at 90° [Square Profile]	100 x 100 mm
Max. Cutting Capacity at 90° [Rectangular Profile]	75 x 130 mm
Max. Cutting Capacity at 90° [L-Shape Profile]	92 x 92 mm
Max. Cutting Capacity at 90° [Rounded Profile]	130 mm
Max. Cutting Capacity at 45° [Square Profile]	79 x 79 mm
Max. Cutting Capacity at 45° [Rectangular Profile]	79 x 123 mm
Max. Cutting Capacity at 45° [L-Shape Profile]	56 x 56 mm
Max. Cutting Capacity at 45° [Rounded Profile]	79 mm
Weight	22.5 kg
Length x Height	525 x 430 mm



1200 W - 178 mm Sander

DW630\*



Abrasion protected motor for increased durability  
Dust sealed bearings for long product life  
Precision heat treated gears for smooth power transmission  
Spindle lock for ease of disc changing

**Standard Equipment:** Rubber backing pad, Threaded flange, Two pin spanner, Side handle & guard

Power Input	1200 Watts
Power Output	700 Watts
No Load Speed	5000 rpm
Max. Disc Diameter	178 mm
Spindle Thread	M14
Weight	3.2 kg
Length x Height	410 x 140 mm



\*DW630 not available in the UK

1150 W - 178 mm Variable Speed Right Angle Polisher

DW849



Full power variable speed electronics with constant speed control  
Abrasion protected high power motor for increased durability  
Heat treated precision gears for smooth power transmission  
Top rubber bumper to protect from scratching the work piece

**Standard Equipment:** Rubber backing pad, Polishing bonnet, Outer flange, Side handle

Power Input	1150 Watts
Power Output	670 Watts
No Load Speed	0-3000 rpm
Max. Disc Diameter	178 mm
Spindle Thread	M14
Weight	3.8 kg
Length x Height	455 x 135 mm



**Medium Crown Stapler 11.1 mm**

**D51430\***



5-position indexed depth setting is lockable and repeatable, which enables the user to find the perfect depth, saving time and materials  
The rear load magazine is fast and easy to load and unload with a 160 staples capacity  
Open contact tip allows for better visibility and durability  
Tool-free jam clearing feature eliminates down-time from bent nails caught in the nose piece

**Standard Equipment:** Safety glasses, 28 ml bottle of pneumatic tool oil, Replacement sequential trigger

Staple diameter	1.6 mm (16 gauge)
Magazine angle	0 °
Staple length capacity	25-51 mm
Staple width	11.1 mm
Magazine Capacity	160 Staples
Magazine loading	Rear load
Operating pressure range	4.8 - 8.3 Bar
Air consumption per shot @6.9 Bar	1.1 l
Firing mode	Bump trigger installed
Length x Height	290 x 370 mm
Weight	2.1 kg

\*D51430 not available in the UK



**Medium Crown Stapler 12.7 mm**

**D51431\***



5-position indexed depth setting is lockable and repeatable, which enables the user to find the perfect depth, saving time and materials  
The rear load magazine is fast and easy to load and unload with a 160 staples capacity  
Open contact tip allows for better visibility and durability  
Tool-free jam clearing feature eliminates down-time from bent nails caught in the nose piece

**Standard Equipment:** Safety glasses, 28 ml bottle of pneumatic tool oil, Replacement sequential trigger

Staple diameter	1.6 mm (16 gauge)
Magazine angle	0 °
Staple length capacity	25-51 mm
Staple width	12.7 mm
Magazine Capacity	160 Staples
Magazine loading	Rear load
Operating pressure range	4.8 - 8.3 Bar
Air consumption per shot @6.9 Bar	1.1 l
Firing mode	Bump trigger installed
Length x Height	290 x 370 mm
Weight	2.1 kg

\*D51431 not available in the UK



**Coil Roofing Nailer**

**D51321\***



2.2 kg magnesium housing and magazine aid to provide lightweight nailer  
Tool-free adjustable depth setting allows for quick and easy depth of drive setting  
Titanium exhaust cap protects tool from impacts to the cap  
Quick release jam clearing feature eliminates down-time removing bent nails caught in nosepiece

**Standard Equipment:** Safety glasses, 34 ml bottle of pneumatic tool oil, Replacement sequential trigger

Nail Style	Full round head
Magazine angle	15 °
Nail Length	19.45 mm
Nail diameter range	2.9 - 3.8 mm
Magazine capacity	120 Nails
Energy @ 6.9 Bar	70 Nm
Operating pressure range	4.8 - 8.3 Bar
Air consumption per shot @6.9 Bar	1.18 l
Length x Height	290 x 265 mm
Weight	2.2 kg

\*D51321 not available in the UK



**Full Head Framing Nailer**

**D51850\***



Optimised design, generates power for the toughest applications using less air consumption  
Unique motor design generates power to bury nails in both standard framing timber and engineered timber with minimal recoil  
Tool-free adjustable depth allows for quick and easy depth of drive setting  
Dry fire lockout extends bumper life by preventing tool from firing when magazine is empty

**Standard Equipment:** Replacement sequential trigger

Nail Style	Full round head
Magazine angle	20 °
Nail Length	50 - 90 mm
Nail diameter range	2.9 - 3.8 mm
Magazine capacity	65 Nails
Energy @ 6.9 Bar	101.7 Nm
Operating pressure range	4.8 - 8.3 Bar
Air consumption per shot @6.9 Bar	2.04 l
Length x Height	482 x 362 mm
Weight	3.7 kg

\*D51850 not available in the UK



**Clipped Head Framing Nailer**

**D51825\***



Optimised design generates power for the toughest applications and using less air consumption  
Tool-free adjustable depth allows for quick and easy depth of drive setting  
Driver piston catch allows for a consistent drive each time  
Unique motor design generates power to bury nails in both standard framing timber and engineered timber with minimal recoil

**Standard Equipment:** Replacement sequential trigger

Nail Style	Clipped head
Magazine angle	31-34 °
Nail Length	50 - 90 mm
Nail diameter range	2.9 - 3.3 mm
Magazine capacity	80 Nails
Energy @ 6.9 Bar	101.7 Nm
Operating pressure range	4.8 - 8.3 Bar
Air consumption per shot @6.9 Bar	2.04 l
Length x Height	482 x 362 mm
Weight	3.70 kg

\*D51825 not available in the UK



## Palm Nailer

D51180\*



Lightweight - Compact Design  
 Jobsite versatility - Will drive most 19-83 mm jobsite nails  
 Durability - Full metal housing to withstand jobsite abuse  
 Magnetic Tip - For easy nail placement

**Standard Equipment:** Bottle of oil, Leather comfort grip, Safety Glasses

Nail Style	Bulk
Nail Length	19-89 mm
Nail diameter range	10 mm
Operating pressure range	5.0 - 8.5 Bar
Air consumption per shot @6.9 Bar	0.4 l
Length x Height	105 x 125 mm
Weight	1.2 kg

\*D51180 not available in the UK

## 100 mm Framing Nailer

D51856\*



Fires nails up to 100 mm  
 Tool-free adjustable depth allows for quick and easy depth of drive setting  
 Dry fire lockout extends bumper life and prevents tool from firing when magazine is empty  
 Bump and sequential trigger allows rapid change for varying applications

Nail Style	Clipped head
Magazine angle	34 °
Nail Length	57-100 mm
Nail diameter range	2.8-3.3 mm
Magazine capacity	90 Nails
Energy @ 6.9 Bar	100 Nm
Operating pressure range	4.8-8.3 Bar
Air consumption per shot @6.9 Bar	2.5 l
Length x Height	507 x 373 mm
Weight	3.8 kg

\*D51856 not available in the UK

## Coil framing Nailer

D51855\*



Optimized power design, generates power for the toughest applications and delivers less air consumption  
 Unique engine design generates power to bury nails in both standard framing lumber and engineered lumber with minimal recoil  
 Tool-free adjustable depth allows for quick and easy depth of drive setting  
 Dry fire lockout extends bumper life by preventing tool from actuating when magazine is empty

**Standard Equipment:** Bump fire trigger (optional)

Nail Style	Full Head Coil
Magazine angle	15 °
Nail Length	38-90 mm
Nail diameter range	2.5-3.3 mm
Magazine capacity	300 Nails
Energy @ 6.9 Bar	102 Nm
Operating pressure range	4.8-8.3 Bar
Air consumption per shot @6.9 Bar	2.04 l
Length x Height	370 x 320 mm
Weight	3.7 kg

\*D51855 not available in the UK

## 18 Gauge Brad Nailer Kit

D51238K\*



16-50 mm nail capacity provides a complete range for trim carpenters and woodworkers  
 4-position indexed depth setting is lockable and repeatable, which enables the user to find the perfect depth, saving time and materials  
 Top and side low nail indicator windows to allow the user to quickly and easily see when it is time to reload - before they punch empty holes into their wood  
 Tool-free jam clearing feature eliminates down-time from bent nails caught in the nose piece

**Standard Equipment:** Safety glasses, 28 ml bottle of pneumatic tool oil, Allen wrench, Replacement sequential trigger, Heavy duty carrying case

Magazine angle	0 °
Nail Diameter	1.2 mm (18 gauge)
Nail Length	16 - 50 mm
Magazine capacity	110 Nails
Magazine loading	Side load
Operating pressure range	4.8 - 8.3 Bar
Air consumption per shot @6.9 Bar	1.0 l
Firing mode	Bump trigger installed
Length x Height	216 x 222 mm
Weight	1.27 kg

\*D51238K not available in the UK

## 16 Gauge Finish Nailer

D51257K\*



5-position indexed depth setting is lockable and repeatable, enabling the user to set the depth and save time and materials  
 Sealed lube dual-tech motor works as an oil free and oil lube unit  
 Tool-free features: adjustable belt hook, nail depth adjustment, jam clearing, 360 degree exhaust meaning less down-time for adjustment  
 For maximum convenience, this tool uses a patented dual-load magazine that can be loaded by either load & lock or lock & load

**Standard Equipment:** Replacement sequential trigger, Heavy-duty carrying case

Magazine angle	0 °
Nail Diameter	1.6 mm (16 gauge)
Nail Length	32 - 63 mm
Magazine capacity	100 Nails
Magazine loading	Rear load, dual load
Operating pressure range	4.8 - 8.3 Bar
Air consumption per shot @6.9 Bar	1.27 l
Firing mode	Bump trigger installed
Length x Height	299 x 269 mm
Weight	1.75 kg

\*D51257K not available in the UK



**15 Gauge Angled Finish Nailer**

**D51276K\***



5-position indexed depth setting is lockable and repeatable, enabling the user to set the depth and save time and materials  
 Sealed Lube Dual Tech: motor works as an oil free and oil lube unit.  
 Tool-free features: adjustable belt hook, nail depth adjustment, jam clearing, 360 degree exhaust meaning less down-time for adjustment  
 Low profile no-mark pad gives the user greater visibility whilst protecting surfaces from being damaged

**Standard Equipment:** Replacement sequential trigger, Heavy duty carrying case

Magazine angle	34 °
Nail Diameter	1.8 (15Ga) mm
Nail Length	25-63 mm
Magazine capacity	100 Nails
Magazine loading	Rear Load, Load & Lock / Lock & Load
Operating pressure range	4.8-8.3 Bar
Air consumption per shot @6.9 Bar	1.9 l
Firing mode	Sequential, with optional bump trigger
Length x Height	330 x 292 mm
Weight	1.75 kg



\*D51276K not available in the UK

**18 Volt Heavy Duty 16 Gauge Cordless Nail Gun**

**DC618KB**



Versatility in the loading and unloading of fasteners - 20 degree angled magazine 120 nail capacity  
 The tool works as fast as you do with consistent nail penetration  
 The sequential operating mode allows for precision placement and the bump operating mode provides the user with production speed  
 Depths can be easily referenced utilising numbered dial and user does not sacrifice performance when changing depths

**Standard Equipment:** 1 Hour Charger, 2 batteries, DeWALT safety glasses, Reversible belt hook, No-mark tip, Heavy duty carrying case

Nail Diameter	1.6 mm
Battery Capacity	NiMH 2.6 Ah
Magazine angle	20 °
Nail Length	32-63 mm
Magazine capacity	Up to 120 Nails
Magazine loading	Rear - load
Firing mode	Bump & Sequential
Length x Height	330 x 320 mm
Weight	3.9 kg
Nailer Operating Mode	Selective
Integrated Belt Hook	Yes
Jam Clearing	Yes
Features	LED Headlights



**18 Volt 18 Gauge Cordless Nailer**

**DC608KB**



The tool works as fast as you do with consistent nail penetration  
 The sequential operating mode allows for precision placement and the bump operating mode provides the user with production speed  
 Depths can be easily referenced utilising numbered dial and user does not sacrifice performance when changing depths  
 Provides easy access to the nosepiece for the simple removal of a jammed fastener without the use of screwdrivers or tool wrenches

**Standard Equipment:** 1 Hour Charger, 2 batteries, Heavy duty carrying case

Nail Diameter	1.2 mm
Battery Capacity	NiMH 2.6 Ah
Magazine angle	0 °
Nail Length	16-50 mm
Magazine capacity	110 Nails
Magazine loading	Side Load
Firing mode	Bump & Sequential
Length x Height	295 x 290 mm
Weight	3.4 kg
Nailer Operating Mode	Selective
Integrated Belt Hook	Yes
Jam Clearing	Yes



**18 Volt Heavy Duty 16 Gauge Straight Cordless Nailer**

**DC616KB**



Versatility in the loading and unloading of fasteners - straight magazine 110 nail capacity  
 The tool works as fast as you do with consistent nail penetration  
 The sequential operating mode allows for precision placement and the bump operating mode provides the user with production speed  
 Depths can be easily referenced utilising numbered dial and user does not sacrifice performance when changing depths

**Standard Equipment:** 1 Hour Charger, 2 batteries, DeWALT safety glasses, Reversible belt hook, No-mark tip, Heavy duty carrying case

Nail Diameter	1.6 mm
Battery Capacity	NiMH 2.6 Ah
Magazine angle	0 °
Nail Length	32-63 mm
Magazine capacity	110 Nails
Magazine loading	Rear - load
Firing mode	Bump & Sequential
Length x Height	330 x 320 mm
Weight	3.9 kg
Nailer Operating Mode	Selective
Integrated Belt Hook	Yes
Jam Clearing	Yes
Features	LED indicators



**12 Volt 18 Gauge Cordless Nailer**

**DC602KB\***



The tool works as fast as you do with consistent nail penetration  
 The sequential operating mode allows for precision placement and the bump operating mode provides the user with production speed  
 Depths can be easily referenced utilising numbered dial and user does not sacrifice performance when changing depths  
 Provides easy access to the nosepiece for the simple removal of a jammed fastener without the use of screwdrivers or tool wrenches

**Standard Equipment:** 1 Hour Charger, 2 batteries, Heavy duty carrying case

Nail Diameter	1.2 mm
Battery Capacity	NiMH 2.6 Ah
Magazine angle	0 °
Nail Length	16-50 mm
Magazine capacity	110 Nails
Magazine loading	Side Load
Firing mode	Bump & Sequential
Length x Height	295 x 290 mm
Weight	3.0 kg
Nailer Operating Mode	Selective
Integrated Belt Hook	Yes
Jam Clearing	Yes



\*DC602KB not available in the UK

**900W 8mm ( 1/4" ) Premium Plunge & Fixed Base Router Combination**

**D26204K**



Full wave electronic speed control with feedback ensures the selected speed is maintained under any load for a consistent finish in all grades of timber, aluminium and plastics

Variable speed control 16,000 to 27,000 which enables the router bit to be optimised for application

Compact, light weight design that increase ease of use and user comfort

Aluminium motor housing can be transitioned quickly to a fixed base attachment increasing the versatility of the machine

**Standard Equipment:** 2 x Parallel fences, 2 x Dust extraction adaptor, 8 mm collet (1/4" GB), 17 mm spanner, 17 mm guide bush, Plunge and Fixed base, Centering cone, Tough Kit Box

Power Input	900 Watts
Power Output	620 Watts
No Load Speed	16000-27000 rpm
Plunge Stroke/Movement	55 mm
Collet Size	6-8 mm
Max. Cutter Diameter	36 mm
Weight	2.9 kg
Length x Height	110 x 270 mm



**900W 8mm ( 1/4" ) Fixed Base Router**

**D26200**



Full wave electronic speed control with feedback ensures the selected speed is maintained under any load for a consistent finish in all grades of timber, aluminium and plastics

Variable speed control 16,000 to 27,000 enables router bit to be optimised for application

Depth ring and clamping mechanism combine to ensure motor remains accurate

Aluminium motor housing and base construction provides long term durability

**Standard Equipment:** Parallel fence, Dust extraction adaptor, 8 mm collet (1/4" GB), 17 mm spanner, Also available as accessories - Plunge base, Round base with guide bush application - Guide rail attachment

Power Input	900 Watts
Power Output	620 Watts
No Load Speed	16000-27000 rpm
Plunge Stroke/Movement	55 mm
Collet Size	6-8 mm
Max. Cutter Diameter	36 mm
Weight	1.9 kg
Length x Height	120 x 200 mm



**900W 8mm (1/4") Variable Speed Plunge Router**

**D26203**



Full wave electronic speed control with feedback ensures the selected speed is maintained under any load for a consistent finish in all grades of timber, aluminium and plastics

Variable speed control 16,000 to 27,000 which enables the router bit to be optimised for application

Compact, light weight design that increase ease of use and user comfort

Aluminium motor housing can be transitioned quickly to a fixed base attachment ( not included ) increasing the versatility of the machine

**Standard Equipment:** Parallel fence, Dust extraction adaptor, 8 mm collet (1/4" GB), 17 mm spanner, 17 mm guide bush, Centering Cone

Power Input	900W Watts
Power Output	620W Watts
No Load Speed	16000-27000 rpm
Plunge Stroke/Movement	55 mm
Collet Size	6-8 mm
Max. Cutter Diameter	36 mm
Weight	2.9 kg
Length x Height	110 x 270 mm



**900 W - 1/4" (6-8 mm) Variable Speed Plunge Router**

**DW615**



Soft start to eliminate any small initial movement that might misalign the cutter

Lightweight and compact design increases ease of use as the cutter remains visible at all times for error free routing

Two column precision guide for plunging accuracy in a high quality aluminium housing with phosphor bronze bushing so that carefully controlled plunge cuts can be made

Electronic speed control ensures that a consistent finish is achieved in all grades of timber, aluminium and plastics since the full wave electronic control ensures the selected speed is maintained under any load

**Standard Equipment:** Parallel fence & 2 guide rods, 17 mm guide bush, Dust extraction adaptor, 17/13 mm & 8 mm spanners, 8 mm collet (1/4" GB)

Power Input	900 Watts
Power Output	590 Watts
No Load Speed	8000-24000 rpm
Plunge Stroke/Movement	55 mm
Collet Size	6-8 mm
Max. Cutter Diameter	36 mm
Weight	2.9 kg
Length x Height	110 x 260 mm



**1100 Watt 1/4" (6-8mm) Variable Speed Plunge Router**

**DW621K/ DW621\***



Unique through the column dust extraction for excellent cutter visibility - no adaptor or hose which restrict visibility is required

Full wave electronic speed control with feedback ensures the selected speed is maintained under any load for a consistent finish in all grades of timber, aluminium and plastics

Two column precision guide with phosphor bronze bushing - the extra broad column provides superior rigidity for the greatest accuracy in this size of router

Power switch located in the handle for ease of use features lock off and lock on actions

**Standard Equipment:** Parallel fence with fine adjustment, Dust extraction adaptor and cap, 8mm collet (1/4" GB), 17/10mm spanner, 24 mm guide bush, Heavy duty carrying case, Also available in a 1400W 12mm ( 1/2" ) version

Power Input	1100 Watts
Power Output	620 Watts
No Load Speed	8000-24000 rpm
Plunge Stroke/Movement	55 mm
Collet Size	6-8 mm
Max. Cutter Diameter	36 mm
Weight	4.1 kg
Length x Height	165 x 325 mm



\*Jan 2011 - DW622 - 1400 Watt (8-12mm) variable speed plunge router, DW621 not available in the UK

**2000 Watt 1/2" (12mm) Variable Speed Plunge Router**

**DW625EK/ DW625E\***



Soft start to eliminate small initial movements that might misalign the cutter, especially important with such a powerful router  
 Two column precision guide with large phosphor bronze bushes for plunging accuracy in a high quality die cast aluminium housing so that carefully controlled plunge cuts can be made  
 Electronic speed control ensures that the same fine finish is achieved in all grades of timber, aluminium and plastics since the full wave electronic control ensures the selected speed is maintained under any load  
 Large comfortable handles with the on/off switch and plunge lock at your finger tips for excellent control

**Standard Equipment:** Parallel fence with fine adjustment, Dust extraction adaptor, 30mm guide bush, 12mm collet (1/2" UK), 22mm spanner, Heavy duty carrying case

Power Input	2000 Watts
Power Output	1400 Watts
No Load Speed	8000-20000 rpm
Plunge Stroke/Movement	80 mm
Collet Size	6-12.7 mm
Max. Cutter Diameter	50 mm
Weight	5.1 kg
Length x Height	290 x 295 mm



\*DW625E not available in the UK

**2300 W - 1/2" (12 mm) Variable Speed Plunge Router**

**DW626**



Powerful 2300 Watt motor with massive overload reserves to deal with the most demanding of applications in freehand, template or inverted table operations

Soft start to eliminate any small initial movement that might misalign the cutter, especially important with such a powerful router  
 Two column precision guide with large phosphor bronze bushes for plunging accuracy in a high quality die cast aluminium housing so that carefully controlled plunge cuts can be made  
 Electronic speed control ensures that the same fine finish is achieved in all grades of timber, aluminium and plastics since the full wave electronic control ensures the selected speed is maintained under any load

**Standard Equipment:** Parallel fence with fine adjustment, Dust extraction adaptor (factory fitted), 30 mm guide bush, 8 mm & 12 mm collet (1/2" GB), 22 mm spanner, Heavy duty carrying case

Power Input	2300 Watts
Power Output	1560 Watts
No Load Speed	8000-21000 rpm
Plunge Stroke/Movement	70 mm
Collet Size	8-12 mm
Max. Cutter Diameter	50 mm
Weight	7 kg
Length x Height	290 x 320 mm



**1600 W - 1/2" (12 mm) Plunge Router**

**DW624**



1600 Watt of power make this unit ideal for heavy duty use where a single speed is sufficient  
 Routing depth setting with fine adjustment and magnified scale for simple setting

Two column precision guide with large phosphor bronze bushes for plunging accuracy in a high quality die cast aluminium housing so that carefully controlled plunge cuts can be made  
 Large comfortable handles with the on/off switch and plunge lock at your finger tips for excellent control

**Standard Equipment:** Parallel fence with fine adjustment, Dust extraction adaptor, 30 mm guide bush, 22 mm spanner, 12 mm collet (1/2" GB)

Power Input	1600 Watts
Power Output	960 Watts
No Load Speed	20000 rpm
Plunge Stroke/Movement	62 mm
Collet Size	6-12.7 mm
Max. Cutter Diameter	40 mm
Weight	5.1 kg
Length x Height	290 x 295 mm



**Dovetail Jigs\***



- Cuts through, half-blind, rebated half-blind and sliding dovetail joints as well as finger joints
- Fully adjustable combs and offset stops ensure perfect joints
- Patented adjustable cutter depth stops give extremely accurate, repeatable joint size and tightness
- Patented alignment lines for quick, accurate jig set-up
- Twin dual-cam clamps with pre-mounted abrasive pads firmly grip the whole width of the wood
- Heavy-duty steel base with chamfered front panel for maximum rigidity and durability
- Setup instructions mounted on jig for ease of use
- Detachable combs give infinite joint lengths
- DE6215 miniature dovetail template available separately for miniature half-blind, through and finger joints

Cat. No.	Description	Standard Equipment	Capacity	Pitch
DE6212	Multi-Functional Dovetail Jig	8mm shank dovetail & straight cutters (1/4" GB); Guide bushes; 3 base adaptors; 2 templates; Offset guides	305 x 30 mm	25.4 mm
DE6215	Miniature Dovetail Comb for DE6212	8mm dovetail & straight cutters (1/4" GB); Guide bushes; Offset guides	305 x 35 mm	12.7 mm

\* not available in the UK

Collets



DE6274



DE6259

Cat. No.	Description	D26200	D26203	DW609	DW614	DW615	DW621/K	DW622/K	DW624	DW625E/FEK	DW626	DW629	DW670
DE6257	12.7 mm Collet										•		
DE6258	12 mm Collet										•		
DE6259	10 mm Collet										•		
DE6260	8 mm Collet										•		
DE6261	6.35 mm (1/4") Collet										•		
DE6262	6 mm Collet										•		
DE6272	6 mm Collet								•	•		•	
DE6273	6.35 mm (1/4") Collet								•	•		•	
DE6274	8 mm Collet								•	•		•	
DE6275	9.52 mm (3/8") Collet								•	•		•	
DE6276	10 mm Collet								•	•		•	
DE6277	12 mm Collet								•	•		•	
DE6278	12.7 mm (1/2") Collet								•	•		•	
DE6950	6 mm Collet	•	•	•	•	•	•	•					
DE6951	6.35 mm (1/4") Collet	•	•	•	•	•	•	•					
DE6952	8 mm Collet	•	•	•	•	•	•	•					

Guide Bushes



DE6301



DE6960



DE6991

Cat. No.	Description	D26200	D26203	DW609	DW614	DW615	DW621/K	DW622/K	DW624	DW625E/FEK	DW626	DW629	DW670
DE6301	Guide bush system								•	•		•	
DE6310	10 mm guide bush - use with DE6301								•	•		•	
DE6324	24 mm guide bush - use with DE6301								•	•		•	
DE6327	27 mm guide bush - use with DE6301								•	•		•	
DE6330	30 mm guide bush - use with DE6301								•	•		•	
DE6340	40 mm guide bush - use with DE6301								•	•		•	
DE6427	27 mm guide bush - fixes to base								•	•		•	
DE6430	30 mm guide bush - fixes to base								•	•		•	
DE6440	40 mm guide bush - fixes to base								•	•		•	
DE6910	10.8 mm guide bush - fixes to base						•	•			•		
DE6914	14 mm guide bush - fixes to base						•	•			•		
DE6916	16 mm guide bush - fixes to base						•	•			•		
DE6917	17 mm guide bush - fixes to base						•	•			•		
DE6918	18 mm guide bush - fixes to base						•	•			•		
DE6920	20 mm guide bush - fixes to base						•	•			•		
DE6924	24 mm guide bush - fixes to base						•	•			•		
DE6926	26 mm guide bush - fixes to base						•	•			•		
DE6927	27 mm guide bush - fixes to base						•	•			•		
DE6930	30 mm guide bush - fixes to base						•	•			•		
DE6940	40 mm guide bush - fixes to base						•	•			•		
DE6960	Complete set of 12 base-fixing guide bushes (10-40 mm)						•	•			•		
DE6961	10 mm guide bush - fixes to base						•	•			•		
DE6989	17 mm guide bush - fixes to base			•	•	•	•						
DE6990	24 mm guide bush - fixes to base			•	•	•	•						
DE6991	27 mm guide bush - fixes to base			•	•	•	•						
DE6992	30 mm guide bush - fixes to base			•	•	•	•						

**Dust Extraction**



Cat. No.	Description	D26200	D26203	DW609	DW614	DW615	DW621/K	DW622/K	DW624	DW625E/EK	DW626	DW629	DW670
DE6211	Fits post-1999 models of DW624/5/6/9									•	•	•	•
DE6269	Fits pre-1999 models of DW624/5/6/9								•	•		•	

**Thread Adaptors**



Cat. No.	Description	D26200	D26203	DW609	DW614	DW615	DW621/K	DW622/K	DW624	DW625E/EK	DW626	DW629	DW670
DE6281	M12 thread collet conversion / spindle extension kit. For use with DE6282 or DE6283									•	•	•	•
DE6282	12.7 mm (1/2") shank - M12 adaptor									•	•	•	•
DE6283	12 mm shank - M12 adaptor									•	•	•	•

**Fine Height Adjusters**



Cat. No.	Description	D26200	D26203	DW609	DW614	DW615	DW621/K	DW622/K	DW624	DW625E/EK	DW626	DW629	DW670
DE6956	Fits DW621/20/15/14/13					•	•	•					
DE6966	Fits DW624/5/6/9								•	•	•	•	

**Fences, Bars, Bases & Copy Follower**



Cat. No.	Description	D26200	D26203	DW609	DW614	DW615	DW621/K	DW622/K	DW624	DW625E/EK	DW626	DW629	DW670
DE6263	Fence holder with fine adjustment. Compatible with DE6265 copy follower				•	•	•	•		•	•	•	•
DE6913	Universal micro adjustable fence with dust extraction port				•	•	•	•		•	•	•	•
DE6265	Micro adjustment roller follower. Compatible with DE6263				•	•	•	•		•	•	•	•
DE6905	Trammel bar for cutting circles				•	•	•	•			•		
DE6284	Circular Sub Base								•	•		•	

600 W - (6-8 mm) Laminate Trimmer

DW670



Especially for small radius, chamfers and shaping edges  
 Light weight makes it ideal for one hand use and accurate work  
 Copy follower system with 19 mm ball bearing for long life, comfort and precision  
 Spindle lock mechanism for quick and easy cutter changes with a single spanner

**Standard Equipment:** Square base, 8 mm, 6 mm and 1/4" collets, Copy follower and fence, 17/19 mm spanner, Dust extraction adaptor

Power Input	600 Watts
Power Output	340 Watts
No Load Speed	30000 rpm
Plunge Stroke/Movement	22 mm
Collet Size	6 - 8 mm
Max. Cutter Diameter	28 mm
Weight	1.9 kg
Length x Height	90 x 230 mm



600 W - Laminate Trimmer

DW609\*



Ideal for laminate trimming and general edge work, especially intensive production work  
 Large base plate for good balance and control on the edge of the work piece  
 Pistol grip design with built in on/off switch for greater control and safety  
 Accurate edge trimming through the copy follower and built in fine height and edge adjusters

**Standard Equipment:** 8 mm collet (1/4" GB), Self aligning guide with slider, Following roller, 13/17 mm & 11/13 mm spanners

Power Input	600 Watts
Power Output	400 Watts
No Load Speed	24000 rpm
Collet Size	8 mm
Max. Cutter Diameter	32 mm
Weight	3.3 kg
Length x Height	230 x 240 mm

\*240V only

600 W - Biscuit Jointer

DW682K



Rack and pinion control provides precise vertical adjustment and fence alignment  
 Pre-set cutting depths for 0, 10 and 20 biscuit sizes with additional fine adjustment for ultimate accuracy  
 Grooving setting with up to 20 mm depth of cut gives increased versatility  
 Anti slide grippers, eight guiding notches and fence window to aid accurate cuts

**Standard Equipment:** Tungsten carbide tipped grooving cutter, Shavings bag, Spanner, 35 mm Dust extraction spout, Heavy duty carrying case

Power Input	600 Watts
Power Output	335 Watts
No Load Speed	10000 rpm
Max. Cutter Diameter	100 mm
Max. Cutting Depth	20 mm
Fence adjustment	0-90 °
Joint Groover Setting	4 mm
Weight	3.0 kg
Length x Height	320 x 150 mm



600 W - Flat Dowel Jointer and Groover

DW685K\*



This tool combines a flat dowel jointer with a groover making this one of our most versatile tools  
 Guiding notches on base and fine adjustment screws for extremely accurate operation  
 45° corner joints are extremely easy to make with the special bevel fence  
 Smooth pivot action for precise control, especially important for the start and end of a groove

**Standard Equipment:** Tungsten carbide tipped grooving cutter (105 mm), Parallel fence, Single-position side handle, Heavy duty carrying case

Power Input	600 Watts
Power Output	360 Watts
No Load Speed	7500 rpm
Max. Cutter Diameter	100/105 mm
Max. Cutting Depth	24 mm
Fence adjustment	45 °
Joint Groover Setting	9.5-18 mm
Weight	2.8 kg
Length x Height	360 x 145 mm

\*240V only

Replacement Inserts

Dust Extraction Adaptors



Cat. No.	Fits
DE6853	DW685K



Cat. No.	Fits
DE6852	DW685K

**4 mm Electronic Planer**

**D26501K**



A powerful planer that copes effortlessly with hard woods, even at maximum depth of cut, giving a smooth, consistent finish  
 Electronic brake stops the blades in 2 seconds for safety  
 Front handle depth control in clearly marked 0.1 mm steps for accurate setting with positive indexing  
 3 chamfering grooves in the front shoe simplify precision fitting jobs

**Standard Equipment:** Tungsten carbide tipped reversible blades, Parallel fence, Rebate depth guide, Dust extraction spout, Chip ejector, Chip deflector and high capacity collapsible collection container, Heavy duty carrying case

Power Input	1150 Watts
Power Output	680 Watts
No Load Speed	11500 rpm
Maximum Depth of Cut	4 mm
Rebating Depth	25 mm
Planer Width	82 mm
Shoe Length	320 mm
Drum Diameter	64 mm
Weight	4.0 kg
Length x Height	320 x 180 mm



**4 mm Planer**

**D26500/ D26500K\***



A powerful planer that copes effortlessly with hard woods, even at maximum depth of cut, giving a smooth, consistent finish  
 Left and right chip ejection for convenience  
 Front handle depth control in clearly marked 0.1 mm steps for accurate setting with positive indexing  
 3 chamfering grooves in the front shoe simplify precision fitting jobs

**Standard Equipment:** Tungsten carbide tipped reversible blades, Parallel fence, Rebate depth guide, Dust extraction spout, Chip ejector

Power Input	1050 Watts
Power Output	620 Watts
No Load Speed	13500 rpm
Maximum Depth of Cut	4 mm
Rebating Depth	25 mm
Planer Width	82 mm
Shoe Length	320 mm
Drum Diameter	64 mm
Weight	4.0 kg
Length x Height	320 x 180 mm



\*K version available with kitbox, D26500 not available in the UK

**2.5 mm Planer**

**DW680/ DW680K\***



Low weight and perfect balance make this planer ideal for single handed use in awkward applications  
 Front handle depth control in clearly marked 0.1 mm steps for accurate setting with a positive stop position  
 High power motor for smooth results, even in hard woods  
 3 different size chamfering grooves in the front shoe simplify precision fitting jobs

**Standard Equipment:** Tungsten carbide tipped reversible blades, Parallel fence, Dust extraction adaptor

Power Input	600 Watts
Power Output	350 Watts
No Load Speed	15000 rpm
Maximum Depth of Cut	2.5 mm
Rebating Depth	12 mm
Planer Width	82 mm
Shoe Length	290 mm
Drum Diameter	54 mm
Weight	3.2 kg
Length x Height	290 x 170 mm



\*K version available with kitbox, DW680 not available in the UK

**1.5 mm Planer**

**DW677**



Low weight and perfect balance make this planer ideal for single handed use in awkward applications  
 Front handle depth control in clearly marked 0.1 mm steps for accurate setting with a positive stop position.  
 A large planer blade drum rotating at high speed provides an excellent finish  
 3 different size chamfering grooves in the front shoe simplify precision fitting jobs

**Standard Equipment:** Tungsten carbide tipped reversible blades, Parallel fence, Dust extraction spout

Power Input	600 Watts
Power Output	350 Watts
No Load Speed	15000 rpm
Maximum Depth of Cut	1.5 mm
Rebating Depth	12 mm
Planer Width	82 mm
Shoe Length	290 mm
Drum Diameter	54 mm
Weight	2.8 kg
Length x Height	290 x 170 mm



**Dust Extraction Adaptor**



Cat. No.	Fits
DE2651	D26500, D26501
DE6775	DW677, DW680

**Chip Containers**



Cat. No.	Fits
DE2650	D26500(K) D26501K
DE6784	DW677 DW680 DW678K DW678EK

**¼ Sheet Orbital Palm Grip Sander**

**D26441**



230 Watt motor sands at 14,000 orbits per minute, providing a superior finish  
Sealed 100% ball-bearing construction provides longer life  
Dual plane counter-balance low-vibration design reduces user fatigue  
Textured anti-slip top and body grip provides ultimate comfort and control during prolonged use

**Standard Equipment:** Sanding sheets, Paper punch, Dust bag with built-in extractor connection

Power Input	230 Watts
Power Output	120 Watts
Rotation speed	14000 rpm
Orbits Per Minute	28000 opm
Orbit Size	1.4 mm
Paper Size	140x115 mm
Pad Size	108x115 mm
Weight	1.4 kg
Length x Height	130 x 160 mm



**1/3 Sheet Electronic Orbital Sander**

**D26422/ D26423\***



High performance motor with aluminium bearing seats for continuous use and a long life  
Small orbit size for a smooth finish  
Efficient dust collection using integrated dustbag or external dust extractor for a better sanding performance and sheet life  
Optional hook and loop base pad included to enable fast sanding sheet changes

**Standard Equipment:** Fabric and paper dust bags with built-in extractor connection and support tray, Nylon hook & loop sanding pad, Hook & loop sanding sheet

Power Input	350 Watts
Power Output	190 Watts
Rotation speed	12000-22000 rpm
Orbits Per Minute	24000-44000 opm
Orbit Size	2.5 mm
Paper Size	93 x 230 mm
Pad Size	92 x 190 mm
Weight	2.6 kg
Length x Height	270 x 190 mm



\*D26422, D26423 not available in the UK

**½ Sheet Electronic Orbital Sander**

**D26420/ D26421\***



High performance motor with aluminium bearing seats for continuous use and a long life  
Small orbit size for a smooth finish  
Efficient dust collection using integrated extraction or external dust extractor for a better sanding performance and sheet life  
Optional hook and loop base pad included to enable fast sanding sheet changes

**Standard Equipment:** Fabric and paper dust bags with built-in extractor connection and support tray, Nylon hook & loop sanding pad, Hook & loop sanding sheet

Power Input	350 Watts
Power Output	190 Watts
Rotation speed	12000-22000 rpm
Orbits Per Minute	24000-44000 opm
Orbit Size	2.5 mm
Paper Size	113 x 280 mm
Pad Size	112 x 236 mm
Weight	2.8 kg
Length x Height	270 x 190 mm



\*D26421 - non-electronic version (22.000 opm)

**Detail Sander**

**D26430\***



High performance motor for extended life  
Large orbit size for high stock removal  
Dust collection using integrated extraction or external dust extractor for a better sanding performance and sheet life  
Interchangeable quick fit sanding pad, with optional scraper blade or louvre attachments

**Standard Equipment:** Dust Cartridge, Hook & Loop sanding sheet

Power Input	300 Watts
Power Output	130 Watts
Rotation speed	14000-22000 rpm
Orbits Per Minute	28000-44000 opm
Orbit Size	1.8 mm
Paper Size	93 x 93 x 93 mm
Pad Size	93 x 93 x 93 mm
Weight	1.3 kg
Length x Height	305 x 100 mm



\*240V only

**500 W - Compact Belt Sander**

**D26480**



Ergonomic palm grip design with soft grip maximises user comfort and control in all applications  
Lightweight configuration increases ease of use  
Flush sided design allows sanding right up to an edge or vertical surface  
Dust sealed construction maximises unit life

**Standard Equipment:** Belt Pack, Dust Extraction Port, Secondary Handle

Power Input	500 Watts
Power Output	350 Watts
Belt Speed	365 m/min
Belt Size	64 x 356 mm
Sanding Size	64 x 80 mm
Weight	2.4 kg
Length x Height	200 x 120 mm





**125 mm Random Orbit Palm Grip Sander**

**D26453\***



Controlled finishing system controls pad speed and minimises gouging during start up  
 Compact palm grip design  
 Sealed 100% ball-bearing construction provides longer life  
 Dust-sealed switch prevents contamination

**Standard Equipment:** Sanding sheet, Fabric dust bag with built-in extractor ports

Power Input	280 Watts
Power Output	120 Watts
Rotation speed	7000-12000 rpm
Orbits Per Minute	14000-24000 opm
Orbit Size	2.4 mm
Paper Size	125 mm
Weight	1.6 kg
Length x Height	130 x 160 mm

\*240V only



**150 mm Pistol Grip Dual-Orbit Random Orbit Sander**

**D26410**



Two orbit size settings: a 3 mm orbit for fine finishing and a 6 mm orbit for fast material removal  
 Controlled finishing system eliminates start-up scratching by keeping the sanding pad at a controlled speed  
 Variable speed for heat sensitive sanding, polishing and superior finishing  
 Dust sealed switch and bearings for a long life

**Standard Equipment:** Sanding sheet, Fabric and paper dust bags with built-in extractor connection and support tray

Power Input	400 Watts
Power Output	250 Watts
Rotation speed	4000 - 10000 rpm
Orbits Per Minute	8000-20000 opm
Orbit Size	3.0 & 6.0 mm
Paper Size	150 mm
Weight	2.7 kg
Length x Height	129 x 200 mm



**150 mm Body Grip Random Orbit Sander**

**DW443\***



Controlled finishing system eliminates start-up scratching by keeping the sanding pad at a controlled speed  
 Variable speed for heat sensitive sanding, polishing and superior finishing  
 Right angle design and side handle make this sander ideal for extended use especially when sanding large surfaces, such as boat hulls, walls, doors and tables  
 Dust sealed switch and bearings for a long life

**Standard Equipment:** Sanding sheets, Multi-position side handle, Dust bag

Power Input	530 Watts
Power Output	295 Watts
Rotation speed	4,200 - 7,600 rpm
Orbits Per Minute	8,400-15,200 opm
Orbit Size	5.0 mm
Paper Size	150 mm
Weight	2.7 kg
Length x Height	320 x 125 mm

\*240V only



**800 W - 75 mm Belt Sander**

**DW432/ DW433\***



Automatic tracking, with manual override provides precise belt running to the users requirements  
 Efficient dust collection using integrated dust container or external dust extractor for a better sanding performance and belt life  
 Three wheel design increases contact area of sanding belt giving improved sanding performance  
 Two handle arrangement for good balance and control, can be used single handed.

**Standard Equipment:** Sanding belt, Dust container

Power Input	800 Watts
Power Output	360 Watts
Belt Speed	427 m/min
Belt Size	75 x 533 mm
Sanding Size	75 x 140 mm
Weight	5.6 kg
Length x Height	280 x 150 mm

\*DW432 not available in the UK



**1010 W - Heavy Duty Belt Sander**

**DW650/ DW650E\***



Robust construction using aluminium and dust sealed bearings for extended life  
 High performance motor to minimise slow down in use  
 2 central handles arranged for good balance and control, especially when flush sanding  
 Efficient dust collection using integrated dustbag or external dust extractor for a better sanding performance and sheet life

**Standard Equipment:** Sanding belt, Dust bag

Power Input	1010 Watts
Power Output	560 Watts
Belt Speed	350 m/min
Belt Size	100 x 560 mm
Sanding Size	100 x 110 mm
Weight	6.3 kg
Length x Height	340 x 210 mm

\*E version is variable speed



**415 W - 150/40 mm Linishing/Grinding Machine**

**DW753**



Quiet and vibration free high torque induction motor  
Grinding wheel with workpiece clamp for exact grinding and sharpening  
Leather honing belt with adjustable support for concave/convex shapes  
Robust lightweight aluminium base

**Standard Equipment:** Grinding wheel, 2 x Honing belts, Clamping and tool sharpening attachments, Spark guard, Spanner

Power Input	415 Watts
Power Output	300 Watts
No Load Speed	2750 rpm
Wheel Diameter	150 mm
Wheel Width	25 mm
Bore Size	20 mm
Belt Size	577x40 mm
Weight	9.3 kg
Length x Height	310 x 215 mm

**415 W - 125 mm Dual Honing/Grinding Machine**

**DW754**



Quiet and vibration free high torque induction motor  
Grinding wheel with workpiece clamp for exact grinding and sharpening  
Honing wheel with machining support  
Robust lightweight aluminium base

**Standard Equipment:** Grinding wheel, Honing wheel, Clamping and tool sharpening attachments, Spark guards, Spanner

Power Input	415 Watts
Power Output	300 Watts
No Load Speed	2750 rpm
Wheel Diameter	125 mm
Wheel Width	25 mm
Bore Size	20 mm
Belt Size	None mm
Weight	9.3 kg
Length x Height	310 x 215 mm

**415 W - 125/45 mm Wet Linishing/Grinding Machine**

**DW755\***



Water supply for an optimal finish on the cutting edge  
Quiet and vibration free high torque induction motor  
Grinding wheel with workpiece clamp for exact grinding and sharpening  
Leather honing belt with adjustable support for concave/convex shapes

**Standard Equipment:** Grinding wheel, Clamping and tool sharpening attachments, Tap and reservoir, Spark guard, Spanner

Power Input	415 Watts
Power Output	300 Watts
No Load Speed	2750 rpm
Wheel Diameter	125 mm
Wheel Width	20 mm
Bore Size	20 mm
Belt Size	715x45 mm
Weight	9.5 kg
Length x Height	310 x 320 mm

\*DW755 not available in the UK

**1800W Standard Heatgun**

**D26411\***



Durable design with added protection for the heating element  
Light weight ergonomics and compact design for increased comfort and application use  
Two air flows to maximise control in most applications  
Large stable support stand to ensure safety in stationary applications

**Standard Equipment:** Cone nozzle, Fish tail surface nozzle

Power Input	1800 Watts
Operating Temperature	50-400 / 50-600 °C
Air Flow	250 / 450 l/min
Weight	0.80 kg
Length x Height	253 x 210 mm

\*D26411 not available in the UK

**Specialist Platens & Backing Pads, Dust Extraction Adaptors, Dust Filters & Bags**



Cat. No.	Description	Fits
D264301	Louvre attachment	D26430
D264302	Replacement hook & loop pad liner	D26430
D264303	Replacement foam sanding pad	D26430
D264306	50 mm Scraper Blade	D26430
D264411	1/4 Sheet Hook & Loop Platen	D26441, DW411
D264412	1/4 Sheet Foam Backed Platen	D26441, DW411
DE2639	150 mm 6 & 8-hole pattern	D26410, DW443
DE2643	150 mm medium-hard hook and loop platen	D26410
DE2644	150 mm soft hook and loop platen	D26410
DE2645	160 mm sponge backed disc for sanding curved surfaces	D26410, DW443
DE2646	160 mm Polishing Sponge	D26410, DW433
DE2647	160 mm Lambswool Buffing Disc	D26410, DW443
DE2648	160 mm felt disc for fine finishing	D26410, DW443
DE2649	150 mm nylon coarse polishing / oxide removal disc	D26410, DW443



Cat. No.	Fits
D264304	D26430
DE4050	DW432, DW433
DE6502	DW650, DW650E



Cat. No.	Fits	Description	Pack Qty
D264305	D26430	Dust filters	10
DE2642	D26410, D26420, D26421, D26422, D26423	Pack of 5 disposable dust bags	5

**55mm Depth of Cut Heavy Duty Plunge Saw + 1.5m Guide Rail**

**DWS520KR**



55mm depth of cut allows the trimming and sizing of most common door sizes  
 Parallel plunge allows the user to maintain a smooth and constant hand position while cutting  
 The anti kickback function stops the saw from moving backwards along the rail and helps stop the saw from climbing out of the work piece when making plunge cuts  
 A 48 tooth blade gives a fine and accurate finish with very little breakout in laminates

**Standard Equipment:** 48 tooth precision circular saw blade, Heavy duty carrying case

Power Input	1300 Watts
Power Output	690 Watts
No Load Speed	1750 - 4000 rpm
Blade Diameter	165 mm
Blade Bore	20 mm
Bevel Capacity	47 °
Max. Depth of Cut at 90°[with guide rails]	55 mm
Max. Depth of Cut at 45°[with guide rails]	40 mm
Weight	5.1 kg
Length x Height	303 x 265 mm



**55 mm Depth of Cut Heavy Duty Plunge Saw**

**DWS520K**



55mm depth of cut allows the trimming and sizing of most common door sizes  
 Parallel plunge allows the user to maintain a smooth and constant hand position while cutting  
 The anti kickback function stops the saw from moving backwards along the rail and helps stop the saw from climbing out of the work piece when making plunge cuts  
 A 48 tooth blade gives a fine and accurate finish with very little breakout in laminates

**Standard Equipment:** 48 tooth precision circular saw blade, Heavy duty carrying case

Power Input	1300 Watts
Power Output	690 Watts
No Load Speed	1750 - 4000 rpm
Blade Diameter	165 mm
Blade Bore	20 mm
Bevel Capacity	47 °
Max. Depth of Cut at 90°[with guide rails]	55 mm
Max. Depth of Cut at 45°[with guide rails]	40 mm
Weight	5.1 kg
Length x Height	303 x 265 mm



**Guide Rails**

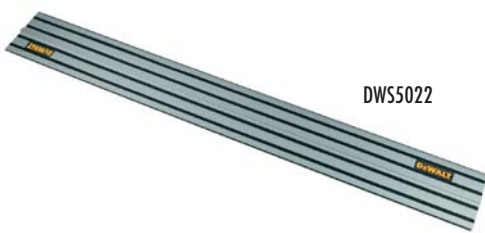

DWS5022



DWS5029



DWS5031

Cat. No.	Description
DWS5021	1 m guide rail
DWS5022	1.5 m guide rail
DWS5023	2.6 m guide rail
DWS5025	Bag - for use with 1 m and 1.5 m DeWALT guide rails
DWS5026	Clamps for use with DeWALT guide rails
DWS5027	T' square attachment for guide rails
DWS5028	Angle attachment for guide rails
DWS5029	Replacement edge strip
DWS5030	Replacement 'Teflon' strip
DWS5031	Router attachment for guide rail



DWS5025



DWS5026



DWS5028



DWS5027

701 W - Heavy Duty Top Handle Jigsaw

DW331K



Quick and easy patented keyless blade change system accepts T-shank blades  
 Powerful 701 Watt motor with variable speed delivers fast cutting action up to 3100 strokes per minute  
 Patented anti-vibration counterbalance mechanism and rubber grip provide smooth operation  
 4-position pendulum action controls the aggressiveness or smoothness of cuts

**Standard Equipment:** Blade, Anti-scratch cover, Anti-splinter insert, Dust extraction adaptor, Heavy duty carrying case

Power Input	701 Watts
Power Output	445 Watts
No Load Stroke Rate	0-3100 spm
Stroke Length	26 mm
Bevel Capacity	45 °
Max. Cutting Capacity [Wood]	135 mm
Max. Cutting Capacity [Steel]	12 mm
Max. Cutting Capacity [Non Ferrous Metal]	30 mm
Weight	2.8 kg
Length x Height	250 x 210 mm



701 W - Heavy Duty Body Grip Jigsaw

DW333K\*



Quick and easy patented keyless blade system accepts T-shank blades  
 Powerful 701 Watt motor with variable speed delivers fast cutting action up to 3100 strokes per minute  
 Patented anti-vibration counter-balance mechanism and rubber grip provide smooth operation  
 4-position pendulum action controls the aggressiveness or smoothness of cuts

**Standard Equipment:** Blade, Anti-scratch cover, Anti-splinter insert, Dust extraction adaptor, Heavy duty carrying case

Power Input	701 Watts
Power Output	445 Watts
No Load Stroke Rate	800-3100 spm
Stroke Length	26 mm
Bevel Capacity	45 °
Max. Cutting Capacity [Wood]	135 mm
Max. Cutting Capacity [Steel]	12 mm
Max. Cutting Capacity [Non Ferrous Metal]	30 mm
Weight	2.8 kg
Length x Height	265 x 210 mm



\*DW333K not available in the UK

550 W - Top Handle Compact Jigsaw

DW341K



Keyless blade change with patented anti-deflection clamp design for ease of use and accuracy  
 Compact, ergonomic, design gives user comfort and versatility in use  
 Variable speed dial and trigger allows controlled cutting in all materials  
 Adjustable pendulum action gives increased cutting performance and longer saw blade life

**Standard Equipment:** Blade, Allen key, Anti-scratch shoe cover, Dust extraction shield, Vacuum adaptor, Heavy duty carrying case

Power Input	550 Watts
Power Output	350 Watts
No Load Stroke Rate	0-3100 spm
Stroke Length	20 mm
Bevel Capacity	45 °
Max. Cutting Capacity [Wood]	85 mm
Max. Cutting Capacity [Steel]	10 mm
Max. Cutting Capacity [Non Ferrous Metal]	20 mm
Weight	2.0 kg
Length x Height	230 x 200 mm



550 W - Body Grip Compact Jigsaw

DW343K\*



Keyless blade change with patented anti-deflection clamp design for ease of use and accuracy  
 Compact, ergonomic, design gives user comfort and versatility in use  
 Variable speed dial allows controlled cutting in all materials  
 Adjustable pendulum action gives increased cutting performance and longer saw blade life

**Standard Equipment:** Blade, Allen key, Anti-scratch shoe cover, Vacuum adaptor, Dust extraction shield, Heavy duty carrying case

Power Input	550 Watts
Power Output	350 Watts
No Load Stroke Rate	650-3100 spm
Stroke Length	20 mm
Bevel Capacity	45 °
Max. Cutting Capacity [Wood]	85 mm
Max. Cutting Capacity [Steel]	10 mm
Max. Cutting Capacity [Non Ferrous Metal]	20 mm
Weight	2.0 kg
Length x Height	250 x 185 mm



\*DW343K not available in the UK

JIGSAW BLADES



XPC - DEWALT's ultimate jigsaw blade solution for control and accuracy of cut

- Premium steel for maximum durability and thicker body for easy control and ultimate accuracy
- Optimised tooth geometry for longer life and reduced breakout
- Increased speed - large deep gullets for easy chip removal
- Plunge point tip design for easy plunge cut

For the complete range of jigsaw blades see page 143

**55 mm Depth of Cut Heavy Duty Circular Saw D23550**



Compact, well balanced and easy to use circular saw with 55 mm cutting depth  
Quick and easy depth and angle adjustment  
High torque motor for durability and power for cutting job site and joinery materials  
Aluminium shoe for accuracy and durability

**Standard Equipment:** Precision 12 tooth saw blade, Rip fence, Blade spanner

Power Input	1050 Watts
Power Output	570 Watts
No Load Speed	5000 rpm
Blade Diameter	165 mm
Blade Bore	20 mm
Bevel Capacity	45 °
Max. Depth of Cut at 90°[with guide rails]	51 mm
Max. Depth of Cut at 45°[with guide rails]	37 mm
Weight	4.1 kg
Length x Height	270 x 215 mm



**52mm Depth of Cut Circular Saw D23551\***



Compact, well balanced and easy to use circular saw with 52 mm cutting depth  
Quick and easy depth and angle adjustment  
High torque motor for durability and power for cutting job site and joinery materials  
Guide rail compatible for quick and easy use with the DEWALT guide rail system

**Standard Equipment:** Precision 12 tooth saw blade, Rip fence, Blade spanner

Power Input	1050 Watts
Power Output	570 Watts
No Load Speed	5000 rpm
Blade Diameter	165 mm
Blade Bore	20 mm
Bevel Capacity	45 °
Max. Depth of Cut at 90°[with guide rails]	47 mm
Max. Depth of Cut at 45°[with guide rails]	32 mm
Weight	4.4 kg
Length x Height	270 x 215 mm



\*D23551 not available in the UK

**65 mm Depth of Cut Precision Circular Saw D23650K**



Scale for precise cutting depth setting to 65 mm  
General purpose ripping, cross-cutting and bevelling circular saw for wood and other construction materials  
High torque motor for durability and power for cutting job site and joinery materials  
Stable block construction for low vibration running and long service life

**Standard Equipment:** Precision 18 tooth saw blade, Rip Fence, Blade Spanner, Heavy duty carrying case

Power Input	1350 Watts
Power Output	800 Watts
No Load Speed	5000 rpm
Blade Diameter	190 mm
Blade Bore	30 mm
Bevel Capacity	55 °
Max. Depth of Cut at 90°[with guide rails]	61 mm
Max. Depth of Cut at 45°[with guide rails]	41 mm
Weight	5.4 kg
Length x Height	355 x 245 mm



**62mm Depth of Cut Heavy Duty Circular Saw D23651K\***



Scale for precise cutting depth setting to 62 mm  
General purpose ripping, cross-cutting and bevelling circular saw for wood and other construction materials  
High torque motor for durability and power for cutting job site and joinery materials  
Guide rail compatible for quick and easy use with the DEWALT guide rail system

**Standard Equipment:** Precision 18 tooth saw blade, Rip Fence, Blade Spanner, Heavy duty carrying case

Power Input	1350 Watts
Power Output	800 Watts
No Load Speed	5000 rpm
Blade Diameter	190 mm
Blade Bore	30 mm
Bevel Capacity	55 °
Max. Depth of Cut at 90°[with guide rails]	57 mm
Max. Depth of Cut at 45°[with guide rails]	44 mm
Weight	6.0 kg
Length x Height	355 x 245 mm



\*D23651K not available in the UK

**65 mm Depth of Cut Tradesman Circular Saw D23620/ D23620K\***



Compact, well balanced and easy to use circular saw with 65 mm depth of cut  
High torque motor gives durability and power for cutting job site and joinery materials  
Efficient dust extraction port to minimize airborne dust particles when connected to an extractor unit  
Gears and drive spindle mounted in a durable cast aluminium housing

**Standard Equipment:** 18 tooth saw blade, Rip fence, Blade spanner

Power Input	1150 Watts
Power Output	570 Watts
No Load Speed	5000 rpm
Blade Diameter	184 mm
Blade Bore	16 mm
Bevel Capacity	50 °
Max. Depth of Cut at 90°[with guide rails]	N/A mm
Max. Depth of Cut at 45°[with guide rails]	N/A mm
Weight	5.1 kg
Length x Height	315 x 250 mm



\*K version comes with kitbox

86mm Depth of Cut Circular Saw

D23700



High power, durable motor delivers excellent power even at maximum depth of cut  
 Stable block construction for low vibration running and long service life  
 Spindle lock for ease of blade change  
 Optimum balance for fatigue-free operation

**Standard Equipment:** 24 tooth Precision saw blade, Rip fence, Blade spanner

Power Input	1750 Watts
Power Output	960 Watts
No Load Speed	4700 rpm
Blade Diameter	235 mm
Blade Bore	30 mm
Bevel Capacity	45 °
Max. Depth of Cut at 90° [with guide rails]	N/A mm
Max. Depth of Cut at 45° [with guide rails]	N/A mm
Weight	8.2 kg
Length x Height	430 x 290 mm



1200 Watt Heavy Duty Reciprocating Saw

DW311K



1200 Watt motor delivers increased power for heavy duty applications  
 Orbital action delivers fast cutting in wood applications  
 0-2,600 SPM and 28 mm stroke length for fast and efficient cutting  
 Keyless adjustable shoe easily adjusts depth of cut and extends the blade life

**Standard Equipment:** 1 professional bi-metal blade, Heavy duty carrying case

Power Input	1200 Watts
Power Output	630 Watts
No Load Stroke Rate	0-2600 spm
Stroke Length	28 mm
Max. Cutting Capacity [Wood]	300 mm
Max. Cutting Capacity [Steel Sections & Pipes]	130 mm
Max. Cutting Capacity [PVC]	160 mm
Weight	4.0 kg
Length x Height	460 x 60 mm



1200 Watt Heavy Duty Reciprocating Saw

DW310K\*



1200 Watt motor delivers increased power for heavy duty applications  
 0 - 2,600 SPM and 28 mm stroke length for fast and efficient cutting  
 Keyless adjustable shoe easily adjusts the depth of cut and extends the blade life  
 Variable speed trigger provides control and versatility

**Standard Equipment:** 1 professional bi-metal blade, Heavy duty carrying case

Power Input	1200 Watts
Power Output	630 Watts
No Load Stroke Rate	0-2600 spm
Stroke Length	28 mm
Max. Cutting Capacity [Wood]	300 mm
Max. Cutting Capacity [Steel Sections & Pipes]	130 mm
Max. Cutting Capacity [PVC]	160 mm
Weight	4.0 kg
Length x Height	460 x 60 mm



\*240V only

1050 Watt - Reciprocating Saw

DW304PK\*



1050 Watt motor designed for heavy duty applications  
 4 position blade clamp allows for flush cutting and increased versatility  
 With a 29 mm stroke length, the DW304PK delivers excellent cutting performance  
 Lever-action keyless blade clamp for quick and easy blade changing

**Standard Equipment:** 1 professional bi-metal blade, Heavy duty carrying case

Power Input	1050 Watts
Power Output	525 Watts
No Load Stroke Rate	0-2800 spm
Stroke Length	29 mm
Max. Cutting Capacity [Wood]	280 mm
Max. Cutting Capacity [Steel Sections & Pipes]	100 mm
Max. Cutting Capacity [PVC]	130 mm
Weight	3.5 kg
Length x Height	435 x 178 mm



\*240V only

PROFESSIONAL SAW BLADES



DEWALT High Performance Professional Saw Blades

- Deliver outstanding performance across a wide variety of wood, composite materials and non-ferrous metals
- Excellent surface finish ensured by laser-cut expansion slots that also reduce noise and vibration
- Longer intervals between re-sharpening through use of large micro-grain carbide teeth
- Consistently precise cutting from a balanced and tensioned laser-cut plate

For the complete range of saw blades see page 135-142

**275 mm ALLIGATOR® Power Saw**

**DW390/ DW391\***



Blades available for cutting wood, drywall, plastic and poroton blocks  
 Long life, low vibration double blade system with blade break of less than 3 secs  
 Ergonomic design and rubberised handles for superior handling and less fatigue  
 Two saw blades running in opposite directions so the material will not move while cutting

**Standard Equipment:** Hard metal blade, Saw blade protection guard, Hex key

Power Input	1350 Watts
Power Output	700 Watts
No Load Stroke Rate	3300 spm
Stroke Length	38 mm
Blade Length	275 cm
Blade Stop	3 s
Weight	4.0 kg
Length x Height	345 x 210 mm



\*DW391 not available in the UK

**425 mm ALLIGATOR® Power Saw For Cutting Bricks**

**DW392\***



Ideal for cutting aerated concrete (gasbeton) and drywall  
 Constant speed for optimal cutting capabilities  
 Powerful motor to meet all application needs  
 Two long life and durable saw blades running in opposite directions so the material will not move while cutting

**Standard Equipment:** Hard metal set of blades (yellow) for breeze block, drywall, Saw blade protection guard, Hex key

Power Input	1350 Watts
Power Output	700 Watts
No Load Stroke Rate	3300 spm
Stroke Length	38 mm
Blade Length	425 cm
Blade Stop	3 s
Weight	4.3 kg
Length x Height	490 x 210 mm



\*DW392 not available in the UK

**425 mm ALLIGATOR® Power Saw for cutting Poroton Bricks**

**DW393\***



Ideal for cutting Class 20 thermal bricks (Poroton brick/ Porotherm brick)  
 Constant speed for optimal cutting capabilities  
 Powerful motor to meet all application needs  
 Two long life and durable saw blades running in opposite directions so the material will not move while cutting

**Standard Equipment:** Hard metal set of blades (black) for porosite brick, Saw blade protection guard, Hex key

Power Input	1350 Watts
Power Output	700 Watts
No Load Stroke Rate	3300 spm
Stroke Length	38 mm
Blade Length	425 cm
Blade Stop	3 s
Weight	4.3 kg
Length x Height	490 x 210 mm



\*DW393 not available in the UK

**425mm ALLIGATOR® Power Saw**

**DW394\***



Two 39 tooth Tungsten carbide tipped blades enable the user to cut class 20 Poroton bricks  
 Constant speed for optimal cutting capabilities  
 Powerful motor to meet all application needs  
 Two long life and durable saw blades running in opposite directions so the material will not move while cutting

**Standard Equipment:** Hard metal set of blades (black) for porosite brick, Saw blade protection guard, Hex key

Power Input	1350 Watts
Power Output	700 Watts
No Load Stroke Rate	3300 spm
Stroke Length	38 mm
Blade Length	425 cm
Blade Stop	3 s
Weight	4.3 kg
Length x Height	490 x 210 mm



\*DW394 not available in the UK

**ALLIGATOR BLADES**



**DEWALT ALLIGATOR® Saw Blades are essential to optimise the performance of your Alligator saw**

Ideal for fast and easy cutting in:

- Building blocks
- Wood
- Plywood
- Chipboard
- Drywall

For the complete range of Alligator Saw Blades see page 149

216 mm Crosscut Mitre Saw

DW777 / DW771\*



Cut Capacities

90°/90°	270 x 60 mm	265 x 62 mm
45°/90°	190 x 60 mm	189 x 62 mm
90°/45°	270 x 48 mm	173 x 62 mm
45°/45°	190 x 48 mm	190 x 48 mm

The classic pull saw design improved and updated for the modern user  
 New 1800 Watt motor for powerful cutting in all materials  
 The base and fence have been machined to meet the accuracy requirements of the most demanding applications  
 Compact internal rail design for huge cutting capacity in a highly transportable format

**Standard Equipment:** 24 tooth saw blade, 2 bench mounting bolts, Blade spanner

	DW777	DW771
Power Input	1800 Watts	1600 Watts
Power Output	1100 Watts	1100 Watts
Blade Speed	6300 rpm	2600 - 5200 rpm
Blade Diameter	216 mm	216 mm
Blade Bore	30 mm	30 mm
Bevel Capacity	48 °	48 °
Mitre Capacity [right/left]	50/50 °	50/50 °
Weight	14.0 kg	14.0 kg
Depth	550 mm	550 mm
Length x Height	490 x 590 mm	490 x 590 mm



\*DW771 is electronic

216 mm Slide Compound Mitre Saw

DW712 / DW712N\*



Cut Capacities

90°/90°	300 x 70 mm
45°/90°	215 x 70 mm
90°/45°	300 x 50 mm
45°/45°	212 x 50 mm

New mitre angle adjustment system provides accurate and consistent setting of mitre angles between 0 and 60° right and 0 and 50° left  
 The innovative grooving stop allows adjustment of the cutting depth for grooving and rebating applications  
 The large dual sliding fence mechanism gives maximum support in large material cuts at any angle or combination of angles  
 The aluminium base construction provides stability to the saw while still retaining its portability

**Standard Equipment:** 24 tooth saw blade, On-board blade spanner

Power Input	1600 Watts
Power Output	930 Watts
Blade Speed	3700-4600 rpm
Blade Diameter	216 mm
Blade Bore	30 mm
Bevel Capacity	48/2 °
Mitre Capacity [right/left]	60/50 °
Weight	19.5 kg
Depth	457 mm
Length x Height	580 x 480 mm



\*DW712 and DW712N not available in the UK

250mm Compound Mitre Saw

DW713XPS / DW713\*



Cut Capacities

90°/90°	162 x 41 mm	95 x 89 mm
45°/90°	114 x 41 mm	67 x 89 mm
90°/45°	162 x 25 mm	95 x 61 mm
45°/45°	114 x 25 mm	114 x 25 mm

Powerful universal motor delivers plenty of cutting power in high torque cutting applications  
 Ultra smooth head actuation for safe precise cuts at any angle or compound angle  
 Extremely light unit weight with rugged construction for maximum jobsite versatility  
 XPS Shadow line cut indicator provides fast accurate alignment of the blade while illuminating the work piece for increased productivity

**Standard Equipment:** 24 tooth precision saw blade, Blade spanner, Dust bag

Power Input	1600 Watts
Power Output	1000 Watts
Blade Speed	5000 rpm
Blade Diameter	250 mm
Blade Bore	30 mm
Bevel Capacity	48/3 °
Mitre Capacity [right/left]	50/50 °
Weight	13.6 kg
Depth	485 mm
Length x Height	600 x 425 mm

\*DW713 version does not have XPS, DW713 not available in the UK



**250 mm Slide Compound Mitre Saw**

**DW717XPS**



**Cut Capacities**

90°/90°	320 x 76 mm	302 x 88 mm		
45°/90°	226 x 76 mm	213 x 88 mm		
90°/45°	320 x 50 mm	302 x 58 mm		
45°/45°	226 x 50 mm	226 x 50 mm		

Maximum rear fence vertical cut capacity 152mm

XPS Shadow line cut indicator provides fast accurate alignment of the blade while illuminating the work piece for increased productivity  
 Compact and lightweight design characteristics deliver a saw with enormous capacity which is easy to transport around the jobsite  
 Linear horizontal rails utilise bronze guides to provide maximum precision when cutting materials up to 320 mm wide  
 The large dual sliding fence gives maximum support in large material cuts at any angle or combination of angles. This provides maximum stability and accuracy.

**Standard Equipment:** 60 tooth blade, Blade spanner, Dust bag

Power Input	1675 Watts
Power Output	750 Watts
Blade Speed	4000 rpm
Blade Diameter	250 mm
Blade Bore	30 mm
Bevel Capacity	48/48 °
Mitre Capacity [right/left]	50/60 °
Weight	23 kg
Depth	541 mm
Length x Height	718 x 442 mm

**305mm Double Bevel Mitre Saw**

**DW716EXPS/ DW716\***



**Cut Capacities**

90°/90°	190 x 85 mm	203 x 72 mm		
45°/90°	134 x 85 mm	142 x 72 mm		
90°/45°	190 x 56 mm	203 x 47 mm		
45°/45°	134 x 56 mm	142 x 47 mm		

XPS Shadow line cut indicator provides fast accurate alignment of the blade while illuminating the work piece for increased productivity  
 Powerful 95mm universal motor provides superior power in high torque cutting applications  
 Solid aluminium base and fence machined to exacting tolerances delivers precision cuts in the largest materials. Stainless steel detent system has been designed to maintain accuracy for the life of the machine.

**Standard Equipment:** 80 tooth TCG blade, Blade and guard spanner

Power Input	1600 Watts
Blade Speed	1900-3600 rpm
Blade Diameter	305 mm
Blade Bore	30 mm
Bevel Capacity	50/50 °
Mitre Capacity [right/left]	50/50 °
Weight	18 kg
Depth	680 mm
Length x Height	620 x 690 mm

\*DW716EXPS, DW716 not available in the UK

**305mm Compound Slide Mitre Saw + XPS**

**DW718XPS/ DW718\***



**Cut Capacities**

90°/90°	345 x 71 mm	50 x 163 mm	327 x 90 mm	
45°/90°	241 x 71 mm	35 x 163 mm	231 x 90 mm	
90°/45°	345 x 48 mm	50 x 114 mm	327 x 58 mm	
45°/45°	242 x 52 mm	35 x 114 mm	242 x 52 mm	

XPS Shadow line cut indicator provides fast accurate alignment of the blade while illuminating the work piece for increased productivity  
 Compact and lightweight design characteristics deliver a saw with enormous capacity which is easy to transport around the jobsite  
 Electronic speed control for adjusting cutting speed when cutting materials other than wood  
 Linear horizontal rails utilise bronze guides to provide maximum precision when cutting materials up to 345 mm wide

**Standard Equipment:** 60 tooth blade, Blade spanner, Dust bag

Power Input	1600 Watts
Power Output	960 Watts
Blade Speed	1900 - 3400 rpm
Blade Diameter	305 mm
Blade Bore	30 mm
Bevel Capacity	48/48 °
Mitre Capacity [right/left]	50/60 °
Weight	24.8 kg
Depth	470 mm
Length x Height	770 x 396 mm

\*DW718 not available in the UK

For DW702 / 713 / 706 / 706E / 708 / 017 / 712 / 716 / 716E / 717 / 718 / D27111 / D27112



Cat. No.	Item	Description
DE7080	1	Extension kit
DE7051	2	Length stop
DE7082	3	Vertical clamp
DE7088	Illustrated	Dust extraction adaptor. For DW708 only
DE7053	Not illustrated	Dust bag
DE7084	Not illustrated	Crown stops

For DW700 / 701 / 707 / 711 / 771 / 777



DE3499



DE7777



DE7778



Cat. No.	Item	Description
DE3490	1	Table end plate
DE3491	2	Pair of guide rods, 500 mm length
DE3492	3	Length stop for short work pieces
DE3462	4	Swivel stop
DE3493	5	Leg stand
DE3494	6	Pair of guide rods, 1000 mm length
DE3495	7	Material support plate
DE3477	8	Adjustable support stand 740 mm
DE3499	Illustrated	Workpiece clamp
DE7777	Illustrated	Dust extraction kit 100 mm connection port
DE7778	Illustrated	Dust extraction kit 35 mm connection port

Mitre Saw Workstation



- Accommodates all DEWALT mitre saws
- Lightweight aluminium construction provides portability in and around the jobsite
- 1.7 metre beam extends to support up to 3.9 metres for use with large workpieces
- The beam can support up to 182 kg providing maximum flexibility and capacity
- Work stops can be converted into end stops for repetitive cutting to length
- Integral folding legs avoids unnecessary assembly
- Integrated carry handle provides ease of transportation
- Cutting to length
- Roofing timbers
- All material support requirements
- Large workpiece support

Cat. No.	Fits	Description
DE7023	All DEWALT mitre saws	Heavy Duty Mitre Saw Workstation

For DE7023



Cat. No.	Item	Description
DE7024	1	Work support
DE7025	2	Mounting bracket
DE7027	3	Roller work support
DE7028	4	Extension arm support
DE7029	5	Increased width work support
DE7030	6	Increased length mitre brackets
DE7031	7	Heavy duty extension arm support
DE7026	Not illustrated	Carry strap

**260 mm Table Top Mitre Saw**

**DW711**



**Cut Capacities**

90°/90°	125 x 55 mm	140 x 40 mm
45°/90°	90 x 55 mm	100 x 40 mm
90°/45°	125 x 50 mm	140 x 20 mm
45°/45°	90 x 50 mm	100 x 20 mm

50mm 175mm

Powerful dust protected 1300 Watt induction motor, provides years of maintenance free service  
 Integrated blade brake, for active user protection and additional machine safety  
 Precision cast aluminium machined base and table top, guarantees high quality precision cuts in both cutting modes  
 High and stable back fence increases accuracy in all mitring applications

**Standard Equipment:** 260 mm 24 tooth tungsten carbide tipped saw blade, Top guard with extraction, Blade spanner, Hex key, Push stick

Power Input	1300 Watts
Power Output	900 Watts
Blade Speed	2750 rpm
Blade Diameter	260 mm
Blade Bore	30 mm
Bevel Capacity	48 °
Mitre Capacity [right/left]	50 °
Max. Cutting Capacity [Sawbench position 90°/90°]	50 mm
Weight	20.0 kg
Depth	590 mm
Length x Height	490 x 620 mm
Max. Cutting Capacity at 90°/90°	96 mm
Max. Ripping Capacity [right]	175 mm
Max. Ripping Capacity [left]	60 mm

**305 mm Slide Table Top Mitre Saw**

**D27112**



**Cut Capacities**

90°/90°	285 x 90 mm
45°/90°	200 x 90 mm
90°/45°	285 x 62 mm
45°/45°	200 x 62 mm

51mm 200mm

Lightweight, powerful 1600 Watt universal motor for demanding applications  
 Combination saw with crosscut and ripping capabilities  
 Slide mechanism incorporated to increase cross cut capacity  
 Precision cast aluminium base and table top guarantees high precision cuts in both cutting modes

**Standard Equipment:** Saw blade, Push Stick, Blade Wrench, Rip Fence, Table Saw Blade Guard, Allen Key

Power Input	1600 Watts
Power Output	1370 Watts
Blade Speed	3650 rpm
Blade Diameter	305 mm
Blade Bore	30 mm
Bevel Capacity	45 °
Mitre Capacity [right/left]	60/50 °
Max. Cutting Capacity [Sawbench position 90°/90°]	51 mm
Weight	23.0 kg
Depth	980 mm
Length x Height	580 x 710 mm
Max. Cutting Capacity at 90°/90°	285 x 90 mm
Max. Ripping Capacity [right]	200 mm
Max. Ripping Capacity [left]	220 mm

**305 mm Slide Table Top Mitre Saw**

**D27111\***



**Cut Capacities**

90°/90°	220 x 90 mm
45°/90°	155 x 90 mm
90°/45°	220 x 62 mm
45°/45°	155 x 62 mm

51mm 200mm

Combination saw with crosscut and ripping capabilities  
 Powerful 1500 Watt induction motor to meet the needs of the most demanding applications  
 Precision cast aluminium base and table top guarantees high precision cuts in both cutting modes  
 Slide mechanism incorporated to increase cross cut capacity

**Standard Equipment:** Saw blade, Push Stick, Blade Wrench, Rip Fence, Table Saw Blade Guard, Allen Key

Power Input	1500 Watts
Power Output	1100 Watts
Blade Speed	3000 rpm
Blade Diameter	305 mm
Blade Bore	30 mm
Bevel Capacity	45 °
Mitre Capacity [right/left]	60/50 °
Max. Cutting Capacity [Sawbench position 90°/90°]	51 mm
Weight	26.5 kg
Depth	800 mm
Length x Height	580 x 710 mm
Max. Cutting Capacity at 90°/90°	220x90 mm
Max. Ripping Capacity [right]	200 mm
Max. Ripping Capacity [left]	220 mm

\*D27111 not available in the UK

**Heavy Duty Electronic Portable Table Saw**

**DW744XP**



Powerful 2000 Watt motor for high performance in all applications  
Telescoping fence rails provide over 610 mm of rip capacity in a portable design for cutting large sheet materials to size  
Cast aluminium table top design ensures accuracy and precision  
Soft start electronics increases accuracy and motor durability

**Standard Equipment:** 24 tooth SERIES 40<sup>®</sup> saw blade, Mitre fence, 2 blade spanners, Parallel fence, Dust port reducer, Push stick

Power Input	2000 Watts
Power Output	1600 Watts
Blade Speed	3000 rpm
Blade Diameter	250 mm
Blade Bore	30 mm
Bevel Capacity	-3 to 48 °
Max. Ripping Capacity [right]	625 mm
Max. Ripping Capacity [left]	342 mm
Table Size	627 x 678 mm
Weight	35 kg
Depth	740 mm
Length x Height	680 x 465 mm



**Heavy Duty Lightweight Table Saw**

**DW745**



22 kg unit weight and optimised footprint make this the most portable saw in its class  
Fence system provides 410 mm of rip capacity in a portable design for cutting large sheet materials to size  
Steel roll cage protects saw against jobsite drops and impacts  
Powerful 1700 Watt motor for high performance in all applications

**Standard Equipment:** 24 tooth SERIES 30<sup>®</sup> saw blade, Mitre fence, 2 blade spanners, Parallel fence, Dust port reducer, Push stick

Power Input	1700 Watts
Power Output	1100 Watts
Blade Speed	3800 rpm
Blade Diameter	250 mm
Blade Bore	30 mm
Bevel Capacity	-3 to 48 °
Max. Ripping Capacity [right]	410 mm
Max. Ripping Capacity [left]	315 mm
Table Size	630 x 570 mm
Weight	22 kg
Depth	742 mm
Length x Height	577 x 425 mm



**Heavy Duty Rolling Saw Workstation**

**DE7400**



Large Heavy-Duty wheels designed to easily roll over steps, kerbs, and jobsite debris  
Folding legs with quick release levers which retract under the stand in a few seconds for easy and quick transport  
Lightweight aluminium construction which improves the portability  
Heavy-Duty kick stand allows the stand to balance upright for mobility and storage

**Standard Equipment:** Universal Brackets to attach most Table saws

**305 mm Combination Saw**

**D27107 / D27107V\***



**Cut Capacities**

90°/90°	50 x 155 mm	205 x 63 mm
45°/90°	45 x 155 mm	160 x 63 mm
90°/45°	60 x 110 mm	205 x 50 mm
45°/45°	60 x 100 mm	—

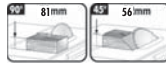

The next generation of TGS combination saw combines the accuracy of modern mitre saws with the power and capacity of dedicated table saws  
 Electronic pack provides massive overload protection and constant cutting speed for optimal cutting performance  
 305 mm head provides an massive 155 mm depth of cut  
 New mitre and bevel adjustment systems ensure high accuracy and simple adjustment

**Standard Equipment:** 48 tooth saw blade, Parallel fence, Riving knife, Push stick, Mitre dust collector, Table saw guard, Assembly wrench

Power Input	2000 Watts
Power Output	1400 Watts
Blade Speed	4000 rpm
Blade Diameter	305 mm
Blade Bore	30 mm
Bevel Capacity	48 °
Mitre Capacity (right/left)	48/48 °
Max. Cutting Capacity [Sawbench position 90°/90°]	0 - 81 mm
Max. Cutting Capacity [Sawbench position 90°/45°]	0 - 56 mm
Weight	40 kg
Depth	800 mm
Length x Height	720 x 770 mm



\*D27107V not available in the UK

**For D27107/D27105**



Cat. No.	Item	Description
D271055	1	Sliding table for D27105/7 TGS
D271057	2	Replacement table saw guard for D27105/7 TGS
D271058	3	Right extension table for D27105/7 TGS
DE3460	4	Length stop for short workpieces
DE3462	5	Swivel stop
DE3474	6	Adjustable support stand
DE3491	7	Pair of guide rods, 500 mm length
DE3494	8	Pair of guide rods, 1000 mm length
DE3495	9	Material support plate
D271051	Illustrated	Clamp assembly
D271052	Illustrated	Mitre gauge for D27105/7 TGS
D271053	Illustrated	Crown stop for D27105/7 TGS
D271054	Illustrated	Dust extraction kit for D27105/7 TGS
D271059	Illustrated	Laser site line attachment

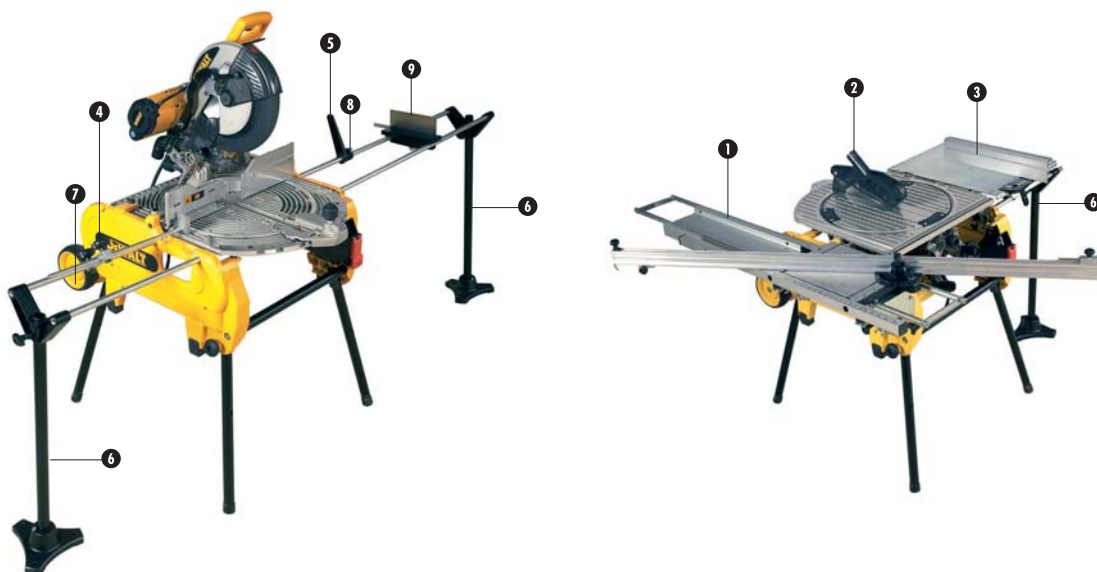

250 mm Combination Saw

DW743N



**Cut Capacities**

90°/90°	140 x 68 mm	180 x 20 mm
45°/90°	95 x 70 mm	120 x 46 mm
90°/45°	70 x 95 mm	150 x 20 mm



The classic TGS flip-over beveling saw  
Rapid tool free transformation from a saw bench to a mitre saw provides flexibility in a range of site and workshop applications

New high output heavy duty high torque induction motor provides years of maintenance free use, suitable for workshop applications where low noise characteristics are desirable  
Updated design for maximum cutting capacity across the range of mitre and bevel angles

**Standard Equipment:** 30 tooth saw blade, Parallel fence, Push stick, 4 detachable legs, Saw blade guard, Assembly tool

Power Input	2000 Watts
Power Output	1550 Watts
Blade Speed	2850 rpm
Blade Diameter	250 mm
Blade Bore	30 mm
Bevel Capacity	45 °
Mitre Capacity [right/left]	45 / 45 °
Max. Cutting Capacity [Sawbench position 90°/90°]	0 - 70 mm
Max. Cutting Capacity [Sawbench position 90°/45°]	0 - 32 mm
Weight	37 kg
Depth	670 mm
Length x Height	700 x 750 mm



For DW743N



Cat. No.	Item	Description
DE3491	1	Pair of guide rods, 500 mm length
DE3460	2	Length stop for short workpieces
DE3474	3	Adjustable support stand
DE3494	4	Pair of guide rods, 1000 mm length
DE3462	5	Swivel stop
DE3495	6	Material support plate
DE3454	Illustrated	2 x push sticks
DE3472	Illustrated	Right side extension table
DE3489	Illustrated	Roller support
DE3496	Illustrated	Replacement mitre fence for use in bench saw mode
DE3497	Illustrated	Roller support table
DE3500	Illustrated	Shaving extraction kit
DE3461	Not Illustrated	Clamp assembly
DE3471	Not Illustrated	Single sliding table
DE3473	Not Illustrated	Ripping/parallel fence
DE3488	Not Illustrated	Replacement table saw guard



DE3497



DE3500



DE3489



DE3496



DE3472



DE3454

**300mm RADIAL ARM SAW**

**DW721KN / DW722KN\***

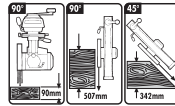

Free standing radial arm saw with 507mm of crosscut capacity and 90 mm depth of cut  
 Solid cast iron arm and four roller bearings in the motor head assembly ensure high accuracy and durability  
 Quiet maintenance free induction motor delivers high power even at the maximum cutting capacities of the machine. Also available in three phase voltage as a DW722KN  
 Simple yet positive controls and adjustment scales enable the width, depth and angle of cut to be set with accuracy in seconds

**Standard Equipment:** 32 tooth saw blade, Assembly tools, Automatic safety return, Blade brake, Legstand

	DW721KN	DW722KN
Power Input	2000 Watts	3000 Watts
Power Output	1580 Watts	2280 Watts
Blade Speed	3000 rpm	3000 rpm
Blade Diameter	300 mm	300 mm
Blade Bore	30 mm	30 mm
Max. Cutting Speed	36 m/sec	36 m/sec
Weight	115 kg	115 kg
Depth	1200 mm	1200 mm
Length x Height	1490 x 1470 mm	1490 x 1470 mm

\*DW722KN not available in the UK

**350mm Radial Arm Saw**

**DW728KN / DW729KN\***

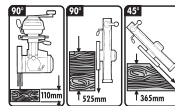

The industrial radial arm saw performs accurate crosscuts time after time. Unrivaled reputation in the professional woodworking industry  
 Solid cast iron arm machined to provide arm tracks with no inserts, increasing accuracy and life  
 Simple yet positive controls and adjustment scales enable the width, depth and angle of cut to be set with accuracy in seconds  
 Quiet maintenance free induction motor delivers high power even at the maximum cutting capacities of the machine. Also available in three phase voltage as DW729K

**Standard Equipment:** 32 tooth saw blade, Assembly tools, Automatic safety return, Blade brake, Legstand

	DW728KN	DW729KN
Power Input	2200 Watts	4000 Watts
Power Output	1820 Watts	3300 Watts
Blade Speed	2800 rpm	2780 rpm
Blade Diameter	350 mm	350 mm
Blade Bore	30 mm	30 mm
Max. Cutting Speed	53 m/sec	53 m/sec
Weight	149 kg	149 kg
Depth	1380 mm	11380 mm
Length x Height	1800 x 1450 mm	1800 x 1450 mm

\*DW729K is a 3-phase unit

**155 mm 2 Speed Bandsaw**

**DW738\***



High quality, rigid, cast aluminium construction suitable for wood, non-ferrous metal, foam, composites and plastics applications  
 Two speed control for multiple applications  
 Large balanced aluminium band wheels with rubber linings ensure smooth quiet operation  
 Large aluminium saw table with high quality, wear resistant coating and replaceable insert

**Standard Equipment:** Saw blade, Rip fence

Power Input	749 Watts
Power Output	550 Watts
Max. Cutting Height	155 mm
Max. Cutting Width	310 mm
Cutting Speed	330/800 m/min
Table Size	380 x 380 mm
Weight	23.0 kg
Depth	520 mm
Length x Height	660 x 1550 mm

\*240V only



155 mm Variable Speed Bandsaw

DW739\*



High quality, rigid, cast aluminium construction suitable for wood, non-ferrous metal, foam, composites and plastics applications

Adjustable blade speed from 300 to 800 m/min increases control in delicate operations

Large aluminium saw table with high quality, wear resistant coating and replaceable insert

Bevel adjustment from 0° to 45°

**Standard Equipment:** Saw blade, Rip fence

Power Input	749 Watts
Power Output	550 Watts
Max. Cutting Height	155 mm
Max. Cutting Width	310 mm
Cutting Speed	330-800 m/min
Table Size	380 x 380 mm
Weight	23.0 kg
Depth	520 mm
Length x Height	660 x 1550 mm



\*240V only

200 mm 2 Speed Bandsaw

DW876\*



All steel welded construction provides extreme rigidity and accuracy even at maximum depths of cut  
500 x 500 mm aluminium extruded table provides a large support area built for flatness and accuracy  
Easy to adjust blade tensioning with integrated tension indicator for different blade types and applications  
Micro switch incorporated in door to prevent accidental starting while open

**Standard Equipment:** Diamond ground steel blade, No volt release switch, Legstand, Mitre and rip fence

Power Input	1000 Watts
Power Output	750 Watts
Max. Cutting Height	200 mm
Max. Cutting Width	310 mm
Cutting Speed	380/880 m/min
Table Size	500x500 mm
Weight	54.0 kg
Depth	650 mm
Length x Height	770 x 1590 mm



\*240V only

Machinery Planer Thicknesser

D27300\*



Large aluminium fence for accurate bevel angles in the surface planing mode  
Large, extruded aluminium top planing table for high accuracy and ease of use  
Integrated motor design to save space and improve transportation  
New control design to improve ease of use and accuracy of adjustment

**Standard Equipment:** HSS knives, Adjustable fence, Allen keys, Spanner, Blade setting gauge, Dust extraction mouthpiece, Push stick, Legset

Power Input	2100 Watts
Power Output	1600 Watts
No Load Speed	6200 rpm
Max. Capacity	260 mm
Max. Depth of Cut	4 mm
Max. Planing Depth	3 mm
Planer Table Size	1000 x 260 mm
Thicknesser Table Size	500 x 250 mm
Max. Thicknesser Capacity	160 mm
Feed Rate	5 m/min
Weight	53 kg
Depth	700 mm
Length x Height	1050 x 950 mm



\*240V only



**317 mm Portable Thicknesser**

**DW733**



4 post column design allows the cutter head to move up and down smoothly and accurately  
 Large infeed and outfeed tables provide added material support when cutting large materials to improve the surface finish  
 Powerful 1800 Watt motor makes large surface planing easy  
 Designed for portability on the job site and in small workshops

**Standard Equipment:** Dust shroud and adaptor, Allen key, Blade spanner, Blade changing guides

Power Input	1800 Watts
Power Output	1000 Watts
No Load Speed	10000 rpm
Max. Capacity	317 mm
Max. Planing Depth	2 mm
Max. Thicknesser Capacity	152 mm
Feed Rate	8 m <sup>3</sup> /min
Weight	33.6 kg
Depth	310 mm
Length x Height	520 x 445 mm



**27 Litre Dust Extractor**

**D27900\***



Wet and dry pick up with separate motor cooling system for extended operating times in workshop or site environment  
 Powerful motor generating 208 mbar of vacuum pressure  
 Built-in power take off socket allows power tool connection for automatic switching of the vacuum system  
 Light and powerful, this machine is easily transportable with the carrying handle or transport wheels

**Standard Equipment:** 4 m x 35 mm extraction hose, 35 mm stepped adaptor, Crevice tool, Dust bag

Power Input	1200 Watts
Power Take Off Rating: UK & Ireland	N/A Watts
Power Take Off Rating: Switzerland	N/A Watts
Power Take Off Rating: Europe	N/A Watts
Max. Airflow	4020 l/min
Capacity	27 hr
Wet/Dry Capacity	14 hr
Weight	7.5 kg
Length x Height	420 x 525 mm



\*240V only

**45 Litre Dust Extractor**

**D27901\***



Wet and dry pick up with a large 45 litre capacity  
 Automatic start and stop control when the power tool is operated, machine continues to run for 15 seconds to allow all dust to be cleared from system  
 Built-in power take off socket allows power tool connection for automatic switching of the vacuum system  
 Light and powerful, this machine is easily transportable with the carrying handle or transport wheels

**Standard Equipment:** 4 m x 35 mm extraction hose, Crevice tool, Universal hose adaptor, Dust bag

Power Input	1200 Watts
Power Take Off Rating: UK & Ireland	1800 Watts
Power Take Off Rating: Switzerland	1100 Watts
Power Take Off Rating: Europe	2200 Watts
Max. Airflow	3420 l/min
Capacity	45 hr
Wet/Dry Capacity	45 hr
Weight	11.0 kg
Length x Height	505 x 640 mm



\*240V only

**45 Litre Dust Extractor with Constant Automatic Filter Cleaning**

**D27902\***



Wet and dry pick up with variable suction control allows for the reduction of suction power if required  
 Constant suction power even with the finest concrete and wood dust  
 The filter is automatically cleaned every 15 seconds reducing filter clogging and delivering constant air flow

**Standard Equipment:** 4 m x 35 mm extraction hose, Crevice tool, Universal hose adaptor, Dust bag

Power Input	1380 Watts
Power Take Off Rating	2200 Watts
Max. Airflow	3660 l/min
Capacity	45 hr
Wet/Dry Capacity	45 hr
Weight	13.5 kg
Length x Height	520 x 695 mm



\*110V only

# DEWALT

## SERVICE

# BRUSH PAIRS



- Spare parts such as brush pairs can only be purchased by a DEWALT Service Agent. To find your nearest Service Agent, visit our service web site: [www.2helpU.com](http://www.2helpU.com)
- Repairs on power tools should be carried out by an authorised technician
- Any attempt by anyone other than an authorised service repair agent to service a tool during the warranty period will invalidate the warranty for said tool.
- To have the most recent data on spare parts: technical features and the tools they fit, visit our service web site: [www.2helpU.com](http://www.2helpU.com)

Fits	Pair Number	Voltage
D21101 (T1 + 2)	578393-02	230V
D21441 (T1 + 2)	578393-02	230V
D21620K (T1)	596825-00	115V-230V
D21710 (T1 + 2 + 3 + 5)	578393-02	230V
D21711 (T1 + 2 + 3 + 5)	578393-02	230V
D21716 (T1 + 2)	578393-02	230V
D21717 (T1 + 2)	578393-02	230V
D21720 (T1 + 2 + 3 + 4 + 5)	578393-02	230V
D21721 (T1 + 2 + 4)	578393-02	230V
D21805 (T1)	578393-02	230V
D21810 (T1)	578393-02	230V
D21815 (T1)	578393-02	230V
D25011K (T1)	N032831	230V
D25012K (T1)	N032831	230V
D25013K (T1)	N032831	230V
D25101K (T1 + 2 + 3)	585475-00	230V
D25102K (T1 + 2 + 3)	585475-00	230V
D25103K (T1 + 2 + 3 + 4)	585475-00	230V
D25104K (T1 + 2 + 3)	585475-00	230V
D25112K (T1)	585475-00	230V
D25113K (T1)	585475-00	230V
D25114K (T1)	585475-00	230V
D25201K (T1 + 2 + 3)	585475-00	230V
D25203K (T1 + 2 + 3)	585475-00	230V
D25213K (T1)	585475-00	230V
D25223K (T1)	585475-00	230V
D25303K (T1 + 2 + 3)	584429-00	230V
D25304K (T1 + 2 + 3)	584429-00	230V
D25313K (T1)	584429-00	230V
D25314K (T1)	584429-00	230V
D25323K (T1)	584429-00	230V
D25324K (T1)	584429-00	230V
D25330K (T1 + 2)	584429-00	230V
D25404K (T2)	487131-00	230V
D25405K (T2)	487131-00	230V
D25500K (T1 + 2)	582621-00	230V
D25600K (T1 + 2)	327148-01	230V
D25700K (T1)	489256-00	230V
D25701K (T1 + 2)	489256-00	230V
D25730K (T1 + 2)	489256-00	230V
D25830K (T1 + 2)	327148-01	230V
D25840K (T1)	489256-00	230V
D25890K (T1)	489256-00	230V
D25899 (T1)	1005550-02	230V
D25900K (T1 + 2)	588698-00	230V
D25901K (T1)	1005550-02	230V
D25940K (T1 + 2)	588698-00	230V
D25941K (T1)	1005550-02	230V
D25980 (T1 + 2)	1005550-02	230V
D26410 (T1)	589016-00	230V
D26410 (T1)	596106-00	230V
D26420 (T1)	589016-00	230V
D26420 (T1)	596106-00	230V
D26421 (T1)	589016-00	230V
D26421 (T1)	596106-00	230V
D26422 (T1)	589016-00	230V
D26422 (T1)	596106-00	230V
D26423 (T1)	589016-00	230V
D26423 (T1)	596106-00	230V
D26441 (T1 + 2)	1006269-00	230V
D26451 (T1)	1006269-00	230V
D26453 (T1)	1006269-00	230V
D26500	575963-00	230V
D26501 (T1)	575963-03	230V
D27900 (T1)	597226-00	230V
D27901 (T1)	597093-00	230V
D28108	1003859-00	230V
D28111	1003860-00	230V
D28113	1003860-00	230V
D28116	1003860-00	230V
D28117	1003860-00	230V
D28127	1003859-00	230V
D28128	1003859-00	230V
D28129	1003859-00	230V
D28130	1003860-00	230V

Fits	Pair Number	Voltage
D28132	1003860-00	230V
D28132C	1003857-00	230V
D28133	1003860-00	230V
D28134	1003860-00	230V
D28135	1003857-00	230V
D28136	1003857-00	230V
D28137	1003857-00	230V
D28139	1003860-00	230V
D28141	1003857-00	230V
D28151	1003859-00	230V
D28152	1003859-00	230V
D28153	1003861-00	230V
D28154	1003861-00	230V
D28155	1003861-00	230V
D28156	1003861-00	230V
D28157	1003861-00	230V
D28187	1003861-00	230V
D28400 (T1 + 2)	585041-00	230V
D28401 (T1 + 2)	585041-00	230V
D28410 (T1 + 2)	585041-00	230V
D28411 (T1 + 2)	585041-00	230V
D28413 (T1 + 2)	585041-00	230V
D28414 (T1 + 2)	585041-00	230V
D28415 (T1 + 2)	585041-00	230V
D28420 (T1)	585041-00	230V
D28421 (T1 + 2)	585041-00	230V
D28422 (T1 + 2)	585041-00	230V
D28423 (T1 + 2)	585041-00	230V
D28430 (T1)	585041-00	230V
D28432C (T1 + 2)	585041-00	230V
D28490 (T1)	585041-00	230V
D28491 (T1)	585041-00	230V
DC210K (T1)	493511-00	N/A
DC212K (T1)	493511-00	N/A
DC213 (T1)	493511-00	N/A
DC213KL (T1)	493511-00	N/A
DC222K (T1)	493511-00	N/A
DC223K (T1)	493511-00	N/A
DC224K (T1)	493511-00	N/A
DC330 (T1)	493511-00	N/A
DC520K (T1)	493511-00	N/A
DC920K (T10)	493511-00	N/A
DC925K (T10)	493511-00	N/A
DC930K (T10)	493511-00	N/A
DC935K (T10)	493511-00	N/A
DC940K (T10)	493511-00	N/A
DC945K (T10)	493511-00	N/A
DC980K (T10)	493511-00	N/A
DC981K (T10)	493511-00	N/A
DC984K (T1)	493511-00	N/A
DC984K (T1)	493511-00	N/A
DW205 (T1 + 2)	578393-02	230V
DW233K (T3)	578393-02	230V
DW241	578393-02	230V
DW268 (T5)	N023113	230V
DW331 (T1)	589016-00	230V
DW333 (T1)	589016-00	230V
DW341 (T1 + 2)	494040-00	230V
DW341K (T1 + 2)	494043-00	230V
DW343 (T2)	494040-00	230V
DW343K (T1 + 2)	494043-00	230V
DW448	1003859-00	230V
DW451 (T1 + 2)	1003859-00	230V
DW456 (T1 + 2)	1003861-00	230V
DW625E (T6)	869368-00	230V
DW626 (T1)	585443-00	230V
DW678 (T1 + 2 + 3 + 4)	575963-00	230V
DW678E (T1 + 2 + 4)	575963-03	230V
DW770 (T1)	659512-00	115V-230V
DW770 (T1)	659513-00	115V-230V
DW771 (T1 + 2)	659512-00	115V-230V
DW771 (T1 + 2)	659513-00	115V-230V
DW777 (T1 + 2)	659512-00	115V-230V
DW777 (T1 + 2)	659513-00	115V-230V
DW5520 (T1)	1007368-00	230V

[www.2helpU.com](http://www.2helpU.com)



# ACCESSORIES SECTION

**YOUR PREMIUM DEWALT TOOLS DESERVE  
THE RIGHT ACCESSORY**

**USING PROFESSIONAL QUALITY ACCESSORIES WILL  
IMPROVE THE PERFORMANCE OF YOUR TOOL**



## ICON REFERENCE

Aluminium	Block	Brass	Brick	Filler	Primer	Ceramics	Chipboard	Concrete
Fibre Cement Board	Fibreglass	Floor Tile	Granite	Graphite	Natural Wood	Hardboard	Hardwood	Iron
Laminates	Marble	Masonry	MDF	Metal Tube	Nickel	Painted Wood	Plastic	Plywood
Porcelain	Light Masonry Block	Reclaimed Wood	Rust	Slate	Softwood	Steel	Stainless Steel	Stone
Terracotta	Thin Steel	Tile	Veneers	Wall Tile	White Veneer	Wood	Filler	

**EXTREME DeWALT® MASONRY DRILL BITS**



**APPLICATIONS**

- Typically used for drilling anchor, plastic plug, fixing or pipework clearance holes.
- Suitable for masonry, brick, stone, tiles and light concrete.

**FEATURES**

- Lasts up to 2x longer and delivers up to 50% more holes per charge than a standard masonry bit.
- Unique Carbide Grade - optimum grade maximises durability.



**SINGLE PACKS**

Cat. No.	Diameter mm	Length mm	Working Length mm	Pack Qty.	M.O.Q.	Barcode	List Price Ex. VAT (£)
DT6695-QZ	3	110	70	1	1	5035048061879	2,32
DT6699-QZ	3.5	110	70	1	1	5035048014028	NOT UK
DT6696-QZ	4	110	70	1	1	5035048061886	2,37
DT6671-QZ	4	75	50	1	1	5035048060568	2,22
DT6672-QZ	5	85	50	1	1	5035048060575	2,24
DT6673-QZ	5	150	100	1	1	5035048060582	3,52
DT6674-QZ	5.5	85	50	1	1	5035048060599	2,37
DT6675-QZ	6	100	60	1	1	5035048060605	2,44
DT6676-QZ	6	150	100	1	1	5035048060612	3,27
DT6677-QZ	6	200	150	1	1	5035048060629	4,06
DT6678-QZ	6.5	100	60	1	1	5035048060636	2,48
DT6679-QZ	6.5	150	100	1	1	5035048060643	3,52
DT6680-QZ	7	100	60	1	1	5035048060650	2,88
DT6681-QZ	7	150	100	1	1	5035048060667	3,52
DT6682-QZ	8	120	80	1	1	5035048060674	3,43
DT6683-QZ	8	200	150	1	1	5035048060681	4,19
DT6684-QZ	9	120	80	1	1	5035048060698	4,40
DT6685-QZ	10	120	80	1	1	5035048060704	3,71
DT6686-QZ	10	200	150	1	1	5035048060711	4,42
DT6687-QZ	12	150	100	1	1	5035048060728	5,16
DT6688-QZ	12	200	150	1	1	5035048060735	6,18
DT6689-QZ	13	150	100	1	1	5035048060742	6,70
DT6690-QZ	14	150	100	1	1	5035048060759	7,87
DT6691-QZ	14	200	150	1	1	5035048060766	8,98
DT6692-QZ	16	150	100	1	1	5035048060773	9,53
DT6693-QZ	16	200	150	1	1	5035048060780	9,59

**EXTREME DeWALT® MASONRY DRILL BIT SETS**

Cat. No.	Description	Diameter mm	Pack Qty.	M.O.Q.	Barcode	List Price Ex. VAT (£)
DT6956-QZ	5 piece set in plastic cassette.	4, 5, 6, 8, 10	5	1	5035048060797	12,18
DT79288-QZ	Small tough case in blister with EXTREME DeWALT® Masonry drill bits: Ph2x4, Pz2x4, Ph2x50mm, Pz2x50mm, Slotted 5.5x50mm, Magnetic holder, Magnetic drive guide.	4, 5, 5.5, 6, 7, 8, 19	1	1	5035048072219	53,56

**MASONRY DRILL BITS**



**APPLICATIONS**

- Typically used for drilling anchor, plastic plug, fixing or pipework clearance holes.
- Suitable for masonry, brick/blockwork, stone.

**FEATURES**

- Rotary/percussion masonry drill bit 130° Douglas form carbide tip.
- Shank diameter of drill bits 10-13 mm is reduced to 9.5 mm.
- Shank diameter of drill bits larger than 13 mm is reduced to 12.7 mm.



**SINGLE PACKS**

Cat. No.	Diameter mm	Length mm	Working Length mm	Pack Qty.	M.O.Q.	Barcode	List Price Ex. VAT (£)
DT6500-QZ	3	60	28	1	1	5011402382309	1,10
DT6504-QZ	4	75	38	1	1	5011402372379	1,09
DT6505-QZ	5	85	44	1	1	5011402372416	1,19
DT6502-QZ	5.5	85	44	1	1	5011402372454	1,22
DT6552-QZ	5.5	150	82	1	1	5011402372478	1,64
DT6506-QZ	6	100	54	1	1	5011402372492	1,38
DT6556-QZ	6	150	82	1	1	5011402372515	2,04
DT6606-QZ	6	200	135	1	1	5011402372539	2,31
DT6503-QZ	6.5	100	54	1	1	5011402372553	1,40
DT6507-QZ	7	100	54	1	1	5011402372614	1,46
DT6557-QZ	7	150	82	1	1	5011402372638	2,21
DT6508-QZ	8	120	67	1	1	5011402372676	1,58
DT6558-QZ	8	150	82	1	1	5011402372690	2,21
DT6608-QZ	8	200	135	1	1	5011402372713	2,61
DT6708-QZ	8	400	230	1	1	5011402372737	5,23
DT6509-QZ	9	120	67	1	1	5011402372751	2,26
DT6510-QZ	10	120	67	1	1	5011402372836	2,26
DT6560-QZ	10	150	82	1	1	5011402372850	2,21
DT6610-QZ	10	200	135	1	1	5011402372874	2,79
DT6710-QZ	10	400	230	1	1	5011402372898	5,84
DT6732-QZ	10	600	400	1	1	5011402382361	7,08
DT6562-QZ	12	150	82	1	1	5011402372935	3,01
DT6612-QZ	12	200	135	1	1	5011402372959	3,86
DT6712-QZ	12	400	230	1	1	5011402372973	6,92
DT6733-QZ	12	600	400	1	1	5011402382378	7,38
DT6563-QZ	13	150	82	1	1	5011402372997	3,17
DT6564-QZ	14	150	82	1	1	5011402373055	3,17
DT6714-QZ	14	400	230	1	1	5011402373093	8,47
DT6734-QZ	14	600	400	1	1	5011402382385	8,10
DT6566-QZ	16	150	82	1	1	5011402373130	5,97
DT6716-QZ	16	400	230	1	1	5011402373154	8,89
DT6735-QZ	16	600	400	1	1	5011402382392	11,08
DT6718-QZ	18	400	230	1	1	5011402373192	11,48
DT6720-QZ	20	400	230	1	1	5011402373239	12,18

**MASONRY DRILL BITS**



**MASONRY DRILL BIT SETS**

Cat. No.	Description	Diameter mm	Pack Qty.	M.O.Q.	Barcode	List Price Ex. VAT (€)
DT6952-QZ	5 piece set in plastic cassette	4, 5, 6, 8, 10	5	1	5011402373413	8,09

**MULTI MATERIAL DRILL BITS**



**MULTI MATERIAL DRILL BITS**

**APPLICATIONS**

- Suitable for wood, plastics, mild steel and non ferrous metals and masonry.
- For use in rotary or percussion drilling modes.

**FEATURES**

- Unique 120° tip grind for maximum sharpness.
- Fully supported carbide head gives faster drilling and extended life.
- Non slip shank ensures better retention in chuck.

Cat. No.	Diameter mm	Length mm	Working Length mm	Pack Qty.	M.O.Q.	Barcode	List Price Ex. VAT (€)
DT6515-QZ	3	113	83	1	1	5035048066010	2,21
DT6516-QZ	3.5	113	83	1	1	5035048066027	2,43
DT6517-QZ	4	103	73	1	1	5035048066034	2,76
DT6518-QZ	5	113	83	1	1	5035048066041	2,89
DT6527-QZ	5.5	113	83	1	1	5035048077504	2,77
DT6528-QZ	5.5	200	170	1	1	5035048077511	3,37
DT6519-QZ	6	123	93	1	1	5035048066058	3,14
DT6529-QZ	6	200	170	1	1	5035048077528	3,82
DT6520-QZ	6.5	123	93	1	1	5035048066065	3,42
DT6530-QZ	6.5	200	170	1	1	5035048077535	4,17
DT6521-QZ	7	123	93	1	1	5035048066072	4,03
DT6522-QZ	8	134	104	1	1	5035048066089	4,15
DT6531-QZ	8	200	170	1	1	5035048077542	5,07
DT6523-QZ	9	134	104	1	1	5035048066096	4,41
DT6524-QZ	10	134	104	1	1	5035048066102	4,52
DT6533-QZ	10	200	170	1	1	5035048077559	4,75
DT6525-QZ	12	153	123	1	1	5035048066119	6,07
DT6526-QZ	13	160	130	1	1	5035048066126	8,94

**SDS-Plus EXTREME DeWALT® 2 DRILL BITS**



**SINGLE PACKS**

**APPLICATIONS**

- Suitable for fast drilling of plug, anchor or clearance holes in masonry, stone, concrete and brick/black work.

**FEATURES**

- The innovative EXTREME DeWALT® 2 SDS-Plus drill bit is amongst the very best in terms of its durability drilling life and speed.
- The Superior carbide grade ensures a tip with outstanding durability which gives consistent drilling life.
- The NEW 4 FLUTE SPIRAL incorporates a maximized central core for increased durability and energy transmission.
- The 140° tip design ensures better bit penetration and longer life.
- Hardened Steel body for extra strength and reduced breakage.

Cat. No.	Diameter mm	Length mm	Working Length mm	Pack Qty.	M.O.Q.	Barcode	List Price Ex. VAT (€)
DT9625-QZ	3	135	75	1	1	5035048014011	NOT UK
DT9500-QZ	3.5	110	50	1	1	5035048054758	6,00
DT9502-QZ	4	110	50	1	1	5035048054772	3,38
DT9503-QZ	4	160	100	1	1	5035048054789	5,22
DT9504-QZ	5	110	50	1	1	5035048054796	3,00
DT9505-QZ	5	160	100	1	1	5035048054802	3,55
DT9506-QZ	5	210	150	1	1	5035048054819	5,31
DT9507-QZ	5	310	250	1	1	5035048054826	9,09
DT9620-QZ	5	460	400	1	1	5035048061855	18,34
DT9508-QZ	5.5	110	50	1	1	5035048054833	3,10
DT9509-QZ	5.5	160	100	1	1	5035048054840	3,40
DT9510-QZ	5.5	210	150	1	1	5035048054857	4,99
DT9511-QZ	5.5	260	200	1	1	5035048054864	6,77
DT9512-QZ	5.5	310	250	1	1	5035048054871	9,22
DT9513-QZ	5.5	460	400	1	1	5035048054888	20,83
DT9514-QZ	6	110	50	1	1	5035048054895	3,11
DT9515-QZ	6	160	100	1	1	5035048054901	3,55
DT9516-QZ	6	210	150	1	1	5035048054918	5,01
DT9517-QZ	6	260	200	1	1	5035048054925	7,63
DT9621-QZ	6	310	250	1	1	5035048061862	8,91
DT9518-QZ	6	460	400	1	1	5035048054932	19,98
DT9519-QZ	6.5	110	50	1	1	5035048054949	3,28
DT9520-QZ	6.5	160	100	1	1	5035048054956	3,70
DT9521-QZ	6.5	210	150	1	1	5035048054963	3,94
DT9522-QZ	6.5	260	200	1	1	5035048054970	8,66
DT9523-QZ	6.5	310	250	1	1	5035048054987	9,82
DT9524-QZ	7	110	50	1	1	5035048054994	3,60
DT9525-QZ	7	160	100	1	1	5035048055007	3,86
DT9526-QZ	7	210	150	1	1	5035048055014	5,82
DT9527-QZ	7	260	200	1	1	5035048055021	6,38
DT9528-QZ	8	110	50	1	1	5035048055038	3,61
DT9529-QZ	8	160	100	1	1	5035048055045	4,00

**SDS-Plus EXTREME DeWALT® 2 DRILL BITS**



**APPLICATIONS**

- Suitable for fast drilling of plug, anchor or clearance holes in masonry, stone, concrete and brick/block work.

**FEATURES**

- The innovative EXTREME DeWALT® 2 SDS-Plus drill bit is amongst the very best in terms of its durability drilling life and speed.
- The Superior carbide grade ensures a tip with outstanding durability which gives consistent drilling life.
- The NEW 4 FLUTE SPIRAL incorporates a maximized central core for increased durability and energy transmission.
- The 140° tip design ensures better bit penetration and longer life.
- Hardened Steel body for extra strength and reduced breakage.



**SINGLE PACKS**

Cat. No.	Diameter mm	Length mm	Working Length mm	Pack Qty.	M.O.O.	Barcode	List Price Ex. VAT (£)
DT9530-QZ	8	210	150	1	1	5035048055052	4,67
DT9531-QZ	8	260	200	1	1	5035048055069	7,63
DT9532-QZ	8	310	250	1	1	5035048055076	9,21
DT9533-QZ	8	410	350	1	1	5035048055083	14,57
DT9534-QZ	8	460	400	1	1	5035048055090	13,39
DT9535-QZ	8	600	540	1	1	5035048055106	19,50
DT9536-QZ	9	160	100	1	1	5035048055113	5,18
DT9537-QZ	9	210	150	1	1	5035048055120	6,86
DT9539-QZ	10	110	50	1	1	5035048055144	3,73
DT9540-QZ	10	160	100	1	1	5035048055151	4,38
DT9541-QZ	10	210	150	1	1	5035048055168	5,24
DT9542-QZ	10	260	200	1	1	5035048055175	7,07
DT9543-QZ	10	310	250	1	1	5035048055182	8,33
DT9544-QZ	10	350	300	1	1	5035048055199	8,25
DT9545-QZ	10	460	400	1	1	5035048055205	12,67
DT9546-QZ	10	600	550	1	1	5035048055212	17,63
DT9547-QZ	10	1000	950	1	1	5035048055229	43,93
DT9548-QZ	11	160	100	1	1	5035048055236	5,45
DT9549-QZ	11	210	150	1	1	5035048055243	5,91
DT9550-QZ	11	260	200	1	1	5035048055250	6,02
DT9551-QZ	11	310	250	1	1	5035048055267	8,33
DT9552-QZ	12	160	100	1	1	5035048055274	5,39
DT9553-QZ	12	200	150	1	1	5035048055281	5,93
DT9554-QZ	12	260	200	1	1	5035048055298	6,27
DT9555-QZ	12	300	250	1	1	5035048055304	7,21
DT9556-QZ	12	350	300	1	1	5035048055311	9,19
DT9557-QZ	12	450	400	1	1	5035048055328	11,51
DT9558-QZ	12	600	550	1	1	5035048055335	19,69
DT9559-QZ	12	1000	950	1	1	5035048055342	46,31
DT9560-QZ	13	160	100	1	1	5035048055359	6,21
DT9561-QZ	13	200	150	1	1	5035048055366	6,20
DT9562-QZ	13	260	200	1	1	5035048055373	7,88
DT9563-QZ	13	300	250	1	1	5035048055380	8,83
DT9565-QZ	13	450	400	1	1	5035048055403	12,33
DT9566-QZ	14	160	100	1	1	5035048055410	7,23
DT9567-QZ	14	200	150	1	1	5035048055427	7,35
DT9568-QZ	14	260	200	1	1	5035048055434	8,05
DT9569-QZ	14	300	250	1	1	5035048055441	9,32
DT9570-QZ	14	450	400	1	1	5035048055458	13,83
DT9571-QZ	14	600	550	1	1	5035048055465	19,67
DT9572-QZ	14	1000	950	1	1	5035048055472	50,56
DT9573-QZ	15	160	100	1	1	5035048055489	6,89
DT9574-QZ	15	200	150	1	1	5035048055496	7,88
DT9575-QZ	15	260	200	1	1	5035048055502	9,27
DT9576-QZ	15	300	250	1	1	5035048055519	10,33
DT9577-QZ	15	450	400	1	1	5035048055526	13,90
DT9578-QZ	16	160	100	1	1	5035048055533	7,53
DT9579-QZ	16	200	150	1	1	5035048055540	8,90
DT9580-QZ	16	260	200	1	1	5035048055557	9,62
DT9581-QZ	16	300	250	1	1	5035048055564	11,34
DT9582-QZ	16	450	400	1	1	5035048055571	15,70
DT9583-QZ	16	600	550	1	1	5035048055588	23,84
DT9584-QZ	16	800	750	1	1	5035048055595	46,67
DT9585-QZ	16	1000	950	1	1	5035048055601	52,73
DT9586-QZ	17	200	150	1	1	5035048055618	16,67
DT9587-QZ	18	200	150	1	1	5035048055625	10,98
DT9588-QZ	18	250	200	1	1	5035048055632	12,17
DT9589-QZ	18	300	250	1	1	5035048055649	15,29
DT9590-QZ	18	450	400	1	1	5035048055656	22,01
DT9591-QZ	18	600	550	1	1	5035048055663	29,88
DT9592-QZ	18	800	750	1	1	5035048055670	48,90
DT9593-QZ	18	1000	950	1	1	5035048055687	70,18
DT9596-QZ	19	450	400	1	1	5035048055717	24,84
DT9597-QZ	20	200	150	1	1	5035048055724	12,49
DT9598-QZ	20	300	250	1	1	5035048055731	17,30
DT9599-QZ	20	450	400	1	1	5035048055748	25,05
DT9600-QZ	20	600	550	1	1	5035048055755	34,59
DT9601-QZ	20	1000	950	1	1	5035048055762	79,00
DT9602-QZ	22	250	200	1	1	5035048055779	19,26
DT9603-QZ	22	300	250	1	1	5035048055786	20,85
DT9604-QZ	22	450	400	1	1	5035048055793	27,43
DT9605-QZ	22	600	550	1	1	5035048055809	34,75
DT9606-QZ	22	800	750	1	1	5035048055816	63,17
DT9607-QZ	22	1000	950	1	1	5035048055823	86,64
DT9609-QZ	24	250	200	1	1	5035048055847	21,81
DT9610-QZ	24	450	400	1	1	5035048055854	29,77
DT9611-QZ	25	250	200	1	1	5035048055861	23,92
DT9612-QZ	25	300	250	1	1	5035048055878	25,14
DT9613-QZ	25	450	400	1	1	5035048055885	31,02
DT9614-QZ	25	1000	950	1	1	5035048055892	92,02
DT9615-QZ	26	250	200	1	1	5035048055908	27,56
DT9616-QZ	26	450	400	1	1	5035048055915	32,81
DT9617-QZ	26	800	750	1	1	5035048055922	72,44
DT9618-QZ	30	250	200	1	1	5035048055939	41,75
DT9619-QZ	30	450	400	1	1	5035048055946	49,51

**SDS-Plus EXTREME DeWALT® 2 DRILL BITS**

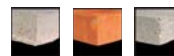

**APPLICATIONS**

- Suitable for fast drilling of plug, anchor or clearance holes in masonry, stone, concrete and brick/block work.

**FEATURES**

- The innovative EXTREME DeWALT® 2 SDS-Plus drill bit is amongst the very best in terms of its durability drilling life and speed.
- The Superior carbide grade ensures a tip with outstanding durability which gives consistent drilling life.
- The NEW 4 FLUTE SPIRAL incorporates a maximized central core for increased durability and energy transmission.
- The 140° tip design ensures better bit penetration and longer life.
- Hardened Steel body for extra strength and reduced breakage.

**BULK PACKS**

Cat. No.	Diameter mm	Length mm	Working Length mm	Pack Qty.	M.O.Q.	Barcode	List Price Ex. VAT (£)
DT9800-QZ	5	110	50	10	1	5035048055953	28,03
DT9803-QZ	5	160	100	10	1	5035048055984	34,00
DT9806-QZ	5.5	110	50	10	1	5035048056011	28,37
DT9809-QZ	5.5	160	100	10	1	5035048056042	31,50
DT9812-QZ	6	110	50	10	1	5035048056073	28,64
DT9814-QZ	6	110	50	100	1	5035048056097	249,10
DT9815-QZ	6	160	100	10	1	5035048056103	32,43
DT9816-QZ	6	160	100	50	1	5035048056110	159,84
DT9817-QZ	6	160	100	100	1	5035048056127	304,22
DT9818-QZ	6	210	150	10	1	5035048056134	47,72
DT9848-QZ	6	210	150	50	1	5035048013977	209,59
DT9820-QZ	6.5	160	100	10	1	5035048056158	35,49
DT9846-QZ	6.5	210	150	10	1	5035048013953	42,84
DT9847-QZ	6.5	210	150	50	1	5035048013960	220,63
DT9823-QZ	7	160	100	10	1	5035048056189	34,78
DT9826-QZ	8	110	50	10	1	5035048056219	32,42
DT9827-QZ	8	160	100	10	1	5035048056226	37,57
DT9828-QZ	8	160	100	50	1	5035048056233	174,18
DT9829-QZ	8	160	100	100	1	5035048056240	324,51
DT9830-QZ	8	210	150	10	1	5035048056257	41,70
DT9831-QZ	8	260	200	10	1	5035048056264	74,56
DT9833-QZ	10	110	50	10	1	5035048056288	33,78
DT9834-QZ	10	160	100	10	1	5035048056295	41,75
DT9835-QZ	10	160	100	50	1	5035048056301	196,85
DT9837-QZ	10	210	150	10	1	5035048056325	47,66
DT9838-QZ	10	260	200	10	1	5035048056332	67,77
DT9839-QZ	12	160	100	10	1	5035048056349	50,70
DT9840-QZ	12	160	100	50	1	5035048056356	237,40
DT9841-QZ	12	200	150	10	1	5035048056363	54,58
DT9842-QZ	12	260	200	10	1	5035048056370	58,12
DT9843-QZ	14	160	100	10	1	5035048056387	57,26
DT9844-QZ	14	200	150	10	1	5035048056394	66,81

**SDS-Plus EXTREME DeWALT® 2 DRILL BIT SETS**

Cat. No.	Description	Diameter mm	Pack Qty.	M.O.Q.	Barcode	List Price Ex. VAT (£)
DT9700-QZ	4 piece set in plastic cassette.	5,6,8,10	4	1	5035048056400	20,85
DT9701-QZ	7 piece set in metal cassette.	5,6x2,8x2,10,12	7	1	5035048056417	40,54
DT9702-QZ	4 piece set in plastic cassette.	5,5,7,8,10	4	1	5035048056424	17,37



**EXTREME DeWALT® XLR FULL HEAD CARBIDE DRILL BITS**



**APPLICATIONS**

- Suitable for drilling plug & anchor holes in masonry, all types of stone and concrete.

**FEATURES**

- New solid carbide drill tip with optimised 4 cutter geometry offers the highest levels of drill bit life and durability from DeWALT to date.
- 4 cutter geometry drills a more concentric hole to offer the best fixing retention.
- 4 flute spiral aids consistent drilling speed and efficient debris removal.
- Unique bonding system joins the solid carbide head to the 4 flute spiral as one to ensure the highest standards available in DeWALT® SDS-Plus drilling to date.



**SINGLE PACKS**

Cat. No.	Diameter mm	Length mm	Working Length mm	Pack Qty.	M.O.Q.	Barcode	List Price Ex. VAT (£)
DT8907-QZ	5	110	50	1	1	503504807689	4,92
DT8908-QZ	5	160	100	1	1	503504807696	7,07
DT8909-QZ	5	210	150	1	1	503504807702	7,12
DT8910-QZ	5.5	110	50	1	1	503504807719	5,74
DT8911-QZ	5.5	160	100	1	1	503504807726	7,77
DT8912-QZ	6	110	50	1	1	503504807733	6,36
DT8913-QZ	6	160	100	1	1	503504807740	7,95
DT8914-QZ	6	210	150	1	1	503504807757	8,48
DT8915-QZ	6	260	200	1	1	503504807764	8,04
DT8916-QZ	6.5	160	100	1	1	503504807771	9,19
DT8917-QZ	6.5	210	150	1	1	503504807788	7,25
DT8918-QZ	6.5	260	200	1	1	503504807795	8,62
DT8919-QZ	6.5	310	250	1	1	503504807801	10,10
DT8920-QZ	7	160	100	1	1	503504807818	7,83
DT8921-QZ	7	210	150	1	1	503504807825	9,17
DT8922-QZ	8	110	50	1	1	503504807832	6,18
DT8923-QZ	8	160	100	1	1	503504807849	7,67
DT8924-QZ	8	210	150	1	1	503504807856	8,01
DT8925-QZ	8	260	200	1	1	503504807863	9,12
DT8926-QZ	8	310	250	1	1	503504807870	10,90
DT8927-QZ	8	460	400	1	1	503504807887	21,47
DT8928-QZ	10	160	100	1	1	503504807894	8,06
DT8929-QZ	10	210	150	1	1	503504807900	9,18
DT8930-QZ	10	260	200	1	1	503504807917	10,05
DT8931-QZ	10	310	250	1	1	503504807924	11,81
DT8932-QZ	10	460	400	1	1	503504807931	24,17
DT8933-QZ	12	160	100	1	1	503504807948	10,33
DT8934-QZ	12	200	150	1	1	503504807955	11,12
DT8935-QZ	12	260	200	1	1	503504807962	11,84
DT8936-QZ	12	310	260	1	1	503504807979	12,70
DT8937-QZ	12	460	410	1	1	503504807986	24,36
DT8938-QZ	14	160	100	1	1	503504807993	NOT UK
DT8939-QZ	14	200	150	1	1	503504808006	NOT UK
DT8940-QZ	14	260	200	1	1	503504808013	NOT UK
DT8941-QZ	14	310	250	1	1	503504808020	NOT UK
DT8942-QZ	14	460	400	1	1	503504808037	NOT UK

**BULK PACKS**

Cat. No.	Diameter mm	Length mm	Working Length mm	Pack Qty.	M.O.Q.	Barcode	List Price Ex. VAT (£)
DT8950-QZ	5	110	50	10	1	5035048078105	41,72
DT8951-QZ	5	160	100	10	1	5035048078112	54,33
DT8952-QZ	5	210	150	10	1	5035048078129	64,21
DT8953-QZ	5.5	110	50	10	1	5035048078136	49,98
DT8954-QZ	5.5	160	100	10	1	5035048078143	58,08
DT8955-QZ	6	110	50	10	1	5035048078150	42,86
DT8956-QZ	6	160	100	10	1	5035048078167	55,17
DT8957-QZ	6	210	150	10	1	5035048078174	63,57
DT8958-QZ	6	260	200	10	1	5035048078181	73,64
DT8959-QZ	6.5	160	100	10	1	5035048078198	60,97
DT8960-QZ	6.5	210	150	10	1	5035048078204	65,49
DT8961-QZ	6.5	260	200	10	1	5035048078211	79,38
DT8962-QZ	7	160	100	10	1	5035048078228	69,25
DT8963-QZ	7	260	150	10	1	5035048078235	75,96
DT8964-QZ	8	110	50	10	1	5035048078242	54,32
DT8965-QZ	8	160	100	10	1	5035048078259	67,25
DT8966-QZ	8	210	150	10	1	5035048078266	73,29
DT8967-QZ	10	160	100	10	1	5035048078273	79,92
DT8968-QZ	10	210	150	10	1	5035048078280	85,02
DT8969-QZ	10	260	200	10	1	5035048078297	93,76
DT8970-QZ	10	310	260	10	1	5035048078303	111,45
DT8971-QZ	12	160	100	10	1	5035048078310	95,95
DT8972-QZ	12	200	150	10	1	5035048078327	113,97
DT8973-QZ	14	200	150	10	1	5035048078334	NOT UK

**EXTREME DeWALT® FULL HEAD CARBIDE DRILL BIT SETS**

Cat. No.	Description	Diameter mm	Pack Qty.	M.O.Q.	Barcode	List Price Ex. VAT (£)
DT8976-QZ	7 piece set in metal cassette	5, 6x2, 8x2, 10, 12	7	1	5035048078341	NOT UK
DT8977B-QZ	Medium Tough Case with SDS-Plus XLR Full Head Carbide drill bits	5, 6x2, 8x2, 10, 12	10	1	5035048078358	76,67



**SDS-Plus 4-CUTTER DRILL BITS**



**SINGLE PACKS**

**APPLICATIONS**

- For fixing holes and through holes 16mm - 30mm.

**FEATURES**

- 4 flute spiral with maximum flute entry enables faster debris removal.
- Maximised central core enables more efficient energy transmission to the drill bit head.
- Fully supported carbide head gives longer life and cleaner, more concentric holes for better fixing retention.
- Open head design ensures faster drilling.

Cat. No.	Diameter mm	Length mm	Working Length mm	Pack Qty.	M.O.Q.	Barcode	List Price Ex. VAT (£)
DT9680-QZ	16	250	200	1	1	5035048066133	31,44
DT9681-QZ	16	450	400	1	1	5035048066140	37,01
DT9682-QZ	18	250	200	1	1	5035048066157	33,74
DT9683-QZ	18	450	400	1	1	5035048066164	39,12
DT9684-QZ	20	250	200	1	1	5035048066171	35,95
DT9685-QZ	20	450	400	1	1	5035048066188	45,31
DT9686-QZ	22	250	200	1	1	5035048066195	46,61
DT9687-QZ	22	450	400	1	1	5035048066201	51,97
DT9688-QZ	24	250	200	1	1	5035048066218	51,57
DT9689-QZ	24	450	400	1	1	5035048066225	56,05
DT9690-QZ	25	250	200	1	1	5035048066232	56,92
DT9691-QZ	25	450	400	1	1	5035048066249	58,04
DT9692-QZ	26	450	400	1	1	5035048066256	63,14
DT9693-QZ	28	250	200	1	1	5035048066263	71,15
DT9694-QZ	28	450	400	1	1	5035048066270	74,37
DT9695-QZ	30	250	200	1	1	5035048066287	79,59
DT9696-QZ	30	450	400	1	1	5035048066294	85,12

**SDS-MAX HAMMER DRILL BITS**



**SINGLE PACKS**

**APPLICATIONS**

- For use with SDS-Max drive hammer drills (Hilti type F,G or Y) for anchor, fixing or clearance holes in masonry concrete, brick or block work.

**FEATURES**

- 4 flute spiral with maximum flute entry enables faster debris removal.
- Maximised central core enables more efficient energy transmission to the drill bit head.
- Fully supported carbide head gives longer life and cleaner, more concentric holes for better fixing retention.
- Open head design ensures faster drilling.



Cat. No.	Diameter mm	Length mm	Working Length mm	Cutters	Pack Qty.	M.O.Q.	Barcode	List Price Ex. VAT (£)
DT9400-QZ	12	340	200	2	1	1	5035048059678	28,38
DT9401-QZ	12	540	400	2	1	1	5035048059685	35,44
DT9402-QZ	12	670	550	2	1	1	5035048059692	47,26
DT9403-QZ	13	340	200	2	1	1	5035048059708	33,13
DT9404-QZ	13	540	400	2	1	1	5035048059715	36,66
DT9405-QZ	14	340	200	2	1	1	5035048059722	35,44
DT9406-QZ	14	540	400	2	1	1	5035048059739	40,20
DT9407-QZ	15	340	200	2	1	1	5035048059746	39,97
DT9408-QZ	15	540	400	2	1	1	5035048059753	41,23
DT9409-QZ	16	340	200	4	1	1	5035048059760	47,43
DT9410-QZ	16	540	400	4	1	1	5035048059777	43,84
DT9411-QZ	18	340	200	4	1	1	5035048059784	42,51
DT9412-QZ	18	540	400	4	1	1	5035048059791	43,84
DT9413-QZ	19	340	200	4	1	1	5035048059807	43,41
DT9414-QZ	19	540	400	4	1	1	5035048059814	45,87
DT9415-QZ	19	670	550	4	1	1	5035048059821	57,45
DT9416-QZ	20	340	200	4	1	1	5035048059838	47,26
DT9417-QZ	20	540	400	4	1	1	5035048059845	51,55
DT9418-QZ	20	920	800	4	1	1	5035048059852	98,28
DT9419-QZ	22	340	200	4	1	1	5035048059869	49,57
DT9420-QZ	22	540	400	4	1	1	5035048059876	51,55
DT9421-QZ	22	920	800	4	1	1	5035048059883	100,02
DT9422-QZ	24	340	200	4	1	1	5035048059890	51,89
DT9423-QZ	24	540	400	4	1	1	5035048059906	56,97
DT9424-QZ	25	340	200	4	1	1	5035048059913	56,29
DT9425-QZ	25	540	400	4	1	1	5035048059920	61,33
DT9426-QZ	25	920	800	4	1	1	5035048059937	147,69
DT9427-QZ	26	340	200	4	1	1	5035048059944	68,11
DT9428-QZ	26	540	400	4	1	1	5035048059951	70,42
DT9429-QZ	28	380	250	4	1	1	5035048059968	72,74
DT9430-QZ	28	570	450	4	1	1	5035048059975	72,97
DT9431-QZ	28	670	550	4	1	1	5035048059982	84,09
DT9432-QZ	30	380	250	4	1	1	5035048059999	69,50
DT9433-QZ	30	570	450	4	1	1	5035048060001	69,55
DT9434-QZ	32	380	250	4	1	1	5035048060018	69,27
DT9435-QZ	32	570	450	4	1	1	5035048060025	83,33
DT9436-QZ	32	920	800	4	1	1	5035048060032	152,32
DT9437-QZ	35	380	250	4	1	1	5035048060049	75,06
DT9438-QZ	35	570	450	4	1	1	5035048060056	88,61
DT9439-QZ	35	670	550	4	1	1	5035048060063	101,55
DT9440-QZ	36	570	450	4	1	1	5035048060070	103,80
DT9441-QZ	38	380	250	4	1	1	5035048060087	116,67
DT9442-QZ	38	570	450	4	1	1	5035048060094	126,67
DT9443-QZ	38	670	550	4	1	1	5035048060101	133,33
DT9444-QZ	40	380	250	4	1	1	5035048060117	116,67
DT9445-QZ	40	570	450	4	1	1	5035048060124	126,14
DT9446-QZ	40	920	800	4	1	1	5035048060131	196,68
DT9447-QZ	42	570	450	4	1	1	5035048060148	153,33
DT9448-QZ	45	570	450	4	1	1	5035048060155	209,08
DT9449-QZ	50	570	450	4	1	1	5035048060162	220,77
DT9450-QZ	52	570	450	4	1	1	5035048060179	229,57

**SDS-Plus CHISELS**



**SINGLE PACKS**

**APPLICATIONS**

- For light chipping and chiselling of tile, mortar, glazing compounds and other masonry products with hammers with a rotation stop feature.

Cat. No.	Description	Width mm	Length mm	Pack Qty.	M.O.Q.	Barcode	List Price Ex. VAT (£)
DT6801-QZ	Pointed	-	250	1	1	5011402371426	14,04
DT6802-QZ	Flat	20	250	1	1	5011402371433	14,04
DT6803-QZ	Flat	40	200	1	1	5011402371440	21,44
DT6804-QZ	Sliding Chasing	22	250	1	1	5011402371457	56,00
DT6805-QZ	Hollow/Gouge	22	240	1	1	5011402371464	25,96
DT6806-QZ	Tile Chisel	40	200	1	1	5011402371471	23,80
DT6807-QZ	TCT Comb	32	130	1	1	5011402371488	125,60
DT6810-QZ	TCT Comb	32	200	1	1	5035048014301	NOT UK

**EXTREME DeWALT CHISELS**

Coming soon in 2011



**APPLICATIONS**

- For heavy duty chiselling, channelling and demolition tasks in concrete/rebar and hard stone.
- The new EXTREME chisels combined with DeWALT demolition hammers are ideal for even the toughest requirements.

**FEATURES**

- High grade toughened steel shank designed for optimum durability in heavy duty tasks.
- Fully hardened steel for high wear resistance and increased service life.
- Innovative cutting geometry and aggressive angles for improved material removal over complete life of chisel

**EXTREME DeWALT SDS-MAX CHISELS**

Cat. No.	Description	Width mm	Length mm	Pack Qty.	M.O.Q.	Barcode	List Price Ex. VAT (£)
DT6888-QZ	300mm pointed chisel SDS-Max		300	1	1	5035048082393	TBC
DT6889-QZ	400mm pointed chisel SDS-Max		400	1	1	5035048082409	TBC
DT6890-QZ	600mm pointed chisel SDS-Max		600	1	1	5035048082416	TBC
DT6811-QZ	300mm x 25mm flat chisel SDS-Max	25	300	1	1	5035048082423	TBC
DT6812-QZ	400mm x 25mm flat chisel SDS-Max	25	400	1	1	5035048082430	TBC
DT6818-QZ	360mm x 50mm flat chisel SDS-Max	50	360	1	1	5035048082447	TBC

**EXTREME DeWALT 19MM CHISELS**

Cat. No.	Description	Width mm	Length mm	Pack Qty.	M.O.Q.	Barcode	List Price Ex. VAT (£)
DT6953-QZ	400mm pointed chisel 19mm hex		400	1	1	5035048082461	TBC
DT6954-QZ	600mm pointed chisel 19mm hex		600	1	1	5035048082478	TBC
DT6958-QZ	400mm x 25mm flat chisel 19mm hex	25	400	1	1	5035048082485	TBC
DT6959-QZ	600mm x 25mm flat chisel 19mm hex	25	600	1	1	5035048082492	TBC

**EXTREME DeWALT 28MM CHISELS**

Cat. No.	Description	Width mm	Length mm	Pack Qty.	M.O.Q.	Barcode	List Price Ex. VAT (£)
DT6971-QZ	520mm pointed chisel 28mm hex		520	1	1	5035048082508	TBC
DT6972-QZ	520mm x 36mm flat chisel 28mm hex	28	520	1	1	5035048082515	TBC

**EXTREME DeWALT 30MM CHISELS**

Cat. No.	Description	Width mm	Length mm	Pack Qty.	M.O.Q.	Barcode	List Price Ex. VAT (£)
DT6808-QZ	520mm pointed chisel 30mm hex		520	1	1	5035048083246	TBC
DT6809-QZ	520mm x 36mm flat chisel 30mm hex	36	520	1	1	5035048083253	TBC



**SDS-MAX CHISELS**



**SINGLE PACKS**

**APPLICATIONS**

- For heavy duty chiselling, channelling, and demolition tasks in concrete, stone (medium hardness), floor and wall tiles, general masonry and mortar.

**FEATURES**

- DeWALT has a wide range of chisels covering most common applications. Specially toughened steel and micro-processor controlled heat treatment ensures consistent tough bits with long life.

Cat. No.	Description	Width mm	Length mm	Pack Qty.	M.O.Q.	Barcode	List Price Ex. VAT (£)
DT6820-QZ	Pointed	-	300	1	1	5011402378067	20,40
DT6821-QZ	Pointed	-	400	1	1	5011402378104	24,20
DT8087-QZ	Pointed	-	600	1	1	5035048061411	31,67
DT6822-QZ	Flat	25	300	1	1	5011402378074	20,60
DT6823-QZ	Flat	25	400	1	1	5011402378111	24,20
DT6824-QZ	Flat	50	360	1	1	5011402378128	32,44
DT6825-QZ	Flat	80	300	1	1	5011402378081	48,00
DT8088-QZ	Flat	25	600	1	1	5035048061428	33,33
DT6826-QZ	Hollow/Gauge	26	300	1	1	5011402378098	52,00
DT6832-QZ	Sliding Chasing	32	300	1	1	5035048034217	57,20
DT6833-QZ	Sliding Chasing	35	380	1	1	5035048034224	101,00
DT6834-QZ	Tile Chisel	80	300	1	1	5035048034231	56,00
DT6837-QZ	TCT Comb Chisel	38	280	1	1	5035048034248	146,00
DT8090-QZ	Clay Spade	110	400	1	1	5035048034514	106,00
DT8091-QZ	Asphalt Cutter	90	400	1	1	5035048034521	106,00
DT8092-QZ	Earth Rod Driver	13	260	1	1	5035048034538	64,00
DT8093-QZ	Earth Rod Driver	16.5	260	1	1	5035048034545	64,00

**19MM HEXAGON CHISELS**



**SINGLE PACKS**

**APPLICATIONS**

- For heavy duty chiselling, channelling, and demolition tasks in concrete, stone (medium hardness), floor and wall tiles, general masonry and mortar.

Cat. No.	Description	Width mm	Length mm	Pack Qty.	M.O.Q.	Barcode	List Price Ex. VAT (£)
DT6940-QZ	Pointed	-	400	1	1	5035048025031	23,33
DT6941-QZ	Pointed	-	600	1	1	5035048025048	46,67
DT6942-QZ	Flat	25	400	1	1	5035048025055	23,33
DT6943-QZ	Flat	25	600	1	1	5035048025062	46,67
DT6944-QZ	Flat	60	300	1	1	5035048025079	60,00
DT6945-QZ	Flat	60	450	1	1	5035048025086	66,67
DT6946-QZ	Flat wide	140	350	1	1	5035048025093	100,00
DT6947-QZ	Clay Spade	115	400	1	1	5035048058893	116,67
DT6948-QZ	Asphalt Cutter	90	400	1	1	5035048058909	100,00

**PAVEMENT BREAKER CHISELS**



**28MM PAVEMENT BREAKER CHISELS**

**APPLICATIONS**

- Heavy duty breaking of concrete, asphalt & stone. Heavy duty tamping tasks and earth rod driving.

Cat. No.	Description	Width mm	Length mm	Pack Qty.	M.O.Q.	Barcode	List Price Ex. VAT (£)
DT6927-QZ	Bull point	-	500	1	1	5035048070505	37,64
DT6928-QZ	Clay Spade	140	540	1	1	5035048070512	134,12
DT6929-QZ	Cold Chisel	32	500	1	1	5035048070529	37,64
DT6932-QZ	Scaling Tool	75	500	1	1	5035048070536	51,48
DT6933-QZ	Ground Rod Driver	-	400	1	1	5035048070543	134,12
DT6934-QZ	Asphalt Cutter	115	430	1	1	5035048070550	116,80
DT6935-QZ	Tamper shank	-	400	1	1	5035048070567	90,84
DT6936-QZ	Tamping Plate	150	150	1	1	5035048070574	168,28

**30MM PAVEMENT BREAKER CHISELS**

Cat. No.	Description	Width mm	Length mm	Pack Qty.	M.O.Q.	Barcode	List Price Ex. VAT (£)
DT6827-QZ	Scaling Tool	75	500	1	1	5035048083260	NOT UK
DT6828-QZ	Clay Spade	140	540	1	1	5035048083277	NOT UK
DT6839-QZ	Asphalt Cutter	115	430	1	1	5035048083284	NOT UK

**LIGHT DUTY SDS-Plus CORE DRILLS**



**APPLICATIONS**

- For fitting drainage and water pipes, heating pipes, switches, junction & distribution boxes.
- To be used with light duty SDS-Plus core drills - must be used with a pilot bit.

**LIGHT DUTY SDS-Plus CORE DRILLS**

Cat. No.	Diameter mm	Length mm	Pack Qty.	M.O.Q.	Barcode	List Price Ex. VAT (£)
DT6740-QZ	30	72	1	1	5035048013595	60,00
DT6741-QZ	35	72	1	1	5035048013601	48,41
DT6742-QZ	40	72	1	1	5035048013618	61,33
DT6743-QZ	45	72	1	1	5035048013625	53,55
DT6744-QZ	50	72	1	1	5035048013632	65,00
DT6745-QZ	68	72	1	1	5035048013649	83,33
DT6746-QZ	72	72	1	1	5035048013656	99,50
DT6747-QZ	80	72	1	1	5035048013663	112,99
DT6748-QZ	90	72	1	1	5035048013670	125,57

**LIGHT DUTY CORE ADAPTORS**

Cat. No.	Description	Length mm	Pack Qty.	M.O.Q.	Barcode	List Price Ex. VAT (£)
DT6750-QZ	SDS-Plus adaptor	110	1	1	5035048013687	20,60
DT6751-QZ	SDS-Plus adaptor	300	1	1	5035048013694	51,50
DT6752-QZ	Hex adaptor	110	1	1	5035048013700	27,41
DT6753-QZ	Pilot drill	120	1	1	5035048013717	5,15

**HEAVY DUTY SDS-MAX CORE DRILLS**



**APPLICATIONS**

- For clean round holes in blocks, bricks and light concrete.
- To be used with Heavy duty SDS-Max Core drills in conjunction with a pilot bit.

**HEAVY DUTY SDS-MAX CORE DRILLS**

Cat. No.	Diameter mm	Length mm	Pack Qty.	M.O.Q.	Barcode	List Price Ex. VAT (£)
DT6760-QZ	40	107	1	1	5035048013724	93,66
DT6761-QZ	50	107	1	1	5035048013731	105,40
DT6762-QZ	68	107	1	1	5035048013748	117,10
DT6763-QZ	80	107	1	1	5035048013755	154,50
DT6764-QZ	90	107	1	1	5035048013762	163,93
DT6765-QZ	100	107	1	1	5035048013779	233,33
DT6766-QZ	125	107	1	1	5035048013786	340,00

**HEAVY DUTY CORE ADAPTORS**

Cat. No.	Description	Length mm	Pack Qty.	M.O.Q.	Barcode	List Price Ex. VAT (£)
DT6770-QZ	SDS-Max Adaptor	180	1	1	5035048013793	68,67
DT6771-QZ	SDS-Max Adaptor	400	1	1	5035048013809	93,33
DT6772-QZ	Pilot bit	155	1	1	5035048013816	27,47
DT6773-QZ	Extension Piece	280	1	1	5035048013823	120,17

**SINGLE PIECE CORES**

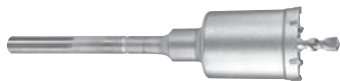

- For SDS-Max hammer drills - for drilling holes in concrete or masonry from 50 to 80mm diameter.

**SINGLE PIECE CORES**

Cat. No.	Description	Diameter mm	Length mm	Pack Qty.	M.O.Q.	Barcode	List Price Ex. VAT (£)
DT6780-QZ	SDS-Max core	50	300	1	1	5035048013830	171,67
DT6783-QZ	SDS-Max core	68	300	1	1	5035048013847	87,04
DT6784-QZ	SDS-Max core	80	300	1	1	5035048013854	206,00
DT6785-QZ	Pilot bit	-	185	1	1	5035048013908	90,18

**THROUGH DRILLING BITS**



- For drilling through holes (55 to 80mm diameter) up to 550mm depth in concrete and masonry.

**THROUGH DRILLING BITS**

Cat. No.	Description	Diameter mm	Length mm	Pack Qty.	M.O.Q.	Barcode	List Price Ex. VAT (£)
DT6790-QZ	SDS-Max through drilling bit	55	550	1	1	5035048013861	497,83
DT6791-QZ	SDS-Max through drilling bit	65	550	1	1	5035048013878	548,71
DT6792-QZ	SDS-Max through drilling bit	80	550	1	1	5035048013885	636,17
DT6793-QZ	Pilot bit	-	88	1	1	5035048013892	31,81

**ADAPTOR - SDS-Plus**



- Allows use of round shank drill bits in SDS-Plus fitment hammers. **USE IN ROTARY MODE ONLY.**

**ADAPTOR - SDS-Plus**

Cat. No.	Description	Pack Qty.	M.O.Q.	Barcode	List Price Ex. VAT (£)
DT17030-QZ	SDS-Plus - 1/2" x 20 UNF (Chuck adaptor)	1	1	5011402371419	18,00
DT6829-QZ	SDS-Plus - 1/2" x 20 UNF chuck adaptor / screwdriver bit holder	1	1	5035048034170	21,68

**DRIVE ADAPTORS**



- Allows interchangeability between tool & hammer bit fitments.

**DRIVE ADAPTORS**

Cat. No.	Description	Pack Qty.	M.O.Q.	Barcode	List Price Ex. VAT (£)
DT6830-QZ	SDS-Max to SDS-Plus	1	1	5011402378135	112,04



HSS-CO EXTREME DeWALT® COBALT DRILL BITS

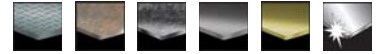

APPLICATIONS

- Suitable for portable or stationary drilling of high alloy content steels and metals with a tensile strength up to 1100N/mm<sup>2</sup> e.g. heat and acid proof steel, cast iron, bronze, welded seams, stainless and chrome nickel steels.

FEATURES

- Faster drilling - up to 4x faster than standard HSS-R drill bits.
- Increased durability - up to 50% stronger than standard HSS-R drill bits.
- Cleaner, more accurate, burr-free holes due to recessed cutting wings.
- Innovative tapered web greatly reduces breakage.
- No-Slip shank with 3 flats eliminates slipping in the chuck (diameters 5,0mm and above only).
- Gold Ferrous Oxide coating prevents overheating for longer bit life.
- 5% cobalt alloyed High Speed Steel for stability at high temperatures when drilling tough materials.



SINGLE PACKS

Cat. No.	Diameter mm	Length mm	Working Length mm	Pack Qty.	M.O.Q.	Barcode	List Price Ex. VAT (€)
DTS403-QZ	2	49	24	2	1	5011402375912	3,76
DTS630-QZ	1.0	34	12	2	1	5035048076958	NOT UK
DTS631-QZ	1.5	40	18	2	1	5035048076965	NOT UK
DTS632-QZ	1.6	43	20	2	1	5035048076972	NOT UK
DTS404-QZ	2.5	57	30	2	1	5011402375936	4,04
DTS405-QZ	3	61	33	2	1	5011402375950	4,34
DTS633-QZ	3.1	65	36	2	1	5035048076989	NOT UK
DTS634-QZ	3.3	65	36	2	1	5035048076996	NOT UK
DTS408-QZ	3.5	70	39	2	1	5011402375974	5,13
DTS409-QZ	4	75	43	2	1	5011402375998	5,60
DTS635-QZ	4.1	75	43	1	1	5035048077009	NOT UK
DTS636-QZ	4.2	75	43	1	1	5035048077016	NOT UK
DTS412-QZ	4.5	80	47	1	1	5011402376018	3,25
DTS637-QZ	4.9	86	46	1	1	5035048077023	NOT UK
DTS414-QZ	5	86	52	1	1	5011402376032	3,55
DTS638-QZ	5.1	86	46	1	1	5035048077030	NOT UK
DTS415-QZ	5.5	93	57	1	1	5011402376056	4,25
DTS416-QZ	6	93	57	1	1	5011402376070	4,25
DTS639-QZ	6.1	101	58	1	1	5035048077047	NOT UK
DTS417-QZ	6.5	101	63	1	1	5011402376094	4,94
DTS640-QZ	6.8	109	66	1	1	5035048077054	NOT UK
DTS418-QZ	7	109	69	1	1	5011402376117	5,53
DTS641-QZ	7.5	109	66	1	1	5035048077061	NOT UK
DTS642-QZ	7.8	117	75	1	1	5035048077078	NOT UK
DTS643-QZ	7.9	117	75	1	1	5035048077085	NOT UK
DTS419-QZ	8	117	75	1	1	5011402376131	6,16
DTS644-QZ	8.5	117	72	1	1	5035048077092	NOT UK
DTS421-QZ	9	125	81	1	1	5011402376155	7,87
DTS645-QZ	9.5	125	78	1	1	5035048077108	NOT UK
DTS422-QZ	10	133	87	1	1	5011402376179	8,98
DTS646-QZ	10.2	133	84	1	1	5035048077115	NOT UK
DTS647-QZ	10.5	133	84	1	1	5035048077122	10,51
DTS424-QZ	11	142	94	1	1	5011402376193	10,82
DTS648-QZ	11.5	142	91	1	1	5035048077139	NOT UK
DTS426-QZ	12	151	101	1	1	5011402376216	14,32
DTS649-QZ	12.2	151	98	1	1	5035048077146	NOT UK
DTS650-QZ	12.5	151	98	1	1	5035048077153	NOT UK
DTS427-QZ	13	151	101	1	1	5011402376230	17,18

BULK PACKS

Cat. No.	Diameter mm	Length mm	Working Length mm	Pack Qty.	M.O.Q.	Barcode	List Price Ex. VAT (€)
DTS442-QZ	2	49	24	10	1	5011402384518	15,80
DTS660-QZ	1.5	40	18	10	1	5035048077160	NOT UK
DTS661-QZ	1.6	43	20	10	1	5035048077177	NOT UK
DTS443-QZ	2.5	57	30	10	1	5011402384525	17,71
DTS444-QZ	3	61	33	10	1	5011402384532	19,49
DTS662-QZ	3.1	65	36	10	1	5035048077184	NOT UK
DTS446-QZ	3.2	65	36	10	1	5011402384549	20,25
DTS447-QZ	3.3	65	36	10	1	5011402386208	22,83
DTS448-QZ	3.5	70	39	10	1	5011402384563	23,32
DTS449-QZ	4	75	43	10	1	5011402384570	25,23
DTS450-QZ	4.1	75	43	10	1	5011402384587	NOT UK
DTS451-QZ	4.2	75	43	10	1	5011402384594	27,14
DTS452-QZ	4.5	80	47	10	1	5011402384600	29,31
DTS453-QZ	4.8	86	52	10	1	5011402384617	31,34
DTS663-QZ	4.9	86	46	10	1	5035048077191	NOT UK
DTS454-QZ	5	86	52	10	1	5011402384624	31,98
DTS455-QZ	5.1	86	52	10	1	5011402384631	NOT UK
DTS456-QZ	5.2	86	52	10	1	5011402384648	38,22
DTS457-QZ	5.5	93	57	10	1	5011402384655	38,22
DTS458-QZ	6	93	57	10	1	5011402384662	38,22
DTS664-QZ	6.1	101	58	10	1	5035048077207	NOT UK
DTS459-QZ	6.5	101	63	10	1	5011402384679	44,60
DTS460-QZ	6.8	109	69	10	1	5011402384686	NOT UK
DTS461-QZ	7	109	69	10	1	5011402384693	49,83
DTS462-QZ	7.5	109	69	10	1	5011402384709	53,51
DTS665-QZ	7.8	117	75	10	1	5035048077214	NOT UK
DTS666-QZ	7.9	117	75	10	1	5035048077221	NOT UK
DTS463-QZ	8	117	75	10	1	5011402384716	57,98
DTS464-QZ	8.5	117	75	10	1	5011402384723	68,29
DTS465-QZ	9	125	81	10	1	5011402384730	70,08
DTS466-QZ	9.5	125	81	10	1	5011402384747	79,63
DTS467-QZ	10	133	87	10	1	5011402384754	86,01
DTS468-QZ	10.2	133	87	10	1	5011402384761	100,00
DTS667-QZ	10.5	133	84	5	1	5035048077238	NOT UK
DTS469-QZ	11	142	94	5	1	5011402384778	56,67
DTS668-QZ	11.5	142	91	5	1	5035048077245	NOT UK
DTS470-QZ	12	151	101	5	1	5011402384785	64,47
DTS669-QZ	12.2	151	98	5	1	5035048077252	NOT UK
DTS670-QZ	12.5	151	98	5	1	5035048077269	75,02
DTS471-QZ	13	151	101	5	1	5011402384792	77,27

**EXTREME DeWALT® 2 METAL DRILL BITS**

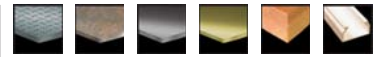

**SINGLE PACKS**

**APPLICATIONS**

- Suitable for portable drilling of steel, alloyed and non-alloyed up to 900 N/mm<sup>2</sup>.
- For drilling sheet or thin materials (suitable for use in wood and plastics).

**FEATURES**

- Faster drilling - up to 4x faster than standard HSS-R drill bits.
- Increased durability - up to 50% stronger than standard HSS-R drill bits.
- Cleaner, more accurate, burr-free holes due to recessed cutting wings.
- Innovative tapered web greatly reduces breakage.
- No-Slip shank with 3 flats eliminates slipping in the chuck (diameters 5.0mm and above only).
- Gold Ferrous Oxide coating prevents overheating for longer bit life.



For drilling sets see page 134

Cat. No.	Diameter mm	Length mm	Working Length mm	Pack Qty.	M.O.Q.	Barcode	List Price Ex. VAT (€)
DT5034-QZ	1	34	12	2	1	5035048034767	2,77
DT5035-QZ	1.5	40	18	2	1	5035048034774	2,91
DT5600-QZ	1.6	43	20	2	1	5035048076811	NOT UK
DT5036-QZ	2	49	24	2	1	5035048034781	3,04
DT5037-QZ	2.5	57	30	2	1	5035048034798	3,30
DT5038-QZ	3	61	33	2	1	5035048034804	3,91
DT5601-QZ	3.1	65	36	2	1	5035048076828	NOT UK
DT5039-QZ	3.2	65	36	2	1	5035048034811	4,30
DT5040-QZ	3.3	65	36	2	1	5035048034828	4,30
DT5041-QZ	3.5	70	39	2	1	5035048034835	4,56
DT5042-QZ	4	75	43	2	1	5035048034842	4,85
DT5063-QZ	4.1	75	43	1	1	5035048052648	2,50
DT5043-QZ	4.2	75	43	1	1	5035048034859	2,55
DT5044-QZ	4.5	80	46	1	1	5035048034866	2,56
DT5045-QZ	4.8	86	46	1	1	5035048034873	2,60
DT5046-QZ	5	86	46	1	1	5035048034880	3,00
DT5064-QZ	5.1	86	46	1	1	5035048052655	2,97
DT5065-QZ	5.2	86	46	1	1	5035048052662	3,07
DT5066-QZ	5.4	93	52	1	1	5035048052679	3,13
DT5047-QZ	5.5	93	57	1	1	5035048034897	3,10
DT5048-QZ	6	93	57	1	1	5035048034903	3,23
DT5603-QZ	6.1	101	58	1	1	5035048076842	NOT UK
DT5049-QZ	6.5	101	58	1	1	5035048034910	3,50
DT5067-QZ	6.8	109	66	1	1	5035048052686	NOT UK
DT5050-QZ	7	109	66	1	1	5035048034927	3,91
DT5051-QZ	7.5	109	66	1	1	5035048034934	4,41
DT5604-QZ	7.8	117	75	1	1	5035048076859	NOT UK
DT5605-QZ	7.9	117	75	1	1	5035048076866	NOT UK
DT5052-QZ	8	117	72	1	1	5035048034941	4,53
DT5053-QZ	8.5	117	72	1	1	5035048034958	5,34
DT5054-QZ	9	125	78	1	1	5035048034965	5,86
DT5055-QZ	9.5	125	78	1	1	5035048034972	6,67
DT5056-QZ	10	133	84	1	1	5035048034989	7,33
DT5606-QZ	10.2	133	84	1	1	5035048076873	NOT UK
DT5057-QZ	10.5	133	84	1	1	5035048034996	8,00
DT5058-QZ	11	142	91	1	1	5035048052006	8,58
DT5059-QZ	11.5	142	91	1	1	5035048052013	9,08
DT5060-QZ	12	151	98	1	1	5035048052020	10,77
DT5061-QZ	12.5	151	98	1	1	5035048052037	10,58
DT5062-QZ	13	151	98	1	1	5035048052044	11,83

**BULK PACKS**

Cat. No.	Diameter mm	Length mm	Working Length mm	Pack Qty.	M.O.Q.	Barcode	List Price Ex. VAT (€)
DT5535-QZ	1	34	12	10	1	5035048052051	10,39
DT5536-QZ	1.5	40	18	10	1	5035048052068	10,42
DT5615-QZ	1.6	43	20	10	1	5035048076880	NOT UK
DT5537-QZ	2	49	24	10	1	5035048052075	10,42
DT5538-QZ	2.5	57	30	10	1	5035048052082	11,17
DT5539-QZ	3	61	33	10	1	5035048052099	12,23
DT5616-QZ	3.1	65	36	10	1	5035048076897	NOT UK
DT5540-QZ	3.2	65	36	10	1	5035048052105	18,59
DT5541-QZ	3.3	65	36	10	1	5035048052112	18,59
DT5542-QZ	3.5	70	39	10	1	5035048052129	19,30
DT5543-QZ	4	75	43	10	1	5035048052136	19,88
DT5544-QZ	4.2	75	43	10	1	5035048052143	20,48
DT5545-QZ	4.5	80	46	10	1	5035048052150	21,29
DT5546-QZ	4.8	86	46	10	1	5035048052167	25,22
DT5617-QZ	4.9	86	46	10	1	5035048076903	NOT UK
DT5547-QZ	5	86	46	10	1	5035048052174	25,67
DT5567-QZ	5.1	86	46	10	1	5035048052716	25,93
DT5568-QZ	5.2	86	46	10	1	5035048052723	26,37
DT5548-QZ	5.5	93	57	10	1	5035048052181	27,00
DT5549-QZ	6	93	57	10	1	5035048052198	28,17
DT5618-QZ	6.1	101	58	10	1	5035048076910	NOT UK
DT5550-QZ	6.5	101	58	10	1	5035048052204	30,63
DT5551-QZ	7	109	66	10	1	5035048052211	35,95
DT5552-QZ	7.5	109	66	10	1	5035048052228	38,38
DT5619-QZ	7.8	117	75	10	1	5035048076927	NOT UK
DT5620-QZ	7.9	117	75	10	1	5035048076934	NOT UK
DT5553-QZ	8	117	72	10	1	5035048052235	41,81
DT5554-QZ	8.5	117	72	10	1	5035048052242	47,23
DT5555-QZ	9	125	78	10	1	5035048052259	51,51
DT5556-QZ	9.5	125	78	10	1	5035048052266	56,36
DT5557-QZ	10	133	84	10	1	5035048052273	65,86
DT5621-QZ	10.2	133	84	10	1	5035048076941	NOT UK
DT5558-QZ	10.5	133	84	10	1	5035048052280	72,50
DT5559-QZ	11	142	91	10	1	5035048052297	78,21
DT5600-QZ	11.5	142	91	10	1	5035048052303	82,79
DT5561-QZ	12	151	98	10	1	5035048052310	90,17
DT5562-QZ	12.5	151	98	10	1	5035048052327	96,12
DT5563-QZ	13	151	98	10	1	5035048052334	102,09

HSS-G DIN 338 JOBBER METAL DRILL BITS

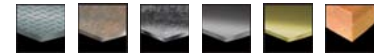

APPLICATIONS

- Suitable for portable or stationary drilling in steel cast steel, alloyed and non-alloyed material, grey cast-iron, spherical-graphite cast iron, sintered iron, nickel, brass, etc up to 900N/mm<sup>2</sup>.

FEATURES

- Precision ground twist drill bit for rapid drilling, long life and excellent concentricity.
- Ground from solid stock right hand cutting, type N flute, precision ground at 118° point angle.
- Diameter tolerance to h8.
- Drills above 13mm (1/2") have a shank reduced to 12.7mm.



SINGLE PACKS

Cat. No.	Diameter mm	Length mm	Working Length mm	Pack Qty.	M. O. Q.	Barcode	List Price Ex. VAT (£)
DT5201-QZ	1	34	12	2	1	5011402373437	2,22
DT5200-QZ	1.1	36	14	2	1	5035048080481	NOT UK
DT5207-QZ	1.2	38	16	2	1	5035048080498	NOT UK
DT5210-QZ	1.3	38	16	2	1	5035048080504	NOT UK
DT5223-QZ	1.4	40	18	2	1	5035048080511	NOT UK
DT5202-QZ	1.5	40	18	2	1	5011402373451	2,34
DT5225-QZ	1.6	43	20	2	1	5035048080528	NOT UK
DT5231-QZ	1.7	43	20	2	1	5035048080535	NOT UK
DT5236-QZ	1.8	46	22	2	1	5035048080542	NOT UK
DT5237-QZ	1.9	46	22	2	1	5035048080559	NOT UK
DT5203-QZ	2	49	24	2	1	5011402373475	2,34
DT5238-QZ	2.1	49	24	2	1	5035048080566	NOT UK
DT5239-QZ	2.2	53	27	2	1	5035048080573	NOT UK
DT5240-QZ	2.3	53	27	2	1	5035048080580	NOT UK
DT5241-QZ	2.4	57	30	2	1	5035048080597	NOT UK
DT5204-QZ	2.5	57	30	2	1	5011402373499	2,34
DT5242-QZ	2.6	57	30	2	1	5035048080603	NOT UK
DT5243-QZ	2.7	61	33	2	1	5035048080610	NOT UK
DT5244-QZ	2.8	61	33	2	1	5035048080627	NOT UK
DT5245-QZ	2.9	61	33	2	1	5035048080634	NOT UK
DT5205-QZ	3	61	33	2	1	5011402373512	2,58
DT5246-QZ	3.1	65	36	2	1	5035048080641	NOT UK
DT5206-QZ	3.2	65	36	2	1	5011402373536	2,58
DT5247-QZ	3.3	65	36	2	1	5035048080658	NOT UK
DT5248-QZ	3.4	70	39	2	1	5035048080665	NOT UK
DT5208-QZ	3.5	70	39	2	1	5011402373574	3,07
DT5249-QZ	3.6	70	39	2	1	5035048080672	NOT UK
DT5250-QZ	3.7	70	39	2	1	5035048080689	NOT UK
DT5251-QZ	3.8	75	43	2	1	5035048080696	NOT UK
DT5252-QZ	3.9	75	43	2	1	5035048080702	NOT UK
DT5209-QZ	4	75	43	2	1	5011402373598	3,20
DT5253-QZ	4.1	75	43	1	1	5035048080719	NOT UK
DT5211-QZ	4.2	75	43	1	1	5011402373635	1,86
DT5254-QZ	4.3	80	47	1	1	5035048080726	NOT UK
DT5269-QZ	4.4	80	47	1	1	5035048076477	NOT UK
DT5212-QZ	4.5	80	47	1	1	5011402373659	1,89
DT5270-QZ	4.6	80	47	1	1	5035048076484	NOT UK
DT5271-QZ	4.7	80	47	1	1	5035048076491	NOT UK
DT5213-QZ	4.8	86	52	1	1	5011402373673	1,89
DT5272-QZ	4.9	86	52	1	1	5035048076507	NOT UK
DT5214-QZ	5	86	52	1	1	5011402373697	1,89
DT5273-QZ	5.1	86	52	1	1	5035048076514	NOT UK
DT5274-QZ	5.2	86	52	1	1	5035048076521	NOT UK
DT5275-QZ	5.3	86	52	1	1	5035048076538	NOT UK
DT5276-QZ	5.4	93	57	1	1	5035048076545	NOT UK
DT5215-QZ	5.5	93	57	1	1	5011402373710	2,40
DT5277-QZ	5.6	93	57	1	1	5035048076552	NOT UK
DT5278-QZ	5.7	93	57	1	1	5035048076569	NOT UK
DT5279-QZ	5.8	93	57	1	1	5035048076576	NOT UK
DT5280-QZ	5.9	93	57	1	1	5035048076583	NOT UK
DT5216-QZ	6	101	63	1	1	5011402373734	2,58
DT5281-QZ	6.1	101	63	1	1	5035048076590	NOT UK
DT5282-QZ	6.2	101	63	1	1	5035048076606	NOT UK
DT5283-QZ	6.3	101	63	1	1	5035048076613	NOT UK
DT5284-QZ	6.4	101	63	1	1	5035048076620	NOT UK
DT5217-QZ	6.5	101	63	1	1	5011402373758	2,93
DT5285-QZ	6.6	101	63	1	1	5035048076637	NOT UK
DT5255-QZ	6.7	101	63	1	1	5035048080733	NOT UK
DT5256-QZ	6.8	109	69	1	1	5035048080740	NOT UK
DT5257-QZ	6.9	109	69	1	1	5035048080757	NOT UK
DT5218-QZ	7	109	69	1	1	5011402373772	3,68
DT5258-QZ	7.1	109	69	1	1	5035048080764	NOT UK
DT5259-QZ	7.2	109	69	1	1	5035048080771	NOT UK
DT5286-QZ	7.3	109	69	1	1	5035048080788	NOT UK
DT5287-QZ	7.4	109	69	1	1	5035048080795	NOT UK
DT5288-QZ	7.6	117	75	1	1	5035048080801	NOT UK
DT5289-QZ	7.7	117	75	1	1	5035048080818	NOT UK
DT5290-QZ	7.8	117	75	1	1	5035048080825	NOT UK
DT5291-QZ	7.9	117	75	1	1	5035048080832	NOT UK
DT5219-QZ	8	117	75	1	1	5011402373796	4,61
DT5292-QZ	8.1	117	75	1	1	5035048080849	NOT UK
DT5293-QZ	8.2	117	75	1	1	5035048080856	NOT UK
DT5294-QZ	8.3	117	75	1	1	5035048080863	NOT UK
DT5295-QZ	8.4	117	75	1	1	5035048080870	NOT UK
DT5220-QZ	8.5	117	75	1	1	5011402373819	4,67
DT5296-QZ	8.6	125	81	1	1	5035048080887	NOT UK
DT5297-QZ	8.7	125	81	1	1	5035048080894	NOT UK
DT5298-QZ	8.8	125	81	1	1	5035048080900	NOT UK
DT5299-QZ	8.9	125	81	1	1	5035048080917	NOT UK
DT5221-QZ	9	125	81	1	1	5011402373833	5,28
DT5400-QZ	9.1	125	81	1	1	5035048080924	NOT UK
DT5401-QZ	9.2	125	81	1	1	5035048080931	NOT UK
DT5402-QZ	9.3	125	81	1	1	5035048080948	NOT UK
DT5406-QZ	9.4	125	81	1	1	5035048080955	NOT UK
DT5407-QZ	9.5	125	81	1	1	5035048080962	NOT UK
DT5410-QZ	9.6	133	87	1	1	5035048080979	NOT UK
DT5411-QZ	9.7	133	87	1	1	5035048080986	NOT UK
DT5413-QZ	9.8	133	87	1	1	5035048080993	NOT UK



**HSS-G DIN 338 JOBBER METAL DRILL BITS**



**APPLICATIONS**

- Suitable for portable or stationary drilling in steel cast steel, alloyed and non-alloyed material, grey cast-iron, spherical-graphite cast iron, sintered iron, nickel, brass, etc up to 900N/mm<sup>2</sup>.

**FEATURES**

- Precision ground twist drill bit for rapid drilling, long life and excellent concentricity.
- Ground from solid stock right hand cutting, type N flute, precision ground at 118° point angle.
- Diameter tolerance to h8.
- Drills above 13mm (1/2") have a shank reduced to 12.7mm.

**SINGLE PACKS**

Cat. No.	Diameter mm	Length mm	Working Length mm	Pack Qty.	M.O.Q.	Barcode	List Price Ex. VAT (£)
DTS420-QZ	9.9	133	87	1	1	5035048081006	NOT UK
DTS425-QZ	10	133	87	1	1	5011402373857	5,89
DTS423-QZ	10.2	133	87	1	1	5035048081013	NOT UK
DTS425-QZ	10.5	133	87	1	1	5035048081020	NOT UK
DTS424-QZ	11	142	94	1	1	5011402373895	7,39
DTS428-QZ	11.5	142	94	1	1	5035048081037	NOT UK
DTS426-QZ	12	151	101	1	1	5011402373932	9,31
DTS429-QZ	12.5	151	101	1	1	5035048081044	NOT UK
DTS427-QZ	13	151	101	1	1	5011402373956	10,48
DTS430-QZ	13.5	151	101	1	1	5035048081051	NOT UK
DTS428-QZ	14	160	108	1	1	5011402373970	13,51
DTS431-QZ	14.5	160	108	1	1	5035048081068	NOT UK
DTS429-QZ	15	169	114	1	1	5011402373994	15,37
DTS432-QZ	15.5	169	114	1	1	5035048081075	NOT UK
DTS430-QZ	16	178	120	1	1	5011402374014	16,60
DTS433-QZ	16.5	178	120	1	1	5035048081082	NOT UK
DTS434-QZ	17	178	120	1	1	5035048081099	NOT UK
DTS435-QZ	17.5	178	120	1	1	5035048081105	NOT UK
DTS436-QZ	18	191	130	1	1	5035048081112	NOT UK
DTS437-QZ	18.5	191	130	1	1	5035048081129	NOT UK
DTS438-QZ	19	198	135	1	1	5035048081136	NOT UK
DTS439-QZ	19.5	198	135	1	1	5035048081143	NOT UK
DTS472-QZ	20	205	140	1	1	5035048081150	NOT UK

**BULK PACKS**

Cat. No.	Diameter mm	Length mm	Working Length mm	Pack Qty.	M.O.Q.	Barcode	List Price Ex. VAT (£)
DTS301-QZ	1	34	12	10	1	5011402383504	11,36
DTS311-QZ	2	49	24	10	1	5011402383603	9,27
DTS321-QZ	3	61	33	10	1	5011402383702	9,62
DTS332-QZ	4	75	43	10	1	5011402383818	11,58
DTS342-QZ	5	86	52	10	1	5011402383917	14,59
DTS352-QZ	6	93	57	10	1	5011402384013	19,23
DTS362-QZ	7	109	69	10	1	5011402384112	25,25
DTS372-QZ	8	117	75	10	1	5011402384211	32,32
DTS382-QZ	9	125	81	10	1	5011402384310	41,47
DTS392-QZ	10	133	87	10	1	5011402384419	52,01
DTS473-QZ	10.2	133	87	5	1	5035048081167	28,11
DTS393-QZ	10.5	133	87	5	1	5011402384426	28,96
DTS394-QZ	11	142	94	5	1	5011402384433	31,21
DTS395-QZ	11.5	142	94	5	1	5011402384440	35,91
DTS396-QZ	12	151	101	5	1	5011402384457	39,56
DTS398-QZ	13	151	101	5	1	5011402384471	48,36

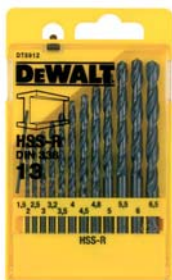

**HSS-G DIN 338 JOBBER METAL DRILL BIT SETS**

Cat. No.	Description	Diameter mm	Pack Qty.	M.O.Q.	Barcode	List Price Ex. VAT (£)
DTS921-QZ	10 piece set in plastic cassette.	1, 2, 3, 4, 5, 6, 7, 8, 9, 10	10	1	5011402374137	23,70
DTS922-QZ	13 piece set in plastic cassette.	1, 5, 2, 2.5, 3.2, 3, 3.5, 4.4, 5, 5 (x2), 5.5, 6, 6.5	13	1	5011402374151	18,72
DTS923-QZ	19 piece set in metal cassette.	1, 1.5, 2, 2.5, 3, 3.5, 4.4, 5, 5.5, 6, 6.5, 7, 7.5, 8, 8.5, 9, 9.5, 10	19	1	5011402374175	59,01
DTS929-QZ	29 piece set in metal case	1, 1.5, 2, 2.5, 3, 3.2, 3.3, 3.5, 6.6, 5, 7, 7.5, 8, 8.5, 9, 9.5, 10, 10.5, 11, 11.5, 12, 12.5, 13	29	1	5035048077429	120,00

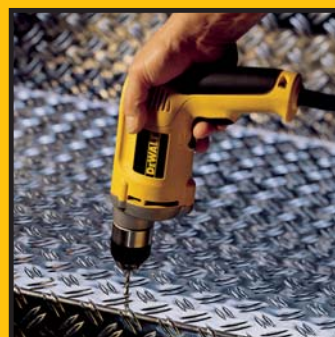

HSS-G DIN 340 LONG SERIES METAL DRILL BITS

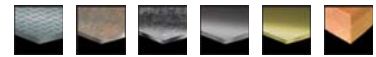

BULK PACKS

APPLICATIONS

- Used either portable or stationary for drilling of deep holes in steel cast steel, alloyed and non-alloyed material, grey cast-iron, spherical-graphite cast iron, sintered iron, nickel, brass, etc up to 900N/mm<sup>2</sup>.

Cat. No.	Diameter mm	Length mm	Working Length mm	Pack Qty.	M.O.Q.	Barcode	List Price Ex. VAT (£)
DT5776-QZ	1.56	85	55	10	1	5035048081174	NOT UK
DT5707-QZ	3	100	66	10	1	5011402385331	20,64
DT5777-QZ	3.1	100	66	10	1	5035048081181	NOT UK
DT5709-QZ	3.2	106	69	10	1	5011402385348	24,47
DT5778-QZ	3.3	106	69	10	1	5035048081198	NOT UK
DT5712-QZ	3.5	112	73	10	1	5011402385355	23,32
DT5717-QZ	4	119	78	10	1	5011402385379	25,61
DT5719-QZ	4.2	119	78	10	1	5011402385393	26,50
DT5722-QZ	4.5	126	82	10	1	5011402385409	30,33
DT5725-QZ	4.8	132	87	10	1	5011402385416	31,98
DT5779-QZ	4.9	132	87	10	1	5035048081204	NOT UK
DT5726-QZ	5	132	87	10	1	5011402385423	31,98
DT5731-QZ	5.5	139	91	10	1	5011402385447	38,09
DT5736-QZ	6	139	91	10	1	5011402385454	38,48
DT5780-QZ	6.1	139	91	10	1	5035048081211	NOT UK
DT5741-QZ	6.5	148	97	10	1	5011402385461	49,82
DT5781-QZ	6.8	148	97	10	1	5035048081228	NOT UK
DT5746-QZ	7	156	102	10	1	5011402385478	56,82
DT5748-QZ	7.5	156	102	10	1	5011402385485	64,70
DT5782-QZ	7.8	156	102	10	1	5035048081235	NOT UK
DT5783-QZ	7.9	156	102	10	1	5035048081242	NOT UK
DT5749-QZ	8	165	109	10	1	5011402385492	60,58
DT5784-QZ	8.5	165	109	10	1	5035048081259	NOT UK
DT5785-QZ	9.5	175	115	10	1	5035048081266	NOT UK
DT5753-QZ	10	184	121	10	1	5011402385515	106,77
DT5786-QZ	10.2	184	121	5	1	5035048081273	NOT UK
DT5787-QZ	10.5	184	121	5	1	5035048081280	NOT UK
DT5755-QZ	11	195	128	5	1	5011402385522	62,00
DT5788-QZ	11.5	195	128	5	1	5035048081297	NOT UK
DT5757-QZ	12	200	134	5	1	5011402385539	71,99
DT5789-QZ	12.5	200	134	5	1	5035048081303	NOT UK
DT5759-QZ	13	205	134	5	1	5011402385546	76,87

EXTREME DeWALT IMPACT STEP BITS



Coming soon in 2011



SINGLE PACKS

APPLICATIONS

- For drilling and enlarging existing holes from 4mm to 34mm

FEATURES

- Durable hex shank designed to fit all impact drivers

Cat. No.	Description	Pack Qty.	M.O.Q.	Barcode	List Price Ex. VAT (£)
DT5020-QZ	4-12mm Impact Step Drill	1	1	5035048083390	TBC
DT5021-QZ	6-18mm Impact Step Drill	1	1	5035048083406	TBC
DT5022-QZ	14-25mm Impact Step Drill	1	1	5035048083413	TBC
DT5023-QZ	20-34mm Impact Step Drill	1	1	5035048083420	TBC

STEP DRILLS

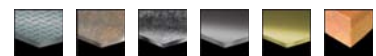

SINGLE PACKS

FEATURES

- For drilling and enlarging existing holes from 14mm up to 34mm

Cat. No.	Description	Pack Qty.	M.O.Q.	Barcode	List Price Ex. VAT (£)
DT5026-QZ	4-12mm Step Drill	1	1	5035048077276	23,33
DT5027-QZ	6-18mm Step Drill	1	1	5035048077283	25,00
DT5030-QZ	14-25mm Step Drill	1	1	5035048077290	43,33
DT5031-QZ	20-34mm Step Drill	1	1	5035048077306	73,33

**EXTREME DEWALT IMPACT DRILL BITS**

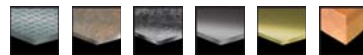

**FEATURES**

- Full range of metal drill bits designed and optimised for use in an impact driver.
- Unique tip design eliminates walking and increases drilling speed.
- Single piece design, optimised flute angle and hardening process deliver extreme life in impact driver applications.



**SINGLE PACKS**

Cat. No.	Diameter mm	Length mm	Working Length mm	Pack Qty.	M.O.Q.	Barcode	List Price Ex. VAT (£)
DT50600-QZ	3	64	26	1	1	5035048081723	9,04
DT50601-QZ	3.2	67	29	1	1	5035048081730	NOT UK
DT50602-QZ	3.5	70	29	1	1	5035048081747	9,04
DT50603-QZ	4	71	30	1	1	5035048081754	9,04
DT50604-QZ	4.2	71	31	1	1	5035048081761	NOT UK
DT50605-QZ	4.5	75	31	1	1	5035048081778	9,68
DT50606-QZ	4.8	76	32	1	1	5035048081785	NOT UK
DT50607-QZ	5	78	33	1	1	5035048081792	10,60
DT50608-QZ	5.5	78	35	1	1	5035048081808	10,76
DT50609-QZ	6	80	37	1	1	5035048081815	10,76
DT50610-QZ	6.5	81	38	1	1	5035048081822	NOT UK
DT50611-QZ	7	89	45	1	1	5035048081839	11,56
DT50612-QZ	7.5	95	50	1	1	5035048081846	NOT UK
DT50613-QZ	8	102	50	1	1	5035048081853	11,36
DT50614-QZ	8.5	102	50	1	1	5035048081860	NOT UK
DT50615-QZ	9	102	50	1	1	5035048081877	NOT UK
DT50616-QZ	10	102	50	1	1	5035048081884	14,88
DT50617-QZ	11	102	50	1	1	5035048081891	15,96
DT50618-QZ	12	102	50	1	1	5035048081907	16,76
DT50619-QZ	13	102	50	1	1	5035048081914	19,24

**SETS**

Cat. No.	Description	Diameter mm	Pack Qty.	M.O.Q.	Barcode	List Price Ex. VAT (£)
DT705008-QZ	10 piece set	3, 3.2, 3.5, 4, 4.5, 5, 6, 8, 10, 12	10	1	5035048081921	94,76

**BRAD POINT WOOD DRILL BITS**

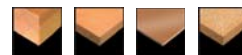

**APPLICATIONS**

- Suitable for drilling hardboard, plywood, chipboard and all natural hard and softwood.
- Typically used for doweling applications or wood screw clearance holes.

**FEATURES**

- Manufactured from chrome vanadium alloyed steel.
- Centre location point and outer cutting spurs for clean accurate holes.

**SINGLE PACKS**

Cat. No.	Diameter mm	Length mm	Working Length mm	Pack Qty.	M.O.Q.	Barcode	List Price Ex. VAT (£)
DT4503-QZ	3	70	46	1	1	5011402385553	1,28
DT4504-QZ	4	80	52	1	1	5011402385560	1,40
DT4505-QZ	5	90	60	1	1	5011402385577	1,53
DT4506-QZ	6	100	66	1	1	5011402385584	1,64
DT4507-QZ	7	110	72	1	1	5011402385591	1,77
DT4508-QZ	8	120	80	1	1	5011402385607	2,22
DT4509-QZ	9	130	84	1	1	5011402385614	2,35
DT4510-QZ	10	133	90	1	1	5011402385621	2,70
DT4511-QZ	11	150	100	1	1	5011402385638	3,87
DT4512-QZ	12	155	102	1	1	5011402385645	3,98
DT4513-QZ	13	155	102	1	1	5011402385652	4,46
DT4514-QZ	14	160	107	1	1	5011402385669	5,54
DT4516-QZ	16	165	112	1	1	5011402385683	7,74
DT4518-QZ	18	200	130	1	1	5011402385690	9,83
DT4520-QZ	20	200	130	1	1	5011402385706	11,04

**SETS**

Cat. No.	Description	Diameter mm	Pack Qty.	M.O.Q.	Barcode	List Price Ex. VAT (£)
DT4535-QZ	5 piece set in plastic cassette	4, 5, 6, 8, 10	5	1	5011402385713	9,50



## FRAME DRILL BITS

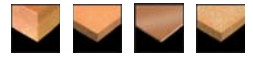

## APPLICATIONS

- For very rapid and accurate drilling of clean holes in hard/softwoods and laminates.

## SINGLE PACKS

Cat. No.	Diameter mm	Length mm	Pack Qty.	M.O.Q.	Barcode	List Price Ex. VAT (£)
DT4870-QZ	7	600	1	1	5035048014035	NOT UK
DT4871-QZ	8	600	1	1	5035048014042	NOT UK
DT4872-QZ	10	600	1	1	5035048014059	NOT UK
DT4873-QZ	12	600	1	1	5035048014066	NOT UK
DT4874-QZ	16	600	1	1	5035048014073	NOT UK
DT4875-QZ	18	600	1	1	5035048014080	NOT UK
DT4876-QZ	20	600	1	1	5035048014097	NOT UK
DT4877-QZ	22	600	1	1	5035048014103	NOT UK

## TCT HINGE BORING BITS

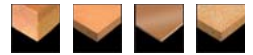

## APPLICATIONS

- Typically used to fit cantilever hinges.

## FEATURES

- Tungsten carbide tipped wood boring tool for clean accurate flat bottom recess holes.
- Hexagonal shank facilitates a firm chuck grip.

## SINGLE PACKS

Cat. No.	Diameter mm	Length mm	Pack Qty.	M.O.Q.	Barcode	List Price Ex. VAT (£)
DT4541-QZ	26	65	1	1	5011402386161	14,30
DT4542-QZ	30	65	1	1	5011402386178	14,88
DT4543-QZ	35	65	1	1	5011402386185	15,91

## WOOD AUGER DRILL BITS

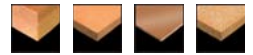

## APPLICATIONS

- Typically used for boring clean precise holes through beams, joists, doors etc.

## FEATURES

- Threaded centre point to aid accurate drilling.
- Outer cutting spur provides clean holes with less splintering.
- Special "Lewis" spiral flute allows for fast removal of debris and rapid drilling.



## SINGLE PACKS

Cat. No.	Diameter mm	Length mm	Working Length mm	Pack Qty.	M.O.Q.	Barcode	List Price Ex. VAT (£)
DT4600-QZ	6	200	100	1	1	5011402385720	8,58
DT4602-QZ	8	200	100	1	1	5011402385737	9,61
DT4604-QZ	10	200	100	1	1	5011402385744	10,40
DT4606-QZ	12	200	100	1	1	5011402385751	10,52
DT4608-QZ	14	200	100	1	1	5011402385768	11,40
DT4610-QZ	16	200	100	1	1	5011402385775	13,01
DT4612-QZ	18	200	100	1	1	5011402385782	14,00
DT4614-QZ	20	200	100	1	1	5011402385799	16,44
DT4615-QZ	22	200	100	1	1	5011402385805	17,80
DT4616-QZ	24	200	100	1	1	5011402385812	19,64
DT4618-QZ	26	200	100	1	1	5011402385829	23,02
DT4619-QZ	28	200	100	1	1	5011402385836	26,36
DT4620-QZ	30	200	100	1	1	5011402385843	31,25
DT4621-QZ	32	200	100	1	1	5011402385850	36,46
DT4632-QZ	8	380	280	1	1	5011402385867	18,66
DT4634-QZ	10	380	280	1	1	5011402385874	18,89
DT4636-QZ	12	380	280	1	1	5011402385881	19,64
DT4638-QZ	14	380	280	1	1	5011402385898	20,69
DT4640-QZ	16	380	280	1	1	5011402385904	22,14
DT4642-QZ	18	380	280	1	1	5011402385911	27,03
DT4644-QZ	20	380	280	1	1	5011402385928	27,95
DT4645-QZ	22	380	280	1	1	5011402385935	31,25
DT4646-QZ	24	380	280	1	1	5011402385942	41,79
DT4648-QZ	26	380	280	1	1	5011402385959	44,11
DT4649-QZ	28	380	280	1	1	5011402385966	52,85
DT4650-QZ	30	380	280	1	1	5011402385973	59,25
DT4651-QZ	32	380	280	1	1	5011402385980	65,70

**SELF FEED DRILL BITS**

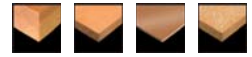

**APPLICATIONS**

- For rapid drilling of clean large diameter holes in wood.

**FEATURES**

- 2 x sharp cutting edges for extremely fast drilling in woods with reduced risk of binding.
- Aggressive 'Self feed' spur for rapid penetration into material.
- Non slip shank gives better bit retention in chuck.

**SINGLE PACKS**

Cat. No.	Diameter mm	Pack Qty.	M.O.Q.	Barcode	List Price Ex. VAT (£)
DT4575-QZ	25	1	1	5035048072004	17,72
DT4576-QZ	28	1	1	5035048072011	21,64
DT4577-QZ	32	1	1	5035048072028	23,80
DT4578-QZ	35	1	1	5035048072035	27,68
DT4579-QZ	38	1	1	5035048072042	29,84
DT4580-QZ	41	1	1	5035048072059	30,72
DT4581-QZ	45	1	1	5035048072066	34,60
DT4582-QZ	51	1	1	5035048072073	38,08
DT4583-QZ	54	1	1	5035048072080	38,92
DT4584-QZ	57	1	1	5035048072097	42,84
DT4585-QZ	65	1	1	5035048072103	46,72
DT4586-QZ	68	1	1	5035048072110	48,88
DT4587-QZ	74	1	1	5035048072127	53,20
DT4588-QZ	76	1	1	5035048072134	57,52
DT4589-QZ	92	1	1	5035048072141	65,76
DT4590-QZ	117	1	1	5035048072158	73,56
DT4591-QZ	Self Feed Set - 5 pce (35mm, 38mm, 54mm, 65mm plus extension bar 140mm)	1	1	5035048072165	147,00
DT4592-QZ	Self Feed Extension piece 140mm	1	1	5035048072172	19,88

**EXTREME DeWALT® FLATWOOD DRILL BITS**



**APPLICATIONS**

- For the rapid drilling of holes in wood.
- Suitable for natural hard and soft wood, chipboard and other man made materials.
- Ideal for door locks, mortising, electrical and plumbing work.

**FEATURES**

- Extra thick robust steel shank for outstanding durability and bit life.
- Chamfered outer cutting spurs for clean, very fast drilling and extended drilling life.
- Precision ground central point with optimised design for faster material penetration and increased drilling speed.

**SINGLE PACKS**

Cat. No.	Diameter mm	Length mm	Pack Qty.	M.O.Q.	Barcode	List Price Ex. VAT (£)
DT4762-QZ	10	152	1	1	5035048072950	4,11
DT4763-QZ	12	152	1	1	5035048072967	4,11
DT4764-QZ	13	152	1	1	5035048072974	5,01
DT4765-QZ	14	152	1	1	5035048072981	5,01
DT4766-QZ	16	152	1	1	5035048072998	4,15
DT4767-QZ	18	152	1	1	5035048073001	5,30
DT4768-QZ	20	152	1	1	5035048073018	4,51
DT4769-QZ	22	152	1	1	5035048073025	4,69
DT4770-QZ	24	152	1	1	5035048073032	5,96
DT4771-QZ	25	152	1	1	5035048073049	5,05
DT4772-QZ	26	152	1	1	5035048073056	6,40
DT4773-QZ	28	152	1	1	5035048073063	6,62
DT4774-QZ	30	152	1	1	5035048073070	6,84
DT4775-QZ	32	152	1	1	5035048073087	5,77
DT4776-QZ	35	152	1	1	5035048073094	7,83
DT4777-QZ	38	152	1	1	5035048073100	8,17
DT4778-QZ	40	152	1	1	5035048073117	8,17
DT79438-QZ	8 piece set (12, 16, 18, 20, 22, 25, 28, 32)	152	1	1	5035048073292	43,28

**EXTREME DeWALT® LONG FLATWOOD DRILL BITS**

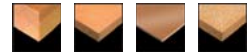

**APPLICATIONS**

- For the rapid drilling of holes in wood.
- Suitable for natural hard and soft wood, chipboard and other man made materials.
- Ideal for door locks, mortising, electrical and plumbing work.

**FEATURES**

- Extra thick robust steel shank for outstanding durability and bit life.
- Chamfered outer cutting spurs for clean, very fast drilling and extended drilling life.
- Precision ground central point with optimised design for faster material penetration and increased drilling speed.

**SINGLE PACKS**

Cat. No.	Diameter mm	Length mm	Pack Qty.	M.O.Q.	Barcode	List Price Ex. VAT (£)
DT4780-QZ	10	406	1	1	5035048073124	NOT UK
DT4781-QZ	12	406	1	1	5035048073131	NOT UK
DT4783-QZ	14	406	1	1	5035048073155	NOT UK
DT4784-QZ	16	406	1	1	5035048073162	NOT UK
DT4785-QZ	20	406	1	1	5035048073179	NOT UK
DT4786-QZ	22	406	1	1	5035048073186	NOT UK
DT4787-QZ	24	406	1	1	5035048073193	NOT UK
DT4788-QZ	25	406	1	1	5035048073209	NOT UK
DT4789-QZ	26	406	1	1	5035048073216	NOT UK
DT4791-QZ	30	406	1	1	5035048073230	NOT UK
DT4792-QZ	32	406	1	1	5035048073247	NOT UK
DT4793-QZ	35	406	1	1	5035048073254	NOT UK

FLATWOOD DRILL BITS

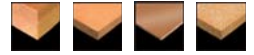

APPLICATIONS

- For the rapid drilling of holes in wood.
- Suitable for natural hard and soft wood, chipboard and other man made materials.
- Ideal for door locks, mortising, electrical and plumbing work.

FEATURES

- High quality chrome vanadium flat drill bit.
- Ground central point and cutting edges for accurate location and clean cutting.
- Ground chip breaker to reduce splintering providing relatively clean holes and improved drilling efficiency.

SINGLE PACKS

Cat. No.	Diameter mm	Length mm	Pack Qty.	M.O.Q.	Barcode	List Price Ex. VAT (£)
DT4810-QZ	10	150	1	1	5011402385997	4,73
DT4812-QZ	12	150	1	1	5011402386000	4,80
DT4813-QZ	13	150	1	1	5011402386017	4,86
DT4814-QZ	14	150	1	1	5011402386024	5,35
DT4816-QZ	16	150	1	1	5011402386031	5,54
DT4818-QZ	18	150	1	1	5011402386048	5,85
DT4820-QZ	20	150	1	1	5011402386055	5,95
DT4822-QZ	22	150	1	1	5011402386062	6,00
DT4824-QZ	24	150	1	1	5011402386079	6,27
DT4825-QZ	25	150	1	1	5011402386086	6,70
DT4826-QZ	26	150	1	1	5011402386093	6,99
DT4828-QZ	28	150	1	1	5011402386109	7,56
DT4830-QZ	30	150	1	1	5011402386116	7,96
DT4832-QZ	32	150	1	1	5011402386123	8,25
DT4835-QZ	35	150	1	1	5011402386130	9,18
DT4838-QZ	38	150	1	1	5011402386147	9,52

FLATWOOD DRILL BIT EXTENSION

Cat. No.	Length mm	Pack Qty.	M.O.Q.	Barcode	List Price Ex. VAT (£)
DT4849-QZ	300 x 1/4"	1	1	5035048058923	7,59



**EXTREME IMPACT HOLESAWS**



**APPLICATIONS**

- Ideal for cutting holes in thin metals, plastics and fibreglass board
- For use with all Impact drivers and wrenches

**FEATURES**

- Optimised tooth design for faster drilling and more holes per charge
- Thin walled design for optimum efficiency in cutting thin materials
- Durable hex shank designed to fit all impact drivers
- Ejection spring for easy plug removal
- Single piece design to avoid lock up on mandrel

**SINGLE PACKS**

Cat. No.	Diameter mm	Depth of Cut mm	Pack Qty.	M.O.Q.	Barcode	List Price Ex. VAT (€)
DT8253-QZ	19	5	1	1	5035048079959	30,92
DT8254-QZ	22	5	1	1	5035048079966	31,92
DT8255-QZ	25	5	1	1	5035048079973	32,96
DT8256-QZ	29	5	1	1	5035048079980	34,00
DT8257-QZ	32	5	1	1	5035048079997	35,04
DT8258-QZ	35	5	1	1	5035048080009	36,04
DT8259-QZ	38	5	1	1	5035048080016	37,08

**BI-METAL DEEP CUT HOLESAWS**

**APPLICATIONS**

- Ideal for cutting holes in steel, stainless steel, brass, copper, aluminium, wood, plastic and other composites.

**FEATURES**

- Industrial, rugged hole saws designed for heavy duty cutting in standard or deep cut applications.
- Extra hard variable pitch high speed steel teeth.
- M3 Steel cutting edge providing extended hole saw life.
- 12.5 mm deeper cut than standard bi-metal hole saw.
- Increased depth of cutting edge providing extended hole saw cutting life.

**SINGLE PACKS**



Cat. No.	Diameter mm	Depth of Cut mm	Pack Qty.	M.O.Q.	Barcode	List Price Ex. VAT (€)
DT8116-QZ	16	38	1	1	5011402370290	12,00
DT8119-QZ	19	38	1	1	5011402370306	13,33
DT8120-QZ	20	38	1	1	5011402370313	14,00
DT8121-QZ	21	38	1	1	5035048061145	14,17
DT8122-QZ	22	38	1	1	5011402370320	14,17
DT8124-QZ	24	38	1	1	5035048061152	14,17
DT8125-QZ	25	38	1	1	5011402370337	14,33
DT8127-QZ	27	38	1	1	5035048061169	14,50
DT8129-QZ	29	38	1	1	5011402370344	14,67
DT8130-QZ	30	38	1	1	5035048061176	14,83
DT8132-QZ	32	38	1	1	5011402370351	14,83
DT8133-QZ	33	38	1	1	5035048061183	15,00
DT8135-QZ	35	38	1	1	5011402370368	15,00
DT8138-QZ	38	40	1	1	5011402370375	15,50
DT8141-QZ	40	40	1	1	5035048061206	14,83
DT8140-QZ	41	40	1	1	5011402370382	15,83
DT8143-QZ	43	40	1	1	5035048061213	14,87
DT8145-QZ	44	40	1	1	5011402370399	16,00
DT8146-QZ	46	40	1	1	5035048061220	15,07
DT8148-QZ	48	40	1	1	5035048053683	16,50
DT8151-QZ	51	40	1	1	5011402370405	15,07
DT8152-QZ	52	40	1	1	5035048061237	15,39
DT8154-QZ	54	40	1	1	5035048053690	16,67
DT8157-QZ	57	40	1	1	5011402370412	17,00
DT8160-QZ	60	40	1	1	5035048053706	17,50
DT8164-QZ	64	40	1	1	5011402370429	17,83
DT8165-QZ	65	40	1	1	5035048061244	17,67
DT8167-QZ	67	40	1	1	5011402370436	18,33
DT8168-QZ	68	40	1	1	5035048061251	17,45
DT8170-QZ	70	40	1	1	5035048053713	18,83
DT8173-QZ	73	40	1	1	5011402370443	19,33
DT8176-QZ	76	40	1	1	5035048053720	19,67
DT8179-QZ	79	40	1	1	5035048053737	20,00
DT8183-QZ	83	40	1	1	5011402370450	20,83
DT8186-QZ	86	40	1	1	5035048053744	21,17
DT8189-QZ	89	40	1	1	5035048061268	23,33
DT8192-QZ	92	40	1	1	5035048053751	25,83
DT8195-QZ	95	40	1	1	5011402370467	26,67
DT8202-QZ	102	40	1	1	5035048053799	29,33
DT8205-QZ	105	40	1	1	5035048053805	30,00
DT8208-QZ	108	40	1	1	5035048053812	35,00
DT8265-QZ	111	40	1	1	5035048014271	NOT UK
DT8214-QZ	114	40	1	1	5035048053829	38,33
DT8221-QZ	121	40	1	1	5035048053836	44,92
DT8227-QZ	127	40	1	1	5035048053843	49,57
DT8240-QZ	140	40	1	1	5035048053850	53,67
DT8252-QZ	152	40	1	1	5035048053867	61,49
DT8260-QZ	160	40	1	1	5035048061282	70,13
DT8266-QZ	177	40	1	1	5035048014288	NOT UK
DT8267-QZ	210	40	1	1	5035048014295	NOT UK

**BI-METAL HOLESAW SETS**

**FEATURES**

- Sets designed specifically for plumbers, electricians and general purpose users.
- All sets supplied in durable plastic boxes for easy transportation and storage



**BI-METAL HOLESAW SETS**

Cat. No.	Description	Pack Qty.	Barcode	List Price Ex. VAT (£)
DT8104-XJ	General purpose set in plastic kitbox, 2x hex shank mandrels, 2x pilot drill bits, 9 hole saws ø 16, 19, 25, 32, 38, 44, 48, 51, 64mm.	13 pieces	5035048053768	140,00
DT8105-XJ	Electrician's set in plastic kitbox, 2x hex shank mandrels, 2x pilot drill bits, 7 hole saws ø 22, 29, 35, 38, 44, 51, 64mm.	11 pieces	5035048053775	140,00
DT8106-XJ	Plumber's set in plastic kitbox, 2x hex shank mandrels, 2x pilot drill bits, 9 hole saws ø 19, 22, 29, 35, 38, 44, 57, 64, 76mm.	13 pieces	5035048053782	140,00
DT8110-XJ	Electrician's set in plastic kitbox, 2x hex shank mandrels, 2x pilot drill bits, 7 hole saws ø 16, 20, 25, 32, 40, 51, 64mm.	11 pieces	5035048061336	140,00
DT8111-XJ	Electrician's set in plastic kitbox, 2x hex shank mandrels, 2x pilot drill bits, 7 hole saws ø 20, 25, 35, 32, 40, 51, 64mm.	11 pieces	5035048061343	140,00

**EXTREME DeWALT HOLESAW SETS**

Cat. No.	Description	Pack Qty.	M.O.Q.	Barcode	List Price Ex. VAT (£)
DT8270-QZ	EXTREME DeWALT™ EXTREME 11 piece set in plastic kit box - 1x small quick change mandrel, 1x large quick change mandrel, 2x EXTREME pilot drill bits, 7 hole saws ø 22, 29, 35, 44, 51, 64, 68 mm	11	1	5035048073414	173,04
DT8269-QZ	EXTREME DeWALT™ 11 piece Plumbers Kit - 1x small quick change mandrel, 1x large quick change mandrel, 2x EXTREME pilot drill bits, 7 hole saws ø 19, 22, 29, 38, 44, 51, 57mm	11	1	5035048073995	173,04
DT8273-QZ	EXTREME DeWALT™ 11 piece Electricians Kit - 1x small quick change mandrel, 1x large quick change mandrel, 2x EXTREME pilot drill bits, 7 hole saws ø 16, 20, 25, 32, 35, 51, 64mm	11	1	5035048074008	173,04

**CARBIDE GRIT HOLESAWS**

**APPLICATIONS**

- Ideal for cutting holes in masonry, light concrete, fibre glass and other abrasive composites.

**FEATURES** • Nickel alloy brazed carbide grit edge (Hrcc 85) ensures long life, 'go anywhere' performance.

- Dual directional cut ensures smooth cutting action with no 'kickback'.
- Wear resistant grit ensures longer life when working with abrasive materials such as masonry/concrete.



**CARBIDE GRIT HOLESAWS**

Cat. No.	Diameter mm	Depth of Cut mm	Pack Qty.	M.O.Q.	Barcode	List Price Ex. VAT (£)
DT8118-QZ	16	40	1	1	5035048012345	14,67
DT8123-QZ	19	40	1	1	5035048012116	15,00
DT8126-QZ	20	40	1	1	5035048012123	15,19
DT8128-QZ	22	40	1	1	5035048012130	15,68
DT8131-QZ	25	40	1	1	5035048012147	14,99
DT8134-QZ	29	40	1	1	5035048012154	16,80
DT8136-QZ	32	40	1	1	5035048012161	17,58
DT8139-QZ	35	40	1	1	5035048012178	18,12
DT8142-QZ	38	40	1	1	5035048012185	19,05
DT8144-QZ	40	40	1	1	5035048012192	19,35
DT8147-QZ	44	40	1	1	5035048012208	19,69
DT8149-QZ	48	40	1	1	5035048012215	20,28
DT8150-QZ	51	40	1	1	5035048012352	20,62
DT8155-QZ	54	40	1	1	5035048012369	22,10
DT8156-QZ	57	40	1	1	5035048012222	22,48
DT8163-QZ	64	40	1	1	5035048012239	24,10
DT8172-QZ	76	40	1	1	5035048012246	26,45
DT8174-QZ	68	40	1	1	5035048072875	NOT UK
DT8175-QZ	83	40	1	1	5035048072882	NOT UK
DT8177-QZ	102	40	1	1	5035048072899	NOT UK

**CARBIDE GRIT HOLESAW SETS**

**FEATURES**

- Sets designed specifically for plumbers, electricians and general purpose users.
- All sets supplied in durable plastic boxes for easy transportation and storage.



**CARBIDE GRIT HOLESAW SETS**

Cat. No.	Description	Pack Qty.	M.O.Q.	Barcode	List Price Ex. VAT (£)
DT8275-QZ	Electrician's set in plastic kitbox, 2 x hex shank mandrels, 2 x pilot drill bits, 7 holesaws ø 16, 20, 25, 32, 40, 51, 64	11	1	5035048012307	173,04
DT8276-QZ	Electrician's set in plastic kitbox, 2 x hex shank mandrels, 2 x pilot drill bits, 7 holesaws ø 20, 25, 32, 38, 44, 51, 64	11	1	5035048012314	173,04
DT8277-QZ	General purpose set in plastic kitbox, 2 x hex shank mandrels, 2 x pilot drill bits, 9 holesaws ø 16, 19, 25, 32, 38, 44, 48, 51, 64	13	1	5035048012321	173,04
DT8278-QZ	Plumber's set in plastic kitbox, 2 x hex shank mandrels, 2 x pilot drill bits, 9 holesaws ø 19, 22, 29, 35, 38, 44, 57, 64, 76	13	1	5035048012338	144,20



**EXTREME DEWALT QUICK CHANGE MANDRELS**



FOR USE WITH BI-METAL HOLESAWS

**FEATURES**

- Fast, tool free changeovers.
- Quick release collar to prevent hole saw lock up
- Available as single units and in sets

Cat. No.	Description	Pack Qty.	M.O.Q.	Barcode	List Price Ex. VAT (£)
DT8286-QZ	EXTREME Small Quick Change Mandrel (No drive pins) ø 14mm - 30mm	1	1	5035048073377	25,52
DT8288-QZ	EXTREME DeWALT® Large Quick Change Mandrel (Drive pins) ø 32mm - 210mm	1	1	5035048073391	17,17
DT8289-QZ	EXTREME DeWALT® EXTREME Replacement pilot drill (6.3mm diameter)	1	1	5035048073407	4,33

**HOLESAW MANDRELS AND ACCESSORIES**



FOR USE WITH BI-METAL HOLESAWS

**FEATURES**

- Quick release mandrel prevents lock up of the holesaw on the mandrel enabling easy removal.

Cat. No.	Description	Pack Qty.	M.O.Q.	Barcode	List Price Ex. VAT (£)
DT8101-QZ	Mandrel for 14 - 29 mm diameter hole saws. For 10 mm capacity chuck or larger.	1	1	5011402370474	10,41
DT8102-QZ	Quick release mandrel for 32 - 210mm diameter hole saws. For 13 mm capacity chuck or larger.	1	1	5011402370481	14,22
DT8103-QZ	Replacement pilot drill bit (6.3 mm diameter).	1	1	5011402370498	5,05
DT8290-QZ	Extension Rod 300mm. For use with holesaw mandrel DT8102	1	1	5035048061299	21,91
DT8295-QZ	Plug Ejection Spring	1	1	5035048061312	4,12
DT8107-QZ	Quick release mandrel - SDS+ fitment - for 14-30mm diameter holesaws	1	1	5035048053935	15,70
DT8108-QZ	Quick release mandrel - SDS+ fitment - for 32-210mm diameter holesaws	1	1	5035048061329	14,40

**HOLESAW MANDRELS AND ACCESSORIES**



FOR USE WITH CARBIDE GRIT HOLESAWS

Cat. No.	Description	Pack Qty.	M.O.Q.	Barcode	List Price Ex. VAT (£)
DT8280-QZ	Pilot bit masonry - long	1	1	5035048012253	5,38
DT8285-QZ	Pilot bit masonry - small	1	1	5035048013939	NOT UK
DT8281-QZ	Small mandrel & masonry bit	1	1	5035048012260	6,61
DT8282-QZ	Large mandrel & masonry bit	1	1	5035048012277	14,21
DT8283-QZ	SDS & small mandrel & pilot bit	1	1	5035048012284	43,30
DT8284-QZ	SDS & large mandrel & pilot bit	1	1	5035048012291	80,42

**MIXER TOOLS**



MIXER TOOLS

**APPLICATIONS**

- For wallpaper paste, gloss paint, emulsion, mortar and plaster.

**FEATURES**

- Universal stirring/mixing tool for hand-held drills with a 13mm chuck. Mixing effect from bottom to top.
- Suitable for DW130.
- M14 version also available.

Cat. No.	Diameter mm	Length mm	Pack Qty.	Shank	M.O.Q.	Barcode	List Price Ex. VAT (£)
DT4950-QZ	100	600	1	Hex	1	5035048027202	22,93
DT4951-QZ	120	600	1	Hex	1	5035048027219	27,74
DT4952-QZ	120	600	1	M14	1	5035048011300	34,33

**CHUCKS AND KEYS**

**APPLICATIONS**

- Professional heavy duty chucks & keys.
- For use with DEWALT and other makes of drills.

**FEATURES**

- Choose from metal or plastic body.
- Single or twin sleeved.
- Carbide jaws for extra grip.

**KEYLESS CHUCKS 10MM/13MM**



Cat. No.	Chuck Capacity mm	Fitment	Sleeves	Metal/ Plastic	Pack Qty.	M.O.Q.	Barcode	List Price Ex. VAT (£)
D17001-QZ	10	1/2" x 20 UNF	2	Plastic	1	1	5011402371358	30,00
D17040-QZ	10	3/8" x 24 UNF	2	Plastic	1	1	5035048060209	30,00
D17041-QZ	10	1/2" x 20 UNF	2	Metal	1	1	5035048060216	32,00
D17042-QZ	10	1/2" x 20 UNF	1	Metal	1	1	5035048060223	36,00
D17002-QZ	13	1/2" x 20 UNF	2	Plastic	1	1	5011402371365	18,00
D17043-QZ	13	1/2" x 20 UNF	2	Metal	1	1	5035048060230	41,08
D17044-QZ	13	1/2" x 20 UNF	2	Metal/carbide	1	1	5035048060247	48,00
D17045-QZ	13	1/2" x 20 UNF	1	Metal	1	1	5035048060254	41,08
D17046-QZ	13	1/2" x 20 UNF	1	Metal/carbide	1	1	5035048060261	54,08
D17025-QZ	13	1/2" x 20 UNF	2	Plastic/Metal	1	5	5035048061718	28,11

**KEYED CHUCKS 10MM/13MM**



Cat. No.	Chuck Capacity mm	Fitment	Pack Qty.	M.O.Q.	Barcode	List Price Ex. VAT (£)
D17013-QZ	10	3/8" x 24 UNF	1	1	5035048060186	18,56
D17011-QZ	10	1/2" x 20 UNF	1	1	5011402371372	18,56
D17012-QZ	13	1/2" x 20 UNF	1	1	5011402371389	18,56
D17014-QZ	13	5/8" x 16 UNF	1	1	5035048060193	48,00

**CHUCK KEYS**



Cat. No.	Chuck Capacity mm	Pack Qty.	M.O.Q.	Barcode	List Price Ex. VAT (£)
D17021-QZ	Fits 10 mm and 13 mm chucks (S2).	1	1	5011402371396	5,00
D17022-QZ	Fits 5/8" x 16 UNF keyed chucks (S9).	1	1	5035048060506	6,18

**SPECIAL CHUCKS/ADAPTORS**



Cat. No.	Chuck Capacity mm	Fitment	Pack Qty.	M.O.Q.	Barcode	List Price Ex. VAT (£)
D17005-QZ	13	1/2" x 20 UNF keyed chuck with SDS adaptor.	1	1	5035048060278	18,00
D17030-QZ	-	SDS-Plus - 1/2" x 20 UNF (Chuck adaptor).	1	1	5011402371419	18,00
D16829-QZ	-	SDS-Plus - 1/2" x 20 UNF Chuck adaptor / screwdriver bit holder.	1	1	5035048034170	21,68
D17017-QZ	13	2 Sleeve plastic chuck for 2&4kg quick change hammers (eg. D25104K)	1	1	5035048061695	48,00
D17018-QZ	13	2 Sleeve metal chuck for 2&4kg quick change hammers (eg. D25104K)	1	1	5035048061701	76,00

**SCREWDRIVING ACCESSORIES**



**APPLICATIONS**

- For all heavy duty screwdriving applications

**FEATURES**

- Durable hex shank designed to fit all impact drivers
- Full hex body design for increased strength and life
- Optimised tip design for reduced cam out
- Heat treated body for increased durability

**EXTREME DeWALT IMPACT BITS FOR POZIDRIV SCREWS**



Cat. No.	Size	Description	Pack Qty.	M.O.Q.	Barcode	List Price Ex. VAT (£)
DT7386-QZ	Pz1	25mm Impact bit	5	1	5035048082201	6,20
DT7387-QZ	Pz2	25mm Impact bit	5	1	5035048082218	6,20
DT7388-QZ	Pz3	25mm Impact bit	5	1	5035048082225	6,20
DT7390-QZ	Pz1	50mm Impact bit	5	1	5035048082249	6,40
DT7391-QZ	Pz2	50mm Impact bit	5	1	5035048082256	6,40
DT7392-QZ	Pz3	50mm Impact bit	5	1	5035048082263	6,40

**EXTREME DeWALT IMPACT BITS FOR PHILLIPS SCREWS**



Cat. No.	Size	Description	Pack Qty.	M.O.Q.	Barcode	List Price Ex. VAT (£)
DT7993-QZ	Ph1	25mm Impact bit	5	1	5035048082270	6,20
DT7994-QZ	Ph2	25mm Impact bit	5	1	5035048082287	6,20
DT7995-QZ	Ph3	25mm Impact bit	5	1	5035048082294	6,20
DT7997-QZ	Ph1	50mm Impact bit	5	1	5035048082317	6,40
DT7998-QZ	Ph2	50mm Impact bit	5	1	5035048082324	6,40
DT7999-QZ	Ph3	50mm Impact bit	5	1	5035048082331	6,40

**EXTREME IMPACT BITS FOR TORX® SCREWS**



Cat. No.	Size	Description	Pack Qty.	M.O.Q.	Barcode	List Price Ex. VAT (£)
DT7379-QZ	T10	25mm Impact bit	5	1	5035048082133	NOT UK
DT7380-QZ	T15	25mm Impact bit	5	1	5035048082140	NOT UK
DT7381-QZ	T20	25mm Impact bit	5	1	5035048082157	6,20
DT7382-QZ	T25	25mm Impact bit	5	1	5035048082164	6,20
DT7383-QZ	T27	25mm Impact bit	5	1	5035048082171	NOT UK
DT7384-QZ	T30	25mm Impact bit	5	1	5035048082188	6,20
DT7385-QZ	T40	25mm Impact bit	5	1	5035048082195	NOT UK
DT7393-QZ	T10	50mm Impact bit	5	1	5035048082843	NOT UK
DT7394-QZ	T15	50mm Impact bit	5	1	5035048082850	NOT UK
DT7395-QZ	T20	50mm Impact bit	5	1	5035048082867	NOT UK
DT7396-QZ	T25	50mm Impact bit	5	1	5035048082874	NOT UK
DT7397-QZ	T27	50mm Impact bit	5	1	5035048082881	NOT UK
DT7398-QZ	T30	50mm Impact bit	5	1	5035048082898	NOT UK
DT7399-QZ	T40	50mm Impact bit	5	1	5035048082904	NOT UK

**SCREWDRIVING ACCESSORIES**

**APPLICATIONS**

- For all screwdriving applications.

**FEATURES**

- High quality professional screwdriver bits.
- Flexible Torsion Zone absorbs torque peaks and reduces breakage.
- All bits are provided in sturdy plastic re-useable storage containers.

**SLOTTED BITS**



Cat. No.	Size	Description	Pack Qty.	M.O.Q.	Barcode	List Price Ex. VAT (£)
DT7105-QZ	4.5mm	25mm Torsion bit Slotted	5	1	5035048012437	5,33
DT7106-QZ	5.5mm	25mm Torsion bit Slotted	5	1	5035048012444	5,33
DT7116-QZ	5.5mm	25mm Torsion bit Slotted	20	1	5035048012475	20,00
DT7107-QZ	6.5mm	25mm Torsion bit Slotted	5	1	5035048012451	5,33
DT7117-QZ	6.5mm	25mm Torsion bit Slotted	20	1	5035048012482	20,00

**TORSION BITS FOR POZIDRIV SCREWS**



Cat. No.	Size	Description	Pack Qty.	M.O.Q.	Barcode	List Price Ex. VAT (£)
DT7210-QZ	Pz0	25mm Torsion bit	5	1	5035048012499	5,33
DT7211-QZ	Pz1	25mm Torsion bit	5	1	5035048012505	5,33
DT7217-QZ	Pz1	25mm Torsion bit	20	1	5035048012512	20,00
DT7212-QZ	Pz2	25mm Torsion bit	5	1	5035048012529	5,33
DT7218-QZ	Pz2	25mm Torsion bit	20	1	5035048012536	20,00
DT7213-QZ	Pz3	25mm Torsion bit	5	1	5035048012543	5,33
DT7219-QZ	Pz3	25mm Torsion bit	20	1	5035048012550	20,00
DT7214-QZ	Pz4	32mm Torsion bit	5	1	5035048012567	20,00
DT7225-QZ	Pz1	50mm bit with "extra grip" ribs	5	1	5035048013083	9,33
DT7226-QZ	Pz2	50mm bit with "extra grip" ribs	5	1	5035048013090	9,33
DT7227-QZ	Pz3	50mm bit with "extra grip" ribs	5	1	5035048013106	9,33

SCREWDRIVING ACCESSORIES

APPLICATIONS

- For all screwdriving applications.

FEATURES

- High quality professional screwdriver bits.
- Flexible Torsion Zone absorbs torque peaks and reduces breakage.
- All bits are provided in sturdy plastic re-useable storage containers.

TORSION BITS FOR PHILLIPS SCREWS



Cat. No.	Size	Description	Pack Qty.	M.O.Q.	Barcode	List Price Ex. VAT (£)
D17230-QZ	Ph0	25mm Torsion bit	5	1	5035048012574	5,33
D17231-QZ	Ph1	25mm Torsion bit	5	1	5035048012581	5,33
D17237-QZ	Ph1	25mm Torsion bit	20	1	5035048012598	20,00
D17232-QZ	Ph2	25mm Torsion bit	5	1	5035048012604	5,33
D17238-QZ	Ph2	25mm Torsion bit	20	1	5035048012611	20,00
D17233-QZ	Ph3	25mm Torsion bit	5	1	5035048012628	5,33
D17234-QZ	Ph4	32mm Torsion bit	5	1	5035048012642	20,00
D17235-QZ	Ph2	25mm Reduced tip	5	1	5035048066430	NOT UK
D17236-QZ	Ph2	25mm Reduced tip	20	1	5035048066423	NOT UK
D17245-QZ	Ph1	50mm bit with "extra grip" ribs	5	1	5035048013113	9,33
D17246-QZ	Ph2	50mm bit with "extra grip" ribs	5	1	5035048013120	9,33
D17247-QZ	Ph3	50mm bit with "extra grip" ribs	5	1	5035048013137	9,33

HEX BITS



Cat. No.	Size	Description	Pack Qty.	M.O.Q.	Barcode	List Price Ex. VAT (£)
D17165-QZ	4	25mm Hex bit	5	1	5035048012659	5,33
D17166-QZ	5	25mm Hex bit	5	1	5035048012666	5,33
D17167-QZ	6	25mm Hex bit	5	1	5035048012673	5,33
D17168-QZ	8	25mm Hex bit	5	1	5035048012680	5,33

SQUARE BITS



Cat. No.	Size	Description	Pack Qty.	M.O.Q.	Barcode	List Price Ex. VAT (£)
D17170-QZ	1	25mm Square bit	5	1	5035048013564	7,33
D17171-QZ	2	25mm Square bit	5	1	5035048013571	7,33
D17172-QZ	3	25mm Square bit	5	1	5035048013588	7,33

SCREWDRIVER BITS FOR TORX® SCREWS



Cat. No.	Size	Description	Pack Qty.	M.O.Q.	Barcode	List Price Ex. VAT (£)
D17251-QZ	T8	25mm bit for Torx	5	1	5035048012703	5,07
D17252-QZ	T9	25mm bit for Torx	5	1	5035048012710	5,07
D17253-QZ	T10	25mm bit for Torx	5	1	5035048012727	5,07
D17254-QZ	T15	25mm bit for Torx	5	1	5035048012734	5,07
D17265-QZ	T15	25mm bit for Torx	20	1	5035048012741	NOT UK
D17255-QZ	T20	25mm bit for Torx	5	1	5035048012758	5,07
D17266-QZ	T20	25mm bit for Torx	20	1	5035048012765	NOT UK
D17270-QZ	T20	25mm bit for Torx	50	1	5035048012772	NOT UK
D17256-QZ	T25	25mm bit for Torx	5	1	5035048012789	5,07
D17267-QZ	T25	25mm bit for Torx	20	1	5035048012796	NOT UK
D17271-QZ	T25	25mm bit for Torx	50	1	5035048012802	NOT UK
D17257-QZ	T27	25mm bit for Torx	5	1	5035048012819	5,07
D17258-QZ	T30	25mm bit for Torx	5	1	5035048012826	5,07
D17268-QZ	T30	25mm bit for Torx	20	1	5035048012833	NOT UK
D17272-QZ	T30	25mm bit for Torx	50	1	5035048012840	NOT UK
D17259-QZ	T40	25mm bit for Torx	5	1	5035048012857	5,07
D17290-QZ	T10	70mm bit for Torx	5	1	5035048013182	20,00
D17291-QZ	T15	70mm bit for Torx	5	1	5035048013199	20,00
D17292-QZ	T20	70mm bit for Torx	5	1	5035048013205	20,00
D17293-QZ	T25	70mm bit for Torx	5	1	5035048013212	20,00
D17294-QZ	T27	70mm bit for Torx	5	1	5035048013229	16,07
D17295-QZ	T30	70mm bit for Torx	5	1	5035048013236	20,00
D17296-QZ	T40	70mm bit for Torx	5	1	5035048013243	20,00

60 MM DOUBLE ENDED BITS



Cat. No.	Size	Description	Pack Qty.	M.O.Q.	Barcode	List Price Ex. VAT (£)
D17304-QZ	Pz1	60mm double ended bits	5	1	5035048013144	18,20
D17305-QZ	Pz2	60mm double ended bits	5	1	5035048013151	18,20
D17315-QZ	Ph2	60mm double ended bits	5	1	5035048013175	17,67

110 MM POWER BITS



Cat. No.	Size	Description	Pack Qty.	M.O.Q.	Barcode	List Price Ex. VAT (£)
D17203-QZ	Pz2	110mm bit	5	1	5035048013250	NOT UK
D17204-QZ	Ph2	110mm bit	5	1	5035048013267	NOT UK

**SCREWDRIVING ACCESSORIES**

**APPLICATIONS**

- For all screwdriving applications.

**PILOT BITS, DRIVE GUIDES & HOLDERS**



Cat. No.	Length mm	Description	Pack Qty.	M.O.Q.	Barcode	List Price Ex. VAT (£)
DT7501-QZ	57	Non-magnetic	1	1	5011402371327	5,00
DT7500-QZ	60	Magnetic	1	1	5011402371310	6,67
DT7511-QZ	60	Quick change bit holder	1	1	5035048078365	9,41
DT7515-QZ	60	Quick connector	1	1	5035048013274	23,33
DT7516-QZ	60	Rapidfix holder	1	1	5035048013281	26,67
DT7615-QZ	38	Hex Shank Pilot bit 3mm	3	1	5035048013298	18,21
DT7616-QZ	43	Hex Shank Pilot bit 4mm	2	1	5035048013304	13,24
DT7617-QZ	48	Hex Shank Pilot bit 6mm	2	1	5035048013311	16,07
DT7701-QZ	80	DeWALT Screw drive guide 9.5mm diameter	1	1	5035048031995	9,65
DT7702-QZ	120	DeWALT Screw drive guide 12mm diameter	1	1	5035048032008	13,50
DT7508-QZ		1/2" Sq to 1/4" Hex Impact Wrench Adaptor	1	1	5035048082034	18,56
DT7512-QZ		1/4" hex to 1/2" square adaptor	1	1	5035048083055	18,40

**SCREWDRIVING SETS**



**APPLICATIONS**

- For all screwdriving applications.

**FEATURES**

- High quality professional screwdriver bits.
- Flexible Torsion Zone absorbs torque peaks and reduces breakage.
- All bits are provided in sturdy plastic re-useable storage containers.

**SCREWDRIVING SETS**

Cat. No.	Pieces	Description	Pack Qty.	M.O.Q.	Barcode	List Price Ex. VAT (£)
DT7917-QZ	11	TORX® 7, 8, 9, 10, 15, 20, 25, 27, 30, 40, Magnetic bit holder.	1	1	5035048060445	18,44
DT7944-QZ	31	31 Piece Set with 1x2, Pz2x3, Pz3x1, Ph1x2, Ph2x2, Ph3x1, S14.5x1, S15.5x1, S16.5x1, T10x2, T15x2, T20x2, T25x2, T30x2, T40x2, H3 x1, H4x2, H5x1 & Quick Connector	1	1	5035048078372	36,76
DT7945-QZ	11	TORX® Quick Connector set (7, 8, 9, 10, 15, 20, 25, 27, 30, 40)	1	1	5035048013328	NOT UK
DT7946-QZ	11	Torx/Pazi Quick Connector set (T15, 20, 25, 30, 40Pz1, 2x2, 2x3)	1	1	5035048013335	NOT UK
DT7915-QZ	11	Torsion with "Extra Grip" ribs, Incl Pz 1, 2, 3 Ph 1, 2, 3 Slotted 4.5, 5.5, 6.5, 8 Magnetic bit holder	1	1	5035048060421	21,48
DT7916-QZ	11	Torsion with "Extra Grip" ribs, Incl Pz 1, 2, 3 Ph 1, 2, 3, T10, 15, 20, 25 Magnetic bit holder	1	1	5035048060438	18,44
DT7947-QZ	11	Torsion Pz/Ph Quick Connector set (Pz1, 2x2, 2x3, Ph1, 2x2, 2x3)	1	1	5035048013342	NOT UK
DT7948-QZ	11	Torsion Pz/Ph/SI Quick Connector set (Pz1, 2x2, 3, Ph1, 2x2, 3 SI 5.5, 6.5)	1	1	5035048013359	28,84

**EXTREME DeWALT IMPACT SETS**



**APPLICATIONS**

- For all heavy duty screwdriving applications

**FEATURES**

- Durable hex shank designed to fit all impact drivers
- Full hex body design for increased strength and life
- Optimised tip design for reduced cam out
- Heat treated body for increased durability



**EXTREME DeWALT IMPACT SETS**

Cat. No.	Description	Pack Qty.	M.O.Q.	Barcode	List Price Ex. VAT (£)
DT705018-QZ	29pc Impact Screwdriving set	29	1	5035048082591	45,32
DT705028-QZ	26pc Impact Drill Drive set - PH/PZ	29	1	5035048082607	70,04
DT705038-QZ	26pc Impact Drill Drive set - T	29	1	5035048082614	NOT UK

**DeWALT 'FLIP & DRIVE' SYSTEM**

**APPLICATIONS**

- For use in hard and soft wood, composite board and MDF.
- Ideal for cabinet making, furniture assembly, remodelling and shop fitting.

**FEATURES**

- Complete drill drive accessory system for drilling countersink & pilot holes in one action and screwdriving.
- One-handed connector release with push forward collar for easily changing between drilling and screwdriving applications.
- 5/16" (8mm) shank for added durability.

**'FLIP & DRIVE' UNITS**



Cat. No.	Size	Description	Pack Qty.	Barcode	List Price Ex. VAT (£)
D17600-XJ	No.6	Connector, countersink, pilot drill bit & Pz2 screw driver bit.	1	5035048052365	32,66
D17601-XJ	No.8	Connector, countersink, pilot drill bit & Pz2 screw driver bit.	1	5035048052372	32,66
D17602-XJ	No.10	Connector, countersink, pilot drill bit & Pz2 screw driver bit.	1	5035048052389	32,66
D17603-XJ	No.12	Connector, countersink, pilot drill bit & Pz2 screw driver bit.	1	5035048052396	32,66

**PILOT BITS**



Cat. No.	Size	Description	Pack Qty.	Barcode	List Price Ex. VAT (£)
D17608-XJ	No.6	Pilot drill bit	3	5035048031773	7,18
D17609-XJ	No.8	Pilot drill bit	3	5035048031780	7,18
D17610-XJ	No.10	Pilot drill bit	3	5035048031797	7,18

**COUNTERSINK & PILOT**



Cat. No.	Size	Description	Pack Qty.	Barcode	List Price Ex. VAT (£)
D17604-XJ	No.6	Pilot drill bit & 4 cutter countersink.	1	5035048052402	6,02
D17605-XJ	No.8	Pilot drill bit & 4 cutter countersink.	1	5035048052419	6,02
D17606-XJ	No.10	Pilot drill bit & 4 cutter countersink.	1	5035048031759	6,02
D17607-XJ	No.12	Pilot drill bit & 4 cutter countersink.	1	5035048031766	6,02

**DeWALT 'FLIP & DRIVE' SETS**



Cat. No.	Size	Description	Pack Qty.	Barcode	List Price Ex. VAT (£)
D17612-XJ	No.6, 8,10, 12	Case containing No.6 connector, countersink, pilot bit & Pz 2, No.8, 10, 12 countersink & pilot bits, Pz2 x2, Ph2 x2.	1	5035048031810	53,33

**DeWALT IMPACT RATED SOCKET SETS**



**DeWALT IMPACT RATED SOCKET SETS**

Cat. No.	Description	M.O.Q.	Barcode	List Price Ex. VAT (£)
D17506-QZ	17 Pce Impact Socket Set (6,8,10,11,12,13,14,16,17,18,19,20,21,22,24,27mm & 1/4" to 1/2" Adaptor)	1	5035048078624	176,00
D17507-QZ	9 Pce Impact Socket Set (10,13,15,17,19,22,24,27mm) 1/4" to 1/2" Adaptor	1	5035048078631	96,00
D17512-QZ	1/4" to 1/2" Impact Driver Adaptor	1	5035048083055	18,40

**HEXAGONAL SOCKET DRIVERS - 50 MM**



**SINGLE PACKS**

Cat. No.	Size	Description	Pack Qty.	M.O.Q.	Barcode	List Price Ex. VAT (£)
D17415-QZ	6	Magnetic	1	1	5035048061473	3,94
D17416-QZ	6.35	Magnetic	1	1	5035048061480	3,94
D17401-QZ	7	Magnetic	1	1	5011402371181	11,06
D17402-QZ	8	Magnetic	1	1	5011402371198	11,06
D17403-QZ	10	Magnetic	1	1	5011402371204	11,06
D17422-QZ	11	Magnetic	1	1	5035048077580	NOT UK
D17423-QZ	11	12 Point Magnetic	1	1	5035048077597	NOT UK
D17404-QZ	13	Magnetic	1	1	5011402371211	11,06
D17424-QZ	17	Magnetic	1	1	5035048077603	NOT UK

**DRILLING ACCESSORY SETS - MASONRY**



**MASONRY DRILL BIT SETS**

Cat. No.	Description	Diameter mm	Pack Qty.	M.O.Q.	Barcode	List Price Ex. VAT (£)
DT6952-QZ	5 piece set in plastic cassette	4, 5, 6, 8, 10	5	1	5011402373413	8,09



**EXTREME DeWALT® MASONRY DRILL BIT SETS**

Cat. No.	Description	Diameter mm	Pack Qty.	M.O.Q.	Barcode	List Price Ex. VAT (£)
DT6956-QZ	5 piece set in plastic cassette.	4,5,6,8,10	5	1	5035048060797	12,18
DT79288-QZ	Small tough case in blister with EXTREME DeWALT® Masonry drill bits. Ph2x4, Pz2x4, Ph2x50mm, Pz2x50mm, Slotted 5.5x50mm, Magnetic holder, Magnetic drive guide.	4, 5, 5.5, 6, 7, 8	19	1	5035048072219	53,56



**SDS-PLUS EXTREME DeWALT® 2 DRILL BIT SETS**

Cat. No.	Description	Diameter mm	Pack Qty.	M.O.Q.	Barcode	List Price Ex. VAT (£)
DT9700-QZ	4 piece set in plastic cassette.	5,6,8,10	4	1	5035048056400	20,85
DT9701-QZ	7 piece set in metal cassette.	5,6x2,8x2,10,12	7	1	5035048056417	40,54
DT9702-QZ	4 piece set in plastic cassette.	5,5,7,8,10	4	1	5035048056424	17,37

**DRILLING ACCESSORY SETS - METAL**



**EXTREME DeWALT® 2 METAL DRILL BIT SETS**

Cat. No.	Description	Pack Qty.	M.O.Q.	Barcode	List Price Ex. VAT (£)
DT79208-QZ	Small tough case in blister with EXTREME DeWALT® 2 Metal drill bits 1.5, 2, 2.5, 3, 3.2, 3.5, 4, 4.5, 5, 5.5, 6, 6.5, 7.	13	1	5035048072189	49,44
DT79218-QZ	Small tough case in blister with EXTREME DeWALT® 2 Metal drill bits 1.5, 2, 2.5, 3, 3.2, 3.5, 4, 4.5, 5, 5.5, 6, 6.5, 7.	13	1	5035048072196	55,64
DT7926-XJ	Large tough case with EXTREME DeWALT® 2 Metal drill bits 1.1, 1.5, 2, 2.5, 3, 3.2, 3.3, 3.5, 4, 4.2, 4.5, 4.8, 5, 5.5, 6, 6.5, 7, 7.5, 8, 8.5, 9, 9.5, 10, 10.5, 11, 11.5, 12, 12.5, 13 mm.	29	1	5035048052341	132,00



**HSS-R DIN 338 JOBBER METAL DRILL BIT SETS**

Cat. No.	Description	Diameter mm	Pack Qty.	M.O.Q.	Barcode	List Price Ex. VAT (£)
DT5911-QZ	10 piece set in plastic cassette.	1, 2, 3, 4, 5, 6, 7, 8, 9, 10	10	1	5011402383191	13,90
DT5912-QZ	13 piece set in plastic cassette.	1.5, 2, 2.5, 3, 3.2, 3.5, 4, 4.5, 5(x2), 5.5, 6, 6.5	13	1	5011402383207	14,85
DT5913-QZ	19 piece set in metal cassette.	1, 1.5, 2, 2.5, 3, 3.5, 4, 4.5, 5, 5.5, 6, 6.5, 7, 7.5, 8, 8.5, 9, 9.5, 10	19	1	5011402383214	45,47
DT5930-QZ	29 piece set in metal case.	1, 1.5, 2, 2.5, 3, 3.2, 3.3, 3.5, 4, 4.2, 4.5, 4.8, 5, 5.5, 6, 6.5, 7, 7.5, 8, 8.5, 9, 9.5, 10, 10.5, 11, 11.5, 12, 12.5, 13	29	1	5035048077436	72,00



**HSS-G DIN 338 JOBBER METAL DRILL BIT SETS**

Cat. No.	Description	Diameter mm	Pack Qty.	M.O.Q.	Barcode	List Price Ex. VAT (£)
DT5921-QZ	10 piece set in plastic cassette.	1, 2, 3, 4, 5, 6, 7, 8, 9, 10	10	1	5011402374137	23,70
DT5922-QZ	13 piece set in plastic cassette.	1.5, 2, 2.5, 3.2, 3, 3.5, 4.4, 5, 5(x2), 5.5, 6, 6.5	13	1	5011402374151	18,72
DT5923-QZ	19 piece set in metal cassette.	1, 1.5, 2, 2.5, 3, 3.5, 4.4, 5, 5.5, 6, 6.5, 7, 7.5, 8, 8.5, 9, 9.5, 10	19	1	5011402374175	59,01
DT5929-QZ	29 piece set in metal case	1, 1.5, 2, 2.5, 3, 3.2, 3.3, 3.5, 4, 4.2, 4.5, 4.8, 5, 5.5, 6, 6.5, 7, 7.5, 8, 8.5, 9, 9.5, 10, 10.5, 11, 11.5, 12, 12.5, 13	29	1	5035048077429	120,00



**HSS-CO EXTREME DeWALT® COBALT DRILL BIT SETS**

Cat. No.	Description	Diameter mm	Pack Qty.	M.O.Q.	Barcode	List Price Ex. VAT (£)
DT5940-QZ	6 piece set in plastic cassette	2, 3, 4, 5, 6, 8	6	1	5011402376254	28,00
DT5928-QZ	29 piece Cobalt set in plastic case	1, 1.5, 2, 2.5, 3, 3.2, 3.3, 3.5, 4, 4.2, 4.5, 4.8, 5, 5.5, 6, 6.5, 7, 7.5, 8, 8.5, 9, 9.5, 10, 10.5, 11, 11.5, 12, 12.5, 13 mm.	29	1	5035048077412	216,32

**DRILLING ACCESSORY SETS - WOOD**



**WOOD DRILL BIT SETS**

Cat. No.	Description	Diameter mm	Pack Qty.	M.O.Q.	Barcode	List Price Ex. VAT (£)
DT4535-QZ	5 piece set in plastic cassette	4, 5, 6, 8, 10	5	1	5011402385713	9,50
DT4591-QZ	5 piece self feed bit set.	35, 38, 54, 65 plus Extension bar 140mm	5	1	5035048072165	147,00

**MAG BOX MAGNETIC SETS**



**APPLICATIONS**

- Flexible storage solution fits most common accessories

**FEATURES**

- Compact design for easy storage and portability
- High impact materials for optimum durability
- High strength magnets and built in hooks for increased functionality

**MAG BOX MAGNETIC SETS**

Cat. No.	Description	Pack Qty.	M.O.Q.	Barcode	List Price Ex. VAT (€)
D17918-QZ	Magnetic Set - Ph1, Ph2, Ph3, PZ1, PZ2 x 2, PZ3, T20, T25, 50mm Ph2, 50mm Ph3, Magnetic holder, 7mm, 8mm, 10mm socket drivers	15	1	5035048082553	48,00
D17919-QZ	Magnetic Impact Set - Ph1, Ph2, Ph3, PZ1, PZ2 x 2, PZ3, T20, T25, 50mm Ph2, 50mm Ph3, Magnetic holder, 7mm, 8mm, 10mm socket drivers	15	1	5035048082560	50,00
D17965-QZ	Magnetic Impact Set - 3mm, 4mm Impact drills, Ph1, Ph2, Ph3, PZ1, PZ2 x 2, PZ3, T20, T25, 50mm Ph2, 50mm Ph3, Magnetic holder, 7mm, 8mm, 10mm socket drivers	20	1	5035048083208	54,00

**TOUGH CASE STORAGE**



**SMALL TOUGH CASE SETS**

Cat. No.	Description	Pack Qty.	M.O.Q.	Barcode	List Price Ex. VAT (€)
D179288-QZ	Small tough case in blister with 6 piece EXTREME DEWALT™ Masonry drill bits 4, 5, 5.5, 6, 7, 8. Ph2x4, Pz2x4, Ph2x50mm, Pz2x50mm, Slotted 5.5x50mm, Magnetic holder, Magnetic drive guide.	19	1	5035048072219	53,56
D179208-QZ	Small tough case in blister with EXTREME DEWALT™ 2 Metal drill bits 1.5, 2, 2.5, 3, 3.2, 3.5, 4, 4.5, 5, 5.5, 6, 6.5, 7.	13	1	5035048072189	49,44
D179218-QZ	Small tough case in blister with EXTREME DEWALT™ 2 Metal drill bits 1.5, 2, 2.5, 3, 3.2, 3.5, 4, 4.5, 5, 5.5, 6, 6.5, 7.	13	1	5035048072196	55,64
D179228-QZ	Small tough in blister case with Ph1, 2x6, 3, Pz1, 2x6, 3, T10, 15, 20, 25, 30, 40, Slotted 5.5, 8, Ph2x50mm, Pz2x50mm, Slotted 5.5x50mm, Magnetic holder, Magnetic drive guide.	29	1	5035048072202	57,68
D17942-QZ	Small tough case with EXTREME DEWALT™ Cobalt bits 4, 1.5, 2, 2.5, 3, 3.2, 4, 4.5, 5, 5.5, 6, 6.5, 7	13	1	5035048066003	54,08
D1705008-QZ	10 piece Impact metal drilling set 3, 3.2, 3.5, 4, 4.5, 5, 6, 8, 10, 12	10	1	5035048081921	94,76
D1705018-QZ	29pc Impact Screwdriving set	29	1	5035048082591	45,32
D1705028-QZ	26pc Impact Drill Drive set - PH/PZ	29	1	5035048082607	70,04
D1705038-QZ	26pc Impact Drill Drive set - T	29	1	5035048082614	NOT UK



**MEDIUM TOUGH CASE SETS**

Cat. No.	Description	Pack Qty.	M.O.Q.	Barcode	List Price Ex. VAT (€)
D179338-QZ	Medium tough case set in blister with 45 screwdriving bits. (Pz2x10, Ph2x10, Sl6x5, Sl4x5, T10x5, T15x3, T25x3) screwguide, bit holder and nutdrivers (x2).	45	1	5035048072233	72,12
D179348-QZ	Medium tough case 42 piece Hex shank set in blister with Screwdriver bits - Pz2x10, Ph2x10, Sl6x5, Pz2x2(50mm), Ph2x2(50mm), Hex shank pilot drill bits - 1.5mmx2, 2mmx2, 3mmx2, 4mmx1, 5mmx1, 6mmx1, Screwguide, bit holder and nutdrivers(x2).	42	1	5035048072240	72,12
D179358-QZ	Medium tough case in blister with SDS Plus EXTREME DEWALT™ 2 drill bits 5, 6x2(110mm), 6x2, 7, 8, 9, 10, 12, 160mm	10	1	5035048072257	65,92
D179378-QZ	Medium tough case in blister with SDS Plus EXTREME DEWALT™ 2 drill bits 5, 6, 6.5, 7, 8, Extreme™ Masonry drill bits 4, 5, 2x6, 7, 2x8, Pz1x2, Pz2x2, Pz3, Ph1, Ph2x2, Ph3 25mm bits	21	1	5035048072271	70,04
D17939-QZ	Medium tough case with SDS Plus EXTREME DEWALT™ 2 drill bits 5, 5.5, 6, 7, 8, Pz1x2, Pz2x2, Pz3, Ph1, Ph2x2, Ph3 25mm bits, T10, T15, T20, T25, T30, T40 25mm bits, Sl4.5mm, Sl5.5mm, Sl6.5mm 25mm bits, Pz1x2, Pz2x2, Pz3, Ph1x2, Ph2x2, Ph3 50mm bits, T20, T25, T30 70mm bits, Magnetic bit holder, 7mm, 8mm socket drivers	39	1	5035048011386	82,40
D179368-QZ	Medium tough case in blister with SDS Plus EXTREME DEWALT™ Plus 2 drill bits 5, 6, 6.5, 8, 10, Pz1x2, Pz2x2, Pz3, Ph1, Ph2x2, Ph3 25mm bits, T10, T15, T20, T25, T30, T40 25mm bits, Sl4.5mm, Sl5.5mm, Sl6.5mm 25mm bits, Pz1x2, Pz2x2, Pz3, Ph1x2, Ph2x2, Ph3 50mm bits, T20, T25, T30 70mm bits, Magnetic bit holder, 7mm socket driver, 8mm socket drive	39	1	5035048072264	103,00
D179388-QZ	Medium tough case set in blister with EXTREME DEWALT™ 2 Metal drill bits 1, 1.5, 2, 2.5, 3, 3.2, 3.3, 3.5, 4, 4.2, 4.5, 4.8, 5, 5.5, 6, 6.5, 7, 7.5, 8, 8.5, 9, 9.5, 10, 10.5, 11, 11.5, 12, 12.5, 13 mm.	36	1	5035048072288	115,36



**LARGE TOUGH CASE SETS**

Cat. No.	Description	Pack Qty.	M.O.Q.	Barcode	List Price Ex. VAT (€)
D17926-XJ	Large tough case with EXTREME DEWALT™ 2 Metal drill bits 1,1.5, 2, 2.5, 3, 3.2, 3.3, 3.5, 4, 4.2, 4.5, 4.8, 5, 5.5, 6, 6.5, 7, 7.5, 8, 8.5, 9, 9.5, 10, 10.5, 11, 11.5, 12, 12.5, 13 mm.	29	1	5035048052341	132,00
DT5928-QZ	Cobalt 29 piece set with Plastic Tough Case 1,1.5, 2, 2.5, 3, 3.2, 3.3, 3.5, 4, 4.2, 4.5, 4.8, 5, 5.5, 6, 6.5, 7, 7.5, 8, 8.5, 9, 9.5, 10, 10.5, 11, 11.5, 12, 12.5, 13 mm.	29	1	5035048077412	216,32
DT5929-QZ	HSS-G 29 piece set with Metal Case 1,1.5, 2, 2.5, 3, 3.2, 3.3, 3.5, 4, 4.2, 4.5, 4.8, 5, 5.5, 6, 6.5, 7, 7.5, 8, 8.5, 9, 9.5, 10, 10.5, 11, 11.5, 12, 12.5, 13 mm.	29	1	5035048077429	120,00
DT5930-QZ	HSS-R 29 piece set with Metal Case 1,1.5, 2, 2.5, 3, 3.2, 3.3, 3.5, 4, 4.2, 4.5, 4.8, 5, 5.5, 6, 6.5, 7, 7.5, 8, 8.5, 9, 9.5, 10, 10.5, 11, 11.5, 12, 12.5, 13 mm.	29	1	5035048077436	72,00



**MODULAR ACCESSORY CASES**



Made from tough, heavy-duty plastic, the full size modular accessory case can carry a very large selection of accessory items as well as providing plenty of storage space for other consumables such as plugs and fixings.

**MODULAR ACCESSORY CASES**

Cat. No.	Description	M.O.Q.	Barcode	List Price Ex. VAT (£)
DT9289-QZ	90 piece set	1	5035048082041	NOT UK
DT9290-QZ	106 piece set	1	5035048082058	NOT UK
DT9291-QZ	95 piece set including EXTREME DEWALT <sup>®</sup> Masonry, Extreme DeWALT <sup>®</sup> 2 Metal, Flatwood, SDS Plus, Torx, Pz, Ph & pilot bits	1	5035048012376	NOT UK
DT9292-QZ	100 piece set including EXTREME DEWALT <sup>®</sup> Masonry, Extreme DeWALT <sup>®</sup> 2 Metal, Flatwood, SDS Plus, Torx, Slotted, Pz, Ph, 50mm bits & pilot bits	1	5035048012383	160,00
DT9293-QZ	100 piece set including EXTREME DEWALT <sup>®</sup> Masonry, Extreme DeWALT <sup>®</sup> 2 Metal, Flatwood, Bradpoint, Torx, Slotted, Pz, Ph, 50mm bits & pilot bits	1	5035048012390	160,00
DT9294-QZ	100 piece set including EXTREME DEWALT <sup>®</sup> Masonry, Extreme DeWALT <sup>®</sup> 2 Metal, Flatwood, Bradpoint, Torx, Slotted, Pz, Ph, 50mm bits & pilot bits	1	5035048012406	NOT UK
DT9296-QZ	90 piece set	1	5035048061626	120,00
DT9298-QZ	106 piece set	1	5035048245385	NOT UK
DT9299-QZ	100 piece set	1	5035048245392	NOT UK

**MINI MAC CASE SETS**



Offering excellent value, the more compact 'Mini' modular accessory case provides the same robustness and job-site durability as well as being easy to store away in situations where space is at a premium.

**MINI MAC CASE SETS**

Cat. No.	Description	M.O.Q.	Barcode	List Price Ex. VAT (£)
DT9281-QZ	63 piece set with EXTREME DEWALT <sup>®</sup> Masonry (4,5,6x2,8x2 mm), EXTREME DEWALT <sup>®</sup> 2 Metal (1,5,2,2,5,3,3,5,4,4,5,5,5,5,6,6,5,7mm). Screwdriver bits: 50mm Pz2, Ph2, S15.5, S16.5, 25mm Ph1, Ph2x3, Ph3, Pz1, Pz2x23, Pz3, T15, T20x2, T25x3, T30, T40, Magnetic bit holder and drive guide	1	5035048073308	104,00
DT9282-QZ	57 piece set with Brad Point (3,4,5,6,8,10,12mm), EXTREME DEWALT <sup>®</sup> Flatwood (12,14,16,20,22,25mm). Screwdriver bits: 50mm Pz2, Ph2, S15.5, S16.5, 25mm Ph1, Ph2x2, Ph3, Pz1, Pz2x3, Pz3, T15, T20x22, T25x3, T30, T40, Magnetic bit holder and drive guide	1	5035048073315	104,00
DT9283-QZ	69 piece set with EXTREME DEWALT <sup>®</sup> SDS-Plus (6x110,6x160x2,8x160x2,10x160), EXTREME DEWALT <sup>®</sup> 2 Metal (1,5,2,2,5,3,3,5,4,4,5,5,5,5,6,6,5,7mm), EXTREME DEWALT <sup>®</sup> Masonry (4,5,6x2,8x2 mm). Screwdriver bits: 50mm Pz2, Ph2, S15.5, S16.5, 25mm Ph1, Ph2x2, Ph3, Pz1, Pz2x3, Pz3, T15, T20x22, T25x3, T30, T40, Magnetic bit holder and drive guide	1	5035048073322	NOT UK
DT9284-QZ	77 piece set with EXTREME DEWALT <sup>®</sup> Cobalt (1,5,2,2,5,3,3,5,4,4,2,4,5,4,8,5,5,5,6,6,5,7,7,5,8,10,12mm), EXTREME DEWALT <sup>®</sup> 2 Metal (1,1,5,2,2,5,3,3,2,3,3,5,4,4,2,4,5,4,8,5,5,5,6,6,5,7,7,5,8,10,12mm). Screwdriver bits: 50mm Pz2, Ph2, S15.5, S16.5, 25mm Ph1, Ph2x3, Ph3, Pz1, Pz2x23, Pz3, T15, T20x2, T25x3, T30, T40, Magnetic bit holder and drive guide	1	5035048073339	NOT UK
DT9285-QZ	65 piece set with HSS-G (1,1,5,2,2,5,3,3,2,3,3,3,5,4,4,2,4,5,4,8,5,5,5,6,6,5,7,7,5,8,10,12mm). Screwdriver bits: 50mm Pz2, Ph2, S15.5, S16.5, 25mm Ph1, Ph2x3, Ph3, Pz1, Pz2x23, Pz3, T15, T20x2, T25x3, T30, T40, Magnetic bit holder and drive guide	1	5035048073346	NOT UK
DT9286-QZ	72 piece set with Masonry Bits (4,5,6x2,8x2 mm), HSS-G (1,1,5,2,2,5,3,3,2,3,3,3,5,4,4,2,4,5,4,8,5,5,5,6,6,5,7,7,5,8,10,12mm). Screwdriver bits: 50mm Pz2, Ph2, S15.5, S16.5, 25mm Ph1, Ph2x2, Ph3, Pz1, Pz2x3, Pz3, T15, T20x22, T25x3, T30, T40, Magnetic bit holder and drive guide	1	5035048073353	NOT UK
DT9287-QZ	85 piece set with HSS-G (1,1,5,2,2,5,3,3,2,3,3,3,5,4,4,2,4,5,4,8,5,5,5,6,6,5,7,7,5,8,10,12mm). Screwdriver bits: 50mm Pz2, Ph2, S15.5, S16.5, 25mm Ph1, Ph2x23, Ph3, Pz1, Pz2x23, Pz3, T15, T20x2, T25x3, T30, T40, Magnetic bit holder and drive guide	1	5035048073445	NOT UK



EXTREME DeWALT® STATIONARY CIRCULAR SAW BLADES



• See individual blades for machine fitment, material suitability and finish.

- Teeth remain sharp for longer through use of extra-large sub micrograin carbide teeth.
- Exceptional surface finish due to unique anti-vibration slots that minimise blade vibration.
- Extended cutting life in difficult materials such as tropical hardwoods and MDF through use of corrosion resistant carbide teeth.
- Excellent blade to spindle fitting is provided by honed arbor holes.

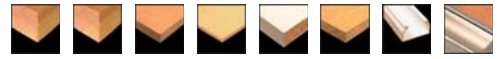

EXTREME DeWALT® STATIONARY CIRCULAR SAW BLADES

Cat. No.	Diameter / Bore	Plate / Kerf	Teeth	Grind	Rake	Fast Rip	General Purpose	Fine Finish	Extra Fine Finish	Aluminium	Barcode	List Price Ex. VAT (€)
DT4211-QZ	210/30	1.8/2.6	18	ATB	25°	●					5035048057360	60,00
DT4221-QZ	210/30	1.8/2.6	24	ATB	-5°		●				5035048057421	68,36
DT4250-QZ	210/30	1.8/2.6	40	ATB	10°			●			5035048057520	84,00
DT4252-QZ	210/30	1.8/2.6	48	ATB	-5°			●			5035048057544	90,00
DT4253-QZ	210/30	1.8/2.6	56	TCG	-5°			●			5035048057551	98,00
DT4285-QZ	210/30	1.8/2.6	80	TCG	-5°				●	●	5035048057568	100,00
DT4254-QZ	215/30	1.8/2.6	60	TCG	-5°			●			5035048057568	102,00
DT4310-QZ	216/30	1.8/2.6	24	ATB	-5°	●					5035048057827	70,00
DT4320-QZ	216/30	1.8/2.6	48	ATB	-5°		●				5035048057902	96,00
DT4350-QZ	216/30	1.8/2.6	60	ATB	-5°			●			5035048058107	105,32
DT4370-QZ	216/30	1.8/2.6	60	TCG	-5°				●		5035048058220	121,56
DT4286-QZ	216/30	1.8/2.6	80	TCG	-5°				●	●	5035048057704	109,40
DT4213-QZ	250/30	2.2/3.0	24	ATB	-5°	●					5035048057384	NOT UK
DT4311-QZ	250/30	2.2/3.0	24	FT	10°	●					5035048057834	76,00
DT4321-QZ	250/30	2.2/3.0	30	ATB	10°		●				5035048057919	88,00
DT4226-QZ	250/30	2.2/3.0	30	ATB	20°		●				5035048057476	78,00
DT4322-QZ	250/30	2.2/3.0	40	ATB	10°		●				5035048057926	100,80
DT4323-QZ	250/30	2.2/3.0	48	ATB	20°		●				5035048057933	102,56
DT4351-QZ	250/30	2.2/3.0	60	ATB	10°			●			5035048058114	109,40
DT4352-QZ	250/30	2.2/3.0	60	TCG	-5°			●			5035048058121	122,68
DT4353-QZ	250/30	2.2/3.0	80	ATB	10°			●			5035048058138	137,28
DT4354-QZ	250/30	2.2/3.0	80	ATB	-5°			●			5035048058145	137,28
DT4287-QZ	250/30	2.2/3.0	80	TCG	-5°				●	●	5035048057711	116,00
DT4373-QZ	250/30	2.2/3.0	80	TCG	10°				●		5035048058251	137,28
DT4282-QZ	250/30	2.2/3.0	96	TCG	-5°				●	●	5035048057667	131,52
DT4214-QZ	260/30	1.8/2.6	24	ATB	15°	●					5035048057391	90,00
DT4312-QZ	260/30	1.8/2.6	24	ATB	15°	●					5035048057841	80,32
DT4324-QZ	260/30	1.8/2.6	48	ATB	10°		●				5035048057940	119,76
DT4280-QZ	260/30	1.8/2.6	80	TCG	-5°				●	●	5035048057643	116,84
DT4314-QZ	300/30	2.2/3.0	30	ATB	10°	●					5035048057865	106,36
DT4327-QZ	300/30	2.2/3.0	48	ATB	10°		●				5035048057971	109,52
DT4328-QZ	300/30	2.2/3.0	60	ATB	10°		●				5035048057988	124,12
DT4329-QZ	300/30	2.2/3.0	60	TCG	10°			●			5035048057995	159,56
DT4357-QZ	300/30	2.2/3.0	72	TCG	10°			●			5035048058176	157,24
DT4281-QZ	300/30	2.2/3.0	80	TCG	-5°				●	●	5035048057650	121,56
DT4376-QZ	300/30	2.2/3.0	96	TCG	10°				●		5035048058299	189,92
DT4378-QZ	300/30	2.2/3.0	96	TCG	-5°				●	●	5035048058305	NOT UK
DT4210-QZ	305/30	1.8/2.6	32	ATB	-5°	●					5035048057353	NOT UK
DT4330-QZ	305/30	2.2/3.0	36	ATB	-5°		●				5035048058008	94,92
DT4340-QZ	305/30	2.2/3.0	48	ATB	10°		●				5035048061909	NOT UK
DT4260-QZ	305/30	1.8/2.6	60	ATB	-5°			●			5035048057629	106,00
DT4331-QZ	305/30	2.2/3.0	60	ATB	-5°			●			5035048058015	114,32
DT4283-QZ	305/30	1.8/2.6	80	TCG	-5°				●	●	5035048057674	NOT UK
DT4288-QZ	305/30	2.2/3.0	80	TCG	-5°				●	●	5035048057728	146,00
DT4290-QZ	305/30	2.2/3.0	96	TCG	-5°				●	●	5035048057742	NOT UK
DT4215-QZ	315/30	2.2/3.0	24	ATB	10°	●					5035048057407	101,00
DT4332-QZ	315/30	2.2/3.0	48	ATB	10°		●				5035048058022	129,16
DT4358-QZ	315/30	2.2/3.0	72	ATB	10°			●			5035048058183	159,56
DT4289-QZ	315/30	2.2/3.0	80	TCG	-5°				●	●	5035048057735	NOT UK
DT4333-QZ	350/30	2.2/3.0	42	ATB	10°		●				5035048058039	133,72
DT4334-QZ	350/30	2.2/3.0	54	ATB	10°		●				5035048058046	144,48
DT4359-QZ	350/30	2.2/3.0	80	TCG	-5°			●			5035048058190	167,12
DT4360-QZ	350/30	2.2/3.0	84	ATB	10°			●			5035048058206	177,84
DT4291-QZ	350/30	2.2/3.0	96	TCG	-5°				●	●	5035048057759	144,00
DT4317-QZ	400/30	2.5/3.0	36	ATB	10°		●				5035048057896	124,68
DT4338-QZ	400/30	2.5/3.5	60	ATB	10°		●				5035048058084	158,04



**FLAT TOP GRIND (FT)**

Teeth ground flat across top with 0 degree bevel. Best for ripping and general purpose, where quality of finish is less important than cut force.



**ALTERNATE TOP BEVEL (ATB)**

Teeth where the top bevel alternates from left to right, with bevel angle ranging 10 to 25 degrees. Ideal for cross cutting in hard and softwoods and general purpose woodcutting.



**TRIPLE CHIP GRIND (TCG)**

Flat top teeth alternate with slightly trapezoidal teeth that make a narrower cut, to prevent chipping brittle materials such as laminates.



**HOLLOW GRIND (HG)**

Very sharp edges designed to leave a chip-free finish - top and bottom. Ideal for cutting double sided composite board, eg. melamine.

**EXTREME DeWALT® STATIONARY CIRCULAR SAW BLADES**



- Suitable for cutting metal/steel and stainless steel. See individual blades for details.

**FEATURES**

- Range of blades for most metal cutting applications.
- Modified ATB tooth Geometry for clean, burr free cuts.
- Cuts 4x faster than abrasive discs.
- Unsuitable for cast iron.
- Check bore and diameter before selection.

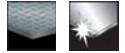

**FOR METAL CUTTING**

Cat. No.	Diameter / Bore	Plate / Kerf	Teeth	Grind	Rake	Thick Section	Thin Section	Stainless Steel	Clean Cut	Barcode	List Price Ex. VAT (£)
DT1903-QZ	305/25.4	1.8/2.2	60	MATB	0	●			●	5035048052860	168,68
DT1905-QZ	305/25.4	1.75/2.2	80	MATB	10			●	●	5035048052884	466,67
DT1900-QZ	355/25.4	1.8/2.2	70	MATB	0	●			●	5035048030479	183,33
DT1901-QZ	355/25.4	1.8/2.2	90	MATB	0		●		●	5035048052846	200,00
DT1902-QZ	355/25.4	1.8/2.2	90	MATB	10			●	●	5035048052853	550,00

**EXTREME DeWALT® STATIONARY CIRCULAR SAW BLADES**



- Suitable for cutting melamine/laminated. See individual blades for details.
- Blades designed for extra fine cuts in laminated and PVC coated panels.
- Hollow Ground Tooth for flawless finish.

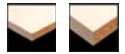

**FOR MELAMINE, LAMINATED PANELS AND PVC COATED PANELS**

Cat. No.	Blade Diameter	Bore Size mm	Plate Thickness mm	Kerf Thickness mm	Tooth Count	Grind Geometry	Rake Angle	Barcode	List Price Ex. VAT (£)
DT4217-QZ	250	30	2.5	3.2	60	HG	10°	5035048080399	TBC
DT4218-QZ	305	30	2.5	3.2	72	HG	10°	5035048080405	TBC

**EXTREME DeWALT® STATIONARY CIRCULAR SAW BLADES**



- Suitable for cutting wood, MDF and plywood. See individual blades for details.
- All blades have depth limiting feature.
- FT grind provides fast accurate cut.



**FOR RADIAL ARM SAWS**

Cat. No.	Blade Diameter	Bore Size mm	Plate Thickness mm	Kerf Thickness mm	Tooth Count	Grind Geometry	Rake Angle	Barcode	List Price Ex. VAT (£)
DT4202-QZ	250	30	1.8	2.8	24	FT/DL	10°	5035048057322	58,33
DT4301-QZ	250	30	2.2	3.0	24	FT/DL	10°	5035048057766	88,00
DT4204-QZ	300	30	2.2	3.0	32	FT/DL	10°	5035048057803	81,67
DT4305-QZ	350	30	2.2	3.0	36	FT/DL	10°	5035048057803	106,36

**STATIONARY CIRCULAR SAW BLADES**



- See individual blades for machine fitment, material suitability and finish.

- Precision ground cutting angles for excellent blade sharpness and faster cutting.
- "K20" extra robust carbide and unique wedge shoulder design for greater durability.
- Thick steel plate hard body for professional quality.

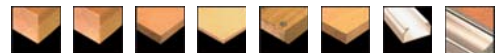

**STATIONARY CIRCULAR SAW BLADES**

Cat. No.	Diameter / Bore	Plate / Kerf	Teeth	Grind	Rake	Additional Insert Rings	Fast Rip	General Purpose	Barcode	List Price Ex. VAT (£)
DT1154-QZ	216/30	1.7/2.6	24	ATB	-5°		●		5035048011157	35,04
DT1155-QZ	216/30	1.7/2.6	40	ATB	-5°			●	5035048011164	37,08
DT1158-QZ	250/30	2.0/3.0	24	ATB	10°	16/20/25.4	●		5035048011195	41,20
DT1159-QZ	250/30	1.8/3.0	48	ATB	10°	16/20/25.4		●	5035048011201	43,28
DT1177-QZ	300/30	2.2/3.2	20	ATB	20°		●		5035048080337	NOT UK
DT1160-QZ	305/30	2.0/3.0	24	ATB	-5°	25.4	●		5035048011218	53,56
DT1161-QZ	305/30	2.0/3.0	40	ATB	10°	25.4		●	5035048011225	57,68
DT1162-QZ	305/30	2.0/3.0	60	ATB	-5°	25.4		●	5035048011232	61,80
DT1163-QZ	315/30	2.2/3.2	24	ATB	20°	25.4	●		5035048011249	63,88



STATIONARY CIRCULAR SAW BLADES 210mm TO 400mm

- STEP 1: SELECT TOOL FITMENT & BLADE SIZE
- STEP 2: SELECT MATERIAL TO BE CUT
- STEP 3: SELECT FINISH REQUIRED

For geometry details refer to page 135

1.					Diameter Ø mm													
2. Material					Bore Ø mm													
3. Cut					210	215	216	250	260	300	305	305	315	350	355	400		
Teeth	Geometry	Angle			30	30	30	30	30	30	25.4	30	30	25.4	30			
Plywood Natural Wood MDF	Fast Rip	18	ATB	25	DT4211													
		24	ATB	-5			DT4310	DT4213										
		24	ATB	10														
		24	FT	10				DT4311						DT4215				
		24	FT/DL	10														
		24	ATB	15														
		30	ATB	10								DT4314						
		32	ATB	-5										DT4210				
		36	ATB	10														DT4317
		General Purpose	24	ATB	-5	DT4221												
	30		ATB	10				DT4321										
	30		ATB	20				DT4226										
	32		FT/DL	10							DT4204							
	40		ATB	10				DT4322										
	36		ATB	-5														
	36		FT/DL	10										DT4330		DT4305		
	42		ATB	10												DT4333		
	48		ATB	-5				DT4320										
	48		ATB	10						DT4324	DT4327			DT4332				
	48	ATB	20					DT4323					DT4340					
	54	ATB	10												DT4334			
	60	ATB	10								DT4328					DT4338		
	Fine Finish	40	ATB	10	DT4250													
		48	ATB	-5	DT4252													
		56	TCG	-5	DT4253													
		60	ATB	-5														
		60	TCG	-5				DT4350										
		60	ATB	10			DT4254		DT4352									
		60	ATB	10					DT4351									
		60	TCG	10								DT4329						
72		TCG	10								DT4357			DT4358				
80		ATB	-5												DT4359			
80	ATB	10						DT4354										
84	ATB	10						DT4353										
Veneers Laminates Plastics Aluminium	Extra Fine Finish	60	TCG	-5				DT4370*										
		80	TCG	-5	DT4285		DT4286	DT4287	DT4280	DT4281			DT4289					
		80	TCG	10					DT4373*									
		96	TCG	-5					DT4282				DT4290		DT4291			
		96	TCG	10								DT4376*						
Construction Materials Softwood Reclaimed wood Wood with nails	Fast Rip	24	ATB	10				DT1158										
		24	ATB	20						DT1177			DT1163	DT1178				
		24	ATB	-5					DT1154				DT1160					
	General Purpose	28	ATB	15													DT1179	
		32	ATB	15														
		36	ATB	15														
		40	ATB	-5					DT1155									
48	ATB	10						DT1159				DT1161						
60	ATB	-5										DT1162						
Ferrous metals		60	MATB	0							DT1903							
		70	MATB	0												DT1900		
		90	MATB	0												DT1901		
Stainless Steel		80	MATB	10							DT1905							
		90	MATB	10												DT1902		
Aluminium		80	TCG	-5	DT4285		DT4286	DT4287	DT4280	DT4281		DT4283	DT4289					
		96	TCG	-5				DT4282		DT4378		DT4288	DT4290		DT4291			
Laminate/ PVC Coated Panels		60	HDF	10				DT4217				DT4218						

DT4370, DT4373, DT4376 are not suitable for aluminium cutting.

Refer to packaging for individual blade details.

**EXTREME DeWALT® PORTABLE CIRCULAR SAW BLADES**



- See individual blades for machine fitment, material suitability and finish.

- Excellent surface finish ensured by laser-cut expansion slots that reduce vibration and noise.
- Consistently precise cutting from a balanced and tensioned laser-cut plate.
- Longer intervals between re-sharpenings through use of large micrograin carbide teeth.



**EXTREME DeWALT® PORTABLE CIRCULAR SAW BLADES**

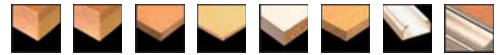

Cat. No.	Diameter /Bore	Plate/ Kerf	Teeth	Grind	Rake	Fast Rip	General Purpose	Fine Finish	Extra Fine Finish	Aluminium	Barcode	List Price Ex. VAT (€)
DT4053-QZ	150/20	1.8/2.6	30	ATB	10°			•			5035048056943	57,50
DT4081-QZ	150/20	1.8/2.6	40	TCG	-5°				•		5035048057124	65,86
DT4004-QZ	152/20	1.8/2.6	12	ATB	25°	•				•	5035048056592	NOT UK
DT4022-QZ	152/20	1.8/2.6	18	ATB	25°		•				5035048056745	45,10
DT4055-QZ	152/20	1.8/2.6	30	ATB	10°			•			5035048056967	57,50
DT4005-QZ	160/16	1.8/2.6	24	ATB	25°		•				5035048056608	50,64
DT4056-QZ	160/16	1.8/2.6	36	ATB	10°						5035048056974	59,01
DT4083-QZ	160/16	1.8/2.6	48	TCG	-5°				•	•	5035048057148	70,09
DT4006-QZ	160/20	1.8/2.6	12	ATB	25°	•					5035048056615	42,58
DT4023-QZ	160/20	1.8/2.6	24	ATB	25°		•				5035048056752	50,64
DT4057-QZ	160/20	1.8/2.6	36	ATB	10°			•			5035048056981	58,33
DT4084-QZ	160/20	1.8/2.6	48	TCG	-5°				•	•	5035048057155	72,19
DT4024-QZ	160/30	1.8/2.6	24	ATB	25°		•				5035048056769	48,67
DT4085-QZ	160/30	1.8/2.6	48	TCG	-5°				•	•	5035048057162	47,25
DT4025-QZ	165/16	1.8/2.6	24	ATB	25°		•				5035048056776	50,64
DT4026-QZ	165/20	1.8/2.6	24	ATB	25°		•				5035048056783	53,33
DT4087-QZ	165/20	1.8/2.6	48	TCG	-5°				•	•	5035048057186	74,17
DT4007-QZ	165/30	1.8/2.6	12	ATB	25°	•					5035048056622	71,30
DT4027-QZ	165/30	1.8/2.6	24	ATB	25°		•				5035048056790	54,46
DT4088-QZ	165/30	1.8/2.6	48	TCG	-5°				•	•	5035048057193	52,88
DT4058-QZ	170/30	1.8/2.6	30	ATB	10°			•			5035048056998	NOT UK
DT4059-QZ	180/30	1.8/2.6	30	ATB	10°			•			5035048057001	61,83
DT4091-QZ	180/30	1.8/2.6	48	TCG	-5°				•	•	5035048057223	75,00
DT4012-QZ	184/16	1.8/2.6	12	ATB	25°	•					5035048056677	55,00
DT4011-QZ	184/16	1.8/2.6	16	ATB	25°	•					5035048056660	53,33
DT4031-QZ	184/16	1.8/2.6	28	ATB	25°		•				5035048056837	62,50
DT4063-QZ	184/16	1.4/2.6	40	ATB	10°			•			5035048057049	68,33
DT4092-QZ	184/16	1.8/2.6	48	TCG	-5°				•	•	5035048057230	76,67
DT4032-QZ	184/20	1.8/2.6	28	ATB	25°		•				5035048056844	63,33
DT4062-QZ	184/20	1.8/2.6	40	ATB	10°			•			5035048057032	68,33
DT4034-QZ	190/20	1.8/2.6	28	ATB	10°		•				5035048056868	64,17
DT4065-QZ	190/20	1.8/2.6	40	ATB	10°			•			5035048057063	68,50
DT4095-QZ	190/20	1.8/2.6	48	TCG	-5°				•	•	5035048057261	76,00
DT4013-QZ	190/30	1.8/2.6	16	ATB	25°	•					5035048056684	58,33
DT4033-QZ	190/30	1.8/2.6	28	ATB	10°		•				5035048056851	64,17
DT4064-QZ	190/30	1.8/2.6	40	ATB	10°			•			5035048057056	68,50
DT4094-QZ	190/30	1.8/2.6	48	TCG	-5°				•	•	5035048057254	75,00
DT4096-QZ	200/30	1.8/2.6	56	TCG	-5°				•	•	5035048057278	81,67
DT4224-QZ	230/30	2.2/3.0	28	ATB	25°		•				5035048057452	80,00
DT4225-QZ	230/30	2.2/3.0	40	ATB	10°			•			5035048057469	88,00
DT4256-QZ	230/30	2.2/3.0	56	TCG	-5°				•	•	5035048057582	104,00
DT4037-QZ	235/25.4	2.2/3.0	28	ATB	25°		•				5035048056889	NOT UK
DT4068-QZ	235/25.4	2.2/3.0	40	ATB	10°			•			5035048057094	NOT UK
DT4098-QZ	235/25.4	2.2/3.0	56	TCG	-5°				•	•	5035048057292	NOT UK
DT4015-QZ	235/30	2.2/3.0	18	ATB	25°	•					5035048056707	60,83
DT4036-QZ	235/30	2.2/3.0	28	ATB	25°		•				5035048056882	70,00
DT4067-QZ	235/30	2.2/3.0	40	ATB	10°			•			5035048057087	78,33
DT4097-QZ	235/30	2.2/3.0	56	TCG	-5°				•	•	5035048057285	86,67
DT4016-QZ	240/30	2.2/3.0	18	ATB	20°	•					5035048056714	61,67
DT4038-QZ	240/30	2.2/3.0	28	ATB	20°		•				5035048056905	70,83
DT4069-QZ	240/30	2.2/3.0	40	ATB	20°			•			5035048057100	80,00
DT4099-QZ	240/30	2.2/3.0	56	TCG	-5°				•	•	5035048057308	86,67



**FAST RIP**

- Blades designed for fast rip of soft and hard natural wood
- Ideal for pre-sizing applications
- ATB grind geometry, low tooth count and aggressive rake angles



**GENERAL PURPOSE & CROSS CUT**

- For all purpose rip and cross cutting in natural wood, plywood, laminates and particle board
- ATB grind geometry, medium tooth count and positive rake angles allow the blades to cut at higher feed speeds



**FINE FINISH & CROSS CUT**

- For smooth cross cuts in plywood, softwood, and all hardwoods
- ATB grind geometry, high tooth count and tuned grinding angles give excellent surface finish



**EXTRA FINE FINISH**

- Blades designed for EXTRA fine cuts in plywood, veneers, laminates and plastics
- Blades are tuned to avoid breakout on laminate materials
- TCG grind geometry gives excellent surface finish on workpiece



**ALUMINIUM CUTTING**

- Blades optimised for cutting in Aluminium
- TCG grind geometry gives clean and accurate finish on workpiece

CORDLESS CIRCULAR SAW BLADES



- Heavy duty tungsten carbide tips maintain cutting edge for longer blade life.
- Thin kerf blade design - yields more cuts per charge by minimising battery drain.
- Triple action sharpening process which grinds the tip to a razor sharp edge for a smooth finish.
- Specifically designed for use with DeWalt Cordless Trimsaws. The range comprises of blades for cutting wood and for cutting plastic & non-ferrous metals.



CORDLESS CIRCULAR SAW BLADES

Cat. No.	Diameter / Bore	Plate / Kerf	Teeth	Grind	Rake	Fast Rip	General Purpose	Fine Finish	Extra Fine Finish	Aluminium	Stainless Steel	Barcode	List Price Ex. VAT (£)
DT1200-QZ	136/10	1.5	16	ATB	+20°	●						5011402378159	36,00
DT1201-QZ	136/10	1.5	24	ATB	+20°		●					5011402370160	40,00
DT1202-QZ	136/10	1.5	30	FT	+3°			●	●			5011402378173	44,00
DT1203-QZ	165/10	1.5	18	ATB	+20°	●						5035048031056	38,00
DT1204-QZ	165/10	1.5	24	ATB	+20°		●					5035048031063	44,00
DT1205-QZ	165/10	1.5	36	FT	+3°			●	●			5035048031186	48,00
DT1208-QZ	165/20	1.5	16	ATB	+20°	●						5035048060490	36,00
DT1207-QZ	165/20	1.5	24	ATB	+20°		●					5035048060483	40,00
DT1206-QZ	165/20	1.5	36	FT	+3°			●	●			5035048060476	44,00
DT1210-XJ	173/20	2.2	50	TCG	0°					●		5035048056431	82,20
DT1266-QZ	173/20	1.8	40	MTCG	0°						●	5035048080429	
DT1211-QZ	184/20	1.8	24	ATB	+18°		●					5035048061992	44,36

PORTABLE CIRCULAR SAW BLADES



- See individual blades for machine fitment, material suitability and finish.
- Precision ground cutting angles for excellent blade sharpness and faster cutting.
- "K20" extra robust carbide and unique wedge shoulder design for greater durability.
- Thick steel plate hard body for professional quality.



FOR CONSTRUCTION MATERIALS

Cat. No.	Diameter / Bore	Plate / Kerf	Teeth	Grind	Rake	Additional Insert Rings	Fast Rip	General Purpose	Barcode	List Price Ex. VAT (£)
DT1164-QZ	150/20	1.5/2.4	12	ATB	+20°		●		5035048011263	19,48
DT1140-QZ	152/20	1.5/2.4	12	ATB	+20°		●		5035048011010	19,48
DT1141-QZ	152/20	1.5/2.4	24	ATB	+10°			●	5035048011027	23,80
DT1142-QZ	160/20	1.5/2.4	18	ATB	+20°	16	●		5035048011034	23,80
DT1143-QZ	160/20	1.5/2.4	30	ATB	+10°	16		●	5035048011041	33,52
DT1166-QZ	165/20	1.5/2.4	18	ATB	+20°		●		5035048080290	24,88
DT1167-QZ	165/20	1.5/2.4	30	ATB	+10°			●	5035048080306	34,60
DT1144-QZ	165/30	1.5/2.4	18	ATB	+20°	16,20	●		5035048011058	24,88
DT1145-QZ	165/30	1.5/2.4	30	ATB	+10°	16,20		●	5035048011065	34,60
DT1146-QZ	170/30	1.5/2.4	18	ATB	+20°		●		5035048011072	25,96
DT1147-QZ	170/30	1.5/2.4	30	ATB	+10°			●	5035048011089	34,60
DT1149-QZ	184/16	1.7/2.6	18	ATB	+20°		●		5035048011102	21,64
DT1151-QZ	184/16	1.7/2.6	30	ATB	+10°			●	5035048011126	32,44
DT1148-QZ	184/30	1.7/2.6	18	ATB	+20°	20	●		5035048011096	21,64
DT1150-QZ	184/30	1.7/2.6	30	ATB	+10°	20		●	5035048011119	32,44
DT1165-QZ	190/16	1.7/2.6	18	ATB	+20°		●		5035048014318	39,13
DT1152-QZ	190/30	1.7/2.6	18	ATB	+20°	20	●		5035048011133	23,80
DT1153-QZ	190/30	1.7/2.6	40	ATB	+10°	16,20		●	5035048011140	34,60
DT1175-QZ	230/30	1.7/2.6	24	ATB	+20°		●		5035048080313	NOT UK
DT1176-QZ	230/30	1.7/2.6	40	ATB	+10°			●	5035048080320	NOT UK
DT1156-QZ	235/30	1.7/2.6	24	ATB	+20°	25.4	●		5035048011171	32,44
DT1157-QZ	235/30	1.7/2.6	40	ATB	+10°	25.4		●	5035048011188	38,92

**PORTABLE CIRCULAR SAW BLADES 150mm TO 240mm**

- STEP 1:** SELECT TOOL FITMENT & BLADE SIZE
- STEP 2:** SELECT MATERIAL TO BE CUT
- STEP 3:** SELECT FINISH REQUIRED

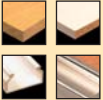
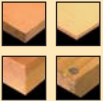
1.		Diameter Ø mm Bore Ø mm			150 20	152 20	160 16	160 20	160 30	165 16	165 20		
2. Material	3. Cut	Teeth	Geometry	Angle									
Plywood Natural Wood MDF 	Fast Rip	12	ATB	25		DT4004		DT4006					
		16	ATB	25									
		18	ATB	25									
	General Purpose	18	ATB	25		DT4022							
		24	ATB	25			DT4005	DT4023	DT4024	DT4025	DT4026		
		28	ATB	10									
		28	ATB	20									
		28	ATB	25									
	Fine Finish	30	ATB	10		DT4053	DT4055						
		36	ATB	10				DT4056	DT4057				
		40	ATB	10									
		40	ATB	20									
48		ATB	5								DT1090		
Veneers Laminates Plastics Aluminium 	Extra Fine Finish	40	TCG	-5	DT4081								
		48	TCG	-5				DT4084	DT4085		DT4087		
		56	TCG	-5									
<b>Construction Materials</b> Softwood Reclaimed wood Wood with nails 	Fast Rip	12	ATB	20	DT1164	DT1140							
		18	ATB	20				DT1142			DT1166		
		24	ATB	20									
	General Purpose	24	ATB	20			DT1141						
		30	ATB	20					DT1143			DT1167	
		40	ATB	20									

For geometry details refer to page 135



	165 30	170 30	180 30	184 16	184 20	184 30	190 16	190 20	190 30	200 30	230 30	235 25.4	235 30	240 30
	DT4007			DT4012										
				DT4011					DT4013					
													DT4015	DT4016
	DT4027													
								DT4034	DT4033					
														DT4038
				DT4031	DT4032						DT4224	DT4037	DT4036	
		DT4058	DT4059											
				DT4063	DT4062			DT4065	DT4064		DT4225	DT4068	DT4067	DT4069
	DT4088		DT4091	DT4092				DT4095	DT4094					
										DT4096	DT4256	DT4098	DT4097	DT4099
	DT1144	DT1146		DT1149		DT1148	DT1165		DT1152					
													DT1156	
	DT1145	DT1147		DT1151		DT1150								
									DT1153				DT1157	



**EXTREME DeWALT® PORTABLE CIRCULAR SAW BLADES**



• Blades designed specifically for use with plunge saws. See individual blades for details.



**FOR PLUNGE SAWS**



Cat. No.	Diameter / Bore	Plate / Kerf	Teeth	Grind	Rake	Fast Rip	General Purpose	Fine Finish	Extra Fine Finish	Aluminium	Barcode	List Price Ex. VAT (£)
DT1089-QZ	165/20	1.6/2	18	ATB		•					5035048083383	TBC
DT1091-QZ	165/20	1.6/2	40	ATB			•				5035048072677	92,00
DT1090-QZ	165/20	1.6/2	48	ATB				•			5035048066416	96,00
DT1086-QZ	165/20	1.6/2	48	TCG					•		5035048083352	TBC
DT1087-QZ	165/20	1.6/2	54	MTCG					•		5035048083369	TBC
DT1088-QZ	165/20	1.6/2	54	TCG					•	•	5035048083376	TBC

**BLADE FOR CORDLESS MITRE SAW**



Specially for use with DW017 24V Mitre Saw

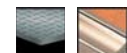

**BLADE FOR CORDLESS MITRE SAW**

Cat. No.	Blade Diameter	Bore Size mm	Plate Thickness mm	Kerf Thickness mm	Tooth Count	Grind Geometry	Rake Angle	Barcode	List Price Ex. VAT (£)
DT1700-QZ	216	30	1.6	2.4	24	ATB	0°	5035048056448	60,00

**INSERT RINGS**



**INSERT RINGS**

Cat. No.	Outside diameter mm	Inside diameter mm	Thickness mm	Pack Qty.	M.O.Q.	Barcode	List Price Ex. VAT (£)
DT1094-QZ	30	16	1.8	10	10	5011402382071	5,33
DT1095-QZ	30	20	1.8	10	10	5011402382088	5,33
DT1096-QZ	30	25	1.8	10	10	5011402382095	5,33
DT1099-QZ	30	25	2.2	10	10	5011402382101	5,33

XPC WOOD CUTTING BLADES

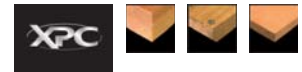

FEATURES

- Unique jigsaw blade solution for ultimate control and accuracy of cut, even on the tightest of corners
- New optimised tooth angle provides long life and clean tear-free cuts at high speed in all wood materials
- Plunge Point tip design for easy plunge cutting with no 'kick-back' in all wood materials
- Extra long life bi-metal blades provide up to twice the number of cuts of standard HCS blades

T SHANK & U-SHANK

Cat. No.	Applications	Overall Length mm	Working Length mm	Tooth Pitch mm	Max DOC mm	Equivalent Bosh Reference	Pack Qty.	Barcode	List Price Ex. VAT (£)
DT2205-QZ	For clean and fast accurate cutting in wood, chipboard, plywood, laminates and plastic up to 30mm thick.	100	75	2.5	30	T101B	5	5035048074978	10,40
DT2206-QZ	For clean and fast accurate cutting in wood, chipboard, plywood, laminates and plastic up to 30mm thick.	100	75	2.5	30	T101B	20	5035048074985	38,60
DT2207-QZ	Downcutter blade for clean, splinter free cutting in laminates and wood up to 40mm thick.	100	75	2.5	40	T101BR	5	5035048074992	10,40
DT2209-QZ	For clean and fast accurate cutting in wood, chipboard, plywood, laminates and plastic up to 60mm thick.	100	75	4.2	60	T101D	5	5035048074992	10,40
DT2210-QZ	For clean and fast accurate cutting in wood, chipboard, plywood, laminates and plastic up to 60mm thick.	100	75	4.2	60	T101D	20	5035048074992	38,60
DT2211-QZ	For coarse accurate cutting in wood, chipboard, plywood, laminates and plastic up to 60mm thick.	100	75	3.1	60	T111C	5	5035048074992	10,40
DT2212-QZ	For coarse accurate cutting in wood, chipboard, plywood, laminates and plastic up to 60mm thick.	100	75	3.1	60	T111C	20	5035048074992	38,60
DT2213-QZ	For fast accurate cutting in wood, chipboard, plywood, laminates and plastic up to 60mm thick.	100	75	4.2	60	T144D	5	5035048074992	10,40
DT2214-QZ	For fast accurate cutting in wood, chipboard, plywood, laminates and plastic up to 60mm thick.	100	75	4.2	60	T144D	20	5035048074992	38,60
DT2216-QZ	Scroller blade for fast accurate curve cutting in wood, chipboard and plywood up to 15mm thick. NOT suitable for plunge cutting	82	54	2.0	15	T119B0	5	5035048074992	10,40
DT2217-QZ	Bi-metal blade for extra long life. For clean and fast accurate cutting in wood, chipboard, plywood, laminates and plastic up to 30mm thick	100	75	2.5	30	T101BF	3	5035048074992	10,40
DT2218-QZ	Bi-metal blade for extra long life. For clean and fast accurate cutting in wood, chipboard, plywood, laminates and plastic up to 60mm thick	100	75	4.0	60	T1101DF	3	5035048074992	10,40
DT2219-QZ	Bi-metal blade for extra long life. Downcutter blade for clean, splinter free cutting in laminates and wood up to 40mm thick	100	75	2.5	40	T101BRF	3	5035048074992	10,40
DT2220-QZ	Bi-metal blade for extra long life. For fast accurate cutting in wood, chipboard, plywood, laminates and plastic up to 60mm thick	100	75	4.0	60	T144DF	3	5035048074992	10,40
DT2221-QZ	Bi-metal blade for extra long life. For fast accurate cutting in aluminium up to 15mm and plastics up to 30mm	100	75	3.0	30	T127DF	3	5035048074992	10,40
DT2208-QZ	For clean and fast accurate cutting in wood, chipboard, plywood, laminates and plastic up to 30mm thick. U shank blade	94	75	2.5	30	U101B	5	5035048074992	NOT UK
DT2215-QZ	For fast accurate cutting in wood, chipboard, plywood, laminates and plastic up to 60mm thick. U shank blade	94	75	4.0	60	U144D	5	5035048074992	NOT UK

BLADE KITS

Cat. No.	Description	Contents	Barcode	List Price Ex. VAT (£)
DT2296-QZ	10 piece jigsaw kit	DT2209 x2, DT2205 x2, DT2213 x2, DT2216, DT2218, DT2217, DT2220	5035048065142	34,00
DT2298-QZ	14 piece jigsaw kit	DT2209 x3, DT2205 x3, DT2213 x3, DT2216 x2, DT2218, DT2217, DT2220	5035048065159	40,56



**WOOD CUTTING BLADES**



**FEATURES**

- DEWALT HCS jigsaw blades are engineered to deliver a quality cut in a variety of materials, including wood, laminates and plastics.
- Made from high carbon steel.
- For use in soft materials such as wood, laminates, plywood, chipboard and plastics.



**T SHANK**

Cat. No.	Applications	Overall Length mm	Working Length mm	Tooth Pitch mm	Max DOC mm	Equivalent Bosch Reference	Pack Qty.	Barcode	List Price Ex. VAT (£)
DT2177-QZ	For coarse, straight cuts in wood & plastic up to 60mm thick.	100	72	3	60	T111C	20	5035048033210	26,67
DT2187-QZ	For coarse, straight cuts in wood & plastic up to 60mm thick.	100	72	3	60	T111C	100	5035048033227	116,67
DT2050-QZ	Scroller blade - for softwoods, plywood & chipboard - basic cutting up to 15mm thick.	76	48	2	15	T119B0	5	5035048060896	8,80
DT2052-QZ	Wood, chip & fibreboard - fast/clean cutting up to 60mm thick.	116	87	3	65	T301CD	5	5035048060919	16,00
DT2053-QZ	For wood & laminates - downcutter for 'splinter free' cuts.	100	73	2.5	40	T101BR	5	5035048060926	8,00
DT2164-QZ	For fast, straight cuts in wood, chipboard, plywood, laminated chipboard & plastic up to 60mm thick.	100	68	4	60	T101D	5	5035048033128	8,00
DT2174-QZ	For fast, straight cuts in wood, chipboard, plywood, laminated chipboard & plastic up to 60mm thick.	100	68	4	60	T101D	20	5035048033159	26,67
DT2184-QZ	For fast, straight cuts in wood and chipboard up to 60mm thick.	100	68	4	60	T101D	100	5035048033203	116,67
DT2165-QZ	For straight, fine cuts in wood, chipboard, plywood, laminated chipboard & plastic up to 30mm thick.	100	73	2.5	30	T101B	5	5035048033135	8,00
DT2175-QZ	For straight, fine cuts in wood, chipboard, plywood, laminated chipboard & plastic up to 30mm thick.	100	73	2.5	30	T101B	20	5035048033166	26,67
DT2185-QZ	For straight, fine cuts in wood, chipboard, plywood, laminated chipboard & plastic up to 30mm thick.	100	73	2.5	30	T101B	100	5035048033197	116,67
DT2168-QZ	For fine, curve cutting in wood, chipboard, plywood, laminated chipboard & plastic up to 30mm thick.	76	47	1.4	30	T101A0	5	5035048033234	8,80
DT2049-QZ	For clean extra straight cutting in wood and chipboard up to 60mm thick. (Extra thick blade).	100	68	4	60	T101DP	5	5035048060889	8,80
DT2051-QZ	Wood & plywood, chip & fibreboard - fast/rough cutting up to 85mm thick.	132	100	4	85	T301DL	5	5035048060902	16,00
DT2077-QZ	Scroller blade - for wood & chipboard - fast curve cutting up to 60mm thick.	100	70	4	60	T244D	5	5035048060858	16,00
DT2166-QZ	For fast, straight cuts in wood and chipboard up to 60mm thick.	100	68	4	60	T144D	5	5035048033142	8,80
DT2176-QZ	For fast, straight cuts in wood and chipboard up to 60mm thick.	100	68	4	60	T144D	20	5035048033173	26,67
DT2186-QZ	For fast straight cuts in wood, chipboard, plywood, laminated chipboard & plastic up to 60mm thick.	100	68	4	60	T144D	100	5035048033180	116,67
DT2169-QZ	For fast, straight cuts in wood & chipboard up to 100mm thick.	152	116	4	100	T344D	5	5035048033241	16,00
DT2048-QZ	For clean cuts in wood, chipboard, plywood & laminates up to 65mm thick.	116	87	2.5	65	T301BCP	5	5035048060872	16,00
DT2074-QZ	For straight fine cuts in wood - cuts flush to surface 180°.	112	74	2.3	65	T142HB	1	5035048060827	15,00
DT2075-QZ	For fast extra straight cutting in wood and chipboard up to 60mm thick. (Extra thick blade).	100	68	4	60	T144DP	5	5035048060834	8,80
DT2076-QZ	For fast extra straight cutting in wood and chipboard up to 100mm thick. (Extra thick blade).	152	116	4	100	T344DP	5	5035048060841	16,00
DT2057-QZ	For wood, chipboard & fibreboards up to 65mm thick. Progressor blade for fast cutting in different material thicknesses.	116	91	2-3	65	T234X	5	5035048060964	8,80
DT2167-QZ	For fast, rough cuts in thick construction timber up to 120mm thick.	180	155	4	120	T744D	5	5035048014455	16,00

**U SHANK**

Cat. No.	Applications	Overall Length mm	Working Length mm	Tooth Pitch mm	Max DOC mm	Equivalent Bosch Reference	Pack Qty.	Barcode	List Price Ex. VAT (£)
DT2062-QZ	For basic cuts in wood & chipboard up to 60mm thick.	91	70	2.5	60	U111D	5	5035048061015	NOT UK
DT2060-QZ	For straight fine cuts in wood, chipboard, plywood, laminates & plastic up to 30mm thick.	100	78	2.5	30	U101B	5	5035048060995	NOT UK
DT2061-QZ	For fast straight cuts in wood & chipboard up to 60mm thick.	100	76	4	60	U144D	5	5035048061008	NOT UK

**EXTREME DeWALT® BI-METAL METAL CUTTING BLADES**



**T SHANK**

**FEATURES**

- DeWALT HSS jigsaw blades are engineered to deliver a quality cut in a variety of ferrous and non-ferrous materials.
- EXTREME DeWALT® bi-metal blades are designed for long life and extra durability in ferrous and non-ferrous materials
- Fully hardened high speed steel for increased durability.
- For use in aluminium, ferrous and non-ferrous materials.

Cat. No.	Applications	Overall Length mm	Working Length mm	Tooth Pitch mm	Max DOC mm	Equivalent Bosch Reference	Pack Qty.	Barcode	List Price Ex. VAT (£)
DT2150-QZ	For fast cuts in steel to 3mm thick. Also for aluminium, copper, brass and other soft metals to 3mm thick.	86	61	1	3	T118AF	3	5035048059425	7,33
DT2154-QZ	For fast cuts in steel to 6mm thick. Also for aluminium, copper, brass and other soft metals from 3-5mm thick.	76	51	1.8	6	T118BF	3	5035048059432	7,33
DT2156-QZ	For fast cuts in sheet metal to 2.5mm thick.	76	51	0.8	2.5	T118GF	3	5035048059449	7,33
DT2054-QZ	Bi-Metal - scroller blade for mainly metal - curve cutting & thin sheet metal from 1.5 - 4mm thick.	82	55	1.5	4	T118EOF	5	5035048060933	16,00

**METAL CUTTING BLADES**

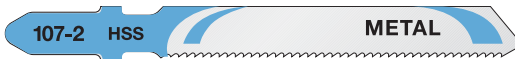

**T SHANK**

**FEATURES**

- DeWALT HSS jigsaw blades are engineered to deliver a quality cut in a variety of ferrous and non-ferrous materials.
- Fully hardened high speed steel for increased durability.
- For use in aluminium, ferrous and non-ferrous materials.

Cat. No.	Applications	Overall Length mm	Working Length mm	Tooth Pitch mm	Max DOC mm	Equivalent Bosch Reference	Pack Qty.	Barcode	List Price Ex. VAT (£)	
DT2160-QZ	For straight cuts in thin metal, non-ferrous metal, aluminium & sheet metal from 1.5 - 4mm thick.	76	50	1.2	4	T118A	5	5035048033050	8,00	
DT2170-QZ	For straight cuts in thin metal, non-ferrous metal, aluminium & sheet metal from 1.5 - 4mm thick.	76	50	1.2	4	T118A	20	5035048033098	26,67	
DT2190-QZ	For straight cuts in thin metal, non-ferrous metal, aluminium & sheet metal from 1.5 - 4mm thick.	76	50	1.2	4	T118A	100	5035048034057	116,67	
DT2161-QZ	For straight cuts in thick metal, non-ferrous metal & aluminium from 2.5 - 6mm thick.	76	50	2	6	T118B	5	5035048033067	8,80	
DT2171-QZ	For straight cuts in thick metal, non-ferrous metal & aluminium from 2.5 - 6mm thick.	76	50	2	6	T118B	20	5035048033104	26,67	
DT2191-QZ	For straight cuts in thick metal, non-ferrous metal & aluminium from 2.5 - 6mm thick.	76	50	2	6	T118B	100	5035048034064	116,67	
DT2162-QZ	For straight cuts in very thin metal, non-ferrous metal & aluminium from 0.8 - 2mm thick.	76	50	0.7	2	T118G	5	5035048033074	8,80	
DT2172-QZ	For straight cuts in very thin metal, non-ferrous metal, sheet metal & aluminium from 0.8 - 2mm thick.	76	50	0.7	2	T118G	20	5035048033111	26,67	
DT2085-QZ	For straight cuts in thin metal, non-ferrous metal (1.5 - 3mm) and aluminium up to 65mm thick.	132	108	1.2	3	T318A	5	5035048070581	16,00	
DT2163-QZ	For fast, straight cuts in aluminium 4 - 15mm; metal & non-ferrous metal 4 - 6mm & plastic up to 30mm thick.	100	72	3		Aluminium 15, Metal 6, Plastic 30	T127D	5	5035048033081	8,80
DT2058-QZ	For metal plate - thick & thin pipes & profiles, aluminium for thicknesses of 1.5 - 10mm. Progressor blade for fast cutting in different material thicknesses.	100	74	1.2 - 2.6	10		T123X	5	5035048060971	16,00

**METAL CUTTING BLADES**

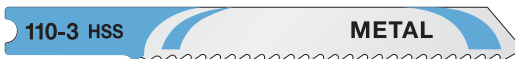

**U SHANK**

**FEATURES**

- DeWALT HSS jigsaw blades are engineered to deliver a quality cut in a variety of ferrous and non-ferrous materials.
- Fully hardened high speed steel for increased durability.
- For use in aluminium, ferrous and non-ferrous materials.

Cat. No.	Applications	Overall Length mm	Working Length mm	Tooth Pitch mm	Max DOC mm	Equivalent Bosch Reference	Pack Qty.	Barcode	List Price Ex. VAT (£)
DT2063-QZ	Metal cutting blade - medium sheet steel 2.5 - 6mm thick.	70	50	2	6	U118B	5	5035048061022	NOT UK

**WOOD & METAL CUTTING BLADES**



**T SHANK**

**APPLICATIONS:**

- BIM - for wood up to 65mm thick & metals, pipes and profiles 3 - 10mm thick.
- Progressor blade for fast cutting in different material thicknesses.

Cat. No.	Overall Length mm	Working Length mm	Tooth Pitch mm	Max DOC mm	Equivalent Bosch Reference	Pack Qty.	Barcode	List Price Ex. VAT (€)
DT2059-QZ	132	101	2.4 - 5	Wood 65, Metal 10	T345XF	5	5035048060988	16,00

**EXTREME DeWALT® SPECIAL MATERIAL BLADES**

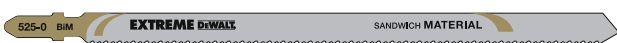

**T SHANK**

**APPLICATIONS**

- Specialist blades for cutting a wide variety of materials
- See individual blades for details



Cat. No.	Applications	Overall Length mm	Working Length mm	Tooth Pitch mm	Max DOC mm	Equivalent Bosch Reference	Pack Qty.	Barcode	List Price Ex. VAT (€)
DT2080-QZ	For clean and straight cuts in all laminates up to 15mm thick.	82	59	1.7	15	T101BIF	5	5035048014400	16,00
DT2081-QZ	For clean and curved cuts in all laminates up to 15mm thick.	82	59	1.4	15	T101AOF	3	5035048014417	16,00
DT2055-QZ	Tungsten Carbide Tipped blade (TCT) for stainless steel sheet metal (inox) from 1.5 - 5mm thick.	82	55	1.4	5	T118EHM	1	5035048060940	16,00
DT2101-QZ	Tungsten carbide for stainless steel, sheet & mild steel 1.2 - 3mm.	76	47	1	3	T118AHM	1	5035048059340	16,00
DT2082-QZ	For thin Metal and inox cutting - new technology up to 2mm thick.	82	59	0.8	1-2	T118GFS	1	5035048014424	16,00
DT2083-QZ	For medium Metal and inox cutting - new technology up to 4mm thick.	82	59	1.4	1.5 - 4	T118EFS	1	5035048014431	16,00
DT2056-QZ	Tungsten Carbide Tipped blade (TCT) for fibreglass, plastics & conon up to 65mm thick.	132	100	4.3	65	T341HM	1	5035048060957	20,00
DT2103-QZ	Tungsten carbide tipped blade for ceramic tiles, fibreglass & reinforced plastic to 20mm thick.	100	69	4.3	20	T141HM	1	5035048059364	16,00
DT2102-QZ	Tungsten carbide grit blade for ceramic tiles, fibreglass & reinforced plastic to 10mm thick.	76	50	-	10	T130RF	1	5035048059357	16,00
DT2201-QZ	Knife blade for soft materials, rubber, foam & polystyrene up to 100mm thick.	152	125	-	100	T313AW	5	5011402370764	16,67
DT2084-QZ	For straight and curved cuts in Sandwich materials and medium thick sheet metal up to 120mm thick.	180	148	2	120	T718BF	5	5035048014448	20,00

**WOOD & METAL CUTTING BLADE KITS**

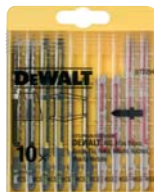

**WOOD & METAL CUTTING BLADE KITS**

Cat. No.	Description	Contents	Barcode	List Price Ex. VAT (€)
DT2290-QZ	10 piece jigsaw kit - wood cutting	DT2165 x 2, DT2050 x 1, DT2168 x 1, DT2177 x 2, DT2166 x 2, DT2075 x 2 (Bosch equivalent T1018, T11980, T101A0, T111C, T144D, T144DP)	5035048061077	19,13
DT2292-QZ	10 piece jigsaw kit - metal cutting	DT2160 x 3, DT2172 x 2, DT2054 x 1, DT2161 x 2, DT2163 x 2 (Bosch equivalent T118A, T1186, T118E0F, T1188, T127D)	5035048061084	19,13
DT2294-QZ	10 piece jigsaw kit - wood/metal cutting	DT2165 x 2, DT2050 x 2, DT2163 x 2, DT2177 x 2, DT2160 x 2 (Bosch equivalent T1018, T11980, T127D, T111C, T118A)	5035048061091	19,13

WOOD CUTTING BLADES

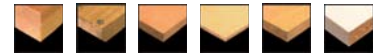

APPLICATIONS

- Blades available for almost all materials and applications

FEATURES

- Bi-metal construction combining HCS and HSS for increased flexibility and durability.
- Tough cutting edge made from M2 High Speed Steel.
- Raker tooth pitch to maximise blade durability.
- Universal 1/2" (13mm) shank suitable for DEWALT, Bosch, Hitachi, Flex, Makita, Metabo, Skil.
- New "Plunge Point" tip for fast and accurate plunge cutting into all wood materials

APPLICATIONS

- For fast cuts in wood and plastics.

FEATURES

- High Carbon Steel construction.
- For use in wood, plywood, laminates and plastics.
- Universal 1/2" (13mm) shank suitable for DEWALT, Bosch, Hitachi, Flex, Makita, Metabo, Skil.



BI-METAL

Cat. No.	Applications	Length mm	Pitch mm	Equivalent Bosch Reference	Pack Qty.	Barcode	List Price Ex. VAT (£)
DT2351-QZ	Fine, fast cuts, specially for curve cutting in wood and plastic.	152	4.2	S611DF	5	5035048033319	19,17
DT2359-QZ	Fast cuts in wood with nails and tough plastics. New "Plunge Point" tip for fast and accurate plunge cutting into all wood materials.	152	4.2	S611VF	5	5035048034583	19,69
DT2349-QZ	Fast cuts in wood with nails and tough plastics. New "Plunge Point" tip for fast and accurate plunge cutting into all wood materials.	228	4.2	S1111VF	5	5035048034590	24,39
DT2320-QZ	Fast cuts in wood with nails and tough plastics. New "Plunge Point" tip for fast and accurate plunge cutting into all wood materials.	228	4.2	S1111VF	100	5035048034071	350,00
DT2350-QZ	Fast cuts in wood with nails and tough plastics. New "Plunge Point" tip for fast and accurate plunge cutting into all wood materials.	305	4.2	S1411VF	5	5035048033302	30,90
DT2344-QZ	Fine, fast cuts, specially for curve cutting in wood and plastic. Ideal for use with cordless reciprocating saws.	152	3.6 - 5.1	S711VF	5	5035048034668	18,01

HCS

Cat. No.	Applications	Length mm	Pitch mm	Equivalent Bosch Reference	Pack Qty.	Barcode	List Price Ex. VAT (£)
DT2362-QZ	Fine fast and curved cuts in wood and plastic.	152	4.2	S611D	5	5035048033272	14,50
DT2363-QZ	Fine fast cuts and curve cuts in wood and plastic.	228	4.2	S1544D	5	5035048033289	22,50
DT2364-QZ	Fine fast cuts and curve cuts in wood and plastic.	305	4.2	S1344D	5	5035048033296	23,33
DT2402-QZ	Progressor blade for different material thicknesses. Construction timber (6 - 150mm), chipboard and MDF (6-60mm), plywood, plastic (6 - 150mm), wooden panels (to 175mm).	203	2.4 - 4	S2345X	5	5035048072691	37,50
DT2410-QZ	Progressor blade for different material thicknesses. Construction timber (6 - 150mm), chipboard and MDF (6-60mm), plywood, plastic (6 - 150mm), wooden panels (to 175mm). Ideal for use with cordless recip saws.	203	2.5 - 4	SA2345X	5	5035048072721	36,67
DT2430-QZ	Coarse wood with no nails (20-100mm), living wood and pruning (to 100mm). Ideal for plunge and curve cutting.	152	8.5	S617K	5	5035048072806	20,00
DT2352-QZ	Coarse, fast cuts in wood (logs and pruning).	240	5 - 6.5	S1531L	5	5035048033326	29,77
DT2432-QZ	Coarse wood with no nails (20-250mm), living wood and pruning (to 250mm).	305	8.5	S1617K	5	5035048072813	33,33

METAL CUTTING BLADES



APPLICATIONS

- Blades available for almost all materials and applications

FEATURES

- Bi-metal construction combining HCS and HSS for increased flexibility and durability.
- Tough cutting edge made from M2 High Speed Steel.
- Raker tooth pitch to maximise blade durability.
- Universal 1/2" (13mm) shank suitable for DEWALT, Bosch, Hitachi, Flex, Makita, Metabo, Skil.

BI-METAL

Cat. No.	Applications	Length mm	Pitch mm	Equivalent Bosch Reference	Pack Qty.	Barcode	List Price Ex. VAT (£)
DT2385-QZ	Fine cuts in metal, sheet material, pipes and profiles up to 1.5mm thick.	152	1.1	S922AF	5	5035048034620	16,46
DT2384-QZ	Cuts in metal, sheet metal, pipes and profiles up to 3mm thick.	152	1.4	S922EF	5	5035048034613	16,47
DT2354-QZ	Cuts in metal, sheet metal, pipes and profiles up to 3mm thick.	203	1.4	S1022EF	5	5035048033340	18,50
DT2361-QZ	Fast cuts in ferrous and non-ferrous metal, sheet metal, pipes and profiles from 3-8mm thick.	152	1.8	S922BF	5	5035048034606	17,96
DT2353-QZ	Fast cuts in ferrous and non-ferrous metal, sheet metal, pipes and profiles from 3-8mm thick.	203	1.8	S1022BF	5	5035048033333	18,50
DT2323-QZ	Fast cuts in ferrous and non-ferrous metal, sheet metal, pipes and profiles from 3-8mm thick.	203	1.8	S1022BF	100	5035048034101	336,67
DT2346-QZ	Ferrous and non-ferrous metals up to 3mm thick. Ideal for use with cordless reciprocating saws.	152	1.4	S922EF	5	5035048034682	16,52
DT2404-QZ	Progressor blade for different material thicknesses. Thin to thick sheet metal (1 - 8mm), thin to thick metal profiles (5 - 100mm).	150	1.4 - 3.35	S123XF	5	5035048072707	32,50

HARD METAL

Cat. No.	Applications	Length mm	Pitch mm	Barcode	List Price Ex. VAT (£)
DT2407-QZ	152mm hard metal cutting blade	152	4.2	5035048083321	TBC
DT2408-QZ	152mm hard metal cutting blade	152	2.5	5035048083338	TBC
DT2409-QZ	152mm hard metal cutting blade	152	2	5035048083345	TBC

**GENERAL PURPOSE BLADES**



**APPLICATIONS**

- Blades available for almost all materials and applications

**FEATURES**

- Bi-metal construction combining HCS and HSS for increased flexibility and durability.
- Tough cutting edge made from M2 High Speed Steel.
- Raker tooth pitch to maximise blade durability.
- Universal 1/2" (13mm) shank suitable for DeWALT, Bosch, Hitachi, Flex, Makita, Metabo, Skil.

**BI-METAL**

Cat. No.	Applications	Length mm	Pitch mm	Equivalent Bosch Reference	Pack Qty.	Barcode	List Price Ex. VAT (£)
DT2348-QZ	For use in tough plastics, sandwich material and pipes from 3-12mm thick.	152	1.8-2.5	S922VF	5	5035048034637	16,46
DT2387-QZ	For use in tough plastics, sandwich material and pipes from 3-12mm thick.	203	1.8-2.5	S1122VF	5	5035048034644	18,50
DT2355-QZ	For use in heavy gauge metal, rubber, fibreglass and angle iron.	305	1.8-2.5	S1222VF	5	5035048033357	23,75
DT2345-QZ	General purpose for wood, wood with nails, aluminium and fibreglass. Ideal for use with cordless reciprocating saws.	152	2.5	S922VF	5	5035048034675	16,52
DT2406-QZ	Progressor blade for different material thicknesses. Wood with nails/metal, chipboard (5 - 150mm), sheet metal, aluminium profiles (3 - 18mm), plastic, fibre glass, reinforced plastic profiles (5 - 150mm).	203	2.4 - 4.6	S3456XF	5	5035048072714	40,00

**DEMOLITION BLADES**

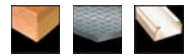

**APPLICATIONS**

- Ideal or extreme applications and demolition tasks.
- For cutting hard and soft wood including wood with nails.
- Range also includes metal and plastic cutting (sheet metals, profiles and tubes).

**FEATURES**

- Wider blade body gives greater stability during cutting.
- Thicker blade ensures greater strength.
- Bi-metal construction gives strong, flexible blade and hardened teeth.
- Deeper tooth strip ensures longer cutting life.
- New "Plunge Point" tip for fast and accurate plunge cutting into all wood materials

**BI-METAL**

Cat. No.	Applications	Length mm	Pitch mm	Equivalent Bosch Reference	Pack Qty.	Barcode	List Price Ex. VAT (£)
DT2300-QZ	For fast/rough cutting of hard & soft woods. New "Plunge Point" tip for fast and accurate plunge cutting into all wood materials.	152	4.2	S610VF	5	5035048059500	28,33
DT2307-QZ	For fast/rough cutting of hard & soft woods. New "Plunge Point" tip for fast and accurate plunge cutting into all wood materials.	228	4.2	S1110DF	5	5035048059555	33,33
DT2314-QZ	For fast/rough cutting of hard & soft wood. New "Plunge Point" tip for fast and accurate plunge cutting into all wood materials.	305	4.2	S1210DF	5	5035048059609	40,00
DT2303-QZ	For fast cutting of metals - sheet, profiles & tube	152	1.8	S923BEF	5	5035048059531	28,33
DT2304-QZ	For fast cutting of metals - sheet, profiles & tubes	152	1.8	S923BEF	100	5035048059548	383,33
DT2310-QZ	For fast cutting of metals - sheet, profiles & tubes	228	1.8	S1125VF	5	5035048059586	33,33
DT2301-QZ	For fast cutting of metals, plastics & sandwich materials.	152	2.5	S920CF	5	5035048059517	28,33
DT2302-QZ	For fast cutting of metals, plastics & sandwich materials.	152	2.5	S920CF	100	5035048059524	383,33
DT2308-QZ	For fast cutting of metals, plastics & 'sandwich materials'	228	2.5	S1120CF	5	5035048059562	33,33
DT2309-QZ	For fast cutting of metals, plastics & 'sandwich materials'	228	2.5	S1120CF	100	5035048059579	566,67

**RECIPROCATING BLADE SETS**



**RECIPROCATING BLADE SETS**

Cat. No.	Description	Contents	Barcode	List Price Ex. VAT (£)
DT2440-QZ	6 piece set and storage case	DT2307 x 2, DT2349 x 2, DT2353 x 2	5035048072912	32,00
DT2441-QZ	12 piece set and storage case	DT2307 x 1, DT2349 x 3, DT2359 x 2, DT2353 x 3, DT2361 x 3	5035048072929	48,00

SPECIALIST MATERIAL BLADES

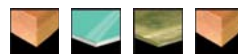
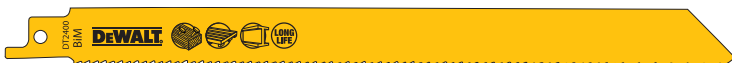

APPLICATIONS

- Specialist blades for cutting a wide variety of materials
- See individual blades for details

SPECIALIST MATERIAL BLADES

Cat. No.	Applications	Length mm	Pitch mm	Equivalent Bosch Reference	Pack Qty.	Barcode	List Price Ex. VAT (€)
DT2356-QZ	Bi-metal construction blade for splinter free cuts in plaster.	152	1.8	S628DF	5	5035048033364	19,50
DT2332-QZ	Wear resistant carbide grit edged blade for cutting light masonry blocks, bricks, abrasive materials, ceramics, fibreglass, mild steel and wood with nails.	152	2	-	1	5035048011287	13,79
DT2333-QZ	Wear resistant carbide grit edged blade for cutting light masonry blocks, bricks, abrasive materials, ceramics, fibreglass, mild steel and wood with nails.	228	2	S1130Riff	1	5035048011294	17,65
DT2335-QZ	Tungsten carbide toothed blade for cutting light masonry blocks, bricks, abrasive materials.	235	1	-	1	5035048014264	17,14
DT2400-QZ	Bi-metal construction blade for pallet repair, wood with nails (5 - 175mm), sheet metal pipes, aluminium profiles (3 - 12mm). Ideal for flexible flush cutting.	225	2.5	S1122HF	100	5035048072684	463,33
DT2401-QZ	Bi-metal construction blade for pallet repair, wood with nails (5 - 175mm), sheet metal pipes, aluminium profiles (3 - 12mm). Ideal for flexible flush cutting.	200	1.8-2.5	S1122HF	100	5035048082577	280,16
DT2420-QZ	Tungsten carbide tipped blade for cutting aerated Concrete, red brick and fibre cement to 150mm.	240	12.7	S1543HM	1	5035048072752	55,00
DT2421-QZ	Tungsten carbide tipped blade for cutting aerated Concrete, red brick and fibre cement to 250mm.	305	12.7	S1243HM	1	5035048072769	75,00
DT2422-QZ	Tungsten carbide tipped blade for cutting aerated Concrete, red brick and fibre cement to 400mm.	457	12.7	S2243HM	1	5035048072776	105,00
DT2423-QZ	Tungsten carbide tipped blade for aerated Concrete, red brick and fibre cement, reinforced plastics (6 - 100mm). Ideal for abrasive materials.	152	4.3	S641HM	1	5035048072783	31,67
DT2426-QZ	Tungsten carbide tipped blade for stainless steel plates (2 - 4mm), stainless steel profiles (2 - 80mm), fibre glass, reinforced plastics (2 - 15mm).	150	1.4	S922EHM	2	5035048072790	66,67

ALLIGATOR® SAW BLADES



ALLIGATOR® SAW BLADES

Cat. No.	Applications	Overall Length mm	Working Length mm	Tip Material	Pack Qty.	M.O.O.	Barcode	List Price Ex. VAT (€)
DT2960-QZ	Drywall, Board.	360	275	HSS	1	1	5035048025390	40,00
DT2961-QZ	Hardwood, Softwood, Plywood.	360	275	HSS	1	1	5035048025406	26,67
DT2962-QZ	Plywood, Chipboard and MDF.	360	275	TCT	1	1	5035048025413	57,50
DT2963-QZ	Building Block, Class 12 Poroton.	360	275	TCT	1	1	5035048025420	49,17
DT2964-QZ	Building Block, Class 12 Poroton.	528	425	TCT	1	1	5035048033258	83,33
DT2965-QZ	Building block, gas beton.	528	425	TCT	1	1	5035048033265	83,33
DT2966-QZ	Building Block, Class 20 Poroton.	528	425	TCT	1	1	5035048058855	133,33

APPLICATIONS

- Ideal for fast and easy cutting in building blocks, wood, plywood, chipboard and drywall.
- See individual blades for details.

FEATURES

- Blades designed with HSS or TCT teeth to optimise the performance of the DeWalt Alligator® Power Saw.





**BANDSAW BLADES**



**FOR USE WITH DW738 AND DW739**

**FEATURES**

- High Grade Steel.
- Sharp ground teeth slice through the workpiece, producing a fine finish. (Wood cutting blades only).

**FEATURES**

- High Grade Steel.
- Sharp ground teeth slice through the workpiece, producing a fine finish. (Wood cutting blades only).

**APPLICATIONS**

- Range for most wood and some steel applications.

**FEATURES**

- Premium Grade Steel.
- Ultra sharp diamond ground teeth slice cleanly through the work piece producing a sandpaper fine finish (woodcutting blades only).
- Edge hardened teeth maintain ultra sharp edge.

Cat. No.	Primary Application	Overall Length mm	Width mm	Thickness mm	Pitch mm	Pack Qty.	Barcode	List Price Ex. VAT (£)
DT8480-QZ	Wood-Fretsaw Blade.	2095	3	0.6	4.2	1	5035048025543	68,67
DT8481-QZ	General Purpose Blade.	2095	12	0.6	4.2	1	5035048025550	30,90
DT8482-QZ	Wood - thick cuts.	2095	16	0.6	6.4	1	5035048025567	51,50
DT8483-QZ	Wood - contour.	2095	6	0.6	3.2	1	5035048025574	30,90
DT8484-QZ	Non-ferrous Metal - Thin cuts.	2095	6	0.6	1.8	1	5035048025581	30,90
DT8485-QZ	Non-ferrous Metal - Thick cuts.	2095	12	0.6	3.2	1	5035048025598	30,90
DT8486-QZ	Wood, Formica and Laminates.	2095	10	0.6	3.2	1	5035048025604	30,90

**FOR USE WITH DW876**

Cat. No.	Primary Application	Overall Length mm	Width mm	Thickness mm	Pitch mm	Pack Qty.	Barcode	List Price Ex. VAT (£)
DT8470-QZ	Wood - Fretsaw Blade.	2215	4	0.6	1.8	1	5011402380978	68,67
DT8471-QZ	Wood - contour / scroll.	2215	6	0.4	4.2	1	5011402380985	44,94
DT8472-QZ	Wood - Rip & Cross cut.	2215	10	0.4	4.2	1	5011402380992	44,94
DT8473-QZ	Wood - Fast rip cut, medium composites.	2215	16	0.6	6.4	1	5011402381005	44,94
DT8474-QZ	Wood - Fast rip cut, thick wood.	2215	20	0.6	6.4	1	5011402381012	51,50
DT8475-QZ	Metal - Non-ferrous - thin steel.	2215	6	0.6	1.4	1	5011402381029	29,54
DT8476-QZ	Metal - Non-ferrous - thick steel.	2215	12	0.6	1.8	1	5011402381036	30,83

**PLANER BLADES**



**FOR USE WITH DW676K**

Cat. No.	Description	Pack Qty.	M.O.Q.	Barcode	List Price Ex. VAT (£)
DT3901-QZ	80mm TCT reversible planer blades.	1 pair	1	5035048059456	13,80

**FOR USE WITH DW677, DW678K, DW678EK AND DW680K**

Cat. No.	Description	Pack Qty.	M.O.Q.	Barcode	List Price Ex. VAT (£)
DT3905-QZ	82mm HSS reversible planer blades.	1 pair	1	5011402381852	11,00
DT3906-QZ	82mm TCT reversible planer blades.	1 pair	1	5011402381869	13,80

**JOINTER ACCESSORIES**



**BISCUIT JOINTER BLADES**

Cat. No.	Blade Diameter	Blade Thickness mm	Bore Size mm	Tooth Count	M.O.Q.	Barcode	List Price Ex. VAT (£)
DT1306-QZ	102	3.9	22	12	1	5011432382118	53,33
DT1307-QZ	105	2.4	22	30	1	5011402382125	70,00

**BISCUITS**

Cat. No.	Size	Description	Pack Qty.	M.O.Q.	Barcode	List Price Ex. VAT (£)
DT3930-QZ	0	6 - 12 mm board	1000	1	5035048025369	63,33
DT3931-QZ	10	13-18 mm board	1000	1	5035048025376	65,00
DT3932-QZ	20	>19 mm board	1000	1	5035048025383	68,33

**Straight Cutters**

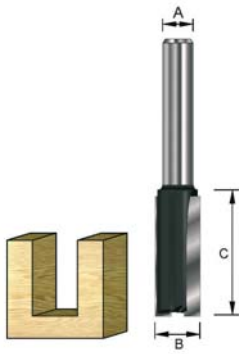

**APPLICATIONS**

- For general cutting of straight edges, slots, grooves and straight rebates in hard woods, MDF, HDF, plywood and chipboard
- Can be used for straight trimming of laminates

**FEATURES**

- Single flute cutters available for fast cutting.
- Two flute cutters available for superior finish
- Long reach bits for deep grooving and mortising. Include carbide bottom plate for easier plunge cutting and long life in abrasive materials
- Straight cutter with bearing for following a template
- Available with 8mm and 12mm shanks (also available in 1/4" & 1/2" shanks for UK and Eire only)

**Straight Cutters**

Cat. No.	Description	Shank mm (A)	Cut Diameter mm (B)	Working Length mm (C)	Total Length mm	Barcode	List Price Ex. VAT (£)
DR1002.XC	Straight Cutter - 1 Flute	8	4	10	48	7392585010011	NOT UK
DR1003.XC	Straight Cutter - 2 Flutes	8	5	12	50	7392585010028	NOT UK
DR1004.XC	Straight Cutter - 2 Flutes	8	6	19	55	7392585010035	NOT UK
DR1005.XC	Straight Cutter - 2 Flutes	8	8	20	55	7392585010042	NOT UK
DR1006.XC	Straight Cutter - 2 Flutes	8	10	20	52	7392585010059	NOT UK
DR1007.XC	Straight Cutter - 2 Flutes	8	12	20	52	7392585010066	NOT UK
DR1008.XC	Straight Cutter - 2 Flutes	8	14	20	52	7392585010073	NOT UK
DR1009.XC	Straight Cutter - 2 Flutes	8	15	20	52	7392585010080	NOT UK
DR1010.XC	Straight Cutter - 2 Flutes	8	16	20	52	7392585010097	NOT UK
DR1011.XC	Straight Cutter - 2 Flutes	8	18	20	52	7392585010103	NOT UK
DR1012.XC	Straight Cutter - 2 Flutes	8	20	20	52	7392585010110	NOT UK
DR1013.XC	Straight Cutter - 2 Flutes	8	22	20	52	7392585010127	NOT UK
DR1014.XC	Straight Cutter - 2 Flutes	8	24	20	52	7392585010134	NOT UK
DR1015.XC	Straight Cutter - 2 Flutes	8	25	20	52	7392585010141	NOT UK
DR6011.XC	Straight Cutter - 2 Flutes	12	25	30	70	7392585010257	NOT UK
DR1020-QZ	Straight Cutter - 2 Flutes	8	12	30	90	5035048073490	NOT UK
DR1022-QZ	Straight Cutter - 2 Flutes	8	16	30	90	5035048073513	NOT UK
DR1023-QZ	Long Reach Straight Cutters	12	12	50	94	5035048073520	NOT UK
DR1024-QZ	Long Reach Straight Cutters	12	16	50	90	5035048073537	NOT UK
DR1101.XC	Straight Cutter with bearing	8	12	25	-	7392585010264	NOT UK

**Profiles For Grooving / Moulding**



**APPLICATIONS**

- For hard woods, MDF and plywood
- For grooving and moulding various profiles

**FEATURES**

- Two cutting flutes for superior finish

**Profiles For Grooving / Moulding**

Cat. No.	Description	Shank mm (A)	Cut Diameter mm (B)	Working Length mm (C)	Radius mm (D)	Barcode	List Price Ex. VAT (£)
DR1402.XC	Straight Cutter - 2 Flutes	8	8	8	4	7392585010325	NOT UK
DR1403.XC	Straight Cutter - 2 Flutes	8	12	9.5	6	7392585010332	NOT UK
DR1302.XC	Straight Cutter - 2 Flutes	8	12.7	12.7	90	7392585010295	NOT UK
DR1301.XC	Straight Cutter - 2 Flutes	8	12.7	15.9	60	7392585010288	NOT UK

**Edge Trimmers / Cutters**



**APPLICATIONS**

- For cutting, trimming and bevelling soft woods, hard woods, MDF and laminates

**Edge Trimmers / Cutters**

Cat. No.	Description	Shank mm (A)	Cut Diameter mm (B)	Working Length mm (C)	Radius mm (D)	Barcode	List Price Ex. VAT (£)
DR2201.XC	Trimming Cutter Triple Flute	8	12.7	25.4	68	7392585010523	NOT UK
DR4401.XC	Straight Cutter - 2 Flutes	8	31.8	12.7	-	7392585011162	NOT UK
DR2502.XC	3 Wing Slotting Cutter	-	8	47.6	3	7392585010608	NOT UK
DR2503.XC	3 Wing Slotting Cutter	-	8	47.6	4	7392585010615	NOT UK
DR2504.XC	3 Wing Slotting Cutter	-	8	47.6	5	7392585010622	NOT UK
DR2701.XC	Arbor with Bearing	8	8	-	-	7392585010646	NOT UK
DR2603.XC	2 Wing Flat Bottom Slotter	8	40	4	10.5	7392585011476	NOT UK
DR2604.XC	2 Wing Flat Bottom Slotter	8	40	5	10.5	7392585011483	NOT UK

**Edge Profiling and Moulding**

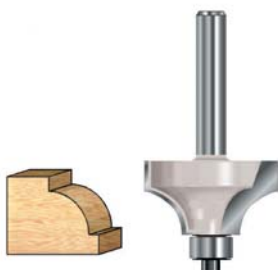

**APPLICATIONS**

- For creating decorative edges on worktops, furniture, cabinet doors, window sills and picture frames
- For soft wood, hardwood, MDF and plywood

**FEATURES**

- Two cutting flutes for superior finish
- Available with replacement ball bearing where applicable

**Edge Profiling and Moulding**

Cat. No.	Description	Shank mm (A)	Cut Diameter mm (B)	Working Length mm (C)	Radius mm (D)	Barcode	List Price Ex. VAT (£)
DR3102-XC	Cove Cutter with Bearing	8	19.5	9.5	5	7392585010851	NOT UK
DR3103-XC	Cove Cutter with Bearing	8	22.2	12.7	6.35	7392585010868	NOT UK
DR3104-XC	Cove Cutter with Bearing	8	28.6	12.7	9.5	7392585010875	NOT UK
DR6701-XC	Chamfer with Bearing	12	44.5	15.9	45	7392585010585	NOT UK
DR2402-XC	Bevel Trimmer with Bearing	8	28	11.2	45	7392585010578	NOT UK
DR3801-XC	Covetto Cutter with Bearing	8	25.4	12.7	4.8	7392585011025	NOT UK
DR2802-XC	Rounding Over Cutter	8	18.7	9.5	3	7392585010660	NOT UK
DR2803-XC	Rounding Over Cutter	8	22.7	9.5	5	7392585010667	NOT UK
DR2804-XC	Rounding Over Cutter	8	25.4	12.7	6.35	7392585010684	NOT UK
DR2805-XC	Rounding Over Cutter	8	28.6	12.7	8	7392585010691	NOT UK
DR2806-XC	Rounding Over Cutter	8	31.8	15.9	9.5	7392585010707	NOT UK
DR2807-XC	Rounding Over Cutter	8	38.1	19	12.7	7392585010714	NOT UK
DR2903-XC	Beading Cutter	8	25.4	12.7	6.35	7392585010769	NOT UK
DR2905-XC	Beading Cutter	8	31.8	15.9	9.5	7392585010783	NOT UK
DR3301-XC	Ogee Cutter	8	31.8	12.7	4.8	7392585010905	NOT UK
DR3401-XC	Roman Ogee Cutter	8	27	11.9	4	7392585010929	NOT UK
DR3501-XC	Ogee Fillet Cutter	8	34.9	14.3	4.8	7392585010943	NOT UK
DR3602-XC	Classic Ogee Cutter	8	31.8	14.3	4.8	7392585010967	NOT UK
DR3702-XC	Classic Roman Ogee Cutter	8	31.8	15.9	4.8	7392585010998	NOT UK

**Dovetail & Glue Jointing**



**APPLICATIONS**

- For soft woods, hard woods, MDF, Plywood and Chipboard

**FEATURES**

- Two cutting flutes for superior finish
- Replacement ball bearings available where applicable

**Dovetail & Glue Jointing**

Cat. No.	Description	Shank mm (A)	External Diameter mm (B1)	Internal Diameter mm (B2)	Angle °	Barcode	List Price Ex. VAT (£)
DR4201-XC	Dovetail Cutter	8	14.3	12.7	13.5	7392585011131	NOT UK
DR1028-QZ	Dovetail Cutter	8	14.3	N/A	13.5	5035048073575	NOT UK
DR5301-XC	Router Hinge Bit	8	35	-	-	7392585011346	NOT UK
DR4701-XC	Tongue & Groove Set	8	41	6.35	9.5	7392585011230	NOT UK
DR4301-XC	Off Set Tongue & Groove Cutter	8	30.2	25.4	-	7392585011148	NOT UK
DR4801-XC	Rail & Stile - Roman Ogee	8	41	23.8	4.76	7392585011254	NOT UK
DR4901-XC	Rail & Stile - Classical	8	41	23.8	2.38	7392585011278	NOT UK

**Replacement Ball Bearings**

Cat. No.	Description	External Diameter mm (B1)	Internal Diameter mm (B2)	Range	Barcode	List Price Ex. VAT (£)
DR9907-XC	Replacement Bearing	15.9	6.35	4.76	7392585011421	NOT UK

**Router Bit Sets**



**Router Bit Sets**

Cat. No.	Description	Barcode	List Price Ex. VAT (£)
DR9992-XC	12 Piece Router bit set - Straight bit x3, Trimming cutter with BB, Rounding over bit with BB x2, Core box, Dovetail cutter, V-groove bit, Cove bit with BB, Roman ogee with BB, Chamfer bit with BB	5035048940211	NOT UK
DR9994-QZ	22 Piece Router bit set - Straight bit x6, Trimming cutter with BB, Rounding over bit with BB x2, Core box x2, Dovetail cutter, V-groove bit x2, Cove bit with BB x2, Roman ogee with BB, Chamfer bit with BB, Beading nit, New traditional beading bit of Freud, Bevel trim cutter with BB, Rebate cutter with BB	5035048905630	NOT UK

**FULL SHEET 230mm x 280mm**

**APPLICATIONS**

- Wood and paint preparation and finish.

**FEATURES**

- High quality aluminium oxide grain gives superior finish.
- Strong & flexible D/C weight backing.
- Stearate coating helps reduce clogging (80g and above).



**ALUMINIUM OXIDE PAPER**



Cat. No.	Description	Grit Size	Pack Qty.	M.O.Q.	Barcode	List Price Ex. VAT (£)
DT3230-QZ	Multi Purpose Wood/paint-dry	40	1	10	5035048073612	NOT UK
DT3231-QZ	Multi Purpose Wood/paint-dry	60	1	10	5035048073629	NOT UK
DT3232-QZ	Multi Purpose Wood/paint-dry	80	1	10	5035048073636	NOT UK
DT3233-QZ	Multi Purpose Wood/paint-dry	120	1	10	5035048073643	NOT UK
DT3234-QZ	Multi Purpose Wood/paint-dry	180	1	10	5035048073650	NOT UK
DT3235-QZ	Multi Purpose Wood/paint-dry	240	1	10	5035048073667	NOT UK
DT3236-QZ	Multi Purpose Wood/paint-dry	320	1	10	5035048073674	NOT UK
DT3238-QZ	Multi Purpose Wood/paint-dry	60	1	50	5035048073698	NOT UK
DT3239-QZ	Multi Purpose Wood/paint-dry	80	1	50	5035048073704	NOT UK
DT3240-QZ	Multi Purpose Wood/paint-dry	120	1	50	5035048073711	NOT UK
DT3241-QZ	Multi Purpose Wood/paint-dry	180	1	50	5035048073728	NOT UK
DT3242-QZ	Multi Purpose Wood/paint-dry	240	1	50	5035048073735	NOT UK

**APPLICATIONS**

- Fine sanding of primers and fillers.

**FEATURES**

- Flexible waterproof latex paper backing enables easier sanding on contoured surfaces and finishing applications.
- High quality sharp aluminium oxide grain provides excellent finish.
- High water resistance - no paper curl.



**WATERPROOF PAPER**

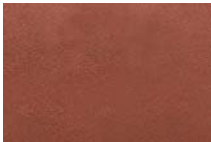

Cat. No.	Description	Grit Size	Pack Qty.	M.O.Q.	Barcode	List Price Ex. VAT (£)
DT3244-QZ	Multi Purpose Wet & Dry	180	1	10	5035048073759	NOT UK
DT3245-QZ	Multi Purpose Wet & Dry	240	1	10	5035048073766	NOT UK
DT3246-QZ	Multi Purpose Wet & Dry	320	1	10	5035048073773	NOT UK
DT3247-QZ	Multi Purpose Wet & Dry	400	1	10	5035048073780	NOT UK
DT3248-QZ	Multi Purpose Wet & Dry	1000	1	10	5035048073797	NOT UK
DT3249-QZ	Multi Purpose Wet & Dry	1200	1	10	5035048073803	NOT UK

**APPLICATIONS**

- Rust removal, surface grinding deburring and final finish.

**FEATURES**

- Heavyweight 'J' Cloth backing - tough durable sanding on metals.
- Industrial grade Aluminium oxide grain - fast aggressive stripping/sanding.

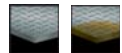

**METALWORKING CLOTH**

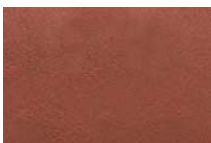

Cat. No.	Description	Grit Size	Pack Qty.	M.O.Q.	Barcode	List Price Ex. VAT (£)
DT3281-QZ	Steel, Stainless Steel, Non-Ferrous Metal	80	1	10	5035048073872	NOT UK
DT3282-QZ	Steel, Stainless Steel, Non-Ferrous Metal	120	1	10	5035048073889	NOT UK
DT3283-QZ	Steel, Stainless Steel, Non-Ferrous Metal	180	1	10	5035048073896	NOT UK
DT3284-QZ	Steel, Stainless Steel, Non-Ferrous Metal	240	1	10	5035048073902	NOT UK
DT3285-QZ	Steel, Stainless Steel, Non-Ferrous Metal	320	1	10	5035048073919	NOT UK

**HAND SANDING BLOCK**



Cat. No.	Description	Pack Qty.	M.O.Q.	Barcode	List Price Ex. VAT (£)
DT3199-QZ	Hand Sanding Block	1	1	5035048082829	NOT UK

**HALF SHEET 115mm x 280mm**



**APPLICATIONS**

- For all sanding and finishing tasks on wood, painted surfaces and fillers.

**FEATURES**

- Industrial grade abrasive paper for all stripping, sanding and finishing tasks on wood, paint and fillers.
- High quality aluminium oxide grain gives superior finish.
- Resin bonding provides excellent grain adhesion and heat resistance for powered sanding.
- Tough, durable "E" weight backing ensures longer life and performance.



PRE-PUNCHED Fits: DeWALT, Bosch, Festool, Makita, Metabo, Hitachi, Peugeot, Ryobi

Cat. No.	Description	Grit Size	Pack Qty.	M.O.Q.	Barcode	List Price Ex. VAT (£)
DT8570-QZ	Multi Purpose Wood/paint-dry	40	10	1	5035048070598	5,78
DT8510-QZ	Multi Purpose Wood/paint-dry	60	10	1	5035048069202	5,17
DT8511-QZ	Multi Purpose Wood/paint-dry	80	10	1	5035048069219	5,17
DT8512-QZ	Multi Purpose Wood/paint-dry	120	10	1	5035048069226	5,17
DT8513-QZ	Multi Purpose Wood/paint-dry	180	10	1	5035048069233	5,17
DT8514-QZ	Multi Purpose Wood/paint-dry	220	10	1	5035048069240	5,17

**HALF SHEET 'QUICK FIT' 115mm x 228mm**

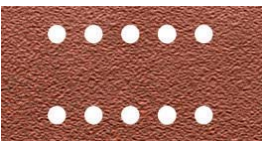

**APPLICATIONS**

- For all sanding and finishing tasks on wood, painted surfaces and fillers.

**FEATURES**

- Industrial grade abrasive paper for all stripping, sanding and finishing tasks on wood, paint and fillers.
- High quality aluminium oxide grain gives superior finish.
- Resin bonding provides excellent grain adhesion and heat resistance for powered sanding.
- Tough, durable "E" weight backing ensures longer life and performance.



PRE-PUNCHED Fits: DeWALT, Bosch, Festool, Makita, Metabo, Hitachi, Peugeot, Ryobi

Cat. No.	Description	Grit Size	Pack Qty.	M.O.Q.	Barcode	List Price Ex. VAT (£)
DT8574-QZ	Multi Purpose Wood/paint-dry	40	10	1	5035048070635	7,07
DT8550-QZ	Multi Purpose Wood/paint-dry	60	10	1	5035048069608	6,44
DT8551-QZ	Multi Purpose Wood/paint-dry	80	10	1	5035048069615	6,22
DT8552-QZ	Multi Purpose Wood/paint-dry	120	10	1	5035048069622	5,74
DT8553-QZ	Multi Purpose Wood/paint-dry	180	10	1	5035048069639	5,62

**THIRD SHEET 93mm x 230mm**



**APPLICATIONS**

- For all sanding and finishing tasks on wood, painted surfaces and fillers.

**FEATURES**

- Industrial grade abrasive paper for all stripping, sanding and finishing tasks on wood, paint and fillers.
- High quality aluminium oxide grain gives superior finish.
- Resin bonding provides excellent grain adhesion and heat resistance for powered sanding.
- Tough, durable "E" weight backing ensures longer life and performance.



PRE-PUNCHED Fits: DeWALT, Bosch, Festool, Makita, Metabo, Ryobi, Skil, AEG

Cat. No.	Description	Grit Size	Pack Qty.	M.O.Q.	Barcode	List Price Ex. VAT (£)
DT8590-QZ	Multi Purpose Wood/paint-dry	60	10	1	5035048069905	3,88
DT8591-QZ	Multi Purpose Wood/paint-dry	80	10	1	5035048069912	3,82
DT8592-QZ	Multi Purpose Wood/paint-dry	120	10	1	5035048069929	3,70
DT8488-QZ	Multi Purpose Wood/paint-dry	40	25	1	5035048070727	8,61
DT8595-QZ	Multi Purpose Wood/paint-dry	60	25	1	5035048069950	8,13
DT8596-QZ	Multi Purpose Wood/paint-dry	80	25	1	5035048069967	8,01
DT8597-QZ	Multi Purpose Wood/paint-dry	120	25	1	5035048069974	7,72
DT8598-QZ	Multi Purpose Wood/paint-dry	180	25	1	5035048069981	7,72

**THIRD SHEET 'QUICK FIT' 93mm x 190mm**

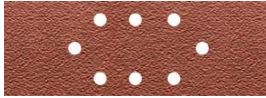

**APPLICATIONS**

- For all sanding and finishing tasks on wood, painted surfaces and fillers.

**FEATURES**

- Industrial grade abrasive paper for all stripping, sanding and finishing tasks on wood, paint and fillers.

PRE-PUNCHED Fits: DeWALT, AEG, Bosch, Casals, Einhell, Festool, Hitachi, Makita, Metabo, Peugeot, Skil



Cat. No.	Description	Grit Size	Pack Qty.	M.O.Q.	Barcode	List Price Ex. VAT (€)
DT8620-QZ	Multi Purpose Wood/paint-dry	60	10	1	5035048070208	5,69
DT8621-QZ	Multi Purpose Wood/paint-dry	80	10	1	5035048070215	5,51
DT8622-QZ	Multi Purpose Wood/paint-dry	120	10	1	5035048070222	5,07
DT8623-QZ	Multi Purpose Wood/paint-dry	180	10	1	5035048070239	5,07
DT8624-QZ	Multi Purpose Wood/paint-dry	240	10	1	5035048070246	5,07

**QUARTER SHEET**

**APPLICATIONS**

- For all sanding and finishing tasks on wood, painted surfaces and fillers.

**FEATURES**

- Industrial grade abrasive paper for all stripping, sanding and finishing tasks on wood, paint and fillers.
- High quality aluminium oxide grain gives superior finish.
- Resin bonding provides excellent grain adhesion and heat resistance for powered sanding.
- Tough, durable "E" weight backing ensures longer life and performance.

QUARTER SHEET 115mm x 140mm Fits: DeWALT, Bosch, Makita, Ryobi, Skil



Cat. No.	Description	Grit Size	Pack Qty.	M.O.Q.	Barcode	List Price Ex. VAT (€)
DT3001-QZ	Multi Purpose Wood/paint-dry	40	10	1	5035048066546	5,00
DT3002-QZ	Multi Purpose Wood/paint-dry	60	10	1	5035048066553	5,00
DT3004-QZ	Multi Purpose Wood/paint-dry	100	10	1	5035048066560	5,00
DT3005-QZ	Multi Purpose Wood/paint-dry	150	10	1	5035048066577	5,00
DT3007-QZ	Multi Purpose Wood/paint-dry	220	10	1	5035048066584	5,00
DT3011-QZ	Multi Purpose Wood/paint-dry	40	25	1	5035048058947	10,33
DT3012-QZ	Multi Purpose Wood/paint-dry	60	25	1	5035048058954	10,33
DT3014-QZ	Multi Purpose Wood/paint-dry	100	25	1	5035048058961	10,33
DT3015-QZ	Multi Purpose Wood/paint-dry	150	25	1	5035048058978	10,33
DT3017-QZ	Multi Purpose Wood/paint-dry	220	25	1	5035048058985	10,33

QUARTER SHEET 'QUICK FIT' 115mm x 115mm Fits: DeWALT, Bosch, Makita, Hitachi, Metabo

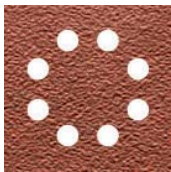

Cat. No.	Description	Grit Size	Pack Qty.	M.O.Q.	Barcode	List Price Ex. VAT (€)
DT3020-QZ	Multi Purpose Wood/paint-dry	40	10	1	5035048014462	6,17
DT3021-QZ	Multi Purpose Wood/paint-dry	60	10	1	5035048014486	6,17
DT3022-QZ	Multi Purpose Wood/paint-dry	80	10	1	5035048014509	6,17
DT3023-QZ	Multi Purpose Wood/paint-dry	120	10	1	5035048014523	6,17
DT3024-QZ	Multi Purpose Wood/paint-dry	180	10	1	5035048014547	6,17
DT3025-QZ	Multi Purpose Wood/paint-dry	240	10	1	5035048014561	6,17
DT3026-QZ	Multi Purpose Wood/paint-dry	320	10	1	5035048071953	6,17
DT3030-QZ	Multi Purpose Wood/paint-dry	40	25	1	5035048014479	12,17
DT3031-QZ	Multi Purpose Wood/paint-dry	60	25	1	5035048014493	12,17
DT3032-QZ	Multi Purpose Wood/paint-dry	80	25	1	5035048014516	12,17
DT3033-QZ	Multi Purpose Wood/paint-dry	120	25	1	5035048014530	12,17
DT3034-QZ	Multi Purpose Wood/paint-dry	180	25	1	5035048014554	12,17
DT3035-QZ	Multi Purpose Wood/paint-dry	240	25	1	5035048014578	12,17
DT3036-QZ	Multi Purpose Wood/paint-dry	320	25	1	5035048070819	12,17

QUARTER SHEET 'QUICK FIT' 80mm x 133mm Fits: Festool

Cat. No.	Description	Grit Size	Pack Qty.	M.O.Q.	Barcode	List Price Ex. VAT (€)
DT3100-QZ	Multi Purpose Wood/paint-dry	40	25	1	5035048082638	NOT UK
DT3104-QZ	Multi Purpose Wood/paint-dry	60	25	1	5035048082645	NOT UK
DT3109-QZ	Multi Purpose Wood/paint-dry	80	25	1	5035048082652	NOT UK
DT3110-QZ	Multi Purpose Wood/paint-dry	120	25	1	5035048082669	NOT UK
DT3114-QZ	Multi Purpose Wood/paint-dry	180	25	1	5035048082676	NOT UK

**DETAIL SANDING SHEETS**



**APPLICATIONS**

- For all sanding and finishing tasks on wood, painted surfaces and fillers.

**FEATURES**

- Industrial grade abrasive paper for all stripping, sanding and finishing tasks on wood, paint and fillers.
- High quality aluminium oxide grain gives superior finish.
- Resin bonding provides excellent grain adhesion and heat resistance for powered sanding.
- Tough, durable "E" weight backing ensures longer life and performance.



PRE-PUNCHED 93mm x 93mm Fits: DeWALT, Bosch, AEG, Makita, Metabo, Skil, Kress

Cat. No.	Description	Grit Size	Pack Qty.	M.O.Q.	Barcode	List Price Ex. VAT (€)
DT3090-QZ	Detail Sanding Sheet	40	10	1	5035048061770	5,40
DT3091-QZ	Detail Sanding Sheet	60	10	1	5035048061787	5,40
DT3092-QZ	Detail Sanding Sheet	80	10	1	5035048061794	5,40
DT3093-QZ	Detail Sanding Sheet	120	10	1	5035048061800	5,40
DT3094-QZ	Detail Sanding Sheet	180	10	1	5035048061817	5,40
DT3095-QZ	Detail Sanding Sheet	240	10	1	5035048061824	5,40

PRE-PUNCHED 94mm x 94mm Fits: Festool

Cat. No.	Description	Grit Size	Pack Qty.	M.O.Q.	Barcode	List Price Ex. VAT (€)
DT3560-QZ	Detail Sanding Sheet	40	10	1	5035048067338	4.61
DT3561-QZ	Detail Sanding Sheet	60	10	1	5035048067345	4.32
DT3562-QZ	Detail Sanding Sheet	80	10	1	5035048067352	4.29
DT3563-QZ	Detail Sanding Sheet	120	10	1	5035048067369	4.08
DT3564-QZ	Detail Sanding Sheet	180	10	1	5035048067376	4.08

**ROLLS**



**APPLICATIONS**

- For all sanding and finishing tasks on wood, painted surfaces and fillers.

**FEATURES**

- Industrial grade abrasive paper for all stripping, sanding and finishing tasks on wood, paint and fillers.
- High quality aluminium oxide grain gives superior finish.
- Resin bonding provides excellent grain adhesion and heat resistance for powered sanding.
- Tough, durable "E" weight backing ensures longer life and performance.



ROLLS - HALF SHEET & QUARTER SHEET

Cat. No.	Description	Grit Size	Size (Length x Width)	Pack Qty.	M.O.Q.	Barcode	List Price Ex. VAT (€)
DT3580-QZ	Multi Purpose Wood/paint-dry	60	5m x 115mm	1	1	5035048067079	20,00
DT3581-QZ	Multi Purpose Wood/paint-dry	80	5m x 115mm	1	1	5035048067086	20,00
DT3582-QZ	Multi Purpose Wood/paint-dry	120	5m x 115mm	1	1	5035048067093	20,00
DT3583-QZ	Multi Purpose Wood/paint-dry	180	5m x 115mm	1	1	5035048067109	20,00
DT3584-QZ	Multi Purpose Wood/paint-dry	220	5m x 115mm	1	1	5035048067116	20,00

ROLLS - THIRD SHEET

Cat. No.	Description	Grit Size	Size (Length x Width)	Pack Qty.	M.O.Q.	Barcode	List Price Ex. VAT (€)
DT3154-QZ	Multi Purpose Wood/paint-dry	40	5m x 93mm	1	1	5035048082942	9.35
DT3590-QZ	Multi Purpose Wood/paint-dry	60	5m x 93mm	1	1	5035048067178	11,00
DT3591-QZ	Multi Purpose Wood/paint-dry	80	5m x 93mm	1	1	5035048067185	9,08
DT3592-QZ	Multi Purpose Wood/paint-dry	120	5m x 93mm	1	1	5035048067192	8,80
DT3593-QZ	Multi Purpose Wood/paint-dry	180	5m x 93mm	1	1	5035048067208	11,00
DT3594-QZ	Multi Purpose Wood/paint-dry	220	5m x 93mm	1	1	5035048067215	8,80
DT3579-QZ	Multi Purpose Wood/paint-dry	40	25m x 93mm	1	1	5035048070871	25.69
DT3595-QZ	Multi Purpose Wood/paint-dry	60	25m x 93mm	1	1	5035048067222	23.82
DT3596-QZ	Multi Purpose Wood/paint-dry	80	25m x 93mm	1	1	5035048067239	23.60
DT3597-QZ	Multi Purpose Wood/paint-dry	120	25m x 93mm	1	1	5035048067246	21.42
DT3598-QZ	Multi Purpose Wood/paint-dry	180	25m x 93mm	1	1	5035048067253	21.42
DT3599-QZ	Multi Purpose Wood/paint-dry	220	25m x 93mm	1	1	5035048067260	21.42

**BELTS**



**APPLICATIONS**

- For all stripping sanding and finishing tasks on wood, metal and painted surfaces.

**FEATURES**

- Heavy duty 'X' weight backing cloth.
- Heat resistant resin bonding.
- High quality Aluminium Oxide grain for fast, aggressive stock removal and fine finishing on wood, metal or painted surfaces.
- EXTREME belts (grits up to 120) have an 'Anti Static' resin bonding - reduces clogging and ensures more efficient dust extraction - Longer belt sanding life.



**100mm x 610mm Fits: Hitachi, Makita, Ryobi**

Cat. No.	Description	Grit Size	Pack Qty.	M.O.Q.	Barcode	List Price Ex. VAT (£)
DT3320-QZ	Multi Purpose Wood/paint-belt	40	3	1	5035048068151	9,20
DT3321-QZ	Multi Purpose Wood/paint-belt	60	3	1	5035048068168	8,96
DT3322-QZ	Multi Purpose Wood/paint-belt	80	3	1	5035048068175	8,96
DT3323-QZ	Multi Purpose Wood/paint-belt	100	3	1	5035048068182	8,96
DT3324-QZ	Multi Purpose Wood/paint-belt	150	3	1	5035048068199	8,96
DT3670-QZ	Multi Purpose Wood/paint-belt	40	10	1	5035048068205	18,18
DT3671-QZ	Multi Purpose Wood/paint-belt	60	10	1	5035048068212	17,47
DT3672-QZ	Multi Purpose Wood/paint-belt	80	10	1	5035048068229	17,47
DT3673-QZ	Multi Purpose Wood/paint-belt	100	10	1	5035048068236	17,47
DT3674-QZ	Multi Purpose Wood/paint-belt	150	10	1	5035048068243	17,47

**100mm x 560mm Fits: DeWALT, AEG, Ryobi**



Cat. No.	Description	Grit Size	Pack Qty.	M.O.Q.	Barcode	List Price Ex. VAT (£)
DT3312-QZ	Multi Purpose Wood/paint-belt	40	3	1	5035048025642	9,45
DT3314-QZ	Multi Purpose Wood/paint-belt	60	3	1	5035048025659	9,45
DT3315-QZ	Multi Purpose Wood/paint-belt	80	3	1	5035048025666	9,45
DT3316-QZ	Multi Purpose Wood/paint-belt	100	3	1	5035048025673	9,45
DT3362-QZ	Multi Purpose Wood/paint-belt	120	3	1	5035048034884	9,45
DT3318-QZ	Multi Purpose Wood/paint-belt	150	3	1	5035048025680	9,45
DT3683-QZ	Multi Purpose Wood/paint-belt	40	10	1	5035048068458	20,00
DT3686-QZ	Multi Purpose Wood/paint-belt	60	10	1	5035048068465	20,00
DT3687-QZ	Multi Purpose Wood/paint-belt	80	10	1	5035048068472	20,00
DT3626-QZ	Multi Purpose Wood/paint-belt	100	10	1	5035048070826	20,00
DT3688-QZ	Multi Purpose Wood/paint-belt	120	10	1	5035048068489	20,00

**75mm x 533mm Fits: DeWALT, Bosch, Hitachi, Atlas Copco, Holz-Her, Makita, Metabo, Peugeot, Ryobi, Skil**



Cat. No.	Description	Grit Size	Pack Qty.	M.O.Q.	Barcode	List Price Ex. VAT (£)
DT3376-QZ	Multi Purpose Wood/paint-belt	60	3	1	5035048068717	6,46
DT3377-QZ	Multi Purpose Wood/paint-belt	80	3	1	5035048068724	6,46
DT3628-QZ	Multi Purpose Wood/paint-belt	100	3	1	5035048070840	6,46
DT3301-QZ	Multi Purpose Wood/paint-belt	40	10	1	5011402375172	19,50
DT3302-QZ	Multi Purpose Wood/paint-belt	60	10	1	5011402375189	19,50
DT3303-QZ	Multi Purpose Wood/paint-belt	80	10	1	5011402375196	19,50
DT3304-QZ	Multi Purpose Wood/paint-belt	100	10	1	5011402375202	19,50
DT3629-QZ	Multi Purpose Wood/paint-belt	120	10	1	5035048070857	19,50
DT3305-QZ	Multi Purpose Wood/paint-belt	150	10	1	5011402375219	19,50
DT3307-QZ	Multi Purpose Wood/paint-belt	220	10	1	5011402375226	19,50

**75mm x 480mm Fits: Elu**

Cat. No.	Description	Grit Size	Pack Qty.	M.O.Q.	Barcode	List Price Ex. VAT (£)
DT3364-QZ	Multi Purpose Wood/paint-belt	40	3	1	5035048053942	6,46
DT3365-QZ	Multi Purpose Wood/paint-belt	60	3	1	5035048053959	6,46
DT3366-QZ	Multi Purpose Wood/paint-belt	80	3	1	5035048053966	6,46
DT3367-QZ	Multi Purpose Wood/paint-belt	100	3	1	4024048053973	6,46
DT3368-QZ	Multi Purpose Wood/paint-belt	120	3	1	5035048053980	6,46
DT3369-QZ	Multi Purpose Wood/paint-belt	150	3	1	5035048053997	6,46

**75mm x 457mm Fits: Makita, Metabo, Peugeot, Skil**

Cat. No.	Description	Grit Size	Pack Qty.	M.O.Q.	Barcode	List Price Ex. VAT (£)
DT3640-QZ	Multi Purpose Wood/paint-belt	40	3	1	5035048068809	5,47
DT3641-QZ	Multi Purpose Wood/paint-belt	60	3	1	5035048068816	5,47
DT3642-QZ	Multi Purpose Wood/paint-belt	80	3	1	5035048068823	5,47
DT3643-QZ	Multi Purpose Wood/paint-belt	100	3	1	5035048068830	5,47
DT3644-QZ	Multi Purpose Wood/paint-belt	150	3	1	5035048068847	5,47



**BELTS**



**APPLICATIONS**

- For all stripping, sanding and finishing tasks on wood, metal and painted surfaces.

**FEATURES**

- Flexible J weight backing cloth.
- Heat resistant resin bonding.
- High quality Aluminium Oxide grain for fast, accurate stock removal and fine finishing on wood, metal or painted surfaces.

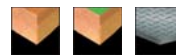

**64mm x 356mm (MINI BELT SANDER)**

Cat. No.	Description	Grit Size	Pack Qty.	M.O.Q.	Barcode	List Price Ex. VAT (£)
DT3661-QZ	Multi Purpose Wood/paint-belt	60	3	1	5035048069011	11,67
DT3662-QZ	Multi Purpose Wood/paint-belt	80	3	1	5035048069028	11,67
DT3663-QZ	Multi Purpose Wood/paint-belt	100	3	1	5035048069035	11,67
DT3664-QZ	Multi Purpose Wood/paint-belt	150	3	1	5035048069042	11,67
DT3299-QZ	Multi Purpose Wood/paint-belt	220	3	1	5035048071960	11,67
DT3666-QZ	Multi Purpose Wood/paint-belt	60	10	1	5035048069066	35,00
DT3667-QZ	Multi Purpose Wood/paint-belt	80	10	1	5035048069073	35,00
DT3668-QZ	Multi Purpose Wood/paint-belt	100	10	1	5035048069080	35,00
DT3669-QZ	Multi Purpose Wood/paint-belt	150	10	1	5035048069097	35,00

**GRINDING BELTS**

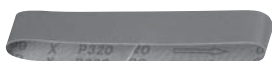

**APPLICATIONS**

- For use with bench grinder.
- Coarse grits or shaping metal, wood and ceramics.

**FEATURES**

- High performance 'X' weight backing cloth.
- Heat resistant resin bonding.
- High quality aluminium oxide grain.



**40mm x 577mm**

Cat. No.	Description	Grit Size	Pack Qty.	M.O.Q.	Barcode	List Price Ex. VAT (£)
DT3340-QZ	Grinding belt	40	3	1	5035048034262	7,36
DT3341-QZ	Grinding belt	60	3	1	5035048034279	7,36
DT3342-QZ	Grinding belt	80	3	1	5035048034286	7,36
DT3343-QZ	Grinding belt	100	3	1	5035048034293	7,36
DT3344-QZ	Grinding belt	120	3	1	5035048034309	7,36
DT3345-QZ	Grinding belt	150	3	1	5035048034316	7,36
DT3346-QZ	Grinding belt	240	3	1	5035048034323	7,36
DT3347-QZ	Grinding belt	320	3	1	5035048034330	7,36

**45mm x 715mm**

Cat. No.	Description	Grit Size	Pack Qty.	M.O.Q.	Barcode	List Price Ex. VAT (£)
DT3349-QZ	Grinding belt	40	3	1	5035048034354	8,46
DT3350-QZ	Grinding belt	60	3	1	5035048034361	8,46
DT3351-QZ	Grinding belt	80	3	1	5035048034378	8,46
DT3352-QZ	Grinding belt	100	3	1	5035048034385	8,46
DT3353-QZ	Grinding belt	120	3	1	5035048034392	8,46
DT3354-QZ	Grinding belt	150	3	1	5035048034408	8,46
DT3355-QZ	Grinding belt	240	3	1	5035048034415	8,46
DT3356-QZ	Grinding belt	320	3	1	5035048034422	8,46

**HONING BELTS**



**FEATURES**

- Use after regrinding tools to bring them to a very sharp edge.
- Use in conjunction with DeWALT honing paste.

**40mm X 577mm**

Cat. No.	Description	Pack Qty.	M.O.Q.	Barcode	List Price Ex. VAT (£)
DT3395-QZ	Leather honing belt	1	1	5035048054017	66,67

**45mm X 715mm**

Cat. No.	Description	Pack Qty.	M.O.Q.	Barcode	List Price Ex. VAT (£)
DT3396-QZ	Leather honing belt	1	1	5035048054024	66,67

**HONING PASTE**

Cat. No.	Description	Pack Qty.	M.O.Q.	Barcode	List Price Ex. VAT (£)
DT3398-QZ	Honing Paste	1	1	5035048054031	26,67

**'QUICK FIT NYLON' LOOP DISCS**

**APPLICATIONS**

- For all stripping sanding and finishing tasks on wood, metal and painted surfaces.

**FEATURES**

- Heat resistant resin adhesive bond, ideal for power sanding.
- Tough, durable paper backing ensures longer disc life and performance.
- Stearate coating reduces clogging, excellent for softwoods & painted surfaces (grits 80 or greater).
- Quick Fit nylon loop backing allows fast and easy disc changeover.

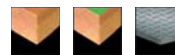

**8 HOLES PUNCHED Ø125mm Fits: DEWALT, AEG, Bosch, Atlas Copco, Festool, Elu, Fein, Hitachi, Kress, Makita, Metabo, Skil**

Cat. No.	Description	Grit Size	Pack Qty.	M.O.Q.	Barcode	List Price Ex. VAT (£)
DT3101-QZ	Multi Purpose Wood/paint-dry	40	10	1	5035048058992	8,17
DT3102-QZ	Multi Purpose Wood/paint-dry	60	10	1	5035048059005	8,17
DT3103-QZ	Multi Purpose Wood/paint-dry	80	10	1	5035048059012	8,17
DT3105-QZ	Multi Purpose Wood/paint-dry	120	10	1	5035048059029	8,17
DT3106-QZ	Multi Purpose Wood/paint-dry	180	10	1	5035048059036	8,17
DT3107-QZ	Multi Purpose Wood/paint-dry	240	10	1	5035048059043	8,17
DT3108-QZ	Multi Purpose Wood/paint-dry	320	10	1	5035048059050	8,17
DT3111-QZ	Multi Purpose Wood/paint-dry	40	25	1	5035048059067	14,83
DT3112-QZ	Multi Purpose Wood/paint-dry	60	25	1	5035048059074	14,83
DT3113-QZ	Multi Purpose Wood/paint-dry	80	25	1	5035048059081	14,83
DT3115-QZ	Multi Purpose Wood/paint-dry	120	25	1	5035048059098	12,50
DT3116-QZ	Multi Purpose Wood/paint-dry	180	25	1	5035048059104	12,50
DT3117-QZ	Multi Purpose Wood/paint-dry	240	25	1	5035048059111	12,50
DT3118-QZ	Multi Purpose Wood/paint-dry	320	25	1	5035048059128	12,50

**8 HOLES PUNCHED Ø125mm Fits: Festool**

Cat. No.	Description	Grit Size	Pack Qty.	M.O.Q.	Barcode	List Price Ex. VAT (£)
DT3119-QZ	Multi Purpose Wood/paint-dry	40	25	1	5035048082683	NOT UK
DT3120-QZ	Multi Purpose Wood/paint-dry	60	25	1	5035048082690	NOT UK
DT3124-QZ	Multi Purpose Wood/paint-dry	80	25	1	5035048082706	NOT UK
DT3129-QZ	Multi Purpose Wood/paint-dry	120	25	1	5035048082713	NOT UK
DT3130-QZ	Multi Purpose Wood/paint-dry	180	25	1	5035048082720	NOT UK
DT3139-QZ	Multi Purpose Wood/paint-dry	240	25	1	5035048082911	NOT UK

**6 HOLES PUNCHED Ø150mm Fits: DEWALT, Bosch, Hitachi, Metabo, Peugeot**

Cat. No.	Description	Grit Size	Pack Qty.	M.O.Q.	Barcode	List Price Ex. VAT (£)
DT3121-QZ	Multi Purpose Wood/paint-dry	40	10	1	5035048059135	10,00
DT3122-QZ	Multi Purpose Wood/paint-dry	60	10	1	5035048059142	10,00
DT3123-QZ	Multi Purpose Wood/paint-dry	80	10	1	5035048059159	10,00
DT3125-QZ	Multi Purpose Wood/paint-dry	120	10	1	5035048059166	10,00
DT3126-QZ	Multi Purpose Wood/paint-dry	180	10	1	5035048059173	10,00
DT3127-QZ	Multi Purpose Wood/paint-dry	240	10	1	5035048059180	10,00
DT3128-QZ	Multi Purpose Wood/paint-dry	320	10	1	5035048059197	10,00
DT3131-QZ	Multi Purpose Wood/paint-dry	40	25	1	5035048059203	20,00
DT3132-QZ	Multi Purpose Wood/paint-dry	60	25	1	5035048059210	20,00
DT3133-QZ	Multi Purpose Wood/paint-dry	80	25	1	5035048059227	20,00
DT3135-QZ	Multi Purpose Wood/paint-dry	120	25	1	5035048059234	20,00
DT3136-QZ	Multi Purpose Wood/paint-dry	180	25	1	5035048059241	20,00
DT3137-QZ	Multi Purpose Wood/paint-dry	240	25	1	5035048059463	20,00
DT3138-QZ	Multi Purpose Wood/paint-dry	320	25	1	5035048059258	20,00

**9 HOLES PUNCHED Ø150mm Fits: Festool**

Cat. No.	Description	Grit Size	Pack Qty.	M.O.Q.	Barcode	List Price Ex. VAT (£)
DT3151-QZ	Multi Purpose Wood/paint-dry	40	25	1	5035048068083	20,00
DT3152-QZ	Multi Purpose Wood/paint-dry	60	25	1	5035048068090	20,00
DT3153-QZ	Multi Purpose Wood/paint-dry	80	25	1	5035048068106	20,00
DT3155-QZ	Multi Purpose Wood/paint-dry	120	25	1	5035048068113	15,48
DT3156-QZ	Multi Purpose Wood/paint-dry	180	25	1	5035048068120	15,48

**9 HOLES PUNCHED Ø225mm Fits: Festool, Flex**

Cat. No.	Description	Grit Size	Pack Qty.	M.O.Q.	Barcode	List Price Ex. VAT (£)
DT3164-QZ	Multi Purpose Wood/paint-dry	60	10	1	5035048082782	NOT UK
DT3169-QZ	Multi Purpose Wood/paint-dry	80	10	1	5035048082799	NOT UK
DT3179-QZ	Multi Purpose Wood/paint-dry	100	10	1	5035048082928	NOT UK
DT3170-QZ	Multi Purpose Wood/paint-dry	120	10	1	5035048082805	NOT UK



**EXTREME DEWALT FIBRE DISCS**



**APPLICATIONS**

- Stock removal /stripping tasks on metal and derusting.

**FEATURES**

- Extra tough Vulcanised fibre backing for aggressive fast sanding.
- Extremely durable hard Zirconia grain for fast aggressive stock removal on metals.
- Heat resistant resin bond keeps the abrasive grain in place for longer ensuring longer disc life.
- Cool cut for low discolouration of metal.

**115mm Ø**

Cat. No.	Description	Grit Size	Pack Qty.	M.O.Q.	Barcode	List Price Ex. VAT (€)
DT3201-QZ	Fibre Disc	40	25	1	5011402375257	46,67
DT3202-QZ	Fibre Disc	60	25	1	5011402375271	46,67
DT3203-QZ	Fibre Disc	80	25	1	5011402375295	46,67
DT3205-QZ	Fibre Disc	100	25	1	5035048067277	46,67
DT3206-QZ	Fibre Disc	120	25	1	5035048067284	46,67

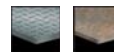

**125mm Ø**

Cat. No.	Description	Grit Size	Pack Qty.	M.O.Q.	Barcode	List Price Ex. VAT (€)
DT3211-QZ	Fibre Disc	40	25	1	5011402375356	39,32
DT3212-QZ	Fibre Disc	60	25	1	5011402375370	33,28
DT3213-QZ	Fibre Disc	80	25	1	5011402375394	26,61
DT3215-QZ	Fibre Disc	100	25	1	5035048067291	26,61
DT3216-QZ	Fibre Disc	120	25	1	5035048067307	26,61

**FLAP DISCS**



**APPLICATIONS**

- For rust removal, grinding and cleaning metal.

**FEATURES**

- Tough durable zirconia grain.
- Very strong with very high removal rate.
- Low noise.
- Cool grinding.

**FLAP DISCS**

Cat. No.	Description	Diameter mm	Grit Size	Pack Qty.	M.O.Q.	Barcode	List Price Ex. VAT (€)
DT3269-QZ	Type 29 Angled	100mm	60	10	1	5035048077344	NOT UK
DT3274-QZ	Type 29 Angled	100mm	80	10	1	5035048077351	NOT UK
DT3255-QZ	Type 29 Angled	115mm	36	10	1	5035048075166	NOT UK
DT3256-QZ	Type 29 Angled	115mm	60	10	1	5035048075173	NOT UK
DT3257-QZ	Type 29 Angled	115mm	80	10	1	5035048075180	NOT UK
DT3258-QZ	Type 29 Angled	115mm	120	10	1	5035048075197	NOT UK
DT3265-QZ	Type 29 Angled	125mm	36	10	1	5035048075203	NOT UK
DT3266-QZ	Type 29 Angled	125mm	60	10	1	5035048075210	NOT UK
DT3267-QZ	Type 29 Angled	125mm	80	10	1	5035048075227	NOT UK
DT3268-QZ	Type 29 Angled	125mm	120	10	1	5035048075234	NOT UK
DT3208-QZ	Type 27 Flat	100mm	36	10	1	5035048077375	NOT UK
DT3209-QZ	Type 27 Flat	100mm	60	10	1	5035048077382	NOT UK
DT3218-QZ	Type 27 Flat	100mm	80	10	1	5035048077399	NOT UK
DT3219-QZ	Type 27 Flat	100mm	120	10	1	5035048077405	NOT UK
DT3292-QZ	Type 27 Flat	115mm	36	10	1	5035048075241	NOT UK
DT3293-QZ	Type 27 Flat	115mm	60	10	1	5035048075258	NOT UK
DT3294-QZ	Type 27 Flat	115mm	80	10	1	5035048075265	NOT UK
DT3295-QZ	Type 27 Flat	115mm	120	10	1	5035048075272	NOT UK
DT3308-QZ	Type 27 Flat	125mm	36	10	1	5035048075289	NOT UK
DT3309-QZ	Type 27 Flat	125mm	60	10	1	5035048075296	NOT UK
DT3310-QZ	Type 27 Flat	125mm	80	10	1	5035048075302	NOT UK

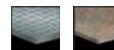

**'QUICK FIT' PLATENS**

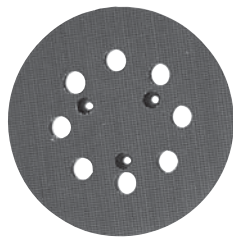

**FEATURES**

- Quick Fit replacement platens for DeWALT Random Orbit Sanders. Hardness grade - medium.

**'QUICK FIT' PLATENS**

Cat. No.	Description	Diameter mm	Pack Qty.	M.O.Q.	Barcode	List Price Ex. VAT (£)
DT3600-QZ	Quick Fit Platen	125	1	1	5035048059265	23,33
DT3601-QZ	Quick Fit Platen	150	1	1	5035048059272	23,33
DE2639-XJ	150MM 6 & 8 HOLE BACKING PAD	150	1	1	5035048136553	NOT UK

**BACKING PADS & BONNETS**



**APPLICATIONS**

- For use with angle grinder fibre discs and polishing bonnets.

**FEATURES**

- Thermoplastic backing pad supplied with flange locking nut.

**BACKING PADS & BONNETS**

Cat. No.	Diameter mm	Max Speed	Bore Size mm	Pack Qty.	M.O.Q.	Barcode	List Price Ex. VAT (£)
DT3610-QZ	115	13000 rpm	M 14	1	1	5035048059289	11,67
DT3611-QZ	125	15000 rpm	M 14	1	1	5035048059296	13,33
DT3612-QZ	178	8500 rpm	M 14	1	1	5035048059302	26,67

**ANGLE GRINDER POLISHING BONNETS**



**APPLICATIONS**

- High Speed polishing on a wide variety of surfaces (e.g.) unpainted metals and stone.

**FEATURES**

- Lambswool pile polishing bonnets.

**ANGLE GRINDER POLISHING BONNETS**

Cat. No.	Diameter mm	Pack Qty.	M.O.Q.	Barcode	List Price Ex. VAT (£)
DT3620-QZ	115	1	1	5035048059319	7,41
DT3621-QZ	125	1	1	5035048059326	7,20
DT3622-QZ	178	1	1	5035048059333	12,33
DT3557-QZ	125	1	1	5035048083031	NOT UK
DT3558-QZ	150	1	1	5035048083048	NOT UK



**POLISHING FOAMS**

Cat. No.	Diameter mm	Pack Qty.	M.O.Q.	Barcode	List Price Ex. VAT (£)
DT3555-QZ	115	1	1	5035048083017	NOT UK
DT3558-QZ	150	1	1	5035048083048	NOT UK



**CLEANING FLEECES**

Cat. No.	Diameter mm	Pack Qty.	M.O.Q.	Barcode	List Price Ex. VAT (£)
DT3550-QZ	115	1	1	5035048082980	NOT UK

**METAL CUTTING DISCS**



**APPLICATIONS**

- Cutting ferrous metals such as steel, iron, rebar and welds.

**FEATURES**

- Professional grade aluminium oxide.
- Premium resin bond.
- Reinforced fibre glass.

**FLAT**

Cat. No.	Diameter mm	Material	Thickness mm	Bore Size mm	Pack Qty.	M.O.Q.	Barcode	List Price Ex. VAT (£)
DT3405-QZ	115	A46TBF	1.6	22.2	1	25	5035048014592	1,36
DT3400-QZ	115	A30TBF	2.5	22.2	1	25	5011402375646	2,26
DT3409-QZ	125	A46TBF	1.6	22.2	1	25	5035048014608	1,56
DT3410-QZ	125	A30TBF	2.5	22.2	1	25	5011402365677	2,60
DT3415-QZ	150	A30TBF	2.5	22.2	1	25	5035048059470	NOT UK
DT3420-QZ	180	A30TBF	3	22.2	1	25	5011402375707	3,07
DT3430-QZ	230	A30TBF	3	22.2	1	25	5011402375738	5,08
DT3481-QZ*	115	A46TBF	1.7	22.2	1	25	5035048077443	1,80
DT3482-QZ*	125	A46TBF	1.7	22.2	1	25	5035048077450	2,16
DT3483-QZ*	180	A46TBF	1.7	22.2	1	25	5035048077467	NOT UK
DT3484-QZ*	230	A46TBF	1.8	22.2	1	25	5035048077474	NOT UK
DT3487-QZ*	230	A30TBF	3.1	22.2	1	25	5035048078396	NOT UK

\*EXTREME DEWALT

**DEPRESSED CENTRE**

Cat. No.	Diameter mm	Material	Thickness mm	Bore Size mm	Pack Qty.	M.O.Q.	Barcode	List Price Ex. VAT (£)
DT3406-QZ	115	A30TBF	2.5	22.2	1	25	5035048014615	1,24
DT3413-QZ	125	A30TBF	2.5	22.2	1	25	5035048014622	1,28
DT3423-QZ	180	A30TBF	3.0	22.2	1	25	5035048014639	2,16
DT3433-QZ	230	A30TBF	3.0	22.2	1	25	5035048014646	3,16

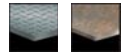

**METAL GRINDING DISCS**



**APPLICATIONS**

- For general metal grinding applications on ferrous and non-ferrous metals, including weld and surface preparation.

**FEATURES**

- Professional grade aluminium oxide.
- Reinforced fibre glass.
- Premium resin bond.

**DEPRESSED CENTRE**

Cat. No.	Diameter mm	Material	Thickness mm	Bore Size mm	Pack Qty.	M.O.Q.	Barcode	List Price Ex. VAT (£)
DT3458-QZ	115	A24TBF	4.5	22.2	1	25	5035048014806	1,56
DT3402-QZ	115	A24TBF	6.0	22.2	1	25	5011402375660	3,24
DT3412-QZ	125	A24TBF	6.0	22.2	1	25	5011402375691	3,60
DT3416-QZ	150	A24TBF	6.0	22.2	1	10	5035048059487	2,08
DT3422-QZ	180	A24TBF	6.0	22.2	1	25	5011402375721	4,67
DT3432-QZ	230	A24TBF	7	22.2	1	25	5011402375752	8,12

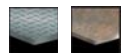

**CHOP SAW WHEEL – FOR METAL**



**APPLICATIONS**

- Cutting ferrous metals such as steel, iron, rebar and welds.

**FEATURES**

- Professional grade aluminium oxide.
- Premium resin bond.
- Reinforced fibre glass.

**CHOP SAW WHEEL – FOR METAL**

Cat. No.	Diameter mm	Material	Thickness mm	Bore Size mm	Pack Qty.	M.O.Q.	Barcode	List Price Ex. VAT (£)
DT3450-QZ	355	A30TBF	3	25.4	1	10	5011402375769	17,80

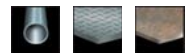

STAINLESS STEEL AND THIN METAL CUTTING DISCS



APPLICATIONS

- For cutting all types of steel.

FEATURES

- Professional grade aluminium oxide formulation for high durability, aggressive cutting action and long life.

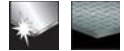

FLAT

Cat. No.	Diameter mm	Material	Thickness mm	Bore Size mm	Pack Qty.	M.O.Q.	Barcode	List Price Ex. VAT (€)
DT3440-QZ	100	A60TBF	1.0	16.0	1	25	5035048014707	1,04
DT3442-QZ	115	A60TBF	1.0	22.2	1	25	5035048014714	1,36
DT3445-QZ	125	A60TBF	1.0	22.2	1	25	5035048014738	1,56
DT3485-QZ	115	A60SBF	1.0	22.2	1	25	5035048077481	NOT UK
DT3486-QZ	125	A60SBF	1.0	22.2	1	25	5035048077498	NOT UK
DT3443-QZ*	115	A/ WA30T BF	2.5	22.2	1	25	5035048014721	1,36
DT3446-QZ*	125	A/ WA30T BF	2.5	22.2	1	25	5035048014745	1,56
DT3447-QZ*	180	A/ WA30T BF	2.8	22.2	1	25	5035048014752	2,32
DT3449-QZ*	230	A/ WA30T BF	2.8	22.2	1	25	5035048014769	3,48

\*EXTREME DEWALT

STAINLESS STEEL GRINDING DISCS



APPLICATIONS

- For cutting all types of steel.

FEATURES

- Professional grade aluminium oxide formulation for high durability, aggressive cutting action and long life.

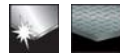

DEPRESSED CENTRE

Cat. No.	Diameter mm	Material	Thickness mm	Bore Size mm	Pack Qty.	M.O.Q.	Barcode	List Price Ex. VAT (€)
DT3467-QZ	115	A/ WA24T BF	4.5	22.2	1	25	5035048014851	1,72
DT3468-QZ	125	A/ WA24T BF	4.5	22.2	1	25	5035048014868	1,76

ALUMINIUM CUTTING DISCS



APPLICATIONS

- Fast cutting and long life in aluminium.

FEATURES

- Professional grade aluminium oxide and silicone carbide.
- Premium resin bond.
- Reinforced fibre glass.



FLAT

Cat. No.	Diameter mm	Material	Thickness mm	Bore Size mm	Pack Qty.	M.O.Q.	Barcode	List Price Ex. VAT (€)
DT3453-QZ	115	AC46TBF	1.6	22.2	1	25	5035048014776	1,36
DT3454-QZ	125	AC46TBF	1.6	22.2	1	25	5035048014783	1,56

HIGH SPEED STONE CUTTING DISCS



APPLICATIONS

- For cutting natural stone, concrete, brick.

FEATURES

- Professional grade silicon carbide for aggressive cutting action and long life.



HIGH SPEED STONE CUTTING DISCS

Cat. No.	Diameter mm	Material	Thickness mm	Bore Size mm	Pack Qty.	M.O.Q.	Barcode	List Price Ex. VAT (€)
DT3476-QZ	300	C24RBF	3.5	20.0	1	10	5035048074916	8,44
DT3477-QZ	300	C24RBF	3.5	25.4	1	10	5035048074923	NOT UK

**STONE CUTTING DISCS**



**APPLICATIONS**

- For cutting general masonry products including concrete, stone and aggregate.

**FEATURES**

- Professional grade silicon carbide.
- Premium resin bond.
- Fibre glass reinforcements.



**FLAT**

Cat. No.	Diameter mm	Material	Thickness mm	Bore Size mm	Pack Qty.	M.O.Q.	Barcode	List Price Ex. VAT (£)
DT3401-QZ	115	C30TBF	2.5	22.2	1	25	5011402375653	2,26
DT3411-QZ	125	C30TBF	2.5	22.2	1	25	5011402375684	2,60
DT3421-QZ	180	C30TBF	3	22.2	1	25	5011402375714	3,07
DT3431-QZ	230	C30TBF	3	22.2	1	25	5011402375745	5,08

**DEPRESSED CENTRE**

Cat. No.	Diameter mm	Material	Thickness mm	Bore Size mm	Pack Qty.	M.O.Q.	Barcode	List Price Ex. VAT (£)
DT3407-QZ	115	C30TBF	2.5	22.2	1	25	5035048014660	1,36
DT3414-QZ	125	C30TBF	2.5	22.2	1	25	5035048014677	1,44
DT3424-QZ	180	C30TBF	3.0	22.2	1	25	5035048014684	2,32
DT3434-QZ	230	C30TBF	3.0	22.2	1	25	5038048014691	3,48

**STONE GRINDING DISCS**



**APPLICATIONS**

- For cutting general masonry products including concrete, stone and aggregate.

**FEATURES**

- Professional grade silicon carbide.
- Premium resin bond.
- Fibre glass reinforcements.



**DEPRESSED CENTRE**

Cat. No.	Diameter mm	Material	Thickness mm	Bore Size mm	Pack Qty.	M.O.Q.	Barcode	List Price Ex. VAT (£)
DT3461-QZ	115	C24TBF	7.0	22.2	1	25	5035048014813	1,96
DT3462-QZ	125	C24TBF	7.0	22.2	1	25	5035048014820	2,00
DT3464-QZ	230	C24TBF	7.0	22.2	1	25	5038048014844	5,48

**GRINDING AND HONING WHEELS**

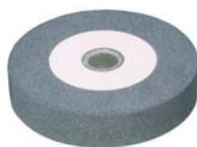

**GRINDING AND HONING WHEELS**

Cat. No.	Grit Size	Material	Diameter mm	Width mm	Bore Size mm	M.O.Q.	Barcode	List Price Ex. VAT (£)
DT3384-QZ	60	Blue Aluminium Oxide	125	25	20	1	5035048054093	24,09
DT3385-QZ	80	White Aluminium Oxide	125	25	20	1	5035048054116	24,09
DT3386-QZ	80	Silicon Carbide	125	25	20	1	5035048054130	39,50
DT3389-QZ	60	White Aluminium Oxide	150	20	20	1	5035048054161	40,66
DT3380-QZ	400	Silicon Carbide	125	25	20	1	5035048054048	126,82
DT3381-QZ	800	Silicon Carbide	125	12	20	1	5035048054055	106,92



**GRINDING CUPS**



**APPLICATIONS**

- For manual grinding large surface areas of natural and synthetic stones.

**FEATURES**

- Professional grade silicon carbide for high removal rate.
- Available in coarse and medium.



**GRINDING CUPS**

Cat. No.	Diameter mm	Material	Thickness mm	Bore Size mm	Pack Qty.	M.O.Q.	Barcode	List Price Ex. VAT (£)
DT3551-QZ	110	C16	55	22.2	1	1	5035048082997	NOT UK
DT3552-QZ	110	C24	55	22.2	1	1	5035048083000	NOT UK

## WIRE BRUSHES



## APPLICATIONS

- Aggressive twist knot wire wheel and cup brushes for heavy duty cleaning work, derusting and deburring
- Crimped wire wheel and cup brushes for medium duty cleaning
- Wire wheel and cup brushes for multi purpose cleaning applications in hard to reach areas

## FEATURES

- Highly specified wire grades for optimum material removal
- High wire content for extra brush durability

## WIRE WHEEL BRUSHES FOR DRILLS For: Cleaning Work eg Paint, Rust, Scale, Burr and Rust Removal

Cat. No.	Diameter mm	Wire Length mm	Bore Size mm	Pack Qty.	M.O.Q.	Barcode	List Price Ex. VAT (£)
DT3496-OZ	40	8	6	1	1	5035048079423	NOT UK
DT3494-OZ	50	8	6	1	1	5035048079430	NOT UK
DT3408-OZ	60	10	6	1	1	5035048079447	NOT UK
DT3418-OZ	75	10	6	1	1	5035048078454	NOT UK
DT3419-OZ	100	10	6	1	1	5035048079461	NOT UK
DT3425-OZ	75	10	6	1	1	5035048079478	NOT UK
DT3426-OZ	75	10	6	1	1	5035048079485	18,72

## WIRE CUP BRUSHES FOR DRILLS For: Medium duty work on surfaces eg paint removal, de-rusting, cleaning, deburring, descaling

Cat. No.	Diameter mm	Wire Length mm	Bore Size mm	Pack Qty.	M.O.Q.	Barcode	List Price Ex. VAT (£)
DT3427-OZ	17	25	6	1	1	5035048079492	NOT UK
DT3428-OZ	25	25	6	1	1	5035048079508	NOT UK
DT3429-OZ	30	30	6	1	1	5035048079515	NOT UK
DT3435-OZ	40	17	6	1	1	5035048079522	NOT UK
DT3436-OZ	50	16	6	1	1	5035048079539	7,24
DT3437-OZ	60	18	6	1	1	5035048079546	NOT UK
DT3439-OZ	75	19	6	1	1	5035048079560	NOT UK
DT3441-OZ	50	16	6	1	1	5035048079577	NOT UK
DT3495-OZ	50	16	6	1	1	5035048079584	NOT UK

## CRIMPED WIRE WHEEL BRUSHES FOR BENCH GRINDERS For: Light and medium cleaning jobs

Cat. No.	Diameter mm	Wire Length mm	Bore Size mm	Pack Qty.	M.O.Q.	Barcode	List Price Ex. VAT (£)
DT3451-OZ	100	20	20	1	1	5035048079607	NOT UK
DT3455-OZ	115	20	20	1	1	5035048079621	NOT UK
DT3448-OZ	125	20	20	1	1	5035048079591	NOT UK
DT3456-OZ	150	25	32	1	1	5035048079638	NOT UK
DT3459-OZ	200	25	32	1	1	5035048079645	NOT UK

## TWIST KNOT WIRE WHEEL BRUSHES FOR ANGLE GRINDERS For: Heavy duty cleaning work eg deburring, paint stripping, rust removal

Cat. No.	Diameter mm	Wire Length mm	Bore Size mm	Pack Qty.	M.O.Q.	Barcode	List Price Ex. VAT (£)
DT3475-OZ	100	22	16	1	1	5035048079652	NOT UK
DT3466-OZ	115	22	22.2	1	1	5035048079676	NOT UK
DT3502-OZ	115	22	22.2	1	1	5011402375790	16,62
DT3452-OZ	150	22	22.2	1	1	5035048079614	NOT UK
DT3470-OZ	180	40	22.2	1	1	5035048079683	NOT UK

## CRIMPED WIRE CUP BRUSHES FOR ANGLE GRINDERS For: Medium duty work on surfaces eg paint removal, de-rusting, cleaning, deburring

Cat. No.	Diameter mm	Wire Length mm	Bore Size mm	Pack Qty.	M.O.Q.	Barcode	List Price Ex. VAT (£)
DT3475-OZ	65	19	M10	1	1	5035048079690	NOT UK
DT3480-OZ	65	19	M14	1	1	5035048079706	7,07
DT3488-OZ	75	23	M14	1	1	5035048079713	7,90
DT3489-OZ	100	26	M14	1	1	5035048079720	13,31
DT3490-OZ	100	26	5/8"	1	1	5035048079737	NOT UK
DT3465-OZ	125	26	M14	1	1	5035048079669	NOT UK

## TWIST KNOT WIRE CUP BRUSHES FOR ANGLE GRINDERS For: Heavy duty cleaning work

Cat. No.	Diameter mm	Wire Length mm	Bore Size mm	Pack Qty.	M.O.Q.	Barcode	List Price Ex. VAT (£)
DT3491-OZ	60	18	M10	1	1	5035048079744	NOT UK
DT3500-OZ	65	18	M14	1	1	5011402375776	14,13
DT3492-OZ	75	22	M14	1	1	5035048079751	12,27
DT3501-OZ	100	24	M14	1	1	5011402375783	20,38
DT3493-OZ	100	24	5/8"	1	1	5035048079768	25,69



**SELECT THE BLADE FOR THE MATERIAL**



	Professional High Performance					Professional Sintered		
	Building materials/ Concrete	Abrasive Materials/ Concrete	Hard Concrete/ Granite	Tile	Asphalt	Building materials/ Concrete	Turbo-Building Materials/Concrete	Tile
	1	2	3	4	6			
VERY ABRASIVE AND NOT COMPACT								
ASPHALT					●			
GREEN CONCRETE					●			
LIGHT EXPANDED CLAY BLOCK (Argex, Syporex, Porolon)	○	●			●			
SILICA BASED ABRASIVE REFRACTORY (Brick)	○	●			●			
BREEZE BLOCK	●	●			●			
MEDIUM-ABRASIVE AND COMPACT								
MARBLE CEMENT BLOCK (Granito, Terrazo)	●	●		○	○	○	○	○
FIBROUS CONCRETE (Eternit roof tile)								
CELLULAR CONCRETE	●	●		○	○	○	○	○
FIRED CLAY (Brick, roof tile)								
GYPSUM PLASTER	●	●		○	○	●	○	○
NATURAL SOFT STONES (Limestone, Sandstone)	●	●		○	○	●	○	○
SOFT REFRACTORY (Hand made bricks, abrasive concrete)	●	●	○	○	○	●	○	○
CONCRETE ROOF TILE	●	●	○	○		●	○	
KALKSANDSTEIN (KSS)	●	●	○			●	●	
ABRASIVE AND VERY COMPACT								
SOFT AGGREGATES CONCRETE (Industrial floors)	●	●	○			●	●	
MEDIUM-HARD SANDSTONE	●	●	○			●	●	
ABRASIVE MARBLE (Crystalline)	●	●	○			●	●	
MEDIUM-HARD REFRACTORY (Facing bricks, Limestone concrete)	●	●	○			●	●	
FIRED CLAY, EARTHENWARE PIPE	●	●	○			●	●	
MEDIUM-HARD AND COMPACT								
NATURAL SLATE, SCHIST	●	○	○			○	○	
CONCRETE (Kerb, Paving block, Driveway blocks)	●		○			○		
LIGHT REINFORCED CONCRETE	●		●			○		
MEDIUM-HARD AGGREGATES CONCRETE (Industrial floors)	●		●			○		
CURED CONCRETE, MEDIUM-HARD AGGREGATES	●		●			○	○	
HARD NATURAL SANDSTONE	●		●			○	○	
HARD AND COMPACT								
HARD MARBLE	○		●			○		
REINFORCED CONCRETE (Lintels)	○		●			○		
CURED CONCRETE, HARD AGGREGATES, FLINT	○		●					
FACING BRICK	○		●					
QUARTZITE			●					
HARD REFRACTORY (Hard bricks, Medium concrete)			●					
SOFT GRANITE (Black)			●					
VERY HARD								
LIGHT REINFORCED CONCRETE, FLINT AGGREGATES			●					
COLOURED GRANITE			●					
SILICON CARBIDE REFRACTORIES (Bricks)			●					
OTHERS								
SOFT TILE (Terracotta, Ceramic)				○			○	●
HARD TILE (Grès)				●				
STONEWARE (Porcelain tiles)				●				
MORTAR (Joints)								

● Recommended Material      ○ Suitable Material

## HIGH PERFORMANCE DIAMOND DISCS

## APPLICATIONS

- For use in standard construction materials including concrete, brick, tiles and paving slabs.



## LASER: BUILDING MATERIALS/ CONCRETE

Cat. No.	Diameter mm	Bore Size mm	Segment Height mm	Segment Width mm	Pack Qty.	M.O.Q.	Barcode	List Price Ex. VAT (£)
DT3740-XJ	115	22.2	7.5	2	1	1	5035048058374	18,33
DT3741-XJ	125	22.2	7.5	2	1	1	5035048058381	21,63
DT3742-XJ	180	22.2	8.5	2.4	1	1	5035048058398	NOT UK
DT3743-XJ	230	22.2	8.5	2.4	1	1	5035048058404	49,73
DT3744-XJ	300	20	8.5	2.8	1	1	5035048058411	86,40
DT3747-XJ	350	20	8.5	2.8	1	1	5035048058442	109,47
DT3749-XJ	350	25.4	8.5	2.8	1	1	5035048058466	109,47

## FEATURES

- The best choice of diamond blade for fast, aggressive cuts in most standard construction materials.
- Segments laser welded to the core for use in tougher applications.
- High quality, low carbon steel core reduces core distortion at high temperatures, giving better cutting performance and longer life.

## APPLICATIONS

- For use in abrasive materials including sandstone, concrete, concrete roof tiles, brick and breeze blocks.



## LASER: ABRASIVE MATERIALS/ CONCRETE

Cat. No.	Diameter mm	Bore Size mm	Segment Height mm	Segment Width mm	Pack Qty.	M.O.Q.	Barcode	List Price Ex. VAT (£)
DT3770-XJ	115	22.2	7.5	2	1	1	5035048058572	20,47
DT3771-XJ	125	22.2	7.5	2	1	1	5035048058589	23,40
DT3772-XJ	180	22.2	7.5	2.4	1	1	5035048058596	NOT UK
DT3773-XJ	230	22.2	7.5	2.4	1	1	5035048058602	54,47
DT3774-XJ	300	20	7.5	2.8	1	1	5035048058619	97,33
DT3777-XJ	350	20	7.5	2.8	1	1	5035048058640	125,00
DT3779-XJ	350	25.4	7.5	2.8	1	1	5035048058664	124,99

## FEATURES

- High performance diamond blade providing a balanced combination of cut speed and durability in abrasive materials.
- Segments laser welded to the core for use in tougher applications.
- High quality, low carbon steel core gives better cutting performance and longer life.

## APPLICATIONS

- These blades achieve optimum speed of cut in granite, reinforced concrete and most construction materials.



## LASER: HARD MATERIALS/ GRANITE

Cat. No.	Diameter mm	Bore Size mm	Segment Height mm	Segment Width mm	Pack Qty.	M.O.Q.	Barcode	List Price Ex. VAT (£)
DT3760-XJ	115	22.2	7.5	2	1	1	5035048058473	20,00
DT3761-XJ	125	22.2	7.5	2	1	1	5035048058480	22,90
DT3762-XJ	180	22.2	8.5	2.4	1	1	5035048058497	NOT UK
DT3763-XJ	230	22.2	8.5	2.8	1	1	5035048058503	53,47
DT3766-XJ	230	22.2	10	2.8	1	1	5035048058534	NOT UK
DT3764-XJ	300	20	8.5	2.8	1	1	5035048058510	95,83
DT3767-XJ	350	20	8.5	2.8	1	1	5035048058541	122,10
DT3769-XJ	350	25.4	8.5	2.8	1	1	5035048058565	323,87

## FEATURES

- Manufactured using 'Advanced Bond Technology' which increases blade productivity and operating life.
- A layer of pre-alloyed metal encloses the diamond creating a pellet that is held more securely and distributed better within the segment.
- Segments laser welded to the core for use in tougher applications.
- High quality, low carbon steel core gives better cutting performance and longer life.

## APPLICATIONS

- For porcelain tiles, floor and wall tiles, slate, concrete tiles, bricks, terracotta etc.
- Not recommended for use on wet tile saws.

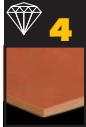

## SINTERED: TILES

Cat. No.	Diameter mm	Bore Size mm	Segment Height mm	Segment Width mm	Pack Qty.	M.O.Q.	Barcode	List Price Ex. VAT (£)
DT3735-XJ	115	22.2	7	1.6	1	1	5035048058732	8,67
DT3736-XJ	125	22.2	7	1.6	1	1	5035048058749	10,00
DT3737-XJ	180	22.2	7	2.1	1	1	5035048058756	NOT UK
DT3738-XJ	230	22.2	7	2.1	1	1	5035048058763	23,33

## FEATURES

- Diamond blade containing a high concentration of top quality diamonds with excellent cutting performance in extremely hard materials.
- Continuous rim sintered blade for fine finish and minimal chipping in tiles and ceramics.
- High quality, low carbon steel core reduces core distortion at high temperatures, giving better cutting performance and longer life.

## APPLICATIONS

- Ideal for use in very abrasive materials such as asphalt and green concrete, these blades can be used in wet or dry applications.



## LASER: ASPHALT

Cat. No.	Diameter mm	Bore Size mm	Segment Height mm	Segment Width mm	Pack Qty.	M.O.Q.	Barcode	List Price Ex. VAT (£)
DT3780-XJ	300	20	7.5	2.8	1	1	5035048058671	138,67
DT3783-XJ	350	20	7.5	3.2	1	1	5035048058701	169,90
DT3785-XJ	350	25.4	7.5	3.2	1	1	5035048058725	169,90

## FEATURES

- Featuring a hard bond coupled with a high concentration of diamonds, giving optimum speed and a long service life.
- Designed to be used on petrol saws, utilised hand held / placed on a cart or on lightweight floor saws.
- Segments laser welded to the core for use in tougher applications.
- High quality, low carbon steel core gives better cutting performance and longer life.

**DRY DIAMOND DISCS**



**APPLICATIONS**

- Fast, dry cutting of general masonry construction materials eg. building bricks/blocks, tiles, paving blocks, medium concrete.

**FEATURES**

- Segmented rim design allows fast cutting.
- Sintered diamond wheel for dry cutting general masonry materials.
- All wheels up to 230 mm diameter have 22.2 mm bore.
- 300 mm wheel has a 20 mm bore for petrol saws.

**DRY DIAMOND SEGMENTED RIM WHEELS**

Cat. No.	Diameter mm	Bore Size mm	Segment Height mm	Segment Width mm	Pack Qty.	M.O.Q.	Barcode	List Price Ex. VAT (£)
DT3701-QZ	115	22.2	7	1.75	1	1	5035048025895	10,00
DT3711-QZ	125	22.2	7	1.8	1	1	5035048025901	12,50
DT3721-QZ	180	22.2	7	2.1	1	1	5035048025918	NOT UK
DT3731-QZ	230	22.2	7	2.3	1	1	5035048025925	34,13
DT3751-QZ	300	20	7	2.8	1	1	5035048025932	72,80



**APPLICATIONS**

- Cool clean cutting of masonry construction materials particularly suitable for marble, granite and natural stone.

**FEATURES**

- Sintered diamond wheel for dry cutting general masonry materials.
- Turbo rim design provides cooler, cleaner cutting of harder materials.
- All wheels have 22.2 mm bore.

**TURBO DRY DIAMOND CUTTING WHEELS**

Cat. No.	Diameter mm	Bore Size mm	Segment Height mm	Segment Width mm	Pack Qty.	M.O.Q.	Barcode	List Price Ex. VAT (£)
DT3702-QZ	115	22.2	7	2.1	1	1	5035048025970	12,17
DT3712-QZ	125	22.2	7	2.2	1	1	5035048025987	NOT UK
DT3722-QZ	180	22.2	7	2.4	1	1	5035048025994	NOT UK
DT3732-QZ	230	22.2	7	2.6	1	1	5035048026007	NOT UK



**APPLICATIONS**

- Fine finish cutting tiles, ceramics etc.

**FEATURES**

- Continuous rim design for fine finish in hard materials.
- Sintered dry cutting wheel with 22.2mm bore.

**DRY DIAMOND CONTINUOUS RIM WHEELS**

Cat. No.	Diameter mm	Bore Size mm	Segment Height mm	Segment Width mm	Pack Qty.	M.O.Q.	Barcode	List Price Ex. VAT (£)
DT3703-QZ	115	22.2	5	1.6	1	1	5035048025956	10,00
DT3713-QZ	125	22.2	5	1.6	1	1	5035048025963	NOT UK



**WET DIAMOND TILE SAW**

**APPLICATIONS**

- Fine finish cutting tiles, ceramics etc.

**FEATURES**

- Continuous rim design for fine finish in hard materials.
- Sintered dry cutting wheel with 25.4mm bore.
- Music slots for hard materials eg. stone and granite (DT3734XJ).



**WET DIAMOND TILE SAW**

Cat. No.	Diameter mm	Bore Size mm	Segment Height mm	Segment Width mm	Pack Qty.	M.O.Q.	Barcode	List Price Ex. VAT (£)
DT3733-XJ	250	25.4	5	1.6	1	1	5035048012413	63,33
DT3734-XJ	250	25.4	8	1.6	1	1	5035048012420	76,67



**WET & DRY TILE SAW**



**APPLICATIONS**

- For manual wet and dry cutting of tiles.

**FEATURES**

- Continuous rim design for fine finish in all tile materials
- DT3715-QZ designed for extra fine finish in porcelain, marble and granite tiles.

**WET & DRY TILE SAW**

Cat. No.	Diameter mm	Bore Size mm	Segment Height mm	Segment Width mm	Pack Qty.	M.O.Q.	Barcode	List Price Ex. VAT (£)
DT3714-QZ	110	20	5	1.6	1	1	5035048083109	32,00
DT3715-QZ	110	20	8	1.6	1	1	5035048083116	48,00



DRY DIAMOND CORE DRILLS



APPLICATIONS

- Standard 1/2" BSP female fitment to allow usage with DEWALT and other diamond drill brands (use in conjunction with adaptor for machines with different threads).
- For dry drilling clean large diameter holes in masonry and stone.

FEATURES

- Optimised diamond segment design for high speed drilling and long life in a wide range of building materials.
- Laser welding to prevent segment loss when dry drilling
- Solid core body for optimum dust extraction performance.



FITMENT 1/2" BSP (FEMALE) UNIVERSAL

Cat. No.	Diameter mm	Length mm	Number of Segments	Pack Qty.	M.O.Q.	Barcode	List Price Ex. VAT (£)
DT3876-QZ	28	300	1	1	1	5035048070918	126.53
DT3877-QZ	32	300	1	1	1	5035048070925	236.25
DT3885-QZ	38	150	3	1	1	5035048070932	108.40
DT3886-QZ	48	150	4	1	1	5035048070949	125.43
DT3887-QZ	52	150	3	1	1	5035048070956	103.33
DT3888-QZ	60	150	3	1	1	5035048070963	236.88
DT3889-QZ	65	150	3	1	1	5035048070970	236.88
DT3890-QZ	72	150	4	1	1	5035048070987	286.65
DT3891-QZ	78	150	4	1	1	5035048070994	160.00
DT3892-QZ	82	150	4	1	1	5035048071007	305.55
DT3893-QZ	91	150	4	1	1	5035048071014	324.45
DT3894-QZ	107	150	4	1	1	5035048071021	143.33
DT3895-QZ	117	150	5	1	1	5035048071038	166.67
DT3896-QZ	127	150	5	1	1	5035048071045	220.00
DT3897-QZ	132	150	5	1	1	5035048071052	453.60
DT3898-QZ	152	150	6	1	1	5035048071069	266.67

DOSENSENER

APPLICATIONS

- User length of 62mm, M16 fitment.
- Used for electrical installations e.g wall sockets or boxes etc.

DOSENSENER

Cat. No.	Diameter mm	Length mm	Thread	Number of Segments	Pack Qty.	M.O.Q.	Barcode	List Price Ex. VAT (£)
DT3865-QZ	68	62	M16F	3	1	1	5035048071076	84.98
DT3866-QZ	82	62	M16F	4	1	1	5035048071083	104.12

ACCESSORIES FOR DOSENSENER

Cat. No.	Thread Conversion from	Thread Conversion to	Range	Pack Qty.	M.O.Q.	Barcode	List Price Ex. VAT (£)
DT3864-QZ	1/2" BSP F	M16M	Dry	1	1	5035048072349	NOT UK
DT3868-QZ	3 Jaw Chuck	M16M	Dry	1	1	5035048072356	NOT UK
DT3869-QZ	SDS Plus	M16M	Dry	1	1	5035048072363	NOT UK
DT3873-QZ	120mm A Taper pilot drill		Dry	1	1	5035048066607	NOT UK

ADAPTORS DRY

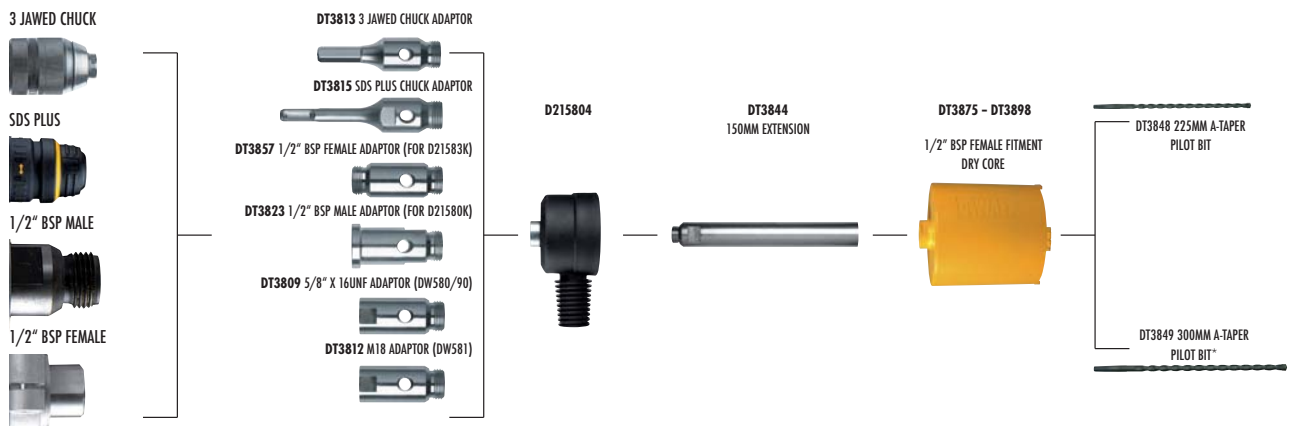

\* 300mm Pilot bit required when dust extraction system is used.

**WET DIAMOND CORE BITS**



**APPLICATIONS**

- Standard 1/2 BSP male fitment to allow usage with DeWALT and other diamond drill brands (use in conjunction with adaptor for machines with different threads).

**FEATURES**

- Optimised diamond segment design for high speed drilling and long life in a wide range of building materials.
- Laser welding to prevent segment loss when wet drilling.
- Available in 2 performance grades for fast cutting and long life in both standard and hard materials.



**FITMENT 1/2" BSP (MALE) UNIVERSAL**

Cat. No.	Diameter mm	Length mm	Number of Segments	Pack Qty.	M.O.Q.	Barcode	List Price Ex. VAT (£)
DT9710-QZ	25	350	1	1	1	5035048071274	152.38
DT9712-QZ	30	350	1	1	1	5035048071298	156.66
DT9714-QZ	37	350	4	1	1	5035048071311	126.85
DT9715-QZ	40	350	4	1	1	5035048071328	181.28
DT9716-QZ	45	350	5	1	1	5035048071335	149.93
DT9717-QZ	52	350	5	1	1	5035048071342	213.99
DT9718-QZ	60	350	6	1	1	5035048071359	216.55
DT9719-QZ	65	350	7	1	1	5035048071366	262.56
DT9720-QZ	72	350	7	1	1	5035048071373	272.26
DT9721-QZ	78	350	8	1	1	5035048071380	294.95
DT9722-QZ	82	350	8	1	1	5035048071397	269.34
DT9724-QZ	102	350	9	1	1	5035048071410	333.13
DT9726-QZ	112	350	10	1	1	5035048071434	362.04
DT9727-QZ	122	350	11	1	1	5035048071441	443.16
DT9728-QZ	127	350	11	1	1	5035048071458	402.36
DT9729-QZ	132	350	12	1	1	5035048071465	424.59
DT9730-QZ	152	350	13	1	1	5035048071472	466.95

**APPLICATIONS**

- Standard 1/2 BSP male fitment to allow usage with DeWALT and other diamond drill brands (use in conjunction with adaptor for machines with different threads).

**FEATURES**

- Optimised diamond segment design for use with hard materials.
- Laser welding to prevent segment loss when wet drilling.



**FITMENT 1/2" BSP (MALE) HARD MATERIALS**

Cat. No.	Diameter mm	Length mm	Number of Segments	Pack Qty.	M.O.Q.	Barcode	List Price Ex. VAT (£)
DT9735-QZ	25	350	1	1	1	5035048071489	167.19
DT9736-QZ	28	350	1	1	1	5035048071496	172.62
DT9737-QZ	30	350	1	1	1	5035048071502	171.99
DT9738-QZ	32	350	1	1	1	5035048071519	173.97
DT9740-QZ	40	350	4	1	1	5035048071533	199.65
DT9742-QZ	52	350	5	1	1	5035048074557	236.01
DT9743-QZ	60	350	6	1	1	5035048071564	238.88
DT9744-QZ	65	350	7	1	1	5035048071571	290.67
DT9746-QZ	78	350	8	1	1	5035048071595	325.52
DT9747-QZ	82	350	8	1	1	5035048071601	296.77
DT9748-QZ	91	350	9	1	1	5035048071618	361.31
DT9749-QZ	102	350	9	1	1	5035048071625	366.16
DT9751-QZ	112	350	10	1	1	5035048071649	309.48
DT9752-QZ	122	350	11	1	1	5035048071656	378.84
DT9753-QZ	127	350	11	1	1	5035048071663	348.84
DT9754-QZ	132	350	12	1	1	5035048071670	469.14
DT9755-QZ	152	350	13	1	1	5035048071687	399.03

**APPLICATIONS**

- Standard 1 1/4" UNC female fitment to allow usage with DeWALT and other diamond drill brands (use in conjunction with adaptor for machines with different threads).

**FEATURES**

- Optimised diamond segment design for high speed drilling and long life in a wide range of building materials.
- Available in 2 performance grades for fast cutting and long life in both standard and hard materials.



**FITMENT 1 1/4" UNC (FEMALE) UNIVERSAL**

Cat. No.	Diameter mm	Length mm	Number of Segments	Pack Qty.	M.O.Q.	Barcode	List Price Ex. VAT (£)
DT9760-QZ	52	400	5	1	1	5035048071694	221.18
DT9761-QZ	60	400	6	1	1	5035048071700	175.57
DT9762-QZ	65	400	7	1	1	5035048071717	269.86
DT9763-QZ	72	400	7	1	1	5035048071724	279.46
DT9764-QZ	78	400	8	1	1	5035048071731	302.20
DT9765-QZ	82	400	8	1	1	5035048071748	276.64
DT9766-QZ	91	400	9	1	1	5035048071755	333.87
DT9767-QZ	102	400	9	1	1	5035048071762	340.39
DT9768-QZ	107	400	10	1	1	5035048071779	308.89
DT9769-QZ	112	400	10	1	1	5035048071786	369.35
DT9770-QZ	122	400	11	1	1	5035048071793	450.41
DT9771-QZ	127	400	11	1	1	5035048071809	409.67
DT9772-QZ	132	400	12	1	1	5035048071816	285.35
DT9773-QZ	152	400	13	1	1	5035048071823	317.93
DT9774-QZ	162	400	13	1	1	5035048071830	586.88
DT9775-QZ	178	400	14	1	1	5035048071847	501.59
DT9776-QZ	187	400	15	1	1	5035048071854	665.81
DT9777-QZ	200	400	16	1	1	5035048071861	587.82
DT9778-QZ	212	400	16	1	1	5035048071878	616.40
DT9779-QZ	225	400	17	1	1	5035048071885	808.49
DT9780-QZ	250	400	17	1	1	5035048071892	904.21
DT9781-QZ	300	400	22	1	1	5035048071908	889.79

ACCESSORIES



ADAPTORS

Cat. No.	Thread Conversion from	Thread Conversion to	Applications	Pack Qty.	M.O.Q.	Barcode	List Price Ex. VAT (£)
DT3800-QZ	1/2" BSP M	1 1/4" UNC M	Wet	1	1	5035048071106	58,21
DT3801-QZ	Hilti DCM1/DD80	1/2" BSP F	Wet	1	1	5035048071113	166,45
DT3803-QZ	Hilti DCM1.5, DD1160, DCM2, DD250	1 1/4" UNC M	Wet	1	1	5035048071120	293,27
DT3809-QZ	5/8" x 16UNF	1/2" BSP M	Dry	1	1	5035048071137	39,18
DT3812-QZ	M18	1/2" BSP M	Dry	1	1	5035048071144	38,05
DT3813-QZ	3 jaw chuck	1/2" BSP M	Dry	1	1	5035048071151	23,43
DT3815-QZ	SDS Plus	1/2" BSP M	Dry	1	1	5035048071168	42,45
DT3823-QZ	1/2" BSP F	1/2" BSP M	Dry	1	1	5035048071182	48,82
DT3857-QZ	1/2" BSP M	1/2" BSP M	Wet to Dry	1	1	5035048071946	59,19
DT3858-QZ	1 1/4" UNC F	1/2" BSP F	Wet	1	1	5035048072325	53,58

EXTENSION RODS



Cat. No.	Thread Conversion from	Thread Conversion to	Length mm	Applications	Pack Qty.	M.O.Q.	Barcode	List Price Ex. VAT (£)
DT3829-QZ	1 1/4" UNC F	1 1/4" UNC M	150	Wet	1	1	5035048071199	65,32
DT3839-QZ	1 1/4" UNC F	1 1/4" UNC M	300	Wet	1	1	5035048071205	80,01
DT3846-QZ	1/2" BSP M	1/2" BSP F	150	Wet	1	1	5035048071236	57,15
DT3844-QZ	1/2" BSP F	1/2" BSP M	150	Dry	1	1	5035048071212	81,64
DT3847-QZ	1/2" BSP M	1/2" BSP F	300	Wet	1	1	5035048071243	65,32



PILOT BITS

Cat. No.	Length mm	Applications	Pack Qty.	M.O.Q.	Barcode	List Price Ex. VAT (£)
DT3848-QZ	225	Dry	1	1	5035048071250	15,92
DT3849-QZ	300	Dry	1	1	5035048071267	31,02

ADAPTORS WET

1 1/4" UNC MALE



DT3800 1/2" BSP FEMALE TO 1 1/4" UNC MALE



DT3803 HILTI TO 1 1/4" UNC



DT3801 HILTI TO 1/2" BSP FEMALE



1/2" BSP FEMALE



DT3829 150mm 1 1/4" UNC



DT3839 300mm 1 1/4" UNC



DT3846 150mm 1/2" BSP



DT3847 300mm 1/2" BSP



1 1/4" UNC WET CORES



1/2" BSP MALE GENERAL MATERIAL WET CORE



1/2" BSP MALE HARD MATERIAL WET CORE



DIAMOND TILE DRILL BITS



APPLICATIONS

- Diamond grit edged head - tough & hard wearing - enables 'easy start' drilling at 45° into material and copes with almost any hardness of tile.
- Open head design helps more effective cooling with water.
- Ejection slot enables easy removal of material 'core' after drilling in deeper tiles.

FEATURES

- Clean concentric holes in all wall and floor tiles (up to and including Class 5 hardness), porcelain, marble, granite and slate. Ideal for installing fixtures and fittings in bathrooms and kitchens.



Cat. No.	Diameter mm	Description	Pack Qty.	M.O.Q.	Barcode	List Price Ex. VAT (£)
DT6037-QZ	5	Diamond Tile Drill	1	1	5035048066300	24,24
DT6038-QZ	6	Diamond Tile Drill	1	1	5035048066317	24,24
DT6039-QZ	7	Diamond Tile Drill	1	1	5035048066324	24,24
DT6040-QZ	8	Diamond Tile Drill	1	1	5035048066331	24,24
DT6041-QZ	10	Diamond Tile Drill	1	1	5035048066348	24,24
DT6042-QZ	12	Diamond Tile Drill	1	1	5035048066355	28,32
DT6043-QZ	15	Diamond Tile Drill	1	1	5035048066362	34,16
DT6044-QZ	20	Diamond Tile Drill	1	1	5035048066379	35,68
DT6045-QZ	25	Diamond Tile Drill	1	1	5035048066386	48,00
DT6046-QZ	-	Mixed Pack Diamond Tile Drill	1	1	5035048066393	147,08

**NAILS**



DC618



**NAILS FOR CORDLESS FINISHING NAILERS (16 GAUGE 20°)**

Cat. No.	Description	Type	Diameter mm	Length mm	Pack Qty.	M.O.Q.	Barcode	List Price Ex. VAT (£)
DT9900-QZ	Galvanised	Angled 20°	1.39 x 1.61	32	2500	1	5035048016140	25,96
DT9901-QZ	Galvanised	Angled 20°	1.39 x 1.61	38	2500	1	5035048016157	29,20
DT9902-QZ	Galvanised	Angled 20°	1.39 x 1.61	44	2500	1	5035048016164	30,28
DT9903-QZ	Galvanised	Angled 20°	1.39 x 1.61	50	2500	1	5035048016171	32,44
DT9904-QZ	Galvanised	Angled 20°	1.39 x 1.61	63	2500	1	5035048016188	36,76
DT9910-QZ	Stainless Steel	Angled 20°	1.39 x 1.61	32	2500	1	50350480111461	77,88
DT9911-QZ	Stainless Steel	Angled 20°	1.39 x 1.61	38	2500	1	50350480111478	90,84
DT9912-QZ	Stainless Steel	Angled 20°	1.39 x 1.61	44	2500	1	50350480111485	103,84
DT9913-QZ	Stainless Steel	Angled 20°	1.39 x 1.61	50	2500	1	50350480111492	112,48
DT9914-QZ	Stainless Steel	Angled 20°	1.39 x 1.61	63	2500	1	5035048011508	138,44

**NAILS FOR ANGLED FINISHING NAILERS (15 GAUGE 34°)**

Cat. No.	Description	Type	Diameter mm	Length mm	Pack Qty.	M.O.Q.	Barcode	List Price Ex. VAT (£)
D19920-QZ	Galvanised	Angled 34°	1.75 x 1.75	32	4000	1	5035048011515	39,92
DT9921-QZ	Galvanised	Angled 34°	1.75 x 1.75	38	4000	1	5035048011522	45,76
DT9922-QZ	Galvanised	Angled 34°	1.75 x 1.75	44	4000	1	5035048011539	51,60
DT9923-QZ	Galvanised	Angled 34°	1.75 x 1.75	50	4000	1	5035048011546	53,56
DT9924-QZ	Galvanised	Angled 34°	1.75 x 1.75	63	4000	1	5035048011553	62,28
DT9986-QZ	Inox	Angled 34°	1.75 x 1.75	32	4000	1	5035048079287	NOT UK
DT9987-QZ	Inox	Angled 34°	1.75 x 1.75	38	4000	1	5035048079294	NOT UK
DT9988-QZ	Inox	Angled 34°	1.75 x 1.75	44	4000	1	5035048079300	NOT UK
DT9989-QZ	Inox	Angled 34°	1.75 x 1.75	50	4000	1	5035048079317	NOT UK
DT9995-QZ	Inox	Angled 34°	1.75 x 1.75	63	4000	1	5035048079324	NOT UK



D51276



**NAILS FOR STRAIGHT FINISHING NAILERS (16 GAUGE)**

Cat. No.	Description	Type	Diameter mm	Length mm	Pack Qty.	M.O.Q.	Barcode	List Price Ex. VAT (£)
DT9930-QZ	Galvanised	Straight	1.38 x 1.64	35	5000	1	5035048011560	25,96
DT9931-QZ	Galvanised	Straight	1.38 x 1.64	38	5000	1	5035048011577	29,20
DT9932-QZ	Galvanised	Straight	1.38 x 1.64	44	5000	1	5035048011584	30,28
DT9933-QZ	Galvanised	Straight	1.38 x 1.64	50	5000	1	5035048011591	32,44
DT9935-QZ	Galvanised	Straight	1.38 x 1.64	63	5000	1	5035048011607	36,76



D51257



**NAILS FOR STRAIGHT FINISHING NAILERS (18 GAUGE)**

Cat. No.	Description	Type	Diameter mm	Length mm	Pack Qty.	M.O.Q.	Barcode	List Price Ex. VAT (£)
DT9940-QZ	Galvanised	Straight	1.00 x 1.25	16	5000	1	5035048011614	8,80
DT9941-QZ	Galvanised	Straight	1.00 x 1.25	20	5000	1	5035048011621	9,72
DT9942-QZ	Galvanised	Straight	1.00 x 1.25	25	5000	1	5035048011638	11,68
DT9943-QZ	Galvanised	Straight	1.00 x 1.25	30	5000	1	5035048011645	12,68
DT9944-QZ	Galvanised	Straight	1.00 x 1.25	35	5000	1	5035048011652	14,64
DT9945-QZ	Galvanised	Straight	1.00 x 1.25	40	5000	1	5035048011669	16,56
DT9946-QZ	Galvanised	Straight	1.00 x 1.25	44	5000	1	5035048011676	17,52
DT9947-QZ	Galvanised	Straight	1.00 x 1.25	50	5000	1	5035048011683	19,48
DT9927-QZ	Inox	Straight	1.00 x 1.25	20	5000	1	5035048079355	NOT UK
DT9928-QZ	Inox	Straight	1.00 x 1.25	25	5000	1	5035048079362	NOT UK
DT9929-QZ	Inox	Straight	1.00 x 1.25	30	5000	1	5035048079379	NOT UK
DT9936-QZ	Inox	Straight	1.00 x 1.25	35	5000	1	5035048079386	NOT UK
DT9937-QZ	Inox	Straight	1.00 x 1.25	40	5000	1	5035048079393	NOT UK
DT9938-QZ	Inox	Straight	1.00 x 1.25	44	5000	1	5035048079409	NOT UK
DT9939-QZ	Inox	Straight	1.00 x 1.25	50	5000	1	5035048079416	NOT UK



D51238



NAILS

NAILS FOR CLIPPED-HEAD FRAMERS (34°)



D51825

Cat. No.	Description	Type	Diameter mm	Length mm	Pack Qty.	M.O.Q.	Barcode	List Price Ex. VAT (£)
DT9955-QZ	Hot Dipped Galvanised	Angled 34°	2.85	50	2500	1	5035048013410	83,84
DT9956-QZ	Hot Dipped Galvanised	Angled 34°	3.05	63	2500	1	5035048013427	110,32
DT9959-QZ	Hot Dipped Galvanised	Angled 34°	2.90	75	2500	1	5035048072370	NOT UK
DT9996-QZ	Hot Dipped Galvanised	Angled 34°	3.10	90	2500	1	5035048072387	NOT UK

NAILS FOR FULL ROUND-HEAD FRAMERS (20°)



D51850

Cat. No.	Description	Type	Diameter mm	Length mm	Pack Qty.	M.O.Q.	Barcode	List Price Ex. VAT (£)
DT9965-QZ	Hot Dipped Galvanised	Angled 20°	2.87	50	4000	1	5035048013458	110,32
DT9966-QZ	Hot Dipped Galvanised	Angled 20°	3.05	63	4000	1	5035048013465	158,84
DT9969-QZ	Hot Dipped Galvanised	Angled 20°	2.90	75	2500	1	5035048072394	168,00
DT9998-QZ	Hot Dipped Galvanised	Angled 20°	3.10	90	2500	1	5035048072400	180,00

NAILS FOR COIL ROOFING NAILERS (15°)



D51321

Cat. No.	Description	Type	Diameter mm	Length mm	Pack Qty.	M.O.Q.	Barcode	List Price Ex. VAT (£)
DT9976-QZ	Hot Dipped Galvanised	Angled 15°	3.10	25	7000	1	5035048013502	154,44
DT9977-QZ	Hot Dipped Galvanised	Angled 15°	3.10	32	7000	1	5035048013519	157,08
DT9978-QZ	Hot Dipped Galvanised	Angled 15°	3.10	38	7000	1	5035048013526	185,64

NAILS FOR COIL FRAMING NAILERS (15°)

Cat. No.	Description	Type	Diameter mm	Length mm	Pack Qty.	M.O.Q.	Barcode	List Price Ex. VAT (£)
DT9916-QZ	Hot Dipped Galvanised	Angled 15°	2.90	63	4500	1	5035048079249	NOT UK
DT9917-QZ	Hot Dipped Galvanised	Angled 15°	3.10	75	4500	1	5035048079256	NOT UK
DT9918-QZ	Hot Dipped Galvanised	Angled 15°	3.10	90	4500	1	5035048079263	NOT UK

STAPLES

STAPLES FOR 11.1MM MEDIUM CROWN STAPLERS (16 GAUGE)



D51430

Cat. No.	Description	Type	Diameter mm	Length mm	Pack Qty.	M.O.Q.	Barcode	List Price Ex. VAT (£)
DT9990-QZ	Staples	Crown 11.1mm	1.33 x 1.60	25	5000	1	5035048011829	27,24
DT9991-QZ	Staples	Crown 11.1mm	1.33 x 1.60	32	5000	1	5035048011836	30,20
DT9992-QZ	Staples	Crown 11.1mm	1.33 x 1.60	38	5000	1	5035048011843	37,00
DT9993-QZ	Staples	Crown 11.1mm	1.33 x 1.60	44	5000	1	5035048011850	40,88
DT9994-QZ	Staples	Crown 11.1mm	1.33 x 1.60	50	5000	1	5035048011867	44,76

STAPLES FOR 12.7MM MEDIUM CROWN STAPLERS (16 GAUGE)



D51431

Cat. No.	Description	Type	Diameter mm	Length mm	Pack Qty.	M.O.Q.	Barcode	List Price Ex. VAT (£)
DT9990-QZ	Staples	Crown 12.7mm	1.33 x 1.60	25	5000	1	5035048011874	27,24
DT9991-QZ	Staples	Crown 12.7mm	1.33 x 1.60	32	5000	1	5035048011881	30,20
DT9992-QZ	Staples	Crown 12.7mm	1.33 x 1.60	38	5000	1	5035048011898	37,00
DT9993-QZ	Staples	Crown 12.7mm	1.33 x 1.60	44	5000	1	5035048011904	40,88
DT9994-QZ	Staples	Crown 12.7mm	1.33 x 1.60	50	5000	1	5035048011911	44,76





# DEWALT®

## SERVICE



**OUR PROMISE OF 5-STAR  
SERVICE QUALITY,  
CONVENIENCE AND SPEED**

### DEWALT 5-STAR SERVICE STARTS WITH CONVENIENCE

At the heart of DeWALT's 5 star service promise are its 5 star service agents which are conveniently located throughout the country, with specialists always available to answer any questions whether you are on or off the jobsite.



#### SPEED OF REPAIR

Having your tools back in action in the fastest time possible is our prime objective. Subject to parts availability, most repairs should not take more than 48 hours in the workshop and for those smaller urgent repairs we provide a "while-u-wait" service.

#### DEWALT GENUINE FACTORY PARTS

All parts used in repairs are original, ensuring both the highest quality and a perfect fit every time.



#### HIGHEST QUALITY

Highest Quality is assured with DeWALT factory trained technicians carrying out all repairs with all work being backed by our 90 day warranty. Each DeWALT repair comes with our personal "satisfaction tag" listing all the work done and a DeWALT contact telephone number should you be less than 100% happy with the repair.

#### ALL BACKED UP BY THE DEWALT ON-LINE SERVICE

Instantly accessed via the internet providing information on our wide range of products and services, including dealer and service locations, spare parts and technical support.



#### WARRANTY REPAIRS

All 5 star service agents carry out warranty repairs. If the tool is covered by its original DeWALT 1 year Warranty, all repairs are free, including parts and labour. Proof of purchase must be produced.

**TO LOCATE YOUR NEAREST 5 STAR  
AGENT PLEASE GO TO PAGE 175 OF THIS  
CATALOGUE OR VISIT:**

**[www.DEWALT.co.uk](http://www.DEWALT.co.uk)**

Not all DeWALT service agents are 5 star rated. Those that are not may not be able to provide all services available above but will display in-store a detailed list of their selected services.



## 5 - STAR AGENTS:

- OFFERING FULL REPAIR SERVICE
- COMPREHENSIVE RANGE OF SPARE PARTS
- RAPID REPAIR COMPLETED WITHIN 48 HOURS
- FACTORY TRAINED TECHNICIANS
- FOR MORE INFORMATION PLEASE SEE PAGE 147

### \*\*\*\*\* = 5 - STAR SERVICE AGENTS

[Other agents, not carrying this 5 Star symbol, may not provide all services available]



# SERVICE AGENT NETWORK

## ANTRIM

BELFAST	S I A (AGENCIES)	*****	02890 492744
MALLUSK	MCBRIDE TOOL SERVICES	*****	02890 841688
BALLYMENA	DFT - DIAMOND FIXINGS & TOOLS	*****	02825 822877
BELFAST	S I A (AGENCIES)	*****	02890 492744

## AYRSHIRE

AYR	POWERCRAFT		01292 287963
-----	------------	--	--------------

## BEDFORDSHIRE

TODDINGTON	J P SERVICES		01525 872574
------------	--------------	--	--------------

## BERKSHIRE

ALDERMASTON	ALDERMASTON TOOL CO.	*****	01189 816215
-------------	----------------------	-------	--------------

## BUCKINGHAMSHIRE

HIGH WYCOMBE	ISAAC LORD	*****	01494 835262
--------------	------------	-------	--------------

## CAMBRIDGESHIRE

PETERBOROUGH	CBS POWER TOOLS		01733 343031
--------------	-----------------	--	--------------

## CHANNEL ISLES

JERSEY	B G ROMERIL & CO LTD		01534 738806
--------	----------------------	--	--------------

## CHESHIRE

WIDNES	POWER TOOL CENTRE	*****	0151 423 2444
--------	-------------------	-------	---------------

## CLEVELAND

MIDDLESBROUGH	BUCK & HICKMAN	*****	01642 240116
MIDDLESBROUGH	CLEVELAND WOODCRAFT		01642 230160

## CLWYD

COLWYN BAY	FIXIT	*****	01492 530391
------------	-------	-------	--------------

## COOKSTOWN

STRABANE COOKSTOWN	LINTON & ROBINSON	*****	02871 384920
--------------------	-------------------	-------	--------------

## DERBYSHIRE

DERBY	JAYMAC	*****	01332 755799
DERBY	DIPT LTD		01332 680100

## DEVON

NEWTON ABBOT	TOOLFIX	*****	01626 362129
--------------	---------	-------	--------------

## DYFED

CARMARTHEN	TIMBERMAN		01267 232621
------------	-----------	--	--------------

## EAST SUSSEX

BRIGHTON	BRIGHTON TOOLS & FIXINGS		01273 620456
----------	--------------------------	--	--------------

## ESSEX

LEIGH-ON-SEA	MARSHALL & PARSONS	*****	01702 470100
WESTCLIFF-ON-SEA	TOOL-LINE	*****	01702 391791

## FIFE

DUNFERMLINE	ENGINEERING AGENCIES	*****	01383 721677
-------------	----------------------	-------	--------------

## GLOUCESTERSHIRE

MITCHELDEAN	THE TOOLITE CO		01594 544521
-------------	----------------	--	--------------

## GREATER LONDON

HOUNSLOW	Q R TOOLS LTD		0208 5702103
LONDON	TOUCAN TOOL COMPANY		0208 556 6060
NORTHOLT	JAYCEE TOOLS		0208 8411099
LONDON	LONDON POWER TOOLS LLP		0207 237 9884

## GWENT

NEWPORT	DATA POWER TOOLS	*****	01633 250579
---------	------------------	-------	--------------

## HAMPSHIRE

WINCHESTER	SOUTHERN POWER TOOL SERVICES		01962 863507
SOUTHAMPTON	SALLCO TOOLS LTD	*****	02380 737355

## HERTFORDSHIRE

LETCWORTH GARDEN CITY	AC SUPPLY		01462 481 808
-----------------------	-----------	--	---------------

## HIGHLAND

INVERNESS	HIGHLAND INDUSTRIAL SUPPLIES		01463 239160
-----------	------------------------------	--	--------------

## ISLE OF MAN

ISLE OF MAN	WHITTAKER TRADING LTD	*****	01624 627122
-------------	-----------------------	-------	--------------

## ISLE OF WIGHT

NEWPORT	I T S TOOLS	*****	01983 526344
---------	-------------	-------	--------------

## KENT

MARGATE	GOODWINS OF WESTBROOK LTD	*****	01843 220966
---------	------------------------------	-------	--------------

## LANCASHIRE

ROCHDALE	ROCHDALE RE-TOOL LTD	*****	01706 711430
BLACKPOOL	BLACKPOOL POWER TOOL CO	*****	01253 305085
WIGAN	ENTWISTLE & JOYNT LTD	*****	01942 243081
LEIGH	TOOL & FIX LTD		01942 677111

## LEICESTERSHIRE

LEICESTER	TERRATRUCK LTD		0116 2662456
WIGSTON	CROMWELL GROUP HOLDINGS		0116 257 2397

## LINCOLNSHIRE

BRACEBRIDGE	POWER TOOL SOLUTIONS LTD	*****	01522 535352
-------------	--------------------------	-------	--------------

## LONDONDERRY

COLERAINE	WELDTEC IND SUPPLIES	*****	02870 329523
COLERAINE	COLERAINE PLANT HIRE LTD		028 7034 4313

## MERSEYSIDE

LIVERPOOL	POWER TOOL CENTRE		0151 2071400
-----------	-------------------	--	--------------

## MID GLAMORGAN

BRIDGEND	DATA POWER TOOLS	*****	01656 669609
----------	------------------	-------	--------------

**MIDDLESEX**

BRETFORD N &amp; J TOOLS LTD \*\*\*\*\* 0208 5600885

**NORTH YORKSHIRE**

DRIFFIELD ELCOCK LTD 01377 256666

**NORTHAMPTONSHIRE**

NORTHAMPTON MTS POWER TOOLS 01604 751688

RUSHDEN KINGTOOLS 01933 410900

**NOTTINGHAM CITY**

NOTTINGHAM POWER TOOL PLUS LTD \*\*\*\*\* 0115 941 0037

**NOTTINGHAMSHIRE**

GILTBROOK BIRCHWOOD PRICE TOOLS \*\*\*\*\* 0121 6892000

**REPUBLIC OF IRELAND**

DUBLIN PARAGON POWERTOOLS \*\*\*\*\* 01459 6888

MULLINGAR CHRIS LYNCH HIRE \*\*\*\*\* 044 93 40678

LIMERICK ERS \*\*\*\*\* 061 417070

MONAGHAN SMP HIRE 047 82786

CARLOW ENGINEERING POWER TOOLS 059 9143300

GALWAY CAULFIELD INDUSTRIAL \*\*\*\*\* 091 795000

MOUNTMELICK BIZ E QUIP \*\*\*\*\* 057 8679832

CORK FRANK CLARK \*\*\*\*\* 021 4542222

MILLTOWN TOOL-LINE 066 9767970

**SHETLAND**

SHETLAND B H GIFFORD MACHINERY 01595 690440

**SOMERSET**

YEOVIL MILES HARDWARE \*\*\*\*\* 01935 421281

**SOUTH GLAMORGAN**

ELY DATA POWER TOOLS LTD \*\*\*\*\* 02920 595710

**SOUTH YORKSHIRE**

SHEFFIELD POWERTECH \*\*\*\*\* 0114 2474080

**STAFFORDSHIRE**

CANNOCK HEATH HAYES MARINE 01543 275048

**STRATHCLYDE**

GLASGOW KELVIN POWER TOOLS 0141 883 4794

GLASGOW R&amp;J SAW SERVICES LTD. \*\*\*\*\* 0141 5518800

GLASGOW THE SAW CENTRE 0141 4294444

**SURREY**

CROYDON SHAW ELECTRICAL LTD 0208 6880491

REDHILL FIXINGS &amp; POWER \*\*\*\*\* 01293 820088

**TAYSIDE**

DUNDEE LAWNTech 08712 775715

**TYNE AND WEAR**

NEWCASTLE R LORD &amp; CO \*\*\*\*\* 0191 2653880

**WEST GLAMORGAN**

SWANSEA C M E DEVELOPMENTS LTD \*\*\*\*\* 01639 845184

**WEST MIDLANDS**

BIRMINGHAM MIDLAND FIXING SERVICES LTD 0121 3286033

COVENTRY ECA SUPPLIES \*\*\*\*\* 02476 602080

NEWTOWN BIRCHWOOD PRICE TOOLS \*\*\*\*\* 0121 689 2105

**WEST YORKSHIRE**

LEEDS BARON BROS LTD \*\*\*\*\* 0113 2707454

BRIGHOUSE A ONE TOOLS &amp; FIXINGS \*\*\*\*\* 01484 710282

LEEDS TRUPOWER LTD 0113 399 3382

**YORK**

YORK ELCOCK LTD \*\*\*\*\* 01904 611100

# DEWALT®

## POWERTOOLS & ACCESSORIES CATALOGUE 2011



POWERTOOLS AND ACCESSORIES CATALOGUE



[www.DEWALT.co.uk](http://www.DEWALT.co.uk)

MP09603-GB

2011