

SCHEREN / SCISSORS



120-572-190
Gorney-Freeman TC Face Lift Schere, gerade, 19.0 cm
Gorney-Freeman TC Face Lift Scissors, straight, 7¹/₂ inch

120-572-230 gerade, straight, 23.0 cm, 9 inch
120-573-190 gebogen, curved, 19.0 cm, 7¹/₂ inch
120-573-230 gebogen, curved, 23.0 cm, 9 inch



120-584-190
Gorney TC Face Lift Schere, gerade, 19.0 cm
Gorney TC Face Lift Scissors, straight, 7¹/₂ inch

120-584-230 TC gerade, straight, 23.0 cm, 9 inch
120-585-190 gebogen, curved, 19.0 cm, 7¹/₂ inch
120-585-230 gebogen, curved, 23.0 cm, 9 inch
121-336-185 SC straight, gerade, 18.5 cm, 7¹/₄ inch
121-337-185 SC curved, gebogen, 18.5 cm, 7¹/₄ inch



120-575-145
Aufricht TC Schere, gebogen, 14.5 cm
Aufricht TC Scissors, curved, 5³/₄ inch

121-575-145
Aufricht SC Schere, gebogen, 14.5 cm
Aufricht SC Scissors, curved, 5³/₄ inch



120-311-180
Kaye-Freeman TC Face Lift Schere, gebogen, 18.0 cm, mit Zahnung
Kaye-Freeman TC Face Lift Scissors, curved, 7 inch, with serrations
120-310-180 gerade, straight
ohne Zahnung / without serrations



121-311-190
Kaye SC Schere, gebogen, 19.0 cm
Kaye SC Scissors, curved, 7¹/₂ inch

121-311-230 gebogen, curved, 23.0 cm, 9 inch
121-310-190 gerade, straight, 19.0 cm, 7¹/₂ inch
121-310-230 gerade, straight, 23.0 cm, 9 inch
120-511-190 TC, gebogen, 19.0 cm
TC, curved, 7¹/₂ inch



121-137-145
Kahn SC Face Lift Schere, gebogen, 14.5 cm
Kahn SC Face Lift Scissors, curved, 5³/₄ inch

SCHEREN / SCISSORS



120-595-180
Stella TC Face Lift Schere, S-Form, 18.0 cm
Stella TC Face Lift Scissors, S-shape, 7 inch



120-283-140
Beus-Joseph Schere, S-Form, 14.0 cm
Beus-Joseph Scissors, S-shape, 5^{1/2} inch



120-591-140
Gregory TC Face Lift Schere, leicht gebogen, 14.0 cm
Gregory TC Face Lift Scissors, slightly curved, 5^{1/2} inch



120-323-110
Par-Type TC Schere, gerade, 11.0 cm
Par-Type TC Scissors, straight, 4^{1/2} inch



120-283-130
Rees Bulldog Schere, leicht gebogen, 13.0 cm
Rees Bulldog Scissors, slightly curved, 5 inch

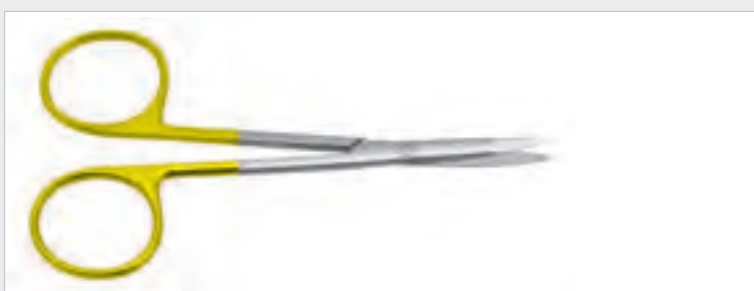

120-593-115
Greenberg-Par TC Schere, leicht gebogen, 11.5 cm
Greenberg-Par TC Scissors, slightly curved, 4^{1/2} inch

SCHEREN / SCISSORS



120-520-145

Metzenbaum-Fino TC Präparierschere, gerade, 14.5 cm
Metzenbaum-Fino TC Dissecting Scissors, straight, 5³/₄ inch

120-521-145 gebogen, curved



120-527-145

Metzenbaum-Fino TC Schere, S-Form, spitz, gebogen, 14.5 cm
Metzenbaum-Fino TC Scissors, S-Shape, pointed, curved, 5¹/₂ inch



120-514-145

Metzenbaum TC Schere, spitz, gerade, 14.5 cm
Metzenbaum TC Scissors, pointed, straight, 5¹/₂ inch



120-121-150

Nerven Präparierschere, spitz, gebogen, 15.0 cm
Nerve Dissecting Scissors, pointed, curved, 6 inch



121-257-170

Toennis Adson SC Präparierschere, gebogen, 17.0 cm
Toennis Adson SC Dissecting Scissors, curved, 6³/₄ inch

120-531-170

Toennis Adson TC Präparierschere, gebogen, 17.0 cm
Toennis Adson TC Dissecting Scissors, curved, 6³/₄ inch



120-079-105

Sealy Schere, gebogen, spitz, 10.5 cm
Sealy Scissors, curved, pointed, 4¹/₄ inch

SCHEREN / SCISSORS



120-315-150

Jameson Schere, gebogen, 15.0 cm

Jameson Scissors, curved, 6 inch

121-315-150

Jameson SC Schere, gebogen, 15.0 cm

Jameson SC Scissors, curved, 6 inch

121-315-180 18.0 cm, 7 inch



120-065-130

Ragnell Schere, leicht gebogen, 13.0 cm

Ragnell Scissors, slightly curved, 5 inch

120-599-120

Ragnell TC Schere, leicht gebogen, 12.0 cm

Ragnell TC Scissors, slightly curved, 4^{3/4} inch



120-065-150

Ragnell (Kilner) Schere, gebogen, 15.0 cm

Ragnell (Kilner) Scissors, curved, 6 inch

121-332-150

Ragnell (Kilner) SC Schere, gebogen, 15.0 cm

Ragnell (Kilner) SC Scissors, curved, 6 inch

121-332-180 SC gebogen, curved, 18.0 cm, 7 inch,

121-332-200 SC gebogen, curved, 20.0 cm, 8 inch,



120-134-120

Gradle Schere, gebogen, spitz, 12.0 cm

Gradle Scissors, curved, pointed, 4^{3/4} inch



120-092-125

Stevens Sehnen Schere, gebogen, stumpf, 12.5 cm

Stevens Tenotomy Scissors, curved, blunt, 5 inch

121-092-125

Stevens SC Sehnen Schere, gebogen, stumpf, 12.5 cm

Stevens SC Tenotomy Scissors, curved, blunt, 5 inch



120-093-115

Stevens Sehnen Schere, gebogen, stumpf, 11.5 cm

Stevens Tenotomy Scissors, curved, blunt, 4^{1/2} inch

121-093-115

Stevens SC Sehnen Schere, gebogen, stumpf, 11.5 cm

Stevens SC Tenotomy Scissors, curved, blunt, 4^{1/2} inch

SCHEREN / SCISSORS

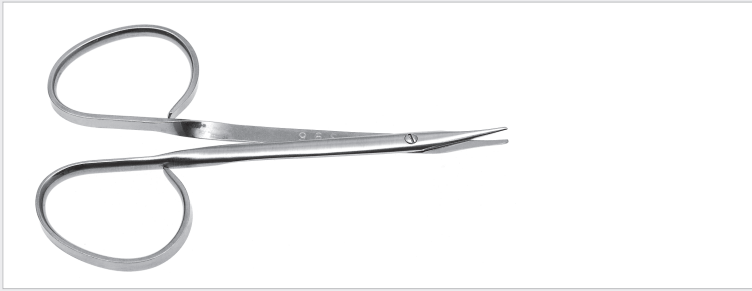

120-099-100

Stevens Sehnen Schere mit Ribbon Handgriff, gebogen, stumpf, 10.0 cm

Stevens Tenotomy Scissors with Ribbon Handle, curved, blunt, 4 inch



120-095-115

Strabismus Schere, gebogen, stumpf, 11.5 cm

Strabismus Scissors, curved, blunt, 4^{3/4} inch

121-095-115

Strabismus SC Schere, gebogen, stumpf, 11,5 cm

Strabismus SC Scissors, curved, blunt, 4^{3/4} inch



120-595-115

Strabismus TC Schere, gebogen, stumpf, 11.5 cm

Strabismus TC Scissors, curved, blunt, 4^{1/2} inch



120-093-105

Stevens Sehnen Schere, gebogen, stumpf, 10.5 cm

Stevens Tenotomy Scissors, curved, blunt, 4^{1/8} inch

121-093-105

Stevens SC Sehnen Schere, gebogen, stumpf, 10.5 cm

Stevens SC Tenotomy Scissors, curved, blunt, 4^{1/8} inch



120-091-095

Stevens Sehnen Schere mit Ribbon Handgriff, gebogen, spitz, 9.5 cm

Stevens Tenotomy Scissors with Ribbon Handle, curved, pointed, 3^{3/4} inch



120-083-100

Iris Schere mit großen Ringen, gebogen, 10.0 cm

Iris Scissors with large rings, curved, 4 inch

120-082-100

gerade, straight, 10,4 cm, 4 inch

SCHEREN / SCISSORS



121-139-135

Fomon Saber SC Face Lift Schere, gebogen, 13.5 cm
Fomon Saber SC Face Lift Scissors, curved, 5³/₈ inch



120-135-115

Kaye Blepharoplasty Schere mit Ribbon Handgriff, gezahnt, gebogen, 11.5 cm
Kaye Blepharoplasty Scissors with Ribbon Style Handle, serrated, curved, 4¹/₂ inch



120-209-180

Boettcher Schere, gebogen, 18.0 cm
Boettcher Scissors, curved, 7 inch



120-173-180

Davis Face Lift Schere mit gezahnten Schneiden, gebogen, 18.0 cm
Davis Face Lift Scissors with serrated blades, curved, 7 inch



120-561-140

Peck-Joseph TC-SC Präparierschere, gebogen, 14.0 cm
Peck-Joseph TC-SC Dissecting Scissors, curved, 5¹/₂ inch



120-574-170

Tessier TC Schere, gerade, 17.0 cm
Tessier TC Scissors, straight, 6³/₄ inch

SCHEREN / SCISSORS



122-411-135
Giunta TC Nasenschere, S-Form, 13.5 cm
Giunta TC Nasal Scissors, S-shape, 5¹/₄ inch

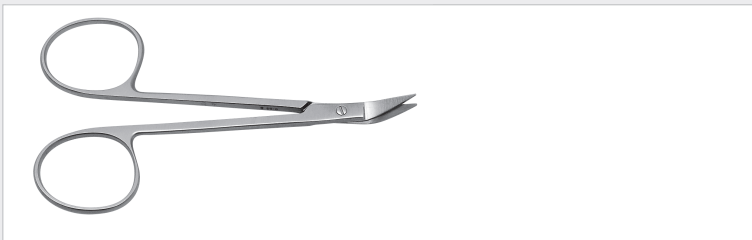

120-411-090
Daniels Nasenschere, abgewinkelt, 9.0 cm
Daniels Nasal Scissors, angled, 3³/₄ inch



120-131-110
Fomon Lower Lateral Nasenschere, gebogen, 11.0 cm
Fomon Lower Lateral Nasal Scissors, curved, 4¹/₄ inch



120-585-180
Knight TC Nasenschere, 18.0 cm
Knight TC Nasal Scissors, 7 inch



120-281-130
Beuse Nasenschere, leicht gebogen, spitz, 13.0 cm
Beuse Nasal Scissors, slightly curved, pointed, 5 inch

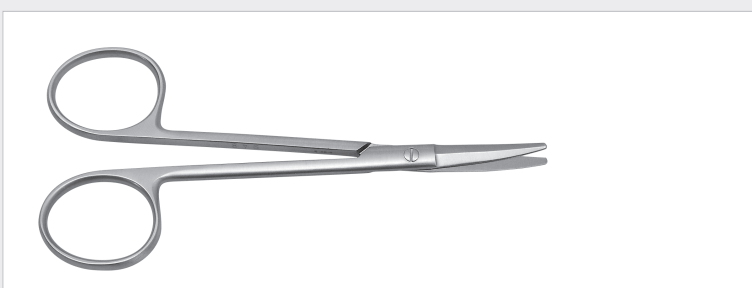

120-281-110
Beuse Nasenschere, leicht gebogen, stumpf, 11.0 cm
Beuse Nasal Scissors, slightly curved, blunt, 4³/₄ inch

SCHEREN / SCISSORS

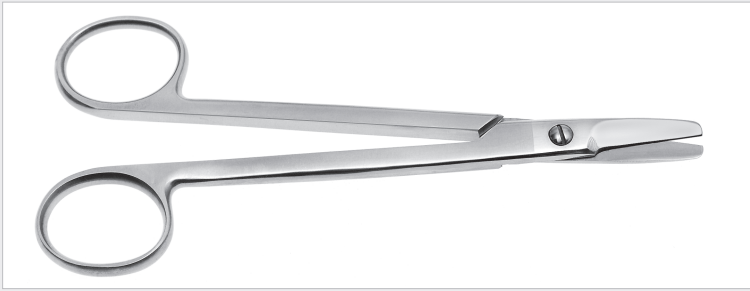

120-338-160
Castanares Face Lift Schere, gerade, 16 cm
Castanares Face Lift Scissors, straight, 6¹/₄ inch



120-538-160
Castanares TC Face Lift Schere, gerade, 16 cm
Castanares TC Face Lift Scissors, straight, 6¹/₄ inch



120-507-145
Mayo TC Schere, gebogen, 14.5 cm
Mayo TC Scissors, curved, 5³/₄ inch

120-506-145 TC gerade, straight
121-030-145 SC gerade, straight
121-031-145 SC gebogen, curved



120-047-160
Kelly Schere, gebogen, 16.0 cm
Kelly Scissors, curved, 6¹/₄ inch

120-046-160 gerade, straight

120-967-130
Goldman Fox TC Schere, gezahnte Schneiden, gebogen, 13.0 cm
Goldman Fox TC Scissors, serrated blades, curved, 5 inch



120-141-120
Shea Schere, gebogen, spitz, 12.0 cm
Shea Scissors, curved, pointed, 4³/₄ inch



120-511-145
Metzenbaum TC Präparierschere, gebogen, 14.5 cm
Metzenbaum TC Dissecting Scissors, curved, 5³/₄ inch

120-511-180 18.0 cm, 7 inch
120-511-200 20.0 cm, 8 inch
120-511-230 23.0 cm, 9 inch

SCHEREN / SCISSORS



120-083-105

Iris Schere mit Ribbon Handgriff, gebogen, spitz, 10.5 cm
Iris Scissors with Ribbon handle, curved, pointed, 4¹/₈ inch



120-078-100

Fadenschere mit Ribbon Handgriff, leicht gebogen, 10.0 cm
Stitch Removal Scissors with Ribbon handle, slight curved, 4 inch



120-080-095

Iris Schere mit Ribbon Handgriff, gerade, 9.5 cm
Iris Scissors with Ribbon handle, straight, 3³/₄ inch



120-071-090

Iris Schere, gebogen, 9.0 cm
Iris Scissors, curved, 3¹/₂ inch

120-070-090 gerade, straight, 9,0 cm, 3¹/₂ inch

120-070-115 gerade, straight, 11.5 cm, 4¹/₂ inch

120-071-115 gebogen, curved, 11.5 cm, 4¹/₂ inch



120-073-080

Bonn feine Schere, extra feine Schneiden, gebogen, 8.0 cm
Bonn delicate Scissors, extra delicate Blades, curved, 3¹/₂ inch

PINZETTEN/FORCEPS



130-532-120
Adson anatomische TC Pinzette, 12.0 cm
Adson Dissecting TC Forceps, 4^{3/4} inch
130-532-150 15.0 cm, 6 inch



130-538-120
Micro Adson anatomische TC Pinzette, 12.0 cm
Micro Adson Dressing TC Forceps, 4^{3/4} inch



130-529-120
Adson-Brown chirurgische TC Pinzette mit 7 x 7 Zähnen, 12.0 cm
Adson-Brown Tissue TC Forceps 7 x 7 teeth, 4^{3/4} inch
130-529-150 15.0 cm, 6 inch



130-534-120
Adson chirurgische TC Pinzette mit 1 x 2 Zähnen, 12.0 cm
Adson Tissue TC Forceps with 1 x 2 teeth, 4^{3/4} inch
130-534-150 15.0 cm, 6 inch



130-242-120
Titan Adson anatomische Pinzette, 12.0 cm
Titanium Adson Dressing Forceps, 4^{3/4} inch
130-242-150 15.0 cm, 6 inch



130-537-120
Mikro-Adson chirurgische TC Pinzette mit 1 x 2 Zähnen, 12.0 cm
Micro-Adson Tissue TC Forceps with 1 x 2 teeth, 4^{3/4} inch



130-243-120
Titan Adson-Brown chirurgische Pinzette mit 7 x 7 Zähnen, 12.0 cm
Titanium Adson-Brown Tissue Forceps with 7 x 7 teeth, 4^{3/4} inch
130-243-150 15.0 cm, 6 inch



130-527-120
Adson DeBailey atraumatische Pinzette, 12.0 cm
Adson DeBailey Atraumatic Forceps, 4^{3/4} inch



130-570-150
DeBailey atraumatische TC Pinzette, 2.0 mm breit, 15.0 cm
DeBailey Atraumatic TC Forceps, 2.0 mm wide, 6 inch



290-552-160
De Bailey atraumatische Pinzetten 16 cm,
gerade, 2 mm breit
De Bailey Atraumatic Forceps 16.0 cm, 6^{1/4} inch,
straight, 2.0 mm wide

PINZETTEN/FORCEPS

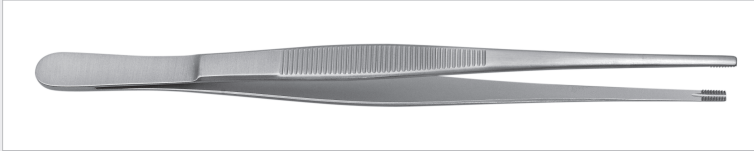

130-554-200
Brown chirurgische Pinzette mit 7 x 7 Zähnen, 20.0 cm
Brown Tissue Forceps with 7 x 7 teeth, 8 inch
130-554-160 16.0 cm / 6¹/₄ inch



130-520-150
Gillies chirurgische TC Pinzette mit 1 x 2 Zähnen, 15.0 cm
Gillies Tissue TC Forceps 1 x 2 teeth, 6 inch



130-239-150
Titan Gillies chirurgische TC Pinzette mit 1 x 2 Zähnen, 15.0 cm
Titanium Gillies Tissue TC Forceps with 1 x 2 teeth, 6 inch



130-536-150
Tickner anatomische TC Pinzette 15.0 cm
Tickner Dressing TC Forceps, 6 inch



130-518-160
Standard anatomische TC Pinzette 16.0 cm
Standard Dressing TC Forceps, 6¹/₄ inch
130-518-145 14.5 cm, 5³/₄ inch
130-518-180 18.0 cm, 7 inch



130-324-160
Semken anatomische TC Pinzette 16.0 cm
Semken Dressing TC Forceps, 6¹/₄ inch



130-524-180
Semken chirurgische TC Pinzette mit 1 x 2 Zähnen, 16.0 cm
Semken Tissue TC Forceps with 1 x 2 teeth, 6¹/₄ inch



130-522-150
McIndoe anatomische TC Pinzette, 15.0 cm
McIndoe Dressing TC Forceps, 6 inch



130-522-160
Oehler chirurgische TC Pinzette, 16.0 cm, 1 x 2 Zähnen
Oehler Tissue TC Forceps, 6¹/₄ inch, 1 x 2 teeth
130-522-145 14.5 cm, 5³/₄ inch
130-522-180 18.0 cm, 7 inch



130-536-175
Cushing anatomische TC Pinzette 17.5 cm
Cushing Dressing TC Forceps, 6⁵/₈ inch

PINZETTEN/FORCEPS



130-516-170
Gerald anatomische TC Pinzette 17.0 cm
Gerald Dressing TC Forceps, 6^{3/4} inch



130-518-170
Gerald chirurgische TC Pinzette mit 1 x 2 Zähnen, 17.0 cm
Gerald Tissue TC Forceps, with 1 x 2 teeth, 6^{3/4} inch



130-151-180
Gerald chirurgische Pinzette mit 1 x 2 Zähnen, gebogen 17.0 cm
Gerald Tissue Forceps with 1 x 2 teeth, curved 6^{3/4} inch



410-391-140
Lucae anatomische Pinzette bajonett abgewinkelt, 14.0 cm
Lucae Dressing Forceps, bayonet shaped, 5^{1/2} inch



410-395-190
Jansen anatomische Nasenpinzette bajonett abgewinkelt, 19.0 cm
Jansen Dressing Nasal Forceps, bayonet shaped 7^{3/4} inch
410-396-190 1 x 2 Zähne, 1 x 2 teeth



130-541-180
Cushing-Taylor anatomische TC Pinzette bajonett abgewinkelt, 18.0 cm
Cushing-Taylor Dressing TC Forceps bayonet shaped, 7 inch



130-490-100
RZ Feine anatomische Pinzette, gerade, 0.7 mm breit, 10.0 cm
RZ Delicate Dressing Forceps, straight, 0.7 mm wide, 4 inch
130-491-100 leicht gebogen / slightly curved
130-492-100 stark gebogen / strongly curved



130-503-100
Feine chirurgische Pinzette mit 1 x 2 Zähnen, 10.0 cm
Delicate Tissue Forceps, with 1 x 2 teeth, 4 inch



130-500-100
Graefe anatomische Pinzette, gerade, 10.0 cm
Graefe Dressing Forceps, straight, 4 inch
130-501-100 gebogen, curved



130-511-110
Stevens anatomische Pinzette, leicht gebogen, 11.0 cm
Stevens Dressing Forceps, slightly curved, 4^{3/8} inch

PINZETTEN/FORCEPS



130-513-110
Stevens chirurgische Pinzette mit 1 x 2 Zähnen,
leicht gebogen, 11.0 cm
Stevens Tissue Forceps with 1 x 2 teeth, slightly curved, 4³/₈ inch



400-018-005
Bishop-Harmon anatomische Pinzette, 0.5 mm Spitze, 8.5 cm
Bishop-Harmon Dressing Forceps, 0.5 mm tip, 3¹/₃ inch
400-118-005 1 x 2 Zähne, 1 x 2 teeth



400-137-150
Castroviejo Nahtpinzette mit Fadenplatte,
1 x 2 Zähne, 1 mm, 10 cm
Castroviejo Suture Forceps with tying platform,
1 x 2 teeth, 1 mm, 4 inch



400-137-050
Castroviejo Nahtpinzette mit Fadenplatte, 0.5 mm Spitzen, 10 cm,
1 x 2 Zähne,
Castroviejo Suture Forceps with tying platform, 0.5 mm tips, 4 inch,
1 x 2 teeth,



400-139-050
Castroviejo Brown chirurgische Pinzette mit 7 x 7 Zähnen, 10 cm,
Castroviejo Brown Tissue Forceps with 7 x 7 teeth, 4 inch,



400-137-003
Castroviejo Nahtpinzette mit diamantierter Fadenplatte,
0.3 mm Spitze, 1 x 2 Zähne, 10 cm
Castroviejo Suture Forceps with diamond dusted tying platform,
0.3 mm tip, 1 x 2 teeth, 10 cm, 4 inch,



400-082-100
Kirby Fixierpinzette mit 1 x 2 Zähnen, 10.0 cm
Kirby Fixation Forceps with 1 x 2 teeth, 4 inch



400-083-100
Kirby Fixierpinzette mit 2 x 3 Zähnen, 10.0 cm
Kirby Fixation Forceps with 2 x 3 teeth, 4 inch



400-022-090
Castroviejo Fixierpinzette mit 2 x 2 Zähnen, 10 cm
Castroviejo Fixation Forceps with 2 x 2 teeth, 4 inch,



400-029-012
Green Fixierpinzette mit 12 mm breitem Maul und feinen Zähnen, 11 cm
Green Fixation Forceps, 12 mm jaws and delicate teeth, 4³/₈ inch

PINZETTEN/FORCEPS



400-025-110

Graefe Fixierpinzette mit 7 x 8 Zähnen, 11,0 cm
Graefe Fixation Forceps with 7 x 8 teeth 4^{3/8} inch



400-084-100

Kirby Barraquer Fixierpinzette mit feinen Zähnen, 11,0 cm
Kirby Barraquer Fixation Forceps with delicate teeth, 4^{3/8} inch



260-411-150

Millard Hakenpinzette 1x2 Zähne, mit Ring, 15,0 cm
Millard Hook Forceps 1x2 teeth, with ring, 6 inch

260-412-150

Millard Hakenpinzette mit Brown Zahnung, mit Ring, 15,0 cm
Millard Hook Forceps with Brown serrations, with ring, 6 inch

NADELHALTER/NEEDLE HOLDERS

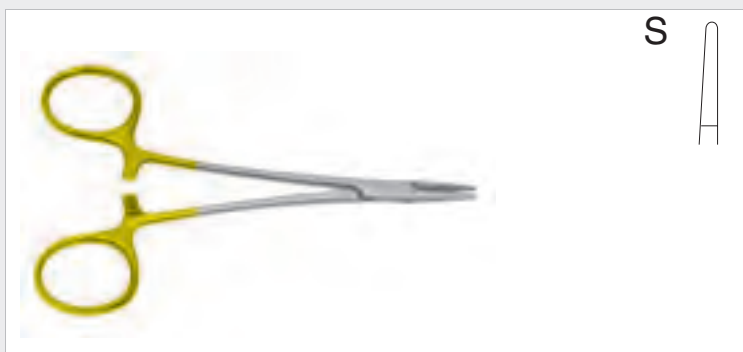

180-536-130

Halsey TC Nadelhalter, 13,0 cm
Halsey TC Needle Holder, 5 inch

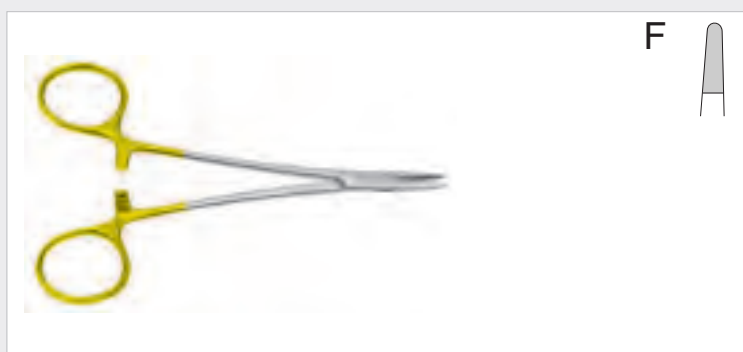

180-532-120

Derf TC Nadelhalter, 12,0 cm
Derf TC Needle Holder, 4^{3/4} inch

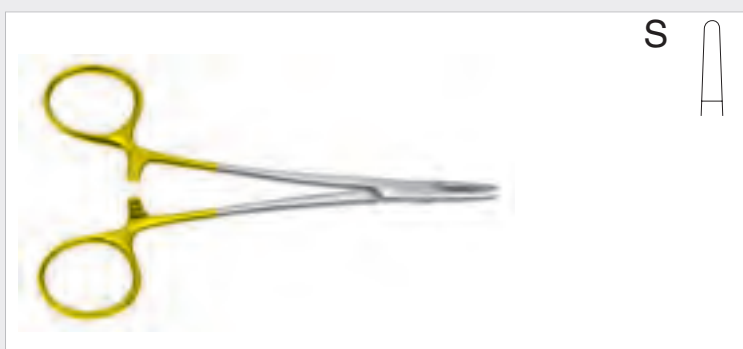

180-570-130

Webster TC Nadelhalter, 13,0 cm
Webster TC Needle Holder, 5 inch

NADELHALTER/NEEDLE HOLDERS

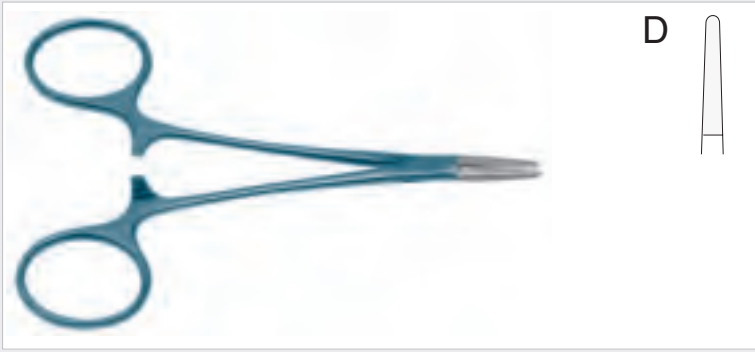

180-670-125
Titan Halsey Nadelhalter, diamantiertes Maul, 12.5 cm
Titanium Halsey Needle Holder, Diamond dusted jaws, 5 inch



180-671-115
Titan Derf Nadelhalter, diamantiertes Maul, 12.5 cm
Titanium Derf Needle Holder, Diamond dusted jaws, 5 inch



180-533-130
Neivert TC Nadelhalter, 13.0 cm
Neivert TC Needle Holder, 5 inch



180-525-135
Kilner TC Nadelhalter, 13.5 cm
Kilner TC Needle Holder 5 1/4 inch



180-561-130
Ryder Vascular TC Nadelhalter, 13.0 cm
Ryder Vascular TC Needle Holder, 5 inch
180-561-160 16.0 cm, 6 1/4 inch
180-561-180 18.0 cm, 7 inch
180-561-200 20.0 cm, 8 inch

NADELHALTER/NEEDLE HOLDERS



180-660-180
Titan Ryder Nadelhalter, diamantiertes Maul,
2 mm Spitze, 18.0 cm
Titanium Ryder Needle Holder Diamond dusted jaws,
2 mm tip, 7 inch



180-534-140
Hegar-Baumgartner TC Nadelhalter, 14.0 cm
Hegar-Baumgartner TC Needle Holder, 5¹/₂ inch



180-661-150
Titan Ryder TC Nadelhalter, feine Spitze, 15.0 cm
Titanium Ryder TC Needle Holder, delicate tips, 6 inch



180-560-130
Ryder TC Nadelhalter, 13.0 cm
Ryder TC Needle Holder, 5 inch
180-560-160 16.0 cm, 6¹/₄ inch
180-560-180 18.0 cm, 7 inch
180-560-200 20.0 cm, 8 inch



180-590-140
Hegar-Vascular TC Nadelhalter, 14.0 cm
Hegar-Vascular TC Needle Holder, 5¹/₂ inch
180-590-180 18.0 cm, 7 inch

NADELHALTER/NEEDLE HOLDERS



180-549-180

DeBakey TC Nadelhalter, gebogen, 18.0 cm
DeBakey TC Needle Holder, curved, 7 inch

180-549-230 gebogen, curved, 23.0 cm, 9 inch

180-548-180 gerade, straight, 18.0 cm, 7 inch

180-548-230 gerade, straight 23.0 cm, 9 inch



180-544-120

Converse TC Nadelhalter, 12.0 cm
Converse TC Needle Holder, 4^{3/4} inch



180-674-160

Titan Vascular Delikat Nadelhalter, diamantiertes Maul, 16.0 cm
Titanium Vascular delicate Needle Holder,
Diamond dusted jaws, 6^{1/4} inch



180-675-160

Titan DeBakey Nadelhalter, diamantiertes Maul, 16.0 cm
Titanium DeBakey Needle Holder, Diamond dusted jaws, 6^{1/4} inch



180-531-150

Senning TC Nadelhalter, 15.0 cm
Senning TC Needle Holder, 6 inch

NADELHALTER/NEEDLE HOLDERS



180-542-150
Baby Crile Wood TC Nadelhalter, 15.0 cm
Baby Crile Wood TC Needle Holder, 6 inch



180-648-180
DeBakey Nadelhalter, diamantiertes Maul,
1 mm Spitze, 18.0 cm
DeBakey Needle Holder, Diamond dusted jaws,
1 mm tip, 7 inch

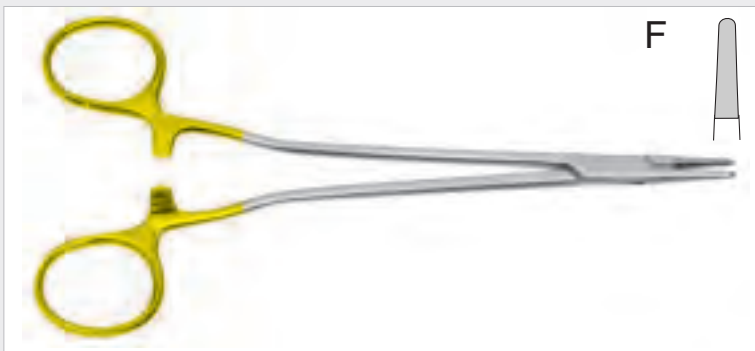

180-545-180
Sarot TC Nadelhalter, 18.0 cm
Sarot TC Needle Holder, 7 inch

180-545-200 20.0 cm, 8 inch



180-540-150
Crile Wood TC Nadelhalter, 15.0 cm
Crile Wood TC Needle Holder 6 inch

180-540-180 18.0 cm, 7 inch

180-540-200 20.0 cm, 8 inch



180-550-140
Mayo Hegar TC Nadelhalter, 14.0 cm
Mayo Hegar TC Needle Holder, 5¹/₂ inch

180-550-160 16.0 cm, 6¹/₄ inch

180-550-180 18.0 cm, 7 inch

180-550-200 20.0 cm, 8 inch

180-550-240 24.0 cm, 9¹/₂ inch

NADELHALTER/NEEDLE HOLDERS



F

180-567-170
Olsen Hegar TC Nadelhalter, runder Schluß, 17.0 cm
Olsen Hegar TC Needle Holder, round screw joint, 6^{3/4} inch

180-567-190 19.0 cm, 7^{1/2} inch



F

180-568-140
Olsen Hegar TC Nadelhalter, 14.0 cm
Olsen Hegar TC Needle Holder, 5^{1/2} inch

180-568-170 17.0 cm, 6^{3/4} inch

180-568-180 18.0 cm, 7 inch



F

180-570-120
Foster Gillies TC Nadelhalter, 12.0 cm
Foster Gillies TC Needle Holder, 4^{3/4} inch



F

180-570-160
Gillies TC Nadelhalter, 16.0 cm
Gillies TC Needle Holder, 6^{1/4} inch



F

180-588-150
Mini Gillies TC Nadelhalter, 15.0 cm
Mini Gillies TC Needle Holder, 6 inch

NADELHALTER/NEEDLE HOLDERS



F



180-568-120

Mini Olsen Hegar TC Nadelhalter, 12.0 cm
Mini Olsen Hegar TC Needle Holder, 4³/₄ inch



D



250-264-246

Jacobson Nadelhalter, diamantiertes Maul, mit Sperre,
gerade, 18.5 cm
Jacobson Needle Holder, Diamond dusted jaws,
with catch, straight, 7¹/₄ inch

250-264-247 gebogenes Maul, curved



EF



180-512-145

Barraquer TC Nadelhalter, mit Sperre, gerade, 14.5 cm
Barraquer TC Needle Holder with catch, straight, 5³/₄ inch

180-513-145 gebogenes Maul, curved



S



400-350-135

Barraquer Nadelhalter mit Sperre, glatt,
feines gebogenes Maul, 13.5 cm
Barraquer Needle Holder with catch, smooth jaws,
delicate curved jaws, 5³/₈ inch

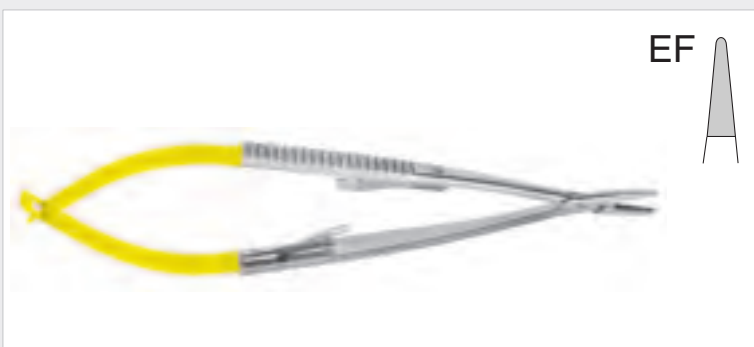

EF



180-520-145

Castroviejo TC Nadelhalter mit Sperre, gerade, 14.5 cm
Castroviejo TC Needle Holder with catch, straight, 5³/₄ inch

180-522-145 gebogenes Maul, curved jaws

NADELHALTER/NEEDLE HOLDERS



400-348-135
 Barraquer Nadelhalter, ohne Sperre, glatt
 extra feines, gebogenes Maul, 13.5 cm
 Barraquer Needle Holder, without catch, smooth jaws,
 extra delicate, curved jaws 5³/₈ inch



251-660-150
 Mikro Nadelhalter Pinzette mit Gewicht, gebogen,
 0.6 mm Spitze, 15.0 cm
 Micro Needle Holder Forceps with weight, curved,
 0.6 mm tip, 6 inch



180-569-130
 TC Drahthaltezange, rundes Maul, 13.0 cm
 TC Wire Holding Forceps, round jaws, 5 inch



180-570-200
 Berry TC Drahthaltezange, rundes Maul, 20.0 cm
 Berry TC Wire Holding Forceps, round jaws, 8 inch

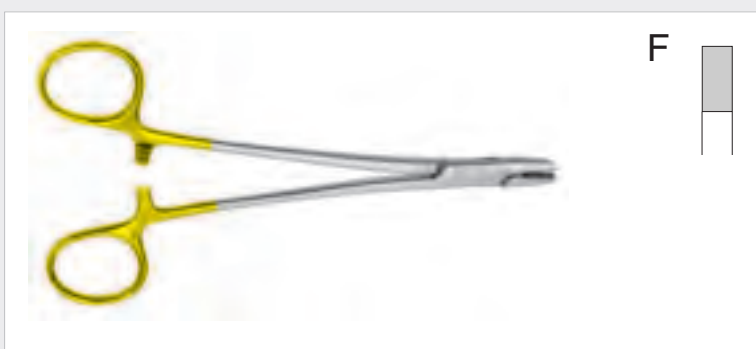

180-571-150
 TC Drahtspannzange, rechteckiges Maul, 15.0 cm
 TC Wire Twisting Forceps, square jaws, 6 inch

WUNDHAKEN/WOUND RETRACTORS

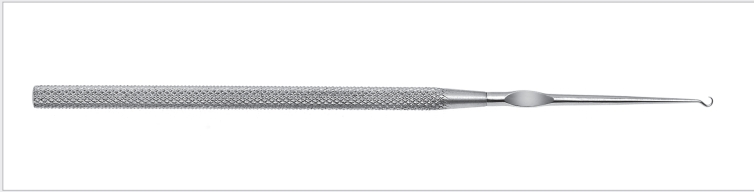

230-203-002
Kilner Wundhäkchen zerlegbar, 2 mm Spitze, 15.0 cm
Kilner Fine Wound Retractor, detachable, 2 mm tip, 6 inch



230-203-150
Kilner (Catspaw), Wundhäkchen, 15.0 cm
Kilner (Catspaw), Fine Wound Retractor, 6 inch



230-205-180
Gillies Wundhäkchen, Fig. 1, 18.0 cm
Gillies Fine Wound Retractor, Fig. 1, 7 inch
230-207-180 Fig. 2
230-209-180 Fig. 3



170-014-165
Cloward Wundhäkchen, 16.5 cm
Cloward Fine Wound Retractor, 6^{1/2} inch



170-010-160
Graefe Wundhäkchen, spitz, 16.0 cm
Graefe Fine Wound Retractor, pointed, 6^{1/4} inch

170-012-160 stumpf, blunt



170-033-120
Lahey Wundhaken, 2 Zähne, spitz, 12.0 cm
Lahey Wound Retractor, 2 prongs, pointed, 4^{3/4} inch

170-034-120 3 Zähne, 3 teeth



170-020-001
Kleinert-Kutz Wundhäkchen, Fig. 1, 16.0 cm
Kleinert-Kutz Fine Wound Retractor, Fig. 1, 6^{1/4} inch

170-020-002 Fig. 2

170-020-003 Fig. 3



170-020-000
Barsky Wundhäkchen, 2 Zähne, zerlegbar
Barsky Fine Wound Retractor, 2 prongs, detachable

170-020-100
Barsky Aufsatz alleine / Barsky double prongs insert only

WUNDHAKEN/WOUND RETRACTORS



170-015-140
Cushing Wundhäkchen, 14.0 cm
Cushing Fine Wound Retractor, 5^{1/2} inch



170-122-175
RZ Square Wundhäkchen, 2 Zähne, stumpf, 17.5 cm
RZ Square Handle Retractor, 2 prongs, blunt, 6^{5/8} inch



170-042-160
Guthrie Wundhäkchen, 2 Zähne, spitz, 16.0 cm
Guthrie Fine Wound Retractor, 2 prongs, pointed, 6^{1/4} inch

170-044-160 stumpf, blunt



170-041-001
Niro Wundhäkchen, Fig. 1, 17.0 cm
Niro Wound Retractor, Fig. 1, 6^{3/4} inch
170-041-002 Fig. 2 170-041-003 Fig. 3
170-041-004 Fig. 4



170-040-160
O'Conner Wundhäkchen, 12.0 cm
O'Conner Fine Wound Retractor, 4^{3/4} inch



170-081-135
RZ Wundhäkchen, 6 Zähne, spitz, mit extra tiefen Zähnen, 13.5 cm
RZ Fine Retractor, 6 prongs, pointed, with extra deep teeth, 5^{3/8} inch



170-085-130
Miller Wundhaken, 9 Zähne, spitz, 13.0 cm
Miller Fine Wound Retractor, 9 prongs, pointed, 5 inch
170-086-130 stumpf, blunt



170-080-001
Knapp Wundhäkchen, 4 Zähne, spitz, 13.0 cm
Knapp Fine Wound Retractor, 4 prongs, pointed, 5 inch
170-080-002 stumpf, blunt



170-079-003
Schwalbenschwanz Wundhaken, 3 Zähne, spitz, 18.0 cm
Schwalbenschwanz Wound Retractor, 3 prongs, pointed, 7 inch

170-079-002 2 Zähne, 2 prongs

WUNDHAKEN/WOUND RETRACTORS

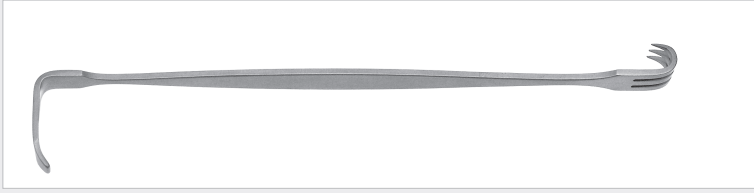

170-214-160

Baby Senn-Miller Wundhaken, 20 x 7 mm, spitz, 16.0 cm
Baby Senn-Miller Retractor, 20 x 7 mm, pointed, 6¹/₄ inch

170-213-160 stumpf, blunt



230-280-160

Fomon Håkchen mit 2 kleinen Kugeln auf den Spitzen, 16.0 cm
Fomon Hooklet with two small balls on the tips, 6¹/₄ inch



230-281-140

Cottle Håkchen mit 1 Kugel auf der rechten Spitze, 14 cm
Cottle Hooklet with 1 small ball on the right tip, 5¹/₂ inch

230-282-140 Kugel auf der linke Spitze, ball on left tip

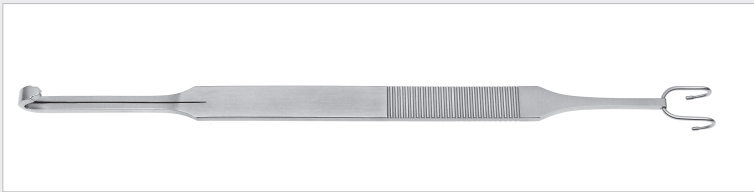

230-260-200

Cottle-Neivert doppelendiger Wundhaken, 21.0 cm lang
Cottle-Neivert double ended Retractor, 8¹/₄ inch

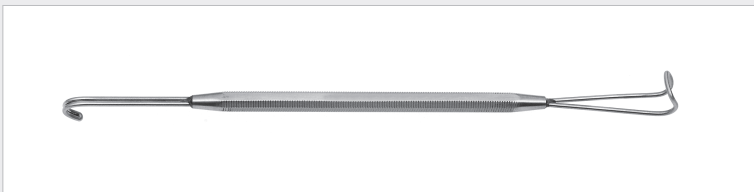

170-036-180

Neivert Nasenhaken, 18.0 cm
Neivert Nasal Retractor, 7 inch



260-501-120

Converse Alar Wundhaken, doppelendig, spitz, 12.0 cm
Converse Alar Retractor, double ended, pointed, 4³/₄ inch



420-184-100

Kilner Nasenhaken, 10.0 cm
Kilner Nasal Retractor, 4 inch

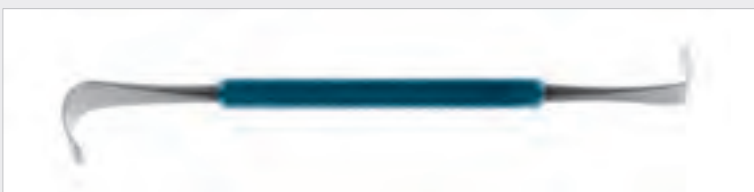

170-130-165

Kasden doppelendiger Wundhaken, 16.5 cm
Kasden double ended Retractor, 6¹/₄ inch

RAKE WUNDHAKEN/RAKE RETRACTORS



260-020-038
Gorney Rake Wundhaken mit Feder, spitz, 7.5 cm
Gorney Rake Retractor, with spring, pointed, 3 inch

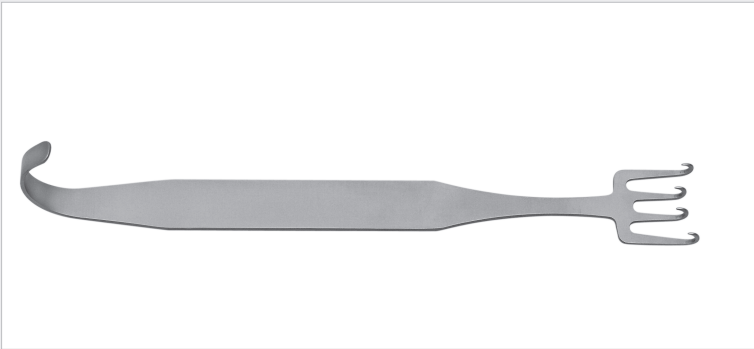

260-012-193
Freeman Rake Wundhaken, 4 Zähne, spitz, 2 Zähne versetzt, 18.0 cm
Freemann Rake Retractor, 4 prongs, 2 prongs recessed pointed, 7 inch

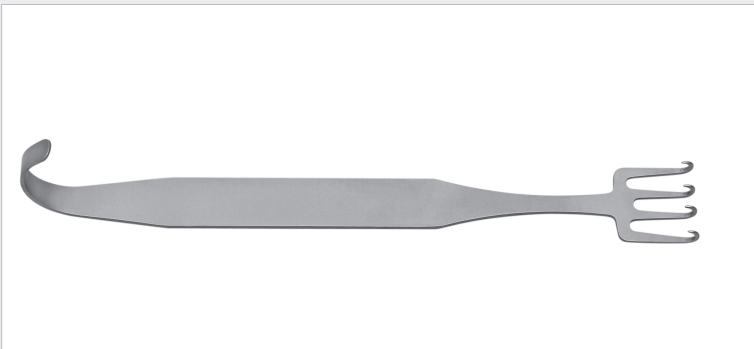

260-012-195
Freeman Rake Wundhaken, 4 Zähne, spitz, 18.0 cm
Freeman Rake Retractor, 4 prongs, pointed, 7 inch



260-012-191
Freeman Rake Wundhaken, 4 Zähne, spitz, 18.0 cm
Freeman Rake Retractor, 4 prongs, pointed, 7 inch



260-012-192
Freeman Rake Wundhaken, 4 Zähne, spitz, 10.0 cm
Freeman Rake Retractor, 4 prongs, pointed, 4 inch

RAKE WUNDHAKEN/RAKE RETRACTORS

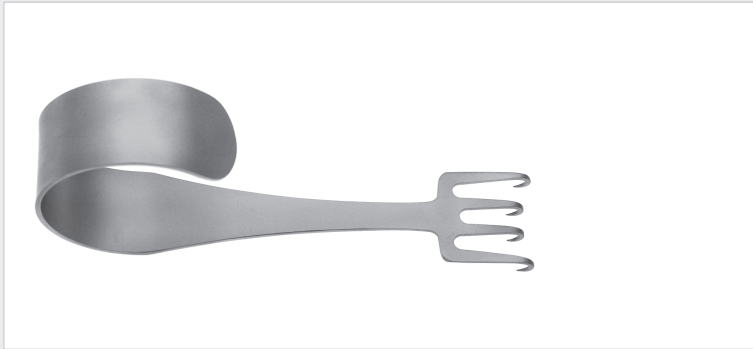

260-013-192
Freeman Retraktor, 4 Zähne, 10.0 cm
Freeman Retractor, 4 prongs, 4 inch

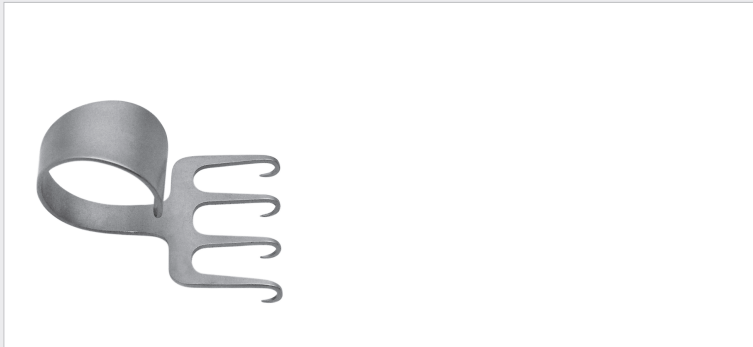

260-012-198
Freeman Rake Wundhaken, 4 Zähne, 5.0 cm
Freeman Rake Retractor, 4 prongs, 2 inch

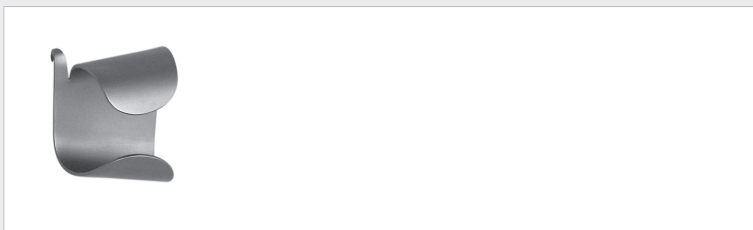

260-418-100
Millard Fingerhut Wundhaken, mit 1 Zahn
Millard thimble hook with 1 prong

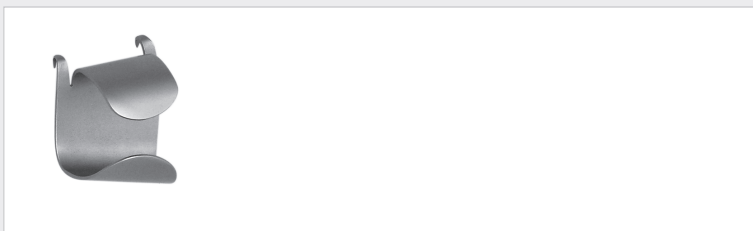

260-418-120
Millard Fingerhut Wundhaken mit 2 Zähnen
Millard thimble hook with 2 prongs



260-200-110
RZ Nasen Retraktor mit einer Fingerstütz 11,0 cm, Kombination eines
Millard Finger hutes und eines Cottle Alar Häkchens
RZ Nasal retractor with thimble hook 11.0 cm, combination of a millard
thimble hook / cottle alar hook



260-012-194
Van Sickle Rake Wundhaken, 4 Zähne, 18.0 cm
Van Sickle Rake Wound Retractor, 4 prongs, 7 inch

WUNDHAKEN/RETRACTORS

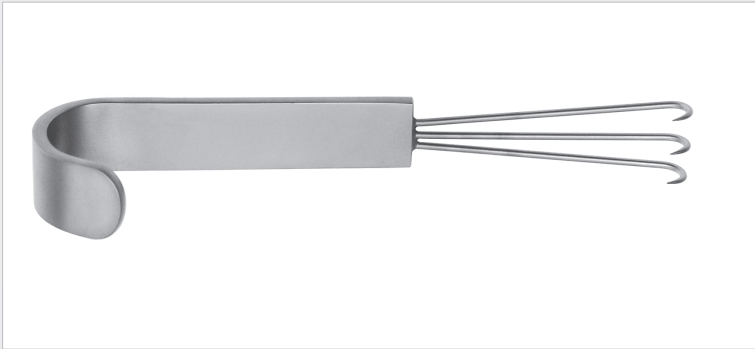

260-012-212

Anderson Wundhaken, 3 Zähne, 12.0 cm
Anderson Retractor, 3 prongs, 4³/₄ inch

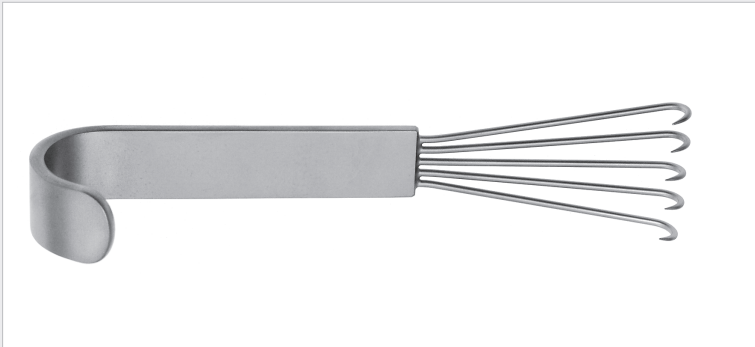

260-012-210

Anderson Wundhaken, 5 Zähne, 12.0 cm
Anderson Retractor, 5 prongs, 4³/₄ inch

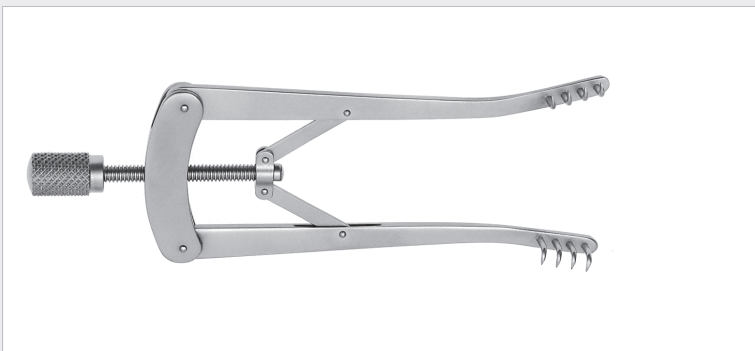

170-714-100

Alm Wundsperrer, spitz, 10.0 cm
Alm Self Retaining Retractor, pointed, 4 inch

170-715-100 stumpf, blunt



170-723-100

Jansen Wundsperrer, stumpf, 10.0 cm
Jansen Self Retaining Retractor, blunt, 4 inch

170-720-100 spitz, sharp

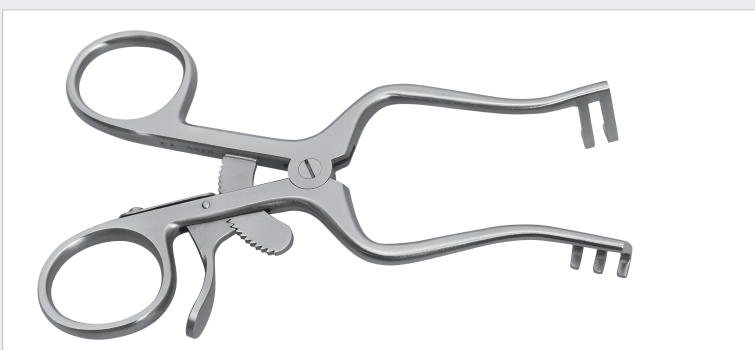

170-749-105

Weitlaner-Loktite Wundsperrer, stumpf, 10.5 cm
Weitlaner-Loktite Self Retaining Retractor, blunt, 4¹/₂ inch

170-750-105 halbscharf, semi-sharp

NASENRASPELN / NASAL RASPS

Hauptvorteile der RZ Hartmetall-Raspeln im Gegensatz zu den konventionellen Raspeln sind die ausgezeichneten Schneideeigenschaften, verlängerte Lebensdauer und ein sauberer, präziser Schnitt.

The major advantages of the RZ Tungsten carbide rasps over conventional models are their superior cutting ability, increased longevity and clean, precise cut.

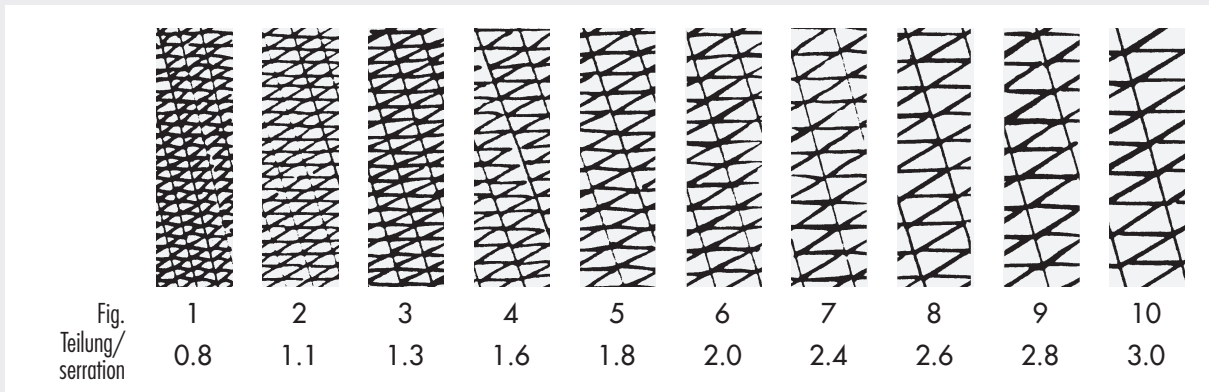

420-655-180
McIndoe Nasenraspel, auf Zug, gerade, 18.0 cm
McIndoe Nasal Rasp, backward cutting, straight, 7 inch



420-654-180
Original Maltz Nasenraspel, auf Zug gerade, 18.0 cm
Original Maltz Nasal Rasp, backward cutting, straight, 7 inch



420-672-000
Original TC Maltz Nasenraspel, auf Zug, gerade, 18.0 cm
Original TC Maltz Nasal Rasp, backward cutting, straight, 7 inch

420-672-004 auf Druck, forward cutting



420-655-000
Gonzi Doppelseitige Nasenraspel, vorwärts/rückwärts schneidend
Gonzi double sided Nasal Rasp, forward / backward cutting

NASENRASPELN / NASAL RASPS



420-656-180
McIndoe Nasenraspel, auf Druck, gerade, 18.0 cm
McIndoe Nasal Rasp, forward cutting, straight, 7 inch



420-692-200
Lamont Nasenraspel, auf Zug, breites Modell, gerade,
grobe Zähne, 17.5 cm
Lamont Nasal Rasp, backward cutting, wide pattern, straight,
agressive teeth, 6³/₄ inch



420-690-200
Lamont Nasenraspel, schlankes Modell, auf Zug, gerade,
feine Zähne, 17.5 cm
Lamont Nasal Rasp, delicate pattern, backward cutting, straight,
fine teeth, 6³/₄ inch



420-691-200
Lamont Nasenraspel, auf Zug, gerade, feine Zähne, 17.5 cm
Lamont Nasal Rasp, backwards cutting, straight, fine teeth,
6³/₄ inch



420-678-190
Gallaher Nasenraspel mit Ring, grob, 19.0 cm
Gallaher Nasal Rasp with ring, coarse, 7¹/₂ inch



420-670-210
Cottle Nasenraspel, auf Zug, gerade, 21.0 cm
Cottle Nasal Rasp, backward cutting, straight, 8¹/₄ inch



420-497-210
Parkes TC Nasenraspel, auf Zug, #8, gerade, 21.0 cm
Parkes TC Nasal Rasp, backward cutting, #8, straight, 8¹/₄ inch
420-499-299 #4
420-498-210 #5

NASENRASPELN / NASAL RASPS



420-650-101

Peet Aufricht DIAMANT Nasenraspel, fein, gebogen, 22.0 cm
Peet Aufricht DIAMOND Nasal Rasp, fine, curved, 8^{3/4} inch



420-650-002

Aufricht Nasenraspel, auf Druck, gebogen, 22.0 cm
Aufricht Nasal Rasp, forward cutting, curved, 8^{3/4} inch



420-756-180

Barsky Glabella Nasenraspel, auf Zug, gebogen, 17.5 cm
Barsky Glabella Nasal Rasp, backward cutting, curved, 6^{3/4} inch



420-669-210

Glabella TC Nasenraspel, 21.0 cm
Glabella TC Nasal Rasp, 8^{1/4} inch



420-650-100

Peet Cottle DIAMANT Nasenraspel, 17.5 cm
Peet Cottle DIAMOND Nasal Rasp, 6^{3/4} inch



420-520-170

Watson Williams Nasenraspel rund, konvex, aufgebogener Schaft, mit feiner Zahnung, 17.0 cm
Watson Williams Nasal Rasp, rounded with convex blade, fine serration, 6^{3/4} inch

420-521-170

grobe Zahnung / coarse serration

NASENRASPELN / NASAL RASPS

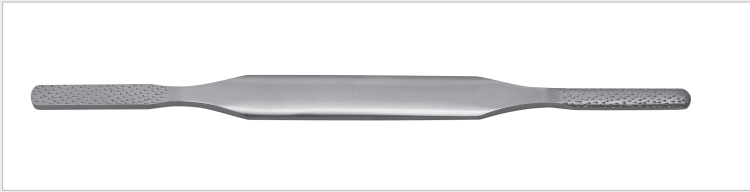

420-661-000
Fomon Nasenraspel, fein, 21.0 cm
Fomon Nasal Rasp, fine, 8¹/₄ inch

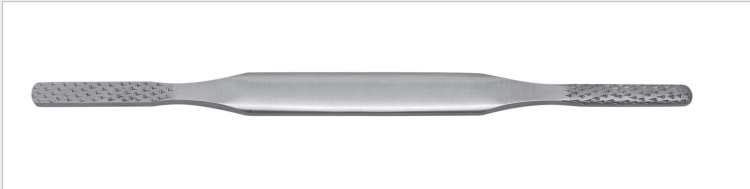

420-660-000
Fomon Nasenraspel, grob, 21.0 cm
Fomon Nasal Rasp, coarse, 8¹/₄ inch



420-653-000
Fomon DIAMANT Nasenraspel, doppelendig, 21.0 cm
Fomon DIAMOND Nasal Rasp, double ended, 8¹/₄ inch



420-660-219
Fomon Nasenraspel, doppelendig, 7 x 40 mm, #1/#2, 21.0 cm
Fomon Nasal Rasp, double ended, 7 x 40 mm, #1/#2,
8¹/₄ inch
420-660-214 #3/#4 420-660-216 #5/#6
420-660-218 #7/#8 420-660-220 #9/#10



420-677-210
Friedman Nasenraspel, doppelendig mit geschlagenen Zähnen
und Lewis Arbeitsende, 21,0 cm
Friedman Nasal rasp, double ended with coarse teeth
and Lewis sweeper, 8¹/₄ inch



260-500-001
Drahtbürste zum Reinigen von Raspeln
Wire Brush for cleaning Rasps

NASEN OSTEOTOME / NASAL OSTEOTOMES



420-582-003
 Walter Nasen Osteotom mit runder Schneide,
 3 mm breit, 19.0 cm
 Walter Nasal Osteotome with round cutting edge,
 3 mm wide, 7^{1/2} inch
 420-582-045 4.5 mm



420-594-002
 Sheehan Nasen Osteotom, 2 mm breit, 17.5 cm
 Sheehan Nasal Osteotome, 2 mm wide, 6^{5/8} inch
 420-594-004 4 mm 420-594-010 10 mm
 420-594-006 6 mm 420-594-012 12 mm
 420-594-008 8 mm 420-594-015 15 mm



420-503-011
 Matthew Nasen Osteotom, 11 mm breit, 18.0 cm
 Matthew Nasal Osteotome, 11 mm wide, 7 inch



420-501-002
 Jayes Nasen Osteotom, 2 mm breit, 19.0 cm
 Jayes Nasal Osteotome, 2 mm wide, 7^{1/2} inch
 420-501-004 4 mm 420-501-010 10 mm
 420-501-006 6 mm 420-501-012 12 mm
 420-501-008 8 mm 420-501-015 15 mm



420-490-005
 French (Gillies) Nasen Osteotom, 5 mm breit, 14.0 cm
 French (Gillies) Nasal Osteotome, 5 mm wide, 6^{1/2} inch
 420-490-007 7 mm 420-490-011 11 mm
 420-490-009 9 mm 420-490-013 13 mm



420-495-003
 Ward Nasen Osteotom, 3 mm breit, 18.0 cm
 Ward Nasal Osteotome, 3 mm wide, 7 inch
 420-495-004 4 mm 420-495-005 5 mm



420-568-002
 RZ Nasen Osteotom, 2 mm breit, 18.0 cm
 RZ Nasal Osteotome, 2 mm wide, 7 inch
 420-568-004 4 mm 420-568-006 6 mm
 420-568-008 8 mm 420-568-010 10 mm

NASEN OSTEOTOME / NASAL OSTEOTOMES

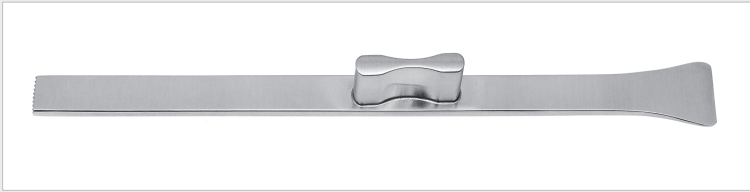

420-587-010
Rubin Nasen Osteotom, 10 mm breit, 18.0 cm
Rubin Nasal Osteotome, 10 mm wide, 7 inch

420-587-012 12 mm 420-587-016 16 mm
420-587-014 14 mm

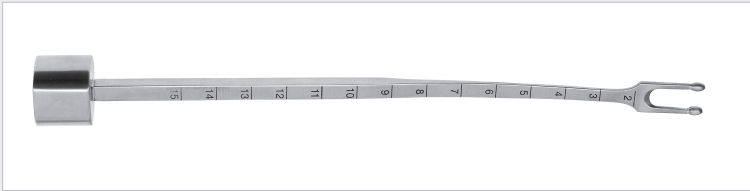

431-662-190
Obwegeser Nasen Osteotom, mit 2 geknöpften Spitzen
und U-Schneide, 18.5 cm
Obwegeser Nasal Osteotome, with 2 buttons on the tips,
U-shape cutting edge, 7¹/₄ inch



420-589-010
Cinelli Osteotom mit beidseitiger Führung, 10.0 mm breit, 16.0 cm
Cinelli Osteotome, double guarded, 10 mm wide, 6¹/₄ inch

420-589-012 12 mm 420-589-016 16 mm
420-589-014 14 mm



420-507-010
Rozner Nasen Osteotom,
beidseitiger Schutz der abgeflachten Schneide, 18.0 cm
Rozner Nasal Osteotome,
probe point on each side of the inclined cutting edge, 7 inch

NASENMEIßEL / NASAL CHISELS



420-459-001
Silver Nasenmeißel, gerade, 18.0 cm
Silver Nasal Chisel, straight, 7 inch
420-459-002 rechts gebogen / right curved
420-459-003 links gebogen / left curved



420-639-001
Neivert Nasenmeißel, gerade, 20.0 cm
Neivert Nasal Chisel, straight, 8 inch
420-639-002 rechts gebogen / right curved
420-639-003 links gebogen / left curved

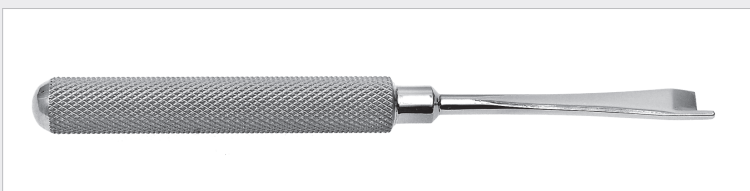

420-485-005
Braithwaite Nasenmeißel, 5 mm breit, mit linker Führung,
14.5 cm
Braithwaite Nasal Chisel, 5 mm wide, guard on left, 14.5 cm
420-486-005 mit rechter Führung / guard on right
420-487-005 ohne Führung / without guard

NASENMEIßEL / NASAL CHISELS

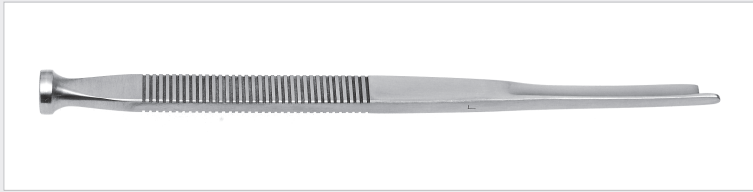

420-491-001
Frenchay Nasenmeißel, links gebogen, mit Führung, 18.0 cm
Frenchay Nasal Chisel, curved left, with guard, 7 inch

420-491-002 rechts gebogen / curved right
420-491-000 gerade / straight



420-493-003
Ward Nasenmeißel, 3 mm breit, 18.0 cm
Ward Nasal Chisel, 3 mm wide, 7 inch



420-494-002
Jenkins Nasenmeißel, 2 mm breit, 14.5 cm
Jenkins Nasal Chisel, 2 mm wide, 5^{3/4} inch

420-494-004 4 mm 420-494-010 10 mm
420-494-006 6 mm 420-494-012 12 mm
420-494-008 8 mm 420-494-014 14 mm



420-460-005
RZ Silver Osteotom mit V-Spitze, gebogen, 17.5 cm
RZ Silver Osteotome, with V-tip, curved, 6^{3/4} inch

420-460-004 gerade / straight



420-505-005
Cottle Nasenmeißel, 5 mm breit, geschwärzt, 18.5 cm
Cottle Nasal Chisel, 5 mm wide, black coated, 7^{1/4} inch

420-505-011 11 mm 420-505-007 7 mm
420-505-016 16 mm 420-505-009 9 mm



420-489-003
Read Nasenmeißel, 3 mm breit, 18.0 cm
Read Nasal Chisel, 3 mm wide, 7 inch

420-489-005 5 mm 420-489-006 6 mm



420-487-009
McIndoe Nasenmeißel mit Mushroom Kopf, 9 mm breit, 15.0 cm
McIndoe Nasal Chisel with Mushroom head, 9 mm wide, 6 inch

420-487-011 11 mm 420-487-015 15 mm
420-487-013 13 mm



420-488-009
McIndoe Nasenmeißel, 9 mm breit, 15.0 cm
McIndoe Nasal Chisel, 9 mm wide, 6 inch

420-488-011 11 mm 420-488-015 15 mm
420-488-013 13 mm

NASEN HOHLMEIßEL / NASAL GOUGES

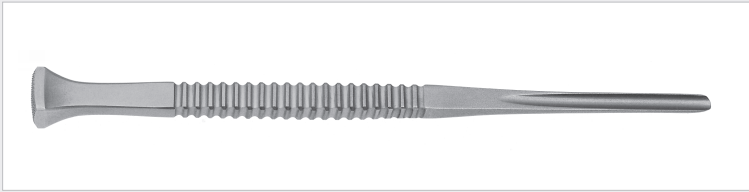

420-492-003

Read Nasen Hohlmeißel, 3 mm breit, 18.0 cm

Read Nasal Gouge, 3 mm wide, 7 inch

420-492-004 4 mm 420-492-006 6 mm

420-492-005 5 mm

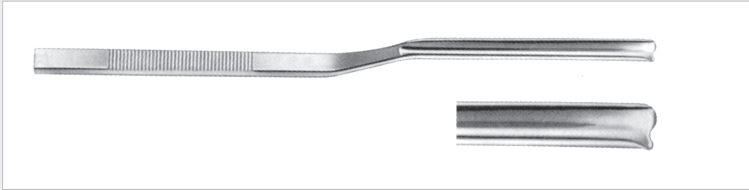

420-551-170

Killian-Claus Septum-Hohlmeißel, bajonettförmig gebogen,
6 mm breit, 17.0 cm

Killian-Claus Septum gouge, bayonet shaped, 6 mm wide, 6³/₄ inch



420-552-170

Killian-Claus Septum-Hohlmeißel, bajonettförmig, runde Schneide
6 mm breit, 17.0 cm

Killian-Claus Septum gouge, bayonet shaped, round cutting edge,
6 mm wide, 6³/₄ inch

HÄMMER / MALLETS



210-240-180

Cottle Hammer, mit flacher und runder Seite, 18.0 cm, 240 g

Cottle Mallet, with flat and round side, 7 inch, 240 g



210-264-140

RZ Hammer, mit austauschbaren Plastikbacken, 18.5 cm, 140 g

RZ Mallet, with interchangeable plastic discs, 7 inch, 140 g

210-265-100

Plastikbacken (1 Paar)

Plastic discs (one pair)



210-262-170

Mead Hammer, mit austauschbaren Plastikbacken,
17.0 cm, 230 g

Mead Mallet, with interchangeable plastic discs, 6³/₄ inch, 230 g

210-263-000

Plastikbacken (1 Paar)

Plastic discs (one pair)

NASENSPEKULA / NASAL SPECULAS



420-143-040

Kilian Nasenspekulum, Standardmodell, 40 mm Blatt, 14.0 cm
Kilian Nasal Specula, Standard pattern, 40 mm blade, 5¹/₂ inch

420-143-055 55 mm Blatt / blade

420-143-070 75 mm Blatt / blade

420-143-090 90 mm Blatt / blade



420-136-035

Kilian-Cottle Nasenspekulum, mit Feststellschraube,
35 mm, 14.0 cm

Kilian-Cottle Nasal Specula, with locking screw,
35 mm, 5¹/₂ inch

420-136-055 55 mm Blatt / blade

420-136-070 70 mm Blatt / blade

420-136-080 80 mm Blatt / blade

420-136-090 90 mm Blatt / blade



420-138-040

Kilian Walter Nasenspekula mit dünnen Blättern,
mit Feststellschraube, 40 mm, 14.0 cm

Kilian Walter Nasal Specula with thin blades,
with locking screw, 40 mm, 5¹/₂ inch

420-138-055 55 mm Blatt / blade

420-138-075 75 mm Blatt / blade

420-138-090 90 mm Blatt / blade



420-144-040

Kilian Nasenspekulum mit 40 mm, spitz zulaufendem Blatt, 14.0 cm
Kilian Nasal Specula with 40 mm, tapered valve, 5¹/₂ inch

420-144-055 55 mm Blatt / blade

420-144-075 75 mm Blatt / blade

420-144-090 90 mm Blatt / blade

NASENSPEKULA/NASAL SPECULAS



420-133-035

Cottle Nasenspekulum, mit Feststellschraube, 35 mm, 13.0 cm
Cottle Nasal Specula, with locking screw, 35 mm, 5 inch

420-133-055 55 mm Blatt / blade

420-133-075 75 mm Blatt / blade



420-100-001

Wiener Modell Nasenspekulum, Fig. 1, 13.0 cm
Vienna Pattern Nasal Specula, Fig. 1, 5 inch

420-100-002 Fig. 2

420-100-003 Fig. 3



420-120-150

Hartmann-Halle Nasenspekulum, Fig. 1, 29 mm Blatt, 15.5 cm
Hartmann-Halle Nasal Specula, Fig. 1, 29 mm blade, 6 inch

420-122-150 Fig. 2, 33 mm Blatt / blade

420-123-150 Fig. 3, 37 mm Blatt / blade



420-140-135

Tieck-Halle Nasenspekulum, 13.5 cm
Tieck-Halle Nasal Specula, 5¹/₄ inch

ELEVATOREN / ELEVATORS



420-530-165

Joseph Periosteal Elevator, leicht gebogen, 2 mm breit, 16.5 cm

Joseph Periosteal Elevator, slightly curved, 2 mm wide, 6^{1/2} inch

420-531-165 3 mm

420-532-165 4 mm



420-585-160

Joseph Periosteal Elevator, gebogen, 4 mm breit

Joseph Periosteal Elevator, curved, 4 mm wide



431-630-009

Obwegeser Periosteal Elevator 17.5 cm, 9 mm wide

Obwegeser Periosteal Elevator, gebogen, 9 mm breit, 17.5 cm

Obwegeser Periosteal Elevator, curved, 9 mm wide, 6^{5/8} inch

431-630-007 7 mm 431-630-006 6 mm

431-630-011 11 mm



420-553-170

Ward Periosteal Elevator 17.0 cm, 6^{3/4} inch



420-550-230

Cottle Septum Elevator, doppelendig, 23.0 cm,

4 x 4 mm rundes Blatt und 3 mm Spalt mit Skalierung

Cottle Septum Elevator, double ended, 9 inch,

4 x 4 mm round blade and 3 mm spatula with scale



420-551-200

Masing Septum Elevator, doppelendig, mit Skalierungen, 20.0 cm

Masing Septum Elevator, double ended, with scale, 8 inch

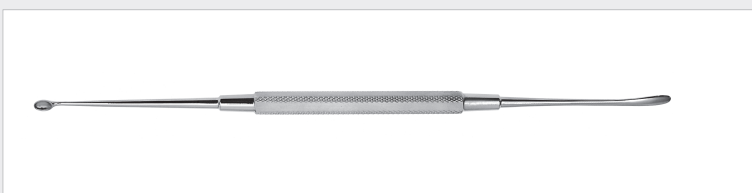

420-551-210

Carter Septum Elevator, doppelendig, 21.0 cm

Carter Septum Elevator, double ended, 8^{1/4} inch



420-532-200

Obwegeser-Freer Septum Elevator, 20.0 cm

Obwegeser-Freer Septum Elevator, 8 inch

RASPATORIEN / RASPATORIES

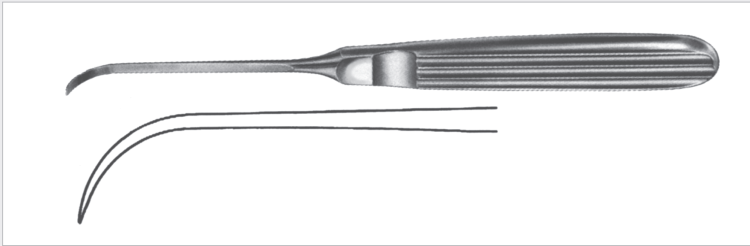

430-531-170

Raspatorium, stark gebogen, scharf, 3 mm breit, 17.0 cm
Raspatory, strongly curved, sharp, 3 mm wide, 6³/₄ inch

430-532-170 6 mm



210-438-010

RZ Howard Raspatorium, gerades und gebogenes Arbeitsende, 22.0 cm
RZ Howard Raspatory, straight and curved working end, 8³/₄ inch

SEPTUM RICHTER / SEPTUM ELEVATOR



420-189-210

Goldmann Septumrichter, 21.0 cm
Goldmann Septum Elevator, 8¹/₄ inch

FACE LIFT ELEVATOREN / FACE LIFT ELEVATORS



260-190-007

Renard Face Lift Elevator, 23.0 cm, 7 mm breit
Renard Face Lift Elevator, 9 inch, 7 mm wide

260-190-012 12 mm

Eignet sich bestens zum Lösen von stark verwachsener Knochenhaut bei subperiostalen Face Lift Operationen.

Facilitates elevation of highly adherent periosteum in sub-periosteal face lift procedures.

SEPTUM RICHTZANGEN / SEPTUM STRAIGHTENING FORCEPS



420-450-230

Cottle-Walsham Septumrichtzange mit aseptischem Verschluss, 22.0 cm

Cottle-Walsham Septum Straightening Forceps with aseptic lock, 8³/₄ inch



420-452-230

Walsham Septumrichtzange rechts, 21.0 cm

Walsham Septum Straightening Forceps, right, 8¹/₄ inch

420-451-230 links, left



420-455-230

Asch Septumrichtzange, 22.0 cm

Asch Septum Straightening Forceps, 8³/₄ inch

SEPTUM QUETSCHZANGEN / SEPTAL MORSELIZERS



420-220-212

Gunter Quetschzange, 18.0 cm, mit kariertem Maulteil

Gunter Lower Lateral Morselizer, 7 inch, with cross serrated jaw



420-220-220

Gorney Septum Quetschzange, 20.0 cm

Gorney Septal Morselizer, double action, angled, 8 inch

420-221-100

Schutzkappe, allein

Guard, only

KNORPELQUETSCHER / CARTILAGE CRUSHERS

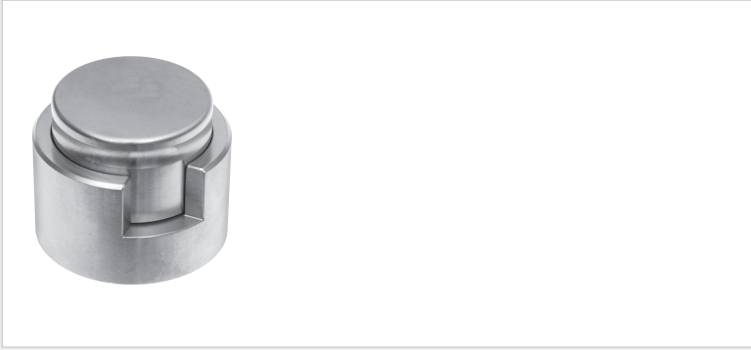

420-366-000
Tolsdorf Knorpelquetscher
Tolsdorf Cartilage Crusher



420-365-000
Cottle Knorpelquetscher mit Entnahmezange
Cottle Cartilage Crusher with removal clip forceps

HOHLMEIßELZANGEN / BONE RONGEURS



210-792-230
Röttgen-Ruskin Hohlmeißelzange, gebogen, 24.0 cm
Röttgen-Ruskin Bone Rongeur, curved, 9¹/₂ inch

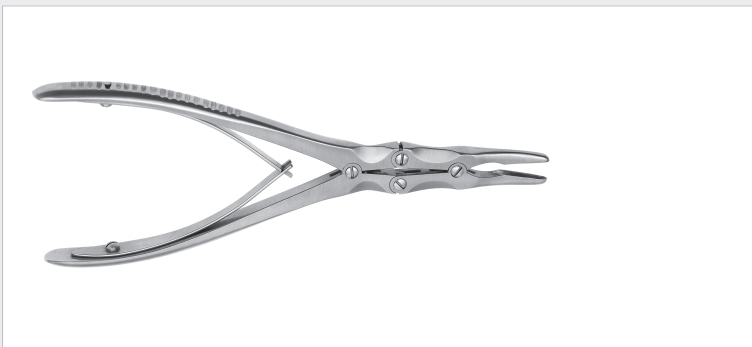

210-790-180
Beyer Hohlmeißelzange, gebogen, 18.0 cm
Beyer Bone Rongeur, curved, 7 inch

KNOCHENSPLITTERZANGEN / BONE CUTTING FORCEPS

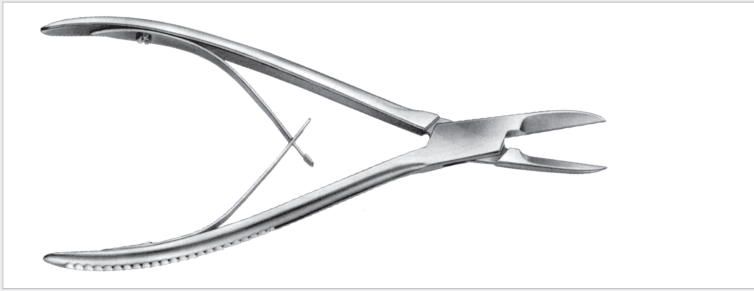

210-845-185

Kazanjian Knochensplitterzange, gerade, 18.5 cm
Kazanjian Bone cutting Forceps, straight, 7¹/₄ inch



210-844-170

Knochensplitterzange, gerade, 17.0 cm
Bone cutting Forceps, straight, 6³/₄ inch

NASENZANGE / SEPTUM FORCEPS

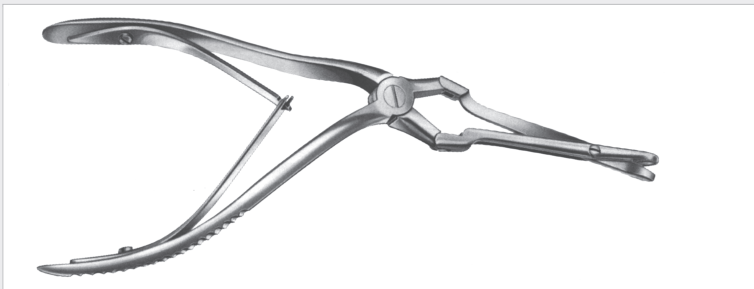

252-031-190

Jansen-Middleton Nasenzange, durchschneidend, 21.0 cm
Jansen-Middleton Septum Forceps, through cutting, 8¹/₄ inch

KNOCHENHALTEZANGEN / BONE HOLDING FORCEPS



210-722-210

Langenbeck Knochenhaltezeange, 21.0 cm
Langenbeck Bone holding Forceps, 8¹/₂ inch

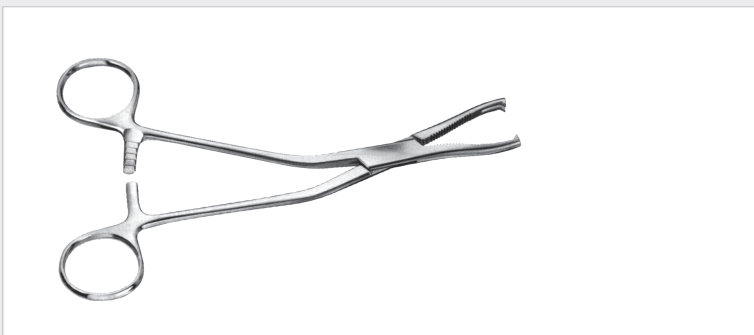

210-626-190

Dingmann Knochenhaltezeange, 18.5 cm
Dingmann Bone holding Forceps, 7¹/₄ inch

NASENSÄGEN / NASAL SAWS



230-202-002

Joseph Nasensäge bajonett, rechts

Joseph Nasal Saw, bayonet, right

230-202-001 bajonett, links / bayonet, left

230-202-000 gerade / straight

NASENRETRAKTOREN / NASAL RETRACTORS



420-250-160

Aufrecht Nasenretractor, 10 x 45 mm Blatt, 18.0 cm

Aufrecht Nasal Retractor, 10 x 45 mm blade, 7 inch

420-255-160

mit Kaltlichtanschluß

with fiber-optic light channel



420-235-110

Converse Nasenretractor, 11 x 44 mm Blatt, 11.0 cm

Converse Nasal Retractor, 11 x 44 mm blade, 4¹/₄ inch

420-236-110

mit Kaltlichtanschluß

with fiber-optic light channel

NASENMESSER / NASAL KNIVES



Ballenger Schwingmesser, bajonett formig

Ballenger swivel Knife, bayonet shaped shaft

420-392-003 3 mm 420-392-004 4 mm

420-392-005 5 mm

gerader Schaft / straight shaft

420-393-003 3 mm 420-393-004 4 mm

420-393-005 5 mm



420-190-003

Joseph doppelschneidendes Nasen Messer, gerade, 14.5 cm

Joseph double-edged Nasal Knife, straight, 5³/₄ inch

420-191-003

gebogen, curved

MESSER / KNIVES

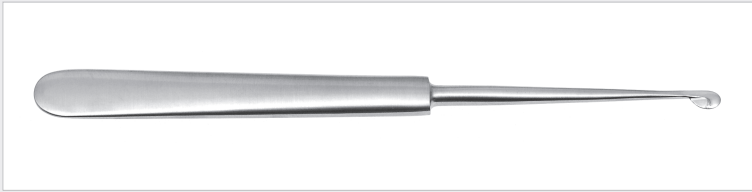

420-195-150
Freer Messer, 15 cm
Freer Mucous Knife, 6 inch



420-205-160
Joseph Nasenmesser, gerade, mit stumpfer Spitze
Joseph Nasal Knife, straight, with blunt tip



110-148-000
Skalpelli Griff
Scalpel Handle

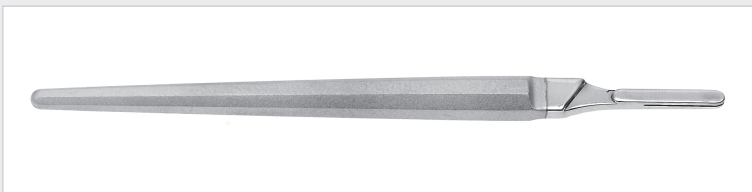

110-140-000
Barron Skalpellgriff, 13.0 cm
Barron Scalpel Handle, 5 inch

Standard Skalpellgriff, Standard Scalpel Handle
110-110-003 Fig. 3 110-140-004 Fig. 4

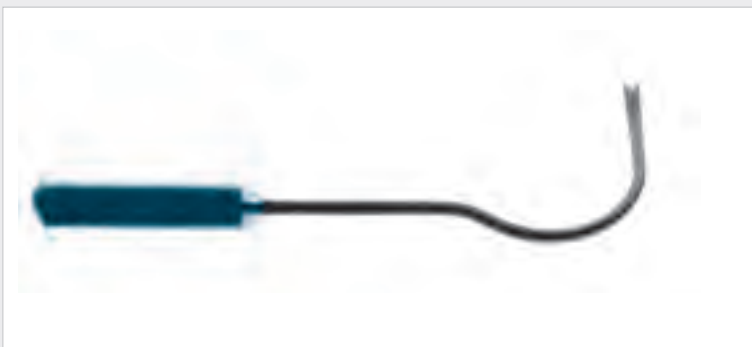

260-310-270
Foerster Kapselmesser zur Trennung einer kugelförmigen Kontraktur, während einer offenen Kapsulotomie. Bei einem submammären Eingriff läuft die stumpfe Schneide des Messers sicher an dem Implantat, während das fibröse Gewebe präpariert wird.

Foerster Capsulotomy for separation of spherical contracture during open capsulotomy. When used in an inframammary incision, the dull edge of the knife safely runs along implant while fibrous tissue is dissected.

HAUT MARKIER STIFT / SKIN MARKING PEN



420-832-145
Eckhoff Haut Markier Stift, mit versenkbarer Spitze
Eckhoff Skin Marking Pen, with reversible holder for point

420-832-001 Ersatz Feder / Spare Nib

KNORPELMESSER / OTOBRADERS



410-033-100

Dingman Knorpelmesser zum Einschneiden von Ohrknorpel während einer Otoplastie.

Dingman Otobraders for scoring of ear cartilage during otoplasty.

bestehend aus... / consisting of...

Set mit linkem und rechtem Messer

Set of left and right pattern

HAUTKÜRETTEN / DERMAL CURETTES



230-151-140

Fox Hautkürette, 3 mm Ø, 14.0 cm

Fox Dermal Curette, 3 mm Ø, 14.0 cm

230-152-140 4 mm Ø

230-153-140 5 mm Ø

HANDSCHNITTMESSER / HAND DERMATOME

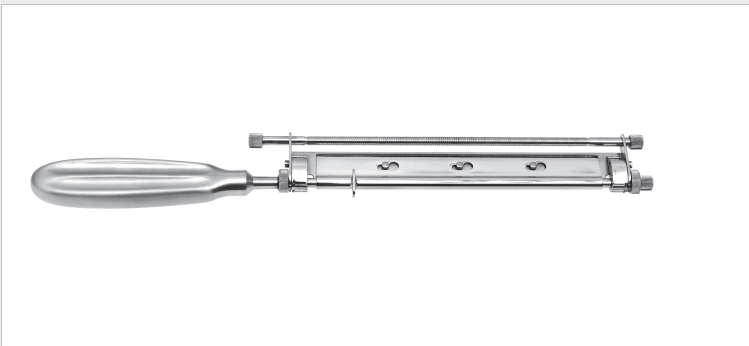

110-097-305

Braithwaite (Modif. Humby) Handschneidmesser, für LINKSHÄNDER, kpl.

Braithwaite (Modif. Humby) Hand Dermatome LEFT HANDED, complete

110-098-305

Desgleichen, für RECHTSHÄNDER / Same, RIGHT HANDED

110-098-399

Ersatzklingen, Pack zu 10 Stück, unsteril

Spare blades, package of 10 pieces, non sterile

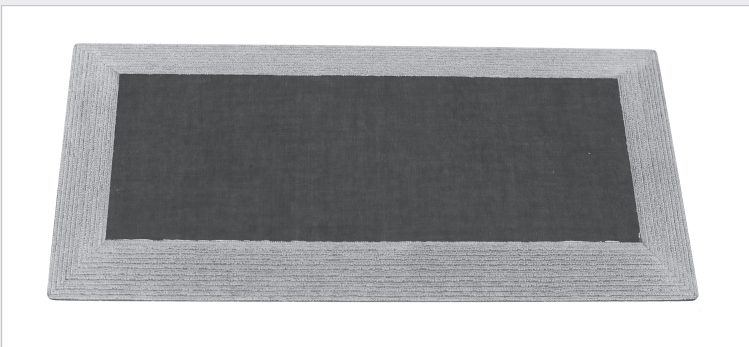

110-090-150

Hauttransplantationsbrett, abgeschrägter Rand, 200 x 100 mm

Skin Graft Board, bevelled edge, 200 x 100 mm

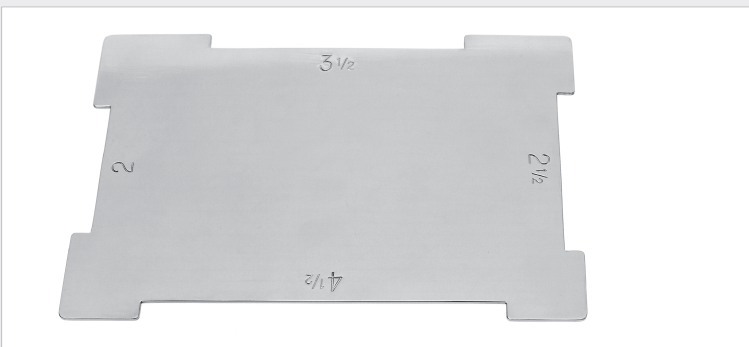

110-090-100

Gabarro Haut Transplantat Meßlehre

Gabarro Skin Graft Measure

GAUMENSPALTEN INSTRUMENTE / CLEFT PALATE INSTRUMENTS

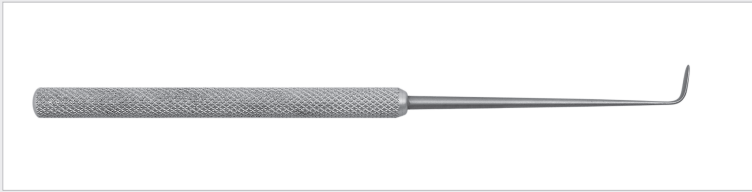

430-100-602
Gaumenspalten Elevator, klein, 18.0 cm
Cleft Palate Elevator, small, 7 inch
430-100-601 mittel, medium
430-100-600 groß, large



430-100-603
Cronin Gaumenspalten Messer, dreieckig, 18.0 cm
Cronin Cleft Palate knife, triangular, 7 inch



420-580-145
Gaumenspalten Raspatorium, aufgebogen
Cleft Palate Raspatory, curved upwards
420-583-145 abgebogen / curved downwards



420-581-145
Gaumenspalter Raspatorium, aufgebogen, rechts
Cleft Palate Raspatory, curved upwards, right
420-582-145 aufgebogen, links / curved upwards, left



430-105-002
Blair Gaumenspalten Elevator, rechts abgewinkelt, stumpf
Blair Cleft Palate Elevator, right angled, blunt



430-105-001
Blair Gaumenspalten Elevator, L-Form, stumpf, abgerundet
Blair Cleft Palate Elevator, L-Shaped, blunt, rounded



430-105-003
Blair Gaumenspalten Elevator, flach, stumpf
Blair Cleft Palate Elevator, flat, blunt

GAUMENSPALTEN INSTRUMENTE / CLEFT PALATE INSTRUMENTS



431-200-003
Gaumenspalten Häkchen, langes Blatt, 18.0 cm
Cleft Palate Hooklet, long blade, 7 inch

431-200-001
Gaumenspalten Häkchen, kurzes Blatt, 18.0 cm
Cleft Palate Hooklet, short blade, 7 inch



431-200-013
Gaumenspalten Dissektor, langes Blatt, 18.0 cm
Cleft Palate Dissector, long blade, 7 inch

431-200-011
Gaumenspalten Dissektor, kurzes Blatt, 18.0 cm
Cleft Palate Dissector, short blade, 7 inch



431-200-021
Gaumenspalten Elevator, leicht gebogen, 18.0 cm
Cleft Palate Elevator, slightly curved, 7 inch

431-200-023
Gaumenspalten Elevator, gebogen, 18.0 cm
Cleft Palate Elevator, curved, 7 inch

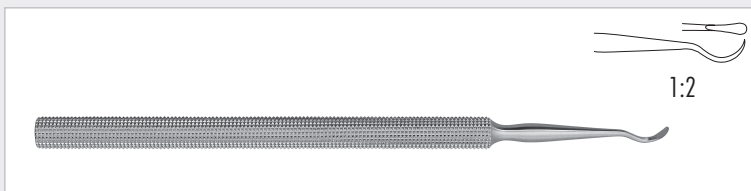

431-200-100
Gaumenspalten Raspatorium, 17.0 cm
Cleft Palate Periosteal Elevator, 6³/₄ inch



431-200-027
Gaumenspalten Messer, dreieckiges Blatt, 18.0 cm
Cleft Palate Knife, triangular blade, 7 inch

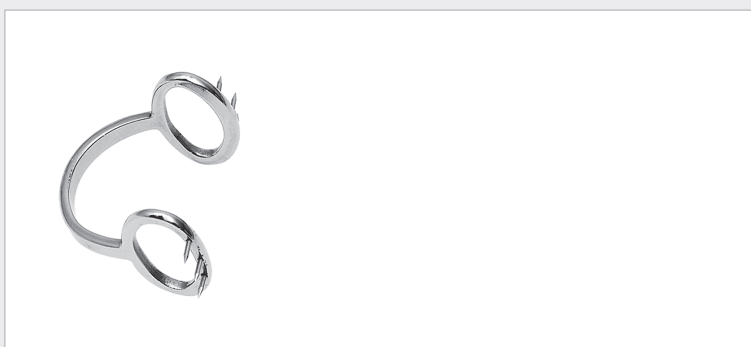

420-985-013
Logan Bogen, mit Zähnen, 28 mm breit
Logan Bow, with teeth, 1¹/₈ inch wide

420-985-014 32 mm breit, 1¹/₄ inch wide

420-985-015 35 mm breit, 1³/₈ inch wide

SAUGKANÜLEN / SUCTION CANNULAS



410-404-030

Magill Saugkanüle, 3 mm Ø, 24.5 cm

Magill Suction Cannula, 3 mm Ø, 9³/₄ inch

410-404-035 3.5 mm Ø

410-404-040 4.0 mm Ø

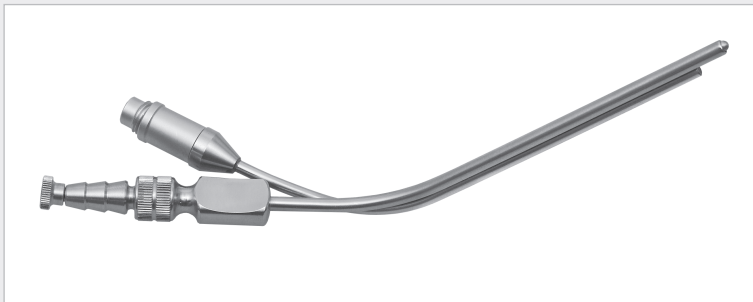

165-523-110

Frazier Saugkanüle mit Kaltlichtkanal, 10 Fr., 19.0 cm

Frazier Suction Cannula with Fiber Optic Light channel,
10 Fr., 7¹/₂ inch

165-523-112 12 Fr.

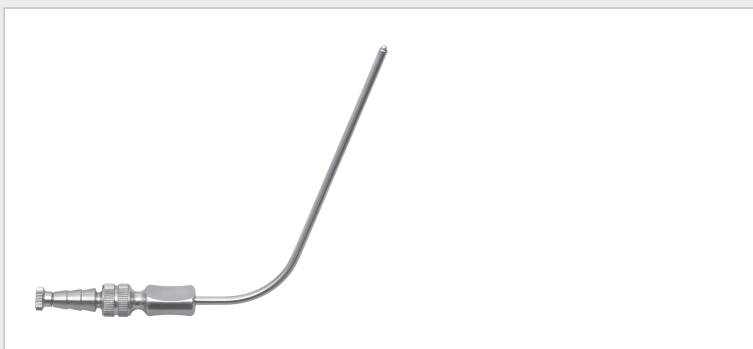

165-525-007

Fergusson Saugkanüle, 7 Fr., 18.0 cm

Fergusson Suction Tube, 7 Fr., 7 inch

165-525-008 8 Fr.

165-525-010 10 Fr.

165-525-012 12 Fr.

165-521-012 12 Fr. biegsam / malleable



165-521-004

Adson Saugkanüle, 4 mm Ø, 21.0 cm

Adson Suction Cannula, 4 mm Ø, 8¹/₄ inch



165-522-200

Guilen Sauggraspatorium, links gebogen, 20.0 cm

Guilen Suction Elevator, left curved, 8 inch

165-521-200 rechts gebogen, right curved



420-395-205

Negus Saug Dissektor, 20.5 cm

Negus Suction Elevator, 8 inch



420-253-185

Gorney Septum Saugelevator 3 mm Spitze, 175 mm,

scharf, rechteckiges Arbeitsende

Gorney Septum Suction Elevator 3 mm tip, 8.5 inch

semi-sharp, square end

KLEMMEN / FORCEPS



140-259-090
Hartmann Titan Arterienklemme, 9.0 cm, gebogen
Hartmann Titanium Artery Forceps, 3¹/₂ inch, curved

140-258-090 gerade, straight



140-259-125
Halstead Mosquito Titan Arterienklemme, 12.5 cm, gebogen
Halstead Mosquito Titanium Artery Forceps, 5 inch, curved

140-258-125 gerade, straight



140-263-125
Micro Halstead Mosquito Titan Arterienklemme, 12.5 cm, gebogen
Micro Halstead Mosquito Titanium Artery Forceps 5 inch, curved

140-262-125 gerade, straight

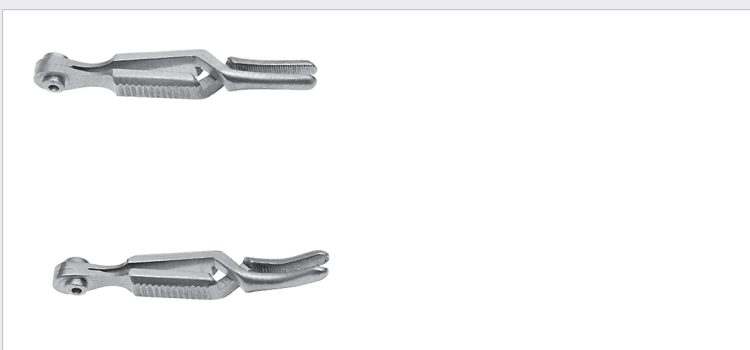

140-050-038
Johns-Hopkins Bulldog Klemme, gerade, 3.8 cm
Johns-Hopkins Bulldog Clamp, straight, 1¹/₂ inch

140-051-038 gebogen, curved



310-014-150
Allis Gewebefabzange, 5 x 6 Zähne, 15.0 cm
Allis Tissue Forceps, 5 x 6 teeth, 6 inch

310-014-190 19.0 cm, 7¹/₂ inch

SHAPERS

Instrumente für die Plastische Gesichtsendoskopie
Instruments for Forehead and Facelift Endoscopy



260-104-030

SHAPER Endoskop für die plastische Endoskopie, 4 mm Durchmesser, 30°, Weitwinkel, autoklavierbar, zur Verwendung mit allen SHAPER Schäften

SHAPER Telescope for Plastic Endoscopy, 4 mm diameter, 30°, Wide Angle, autoclavable, for use with all SHAPER Sheaths



260-501-180

SHAPER Schaft mit einem rotierbaren Hahn mit aufgewinkelter Spatelspitze für eine optimale Sicht während der Gewebedissektion

SHAPER Sheath with one rotating stop cock, with angled spatula tip for the best view during tissue dissection



251-140-175

SHAPER Schaft für die plastische Endoskopie, mit einem rotierbaren Hahn, mit flacher Spatelspitze

SHAPER Sheath for plastic Endoscopy, with one rotating stop cock, with a flat spatula tip



251-340-175

SHAPER Schaft für die plastische Endoskopie, mit zwei rotierbaren Hähnen, mit flacher Spatelspitze

SHAPER Sheath for plastic Endoscopy, with two rotating stop cocks, with a flat spatula tip

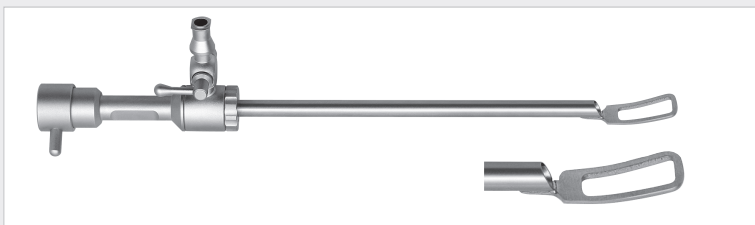

260-502-180

SHAPER Schaft mit einem rotierbaren Hahn mit großer aufgewinkelter Spatelspitze für eine optimale Sicht während der Gewebedissektion

SHAPER Sheath with one rotating stop cock, with large angled up spatula tip for the best view during tissue dissection

SHAPERS

SHAPER Dissektoren: Entwickelt, um sich den Gesichtskonturen anzupassen.

Die große Anzahl an unterschiedlichsten Dissektoren ermöglicht den Einsatz in sämtlichen anatomischen Gegebenheiten. Die Balance der Instrumente wird von beiden Griffvarianten bestens gewährleistet, ebenso eine gute Griffigkeit, welches ein langes und präzises Arbeiten ermöglicht.

SHAPER Dissectors: Designed to fit facial contours.

The large number of most different elevators enables the application in all different anatomical conditions.

The well balanced instruments in combination with the handle designs with a good grip ensuring precise working during long surgeries.



260-001-001

SHAPER Kopfhaut Dissektor, leicht gebogen, 12.5 mm breit
SHAPER Scalp Dissector, slightly curved, 12.5 mm wide

260-001-101

mit Ergo-Handgriff
with Ergo Handle



260-001-002

SHAPER Kopfhaut Dissektor, medium gebogen, mit abgewinkelter Spitze,
12.5 mm breit, 24.0 cm
SHAPER Scalp Dissector, half curved, with angled tip,
12.5 mm wide, 9¹/₂ inch

260-001-102

mit Ergo-Handgriff
with Ergo Handle



260-002-001

SHAPER Dissektor, halb gebogen, 7.0 mm breit, 24.0 cm
SHAPER Dissector, half curved, 7.0 mm wide, 9¹/₂ inch

260-002-101

mit Ergo-Handgriff
with Ergo Handle



260-007-001

SHAPER Transoraler Dissektor, gebogen, 7.0 mm breit, 23.5 cm
SHAPER Transoraler Dissector, curved, 7.0 mm wide, 9¹/₄ inch

260-007-101

mit Ergo-Handgriff
with Ergo Handle

SHAPERS

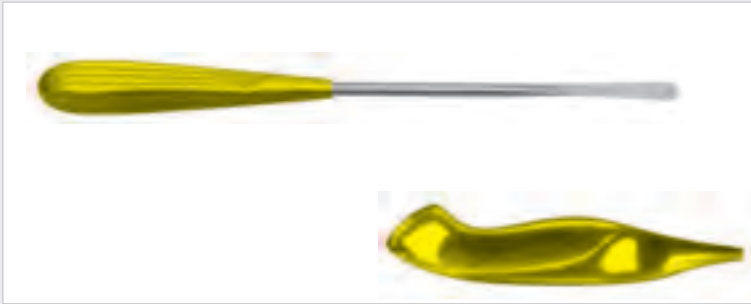

260-002-003

SHAPER Dissektor, gerade, 7.0 mm breit, 24.0 cm
SHAPER Dissector, straight, 7.0 mm wide, 9¹/₂ inch

260-002-103

mit Ergo-Handgriff
with Ergo Handle



260-020-001

SHAPER Hautlappen Dissektor, gebogen, 24.0 cm, 6.5 mm breit
SHAPER Flap Dissector, curved, 9¹/₂ inch, 6.5 mm wide

260-020-101

mit Ergo-Handgriff
with Ergo Handle



260-023-000

SHAPER Sim-Clabella Dissektor, S-Form, 26.6 cm
SHAPER Frantaglabellar Dissector, S-shaped, 10¹/₂ inch

260-023-100

mit Ergo-Handgriff
with Ergo Handle



260-024-000

SHAPER Mittelgesicht-Faszien Dissektor, S-Form, 24.0 cm
SHAPER Midface Fascia Dissector, S-shaped, 9¹/₂ inch

260-024-100

mit Ergo-Handgriff
with Ergo Handle



260-020-000

SHAPER Hautlappen Dissektor, gerade, 22.5 cm, 10 mm breit
SHAPER Flap Dissector, straight, 8³/₄ inch, 10 mm wide

260-020-100

mit Ergo-Handgriff
with Ergo Handle

SHAPERS



260-025-000

SHAPER Periosteal Dissector, S-Form, 24.0 cm, 5 mm breit
SHAPER Periosteal Dissector, S-shaped, 9¹/₂ inch, 5 mm wide

260-025-100

mit Ergo-Handgriff
with Ergo Handle



260-003-001

SHAPER Nerven Dissektor, leicht gebogen, 24.0 cm
SHAPER Nerve Dissector, slightly curved, 9¹/₂ inch

260-003-101

mit Ergo-Handgriff
with Ergo Handle



260-004-001

SHAPER Orbital-Rand Dissektor, medium gebogen
SHAPER Orbital Rim Dissector, half curved

260-004-101

mit Ergo-Handgriff
with Ergo Handle



260-022-000

SHAPER Schläfen Dissektor, gerade, 23.5 cm
SHAPER Temporal Dissector, straight, 9¹/₄ inch

260-022-100

mit Ergo-Handgriff
with Ergo Handle



260-021-000

SHAPER Periosteal Scheitelbein Dissektor, gebogen 25.0 cm
SHAPER Periosteal Dissector, curved, 9³/₄ inch

260-021-100

mit Ergo-Handgriff
with Ergo Handle

SHAPERS



260-003-002

SHAPER Nervenhook, rechts gebogen, 24.0 cm

SHAPER Nerve Hook, curved right, 9¹/₂ inch

260-003-003

SHAPER Nervenhook, links gebogen, 24.0 cm

SHAPER Nerve Hook, curved left, 9¹/₂ inch



260-014-230

SHAPER Nervenhook, leicht biegsam, 23.5 cm, graduiert

SHAPER Nerve Hook, malleable, 9¹/₄ inch, with graduation



260-008-003

SHAPER Nerven Protektor, rechts gebogen, 17.0 cm

SHAPER Nerve Protector, curved right, 6³/₄ inch

260-008-002

SHAPER Nerven Protektor, links gebogen, 17.0 cm

SHAPER Nerve Protector, curved left, 6³/₄ inch



260-002-005

Saugelevator, leicht gebogen, runde Schneide

Suction Elevator, slightly curved, round edge



260-006-001

Skalpellgriff für kleine Klingen, 23,0 cm, nach unten gewinkelt

Scalpel Handle for small blades, 9 inch, downwards angled

SHAPERS



260-601-000
SHAPER Handgriff für modulare Instrumenteneinsätze
SHAPER Handle for modular instrument inserts



260-601-100
Elevator, scharf, 9 mm breit, gerade, Aufsatz alleine
Elevator, sharp, 9 mm wide, straight, insert only
260-601-103 gebogen, curved
260-601-101 biegsam, malleable



260-601-104
Elevator, scharf, 6 mm breit, gerade, Aufsatz alleine
Elevator, sharp, 6 mm wide, straight, insert only
260-601-102 gebogen, curved
260-601-113 biegsam, malleable



260-601-114
Elevator, scharf, 12 x 12 mm breit, gerade, Aufsatz alleine
Elevator, sharp, 12 x 12 mm wide, straight, insert only
260-601-115 gebogen, curved
260-601-105 biegsam, malleable



260-601-116
Elevator, scharf, 5 x 20 mm spatel, gerade, Aufsatz alleine
Elevator, sharp, 5 x 20 mm spatula, straight, insert only
260-601-117 gebogen, curved
260-601-118 biegsam, malleable



260-601-119
Elevator, scharf, leicht gebogener Löffel, 12 mm breit, gerade, Aufsatz alleine
Elevator, sharp, slightly curved spoon shaped spatula, 12 mm wide, straight, insert only
260-601-120 gebogen, curved
260-601-121 biegsam, malleable



260-601-122
Elevator, scharf, Bogen geformt, 9 mm breit, gebogen, Aufsatz alleine
Elevator, sharp, bow shaped spatula, 9 mm wide, curved, insert only
260-601-123 biegsam, malleable

SHAPERS



260-601-124
Elevator, scharf, 4.5 mm breit, leicht abgewinkelt, gebogen,
Aufsatz alleine
Elevator, sharp, 4.5 mm wide, slightly angled, curved,
insert only

260-601-125 biegsam, malleable



260-601-126
Elevator, scharf, leicht gebogen, biegsam, Aufsatz alleine
Elevator, sharp, slightly curved, malleable, insert only



260-601-127
Elevator, scharf, 8 mm breit, leicht gebogen, gerade, Aufsatz alleine
Elevator, sharp, 8 mm wide, slightly curved, straight, insert only

260-601-128 gebogen, curved

260-601-129 biegsam, malleable



260-601-108
Elevator, scharf, 8 mm breit, flacher Spatel, gerade, Aufsatz alleine
Elevator, sharp, 8 mm wide, flat spatula, straight, insert only

260-601-106 biegsam, malleable



260-601-134
Elevator, stumpf, 9 mm breit, gerade, Aufsatz alleine
Elevator, blunt, 9 mm wide, straight, insert only

260-601-136 biegsam, malleable



260-601-137
Elevator, stumpf, 6 mm breit, gerade, Aufsatz alleine
Elevator, blunt, 6 mm wide, straight, insert only

260-601-138 gebogen, curved

260-601-139 biegsam, malleable

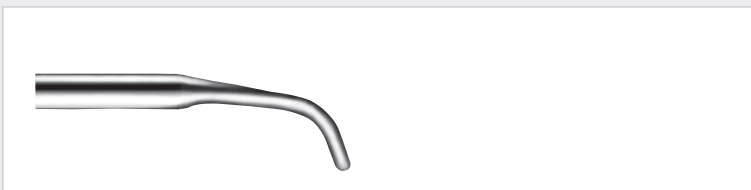

260-601-140
Nervenhaken, Haken links gebogen, Aufsatz alleine
Nerve Hook, curved left, insert only

260-601-141 biegsam, malleable

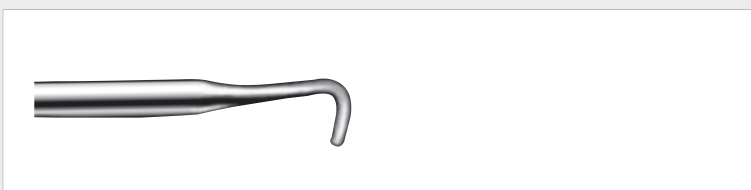

260-601-142
Nervenhaken, Haken rechts gebogen, Aufsatz alleine
Nerve Hook, curved right, insert only

260-601-143 biegsam, malleable

SHAPERS



260-204-100

SHAPER Faßzange mit langem gerieftem Maul, isolierter Schaft, gerade, 2.7 mm Durchmesser, 12.5 cm Arbeitslänge
SHAPER Grasping Forceps with long serrated jaws, insulated shaft, straight, 2.7 mm Diameter, 5 inch working length

260-204-200 rechts gebogen, right curved

260-204-500 links gebogen, left curved



260-204-600

SHAPER Faßzange mit kurzem, starkem Maul, isolierter Schaft, gerade, 2.7 mm Durchmesser, 12.5 cm Arbeitslänge
SHAPER Grasping Forceps with short strong jaws, insulated shaft, straight, 2.7 mm Diameter, 5 inch working length

260-204-400 rechts gebogen, right curved

260-204-300 links gebogen, left curved

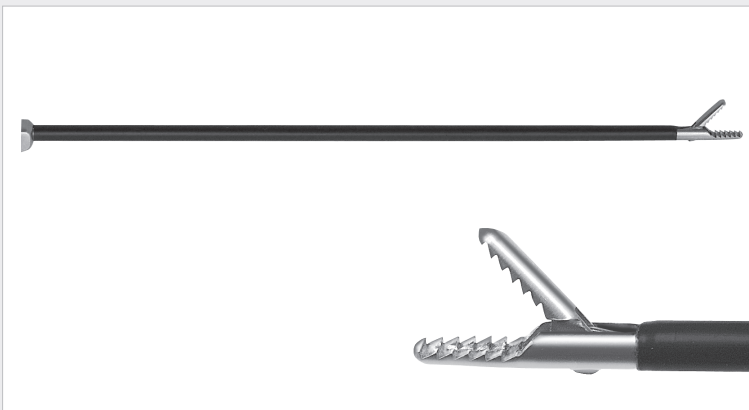

260-204-627

SHAPER Faßzange mit kurzem Maul und aggressiven Zähnen, isolierter Schaft, gerade, 2.7 mm Durchmesser, 12.5 cm Arbeitslänge
SHAPER Grasping Forceps with short jaws with aggressive teeth, insulated shaft, straight, 2.7 mm Diameter, 5 inch working length

260-204-427 rechts gebogen, right curved

260-204-327 links gebogen, left curved



260-203-600

SHAPER Hakenschere, isolierter Schaft, gerade, 2.7 mm Durchmesser, 12.5 cm Arbeitslänge
SHAPER Hook Scissors insulated shaft, straight, 2.7 mm Diameter, 5 inch working length

260-203-700 rechts gebogen, right curved

260-203-800 links gebogen, left curved

SHAPERS

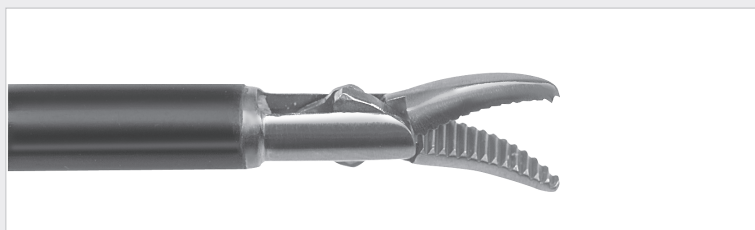

260-610-000

Mikro Maryland Dissektor, mit gebogenem Schaft, drehbar, isoliert, zerlegbar

Micro Maryland Dissecting Forceps, curved shaft, rotating, insulated, detachable

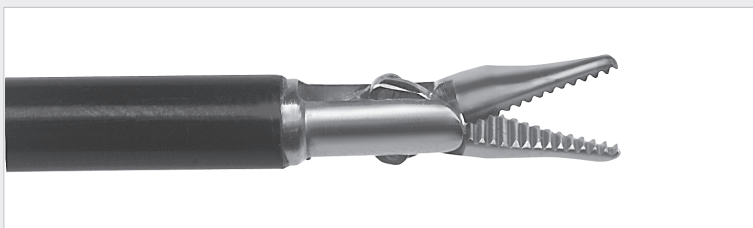

260-604-000

Mikro Faßzange, mit gebogenem Schaft, drehbar, isoliert, zerlegbar

Micro Grasping Forceps, curved shaft, rotating, insulated, detachable



260-608-000

Mikro Faßzange mit Hechtmaul, mit gebogenem Schaft, drehbar, isoliert, zerlegbar

Micro Grasping Forceps with alligator jaws, curved shaft, rotating, insulated, detachable



260-600-000

Mikro Hakenschere mit gebogenem Schaft, drehbar, isoliert, zerlegbar

Micro Hook Scissors, curved shaft, rotating, insulated, detachable



260-614-000

Mikro Metzenbaumschere mit gebogenem Schaft, drehbar, isoliert, zerlegbar

Micro Scissors, curved shaft, rotating, insulated, detachable

SHAPERS



260-712-000

Spatel Elektrode gerade, mit Absaugung und Trompetenventil
Spatula Electrode straight, with suction and stop cock



260-702-000

Spatel Elektrode gebogen, mit Absaugung und Trompetenventil
Spatula Electrode curved, with suction and stop cock



260-710-000

J-Haken Elektrode gerade, mit Absaugung und Trompetenventil
J-Hook Electrode straight, with suction and stop cock



260-700-000

J-Haken Elektrode gebogen, mit Absaugung und Trompetenventil
J-Hook Electrode curved, with suction and stop cock



260-060-005

Fan Retraktor gerade, mit 4 Armen
Fan Retractor straight, with 4 prongs

SCULPO

Instrumente für die Plastische Brust-Endoskopie Instruments for Plastic Breast Surgery

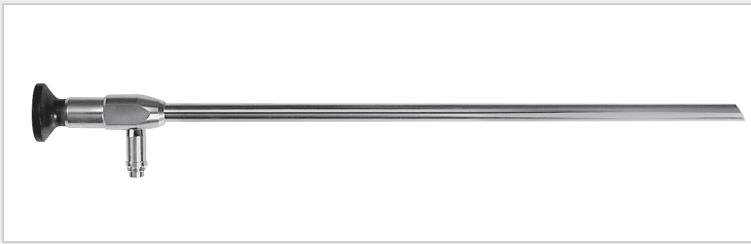

260-110-030

SCULPO Endoskop für die plastische Endoskopie, 10 mm Durchmesser, 30°
SCULPO Plastic Surgery Endoscope, 10 mm diameter, 30°

260-110-000

SCULPO Endoskop für die plastische Endoskopie, 10 mm Durchmesser, 0°
SCULPO Plastic Surgery Endoscope, 10 mm diameter, 0°



260-130-016

SCULPO Brust Retraktor zur Verwendung mit 10 mm RZ Optik, 18.0 cm langes Blatt, 25 mm breit, mit einem rotierbaren Hahn
SCULPO Breast Retractor for use with 10 mm RZ telescope, 7 inch long blade, 1 inch wide, with one rotating stop cock



260-130-015

SCULPO Brust Retraktor zur Verwendung mit 10 mm Optik, 18.0 cm langes Blatt, 25 mm breit, mit einem Hahn, mit Feststellschraube für alle gängigen Optiken
SCULPO Breast Retractor for use with 10 mm telescope, 7 inch long blade, 1 inch wide, with one stop cock, with adjusting screw for all commonly used telescopes



260-130-000

SCULPO Brust Retraktor zur Verwendung mit 4 mm RZ Optik, 18.0 cm langes Blatt, 25 mm breit, mit einem rotierbaren Hahn
SCULPO Breast Retractor for use with 4 mm RZ telescope, 7 inch long blade, 1 inch wide, with one rotating stop cock

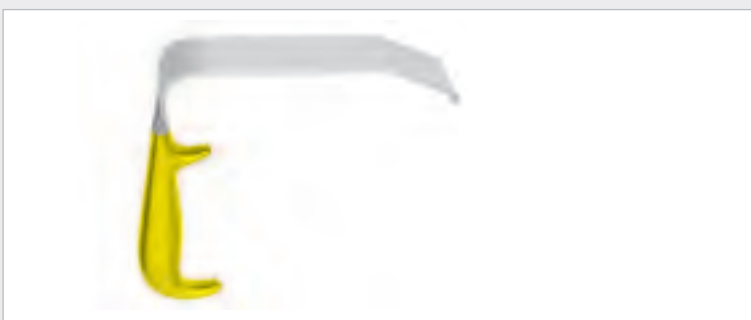

260-137-150

SCULPO Brust Retraktor, 15 cm langes Blatt, 36 mm breit, mit 7 feinen Zähnen
SCULPO Breast Retractor, 15 cm long blade, 36 mm wide, with 7 delicate teeth

260-136-150

mit Kaltlicht und Absaugung / with cold light and suction

260-136-190

mit Kaltlicht und Absaugung, 19.0 cm langes Blatt
with cold light and suction, 7¹/₂ inch long blade

DUARTE SCULPO

Mammoplastik Retraktoren

Die DUARTE SCULPO Retraktoren überzeugen durch Ihre Anwendungsvielfalt und den griffigen Leichtmetall-Handgriff durch welchen wir unsere Kaltlichtkanäle auch in Kombination mit Absaugrohren legen können. In Zusammenarbeit mit Dr. Duarte setzt die RZ Medizintechnik GmbH neue Maßstäbe in der Mammachirurgie.

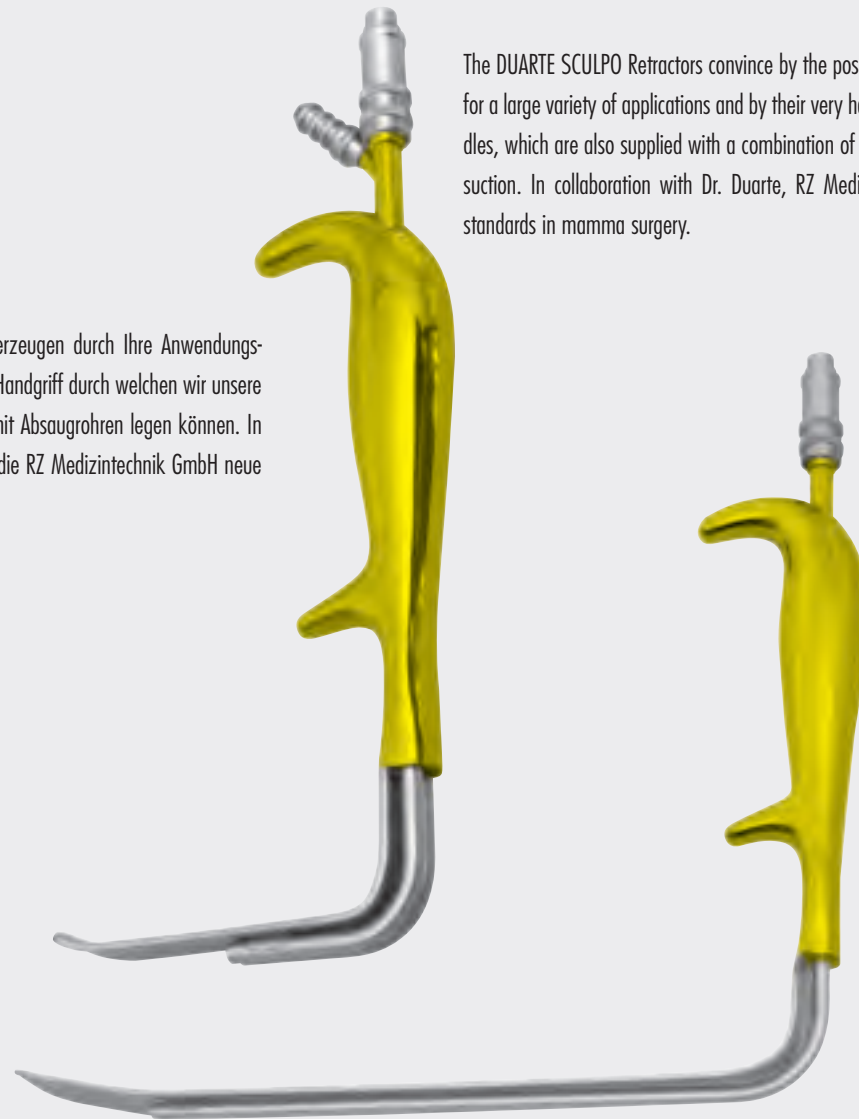

DUARTE SCULPO

Mammoplasty Retractors

The DUARTE SCULPO Retractors convince by the possibility of using them for a large variety of applications and by their very handy light metal handles, which are also supplied with a combination of fiber optic as well as suction. In collaboration with Dr. Duarte, RZ Medizintechnik sets new standards in mamma surgery.

RZ SCULPO

Mammoplastik Retraktoren

Sämtliche RZ SCULPO Mammoplastik Retraktoren werden mit einem Kaltlichtkanal geliefert.

Der einzigartige Handgriff aus sterilisierbarem Silikon ermöglicht ein absolut ermüdungsfreies Arbeiten. Die anatomische Handform garantiert einen guten Halt und vermeidet ein Abrutschen selbst unter schwersten Bedingungen. Der ø 5 mm Kaltlichtkanal mit Universaladapter hat eine äußerst hohe Lichtleiter-Qualität und leuchtet das komplette Operationsfeld bestmöglich aus. Der Kaltlichtkanal wird durch den Handgriff geführt wodurch ein freies OP-Feld entsteht und keine Kabel die Sicht beeinträchtigen.



RZ SCULPO

Mammoplasty Retractors

All RZ SCULPO Mammary Retractors will be supplied with a Fiber Optic Light channel.

The uniquely designed handle made of sterilizable silicon facilitates working without signs of fatigue. The anatomical design handle ensures a secure grip and avoids slippage under hard working conditions. The ø 5 mm fiber optic channel with an universal adapter fitting to the most commonly used fiber optic cables, has an extremely high light carrier quality with good illumination in the complete operating field. The fiber optic channel is built to go inside the handle to increase the view during surgery avoiding that the fiber optic cable is disturbing the operation.

Mit Kaltlichtkanal und Absaugung / Fiber Optic with Suction

260-233-070
Blatt Größe: 70 x 16mm
Blade size: 70 x 16mm

260-244-150
Blatt Größe: 150 x 25 mm
Blade size: 150 x 25 mm

260-233-150
Blatt Größe: 150 x 16mm
Blade size: 150 x 16mm

260-245-180
Blatt Größe: 180 x 25 mm
Blade size: 180 x 25 mm

260-243-070
Blatt Größe: 70 x 25 mm
Blade size: 70 x 25 mm

260-246-220
Blatt Größe: 220 x 25 mm
Blade size: 220 x 25 mm

Mit Kaltlichtkanal ohne Absaugung / Fiber Optic without Suction

260-230-010
Blatt Größe: 220 x 25 mm
Blade size: 220 x 25 mm

260-230-015
Blatt Größe: 70 x 16 mm
Blade size: 70 x 16 mm

260-230-014
Blatt Größe: 150 x 25 mm
Blade size: 150 x 25 mm

260-230-016
Blatt Größe: 180 x 25 mm
Blade size: 180 x 25 mm

260-234-150
Blatt Größe: 150 x 16mm
Blade size: 150 x 16mm

260-247-150
Blatt Größe: 150 x 25 mm
Blade size: 150 x 25 mm

260-235-180
Blatt Größe: 180 x 16mm
Blade size: 180 x 16mm

260-247-180
Blatt Größe: 180 x 25 mm
Blade size: 180 x 25 mm

260-236-220
Blatt Größe: 220 x 16 mm
Blade size: 220 x 16 mm

260-247-220
Blatt Größe: 220 x 25 mm
Blade size: 220 x 25 mm

BIGGS
Mammoplastik Retraktoren

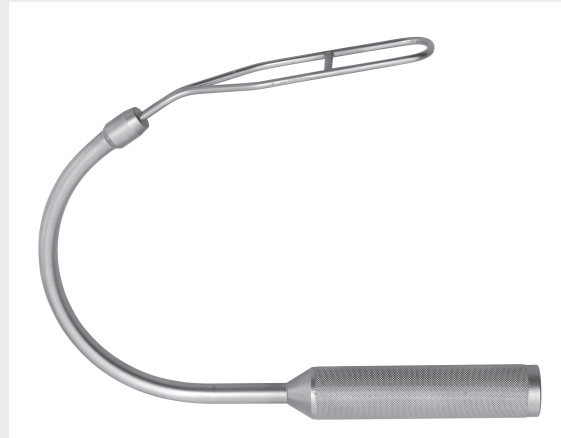

260-037-000
Schmales Blatt, 31 mm breit
Narrow blade, 31 mm wide

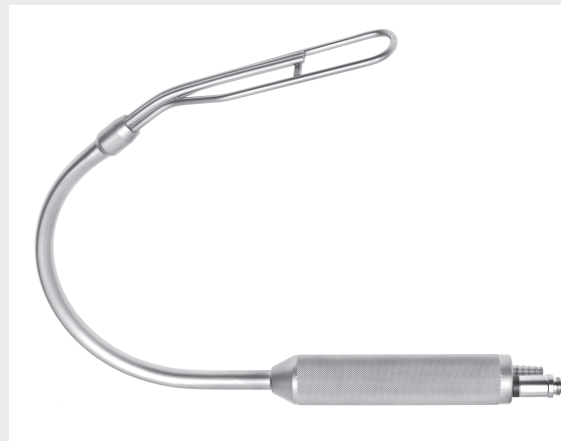

260-131-000
Schmales Blatt, 31 mm breit mit Kaltlicht und Absaugung
Fiber Optic with universal adapter and suction tube, narrow blade, 31 mm wide



260-135-000
Schmales Blatt, 31 mm für 10 mm Optik mit Absaugung
Narrow blade, 31 mm wide for 10 mm scopes with irrigation

BIGGS
Mammoplasty Retractors

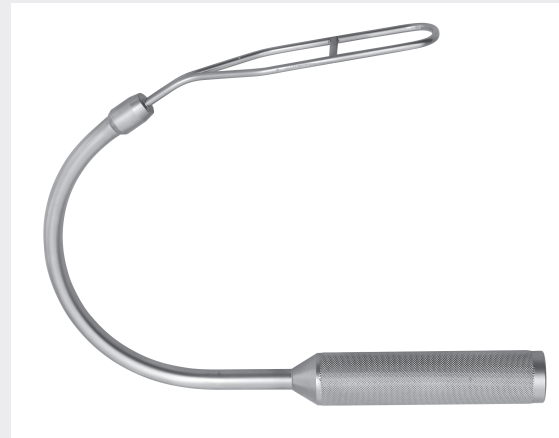

260-039-000
Breites Blatt, 50 mm breit
Standard blade, 50 mm wide

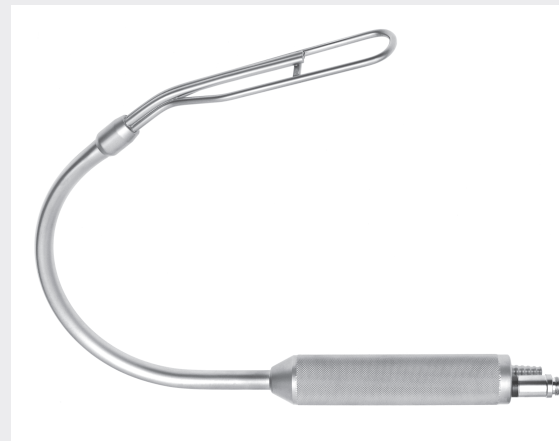

260-141-000
Breites Blatt, 50 mm breit, mit Kaltlicht und Absaugung
Fiber Optic with universal adapter and suction tube, standard blade, 50 mm wide

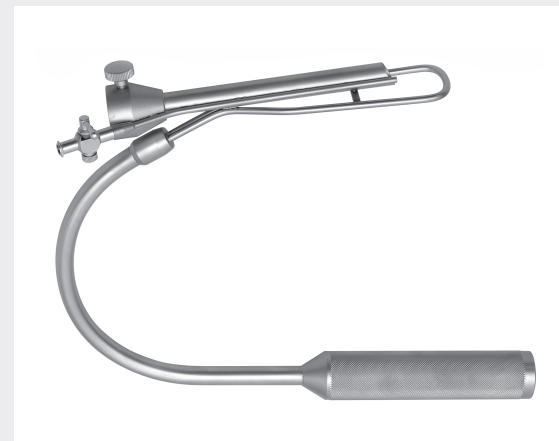

260-145-000
Breites Blatt, 50 mm breit für 10 mm Optik mit Absaugung
Standard blade, 50 mm for 10 mm scopes with irrigation

MAMMAPLASTIK
SCHEREN

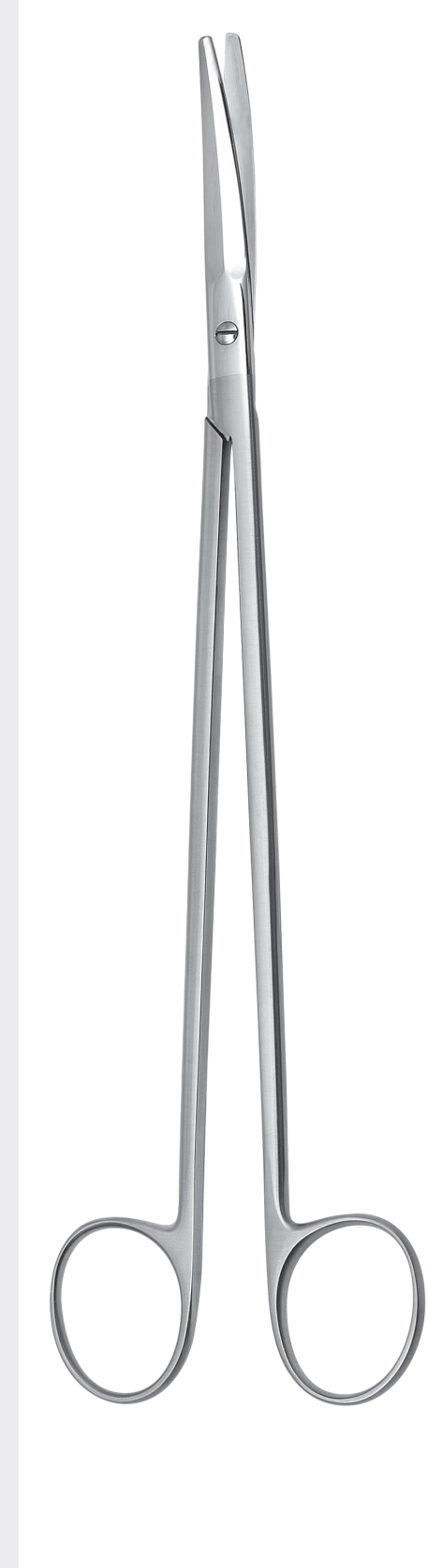

MAMMAPLASTY
SCISSORS



23.0 cm, 9 inch
120-580-230



25.0 cm, 10 inch
120-580-250



30.5 cm, 12 inch
120-580-305

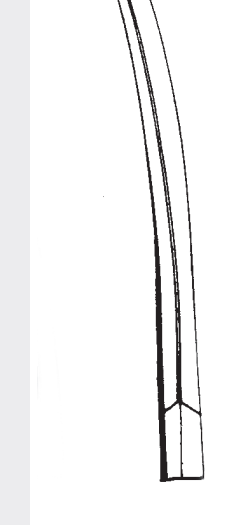

35.5 cm, 14 1/2 inch
120-580-355

120-580-250

Walden-Marshall Brust Dissektions Schere mit doppelseitig schneidenden Blättern. Die verfügbaren Längen gewährleisten einen geeigneten Zugang unter der Achselhöhle bei einer Brustvergrößerung.

Walden-Marshall breast dissection scissors with double cutting edges, curved. The lengths available provide adequate access when using a trans axillary approach to augmentation.

SCULPO



430-497-141

SCULPO Brust Retraktor, mit Kaltlichtanschluß, 31 mm breites gefenstertertes Blatt, feine Zahnung
SCULPO Breast Retractor with cold light, 1 1/4 inch fenestrated blade, fine serrations

430-497-151 51 mm breites Blatt / 2 inch blade



430-297-151

SCULPO Brust- Gesichtsretraktor mit Absaugung, 40 mm breites Blatt, mit feiner Zahnung für einen besseren Halt.
SCULPO Breast and Facial Surgery Retractor with suction, 1 1/2 inch blade, fine serrations reducing slippage.

430-297-141 30 mm breites Blatt, 1 1/8 inch blade

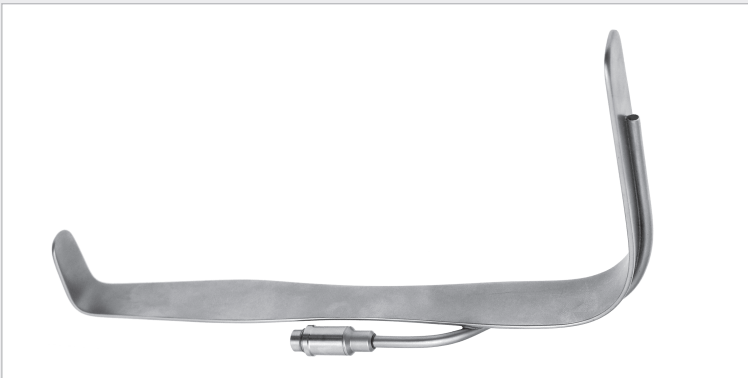

170-581-230

SCULPO Kaltlicht Wundhaken, 25 mm x 23.0 cm
SCULPO Fiber Optic Retractor, 1 x 9 inch



170-581-300

SCULPO Kaltlicht Wundhaken, 25 mm x 30.0 cm
SCULPO Fiber Optic Retractor, 1 x 12 inch

WUNDHAKEN / RETRACTORS



260-012-205

Freeman Flap Wundhaken, 12 mm breit, 20.5 cm

Freeman Flap Retractor, 1/2 inch wide, 8 inch

260-025-205

25 mm breit, 1 inch wide



260-012-201

Freeman Retraktor, 6 Zähne, 18.0 cm

Freeman Coronal Brow Lift Retractor, 6 prongs, 7 inch



260-013-201

Yancoskie Retraktor, 6 Zähne, 15.0 cm

Yancoskie Retractor, 6 prongs, 6 inch

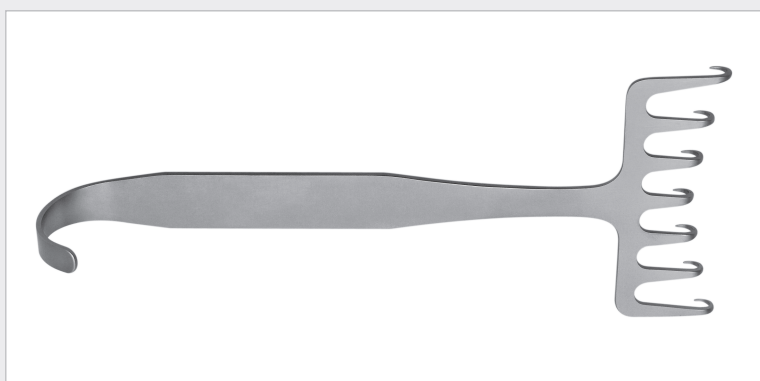

260-012-199

Coronal Lift Wundhaken, 7 Zähne, 18.0 cm

Coronal Lift Retractor, 7 prongs, 7 inch

SCULPO

Brust Spatel

- Bei Dissektionen von Taschen nach der Einführung des Implantates mit Hilfe anderer Retraktoren.
- Hilfreich bei einer Kapselentfernung durch das Ermöglichen einer kapsulären Dissektion.
- Schützt das Implantat beim Schließen submuskulärer Öffnungen.

Breast Spatula

- Use with other retractors for incremental tailoring dissection of pocket, even after implant has been introduced.
- Helpful in capsulectomy permitting extra capsular dissection by means of counter-traction in the implant capsule.
- Protects implant as sutures are placed during submuscular closures.



260-400-315

SCULPO Brust Spatel, halb-biegsam, 15.0 cm langes Blatt, 25 mm breit, 31.5 cm Komplettlänge

SCULPO Breast Spatula, semi-malleable, 1 x 6 inch blade, 12^{1/2} inch total length

260-438-315

SCULPO Brust Spatel, halb-biegsam, 15.0 cm langes Blatt, 33 mm breit, 31.5 cm Komplettlänge

SCULPO Breast Spatula, semi-malleable, 1 x 6 inch blade, 15.0 inch total length



260-400-310

SCULPO doppelendiger Brustretractor, 31.0 cm

SCULPO double ended Breast Retractor, 12^{1/4} inch



260-088-370

Agris-Dingman Transaxillary Dissektoren Set zum Formen von Brusttaschen, skaliert

Agris-Dingman Transaxillary Dissector Set for creation of submammary pockets, with scale



260-016-410

MacCollum-Dingman Brust Dissektor mit abgewinkeltm Schaft eignet sich bei Achseingriffen zur Brustvergrößerung. Ebenso kann er bei einem subglandularem oder subpektoralem Eingriff verwendet werden. MacCollum-Dingman Breast Dissector with angled shaft is designed to facilitate tissue dissection when utilizing transaxillary approach for breast augmentation. Can also be used as a subglandular or subpectoral dissector.



260-001-013

SCULPO Brust Elevator, 15 mm breites scharfes Arbeitsende, medium gebogen, 32 cm Arbeitslänge, isolierter Schaft

SCULPO Breast Elevator, 15 mm wide sharp edge, medium curved, 12^{1/2} inch working length, insulated sheath

SCULPO

Spatelförmiger Brust Retraktor

Nicht isoliert und isoliert für die Verwendung mit HF-Strom

Anwendung:

- Universell einsetzbares Design zum Vergrößern von kleinen Inzisionen.
- Zur Dissektion von Taschen bei Brustvergrößerungen sowie zum Anheben des Brustmuskels bei Brustrekonstruktionen.
- Zum sicheren Platzieren von Brustimplantaten, welche entweder durch die Achseln oder unter der Brust eingeführt werden.

Vorteile:

- Besondere Spatelform verbessert die Effizienz und die Sicherheit während der Dissektion und des Einbringens des Implantates.

Spatulated Breast Retractors

Non-insulated and insulated for use with HF-electricity

Application:

- Versatile design to augment small incisions.
- Dissection of pockets at breast augmentations as well as pectoralis elevation during breast reconstruction.
- Effective positioning of breast implants which were introduced either by the axillary or the submammary approach.

Advantages:

- Unique dissecting shape configuration improving the efficiency and security during dissection and implant introduction.



260-011-000

SCULPO Brust-Spatel-Dissektor, 33 cm lang
SCULPO spatulated Breast Dissector, 13 inch long

260-011-420 42.0 cm / 16¹/₂ inch



260-311-000

SCULPO Brust-Spatel-Dissektor, 33 cm lang, biegsam
SCULPO spatulated Breast Dissector, 13 inch long, malleable

260-311-420 42.0 cm / 16¹/₂ inch



SCULPO Brust-Spatel-Dissektor, 33 cm lang, Schaft isoliert
SCULPO spatulated Breast Dissector, 13 inch long, insulated

260-011-421 42.0 cm / 16¹/₂ inch



260-140-000

SCULPO Brust-Spatel-Dissektor, 32 cm, ovales Blatt
SCULPO Breast Dissector, oval spatulated blade, 13 inch long

SCULPO

Abgewinkelte Brust Retraktoren

Nicht isoliert und isoliert für die Verwendung mit HF-Strom

Anwendung:

- Zur submammären und subpektoralen Dissektion beim Zugang durch die Achseln.
- Für vielfältige Dissektionen bei Brust Rekonstruktionen.

Vorteile:

- Beiderseitige Dissektionen von verschiedenen Positionen.
- der gerade Schaft sowie das symmetrische Design vom elliptischen, schlank zugehenden Arbeitsende maximiert die Effizienz, Genauigkeit und die Sicherheit während der Gewebedissektion.

Angulated Breast Retractors

Non-insulated and insulated for use with HF-electricity

Application:

- For submammary and subpectoral dissections when employing the axillary approach.
- Numerous dissection applications during primary and delayed breast reconstruction.

Advantages:

- Bilateral dissection from multiple directions with one instrument only.
- Straight shaft and symmetric design of the elliptical, tapered shaped working end maximise efficiency, accuracy and safety during tissue dissection.



260-010-000

SCULPO abgewinkelter Brust Dissektor, 33 cm lang
SCULPO angled Breast Dissector, 13 inch long

260-010-420 42.0 cm / 16¹/₂ inch



260-310-000

SCULPO abgewinkelter Brust Dissektor, 33 cm lang, biegsam
SCULPO angled Breast Dissector, 13 inch long, malleable

260-310-420 42.0 cm / 16¹/₂ inch

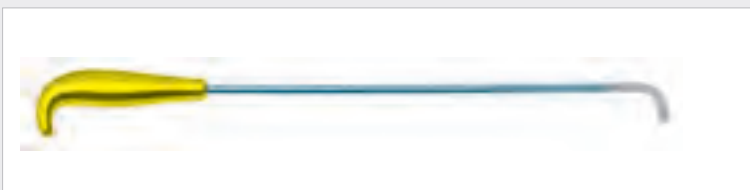

260-010-010

SCULPO abgewinkelter Brust Dissektor, 33 cm lang, Schaft isoliert
SCULPO angled Breast Dissector, 13 inch long, insulated

260-010-421 42.0 cm / 16¹/₂ inch

MARKIERER / MARKER



260-750-125

Freeman Areola Markierer, 25 mm Durchmesser

Freeman Areola Marker, 25 mm Diameter

260-750-130 30 mm 260-750-134 34 mm

260-750-136 36 mm 260-750-138 38 mm

260-750-140 40 mm 260-750-142 42 mm

260-750-145 45 mm 260-750-150 50 mm



260-751-125

Freeman doppelseitiger Areola Markierer, ø 38/42 mm

Freeman double ended Areola Marker, ø 38/42 mm

260-751-142

Freeman doppelseitiger Areola Markierer, ø 42/45 mm

Freeman double ended Areola Marker, ø 42/45 mm



260-745-000

McKissock Brustmarkierer, 45 mm Durchmesser

McKissock Breast Caliper, 45 mm Diameter

260-738-000 38 mm Durchmesser / Diameter

260-742-000 42 mm Durchmesser / Diameter



260-757-000

Halpern Brustmarker, 42 mm Durchmesser

Halpern Breast Caliper, 42 mm Diameter

260-755-000 38 mm Durchmesser / Diameter

FACE LIFT ZANGEN / FACE LIFT FORCEPS



260-520-010

D'Assumpcao Face Lift Klemme, 16.0 cm, für eine genaue Markierung der Gesichtslappen, welche herausgeschnitten werden sollen.

Ohne Sperre

D'Assumpcao Face Lift Forceps, 6¹/₄ inch, for a precise marking of dissected facial flaps for excision.

Without ratchet

260-520-020 mit Sperre / with ratchet



260-233-145

Marten Hautlappen Zange, 14,5 cm

Marten Flap Forceps, 5³/₄ inch

260-234-145 mit Sperre / with ratchet

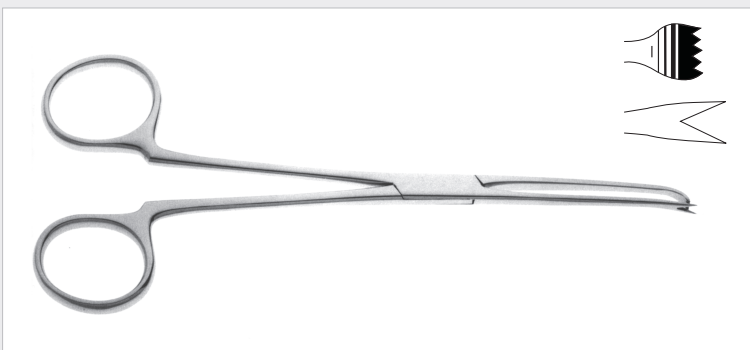

260-267-155

15.5 cm, 6 inch

Pitanguy Lappen Demarkationszangen werden für die genaue Markierung der Gesichts- und Abdominallappen, welche herausgeschnitten werden sollen, verwendet.

Pitanguy Flap Demarcator is used for accurate marking of facial or abdominal flaps that are to be excised.

260-267-260

Pitanguy Lappen Demarkations Zange, 26.0 cm

Pitanguy Flap Demarcator, 10¹/₄ inch

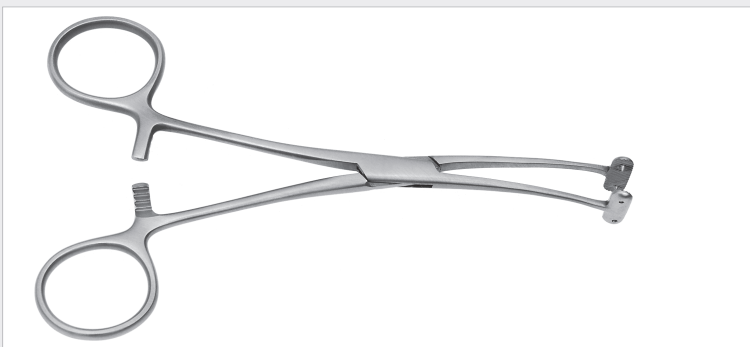

140-267-140

Martel Hauptlappen Faßzange, 14.0 cm

Martel Flap Grasping Forceps, 5¹/₂ inch

ZIRKEL / CALIPERS

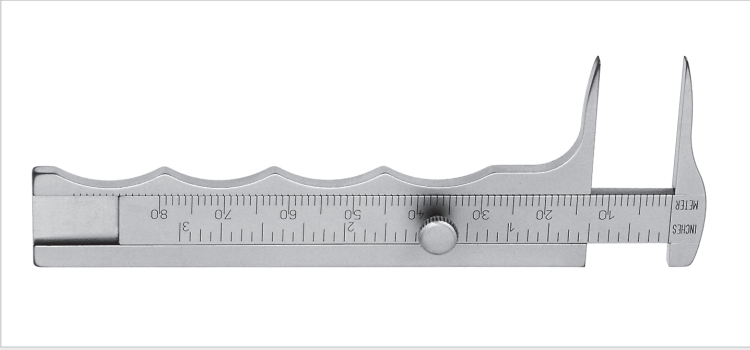

400-421-000
Jameson Zirkel
Jameson Caliper

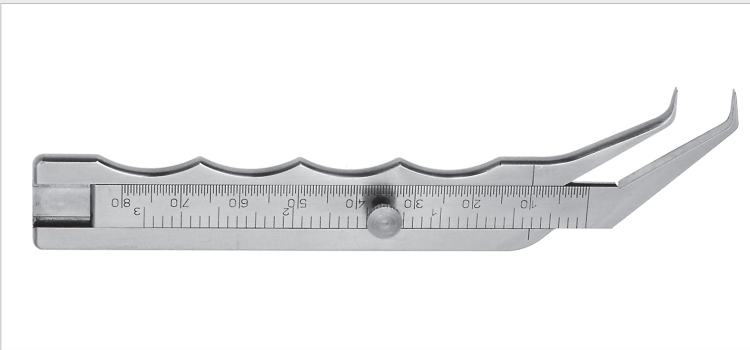

400-420-100
Thorpe Zirkel
Thorpe Caliper



400-583-007
Castroviejo Zirkel, 0-20 mm, mit Feststellschraube, 7.0 cm
Castroviejo Caliper, 0-20 mm, with locking screw, 2³/₄ inch

400-583-008
Castroviejo Zirkel, 0-40 mm, mit Feststellschraube, 18.0 cm
Castroviejo Caliper, 0-40 mm, with locking screw, 7 inch

LINEAL / RULER

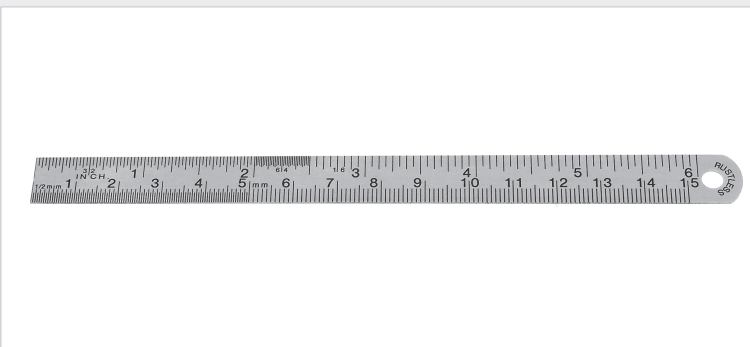

100-418-150
Lineal, 15 cm
Ruler, 6 inch

100-418-200 20.0 cm, 8 inch
100-418-300 30.0 cm, 11³/₄ inch