

Panasonic

Wireless Video Intercom System

VL-SWD501BX/UBX



Anywhere

Easily

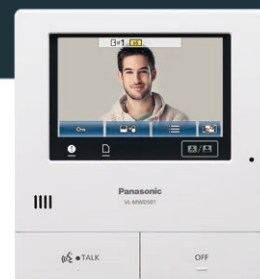

The Panasonic Wireless Video Intercom System watches over the safety of your entire house



Easy View and Talk
Wireless allows flexible layouts and easy operation.

Easy Safety
You can check anywhere you want, from any location in your house, with easy wireless operation.

Easy Expansion
The sub monitors can be easily and flexibly installed, with no wiring work required.



Whole house connection with wireless devices



Kitchen



Second Floor



Bedroom



Balcony



Garage



And more...



Easy view and talk



Anywhere Convenience (Wireless Operation)
It's wireless, so you can move around the house freely without having to worry about cords. You can greet visitors from places in the house that are within the range of the main monitor signal. And you can also add on up to six sub monitors.



Large Touch Panel
The main monitor has a large, 5-inch wide screen that clearly shows each visitor's face. If it is difficult to see, simply touch the screen to activate an approximate 2x zoom horizontally and vertically. This makes it easy for everyone to see, and provides an easy-to-use operating screen.



Electric Lock Release Support for Gate
The electric lock release supports up to 2 systems, each of which can be operated from the main monitor or a sub monitor. The gate or door lock can be easily and quickly released even from the second floor of the house.

* When connecting three or more, an optional doorphone is required.

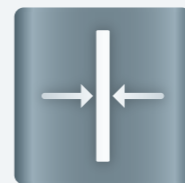

Slim Design
Only 21 mm deep, the main monitor has a slim design that blends in with virtually all room interiors. The stylish doorphone allows both mounted and mount-free use. Choose the type of use that matches your installation conditions and your home's design.

21mm



Easy Safety

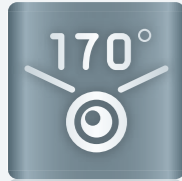

Wide-Angle Camera

The doorphone features an wide-angle lens that covers approximately 170 degrees horizontally and 115 degrees vertically. It gives you images with minimal distortion regardless of the number of people being viewed, or the height of each person. The wide range also increases freedom for choosing the installation location.



SD Card Recording

You can automatically record video images of visitors while you're away from home. It will record up to 3,000 visitors (30 seconds per visitor). This shows you details that aren't possible with still images. And you can save and play the images on a PC that has an SD card slot.



* The SD Memory Card is sold separately. Please use an SD Memory Card with a capacity of 2 GB or more.

** The number of recordings is an estimate for use as a guide only. When the card becomes full, images will be automatically deleted, starting with the oldest, to record new images.

Recorded image type

Capacity	2GB	4GB	8GB	16GB	32GB	48GB	64GB
Doorphone images only	125	255	520	1,040	2,090	3,000	3,000
Camera images only	2,300	3,000	3,000	3,000	3,000	3,000	3,000

- When using a camera, we recommend using an SD card with a capacity of 4 GB or more.
- The number of images that can be recorded in the table are just a guide and may differ from the actual number of images that can be recorded.
- Because SD cards contain data such as file system management information, the complete capacity cannot be used to save data. When other data is saved to an SD card, the number of images and videos that can be saved is reduced.
- The upper limit for saving images is 3,000 images regardless of SD card capacity.



Wireless Sensor Cameras

By installing the optional DECT Wireless Sensor Camera, you can use human (heat) and motion sensors to monitor locations that you are concerned about. At night, a white LED shines to drive intruders away. There is no need to wire it to the doorphone. Installation is possible wherever there is a power supply.



Easy Expansion



Flexible and Easy Expandability

The wireless design means that there is no troublesome wiring required when adding on to the system as well. Simply make the settings quickly and easily on the screen. You can add on up to 6 sub monitors and 4 DECT Wireless Sensor Cameras for large homes, and easily confirm visitors from a monitor in each room.

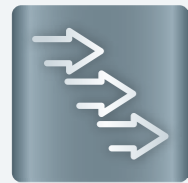

Easy Extension

The use of an optional DECT Repeater extends the communication. It can be extended with a maximum of two DECT Repeaters to reach places like garages, backyards, and gardens with stable communication.

* Up to 2 repeaters can be used. A single repeater can be used to send signals to multiple sub monitors or wireless sensor cameras. However, the same repeater cannot send signals to both sub monitors and wireless sensor cameras.



Wiring Schematic Diagram

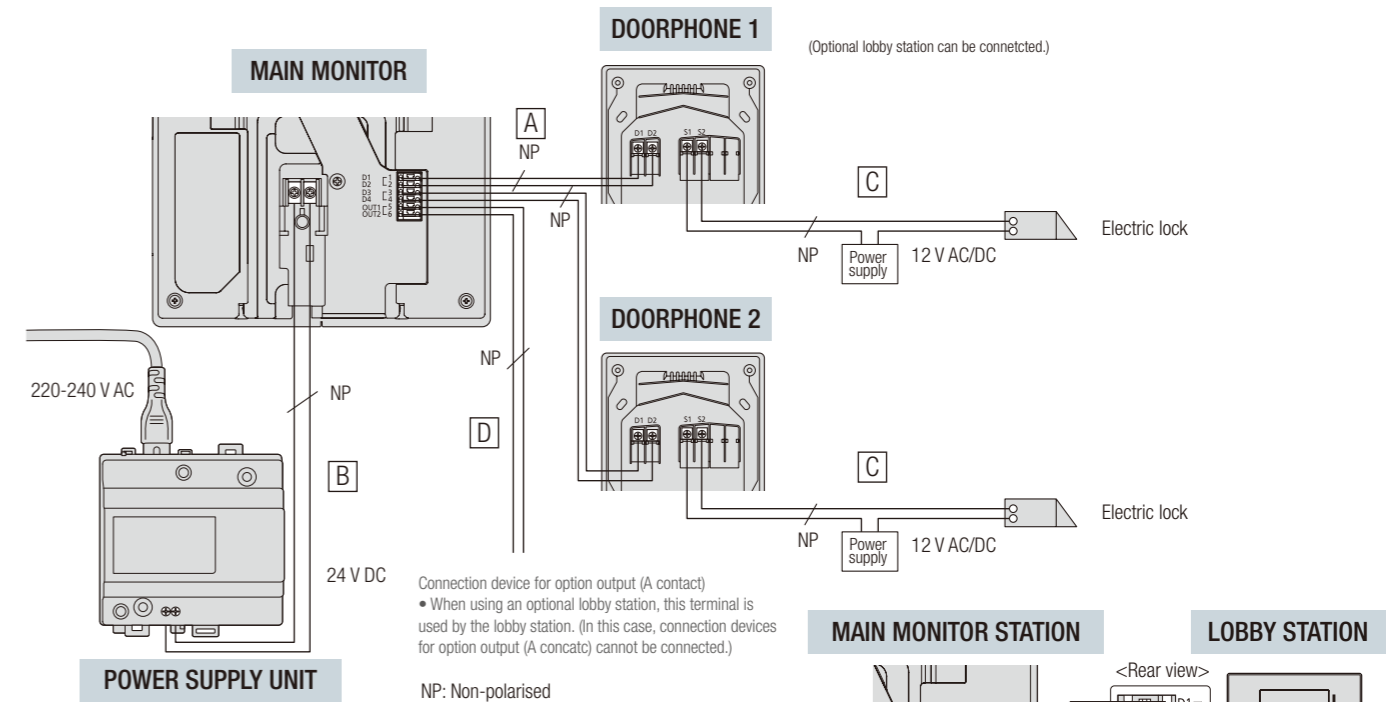

Wire type and length

Wiring run	Wire type ¹	Wire type ¹	
		Diameter	Length (Max.)
Main monitor – Doorphone	A	φ 0.65 mm	22 AWG
		φ 1.0 mm	18 AWG
		φ 0.5 mm	CAT 5
Main monitor – Power supply unit	B	φ 0.65 mm	22 AWG
		φ 1.0 mm	18 AWG
Doorphone – Electric lock ²	C	φ 0.5 mm - φ 1.2 mm (24 AWG - 17 AWG)	According to specification of connected device.
Main monitor – Connection device for option output (A contact) ²	D	φ 0.5 mm - φ 1.2 mm (24 AWG - 17 AWG)	According to specification of connected device.
Wireless sensor camera – Power supply unit	-	φ 0.65 mm	22 AWG
		φ 1.0 mm	18 AWG
Wireless sensor camera – External sensor	-	φ 0.5 mm - φ 0.8 mm (24 AWG - 20 AWG)	According to specification of connected device. Must be no longer than 20 m.

¹ Type: Single-pair cable with outer sheath (jacket) Conductor: Copper solid
 • A certified power supply wiring has to be used with this equipment. The relevant national installation and/or equipment regulations shall be considered. A certified power supply wiring not lighter than ordinary polyvinyl chloride flexible wiring according to IEC 60227 shall be used.

² When using an electric lock or a connection device for option output (A contact), select a device that meets the following guidelines:
 • Electric lock connection terminal (S1/S2):
 - N/O dry closure contact
 - 12 V AC/DC, less than 1 A
 • Connection device for option output (A contact) terminal (OUT1/OUT2):
 - 24 V AC/DC, less than 0.3 A (minimum contact: 5 V DC 1 mA)

Installing the main monitor

Attach the mounting bracket to the wall securely. Install the mounting bracket on a vertical flat wall.

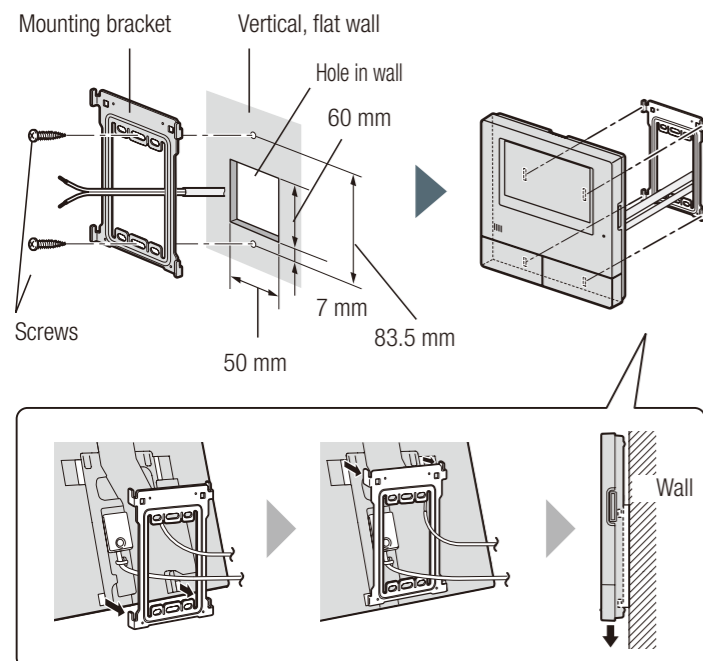

Installing the doorphone

VL-V554BX (Surface mount)

Screw × 2

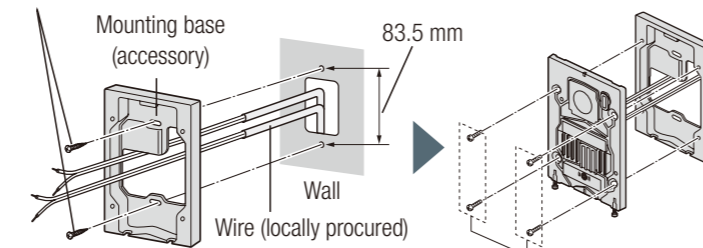

Install the mounting base on a vertical flat wall.

VL-V554UBX (Flush mount)

Flush mounting box (accessory)

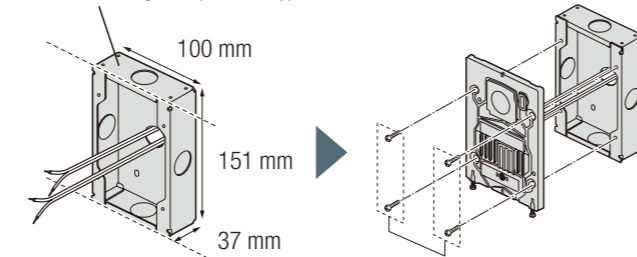

Installing the wireless camera

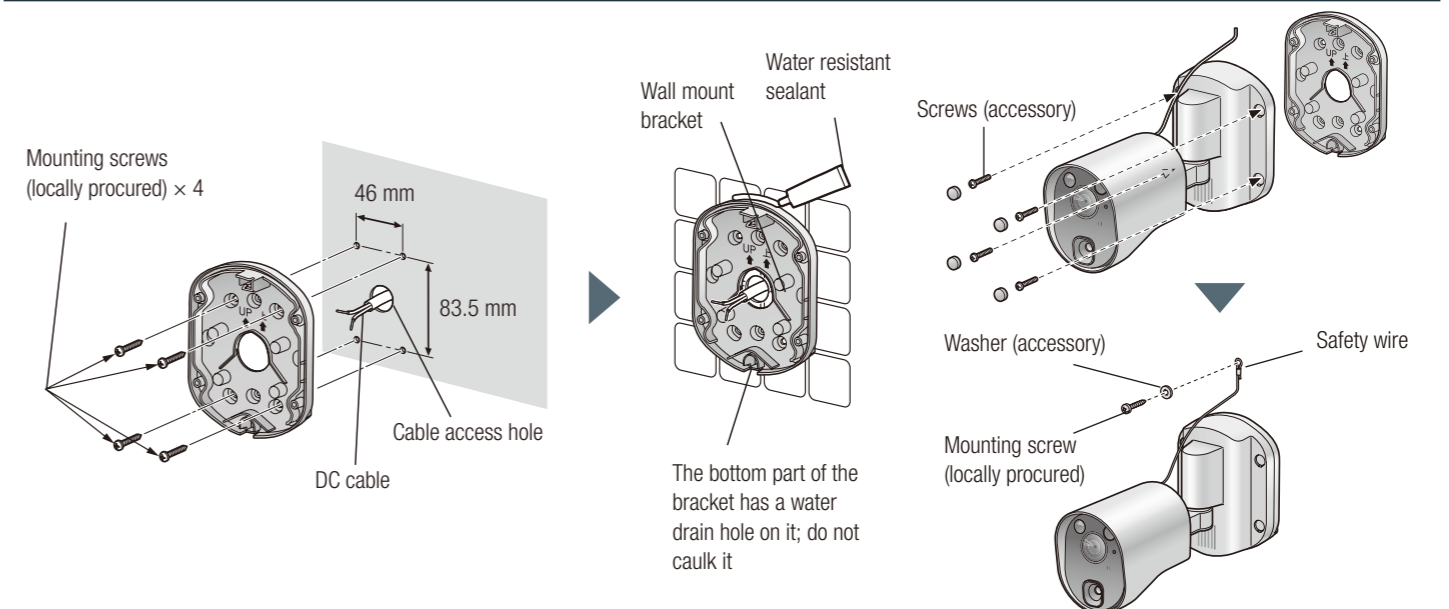

Specifications

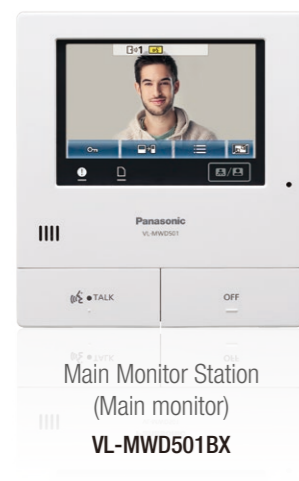

Main Monitor Station
(Main monitor)
VL-MWD501BX



Door Station
(Doorphone)
VL-V554BX (Surface mount)
VL-V554UBX (Flush mount)

Up to
2



Wireless Monitor Station
(Sub monitor)
VL-WD613BX

Up to
6



Wireless Sensor Camera
VL-WD812BX

Up to
4



DECT Repeater
VL-FKD2BX

Up to
2

Model Composition

VL-SWD501BX	VL-MWD501BX x 1, VL-WD613BX x 1, VL-V554BX x 1
VL-SWD501UBX	VL-MWD501BX x 1, VL-WD613BX x 1, VL-V554UBX x 1

Specifications

Model name and number	Main Unit (Main monitor) VL-MWD501BX	Door Station (Doorphone) VL-V554BX (Surface mount) / VL-V554UBX (Flush mount)	Wireless Monitor Station (Sub monitor) VL-WD613BX	
Dimensions				
Power source	Power supply unit (VL-PS241) 24 V DC, 0.5 A	Power supplied by the main monitor 20 V DC, 0.23 A	Rechargeable Ni-MH (AAA x 2)	AC adaptor (PNLV226BX/PNLV226E) Input: 220-240 V AC, 0.1 A, 50/60 Hz Output: 5.5 V DC, 0.5 A Standby: approx. 0.4 W (when the sub monitor is not placed in the charger) During charging: approx. 1.4 W
Power consumption	Standby: approx. 1.4 W During operation: approx. 10 W	-	-	-
Dimensions (mm) (height x width x depth)	Approx. 180 x 165 x 21 mm (excluding protruding sections)	VL-V554BX: Approx. 169 x 118 x 30 mm (excluding protruding sections) VL-V554UBX: Approx. 169 x 118 x 16.5 mm (excluding sections embedded into the wall)	Approx. 173 x 52 x 30 mm (excluding protruding sections)	Approx. 43 x 81 x 76 mm (excluding protruding sections)
Weight	Approx. 470 g	VL-V554BX: approx. 405 g VL-V554UBX: approx. 345 g	Approx. 160 g (including the batteries)	Approx. 70 g (excluding the AC adaptor)
Operating environment	Ambient temperature: approx. 0°C to +40°C Relative humidity (non-condensing): up to 90%	Ambient temperature: Approx. -10°C to +50°C Relative humidity (non-condensing): up to 90%	Ambient temperature: Approx. 0°C to +40°C Relative humidity (non-condensing): up to 90%	Ambient temperature: Approx. 0°C to +40°C Relative humidity (non-condensing): up to 90%
Display	Approx. 5 inches, wide colour display	-	Approx. 2.2 inches, colour display	-
Frequency	1.88 GHz to 1.90 GHz	-	1.88 GHz to 1.90 GHz	-
Talking method	Hands-free	-	Hands-free	-
Viewing angle	-	Horizontally: approx. 170° Vertically: approx. 115°	-	-
Installation method	Wall mount (mounting bracket supplied)	VL-V554BX: surface mount (mounting base supplied) VL-V554UBX: flush mount (flush mounting box supplied)	-	-
Option output (A contact)	Rated load: 24 V AC/DC, 0.3 A or lower Minimum applicable load: 5 V DC, 0.001 A (Output when there is a call from the doorphone)	-	-	-
Minimum illuminance required	-	1 lx (within approx. 50 cm from the camera lens)	-	-
Lighting method	-	LED lights	-	-
Dust protection / water protection	-	IP54 *1	-	-
Resistance against impacts	-	Compliant with IK07	-	-
Operating time *2	-	-	Standby use: approx. 80 hours	-
Charging time *3	-	-	Approx. 8 hours *4	-
Transmitting range	-	-	Approx. 100 m (line-of-sight distance from the main monitor)	-
Included Accessories	Power supply unit (VL-PS241) x 1, Mounting bracket x 1, Cable binder x 1, Screw x2	Mounting base x 1 & Screw x 2 (BX only), Flush mounting box x 1 (UBX only), Screw x 4, Name plate x 2, Hex wrench x 1	AC adaptor x 2 (PNLV226BX x 1, PNLV226E x 1) *5, Rechargeable battery x 2, Charger x 1	

*1 Water resistance is only assured if the doorphone is installed correctly according to the instructions in the Installation Guide, and appropriate water protection measures are taken.

*2 When used fully charged in an operating temperature of 20°C.

*3 When the operating temperature is 20°C. The charging time may increase when the operating temperature is lower than this.

*4 When registered to the main monitor.

*5 Please use the plug type that matches the power supply in your region from the two plug types provided.

Specifications

Model name and number	Wireless Sensor Camera VL-WD812BX * The product label reads as follows: VL-WD812EX	DECT Repeater VL-FKD2BX * The product label reads as follows: VL-FKD2EX	Power Supply Unit (part) VL-PS241
Dimensions			
Power source	Power supply unit (VL-PS241) 24 V DC, 0.4 A	AC adaptor (PQLV219BX/PQLV219E) Input: 220-240 V AC, 0.1 A, 50/60 Hz Output: 6.5 V DC, 0.5 A	Input: 200-240 V AC, 0.2 A, 50/60 Hz Output: 24 V DC, 0.6 A
Power consumption	During standby: approx. 1.5 W During operation: approx. 4.5 W (when the LED lights are not lit), approx. 8 W (when the LED lights are lit)	During standby: approx. 1.5 W During operation: approx. 2.3 W (when transmitting)	-
Dimensions (mm) (height x width x depth)	Approx. 160 x 118 x 290 mm (when the camera is front facing and including the wall mount bracket)	Approx. 82 x 111 x 39 mm	Approx. 104 x 100 x 54 mm (excluding protruding sections)
Weight	Approx. 960 g	Approx. 88 g (excluding the AC adaptor)	Approx. 215 g
Operating Environment	Ambient temperature: approx. -20°C to +50°C Relative humidity (non-condensing): up to 90%	Ambient temperature: approx. 0 °C to +40 °C Relative humidity (non-condensing): up to 90 %	Ambient temperature: approx. 0°C to +40°C Relative humidity (non-condensing): up to 90%
Frequency range	1.88 GHz to 1.90 GHz	1.88 GHz to 1.90 GHz	-
Installation method	Wall mount (wall mount bracket supplied)	-	-
Transmitting range	Approx. 100 m (line-of-sight distance from the main monitor)	Approx. 100 m (line-of-sight distance from the main monitor)	-
Minimum illuminance required	1 lx*1	-	-
Image sensor	0.3 M pixel CMOS	-	-
Lighting method	2 white LED lights*2	-	-
Angular field of view (camera angle)	Horizontal: approx. 53°, vertical: approx. 41°	-	-
Sensor detection method	Pyroelectric infrared sensor (heat sensor) and motion detection	-	-
Sensor detection range	• Heat sensor (when the surrounding temperature is approx. 20°) Horizontal: approx. 63°, vertical: approx. 20°, detection range: approx. 5 m • Motion detection sensor Horizontal: approx. 53°, vertical: approx. 41°	-	-
IP rating	IP54*3	-	-
Adjustable mounting angles	Horizontal: ±90°, vertical: facing forward - facing down approx. 60° (adjustable when mounting)	-	-
Heat sensor adjustable angles	Manually adjustable to 2 angles	-	-
Included Accessories	Power supply unit (VL-PS241) x 1, Wall mount bracket x 1, Screw x 4, Sensor range cap x 1 set of 4, Cap removal tool x 1, Screw cover x 4, Washer x 1	AC adaptor x 2 (PQLV219BX x 1, PQLV219E x 1) *4	AC Cable x 2 *4, Cable binder x 1, Screw x2

*1 The minimum illuminance required when the camera's [Brightness] setting is set to [+3].

*2 Approx. 8.5 lx when 3 m in front of the camera, and approx. 4 lx when 3 m away and 20° to the left or right of the camera.

*3 Water resistance is only assured if the camera is installed correctly according to the instructions in the Installation Guide, and appropriate water protection measures are taken. Do not install the camera in areas directly exposed to water or rain.

*4 Please use the plug type that matches the power supply in your region from the two plug types provided.

(Parts)

Basic System Component (VL-SWD501BX/VL-SWD501UBX)

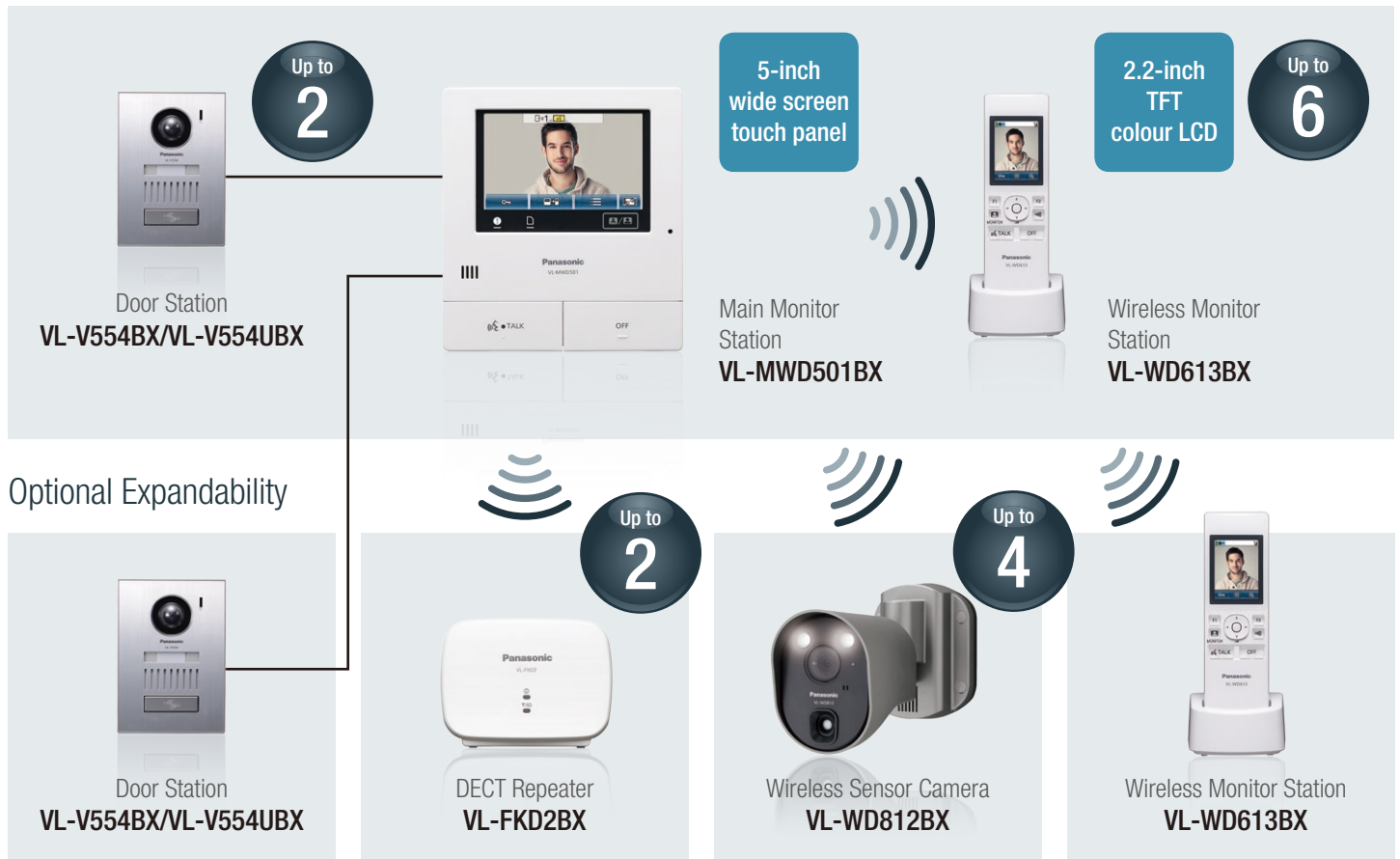

- A power supply (100 VAC) is required for installation.
- Up to 2 repeaters can be used. A single repeater can be used to send signals to multiple sub monitors or wireless sensor cameras. However, the same repeater cannot send signals to both sub monitors and wireless sensor cameras.

System Configuration Example

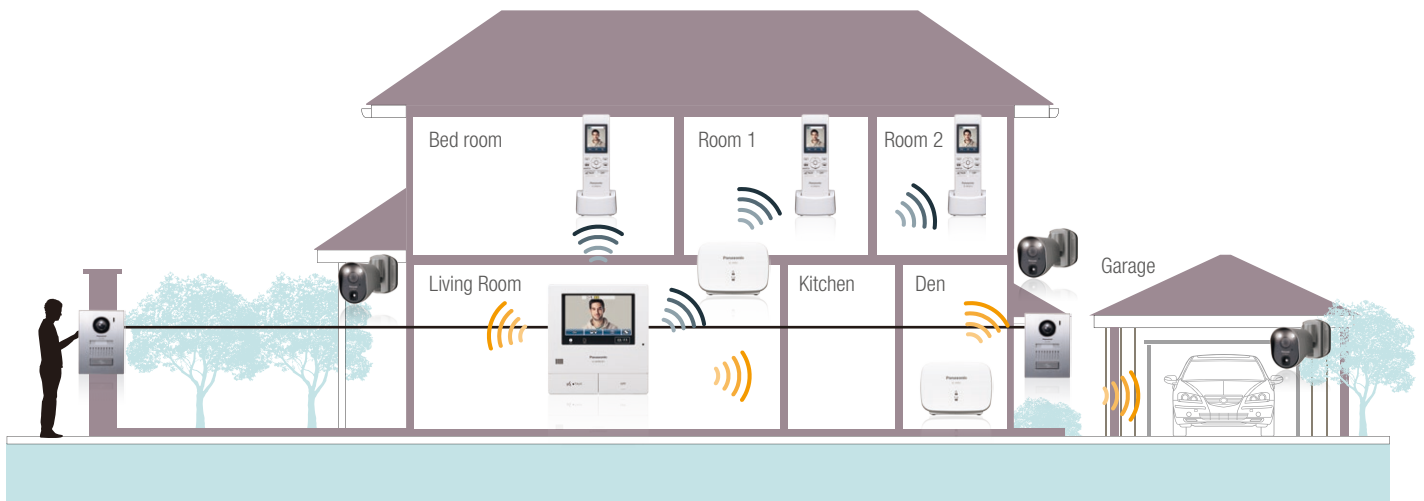

Trademarks and registered trademarks

- The microSDHC Logo is a trademark of SD-3C, LLC.
- The software of the sub monitor is based in part on the work of the Independent JPG Group.
- All other trademarks identified herein are the property of their respective owners.

Important

- Safety Precaution: carefully read the operating instructions and installation manual before using this product.

- The actual product may vary slightly from photograph.
- All pictures of the LCD display are simulated.
- Weights and dimensions are approximate.
- Design and Specifications are subject to change without notice.
- These products may be subject to export control regulations.

DISTRIBUTED BY :

JIA YING TRADING PTE LTD
 1 Rochor Canal Road #02-67/69/34-37
 Sim Lim Square Singapore 188504
 Tel: +65 6336 0404, Fax: +65 6338 0404
 www.jiaying.com
 jiaying@singnet.com.sg | email@jiaying.com

Panasonic