



**RPOWER**

**Catalogo Generale  
Catalogue Général**





Nel 1972, a pochi chilometri da Milano, nasce Resistor. Specializzata nell'ingegnerizzazione e realizzazione di resistenze elettriche per applicazioni industriali, dal 1982 estende la propria attività al settore auto con la progettazione e produzione di candele per motori diesel.

Resistor è stata fra le prime aziende del settore ad ottenere la certificazione del proprio Sistema di Gestione per la Qualità. Oggi, Resistor è certificata secondo la norma UNI EN ISO 9001 dal 2000 e ISO/TS 16949 dal 2009.

L'Azienda, guidata da una politica trasparente e responsabile, si fonda sulla serietà e la competenza dei propri collaboratori e l'imprescindibile attenzione ai bisogni del Cliente. Da trent'anni, Resistor è partner di prestigio di clienti fidelizzati e pienamente soddisfatti.

Il know-how custodito nel DNA dell'azienda e la costante ricerca dell'eccellenza sono gli elementi primari dell'attività aziendale, che mira alla soddisfazione dei clienti e al miglioramento continuo della qualità di prodotti e servizi.

Resistor è sempre orientata ad investire in innovazioni ed in nuove e affidabili partnership per migliorare continuamente il proprio livello di competitività e offrire al cliente un sempre maggiore numero di prodotti, opportunità, soluzioni. Il miglioramento continuo rappresenta la base culturale, intellettuale e motivazionale dell'organizzazione. La capacità di sapersi mettere in gioco, ad ogni livello, rappresenta per noi il requisito necessario.

Con oltre 260 modelli differenti, Resistor soddisfa la totalità delle richieste nel settore auto. Le linee di produzione dedicate, costruite secondo lo stato dell'arte in materia, sono governate da un efficiente sistema di programmazione e pianificazione. Le rigorose procedure per l'accettazione del materiale in ingresso, gli oltre 70 test previsti dai piani di controllo e la severa applicazione delle tecniche statistiche SPC ed MSA garantiscono una qualità eccelsa e una difettosità inferiore ai 10 ppm.





Resistor, established in 1972 near Milan, and specialized in the engineering and manufacturing of Heater Elements for industrial application, in 1982 expanded its activity with the design and manufacture of Diesel Glow Plugs.

Resistor was one of the first companies in the field to obtain the ISO Quality Certification.

Today, Resistor is certified under the UNI EN ISO 9001(since 2000) and the ISO/TS 16949 quality standards (since 2009).

The Company, guided by a clear and responsible policy, is founded on the seriousness and expertise of its employees and on the continuous attention to the Customer's needs.

For over 30 years, Resistor has been a prestigious partner to consolidated and completely satisfied customers.

The company's know-how and the continuous pursuit of excellence are the primary elements of the company's activity, whose goal is customer satisfaction and continuous improvement of product quality and services.

Resistor has always been oriented to invest on innovation and on new and reliable partnership to continuously improve its competitive level and offer to the customer a wider range of products, opportunities, solutions. It is Resistor's cultural and motivational basis: the ability in being part of the game at any level is for us an essential requirement.

With a range including about 260 different models, Resistor covers the whole requests of the automotive sector. The lines dedicated to the manufacture of diesel glow plugs are managed by an efficient programming and planning system and constructed in accordance with the field state of the art. The extremely strict incoming goods inspection procedures, the over 70 tests foreseen in the control plans, and the strict application of statistical SPC and MSA techniques assure an excellent quality and less than 10 ppm product non-conformity.

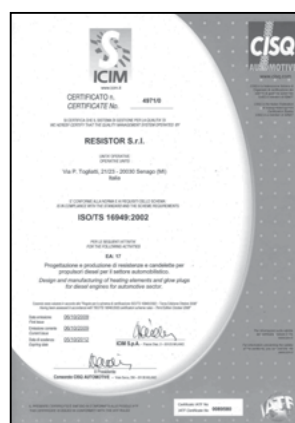



Resistor, créé en 1972 près de Milan, et spécialisée dans l'ingénierie et la fabrication d'éléments de chauffage pour applications industrielles, en 1982 a élargi sa activité à et la fabrication de bougies de préchauffage pour moteurs diesel.

Resistor a été une des premières entreprises dans le secteur à obtenir la certification de la qualité ISO.

Aujourd'hui, la Resistor est certifié en vertu de la norme UNI EN ISO 9001 (depuis 2000) et l'ISO / TS 16949 des normes de qualité (depuis 2009).

La société, guidée par une politique claire et responsable, est fondée sur le sérieux et l'expertise de ses employés et sur l'attention constante aux besoins du Client.

Pendant plus de 30 ans, la Resistor a été un partenaire prestigieux de clients consolidés et entièrement satisfait.

Son know-how et la recherche continue de l'excellence sont les éléments principaux de l'activité de l'entreprise, dont le but est la satisfaction du client et l'amélioration continue de la qualité des produits et services.

Resistor a toujours été orientée à investir sur l'innovation et sur des nouveaux et fiable partenariats pour améliorer constamment son niveau de compétitivité et à offrir au client une gamme toujours plus grande de produits, des opportunités et des solutions. C'est la base culturelle et de motivation de Resistor: la capacité de faire partie du jeu à n'importe quel niveau est pour nous une exigence essentielle.

Avec une gamme comprenant environ 260 modèles différents, Resistor couvre l'ensemble de la demande du secteur automotive. Les lignes utilisées pour la fabrication de bougies de préchauffage diesel sont gérés par une programmation efficace et le système de planification et construit selon le dernier état de l'art. Les procédures très strictes d'inspection de marchandises entrant, le plus de 70 essais prévus dans les plans de contrôle et l'application stricte des statistiques de la CPS et techniques MSA assure une excellente qualité et moins de 10 ppm de produit non-conformité.



# LE CANDELETTE A INCANDESCENZA

Nei motori diesel l'accensione avviene per autocombustione a temperature superiori ai 650°C. L'aumento della temperatura è dato dalla compressione dell'aria nel cilindro che, a seconda dei motori, passa da 1 bar, pressione ambiente, a 20/30 bar, con la conseguente combustione del gasolio.

Nella fase di avvio, a motore freddo, con le pareti dei pistoni e delle camere di combustione fredde, parte del calore, prodotto dalla compressione, viene assorbito in misura tale da impedire la possibilità di autocombustione. Le candele funzionano come fonte addizionale di calore per sopperire a queste perdite. Superata questa fase d'avvio, il calore sprigionato dalla combustione, riesce a mantenere la temperatura minima per l'autocombustione, ma le condizioni rimangono critiche, infatti il gasolio brucia male con presenza di fumo nero e odore di nafta, questo fino al momento in cui il motore non ha raggiunto la temperatura di regime. Questa situazione sussisteva con le candele monofilo di prima generazione.

Nei motori moderni vengono montate candele di nuova generazione dette di pre e post-riscaldamento che, tramite uno speciale filamento, regolano la temperatura nel tempo così da poter rimanere accese più a lungo.

Grazie a questo tipo di candela, il motore diesel risulta poco rumoroso, inodore, parco nei consumi e con bassissime emissioni di ossidi dannosi. Questo tipo di candele sono composte da una struttura a doppio filamento:

**□ Il primo, è un filamento di regolazione, che permette un'autoregolazione dell'intensità della corrente che l'attraversa in funzione della temperatura raggiunta;**

**Il secondo, è un filamento incandescente, che permette, per alcuni secondi, di raggiungere la temperatura circa di 1000°C e quindi di innescare l'autocombustione;**

La combinazione permette di aumentare la longevità della candela e di garantirne l'affidabilità totale in tutte le condizioni climatiche.

# CANDELETTE AUTOREGOLANTI

- 1 - Terminale filettato;
- 2 - Elettrodo
- 3 - Isolatore
- 4 - Corpo candelette
- 5 - Anello isolante
- 6 - Ossido di magnesio
- 7 - Stelo resistivo
- 8 - Spirale di controllo
- 9 - Spirale di riscaldamento

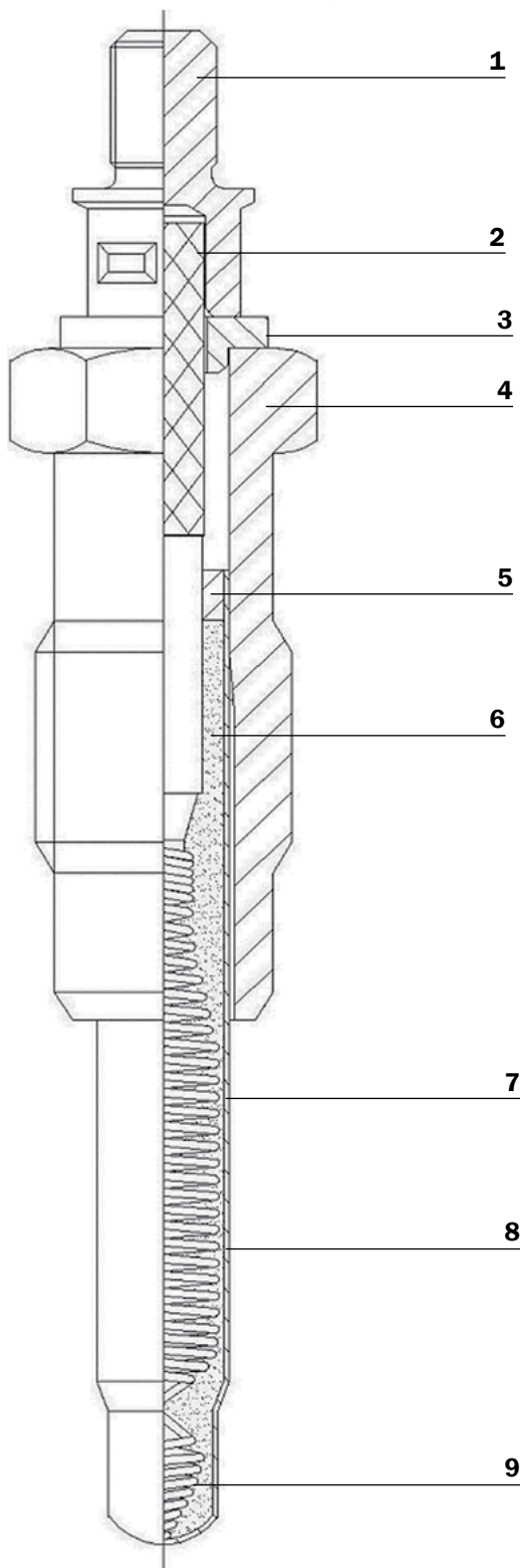

## Struttura e proprietà delle candelette

Le moderne candelette sono composte da un corpo candelette, da un elemento riscaldante con all'interno una spirale di regolazione e una di riscaldamento e da un terminale per la connessione elettrica. L'elemento riscaldante è pressato nel corpo candelette per impedire la fuoriuscita dei gas, ed è isolato dal terminale, per la connessione elettrica, da un isolatore. La candelette è alimentata da una batteria ed è controllata da una centralina elettronica.

## La spirale di riscaldamento e la spirale di regolazione

Il principio fondamentale delle moderne candelette consiste nella combinazione di una spirale riscaldante e una spirale di regolazione, unite tra di loro all'interno di uno stelo resistivo. La spirale riscaldante rappresenta la parte anteriore dello stelo resistivo ed è la parte riscaldante. La spirale di regolazione rappresenta la parte posteriore ed aumenta la sua resistenza elettrica in base alla temperatura, permettendo la regolazione della corrente e della temperatura. In altre parole la spirale di regolazione e quella di riscaldamento sono collegate in serie tra di loro. La spirale di riscaldamento è saldata sulla guaina dello stelo resistivo, mentre quella di regolazione è fissata sul terminale della connessione.

## Protezione della spirale di riscaldamento e della spirale di regolazione

Le spirali sono compresse e isolate elettricamente tramite dell'ossido di magnesio. L'ossido di magnesio è meccanicamente compresso all'interno della guaina, a tal punto che le spirali sono come cementate. Questo permette allo stelo resistivo di resistere a tutte le vibrazioni. Le singole spire delle spirali sono distanti tra di loro qualche decimo di millimetro. L'ossido di magnesio impedisce che si possano toccare, in modo che non vi possa essere un corto circuito che distruggerebbe lo stelo resistivo, il che sarebbe inconcepibile.

# THE DIESEL GLOW PLUGS

The diesel engines ignite for spontaneous combustion at temperatures above 650°C. The rising of the temperature is given by the compression of the air into the cylinder that, depending on the engines, passes from the pressure of 1 bar to 20/30 bars with the consequent combustion of the gasoil.

During the ignition phase, with cold engine, cold walls of the pistons and cold chamber of combustion, part of the heat produced by the compression is absorbed and lost preventing the possibility of spontaneous combustion. The glow plugs work as additional source of heat to compensate for those losses. After the ignition phase, the heat emitted by the combustion is able to keep the lowest temperature for spontaneous combustion, but the conditions still remain critical: in fact the gasoil does not burn properly and causes black smoke and smell of naphtha; that goes on until the engine reaches the temperature for optimal running. That situation was usual with the single coil glow plugs of first generation.

Modern engines are equipped with glow plugs of new generation, called of pre- and post-heating; those glow plugs are able to run longer thanks to a special filament that keeps the temperature regulated longer.

Thanks to that new type of glow plugs, the diesel engines are less noisy, without odour, moderate in the consumptions and with low emissions of harmful oxides. Those glow plugs are structured with double-coil technology:

**the first one is a filament of regulation, that allows a self-regulation of the intensity of current that crosses it in function of the reached temperature;**

**the second one is an incandescent filament that allows to reach the temperature of 1000°C about for some seconds and then to start the spontaneous combustion.**

That combination increases the longevity of the glow plug and guarantees its total reliability under all the climatic conditions.



# SELF-REGULATING SHEATHED HEATER PLUGS

- 1 - Terminal threaded
- 2 - Electrode
- 3 - Seal
- 4 - Plug body
- 5 - Seal ring
- 6 - Magnesium oxide
- 7 - Sheat resistite stem
- 8 - Control spiral
- 9 - Ignition spiral

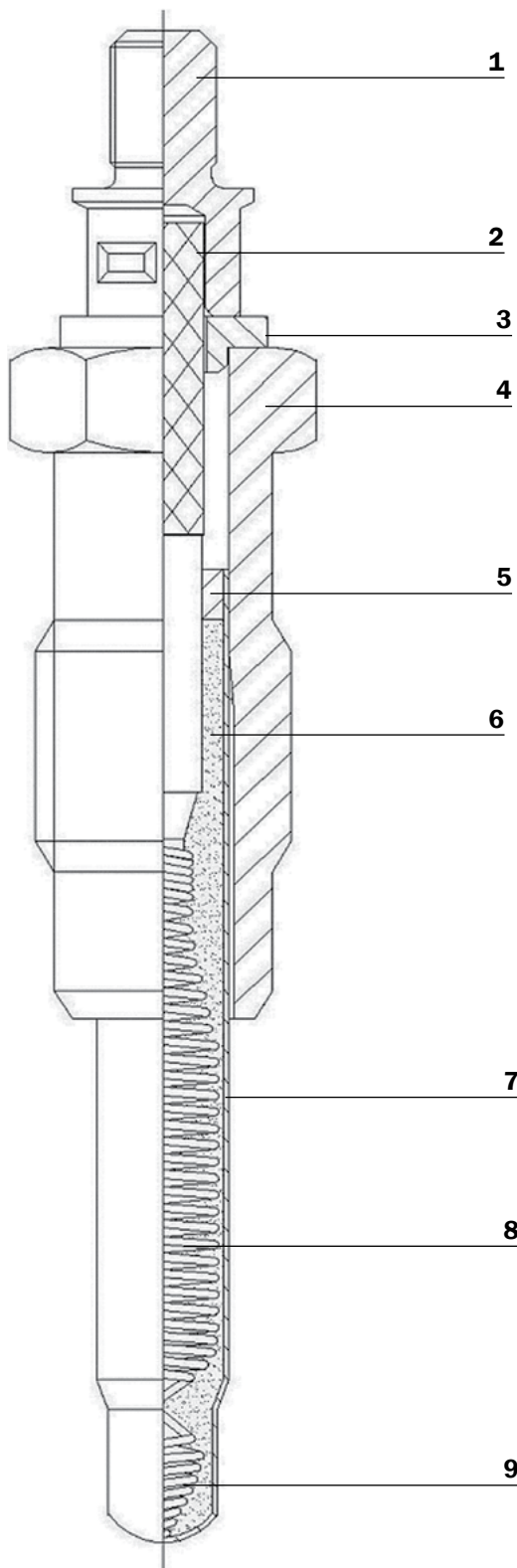

## Structure and properties of the sheathed heater plug

The modern sheathed heater plug consists in the main plug body, the heating element with the heating and regulating coils and the connecting bolt. The non-corrosive glow tube is pressed into the housing in such a way that gases cannot escape. The plug is also sealed by O-ring at the connecting part.

The heater plug draws its electricity from the battery and is controlled by an electronic heating-time control unit.

## The heating coil and regulating coil

The fundamental principle of a modern sheathed heater plug consists of the combination of a heating coil and regulating coil in one joint resistor element. The heating coil and the front part of the heating element comprise the heating zone. The resistance of the regulating coil at the rear increases with the temperature and thus the current and temperature are regulated downwards. Or in other words: the heating coil and the regulating coil are electrically switched in series and welded together. Both coils have positive but varying temperature-resistance factors. The regulating coil has a high coefficient and the heating coil a low one. The heating coil is welded into the dome of the glow tube, the regulating coil is fastened to the conducting connecting bolt.

## Protection of the heating coil and regulating coil

The entire coil is packed tightly into a compressed, electrically insulating, but very heat-conductive ceramic powder, which is normally magnesium oxide. The powder is mechanically compressed to such an extent that the coil is fixed as if cast in cement. This makes it so sturdy that the heating coil's and regulating coil's wires permanently withstand all vibrations. Even though the individual windings are only separated from each other by a few tenths of a millimetre, coil shorts cannot occur and a short circuit with the glow tube, which would destroy the plug, is inconceivable.

# LES BOUGIES DE PRÉCHAUFFA- GE DIESEL

Dans les moteur diesel l'allumage se produit pour une combustion spontanée à des températures supérieures à 650° C. L'augmentation de la température est donnée par compression de l'air dans le cylindre, laquelle, selon les moteurs, va de 1 bar pression ambiante, jusqu'à 20/30 bar, résultant de la combustion du diesel.

Au démarrage, le moteur est froid et avec les parois des pistons et chambres de combustion partie froide, partie de la chaleur, produite par la compression, est absorbé dans une telle mesure qu'il empêche la possibilité d'une combustion spontanée. Les bougies travaillent comme source de chaleur supplémentaire pour compenser ces pertes. Une fois cette étape initiale, la chaleur produite par la combustion peut maintenir la température minimale pour une combustion spontanée, mais les conditions restent critiques, parce que le combustible brûle mal avec la présence de fumée noire et l'odeur de l'huile, cela jusqu'à le moment où le moteur n'a pas atteint la température. Cette situation a existé avec les bougies mono-filament de première génération.

Dans les moteurs modernes sont montés bougies de nouvelle génération appelés de pré-et post-chauffage, qui, par un filament spécial, régissent la température dans le temps afin de rester allumées plus longtemps.

Avec ce type de bougies, le moteur diesel devient plus silencieux, inodore, plus économe de consommation de carburant et avec faibles émissions d'oxydes nocifs. Ce type de bougies sont composés d'une structure avec double filament:

**Le premier est un filament de réglage, ce qui permet l'autorégulation l'intensité du courant qui le traverse en fonction de la température atteint;**

**Le second est un filament incandescent, qui permet, pendant quelques secondes, d'atteindre la température d'environ 1000° C et ainsi déclencher la combustion spontanée;**

La combinaison est conçue pour augmenter la longévité des bougies de préchauffage et d'assurer une fiabilité totale dans toutes les conditions météorologiques

# BOUGIES DE PRÉCHAUFFAGE GAINÉS ET AUTORÉGLABLE

- 1 - Connecteur fileté
- 2 - Conducteur électrique
- 3 - Joint isolant
- 4 - Corps
- 5 - Bague isolant
- 6 - Oxyde de magnésium
- 7 - Élément résistif
- 8 - Spirale de régulation
- 9 - Spirale de chauffage

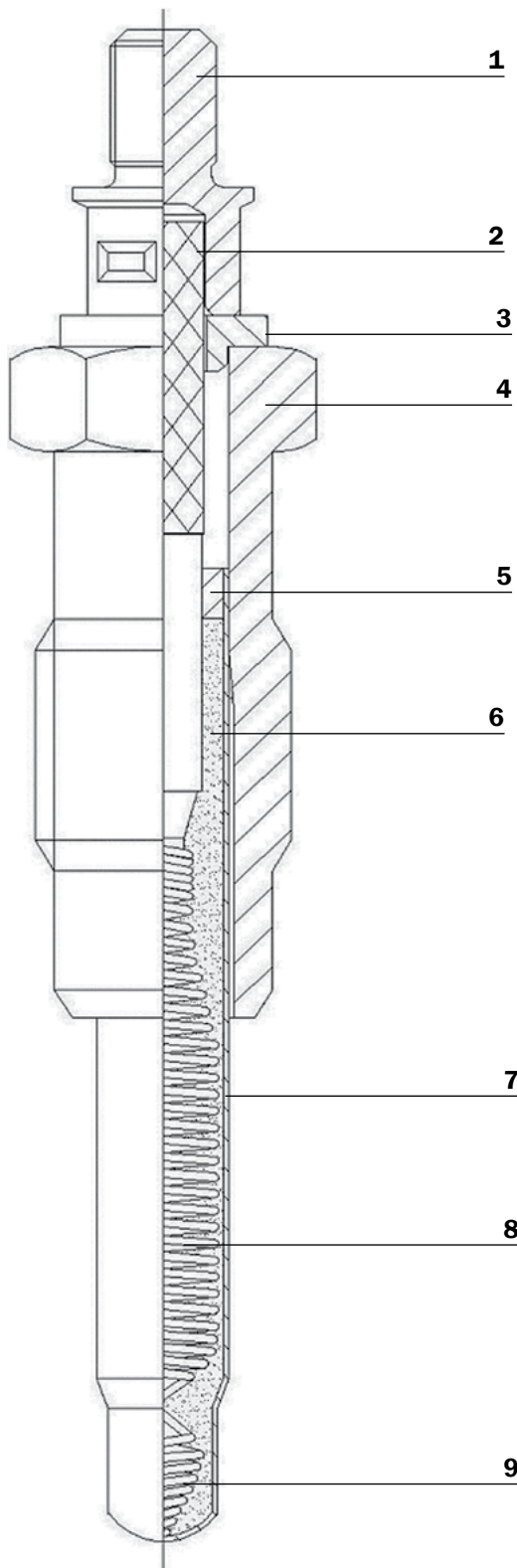

## Structure et propriétés de la bougies de préchauffage gainés

Les bougies de préchauffage gainés modernes consiste dans le corps principale, l'élément de chauffage avec les spirales régulatrices et d'allumage et le boulon de connexion. Le tube non corrosif est enfoncée dans le boîtier de telle manière que les gaz ne peut s'échapper. La bougie est aussi scellé par O-ring à la pièce de raccordement.

La bougie de chauffage tire son électricité de la batterie et est contrôlé par une unité de contrôle électronique en temps de chauffage.

## La spirale de chauffage et la spirale de régulation

Le principe fondamental d'une bougies de préchauffage gainés modernes se compose de la combinaison d'une spirale de chauffage et une spirale de régulation dans un élément de résistance commune. La spirale de chauffage et la partie avant de l'élément chauffant comprend la zone de chauffage. La résistance de la spirale de régulation arrièr accroit avec la température et donc la courant et la température sont réglemmentée vers le bas. Ou en d'autres termes: la spirale de chauffage et celle de régulation sont électriquement soudés ensemble. Les deux spirales ont des facteurs de résistance positives mais divers à la température. La spirale de réglage a un coefficient élevé alors que celui de la spirale de chauffage est bas. La spirale de chauffage est soudé dans le dôme du tube de préchauffage, la spirale de régulation est fixée sur le boulon conduite de raccordement.

## Protection de les spirales de chauffage et de régulation

La spirale entière est emballé hermétiquement dans un comprimé de poudre de céramique, très conducteur de chaleur et isolé électriquement, qui est normalement l'oxyde de magnésium. La poudre est comprimée mécaniquement à un point tel que la spirale est fixe, comme si coulé dans le ciment. Ce qui le rend si solide que le filament des spirale de chauffage et de régulation résistent à toutes les vibrations de façon permanente. Même si les enroulements individuels sont séparés les uns des autres que de quelques dixièmes de millimètre, court-circuites de la spirale ne peuvent pas se produire et un court-circuit du tube à incandescence, ce qui pourraient détruire la bougie, est inconcevable.

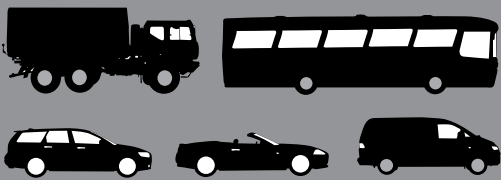

→

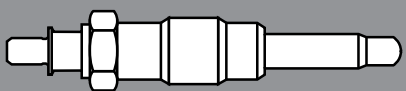

**1**

**?**

→



**2**

**i**

→

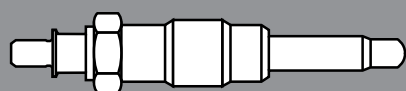

**3**

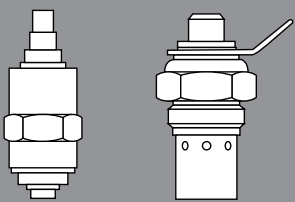

→



**4**

# INDICE INDEX

**1**

TAVOLA APPLICAZIONI  
APPLICATIONS LIST  
LISTE D'AFFECTIONS

pag. 13

**2**

TAVOLA DI CONVERSIONE  
CROSS REFERENCE  
LISTE DES RÉFÉRENCES CROISÉES

pag. 129

**3**

INFORMAZIONI TECNICHE  
TECHNICAL INFORMATION  
INFORMATIONS TECHNIQUES

pag. 175

IMMAGINI TECNICHE  
TECHNICAL PICTURES

IMAGES TECHNIQUES

pag. 185

MANUTENZIONE/SOSTITUZIONE CANDELETTE INCANDESCENZA  
MAINTENANCE AND REPLACEMENT GLOW PLUGS

ENTRETIEN / REMPLACEMENT DES BOUGIES PRÉCHAUFFAGE

pag. 213

**4**

SOLENOIDI  
SOLENOID VALVES  
SOLENOIDS

pag. 219

TERMOAVVIATORI – INFORMAZIONI TECNICHE  
FLAME HEATER PLUGS – TECHNICAL INFORMATION

THERMOSTARTERS - INFORMATIONS TECHNIQUES

pag. 223

TERMOAVVIATORI – TAVOLA DI CONVERSIONE  
FLAME HEATER PLUGS – CROSS REFERENCE

THERMOSTARTERS - LISTE DES RÉFÉRENCES CROISÉES

pag. 226

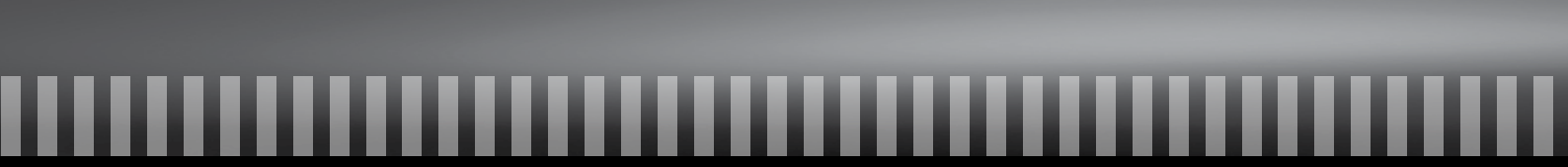

# TAVOLA APPLICAZIONI

# APPLICATIONS LIST

# LISTE D'AFFECTIONS

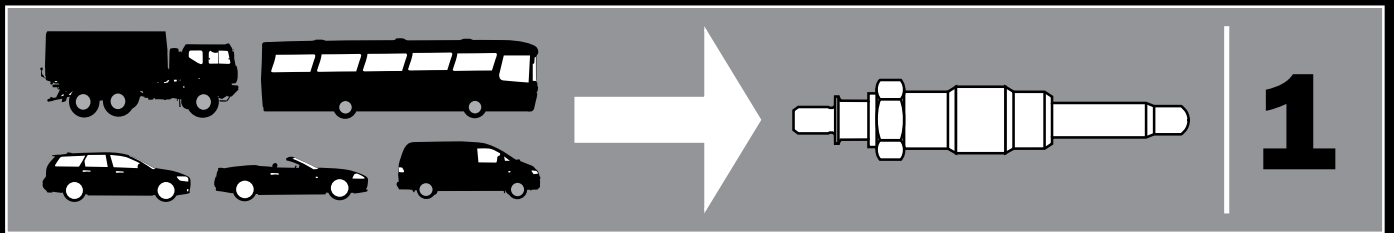



Model	CC	Kw	Year	Engine	Cyl	Pict	Code
<b>ALFA ROMEO</b>							
Alfa 145 JTD	1,9	77	02.99-10.99	AR 32.302	4	94	RP8372
Alfa 145 JTD	1,9	77	11.99-01.01	AR 32.302	4	132	RP8622
Alfa 145 JTD	1,9	77	02.99-10.99	Cooling-water preheater	---	160	RP8898
Alfa 145 TD	1,9	66	12.94-02.99	AR 67.501	4	11	RP4444
Alfa 145 TD	1,9	66	10.94-02.99	AR 33.601	4	11	RP4444
Alfa 146 JTD	1,9	77	01.98-10.99	AR 32.302	4	94	RP8372
Alfa 146 JTD	1,9	77	11.99-01.01	AR 32.302	4	132	RP8622
Alfa 146 JTD	1,9	77	11.99-01.01	Cooling-water preheater	4	160	RP8898
Alfa 146 TD	1,9	66	02.95-09.96	AR 67.501	4	11	RP4444
Alfa 146 TD	1,9	66	10.96-09.97	AR 33.601	4	11	RP4444
Alfa 147 (937) JTDM	1,9	85	10.04-03.10	939 A7.000	4	132	RP8622/30
Alfa 147 (937) JTDM 8V	1,9	88	07.05-	937 A3.000	4	132	RP8622/30
Alfa 147 JTD	1,9	74	06.03-	Cooling-water preheater	4	160	RP8898
Alfa 147 JTD	1,9	74	11.00-	182B9000	4	132	RP8622
Alfa 147 JTD	1,9	74	06.03-	182 B9.000	4	132	RP8622
Alfa 147 JTD	1,9	85	04.01-	937 A2.000	4	132	RP8622
Alfa 147 JTD	1,9	85	04.01-	Cooling-water preheater	4	160	RP8898
Alfa 147 JTD 16V	1,9	93	09.03-09.04	---	4	166	RP8914
Alfa 147 JTD 16V	1,9	103	11.02-	---	4	166	RP8914
Alfa 147 JTD 16V	1,9	110	07.05-	---	4	166	RP8914
Alfa 147 JTDM 16V	1,9	85	10.04-	---	4	132	RP8622
Alfa 147 JTDM 16V	1,9	110	07.05-	937 A5.000	4	166	RP8914
Alfa 147 JTDM 8V	1,9	88	07.05-	---	4	166	RP8914
Alfa 155 TD	1,9	66	04.93-04.96	67.502	4	11	RP4444
Alfa 155 TD	1,9	68	04.93-04.96	AR67.501	4	11	RP4444
Alfa 155 TD	2,0	66	08.93-04.96	AR67.502	4	11	RP4444
Alfa 155 TD	2,5	92	04.93-04.95	VM07B/VM31B/VM 425 CLIEA	4	11	RP4444
Alfa 155 TD	2,5	92	05.95-12.97	VM07B/VM31B/VM 425 CLIEA	4	78	RP8370
Alfa 156 JTD	1,9	77	09.97-10.00	AR32.302	4	94	RP8372
Alfa 156 JTD	1,9	77	09.97-10.00	Cooling-water preheater	4	160	RP8898
Alfa 156 JTD	1,9	81	10.00-	AR 37.101	4	132	RP8622
Alfa 156 JTD	1,9	81	10.00-05.01	---	4	160	RP8898
Alfa 156 JTD	1,9	81	10.00-05.01	Cooling-water preheater	4	160	RP8898
Alfa 156 JTD	1,9	85	02.01-	937 A2.000	4	132	RP8622
Alfa 156 JTD	1,9	85	02.01-	Cooling-water preheater	4	160	RP8898
Alfa 156 JTD	2,4	100	09.97-10.00	AR32.501	5	94	RP8372
Alfa 156 JTD	2,4	100	09.97-10.00	Cooling-water preheater	5	160	RP8898
Alfa 156 JTD	2,4	103	10.00-09.05	839A6.000	5	132	RP8622
Alfa 156 JTD	2,4	103	10.00-09.05	Cooling-water preheater	5	160	RP8898
Alfa 156 JTD	2,4	110	03.02-09.05	841C.000	5	132	RP8622
Alfa 156 JTD	2,4	110	03.02-09.05	Cooling-water preheater	5	160	RP8898
Alfa 156 JTD	2,4	129	10.03-09.95	841 G.000	5	166	RP8914
Alfa 156 JTD 10V	2,4	110	11.99-01.04	841C000	5	132	RP8622





Model	CC	Kw	Year	Engine	Cyl	Pict	Code
Alfa 156 JTD 16V	1,9	103	11.02-	---	4	166	RP8914
Alfa 156 JTDM 8V	1,9	88	12.05-	939A1000	4	132	RP8622
Alfa 156 Sportwagon (932) JTD	2,4	129	10.03-05.06	Cooling-water preheater	5	160	RP8898
Alfa 156 Sportwagon (932) JTD	2,4	129	10.03-05.06	841 G.000	5	166	RP8914
Alfa 156 Sportwagon (932) JTD	1,9	77	05.00-10.00	AR 32.302	5	132	RP8622
Alfa 156 Sportwagon JTD	1,9	81	10.00-05.01	---	4	160	RP8898
Alfa 156 Sportwagon JTD 16V	1,9	103	11.02-	---	4	166	RP8914
Alfa 156 Sportwagon JTD 16V Q4	1,9	110	07.04-	---	4	166	RP8914
Alfa 159 JTDM	2,0	100	06.10-	939 B4.000	4	182	RP8444
Alfa 159 JTDM	2,0	125	05.09-12.10	939 B3.000	4	182	RP8444
Alfa 159 JTDM	2,4	147	06.05-12.08	939 A3.000	5	166	RP8914
Alfa 159 JTDM	2,4	154	02.07-12.08	939 A9.000	5	166	RP8914
Alfa 159 JTDM 16V	1,9	100	01.06-12.08	939 A8.000	4	166	RP8914
Alfa 159 JTDM 16V	1,9	110	06.05-12.08	939 A2.000	4	166	RP8914
Alfa 159 JTDM 16V Sportwagon	1,9	100	03.06-	937 A8.000	4	166	RP8914
Alfa 159 JTDM 8V	1,9	85	01.06-12.08	937 A7.000	4	132	RP8622/30
Alfa 159 JTDM 8V	1,9	88	06.05-12.08	939 A1.000	4	132	RP8622/30
Alfa 159 JTDM Q4	2,4	154	09.06-12.08	939 A9.000	5	166	RP8914
Alfa 164 TD	2,5	84	06.87-08.92	VM 84 A	4	6	RP4410
Alfa 164 TD Super	2,5	92	09.92-04.95	VM 425-SLIRA	4	11	RP4444
Alfa 164 TD Super	2,5	92	05.95-09.98	VM 425-SLIRA	4	78	RP8370
Alfa 166 JTD	2,4	100	10.98-09.00	AR 34202	5	94	RP8372
Alfa 166 JTD	2,4	100	09.98-10.00	Cooling-water preheater	5	160	RP8898
Alfa 166 JTD	2,4	103	10.00-	AR 36.202	5	132	RP8622
Alfa 166 JTD	2,4	110	04.02-	841 C000	5	94	RP8372
Alfa 166 JTD	2,4	110	04.02-	Cooling-water preheater	5	160	RP8898
Alfa 166 JTD	2,4	129	10.03-	841 G.000 / 841 H.000	5	166	RP8914
Alfa 166 JTD	2,4	132	07.06-	---	5	166	RP8914
Alfa 166 JTD	2,4	136	07.05-	---	5	166	RP8914
Alfa 166 JTD 10V	2,4	110	12.99-	841 C000	5	132	RP8622
Alfa 33	1,8	54	02.90-06.90	VM82A	3	6	RP4410
Alfa 33 TD	1,8	55	09.86-03.94	VM 82 A	4	6	RP4410
Alfa 33 TD	1,8	62	09.86-03.94	VM HR-392	3	6	RP4410
Alfa 33 TD	1,8	62	02.90-03.94	VM 82 A	4	6	RP4410
Alfa 33 TD / SW	1,8	62	01.90-03.94	VM 96 A	4	6	RP4410
Alfa 6 TD	2,5	77	06.83-02.87	VM-HR 588HT	5	6	RP4410
Alfa 75 TD	2,0	70	05.85-09.92	VM 80 A	4	6	RP4410
Alfa 75 TD	2,4	81	10.88-02.92	VM 81 A	4	6	RP4410
Alfa 90 TD	2,4	81	10.84-01.87	VM 81 A	4	6	RP4410
Alfa GT JTD	1,9	110	11.03-	---	4	166	RP8914
Alfetta TD	2,0	60-62	10.79-03.83	VM 4 HT/2	4	6	RP4410
Alfetta TD	2,4	69-70	04.83-12.84	VM 4 HT 2,4	4	6	RP4410
Brera JTDM 20V	2,4	147	01.06-	---	5	166	RP8914
Giulietta JTDM	1,6	77	05.10-	940 A3.000	4	182	RP8444



Model	CC	Kw	Year	Engine	Cyl	Pict	Code
Giulietta JTDM	2,0	125	05.10-	940 A4.000	4	182	RP8444
Giulietta TD	2,0	61	03.83-04.85	VM 4 HT	4	6	RP4410
GT JTD	1,9	110	11.03-	937 A5.000	4	166	RP8914
GT JTDM	2,4	147	04.07-	---	5	166	RP8914
MiTo JTD	1,3	66	10.08-	199 A3.000	4	155	RP8678
MiTo JTD	1,3	70	10.08-	199 B1.000	4	155	RP8678
MiTo JTD	1,6	84	09.08-	955 A4.000	4	182	RP8444
MiTo JTD	1,6	88	08.08-	955 A3.000	4	182	RP8444
<b>ALFA ROMEO VAN</b>							
AR 6	1,9	51	04.85-12.89	160D100	4	11	RP4444
AR 6	2,4	53	04.85-02.86	SOFIM-8144.61.200	4	11	RP4444
AR 6 10/13/14 D	2,5	55	03.86-12.89	8144.61.200-8144.67.220	4	11	RP4444
AR 8 30/32/35/40	2,5	53	10.83-12.89	Sofim 8140.61.200	4	11	RP4444
AR 8 30/32/35/40 AR	2,5	53	02.80-06.82	Sofim 8140.61.200	4	11	RP4444
<b>ALPINA</b>							
D 3 E90	2,0	147	02.07-	L1	4	179	RP9004
D10 D Biturbo	3,0	180	09.99-	---	6	134	RP8626
<b>AM GENERAL</b>							
Hummer V8 6,2L	6,2	379	92-94	---	---	40	RP7010
Hummer V8 6,5L	6,5	---	94-05	---	---	40	RP7010
<b>ARO</b>							
10.1 - 10.4	1,9	47	---	Renault F8Q248	4	11	RP4444
240 - 244, 246	2,5	55	---	Peugeot XD 3P	6	11	RP4444
240 - 244, 246	2,5	70	---	Peugeot XD 3TP	6	11	RP4444
240 - 244, 246	2,7	52	---	L 27 Aro	6	22	RP8040
240 - 244, 246	3,1	52	---	D 127 Brasov	6	22	RP8040
240, 241, 242, 244 Di	2,5	---	03.77-09.86	XUD	4	11	RP4444
Enduro X4 id alle Modelle	---	---	01.86-	Mot. VW	4	8	RP4422
Turbo 10	1,9	68	---	F8Q Turbo	4	8	RP4422
<b>ASIA</b>							
Rocsta D / 4x4	2,2	45	06.93-09.99	R2	4	55	RP6912
<b>AUDI</b>							
100 D	2,0	51	08.78-07.89	CB	5	8	RP4422
100 D	2,4	60	08.89-12.90	3D	5	8	RP4422
100 D	2,4	66	05.91-07.94	AAS	5	8	RP4422
100 TD	2,0	74	03.88-12.90	NC	5	8	RP4422
100 TD, Avant	2,0	66	11.81-12.87	DE	5	8	RP4422
100 TDI	2,5	85	06.91-07.92	ABP / AAT	5	78	RP8272
100 TDI	2,5	85	08.91-07.94	AAT / ABP	5	78	RP8272
100 TDI	2,5	88	01.90-12.90	1T	5	78	RP8272
100 TDI, Avant	2,5	88	04.90-12.91	1T	5	78	RP8272
80 D	1,6	40- 37	08.80-07.82	CR	4	8	RP4422
80 D / TD, Avant	1,6	59	04.88-07.90	RA	4	8	RP4422
80 D, Avant	1,6	40	08.82-07.89	JK	4	8	RP4422
80 D, Avant	1,9	47	08.89-12.91	1Y	4	8	RP4422



Model	CC	Kw	Year	Engine	Cyl	Pict	Code
80 TD	1,6	51	02.82-03.87	CY	4	8	RP4422
80 TD, Avant	1,6	59	04.89-12.91	SB	4	8	RP4422
80 TD, Avant	1,9	55	09.91-07.95	AAZ	4	8	RP4422
80 TDI Cabriolet	1,9	66	06.95-08-00	1Z/AHU	4	78	RP8272
80 TDI Cabriolet	1,9	66	06.95-08.00	Cooling-water preheater	---	91	RP8360
80 TDI, Avant	1,9	66	09.91-01.96	1Z	4	78	RP8272
80 TDI, Avant	1,9	66	09.91-01.96	Colling-water preheater	---	91	RP8360
90 TD	1,6	51	10.84-03.87	CY	4	8	RP4422
90 TD	1,6	59	04.88-07.90	RA	4	8	RP4422
90 TD	1,6	59	04.89-12.91	SB	4	8	RP4422
A1 TDI	1,6	66	03.11-	CAYB	4	171	RP8928
A1 TDI	1,6	77	05.10-	CAYC	4	171	RP8928
A1 TDI	2,0	100	09.11-	CFHB	4	171	RP8928
A1 TDI	2,0	105	09.11-	CFHD	4	171	RP8928
A1 TDI Sportback	1,6	66	11.11-	CAYB	4	171	RP8928
A1 TDI Sportback	1,6	77	11.11-	CAYC	4	171	RP8928
A1 TDI Sportback	2,0	100	05.12-	CFHB	4	171	RP8928
A1 TDI Sportback	2,0	105	09.11-	CFHD	4	171	RP8928
A2 TDI	1,2	45	02.00-	ANY	3	78	RP8272
A2 TDI	1,2	45	03.01-08.05	ANY	3	78	RP8674
A2 TDI	1,4	55	02.00-08.03	AMF/BHC	3	78	RP8674
A2 TDI	1,4	55	02.00-	AMF	3	78	RP8272
A2 TDI	1,4	55	05.03-	BAY	4	78	RP8272
A2 TDI	1,4	55-66	09.03-	AMF-BHC-ATL	3	177	RP9000
A3 (8L1) TDI	1,9	66	09.96-07.01	AGR/ALH	4	78	RP8272
A3 (8L1) TDI	1,9	66	09.96-07.01	Cooling-water pre4heater	---	8	RP4422
A3 (8L1) TDI	1,9	74	10.00-	ATD / AXR	4	78	RP8674
A3 (8L1) TDI	1,9	74	10.00-05.03	ATD / AXR	4	78	RP8272
A3 2,0 TDI	2,0	100-103	05.03-	AZV/BKD	4	178	RP9002
A3 Sportback TDI	1,9	77	09.04-	BKC	4	177	RP9000
A3 Sportback TDI	2,0	100-103	09.04-	AZV/BKD	4	178	RP9002
A3 Sportback TDI quattro	2,0	103	06.05-	---	4	178	RP9002
A3 TDI	1,9	66	08.98-	ANU	4	78	RP8272
A3 TDI	1,9	77	10.05-05.07	BLS	4	177	RP9000
A3 TDI	1,9	77	06.03-05.06	BKC	4	177	RP9000
A3 TDI	1,9	77	06.06-	BXE	4	177	RP9000
A3 TDI	1,9	81	08.97-07.01	AHF/ASV	4	78	RP8272
A3 TDI	1,9	81	08.97-07.01	Cooling-water preheater	---	91	RP8360
A3 TDI	1,9	81	08.97-07.01	Cooling-water preheater	---	8	RP4422
A3 TDI	1,9	85	08.98-	AJM	4	78	RP8272
A3 TDI	1,9	96	10.00-	ASK	4	78	RP8272
A3 TDI	1,9	96	08.00-	ASZ	4	78	RP8674
A3 TDI	1,9	96	08.00-	---	4	78	RP8674
A3 TDI	1,9	96	09.96-07.98	Cooling-water preheater	4	91	RP8360



Model	CC	Kw	Year	Engine	Cyl	Pict	Code
A3 TDI	1,9	96	08.00-05.03	Cooling-water preheater	4	91	RP8360
A3 TDI	1,9	96	08.00-05.03	Cooling-water preheater	4	8	RP4422
A3 TDI	1,9	96	06.03-	ASZ	4	78	RP8674
A3 TDI	1,9	75-77	03.03-	---	4	177	RP9000
A3 TDI	2,0	103	06.05-	BMM	4	177	RP9000
A3 TDI	2,0	120	06.06-05.07	BUY	4	179	RP9004
A3 TDI	2,0	125	03.06-	BMN	4	178	RP9002
A3 TDI	2,0	125	03.06-05.07	BMN	4	179	RP9004
A3 TDI (Chassis nr.8L-2-037-877)	1,9	74	11.01-06.03	AXR	4	78	RP8272
A3 TDI (Chassis nr.8L-2-037-877)	1,9	74	01.01.06.03	ATD	4	78	RP8272
A3 TDI (Chassis nr.8L-2-037-878)	1,9	74	11.01-06.03	AXR	4	78	RP8370
A3 TDI (Chassis nr.8L-2-037-878)	1,9	74	01.01.06.03	ATD	4	78	RP8370
A3 TDI (Chassis nr.8L-2-037-878)	1,9	96	05.00-06.03	ASZ	4	78	RP8370
A3 TDI / Quattro	1,9	96	08.00-05.03	ASZ	4	78	RP8272
A3 TDI Cabriolet	1,6	77	05.09-	CAYC	4	171	RP8928
A3 TDI Cabriolet	1,9	77	04.08-05.09	BLS	4	177	RP9000
A3 TDI Cabriolet	2,0	100	04.08-05.10	CBAA	4	171	RP8928
A3 TDI Cabriolet	2,0	100	11.09-	CFFA	4	171	RP8928
A3 TDI Cabriolet	2,0	103	04.08-05.10	CBAB	4	171	RP8928
A3 TDI Cabriolet	2,0	103	11.09-	CFFB	4	171	RP8928
A3 TDI quattro	1,9	96	08.00-	---	4	78	RP8674
A3 TDI quattro	2,0	100	05.03-	---	4	178	RP9002
A3 TDI quattro	2,0	103	08.04-	---	4	178	RP9002
A3 TDI Sportback	2,0	103	06.05-	BMM	4	177	RP9000
A3 TDI Sportback	2,0	125	03.06-	BMN	4	178	RP9002
A4	1,9	85	11.05-	BRB	4	177	RP9000
A4 Avant (8D5, B5) TDI	1,9	85	03.00-09.01	AJM	4	78	RP8272
A4 Avant TDI	1,9	85	06.04-	---	4	177	RP9000
A4 Avant TDI	1,9	85	11.04-	---	4	177	RP9000
A4 Avant TDI	1,9	96	09.01-	AWX	4	78	RP8272
A4 Avant TDI	1,9	96	09.01-	Cooling-water preheater	4	91	RP8360
A4 Avant TDI	2,0	103	11.04-	BPW	4	178	RP9002
A4 Avant TDI quattro	1,9	96	11.00-12.04	AVF/AWX	4	78	RP8272
A4 Avant TDI quattro	1,9	96	11.00-12.04	Cooling-water preheater	4	8	RP4422
A4 Avant TDI quattro	1,9	96	11.00-12.04	Cooling-water preheater	4	8	RP4422
A4 Cabriolet	2,5	120	08.02-	BCZ/BDG/BFC	6	105	RP8404
A4 TDI	1,9	81	02.96-09.01	AFN	4	78	RP8272
A4 TDI	1,9	85	06.04-12.05	BKE	4	177	RP9000
A4 TDI	1,9	85	11.04-	BKE	4	177	RP9000
A4 TDI	2,0	89	01.06-09.06	BVG	4	179	RP9004
A4 TDI	2,0	93	11.05-11.06	BVF	4	179	RP9004
A4 TDI	2,0	100	11.04-	BNA	4	178	RP9002
A4 TDI	2,0	100	11.05-	BRF	4	179	RP9004
A4 TDI	2,0	103	11.04-	BPW	4	177	RP9000



Model	CC	Kw	Year	Engine	Cyl	Pict	Code
A4 TDI	2,0	103	10.05-	BRE	4	179	RP9004
A4 TDI	2,0	120	06.06-	BVA	4	179	RP9004
A4 TDI	2,0	125	06.06-	---	4	178	RP9002
A4 TDI	2,0	125	06.06-	BRD	4	179	RP9004
A4 TDI	2,5	114	04.04-06.02	AYM	6	105	RP8404
A4 TDI	2,5	120	07.02-12.04	BCZ/BDG/BFC	6	105	RP8404
A4 TDI	2,7	132	01.06-	BPP	6	171	RP8928
A4 TDI (Chassis 8E-2-148-697)	1,9	96	12.00-06.03	AWX	4	78	RP8272
A4 TDI (Chassis 8E-2-148-698)	1,9	96	11.00-12.04	AVF	4	78	RP8370
A4 TDI (Chassis 8E-2-148-698)	1,9	96	12.00-06.03	AWX	4	78	RP8370
A4 TDI / Avant	1,9	55	12.95-09.01	AFF	4	78	RP8272
A4 TDI / Avant	1,9	55	12.95-09.01	Cooling-water preheater	4	8	RP4422
A4 TDI / Avant	1,9	55	12.95-09.01	Cooling-water preheater	4	91	RP8360
A4 TDI 16V / Avant	2,0	103	11.04-	BLB / BRE	4	178	RP9002
A4 TDI Avant	2,0	125	06.06-	---	4	178	RP9002
A4 TDI Avant	2,5	120	07.02-12.04	BFC / BCZ / BDG	6	105	RP8404
A4 TDI Avant	2,5	120	11.04-	BCZ / BDG	6	105	RP8404
A4 TDI Avant	2,7	132	01.06-	BPP	6	171	RP8928
A4 TDI Avant Allroad	2,0	100	09.09-	CAGB	4	171	RP8928
A4 TDI Avant Allroad	2,0	100	11.11-	CJCB	4	171	RP8928
A4 TDI Avant Allroad	2,0	105	09.09-	CAGA	4	171	RP8928
A4 TDI Avant Allroad	2,0	105	03.12-	CJCA	4	171	RP8928
A4 TDI Avant Allroad	2,0	120	04.09-	CAHB	4	171	RP8928
A4 TDI Avant Allroad	2,0	120	03.12-	CGLD	4	171	RP8928
A4 TDI Avant Allroad	2,0	125	04.09-	CAHA	4	171	RP8928
A4 TDI Avant Allroad	2,0	130	11.11-	CGLC	4	171	RP8928
A4 TDI Avant Allroad	3,0	176	04.09-	CCWA	6	171	RP8928
A4 TDI Avant Allroad	3,0	180	01.12-	CDUC / CKVB	6	171	RP8928
A4 TDI Avant Quattro	2,5	132	09.11-12.04	AQE / BAU / BDH	6	105	RP8404
A4 TDI Cabriolet	2,0	103	10.05-	BPW	4	177	RP9000
A4 TDI Cabriolet	2,7	132	06.06-	BPP	6	171	RP8928
A4 TDI Cabriolet Quattro	3,0	171	10.05-	ASB	6	171	RP8928
A4 TDI quattro	1,9	85	03.00-11.00	Cooling-water preheater	4	8	RP4422
A4 TDI quattro	1,9	85	03.00-11.00	Cooling-water preheater	4	91	RP8360
A4 TDI quattro	2,5	132	09.01-	AKE/BAU/BDH	6	105	RP8404
A4 TDI quattro / Avant	3,0	150	11.04-	BKN	6	171	RP8928
A4 TDI quattro / Avant	3,0	171	01.06-	ASB	6	171	RP8928
A4 TDI quattro, Avant	1,9	96	11.00-12.04	AVF	4	78	RP8272
A4 TDI quattro, Avant	1,9	81	10.95-09.01	AFN/AVG	4	78	RP8272
A4 TDI quattro, Avant	1,9	81	10.95-09.01	Cooling-water preheater	4	8	RP4422
A4 TDI quattro, Avant	1,9	81	10.95-09.01	Cooling-water preheater	4	91	RP8360
A4 TDI quattro, Avant	1,9	85	03.00-11.00	AJM/ATJ	4	78	RP8272
A4 TDI, Avant	1,9	66	01.95-09.01	1Z/AHU/AHH	4	78	RP8272
A4 TDI, Avant	1,9	66	01.95-09.01	Cooling-water preheater	4	8	RP4422



Model	CC	Kw	Year	Engine	Cyl	Pict	Code
A4 TDI, Avant	1,9	66	01.95-09.01	Cooling-water preheater	4	91	RP8360
A4 TDI, Avant	2,0	100-103	11.04-	---	4	178	RP9002
A4 TDI, Quattro	2,5	110	09.97-09.01	AFB/AKN	6	105	RP8404
A4 TDI, Quattro	2,5	110-132	07.98-	AKN / AKE / AVL	6	105	RP8404
A4, Avant TDI	1,9	74	05.01-12.04	AVB	4	78	RP8272
A5 Sportback (8TA) TDI quattro	2,0	130	12.11-	CGLC	6	171	RP8928
A5 TDI	2,7	140	06.07-	CAMA	6	171	RP8928
A5 TDI	3,0	177	06.07-	CAPA	6	171	RP8928
A5 TDI Cabriolet	2,0	105	10.11-	CJCA	6	171	RP8928
A5 TDI Cabriolet	2,0	120	05.09-	CAHB	6	171	RP8928
A5 TDI Cabriolet	2,0	120	10.11-	CGLD	6	171	RP8928
A5 TDI Cabriolet	2,0	125	05.09-	CAHA	6	171	RP8928
A5 TDI Cabriolet	2,0	130	10.11-	CGLC	6	171	RP8928
A5 TDI Cabriolet	2,7	120	05.09-	CGKB	6	171	RP8928
A5 TDI Cabriolet	2,7	140	03.09-	CGKA	6	171	RP8928
A5 TDI Cabriolet quattro	2,0	130	01.12-	CGLC	6	171	RP8928
A5 TDI Cabriolet quattro	3,0	150	09.11-	CLAB	6	171	RP8928
A5 TDI Cabriolet quattro	3,0	176	03.09-	CCWA	6	171	RP8928
A5 TDI Cabriolet quattro	3,0	180	10.11-	CDUC	6	171	RP8928
A5 TDI Quattro	3,0	176	06.07-	CAP	6	171	RP8928
A6 (4A, C4) TDI quattro, Avant	2,5	103	10.95-10.97	ABC	6	78	RP8272
A6 (4A, C4) TDI, Avant	2,5	84	01.95-10.97	AAT	5	78	RP8272
A6 Avant (4B, C5) TDI	1,9	81	02.98-04.01	AFN	4	78	RP8272
A6 Avant TDI	2,0	103	06.05-	---	4	78	RP8674
A6 Avant TDI	2,0	100-103	06.05-	---	4	178	RP9002
A6 Avant TDI	2,7	120	03.05-	---	6	171	RP8928
A6 Avant TDI / quattro	2,7	132	03.05-	---	6	171	RP8928
A6 Avant TDI quattro	2,7	120	06.05-	---	6	171	RP8928
A6 Avant TDI quattro	3,0	155	03.05-	---	6	171	RP8928
A6 Avant TDI quattro	3,0	165	03.05-	---	6	171	RP8928
A6 L 16V TDI, Avant	2,7	120	05.04-	BSG/BPP	6	171	RP8928
A6 TDI	2,0	89	09.05-06.06	BVG	4	179	RP9004
A6 TDI	2,0	100	06.05-	BNA/BRF	4	178	RP9002
A6 TDI	2,0	100	09.05-	BRF	4	179	RP9004
A6 TDI	2,0	103	07.04-	BLB/BRE	4	178	RP9002
A6 TDI	2,0	103	09.05-	BRE	4	179	RP9004
A6 TDI	2,7	120	11.04-	---	6	171	RP8928
A6 TDI PF Avant	3,0	171	06.06-	ASB (4E-5-003 300)	6	105	RP8404
A6 TDI PF Avant	3,0	171	06.06-	ASB (4E-5-003 301)	6	171	RP8928
A6 TDI Avant Allroad	3,0	150	01.12-	CLAA	6	171	RP8928
A6 TDI Avant Allroad	3,0	180	01.12-	CDUC / CKVC	6	171	RP8928
A6 TDI Avant Allroad	3,0	230	01.12-	CGQB	6	171	RP8928
A6 TDI quattro	2,7	132	11.04-	---	6	171	RP8928
A6 TDI quattro	3,0	155	05.04-	---	6	171	RP8928



Model	CC	Kw	Year	Engine	Cyl	Pict	Code
A6 TDI quattro, Avant	2,7	120	06.05-	---	6	171	RP8928
A6 TDI quattro, Avant	3,0	165	05.04-	---	6	171	RP8928
A6 TDI, Avant	1,9	66	06.94-12.97	1Z/AHU	4	78	RP8272
A6 TDI, Avant	1,9	66	06.94-12.97	Cooling-water preheater	4	8	RP4422
A6 TDI, Avant	1,9	66	06.94-12.97	Cooling-water preheater	4	91	RP8360
A6 TDI, Avant	1,9	81	12.97-01.05	AFN/AVG	4	78	RP8272
A6 TDI, Avant	1,9	81	12.97-01.05	Cooling-water preheater	4	91	RP8360
A6 TDI, Avant	1,9	81	12.97-01.05	Cooling-water preheater	4	8	RP4422
A6 TDI, Avant	1,9	85	07.00-01.05	AJM	4	78	RP8272
A6 TDI, Avant	1,9	85	07.00-01.05	Cooling-water preheater		8	RP4422
A6 TDI, Avant	1,9	85	07.00-01.05	Cooling-water preheater	4	91	RP8360
A6 TDI, Avant	1,9	96	08.01-01.05	AVF/AWX	4	78	RP8272
A6 TDI, Avant	1,9	96	08.01-01.05	Cooling-water preheater	4	91	RP8360
A6 TDI, Avant	1,9	96	08.01-01.05	Cooling-water preheater	4	8	RP4422
A6 TDI, Avant	1,9	103	07.04-	---	4	178	RP9002
A6 TDI, Avant	2,5	85	06.94-10.97	AAT	5	78	RP8272
A6 TDI, Avant	2,5	103	08.94-10.97	AEL	5	78	RP8272
A6 TDI, Avant	2,5	114	08.01-	AYM	6	105	RP8404
A6 TDI, Avant	2,5	120	07.02-	BCZ/BDG/BFC	6	105	RP8404
A6 TDI, Quattro, Avant	2,5	110	04.97-07.98	AFB	6	105	RP8404
A6 TDI, Quattro, Avant	2,5	110	07.98-	AKN	6	105	RP8404
A6 TDI, Quattro, Avant	2,5	132	02.00-	AKE/BAU/BDH	6	105	RP8404
A7 TDI Sportback	3,0	150	11.10-	CLAB	6	171	RP8928
A7 TDI Sportback quattro	3,0	150	12.10-	CLAA	6	171	RP8928
A7 TDI Sportback quattro	3,0	180	07.10-	CDUC	6	171	RP8928
A7 TDI Sportback quattro	3,0	180	11.11-	CKVB	6	171	RP8928
A7 TDI Sportback quattro	3,0	180	05.12-	CKVC	6	171	RP8928
A7 TDI Sportback quattro	3,0	230	11.11-	CGQB	6	171	RP8928
A8 L V6 TDI	3,0	155	05.04-	BNG	8	171	RP8928
A8 TDI	2,5	110	06.97-09.98	AFB	6	105	RP8404
A8 TDI	2,5	110	11.97-09.98	AKN	6	105	RP8404
A8 TDI	2,5	132	09.00-	AKE	6	105	RP8404
A8 TDI quattro	3,0	155	11.03-	---	6	171	RP8928
A8 TDI Quattro	3,0	171	08.03-	ASB	6	105	RP8404
A8 TDI quattro	3,3	165	06.00-	AKF	8	105	RP8404
A8 TDI quattro	4,0	202	03.03-	ASE	8	78	RP8674
A8 TDI Quattro	4,2	235	07.05-	BMC	8	171	RP8928
A8 TDI Quattro	4,2	240	07.05-	BBVM	8	171	RP8928
Allroad TDI Quattro	2,5	120	05.03-	BCZ	6	105	RP8404
Allroad TDI Quattro	2,5	132	05.01-	AKE/BAU	6	105	RP8404
Audi Cabrio TDI	1,9	66	07.95-07.96	1Z	4	78	RP8272
Audi Cabrio TDI	1,9	66	07.96-	AHU	4	78	RP8272
Q3 TDI	2,0	100	09.11-	CFFA	4	171	RP8928
Q3 TDI	2,0	103	09.11-	CFFB	4	171	RP8928



Model	CC	Kw	Year	Engine	Cyl	Pict	Code
Q3 TDI quattro	2,0	103	01.12-	CFFB	4	171	RP8928
Q3 TDI quattro	2,0	120	06.11-	CFGD	4	171	RP8928
Q3 TDI quattro	2,0	130	06.11-	CFGC / CLLB	4	171	RP8928
Q5 TDI quattro	2,0	100	08.09-05.10	CAGB	4	171	RP8928
Q5 TDI quattro	2,0	100	05.10-	CJCB	4	171	RP8928
Q5 TDI quattro	2,0	100	11.10-	CJCB	4	171	RP8928
Q5 TDI quattro	2,0	105	08.09-05.10	CAGA	4	171	RP8928
Q5 TDI quattro	2,0	105	05.10-	CJCA	4	171	RP8928
Q5 TDI quattro	2,0	105	11.10-	CJCA	4	171	RP8928
Q5 TDI quattro	2,0	120	01.08-09.10	CAHB	4	171	RP8928
Q5 TDI quattro	2,0	120	05.10-	CGLA	4	171	RP8928
Q5 TDI quattro	2,0	125	01.08-09.10	CAHA	4	171	RP8928
Q5 TDI quattro	2,0	125	05.10-	CGLB	4	171	RP8928
Q5 TDI quattro	3,0	155	11.08-	CCWB	6	171	RP8928
Q5 TDI quattro	3,0	176	11.08-	CCWA	6	171	RP8928
Q7 TDI, Quattro	3,0	155	03.06-	BUN	6	171	RP8928
Q7 TDI, Quattro	3,0	171	03.06-	BUG	6	171	RP8928
Q7 TDI, Quattro	4,2	240	03.07-	BTR	8	171	RP8928
TT TDI Coupe quattro / Roadster quattro	2,0	125	06.08-06.10	CBBB	4	171	RP8928
<b>AVIA</b>							
A 21.1	---	---	10.90-	---	4	11	RP4444
A2.1/A3.1/AN2.1/AN3.1	---	---	10.96-	---	---	161	RP8900
A2.1/A3.1/AN2.1/AN3.1	---	---	10.60-	---	---	11	RP4444
A2.1/A3.1T/A60/A70	---	---	10.90-	---	---	162	RP8902
Avia	3,6	65	01.93-	D 407	4	11	RP4444
<b>BEDFORD GB</b>							
Astra Van D	1,6	40	03.82-08.84	16D OHC	4	11	RP4444
Astramax D	1,6	40	09.84-08.91	16D OHC	4	11	RP4444
Brava D Pickup 4x4	2,2	52	12.88-	---	4	26	RP6824
CF D	2,3	48	01.81-	Opel 23D OHC	4	11	RP4444
CF D Van	2,3	48-52	09.80-08.86	Opel 23D OHC	4	11	RP4444
Midi D	2,2	45	06.88-08.92	22DIE (5V)	4	71	RP8134
Midi D	2,2	45	06.88-08.92	22DIE (11V)	4	71	RP8324
<b>BMW</b>							
118 d (E87)	2,0	90	09.04-	M47N204D4	4	179	RP9004
120 d	2,0	120	09.04-	M47N204D4/N47D20A	4	179	RP9004
120 d	2,0	130	09.07-	---	4	179	RP9004
318 D (E46)	2,0	85	09.01-02.05	M 47 N-204 D	4	179	RP9004
318 D (E46)	2,0	85	09.01-03.03	M4720D1	4	179	RP9004
318 D (E46/4)	2,0	85	09.01-11.03	M47 D20	4	134	RP8626
318 d (E90) / 318 d Touring (E91)	2,0	90	09.05-	M47N204D4	4	179	RP9004
318 d Touring (E46)	2,0	85	03.02-	---	4	179	RP9004
318 d Touring (E46)	2,0	85	03.03-	---	4	179	RP9004
318 D Touring (E46/3)	2,0	85	09.01-11.03	M47 D20	4	134	RP8626





Model	CC	Kw	Year	Engine	Cyl	Pict	Code
318 TD (E 46) Compact	2,0	85	03.03-02.05	M 47 N-204 D4	4	179	RP9004
318 TDS (E36)	1,7	66	01.95-02.98	M 41 D 18 (inter.)	4	11	RP4444
318 TDS (E36)	1,8	66	11.94-	M 41 D18	4	11	RP4444
320 Cd Cabriolet (E46)	2,0	110	02.05-	---	4	179	RP9004
320 Cd Coupe (E46)	2,0	110	11.03-	---	4	179	RP9004
320 D Coupè (E92)	2,0	130	03.07-	---	4	179	RP9004
320 D (E 46)	2,0	100	04.98-09.01	M 47 D20/M 47 204D1	4	134	RP8626
320 D (E 46)	2,0	110	09.01-	M 47 N 204D4	4	179	RP9004
320 d (E90) / 320 d Touring (E91)	2,0	120	01.05-	M47N204D5	4	179	RP9004
320 D Touring (E46)	2,0	100	03.00-09.01	M 47 D20	4	134	RP8626
320 d Touring (E46)	2,0	110	09.01-	---	4	179	RP9004
320 TD Compact (E46)	2,0	110	09.01-02.05	M 47 N204D4	4	134	RP8626
324 D (E 30)	2,4	63	09.85-08.91	M 21 D 24 W	6	11	RP4444
324 TD (E 30)	2,4	85	09.87-06.93	M 21 D 24	6	11	RP4444
324 TD (E 30) Touring	2,4	85	01.88-12.93	M 21 D 24	6	11	RP4444
325 D (E90)	3,0	145	03.06-	M57N2 D30	6	179	RP9004
325 D Coupe (E92)	3,0	145	03.06-	M57N2 D30	6	179	RP9004
325 TD (E 36)	2,5	85	09.91-02.98	M 51 D 25	6	11	RP4444
325 TDS (E 36)	2,5	105	05.93-02.98	M 51 D 25	6	11	RP4444
330 Cd (E 46) Coupè	3,0	150	03.03-	M 47 N-204 D	6	179	RP9004
330 Cd Touring (E46)	3,0	150	03.03-	---	6	179	RP9004
330 D Cabriolet (E93)	3,0	170	09.06-	---	6	179	RP9004
330 D (E 46)	3,0	150	03.03-	M 57 N306D2	6	179	RP9004
330 d (E46) / Touring	3,0	135	03.03-	M 57 N	6	134	RP8626
330 d (E90) / 330 d Touring (E91)	3,0	170	09.05-	M57306D3	6	179	RP9004
330 d Touring (E46)	3,0	150	03.03-	---	6	179	RP9004
330 xd (E 46)	3,0	150	03.03-02.05	M 47 N-204 D	6	179	RP9004
330 xd (E 46) / Touring	3,0	135	06.00-	M 57 D 30	6	134	RP8626
330 xd Touring (E46)	3,0	150	03.03-	M57 N	6	179	RP9004
330xd (E90) / 330xd Touring (E91)	3,0	170	09.05-	---	6	179	RP9004
335 D (E90)	3,0	210	09.06-	M57N2 D30	6	179	RP9004
335 D Touring (E91)/Coupe (E92)	3,0	145	09.06-	M57N2 D30	6	179	RP9004
520 D (E 39) / Touring	2,0	100	02.00-06.03	M47D20 / M47204D1	4	134	RP8626
520 d (E39) / Touring	2,0	110	06.02-	---	4	134	RP8626
520 D (E60)	2,0	110	09.05-	---	4	179	RP9004
520 D (E60)	2,0	120	07.05-	M47N204D5	4	179	RP9004
520 d (E60) / 520 d Touring (E61)	2,0	120	07.05-	M 47 N 204D5	4	179	RP9004
524 D (E 28)	2,4	63	09.83-12.87	M 21 D 24 W	6	11	RP4444
524 TD (E 28)	2,4	85	09.83-12.87	M 21 D 24	6	11	RP4444
524 TD (E 34)	2,4	85	03.88-08.91	M 21 D 24	6	11	RP4444
525 D (E 39) / Touring	2,5	120	02.00-06.03	M 57 256 D1	6	134	RP8626
525 d (E39)	2,5	120	02.00-	---	6	134	RP8626
525 D (E60)	2,0	120	12.04-	---	6	179	RP9004
525 d (E60) / 525 d Touring (E61)	2,5	130	06.04-	M 57 N 256D4	4	179	RP9004



Model	CC	Kw	Year	Engine	Cyl	Pict	Code
525 TD (E 34)	2,5	85	09.91-	M 51 D 25	6	11	RP4444
525 TD (E34)	2,5	85	03.93-09.95	M 51 D 25	6	11	RP4444
525 TD (E39)	2,5	85	01.97-	M 51 D25	6	11	RP4444
525 TDS (E 34) / Touring	2,5	105	09.91-01.96	M 51 D 25	6	11	RP4444
525 TDS (E39)	2,5	105	01.96-	M 51 D25	6	11	RP4444
530 D (E 60) / Touring	3,0	160	07.03-	N 57 306 D 2	6	179	RP9004
530 D (E39)	3,0	135	08.98-09.00	M 57 D30	6	134	RP8626
530 D (E39) / Touring	3,0	142	09.00-06.03	M 57 D30	6	134	RP8626
530 d (E60)	3,0	170	07.03-	M 57 306 D3	6	179	RP9004
530 D (E60)	3,0	173	01.07-	---	6	179	RP9004
530 d Touring (E61)	3,0	160	06.04-	---	6	179	RP9004
530 d Touring (E61)	3,0	170	07.05-	---	6	179	RP9004
530 TD (E 39) / Touring	3,0	135	08.98-	M 57	6	134	RP8626
530 xd (E60) / 530 xd Touring (E61)	3,0	170	07.05-	---	6	179	RP9004
535 D (E60)	3,0	210	01.07-	---	6	179	RP9004
535 d (E60) / 535 d Touring (E61)	3,0	200	09.04-	M 57 306D4	6	179	RP9004
635 d / Cabrio	3,0	210	09.07-07.10	30 6D 5	6	179	RP9004
725 TDS (E 38)	2,5	105	04.96-11.01	M 51 D 25	6	11	RP4444
730 D (E 38)	3,0	142	04.00-11.01	M 57 306 D1	6	134	RP8626
730 D (E 65, E66)	3,0	160	10.02-	M 57 N-306 D 2 / N 57 30 D2	6	179	RP9004
730 D (E65)	3,0	150	11.01-02.05	M57N D30	6	179	RP9004
730 Ld (E65, E66)	3,0	170	07.05-	---	6	179	RP9004
730 TD (E 38)	3,0	135	08.98-04.00	M 57 D30	6	134	RP8626
740 D (E 65)	3,9	190	10.02-	N 67 39 8 D1	8	180	RP9006
740 D (E38)	3,9	180	05.099-11.01	M 67 D39	8	151	RP8668
740 TD (E 38)	4,0	180	01.99-	M 67	8	151	RP8668
745 d (E65, E66)	4,5	242	07.05-	---	8	180	RP9006
745 D (E65,E66)	4,4	220	03.05-08.05	---	8	180	RP9006
X3 d (E83)	2,0	110	10.04-	M47N204D4	4	179	RP9004
X3 d (E83)	3,0	150-160	01.04-	M54N306D2	6	179	RP9004
X3 SD (E83)	3,0	210	09.06-	---	6	179	RP9004
X3 sd 4x4 (E83)	3,0	210	09.06-	M57N2 D30	6	179	RP9004
X5 3,0 d (E53)	3,0	135	05.01-	M57306D1	6	134	RP8626
X5 d (E53)	3,0	160	12.03-	M57N306D4	6	179	RP9004
X5 D 4x4 (E53)	3,0	142	08.01-11.03	M57 D30	6	134	RP8626
X6 xDrive 30 d	3,0	173	05.08-03.10	30 6D 3	6	179	RP9004
X6 xDrive 35 d	3,0	210	05.08-03.10	30 6D 5	6	179	RP9004
<b>BUICK</b>							
BLS D	1,9	110	06-	Z19DTH Fiat	4	166	RP8914
Century V6 4,3L	4,3	260	82-85	---	---	40	RP7010
Century V6 5,7L	5,7	350	81	---	---	40	RP7010
Electra V6 4,3L	4,3	260	85	---	---	40	RP7010
Electra V8 5,7L	5,7	350	80-84-85	---	---	40	RP7010



Model	CC	Kw	Year	Engine	Cyl	Pict	Code
La Sabre/Centurion/Invicta/Wildcat V8 5,7L	5,7	350	80-85	---	---	40	RP7010
Regal V6 4,3L	4,3	260	82-83-84	---	---	40	RP7010
Regal V8 5,7L	5,7	350	81-85	---	---	40	RP7010
Regal V8 5,7L	8,5	350	82-83	---	---	40	RP7010
Riviera V8 5,7L	5,7	350	81-85	---	---	40	RP7010
<b>CADILLAC</b>							
DeVille V6 4,3L	4,3	260	85	---	---	40	RP7010
DeVille V8 5,7L	5,7	350	79-84	---	---	40	RP7010
Eldorado V8 5,7L	5,7	350	79-85	---	---	40	RP7010
Fleetwood V6 4,3L	4,3	260	85	---	---	40	RP7010
Fleewood V8 5,7L	5,7	350	85	---	---	40	RP7010
Fleewood V8 5,7L	5,7	350	79-84	---	---	40	RP7010
Seville	5,7	350	1979-1983	DIESEL	8	57	RP7002
<b>CHEVROLET</b>							
Captiva 2WD	---	110	09.07-	---	---	111	RP8416
Captiva D	2,0	110	10.06-	---	---	111	RP8416
Captiva D	2,2	---	2007-	A22DMH	4	193	RP8480
Chassis TD all model	6,5	---	01.82-	V8	8	40	RP6816
Cruze CDI	2,0	110	05.09-12.11	Z20S1	4	111	RP8416
Epica D	2,0	110	01.07-	---	---	111	RP8416
Full Size TD CK / RV	6,5	---	01.82-	V8	8	40	RP6816
MD Bus Chassis TD	6,5	---	01.97-12.98	V8	8	40	RP6816
Sierra (C, K series) V8	6,6	400	01-05	---	---	63	RP7016
Silverado (C, K series) V8	6,6	400	01-05	---	---	63	RP7016
Van TD all model	6,5	---	01.82-	V8	8	40	RP6816
<b>CHRYSLER</b>							
300 C CRD	3,0	142	10.05-	V6 C320CDI Mercedes	6	95	RP8374
300 C Touring CRD	3,0	160	09.05-	---	6	170	RP8924
Grand Voyager 6 TD	2,5	88	09.95-	VM HR 425 CLIEE	4	78	RP8370
Grand Voyager TD LE	2,5	87	04.92-04.95	HR 425 CLI	4	11	RP4444
Grand Voyager TD LE	2,5	88	05.95-	VM HR 425 CLIEE	4	78	RP8370
PT Cruiser CRD	2,2	89-110	03.02-	EDJ	4	95	RP8374
Sebring CRD	2,0	103	07-	Engine by VW	4	177	RP9000
Voyager 6 TD	2,5	88	09.95-	VM HR 425 CLIEE	4	78	RP8370
Voyager I TD	2,5	87	01.92-04.95	09B/M00	4	11	RP4444
Voyager II TD	2,5	85	05.95-03.01	425CLIRS/X	4	78	RP8370
Voyager II TDI	2,5	85	01.95.-04.95	425 CLIRS/X	4	11	RP4488
Voyager III CRD	2,5	105	02.00-	---	4	78	RP8370
Voyager III CRD	2,5	105	02.00-	ENC,ENJ	4	173	RP8932
Voyager III CRD	2,8	110	06.04-	ENR	4	173	RP8932
Voyager TD SE	2,5	85	04.92-04.95	VM HR492/VM425 CLIRE	4	11	RP4444
Voyager TD SE	2,5	85	05.95-	VM HR 425 CLIEE	4	78	RP8370
<b>CITROEN</b>							
15 D	1,5	40-43	08.94-12.97	VJY(TUD5)	4	88	RP8352



Model	CC	Kw	Year	Engine	Cyl	Pict	Code
AX 15 D	1,5	40	08.94-12.97	VJY (TUD5)	4	88	RP8352
AX 15 D	1,5	43	08.94-12.97	VJZ (TUD5)	4	88	RP8352
AX D	1,4	37	08.91-12.97	K9Y(TUD3Y)	4	7	RP4420
AX D	1,4	38	09.88-06.92	K9A(TUD3)	4	7	RP4420
AX D	1,6	40-43	10.94-	TUD 5	4	88	RP8352
AX D, GTD, RD, TD, 4X4	1,4	39	09.88-09.94	TUD 3L	4	7	RP4420
BX 17 D, Break	1,8	44	10.85-09.93	161 (XUD 7)	4	11	RP4444
BX 17 TD, TRD, Break	1,8	66	03.88-02.93	A8A (XUD 7TE)/AJZ (XUD 7TE)	4	11	RP4444
BX 19 D, RD, TD, TRD, Break	1,9	47	09.83-12.87	XUD 9	4	11	RP4444
BX 19 D, TD, TRD, Break	1,9	51	03.87-	D9B (XUD 9A/U)/XUD 9 A/L	4	11	RP4444
C1 HDI	1,4	40	06.05-	DV4D	4	146	RP8652
C1 HDI Turbo Diesel	1,4	50	06.05-	DV4D	4	117	RP8436
C2 HDI	1,4	50	09.03-	8HX (DV4TD)	4	146	RP8652
C3 16V HDI	1,6	66	10.05-	---	4	146	RP8652
C3 16V HDI	1,6	80	09.05-	DV6TED4	4	146	RP8652
C3 HDI	1,4	50	02.02-	8HX (DV4TD)	4	146	RP8652
C3 Hdi	1,4	51	12.04-	DV4TD	4	117	RP8436
C3 Hdi	1,4	68	04-12.04	DV4TED4	4	117	RP8436
C3 Hdi	1,6	81	03.06-	DV4TED6	4	117	RP8436
C3 HDI 16V	1,4	66	02.02-	8HY (DV4TED4)	4	146	RP8652
C3 II HDi 110	1,6	82	11.09-	9HR (DV6C)	4	189	RP8472
C3 Picasso HDi	1,6	66	02.09-	9HX	4	117	RP8436
C3 Picasso HDi	1,6	80	02.09-	9HX / 9HZ	4	117	RP8436
C3 Picasso HDi 110	1,6	82	05.10-	9HR (DV6C)	4	189	RP8472
C3 Picasso HDi 90	1,6	68	07.10-	9HP (DV6DTEd)	4	189	RP8472
C3 Pluriel HDI	1,4	50	04.04-	8HX (DV4TD)	4	146	RP8652
C4 (B7) HDi 150	2,0	110	11.09-	---	4	189	RP8472
C4 Aircross HDi 115	1,6	84	04.12-	---	4	189	RP8472
C4 Aircross HDi 115 4WD	1,6	84	05.12-	---	4	189	RP8472
C4 Coupe HDi 110 FAP	1,6	80	11.04-	---	4	146	RP8652
C4 Grand Picasso	1,6	81	09.06-	DV6TED4	4	117	RP8436
C4 Grand Picasso	2,0	102	09.06-	DW10TD	4	108	RP8410
C4 Grand Picasso (UA_) HDi 150	2,0	110	07.09-	---	4	189	RP8472
C4 Grand Picasso (UA_) HDi 165	2,0	120	09.10-	RHH (DW10CTED4)	4	189	RP8472
C4 HDI	1,6	80	11.04-02.06	DV6TED4 / 9HZ-DV6TED4/ 9HY (DV6TED4)	4	146	RP8652
C4 HDI	2,0	100	11.04-	DW10BTED4 / RHR (DW10BTED4)	4	108	RP8410
C4 Hdi / Picasso	1,6	81	03.07-	DV6TED	4	117	RP8436
C4 HDi 110 FAP	1,6	80	11.04-	---	4	146	RP8652
C4 Hdi Coupe	1,6	68	12.04-	---	4	146	RP8652
C4 Hdi Coupe	1,6	81	12.04-06.06	DV6TED4	4	146	RP8652
C4 HDI Grand Picasso	1,6	80	10.06-	9HZ-DV6TED4 / 9HY (DV6TED4)	4	117	RP8436
C4 HDI Grand Picasso	2,0	100	10.06-	RHJ-DW10BTED4 / RHR (DW10BTED4)	4	108	RP8410
C4 Hdi Turbo Diesel	1,6	80	03.06-	9HZ (DV6ATED4) / 9HY (DV6ATED4)	4	117	RP8436
C4 Picasso	1,6	81	02.07-	DV6TED4	4	117	RP8436



Model	CC	Kw	Year	Engine	Cyl	Pict	Code
C4 Picasso	2,0	102	02.07-	DW10TD	4	108	RP8410
C4 Picasso (UD_) HDi 150	2,0	110	07.09-	---	4	189	RP8472
C4 Picasso (UD_) HDi 165	2,0	120	09.10-	RHH (DW10CTED4)	4	189	RP8472
C5 HDi 16 V, Break	2,2	98	03.01-	4HX (DW12TED4/FAP)	4	108	RP8410
C5 HDi, Break	2,0	80	03.01-08.04	RHZ (DW10ATED)	4	108	RP8410
C5 (RD_) HDi	2,2	125	02.08-	4HT (DW12BTED4)	4	118	RP8438
C5 (RD_) HDi 110	1,6	82	07.10-	9HR (DV6C)	4	189	RP8472
C5 (RD_) HDi 165	2,0	120	04.09-	RHH (DW10CTED4)	4	189	RP8472
C5 Break (TD_) HDi	2,2	125	02.08-	4HT (DW12BTED4)	4	118	RP8438
C5 Break HDi	1,6	80	09.04-	---	4	146	RP8652
C5 Break HDi	2,0	100	09.04-	DW10BTED4	4	172	RP8930
C5 Break HDi 110	1,6	82	07.10-	9HR (DV6C)	4	189	RP8472
C5 Break HDi 165	2,0	120	04.09-	RHH (DW10CTED4)	4	189	RP8472
C5 HDi	1,6	80	09.04-	DV6TED4	4	146	RP8652
C5 Hdi	1,6	81	03.06-	DV6	4	117	RP8436
C5 HDi	2,0	66	03.01-08.04	RHY (DW10TD)	4	108	RP8410
C5 Hdi	2,0	66	06.02-	DW10ATD	4	108	RP8410
C5 Hdi	2,2	125	05.06-	DW12BTED4	4	118	RP8438
C5 Hdi 16V	2,2	100	02.01-	DW12TED4	4	108	RP8410
C5 HDi Break	2,7	150	09.05-	DT17ED4	6	145	RP8650
C5 HDi Turbo Diesel	2,2	125	04.06-	DW12BTED4	4	118	RP8438
C5 HDi, Break	2,0	79	06.01-08.04	RHS (DW10ATED4/FAP)	4	108	RP8410
C6 Hdi	2,7	150	12.05-	DT17	6	145	RP8650
C6 HDi Turbo Diesel	2,2	125	06.06-	DW12BTED4	4	118	RP8438
C8 (EA_, EB_) HDi	2,2	125	06.06-	4HT (DW12BTED4)	4	118	RP8438
C8 HDi	2,0	79	07.02-	RHS (DW10ATED4/FAP)	4	108	RP8410
C8 HDi	2,0	88	02.07-	---	4	108	RP8410
C8 HDi	2,2	94	07.02-04.03	4HX (DW12TED4/FAP)	4	108	RP8410
C8 HDi	2,2	94	05.03-	4HX (DW12TED4/FAP)	4	172	RP8930
C8 HDi	2,2	96	02-	DW12	4	108	RP8410
C8 HDi Turbo Diesel	2,0	100	03.06-	---	4	172	RP8930
C-Crosser Hdi	2,2	115	06.07-	DW12MTED4	4	118	RP8438
CX 2200 D / Break	2,2	48	10.75-02.79	---	4	4	RP2096
CX 25 D / Pallas	2,5	54	07.82-12.92	M25-660	4	11	RP4444
CX 25 D Turbo	2,5	70	08.85-12.86	M25-648	4	11	RP4444
CX 25 RD, TRD	2,5	54	07.82-12.92	M25-660	4	11	RP4444
CX 25 TD Turbo 2	2,5	78-88	01.87-12.92	M25-669/671	4	11	RP4444
CX 2500 D / Reflex	2,5	55	08.81-06.82	M25-629	4	11	RP4444
CX II 2500 D Turbo Break	2,5	70	08.85-12.86	M25-648	4	11	RP4444
DS3 HDi 110	1,6	82	11.09-	9HR (DV6C)	4	189	RP8472
DS3 HDi 90	1,6	68	11.09-	9HP (DV6DTED)	4	189	RP8472
DS3 HDi 90	1,6	82	11.09-	9HR (DV6C)	4	189	RP8472
DS4 e-HDi 110	1,6	81	04.11-	---	4	189	RP8472
DS4 HDi 110	1,6	82	04.11-	9HR (DV6C)	4	189	RP8472



Model	CC	Kw	Year	Engine	Cyl	Pict	Code
DS4 HDi 160	2,0	120	04.11-	RHH (DW10CTED4)	4	189	RP8472
DS4 HDi 90	1,6	82	04.11-	9HR (DV6C)	4	189	RP8472
DS5 HDi 110	1,6	82	11.11-	9HR (DV6C)	4	189	RP8472
DS5 HDi 165	2,0	120	11.11-	RHH (DW10CTED4)	4	189	RP8472
DS5 HDi 165 Hybrid4 4x4	2,0	120	12.11-	RHH (DW10CTED4)	4	189	RP8472
Evasion HDi	2,0	80	09.98-	DW10TED	4	108	RP8410
Evasion HDi	2,0	80	08.99-07.02	RHZ (DW10ETED)	4	108	RP8410
Evasion TD	1,9	66	11.94-08.98	D8B (XUD9TF)/DHX (XUD9TF/BTF)	4	11	RP4444
Evasion TD	1,9	66	09.98-07.02	D8B (XUD9TF)/DHX (XUD9TF/BTF)	4	11	RP4444
Evasion TD	1,9	68	07.94-08.98	XUD 9TF	4	11	RP4444
Evasion TD	1,9	68	09.98-	XUD 9TF, XUD 9BTF	4	11	RP4444
Evasion TD	1,9	68	05.97-	DHX	4	11	RP4444
Evasion TD	1,9	68	10.95-12.98	D8B (XUD9TF)	4	11	RP4444
Evasion TD	2,0	68	05.97-07.02	---	4	11	RP4444
Evasion TD	2,1	80	05.96-08.98	P8C (XUD 11BTE)	4	11	RP4444
Evasion TD	2,1	80	09.98-07.02	P8C (XUD 11BTE)	4	11	RP4444
Nemo HDi Station Wagon	1,4	50	04.09-	DV4TED	4	117	RP8436
Saxo 1,6 D	1,6	37	02.96-	TUD5	4	88	RP8352
Saxo D	1,5	40-42	09.96-	VJY (TUD5)/VJZ (TUD5)	4	88	RP8352
Synergie D	1,9	51	09.98-	DW8	4	88	RP8352
Synergie HDi	2,0	80	01.00-	DW 10	4	108	RP8410
Synergie TD	1,9	68	03.94-08.98	XUD 9TF	4	11	RP4444
Synergie TD	1,9	68	09.98-	XUD 9TF	4	11	RP4444
Visa 17 D	1,8	44	04.84-03.91	161A (XUD7)	4	11	RP4444
Xantia	1,9	68	09.98-12.00	XUD9BTF/XUD9BSD	4	11	RP4444
Xantia	2,1	80	09.98-	XUD11BTF	4	11	RP4444
Xantia 1,9 D	1,9	51	06.95-01.98	D9B (XUD9A/L)	4	11	RP4444
Xantia 2 Hdi	1,4	51	12.04-	DV4TD	4	117	RP8436
Xantia 2 Hdi	1,4	51	02.03-12.04	DV4TD	4	146	RP8652
Xantia D	1,9	51	06.94-05.95	D9B (XUD9A/L)	4	11	RP4444
Xantia D	1,9	55	02.96-08.98	XUD 9A	4	11	RP4444
Xantia D	1,9	55	09.98-	XUD 9A	4	11	RP4444
Xantia D	2,0	80	09.98-	DW10TED/DW10TD	4	108	RP8410
Xantia D, Break	1,9	50	06.94-01.98	DJZ (XUD9Y)	4	11	RP4444
Xantia D, Break	1,9	51	03.93-01.96	XUD 9 A/L	4	11	RP4444
Xantia HDi 109, Break	2,0	80	02.99-04.03	RHZ (DW10ATED)	4	108	RP8410
Xantia HDi 90, Break	2,0	66	03.99-04.03	---	4	108	RP8410
Xantia Picasso Hdi	2,0	66	01.00-	DW10TD	4	108	RP8410
Xantia SD, Break	1,9	55	02.96-01.98	DHW (XUD9SD)	4	11	RP4444
Xantia SD, Break	1,9	55	01.98-04.03	DHW (XUD9SD)	4	11	RP4444
Xantia TD	1,9	68	06.93-08.98	XUD9TF	4	11	RP4444
Xantia TD 12V, Break	2,1	80	06.95-01.98	P8C (XUD11BTE)	4	11	RP4444
Xantia TD, Break	1,9	66	01.98/04.03	DHX (XUD9TF/BTF)/DHY (XUD9TE/Y)	4	11	RP4444
Xantia TD, Break, Turbo D	1,9	66	10.94-01.98	DHX (XUD9TF/BTF)/DHY (XUD9TE/Y)	4	11	RP4444



Model	CC	Kw	Year	Engine	Cyl	Pict	Code
Xantia Turbo D 12V	2,1	80	01.98-02.99	PBC (XUD11BTE)	4	11	RP4444
XM D 12V, Break	2,1	60	05.89-06.94	P9A (XUD11A)	4	11	RP4444
XM TD 12V	2,1	80	11.91-04.94	P8A (XUD11ATE) / PHZ (XUD11ATE) / PJZ (XUD11ATE) / P8C (XUD11BTE)	4	11	RP4444
XM TD 12V	2,1	80	05.94-10.00	P8A (XUD11ATE) / PHZ (XUD11ATE) / PJZ (XUD11ATE) / P8C (XUD11BTE)	4	11	RP4444
XM TD 12V Break	2,1	80	05.94-08.98	PHZ (XUD11ATE) / PJZ (XUD11ATE) / P8C (XUD11BTE)	4	11	RP4444
XM TD 12V Break	2,1	80	09.98-10.00	PHZ (XUD11ATE) / PJZ (XUD11ATE) / P8C (XUD11BTE)	4	11	RP4444
XM TD 12V, Break	2,1	80	05.89-10.91	P8A (XUD11ATE)/PHZ (XUD11ATE)/PJZ (XUD11ATE)	4	11	RP4444
XM TD, Break	2,5	95	05.94-10.00	THY (DK5ATE)	4	11	RP4444
Xsara D	1,5	42	04.97-09.00	VJZ (TUD5)	4	11	RP4444
Xsara D	1,9	50	04.97-09.00	DJY (XUD9A)	4	11	RP4444
Xsara D	1,9	51	07.98-03.05	WJZ (DW8) / WJY (DW8B)	4	88	RP8352
Xsara D / Break	1,8	43	04.97-09.00	161A (XUD7)/A9A (XUD7)	4	11	RP4444
Xsara D Coupe	1,9	50	02.98-09.00	DJY (XUD9A)	4	11	RP4444
Xsara D Coupe	1,9	51	07.98-	WJY/WJZ	4	88	RP8352
Xsara D, Break	1,9	50	01.97-10.99	DJZ	4	11	RP4444
Xsara D, Break	1,9	51	07.98-	VJZ/VJY	4	88	RP8352
Xsara HDI	1,4	50	01.03-03.05	8HX(DV4TD)	4	146	RP8652
Xsara HDI 109 Coupe	2,0	80	05.01-	---	4	108	RP8410
Xsara HDI 109, Break	2,0	80	05.01-03.05		4	108	RP8410
Xsara HDI 90 Coupe	2,0	66	02.99-	RHY	4	108	RP8410
Xsara HDI 90, Break	2,0	66	02.99-03.05	RHY (DW10TD)	4	108	RP8410
Xsara HDI Break / Coupe	1,4	50	01.03-	8HX(DV4TD)	4	146	RP8652
Xsara II D / TD	1,9	55-66	10.00-	DHV / DHY	4	11	RP4444
Xsara II HDI	2,0	80	06.00-	DW 10	4	108	RP8410
Xsara Picasso HDI	1,6	66	09.05-02.06	---	4	146	RP8652
Xsara Picasso HDI	1,6	66	03.06-	---	4	117	RP8436
Xsara Picasso HDI	1,6	80	05.04-02.06	DV6TED4	4	146	RP8652
Xsara Picasso HDI	1,6	80	03.06-	DV6TED4	4	117	RP8436
Xsara Picasso HDI	2,0	80	12.99-	RHY (DW10TD)	4	108	RP8410
Xsara SD, Break	1,9	55	01.98-09.00	DHV (XUD9BSD)	4	11	RP4444
Xsara TD / Break	1,8	66	10.97-09.00	XUD 9TE	4	11	RP4444
Xsara TD Coupe	1,9	66	02.98-09.00	DHY (XUD9TE/Y)	4	11	RP4444
Xsara TD, Break	1,9	66	04.97-09.00	DHY (XUD9TE/Y)	4	11	RP4444
ZX	1,4	37	07.94-10.97	---	4	7	RP4420
ZX D	1,4	39	03.91-09.94	TUD 3	4	7	RP4420
ZX D	1,5	40-42	02.96-	TUD 5	4	88	RP8352
ZX D	1,8	44	06.93-06.97	161A (XUD7)	4	11	RP4444
ZX D	1,8	44	05.94-07.98	XUD7	4	11	RP4444
ZX D	1,9	38	05.94-07.98	XUD9A/L	4	11	RP4444
ZX D	1,9	47	05.94-06.97	DJZ (XUD9Y)	4	11	RP4444
ZX D	1,9	50	06.95-06.97	D9B (XUD9A/U)	4	11	RP4444



Model	CC	Kw	Year	Engine	Cyl	Pict	Code
ZX D, Break	1,8	44	03.93-10.97	161A	4	11	RP4444
ZX D, Break	1,9	47	03.91-04.94	DJZ (XUD9Y)	4	11	RP4444
ZX D, Break	1,9	50	06.94-05.95	D9B (XUD9A/U)	4	11	RP4444
ZX D, Break, Reflex	1,8	44	03.91-04.94	XUD7	4	11	RP4444
ZX TD	1,9	68	05.94-07.98	XUD9T/L	4	11	RP4444
ZX TD	1,9	68	09.92-04.94	XUD 9 T/L D8A	4	11	RP4444
ZX TD, Break	1,9	66	07.92-06.97	DHY (XUD9TE/Y)	4	11	RP4444
<b>CITROEN VAN</b>							
Berlingo (MF) HDI 75 (MF9HW)	1,6	55	07.05-	9HW (DV6ETED) / DV6B	4	146	RP8652
Berlingo D	1,8	43	08.96-08.98	XUD7	4	11	RP4444
Berlingo D	1,8	43	09.98-	XUD7	4	11	RP4444
Berlingo D	1,8	43	07.96	A9A (XUD7)	4	11	RP4444
Berlingo D	1,8	51	09.98-	DW8	4	88	RP8352
Berlingo D	1,9	50	07.96-08.98	D9B/DJY	4	11	RP4444
Berlingo D	1,9	50	09.98-	D9B/DJY	4	11	RP4444
Berlingo D	1,9	50	07.96-08.98	DJY (XUD9A) / D9B (XUD9A/L)	4	11	RP4444
Berlingo D	1,9	50	09.98-	DJY (XUD9A) / D9B (XUD9A/L)	4	11	RP4444
Berlingo D	1,9	51	08.96-08.98	XUD9A	4	11	RP4444
Berlingo D	1,9	51	09.98-	XUD9A	4	11	RP4444
Berlingo D	1,9	51	07.96-10.99	---	4	88	RP8352
Berlingo D	1,9	51	07.98-	WJZ (DW8) / WJY (DW8B)	4	88	RP8352
Berlingo D 4WD	1,9	51	07.98-	WJZ (DW8)	4	88	RP8352
Berlingo D, 4WD	1,9	51	07.98-	WJY/WJZ	4	88	RP8352
Berlingo Furgonato (M_) HDI 75	1,6	55	07.05-05.06	9HW (DV6ETED) / DV6B	4	146	RP8652
Berlingo Furgonato HDi 90	1,6	68	07.10-	---	4	189	RP8472
Berlingo HDI	2,0	80	06.00-	DW 10	4	108	RP8410
Berlingo HDi 110	1,6	82	07.10-	9HR (DV6C)	4	189	RP8472
Berlingo HDi 4x4	2,0	66	11.02-10.05	---	4	108	RP8410
Berlingo HDi 75	1,6	55	07.05-	DV6B	4	117	RP8436
Berlingo HDi 90	1,6	66	07.05-	---	4	146	RP8652
Berlingo HDi 90	1,6	66	07.05-	DV6ATED4	4	117	RP8436
Berlingo HDi 90	2,0	66	12.99-	RHY (DW10TD)	4	108	RP8410
Berlingo TD	1,8	51	09.98-	DW8TD	4	88	RP8352
Berlingo X	1,8	44	11.96-10.99	---	4	11	RP4444
C15 D	1,8	44	07.86-12.00	161A (XUD7)	4	11	RP4444
C15 D	1,9	44	12.00-	---	4	88	RP8352
C25 D	1,9	51	07.87-02.94	D9B (XUD9A/U)	4	11	RP4444
C25 D	2,5	54	10.85-02.94	CRD93L (U25-661)	4	11	RP4444
C25 TD	1,9	60	04.92-02.94	M705	4	11	RP4444
C25 TD	2,5	70	08.87-02.94	CRD93LS (U25-673)	4	11	RP4444
C32, C 35 D	2,2	45	09.73-07.79	CRD90	4	4	RP2096
C32, C 35 D	2,2	45	04.79-12.79	CRD90	4	11	RP4444
C35 D	2,5	50	01.80-01.91	CRD93B	4	11	RP4444
C45 D	2,5	50	06.82-01.91	CRD93B	4	11	RP4444
Dispatch D	1,9	51	01.96-08.98	XUD 9A	4	11	RP4444





Model	CC	Kw	Year	Engine	Cyl	Pict	Code
Dispatch D	1,9	51	09.98-	XUD 9A	4	11	RP4444
Dispatch HDI	2,0	80	09.98-	DW 10	4	108	RP8410
Dispatch TD	1,9	68	01.96-08.98	XUD 9TF	4	11	RP4444
Dispatch TD	1,9	68	09.98-	XUD 9TF	4	11	RP4444
Jumper D	1,9	50	07.99-04.02	---	4	11	RP4444
Jumper D	1,9	51	03.94-08.98	XUD 9AU	4	11	RP4444
Jumper D	1,9	51	02.94-04.02	D9B (XUD9A/U)	4	11	RP4444
Jumper D	1,9	66	08.94-04.02	D8C/DHX	4	11	RP4444
Jumper D	2,0	80	09.98-	DW10TED	4	108	RP8410
Jumper D	2,5	63	03.94-04.02	T9A (DJ5)	4	11	RP4444
Jumper HDI	2,0	62	04.02-	DW10UTD	4	108	RP8410
Jumper HDI	2,0	62	11.01-04.02	---	4	108	RP8410
Jumper Hdi	2,0	66	09.98-	DW10TD	4	108	RP8410
Jumper HDI	2,2	74	04.02-	DW12TED	4	108	RP8410
Jumper Hdi	2,2	100	09.98-	DW12TED4	4	108	RP8410
Jumper HDI	2,8	94	09.00-	8140.43S	4	107	RP8408
Jumper HDI	2,8	94	04.02-	F.28TDCR	4	107	RP8408
Jumper Hdi	2,8	107	05.04-	8140.43N	4	107	RP8408
Jumper HDi 100	2,2	74	04.06-	---	4	130	RP8618
Jumper HDi 120	2,2	88	04.06-	---	4	130	RP8618
Jumper TD	1,9	66	08.94-08.98	D8C (XUD9UTF)	4	11	RP4444
Jumper TD	1,9	66	09.98-04.02	D8C (XUD9UTF)	4	11	RP4444
Jumper TD	1,9	66	03.94-08.98	DHX (XUD9TF/BTF)	4	11	RP4444
Jumper TD	1,9	66	09.98-04.02	DHX (XUD9TF/BTF)	4	11	RP4444
Jumper TD	1,9	68	02.94-08.98	D8C (XUD9UTF)	4	11	RP4444
Jumper TD	1,9	68	09.98-04.02	D8C (XUD9UTF)	4	11	RP4444
Jumper TD	2,5	76	03.94-04.02	T8A (DJ5T)	4	11	RP4444
Jumper TDi	2,5	79	12.96-11.00	THX (DJ5TED)	4	102	RP8398
Jumpy (U6U) HDi 110	2,0	80	03.00-	RHZ (DW10ATED4)	4	108	RP8410
Jumpy D	1,8	51	09.98-	DW8	4	88	RP8352
Jumpy D	1,9	51	09.98-	XUD 9A	4	11	RP4444
Jumpy D	1,9	51	10.95-04.98	D9B	4	11	RP4444
Jumpy D	1,9	51	04.98-	WJZ	4	88	RP8352
Jumpy D	1,9	51	10.95-04.98	D9B (XUD9A/U)	4	11	RP4444
Jumpy D	1,9	50-52	11.95-	XUD	4	11	RP4444
Jumpy D 70	1,9	51	04.98-	WJZ (DW8)	4	88	RP8352
Jumpy Furgonato (BS_, BT_, BY_, BZ_) HDi 110	2,0	80	12.03-10.06	RHW (DW10ATED4)	4	108	RP8410
Jumpy Hdi	1,6	66	02.07-	DV6	4	117	RP8436
Jumpy HDI	2,0	69	10.99-	---	4	108	RP8410
Jumpy HDi	2,0	80	09.98-	RHZ (DW10ATED)	4	108	RP8410
Jumpy Hdi	2,0	90	02.07-	---	4	117	RP8436
Jumpy Hdi	2,0	102	02.07-	---	4	117	RP8436
Jumpy HDi 120	2,0	88	01.07-	---	4	108	RP8410
Jumpy HDi 125 / Furgonato	2,0	94	07.11-	---	4	189	RP8472



Model	CC	Kw	Year	Engine	Cyl	Pict	Code
Jumpy HDi 140	2,0	100	01.07-	---	4	108	RP8410
Jumpy HDi 165 / Furgonato	2,0	120	07.10-	RHH (DW10CTED4)	4	189	RP8472
Jumpy HDi 95	2,0	69	10.99-	RHX	4	108	RP8410
Jumpy HDi 95 / Furgonato	2,0	72	07.11-	---	4	189	RP8472
Jumpy HDi TD 90	1,6	66	01.07-	---	4	117	RP8436
Jumpy Pianale piatto/Telaio (BU_, BV_, BW_, BX_) HDi 110	2,0	80	12.03-10.06	RHW (DW10ATED4)	4	108	RP8410
Jumpy Pianale piatto/Telaio/Furgonato/Autobus (230L) D	2,8	64	01.99-02.02	8140.63 (F28D)	4	107	RP8408
Jumpy TD	1,8	51	09.98-	DW 8 TD	4	88	RP8352
Jumpy TD	1,9	66	04.96-09.98	DHX	4	11	RP4444
Jumpy TD	1,9	66	09.98-	DHX	4	11	RP4444
Jumpy TD	1,9	66	10.95-	DHX (XUD9TF/BTF)	4	11	RP4444
Jumpy TD	1,9	68	09.98-	XUD 9TF	4	11	RP4444
Jumpy TD	1,9	68	04.96-	D8B (XUD9TF)	4	11	RP4444
Jumpy TD	1,9	68	04.96-08.98	D8B	4	11	RP4444
Jumpy TD	1,9	68	09.-98-	D8B	4	11	RP4444
Relay	2,0	---	09.98-	DW10TED/DU	4	108	RP8410
Relay 1000 D	1,9	51	11.95-	XUD 9	4	11	RP4444
Relay 1400 D	2,5	63	03.94-	DJ5	4	11	RP4444
Relay 1400 TD	2,5	76	03.94-12.96	DJ5T	4	11	RP4444
Relay 1400 TD	2,5	76	01.97-	DJ5TDE	4	102	RP8398
Relay 1800 D	1,9	51	11.95-	XUD 9	4	11	RP4444
Relay 1800 D	2,5	63	03.94-	DJ5	4	11	RP4444
Relay 1800 TD	2,5	76	03.94-12.96	DJ5T	4	11	RP4444
Relay 1800 TDI	2,5	76	01.97-	DJ5TED	4	102	RP8398
<b>DACIA</b>							
Duster D	1,6	40	11.89-	---	4	11	RP4444
Duster dCi	1,5	63	04.10-	K9K 796	4	133	RP8624
Duster dCi 4x4	1,5	66	10,10-	K9K 894	4	133	RP8624
Logan dci	1,5	50	01.06-	K9K 792	4	133	RP8624
Logan dci	1,5	48	09.05-	K9K 790	4	133	RP8624
Logan MCV dCi	1,5	50	02.07-	K9K 792	4	133	RP8624
Logan MCV dCi	1,5	63	09.07-	K9K 796	4	133	RP8624
Sandero dCi	1,5	50	06.08-	K9K 792	4	133	RP8624
Sandero dCi	1,5	63	06.08-	K9K 796	4	133	RP8624
<b>DAEWOO</b>							
Charade	1,0	28	10.83-02.87	CL	---	30	RP6840
Daewoo D	1,9	40	02.99-	F8Q290	4	131	RP8620
Daewoo D	1,9	40	06.99-	F8Q292	4	131	RP8620
Korando D, Cabrio	2,9	72	01.99-	MB-OM 662	4	13	RP4452
Korando TD	2,3	74	04.00-	---	4	13	RP4452
Korando TD, Cabrio	2,9	88	01.99-	MB-OM 601 29TD	4	13	RP4452
Lublin 3352	---	---	11.95-	---	---	11	RP4444
Musso D	2,9	73	01.99-09.99	MB-OM662	5	13	RP4452



Model	CC	Kw	Year	Engine	Cyl	Pict	Code
Musso SLTD	2,3	74	04.00-	---	4	13	RP4452
Musso TD	2,2	74	09.99-	MB-OM 601	4	13	RP4452
Musso TD	2,9	88	01.99-	MB-OM601 29TTD	5	13	RP4452
Rexton 290 TX Td	2,9	87	05.02-	Mercedes	5	83	RP8342
Rexton TD	2,9	88	04.02-	---	5	13	RP4452
<b>DAF</b>							
400 D	2,5	53	04.89-08.93	---	4	11	RP4444
400 TD	2,5	71	04.89-08.93	---	4	11	RP4444
<b>DAIHATSU</b>							
Charade II TD	1,0	34	02.85-03.87	CL60	3	30	RP6840
Charade III D	1,0	27	03.87-12.92	CL11	3	30	RP8208
Charade III TD	1,0	35	03.87-12.92	CL/CL61	3	30	RP8208
Delta Truck	2,5	45	08.77-09.80	DG	4	30	RP6592
Delta Truck	2,5	54	10.82-07.88	DL40	4	30	RP6592
Delta Truck	3,0	60	02.83-07.88	B	4	30	RP8188
Delta Truck	3,4	70	02.83-07.88	3 B	4	30	RP8188
Delta Truck - 24v -	3,4	70	02.83-07.88	3 B	4	30	RP6914
Fourtrack D	2,8	54	01.85-12.93	DL 40	4	30	RP6592
Fourtrack D / TD	2,8	54-74	01.85-12.93	DL 50	4	30	RP6840
Hijet S77/N	---	---	---	CL20	4	30	RP6840
Rocky 4WD	2,8	---	85-	DL40	4	30	RP6592
Rocky Hard Top D	2,8	54	02.85-	DL	4	30	RP6840
Rocky Hard Top TD	2,8	67	12.87-04.93	DL51	4	30	RP6840
Rocky Hard Top TD	2,8	72	05.93-	DL52	4	30	RP6840
Rocky Hard Top TD	2,8	75	09.91-04.93	DL52	4	30	RP6840
Rocky Soft Top D 4WD	2,8	54	04.84-04.93	DL 50	4	30	RP6840
Rocky Soft Top TD 4WD	2,8	75	05.93-	DL	4	30	RP6840
Rocky Soft Top TD 4WD	2,8	67-75	04.84-04.93	DL	4	30	RP6840
Taft D	2,5	46	08.78-03.84	DG	4	30	RP6592
Taft D 4WD	2,8	54	10.82-05.84	DL-40	4	30	RP6592
Wildcat, Rocky D	2,8	54	02.85-03.87	DL	4	30	RP6840
Wildcat, Rocky TD	2,8	65	09.85-04.87	DL50	4	30	RP6840
<b>FIAT</b>							
127 D	1,3	33	04.83-02.87	127 A., 127 A5.	4	11	RP4482
131 D Mirafiori	2,0	44	03.78-01.84	8144.65	4	11	RP4444
131 D Mirafiori	2,5	53	08.78-12.84	8144.61	4	11	RP4444
132 D	2,0	44	03.78-05.81	8144.65	4	11	RP4444
132 D	2,5	53	03.78-05.81	8144.61	4	11	RP4444
176 TD	1,7	---	06.93-	---	4	11	RP4444
500 MJTD	1,3	55	07.07-	169 A1.000	4	155	RP8678
500 MJTD Cabrio	1,3	55	09.09-	169 A1.000	4	155	RP8678
Argenta D	2,5	53	06.81-11.85	B 144.61	4	11	RP4444
Argenta TD	2,4	66	06.83-11.85	B 144.81	4	11	RP4444
Brava D Multijet	1,9	88	04.07-	---	4	132	RP8622
Brava D Multijet	1,9	88	04.07-	Cooling-water preheater	4	160	RP8898



Model	CC	Kw	Year	Engine	Cyl	Pict	Code
Brava D Multijet	1,9	110	04.07-	---	4	166	RP8914
Brava JTD	1,9	74	09.00-10.01	182 B9.000	4	132	RP8622
Brava/Bravo D	2,0	74	09.95-07.96	---	4	11	RP4444
Brava/Bravo JTD 105	1,9	77	12.98-10.99	182 B4.000	4	94	RP8372
Brava/Bravo JTD 105	1,9	77	11.99-10.01	182 B4.000	4	132	RP8622
Brava/Bravo JTD 105	1,9	77	11.99-10.01	Cooling-water preheater	4	160	RP8898
Brava/Bravo TD 100 S	1,9	74	03.96-10.01	182 A7.000	4	84	RP8344
Brava/Bravo TD 75 S	1,9	55	03.96-10.01	182 A8.000	4	84	RP8344
Bravo D Multijet	1,9	88	04.07-	939A1000	4	132	RP8622
Bravo D Multijet	1,9	88	04.07-	Cooling-water preheater	4	160	RP8898
Bravo D Multijet	1,9	110	04.07-	---	4	166	RP8914
Bravo JTD	1,9	74	09.00-10.01	182 B9.000	4	132	RP8622
Bravo JTD	1,9	74	09.00-10.01	Cooling-water preheater	4	160	RP8898
Bravo/Brava D	1,9	48	10.95-10.96	160A7.000	4	11	RP4482
Bravo/Brava JTD	1,9	77	12.98-09.01	AR32302	4	132	RP8622
Bravo/Brava TD	1,9	74	09.96-09.01	160A7.000	4	84	RP8344
Campagnola D	2,5	53	06.79-10.86	8142.61	4	11	RP4444
Croma	2,5	90	01.93-12.93	---	4	11	RP4444
Croma	2,5	90	01.94-.98	---	4	11	RP4444
Croma (194) D Multijet	1,9	100	12.05-	939 A8.000	4	166	RP8914
Croma D	2,5	55	12.85-12.89	8144.67	4	11	RP4482
Croma D Multijet	1,9	88	06.05-	939A1.000	4	132	RP8622
Croma D Multijet	1,9	110	06.05-	939A2.000	4	166	RP8914
Croma D Multijet	2,4	147	06.05-	939A3.000	5	166	RP8914
Croma TD	2,5	74	12.85-08.89	8144.91.2000	4	11	RP4444
Croma TD	2,5	85	05.89-12.92	8144.97/8144.97Y	4	11	RP4444
Croma TD	2,5	85	05.89-12.93	8144.97/8144.97Y	4	11	RP4444
Croma TD	2,5	85	05.89-08.96	8144.97/8144.97Y	4	81	RP8326
Croma TD i.d.	1,9	66	05.89-10.92	154 C6.000	4	12	RP4446
Croma TD i.d.	1,9	69	11.92-12.96	154D1.000	4	12	RP4446
Croma TDE	2,5	77	12.91-08.96	8144.97S	4	11	RP4444
Doblo (119) JTD MPV	1,9	77	07.03-	---	4	132	RP8622
Doblo (119) D (223AXB1A) MPV	1,9	46	03.01-	223 A 6.000	4	135	RP8628
Doblo (119) D Multijet	1,9	88	10.05-	186 A9.000	4	132	RP8622/30
Doblo (119) JTD (223AXE1A) MPV	1,9	74	10.01-	182 B9.000	4	132	RP8622
Doblo (119) Multijet MPV	1,3	62	10.05-	---	4	155	RP8678
Doblo (152) D 16V Multijet	1,6	66	02.10-	---	4	182	RP8444
Doblo (152) D Multijet	1,3	66	02.10-	---	4	155	RP8678
Doblo (152) D Multijet	1,6	77	02.10-	---	4	182	RP8444
Doblo (152) D Multijet	2,0	99	02.10-	---	4	182	RP8444
Doblo Cargo (223) D (223ZXB1A)	1,9	46	03.01-	---	4	135	RP8628
Doblo Cargo (223) D Multijet	1,3	55	10.05-	---	4	135	RP8628
Doblo Cargo (223) JTD	1,9	77	07.03-	---	4	132	RP8622
Doblo Cargo (223) JTD (223ZXE1A)	1,9	74	10.01-	---	4	132	RP8622



Model	CC	Kw	Year	Engine	Cyl	Pict	Code
Doblo Cargo (223) JTD 16V	1,3	51	05.04-	188 A9.000	4	155	RP8678
Doblo Cargo (223) JTD 16V Multijet	1,3	62	08.06-	223 A9.000	4	155	RP8678
Doblo Cargo (223) JTD Multijet	1,9	88.	12.06-	186 A9.000	4	132	RP8622/30
Doblo Cargo (263) D Multijet	1,3	66	02.10-	199 A3.000	4	155	RP8678
Doblo Cargo (263) D Multijet	1,6	66	02.10-	---	4	182	RP8444
Doblo Cargo (263) D Multijet	1,6	74	02.10-	---	4	182	RP8444
Doblo Cargo (263) D Multijet	1,6	77	02.10-	---	4	182	RP8444
Doblo Cargo (263) D Multijet	2,0	99	02.10-	---	4	182	RP8444
Doblo Cargo Pianale piatto (263) D Multijet	1,3	66	02.10-	199 A3.000 / 263 A2.000	4	155	RP8678
Doblo Cargo Pianale piatto (263) D Multijet	1,6	77	02.10-	---	4	182	RP8444
Doblo Cargo Pianale piatto (263) D Multijet	2,0	99	02.10-	---	4	182	RP8444
Doblo Cargo pianale piatto/telaio (263) D Multijet	1,6	74	02.11-	263 A3.000	4	182	RP8444
Doblo JTD 16V	1,3	51	06.03-	188 A9.000	4	155	RP8678
Duna DS, Weekend	1,7	44	01.87-12.91	149B3.000	4	11	RP4482
Elba D	1,3	33	04.86-10.92	---	4	11	RP4444
Elba D	1,7	43	04.89-12.96	---	4	11	RP4444
Fiorino (146 Uno) 65 TD	1,7	46	01.97-05.01	146 D7.000	4	11	RP4444
Fiorino (146 Uno) 60 D	1,7	44	05.88-	149 B3.000	4	11	RP4482
Fiorino (146 Uno) 60 D	1,7	57	05.88-	146 B2.000	4	11	RP4482
Fiorino D	1,3	33	03.82-10.82	127A5	4	11	RP4444
Fiorino D	1,3	33	11.82-12.87	127A5	4	11	RP4482
Fiorino D	1,3	33	06.90-08.93	146 B1.000	4	11	RP4482
Fiorino D	1,7	42	01.88-	149 B4.046/146 B2.000)	4	11	RP4482
Fiorino D	1,7	44	12.87-12.90	149 B3.000	4	11	RP4482
Fiorino D Multijet	1,3	55	02.08-	---	4	155	RP8678
Fiorino Kasten 60 D	1,7	42	05.88-10.96	146 B2.000	4	11	RP4482
Fiorino Kasten 65 TD	1,7	46	01.97-05.01	146 D7.000	4	11	RP4444
Fiorino pick up D	1,3	33	05.84-12.88	127 A5.000	4	11	RP4482
Fiorino Pick up D	1,7	42	10.93-10.99	---	4	11	RP4482
Fiorino Pick up D	1,7	44	0.5.88-12.93	149 B3.000	4	11	RP4482
Fiorino Pick up TD	1,7	46	01.97-12.98	146 D7.000	4	11	RP4444
Fiorino TD	1,7	47	02.97-	146 D7.000	4	11	RP4444
Freemont	2,0	103	06.11-	940A5000	4	182	RP8444
Freemont / 4x4	2,0	125	06.11-	940A45000	4	182	RP8444
Grande Punto / Punto (199) D Multijet	1,3	62	04.10-	263 A2.000 / 199 B4.000	4	155	RP8678
Grande Punto / Punto D Multijet	1,3	55	10.05-	199 A2.000	4	155	RP8678
Grande Punto / Punto D Multijet	1,3	66	10.05-	199 A3.000	4	155	RP8678
Grande Punto / Punto D Multijet	1,9	85	06.06-	939 A7.000	4	132	RP8622/30
Grande Punto / Punto D Multijet	1,9	88	10.05-	939 A1.000	4	132	RP8622
Grande Punto / Punto D Multijet	1,9	96	10.05-	199 A5.000	4	132	RP8622



Model	CC	Kw	Year	Engine	Cyl	Pict	Code
Idea JTD	1,3	51	01.04-	188 A9.000	4	155	RP8678
Idea JTD	1,9	74	01.04	188 B2.000	4	160	RP8898
Idea JTD	1,9	74	01.04-	188 B2.000	4	132	RP8622
Idea JTD	1,9	74	01.04-	Cooling-water preheater	4	132	RP8622
Idea JTD 16V	1,3	51	06.03	---	4	155	RP8678
Marea JTD	1,9	77	04.99-	182B4.000	4	132	RP8622
Marea JTD	1,9	77	04.99-01.01	---	5	160	RP8898
Marea JTD	2,4	96	04.99-	AR34202	5	132	RP8622
Marea JTD 105, Weekend	1,9	77	04.99-	Cooling-water preheater	4	160	RP8898
Marea JTD 105, Weekend	1,9	77	04.99-	182 B4.000	4	94	RP8372
Marea JTD 105, Weekend	1,9	77	11.99-.01-01	171 6819	4	132	RP8622
Marea JTD 110, Weekend	1,9	81	01.01-	Cooling-water preheater	4	160	RP8898
Marea JTD 110, Weekend	1,9	81	01.01-	186 A6.000	4	132	RP8622
Marea JTD 130	2,4	86	04.99-	839 A5.000/185 A6.000 (Mot.Nr.1713819)	5	132	RP8622
Marea JTD 130	2,4	86	04.99-	Cooling-water preheater	5	160	RP8898
Marea JTD 130, Weekend	2,4	96	04.99-10.99	839 A5.000	5	94	RP8372
Marea TD	1,9	55-74	09.96-04.96	182 A 7.000 / 8.000	4	84	RP8344
Marea TD 100, Weekend	1,9	74	09.96-	182 A7.000	4	84	RP8344
Marea TD 125	2,4	91	09.96-04.99	185 A2.000	5	84	RP8344
Marea TD 75, Weekend	1,9	55	09.96-	182 A8.000	4	84	RP8344
Marengo D	1,9	48	01.92-12.96	160 A 7.000	4	11	RP4482
Marengo D	2,0	48	01.86-07.89	149A1	4	11	RP4482
Marengo D	2,5	53	05.80-07.89	8144.61	4	11	RP4444
Marengo TD	1,9	55	02.97-	---	4	84	RP8344
Marengo TD	1,9	66	01.92-12.96	160 A 6.000	4	11	RP4482
Multipla JTD	1,9	77	01.99-	105 ELX, SX	4	132	RP8622
Multipla JTD	1,9	88	04.02-	186A9.000	4	132	RP8622
Multipla JTD	1,9	88	04.02-	Cooling-water preheater	4	160	RP8898
Multipla JTD 105	1,9	77	04.99-	Cooling-water preheater	4	160	RP8898
Multipla JTD 105	1,9	77	04.99-	182 B4.000	4	94	RP8372
Multipla JTD 105	1,9	77	04.99-	182 B4.000	4	132	RP8622
Multipla JTD 110	1,9	81	03.01-07.02	Cooling-water preheater	4	160	RP8898
Multipla JTD 110	1,9	81	03.01-07.02	186 A6.000	4	132	RP8622
Multipla JTD 115	1,9	85	07.02-	186 A8.000	4	132	RP8622
Multipla JTD 115	1,9	85	07.02-	Cooling-water preheater	4	160	RP8898
Palio D Weekend	1,9	46	03.01-	223 A 6.000	4	135	RP8628
Palio JTD	1,9	74	01.01-	188 A2.000	4	132	RP8622
Palio SDI	1,3	---	09.03-	Cooling-water preheater	4	155	RP8678
Palio TD / D, Weekend	1,7	51	04.96-03.01	176 A 3.000	4	11	RP4444
Panda (169) D Multijet 4x4	1,3	55	09.10-	169 A1.000	4	155	RP8678
Panda D	1,3	27	03.86-12.89	156 A 5.000	4	11	RP4482
Panda D	1,3	27	07.90-08.92	156 A5.000	4	11	RP4482
Panda JTD	1,3	51	09.03-	188 A9.000	4	155	RP8678
Panda JTD 4X4	1,3	51	10.04-	---	4	155	RP8678



Model	CC	Kw	Year	Engine	Cyl	Pict	Code
Punto (199) Multijet	1,3	55	03.12-	199 A2.000 / 199 A9.000	4	155	RP8678
Punto 60 TD	1,7	46	09.96-09.99	176 B7.000	4	11	RP4444
Punto D	1,7	42	04.94-09.97	176 A 3.000	4	11	RP4444
Punto Evo D Multijet	1,3	55	10.09-	199 A2.000 / 199 A9.000	4	155	RP8678
Punto Evo D Multijet	1,3	66	10.09-	199 A3.000	4	155	RP8678
Punto Evo Van D Multijet	1,3	55	03.09-	199 A2.000 / 199 A9.000	4	155	RP8678
Punto II DS 60	1,9	44	09.99-	188 A 3.000	4	135	RP8628
Punto II JTD	1,9	59	09.99-	188 A 2.000	4	132	RP8622
Punto II JTD	1,9	63	07.01-	188 A7.000	4	132	RP8622
Punto II SDI	1,3	51	09.03-	188 A9.000	4	155	RP8678
Punto JTD	1,9	63	10.01-	Cooling-water preheater	4	160	RP8898
Punto JTD	1,9	63	10.01-	188 A7.000	4	132	RP8622
Punto JTD	1,9	74	06.03-	188 B2.000	4	132	RP8622
Punto JTD	1,9	74	06.03-	Cooling-water preheater	4	160	RP8898
Punto JTD 16V	1,3	51	06.03-	188 A9.000	4	155	RP8678
Punto JTD 80	1,9	59	09.99-	188 A2.000	4	132	RP8622
Punto JTD 80	1,9	59	09.99-	Cooling-water preheater	4	160	RP8898
Punto TD	1,7	51	01.94-09.99	176 A3.000	4	11	RP4444
Punto TD	1,7	52	01.94-09.99	176 A5.000	4	11	RP4444
Punto Van D 60	1,9	44	02.00	188 A3.000	4	135	RP8628
Punto Van JTD	1,3	51	06.03-10.05	188 A9.000	4	155	RP8678
Punto Van JTD	1,9	63	02.00	188 A7.000	4	132	RP8622
Punto Van JTD	1,9	63	02.00-	Cooling-water preheater	4	160	RP8898
Qubo Multijet	1,3	55	09.08-	199 A2.000	4	155	RP8678
Regata D 60, Weekend	1,7	44	01.84-03.89	149 B3.000	4	11	RP4482
Regata D 65, Weekend	1,9	48	04.84-07.89	149 A1.000	4	11	RP4482
Regata TD 80, Weekend	1,9	59	05.86-07.89	831 D1.000	4	11	RP4482
Ritmo II D 60	1,7	44	05.85-12.87	138 C.000/149 B3.000	4	11	RP4444
Ritmo II TD 80	1,9	59	12.85-12.87	831 D1.000	4	11	RP4482
Scudo (270_) D Multijet	2,0	120	07.10-	RHH	4	172	RP8930
Scudo Combinato (220P) JTD 16V	2,0	80	05.99-12.06	RHW (DW10ATED4)	4	108	RP8410
Scudo Combinato D	1,8	51	04.98-	WJZ (DW8)	4	88	RP8352
Scudo Combinato D	1,9	51	02.96-04.98	D9B	4	11	RP4444
Scudo Combinato TD	1,9	68	09.98-	D8B	4	11	RP4444
Scudo Combinato TD	1,9	68	02.96-08.98	D8B	4	11	RP4444
Scudo combinato TD Eco	1,9	66	02.96-08.98	DHX (XUD9 TF/L)	4	11	RP4444
Scudo Combinato TD Eco	1,9	66	09.98-	DHX (CUD9 TF/L)	4	11	RP4444
Scudo Combinato/Kasten JTD	2,0	69-80	12.99-	RHZ/RHX	4	108	RP8410
Scudo D Multijet	2,0	88-100	01.07-	RHK / RHR	4	172	RP8930
Scudo Furgonato (220L) JTD 16V	2,0	80	05.99-12.06	RHW (DW10ATED4)	4	108	RP8410
Scudo Furgonato (270_) D Multijet	2,0	120	07.10-	RHH	4	172	RP8930
Scudo Kasten JTD	2,0	80	12.02-	---	4	108	RP8410
Sedici D Multijet	1,9	88	06.06-	---	4	132	RP8622
Siena SDI	1,3	---	09.03-	---	4	155	RP8678



Model	CC	Kw	Year	Engine	Cyl	Pict	Code
Stilo D Multijet	1,9	110	09.05-	937 A5.000	4	166	RP8914
Stilo D Multijet	1,9	74-88	09.05-	192 A9.000	4	132	RP8622
Stilo JTD	1,9	59	02.02-	192 A3.000	4	132	RP8622
Stilo JTD	1,9	85	10.01-	192 A1.000/937 A7.000	4	132	RP8622
Stilo JTD	2,4	100	10.01-	839 A6.000	4	132	RP8622
Stilo JTD / Stilo Multi Wagon JTD	1,9	103	01.04-	192 A5.000	4	166	RP8914
Stilo Multi Wagon D Multijet	1,9	110	09.05-	---	4	166	RP8914
Strada D	1,7	43	10.79-09.82	138 A, 138 AE, 149 B3	4	11	RP4444
Strada D	1,7	43	10.82-12.87	831 D 1	4	11	RP4482
Strada D	1,9	46	12.00-	223A6.000	4	135	RP8628
Strada JTD	1,9	59	04.03	188 A2.000	4	132	RP8622
Strada TD	1,7	51	06.99-	176 A 3.000	4	11	RP4444
Tempra D, SW	1,9	48	07.91-08.96	160 A 7.000	4	11	RP4444
Tempra TD	1,9	59	03.92-08.96	160 B 6.046	4	11	RP4444
Tempra TD	1,9	66	05.90-08.96	160 A6.000/160 D1.000	4	11	RP4444
Tempra TD	1,9	68	06.93-09.96	160 D 1.000	4	11	RP4444
Tempra TD SW	1,9	66	12.90-09.96	160 A 6.000	4	11	RP4444
Tipo D	1,7	43	01.88-10.94	149 B 4.000	4	11	RP4482
Tipo D	1,7	45	01.88-10.95	---	4	11	RP4482
Tipo D	1,9	48	07.91-08.96	149 A1.000/160 A7.000	4	11	RP4482
Tipo TD	1,9	59	03.92-06.93	160 B6.046	4	11	RP4482
Tipo TD	1,9	66	07.87-03.93	160 D 1.000	4	11	RP4482
Tipo TD	1,9	66	09.90-04.95	160 A6.000/160 A6.046/160 D1.000	4	11	RP4482
Tipo TD	1,9	66	04.93-04.95	160 A6.000/160 D1.000	4	11	RP4444
Tipo TD	1,9	68	07.87-03.93	149 A 1.000	4	11	RP4482
Tipo TD	1,9	68	06.93-10.95	160 A 7.000	4	11	RP4444
Ulysse (179AX) D Multijet	2,2	125	03.08-	4HS / 4HT (DW12BTED4)	4	118	RP8438
Ulysse (220) JTD 16V	2,0	80	05.99-08.02	RHW (DW10ATED4)	4	108	RP8410
Ulysse JTD	2,0	79	05.03-	RHM (DW10ATED4)	4	108	RP8410
Ulysse JTD	2,0	80	10.99-08.02	RHZ	4	108	RP8410
Ulysse JTD	2,0	80	08.02-	RHW (DHW10ATED4)	4	108	RP8410
Ulysse JTD	2,2	94	08.02-	4HW (DW12ATED4)	4	108	RP8410
Ulysse TD	1,9	66	02.95-08.02	DHX (XUD9 TF/L)	4	11	RP4444
Ulysse TD	2,1	80	03.96-10.99	P8C/XUD 11 ATE	4	11	RP4444
Uno D	1,9	44	09.89-03.94	149 B5.046	4	11	RP4482
Uno D / TD	1,3	33	10.96-	---	4	11	RP4482
Uno D / TD	1,4	33	10.96-	---	4	11	RP4482
Uno D / TD	1,7	52	10.96-	---	4	11	RP4482
Uno D 60	1,7	42	09.89-12.93	146 B2.000	4	11	RP4482
Uno TD 60	1,7	44	07.86-08.89	149 B3.000	4	11	RP4482
Uno TD 70	1,4	52	10.86-10.90	146 B.000/146 B3.000	4	11	RP4482
<b>FIAT VAN</b>							
242/15D, 18D	2,5	50	09.79-	---	4	11	RP4444
Ducato (244,Z) JTD	2,0	62	04.02-	RHV(DW 10)	4	108	RP8410
Ducato (244,Z) JTD	2,3	81	04.02-	F1AE0481C	4	153	RP8672





Model	CC	Kw	Year	Engine	Cyl	Pict	Code
Ducato (244,Z) JTD	2,8	94	04.02-	8140.43 S	4	107	RP8408
Ducato (244,Z) JTD	3,0	---	04.02-	F1C	4	153	RP8672
Ducato 10 D	1,9	51	03.94-04.02	230 A2.000	4	11	RP4444
Ducato 10 D	2,0	52	02.87-02.94	149B1.000	4	11	RP4482
Ducato 10 D	2,5	53	01.86-02.94	8144.67	4	11	RP4444
Ducato 10 D	2,5	53	04.78-06.82	8140.61	4	11	RP4444
Ducato 10 D	2,5	53	07.82-12.85	---	4	11	RP4444
Ducato 10 TD	1,9	59	03.94-	230 A4.000	4	11	RP4444
Ducato 10 TD	2,0	60	03.94-03.98	230 A3.000	4	11	RP4488
Ducato 10 TD	2,0	60	01.90-02.94	280A1.000	4	11	RP4444
Ducato 100 Multijet (250) D (Autobus)	2,2	74	07.06-	4HV	4	130	RP8618
Ducato 100 Multijet (250) D (Furgonato)	2,2	74	07.06-	4HV	4	130	RP8618
Ducato 100 Multijet (250) D (Pianale piatto)	2,2	74	07.06-	4HV	4	130	RP8618
Ducato 13 D	2,5	53	04.78-06.82	8140.62	4	11	RP4444
Ducato 13 D	2,5	53	07.82-12.85	Sofim	4	11	RP4444
Ducato 14 D / 4x4	2,5	55	01.89-02.94	8144.67.220	4	11	RP4444
Ducato 14 DI	2,5	85	03.94-	8140.47.2200	4	7	RP4486
Ducato 14 TD	2,5	62	03.94-	8140.67.2200	4	11	RP4444
Ducato 14 TD	2,5	81	03.94-	8140.47.2280	4	7	RP4486
Ducato 14 TD / 4X4	2,5	68	01.89-02.94	8144.21.220	4	11	RP4444
Ducato 14 TD, D	2,4	68	01.86-02.94	814421220	4	11	RP4444
Ducato 14TD	1,9	60	01.90-02.94	280A1000	4	11	RP4444
Ducato 18 D	2,8	64	06.98-	8140.63	4	107	RP8408
Ducato 18 JTD	2,8	94	11.00-	8140.63	4	107	RP8408
Ducato 18 Maxi Di	2,5	55	01.86-02.94	---	4	7	RP4486
Ducato 18 Maxi TD	2,5	68	01.86-02.94	8144.21.220	4	11	RP4444
Ducato Autobus (250) 110 Multijet D	2,3	83	10.11-	F1AE3481G	4	153	RP8672
Ducato D	1,9	50	04.98-04.02	D9B/DJY	4	11	RP4444
Ducato D	1,9	52	02.87-03.94	149 B1.000	4	11	RP4482
Ducato D	2,5	62	08.94-04.02	8140.67	4	7	RP4486
Ducato Furgonato (250) 110 Multijet D	2,3	83	10.11-	F1AE3481G	4	153	RP8672
Ducato Furgonato (250) 120 Multijet D	2,3	88	03.10-	F1AE0481D	---	153	RP8672
Ducato JTD	2,0	62	10.01-04.02	RHV	4	108	RP8410
Ducato Pianale piatto/Telaio (250) 110 Multijet D	2,3	83	10.11-	F1AE3481G	4	153	RP8672
Ducato Pianale piatto/Telaio (250) 120 Multijet D	2,3	88	03.10-	F1AE0481D	---	153	RP8672
Ducato TD	1,9	60	03.89-03.94	280A1.000	4	11	RP4444
Ducato TD	1,9	60	04.98-04.02	230 A3.000	4	11	RP4444
Ducato TD	1,9	66	04.98-04.02	DHX	4	11	RP4444
Ducato TD	2,5	70	07.90-03.94	8140.27	4	11	RP4444



Model	CC	Kw	Year	Engine	Cyl	Pict	Code
Talento D	1,9	52	03.89-03.94	149 B 1.000	4	11	RP4482
<b>FISSORE</b>							
Magnum TD 4x4	2,4	77	07.84-04.86	---	6	11	RP4444
Rayton TD 4x4	2,4	82	03.88-	HR 492 HIM	6	6	RP4410
<b>FORD</b>							
A-Series	2,4	---	---	4AA YORK-D	---	11	RP4444
A-Series	3,6	---	---	8AA YORK-D	---	11	RP4444
C-MAX II TDCi	1,6	70	12.10-	T3DA / T3DB	4	189	RP8472
C-MAX II TDCi	1,6	85	12.10-	T1DA / T1DB	4	189	RP8472
C-MAX II TDCi	2,0	85	02.11-	TYDA	4	189	RP8472
C-MAX II TDCi	2,0	103	02.11-	UFDA / UFDB	4	189	RP8472
C-MAX II TDCi	2,0	120	12.10-	TXDB	4	189	RP8472
C-MAX TDCi	1,6	66	02.07-	GPDA / HHDA / HHDB	4	117	RP8436
C-MAX TDCi	1,6	80	02.07-	G8DA / G8DB / G8DD	4	117	RP8436
C-MAX TDCi	2,0	98	02.07-	G6DC / G6DE / G6DF	4	172	RP8930
Courier D	1,8	66	09.91-02.96	RTC,RTD,RTG	4	7	RP4486
Courier D	1,8	66	02.96-	RTJ,RTK	4	98	RP8388
Escort '81 Express D (AVA)	1,6	40	02.84-02.86	LTA	4	7	RP4432
Escort '86 Express D (AVF)	1,6	40	02.86-07.90	LTA	4	7	RP4432
Escort D	1,6	40	01.86-07.90	LTC	4	7	RP4432
Escort D	1,8	44	01.86-07.90	RTA,RTB	4	7	RP4486
Escort D	1,8	44	08.90-07.98	RTE,RTF,RTH	4	7	RP4486
Escort D	1,8	51	08.90-07.98	RVA	4	98	RP8388
Escort D Express	1,8	44	08.90-07.98	RTE,RTF,RTH	4	7	RP4486
Escort D Express Van 35	1,6	40	04.84-07.90	LTA	4	7	RP4432
Escort D Express Van 55	1,6	40	04.84-07.90	LTC	4	7	RP4432
Escort D Turnier	1,6	40	01.86-07.90	LTA, LTC	4	7	RP4432
Escort D, Turnier	1,8	44	01.89-07.98	RTE,RTF,RTH	4	7	RP4486
Escort D, Turnier	1,8	44	01.95-12.95	RTE/RTF/RTH	4	7	RP4486
Escort D, Turnier	1,8	44	01.95-02.99	---	4	7	RP4486
Escort III D (GAA)	1,6	40	02.84-12.85	LTA	4	7	RP4432
Escort III Station wagon D (AWA)	1,6	40	02.84-12.85	LTA	4	7	RP4432
Escort IV D (GAP/AWF/ABFT)	1,6	40	01.86-01.89	LTC	4	7	RP4432
Escort IV Station wagon D (AWF/AVF)	1,6	40	01.86-01.89	LTC	4	7	RP4432
Escort TD	1,8	66	12.95-09.96	RFD/RFK	4	7	RP4486
Escort TD, Turnier	1,8	66	08.90-07.98	RFD,RFK	4	7	RP4486
Escort TD, Turnier	1,8	66	01.95-02.99	RFS	4	98	RP8388
Escort TD, Turnier	1,8	66	01.95-02.99	RFD/RFH	4	7	RP4486
Escort Turbo D Cabriolet	1,8	51	10.96-08.99	RVA	4	98	RP8388
Escort Turbo D, Turnier	1,8	51	12.95-10.98	RVA	4	98	RP8388
Excursion V8	6,0	363	03-04	---	---	62	RP7014
Fiesta D (FBD)	1,6	40	04.84-02.89	LTB	4	7	RP4432
Fiesta D Courier	1,8	44	03.89-06.96	RTC,RTD,RTG	4	7	RP4486
Fiesta D Courier	1,8	44	11.95-	RTK,RTJ	4	98	RP8388



Model	CC	Kw	Year	Engine	Cyl	Pict	Code
Fiesta D, TD	1,8	44-60	11.95-	RTK,RTJ	4	98	RP8388
Fiesta D, TD	1,8	44-60	03.89-06.96	RTC,RTD,RTG	4	7	RP4486
Fiesta DI	1,8	55	04.04-	RTN/RTP/RTQ	4	98	RP8388
Fiesta Furgonato (FVD)	1,6	40	09.83-09.89	LTB	4	7	RP4486
Fiesta V TDCi	1,4	50	11.01-	F6JA/F6JB	4	146	RP8652
Fiesta V TDCi (JH_/JD_)	1,6	66	11.04-	HHJA / HHJB	4	117	RP8436
Fiesta Van TDCi	1,4	50	01.09-	F6 JB	4	117	RP8436
Fiesta Van TDCi	1,6	66	01.09-	HHJC / HHJD / HHJE	4	117	RP8436
Fiesta VI TDCi	1,6	55	10.08-	HHJF / UBJA	4	117	RP8436
Fiesta VI TDCi	1,6	66	10.08-	HHJC / HHJD / HHJE	4	117	RP8436
Fiesta VI TDCi	1,6	70	02.10-	TZJA / TZJB	4	189	RP8472
Focus C-MAX TDCi	1,6	66	02.05-	HHDA/HHDB	4	146	RP8652
Focus C-MAX TDCi	1,6	80	10.03	---	4	146	RP8652
Focus C-Max TDCi	1,8	85	01.05-03.07	KKDA	4	129	RP8616
Focus C-MAX TDCi	2,0	98	10.03-03.07	G6DC / G6DE / G6DF	4	172	RP8930
Focus C-MAX TDCi	2,0	100	10.03-	---	4	172	RP8930
Focus DI / TDDi	1,8	55	08.99-	BHDA/BHDB	4	129	RP8616
Focus DI, TDDi, TURBO	1,8	66	08.98-	C9DC	4	129	RP8616
Focus II (DA_)	1,6	74	11.04-	G8DC / MTDA	4	117	RP8436
Focus II (DA_) TDCi	2,0	98	11.04-	G6DE / G6DF	4	172	RP8930
Focus II Station wagon (DAW_) TDCi	2,0	98	11.04-	G6DE / G6DF	4	172	RP8930
Focus II TDCi	1,6	66	11.04-	HHDA/HHDB	4	146	RP8652
Focus II TDCi	1,6	80	11.04-	---	4	146	RP8652
Focus II TDCi	1,8	85	11.04-	G6DA/G6DB	4	129	RP8616
Focus II TDCi	2,0	100	11.04-	---	4	172	RP8930
Focus II Turnier TDCi	1,6	66	11.04-	---	4	146	RP8652
Focus II Turnier TDCi	1,6	80	11.04-	---	4	146	RP8652
Focus II Turnier TDCi	2,0	100	11.04-	---	4	172	RP8930
Focus III TDCi / Tre volumi	1,6	70	04.11-	T3DA / T3DB	4	189	RP8472
Focus III TDCi / Tre volumi	1,6	85	04.11-	T1DA / T1DB	4	189	RP8472
Focus III TDCi / Tre volumi	2,0	85	04.11-	TYDA	4	189	RP8472
Focus III TDCi / Tre volumi	2,0	103	04.11-	UFDB	4	189	RP8472
Focus III TDCi / Tre volumi	2,0	120	04.11-	TXDB	4	189	RP8472
Focus III Turnier TDCi	1,6	70	05.11-	T3DA / T3DB	4	189	RP8472
Focus III Turnier TDCi	1,6	85	05.11-	T1DA / T1DB	4	189	RP8472
Focus III Turnier TDCi	2,0	85	05.11-	TYDA	4	189	RP8472
Focus III Turnier TDCi	2,0	103	05.11-	UFDB	4	189	RP8472
Focus III Turnier TDCi	2,0	120	05.11-	TXDB	4	189	RP8472
Focus TDCi	1,8	74	09.02-	FFDA	4	129	RP8616
Focus TDCi	1,8	85	03.01	F9DA/F9DB	4	129	RP8616
Focus Tre volumi (DFW) Turbo DI/ TDDi	1,8	55	08.01-03.05	BHDA / BHDB	4	129	RP8616
Fusion TDCi	1,4	50	08.02	F6JA	4	146	RP8652
Fusion TDCi	1,6	66	11.04-	HHJA/HHJB	4	146	RP8652



Model	CC	Kw	Year	Engine	Cyl	Pict	Code
Fusion TDCi (JU_)	1,6	66	11.04-	HHJA / HHJB	4	146	RP8652
Galaxy MPV TDCi Turbo Diesel	2,0	103	05.06-	QXWA/QXWB	4	172	RP8930
Galaxy TDCi	1,6	85	02.11-	---	4	189	RP8472
Galaxy TDCi	1,8	74	05.06-	---	4	129	RP8616
Galaxy TDCi	1,8	92	05.06-	QYWA	4	130	RP8618
Galaxy TDCi	2,0	96	05.06-	---	4	130	RP8618
Galaxy TDCi	2,0	100	05.06-	AZWC / UKWA	4	189	RP8472
Galaxy TDCi	2,0	103	05.06-	QXWA / QXWB / QXWC / UFWA	4	189	RP8472
Galaxy TDCi	2,0	120	03.10-	---	4	189	RP8472
Galaxy TDCi	2,2	129	03.08-	Q4BA / Q4WA	4	118	RP8438
Galaxy TDI	1,9	66	03.95-05.06	1Z/AHU/ANU	4	78	RP8272
Galaxy TDI	1,9	66	10.01-	ANU	4	78	RP8674
Galaxy TDI	1,9	66	03.95-05.06	Cooling-water preheater	4	8	RP4422
Galaxy TDI	1,9	66	03.95-05.06	Cooling-water preheater	4	91	RP8360
Galaxy TDI	1,9	81	02.95-05.99	AFN	4	78	RP8272
Galaxy TDI	1,9	81	08.97-04.00	AFN / AVG	4	78	RP8272
Galaxy TDI	1,9	81	08.97-04.00	Cooling-water preheater	4	8	RP4422
Galaxy TDI	1,9	81	08.97-04.00	Cooling-water preheater	4	91	RP8360
Galaxy TDI	1,9	85	04.00-09.01	AUY	4	78	RP8674
Galaxy TDI	1,9	85	04.00-09.01	Cooling-water preheater	4	8	RP4422
Galaxy TDI	1,9	85	04.00-09.01	Cooling-water preheater	4	91	RP8360
Galaxy TDI	1,9	85	04.00-05.06	NSE / ZVSA	4	78	RP8272
Galaxy TDI	1,9	96	02.03-	ASZ	4	78	RP8674
Galaxy TDI	1,9	96	02.03-05.06	ASZ	4	78	RP8272
Galaxy TDI	1,9	110	05.05-	---	4	78	RP8674
Galaxy TDI	1,9	110	04.00-05.06	BTB	4	78	RP8272
Granada	2,5	68	05.85-10.94	SFA D Turbo/SFB D Turbo	4	11	RP4444
Granada D	1,9	40	08.77-02.79	GD 19	4	2	RP2028
Granada D	1,9	40	03.79-08.82	GD 19	4	11	RP4444
Granada D	2,1	44	09.77-08.82	WTA	4	11	RP4444
Granada D Turnier	2,5	51	09.82-08.85	STP	4	11	RP4444
Grand C-MAX TDCi	1,6	70	12.10-	T3DA / T3DB	4	189	RP8472
Grand C-MAX TDCi	1,6	85	12.10-	T1DA / T1DB	4	189	RP8472
Grand C-MAX TDCi	2,0	85	02.11-	TYDA	4	189	RP8472
Grand C-MAX TDCi	2,0	103	02.11-	UFDB	4	189	RP8472
Grand C-MAX TDCi	2,0	120	12.10-	---	4	189	RP8472
Ka TDCi	1,3	55	09.08-	FD4	4	155	RP8678
Kuga TDCi / 4x4	2,0	100	02.08-	G6DG	4	172	RP8930
Kuga TDCi / 4x4	2,0	103	03.10-	UFDA	4	189	RP8472
Kuga TDCi 4x4	2,0	120-123	04.10-	TXDA	4	172	RP8930
Maverick	2,7	92	05.96-04.98	TD27E	4	148	RP8656
Maverick TD	2,7	74	06.93-04.98	TD 27/ TD 27T	4	86	RP8348
Mondeo 16V DI, TDDi	2,0	66-85	10.00-	D5BA / D6BA	4	130	RP8618
Mondeo D, TD	1,8	65-66	01.93-07.96	RFM,RFN	4	7	RP4486



Model	CC	Kw	Year	Engine	Cyl	Pict	Code
Mondeo D, TD	1,8	65-66	08.96-09.99	RFN	4	98	RP8388
Mondeo III Station wagon (BWY) TDCi	2,2	110	09.04-08.07	QJBC / QJBD	4	130	RP8618
Mondeo III TDCi / Combi	2,2	114	09.04-	QJBA/QJBB	4	130	RP8618
Mondeo IV TDCi	2,0	96	03.07-	---	4	172	RP8930
Mondeo IV TDCi / Tre volumi	2,2	129	03.08-	Q4BA	4	118	RP8438
Mondeo IV TDCi / Turnier	1,6	85	02.11-	---	4	189	RP8472
Mondeo IV TDCi / Turnier	2,0	120	03.10-	TXBA	4	189	RP8472
Mondeo IV Turnier TDCi	2,2	129	03.08-	Q4BA	4	118	RP8438
Mondeo MKIV TDCi Turbo Diesel	2,0	96	03.07-	---	4	172	RP8930
Mondeo TD di	1,8	66	10.99-	D5BA	4	130	RP8618
Mondeo TDCi	2,0	96	10.01	---	4	130	RP8618
Mondeo TDCi	2,2	110	09.04-	QJBC DuraTorq-TDCi	4	130	RP8618
Mondeo TDCi	2,2	110	09.04-	QJBD DuraTorq-TDCi	4	130	RP8618
Mondeo TDCi	2,2	114	09.04-	QJBA DuraTorq-TDCi	4	130	RP8618
Mondeo TDCi	2,2	114	09.04-	QJBB DuraTorq-TDCi	4	130	RP8618
Orion D	1,8	44	01.86-07.93	RTA,RTB,RTE,RTF,RTH	4	7	RP4486
Orion I D (AFD)	1,6	40	04.84-07.90	LTA, LTC	4	7	RP4432
Orion II D (AFF)	1,6	40	12.85-01.89	LTC	4	7	RP4432
Orion TD	1,8	66	08.90-07.93	RFD, RFK	4	7	RP4486
P 100	2,3	---	82-	---	---	11	RP4444
P 100 Turbo	1,8	---	89-	---	---	7	RP4486
Ranger D/TD - D 4X4/TD 4X4	2,5	57-80	10.99-09.01	WL/WL-T	4	55	RP8364
S MAX TDCi Turbo Diesel	2,0	---	05.06-	QXWA/QXWB	4	172	RP8930
Scorpio D	2,5	51	05.85-10.94	STR	4	11	RP4444
Scorpio TD	2,5	68	05.85-10.94	SFA,SFB	4	11	RP4444
Scorpio TD	2,5	85	05.85-10.94	SCB	4	11	RP4444
Scorpio TD	2,5	85	11.94-12.94	SCB	4	78	RP8370
Scorpio TD	2,5	85	10.94-06.98	SCC	4	78	RP8370
Scorpio TD	2,5	92	10.94-06.98	SCD	4	78	RP8370
Sierra D / TD	1,8	55	01.87-12.92	RFA,RFB,RFL	4	7	RP4486
Sierra D, Turnier	2,3	49	06.82-12.92	YTR, YTT	4	11	RP4444
S-Max TDCi	1,6	85	02.11-	---	4	189	RP8472
S-Max TDCi	1,8	92	05.06-	QYWA	4	130	RP8618
S-Max TDCi	2,0	96	05.06-	---	4	130	RP8618
S-Max TDCi	2,0	103	05.06-	---	4	172	RP8930
S-Max TDCi	2,0	103	05.06-	QXWA / QXWB / QXWC / UFWA	4	189	RP8472
S-Max TDCi	2,2	129	03.08-	Q4WA	4	118	RP8438
S-Max/Galaxy	2,0	96	03.06-	AZWA Duratorq-TDCi	4	130	RP8618
S-Max/Galaxy	2,0	103	03.06-	QXWA Duratorq-TDCi	4	130	RP8618
S-Max/Galaxy	2,0	103	03.06-	QXWB ohne-TDCi	4	130	RP8618
Tourneo Connect DI	1,8	55	09.02-	---	4	129	RP8616
Tourneo Connect TDI	1,8	66	06.02-	HCPB Duratorq-TDCi/HCPA Duratorq-TDCi	4	129	RP8616
Tourneo TDI	2,0	74	06.01-	ABFA	4	130	RP8618
Transit TDCi	2,2	---	2011-	---	4	191	RP8476



Model	CC	Kw	Year	Engine	Cyl	Pict	Code
<b>FORD TRUCK</b>							
E150-350 V8-6.0L Diesel Turbo (P)	6,0	---	2004-2008	---	---	62	RP7018
Excursion V8-6.0L Diesel Turbo (P)	6,0	---	2004-2005	---	---	62	RP7018
F150-350 V8-6.0L Diesel Turbo (P)	6,0	---	2004-2007	---	---	62	RP7018
F250 Super Duty P/N	6,4	---	08.08-	V8-391 6,4L Dsl	---	64	RP7020
F350 Super Duty P/N	6,4	---	08.08-	V8-391 6,4L Dsl	---	64	RP7020
F450 (Super Duty) V8-6.0L Diesel Turbo (P)	6,0	---	2004-2007	---	---	62	RP7018
F450 Super Duty	6,4	---	08.08-	V8-391 6,4L Dsl	---	64	RP7020
F550 (Super Duty) V8-6.0L Diesel Turbo (P)	6,0	---	2004-2007	---	---	62	RP7018
Super Duty E V8-6.0L Diesel Turbo (P)	6,0	---	2004-2007	---	---	62	RP7018
Super Duty F V8-6.0L Diesel Turbo (P)	6,0	---	2004-2007	---	---	62	RP7018
<b>FORD VAN</b>							
A 0406, A 0506	2,4	46	01.78-06.83	York	4	7	RP4432
Econoline Van (E series) V8	6,0	366	2004	---	---	62	RP7014
Econovan D	2,0	41	09.85-	RF, R2	4	55	RP6912
P-100 D	1,8	55	10.87-12.92	RFA,RFB,RFL	4	7	RP4486
Pickup (F series) V8	6,0	363	03-04	---	---	62	RP7014
Transit (Front wheel drive)	2,2	63	04.06-	P8FA	4	130	RP8618
Transit (Front wheel drive)	2,2	81	04.06-	QVFA	4	130	RP8618
Transit (Front wheel drive)	2,2	96	04.06-	QWFA	4	130	RP8618
Transit (Rear wheel drive)	2,4	74	04.06-	PHFA	4	130	RP8618
Transit (Rear wheel drive)	2,4	85	04.06-	JXFA	4	130	RP8618
Transit (Rear wheel drive)	2,4	85	01.00-0.506	FXFA	4	130	RP8618
Transit (Rear wheel drive)	2,4	101	01.00-05.06	H9FA	4	130	RP8618
Transit (Rear wheel drive)	2,4	103	04.06-	H9FB	4	130	RP8618
Transit Connect TDCi	1,8	66	06.02-	---	4	129	RP8616
Transit D	2,4	46	06.78-12.85	J York	4	7	RP4432
Transit DI	1,8	55	09.02-	---	4	129	RP8616
Transit DI	2,0	63	08.00-	---	4	130	RP8618
Transit DI	2,0	55-74	03.99-	D3FA / ABFA	4	130	RP8618
Transit DI	2,4	55-66-88	01.00-	F4FA / D2FA / D4FA	4	130	RP8618
Transit TDCi	2,0	92	08.02-	---	4	130	RP8618
Transit TDCi	2,2	63	07.06-	---	4	130	RP8618
Transit TDCi	2,2	81	07.06-	---	4	130	RP8618
Transit TDCi	2,2	96	07.06-	---	4	130	RP8618
Transit TDCi	2,4	74	07.06-	---	4	130	RP8618
Transit TDCi	2,4	85	03.04-	---	4	130	RP8618
Transit TDCi	2,4	101	03.04-	---	4	130	RP8618
Transit TDCi	2,4	103	07.06-	---	4	130	RP8618
Transit TDE	2,4	92	11.01-	---	4	130	RP8618
Transit Tourneo TDCi	2,2	81-96	07.06-	---	4	129	RP8616



Model	CC	Kw	Year	Engine	Cyl	Pict	Code
<b>FREIGHTROVER</b>							
Sherpa	2,0	---	05.86-03.91	Perkins - Prima 65	4	11	RP4444
Sherpa DI Van	2,5	---	01.87-03.89	---	4	11	RP4444
<b>FSO/FSM</b>							
Polonez D	1,6	37	01.86-	VW	4	8	RP4422
Polonez D Caro	1,9	51	08.88-	XUD	4	11	RP4444
<b>GMC</b>							
Chassis TD all model	6,5	---	01.82-	V8	4	40	RP6816
Full Size CK Light Truck	5,7	350	1980-1981	Diesel	8	57	RP7002
Full Size TD CK / RV	6,5	---	01.82-	V8	4	40	RP6816
MD Bus Chassis	6,5	---	01.97-12.98	V8	4	40	RP6816
Sierra 3500HD 6.6L V8 Turbo Diesel	6,6	---	---	DURAMAX	---	167	RP8918
Van TD all model	6,5	---	01.96-	V8	4	40	RP6816
<b>HINDUSTAN</b>							
Ambassador	1,5	40	01.89-	---	---	21	RP6066
Contessa	1,5	40	01.84-	---	---	21	RP6066
Porter	1,5	---	01.80-	---	---	21	RP6066
Trekker	1,5	---	01.77-	---	---	21	RP6066
<b>HINO</b>							
Ranger D	2,5	45	01.78-09.80	DG	4	30	RP6592
Ranger D	3,0	60	01.83-07.88	B	4	30	RP6914
Ranger D	3,4	70	01.83-07.88	3B	4	30	RP6914
<b>HONDA</b>							
Accord DI Turbo	2,0	77	02.99-	---	4	82	RP8340
Accord i TD	2,0	63	01.97-02.01	20T2R	4	82	RP8390
Accord IX (CU) i-DTEC	2,2	110	07.08-	N22B1	4	169	RP8922
Accord IX (CU) i-DTEC	2,2	132	07.09-	N22B2	4	169	RP8922
Accord IX Station Wagon i-DTEC	2,2	110	07.08-	N22B1	4	169	RP8922
Accord IX Station Wagon i-DTEC	2,2	132	09.09-	N22B2	4	169	RP8922
Accord Tdi	2,0	77	05.95-08.99	Rover (L-Serie)	4	82	RP8340
Accord VIII (CL_, CM_) i-CTDi	2,2	103	01.04-	N22A1	4	169	RP8922
Accord VIII Tourer (CM_) i-CTDi	2,2	103	01.04-	N22A1	4	169	RP8922
Civic CTDi	1,7	74	01.02-	4EE-2	4	152	RP8910
Civic DI, DTI	1,7	55	02-	4EE2	4	152	RP8670
Civic TD	2,0	63	10.97-	20T2R	4	82	RP8390
Civic TDI	2,0	77	01.98-	20TN2	4	82	RP8390
Civic VI Aerodeck (MB, MC) i D	2,0	77	04.98-02.01	20T2N	4	169	RP8922
Civic VI Fastback (MA, MB) i TD	2,0	63	01.97-02.01	20T2R	4	169	RP8922
Civic VIII Hatchback (FN, FK) CTDi	2,2	103	01.06-	N22A2	4	169	RP8922
Concerto TD	1,8	64	10.94-12.95	XUD 7 TE	4	11	RP4444
CR-V II (RD_) CTDi	2,2	103	02.05-09.06	N22A2	4	169	RP8922
CR-V III i-CTDi	2,2	103	01.07-	N22A2	4	169	RP8922
CR-V III i-DTEC	2,2	110	01.07-	N22B3	4	169	RP8922
CR-V IV i-DTEC 4WD	2,2	110	10.12-	---	4	169	RP8922



Model	CC	Kw	Year	Engine	Cyl	Pict	Code
FR-V (BE) i-CTDi	2,2	103	07.05-	N22A1	4	169	RP8922
<b>HUMMER</b>							
Hummer H1 D	6,5	125	01.92-12.04	GM	8	40	RP6816
Hummer H1 Turbo D	6,5	143	01.92-12.04	GM	8	40	RP6816
Hummer TD (Military)	6,5	---	01.92-12.96	GM	8	66	RP7030
<b>HYUNDAI</b>							
Accent (LC) CRDi	1,5	81	06.06-	---	---	114	RP8428
Accent CRDi	1,5	60	04.02-	DE-EA	3	140	RP8640
Accent TDi	1,5	55	04.02-	---	3	140	RP8640
Accent Tre volumi (MC) CRDi GLS	1,5	81	11.05-	---	4	114	RP8428
Elantra CRDi	2,0	83	04.01-	D4EA	4	140	RP8640
Galopper	2,5	57	-01.94	4D55	4	50	RP6818
Galopper TC, TCI	2,5	65	11.95-	4D56	4	128	RP8614
Galopper TCI	2,5	77	08.98	---	4	138	RP8636
Galopper TD	2,5	62	07.94-08.94	---	4	74	RP8174
Galopper TD	2,7	76	01.99-	---	4	138	RP8636
Galopper TD 3/5p GLS, Inovation	2,5	74	01.99-	---	4	128	RP8614
Galopper TD Intercooler	2,5	73	08.98	D4BH	4	74	RP8174
Getz CRDi	1,5	60	03.03	D3-EA	3	140	RP8640
Getz CRDi GLS	1,5	81	08.05-	---	4	114	RP8428
Grace H100	2,5	---	---	4D55	4	50	RP6818
H 100 D	2,5	55	07.93-12.94	D4BA/D4BX	4	110	RP8414
H 100 D	2,5	57	09.94-	---	4	110	RP8414
H 100 D Intercooler	2,5	63	07.64-	D4BF	4	138	RP8636
H 100 TD	2,5	59	07.94-03.00	D4BF	4	74	RP8174
H-1 CRDi	2,5	103	08.03-	---	4	176	RP8938
H-1 Starex D	2,5	57	10.97-	D4BB	4	110	RP8414
H-1 Starex TD	2,5	59	10.97-	D4BF	4	74	RP8174
H-1 Starex TD	2,5	73	10.99-11.01	D4BH	4	110	RP8414
i10 CRDi	1,1	55	03.08-12.10	D3FA	3	114	RP8428
i20 CRDi	1,1	55	02.12-	D3FA	4	114	RP8428
i20 CRDi	1,4	55	10.08-	D4FC	4	114	RP8428
i20 CRDi	1,4	66	08.09-	D4FC	4	114	RP8428
i30 CRDi	1,4	66	12.11-	D4FC	4	114	RP8428
i30 CRDi	1,4	81	12.11-	D4FB	4	114	RP8428
i30 CRDi	1,6	66	10.07	D4FB	4	114	RP8428
i30 CRDi	1,6	85	10.07	D4FB	4	114	RP8428
i30 CRDi	1,6	94	12.11-	D4FB	4	114	RP8428
i30 CRDi	2,0	103	10.07-	D4EA	4	140	RP8640
i30 CRDi CW	1,6	66	02.08-	D4FB	4	114	RP8428
i30 CRDi CW	1,6	85	02.08-	D4FB	4	114	RP8428
i30 CRDi CW	2,0	103	02.08-	D4EA	4	140	RP8640
ix35 2,0 16V CDRI VGT	2,0	100	01.10-	---	4	183	RP8446
ix35 2,0 16V CDRI VGT	2,0	135	01.10-	---	4	183	RP8446
Lantra CRDi	2,0	83	04.01-	D4EA	4	140	RP8640





Model	CC	Kw	Year	Engine	Cyl	Pict	Code
Lantra D	1,9	50	98-	XUD9A	4	11	RP4444
Matrix CRDI	1,5	60	10.01-	D4EA	3	140	RP8640
Matrix CRDi	1,5	75	12.04-	D4FA	4	114	RP8428
Matrix CRDI	1,5	81	09.01-	D3EA	3	140	RP8640
Matrix CRDi VGT	1,5	81	08.05-	---	4	114	RP8428
Porter H100	2,5	---	---	4D55	4	50	RP6818
Santa Fe CRDI	2,0	83	08.01-	---	4	140	RP8640
Santa Fe CRDI	2,0	85	03.00-	4DEA	4	140	RP8640
Santa Fé CRDi	2,2	102	03.06-	---	4	140	RP8640
Santa Fé CRDi	2,2	114	03.06-	---	4	140	RP8640
Santa Fe CRDI 4x4	2,0	83-92	04.01-	---	4	140	RP8640
Santa Fé CRDi GLS	2,2	110	10.05-	---	4	140	RP8640
Starex TD	2,5	59	06.97-	---	4	74	RP8174
Terracan CRDI	2,9	110	10.01-	---	4	128	RP8614
Trajet CRDI	2,0	83	04.01-	D4EA	4	140	RP8640
Trajet CRDI	2,0	85	02.00-	4DEA	4	140	RP8640
Tucson CRDI	2,0	83	08.04-	---	4	140	RP8640
Tucson CRDI Allrad	2,0	83	08.04-	---	4	140	RP8640
<b>IHC</b>							
S1600-2100 / S2200-2600	7,3	444	01.96-10.99	---	8	60	RP7008
<b>INNOCENTI</b>							
3-Cylinder	---	---	---	CL-001	3	30	RP6840
990 D	1,0	27	01.82-12.90	Daihatsu CL 10	3	30	RP6840
Elba D	1,7	42	09.92-	146 B 2.000	4	11	RP4444
<b>ISUZU</b>							
Campo D	2,2	39	08.87-10.88	C223	4	26	RP8322
Florian D	2,0	34	11.77-03.83	C 190	4	26	RP6824
Gemini D	1,5	37	10.85-11.88	4EC1	4	26	RP6824
Gemini D	1,5	37	12.88-12.90	4EC1	4	26	RP8322
Gemini D	1,5	37	12.88-12.90	4EC1	4	71	RP8324
Gemini D	1,5	40	10.85-11.88	4EC1	4	26	RP6824
Gemini D	1,5	40	12.88-12.90	4EC1	4	26	RP8322
Gemini D	1,5	40	12.88-12.90	4EC1	4	71	RP8324
Gemini TD	1,5	49	02.88-11.88	4EC1T	4	71	RP8134
Gemini TD	1,5	49	12.88-12.90	4EC1T	4	71	RP8324
Gemini TD	1,5	54	02.88-11.88	4EC1T	4	71	RP8134
Gemini TD	1,5	54	12.88-12.90	4EC1T	4	71	RP8324
Light Bus BE	---	---	76-	6BB1	---	68	RP8122
Light Bus BE	---	---	76-	6BD1	---	68	RP8122
Light Bus BE	---	---	80-	4BD1	---	68	RP8122
Light Bus BL	---	---	07.81-	4BC1	---	68	RP8122
Light Bus BL	---	---	07.81-	4BC2	---	68	RP8122
Light Bus CCM	---	---	07.78-	6BF1	---	68	RP8122
Light Bus CCM	---	---	07.79-	6BD1	---	68	RP8122
Midi D	2,2	45	01.86-	Isuzu	4	71	RP8324



Model	CC	Kw	Year	Engine	Cyl	Pict	Code
Midi D	2,4	56	01.94-	4FG1T	4	71	RP8134
Midi D, Van	2,2	45	01.86-	Isuzu	4	71	RP8134
Midi TD	2,0	51	01.86-	Isuzu	4	71	RP8324
Midi TD Van	2,4	56	01.94	4FG1T	4	71	RP8134
Midi TD, Van	2,0	51	01.86-	Isuzu	4	71	RP8134
Pickup D	2,0	34	01.83-	C 190	4	26	RP6824
Pickup D	2,2	39	04.86-08.87	C 223	4	26	RP6824
Pickup D	2,2	39	08.87-10.88	C 223	4	26	RP8322
Pickup D	2,2	53	08.87-10.88	C223	4	26	RP8322
Trooper D	2,3	39	02.81-07.87	C 223	4	26	RP6824
Trooper D	2,3	39	08.87-10.88	C 223	4	26	RP8322
Trooper TD	2,8	71	10.87-12.91	4JB1T	4	68	RP8106
Trooper TD	2,8	78	10.8-12.91	4JB1-TC	4	68	RP8106
Trooper TD	3,1	83	06.92-	4JG2T	4	71	RP8324
Trooper TD Soft Top	2,2	53	02.81-07.87	C 223 T	4	26	RP6824
Trooper TD Soft Top	2,2	53	08.87-10.88	C 223 T	4	26	RP8322
Trooper TDI	3,0	118	07.98-	4JX1	4	149	RP8658
Trooper TDI Soft Top	3,0	118	04.00-	---	4	149	RP8658
<b>IVECO</b>							
242/15 18 D	2,5	50	09.79-	---	---	11	RP4444
28 F 8 Daily	---	53	04.78-06.82	---	4	11	RP4444
28.40 F 8 Daily	---	---	07.82-12.82	---	4	11	RP4444
30 F 8 Daily	---	---	04.78-06.82	---	4	11	RP4444
32 F 8 Daily	---	---	04.78-06.82	---	4	11	RP4444
35 F 8 Daily	---	---	04.78-06.82	---	4	11	RP4444
40 F 8 Daily	---	---	04.78-06.82	---	4	11	RP4444
Daily	2,5	---	---	---	4	7	RP4432
Daily D	2,8	64	06.98-	8140.63	6	107	RP8408
Daily I 30-8	2,5	53	01.78-12.89	8140.61.200	4	11	RP4488
Daily I 30-8	2,5	55	01.92-08.98	8140.67F.	4	7	RP4486
Daily I 30-8	2,5	60	01.96-08.98	8140.67F.	4	7	RP4486
Daily I 30-8 / V	2,8	62	09.98-	8140.63.	4	107	RP8408
Daily I 30-8 V, 30-8 C	2,5	53	01.78-12.89	8140.61.200	4	11	RP4488
Daily I 30-8 V, 30-8 C	2,5	60	01.96-08.98	8140.67F	4	7	RP4486
Daily I 30-8 V, 30-8 C	2,5	55-60	01.89-08.98	8140.67F.	4	7	RP4486
Daily I 30-8 V, 30-8 C	2,8	62	09.98-	8140.63.	4	107	RP8408
Daily I 35-10 / V / C	2,5	68	01.85-12.89	8140.21.200	4	11	RP4488
Daily I 35-8	2,5	53	01.78-12.89	8140.61.	4	11	RP4488
Daily I 35-8	2,5	55-60	01.89-08.98	8140.67F.	4	7	RP4486
Daily I 35-8 / K	2,8	62	09.98-	8140.63.	4	107	RP8408
Daily I 35-8 V, 35-8 C	2,5	53	01.78-12.89	8140.61.200	4	11	RP4488
Daily I 35-8 V, 35-8 C	2,5	55-60	01.91.08-98	8140.67F.	4	7	RP4486
Daily I 35-8 V, 35-8 C	2,8	62	09.98-	8140.63.	4	107	RP8408
Daily I 40-8 / V	2,5	53	01.83-06.89	8140.61.200	4	11	RP4488
Daily I 45-10 / V	2,5	68	01.85-12.89	8140.21.200	4	7	RP4486



Model	CC	Kw	Year	Engine	Cyl	Pict	Code
Daily I 49-10 / V	2,5	68	01.85-12.89	8140.21.200	4	11	RP4488
Daily II 29 L 9, V	2,8	62	05.99-	8140.63.	4	107	RP8408
Daily II 35 S 9 /V, 35 C 9 /V	2,8	62	05.99-	8140.63.	4	107	RP8408
Daily JTD	3,0	---	04.02-	F1C	4	153	RP8672
Daily TDI	2,8	90	09.97-	---	6	107	RP8408
Daily, Grinta D	2,4	53	04.78-09.83	Sofim 8140.61.200	4	11	RP4444
Daily, Grinta D	2,4	53	10.83-06.89	Sofim 8140.61.200	4	11	RP4444
<b>JAGUAR</b>							
S-Type Biturbo V6 (XJ6)	2,7	152	06.04-	---	6	145	RP8650
X-Type (CF1) D	2,2	107	01.07-	L 146G	4	118	RP8438
X-Type (CF1) D	2,2	114	10.05-	L 146G	4	118	RP8438
X-Type D	2,0	96	07.03	---	4	130	RP8618
X-Type Estate D	2,2	107	01.07-	L 146G	4	118	RP8438
X-Type Estate D	2,2	114	10.05-	L 146G	4	118	RP8438
<b>JEEP</b>							
Cherokee CRD	2,5	105	09.01-	---	4	173	RP8932
Cherokee CRD	2,8	110-120	11.02-	---	4	173	RP8932
Cherokee TD	2,1	59	06.89-03.92	J8S	4	14	RP4458
Cherokee TD	2,1	64	03.92-08.94	J8S	4	14	RP4458
Cherokee TD	2,1	65	02.91-08.94	Renault J8S 890	4	14	RP4458
Cherokee TD	2,1	65	01.87-08.94	Renault J8S 814	4	11	RP4444
Cherokee TD	2,1	65	01.88-01.91	Renault J8S 890	4	11	RP4444
Cherokee TD	2,5	85-87	01.88-04.95	VM HR 425 CLIRX	4	11	RP4444
Cherokee TD	2,5	85-87	05.95	VM HR 425 CLIRX	4	78	RP8370
Commander CRD	3,0	160	06-	Mercedes	6	95	RP8374
Compass CRD	2,0	103	06-	---	4	179	RP9004
Grand Cherokee CRD	2,7	120	10.01	---	5	78	RP8370
Grand Cherokee CRD	3,0	160	06.05-	Mercedes	6	95	RP8374
Grand Cherokee TD	2,5	110	04.99-	ENC	5	78	RP8370
Grand Cherokee TD	2,5	88-92	05.95-	VM-HR 425	4	78	RP8370
Grand Cherokee TD	3,1	103	04.98-	EXA	5	78	RP8370
Grand Voyager Td Le	2,5	88	05.95-	VM HR425 CLIFE	4	78	RP8370
Wrangler	2,5	---	07.98-	---	6	11	RP4444
Wrangler Laredo, Sahara, Texan TD	2,1	65	07.98-	---	4	11	RP4444
Wrangler, Laredo, Sahara	2,5	---	07.98-	---	6	11	RP4444
Wrangler, Texan D	2,5	---	07.88-	---	6	11	RP4444
XJ TD Cherokee	2,0	64	04.84-12.87	Renault J8S 814	4	11	RP4444
<b>KIA</b>							
Besta	2,2	52	03.90-07.99	HW	4	55	RP8364
Besta	2,7	60	03.90-07.99	VN	4	55	RP8364
Besta Furgonato D	2,2	48	02.96-07.00	R2	4	55	RP8364
Bongo	2,4	---	---	E-2400	4	55	RP6912
Carens CRDI EX	2,0	83	2002-	---	4	140	RP8640
Carens III (UN) CRDi 115	2,0	85	05.07-	D4EA	4	140	RP8640
CEE'D CRDi 115	1,6	85	12.06-	---	4	114	RP8428



Model	CC	Kw	Year	Engine	Cyl	Pict	Code
CEE'D CRDi 90	1,6	66	09.07-	---	4	114	RP8428
CEE'D Station wagon CRDi 115	1,6	85	09.07-	---	4	114	RP8428
CEE'D Station wagon CRDi 90	1,6	66	09.07-	---	4	114	RP8428
Cerato CRDi	1,5	75	07.05-	---	4	140	RP8640
K 2500 Diesel	2,5	69	01.03-	---	4	87	RP8896
K 2700 D	2,7	59	10.99-07.04	---	---	55	RP8364
Magentis CRDi	2,0	103	06-	D4EA	4	103	RP8400
Picanto D	1,1	55	11.05-	---	3	114	RP8428
Power Bango	2,4	---	---	E-2400	4	55	RP6912
Pregio D	2,7	60	10.97-	J2	4	55	RP8364
Pregio D	3,0	66	01.98-	JT-Motor W3, NB9	4	55	RP8364
Pregio TDi D	2,5	69	09.02-	D4BH	4	87	RP8896
Prontier D	3,0	66	01.98-	W3 / NB9	4	55	RP8364
RETONA (CE) TD	2,0	61	06.99-12.00	---	---	55	RP8364
Rio II CRDi	1,5	81	03.05-	---	4	114	RP8428
Rio II Tre volumi D	1,5	81	03.05-	---	4	114	RP8428
Sorento (JC) CRDi	2,5	103	08.02-	---	4	176	RP8938
Sorento 2,2 16V CRDi VGT (09MY)	2,2	145	10.09-	---	4	183	RP8446
Soul CRDi	1,6	85-94	01.09-	D4FB	4	114	RP8428
Sportage CRDi 4WD	2,0	83	09.04-	---	4	140	RP8640
Sportage CRDi 4WD	2,0	103	01.06-	D4EA	4	140	RP8640
Sportage TD 4WD	2,0	61	10.97-10.98	RF	4	55	RP8364
Super Titan	3,0	---	---	E-3000	6	55	RP6910
Titan	2,5	---	---	E-2500	4	55	RP6910
Titan	2,7	---	---	E-2700	4	55	RP6910
Tropic	2,7	---	---	E-2700	4	55	RP6910
Venga CRDi	1,4	66	12.09-	D4FC	4	114	RP8428
Venga CRDi	1,4	55-57	12.09-	D4FC	4	114	RP8428
Venga CRDi	1,6	85-94	12.09-	D4FB	4	114	RP8428
<b>KUBOTA</b>							
Combine	---	---	---	RX 3350 (V1200 N-TC)	---	158	RP8888
D1005-E	---	---	---	---	---	99	RP8392
D1105-E	---	---	---	---	---	99	RP8392
D662-E	---	---	---	---	---	99	RP8392
D722-E	---	---	---	---	---	99	RP8392
KD-15	---	---	---	---	---	53	RP8362
KH-1	---	---	---	---	---	53	RP8362
KH-10	---	---	---	---	---	53	RP8362
KH11,12,20	---	---	---	---	---	53	RP8362
KH-11H	---	---	---	---	---	53	RP8362
KH-12FD	---	---	---	---	---	53	RP8362
KH-14	---	---	---	---	---	53	RP8362
KH-15	---	---	---	---	---	53	RP8362
KH-18	---	---	---	---	---	53	RP8362
KH-20	---	---	---	---	---	53	RP8362



Model	CC	Kw	Year	Engine	Cyl	Pict	Code
RC-20FD	---	---	---	---	---	53	RP8362
RW-25	---	---	---	---	---	53	RP8362
Tractor	---	---	---	L SERIES	---	53	RP8362
Universal	---	---	---	Z482	2	99	RP8392
Universal	---	---	---	D662, 722	3	99	RP8392
<b>LADA</b>							
Aleko D	1,8	44	---	Ford RTE, RTS	4	7	RP4486
Niva D	1,9	55	01.99-	XUD9SD	4	11	RP4444
Niva D 4x4	1,9	47	10.93-	Peugeot XUD 9L	4	11	RP4444
Niva D 4x4 - 2121 -	1,9	47	05.84-09.93	Mot. Peugeot	4	11	RP4444
Sagona D	1,5	43	10.95-	TDU 5	4	88	RP8352
Samara D	1,5	40-42	---	TDU 5	4	88	RP8352
<b>LANCIA</b>							
Dedra Eco LE TD	1,9	68	06.93-07.99	160 D 1.000	4	11	RP4444
Dedra TDS	1,9	66	07.94-09.94	160 D 1.000/835A 4.000/835A4.046	4	11	RP4482
Dedra TDS	1,9	66	10.94-07.99	160 D 1.000/835A 4.000/835A4.046	4	11	RP4444
Dedra TDS	1,9	66	04.89-09.94	160 D1.000/835 A4.000	4	11	RP4482
Delta HPE TD	1,9	66	10.96-	160 D 1.000	4	11	RP4444
Delta HPE TD	1,9	66	10.94-09.96	160 D 1.000	4	11	RP4444
Delta HPE Td	1,9	66	10.96-	---	4	84	RP8344
Delta JTD	1,6	88	07.08-	198 A2.000	4	182	RP8444
Delta JTD	1,9	140	08.08-	844 A1.000	4	182	RP8444
Delta JTD	2,0	121	08.08-	198 A5.000	4	182	RP8444
Delta TD	1,9	59	08.86-06.91	831 D 1.000	4	11	RP4482
Delta TD DS	1,9	66	10.94-08.99	160 D 1.000/835 A4.000	4	11	RP4444
Delta TD DS LE / LS	1,9	66	10.94-	160 D 1.000	4	11	RP4444
Delta Turbo DS	1,9	59	10.86-12.89	835 D1.000	4	11	RP4482
Kappa JTD Coupe	2,4	100	07.98-	AR 34202	5	132	RP8622
Kappa SW JTD	2,4	110	06.98-10.01	---	5	160	RP8898
Kappa TDS	2,4	91	08.94-10.01	838 A 3.000	5	84	RP8344
Lybra JTD	1,9	77	07.99-09.00	AR 32302	4	132	RP8622
Lybra JTD	1,9	77	07.99-09.00	Cooling-water preheater	4	160	RP8898
Lybra JTD	1,9	81	09.00-05.01	Cooling-water preheater	4	160	RP8898
Lybra JTD	1,9	81	09.00-05.01	AR37101	4	132	RP8622
Lybra JTD	1,9	85	05.01-	Cooling-water preheater	4	160	RP8898
Lybra JTD	1,9	85	05.01-	---	4	132	RP8622
Lybra JTD	2,4	98	10.99-	---	4	132	RP8622
Lybra JTD	2,4	99	07.99-09.00	Cooling-water preheater	5	160	RP8898
Lybra JTD	2,4	99	07.99-09.00	839 A5.000/AR32501	5	132	RP8622
Lybra JTD	2,4	103	09.00-05.02	Cooling-water preheater	5	160	RP8898
Lybra JTD	2,4	103	09.00-05.02	839 A6.000	5	132	RP8622
Lybra JTD	2,4	110	05.02-	Cooling-water preheater	5	160	RP8898
Lybra JTD	2,4	110	05.02-	841 C.000	5	132	RP8622
Lybra SW JTD	1,9	77	07.99-09.00	---	4	160	RP8898
Lybra SW JTD	1,9	81	09.00-05.01	---	4	160	RP8898



Model	CC	Kw	Year	Engine	Cyl	Pict	Code
Lybra SW JTD	1,9	85	05.01-	---	4	160	RP8898
Lybra SW JTD	2,4	99	10.99-09.00	---	5	160	RP8898
Lybra SW JTD	2,4	103	09.00-	---	5	160	RP8898
Lybra SW JTD	2,4	110	05.02-	---	5	160	RP8898
Musa Multijet	1,3	51	10.04-	---	4	155	RP8678
Musa Multijet	1,9	74	10.04-	188 B2.000	4	132	RP8622
Phedra JTD	2,0	79	07.03-	---	4	108	RP8410
Phedra JTD	2,0	80	09.02-	RHW (DW10ATED4)	4	108	RP8410
Phedra JTD	2,0	88	06.06-	---	4	172	RP8930
Phedra JTD	2,2	94	09.02-	4HW (DW12ATED4)	4	108	RP8410
Prisma TD	1,9	48	06.84-12.89	831 D.	4	11	RP4482
Prisma TD / DS	1,9	59	05.85-12.89	831 D.	4	11	RP4482
Thema TD	2,4	74	01.93-	---	4	11	RP4444
Thema Turbo D	2,5	74	11.84-09.88	8144.91	4	11	RP4444
Thema Turbo DS	2,5	74	03.87-09.90	8144.91	4	11	RP4444
Thema Turbo DS	2,5	77	05.88-07.92	8144.97S	4	11	RP4444
Thema Turbo DS	2,5	85	05.92-07.94	8144.97Y	4	81	RP8326
Thema Turbo DS	2,5	85	06.88-05.92	8144.97	4	11	RP4444
Thesis JTD	1,9	59	10.01-	---	4	132	RP8622
Thesis JTD	1,9	81	10.01-	---	4	132	RP8622
Thesis JTD	2,4	110	04.02-	841C.000	5	132	RP8622
Thesis JTD	2,4	129	05.03-	---	5	166	RP8914
Ypsilon JTD	1,3	51	10.03-	188 A4.000	4	155	RP8678
Ypsilon Multijet	1,3	55-66	09.06-	---	4	155	RP8678
Zeta JTD	2,0	80	09.99-09.02	RHZ/RHW	4	108	RP8410
Zeta TD	1,9	68	04.95-	XUD 9TE	4	11	RP4444
Zeta TD	2,1	80	05.96-09.99	P 8 C	4	11	RP4444
<b>LANDWIND</b>							
Landwind 2,8 D	2,8	68	09.05-	JX493ZQ	4	68	RP8106
<b>LDV</b>							
400 Bus TD	2,5	71	11.95-	---	4	11	RP4444/1
<b>LEXUS</b>							
IS 2,2 (XE2) 220 d (ALE20)	2,2	130	10.05-	Cooling-water preheater	4	120	RP8442
IS 2,2 (XE2) 220 d (ALE20)	2,2	130	10.05-	2ADFHV	4	184	RP8468
<b>LEYLAND</b>							
200-Serie	2,0	46	03.89-	---	6	84	RP8666
200-Serie	2,0	46	05.86-03.89	---	4	11	RP4444
220/240	---	---	---	---	---	20	RP6064
400-Serie LTD DI	2,5	---	01.87-	---	5	11	RP4444
Pilot	1,9	---	96-	Peugeot	4	11	RP4444
Readline 340FG, 350	2,5	---	---	---	4	20	RP6064
Sherpa	2,5	---	04.86-89	---	4	11	RP4444
Sherpa	2,5	---	89-	Peugeot	4	11	RP4444
Sherpa, EA Range	1,8	---	---	---	4	20	RP6064



Model	CC	Kw	Year	Engine	Cyl	Pict	Code
<b>MAHINDRA</b>							
CJ 3 D All Model	2,1 / 2,3 / 2,5	46-48-49	10.88-09.92	Mot. Peugeot	4	11	RP4444
CJ 340 D Classic	2,1	48	01.93-	XD 4.90	4	11	RP4444
CJ 540	2,1	48	1993-	XD A.90	---	11	RP4444
CJ 5D	---	---	04.86-	PEUGEOT	---	11	RP4444
<b>MAZDA</b>							
626	2,0	66	09.98	2.0 DITD	4	116	RP8434
929	2,0	---	---	S2	4	55	RP6910
121 D	1,8	44	03.96-	RTJ	4	98	RP8388
12116V	1,3	53	11.90-03.96	B3 (16V)	4	116	RP8434
2 CD	1,4	50	04.03	---	4	146	RP8652
2 CD	1,4	50	08.07-	F6JB	4	117	RP8436
2 CD	1,6	66	11.08-07.10	Y6	4	146	RP8652
2 CD	1,6	66	07.10-	Y6	4	117	RP8436
3 MZR-CD	1,6	80	12.08-	Y6	4	146	RP8652
3 MZR-CD	1,6	85	11.10-	---	4	146	RP8652
323 (BJ)	1,4	53	01.01-	B3 (16V)	4	116	RP8434
323 16V	1,3	54	04.91-07.94	B3 (16V)	4	116	RP8434
323 16V (BA)	1,3	54	10.96-	BE (16V)	4	116	RP8434
323 D	2,0	52	10.96-09.98	---	4	55	RP8364
323 DITD	2,0	66	09.98-	2.0 DITD	4	116	RP8434
323 GT TURBO	1,6	103	10.85-11.91	B6	4	116	RP8434
323 GT TURBO 4WD (BF2)	1,6	110	08.87-10.89	---	4	116	RP8434
323 TD	1,6	60	02.95-09.98	4EE1-T	4	55	RP8364
323 TD	1,7	60	99-	4EE1-T	4	125	RP8608
323 TD (BJ)	2,0	66	09.98-	---	4	116	RP8434
323 TD (BJ)	2,0	74	10.01-	2	4	116	RP8434
5 2.0 CD	2,0	---	---	---	4	116	RP8434
6 (GG) HATCHBACK, SW	2,0	89	08.02	RF5C	4	116	RP8434
6 DI (GG)	2,0	89	08.02	RF5C	4	116	RP8434
6 DI (GG)	2,0	105	06.05-	RF7J	4	116	RP8434
6 DI (GG) HATCHBACK, SW	2,0	100	08.02-	RF5C	4	116	RP8434
6 DI HATCHBACK (GG)	2,0	105	06.05-	RF7J	4	116	RP8434
6 STATION WAGON (GY) DI	2,0	105	06.05-	RF7J	4	116	RP8434
626 II D	2,0	53	11.82-08.85	RF46	4	55	RP6912
626 III D Complex	2,0	55	05.93-11.96	RF-CX	4	55	RP8364
626 III D HATCHBACK (GD)	2,0	44	07.87-07.91	RF-N	4	55	RP8364
626 III D, SW (GV)	2,0	60	11.94-09.97	---	4	55	RP8364
626 IV D HATCHBACK (GE) GLX COMPLEX	2,0	55	10.92-04.97/01.93-04.97/12.95-	RF OHC	4	55	RP8364
626 DITD HATCHBACK, SW	2,0	66	04.98-	RF3F	4	116	RP8434
626 II HATCHBACK (GC) D / D (GC)	2,0	46	01.83-06.87/07.85-	---	---	55	RP8364



Model	CC	Kw	Year	Engine	Cyl	Pict	Code
626 II HATCHBACK (GF) DITD	2,0	66	04.98-10.02	RF3F	4	116	RP8434
626 II HATCHBACK (GF/Kombi) TURBO DI	2,0	74	04.98-10.02	---	4	116	RP8434
626 III DITD	2,0	66	04.98-10.02	RF3F	4	116	RP8434
626 III HATCHBACK (GF) TD	2,0	81	10.00-10.02	---	4	116	RP8434
626 III STATION WAGON (GW) DITD	2,0	66	09.99-10.02	RF3F	4	116	RP8434
626 III STATION WAGON (GW) TD	2,0	81	10.00-10.02	---	4	116	RP8434
626 III STATION WAGON (GW) TURBO DI	2,0	74	04.98-10.02	RF4F	4	116	RP8434
626 III TD	2,0	81	10.00-10.02	---	4	116	RP8434
626 III TURBO DI	2,0	74	04.98-10.02	---	4	116	RP8434
626 TD (GF) HATCHBACK	2,0	81	10.00-	---	4	116	RP8434
B 2200	2,2	---	---	S2	4	55	RP6910
B 2200 D	2,2	---	08.84-	F2	---	55	RP6912
B 2200 D - 24v -	2,2	---	08.84-	F2, R2	4	55	RP8200
B 2500 D 4WD	2,5	57	09.98-06.99	WL	4	55	RP8364
B 2500 D 4WD	2,5	80	06.99-	MD 25 TI	4	55	RP8364
BONGO VAN R2	2,0	---	06.99-	KF-SK22V,22T,22L/KJ-SK22V,22T/KG-SK22V,22M,22L	4	55	RP8364
Boxer 3700/5500	---	---	11.74-	XC/ZC	---	25	RP6670
B-Serie	---	---	97-11.02	WLT	---	55	RP8364
B-Serie D 4WD	2,5	63	02.96-06.99	---	4	55	RP8364
DEMIO S2	1,3	53	08.98-04.00	BE (16V)	4	116	RP8434
E 2000	2,0	---	93-	RF	4	55	RP6912
E 2000 - E 2200 D	2,2	46	02.83-12.83	F2	4	55	RP6912
E 2000 - E 2200 D (R2)	2,2	46	01.84-02.88	R207	4	55	RP6912
E 2000 - E 2200 D 4x4	2,2	46	01.84-02.88	R2	4	55	RP6912
E 2200	2,2	---	93-96	R2	4	55	RP6912
E 3000	3,0	---	1993-	VS/L4DE	---	156	RP8684
E D	2,2	52	02.97-08.02	R2	4	55	RP8364
E D 4WD	2,2	52	02.97-	R2	4	55	RP8364
E-Serie	---	---	97-	R2	---	156	RP8684
Light Bus Parkway DI	3,0	50-66	10.80-12.92	HA 12V	4	55	RP6912
Light Bus Parkway DI - 24v -	3,0	50-66	10.80-12.92	HA 24V	4	55	RP8200
MPV	2,0	100	1997-06.02	WLT	4	55	RP8364
MPV	2,0	100	07.02-	RF5C	4	116	RP8434
MPV I (LV) TD	2,5	85	05.96-09.99/05.99	---	---	55	RP8364
PREMACY Diesel	2,0	74	07.00-	RF4F	4	116	RP8434
PREMACY TD	2,0	66	10.99-07.00	RF3F, RF4F	4	116	RP8434
Ranger	---	---	---	S2	---	55	RP6910
T 2500 - T 4100 D	2,5	52	10.80-	XA 12V	6	55	RP6912
T 2500 - T 4100 D	3,0	50-66	10.80-12.92	HA 12V	6	55	RP6912
T 2500 - T 4100 D	4,1	---	10.80-	ZB	6	55	RP6912
T 2500 - T 4100 D - 24v -	2,5	52	10.80-	XA 24V	6	55	RP8200
T 2500 - T 4100 D - 24v -	3,0	50-66	10.80-	HA 24V	6	55	RP8200





Model	CC	Kw	Year	Engine	Cyl	Pict	Code
T 2500 - T 4100 D - 24v -	4,1	---	10.80-	ZB	6	55	RP8200
T 3000	3,0	---	10.80-1992	HA 12V	---	55	RP6912
T 3000	3,0	---	10.80-1992	HA 24V	---	55	RP8200
T 3000	3,0	---	1993-	L4DE/HA	---	55	RP8200
T 3700	---	---	04.76-	XC	---	25	RP6670
T 4100	4,1	---	10.80-	ZB 12V	---	55	RP6912
T 4100	4,1	---	10.80-	ZB 24V	---	55	RP8200
T 5500	---	---	1975-	ZC	---	25	RP6670
T-Serie	---	---	97-	VS	---	55	RP8200
<b>MCC</b>							
Smart CDI	0,8	29	07.98-	OM 660 DE 08 LA	3	137	RP8634
<b>MERCEDES</b>							
190 D (Typ 201)	2,0	53-55	03.83-01.89	OM 601.911	4	11	RP4444
190 D (Typ 201)	2,0	53-55	02.89-05.93	OM 601.911	4	13	RP4452
190 D (Typ 201)	2,5	66-69	04.85-01.89	OM 602.911	5	11	RP4444
190 D (Typ 201)	2,5	66-69	02.89-05.93	OM 602.911	5	13	RP4452
190 D, TD (Typ 201)	2,5	90-93	02.88-01.89	OM 602.961	5	11	RP4444
190 D, TD (Typ 201)	2,5	90-93	02.89-05.93	OM 602.961	5	13	RP4452
200 D (115.115)	2,0	55	01.68-01.77	---	---	16	RP4480
200 D (TYP 115)	2,0	40	05.69-01.76	OM 615.913	4	19	RP6122
200 D (TYP 123)	2,0	40-44	02.76-07.80	OM 615.940	4	19	RP6122
200 D (TYP 123)	2,0	40-44	08.80-11.85	OM 615.940	4	11	RP4444
200 D, TD (TYP 124)	2,0	53-55	12.84-01.89	OM 601.912	4	11	RP4444
200 D, TD (TYP 124)	2,0	53-55	02.89-06.93	OM 601.912	4	13	RP4452
200 T D Kombi (TYP 124)	2,0	53	09.85-01.89	OM 601.912	4	11	RP4444
200 T D Kombi (TYP 124)	2,0	53	02.89-08.91	OM 601.912	4	13	RP4452
200 T D Kombi (TYP 124)	2,0	55	09.88-01.89	OM 601.912	4	11	RP4444
200 T D Kombi (TYP 124)	2,0	55	02.89-08.91	OM 601.912	4	13	RP4452
207 D	2,0	40	08.77-10.85	OM 615.944	4	19	RP6122
207 D	2,4	48	05.77-08.82	OM 616	4	19	RP6122
207 D	2,4	53	09.82-09.88	OM 616	4	11	RP4444
208 D	2,3	58-60	10.88-	OM 601.940	4	13	RP4452
209 D	3,0	65	04.82-09.88	OM 617.913	5	11	RP4444
210 D	2,9	70-72	10.88-	OM 602.940	5	13	RP4452
220 D (115.110)	2,2	60	01.68-01.77	---	---	16	RP4480
220 D (TYP 115)	2,2	44	07.73-01.76	OM 615.912	4	19	RP6122
220 D (TYP 123)	2,2	44-49	02.76-03.79	OM 615.912	4	19	RP6122
240 D (115.117)	2,4	48	08.73-01.77	---	---	16	RP4480
240 D (TYP 115)	2,4	48	07.73-01.76	OM 616.916	4	19	RP6122
240 D (TYP 115)	3,0	59	08.74-11.76	OM 617.910	4	19	RP6122
240 D (TYP 123)	2,4	46	08.80-11.84	OM 616.912	4	11	RP4444
240 D (TYP 123)	2,4	48-53	02.76-07.80	OM 616.912	4	19	RP6122
240 D, TD (TYP 123)	2,4	48-53	08.80-11.85	OM 616.912	4	11	RP4444
240 GD (TYP 460)	2,4	53	08.80-08.87	OM 616.936	4	11	RP4444
240 GD (TYP 460)	2,4	53	03.79-07.80	OM 616.936	4	19	RP6122



Model	CC	Kw	Year	Engine	Cyl	Pict	Code
250 D, TD (TYP 124)	2,5	93	09.88-01.89	OM 602.962	5	11	RP4444
250 D, TD (TYP 124)	2,5	93	02.89-06.93	OM 602.962	5	13	RP4452
250 D, TD (TYP 124)	2,5	66-69	04.85-01.89	OM 602.912	5	11	RP4444
250 D, TD (TYP 124)	2,5	66-69	02.89-06.93	OM 602.912	5	13	RP4452
250 GD (TYP 460)	2,5	62-69	09.87-01.89	OM 602.930	5	11	RP4444
250 GD (TYP 460)	2,5	62-69	02.89-07.93	OM 602.930	5	13	RP4452
250 GD (TYP 463)	2,5	69	09.89-06.93	OM 602.931	5	13	RP4452
250 T D Kombi (TYP 124)	2,5	66	09.85-01.89	OM 602.912	5	11	RP4444
250 T D Kombi (TYP 124)	2,5	66	02.89-06.93	OM 602.912	5	13	RP4452
250 T D Kombi (TYP 124)	2,5	69	02.89-06.93	OM 602.912	5	13	RP4452
250 Turbo-D Kombi (TYP 124)	2,5	93	02.89-06.93	OM 602.962	5	13	RP4452
290 GD	2,9	70	04.92-	OM 602.942	5	13	RP4452
290 GDT (TYP 461)	2,9	90	07.97-	OM602.983	5	83	RP8342
300 CD, D (TYP 123)	3,0	57	08.80-08.81	OM 617 A	5	11	RP4444
300 D (TYP 124)	3,0	80-83	12.84-01.89	OM 603.912	6	11	RP4444
300 D (TYP 124)	3,0	80-83	02.89-06.93	OM 603.912	6	13	RP4452
300 D 4-MATIC (TYP 124)	3,0	80-83	09.86-01.89	OM 603.913	6	11	RP4444
300 D 4-MATIC (TYP 124)	3,0	80-83	02.89-06.93	OM 603.913	6	13	RP4452
300 D 4-matic Kombi (TYP 124)	3,0	80	02.89-08.92	OM 603.913	6	13	RP4452
300 D 4-matic Kombi (TYP 124)	3,0	83	08.89-06.93	OM 603.913	6	13	RP4452
300 D, TD (TYP 123)	3,0	59-65	09.77-07.80	OM 617 A	5	19	RP6122
300 D, TD (TYP 123)	3,0	59-65	08.80-11.85	OM 617 A	5	11	RP4444
300 GD (TYP 460)	3,0	65	12.79-07.80	OM 617.931	5	19	RP6122
300 GD (TYP 460)	3,0	65	08.80-01.89	OM 617.931	5	11	RP4444
300 GD (TYP 463)	3,0	83	02.89-06.93	OM 603.931	6	13	RP4452
300 SD (TYP 140)	3,0	110	02.92-09.92	OM 603.971	6	13	RP4452
300 SD (TYP 140)	3,5	110	10.92-04.93	OM 603.971	6	13	RP4452
300 SD TD (TYP 126)	3,0	110	08.80-10.85	OM 617.951	5	11	RP4444
300 SDL TD (TYP 126)	3,0	107-110	11.85-12.87	OM 603.961	6	11	RP4444
300 T D Kombi (TYP 124)	3,0	80	09.86-01.89	OM 603.912	6	11	RP4444
300 T D Kombi (TYP 124)	3,0	80	02.89-06.93	OM 603.912	6	13	RP4452
300 T D Kombi (TYP 124)	3,0	81	01.89-06.93	OM 603.912	6	13	RP4452
300 T D Kombi (TYP 124)	3,0	83	02.89-06.93	OM 603.912	6	13	RP4452
300 TD (TYP 123)	3,0	92	10.80-11.85	OM 617.952	5	11	RP4444
300 TD (TYP 124)	3,0	92	12.84-01.89	OM 603.960	6	11	RP4444
300 TD (TYP 124)	3,0	92	02.89-06.93	OM 603.960	6	13	RP4452
300 TD (TYP 124)	3,0	105-108	01.88-01.89	OM 603.960	6	11	RP4444
300 TD (TYP 124)	3,0	105-108	02.89-06.93	OM 603.960	6	13	RP4452
300 TD 4-MATIC (TYP 124)	3,0	105-108	09.86-01.89	OM 603.963	6	11	RP4444
300 TD 4-MATIC (TYP 124)	3,0	105-108	02.89-06.93	OM 603.963	6	13	RP4452
300 Turbo-D 4-matic Kombi (TYP 124)	3,0	105	09.86-01.89	OM 603.963	6	11	RP4444
300 Turbo-D 4-matic Kombi (TYP 124)	3,0	108	02.89-06.93	OM 603.963	6	13	RP4452
300 Turbo-D Kombi (TYP 124)	3,0	105	09.86-01.89	OM 603.963	6	11	RP4444



Model	CC	Kw	Year	Engine	Cyl	Pict	Code
300 Turbo-D Kombi (TYP 124)	3,0	108	02.89-06.93	OM 603.960	6	13	RP4452
307 D	2,4	48	05.77-08.82	OM 616	4	19	RP6122
307 D	2,4	53	09.82-09.88	OM 616	4	11	RP4444
308 D	2,3	58-60	10.88-	OM 601.940	4	13	RP4452
309 D	3,0	65	04.82-09.88	OM 617.913	5	11	RP4444
310 D	2,9	70-72	10.88-	OM 602.940	5	13	RP4452
350 GD (TYP 463)	3,5	100	02.91-06.93	OM 603.972	6	13	RP4452
350 SD, SDL (USA)	3,5	115	02.89-06.91	OM 603	6	13	RP4452
350 SD, SDL TD (TYP 126)	3,5	100	03.90-06.91	OM 603.970	6	13	RP4452
407 D	2,4	48	07.82-	OM 616	4	19	RP6122
407 D	2,4	53	07.81-09.88	OM 616	4	11	RP4444
408 D	2,3	58-60	10.88-	OM 601	4	13	RP4452
409 D	3,0	65	04.82-08.88	OM 617.913	5	11	RP4444
410 D	2,9	70-72	10.88-	OM 602	5	13	RP4452
507 D	2,4	53	04.82-09.88	OM 616.914	4	11	RP4444
508 D	2,3	58	03.89-	OM 601	4	13	RP4452
A 160 CDI	1,7	55	02.01-	---	4	106	RP8406
A 160 CDI (TYP 168)	1,7	44	07.98-02.01	OM 668.941	4	106	RP8406
A 160 CDI (W169)	2,0	60	09.04-	OM 640.942	4	170	RP8924
A 170 CDI (TYP 168)	1,7	66-70	01.98-	OM 668.940	4	106	RP8406
A 180 CDI	2,0	80	09.04-	OM640.940	4	170	RP8924
A 200 CDI	2,0	103	09.04-	OM640.941	4	170	RP8924
A-CLASS (169) A160 CDI	2,0	---	09.04-	OM640.942	4	170	RP8924
B 180 (W245) CDI	2,0	80	03.05-	---	4	170	RP8924
B 200 (W245) CDI	2,0	103	03.05-	---	4	170	RP8924
C 180 D (TYP 202)	1,8	65	10.98-05.00	OM 604	4	90	RP8358
C 200 CDI (TYP 202)	2,0	75	03.98-05.00	OM 611.960	4	95	RP8374
C 200 CDI (TYP W203)	2,0	75	02.01-	---	4	95	RP8374
C 200 CDI (TYP W203)	2,0	85	09.00-	OM 611.962	4	95	RP8374
C 200 CDI (TYP W203)	2,0	90	04.03-	---	4	95	RP8374
C 200 D (TYP 202)	2,0	55	07.93-05.00	OM 601.913	4	13	RP4452
C 200 D (TYP 202)	2,0	65	10.96-05.00	OM 604.915	4	90	RP8358
C 200 TD (TYP S202)	2,0	65	10.96-03.01	OM 604.915	4	90	RP8358
C 220 CDI (CL203) Sportcoupe	2,2	110	02.04-	OM 646.963	4	95	RP8374
C 220 CDI (TYP 202)	2,2	75	06.98-	OM611.961	4	95	RP8374
C 220 CDI (TYP 202)	2,2	92	09.97-05.00	OM 611.960	4	95	RP8374
C 220 CDI (TYP 203)	2,2	85	09.00-	OM 611.960	4	95	RP8374
C 220 CDI (TYP W203)	2,2	105	05.00-	OM 611.962	4	95	RP8374
C 220 CDI (W202)	2,2	74	03.98-05.00	OM 611.960	4	95	RP8374
C 220 CDI (W203)	2,2	105	05.00-	OM 611.962	4	95	RP8374
C 220 CDI (W203)	2,2	110	02.04-	OM 646.963	4	95	RP8374
C 220 D (TYP 202)	2,2	70	07.93-05.95	OM 604.910	4	80	RP8320
C 220 D (TYP 202)	2,2	70	06.95-05.00	OM 604.910	4	90	RP8358
C 220 D (W202)	2,2	55	07.96-05.00	OM 604.910	4	80	RP8320



Model	CC	Kw	Year	Engine	Cyl	Pict	Code
C 220 D (W202)	2,2	55	07.96-05.00	OM 604.910	4	90	RP8358
C 250 D (TYP 202)	2,5	83	07.93-01.95	OM 605.910	5	80	RP8320
C 250 D (TYP 202)	2,5	83	02.95-08.95	OM 605.910	5	90	RP8358
C 250 TD (TYP 202)	2,5	110	05.96-05.00	OM 605.960	5	90	RP8358
C 250 Turbo- D (TYP 202)	2,5	110	10.95-05.00	OM 605.960	5	90	RP8358
C 270 CDI (TYP 203)	2,7	125	12.00-	OM 612.962	5	95	RP8374
C 30 CDI AMG (S 203)	3,0	170	01.03-	OM 612	5	181	RP9008
C 30 Coupè CDI AMG (CL 203)	3,0	170	09.02-	OM 612	5	181	RP9008
C 30 T CDI (TYP 203)	3,0	170	01.03-	OM 612 AMG	5	181	RP9008
C 320 CDI	3,0	165	01.05-	---	6	170	RP8924
C 320 CDI	3,0	165	01.06-	---	6	170	RP8924
C 350 CDI / 4-matic (W204)	3,0	165	07.09-	OM 642.961	6	170	RP8924
CLK 220 CDI	2,1	110	01.05-	OM646.963 / OM646.963	4	170	RP8924
CLK 270 CDI	2,7	125	10.02-	OM 612.962/OM 612.967	5	95	RP8374
CLK 320 CDI	3,0	165	01.05-	OM642.910	5	170	RP8924
CLS 320 CDI	3,0	165	01.05-	---	6	170	RP8924
E 200 CDI (TYP 210)	2,0	75	06.98-	OM 611.961	4	95	RP8374
E 200 CDI (TYP 210)	2,0	85	07.99-03.02	OM 611.961	4	95	RP8374
E 200 CDI (TYP 211)	2,0	75	07.02-	---	4	95	RP8374
E 200 CDI (TYP 211)	2,0	90	07.02-	---	4	95	RP8374
E 200 D (TYP 124)	2,0	53-55	07.93-05.95	OM 601.912	4	13	RP4452
E 200 D (TYP 210)	2,0	65	01.96-	OM 604.917	4	90	RP8358
E 220 CDI (TYP 210)	2,2	92	06.98-	OM 611.961	4	95	RP8374
E 220 CDI (TYP 210)	2,2	105	07.99-03.02	OM646.963 / OM646.963	4	95	RP8374
E 220 CDI (TYP 211)	2,2	110	03.02-	OM 611.962	4	95	RP8374
E 220 CDI (TYP 211)	2,2	110	03.02-	OM 646.961	4	95	RP8374
E 220 D (TYP 210)	2,2	55	05.96-03.02	OM 604.912	4	90	RP8358
E 220 D (TYP 210)	2,2	70	03.95-	OM 604.912	4	90	RP8358
E 250 D (TYP 124)	2,5	83	07.93-05.95	OM 605.911	5	80	RP8320
E 250 D (TYP 124)	2,5	66-69	07.93-05.95	OM 602.912/OM 602.962	5	13	RP4452
E 250 D (TYP 210)	2,5	83	03.95-07.99	OM 605.912	5	90	RP8358
E 250 D T (TYP 124)	2,5	83	07.93-04.95	OM 605.911	5	80	RP8320
E 250 D T (TYP 124)	2,5	83	07.93-04.96	OM 605.911	5	90	RP8358
E 250 Turbo-D (TYP 124)	2,5	93	06.93-06.95	OM 602.962	5	13	RP4452
E 250 Turbo-D (TYP 210)	2,5	110	06.97-07.99	OM 605.962	5	90	RP8358
E 270 CDI (TYP 210)	2,7	105	07.99-	OM612.961	5	95	RP8374
E 270 CDI (TYP 210)	2,7	125	07.99-03.02	OM 612.961	5	95	RP8374
E 270 CDI (TYP 211)	2,7	130	03.02-	OM 647.961	5	95	RP8374
E 280 CDI	3,0	140	03.05-	OM642.920	6	170	RP8924
E 280 CDI (TYP 211)	3,2	130	05.04-	OM648.961	6	95	RP8374
E 280 CDI / 4-matic / Kombi	3,0	140	03.05-	OM 642.920 / OM 642.921	6	170	RP8924
E 290 TD (TYP 210)	2,9	95	06.95-	OM 602.982	5	83	RP8342
E 300 D (TYP 124)	3,0	100	07.93-05.95	OM 606.910	6	80	RP8320
E 300 D (TYP 210)	3,0	100	06.95-06.97	OM 606.912	6	90	RP8358



Model	CC	Kw	Year	Engine	Cyl	Pict	Code
E 300 TD (TYP 124)	3,0	100	06.95-06.96	OM 606.910	6	90	RP8358
E 300 TD (TYP 124)	3,0	108	07.93-05.95	OM 603.960	6	13	RP4452
E 300 TD (TYP 210)	3,0	130	12.96-07.99	OM 609.962	6	90	RP8358
E 300 TD 4 Matic(TYP 124)	3,0	108	07.93-05.95	OM 603.960	6	13	RP4452
E 300 TD, T (TYP 210)	3,0	130	03.97-	OM606.962	6	80	RP8320
E 320 CDI (TYP 210)	3,2	145	07.99-	OM 613.961	6	95	RP8374
E 320 CDI (TYP 211)	3,2	150	11.02-	---	6	95	RP8374
E 320 CDI 4-matic / Kombi	3,0	165	03.05-	---	6	170	RP8924
E 320 T CDI 4-matic Kombi	3,0	165	03.05-	---	6	170	RP8924
E 320 T CDI Kombi	3,0	165	03.05-	---	6	170	RP8924
E 400 CDI (TYP 211)	4,0	191	02.03-	---	8	95	RP8374
E 420 CDI	4,0	231	01.06-	---	8	170	RP8924
G 250 GD (TYP 460)	2,5	62	10.87-01.89	OM 602.930	5	11	RP4444
G 250 GD (TYP 460)	2,5	62	02.89-12.92	OM 602.930	5	13	RP4452
G 250 GD (TYP 460)	2,5	68	12.88-01.89	OM 602.930	5	11	RP4444
G 250 GD (TYP 460)	2,5	68	02.89-08.92	OM 602.930	5	13	RP4452
G 250 GD (TYP 461)	2,5	68	02.90-	OM 602.939	5	13	RP4452
G 250 GD (TYP 463)	2,5	69	06.90-	OM 302.931	5	13	RP4452
G 250 GD (W460)	2,5	68	12.88-08.92	---	5	67	RP8246
G 270 CDI (TYP 461/463)	2,7	115	10.01-	OM 612.966	5	95	RP8374
G 290 D, TD (TYP 461)	2,9	72-88	08.93-	OM 602.942/947	5	13	RP4452
G 290 GD/G (TYP 461)	2,9	70	04.92-	OM 602.942	5	13	RP4452
G 290 TD (TYP 461)	2,9	88	07.97-09.01	OM 602.983	5	13	RP4452
G 300 D (TYP 463)	3,0	83	08.93	OM 603.931	6	13	RP4452
G 300 GD (TYP 463)	3,0	83	09.89-	OM 603.931	6	13	RP4452
G 300 GD Cabrio (TYP 463)	3,0	83	12.90-09.97	OM 603.931	6	13	RP4452
G 300 TD (TYP 463) / Cabrio	3,0	130	08.96-	OM 606.964	6	90	RP8358
G 350 G Turbo D (TYP 463)	3,5	100	09.91-06.93	OM 603.972	6	13	RP4452
G 350 G Turbo-D Cabrio (TYP 463)	3,5	100	09.91-09.97	OM 603.972	6	13	RP4452
G 400 CDI (TYP 463)	4,0	184	07.00-	OM 628.962	6	95	RP8374
G 400 CDI (TYP 463) / Cabrio	4,0	184	12.00-	OM 628.962	8	95	RP8374
GL 320 CDI	3,0	165	09.06-	OM642.822	6	170	RP8924
GL 420 CDI	4,0	225	09.06-	OM629.912	8	170	RP8924
MB 100	2,4	43	02.89-	OM615.970	4	11	RP4444
MB 100 D	2,4	56	09.87-01.89	OM 616.963	4	11	RP4444
MB 100 D	2,4	56	02.89-	OM 616.963	4	13	RP4452
MB 180 D	2,4	56	01.87-01.89	OM 616.963-01	4	11	RP4444
MB 180 D	2,4	56	02.89-	OM 616.963-01	4	13	RP4452
M-CLASS (164) 420 CDi Diesel 4 Matic	4,2	225	02.06-	OM629.912	8	170	RP8924
ML 270 CDI (TYP 163)	2,7	120	02.98-	OM 612.963	5	95	RP8374
ML 280 CDI	3,0	140	07.05-	OM642.940	6	170	RP8924
ML 320 CDI	3,0	164	07.05-	OM642.940	6	170	RP8924
ML 400 CDI (TYP 163)	4,0	184	09.01-	---	8	95	RP8374
ML 420 CDI (W164) 4-matic	4,0	225	02.06-	OM 692-912	8	170	RP8924



Model	CC	Kw	Year	Engine	Cyl	Pict	Code
R 280 CDI (W251)	3,0	140	05.06-	OM 642.950	6	170	RP8924
R 320 CDI	3,0	165	01.06-	OM6422.950	6	170	RP8924
R-CLASS (251) 280 CDi Diesel 4 Matic	2,8	140	05.06-	OM6422.950	6	170	RP8924
R-CLASS 320 CDI Diesel 4-matic	3,2	165	01.06-	OM6422.950	6	170	RP8924
S 300 TD (TYP 140)	3,0	130	05.96-	OM 606.961	6	90	RP8358
S 302 CDI (TYP 220)	3,2	145	01.00-	OM 613.960	6	95	RP8374
S 320 CDI (TYP 220)	3,2	145	01.00-09.02	OM 613.960	6	95	RP8374
S 320 CDI (TYP 220)	3,2	150	09.02-	OM 648.960	6	95	RP8374
S 320 CDI (W221), Coupé (C216)	3,0	173	12.05-	OM 642.930	6	170	RP8924
S 350 TD (TYP 140)	3,5	110	01.93-04.95	OM 603.971	6	13	RP4452
S 400 CDI (TYP 220)	4,0	184	01.00-	OM 628.960	8	95	RP8374
S 400 CDI (TYP 220)	4,0	191	06.03-	OM 628.960	8	95	RP8374
S 420 CDI (W221), Coupé (C216)	4,0	235	10.06-	---	8	170	RP8924
S-CLASS (221) 320 CDi Diesel	3,0	---	12.05-	OM642.930	6	170	RP8924
S-CLASS (221) 420 CDi Diesel	4,0	---	10.06-	OM629.911	8	170	RP8924
V 200 CDI	2,0	75	03.99-	OM 611.960	4	95	RP8374
V 220 CDI	2,2	90	03.99-	OM 611.980	4	95	RP8374
V 230 TD	2,3	72	09.96-	OM 601.970	4	13	RP4452
Vaneo CDI	1,7	55-67	01.00-	OM 668	4	106	RP8406
Viano (W639) CDI	2,0	85	08.05-	OM 646.982	4	95	RP8374
Viano (W639) CDI	2,2	80	09.03-	OM 646.982	4	95	RP8374
Viano CDI	2,0	80	09.03-	---	4	95	RP8374
Viano CDI	2,2	110	09.03-	OM 646.982	4	95	RP8374
<b>MERCEDES VAN</b>							
100 D (TYP 631)	2,4	41	12.90-12.94	OM 616	4	13	RP4452
100 D (TYP 631)	2,4	53	02.88-05.92	OM 616.963	4	11	RP4444
100 D (TYP 631)	2,4	55	12.90-02.96	OM 616/OM 616.963	4	13	RP4452
O 309 D	2,4	48	01.75-08.82	OM 616.910	4	19	RP6122
O 309 D	2,4	53	09.82-02.89	OM 616.937 / 939	4	11	RP4444
Sprinter 208 CDI	2,2	60	04.00-	OM 611 A	4	95	RP8374
Sprinter 208 D	2,3	58-60	02.95-04.00	OM 601.943	4	13	RP4452
Sprinter 210 D	2,9	75	01.97-	OM 602.986	5	83	RP8342
Sprinter 211 CDI	2,2	80	04.00-	---	4	95	RP8374
Sprinter 212 D	2,9	90	02.95-02.96	OM 602.980.10 DELA Mot.9849	5	11	RP4444
Sprinter 212 D	2,9	90	02.96-	OM 602.980.10 DELA Mot.9850	5	83	RP8342
Sprinter 212 D Automatic	2,9	90	02.95-04.00	OM 602.980.12 DELA Mot.137	5	83	RP8342
Sprinter 212 D Automatic	2,9	90	02.95-04.00	OM 602.980.12 DELA Mot.136	5	11	RP4444
Sprinter 213 CDI	2,2	95	04.00-	OM 611.960	4	95	RP8374
Sprinter 216 CDI	2,7	115	04.00-	OM 612	5	95	RP8374
Sprinter 308 CDI	2,2	60	04.00-	OM 611 A	4	95	RP8374
Sprinter 308 D	2,3	58	04.95-	OM 601.943	4	13	RP4452
Sprinter 310 D	2,9	75	05.97-	OM 602.986	5	83	RP8342
Sprinter 311 CDI	2,2	80	04.00-	OM 611.981	4	95	RP8374
Sprinter 312 D	2,9	90	02.96-	OM 602.980.10 DELA Mot.9850	5	83	RP8342



Model	CC	Kw	Year	Engine	Cyl	Pict	Code
Sprinter 312 D	2,9	90	04.95-	OM 602.980.10 DELA Mot.9849	5	11	RP4444
Sprinter 312 D Automatic	2,9	90	02.95-04.00	OM 602.980.12 DELA Mot.136	5	11	RP4444
Sprinter 312 D Automatic	2,9	90	02.95-04.00	OM 602.980.12 DELA Mot.137	5	83	RP8342
Sprinter 313 CDI	2,2	95	04.00-	OM 611.960	4	95	RP8374
Sprinter 316 CDI	2,7	115	04.00-	---	5	95	RP8374
Sprinter 4,6-t Pianale piatto/Telaio (906) 415 CDI (906.153, 906.155, 906.253, 906.255)	2,0	110	06.06-	OM 646.990	4	95	RP8374
Sprinter 408 CDI	2,2	60	12.99-	---	4	95	RP8374
Sprinter 408 D	2,3	58	04.95-	OM 601.943	4	13	RP4452
Sprinter 410 D	2,9	75	05.97	OM 602.986	5	83	RP8342
Sprinter 410 D	2,9	75	02.96-03.00	OM 602.980 Mot.9849	5	11	RP4444
Sprinter 410 D Automatic	2,9	75	02.96-03.00	OM 602.980 Mot.136	5	11	RP4444
Sprinter 410 D Automatic	2,9	75	02.96-03.00	OM 602.980	5	83	RP8342
Sprinter 411 CDI	2,2	80	12.99	---	4	95	RP8374
Sprinter 412 D	2,9	90	04.95-	OM 602.980.10 DELA Mot.9850	5	11	RP4444
Sprinter 412 D	2,9	90	04.95-	OM 602.980.10 DELA Mot.9849	5	11	RP4444
Sprinter 412 D Automatic	2,9	90	02.96-03.00	OM 602.980.12 DELA Mot.136	5	11	RP4444
Sprinter 412 D Automatic	2,9	90	02.96-03.00	OM 602.980.12 DELA Mot.137	5	83	RP8342
Sprinter 413 CDI	2,2	95	04.00-	---	4	95	RP8374
Sprinter 416 CDI	2,7	115	04.00-	---	4	95	RP8374
T1 208 D (TYP 601)	2,3	58	10.88-02.96	OM 601.940	4	13	RP4452
T1 208 D (TYP 601)	2,3	60	10.88-02.96	OM 601.940	4	13	RP4452
T1 210 D (TYP 601)	2,9	70-72	11.88-02.96	OM 602.940	5	13	RP4452
T1 308 D (TYP 602)	2,3	58	05.90-02.96	OM 601.940	4	13	RP4452
T1 308 D (TYP 602)	2,3	60	06.89-02.96	OM 601.940	4	13	RP4452
T1 310 D (TYP 602)	2,9	70	06.89-02.96	OM 602.940	5	13	RP4452
T1 310 D (TYP 602)	2,9	72	06.90-02.96	OM 602.940	5	13	RP4452
Unimog 100 L	2,9	71	11.92-	OM 602.248	5	13	RP4452
Unimog 421	2,0	34-40	01.66-09.75	OM 621	4	19	RP6122
Unimog 600/650	2,4	38-44	01.88-	OM 616	4	11	RP4444
Unimog U 34	1,8	25	01.65-09.75	OM 636.914	4	19	RP6122
Unimog U 52	2,5	38	05.69-12.76	OM 616.915	4	19	RP6122
Unimog U 60	2,5	44	05.69-12.76	OM 619.930	4	19	RP6122
Unimog U 90	3,0	65	11.92-	OM 602.941	5	13	RP4452
Vario Cassone/Furgonato/Promiscuo 512 D (667.351, 667.352, 667.353)	2,9	90	09.96-	OM 602.984	5	83	RP8342
Vario Cassone/Furgonato/Promiscuo 612 D (668.351, 668.352, 668.353)	2,9	90	09.96-	OM 602.984 / OM 602.985	5	83	RP8342
Vario Cassone/Furgonato/Promiscuo 812 D (670.351, 670.352, 670.353)	2,9	90	09.96-	OM 602.984 / OM 602.985	5	83	RP8342
Vario Painale piatto/Telaio 612 D (668.321, 668.322, 668.323)	2,9	90	09.96-	OM 602.984 / OM 602.985	5	83	RP8342



Model	CC	Kw	Year	Engine	Cyl	Pict	Code
Vario Pianale piatto/Telaio 512 D (667.321, 667.322, 667.323)	2,9	90	09.96-	OM 602.984 LA	5	83	RP8342
Vario Pianale piatto/Telaio 812 D (670.321, 670.323, 670.324)	2,9	90	09.96-	OM 602.984 / OM 602.985	5	83	RP8342
Vario Ribaltabile 812 D (670.331, 670.332)	2,9	90	09.96-	OM 602.984 / OM 602.985	5	83	RP8342
Vito 108 CDI	2,2	60	03.99-	OM 611A	4	95	RP8374
Vito 108 D	2,3	58	02.96-	OM 601.942	4	13	RP4452
Vito 109 CDI	2,2	65	09.03-	---	4	95	RP8374
Vito 109 CDI	2,2	70	09.06-	---	4	95	RP8374
Vito 110 CDI	2,2	75	03.98-	OM 611.960	4	95	RP8374
Vito 110 TD	2,3	72	02.96	OM 601.970	4	13	RP4452
Vito 112 CDI	2,2	90	03.99-	OM 611.980	4	95	RP8374
Vito CDI	2,0	80	09.03-	---	4	95	RP8374
Vito CDI	2,2	110	09.03-	---	4	95	RP8374
<b>MG</b>							
MG ZS TD	2,0	74	01.04-	---	4	82	RP8390
MG ZS TD	2,0	83	01.04-	---	4	82	RP8390
MG ZT CDTi	2,0	85	06.02-09.03	204D2	4	134	RP8626
MG ZT CDTi	2,0	96	11.02-	204D2	4	134	RP8626
<b>MINI</b>							
Mini (R56) Cooper D	1,6	82	06.10-	N47 C16 A	4	190	RP8474
Mini (R56) Cooper D	1,9	82	02.11-	N47 C20 A	4	190	RP8474
Mini (R56) Cooper SD	1,9	105	02.11-	N47 C20 A	4	190	RP8474
Mini (R56) One D	1,6	66	07.10-	N47 C16 A	4	190	RP8474
Mini Cabriolet (R57) Cooper D	1,6	82	06.10-	N47 C16 A	4	190	RP8474
Mini Cabriolet (R57) Cooper D	1,9	82	02.11-	N47 C20 A	4	190	RP8474
Mini Cabriolet (R57) Cooper SD	1,9	105	02.11-	N47 C20 A	4	190	RP8474
Mini Clubman (R55) Cooper D	1,6	82	03.10-	N47 C16 A	4	190	RP8474
Mini Clubman (R55) Cooper D	1,9	82	02.11-	N47 C20 A	4	190	RP8474
Mini Clubman (R55) Cooper SD	1,9	105	02.11-	N47 C20 A	4	190	RP8474
Mini Clubman (R55) One D	1,6	66	03.10-	N47 C16 A	4	190	RP8474
Mini Countryman (R60) Cooper D / ALL4	1,6	82	06.10-	N47 C16 A	4	190	RP8474
Mini Countryman (R60) Cooper D / ALL4	1,9	82	02.11-	N47 C20 A	4	190	RP8474
Mini Countryman (R60) Cooper SD / ALL4	1,9	105	02.11-	N47 C20 A	4	190	RP8474
Mini Countryman (R60) One D	1,6	66	06.10-	N47 C16 A	4	190	RP8474
Mini Coupè (R58) Cooper SD	1,9	105	09.11-	N47 C20 A	4	190	RP8474
Mini D	1,6	80	03.07-	W16 D16	4	117	RP8436
Mini One D	1,4	55	06.03-	1 ND	4	142	RP8644
Mini One D	1,4	65	06.03-	---	4	142	RP8644
<b>MITSUBISHI</b>							
1300 Mini Bus/Van	---	---	---	4D56	4	50	RP6818
Canter	---	---	---	4D56	4	50	RP6818
Canter	---	---	---	4DR51	4	39	RP6678





Model	CC	Kw	Year	Engine	Cyl	Pict	Code
Canter D35/D55 [FB]	3,0	92	11.00-	4M42	4	163	RP8904
Canter N-FE101, 111, 121, 211	---	---	05.83-09.85	4D30	4	69	RP8118
Carisma	1,9	59	---	F9QT	4	133	RP8624
Carisma (DA_) DI-D	1,9	85	09.00-06.06	F9Q2	4	133	RP8624
Carisma (DA_) DI-D (DA5A)	1,9	75	09.00-06.06	F9Q1	4	133	RP8624
Carisma TD	1,9	66	10.96-	F8Q	4	8	RP4422
Carisma Tre volumi (DA_) DI,D (DA5A)	1,9	75-85	09.00-06.06	F9Q2	4	133	RP8624
Challenger	2,5	---	11.98-	---	4	87	RP8896
Colt GLD / GLX	1,8	43-44	02.84-05.92	4D56	4	50	RP6818
Colt V DI-D	1,5	70	08.04-	0M639	4	119	RP8440
Delica Van R2	---	---	06.99-	KG-SK22MM/KJ-SK22VM	4	55	RP8364
Engine MM35	---	---	---	BOBCAT	---	77	RP8256
Galant III Turbo-D	1,8	60	06.84-12.87	4 D 65 T	4	50	RP8150
Galant KOMBI TD	2,3	62	09.81-05.84	4D55T	4	50	RP6818
Galant SIGMA	2,3	62-70	01.80-12.84	4D55, 4D55T	4	50	RP8150
Galant TD	2,3	62-70	05.80-05.84	4D55T	4	50	RP6818
Galant V GLSTD	2,0	66	11.92-08.96	---	5	87	RP8896
Galant VI TDI / Station Wagon	2,0	66	09.96-	---	4	87	RP8896
Galloper TD	2,5	73	98-	D4BH	4	128	RP8614
Grandis DI-D	2,0	100	09.05-	BSY	4	178	RP9002
L 200	2,3	49	04.83-10.86	4D55	4	50	RP6818
L 200 4 WD	2,3	49	04.83-10.86	4D55	4	50	RP8150
L 200 D	2,5	51	11.86-08.96	---	4	87	RP8896
L 200 D	2,5	55	06.96-	---	5	87	RP8896
L 200 D 2WD/D Turbo 4WD [K0-K3]	2,5	54	11.93-03.01	4D56 / 4D56T / SOHC	4	87	RP8896
L 200 D 4WD [K6/K7]	2,5	64	11.92-06.01	4D56	4	87	RP8896
L 200 TD 4WD	2,5	85	09.01-	---	4	87	RP8896
L 200 TD 4x4	2,5	73	06.96-	---	4	87	RP8896
L 200 TD 4x4	2,5	74	11.01-	---	4	87	RP8896
L 300	2,5	51	11.86-	4D56	4	50	RP6818
L 300 , 4WD	2,3	50	04.83-10.86	4D55	4	50	RP6818
L 300 4WD	2,5	64	11.88-05.93	4 D 56 T	4	50	RP6818
L 300 D	2,5	51	11.86-	---	4	87	RP8896
L 300 D	2,5	64	11.94-	---	5	87	RP8896
L 300 D 2WD Van [P] / Wagon [P]	2,5	51	06.93-12.00	4D56	4	87	RP8896
L 400 Bus TD	2,5	64	06.96-	---	4	87	RP8896
L 400 TD	2,5	73	12.94-	4D56	4	128	RP8614
Lancer D	1,8	44	09.86-04.88	4D65	4	50	RP6818
Lancer V Diesel	2,0	50	06.92-	---	4	87	RP8896
Lancer V Station Wagon GLX D	2,0	50	12.92-	---	5	87	RP8896
Montero	---	---	92-93	4D56	4	50	RP6818
Montero	---	---	94-95	4D56	4	128	RP8614
Montero/Sport	---	---	97-	4D56	4	87	RP8896



Model	CC	Kw	Year	Engine	Cyl	Pict	Code
Outlander DI-D	2,0	103	06-	---	4	179	RP9004
Outlander DI-D	2,0	---	02.07	---	4	178	RP9002
Outlander II (CW_W) DI-D 4WD	2,2	115	08.07-	4HK / 4HN	4	118	RP8438
Pajero	2,8	92	06.94-04.00	4M40	4	127	RP8612
Pajero Classic (V2-W) DI-D	3,2	118	05.05-	---	---	163	RP8904
Pajero D Cabrio [V]	2,5	62	04.91-05.99	4D56	4	87	RP8896
Pajero DI-D	3,2	118	04.00-	---	4	163	RP8904
Pajero DI-D [V]	3,2	121	02.00-	4M41	4	163	RP8904
Pajero I TD	2,5	64	01.90-11.90	4 D 56 T	4	50	RP6818
Pajero I TD	2,5	70	11.89-11.90	4 D 56 T	4	50	RP6818
Pajero I TD Canvas Top	2,5	62-70	05.86-11.90	4 D 56 T	4	50	RP6818
Pajero II Canvas Top TD	2,5	73	12.90-04.00	---	4	87	RP8896
Pajero II TD	2,5	73	12.90-06.93	4D56	4	50	RP6818
Pajero II TD	2,5	73	12.90-04.00	---	4	87	RP8896
Pajero III (V60-V70) DI-D	3,2	118	10.01-	---	---	163	RP8904
Pajero Montero, Shogun	2,3	62-64	05.82-11.82	4D55	4	50	RP8150
Pajero TD	2,3	62-64	05.82-11.82	4D55	4	50	RP6818
Pajero TD [V]	2,5	62	08.93-05.99	4D56	4	87	RP8896
ROSA N-BE211	---	---	02.83-	4D30	4	69	RP8118
Shogun	2,5	---	1985-12.90	4D56	4	50	RP6818
Shogun	2,5	---	1994-1995	4D56	4	128	RP8614
Shogun	2,5	---	01.96-03.00	4D56	4	50	RP8150
Shogun IV Di-D	3,2	---	02.07-	---	4	163	RP8904
Shogun MKIII 3.2 DI-D Diesel	3,2	134	10.01-	4M41	4	163	RP8904
Sigma	---	---	80-	4D55	---	50	RP6818
Space Gear D Turbo 2WD	2,5	64	06.94-05.95	4D56	4	87	RP8896
Space Gear TD	2,5	73	05.95-	---	4	87	RP8896
Space Gear TD / 4x4	2,5	73	05.95-	---	4	87	RP8896
Space Runner TD GLX	2,0	60	10.92-08.99	---	5	87	RP8896
Space Star	1,9	59	---	F9QT	4	133	RP8624
Space Star (DG0) DI-D	1,9	85	10.02-12.04	F9Q1	4	133	RP8624
Space Star (DG0) DI-D (DG4A)	1,9	75	02.01-12.04	F9Q1	4	133	RP8624
Space Wagon TD GLX	2,0	60	10.92-10.98	---	5	87	RP8896
Truck, 4WD	---	---	83-	4D55T	---	50	RP8150
<b>MULTICAR</b>							
M21	---	---	-05.81	2 KD 8/8 - 2	2	19	RP6056
M24	2,0	33	-12.88	4 VD 8,8 / 8,5 - 13 RF4	4	100	RP8394
M25	2,0	33	01.78-12.92	4 VD 8,8 / 8,5 - 13 RF	4	8	RP4422
M25/1	1,9	40	01.91-12.92	1 Y VW 028B	4	8	RP4422
M26	1,9	40	01.92-12.94	1 Y VW 028B	4	8	RP4422
<b>NISSAN</b>							
Almera	2,0	55	07.95-2000	CD20E	4	122	RP8602
Almera	2,2	82	02.2000-2003	YD22DDT	4	175	RP8936
Almera II / Hatchback (N16) dCi	1,5	60	01.03-11.06	K9K 722	4	133	RP8624
Almera II dCi	2,2	82	09.03-	YD22DDT	4	175	RP8936



Model	CC	Kw	Year	Engine	Cyl	Pict	Code
Almera II Di	2,2	81	03.00-	YD22DDT	4	175	RP8936
Almera Tino dCi	2,2	100	09.03-	---	4	175	RP8936
Almera Tino Di	2,2	84	08.00-	YD22ET	4	175	RP8936
Bassara	2,5	---	---	---	4	175	RP8936
Bluebird	2,0	---	01.81-	LD20/LD20T	4	72	RP8164
Bluebird	2,8	---	08.81-	LD28	---	72	RP8164
Bluebird (819/910)	2,0	60	01.80-10.85	LD20T	4	31	RP6830
Bluebird (910)	2,0	48	01.80-05.84	LD20	4	31	RP6608
Bluebird (T72, T12) D (SLT72, T12)	2,0	49	03.86-12.90	---	4	121	RP8600
Bluebird / Station Wagon	2,0	49	01.80-10.85	LD20	4	31	RP6830
Bluebird / Station Wagon	2,8	43	04.84-10.85	LD20	6	31	RP6830
BlueBird D	2,0	43	04.84-10.85	LD20	4	31	RP6830
Bluebird Hatchback (T72, T12) D (FSLT72, T12)	2,0	49	03.86-12.90	---	4	121	RP8600
Brougham TD	2,3	51	01.93-	TD23	4	74	RP8174
C120 / Vanette	2,0	---	1987-	LD20	---	121	RP8600
C120 / Vanette QGS Type 1	2,0	---	09.82-	LD20	---	31	RP6830
Caball	3,0	---	12.81-	ED30	---	43	RP8158
Caball D	2,2	47	01.82-	SD22	4	47	RP8162
Cabstar	2,5	---	---	TD25	---	74	RP8174
Cabstar	3,3	---	---	ED33	---	43	RP8158
Cabstar D	2,2	47	01.82-	SD22	4	47	RP8162
Cabstar D	2,3	50	01.82-	23	4	47	RP6838
Cabstar D (F22)	2,5	57	01.82-08.85	SD25	6	47	RP6838
Cabstar D (F22) - 24v -	2,3	54	12.81-	SD23	6	47	RP6800
Cabstar D (F22) - 24v -	2,5	57	01.85-	SD25	6	47	RP6800
Cabstar TD (F22)	2,3	56	10.86-	TD23	6	74	RP8174
Cabstar TD (F22)	2,7	66-73	10.86-	TD25 / TD27	6	74	RP8174
CARAVAN KG-VWE25	---	---	---	ZD30DD/ZD30DDTi eng	4	113	RP8426
Cedric	2,0	---	06.79-	SD20	---	47	RP6838
Cedric	2,2	---	06.79-	SD22	---	47	RP6838
Cedric 220 C/2	2,3	51	01.93-	TD23	4	74	RP8174
Cedric 220 C/2	2,3	50-51	01.84-12.92	SD23	4	47	RP8162
Cedric 280 C	2,8	67	06.82-09.85	LD28	6	31	RP6830
Cedric 280 C	2,8	67	11.79-05.82	LD28	6	31	RP6608
Cedric Gloria KD-UY31	---	---	08.99-	RD28E	6	104	RP8402
Cedric Gloria KD-UY31, UJY31, CUY31, KD-UY33	---	---	06.95-	RD28	6	104	RP8402
Cherry	1,7	45	87-	CD17	4	121	RP8600
Cherry (N 12)	1,7	40	10.82-05.86	CD17	4	56	RP6918
Cherry (N 12)	1,7	45	05.82-05.86	CD17	4	56	RP6918
Civilian	3,0	---	12.81-	ED30	---	43	RP8158
Civilian	3,3	---	04.88-	ED33	---	43	RP8158
Civilian D	2,2	47	01.82-	SD22	4	47	RP8162
Clipper	3,0	---	12.81-	ED30	---	43	RP8158



Model	CC	Kw	Year	Engine	Cyl	Pict	Code
Clipper	3,0	---	12.81-	ED30	---	43	RP8158
Clipper D	2,2	47	01.82-	SD22	4	47	RP8162
D 21	2,7	---	93-	TD27T	---	86	RP8348
D 21 D	2,5	59-61	01.93-	TD25	4	74	RP8174
D 21 D	2,7	73	01.93-	TD27	4	74	RP8174
D 21 D	2,7	73-74	01.93-	TD27T	4	74	RP8174
DELICA VAN	---	---	06.99-	R2/KJ-SK22VM/KG-SK22MM	---	55	RP8364
E 24 D	2,5	59-61	02.87-	TD25	4	74	RP8174
F 22	2,3	---	02.82-	SD23	---	47	RP8162
F 22	3,3	---	---	ED33	---	43	RP8158
F 22 D	2,3	51	11.86-12.93	TD23	4	74	RP8174
F 22 D	2,5	53-55	12.81-08.85	SD25	4	47	RP6838
F 22 D	2,5	59-61	11.86-12.94	TD25	4	74	RP8174
F 22 D	2,7	73	11.86-12.93	TD27	4	74	RP8174
F 22 D - 24v -	2,3	51	02.82-07.85	SD23	4	47	RP6800
F 22 D - 24v -	2,5	53-55	12.81-08.85	SD25	4	47	RP6800
F 22 D (QGS)	2,3	51	02.82-07.85	SD23	4	47	RP6838
F 23 D	2,5	59-61	11.85-12.93	TD25	4	74	RP8174
F 23 D	2,7	73	11.86-12.93	TD27	4	74	RP8174
H 41 D	2,5	59-61	---	TD25	4	74	RP8174
H 41 D	2,7	73	12.86-12.93	TD27	4	74	RP8174
Hommer D	2,2	47	01.82-	SD22	4	47	RP8162
Interstar Autobus (X70) dCi 80	1,9	60	07.02-06.10	F9Q 772	4	133	RP8624
Interstar DCI	2,2	66	07.02	G9T 722	4	109	RP8412
Interstar Furgonato (X70) dCi 80	1,9	60	07.02-06.10	F9Q 772	4	133	RP8624
Junior D	2,5	53-55	01.82-	SD25	4	47	RP6838
Kubistar (X76) dCi	1,5	42	08.03-	K9K 710 / K9K 714	4	133	RP8624
Kubistar (X76) dCi	1,5	45	08.05-	K9K 710 / K9K 714	4	133	RP8624
Kubistar (X76) dCi	1,5	48	08.03-	K9K 704	4	133	RP8624
Kubistar (X76) dCi	1,5	60	08.03-	K9K 722	4	133	RP8624
Kubistar (X76) dCi 70	1,5	50	04.06-	K9K 700	4	133	RP8624
Kubistar (X76) dCi 85	1,5	62	04.06-	K9K 276	4	133	RP8624
Kubistar Furgonato dCi	1,5	45	08.05-	K9K 710 / K9K 714	4	133	RP8624
Kubistar Furgonato dCi	1,5	48	08.03-	K9K 704	4	133	RP8624
Kubistar Furgonato dCi	1,5	60	08.03-	K9K 722	4	133	RP8624
Laurel (C32)	2,8	62	01.85-02.87	LD28	6	123	RP8604
Laurel (C32)	2,8	66	01.85-02.87	RD28	4	31	RP6830
Laurel D	2,0	48-49	10.80-09.81	LD20	4	31	RP6608
Laurel D	2,8	62	10.80-09.81	LD28	6	31	RP6608
Laurel D (C 31)	2,0	48-49	10.81-10.85	LD20	4	31	RP6830
Laurel D (C 31)	2,8	62	01.81-12.84	LD28	6	31	RP6608
Laurel D (C 31)	2,8	62	10.81-10.85	LD28	6	31	RP6830
Laurel KD-SC35	---	---	06.97-08.99	RD28	6	104	RP8402
Laurel KD-SC35	---	---	08.99-	RD28E	6	104	RP8402



Model	CC	Kw	Year	Engine	Cyl	Pict	Code
Micra	1,5	---	04.84-	TUD5	4	88	RP8352
Micra D	1,5	45	02.98-02.03	TD15	4	88	RP8352
Micra DCI	1,5	48	01.93	---	4	133	RP8624
Micra DCI	1,5	60	09.03-	---	4	133	RP8624
Micra III (K12) dCi	1,5	48	01.03-06.10	K9K 704	4	133	RP8624
Micra III (K12) dCi	1,5	50	06.05-09.07	K9K 708	4	133	RP8624
Micra III (K12) dCi	1,5	63	06.05-	K9K 276	4	133	RP8624
Micra III dCi	1,5	60	09.03-	K9K 722	4	133	RP8624
Navara (D40) dCi 4WD	2,5	126	10.06-	YD 25DDTi	4	175	RP8936
Navara D22	---	---	2001-	ZD30DDT eng	4	113	RP8426
Nomad	2,0	---	---	LD20	---	121	RP8600
Note (E11) dCi	1,5	50	03.06-	K9K 700	4	133	RP8624
Note (E11) dCi	1,5	63	03.06-	K9K 276	4	133	RP8624
Note (E11) dCi	1,5	76	07.08-	K9K 292	4	133	RP8624
NP300 dCi 4x4	2,5	98	04.08-	YD 25 DDTi	4	175	RP8936
NV200 Evalia dCi	1,5	63	07.10-	---	4	133	RP8624
NV200 Furgonato dCi	1,5	63	02.10-	---	4	133	RP8624
Pathfinder (R51) dCi 4WD	2,5	126	10.06-	YD 25DDTi	4	175	RP8936
Pathfinder D	2,5	59-61	93-	TD25	4	74	RP8174
Pathfinder D	2,7	73	01.93-	TD27	4	74	RP8174
Pathfinder D	2,7	73-74	93-	TD27T	4	86	RP8348
Pathfinder dCi 4WD	2,5	128	03.05-	---	4	175	RP8936
Pathfinder TD	2,7	96	09.97-	TD27ETi	4	74	RP8174
Patrol 160/Y160 (1,2,3 cyl.)	2,8	---	---	RD28T	---	123	RP8604
Patrol 160/Y160 (4,5,6 cyl.)	2,8	---	---	RD28T	---	124	RP8606
Patrol D	2,7	73	02.93-	TD27	4	74	RP8174
Patrol D	3,2	81	08.88-06.90	---	6	144	RP8648
Patrol D - 24v -	3,2	70	07.85-03.89	SD33	6	143	RP8646
Patrol D (160)	3,3	70	01.87-	SD33	6	47	RP8168
Patrol D (160)	3,3	70	08.82-12.86	SD33	6	47	RP6838
Patrol D (160) - 24v -	3,3	70	06.80-08.82	SD33	6	53	RP6848
Patrol D (160) - 24v -	3,3	70	08.82-06.85	SD33	6	47	RP6800
Patrol D (160) - 24v -	3,3	70	07.85-08.88	SD33	6	143	RP8646
Patrol GR I D	4,2	85	11.88-01.92	---	6	74	RP8176
Patrol GR, Y61, KH-WTY61, VVTY61	3,0	116/118	05.00-	ZD30DDTi eng	4	113	RP8426
Patrol Hardtop D (K160)	3,2	81	07.83-08.88	---	6	144	RP8648
Patrol Hardtop D (K160)	3,3	70	11.79-08.88	---	6	144	RP8648
Patrol Hardtop D (K260)	3,2	81	08.88-06.90	---	6	144	RP8648
Patrol Station Wagon D (W160)	3,3	70	11.79-08.88	---	6	144	RP8648
Patrol Station Wagon TD (W160)	3,2	81	07.83-08.88	---	6	144	RP8648
Patrol TD - 24v -	3,2	88	11.87-01.89	SD33T	6	143	RP8646
Patrol TD (160)	3,3	89	07.83-06.85	SD33T	6	47	RP6838
Patrol TD (160)	3,3	89	07.85-08.88	SD33T	6	47	RP8168
Patrol TD (160)	4,2	91	01.92-12.98	TD42	6	74	RP8174



Model	CC	Kw	Year	Engine	Cyl	Pict	Code
Patrol TD (160) - 24v -	3,3	81	07.83-06.85	SD33T	6	47	RP6800
Patrol TD (160) - 24v -	3,3	81	07.85-08.88	SD33T	6	143	RP8646
Patrol TD (160) - 24v -	3,3	89	07.83-06.85	SD33T	6	47	RP6800
Patrol TD (160) - 24v -	3,3	89	07.85-08.88	SD33T	6	143	RP8646
Patrol TD (160) - 24v -	4,2	91	01.92-12.98	TD42	6	74	RP8176
Patrol Y61	2,8	95	04.98-	RD28	6	124	RP8606
Pick Up	2,7	---	---	TD27T	4	86	RP8348
Pick Up D	2,3	50	01.84-12.86	SD23	4	47	RP6838
Pick Up D	2,5	55	09.87-02.98	TD25	4	74	RP8174
Pick Up D	2,5	59	09.94-08.96	TD25	4	74	RP8174
Pick Up D	2,5	61	03.96-02.98	TD25	4	74	RP8174
Pick Up D	2,5	61	02.98-	TD25	4	74	RP8174
Pick Up D	2,5	53-55	01.83-12.86	SD25	4	47	RP8162
Pick Up D	2,7	73	08.87-02.98	TD27	4	74	RP8174
Pick Up D 4WD	2,5	55	03.86-08.87	SD25	4	47	RP8168
Pick-Up D (720)	2,3	51	01.83-09.85	SD23	4	47	RP8162
Pick-Up D (720)	2,5	53	04.83-08.85	SD25	4	47	RP6838
Pick-Up D (D 21)	2,3	51	09.85-08.87	SD23	4	47	RP8168
Pick-Up D (D 21)	2,5	53-57	09.85-08.87	SD25	4	47	RP8168
Pick-Up TD (720)	2,7	73	01.87-	TD27	4	74	RP8174
Pick-Up TD (D 21)	2,5	59-63	08.87-	TD25	4	74	RP8174
Presage D	2,5	---	---	---	---	175	RP8936
PrimaStar Autobus (X83) dCi 100	1,9	74	03.01-	F9Q 760	4	133	RP8624
PrimaStar Autobus (X83) dCi 80	1,9	60	03.01-	F9Q 762	4	133	RP8624
PrimaStar Furgonato (X83) dCi 100	1,9	74	09.02-	K9K 704 / F9Q 760	4	133	RP8624
PrimaStar Furgonato (X83) dCi 80	1,9	60	09.02-	F9Q 762	4	133	RP8624
PrimaStar dCi 140	2,5	99	09.03-	G9U 730	4	109	RP8412
Primastar DCI 80-100	1,9	60	03.01	---	4	133	RP8624
Primera (P12) dCi	1,9	85-88	01.03-07.10	---	4	133	RP8624
Primera /Wagon W10	2,0	55	07.90-04.96	CD20	4	122	RP8602
Primera dCi	1,9	88	09.03-	F9Q...	4	133	RP8624
Primera dCi	2,2	102	04.03-	---	4	175	RP8936
Primera Di	2,2	93	03.02-	YD22ET	4	175	RP8936
Primera Hatchback (P12) dCi	1,9	85-88	01.03-07.10	---	4	133	RP8624
Primera P10E	2,0	55	01.91-06.96	CD20	4	122	RP8602
Primera Station wagon (WP12) dCi	1,9	85-88	01.03-07.10	---	4	133	RP8624
Pulsar	1,7	41	05.86-08.90	CD17	4	121	RP8600
Pulsar D (N 12)	1,7	45	04.82-05.86	CD17	4	56	RP6918
Qashqai / Qashqai +2 (J10, JJ10) dCi	1,5	78	02.07-	---	4	133	RP8624
Qashqai / Qashqai +2 (J10, JJ10) dCi	1,5	76	07.08-	---	4	133	RP8624
Safari KD-WYY61	---	---	10.97-	RD28ETI	6	104	RP8402
Santana TD	1,6	53	01.84-01.87	CY	4	8	RP4422



Model	CC	Kw	Year	Engine	Cyl	Pict	Code
Sentra 1,7	1,7	---	1987-	CD17	4	121	RP8600
Sentra QGS Type 1	1,7	---	10.82-1986	CD17	4	56	RP6918
Sentra QGS Type 2	1,7	---	10.82-1986	CD17	4	56	RP8160
Serena (C23M) D	2,0	49	11.92-	---	4	121	RP8600
Serena D	2,3	55	11.94-02.98	CD23	4	86	RP8348
Serena D	2,3	55	03.98-	CD23	4	141	RP8642
Serena D	2,5	---	---	---	4	175	RP8936
Skyline D	2,0	66	06.80-09.81	LD20	4	31	RP6608
Skyline D	2,0	43-49	10.81-	LD20	4	31	RP6830
Skyline D	2,8	62	10.81-	LD28	6	31	RP6830
Stanza / T11	2,0	---	1987-	LD20	4	121	RP8600
Sunny II Hatchback (N13) D	1,7	40	06.86-01.91	---	4	121	RP8600
Sunny II Hatchback D	1,7	40	06.86-01.91	CD17	4	56	RP6918
Sunny II Hatchback D	1,7	40	06.86-05.89	CD17	4	56	RP6918
Sunny II Traveller (B12) D	1,7	40	06.86-01.91	---	4	121	RP8600
Sunny II Traveller D	1,7	40	01.86-06.91	CD17	4	56	RP6918
Sunny III D	2,0	55	10.90-05.95	CD20	4	122	RP8602
Sunny Kasten (Y10) D	1,7	40	11.90-	---	4	121	RP8600
Sunny Y10	2,0	55	10.90-	CD20	4	122	RP8602
Terrano	---	---	1999-	ZD30DDTi eng	4	113	RP8426
Terrano 1	2,5	---	---	TD25	4	74	RP8174
Terrano I TD	2,7	62	08.87-	TD25, TD27	4	74	RP8174
Terrano I TD 4WD	2,7	73	02.89-02.93	TD27T	4	86	RP8348
Terrano II Di 4WD	3,0	113	05.02-	ZD30Ti	4	113	RP8426
Terrano II TD 4WD	2,7	74	02.93-01.02	TD27T	4	141	RP8642
Terrano II TDI	2,7	92	10.97-10.99	TD27Ti	4	148	RP8656
Terrano II TDI 4WD	2,7	92	05.06-09.97	TD27Ti	4	86	RP8348
Tiida 2 volumi / Coda spiovente (C11X) dCi	1,5	78	09.07-	K9K 728	4	133	RP8624
Tiida Tre volumi (SC11X) dCi	1,5	78	09.07-	---	4	133	RP8624
Tino 16V V10	2,0	84	07-00-	YD22DT	4	175	RP8936
Trade D	2,0	46	03.87-11.89	LD20II	4	8	RP4422
Trade D	2,8	57	03.87-11.89	A428II	6	11	RP4444
Trade JX1100	2,0	---	03.85-	LD20	4	31	RP6830
Urvan (E23) D	2,3	50	05.82-03.85	SD23	4	47	RP6838
Urvan (E23) D	2,3	51	05.85-11.88	SD23	4	47	RP8162
Urvan (E23) D (24V)	2,3	51	04.85-11.88	SD23	4	47	RP6800
Urvan (E24) D	2,3	51	01.88-	TD23	4	74	RP8174
Urvan (E24) D	2,5	59	12.88-	TD25	4	74	RP8174
Urvan D (E20, E23, E24)	2,0	66	05.82-07.89	LD20T	4	31	RP6830
Urvan D (E20, E23, E24)	2,0	---	09.80-	SD22	4	47	RP6838
Urvan D (E20, E23, E24)	2,3	51	05.82-	SD23	4	47	RP8162
Urvan D (E20, E23, E24) 24V	2,2	47-48	09.80-	SD22	4	53	RP6848
Urvan D (E20, E23, E24) 24V	2,3	51	05.82-	SD23	4	47	RP6800
Urvan KG-VWE2525, VPE25	---	---	---	ZD30DD, ZD30DDTi eng	4	113	RP8426



Model	CC	Kw	Year	Engine	Cyl	Pict	Code
Urvan TD (E 24)	2,3	53	02.87-12.88	TD23	4	74	RP8174
Urvan TD (E20, E23, E24)	2,7	74	01.87-02.93	TD27	4	74	RP8174
Vanette	---	---	06.99-	KF-SK22VN,TN, LN/KJ-SK22VN, TN	4	55	RP8364
Vanette Bus (C22) D (ULC22)	2,0	47	10.86-	---	4	121	RP8600
Vanette Bus/Kasten (C22) D	2,0	49	01.91-01-95	---	4	121	RP8600
Vanette Cargo Bus D	2,3	55	01.95-	LD23 OHC	4	141	RP8642
Vanette Cargo Kasten D	2,3	55	03.98-	LD23 OHC	4	141	RP8642
Vanette D	2,3	55	01.96-02.98	LD23	4	86	RP8348
Vanette D	2,3	55	03.98-	LD23	4	86	RP8348
Vanette D (C 120)	2,0	48-49	06.81-08.82	LD20	4	31	RP6608
Vanette D (C 120)	2,0	48-49	09.82-12.86	LD20	4	31	RP6830
Vanette D (ULC22)	2,0	47	10.86-12.95	LD20	4	31	RP6830
Vanette D (ULC22)	2,0	49	10.86-12.86	LD20	4	31	RP6830
Vanette D Bus	2,3	55	11.94-02.98	LD23 OHC	4	86	RP8348
Vanette D Cargo	2,3	55	11.94-02.98	LD23 OHC	4	86	RP8348
Venette	2,0	---	---	CD20	4	122	RP8602
Venette C220/GC22/Cargo	2,0	44-47-49	04.87-11.94	LD20/110HV/LD2011L/LD200HV	4	121	RP8600
Vitara Escudo RF Turbo	---	---	10.96-	KD-TD31W	4	55	RP8364
X-Trail Di Turbo Diesel 4x4	2,2	84	07.01	YD22ETI	4	175	RP8936
<b>NISSAN - MOTOR IBERICA</b>							
Camion L-35, L-45	2,8	57	03.87-11.89	A4.28II	4	87	RP8350
L 35	2,9	56	05.85-	---	6	11	RP4444
Motor A 4.28	2,8	62	09.87-05.93	A 4.28	4	11	RP4444
Motor A 4.28 - 24v -	2,8	62	09.87-05.83	A 4.28	4	150	RP8664
Patrol	2,8	62	09.87-	A 4.28	4	11	RP4444
Patrol	2,8	62	---	A 4.28 II	4	87	RP8350
SerenaD	---	---	12.94-	GX3	4	86	RP8348
Trade	2,0	43	09.84-02.87	---	4	8	RP4422
Trade	2,0	48	01.87-	LD20	4	87	RP8350
Trade	2,8	62	09.87-	A 4.28	4	11	RP4444
Trade	2,8	57	03.87-11.89	A 4.28 II	4	87	RP8350
Trade (EW)	2,7	73	10.95-	TD27	4	86	RP8348
Vanette	2,0	48	01.87-	LD20	4	87	RP8350
<b>OPEL</b>							
Agila CDTI 16V	1,3	51	06.03	Z13DT	4	155	RP8678
Antara CDTi	2,2	---	2007-	A22DM	4	193	RP8480
Antara CDTI	---	93	03.07-	---	---	111	RP8416
Antara CDTI	---	110	05.06-	---	---	111	RP8416
Arena D	1,9	44	03.98-	F8Q-606	4	101	RP8396
Arena D	2,5	55	03.98-	S8U-758	4	11	RP4444
Ascona B D	2,0	43-49	08.78-10.79	B 20 D Mot. Nr. 90309	4	5	RP2102
Ascona B D	2,0	43-49	11.79-08.81	B 20 D Mot. Nr. 90310	4	11	RP4444
Ascona C D	1,6	40	03.82-08.88	16D, DA OHC	4	11	RP4444
Astra D	1,7	42	10.91-08.94	17 D OHC II	4	11	RP4444
Astra D	1,7	50	09.94-	17 DTL	4	11	RP4488





Model	CC	Kw	Year	Engine	Cyl	Pict	Code
Astra DI 16V	2,0	60	04.98-	X 20 DILC	4	103	RP8400
Astra DTI	2,0	74	08.89-	Y 20 DTL	4	103	RP8400
Astra DTI 16V	1,7	55	02.00-	4EE2	4	152	RP8670
Astra DTI 16V	2,2	92	08.00-	Y22 DTR	4	139	RP8638
Astra F Caravan D	1,7	42	12.91-09.92	17 D	4	11	RP4488
Astra F Caravan D	1,7	44	07.92-01.98	17 DR	4	11	RP4488
Astra F Caravan TD	1,7	50	11.94-01.98	X 17 DTL	4	11	RP4488
Astra F Caravan TDS	1,7	60	12.91-01.98	---	4	125	RP8680
Astra F TD	1,7	60	04.96-02.98	X17DT TC4 EE1 (ISUZU 956633)	4	125	RP8608
Astra F Van D	1,7	42	12.91-09.92	17 D	4	11	RP4488
Astra F Van D	1,7	44	07.92-01.99	17 DR	4	11	RP4488
Astra F Van TD	1,7	50	08.94-01.99	X 17 DTL	4	11	RP4488
Astra G 16V	1,7	---	01.00-	Y17DT	4	152	RP8670
Astra G 2 volumi (F48_, F08_) DTI	2,2	86	09.02-01.05	Y22 DTR	4	139	RP8638
Astra G Cabriolet DTI	2,2	92	09.02-	---	4	139	RP8638
Astra G Caravan CDTI	1,7	59	04.03-	---	4	152	RP8910
Astra G Caravan DI	2,0	60	02.98-	X 20 DTL/Y 20 DTL	4	103	RP8400
Astra G caravan DTI	2,2	92	09.02-	---	4	139	RP8638
Astra G caravan DTI 16V	1,7	55	02.00-	Y 17 DT	4	152	RP8910
Astra G Caravan DTI 16V	2,0	74	08.99-	X 20 DTH/Y 20 DTH	4	103	RP8400
Astra G Caravan TD	1,7	50	02.98-08.00	X 17 DTL	4	11	RP4488
Astra G CC CDTI	1,7	59	04.03-	---	4	152	RP8910
Astra G CC DTI	2,2	92	09.02-	---	4	139	RP8638
Astra G CC DTI 16V	1,7	55	02.00-	---	4	152	RP8910
Astra G Coupe DTI	2,2	92	09.02-	---	4	139	RP8638
Astra G DTI	2,2	92	09.02-	---	4	139	RP8638
Astra G Station wagon (F35_) DTI	2,2	86	09.02-07.04	Y22 DTR	4	139	RP8638
Astra G Stufenheck CDTI	1,7	59	04.03-	---	4	152	RP8910
Astra G Stufenheck DTI 16V	1,7	55	02.00-	---	4	152	RP8910
Astra G tre volumi (F69_) DTI	2,2	86	09.02-01.05	Y22 DTR	4	139	RP8638
Astra H 16V	1,7	59	05.04-	Z17DTH/Z17DTL	4	152	RP8670
Astra H Cabriolet CDTI	1,9	110	09.05-	---	4	166	RP8914
Astra H Caravan CDTI	1,7	59	08.04-	---	4	152	RP8910
Astra H Caravan CDTI	1,9	110	09.04-	---	4	166	RP8914
Astra H Caravan CDTI	1,9	88-74	09.05-	---	4	166	RP8914
Astra H Caravan CDTI 16V	1,9	88	08.04-	---	4	166	RP8914
Astra H CDTI	1,3	66	08.05-	Z13 DTH	4	155	RP8678
Astra H CDTI	1,7	59	03.04-	---	4	152	RP8910
Astra H CDTI	1,9	110	09.04-	---	4	166	RP8914
Astra H CDTI	1,9	88-74	09.05-	---	4	166	RP8914
Astra H CDTI 16V	1,9	74	01.06-	---	4	166	RP8914
Astra H CDTI 16V	1,9	88	04.04-	---	4	166	RP8914
Astra H CDTI Caravan	1,3	66	08.05-	---	4	155	RP8678
Astra H GTC CDTI	1,3	66	01.06-	---	4	155	RP8678



Model	CC	Kw	Year	Engine	Cyl	Pict	Code
Astra H GTC CDTI	1,9	74	01.06-	---	4	166	RP8914
Astra H GTC CDTI	1,9	88-110	03.05-	---	4	166	RP8914
Astra H Tre volumi CDTI	1,7	81	02.07-	Z17 DTJ	4	152	RP8910
Astra H Van CDTI	1,7	74	03.04-	Z17 DTH	4	152	RP8910
Astra H Van CDTI	1,7	81	02.07-	A17 DTJ / Z17 DTJ	4	152	RP8910
Astra H Van CDTI	1,7	92	02.07-	A17 DTR / Z17 DTR	4	152	RP8910
Astra H Van CDTI	1,9	88	09.05-	Z19 DT	4	132	RP8622
Astra H Van CDTI	1,9	110	09.04-	Z19 DTH	4	166	RP8914
Astra H Van CDTI 16V	1,9	88	08.04-	Z19 DTJ	4	166	RP8914
Astra J 2.0 CDTI	2,0	118	12.09-	---	4	182	RP8444
Astra J CDTi	1,7	---	---	A17DTC / A17DTS	4	192	RP8478
Astra J CDTI ecoFLEX	1,3	70	12.09-	A 13 CDTI	4	187	RP8466
Astra Sports Tourer (J) CDTI	1,3	70	10.10-	A13 DTE	4	187	RP8466
Astra Sports Tourer (J) CDTI	1,7	74	10.10-	A17 DTL / A17 DTH	4	152	RP8910
Astra Sports Tourer (J) CDTI	1,7	81	10.10-	A17 DTC / A17 DTJ / A17 DTE	4	152	RP8910
Astra Sports Tourer (J) CDTI	1,7	92	10.10-	A17 DTR	4	152	RP8910
Astra Sports Tourer (J) CDTI	2,0	118	10.10-	A20 DTH	4	182	RP8444
Astra TD	1,7	60	10.91-01.98	TC4 EE1 OHC Isuzu Mot. 956632	4	71	RP8324
Astra TDS	1,7	60	12.91-02.98	956633	4	125	RP8680
Astra Van 16V	1,7	---	02.02-	ISUZU	4	152	RP8670
Campo D	2,2	39	08.91-09.96	C223	4	26	RP8322
Campo D	2,2	45	08.87-08.90	C223	4	26	RP8322
Campo DTI	2,5	74	12.01-	4 JA1	4	68	RP8106
Campo TD	3,1	80	03.95-12.96	4 JG2T	4	71	RP8324
Campo Turbo Diesel	2,5	59	08.91-	4JA1/T	4	68	RP8106
Combo CDTI 16V	1,3	55	10.05-	Z 13 DTJ	4	155	RP8678
Combo DI/DTI 16V	1,7	48-55	10.01-	Y17TD/Y17TDL	4	152	RP8670
Corsa A D	1,5	37	09.87-02.93	15 D/4 EC1 AAD Motor 804 794	4	26	RP6824
Corsa A D	1,5	37	09.87-02.93	15 D/4 EC1 AAD Motor 804 795	4	26	RP8322
Corsa A TD	1,5	49	03.88-02.93	15 DT (T4EC1) Motor 804 795	4	71	RP8324
Corsa B D	1,5	37	03.93-09.00	15D/4 EC1 OHC	4	125	RP8680
Corsa B D	1,5	37	09.94-09.00	15D(4 EC1)	4	125	RP8680
Corsa B D	1,7	44	02.96-09.00	17D (4EE1)/X17D(4EE1 )	4	125	RP8680
Corsa B TD	1,5	49	09.94-09.00	15DT (T4 EC1)	4	125	RP8680
Corsa B TD	1,7	60	03.93-09.00	17TD	4	125	RP8680
Corsa C 16V	1,7	55	10.00-	Y17DT/Y17DTL	4	152	RP8670
Corsa C CTI Ecotec	1,3	51	09.03-	Z13DT	4	155	RP8678
Corsa C DI 16V	1,7	48	09.00-	Y 17 DTL	4	152	RP8910
Corsa C DTI 16V	1,7	55	09.00-	Y 17 DT	4	152	RP8910
Corsa C Kasten CDTI 16V	1,3	51	06.03-	Z 13 DT	4	155	RP8678
Corsa C Kasten DI 16V	1,7	48	09.00-	Y 17 DT	4	152	RP8910
Corsa C Kasten DTI 16V	1,7	55	09.00-	Z 18 XE	4	152	RP8910
Corsa D / Van CDTI	1,3	55	07.06-	A 13 DTC / Z13 DTJ	4	187	RP8466
Corsa D CDTI	1,2	70	12.09-09.10	Z 13 DTE	4	152	RP8910



Model	CC	Kw	Year	Engine	Cyl	Pict	Code
Corsa D CDTI	1,2	70	10.10-	A 13 DTR	4	152	RP8910
Corsa D CDTI	1,3	55-66	07.06-	Z 13 DTJ/Z 13 DTH	4	155	RP8678
Corsa D CDTI	1,7	92	07.06-	Z 17 DTR	4	152	RP8910
Corsa D CDTI	1,7	96	12.09-	A 17 DTS	4	152	RP8910
Corsa D Van CDTI	1,3	55	07.06-	A13 DTC / Z13 DTJ	4	155	RP8678
Corsa DI 16V	1,7	65	01.01-	4EE2	4	152	RP8670
Corsa DTI 16V	1,7	75	01.01-	4EE2	4	152	RP8670
Corsa Van 16V	1,7	---	10.00-	Y17DT/Y17DTL	4	152	RP8670
Frontera A TD	2,8	83	03.95-10.98	28 TDI (4JB1T)	4	68	RP8106
Frontera A TD Intercool	2,3	74	03.92-02.95	DTR OHC	4	11	RP4488
Frontera A TDI	2,5	85	09.96-10.98	25TD / TDS OHC	4	78	RP8370
Frontera B DTI	2,2	85	10.98-09.02	---	4	139	RP8638
Frontera B DTI 16v	2,0	92	10.97-08.00	X 22 DTH	4	103	RP8400
Frontera B DTI 16v	2,2	85	10.97-	X 22 DTH	4	103	RP8400
Frontera B DTI 16v	2,2	92	08.00-	Y 22 DTH	4	139	RP8638
Insignia CDTI	2,0	81	07.08-	---	4	182	RP8444
Insignia CDTI	2,0	96	07.08-	---	4	182	RP8444
Insignia CDTI	2,0	118	07.08-	---	4	182	RP8444
Insignia Tre volumi CDTI	2,0	81	07.08-	---	4	182	RP8444
Insignia Tre volumi CDTI	2,0	96	07.08-	---	4	182	RP8444
Insignia Tre volumi CDTI	2,0	118	07.08-	---	4	182	RP8444
Kadett D D	1,6	40	03.82-08.84	16D OHC	4	11	RP4444
Kadett E D	1,5	37	09.84-08.91	4 EC1 Isuzu Mot.804794	4	26	RP6824
Kadett E D	1,5	37	09.84-08.91	4 EC1 Isuzu Mot.804795	4	26	RP8322
Kadett E D	1,6	40	09.84-01.89	16 D, DA OHC	4	11	RP4444
Kadett E D	1,7	42	02.89-08.91	17 D OHC II	4	11	RP4488
Kadett E D	1,7	44	07.92-07.94	17 DR	4	11	RP4488
Kadett E TD	1,5	53	09.88-08.91	TC4EC1 Isuzu	4	71	RP8324
Kadett E TD	1,7	60	02.90-08.91	TC4 EE1 OHC Isuzu Mot. 817253	4	71	RP8324
Mariva DTI	1,7	55	09.02-	Y17DT	4	152	RP8670
Meriva 16V	1,7	---	10.03-	Y17DT	4	152	RP8670
Meriva B CDTI	1,3	55	06.10-	A 13 DTC	4	187	RP8466
Meriva B CDTI	1,3	70	06.10-	A 13 DTE	4	187	RP8466
Meriva CDTI	1,3	55	09.03-	---	4	155	RP8678
Meriva CDTI	1,7	74	09.03-	Y17DTL/Z17DTL	4	152	RP8670
Meriva CDTI	1,7	92	09.06-	Z17DTR	4	155	RP8678
Meriva DTI	1,7	48	09.03-05.10	Y17 DTL	4	152	RP8910
Meriva DTI	1,7	55	09.03-	Y 17 DT	4	152	RP8910
Meriva II CDTi	1,7	---	---	A17DTC / A17DTS	4	192	RP8478
Monterey A TD	3,1	84	09.91-12.97	4 JG2TC	4	71	RP8324
Monterey B TDI	3,0	117	07.98-	4 JX1	4	149	RP8658
Movano Furgonato (F9) DTI	1,9	60	10.01-	F9Q 772 / F9Q 774	4	133	RP8624
Movano Combi (J9) / Furgonato (F9) DTI	1,9	59	09.00-10.01	F9Q770	4	133	RP8624
Movano Combi (J9) CDTI	2,5	107	08.06-	G9U 632 / G9U 650	4	109	RP8412



Model	CC	Kw	Year	Engine	Cyl	Pict	Code
Movano D	2,5	59	07.98-	S8U772	4	7	RP4486
Movano DTI	2,2	66	09.00-	G9T 720	4	109	RP8412
Movano Furgonato (F9) CDTI	2,5	107	08.06-	G9U 632 / G9U 650	4	109	RP8412
Movano Pianale piatto/Telaio (U9, E9) CDTI	2,5	107	08.06-	G9U 630	4	109	RP8412
Movano Ribaltabile (H9) CDTI	2,5	74	08.06-	G9U 650	4	109	RP8412
Movano Ribaltabile (H9) CDTI	2,5	107	08.06-	G9U 632 / G9U 650	4	109	RP8412
Movano Ribaltabile (H9) DTI	2,5	84	10.01-	G9U 720 / G9U 724 / G9U 750 / G9U 754	4	109	RP8412
Omega A Caravan D	2,3	54	09.86-01.94	23 YD OHC	4	11	RP4488
Omega A Caravan D	2,3	66	09.86-08.88	23 YDT OHC	4	11	RP4488
Omega A Caravan TD Interc.	2,3	74	09.88-01.94	23 DTR OHC	4	11	RP4488
Omega B Caravan DI 16V	2,0	74	09.97-	X 20 DILC	4	103	RP8400
Omega B Caravan DTI	2,0	74	09.97-09.00	X 20 DTH	4	103	RP8400
Omega B Caravan DTI 16V	2,2	88	09.00-07.03	Y 22 DTH	4	139	RP8638
Omega B Caravan TD	2,5	96	02.94-	U 25 TD Mot. BMW	4	11	RP4444
Omega B DTI	2,0	74	09.99-	Y20DTH	4	139	RP8638
Omega B TD	2,5	96	08.96-10.01	X25TD OHC	6	11	RP4444
Omega B TDI	2,5	110	09.01-07.03	Y 25 DT	6	134	RP8626
Omega C DTI 16V	2,0	74-88	09.99-	Y 20 DTH / Y 22 DTR	4	139	RP8638
Omega Caravan B DI 16V	2,0	60	09.96-08.97	X 20 DILC	4	93	RP8368
Rekord D D	2,0	40-43	08.74-12.75	20D	4	5	RP2092
Rekord D D	2,0	40-43	01.76-08.77	20D	4	5	RP2102
Rekord D D	2,1	44	09.72-08.77	21D	4	5	RP2102
Rekord E D	2,0	43	09.77-10.82	Mot. Nr. 90309	4	5	RP2102
Rekord E D	2,0	40-43	09.77-10.82	Mot. Nr. 90310	4	5	RP2102
Rekord E D	2,0	43-49	11.79-08.81	20 D	4	11	RP4444
Rekord E D	2,0	43-49	09.77-10.79	20 D	4	5	RP2102
Rekord E D	2,1	44	09.77-07.78	21 D	4	5	RP2102
Rekord E D	2,3	48	11.79-07.81	23 D	4	11	RP4444
Rekord E D	2,3	48	08.78-10.82	23 D	4	5	RP2102
Rekord E D	2,3	48-52	11.82-08.86	Mot. Nr. 40019	4	11	RP4444
Rekord E TD	2,2	63	06.84-08.86	23 TD Mot. 121527	4	11	RP4488
Rekord E TD	2,3	63	06.84-08.86	23 DT	4	11	RP4488
Senator A TD	2,2	63	11.84-08.87	23 TD Mot.121527	4	11	RP4488
Senator D	2,0	43-49	11.84-08.87	Mot. Nr. 90309	4	5	RP2102
Senator D	2,0	43-49	11.84-08.87	Mot. Nr. 90310	4	11	RP4444
Senator D	2,3	64	11.84-08.87	Mot. Nr. 40018	4	5	RP2102
Senator D	2,3	70	11.84-08.87	Mot. Nr. 40019	4	11	RP4488
Senator TD	2,3	64	11.84-08.87	23 TD	4	11	RP4488
Signum CDTI	1,9	88-110	04.04-	Z 19 DTH	4	166	RP8914
Signum CTDi	3,0	130	05.03	Y30DT	6	115	RP8432
Signum CTDi	3,0	135	09.05	Z30DT	6	115	RP8432
Signum DTI	2,0	74	05.03-	---	4	139	RP8638
Signum DTI	2,2	92	05.03-	---	4	139	RP8638
Singnum DTI	2,0	74	05.03	---	4	139	RP8638



Model	CC	Kw	Year	Engine	Cyl	Pict	Code
Singnum DTI	2,2	92	05.03	---	4	139	RP8638
Sintra TDI	2,2	85	07.97-04.99	X 22 DTH	4	103	RP8400
Tigra CDTI Twin Top	1,3	51	06.04-	---	4	155	RP8678
Vectra A D	1,7	42	10.88-05.93	17D OHC II	4	11	RP4488
Vectra A D	1,7	44	07.92-11.95	17 DR	4	11	RP4488
Vectra A TD	1,7	60	03.90-11.95	17 DT/X 17 DT Mot. 731417	4	26	RP8322
Vectra A TD	1,7	60	10.92-11.95	TC4 EC1 Isuzu Mot.9210	4	125	RP8680
Vectra A TD	1,7	60	03.90-11.95	17 DT/X 17 DT Mot. 731418	4	125	RP8680
Vectra A TD	1,7	60	03.90-	Isuzu TC4EC1 817253	4	71	RP8324
Vectra B Caravan DTI 16V	2,0	74	06.97-07.03	---	4	139	RP8638
Vectra B Caravan DTI 16V	2,2	92	09.00-07.03	---	4	139	RP8638
Vectra B CC DTI 16V	2,0	74	06.97-07.03	---	4	139	RP8638
Vectra B CC DTI 16V	2,2	92	09.00-07.03	---	4	139	RP8638
Vectra B DI 16V	2,0	60	09.96-08.97	X 20 DILC	4	93	RP8368
Vectra B DTI 16V	2,0	74	09.97-07.99	X 20 DILC	4	103	RP8400
Vectra B DTI 16V	2,0	74	06.97-04-02	Y 20 DTH	4	139	RP8638
Vectra B DTI 16V	2,2	92	09.00-04.02	Y 22 DTR	4	139	RP8638
Vectra B TD	1,7	60	10.95-11.96	X17 DT (TC4 EE1)	4	125	RP8680
Vectra C Caravan CDTI	1,9	74	10.05-	---	4	166	RP8914
Vectra C Caravan CDTI	1,9	88-110	04.04-	---	4	166	RP8914
Vectra C Caravan DTI	2,0	74	10.03-	---	4	139	RP8638
Vectra C Caravan DTI	2,2	92	10.03-	---	4	139	RP8638
Vectra C CDTI	1,9	74	10.05-	---	4	166	RP8914
Vectra C CDTI	1,9	88-110	04.04-	Z19DT Fiat	4	166	RP8914
Vectra C CTDi	3,0	130	06.03	Y30DT	6	115	RP8432
Vectra C CTDi	3,0	135	08.05	Z30DT	6	115	RP8432
Vectra C DTI 16V	2,0	74	04.02-	---	4	139	RP8638
Vectra C DTI 16V	2,2	92	04.02-	---	4	139	RP8638
Vectra C GTS CDTI	1,9	74	10.05-	---	4	166	RP8914
Vectra C GTS CDTI	1,9	88-110	04.04-	---	4	166	RP8914
Vectra C GTS DTI 16V	2,0	74	08.02-	---	4	139	RP8638
Vectra C GTS DTI 16V	2,2	92	08.02-	---	4	139	RP8638
Vivaro Combi (J7) DI	1,9	60	08.01-	F9Q 762 / F9Q 774	4	133	RP8624
Vivaro Combi (J7) DTI	1,9	74	08.01-	F9Q 760	4	133	RP8624
Vivaro DI	1,9	60	08.01-	F9Q770	4	133	RP8624
Vivaro DTI	2,5	99	05.03	---	4	109	RP8412
Vivaro Furgonato (F7) CDTI	2,5	84-107	08.06-	G9MB6 / G9U 630	4	109	RP8412
Vivaro Furgonato (F7) DI	1,9	60	08.01-	F9Q 762	4	133	RP8624
Vivaro Furgonato (F7) DTI	1,9	74	08.01-	F9Q 760	4	133	RP8624
Vivaro Pianale piatto/Telaio (E7) CDTI	2,5	84	08.06-	G9U 630	4	109	RP8412
Vivaro Pianale piatto/Telaio (E7) DTi	2,5	99	08.06-	G9U 730	4	109	RP8412
Zafira (P12) CDTi	2,0	81	10.11-	A20 DTL	4	182	RP8444
Zafira (P12) CDTi	2,0	96	10.11-	A20 DTJ	4	182	RP8444



Model	CC	Kw	Year	Engine	Cyl	Pict	Code
Zafira (P12) CDTI	2,0	118-121	10.11-	A20 DTH	4	182	RP8444
Zafira CDTI	1,9	74-88-110	07.05-	Z19DTL Fiat	4	166	RP8914
Zafira DI 16V	2,0	60	10.99-06.05	Y 20 DTH	4	139	RP8638
Zafira DI 16V	2,0	60	09.99-11.00	X20DTL	4	103	RP8400
Zafira DI 16V	2,0	74	04.99-	X 20 DILC	4	103	RP8400
Zafira DTI 16V	2,0	74	08.99-	Y 20 DTH / Y 20 DTH	4	103	RP8400
Zafira DTI 16V	2,2	92	01.02	Y 22 DTR	4	139	RP8638
Zafira Van CDTI	1,7	81	01.08-	A17 DTJ / Z17 DTJ	4	152	RP8910
<b>OPEL VAN</b>							
Bedford Blinz D	2,0	44	09.75-09.78	21 D Serie 97000	4	5	RP2092
Bedford Blinz D	2,0	44	10.78-12.80	Serie 97000	4	11	RP4444
Bedford Blinz D	2,1	44	09.72-09.78	Mot. Nr. 21 DT-36242	4	2	RP2028
Bedford Blinz D	2,1	44	09.72-09.78	Mot. Nr. 21 DT-36243	4	5	RP2102
Bedford Blinz D	2,3	46	09.80-07.87	Opel 23D OHC	4	11	RP4444
Combo 16V	1,7	---	10.00-	Y17DT/Y17DTL	4	152	RP8670
Combo CDTI 16V	1,3	51	08.05-	Z13DT	4	155	RP8678
Combo D	1,7	44	07.94-10.01	17 D(4EE1)/X 17 D(4EE1)	4	125	RP8680
Combo DI	1,7	44	00-	4EE2	4	152	RP8670
Combo Kasten/Kombi DI 16V	1,7	48	10.01-	---	4	152	RP8910
Combo Kasten/Kombi DTI 16V	1,7	55	10.01-	---	4	152	RP8910
Combo Tour CDTI 16V	1,3	51	10.04-	---	4	155	RP8678
Combo Tour DI 16V	1,7	48	10.01-	---	4	152	RP8910
Combo Tour DTI 16V	1,7	55	10.01-	---	4	152	RP8910
<b>OTOSAN (TR)</b>							
600 D Pickup	1,9	---	---	ERK 1.9	4	11	RP4444
<b>PEUGEOT</b>							
204	1,3	28	07.67-07.73	XLD	4	3	RP2074
309	1,5	42	03.94-12.95	TUD5	4	88	RP8352
404	2,0	---	10.63-06.75	XD4.88	4	2	RP2028
405	1,9	55	10.95-	XUD9SD	4	11	RP4444
1007 HDI	1,4	50	03.02-	---	4	146	RP8652
1007 HDi Turbo Diesel	1,4	---	06.07-	8HX/HZ (DV4TD)	4	117	RP8436
106 D	1,5	42	04.96-10.03	TUD5	4	88	RP8352
106 I D	1,5	40	05.96	VJY	4	88	RP8352
106 I D	1,5	43	06.94-04.96	---	4	88	RP8352
106 I D	1,6	40	03.94-	TUD 5	4	88	RP8352
106 I XND, XRD, XTD	1,4	37	10.92-	TUD 3/L	4	7	RP4420
106 II D	1,5	40	05.96-	VJX	4	88	RP8352
106 II D	1,5	42	10.00-	VJX	4	88	RP8352
107 HDI	1,4	40	06.05-	---	4	146	RP8652
107 HDi Turbo Diesel	1,4	---	06.05-	---	4	117	RP8436
204 D	1,4	33	07.73-07.77	XL4D	4	3	RP2074
205 D	1,7	44	07.87-12.89	161A	4	11	RP4444
205 D	1,8	44	10.83-08.98	XUD 7	4	11	RP4444



Model	CC	Kw	Year	Engine	Cyl	Pict	Code
205 D	1,8	44	09.98-	XUD 7	4	11	RP4444
205 D	1,9	47	10.87-08.98	XUD 9	4	11	RP4444
205 D	1,9	47	10.87-09.98	DJZ	4	11	RP4444
205 D	1,9	51	09.98-	XUD 9A	4	11	RP4444
205 TD	1,7	57	01.90-09.98	A8B	4	11	RP4444
205 TD	1,8	58	07.85-08.98	XUD 7T	4	11	RP4444
205 TD	1,8	58	09.98-	XUD 7T	4	11	RP4444
206 , SW	1,4	51	12.04-	DV4TD	4	117	RP8436
206 CC HDI FAP 110	1,6	80	04.05-	---	4	146	RP8652
206 D	1,9	51	09.98-11.01	WJZ (DW 8)	4	88	RP8352
206 HDI	1,4	55	03.01-	DV 4	4	146	RP8652
206 HDI 90	2,0	66	12.99-	RHY	4	108	RP8410
206 HDI Eco 70	1,4	50	09.01-	8HX(DV4TD)	4	146	RP8652
206 HDI FAP 110	1,6	80	05.04-	---	4	146	RP8652
206 SW HDI	1,4	50	07.02-	---	4	146	RP8652
206 SW HDI FAP 110	1,6	80	05.04-	---	4	146	RP8652
207 (WA_ , WC_) HDi 110	1,6	82	08.09-	---	4	189	RP8472
207 CC (WD_) HDi	1,6	82	08.09-	9HR (DV6C)	4	189	RP8472
207 HDi	1,4	50	02.06-	---	4	146	RP8652
207 HDi	1,6	66	02.06-	---	4	146	RP8652
207 HDi	1,6	80	02.06-	---	4	146	RP8652
207 HDi Turbo Diesel	1,4	51	02.06-		4	117	RP8436
207 HDi Turbo Diesel	1,6	66-81	02.06-	9HX (DV6ATED) / 9HY-HZ (DV6TED4)	4	117	RP8436
207 SW (WK_) HDi	1,6	82	08.09-	9HR (DV6C)	4	189	RP8472
208 HDi	1,6	68	03.12-	---	4	189	RP8472
208 HDi	1,6	84	03.12-	---	4	189	RP8472
3008 HDi	1,6	80	05.09	9HZ	4	117	RP8436
3008 HDi	1,6	82	08.10-	9HR (DV6C)	4	189	RP8472
3008 HDi	2,0	110	06.09-	RHE (DW10CTED4)	4	189	RP8472
3008 HDi	2,0	120	06.09-	RHH (DW10CTED4)	4	189	RP8472
3008 Hybrid4	2,0	120	02.11-	(DW10CTED4)	4	189	RP8472
305 D	1,5	32-36	02.79-12.82	XID	4	11	RP4444
305 D	1,6	32-36	11.77-06.81	XD	4	11	RP4444
305 D	1,6	32-36	07.81-10.83	XD	4	11	RP4444
305 D	1,7	44	10.82-06.88	XUD7	4	11	RP4444
305 D	1,8	44	10.82-06.88	XUD7	4	11	RP4444
305 D / Break	1,9	47-48	10.82-07.90	XUD9	4	11	RP4444
306 Break D	1,8	43	05.93-	A9A	4	11	RP4444
306 Break D	1,9	51	09.98-05.01	WJZ (DW8)/WJY (DW8B)	4	88	RP8352
306 Break D	1,9	55	09.98-	DHV (XUD9BSD)	4	11	RP4444
306 Break SLD	1,9	47	06.94-08.98	DJZ (XUD9Y)	4	11	RP4444
306 Break SLD	1,9	47	09.98-	DJZ (XUD9Y)	4	11	RP4444
306 Break SLD	1,9	50	06.94-08.98	DJY (XUD9A)	4	11	RP4444
306 Break SLD	1,9	50	09.98-	DJY (XUD9A)	4	11	RP4444



Model	CC	Kw	Year	Engine	Cyl	Pict	Code
306 Break SRDT	1,9	66	06.94-08.98	DHY (XUD9TE)	4	11	RP4444
306 Break SRDT	1,9	66	09.98-	DHY (XUD9TE)	4	11	RP4444
306 D	1,8	44	09.98-07.02	XUD7	4	11	RP4444
306 D	1,8	51	09.98-	DW8	4	88	RP8352
306 D	1,9	44	09.98-	XUD7	4	11	RP4444
306 D	1,9	51	09.98-	WJZ (DW8B)/WJZ (DW8)	4	88	RP8352
306 Hdi	2,0	66	04.99-07.02	DW10TD	4	108	RP8410
306 HDI	2,0	80	09.98-	DW 10TD	4	108	RP8410
306 TD	1,8	59	09.98-07.02	DW8 TD	4	88	RP8352
306 TD	1,9	55	06.98-	DHV	4	88	RP8352
306 XND, XRD, XTD	1,9	51	03.93-08.98	XUD 9A/L	4	11	RP4444
306 XND, XRD, XTD	1,9	51	09.98-	XUD 9A, XUD 9BSD	4	11	RP4444
306 XRDT / XTDT	1,9	68	03.93-08.98	XUD9TE	4	11	RP4444
306 XRDT / XTDT	1,9	68	09.98-	XUD9TE	4	11	RP4444
307 ,SW	1,4	51	12.04-05.05	DV4TD	4	117	RP8436
307 ,SW Hdi	1,6	68	07.06-	DV6TD	4	117	RP8436
307 ,SW Hdi	1,6	81	07.06-	DV6	4	117	RP8436
307 Break HDI	1,4	50	10.01-	8HX (DV4TD)	4	146	RP8652
307 Break HDI	1,4	50	03.02-	---	4	146	RP8652
307 Break HDI	1,6	66	01.06-	---	4	146	RP8652
307 Break HDI 110 FAP	1,6	80	02.04	---	4	146	RP8652
307 Break HDI 110 FAP	2,0	79	08.00-	RHS (DW10ATED4)	4	108	RP8410
307 Break HDI 135 FAP	2,0	100	02.04-	---	4	172	RP8930
307 CC HDI 135 FAP	2,0	100	06.05-	---	4	172	RP8930
307 HDI	1,4	55	03.01-	8HX (DV4TD)	4	146	RP8652
307 HDI	1,6	66	01.06-	---	4	146	RP8652
307 HDI	2,0	66	03.01-	RHY	4	108	RP8410
307 HDI	2,0	81	03.01-	RHZ	4	108	RP8410
307 SW HDI 110 FAP	1,6	80	02.04-	---	4	146	RP8652
307 SW HDI 135 FAP	2,0	100	02.04-	---	4	172	RP8930
308 (4A_,4C_) HDi	1,6	82	12.09-	---	4	189	RP8472
308 (4A_,4C_) HDi	1,6	82	12.09-	9HR (DV6C)	4	189	RP8472
308 CC HDi	1,6	82	06.09-	QHR (DV6C)	4	189	RP8472
308 CC HDi	2,0	120	06.09-	RHH (DW10CTED4)	4	189	RP8472
308 HDi	1,6	66	09.07-03.10	9HX / 9HV	4	117	RP8436
308 HDi	1,6	80	09.07-03.10	9HZ	4	117	RP8436
308 HDi	2,0	100-103	09.07-	RHR	4	172	RP8930
308 SW HDi	1,6	68	11.09-	---	4	189	RP8472
308 SW HDi	1,6	82	12.09-	9HR (DV6C)	4	189	RP8472
308 SW HDi	2,0	120	06.09-	RHH (DW10CTED4)	4	189	RP8472
309 D	1,6	40	03.94-	TUD 5	4	88	RP8352
309 I D	1,9	47	06.86-12.93	XUD 9, XUD 9Y	4	11	RP4444
309 II D	1,8	44	06.86-12.93	XUD 7	4	11	RP4444
309 II D	1,9	47	07.89-12.93	162 (XUD9)/D9A (XUD9)/DJZ (XUD9Y)	4	11	RP4444





Model	CC	Kw	Year	Engine	Cyl	Pict	Code
309 II TD	1,8	57	08.89-12.93	A8B (XUD7TE)	4	11	RP4444
4007 HdI	2,2	115	02.07-	DW12MTED4	4	118	RP8438
4008 HDi AWC	1,6	84	05.12-	---	4	189	RP8472
405 GLD	1,9	47	07.88-12.92	XUD 9Y	4	11	RP4444
405 GLD, GRD, SRD	1,9	51	03.88-08.98	XUD 9A/L	4	11	RP4444
405 I Break D	1,9	50	07.94-	XUD 9TY	4	11	RP4444
405 I Break D	1,9	51	09.98-	XUD 9A	4	11	RP4444
405 I Break TD	1,8	66	03.88-12.92	XUD 7TE	4	11	RP4444
405 I Break TD	1,9	68	09.93-10.96	XUD 9TE, XUD 9TF	4	11	RP4444
405 II Break D	1,9	47	08.92-10.95	DJZ (XUD9Y)	4	11	RP4444
405 II Break D	1,9	50	06.94-10.95	DJY (XUD9A)	4	11	RP4444
405 II Break TD	1,9	66	09.93-10.95	DHY (XUD9TE)	4	11	RP4444
406 Break D	1,9	55	10.96-	DHW (XUD9SD)	4	11	RP4444
406 Break HDI 110	2,0	80	02.99-08.01	RHZ (DW10ATED)	4	108	RP8410
406 Break HDI 110 FAP	2,0	79	08.01-	RHS (DW10ATED4)	4	108	RP8410
406 Break HDI 90	2,0	66	02.99-	RHY (DW10TD)	4	108	RP8410
406 Break HDI FAP	2,2	98	03.00-	4HX (DW12TED4/FAP)	4	108	RP8410
406 Break TD	1,9	66	01.96-08.98	DHX (XUD9TE)	4	11	RP4444
406 Break TD	1,9	66	09.98-	DHX (XUD9TE)	4	11	RP4444
406 Break TD	1,9	68	01.96-08.98	DHY (XUD9TE)	4	11	RP4444
406 Break TD 12V	2,1	80	01.96-08.98	P8C (XUD11BTE)	4	11	RP4444
406 Break TD 12V	2,1	80	08.98-05.04	P8C (XUD11BTE)	4	11	RP4444
406 Coupé HDI FAP	2,2	98	03.00-	4HX (DW12TED4/FAP)	4	108	RP8410
406 D	1,9	51	09.98-	XUD 9SD, XUD 9BSD	4	11	RP4444
406 D	2,0	80	09.98-	DW 10TED	4	108	RP8410
406 HDI	2,2	100	09.00-	DW12TED	4	108	RP8410
406 TD	1,9	68	10.95-08.98	XUD 9TE	4	11	RP4444
406 TD	1,9	68	09.98-	XUD 9BTF	4	11	RP4444
406 TD	2,0	80	09.98-	DW 10TD	4	108	RP8410
406 TD	2,1	80	10.95-08.98	XUD 11ATE	4	11	RP4444
406 TD	2,1	80-81	09.98-	XUD 11BTE	4	11	RP4444
407 (6D_) / SW (6E_) HDi	2,2	120	06.08-	4HP (DW12BTED4)	4	118	RP8438
407 (6D_) HDi	2,0	120	07.09-	RHH (DW10CTED4)	4	189	RP8472
407 Coupé (6C_) HDi	2,0	120	06.09-	RHH (DW10CTED4)	4	189	RP8472
407 HdI	1,6	81	03.06-	DV6TED	4	117	RP8436
407 HdI	2,0	93	04.04-	DV6TED	4	108	RP8410
407 HDI	2,0	100	05.04	---	4	108	RP8410
407 HDI 110 FAP	1,6	80	05.04-	---	4	146	RP8652
407 HDI 135 FAP	2,0	100	05.04-	---	4	172	RP8930
407 HDi 170 FAP	2,2	125	05.06-	DW12BTED4	4	118	RP8438
407 SW (6E_) HDi	2,0	120	07.09-	RHH (DW10CTED4)	4	189	RP8472
407 SW HDI 135 FAP	2,0	100	05.04-	---	4	172	RP8930
5008 HDi	1,6	80	09.09-	9HZ	4	117	RP8436
5008 HDi	1,6	82	08.10-	9HR (DV6C)	4	189	RP8472



Model	CC	Kw	Year	Engine	Cyl	Pict	Code
5008 HDi	2,0	110	06.09-	RHE (DW10CTED4)	4	189	RP8472
5008 HDi	2,0	120	09.09-	RHH (DW10CTED4)	4	189	RP8472
504 D	1,9	36-42	04.71-05.78	XD 4,88	4	2	RP2028
504 D	1,9	36-42	06.78-06.87	XD 4,88	4	11	RP4444
504 D	2,1	43-48	10.70-05.78	XD 4,90	4	2	RP2028
504 D	2,1	43-48	06.78-04.81	XD 4,90	4	11	RP4444
504 D	2,1	43-48	05.81-09.81	XD 4,90	4	11	RP4444
504 D	2,3	47-51	08.76-05.78	XD 2	4	2	RP2028
504 D	2,3	47-51	06.78-04.81	XD 2	4	11	RP4444
504 D	2,3	47-51	05.81-06.83	XD 2	4	11	RP4444
504 D Pickup	2,3	51	07.84-12.90	XD 2	4	11	RP4444
504 D Pickup	2,5	55	07.87-	XD3	4	11	RP4444
505 D	2,3	44-51	09.79-08.81	XD 2	4	11	RP4444
505 D	2,3	44-51	09.81-06.86	XD 2	4	11	RP4444
505 D	2,5	51-56	06.81-12.93	XD 3	4	11	RP4444
505 TD	2,3	54-59	09.80-08.81	XD 2S	4	11	RP4444
505 TD	2,3	54-59	09.81-06.86	XD 2S	4	11	RP4444
505 TD	2,5	77	10.86-12.93	XD 3TE	4	11	RP4444
505 TD	2,5	66-70	10.83-12.93	XD 3T	4	11	RP4444
508 HDi	2,0	100-103	10.10-	---	4	172	RP8930
508 HDi / SW	1,6	82	11.10-	RHR (DV6C)	4	189	RP8472
508 HDi / SW	1,6	84	02.12-	---	4	189	RP8472
508 HDi / SW	2,0	120	11.10-	RHH (DW10CTED4)	4	189	RP8472
604 TD	2,3	54-59	02.79-09.81	XD 2S	4	11	RP4444
604 TD	2,3	54-59	10.81-06.83	XD 2D	4	11	RP4444
604 TD	2,5	66-70	07.83-06.86	XD 3T	4	11	RP4444
605 D	2,1	60	06.89-07.95	P9A (XUD11A)	4	11	RP4444
605 TD	2,1	80	06.89-08.98	XUD 11 ATE/L, BTE	4	11	RP4444
605 TD 12V	2,1	80	09.98-09.99	P8C (XUD11BTE)	4	11	RP4444
605 TD 12V	2,1	80	08.94-08.98	P8C (XUD11BTE)	4	11	RP4444
605 Turbo Diesel	2,1	80	06.89-09.99	PHZ (XUD11ATE)	4	11	RP4444
605 Turbo Diesel	2,5	95	07.94-09.99	THY (DK5ATE)	4	11	RP4444
607 Hdi	2,0	79	03.01-07.04	---	4	108	RP8410
607 Hdi	2,0	80	05.00-	RHZ (DW10ATED)	4	108	RP8410
607 Hdi	2,0	81	---	DW10TED	4	108	RP8410
607 HDI	2,0	100	09.05-	---	4	172	RP8930
607 HDI	2,2	98	02.00-	DW12 TED4 / HDI	4	108	RP8410
607 Hdi	2,2	125	05.06-	---	4	118	RP8438
607 Hdi	2,2	125	06.06-	DW12BTED4	4	118	RP8438
607 HDI 24V	2,7	150	12.04-	---	6	145	RP8650
806 HDI	2,0	80	08.98-	RHZ	4	108	RP8410
806 HDI	2,0	81	08.99-08.02	RHZ (DW10ATED)	4	108	RP8410
806 TD	1,9	66	09.98-08.02	DHX (XUD9TE)	4	11	RP4444
806 TD	1,9	66	07.95-08.98	DHX (XUD9TE)	4	11	RP4444



Model	CC	Kw	Year	Engine	Cyl	Pict	Code
806 TD	1,9	68	09.98-08.02	DHY (XUD9TE)	4	11	RP4444
806 TD	1,9	68	05.97-08.98	DHY (XUD9TE)	4	11	RP4444
806 TD	2,1	80	05.96-08.98	XUD 11ATE	4	11	RP4444
806 TD	2,1	80	09.98-	XUD 11ATE	4	11	RP4444
806 td 12V	2,1	80	06.96-08.98	P8C (XUD11BTE)	4	11	RP4444
806 td 12V	2,1	80	09.98-08.99	P8C (XUD11BTE)	4	11	RP4444
807 (E) HDi	2,0	120	06.09-	RHH (DW10CTED4)	4	189	RP8472
807 (E) HDi	2,2	125	06.06-	4HP (DW12BTED4)	4	118	RP8438
807 HDi	2,0	81	06.02-05.03	RHW	4	108	RP8410
807 HDi	2,0	81	06.03-	---	4	172	RP8930
807 HDi	2,0	88	03.06-05.10	RHK	4	172	RP8930
807 HDi	2,0	94	06.02-	4HX(DW12TED)	4	108	RP8410
807 HDi	2,0	100	06.06-	---	4	108	RP8410
807 HDi	2,0	100	03.06-05.10	RHR	4	172	RP8930
807 HDi	2,0	100	06.10-	RHD	4	172	RP8930
807 HDi	2,2	79	06.02-	RHS (DW10ATED)	4	108	RP8410
807 HDi	2,2	94	06.02-05.03	4HX	4	108	RP8410
807 HDi	2,2	94	06.03-	4HW	4	172	RP8930
807 HDi	2,2	125	09.07-05.10	4HT	4	118	RP8438
807 HDi FAP	2,0	79	06.02-	RHS (DW10ATED4)	4	108	RP8410
807 HDi FAP	2,2	94	06.02-	4HX (DW12TED4/FAP)	4	108	RP8410
Bipper (AA_) HDi	1,4	50	02.08-	DV4TED	4	117	RP8436
P4 D - 24v -	2,5	56	10.86-12.93	XD 3	4	67	RP8246
RCZ HDi	2,0	120	03.10-	RHH (DW10CTED4)	4	189	RP8472
<b>PEUGEOT VAN</b>							
Boxer 2 Hdi	2,0	66	09.98-	DW10TD	4	108	RP8410
Boxer 2 Hdi	2,2	100	03.01-	DW10TED4	4	108	RP8410
Boxer D	1,8	44	09.98-	XUD 7	4	11	RP4444
Boxer D	1,9	50	07.99-04.02	DJY (XUD9A)	4	11	RP4444
Boxer D	1,9	51	03.94-08.98	XUD 9A	4	11	RP4444
Boxer D	1,9	51	09.98-	XUD 9AU	4	11	RP4444
Boxer D	2,0	80	09.98-	DW 10 TED - DW 10 DU	4	108	RP8410
Boxer D, 4x4	2,5	63	03.94-	T9A (DJ5)	4	11	RP4444
Boxer Furgonato/Autobus (230L) D	2,8	64	01.99-02.02	8140.63 (F28D)	4	107	RP8408
Boxer Furgonato/Pianale piatto/ Telaio (244) HDi	2,8	107	04.04-	8140.43N	4	94	RP8372
Boxer HDi	2,0	62	08.01-04.02	---	4	108	RP8410
Boxer HDi	2,0	62	04.02-	---	4	108	RP8410
Boxer HDi	2,0	69	07.00-	RHZ	4	108	RP8410
Boxer HDi	2,2	74	04.02-	---	4	108	RP8410
Boxer HDi	2,8	94	10.00-	8140.43S	4	107	RP8408
Boxer Hdi	2,8	107	04.04-	---	4	107	RP8408
Boxer TD	1,9	60	03.94-08.98	XUD 9TFU	4	11	RP4444
Boxer TD	1,9	60	09.98-	XUD 9TF	4	11	RP4444
Boxer TD	1,9	66	08.94-08.98	DHY (XUD9TE)	4	11	RP4444



Model	CC	Kw	Year	Engine	Cyl	Pict	Code
Boxer TD	1,9	66	09.98-04.02	DHY (XUD9TE)	4	11	RP4444
Boxer TD	1,9	68	03.94-08.98	D8C (XUD9UTF)	4	11	RP4444
Boxer TD	1,9	68	09.98-04.02	D8C (XUD9UTF)	4	11	RP4444
Boxer TD	2,5	76	03.94-08.96	T8A (DJ5T)	4	11	RP4444
Boxer TDI	2,4	79	01.97-	DJ5TED	4	102	RP8398
Boxer TDI	2,5	76	09.96-	THX (DJ5TED)	4	102	RP8398
Expert	1,8	44	09.98-	DW8	4	88	RP8352
Expert	1,9	68	01.96-08.98	XUD9BTF/XUD9TF	4	11	RP4444
Expert	2,1	80	07.96-	XUD11ATE	4	11	RP4444
Expert D	1,8	51	09.98-	DW 8	4	88	RP8352
Expert D	1,9	51	09.98-	D9B (XUD9A)	4	11	RP4444
Expert D	1,9	51	01.96-08.98	D9B (XUD9A)	4	11	RP4444
Expert Hdi	2,0	69	07.00-	DW10TED	4	108	RP8410
Expert Hdi	2,0	80	08.00-	RHZ (DW10ATED)	4	108	RP8410
Expert Hdi 120	2,0	88	01.07-	DW10UTED4-RHQ	4	108	RP8410
Expert Hdi 140	2,0	100	01.07-	RHR (DW10BTED4)	4	108	RP8410
Expert HDi 90	1,6	66	01.07-	---	4	117	RP8436
Expert TD	1,8	59	09.98-	DW 8 TD	4	88	RP8352
Expert TD	1,9	66	02.96-08.98	DHX (XUD9TE)	4	11	RP4444
Expert TD	1,9	66	09.98-	DHX (XUD9TE)	4	11	RP4444
Expert TD	1,9	68	02.96-08.98	D8B (XUD9TE)	4	11	RP4444
Expert TD	1,9	68	09.98-	D8B (XUD9TE)	4	11	RP4444
Expert Tepee (VF3V_) HDi100	2,0	94	03.11-	---	4	189	RP8472
Expert Tepee (VF3V_) HDi130	2,0	72	03.11-	---	4	189	RP8472
Expert Tepee (VF3V_) HDi165	2,0	120	09.09-	RHH (DW10CTED4)	4	189	RP8472
Expert Tepee (VF3V_, VF3U_, VF3X_) HDi 130	2,0	94	03.11-	---	4	189	RP8472
J5 D	1,9	51	11.87-	XUD9A	4	11	RP4444
J5 D	1,9	51	10.90-01.94	D9B (XUD9A)	4	11	RP4444
J5 D	2,5	54	10.90-06.91	CRD93 (U25/661)	4	11	RP4444
J5 D	2,5	54	07.91-	CRD93 (U25/661)	4	11	RP4444
J5 TD	2,5	70	10.90-06.91	CRD93LS (U25/673)	4	11	RP4444
J5 TD	2,5	70	07.91-	CRD93LS (U25/673)	4	11	RP4444
J5 TD 4x4	2,5	54	10.90-06.91	CRD93 (U25/661)	4	11	RP4444
J5 TD 4x4	2,5	54	07.91-	CRD93 (U25/661)	4	11	RP4444
J5 TD 4x4	2,5	70	10.90-06.91	CRD93LS (U25/673)	4	11	RP4444
J5 TD 4x4	2,5	70	07.91-	CRD93LS (U25/673)	4	11	RP4444
J7 D	1,8	44	10.67-10.78	XDP88	4	2	RP2028
J7 D	2,1	55	10.67-10.78	XDP90	4	2	RP2028
J7 D	2,3	49	10.78-10.79	XD2P94	4	2	RP2028
J7 D	2,3	49	11.79-09.80	XD2P94	4	11	RP4444
J9 D	2,1	41	10.80-	XDP 4.90	4	11	RP4444
J9 D	2,3	49	10.80-10.82	XD2P	4	11	RP4444
J9 D	2,5	53	10.82-	XD3P	4	11	RP4444
J9 Transporter D	2,1	41	05.81-	XDP4.90	4	11	RP4444



Model	CC	Kw	Year	Engine	Cyl	Pict	Code
J9 Transporter D	2,5	53	10.82-	XD3P	4	11	RP4444
J9 Transporter D	---	59	05.81-	---	4	11	RP4444
Partner Combi	1,8	43	07.96-08.98	XUD7	4	11	RP4444
Partner Combi	1,8	44	09.98-03.02	XUD7	4	11	RP4444
Partner Combi	1,8	44	09.98-03.02	DW8	4	88	RP8352
Partner Combi	1,8	59	09.98-03.02	DW8TD	4	88	RP8352
Partner Combi	1,9	51	09.98-03.02	DW8/DW8B	4	88	RP8352
Partner Combi Hdi	2,0	66	20.99-03.02	DW10TD	4	108	RP8410
Partner D	1,8	43	08.96-08.98	A9A (XUD7)	4	11	RP4444
Partner D	1,8	43	09.98-	A9A (XUD7)	4	11	RP4444
Partner D	1,8	51	09.98-	DW 8	4	88	RP8352
Partner D	1,9	50	06.96-08.98	DJY (XUD9A)	4	11	RP4444
Partner D	1,9	50	09.98-	DJY (XUD9A)	4	11	RP4444
Partner D	1,9	51	12.98-	WJY (DW8B)/WJZ (DW8)	4	88	RP8352
Partner D	1,9	51	06.96-08.98	DJY (XUD9A)	4	11	RP4444
Partner D	1,9	51	09.98-	DJY (XUD9A)	4	11	RP4444
Partner Hdi	1,4	55	03.06-	---	4	117	RP8436
Partner HDI	2,0	66	02.00-	RHY (DW10TD)	4	108	RP8410
Partner HDi 75	1,6	55	02.06-	---	4	117	RP8436
Partner HDi 90	1,6	66	02.06-	---	4	117	RP8436
Partner Multispace	1,9	51	09.98-	DW8/DW8B	4	88	RP8352
Partner Multispace Hdi	2,0	66	10.99-	DW10TD	4	108	RP8410
<b>PIAGGIO</b>							
Ape Car	0,5	11	01.83-	---	4	8	RP4422
<b>PORSCHE</b>							
Cayenne (955)	2,5	128	04-	BAC	5	78	RP8370
Cayenne D	3,0	180	06.11-	MCR.CA	6	171	RP8928
Cayenne D	3,0	155	06.10-	MCR.CB	---	171	RP8928
Cayenne D	3,0	176	06.10-	M05.9E	---	171	RP8928
<b>PROTON</b>							
Persona 400, 420 GLS D	2,0	48	05.96-	---	4	87	RP8896
Persona 400, 420 TD	2,0	60	09.96-	---	4	87	RP8896
<b>PUCH</b>							
G-Model 250 GD	2,5	62	10.87-01-89	OM602.930	5	11	RP4444
G-Model 250 GD	2,5	62	02.89-12.92	OM602.930	5	13	RP4452
G-Model 250 GD (W460)	2,5	62	10.87-12.92	---	5	67	RP8246
G-Model 290GD-G290D	2,9	70	04.92	OM602.942	5	13	RP4452
G-Model 300 GD	2,3	83	09.89	OM603.931	6	13	RP4452
G-Model 350G TD	3,5	100	09.91	OM603.972	6	13	RP4452
G-Model G290GD	2,9	88	07.97	---	4	13	RP4452
G-Model G300 TD	3,0	130	08.96	OM606.964	6	90	RP8358
<b>RENAULT</b>							
Avantime dCi	2,2	110	05.02-05.03	G9T 712	4	109	RP8412
Avantime DCI	2,2	---	09.01-	F9Q	4	133	RP8624
Avantime V6 (DE04,DE0T)	3,0	152	09.01-05.03	L7X 720, L7X 721	4	115	RP8432



Model	CC	Kw	Year	Engine	Cyl	Pict	Code
Cherokee D	2,1	59	01.87-04.94	JBS	4	11	RP4444
Clio D	1,9	48	03.91-08.98	F8Q-676	4	89	RP8356
Clio D	1,9	47-48	05.90-02.91	F8Q	4	14	RP4458
Clio Grandtour dCi	1,5	48	02.10-	K9K 752	4	133	RP8624
Clio Grandtour dCi	1,5	50	02.08-	K9K 768	4	133	RP8624
Clio Grandtour dCi	1,5	63	02.08-	K9K 766	4	133	RP8624
Clio Grandtour dCi	1,5	65	08.10-	K9K 770 / K9K 772	4	133	RP8624
Clio Grandtour dCi	1,5	76	02.08-	K9K 772	4	133	RP8624
Clio Grandtour dCi	1,5	78	02.08-	K9K 764	4	133	RP8624
Clio II	1,9	48	03.99-12.03	F9Q632	4	131	RP8620
Clio II / Furgonato dCi	1,5	48	06.01-	K9K 700 / K9K 704	4	133	RP8624
Clio II D	1,9	48	09.98-	F8Q-630, 662	4	101	RP8396
Clio II D	1,9	58	03.99-	F9Q-780	4	133	RP8624
Clio II D 55	1,9	40-47	03.99-	F8Q-632	4	131	RP8620
Clio II dCi	1,5	47	06.05-	K9K 740	4	133	RP8624
Clio II dCi	1,5	50	08.04-	K9K 714	4	133	RP8624
Clio II dCi	1,5	59	06.01-10.03	K9K 702	4	133	RP8624
Clio II dCi	1,5	60	06.01-05.05	K9K 702	4	133	RP8624
Clio II dCi	1,5	62	02.07-	K9K 718	4	133	RP8624
Clio II dCi	1,5	74	01.04-05.05	K9K 712	4	133	RP8624
Clio II dTi	1,9	59	12.99-05.05	F9Q 780	4	133	RP8624
Clio II dTi	1,9	59	01.99-06.01	F9Q782	4	82	RP8390
Clio II dTi	1,9	59	01.99-12.03	F9Q716	4	82	RP8390
Clio II Furgonato dCi	1,5	60	11.03-	K9K 702 / K9K 710 / K9K 716	4	133	RP8624
Clio II Phase 2 dCi	1,5	59	11.01-	K9K702	4	133	RP8624
Clio II Phase 2 dCi	1,5	74	04-	---	4	133	RP8624
Clio II TDI	1,9	72	01.99-	F9Q-716	4	82	RP8390
Clio III	1,5	47	06.05-	K9K 752	4	133	RP8624
Clio III (BR0/1, CR0/1) dCi	1,5	55-66	08.10-	K9K 770	4	133	RP8624
Clio III dCi	1,5	50	06.05-	K9K 768	4	133	RP8624
Clio III dCi	1,5	63	06.05-	K9K 766	4	133	RP8624
Clio III dCi	1,5	76	06.05-	K9K 772	4	133	RP8624
Clio III dCi	1,5	78	06.05-	K9K 764	4	133	RP8624
Espace I TD	2,1	65	01.83-10.96	J8S	4	11	RP4444
Espace II	2,2	85	91-10.96	G8T-714/716/760	4	82	RP8340
Espace II TD	2,1	65	01.91-10.96	J8S 610/J8S 772/J8S 776/J8S 778	4	11	RP4444
Espace II TD	2,1	66	01.91-10.96	J8S 612	4	11	RP4444
Espace III dCi	2,2	96	06.00-12.02	---	4	109	RP8412
Espace III DCI	2,2	85-95	08.00-	G9T-710	4	109	RP8412
Espace III dT	2,2	81	01.97-08.00	G8T-714/716	4	82	RP8340
Espace III dTi	1,9	74	02.99-12.02	F9Q716/730/734	4	82	RP8390
Espace III TD	2,2	95	02.96-	G9T-710	4	109	RP8412
Espace III TDI	1,9	72	02.99-	F9Q-716	4	82	RP8390
Espace III TDI	1,9	72	02.99-10.02	F9Q-722	4	133	RP8624



Model	CC	Kw	Year	Engine	Cyl	Pict	Code
Espace III TDI	2,2	83-85	11.96-	G8T-760	4	82	RP8340
Espace IV dCi	1,9	85	04.03-02.05	F9Q 820	4	133	RP8624
Espace IV dCi	1,9	88	11.02-	F9Q 680 / F9Q 820 / F9Q 826	4	133	RP8624
Espace IV DCI	2,2	110	11.02-	---	4	109	RP8412
Espace IV MPV dCi Turbo Diesel	3,0	132	11.02	P9X 701	6	115	RP8432
Express D	1,6	40	03.86-03.97	F8M	4	14	RP4458
Express D Break, Fourgon	1,9	48	09.91-	F8Q-774 / 776 / 730	4	14	RP4458
Express, Extra, Rapid	1,6/1,9	40-48	03.86-08.91	F8Q, F8M	4	14	RP4458
Express D Extra, Rapid	1,9	47-48	09.94-	F8Q-640	4	89	RP8356
Fuego TD	2,1	65	09.82-07.84	J8S	4	11	RP4444
Grand Espace dT	2,2	81	01.98-08.00	G8T-714/716	4	82	RP8340
Grand Espace dTi	1,9	74	01.00-	F9Q-730/734	4	82	RP8390
Grand Espace III DCI	2,2	85-95	08.00-	G9T-710	4	109	RP8412
Grand Espace IV dCi	1,9	86	10.02-	F9Q	4	133	RP8624
Grand Espace IV DCI	2,2	100	2003-	G9T	4	109	RP8412
Grand Espace IV Dci	2,2	110	10.02-	---	4	109	RP8412
Grand Scenic DCI	1,5	74	03.04-	K9K	4	133	RP8624
Grand Scenic DCI	1,9	81-88-96	03.04-	F9Q	4	133	RP8624
Grand Scenic II	1,5	74	04.04-	K9K 728	4	133	RP8624
Grand Scenic II (JM0/1_) dCi (JM15)	1,9	81	05.05-	F9Q G804	4	78	RP8272
Grand Scenic III (JZ0/1) dCi	1,9	96	02.09-	F9Q 870	4	186	RP8456
Kangoo / Kangoo Express / Garnd Kangoo dCi	1,5	50	02.08-	K9K 800	4	133	RP8624
Kangoo / Kangoo Express / Garnd Kangoo dCi	1,5	63	02.08-	K9K 802	4	133	RP8624
Kangoo D 55	1,9	40	03.98-	F8Q-662	4	101	RP8396
Kangoo D 55	1,9	40	03.99-	F8Q-632	4	131	RP8620
Kangoo D 65	1,9	47	03.98-	F8Q-630	4	101	RP8396
Kangoo D 65	1,9	47	03.99-	F8Q-632	4	131	RP8620
Kangoo dCi	1,5	42	07.03-	K9K 704	4	133	RP8624
Kangoo dCi	1,5	48	12.01-	K9K 700 / K9K 704	4	133	RP8624
Kangoo dCi	1,5	50	06.05-	K9K 718	4	133	RP8624
Kangoo dCi	1,5	60	07.02-	K9K 702 / K9K 710	4	133	RP8624
Kangoo dCi	1,5	62	06.05-	---	4	133	RP8624
Kangoo DTI	1,9	59	03.98-	F9Q-780	4	133	RP8624
Kangoo Express dCi	1,5	42	12.02-	K9K 704	4	133	RP8624
Kangoo Express dCi	1,5	45	10.05-	K9K 704	4	133	RP8624
Kangoo Express dCi	1,5	48	12.01-	K9K 700	4	133	RP8624
Kangoo Express dCi	1,5	50	06.05-	K9K 714	4	133	RP8624
Kangoo Express dCi	1,5	62	06.05-	K9K 718	4	133	RP8624
Kangoo Express dCi	1,5	76	02.08-	K9K 806	4	133	RP8624
Kangoo Express dCi	1,9	59	02.00-	F9Q 780/F9Q 782	4	133	RP8624
Kangoo Express dCi	1,9	60	04.03-	K9K 702 / K9K 710	4	133	RP8624
Kangoo Express dCi	1,9	62	07.03-	F9Q 790	4	133	RP8624



Model	CC	Kw	Year	Engine	Cyl	Pict	Code
Kangoo Express dCi 110	1,5	80	09.10-	K9K 804	4	133	RP8624
Kangoo Express dCi 4x4	1,9	62	07.03-	F9Q 790	4	133	RP8624
Kangoo Express dCi 75	1,5	55	09.10-	K9K 800	4	133	RP8624
Kangoo Express dCi 85	1,5	63	02.08-	K9K 800 / K9K 802	4	133	RP8624
Kangoo II 4x4	1,6	70	03-	F9Q	4	133	RP8624
Kangoo, Kangoo Express dCi 4x4	1,9	59	10.01-	F9Q 790/F9Q 782	4	133	RP8624
Laguna / Nevada D	2,2	62	09.94-	G8T...	4	82	RP8340
Laguna / Nevada Phase2 dCi	1,9	81	01.00-	F9Q718	4	133	RP8624
Laguna / Nevada Phase2 dT	2,2	80	04.98-	G8T-Turbo	4	82	RP8340
Laguna / Nevada Phase2 dTi	1,9	74	10.97-	F9Q-716/730/734	4	82	RP8390
Laguna D	2,2	61	11.93-08.94	G8T 706/G8T 752/G8T 790/G8T 794	4	82	RP8340
Laguna D / Grandtour	2,2	61	09.95-03.01	G8T 706/G8T 752/G8T 790/G8T 794	4	133	RP8624
Laguna DCI	2,2	99	03.01-	F9Q	4	133	RP8624
Laguna DCI / Grandtour	1,9	74	10.01-	---	4	133	RP8624
Laguna DCI / Grandtour	1,9	77	06.01-	---	4	133	RP8624
Laguna DCI / Grandtour	1,9	79	09.99-03.01	F9Q 718 / F9Q 754	4	133	RP8624
Laguna DCI / Grandtour	1,9	88	03.01-	F9Q 750/F9Q 756	4	133	RP8624
Laguna DCI / Grandtour	2,2	110	01.02-	G9T-702	4	109	RP8412
Laguna dT / Grandtour	2,2	83	03.96-03.01	G8T-760	4	82	RP8340
Laguna dTi	1,9	72	10.97-03.01	F9Q 716	4	82	RP8390
Laguna DTI / Grandtour	1,9	72	10.97-03.01	F9Q-716-710-717-718	4	133	RP8624
Laguna I dCi	1,9	72	10.97-03.01	F9Q 710 / F9Q 716 / F9Q717	4	133	RP8624
Laguna I dCi	1,9	79	09.99-03.01	F9Q 718	4	133	RP8624
Laguna II / Grandtour dCi	1,9	81	01.05-	F9Q 674 / F9Q 758	4	133	RP8624
Laguna II / Estate dCi	1,9	74	03.99-	F9Q710/717/718	4	133	RP8624
Laguna II / Grandtour dCi	1,9	74	10.01-	F9Q 754	4	133	RP8624
Laguna II / Grandtour dCi	1,9	88	03.01-	F9Q 670 / F9Q 674 / F9Q 750	4	133	RP8624
Laguna II / Grandtour dCi	1,9	96	05.05-	F9Q 758 / F9Q 759	4	133	RP8624
Laguna II dCi	1,9	68	03.04-	F9Q 664	4	133	RP8624
Laguna II dCi	2,0	110	08.05-	---	4	133	RP8624
Laguna II dCi	2,0	127	01.06-	---	4	133	RP8624
Laguna II dCi	2,2	102	05.05-	---	4	109	RP8412
Laguna II Grandtour dCi	1,9	68	03.04-	F9Q 664	4	133	RP8624
Laguna II Grandtour dCi	2,2	102	05.05-	---	4	133	RP8624
Laguna II, Grandtour dCi	1,9	77	06.01-	F9Q752	4	133	RP8624
Laguna III dCi	1,5	81	10.07-	K9K 780	4	133	RP8624
Megane / Classic dCi	1,9	77	03.99-	F9Q731/732/736/740	4	133	RP8624
Megane / Classic di	1,9	66	01.96-08.99	F9Q730/734	4	82	RP8390
Megane Classic D	1,9	47	09.96-	F8Q 620/F8Q 624	4	89	RP8356
Megane Classic dT	1,9	66	09.96-	F8Q 784/F8Q 786	4	9	RP4422/1
Megane Classic dTi	1,9	59	02.01-	F9Q 744	4	133	RP8624
Megane Classic dTi	1,9	72	03.97-02.01	F9Q 730/F9Q 734	4	133	RP8624
Megane Classic dTi	1,9	72	03.97-02.01	F9Q 731/F9Q 736	4	82	RP8390
Megane Classic TDI	1,9	69	09.96-	---	4	9	RP4422/1





Model	CC	Kw	Year	Engine	Cyl	Pict	Code
Megane Coach dCi	1,9	75	02.01-	F9Q 732/F9Q 733	4	133	RP8624
Megane Coach dTi	1,9	72	03.97-02.01	F9Q 734	4	82	RP8390
Megane Coach dTi	1,9	72	03.97-02.01	F9Q 731/F9Q 736	4	133	RP8624
Megane D	1,9	47	03.99-	F8Q-622-790	4	131	RP8620
Megane D	1,9	47	03.99-	F8Q-788	4	101	RP8396
Megane DCi	1,9	72	03.99-	F9Q-731,736	4	133	RP8624
Megane DDI	1,9	58	06.00-	F9QT-770	4	133	RP8624
Megane Grandtour D	1,9	47	04.99-	F8Q 788	4	101	RP8396
Megane Grandtour D	1,9	47	04.99-	F8Q 620	4	89	RP8356
Megane Grandtour D	1,9	47	04.99-	F8Q 622/F8Q 790	4	131	RP8620
Megane Grandtour dCi	1,9	75	02.01-	F9Q 732/F9Q 733	4	133	RP8624
Megane Grandtour dTi	1,9	59	02.01-	F9Q 744	4	133	RP8624
Megane Grandtour dTi	1,9	72	03.99-02.01	F9Q 731/F9Q 736	4	133	RP8624
Megane I D Eco	1,9	47	01.96-	F8Q 620/F8Q 624	4	89	RP8356
Megane I dCi / Classic / Coach / Grandtour	1,9	75	02.01-08.03	F9Q 732/F9Q 733	4	133	RP8624
Megane I dTi	1,9	72	03.97-02.01	F9Q 731/F9Q 736	4	133	RP8624
Megane I dTi / Classic	1,9	59	02.01-08.03	F9Q 744	4	133	RP8624
Megane I dTi / Classic	1,9	72	03.97-02.01	F9Q 730/F9Q 734	4	82	RP8390
Megane I dTi / Classic / Coach / Grandtour	1,9	72	03.97-02.01	F9Q 731/F9Q 736	4	133	RP8624
Megane I TD	1,9	66	01.96-	F8Q 784/F8Q 786	4	9	RP4422/1
Megane I TDI	1,9	69	09.96-	Cooling-water preheater	4	157	RP8686
Megane I TDI	1,9	69	09.96-	---	4	9	RP4422/1
Megane II Combi dCi	1,9	68	03.04-	---	4	133	RP8624
Megane II Combi dCi	2,0	110	09.05-	---	4	133	RP8624
Megane II Coupè	1,5	74	04-	K9K	4	133	RP8624
Megane II Coupe-Cabriolet dCi	1,5	63	05.05-	---	4	133	RP8624
Megane II Coupe-Cabriolet dCi	1,5	76	01.07-	K9K 734	4	133	RP8624
Megane II Coupe-Cabriolet dCi	1,5	78	03.06-	K9K 732	4	133	RP8624
Megane II Coupe-Cabriolet dCi	1,9	81	05.05-	F9Q 804 / F9Q 816 / F9Q 818	4	133	RP8624
Megane II Coupe-Cabriolet dCi	2,0	110	09.05-	---	4	133	RP8624
Megane II Coupé-Cabriolet dCi	1,9	85	09.03-	F9Q 804 / F9Q 816 / F9Q 818	4	133	RP8624
Megane II dCi	1,5	60	09.03-	K9K722	4	133	RP8624
Megane II dCi	1,5	74	10.03-	K9K 728 / K9K 729	4	133	RP8624
Megane II dCi	1,9	68	03.04-	---	4	133	RP8624
Megane II dCi	1,9	85	11.02-	F9Q 804 / F9Q 816 / F9Q 818	4	133	RP8624
Megane II dCi	1,9	88	11.92	F9Q800	4	133	RP8624
Megane II dCi	1,9	88	11.02-	F9Q 670 / F9Q 674 / F9Q 750	4	133	RP8624
Megane II dCi	1,9	96	05.05-	F9Q 803 / F9Q 816	4	133	RP8624
Megane II dCi	2,0	127	01.07-	---	4	133	RP8624
Megane II Station Wagon dCi	1,5	60	08.03-	K9K 722	4	133	RP8624
Megane II Station Wagon dCi	1,5	76	01.07-	K9K 728	4	133	RP8624
Megane II Station Wagon dCi	1,5	78	05.05-	K9K 732 / K9K 734	4	133	RP8624
Megane II Station wagon dCi	1,9	85	05.05-	F9Q 818	4	133	RP8624



Model	CC	Kw	Year	Engine	Cyl	Pict	Code
Megane II Station Wagon dCi	1,9	96	05.05-	F9Q 803 / F9Q 804	4	133	RP8624
Megane II Station Wagon, Coupé-Cabriolet dCi	1,9	88	08.03-	F9Q 800	4	133	RP8624
Megane II Station Wagon/Tre volumi dCi	1,5	63	05.05-	K9K 724	4	133	RP8624
Megane II Station Wagon/Tre volumi dCi	1,5	74	02.04-	K9K 728 / K9K 729	4	133	RP8624
Megane II Tre volumi dCi	1,9	81	05.05-	F9Q 803 / F9Q 804 / F9Q 816 / F9Q 818	4	133	RP8624
Megane II Tre volumi dCi	1,9	88	09.03-	F9Q 800	4	133	RP8624
Megane II Tre volumi, Coupé-Cabriolet dCi	1,9	96	05.05-	F9Q 803	4	133	RP8624
Megane II, Station Wagon dCi	1,9	81	05.05-	F9Q 804 / F9Q 818	4	133	RP8624
Megane II, Tre volumi dCi	1,5	76	01.07-	K9K 734	4	133	RP8624
Megane III 2 volumi (BZON/BZOJ) dCi	1,9	96	11.08-	F9Q 870 / F9Q 872	4	186	RP8456
Megane III 2 volumi 1,5 dCi	1,5	66	11.08-	K9K H 834	4	185	RP8454
Megane III 2 volumi 1,5 dCi	1,5	81	02.09-	K9K 836	4	185	RP8454
Megane III Coupe (DZoN/DZoJ) dCi	1,9	96	11.08-	F9Q 870 / F9Q 872	4	186	RP8456
Megane III Coupè 1,5 dCi	1,5	66	11.08-	K9K H 834	4	185	RP8454
Megane III Coupè 1,5 dCi	1,5	81	02.09-	K9K J 836	4	185	RP8454
Megane III Station Wagon (KZO/1/KZON) dCi	1,9	96	05.09-	F9Q 870 / F9Q 872	4	186	RP8456
Megane III Station Wagon 1,5 dCi	1,5	66	05.09-	K9K 834	4	185	RP8454
Megane III Station Wagon 1,5 dCi	1,5	81	02.09-	K9K 836	4	185	RP8454
Megane III Tre volumi dCi	1,9	96	06.09-	F9Q 870 / F9Q 872	4	186	RP8456
Megane Phase 2 D	1,9	48	03.99-	F8Q622/790	4	131	RP8620
Megane Phase 2 D	1,9	48	09.99-	F8Q620/624	4	89	RP8354
Mégane Phase 2 D	1,9	48	03.99-	F8Q622/790	4	131	RP8620
Mégane Phase 2 D	1,9	48	09.99-	F8Q620/624	4	89	RP8354
Mégane Phase 2 dCi	1,9	77	03.99-	F9Q718/722/731/736/780	4	133	RP8624
Megane Phase 2 dTi	1,9	74	01.96-	F9Q716/730/734	4	82	RP8390
Mégane Phase 2 dTi	1,9	59	04.01-	F9QT770	4	133	RP8624
Megane Scenic D	1,9	47	03.97-09.99	F8Q 622/F8Q 790	4	131	RP8620
Megane Scenic D	1,9	47	03.97-09.99	F8Q 788	4	101	RP8396
Megane Scenic D	1,9	47	03.97-09.99	F8Q 620	4	89	RP8356
Megane Scenic di	1,9	66	10.96-08.99	F9Q716/730/734	4	82	RP8390
Megane Scenic dT	1,9	66	01.97-09.99	F8Q 784/F8Q 786	4	9	RP4422/1
Megane Scenic dTi	1,9	72	04.97-09.99	F9Q 730/ F9Q 734	4	82	RP8390
Modus (F/JPO_) dCi 75	1,5	55	10.10-	K9K 770	4	133	RP8624
Modus / Grand Modus dCi	1,5	48	12.04-	K9K 752	4	133	RP8624
Modus / Grand Modus dCi	1,5	50	12.04-	K9K 762 / K9K 768	4	133	RP8624
Modus / Grand Modus dCi	1,5	60	09.04-	K9K 750	4	133	RP8624
Modus / Grand Modus dCi	1,5	63	12.04-	K9K 760 / K9K 766	4	133	RP8624
Modus / Grand Modus dCi	1,5	76	05.07-	K9K 772	4	133	RP8624
Modus / Grand Modus dCi	1,5	78	05.05-	K9K 764	4	133	RP8624
R 11 D	1,6	40	01.83-08.89	F8M	4	14	RP4458



Model	CC	Kw	Year	Engine	Cyl	Pict	Code
R 18 D	2,1	48-49	08.80-02.86	J8S	4	11	RP4444
R 18 D 4X4	2,1	48	05.81-02.86	J8S	4	11	RP4444
R 18 TD	2,1	50	05.81-02.86	J8S	4	11	RP4444
R 18 TD	2,1	65	04.84-02.86	J8S-712	4	11	RP4444
R 19 D	1,9	47	03.91-03.96	F8Q	4	14	RP4458
R 19 I Chamade D	1,9	47	10.89-02.91	F8Q 706/F8Q 742	4	11	RP4444
R 19 I Chamade D	1,9	47	03.91-04.92	F8Q 706/F8Q 742	4	14	RP4458
R 19 I Chamade D	1,9	68	09.90-04.92	---	4	9	RP4422/1
R 19 I D	1,9	47	09.88-02.91	F8Q 706/F8Q 742	4	11	RP4444
R 19 I D	1,9	48	01.88-02.91	F8Q 706/F8Q 742	4	11	RP4444
R 19 I D	1,9	47-48	03.91-04.92	F8Q 706/F8Q 742	4	14	RP4458
R 19 II D / Chamade	1,9	47	04.92-12.95	F8Q 742	4	14	RP4458
R 19 II D / Chamade	1,9	66-68	04.92-12.95	F8Q 744	4	9	RP4422/1
R 19 TD	1,9	66-68	09.90-03.96	F8Q	4	8	RP4422
R 20 D	2,1	47	12.79-04.81	J8S	4	11	RP4444
R 20 D	2,1	47	05.81-12.83	J8S	4	11	RP4444
R 20 TD	2,1	63	09.82-12.83	J8S	4	11	RP4444
R 21 D	2,1	46-48	03.86-12.93	F8Q-710	4	11	RP4444
R 21 D / Kombi	1,9	47	09.89-10.93	F8Q 710	4	11	RP4444
R 21 D / Kombi	2,1	48	03.86-12.89	J8S 704	4	11	RP4444
R 21 D / Kombi	2,1	51	02.92-09.95	J8S 784	4	11	RP4488
R 21 D / Kombi	2,1	53	05.89-06.94	J8S 600/J8S 740	4	11	RP4444
R 21 D / Nevada	1,9	48	09.89-02.91	F8Q	4	11	RP4444
R 21 Fastback D	1,9	48	09.89-02.91	F8Q	4	11	RP4444
R 21 Fastback D	1,9	48	03.91-12.93	F8Q	4	14	RP4458
R 21 Fastback D	2,1	53	09.89-12.93	J8S-740	4	11	RP4444
R 21 Fastback D	2,1	54	09.89-12.93	J8S-704	4	11	RP4444
R 21 Nevada D, Savanna	2,1	65-66	03.86-12.93	J8S	4	11	RP4444
R 21 TD	2,1	65-66	03.86-12.93	J8S	4	11	RP4444
R 21 Turbo D / Kombi	2,1	65	08.89-06.94	J8S 714/J8S 786 (KAT)/J8S 788	4	11	RP4444
R 25 D	2,1	46	04.84-05.89	J8S 706	4	11	RP4444
R 25 D	2,1	47	01.84-12.92	J8S	4	11	RP4444
R 25 D	2,1	51	06.89-12.92	J8S 736	4	11	RP4444
R 25 Turbo D	2,1	63	04.84-12.92	J8S 708/J8S 738	4	11	RP4444
R 30 TD	2,1	85	09.81-12.83	J8S-852	4	11	RP4444
R 5 D	1,6	40	09.85-12.96	F8M	4	14	RP4458
R 9 D	1,6	40	09.82-03.91	F8M	4	14	RP4458
R 9 D	1,6	40	01.83-03.91	F8M700/730	4	14	RP4458
R19 II D	1,9	48	03.92-12.95	F8Q 706/F8Q 742	4	14	RP4458
Rapid D	1,6	40	03.86-08.98	F8M 720/F8M 730/F8M 736/F8M760	4	14	RP4458
Rapid D	1,9	40	09.94-03.98	F8Q 640/F8Q 682	4	89	RP8356
Rapid D	1,9	47	09.91-03.98	F8M 722/F8M 724/F8M 774/F8M 776	4	14	RP4458
Rapid Express	1,9	34	09.94-	F8Q640	4	89	RP8354
Safrane I Dt	2,1	65	11.93-07.96	J8S 760	4	11	RP4444



Model	CC	Kw	Year	Engine	Cyl	Pict	Code
Safrane I dT	2,5	83	12.92-07.96	S8U 762/S8U 763	4	11	RP4444
Safrane II TD	2,2	83	07.96-12.00	G8T 740	4	82	RP8340
Scenic D	1,9	48	03.99-	F8Q-622/790	4	131	RP8620
Scenic dCi	1,9	75	09.99-08.03	F9Q 732/F9Q 733	4	133	RP8624
Scenic dCi / RX4	1,9	75	11.00-08.03	F9Q 732/F9Q 733/F9Q 748 / F9Q 740	4	133	RP8624
Scenic di	1,9	66	10.96-08.99	F9Q-716/730/734	4	82	RP8390
Scenic dTi	1,9	59	02.01-08.03	F9QT 744	4	133	RP8624
Scenic dTI	1,9	72	09.99-	F9Q 731, F9Q 734, F9Q 736	4	82	RP8390
Scenic Dti	1,9	72	09.99-	Cooling-water preheater	4	157	RP8686
Scenic dTi	1,9	72	09.99-08.03	F9Q 731 / F9Q 34 / F9Q 736	4	133	RP8624
Scenic II	1,5	63	05.05-	K9K 724	4	133	RP8624
Scenic II / Grand Scenic II dCi	1,5	96	05.05-	F9Q 804 / F9Q 816 / F9Q 818 / F9Q 803	4	133	RP8624
Scenic II / Grand Scenic II dCi	1,9	81	05.05-	F9Q 804	4	133	RP8624
Scenic II / Grand Scenic II dCi	1,9	88	06.03-	F9Q 812	4	133	RP8624
Scenic II dci	1,5	59	03-	K9K	4	133	RP8624
Scenic II dCi	1,5	60	06.03-	K9K 722	4	133	RP8624
Scenic II dCi	1,5	74	11.03-	K9K 728 / K9K 729	4	133	RP8624
Scenic II dCi	1,5	74	04-	K9K	4	133	RP8624
Scenic II dCi	1,5	76	01.07-	K9K 734	4	133	RP8624
Scenic II dCi	1,5	78	05.05-	K9K 732	4	133	RP8624
Scenic II dCi	1,5	88	06.03-	---	4	133	RP8624
Scenic II dCi	1,5	110	09.05-	---	4	133	RP8624
Scenic III (JZ0/1) dCi	1,9	96	02.09-	F9Q 870	4	186	RP8456
Scenic Phase 2 D	1,9	48	09.99-	---	4	89	RP8354
Scenic Phase 2 dCi	1,9	77	03.99-	F9Q718/731/736	4	133	RP8624
Scenic Phase 2 dCi RX4	1,9	77	09.00-	F9Q...	4	133	RP8624
Scenic Phase 2 dTi	1,9	59	06.01-	F9Q-T770	4	133	RP8624
Scenic Phase 2 dTi	1,9	74	09.99-	F9Q-730/734	4	82	RP8390
Super 5 D	1,6	40	09.85-12.96	F8M	4	14	RP4458
Thalia dCi	1,5	47	06.05-	K9K 740	4	133	RP8624
Thalia DCI	1,5	48	04.02-	K9K 700	4	133	RP8624
Thalia dCi	1,5	50	02.03-	K9K 700 / K9K 714	4	133	RP8624
Thalia dCi	1,5	60	06.01-	K9K 702	4	133	RP8624
Twingo (CNO_) dCi (CNOU)	1,5	62	04.08-	K9K 718	4	133	RP8624
Twingo II DCI	1,5	47	03.07-	K9K 740	4	133	RP8624
Vel Satis CDI	3,0	130	06.02-	P9X701	6	115	RP8432
Vel Satis dCi	2,2	85	04.04-	---	4	109	RP8412
Vel Satis Dci	2,2	85	03.02-12.03	G9T	4	109	RP8412
Vel Satis Dci	2,2	85	03.02-	---	4	109	RP8412
Vel Satis dCi	2,2	102	09.04-	---	4	109	RP8412
Vel Satis DCI	2,2	110	06.02-	G9T-702	4	109	RP8412
<b>RENAULT VAN</b>							
Mascott DCI	2,8	92	01.02-	8140.43 S	4	107	RP8408
Master dCi 16S	2,5	88	10.00-	---	4	109	RP8412
Master D	2,5	59	07.98-01.01	S8U 770	4	7	RP4486



Model	CC	Kw	Year	Engine	Cyl	Pict	Code
Master dCi	1,9	60	11.01-	F9Q 772	4	133	RP8624
Master dCi	2,2	66	09.00-	G9T 722	4	133	RP8624
Master dCi	2,2	85	10.00-	G9T-720	4	109	RP8412
Master dCi	2,5	84	10.01-	G9U 720	4	109	RP8412
Master dTi	2,8	84	07.98-10.01	S9W 702	4	107	RP8408
Master Furgonato / Autobus dTi	1,9	59	09.00-	F9QT 770	4	133	RP8624
Master I 28-35 D	2,5	55	08.89-07.98	S8U 742/8140.67.2510	4	11	RP4444
Master I 28-35 D	2,5	72	08.89-07.98	S9U 702/8140.27.2580	4	11	RP4444
Master II dCi 90	2,2	66	09.00-	G9T 722	4	109	RP8412
Master II Furgonato, Autobus dCi 80	1,9	60	11.01-	F9Q 772 / F9Q 774	4	133	RP8624
Master III dCi 100	2,5	73	10.03-	G9U 754	4	109	RP8412
Master P 35D	2,5	52	09.80-05.82	Sofim 8140.61.2300	4	11	RP4444
Master P 35D	2,5	52	06.82-01.89	Sofim 8140.61.2300	4	11	RP4444
Master T 28D	2,5	57	01.81-12.85	Sofim - Motor	4	11	RP4444
Master T 30D	2,1	45	01.86-	J8S	4	11	RP4444
Master T 30D / 35D	2,4	52	09.80-12.87	Sofim 8140.61	4	11	RP4444
Master T 35D	2,4	52-55	05.85-	S8V-748	4	7	RP4486
Master T 35D	2,4	52-55	05.85-	S8U-731, S8U-742	4	11	RP4444
Master T 35D Turbo	2,5	69	05.85-	S8V-748	4	7	RP4486
Master T28, T33, T35	---	---	07.98-	---	4	107	RP8408
Trafic D	1,9	44	06.97-03.01	F8Q-606	4	101	RP8396
Trafic D	2,1	43	03.85-04.89	852 750	4	11	RP4444
Trafic D	2,1	43	05.89-06.94	852 720/852 750	4	11	RP4444
Trafic D	2,1	47	06.94-10.97	J8S 620/J8S 758	4	11	RP4488
Trafic D	2,5	50	01.89-12.95	S8U-750 / 752	4	7	RP4486
Trafic D	2,5	52	10.82-10.97	S8U	4	11	RP4444
Trafic D	2,5	55	05.89-03.01	Sofim 8140.67.2500	4	11	RP4444
Trafic D	2,5	55	05.89-03.01	S8U 750/S8U 752/S8U 758	4	7	RP4486
Trafic D 4x4	2,1	43	09.80-10.97	J8S	4	11	RP4444
Trafic D P 1000/1200	2,1	43	09.80-10.97	852-750	4	11	RP4444
Trafic D T 800/1000/1200	2,1	43	09.80-10.97	J8S	4	11	RP4444
Trafic D T1000	2,1	56	11.97-	S8U-758/780/782	4	7	RP4486
Trafic dCi 100	1,9	74	03.01-	F9Q 760	4	109	RP8412
Trafic dCi 80	1,9	60	03.01-	---	4	109	RP8412
Trafic II dCi 135	2,5	99	03.09-	G9U 730	4	109	RP8412
Trafic II dCi 145	2,5	107	08.06-	G9U 630	4	109	RP8412
Trafic II Furgonato dCi 80	1,9	60	03.01-	F9Q 760 / F9Q 702	4	133	RP8624
Trafic II Pianale piatto/Telaio, Furgonato dCi 100	1,9	74	03.01-	F9Q 760	4	133	RP8624
Winnebago D	2,1	43-57	04.82-06.87	J8S-232, -234	4	11	RP4444
<b>ROVER</b>							
100 114 D	1,4	38	10.92-12.94	TUD 3	4	7	RP4420
100 115 D	1,5	42	12.94-12.98	TUD 5	4	88	RP8352
114 D	1,4	39	01.92-12.94	TUD 3	4	7	RP4420



Model	CC	Kw	Year	Engine	Cyl	Pict	Code
115 SD/CSD	1,6	57	03.95-	TUD 5	4	88	RP8352
200 218 D	1,9	52	09.91-10.95	---	4	11	RP4444
200 218 TD	1,8	65	09.91-10.95	XUD 7TE	4	11	RP4444
200 220 D / SD	2,0	63	11.95-03.00	20 T2R	4	82	RP8340
200 220 SDi	2,0	77	11.95-03.00	20 T2N	4	82	RP8340
217 SD, 218 SD/SLD	1,9	49	09.91-	XUD 9	4	11	RP4444
218 D	1,9	49	03.91-12.96	XUD 9	4	11	RP4444
218 TD	1,8	65	03.91-12.96	XUD 7 TE	4	11	RP4444
218 TD	1,8	107	09.95-	---	4	11	RP4444
220 DI	2,0	63	02.96-	20T2RN	4	82	RP8340
220 TDI	2,0	77	02.96-	20T2N	4	82	RP8340
2400 TD	2,4	67	04.82-10.86	VM-HR 492 HT	4	6	RP4410
25 IDT	2,0	74	10.99-	---	4	82	RP8340
400 418 D	1,9	49	09.91-04.95	---	4	11	RP4444
400, Tourer 418 TD	1,8	65	09.91-04.95	XUD 7TE	4	11	RP4444
400, Tourer 420 D	2,0	63	11.95-03.00	20T2R	4	82	RP8340
400, Tourer 420 Di	2,0	77	05.95-03.00	20T2N	4	82	RP8340
418 D	1,9	49	01.92-12.96	XUD 9	4	11	RP4444
418 TD	1,8	65	01.92-12.96	XUD 7 T	4	11	RP4444
418 TD SLD/GSD	1,8	65	09.91-12.92	XUD 7 T	4	11	RP4444
420 D, SD	2,0	63	03.96-	---	4	82	RP8340
420 Di, Sdi, SLDi	2,0	77	03.96-	---	4	82	RP8340
45 IDT	2,0	74	02.00-	---	4	82	RP8340
600 620 Sdi	2,0	77	12.94-02.99	20T2N	4	82	RP8340
620 Sdi, SLDi, TD	2,0	77	01.95-	L - Serie	4	82	RP8340
75 CDT / Tourer	2,0	85	02.99-	M47 R	4	134	RP8626
75 CDT / Tourer	2,0	85	08.01-	M 47 R	4	134	RP8626
75 CDTI	2,0	96	02.03-	204D2	4	134	RP8626
800 825 D/SD	2,5	87	01.90-04.95	425 SL1RR/492 4 SHIRG	4	11	RP4444
800 825 D/SD (XS)	2,5	87	05.95-02.99	425 SL1RR/492 4 SHIRG	4	78	RP8370
825 D	2,5	87	01.88-07.91	LBB 10249/C-2500 cc	6	6	RP4410
825 D/SD/SLD	2,5	87	09.91-04.95	VM 425 SLIRA	4	11	RP4444
825 SD, TD	2,5	87	01.93-04.95	VM HR-492/VM 425 SLIRR	4	11	RP4444
825 SD, TD	2,5	87	05.95-	VM 425 SLIRA	4	78	RP8370
90 ,110 D	---	---	01.83-	---	4	11	RP4444
CountryTD	2,5	83	01.89-	---	4	6	RP4410
Defender TDI	2,5	102	01.99-	---	4	11	RP4444
FL 2 / R	---	---	08.83-	---	4	11	RP4444
Freelander 2 eD4	2,2	110	09.10-	DW12BTED4	4	118	RP8438
Freelander 2 SD4 AWD	2,2	140	09.10-	DW12BTED4	4	118	RP8438
Freelander 2 TD4 AWD	2,2	110-118	10.06-	224DT	4	118	RP8438
Freelander DI	2,0	72	02.98-11.00	---	4	82	RP8340
Freelander DI Soft Top	2,0	72	02.98-	---	4	82	RP8340
Freelander TD4	2,0	80-82	11.00-	---	4	134	RP8626



Model	CC	Kw	Year	Engine	Cyl	Pict	Code
Freelander TDI	2,5	102	05.98-	---	5	147	RP8654
FX 4R	---	---	08.83-	---	4	11	RP4444
Land Rover (90,110)	2,5	43-63	09.83-07.90	---	4	11	RP4444
Land Rover 90, 110	2,5	63	01.85-12.90	12 J	4	11	RP4444
Land Rover County	---	---	01.89-	---	---	6	RP4410
Land Rover Defender 90 TDI	2,5	83	11.89-03.94	Gemini 1	4	85	RP8346
Land Rover Defender TD5 4WD	2,5	90	01.99-	---	5	147	RP8654
Land Rover Defender TDS 4WD / SW	2,5	90	06.98-	---	5	85	RP8346
Land Rover Discovery IV TDV6 AWD	2,7	140	09.09-08.10	276DT	6	145	RP8650
Land Rover FL 2 / R (Hire Car)	---	---	08.83-	---	4	11	RP4444
Land Rover FX 4R Taxi	---	---	08.83-	---	4	11	RP4444
Land Rover TD5 Discovery II	2,5	102	01.99-	---	5	147	RP8654
Land Rover TDI Defender 90	2,5	83	10.95-	23L	4	85	RP8346
Land Rover TDI Defender 90, 100 SW	2,5	83	09.90-12.98	23L	4	85	RP8346
Land Rover TDI Discovery	2,5	90	10.95-	19L	4	85	RP8346
Land Rover TDI Discovery	2,5	102	01.99-	---	5	147	RP8654
Land Rover TDI Discovery I	2,5	83	09.89-03.94	12 L/21 L	4	85	RP8346
Land Rover TDI Discovery II	2,5	83	08.96-	12 L/21 L	4	85	RP8346
Land Rover TDI Discovery II	2,5	90	10.95-	19 L	4	85	RP8346
Maestro 500 / 700 D	0,5-0,7	---	01.86-	Perkins Prisma 80	4	11	RP4444
Maestro D	2,0	44	09.90-10.92	---	4	11	RP4444
Maestro TD	2,0	60	09.90-01.95	---	4	11	RP4444
Maestro Van TD	2,0	60	01.86-	Perkins	4	11	RP4444
Marina D	1,5	37	01.71-12.82	BMC 1,5 OHV	4	20	RP6064
Marina II D	1,5	37	10.75-09.78	---	4	20	RP6064
Metro D	1,4	39	01.92-12.95	TUD 3	4	7	RP4420
Metro D	1,4	39	01.92-01.95	Peugeot TUID 3	4	7	RP4420
Montego Turbo D	2,0	60	10.88-10.95	BB	4	11	RP4444
Range Rover	2,5	66	04.86-10.92	DM UNIT (NOT GEMINI ENG.)	4	6	RP4410
Range Rover DT/DSE	2,5	100	09.94-	BMW M51-025	6	11	RP4444
Range Rover I D	2,4	78	04.86-12.90	11 A	4	6	RP4410
Range Rover II D	2,5	83	08.94-03.02	14 L	4	11	RP4444
Range Rover II D	2,5	100	07.94-03.02	25 6T (BMW)	6	11	RP4444
Range Rover III 2,5 L Military	2,5	---	---	Wolf-Engine	6	85	RP8916
Range Rover III Td 6	3,0	130	03.02-	M57 D30 BMW	6	134	RP8626
Range Rover IV TDV8 AWD	3,6	200	09.09-	368DT	6	145	RP8650
Range Rover Sport II TDV8 AWD	3,6	200	02.09-	---	6	145	RP8650
Range Rover TD	2,5	---	09.89-12.92	Gemini 1	4	85	RP8346
Range Rover TD Classic	2,5	87	01.94-12.96	VM HR-492/VM425 SLIRA	4	11	RP4444
Range Rover TD Vogue	2,5	87	01.93-12.94	VM HR-492/VM425 SLIRR	4	11	RP4444
Range Rover Tdi	2,5	83	01.95-	BMW 5 TC 2000 N	4	11	RP4444
Range Rover Tdi	2,5	83	01.86-12.94	ETC 9091 N	4	85	RP8346



Model	CC	Kw	Year	Engine	Cyl	Pict	Code
SDI 2400 TD	2,4	---	04.82-04.86	VM-HR 492HT	6	6	RP4410
<b>SAAB</b>							
9-3 Cabriolet TiD	1,9	110	01.06-	---	4	166	RP8914
9-3 Kombi TiD	1,9	88-110	03.05-	---	4	166	RP8914
9-3 TiD	1,9	88-110	09.04-	---	4	166	RP8914
9-3 TiD	2,0	92	09.02-	D223L	4	139	RP8638
9-3 TiD	2,2	85	02.98-11.00	X 22 DTH	4	103	RP8400
9-5 / 39577 TiD	3,0	130	07.01	D308L	6	115	RP8432
9-5 Kombi TiD	3,0	130	07.01-	D308L	6	115	RP8432
9-5 TiD	2,2	88	01.02-	---	4	103	RP8400
<b>SEAT</b>							
131 D	2,5	52	06.82-12.84	---	4	11	RP4444
Alhambra (710) TDI	2,0	85	05.11-	CFFE	4	171	RP8928
Alhambra (710) TDI	2,0	103	06.10-	CFFB	4	171	RP8928
Alhambra (710) TDI	2,0	125	06.10-	CFGB	4	171	RP8928
Alhambra TDI	1,9	66	04.96-	1Z/AHU/ANU	4	78	RP8272
Alhambra TDI	1,9	66	10.01-	ANU	4	78	RP8674
Alhambra TDI	1,9	66	04.96-	Cooling-water preheater	4	8	RP4422
Alhambra TDI	1,9	66	04.96-	Cooling-water preheater	4	91	RP8360
Alhambra TDI	1,9	81	11.96-	AFN	4	78	RP8272
Alhambra TDI	1,9	81	08.96-06.00	AFN	4	78	RP8272
Alhambra TDI	1,9	81	08.96-06.00	Cooling-water preheater	4	8	RP4422
Alhambra TDI	1,9	81	08.96-06.00	Cooling-water preheater	4	91	RP8360
Alhambra TDI	1,9	85	06.00-	Cooling-water preheater	4	8	RP4422
Alhambra TDI	1,9	85	06.00-	Cooling-water preheater	4	91	RP8360
Alhambra TDI	1,9	96	11.02-	ASZ	4	78	RP8674
Alhambra TDI	1,9	110	05.05-	---	4	177	RP9000
Alhambra TDI 4motion	1,9	85	02.01-	AUY	4	78	RP8272
Alhambra TDI 4motion	1,9	85	02.01-	Cooling-water preheater	4	8	RP4422
Alhambra TDI 4motion	1,9	85	02.01-	Cooling-water preheater	4	91	RP8360
Alhambra, 4motion TDI	1,9	85	06.00-03.10	AUY / BVK	4	78	RP8272
Altea TDI	2,0	125	03.06-	BMN	4	178	RP9002
Altea TDI XL	2,0	125	06.07-	BMN	4	178	RP9002
Altea TDI, XL	1,9	77	06.04	BJB/BKC	4	177	RP9000
Altea TDI, XL	2,0	100	03.04-	---	4	177	RP9000
Altea TDI, XL	2,0	103	03.04-	BKB	4	178	RP9002
Arosa SDI	1,7	44	08.97-06.04	AKU	4	78	RP8272
Arosa SDI	1,7	44	10.01	AKU	4	78	RP8674
Arosa TDI	1,4	55	01.98-10.01	AMF	3	78	RP8272
Arosa TDI	1,4	55	11.01	AMF	3	78	RP8674
Cordoba D	1,9	47	01.96-08.96	1Y	4	8	RP4422
Cordoba D	1,9	50	02.93-08.96	1Y	4	8	RP4422
Cordoba SDI	1,7	44	07.97-06.99	---	4	78	RP8272
Cordoba SDI	1,9	47	09.02-12.05	ASY	4	78	RP8674
Cordoba SDI	1,9	47	08.96-06.99	Cooling-water preheater	4	8	RP4422





Model	CC	Kw	Year	Engine	Cyl	Pict	Code
Cordoba SDI	1,9	47	08.96-06.99	Cooling-water preheater	4	91	RP8360
Cordoba SDI	1,9	50	06.99-10.02	Cooling-water preheater	4	8	RP4422
Cordoba SDI	1,9	50	06.99-10.02	Cooling-water preheater	4	91	RP8360
Cordoba SDI	1,9	50	06.99-10.02	ALD / ANV / AUC	4	78	RP8272
Cordoba TD	1,9	55	02.93-08.96	AAZ	4	78	RP8272
Cordoba TDI	1,4	51	05.05-	BNM	3	78	RP8674
Cordoba TDI	1,4	55	10.02-12.05	AMF	3	78	RP8674
Cordoba TDI	1,9	66	07.96-	AHU	4	78	RP8272
Cordoba TDI	1,9	66	08.96-06.99	Cooling-water preheater	4	8	RP4422
Cordoba TDI	1,9	66	08.96-06.99	Cooling-water preheater	4	91	RP8360
Cordoba TDI	1,9	66	06.99-10.02	Cooling-water preheater	4	8	RP4422
Cordoba TDI	1,9	66	06.99-10.02	AGR / AHU / ALH	4	78	RP8272
Cordoba TDI	1,9	74	10.02-	ATD	4	78	RP8674
Cordoba TDI	1,9	81	06.99-10.02	Cooling-water preheater	4	91	RP8360
Cordoba TDI	1,9	81	06.99-10.02	ASK / ASV	4	78	RP8272
Cordoba TDI	1,9	96	10.02-	ASZ	4	78	RP8674
Cordoba Vario TDI	1,9	66	06.99-12.02	AGR/ALH	4	78	RP8272
Cordoba Vario TDI	1,9	81	06.99-12.02	ASK / ASV	4	78	RP8272
Cordoba, Vario SDI	1,9	47	08.96-06.99	AEF/AEY	4	78	RP8272
Cordoba, Vario SDI	1,9	50	06.99-12.02	AGP/AQM	4	78	RP8272
Cordoba, Vario SDI	1,9	81	03.97-06.99	AFN	4	78	RP8272
Cordoba, Vario TDI	1,9	66	08.96-06.99	1Z/AHU	4	78	RP8272
Exeo TDI / ST	2,0	88	12.08-	CAGC / CJCC	4	171	RP8928
Exeo TDI / ST	2,0	105	12.08-	CAGA / CJCA	4	171	RP8928
Exeo TDI / ST	2,0	125	02.09-	CAHA / CGLB	4	171	RP8928
Ibiza D	1,7	47	02.93-	1Y	4	8	RP4422
Ibiza I D	1,7	40	06.84-05.93	022A.5000	4	11	RP4444
Ibiza I D	1,7	42	08.90-05.93	022 A.5000	4	11	RP4482
Ibiza II D	1,9	47	04.93-08.96	1J	4	8	RP4422
Ibiza II SDI	1,7	44	07.97-08.99	---	4	78	RP8272
Ibiza II SDI / TDI	1,9	47-66-81	08.96-08.99	AEF/AEY/1Z/AFN/AHU	4	78	RP8272
Ibiza II SDI / TDI	1,9	47-66-81	08.96-08.99	Cooling-water preheater	4	8	RP4422
Ibiza II SDI / TDI	1,9	47-66-81	08.96-08.99	Cooling-water preheater	4	91	RP8360
Ibiza II TD	1,9	55	03.93-08.96	AAZ	4	8	RP4422
Ibiza III SDI	1,9	50	08.99-02.02	AGP/AQM	4	78	RP8272
Ibiza III TDI	1,9	66	08.99-02.02	AGH / ALH	4	78	RP8272
Ibiza III TDI	1,9	81	08.99-02.02	ASK / ASV	4	78	RP8272
Ibiza III TDI	1,9	66-81	08.99-02.02	Cooling-water preheater	4	8	RP4422
Ibiza III TDI	1,9	66-81	08.99-02.02	Cooling-water preheater	4	91	RP8360
Ibiza IV SDI / TDI	1,9	47-74-96	02.02	ASY/ATD/ASZ	4	78	RP8674
Ibiza IV TDI	1,4	51	05.05-	BNM	3	78	RP8674
Ibiza IV TDI	1,4	55	05.02	AMF	3	78	RP8674
Ibiza IV TDI Cupra	1,9	110	01.04	ARL	4	78	RP8674
Ibiza IV TDI Cupra R	1,9	118	03.04-	---	4	177	RP9000



Model	CC	Kw	Year	Engine	Cyl	Pict	Code
Ibiza V Sportcoupe (6J1) TDI	1,2	55	05.10-	CFWA	4	171	RP8928
Inca D	1,7	42	09.96-	AHB	4	8	RP4422
Inca D	1,9	47	11.95-	1Y	4	8	RP4422
Inca SDI	1,9	47	11.95-06.03	AEY/AYQ	4	78	RP8272
Inca TDI	1,9	66	09.96-06.03	ALH	4	78	RP8272
Inca TDI	1,9	66	09.96-	Cooling-water preheater	4	8	RP4422
Inca TDI	1,9	66	09.96-	Cooling-water preheater	4	91	RP8360
Leon (1P1) TDI	1,6	66	11.10-	CAYB	4	171	RP8928
Leon (1P1) TDI	1,6	77	02.10-	CAYC	4	171	RP8928
Leon (1P1) TDI 16V	2,0	103	07.05-	BKD / CFHC / CLCB	4	171	RP8928
Leon (5F_) TDI	1,6	66	11.12-	CLHB	4	171	RP8928
Leon (5F_) TDI	1,6	77	11.12-	CLHA	4	171	RP8928
Leon SDI	1,9	50	11.99-06.06	AQM	4	78	RP8272
Leon TDI	1,9	66	11.99-06.06	AGR / ALH	4	78	RP8272
Leon TDI	1,9	74	10.05-	---	4	177	RP9000
Leon TDI	1,9	77	09.05-	---	4	177	RP9000
Leon TDI	1,9	81	11.99-06.06	AHF / ASF	4	78	RP8272
Leon TDI	1,9	81	09.05-	---	4	177	RP9000
Leon TDI	1,9	96	05.03-	ASZ	4	78	RP8674
Leon TDI	1,9	110	012.01-06.06	ARL	4	78	RP8272
Leon TDI	1,9	110	02.01-	---	4	78	RP8674
Leon TDI	1,9	110	09.05-	---	4	177	RP9000
Leon TDI	1,9	66-81	11.99-	Cooling-water preheater	4	8	RP4422
Leon TDI	1,9	66-81	11.99-	Cooling-water preheater	4	91	RP8360
Leon TDI	2,0	103	09.05-	---	4	178	RP9002
Leon TDI	2,0	125	02.06-	BMN	4	178	RP9002
Leon TDI Syncro	1,9	110	05.02-	ARL	4	78	RP8674
Malaga D	1,7	40	05.85-08.87	138A5	4	11	RP4444
Malaga D	1,7	40	09.87-08.91	138A5	4	11	RP4482
Malaga D	1,7	42	05.90-12.93	022 A.5000	4	11	RP4482
Ritmo D	1,7	40	09.80-08.88	---	4	11	RP4444
Ronda D	1,7	40	09.85-12.93	022A.5000	4	11	RP4444
Ronda D	1,7	40	06.82-12.88	138A5	4	11	RP4444
Terra D	1,3	33	01.90-12.94	MN	4	8	RP4422
Terra D	1,4	35	10.90-12.95	1W	4	8	RP4422
Terra D / Kombi	1,4	35	10.91-12.95	1W	4	8	RP4422
Toledo I D	1,9	47	12.95-03.99	1Y	4	8	RP4422
Toledo I D	1,9	50	05.91-03.99	1Y	4	8	RP4422
Toledo I SDI	1,9	47	12.95-03.99	1Y	4	78	RP8272
Toledo I TDI	1,9	66	08.95-03.99	1Z/AHU	4	78	RP8272
Toledo I TDI	1,9	66	08.95-03.99	Cooling-water preheater	4	8	RP4422
Toledo I TDI	1,9	66	08.95-03.99	Cooling-water preheater	4	91	RP8360
Toledo I TDI	1,9	81	11.96-03.99	AFN	4	78	RP8272
Toledo I TDI	1,9	81	11.96/03.99	Cooling-water preheater	4	8	RP4422



Model	CC	Kw	Year	Engine	Cyl	Pict	Code
Toledo I TDI	1,9	81	11.96/03.99	Cooling-water preheater	4	91	RP8360
Toledo II SDI	1,9	50	11.99-06.04	---	4	78	RP8272
Toledo II SDI	1,9	50	11.09-06.04	Cooling-water preheater	4	8	RP4422
Toledo II SDI	1,9	50	11.09-06.04	Cooling-water preheater x3	4	91	RP8360
Toledo II TDI	1,9	66	04.99-05.06	AGR/ALH	4	78	RP8272
Toledo II TDI	1,9	81	04.99-05.06	AHF / ASV	4	78	RP8272
Toledo II TDI	1,9	96	05.03-	ASZ	4	78	RP8674
Toledo II TDI	1,9	110	10.00-	ARL	4	78	RP8272
Toledo II TDI	1,9	110	10.00-	Cooling-water preheater	4	8	RP4422
Toledo II TDI	1,9	110	10.00-	Cooling-water preheater	4	91	RP8360
Toledo II TDI	1,9	66-81	04.99-	Cooling-water preheater	4	8	RP4422
Toledo II TDI	1,9	66-81	04.99-	Cooling-water preheater	4	91	RP8360
Toledo III TDI	1,9	77	10.04-	---	4	177	RP9000
Toledo III TDI	2,0	103	10.04-	---	4	178	RP9002
Toledo TD	1,9	55	05.91-04.99	AAZ	4	8	RP4422
<b>SKODA</b>							
Fabia	1,4	59	01.07-	BMS	3	177	RP9000
Fabia	1,9	77	04.07-	BLS	4	177	RP9000
Fabia	1,9	77	04.07-	BSW	4	78	RP8370
Fabia Combi SDI	1,9	47	04.00-12.07	ATD / AXR	4	78	RP8272
Fabia Combi TDI	1,4	51	10.05-	---	3	78	RP8674
Fabia Combi TDI	1,4	55	04.03-	AMF	3	78	RP8674
Fabia Combi TDI	1,4	59	10.05-	---	3	78	RP8674
Fabia Combi TDI	1,9	74	09.00-	ATD	4	78	RP8272
Fabia Combi TDI	1,9	74	09.00-	Cooling-water preheater	4	8	RP4422
Fabia Combi TDI	1,9	74	09.00-	Cooling-water preheater	4	91	RP8360
Fabia Praktik SDI	1,9	47	05.03	ASY	4	78	RP8674
Fabia Praktik SDI	1,9	47	04.02-	---	4	78	RP8674
Fabia Praktik SDI	1,9	47	07.01-12.07	ASY	4	78	RP8272
Fabia Praktik TDI	1,4	51	10.05-	---	3	78	RP8674
Fabia RS	1,9	96	09.03-	ASZ	4	78	RP8674
Fabia SDI	1,9	47	12.99-	AGP	4	78	RP8272
Fabia SDI	1,9	47	12.99-03.08	ASY	4	78	RP8272
Fabia TDI	1,4	51	10.05-	---	3	78	RP8674
Fabia TDI	1,4	55	04.03	AMF	3	78	RP8674
Fabia TDI	1,4	59	10.05-	BNV	3	78	RP8370
Fabia TDI	1,9	72	12.99-	---	4	78	RP8272
Fabia TDI	1,9	74	09.00-	ATD	4	78	RP8272
Fabia TDI	1,9	74	09.00-	Cooling-water preheater	4	8	RP4422
Fabia TDI	1,9	74	09.00-	Cooling-water preheater	4	91	RP8360
Fabia TDI	1,9	74	01.00-03.08	ATD / AXR	4	78	RP8272
Fabia TDI	1,9	77	03.07-	BLS/BSW	4	78	RP8674
Fabia TDI	1,9	81	10.00-	AHF	4	78	RP8272
Fabia TDI	1,9	85	12.99-	AJM	4	78	RP8272
Fabia Tre volumi SDI	1,9	47	11.99-12.07	ASY	4	78	RP8272



Model	CC	Kw	Year	Engine	Cyl	Pict	Code
Fabia Tre volumi TDI	1,9	74	01.00-12.07	ATD / AXR	4	78	RP8272
Felicia D	1,9	47	97-	AEY	4	78	RP8272
Felicia I D / Fun	1,9	47	06.97-	AEF	4	8	RP4422
Felicia I D / Kombi	1,9	47	10.95-03.98	AEF	4	8	RP4422
Felicia II D / Kombi	1,9	47	03.98-06.01	AEF	4	8	RP4422
Octavia	2,0	103	11.05-	BMM	4	177	RP9000
Octavia (1Z3) TDI	2,0	81	03.10-	CFHF / CLCA	4	171	RP8928
Octavia (1Z3) TDI 16V / Combi	2,0	103	02.04-	BKD / CFHC / CLCB	4	171	RP8928
Octavia Combi (1Z5) TDI	2,0	81	03.10-	CFHF / CLCA	4	171	RP8928
Octavia Combi (1Z5) TDI 16V 4x4	2,0	103	05.10-	CFHC	4	171	RP8928
Octavia Combi (1Z5) TDI 4x4	1,6	77	06.09-	CAYC	4	171	RP8928
Octavia Combi TDI	2,0	103	06.04-	---	4	178	RP9002
Octavia Combi TDI 4x4	1,9	66	11.99-02.06	AGR	4	78	RP8272
Octavia Combi TDI 4x4	1,9	74	09.00-01.06	ATD	4	78	RP8272
Octavia Combi TDI 4x4	1,9	77	11.04-	---	4	177	RP9000
Octavia Combi TDI RS	2,0	125	05.08-	CEGA	4	171	RP8928
Octavia Kombi TDI 4x4	1,9	66	11.99-09.00	Cooling-water preheater	4	8	RP4422
Octavia Kombi TDI 4x4	1,9	66	11.99-09.00	Cooling-water preheater x3	4	91	RP8360
Octavia Kombi TDI 4x4	1,9	74	09.00-	Cooling-water preheater	4	8	RP4422
Octavia Kombi TDI 4x4	1,9	74	09.00-	Cooling-water preheater x3	4	91	RP8360
Octavia SDI / Combi	1,9	47	09.96-	AEY	4	78	RP8272
Octavia SDI / Combi	1,9	50	06.97-12.03	AGP/AQM	4	78	RP8272
Octavia TD	1,9	50	97-	---	4	8	RP4422
Octavia TDI	1,9	66	11.99-09.00	AGR	4	78	RP8272
Octavia TDI	1,9	66	09.96-	Cooling-water preheater	4	8	RP4422
Octavia TDI	1,9	66	09.96-	Cooling-water preheater	4	91	RP8360
Octavia TDI	1,9	66	11.99-09.00	Cooling-water preheater	4	8	RP4422
Octavia TDI	1,9	66	11.99-09.00	Cooling-water preheater	4	91	RP8360
Octavia TDI	1,9	74	09.00-	ATD	4	78	RP8272
Octavia TDI	1,9	74	09.00-	Cooling-water preheater	4	91	RP8360
Octavia TDI	1,9	74	09.00-	Cooling-water preheater	4	8	RP4422
Octavia TDI	1,9	85	10.00-	AJM / AUY	4	78	RP8272
Octavia TDI	2,0	103	06.04-	---	4	178	RP9002
Octavia TDI / Combi	1,9	77	06.04-	---	4	177	RP9000
Octavia TDI / Combi	1,9	96	01.03	ASZ	4	78	RP8674
Octavia, Combi TDI	1,9	66	09.96-03.10	AGR / ALH	4	78	RP8272
Octavia, Combi TDI	1,9	81	08.97-01.06	AHF / ASV	4	78	RP8272
Pick-Up D	1,9	47	01.96-	AEF	4	8	RP4422
Roomster (5J) TDI	1,9	74	03.06-05.06	AXR	4	78	RP8370
Roomster (5J) TDI / Praktik (5J) TDI	1,2	55	03.10-	CFWA	3	171	RP8928
Roomster Praktik (5J) TDI	1,6	66	03.10-	CAYB	4	171	RP8928
Roomster TDI	1,4	51	09.06-	BNM	3	78	RP8674
Roomster TDI	1,4	59	09.06-	BNV	3	78	RP8674
Roomster TDI	1,9	77	09.06-	---	4	177	RP9000



Model	CC	Kw	Year	Engine	Cyl	Pict	Code
Superb	1,9	77	10.05-	BSV	4	177	RP9000
Superb	1,9	85	01.07-	BPZ	4	177	RP9000
Superb	2,0	91	02.06-	BWW	4	177	RP9000
Superb (3T4) TDI	1,6	77	09.10-	CAYC	4	171	RP8928
Superb (3T4) TDI 16V 4x4	2,0	103	11.10-	CFFB	4	171	RP8928
Superb Station wagon (3T5) TDI	1,6	77	09.10-	CAYC	4	171	RP8928
Superb Station wagon (3T5) TDI	1,9	77	10.09-11.10	BLS / BXE	4	177	RP9000
Superb Station wagon (3T5) TDI 16V 4x4	2,0	103	11.10-	CFFB	4	171	RP8928
Superb TDI	1,9	74	08.02	AVB	4	78	RP8674
Superb TDI	1,9	96	02.02	ADB/AWX	4	78	RP8674
Superb TDI	2,0	103	10.05-	BSS	4	177	RP9000
Superb TDI	2,5	114	02.02	AYM	6	105	RP8404
Superb TDI	2,5	120	06.03-	BDG	4	105	RP8404
Yeti (5L) TDI	1,6	77	11.10-	CAYC	4	171	RP8928
Yeti (5L) TDI	2,0	103	11.11-	CFHC	4	171	RP8928
Yeti TDI	2,0	103	11.09-	CFHC	4	171	RP8928
Yeti TDI / 4x4	2,0	81	11.09-	CFHA	4	171	RP8928
Yeti TDI 4x4	2,0	81	11.09-	CFHF	4	171	RP8928
Yeti TDI 4x4	2,0	81	09.11-	CLCA	4	171	RP8928
Yeti TDI 4x4	2,0	103	05.09-11.09	CBDB	4	171	RP8928
Yeti TDI 4x4	2,0	103	05.10-	CLCB	4	171	RP8928
Yeti TDI 4x4	2,0	125	05.10-	CFJA	4	171	RP8928
Yeti TDI 4x4	2,0	125	11.09-05.10	CEGA	4	171	RP8928
<b>SMART</b>							
Cabrio CDI	0,8	30	03.01-	OM 660 DE 8LA	3	137	RP8634
City-Coupé CDI	0,8	30	11.99-	OM 660 DE 8LA	3	137	RP8634
ForFour CDI	1,5	50-70	09.04-	OM 639.939	3	119	RP8440
ForTwo Cabrio, Coupe CDI	0,8	30	01.04-	OM 660 DE 8LA	3	137	RP8634
<b>SSANGYONG</b>							
Actyon 200xdi	2,0	104	11.06-	---	4	95	RP8374
Istana D	2,3	57-58	07.95-	661.911	4	13	RP4452
Istana D	2,9	70	07.95-	662.911	5	13	RP4452
Korando D	2,2	50	12.88-12.96	DC23	4	26	RP8322
Korando D	2,3	58	12.96-01.99	MB-OM 601.940	4	13	RP4452
Korando D	2,9	72	12.96-01.99	MB-OM 662	5	13	RP4452
Korando TD	2,3	73	03.99-03.00	---	4	13	RP4452
Korando TD	2,9	88	04.98-	---	5	13	RP4452
Kyron Xdi 4x4	2,0	104	05.2005-	---	4	165	RP8908
Musso D	2,3	59	10.95-	MB-OM 601.940/MB-OM 661	4	13	RP4452
Musso D	2,9	73	03.96-01.99	MB-OM 662	5	13	RP4452
Musso Sports 290S TD	2,9	88	03.04-	---	5	13	RP4452
Musso TD	2,3	73	03.99-03.00	---	4	13	RP4452
Musso TD	2,9	88	04.98-	---	5	13	RP4452
Rexton 270XVT	2,7	137	07-	---	5	95	RP8374



Model	CC	Kw	Year	Engine	Cyl	Pict	Code
Rexton 290 RX Rd	2,9	87	05.02-	Mercedes	5	83	RP8342
Rexton D	2,9	88	04.02-	---	5	13	RP4452
Rexton RX 270XDI	2,7	115	07.04-	---	5	95	RP8374
Rexton Xdi	2,7	120	08.04-	---	5	165	RP8908
Rodius Xdi / 4WD	2,7	120	05.2005-	---	5	165	RP8908
<b>STEYR-DAIMLER-PUCH</b>							
Puch 290 GD	2,9	72/98	08.93-	OM 602	5	13	RP4452
Puch 300 GD	3,0	83-113	09.89-	OM 617/603	6	13	RP4452
Puch 350 GDT	3,5	100-136	09.91-	OM 617/603	6	13	RP4452
<b>SUZUKI</b>							
Baleno D	1,9	46	1998-	---	4	11	RP4444
Baleno TD, Kombi	1,9	55	04.98-	---	4	11	RP4444
Grand Vitara (FT,GT) TD Intercooler	2,0	64	03.98	---	---	55	RP8364
Grand Vitara D	2,0	81	04.01-	HdI PSA	4	108	RP8410
Grand Vitara DDiS (JB419D)	1,9	95	10.05-	F9QB	4	133	RP8624
Grand Vitara HDI 110	2,0	80	07.01-	---	4	108	RP8410
Grand Vitara TD Intercooler	2,0	64	03.98-	RF	4	108	RP8410
Ignis DDiS (RM413D)	1,3	51	09.03-	Z13DT	4	155	RP8678
Jimmy (FJ) DDiS 4WD	1,5	48	12.03-	K9K 700	4	133	RP8624
Jimmy (FJ) DDiS 4x4	1,5	63	08.05-	K9K 266	4	133	RP8624
Jimmy DDiS (SN415D)	1,5	48	12.03-	K9K	4	133	RP8624
Liana DDiS (RH414D)	1,4	66	07.04-	DV4 8HY	4	146	RP8652
Liana DDiS/Kombi	1,4	66	06.05-	8HY	4	146	RP8652
Samurai TD	1,9	46	11.98-	XUD9	4	11	RP4444
Swift DDiS Diesel Turbo Hatchback	1,2	55	02.08-	D13A	4	155	RP8678
Swift DDiS Diesel Turbo Hatchback	1,2	51-55	08.05-	Z13DT	4	155	RP8678
SX4 DDiS Hatchback	1,6	66	04.07-	9HX	4	117	RP8436
SX4 DDiS Hatchback / 4WD	1,9	88	05.06-	D19AA	4	132	RP8622/30
Vitara (ET,TA) TD (ET)	2,0	52	12.94-03.98	---	---	55	RP8364
Vitara (ET,TA) TD Intercooler (ET)	2,0	64	12.95-03.98	---	---	55	RP8364
Vitara Cabrio D	1,9	55	08.96-03.99	---	4	11	RP4444
Vitara D (ET)	1,9	50	01.95-03.98	XUD9A	4	11	RP4444
Vitara TD	1,9	55	08.96-03.99	---	4	11	RP4444
Vitara TD	1,9	66	05.00-	XUD... PSA Group	4	11	RP4444
Vitara TD (ET)	2,0	52	12.94-03.98	RF	4	108	RP8410
Vitara TD Intercooler (ET)	2,0	64	12.95-03.98	RF	4	108	RP8410
Wagon R+ DDiS	1,3	51	09.03-	---	4	155	RP8678
<b>TALBOT</b>							
Express D	1,9	51	11.87-01.94	XUD9A	4	11	RP4444
Express D	2,5	55	09.81-01.94	CRD93	4	11	RP4444
Express TD	2,5	70	07.87-01.94	CRD 93 LS	4	11	RP4444
Horizon D	1,9	47	07.84-06.86	XUD9	4	11	RP4444
Solara D	1,9	48-65	11.84-07.86	XUD9	4	11	RP4444
Tagora TD	2,3	59	09.81-06.83	XD2S	4	11	RP4444



Model	CC	Kw	Year	Engine	Cyl	Pict	Code
<b>TATA</b>							
Tata 206	1,9	44	07.88-	4DL	4	11	RP4444
Tata 207	1,9	50	07.88-	4DL	4	11	RP4444
<b>TOYOTA</b>							
4 Runner Turbo-D	3,0	92	10.93-03.96	KZN130	4	126	RP8610
4 Runner Turbo-D	3,0	92	11.95-	---	4	126	RP8610
4-Runner	2,8	---	---	2L	4	46	RP8184
4-Runner	3,0	92	10.93-	1KZ-T	4	46	RP8332
4-Runner D	2,4	---	---	2L	4	46	RP6804
4-Runner D	2,5	---	01.93-	2LT	4	46	RP8332
4-Runner D	2,8	---	01.93-	3L	4	46	RP8332
4-Runner TD	2,4	66	10.90-12.96	2LT	4	46	RP8332
Auris (_ZE15_, _RE15_) D-4D	1,4	66	03.07-	1ND-TV	4	142	RP8644
Auris 2,2 D-4D	2,2	130	03.07-	2ADFHV	4	184	RP8448
Auris D-4D	2,5	93	03.07-	---	4	164	RP8906
Avensis (T25) D-4D	2,0	85	04.03-	---	4	164	RP8906
Avensis 2,2 D Station Wagon (T25)	2,2	130	02.09-	---	4	184	RP8448
Avensis 2,2 D-CAT (T25) / Combi / Station Wagon	2,2	130	07.05-	---	4	184	RP8448
Avensis D Turbo Liftback, Sedan, Wagon [T25] D-4D	2,0	82	03.03-	1CDFTV	4	164	RP8906
Avensis D-4D (T22)	2,0	81	10.99-02.03	---	4	164	RP8906
Avensis D-4D (T27)	2,0	93	11.08-	1ADFTV	4	184	RP8468
Avensis D-4D (T27)	2,2	110	11.08-	2ADFTV	4	184	RP8468
Avensis D-CAT (T27)	2,2	110-130	11.08-	2ADFHV	4	184	RP8468
Avensis Liftback D-4D (T22)	2,0	81	10.99-02.03	---	4	164	RP8906
Avensis Liftback, Station wagon (T22) D	1,9	85	09.02-02.03	---	4	164	RP8906
Avensis Sedan, Wagon [T22] D-4D	2,0	81	10.99-02.03	1CDETV, 1CDFTV <common Rail>	4	164	RP8906
Avensis Station Wagon D-4D (T25)	2,0	85	04.03-	---	4	164	RP8906
Avensis TD / Liftback / SW	2,0	66	09.97-	2CT / 2C-TE	4	143	RP8646
Avensis Tre volumi / Combi (T25) D-4D	2,0	85	04.03-	---	4	164	RP8906
Avensis Verso (AC) D-4D	2,0	85	08.01-	---	4	164	RP8906
Aygo	1,4	52	06.05-	---	4	117	RP8436
Aygo HDi	1,4	40	07.05-	---	4	146	RP8652
Blizzard	---	---	04.90-	2L-TE	4	46	RP8332
Camry	2,0	62	90-91	2C-T	4	30	RP8208
Camry TD	2,0	63	11.88-05.91	2CT	4	143	RP8646
Camry TD SW	2,0	62	10.86-07.88	2CT	4	30	RP6840
Camry TD SW	2,0	62	11.86-05.91	2CT	4	143	RP8646
Camry TD SW	2,0	63	11.88-05.91	2CT	4	143	RP8646
Camry Turbo-D	1,8	54	10.84-01.88	1C-TL	4	30	RP6840
Camry Turbo-D	2,0	62	11.86-07.88	2C-T	4	30	RP6840
Camry Turbo-D	2,0	62	11.86-05.91	2C-T	4	143	RP8646



Model	CC	Kw	Year	Engine	Cyl	Pict	Code
Carina D	1,8	48	04.82-09.83	1C-T	4	30	RP6840
Carina E	2,0	---	02.92-	2C	4	30	RP8208
Carina E D	2,0	54	04.92-01.96	2C	4	143	RP8646
Carina E D Sportswagon	2,0	54	11.92-01.96	2C	4	143	RP8646
Carina E Stufenheck D	2,0	54	08.92-01.96	---	4	143	RP8646
Carina E TD / Sportswagon	2,0	61	01.96-09.97	2C-T	4	143	RP8646
Carina II D	2,0	50	02.84-11.87	2C-L	4	30	RP6840
Carina II D	2,0	51	10.83-11.87	2C-L	4	30	RP6840
Carina II D	2,0	54	03.88-06.93	2C-L	4	143	RP8646
Carina II D	2,0	55	10.83-12.85	2C-L	4	30	RP8188
Carina II D Stufenheck	2,0	54	03.88-01.92	2C-L	4	143	RP8646
Carina II D SW	2,0	54	12.87-01.92	2C-L	4	143	RP8646
Coaster	4,0	---	05.82-	2H	6	30	RP6914
Coaster	---	---	-93	13B	---	30	RP6916
Corolla	1,5	---	---	1N/1NT	4	46	RP6804
Corolla (_E11_) D	2,0	53	07.92-04.97	2C	4	30	RP8208
Corolla (_E9_) D	1,8	49	08.89-04.92	1C	4	30	RP8208
Corolla (E12U, E12J) D-4D	2,0	66	01.02-	---	---	164	RP8906
Corolla Combi, Station wagon D-4D (E12J/E12T)	2,0	66	01.02-	---	4	164	RP8906
Corolla Combi, Station wagon D-4D (E12J/E12T)	2,0	85	04.04-	---	4	164	RP8906
Corolla Compact D	1,8	47	08.97-04.92	---	4	143	RP8646
Corolla Compact D	1,8	49	08.89-04.92	---	4	143	RP8646
Corolla Compact D	2,0	53	07.92-04.97	---	4	143	RP8646
Corolla Compact D	2,0	53	04.97-02.00	---	4	143	RP8646
Corolla Compact/Lifback/Wagon (E11) D-4D	2,0	66	09.00-01.02	---	4	164	RP8906
Corolla D	1,8	47	07.87-06.93	1C-L	4	30	RP6840
Corolla D	1,8	47	07.85-04.87	1C	4	143	RP8646
Corolla D	1,8	49	11.89-06.93	1C	4	143	RP8646
Corolla D	1,8	53	07.92-04.97	2C	4	143	RP8646
Corolla D	1,8	53	04.97-02.00	2C-E	4	143	RP8646
Corolla D	2,0	43	04.97-02.00	---	4	143	RP8646
Corolla D-4D (E12U/E12J)	2,0	81	01.02-	---	4	164	RP8906
Corolla D-4D (E12U/E12J)	2,0	85	05.03-	---	4	164	RP8906
Corolla FX Compact D	1,8	43	01.85-04.87	1C	4	30	RP6840
Corolla FX Compact D	1,8	47	08.85-04.87	1C-L	4	30	RP6840
Corolla Hatchback D	1,8	44	05.83-04.87	1CL	4	30	RP6840
Corolla Hatchback D	1,8	47-49	05.87-04.92	1C	4	30	RP8208
Corolla Hatchback D	2,0	53-54	05.92-08.97	2C	4	30	RP8208
Corolla Hatchback D Turbo [E11] D-4D	2,0	66	08.00-07.01	1CDFTV <common Rail>	4	164	RP8906
Corolla Hatchback D Turbo [E12] D-4D	2,0	66	10.01	1CDFTV, 1CDFTV <intercooler>	4	164	RP8906
Corolla Liftback D	1,8	47	07.87-04.92	1C	4	143	RP8646





Model	CC	Kw	Year	Engine	Cyl	Pict	Code
Corolla Liftback D	1,8	49	11.89-04.92	1C	4	143	RP8646
Corolla Liftback D	2,0	53	07.92-04.97	2C	4	143	RP8646
Corolla Liftback D	2,0	53	04.97-02.00	---	4	143	RP8646
Corolla Liftback D Turbo [E11] D-4D	2,0	66	08.00-09.01	1CDFTV <common Rail>	4	164	RP8906
Corolla Sedan D	1,8	47	05.87-04.92	1C	4	30	RP8208
Corolla Sedan D	2,0	53-54	05.92-08.97	2C	4	30	RP8208
Corolla Sedan D Turbo [E11] D-4D	2,0	82	08.00-09.01	1CDFTV <common Rail>	4	164	RP8906
Corolla Station Wagon D	1,8	47	12.87-06.92	---	4	143	RP8646
Corolla Station Wagon D	1,8	49	08.89-06.92	---	4	143	RP8646
Corolla Stufenheck D-4D (E12J/E12T)	2,0	66	08.02-	---	4	164	RP8906
Corolla SW D	1,8	43	05.83-07.87	1C	4	30	RP6840
Corolla SW D	1,8	47	08.87-04.92	1C	4	30	RP8208
Corolla SW D	2,0	53	07.92-10.99	2C	4	143	RP8646
Corolla Tre volumi (_E12J_, _E12T_) D4d	2,0	85	06.04-07.07	1CD-FTV	4	164	RP8906
Corolla Verso 2,2 D-4D (ZER_, ZZE_)	2,2	130	07.05-	---	4	184	RP8448
Corolla Verso D-4D (E12J)	2,0	66	01.02-05.04	---	4	164	RP8906
Corolla Verso D-4D (ZER/ZZE)	2,0	85	04.04-	---	4	164	RP8906
Corolla Wagon D	2,0	53	04.97-02.00	---	4	143	RP8646
Corolla Wagon D Turbo [E11] D-4D	2,0	66	08.00-09.01	1CDFTV <common Rail>	4	164	RP8906
Corolla/Kombi D	1,4	66	07.04-	1ND-TV	4	142	RP8644
Corona	2,2	---	08.82-	L	4	75	RP8186
Corona D	2,0	53	01.86-11.86	2C	4	30	RP6840
Corona D	2,0	55	10.83-11.87	2CL	4	30	RP6840
Corona D	2,0	53-54	01.86-07.99	2C	4	143	RP8646
Corona D	2,2	49	08.82-07.84	L	4	46	RP6692
Corona D / Kombi	1,8	48	01.82-12.83	1C	4	30	RP8188
Corona D / Kombi	2,0	54	12.87-01.92	2C	4	143	RP8646
Corona D s.g.s	2,2	49	08.82-07.84	L	4	46	RP6804
Cressida D	2,5	61	08.88-	2L	4	46	RP8332
Cressida D / Kombi	2,2	49	09.80-07.82	L	4	46	RP6692
Cressida D / Kombi	2,2	49	08.82-	L	4	46	RP6804
Cressida D / Kombi	2,2	53	09.80-07.84	L	4	46	RP6692
Cressida D / Kombi	2,5	61	08.84-07.88	2L	4	46	RP6692
Cressida TD / Kombi	2,5	63	08.84-08.86	2LT	4	75	RP8660
Cresta D	2,5	53-61	08.88-	2L-II / 2L-II T	4	46	RP8332
Crown	2,2	---	08.80-	L	4	75	RP8186
Crown D / Kombi	2,2	49	08.80-07.83	L	4	46	RP6804
Crown D / Kombi	2,2	53	09.79-07.83	L	4	46	RP6692
Crown D / Kombi	2,5	53-61	08.83-08.89	2L	4	46	RP6692
Crown D / Kombi	2,5	53-61	08.89-	2L-II/2L-II T/2L-THE II	4	46	RP8332
Dyna 2500	---	---	---	2L	---	46	RP8184
Dyna 3000	3,0	---	05.82-89	B	4	30	RP6914



Model	CC	Kw	Year	Engine	Cyl	Pict	Code
Dyna D - 24v -	2,0	---	08.80-	2B	4	30	RP6916
Dyna D 100	2,5	55	08.87-07.88	2L OHC	4	46	RP6804
Dyna D 100	2,5	55	03.88-	2L	4	46	RP8332
Dyna D 100	2,5	53-54	08.88-	2L	4	46	RP8332
Dyna D 100 / 150	2,5	53	08.85-07.88	2L OHC	4	46	RP6804
Dyna D 100 / 150	2,5	55	08.85-07.87	2L OHC	4	46	RP6692
Dyna D 150	2,8	58	08.88-	3L	4	46	RP8332
Dyna D 200	3,0	59-60	08.87-	B OHV	6	30	RP8188
Dyna D 3000	3,0	---	01.93-	B / 11B	6	30	RP8188
Dyna D 3000 - 24v -	3,0	---	01.93-	B / 11B	6	30	RP6916
Dyna D 3700	3,7	---	01.93-	14 B	6	30	RP8188
Dyna D 3700 - 24v -	3,7	---	01.93-	14 B	6	30	RP6916
Dyna Pianale piatto (KD,LY)	2,5	65-75	08.01-	2KD-FTV	4	164	RP8906
Hi Ace	2,4	---	09.83-92	2L	4	46	RP6804
Hi Ace	2,4	---	-92	2L 24V	4	46	RP8184
Hi Ace	2,4	---	-92	2L 12V	4	46	RP6804
Hi Ace	2,4	---	09.83-92	2L	4	75	RP8186
Hi Ace (LH102-104,112-115,125)	2,8	---	98-	3L	4	46	RP8332
Hi Ace 2800	2,8	---	93-	3L	4	46	RP8332
Hi Ace D	2,2	46	01.80-10.82	---	4	46	RP6692
Hi Ace D	2,2	49	12.82-10.84	L	4	46	RP6804
Hi Ace D	2,4	58	08.95-	2L	4	46	RP8332
Hi Ace D	2,5	55	08.89-	2L	4	46	RP8332
Hi Ace D	2,5	53-61	08.88-	2L-II / 2L-T / 3L	4	46	RP8332
Hi Ace D	2,5	53-61	---	2L	4	46	RP8184
Hi Ace D	3,0	---	01.93-	B / 11B	6	30	RP8188
Hi Ace D	3,7	---	01.93-	14B	6	30	RP8188
Hi Ace D - 24v -	3,0	---	01.93-	B / 11B	6	30	RP6916
Hi Ace D - 24v -	3,7	---	01.93-	14B	6	30	RP6916
Hi Ace D / 4WD	2,5	55	01.84-07.89	2L	4	46	RP6804
Hi Ace D Pickup	2,2	49	11.82-07.85	L	4	46	RP6804
Hi Ace II D	2,4	55	08.84-08.89	2L	4	46	RP6804
Hi Ace II D	2,4	55	09.88-11.89	---	4	46	RP8332
Hi Ace II D 4WD	2,5	54	01.87-01.88	---	4	46	RP6804
Hi Ace III D	2,4	55	08.89-08.95	2L	4	46	RP8332
Hi Ace III D	2,4	57	10.93-08.95	---	4	46	RP8332
Hi Ace IV D	2,4	55	07.99-	---	4	46	RP8332
Hi Ace IV D	2,4	58	08.95-	2L	4	46	RP8332
Hi Ace IV Furgonato (H100) D-4D 4x4	2,5	65	08.01-08.06	---	4	164	RP8906
Hi Ace IV TD	2,4	66	08.95-	2L-T	4	46	RP8332
Hi Ace IV Wagon (H100) D-4D 4x4	2,5	75	08.01-08.06	---	4	164	RP8906
Hi Ace IV Wagon, Furgonato (H1, H2) D-4D, 4WD	2,5	65-75	11.01-	2KD-FTV	4	164	RP8906
Hi Ace TD	2,4	66	08.95-	2LT	4	46	RP8332



Model	CC	Kw	Year	Engine	Cyl	Pict	Code
Hi Ace V Wagon D-4D	2,5	70-86	08.06-	---	4	164	RP8906
Hi Lux 2800	2,8	---	93-	3L	4	46	RP8332
Hi Lux D	2,4	53-61	---	2L	4	46	RP8184
Hi Lux D	2,5	---	-12.90	2C	4	30	RP8208
Hi Lux D Taro	2,4	61	01.89-	2L	4	46	RP8332
Hi Lux III Pick-up D-4D	2,5	88	12.07-	2HD-FTV	4	164	RP8906
Hi Lux Pick-up (N) D-4D, 4WD	2,5	65-75	11.01-	2KD-FTV	4	164	RP8906
Hi Lux Pick-up D	2,4	55	07.98-01.02	---	4	46	RP8332
Hi Lux Pick-up D	2,4	58	03.95-	---	4	46	RP8332
Hi Lux Pick-up D	2,4	59	01.92-	2L	4	46	RP8332
Hi Lux Pick-up D	2,4	61	03.89-	2L	4	46	RP8332
Hi Lux Pick-up D	3,0	126	10.06-	---	4	164	RP8906
Hi Lux Pick-up D 4x4	2,5	75	08.05-	---	4	164	RP8906
Hi Lux Pick-up D-4D	2,5	75	06.06-	---	4	164	RP8906
Hi Lux Pick-up TD	2,4	66	08.98-01.02	2L-T	4	46	RP8332
Hi Lux TD	2,4	66	08.98-	2L-T	4	46	RP8332
IQ ( _ GJ_, AJ1) D-4D	1,4	66	01.09	1ND-TV	4	142	RP8644
Land Cruiser	2,4	---	---	2L 2,4L	4	46	RP6804
Land Cruiser	---	---	---	3B 4 Zyl./2H 6 Zyl.	6	30	RP8188
Land Cruiser	---	---	05.82-	H/2H	6	30	RP6914
Land Cruiser	---	---	10.81-	2B	---	30	RP6914
Land Cruiser (J12) D4D	3,0	120	01.03-	1KD-FTV	4	164	RP8906
Land Cruiser (J12) D-4D	3,0	122	08.04-	---	4	164	RP8906
Land Cruiser (J12) D-4D	3,0	127	01.07-	---	4	164	RP8906
Land Cruiser (J7) TD	3,0	92	05.93-05.96	KZJ70 / KZJ73 / KZJ77	4	126	RP8610
Land Cruiser 150 (J15) D-4D	3,0	127	03.10-	---	4	164	RP8906
Land Cruiser 150 (J15) D-4D	3,0	140	01.10-	---	4	164	RP8906
Land Cruiser 80 D	4,2	99	01.90-12.97	1H-Z	6	143	RP8646
Land Cruiser 80 TD	4,2	118-123	01.90-12.97	1HD-T	6	143	RP8646
Land Cruiser 90 (J9) D-4D	3,0	120	10.00-	1KD-FTV	4	164	RP8906
Land Cruiser D	2,4	53	11.84-10.85	2L	4	46	RP6804
Land Cruiser D	2,5	66	04.90-	2L-TE	4	46	RP8332
Land Cruiser D	2,8	58	01.93-	3L	4	46	RP8332
Land Cruiser D	3,4	66	08.80-10.84	B / 3B	4	30	RP6592
Land Cruiser D	3,4	70	11.84-12.96	---	4	143	RP8646
Land Cruiser D	3,4	70	01.90-12.96	3B	4	143	RP8646
Land Cruiser D	3,4	70	08.88-12.89	3B	4	30	RP6916
Land Cruiser D	4,0	76	01.85-12.87	2H	6	30	RP8188
Land Cruiser D - 24v -	3,4	66	08.80-10.81	3B	4	30	RP6916
Land Cruiser D - 24v -	3,4	66	10.81-10.84	3B	6	30	RP6914
Land Cruiser D - 24v -	3,4	66	11.84-08.88	3B	4	30	RP6914
Land Cruiser D Optional	2,5	85	01.93-	VM HR-492	4	11	RP4444
Land Cruiser Hardtop TD	2,4	66	07.90-05.93	2L-T	4	46	RP8332
Land Cruiser TD	2,4	63	10.85-12.89	2L-T	4	75	RP8660



Model	CC	Kw	Year	Engine	Cyl	Pict	Code
Land Cruiser TD	2,4	63	01.90-05.90	2L-T	4	46	RP8332
Land Cruiser TD	2,4	66	01.90-05.93	2L-T	4	46	RP8332
Land Cruiser TD 90 (J9)	3,0	92	04.96-	KZJ90 / KZJ95	4	126	RP8610
Land Cruiser Turbo-D	4,0	100	08.87/12.89	12HT	6	30	RP6914
Lite Ace Bus D	2,0	53	08.88-01.92	2C	4	143	RP8646
Lite Ace D	1,8	46	10.85-08.88	1C	4	30	RP6840
Lite Ace D	1,8	47	08.88-01.92	2C	4	30	RP8208
Lite Ace D	1,8	48	10.82-08.85	1C	4	30	RP6840
Lite Ace D	2,0	51	01.92-05.94	2C	4	30	RP8208
Liteace Kasten D	2,0	53	08.98-01.92	---	4	143	RP8646
Mark II D	2,5	53-72	08.88-	2L-II / 2L-II T	4	46	RP8332
Master Ace	2,0	---	08.88-	2C-III T	4	30	RP8208
Model F D	2,0	53	05.83-08.85	2C	4	30	RP8188
Model F D Tarago	2,0	53	05.83-02.87	2C	4	30	RP6840
Pick up	2,2	---	08.82-	L	4	75	RP8186
Pick up D	2,2	49	11.82-07.85	L	4	46	RP6804
PicNic D	2,2	66	07.97-12.01	CMX10	4	126	RP8610
Previa (ACR3) D-4D	2,0	85	03.01-	---	4	164	RP8906
Previa D	2,0	85	04.01-	1CD-FTV	4	164	RP8906
RAV 4 D	2,0	85	10.01-	1CD-FTV	4	164	RP8906
RAV 4 II D-4D 4WD (XA2)	2,0	85	09.01-	---	4	164	RP8906
RAV 4 III 2,2 D-4D (ACA_, ACE_, ALA_)	2,2	100	03.06-	---	---	184	RP8468
RAV 4 III 2,2 D-CAT (ACA_, ACE_, ALA_)	2,2	130	03.06-	---	---	184	RP8468
RAV4 D Turbo [A2]	2,0	66	05.01-	1CD-FTV <common Rail>	4	164	RP8906
Starlet D	1,5	40	12.86-11.89	1N	4	46	RP6804
Starlet D	1,5	40	12.89-03.96	1N	4	46	RP8332
Tamarrow D	2,2	49-53	08.82-08.83	L	4	46	RP6692
Tamarrow D s.g.s.	2,2	49-53	08.82-	L	4	46	RP6804
Toyo Ace	2,2	---	03.79-	L	4	46	RP6804
Toyo Ace	2,2	---	03.79-	L	4	75	RP8186
Toyo Ace	3,0	---	01.82-	B	4	30	RP6914
Toyo Ace	---	---	01.82-	2L	---	30	RP6914
Toyo Ace	---	---	09.83-	2L	---	46	RP6804
Toyo Ace D	2,2	49	04.80-01.82	L	4	46	RP6692
Toyo Ace D	2,4	53-61	09.83-	2L	4	46	RP8184
Toyo Ace D	2,5	---	03.79-08.83	2J	4	30	RP8188
Toyo Ace D	2,5	53-61	08.88-	2L-II / 3L	4	46	RP8332
Toyo Ace D - 24v -	2,5	53	08.83-07.85	2L OHC	4	46	RP8184
Toyo Ace D - 24v -	2,5	---	01.82-	2J	4	30	RP6916
Urban Cruiser (NCP11_) D-4D / 4x4	1,4	66	04.09-	1ND-TV	4	142	RP8644
Verso S (NCP12_, NSP12_) D4-D	1,4	66	11.10-	1ND-TV	4	142	RP8644
Vista	---	---	08.88-	---	4	30	RP8208



Model	CC	Kw	Year	Engine	Cyl	Pict	Code
Yaris (_P13_) D-4D	1,4	66	09.11-	1ND-TV	4	142	RP8644
Yaris (NLP90)	1,4	55	11.05-	1ND-TV	4	142	RP8644
Yaris D-4D	1,4	66	01.06-	1ND-TV	4	142	RP8644
Yaris D-4D /Verso	1,4	55	12.01-	1ND-TV	4	142	RP8644
Yaris Di / Verso	1,5	---	01.00-	---	4	142	RP8644
<b>UAZ</b>							
425 PP	---	---	08.81-	Peugeot	4	11	RP4444
468B	---	---	-04.86	VM	---	6	RP4410
469 B	2,5	---	-11.85	Peugeot	4	11	RP4444
469 B TD	2,4	---	-04.86	VM	4	6	RP4410
<b>UNIC</b>							
30-35-40 U8 D	2,5	53	04.78-06.82	Fiat 8140.61	4	11	RP4444
30-35-40 U8 D	2,5	53	07.82-12.82	Fiat 8140.61	4	11	RP4444
<b>VAUXHALL</b>							
Antara CDTi	2,2	---	2007-	A22DM	4	193	RP8480
Antara CDTi	---	110	11.06-	---	---	111	RP8416
Arena D	1,9	44	03.98-	F8Q-606	4	101	RP8396
Arena D	2,5	55	03.98-	S8U-758	4	11	RP4444
Astra D	1,5	37	09.84-08.91	4 EC1 Isuzu Mot.804794	4	26	RP6824
Astra D	1,5	37	09.84-08.91	4 EC1 Isuzu Mot.804795	4	26	RP8322
Astra D	1,6	40	03.82-01.89	16 D OHC	4	11	RP4444
Astra D	1,7	42	01.89-	17 D OHC II	4	11	RP4444
Astra DTi 16V	1,7	55	02.00-	4EE2	4	152	RP8670
Astra G 16V	1,7	---	01.00-	Y17DT	4	152	RP8670
Astra H 16V	1,7	---	05.04-	Z17DTH/Z17DTL	4	152	RP8670
Astra J CDTi	1,7	---	---	A17DTC / A17DTS	4	192	RP8478
Astra Mk II Belmont DT	1,5	49	01.88-08.90	15 DT (T4EC1)	4	71	RP8324
Astra Mk II Belmont DT	1,5	53	01.87-08.89	15 DT	4	71	RP8324
Astra Mk II Belmont DT	1,6	40	09.85-08.91	16 DA	4	11	RP4444
Astra Mk II Belmont DT	1,7	42	01.89-12.91	17 DA	4	11	RP4444
Astra Mk II D / Estate	1,6	40	09.84-12.89	16 DA	4	11	RP4444
Astra Mk II D / Estate	1,7	42	01.89-08.91	17 DR	4	11	RP4444
Astra Mk II Estate DT	1,5	49	01.88-08.91	15 DT (T4EC1)	4	71	RP8324
Astra Mk III DI / Estate	2,0	60	02.98-	X 20 DTL/Y 20 DTL	4	103	RP8400
Astra Mk III DTi 16V / Estate	2,0	74	08.99	X 20 DTH/Y 20 DTH	4	103	RP8400
Astra Mk III TD / Estate	1,7	42	12.91-02.98	17 D	4	11	RP4444
Astra Mk III TD / Estate	1,7	50	02.98-08.00	X 17 DTL	4	11	RP4488
Astra Mk III TD / Estate	1,7	60	12.91-02.98	17 DT (TC4EE1) Mot.731416	4	71	RP8134
Astra Mk III TD / Estate	1,7	60	12.91-05.95	17 DT (TC4EE1) Mot.731417	4	71	RP8324
Astra Mk III TD / Estate	1,7	60	12.91-09.98	17 DT (TC4EE1) Mot.956633	4	125	RP8680
Astra Mk III TD / Estate / Van	1,7	44	03.91-12.94	17 DR	4	11	RP4488
Astra Mk III TD / Estate / Van	1,7	50	11.94-02.98	X 17 DTL	4	11	RP4488
Astra Mk IV CC DTi 16V	1,7	55	02.00-	---	4	152	RP8910
Astra Mk IV DTi 16V	1,7	55	02.00-	---	4	152	RP8910
Astra Mk IV Estate DTi 16V	1,7	55	02.00-	---	4	152	RP8910



Model	CC	Kw	Year	Engine	Cyl	Pict	Code
Astra MK V CC CDTI	1,3	66	10.05-	---	4	155	RP8678
Astra MK V CC CDTI	1,9	88	08.05-	---	4	132	RP8622
Astra MK V CC CDTI	1,9	110	06.04-	---	4	166	RP8914
Astra MK V CC CDTI 16V	1,6	88	04.04-	---	4	166	RP8914
Astra MK V Estate CDTI	1,3	66	08.05-	---	4	155	RP8678
Astra MK V Estate CDTI	1,9	88	09.05-	---	4	166	RP8914
Astra MK V Estate CDTI	1,9	110	08.04-	---	4	166	RP8914
Astra MK V Estate CDTI 16V	1,9	88	08.04-	---	4	166	RP8914
Astra TD	1,5	53	09.88-08.91	TC4 EC1 OHC Isuzu	4	71	RP8324
Astra TD	1,7	60	02.90-12.94	TC4 EE1 OHC Isuzu Mot.731416	4	71	RP8134
Astra TD	1,7	60	02.90-08.95	TC4 EE1 OHC Isuzu Mot.731417	4	71	RP8324
Astra TD	1,7	60	12.91-09.98	956633	4	125	RP8680
Astra Van 16V	1,7	---	02.02-	ISUZU	4	152	RP8670
Astravan Mk IV DI	2,0	60	08.98-	X 20 DTL	4	103	RP8400
Astravan Mk IV DTI	1,7	50	08.98-	X 17 DTL	4	11	RP4488
Belmont D	1,6	---	01.86-01.89	---	4	11	RP4444
Brava D Pickup	2,2	39	08.91-09.96	C223	4	26	RP8322
Brava D Pickup	2,5	56	08.91-06.94	4 JA1	6	11	RP4444
Brava Pickup D 4x4	2,5	56	08.91-06.90	4 JA1T	4	68	RP8106
Brava Pickup DTI	2,5	74	08.01-	4 JA1T	4	68	RP8106
Brava TD Pickup	2,5	56	07.94-	4 JA1T	4	11	RP4444
Carlton Mk III D / Estate	1,7	44	07.92-11.95	17 DR	4	11	RP4488
Carlton Mk III D / Estate	2,3	54	09.86-03.94	23YD	6	11	RP4444
Carlton Mk III TD / Estate	1,7	60	09.88-11.95	17 DT (TC4EE1) Mot.731418	4	125	RP8680
Carlton Mk III TD / Estate	2,2	66	09.86-08.88	23 YDT	4	11	RP4488
Carlton Mk III TD / Estate	2,2	66	10.86-08.88	23 YDT	4	11	RP4488
Carlton Mk III TD Interc. / Estate	2,3	74	03.92-03.94	23 DTR	6	11	RP4444
Cavalier D	1,6	40	03.82-08.88	16 D / DA OHC	4	11	RP4444
Cavalier Mk III D	1,7	42	09.88-09.92	17 D	4	11	RP4444
Cavalier Mk III D	1,7	44	07.92-11.95	17 DR	4	11	RP4488
Cavalier Mk III TD	1,7	60	09.88-11.95	17 DT (TC4 EE1) Mot.731416	4	71	RP8134
Cavalier Mk III TD	1,7	60	03.90-11.95	17 DT (TC4EE1) Mot.731417	4	71	RP8324
Cavalier Mk III TD	1,7	60	09.88-11.95	---	4	125	RP8680
Cavalier Mk III TDI	1,7	60	09.88-01.95	17 DT (TC4EE1) Mot.nr.731417	4	26	RP8322
Cavalier Mk III TDI	1,7	60	09.88-01.95	17 DT (TC4EE1) Mot.nr.731418	4	125	RP8680
Combo 16V	1,7	---	10.00-	Y17DT/Y17DTL	4	152	RP8670
Combo D	1,7	44	04.96-10.01	17 D (4EE1) / X 17 D (4EE1)	4	125	RP8680
Corsa C 16V	1,7	---	10.00-	Y17DT/Y17DTL	4	152	RP8670
Corsa D	1,5	37	09.87-02.93	15 D(4EC1) Mot.804794	4	26	RP6824
Corsa D	1,5	37	09.87-02.93	15 D(4EC1) Mot.804 795	4	26	RP8322
Corsa D	1,5	37	09.94-09.00	15 D (4EC1)	4	125	RP8680
Corsa D	1,7	44	02.96-09.00	17D (4EE1) / X17D (4EE1)	4	125	RP8680
Corsa D CDTi	1,7	---	---	A17DTS	4	192	RP8478
Corsa DI 16V	1,7	65	01.01-	4EE2	4	152	RP8670



Model	CC	Kw	Year	Engine	Cyl	Pict	Code
Corsa DTI 16V	1,7	75	01.01-	4EE2	4	152	RP8670
Corsa Mk II CDTI 16V	1,3	52	04.04-	---	4	155	RP8678
Corsa TD	1,5	49	03.88-02.93	15 DT(T4EC1) Mot.804794	4	71	RP8134
Corsa TD	1,5	49	03.88-02.93	15 DT(T4EC1) Mot 804795	4	71	RP8324
Corsa TD	1,5	49	09.94-10.96	15 DT (T4 EC1) /X 15 DT (T4EC1)	4	125	RP8680
Corsa Van 16V	1,7	---	10.00-	Y17DT/Y17DTL	4	152	RP8670
Corsa Van D	1,7	44	01.94-09.00	---	4	125	RP8680
Corsa Van Mk II CDTI 16V	1,3	52	04.04-	---	4	155	RP8678
Frontera TD	2,3	74	03.92-10.98	23 DTR	4	11	RP4488
Frontera Mk II DTI	2,2	85	10.98-	X 22 DTH/Y 22 DTH	4	103	RP8400
Frontera Sport TDS	2,5	85	09.96-10.98	25TD (VM41B)	4	78	RP8370
Frontera TD	2,8	83	03.95-10.98	28TDI (4JB1T)	4	68	RP8106
Meriva 16V	1,7	---	10.03-	Y17DT	4	152	RP8670
Meriva CDTI	1,3	55	09.03-	Z13DTJ	4	155	RP8678
Meriva II CDTi	1,7	---	---	A17DTC / A17DTS	4	192	RP8478
Mokka CDTi	1,7	---	---	A17DTS	4	192	RP8478
Monterey TDI	3,0	117	07.98-08.99	4 JX1	4	149	RP8658
Movano D	2,5	59	10.98-09.00	S8U 770	4	7	RP4486
Movano MK I (A) Chassis/Cab (ED, UD, HD) CDTI	2,5	88/107	08.06-	G9U 632 / G9U 650	4	109	RP8412
Movano MK I (A) Combi (JD) CDTI	2,5	88	02.03-08.09	G9U 630 / G9U 632 / G9U 650	4	109	RP8412
Movano MK I (A) Combi (JD) CDTI	2,5	107	08.06-	G9U 632	4	109	RP8412
Movano MK I (A) Van (FD) CDTI	2,5	88	08.06-	G9U 632 / G9U 650	4	109	RP8412
Movano MK I (A) Van (FD) CDTI	2,5	107	08.06-	G9U 632	4	109	RP8412
Movano MK V (H) Station wagon CDTI	1,9	88	08.04-03.09	Z19 DT	4	132	RP8622
Movano TDI	1,9	59	09.00-10.01	F9Q 770	4	133	RP8624
Movano TDI	1,9	60	10.01-	---	4	133	RP8624
Movano TDI	2,2	66	09.00-	G9T 720	4	109	RP8412
Movano TDI	2,5	84	10.01-	---	4	109	RP8412
Nova D	1,5	37	09.87-03.93	15 D (4EC1) Mot.804795	4	26	RP8322
Nova TD	1,5	49	01.90-02.93	15 DT (T4EC1) Mot.804794	4	71	RP8134
Nova TD	1,5	49	01.90-02.93	15 DT (T4EC1) Mot.804795	4	71	RP8324
Omega A D	2,3	54	09.86-01.94	23 YD OHC	4	11	RP4488
Omega A D	2,3	66	9.86-08.88	23 YDT OHC	4	11	RP4488
Omega A TD	2,3	74	09.88-01.94	23 DTR OHC	4	11	RP4488
Omega B DI 16V	2,0	60	09.96-08.97	X 20 DILC	4	93	RP8368
Omega B DI 16V	2,0	74	09.97-	X 20 DILC	4	103	RP8400
Omega B TD	2,5	96	02.94-	BMW	6	11	RP4444
Omega C DTI 16V	2,0	74	09.99-	Y 20 DTH	4	139	RP8638
Omega C DTI 16V	2,2	88	10.00-	Y 22 DTH	4	139	RP8638
Omega C DTI 16V	2,2	92	08.00-	Y 22 DTH	4	139	RP8638
Omega DTI 16V / Estate	2,2	88	09.00-	Y 22 DTH	4	139	RP8638
Omega DTI 16V/ Estate	2,0	74	10.98-09.00	X 20 DTH	4	103	RP8400
Royale TD	2,2	63	11.84-08.87	23 TD	4	11	RP4488



Model	CC	Kw	Year	Engine	Cyl	Pict	Code
Signum CDTI	1,9	88	04.04-	---	4	166	RP8914
Signum CDTI 16V	1,9	110	04.04-	---	4	166	RP8914
Signum CTDi	3,0	130	05.03	Y30DT	6	115	RP8432
Signum CTDi	3,0	135	09.05	Z30DT	6	115	RP8432
Sintra TDI	2,2	85	07.97-04.99	X 22 DTH	4	103	RP8400
Tigra Twin Top CDTI	1,3	51	06.04-	---	4	155	RP8678
Vectra CC DTI 16V	2,2	74	06.97-	---	4	139	RP8638
Vectra CC DTI 16V	2,2	92	09.00-	---	4	139	RP8638
Vectra CTDi	3,0	130	06.03	Y30DT	6	115	RP8432
Vectra CTDi	3,0	135	08.05	Z30DT	6	115	RP8432
Vectra DI 16V	2,0	60	08.99-	X20DTL	4	103	RP8400
Vectra DI 16V / Estate	2,0	60	11.96-07.99	X 20 DTL	4	93	RP8368
Vectra DTI 16V / Estate	2,0	74	08.99-	Y 20 DTH	4	139	RP8638
Vectra DTI 16V / Estate	2,2	92	09.00-	Y 22 DTR	4	139	RP8638
Vectra Mk II CDTI	1,9	88	04.04-	---	4	166	RP8914
Vectra Mk II CDTI 16V	1,9	110	04.04-	---	4	166	RP8914
Vectra Mk II DTI 16V	2,0	74	04.02-	---	4	139	RP8638
Vectra Mk II DTI 16V	2,2	92	04.02-	---	4	139	RP8638
vectra Mk II Estate CDTI	1,9	88	04.04-	---	4	166	RP8914
Vectra Mk II Estate CDTI 16V	1,9	110	04.04-	---	4	166	RP8914
Vectra Mk II GTS CDTI	1,9	88	04.04-	---	4	166	RP8914
Vectra Mk II GTS CDTI 16V	1,9	110	04.04-	---	4	166	RP8914
Vectra Mk II GTS DTI 16V	2,2	92	04.02-	---	4	139	RP8638
Vectra TD / Estate	1,7	60	10.95-11.96	X 17 DT (TC4EE1)	4	125	RP8680
Vectra TDI 16V / Estate	2,0	74	09.97-	X 20 DTH	4	103	RP8400
Vivaro DI	1,9	59	08.01-	---	4	133	RP8624
Vivaro DTI	1,9	74	08.01-	F9Q 760	4	133	RP8624
Vivaro DTI	2,5	99	04.04-	G9U 730	4	109	RP8412
Zafira DI 16V / TDI	2,0	60	10.99-	X 20 DTL	4	103	RP8400
Zafira DTI 16V	2,0	74	04.99-	X 20 DTH	4	139	RP8638
Zafira DTI 16V	2,2	92	01.02-	---	4	139	RP8638
<b>VOLKSWAGEN</b>							
Bora Kombi TDI	1,9	74	09.00-	---	4	78	RP8674
Bora Kombi TDI	1,9	96	11.00-	---	4	78	RP8674
Bora Kombi TDI	1,9	110	05.01-	---	4	78	RP8674
Bora Kombi TDI 4motion	1,9	74	09.00-	---	4	78	RP8674
Bora Kombi TDI 4motion	1,9	96	11.00-	---	4	78	RP8674
Bora Kombi TDI 4motion	1,9	110	05.01-	---	4	78	RP8674
Bora SDI / Variant	1,9	50	10.98-06.01	AGP/AQM	4	78	RP8272
Bora Station Wagon TDI	1,9	66	07.04-05.05	AGR	4	78	RP8272
Bora TDI	1,9	96	10.00-09.01	AVF	4	78	RP8272
Bora TDI	1,9	96	10.01-	ASZ	4	78	RP8674
Bora TDI	1,9	110	10.01-	ARZ	4	78	RP8674
Bora TDI / Station Wagon	1,9	74	09.00-05.05	ATD / AXR	4	78	RP8272
Bora TDI / Variant	1,9	66	10.98-06.01	AGR / ALH	4	78	RP8272





Model	CC	Kw	Year	Engine	Cyl	Pict	Code
Bora TDI / Variant	1,9	66	10.98-06.01	Cooling-water preheater	4	8	RP4422
Bora TDI / Variant	1,9	66	10.98-06.01	Cooling-water preheater	4	91	RP8360
Bora TDI / Variant	1,9	66	05.99-06.01	ANU	4	78	RP8272
Bora TDI / Variant	1,9	74	11.01-	ATD/AXR	4	78	RP8674
Bora TDI / Variant	1,9	74	09.00-10.01	Cooling-water preheater	4	8	RP4422
Bora TDI / Variant	1,9	74	09.00-10.01	Cooling-water preheater	4	91	RP8360
Bora TDI / Variant	1,9	81	05.99-06.01	Cooling-water preheater	4	91	RP8360
Bora TDI / Variant	1,9	81	05.99-06.01	Cooling-water preheater	4	8	RP4422
Bora TDI / Variant / 4motion	1,9	85	05.99-06.01	Cooling-water preheater	4	8	RP4422
Bora TDI / Variant / 4motion	1,9	85	05.99-06.01	Cooling-water preheater	4	91	RP8360
Bora TDI / Variant / 4motion	1,9	96	11.00-10.01	Cooling-water preheater	4	8	RP4422
Bora TDI / Variant / 4motion	1,9	96	11.00-10.01	Cooling-water preheater	4	91	RP8360
Bora TDI / Variant / 4motion	1,9	110	05.00-09.01	Cooling-water preheater	4	91	RP8360
Bora TDI / Variant / 4motion	1,9	110	05.00-09.01	Cooling-water preheater	4	8	RP4422
Bora TDI / Variant / 4motion / Station Wagon	1,9	85	05.99-06.01	AJM/AUY	4	78	RP8272
Bora TDI / Variant / 4motion / Station Wagon	1,9	96	11.00-05.05	ASZ	4	78	RP8272
Bora TDI / Variant / 4motion / Station Wagon	1,9	110	05.00-09.01	ARL	4	78	RP8272
Bora TDI / Variant / Station Wagon	1,9	81	05.99-06.01	AHF/ASV	4	78	RP8272
Bora TDI / Variant / Station Wagon / 4motion	1,9	74	09.00-05.05	ATD	4	78	RP8272
Bora TDI 4motion	1,9	110	05.00-	---	4	78	RP8674
Bora TDI 4motion / Variant	1,9	66	02.99-06.01	AGR/ALH	4	78	RP8272
Bora TDI 4motion / Variant	1,9	66	02.99-06.01	Cooling-water preheater	4	8	RP4422
Bora TDI 4motion / Variant	1,9	66	02.99-06.01	Cooling-water preheater	4	91	RP8360
Bora TDI 4motion / Variant	1,9	74	09.00-04.01	ATD	4	78	RP8272
Bora TDI 4motion / Variant	1,9	74	09.00-04.01	Cooling-water preheater	4	8	RP4422
Bora TDI 4motion / Variant	1,9	74	09.00-04.01	Cooling-water preheater	4	91	RP8360
Bora TDI Variant	1,9	110	10.01-	ARL	4	78	RP8674
Caddy D	1,6	40	10.82-07.92	ME / JK	4	8	RP4422
Caddy II D	1,9	47	06.96-	AEF	4	8	RP4422
Caddy II D	1,9	47	11.95-	1Y	4	8	RP4422
Caddy II SDI	1,7	42	07.96-	AHB	4	78	RP8272
Caddy II Station Wagon TDI	1,9	66	10.96-01.04	AHU / ALE / ALH	4	78	RP8272
Caddy II TDI	1,9	66	09.96-01.04	1Z / AHU / ALE	4	78	RP8272
Caddy II TDI	1,9	66	09.96	Cooling-water preheater	4	8	RP4422
Caddy II TDI	1,9	66	09.96	Cooling-water preheater	4	91	RP8360
Caddy II, Station Wagon, Furgonato SDI	1,9	47	11.95-01.04	AEY / AYQ	4	78	RP8272
Caddy III	1,9	55	09.05-	BSU	4	177	RP9000
Caddy III Furgonato (2KA, 2KH, 2CA, 2CH) TDI 16V 4motion	2,0	103	11.10-	CFHC	4	171	RP8928
Caddy III Furgonato (2KA, 2KH, 2CA, 2CH) TDI 4motion	1,9	77	11.08-08.10	BLS	4	177	RP9000



Model	CC	Kw	Year	Engine	Cyl	Pict	Code
Caddy III Kombi TDI	1,9	77	04.04-	---	4	177	RP9000
Caddy III SDI Kasten/Kombi	2,0	51	03.04-	BDJ	4	178	RP9002
Caddy III TDI	1,9	77	04.04-	BKC	4	177	RP9000
Caddy SDI	2,0	52	06.05-	BST	4	78	RP8370
Caddy TDI	1,6	55	08.10-	CAYE	4	171	RP8928
Caddy TDI	1,6	75	08.10-	CAYD	4	171	RP8928
Caddy TDI	2,0	103	09.07-	BMM	4	177	RP9000
Caddy TDI / 4Motion	2,0	81	08.10-	CLCA / CFHF	4	171	RP8928
Caddy TDI 4motion / Station wagon	2,0	103	11.10-	CFHC / CFHE	4	171	RP8928
EOS TDI	2,0	103	06.06-	---	4	177	RP9000
Eurovan D (USA)	2,4	57	10.92-	AAB	5	8	RP4422
Eurovan TDI (USA)	2,5	75	01.95-	ACV	5	78	RP8272
Fox TDI	1,4	51	04.05-	---	3	78	RP8674
Golf I D	1,5	37	08.76-07.80	CK	4	8	RP4422
Golf I D	1,6	40	08.80-12.84	CR / JK	4	8	RP4422
Golf I TD	1,6	51	02.82-12.83	CY	4	8	RP4422
Golf II D	1,6	40	02.82/07.92	ME / JK / JP	4	8	RP4422
Golf II D	1,6	44	08.89-07.92	1V	4	8	RP4422
Golf II TD	1,6	51	05.88-10.91	MF / JR	4	8	RP4422
Golf II TD	1,6	59	04.89-10.91	RA / SB	4	8	RP4422
Golf III Cabriolet TDI	1,9	66	08.95-05.98	AS1Z / AHV / ALE	4	78	RP8272
Golf III D / TD / GTD / Variant	1,9	48	11.91-08.98	1Y / AAZ	4	8	RP4422
Golf III SDI / Variant	1,9	47	07.95-04.99	AEY	4	78	RP8272
Golf III TD, GTD (1H1)	1,9	55	11.91-08.97	AAZ	4	8	RP4422
Golf III TDI / Variant	1,9	66	03.94-04.99	Cooling-water preheater	4	91	RP8360
Golf III TDI / Variant	1,9	66	03.94-04.99	Cooling-water preheater	4	8	RP4422
Golf III TDI / Variant	1,9	66	07.95-04.99	1Z/AHU	4	78	RP8272
Golf III TDI / Variant	1,9	66	07.95-04.99	Cooling-water preheater	4	8	RP4422
Golf III TDI / Variant	1,9	66	07.95-04.99	Cooling-water preheater	4	91	RP8360
Golf III TDI / Variant	1,9	81	04.96-04.99	AFN	4	78	RP8272
Golf III TDI / Variant	1,9	81	04.96-04.99	Cooling-water preheater	4	8	RP4422
Golf III TDI / Variant	1,9	81	04.96-04.99	Cooling-water preheater	4	91	RP8360
Golf III TDI / Variant / Syncro	1,9	66	03.94-04.99	1Z/AHU/ALE	4	78	RP8272
Golf III TDI Cabriolet	1,9	66	08.95-05.98	1Z/AHU	4	78	RP8272
Golf III TDI Cabriolet	1,9	66	08.95-05.98	Cooling-water preheater	4	8	RP4422
Golf III TDI Cabriolet	1,9	66	08.95-05.98	Cooling-water preheater	4	91	RP8360
Golf III TDI Cabriolet	1,9	81	07.96-05.98	AFN	4	78	RP8272
Golf III TDI Cabriolet	1,9	81	07.96-05.98	Cooling-water preheater	4	8	RP4422
Golf III TDI Cabriolet	1,9	81	07.96-05.98	Cooling-water preheater	4	91	RP8360
Golf III Variant D (1H5)	1,9	48-55	07.93-04.99	1YAAZ/AAZ	4	8	RP4422
Golf IV SDI / Variant	1,9	50	07.97-	AGP / AQM	4	78	RP8272
Golf IV TDI (1J1)	1,9	85	12.98-06.01	AJM/AUY	4	78	RP8674
Golf IV TDI / 4motion	1,9	96	11.00-10.01	Cooling-water preheater	4	8	RP4422
Golf IV TDI / 4motion	1,9	96	11.00-10.01	Cooling-water preheater	4	91	RP8360



Model	CC	Kw	Year	Engine	Cyl	Pict	Code
Golf IV TDI / 4motion	1,9	110	05.00-10.01	ARL	4	78	RP8272
Golf IV TDI / 4motion	1,9	110	05.00-10.01	Cooling-water preheater	4	8	RP4422
Golf IV TDI / 4motion	1,9	110	05.00-10.01	Cooling-water preheater	4	91	RP8360
Golf IV TDI / 4motion / Variant	1,9	74	09.00-06.05	ATD/AXR	4	78	RP8272
Golf IV TDI / 4motion / Variant	1,9	74	09.00-10.01	Cooling-water preheater	4	8	RP4422
Golf IV TDI / 4motion / Variant	1,9	74	09.00-10.01	Cooling-water preheater	4	91	RP8360
Golf IV TDI / 4motion / Variant	1,9	96	11.00-06.06	ASZ	4	78	RP8272
Golf IV TDI / 4motion / Variant	1,9	66-81	05.99-06.01	AGR/ALH/AHF/ASV/AJM	4	78	RP8272
Golf IV TDI / 4motion / Variant	1,9	66-81-85	05.99-06.01	Cooling-water preheater	4	91	RP8360
Golf IV TDI / 4motion / Variant	1,9	66-81-85	05.99-06.01	Cooling-water preheater	4	8	RP4422
Golf IV TDI / Variant	1,9	74	11.01-	ATD/AXR	4	78	RP8674
Golf IV TDI / Variant	1,9	96	11.01-	ASZ	4	78	RP8674
Golf IV TDI / Variant	1,9	110	11.01-	ARL	4	78	RP8674
Golf IV TDI / Variant / 4motion	1,9	85	09.99-06.01	AJM / AVY	4	78	RP8272
Golf IV TDI 4motion	1,9	74	09.00-	---	4	78	RP8674
Golf IV TDI 4motion	1,9	96	11.00-	---	4	78	RP8674
Golf IV TDI 4motion	1,9	110	02.00-	---	4	78	RP8674
Golf IV TDI Cabriolet	1,9	66-81	06.98-	AHU/ALE/AFN/AVG	4	78	RP8272
Golf IV Variant TDI	1,9	74	09.00-	---	4	78	RP8674
Golf IV Variant TDI	1,9	96	11.00-	---	4	78	RP8674
Golf IV Variant TDI 4motion	1,9	74	09.00-	---	4	78	RP8674
Golf IV Variant TDI 4motion	1,9	96	11.00-	---	4	78	RP8674
Golf Plus (5M1, 521) TDI	1,6	66	02.09-	CAYB	4	171	RP8928
Golf Plus (5M1, 521) TDI	2,0	96	05.05-05.07	BEE	4	178	RP9002
Golf Plus (5M1, 521) TDI	2,0	100	05.05-	AZV / CBDA / CFHB	4	171	RP8928
Golf V GTD	2,0	125	11.05-	---	4	178	RP9002
Golf V GTD (1K1)	2,0	125	11.05-	BMN	4	178	RP9002
Golf V only with DPF	1,9	77	06.05-05.07	BLS	4	177	RP9000
Golf V Plus TDI	1,9	66	05.05-	---	4	177	RP9000
Golf V Plus TDI	1,9	77	01.05-	---	4	177	RP9000
Golf V Plus TDI	2,0	100	05.05-	---	4	178	RP9002
Golf V Plus TDI	2,0	103	01.05-	---	4	178	RP9002
Golf V SDI	2,0	55	01.04-05.07	BDK	4	178	RP9002
Golf V TDI	1,9	66	05.04-	---	4	177	RP9000
Golf V TDI	1,9	74-77	10.03-	BJB/BKC	4	177	RP9000
Golf V TDI	2,0	96	06.07-	BVB	4	177	RP9000
Golf V TDI	2,0	103	10.03-	BKD	4	178	RP9002
Golf V TDI	2,0	103	12.04-05.07	BMM	4	177	RP9000
Golf V TDI	2,0	125	11.05-05.07	BMN	4	179	RP9004
Golf V TDI (1K1)	2,5	120	10.03-02.06	BDG	6	105	RP8404
Golf V TDI 4motion	1,9	77	08.04-	---	4	177	RP9000
Golf V TDI 4motion	2,0	103	08.04-	---	4	178	RP9002
Golf VI Cabriolet (517) TDI	1,6	77	03.11-	CAVC	4	171	RP8928
Golf VI Cabriolet (517) TDI	2,0	103	11.11-	CFHC	4	171	RP8928



Model	CC	Kw	Year	Engine	Cyl	Pict	Code
Golf VI Variant (AJ5) TDI 4motion	1,6	77	07.09-	CAYC	4	171	RP8928
Ittis D	1,6	51	08.87-12.88	1C	4	8	RP4422
Jetta (USA)	1,9	74	01.05-	BRM	4	177	RP9000
Jetta II D	1,6	40	01.84-08.91	JP/ME	4	8	RP4422
Jetta II D	1,6	40	09.91-10.91	JP/ME	4	8	RP4422
Jetta II TD	1,6	44	01.90-08.91	1V	4	8	RP4422
Jetta II TD	1,6	44	01.91-10.91	1V	4	8	RP4422
Jetta II TD	1,6	51	01.84-08.91	JR/MF	4	8	RP4422
Jetta II TD	1,6	51	09.91-10.91	JR/MF	4	8	RP4422
Jetta II TD	1,6	59	04.89-08.91	RA/SB	4	8	RP4422
Jetta II TD	1,6	59	09.91-10.91	RA/SB	4	8	RP4422
Jetta III (1K2) TDI	1,6	66	12.09-10.10	CAYB	4	171	RP8928
Jetta III (1K2) TDI	1,6	77	06.09-10.10	CAYC	4	171	RP8928
Jetta III (1K2) TDI 16V	2,0	103	08.05-10.10	BKD / CBDB / CJAA	4	178	RP9002
Jetta III TDI	1,9	77	09.05-	---	4	177	RP9000
Jetta III TDI	2,0	100	09.05-	AZV	4	178	RP9002
Jetta III TDI	2,0	103	08.05-	---	4	178	RP9002
Jetta III TDI	2,0	125	10.06-	---	4	178	RP9002
Jetta IV (162) TDI	1,6	77	02.11-	CAYC	4	171	RP8928
Jetta IV (162) TDI	2,0	103	02.11-	CFFB / CFHC / CJAA / CLCB	4	171	RP8928
Jetta TDI	1,9	77	08.05-	BLS	4	177	RP9000
Jetta TDI	2,0	100	09.05-	AZV	4	178	RP9002
Jetta TDI	2,0	103	10.05-	BMM	4	177	RP9000
Jetta TDI	2,0	125	06.06-	BMN	4	179	RP9004
Lupo SDI	1,7	44	09.98-07.05	AKU	3	78	RP8272
Lupo SDI	1,7	42-44	11.01	AKU	4	78	RP8674
Lupo TDI	1,2	45	11.98-	ANY	3	78	RP8272
Lupo TDI	1,4	55	01.99-07.05	AMF	3	78	RP8272
Lupo TDI	1,4	55	11.01-	AMF	3	78	RP8674
Lupo TDI 3L	1,2	45	07.99-10.01	AYZ/ANY	3	78	RP8272
Lupo TDI 3L	1,2	45	11.01-	AYZ	3	78	RP8674
New Beetle Cabriolet TDI	1,9	77	07.05-	---	4	177	RP9000
New Beetle TDI	1,9	66	01.98-06.04	ALH	4	78	RP8272
New Beetle TDI	1,9	66	01.98-02.01	Coolin-water preheater	4	8	RP4422
New Beetle TDI	1,9	66	01.98-02.01	Coolin-water preheater	4	91	RP8360
New Beetle TDI	1,9	74	11.01-	ATD	4	78	RP8272
New Beetle TDI	1,9	74	11.01-	Coolin-water preheater	4	91	RP8360
New Beetle TDI	1,9	74	11.01-	Coolin-water preheater	4	8	RP4422
New Beetle TDI	1,9	74	07.05-	BEW	4	177	RP9000
New Beetle TDI	1,9	74	02.01-	ATD / BEW	4	78	RP8272
New Beetle TDI	1,9	77	07.05-	---	4	177	RP9000
New Beetle TDI Cabriolet	1,9	74	03.03-	AXR	4	78	RP8674
New Beetle ùTDI	1,9	74	02.01-10.01	ATD	4	78	RP8674
Parati D	1,9	47	08.02-	1Y	4	8	RP4422



Model	CC	Kw	Year	Engine	Cyl	Pict	Code
Passat (362) TDI	1,6	77	08.10-	CAYC	4	171	RP8928
Passat (362) TDI	2,0	103	08.10-	CFFB	4	171	RP8928
Passat (362) TDI	2,0	125	08.10-	CGGA / CLLA	4	171	RP8928
Passat (362) TDI 4motion	2,0	103	08.10-	CFFB	4	171	RP8928
Passat (362) TDI 4motion	2,0	125	08.10-	CFGB / CLLA	4	171	RP8928
Passat D	1,5	37	08.77-07.80	CK	4	8	RP4422
Passat D	1,6	40	08.80-03.88	CR/JK	4	8	RP4422
Passat D	1,9	50	05.89-10.93	1Y	4	78	RP8272
Passat D / Variant	1,9	50	05.89-12.96	1Y	4	8	RP4422
Passat III (Type 35i) D/TD	1,9	47	05.89-10.93	1Y	4	8	RP4422
Passat TD / Variant	1,6	51	01.85-03.88	CY	4	8	RP4422
Passat TD / Variant	1,6	59	08.88-09.93	RA/SB	4	8	RP4422
Passat TD / Variant	1,6	59	05.86-03.88	RA	4	8	RP4422
Passat TDI	1,9	74	11.01-	AVB	4	78	RP8674
Passat TDI	1,9	77	03.05-	---	4	177	RP9000
Passat TDI	2,0	100	12.03-	---	4	178	RP9002
Passat TDI	2,0	103	03.05-	---	4	178	RP9002
Passat TDI	2,0	125	08.05-	---	4	178	RP9002
Passat TDI / Variant	1,9	55	03.91-05.97	AAZ	4	8	RP4422
Passat TDI / Variant	1,9	66	10.93-05.97	1Z/AHU	4	78	RP8272
Passat TDI / Variant	1,9	66	10.93-05.97	Cooling-water preheater	4	8	RP4422
Passat TDI / Variant	1,9	66	10.93-05.97	Cooling-water preheater	4	91	RP8360
Passat TDI / Variant	1,9	74	02.00-11.00	AVB	4	78	RP8272
Passat TDI / Variant	1,9	74	02.00-11.00	Cooling-water preheater	4	8	RP4422
Passat TDI / Variant	1,9	74	02.00-11.00	Cooling-water preheater	4	91	RP8360
Passat TDI / Variant	1,9	74	11.00-05.05	AVB	4	78	RP8272
Passat TDI / Variant	1,9	74	11.00-10.01	Cooling-water preheater	4	8	RP4422
Passat TDI / Variant	1,9	74	11.00-10.01	Cooling-water preheater	4	91	RP8360
Passat TDI / Variant	1,9	81	03.96-05.97	AFN	4	78	RP8272
Passat TDI / Variant	1,9	81	03.96-05.97	Cooling-water preheater	4	8	RP4422
Passat TDI / Variant	1,9	81	03.96-05.97	Cooling-water preheater	4	91	RP8360
Passat TDI / Variant	1,9	85	08.09-11.00	AJM/ATJ	4	78	RP8272
Passat TDI / Variant	1,9	85	08.98-11.00	Cooling-water preheater	4	8	RP4422
Passat TDI / Variant	1,9	85	08.98-11.00	Cooling-water preheater	4	91	RP8360
Passat TDI / Variant	2,5	120	05.03-	BDG	6	105	RP8404
Passat TDI / Variant / 4motion	1,9	85	08.99-11.00	ATJ	4	78	RP8272
Passat TDI / Variant / 4motion	1,9	85	08.99-11.00	Cooling-water preheater	4	8	RP4422
Passat TDI / Variant / 4motion	1,9	85	08.99-11.00	Cooling-water preheater	4	91	RP8360
Passat TDI / Variant / 4motion	1,9	96	11.00-	AVF/AWX	4	78	RP8674
Passat TDI / Variant / 4motion	1,9	96	11.00-05.05	AVF/AWX	4	78	RP8272
Passat TDI / Variant / 4motion	1,9	96	11.00-10.01	Cooling-water preheater	4	8	RP4422
Passat TDI / Variant / 4motion	1,9	96	11.00-10.01	Cooling-water preheater	4	91	RP8360
Passat TDI / Variant / 4motion	2,5	110	11.00-	AFB/AKN	6	105	RP8404
Passat TDI / Variant / 4motion	2,5	132	01.03-	BAU/BDH	6	105	RP8404



Model	CC	Kw	Year	Engine	Cyl	Pict	Code
Passat TDI / Variant / Syncro / 4motion	1,9	81	10.96-11.00	AFN/AVG	4	78	RP8272
Passat TDI / Variant / Syncro / 4motion	1,9	81	10.96-11.00	Cooling-water preheater	4	8	RP4422
Passat TDI / Variant / Syncro / 4motion	1,9	81	10.96-11.00	Cooling-water preheater	4	91	RP8360
Passat TDI / Variant / Syncro / 4motion	1,9	66-81	10.96-11.00	AHH/AHU/AFN/AVG	4	78	RP8272
Passat TDI / Variant / Syncro / 4motion	1,9	66-81	10.96-11.00	Cooling-water preheater	4	8	RP4422
Passat TDI / Variant / Syncro / 4motion	1,9	66-81	10.96-11.00	Cooling-water preheater	4	91	RP8360
Passat TDI / Variant / Syncro / 4motion	2,5	110	07.98-11.00	AFB / AKN	6	105	RP8404
Passat V TDI (Type 3C)	1,9	77	06.05-05.07	BLS	4	177	RP9000
Passat V TDI (Type 3C)	2,0	88	11.05-05.07	BWV	4	179	RP9004
Passat V TDI (Type 3C)	2,0	90	06.05-	BVD	4	177	RP9000
Passat V TDI (Type 3C)	2,0	90	06.05-02.06	BVE	4	179	RP9004
Passat V TDI (Type 3C)	2,0	103	03.05-05.07	BMP	4	177	RP9000
Passat V TDI (Type 3C)	2,0	120	10.05-05.07	BUZ	4	179	RP9004
Passat Variant (365) TDI	1,6	77	08.10-	CAYC	4	171	RP8928
Passat Variant (365) TDI	2,0	103	08.10-	CFFB	4	171	RP8928
Passat Variant (365) TDI	2,0	125	08.10-	CFGB / CLLA	4	171	RP8928
Passat Variant (365) TDI 4motion	2,0	103	08.10-	CFGB / CLLA	4	171	RP8928
Passat Variant TDI	1,9	77	08.05-	---	4	177	RP9000
Passat Variant TDI	2,0	100	12.03-	---	4	178	RP9002
Passat Variant TDI	2,0	103-90-100	08.05-	---	4	178	RP9002
Phaeton TDI	3,0	172	06.07-	CARA	6	171	RP8928
Phaeton V10 TDI	5,0	230	11.02-	AJS	10	78	RP8674
Phaeton V6	3,2	177	04.02-	AYT/BKL	6	177	RP9000
Phaeton V6 4-motion	3,2	177	02.04-	BRK/VKL	6	177	RP9000
Phaeton V6 TDI	3,0	165	09.04-	4F 5026001	6	171	RP8928
Polo 110 TDI Classic	1,9	81	06.98-09.01	AFN/ASV	4	78	RP8272
Polo 110 TDI Classic	1,9	81	06.98-09.01	Cooling-water preheater	4	8	RP4422
Polo 110 TDI Classic	1,9	81	06.98-09.01	Cooling-water preheater	4	91	RP8360
Polo 57 SDI Classic	1,7	42	07.97-09.01	AKW	4	78	RP8272
Polo 57 SDI Classic	1,7	42	07.97-09.01	Cooling-water preheater	4	8	RP4422
Polo 57 SDI Classic	1,7	42	07.97-09.01	Cooling-water preheater	4	91	RP8360
Polo 60 D	1,9	47	10.94-10.99	AEF	4	8	RP4422
Polo 64 SDI	1,9	47	07.96-10.99	AGD	4	78	RP8272
Polo 64 SDI Classic	1,9	47	12.95-09.01	1Y/AEY	4	78	RP8272
Polo 68 SDI Classic	1,9	50	08.99-09.01	AGP/AQM	4	78	RP8272
Polo 90 TDI Classic	1,9	66	09.96-09.01	Cooling-water preheater	4	8	RP4422
Polo 90 TDI Classic	1,9	66	09.96-09.01	Cooling-water preheater	4	91	RP8360
Polo Classic 110 TDI	1,9	81	06.98-09.01	AFN / ASV	4	78	RP8272
Polo D	1,3	33	08.86-07.90	MN	4	8	RP4422



Model	CC	Kw	Year	Engine	Cyl	Pict	Code
Polo D	1,4	35	10.90-09.94	1W	4	8	RP4422
Polo D	1,9	47	10.99-09.01	AEF	4	8	RP4422
Polo D / Classic	1,4	35	10.90-07.94	1W	4	8	RP4422
Polo D / Classic	1,9	47	01.96-10.96	1Y/AEF	4	8	RP4422
Polo D Classic	1,3	33	08.86-12.88	MN	4	8	RP4422
Polo D Coupé	1,3	33	08.86-08.90	MN	4	8	RP4422
Polo D Coupé	1,4	35	08.90-09.94	1W	4	8	RP4422
Polo Furgonato SDI	1,7	44	08.97-12.99	AKU	4	78	RP8272
Polo Furgonato SDI	1,9	47	07.96-12.99	AGD	4	78	RP8272
Polo III TDI	1,4	66	01.00-04.00	ATL	3	78	RP8370
Polo IV TDI	1,4	51	05.06-	BWB	3	177	RP9000
Polo IV TDI	1,4	58	04.05-	BNV	3	78	RP8370
Polo Kasten SDI	1,7	44	08.97-	---	4	78	RP8674
Polo SDI	1,7	42	04.97-10.99	AHG	4	78	RP8272
Polo SDI	1,7	44	10.99-09.01	AKU	4	78	RP8272
Polo SDI	1,7	44	10.99-09.01	Cooling-water preheater	4	8	RP4422
Polo SDI	1,7	44	10.99-09.01	Cooling-water preheater	4	91	RP8360
Polo SDI	1,7	44	10.01-	AKU	4	78	RP8674
Polo SDI	1,9	47	10.01-	ASY	4	78	RP8674
Polo SDI	1,9	47	10.99-09.01	AGD/ASX	4	78	RP8272
Polo SDI	1,9	47	11.03-	---	4	78	RP8674
Polo SDI	1,9	47	10.99-09.01	AGD/ASX	4	8	RP4422
Polo SDI	1,9	47	10.99-09.01	AGD/ASX	4	91	RP8360
Polo SDI	1,9	47	10.01-11.09	ASY	4	78	RP8272
Polo SDI / Classic	1,9	47	12.95-04.96	AEY	4	78	RP8272
Polo SDI Variant	1,7	42	08.97-09.01	AKU	4	78	RP8272
Polo SDI Variant	1,7	42	08.97-09.01	Cooling-water preheater	4	8	RP4422
Polo SDI Variant	1,7	42	08.97-09.01	Cooling-water preheater	4	91	RP8360
Polo SDI Variant	1,9	47	06.97-09.01	AEY	4	78	RP8272
Polo SDI Variant / Classic	1,9	50	08.99-09.01	AGP/AQM	4	78	RP8272
Polo TDI	1,4	51	04.05-	---	3	78	RP8674
Polo TDI	1,4	55	10.99-09.01	AMF	3	78	RP8272
Polo TDI	1,4	55	10.01-	AMF/BAY	3	78	RP8674
Polo TDI	1,4	55	07.03-	---	3	78	RP8674
Polo TDI	1,4	55	10.01-06.05	AMF / BAY	3	78	RP8272
Polo TDI	1,4	59	04.05-	---	3	78	RP8674
Polo TDI	1,4	66	01.00-10.00	---	3	78	RP8272
Polo TDI	1,9	66	01.97-	AHU/ALE	4	78	RP8272
Polo TDI	1,9	74	10.01-	ATD/AXR	4	78	RP8674
Polo TDI	1,9	96	11.03-	---	4	177	RP9000
Polo TDI	1,9	74-81	06.98-	ATD/AFN	4	78	RP8272
Polo TDI Variant	1,9	81	06.98-09.01	AFN/ASV	4	78	RP8272
Polo TDI Variant	1,9	81	06.98-09.01	cooling-water preheater	4	8	RP4422
Polo TDI Variant	1,9	81	06.98-09.01	cooling-water preheater	4	91	RP8360



Model	CC	Kw	Year	Engine	Cyl	Pict	Code
Polo TDI Variant / Classic	1,9	66	09.96-09.01	AGR/AHU/ALE/ALH	4	78	RP8272
Polo TDI Variant / Classic	1,9	66	05.97-09.01	AGR/AHU/ALE/ALH	4	78	RP8272
Polo TDI Variant / Classic	1,9	66	05.97-09.01	Cooling-water preheater	4	8	RP4422
Polo TDI Variant / Classic	1,9	66	05.97-09.01	Cooling-water preheater	4	91	RP8360
Polo Tre volumi SDI	1,9	47	09.02-	ASY	4	78	RP8272
Polo Tre volumi TDI	1,4	55	07.03-	BAY	3	78	RP8272
Santana D	1,6	40	08.81-12.84	CR / JK	4	8	RP4422
Santana TD	1,6	51	12.81-12.84	CY	4	8	RP4422
Scirocco TDI	2,0	100	11.10-	CFHB	4	171	RP8928
Scirocco TDI	2,0	103	10.08-11.10	CBDB	4	171	RP8928
Scirocco TDI	2,0	103	11.10-	CFHC	4	171	RP8928
Scirocco TDI	2,0	125	05.09-11.10	CBBB	4	171	RP8928
Scirocco TDI	2,0	125	11.10-	CFGB	4	171	RP8928
Sharan (7N) TDI 4motion	2,0	103	05.11-	CFFB	4	171	RP8928
Sharan TDI	1,9	66	09.95-03.10	1Z/AHU/ANU	4	78	RP8272
Sharan TDI	1,9	66	03.00-	ANU	4	78	RP8674
Sharan TDI	1,9	66	09.95-02.00	Cooling-water preheater	4	91	RP8360
Sharan TDI	1,9	66	09.95-02.00	Cooling-water preheater	4	8	RP4422
Sharan TDI	1,9	81	09.96-04.00	AFN/AVG	4	78	RP8272
Sharan TDI	1,9	81	09.96-04.00	Cooling-water preheater	4	8	RP4422
Sharan TDI	1,9	81	09.96-04.00	Cooling-water preheater	4	91	RP8360
Sharan TDI	1,9	85	11.01-	AUY	4	78	RP8674
Sharan TDI	1,9	96	11.02-	ASZ	4	78	RP8674
Sharan TDI	1,9	110	06.05-	---	4	177	RP9000
Sharan TDI	2,0	100	11.05-	BVH	4	177	RP9000
Sharan TDI	2,0	103	11.05-	BRT	4	177	RP9000
Sharan TDI / 4motion	1,9	85	04.00-03.10	AUY / BVK	4	78	RP8272
Sharan TDI / 4motion	1,9	85	04.00-10.01	Cooling-water preheater	4	8	RP4422
Sharan TDI / 4motion	1,9	85	04.00-10.01	Cooling-water preheater	4	91	RP8360
Taro D	2,4	58	07.94-03.97	2L	4	46	RP8332
Taro D	2,4	59	09.91-07.94	2L	4	46	RP8332
Taro D	2,4	61	06.89-09.91	2L	4	46	RP8332
Tiguan (5N1) TDI	2,0	81	05.10-05.11	CFFD	4	171	RP8928
Tiguan (5N1) TDI	2,0	103	03.08-05.11	CBAB	4	171	RP8928
Tiguan (5N1) TDI / 4motion	2,0	103	11.09-05.11	CFFB	4	171	RP8928
Tiguan (5N1) TDI 4motion	2,0	100	11.07-05.11	CBAA	4	171	RP8928
Tiguan (5N1) TDI 4motion	2,0	100	05.10-05.11	CFFA	4	171	RP8928
Tiguan (5N1) TDI 4motion	2,0	103	11.07-05.11	CBABB	4	171	RP8928
Tiguan (5N1) TDI 4motion	2,0	103	11.10-05.11	CLJA	4	171	RP8928
Tiguan (5N1) TDI 4motion	2,0	120	03.08-05.11	CBBA	4	171	RP8928
Tiguan (5N1) TDI 4motion	2,0	125	02.08-05.11	CBBB	4	171	RP8928
Tiguan (5N1) TDI 4motion	2,0	125	05.10-05.11	CFGB	4	171	RP8928
Touareg (7P5) V6 TDI	3,0	150	01.10-	CASD / CJMA	6	171	RP8928
Touareg R5 TDI	2,5	128	01.03-	BAC	5	78	RP8674





Model	CC	Kw	Year	Engine	Cyl	Pict	Code
Touareg TDI	2,5	120	01.06-	BPD	5	177	RP9000
Touareg TDI	2,5	128	01.06-	BPE	5	177	RP9000
Touareg TDI	3,0	150	11.10-05.11	CASD	6	171	RP8928
Touareg TDI	3,0	150	05.11-	CJMA	6	171	RP8928
Touareg TDI	3,0	155	04.06-	BUN	6	171	RP8928
Touareg TDI	3,0	176	01.10-05.11	CASA	6	171	RP8928
Touareg TDI	3,0	180	05.11-	CRCA	6	171	RP8928
Touareg TDI	4,2	250	01.10-	CKDA	8	171	RP8928
Touareg TDI	4,9	230	11.04-	BLE	10	177	RP9000
Touareg TDI	5,0	230	11.02-11.06	AYH	10	78	RP8370
Touareg V10 TDI	5,0	230	10.02-	AYH	10	78	RP8674
Touareg V6 TDI	3,0	165	11.04-	---	6	171	RP8928
Touran TDI	1,9	66	11.04-	---	4	177	RP9000
Touran TDI	1,9	74	02.03-	AVQ	4	177	RP9000
Touran TDI	1,9	77	08.03-	BKC	4	177	RP9000
Touran TDI	2,0	100	08.03-	BKD	4	178	RP9002
Touran TDI	2,0	100	02.03-	AZV	4	178	RP9002
Touran TDI	2,0	103	12.05-	BMM	4	177	RP9000
Touran TDI	2,0	125	12.05-	BMN	4	178	RP9002
Touran TDI 16V	2,0	103	08.03-	BKD	4	178	RP9002
Transporter T4 Kasten TDI	2,5	111	09.00-	---	5	78	RP8674
Transporter T4 TDI Syncro	2,5	75	05.98-	---	5	78	RP8674
Transporter T5 Kasten TDI	1,9	63	04.03-	---	4	78	RP8674
Transporter T5 Kasten TDI	1,9	77	04.03-	---	4	78	RP8674
Transporter T5 Kasten TDI	2,5	96	04.03-	---	5	78	RP8674
Transporter T5 Kasten TDI	2,5	128	04.03-	---	5	78	RP8674
Transporter T5 Kasten TDI 4motion	2,5	96	07.04-	---	5	78	RP8674
Transporter T5 Kasten TDI 4motion	2,5	128	07.04-	---	5	78	RP8674
Transporter T5 TDI	1,9	77	04.03-	---	4	78	RP8674
Transporter T5 TDI	2,5	96	04.03-	---	5	78	RP8674
Transporter T5 TDI	2,5	128	04.03-	---	5	78	RP8674
Transporter T5 TDI 4motion	2,5	96	07.04-	---	5	78	RP8674
Vento D / TD	1,9	48-55	01.91-09.98	1Y / AAZ	4	8	RP4422
Vento SDI	1,9	47	04.97-09.98	AEY	4	78	RP8272
Vento TDI	1,9	66	09.93-09.98	1Z/AHU/ALE	4	78	RP8272
Vento TDI	1,9	66	09.93-09.98	Cooling-water preheater	4	8	RP4422
Vento TDI	1,9	66	09.93-09.98	Cooling-water preheater	4	91	RP8360
Vento TDI	1,9	81	04.96-09.98	AFN	4	78	RP8272
Vento TDI	1,9	81	04.96-09.98	Cooling-water preheater	4	8	RP4422
Vento TDI	1,9	81	04.96-09.98	Cooling-water preheater	4	91	RP8360
Vento TDI	1,9	66-81	07.93-12.97	1Z / AHU / ALE / AFN	4	78	RP8272
<b>VOLKSWAGEN VAN</b>							
Bus D	1,8	42	08.84-07.92	KY	4	8	RP4422
Bus D / TD	1,6	37-51	01.81-07.92	CS / JX	4	8	RP4422



Model	CC	Kw	Year	Engine	Cyl	Pict	Code
Bus LT 28 I D	2,4	51	08.89-06.96	1S/ACT	6	8	RP4422
Bus LT 28 I TD	2,4	68	08.89-08.92	1G	6	8	RP4422
Bus LT 28 I TD	2,4	70	09.92-06.96	ACL	6	8	RP4422
Bus LT 28-35 I D	2,4	51	07.90-05.96	1S/ACT	6	8	RP4422
Bus LT 28-35 I TD	2,4	68	08.88-08.92	1G	6	8	RP4422
Bus LT 28-35 I TD	2,4	70	06.92-05.96	ACL	6	8	RP4422
Bus LT 28-35 I TD	2,4	75	02.86-08.92	DV	6	8	RP4422
Bus LT 28-35 II Autobus TDI	2,5	66	05.99-07.06	APA	5	78	RP8272
Bus LT 28-35 II TDI	2,5	61	05.01-	BBE	5	78	RP8272
Bus LT 28-35 II TDI	2,5	70	05.01-	BBF	5	78	RP8674
Bus LT 28-35 II TDI	2,5	75	05.96-08.99	AHD	5	78	RP8272
Bus LT 28-35 II TDI	2,5	80	05.99-	ANJ/AVR	5	78	RP8272
Bus LT 28-46 II Furgonato TDI	2,5	66	05.99-07.06	APA	5	78	RP8272
Bus LT 28-46 II Furgonato/Auto- bus/Pianale piatto/telaio TDI	2,5	75	05.96-08.99	AHD	5	78	RP8272
Bus LT 28-46 II Pianale piatto/Te- laiio/Furgonato/Autobus TDI	2,5	61	05.01-07.06	BBE	5	78	RP8272
Bus LT 28-46 II Pianale piatto/Te- laiio/Furgonato/Autobus TDI	2,5	80	05.99-07.06	ANJ/AVR	5	78	RP8272
Bus LT 28-46 II TDI	2,8	92	06.97-12.98	AGK	4	136	RP8630
Bus LT 28-46 II TDI	2,8	96	01.99-	ATA	4	78	RP8272
Bus LT 40-55 I D	2,4	51	07.90-05.96	1S/ACT	6	8	RP4422
Bus LT 40-55 I TD	2,4	68	08.88-08.92	1G	6	8	RP4422
Bus LT 40-55 I TD	2,4	70	06.92-05.96	ACL	6	8	RP4422
Bus LT 40-55 I TD	2,4	75	02.86-08.92	DV	6	8	RP4422
Bus T3 D	1,7	42	03.86-07.92	KY	4	8	RP4422
Bus T3 TD	1,6	51	07.84-07.92	JX	4	8	RP4422
Bus T3 TD Syncro	1,6	51	03.86-07.92	JX	4	8	RP4422
Bus T4 D	1,9	44	09.90-04.98	1X	4	8	RP4422
Bus T4 D	2,4	55	08.97-	AJA	5	8	RP4422
Bus T4 D	2,4	57	09.90-	AAB	5	8	RP4422
Bus T4 D Syncro	2,4	57	10.92-	AAB	5	8	RP4422
Bus T4 TD	1,9	50	10.92-	ABL	4	8	RP4422
Bus T4 TDI	2,5	65	05.98-	AJT	5	78	RP8272
Bus T4 TDI	2,5	75	09.95-	ACV/AUF	5	78	RP8272
Bus T4 TDI	2,5	111	05.98-	AHY	5	78	RP8272
Bus T4 TDI Syncro	2,5	75	01.96-	ACV	5	78	RP8272
Bus TDI	2,5	75-102	09.95-04.98	ACV	5	78	RP8272
Bus V TDI	1,9	63	04.03-	AXC	4	78	RP8674
Bus V TDI	1,9	77	04.03-	AXB	4	78	RP8674
Bus V TDI	2,5	96	04.03-	AXD	5	78	RP8674
Bus V TDI	2,5	128	04.03-	AXE	5	78	RP8674
California T4 D	2,4	55-57	09.90-04.98	AJA / AAB	5	8	RP4422
California T4 D / TD	1,9	44-50	09.90-03.98	1X / ABL	4	8	RP4422
California T4 TDI	2,5	65	05.98-	AJT	5	105	RP8404



Model	CC	Kw	Year	Engine	Cyl	Pict	Code
California T4 TDI	2,5	75	08.96-03.98	ACV	5	78	RP8272
Caravelle T4 TDI	2,5	75	08.95-03.98	ACV	5	78	RP8272
Crafter 30-35 Autobus TDI	2,0	100	05.11-	CKTC	4	171	RP8928
Crafter 30-35 Autobus TDI	2,5	65	04.06-07.11	BJJ / CEBA	5	177	RP9000
Crafter 30-35 Autobus TDI	2,5	80	04.06-	BJK / CEBB	5	177	RP9000
Crafter 30-35 Autobus TDI	2,5	100	04.06-	BJL/CECA	5	177	RP9000
Crafter 30-35 Autobus TDI	2,5	120	04.06-07.11	BJM / CECB	5	177	RP9000
Crafter 30-35 Autobus/4motion TDI	2,0	120	07.11-	CKUB	4	171	RP8928
Crafter 30-50 Furgonato TDI	2,5	65	04.06-07.11	BJJ / CEBA	5	177	RP9000
Crafter 30-50 Furgonato/Pianale piatto/Telaio TDI	2,5	80	04.06-	BJK/CEBB	5	177	RP9000
Crafter 30-50 Furgonato/Pianale piatto/Telaio TDI	2,5	100	04.06-	BJL/CECA	5	177	RP9000
Crafter 30-50 Furgonato/Pianale piatto/Telaio TDI	2,5	120	04.06-07.11	BJM / CECB	5	177	RP9000
Crafter 30-50 Pianale piatto/Telaio TDI	2,0	100	05.11-	CKTC	4	171	RP8928
Crafter 30-50 Pianale piatto/Telaio TDI	2,5	65	04.06-07.11	BJJ / CEBA	5	177	RP9000
Crafter 30-50 Pianale piatto/Telaio/Furgonato TDI	2,0	120	07.11-	CKUB	4	171	RP8928
Crafter 30-50 Pianale piatto/Telaio/Furgonato/Autobus TDI	2,0	80	05.11-	CKTB	4	171	RP8928
Crafter 30-50 Pianali piatto/Telaio/Furgonato TDI	2,0	105	10.11-	CKUC	4	171	RP8928
Crafter 30-50 Pianali piatto/Telaio/Furgonato TDI 4motion	2,0	120	11.11-	CKUB	4	171	RP8928
LT	2,5	65	04.06-	BJJ	5	177	RP9000
LT 28 D TD	2,4	68	12.82-	---	6	8	RP4422
LT 28-35 Autobus TDI	2,5	70	04.01-07.06	BBF	5	78	RP8272
LT 28-35 II SDI	2,5	55	07.96-07.06	AGX	5	78	RP8272
LT 28-46 II Kasten TDI	2,5	70	05.01-	---	5	78	RP8674
LT 28-46 II Pianale piatto/Furgonato TDI	2,5	70	05.01-07.06	BBF	5	78	RP8272
LT 28-46 II Pianale piatto/Telaio / Furgonato SDI	2,5	55	09.96-07.06	AGX	5	78	RP8272
LT 28-46 II TDI	2,8	96	01.99-	ATA	4	78	RP8272
LT 28-46 II TDI	2,8	116	04.02-	AUH	4	154	RP8676
LT 31 D	2,4	51	08.88-12.95	1S	6	8	RP4422
LT 31 D	2,4	55	08.78-	---	6	8	RP4422
LT 31 D TD	2,4	68	12.82-	---	6	8	RP4422
LT 35 TDi	2,8	92	05.96-	---	5	78	RP8272
LT 40 D	2,4	55	08.78-	---	6	8	RP4422
LT 40 D/TD 4X4	2,4	55	09.85-	---	4	8	RP4422
LT D	2,4	51-55	08.78-12.95	ACT / 1S / CP / DW	6	8	RP4422
LT SDI	2,5	55	05.96-	AGX	5	78	RP8272
LT TD	2,4	68	12.82-03.96	---	5	8	RP4422



Model	CC	Kw	Year	Engine	Cyl	Pict	Code
LT Td	2,4	68	08.88-07.91	1G	6	8	RP4422
LT TD	2,4	70	08.91-12.95	ACL	6	8	RP4422
LT TD	2,4	75	12.82-07.92	DV	6	8	RP4422
LT TD	2,4	55-75	12.82-07.92	DV	6	8	RP4422
LT TDI	2,5	61	05.01-	---	5	78	RP8272
LT TDI	2,5	66	05.99-	APA	5	78	RP8272
LT TDI	2,5	70	05.01-	---	5	78	RP8272
LT TDI	2,5	80	04.06-	BJK	5	177	RP9000
LT TDI	2,5	100	04.06-	BJM	5	177	RP9000
LT TDI	2,5	75-80	08.95-	ACV / AHD / ANJ	5	78	RP8272
LT TDI	2,8	92	07.97-	AGK	4	136	RP8630
Multivan T4 D	2,4	55-57	09.90-04.98	AJA / AAB	5	8	RP4422
Multivan T4 D / TD	1,9	44-50	09.90-03.98	1X / ABL	4	8	RP4422
Multivan T4 TDI	2,5	65	05.98-	AJT	5	105	RP8404
Multivan T4 TDI	2,5	75	08.95-03.98	ACV	5	78	RP8272
Multivan T5 TDI	1,9	77	04.03-	AXB	4	78	RP8674
Multivan T5 TDI	2,5	96	04.03-	AXD	5	78	RP8674
Multivan T5 TDI	2,5	128	04.03-	AXE	5	78	RP8674
Multivan T5 TDI 4motion	2,5	96	07.04-	---	5	78	RP8674
Multivan T5 TDI 4motion	2,5	128	07.04-	---	5	78	RP8674
Multivan V TDI	1,9	75	06.06-	BRS	4	177	RP9000
Transporter IV Autobus TDI	2,5	111	04.03-	AHY / AXG	5	78	RP8272
Transporter IV Autobus TDI Syncro	2,5	75	01.96-04.03	ACV / AXL	5	78	RP8272
Transporter IV Autobus/Pianale piatto/Telaio/Furgonato TDI	2,5	65	05.98-04.03	AJT / AYY	5	78	RP8272
Transporter IV Furgonato TDI	2,5	111	04.03-	AXG	5	78	RP8272
Transporter IV Furgonato TDI Syncro	2,5	75	09.95-04.03	ACV / AXL	5	78	RP8272
Transporter IV Furgonato/Autobus/Pianale piatto/telaio TDI	2,5	75	09.95-04.03	ACV / AUF / AYC	5	78	RP8272
Transporter IV Pianale piatto/Telaio TDI Syncro	2,5	75	05.98-04.03	ACV / AXL	5	78	RP8272
Transporter T2	1,7	42	10.86-07.92	---	4	8	RP4422
Transporter T3	1,7	31	10.86-07.92	KY	4	8	RP4422
Transporter T3 D	1,7	42	10.86-07.92	KY	4	8	RP4422
Transporter T3 TD	1,6	51	08.84-07.92	JX	4	8	RP4422
Transporter T3 TD Syncro	1,6	51	03.86-07.92	JX	4	8	RP4422
Transporter T4 D	1,9	44	09.90-	1X	4	8	RP4422
Transporter T4 D	2,4	55	08.97-	AJA	5	8	RP4422
Transporter T4 D	2,4	57	09.90-	AAB	5	8	RP4422
Transporter T4 D Syncro	2,4	57	10.92-	AAB	5	8	RP4422
Transporter T4 TD	1,9	50	10.92-	ABL	4	8	RP4422
Transporter T4 TDI	2,5	65	05.98-	AJT	5	78	RP8272
Transporter T4 TDI	2,5	75	09.95-	ACV/AUF	5	78	RP8272
Transporter T4 TDI	2,5	111	05.98-	AHY	5	78	RP8272
Transporter T4 TDI Syncro	2,5	75	01.96-	ACV	5	78	RP8272



Model	CC	Kw	Year	Engine	Cyl	Pict	Code
Transporter T5 TDI	1,9	62	01.06-05.07	BRR	4	177	RP9000
Transporter T5 TDI	2,5	96	01.06-05.07	BNZ	5	177	RP9000
Transporter T5 TDI	2,5	128	01.06-05.07	BPC	5	177	RP9000
Transporter V TDI	1,9	63	04.03-	AXC	4	78	RP8674
Transporter V TDI	1,9	75	06.06-	BRS	4	177	RP9000
Transporter V TDI	1,9	77	04.03-	AXB	4	78	RP8674
Transporter V TDI	2,5	96	04.03-	AXD	5	78	RP8674
Transporter V TDI	2,5	128	04.03-	AXE	5	78	RP8674
Trasporter T5 Bus TDI 4motion	2,5	96	07.04-	---	5	78	RP8674
Trasport T4 TDI	2,5	65	05.98-09.01	AJT	5	105	RP8404
Trasport T4 TDI	2,5	65	10.01-	AYY	5	78	RP8674
Trasport T4 TDI	2,5	75	09.95-04.98	ACV	5	78	RP8272
Trasport T4 TDI	2,5	111	05.98-	AHY	5	105	RP8404
Trasporter T2 D	1,8	42	08.84-07.92	KY	4	8	RP4422
Trasporter T2 D / TD	1,6	37-51	01.81-07.92	CS / JX	4	8	RP4422
Trasporter T4 D / TD	2,4	55-57	09.90-04.98	AJA / AAB	5	8	RP4422
Trasporter T5 TDI	1,9	63	04.03-	AXC/AXB	4	78	RP8674
Trasporter T5 TDI	2,5	96	04.03-	AXD/AXE	5	78	RP8674
<b>VOLVO</b>							
240 D	2,0	50	08.79-09.81	D20	4	8	RP4422
240 D	2,4	58	08.79-08.93	D24	4	8	RP4422
340-360 D	1,6	40	08.84-07.91	D16	4	14	RP4458
360 D	1,6	40	07.84-07.91	D16	4	14	RP4458
360 D	1,8	44	09.98-	XUD 7	4	95	RP8374
440 K TD	1,9	66	07.94-12.96	D 19 T	4	8	RP4422
460 L TD	1,9	66	07.94-07.96	D 19 T	4	8	RP4422
740 D / Kombi	2,4	60	08.84-07.92	D 24	6	8	RP4422
740 TD / Kombi	2,4	80	09.85-07.92	D 24 T	6	8	RP4422
740 TD / Kombi	2,4	83	07.84-07.90	---	6	8	RP4422
740 TD Interc. / Kombi	2,4	90	08.86-07.88	D 24 TIC	6	8	RP4422
760 TD / Kombi	2,4	80	04.87-07.92	D 24 T	6	8	RP4422
760 TD Interc. / Kombi	2,4	85	08.87-07.92	D 24 TIC	6	8	RP4422
780 TD	2,4	85	08.85-07.91	D24TIC	6	8	RP4422
850 TDI / Kombi	2,5	103	08.95-12.96	D 5252 T	5	78	RP8272
940 D / Kombi	2,4	60	08.90-12.94	D 24	6	8	RP4422
940 II TD Interc. / Kombi	2,4	85	09.91-07.94	D 24 TIC	6	8	RP4422
940 II TD Interc. / Kombi	2,4	85	08.94-10.98	D 24 TIC	6	8	RP4422
940 TD Interc. / Kombi	2,4	90	07.92-12.94	D 24 TIC	6	8	RP4422
940 Turbo Diesel / Kombi	2,4	80	08.90-08.93	D 24 T	6	8	RP4422
960 TD	2,4	85	09.91-08.97	D24TIC	6	8	RP4422
C30 D	2,0	96	10.06-07.07	D4204T2	4	172	RP8930
C30 D	2,0	100	10.06-09.10	D4204T	4	172	RP8930
C30 D DRIVE	1,6	80	10.06-07.11	D4164T (nr.mot.16125<-)	4	146	RP8652
C30 D DRIVE	1,6	80	10.06-07.11	D4164T (nr.mot.16126->)	4	117	RP8436
C30 D5	2,4	120	10.06-	D5244T9	5	145	RP8470



Model	CC	Kw	Year	Engine	Cyl	Pict	Code
C30 D5	2,4	132	10.06-	D5244T13	5	145	RP8470
C70 II D Cabrio	2,0	100	01.08-07.10	D4204T	4	172	RP8930
C70 II D Cabrio	2,4	120	08.06-07.10	D5244T9	5	145	RP8470
C70 II D5 Cabrio	2,4	132	08.06-07.10	D5244T8 (nr.tel.49640<-)	5	145	RP8470
F 407/408	3,6	80-88	04.78-02.86	TD40A	6	6	RP4410
S40 DI	1,9	70	03.99-06.00	D4142T2	4	82	RP8390
S40 I DI	1,9	75-85	07.00-12.03	D4192T4/D4192T3	4	133	RP8624
S40 II (MS) D	1,6	81	01.05-	D4164T	4	117	RP8436
S40 II (MS) D5	2,4	132	03.06-	D5244T8	5	145	RP8470
S40 II D	1,6	81	01.05-	---	4	146	RP8652
S40 II D	2,0	96	04.04-07.07	D4204T2	4	172	RP8930
S40 II D	2,0	100	01.04-07.10	D4204T	4	172	RP8930
S40 II D DRIVe	1,6	80-81	11.04-	D4164T (nr.mot.16125<-)	4	146	RP8652
S40 II D DRIVe	1,6	80-81	11.04-	D4164T (nr.mot.16126->)	4	117	RP8436
S40 TD	1,9	66	05.96-	F8Q	4	8	RP4422
S40 TD	1,9	66	07.95-08.99	D 4192 T	4	9	RP4422/1
S60 D	2,4	93	09.05-04.10	D5244T7	5	145	RP8470
S60 D	2,4	96	12.01-	---	5	145	RP8650
S60 D	2,4	120	09.05-01.09	D5244T5	5	145	RP8470
S60 D5	2,4	120	07.01-	D5244T	5	145	RP8650
S60 D5	2,4	136	09.05-04.10	D5244T4	5	145	RP8470
S60 II D3	2,0	120	08.10-07.11	D5204T2	5	145	RP8470
S60 II D3	2,0	120	08.11-	D5204T3	5	145	RP8470
S60 II D5 / AWD	2,4	151	08.10-07.11	D5244T10	5	145	RP8470
S60 II D5 / AWD	2,4	158	08.11-	D5244T11 / D5244T15	5	145	RP8470
S60 TDI	2,5	103	10.01-	D5252T	5	78	RP8272
S70 TDI	2,5	103	01.97-11.00	D 5252 T	5	78	RP8272
S80 D	2,4	96	10.01-	D5244T	5	145	RP8650
S80 D5	2,4	120	08.01-	D 5244 T	5	145	RP8650
S80 II (AS) D3	2,0	120	01.10-	D5204T2 / D5204T3	5	145	RP8470
S80 II D	2,0	100	08.07-07.10	D4204T	4	172	RP8930
S80 II D	2,4	120	08.06-07.09	D5244T5	5	145	RP8470
S80 II D3	2,0	100	08.12-	D5204T7	5	145	RP8470
S80 II D3	2,0	120	08.10-07.11	D5204T2	5	145	RP8470
S80 II D3	2,4	120	08.10-07.12	D5204T3	5	145	RP8470
S80 II D4	2,0	120	08.12-	D5204T3	5	145	RP8470
S80 II D5 / AWD	2,4	136	03.06-07.09	D5244T4	5	145	RP8470
S80 TDI	2,5	103	01.99-	D 5252 T	5	78	RP8272
V40 I D	1,9	66	01.96-07.99	D4192T	4	9	RP4422/1
V40 I D	1,9	70	08.98-07.00	D4192T2	4	82	RP8390
V40 I D	1,9	75	03.00-04.04	D4192T4/DI	4	91	RP8360
V40 I D	1,9	85	03.00-04.04	D4192T3/DI	4	91	RP8360
V40 Kombi DI	1,9	70	03.99-07.00	D 4192T 2	4	82	RP8390
V40 Kombi TD	1,9	66	07.95-08.99	D 4192 T	4	8	RP4422



Model	CC	Kw	Year	Engine	Cyl	Pict	Code
V50 (MW) D5	2,4	132	03.06-	D5244T13 / D5244T8	5	145	RP8470
V50 (MW) Tdi	2,4	120	05.07-	D5244T9	5	145	RP8470
V50 D	1,6	81	01.05-	---	4	146	RP8652
V50 D	2,0	96	04.04-07.07	D4204T2	4	172	RP8930
V50 D	2,0	100	04.04-07.10	D4204T	4	172	RP8930
V50 D DRIVE	1,6	80-81	11.04-07.10	D4164T (nr.mot 16125<-)	4	146	RP8652
V50 D DRIVE	1,6	80-81	11.04-07.10	D4164T (nr.mot 16126->)	4	117	RP8436
V60 D3	2,0	120	09.10-08.11	D5204T2	5	145	RP8470
V60 D3	2,0	120	09.11-	D5204T3	5	145	RP8470
V60 D5	2,4	158	09.11-	DD5244T15 / D5244T11	5	145	RP8470
V60 D5 / AWD	2,4	151	09.10-08.11	D5244T10	5	145	RP8470
V60 D5 AWD	2,4	158	09.11-	DD5244T15	5	145	RP8470
V70 I Kombi TDI	2,5	103	01.97-03.00	D 5252 T	5	78	RP8272
V70 II (P80_) D	2,4	93	05.05-08.07	D5244T7	5	145	RP8470
V70 II (P80_) D5	2,4	120	08.01-08.07	D5244T / D5244T5	5	145	RP8470
V70 II (P80_) D5 / AWD	2,4	136	12.05-08.07	D5244T4	5	145	RP8470
V70 II Kombi D	2,4	96	12.01-	---	5	145	RP8650
V70 II Kombi D5	2,4	120	08.01-	---	5	145	RP8650
V70 II Kombi D5 AWD	2,4	120	03.03-	---	5	145	RP8650
V70 II Kombi TDI	2,5	103	03.00-	D 5252 T	5	78	RP8272
V70 III D	2,4	120	08.07-	D5244T5	5	145	RP8470
V70 III D	2,4	129	10.09-	D5244T4	5	145	RP8470
V70 III D5	2,4	136	08.07-	D5244T4	5	145	RP8470
V70 III D5 / AWD	2,4	158	06.11-	D5244T11 / D5244T15	5	145	RP8470
V70 III D5 AWD	2,4	136	10.07-	D5244T4	5	145	RP8470
XC60 D AWD	2,4	120	05.08-	D5244T16 / D5244T17 / D5244T5	5	145	RP8470
XC60 D5 AWD	2,4	136	03.09.-07.09	D5244T4	5	145	RP8470
XC70 Cross Country D5 AWD	2,4	136	12.05-08.07	D5244T4	5	145	RP8470
XC70 Cross Country D5 XC AWD	2,4	120	09.02-	---	5	145	RP8650
XC70 II D	2,4	129	01.10-	D5244T14	5	145	RP8470
XC70 II D AWD	2,4	120	08.07-07.09	D5244T5	5	145	RP8470
XC70 II D AWD	2,4	120	08.09-07.11	D5244T16	5	145	RP8470
XC70 II D AWD	2,4	120	08.07-	D5244T16 / D5244T5	5	145	RP8470
XC70 II D DRIVE	2,4	129	08.09-07.10	D5244T14	5	145	RP8470
XC70 II D3 AWD	2,4	120	08.11-	D5244T17	5	145	RP8470
XC70 II D3 DRIVE	2,0	120	08.10-07.11	D5204T2	5	145	RP8470
XC70 II D3 DRIVE	2,0	120	08.11-	D5204T3	5	145	RP8470
XC70 II D5 AWD	2,4	136	08.07-07.09	D5244T4	5	145	RP8470
XC70 II D5 AWD	2,4	158	08.11-	D5244T11 / D5244T15	5	145	RP8470
XC90 D3	2,4	120	08.10-	D5244T5	5	145	RP8470
XC90 D5	2,4	120	04.09-	D5244T5	5	145	RP8470
XC90 D5	2,4	120	04.09-	D5244T5	5	145	RP8470
XC90 D5	2,4	136	05.06-	D5244T4	5	145	RP8470
XC90 D5	2,4	136	05.06-	D5244T4	5	145	RP8470



Model	CC	Kw	Year	Engine	Cyl	Pict	Code
XC90 D5	2,4	147	01.11-	D5244T18	5	145	RP8470
XC90 D5	2,4	147	01.11-	D5244T18	5	145	RP8470
XC90 D5 AWD	2,4	120	01.03-07.06	D5244T	5	145	RP8650
ZUK							
Trasporter	2,4	51-68	---	C90 / CT90	4	5	RP2102





Model	CC	Kw	Year	Engine	Cyl	Pict	Code
-------	----	----	------	--------	-----	------	------

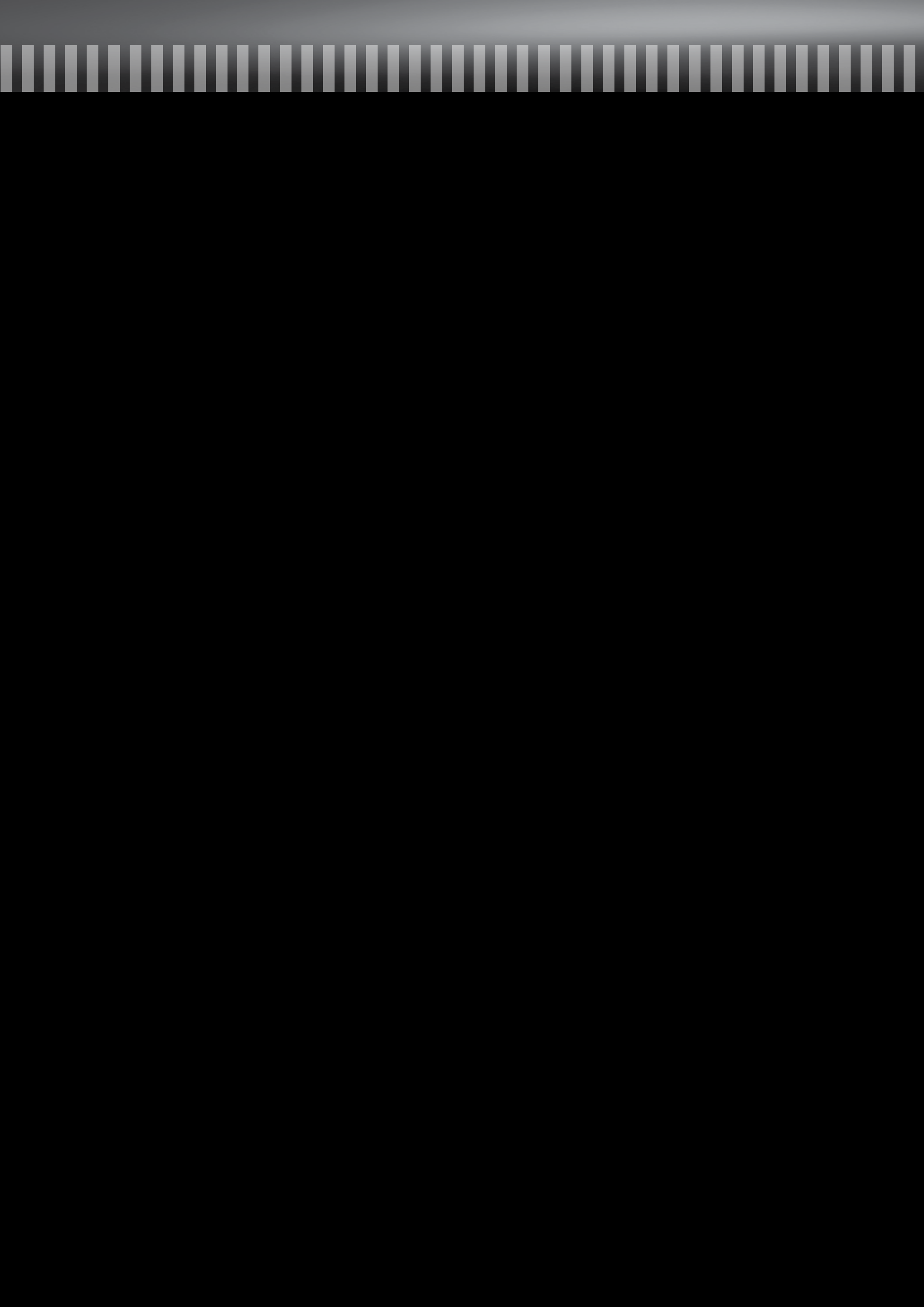

**TAVOLA DI CONVERSIONE  
CROSS REFERENCE  
LISTE DES RÉFÉRENCES  
CROISÉES**



**2**

AC-DELCO	RPOWER
93893040	RP4422
93893041	RP6122
93893042	RP4410
93893043	RP4444
93893044	RP2096
93893045	RP2028
93893046	RP2102
93893047	RP4444
93893048	RP4422
93893049	RP4410
93893050	RP4432
93893051	RP4444
93893052	RP4444
93893053	RP6056
93893054	RP6088
93893056	RP6090
93893057	RP6824
93893058	RP6818
93893059	RP6592
93893060	RP6918
93893061	RP6692
93893062	RP6608
93893063	RP6912
93893065	RP4444
93893066	RP4482
93893067	RP4432
7G	RP7012
8G	RP7002
9G	RP6816
11G	RP6816
12G	RP7006
13G	RP7026
15G	RP7030
26G	RP6056
27G	RP6820
28G	RP4422
29G	RP6122
30G	RP4444
31G	RP4422
32G	RP7004
33G	RP6824
35G	RP7008
37G	RP7008
63G	RP8920
101G	RP8374
110G	RP8272

114G	RP8320
118G	RP8358
148G	RP4444
241G	RP4444
500GG	RP4422
501GG	RP6122
503GG	RP4444
504GG	RP2096
505GG	RP2028
506GG	RP2102
507GG	RP4444
508GG	RP4422
509GG	RP4410
510GG	RP4432
511GG	RP4444
512GG	RP4444
513GG	RP6056
514CG	RP6088
516GG	RP6090
517GG	RP6824
518GG	RP6818
519GG	RP6592
520GG	RP6918
521GG	RP6692
522GG	RP6608
523GG	RP6912
525GG	RP4444
526GG	RP4482
527GG	RP4432
AGRIA	RPOWER
60079	RP4466
ALFA ROMEO	RPOWER
4729595	RP4444
4849406	RP4444
46072001	RP4444
46451951	RP8372
46754154	RP8622
46792355	RP8914
55200817	RP8622/30
60507123	RP4410
60596245	RP4444
60617002	RP8370
60732896	RP4410
60816139	RP8372
77359200	RP4444
500316493	RP8408
9633214380	RP4444

116610535800	RP4410
116760535801	RP4410
116610535800/00	RP4410
116760535801/00	RP4410
717 34 087	RP8372
AUDI	RPOWER
03L 963 319 A	RP8928
059 963 319 E	RP8928
059 963 319 F	RP8928
060 963 319 F	RP8928
vedi/see: VOLKSWAGEN	
AUTO DELTA	RPOWER
1001	RP4422
1002	RP4444
1004	RP4444
1007	RP4410
1014	RP2028
1020	RP2028
1051	RP2102
1066	RP4432
2001	RP4422
2002	RP4444
2003	RP4444
2004	RP4444
2005	RP4410
2066	RP4410
3004	RP6800/1
3045	RP6090
3061	RP6122
3294	RP6588
3296	RP6592
3346	RP6692
3409	RP6818
3412	RP6824
3415	RP6830
3420	RP6840
3424	RP6848
3459	RP6918
GP2001	RP4482
GP2003	RP4482
GP2026	RP4452
GP2029	RP4458
GP4042	RP6918
GP4162	RP8324
AUTOLITE	RPOWER
1101	RP4422
1102	RP6122

1103	RP4444
1104	RP4422
1106	RP7012
1107	RP7002
1108	RP7004
1109	RP7006
1110	RP6816
1111	RP7008
1113	RP7016
1114	RP7014
1116	RP8272
1117	RP7018
1118	RP8374
B1N	RP2028
B2N	RP2074
B3N	RP2096
B4N	RP2102
B5N	RP2092
B6N	RP6818
B9N	RP8120
B11N	RP6608
B17N	RP4422
B18N	RP4432
B19N	RP4444
B20N	RP4444
B21N	RP4410
B22N	RP4444
B23R	RP4444
B34N	RP6848
B36N	RP6838
B48R	RP4458
B7SR	RP8150
B8SR	RP6918
B10SR	RP8164
B12SR	RP6830
B13SR	RP6840
B14SR	RP6804
B15SR	RP6914
B16SR	RP6912
B24SR	RP4410
B25SR	RP4422
B26SR	RP4466
B27SR	RP4486
B28SR	RP4432
B29SR	RP4482
B30SR	RP4444
B31SR	RP4444

B32SR	RP4446
B33SR	RP6800
B35SR	RP8168
B37SR	RP8192
B38SR	RP6824
B39SR	RP8134
B41SR	RP4452
B42SR	RP4420
B43SR	RP4422
B44SR	RP4444
B46SR	RP8322
B47SR	RP8324
<b>BECK</b>	<b>RPOWER</b>
176-1011	RP4422
176-1037	RP4444
176-1038	RP4444
176-1039	RP6918
176-1042	RP6912
176-1044	RP4444
176-1045	RP4422
176-1046	RP8364
176-1047	RP8364
176-1049	RP6804
176-1050	RP6840
176-1057	RP8320
178-1043	RP6824
<b>BEDFORD</b>	<b>RPOWER</b>
vedi/see: GM	
<b>BERU</b>	<b>RPOWER</b>
0.100.100.201	RP6090
0.100.100.203	RP6090
0.100.100.302	RP6056
0.100.101.302	RP6056
0.100.101.304	RP6056
0.100.101.305	RP6122
0.100.101.306	RP6056
0.100.101.307	RP6056
0.100.101.308	RP6122
0.100.101.322	RP6056
0.100.220.101	RP4422
0.100.220.102	RP4444
0.100.220.103	RP4422
0.100.220.108	RP4422
0.100.220.113	RP6830
0.100.220.114	RP6838
0.100.220.115	RP8162
0.100.220.117	RP4422

0.100.220.118	RP8168
0.100.220.119	RP8168
0.100.220.121	RP6838
0.100.220.176	RP4452
0.100.220.206	RP2102
0.100.220.210	RP2102
0.100.221.102	RP4444
0.100.221.103	RP4444
0.100.221.104	RP4444
0.100.221.105	RP4422
0.100.221.106	RP4444
0.100.221.107	RP4444/1
0.100.221.108	RP4422
0.100.221.110	RP4422
0.100.221.112	RP4444
0.100.221.113	RP4444
0.100.221.114	RP4444
0.100.221.118	RP4444
0.100.221.125	RP4466
0.100.221.128	RP4444
0.100.221.132	RP4432
0.100.221.133	RP4444
0.100.221.134	RP4422
0.100.221.135	RP4444
0.100.221.136	RP6064
0.100.221.138	RP8248
0.100.221.141	RP4410
0.100.221.144	RP4420
0.100.221.145	RP4482
0.100.221.146	RP4486
0.100.221.147	RP6818
0.100.221.148	RP6592
0.100.221.149	RP6918
0.100.221.150	RP4422
0.100.221.151	RP6692
0.100.221.152	RP6608
0.100.221.153	RP8248
0.100.221.154	RP6912
0.100.221.155	RP4444
0.100.221.162	RP4490
0.100.221.163	RP4444
0.100.221.164	RP4444
0.100.221.165	RP8272
0.100.221.167	RP4444
0.100.221.168	RP8350
0.100.221.169	RP4444
0.100.221.170	RP4446

0.100.221.186	RP6824
0.100.221.199	RP6066
0.100.221.201	RP2102
0.100.221.206	RP2074
0.100.221.209	RP2092
0.100.221.210	RP2096
0.100.221.301	RP6088
0.100.221.304	RP8040
0.100.221.305	RP4444
0.100.221.306	RP4480
0.100.221.311	RP4480
0.100.221.313	RP8394
0.100.221.314	RP8394
0.100.222.101	RP6804
0.100.222.102	RP8184
0.100.222.103	RP6804
0.100.222.104	RP8660
0.100.222.105	RP8660
0.100.222.106	RP8938
0.100.222.301	RP2028
0.100.222.302	RP2028
0.100.222.304	RP2028
0.100.222.307	RP2028
0.100.226.114	RP4486
0.100.226.118	RP4466
0.100.226.120	RP8162
0.100.226.121	RP6628
0.100.226.122	RP6226
0.100.226.123	RP6590
0.100.226.124	RP6830
0.100.226.125	RP6838
0.100.226.126	RP6422
0.100.226.128	RP8666
0.100.226.129	RP8346
0.100.226.134	RP4422
0.100.226.138	RP7008
0.100.226.163	RP4458
0.100.226.164	RP4422
0.100.226.170	RP8348
0.100.226.171	RP8348
0.100.226.172	RP8272
0.100.226.173	RP4422
0.100.226.175	RP8320
0.100.226.176	RP4452
0.100.226.180	RP6840
0.100.226.182	RP8188
0.100.226.183	RP8150

0.100.226.184	RP8340
0.100.226.185	RP4444
0.100.226.186	RP4444
0.100.226.188	RP8352
0.100.226.189	RP4444
0.100.226.190	RP4432
0.100.226.194	RP8174
0.100.226.197	RP8326
0.100.226.198	RP4486
0.100.226.199	RP8360
0.100.226.203	RP8618
0.100.226.205	RP8388
0.100.226.206	RP8368
0.100.226.207	RP8322
0.100.226.208	RP8324
0.100.226.209	RP8134
0.100.226.210	RP8358
0.100.226.226	RP4458
0.100.226.227	RP8272
0.100.226.229	RP4488
0.100.226.231	RP4458
0.100.226.233	RP8414
0.100.226.234	RP4452
0.100.226.235	RP8358
0.100.226.237	RP4422
0.100.226.238	RP8390
0.100.226.241	RP8342
0.100.226.242	RP8208
0.100.226.243	RP8332
0.100.226.245	RP8396
0.100.226.246	RP8398
0.100.226.248	RP8388
0.100.226.249	RP8344
0.100.226.250	RP8342
0.100.226.251	RP4452
0.100.226.253	RP8686
0.100.226.254	RP4444
0.100.226.255	RP8654
0.100.226.256	RP8404
0.100.226.258	RP8320
0.100.226.260	RP8374
0.100.226.284	RP8630
0.100.226.299	RP8356
0.100.226.300	RP8400
0.100.226.301	RP8616
0.100.226.302	RP8656
0.100.226.304	RP7006

0.100.226.305	RP6840
0.100.226.306	RP4420
0.100.226.307	RP8174
0.100.226.308	RP8134
0.100.226.309	RP8322
0.100.226.310	RP8324
0.100.226.311	RP8332
0.100.226.312	RP8658
0.100.226.331	RP6840
0.100.226.333	RP8418
0.100.226.336	RP8364
0.100.226.338	RP8404
0.100.226.343	RP8370
0.100.226.344	RP8410
0.100.226.345	RP8188
0.100.226.346	RP6910
0.100.226.348	RP8206
0.100.226.349	RP8646
0.100.226.351	RP8412
0.100.226.352	RP8642
0.100.226.353	RP8406
0.100.226.354	RP8408
0.100.226.361	RP8626
0.100.226.362	RP8626
0.100.226.365	RP8406
0.100.226.366	RP4444
0.100.226.367	RP8388
0.100.226.368	RP8634
0.100.226.369	RP8388
0.100.226.370	RP8668
0.100.226.371	RP8352
0.100.226.372	RP8372
0.100.226.373	RP8624
0.100.226.375	RP8620
0.100.226.376	RP8898
0.100.226.379	RP8374
0.100.226.381	RP8388
0.100.226.382	RP8912
0.100.226.383	RP8636
0.100.226.384	RP8616
0.100.226.385	RP8618
0.100.226.391	RP8628
0.100.226.392	RP8634
0.100.226.394	RP7016
0.100.226.395	RP8374
0.100.226.396	RP8626
0.100.226.397	RP8404

0.100.226.417	RP8638
0.100.226.418	RP4452
0.100.226.419	RP8374
0.100.226.422	RP8640
0.100.226.432	RP8326
0.100.226.435	RP8676
0.100.226.436	RP8622
0.100.226.437	RP8644
0.100.226.438	RP4444
0.100.226.439	RP4458
0.100.226.440	RP4422
0.100.226.441	RP4444
0.100.226.442	RP4444
0.100.226.443	RP4486
0.100.226.444	RP4482
0.100.226.445	RP4444
0.100.226.446	RP4420
0.100.226.447	RP4444
0.100.226.448	RP4444
0.100.226.449	RP4452
0.100.226.450	RP8344
0.100.226.451	RP4444
0.100.226.452	RP4432
0.100.226.453	RP4488
0.100.226.454	RP8352
0.100.226.455	RP8272
0.100.226.456	RP8320
0.100.226.457	RP8358
0.100.226.458	RP8374
0.100.226.459	RP8370
0.100.226.460	RP8404
0.100.226.461	RP8406
0.100.226.462	RP8634
0.100.226.463	RP8388
0.100.226.464	RP8626
0.100.226.465	RP6824
0.100.226.466	RP6824
0.100.226.473	RP8374
0.100.226.474	RP8674
0.100.226.475	RP8646
0.100.226.480	RP8644
0.100.226.481	RP8912
0.100.226.482	RP8674
0.100.226.489	RP8638
0.100.226.492	RP8930
0.100.226.494	RP8932
0.100.226.495	RP8680

0.100.226.496	RP8908
0.100.226.497	RP8910
0.100.226.508	RP8910
0.100.226.511	RP8896
0.100.226.513	RP8602
0.100.226.514	RP8600
0.100.226.517	RP8908
0.100.226.520	RP8106
0.100.226.522	RP8428
0.100.226.525	RP8432
0.100.226.526	RP8434
0.100.226.527	RP8906
0.100.226.538	RP8448
0.100.226.568	RP8610
0.100.226.569	RP8612
0.100.226.570	RP8906
0.100.230.101	RP6848
0.100.230.102	RP6800
0.100.230.103	RP6800
0.100.230.105	RP6848
0.100.230.106	RP8648
0.100.230.107	RP8648
0.100.231.101	RP7992
0.100.231.102	RP8246
0.100.231.104	RP8200
0.100.231.107	RP6914
0.100.231.109	RP8176
0.100.231.110	RP8916
0.100.231.114	RP6916
0.100.231.115	RP6914
0.100.231.116	RP6914
0.100.231.119	RP8420
0.100.231.120	RP8246
0.100.231.121	RP7992
0.100.231.122	RP8200
0.100.231.123	RP6588
0.100.231.302	RP2082
0.100.231.303	RP2082
0.100.231.304	RP2022
0.100.232.301	RP2030
0.100.266.002	RP9004
0.100.266.003	RP9006
0.100.266.004	RP9002
0.100.266.005	RP9008
0.100.266.006	RP8920
0.100.266.007	RP8924
0.100.266.008	RP9000

0.100.266.009	RP9002
0.100.266.010	RP9008
0.100.266.011	RP8924
0.100.266.016	RP8928
0.100.266.017	RP8918
0.100.266.018	RP8920
0.100.266.023	RP8454
0.100.266.024	RP8444
0.100.266.025	RP8466
0.100.266.026	RP8456
0.100.266.028	RP8478
0.100.266.030	RP8480
0.100.266.031	RP8466
0.100.266.032	RP8454
0.100.266.033	RP8456
0.100.266.034	RP8444
0.100.266.037	RP8474
0.100.266.038	RP8476
0.100.266.040	RP8928
0.100.266.053	RP8456
0.100.271.101	RP7004
0.100.271.102	RP7002
0.100.271.103	RP7004
0.100.271.106	RP6816
0.100.271.201	RP7014
0.100.271.205	RP7018
0.100.271.301	RP6042
0.100.271.601	RP6820
0.100.276.002	RP8650
0.100.276.003	RP8672
0.100.276.004	RP8652
0.100.276.005	RP8650
0.100.276.006	RP8650
0.100.276.007	RP8678
0.100.276.008	RP8678
0.100.276.010	RP8914
0.100.276.012	RP8436
0.100.276.014	RP8440
0.100.276.015	RP8914
0.100.276.019	RP8612
0.100.276.024	RP8438
0.100.278.008	RP8678
0.100.281.301	RP6044
0.100.331.301	RP2030
0.100.800.002	RP7030
0.100.800.031	RP8936
0.100.800.033	RP8904

0.100.800.034	RP6806
0.100.800.035	RP8426
0.100.800.036	RP8922
0.100.800.037	RP8122
0.100.800.038	RP8402
0.100.800.039	RP6678
0.100.800.040	RP6632
0.100.800.041	RP6672
0.100.800.042	RP6678
0.100.800.043	RP8362
0.100.800.044	RP8888
0.100.800.045	RP8392
0.102.224.204	RP1012
103MJ	RP2022
105MJ	RP2092
105MN	RP4444
106MJ	RP2092
107M	RP2028
107MJ	RP2028
108MJ	RP2028
115MJ	RP2074
117MJ	RP2030
124MJ	RP2028
128M	RP6044
130MJ	RP2096
131MJ	RP2022
134M	RP6820
137MJ	RP2102
141M	RP4422
141MJ	RP4422
145M	RP6042
151MJ	RP4444
153MJ	RP7992
155MJ	RP2074
161MJ	RP4444
162MJ	RP4422
165MJ	RP2082
170M	RP6088
170MJ	RP6088
171MJ	RP2028
191MJ	RP2082
197MJ	RP8040
202GK	RP6056
214Ge	RP6056
214GK	RP6056
219CG	RP6090
220G	RP6090

315Ge	RP6056
318Ge	RP6056
318GK(MB11)	RP6056
322Ge	RP6056
332Ge	RP6056
348GK	RP6122
368GK	RP6056
370GK	RP6056
381GK	RP6122
382GK	RP6122
601MJ	RP4422
602MJ	RP4444
603MJ	RP4444/1
604MJ	RP4432
605MJ	RP4422
606MJ	RP4444
607MJ	RP4444
609MJ	RP4444
611MJ	RP4480
613MJ	RP4444
624MJ	RP4466
626MJ	RP4480
631MJ	RP4432
633MJ	RP4444
636MJ	RP4444
642MJ	RP4444
651MJ	RP8248
657MJ	RP4410
658MJ	RP6918
661MJ	RP4420
663MJ	RP4482
666MJ	RP4486
673MJ	RP6818
678MJ	RP6592
685MJ	RP6918
687MJ	RP4422
688MJ	RP6692
689MJ	RP6608
691MJ	RP8248
705MJ	RP6912
718MJ	RP4490
719MJ	RP4444
725MJ	RP8272
727MJ	RP4444
729MJ	RP4444
730MJ	RP4446
736MJ	RP8246

749MJ	RP6824
783MJ	RP8346
784MJ	RP4486
815MJ	RP4422
819MJ	RP7008
823MJ	RP7004
835MJ	RP7002
844MJ	RP4422
852MJ	RP4458
853MJ	RP8348
854MJ	RP8348
855GMJ	RP8272
855MJ	RP8272
857MJ	RP4422
858MJ	RP4452
860MJ	RP8320
880MJ	RP8200
883MJ	RP6628
884MJ	RP6590
885MJ	RP6588
886MJ	RP6840
887MJ	RP6848
888MJ	RP6830
889MJ	RP6838
890MJ	RP6800
892MJ	RP8162
894MJ	RP6804
895MJ	RP6914
897MJ	RP8188
898MJ	RP8150
905MJ	RP8340
908MJ	RP4444
909MJ	RP4444
910MJ	RP8394
912MJ	RP8352
917MJ	RP4444
918MJ	RP4432
920MJ	RP8168
921MJ	RP8174
922MJ	RP8176
925MJ	RP8326
927MJ	RP4486
928MJ	RP8360
944MJ	RP8368
945MJ	RP8134
946MJ	RP8322
947MJ	RP8324



948MJ	RP8358
954MJ	RP4488
961MJ	RP8342
963MJ	RP8396
964MJ	RP8398
967MJ	RP8208
968MJ	RP8332
969MJ	RP6916
970MJ	RP8344
991MJ	RP8356
995MJ	RP6816
996MJ	RP7006
999MJ	RP8390
GD214	RP6056
GD220	RP6090
GD318	RP6056
GD348	RP6122
GD368	RP6056
GD382	RP6122
GE100	RP9000
GE101	RP9002
GE102	RP9004
GE103	RP9006
GE104	RP9008
GE105	RP8924
GE106	RP8920
GE108	RP8928
GE110	RP8454
GE111	RP8456
GE112	RP8466
GE114	RP8444
GE115	RP8928
GE118	RP8474
GN001	RP8418
GN002	RP8420
GN003	RP8374
GN005	RP8364
GN007	RP8370
GN008	RP8404
GN010	RP8406
GN012	RP8408
GN013	RP4444
GN015	RP8634
GN016	RP8352
GN017	RP8372
GN018	RP8624
GN019	RP8620

GN020	RP8898
GN022	RP8388
GN023	RP8912
GN024	RP8626
GN025	RP8668
GN026	RP8412
GN027	RP8410
GN028	RP8636
GN030	RP8628
GN033	RP8638
GN035	RP8640
GN037	RP8672
GN039	RP8642
GN041	RP8622
GN042	RP8644
GN043	RP8646
GN044	RP8648
GN045	RP8650
GN046	RP8674
GN047	RP8652
GN049	RP7018
GN050	RP8676
GN053	RP8678
GN054	RP8930
GN055	RP8932
GN056	RP8436
GN057	RP8938
GN058	RP8440
GN059	RP8914
GN060	RP8908
GN061	RP8106
GN062	RP8428
GN063	RP8438
GN064	RP8434
GN065	RP8906
GN067	RP8612
GN068	RP8906
GN070	RP8904
GN071	RP6806
GN072	RP8426
GN073	RP8922
GN074	RP8122
GN075	RP8402
GN076	RP6678
GN077	RP6632
GN078	RP6672
GN079	RP6678

GN080	RP8362
GN081	RP8888
GN082	RP8392
GN101	RP8600
GN102	RP8602
GN103	RP8680
GN104	RP8910
GN106	RP8432
GN107	RP8896
GN108	RP8448
GN109	RP8936
GN110	RP8610
GN217	RP8396
GN853	RP8348
GN854	RP8348
GN855	RP8272
GN857	RP4422
GN858	RP4452
GN860	RP8320
GN905	RP8340
GN908	RP4444
GN909	RP4444
GN912	RP8352
GN917	RP4444
GN918	RP4432
GN925	RP8326
GN926	RP8916
GN927	RP4486
GN928	RP8360
GN939	RP8618
GN944	RP8368
GN948	RP8358
GN954	RP4488
GN955	RP8414
GN959	RP4422/1
GN961	RP8342
GN963	RP8396
GN964	RP8398
GN966	RP8388
GN970	RP8344
GN984	RP8686
GN985	RP8654
GN989	RP8630
GN991	RP8356
GN992	RP8400
GN993	RP8616
GN994	RP8656

GN997	RP8658
GN999	RP8390
GV001	RP8660
GV003	RP7030
GV004	RP6816
GV006	RP4422
GV105	RP4444
GV106	RP2092
GV107	RP2028
GV108	RP2028
GV112	RP6064
GV117	RP2030
GV119	RP2102
GV124	RP2028
GV128	RP6044
GV130	RP2096
GV133	RP2082
GV134	RP6820
GV137	RP2102
GV145	RP6042
GV151	RP4444
GV153	RP7992
GV155	RP2074
GV165	RP2082
GV170	RP6088
GV191	RP2082
GV197	RP8040
GV602	RP4444
GV603	RP4444/1
GV604	RP4432
GV624	RP4466
GV626	RP4480
GV631	RP4432
GV636	RP4444
GV642	RP4444
GV657	RP4410
GV661	RP4420
GV663	RP4482
GV666	RP4486
GV673	RP6818
GV678	RP6592
GV685	RP6918
GV688	RP6692
GV689	RP6608
GV691	RP8248
GV705	RP6912
GV719	RP4444

GV727	RP4444
GV728	RP8350
GV730	RP4446
GV736	RP8246
GV749	RP6824
GV764	RP6066
GV776	RP8664
GV783	RP8346
GV798	RP8666
GV815	RP4422
GV819	RP7008
GV823	RP7004
GV835	RP7002
GV844	RP4422/1
GV852	RP4458
GV880	RP8200
GV886	RP6840
GV887	RP6848
GV888	RP6830
GV889	RP6838
GV890	RP6800
GV892	RP8162
GV894	RP6804
GV895	RP6914
GV896	RP8184
GV897	RP8188
GV898	RP8150
GV910	RP8394
GV920	RP8168
GV921	RP8174
GV922	RP8176
GV945	RP8134
GV946	RP8322
GV947	RP8324
GV967	RP8208
GV968	RP8332
GV969	RP6916
GV995	RP6816
GV996	RP7006
MB11	RP6056
MC03	RP8394
MC06	RP4422
<b>BMW</b>	<b>RPOWER</b>
12232248059	RP8626
12232248422	RP8638
12237791101	RP8644
12 23 7 798 001	RP8474

12.12.1.286.059	RP4444
12.12.1.288.161	RP4444
12.23.0.035.934	RP9702
12.23.1.288.245	RP4444
12.23.2.241.387	RP4444
12.23.2.241.388	RP4444
12.23.2.241.389	RP4444
12.23.7.786.869	RP9004
12.23.7.788.957	RP9006
12.23.7.803.368	RP9702
12.23.9.061.353	RP4444
12.23.9.061.354	RP4444
77.86.8.69	RP9004
77.88.9.57	RP9006
<b>BOMAG</b>	<b>RPOWER</b>
05719903	RP2028
<b>BOSCH</b>	<b>RPOWER</b>
0.250.001.001	RP6056
0.250.001.005	RP6056
0.250.001.008	RP6122
0.250.001.010	RP6056
0.250.001.012	RP6122
0.250.001.015	RP6122
0.250.001.016	RP6122
0.250.001.017	RP6122
0.250.001.416	RP6122
0.250.001.782	RP8930
0.250.001.901	RP6122
0.250.002.002	RP6056
0.250.002.003	RP6056
0.250.002.008	RP6056
0.250.002.009	RP6090
0.250.200.001	RP2028
0.250.200.004	RP2030
0.250.200.006	RP6044
0.250.200.008	RP2028
0.250.200.011	RP2022
0.250.200.013	RP6088
0.250.200.014	RP2028
0.250.200.016	RP2028
0.250.200.020	RP2028
0.250.200.021	RP8040
0.250.200.022	RP2082
0.250.200.025	RP2102
0.250.200.032	RP2102
0.250.200.035	RP6064
0.250.200.037	RP2074

0.250.200.041	RP2082
0.250.200.046	RP2092
0.250.200.048	RP2096
0.250.200.049	RP4410
0.250.200.051	RP2102
0.250.200.052	RP4422
0.250.200.053	RP4410
0.250.200.054	RP4444
0.250.200.055	RP2028
0.250.200.056	RP4444
0.250.200.057	RP4444
0.250.200.058	RP4444
0.250.200.059	RP4444
0.250.200.060	RP4444
0.250.200.061	RP4444
0.250.200.063	RP4422
0.250.200.064	RP7992
0.250.200.065	RP4444
0.250.200.066	RP4432
0.250.200.068	RP4444
0.250.200.069	RP4444
0.250.200.070	RP8280
0.250.200.420	RP2028
0.250.200.422	RP2082
0.250.200.451	RP2102
0.250.200.454	RP4444
0.250.200.456	RP4444
0.250.200.464	RP7992
0.250.200.465	RP4444
0.250.200.468	RP4444
0.250.200.469	RP4444
0.250.201.001	RP4444
0.250.201.004	RP4422
0.250.201.005	RP4488
0.250.201.006	RP4444
0.250.201.008	RP4444
0.250.201.009	RP4444
0.250.201.010	RP4480
0.250.201.011	RP4422
0.250.201.012	RP4410
0.250.201.013	RP4466
0.250.201.014	RP4410
0.250.201.015	RP4422
0.250.201.017	RP4432
0.250.201.019	RP4444
0.250.201.021	RP4422
0.250.201.022	RP8276

0.250.201.026	RP4452
0.250.201.027	RP4444
0.250.201.029	RP4458
0.250.201.030	RP4444
0.250.201.031	RP4422/1
0.250.201.032	RP4422
0.250.201.033	RP4444
0.250.201.034	RP4410
0.250.201.035	RP8320
0.250.201.036	RP8360
0.250.201.037	RP4444
0.250.201.038	RP8358
0.250.201.039	RP4444
0.250.201.040	RP4422
0.250.201.041	RP4452
0.250.201.042	RP4444
0.250.201.043	RP4488
0.250.201.044	RP4480
0.250.201.045	RP4444
0.250.201.046	RP4422
0.250.201.047	RP4452
0.250.201.048	RP8358
0.250.201.049	RP8388
0.250.201.050	RP4422/1
0.250.201.053	RP8628
0.250.201.054	RP8358
0.250.201.405	RP4482
0.250.201.406	RP4444
0.250.201.415	RP4422
0.250.201.469	RP4444
0.250.201.901	RP4480
0.250.201.904	RP4444
0.250.201.905	RP4422
0.250.201.906	RP4444
0.250.201.927	RP4444
0.250.201.929	RP4444
0.250.201.930	RP4422
0.250.201.932	RP4444
0.250.201.934	RP4432
0.250.201.935	RP4458
0.250.201.936	RP4444
0.250.201.937	RP4444
0.250.201.938	RP4422
0.250.201.939	RP4444
0.250.201.940	RP4452
0.250.201.952	RP4444
0.250.201.955	RP4480

0.250.202.001	RP4420
0.250.202.002	RP8408
0.250.202.003	RP6818
0.250.202.004	RP6592
0.250.202.005	RP8084
0.250.202.006	RP6692
0.250.202.007	RP6912
0.250.202.008	RP6824
0.250.202.009	RP8272
0.250.202.010	RP6608
0.250.202.011	RP6226
0.250.202.012	RP6590
0.250.202.013	RP6830
0.250.202.014	RP6838
0.250.202.015	RP6422
0.250.202.016	RP6628
0.250.202.017	RP8162
0.250.202.018	RP4486
0.250.202.019	RP8398
0.250.202.020	RP8352
0.250.202.021	RP8354
0.250.202.022	RP8272
0.250.202.023	RP8370
0.250.202.024	RP8356
0.250.202.025	RP8340
0.250.202.026	RP8342
0.250.202.027	RP8368
0.250.202.028	RP8372
0.250.202.029	RP8374
0.250.202.030	RP8384
0.250.202.032	RP8410
0.250.202.033	RP4486
0.250.202.034	RP8344
0.250.202.035	RP8396
0.250.202.036	RP8622
0.250.202.038	RP8932
0.250.202.039	RP8374
0.250.202.040	RP8346
0.250.202.041	RP8406
0.250.202.042	RP8400
0.250.202.043	RP8638
0.250.202.045	RP8374
0.250.202.046	RP8674
0.250.202.048	RP8930
0.250.202.051	RP6840
0.250.202.053	RP8332
0.250.202.054	RP6804

0.250.202.056	RP8206
0.250.202.058	RP8188
0.250.202.059	RP8160
0.250.202.060	RP8174
0.250.202.062	RP8164
0.250.202.064	RP6802
0.250.202.064	RP8648
0.250.202.065	RP8106
0.250.202.069	RP6800
0.250.202.070	RP8184
0.250.202.071	RP6848
0.250.202.073	RP8192
0.250.202.074	RP8210
0.250.202.076	RP6914
0.250.202.077	RP8168
0.250.202.079	RP8338
0.250.202.085	RP8322
0.250.202.086	RP8134
0.250.202.087	RP8324
0.250.202.088	RP7008
0.250.202.089	RP8364
0.250.202.090	RP8684
0.250.202.091	RP8376
0.250.202.092	RP8896
0.250.202.093	RP8348
0.250.202.094	RP6818
0.250.202.095	RP8646
0.250.202.096	RP8332
0.250.202.097	RP6916
0.250.202.102	RP8404
0.250.202.103	RP8626
0.250.202.104	RP6632
0.250.202.105	RP8122
0.250.202.106	RP6910
0.250.202.107	RP8200
0.250.202.110	RP6838
0.250.202.115	RP8190
0.250.202.119	RP6588
0.250.202.120	RP8122
0.250.202.121	RP8612
0.250.202.124	RP8904
0.250.202.125	RP8906
0.250.202.126	RP7010
0.250.202.127	RP7008
0.250.202.128	RP8412
0.250.202.129	RP8620
0.250.202.130	RP8618

0.250.202.131	RP8616
0.250.202.132	RP8622/30
0.250.202.135	RP8930
0.250.202.137	RP8910
0.250.202.251	RP7002
0.250.202.252	RP6816
0.250.202.253	RP7006
0.250.202.254	RP7004
0.250.202.710	RP4446
0.250.202.901	RP4486
0.250.202.902	RP8272
0.250.203.001	RP8914
0.250.203.002	RP8678
0.250.203.003	RP8678
0.250.203.004	RP8650
0.250.203.009	RP8672
0.250.204.001	RP8652
0.250.204.002	RP8436
0.250.212.006	RP8640
0.250.212.009	RP8624
0.250.312.001	RP8600
0.250.312.002	RP8602
0.250.312.003	RP8608
0.250.312.007	RP8614
0.250.402.001	RP9000
0.250.402.002	RP9004
0.250.402.005	RP9000
0.250.403.001	RP8470
0.250.403.002	RP9002
0.250.403.003	RP8416
0.250.403.005	RP8444
0.250.403.006	RP8924
0.250.403.008	RP8924
0.250.403.009	RP8928
0.250.403.010	RP8416
0.250.403.011	RP8444
0.250.503.003	RP8922
0.250.603.001	RP9706
0.250.603.006	RP9702
0.250.603.008	RP9704
F 01G 000 00P	RP8448
F 01G 004 02X	RP8922
F 01G 004 02Z	RP8468
GS2AS10	RP6056
GS2AS8	RP6056
GS2D11	RP6090
GS2D14	RP6056

GS2D22	RP6056
GS2D6	RP6056
GS2D8	RP6056
GSA 11/29	RP6064
GSA10/1	RP2028
GSA18/10	RP2082
GSA9/1	RP2028
GSA9/10	RP8040
GSA9/31	RP2074
GRP26	RP6056
GRP27	RP6056
KE/GA1/(21/1)	RP6122
KE/GA1/21	RP6122
KE/GA1/24	RP6056
KE/GA1/35	RP6122
KE/GA1/8	RP6056
KE/GA10/1	RP2028
KE/GA10/15	RP2028
KE/GA10/7	RP2074
KE/GA2/12	RP6056
KE/GA2/15	RP6090
KE/GA2/2	RP6056
KE/GSA10/1	RP2028
KE/GSA10/10	RP6088
KE/GSA10/1J	RP2028
KE/GSA10/7	RP2074
KE/GSA12/1	RP2028
KE/GSA22/1	RP2030
KE/GSA24/5	RP6044
<b>BOSCH (USA)</b>	<b>RPOWER</b>
80002	RP6122
80003	RP6122
80004	RP2028
80005	RP2028
80006	RP4444
80007	RP4444
80008	RP4444
80009	RP4452
80010	RP4422
80011	RP8320
80012	RP8360
80013	RP8358
80014	RP6918
80015	RP6912
80016	RP6824
80017	RP6830
80018	RP6840

80019	RP6804
80020	RP8364
80021	RP8192
80024	RP7002
80027	RP7004
80028	RP8272
80031	RP4452
80033	RP7008
80035	RP4480
80037	RP7014
80038	RP7016
80039	RP8674
0.250.302.002	RP8272
<b>BRISK</b>	<b>RPOWER</b>
01R185	RP6918
01R185E	RP6918
01R185R	RP8160
01R447	RP8324
01R447E	RP8324
01R467	RP8208
01S355	RP8272
01S355E	RP8272
01S405	RP8340
01S405E	RP8340
01S412	RP8352
01S412E	RP8352
01S439	RP8618
01S439E	RP8618
01S492	RP8400
01S492E	RP8400
01S499	RP8390
01S503	RP8374
01S503E	RP8374
01S507	RP8370
01S507E	RP8370
01S508	RP8404
01S508E	RP8404
01S510	RP8406
01S510E	RP8406
01S512	RP8408
01S512E	RP8408
01S518	RP8624
01S527	RP8410
01S527E	RP8410
01S533	RP8638
01S533E	RP8638
01S541	RP8622

01S541E	RP8622
01S543E	RP8208
11R173	RP6818
11R173E	RP6818
11R205	RP6912
11R205E	RP6912
11R398	RP8150
11R398E	RP8150
11R421	RP8174
11R421E	RP8174
11R468	RP8332
11R468E	RP8332
11S505	RP8364
11S505E	RP8364
11S543	RP8646
11S543E	RP8646
12R380	RP8200
21N01	RP6608
21N21	RP4444
21N22	RP4444
21R01	RP4422/1
21R02	RP4432
21R102	RP4444
21R131	RP4432
21R131E	RP4432
21R136	RP4444
21R136E	RP4444
21R157	RP4410
21R157E	RP4410
21R161	RP4420
21R163	RP4444
21R166	RP4486
21R21	RP4444
21R219	RP4444
21R219E	RP4444
21R23	RP4444
21R26	RP4444
21R28D	RP4444
21R352	RP4458
21R352E	RP4458
21R398	RP4458
21R76D	RP4490
21S357	RP4422
21S357E	RP4422
21S358	RP4452
21S358E	RP4452
21S408	RP4444

21S409	RP4444
21S417	RP4444
21S427	RP4486
21S427E	RP4420
21S448	RP8358
21S448E	RP8358
21S454	RP4488
21S461	RP8342
21S461E	RP8342
21S513	RP4444
21S522	RP8388
21S522E	RP8388
33.50	RP6122
33.50	RP6056
41N71	RP2102
41R76	RP2102
41R76E	RP2102
81P71	RP6088
<b>BRUEGGEMANN</b>	<b>RPOWER</b>
vedi/see: STELLA	
<b>C.R.E.</b>	<b>RPOWER</b>
AN201	RP6044
ANS840KH	RP8040
E200 PE	RP6064
GJ152 HI	RP6642
GJ10 IS	RP6632
GJ12 IS	RP8122
GJ24 IS	RP8106
GJ26 IS	RP8324
GJ26 IS-5V	RP8134
GJ28 IS	RP8322
GJ28 IS-5V	RP6824
GJ29 IS	RP8680
GJ1136 IS	RP8432
GJ1143 IS	RP8658
GJ130 MA	RP8364
GJ131 MA	RP8632
GJ132 MA	RP8200
GJ1300 MA	RP8364
GJ1301 MA	RP8434
GJ1302 MA	RP8912
GJ31 MI	RP8256
GJ32 MI	RP6672
GJ37 MI	RP8904
GJ39 MI	RP8612
GJ42 MI	RP6680
GJ49 MI	RP8376

GJ53 MI	RP8896
GJ54 MI	RP8116
GJ55 MI	RP6818
GJ59 NI	RP8348
GJ67 NI	RP6682
GJ68 NI	RP6684
GJ69 NI-6,5V	RP6918
GJ75 NI-6,5V	RP6830
GJ80 NI	RP6848
GJ84 NI	RP8168
GJ85 NI	RP8648
GJ88 NI	RP8176
GJ260 NI	RP8642
GJ261 NI	RP8602
GJ262 NI	RP8936
GJ263 NI	RP8656
GJ264 NI	RP8426
GJ180 KU	RP6666
GJ93 TO	RP8906
GJ94 TO	RP8644
GJ106 TO	RP8126
GJ114 TO	RP8332
GJ117 TO	RP8610
GJ118 TO	RP6916
GJ121 TO	RP8646
GJ121 TO-7V	RP6840
GJ125 TO	RP8184
GUS565 CH	RP7002
GUS566 CH	RP7012
GUS575 CH	RP7004
GX59	RP4422
GX60	RP4422/1
GX61	RP8388
GX63	RP8356
GX64	RP4458
GX66	RP4420
GX67	RP8344
GX68	RP4432
GX69	RP4488
GX70	RP4452
GX74	RP4444
GX76	RP8360
GX78	RP4410
GX79	RP8408
GX80	RP8898
GX82	RP8624
GX83	RP4446

GX84	RP8390
GX86	RP8342
GX89	RP8352
GX90	RP8352
GX91	RP8628
GX93	RP8272
GX94	RP8396
GX95	RP8372
GX96	RP8616
GX97	RP8370
GX98	RP8674
GX99	RP8620
GX102	RP8640
GX103	RP8622
GX106	RP8626
GX107	RP8410
GX108	RP8654
GX116	RP8358
GX119	RP8320
GX120	RP8398
GX122	RP8634
GX123	RP8932
GX124	RP8404
GX125	RP8346
GX126	RP8368
GX128	RP8406
GX129	RP8374
GX130	RP8930
GX131	RP8676
GX132	RP8400
GX133	RP8668
GX135	RP8638
GX145	RP8910
GX148	RP8618
GX149	RP8630
GX150	RP8412
GX1106	RP9004
GX1133	RP9008
GX1135	RP9006
GZ001	RP9000
GZ002	RP9002
GZ003	RP8928
GZ004	RP8440
GZ005	RP8938
GZ006	RP8650
GZ007	RP8914
GZ008	RP8652

GZ009	RP8678
GZ010	RP8672
GZ011	RP8908
GZ012	RP8924
GZ013	RP8416
GZ014	RP8922
GZ015	RP8436
JA174CA	RP6812
JA156HI	RP8122
JA24IS	RP8106
JA25IS	RP8322
JA26IS	RP8324
JA28IS	RP8322
JA29IS	RP8680
JA130MA	RP8364
JA135MA	RP8364
JA136MA	RP8364
JA137MA	RP8364
JA138MA	RP8364
JA34MI	RP6666
JA53MI	RP8896
JA54MI	RP8116
JA55MI	RP6818
JA56MI	RP6818
JA59NI	RP8348
JA62NI	RP8168
JA84NI	RP8168
JA86NI	RP6818
JA87NI-6,5V	RP8604
JA89NI-6,5V	RP8606
JA114TO	RP8332
JA117TO	RP8610
JA127TO	RP8332
LA1000 ME	RP6122
LA101	RP6042
LA201	RP6044
LA400 PG	RP2028
LA500 CI	RP2096
LA600 OP	RP2102
LA800 KH	RP8040
LA820 KH	RP2028
N58	RP4422
N76	RP4444
SR64	RP4458
SR65	RP4458
SR71	RP4452
SR72	RP4444

SR74	RP4444
SR78	RP4410
SX120	RP8398
SX59	RP4422
SX60-K	RP4422/1
SX63	RP8356
SX64	RP4458
SX66	RP4420
SX68	RP4432
SX69	RP4488
SX70	RP4452
SX74	RP4444
SX76	RP8360
SX78	RP4410
SX79	RP8408
SX86	RP8342
SX90	RP8352
SX94	RP8396
WW68	RP8686
<b>CASE</b>	<b>RPOWER</b>
vedi/see: NAVISTAR	
<b>CATERP-ILLAR</b>	<b>RPOWER</b>
1P7324	RP6806
1P7912	RP6812
3H2033	RP6842
3S9624	RP6806
3T8705	RP6844
3T8706	RP6808
3T9561	RP6812
3T9562	RP6806
3T9563	RP6814
4N0184	RP6810
4N0360	RP6808
4S7824	RP6806
6N1058	RP6808
9H4577	RP6806
9N194X	RP6812
<b>CHAMPION</b>	<b>RPOWER</b>
AG28	RP6056
AG32	RP6064
AG44	RP6088
AG45	RP6090
CH08	RP4444
CH10	RP6056
CH16	RP6122
CH28	RP6056
CH32	RP6064

CH40	RP6820
CH44	RP6088
CH45	RP6090
CH50	RP6100
CH60	RP4422
CH61	RP6122
CH62	RP4410
CH63	RP4444
CH64	RP2096
CH65	RP2028
CH66	RP2102
CH68	RP4444
CH69	RP4422
CH70	RP4410
CH77	RP6816
CH78	RP7012
CH79	RP4432
CH80	RP7002
CH84	RP7004
CH87	RP4444
CH88	RP4444
CH88TWS	RP4466
CH90	RP4446
CH94	RP6818
CH95	RP6840
CH96	RP6830
CH97	RP6912
CH98	RP6918
CH99	RP8160
CH101	RP8150
CH102	RP6838
CH103	RP6692
CH104	RP6914
CH105	RP8164
CH108	RP6632
CH110	RP6824
CH117	RP6848
CH121	RP6592
CH128	RP6800
CH129	RP8162
CH130	RP6434
CH132	RP6804
CH133	RP8188
CH134	RP8382
CH137	RP4444
CH140	RP4444
CH141	RP4432

CH147	RP4486
CH152	RP8888
CH154	RP8332
CH155	RP4466
CH156	RP4490
CH157	RP8322
CH158	RP8324
CH159	RP4444
CH160	RP4422
CH161	RP8168
CH162	RP8174
CH163	RP4444
CH164	RP8666
CH166	RP8372
CH167	RP8344
CH168	RP8352
CH169	RP8340
CH170	RP8410
CH171	RP8272
CH172	RP8390
CH173	RP4458
CH174	RP4444
CH175	RP8320
CH176	RP4452
CH177	RP8358
CH178	RP8346
CH179	RP4422/1
CH180	RP8932
CH181	RP8370
CH184	RP8624
CH185	RP8352
CH186	RP8348
CH187	RP8642
CH188	RP8134
CH189	RP4444
CH190	RP8368
CH191	RP8184
CH196	RP8616
CH200	RP8652
CH200/02	RP8652
CH201	RP8436
CH202	RP8360
CH203	RP8626
CH204	RP8342
CH205	RP8388
CH206	RP8356
CH207	RP8400

CH208	RP8398
CH209	RP8628
CH210	RP8434
CH215	RP8404
CH216	RP8408
CH217	RP8396
CH218	RP8374
CH219	RP8406
CH221	RP8174
CH222	RP8622
CH223	RP8678
CH224	RP8914
CH225	RP8414
CH226	RP8640
CH227	RP8658
CH228	RP8634
CH229	RP8618
CH230	RP8936
CH231	RP8638
CH232	RP8412
CH233	RP8620
CH234	RP8938
CH237	RP7008
CH238	RP6816
CH239	RP8630
CH240	RP8650
CH242	RP8364
CH248	RP8686
CH252	RP8644
CH256	RP8896
CH258	RP8906
CH260	RP4422
CH263	RP8904
CH268	RP8930
CH269	RP8622/30
CH270	RP8672
CH271	RP8272
CH272	RP8654
CH273	RP8908
CH275	RP8676
CH302	RP8646
CH306	RP8106
CH360	RP8400
CH386	RP8368
CH600	RP8602
CH601	RP8608
CH602	RP8896

CH603	RP8670
CH607	RP8612
CH608	RP8610
CH613	RP8600
CH614	RP8386
CH700	RP9000
CH701	RP9004
CH702	RP9002
CH703	RP9006
CH704	RP9008
CH705	RP8928
CH709	RP8924
G9/11W95	RP6820
GE/GA477	RP6820
GE6A477	RP6820
<b>CHEVROLET</b>	<b>RPOWER</b>
89 417 515 81	RP8106
93 321 136	RP8346
MI 074 192	RP8346
<b>CHRYSLER</b>	<b>RPOWER</b>
05066840 AA	RP8932
<b>CITROEN</b>	<b>RPOWER</b>
596078	RP8436
596099	RP8438
5414326	RP2096
5415813	RP2028
5460556	RP2096
5477234	RP2096
5491387	RP2096
5500842	RP2096
5906079	RP8436
5962.008	RP4444
75492325	RP2096
91521849	RP4444
91521918	RP4444
91536646	RP4444
93010500	RP7992
95493205	RP4444
95493206	RP4444
95534788	RP4444
96009783	RP4444
96076258	RP4420
96104689	RP4444
96141678	RP4444
96165724	RP4444
96165734	RP8352
96236383	RP8410

96332143	RP4444
96389858	RP8410
5960E6	RP8472
7932564528	RP4444
7932567717	RP4444
7932567718	RP4444
9004100280	RP4420
9150771880	RP4444
9150861080	RP4444
9152191880	RP4444
9153664680	RP4444
9153891099	RP4420
9301050080	RP7992
9607038880	RP4420
9683195280	RP8472
5960 32	RP4444
5960 33	RP8344
5960 34	RP8344
5960 35	RP8358
5960 38	RP8626
5960 39	RP4446
5960 40	RP8646
5960 41	RP8372
5960 72	RP4446
5960 A4	RP8672
5960 G6	RP8438
5960 K4	RP8672
5960 k5	RP4446
5960 K5	RP8408
5960.12	RP8652
5960.19	RP8652
5961 05	RP2028
5961 22	RP2028
5961 39	RP4444
5961 40	RP4444
5961 53	RP4444
5961 54	RP4444
5961 57	RP4444
5961 58	RP4444
5962 3C	RP8410
5962 3H	RP4444
5962 4J	RP8624
5962 4K	RP8354
5962 4L	RP8340
5962 58	RP4444
5962 5A	RP8408
5962 74	RP4444



5962 7F	RP8410
5962 7G	RP8410
5962 7Z	RP4422
5962 C7	RP2028
5962 J2	RP4444
5962 J3	RP4444
5962 J4	RP4444
5962 J5	RP4444
5962 J6	RP4444
5962 J7	RP4422
5962 K5	RP4444
5962 R8	RP4444
5962 S8	RP4444
5962.1P	RP8398
5962.1Q	RP8398
5962.1R	RP4444
5962.1S	RP4432
5962.1T	RP4444
5962.1V	RP4482
5962.1W	RP4486
5962.1X	RP4422
5962.1Y	RP4458
5962.1Z	RP4422
5962.2Z	RP8352
5962.3E	RP8410
5962.3J	RP4444
5962.R8	RP4444
5962.S8	RP4444
5962.T1	RP4458
5962.T2	RP4422
5962.T3	RP6824
5962.T7	RP4420
5962.W2	RP8352
5962.W3	RP8352
5962.W8	RP4444
5962.X1	RP4444
8962 5A	RP4446
HG2621	RP2028
MKD00066	RP4444
MKP00064	RP4466
MKP00065	RP4444
MKP00067	RP4444
MKP00069	RP4444
MKP00070	RP6122
MKP00071	RP4422
<b>DACIA</b>	<b>RPOWER</b>
82 00 682 592	RP8454

<b>DAF</b>	<b>RPOWER</b>
105977	RP4444
1353958	RP4444
<b>DAIHATSU</b>	<b>RPOWER</b>
19850 87702 000	RP8646
19850-54030-000	RP6692
19850-54050-000	RP6804
19850-54090-000	RP8332
19850-56010-000	RP6590
19850-56012-000	RP6588
19850-56022-000	RP6592
19850-58030-000	RP6592
19850-58040-000	RP6588
19850-64010-000	RP6840
19850-64020-000	RP8208
19850-68010-000	RP8188
19850-68030-000	RP6592
19850-68040-000	RP6588
19850-68060-000	RP6914
19850-86022-000	RP6592
19850-87209-000	RP6592
19850-87303-000	RP6634
19850-87309-000	RP6592
19850-87701-000	RP6840
19850-87702-000	RP8208
19850-87703-000	RP8210
<b>DELPHI</b>	<b>RPOWER</b>
DS001	RP4444
DS002	RP4422
DS003	RP4444
DS006	RP4444
DS025	RP6800
DS090	RP7012
DS091	RP7002
DS092	RP7004
DS095A	RP7008
DS101	RP6122
DS902A	RP7004
HDS212	RP4444
HDS216	RP4444
HDS217	RP4422
HDS218	RP4444
HDS219	RP4422
HDS220	RP2102
HDS221	RP4488
HDS222	RP4432
HDS223	RP4422

HDS224	RP2096
HDS225	RP2028
HDS226	RP2074
HDS227	RP6064
HDS229	RP4458
HDS230	RP6918
HDS231	RP6830
HDS232	RP6818
HDS233	RP6840
HDS234	RP6692
HDS235	RP6804
HDS236	RP6590
HDS237	RP6916
HDS238	RP6588
HDS239	RP6838
HDS240	RP6800
HDS241	RP6912
HDS242	RP6914
HDS243	RP6838
HDS244	RP8200
HDS245	RP6592
HDS246	RP6848
HDS247	RP6824
HDS248	RP8120
HDS249	RP6226
HDS250	RP6678
HDS251	RP2092
HDS252	RP6592
HDS253	RP6918
HDS254	RP8164
HDS255	RP4444
HDS256	RP6838
HDS257	RP6628
HDS258	RP6608
HDS262	RP8332
HDS264	RP6692
HDS265	RP6100
HDS266	RP4410
HDS267	RP4410
HDS268	RP8188
HDS269	RP8116
HDS270	RP8150
HDS271	RP4432
HDS272	RP6910
HDS273	RP4486
HDS274	RP4444
HDS275	RP8208

HDS276	RP8174
HDS278	RP4410
HDS280	RP8162
HDS283	RP8168
HDS284	RP8184
HDS291	RP6848
HDS294	RP8176
HDS295	RP4482
HDS295	RP4444
HDS297	RP4452
HDS302	RP6824
HDS303	RP8346
HDS305	RP7002
HDS307	RP7004
HDS308	RP7006
HDS309	RP6816
HDS310	RP7008
HDS316	RP6122
HDS317	RP6090
HDS319	RP6056
HDS336	RP6066
HDS337	RP4444
HDS338	RP8134
HDS339	RP4444
HDS340	RP6802
HDS341	RP4422
HDS342	RP8272
HDS343	RP4422
HDS345	RP8322
HDS346	RP8324
HDS347	RP4458
HDS348	RP4444
HDS350	RP8352
HDS352	RP4452
HDS353	RP4444
HDS354	RP8358
HDS355	RP8340
HDS356	RP8666
HDS357	RP4446
HDS358	RP8348
HDS359	RP8348
HDS360	RP8400
HDS361	RP8370
HDS362	RP8388
HDS363	RP8320
HDS364	RP8372
HDS365	RP8398

HDS366	RP8356
HDS367	RP8410
HDS368	RP8624
HDS369	RP8352
HDS370	RP8340
HDS371	RP4444
HDS372	RP8626
HDS373	RP8342
HDS374	RP8404
HDS375	RP8408
HDS376	RP8396
HDS377	RP8374
HDS378	RP8406
HDS379	RP8616
HDS380	RP8628
HDS382	RP8622
HDS383	RP8618
HDS384	RP8638
HDS385	RP8620
HDS386	RP8368
HDS387	RP8634
HDS390	RP8658
HDS391	RP8896
HDS391	RP8896
HDS392	RP8904
HDS393	RP8906
HDS394	RP8364
HDS396	RP8412
HDS397	RP8640
HDS398	RP8630
HDS399	RP8652
HDS400	RP8106
HDS401	RP8602
HDS402	RP8680
HDS403	RP8614
HDS404	RP8650
HDS405	RP8910
HDS406	RP8930
HDS407	RP8654
HDS408	RP8932
HDS409	RP8914
HDS410	RP8644
HDS411	RP8612
HDS412	RP8600
HDS413	RP9000
HDS414	RP9002
HDS415	RP9004

HDS416	RP8436
HDS417	RP8434
HDS419	RP8672
HDS420	RP8938
HDS421	RP8908
HDS422	RP8386
HDS423	RP8924
HDS432	RP8928
HDS802	RP7016
HDS805	RP7018
<b>DEP</b>	<b>RPOWER</b>
54	RP6056
62	RP6056
67	RP6056
313	RP6090
315	RP6122
203-10	RP2028
203-12	RP2028
215-24	RP6044
218-22	RP2030
F41	RP6056
<b>DEUTZ</b>	<b>RPOWER</b>
vedi/see: KHD	
<b>DIPACO</b>	<b>RPOWER</b>
11117F2	RP7002
11118F	RP7004
11126S2	RP7008
6A843G080	RP7002
6A843G084	RP7004
6A843G138	RP7008
6A843G540	RP7014
<b>DODGE</b>	<b>RPOWER</b>
05117592AA	RP8374
<b>DRESSER</b>	<b>RPOWER</b>
710348R191	RP6056
<b>E.T.1</b>	<b>RPOWER</b>
AN1000ME	RP6122
AN101	RP6042
AN201	RP6044
AN207	RP6046
AN1020ME	RP6056
AN1050RO	RP6090
AN1200ME	RP4480
AN400PG	RP2028
AN450PG	RP2074
AN500CI	RP2096
AN6000P	RP2102
AN6500P	RP2092

AN750IH	RP6820
AN800KH	RP8040
AN820KH	RP2028
AN840KH	RP6088
AN920VO	RP2028
AN930VO	RP2030
E200PE	RP6064
GJ152HI	RP6642
GJ10IS	RP6632
GJ12IS	RP8122
GJ24IS	RP8106
GJ26IS-7V	RP8134
GJ28IS	RP8322
GJ28IS	RP6824
GJ29IS	RP8680
GJ1136IS	RP8432
GJ1143IS	RP8658
GJ130MA	RP8364
GJ131MA	RP8684
GJ132MA	RP8200
GJ1300MA	RP8364
GJ1301MA	RP8434
GJ1302MA	RP8364
GJ31MI	RP8256
GJ32MI	RP6672
GJ37MI	RP8904
GJ42MI	RP6680
GJ49MI	RP8376
GJ53MI	RP8896
GJ54MI	RP8116
GJ55MI	RP6818
GJ59NI	RP8348
GJ67NI	RP6682
GJ68NI	RP6684
GJ69NI	RP6918
GJ75NI	RP6830
GJ80NI	RP6848
GJ82NI	RP6830
GJ84NI	RP8168
GJ85NI	RP8648
GJ88NI	RP8176
GJ260NI	RP8642
GJ261NI	RP8602
GJ262NI	RP8936
GJ263NI	RP8656
GJ264NI	RP8426
GJ93TO	RP8906

GJ94TO	RP8644
GJ106TO	RP8126
GJ114TO	RP6804
GJ117TO	RP8610
GJ118TO	RP6914
GJ121TO	RP6592
GJ121TO-7V	RP6840
GJ125TO	RP8184
GJ180KU	RP6666
GUS555CH	RP7002
GUS566CH	RP7012
GUS575CH	RP7004
GX59	RP4422
GX60	RP4422
GX61	RP8388
GX63	RP8356
GX64	RP4458
GX66	RP4420
GX67	RP8344
GX68	RP4432
GX69	RP4444
GX70	RP4452
GX74	RP4444
GX76	RP8360
GX78	RP4410
GX79	RP8408
GX80	RP8898
GX82	RP8624
GX83	RP4446
GX84	RP8340
GX86	RP8342
GX89	RP8352
GX90	RP8352
GX91	RP8628
GX93	RP8272
GX94	RP8396
GX95	RP8372
GX96	RP8616
GX97	RP8370
GX98	RP8674
GX99	RP8620
GX102	RP8640
GX103	RP8622
GX106	RP8626
GX107	RP8410
GX108	RP8654
GX116	RP8358

GX117	RP8930
GX119	RP8320
GX120	RP8398
GX122	RP8634
GX123	RP8932
GX124	RP8404
GX125	RP8346
GX126	RP8368
GX127	RP8916
GX128	RP8406
GX129	RP8374
GX130	RP7008
GX131	RP8676
GX132	RP8400
GX133	RP8668
GX135	RP8638
GX145	RP8910
GX148	RP8618
GX149	RP8630
GX150	RP8412
GX151	RP8914
GX1106	RP9004
GX1119	RP8678
GX1126	RP8650
GX1133	RP9008
GX1135	RP9006
GX2090	RP8456
GX2094	RP8416
GX2096	RP8454
GX2097	RP9000
GX2106	RP9004
GX2117	RP9002
GX2119	RP8466
GX2133	RP9008
GX2148	RP8924
GX2157	RP8444
GX4098	RP8438
GX4118	RP8652
GX4126	RP8650
GX4127	RP8436
GX4151	RP8914
GX4153	RP8672
JA170CA	RP6806
JA172CA	RP6808
JA174CA	RP6812
JA142DA	RP6634
JA144DA	RP8208

JA146DA	RP8208
JA148DA	RP8210
JA151HI	RP8106
JA152HI	RP6642
JA153HI	RP6592
JA154HI	RP6444
JA156HI	RP8122
JA158HI	RP8122
JA160KO	RP6850
JA181KU	RP6422
JA182KU	RP8362
JA183KU	RP6912
JA185KU	RP6912
JA186KU	RP8888
JA189KU	RP6838
JA8IS	RP6226
JA24IS	RP8106
JA25IS	RP6824
JA26IS	RP8324
JA28IS	RP8322
JA29IS	RP8680
JA16IS	RP6824
JA14IS	RP8322
JA12IS	RP8122
JA130MA	RP8364
JA131MA	RP8684
JA132MA	RP8200
JA134MA	RP8200
JA135MA	RP8364
JA136MA	RP8364
JA138MA	RP8364
JA32MI	RP6672
JA34MI	RP6666
JA36MI	RP6668
JA40MI	RP6678
JA42MI	RP6680
JA43MI	RP6912
JA29NI	RP8608
JA50MI	RP6642
JA53MI	RP8896
JA54MI	RP8116
JA55MI	RP6818
JA56MI	RP6818
JA57MI	RP8150
JA59NI	RP8348
JA61NI	RP6689
JA62NI	RP8168

JA63NI	RP6838
JA64NI	RP6682
JA65NI	RP6800
JA67NI	RP8158
JA68NI	RP6684
JA69NI	RP6918
JA70NI	RP6626
JA71NI	RP6918
JA72NI	RP6628
JA73NI	RP8162
JA74NI	RP6838
JA75NI	RP6830
JA76NI	RP6648
JA77NA	RP6682
JA78NI	RP6608
JA79NI	RP6682
JA80NI	RP6848
JA82NI	RP6830
JA84NI	RP8168
JA85NI	RP6802
JA86NI	RP6818
JA87NI	RP8604
JA88NI	RP8176
JA89NI	RP8606
JA261NI	RP8602
JA92TO	RP6434
JA98TO	RP6592
JA100TO	RP6590
JA102TO	RP6592
JA104TO	RP6588
JA106TO	RP8126
JA108TO	RP6692
JA109TO	RP8646
JA110TO	RP6592
JA111TO	RP8338
JA112TO	RP8184
JA114TO	RP8332
JA116TO	RP6840
JA118TO	RP6916
JA120TO	RP6588
JA121TO	RP8188
JA122TO	RP6804
JA123TO	RP8190
JA124TO	RP6914
JA125TO	RP6914
JA126TO	RP8184
JA127TO	RP8332

JA128TO	RP6692
JA129TO	RP8660
JAS114TO	RP8332
JAS121TO	RP8646
JA300YA	RP6838
JA503HN	RP6066
K30	RP4480
N58	RP4422
N68	RP4432
N75	RP7992
N76	RP4444
N78	RP4410
R69	RP4458
R74	RP4444
R78	RP4410
SR58	RP4422
SR60	RP4422
SR64	RP4458
SR66	RP4420
SR67	RP4486
SR68	RP4432
SR71	RP4452
SR72	RP4444
SR73	RP4444
SR74	RP4444
SR78	RP4410
SR83	RP4446
ST68	RP8686
SR125	RP8346
SX59	RP4422
SX60	RP4422
SX61	RP8388
SX63	RP8356
SX64	RP4458
SX66	RP4486
SX67	RP8344
SX68	RP4432
SX69	RP4444
SX70	RP4452
SX71	RP4432
SX72	RP8666
SX74	RP4444
SX75	RP4444
SX76	RP8360
SX77	RP4444
SX78	RP4410
SX79	RP8408

SX84	RP8340
SX86	RP8342
SX89	RP8352
SX90	RP8352
SX91	RP8628
SX93	RP8272
SX94	RP8396
SX95	RP8372
SX97	RP8370
SX107	RP8410
SX116	RP8358
SX119	RP8320
SX120	RP8398
SX126	RP8368
US565CH	RP7002
US566CH	RP7012
US575CH	RP7004
WW68	RP8686
<b>EIKO</b>	<b>RPOWER</b>
GD901	RP6634
GD904	RP8210
GF101	RP6672
GF102	RP6668
GF103	RP8116
GF104	RP6670
GF105	RP6670
GF106	RP6666
GF108	RP6678
GF109	RP6678
GF110	RP6680
GF111	RP6654
GF112	RP6818
GF114	RP8118
GF115	RP8150
GF121	RP8636
GF122	RP6912
GH401	RP6642
GH402	RP6444
GH501	RP6910
GH502	RP6912
GH503	RP8200
GI001	RP6648
GI002	RP6650
GI003	RP6226
GI004	RP8328
GI005	RP6824
GI006	RP6826

GI007	RP6632
GI008	RP8122
GI009	RP6854
GI010	RP8106
GI011	RP8134
GI013	RP8322
GI018	RP8324
GK911	RP6850
GM501	RP6910
GM502	RP6912
GM503	RP8200
GM504	RP6670
GM505	RP8200
GM508	RP8680
GN302	RP8120
GN303	RP6628
GN304	RP6684
GN305	RP6682
GN306	RP6838
GN308	RP6848
GN309	RP6608
GN310	RP6626
GN311	RP8158
GN314	RP8160
GN315	RP6918
GN316	RP6830
GN317	RP6800
GN318	RP8162
GN319	RP6838
GN320	RP8164
GN322	RP6838
GN324	RP6802
GN327	RP8174
GN329	RP8176
GN331	RP8348
GN332	RP8602
GPBS	RP6850
GPCM	RP6806
GPCS	RP6668
GPDS	RP6634
GPES	RP6650
GPFS	RP6670
GPHS	RP6642
GPIS	RP6648
GPJ6D10	RP6680
GPJS	RP6654
GPKS-12	RP6666

GPLS	RP6678
GPMS	RP6672
GPNCS	RP8116
GPNES	RP6226
GPNES-1	RP8116
GPNES-2	RP6824
GPNES-3	RP6826
GPNFS	RP6670
GPNS3	RP8120
GPNS3-1	RP6628
GPNS4	RP6684
GPNS5	RP6682
GPNS7	RP6688
GPNS8	RP6848
GPNS9	RP6608
GPNWS	RP8122
GPRS	RP6444
GPTDS-12	RP6434
GPTDS-24	RP6690
GPTDS-2D	RP8126
GPTDS-2J	RP6588
GPTDS-B	RP6592
GPTDS-BU	RP6590
GPTDS-JY	RP6438
GPTDS-L	RP6692
GPWS	RP6632
GPZS	RP6910
GS2D11	RP6090
GSA10/1	RP2028
GSA9/1	RP2028
GSA9/31	RP2074
GT201	RP6434
GT202	RP6690
GT203	RP6438
GT204	RP6590
GT205	RP6692
GT206	RP8126
GT207	RP6588
GT208	RP6592
GT212	RP6840
GT213	RP6916
GT214	RP8190
GT215	RP8186
GT216	RP6804
GT217	RP6914
GT218	RP8188
GT219	RP8184

GT220	RP8338
GT221	RP8332
GT223	RP8208
GT226	RP8660
KE/GA1(21/1)	RP6122
KE/GA1/21	RP6122
KE/GA1/24	RP6056
KE/GA1/35	RP6122
KE/GA1/8	RP6056
KE/GA10/1	RP2028
KE/GA10/15	RP2028
KE/GA10/7	RP2074
KE/GA2/15	RP6090
KE/GSA10/1J	RP2028
<b>FAI</b>	<b>RPOWER</b>
GGP01	RP4422
GGP03	RP6100
GGP04	RP4444
GGP05	RP4444
GGP06	RP8322
GGP07	RP4444
GGP08	RP4444
GGP09	RP8248
GGP10	RP4432
GGP11	RP4486
GGP12	RP6090
GGP13	RP4410
GGP14	RP6692
GGP15	RP4466
GGP16	RP4422
GGP17	RP4410
GGP18	RP4420
GGP19	RP6912
GGP20	RP6840
GGP21	RP8150
GGP22	RP6818
GGP23	RP8164
GGP24	RP6838
GGP25	RP6800/1
GGP26	RP8174
GGP27	RP6918
GGP28	RP6804
GGP29	RP4422
GGP30	RP8200
GGP31	RP6824
GGP33	RP8272
GGP36	RP6914

GGP36	RP8322
GGP37	RP6592
GGP40	RP8324
GGP41	RP4452
GGP42	RP4452
GGP43	RP8188
GGP44	RP4422
GGP44	RP4422
GGP45	RP6122
GGP46	RP4444
GGP47	RP8352
GGP50	RP8134
GGP53	RP8388
GGP54	RP8370
GGP56	RP8344
GGP58	RP8342
GGP59	RP8320
GGP60	RP8358
GGP64	RP8372
GGP65	RP8396
GGP68	RP4444
GGP69	RP4444
GGP70	RP8898
GGP71	RP8622
GGP72	RP8404
GGP73	RP8668
GGP74	RP8626
GGP76	RP8616
GGP77	RP8406
GGP78	RP8374
GGP80	RP8686
GGP84	RP8272
<b>FAUN</b>	<b>RPOWER</b>
1714014	RP6056
<b>FEDERAL MOGUL</b>	<b>RPOWER</b>
GP1000	RP4444
GP1010	RP4410
GP1011	RP4422
GP1012	RP4422
GP1013	RP2096
GP1014	RP4432
GP1015	RP2028
GP1016	RP2102
GP1018	RP4410
GP1019	RP6806
GP1020	RP6056
GP1021	RP6122

GP1022	RP4444
GP1023	RP6808
GP1024	RP6592
GP1025	RP6590
GP1026	RP6642
GP1028	RP6588
GP1029	RP6824
GP1030	RP6226
GP1035	RP6668
GP1036	RP6678
GP1037	RP6680
GP1038	RP6670
GP1040	RP6684
GP1041	RP6626
GP1042	RP6628
GP1043	RP6838
GP1044	RP8158
GP1045	RP6608
GP1046	RP6918
GP1047	RP6692
GP1049	RP6692
GP1050	RP6912
GP1051	RP6670
GP1052	RP6910
GP1053	RP8200
GP1055	RP6650
GP1056	RP6818
GP2000	RP4444
<b>FIAT</b>	<b>RPOWER</b>
980611	RP6042
4122453	RP6046
4137983	RP6048
4393814	RP4444
4474413	RP4444
4714294	RP4444
4729585	RP4444
4738576	RP4444
4752281	RP4444
4754011	RP4444
4774412	RP4444
4774413	RP4444
4781356	RP4444
4783047	RP4444
4833643	RP4444
4841294	RP4444
4849406	RP4444
5493206	RP4444

5500842	RP2096
5946920	RP4444
5950464	RP4444
5951861	RP4444
5951879	RP4444
5951881	RP4482
5951882	RP4444
5973752	RP4482
5973753	RP4482
5973763	RP4444
5990986	RP4444
07029585	RP4444
7029585	RP4444
7632587	RP4446
7735920	RP4444
7777837	RP4486
9753331	RP6044
46447610	RP8344
46451951	RP8372
46751764	RP8628
46754154	RP8622
46779614	RP8678
46792355	RP8914
46796050	RP8678
55200755	RP8444
55200817	RP8622/30
57029585	RP4444
60507123	RP4410
60596245	RP4444
60617002	RP8370
60812292	RP4444
60814613	RP8372
60815294	RP8898
60816139	RP8622
61617002	RP8370
71713981	RP8898
71719015	RP4444
71734087	RP8372
71735458	RP8622
71735459	RP8344
71735460	RP4432
71735461	RP4444
71735462	RP8408
71735463	RP4446
71735464	RP8628
71735465	RP8370
76226740	RP4482

88900062	RP4466
88900066	RP6088
96165724	RP4444
98459883	RP8326
98462490	RP4444
98462492	RP8326
98498630	RP4486
500303569	RP8408
500316493	RP8408
500351992	RP8672
9616572480	RP4444
9623638380	RP8410
9631658980	RP8352
46072001F	RP4444
500 3164 93	RP4446
F2VB	RP4444
F4VB	RP4444
F6VB	RP4444
FU2A	RP4482
FU2B	RP4444
FU4A	RP4488
FU4B	RP4444
<b>FORD</b>	<b>RPOWER</b>
186466	RP8476
1001049	RP8388
1008792	RP8388
1037204	RP8272
1045261	RP8388
1056857	RP8388
1079401	RP8616
1148105	RP8652
1207068	RP8674
1313809	RP8930
1447128	RP8436
1542845	RP8678
1587444	RP4444
1590416	RP4432
1590417	RP4432
1669977	RP8272
1682276	RP8472
1690048	RP8370
1717631	RP8476
1952464	RP8642
1952464	RP8348
4025139	RP6912
5023129	RP6818
5023133	RP6912

5023372	RP4444
5031006	RP4444
6048827	RP6088
6063505	RP4444
6075812	RP4432
6132244	RP4432
6132246	RP4432
6154593	RP4444
6163811	RP4420
7072673	RP4444
7088988	RP4486
10968527	RP8618
73205072	RP8476
1 427 905	RP8438
2S6Q6M090AA	RP8652
2S6Q6M090BB	RP8436
3C3Z-12A342-AA	RP7014
3M5Q6M090AB	RP8930
4C3Z-12A342-AA	RP7018
537209 (USA)	RP7004
5960 33	RP8344
5960 34	RP8344
6G9Q 6M090 AA	RP8438
759F6M090AA	RP4432
785F6M090BA	RP4444
785F6M090CB	RP4444
786B6M090CA	RP4444
786F6M090CA	RP4488
78GB6M090A2A	RP4488
78GB6M090BA	RP6088
78GB6M090CA	RP4444
795F6M090AA	RP4432
795F6M090BA	RP4432
795F6M090CA	RP4432
83BB6M080A1A	RP4488
83BB6M080A2A	RP4488
83BB6M090A1A	RP4444
83BB6M090A2A	RP4444
84BB6M080AA	RP4488
84BB6M090AA	RP4444
84FF6M090B1A	RP4432
84FF6M090B2A	RP4432
84FF6M091AA	RP4420
84FF6M091BA	RP4432
890X6M090TA	RP2028
890X6M090UA	RP4444
89FF6M090AA	RP4420

89FF6M091AA	RP4444
8C3Z-12A342-A	RP7020
910X6M090AA	RP4458
910X6M090BA	RP4444
93BB6M090A2A	RP4444
94DD6M090AA	RP4444
9551 6M090 AA	RP8678
95DD6M090AA	RP8370
96FF6M090CA	RP8388
AV6Q6M090BA	RP8472
E2TZ12A342A	RP7004
E2TZ-12A342-A	RP7004
E3TZ-12A342-A	RP7002
E4TZ12A342A	RP7004
E5TZ-12A-342	RP8892
E5TZ-12A342-B	RP7002
E7TZ12A342A	RP7004
E7TZ-12A342-A	RP7004
EZD.1	RP2028
EZD.2	RP4488
EZD.4	RP4432
EZD.5	RP4488
EZD.6	RP4432
EZD.8	RP4486
EZD.9	RP6912
EZD.10	RP4422
EZD.11	RP4444
EZD.12	RP4466
EZD.13	RP4410
EZD.14	RP4482
EZD.15	RP4444
EZD.16	RP4444
EZD.17	RP6122
EZD.18	RP6818
EZD.19	RP6592
EZD.20	RP8160
EZD.21	RP6692
EZD.22	RP6912
EZD.24	RP6824
EZD.27	RP4458
EZD.28	RP4444
EZD.30	RP4444
EZD.35	RP8388
EZD.36	RP8370
EZD.37	RP8616
EZD.38	RP8618
EZD.39	RP8388

EZD.A	RP4422
EZD.B	RP4444
EZD.C	RP4444
EZD.D	RP4410
EZD.E	RP4444
EZD.F	RP4444
EZD.G	RP4444
EZD.H	RP6122
EZD.U	RP6818
EZD.V	RP6592
EZD.W	RP6918
EZD.X	RP6692
EZD.Y	RP6912
EZD.Z	RP6824
F2TZ12A342A	RP7004
F2TZ-12A342-A	RP7004
F4TX-12A342-A	RP7008
F4TZ-12A342-BA	RP7008
RZD4	RP8388
SBA185266060	RP6912
V94DD6M090A	RP4444
V94DX6M090A	RP4444
V94DX6M090AA	RP4444
V95DD6M090A	RP8370
XM3412A342BA	RP8364
XM34-12A342BA	RP6912
XS 7H 6M090 AA	RP8686
XS4U6M090AB	RP8616
XS7U6M090BA	RP8618
ZD.8	RP7004
ZD.9 (USA)	RP7004
<b>GLAS</b>	<b>RPOWER</b>
B 24 SR	RP4410
<b>GM</b>	<b>RPOWER</b>
1214033	RP8638
1214034	RP8914
1214040	RP8622
1214042	RP8324
1214043	RP8680
1214056	RP8638
1214300	RP2028
1214301	RP2028
1214302	RP2092
1214303	RP2102
1214304	RP4444
1214305	RP4488
1214306	RP4488

1214307	RP4488
1214308	RP6824
1214309	RP8134
1214310	RP8324
1214311	RP8322
1214312	RP8322
1214315	RP8324
1214316	RP8680
1214317	RP4444
1214319	RP4488
1214321	RP8106
1214322	RP8368
1214323	RP8106
1214324	RP4444
1214427	RP8370
1214456	RP8400
1214457	RP8400
1214459	RP8658
1214702	RP4488
03443087	RP2028
03443450	RP6088
3448796	RP2092
4300425	RP8106
4402945	RP8396
4403145	RP4486
4416912	RP8272
5613673	RP7006
5613680	RP7002
5613738	RP6816
5613826	RP7006
5613939	RP7004
5614017	RP7030
5614214	RP6056
5614215	RP6820
5614216	RP4422
5614217	RP6122
5614218	RP4444
5614219	RP4422
5614220	RP7004
5614221	RP6824
9110945	RP8396
9110945	RP8396
9111145	RP4486
9118201	RP8400
9196669	RP8638
12563554	RP6816
25163212	RP6816



25168651	RP7010
25181860	RP8480
55564162	RP8444
55564219	RP8466
55567737	RP8478
56144221	RP6824
88900715	RP8374
88900716	RP8370
88900717	RP8404
88900718	RP8406
88900719	RP8634
88900720	RP8388
88900721	RP8626
88900722	RP8272
88900723	RP4422
88900724	RP8320
88900725	RP4444
88900726	RP8352
88900727	RP8358
88900728	RP4488
88900729	RP8344
88900730	RP4444
88900731	RP4444
88900732	RP4432
88900733	RP4444
88900734	RP4444
88900735	RP4420
88900736	RP4482
88900737	RP4486
88900738	RP4444
88900739	RP6824
88900740	RP4458
88900741	RP4452
88900742	RP4444
88900743	RP8322
90003450	RP2092
90019495	RP2102
90033357	RP2102
90040991	RP4432
90051950	RP4444
90093867	RP4444
90093897	RP4444
90166155	RP4488
90210824	RP4488
90464737	RP8368
90487858	RP4444
90510924	RP4444

90540864	RP4444
90569338	RP8400
91153919	RP8370
93171875	RP8626
93178047	RP8678
93178225	RP8638
93178411	RP8914
93893040	RP4422
93893041	RP6122
93893042	RP4410
93893043	RP4444
93893044	RP2096
93893045	RP2028
93893046	RP2102
93893047	RP4444
93893048	RP4422
93893049	RP4410
93893050	RP4432
93893051	RP4444
93893052	RP4444
93893053	RP6056
93893054	RP6088
93893056	RP6090
93893057	RP6824
93893058	RP6818
93893059	RP6592
93893060	RP6918
93893061	RP6692
93893062	RP6608
93893063	RP6912
93893065	RP4444
93893066	RP4482
93893067	RP4432
94133759	RP8106
94140115	RP8106
94175158	RP8106
94221719	RP6824
94241449	RP6824
94319700	RP8322
94402303	RP8134
94422171	RP6824
94439218	RP6824
94481972	RP8324
96440144	RP8416
97080554	RP8608
97127646	RP8432
97143674	RP8658

97210818	RP8910
97326305	RP8920
97357290	RP8432
97364968	RP8918
97389905	RP8910
97464737	RP8638
12.14.035	RP8910
12.14.063	RP8910
12.14.065	RP8910
2666A003	RP4410
55 564 219	RP8466
93 183 990	RP8368
93 190 433	RP8622/30
97 226 202	RP7016
<b>HANOMAG</b>	<b>RPOWER</b>
135 906 129	RP2028
151 120 075	RP2028
151 120 106	RP2028
151 126 000	RP6056
151 126 501	RP6088
<b>HERTS+BUSS</b>	<b>RPOWER</b>
29 200 010	RP4422
29 200 011	RP4444
29 200 012	RP4422
29 200 013	RP2096
29 200 014	RP4444
29 200 015	RP4432
29 200 016	RP2102
J5712021	RP8448
<b>HINO</b>	<b>RPOWER</b>
19110-1040	RP6444
19110-1040A	RP6444
19110-1050	RP6642
19110-1051	RP6642
19110-1140	RP8122
1985A-56010	RP6590
1985A-56012	RP6588
1985A-56021	RP6592
1985A-56022	RP6592
1985A-64060	RP6914
1985A-68060	RP6914
28550-1100	RP6444
60543-30901	RP6642
63013-30010	RP6444
63013-30011	RP6444
<b>HKT</b>	<b>RPOWER</b>
vedi/see: KITAHARA	

HKT (KITAHARA)	RPOWER
B001	RP6056
B004	RP6122
B006	RP6090
B021	RP6088
B022	RP2028
B025	RP2074
B026	RP2092
B027	RP2096
B028	RP4422
B029	RP2028
B030	RP4444
B031	RP2102
B032	RP4432
B033	RP4488
B034	RP4444
B035	RP6088
B036	RP2028
B037	RP4422
B038	RP4444
B039	RP4444
B040	RP4444
B041	RP4444
B042	RP4444
B043	RP4422
B044	RP4488
B045	RP4488
B046	RP4422
B048	RP4410
B049	RP4410
B050	RP4444
B051	RP4466
B052	RP4488
B053	RP4432
B054	RP4480
B055	RP8602
B062	RP2082
B072	RP4420
B074	RP8346
B077	RP8272
B078	RP4452
B080	RP4422
B081	RP4444
B083	RP8356
B085	RP8340
B086	RP8370
B087	RP8352

B088	RP8388
B089	RP8410
B094	RP8396
B097	RP8408
B098	RP8400
B099	RP8374
B100	RP8368
B101	RP8272
B102	RP8620
B103	RP8624
B104	RP8626
B105	RP8616
B106	RP8652
B107	RP8638
B109	RP8622
B110	RP8640
B111	RP8404
B114	RP8634
B116	RP8412
CP01	RP8600
CP02	RP8602
CP03	RP8656
CP04	RP8402
CP05	RP8612
CP06	RP8892
CP07	RP8614
CP20	RP8646
CP22	RP8610
CP23	RP8468
CP50	RP8680
CP51	RP8910
CP52	RP8432
CP53	RP8922
CP60	RP8364
CP70	RP8604
CP71	RP8606
CP72	RP8936
CP73	RP8426
JKC7MJNC	RP8134
JKC8DQ1	RP6824
PD190	RP6840
PD191	RP8208
PD192	RP8210
PD99	RP6634
PH104	RP6592
PH20	RP6642
PH21	RP6444

PH22	RP8122
PH23	RP8122
PH25	RP8106
PI170	RP8380
PI172	RP8658
PI40	RP6648
PI41	RP6650
PI42	RP6226
PI43	RP6632
PI44	RP8122
PI45	RP8328
PI46	RP6824
PI47	RP6826
PI48	RP6854
PI49	RP8106
PI50	RP8122
PI51	RP8134
PI53	RP6632
PI54	RP6632
PI55	RP6824
PI56	RP8106
PI57	RP8324
PI58	RP8322
PI59	RP8324
PK111	RP6808
PK112	RP6812
PK116	RP6850
PK96	RP6850
PK98	RP6806
PM160	RP8118
PM161	RP8150
PM163	RP8376
PM164	RP6912
PM165	RP8348
PM166	RP6818
PM167	RP8896
PM168	RP8904
PM60	RP6670
PM61	RP6672
PM62	RP6666
PM63	RP6668
PM64	RP6654
PM65	RP6678
PM66	RP6680
PM68	RP6658
PM70	RP6642
PM71	RP6670

PM73	RP8116
PM74	RP6678
PM75	RP6818
PM79	RP8256
PN81	RP8120
PN82	RP6682
PN83	RP6908
PN84	RP6684
PN85	RP6626
PN86	RP6628
PN87	RP6838
PN88	RP6648
PN89	RP6608
PN120	RP6848
PN121	RP6830
PN122	RP6689
PN123	RP6838
PN124	RP6800
PN125	RP8158
PN126	RP6918
PN127	RP8160
PN128	RP8162
PN129	RP8164
PN130	RP6682
PN131	RP6802
PN132	RP8168
PN133	RP8170
PN134	RP8172
PN135	RP8174
PN136	RP8176
PN137	RP6682
PN138	RP8642
PN139	RP8348
PS201	RP6422
PS202	RP8362
PS203	RP6912
PS204	RP8362
PS205	RP6912
PS206	RP8392
PS207	RP8888
PS210	RP6838
PT100	RP6592
PT101	RP6588
PT102	RP8126
PT103	RP6692
PT104	RP6592
PT105	RP8184

PT106	RP6692
PT107	RP6840
PT108	RP6916
PT109	RP6588
PT140	RP6804
PT141	RP6914
PT142	RP8184
PT144	RP8186
PT145	RP8188
PT146	RP8190
PT147	RP8192
PT149	RP6914
PT150	RP8208
PT151	RP8332
PT152	RP8338
PT153	RP8378
PT154	RP8890
PT155	RP8332
PT157	RP8906
PT158	RP8890
PT159	RP8644
PT167	RP8636
PT500	RP8448
PT90	RP6434
PT91	RP6690
PT93	RP6438
PT94	RP6590
PZ30	RP6910
PZ31	RP8200
PZ32	RP8200
PZ33	RP6912
PZ34	RP6912
PZ35	RP8206
PZ36	RP8632
PZ37	RP6912
PZ38	RP6912
PZ39	RP8364
PZ60	RP6670
PZ703	RP8388
PZ704	RP8434
<b>HONDA RPOWER</b>	
31812-ZG5-0030	RP8208
<b>HYUNDAI RPOWER</b>	
3671042500	RP8896
3671042510	RP8614
36710-27000	RP8640
36710-27010	RP8640

36710-2A100	RP8428
36710-2F100	RP8446
36710-42000	RP6818
36710-42010	RP8414
36710-42020	RP8414
36710-42021	RP8414
36710-42060	RP8414
36710-42510	RP8414
36710-42550	RP8414
36710-4A000	RP8938
36710-4A100	RP8938
<b>ICAT RPOWER</b>	
000172	RP8272
000360	RP6808
000382	RP6056
000685	RP6918
001036	RP8346
001201	RP4444
001202	RP4486
001208	RP6042
002408	RP6044
003024	RP6840
003025	RP6800
003028	RP6100
003029	RP2028
003202	RP6818
004202	RP6592
005201	RP4444
005202	RP8084
006201	RP4444
006202	RP6692
007202	RP6912
007912	RP6812
008201	RP4444
008202	RP6824
009624	RP6806
010202	RP6608
012201	RP4410
013200	RP6088
013201	RP4466
013202	RP6830
014200	RP2028
014202	RP6838
015201	RP4422
017201	RP4432
017202	RP8162
018202	RP4486

019201	RP4444
020200	RP2028
021200	RP8040
021201	RP4422
026201	RP4490
027201	RP4444
029201	RP4458
030201	RP4444
031201	RP4422
032201	RP4422
033201	RP4444
035200	RP6064
035201	RP8320
037200	RP2074
046200	RP2092
048200	RP2096
049200	RP4422
051200	RP2102
052200	RP4422
053200	RP4410
054200	RP4444
055200	RP2028
056200	RP4444
058202	RP8188
059200	RP4444
063200	RP4422
065202	RP6854
066200	RP4432
068200	RP4444
069200	RP4444
070200	RP8280
076202	RP6914
085202	RP8322
086202	RP8134
087202	RP8324
101208	RP6048
102408	RP6046
134226	RP4422
904016	RP4444
904044	RP2022
904060	RP2030
904164	RP2082
908804	RP4402
908820	RP4410
908840	RP4420
908844	RP4422
908864	RP4432

908888	RP4444
908892	RP4446
908904	RP4452
908916	RP4458
908932	RP4466
908960	RP4480
908964	RP4482
908972	RP4486
908976	RP4488
908980	RP4490
912132	RP6066
912244	RP6122
912452	RP6226
912844	RP6422
912868	RP6434
912876	RP6438
912888	RP6444
913176	RP6588
913180	RP6590
913184	RP6592
913252	RP6626
913256	RP6628
913264	RP6632
913268	RP6634
913284	RP6642
913296	RP6648
913300	RP6650
913308	RP6654
913316	RP6658
913332	RP6666
913336	RP6668
913340	RP6670
913344	RP6672
913356	RP6678
913360	RP6680
913364	RP6682
913368	RP6684
913372	RP6686
913380	RP6690
913604	RP6802
913608	RP6804
913620	RP6810
913628	RP6814
913632	RP6816
913640	RP6820
913652	RP6826
913684	RP6842

913688	RP6844
913692	RP6846
913696	RP6848
913700	RP6850
913816	RP6908
913820	RP6910
913832	RP6916
914004	RP7002
914008	RP7004
914012	RP7006
914016	RP7008
914020	RP7010
914024	RP7012
914028	RP7014
914032	RP7016
914036	RP7018
914040	RP7020
914052	RP7026
914060	RP7030
915984	RP7992
916212	RP8106
916232	RP8116
916236	RP8118
916240	RP8120
916244	RP8122
916252	RP8126
916316	RP8158
916320	RP8160
916328	RP8164
916336	RP8168
916340	RP8170
916344	RP8172
916352	RP8176
916368	RP8184
916372	RP8186
916380	RP8190
916384	RP8192
916400	RP8200
916412	RP8206
916416	RP8208
916420	RP8210
916492	RP8246
916496	RP8248
916508	RP8256
916552	RP8276
916652	RP8326
916656	RP8328

916664	RP8332
916668	RP8334
916672	RP8336
916676	RP8338
916680	RP8340
916684	RP8342
916688	RP8344
916696	RP8348
916700	RP8350
916704	RP8352
916708	RP8354
916712	RP8356
916716	RP8358
916720	RP8360
916724	RP8362
916728	RP8364
916732	RP8366
916736	RP8368
916740	RP8370
916744	RP8372
916748	RP8374
916752	RP8376
916756	RP8378
916760	RP8380
916763	RP8384
916764	RP8382
916772	RP8386
916776	RP8388
916780	RP8390
916784	RP8392
916788	RP8394
916792	RP8396
916796	RP8398
916800	RP8400
916804	RP8402
916808	RP8404
916812	RP8406
916816	RP8408
916820	RP8410
916824	RP8412
916828	RP8414
916832	RP8416
916836	RP8418
916840	RP8420
916852	RP8426
916856	RP8428
916864	RP8432

916868	RP8434
916872	RP8436
916876	RP8438
916880	RP8440
916884	RP8442
916888	RP8444
916892	RP8446
916896	RP8448
916908	RP8454
916912	RP8456
916924	RP8462
916932	RP8466
916936	RP8468
916940	RP8470
916944	RP8472
916948	RP8474
916952	RP8476
916956	RP8478
916960	RP8480
917200	RP8600
917204	RP8602
917208	RP8604
917212	RP8606
917216	RP8608
917220	RP8610
917224	RP8612
917228	RP8614
917232	RP8616
917236	RP8618
917240	RP8620
917244	RP8622
917248	RP8624
917252	RP8626
917256	RP8628
917260	RP8630
917264	RP8632
917268	RP8634
917272	RP8636
917276	RP8638
917280	RP8640
917284	RP8642
917288	RP8644
917292	RP8646
917296	RP8648
917300	RP8650
917304	RP8652
917308	RP8654

917312	RP8656
917316	RP8658
917320	RP8660
917328	RP8664
917332	RP8666
917336	RP8668
917340	RP8670
917344	RP8672
917348	RP8674
917352	RP8676
917356	RP8678
917360	RP8680
917368	RP8684
917372	RP8686
917776	RP8888
917780	RP8890
917784	RP8892
917788	RP8894
917792	RP8896
917796	RP8898
917800	RP8900
917804	RP8902
917808	RP8904
917812	RP8906
917816	RP8908
917820	RP8910
917824	RP8912
917828	RP8914
917832	RP8916
917836	RP8918
917840	RP8920
917844	RP8922
917848	RP8924
917856	RP8928
917860	RP8930
917864	RP8932
917868	RP8934
917872	RP8936
917876	RP8938
918000	RP9000
918004	RP9002
918008	RP9004
918012	RP9006
918016	RP9008
000320/R	RP8174
001036/R	RP6090
003025/R	RP4444

003202/6	RP8150
908844/1	RP4422/1
908888/1	RP4444/1
913376/1	RP6688
913600/1	RP6800/1
917244/30	RP8622/30
<b>IFA</b>	<b>RPOWER</b>
834019	RP4422
<b>IHC</b>	<b>RPOWER</b>
vedi/see: NAVISTAR	
<b>INTERNATIONAL HARV.</b>	<b>RPOWER</b>
305 471 6 R91	RP8040
<b>ISEKI</b>	<b>RPOWER</b>
5606-665-7300-0	RP8256
6281-410-0011-0	RP8334
6281-410-0022-0	RP8336
6581-410-0401-0	RP8328
6982-511-9780-0	RP6226
<b>ISHIKAWA JIMA</b>	<b>RPOWER</b>
18536-6080	RP6912
<b>ISKRA</b>	<b>RPOWER</b>
11170103	RP6056
11720601	RP8040
11720602	RP2022
11720605	RP4444
11720607	RP4422
11720608	RP4444
11720609	RP6088
11720610	RP2102
11720611	RP2028
11720612	RP4422
11720614	RP4432
11720615	RP4444
11720624	RP4422
11720625	RP4444
11720626	RP4422
11720627	RP4444
11720628	RP4410
11720637	RP2082
11720643	RP6824
11720651	RP8902
11720680	RP8900
11720711	RP7002
11720712	RP6816
11720713	RP7004
11720809	RP4410
11720811	RP2074
11721001	RP4422

11721002	RP4444
11721003	RP4422
11721004	RP4444
11721005	RP4410
11721006	RP4432
11721007	RP4480
11721052	RP4458
11721078	RP4452
11721087	RP8358
11721088	RP8320
11721089	RP8390
11721090	RP8400
11721096	RP8388
11721098	RP4422
11721512	RP6840
11721532	RP6912
11721547	RP6818
11721561	RP6838
11721568	RP8162
11721574	RP6830
11721575	RP8168
11721576	RP8604
11721577	RP6800
11721594	RP6592
11721597	RP6692
11721605	RP6804
11721637	RP4466
11721638	RP4420
11721656	RP4444
11721657	RP4422
11721659	RP8272
11721661	RP6066
11721665	RP4486
11721667	RP8332
11721671	RP8388
11721691	RP8324
11721692	RP8322
11721693	RP8398
11721700	RP8602
11721703	RP8150
11721705	RP8618
11721709	RP8396
11721710	RP8606
11721711	RP8208
11721712	RP8344
11721715	RP7010
11721716	RP7008

11721731	RP8352
11721732	RP8410
11721738	RP8342
11721739	RP8374
11721755	RP6916
11721788	RP8352
11721789	RP8364
11721790	RP8188
11721792	RP4444
11721793	RP8372
11721794	RP8616
11721795	RP8346
11721796	RP8200
11721797	RP8348
11721798	RP6918
11721799	RP8174
11721800	RP8340
11721801	RP8164
11721802	RP8622
11721804	RP6608
11721806	RP6226
11721807	RP6854
11721808	RP8408
11721809	RP8660
11721810	RP8370
11721811	RP6910
11721821	RP4446
11721824	RP8340
11721825	RP8624
11721826	RP4444
<b>ISUZU</b>	<b>RPOWER</b>
1214321	RP8106
8973263052	RP8920
1 82513 044 00	RP8122
1-82513043-0	RP8122
1-82513044-0	RP8122
5-81410040-0	RP8328
5-81410044-0	RP6632
5-81410045-0	RP6632
5-81410055-2	RP6826
5-81410056-2	RP6854
5-81410056-3	RP6854
5-81410057-2	RP6826
5-81410057-3	RP8404
5-81410058-3	RP6854
8 97143 674 1	RP8658
8 97226 202 2	RP7016

8-94133-759-0	RP8106
8-94133759-1	RP8106
8-94133759-2	RP8106
8-94133759-3	RP8106
8-94133759-4	RP8106
8-94133759-5	RP8106
8-94133759-6	RP8106
8-94133759-7	RP8106
8-94140115-3	RP8106
8-94140-153	RP8106
8-94144412-0	RP8322
8-94144-412-1	RP6824
8-94175158-0	RP8106
8-94175158-1	RP8106
8-94221719-2	RP6824
8-94221719-3	RP6824
8-94221-719-3	RP6824
8-94241449-0	RP6824
8-94241-449-0	RP6824
8-94241-449-1	RP6824
8-94241-490	RP6824
8-94249-692-1	RP6824
8-94255588-0	RP6824
8-94255-588-0	RP6824
8-94319700-1	RP8322
8-94319-700-2	RP6824
8-94402303-0	RP8134
8-94402303-1	RP8134
8-94439-218-0	RP6824
8-94481972-0	RP8324
8-970440370	RP8324
8-97073641-0	RP8106
8-97080554-0	RP8608
8-97210818-2	RP8910
8-97389905-0	RP8910
9 82513 928 1	RP8122
9413-3759	RP8106
9414-0115	RP8106
9417-5158	RP8106
9-82511945-0	RP6648
9-82511-957-0	RP6824
9-82511-964-0	RP6824
9-82511-965-0	RP6632
9-82511977-0	RP6650
9-82511978-0	RP6226
9-82511-978-0	RP6824
9-82511978-1	RP6226

9-82511-978-1	RP6824
9-82511-978-2	RP6824
9-82511-978-3	RP6824
9-82511-979-0	RP6632
9-82511994-0	RP6648
9-82513928-0	RP8122
9-82513928-2	RP8122
9-8251-3928-3	RP8122
9-8251-3928-4	RP8122
9-8251-3928-5	RP8122
9-8251-3928-6	RP8122
9-8251-3928-7	RP8122
9-8251-3928-8	RP8122
9-8251-3928-9	RP8122
9-82513959-0	RP6632
9-8251-3959-0	RP6632
9-8251-3959-1	RP6632
9-8251-3959-2	RP6632
9-8251-3959-3	RP6632
9-8251-3959-4	RP6632
<b>IVECO</b>	<b>RPOWER</b>
4729585	RP4444
4774413	RP4444
4781356	RP4444
4792112	RP4444
4841294	RP4444
4849406	RP4444
5951879	RP4444
7632587	RP4446
9462703	RP4444
0009720203	RP2102
27600323	RP8672
98459883	RP4432
98462490	RP4444
98462492	RP8326
98498630	RP4486
500316493	RP8408
500351992	RP8672
<b>JAGUAR</b>	<b>RPOWER</b>
02JD61604	RP8650
<b>JEEP</b>	<b>RPOWER</b>
0 506 6840 AA	RP8932
<b>KAELBLE</b>	<b>RPOWER</b>
40300134	RP6090
<b>KHD</b>	<b>RPOWER</b>
1162543	RP6056
1169113	RP6056

1169117	RP2028
01170058	RP8040
1170058	RP8040
1170060	RP2082
1170749	RP2082
1170841	RP6056
01180897	RP8420
1301086	RP8040
2446328	RP6056
4729585	RP4444
4781356	RP4444
01200772020	RP4444
595H7631	RP2028
A12H7631	RP4482
B015H7633	RP6056
B09H7631	RP6056
H7631B0	RP6056
S18LH7631B0	RP2082
S95H7631	RP2028
S95L7631	RP8040
<b>KIA</b>	<b>RPOWER</b>
3671042500	RP8896
3671042510	RP8348
6008152310	RP6850
15221-6551-0	RP6666
15221-6551-2	RP6666
15221-6551-3	RP6666
36710-2A 100	RP8428
36710-2F100	RP8446
36710-4A 000	RP8938
36710-4A 100	RP8938
36710-4A000	RP8914
600-815-2650	RP6850
600-815-2660	RP6850
611-013-2511	RP6850
611-013-2610	RP6850
OK054-18140	RP8364
OK054-18-140	RP8364
OK710-18140	RP8364
OK710-18-140A	RP8364
OK710-18410A	RP8364
OK71E-18140	RP8684
OK71E-18140A	RP8366
OK75A-18140	RP8364
OK75A-18-140	RP8364
OK75B-18-140	RP8364

<b>KLG</b>	<b>RPOWER</b>
737	RP6056
847/2	RP6056
GF205T	RP6090
GF210T	RP6090
Z161	RP6090
Z161/3	RP6090
Z737	RP6056
Z847/2	RP6056
<b>KOMATSU</b>	<b>RPOWER</b>
6008-15-2320	RP6850
6008-15-2760	RP8208
6110-13-2511	RP6850
<b>KUBOTA</b>	<b>RPOWER</b>
15221-6551-0	RP8362
15221-6551-2	RP8362
15221-6551-3	RP8362
15261-6551-4	RP6422
15451-6551-1	RP2092
16241-6551-1	RP8888
16851-6551-2	RP8392
18536-6060	RP6912
61-01522165510	RP8362
61-01526165510	RP6422
<b>LANCIA</b>	<b>RPOWER</b>
975331	RP6044
4393814	RP4444
4714294	RP4444
4729585	RP4444
4754011	RP4444
4774413	RP4444
4781356	RP4444
4792112	RP4444
4849406	RP4444
5493206	RP4444
5500842	RP2096
5950464	RP4444
5951881	RP4444
5951882	RP4444
5973752	RP4482
7632587	RP4446
7735920	RP4444
46447610	RP8344
46451951	RP8372
46754154	RP8622
60812292	RP4444
61617002	RP8370

77359200	RP4444
88900066	RP2028
96165724	RP4444
98462492	RP8326
464447610	RP8344
500316493	RP8408
9623638380	RP8410
605 07 123	RP4410
<b>LAND ROVER</b>	<b>RPOWER</b>
vedi/see: ROVER	
<b>LITZ</b>	<b>RPOWER</b>
260	RP6056
<b>LODGE</b>	<b>RPOWER</b>
DR2	RP4444
<b>LUCAS</b>	<b>RPOWER</b>
1855018	RP4444
6415-3	RP4422
6415-4	RP4444
DS001	RP4444
DS002	RP4422
DS003	RP4488
DS004	RP4422
DS005	RP2102
DS006	RP4488
DS007	RP4432
DS008	RP4422
DS009	RP2096
DS010	RP2028
DS011	RP2074
DS014	RP4466
DS015	RP6918
DS016	RP6830
DS017	RP6818
DS018	RP6840
DS019	RP6692
DS020	RP6804
DS021	RP6590
DS022	RP6916
DS023	RP6588
DS024	RP6838
DS025	RP6800/1
DS026	RP6912
DS027	RP6914
DS028	RP6838
DS029	RP8200
DS030	RP6592
DS031	RP6848

DS032	RP6824
DS033	RP8120
DS034	RP6226
DS035	RP6678
DS036	RP2092
DS037	RP6438
DS038	RP8160
DS039	RP8164
DS040	RP4444
DS041	RP6626
DS042	RP6628
DS043	RP6608
DS044	RP8172
DS046	RP8126
DS050	RP6100
DS051	RP4410
DS052	RP4410
DS053	RP8188
DS054	RP8116
DS055	RP8150
DS056	RP4432
DS057	RP6910
DS058	RP4486
DS059	RP4444
DS061	RP8174
DS065	RP8162
DS067	RP6634
DS079	RP8176
DS080	RP4482
DS081	RP8248
DS082	RP4490
DS084	RP4444
DS090	RP7002
DS090A	RP7002
DS091	RP6816
DS091A	RP6816
DS092	RP7004
DS092A	RP7004
DS093	RP7006
DS093A	RP7006
DS094	RP7010
DS094A	RP7010
DS095	RP7008
DS095A	RP7008
DS101	RP6122
DS102	RP6090
DS104	RP6056



DS121	RP6066
DS122	RP4444
DS123	RP8134
DS124	RP4420
DS125	RP6802
DS850	RP4486
HDS216	RP4444
HDS217	RP4422
HDS218	RP4488
HDS219	RP4422
HDS220	RP2102
HDS221	RP4488
HDS222	RP4432
HDS223	RP4422
HDS224	RP2096
HDS225	RP2028
HDS226	RP2074
HDS229	RP4466
HDS230	RP6918
HDS231	RP6830
HDS232	RP6818
HDS233	RP6840
HDS234	RP6692
HDS235	RP6804
HDS236	RP6590
HDS237	RP6916
HDS238	RP6588
HDS239	RP6838
HDS240	RP6800/1
HDS241	RP6912
HDS242	RP6914
HDS243	RP6838
HDS244	RP8200
HDS245	RP6592
HDS246	RP6848
HDS247	RP6824
HDS248	RP8120
HDS249	RP6226
HDS250	RP6678
HDS251	RP2092
HDS252	RP6438
HDS253	RP8160
HDS254	RP8164
HDS255	RP4444
HDS256	RP6626
HDS257	RP6628
HDS258	RP6608

HDS259	RP8172
HDS261	RP8126
HDS262	RP6592
HDS265	RP6100
HDS266	RP4410
HDS267	RP4410
HDS268	RP8188
HDS269	RP8116
HDS270	RP8150
HDS271	RP4432
HDS272	RP6910
HDS273	RP4486
HDS274	RP4444
HDS275	RP8208
HDS276	RP8174
HDS280	RP8162
HDS282	RP6634
HDS294	RP8176
HDS295	RP4482
HDS296	RP8248
HDS297	RP4490
HDS299	RP4444
HDS303	RP8346
HDS305	RP7002
HDS306	RP6816
HDS307	RP7004
HDS308	RP7006
HDS316	RP6122
HDS317	RP6090
HDS319	RP6056
HDS337	RP4444
HDS338	RP8134
HDS339	RP4420
HDS340	RP6802
HDS341	RP4422
HDS342	RP8272
HDS343	RP4422
HDS345	RP8322
HDS346	RP8324
HDS347	RP4458
HDS348	RP4444
HDS349	RP4488
HDS350	RP8352
HDS351	RP4444
HDS352	RP4452
HDS353	RP4444
HDS354	RP8358

HDS355	RP8340
HDS356	RP8344
HDS357	RP4446
HDS358	RP8348
HDS359	RP8348
HDS361	RP8370
HDS362	RP8388
HDS363	RP8320
HDS364	RP8372
HDS366	RP8356
<b>MAN</b>	<b>RPOWER</b>
000159.2501	RP6122
000159.6001	RP6122
000159.6101	RP6122
000159.6301	RP2082
000159.8101	RP4444
000159.8301	RP4444
000.159.2401	RP6056
90 80112 4105	RP6056
90 80112 4113	RP6056
IE07-18-601	RP8388
RFG1-18-601	RP8364
RFN1-18-601A	RP8364
RFR1-18-601	RP8364
RFS5-18-601	RP8684
RFS5-18-601A	RP8684
WLO2-18-601	RP8364
<b>MARELLI</b>	<b>RPOWER</b>
CIM04A	RP6042
CIM04B	RP6044
CIM07A	RP6056
CIM12B	RP2030
CIM14A	RP6048
CIM14B	RP6046
CIM15A	RP2028
CIM15B	RP2030
DX1A	RP4422
FU2A	RP4482
FU4A	RP4488
NIB6	RP6056
REP1A	RP4444
TIW4A	RP2096
TIW6A	RP2102
TIX1A	RP4422
TIX2A	RP4444
TIX4A	RP4444
TIX6A	RP4444

TIX7A	RP4410
TLX2A	RP4488
UC2A	RP4446
UC3A	RP8272
UC4A	RP8344
UC7A	RP8352
UC8A	RP8340
UC9A	RP8324
UC10A	RP8322
UC17A	RP8374
UC18A	RP8406
UX1A	RP4422
UX2A	RP4444
UX4A	RP4488
UX5A	RP4466
UX7A	RP4410
UX8A	RP4422
UX9A	RP4444
UX11A	RP4420
UX12A	RP4432
UX13A	RP4452
UX14A	RP4458
UX15A	RP4444
UX21A	RP8628
UX26A	RP8686
UY3A	RP8914
UY6A	RP8672
<b>MAZDA</b>	<b>RPOWER</b>
1304-18140	RP6670
1353-18140	RP6910
1353-18140A	RP6910
1N02-18-601	RP8602
PN1118601	RP8386
R2L2-18-601	RP8632
RF1M-18-601	RP8364
RF2A-18-601	RP8434
RF8G-18-601	RP8434
RFG118601	RP8364
RFN118601	RP8364
RFN118601A	RP8364
RFR118601	RP8364
S201-18140	RP6912
S21018140	RP8364
S210-18140	RP8206
S210-18140A	RP8206
S501-18140	RP6912
S501-18140A	RP6912

S501-18-140A	RP6912
SE01-18140	RP8200
SE01-18140A	RP8200
VS01-18-601	RP8632
WL0318601	RP8364
WL03-18-601	RP8364
WL8118601	RP8364
WL0118601	RP8364
WL0318601	RP8364
WLY5-18-601	RP8364
<b>MERCEDES</b>	<b>RPOWER</b>
0001500081	RP8346
0001522601	RP8342
0001591501	RP8320
0001591601	RP8320
0001592001	RP8358
0001592101	RP8358
0001592201	RP4444
0001592601	RP6056
0001592701	RP8406
0001592801	RP8374
0001593501	RP4444
0001593701	RP8374
0001593801	RP8374
0001594201	RP8374
0001594801	RP8374
0001594901	RP8374
0001595201	RP9008
0001598201	RP7992
000.159.00.01	RP4490
000.159.04.01	RP8246
000.159.06.01	RP6056
000.159.17.01	RP4452
000.159.24.01	RP6056
000.159.25.01	RP6122
000.159.40.01	RP2028
000.159.41.01	RP6088
000.159.43.01	RP2022
000.159.60.01	RP6122
000.159.61.01	RP6122
000.159.62.01	RP2082
000.159.75.01	RP4444
000.159.77.01	RP4444
000.159.81.01	RP4444
000.159.83.01	RP4444
000.159.90.01	RP6122
000.159.91.01	RP4480

000.159.96.01	RP8248
000.159.99.01	RP8248
001 159 46 01	RP8440
001.159.00.01	RP4452
001.159.04.01	RP8246
001.159.08.01	RP1012
001.159.15.01	RP8320
001.159.16.01	RP8320
001.159.17.01	RP4452
001.159.20.01	RP8358
001.159.21.01	RP8358
001.159.22.01	RP4444
001.159.25.01	RP8040
001.159.26.01	RP8342
001.159.27.01	RP8406
001.159.28.01	RP8374
001.159.35.01	RP4444
001.159.36.01	RP4452
001.159.37.01	RP8374
001.159.38.01	RP8374
001.159.48.01	RP8374
001.159.49.01	RP8374
001.159.50.01	RP8924
001.159.51.01	RP9008
001.159.60.01	RP6122
001.159.61.01	RP6122
001.159.83.01	RP4444
001.159.90.01	RP6122
660 159 00 01	RP8634
660 159 02 01	RP8634
664.159.00.01	RP8908
664.159.01.01	RP8908
665 159 00 01	RP8908
665 159 01 01	RP8908
A 000 150 05 81	RP8346
A 000 159 41 01	RP8040
A 001 159 25 01	RP8040
A 001 159 56 01	RP9700
A 001 159 5701	RP9708
A 001 159 5801	RP9708
A 001 159 6601	RP9708
A 001 159 68 01	RP9700
A 660 159 00 01	RP8634
A 660 159 02 01	RP8634
A 665 159 00 01	RP8908
A 665 159 01 01	RP8908
A.001.159.50.01	RP8924

A.001.159.51.01	RP9008
A.664.159.00.01	RP8908
A.664.159.01.01	RP8908
<b>MITSUBISHI</b>	<b>RPOWER</b>
3444469	RP8614
3671042500	RP8896
30666-20309	RP6666
30666-57300	RP8256
30866-04104	RP6670
30866-04105	RP6670
30866-04709	RP6670
31166-03101	RP6672
31166-03104	RP6672
31366-02100	RP6678
31366-02109	RP6678
31366-14300	RP6668
31366-14301	RP6668
31366-14302	RP6668
31366-14700	RP6678
31366-14701	RP6678
31666-02100	RP6678
31666-02109	RP6678
32A66-03100	RP8256
K4171313	RP6654
K4171363	RP6658
K9670240	RP6668
M816732	RP4422
M883828	RP8624
MD 197511	RP8896
MD014997	RP8150
MD050212	RP6818
MD070194	RP6818
MD077167	RP8414
MD092392	RP8892
MD197511	RP8614
MD301950	RP8896
MD344469	RP8896
MD354500	RP8896
ME 201632	RP8612
ME 203754	RP8612
ME 300970	RP8612
ME007545	RP6678
ME007546	RP6668
ME007547	RP6678
ME007637	RP8376
ME007649	RP8376
ME017009	RP8118

ME017010	RP8116
ME017013	RP8116
ME020911	RP6670
ME021302	RP6670
ME037002	RP6680
ME067459	RP6672
ME200970	RP8612
ME201632	RP8348
ME201638	RP8612
ME202785	RP8612
ME203539	RP8904
ME203583	RP8612
ME967559	RP6672
MM105560	RP6678
MM401625	RP6678
MM409510	RP8256
MN960270	RP8440
MN980234	RP9002
MQ901659	RP8364
MR 577131	RP8896
<b>MONARK</b>	<b>RPOWER</b>
090 501 001	RP6056
090 501 008	RP6122
090 501 010	RP6056
090 501 016	RP6122
090 505 014	RP2028
090 505 020	RP2028
090 505 022	RP2082
090 505 051	RP2102
090 505 056	RP4444
090 505 059	RP4444
090 505 063	RP4422
090 505 066	RP4432
090 505 906	RP4480
090 505 907	RP4444
090 505 910	RP4422
090 506 006	RP4444
090 506 012	RP4410
090 506 013	RP4466
090 506 017	RP4432
090 506 019	RP4444
090 506 026	RP4452
090 506 033	RP4444
090 507 006	RP6692
090 507 008	RP6824
090 507 013	RP6830
090 507 018	RP4486

090 998 006	RP4444
090 998 009	RP6090
090 998 012	RP4410
090 998 013	RP4466
090 998 015	RP4422
090 998 017	RP4432
090 998 046	RP2092
090 998 051	RP2102
<b>MOTORCRAFT</b>	<b>RPOWER</b>
7088988	RP4486
5 031 006	RP4444
537209 (USA)	RP7004
EZD.1	RP2028
EZD.2	RP4488
EZD.4	RP4432
EZD.5	RP4488
EZD.6	RP4432
EZD.8	RP4486
EZD.9	RP6912
EZD.10	RP4422
EZD.11	RP4444
EZD.12	RP4466
EZD.13	RP4410
EZD.14	RP4482
EZD.15	RP4444
EZD.16	RP4444
EZD.17	RP6122
EZD.18	RP6818
EZD.19	RP6592
EZD.20	RP8160
EZD.21	RP6692
EZD.22	RP6912
EZD.23	RP6824
EZD.24	RP6824
EZD.27	RP4458
EZD.28	RP4444
EZD.30	RP4444
EZD.33	RP8272
EZD.35	RP8388
EZD.36	RP8370
EZD.37	RP8616
EZD.38	RP8618
EZD.39	RP8388
EZD.40	RP8652
EZD.41	RP8930
EZD.A	RP4422
EZD.B	RP4444

EZD.D	RP4410
EZD.E	RP4444
EZD.F	RP4444
EZD.G	RP4444
EZD.H	RP6122
EZD.U	RP6818
EZD.V	RP6592
EZD.W	RP6918
EZD.X	RP6692
EZD.Y	RP6912
EZD.Z	RP6824
F2TZ-12A342-A	RP7004
RZD4	RP8388
ZD-1	RP7002
ZD-3	RP4444
ZD-8	RP7004
ZD-9	RP7004
ZD-10	RP7008
ZD-11	RP7008
ZD-12	RP7014
ZD-13	RP7018
ZD-15	RP7020
ZD-1A	RP7002
ZD-9 (USA)	RP7004
<b>MTU</b>	<b>RPOWER</b>
000159.4001	RP2028
<b>MWM-DIESEL</b>	<b>RPOWER</b>
60579 411 0003	RP6056
60579 412 0009	RP6056
<b>NAVISTAR</b>	<b>RPOWER</b>
1804211C2	RP7002
1819649C1	RP7004
1820697C1	RP7008
304131R2	RP6820
304131R3	RP6820
3054716R91	RP8040
710348R1	RP6056
710778R3	RP6056
763837R92	RP6056
W0041512	RP2028
<b>NGK</b>	<b>RPOWER</b>
19077-6551-1	RP8460
19077-6551-3	RP8460
8ZNA	RP8680
CX01	RP8606
CX51	RP8606
CY01	RP8600

CY02	RP8602
CY03	RP8608
CY05	RP8612
CY07	RP8614
CY08	RP8656
CY51	RP8600
CY52	RP8602
CY53	RP8608
CY55	RP8612
CY57	RP8614
CY58	RP8656
CZ01	RP8604
CZ21	RP8426
CZ22	RP8670
CZ24	RP8432
CZ51	RP8604
CZ71	RP8426
CZ101	RP9000/1
CZ104	RP9710
CZ106	RP9700
CZ301	RP9004
CZ303	RP9708
CZ304	RP9712
DG200AL	RP6056
DG237	RP6122
DG238	RP6914
Y03X	RP6838
Y1003AS	RP8446
Y1012J	RP8448
Y102	RP6666
Y103	RP8120
Y103-1	RP6626
Y103-2	RP6628
Y103-2A	RP6628
Y103K	RP6422
Y103V	RP6422
Y104	RP6226
Y104R	RP6824
Y106-1	RP8362
Y106V	RP8362
Y107R	RP6912
Y107T	RP6910
Y107V	RP6910
Y108	RP6634
Y109	RP6812
Y110	RP8256
Y110V	RP8256

Y112M	RP6838
Y112M1	RP6838
Y112R	RP8162
Y112R1	RP8162
Y112RS	RP8162
Y112RS1	RP8162
Y112T	RP6838
Y112T1	RP6838
Y112TS	RP6838
Y114T	RP8256
Y115R	RP6818
Y115R1	RP8150
Y115T	RP6818
Y115T1	RP6818
Y117RS	RP6918
Y117SS	RP8160
Y118R	RP6804
Y118T	RP6692
Y118T1	RP8186
Y122	RP6912
Y128	RP6438
Y128T	RP6592
Y144RS	RP8172
Y144SS	RP8170
Y146R	RP6840
Y147T	RP8188
Y154	RP6632
Y154R	RP6826
Y154RS	RP6854
Y157R	RP8200
Y159	RP6808
Y160	RP6678
Y162R	RP6800
Y162R1	RP6800
Y168R	RP8184
Y171	RP6806
Y172	RP6670
Y173	RP6642
Y174S1	RP6850
Y174TS	RP6850
Y175-2	RP6672
Y175S2	RP6672
Y176	RP6444
Y177-1	RP6648
Y178	RP6590
Y178T	RP6588
Y179	RP6686

Y180	RP6680
Y181T	RP6848
Y197R	RP6914
Y197T	RP6916
Y201	RP6668
Y202	RP6684
Y202-2	RP6689
Y203	RP2092
Y204	RP2074
Y204RS	RP6830
Y204SS	RP8164
Y204TS	RP6608
Y204TS-1	RP6608
Y204V	RP4422
Y206T	RP4444
Y207T	RP4422
Y207TS	RP4422
Y208T	RP4444
Y251	RP6678
Y252	RP6682
Y271-2	RP8122
Y272R1	RP8158
Y272T	RP6682
Y274	RP8116
Y274R	RP8118
Y302	RP6064
Y306R	RP6824
Y307R	RP8134
Y310-1	RP6626
Y402-2	RP6434
Y403	RP2092
Y403-1	RP2092
Y403T	RP2102
Y403T	RP2102
Y404	RP2074
Y405	RP2096
Y408JS	RP7020
Y452-1	RP6690
Y501U	RP8404
Y502R	RP8408
Y503J	RP8352
Y503R	RP8352
Y504J	RP8410
Y504R	RP8410
Y506R	RP8396
Y507J	RP8626
Y507R	RP8626

Y508J	RP8938
Y509J	RP8348
Y515J	RP8624
Y516J	RP8620
Y517J	RP8412
Y519J	RP8936
Y523J	RP8638
Y524J	RP8616
Y525J	RP8618
Y527J	RP8428
Y529J	RP8434
Y531J	RP8906
Y532J	RP8904
Y534J	RP8622
Y541J	RP8670
Y542J	RP8644
Y543J	RP8634
Y547AS	RP9004
Y607AS	RP9000
Y609AS	RP8928
Y701J	RP8364
Y701R	RP8364
Y701RS	RP8364
Y701U	RP6912
Y702R	RP8168
Y702U	RP8168
Y703R	RP8208
Y705RS	RP8168
Y706R	RP8362
Y707RS	RP8174
Y708R	RP8176
Y709R	RP8888
Y710R	RP8322
Y711	RP8134
Y711J	RP8324
Y711R	RP8134
Y711RS	RP8324
Y712RS	RP8348
Y715R	RP8332
Y716RS	RP8460
Y719RS	RP8324
Y720U	RP6666
Y721RS	RP8684
Y729U	RP8346
Y730U	RP8340
Y731U	RP8352
Y732U	RP8272

Y733J	RP8896
Y738J	RP8398
Y738U	RP8398
Y739R	RP4446
Y740U	RP8390
Y741U	RP8370
Y743U	RP8324
Y745U	RP8374
Y746J	RP8406
Y746R	RP8406
Y747U	RP8372
Y748U	RP8400
Y749J	RP8640
Y752M	RP4444
Y755RS	RP6802
Y-755RS	RP8648
Y757RS	RP8176
Y771R	RP8200
Y784U	RP8400
Y8001AS	RP8472
Y8003J	RP8678
Y8008AS	RP8470
Y802-2	RP6654
Y805	RP6908
Y805-1	RP6908
Y808-1	RP6650
Y810	RP2028
Y811	RP6088
Y852-2	RP6658
Y874-1	RP6648
Y901R	RP4422/1
Y901R	RP4422
Y902R	RP4444
Y904M	RP8106
Y904M1	RP8106
Y907R	RP4432
Y908R	RP4444
Y909R	RP4410
Y910R	RP4486
Y911J	RP4410
Y911R	RP4420
Y913J	RP4458
Y913M	RP4458
Y914U	RP4444
Y916J	RP4452
Y916R	RP4452
Y917U	RP4444

Y918J	RP4422
Y918R	RP4422
Y920R	RP4482
Y922R	RP4444
Y923U	RP4444
Y924J	RP4444
Y924U	RP4488
Y925J	RP8358
Y925R	RP8358
Y926U	RP8326
Y927J	RP8354
Y927R	RP8354
Y928U	RP8344
Y929U	RP8342
Y930U	RP8320
Y932R	RP4422
Y933J	RP4422
Y933R	RP4422
Y935U	RP4486
Y937J	RP8388
Y937R	RP8388
Y938R	RP4444
Y939J	RP8628
Y955RS	RP8158
YE01	RP8392
YE04	RP8652
YE05	RP8436
YE06	RP8678
YE07	RP8914
YE08	RP8438
YE12	RP8650
YE13	RP8440
YE14	RP9002
<b>NGK/D-POWER</b>	<b>RPOWER</b>
DP1	RP4444
DP2	RP4422
DP3	RP4486
DP4	RP8272
DP5	RP8388
DP6	RP4452
DP7	RP8396
DP8	RP8608
DP9	RP8352
DP10	RP8352
DP11	RP8374
DP12	RP8620
DP13	RP8896

DP14	RP8400
DP15	RP4458
DP16	RP8358
DP17	RP8340
DP18	RP8624
DP19	RP8354
DP20	RP8370
DP21	RP8614
DP22	RP8390
DP23	RP4486
DP24	RP8410
DP25	RP4422
DP26	RP8372
DP27	RP8616
DP28	RP8324
DP29	RP8344
DP30	RP8320
DP31	RP8404
DP32	RP8626
DP33	RP4420
DP34	RP8346
DP35	RP8618
DP36	RP8622
DP37	RP8638
DP38	RP8406
DP43	RP8628
DP44	RP8906
DP45	RP8644
DP47	RP9004
DP48	RP9002
DP49	RP8928
<b>NIPPARTS</b>	<b>RPOWER</b>
J5712024	RP8448
<b>NIPPON DENSO</b>	<b>RPOWER</b>
067100-1042	RP6434
067100-1043	RP6690
067100-1070	RP6444
067100-1071	RP6444
067100-1090	RP6634
067100-1120	RP6590
067100-1130	RP6438
067100-1161	RP6588
067100-1170	RP6592
067100-1171	RP6592
067100-1175	RP6592
067100-1190	RP8126
067100-1220	RP6914

067100-1250	RP8126
067100-1270	RP6692
067100-1280	RP8184
067100-1330	RP8188
067100-1340	RP6916
067100-1350	RP6592
067100-1360	RP6588
067100-1370	RP6804
067100-1380	RP8184
067100-1430	RP6840
067100-1450	RP8190
067100-1460	RP6914
067100-1500	RP8192
067100-1530	RP6840
067100-1591	RP8106
067100-1630	RP8186
067100-1670	RP8210
067100-1690	RP8208
067100-1700	RP8378
067100-1710	RP8332
067100-1840	RP6692
067100-1841	RP6692
067100-1860	RP8188
067100-1861	RP8188
067100-1900	RP8434
067100-1910	RP6692
067100-2020	RP8442
DG-001	RP4444
DG-002	RP4422
DG-003	RP8352
DG-004	RP4420
DG-005	RP8272
DG-006	RP4458
DG-007	RP8388
DG-008	RP8396
DG-009	RP8356
DG-010	RP4452
DG-101	RP8340
DG-102	RP8344
DG-103	RP4422
DG-104	RP8324
DG-105	RP6818
DG-106	RP8358
DG-107	RP8624
DG-108	RP8106
DG-109	RP8370
DG-110	RP8342

DG-111	RP8408
DG-112	RP8620
DG-113	RP8652
DG-114	RP6912
DG-115	RP8346
DG-116	RP8410
DG-117	RP8374
DG-118	RP8400
DG-119	RP8320
DG-120	RP8174
DG-121	RP7008
DG-122	RP8622
DG-123	RP4432
DG-124	RP8322
DG-125	RP8666
DG-126	RP8412
DG-127	RP8372
DG-129	RP8628
DG-130	RP8618
DG-131	RP6090
DG-132	RP4446
DG-133	RP8368
DG-135	RP6056
DG-136	RP8348
DG-137	RP8348
DG-139	RP8630
DG-140	RP8650
DG-142	RP8638
DG-143	RP6824
DG-144	RP8404
DG-145	RP8626
DG-146	RP8364
DG-155	RP8406
DG-157	RP8168
DG-159	RP8184
DG-161	RP8398
DG-170	RP8914
DG-171	RP8678
DG-172	RP8636
DG-173	RP8640
DG-174	RP8896
DG-175	RP6816
DG-176	RP8932
DG-177	RP9000
DG-178	RP9002
DG-180	RP8436
DG-184	RP8634

DG-187	RP8904
DG-188	RP8908
DG-189	RP8938
DG-191	RP9006
DG-192	RP9008
DG-193	RP8928
DG-194	RP8924
DG-195	RP8672
DG-197	RP8936
DG-202	RP4410
DG-211	RP8332
DG-212	RP6692
DG-213	RP8660
DG-214	RP8188
DG-215	RP6804
DG-216	RP8208
DG-217	RP8906
DG-218	RP6692
DG-219	RP8378
DG-221	RP6692
DG-222	RP6914
DG-223	RP6840
DG-224	RP6434
DG-225	RP6690
DG-226	RP6590
DG-227	RP6438
DG-229	RP8126
DG-231	RP8126
DG-232	RP8188
DG-233	RP6916
DG-234	RP6592
DG-235	RP6588
DG-236	RP6444
DG-239	RP8184
DG-240	RP8644
DG-245	RP8906
DG-246	RP8906
DG-300	RP8680
DG-301	RP8614
DG-302	RP8670
DG-304	RP8602
DG-305	RP8610
DG-306	RP8612
DG-307	RP8600
DG-401	RP8442
DG-502	RP8434
DG-703	RP8686

NISSAN	RPOWER
997261	RP4410
03903417-0	RP4422
11065 43G01	RP8174
11065 63G00	RP8174
11065-00Q0C	RP9706
11065-00Q0D	RP8624
11065-00Q0E	RP8454
11065-00Q0G	RP9706
11065-00QAA	RP8624
11065-00QAF	RP8624
11065-00QAG	RP8624
11065-02T0	RP8348
11065-02T00	RP6682
11065-0W801	RP8656
11065-10A06	RP8172
11065-10A16	RP8172
11065-10G00	RP8168
11065-10T01	RP8176
11065-16A00	RP8160
11065-16A01	RP8170
11065-16A05	RP6918
11065-16A06	RP8172
11065-16A10	RP8160
11065-16A11	RP8170
11065-16A15	RP6918
11065-16A16	RP8172
11065-2TB0A	RP8936
11065-2W202	RP8426
11065-2W204	RP8426
11065-2W211	RP8426
11065-31N00	RP8642
11065-31W00	RP6838
11065-31W01	RP6838
11065-31W02	RP6838
11065-34W00	RP6838
11065-37503	RP6908
11065-37506	RP8120
11065-37507	RP8120
11065-43G01	RP8414
11065-4P400	RP8402
11065-57J00	RP8602
11065-5C900	RP8602
11065-5C90A	RP8602
11065-5X00A	RP9706
11065-63G00	RP8414
11065-65N01	RP8642

11065-7C000	RP8642
11065-7F400	RP8656
11065-9C600	RP8348
11065-AD 20A	RP8936
11065-AD200	RP8936
11065-AD201	RP8936
11065-BN701	RP8624
11065-C8600	RP6802
11065-C8600	RP8648
11065-D9701	RP8348
11065-G2400	RP8348
11065-G2460	RP8348
11065-G5501	RP8600
11065-HA300	RP8364
11065-J2000	RP6684
11065-J5501	RP6689
11065-J5502	RP6689
11065-Q4001	RP6838
11065-T3470	RP6848
11065-T8200	RP8162
11065-T8201	RP6800
11065-T8202	RP8162
11065-T8203	RP6800
11065-T9000	RP8158
11065-T9001	RP8158
11065-V0700	RP6608
11065-V0701	RP6608
11065-V0710	RP6608
11065-V7202	RP8606
11065-V7203	RP8604
11065-W2500	RP6830
11065-W2510	RP6830
11065-W3400	RP8164
11065-W3410	RP8164
11065-Y1400	RP6626
11065-Y1401	RP6626
11065-Y1402	RP6628
11065-Y1403	RP6628
11065-Y1404	RP6628
11065-Y9703	RP4422
11065-Z5000	RP6682
11065-Z5500	RP6682
75800006-0	RP4444
<b>NISSAN MOT.IBERICA</b>	<b>RPOWER</b>
11065-D9701	RP8348
11065-D9702	RP8348
11065-G2400	RP8348

11065-Y9703	RP4422
75800006-0	RP4444
<b>OPEL</b>	<b>RPOWER</b>
1214028	RP8432
1214032	RP8678
1214036	RP8432
1214045	RP8368
1214064	RP8622/30
1214300	RP2028
1214308	RP6824
1214311	RP6824
1214321	RP8106
1214322	RP8368
1214334	RP8444
1214459	RP8658
1414323	RP8106
1826357	RP8466
03443087	RP2028
03443450	RP2028
4300425	RP8106
4300615	RP8106
5614221	RP6824
5954839	RP8432
9110724	RP8624
55564162	RP8444
88900739	RP6824
90464737	RP8368
93161575	RP9706
93178047	RP8678
93.178.411	RP8914
93190433	RP8622/30
93198468	RP9706
94319700	RP6824
94439218	RP6824
96440144	RP8416
944221719	RP6824
12 14 067	RP8478
12.14.034	RP8914
48 02 239	RP8480
88 900 719	RP8634
88 900 729	RP8344
93 191 771	RP8444
97 127 646	RP8432
97 143 674	RP8658
97 357 290	RP8432
vedi/see: GM	

<b>PAL</b>	<b>RPOWER</b>
33-50	RP6056
<b>PERKINS</b>	<b>RPOWER</b>
1353-18140A	RP6910
2666 A 003	RP4410
2666A002	RP4410
2666A003	RP4410
2666A016	RP8894
K166AF01	RP4444
K666AF01	RP4444
<b>PEUGEOT</b>	<b>RPOWER</b>
596032	RP4444
596033	RP8344
596034	RP4490
596035	RP8358
596041	RP8372
596078	RP8436
596079	RP8436
596099	RP8438
596154	RP4444
596157	RP4444
598110	RP4444
598111	RP4444
598115	RP4444
5414326	RP2096
5415813	RP6088
5460556	RP2096
5477234	RP2096
5491387	RP2096
5500842	RP2096
7549.2325	RP2096
75492365	RP2096
91507718	RP4444
91508610	RP4444
91521849	RP4444
91536646	RP4444
92515867	RP4444
92515869	RP4444
93010500	RP7992
95493206	RP4444
95534787	RP4444
9553.4788	RP4444
96009783	RP4420
9607.6258	RP4444
9614.1678	RP4444
9616.5724	RP4444
9616.5734	RP8352



96389858	RP8410
5932.565882	RP2028
5960E6	RP8472
7563.225100	RP2074
7932564528	RP4444
7932.565492	RP2074
7932.565563	RP2074
7932.565882	RP2028
7932.567619	RP2028
7932.567717	RP4444
7932.567718	RP4444
7932.567877	RP2028
7950076593	RP4444
9150.771580	RP4444
9150.771880	RP4444
9150.771980	RP4444
9150.860280	RP4444
9150.861080	RP4444
9151586780	RP4444
9152.184980	RP4444
9152.191880	RP4444
9153.664680	RP4444
9190.861080	RP4444
9301.050080	RP7992
9553.478880	RP4444
9600.978380	RP4444
9614.167880	RP4444
9616.572480	RP4444
9631658980	RP8352
9633.214380	RP4444
9683195280	RP8472
5 412 813	RP2028
59322Y	RP8352
5960 033	RP8344
5960 38	RP8626
5960 39	RP4446
5960 40	RP8646
5960 4Z	RP4446
5960 A3	RP8672
5960 A4	RP8672
5960 G6	RP8438
5960 K4	RP8672
5960 K5	RP4446
5960.12	RP8652
5960.19	RP8652
5960.64	RP8930
5960.65	RP8930

5960.76	RP8650
5960.77	RP8650
5961.05	RP2028
5961.18	RP2074
5961.22	RP2028
5961.35	RP2028
5961.39	RP4444
5961.40	RP4444
5961.53	RP4444
5961.54	RP4444
5961.57	RP4444
5961.58	RP4444
5961.95	RP7992
5962 4K	RP8354
5962 4L	RP8390
5962 4Z	RP8408
5962.1C	RP4482
5962.1E	RP6590
5962.1F	RP4486
5962.1G	RP4422
5962.1H	RP4432
5962.1P	RP8398
5962.1Q	RP8398
5962.35	RP4444
5962.3H	RP4444
5962.74	RP4444
5962.7F	RP8410
5962.C7	RP2028
5962.J2	RP4458
5962.J3	RP4420
5962.J4	RP4444
5962.J5	RP4444
5962.J6	RP4482
5962.J7	RP4422
5962.K5	RP4444
5962.KS	RP4444
5962.OX	RP4444
5962.OY	RP4458
5962.OZ	RP4444
5962.R8	RP4444
5962.S8	RP4444
5962.T1	RP4458
5962.T2	RP4422
5962.T3	RP6824
5962.T7	RP4420
5962.W2	RP8352
5962.W3	RP8352

5962.W8	RP4444
5962.X1	RP4444
59622Y	RP8352
59622Z	RP8352
59623C	RP8410
59623E	RP8410
59624J	RP8272
59624K	RP8356
59624L	RP8340
59627G	RP8410
59627Z	RP4422
HG 262 1	RP2028
MKD 000 66	RP4444
MKD00068	RP4420
MKP 000 71	RP4422
MKP00064	RP4444
MKP00065	RP4444
MKP00067	RP4444
MKP00068	RP4420
MKP00069	RP4444
<b>POCLAIN</b>	<b>RPOWER</b>
W0041512	RP2028
<b>PORSCHE</b>	<b>RPOWER</b>
955 170 320 90	RP8928
<b>PROTON</b>	<b>RPOWER</b>
MD 197511	RP8614
<b>PUCH</b>	<b>RPOWER</b>
716 1 09 033 0	RP8276
<b>REINSTAHL AG</b>	<b>RPOWER</b>
vedi/see: HANOMAG	
<b>RENAULT</b>	<b>RPOWER</b>
0025871045	RP2022
770135956	RP4444
0854997100	RP2028
5001001587	RP4444
5001829283	RP2028
7700100558	RP8396
7700100586	RP8390
7700100635	RP8620
7700103674	RP8412
7700105290	RP8356
7700111323	RP8624
7700111940	RP8620
7700662199	RP4444
7700673874	RP4444
7700701130	RP4444
7700704185	RP4466
7700715768	RP4444

7700733076	RP4444
7700734956	RP4458
7700741144	RP4444
7700854538	RP4422
7700855865	RP4458
7700856238	RP4458
7700856292	RP4422
7700858208	RP8340
7700860796	RP8340
7700861906	RP8340
7700867002	RP8354
7700867617	RP4422
7700874336	RP8356
7701029762	RP4444
7701031105	RP4444
7701033403	RP4444
7701035956	RP4444
7701039387	RP4444
7701040208	RP4486
7701052949	RP8432
7701057806	RP8432
7701069730	RP8624
7701349475	RP4444
7701349943	RP4458
7701349949	RP4422
7701414072	RP4444
7701414076	RP4444
7701414077	RP4422
7701414078	RP4432
7701414079	RP4444
7701414080	RP4482
7701414081	RP4486
7701414083	RP4420
7701414084	RP4410
7701414086	RP4444
7701414088	RP4422
7701414089	RP4420
7701414107	RP4452
7701414108	RP4444
7701414123	RP4444
7701414157	RP4452
7701414162	RP4444
7932563970	RP2028
7932567717	RP4444
8200012099	RP8412
8200445627	RP8412
8200464077	RP8624

8200682592	RP8454
8671004016	RP4422
8671004017	RP4420
8671004018	RP4444
08 54 647 500	RP2028
77 00 858 208	RP8390
77 00 861 906	RP8390
82 00 561 251	RP9706
82 00 794 920	RP8456
<b>ROVER</b>	<b>RPOWER</b>
510078	RP6090
568335	RP6090
19ERC8648	RP4410
247712F1	RP6090
ADU9830	RP4444
ERC8450	RP4488
ERC8648	RP4410
ERR4084	RP8916
ERR6066	RP8654
ETC8847	RP8346
LR001302	RP8438
NCC 1000 50	RP8390
NCC10002	RP4420
NCC100050	RP8340
NCC100050L	RP8340
NCC100080	RP8370
NCC100080L	RP8370
NCC100100	RP8352
NCC100120	RP8626
NCC100120L	RP8626
NCC10050	RP8340
NNC 1000 50 L	RP8390
STC1303	RP4444
<b>SAAB</b>	<b>RPOWER</b>
93178047	RP8444
93191771	RP8444
97357290	RP8432
<b>SAVIEM</b>	<b>RPOWER</b>
0025871045	RP2022
0854997100	RP2028
854997100	RP2028
7932563970	RP2028
79 32 563 970	RP2028
85 49 971 00	RP2028
<b>SEAT</b>	<b>RPOWER</b>
0003940685	RP4444
3940685	RP4444

03L 963 319 A	RP8928
0581CR1	RP4444
059 963 319 E	RP8928
059 963 319 F	RP8928
N10579201	RP8674
N10579202	RP8674
N10591604	RP9710
N10591608	RP9710
SE138919000A	RP4444
X039655020	RP4482
<b>SINTEROM</b>	<b>RPOWER</b>
B1-42	RP8040
<b>SKODA</b>	<b>RPOWER</b>
03L 963 319 A	RP8928
059 963 319 E	RP8928
<b>SMART</b>	<b>RPOWER</b>
0004562V003000000	RP8634
<b>SSANGYONG</b>	<b>RPOWER</b>
664.159.00.01	RP8908
664.159.01.01	RP8908
665 159 00 01	RP8908
665 159 01 01	RP8908
A 665 159 00 01	RP8908
A 665 159 01 01	RP8908
A.664.159.00.01	RP8908
A.664.159.01.01	RP8908
<b>STEINBOCK</b>	<b>RPOWER</b>
007488	RP6056
7488	RP6056
<b>STELLA</b>	<b>RPOWER</b>
D22	RP6056
<b>STEYR</b>	<b>RPOWER</b>
000159.6101	RP6122
1596101	RP6122
7161090330	RP8276
<b>SUPERDIESEL</b>	<b>RPOWER</b>
SD2022	RP2022
SD2028	RP2028
SD2030	RP2030
SD2074	RP2074
SD2082	RP2082
SD2092	RP2092
SD2096	RP2096
SD2102	RP2102
SD4402	RP4402
SD4410	RP4410
SD4420	RP4420
SD4422	RP4422

SD4422/1	RP4422/1
SD4432	RP4432
SD4444	RP4444
SD4444/1	RP4444/1
SD4446	RP4446
SD4452	RP4452
SD4458	RP4458
SD4466	RP4466
SD4480	RP4480
SD4482	RP4482
SD4486	RP4486
SD4488	RP4488
SD4490	RP4490
SD6042	RP6042
SD6044	RP6044
SD6046	RP6046
SD6048	RP6048
SD6056	RP6056
SD6064	RP6064
SD6066	RP6066
SD6088	RP6088
SD6090	RP6090
SD6100	RP6100
SD6122	RP6122
SD6226	RP6226
SD6422	RP6422
SD6434	RP6434
SD6438	RP6438
SD6444	RP6444
SD6588	RP6588
SD6590	RP6590
SD6592	RP6592
SD6608	RP6608
SD6626	RP6626
SD6628	RP6628
SD6632	RP6632
SD6634	RP6634
SD6642	RP6642
SD6648	RP6648
SD6650	RP6650
SD6654	RP6654
SD6658	RP6658
SD6666	RP6666
SD6668	RP6668
SD6670	RP6670
SD6672	RP6672
SD6678	RP6678

SD6680	RP6680
SD6682	RP6682
SD6684	RP6684
SD6686	RP6686
SD6688	RP6688
SD6689	RP6689
SD6690	RP6690
SD6692	RP6692
SD6800	RP6800
SD6800/1	RP6800/1
SD6802	RP6802
SD6804	RP6804
SD6806	RP6806
SD6808	RP6808
SD6810	RP6810
SD6812	RP6812
SD6814	RP6814
SD6816	RP6816
SD6818	RP6818
SD6820	RP6820
SD6824	RP6824
SD6826	RP6826
SD6830	RP6830
SD6838	RP6838
SD6840	RP6840
SD6842	RP6842
SD6844	RP6844
SD6846	RP6846
SD6848	RP6848
SD6850	RP6850
SD6854	RP6854
SD6908	RP6908
SD6910	RP6910
SD6912	RP6912
SD6914	RP6914
SD6916	RP6916
SD6918	RP6918
SD7002	RP7002
SD7004	RP7004
SD7006	RP7006
SD7008	RP7008
SD7010	RP7010
SD7012	RP7012
SD7014	RP7014
SD7016	RP7016
SD7018	RP7018
SD7020	RP7020

SD7026	RP7026
SD7030	RP7030
SD7992	RP7992
SD8040	RP8040
SD8084	RP8084
SD8106	RP8106
SD8116	RP8116
SD8118	RP8118
SD8120	RP8120
SD8122	RP8122
SD8126	RP8126
SD8134	RP8134
SD8150	RP8150
SD8158	RP8158
SD8160	RP8160
SD8162	RP8162
SD8164	RP8164
SD8168	RP8168
SD8170	RP8170
SD8172	RP8172
SD8174	RP8174
SD8176	RP8176
SD8184	RP8184
SD8186	RP8186
SD8188	RP8188
SD8190	RP8190
SD8192	RP8192
SD8200	RP8200
SD8206	RP8206
SD8208	RP8208
SD8210	RP8210
SD8246	RP8246
SD8248	RP8248
SD8256	RP8256
SD8272	RP8272
SD8276	RP8276
SD8280	RP8280
SD8320	RP8320
SD8322	RP8322
SD8324	RP8324
SD8326	RP8326
SD8328	RP8328
SD8332	RP8332
SD8334	RP8334
SD8336	RP8336
SD8338	RP8338
SD8340	RP8340

SD8342	RP8342
SD8344	RP8344
SD8346	RP8346
SD8348	RP8348
SD8350	RP8350
SD8352	RP8352
SD8354	RP8354
SD8356	RP8356
SD8358	RP8358
SD8360	RP8360
SD8362	RP8362
SD8364	RP8364
SD8366	RP8366
SD8368	RP8368
SD8370	RP8370
SD8372	RP8372
SD8374	RP8374
SD8376	RP8376
SD8378	RP8378
SD8380	RP8380
SD8382	RP8382
SD8384	RP8384
SD8386	RP8386
SD8388	RP8388
SD8390	RP8390
SD8392	RP8392
SD8394	RP8394
SD8396	RP8396
SD8398	RP8398
SD8400	RP8400
SD8402	RP8402
SD8404	RP8404
SD8406	RP8406
SD8408	RP8408
SD8410	RP8410
SD8412	RP8412
SD8414	RP8414
SD8416	RP8416
SD8418	RP8418
SD8420	RP8420
SD8426	RP8426
SD8428	RP8428
SD8432	RP8432
SD8434	RP8434
SD8436	RP8436
SD8438	RP8438
SD8440	RP8440

SD8442	RP8442
SD8444	RP8444
SD8446	RP8446
SD8448	RP8448
SD8454	RP8454
SD8456	RP8456
SD8462	RP8462
SD8466	RP8466
SD8468	RP8468
SD8470	RP8470
SD8472	RP8472
SD8474	RP8474
SD8476	RP8476
SD8478	RP8478
SD8480	RP8480
SD8600	RP8600
SD8602	RP8602
SD8604	RP8604
SD8606	RP8606
SD8608	RP8608
SD8610	RP8610
SD8612	RP8612
SD8614	RP8614
SD8616	RP8616
SD8618	RP8618
SD8620	RP8620
SD8622	RP8622
SD8622/30	RP8622/30
SD8624	RP8624
SD8626	RP8626
SD8628	RP8628
SD8630	RP8630
SD8632	RP8632
SD8634	RP8634
SD8636	RP8636
SD8638	RP8638
SD8640	RP8640
SD8642	RP8642
SD8644	RP8644
SD8646	RP8646
SD8648	RP8648
SD8650	RP8650
SD8652	RP8652
SD8654	RP8654
SD8656	RP8656
SD8658	RP8658
SD8660	RP8660

SD8664	RP8664
SD8666	RP8666
SD8668	RP8668
SD8670	RP8670
SD8672	RP8672
SD8674	RP8674
SD8676	RP8676
SD8678	RP8678
SD8680	RP8680
SD8684	RP8684
SD8686	RP8686
SD8888	RP8888
SD8890	RP8890
SD8892	RP8892
SD8894	RP8894
SD8896	RP8896
SD8898	RP8898
SD8900	RP8900
SD8902	RP8902
SD8904	RP8904
SD8906	RP8906
SD8908	RP8908
SD8910	RP8910
SD8912	RP8912
SD8914	RP8914
SD8916	RP8916
SD8918	RP8918
SD8920	RP8920
SD8922	RP8922
SD8924	RP8924
SD8928	RP8928
SD8930	RP8930
SD8932	RP8932
SD8934	RP8934
SD8936	RP8936
SD8938	RP8938
SD9000	RP9000
SD9002	RP9002
SD9004	RP9004
SD9006	RP9006
SD9008	RP9008
<b>SUZUKI</b>	<b>RPOWER</b>
1855078E00	RP8364
1855078E00000	RP8364
1855078E11	RP8364
09900RF001000	RP8364
18550 84E50	RP8678

18550 84E50 000	RP8678
18550-79J50-000	RP8622/30
18550-79J81-000	RP8444
18550-80KA0-000	RP8456
18550-84A51	RP8624
19550-78E11000	RP8364
<b>TALBOT</b>	<b>RPOWER</b>
9150.771580	RP4444
9150.771880	RP4444
9150.771980	RP4444
9152.191880	RP4444
9301.050080	RP7992
9553.478880	RP4444
<b>TATA</b>	<b>RPOWER</b>
2547-1518-9902	RP4422
2654-5420-4912	RP4444
<b>TECNOMECCANICA</b>	<b>RPOWER</b>
5171721SR	RP8168
5181769SR	RP8324
5191924R	RP6848
5192854SR	RP8162
5194260SR	RP6800
5200614SR	RP4420
5201622SR	RP4486
5222331SR	RP6818
5222841SR	RP6912
5224341SR	RP8200
5225141SR	RP6910
5242415R	RP6824
5250143SR	RP4446
5251139R	RP8160
5252039R	RP8084
5271723SR	RP6816
5281310R	RP8188
5281340R	RP8188
5281810R	RP6846
5282010R	RP6840
5291110SR	RP6592
5322535SR	RP6804
5323642R	RP6692
5482533R	RP6842
6200102S	RP4422
6200103R	RP4432
6200313SR	RP4422
6200613SR	RP4422
6200614SR	RP4432
6205113SR	RP8164

6210619SR	RP6090
6220727R	RP6844
6221027R	RP6808
6230728R	RP6812
6231028R	RP6806
6232214SR	RP4490
6232928R	RP6814
6240305R	RP2096
6240407R	RP6044
6240420R	RP6046
6240613SR	RP4466
6240626SR	RP6846
6240707R	RP6042
6240720R	RP6048
6250101R	RP4444
6250103R	RP4444
6250406R	RP2030
6250506R	RP2028
6250612SR	RP4488
6250614SR	RP4444
6252103R	RP4444
6252214SR	RP4488
6254914SR	RP4444
6254968SR	RP4458
6260614SR	RP4444
6280101R	RP4444
6280109R	RP2102
6300508R	RP2074
6300614SR	RP4410
<b>TOYOTA</b>	<b>RPOWER</b>
19850 64020	RP8646
19850 64031	RP8646
19850-0L010	RP8906
19850-0R020	RP8448
19850-0W010	RP8644
19850-26010	RP8448
19850-26020	RP8468
19850-26022	RP8468
19850-27010	RP8906
19850-30010	RP8906
19850-45030	RP6692
19850-45031	RP6692
19850-46020	RP6434
19850-46021	RP6434
19850-46030	RP6690
19850-46031	RP6690
19850-54010	RP6692

19850-54030	RP6692
19850-54031	RP8186
19850-54050	RP6804
19850-54060	RP8184
19850-54070	RP8192
19850-54071	RP8192
19850-54090	RP8332
19850-56010	RP6590
19850-56011	RP6588
19850-56012	RP6588
19850-56020	RP6438
19850-56021	RP6592
19850-56022	RP6592
19850-58010	RP6916
19850-59130	RP8646
19850-64010	RP6840
19850-64020	RP8208
19850-64030	RP8646
19850-64031	RP8338
19850-64031B	RP8646
19850-64050	RP8646
19850-67010	RP6444
19850-67020	RP8610
19850-67030	RP8610
19850-68010	RP8188
19850-68020	RP6916
19850-68030	RP6592
19850-68040	RP6588
19850-68050	RP8190
19850-68060	RP6914
19850-77010	RP8126
19850-77011	RP8126
19850-87303	RP6634
19850-87309	RP6592
19850-87701	RP6840
19850-87703	RP8210
87343-30010	RP8442
<b>UNIC-IVECO</b>	<b>RPOWER</b>
004729585	RP4444
<b>UNIC-SIMCA</b>	<b>RPOWER</b>
19ERC8648	RP4410
<b>UNIPART</b>	<b>RPOWER</b>
ADU9830	RP4488
ADU9955	RP4410
GGP1	RP4444
GGP2	RP4488
GGP3	RP6090

GGP4	RP4422
GGP5	RP4432
GGP6	RP4444
GGP7	RP4444
GGP8	RP4486
GGP17	RP4422
NCC10001	RP4444
NCC10002	RP4420
NCC10050	RP8340
NCC10058	RP8340
NCC10060	RP8352
<b>VAG</b>	<b>RPOWER</b>
062 905 061 A	RP8676
<b>VALEO</b>	<b>RPOWER</b>
C11P	RP4444
C12P	RP4422
C13P	RP4444
C14P	RP4432
C15P	RP4410
C16P	RP4482
C17P	RP4444
C18P	RP4486
C21P	RP4466
C22P	RP4444
C23P	RP4452
C25P	RP8272
C28P	RP4452
C29P	RP4458
C31P	RP4444
C32P	RP4422
C33P	RP4444
C34P	RP4444
C35P	RP2102
C40P	RP6122
C41P	RP2096
C52P	RP6824
C54P	RP8346
C114R	RP6824
C100S	RP4444
C101S	RP4482
C102S	RP4444
C103S	RP4410
C104S	RP4432
C105S	RP4486
C106S	RP4444
C107S	RP4444
C108S	RP4420

C109S	RP4446
C111R	RP4444
C111S	RP4444
C112R	RP4432
C112S	RP4432
C115S	RP8134
C116S	RP8322
C117S	RP8324
C118S	RP4422
C200S	RP4422
C201S	RP4452
C202S	RP4458
C203S	RP4486
C204S	RP4444
C205S	RP8272
C206S	RP4444
C208S	RP4444
C209S	RP4488
C210S	RP8340
<b>VAUXHALL</b>	<b>RPOWER</b>
vedi/see: GM	
<b>VM</b>	<b>RPOWER</b>
46 07 0003A	RP4410
46 07 2020 F	RP9704
46 072 007 F	RP8932
46072016F	RP8444
D6 07 0054 A	RP9704
<b>VOLKSWAGEN</b>	<b>RPOWER</b>
0003954619	RP4444
6370601	RP6056
059963319	RP8404
061905061	RP4422
062905061	RP8630
068905061	RP4422
03L 963 319	RP8928
03L 963 319 A	RP8928
059 963 319 C	RP8928
059 963 319 E	RP8928
059 963 319 F	RP8928
059 963 319 J	RP8928
059963319A	RP8404
062 905 061	RP8630
062 905 061 A	RP8676
068 905 061	RP4422
J19 850 540 90	RP6692
N01908101	RP4422
N01908102	RP4422

N01908104	RP4422
N0190811	RP4422
N0190812	RP4422
N0190814	RP4422
N01909701	RP4422
N0190971	RP4422
N01910001	RP4422
N01910002	RP4422
N01910005	RP4422
N01910006	RP4422
N0191001	RP4422
N0191002	RP4422
N0191005	RP4422
N0191006	RP4422
N10140101	RP8272
N10140102	RP8272
N10140103	RP8272
N10140104	RP8272
N10140105	RP8272
N10166401	RP8276
N1016641	RP8276
N10213001	RP4422
N10213002	RP4422
N10302101	RP8360
N10302102	RP8360
N105790802	RP9002
N10579201	RP8674
N10579202	RP8674
N105798.02	RP9002
N10579803	RP9712
N10579805	RP9712
N105916.02	RP9000
N105916.03	RP9000
N10591601	RP9710
N10591604	RP9000/1
N10591608	RP9710
<b>VOLVO</b>	<b>RPOWER</b>
829857	RP4444
829859	RP7992
838954	RP8280
840643	RP4444
870325	RP6056
870680	RP2028
870681	RP2030
870846	RP2028
1257141	RP4422
1257889	RP4422

1275580	RP8360
1542319	RP4410
1542411	RP4410
3092109	RP4410
3094343	RP4410
3287815	RP4444
8631607	RP8650
8653880	RP8470
30777311	RP9704
30862690	RP8390
V0861607	RP8650
<b>VOLVO FLYGMOTOR</b>	<b>RPOWER</b>
840643	RP4444
870325	RP6056
870680	RP2028
870846	RP2028
<b>WELLMAN</b>	<b>RPOWER</b>
6A843G277 (USA)	RP6816
6A843G280 (USA)	RP7002
E003	RP4444
E004	RP4422
E005	RP4422
E006	RP4444
E011	RP4444
E015	RP4432
E016	RP4486
E017	RP4432
G080	RP7002
G084	RP7004
G138	RP7008
G540	RP7014
W101	RP6056
W102	RP6090
W103	RP6122
W300	RP6064
W403	RP8372
W404	RP8618
W408	RP8106
W420	RP8408
W421	RP8898
W423	RP8374
W424	RP8406
W425	RP8626
W426	RP8342
W430	RP8622
W432	RP8658
W433	RP8412

W434	RP8620
W436	RP8614
W438	RP8670
W439	RP8654
W500	RP6100
W501	RP6918
W507	RP6226
W509 (USA)	RP6816
W519	RP6824
W524	RP4420
W525	RP8352
W526	RP6802
W527	RP8324
W528	RP8322
W529	RP8134
W530	RP6818
W531	RP6840
W532	RP6912
W534	RP8160
W535	RP6838
W536	RP6692
W537	RP6914
W538	RP8120
W539	RP6626
W540	RP6628
W541	RP6824
W542	RP8200
W543	RP6838
W544	RP6438
W545	RP6592
W546	RP8172
W547	RP8188
W548	RP8200
W549	RP6800/1
W550	RP6590
W551	RP6588
W552	RP6848
W553	RP6916
W554	RP6678
W555	RP8116
W556	RP6592
W558	RP6804
W559	RP6692
W560	RP8174
W561	RP4486
W562	RP8162
W564	RP8150

W566	RP8272
W567	RP8600
W571	RP8168
W572	RP8188
W575	RP8410
W576	RP8668
W577	RP8602
W580	RP8616
W581	RP8368
W582	RP8344
W589	RP8608
W590	RP8370
W595	RP8398
W597	RP8396
W598	RP8638
W599	RP8634
W601	RP4422
W602	RP4410
W603	RP4444
W604	RP2096
W605	RP2028
W606	RP2102
W607	RP4444
W608	RP4422
W609	RP4410
W610	RP4432
W613	RP4466
W614	RP4432
W615	RP4422
W617	RP6830
W618	RP8164
W619	RP6608
W620	RP2074
W621	RP8248
W624	RP2092
W627	RP4444
W630	RP4444
W631	RP4444
W632	RP4422
W633	RP4410
W634	RP4452
W635	RP8388
W640	RP8358
W641	RP8320
W643	RP8686
W803	RP8404
W8628	RP8628

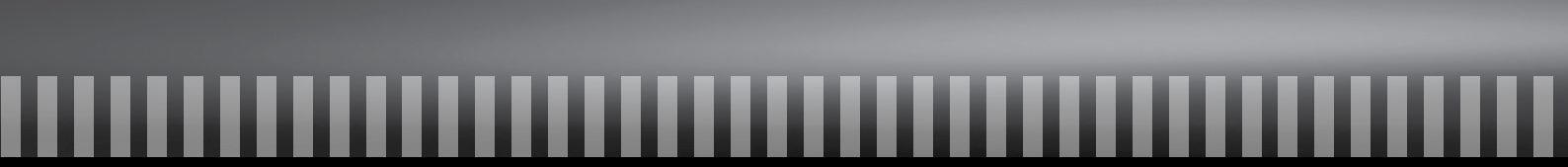



# INFORMAZIONI TECNICHE TECHNICAL INFORMATION INFORMATIONS TECHNIQUES

**i**

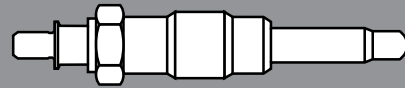

**3**

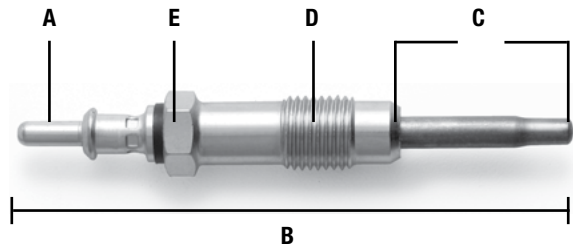
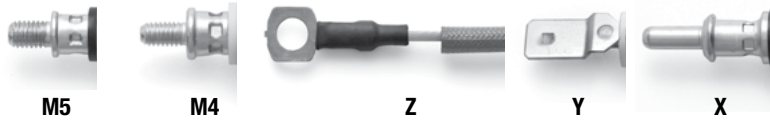

Picture	Code	B mm	C mm	D	E mm	BodyTorque	A	Connection Torque	Glowplug Voltage
1	RP2022	78,4	15,5	M18X1,5	21	40	M5	3	22,5
2	RP2028	87,9	25,0	M18X1,5	21	40	M5	3	10,5
2	RP2030	87,9	25,0	M18X1,5	21	40	M5	3	22,5
3	RP2074	97,9	30,0	M14X2	14	27	M5	3	9,5
1	RP2082	78,4	15,5	M18X1,5	21	40	M5	3	18
5	RP2092	77,4	28,0	M14X1,25	14	27	M5	3	8
4	RP2096	81,4	24,0	M14X1,25	17	27	M5	3	9,5
5	RP2102	77,4	28,0	M14X1,25	14	27	M5	3	11
5	RP4402	77,4	28,0	M14X1,25	14	27	M5	3	11
6	RP4410	76,4	29,0	M12X1,25	12	22	M5	3	11
7	RP4420	66,9	20,0	M12X1,25	12	22	M4	2,5	11
8	RP4422	61,4	20,0	M12X1,25	12	22	M5	3	11
9	RP4422/1	61,4	20,0	M12X1,25	12	22	M5	3	11
7	RP4432	66,9	20,0	M12X1,25	12	22	M4	2,5	11
11	RP4444	72,4	25,0	M12X1,25	12	22	M5	3	11
11	RP4444/1	72,4	25,0	M12X1,25	12	22	M5	3	11,5
12	RP4446	81,4	24,0	M10X1	10	15	M4	2,5	11
13	RP4452	69,4	22,0	M12X1,25	12	22	M5	3	11,5
14	RP4458	69,4	25,0	M12X1,25	12	22	M5	3	11
15	RP4466	65,4	24,0	M12X1,25	12	22	M5	3	11
16	RP4480	78,4	28,0	M18X1,5	21	40	M5	3	9
11	RP4482	72,4	25,0	M12X1,25	12	22	M5	3	11
7	RP4486	66,9	20,0	M12X1,25	12	22	M4	2,5	11
11	RP4488	72,4	25,0	M12X1,25	12	22	M5	3	11
13	RP4490	69,4	22,0	M12X1,25	12	22	M5	3	11,5
17	RP6042	100,5	25,5	M18X1,5	19	40	X	-	12
17	RP6044	100,5	25,5	M18X1,5	19	40	X	-	24
18	RP6046	110,5	26,0	M18X1,5	19	40	X	-	24
18	RP6048	110,5	26,0	M18X1,5	19	40	X	-	12
19	RP6056	90,0	27,5	M18X1,5	21	40	M5	3	1,7
20	RP6064	98,5	28,5	M10X1	17	12	M4	2,5	12
21	RP6066	85,8	29,4	M10X1	10	15	M4	2,5	11,5
22	RP6088	87,9	15,5	M18X1,5	21	40	M5	3	10,5
23	RP6090	105	18,5	M14X1,25	18	27	M5	3	1,7
24	RP6100	99,8	32,0	M10X1	17	12	M4	2,5	11
19	RP6122	90,0	27,5	M18X1,5	21	40	M5	3	0,9
26	RP6226	88,4	25,0	M10X1,25	12	18	M4	2,5	10,5

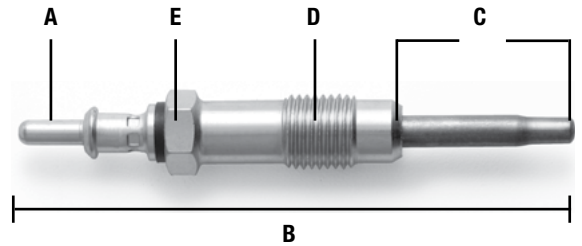
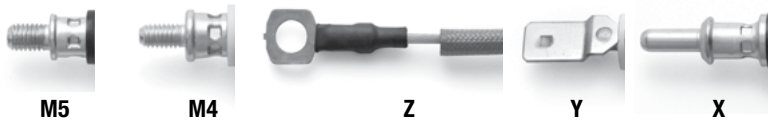

Picture	Code	B mm	C mm	D	E mm	BodyTorque	A	Connection Torque	Glowplug Voltage
27	RP6422	66,4	17,5	M10X1,25	12	18	M4	2,5	10,5
28	RP6434	82,9	20,0	M14X1,25	17	27	M4	2,5	8
30	RP6438	95,4	27,0	M10X1,25	12	18	M4	2,5	8
29	RP6444	81,4	25,0	M10X1,25	12	18	M4	2,5	19
30	RP6588	95,9	27,5	M10X1,25	12	18	M4	2,5	20,5
30	RP6590	95,9	27,5	M10X1,25	12	18	M4	2,5	19
30	RP6592	95,9	27,5	M10X1,25	12	18	M4	2,5	8,5
31	RP6608	64,4	20,0	M12X1,25	12	22	M5	3	11
27	RP6626	65,9	17,0	M10X1,25	12	18	M4	2,5	9,5
32	RP6628	67,9	19,0	M10X1,25	12	18	M4	2,5	9,5
26	RP6632	88,4	25,0	M10X1,25	12	18	M4	2,5	20,5
33	RP6634	89,5	25,0	M10X1,25	12	18	M4	2,5	8
29	RP6642	81,4	25,0	M10X1,25	12	18	M4	2,5	22,5
34	RP6648	83,4	20,0	M18X1,5	19	40	M5	3	22,5
35	RP6650	83,1	20,0	M18X1,5	19	40	M4	2,5	10,5
36	RP6654	83,4	20,0	M18X1,5	19	40	M5	3	10,5
37	RP6658	85,6	20,0	M18X1,5	19	40	M5	3	20,5
38	RP6666	74,9	18,0	M10X1,25	12	18	M4	2,5	10,5
39	RP6668	77,0	20,0	M12X1,25	12	22	M4	2,5	10,5
25	RP6670	85,5	20,0	M10X1,25	12	18	M4	2,5	22,5
41	RP6672	129,3	30,0	M10X1,25	12	18	M4	2,5	22,5
39	RP6678	82,3	20,0	M12X1,25	12	22	M4	2,5	22,5
42	RP6680	93,4	23,0	M10X1,25	12	18	M4	2,5	21
43	RP6682	92,4	22,0	M12X1,25	14	22	M4	2,5	19
43	RP6684	92,4	22,0	M12X1,25	14	22	M4	2,5	10,5
44	RP6686	127,6	30,0	M10X1,25	12	18	M4	2,5	20,5
45	RP6688	73,4	18,0	M10X1,25	12	18	M4	2,5	20,5
43	RP6689	91,4	21,0	M12X1,25	14	22	M4	2,5	9,5
28	RP6690	82,9	20,0	M14X1,25	17	27	M4	2,5	19
46	RP6692	89,4	31,0	M10X1,25	12	18	M4	2,5	11
47	RP6800	67,9	19,0	M10X1,25	12	18	M4	2,5	23
47	RP6800/1	67,9	19,0	M10X1,25	12	18	M4	2,5	23
47	RP6802	66,9	18,0	M10X1,25	12	18	M4	2,5	24
46	RP6804	89,4	31,0	M10X1,25	12	18	M4	2,5	7
48	RP6806	118,5	23,0	3/8" (24UNF)	3/8"	18	X	-	24
49	RP6808	88,5	22,0	3/8" (24UNF)	8	12	-	-	24

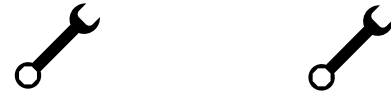
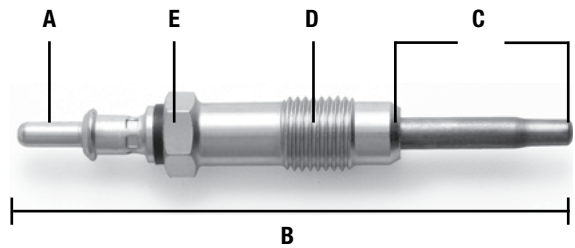
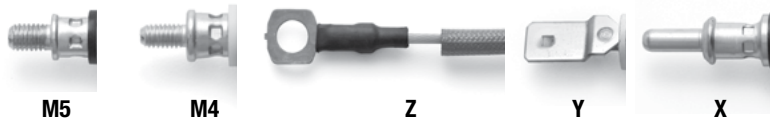

Picture	Code	B mm	C mm	D	E mm	BodyTorque	A	Connection Torque	Glowplug Voltage
49	RP6810	88,5	22,0	3/8" (24UNF)	8	12	-	-	12
48	RP6812	118,5	23,0	3/8" (24UNF)	3/8"	18	X	-	12
48	RP6814	118,5	23,0	3/8" (24UNF)	3/8"	18	X	-	32
40	RP6816	77,3	28,5	M10X1	3/8"	15	Y	-	10,5
50	RP6818	89,4	22,0	M10X1,25	12	18	M4	2,5	12
51	RP6820	128,5	26,0	3/8" (24UNF)	3/8"	18	Y	-	11
26	RP6824	87,4	24,0	M10X1,25	12	18	M4	2,5	5
26	RP6826	88,4	25,0	M10X1,25	12	18	M4	2,5	9,5
31	RP6830	64,4	20,0	M12X1,25	12	22	M5	3	6,5
47	RP6838	67,4	18,5	M10X1,25	12	18	M4	2,5	11
30	RP6840	95,9	27,5	M10X1,25	12	18	M4	2,5	7
52	RP6842	141,6	48,5	5/16" UNF	5/16"	12	X	-	24
49	RP6844	88,5	22,0	3/8" (24UNF)	8	12	-	-	12
30	RP6846	96,4	28,0	M10X1,25	12	18	M4	2,5	12
53	RP6848	71,4	17,0	M10X1,25	12	18	M4	2,5	23
54	RP6850	96,9	25,0	M10X1,25	12	18	M4	2,5	22,5
26	RP6854	88,4	25,0	M10X1,25	12	18	M4	2,5	9,5
47	RP6908	67,4	18,5	M10X1,25	12	18	M4	2,5	10,5
55	RP6910	82,9	22,0	M10X1,25	12	18	M4	2,5	12
55	RP6912	82,9	22,0	M10X1,25	12	18	M4	2,5	10,5
30	RP6914	96,4	28,0	M10X1,25	12	18	M4	2,5	14
30	RP6916	95,9	27,5	M10X1,25	12	18	M4	2,5	23
56	RP6918	87,9	24,5	M10X1	12	15	M4	2,5	6,5
57	RP7002	78,9	27,0	M10X1	3/8"	15	Y	-	11,5
58	RP7004	81,5	27,0	M10X1	3/8"	15	X	-	5
59	RP7006	82,0	27,0	M10X1	3/8"	15	Y	-	11,5
60	RP7008	129,5	31,0	M10X1	10	15	X	-	11
40	RP7010	77,3	28,5	M10X1	3/8"	15	Y	-	10,5
61	RP7012	78,8	27,0	M10X1	3/8"	15	Y	-	11
62	RP7014	120,0	21,5	M14X1,25	10	27	X	-	11
63	RP7016	136,3	28,0	M10X1,25	12	18	M4	2,5	11
62	RP7018	122,0	23,5	M14X1,25	10	27	X	-	11
64	RP7020	120,5	21,5	M14X1,25	10	27	X	-	11
65	RP7026	76,3	28,5	M10X1	3/8"	15	Y	-	10,5

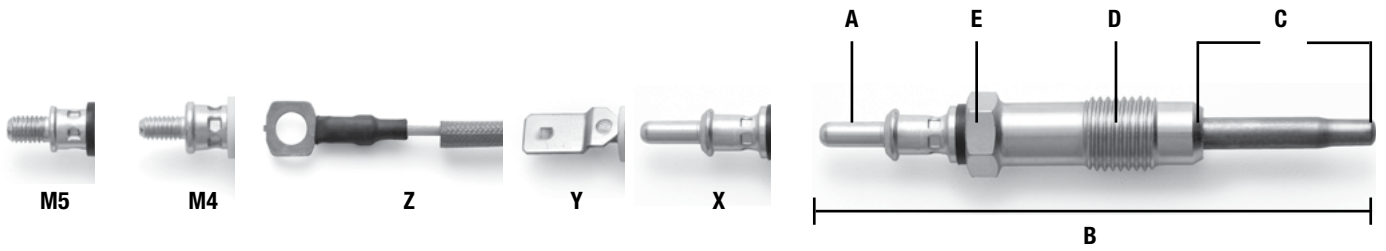

Picture	Code	B mm	C mm	D	E mm	BodyTorque	A	Connection Torque	Glowplug Voltage
66	RP7030	77,2	28,5	M10X1	3/8"	15	X	-	17,5
67	RP7992	71,4	24,0	M12X1,25	12	22	M5	3	18
22	RP8040	87,9	15,5	M18X1,5	21	40	M5	3	9,5
56	RP8084	87,9	24,5	M10X1	12	15	M4	2,5	6,5
68	RP8106	135,4	24,0	M12X1,25	12	22	M4	2,5	11
69	RP8116	94,4	20,0	M12X1,25	12	22	M4	2,5	20,5
69	RP8118	94,4	20,0	M12X1,25	12	22	M4	2,5	24
47	RP8120	67,4	18,5	M10X1,25	12	18	M4	2,5	10,5
68	RP8122	135,4	24,0	M12X1,25	12	22	M4	2,5	20,5
70	RP8126	90,4	22,0	M10X1,25	12	18	M4	2,5	21
71	RP8134	81,9	18,5	M10X1,25	12	18	M4	2,5	5
50	RP8150	89,4	22,0	M10X1,25	12	18	M4	2,5	6
43	RP8158	91,9	21,5	M12X1,25	14	22	M4	2,5	23
56	RP8160	87,4	24,0	M10X1	12	15	M4	2,5	6,5
47	RP8162	67,4	18,5	M10X1,25	12	18	M4	2,5	10,5
72	RP8164	61,7	20,0	M12X1,25	12	22	M5	3	8,5
47	RP8168	67,4	18,5	M10X1,25	12	18	M4	2,5	11
73	RP8170	87,4	24,5	M10X1,25	12	18	M4	2,5	11
73	RP8172	87,4	24,5	M10X1,25	12	18	M4	2,5	11
74	RP8174	87,9	22,5	M10X1,25	12	18	M4	2,5	11
74	RP8176	87,4	22,0	M10X1,25	12	18	M4	2,5	24
46	RP8184	89,9	31,5	M10X1,25	12	18	M4	2,5	16
75	RP8186	90,4	32,0	M10X1,25	12	18	M4	2,5	11
30	RP8188	95,9	27,5	M10X1,25	12	18	M4	2,5	10,5
30	RP8190	96,4	28,0	M10X1,25	12	18	M4	2,5	6
75	RP8192	90,4	32,0	M10X1,25	12	18	M4	2,5	6
55	RP8200	83,4	22,5	M10X1,25	12	18	M4	2,5	23
55	RP8206	83,9	23,0	M10X1,25	12	18	M4	2,5	12
30	RP8208	96,4	28,0	M10X1,25	12	18	M4	2,5	11
30	RP8210	95,9	27,5	M10X1,25	12	18	M4	2,5	11
67	RP8246	70,4	23,0	M12X1,25	12	22	M5	3	18
76	RP8248	74,4	27,0	M12X1,25	12	22	M5	3	11,5
77	RP8256	83,4	23,0	M10X1,25	12	18	M4	2,5	10,5
78	RP8272	92,0	24,0	M10X1	10	15	X	-	11
8	RP8276	61,4	20,0	M12X1,25	12	22	M5	3	24
79	RP8280	76,4	29,0	M12X1,25	12	22	M5	3	18
80	RP8320	120,4	27,5	M12X1,25	12	22	X	-	11,5

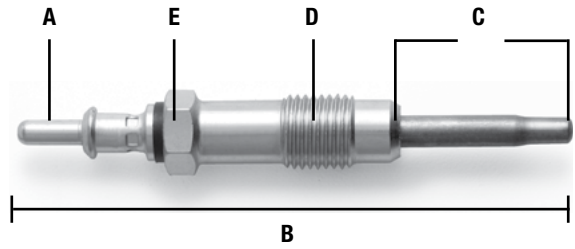
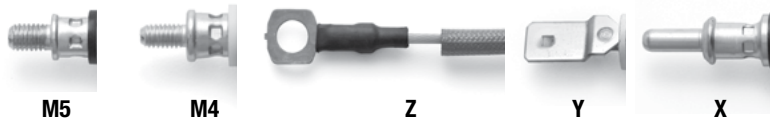

Picture	Code	B mm	C mm	D	E mm	BodyTorque	A	Connection Torque	Glowplug Voltage
26	RP8322	87,4	24,0	M10X1,25	12	18	M4	2,5	11
71	RP8324	80,9	17,5	M10X1,25	12	18	M4	2,5	11
81	RP8326	67,9	15,5	M12X1,25	12	22	M4	2,5	11
26	RP8328	87,9	24,5	M10X1,25	12	18	M4	2,5	9
46	RP8332	90,4	32,0	M10X1,25	12	18	M4	2,5	11
53	RP8334	76,4	22,0	M10X1,25	12	18	M4	2,5	9
53	RP8336	76,4	22,0	M10X1,25	12	18	M4	2,5	11
30	RP8338	95,9	27,5	M10X1,25	12	18	M4	2,5	11
82	RP8340	85,4	24,0	M10X1	10	15	M4	2,5	11
83	RP8342	87,0	27,0	M12X1,25	12	22	X	-	11,5
84	RP8344	71,9	24,5	M12X1,25	12	22	M4	2,5	11
85	RP8346	124,9	26,5	M10X1	10	15	M4	2,5	11,5
86	RP8348	84,4	19,0	M10X1,25	12	18	M4	2,5	11
87	RP8350	81,4	18,5	M10X1,25	12	18	M4	2,5	11
88	RP8352	90,4	29,0	M10X1	10	15	M4	2,5	11
89	RP8354	67,4	25,0	M12X1,25	12	22	M4	2,5	11
89	RP8356	67,4	25,0	M12X1,25	12	22	M4	2,5	11
90	RP8358	115,9	27,0	M12X1,25	12	22	X	-	11,5
91	RP8360	75,5	20,0	M12X1,25	12	22	X	-	12
53	RP8362	70,4	16,0	M10X1,25	12	18	M4	2,5	10,5
55	RP8364	83,4	22,5	M10X1,25	12	18	M4	2,5	11
92	RP8366	76,4	16,0	M10X1,25	12	18	M4	2,5	12
93	RP8368	125,4	29,0	M10X1	10	15	M4	2,5	11
78	RP8370	97,0	29,0	M10X1	10	15	X	-	11
94	RP8372	96,4	24,0	M10X1	10	15	M4	2,5	11
95	RP8374	130,5	27,0	M10X1	10	15	X	-	11,5
96	RP8376	123,9	25,0	M10X1,25	12	18	M4	2,5	23
30	RP8378	95,9	27,5	M10X1,25	12	18	M4	2,5	23
68	RP8380	135,3	24,5	M12X1,25	12	22	M4	2,5	11
55	RP8382	82,9	22,0	M10X1,25	12	18	M4	2,5	12
97	RP8384	97,0	29,0	M10X1	10	15	X	-	23
55	RP8386	82,9	22,0	M10X1,25	12	18	M4	2,5	11
98	RP8388	62,9	17,5	M12X1,25	12	22	M5	3	11
82	RP8390	85,4	24,0	M10X1	10	15	M4	2,5	11
99	RP8392	68,8	19,0	M8X1	10	15	M4	2,5	11
100	RP8394	85,9	14,0	M18X1,5	19	40	M5	3	10,5
101	RP8396	92,9	24,5	M10X1	10	15	M4	2,5	11

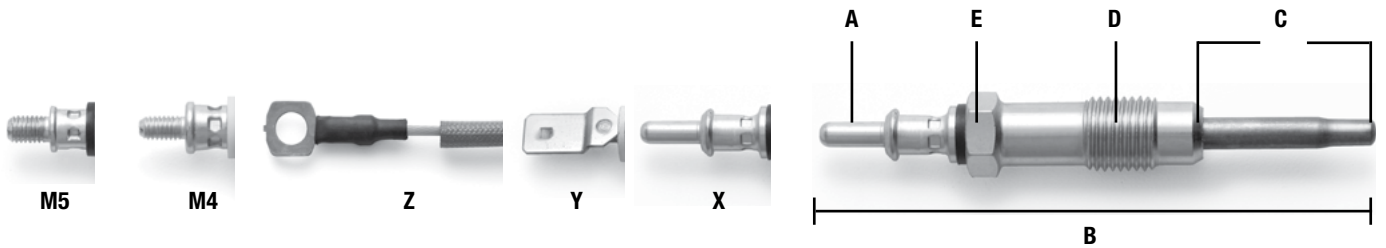

Picture	Code	B mm	C mm	D	E mm	BodyTorque	A	Connection Torque	Glowplug Voltage
102	RP8398	118,9	33,5	M10X1	10	15	M4	2,5	11
103	RP8400	132,5	28,5	M10X1	10	15	X	-	11
104	RP8402	86,9	21,5	M10X1.25	12	18	M4	2,5	11
105	RP8404	126,5	34,5	M10X1	10	15	X	-	12
106	RP8406	128,4	30,0	M10X1	10	15	M4	2,5	11,5
107	RP8408	77,9	24,5	M10X1	10	15	M4	2,5	11
108	RP8410	105,9	27,0	M10X1	10	15	M4	2,5	11
109	RP8412	151,0	24,0	M10X1	10	15	X	-	11
110	RP8414	91,4	22,0	M10X1,25	12	18	M4	2,5	11
111	RP8416	93,9	29,0	M8X1	8	12	X	-	4,4
112	RP8418	119,8	24,5	M12X1.25	12	22	Z	-	11
112	RP8420	119,8	24,5	M12X1.25	12	22	Z	-	23
113	RP8426	213,0	23,0	M10X1.25	12	18	M4	2,5	11
114	RP8428	134,5	30,0	M10X1.25	12	18	M4	2,5	11
115	RP8432	132,4	24,0	M10X1.25	12	18	M4	2,5	11
116	RP8434	120,8	30,0	M10X1.25	12	18	M4	2,5	11
117	RP8436	124,1	27,5	M8X1	8	12	X	-	11
118	RP8438	98,4	27,5	M8X1	8	12	X	-	11
119	RP8440	147,9	26,5	M8X1	8	12	X	-	11,5
120	RP8442	90,3	33,0	M10X1.25	12	18	M4	2,5	11
182	RP8444	156,4	35,0	M9X1	9	12	X	-	4,4
183	RP8446	139,0	28,5	M10X1.25	10	18	M4	2,5	4,4
184	RP8448	160,0	28,5	M10X1,25	10	18	M4	2,5	11
185	RP8454	96,4	24,0	M10X1	10	15	X	-	4,4
186	RP8456	90,5	24,0	M10X1	10	15	X	-	4,4
187	RP8466	119,0	27,5	M9X1	9	12	X	-	4,4
184	RP8468	160,0	28,5	M10X1.25	10	18	M4	2,5	11
145	RP8470	135	27,5	M8X1	8	12	X	-	4,4
189	RP8472	113,9	27,5	M8X1	8	12	X	-	5
190	RP8474	133,5	28,0	M10X1	10	15	X	-	4,4
191	RP8476	148,5	35,0	M10X1	10	15	M4	2,5	4,4
192	RP8478	137,4	24,0	M10X1,25	10	18	X	-	4,4
193	RP8480	144,4	31,0	M8X1	8	12	X	-	4,4
121	RP8600	83,9	18,5	M10X1,25	12	18	M4	2,5	11
122	RP8602	96,9	19,0	M10X1,25	12	18	M4	2,5	11
123	RP8604	84,4	21,5	M10X1,25	12	18	M4	2,5	6,5
124	RP8606	89,0	22,0	M10X1,25	12	18	M4	2,5	6,5

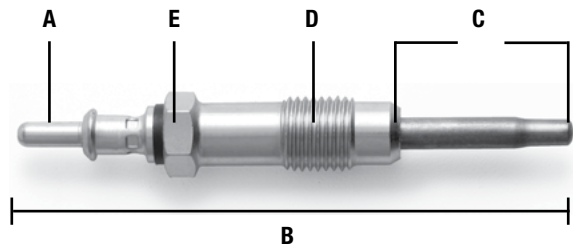
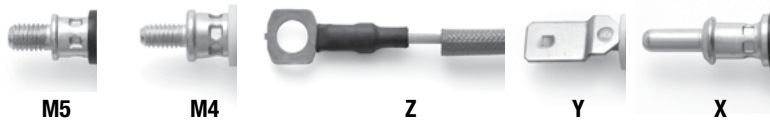

Picture	Code	B mm	C mm	D	E mm	BodyTorque	A	Connection Torque	Glowplug Voltage
125	RP8608	85,9	17,5	M10X1,25	12	18	M4	2,5	11
126	RP8610	98,3	25,0	M10X1,25	12	18	M4	2,5	11
127	RP8612	88,8	21,0	M10X1,25	12	18	M4	2,5	11
128	RP8614	78,4	17,5	M10X1,25	12	18	M4	2,5	11
129	RP8616	94,9	24,5	M10X1	10	15	M4	2,5	10
130	RP8618	146,1	35,0	M10X1	10	15	M4	2,5	11,5
131	RP8620	99,5	24,5	M10X1	10	15	X	-	11
132	RP8622	103,0	24,0	M10X1	10	15	X	-	11
132	RP8622/30	109,0	30,0	M10X1	10	15	X	-	11
133	RP8624	90,5	24,0	M10X1	10	15	X	-	11
134	RP8626	106,0	32,0	M10X1	10	15	X	-	11
135	RP8628	79,5	20,0	M12X1,25	12	22	X	-	11
136	RP8630	150,0	26,0	M10X1	8	15	X	-	11
92	RP8632	76,4	16,0	M10X1,25	12	18	M4	2,5	11
137	RP8634	120,5	39,5	M10X1	10	15	X	-	11,5
138	RP8636	89,5	18,0	M10X1,25	12	18	M4	2,5	11
139	RP8638	134,5	30,5	M10X1	10	15	X	-	11
140	RP8640	112,2	29,5	M10X1	10	15	M4	2,5	11
141	RP8642	84,4	19,0	M10X1,25	12	18	M4	2,5	11
142	RP8644	160,2	36,0	M10X1,25	10	18	M4	2,5	11
143	RP8646	98,4	28,0	M10X1,25	12	18	M4	2,5	11
144	RP8648	65,4	16,5	M10X1,25	12	18	M4	2,5	24
145	RP8650	125,9	24,5	M8X1	8	12	X	-	11
146	RP8652	119,9	27,5	M8X1	8	12	M4	2,5	11
147	RP8654	107,0	24,0	M10X1	10	15	X	-	11
148	RP8656	81,4	16,0	M10X1,25	12	18	M4	2,5	11
149	RP8658	142,4	23,5	M10X1,25	12	18	M4	2,5	11
75	RP8660	90,4	32,0	M10X1,25	12	18	M4	2,5	6
150	RP8664	70,0	25,0	M12X1,25	12	22	M5	3	22,5
84	RP8666	71,4	24,0	M12X1,25	12	22	M4	2,5	11,5
151	RP8668	133,5	28,5	M10X1	10	15	X	-	11
152	RP8670	145,0	24,0	M10X1,25	12	18	X	-	11
153	RP8672	150,9	39,5	M8X1	8	12	X	-	11
78	RP8674	97,0	29,0	M10X1	10	15	X	-	11
154	RP8676	131,0	26,0	M10X1	10	15	X	-	11,5
155	RP8678	118,9	27,5	M8X1	8	12	X	-	11
125	RP8680	85,9	17,5	M10X1,25	12	18	M4	2,5	11



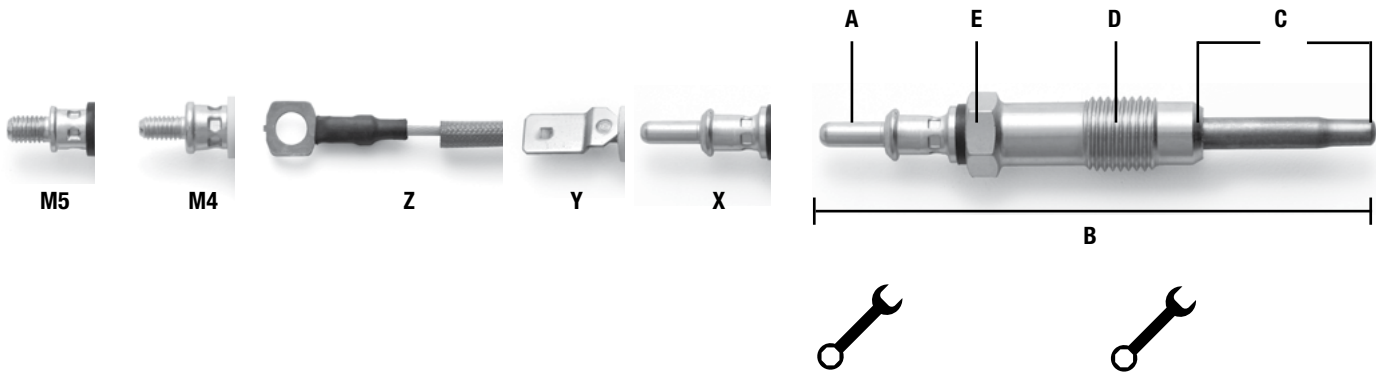

Picture	Code	B mm	C mm	D	E mm	BodyTorque	A	Connection Torque	Glowplug Voltage
156	RP8684	82,4	17,0	M10X1,25	12	18	M4	2,5	11
157	RP8686	70,4	29,0	M12X1,25	12	22	M5	3	11
158	RP8888	72,9	24,0	M10X1,25	12	18	M4	2,5	11
30	RP8890	95,9	27,5	M10X1,25	12	18	M4	2,5	11
50	RP8892	87,4	20,0	M10X1,25	12	18	M4	2,5	11
159	RP8894	138,0	22,0	M10X1	10	15	M4	2,5	11,5
87	RP8896	81,4	18,5	M10X1,25	12	18	M4	2,5	11
160	RP8898	84,0	28,5	M12X1,25	12	22	X	-	12
161	RP8900	96,4	24,0	M12X1,25	12	22	M5	3	11
162	RP8902	111,9	24,5	M12X1,25	12	22	M5	3	11
163	RP8904	170,0	35,0	M10X1,25	12	18	M4	2,5	11
164	RP8906	170,0	36,5	M10X1,25	12	18	M4	2,5	11
165	RP8908	150,4	24,0	M10X1	10	15	X	---	11
152	RP8910	145,6	24,0	M10X1,25	12	18	X	-	11
55	RP8912	82,9	22,0	M10X1,25	12	18	M4	2,5	11
166	RP8914	150,9	29,5	M9X1	9	12	X	-	11
85	RP8916	124,4	26,0	M10X1	10	15	M4	2,5	23
167	RP8918	136,4	28,0	M10X1,25	12	18	M4	2,5	4,7
168	RP8920	135,9	28,0	M10X1,25	12	18	M4	2,5	4,7
169	RP8922	160,9	31,0	M10X1,25	12	18	X	---	11
170	RP8924	147,9	26,5	M8X1	8	12	X	---	4,4
171	RP8928	129,4	27,0	M10X1	10	15	X	---	4,4
172	RP8930	117,4	27,0	M10X1	10	15	X	---	11
173	RP8932	130,0	25,0	M10X1	10	15	X	---	11
174	RP8934	99,0	24,0	M10X1	10	15	X	---	11
175	RP8936	181,5	21,0	M10X1,25	12	18	M4	2,5	11
176	RP8938	148,9	31,0	M10X1,25	12	18	M4	2,5	11
177	RP9000	97,0	29,0	M10X1	10	15	X	-	5
178	RP9002	116,5	29,5	M8X1	8	12	X	-	4,4
179	RP9004	106,0	32,0	M10X1	10	15	X	-	5
180	RP9006	133,5	28,5	M10X1	10	15	X	-	5
181	RP9008	133,5	30,0	M10X1	10	15	X	-	5

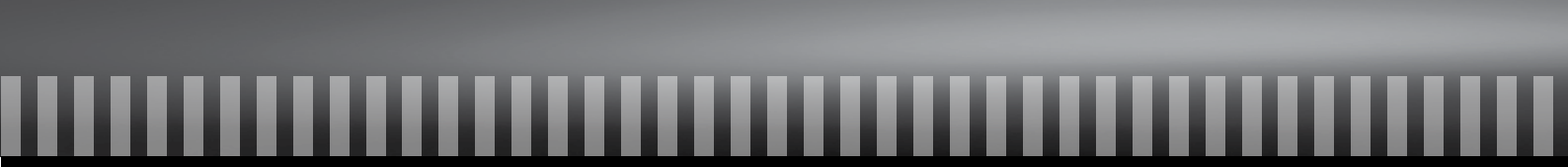

Three vertical bars of varying heights on the left side of the text.

**IMMAGINI TECNICHE**  
**TECHNICAL PICTURES**  
**IMAGES TECHNIQUES**

**1**  
RP2022  
RP2082



**2**  
RP2028  
RP2030



**3**  
RP2074



**4**  
RP2096



**5**  
RP2092  
RP2102  
RP4402



**6**  
RP4410



**7**  
RP4420  
RP4486



**8**  
RP4422  
RP8276



**9**  
RP4422/1



**10**  
RP4432



**11**  
RP4444  
RP4444/1  
RP4482  
RP4488



**12**  
RP4446



**13**  
RP4452  
RP4490



**14**  
RP4458



**15**  
RP4466



**16**  
RP4480



**17**  
RP6042  
RP6044

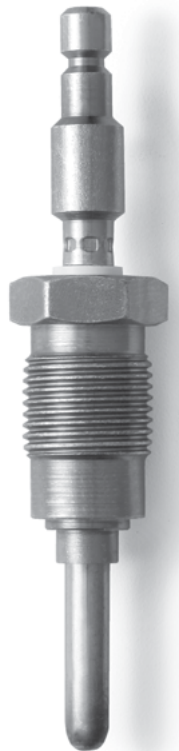

**18**  
RP6046  
RP6048



**19**  
RP6056  
RP6122



**20**  
RP6064



**21**  
RP6066



**22**  
RP6088  
RP8040



**23**  
RP6090



**24**  
RP6100



**25**  
RP6670

**26**

RP6226  
 RP6632  
 RP6824  
 RP6826  
 RP6854  
 RP8322  
 RP8328



**27**

RP6422  
 RP6626



**28**

RP6434  
 RP6690



**29**

RP6444  
 RP6642



**30**

RP6438  
 RP6588  
 RP6590  
 RP6592  
 RP6840  
 RP6846  
 RP6914  
 RP6916  
 RP8188  
 RP8190  
 R08208  
 RP8210  
 RP8338  
 RP8378  
 RP8890



**31**

RP6608  
 RP6830



**32**

RP6628



**34**

RP6648



**35**  
RP6650



**38**  
RP6666



**39**  
RP6668  
RP6678



**40**  
RP6816  
RP7010



**43**  
RP6682  
RP6684  
RP6689  
RP8158



**45**  
RP6688



**46**  
RP6692  
RP6804  
RP8184  
RP8332



**47**  
RP6800  
RP6800/1  
RP6802  
RP6838  
RP6908  
RP8120  
RP8162  
RP8168



**48**  
RP6806  
RP6812  
RP6814



**49**  
RP6808  
RP6810  
RP6844



**52**  
RP6842

**50**  
RP6818  
RP8150  
RP8892



**53**  
RP6848  
RP8334  
RP8336  
RP8362



**51**  
RP6820



**54**  
RP6850



**54**  
RP6850

**55**  
RP6910  
RP6912  
RP8200  
RP8206  
RP8364  
RP8382  
RP8386  
RP8912



**56**  
RP6918  
RP8084  
RP8160



**57**  
RP7002



**58**  
RP7004



**59**  
RP7006



**60**  
RP7008



**62**  
RP7014  
RP7018



**63**  
RP7016



**64**  
RP7020



**65**  
RP7026



**66**  
RP7030



**67**  
RP7992  
RP8246



**68**  
RP8106  
RP8122  
RP8380



**69**  
RP8116  
RP8118



**70**  
RP8126



**71**  
RP8134  
RP8324



**72**  
RP8164



**73**  
RP8170  
RP8172



**74**  
RP8174  
RP8176



**75**  
RP8186  
RP8192  
RP8660



**76**  
RP8248



**77**  
RP8256



**78**  
RP8272  
RP8370  
RP8674



**79**  
RP8280

**80**  
RP8320



**81**  
RP8326



**82**  
RP8340  
RP8390



**83**  
RP8342



**85**  
RP8346  
RP8916



**84**  
RP8344  
RP8666



**86**  
RP8348



**87**  
RP8350  
RP8896

**88**  
RP8352



**89**  
RP8354  
RP8356



**90**  
RP8358



**91**  
RP8360



**92**  
RP8366  
RP8632



**93**  
RP8368



**94**  
RP8372



**95**  
RP8374



**96**  
RP8376



**97**  
RP8384



**98**  
RP8388



**99**  
RP8392



**100**  
RP8394



**101**  
RP8396



**102**  
RP8398



**103**  
RP8400

**104**  
RP8402



**105**  
RP8404



**106**  
RP8406



**107**  
RP8408



**108**  
RP8410



**109**  
RP8412



**110**  
RP8414





**111**  
RP8416



**112**  
RP8418  
RP8420



**113**  
RP8426



**114**  
RP8428



**115**  
RP8432



**116**  
RP8434



**117**  
RP8436



**118**  
RP8438



**119**  
RP8440



**120**  
RP8442



**121**  
RP8600



**122**  
RP8602



**123**  
RP8604



**124**  
RP8606



**125**  
RP8608  
RP8680

**126**  
RP8610



**127**  
RP8612



**128**  
RP8614



**129**  
RP8616



**130**  
RP8618



**131**  
RP8620



**132**  
RP8622



**133**  
RP8624



**134**  
RP8626



**135**  
RP8628



**136**  
RP8630



**137**  
RP8634



**138**  
RP8636



**139**  
RP8638



**140**  
RP8640

**141**  
RP8642



**142**  
RP8644



**143**  
RP8646



**144**  
RP8648



**145**  
RP8650



**146**  
RP8652



**147**  
RP8654



**148**  
RP8656



**149**  
RP8658



**151**  
RP8668



**152**  
RP8670  
RP8910



**153**  
RP8672

**154**  
RP8676



**155**  
RP8678



**157**  
RP8686



**158**  
RP8888



**159**  
RP8894



**160**  
RP8898



**161**  
RP8900





**162**  
RP8902



**163**  
RP8904



**164**  
RP8906



**165**  
RP8908



**166**  
RP8914



**167**  
RP8918



**168**  
RP8920



**169**  
RP8922



**170**  
RP8924



**171**  
RP8928



**172**  
RP8930



**173**  
RP8932



**175**  
RP8936



**177**  
RP9000



**178**  
RP9002



**179**  
RP9004



**180**  
RP9006



**181**  
RP9008



**182**  
RP8444



**183**  
RP8446



**184**  
RP8448





**185**  
RP8454



**186**  
RP8456



**187**  
RP8466



**189**  
RP8472



**190**  
RP8474



**191**  
RP8476



**192**  
RP8478



**193**  
RP8480

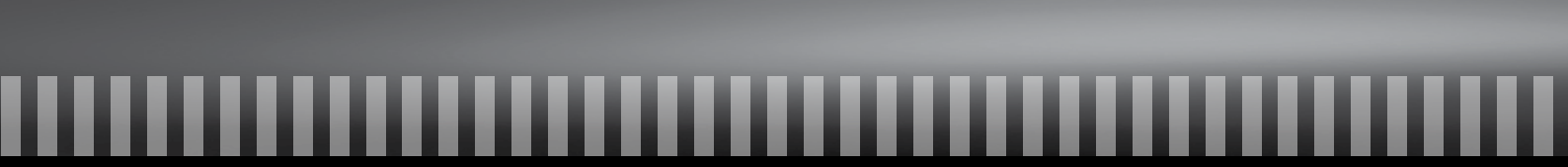

Three vertical bars of varying heights on the left side of the text.

**MANUTENZIONE**  
**MAINTENANCE**  
**ENTRETIEN**

# ISTRUZIONI DI MONTAGGIO

## DURANTE LA SOSTITUZIONE DELLE CANDELETTE SI DEVE FARE PARTICOLARE ATTENZIONE AI SEGUENTI PUNTI:

- Lasciare raffreddare il motore;
- Assicurarsi che la chiave per l'avviamento del motore sia in posizione OFF;
- I depositi di sporczia che si trovano sulla cava della candele non devono assolutamente cadere nella camera di combustione;
- Le candele devono essere rimosse utilizzando delle apposite chiavi a tubo;
- Le candele devono essere montate utilizzando delle apposite chiavi a tubo e per il serraggio, se possibile una chiave dinamometrica;
- I dadi per il collegamento elettrico della candele, devono essere stretti con la coppia di serraggio corretta, altrimenti se tale coppia di serraggio viene oltrepassata, è possibile che la candele venga danneggiata, provocandone il completo danneggiamento (la rottura del perno di collegamento o il surriscaldamento a causa della fessura anulare chiusasi);

## SMONTAGGIO CANDELETTE

- Smontare i dati di collegamento elettrico utilizzando una chiave a tubo (da 7mm o 8mm);
- Con un pennello pulire la cavità intorno alla candele senza smontarla;
- Smontare la candele con una chiave a tubo (a seconda del dado della candele la chiave può variare da 3/8" a 21mm);

## INSTALLAZIONE DELLE CANDELETTE DI PRERISCALDAMENTO

### Specifiche della coppia di serraggio consigliata per le candele RPOWER:

- 1 - Impiegare la chiave dinamometrica corretta per le candele ed il morsetto.
- 2 - Durante la fase di sostituzione delle candele, assicurarsi che eventuali olio o sporchie, etc., accumulati sull'esterno della candele smontata, non penetrino nel cilindro.
- 3 - Durante il montaggio delle candele, pulire il lato motore della flangia, ed assicurarsi che la candele sia allineata correttamente con la filettatura della testata dei cilindri.
- 4 - Assicurarsi che la candele sia posizionata correttamente ed avvitata a mano, fino al punto in cui non può più essere ulteriormente serrata.
- 5 - A questo punto, utilizzare una chiave dinamometrica per serrarla fino al valore di coppia illustrato nel diagramma sottostante.

### ! NON UTILIZZARE UN LUBRIFICANTE PER FILETTI!

Se sulla filettatura viene applicato uno strato di lubrificante per filetti, quale del grasso, la resistenza tra la candele e la testata dei cilindri sarà inferiore, e provocherà quindi un eccessivo serraggio.

! Un serraggio superiore ai valori delle coppie illustrati nella tavola qui sopra potrebbe provocare danni alla candele ed al motore.

! La rottura delle candele è spesso causata da tensione eccessiva e/o surriscaldamento. Le candele sono progettate per lavorare tra gli 850 e i 1200 gradi centigradi. Un eccessivo e prolungato passaggio di corrente può causare il surriscaldamento della candele generando rigonfiamento, rottura o bruciatura della medesima, portando cioè all'immediata rottura. Un relè difettoso può essere causa di un guasto delle candele, pertanto è necessario verificare l'intero sistema prima di sostituire le candele.

### SPECIFICHE DI COPPIA CONSIGLIATE PER L'INSTALLAZIONE

	Dimensione filetto	Coppia consigliata
Filetto corpo candele	M8x1,00	8-12 Nm
	M9x1,00	8-12 Nm
	M10x1,00	10-15 Nm
	M10x1,25	10-18 Nm
	M12x1,25	15-22 Nm
	M14x1,25	20-27 Nm
	M14x2,00	20-27 Nm
	M18x1,50	30-40 Nm
Filetto terminale	M4x0,7	1-1,5 Nm
	M5x0,8	3-4 Nm



# MAINTENANCE AND REPLACE- MENT

## WHEN REPLACING GLOW PLUGS, SPECIAL ATTENTION MUST BE PAID TO THE FOLLOWINGS ASPECTS:

- leave to cool the engine;
- make sure that the key for the starting of the engine is on OFF position;
- dirt around the hole for the plug must not fall into the combustion chamber under any circumstances;
- glow plugs must be removed by using special plug box wrench;
- glow plugs must be fitted by using special plug box wrench and tightened, if possible, by using a torque wrench;
- the power connection nuts for the electric connection of the glow plug, must be tightened to the correct torque. Otherwise, the glow plug may be damaged by excessive torque. This can result in irreparable damage to the plug (connecting stud shear or overheating due to closed annular gap);

## REMOVING THE GLOW PLUG

- remove the power connection nuts by using a plug box wrench (7mm or 8mm);
- by using a brush, clean the hollow around the glow plug without removing it;
- remove the glow plug with a plug box wrench (the key can vary from 3/8" to 21mm, according to the nut of the glow plug);

## GLOW PLUG INSTALLATION

### Recommended torque specification for RPOWER glow plugs:

- 1 - Use the correct wrench for the Glow Plug and
- 2 - When changing glow plugs, make sure that oil, dirt etc. on the outside of the disassembled glow plug does not enter into the cylinder.
- 3 - When mounting the glow plug, clean the engine side of the flange and make sure the glow plug is correctly inline with the thread of the cylinderhead.
- 4 - Make sure the plug is correctly positioned and tighten it by hand until it cannot be tightened any further.
- 5 - Then, use a torque wrench to tighten it accurately to the torque showed in the chart below.

### ! DO NOT USE A THREAD LUBRICANT!

If a thread lubricant such as grease is coated on the thread, the resistance between the glow plug and the cylinderhead will be less -> resulting in over tightening

! Tightening more than the torques shown in the table could result in damage to the glow plug and engine.

! Glow plug failure is most commonly caused from over voltage and/ or excessive heat. Glow plugs are designed to operate between 850 to 1200 degrees. When the electrical current to the glow plug is held too long it can lead to overheating which will cause the glow plug to swell, split or burst and cause immediate failure. Overly advanced injection timing, leaky injectors, or running gasoline in your engine will cause the combustion temperature to get hot enough to damage the glow plug.

A faulty relay and controller can also cause glow plug failure so it is advisable to check out the entire system before changing to new glow plugs.

### RECOMMENDED INSTALLATION TORQUE SPECIFICATION

	Thread size	Recommended torque
Glow plug	M8x1,00	8-12 Nm
	M9x1,00	8-12 Nm
	M10x1,00	10-15 Nm
	M10x1,25	10-18 Nm
	M12x1,25	15-22 Nm
	M14x1,25	20-27 Nm
	M14x2,00	20-27 Nm
Terminal	M18x1,50	30-40 Nm
	M4x0,7	1-1,5 Nm
	M5x0,8	3-4 Nm

# MAINTENANCE AND REPLACE- MENT

## LORSQUE VOUS CHANGEZ LES BOUCHONS DEVRAIENT ACCORDER UNE ATTENTION PARTICULIÈRE AUX ÉLÉMENTS SUIVANTS:

- Laisser refroidir le moteur;
- Veiller à ce que la clé de démarrage du moteur est en position éteint;
- Les dépôts de saleté qui se trouvent dans la cavité de la bougie, ne doit pas tomber dans la chambre de combustion;
- Les bougies doivent être enlevées en utilisant la clé appropriée;
- Les bougies doivent être montées en utilisant la clé appropriée et serrées, si possible, avec une clé dynamométrique;
- Les écrous pour le raccordement électrique de la bougie doivent être serrées avec la couple de serrage correcte, sinon, si la couple est dépassée, il est possible que la bougie est endommagée, en provoquant des dégâts complète (casse de la tige de connexion ou la brûlure à cause de l'espace annulaire qui s'a serré);

## DÉMONTAGE DES BOUGIES

- Démontez les écrous du câblage électrique en utilisant une clé tubulaire (7mm ou 8mm);
- Utilisez une brosse pour nettoyer la cavité autour de la bougie sans démonter;
- Démontez la bougie avec une clé tubulaire (en fonction de l'écrou de la bougie la clé peut varier de 3/8" à 21 mm);

## INSTALLATION DE BOUGIES DE PRÉCHAUFFAGE

### Couple recommandé pour le bougies de préchauffage RPOWER:

- 1 - Utilisez la clé correcte pour la bougie de préchauffage et la borne.
- 2 - Lorsque vous remplacez les bougies de préchauffage, assurez-vous que l'huile, la saleté, etc. se trouvant à l'extérieur de la bougie de préchauffage démontée ne pénètrent pas dans le cylindre.
- 3 - Lorsque vous montez la bougie de préchauffage, nettoyez le côté moteur du flasque et assurez-vous que la bougie de préchauffage est bien en ligne avec le filetage de la culasse.
- 4 - Assurez-vous que la bougie est bien placée et serrez-la à la main jusqu'à ce qu'elle soit bloquée.
- 5 - Ensuite, utilisez une clé dynamométrique pour la serrer avec précision au couple indiqué sur le graphique ci-dessous.

### ! NE PAS UTILISER DE LUBRIFIANT POUR FILETAGES!

Si on applique un lubrifiant pour filetages ( huile de graissage, par ex.) sur le filetage, la résistance entre la bougie de préchauffage et la culasse diminuera -> ce qui entraînera un serrage trop important. ! Un serrage supérieur aux couples indiqués dans le tableau ci dessous peut endommager la bougie de préchauffage et le moteur.

! La défaillance d'une bougie de préchauffage se doit, la plupart du temps, au survoltage et/ou réchauffement excessif. Les bougies sont conçues pour un environnement entre 850 et 1200 degrés. Si la tension est appliquée pendant trop longtemps, les bougies peuvent fondre ou se fissurer, occasionnant ainsi la panne immédiate. Une surtension, des injecteurs qui fuient ou une fuite de carburant dans votre moteur peuvent augmenter la température de combustion jusqu'à endommager les bougies de préchauffage. Un dispositif de contrôle ou un relai défectueux peuvent aussi occasionner la défaillance de la bougie. Il est donc conseillé de vérifier le système complètement avant l'installation de nouvelles bougies de préchauffage.

### COUPLE RECOMMANDÉ POUR L'INSTALLATION

	Dimension de filetage	Couple recommandé
Bougies de préchauffage	M8x1,00	8-12 Nm
	M9x1,00	8-12 Nm
	M10x1,00	10-15 Nm
	M10x1,25	10-18 Nm
	M12x1,25	15-22 Nm
	M14x1,25	20-27 Nm
	M14x2,00	20-27 Nm
	M18x1,50	30-40 Nm
Plot	M4x0,7	1-1,5 Nm
	M5x0,8	3-4 Nm



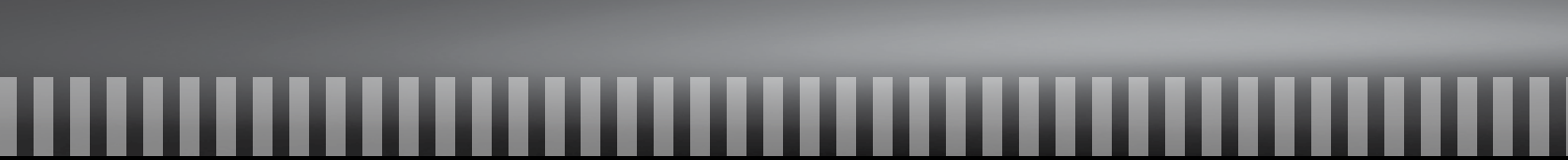

# SOLENOIDI SOLENOID VALVES SOLENOIDS

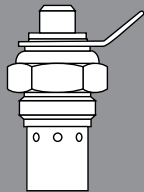
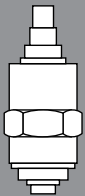

**4**

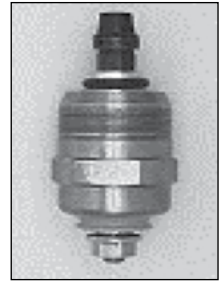
**1****2****3****4****5****6**

Picture	Part No. RPOWER	BOSCH	CAV	DELPHI	FIAT	Voltage (V)
<b>1</b>	RP40800	---	9009.041	7185-900W	9943882	12,0
			9009.049			
			9108.073A			
			9145.040D			
			7167.620B			
<b>2</b>	RP40802	---	9108.73A	---	---	12,0
			7167.620A			
<b>3</b>	RP40806	0330001015	---	7240-5	8191.393	12,0
		0330001018				
		0330001024				
		0330001025				
		0330001028				
		0330001040				
		0330001041				
		0330001042				
<b>4</b>	RP40812	---	7180049	7185-900K	---	24,0
<b>5</b>	RP40814	---	7180.049A	---	---	24,0
<b>6</b>	RP40816	0330001016	---	7240-6	---	24,0
		0330001045				
		0330001046				
		0330001047				
---	RP40817	---	---	9108-152A	---	---



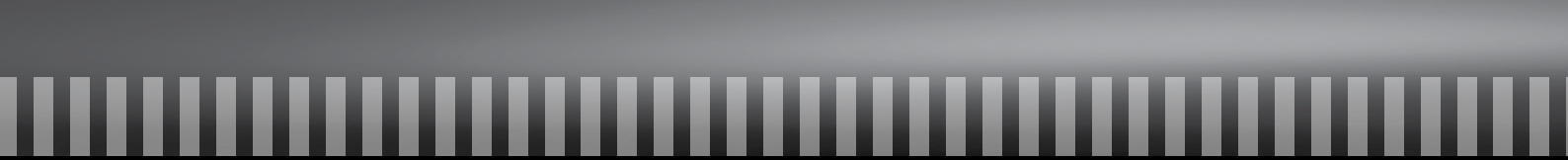



# TERMOAVVIATORI FLAME HEATER PLUGS THERMOSTARTERS

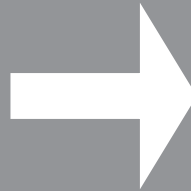
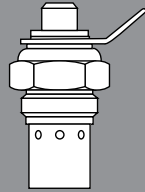
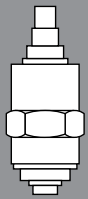

**4**

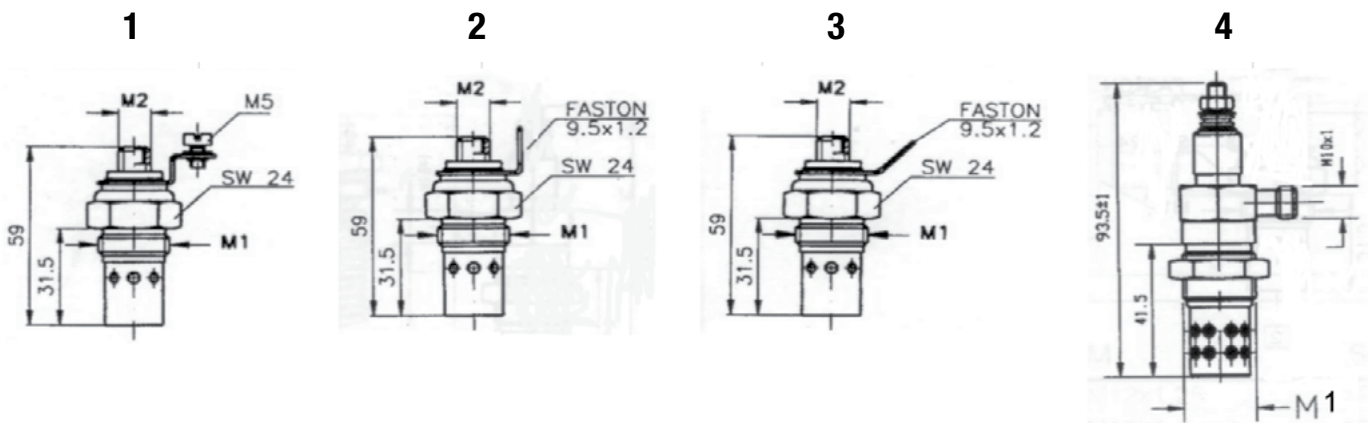

Picture	Part No. RPOWER	M1	M2	cm3/min (*)	A	V
4 (T1)	RP0338	M20X1,5	---	13,7/ 320(**)	---	9,5
4 (T1)	RP0344	M20X1,5	---	9,6 / 280(**)	---	19,0
1	RP0400	7/8" 14 UNF	3/8" 24 UNF	3,5-5	12,5	12,0
1	RP0402	7/8" 14 UNF	3/8" 24 UNF	7-12	8,0	24,0
2	RP0430	7/8" 14 UNF	3/8" 24UNF	3,5-5	12,5	12,0
2	RP0432	7/8" 14 UNF	3/8" 24 UNF	7-12	8,0	24,0
2	RP0434	M22X1,5	3/8" 24 UNF	2-3,2	12,5	12,0
4 (T1)	RP0504	M20X1,5	---	13,7/ 320(**)	---	19,0
4 (T1)	RP0506	M20X1,5	---	8,3 / 250(**)	---	19,0
4 (T1)	RP0510	M20X1,5	---	8,3 / 250(**)	---	19,0
1	RP0614	1/2" BSP	3/8" 24 UNF	7-12	15,5	12,0
2	RP0622	M22X1,5	M10X1	3,5-5	12,5	12,0
1	RP0644	1/2" BSP	3/8" 24 UNF	7-12	8,0	24,0
1	RP0720	7/8" 14 UNF	3/8" 24 UNF	7-12	15,5	12,0
1	RP0722	1/2" BSP	3/8" 24 UNF	3,5-5	12,5	12,0
2	RP0724	7/8" 14 UNF	3/8" 24 UNF	2-3,2	12,5	12,0
2	RP0726	1/2" BSP	3/8" 24 UNF	2-3,2	12,5	12,0
2	RP0728	1/2" BSP	3/8" 24 UNF	11-15	8,0	24,0
2	RP0730	1/2" BSP	3/8" UNF	3,5-5	12,5	12,0
2	RP0734	7/8" 14 UNF	3/8" 24 UNF	7-12	15,5	12,0
2	RP0736	1/2" BSP	3/8" 24 UNF	11-15	8,0	24,0
4 (T1)	RP0738	M20X1,5	---	7,3 / 220(**)	---	9,5
2	RP0800	7/8" 14 UNF	3/8" 24 UNF	3,5-5	12,5	12,0
2	RP0804	7/8" 14 UNF	3/8" 24 UNF	2-3,2	12,5	12,0
2	RP0806	7/8" 14 UNF	3/8" 24 UNF	3,5-5	12,5	12,0
4 (T2)	RP7038	M20X1,5	---	9,6 / 280(**)	---	23,0
2	RP7040	1/2" BSP	3/8" 24 UNF	3,5-5	6,0	24,0
1	RP7042	M22X1,5	M10X1	3,5-5	12,5	12,0
1	RP7044	M22X1,5	M10X1	2-3,2	12,5	12,0
1	RP7046	M22X1,5	M10X1	3,5-5	6,0	24,0
1	RP7048	7/8" 14 UNF	3/8 24 UNF	3,5-5	12,5	12,0
1	RP7050	M20X1,5	M10X1	7-12	8,0	24,0
2	RP7052	M20X1,5	M10X1	3,5-5	6,0	24,0
1	RP7054	7/8" 14 UNF	3/8" 24 UNF	3,5-5	6,0	24,0

(\*) FUEL FLOWRATE - GAS OIL AT 20°C, VISCOSITY 1,55°E, PRESSURE 2,5kPa

(\*\*) AIR FLOW cm3/min AT 20°C AND PRESSURE 150kPa

(T1) ASSEMBLY WITH SERIAL RESISTORS AND MAGNETIC VALVE

(T2) ASSEMBLY WITH SERIAL RESISTORS AND MAGNETIC VALVE

(T3) ASSEMBLY WITH CONTROL UNIT AND MAGNETIC VALVE (POST HEATING)

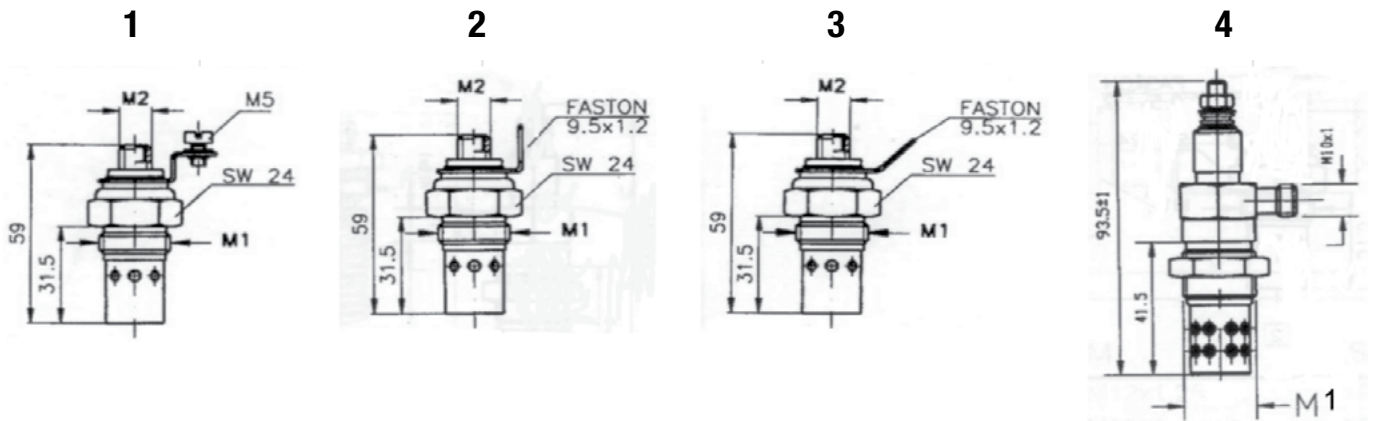

Picture	Part No. RPOWER	M1	M2	cm <sup>3</sup> /min (*)	A	V
2	RP7056	1/2" BSP	3/8" 24 UNF	7-12	8,0	24,0
2	RP7058	1/2" BSP	3/8" 24 UNF	3,5-5	12,5	12,0
1	RP7060	7/8" 14 UNF	3/8" 24 UNF	2-3,2	12,5	12,0
2	RP7062	M22X1,5	3/8" 24 UNF	3,5-5	12,5	12
2	RP7064	1/2" BSP	3/8" 24 UNF	7-12	8,0	24
2	RP7066	M22X1,5	3/8" 24 UNF	3,5-5	12,5	12
1	RP7068	M22X1,5	3/8" 24 UNF	3,5-5	12,5	12
2	RP7070	7/8" 14 UNF	3/8" 24 UNF	7-12	15,5	12
4 (T1)	RP7072	M20X1,5	---	9,6 / 280(**)	---	9,5
4 (T1)	RP7074	M20X1,5	---	15,7 / 360(**)	---	9,5
4 (T2)	RP7076	M20X1,5	---	9,6 / 280(**)	---	11
4 (T3)	RP7078	M20X1,5	---	7,3 / 220(**)	---	11
3	RP7996	M22X1,5	M10X1	300 (**)	24,0	8

(\*) FUEL FLOWRATE - GAS OIL AT 20°C, VISCOSITY 1,55°E, PRESSURE 2,5kPa

(\*\*) AIR FLOW cm<sup>3</sup>/min AT 20°C AND PRESSURE 150kPa

(T1) ASSEMBLY WITH SERIAL RESISTORS AND MAGNETIC VALVE

(T2) ASSEMBLY WITH SERIAL RESISTORS AND MAGNETIC VALVE

(T3) ASSEMBLY WITH CONTROL UNIT AND MAGNETIC VALVE (POST HEATING)

## TAVOLA DI CONVERSIONE - CROSS REFERENCE - LISTE DES RÉFÉRENCES CROISÉES

Modello / Model	
<b>BERU</b>	<b>RPOWER</b>
0.101.072.405	RP7996
0.101.072.408	RP7996
0.101.072.409	RP7996
0.101.072.603	RP0400
0.101.223.449	RP0338
0.101.223.454	RP0738
0.101.223.459	RP0738
0.101.223.461	RP0338
0.101.233.401	RP0504
0.101.233.413	RP0344
0.101.233.418	RP0506
0.101.233.486	RP0738
154GS	RP0400
154GSF	RP0400
166GS	RP0728
167G	RP0504
169G	RP0338
172G	RP0344
511G	RP7074
60G	RP0344
630G	RP0344
634GS	RP7996
683G	RP0738
690G	RP0510
699G	RP0506
700G	RP0510
703G	RP0344
721G	RP0338
742G	RP07076
754G	RP07038
843G	RP0338
913G	RP0338
GF006	RP07078
GF154	RP0400
GF167	RP0504
GF169	RP0338
GF177	RP0432
GF630	RP0344
GF671	RP0506
GF683	RP0738
GF699	RP0506

GF700	RP0510
GF859	RP7996
GF974	RP07076
GF978	RP07038
GF982	RP7996
GF982	RP7996
GF983	RP7996
GF983	RP7996
GF984	RP0338
<b>BOSCH</b>	<b>RPOWER</b>
0.257.100.009	RP0430
0.257.100.010	RP0400
0.257.200.003	RP0510
0.257.201.001	RP0344
0.257.201.004	RP0506
0.257.202.001	RP0504
0.257.202.002	RP0338
0.257.204.002	RP0338
0.257.204.003	RP0338
<b>MARELLI</b>	<b>RPOWER</b>
CTZ4U	RP0736
CTZ5U	RP0400
CTZ6U	RP0430
<b>PERKINS</b>	<b>RPOWER</b>
2666103	RP0430
2666104	RP0402
2666108	RP0400
CD10199	RP0402
OE42898	RP0728
<b>POCLAIN</b>	<b>RPOWER</b>
D0041518	RP0344
Q0041506	RP0504
<b>RENAULT</b>	<b>RPOWER</b>
5000270881	RP0504
5000590058	RP0504
<b>VOLVO</b>	<b>RPOWER</b>
837329	RP0344

<b>CHAMPION</b>	<b>RPOWER</b>
CH139	RP0430
<b>CUMMINGS</b>	<b>RPOWER</b>
3.925.441	RP0510
3.928.188	RP0510
3.928.189	RP0338
<b>DAF</b>	<b>RPOWER</b>
105977	RP0344
<b>DELPHI</b>	<b>RPOWER</b>
1854040	RP0614
1854050	RP0400
1854060	RP0402
1854080	RP0724
1854090	RP0432
1854101	RP0726
1854102	RP0430
1854103	RP0728
1854104	RP0730
1854105	RP0736
1854106	RP0734
1854109	RP0434
1854111	RP0622
<b>FIAT</b>	<b>RPOWER</b>
4221168	RP0728
4232051	RP0736
4232052	RP0728
4724601	RP0730
4724603	RP0728
4724604	RP0736
4775705	RP0338
4776085	RP0338
4832279	RP0338
4849601	RP0338
5141702	RP0730
8122180	RP0504
8122193	RP0338
500314583	RP0338
<b>HKT</b>	<b>RPOWER</b>
B-200	RP0400

## TAVOLA DI CONVERSIONE - CROSS REFERENCE - LISTE DES RÉFÉRENCES CROISÉES

ISKRA	RPOWER
11720430	RP7996
11720533	RP7038
IVECO	RPOWER
4775705	RP0338
4776085	RP0338
4832279	RP0338
4849601	RP0338
99444499	RP7038
99450392	RP7038
99450396	RP0338
99450396	RP0338
500314583	RP0338
KHD	RPOWER
1161134	RP0338
1161135	RP0504
KHD	RPOWER
1161636	RP0338
1161637	RP0504
1173889	RP7038
1174299	RP0338
1174599	RP0344
8122180	RP0504
8122193	RP0338
1179031EC	RP0338
1179702ED	RP0338
1179703ED	RP0338
B12VH7632	RP0338
B24VH7632	RP0504
C12VH7632	RP0338
C24VH7632	RP0344
LANCIA	RPOWER
4775705	RP0338
4776085	RP0338
8122180	RP0504
8122193	RP0338
LUCAS	RPOWER
1854010	RP0720
1854030	RP0644
1854040	RP0614
1854050	RP0400

1854060	RP0402
1854070	RP0722
1854080	RP0724
1854090	RP0432
1854101	RP0726
1854102	RP0430
1854103	RP0728
1854104	RP0730
1854105	RP0736
1854106	RP0734
1854109	RP0434
1854111	RP0622
1854112	RP0644
1854115	RP0432
1854120	RP0430
1854123	RP07070
1854124	RP0804
1854125	RP0800
1854126	RP0806
MAN	RPOWER
5126030019	RP0504
51268030008	RP0504
51268030015	RP0504
51268030019	RP0504
51268030021	RP0504
51268030022	RP0504
51268030034	RP0338
51268030034	RP0338
81259230001	RP0344
A5000041358	RP0400
MARELLI	RPOWER
CTZ1U	RP0726
CTZ2U	RP0730
CTZ3U	RP0728







Le descrizioni non sono vincolanti. L'Azienda si riserva di apportare tutte le modifiche che saranno ritenute necessarie.

Due to outgoing product changes, updated test results or new industry standards, this information may change over time.

Les descriptions ne sont pas contraignantes.

La société se réserve le droit d'apporter les modifications qui pourraient être nécessaires.

Catalogo Generale Rpower - luglio 2013 - III edizione

Rpower Catalogue - july 2013 - III edition

Rpower Catalogue - juillet 2013 - III édition







Resistor S.r.l. - Via P. Togliatti, 21/23 - Senago (MI)  
Tel. +39 02 990 108 09 - +39 02 990 102 02 - Fax. +39 02 990 105 93  
<http://www.resistor.it> - [info@resistor.it](mailto:info@resistor.it)