

# GROUND ZERO®

GERMAN ENGINEERING

25  
YEARS

---

*Sophisticated car audio since 1995*

2020 / 2021

# GROUND ZERO®

## GERMAN ENGINEERING

---

*Sophisticated car audio since 1995*

---

### **The Rise of the GROUND ZERO Company**

GROUND ZERO has been founded back in 1995 by Karl Felix Lautner distributing car audio products "Made in USA" and introduced the revolutionary subwoofers of GZ Engineering USA to the European market in 1997.

The following years, the German company took over the European trademark rights of "GROUND ZERO" and started developing market specific products.

Finally, 2003 the GROUND ZERO GmbH took over all global trademarks from the discontinued US company and expanded the distribution to customers worldwide.

Today, more than 400 sophisticated audio products developed and designed at the GROUND ZERO in-house engineering department are available in more than 65 countries globally.

### **Ensuring Superior Quality of GROUND ZERO Products**

The GROUND ZERO product range includes speakers, subwoofers, amplifiers and further digital audio equipment for enthusiastic customers. Satisfying high demands and quality, Ground Zero carefully monitors every step of the production starting at the development using top-notch tools and highly accurate measurement equipment such as the laser controlled KLIPPEL® system to optimize every detail.

Precise amplifier measurement equipment by Audio Precision® results in power ratings corresponding to the acknowledged CEA 2006-A standard. Without exceptions, every single product is evaluated by extensive testing and quality control prior to its final production release and market launch.

### **On the Winner's Side with GROUND ZERO**

Many international car audio journals confirm the highest product quality impressing even sophisticated customers. However, the most convincing evidence is provided by the huge amount of GROUND ZERO equipped cars worldwide.

With an outstanding audio performance, they succeed to be part of the winner's circle of European and World SQ and SPL Championships every season.

25 <sup>th</sup> ANNIVERSARY	4
ULTRA	6
REFERENCE	8
PLUTONIUM	12
NUCLEAR	16
URANIUM	20
HYDROGEN	24
RADIOACTIVE	28
TITANIUM	34
IRIDIUM	38
COMPETITION	44
DSP	52
CAR SPECIFIC	56
Damping	62
Accessories	64
MARINE	69
Headphones	70
Product Specifications	71

## 25<sup>th</sup> Anniversary

25 years of sophisticated car audio products

GROUND ZERO was founded in 1995 by Karl Felix Lautner. Initially, car audio products from the US were offered in sales and from 1997, the revolutionary subwoofer from GZ Engineering USA brought to the European market.

The following years, the German company took over the European trademark rights to GROUND ZERO and began developing market-specific products. Finally in 2003, GROUND ZERO GmbH acquired all worldwide registered rights from the US company that had ceased operations. Expanded sales to distributors and customers worldwide started since. Today, more than 400 advanced audio products designed and developed at GROUND ZERO's in-house development department are available in over 65 countries worldwide. To this day, every single loudspeaker, subwoofer or amplifier of GROUND ZERO's current line-up carries parts of the visionary ideas of its company founder and is personally reviewed by him prior to the market launch. Without exception, only if a new development meets its high demands, his signature starts the production.

GZRC 165 Anniversary-25 is a limited-edition loudspeaker system celebrating amazing 25 years of sophisticated car audio products signed by Karl Felix Lautner.

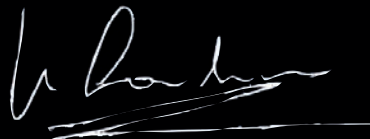
A handwritten signature in white ink, appearing to read 'K. Felix Lautner', with a horizontal line underneath it.

## Model specifications

GZRC 165 ANNIVERSARY-25

*25<sup>th</sup> Anniversary*

- Klippel® optimized midwoofer with black aluminum cone
- Gold colour anodized dust cap
- Nomex spider / rubber surround
- Copper cap for impedance linearizing
- High-efficient 3-ohms impedance
- Resonance-free steel basket with anti-corrosive coating
- Gold-plated terminals
- 28 mm / 1.1" coated silk dome SQ tweeter
- 12 dB / oct. crossover with level adjustment including a high-quality Mundorf® capacitor
- Freq. response 35 – 25000 Hz
- Power handling 130 W RMS / 200 W max
- 25th Anniversary key ring pendant included





Collecting 25 years of experience in developing loudspeakers, subwoofers and amplifiers for highly demanding customers and having launched products to be used at in-car sound quality competitions all over the world, GROUND ZERO started to put all these gathered skills into a very new product line.

The upcoming ULTRA series will set once more a remarkable milestone in car audio. Starting with an amplifier, but completed to a family with loudspeakers in the future, ULTRA series products are created by highly attentive engineers for the most sophisticated customers not willing to accept any compromise in sound quality performance.



Coming soon....

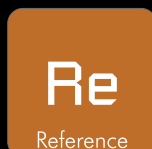

The EISA awarded REFERENCE components obtain the highest attention and care during a long lasting development. Without any compromise, each component is selected from the best ones available on the market. Highest production quality and the most accurate supervision of every single part ensure not less than perfect performance, ultimate sound quality and workmanship for the highest demanding customer. Emphasizing the high-end status of the REFERENCE products, each amplifier, speaker and subwoofer is finally certified by GROUND ZERO's in-house quality department and delivered in a classy, logo-branded wooden box handmade in Germany.



Check our webpage  
for more details and 360° view!



Model specifications

GZPA Reference 4PURE-SQ  
 High End Pure SQ 4-channel amplifier  
 4x 150 / 270 / 425 W @ 4 / 2 / 1 Ω  
 Bridged mode 2x 1000 W max @ 2 Ω  
 Symmetrical dual 2 channel design

Upgraded SQ Version



GZPA Reference 2PURE  
 High End Pure SQ 2-channel amplifier  
 2x 420 / 750 / 1150 W @ 4 / 2 / 1 Ω  
 Bridged mode 1x 2700 W max @ 2 Ω  
 Symmetrical dual mono design



General information

The designation of the REFERENCE 2PURE and REFERENCE 4PURE-SQ amplifiers reveal the essential idea behind: Pure Sound Quality

These two models waive all kind of filters and unnecessary controllers influencing the signal. Removing these parts during the development process leads to a completely new circuit layout with short and direct signal flow from the input sockets to the speaker terminals.

The components used for these master pieces of analog amplification technology have been selected with highest care opposing any compromises and have even been engineered exclusively for the REFERENCE PURE models.

The brand-new upgraded 4-channel amplifier called "SQ" has been improved using some latest electrical parts available on the market. These changes allow a new and wider BIAS range setting increasing the ambience of the music reproduction.

The power supply has been separated electrically as well as physically leading to an absolute symmetrical layout of the circuit that is the basis for these real dual mono and dual stereo amplifiers.

The amazing output power of up to 1150 Watts per channel provides another contribution to the unbelievable precise and detailed REFERENCE sound, punchy and dynamic as well as warm and enjoyable.

With highest imaginable quality, these amplifiers are setting benchmarks in each category.

Features:

- High End Sound quality amplifiers
- Variable Bias setting
- Symmetrical design
- Separated L & R Gain control
- No filters – PURE and direct sound
- Rhodium RCA sockets
- Audio optimized ALPS potentiometers
- High End Sanken transistors
- GZ exclusive Mundorf capacitors
- White LED illuminated PCB
- Plexi glas bottom plate



## General information

REFERENCE speakers are designed for demanding high-end music lovers. Accurately hand built in Europe, selected in corresponding pairs and delivered in classy wooden boxes. Midbass and midrange speakers are made from hand-coated, pressed paper cones and hand-spooled copper voice coils, inserted into manually machined aluminum parts of the basket, forming the basis for outstanding high-end sound quality.

The tweeter features a particularly low resonance frequency. The usable wide frequency range of the hand-coated silk dome thus enables astonishingly spatial and precise audio reproduction.



## Model specifications

**GZPT Reference 28EVO**  
High End 28 mm / 1.1" tweeter  
100 W RMS / 150 W max  
1.5 – 30 kHz / FS: 600 Hz  
2 layer hand coated silk dome  
Damped coupled chamber  
Chromed aluminum housing  
Linearized dual neo magnet

 Made in Germany



**GZPM Reference 80**  
High End 80 mm / 3.15" midrange  
80 W RMS / 120 W max  
150 – 6000 Hz / FS: 107.5 Hz  
High flexible Conex spider  
Low loss flat rubber surround  
Hand assembled aluminum basket  
Handmade in Europe



**GZMW Reference 180**  
High End 180 mm / 7.09" midwoofer  
100 W RMS / 150 W max  
40 – 3500 Hz / FS: 56.8 Hz  
High flexible Conex spider  
Low loss flat rubber surround  
Hand assembled aluminum basket  
Handmade in Europe



Model specifications

GZPW Reference 250  
 High End 250 mm / 10" subwoofer  
 500 W RMS / 2x 2 Ω  
 31.3 Hz / Qts 0.50  
 VAS 36.5 L / 1.29 ft³

 Made in Germany

General information

For most accurate bass performance, the unique REFERENCE subwoofer comes with a lot of particular solutions, such as a number of linearization parts added to the magnet system optimizing the impedance and eliminating distortion. This exceptional subwoofer has been optimized to perform in small enclosures.

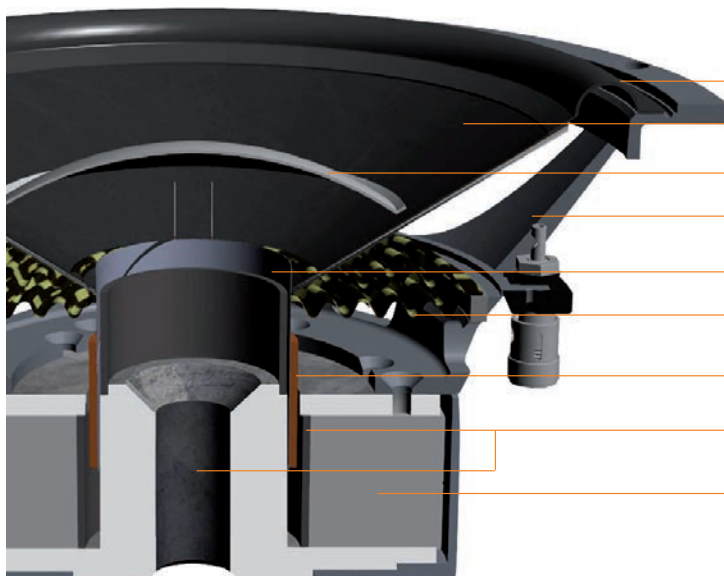

**SURROUND**  
 Light-weight rubber

**CONE**  
 Three layer sandwich  
 (Paper - 2 component foam - paper)

**DUSTCAP**  
 Coated highly pressed paper

**BASKET**  
 Resonance free aluminum cast

**VOICE COIL FORMER**  
 High temperature stable glassfiber

**SPIDER**  
 Double-layer BIMAX®  
 (Polyester - Cotton)

**VOICE COIL**  
 50 mm / 2" copper voice coil

**SHORT CIRCUIT RINGS**  
 Aluminum rings for impedance linearizing  
 and distortion elimination

**MOTOR**  
 Linearized high efficient motor  
 with double ferrite magnet

PI

Plutonium

The products of the PLUTONIUM line are suitable for ultimate sound quality, world record SPL levels or extreme low frequency response. To achieve one of these targets, exceptional materials and technologies are applied during the development.

The technical, electrical and mechanical skills of the resulting products stand out continuously at worldwide SPL and SQ competitions. The neodymium driven subwoofer sets SPL level benchmarks while the SQ amplifiers have been awarded by EISA for best performance representing numerous car audio test magazines from all around the world.



Check our webpage  
for more details and 360° view!

Model specifications

**GZPA 2SQ**  
 High performance SQ 2-channel amplifier  
 2x 175 / 315 / 500 W @ 4 / 2 / 1 Ω  
 Bridged mode 1x 1000 W max @ 2 Ω  
 High-resolution response



**GZPA 4SQ**  
 High performance SQ 4-channel amplifier  
 4x 125 / 225 / 350 W @ 4 / 2 / 1 Ω  
 Bridged mode 2x 700 W max @ 2 Ω  
 High-resolution response



General information

The PLUTONIUM series contains two sound quality amplifiers simply leaving no wishes unfulfilled. The 4-channel version has been awarded by the EISA organization as the world's best in-car amplifier 2018/2019.

- Features:
- Shielded dual power supply
  - High-end sound quality amplifier
  - Discretely constructed MOS-FET amplifier section
  - 1-ohm stable stereo / 2-ohms stable in bridged mode
  - Smoothly variable BIAS adjustment
  - Variable input sensitivity
  - Capsulated potentiometers
  - Wide range high pass and low pass filter
  - Filter range multiplication switch (x10)
  - High resolution frequency range (10 Hz – 50 kHz)
  - Soft start delay
  - Operation and protection indicator
  - Start-Stop capability (9 - 16 Volt)
  - Overheat and short circuit protection
  - Low distortion Burr-Brown OPA2134PA operation amplifiers
  - Exclusively manufactured Mundorf Mcap® capacitors
  - Solid and high-efficient black anodized heatsink
  - White illuminated lasered glass logo plate
  - Winner of the German Design Award 2020 (PA 4SQ)



# PLUTONIUM Speaker systems

## General information

The components of the PLUTONIUM line have been developed for highly sophisticated sound quality requests. The drivers are available as a 2- or 3-way system with no passive crossover for full active applications. Each speaker component is available separately for individual setups, as well.

### Features:

- High-end speakers for SQ enthusiasts
- Made in Germany and selected in pairs
- Resonance free aluminum cast baskets
- High-tech aluminum & ceramic-coated cones
- Impedance linearizing copper caps
- Powerful Klippel® optimized motors
- High-dynamic sound reproduction
- Solid stainless steel tweeter housing



## Model Specifications

**GZPC 165S.3Q-ACT**  
High-end 3-way active system  
Freq. response 30 – 30000 Hz  
Components:  
GZPK 16SQ  
GZPM 80SQX-II  
GZPT 28SQ

Made in Germany



**GZPC 165.2SQ-ACT**  
High-end 2-way active system  
Freq. response 30 – 30000 Hz  
GZPK 16SQ  
GZPT 28SQ

Made in Germany



## PLUTONIUM Speaker components



**GZPT 28SQ**  
High-end 28 mm / 1.1"  
silk dome tweeter  
100 W RMS / 150 W max

Made in Germany



**GZPF 40SQ**  
High-end 40 mm / 1.6"  
full range speaker  
50 W RMS / 80 W max

Made in Germany



**GZPM 80SQX-II**  
High-end 80 mm / 3.15"  
midrange speaker  
70 W RMS / 110 W max

Made in Germany



**GZPK 16SQ**  
High End 165 mm / 6.5"  
midwoofer  
130 W RMS / 210 W max

Made in Germany

## PLUTONIUM SQ Subwoofer

### General information

GROUND ZERO engineers and product designers were concentrated on developing this amazing high-end sound quality subwoofer. Optimized for small sealed enclosures for highest audiophile expectations, this 25 cm / 10" SQ model is now available.

### Features:

- 25 cm / 10" high-end sound quality subwoofer
- Klippel® optimized (for sealed enclosures)
- Anodized aluminum cone and dust cap
- Solid aluminum cast basket
- Rubber surround
- Copper wire voice coil
- Aluminum cast fastening rim/grill included

### Model Specifications

**GZPW 10SQ**  
High-end sound quality subwoofer  
400 W RMS / 2x 2 Ω



Aluminum cast fastening rim and grill included

Model specifications

GZPW 15NEO-SPL  
High power SPL subwoofer  
3000 W RMS / 10000 WSPL / 2x 1 Ω



General information

GROUND ZERO introduced the ultimate SPL subwoofer for competition use with the PLUTONIUM series neodymium-driven top-of-the-line 38 cm / 15" model. Starting from the market release, this subwoofer has set benchmarks in all SPL competitions around the world.

- Features:
- 38 cm / 15" high power SPL subwoofer
  - Multi-piece neodymium motor
  - Klippel® optimized
  - Carbon fiber mixed cone
  - SPL U-shape surround
  - Solid aluminum cast basket
  - 100 mm / 4" flat wire voice coil
  - 4-layer Nomex spider
  - Carbon fiber dust cap

PLUTONIUM XXmax Subwoofer

Model specifications

GZPW 15XXmax  
15" high-power long stroke subwoofer  
6000 W RMS / 2x 1 Ω



General information

The new PLUTONIUM series XXmax subwoofer follows in the footsteps of the legendary GZPW 15XQ setting a new benchmark for cone excursions. Using only components with extremely high-power handling and an even stronger ferrite motor than its Xmax predecessor.

- Features:
- 38 cm / 15" high-power long stroke subwoofer
  - Klippel® optimized
  - Solid Aluminum cone and dust cap
  - Long stroke foam surround
  - Solid aluminum cast basket
  - 100 mm / 4" aluminum flat wire voice coil
  - 4-layer Nomex spider

PLUTONIUM SPL Subwoofer

Model specifications

GZPW 15SPL-D1  
High power SPL subwoofer  
5000 W RMS / 10000 W SPL / 2x 1 Ω

GZPW 15SPL-D2  
High power SPL subwoofer  
5000 W RMS / 10000 W SPL / 2x 2 Ω



General information

The PLUTONIUM SPL subwoofers are probably the most famous GROUND ZERO products. Starting from the market release, the subwoofers have set benchmarks in all SPL competitions around the world and have been awarded for best performance by numerous test magazines. The brand-new models are available with double 2-ohm or 1-ohm voice coils for more flexible subwoofer setups.

- Features:
- 38 cm / 15" high power SPL subwoofer
  - Klippel® optimized ferrite motor
  - Reinforced pressed paper cone & dust cap
  - SPL-shaped high-roll foam surround
  - Solid aluminium cast basket
  - 100 mm / 4" aluminium flat wire voice coil
  - 4-layer Nomex spider
  - Designed for advanced SPL competition



With several particular features of the high-end PLUTONIUM line, the NUCLEAR line contains amazingly sounding speakers, partially "Made in Germany" and a range of extraordinary power capable subwoofers made for high-level audio setups as well as for SPL competition use.



Check our webpage  
for more details and 360° view!



Model specifications

General information



GZNC 165.3SQ-ACT  
High End 3-way active system  
150 W RMS / 250 W max  
40 – 28000 Hz  
Components:  
GZNK 165SQ  
GZNM 80SQ  
GZNT 25SQ  
Speaker grill

 Made in Germany



GZNC 165.2SQ-ACT  
High End 2-way active system  
150 W RMS / 250 W max  
40 – 28000 Hz  
Components:  
GZNK 165SQ  
GZNT 25SQ  
Speaker grill

 Made in Germany



GZNC 1650SQ  
High End 2-way passive system  
150 W RMS / 250 W max  
40 – 28000 Hz / Cut-off 2800 Hz  
Components:  
GZNK 165SQ  
GZNT 25SQ  
High quality crossover  
Speaker grill

 Made in Germany

The NUCLEAR line includes a wide range of speaker components available separately in pairs. There is no limit for an individual speaker setup.

More than that, GROUND ZERO offers some perfectly matching 2-way and 3-way sets for active use and one set for passive applications.

Features:

- High quality speakers for SQ enthusiasts
- Made in Germany (most of the line)
- Selected in matching pairs
- Resonance free aluminum cast baskets
- Lightweight coated paper cones
- Impedance linearizing copper caps
- Powerful Klippel® optimized motors
- Natural sound performance

NUCLEAR Speaker components



GZNT 25SQ  
High quality tweeter  
25 mm / 1"  
80 W RMS / 130 W max

 Made in Germany



GZNF 50SQ  
High quality full range  
50 mm / 2"  
50 W RMS / 80 W max



GZNM 80SQ  
High quality midrange  
80 mm / 3.15"  
60 W RMS / 100 W max

 Made in Germany



GZNK 165SQ  
High End midwoofer  
165 mm / 6.5"  
130 W RMS / 200 W max

 Made in Germany

## NUCLEAR SPL Subwoofer

### General information

Taking the time to launch a worthy successor for the legendary NUCLEAR SPL subwoofers, GROUND ZERO developed two extraordinary power capable models with huge SPL output for daily use and SPL competition purpose. This new model is available in a double 2-ohms and a double 1-ohm version.

#### Features:

- High-power SPL subwoofer
- Klippel® optimized
- Reinforced paper cone and dust cap
- Long stroke foam surround
- Solid aluminum cast basket
- 75 mm / 3" aluminum wire voice coil
- 4-layer Nomex spider

### Model specifications

**GZNW 30SPL-D1**  
High power SPL subwoofer  
3000 W RMS / 6000 W SPL / 2x 1 Ω

**GZNW 30SPL-D2**  
High power SPL subwoofer  
3000 W RMS / 6000 W SPL / 2x 2 Ω



**GZNW 38SPL-D1**  
High power SPL subwoofer  
3500 W RMS / 7000 W SPL / 2x 1 Ω

**GZNW 38SPL-D2**  
High power SPL subwoofer  
3500 W RMS / 7000 W SPL / 2x 2 Ω



## NUCLEAR NEO SPL Subwoofer

### General information

Using carbon fiber instead of pressed paper increases the maximum amount of power usable for the EXTREME version of the NUCLEAR NEO-SPL subwoofer.

#### Features:

- 38 cm / 15" high power SPL subwoofer
- Multi-piece neodymium motor
- Klippel® optimized
- U-shape high roll SPL surround
- Solid aluminum cast basket
- 75 mm / 3" 8-layer aluminum voice coil
- 3-layer Nomex spider

### Model specifications

**GZNW 38NEO-SPL**  
High power SPL subwoofer  
Reinforced pressed paper cone  
2500 W RMS / 5000 W SPL / 2x 1 Ω

**GZNW 38NEO-EXTREME**  
High power SPL subwoofer  
Coated carbon-fiber cone  
3000 W RMS / 6000 W SPL / 2x 1 Ω



Model specifications

General information



GZNW 12SPL-Xflex  
High performance SPL subwoofer  
2500 W RMS / 4500 W SPL / 2x 1 Ω

GZNW 15SPL-Xflex  
High performance SPL subwoofer  
3000 W RMS / 5500 W SPL / 2x 1 Ω

GZNW 18SPL-Xflex  
High performance SPL subwoofer  
3000 W RMS / 6500 W SPL / 2x 1 Ω

Paired with the yellow colored surround stitch and an ultra-solid as well as perfectly ventilated aluminum cast basket, the SPL-Xflex subwoofers with powerful ferrite motor are predestined for high level audio setups. The particular Xflex high roll surround combines high excursion capability with flexibility for low frequency music reproduction.

Features:

- High performance SPL music subwoofer
- Klippel® optimized
- Reinforced paper cone
- SPL high-roll Xflex surround
- Solid aluminum cast basket
- 75 mm / 3" CCA round wire voice coil
- 4-layer progressive spider
- IMPP dust cap with 3D structure logo

NUCLEAR Xmax subwoofers

Model specifications

General information



GZNW 12Xmax  
High performance long stroke subwoofer  
3000 W RMS / 2x 1 Ω

GZNW 15Xmax  
High performance long stroke subwoofer  
4000 W RMS / 2x 1 Ω

The NUCLEAR line Xmax subwoofers share some of the features of the PLUTONIUM series top subwoofer and expand the line of high excursion models providing excellent low bass performance.

Features:

- High power low bass subwoofers
- Klippel® optimized
- Aluminum cone and dust cap
- Long stroke compound surround
- Solid aluminum cast basket
- 75 mm/ 3" CCA round wire voice coil
- 4-layer Nomex spider

Ur

Uranium

Each product of the URANIUM line-up has been developed carefully to fulfill the demands of music enthusiasts with high audiophile expectations at a reasonable price level.

Applying all of Ground Zero's sound quality competition experience while tuning the product details carefully, results in emotional and amazing audio reproduction. The distinguished amplifiers point out the main purpose by their designation: SQ beyond the average!



Check our webpage  
for more details and 360° view!

Model specifications

**GZUA 2.250SQ-PLUS**  
 Sound quality 2-channel amplifier  
 2x 180 / 320 / 500 W @ 4 / 2 / 1 Ω  
 Bridged mode 1x 1200 W max @ 2 Ω  
 Bass remote control included



**GZUA 4.150SQ-PLUS**  
 Sound quality 4-channel amplifier  
 4x 110 / 190 W @ 4 / 2 Ω  
 Bridged mode 2x 460 W max @ 4 Ω



**GZUA 6.200SQ-PLUS**  
 Sound quality 6-channel amplifier  
 4x 110 / 160 W Channel 1-4 @ 4 / 2 Ω  
 2x 160 / 280 W Channel 5-6 @ 4 / 2 Ω  
 2x 320 W Channel 1-4 @ 4 Ω bridged mode  
 1x 560 W Channel 5-6 @ 4 Ω bridged mode



General information

The distinguished URANIUM SQ amplifiers point out the main purpose by their designation. Particular features like the unique variable BIAS setting increase the sound quality to the next level while highly accurate and variable wide band filters allow various combinations of full active speaker setups.

Features:

- Sound quality amplifiers
- Variable BIAS setting
- Class A/B technology
- Variable active crossover
- Stable power supply
- Gold-plated connectors
- Flat heatsink with engraved Ground Zero lettering

**Variable BIAS setting**

The BIAS setting affects the operation mode of the amplifier.

It is continuously adjustable from <MIN> (actual Class A/B mode) to <MAX> (close to Class A mode).

An amplifier in Class A mode sounds warm and creates a pleasant atmosphere. Compared to that, the Class A/B mode of an amplifier sounds more direct and dynamic. Depending on the BIAS setting, the current consumption of the amplifier is growing the closer the operation comes to the Class A mode leading to an increased temperature. The power rating however, remains identical.

The BIAS can be set using the control on the bottom of the amplifier for each pair of channels, independently.

## General information

Using particular materials for cones and running hours of accurate tuning during the development, these speakers provide an amazing sound quality performance.

Apart from the separately available components, GROUND ZERO offers some models compiled to high quality passive speaker systems.

### Features:

- High-tech speakers for ambitious SQ-applications
- GZ design aluminum cast basket
- High-efficient neodymium motor
- Black aluminum cone
- Rubber surround
- 28 mm / 1.1" coated silk dome tweeter
- 55 mm / 2.17" silk dome midrange (3-way only)
- Variable 12 dB/oct crossover
- Linearized, Klippel® optimized ferrite motors
- Hexagon style protection grill



**GZTH 25-28B**

Optional tweeter housing for GZUT 28SQ

### GZUC 650SQ-II Features:

- Speaker system for SQ-applications
- Resonance free aluminum cast basket
- WFVC® cone with woven wooden fibre
- Rubber surround
- Variable 12 dB/oct crossover
- Linearized, Klippel® optimized ferrite motor
- Protection grill

## Model specifications

**GZUC 165.3SQ**  
Sound quality 3-way component speaker system  
160 W RMS / 250 W max  
Freq. response 40 – 25000 Hz

**GZUC 165.3SQ-ACT**  
Sound quality 3-way active component speaker system  
Freq. response 40 – 25000 Hz  
Components:  
GZUK 165SQ  
GZUM 55SQ  
GZUT 28SQ

**GZUC 165.2SQ**  
Sound quality 2-way component speaker system  
140 W RMS / 230 W max  
Freq. response 40 – 25000 Hz

**GZUC 165.2SQ-ACT**  
Sound quality 2-way active component speaker system  
Freq. response 40 – 25000 Hz  
Components:  
GZUK 165SQ  
GZUT 28SQ

**GZUC 650SQ-II**  
Sound quality 2-way component speaker system  
130 W RMS / 210 W max  
Freq. response 40 – 24000 Hz



## URANIUM SQ Speaker components



**GZUT 28SQ**  
SQ 28 mm / 1.1" silk dome tweeter  
50 W RMS / 80 W max  
Freq. response 300 – 25000 Hz



**GZUM 55SQ**  
SQ 55 mm / 2.17" silk dome midrange  
90 W RMS / 150 W max  
Freq. response 600 – 16000 Hz



**GZUF 60SQX**  
SQ 60 mm / 2.36" full range speaker  
50 W RMS / 80 W max  
Freq. response 300 – 20000 Hz



**GZUM 80SQ**  
SQ 80 mm / 3.15" midrange  
50 W RMS / 80 W max  
Freq. response 160 – 4000 Hz



**GZUX 165.3SQ**  
SQ 3-way passive crossover (1 pair)



**GZUK 165SQ**  
SQ 165 mm / 6.5" midwoofer  
120 W RMS / 180 W max  
Freq. response 40 – 3500 Hz

Model specifications

General information



GZUW 8SQX  
Sound quality subwoofer  
300 W RMS / 2x 2 Ω



GZUW 10SQX\*  
Sound quality subwoofer  
450 W RMS / 2x 2 Ω  
\*Improved Q version



GZUW 12SQX  
Sound quality subwoofer  
600 W RMS / 2x 2 Ω

High-performance SQ speaker setups require equivalent low frequency extension. The URANIUM line of SQX subwoofers match perfectly and offer various options for individually calculated custom enclosures.

Features:

- Sound quality subwoofer
- Klippel® optimized
- Scooped and pressed paper cone
- U-shape foam surround
- Solid aluminum cast basket
- 50 mm / 2" copper voice coil
- Audiophile Polycot spider
- Reinforced paper dust cap

Optional accessories:  
GZPG 250G  
Aluminum cast fastening rim and grill for GZUW 10SQX

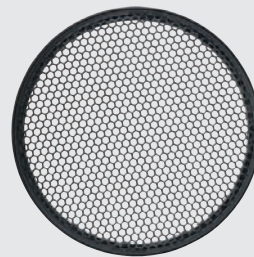

URANIUM Active subwoofers

Model specifications

General information



GZUB 800XACTII  
Flat active subwoofer  
20 cm / 8" woofer  
Triple voice coil  
120 W RMS / 180 W max



GZUB 1000XACTII  
Flat active subwoofer  
25 cm / 10" woofer  
Triple voice coil  
150 W RMS / 210 W max

Fulfilling the customer's desire for lower frequency response and compact bass upgrades, GROUND ZERO offers two aluminum cast active subwoofers. Each of these active under-seat subwoofers comes with a very flat housing, enabling the installer to find a place even at the most limited space.

Features:

- High-quality active flat subwoofer
- High-power integrated amplifier
- Solid aluminum cast housing
- High-level input
- Automatic turn-on function
- Low pass filter
- Phase correction
- Incl. wired remote control & wiring kit

Bass remote included





The HYDROGEN line satisfies all demands of highly sophisticated customers. Amazing performance, great sound quality and much higher SPL than imagined. The subwoofers have been developed to handle a huge amount of input power reaching extremely high bass levels to be used successfully under competition conditions. The line of MINI class D amplifiers contains a matching model for each application purpose, even for 24 V truck use.



Check our webpage  
for more details and 360° view!



## Model Specifications

## General information



**GZHA MINI ONE**  
Compact mono subwoofer amplifier  
220 / 390 / 630 W @ 4 / 2 / 1 Ω  
Link mode 1500 W max @ 2 Ω



**GZHA MINI ONE-K**  
Compact mono subwoofer amplifier  
1x 340/600/1000 W RMS @ 4 / 2 / 1 Ω  
Link mode 2300 W max @ 2 Ω

**GZHA MINI ONE-K 24V**  
24 V power supply



Especially for limited installation space, GROUND ZERO offers the compact sized HYDROGEN MINI full-range class D amplifiers. Meeting all requirements, a 2-channel, a 4-channel and a 5-channel model is available in a small-sized black-anodized heatsink. Two mono amplifiers deliver a bunch of power for subwoofers, while another mono amplifier and a 4-channel version are offered for 24 V applications.

### Features:

- Compact sized amplifiers
- High-efficient class D technology
- SMD components
- Variable active crossover
- Bass boost & phase shift (not GZHA MINI FIVE)
- Stabilized power supply
- Large terminals
- Solid heatsink with engraved GZ lettering
- High-level input with auto-on function (suitable for impedance controlling OEM head units, e.g. latest Volkswagen models)
- Link mode for two amplifiers (MINI ONE / ONE-K)

- Bass remote control included (not for GZHA MINI FOUR)



**GZHA MINI TWO\***  
Compact 2-channel full-range amplifier  
2x 130/230 W RMS @ 4 / 2 Ω  
Bridged mode 1x 550 W max @ 4 Ω  
\*SQ upgrade version



**GZHA MINI FOUR\***  
Compact 4-channel full-range amplifier  
4x 80/130 W RMS @ 4 / 2 Ω  
Bridge mode 2x 320 W max @ 4 Ω  
\*SQ upgrade version

**GZHA MINI FOUR-24V**  
24 V power supply



**GZHA MINI FIVE\***  
Compact 5-channel full-range amplifier  
4x 75/125/- & 1x 190/320/500 W RMS @ 4 / 2 / 1 Ω  
\*SQ upgrade version

## \*Upgraded SQ Version

The SQ upgrade stage contains not only the latest high-level input circuit, but indicates that a number of electronic parts influencing the sound quality have been changed to enhance the overall performance. Each full range amplifier received the SQ upgrade.

## General information

The HYDROGEN SPL subwoofer line-up contains a great variety of models in many different sizes for various demands. Massive aluminum cast baskets and a lot of further technologies enhance the reachable SPL level. Apart from the smallest member of the family, each model is available in D1 or D2 voice coil version for a more flexible amplifier setup.

### Features:

- High power SPL subwoofers
- Fiber reinforced paper cone
- High excursion foam surround
- High temperature copper voice coils
- Progressive 2-layer spiders
- Massive aluminum cast basket
- Powerful street bass and SPL performance

## Model specifications



**GZHW 16SPL**  
High quality SPL subwoofer  
1000 W SPL / 2x 2 Ω  
50 mm / 2" voice coil

● Also available in green color



**GZHW 20XSPL-D1**  
High quality SPL subwoofer  
1500 W SPL / 2x 1 Ω

**GZHW 20XSPL-D2**  
High quality SPL subwoofer  
1500 W SPL / 2x 2 Ω



**GZHW 25XSPL-D1**  
High quality SPL subwoofer  
2500 W SPL / 2x 1 Ω

**GZHW 25XSPL-D2**  
High quality SPL subwoofer  
2500 W SPL / 2x 2 Ω



Model specifications

General information

The HYDROGEN SPL subwoofer line-up contains a great variety of models in many different sizes for various demands. Massive aluminum cast baskets and a lot of further technologies enhance the reachable SPL level. Apart from the smallest member of the family, each model is available in D1 or D2 voice coil version for a more flexible amplifier setup.

Features:

- High power SPL subwoofers
- Fiber reinforced paper cone
- High excursion foam surround
- High temperature copper voice coils
- Progressive 2-layer spiders
- Massive aluminum cast basket
- Powerful street bass and SPL performance



GZHW 30XSPL-D1  
High quality SPL subwoofer  
3000 W SPL / 2x 1 Ω

● Also available in green color

GZHW 30XSPL-D2  
High quality SPL subwoofer  
3000 W SPL / 2x 2 Ω



GZHW 38XSPL-D1  
High quality SPL subwoofer  
3500 W SPL / 2x 1 Ω

GZHW 38XSPL-D2  
High quality SPL subwoofer  
3500 W SPL / 2x 2 Ω





The RADIOACTIVE line offers a wider range of exceptional high-efficient loudspeakers and subwoofers for daily use but ready for SQ and SPL competition, as well.

During the development GROUND ZERO focused especially on natural and dynamical audio reproduction of digitally compressed music. Two brand new powerful class D amplifiers expand the RADIOACTIVE series in addition to the MICRO models suitable for applications where space is very limited.



Check our webpage  
for more details and 360° view!

## Model specifications

**GZRA 2HD**  
Compact 2-channel class D amplifier  
2x 300/500 W RMS @ 4 / 2 Ω  
Bridge mode 1x 1000 W RMS @ 4 Ω  
Bass remote control optional



**GZRA 4HD**  
Compact 4-channel class D amplifier  
4x 170/250 W RMS @ 4 / 2 Ω  
Bridge mode 2x 500 W RMS @ 4 Ω



## General information

The brand-new class D RADIOACTIVE HD amplifiers deliver a lot of power with amazing sound quality and an extraordinary frequency range for actual high-resolution music reproduction.

### Features:

- Space-saving high-efficient amplifiers
- High-level input with auto-on function
- Wide band low pass filter
- Wide band high pass filter
- Variable bass boost
- Solid black anodized aluminum heatsinks
- Protection circuit

**GZTA Bassremote**  
Optional remote control for GZRA 2HD



# RADIOACTIVE MICRO Amplifiers

## Model specifications

**GZRA MICRO ONE**  
Compact mono class D amplifier  
220 / 350 W @ 4 / 2 Ω



**GZRA MICRO FOUR**  
Compact 4-channel class D amplifier  
4x 60 / 100 @ 4 / 2 Ω  
Bridged mode 2 x 250 W max @ 4 Ω



Optionally available:  
**GZCS 4.0BMW-CONNECT**  
Car specific harness suitable for BMW  
**GZCS MB-CONNECT**  
Car specific harness suitable for Mercedes-Benz

## General information

In a modern car environment, the installation space for an audio system could be very limited. For this reason, the RADIOACTIVE line includes the smallest amplifiers GROUND ZERO ever built. The GZRA MICRO series amplifiers allow space-saving installation and offer all necessary filters for the sound setup.

### Features:

- Extremely compact amplifiers
- High-efficient class D technology
- 2 ohms stable SMD circuit
- Wide band crossover filters
- High-level inputs
- Automatic turn-on function



## General information

The RADIOACTIVE SQ speaker systems have been developed for highly demanding listeners. Containing coated silk dome tweeters and high-grade passive crossovers with various options, the passive sets are available as a 2- or 3-way package.

### Features:

- High-dynamic SQ speakers
- Black anodized aluminum cone for high precision
- Klippel® optimized ferrite motor
- Coated silk dome tweeter
- 12 dB/oct high-grade crossover
- 6/12 dB/oct crossover (IV version)
- High-efficient 3-ohm impedance
- Linearizing copper cap
- Hexagon style protection grill
- Detailed and natural music reproduction



**GZTH 25-28B**

Optional tweeter housing for GZRT 25SQ

## Model specifications

### GZRC 165.3SQ

High-dynamic 3-way component speaker system  
160 W RMS / 250 W max



### GZRC 165.3SQ-ACT

High-dynamic 3-way active component speaker system

Components:  
GZRK 165SQ  
GZRM 80SQ  
GZRT 25SQ

### GZRC 165.2SQ

High-dynamic 2-way component speaker system  
120 W RMS / 190 W max



### GZRC 165.2SQ-ACT

High-dynamic 2-way active component speaker system

Components:  
GZRK 165SQ  
GZRT 25SQ

### GZRC 165SQ-IV

High-dynamic 2-way component speaker system  
Installer version  
120 W RMS / 190 W max  
Tweeter housing included



## RADIOACTIVE Speaker components



### GZRT 25SQ

Sound-quality silk dome tweeter  
70 W RMS / 110 W max  
Freq. response 3 – 25 kHz



### GZRM 80SQ

Sound-quality midrange  
50 W RMS / 80 W max  
Freq. response 160 – 4000 Hz



### GZRK 165SQ

High-dynamic midwoofer  
110 W RMS / 160 W max  
Freq. response 35 – 4000 Hz

Model specifications

General information



GZRC 100NEO-IV  
High-efficient 2-way flat passive system  
80 W RMS / 120 W max  
Freq. response 80 – 26000 Hz



GZRC 165NEO-IV  
High-efficient 2-way flat passive system  
110 W RMS / 170 W max  
Freq. response 50 – 26000 Hz  
Components:  
GZMW 165X-NEO  
GZRT 25T



GZRC 200NEO-IV  
High-efficient 2-way flat passive system  
120 W RMS / 190 W max  
Freq. response 35 – 26000 Hz

The RADIOACTIVE NEO speaker systems are the right choice when the space is limited. Developed following the market request for dynamical and high-efficient audio reproduction, the flat motor offers a significantly reduced installation depth by using high-effective neodymium magnets.

Features:

- High-dynamic flat speakers
- Low installation depth
- Lightweight coated paper cones for dynamic sound
- Titanium dome tweeter
- 12dB inline-crossover for tweeter and midwoofer
- High-efficient 3 ohm impedance
- Klippel® optimized neodymium motor
- Slant tweeter housing with rubber touch surface finish
- Protection grill
- Detailed and dynamic music reproduction



Tweeter surface housing included

RADIOACTIVE Speaker components



GZMW 165X-NEO  
High-efficient flat midwoofer  
90 W RMS / 140 W max  
Freq. response 50 - 4000 Hz



GZRT 25T  
High-dynamic titanium dome tweeter  
70 W RMS / 110 W max  
Freq. response 3 – 26 kHz

RADIOACTIVE Flat woofer

Model specifications

General information



GZRW 8FL  
High quality 200 mm / 8" flat woofer  
150 W RMS / 250 W max / 1x 2 Ω  
Freq. Response 30 – 600 Hz

Flat neodymium motor  
Fits perfectly for Porsche, Audi and further vehicles

This particular neodymium driven subwoofer can be used when installation space is limited. The specifications of this model are perfect for free-air applications as well as some enclosures.

Features:

- High-strength, extremely flat IMPP Cone
- High-efficient neodymium motor
- Aluminum dust cap
- Copper Voice Coil
- Extremely low installation depth
- Wide band performance
- Powerful in-door and free air kick woofer application

Available accessory  
X-GZRW 8FL Grill



## RADIOACTIVE SQ Coaxial speakers

### General information

The new RADIOACTIVE SQ coaxial speakers satisfy the request for dynamical and high-efficient audio reproduction. Black anodized aluminum cones used for the mid woofers in combination with a new coated silk dome tweeter deliver an amazing sound performance.

#### Features:

- High-dynamic coaxial speakers
- Black anodized aluminum cone
- Rubber surround
- Resonance free steel basket
- High-efficient 3-ohm impedance
- 25 mm / 1" silk dome tweeter (not GZRF 69SQ)
- Mylar midrange and tweeter (GZRF 69SQ)
- Tweeter and overload protection
- Hexagon style protection grill

### Model specifications

#### GZRF 4.0SQ

High-dynamic 2-way coaxial loudspeaker  
70 W RMS / 110 W max  
Freq. response 70 – 24000 Hz



#### GZRF 5.2SQ

High-dynamic 2-way coaxial loudspeaker  
80 W RMS / 120 W max  
Freq. response 60 – 24000 Hz



#### GZRF 6.5Q

High-dynamic 2-way coaxial loudspeaker  
100 W RMS / 140 W max  
Freq. response 50 – 24000 Hz



#### GZRF 69SQ

High-dynamic 3-way coaxial loudspeaker  
130 W RMS / 200 W max  
Freq. response 40 – 24000 Hz



## RADIOACTIVE Subwoofer

### General information

Using most of the particular features previously developed for the SPL subwoofers, the street versions have been equipped with a large long stroke surround and a special spider to reduce the resonance frequency for daily music reproduction.

#### Features:

- Powerful low bass subwoofers
- Fiber reinforced paper cone
- Multilayer foam U-Shape surround
- High temperature copper voice coil
- High excursion single layer spider
- Optimal for daily use

### Model specifications

#### GZRW 30-D2

High-quality subwoofer  
800 W RMS  
2x 2 Ω



#### GZRW 38-D2

High-quality subwoofer  
1000 W RMS  
2x 2 Ω





Model specifications

General information

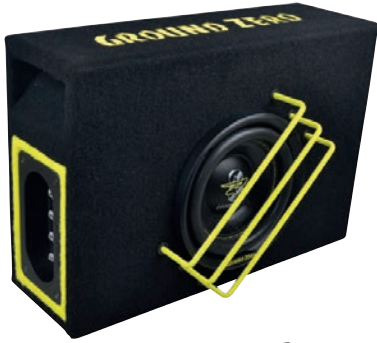

**GZRB 16SPL**  
Space-saving SPL subwoofer  
450 W RMS / 700 W SPL  
2x 2 Ω

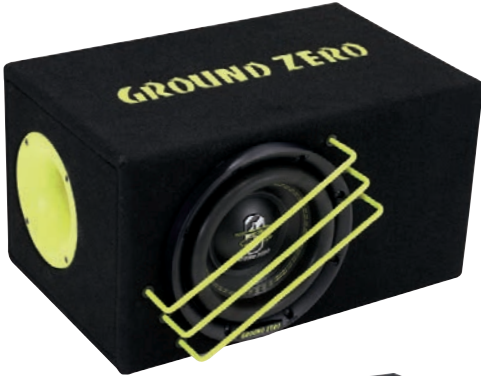

**GZRB 20SPL**  
Space-saving SPL subwoofer  
650 W RMS / 1000 W SPL  
2x 2 Ω



**GZRB 30SPL**  
High-quality SPL subwoofer  
1000 W RMS / 1500 W SPL  
2x 2 Ω

RADIOACTIVE SPL subwoofers include some particular technologies for SPL use at a very reasonable price. The right choice for everyday listening and dedicated SPL competition rookies. The line contains three ready-to-play enclosure subwoofers.

Features:

- High-power SPL subwoofers
- Fiber reinforced paper cone
- Multilayer foam U-Shape SPL surround
- High-temperature voice coils
- Progressive double layer spiders
- Ultimate choice for SPL-Rookies



**GZST 4S**  
4-pin push terminal

RADIOACTIVE SPL Subwoofers

Model specifications

General information

**GZRW 6XSPL**  
High-quality SPL subwoofer  
450 W RMS / 700 W SPL  
2x 2 Ω

**GZRW 10XSPL**  
High-quality SPL subwoofer  
800 W RMS / 1200 W SPL  
2x 2 Ω

**GZRW 12XSPL**  
High-quality SPL subwoofer  
1000 W RMS / 1500 W SPL  
2x 2 Ω

RADIOACTIVE SPL subwoofers include some particular technologies for SPL use at a very reasonable price. The right choice for dedicated SPL competition rookies. The line contains three ready-to-play enclosure subwoofers.

Features:

- High-power SPL subwoofers
- Fiber reinforced paper cone
- Multilayer foam U-Shape SPL surround
- High-temperature voice coils
- Progressive double layer spiders
- Ultimate choice for SPL-Rookies



**GZRW 8XSPL (w/o picture)**  
High-quality SPL subwoofer  
650 W RMS / 1000 W SPL  
2x 2 Ω

**GZRW 15XSPL (w/o picture)**  
High-quality SPL subwoofer  
1200 W RMS / 1800 W SPL  
2x 2 Ω



The products of the TITANIUM line combine premium quality and high efficiency. A wide range of dedicated speakers meet most of the customer's need. The amplifiers are equipped with sophisticated technology and encased by a posh heatsink with brushed black aluminum surface. Flat subwoofer drivers and a ready-to-play flat subwoofer enclosure complete the line.



Check our webpage  
for more details and 360° view!

Model specifications

**GZTA 2255X-B**  
 Powerful 2-channel class AB amplifier  
 2x 150/250 W RMS @ 4 / 2 Ω  
 Bridge mode 1x 600 W max @ 4 Ω



**GZTA 4125X-B**  
 Powerful 4-channel class AB amplifier  
 4x 90/130 W RMS @ 4 / 2 Ω  
 Bridge mode 2x 320 W max @ 4 Ω



**GZTA 4230X-B**  
 Powerful 4-channel class AB amplifier  
 4x 140/230 W RMS @ 4 / 2 Ω  
 Bridge mode 2x 550 W max @ 4 Ω



General information

The products of the TITANIUM line combine premium quality and high efficiency. A wide range of dedicated speakers meet most of the customer's need. The amplifiers are equipped with sophisticated technology and encased by a posh heatsink with brushed black aluminum surface. For an individual design, both black and yellow color side panels are included for each model.

Features:

- High power amplifiers
- Stabilized power supplies
- Variable active crossover
- Subsonic filter
- Bass Boost
- Massive aluminum heatsinks
- High-gloss acrylic glass inlay
- 2 pairs of side panels included (yellow and black color)

**GZTA Bassremote**  
 Optional remote control



## TITANIUM Speaker systems

### General information

The TITANIUM line contains a wide range of component speaker systems with yellow color 3D-HQPP cone. The new 2-way component systems include 20 mm / 0.79" soft dome tweeters and installer friendly crossovers.

#### Features:

- High-efficient component systems
- 3D-HQPP cone
- Rubber surround
- Resonance free steel basket
- High-efficient 3 Ω impedance
- Soft dome tweeter
- Hexagon style protection grill

### Model specifications

#### GZTC 165.3

High-quality 3-way component speaker system  
120 W RMS / 180 W max  
Freq. response 50 – 22000 Hz  
12 dB/oct crossover

#### GZTC 165.3-ACT

High-quality 3-way active component speaker system

#### GZTC 165.2X

High-quality 2-way component speaker system  
100 W RMS / 150 W max  
Freq. response 50 – 20000 Hz  
Compact 12 dB/oct high pass crossover

#### GZTC 130

High-quality 2-way component speaker system  
80 W RMS / 130 W max  
Freq. response 60 – 22000 Hz  
In-line crossover



## TITANIUM Speaker components



#### GZTT 20S

High-quality 20 mm / 0.79" silk dome tweeter  
40 W RMS / 70 W max  
Freq. response 3 - 20 kHz



#### GZTM 100NEO

High-quality neodymium midrange  
40 W RMS / 60 W max  
Freq. response 250 - 7000 Hz

## TITANIUM Active subwoofer

### General information

Fulfilling the customer's desire for lower frequency response and compact bass upgrades, GROUND ZERO offers an affordable active subwoofer in the TITANIUM line with a plastic-injection housing.

This under-seat subwoofer comes with a flat housing, enabling the installer to find a place even at the most limited space.

### Model specifications

#### GZTB 20ACT

Flat active subwoofer  
20 cm / 8" woofer  
100 W RMS / 160 W max  
Plastic injection enclosure



Bass remote included

Model specifications

General information



**GZTF 10**  
High-quality 2-way coaxial speaker system  
70 W RMS / 100 W max

**GZTF 13**  
High-quality 2-way coaxial speaker system  
80 W RMS / 110 W max

**GZTF 16**  
High-quality 2-way coaxial speaker system  
90 W RMS / 130 W max

**GZTF 69**  
High-quality 3-way coaxial speaker system  
130 W RMS / 190 W max

High-efficiency coaxial speakers of the TITANIUM line offer a great value sound upgrade for OEM or aftermarket head units with the significant yellow 3D-HQPP cone.

- Features:
- High-efficient coaxial speakers
  - 3D-HQPP cone
  - Rubber surround
  - Resonance free steel basket
  - High-efficient 3 Ω impedance
  - 13 mm / 0.51" Mylar tweeter
  - 55 mm / 2.2" Mylar midrange (GZTF 69)
  - Protection grill included

TITANIUM Flat subwoofers

Model specifications

General information

**GZTW 10F\***  
High-quality flat subwoofer  
300 W RMS / 2x 2 Ω

**\*Improved Q Version**  
Developed for high SQ in small, sealed enclosures

**GZTW 12F**  
High quality flat subwoofer  
350 W RMS / 2x 2 Ω



When space is limited, special solutions are required. That's why GROUND ZERO's offers two particularly flat subwoofers in the TITANIUM line.

- Features:
- Extremely flat IMPP cone
  - Resonance free steel basket
  - Aluminum dustcap
  - Push terminal

TITANIUM Passive enclosure

Model specifications

General information



**GZTB 120F**  
High quality extra flat subwoofer enclosure

The sealed enclosure is equipped with the flat TITANIUM 30 cm / 12" subwoofer, fits perfectly for trunk installations with through-loading system and requires just a modest amount of space.

- Features:
- 12" subwoofer with high-strength IMPP cone
  - 350 W RMS / 2 x 2 Ω
  - Sealed MDF-Enclosure
  - Push terminals



Representing the entry level of GROUND ZERO, the IRIDIUM line offers a lot of useful features and an amazing performance. The range contains a variety of affordable amplifiers, speakers and subwoofers for the daily use and for SPL purpose. These are available as single drivers for custom-built applications as well as in loaded passive and active enclosures.



Check our webpage  
for more details and 360° view!

## Model specifications

## General information



GZIA 1.600HPX-II  
High quality full range class AB amplifier  
230 / 400 / 600 W @ 4 / 2 / 1  $\Omega$   
Bass remote control included



GZIA 1.1000DXII  
High quality mono class D amplifier  
350 / 650 / 1000 W @ 4 / 2 / 1  $\Omega$   
Bass remote control included



GZIA 1.1450DXII  
High quality mono class D amplifier  
400 / 750 / 1250 W @ 4 / 2 / 1  $\Omega$   
Bass remote control included



GZIA 2080HPX-II  
High quality 2-channel class AB amplifier  
2x 60 / 80 @ 4 / 2  $\Omega$   
Bridged mode 240 W max @ 4  $\Omega$



GZIA 2130HPX-II  
High quality 2-channel class AB amplifier  
2x 85 / 130 @ 4 / 2  $\Omega$   
Bridged mode 320 W max @ 4  $\Omega$   
Bass remote control optional



GZIA 2235HPX-II  
High quality 2-channel class AB amplifier  
2x 150 / 235 @ 4 / 2  $\Omega$   
Bridged mode 540 W max @ 4  $\Omega$   
Bass remote control optional



GZIA 4115HPX-II  
High quality 4-channel class AB amplifier  
4x 70 / 115 @ 4 / 2  $\Omega$   
Bridged mode 2x 250 Wmax @ 4  $\Omega$

The range of amplifiers contains a variety of affordable models for the daily use and for SPL purpose. The feature list includes the most important functions like high-level input with auto turn-on or a remote control for the low impedance stable mono amplifiers.

## Features:

- 4  $\Omega$  / 2  $\Omega$  stable stereo
- 1  $\Omega$  stable (mono amplifiers)
- Power & Protection indicator
- Bass Boost (mono amplifiers)
- Variable active crossover
- High level input with Auto-on
- Adjustable input sensitivity
- Soft delayed remote turn-on
- Thermal / Short / Overload protection



GZTA Bassremote  
Optional remote control

## IRIDIUM Speaker systems



**GZIC 13X**  
High quality 2-way passive system  
90 W RMS / 140 W max  
Freq. response 60 – 20000 Hz  
19 mm / 0.75" softdome tweeter



**GZIC 16X**  
High quality 2-way passive system  
100 W RMS / 150 W max  
Freq. response 50 – 20000 Hz  
19 mm / 0.75" softdome tweeter



**GZIC 400FX**  
High quality 2-way flat passive system  
60 W RMS / 100 W max  
Freq. response 70 – 20000 Hz  
19 mm / 0.75" softdome tweeter



**GZIC 650FX**  
High quality 2-way flat passive system  
100 W RMS / 140 W max  
Freq. response 50 – 20000 Hz  
19 mm / 0.75" softdome tweeter

## IRIDIUM Coaxial speakers



**GZIF 40X**  
High quality 2-way coaxial speaker  
60 W RMS / 100 W max  
Freq. response 80 – 20000 Hz  
13 mm / 1" Mylar tweeter



**GZIF 52X**  
High quality 2-way coaxial speaker  
70 W RMS / 110 W max  
Freq. response 60 – 20000 Hz  
13 mm / 0.51" Mylar tweeter



**GZIF 65X**  
High quality 2-way coaxial speaker  
80 W RMS / 120 W max  
Freq. response 50 – 20000 Hz  
13 mm / 1" Mylar tweeter



**GZIF 69X**  
High quality 3-way coaxial speaker  
120 W RMS / 180 W max  
Freq. response 40 – 20000 Hz  
13 mm / 0.51" Mylar tweeter  
50 mm / 2" Mylar midrange



**GZIF 4001FX**  
High quality 2-way flat coaxial speaker  
50 W RMS / 90 W max  
Freq. response 80 – 20000 Hz  
13 mm / 0.51" Mylar tweeter



**GZIF 5201FX**  
High quality 2-way flat coaxial speaker  
60 W RMS / 100 W max  
Freq. response 70 – 20000 Hz  
13 mm / 0.51" Mylar tweeter



**GZIF 6501FX**  
High quality 2-way flat coaxial speaker  
70 W RMS / 110 W max  
Freq. response 60 – 20000 Hz  
13 mm / 0.51" Mylar tweeter

## Tweeters



**GZHT 25X**  
High quality 25 mm / 1" tweeter  
60 W RMS / 100 W max  
3 – 20 kHz / FS: 1600 Hz  
Coated silk dome  
Ferrofluid cooling



Model specifications

General information



GZIW 10SPL  
High power SPL subwoofer  
700 W SPL / 2x 2 Ω



GZIW 12SPL  
High power SPL subwoofer  
1000 W SPL / 2x 2 Ω



Available in yellow, green or pink color

The IRIDIUM line contains a 25 cm / 10" and a 30 cm / 12" SPL model. The larger version is available in pink or in green color as a special edition to fit the individual needs of our customers perfectly.



IRIDIUM Street Subwoofers

Model specifications

General information



GZIW 165X-II  
High-quality subwoofer  
150 W RMS / 4 Ω



GZIW 200X-II  
High quality subwoofer  
150 W RMS / 4 Ω



GZIW 250X-II  
High quality subwoofer  
250 W RMS / 4 Ω



GZIW 300X-II  
High quality subwoofer  
350 W RMS / 4 Ω

The IRIDIUM street subwoofers with a single 4 ohm voice coil, long stroke rubber surround and IMPP cone are perfect for daily use.

- Features:
- Stable IMPP cone
  - U-shape rubber surround
  - High power copper voice coil
  - Audiophile PC spider
  - Push terminal
  - Woven-in lead wires
  - Resonance free steel basket
  - 3D dustcap logo
  - Rubber gasket

## General information

A subwoofer can cover all demands on low frequency reproduction in a suitable housing. The IRIDIUM series offers a wide selection of passive models as well as some active versions.

### Features:

- Solid enclosure from MDF wood
- Logo embroidery
- Flow optimized bass tunnel (ventilation)
- Push terminal
- Stable IMPP cone
- Rubber surround
- High power copper voice coil
- Audiophile PC spider
- Woven-in lead wires
- Resonance free steel basket
- 3D dustcap logo
- Plastic injection gasket with logo

ACT Version  
with integrated amplifier



## Quick release power connector

### ACT Models:

- Powerful active subwoofer
- Class AB MOSFET amplifier
- Adjustable bass boost
- Phase shift option (phase switch)
- Low pass filter (30 - 120 Hz)
- High level input with auto-on function
- Quick release power connector
- Remote control connector\*

\*Remote control available separately



GZTA Bassremote  
Optional remote control for ACT models

## Model specifications

**GZIB 200XBR**  
High-quality vented subwoofer enclosure  
150 W RMS / 4 Ω



**GZIB 200XBR-ACT**  
High-quality vented active subwoofer enclosure  
120 W RMS / 220 W max

**GZIB 250XBR**  
High-quality vented subwoofer enclosure  
250 W RMS / 4 Ω



**GZIB 250XBR-ACT**  
High-quality vented active subwoofer enclosure  
150 W RMS / 270 W max

**GZIB 300XBR**  
High-quality vented subwoofer enclosure  
350 W RMS / 4 Ω



**GZIB 300XBR-ACT**  
High-quality vented active subwoofer enclosure  
180 W RMS / 300 W max



**GZIB 2.300XBR**  
High-quality vented subwoofer enclosure  
700 W RMS / 2x 2 Ω

Model specifications

General information



GZIB 3000XSPL  
High-quality SPL subwoofer enclosure  
500 W RMS / 1000 W SPL / 2x 2 Ω

GZIB 2.3000XSPL  
High-quality SPL subwoofer enclosure  
1000 W RMS / 2000 W SPL / 4x 2 Ω



Satisfying the demand for high level sound pressure, GROUND ZERO offers a single and a double 30 cm / 12" SPL subwoofer enclosure.

Features:

- Solid enclosure from MDF wood
- Logo embroidery
- Flow optimized bass tunnel (ventilation)
- Push terminal
- High power SPL subwoofer
- Klippel® optimized
- Reinforced paper cone
- 64 mm / 2.5" copper round wire voice coil
- High-Roll sandwich surround
- Progressive 2-layer spider
- Speaker protection bars



GZST 4S  
4-pin push terminal

IRIDIUM Bass Kit

Model Specifications

Features

GZ BASS KIT 12.300X  
Powerful 30 cm / 12" bass kit  
Mono class AB amplifier

- Powerful 30 cm / 12" bass kit
- Loaded subwoofer enclosure
- 40 Liter / 1.41 ft<sup>3</sup>
- Efficient front aero port
- Mono class AB amplifier
- Output power 300 Watts max
- Bass boost control
- Variable lowpass filter
- High-level input with auto-on function

Also available including wiring kit



Optional wiring kit GZPK 10XLC-II

- 10 mm<sup>2</sup> / 7 AWG power kit
- Twisted RCA cable
- 1.5 m / 4.92 ft 2.5 mm<sup>2</sup> / 13 AWG speaker cable
- Mini ANL fuseholder incl. 60 A fuse
- Remote cable



GZST 2S  
2-pin push terminal



The experience of a real concert atmosphere or club feeling needs professional high SPL levels to be achieved. This however, requires very special and powerful speakers as well as amplifiers. GROUND ZERO's development department doesn't make any compromise, whenever the purpose of the product is that clear. Because of this, a COMPETITION product is the right choice for demanding customers with high SPL level expectations.



Check our webpage  
for more details and 360° view!

Model specifications

General information

GZCA 20.0SPL-M1  
 Mono competition SPL amplifier  
 1x 12000/20000 W RMS @ 2 / 1  $\Omega$   
 Freq. response 10 – 500 Hz

This line of class D competition amplifiers offers a huge amount of output power for any kind of open show or SPL application. At the top end, the COMPETITION line includes one of the most powerful amplifiers in the world – delivering the unbelievable power of 35.000 Watts RMS!



GZCA 20.0SPL-M1

Features:

- 1  $\Omega$  stable subwoofer amplifier
- Power status, clipping and protection LED
- Huge power connector
- Up to 12 dB adjustable bass boost
- Adjustable high pass filter
- Adjustable low pass filter
- 1x Mono RCA input
- 1x Mono RCA output

GZCA 35.0SPL-M1  
 Mono competition SPL amplifier  
 1x 35000 W RMS @ 1  $\Omega$   
 Freq. response 5 – 1000 Hz



GZCA 35.0SPL-M1

Features:

- 1  $\Omega$  stable subwoofer amplifier for competition use
- Link mode option

**PURE COMPETITION**

## COMPETITION Mono SPL amplifiers

### General information

Each of the full-range class D amplifiers offers a huge amount of output power for any kind of open show or SPL application.

Some of the high-efficient amplifiers are available as an M1 or M2 version, delivering the maximum output power accordingly at 1 ohm or at 2 ohms. Customers can select the best matching model for the subwoofer or speaker setup.

### Model specifications

**GZCA 1.5SPL-M1 / M2**  
Mono competition SPL amplifier  
1x 825/1200 W RMS @ 2 / 1 Ω (M1) / @ 4 / 2 Ω (M2)  
Freq. response 10 – 20000 Hz

**GZCA 3.0SPL-M1 / M2**  
Mono competition SPL amplifier  
1x 1800/3400 W RMS @ 2 / 1 Ω (M1) / @ 4 / 2 Ω (M2)  
Freq. response 10 – 20000 Hz

**GZCA 5.0SPL-M1 / M2**  
Mono competition SPL amplifier  
1x 2800/5600 W RMS @ 2 / 1 Ω (M1) / @ 4 / 2 Ω (M2)  
Freq. response 10 – 15000 Hz

**GZCA 8.0SPL-M1 / M2**  
Mono competition SPL amplifier  
1x 4480/8960 W RMS @ 2 / 1 Ω (M1) / @ 4 / 2 Ω (M2)  
Freq. response 10 – 15000 Hz

**GZCA 12.0SPL-M1 (IPV)\***  
Mono competition SPL amplifier  
1x 9000/13700 W RMS @ 2 / 1 Ω  
Freq. response 10 – 15000 Hz

\*Improved Power Version

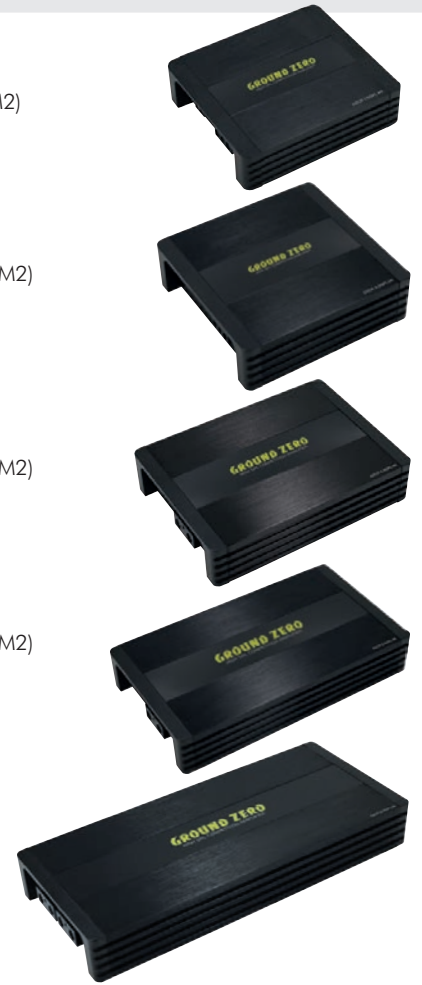

## COMPETITION 2-Channel SPL amplifiers

### General information

Apart from the mono amplifiers, GROUND ZERO offers two full range stereo models with an incredible high output power.

Both high-efficient amplifiers are available as a D1 or D2 version, delivering the maximum output power accordingly at 1 ohm or at 2 ohms. Customers can select the best matching model for the subwoofer or speaker setup.

### Model specifications

**GZCA 750.2-D1 / D2**  
2-channel competition SPL amplifier  
2x 400/750 W RMS @ 2 / 1 Ω (D1) / @ 4 / 2 Ω (D2)  
Freq. response 15 – 20000 Hz

**GZCA 1500.2-D1 / D2**  
2-channel competition SPL amplifier  
2x 900/1500 W RMS @ 2 / 1 Ω (D1) / @ 4 / 2 Ω (D2)  
Freq. response 11 – 20000 Hz



## COMPETITION 4-Channel SPL amplifiers

### General information

When space is limited but a lot of power is needed this small and high-efficient 4-channel amplifier can cover the requirements including an easy-to-set active crossover.

### Model specifications

**GZCA 4.200-4**  
4-channel compact amplifier  
4x 140/250 W RMS @ 4 / 2 Ω (14.4V)  
Freq. response 5 – 20000 Hz



Model specifications

GZCC 165.2SQL  
High-power 2-way SQL speaker system  
160 W RMS / 300 W max  
Freq. response 50 – 22000 Hz

GZCC 165.2SQL-ACT  
High-power 2-way SQL speaker system  
for active application  
Components:  
GZCK 165SPL  
GZCT 25SQL

GZCC 200.2SQL  
High-power 2-way SQL speaker system  
200 W RMS / 380 W max  
Freq. response 50 – 22000 Hz

GZCC 200.2SQL-ACT  
High-power 2-way SQL speaker system  
for active application  
Components:  
GZCK 200SPL  
GZCT 25SQL



General information

For passive applications, GROUND ZERO offers a 165 mm / 6.5" and a 200 mm / 8" 2-way component speaker system. Each passive system contains a crossover with an option to expand the set by another pair of kick woofers for even more fun and SPL.

- Features:
- High power passive speaker system
  - High power crossover (not for ACT version)
  - Double-woofer connecting option
  - Hexagon style protection grill
  - 25 mm / 1" SQL silk dome tweeter

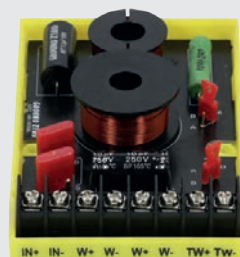

GZCX 165-200.2SQL  
2-way high-power competition crossover  
also available separately

COMPETITION SPL Coaxial speakers

Model specifications

GZCF 6.5SPL  
High-power 2-way SPL coaxial speaker  
100 W RMS / 250 W max  
Freq. response 50 – 20000 Hz

GZCF 8.0SPL  
High-power 2-way SPL coaxial speaker  
150 W RMS / 300 W max  
Freq. response 40 – 20000 Hz

GZCF 7104XSPL  
High-power 4-way SPL coaxial speaker  
200 W RMS / 300 W max  
Freq. response 35 – 25000 Hz



General information

Apart from the tweeters and midrange drivers, the COMPETITION line includes some high-tech full range speakers for extremely loud applications on highest sound quality level.



Hexagon style protection grill included

## COMPETITION PRO Midrange speakers

### General information

The COMPETITION PRO line marks the very top level of electrically and mechanically possible power handling, nowadays. These drivers have been designed especially for long distance open show and demonstration performances at very high SPL level.

### Model specifications

**GZCM 6.5N-PRO**  
High end 165 mm / 6.5" midrange  
200 W RMS / 400 W max  
150 – 12000 Hz / SPL 96 dB  
Neodymium magnet

**GZCM 8.0N-PRO**  
High end 200 mm / 8" midrange  
300 W RMS / 500 W max  
130 – 10000 Hz / SPL 98 dB  
Neodymium magnet



## COMPETITION NEO Midrange speakers

### General information

Using neodymium for the motor of a loudspeaker, increases the efficiency drastically. Subsequently, these new midrange drivers offer amazing high SPL levels with reasonable power input. Black steel baskets reduce the required installation space and fit to pre-designed mounting positions.

### Model specifications

**GZCM 6.5NEO**  
High-efficient SPL midrange  
120 W RMS / 320 W max  
250 – 10000 Hz / SPL 98 dB

**GZCM 8.0NEO**  
High-efficient SPL midrange  
180 W RMS / 420 W max  
170 – 6000 Hz / SPL 100 dB



## COMPETITION Flat midrange speakers

### General information

The FX models have been equipped with very strong ferrite magnets, but still have a quite shallow installation depth matching the need for flat but high-power handling midrange speakers.

### Model specifications

**GZCM 6-4FX**  
High-power flat midrange  
100 W RMS / 300 W max  
200 – 5000 Hz / SPL 94 dB

**GZCM 8-4FX**  
High-power flat midrange  
100 W RMS / 400 W max  
150 – 4000 Hz / SPL 94 dB



## COMPETITION Coaxial speakers

### General information

Coaxial loudspeakers have a major acoustical advantage compared to multi-way component speaker systems. There is hardly any phase deviation of the reproduced music signal between the midrange driver and the tweeter. The speakers can be used in active or passive setups.

### Model specifications

**GZCF 165COAX**  
High-power 2-way coaxial speaker  
125 W RMS / 200 W max  
Freq. response 180 – 25000 Hz

**GZCF 200COAX**  
High-power 2-way coaxial speaker  
150 W RMS / 250 W max  
Freq. response 150 – 25000 Hz





Model specifications

**GZCM 6.5SPL**  
High-power SPL midrange  
100 W RMS / 300 W max  
250 – 10000 Hz / SPL 94 dB

**GZCM 8.0SPL**  
High power SPL midrange  
150 W RMS / 450 W max  
170 – 10000 Hz / SPL 95 dB

**GZCM 10.0SPL**  
High-power SPL midrange  
200 W RMS / 500 W max  
150 – 10000 Hz / SPL 96 dB

General information

A particular customer high-power setup requires midrange speakers capable of handling a huge amount of input power. The line of COMPETITION midrange drivers contains one matching model for each demand.



COMPETITION Mid- / Subwoofer

Model specifications

**GZCK 165XSPL**  
High-power SPL  
mid- / subwoofer  
100 W RMS / 250 W max  
50 – 4000 Hz / SPL 93 dB

**GZCK 200XSPL**  
High-power SPL  
mid- / subwoofer  
150 W RMS / 300 W max  
50 – 6000 Hz / SPL 93 dB

**GZCK 250XSPL**  
High-power SPL  
mid- / subwoofer  
200 W RMS / 400 W max  
40 – 6000 Hz / SPL 94 dB

General information

The COMPETITION PRO line marks the very top level of electrically and mechanically possible power handling, nowadays. These drivers have been designed especially for long distance open show and demonstration performances at very high SPL level.



GZCK 250XSPL-GRILL  
Hexagon style protection grill available separately

COMPETITION SPL Woofer

Model specifications

**GZCW 12.1200-PRO**  
High-end SPL woofer  
800 W RMS / 1200 W max  
60 – 2800 Hz / SPL 96 dB  
100 mm / 4" copper VC

**GZCW 12-75SPL**  
High-power SPL woofer  
400 W RMS / 800 W max  
40 – 3000 Hz / SPL 96 dB  
75 mm / 3" voice coil

**GZCW 12-50**  
High-power woofer  
300 W RMS / 600 W max  
50 – 3000 Hz / SPL 96 dB  
50 mm / 2" voice coil

General information

For each line of COMPETITION drivers, GROUND ZERO offers a matching subwoofer completing a custom speaker setup.



## COMPETITION PRO Tweeters

### General information

The COMPETITION PRO line marks the very top level of electrically and mechanically possible power handling, nowadays. These drivers have been designed especially for long distance open show and demonstration performances at very high SPL level

### Model specifications

**GZCT 19N-PROX B / S**  
High-end compression tweeter  
30 W RMS / 100 W max  
3 – 22 kHz / SPL 109 dB

Available in black or silver finish



## COMPETITION SQL Tweeter

### General information

While the main the purpose of an compression tweeter is delivering a lot of SPL level at high frequencies, this particular tweeter does not only handle a vast amount of input power but combines SQ music reproduction at SPL level. That's called SQL.

### Model specifications

**GZCT 25SQL**  
25 mm / 1" horn SQ tweeter  
100 W RMS / 150 W max  
3 – 22 kHz / SPL 93 dB



## COMPETITION Tweeters

### General information

Most competition grade high efficiency tweeters require a lot of installation space. These two models however, have been designed for applications with limited space like a motorbike.

### Model specifications

**GZCT 0500X**  
High power compression tweeter  
30 W RMS / 100 W max  
4 – 25 kHz / SPL 102 dB



**GZCT 500IV-B**  
High-power compression tweeter  
30 W RMS / 100 W max  
4 – 25 kHz / SPL 102 dB



**GZCT 3500X-B / S**  
High power compression tweeter  
30 W RMS / 100 W max  
3 – 25 kHz / SPL 99 dB

Available in black or silver finish

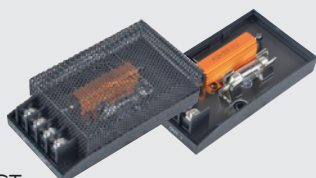

### GZ PROTECT

High quality speaker protection  
Powerhandling 150 W / min. impedance load 2 Ω

Model specifications

General information



**GZCT 1000X**  
 High power compression tweeter  
 30 W RMS / 100 W max  
 5 – 20 kHz / SPL 105 dB



**GZCT 2100X-B**  
 High-power compression tweeter  
 30 W RMS / 100 W max  
 3 – 25 kHz / SPL 99 dB



**GZCT 3000X**  
 High-power compression tweeter  
 40 W RMS / 120 W max  
 4 – 25 kHz / SPL 105 dB



**GZCT 4000X**  
 High power compression tweeter  
 50 W RMS / 140 W max  
 2.5 – 20 kHz / SPL 103 dB



**GZCT 5000SPL / -B**  
 High power compression tweeter  
 70 W RMS / 180 W max  
 2.5 – 20 kHz / SPL 108 dB

Available in yellow or black finish

GROUND ZERO offers a wide range of particular compression tweeters with a rectangular, black finish surface mounting plate matching each demand and high-power application.

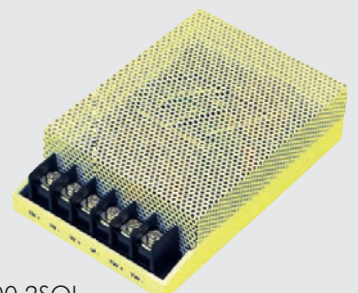

**GZCX 165-200.2SQL**  
 2-way high-power competition crossover



The in-car environment offers adverse conditions and installation positions for speakers. However, inaccurate audio reproduction can be corrected using digital technologies. For this purpose, the GROUND ZERO DSP product line-up contains some multi-channel DSP units with a variety of connection options for OEM or after-market systems. The adjustment can be done in real time using the included PC software or even via APP. These features are available for some amplifiers with integrated DSP, as well.



Check our webpage  
for more details and 360° view!

Model specifications

GZDSP 6-8X PRO  
High-quality 6 to 8 channel DSP  
6x RCA input / 6x high-level input



General information

The advantage of the DSP technology is available as a stand-alone processor unit ready to be added to every sound system including all important features like time alignment, equalizing and crossover adjustment.

Features:

- 8-channel digital signal processor
- High-level and line (RCA) input
- Realtime setting via PC software
- 32-bit Cirrus Logic processor
- Windows GUI software
- 31-band equalizer for each channel
- Time delay correction
- Variable crossover
- Phase correction
- Automatic turn-on function (high-level input)
- Optical digital input
- Coaxial digital input

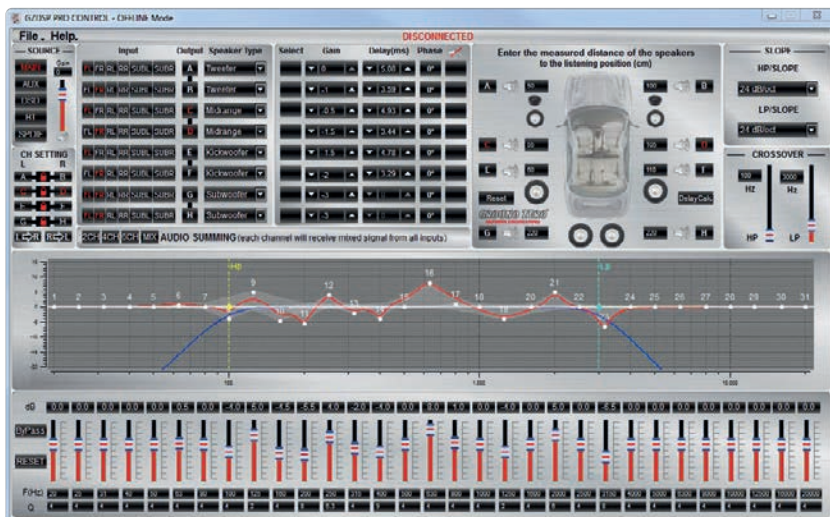

Scan code for latest software updates!

DSP PRO Accessories



**GZDSP REMOTE PRO**  
This remote control enables the user to adjust GZDSP PRO units easily from the drivers or passengers seat.

**GZDSP REMOTE PRO-X**  
This remote control enables the user to adjust GZDSP PRO units easily from the drivers or passengers seat.

- Features:
- Source selection (w/o coaxial input)
  - Main level
  - Subwoofer level
  - Preset selection
  - Mute function
  - Including connection wire

- Features:
- Source selection (with coaxial input)
  - Main level
  - Subwoofer level
  - Preset selection
  - Mute function
  - Including connection wire



**GZDSP BT-BOX**  
Interface for wireless music streaming  
Compatible with:  
GZDSP 6-8X and 6-8X PRO,  
GZDSP 4.60ISO, GZDSP 4.80A-PRO

**GZDSP BTB-APP**  
Interface for wireless music streaming and app control  
Compatible with:  
GZDSP 6-8X PRO and  
GZDSP 4.80A-PRO

- Features:
- Interface for wireless music streaming
  - SBC coded transmission
  - Max. transmission 44.1kHz/16-bit
  - Transmission speed 328 kb/s
  - Max. range 10 m
  - Including connection wire

- Features:
- Interface for wireless music streaming and app control (iOS and Android)
  - SBC coded transmission
  - Max. transmission 44.1kHz/16-bit
  - Transmission speed 328 kb/s
  - Max. range 10 m
  - Including connection wire

# DSP ISO Amplifier

## General information

The GZDSP 4.60ISO space saving amplifier combines the whole feature range of a DSP with the simple integration method of a 4-channel ISO amplifier offering another four processed pre-out channels to expand the setup with further amps if required.

### Features:

- 8-channel digital signal processor
- High-level and line (RCA) input
- Realtime setting via PC software
- 32-bit Cirrus Logic processor
- Windows GUI software
- 31-band equalizer for each channel
- Time delay correction
- Variable crossover
- Phase correction
- Automatic turn-on function (high-level input)
- Optical digital and Aux input
- 4x RCA output

## Model specifications

**GZDSP 4.60ISO**  
 High-quality 4-channel ISO-amplifier  
 Integrated 8-channel DSP  
 4x 40 W RMS / 4x 60 W max @ 4 / 2 Ω



**GZDSP REMOTE**  
 Optional wired remote control



**GZDSP BT-BOX**  
 Optional interface for wireless music streaming



# DSP PRO Amplifier

## General information

The GZDSP 4.80A-PRO is a powerful and high efficient 4-channel amplifier offering the features of the GZDSP 6-8X PRO unit.

### Features:

- 8-channel digital signal processor
- 6-channel high-level input
- 6-channel RCA input
- Realtime setting via PC software
- 32-bit Cirrus Logic processor
- Windows GUI software
- 31-band equalizer for each channel
- Time delay correction
- Variable crossover
- Phase correction
- Automatic turn-on function (high-level input)
- Optical and coaxial digital input
- 4x RCA output

## Model specifications

**GZDSP 4.80A-PRO**  
 High-quality 4-channel class D amplifier  
 Integrated 8-channel DSP  
 4x 90 / 150 RMS @ 4 / 2 Ω  
 2x 350 W max @ 4 Ω (bridged)

**GZCS HLC-2.6**  
 Optional adapter for car specific harness compatible with  
 GZCS 4.0BMW-Connect  
 GZCS MB-Connect



# DSP PRO Accessories



**GZDSP REMOTE PRO**  
 This remote control enables the user to adjust GZDSP PRO units easily from the drivers or passengers seat.

**GZDSP REMOTE PRO-X**  
 This remote control enables the user to adjust GZDSP PRO units easily from the drivers or passengers seat.

**GZDSP BT-BOX**  
 Interface for wireless music streaming  
 Compatible with:  
 GZDSP 6-8X and 6-8X PRO,  
 GZDSP 4.60ISO, GZDSP 4.80A-PRO

**GZDSP BTB-APP**  
 Interface for wireless music streaming and app control  
 Compatible with:  
 GZDSP 6-8X PRO and  
 GZDSP 4.80A-PRO

- Features:
- Source selection (w/o coaxial input)
  - Main level
  - Subwoofer level
  - Preset selection
  - Mute function
  - Including connection wire

- Features:
- Source selection (with coaxial input)
  - Main level
  - Subwoofer level
  - Preset selection
  - Mute function
  - Including connection wire

- Features:
- Interface for wireless music streaming
  - SBC coded transmission
  - Max. transmission 44.1kHz/16-bit
  - Transmission speed 328 kb/s
  - Max. range 10 m
  - Including connection wire

- Features:
- Interface for wireless music streaming and app control (iOS and Android)
  - SBC coded transmission
  - Max. transmission 44.1kHz/16-bit
  - Transmission speed 328 kb/s
  - Max. range 10 m
  - Including connection wire

Model specifications

GZDSP 4-8XII  
High-quality 4 to 8 channel DSP  
4x RCA input / 4x high-level input



General information

The advantage of the DSP technology is available as a stand-alone processor unit ready to be added to every sound system.

Features:

- 8-channel digital signal processor
- 4-channel high-level input
- 4-channel RCA input
- Realtime setting via PC software or APP\*  
\*(requires optional GZDSP BT-STICK)
- 2x 28-bit Analog Devices signal processor
- Windows GUI software
- 10-band equalizer for each channel
- Time delay correction
- Variable crossover
- Phase correction
- Automatic turn-on function



GZDSP REM 4-8XII  
Optional wired remote control



GZDSP BT-STICK  
USB interface for wireless music streaming & app control  
Compatible with GZDSP 4-8X / GZDSP 4-8XII  
Control app available for iOS and Android

Features:

- USB Stick (BT class II)
- BT V4.2 standard
- Transmission frequency 2.4GHz
- Max. range 10 m



Car Specific - Mono amplifier

Model specifications

GZCS A-1.650D  
High-quality mono class D amplifier  
1x 250/450/650 W RMS @ 4 / 2 / 1 Ω



General information

This space-saving and high-efficient mono amplifier delivers the required power for a demanding subwoofer in any system setup. Furthermore, it matches the GZDSP PRO units perfectly.

Features:

- Class D mono amplifier
- High-level input with auto-on function
- 2-channel RCA input
- Low pass filter
- Subsonic filter
- Adjustable Bass Boost
- Remote control connector



GZTA Bassremote  
Optimal remote control



Most OEM speaker systems cannot completely satisfy the expectations of sophisticated customers. Especially the basic equipment leaves a lot of space for improvements of dynamics and sound quality. Installing car specific aftermarket speakers is a simple way to enhance the audio system. GROUND ZERO's line of CAR SPECIFIC solutions consists of various components designed for upgrading the OEM audio systems of modern cars easily.



Will it fit?  
Scan code for compatibility list!



Model specifications

General information



GZCS 100MB  
Car specific 2-way  
component speaker system  
50 W RMS / 100 W max  
Freq. response 70 – 30000 Hz

In order to upgrade the basic version of the factory-installed audio system of a Mercedes-Benz car, a specially tailored speaker system is available for the original slots.

Features:

- Car specific 2-way component speaker system
- 100 mm / 4" midwoofer with aluminum cone
- Car specific aluminum cast basket / connectors
- Rubber surround
- Neodymium motor
- 25 mm / 1" silk dome tweeter
- 12 dB/oct in-line crossover
- Suitable to cars listed in the compatibility chart

CAR SPECIFIC Subwoofer - Mercedes-Benz

Model specifications

General information



GZCS 200MBL-LHD/MBR-LHD  
Car specific subwoofer  
50 W RMS / 90 W max  
Freq. response 40 – 2000 Hz

Additionally, the OEM woofer can be replaced by a powerful model. Due to the specific design, there are no changes to the original wiring needed. Check the compatibility chart on the GROUND ZERO web page for the appropriate product for your car model.

LHD vehicles  
200 mm / 8" pressed paper cone  
Neodymium motor  
Suitable for LHD vehicles only

Suitable to cars listed in the compatibility chart

Available versions:

GZCS W-200MB.RH-L/RH-R  
Car specific subwoofer  
110 W RMS / 220 W max  
Freq. response 30 – 1500 Hz

- GZCS 200MBL-LHD:  
Driver side / left hand drive cars

- GZCS 200MBR-LHD:  
Passenger side / left hand drive cars

RHD vehicles  
200 mm / 8" coated glass-fiber cone  
Neodymium motor  
Solid aluminum cast protection grill  
Suitable for RHD vehicles only

- GZCS W-200MB.RH-R:  
Driver side / right hand drive cars

- GZCS W-200MB.RH-L:  
Passenger side / right hand drive cars

CAR SPECIFIC - Mercedes-Benz sound upgrade kits



GZCS MB-KIT.RH  
Plug & Play upgrade kit  
for right hand drive vehicles  
including car specific harness



GZCS MB-KIT.LH  
Plug & Play upgrade kit  
for left hand drive vehicles  
including car specific harness

## CAR SPECIFIC Speakers - BMW

### General information

In order to upgrade the basic sound system of a BMW vehicle, GROUND ZERO offers some speaker systems matching the OEM installation positions as well as woofers or subwoofers. Due to the specific design, no change to the original wiring is necessary. Check the compatibility chart on the GROUND ZERO web page for the appropriate product for your car model.

#### Features:

- Car specific 2-way speaker system
- Pressed paper cone
- Rubber surround
- Compound basket
- High-efficient 3 ohms impedance
- 25 mm / 1" silk dome tweeter
- Car specific mounting frame
- Car specific connection
- In-line crossover
- Freq. response 100 Hz – 25 kHz

 Made in Germany

In-line high pass filter  
Included in SQ+ version



Rear shelf mounting bracket and tweeter high-pass crossover included!

### Model specifications

#### GZCS 100BMW-SQA

Car specific 2-way speaker system  
50 W RMS / 100 W max  
Freq. response 100 – 25000 Hz  
Tweeter in-line high-pass crossover

#### GZCS 100BMW-SQ+A

Incl. midrange high-pass crossover

#### GZCS 100BMW-SQB

Car specific 2-way speaker system  
50 W RMS / 100 W max  
Freq. response 100 – 25000 Hz  
Tweeter in-line high-pass crossover

#### GZCS 100BMW-SQ+B

Incl. midrange high-pass crossover

#### GZCS 100BMW-SQC

Car specific 2-way speaker system  
50 W RMS / 100 W max  
Freq. response 100 – 25000 Hz  
Tweeter in-line high-pass crossover

#### GZCS 100BMW-SQ+C

Incl. midrange high-pass crossover

#### GZCS 100BMW-SQD

Car specific 2-way speaker system  
50 W RMS / 100 W max  
Freq. response 100 – 25000 Hz  
Tweeter in-line high-pass crossover

#### GZCS 100BMW-SQ+D

Incl. midrange high-pass crossover



## CAR SPECIFIC Speakers - BMW

### General information

Additionally to the component speaker system, GROUND ZERO offers matching subwoofers for BMW/MINI in both, 2- & 4-ohms version.

#### Features:

- Car specific under-seat subwoofer (1 pair)
- 200 mm / 8" diameter
- Neodymium motor (2 Ω version)
- Double neodymium motor (4 Ω version)
- 50 mm / 2" copper voice coil
- Freq. response 35 - 250 Hz



Will it fit?  
Scan code for compatibility list!

### Model specifications

#### GZCS 200BMW-SW

Car specific under-seat subwoofer  
100 W RMS / 160 W max / 2 Ω  
Efficiency 86 dB (SPL)

#### GZCS 200BMW-SW4

Car specific under-seat subwoofer  
Improved Qts for best performance  
100 W RMS / 160 W max / 4 Ω  
Efficiency 89.1 dB (SPL)

#### GZCS 4.0BMW-CONNECT

Optional car specific harness



For Mercedes-Benz

For BMW

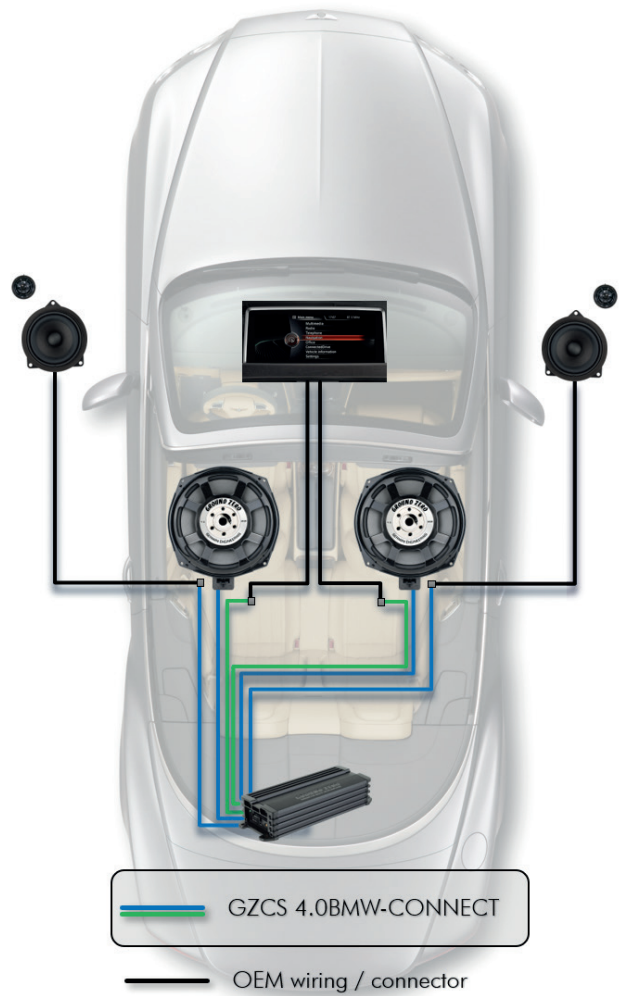
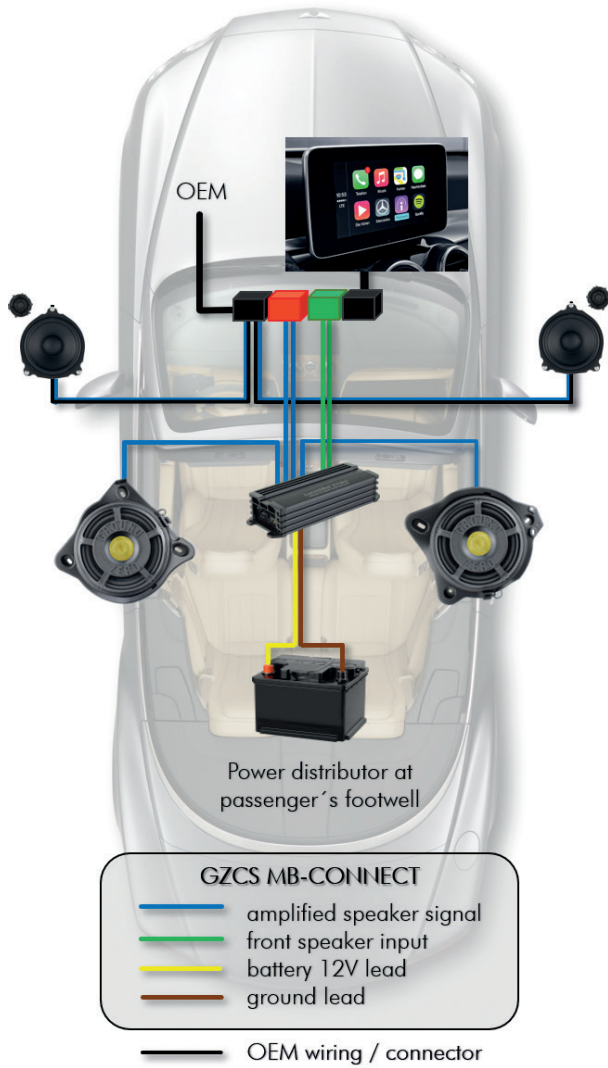

GZCS MB-CONNECT is used for simple and quick installation of GZRA MICRO FOUR\* amplifying the front speaker system (GZCS 100MB) and the subwoofers (GZCS 200MB / W-200MB)

\*check the adapter chart for further amplifier models

GZCS 4.0BMW-CONNECT is used for simple and quick installation of GZRA MICRO FOUR\* amplifying the front speaker system (GZCS 100BMW) and the subwoofers (GZCS 200BMW)

\*check the adapter chart for further amplifier models

CAR SPECIFIC - Adapter chart

<b>GZDSP unit</b> GZDSP 6-8X / GZDSP 4.80AMP	<b>GZDSP PRO unit</b> GZDSP 6-8X PRO / GZDSP 4.80A-PRO	<b>GZRA MICRO FOUR</b>
		
<p>GZCS MB-CONNECT / 4.0BMW-CONNECT</p>	<p>GZCS MB-CONNECT / 4.0BMW-CONNECT</p>	<p>GZCS MB-CONNECT / 4.0BMW-CONNECT</p>
 <p>GZCS HLC-1.12</p>	 <p>GZCS HLC-2.6</p>	 <p>No adapter required</p>

## General information

GROUND ZERO offers a specific component speaker system matching the OEM installation positions. Due to the specific design, the OEM wiring remains unchanged.

### Features:

- Car specific 2-way speaker system
- High-efficient 3-ohms impedance
- Aluminum cone
- 25 mm / 1" titanium dome tweeter
- In-line crossovers
- Car specific connectors
- Variable mounting accessories



Suitable to cars listed in the compatibility chart online.

## Model specifications

### GZCS 165VW

Car specific 2-way speaker system  
120 W RMS / 190 W max  
Freq. response 35 – 26000 Hz  
compatible with VW / Skoda / Seat



# CAR SPECIFIC Speakers

## General information

GROUND ZERO offers some car specific coaxial speaker systems matching the OEM installation positions of a variety of vehicles.

### Features:

- Car-specific 2-way coaxial speaker
- Coated paper cone
- Mylar tweeter

## Model specifications

### GZCS 8.7CX

Car specific 2-way coaxial speaker system  
50 W RMS / 90 W max  
Freq. response 100 – 20000 Hz  
Suitable for various vehicles



### GZCS 46CX

Car specific 2-way coaxial speaker system  
70 W RMS / 110 W max  
80 – 20000 Hz  
Suitable for various vehicles



### GZCS 12CX

Car specific 2-way coaxial speaker system  
60 W RMS / 100 W max  
Freq. response 75 – 20000 Hz  
Suitable for Mercedes-Benz W124



Model specifications

GZCS 10SUB  
 Flat spare wheel subwoofer  
 Double voice coil 2x 2 Ω  
 Power handling 300 W



GZCS 10SUB-ACT  
 Flat spare wheel active subwoofer  
 Class AB amplifier 300 W MAX  
 High-Level input with auto-on



General information

Especially the bass response of a basic OEM speaker system leaves many wishes unfulfilled. For some models, GROUND ZERO offers a simple solution that significantly increases the low frequency response. Using the spare wheel compartment, the trunk space remains untouched. This subwoofer solution is available as an active version with integrated amplifier or as a passive version.

Passive model features:

- High quality spare wheel recess subwoofer
- Perfect solution for a flat spare wheel recess
- No cut-out in the trunk floor panel required
- Efficient down-firing technology
- Solid, sealed MDF enclosure with black carpet
- High-power 25 cm / 10" woofer
- Klippel® optimized



GZST 4S  
 4-pin push terminal

Active model additional features:

- Class AB MOSFET amplifier
- Adjustable bass boost
- Phase shift option (phase switch)
- Low pass filter (30 – 120 Hz)
- High-level input with auto-on function
- Remote control connector



GZTA Bassremote  
 Optional remote control for GZCS 10SUB-ACT

# ((NO VIBRATION - JUST SOUND))



Stop  
Vibration



Higher Acoustic  
Performances



Insulate  
Heat

Listening to favorite music is most enjoyable if there is no disturbing noise around. Unfortunately, in-car environments consist of a wide range of materials causing a lot of annoying noises. Especially large scaled body parts tend to vibrate and affect the audio reproduction of the car speakers in a negative way. GROUND ZERO damping materials offer high efficient noise proofing. They reduce vibration, increase bass response as well as dynamics and by that ensure precise audio reproduction. There are particular products for each neuralgic car part influencing the sound quality available.

## DAMPING

### Model specifications

#### GZDM DOORKIT PRO

Damping kit for 2 doors

Self-adhesive high-efficient damping material

Package content:

- 2 sheets GZDA 1200AL-GOLD
- Self-adhesive aluminum plate
- 8 sheets GZDM 3750AB-SILVER
- Polymer damping material based on butyl rubber with layer of aluminum
- 4 sheets GZDF 1500SA
- High-efficient sound absorbing polyurethane foam
- 2 sheets GZDF 400SI
- Waterproof high-density noise damping polyethylene foam

Size per sheet: 375 x 500 mm / 14.76" x 19.69"

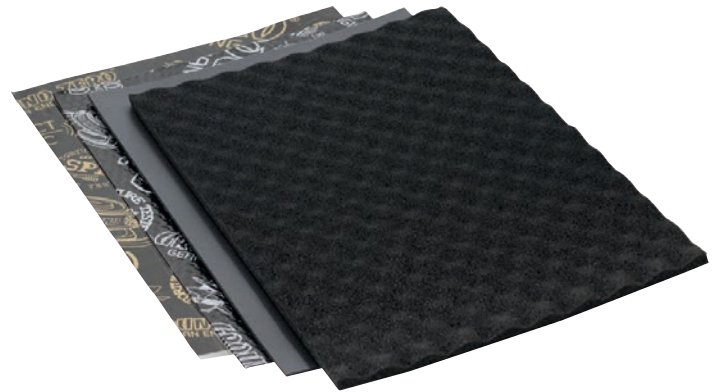

#### GZDF 400SI

Self-adhesive noise damping and heat insulating material.

High-density, waterproof polyethylene foam reducing standing waves inside the door panel

- Operating temperature -30° to 90° C
- Total thickness 4.0 mm / 0.158"
- Dimensions (sheet) 375 mm x 500 mm / 14.76" x 19.69"
- Package content 20 sheets

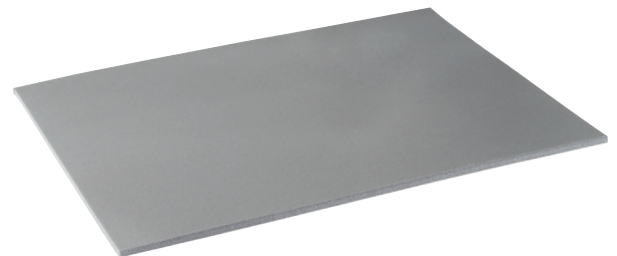

#### GZDF 1500SA

High-efficient viscous-elastic sound absorbing formed foam.

Self-adhesive, heat insulating and vibration damping when compressed.

- Total thickness 15 mm / 0.59"
- Noise absorbing -85%
- Dimensions (sheet) 500 x 375 mm / 14.76" x 19.69"
- Package content 8 sheets



#### GZDR 1000

Heavy duty damping roller



## Model specifications

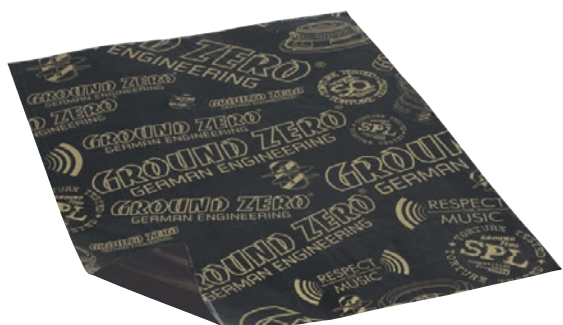

Polymer based on butyl rubber, supplemented with anti-corrosive additives to ensure that the treated surface does not rust. Flexible and waterproof material providing high-effective anti-vibration damping.

### GZDM 3750AB-GOLD

◦ Total thickness	2.2 mm / 0.087"
◦ Mass (kg/m <sup>2</sup> ), at least	3.0 kg
◦ Dimensions (sheet)	750 mm x 500 mm / 29.53" x 19.69"
◦ Package content	10 sheets



### GZDM 3750AB-SILVER

◦ Total thickness	1.7 mm / 0.067"
◦ Mass (kg/m <sup>2</sup> ), at least	2.4 kg
◦ Dimensions (sheet)	750 mm x 500 mm / 29.53" x 19.69"
◦ Package content	10 sheets



### GZDM 1900ML-GOLD

Flexible multi-layer damping material with polymer based on butyl rubber in combination with bitumen mastic and aluminum foil outer surface.

◦ Total thickness	4.2 mm / 0.165"
◦ Mass (kg/m <sup>2</sup> ), at least	6.5 kg
◦ Dimensions (sheet)	375 mm x 500 mm / 14.76" x 19.69"
◦ Package content	10 sheets



### GZDA 1200AL-GOLD

Massive aluminum foil to cut individually and to seal openings inside the doors for acoustical reasons and to avoid the intrusion of moisture into the vehicle's compartment. Self-adhesive, temperature and water resistant, not flammable.

◦ Total thickness	300 μm / 0.12"
◦ Dimensions (plate)	500 x 375 mm / 14.76" x 19.69"
◦ Package content	6 sheets



### GZDM 250AL-BassBoost

Self-adhesive multilayer, non-flammable damping material with a specifically molded aluminum surface reducing the reflection of sound waves and pressure when installed directly behind the speaker.

◦ Total thickness	15 mm +/- 4 mm
◦ Dimensions (sheet)	250 x 183 mm / 9.84" x 7.20"
◦ Package content	2 sheets (for 2 doors)



### GZDM 1900MC-GOLD

Bitumen saturated damping material based on viscous elastic polyurethane foam for soundproofing in combination with a layer of polymer-based butyl rubber and aluminum foil outer surface.

High-efficient soundproofing and anti-vibration damping.

◦ Total thickness	7 mm / 0.28"
◦ Noise absorption	-85%
◦ Water absorption	<18%
◦ Dimensions (sheet)	375 mm x 500 mm / 14.76" x 19.69"
◦ Package content	10 sheets



This line includes optionally available products to be used at the installation or offer additional features.

ACCESSORIES - Integration / Wiring



**GZCS MB-CONNECT**  
Car specific wiring harness for Mercedes-Benz

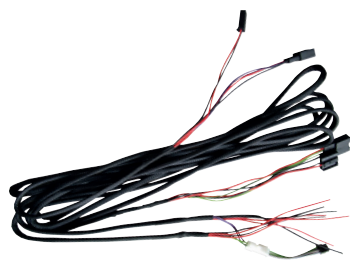

**GZCS 4.0BMW-CONNECT**  
Car specific wiring harness for BMW / MINI



**GZCV 2.0HL**  
Active high to low converter  
12 V Remote out

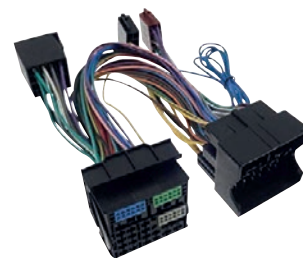

**GZCS ISO QUADLOCK I**  
Quadlock to ISO connector  
**GZCS ISO QUADLOCK II**  
Quadlock II to ISO connector

ACCESSORIES - Triple shielded RCA cables

General information

In order to transmit the music signal unaffectedly and as lossless as possible from the signal source to the amplifier, it requires a high-quality and well-shielded RCA cable. GROUND ZERO offers a number of different models in common lengths.

Features:

- Triple shielded, twisted RCA cable
- Gold plated brass RCA connectors
- Black & yellow snake skin
- Blister packaging

Model specifications

GZCC X-TP

- Available versions:
- GZCC 0.57X-TP: 0.57 m / 1.87 ft
  - GZCC 1.14X-TP: 1.14 m / 3.74 ft
  - GZCC 3.14X-TP: 3.14 m / 10.3 ft
  - GZCC 5.49X-TP: 5.49 m / 18.01 ft





Model specifications

General information



GZCC 1.3X  
High-quality RCA cable  
1 m / 3.28 ft triple shielded  
Including remote wire

Universal shielded or twisted RCA signal cables, available in different sizes.



GZCC 5.3X  
High quality RCA cable  
5 m / 16.4 ft triple shielded  
Including remote wire



GZCC 5.1XLC  
High quality twisted RCA cable  
5 m / 16.4 ft single shielded

GZCY 30X  
High quality Y-adapter  
1 x female / 2 x male

ACCESSORIES - Power kits

Model specifications

General information



GZPK 50X-II  
50 mm<sup>2</sup> / 0 AWG power kit  
Triple shielded RCA cable  
ANL fuseholder incl. 300 A fuse

GZPK 35X-II  
35 mm<sup>2</sup> / 2 AWG power kit  
Triple shielded RCA cable  
ANL fuseholder incl. 200 A fuse

GZPK 20X-II  
20 mm<sup>2</sup> / 4 AWG power kit  
Triple shielded RCA cable  
Mini ANL fuseholder incl. 80 A fuse

Only an adequately dimensioned and need-based power wiring ensures that the best performance and highest possible power will be delivered by the amplifier. GROUND ZERO offers amplifier wiring kits with different diameters for each power demand including an RCA signal cable.

- High quality amplifier wiring kits
- Flexible CCA wire with copper coating
- Yellow power wire (5.2 m / 17.06 ft)
- Black ground wire (0.8 m / 2.62 ft)
- 2-channel shielded RCA cable (5 m / 16.4 ft)
- Fuse Holder incl. matching fuse
- Connectors and covers



GZPK 10X-II  
10 mm<sup>2</sup> / 7 AWG power kit  
Triple shielded RCA cable  
Mini ANL fuseholder incl. 60 A fuse

GZPK 10XLC-II (w/o picture)  
10 mm<sup>2</sup> / 7 AWG power kit  
Twisted RCA cable  
1.5 m / 4.92 ft speaker cable  
Mini ANL fuseholder incl. 60 A fuse  
Remote cable

## ACCESSORIES - OFC speaker cables

### General information

In order to transport the music signal as lossless as possible from the amplifier to the loud-speaker, a high-quality and sufficiently dimensioned cable is required.

GROUND ZERO offers highly flexible CCA and OFC cable in many common diameters.

#### Features:

- High quality OFC copper speaker cable
- Black and yellow color isolation
- Highly flexible
- Wooden spool

### Model specifications



#### Available diameters:

GZSC 1.5X2 OFC: 2x 1.50 mm<sup>2</sup> - 100 m / 328.08 ft spool

GZSC 2.5X2 OFC: 2x 2.50 mm<sup>2</sup> - 100 m / 328.08 ft spool

GZSC 4.0X2 OFC: 2x 4.00 mm<sup>2</sup> - 75 m / 246.06 ft spool

GZSC 6.0X2 OFC: 2x 6.00 mm<sup>2</sup> - 50 m / 164.04 ft spool

GZSC 10.0X2 OFC: 2x 10.00 mm<sup>2</sup> - 50 m / 164.04 ft spool

## ACCESSORIES - CCA speaker cables

### General information

In order to transport the music signal as lossless as possible from the amplifier to the loud-speaker, a high-quality and sufficiently dimensioned cable is required.

GROUND ZERO offers highly flexible CCA and OFC cable in many common diameters.

#### Features:

- CCA speaker cable features:
- High quality CCA speaker cable
- Black and yellow color isolation
- Highly flexible
- Plastic spool

### Model specifications

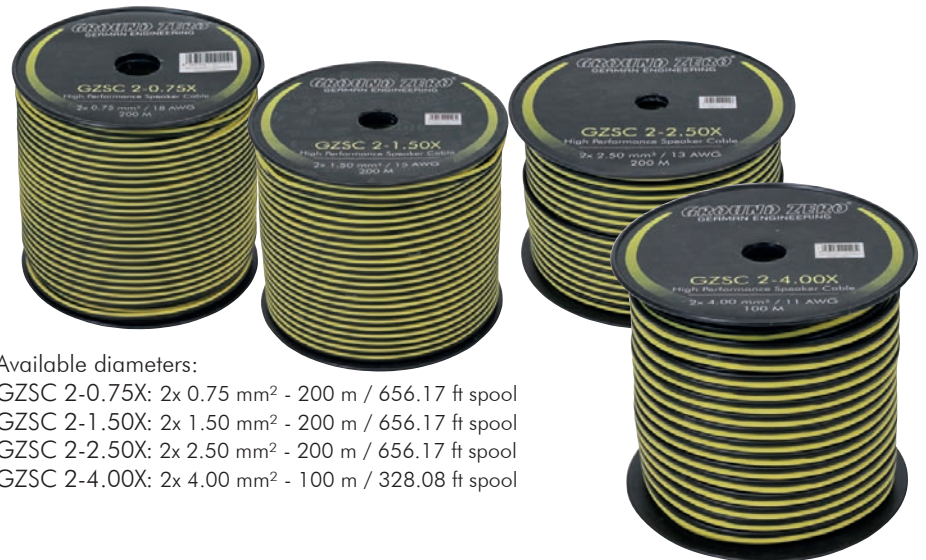

#### Available diameters:

GZSC 2-0.75X: 2x 0.75 mm<sup>2</sup> - 200 m / 656.17 ft spool

GZSC 2-1.50X: 2x 1.50 mm<sup>2</sup> - 200 m / 656.17 ft spool

GZSC 2-2.50X: 2x 2.50 mm<sup>2</sup> - 200 m / 656.17 ft spool

GZSC 2-4.00X: 2x 4.00 mm<sup>2</sup> - 100 m / 328.08 ft spool

## ACCESSORIES - Power cap

### General information

Powerful amplifiers require a stable battery voltage to deliver full performance.

This power capacitor compensates the battery's voltage drops caused by high current flow.

### Model specifications

GZTC 1.0FX

1.0 Farad Power Cap

16 V / 20 V Surge

Voltmeter with white illumination



Including mounting brackets



**Model specifications**

Available diameters:  
 GZPC 10B/Y: 10 mm<sup>2</sup> / 7 AWG - 50 m / 164.04 ft spool  
 GZPC 20B/Y: 20 mm<sup>2</sup> / 4 AWG - 50 m / 164.04 ft spool  
 GZPC 35B/Y: 35 mm<sup>2</sup> / 2 AWG - 30 m / 98.43 ft spool  
 GZPC 50B/Y: 50 mm<sup>2</sup> / 0 AWG - 20 m / 65.62 ft spool

**General information**

Only an adequately dimensioned and needs-based power wiring ensures that the best performance and highest possible power will be delivered by the installed components. For this reason, GROUND ZERO offers highly flexible CCA power cables in all common diameters on roles.

**Features:**

- High quality CCA power wire
- Black/Yellow isolation
- Highly flexible
- Plastic spool



**More ACCESSORIES**



**GZST 2S**  
 2-pin push terminal up to 6 mm<sup>2</sup> speaker cable



**GZST 2B**  
 2-pin push terminal up to 10 mm<sup>2</sup> speaker cable



**GZST 4S**  
 4-pin push terminal up to 6 mm<sup>2</sup> speaker cable including bridges for parallel wiring



**GZTH 25-28B**  
 Tweeter surface housing black rubber touch finish suitable for GZRT 25SQ GZUT 28SQ

## General information

GROUND ZERO offers a wide range of distribution blocks and fuseholders needed for the installation of audio components in your vehicle. Besides that, further products complete the accessory line.

## Model specifications

**GZBT 2.50MANL-POS**  
Positive battery terminal  
with Mini-ANL fuseholder  
1x 50 mm<sup>2</sup> / 0 AWG unfused  
1x 50 mm<sup>2</sup> / 0 AWG fused



**GZBT 2.50NEG**  
Negative battery terminal  
2x 50 mm<sup>2</sup> / 0 AWG



**GZDB 3.50/4.20**  
Distribution block  
3x 50 mm<sup>2</sup> / 0 AWG  
4x 20 mm<sup>2</sup> / 4 AWG



**GZFH 1.20 IL-MANL**  
In-line Mini-ANL fuseholder  
20 mm<sup>2</sup> / 4 AWG



**GZFH 1.20/1.20 MANL**  
Mini-ANL fuseholder  
20 mm<sup>2</sup> / 4 AWG



**GZFH 1.50/1.50 ANL/MANL**  
ANL / Mini-ANL fuseholder  
50 mm<sup>2</sup> / 0 AWG



**GZFH 1.50/2.20 ANL/MANL**  
ANL / Mini-ANL fuseholder  
1x 50 mm<sup>2</sup> / 0 AWG  
2x 20 mm<sup>2</sup> / 4 AWG



**GZFH 3.50/4.20 ANL/MANL**  
ANL / Mini-ANL fuseholder  
3x 50 mm<sup>2</sup> / 0 AWG  
4x 20 mm<sup>2</sup> / 4 AWG



Blister packaging

## FUSES

### General information

High quality ANL and MANL fuses from 40 up to 400 Ampere, available in blister or in 10 piece bulk packaging.

### Model specifications

**GZFU ANL**  
available 100 – 400 Ampere



**GZFU MANL**  
available 40 – 200 Ampere



Model specifications

GZRM 165X  
 Water-resistant 2-way coaxial speaker  
 70 WRMS / 120 WMAX  
 Freq. response 60 – 25000 Hz



General information

Since listening to favorite music isn't limited to cars, GROUND ZERO offers a particular speaker for environments with special requirements to the construction and water resistance.

The MARINE series coaxial speaker is available in white finish, suitable for places with high humidity such as bathrooms and pool areas or even for off-shore applications with occasionally appearing direct splashing water such as on outer decks or on leisure boats.

- Features:
- 2-way marine coaxial speaker system
  - IMPP cone
  - Rubber surround
  - Rainwater and splash protected
  - Salt water resistant
  - 13 mm / 0.51" PEI tweeter
  - White frame and protection grill



MARINE Music streaming

Model specifications

GZWR 10M  
 Wireless music streaming receiver  
 Main level control  
 RCA output (1- pair / max 3 V)  
 Remote input / output (12 V / 300 mA)  
 AUX input

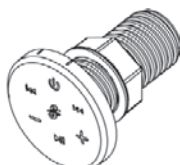

General information

Universal wireless music streaming receiver with water-resistant chromed bezel and touch screen display.

- Features:
- Wireless music streaming receiver
  - LED illumination
  - AUX input 3.5 mm jack
  - RCA output (1 pair / max. 3 V)
  - Remote input/output
  - Mobile device player control
  - Main level control
  - Operation voltage 9-16 Volt

## General information

If you would like to enjoy the typical GROUND ZERO sound not only in your vehicle, you may choose one of the two headphones. Both of them delivering a distinctive bass response and the dynamic sound character.



## Model specifications

### GZHP 10-IE











Powerful in-ear headphone with aluminum housing  
 Speaker: 10 mm  
 Sensitivity:  $98 \pm 3$  dB at 1 KHz  
 Microphone sensitivity:  $-42 \pm 4$  dB  
 Frequency Response: 20 Hz – 20 kHz  
 Impedance:  $32 \pm 15\%$   $\Omega$   
 Plug Type: 3.5 mm jack  
 Cable length: 120 cm / 47 in.  
 Weight: 15 g  
 In-line microphone  
 Headset function  
 Accessories included



### GZHP 40-OE

High quality foldable on-ear headphone  
 Speaker: 40 mm  
 Sensitivity:  $100 \pm 3$  dB at 1 KHz  
 Microphone sensitivity:  $-43 \pm 4$  dB  
 Frequency Response: 20 Hz – 20KHz  
 Impedance:  $32 \pm 15\%$   $\Omega$   
 Max Power: 30 mW  
 Plug Type: 3.5 mm  
 Cable length: 120 cm / 47"  
 Cable: Dual side cable  
 Weight: 150 g  
 In-Line Mic compatible with Apple/Samsung/HTC and more



Technical product information		
	Amplifiers	72
	DSP amplifiers	72
	Competition amplifiers	73
	Active subwoofers	73
	Subwoofer enclosures	73
	Speaker systems	74
	Coaxial speakers	75
	Kickwoofer / Midwoofer / Midrange / Fullrange speakers	75
	Tweeters	76
	Subwoofers	77

 Amplifiers

Series	Product	Output power @ 4/2/1 Ohm	Bridged max @ 4/2 Ohm (link mode)	LPF	HPF / *Subsonic	BP	Bass-boost	Phase-shift	Remote	Line Out	High-level & auto-on	Dimensions (mm/inch)	
Orange	GZPA Reference 2 Pure	2x 420/750/1150 W	1x 1800/2700 W									236 x 68 x 590 mm 9.29 x 2.67 x 23.23"	
	GZPA Reference 4 Pure-SQ	4x 150/270/425 W	2x 650/1000 W									236 x 67.5 x 590 mm 9.29 x 2.66 x 23.23"	
Black	GZPA 2SQ	2x 175/315/500 W	1x 630/1000 W	✓	✓	✓	✓	✓				222 x 61 x 420 mm 8.74 x 2.40 x 16.54"	
	GZPA 4SQ	4x 125/225/350 W	2x 450/700 W	✓	✓	✓	✓					222 x 60.5 x 420 mm 8.74 x 2.38 x 16.54"	
Brown	GZUA 2.250SQ-Plus	2x 180/320/500 W	1x 640/1000 W @ 2 ohms	✓	✓	✓	✓	✓	✓	✓		209 x 46 x 360 mm 8.23 x 1.81 x 14.17"	
	GZUA 4.150SQ-Plus	4x 110/190/- W	2x 380 W @ 4 ohms	✓	✓	✓						209 x 46 x 360 mm 8.23 x 1.81 x 14.17"	
	GZUA 6.200SQ-Plus	4x 110/160/- & 2x 160/280/- W	2x 320 W + 560 W @ 4 ohms	✓	✓	✓						209 x 46 x 550 mm 8.23 x 1.81 x 21.65"	
Grey	GZHA MINI ONE	1x 220/390/630 W	1x 1500 W max @ 2 ohms (linkmode)	✓	Subsonic	✓	✓	✓	✓	✓	✓	135 x 52 x 210 mm 5.32 x 2.05 x 8.27"	
	GZHA MINI ONE-K	1x 340/600/1000 W	1x 2300 W max @ 2 ohms (linkmode)	✓	Subsonic	✓	✓	✓	✓	✓	✓	135 x 52 x 322 mm 5.32 x 2.05 x 12.68"	
	GZHA MINI ONE-K 24V	1x 340/600/1000 W	1x 2300 W max @ 2 ohms (linkmode)	✓	Subsonic	✓	✓	✓	✓	✓	✓	135 x 52 x 322 mm 5.32 x 2.05 x 12.68"	
	GZHA MINI TWO	2x 130/230/- W	1x 550 W max @ 4 ohms	✓	✓	✓		✓	✓	✓	✓	135 x 52 x 210 mm 5.32 x 2.05 x 8.27"	
	GZHA MINI FOUR	4x 80/130/- W	2x 320 W max @ 4 ohms	✓	✓	✓		✓			✓	135 x 52 x 210 mm 5.32 x 2.05 x 8.27"	
	GZHA MINI FOUR 24V	4x 80/130/- W	2x 320 W max @ 4 ohms	✓	✓	✓		✓			✓	135 x 52 x 210 mm 5.32 x 2.05 x 8.27"	
	GZHA MINI FIVE	4x 75/125/- W & 1x 190/320/500 W	2x 300 W + 600 W max @ 4 ohms	✓	✓	✓			✓		✓	135 x 52 x 322 mm 5.32 x 2.05 x 12.68"	
Yellow	GZRA MICRO ONE	1x 220/350/- W		✓	Subsonic		✓		✓		✓	75 x 44 x 190 mm 2.95 x 1.73 x 7.48"	
	GZRA MICRO FOUR	4x 60/100/- W	2x 250 W max @ 4 ohms	✓	✓						✓	75 x 44 x 190 mm 2.95 x 1.73 x 7.48"	
	GZRA 2HD	2x 300/500/- W	1x 1000 W @ 4 ohms	✓	✓	✓	✓		optional		✓	186 x 50 x 262 mm 7.32 x 1.96 x 10.31"	
Red	GZRA 4HD	4x 170/250/- W	2x 500 W @ 4 ohms	✓	✓	✓	✓				✓	186 x 50 x 262 mm 7.32 x 1.96 x 10.31"	
	GZTA 2255X-B	2x 150/250/- W	1x 600 W max @ 4 ohms	✓	✓	✓	✓		✓			230 x 53 x 396 mm 9.06 x 2.09 x 16.34"	
	GZTA 4125X-B	4x 90/130/- W	2x 320 W max @ 4 ohms	✓	✓	✓	✓					230 x 53 x 396 mm 9.06 x 2.09 x 15.59"	
Orange	GZTA 4230X-B	4x 140/230/- W	2x 550 W max @ 4 ohms	✓	✓	✓	✓					230 x 53 x 476 mm 9.06 x 2.09 x 18.74"	
	GZIA 1.600HPX-II	1x 230/400/600 W		✓			✓		✓		✓	192 x 49 x 332 mm 7.56 x 1.93 x 13.07"	
	GZIA 1.1000DX-II	1x 350/650/1000 W		✓			✓	✓	✓		✓	192 x 49 x 302 mm 7.56 x 1.93 x 11.89"	
	GZIA 1.1450DX-II	1x 400/750/1250 W		✓			✓	✓	✓		✓	192 x 49 x 360 mm 7.56 x 1.93 x 14.17"	
	GZIA 2080HPX-II	2x 60/80/- W	1x 240 W max @ 4 ohms	✓							✓	192 x 49 x 174 mm 7.56 x 1.93 x 6.85"	
	GZIA 2130HPX-II	2x 85/130/- W	1x 320 W max @ 4 ohms	✓	✓				optional		✓	192 x 49 x 214 mm 7.56 x 1.93 x 8.43"	
	GZIA 2235HPX-II	2x 150/235/- W	1x 540 W max @ 4 ohms	✓	✓				optional		✓	192 x 49 x 284 mm 7.56 x 1.93 x 11.18"	
	GZIA 4115HPX-II	4x 70/115/- W	2x 250 W max @ 4 ohms	✓	✓						✓	192 x 49 x 284 mm 7.56 x 1.93 x 11.18"	
	GZBA 1.300X available with GZ BASS KIT only	1x 200/-/- W	1x 300 W max @ 4 ohms	✓	✓	✓	✓	✓	✓	✓	✓	✓	180 x 53 x 236 mm 7.09 x 2.09 x 9.29"

 DSP Amplifiers

Series	Product	Output power @ 4/2/1 Ohm	Bridged max @ 4/2 Ohm	LPF	HPF / *Subsonic	BP	Bass-boost	Phase-shift	Remote	Line Out	High-level & auto-on	Dimensions (mm/inch)
Purple	GZCS A-1.650D	1x 250/450/650 W		✓	✓	✓	✓	✓	✓		✓	185 x 47 x 148 mm 7.28 x 1.85 x 5.83"
	GZDSP 4.60ISO	4x 40/50/- W				DSP			optional	4 channel	✓	185 x 40 x 100 mm 7.28 x 1.57 x 3.94"
	GZDSP 4.80A-PRO	4x 80/130/- W	2x 260 W @ 4 ohms			DSP			optional	4 channel	✓	185 x 42 x 237 mm 7.28 x 1.77 x 9.33"



## Competition Amplifiers

Series

Product	Output power @ 4/2/1 Ohm	Bridged @ 4/2 Ohm (link mode)	LPF	HPF / *Subsonic	BP	Bass-boost	Phase-shift	Remote	Line Out	High-level & auto-on	Dimensions (mm/inch)
GZCA 1.5SPL-M1	1x -/825/1500 W		✓	Subsonic	✓	✓			✓		184 x 55 x 210 mm 4.67 x 2.16 x 8.27"
GZCA 1.5SPL-M2	1x 825/1500/- W		✓	Subsonic	✓	✓			✓		184 x 55 x 210 mm 4.67 x 2.16 x 8.27"
GZCA 3.0SPL-M1	1x -/1800/3400 W		✓	Subsonic	✓	✓			✓		228 x 70 x 236 mm 8.97 x 2.75 x 9.29"
GZCA 3.0SPL-M2	1x 1800/3400/- W		✓	Subsonic	✓	✓			✓		228 x 70 x 236 mm 8.97 x 2.75 x 9.29"
GZCA 5.0SPL-M1	1x -/2800/5600 W		✓	Subsonic	✓	✓			✓		228 x 70 x 315 mm 8.97 x 2.75 x 12.40"
GZCA 5.0SPL-M2	1x 2800/5600/- W		✓	Subsonic	✓	✓			✓		228 x 70 x 315 mm 8.97 x 2.75 x 12.40"
GZCA 8.0SPL-M1	1x -/4480/8960 W		✓	Subsonic	✓	✓			✓		228 x 70 x 401 mm 8.97 x 2.75 x 15.79"
GZCA 8.0SPL-M2	1x 4480/8960/- W		✓	Subsonic	✓	✓			✓		228 x 70 x 401 mm 8.97 x 2.75 x 15.79"
GZCA 12.0SPL-M1 (IPV)	1x -/9000/13700 W		✓	Subsonic	✓	✓			✓		228 x 70 x 51 mm 8.97 x 2.75 x 20.1"
GZCA 20.0SPL-M1	1x -/12000/20000 W		✓	Subsonic	✓	✓			✓		228 x 70 x 861 mm 8.97 x 2.75 x 33.90"
GZCA 35.0SPL-M1	35000 W @ 1 Ohm		✓	Subsonic	✓	✓			✓		228 x 70 x 861 mm 8.97 x 2.75 x 33.90"
GZCA 750.2-D1	2x 200/400/750 W	1x 1500 W @ 2 ohms	✓	✓							184 x 55 x 172 mm 4.67 x 2.16 x 6.77"
GZCA 750.2-D2	2x 400/750/- W	1x 1500 W @ 4 ohms	✓	✓							184 x 55 x 172 mm 4.67 x 2.16 x 6.77"
GZCA 1500.2-D1	2x 450/900/1500 W	1x 3000 W @ 2 ohms	✓	✓							228 x 70 x 182 mm 8.97 x 2.75 x 7.16"
GZCA 1500.2-D2	2x 900/1500/- W	1x 3000 W @ 4 ohms	✓	✓							228 x 70 x 182 mm 8.95 x 2.75 x 7.16"
GZCA 4.200-4	4x 140/250/- W	2x 500 W @ 4 ohms	✓	✓							147 x 46 x 198 mm 5.79 x 1.81 x 7.8"

## Active Subwoofers

Series

Product	Woofers	Type	Enclosure	Dimensions (mm/inch)	Lowpass	Bass remote	Output power
GZUB 1000XACTII	250 mm / 10" Flat	Flat active woofer	Aluminum cast	360 x 270 x 78 mm / 14.17 x 10.63 x 3.07"	50 - 100 Hz	✓	150 / 210 W
GZUB 800XACTII	200 mm / 8" Flat	Flat active woofer	Aluminum cast	345 x 240 x 68 mm / 13.58 x 9.45 x 2.68"	50 - 100 Hz	✓	120 / 180 W
GZTB 20ACT	200 mm / 8" Flat	Flat active woofer	Plastic injection	345 x 237 x 72 mm / 13.58 x 9.33 x 2.83"	50 - 100 Hz	✓	100 / 160 W
GZIB 200XBR-ACT	200 mm / 8"	Front-Basstunnel	17 L / 0.6 ft³	400 x 270 x 290 (230 mm) / 15.75 x 10.63 x 11.42 (9.06")	30 - 120 Hz	optional	120 / 220 W
GZIB 250XBR-ACT	250 mm / 10"	Front-Basstunnel	33 L / 1.17 ft³	440 x 360 x 320 (285 mm) / 17.32 x 14.17 x 12.60 (11.22")	30 - 120 Hz	optional	150 / 270 W
GZIB 300XBR-ACT	300 mm / 12"	Front-Basstunnel	37 L / 1.31 ft³	460 x 370 x 400 (310 mm) / 18.11 x 14.57 x 15.75 (12.20")	30 - 120 Hz	optional	180 / 300 W
GZCS 10SUB-ACT (2020)	1 x 250 mm / 10"	Sealed	15 L / 0.53 ft³	620 x 440 x 120 (153 mm incl. feet) / 24.4 x 17.32 x 4.72 (5.98" incl. feet)	30 - 120 Hz	optional	160 / 300 W

## Subwoofer Enclosures

Series

Product	Woofers	Type	Net. Volume	Dimensions (mm/inch)	Impedance	Power handling	Recommended amplifier power
GZ BASS KIT 12.300X	300 mm / 12"	Aero Port	40 L / 1.41 ft³	520 x 360 x 250 (350) mm / 20.47 x 14.17 x 9.84 (13.78")	4 Ω	300 WRMS	200 - 500 W
GZIB 200XBR	200 mm / 8"	Front-Basstunnel	17 L / 0.6 ft³	400 x 270 x 290 (230 mm) / 15.75 x 10.63 x 11.42 (9.06")	4 Ω	150 WRMS	100 - 200 W
GZIB 250XBR	250 mm / 10"	Front-Basstunnel	33 L / 1.17 ft³	440 x 360 x 320 (285 mm) / 17.32 x 14.17 x 12.60 (11.22")	4 Ω	250 WRMS	150 - 270 W
GZIB 300XBR	300 mm / 12"	Front-Basstunnel	37 L / 1.31 ft³	460 x 370 x 400 (310 mm) / 18.11 x 14.57 x 15.75 (12.20")	4 Ω	350 WRMS	250 - 400 W
GZIB 2.300XBR	2 x 300 mm / 12"	Front-Basstunnel	70 L / 2.47 ft³	815 x 370 x 400 (310 mm) / 32.09 x 14.57 x 15.75 (12.20")	2 x 2 Ω	700 WRMS	500 - 800 W
GZIB 3000XSPL	GZIW 12XSPL	Front-Basstunnel	45 L / 1.59 ft³	560 x 380 x 360 (260) / 22.05 x 14.96 x 14.17 (10.24")	2 x 2 Ω	1000 W SPL	600 - 1000 W
GZIB 2.3000XSPL	2 x GZIW 12XSPL	Front-Basstunnel	90 L / 3.54 ft³	840 x 400 x 430 (310 mm) / 33.07 x 15.75 x 16.93 (12.2")	4 x 2 Ω	2000 W SPL	1200 - 2000 W
GZTB 120F	GZTW 12F	Sealed	29.5 L / 1.04 ft³	725 x 385 x 110 (195 mm) / 28.54 x 15.16 x 4.33 (7.68")	2 x 2 Ω	350 WRMS	200 - 500 W
GZRB 16SPL	165 mm / 6.5"	Basstunnel	8.5 L / 0.3 ft³	410 x 280 x 130 mm / 16.14 x 11.02 x 5.12"	2 x 2 Ω	700 WSPL	300 - 700 W
GZRB 20SPL	200 mm / 8"	Aero Port	21 L / 0.74 ft³	440 x 240 x 280 mm / 17.32 x 9.45 x 11.02"	2 x 2 Ω	1000 W SPL	400 - 1000 W
GZRB 30SPL	300 mm / 12"	Front-Basstunnel	66.6 L / 2.35 ft³	650 x 380 x 450 (330) mm / 25.59 x 14.96 x 17.72 (12.99")	2 x 2 Ω	1350 WSPL	600 - 1350 W
GZCS 10SUB (2020)	250 mm / 10"	Sealed	15 L / 0.53 ft³	620 x 440 x 120 (145 mm incl. feet) / 24.4 x 17.32 x 4.72 (5.71" incl. feet)	2 x 2 Ω	150 WRMS	100 - 300 W

 Speaker Systems

Series

Product	Nominal Ø	Mounting Ø	Depth	Tweeter	Midwoofer	Frequency range	Impedance	Power handling RMS/MAX
GZRC 165 Anniversary-25	165 mm / 6.5"	142.5 mm / 5.61"	68 mm / 2.68"	GZUT 28SQ - 25th	GZRK 165SQ - 25th	35 Hz - 25 kHz	3 Ω	130 / 200 W
GZPC 165.2SQ-ACT	165 mm / 6.5"	143.5 mm / 5.65"	68 mm / 2.68"	GZPT 28SQ	GZPK 165SQ	30 Hz - 30 kHz	4 / 4 Ω	130 / 210 W + 100 / 150 W (Tw)
GZPC 165.3SQ-ACT	165 mm / 6.5" 80 mm / 3.15"	143.5 mm / 5.65" 76.5 mm / 3.01"	68 mm / 2.68" 34 mm / 1.34"	GZPT 28SQ	GZPK 165SQ GZPM 80SQX-II	30 Hz - 30 kHz	4 / 4 / 4 Ω	130 / 210 W + 70 / 110 W + 100 / 150 W (Tw)
GZNC 1650SQ	165 mm / 6.5"	143.5 mm / 5.65"	68 mm / 2.68"	GZNT 25SQ	GZNK 165SQ	40 Hz - 26 kHz	4 Ω	150 / 250 W
GZNC 165.2SQ-ACT	165 mm / 6.5"	143.5 mm / 5.65"	68 mm / 2.68"	GZNT 25SQ	GZNK 165SQ	40 Hz - 26 kHz	4 / 4 Ω	130 / 200 W + 80 / 130 W (Tw)
GZNC 165.3SQ-ACT	165 mm / 6.5" 80 mm / 3.15"	143.5 mm / 5.65" 76.5 mm / 3.01"	68 mm / 2.68" 34 mm / 1.34"	GZNT 25SQ	GZNK 165SQ GZNM 80SQ	40 Hz - 26 kHz	4 / 4 / 4 Ω	130 / 200 W + 60 / 100 W + 80 / 130 W (Tw)
GZUC 650SQ-II	165 mm / 6.5"	145.7 mm / 5.74"	66 mm / 2.6"	25 mm / 1" silk dome	WFWC Cone	40 Hz - 24 kHz	4 Ω	130 / 210 W
GZUC 165.2SQ	165 mm / 6.5"	144 mm / 5.67"	63 mm / 2.48"	GZUT 28SQ	GZUK 165SQ	30 Hz - 25 kHz	4 Ω	140 / 230 W
GZUC 165.2SQ-ACT	165 mm / 6.5"	144 mm / 5.67"	63 mm / 2.48"	GZUT 28SQ	GZUK 165SQ	30 Hz - 25 kHz	4 / 4 Ω	120 / 200 W + 80 / 120 W (Tw)
GZUC 165.3SQ	165 mm / 6.5" 55 mm / 2.17"	144 mm / 5.67" 64.5 mm / 2.54"	63 mm / 2.48" 33 mm / 1.30"	GZUT 28SQ	GZUK 165SQ GZUM 55SQ	30 Hz - 25 kHz	4 Ω	160 / 250 W
GZUC 165.3SQ-ACT	165 mm / 6.5" 55 mm / 2.17"	144 mm / 5.67" 64.5 mm / 2.54"	63 mm / 2.48" 33 mm / 1.30"	GZUT 28SQ	GZUK 165SQ GZUM 55SQ	30 Hz - 25 kHz	4 / 4 / 4 Ω	120 / 200 W + 90 / 150 W + 80 / 120 (Tw)
GZRC 165.2SQ	165 mm / 6.5"	142.5 mm / 5.61"	68 mm / 2.68"	GZRT 25SQ	GZRK 165SQ	35 Hz - 25 kHz	3 Ω	120 / 190 W
GZRC 165.2SQ-IV	165 mm / 6.5"	142.5 mm / 5.61"	68 mm / 2.68"	GZRT 25SQ	GZRK 165SQ	35 Hz - 25 kHz	3 Ω	120 / 190 W
GZRC 165.2SQ-ACT	165 mm / 6.5"	142.5 mm / 5.61"	68 mm / 2.68"	GZRT 25SQ	GZRK 165SQ	35 Hz - 25 kHz	3 / 4 Ω	110 / 160 W + 70 / 110 W (Tw)
GZRC 165.3SQ	165 mm / 6.5"	142.5 mm / 5.61"	68 mm / 2.68"	GZRT 25SQ	GZRK 165SQ	35 Hz - 25 kHz	3 Ω	150 / 230 W
GZRC 165.3SQ-ACT	165 mm / 6.5"	142.5 mm / 5.61"	68 mm / 2.68"	GZRT 25SQ	GZRK 165SQ GZRM 80SQ	35 Hz - 25 kHz	3 / 4 / 4 Ω	110 / 160 W + 50 / 80 W + 70 / 110 (Tw)
GZRC 100NEO-IV	100 mm / 4"	94 mm / 3.7"	31 mm / 1.22"	GZRT 25T	Coated paper cone	80 Hz - 26 kHz	3 Ω	80 / 120 W
GZRC 165NEO-IV	165 mm / 6.5"	142.5 mm / 5.61"	48 mm / 1.89"	GZRT 25T	Coated paper cone	50 Hz - 26 kHz	3 Ω	110 / 170 W
GZRC 200NEO-IV	200 mm / 8"	182 mm / 7.17"	57 mm / 2.24"	GZRT 25T	Coated paper cone	35 Hz - 26 kHz	3 Ω	120 / 190 W
GZTC 130	130 mm / 5.25"	117.5 mm / 4.61"	61 mm / 2.40"	19 mm / 0.75" silk dome	HQPP cone	60 Hz - 22 kHz	3 Ω	80 / 130 W
GZTC 165.2X	165 mm / 6.5"	142.5 mm / 5.61"	68 mm / 2.68"	GZTT 20S	HQPP cone	50 Hz - 22 kHz	3 Ω	100 / 150 W
GZTC 165.3	165 mm / 6.5" 100 mm / 4"	142.5 mm / 5.61" 94 mm / 3.70"	68 mm / 2.68" 32 mm / 1.26"	19 mm / 0.75" silk dome	HQPP cone	50 Hz - 22 kHz	3 Ω	100 / 150 W
GZTC 165.3-ACT	165 mm / 6.5" 100 mm / 4"	142.5 mm / 5.61" 94 mm / 3.70"	68 mm / 2.68" 32 mm / 1.26"	19 mm / 0.75" silk dome	HQPP cone	50 Hz - 22 kHz	3 / 3 / 3 Ω	80 / 110 W + 40 / 50 W + 30 / 40 W (Tw)
GZIC 13X	130 mm / 5.25"	114 mm / 4.49"	50 mm / 1.97"	19 mm / 0.75" soft dome	HQPP cone	60 Hz - 20 kHz	4 Ω	90 / 140 W
GZIC 16X	165 mm / 6.5"	143.5 mm / 5.65"	60 mm / 2.36"	19 mm / 0.75" soft dome	HQPP cone	50 Hz - 20 kHz	4 Ω	100 / 150 W
GZIC 400FX	100 mm / 4"	93 mm / 3.66"	30 mm / 1.18"	19 mm / 0.75" soft dome	Coated paper cone	70 Hz - 20 kHz	4 Ω	60 / 100 W
GZIC 650FX	165 mm / 6.5"	142.5 mm / 5.61"	44 mm / 1.73"	19 mm / 0.75" soft dome	Coated paper cone	50 Hz - 20 kHz	4 Ω	100 / 140 W
GZCC 165.2SQL	165 mm / 6.5"	145 mm / 5.7"	71.5 mm / 2.81"	25 mm / 1.0" silk dome	Fiber reinforced paper cone	50 Hz - 22 kHz	4 Ω	160 / 300 W
GZCC 165.2SQL-ACT	165 mm / 6.5"	145 mm / 5.7"	71.5 mm / 2.81"	25 mm / 1.0" silk dome	Fiber reinforced paper cone	50 Hz - 22 kHz	4 / 4 Ω	100 / 300 W + 100 / 150 W (Tw)
GZCC 200.2SQL	200 mm / 8"	183 mm / 7.2"	86 mm / 3.39"	25 mm / 1.0" silk dome	Fiber reinforced paper cone	50 Hz - 22 kHz	4 Ω	200 / 380 W
GZCC 200.2SQL-ACT	200 mm / 8"	183 mm / 7.2"	86 mm / 3.39"	25 mm / 1.0" silk dome	Fiber reinforced paper cone	50 Hz - 22 kHz	4 / 4 Ω	150 / 300 W + 100 / 150 W (Tw)
GZCS 100BMW-SQ+A	100 mm / 4"	Car Specific	Car Specific	25 mm / 1.0" silk dome	Paper-fibre cone	100 Hz - 25 kHz	3 Ω	50 / 100 W
GZCS 100BMW-SQ+B	100 mm / 4"	Car Specific	Car Specific	25 mm / 1.0" silk dome	Paper-fibre cone	100 Hz - 25 kHz	3 Ω	50 / 100 W
GZCS 100BMW-SQ+C	100 mm / 4"	Car Specific	Car Specific	25 mm / 1.0" silk dome	Paper-fibre cone	100 Hz - 25 kHz	3 Ω	50 / 100 W
GZCS 100BMW-SQ+D	100 mm / 4"	Car Specific	Car Specific	25 mm / 1.0" silk dome	Paper-fibre cone	100 Hz - 25 kHz	3 Ω	50 / 100 W
GZCS 100BMW-SQA	100 mm / 4"	Car Specific	Car Specific	25 mm / 1.0" silk dome	Paper-fibre cone	100 Hz - 25 kHz	3 Ω	50 / 100 W
GZCS 100BMW-SQB	100 mm / 4"	Car Specific	Car Specific	25 mm / 1.0" silk dome	Paper-fibre cone	100 Hz - 25 kHz	3 Ω	50 / 100 W
GZCS 100BMW-SQC	100 mm / 4"	Car Specific	Car Specific	25 mm / 1.0" silk dome	Paper-fibre cone	100 Hz - 25 kHz	3 Ω	50 / 100 W
GZCS 100BMW-SQD	100 mm / 4"	Car Specific	Car Specific	25 mm / 1.0" silk dome	Paper-fibre cone	100 Hz - 25 kHz	3 Ω	50 / 100 W
GZCS 165VW	165 mm / 6.5"	Car Specific	Car Specific	25 mm / 1" titanium dome	Aluminum cone	35 Hz - 26 kHz	3 Ω	120 / 190 W
GZCS 100MB	100 mm / 4"	Car Specific	Car Specific	25 mm / 1" silk dome	Aluminum cone	70 Hz - 30 kHz	4 Ω	50 / 100 W

 Coaxial Speakers

Series	Product	Nominal Ø	Mounting Ø	Depth	Tweeter	Midwoofer	Frequency range	Impedance	Power handling RMS/MAX
Yellow	GZRF 4.0SQ	100 mm / 4"	93 mm / 3.66"	47 mm / 1.85"	19 mm / 0.51" silk dome	Black aluminum cone	70 Hz - 24 kHz	3 Ω	70 / 110 W
	GZRF 5.2SQ	130 mm / 5.25"	117.5 mm / 4.63"	59 mm / 2.32"	19 mm / 0.51" silk dome	Black aluminum cone	60 Hz - 24 kHz	3 Ω	80 / 120 W
	GZRF 6.5SQ	165 mm / 6.5"	142.5 mm / 5.61"	68 mm / 2.68"	19 mm / 0.51" silk dome	Black aluminum cone	50 Hz - 24 kHz	3 Ω	100 / 140 W
	GZRF 69SQ	150 x 230 mm / 6 x 9"	152 x 214 mm / 5.98 x 8.4"	82 mm / 3.23"	13 mm / 0.51" PEI & 50 mm / 2" PEI midrange	Black aluminum cone	40 Hz - 24 kHz	3 Ω	130 / 200 W
Red	GZTF 10	100 mm / 4"	93 mm / 3.66"	51 mm / 2.01"	13 mm / 0.51" Mylar	HQPP cone	70 Hz - 22 kHz	3 Ω	70 / 100 W
	GZTF 13	130 mm / 5.25"	117.5 mm / 4.63"	62 mm / 2.44"	13 mm / 0.51" Mylar	HQPP cone	60 Hz - 22 kHz	3 Ω	80 / 110 W
	GZTF 16	165 mm / 6.5"	143.5 mm / 5.65"	67 mm / 2.64"	13 mm / 0.51" Mylar	HQPP cone	50 Hz - 22 kHz	3 Ω	90 / 130 W
	GZTF 69	150 x 230 mm / 6 x 9"	152 x 214 mm / 5.98 x 8.4"	85 mm / 3.35"	13 mm / 0.51" Mylar & 55 mm / 2.2" midrange	HQPP cone	40 Hz - 22 kHz	3 Ω	130 / 190 W
Orange	GZIF 4001FX	100 mm / 4"	93 mm / 3.66"	30 mm / 1.18"	13 mm / 0.51" Mylar	Coated paper cone	80 Hz - 20 kHz	4 Ω	50 / 90 W
	GZIF 5201FX	130 mm / 5.25"	117.5 mm / 4.63"	37 mm / 1.46"	13 mm / 0.51" Mylar	Coated paper cone	70 Hz - 20 kHz	4 Ω	60 / 100 W
	GZIF 6501FX	165 mm / 6.5"	142.5 mm / 5.61"	44 mm / 1.73"	13 mm / 0.51" Mylar	Coated paper cone	60 Hz - 20 kHz	4 Ω	70 / 110 W
	GZIF 40X	100 mm / 4"	92 mm / 3.6"	47 mm / 1.85"	13 mm / 0.51" Mylar	HQPP cone	80 Hz - 20 kHz	4 Ω	60 / 100 W
	GZIF 52X	130 mm / 5.25"	114 mm / 4.49"	50 mm / 1.97"	13 mm / 0.51" Mylar	HQPP cone	60 Hz - 20 kHz	4 Ω	70 / 110 W
	GZIF 65X	165 mm / 6.5"	143.5 mm / 5.65"	60 mm / 2.36"	13 mm / 0.51" Mylar	HQPP cone	50 Hz - 20 kHz	4 Ω	80 / 120 W
	GZIF 69X	150 x 230 mm / 6 x 9"	150 x 220 mm / 5.9 x 8.66"	81.5 mm / 3.2"	13 mm / 0.51" Mylar & 50 mm / 2" midrange	HQPP cone	40 Hz - 20 kHz	4 Ω	120 / 180 W
Green	GZCF 165COAX	165 mm / 6.5"	147.5 mm / 5.8"	79 mm / 3.11"	35 mm / 1.38" PEN compression horn	Fiber reinforced paper cone	TW: 3.5 - 25 kHz / MID: 180 Hz-3.5 kHz	TW: 4 Ω MID: 4 Ω	TW: 25 / 100 W Mid: 125 / 200 W
	GZCF 200COAX	200 mm / 8"	184 mm / 7.24"	89 mm / 3.5"	44.5 mm / 1.75" titanium compression horn	Fiber reinforced paper cone	TW: 3 - 25 kHz / MID: 150 Hz - 3 kHz	TW: 4 Ω MID: 4 Ω	TW: 50/150 W Mid: 150 / 250 W
	GZCF 6.5SPL	165 mm / 6.5"	145 mm / 5.7"	72 mm / 2.83"	25 mm / 1" PEI	Fiber reinforced paper cone	50 Hz - 20 kHz	4 Ω	100 / 250 W
	GZCF 8.0SPL	200 mm / 8"	183 mm / 7.2"	87 mm / 3.43"	25 mm / 1" PEI	Fiber reinforced paper cone	40 Hz - 20 kHz	4 Ω	150 / 300 W
	GZCF 7104XSPL	180 x 250 mm / 7 x 10"	152 x 214 mm / 5.98 x 8.4"	86 mm / 3.39"	13 mm / 0.51" PEI & 13 mm / 0.51" piezoelectric 50 mm / 2" paper cone mid	Fiber reinforced paper cone	35 Hz - 25 kHz	4 Ω	200 / 300 W
Purple	GZCS 12CX	120 mm / 4.7"	Car Specific		13 mm / 0.51" Mylar	Coated paper cone	75 Hz - 20 kHz	4 Ω	60 / 100 W
	GZCS 46CX	100 x 150 mm / 4 x 6"	Car Specific	48 mm / 1.89"	13 mm / 0.51" Mylar	Coated paper cone	80 Hz - 20 kHz	4 Ω	70 / 110 W
	GZCS 8.7CX	87 mm / 3.43"	Car Specific	43 mm / 1.69"	13 mm / 0.51" Mylar	Coated paper cone	100 Hz - 20 kHz	4 Ω	50 / 90 W
Teal	GZRM 165X	165 mm / 6.5"	142.5 mm / 5.61"	62 mm / 2.44"	13 mm / 0.51" Mylar	IMP PP cone	60 Hz - 25 kHz	4 Ω	70 / 120 W

 Kickwoofer / Midwoofer / Midrange / Fullrange Speakers

Series	Product	Nominal Ø	Mounting Ø	Depth	Voice coil Ø	Cone	FS	QTS	VAS	Frequency range	Impedance	Power handling RMS/MAX
Orange	GZPM Reference 80	80 mm / 3.15"	85.4 mm / 3.36"	45 mm / 1.77"	19 mm / 0.75"	Coated paper	107.5 Hz	0.6	0.8 L / 0.028 ft³	150 Hz - 6 kHz	4 Ω	80 / 120 W
	GZMW Reference 180	180 mm / 7.1"	155.5 mm / 6.12"	68 mm / 2.68"	25 mm / 1"	Coated paper	56.8 Hz	0.58	16 L / 0.56 ft³	40 Hz - 3.5 kHz	4 Ω	100 / 150 W
Black	GZPF 40SQ	40 mm / 1.57"	48 mm / 1.89"	39 mm / 1.54"	16 mm / 0.63"	Black Aluminum	400 Hz			500 Hz - 24 kHz	4 Ω	50 / 80 W
	GZPM 80SQX-II	80 mm / 3.15"	77 mm / 3.03"	34 mm / 1.34"	25 mm / 1"	Aluminum	109.4 Hz	0.46	0.9 L / 0.032 ft³	150 Hz - 4 kHz	4 Ω	70 / 110 W
Blue	GZPK 165SQ	165 mm / 6.5"	143.5 mm / 5.65"	68 mm / 2.68"	36 mm / 1.42"	Alu-Ceramic	45.3 Hz	0.62	22.1 L / 0.78 ft³	30 Hz - 3 kHz	4 Ω	130 / 210 W
	GZNF 50SQ	50 mm / 1.97"	50 mm / 1.97"	30 mm / 1.18"	22 mm / 0.87"	Black Aluminum	130 Hz			250 Hz - 22 kHz	4 Ω	50 / 80 W
Light Blue	GZNM 80SQ	80 mm / 3.15"	76.5 mm / 3.01"	34 mm / 1.34"	25 mm / 1"	Coated paper	115 Hz	0.39	1 L / 0.035 ft³	150 Hz - 5 kHz	4 Ω	60 / 100 W
	GZNK 165SQ	165 mm / 6.5"	143.5 mm / 5.65"	68 mm / 2.68"	36 mm / 1.42"	Coated paper	55.2 Hz	0.65	14.6 L / 0.52 ft³	40 Hz - 3 kHz	4 Ω	130 / 200 W
Brown	GZUM 55SQ	55 mm / 2.2"	64.5 mm / 2.54"	33 mm / 1.30"	55 mm / 2.17"	Coated silk dome	please check the manual			500 Hz - 7 kHz	4 Ω	90 / 150 W
	GZUF 60SQX	60 mm / 2.36"	61 mm / 2.4"	36 mm / 1.42"	25 mm / 1"	Black Aluminum	150 Hz	0.64	0.4 L / 0.14 ft³	300 Hz - 20 kHz	4 Ω	50 / 80 W
Dark Blue	GZUM 80SQ	80 mm / 3.15"	76.5 mm / 3.01"	35mm / 1.38"	25 mm / 1"	Black Aluminum	please check the manual			200 Hz - 6 kHz	4 Ω	50 / 80 W
	GZUK 165SQ	165 mm / 6.5"	144 mm / 5.67"	61 mm / 2.40"	50 mm / 2"	Black Aluminum	please check the manual			40 Hz - 3.5 kHz	4 Ω	120 / 180 W
Yellow	GZRM 80SQ	80 mm / 3.15"	76.5 mm / 3.01"	34 mm / 1.34"	25 mm / 1"	Black Aluminum	113 Hz	0.38	1.5 L / 0.52 ft³	160 Hz - 4 kHz	3 Ω	50 / 80W
	GZRK 165SQ	165 mm / 6.5"	142.5 mm / 5.61"	68 mm / 2.68"	25 mm / 1"	Black Aluminum	60.1 Hz	0.65	11.5 L / 0.41 ft³	35 Hz - 4 kHz	3 Ω	110 / 160 W
Red	GZMW 165X-NEO	165 mm / 6.5"	142.5 mm / 5.61"	48 mm / 1.89"	30 mm / 1.18"	Coated paper	44.3 Hz	0.47	21.4 L / 0.76 ft³	50 Hz - 4 kHz	3 Ω	90 / 140 W
	GZTM 100NEO	100 mm / 4"	94 mm / 3.7"	32 mm / 1.26"	25 mm / 1"	HQPP	127.8	1.77	1.8 L / 0.06 ft³	250 Hz - 7 kHz	3 Ω	40 / 60 W

## Kickwoofer / Midwoofer / Midrange Speakers

Series	Product	Nominal Ø	Mounting Ø	Depth	Voice coil Ø	Cone	FS	QTS	VAS	Frequency range	Impedance	Power handling RMS/MAX
	GZCM 6.5N-PRO	170 mm / 6"	148 mm / 5.83"	68 mm / 2.68"	38 mm / 1.5"	Reinforced paper	116.2 Hz	0.33	5.6 L / 0.20 ft³	150 Hz - 12 kHz	4 Ω	200 / 400 W
	GZCM 8.0N-PRO	200 mm / 8"	184 mm / 7.24"	83 mm / 3.27"	63 mm / 2.5"	Reinforced paper	102.2 Hz	0.28	9.1 L / 0.32 ft³	130 Hz - 10 kHz	4 Ω	300 / 500 W
	GZCM 6.5NEO	165 mm / 6.5"	143 mm / 5.63"	65 mm / 2.56"	38 mm / 1.5"	Reinforced paper	140.6 Hz	0.33	4.3 L / 0.15 ft³	250 Hz - 10 kHz	3 Ω	120 / 320 W
	GZCM 8.0NEO	200 mm / 8"	182 mm / 7.17"	76 mm / 2.99"	38 mm / 1.5"	Reinforced paper	130.6 Hz	0.43	13.8 L / 0.49 ft³	170 Hz - 6 kHz	3 Ω	180 / 420 W
	GZCM 6.5SPL	165 mm / 6.5"	143 mm / 5.63"	72 mm / 2.83"	38 mm / 1.5"	Reinforced paper	189.4 Hz	0.96	1.9 L / 0.067 ft³	250 Hz - 10 kHz	4 Ω	100 / 300 W
	GZCM 8.0SPL	200 mm / 8"	182 mm / 7.17"	87 mm / 3.43"	38 mm / 1.5"	Reinforced paper	90.6 Hz	0.58	17.2 L / 0.607 ft³	170 Hz - 10 kHz	4 Ω	150 / 400 W
	GZCM 10.0SPL	250 mm / 10"	231 mm / 9.09"	98 mm / 3.86"	50 mm / 2"	Reinforced paper	76.2 Hz	0.65	31 L / 1.095 ft³	150 Hz - 10 kHz	4 Ω	200 / 500 W
	GZCM 6-4FX	165 mm / 6.5"	143 mm / 5.63"	52 mm / 2.05"	38 mm / 1.5"	Reinforced paper	216.6 Hz	0.94	1.8 L / 0.06 ft³	200 Hz - 5 kHz	4 Ω	100 / 300 W
	GZCM 8-4FX	200 mm / 8"	180 mm / 7.09"	65 mm / 2.56"	38 mm / 1.5"	Reinforced paper	132.1 Hz	1.02	6.3 L / 0.22 ft³	150 Hz - 4 kHz	4 Ω	100 / 400 W
	GZCK 165XSPL	165 mm / 6.5"	145 mm / 5.7"	71 mm / 2.80"	38 mm / 1.5"	Reinforced paper	56.8 Hz	0.31	16.2 L / 0.57 ft³	50 Hz - 4 kHz	4 Ω	100 / 250 W
	GZCK 200XSPL	200 mm / 8"	183 mm / 7.2"	86 mm / 3.39"	38 mm / 1.5"	Reinforced paper	54.3 Hz	0.38	31.2 L / 1.10 ft³	50 Hz - 6 kHz	4 Ω	150 / 300 W
	GZCK 250XSPL	250 mm / 10"	235 mm / 9.25"	110 mm / 4.33"	50 mm / 2"	Reinforced paper	43.6 Hz	0.41	43.6 L / 1.54 ft³	40 Hz - 6 kHz	4 Ω	200 / 400 W
	GZCW 12.1200-PRO	300 mm / 12"	283 mm / 11.14"	117 mm / 4.6"	100 mm / 4"	Reinforced paper	51.4 Hz	0.28	43.8 L / 1.55 ft³	60 Hz - 2.8 kHz	4 Ω	800 / 1200 W
	GZCW 12-75SPL	300 mm / 12"	282 mm / 11.1"	133 mm / 5.24"	75 mm / 3"	Reinforced paper	42.2 Hz	0.27	71.9 L / 2.54 ft³	40 Hz - 3 kHz	4 Ω	400 / 800 W
	GZCW 12-50	300 mm / 12"	282 mm / 11.1"	130 mm / 5.12"	50 mm / 2"	Reinforced paper	47.1 Hz	0.42	93.4 L / 3.68 ft³	50 Hz - 3 kHz	4 Ω	300 / 600 W

## Tweeters

Series	Product	Outer Ø incl. frame	Mounting Ø incl. frame	Mounting depth	Voice coil Ø	Dome	FS	Frequency range	Impedance	Power handling RMS/max
	GZPT Reference 28EVO	54 mm / 2.13"	48 mm / 1.89"	39 mm / 1.54"	28 mm / 1.1"	Coated silk	630 Hz	1 - 30 kHz	4 Ω	100 / 150 W
	GZPT 28SQ	54 mm / 2.13"	48 mm / 1.89"	35 mm / 1.38"	28 mm / 1.1"	Coated silk	770 Hz	2 - 30 kHz	4 Ω	100 / 150 W
	GZNT 25SQ	49 mm / 1.93"	43.1 mm / 1.7"	21.5 mm / 0.85"	25 mm / 1"	Coated silk	750 Hz	2 - 28 kHz	4 Ω	80 / 130 W
	GZUT 28SQ	54 mm / 2.13"	48 mm / 1.89"	18 mm / 0.70"	28 mm / 1.1"	Coated silk	1300 Hz	2.5 - 25 kHz	4 Ω	80 / 130 W
	GZRT 25SQ	54 mm / 2.13"	48 mm / 1.89"	16 mm / 0.63"	25 mm / 1"	Coated silk	1550 Hz	3 - 25 kHz	4 Ω	70 / 110 W
	GZRT 25T	49.5 mm / 1.95"	44 mm / 1.73"	10 mm / 0.39"	25 mm / 1"	Titanium	1500 Hz	3 - 26 kHz	3 Ω	70 / 110 W
	GZTT 20S	54 mm / 2.13"	46 mm / 1.81"	18 mm / 0.70"	20 mm / 0.79"	Coated silk	1700 Hz	3 - 20 kHz	4 Ω	40 / 70 W
	GZHT 25X	54 mm / 2.13"	48 mm / 1.89"	20 mm / 0.79"	25 mm / 1"	Coated silk	1600 Hz	3 - 20 kHz	4 Ω	60 / 100 W

## Competition & Competition PRO Tweeters

Series	Product	Outer Ø w/o frame	Mounting Ø	Mounting depth	Voice coil Ø	Dome	Frequency range	Impedance	Power handling RMS/MAX
	GZCT 0500X	58 mm / 2.28"	43 mm / 1.69"	43 mm / 1.69"	25 mm / 1"	Aluminum	4 - 25 kHz	4 Ω	30 / 100 W
	GZCT 1000X	100 x 75 mm / 4 x 3"	82 x 58 mm / 3.23 x 2.28"	56 mm / 2.2"	25 mm / 1"	Aluminum	5 - 20 kHz	4 Ω	30 / 100 W
	GZCT 19N-PROX (B/S)	83 x 67 mm / 3.27 x 2.64"	60 x 46 mm / 2.36 x 1.81"	48 mm / 1.89"	25 mm / 1"	Titanium	3 - 22 kHz	4 Ω	30 / 100 W
	GZCT 2100X-B	89 x 89 mm / 3.5 x 3.5"	80 mm / 3.15"	42.5 mm / 1.67"	25 mm / 1"	Aluminum	3 - 25 kHz	4 Ω	30 / 100 W
	GZCT 255QL	75 mm / 2.95"	50 mm / 1.97"	36 mm / 1.42"	25 mm / 1"	Coated silk	3 - 22 kHz	4 Ω	100 / 150 W
	GZCT 3000X	102 x 102 mm / 4.02 x 4.02"	90 mm / 3.54"	66 mm / 2.6"	38 mm / 1.5"	Aluminum	4 - 25 kHz	4 Ω	40 / 120 W
	GZCT 3500X (B/S)	98 mm / 3.86"		40 mm / 1.57"	25 mm / 1"	Aluminum	3 - 25 kHz	4 Ω	30 / 100 W
	GZCT 4000X	160 x 120 mm / 6.3 x 4.7"	128 x 88 mm / 5 x 3.46"	87 mm / 3.43"	44.5 mm / 1.75"	Aluminum	2.5 - 20 kHz	4 Ω	50 / 140 W
	GZCT 5000SPL (-B)	200 x 150 mm / 8 x 5.9"	165 x 130 mm / 6.5 x 5.12"	142 mm / 5.59"	44.5 mm / 1.75"	Titanium	1.5 - 20 kHz	4 Ω	70 / 180 W
	GZCT 500IV-B	58 mm / 2.28"	43 mm / 1.69"	37 mm / 1.46"	25 mm / 1"	Aluminum	4 - 25 kHz	4 Ω	30 / 100 W

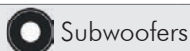

Series

Product	Outer Ø	Mounting Ø	Depth	Voice coil Ø	Cone	FS	QTS	VAS	Impedance	Power handling	Recommended amplifier power
GZPW Reference 250	275 mm / 10.8"	235 mm / 9.25"	128 mm / 5.04"	50 mm / 2"	3 layer sandwich	31.3 Hz	0.50	36.5 L / 1.29 ft³	2 x 2 Ω	500 W RMS	300 - 600 W
GZPW 10SQ	259 mm / 10.20"	236 mm / 9.29"	148 mm / 5.83"	50 mm / 2"	Aluminum	34 Hz	0.58	23.5 L / 0.83 ft³	2 x 2 Ω	400 W RMS	400 - 700 W
GZPW 15NEO-SPL	391 mm / 15.39"	358 mm / 14.09"	307 mm / 12.09"	100 mm / 4"	Carbon fiber mixed	41.2 Hz	0.19	25.6 L / 0.9 ft³	2 x 1 Ω	3000 W RMS	2000 - 10000 W
GZPW 15SPL-D1	392 mm / 15.43"	358 mm / 14.09"	269 mm / 10.59"	100 mm / 4"	Reinforced paper	30.3 Hz	0.26	73 L / 2.58 ft³	2 x 1 Ω	5000 W / 10000 WSPL	4000 - 10000 W
GZPW 15SPL-D2	392 mm / 15.43"	358 mm / 14.09"	269 mm / 10.59"	100 mm / 4"	Reinforced paper	please check the manual			2 x 2 Ω	5000 W / 10000 WSPL	4000 - 10000 W
GZPW 15Xmax	392 mm / 15.43"	358 mm / 14.09"	297 mm / 11.69"	100 mm / 4"	Aluminum	31.6 Hz	0.40	27.0 L / 0.95 ft³	2 x 1 Ω	6000 W RMS	4000 - 8000 W
GZNW 38NEO-SPL	391 mm / 15.39"	358 mm / 14.09"	300 mm / 11.81"	75 mm / 3"	Reinforced paper	31.6 Hz	0.18	34.9 L / 1.23 ft³	2 x 1 Ω	2500 W RMS / 5000 W SPL	1500 - 5000 W
GZNW 38NEO-EXTREME	391 mm / 15.39"	358 mm / 14.09"	300 mm / 11.81"	75 mm / 3"	Carbon fiber mixed	30.3 Hz	0.19	36.2 L / 1.28 ft³	2 x 1 Ω	3000 W RMS / 6000 W SPL	2000 - 6000 W
GZNW 12SPL-Xflex	314 mm / 12.36"	284 mm / 11.18"	226 mm / 8.9"	75 mm / 3"	Reinforced paper	33.9 Hz	0.36	27.3 L / 0.96 ft³	2 x 1 Ω	2500 W RMS / 4500 W SPL	1500 - 4500 W
GZNW 15SPL-Xflex	392 mm / 15.43"	358 mm / 14.09"	260 mm / 10.24"	75 mm / 3"	Reinforced paper	30.2 Hz	0.49	59.1 L / 2.09 ft³	2 x 1 Ω	3000 W RMS / 5500 W SPL	2000 - 5500 W
GZNW 18SPL-Xflex	465 mm / 18.3"	425 mm / 16.73"	286 mm / 11.26"	75 mm / 3"	Reinforced paper	26 Hz	0.53	159.2 L / 5.62 ft³	2 x 1 Ω	3000 W RMS / 6500 W SPL	1500 - 6500 W
GZNW 12Xmax	314 mm / 12.36"	282 mm / 11.1"	250 mm / 9.84"	75 mm / 3"	Aluminum	35.6 Hz	0.61	13.6 L / 0.48 ft³	2 x 1 Ω	3000 W RMS	2000 - 4000 W
GZNW 15Xmax	392 mm / 15.43"	358 mm / 14.09"	285 mm / 11.22"	75 mm / 3"	Aluminum	29.5 Hz	0.33	35.7 L / 1.26 ft³	2 x 1 Ω	4000 W RMS	3000 - 5000 W
GZNW 30SPL-D1	315 mm / 12.4"	281 mm / 11.06"	237 mm / 9.33"	75 mm / 3"	Reinforced paper	38.6 Hz	0.38	23.6 L / 0.83 ft³	2 x 1 Ω	3000 W RMS / 6000 W SPL	2000 - 6000 W
GZNW 30SPL-D2	315 mm / 12.4"	281 mm / 11.06"	237 mm / 9.33"	75 mm / 3"	Reinforced paper	please check the manual			2 x 2 Ω	3000 W RMS / 6000 W SPL	2000 - 6000 W
GZNW 38SPL-D1	392 mm / 15.43"	358 mm / 14.09"	269 mm / 10.59"	75 mm / 3"	Reinforced paper	36 Hz	0.52	54 L / 1.91 ft³	2 x 1 Ω	3500 W RMS / 7000 W SPL	3000 - 7000 W
GZNW 38SPL-D2	392 mm / 15.43"	358 mm / 14.09"	269 mm / 10.59"	75 mm / 3"	Reinforced paper	please check the manual			2 x 2 Ω	3500 W RMS / 7000 W SPL	3000 - 7000 W
GZUW 8SQX	215 mm / 8.46"	181 mm / 7.13"	108 mm / 4.25"	50 mm / 2"	Reinforced paper	56.4 Hz	0.68	5.9 L / 0.21 ft³	2 x 2 Ω	300 W RMS	200 - 400 W
GZUW 10SQX	262 mm / 10.31"	236 mm / 9.29"	148 mm / 5.83"	50 mm / 2"	Reinforced paper	41.0 Hz	0.56	25 L / 0.95 ft³	2 x 2 Ω	450 W RMS	300 - 600 W
GZUW 12SQX	315 mm / 12.4"	281 mm / 11.06"	150 mm / 5.91"	50 mm / 2"	Reinforced paper	38.6 Hz	0.62	41.1 L / 1.45 ft³	2 x 2 Ω	600 W RMS	400 - 800 W
GZHW 16SPL	177 mm / 6.97"	153 mm / 6.02"	110 mm / 4.33"	50 mm / 2"	Reinforced paper	51 Hz	0.46	2.8 L / 0.10 ft³	2 x 2 Ω	500 W RMS / 1000 W SPL	400 - 1000 W
GZHW 20XSPL-D1	211 mm / 8.31"	187 mm / 7.36"	143 mm / 5.65"	63 mm / 2.5"	Reinforced paper	38.9 Hz	0.55	5.2 L / 0.18 ft³	2 x 1 Ω	700 W RMS / 1500 W SPL	500 - 1500 W
GZHW 20XSPL-D2	211 mm / 8.31"	187 mm / 7.36"	143 mm / 5.65"	63 mm / 2.5"	Reinforced paper	42.4 Hz	0.63	4.3 L / 0.15 ft³	2 x 2 Ω	700 W RMS / 1500 W SPL	500 - 1500 W
GZHW 25XSPL-D1	274 mm / 10.79"	238 mm / 9.37"	178 mm / 7"	63 mm / 2.5"	Reinforced paper	40.3 Hz	0.52	9.9 L / 0.35 ft³	2 x 1 Ω	1200 W RMS / 2500 W SPL	800 - 2500 W
GZHW 25XSPL-D2	274 mm / 10.79"	238 mm / 9.37"	178 mm / 7"	63 mm / 2.5"	Reinforced paper	40.1 Hz	0.58	12.7 L / 0.45 ft³	2 x 2 Ω	1200 W RMS / 2500 W SPL	800 - 2500 W
GZHW 30XSPL-D1	315 mm / 12.4"	284 mm / 11.18"	19.8 mm / 7.8"	75 mm / 3"	Reinforced paper	39.1 Hz	0.56	17.6 L / 0.62 ft³	2 x 1 Ω	1500 W RMS / 3000 W SPL	1000 - 3000 W
GZHW 30XSPL-D2	315 mm / 12.4"	284 mm / 11.18"	19.8 mm / 7.8"	75 mm / 3"	Reinforced paper	42.4 Hz	0.60	16.9 L / 0.60 ft³	2 x 2 Ω	1500 W RMS / 3000 W SPL	1000 - 3000 W
GZHW 38XSPL-D1	390 mm / 15.35"	360 mm / 14.17"	23.1 mm / 9.09"	75 mm / 3"	Reinforced paper	43.4 Hz	0.77	22.2 L / 0.78 ft³	2 x 1 Ω	2000 W RMS / 3500 W SPL	1500 - 3500 W
GZHW 38XSPL-D2	390 mm / 15.35"	360 mm / 14.17"	23.1 mm / 9.09"	75 mm / 3"	Reinforced paper	39 Hz	0.65	35 L / 1.24 ft³	2 x 2 Ω	2000 W RMS / 3500 W SPL	1500 - 3500 W
GZRW 6XSPL	169 mm / 6.65"	147 mm / 5.79"	99 mm / 3.9"	50 mm / 2"	Reinforced paper	49.5 Hz	0.58	2.2 L / 0.08 ft³	2 x 2 Ω	700 W SPL	300 - 700 W
GZRW 8XSPL	209 mm / 8.23"	182 mm / 7.17"	133 mm / 5.24"	50 mm / 2"	Reinforced paper	45.8 Hz	0.36	7.4 L / 0.26 ft³	2 x 2 Ω	1000 W SPL	400 - 1000 W
GZRW 10XSPL	257 mm / 10.12"	228 mm / 8.98"	140 mm / 5.51"	63 mm / 2.5"	Reinforced paper	44.3 Hz	0.75	9.0 L / 0.32 ft³	2 x 2 Ω	800 W RMS / 1200 W SPL	600 - 1200 W
GZRW 12XSPL	311 mm / 12.24"	288 mm / 11.34"	166 mm / 6.54"	75 mm / 3"	Reinforced paper	31.8 Hz	0.68	27.2 L / 0.96 ft³	2 x 2 Ω	1000 W RMS / 1500 W SPL	800 - 1500 W
GZRW 15XSPL	387 mm / 15.24"	358 mm / 14.09"	186 mm / 7.09"	75 mm / 3"	Reinforced paper	34.1 Hz	0.59	63.3 L / 2.24 ft³	2 x 2 Ω	1200 W RMS / 1800 W SPL	1000 - 1800 W
GZRW 30-D2	311 mm / 12.24"	288 mm / 11.34"	166 mm / 6.54"	75 mm / 3"	Reinforced paper	25.7 Hz	0.50	31.2 L / 1.10 ft³	2 x 2 Ω	800 W RMS	600 - 1200 W
GZRW 38-D2	390 mm / 15.35"	359 mm / 14.1"	195 mm / 7.68"	75 mm / 3"	Reinforced paper	22.9 Hz	0.50	110.4 L / 3.90 ft³	2 x 2 Ω	1000 W RMS	800 - 1400 W
GZRW 8FL	204 mm / 8.03"	178 mm / 7.01"	55 mm / 2.17"	36 mm / 1.42"	IMPP	45.3 Hz	0.94	17.6 L / 0.62 ft³	2 Ω	150 W RMS	80 - 250 W

**Subwoofers**

Series

Product	Outer Ø	Mounting Ø	Depth	Voice coil Ø	Cone	FS	QTS	VAS	Impedance	Power handling	Recommended amplifier power
GZTW 10F (Improved Q)	260 mm / 10.12"	232 mm / 9.13"	88 mm / 3.46"	50 mm / 2"	IMPP	45.1 Hz	0.56	24.1 L / 0.85 ft <sup>3</sup>	2 x 2 Ω	300 W RMS	150 - 450 W
GZTW 12F	313 mm / 12.32"	284 mm / 11.18"	97.5 mm / 3.84"	50 mm / 2"	IMPP	35.1 Hz	0.53	53.2 L / 1.88 ft <sup>3</sup>	2 x 2 Ω	350 W RMS	200 - 500 W
GZIW 10SPL	257 mm / 10.12"	230 mm / 9.06"	147 mm / 5.79"	63 mm / 2.5"	Reinforced paper	40.8 Hz	0.62	14.3 L / 0.51 ft <sup>3</sup>	2 x 2 Ω	500 W RMS / 700 W SPL	400 - 800 W
GZIW 12SPL	310 mm / 12.2"	285 mm / 11.22"	162 mm / 6.38"	63 mm / 2.5"	Reinforced paper	36.9 Hz	0.67	35.6 L / 1.26 ft <sup>3</sup>	2 x 2 Ω	700 W RMS / 1000 W SPL	600 - 1000 W
GZIW 165X-II	168 mm / 6.6"	147 mm / 5.79"	80 mm / 3.15"	38 mm / 1.5"	IMPP	41.5 Hz	0.45	8.6 L / 0.3 ft <sup>3</sup>	4 Ω	100 W RMS	60 - 150 W
GZIW 200X-II	211 mm / 8.3"	182 mm / 7.17"	101 mm / 3.98"	38 mm / 1.5"	IMPP	39.9 Hz	0.56	17 L / 0.6 ft <sup>3</sup>	4 Ω	150 W RMS	100 - 200 W
GZIW 250X-II	257 mm / 10.12"	230 mm / 9.06"	129 mm / 5.1"	50 mm / 2"	IMPP	32.7 Hz	0.49	35 L / 1.24 ft <sup>3</sup>	4 Ω	250 W RMS	200 - 300 W
GZIW 300X-II	310 mm / 12.2"	287 mm / 11.3"	149 mm / 5.87"	50 mm / 2"	IMPP	30.7 Hz	0.57	60 L / 2.12 ft <sup>3</sup>	4 Ω	350 W RMS	200 - 400 W
GZCS 200BMW-SW	Car specific			50 mm / 2"	Pressed paper	55.2 Hz	1.05	20.1 L / 0.71 ft <sup>3</sup>	2 Ω	100 WRMS	80 - 160 W
GZCS 200BMW-SW4	Car specific			50 mm / 2"	Pressed paper	57.9 Hz	0.67	21.3 L / 0.75 ft <sup>3</sup>	4 Ω	100 WRMS	80 - 160 W
GZCS 200MB (R/L)	Car specific			35.5 mm / 1.4"	Pressed paper	51 Hz	0.79	15.8 L / 0.56 ft <sup>3</sup>	4 Ω	50 WRMS	40 - 100 W
GZCS W-200MB.RH	Car specific			38 mm / 1.5"	Coated carbon fiber	52 Hz	0.53	16.9 L / 0.60 ft <sup>3</sup>	4 Ω	110 WRMS	50 - 150 W



Listening to music can be emotional, impressive, relaxing or enjoyable.  
At that, it doesn't really matter what kind of music is the personal favorite,  
whether it's Instrumental, Jazz, Electro, Latin, Classic, Rock or any other music direction.

However, audio reproduction quality at each desired volume is elementary.  
Some music styles require higher levels while others prefer the soft tones.

GROUND ZERO considers all the different wishes of customers during  
the development of new products.

Along with this, the target is to create the most realistic sound,  
to transfer the soul of the music and the intention of the performer.

**RESPECT THE MUSIC!**



Check out [www.ground-zero-audio.com](http://www.ground-zero-audio.com)  
for all information on GROUND ZERO!



Follow „GROUND ZERO Official Fanpage“  
together with more than 800.000 people  
from around the world!  
#ShowYourGZ



GroundZeroAudioCom



Ground-Zero-Audio.com



GroundZeroAudioCom

Ground Zero GmbH  
Erlenweg 25  
85635 Eggening, Germany

All listed brands are trademarks of the respective companies.  
Errors and omissions excepted, and subject to technical changes.  
Our general terms of business are applied.