

Linear PCM Recorder

Operating Instructions

PCM-D1

Owner's Record

The model number is located at the rear and the serial number is located inside the battery compartment. Record the serial number in the space provided below. Refer to them whenever you call upon your Sony dealer regarding this product.

Model No. PCM-D1

Serial No. _____

WARNING

To reduce the risk of fire or electric shock, do not expose this apparatus to rain or moisture.

Do not install the appliance in a confined space, such as a bookcase or built-in cabinet.

To reduce the risk of fire, do not cover the ventilation of the apparatus with newspapers, tablecloths, curtains, etc. And do not place lighted candles on the apparatus.

To reduce the risk of fire or electric shock, do not place objects filled with liquids, such as vases, on the apparatus.

Certain countries may regulate disposal of the battery used to power this product. Please consult with your local authority.

If you have any questions about this product, you may call:

Sony Customer Information Services Center
1-800-222-7669 or <http://www.sony.com/>

Declaration of Conformity

Trade Name: SONY

Model: PCM-D1

Responsible Party: Sony Electronics Inc.

Address: 16450 W. Bernardo Dr,
San Diego, CA
92127 U.S.A.

Telephone Number: 858-942-2230

This device complies with part 15 of the FCC Rules. Operation is subject to the following two conditions: (1) This device may not cause harmful interference, and (2) this device must accept any interference received, including interference that may cause undesired operation.

Information

IN NO EVENT SHALL SELLER BE LIABLE FOR ANY DIRECT, INCIDENTAL OR CONSEQUENTIAL DAMAGES OF ANY NATURE, OR LOSSES OR EXPENSES RESULTING FROM ANY DEFECTIVE PRODUCT OR THE USE OF ANY PRODUCT.

Product registration

Please register this product on line at www.sony.com/productregistration
<<http://www.sony.com/productregistration>>

Proper registration will enable us to send you periodic mailings about new products, services and other important announcements. Registering your product will also allow us to contact you in the unlikely event that the product needs adjustment or modification.

Thank you.

Information

This equipment has been tested and found to comply with the limits for a Class B digital device, pursuant to Part 15 of the FCC Rules.

These limits are designed to provide reasonable protection against harmful interference in a residential installation. This equipment generates, uses, and can radiate radio frequency energy and, if not installed and used in accordance with the instructions, may cause harmful interference to radio communications.

However, there is no guarantee that interference will not occur in a particular installation. If this equipment does cause harmful interference to radio or television reception, which can be determined by turning the equipment off and on, the user is encouraged to try to correct the interference by one or more of the following measures:

- Reorient or relocate the receiving antenna.
- Increase the separation between the equipment and receiver.
- Connect the equipment into an outlet on a circuit different from that to which the receiver is connected.
- Consult the dealer or an experienced radio/TV technician for help.

You are cautioned that any changes or modifications not expressly approved in this manual could void your authority to operate this equipment.

RECYCLING NICKEL METAL HYDRIDE BATTERIES

Nickel Metal Hydride batteries are recyclable.

You can help preserve our environment by returning your used rechargeable batteries to the collection and recycling location nearest you.



For more information regarding recycling of rechargeable batteries, call toll free 1-800-822-8837, or visit <http://www.rbrbc.org/>

Caution: Do not handle damaged or leaking Nickel Metal Hydride batteries.

On this manual

These operating instructions are written mainly for models outside of Japan. In the case of the model for use in Japan, the display indications may differ slightly, but operations are identical.

IMPORTANT SAFEGUARDS

For your protection, please read these safety instructions completely before operating the appliance, and keep this manual for future reference.

Carefully observe all warnings, precautions and instructions on the appliance and in the operating instructions, and adhere to them.

INSTALLATION

Water and Moisture – Do not use powerline operated appliances near water – for example, near a bathtub, washbowl, kitchen sink, or laundry tub, in a wet basement, or near a swimming pool, etc.

Heat – Do not place the appliance near or over a radiator or heat register, or where it is exposed to direct sunlight.

Ventilation – The slots and openings in the cabinet are provided for necessary ventilation. To ensure reliable operation of the appliance, and to protect it from overheating, these slots and openings must never be blocked or covered.

- Never cover the slots and openings with a cloth or other materials.
- Never block the slots and openings by placing the appliance on a bed, sofa, rug or other similar surface.
- Never place the appliance in a confined space, such as a bookcase, or built-in cabinet, unless proper ventilation is provided.

Accessories – Do not place the appliance on an unstable cart, stand, tripod, bracket, or table. The appliance may fall, causing serious injury to a child or an adult, and serious damage to the appliance. Use only a cart, stand, tripod, bracket, or table recommended by Sony.

USE

Power Source – This appliance should be operated only from the type of power source indicated on the marking label. If you are not sure of the type of electrical power supplied to your home, consult your dealer or local power company. For those appliances designed to operate from battery power, or other sources, refer to the operating instructions.

Grounding or Polarization – This appliance is equipped with a polarized AC power cord plug (a plug having one blade wider than the other), or with a three-wire grounding type plug (a plug having a third pin for grounding). Follow the instructions below:

- **For the appliance with a polarized AC power cord plug:**
This plug will fit into the power outlet only one way. This is a safety feature. If you are unable to insert the plug fully into the outlet, try reversing the plug. If the plug should still fail to fit, contact your electrician to have a suitable outlet installed. Do not defeat the safety purpose of the polarized plug by forcing it in.
- **For the appliance with a three-wire grounding type AC plug:**
This plug will only fit into a grounding-type power outlet. This is a safety feature. If you are unable to insert the plug into the outlet, contact your electrician to have a suitable outlet installed. Do not defeat the safety purpose, of the grounding plug.

Overloading – Do not overload wall outlets, extension cords or convenience receptacles beyond their capacity, since this can result in fire or electric shock.

When not in use – Unplug the power cord of the appliance from the outlet when left unused for a long period of time.

To disconnect the cord, pull it out by grasping the plug. Never pull the plug out by the cord.

Power-Cord Protection – Route the power cord so that it is not likely to be walked on or pinched by items placed upon or against them, paying particular attention to the plugs, receptacles, and the point where the cord exits from the appliance.

Lightning – For added protection for this appliance during a lightning storm, or when it is left unattended and unused for long periods of time, unplug it from the wall outlet and disconnect the antenna or cable system. This will prevent damage to the appliance due to lightning and powerline surges.

Attachments – Do not use attachments not recommended by Sony, as they may cause hazards.

Cleaning – Unplug the appliance from the wall outlet before cleaning or polishing it. Do not use liquid cleaners or aerosol cleaners. Use a cloth lightly dampened with water for cleaning the exterior of the appliance. Clean the appliance only as recommended by Sony.

Object and Liquid Entry – Never push objects of any kind into the appliance through openings as they may touch dangerous voltage points or short out parts that could result in a fire or electric shock. Never spill liquid of any kind on the appliance.

SERVICE

Damage Requiring Service – Unplug the appliance from the wall outlet and refer servicing to qualified service personnel under the following conditions:

- When the power cord or plug is damaged or frayed.
- If liquid has been spilled or objects have fallen into the appliance.
- If the appliance has been exposed to rain or water.
- The appliance does not appear to operate normally or exhibits a marked change in performance. – This indicates a need for service.
- If the appliance does not operate normally when following the operating instructions, adjust only those controls that are specified in the operating instructions. Improper adjustment of other controls may result in damage and will often require extensive work by a qualified technician to restore the appliance to normal operation.
- If the appliance has been subject to excessive shock by being dropped, or the cabinet has been damaged.

Servicing – Do not attempt to service the appliance yourself as opening or removing covers may expose you to dangerous voltage or other hazards. Refer all servicing to qualified service personnel.

Replacement parts – When replacement parts are required, be sure the service technician has used replacement parts specified by Sony that have the same characteristics as the original parts. Unauthorized substitutions may result in fire, electric shock, or other hazards.

Safety Check – Upon completion of any service or repairs to the appliance, ask the service technician to perform routine safety checks (as specified by Sony) to determine that the appliance is in safe operating condition.

Table of Contents

Overview

Built-in microphones — Pick up sound.....	10
Electrical circuit — Amplifies sound.....	11
Exterior — Increase rigidity.....	12
Identifying parts and controls.....	14

Getting Started

Checking the supplied accessories.....	18
Step 1: Preparing a power source.....	19
Step 2: Setting the clock.....	21

Recording

Preparation before recording.....	22
Recording.....	24
Monitoring the recording.....	26
Recording with an external microphone.....	27
Recording from external equipment.....	27

Operations after Recording

Playing back recorded audio data (tracks).....	28
Dividing a track.....	30
Storing tracks in a computer.....	30

Menu Operations

Using the menu display	34
Menu items	35
REC MODE (Sampling frequency/quantifying bit number)	
LIMITER (Preventing distortion)	
200Hz HPF (High Pass Filter function)	
SBM (Super Bit Mapping function)	
DELETE TRK (Deleting track)	
DELETE ALL (Deleting all tracks in folder)	
FORMAT (Initializing memory)	
LED (Indicator lighting)	
CLOCK (Date/time setting)	
MEMORY (Recording/playback memory)	
FOLDER (Recording/playback folder)	

Additional Information

Using a "Memory Stick PRO (High Speed)" (not supplied)	38
Maintenance	40
Troubleshooting	41
Specifications	46
File specifications	48
Index	50

Overview



PCM-D1 combines these features for recordings that are faithful to the original sound and reproduce even the subtlest of nuances.

- A structure free of drive mechanisms
- Highly sensitive, built-in condenser microphones
- Circuits that process sound with little noise
- Body made of pressed titanium with minimal joins

Overview (continued)

Built-in microphones—Pick up sound

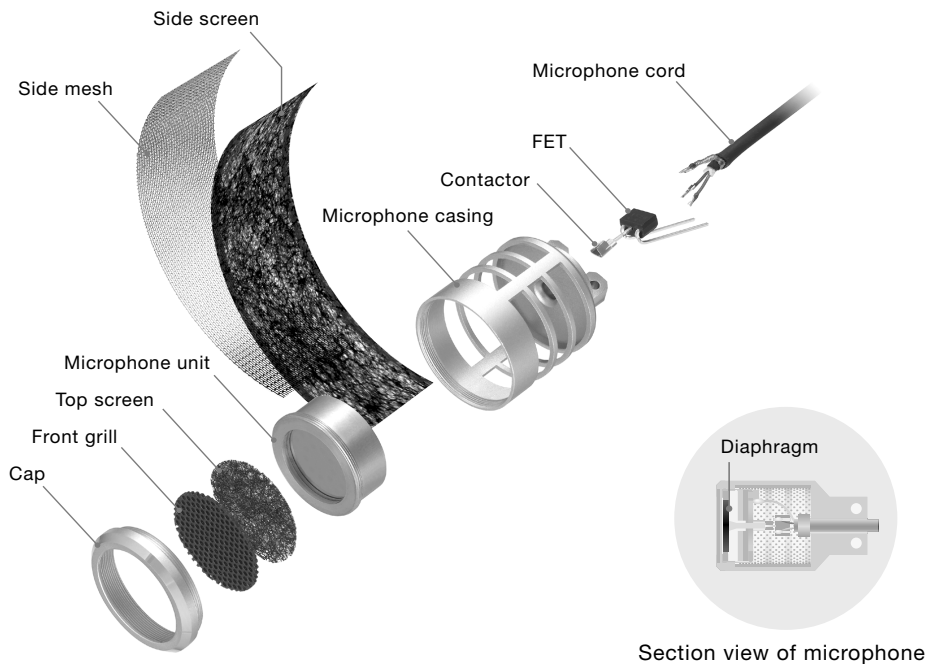

PCM-D1 incorporates electret condenser microphones that were developed for their high sensitivity and low noise. Unlike tape or disc recorders, PCM-D1 has no drive mechanism and is free of motor noise. This makes it possible to employ a highly sensitive microphone to be used as a component. All microphone casing parts are cut from metal and fit together nearly seamlessly. Each part is positioned and the front and rear openings are adjusted with 100-micron level precision. Peaks and dips in the microphone's range are minimized so that

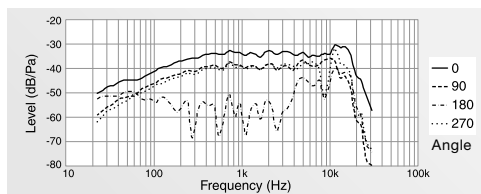

Figure 1: Built-in microphone, frequency response

acoustic energy is transmitted effectively to the diaphragm in the microphone unit.

To ensure that sound is then converted to electrical signals, the conditions for manufacturing the electret (charging the diaphragm to increase sensitivity to subtle sounds) were reviewed—resulting in a sensitivity nearly 6 dB superior to that of a standard microphone.

In addition, the frequency response of the microphone is improved to nearly ± 30 kHz, achieving a sampling rate of 96 kHz (Figure 1). This performance is barely affected even when the supplied windscreens is used.

The microphones are positioned using the X-Y pattern and then angled toward each other with the left and right diaphragms close together, thereby covering a wide sound range and reducing phase shifts. The recorded sound has depth and perspective and projects a natural stereo image.

Electrical circuit — Amplifies sound



Microphone amplifier



Coupling condenser

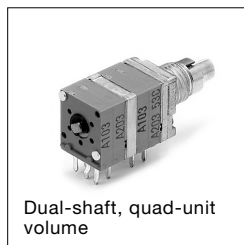

Dual-shaft, quad-unit volume

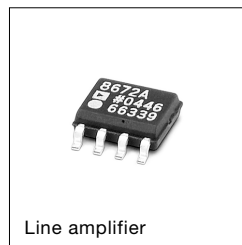

Line amplifier

Sound picked up by the microphones is amplified in the analog circuit, which achieves a frequency response that reaches the high frequencies (Figure 2) and enables the wide dynamic range of PCM-D1. The microphone amplifier provided for each channel is Analog Devices' AD797, which boasts ultra-low noise and distortion. A variable gain circuit is adopted for amplitude control, thus improving the actual signal-to-noise ratio. In the signal line, direct current is removed by Elna's coupling condenser, which has a separator made of synthetic mica mix paper.

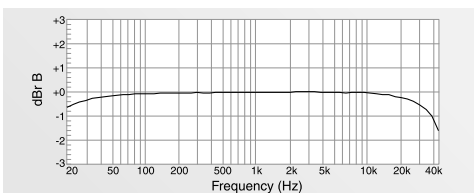

Figure 2: Electrical circuit, frequency response

A dual-shaft, quad-unit volume control with ten times the life of a standard volume control was developed for recording. Special carbon ink is applied to the resistor in the control to suppress noise produced by sliding. Like the microphone amplifier, the line amplifier, AD8672, is provided by Analog Devices.

Interference between blocks is prevented by placing the analog circuit on a different board from digital circuits and providing separate \pm power. The analog circuit also achieves superior linearity so that the recorded sound is output faithfully (Figure 3).

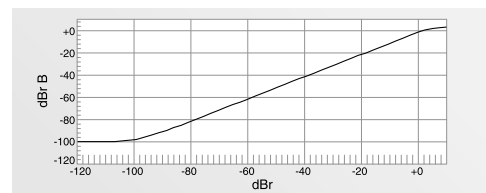

Figure 3: Electrical circuit, linearity

Overview (continued)

Exterior — Increase rigidity



Front/back panels
(1 mm thick pressed titanium)

The electrical circuits are protected by a body made of 1 mm thick pure titanium. By means of a pressing process called “drawing,” titanium is shaped into a box to achieve a body rigidity that cannot be obtained through bending or using pressed aluminum. The use of drawn titanium minimizes resonance, which tends to occur when the body comes into contact with acoustic energy.

The surface of pure titanium material undergoes a process that increases the hardness of the material. The surface is then covered with ion plating (a nitrate titanium coating that is resistant to scratches). The finished titanium surface is approximately ten times as hard as that of alumite treated aluminum.

The distinctive arch-shaped frame (microphone guard) protects the built-in microphone units against impact damage when dropped. Exhaustive tests were carried

out seeking a form and material that were rugged enough without obstructing sound. The final choice: stainless steel rods (SUS316), 3 mm in diameter, bent into the shape of the frame and hand polished by skilled craftsmen.

The rugged exterior produced in this way protects the circuits and microphones and enhances the high recording quality of PCM-D1.



Microphone guard (SUS316 stainless steel rod)

Overview (continued)

Identifying parts and controls

Front



Right side

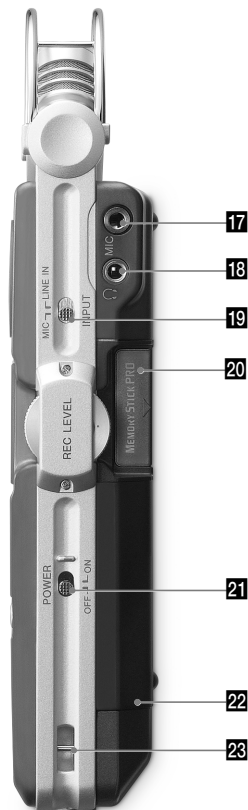

1 Built-in microphones (page 22)**2 Analog level meters (page 25)**

Displays left and right volume levels of an audio signal input from microphones in analog values.

3 Display (page 16)**4 VOLUME dial**

Adjusts the playback volume when turned in +/- directions.

5 ►► FF (fast-forward) /UP button (pages 21, 29)**6 MENU button (page 34)****7 LIGHT button**

Turns on or off the backlight of the display and the analog level meters.

8 ◀◀ FR (fast-rewind) /DOWN button (pages 21, 29)**9 REC LEVEL L/R (recording level left/right) dials (page 24)****10 DISPLAY button (page 17)**

Switches time information in the display.

11 ■■ PAUSE button/indicator (pages 25, 29)**12 ACCESS indicator (pages 20, 38)**

Flashes when accessing memory (except during recording).

13 ● REC (recording) button/indicator (page 24)**14 DIVIDE button (page 30)****15 ► PLAY/ENTER button/indicator (pages 21, 28)****16 ■ STOP button (pages 25, 29)****17 MIC (microphone) jack (page 27)****18 ◡ (headphone) jack (pages 26, 28)****19 MIC (microphone) /LINE IN switch (page 24)**

When set to "MIC," records an audio signal input from the built-in microphones or an external microphone that is connected to the MIC jack. When set to "LINE IN," records an audio signal output from external equipment that is connected to the LINE IN jack.

20 Memory Stick slot (page 38)**21 POWER switch**

Turns on or off the power.

22 Battery compartment lid (page 19)**23 Slit for a wrist strap (page 18)**

Continued on the next page →

Overview (continued)

Left side

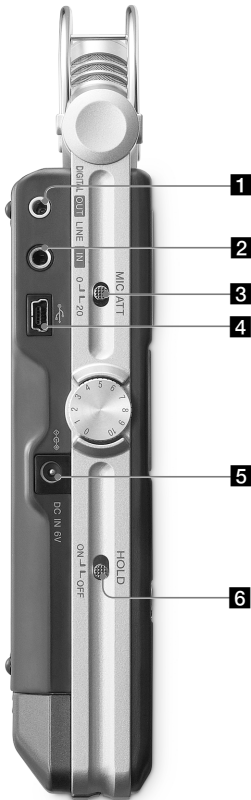

Display

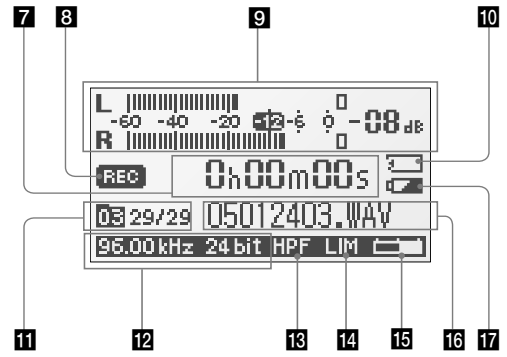

- 1** LINE OUT/optical DIGITAL OUT jack (page 29)
- 2** LINE IN jack (page 27)
- 3** MIC ATT (microphone attenuator) switch (page 23)

4 USB connector (page 30)

5 DC IN 6V jack (page 20)

6 HOLD switch

When set to “ON,” the buttons on the recorder are locked to prevent accidental operation. It is recommended to set to “ON” during recording and playback. To unlock the controls, set to “OFF.”

7 Time information

Each time the DISPLAY button is pressed, the time information changes as follows (Flashes when the recorder is paused):

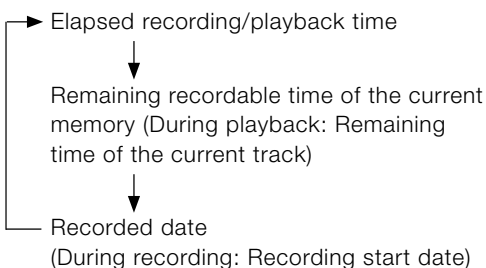

8 Recording/playing status

Displays as follows according to the current operation:

	Recording
(Flashing)	Recording pause, standby for recording
	Playback
(Flashing)	Playback pause
	Stop
/	Fast reverse/forward
/	Go to previous/succeeding tracks

9 Peak meter (page 25)

10 Memory Stick indicator

Displayed when the current memory is a “Memory Stick PRO (High Speed).”

11 Folder number, track numbers

Track numbers are displayed as “current track number/total numbers of tracks.”

12 Sampling frequency and quantifying bit number of currently recording/playing track (page 35)

13 HPF (High Pass Filter) setting

Displayed when “200Hz HPF” is set to “ON” (page 36).

14 Limiter setting

Displayed when “LIMITER” is set to “ON” (page 35).

15 Remaining memory volume

Displayed the remaining volume of current memory (page 26).

16 File name of currently recording/playing track

17 Remaining battery power (page 20)

Getting Started

Checking the supplied accessories

- Windscreen (page 23)

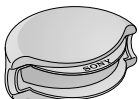

- AC power adaptor (6V) (page 20)

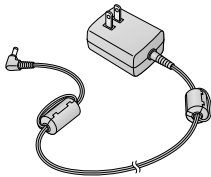

- USB cable (page 30)

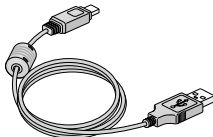

- Carrying case
- Wrist strap
- Charging set (page 19) (Battery charger BCG-34HRE, four size AA (LR06) nickel metal hydride rechargeable batteries NH-AA)

- Size AA (LR06) battery case

- CD-ROM (“DigiOnSound5”^{**} and “Driver for Windows 2000”)

* For instructions, refer to the help function of each application.

- Operating Instructions (this book)

To use the wrist strap

Attach the wrist strap to the slit for the wrist strap on the right side of the recorder.

When an optional headphone, external microphone, audio cable, etc., is connected to the recorder (pages 26 to 29), slip the cord(s) through the wrist strap and tighten the stopper as shown below. This prevents the cord(s) from being accidentally pulled out.

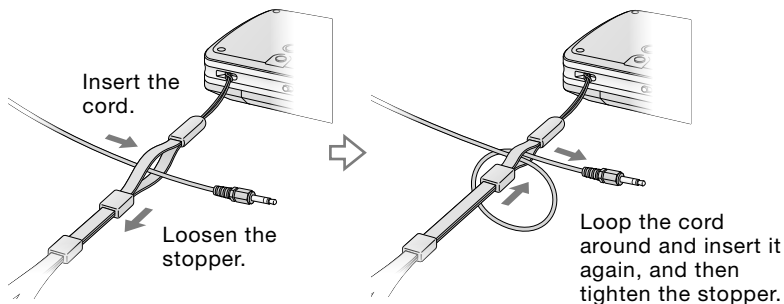

Step 1: Preparing a power source

Use the supplied size AA (LR06) nickel metal hydride rechargeable batteries after charging them.

- 1 Insert the four rechargeable batteries into the battery charger (supplied). Be sure to insert the rechargeable batteries with the \oplus and \ominus ends in the right position.

Open the lid of the battery charger.

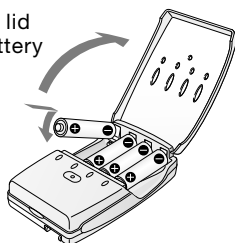

- 2 Connect the battery charger to a wall outlet. The CHARGE lamps light up during charging. Charging takes about 5 hours. (The charging time varies depending on the temperature.)

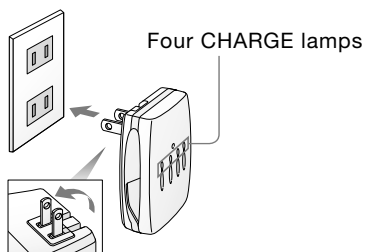

- 3 When charging is completed, the CHARGE lamps turn off. Remove the rechargeable batteries from the battery charger. Note that the rechargeable batteries and the battery charger emit some heat during charging.

- 4 Open the battery compartment lid on the rear of the recorder.

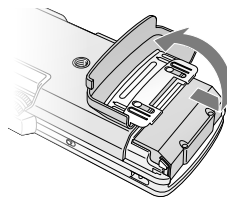

First slide the lid downward and then open it.

- 5 Pull out the battery case from the recorder.

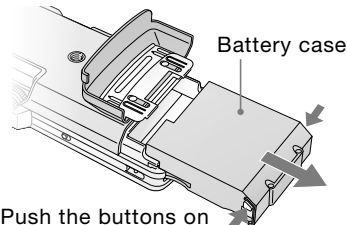

Push the buttons on both sides to pull out.

- 6 Insert four batteries into the battery case. Be sure to insert the batteries with the \oplus and \ominus ends in the right position.

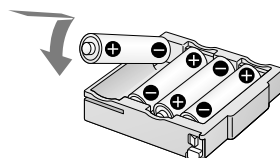

- 7 Insert the battery case back into the recorder, and close the battery compartment lid.

To use the recorder with size AA (LR06) alkaline batteries

The recorder can operate on size AA (LR06) alkaline batteries. Follow steps 4 to 7.

Note

- Turn off the recorder power before taking out the battery case.
- Charge the built-in battery at a temperature of 0°C to 35°C (32°F to 95°F). The charging time will vary according to the room temperature. (If the room temperature is low, the required charging time will be longer. This is a characteristic of the Nickel Metal Hydride battery.)

Continued on the next page ...▶

Getting Started (continued)

When you turn on the recorder for the first time after purchasing

When the POWER switch is set to the “ON” position, “ACCESSING MEMORY” appears in the display, and the ACCESS indicator flashes. Information for operation is read in the recorder’s built-in memory. Then, the display changes to the clock set menu to enable you to set the clock.

When to charge or replace the batteries

When using nickel metal hydride rechargeable batteries, the remaining battery power is indicated in the display. The indicator also appears when using alkaline batteries, but it may differ from the actual remaining power.

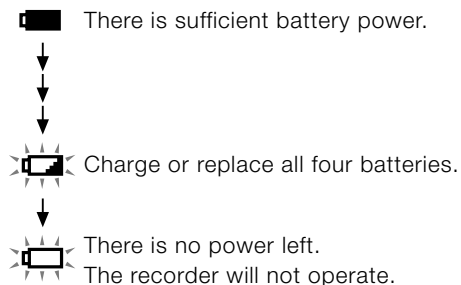

Battery life (Approximate continuous recording/playback time)*

Type of battery	96 kHz 24 bit	44 kHz 16 bit
Nickel metal hydride rechargeable batteries (supplied)	4.0 hours	5.0 hours
Alkaline batteries	2.0 hours	2.0 hours

* Approximate values for continuous recording/playback using Sony size AA (LR06) batteries under a temperature of 20°C (68°F). The battery capacity decreases and battery life becomes shorter in low temperatures.

To operate with the AC power adaptor

Connect the supplied AC power adaptor to the DC IN 6V jack.

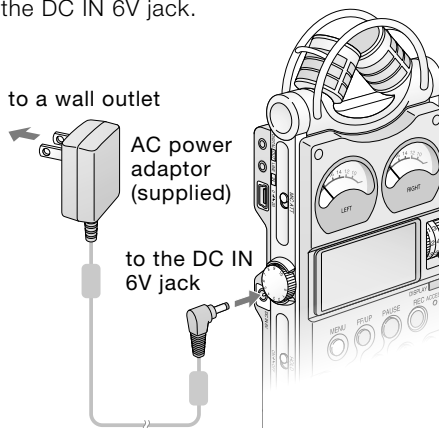

Notes on the AC power adaptor

Use only the supplied AC power adaptor. Using any other AC power adaptor may cause a malfunction.

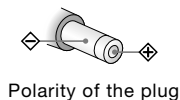

Notes

- During charging and refreshing, the rechargeable batteries and the battery charger may emit some heat, but this is not a malfunction. Note that the temperature is higher right after charging finishes. It is recommended that you wait for a while before removing the batteries.
- Use only the supplied battery charger. Using any other charger may cause a malfunction.
- The batteries cannot be charged with the recorder only without using the battery charger.
- Do not use a dry battery and a rechargeable battery together.
- The recorder is accessing memory while “ACCESSING MEMORY” appears in the display or the ACCESS indicator flashes. During this time, do not remove or insert batteries and do not disconnect or connect the AC power adaptor, or the USB cable. Doing so may damage the data.
- Because of the battery’s characteristics, the capacity of the rechargeable batteries may be smaller than normal when they are used for the first time or after a long period of disuse. In this case, charge and discharge them several times. The normal battery life will be restored.
- If the life of the rechargeable batteries drops to half the normal length, the batteries should be replaced.

Step 2: Setting the clock

Recorded audio files (tracks) are named using the date and time of the internal clock. By setting the clock before recording, the recording's date and time will be correctly saved.

- 1 When the recorder is turned on before the clock has been set, "SET CLOCK" appears in the display. After about 3 seconds, the message disappears automatically, and the "CLOCK" display of the menu appears.



- 2 Press the **UP** and **DOWN** buttons to set the year (y), and press the **ENTER** button.



- 3 Repeat step 2 to set the month (m), day (d), hour, minute, and second. Then press the **ENTER** button after setting the seconds to start operating the clock.

To reset the clock

- 1 While the recorder is stopped, press the **MENU** button to display the menu.
- 2 Press the **UP** and **DOWN** buttons to select "CLOCK," and press the **ENTER** button. The "CLOCK" display appears.
- 3 Follow steps 2 and 3 of "Step 2: Setting the clock" to reset the clock.

Note

- If you leave the recorder for more than approximately 10 minutes with no battery inserted, the date and time change to the default settings. In this case, reset the clock.

Recording

Preparation before recording

When you position the recorder, place it so that the microphone points to the sound source. For accurate recording of left and right sources, place the recorder with its front side facing upward (see the illustration below).

The placement of the recorder and the direction of the microphone depend on the sound source, the microphone, the settings of the recorder, etc. It is recommended that you try recording with the recorder in various positions and settings after referring to the illustration below and the characteristics of the microphone.

Example: Placement when recording a musical performance using the built-in microphones

For best results, place the recorder about 2 to 3 m (6.56 to 9.84 ft) from the sound source. Referring to the characteristics of the built-in microphones, adjust direction of the recorder and the angle of the microphones.

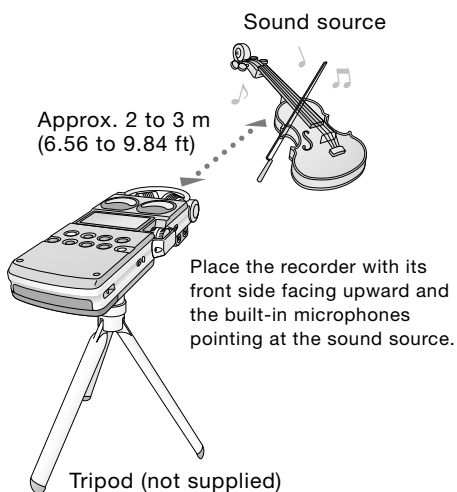

On characteristics of the built-in microphones

The built-in microphones are unidirectional (see figure 1).

Because the two capsules are in an XY arrangement, the microphone on the right records sound from the left; the microphone on the left records sound from the right (see figure 2).

However, if the sound source is too close to the microphone, the right microphone records the right and the left microphone records the left.

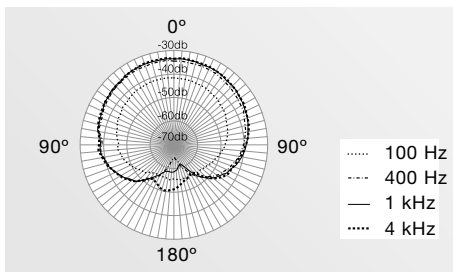

Figure 1: Directivity of the built-in microphones

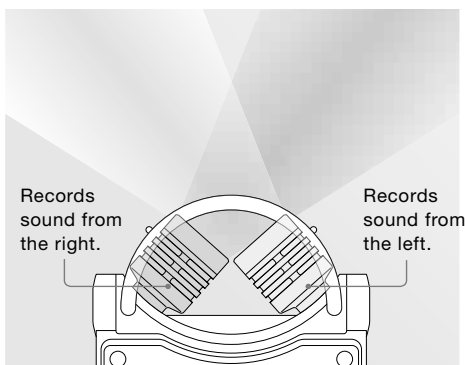

Figure 2: Direction of sound that the built-in microphones gather

To switch the microphone input sensitivity

Use the MIC ATT switch.

Usually set it to the “0” position. When recording loud sounds, set it to the “20” position.

To position the recorder using the tripod (not supplied)

By attaching the tripod (not supplied), you can adjust angles of the recorder and the microphones more precisely. It also prevents noise caused when holding the recorder in your hand.

Attach the tripod to the hole on the back of the recorder.

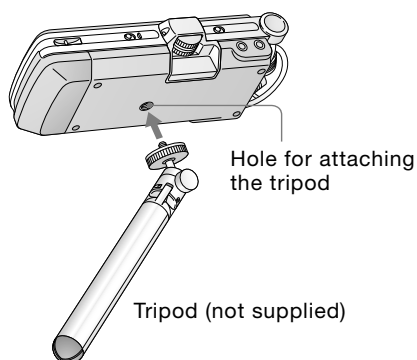

To use the supplied windscreen

By covering the built-in microphones with the supplied windscreen, you can reduce noise caused by wind or breath that directly hits the microphones.

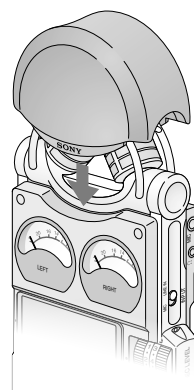

Recording (continued)

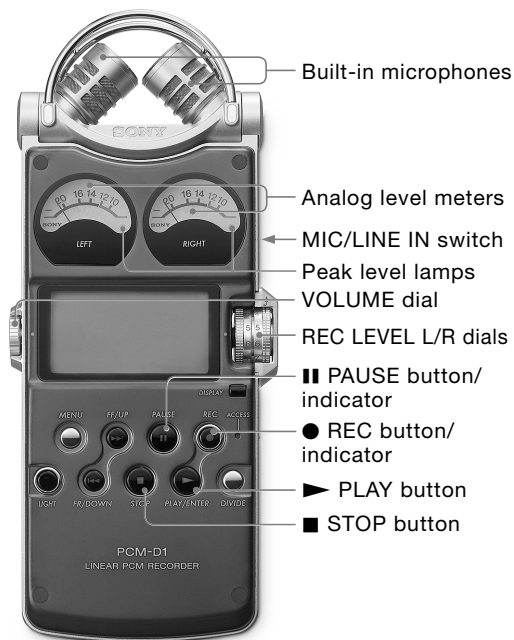

Recording

To change sampling frequency, quantifying bit number, or the memory and folder for a recording, go to the menu display (page 34). The default sampling frequency and quantifying bit number are “44.10 kHz 16 bit.”

- 1 Position the recorder and the built-in microphones referring to “Preparation before recording” (page 22).
- 2 Set the MIC/LINE IN switch to the “MIC” position.
- 3 Press the ● REC button. The recorder stands by for recording, and the || PAUSE indicator flashes.
- 4 Turn the REC LEVEL L/R dials to adjust the recording levels of the right and left channels, checking the level on the display and the analog level meters. To adjust the level of the right channel only, pull out the outside (R side) dial slightly and turn it.

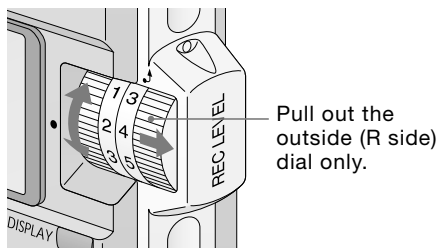

You can check the recording level on both the peak meter of the display and the analog level meters. Adjust the level closer to -12dB into appropriate range that is suitable for your sound source.

When checking the level on the peak meter of the display

When recording sound that has “quick attack” parts such as percussive sound, use the peak meter to check the level. If **OVER** appears when the maximum peak value is output, distortion may occur.

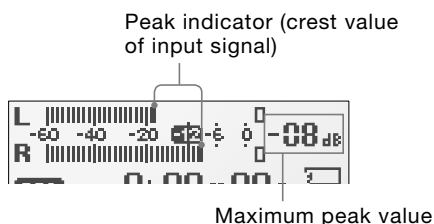

When checking the level on the analog level meters

The input signal is displayed in analog values. You can see the value close to the magnitude of volume that the human ear can hear.

If the peak level lamp lights up in red (when the recording level exceeds -1dB), distortion may occur.

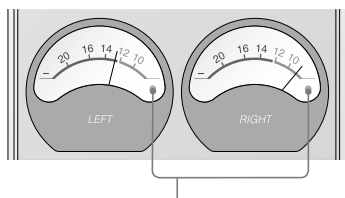

Peak level lamps

Green: Distortion will not occur.
(Recording level is -12 to -1dB .)
Red: Recording level is more than -1dB . Lower the level.

- Press the **|| PAUSE** or **▶ PLAY** button. The standby for recording is released, and recording starts. The **● REC** indicator lights up while recording.

To stop recording

Press the **■ STOP** button.

To pause recording

Press the **|| PAUSE** button. The **|| PAUSE** indicator flashes.

The recorder does not start recording automatically. Be sure to press the **|| PAUSE** button again to restart or stop recording.

When recording level adjustment is unnecessary

In step **3**, press the **▶ PLAY** button while pressing and holding the **● REC** button. Recording starts immediately.

Notes

- While the **● REC** indicator is lit, do not remove the batteries or the AC power adaptor. Doing so may damage the data.
- If the recorder remains in stop mode for about 10 minutes or longer, the recorder will enter low-power consumption mode automatically.
- Noise may be recorded if an object, such as your finger, etc., accidentally rubs or scratches the recorder during recording.
- Do not connect the USB cable to the recorder during recording. Doing so stops recording automatically (because connection with a computer has priority).
- For recording with a sampling frequency of 96 kHz, you should format the memory beforehand in order to write data efficiently.

Continued on the next page **→**

Recording (continued)

On display of remaining recordable time

Remaining recordable time appears in the display when the remaining time becomes 5 minutes or less.



Remaining recordable time

If an operation other than stop recording, such as fast forward, etc., is done, the remaining recordable time appears in the position where remaining memory volume is usually displayed.



Remaining recordable time*

When the remaining time runs out, "MEMORY FULL" appears and recording stops.

* When the remaining recordable time is more than 5 minutes, the icon that represents remaining memory volume appears. When memory is unused, "100%" appears.

Monitoring the recording

Connect optional headphones or earphones to the Ω (headphone) jack of the recorder to monitor the recording sound. The volume of monitored sound can be adjusted by turning the VOLUME dial.

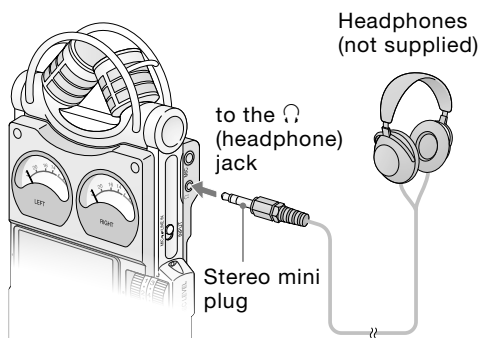

Notes

- If you turn up the volume excessively or place the headphones near the microphone while monitoring recording, the microphone may pick up the sound from the headphones, causing acoustic feedback (howling sound).
- For best results, use encapsulated-type headphones, which have less sound leakage.

Recording with an external microphone

You can connect an optional external microphone to the recorder.

- 1 Connect an external microphone to the MIC jack of the recorder, and adjust the position of the microphone. For characteristics of the microphone, refer to the operating instructions supplied with it.

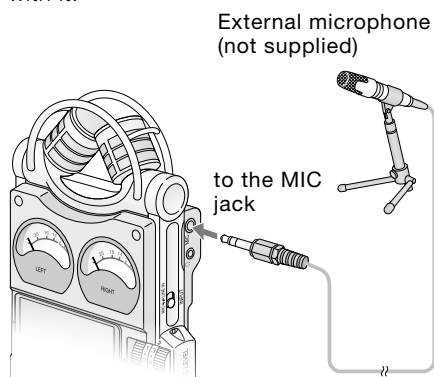

- 2 Follow steps 2 to 5 of “Recording” (page 24) to start recording.

Notes

- When an external microphone is connected to the recorder, the built-in microphones cannot be used for recording.
- The recorder does not supply power to connected microphone (not suitable for plug-in power). Note that a plug-in power only microphone cannot be used with the recorder.

Recording from external equipment

You can connect external equipment to the recorder, for example, to record from a Super Audio CD/CD player, etc.

- 1 Connect the audio output jacks of external equipment to the LINE IN jack of the recorder by using an optional Sony audio cable.

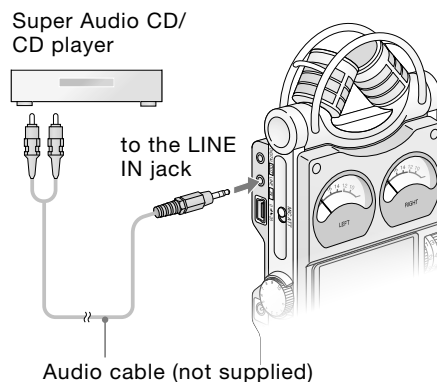

- 2 Set the MIC/LINE IN switch to the “LINE IN” position.
- 3 Follow steps 3 and 4 of “Recording” (page 24).
- 4 Start playback of the external equipment.
- 5 Press the **|| PAUSE** or **▶ PLAY** button where you want to start recording. The standby for recording is released, and recording starts.

Operations after Recording

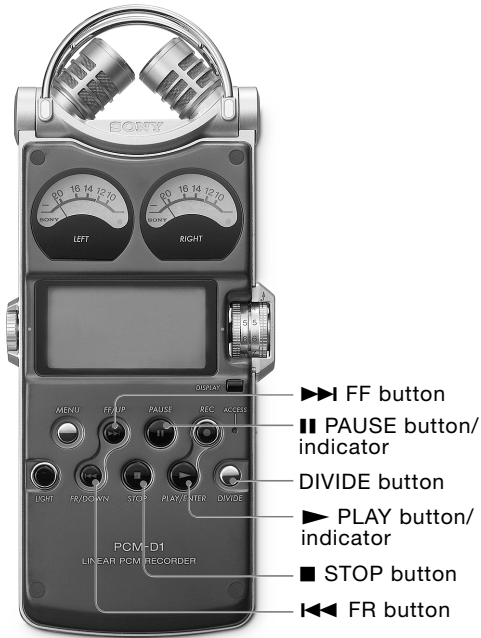



Playing back recorded audio data (tracks)

To change the memory and folder to play back, go to the menu display (page 34).

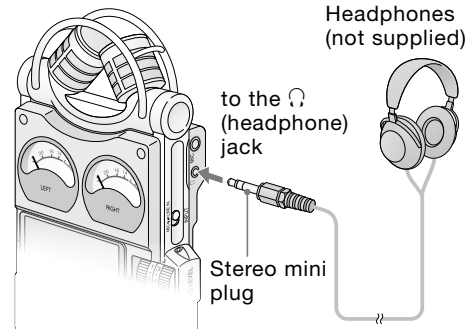
- 1 Connect optional headphones or earphones to the  (headphone) jack of the recorder.



- 2 Press the  PLAY button. Playback starts from the first track of the selected folder or the last point at which you stopped playback. The  PLAY indicator lights up. All the tracks in the folder are played in track number order.

Operations during playback

To	Operation
Stop	Press the ■ STOP button.
Pause	Press the PAUSE button. The PAUSE indicator flashes. To resume play after pausing, press the PAUSE button again.
Fast forward	Press and hold the ►► FF button.
Fast reverse	Press and hold the ◀◀ FR button.
Go back to the beginning of current track	Press the ◀◀ FR button once.
Go back to previous tracks	Press the ◀◀ FR button repeatedly.
Go to the beginning of next track	Press the ►► FF button once.
Go to the beginning of succeeding tracks	Press the ►► FF button repeatedly.

Note

- During playback, do not remove the batteries or AC power adaptor. Doing so may cause noise in audio output from the LINE OUT jack and ◌ (headphone) jack.

To connect with external equipment for playback

To output recorded tracks from speakers of external equipment, connect the audio input jack or digital input jack of the external equipment to the LINE OUT/optical DIGITAL OUT jack of the recorder using an optional Sony audio cable or optical digital cable.

AV amplifier/player

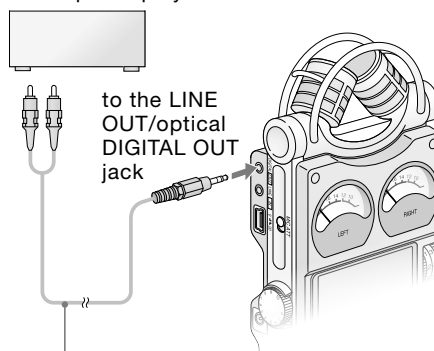

Audio cable (not supplied)
or
optical digital cable (not supplied)

Operations after Recording (continued)

Dividing a track

You can divide a recorded track. Note that tracks cannot be combined on the recorder after they have been divided.

- 1 During recording, record pausing, playback, or playback pausing, press the DIVIDE button.
The track is divided into two at the point you pressed the button, and “DIVIDING” appears in the display.

Notes

- Divided tracks are named as follows:
 - During recording/record pausing: The new track will have a new name in the same way as when a new recording starts.
 - During playback/playback pausing: “_0” is added to the name of the original track, and “_1” is added to the name of the new track. However, if the original track name is less than 8 bytes, underbars “_” are added to make a 10-byte name. For example, when dividing the file named “123.WAV”, the tracks are named “123_____0.WAV” and “123_____1.WAV”.
- Tracks cannot be divided if:
 - you press the button in the position within less than 0.5 second from the beginning or the end of a track.
 - the total number of recorded track reaches the maximum number of recordable tracks (page 48). (“TRACK FULL” appears in the display.)
 - the new track name exceeds the maximum number of characters (227 bytes without “.WAV”).

Storing tracks in a computer

Connect the recorder to a computer to save recorded tracks to the hard disk drive of the computer.

- 1 Connect the USB connectors of a computer and the recorder using the supplied USB connecting cable. “PC CONNECT” appears in the display of the recorder, and it is recognized as a USB Mass Storage Class device on the computer.
You cannot operate the recorder while it is connected to the computer.

Computer
(not supplied)

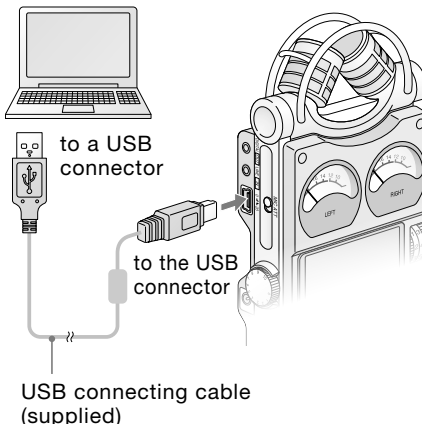

- 2 The recorder is viewed on Windows Explorer or Mac Desktop as a removable storage device. Drag and drop the track file you want to store to the hard disk drive of the computer.

Note

- Turn off the recorder power when connecting the USB cable. Leaving the power on may cause noise in the audio output from the LINE OUT jack and ⌚ (headphone) jack.

System requirements for a computer to be connected to the recorder

- IBM PC/AT or compatible ¹⁾
 - USB port
 - OS:
 - Windows® XP Media Center Edition 2005/
 - Windows® XP Media Center Edition 2004/
 - Windows® XP Media Center Edition/
 - Windows® XP Professional/
 - Windows® XP Home Edition/
 - Windows® 2000 Professional ²⁾³⁾
 (You cannot connect the recorder with Windows® 98, Windows® 95, Windows® ME, or Windows NT®.)
- Macintosh ⁴⁾
 - USB port
 - OS: Mac OS Ver. 10.2.8 or later ⁴⁾⁵⁾

- 1) IBM and PC/AT are registered trademarks of International Business Machines Corporation.
- 2) Install Service Pack 3 or later when recording audio on “Memory Stick PRO (High Speed)”.
- 3) Microsoft, Windows, Windows NT, and Windows Media are trademarks or registered trademarks of Microsoft Corporation in the United States and/or other countries.
- 4) Macintosh and Mac OS are trademarks or registered trademarks of Apple Computer, Inc.
- 5) Sleep mode of the Mac OS is not supported.

Note

- We do not ensure trouble-free operation of the system suspend, sleep, or hibernation function on all computers.

To use Windows 2000

Installation of the supplied driver is required.

- 1 Insert the supplied CD-ROM into the CD-ROM drive of the computer.
- 2 When the install screen for the supplied software appears, close the screen.
- 3 Open Windows Explorer or Mac Desktop and select “/Driver/EULA.txt” in the CD-ROM drive.
“Software license agreement” appears.
Read through the contents carefully.

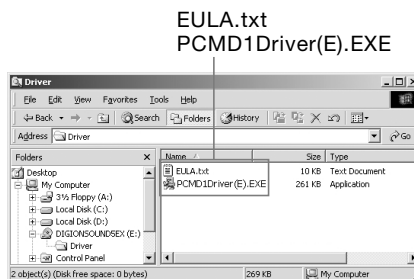

- 4 If you agree to the contents, select “/Driver/PCMD1Driver(E).EXE”.
- 5 Follow the instructions on the screen to install the driver.

Continued on the next page →

Operations after Recording (continued)

On folder and track file structure

Once you record audio on the recorder, the 10 folders for saving tracks are automatically created in memory. One “.WAV” file is created for each recording.

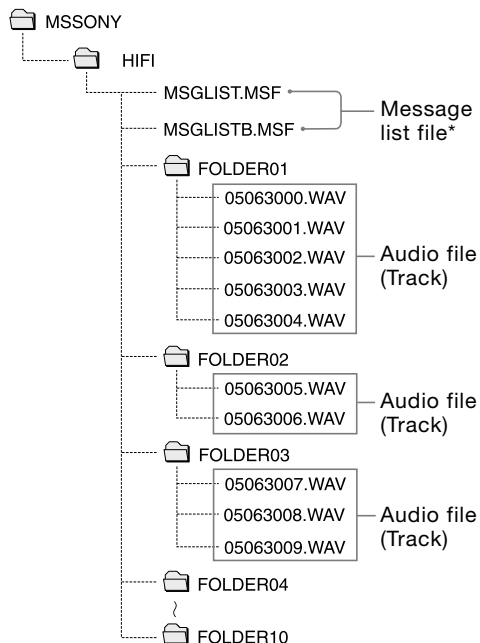

* Information, such as the order of folders, playback order of audio files, recording date and time, etc., is included. Do not delete or change these files.

Note on folder name

Do not use the computer to delete the “FOLDER 01” through “FOLDER 10” or change their names. If you do so, the folders will not be recognized by the recorder. For details about the specifications of folder and track files, see page 48.

Menu Operations

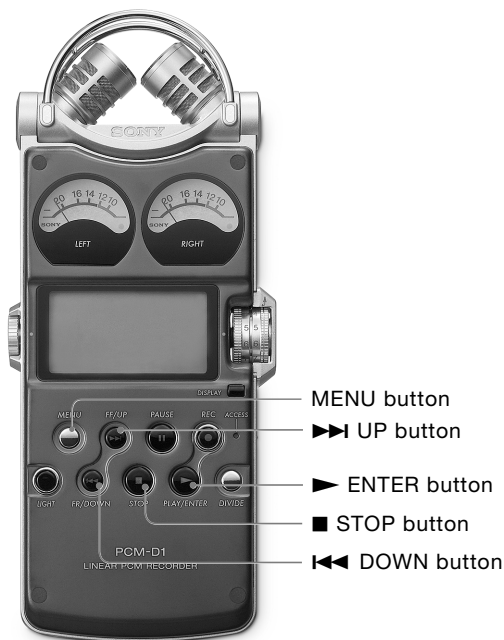

Using the menu display

You can change various adjustments and settings using the menu display.

- 1 Press the MENU button.
The menu display appears. The currently selected item and option are in the center of the display in reversed-color characters.

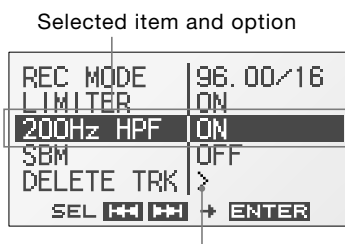

When selecting the item with > in step 2, the confirmation display will appear.

- 2 Press the ►►► UP and ◀◀◀ DOWN buttons to select an item, and press the ► ENTER button.
The setting display of the selected item appears. For details about each item and option, refer to “Menu items” (on the next page).

Example: When “REC MODE” is selected



- 3 Press the ►►► UP and ◀◀◀ DOWN buttons to select an option or operation, and press the ► ENTER button.
The option or operation is executed, and the menu display appears again.

To return to the normal display

Press the MENU or ■ STOP button.

Menu items

While the recorder is stopped, all the items in the following chart appear. During recording/standby for recording/record pausing, only “LIMITER,” “LED,” and “200Hz HPF” appear. During playback/playback pausing, only “DELETE TRK” and “LED” appear.

Item	Options (Default settings are underlined.)
REC MODE ¹⁾ (Sampling frequency/ quantifying bit number)	<p>You can select the sampling frequency and quantifying bit number for recording.</p> <p>22.05 kHz 16 bit You can record for a longer time. <u>44.10 kHz 16 bit</u> The default setting 44.10 kHz 24 bit 48.00 kHz 16 bit 48.00 kHz 24 bit 96.00 kHz 16 bit 96.00 kHz 24 bit</p> <p style="text-align: center;">↓ You can record with higher sound quality.</p> <p>Notes</p> <ul style="list-style-type: none"> • Sampling frequency is a value that represents how many times an analog signal is converted into a digital signal (A/D conversion) per second. The larger the value of sampling frequency, the better the sound quality, but also the larger the amount of data. Sound quality of 44.1 kHz is equivalent to a CD, 48 kHz is equivalent to a DAT, and 96 kHz is equivalent to DVD Audio. • Quantifying bit number is a value that represents the amount of data it takes for one second of audio. The larger the value of the bit number, the larger amount of data it takes and better the sound quality.
LIMITER (Preventing distortion)	<p>The recorder always reserves audio for the digital limiter, which is 20dB lower than audio processed in the normal circuit. This compensates for clipping that happens during digital processing if audio is over-input.</p> <p><u>ON</u> Digital limiter functions to prevent distortion. OFF Digital limiter does not function.</p> <p>Notes</p> <ul style="list-style-type: none"> • Limiter circuit functions to keep the signal level below the maximum input level. When a loud sound is suddenly input, the excess part of the sound is automatically set within the range of the maximum input level in order to prevent distortion. • The limiter circuit of the recorder does not compensate for clipping when audio over 20dB is input. In this case, sound may distort. • When the setting is “ON,” if the maximum peak value exceeds 0 dB, the peak value with the limiter circuit working appears.

1) Your computer must have software that supports 24-bit audio data to play back, edit, etc., the sound with a quantifying bit number of 24 bits.

Continued on the next page →

Menu Operations (continued)

Item	Options (Default settings are underlined.)
200Hz HPF (High Pass Filter function)	Audio under 200 Hz is filtered and is not recorded. This function reduces noise caused by the flow of air-conditioning equipment, outdoor air, etc. ON High Pass Filter functions to reduce noise. <u>OFF</u> High Pass Filter does not function.
SBM ¹⁾ (Super Bit Mapping function)	Super Bit Mapping reduces noise when the quantifying bit number is set to 16 bit in "REC MODE." ON Super Bit Mapping functions to reduce noise. <u>OFF</u> Super Bit Mapping does not function. Note • Super Bit Mapping significantly increases dynamic range acoustically by reducing noise that is particularly easy to hear within the human audible band. In order to improve the audio quality when converting 20-bit data into 16 bit, the top 4-bit amount of information within the lower data, which is usually thrown away, is integrated into 16-bit data.
DELETE TRK ²⁾³⁾⁴⁾ (Deleting track)	You can delete one selected track. Be sure to confirm the track name to be deleted before selecting "YES." For details about folder and track file structure, refer to page 32.
DELETE ALL ²⁾⁴⁾ (Deleting all tracks in folder)	You can delete all the tracks in a selected folder. Be sure to confirm the folder name to be deleted before selecting "YES." For details about folder and track file structure, refer to page 32.
FORMAT ²⁾ (Initializing memory)	You can delete all data in current memory selected in "MEMORY" (page 37) and change the folder structure (page 32) to the default setting. Be sure to confirm that the current memory is the internal memory or "Memory Stick PRO (High Speed)" before selecting "YES."
LED (Indicator lighting)	The ACCESS indicator, peak level lamps, ● REC indicator, ► PLAY indicator, and ■ PAUSE indicator light up or flash to represent the operational status of the recorder. <u>ON</u> The indicators light up or flash. OFF The indicators do not light up or flash.

Item	Options (Default settings are underlined.)
CLOCK (Date/time setting)	You can set the clock. For details, refer to page 21.
MEMORY ⁵⁾ (Recording/playback memory)	<p>You can select the memory where the recorded tracks will be saved and where the tracks to be played back are saved.</p> <p><u>BUILT-IN</u> The built-in memory of the recorder is used. <u>MEMORY STICK</u> An optional “Memory Stick PRO (High Speed)” is used.</p> <p>Note</p> <ul style="list-style-type: none"> • “BUILT-IN” is selected once the “Memory Stick PRO (High Speed)” is removed.
FOLDER (Recording/playback folder)	<p>You can select the folder where the recorded tracks will be saved and where the tracks to be played back are saved.</p> <p><u>FOLDER 01</u> to 10 Folder names of current memory</p>

1) The setting cannot be executed when the quantifying bit number is set to 24 bit in “REC MODE.”

2) The function does not work when the remaining battery power is low.

3) The function does not work when a track file is set to be read-only.

4) The function does not work when no track is saved in a folder.

5) The setting cannot be executed when no optional “Memory Stick PRO (High Speed)” is inserted.

Using a “Memory Stick PRO (High Speed)” (not supplied)

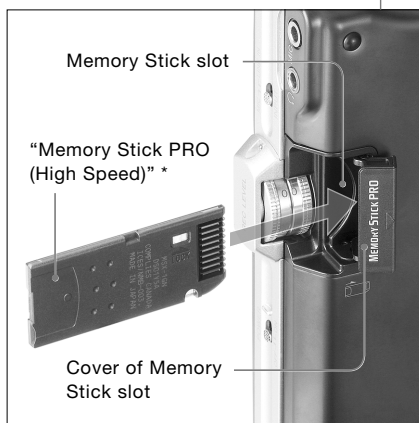

* When you use “Memory Stick PRO Duo (High Speed),” be sure to use the Memory Stick Duo adaptor.

You can record audio using a “Memory Stick PRO (High Speed)” instead of the built-in memory of the recorder.

“Memory Stick PRO (High Speed)” is the only “Memory Stick” that can be used for the recorder. Note that other kinds of “Memory Stick” are not supported.

Inserting a “Memory Stick PRO (High Speed)”

Before recording, be sure to copy all the data saved in the “Memory Stick PRO (High Speed)” to a computer and format the “Memory Stick PRO (High Speed)” on the recorder so it contains no data.

- 1 Open the cover of the Memory Stick slot.
- 2 Insert the “Memory Stick PRO (High Speed)” into the Memory Stick slot firmly until it clicks in the direction shown in the illustration on the left, and close the cover.

When you insert the “Memory Stick PRO (High Speed)” into the recorder

“ACCESSING MEMORY” appears in the display, and the ACCESS indicator flashes. Information for operation is read in the “Memory Stick PRO (High Speed).”

To remove the “Memory Stick PRO (High Speed)”

Be sure that the ACCESS indicator light is off, and then push the “Memory Stick PRO (High Speed)” into the recorder. When it pops out, remove it from the slot.

Using the “Memory Stick PRO (High Speed)” for recording/ playback

- 1 Go to the menu display, and set the “MEMORY” setting to “MEMORY STICK” (page 34).
- 2 Follow the steps of “Recording” (page 24) or “Playing back recorded audio data (tracks)” (page 28).

To store tracks on a computer

Connect the recorder with the “Memory Stick PRO (High Speed)” inserted to a computer (page 30).

On folder and track file structure

Ten folders are created in the “Memory Stick PRO (High Speed)” separately from the folders of the built-in memory. The structure of folders and track files are same as the built-in memory (page 32).

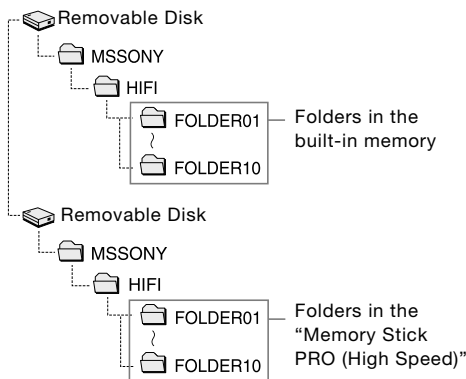

For details about the specifications of folder and track files, see page 48.

Notes

- Do not insert or remove the “Memory Stick PRO (High Speed)” during recording/playback. Doing so may cause a malfunction of the recorder.
- The recorder is accessing memory while “ACCESSING MEMORY” appears in the display or the ACCESS indicator flashes. During this time, do not remove the “Memory Stick PRO (High Speed).” Doing so may damage the data.
- When you use “Memory Stick PRO Duo (High Speed),” be sure to use the Memory Stick Duo adaptor.
- Operations of “Memory Stick PRO (High Speed)” up to 4 GB are checked on the recorder, but this does not guarantee operations of all “Memory Stick PRO (High Speed).” Because the Sony “Memory Stick PRO (High Speed)” is the only “Memory Stick” that is operationally tested on the recorder, “Memory Stick PRO (High Speed)” of other makers may cause a malfunction.

“Memory Stick”, “Memory Stick PRO”, “Memory Stick PRO Duo” and  are trademarks of Sony Corporation.

Maintenance

On noise

- Noise may be heard when the recorder is placed near an AC power source, a fluorescent lamp or a mobile phone during recording or playback.
- Noise may be recorded when an object, such as your finger, etc., rubs or scratches the recorder during recording.

On safety

Do not operate the recorder while driving, cycling or operating any motorized vehicle.

On handling

- Do not subject the recorder to strong shock or vibration. Doing so may cause a malfunction of the recorder.
- Do not place the recorder in the following locations:
 - Anywhere extremely hot. Never exposed it to temperatures above 60°C.
 - Under direct sunlight or close to heaters
 - In a sun-heated car with windows closed (especially in summer)
 - Humid place, such as in a bathroom
 - Anywhere dusty

On the built-in microphones

The built-in microphones are high-performance electret condenser microphones. Do not expose them to strong wind or water.

On maintenance

When the exterior is dirty, clean the surface gently with a soft cloth slightly moistened in water, and then wipe it again with a dry cloth. Do not use alcohol, benzene, or thinner, etc., to avoid damaging the finish.

Backup recommendations

To avoid potential risk of data loss caused by accidental operation or malfunction of the recorder, we recommend that you save a backup copy of your recorded tracks to a computer.

Troubleshooting

If you experience trouble with your recorder, try the following solutions.

- 1 Turn off the recorder completely by removing the batteries and the AC power adaptor, and then turn it on again. Or use the recorder to initialize the built-in memory or the "Memory Stick PRO (High Speed)." (Note that initializing will delete all data in the memory.)
- 2 Read through the symptoms and solutions on pages 41 to 43 and messages on pages 44 and 45 to check your recorder.
- 3 If the problem persists, consult with qualified Sony personnel (see the warranty for contact information).

Symptom	Cause/Solution
The recorder does not operate.	<ul style="list-style-type: none">•The batteries have been inserted with incorrectly. Reinsert them correctly (page 19).•The batteries are exhausted. Charge them or replace them with new ones (page 19).•The buttons are locked with the HOLD switch. Set the HOLD switch to the "OFF" position (page 17).•The POWER switch is set to the "OFF" position. Set it to the "ON" position.
You cannot start recording.	<ul style="list-style-type: none">•The MIC/LINE IN switch is in the wrong position. Set it to the "MIC" position when using the built-in microphones or an external microphone to input audio for recording. Set it to the "LINE IN" position when external equipment is connected for recording (page 15).•The memory is full, or the maximum number of tracks (page 48) have already been recorded. Delete some of the tracks (page 36) or store the tracks to the hard disk of your computer (page 30), and then delete them from the recorder. You can also use a "Memory Stick PRO (High Speed)" with sufficient capacity (page 39).•99 tracks have already been recorded in the selected folder. Select another folder (page 37) or delete some of the tracks (page 36).•The write-protect switch on the inserted "Memory Stick PRO (High Speed)" is set to "LOCK." Release the lock.
The ACCESS indicator, peak level lamps, or ● REC / ► PLAY / ■ PAUSE indicators do not light/flash.	<ul style="list-style-type: none">•The "LED" item in the menu is set to "OFF." Display the menu and set it to "ON" (page 36).

Continued on the next page ...▶

Troubleshooting (continued)

Symptom	Cause/Solution
You cannot erase a track.	<ul style="list-style-type: none"> • The write-protect switch on the inserted "Memory Stick PRO (High Speed)" is set to "LOCK." Release the lock. • When you use a Windows computer, the track or the folder containing the track is set to "Read-only" in the computer. Display the track or the folder using Windows Explorer and remove the check for "Read-only" under "Properties." • When you use a Mac computer, the track or the folder containing the track is set to "Locked" in the computer. Display the track or the folder on Mac Desktop and remove the check for "Locked" under "GetInfo" of "File." • The remaining battery power is insufficient. Connect the AC power adaptor to the recorder (page 20), charge the batteries, or replace them with new ones (page 19).
Noise is heard.	<ul style="list-style-type: none"> • An object, such as your finger, etc., accidentally rubbed or scratched the recorder during recording so that noise was recorded. • Noise may occur if many low volume files are recorded in the current memory. Save the tracks to the hard disk of your computer (page 30), and then format the memory (page 36). • The recorder was placed near an AC power source, a fluorescent lamp or a mobile phone during recording or playback. • Noise may occur if the plug of the connected external microphone was dirty when recording. Clean the plug. • Noise may occur if the plug of the connected headphones/earphones is dirty during playback or monitoring the recording sound. Clean the plug.
The sound picked up is distorted.	<ul style="list-style-type: none"> • The MIC/LINE IN switch is in the wrong position. Set it to the position that corresponds to the sound source and connections (page 15). • The recording level is too high. Adjust the recording level to an appropriate range (page 24). • The sound source is too loud when recording with an external microphone. Set the MIC ATT switch to the "20" position (page 23), or move the microphone away from the sound source. • The sound source has parts that are too loud. Set the "LIMITER" item to "ON" in the menu display (page 35).
Noise occurs during recording.	<ul style="list-style-type: none"> • When monitoring the recording sound with headphones or earphones, they are placed too close to the microphone. Decrease the sound level from headphones or keep the microphone away from them.
"--h--m--s" is displayed as the recorded date.	<ul style="list-style-type: none"> • Set the clock (page 21). The date and time of recording are displayed after the clock is set.
There are fewer menu items in the menu display.	<ul style="list-style-type: none"> • Some menu items are not displayed during playback or recording (page 35).

Symptom	Cause/Solution
A character in a folder or track name is displayed in unreadable characters.	<ul style="list-style-type: none"> The recorder cannot support or display some special characters and symbols that are entered on a computer using Windows Explorer or Mac Desktop.
“ACCESSING MEMORY” display does not disappear.	<ul style="list-style-type: none"> If the recorder is required to process an excessive amount of data, the message may be displayed for an extended period of time. This is not a malfunction of the recorder. Wait until the message disappears.
You cannot record tracks up to the maximum recording time on page 49.	<ul style="list-style-type: none"> There are other formatted data (for example, images) in the memory. “Memory Stick PRO (High Speed)” requires a minimum amount of memory, even when recording very short tracks. As a result, the actual total recording time of “Memory Stick PRO (High Speed)” may be shorter than the maximum recording time of the recorder. The maximum recording time indicated on page 49 is estimated. It varies depending on the number of tracks. Due to these limitations of the recording system, the sum of the total recorded time in the counter (elapsed time) and the remaining time becomes shorter than the maximum recording time of the recorder. Even when “MEMORY FULL” is displayed and the recorder stops recording, the recorder has an extra memory space for editing. This is not a malfunction of the recorder. If recording data volume of one track requires over 2 GB, the consecutive recording starts as a new track due to the specification of the recorder.
The “Memory Stick PRO (High Speed)” is not recognized.	<ul style="list-style-type: none"> Since the “Memory Stick PRO (High Speed)” contains image data or other files, the memory required for creating initial folders is insufficient. Use Windows Explorer or other tools to delete unnecessary files or initialize the “Memory Stick PRO (High Speed)” on the recorder.
“.WAV” files cannot be played back on the recorder.	<ul style="list-style-type: none"> A file recorded in a frequency that the recorder does not support cannot be played back.
The remaining memory volume does not reach 100%.	<ul style="list-style-type: none"> Data may be damaged because the power source was removed during recording. Initialize the memory using the recorder.

Continued on the next page >>>

Troubleshooting (continued)

Error messages

Message	Meaning/Solution
SET CLOCK	The clock is not set. Set it before operating the recorder (page 21).
16 bit ONLY	The "SBM" item can be set to "ON" only when the quantifying bit number is set to 16 bit. Change the quantifying bit number to 16 bit on "REC MODE" in the menu display, and then set "SBM" again (page 35, 36).
TRACK FULL	The number of tracks saved in the current folder has reached the maximum (99 tracks), and recording or track dividing cannot be done. To reduce the number of tracks, record new tracks in another folder, delete unnecessary tracks (page 36), or store some of the tracks to your computer (page 30).
MEMORY FULL	There is no remaining data space in the built-in memory or the "Memory Stick PRO (High Speed)." Delete unnecessary tracks (page 36) or store some of the tracks to your computer (page 30), and then erase the contents of the memory.
M.S. LOCKED	The write-protect switch on the inserted "Memory Stick PRO (High Speed)" is set to "LOCK." Release the lock.
NO MEMORY STICK	Insert the "Memory Stick PRO (High Speed)" (page 38).
FILE PROTECTED	For Windows computers The track is set to "Read-only" in the computer. Display the track using Windows Explorer and remove the check for "Read-only" under "Properties." For Mac computers The track is set to "Locked" in the computer. Display the track on Mac Desktop and remove the check for "Locked" under "GetInfo" of "File."
UNKNOWN DATA	The file cannot be played back, because it is in an unsupported data or file format.
BATTERY LOW	The remaining battery power is insufficient. Connect the AC power adaptor to the recorder (page 20), charge the batteries, or replace them with new ones (page 19).
NO DELETE	For Windows computers This track cannot be deleted. The track may be set to "Read-only" in the computer. Display the track using Windows Explorer and remove the check for "Read-only" under "Properties." For Mac computers This track cannot be deleted. The track may be set to "Locked" in the computer. Display the track on Mac Desktop and remove the check for "Locked" under "GetInfo" of "File."

Message	Meaning/Solution
FILE SIZE FULL	The maximum data capacity for one track is 2 GB. When the data of one track exceeds 2 GB during recording, recording as a new track starts. In this situation, because the number of tracks saved in the current folder has reached the maximum (99 tracks), the recording stopped. Record the new track in another folder. Or you can delete unnecessary tracks (page 36) or store some of the tracks (page 30) to reduce the number of tracks.
M.S. ERROR	Insert the "Memory Stick PRO (High Speed)" again. If this message appears again, the "Memory Stick PRO (High Speed)" may have a problem.
NO MEMORY SPACE	The recorder cannot be operated because there is no remaining space in memory. Initialize the memory using "FORMAT" in the menu display (page 36), or store some of the tracks to your computer (page 30) and delete these tracks.
FILE DAMAGED	The track cannot be played back because it is damaged.
FORMAT ERROR	The memory that is initialized on the other equipment cannot be used in the recorder. Initialize the memory using "FORMAT" in the menu display (page 36).
CANNOT OPERATE	The track name has reached the maximum number of characters. Shorten the file name using the computer.
CHANGE BATTERY	The batteries are exhausted. Charge the batteries, or replace them with new ones (page 19).
SYSTEM ERROR	A system error has occurred. Remove the batteries or the AC power adaptor to turn off the recorder completely, and then turn on the recorder again. If this message appears again, consult with qualified Sony personnel (see the warranty for contact information).
POWER PROBLEM	Incompatible batteries or AC power adaptor is being used, which could cause a malfunction. Use only compatible batteries and AC power adaptors.

Specifications

Recording media

Built-in flash memory 4 GB, "Memory Stick PRO (High Speed)" (not supplied), Stereo recording

Maximum recording time

Refer to "Maximum recordable time" on page 49.

Quantization

16-bit linear, 24-bit linear

Frequency range (Input from the LINE IN jack when recording/playing back) (0 to -2 dB)

Fs 22.05 kHz: 20 to 10,000 Hz

Fs 44.10 kHz: 20 to 20,000 Hz

Fs 48.00 kHz: 20 to 22,000 Hz

Fs 96.00 kHz: 20 to 44,000 Hz

Signal-to-noise ratio (S/N) (Input from the LINE IN jack when recording/playing back)

96 dB or above (1 kHz IHF-A)
(for 24 bit)

Total harmonic distortion (Input from the LINE IN jack)

22.05 kHz 16 bit, 44.10 kHz 16/24 bit:

0.008% or below (1 kHz, 22 kHz LPF)

48.00 kHz 16/24 bit, 96.00 kHz

16/24 bit: 0.008% or below (1 kHz,
22 kHz LPF)

Wow and flutter

Below measurable limit (less than
 $\pm 0.001\%$ W.PEAK)

Input/output

MIC jack (stereo mini jack)

Input impedance: 22k Ω

Rated input level: 2.5mV

Minimum input level: 0.7mV

Ⓜ (headphone) jack (stereo mini jack)

Rated output level: 400mV

Maximum output level: 30mW +
30mW or more

Load impedance: 16 Ω

LINE IN jack

Input impedance: 47k Ω

Rated input level: 2.0V

Minimum input level: 570mV

LINE OUT/optical DIGITAL OUT jack

Output impedance: 220 Ω

Rated output level: 1.8V

Load impedance: 22k Ω

Output level: -21 to -15dBm

(for optical digital output)

Emission wavelength: 630 to 690 nm

(for optical digital output)

DC IN 6V jack

USB connector (Hi-speed USB, Mass
Storage Class)

Memory Stick slot

General

Power requirements

DC IN 6V (AC 120V, 60 Hz)

Four size AA (LR06) nickel metal hydride rechargeable batteries NH-AA (supplied)

Four size AA (LR06) alkaline batteries (not supplied)

Power consumption

2.1W

Dimensions

Approx. 72.0 × 193.0 × 32.7 mm
(2^{7/8} × 6^{3/4} × 1^{5/16}) (w/h/d) (not including projecting parts and controls)

Mass 525 g (18.52 oz) (including batteries)

Supplied accessories

Refer to "Checking the supplied accessories" on page 18.

Optional accessories

"Memory Stick PRO (High Speed)"

MSX-1GN (1 GB), MSX-2GN (2 GB),
MSX-4GN (4 GB)

"Memory Stick PRO Duo (High Speed)"

MSX-M1GN (1 GB),
MSX-M2GN (2 GB)

Stereo headphones

MDR-V900, MDR-V700DJ

Audio connecting cable

RK-G129

Optical digital cable

POC-N120B (optical mini plug ↔
optical mini plug)

POC-N120AB (optical mini plug ↔
rectangular-shaped optical plug)

External microphone

ECM-MS957

Design and specifications are subject to change without notice.



Printed on 100% recycled paper using VOC (Volatile Organic Compound)-free vegetable oil based ink.

File specifications

Once you record audio in the built-in memory or a “Memory Stick PRO (High Speed),” the 10 folders for saving tracks are automatically created in each memory. One “.WAV” file is created for each recording. For details about the folders and track file structure, refer to page 32.

Notes about folder/track file

- Because the folder names “FOLDER 01” to “FOLDER 10” are fixed, do not change the names on a computer. If changed, the recorder cannot recognize the folders.
 - The number of folders is fixed at 10 for each memory. If a folder is deleted on a computer, a new folder is created in the built-in memory or “Memory Stick PRO (High Speed).”
 - The maximum number of tracks that can be saved in one folder is 99 tracks.
 - The maximum data capacity that one WAV format track can deal with is 2 GB. If the data amount of one track exceeds 2 GB during recording, recording as a new track starts automatically. In this case, the elapsed recording time display changes to 0 second, but the contents that have been recorded up to 2 GB are stored normally.
- If recording is stopped right after starting recording, one track is created.
 - File names can be changed in Japanese on a computer. However, operations, such as playback, etc., may not be carried out if the characters that the recorder does not support are used. In this case, change the file name again. When the file name is changed, the playback order also changes.
 - If you use 8 or fewer alphanumeric characters in lower case for a file name, the characters are displayed in upper case on the recorder. If you use 9 letters or more, they are displayed in lower case.

Maximum recordable time (Approximate)

The total maximum recordable time (approximate) of all the folders is as follows.

Built-in flash memory (4 GB)

Sampling frequency/ quantifying bit number	Maximum recordable time *
22.05 kHz 16 bit	13 hrs 10 min.
44.10 kHz 16 bit	6 hrs 35 min.
44.10 kHz 24 bit	4 hrs 20 min.
48.00 kHz 16 bit	6 hrs
48.00 kHz 24 bit	4 hrs
96.00 kHz 16 bit	3 hrs
96.00 kHz 24 bit	2 hrs

“Memory Stick PRO (High Speed)”

Sampling frequency/ quantifying bit number	Maximum recordable time *				
	256 MB	512 MB	1 GB	2 GB	4 GB
22.05 kHz 16 bit	45 min.	1 hr 30 min.	3 hrs 5 min.	6 hrs 25 min.	12 hrs 45 min.
44.10 kHz 16 bit	20 min.	45 min.	1 hr 30 min.	3 hrs 10 min.	6 hrs 20 min.
44.10 kHz 24 bit	15 min.	30 min.	1 hr	2 hrs 5 min.	4 hrs 15 min.
48.00 kHz 16 bit	20 min.	40 min.	1 hr 25 min.	2 hrs 55 min.	5 hrs 50 min.
48.00 kHz 24 bit	10 min.	25 min.	55 min.	1 hr 55 min.	3 hrs 50 min.
96.00 kHz 16 bit	10 min.	20 min.	40 min.	1 hr 25 min.	2 hrs 55 min.
96.00 kHz 24 bit	5 min.	10 min.	25 min.	55 min.	1 hr 55 min.

* The maximum recordable time is varied depending on recording condition.

Index

Symbols

🎧 (headphone) jack.....	26, 28
▶▶ FF/UP button.....	21, 29
◀◀ FR/DOWN button.....	21, 29
⏸ PAUSE button/indicator .	25, 29
▶ PLAY/ENTER button/indicator 21, 28	
● REC button/indicator.....	24
■ STOP button.....	25, 29
200Hz HPF.....	36

A

ACCESS indicator.....	20, 38
AC power adaptor	20
Alkaline battery	19
Analog level meters.....	25

B

Battery case	19
Battery charger.....	19
Battery compartment lid.....	19
Built-in microphones	10, 22
Direction of sound	22
Directivity.....	22

C

Carrying case	18
CD-ROM ("DigiOnSound", "DigiOnAudio" softwares).....	18
CHARGE lamp.....	19
CLOCK	37
Clock.....	21
Computer.....	30
Continuous playback time	20
Continuous recording time.....	20

D

DC IN 6V jack.....	20
DELETE ALL.....	36
DELETE TRK.....	36
Digital limiter.....	35
DIGITAL OUT jack.....	29
Display.....	16
DISPLAY button.....	17
DIVIDE button.....	30
Dividing.....	30

E

Elapsed recording/playback time.....	17
Electrical circuit	11
Exterior	12
External microphone	27

F

Fast forwards	29
Fast reverse.....	29
FOLDER.....	37
Folder	32, 48
FORMAT	36

G

Go to the beginning of track	29
-----------------------------------	----

H

High Pass Filter	36
HOLD switch	17

L

LED	36
LIGHT button.....	15
LIMITER	35
LINE IN jack	27
LINE OUT jack.....	29

M

“Memory Stick PRO (High Speed)”	38
Maintenance	40
Maximum recordable time	49
MEMORY	37
Memory Stick slot	38
MENU button	34
Menu display	34
MIC/LINE IN switch	15, 24
MIC ATT switch	23
MIC jack	27
Monitoring the recording	26

P

Peak level lamps	25
Peak meter	25
Playing back	28
Pause	29
Stop	29
Power source	19
POWER switch	15
Preparation before recording ...	22

Q

Quantifying bit number	35
------------------------------	----

R

Rechargeable battery	19
Recording	24
Pause	25
Stop	25
REC LEVEL L/R dials	24
REC MODE	35
Remaining battery power	20
Remaining memory volume	17
Remaining recordable time	17, 26
Remaining time of the current track	17

S

Sampling frequency	35
SBM	36
Size AA (LR06) battery case	18
Slit for a wrist strap	15
Specifications	46
Super Bit Mapping	36
Supplied accessories	18

T

Time information	17
Track file	32, 48
Tripod	23
Troubleshooting	41

U

USB connecting cable	30
USB connector	30

V

VOLUME dial	15
-------------------	----

W

Windscreen	23
Wrist strap	18

