

NO NONSENSE

International
LIGHTACTS
2007

SLV®

Pendelleuchten	005 - 049
Wand- + Deckenleuchten	050 - 113
Tisch- + Standleuchten	114 - 123

Basisprodukte**005**

Easytec II® Hochvolt-Schiene chrom/schwarz	124 - 131
Easytec II® Hochvolt-Schiene silber-grau	132 - 145
Linux Light® NV-Schiene silber-grau	146 - 155
Linux Light® NV-Schiene gold	156 - 161
C-Track® NV-Regalschienensystem	162 - 166
Glu-Trax	167
Cabline	168 - 169
Trek ²	170 - 173
Rosen Lite® NV-Schienen	174 - 177
Apollo NV-Schiene	178 - 180
Wave NV-Stangensystem	181 - 184
NV-Seilsystem	185 - 189
HV-1Phasen-Stromschiene	190 - 200
HV-3Phasen-Stromschiene	201 - 223

Stromschienen-Systeme**124**

LIM® - Light in Motion	224 - 227
Stage Factory Line®	228 - 235
Display-/Spiegel-/Stableuchten	236 - 249
Jacky	250 - 253
Saluna	254
Armaturen	255 - 257

Spezielle Produktserien**224**

Einbauleuchten	258 - 290
LED-Einbauleuchten	291 - 293
Einbauringe	294 - 313
HV-Downlights	314 - 323
Einbauleuchten Indoor-Outdoor	324 - 329

Einbauleuchten**258**

Outdoor Leuchtenserien	330 - 359
Outdoor Standleuchten, Wand- + Deckenleuchten	360 - 387
Outdoor Strahler	388 - 405
Outdoor Lichtobjekte	406 - 407
Outdoor Einbauleuchten	418 - 432

Outdoor**330**

Dekoratives Licht Lichterketten	433 - 437
Dekoratives Licht Penlight®	438 - 440
Dekoratives Licht LED-Strips	441 - 452

Dekoratives Licht**433**

LED-Zubehör	453 - 457
allgemein Zubehör	458 - 462
Konventionelle Trafos	463 - 465
Elektronische Trafos	466 - 468
Einbauhilfen	469
Leuchtmittel-LED	470 - 472
Leuchtmittel	473 - 489

Zubehör**453**

Index	490 - 497
Notizen	498

Index**490**

Easy LIM® LED Steuergerät



24V= oder 12V=	31VA pro Kanal		
			0,05
L/B/H: 18,5/4,5/1,9 cm			

Easy LIM® LED Steuergerät
470503
179,00 €

Mit eingebautem Wandler auf RGB-Ausgangssignal.
Bei 12V= : max. 15W/Kanal
bei 24V= : max. 31W/Kanal



Integrierter PWM Controller, 8 fest programmierte Programme und Zeiten, Memoryfunktion, Anschluss für externe Tasten, Anschluss an 12V= oder 24V= Netzteil für LED. Max. Belastung 4A gesamt.

LIM® Steuergerät



230~			
			0,62
L/B/H: 19/13,5/5 cm			

LIM® 3/110 Steuergerät
410400
475,00 €

Stromsenke 1-10V,
Ri<100 Ohm,
Imax. 50 mA



Das LIM® 3/110 3-Kanal-Steuergerät ermöglicht Einstellung und Abruf von Lichtfarbe oder Lichtniveau auf Tastendruck. 3 Leuchtengruppen mit digitalen Betriebsgeräten für eine Steuerspannung von 1-10 Volt (z.B. Leuchtstofflampen, Niedervolt-Halogen- oder Hochvolt-Halogenlampen) lassen sich ansteuern, 4 Lichtszenen vorprogrammierten und ebenfalls auf Tastendruck abrufen. Auch dynamische Abläufe der eingestellten Lichtszenen sind dank wählbarer Stand- und Überblendzeiten möglich. 4 verschiedene Ablaufprogramme mit je 8 Lichtszenen sind im System bereits abgespeichert.

Weitere Features sind Panikschtaltung, externer Schalteingang, variable Zeitintervalle, u.v.m..
Ein komfortables System, das keine Systemkenntnisse verlangt und auch vom Laien problemlos bedient werden kann.

**Wandler, 3 Kanal von Steuer-
spannung auf
24V(12V)-2A/Kanal**



24V= oder 12V=	2A pro Kanal		
			0,1
L/B/H: 17/4/3 cm			

Wandler, 3 Kanal
470504
119,00 €

Belastung 2A max./Kanal.
Einstellbares Eingangssignal: 0-10V
oder 1-10V, einstellbar 12-24V, DC
Eingang.

**EP1
Dimmer 1-10V**

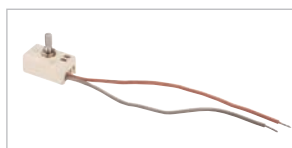











	Achse-Ø 0,6		0,02
L/B/H1/H2: 2,3/3,9/2/3,6 cm			

EP1 Dimmerbaustein
470505
11,80 €











Für den Anschluss an 1-10V
Steuerungen.
10W max.











Power LIM® 24V Mastersteuerung

	230~ 24V=			Power LIM® 24V Master 470521 165,00 €
				
L/B/H: 17,5/7,8/3,5 cm Optional mit Fernbedienung 470520.				
Geeignet für RGB LED Strips Outdoor 229800, 229801+ 229813 wie RGB LED Strips 550220 + 550225. Anschluss von maximal 22 RGB-LED Strips. Erweiterung mit bis zu 9 Slavesteuerungen. 3 festingestellte Programme. Jede Farbe kann über einen Taster gedimmt werden. Einfache Handhabung.				

Power LIM® 24V Slavesteuerung

	230~ 24V=			Power LIM® 24V Slave 470522 149,00 €
				
Anschluss von max. 22 RGB-LED Strips incl. 1,2m Steuerleitung zur Verbindung mit der Mastersteuerung.				
L/B/H: 17,5/7,8/3,5 cm				

Fernbedienung für Power LIM®

			Fernbedienung für Power LIM® Mastersteuerungen 470521 und 470523 470520 34,90 €	
				Mit integriertem Netzteil. Zur Erweiterung der Mastersteuerung 470521. Für LED Produkte mit 24V Konstantspannung. Ausgangsleistung 20W/Kanal, 60W max.
L/B/H: 17,8/4,8/1,9 cm				
Zum Steuern der RGB-Mastersteuerungen 470521 und 470523.				

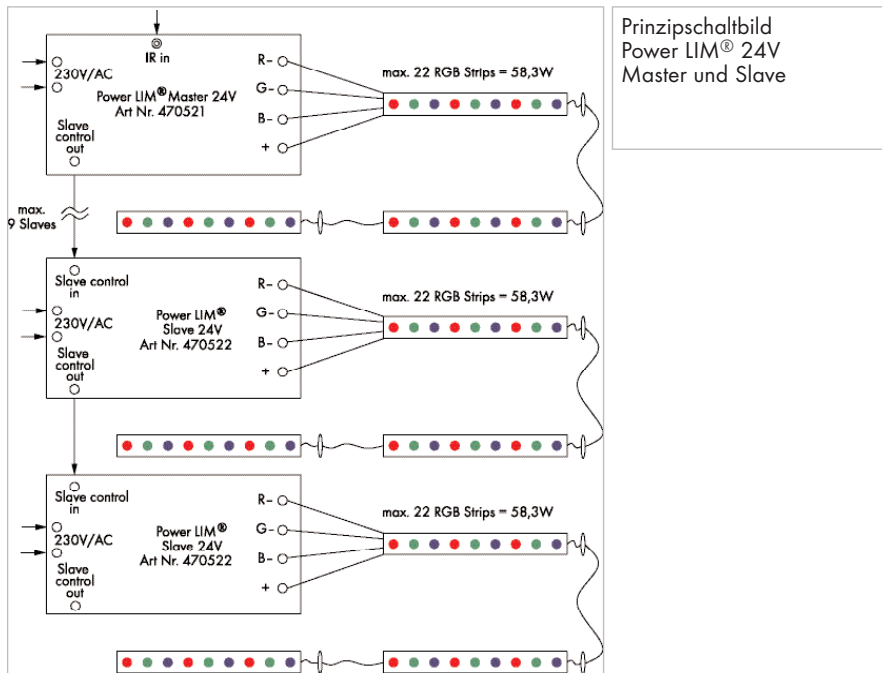









**Power LIM® RGB
Mastersteuerung
350mA**

	230~ 350mA			Power LIM® RGB Master, 350mA 470523 179,00 €
				
L/B/H: 17,5/7,8/3,5 cm Optional mit Fernbedienung 470520.				Mit integriertem Netzteil. Für 1W PowerLED Ausgangsleistung 7W/Kanal, 21W max.

LED Mastersteuergerät mit integriertem Netzteil. Geeignet zum Betrieb von PowerLED mit 350mA Konstantstrom, z.B. Anschluss von max. 5 RGB LED Frames Art.-Nr. 111263. Erweiterbar mit bis zu 9 Slavesteuergeräten 470524, wobei die ersten zwei Slave Geräte die 24V Spannungsversorgung des Master-Gerätes nutzen können.
3 festeingestellte Programme abrufbar und eine statische Farbe über Taster einstellbar.

**Power LIM® RGB
Slavesteuerung
350mA**





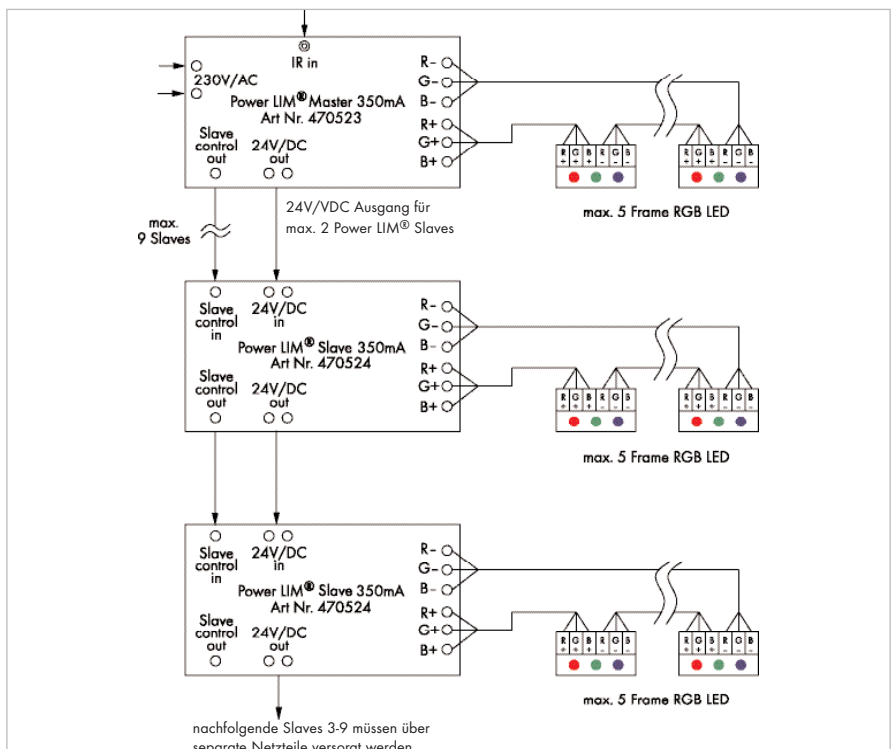

	24= 350mA			Power LIM® RGB Slavesteuerung 350mA / 21,3W 470524 149,00 €
				
L/B/H: 17,5/7,8/3,5 cm				Ausgangsleistung 7W/Kanal, 21W max. Incl. 1,2 m Steuerleitung zur Verbindung mit der Mastersteuerung

Zur Erweiterung der Mastersteuerung 470523 für PowerLED mit 350mA Konstantstrom, max. 5x 1W PowerLED pro Kanal, z.B. Anschluss von max. 5 RGB LED Frames Art.-Nr. 111263











Prinzipschaltbild
Power LIM® 350mA
Master und Slave













Netzteil für LED Strips 12W

	230~ 24V=	VA 1-12			Netzteil für LED Strips 24V, 12W 470502 23,50 €
					
	L/B/H: 8,5/4/2,3 cm				











Netzteil für LED Strips 60W

	230~ 24V=	VA 1-60			Netzteil für LED Strips 24V, 60W 470506 119,00 €
					
					
L/B/H: 17,5/7,8/3,5 cm					











Netzteil für LED Strips 100W

	230~ 24V=	VA 1-100			Netzteil für LED Strips 24V, 100W 470500 129,00 €
					
					
L/B/H: 18,2/8,8/3,5 cm					

Netzteil für Mini-LED-Modul-Kette 12W

	230~ 12V=				Netzteil für Mini-LED-Modul-Kette 12W 12V, 12W 470507 24,90 €
					
					
L/B/H: 8,5/4/2,3 cm					

Netzteil für Mini-LED-Modul-Kette 60W

	230~ 12V=				Netzteil für Mini-LED-Modul-Kette 60W 12V, 60W 470508 119,00 €
					
					
L/B/H: 18,2/8,8/3,5 cm					

**Anschlussbox
rund**



			IP55
Klemme incl.			0,25
Ø/L/B: 11,5/15,5/15,5 cm Leitungs-Ø: 7-14 mm			

Anschlussbox rund
schwarz 229260
19,90 €
passend für Treiber 464108
z.B. für Power Trail-Lite

**LED Treiber 3W,
350mA**



230~ 350mA			
			0,05
L/B/H: 5,5/4/2 cm			

LED Treiber 3W, 350mA
464108
19,90 €
Leistung 3W (3VA)
Ausgangsstrom 320mA
mit Zugentlastung
Für den Anschluss von bis zu 3
Power LED, 350mA

**LED Treiber 10W,
350mA**



230~ 350mA			
Sekundärleitung max. 2m			0,11
L/B/H: 16,5/4/3 cm			

LED Treiber 10W, 350mA
464110
29,90 €
Leistung 1-11W
mit Zugentlastung
Für den Anschluss von bis zu 9
Power LED, 350mA
mit Buchse für Steckerset 111850
s. unten.

**LED Treiber 18W,
350mA**



230~ 350mA			
			0,15
L/B/H: 14/6,8/3,5 cm			

LED Treiber 18W, 350mA
464111
79,90 €
Leistung 18W max.
mit Zugentlastung
Für den Anschluss von bis zu 15
Power LED, 350mA
mit Buchse für Steckerset 111850
s. unten.

Steckerleiste

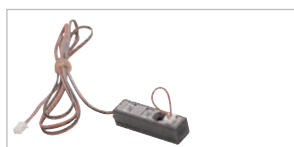

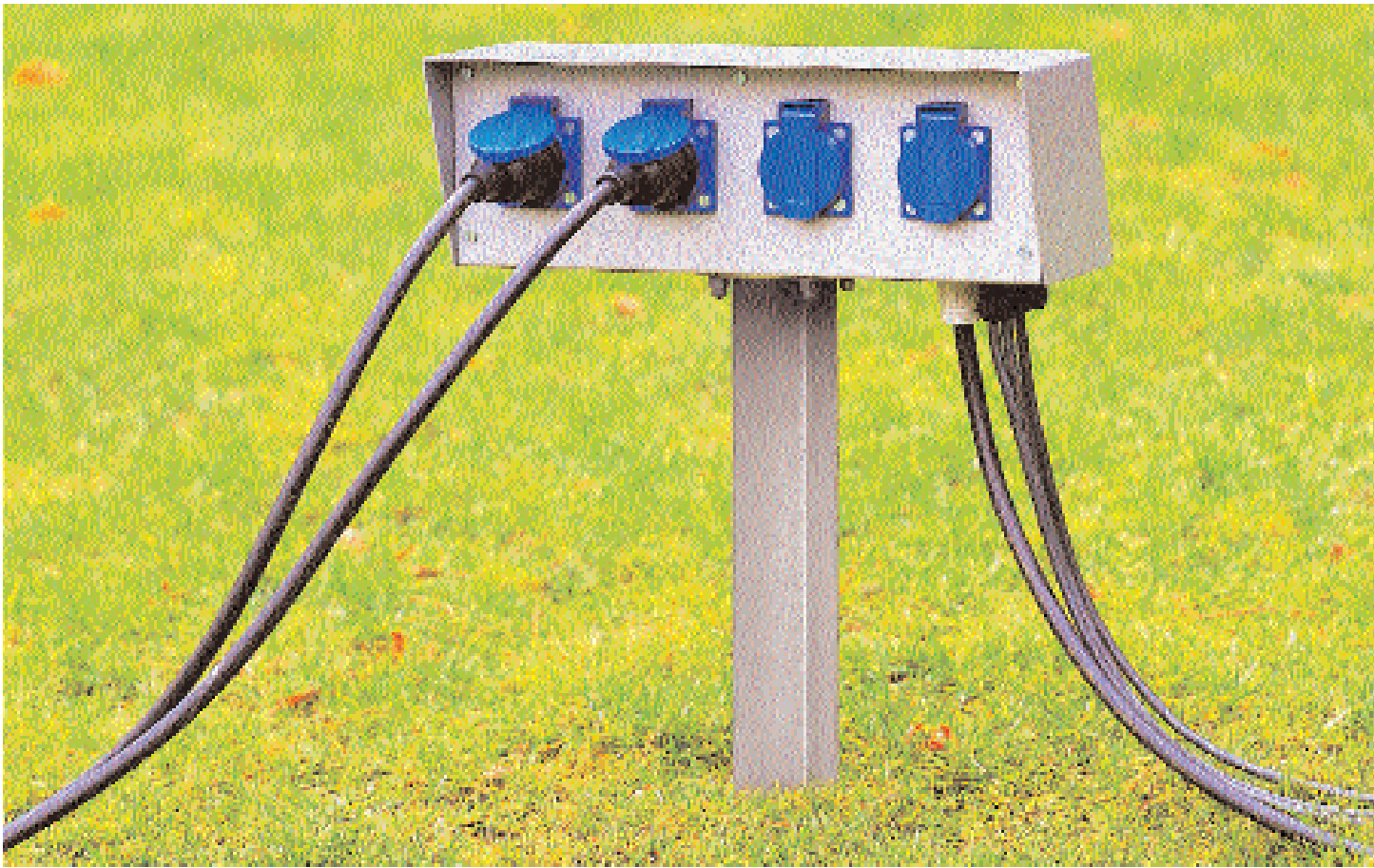

		Zulei- tung 1m	0,015
L/B/H: 5,2/1,4/1,3 cm			

Steckerleiste
111850
5,95 €
max. Strombelastung 350mA
Reihenschaltung
3 Ausgänge incl. Brücke



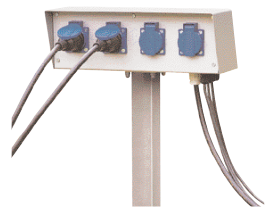

Energie-Pack



	230~		IP54	Energie-Pack 227000 119,00 € incl. 50 cm Erdspieß incl. Montageschrauben
			2,5	
L/B/H: 35/12/12 cm				

4 Schutzkontaktsteckdosen 230V/16A max. mit Klappdeckel.
 3 Ausgänge für metrische Kabelverschraubungen nach EN 50262 M 12 (Kabel-Ø: 9-17 mm).
 1 Eingang für metrische Kabelverschraubung nach EN 50262 M 25 (Kabel-Ø: 9-17 mm).
 Nicht für den Außenbereich geeignete Trafos können im Energie-Pack untergebracht werden.

4-Kanal Empfänger

	230~		IP54	4-Kanal Empfänger hell-grau 410850 139,00 € Max. Last pro Kanal 900W 2 Schließerkontakte und 2 Wechslerkontakte, Codierung frei wählbar.
			0,25	
L/B/H: 5,7/12/8 cm				

8-Kanal Funksender

	12~			8-Kanal Funksender schwarz 410851 69,50 € Für 2x 410850 Reichweite außen: ca. 50 m Reichweite innen: ca. 30 m Codierung frei wählbar.
	Batterie incl.		0,03	
L/B/H: 15/4,2/7,8 cm				

Anschlussbox klein



			IP55
Klemme incl.			0,04
L/Ø: 6/4,6 cm Leitungs-Ø: 6-8 mm			

Anschlussbox klein
schwarz 228700
10,95 €
Für Außenleuchten

Anschlussbox groß



			IP55
Klemme incl.			0,13
L/Ø: 9,2/4,7 cm Leitungs-Ø: 6-14 mm			

Anschlussbox groß
schwarz 228710
15,95 €
Für Außenleuchten

Anschlussbox rund



			IP55
Klemme incl.			0,25
Ø/L/B: 11,5/15,5/15,5 cm Leitungs-Ø: 7-14 mm			

Anschlussbox rund
schwarz 229260
19,90 €
Für Außenleuchten

Verbindungsbox IP68



			IP68
			0,2
L/Ø: 11,5/2,7 cm Leitungs-Ø: 6-12 mm			

Verbindungsbox IP68
3-polig 228730
6,90 €

Verbindungsbox IP68



			IP68
			0,2
L/Ø: 13/3,2 cm Leitungs-Ø: 8-17 mm			

Verbindungsbox IP68
5-polig 228725
10,95 €

Trafofox



			IP55
			0,15
L/Ø: 20/5 cm Deckel-Ø: 7 cm Leitungs-Ø: 6-8 mm			

Trafofox
schwarz 228720
12,90 €
Für Außenleuchten
Für Minitrafo 461060







Anschlussleitung HV

Leitungs-L: 2 m

Für HQI-CDM
Vorschaltgeräte:
SIHSLJ, Cu uz,
3 x 0,75 mm.

Anschlussleitung HV
2 m Stück 961062
8,90 €

Profi KVG 70

	230~				Profi KVG 70 470070 69,50 €
				2,5	
L/B/H: 19,5/8/6,5 cm Kabel-Ø: 7-9 mm					









Profi KVG 150

	230~				Profi KVG 150 470150 79,90 €
				3,2	
L/B/H: 23/8/6,5 cm Kabel-Ø: 7-9 mm					

Norm KVG 70/150

	230~				Norm KVG 70 460070 ▼ 59,50 €
					
	KVG im Alu-Gehäuse für HQI/CDM Leuchtmittel.				

EVG HQI/CDM

	230~				EVG HQI/CDM 35W 470360 70W 470370 79,90 €
					
	L/B/H: 19,2/8,7/3,6 cm				

Wieland HV-Buchse

	250~ / 16A	2,5 ²			Wieland HV-Buchse schwarz 956171 5,95 €
	Zur Weiterverdrahtung geeignet. Zündspannungstest bis 4,5KV.				

Wieland HV-Stecker

	250~ / 16A	2,5 ²			Wieland HV-Stecker schwarz 956170 2,40 € Zündspannungstest bis 4,5KV.

NV-Verteilerbox 6-fach

	12~	2,5 ²			NV-Verteilerbox 6-fach weiß 410140 6,90 €
	Eine Einzelklemme kann mit 50W belastet werden. Die max. Belastung darf jedoch 250W nicht überschreiten.				

**Wieland
NV-Steck-
verbindung**

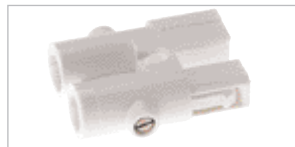

48~ 25A	0,5-2,5 ²		
			0,004

Wieland NV-Steckverbindung weiß	956172
	1,45 €

**Wieland
NV-Stecker**



48~ 25A			
			0,1

Wieland NV-Stecker weiß	956174
	13,80 €
Mit Sicherungshalter/1 m Kabel.	

**Wieland
NV-Verteilerblock**

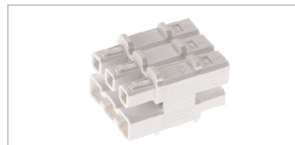

48~ 25A	2,5 ²		
			0,02

Wieland NV-Verteilerblock weiß	956173
	8,90 €

Dekoring 111



			0,1

Dekoring 111 silber-grau	151051
	6,90 €
Für ES111 und QRB111 LM	

Dekoring 51



			0,02

Dekoring 51 silber-grau	151050
	2,40 €
Für MR16 und GU10 LM	

BackwarenfILTER

L/B: 16,7/8 cm

BackwarenfILTER 931086	29,90 €
Für HQI-TS Strahler 70W	

Speziell für den Bäckereibedarf.
Läßt Backwaren besonders appetitlich wirken.

Halogen-Fassung



			0,01
L/B: 1,8/1,55 cm			

Halogen-Fassung 15 cm Leitung	955000
	1,20 €
60 cm Leitung	955020
	2,40 €
120 cm Leitung	955030
	2,90 €

GU10 Fassung



			0,02

GU10 Fassung 15 cm Leitung	955135
	2,90 €

Porzellanklemme



			0,13

Porzellanklemme
10 Stk. 956105
12,90 €

Kabel-Clip



	8,5A		

2,5-6 mm²

Kabel-Clip
10 Stk. 956150 15,80 €
100 Stk. 956155 149,00 €

Clip-Zange



			0,1

2,5-6 mm²

Clip-Zange 956160
79,90 €

Dimmermodul Dodi



230~			
			0,08

L/B/H: 1,5/4/5 cm

Dimmermodul Dodi
410120
39,90 €

Das Dimmermodul Dodi ist ein Phasenanschnittdimmer für den Einbau in Abzweigdosen für eine Leistung von 60-500W und für induktive/ohmsche Last geeignet.

Incl. Softstart für lampenschonenden Betrieb. Steuerung erfolgt über Wand-Tastschalter.

Hinweis:

Das Dimmermodul Dodi ist nicht in Verbindung mit elektronischen Trafos zu verwenden!

Dimmermodul Run

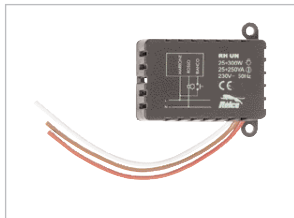

230~			
			0,08

L/B/H: 5/3,2/2 cm

Dimmermodul Run
410130
39,90 €

Das Dimmermodul Run ist ein Phasenabschnittdimmer für den Einbau in Abzweigdosen für eine Leistung von 40-300W und für induktive/ohmsche Last geeignet.

Incl. Softstart für lampenschonenden Betrieb. Steuerung erfolgt über Wand-Tastschalter.

Klares Kabel



			0,51

Klares Kabel
10 m Rolle 961250
19,90 €
3x 0,75 mm², isoliert

Deckeneinbauring



↑	←		0,15
L/B/H: 20,5/14/10 cm			

Einbaugehäuse
weiß ▼ 112790
9,90 €

Einbaugehäuse mit Trafotunnel

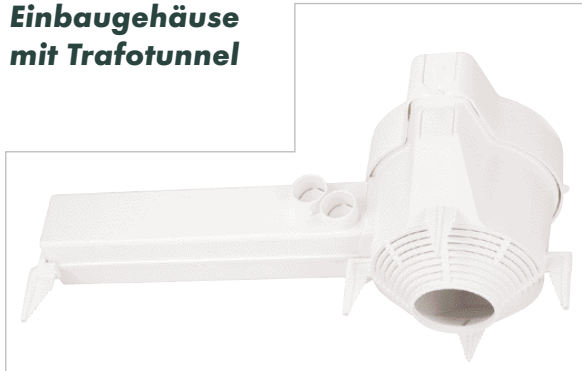

↑	←		0,3
L/B/H: 36/20,5/12,5 cm			

Einbaugehäuse mit Trafotunnel
weiß ▼ 112791
14,90 €

Zum Eingießen in Betondecke/-wand; Montage in Hohlwand/-decke und Mauerwerk.

Mögl. Einbaumaße: 50, 57, 63, 70, 76, 83, 89, 96 und 103 mm Ø.

Bei der kleinsten Ausschnittöffnung lassen sich nur 60VA-Trafos einsetzen.

Einbauhilfe für Einbaugehäuse



			0,65
L/B/H: 36/20,5/12,5 cm			

Einbauhilfe für Einbaugehäuse
silber ▼ 112792
49,90 €

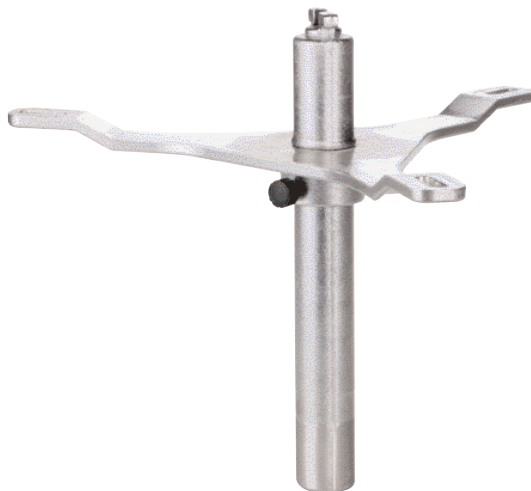

Zubehör/ Konventionelle Trafos

K-Trafo Manta 100

	230~ / 12~	VA 105			Manta 100 silber-grau 455019 79,90 € Sek. abgesichert 1x 10A
	Stahl			1,9	
	Ø/H: 20/8 cm				

K-Trafo Manta 200

	230~ / 12~	VA 200			Manta 200 weiß 455201 silber-grau 455209 chrom 455202 matt-gold 455203 brushed metal 455208 149,00 € Sek. abgesichert 1x 20A
	Stahl			2,75	
	Ø/H: 20/8 cm				

K-Trafo Manta 300

	230~ / 12~	VA 300			Manta 300 weiß 455301 silber-grau 455309 chrom 455302 matt-gold 455303 brushed metal 455308 199,00 € Sek. abgesichert 2x 15A
	Stahl			3,8	
	Ø/H: 20/9 cm				

Konventionelle Transformatoren sollten zu 80 % ausgelastet werden. Die hier abgebildeten Transformatoren sind mit Phasenabschnitt- & Phasenanschnitt-dimmern zu dimmen. Beachten Sie hierzu bitte die Herstellerhinweise.

Arte 300

	230~ / 12~	VA 300			Arte 300 chrom 167032 silber-grau 167039 199,00 €
	Stahl			3,5	
Trafo-Ø/H: 16/9,5 cm					

464

Square Transformator 300VA

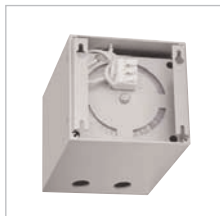

	230~ / 12~	VA 300			Square Transformator 300VA silber-grau 455314 149,00 € Sek. abgesichert 30A
	Alu			3,65	
	L/B/H: 13/13/13,5 cm				

K-Trafo Dus 300



230~ 12~	VA 300		
L/B/H: 12,9/11,3/10 cm			

Trafo Dus 300 300VA	451300 129,00 €
Sekundäranschluß: 6 Ausgänge, einzeln durch Stecksicherungen abgesichert Primärleitung: 2 m	

K-Trafo Out 305



230~ 12~	VA 300		IP43
L/B/H: 14/13,5/8,5 cm			

Trafo Out 305 IP43 300VA	451305 139,50 €
Sekundäranschluß: 5 12V Ausgänge	

K-Trafo Out IP43



230~ 12~	VA 300		IP43
L/B/H: 14/15/9 cm			

Trafo Out IP43 300VA	451302 129,00 €
Sekundäranschluß: 2x 150VA Ausgänge mit PG-Verschraubungen 2 zusätzliche Sekundärsicherungen	

IP44 Trafo 10



230~ 12~	VA 10		IP44
L/B/H: 5,5/8/5 cm			

IP44 Trafo 10VA 10VA	451010 14,90 €
Primärleitung mit Stecker: 2 m Sekundärleitung: 2 m	

IP44 Marine 60

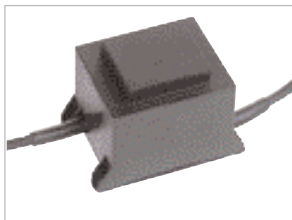

230~ 12~	VA 60		IP44
L/B/H: 6/10/6,3 cm			

IP44 Marine 60VA 60VA	227160 34,90 €
Primärleitung mit Stecker: 2 m Sekundärleitung: 1 m	

IP44 Marine 150

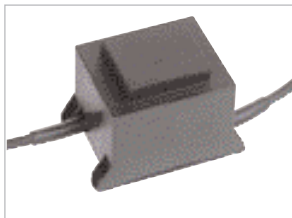

230~ 12~	VA 150		IP44
L/B/H: 8/11/7,5 cm			

IP44 Marine 150VA 150VA	227150 59,50 €
Primärleitung mit Stecker: 2 m Sekundärleitung: 1 m	











Steckertrafo 20VA













230~ 12~	VA 20		
L/B/H: 5/6,5/9 cm Zuleitung: 1,5 m			

Steckertrafo 20VA schwarz	451020 12,90 €
-------------------------------------	-------------------











K-Trafo 60VA

	230~ 12~ 24~	VA 60			12V K-Trafo 60VA 451060 24V K-Trafo 60VA 452060 29,90 € Incl. Primärsicherung Primärleitung 25 cm Sekundärleitung 25 cm
					
				1,25	
	L/B/H: 6/10/6,3 cm				











K-Trafo 105VA

	230~ 12~	VA 105			12V K-Trafo 105VA 451105 39,90 € Incl. Primärsicherung Primärleitung 25 cm Sekundärleitung 25 cm
					
				2,5	
	L/B/H: 11/7,5/8 cm				











K-Trafo 150VA

	230~ 12~ 24~	VA 150			12V K-Trafo 150VA 451150 24V K-Trafo 150VA 452135 59,50 € Incl. Primärsicherung Primärleitung 25 cm Sekundärleitung 25 cm
					
				2,2	
	L/B/H: 8/11/8 cm				











K-Trafo 250VA

	230~ 12~ 24~	VA 250			12V K-Trafo 250VA 451250 24V K-Trafo 250VA 452250 79,90 € Incl. Primärsicherung Primärleitung 25 cm Sekundärleitung 25 cm
					
				3,1	
	L/B/H: 8/11/8 cm				

K-Trafo 300VA

	230~ 12~ 24~	VA 300			12V K-Trafo 300VA 451301 99,00 € Incl. Primärsicherung Primärleitung 25 cm Sekundärleitung 25 cm
					
				3,9	
	L/B/H 9/13/11 cm				

K-Trafo 500VA

	230~ 12~	VA 500			12V K-Trafo 500VA 451500 149,00 € Incl. Primärsicherung Primärleitung 25 cm Sekundärleitung 25 cm
					
				8,2	
	L/B/H: 11/18,5/13 cm				

**Cotto 150
Trafogehäuse**



Kunststoff			0,18
L/B/H: 24/8/7,5 cm			

**Cotto 150
Trafogehäuse**
silber-grau 186872
29,90 €
Für elektr. Transformatoren
bis 150VA

Cotto M10 Trafo



230~ 12~	VA 20-60		
Kunststoff	E-Trafo incl.		0,23
L/B/H: 9,5/9,5/6 cm			

Cotto M10 Trafo
silber-grau 186862
34,90 €
Trafo mit M10 x 1 Innengewinde
für NV-Pendelleuchten. 20-60VA,
12V.

Design Gehäuse II



230~			
Stahl	Trafo excl.		0,8
L/B/H: 26,4/21,2/4 cm			

Design Gehäuse II
silber-grau 459912
34,90 €
für 2 Trafos 150W max.

F.N. Minitrafo



230~ 12~	VA 10-60		
	KEMA EUR		
	110	F	0,07
L/B/H: 8,5/4,2/2,2 cm			

F.N. Minitrafo
10-60VA 461062
15,95 €
Reversibler Übertemperatur-Schalter
LF: cos j = 0,98, ta = 50 °C
Sekundäranschluß:
1 Schraubklemmenpaar

**F.N. Minitrafo
für Trafobox**



230~ 12~	VA 10-60		
	KEMA EUR		
		W	0,07
L/B/H: 10,5/3,3/2,2 cm			

Minitrafo für Trafobox
10-60VA 461060
15,95 €
Reversibler Übertemperatur-Schalter
LF: cos j = 0,96, ta = 40 °C
Sekundäranschluß:
1 Schraubklemmenpaar

Trafobox



			IP55
			0,15
L/Ø: 20/5 cm Deckel-Ø: 7 cm Leitungs-Ø: 6-8 mm			

Trafobox
schwarz 228720
12,90 €
Für Minitrafo 461060
Für Außenleuchten

Profitrafo Whole



230~ 12~	VA 10-70		
			0,1
Ø/T: 5,5/2,3 cm			

Profitrafo Whole
10-70VA 461050
19,90 €
Reversibler Übertemperatur-Schalter
LF: cos j = 0,98, ta = 35 °C
Sekundäranschluß:
freie Zuleitungen ca. 20 cm

E-Trafo 105VA



230~ 12~	VA 35-105		
	110		0,12
L/B/H: 16/4,5/1,8 cm			

Elektronischer Trafo 105VA
weiß 461310
12,90 €
Incl. Zugentlastung

Osram Mouse 70



230~ 12~	VA 20-70		
			0,12
L/B/H: 11/5,5/3,5 cm			

Osram Mouse 70
Sekundärseite:
1 Schraubklemmenpaar
dimbar mit Phasen- und
Phasenabschrittdimmer
hellgrau-blau 461075
29,90 €

Osram Mouse 105



230~ 12~	VA 35-105		
			0,12
L/B/H: 11/5,5/3,5 cm			

Osram Mouse 105
Sekundärseite:
1 Schraubklemmenpaar
dimbar mit Phasen- und
Phasenabschrittdimmer
hellgrau-blau 461105
34,90 €

Osram Mouse 150



230~ 12~	VA 35-105		
			0,19
L/B/H: 15,2/5,4/6,2 cm			

Osram Mouse 150
230V Durchgangsver-
drahtung
Sekundärseite:
3 Schraubklemmenpaare
dimbar mit Phasen- und
Phasenabschrittdimmer
hellgrau-blau 461155
49,90 €











Die hier abgebildeten elektronischen Trafos sind Sicherheitstransformatoren in Kompaktbauweise. Sie sind leerlauf- und kurzschlußfest, sowie überlastsicher.

Die elektronischen Transformatoren unseres Lieferprogramms sind mit handelsüblichen Phasen-Abschntidimmern zu betreiben. Beachten Sie dazu die Hinweise der Hersteller.





Bitte beachten Sie:

Bei elektronischen Transformatoren darf eine Leitungslänge von 2 m grundsätzlich aus Gründen der Störstrahlung nicht überschritten werden.



E-Trafo F.N. 01

	230~ 12~	VA 20-60			<p>E-Trafo F.N. 01 20-60VA 461067 14,90 €</p> <p>Reversibler Übertemperatur-Schalter ta = 50 °C Sekundäranschluß: 2 Schraubklemmenpaare</p>
					
					
	L/B/H: 15,1/3,6/2,7 cm				











E-Trafo F.N. 02

	230~ 12~	VA 20-105			<p>E-Trafo F.N. 02 20-105VA 461107 19,90 €</p> <p>Reversibler Übertemperatur-Schalter ta = 50 °C Sekundäranschluß: 3 Schraubklemmenpaare</p>
					
					
	L/B/H: 16,6/3,9/3,3 cm				

E-Trafo F.N. 03

	230~ 12~	VA 50-150			<p>E-Trafo F.N. 03 50-150VA 461157 23,50 €</p> <p>Reversibler Übertemperatur-Schalter ta = 50 °C Sekundäranschluß: 3 Schraubklemmenpaare</p>
					
					
	L/B/H: 16,6/3,9/3,3 cm				

E-Trafo F.N. 04

	230~ 12~	VA 50-150			<p>E-Trafo F.N. 04 50-210 VA 461217 39,90 €</p> <p>Reversibler Übertemperatur-Schalter ta = 50 °C Sekundäranschluß: 3 Schraubklemmenpaare</p>
					
					
	L/B/H: 20/4,3/3,9 cm				

Die auf diesen Seiten gezeigten Leuchtmittel stammen, sofern nicht anderweitig gekennzeichnet, von folgenden Markenherstellern:



Ledi-Light® MR16



12~	K-Trafo excl.		
	incl.	GU5,3	
Ø: 5 cm Mit je 18 LED.			

Ledi-Light® MR16

gelb	1,1W	550154
rot	1,1W	550156
7,90 €		
weiß	2W	550151
warm-weiß	2W	550152
grün	2W	550155
blau	2W	550157
14,90 €		

Nur mit konventionellen Trafos einsetzbar! Auslastung des Trafos beachten!



MR16 PowerLED



12~			Ø 5cm
	incl.	EVG incl.	
Ø/L: 12/6 cm			

MR16, 3x 1W PowerLED

LED weiß	550281
LED blau	550287
99,00 €	
PowerLED	3x 1W

Abstrahlwinkel von 25°.
Nur mit konventionellem Trafo zu betreiben!



FOCU-LED G5,3



12~			
	incl.	EVG incl.	
H/Ø: 5,3/2,7 cm			

FOCU-LED G5,3

weiß	550261
39,90 €	
Power LED	1W

Fokussierbar mit einem Abstrahlwinkel von 15°-30°.



G4 LED Super Flux

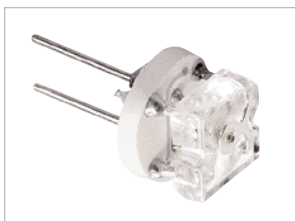

12~			
	incl.	G4	
Ø/L: 9/18 cm			

G4 LED Super-Flux

weiß 60°	550311
warmweiß 60°	550312
blau 100°	550317
2,98 €	
Superflux LED	0,2W

Betrieb nur mit konventionellen Trafo



Octagon LED Modul 12V



12~	9 LED		
	incl.	G4	
L/B/H: 3/3,9/0,4 cm			

Octagon LED Modul

weiß	550251
12,90 €	
Top LED	1,5W

Zum Umrüsten von dafür geeigneten Leuchten (siehe Produktbeschreibung) auf LED-Technik. Nur mit konventionellem Trafo zu betreiben!



LED Einsatz 12V

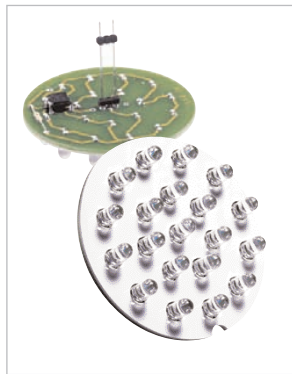

12~	Trafo excl.		
	LED incl. 20 Stk.		
Platinen-Ø: 6,4 cm			

LED Einsatz 12V
1,4W 92 lx*
weiß 227531

LED Einsatz 12V
1,4 W 96 lx*
blau 227537
29,90 €

Z.B. für Nautic Square
und Wetsy LED 230V

* Messung in 1 m Abstand.
Nur mit konventionellen Trafos zu
betreiben!

**RGB-LED Platine
12V für
Nautic und
Wetsy LED 230V**



12~	Trafo excl.		
	LED incl. 18 Stk.		
Platinen-Ø: 6,4 cm			

RGB-LED Platine 12V
colorchanging 550210
24,90 €

18 LED 2,25W max.

ca. alle 3 Sek. ein sanfter Farb-
wechsel von 12 Farben.

Ledi-Light® GU10



230~			
	incl. GU10		
Ø: 5 cm Mit je 18 LED.			

Ledi-Light® GU10
gelb 1,6W 550164
rot 1,6W 550166
7,90 €

weiß 1,8W 550161
warmweiß 1,8W 550162
grün 1,8W 550165
blau 1,8W 550167
14,90 €

ES111 LED



230~			
	incl. GU10		
Ø: 11,1 cm			

ES111 LED 57 LED
3,8W
weiß 550111
blau 550117
49,90 €

**LED QRB
einfarbig**



12~			
	incl. G53		
Ø: 11,1 cm			

LED QRB 57 LED
weiß 550121
blau 550127
49,90 €

3,8W
Nur mit konventionellen Trafos
betreibbar.

**LED QRB
RGB**



12~			
	incl. G53		
Ø: 11,1 cm			





LED QRB, RGB 54 LED
4W
RGB 550120
49,90 €

Automatischer 7-Farbenwechsler.
Nur mit konventionellen Trafos
betreibbar.

Zubehör/ Leuchtmittel LED

LED QRB





	350mA	EVG excl.			LED QRB weiß 550271 blau 550277 429,00 € Power LED 15x 1W
	incl.		Alu	0,3	
	Ø/T: 11,1/4 cm Zuleitung: 30 cm mit Stecker				

LED QRB Leuchtmittel mit 15 Power LEDs à 1W. Leuchtmittel nur mit 350mA Treiber 18W betreiben. Nicht geeignet für Karadaframes! Der Abstrahlwinkel beträgt 25°.



LED GX53



	230~				LED GX53 weiß 1,2W 550301 blau 1,2W 550307 19,90 €
	incl.	GX53		0,05	
	Ø/H: 7,5/2,5 cm				

LED Cabline





	12~				LED Cabline weiß 60° 550421 warmweiß 60° 550422 13,80 € 6 LED 0,52W gesamt
	incl.	SV8,5-8		0,02	
	L: 4,2 cm				

LED E27



Design by CDC



	230~				LED E27 weiß 550291 34,90 € 33 LED 8W
	incl.	E27	Kolben Glas	0,06	
	Ø/L: 4,2/13 cm				



Fiesta Bulb Farbwechselluchtmittel



	230~				Fiesta bulb Farbwechsel 550170 9,90 € Incl. 12 LED 5W
	incl.	E27	Kolben Glas	0,05	
	Ø/L: 12/6 cm				

Fiesta Bulb Single color



	230~				Fiesta bulb weiß 550241 grün 550245 blau 550247 14,90 € amber 550244 rot 550246 9,90 € Incl. 12 LED 0,8W
	incl.	E27	Kolben Glas	0,05	
	Ø/L: 12/6 cm				

LED Gooseneck mit M10x1 Gewinde 12V



12~	Treiber incl.		
	incl.	Alu	0,05
Kopf-Ø: 3,2 cm Goose-L: 20 cm			

LED Gooseneck mit M10x1 Gewinde
LED weiß
silber 922062
99,00 €

PowerLED 1W

Zur Adaption an NV-Schieneadapter.



Direktspiegel MR16



	2500	GU5,3	
Ø: 5 cm			

MR16 Direktspiegel
10W 40° 536138
BAB 20W 40° 536240
FMW 35W 38° 536338
EXN 50W 40° 536540
1,90 €

12V Halogen LM

Metallbeschichtet für geringere Wärmeentwicklung an der Reflektor Rückseite.

Direktspiegel MR16 chrome



	2500	GU5,3	
Ø: 5 cm			

MR16 Reflektor silber
BAB 20W 40° 534240
FMW 35W 40° 534338
EXN 50W 40° 534540
2,98 €

12V Halogen LM

Mit silberner Reflektorrückseite

Kaltlichtspiegel MR16 frosted



	2500	GU5,3	
Ø: 5 cm			

MR16 frosted
BAB 20W 40° 538240
FMW 35W 40° 538338
EXN 50W 40° 538540
2,98 €

12V Halogen LM

Mit gefrostetem Frontglas

Decostar 51 MR16



	4000	GU5,3	
Ø: 5 cm			

Decostar 51 MR16
ESX 20W 10° 526210
BAB 20W 38° 526238
FRA 35W 10° 526310
FMW 35W 38° 526338
EXT 50W 10° 526510
EXZ 50W 24° 526524
EXN 50W 38° 526538
5,95 €

Titan 12V Halogen LM

Die Supernova als MR16
Kaltlichtspiegellampe

4000 Kelvin

2900 Kelvin

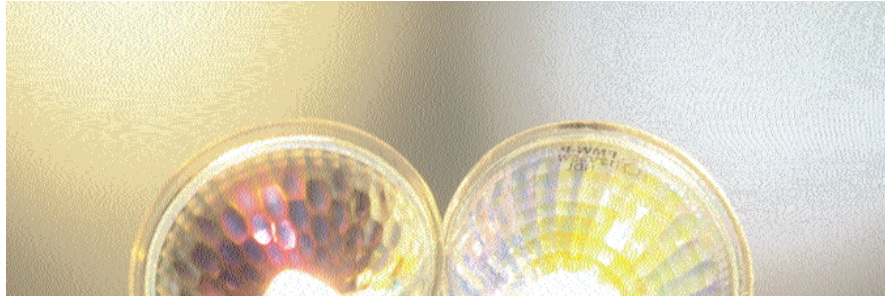

**Kaltlichtspiegel
MR11**



2500	GU4		
Ø: 3,5 cm			

MR11		
FTD	20W 30°	533228
FTH	35W 30°	533330
		1,90 €
12V	Halogen LM	

**Kaltlichtspiegel
MR16 4000K**



2500	GU5,3		
Ø: 5 cm			

MR16 4000K		
BAB	20W 40°	537240
FMW	35W 38°	537338
EXN	50W 40°	537540
		2,98 €
12V	Halogen LM	
Kalt-weißes Licht 4000K		

**Kaltlichtspiegel
MR16**



2500	GU5,3		
Ø: 5 cm			

MR16		
ESX	20W 13°	535213
BAB	20W 40°	535240
FRB	35W 8°	535312
FMW	35W 40°	535338
EXT	50W 14°	535514
EXZ	50W 25°	535527
EXN	50W 40°	535540
FNV	50W 55°	535560
		1,90 €
12V	Halogen LM	

**Kaltlichtspiegel
MR16 farbig**



2500	GU5,3		
Ø: 5 cm			

MR16 20W farbig		
ESX	gelb 13°	575214
ESX	grün 13°	575215
ESX	rot 13°	575216
ESX	blau 13°	575217
MR16 50W farbig		
EST	gelb 14°	575514
EST	grün 14°	575515
EST	rot 14°	575516
EST	blau 14°	575517
		3,95 €
12V	Halogen LM	
Mit dichroitischem Farbfilter		

Xenon

Xenon MR16 2700K



10000	GU5,3		
Ø: 5 cm			

Xenon MR16 2700K	
BAB 20W 40°	539240
FMW 35W 38°	539340
EXN 50W 40°	539540
	3,45 €
12V	Xenon LM

Leuchtmittelzange



Leuchtmittelzange	
	920910
	4,80 €
Wichtiges Hilfsmittel zum Einsetzen & Entfernen von MR11 & MR16 Kaltlichtspiegellampen bei kompakten Einbaustrahlern!	

GU10



2500	GU10		
Ø: 5 cm			

GU10	
Reflektor Alu-beschichtet	
35W 25°	575520
50W 25°	575530
50W 50°	575535
	6,90 €
230V Quarz Halogen LM	

PAR20, GU10



2000	GU10		
Ø/L: 6,4/6,4 cm			

PAR20	
75W 50°	575682
	4,80 €
230V	Reflektor LM

GU10



1500	GU10		
Ø: 5 cm			

GU10 2700K	
Reflektor Alu-beschichtet	
35W 50°	575351
50W 50°	575510
	4,80 €
GU10 4000K	
Reflektor Alu-beschichtet	
35W 50°	575350
50W 50°	575511
	4,80 €
230V Quarz Halogen LM	





GU10 Color







1500	GU10		
Ø: 5 cm			

GU10 50W	
Reflektor Alu-beschichtet	
gelb, 50°	575504
grün, 50°	575505
rot, 50°	575506
blau, 50°	575507
	6,80 €
230V Quarz Halogen LM	





ES111

					ES111 75 W, 24° 575540 29,90 €
	Ø: 11,1 cm				

F.N. ES111 50W

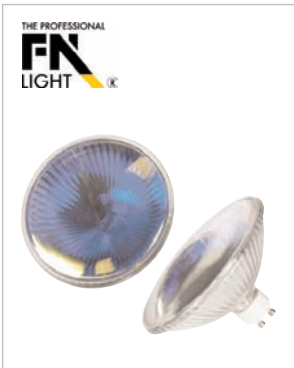

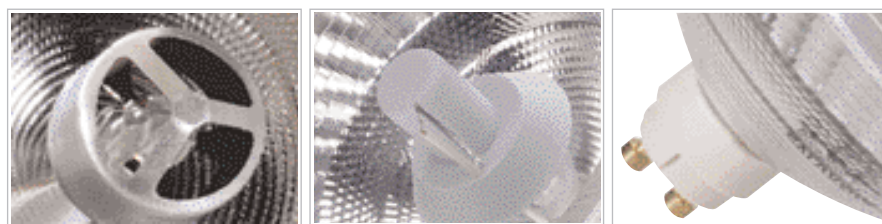

					F.N. ES111 2700K 24° 575652 9,90 € 4000K, 24° 575651 gelb, 24° 575654 grün, 24° 575655 rot, 24° 575656 blau, 24° 575657 12,90 € 230V 50W Reflektor Alu beschichtet
	Ø: 11,1 cm				

F.N. ES111 75W





					F.N. ES111 2700K 24° 575672 9,90 € 4000K, 24° 575671 gelb, 24° 575674 grün, 24° 575675 rot, 24° 575676 blau, 24° 575677 12,90 € 230V 75W Reflektor Alu beschichtet
	Ø: 11,1 cm				



CDM-R Britespot ES111 GX10 35W

					ES111 Britespot 35W, 24° 506992 79,90 € 230V, 10000cd Reflektor Alu beschichtet mit Abschatter
	Ø: 11,1 cm				

CDM-R Britespot ES111 GX10 70W

					ES111 Britespot 70W, 24° 506982 79,90 € 230V, 20000cd Reflektor Alu beschichtet mit Abschatter
	Ø: 11,1 cm				

**CDM-R Britespot
ES50 GX10**



Ø: 5,1 cm			

ES50 Britespot	
35W, 38°	507013
	69,50 €
Halogenmetall dampflampe 230V, 4000cd Reflektor Alu-beschichtet	

CDM-R111



Ø: 11,1 cm			

CDM-R111	230V
35W, 10°	507001
35W, 40°	507004
	119,00 €
Reflektor Alu beschichtet mit Ab- schatter	

QRB111 12V



Ø: 11,1 cm			

QRB111 2700K		
20W 8°	543208	
20W 24°	543224	
20W 45°	543245	
35W 8°	543308	
35W 24°	543324	
35W 45°	543345	
50W 8°	543508	
50W 24°	543524	
50W 45°	543545	
75W 8°	543708	
75W 24°	543724	
75W 45°	543745	
	7,90 €	
12V	Niederdrucklampe	

Halostar111 12V



Ø: 11,1 cm			

QRB111 3000K		
50W 4°	544502	
50W 8°	544512	
50W 24°	544522	
75W 8°	544751	
75W 24°	544752	
75W 45°	544753	
100W 8°	544108	
100W 24°	544124	
100W 45°	544145	
	14,90 €	
12V	Niederdrucklampe	

**Dichrofilter für
QRB**





	Halte- feder incl.		
Ø/Stärke: 10/0,4 cm			

Dichrofilter für QRB	
gelb	543004
grün	543005
rot	543006
blau	543007
	14,90 €
Dichroitisches Filterglas zum Aufklipsen auf QRB111 Leuchtmittel.	



Norm IEC 357: Der Betrieb bei offenen Leuchten ist nur mit Niederdrucklampen erlaubt.

Stiftsockel

	<input type="checkbox"/>	<input type="checkbox"/>	<input checked="" type="checkbox"/>	<input checked="" type="checkbox"/>
	<input type="checkbox"/>	<input type="checkbox"/>	<input type="checkbox"/>	<input type="checkbox"/>
			<input type="checkbox"/>	<input type="checkbox"/>
	<input type="checkbox"/>			



Niederdruck Stiftsockel	
5W	512205
	1,15 €
10W	512210
20W	512220
	0,90 €
12V	Quarz Halogen LM

Stiftsockel

	<input type="checkbox"/>	<input type="checkbox"/>	<input checked="" type="checkbox"/>	<input checked="" type="checkbox"/>
	<input type="checkbox"/>	<input type="checkbox"/>	<input type="checkbox"/>	<input type="checkbox"/>
			<input type="checkbox"/>	<input type="checkbox"/>
	<input type="checkbox"/>			



Niederdruck Stiftsockel	
35W	512235
50W	512250
	0,90 €
12V	Quarz Halogen LM

Stiftsockel

	<input type="checkbox"/>	<input type="checkbox"/>	<input checked="" type="checkbox"/>	<input checked="" type="checkbox"/>
	<input type="checkbox"/>	<input type="checkbox"/>	<input type="checkbox"/>	<input type="checkbox"/>
			<input type="checkbox"/>	<input type="checkbox"/>
	<input type="checkbox"/>			



Niederdruck Stiftsockel	
5W	513205
	1,29 €
10W	513210
20W	513220
	0,95 €
12V	Quarz Halogen LM

TC LM G8,5

	<input type="checkbox"/>	<input type="checkbox"/>	<input checked="" type="checkbox"/>	<input checked="" type="checkbox"/>
	<input type="checkbox"/>	<input type="checkbox"/>	<input type="checkbox"/>	<input type="checkbox"/>
			<input type="checkbox"/>	<input type="checkbox"/>
	<input type="checkbox"/>			



TC LM G8,5	
60W	519560
	29,90 €
12V	Halogen-LM

Stiftsockel

	<input type="checkbox"/>	<input type="checkbox"/>	<input checked="" type="checkbox"/>	<input checked="" type="checkbox"/>
	<input type="checkbox"/>	<input type="checkbox"/>	<input type="checkbox"/>	<input type="checkbox"/>
			<input type="checkbox"/>	<input type="checkbox"/>
	<input type="checkbox"/>			

Niederdruck Stiftsockel	
35W	513235
50W	513250
	0,95 €
12V	Quarz Halogen LM

Halogen Mini Reflector

	<input type="checkbox"/>	<input type="checkbox"/>	<input checked="" type="checkbox"/>	<input checked="" type="checkbox"/>
	<input type="checkbox"/>	<input type="checkbox"/>	<input type="checkbox"/>	<input type="checkbox"/>
			<input type="checkbox"/>	<input type="checkbox"/>
	<input type="checkbox"/>			

Halogen Mini Reflector	
20W, 20°	512320
35W, 30°	512335
50W, 30°	512350
	11,80 €
12V	Halogen-LM

G9 Leuchtmittel

<p>THE PROFESSIONAL FN LIGHT</p> <p>Matt</p>					<p>G9 LM</p> <p>25W 519325 40W 519340 60W 519360</p> <p>3,45 €</p> <p>230V Quarz Halogen LM</p>

Osram G9

					<p>Osram G9</p> <p>25W matt 519425 40W klar 519440</p> <p>9,90 €</p> <p>230V Quarz Halogen LM</p>

CDM-TC G8,5

					<p>CDM-TC G 8,5</p> <p>35W 3000K 507035 70W 3000K 507037 35W 4200K 507045 70W 4200K 507047</p> <p>59,50 €</p> <p>230V CDM-T-LM</p> <p>Halogen-Metall dampflampe</p>

B15d

<p>THE PROFESSIONAL FN LIGHT</p>					<p>B15d</p> <p>75W 519507 100W 519510 150W 519515</p> <p>5,95 €</p> <p>230V Quarz Halogen LM</p>





















R7s 78 mm

<p>THE PROFESSIONAL FN LIGHT</p>					<p>R7s 78 mm</p> <p>60W 519206</p> <p>2,90 €</p> <p>100W 519210 150W 519215</p> <p>1,98 €</p> <p>230V Quarz Halogen LM</p>





















R7s 118 mm

<p>THE PROFESSIONAL FN LIGHT</p>					<p>R7s 118 mm</p> <p>100W 519221</p> <p>1,98 €</p> <p>200W 519222 300W 519223 500W 519225</p> <p>1,48 €</p> <p>230V Quarz Halogen LM</p>























Linienlampe

					Linienlampe 2700K, matt 35W, 30 cm	590150
						10,80 €
					60W, 50 cm	590151
					2700K, klar 60W, 50 cm	590152
						17,90 €
						
Ø: 30 mm						230V























HQI-T G12 70

					HQI-T G12 70W WDL 3000K	507180
					NDL 4000K	507181
						69,50 €
					230V	HQI-T-LM
						Halogen-Metall dampflampe
					HQI-T G12 70W blau	510277
					grün	510275
						129,00 €























HQI-T G12 150

					HQI-T G12 150W WDL 3000K	507190
					NDL 4000K	507191
						69,50 €
					230V	HQI-T-LM
						Halogen-Metall dampflampe
					HQI-T G12 150W blau	510357
					grün	510355
						129,00 €

CDM-T G12 70

					CDM-T G12 70W WDL 3000K	507130
					NDL 4000K	507131
						59,50 €
						Halogen-Metall dampflampe, Keramik-Technologie
						
						

CDM-T G12 150

					CDM-T G12 150W WDL 3000K	507140
					NDL 4000K	507141
						59,50 €
						Halogen-Metall dampflampe, Keramik-Technologie
						
						

Rx7s HQI 70

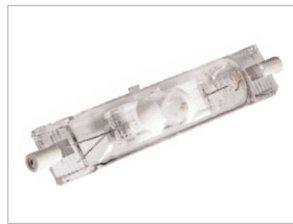

L: 12 cm			

Rx7s HQI 70W
 WDL 3000K 509070
 NDL 4200K 509071
 24,90 €
 230V Rx7s HQI-LM
 Halogen-Metaldampfampe

Rx7s HQI 150



L: 13,5 cm			

Rx7s HQI 150W
 WDL 3000 K 509150
 NDL 4200 K 509151
 24,90 €
 230V Rx7s HQI-LM
 Halogen-Metaldampfampe

Rx7s HQI 70c

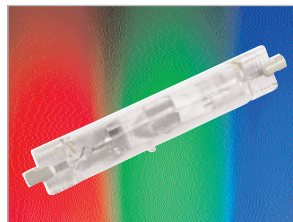

L: 12 cm			

Rx7s HQI 70Wc
 grün 510075
 magenta 510076
 blau 510077
 99,00 €
 230V Rx7s HQI-LM
 Halogen-Metaldampfampe

Rx7s HQI 150c

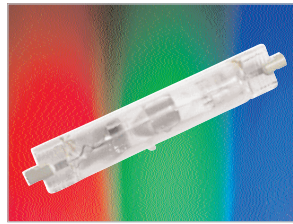

L: 13,5 cm			

Rx7s HQI 150Wc
 grün 510155
 magenta 510156
 blau 510157
 99,00 €
 230V Rx7s HQI-LM
 Halogen-Metaldampfampe

Rx7s CDM-TD 70



L: 12 cm			

Rx7s CDM-TD 70W
 WDL 3000K 507070
 NDL 4200K 507071
 49,90 €
 230V Rx7s HQI-LM
 Halogen-Metaldampfampe
 Keramikbrenner für hohe Farbtreue
 über die gesamte Lebensdauer





















Rx7s CDM-TD 150



















L: 13,5 cm			

Rx7s CDM-TD 150W
 WDL 3000K 507150
 NDL 4200K 507151
 49,90 €
 230V Rx7s HQI-LM
 Halogen-Metaldampfampe
 Keramikbrenner für hohe Farbtreue
 über die gesamte Lebensdauer





















HQI-E, E27

					HQI E27 WDL 3000K NDL 4200K	70W 508170 508171
					HQI E27 WDL 3000K NDL 4200K	100W 507170 507171
					HQI E27 WDL 3000K NDL 4200K	150W 509170 509171
						49,90 €
						230V E27 HQI-E Halogen-Metaldampfampe
					Betrieb ausschließlich in Verbindung mit VG's möglich!	

















HQI-E, E40

					HQI-E, E40 NDL 250W NDL 400W	509180 509191
						79,90 €
						230V HQI-E Halogen-Metaldampfampe
						Betrieb ausschließlich in Verbindung mit VG's möglich!





















HIT-T, E40

					HIT-T, E40 4200K, klar	510400
						69,50 €
						grün 510405 magenta 510406 blau 510407
						129,00 €
						230V 400W
Ø/L: 4,5/26,5 cm						

CDM-R, E27





					CDM-R, E27 3000K	508172
						99,00 €
						230V 70W Abstrahlwinkel 40°
						
	Ø/L: 5,5/13,8 cm					

HMLI, E27





					HMLI 160W 4000K 3000 lm	506160
						18,80 €
						HMLI 250W 4200K 5500 lm
						23,50 €
						230V Mischlicht-LM
Ø/L: 7,4/17 cm						

HMLI-Leuchtmittel werden mit Netzspannung **ohne Vorschaltgerät** betrieben. Sie sind mit einem Wolframwendel ausgerüstet, der in Reihe mit einer Quecksilberdampföhre geschaltet ist.





PAR20, E27

	 1500	 E27			<p>PAR20, E27</p> <p>50W 24° 519725 75W 24° 519727</p> <p>7,90 €</p> <p>230V Reflektor LM</p>
	<p>Ø/L: 6,5/8,2 cm</p>				





PAR30, E27

	 2000	 E27			<p>PAR30, E27</p> <p>75W 24° 519737 150W 24° 519739</p> <p>9,90 €</p> <p>230V Reflektor LM</p>
	<p>Ø/L: 9,5/9,3 cm</p>				





PAR38, E27

	230~				<p>PAR38, E27</p> <p>80W 24° 519760</p> <p>9,90 €</p> <p>230V Reflektor LM</p>
		 E27			
<p>Ø/L: 12,2/13,6 cm</p>					





PAR56

					<p>PAR56</p> <p>NSP 300W 519740 MFL 300W 519741</p> <p>34,90 €</p> <p>230V Reflektor LM</p> <p>Achtung: Effektstrahler. Nicht für Dauerbetrieb!</p>
		 GX16d			
<p>Ø: 17,5 cm</p>					







PAR64

					<p>PAR64</p> <p>500W 519742</p> <p>79,90 €</p> <p>230V Reflektor LM</p> <p>Achtung: Effektstrahler. Nicht für Dauerbetrieb!</p>
		 GX16d			
<p>Ø: 20 cm</p>					







Hochglanz-Reflektor SFL® PAR64

					<p>SFL® PAR64 156932</p> <p>14,80 €</p> <p>Stiftsockel GY9,5 500W 519750</p> <p>29,90 €</p> <p>Hochglanz-Reflektor 230V</p>
	 2000	 GX16d			







Microlynx 6W

				Microlynx 6W 3000K 508421 4000K 508422 24,90 € 230V Energiespar-LM Incl. EVG.
	 6000	 GX53		
Ø/L: 7,5/2,1 cm Gleichstrombetrieb möglich!				







Microlynx 6W Color

				Microlynx 6W Color grün 508425 rot 508426 blau 508427 39,90 € 230V Energiespar-LM Incl. EVG.
	 6000	 GX53		
Ø/L: 7,5/2,1 cm Gleichstrombetrieb möglich!				







PL 18W

				TC-L 2G11, 4-Pin 18W, 2700K 508460 18W, 4000K 508461 9,90 € 230V Energiespar-LM
	 10000	 2G11		
L/B/H: 22,5/4,4/2,4 cm				







PL 24W

				TC-L 2G11, 4-Pin 24W, 2700K 508440 24W, 4000K 508441 9,90 € 230V Energiespar-LM
	 10000	 2G11		
L/B: 32/3,8 cm				

PL 36W

				TC-L 2G11, 4-Pin 36W, 4000K 590145 9,90 € 230V Energiespar-LM
	 12000	 2G11		
L/B: 41,5/3,8 cm				

PL 55W

				TC-L 2G11, 4-Pin 55W, 2700K 508450 55W, 4000K 508451 11,80 € 230V Energiespar-LM
	 10000	 2G11		
L/B: 53,3/3,8 cm				

ELD 11W, E27

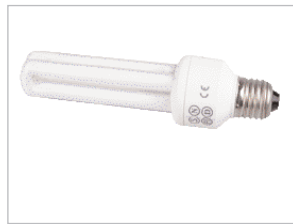

12000	E27		
Ø/L: 4,4/13,4 cm			

ELD 2-fach E27
 11W 2700K 508211
 14,90 €
 230V Energiespar-LM

ELD 15W, E27



12000	E27		
Ø/L: 4,5/17 cm			

ELD 2-fach E27
 15W 2700K 508415
 9,90 €
 230V Energiespar-LM

ELT 21W, E27



10000	E27		
Ø/L: 4,5/14,5 cm			

ELT 3-fach E27
 21W 2700K 508416
 14,90 €
 230V Energiespar-LM

ELT 24W, E27



10000	E27		
Ø/L: 5,2/17,3 cm			

ELT 3-fach E27
 24W 2700K 508417
 14,90 €
 230V Energiespar-LM

**ELD 15W, E27
 Color**







12000	E27		
Ø/L: 4,5/17 cm			

ELD 2-fach E27 Color
 15W, grün 508255
 15W, rot 508256
 15W, blau 508257
 9,90 €
 230V Energiespar-LM





TC-S 7W, G23

					G23 2-Stift 7W 2700K 508207 4,80 € 230V Energiespar-LM
	Ø/L: 3,2/13,6 cm				

TC-S 9W, G23

					G23 2-Stift 9W 2700K 508209 9W 4000K 508309 4,80 € 230V Energiespar-LM
	Ø/L: 3,2/16,5 cm				

TC-S 11W, G23



					G23 2-Stift 11W 2700K 508310 11W 4000K 508311 4,80 € 230V Energiespar-LM
	Ø/L: 3,2/23,5 cm				

Sparen Sie Energie mit den folgenden TC-D Glühlampen!









10W entspricht 60W
13W entspricht 75W

18W entspricht 100W
26W entspricht 2 x 75W









TC-D 10W G24d-1

					G24d-1 2-Stift 10W 2700K 508210 9,90 € 230V Energiespar-LM
	Ø/L: 4/10,7 cm				









TC-D 13W G24d-1

					G24-d1 2-Stift 13W 3500K 508213 13W 4000K 508313 8,90 € 230V Energiespar-LM
					
Ø/L: 4,1/13,5 cm					





TC-D 18W G24d-2

					G24-d2 2-Stift 18W 2700K 508218 18W 4000K 508318 8,90 € 230V Energiespar-LM
					
Ø/L: 4,1/15,1 cm					





TC-D 26W G24d-3

					G24d-3 2-Stift 26W 2700K 508226 26W 4000K 508326 8,90 € 230V Energiespar-LM
					
Ø/L: 4,1/17 cm					





TC-DE 13W G24q-1

					G24q-1 4-Stift 13W 3000K 508212 13W 4000K 508312 8,90 € 230V Energiespar-LM
	10000	G24q-1			

TC-DE 18W G24q-2

					G24q-2 4-Stift 18W 3000K 508220 18W 4000K 508320 8,90 € 230V Energiespar-LM
	10000	G24q-2			





TC-DE 26W G24q-3

					G24q-3 4-Stift 26W 3000K 508222 26W 4000K 508322 8,90 € 230V Energiespar-LM
	10000	G24q-3			





Achtung! Alle nachfolgenden T-5 und T-8-Leuchtmittel (außer Ringröhren) sind entweder in den jeweils angegebenen Verpackungseinheiten erhältlich oder **mit Aufpreis pro 3er Verpackung** wie folgt:

Aufpreis für T5 Leuchtstofflampe in 3er Verpackung	8W, 13W, 24W	Art.-Nr.:980010	5,00 €
Aufpreis für T5 Leuchtstofflampe in 3er Verpackung	21W, 28W, 39W, 54W	Art.-Nr.:980011	5,00 €
Aufpreis für T5 Leuchtstofflampe in 3er Verpackung	35W	Art.-Nr.:980012	15,00 €
Aufpreis für T8 Leuchtstofflampe in 3er Verpackung	18W	Art.-Nr.:980013	5,00 €
Aufpreis für T8 Leuchtstofflampe in 3er Verpackung	36W	Art.-Nr.:980014	5,00 €





**T5 Leuchtmittel
8W**

3er Verpackungen sind mit Aufpreis möglich siehe Infokasten oben 					T5, Stecksockel 2700K 8W 591293 4000K 8W 591294 3,95 € pro Stück 230V Energiespar-LM
	10000	G5			

**T5 Leuchtmittel
13W**

3er Verpackungen sind mit Aufpreis möglich siehe Infokasten oben 					T5, Stecksockel 2700K 13W 591295 4000K 13W 591296 6,90 € pro Stück 230V Energiespar-LM
	10000	G5			



**T5 Leuchtmittel
21W**

3er Verpackungen sind mit Aufpreis möglich siehe Infokasten oben 					T5, Stecksockel 3000K 21W 548021 4000K 21W 548121 7,90 € 230V Energiespar-LM
	10000	G5			

**T5 Leuchtmittel
24W**

3er Verpackungen sind mit Aufpreis möglich siehe Infokasten Seite 487



			
10000	G5		
Ø/L: 1,6/55 cm Verpackungseinheit 10 Stück.			

T5
3000K 24W 548024
4000K 24W 548124
9,90 € pro Stück
230V Energiespar-LM

**T5 Leuchtmittel
28W**

3er Verpackungen sind mit Aufpreis möglich siehe Infokasten Seite 487



			
10000	G5		
Ø/L: 1,6/115 cm Verpackungseinheit 10 Stück.			

T5
3000K 28W 548028
4000K 28W 548128
8,90 € pro Stück
230V Energiespar-LM

**T5 Leuchtmittel
35W**

3er Verpackungen sind mit Aufpreis möglich siehe Infokasten Seite 487



			
10000	G5		
Ø/L: 1,6/145 cm Verpackungseinheit 10 Stück.			

T5
3000K 35W 548035
4000K 35W 548135
12,90 € pro Stück
230V Energiespar-LM

**T5 Leuchtmittel
39W**

3er Verpackungen sind mit Aufpreis möglich siehe Infokasten Seite 487



			
10000	G5		
Ø/L: 1,6/85 cm Verpackungseinheit 10 Stück.			

T5
3000K 39W 548039
4000K 39W 548139
9,90 € pro Stück
230V Energiespar-LM

**T5 Leuchtmittel
54W**

3er Verpackungen sind mit Aufpreis möglich siehe Infokasten Seite 487



			
10000	G5		
Ø/L: 1,6/115 cm Verpackungseinheit 10 Stück.			

T5
3000K 54W 548054
4000K 54W 548154
9,90 € pro Stück
230V Energiespar-LM

**T5 Leuchtmittel
Color 21W**

3er Verpackungen sind mit Aufpreis möglich siehe Infokasten Seite 487





			
10000	G5		
Ø/L: 1,6/85 cm Verpackungseinheit 25 Stück.			

T5 Leuchtmittel Color
grün 21W 548165
rot 21W 548166
blau 21W 548167
23,50 € pro Stück
230V Energiespar-LM

**T5 Leuchtmittel
Color 24W**

3er Verpackungen sind mit Aufpreis möglich siehe Infokasten Seite 487



			
10000	G5		
Ø/L: 1,6/55 cm Verpackungseinheit 25 Stück.			

T5 Leuchtmittel Color
grün 24W 548185
rot 24W 548186
blau 24W 548187
23,50 € pro Stück
230V Energiespar-LM

**T5 Leuchtmittel
Color 35W**

3er Verpackungen sind mit Aufpreis
möglich siehe Infokasten Seite 487

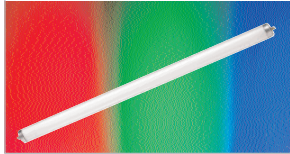

Ø/L: 1,6/145 cm
Verpackungseinheit 25 Stück.

T5 Leuchtmittel Color		
grün	35W	548175
rot	35W	548176
blau	35W	548177
29,90 € pro Stück		
230V	Energiespar-LM	

**T8 Leuchtmittel
Color 18W**

3er Verpackungen sind mit Aufpreis
möglich siehe Infokasten Seite 487

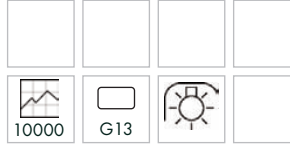
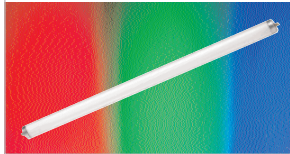

Ø/L: 2,6/59 cm
Verpackungseinheit 25 Stück.

T8 Leuchtmittel Color		
grün	18W	548205
rot	18W	548206
blau	18W	548207
9,90 € pro Stück		
230V	Energiespar-LM	

**T8 Leuchtmittel
Color 36W**

3er Verpackungen sind mit Aufpreis
möglich siehe Infokasten Seite 487



Ø/L: 2,6/120 cm
Verpackungseinheit 25 Stück.

T8 Leuchtmittel Color		
grün	36W	548195
rot	36W	548196
blau	36W	548197
12,90 € pro Stück		
230V	Energiespar-LM	

**T5 Ringröhre
22W**



Ø: 22,5 cm
Verpackungseinheit 1 Stück.

T5 Ringröhre		
3000K	22W	548220
4000K	22W	548221
29,90 €		
230V	Energiespar-LM	

**T5 Ringröhre
40W**



Ø: 30 cm
Verpackungseinheit 1 Stück.

T5 Ringröhre		
2700K	40W	548240
4000K	40W	548241
29,90 €		
230V	Energiespar-LM	

**T8 Ringröhre
32W**



Ø: 30,5 cm
Verpackungseinheit 1 Stück.

T8 Ringröhre		
3000K	32W	548230
4000K	32W	548231
8,90 €		
230V	Energiespar-LM	

**T8 Ringröhre
40W**



Ø: 40,6 cm
Verpackungseinheit 1 Stück.

T8 Ringröhre		
3000K	40W	548210
4000K	40W	548211
8,90 €		
230V	Energiespar-LM	

A

ADJUST MR16 ROUND	425
ADJUST MR16 SQUARE	425
ADJUST QUADRO GU10	424
ADJUST QUADRO MR16	424
ADJUST ROUND GU10	425
ADJUST ROUND HQI	429
ADJUST ROUND QRB	428
ADJUST SQUARE GU10	425
ADJUST SQUARE QRB	428
AERO GU10 FÜR 1-PHASEN	194
AERO GU10 FÜR 3-PHASEN	208
AERO PAR30 FÜR 1-PHASEN	198
AERO PAR30 FÜR 3-PHASEN	211
AIDAN LED	77
AIDAN LED UP/DOWN	77
AITES 16	75, 415
AITES 20	75, 415
AIXLIGHT OFFICE	34
AIXLIGHT PRO FRAME	281
AIXLIGHT PRO MODULE	282
AIXLIGHT PRO ZUBEHÖR	283
AIXLIGHT PRO FRAMELESS	280
ALAIN	313
ALDA	414
ALDOS	302
ALPA II 75	334
ALPA II 100	334
ALPA WALL II	336
ALPATRANS	337
ANABA FÜR EASYTEC II SCHWARZ/CHROM	128
ANABA SPOT FÜR EASYTEC II	137
ANABA SPOT FÜR LINUX LIGHT	148
ANDREAS	74
ANDREAS CURVE	74
ANGENI I	101
ANGENI II	101
ANILA FÜR EASYTEC II SCHWARZ/CHROM	125
ANILA FÜR LINUX LIGHT	148
ANILA SPOT FÜR EASYTEC II	135
ANOKI FÜR EASYTEC II SCHWARZ/CHROM	128
ANOKI SPOT FÜR EASYTEC II	137
APOLLO ZUBEHÖR	178-180
AQUADISC	422
AQUADOWN MICRO	423
AQUATECH	431
ARGON FÜR EASYTEC II	133
ARGON FÜR EASYTEC II SCHWARZ/CHROM	128
ARGON FÜR LINUX LIGHT	149
ARTE 300	184, 465
ASS 3-PHASEN STROMSCHIENE ZUBEHÖR	221-223
ASTIL DESK	120
ASTIL FLOOR	120
ASTIL PENDEL	13
ASTINA	87
ASTINA UP/DOWN	87
ASTO I	85
ASTO II	85
ASTO III	85
ASTO IV	85
AUDIENCE	246
AUFBAU-FASSUNG 7W	313
AUSTIN	123
AUSTRATURN	299

B

BAGUS	295
BARRO	91
BARRO GLAS	21
BARRO GLAS PENDEL FÜR EASYTEC II	142
BARRO GLAS PENDEL FÜR EASYTEC II SCHWARZ/CHROM	127
BARRO PENDEL	21
BARRO PENDEL FÜR EASYTEC II	142
BARRO SPOT FÜR EASYTEC II	134
BARRO UP/DOWN	91
BEAM G9	379
BEAM HQI 35W	379
BELPA II LEUCHTENKOPF + ZUBEHÖR	330
BELPA WALL II	333
BIBA BRACKET	55
BIBA BRACKET ES111 FÜR 1-PHASEN	198
BIBA BRACKET FÜR 3-PHASEN	210
BIBA BRACKET FÜR EASYTEC II SCHWARZ/CHROM	125
BIBA BRACKET PAR30 FÜR 1-PHASEN	198
BIBA I PENDEL	17
BIBA II PENDEL	17
BIBA III PENDEL	17
BIBA PENDEL FÜR EASYTEC II	140
BIBA PENDEL FÜR EASYTEC II SCHWARZ/CHROM	127
BIBA PLATE	53
BIG BLOX PENDEL	21
BIG BLUR	392

BIG DICE ES111	387
BIG DICE G12	387
BIG DICE QRB	387
BIG GIMBLE G12	309
BIG NAILS 50	352
BIG NAILS 80	352
BIG SURA DECKE	51
BIG SURA PENDEL FÜR WAVE	183
BIG SURA SINGLE PENDEL	10
BIG SURA TRIPLE PENDEL	11
BIG SURA WALL	86
BIG THEO CEILING	93
BIG THEO ES111 FLOOR	380
BIG THEO SINGLE	93
BIG THEO SINGLE OUTDOOR ES111	380
BIG THEO UP/DOWN	93
BIG THEO UP/DOWN OUTDOOR ES111	380
BIG THEO WALL BRITESPOT	380
BIGLA PENDEL	18
BIGLA PENDEL FÜR LINUX LIGHT	153
BIKO	246
BILDERLEUCHE 8W	238
BILDERLEUCHE 13W	208
BIMA II FÜR EASYTEC II	134
BL20	245
BLOX DOWNLIGHT	55
BLOX FÜR 1-PHASEN	195
BLOX FÜR EASYTEC II SCHWARZ/CHROM	125
BLOX PENDEL FÜR LINUX LIGHT	150
BLOX SPOT FÜR EASYTEC II	135
BLOX WAND	100
BLUR	394
BOWTOW	96
BRICK 24	415
BRICK BLUE 16	415
BRICK MESH	414
BRICK WHITE 16	415
BULAN	376

C

CABLINE	168-169
CAI	84
CAI PENDEL	21
CAI PENDEL FÜR EASYTEC II	142
CALMA	97
CALU	296, 409
CDM-R/PAR30 MODUL	285
CDM-R/PAR30 TURNO	312
COMET SEIL	186
CONE AUSSENLEUCHE	360
CONE LIGHTPOINT	294
COPPA	105
CORNET	18
CORNET PENDEL FÜR LINUX LIGHT	150
COTTO 150	466
COTTO M10 TRAF0	466
CREST 1	106
CREST 2	106
CREST 3	106
CRYSTAL I	289
CRYSTAL II	289
CRYSTAL III	289
CRYSTAL IV	289
CRYSTAL V	289
C-TRACK ZUBEHÖR	164-166
CUBIX I	114, 400
CUBIX II	114, 400
CUBIX LED	114
CYCLE 22 FÜR 1-PHASEN	197
CYCLE 22 FÜR 3-PHASEN	212
CYCLE 22 WAND	59
CYCLE QRB FÜR 1-PHASEN	196
CYCLE QRB FÜR 3-PHASEN	208
CYLOVA PENDEL	24
CYLOVA WAND	105

D

DABO FÜR C-TRACK	163
DACU 60	367
DACU G9	366
DACU IN	78
DACU LED	78, 366
DACU UP/DOWN G9	368
DANAX	107
DARIUS	107
DASAR 115, MR16	425
DASAR 215 UNI	427
DASAR 215, ES111	426
DASAR 260 UNI	427
DASAR 260, HIT-DE	430
DASAR 260, HIT-T	429
DASAR 260, QRB111	428

DAVES 111 PENDEL	24	FRAME BASIC LED	263
DAVES 111 PENDEL FÜR EASYTEC II	142	FRAME BASIC MR16	261
DAVES DOUBEL FÜR TREK	173	FRAME CURVE	262
DAVES MR16 PENDEL FÜR LINUX LIGHT	151	FRAME CURVE LED	263
DAVES SINGLE FÜR TREK	173	FRAME DISTA GU10	261
DAVES UNI	115	FRAME DISTA JC	261
DAVES WALL ES111	82	FRAME DISTA MR16	261
DECORING 51 MM	461	FRAME RGB LED	263
DECORING 111 MM	461	FURNITURE 2	257
DELSIN GROSS	374	FURNITURE 3	257
DELSIN KLEIN	374	FURNITURE 513	256
DENA I	101	FURNITURE LED	256, 292
DENA II	101	FURNITURE TYP 2	255
DEWI DESK	121	FURNITURE TYP 3	255
DEWI FLOOR	121		
DEWI PENDEL FÜR EASYTEC II	141	G	
DEWI PENDEL FÜR LINUX LIGHT	151	G 12 MODUL	285
DIGO	315	GIMBLE PRO ES111	309
DINA 6 PENDEL	24	GIMBLE PRO ES111 BRITESPOT	309
DINA Z	24	GIMBLE PRO QRB	309
DINA Z PENDEL FÜR EASYTEC II	142	GIMBLE ROUND	308
DINA Z PENDEL FÜR EASYTEC II SCHWARZ/CHROM	127	GIMBLE SQUARE	308
DIO	90	GLADOS	290
DISC	295	GLASS LENSE OVAL	375
DISPLAYLEUCHE GU10	245	GLASS LENSE ROUND	374
DOMEGA I	22	GLENOS	265
DOMEGA II	22	GLOO 200	378
DOMEGA III	23	GLOO PENDEL	15
DORU	296, 409	GLU-TRAX ZUBEHÖR	167
DOWNLIGHT 12/36	310	GOOSE SPOT FÜR C-TRACK	163
DOWNUNDER 05	269	GRAFIT 30	344
DOWNUNDER 05 LED	268	GRAFIT 50	344
DOWNUNDER 18 OUT	412	GRAFIT WAND	344
DOWNUNDER E14, SILBER	413	GRID	290
DOWNUNDER G9	413	GRID G9	290
DOWNUNDER I	269	GU10 TURNO	312
DOWNUNDER II	269	GU10 SP	312
DOWNUNDER III	269		
DOWNUNDER III LED	268	H	
DOWNUNDER LED 14	267, 411	H10 HQI	322
DOWNUNDER LED 15	267, 413	HALOGEN-ERDSPIß	403
DOWNUNDER LED 27	413	HANG UP	44
DOWNUNDER MID	270	HIBIT	243
DOWNUNDER OUT TCD	413	HQI/CDM VERSORGUNGSEINHEIT	460
DOWNUNDER PL36	270	HQI-TS DOWNLIGHT 150W	321
DRAGAN	376	HQI-TS DOWNLIGHT 70W	321
DREI PHASEN SCHIENEN ZUBEHÖR	221-223	HQI-TS FLOOD 150W	217
DROP 50	364	HQI-TS FLOOD 70W	216
DROP 100	364	HURIT SINGLE	83
		HURIT TWIN VERT	83
E		I	
E27 AUFBAUDOWNLIGHT	55	IGU PENDEL	8
E27 DOWNLIGHT	312	IGU WALL	94
EASY LIM	453	IGU WALL UP-DOWN	94
EASYTEC II SCHWARZ/CHROM ZUBEHÖR	131	I-LINE FLOOR	117
EASYTEC II SILBER ZUBEHÖR	143-145	I-LINE PENDEL HORIZONTAL	48
EDGE WANDLEUCHE, CHROM	95	I-LINE PENDEL VERTIKAL	48
EIN PHASEN SCHIENEN ZUBEHÖR	199-200	I-LINE WAND	66
EINBAU-FASSUNG 7W	313	INDI 1F1S	272
ELEA	122	INDI 1S	272
ELSU	12	ISTU	12
ELT 25W MODUL	285	IVED DISPLAY	241
ELT DOWNLIGHT	323	IVED GOOSE	241
ENERGIE PACK	458	IVED GOOSENECK	240
ENNA	90	IVED	77
ENOLA	20	IVED CHROM	77
ES/36 DOWNLIGHT	310	IVED II	77
ES111 MODUL	285	IVED II CHROM	77
EUROFLOOD	215	IVED LED SPOT	241
EXPAND MASTER LICHTERKETTE	434	IVES FÜR EASYTEC II, CHROM	130
EXPAND NET	434	IVES I	84
EXPAND SLAVE LICHTERKETTE	434	IVES II	84
EYEBALL MR11	307	IVES SPOT FÜR EASYTEC II	139
EYEBALL MR16	307	IVES SPOT FÜR LINUX LIGHT	148
F		J	
FARBFOLIE FÜR SFL	234	JACKY	251-252
FGL OUTDOOR	297, 408	K	
FGL OUTDOOR MR16	297, 408	KANO	54
FGL STANDARD	298	KANO FÜR EASYTEC II	135
FIBER SET LED	437	KARDA I MOD, ES111 BRITE SPOT	277
FILI	242	KARDAFRAME 4, GU10	35
FLAT 121	65	KARDAFRAME 4, GU10, STEHLEUCHE	118
FLAT 221	65	KARDAFRAME 4, MR16	36
FLAT FRAME SERIE	259	KARDAFRAME 4, QRB111	37
FLEX LAMPENHALTER FÜR ROSEN LITE	175	KARDAFRAME DUO CDM-R	38
FOCUS-LED	293	KARDAFRAME DUO ES111	36
FOK LED	266	KARDAFRAME DUO ES111 BRITESPOT	38
FRAME	262	KARDAFRAME I PENDEL ES111 BRITESPOT	38
FRAME 113	259	KARDAFRAME LONG ES111	36
FRAME BASIC GU10	261		
FRAME BASIC JC	260		

Index/ nach Produktname

KARDAFRAME WALL ES111 BRITESPOT	79	LLINE 60	239
KARDAFRAME WALL MR16	79	LUNA 1 FÜR 1PHASEN	196
KARDAFRAME WALL QRB111	79	LUNA 1 FÜR 3PHASEN	209
KARDAN RIFF	185	LUNA 2 FÜR 1PHASEN	196
KARDANIC-SPOT FÜR C-TRACK	163	LUNA 2 FÜR 3PHASEN	209
KARDATRACK GU10 FÜR 3PHASEN	213	LUX 49	390
KARDATRACK MR16 FÜR 3PHASEN	212	LUZO II	299
KARDATRACK QRB111 FÜR 3PHASEN	212		
KASPO FÜR 1-PHASEN	195	M	
KERAFLEX	237	MANTA	464
KERAS ELT	372	MARCO	298
KERAS TC	372	MARCO SQUARE	298
KETO LED PROFIL	398	MEDO DECKE	56
KETO RGB LED PANEL	398	MEDO PENDEL	12
KETO RGB LED PROFIL	398	MERIDIAN	373
KLEBEBAND 9 MM	167	MESH WALL	104
KOKO I	100	MHL 70	216
KOKO II	100	MHL 150	216
KONI	296, 409	MIANDA	373
KOTAK 2X26W	322	MIBO CURVE	237
KOTAK LED	322	MIBO STRAIGHT	237
KOTAK WAND	271	MIBO WALL UP/DOWN	98
KUNO PENDEL	33	MICRO FLAT	51, 374
		MICRO MOON	51, 374
L		MIL	255
LALU	116, 407	MINI BEAM	89
LALU DECKE	51	MINI EYE	262
LALU PENDEL	15	MINI EYEBALL	307
LALU WALL 1/2	59, 378	MINI FRAME LED	262
LAMBAT	239	MINI PEN FÜR LINUX LIGHT GOLD	157
LAMOO	56	MINI PEN FÜR LINUX LIGHT	150
LAMPENHALTER EINFACH FÜR SEIL	188	MINISPOT TEL	244
LAMPENHALTER SCHWENKBAR FÜR APOLLO	178	MOD 1 ES111	276
LAMPENHALTER SCHWENKBAR FÜR SEIL	188	MOD 1 GU10	273
LED AUFBAUDOWNLIGHT	91	MOD 1 MR16	273
LED EYEBALL	292	MOD 1 QRB111	275
LED EYEBALL FÜR C-TRACK	163	MOD 2 ES111	276
LED GOOSENECK	473	MOD 2 GU10	274
LED GOOSENECK FÜR C-TRACK	163	MOD 2 MR16	273
LED LICHTKETTE	434	MOD 2 QRB111	275
LED LIGHTPOINT	292	MOD 3 ES111	277
LED MULTIFLEX STRIPS	444	MOD 3 GU10	274
LED PENLIGHT PRO, 230V	439	MOD 3 MR16	273
LED PLOT	329, 416	MOD 3 QRB111	275
LED PLOT ABDECKUNG	329, 416	MOD 4 ES111	277
LED RGB STRIP OUTDOOR	449	MOD 4 GU10	274
LED STARLIGHT	435	MOD 4 MR16	273
LED STRIP OUTDOOR	449	MOD 4 QRB111	275
LED STRIP OUTDOOR SUPERFLUX	448	MOD HQI/QRB	277
LED STRIPS	442	MOD PL/QRB	277
LEDISC	291	MODUL RAHMEN	284
LED-TREIBER	457	MR11 SP	301
LEER-ROHR	445	MR16 SP	301
LELEX 1	293	MULTI LED KIT	436
LELEX 3	293	MYRA	354
LELEX REF	293	MYRA DISPLAY	359
LEUCHTMITTEL	470-489	MYRA DISPLAY STRAIGHT	358
LEUCHTMITTELZANGE	475	MYRA UP/DOWN	357
LIGHT EYE FLOOR	115	MYRA WALL	356
LIGHT EYE FÜR EASYTEC II	136	MYRA LED WALL	356
LIGHT EYE SPOT GU10 FÜR EASYTEC II SCHWARZ/CHROM	126		
LIGHT EYE SPOT ES111 FÜR EASYTEC II SCHWARZ/CHROM	126	N	
LIGHT EYE	55	NAILS SPIEB	353
LIGHT EYE MR16 FÜR LINUX LIGHT	149	NAILS STEHLEUCHTE	353
LIGHT EYE PENDEL	6	NAILS WAND	353
LIGHT EYE PENDEL FÜR 3-PHASEN	209	NARA	100
LIGHT EYE PENDEL FÜR EASYTEC II SCHWARZ/CHROM	126	NAUTIC ROUND	324, 418
LIGHT EYE SPOT FÜR 3-PHASEN	209	NAUTIC SQUARE	324, 418
LIGHT EYE X3	7	NAUTIC-SPOT 230V	54
LIGHTPOINT	294	NAUTILUS ECO LED	404
LIGHTTUBE FÜR EASYTEC II SCHWARZ/CHROM	130	NAUTILUS EDELSTAHL	401
LIGHTTUBE FÜR EASYTEC II,	139	NAUTILUS IP67	401
LIGHTTUBE FÜR LINUX LIGHT	150	NAUTILUS LED	404
LIGHTTUBE FÜR WAVE	183	NAUTILUS PAR38	401
LKA 4	82	NAUTILUS QRB	404
LKA FÜR LINUX LIGHT	148	NAUTILUS SPIKE	402
LKA SPOT FÜR EASYTEC II	133	NAUTILUS SPIKE LED	404
LILIN DISPLAY	245	NAVIGATOR FÜR EASYTEC II	139
LILIN PENDEL	18	NAVIGATOR G8,5 FÜR 3-PHASEN	211
LIM LICHTMODUL	225	NAVIGATOR PAR30 FÜR 1-PHASEN	198
LIM LICHTWANNE	226	NAVIGATOR PAR30 FÜR 3-PHASEN	211
LIMA	89	NEAT DISPLAY	248
LIMA FÜR EASYTEC II SCHWARZ/CHROM	125	NEAT FLEX	244
LIMA SPOT FÜR EASYTEC II	134	NEAT FLEX MIT KLEMME	244
LIMA UP/DOWN	89	NEAT FLEX PLATE	244
LINE ARMATUR	95	NEOPAN	62
LINUX LIGHT GOLD ZUBEHÖR	158-161	NEPRO DECKE	45
LINUX LIGHT ZUBEHÖR	153-155	NEPRO DISPLAY	249
LIPSY DECKE	57	NEPRO FÜR EASYTEC II	138
LIPSY DOUBLE PENDEL	14	NEPRO HQI FÜR 3-PHASEN	214
LIPSY FLOOR	406	NEPRO HQI FÜR 1-PHASEN	197
LIPSY PENDEL	14	NEPRO LEUCHTENKOPF FÜR 3-PHASEN	214

NEPRO LINE	71	PURI FÜR 1-PHASEN	195
NEPRO R7S FÜR EASYTEC II SCHWARZ/CHROM	130	PWM-KONTROLLER	453
NEPRO WAND	71		
NEW BANKERS	122	Q	
NEW TRIA	302	Q-LINE DOUBLE	40
NEW TRIA I ES111	305	Q-LINE SINGLE	40
NEW TRIA I GU10	304	Q-LINE WALL	68
NEW TRIA I MR16	303	QRB111 MODUL	285
NEW TRIA I QRB	304	QRB KARDA FÜR SEIL	188
NEW TRIA II ES111	305	QRB LAMPENHALTER FÜR ROSEN LITE	175
NEW TRIA II GU10	304	QRB SPOT FÜR LINUX LIGHT	149
NEW TRIA II MR16	303	QRB SPOT FÜR SEIL	188
NEW TRIA II QRB	305	QRB SPOT FÜR WAVE	182
NEW TRIA III ES111	305	Q-TECH ES111 FÜR 3-PHASEN	203
NEW TRIA III GU10	304	Q-TECH DOUBLE QRB111 FÜR 1-PHASEN	191
NEW TRIA III MR16	303	Q-TECH DOUBLE QRB111 FÜR 3-PHASEN	202
NEW TRIA III QRB	305	Q-TECH ES111 FÜR 1-PHASEN	191
NEW TRIA IV GU10	304	Q-TECH G12 FÜR 1-PHASEN	191
NEW TRIA IV MR16	303	Q-TECH G12 FÜR 3-PHASEN	203
NEW TURNO MR11	300	Q-TECH GU10 FÜR 1-PHASEN	190
NEW TURNO MR16	300	Q-TECH GU10 FÜR 3-PHASEN	201
NIABI	96	Q-TECH MR16 FÜR 1-PHASEN	190
NITA DOUBLE PENDEL	9	Q-TECH MR16 FÜR 3-PHASEN	201
NITA PENDEL	9	Q-TECH QRB111 FÜR 1-PHASEN	191
NONDRI FÜR EASYTEC II	137	Q-TECH QRB111 FÜR 3-PHASEN	202
NONDRI FÜR LINUX LIGHT	147	Q-TECH SPOT FÜR EASYTEC II SCHWARZ/CHROM	128
NONDRI FÜR LINUX LIGHT GOLD	157	Q-TECH SPOT GU10 FÜR EASYTEC II	134
NONDRI I	86	Q-TECH SPOT MR16 FÜR LINUX LIGHT	149
NONDRI II	86	QUAD 1 LED	265
NOON FÜR EASYTEC II	133	QUAD 2 LED	265
NOVA	369	QUADRA 44	102, 370
		QUADRASYL D	103, 370
O		QUADRASYL WALL	103, 370
OCKER PENDEL	18	QUOR	322
OCKER PENDEL FÜR LINUX LIGHT	153	QUOR 52	319
OCTO TURNO	299		
ONIDA	99	R	
ONIO	63	RAJO LED	422
OPEN GRILL	32	RAPIDO	314-315
OPEN GRILL WALL	63	RAPIDO OUT	410
ORION JOJO FÜR LINUX LIGHT	152	RASTERLEUCHTE	272
ORION JOJO FÜR LINUX LIGHT GOLD	158	RAY	106
ORION PENDEL FÜR EASYTEC II	141	RECESS CAN LED	292
ORION PENDEL FÜR EASYTEC II SCHWARZ/CHROM	127	RGB LED STRIP	446
ORION PENDEL FÜR LINUX LIGHT	152	RGB LED STRIP, (3 IN 1)	446
ORION PENDEL FÜR LINUX LIGHT GOLD	158	RGB-LED LIGHT PANEL	226
ORION PLATE	53	RIBA	323
OTOS GLASS	362	ROBOT FÜR ROSEN LITE UND GLUE-TRAX	167, 175
OTOS PL	363	ROSEN LITE ZUBEHÖR	176-177
OUT 65 DOWNLIGHT	296, 408	ROSETTE 54MM	19
OUT-BEAM R7S	379	ROW 1 GU10	287
OVA 75	338	ROW 1 LED	288
OVA 100	338	ROW 1 MR16	286
OVA FACKEL	340	ROW 1 OVAL	286
OVA WALL	104	ROW 1 QRB111	288
OVA WALL	340	ROW 2 MR16	287
		ROW 3 MR16	287
P		ROW ELT	287
PA10	248	ROW ES111	288
PALLAS FÜR 3-PHASEN	218	ROW G12	288
PAR 16 MESH	230	ROX CEILING	92
PAR 16 MESH FÜR 3-PHASEN	221	ROX OUT CEILING	385
PAR 20 MESH	230	ROX OUT UP/DOWN	385
PAR 20 MESH FÜR 3-PHASEN	221	ROX OUT WALL	385
PAR 20 TURNO	312	ROX UP/DOWN	92
PAR 30 MESH	230	ROX WALL	92
PAR 30 MESH FÜR 3-PHASEN	221	RUSTY 40	346
PAR30 DISPLAY	248	RUSTY 40 SQUARE	348
PARA 380	29	RUSTY 70	346
PARA DOME 320	26	RUSTY 70 SQUARE	348
PARA DOME 500	26	RUSTY ERDSPIß	346
PARA MULTI	28	RUSTY SQUARE ERDSPIß	348
PEN FÜR SEIL	185		
PEN LIGHT 230V	439	S	
PERRI	99	SAIL FÜR LINUX LIGHT	150
PERRI PENDEL	10	SAIL FÜR LINUX LIGHT GOLD	158
PIKA	298	SAIL FÜR WAVE	182
PL AUFBAUSTRÄHLER	317	SAIL PAR30 FÜR 3-PHASEN	210
PL2/24 SHOP FÜR 3-PHASEN	215	SAIL R7S FÜR EASYTEC II	135
PLADO	314	SAIL SPOT FÜR SEIL	185
PLDOWNLIGHT IP65	410	SAINTURN	58
POL	361	SALUNA FÜR SEIL	187
POL WAND	361	SALUNA GEHÄUSE	254
POTENTIOMETER	453	SALUNA SPOT KURZ	254
POWER LIM LED RGB 350MA	455	SALUNA SPOT LANG	254
POWER LIM RGB 24V	454	SATELLITE FÜR EASYTEC II	133
POWER TRAIL LIGHT	328, 417	SATINA	295
PUK ROSETTE	19	SCOPE 3	81
PUR DISPLAY	247	SDL HQI 70W	215
PUR FLEX	247	SDL HQI 150W	215
PUR FÜR PA 10	248	SEILLEUCHTE	187
PUR STABLEUCHTE	247	SEILLEUCHTE SEGEL	185

Index/ nach Produktname

SEILSYSTEM ZUBEHÖR	188-189	THEOLU	46
SEKARA PENDEL	8	TOBU FÜR 1 PHASEN	195
SFL PAR16	229	TONGA I PENDEL	16
SFL PAR20	229	TONGA I PENDEL FÜR EASYTEC II	141
SFL PAR36	230	TONGA I PENDEL FÜR LINUX LIGHT	152
SFL PAR56	233	TONGA II PENDEL	16
SFL PAR56	232	TONGA III PENDEL	16
SFL PAR64	234	TONGA III PENDEL FÜR LINUX LIGHT	152
SHELL HQI 70W	72	TONGA IV PENDEL	16
SHELL HQI 150W	72	TONGA IV PENDEL FÜR 1-PHASEN	197
SHOP I	35	TONGA IV PENDEL FÜR EASYTEC II	141
SHOP II	35	TONGA IV PENDEL FÜR LINUX LIGHT	152
SIENA DISPLAY FÜR EASYTEC II	139	TRAFU AUFBAU	464
SIENA FÜR EASYTEC II	133	TRAFU ELEKTRONSCH	467-469
SIENA FÜR EASYTEC II SCHWARZ/CHROM	128	TRAFU KONVENTIONELL	466
SIENA I	84	TRAFU OUTDOOR	465
SIENA II	84	TRAIL-LIGHT	328, 417
SIGHT PENDEL	43	TREK 2 ZUBEHÖR	170-173
SIGHT WAND	71	TREPPENSTUFENPROFIL	445
SIKION	71	TRIA II	302
SIRAN	64	TRISTAN	61
SKELETTO DISPLAY	249	TRITON	292
SKELETTO FÜR 1-PHASEN	198	TRON ROSETTE	33
SKELETTO FÜR 3-PHASEN	214	TRUST 30	343
SKELETTO FÜR EASYTEC II	138	TRUST 60	343
SKELETTO FÜR EASYTEC II SCHWARZ/CHROM	130	TRUST RASTER	343
SLICE	295	TRUST WALL	343
SLIM DOWNLIGHT	311	TUBE FÜR EASYTEC II	139
SOLO 90° FÜR ROSEN LITE UND GLUE-TRAX	167, 174	TUBE FÜR EASYTEC II SCHWARZ/CHROM	130
SOSO DISPLAY	248	TWINKLE-LIGHT	434
SPACE FÜR LINUX LIGHT	149	TWINTUBE FÜR 1-PHASEN	197
SPACE FÜR WAVE	182	TWINTUBE FÜR 3-PHASEN	212
SPOT "79"	54	TWINTUBE PENDEL	45
SQUARE	299	TWISTER	295
SQUARE DICE I	112	TYRO QUAD	22
SQUARE DICE MR16	112		
SQUARE DICE II	113	U	
SQUARE DISI	110	UFO BEAM	365
SQUARE GU10	111		
SQUARE WALL	111	V	
STAR FÜR LINUX LIGHT	147	VANO	389
STAR FÜR LINUX LIGHT GOLD	157	VANO BASE	389, 396
STAR FÜR WAVE	182	VANO RGB	396
STICK FÜR APOLLO	178	VANO TC	389
STICK FÜR SEIL	186	VAP 100	350
STRATOS FÜR LINUX LIGHT	147	VAP 60	350
STRATOS FÜR LINUX LIGHT GOLD	157	VESUVIO	57
SUN	51	VISIR	264
SUN PENDEL	10	VISIR LED	264
SURA FÜR SEIL	186		
SURA PENDEL FÜR SEIL	186	W	
SURA TISCHLEUCHTE	123	WAKI FÜR EASYTEC II SCHWARZ/CHROM	125
SURA WAND	86	WAKI SPOT FÜR EASYTEC II	135
SWAN	299	WAKI SPOT FÜR LINUX LIGHT	148
SWAR	290	WAVE STANGENSYSTEM ZUBEHÖR	183-184
SWIFTEC FÜR EASYTEC II	137	WETSY	326, 421
SWIFTEC PENDEL FÜR EASYTEC II	141	WETSY LED ROUND	326, 420
SXL 150W	391	WETSY LED SQUARE	326, 420
SXL 400W	392	WETSY POWER LED	326, 420
SXL ECO	391	WHEEL	25
SYROS FÜR LINUX LIGHT	147	WORK LIGHT FLOOR	118
SYROS FÜR LINUX LIGHT GOLD	157	WORK LIGHT PENDEL	33
SYROS FÜR SEIL	186		
SYROS FÜR WAVE	182	Y	
		YANTI FÜR EASYTEC II	137
T		YANTI FÜR LINUX LIGHT	147
T5 GRILL	30-31	YOKI ES111 BRITESPOT FÜR EASYTEC II	136
T5 GRILL WALL	62	YOKI ES111 BRITESPOT FÜR EASYTEC II SCHWARZ/CHROM	129
TARMO PENDEL	47	YOKI FÜR EASYTEC II SCHWARZ/CHROM	129
TC DOWNLIGHT	321	YOKI SPOT FÜR 3-PHASEN	209
TC RASTER 218	60	YOKI SPOT FÜR EASYTEC II	136
TC RASTER 336	60		
TC-DOWNLIGHT	316-317	Z	
TEC 1 FÜR 1-PHASEN	194	Z 211	97
TEC 1 TC-DE FÜR 1-PHASEN	197	ZELOS 70W	72
TEC 2 FÜR 1-PHASEN	194	ZELOS 150W	72
TEC 2 WAND	80	ZENIT	106
TEC 4 FÜR 1-PHASEN	194	ZERAN	107
TEC 4 WAND	80	ZUBEHÖR	459-463
TEC 6 WAND	81	ZUGENTLASTUNG	19
TEC I LED FÜR 3-PHASEN	206		
TEC STRAHLER BRITESPOT FÜR 3-PHASEN	207		
TEC STRAHLER CDM-R111 FÜR 3-PHASEN	207		
TEC STRAHLER FÜR 3-PHASEN	206		
TEC STRAHLER TC-DE FÜR 3-PHASEN	207		
TELESKOP FÜR ROSEN LITE	175		
TELESKOP FÜR SEIL	187		
TERANG 50	403		
THEO GU10 OUT DECKENLEUCHTE	380		
THEO WALL	109		
THEO WALL OUT	381		
THEOLED	109, 383		

111001	297	111383	305	112221	91	116041	255	138073	157	143041	199	144801	223	150302	216
	408	111402	313	112420	111	116042	255	138090	150	143042	199	144980	223	150310	216
111002	297	111412	312	112430	112	116043	255	138132	148	143051	200	144981	223	150311	216
	408	111422	296	112510	272	116050	255	138141	152	143052	200	145700	223	150312	216
111007	297		409	112520	272	116051	255	138143	152	143061	200	145701	223	150320	216
	408	111432	296	112530	286	116057	255	138144	152	143062	200	146110	123	150321	216
111008	297		409	112531	286	116059	255	138154	148	143071	200	146120	13	150322	216
	408	111441	302	112532	287	116101	312	138164	148	143072	200	146130	120	150331	72
111011	296	111442	302	112533	287	116102	312	138174	148	143081	200	146140	120	150332	72
	408	111447	302	112540	288	116103	312	138184	149	143082	200	146192	122	150451	72
111018	296	111449	302	112550	288	116107	312	138200	155	143091	199	146202	122	150454	72
	408	111462	302	112551	288	116111	312	138201	152	143092	199	146209	121	150461	72
111019	296	111472	55	112552	287	116112	312	138202	154	143101	199	146212	123	150464	72
	408	111482	102	112553	288	116117	312	138203	160	143102	199	146221	239	150521	216
111031	307		370	112554	288	116118	312	138210	153	143111	200	146311	245	150522	216
111032	307	111492	102	112561	287	116119	312	138211	150	143112	200	146312	245	150531	216
111033	307		370	112630	286	116202	91	138212	147	143131	199	146332	245	150532	216
111038	307	111502	290	112631	286	116212	87	138213	157	143132	199	146362	237	150541	216
111039	307	111512	290	112632	287	117001	310	138217	153	143141	199	146372	244	150542	216
111041	307	111522	102	112633	287	117004	285	138220	153	143142	199	146390	237	150551	215
111042	307		370	112640	288	117005	285	138221	153	143301	194	146392	237	150552	215
111043	307	111532	295	112650	288	117006	285	138222	153	143307	195	146422	244	150561	215
111048	307	111542	296	112651	288	117007	285	138223	160	143317	198	146432	244	150562	215
111051	301		409	112652	287	117008	285	138224	153	143321	198	146442	244	150571	215
111052	301	111552	84	112653	288	117009	310	138231	152	143327	198	146452	242	150572	215
111053	301	111554	84	112661	287	117010	284	138232	154	143372	195	146462	243	150600	217
111057	301	111631	309	112701	299	117020	284	138233	160	143381	200	146472	249	150601	217
111059	301	111632	309	112702	299	117030	284	138240	155	143382	200	146482	242	150602	217
111061	300	111633	309	112703	299	117051	310	138241	161	143392	195	146509	121	150610	217
111062	300	111634	309	112711	262	117059	310	138242	155	143402	197	146511	240	150611	217
111063	300	111638	309	112717	262	118011	294	138243	161	143412	197	146521	240	150612	217
111064	300	111641	309	112722	262	118012	294	138245	161	143422	195	146552	241	150620	217
111068	300	111642	309	112732	259	118013	294	138250	155	143432	196	146562	241	150621	217
111069	300	111643	309	112742	259	118021	294	138252	154	143438	196	146564	241	150622	217
111072	299	111644	309	112752	259	118022	294	138253	161	143442	196	146572	238	150631	72
111108	255	111648	309	112762	259	118023	294	138260	155	143448	196	146573	238	150632	72
111112	295	111651	309	112772	259	118025	294	138262	155	143452	196	146582	238	150911	322
111121	297	111654	309	112780	259	118042	294	138270	155	143462	197	146583	238	150919	322
	408	111658	309		263	118048	294	138280	153	143482	196	147112	104	150921	321
111122	297	111801	292	112781	259	131102	54	138281	147	143492	196	147122	104	150929	321
	408	111811	293		263	131108	54	138287	147	143502	195	147141	54	150931	321
111127	297	111821	292	112790	463	132010	54	138291	147	143512	194	147211	257	150939	321
	408	111831	291	112791	463	132011	54	138297	147	143522	194	147212	257	150941	322
111128	297	111833	291	112792	463	132014	54	138301	158	143532	194	147218	257	150949	322
	408	111837	291	112801	266	132020	54	138311	158	143542	194	147301	257	150951	322
111131	103	111841	292	112807	266	132021	54	138321	158	143552	194	147302	257	150959	322
	370	111850	457	112810	265	132024	54	138322	149	143572	200	147308	257	150961	322
111132	103	111851	292	112811	265	132810	104	138331	150	143582	197	147310	257	150969	322
	370	111861	322	112817	265	132822	115	138333	157	143594	197	147311	257	151011	208
111133	103	111871	293	112830	300	132832	114	138342	149	143604	198	147320	257	151017	208
111134	103	111873	293	112831	300		400	138350	160	143614	198	147321	257	151032	84
111151	309	111881	256	112832	300	132842	114	138352	149	143624	198	147441	85	151042	84
111158	309	111891	290	112833	300		400	138360	150	143631	190	147442	85	151050	461
111159	309	111897	290	112834	300	132854	114	138362	147	143634	190	147443	85	151051	461
111168	298	111901	293	112837	300	132862	115	138372	148	143641	191	147444	85	151052	86
111169	298	111918	292	112838	300	133428	24	138375	151	143644	191	147455	97	151062	86
111171	298	112038	298	112839	300	133432	21	138380	160	143651	191	147469	100	151112	84
111172	298	112039	298	113201	299	133441	16	138381	157	143654	191	147479	100	151122	84
111173	298	112041	307	113202	299	133442	16	138391	157	143661	191	147489	100	151132	112
111179	298	112042	307	113203	299	133443	16	138402	154	143664	191	147499	101	151142	113
111181	298	112043	307	113207	299	133444	16	138403	160	143671	191	147509	101	151152	86
111182	298	112048	307	113208	299	133452	17	138412	154	143674	191	147519	101	151162	86
111183	298	112051	298	113209	299	133454	17	138413	160	143681	190	147529	101	151191	77
111189	298	112052	298	113311	299	133464	17	138422	154	143684	190	149042	55	151194	77
111202	260	112053	298	113317	299	133472	21	138423	160	144100	221	149142	80	151197	77
111212	261	112054	298	113318	299	133482	6	138432	155	144101	221	149144	80	151240	55
111222	261	112058	298	113319	299	133492	24	138522	154	144102	221	149146	81	151250	100
111232	261	112061	299	114701	295	133502	21	138532	151	144200	221	149150	80	151260	100
111242	261	112062	299	114707	295	133504	21	138544	149	144201	221	149200	25	151282	98
111252	261	112063	299	114901	295	133511	10	138800	183	144202	221	149214	25	151291	77
111261	263	112067	299	114911	295	133522	7	138803	184	144300	221	149217	25	151294	77
111263	263	112068	299	114917	295	133541	10	138804	183	144301	221	149219	25	151297	77
111264	263	112069	299	114920	289	133701	22	138805	183	144302	221	149222	45	151320	215
111265	263	112090	301	114921	289	133702	22	138806	183	144510	223	149232	46	151321	215
111266	263	112091	301	114922	289	133703	23	138807	184	144511	223	149240	58	151328	215
111267	263	112092	301	114923	289	133721	14	138808	183	144520	223	149241	58	151331	77
111274	302	112093	301	114924	289	133722	14	138809	184	144521	223	149246	58	151337	77
111284	302	112097	301	115004	282	133723	57	138812	184	144560	222	149247	58	151341	77
111291	263	112098	301	115014	282	133731	15	138822	184	144561	222	149249	58	151347	77
111297	263	112099	301	115024	282	133744	15	138830	184	144570	222	149252	56	151351	77
11															

151635	107	153211	193	155012	40	158000	226	170124	247	184211	141	186792	176	227421	326
151644	107		205	155022	40	158001	226	170132	247	184232	142	186862	467		420
151661	106	153214	193	155032	41	158020	225	170134	247	184282	137	186872	467	227424	326
151691	106		205	155042	41	158021	225	170142	247	184292	145	186952	167		420
151695	106	153220	193	155052	41	158030	226	170144	247	184302	143		176	227427	326
151722	82		205		69	158100	226	170152	247	184312	144	188002	164		420
151732	78	153230	193	155062	41	158101	226	170154	247	184322	134	188022	164	227431	326
151751	365		205		69	158110	226	170162	247	184332	144	188032	164		420
151757	365	153241	193	155077	41		272	170164	247	184342	145	188042	165	227434	326
151862	262		205		68	158202	272	170172	248	184362	142	188052	165		420
151871	262	153244	193	155087	41	160011	321	170174	248	184372	141	188062	165	227437	326
151878	262		205		68	160019	321	170182	248	184392	139	188072	166		420
151901	87	153246	193	155092	42	160020	319	170184	248	184402	139	188082	166	227440	326
151902	81		205	155102	42	160021	319	170192	248	184442	134	188092	166		420
151907	87	153250	203	155112	42	160022	318	170194	248	184452	134	188102	166	227450	324
151910	91	153251	203	155204	107	160029	319	170392	247	184482	133	188112	166		418
151912	90	153254	203	155205	107	160031	321	170402	247	184492	134	188122	163	227457	324
151922	90	153260	202	156602	232	160039	321	170412	249	184502	139	188131	163		418
151932	106	153261	202	156612	229	160041	322	170414	249	184512	142	188142	163	227461	328
151958	264	153264	202	156622	229	160048	322	170422	248	184520	140	188152	163		417
151959	264	153270	202	156632	229	160049	322	170424	248	184521	140	188162	165	227465	328
151970	269	153271	202	156662	233	160050	323	170431	248	184531	141	188172	164		417
151971	269	153274	202	156672	233	160051	271	170434	248	184534	141	188182	165	227466	328
151972	269	153280	203	156682	233	160059	271	170454	59	184542	135	188191	163		417
151973	269	153281	203	156692	233	160061	315	170461	246	184552	138	189001	251	227467	328
151974	270	153284	203	156702	234	160069	315	170471	246	184562	139	189059	251		417
151975	270	153290	201	156722	230	160071	315	170491	241	184572	135	189109	252	227471	328
151982	71	153291	201	156802	229	160079	315	170504	248	184602	142	189121	252		417
152001	265	153294	201	156812	229	160081	315	178004	171	184614	135	189122	252	227475	328
152011	265	153300	201	156822	230	160089	315	178014	170	184624	136	189123	251		417
152021	264	153301	201	156832	232	160091	315	178024	170	184634	135	189609	252	227476	328
152027	64	153304	201	156902	229	160099	315	178034	172	184641	137	189621	252		417
152031	264	153311	192	156912	230	160101	315	178054	171	184651	137	189622	252	227477	328
152037	264		204	156914	234	160109	315	178064	171	184664	142	189814	251		417
152041	78	153314	192	156915	234	160114	259	178074	173	184674	139	189824	251	227480	326
	366		204	156916	234	160202	71	178084	173	184684	136	189834	251		420
152044	78	153320	192	156917	234	160212	71	178094	173	184694	136	190002	254	227482	326
	366		204	156919	234	160222	43	178104	173	184704	134	190012	254		420
152047	78	153330	192	156932	234	160232	95	178114	173	185002	131	190022	254	227485	326
	366		204		483	160241	95	178124	173	185020	131	190032	254		421
152051	268	154011	275	157002	66	160242	95	180000	179	185032	131	190042	254	227490	326
152057	268	154012	275	157012	48	160251	95	180001	179	185042	131	211200	445		421
152061	268	154021	275	157022	48	160252	95	180002	179	185062	131	213302	445	227495	326
152067	268	154022	275	157031	48	160301	71	180012	179	185092	128	213303	445		421
152082	109	154031	275		67	160701	256	180030	179	185122	128	220000	167	227500	401
152089	109	154032	275	157037	48	160702	95	180031	179	185142	131	220001	435	227520	324
152154	221	154041	275		67	160721	256	180040	179	185162	130	220011	435		418
152164	221	154042	275	157040	48	160731	256	180041	179	185172	131	220601	168	227531	325
152174	221	154051	276		67	160761	61	180042	179	185211	127	220611	169		419
152182	212	154052	276	157052	71	160771	60	180050	179	185294	131	220621	168		471
152192	210	154061	276	157062	8	160781	60	180051	179	185302	131	220631	168	227537	325
152202	214	154062	276	157072	24	160802	44	180052	179	185392	130		447		419
152222	214	154071	277	157082	82	160812	44	180060	179	185492	125	220641	168		471
152232	208	154072	277	157092	62	160822	44	180061	179	185502	130	220651	169	227580	425
152238	208	154081	277	157102	31	160832	33	180062	179	185521	127	225221	434	227582	425
152242	208	154082	277	157112	30	160841	61	180080	178	185532	125	225227	434	227588	424
152248	208	154111	273	157121	8	160851	61	180081	178	185542	125	225231	434	227648	392
152252	208	154112	273	157122	8	160861	61	180082	178	185552	130	225237	434	227668	395
152262	212	154121	273	157132	117	161010	317	180160	179	185582	126	225241	434	227670	394
152272	215	154122	273	157141	117		410	180161	179	185592	126	226781	434	227671	394
152282	209	154131	273	157147	117	161020	317	180180	178	185602	127	226787	434	227678	394
152292	209	154132	273	157152	118		410	180181	178	185612	125	226801	434	227680	395
152371	312	154141	273	157154	119	161118	317	180210	180	185622	129	226807	434	227681	395
152372	312	154142	273	157162	56	161126	317	180211	180	185632	125	227000	458	227688	395
152379	312	154152	277	157164	56	161213	316	180212	180	185640	128	227015	379	227690	395
152381	312	154162	277	157165	56	161218	317	181070	188	185650	128	227020	379	227691	395
152382	312	154202	37	157171	94	161226	317	181080	188	185662	127	227023	379	227698	395
152383	312	154212	37	157172	94	161326	314	181160	186	185672	130	227024	379	227892	361
152401	214	154222	36	157181	94	161342	315	181180	187	185682	129	227032	369	227895	361
152404	214	154232	36	157182	94	161431	317	181190	187	185692	126	227041	364	227902	361
152408	214	154242	35	157192	65	161434	317	181212	186	185700	128	227042	364	227905	361
152417	211	154252	35	157202	65	161501	314	181222	188	186015	167	227052	373	227922	343
152561	323	154262	79	157212	89	161511	314	181232	186	186032	176	227064	379		344
153002	206	154272	79	157214	89	161521	314	181242	186	186060	176	227065	379		353
153012	206	154302	39	157222	89	161531	314	181252	185	186112	176	227080	422	227932	343
153022	206	154312	39	157224	89	165000	26	181532	188	186162	176	227090	428	227942	343
153032	206	154322	39	157232	51	165010	26	182150	180	186172	176	227092	428	227952	343
153042	206	154332	34	157242	86	165020	26	182151	180	186182	176	227102	366	227962	343
153052	207	154342	38	157252	10	165030	26	182152	180	186200	175	227112	367	228020	390
153062	207	154352	36	157272	11	165040	26	182162	180	186252	175	227122	367	228021	390
153074	211	154362	36	157284	33	165050	26	183272	45	186262	175		406	228030	390
153102	209	154372	36	157294	21	165060	26	184000	145	1862					

Table with 10 columns of numbers (328, 429, 415, 456, 510405, 482, 544751, 477, 550301, 472, 955000, 461) representing an index of article numbers.

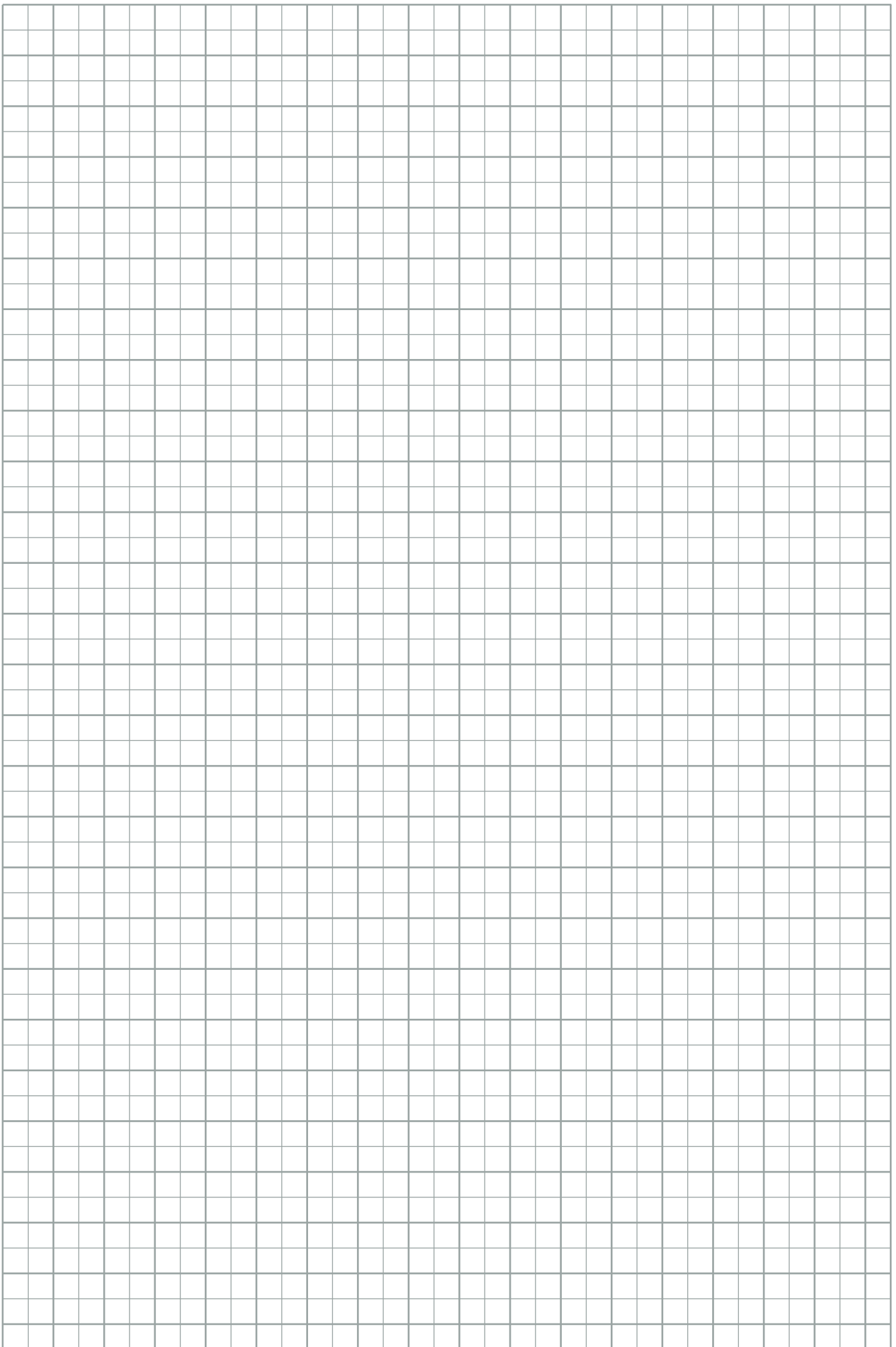

Betriebsspannung
Niedervolt - 12~
Niedervolt mit Spannungswandler
für Hochvoltsysteme - 230~/12~

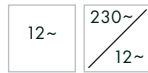

Betriebsspannung
Hochvolt - 230~

Angabe zur max. Strombelastbarkeit



Angabe zur Anschlußkabellänge

Art des Transformators
im Lieferumfang (incl.)
nicht im Lieferumfang (excl.)



Art des Vorschaltgerätes
im Lieferumfang (incl.)
nicht im Lieferumfang (excl.)

Schutzklasse
Eins - Zwei - Drei



Auf Anfrage senden wir Ihnen zu dem
betreffenden Produkt gern eine
Lichtverteilungskurve

Produkt ist ausschließlich für den Einsatz
in Innenräumen geeignet



Incl. Solarzelle

Produkt ist nicht für den Einsatz in
Innenräumen geeignet



Kennzeichnung Einsatzbereich
Eignung für den Außenbereich

Kennzeichnung des Einsatzbereichs
Decke - Wand - Boden



Angabe zum Einsatzbereich mit
entsprechendem Zubehör (Accessoires)

Angabe zum max. Seilabstand



Schwenkbereich des
Produktes mit Gradangabe

Höhenverstellbarkeit und
Pendel-Kabel-Länge
bei höhenverstellbarer Jojo-Leuchte
bei normaler Pendelleuchte

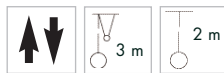

Einbautiefe
Maßangaben in cm

Drehbereich des Produktes
mit Gradangabe



Zubehör im Lieferumfang (incl.)
Zubehör nicht im Lieferumfang (excl.)

Form der Einbauöffnung
Maßangaben in cm



Wichtiges Detail

Werkstoff



Leuchtmittel/Leuchtenteil
kardanisch schwenkbar

Art des Leuchtmittels
Leuchtmittel im Lieferumfang (incl.)
Leuchtmittel nicht im Lieferumfang (excl.)



Gewicht des Produktes in kg

Art des Oberflächenschutzes



Hinweis auf die Art des Sockels

Blendklappen sind Zubehör und müssen
separat bestellt werden



Kennzeichen für einen unabhängigen
Konverter (elektronischer Transformator auch
zur Verwendung außerhalb von Leuchten)

Leuchtenmodell incl. Schienenadapter



Kurzschlußfester Sicherungstransformator

Gewichtsbelastbarkeit des Produktes bis zum angegebenen Wert
Messungen basieren auf Betoneinbau



Schlagfestigkeit des Produktes bis zum angegebenen Wert

Angabe zur Windangriffsfläche



Hitzeentwicklung an der Oberfläche des Bodeneinbaustrahlers

Angabe zum Kabeldurchmesser



TÜV-/GS-geprüfte Produkte

Durchverdrahtung möglich



Erlaubt die Montage des Gerätes auf Werkstoffen (u. a. Holz), deren Entflammverhalten nicht bekannt ist

Gerät KEMA geprüft (Niederlande)



Gerät VDE geprüft

Gerät ENEC geprüft (Steht für Normenkonformität mit den Europäischen Sicherheitsnormen)



Gerät ist auf elektromagnetische Verträglichkeit vom VDE geprüft (Funkschutzzeichen)

Semco geprüft (Schweden)



Leuchtmittel ist mit UV-Schutz ausgestattet

Schutz bei über 110°C im Fehlerfall



Leuchtmittel geeignet für den Einsatz in Leuchten mit Schutzglas

Die in diesem Katalog präsentierten Geräte sind - sofern nicht anders angegeben - für die direkte Befestigung auf normal entflammbar Flächen geeignet



Leuchtmittel geeignet für den Einsatz in Leuchten ohne Schutzglas

Angabe zum Material



Kennzeichnet die mittlere Lebensdauer in Stunden

Edelstahl 304:

(1.4301) Eine gute Korrosionsbeständigkeit zeigt sich in natürlichen Umwelmedien (Wasser, städtische und ländliche Atmosphäre) bei Abwesenheit von bedeutenden Chlor- und Salzkonzentrationen. 14301 ist jedoch nicht geeignet für Einsatzgebiete, bei denen es zum Kontakt mit Meer- bzw. Salzwasser oder salzhaltiger Atmosphäre kommt, noch ist der Edelstahl für den Einsatz in Schwimmbädern oder Ähnlichem geeignet.

Edelstahl 316:

(1.4404) In natürlichen Umwelmedien (Wasser, städtische und ländliche Atmosphäre) sowie in Industriegebieten mit mäßiger Chlor- und Salzkonzentration, im Bereich der Lebensmittel- und Pharmaindustrie und auf dem landwirtschaftlichen Nahrungsmittelsektor weist 1.4404 eine ausgezeichnete Korrosionsbeständigkeit auf. 1.4404 ist nicht meerwasserbeständig.

Bitte beachten Sie:

Ein großer Teil der in diesem Katalog vorgestellten Produkte sind durch Warenzeichen, Geschmacksmuster, Gebrauchsmuster oder Patente geschützt.

Ein Verstoß gegen die Schutzrechte oder eine Verwendung von Text- und Layoutgestaltung ohne unsere Genehmigung wird gerichtlich verfolgt.

Alle Produkte unseres Sortiments unterliegen einer strengen Qualitätssicherung & erfüllen die allgemein gültigen Normen (CE).

Die in diesem Katalog enthaltenen Abbildungen und Angaben dienen nur der Veranschaulichung und sind unverbindlich in Farbe, Form, Ausführung und technischen Daten.

Alle Gewichts- und Längenangaben sind in kg bzw. in cm angegeben, sofern nicht anders bezeichnet.

Konzeption und Design:

Corporate Creative Center, Übach-Palenberg, 2006

Fotografie: (nach Anzahl der Bilder)

Fotostudio CCC, Übach-Palenberg

Fotostudio Gerd Arnolds, Aachen

Fotostudio Andreas Fein, Köln

Fotostudio Günter Preissler, Stolberg

Sonstige: Werksfoto Déclíc S. 229

Druck:

VVA Vereinigte Verlagsanstalten GmbH, Düsseldorf

Artikel mit dem Zeichen ▼ sind nur noch in begrenzten Mengen verfügbar.

Die Präsentation unserer Leuchten mit realistischen und beispielhaften Anwendungsfotos wird ermöglicht durch das freundliche Entgegenkommen und die Zustimmung der Eigentümer oder Gestalter der jeweils vordergründig in den Bildern zu sehenden Umgebungen.

All jenen, die durch ihr Einverständnis zur Entstehung und zur Verwendung unserer Fotos beigetragen haben, sei an dieser Stelle nochmals herzlich gedankt.

Allgemeine Verkaufsbedingungen der Firma SLV Elektronik GmbH

§ 1 Allgemeines - Geltungsbereich

- 1) Unsere Verkaufsbedingungen gelten ausschließlich.
- 2) Entgegenstehende, abweichende oder ergänzende Allgemeine Geschäftsbedingungen unseres Kunden werden selbst bei unserer Kenntnis nicht Vertragsbestandteil, es sei denn, ihrer Geltung wird ausdrücklich schriftlich zugestimmt. Unsere Verkaufsbedingungen gelten auch dann, wenn wir in Kenntnis entgegenstehender oder von unseren Verkaufsbedingungen abweichender Bedingungen des Kunden die Lieferung an den Kunden vorbehaltslos ausführen.
- 3) Mit der ersten Bestellung nach Erhalt dieser Verkaufsbedingungen und jeder weiteren erkennt der Kunde diese als verbindliche Regelung der Geschäftsbeziehung zu uns an und verzichtet auf die Stellung und Anwendung eigener für eine Vielzahl von Verträgen vorformulierter Vertragsbedingungen.
- 4) Unsere Verkaufsbedingungen gelten nur gegenüber Unternehmern gemäß der in § 310 Bürgerliches Gesetzbuch (BGB) im Einzelnen gegebenen Legaldefinition.
- 5) Alle Vereinbarungen, die zwischen uns und dem Kunden zwecks Ausführung des Vertrages getroffen werden, sind in dem Vertrag schriftlich niedergelegt.

§ 2 Vertragsabschluss

- 1) Unsere Angebote sind freibleibend.
Technische Änderungen in Form und / oder Farbe und / oder Gewicht bleiben in Rahmen des Zumulbaren vorbehalten.
Die zum Angebot gehörenden Unterlagen stellen keine Zusicherung von Eigenschaften dar, sie dienen nur der Orientierung des Bestellers.
- 2) Mit der Bestellung einer Ware erklärt der Kunde verbindlich, die bestellte Ware erwerben zu wollen.
Wir sind berechtigt, das in der Bestellung liegende Vertragsangebot innerhalb von 2 Wochen nach Eingang bei uns anzunehmen. Die Annahme kann entweder schriftlich oder durch Auslieferung der Ware erklärt werden.
- 3) Der Vertragsabschluss erfolgt unter dem Vorbehalt der richtigen und rechtzeitigen Selbstbelieferung durch unsere Zulieferer. Dies gilt nur für den Fall, dass die Nichtlieferung nicht von uns zu vertreten ist. Diese ist insbesondere bei Abschluss eines kongruenten Deckungsgeschäftes mit unserem Zulieferer und dessen unrichtiger oder säumiger Nichtlieferung von uns nicht zu vertreten.
- 4) Bestellt der Unternehmer die Ware auf elektronischem Wege, wird die Verpflichtung zur Bestätigung der Bestellung gemäß § 312 e I BGB ausdrücklich ausgeschlossen.

§ 3 Eigentumsvorbehalt

- 1) Wir behalten uns das Eigentum an der Kaufsache bis zum Eingang aller Zahlungen aus der Geschäftsverbindung mit dem Kunden vor. Bei vertragswidrigem Verhalten des Kunden, insbesondere bei Zahlungsverzug, sind wir berechtigt, die Kaufsache zurückzunehmen. In der Rücknahme der Kaufsache durch uns liegt ein Rücktritt vom Vertrag. Wir sind nach Rücknahme der Kaufsache zu deren Verwertung befugt; der Verwertungserlös ist auf die Verbindlichkeiten des Kunden – abzüglich angemessener Verwertungskosten – anzurechnen.
- 2) Der Kunde ist gehalten, die Kaufsache pfleglich zu behandeln; insbesondere ist er verpflichtet, diese auf eigene Kosten gegen Feuer, Wasser- und Diebstahlsschäden ausreichend zum Neuwert zu versichern. Sofern Wartungs- und Inspektionsarbeiten erforderlich sind, muss der Kunde diese auf eigene Kosten rechtzeitig durchführen.
- 3) Bei Pfändungen oder sonstigen Eingriffen Dritter hat uns der Kunde unverzüglich schriftlich zu benachrichtigen, damit wir Klage gemäß § 771 ZPO erheben können. Soweit der Dritte nicht in der Lage ist, uns die gerichtlichen und außergerichtlichen Kosten einer Klage gemäß § 771 ZPO zu erstatten, haftet der Kunde für den uns entstandenen Ausfall.
- 4) Der Kunde ist berechtigt, die Kaufsache im ordentlichen Geschäftsgang weiter zu verkaufen; er tritt uns jedoch bereits jetzt alle Forderungen in Höhe des Faktura-Endbetrages (einschließlich MwSt.) unserer Forderung ab, die ihm aus der Weiterveräußerung gegen seine Abnehmer oder Dritte erwachsen, und zwar unabhängig davon, ob die Kaufsache ohne oder nach Verarbeitung weiterverkauft worden ist. Zur Einziehung dieser Forderung bleibt der Kunde auch nach der Abtretung ermächtigt. Unsere Befugnis, die Forderung selbst einzuziehen, bleibt hiervon unberührt. Wir verpflichten uns jedoch, die Einziehung zu unterlassen, solange der Kunde seinen Zahlungsverpflichtungen aus den vereinnahmten Erlösen nachkommt, nicht in Zahlungsverzug gerät und insbesondere keine Zahlungseinstellung eintritt oder ein Antrag auf Eröffnung eines Vergleichs- oder Insolvenzverfahrens gestellt ist. Ist aber dies der Fall, so können wir verlangen, dass der Kunde uns die abgetretenen Forderungen und deren Schuldner bekannt gibt, alle zum Einzug erforderlichen Angaben macht, die dazugehörigen Unterlagen aushändigt und den Schuldnern (Dritten) die Abtretung mitteilt.
- 5) Wird die Kaufsache mit anderen, uns nicht gehörenden Gegenständen untrennbar vermischt, so erwerben wir das Miteigentum an der neuen Sache im Verhältnis des Wertes der Kaufsache (Fakturaendbetrag, einschließlich MwSt.) zu den anderen vermischten Gegenständen zum Zeitpunkt der Vermischung. Erfolgt die Vermischung in der Weise, dass die Sache des Kunden als Hauptsache anzusehen ist, so gilt als vereinbart, dass der Kunde uns anteilmäßig Miteigentum überträgt. Der Kunde verwahrt das so entstandene Alleineigentum oder Miteigentum für uns.
- 6) Der Kunde tritt uns auch die Forderungen zur Sicherung unserer Forderungen gegen ihn ab, die durch die Verbindung der Kaufsache mit einem Grundstück gegen einen Dritten erwachsen.
- 7) Wir verpflichten uns, die uns zustehenden Sicherheiten auf Verlangen des Kunden insoweit freizugeben, als der realisierbare Wert unserer Sicherheiten die zu sichernden Forderungen um mehr als 10% übersteigt; die Auswahl der freizugebenden Sicherheiten obliegt uns.
- 8) An Abbildungen, Zeichnungen, Kalkulationen und sonstigen Unterlagen behalten wir uns Eigentums- und Urheberrechte vor.

§ 4 Preise – Zahlungsbedingungen

- 1) Unsere im Angebot genannten Preise gelten unter dem Vorbehalt, dass die der Angebotsangabe zugrundeliegenden Auftragsdaten unverändert bleiben.
Unsere Preise verstehen sich "ab Werk". Die Mehrwertsteuer ist nicht eingeschlossen; diese wird in der am Tage der Rechnungsstellung geltenden Höhe gesondert ausgewiesen. Versandverpackung, Fracht, Porto, Versandkosten und Versicherung werden gesondert berechnet.
- 2) Sofern sich aus der Auftragsbestätigung nichts anders ergibt, ist Lieferung "ab Werk" vereinbart. Der Versand erfolgt unfrei und grundsätzlich gegen Nachnahme, wenn nicht insoweit eine andere Vereinbarung getroffen wurde. Liefern wir nicht gegen Nachnahme, ist der Kunde verpflichtet, innerhalb von 10 Tagen den Kaufpreis netto (ohne Abzug) zu zahlen. Nach Ablauf dieser Frist kommt der Kunde in Zahlungsverzug. Skonti bedürfen der gesonderten Vereinbarung. Die Geltendmachung von Mängeln oder Minderungen berührt die Fälligkeit der übrigen Kaufpreiszahlung nicht. Mängel eines Teils der gelieferten Ware berechtigen nicht zur Beanstandung

der gesamten Lieferung. Nach Eintritt des Verzugs hat der Kunde die Geldschuld in Höhe von 8% über dem Basiszinssatz zu verzinsen. Wir behalten uns vor, einen höheren Verzugschaden nachzuweisen und geltend zu machen.

- 3) Aufrechnungsrechte stehen dem Kunden nur zu, wenn seine Gegenansprüche rechtskräftig festgestellt, unbestritten oder von uns anerkannt sind. Zur Ausübung eines Zurückbehaltungsrechtes ist er insoweit befugt, als sein Gegenanspruch auf dem gleichen Vertragsverhältnis beruht.
- 4) Praktizierte aber nicht vereinbarte Zahlungsziele können wir jederzeit mit angemessener Frist anpassen.
- 5) Bei Vorausleistungen unsererseits, insbesondere bei weiteren, sind wir berechtigt, Sicherheitsleistung zu verlangen und hiervon unsere Leistung abhängig zu machen. Dies gilt insbesondere, wenn Zweifel an der Bonität des Kunden, Unterdeckung oder Liquiditätslücken auftreten oder sich das ursprüngliche Kreditvolumen erhöht. Wir sind berechtigt, Teillieferungen als besondere Geschäfte abzurechnen. Werden unsere Zahlungsbedingungen nicht erfüllt oder treten beim Kunden andere Ereignisse ein, die seine Kreditwürdigkeit zweifelhaft erscheinen lassen oder werden uns solche vor Vertragsabschluss vorhandenen Umstände erst nachträglich bekannt, können wir unbeschadet unserer sonstigen gesetzlichen Rechte für die Dauer des Zahlungsrückstandes weitere Lieferungen aus demselben rechtlichen Verhältnis bis zur Tilgung der hieraus offenen Forderungen von Vorauszahlungen abhängig machen.

§ 5 Lieferzeit

- 1) Der Beginn der von uns angegebenen Lieferzeit setzt die Klärung aller technischen Fragen voraus.
- 2) Die Einhaltung unserer Lieferverpflichtung setzt weiter die rechtzeitige und ordnungsgemäße Erfüllung der Verpflichtung des Kunden voraus. Die Einrede des nichterfüllten Vertrages bleibt vorbehalten.
- 3) Die Gefahr des zufälligen Untergangs und der zufälligen Verschlechterung der Ware geht mit der Übergabe, beim Versendungskauf mit der Auslieferung der Sache an den Spediteur, den Frachtführer oder sonst zur Ausführung der Versendung bestimmten Person auf den Käufer über.
- 4) Der Übergabe steht es gleich, wenn der Kunde in Verzug der Annahme ist.
- 5) Lieferzeitanlagen werden nach Möglichkeit eingehalten. Bei Überschreiten der vereinbarten Lieferzeit sind Schadenersatzansprüche des Kunden wegen fahrlässiger Vertragsverletzung ausgeschlossen.
Die angegebene Lieferzeit gilt nur annähernd. Werden wir an der rechtzeitigen Lieferung durch unvorhersehbare oder unverschuldete Ereignisse gehindert, die bei zumutbarer Sorgfalt unabwendbar sind, verlängert sich die Lieferzeit angemessen.

§ 6 Gewährleistung

- 1) Wir bestätigen, dass die von uns gelieferte Ware hinsichtlich ihrer Zusammensetzung, Qualität, Verpackung, Deklaration und Warenspezifikation den gesetzlichen Bestimmungen entspricht. Mängelansprüche des Kunden setzen voraus, dass dieser seinen nach § 377 Handelsgesetzbuch (HGB) geschuldeten Untersuchungs- und Rügeobliegenheiten ordnungsgemäß nachgekommen ist.
- 2) Wir leisten für Mängel der Ware zunächst nach unserer Wahl Gewähr durch Nachbesserung oder Ersatzlieferung.
Schlägt die Nachlieferung fehl, kann der Kunde grundsätzlich nach seiner Wahl Herabsetzung der Vergütung (Minderung) oder Rückgängigmachung des Vertrages (Rücktritt) verlangen. Bei einer nur geringfügigen Vertragswidrigkeit, insbesondere bei nur geringfügigen Mängeln, steht dem Kunden jedoch kein Rücktrittrecht zu.
- 3) Wählt der Kunde wegen eines Rechts- oder Sachmangels nach gescheiterter Nacherfüllung den Rücktritt vom Vertrag, steht ihm daneben kein Schadenersatz wegen des Mangels zu. Wählt er nach gescheiterter Nacherfüllung Schadenersatz, verbleibt die Ware bei ihm, wenn ihm dies zumutbar ist. Der Schadenersatz beschränkt sich auf die Differenz zwischen Kaufpreis und Wert der mangelhaften Ware. Dies gilt nicht, wenn wir die Vertragsverletzung arglistig verursacht haben.
- 4) Die Gewährleistungsfrist beträgt 1 Jahr ab Ablieferung der Ware; es sei denn, aufgrund der Beschaffenheit der Ware ist die gewöhnliche Nutzungsdauer (z.B. bei Leuchtmitteln) kürzer.
- 5) Als Beschaffenheit der Ware gilt grundsätzlich nur die Produktbeschreibung des Herstellers als vereinbart. Öffentliche Äußerungen, Anpreisungen oder Werbung des Herstellers stellen daneben keine vertragsgemäße Beschaffenheit der Ware dar.
- 6) Garantien im Rechtsinne erhält der Kunde durch uns nicht. Herstellergarantien bleiben hiervon unberührt.
- 7) Erhält der Kunde eine mangelhafte Montageanleitung, sind wir lediglich zur Lieferung einer mangelfreien verpflichtet und dies auch nur dann, wenn der Mangel der Montageanleitung einer ordnungsgemäßen Montage entgegensteht.
- 8) Unsere Gewährleistung erstreckt sich nur auf die von uns gelieferten Waren, nicht jedoch auf etwaige Folgekosten.

§ 7 Haftungsbeschränkungen

- 1) Bei leicht fahrlässigen Pflichtverletzungen beschränkt sich unsere Haftung auf den nach der Art der Ware vorhersehbaren, vertragstypischen, unmittelbaren Durchschnittsschaden. Dies gilt auch bei leicht fahrlässigen Pflichtverletzungen unserer gesetzlichen Vertreter oder Erfüllungsgehilfen. Bei leicht fahrlässiger Verletzung unwesentlicher Vertragspflichten haften wir nicht.
- 2) Die vorstehenden Haftungsbeschränkungen betreffen nicht Ansprüche des Kunden aus Produkthaftung. Weiter gelten die Haftungsbeschränkungen nicht bei uns zurechenbaren Körper- und Gesundheitsschäden oder bei Verlust des Lebens des Kunden.
- 3) Schadenersatzansprüche des Kunden wegen eines Mangels verjähren nach 1 Jahr ab Ablieferung der Ware. Dies gilt nicht, wenn uns Arglist vorwerfbar ist.

§ 8 Schlußbestimmungen

- 1) Es gilt das Recht der Bundesrepublik Deutschland; die Geltung des UN-Kaufrechtes ist ausgeschlossen.
- 2) Ist der Kunde Kaufmann, ist ausschließlicher Gerichtsstand für alle Streitigkeiten aus diesem Vertrag unser Geschäftssitz. Dasselbe gilt, wenn der Kunde keinen allgemeinen Gerichtsstand in Deutschland hat oder Wohnsitz oder gewöhnlichen Aufenthalt zum Zeitpunkt der Klageerhebung nicht bekannt sind.
- 3) Sofern sich aus der Auftragsbestätigung nichts anderes ergibt, ist unser Geschäftssitz Erfüllungsort.
- 4) Etwaige Unwirksamkeit einzelner Bestimmungen berührt die Wirksamkeit der übrigen nicht.

NO NONSENSE

SLV®