



Magic Icecycle

ORDERCODE 43105



Highlite International B.V.
Vestastraat 2
6468 EX Kerkrade
The Netherlands
Phone: +31 45-5667700

SHOWELECTRONICS FOR PROFESSIONALS

Congratulations!

You have bought a great, innovative product from Showtec.

The Showtec Magic Icecycle brings excitement to any venue. Whether you want simple plug-&-play action or a sophisticated DMX show, this product provides the effect you need.

You can rely on Showtec, for more excellent lighting products.

We design and manufacture professional light equipment for the entertainment industry.

New products are being launched regularly. We work hard to keep you, our customer, satisfied.

For more information: iwant@showtec.info

You can get some of the best quality, best priced products on the market from Showtec.

So next time, turn to Showtec for more great lighting equipment.

Always get the best -- with Showtec !

Thank you!



Showtec Magic Icecycle™ Product Guide

Warning 3
 Safety Instructions 3
 Operating Determinations..... 5
 Rigging 5
 Return Procedure 6
 Claims 6

Description of the device 7
 Overview 7

Installation 8

Set Up and Operation 8
 Coupling Magic Icecycles 9
 Controller 10

Maintenance 11

Troubleshooting 12
 No Light 12

Product Specification..... 12

Warning

**FOR YOUR OWN SAFETY, PLEASE READ THIS USER MANUAL CAREFULLY
BEFORE YOUR INITIAL START-UP!**

Unpacking Instructions

Immediately upon receiving this product, carefully unpack the carton and check the contents to ensure that all parts are present, and have been received in good condition. Notify the dealer immediately and retain packing material for inspection if any parts appear damaged from shipping or the carton itself shows signs of mishandling. Save the carton and all packing materials. In the event that a fixture must be returned to the factory, it is important that the fixture be returned in the original factory box and packing.

Your shipment includes:

- Magic Icecycle
- Controller
- End cap for buffer connector
- User manual



LED Expected Lifespan

LEDs gradually decline in brightness over time. HEAT is the dominant factor that leads to the acceleration of this decline. Packaged in clusters, LEDs exhibit higher operating temperatures than in ideal or singular optimum conditions. For this reason when all color LEDs are used at their fullest intensity, life of the LEDs is significantly reduced. It is estimated that a viable lifespan of 20.000 hours will be achieved under normal operational conditions. If improving on this lifespan expectancy is of a higher priority, place care in providing for lower operational temperatures. This may include climatic-environmental and the reduction of overall projection intensity.

Safety Instructions

Every person involved with the installation, operation and maintenance of this device has to:

- be qualified
- follow the instructions of this manual



**CAUTION! Be careful with your operations.
With a dangerous voltage you can suffer
a dangerous electric shock when touching the wires!**



Before your initial start-up, please make sure that there is no damage caused by transportation. Should there be any, consult your dealer and do not use the device.

To maintain perfect condition and to ensure a safe operation, it is absolutely necessary for the user to follow the safety instructions and warning notes written in this manual.

Please consider that damages caused by manual modifications to the device are not subject to warranty.

This device contains no user-serviceable parts. Refer servicing to qualified technicians only.

IMPORTANT:

The manufacturer will not accept liability for any resulting damages caused by the non-observance of this manual or any unauthorized modification to the device.

- Never let the power-cord come into contact with other cables! Handle the power-cord and all connections with the mains with particular caution!
- Never remove warning or informative labels from the unit.
- Never use anything to cover the ground contact.
- Never look directly into the light source.
- Do not open the device and do not modify the device.
- Never leave any cables lying around.
- Do not connect this device to a dimmerpack.
- Do not switch the device on and off in short intervals, as this would reduce the LEDs life.
- Never use the device during thunderstorms, unplug the device immediately.
- Do not shake the device. Avoid brute force when installing or operating the device. The Magic Icecycle reacts very sensitive to force.
- Only use device indoor, avoid contact with water or other liquids.
- Do not touch the Magic Icecycle bare-handed during its operation.
- Only operate the device after having familiarized with its functions.
- Avoid flames and do not put close to flammable liquids or gases.
- Always allow free air space of at least 50 cm around the unit for ventilation.
- Always disconnect power from the mains, when device is not used or before cleaning! Only handle the power-cord by the plug. Never pull out the plug by tugging the power-cord.
- Make sure that the device is not exposed to extreme heat, moisture or dust.
- Make sure that the available voltage is not higher than stated on the rear panel.
- Make sure that the power-cord is never crimped or damaged. Check the device and the power-cord from time to time.
- Make sure that the cable diameter of the extension cords and powercables are sufficient for the current consumption of the device.
- The powercable may not be modified, broken, mechanically strained, pressed together or heated.
- The cable insert or the female part in the device must never be strained. There must always be sufficient cable to the device. Otherwise, the cable may be damaged which may lead to deadly electrical shocks.
- If the external cable is damaged, it has to be replaced by a qualified technician.
- If the Magic Icecycle is obviously damaged, it has to be replaced. So that its functions are not impaired.
- Never hit the Magic Icecycle with a hammer or other tools, as this may lead to damage.
- Never operate the device in the packaging or wrapped in order to avoid heating-up.
- If device is dropped or struck, disconnect mains power supply immediately. Have a qualified engineer inspect for safety before operating.
- If the device has been exposed to drastic temperature fluctuation (e.g. after transportation), do not switch it on immediately. The arising condensation water might damage your device. Leave the device switched off until it has reached room temperature.
- If your Showtec device fails to work properly, discontinue use immediately. Pack the unit securely (preferably in the original packing material), and return it to your Showtec dealer for service.
- For adult use only. Light effect must be installed out of the reach of children. Never leave the unit running unattended.
- Allow time to cool down, before storing.
- The user is responsible for correct positioning and operating of the Magic Icecycle. The manufacturer will not accept liability for damages caused by the misuse or incorrect installation of this device.
- This device falls under protection class I. Therefore it is essential to connect the yellow/green conductor to earth.
- During the initial start-up some smell may arise. This is a normal process and does not necessarily mean that the device is defective.
- Repairs, servicing and electric connection must be carried out by a qualified technician.
- WARRANTY: Till one year after date of purchase.



CAUTION ! EYEDAMAGES !
Avoid looking directly into the light source.
(meant especially for epileptics) !



Operating Determinations

- This device is not designed for permanent operation. Consistent operation breaks will ensure that the device will serve you for a long time without defects.
- The minimum distance between light-output and the illuminated surface must be more than 0.5 meter.
- The maximum ambient temperature $t_a = 45^\circ\text{C}$ must never be exceeded.
- The relative humidity must not exceed 50 % with an ambient temperature of 45°C .
- If this device is operated in any other way, than the one described in this manual, the product may suffer damages and the warranty becomes void.
- Any other operation may lead to dangers like short-circuit, burns, electric shock, crash etc.

You endanger your own safety and the safety of others!

Improper installation can cause serious damage to people and property !

Rigging

Please follow the European and national guidelines concerning rigging, trussing and all other safety issues.

Do not attempt the installation yourself !

Always let the installation be carried out by an authorized dealer !

Procedure:

- If the Magic Icecycle is lowered from the ceiling or high joists, professional trussing systems have to be used.
- Use a clamp to mount the Magic Icecycle, with the mounting-bracket, to the trussing system.
- The Magic Icecycle must never be fixed swinging freely in the room.
- The installation must always be secured with a safety attachment, e.g. an appropriate safety net or safety-cable.
- When rigging, derigging or servicing the Magic Icecycle, always make sure, that the area below the installation place is blocked and staying in the area is forbidden.

The Magic Icecycle can only be mounted in a hanging position. Mounting the Magic Icecycle with a clamp or any other mounting bracket is recommended, depending on the requirements of your application.

Improper installation can cause serious damage to people and property !

Connection with the mains

Connect the device to the mains with the power-plug.

Always pay attention, that the right color cable is connected to the right place.

International	EU Cable	UK Cable	US Cable	Pin
L	BROWN	RED	YELLOW/COPPER	FASE
N	BLUE	BLACK	SILVER	NUL
	YELLOW/GREEN	GREEN	GREEN	EARTH

Make sure that the device is always connected properly to the earth!



Return Procedure

Returned merchandise must be sent prepaid and in the original packing, call tags will not be issued. Package must be clearly labeled with a Return Authorization Number (RMA number). Products returned without an RMA number will be refused. Highlite will not accept the returned goods or any responsibility. Call Highlite 0031-455667723 or mail aftersales@highlite.nl and request an RMA prior to shipping the fixture. Be prepared to provide the model number, serial number and a brief description of the cause for the return. Be sure to properly pack fixture, any shipping damage resulting from inadequate packaging is the customer's responsibility. Highlite reserves the right to use its own discretion to repair or replace product(s). As a suggestion, proper UPS packing or double-boxing is always a safe method to use.

Note: If you are given an RMA number, please include the following information on a piece of paper inside the box:

- 1) Your name
- 2) Your address
- 3) Your phone number
- 4) A brief description of the symptoms

Claims

The client has the obligation to check the delivered goods immediately upon delivery for any shortcomings and/or visible defects, or perform this check after our announcement that the goods are at their disposal. Damage incurred in shipping is the responsibility of the shipper; therefore the damage must be reported to the carrier upon receipt of merchandise.

It is the customer's responsibility to notify and submit claims with the shipper in the event that a fixture is damaged due to shipping. Transportation damage has to be reported to us within one day after receipt of the delivery.

Any return shipment has to be made post-paid at all times. Return shipments must be accompanied with a letter defining the reason for return shipment. Non-prepaid return shipments will be refused, unless otherwise agreed in writing.

Complaints against us must be made known in writing or by fax within 10 working days after receipt of the invoice. After this period complaints will not be handled anymore.

Complaints will only then be considered if the client has so far complied with all parts of the agreement, regardless of the agreement of which the obligation is resulting.

Description of the device

Features

The Showtec Magic Icecycle is a light effect with high output and great effects.

- Play traditional snowfall effects as well as several other built in effects
- Dipswitch selectable programs
- Indoor and outdoor use
- Plug & play set with 18 tubes
- Long-life LEDs around 20.000 hr.
- Input voltage: AC 230V
- Power consumption: 22W
- Tube length: 825mm
- Tube diameter: 15mm
- Max. distance between tubes: 340mm
- Max. width when unfold: 5,5m
- Controller size: 50x50x195mm
- Light source: 5mm LEDs, 120 degrees
- IP Rating: IP44 (protected against splashing water)
- Visual angle: 360 degrees
- Control: Dedicated controller (included)
- Programs: 1 automatic, 7 sound active
- Weight: 5,3 kg (total set of 18 tubes)

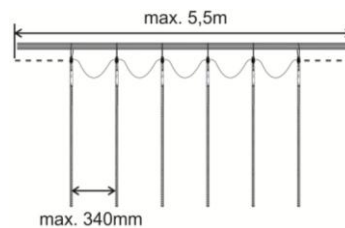

Overview

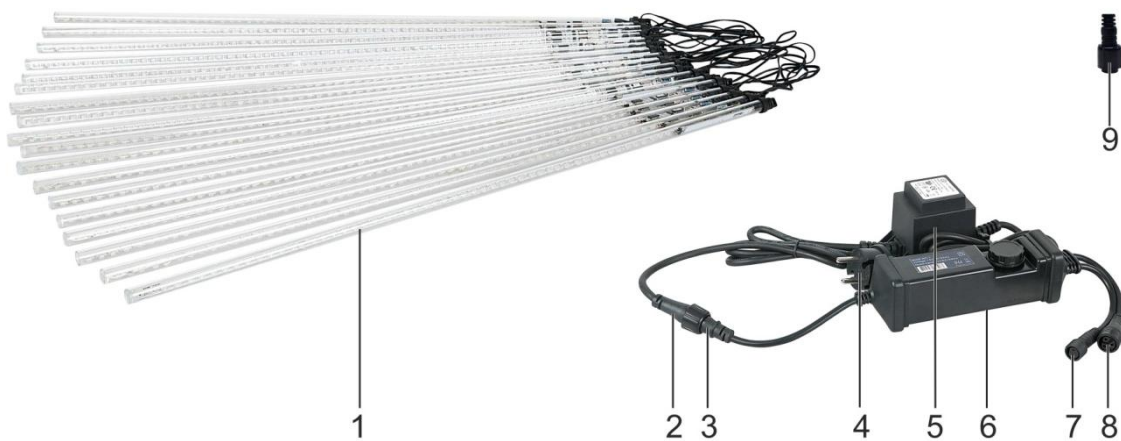

Fig. 1

- 1) Magic Icecycle
- 2) 3 Pole female power supply connector
- 3) 3 Pole male power in connector
- 4) IEC cable
- 5) Power supply
- 6) Controller
- 7) 2 Pole female buffer connector
- 8) 3 Pole Magic Icecycle connector
- 9) End cap for 2 pole buffer connector.

Optional accessoires

43105-01 Icecycle buffer for looping Icecycle sets

Installation

Remove all packing materials from the Magic Icecycle. Check that all foam and plastic padding is removed. Connect all cables.

Do not supply power before the whole system is set up and connected properly.

Always disconnect from electric mains power supply before cleaning or servicing.

Damages caused by non-observance are not subject to warranty.

Set Up and Operation

Before plugging the unit in, always make sure that the power supply matches the product specification voltage. Do not attempt to operate a 120V specification product on 230V power, or vice versa.

- 1) Carefully unfold the Magic Icecycle and install it.

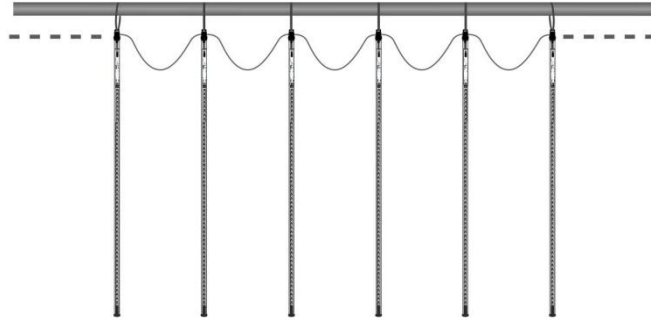

- 2) Connect the controller and power supply to the curtain. Make sure that the connectors are plugged in properly, then tighten the nut.

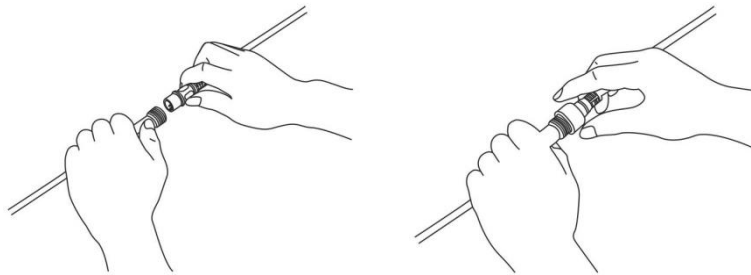

- 3) Double check all connections and plug the power cable in a proper electrical power supply socket.

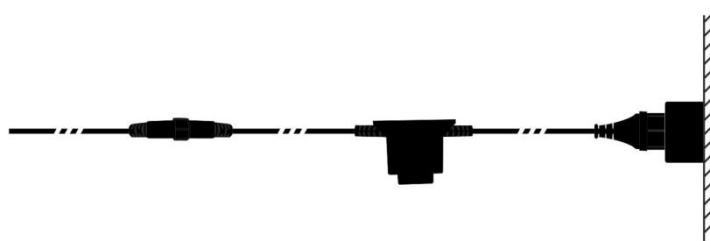

Coupling Magic Icecycles

If you want to run more than one Magic Icecycle synchronously, you have to obtain an optional buffer (43105-01) for each additional Magic Icecycle.

- 1) Connect the controller and the powersupply to the Magic Icecycle as you would do with a single standalone Magic Icecycle.

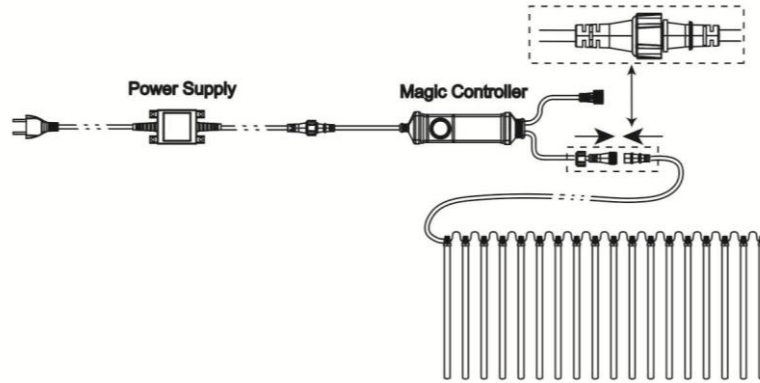

- 2) Connect the (optional) buffer to the **buffer connector (7)** of the controller for the first Magic Icecycle.

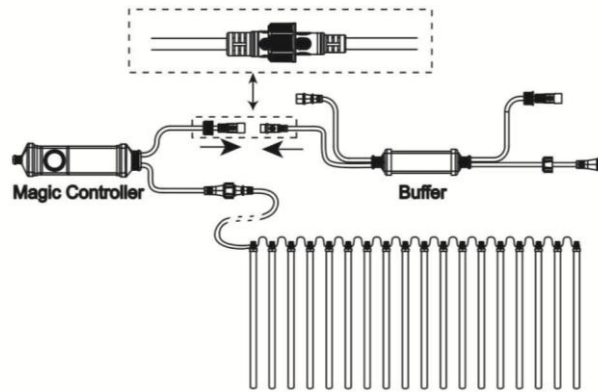

- 3) Each buffer needs to be connected to an additional power supply.

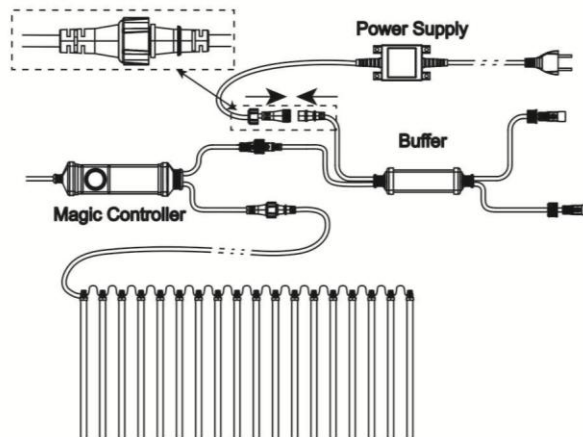

- 4) Connect the other side of the (optional) buffer to the second Magic Icecycle and so on. You can connect up to 50 Magic Icecycles in this way.

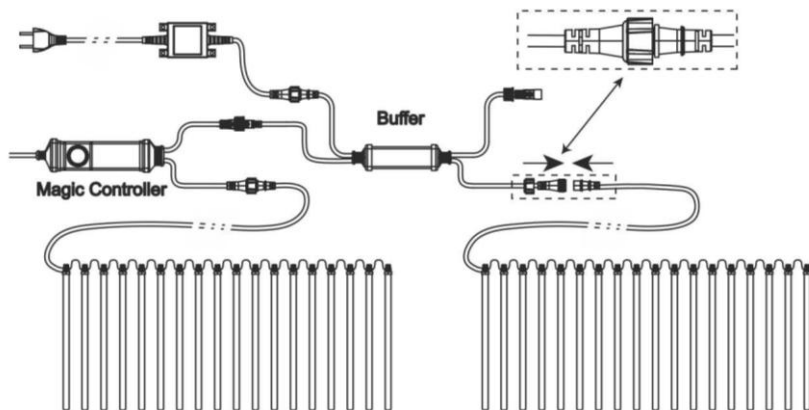

- 5) Make sure that each connection is set up properly and tighten the according nuts.

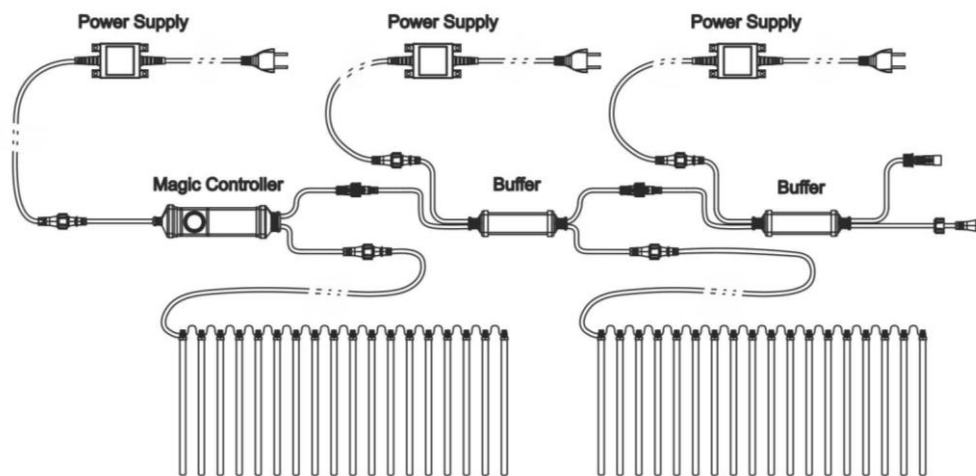

- 6) Check all connections, plug the power cable in a proper electrical power supply socket.

Controller

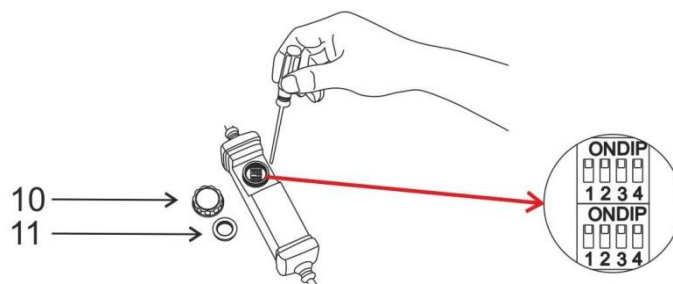

- 1) Unscrew the plastic **cover (10)** and remove it.
- 2) Remove the rubber **seal (11)**.
- 3) Now you are able to set up the desired sound mode. The upper dipswitches allow you to select pattern 1-4 and the lower dipswitch allow you to select pattern 5-8.

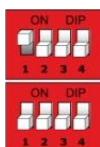

Pattern 1: Music screen.

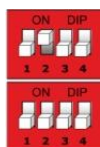

Pattern 2: Star sparkling.

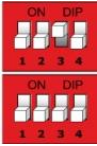

Pattern 3: Whole tube flashes irregularly.

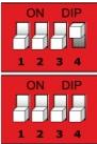

Pattern 4: Waves.

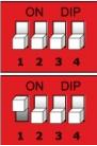

Pattern 5: Running forward en backwards.

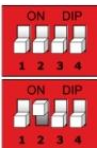

Pattern 6: Random square.

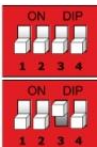

Pattern 7: Musical sound waves.

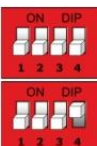

Pattern 8: Icecycle effect. No sound control.

- 4) Setting more than one DIP switch allows you to run the according patterns in sequence.
- 5) Replace the rubber **seal (10)** and reinstall the plastic **cover (9)**.

Maintenance

The Showtec Magic Icecycle requires almost no maintenance. However, you should keep the unit clean. Otherwise, the fixture's light-output will be significantly reduced. Disconnect the mains power supply, and then wipe the cover with a damp cloth. Do not immerse in liquid. The housing will require monthly cleaning, as smoke-fluid tends to build up residues, reducing the light-output very quickly. Do not use alcohol or solvents. Keep connections clean. Disconnect electric power, and then wipe the connections with a damp cloth. Make sure connections are thoroughly dry before linking equipment or supplying electric power.

The operator has to make sure that safety-relating and machine-technical installations are to be inspected by an expert after every four years in the course of an acceptance test. The operator has to make sure that safety-relating and machine-technical installations are to be inspected by a skilled person once a year.

The following points have to be considered during the inspection:

1. All screws used for installing the device or parts of the device have to be tightly connected and must not be corroded.
2. There may not be any deformations on housings, fixations and installation spots.
3. The electric power supply cables must not show any damages or material fatigue.

Troubleshooting

No Light

This troubleshooting guide is meant to help solve simple problems. If a problem occurs, carry out the steps below in sequence until a solution is found. Once the unit operates properly, do not carry out following steps.

If the light effect does not operate properly, refer servicing to a technician.

Response: Suspect three potential problem areas: the power supply, the controller and the LEDs.

1. The power supply. Check that the unit is plugged into an appropriate power supply.
2. The controller. Disconnect the controller and connect the power supply directly to the Magic Icecycle. The Magic Icecycle should run the standalone pattern. If the controller is not functioning, return the device to your Showtec dealer.
3. The LED. Return the device to your Showtec dealer.

Product Specification

Model: Showtec Magic Icecycle

- Play traditional snowfall effects as well as several other built in effects
- Dipswitch selectable programs
- Indoor and outdoor use
- Plug & play set with 18 tubes
- Long-life LEDs around 20.000 hr.
- Input voltage: AC 230V
- Power consumption: 22W
- Tube length: 825mm
- Tube diameter: 15mm
- Max. distance between tubes: 340mm
- Max. width when unfold: 5,5m
- Controller size: 50x50x195mm
- Light source: 5mm LEDs, 120 degree
- IP Rating: IP44 (protected against splashing water)
- Visual angle: 360 degrees
- Control: Dedicated controller (included)
- Programs: 1 automatic, 7 sound active
- Weight: 5,3 kg (total set of 18 tubes)

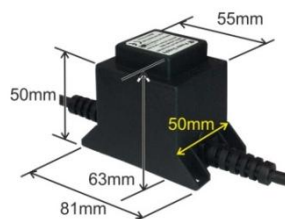
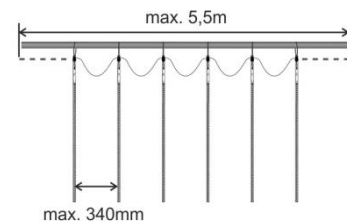

Minimum distance:

Minimum distance from flammable surfaces: 0.5m

Minimum distance to lighted object: 1m

Design and product specifications are subject to change without prior notice.



Website: www.Showtec.info

Email: service@highlite.nl



© 2012 Showtec.