

# Philips Lighting Catalogue 2014/15

**PHILIPS**



Philips  
Lighting Catalogue  
2014/15

---









# Philips delivers innovation that matters to you

A technology company that cares about people.

From the very first light bulbs and radios, we've had one message at the heart of our company – our mission to improve people's lives through innovation that matters.

We don't just invent; we entertain, we enlighten, we solve. We are a technology company that cares about people.

It's in our DNA, and it's time to let it shine.

## **Terms and Conditions**

All illustrations, information and specifications presented and referred to herein are believed to be correct at the time of publication. All measurements shown in millimetres unless otherwise stated.

Attachments to some products are optional and available at additional cost.

Philips Lighting reserves the right to make changes from time to time without notice or obligation in the specifications, design, colour or materials. Philips Lighting reserves the right to change and discontinue products.

Additional details and specifications are available from Philips Lighting on request. Or refer to product content online at [www.philips.com.au/lighting](http://www.philips.com.au/lighting)

All due care has been taken to ensure that technical details listed in this guide are correct, however should any errors be found, Philips Lighting reserves the right to make alterations without notice.

Contact Philips Customer Service:

Ph: 1300 304 404

Fax: (02) 9947 0363

[lightingsalesdesk@philips.com](mailto:lightingsalesdesk@philips.com)

[www.philips.com.au/lighting](http://www.philips.com.au/lighting)

# Contents

---

## 1 Introduction

■ Your Lighting Partner	1.0
-------------------------	-----

---

## 2 Professional Luminaires

■ Office Lighting	2.2
-------------------	-----

---

■ Downlights & Projectors	2.21
---------------------------	------

---

■ Battens	2.39
-----------	------

---

■ WaterProof Battens	2.44
----------------------	------

---

■ Highbay	2.49
-----------	------

---

■ Lowbay	2.54
----------	------

---

■ Area Lighting	2.60
-----------------	------

---

■ Road Lighting	2.63
-----------------	------

---

■ Floodlighting	2.66
-----------------	------

---

■ Security	2.80
------------	------

---

## 3 Consumer Luminaires

■ Ledino	3.2
----------	-----

---

■ Essential LED	3.6
-----------------	-----

---

■ RoomStylers	3.8
---------------	-----

---

■ Kidsplace	3.12
-------------	------

---

■ Aquafit	3.18
-----------	------

---

■ Outerstylers	3.26
----------------	------

---

■ LED Desk Lamps	3.30
------------------	------

---

■ Living Colors	3.32
-----------------	------

---



---

<b>4 Lamps</b>	
■ General Lamps	4.2
■ Halogen	4.8
■ Fluorescent Lamps • Linear Tubes	4.20
■ Fluorescent Lamps • Compact Non-Integrated	4.36
■ Fluorescent Lamps • Compact Integrated (CFLi)	4.44
■ LED	4.48
■ High Intensity Discharge	4.66
■ Special Lamps	4.85
<hr/>	
<b>5 Stand Alone Controls</b>	5.0
<hr/>	
<b>6 Electronic Control Gear</b>	6.0
<hr/>	
<b>7 Technical Data</b>	7.0
<hr/>	
<b>8 Glossary of Terminology</b>	8.0
<hr/>	

# Product Overview

## OFFICE LIGHTING 2.2

2.3



PowerBalance 2.0

2.5

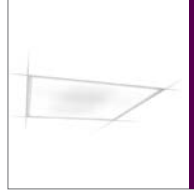

SmartPanel LED

2.7



Coreline LED

2.9



Smartform LED

2.11



SmartBalance LED

2.13



Celino LED

2.15



LumiStone LED

2.17



Sereno TBS 299

2.18



Sereno TBS 528/869

2.20



Modella TCS 125

## DOWNLIGHTS & PROJECTORS 2.21

2.21



LuxSpace Gen III

2.24



LuxSpace Gen III  
- IP54

2.26



LuxSpace Gen III  
Wall-wash

2.28



LuxSpace Gen II -  
Surface Mounted

2.30



GreenAccent Gen II

2.34



GreenSpace Gen III

2.36



Essential Downlight  
LED

2.37



SmartBright Mini  
Dimmable LED

2.38



CoreLine ProSet

## BATTENS 2.39

2.39



CoreLine Trunking

2.40



GreenPerform LED  
Batten

2.42



SmartBright LED  
Batten Gen2

2.43



TCW060  
Fluorescent  
WaterProof Batten



WATERPROOF  
BATTENS

2.44

2.44



GreenPerform  
Waterproof Batten

2.46



CoreLine  
Waterproof Batten

2.48



Pacific LED  
Waterproof Batten

HIGHBAY

2.49

2.49



Prolux T5 Highbay  
TPS 550

2.51



GreenPerform  
Highbay Gen2

2.53



GentleSpace Gen2

LOWBAY

2.54

2.55



SmartBay Lowbay

2.56



Mini 300 Gen2

2.58



Mini 300 HID

AREA LIGHTING

2.60

2.60



Metro

2.62



Metro LED

ROAD LIGHTING

2.63

2.63



RoadStar

2.64



GreenVision Xceed

FLOODLIGHTING

2.66

2.66



Tango LED

2.68



Tango G2 LED

2.70

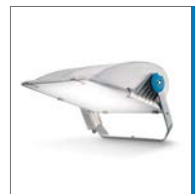

OptiVision

2.71



ArenaVision

2.73



ComfortVision

2.75



ConTempo HID

2.77



Tango HID

2.79



HNF901 (Puma)

SECURITY

2.80

2.80



Mini Vandalite LED

2.82



Twin Motion LED Sensor

2.83



Vandalite

LEDINO

3.2

3.4



69092/31

3.4



69092/87

3.4



69064/87

3.4



69070/31

3.4



69072/31

3.5



69074

3.5



69080/87

3.5



69082/87

3.5



69084/87

3.5



69089/31

ESSENTIAL LED

3.6

3.7



30804

3.7



30805

3.7



30806

ROOMSTYLERS

3.8

3.10



TCG701

3.10



TCG702

3.10



TCG700

3.10



TCG700

3.10



TCG700



3.11



QCG307

3.11



QCG307

3.11



QWG306

3.11



FWG301

3.11



QWG311

KIDSPLACE  
3.12

3.14



QCG316

3.14



QPG308

3.14



QCG310

3.14



QCG311

3.14



QCG315

3.15



QPG314

3.15



QPG315

3.15



FPG302

3.15

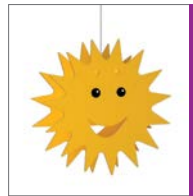

QPG313

3.15



QPG316

3.16



40229

3.16



40295

3.16



69112

3.16



69112

AQUAFIT  
3.18

3.21



QCZ800

3.21



QCZ806

3.21



QCZ802

3.21



QCZ802

3.21



32047

3.22

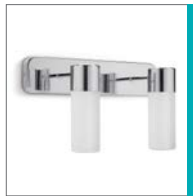

32048

3.22



32049

3.22



32029

3.22

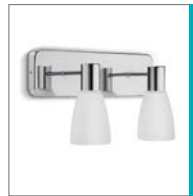

32030

3.22



32031

3.23



32032

3.23

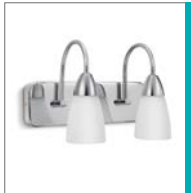

32033

3.23



32035

3.23



32036

3.23



32044

3.24



32045

3.24



32046

OUTERSTYLERS

3.26

3.28



EWS300

3.28



EWP300

3.28



17105

3.28



17105

3.28



17173

LED DESK LAMPS

3.30

3.31



Eyecare Black

3.31



Eyecare White

3.31



Vane Blue

3.31



Vane Pink

3.31



Vane Grey

LIVING COLORS

3.32

3.34



Living Colors  
Micro-White

3.34



Living Colors  
Iris-Black

GENERAL LAMPS

4.2

4.2



Classictone Candle

4.3



Classictone Lustre

4.3



Practitone Philinea

4.4



Practitone Tubular

4.5



Partytone Coloured

4.6



Floodlight PAR38  
& PAR 38 Colour

4.7

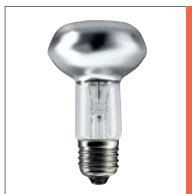

Reflector Ring  
Mirror

4.7



Reflector Standard  
Floodline



HALOGEN

4.8

4.9



Masterline ES  
Dichroic

4.10



Brilliantline Pro  
Dichroic

4.11



Essential Plus  
Dichroic

4.12



Masterline III

4.13



Essential Twistline  
Dichroic

4.14



Essential Capsule

4.15



Essential Capsule  
MV

4.16



EcoClassic A55

4.17



EcoClassic Candle

4.18



EcoClassic Lustre

4.19



Plusline Pro

LINEAR TUBES

4.20

4.21



Master TL5  
High Efficiency ECO

4.22



Master TL5  
High Output ECO

4.23



Master TL5  
High Efficiency

4.24



Master TL5  
High Output

4.25



Master TL5  
HO Xtra

4.26



Master TL5  
HO TOP

4.27



Master TL5 HO  
90 Deluxe

4.28



Master TL5 Circular

4.29



Master TL-D ALTO

4.30



Master TL-D  
Super 80

4.30



Master TL-D  
Xtreme

4.31



Master TL-D  
90 Deluxe

4.32



Master TL-D  
Secura

4.32



Master TL-D  
Food Pro

4.33



TL-D Standard  
Colours

4.33



TL-D Coloured

4.34



TL-E Circular  
Super 80

4.34



TL Miniature

4.35



TL-X XL  
Instant Start

4.35



Starter Switches

COMPACT  
NON-INTEGRATED

4.36



Master PL-R Eco

4.37



PL-C 2-PIN

4.38



PL-C 4-PIN

4.38



Master PL-L 4-PIN

4.39



PL-S 2-PIN

4.39



PL-S 4-PIN

4.40



PL-T 2-PIN

4.41



PL-T TOP 4-PIN

4.42



Master PL-T Xtra

4.42



PL-Q 2-PIN &  
4-PIN Quadrant

COMPACT  
INTEGRATED

4.44



Ambiance Lustre

4.45



Ambiance Candle

4.45



Ambiance PAR38

4.46



Genie

4.47



Tornado

LED LAMPS

4.48



LEDspot Mains  
Voltage GU10

4.53

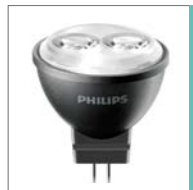

LEDspot Low  
Voltage MR11 - ND

4.53



LEDspot Low  
Voltage MR16 - ND

4.54



LEDspot Low  
Voltage MR16 - D

4.57



LEDbulb A60

4.58



LEDbulb A67

4.60



LED Decorative  
Candle

4.61



LEDspot PAR

4.62

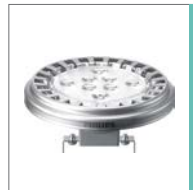

LEDspot ARI II

4.63



LEDtube

4.65



CorePro LEDtube

HIGH INTENSITY  
DISCHARGE

4.66



Master CDM-T

4.66



CDM-T Elite

4.67



CDM-T Elite  
Light Boost

4.67



CDM-TC

4.68



CDM-TC Elite

4.68



CDM-TC Elite  
Light Boost

4.69



CDM-TD

4.69



MHN-TD

4.70



CDM-/TP Medium  
Wattage Elite

4.71



CDM-R Mini

4.72



CDM-R Mini Elite

4.72



CDM-R Par 20

4.73



CDM-R Par 30

4.73



CDM-R Par 30 Elite

4.74



CDM-R III

4.75



CosmoPolis  
Outdoor

4.76



CDO-TT &  
CDO-ET Elliptical

4.77



HPI-T

4.78



HPI Plus

4.80



Universal Operating  
Ovoid

4.81



ArenaVision/  
OptiVision Lamps

4.82



SON

4.82



SON-T

4.83



SON-T Agro

4.84



HPL-N

4.85

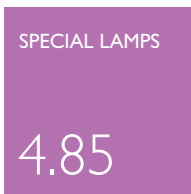

UV - Blacklight Blue



5.2

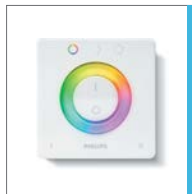

ToBeTouched

5.3



OccuSwitch DALI

5.3



OccuSwitch -  
LRM1000

5.4



OccuSwitch -  
LRM1010

5.4



OccuSwitch -  
LRM1040

5.5



OccuSwitch –  
LRM1070

5.5



Highbay Sensor

ELECTRONIC  
CONTROL GEAR  
  
6.0

6.2



HF-Ri TD

6.4



HF-RTD PL-R Eco

6.5



HF Performer III

6.6



HF Selectalume II

6.7



HID-Primavision

6.9



HID-Primavision  
Economy

6.10



HID AspiraVision

6.10



HID PrimaVision  
Medium Wattage

6.11



HID PrimaVision for  
Mini White SON

6.11



HID PrimaVision  
Xtreme for CPO

6.12



ET-S Halogen  
Transformer













Philips –

Your  
Lighting  
Partner

# Philips Companies



## Dyalite

Philips Dyalite is synonymous with the creation of sophisticated, simple, reliable and energy-efficient lighting control solutions for a wide range of industry sectors, including residential, custom installation, offices, retail, hospitality and public spaces. An industry leading innovator for over 20 years, Philips Dyalite is the solution of choice for a wide range of 'smart home', energy management and architectural lighting control applications. Philips Dyalite solutions blend high-level functionality with dramatic aesthetic sustainability to enable and enhance our lives.

**Phone:** 1300 554 178

**Email:** [dyalite.info@philips.com](mailto:dyalite.info@philips.com)

**Website:** [www.philips.com/dyalite](http://www.philips.com/dyalite)



## ColorKinetics

Philips ColorKinetics transforms environments through dynamic and innovative uses of light. Our award-winning LED lighting systems, lighting controllers, and custom lighting solutions reinvent light as a highly efficient, long lasting, environmentally friendly, and inherently digital source of illumination.

**Phone:** 1300 304 404

**Email:** [lightingsalesdesk@philips.com](mailto:lightingsalesdesk@philips.com)

**Website:** [www.philips.com.au/lighting](http://www.philips.com.au/lighting)



## Selecon

The passion for performance is the philosophy behind every luminaire manufactured by Philips Selecon. We offer lighting designers the tools to light the 'theatre of life' utilising innovative materials and design principals, and the latest lamp sources including LED, metal halide and tungsten halogen. Our luminaires are designed for entertainment applications, theatres, themed environments, convention centres, retail applications, museums and art galleries.

Where our light falls experiences are made.

**Phone:** 0419 133 342

**Email:** [peter.mckenzie@philips.com](mailto:peter.mckenzie@philips.com)

**Website:** [www.seleconlight.com](http://www.seleconlight.com)



## Strand Lighting

Philips Strand offers a comprehensive and competitive range of dimming, control systems and software to answer the creative needs of the lighting designer, whether working in theatre, television, themed environments and sophisticated architectural applications.

**Phone:** 0419 133 342

**Email:** [peter.mckenzie@philips.com](mailto:peter.mckenzie@philips.com)

**Website:** [www.strandlighting.com](http://www.strandlighting.com)











# Philips – Your Lighting Partner

As the world's leader in Lighting, Philips is driving the switch to energy-efficient lighting solutions. Philips provides a unique combination of advanced technologies, which include LED systems, lamps, drivers, optics, luminaires, lighting controls and accessories, as well as the supporting tools to help you apply them.

Here are a few examples of how we can work with you and support the Australian lighting industry.



## Design and Project Support

The Philips Lighting projects team can provide consultation, guidance, and support with projects featuring lighting. This includes solutions for office, retail, industrial, commercial, institutional, sports facilities, city beautification and more.

Our experienced team can help you at every step of the way with lighting project management.

- Latest technology and innovations
- Energy efficient and sustainable lighting
- Total cost of ownership tools and comparisons
- Lighting design featuring the latest software
- Pricing and delivery
- After sales support



Philips Lighting  
University

## Online Training

Looking for in-depth personal training? – Try our Philips Lighting online training course.

Start with the fundamentals, and work your way through luminaires, lamps, and gear products, covering technologies, benefits and applications. The Philips Lighting University aims to grow your lighting knowledge at your own pace in a lively interactive environment.

## Sustainability

In 2050 there will be 9 billion people living on Earth. Sustainable development for Philips means enabling all mankind to live healthy and well within the ecological carrying capacity of our planet.

Philips has a long sustainability history stretching all the way back to our founding fathers. In 1994 we launched our first program and set sustainability targets for our own operations. In 1998, we launched our first EcoVision program focused on operations and products showing energy saving characteristics and minimising hazardous materials in products and packaging. We also started to focus on sustainability in our supply chain in 2003. In 2010 we extended our scope further by including the social dimension of products and solutions, which is now reflected in our renewed company vision stating that we strive to make the world healthier and more sustainable through innovation. Our goal is to improve the lives of 3 billion people a year by 2025.





# Philips Online

By its very nature, a printed catalogue like this represents the situation at a given moment in time.

For the very latest details on our extensive range of innovative lighting solutions and products, please check our website at [www.philips.com.au/lighting](http://www.philips.com.au/lighting)

- eCatalogue
- New products
- Project planners
- Application information and trends
- Case studies



Lighting Hub iPad app



[facebook.com/seewhatlightcando](https://facebook.com/seewhatlightcando)



Innovations in Light



@PhilipsLight

In addition, sign up for our e-newsletters via the Philips website for the latest in Philips' news and product innovations.

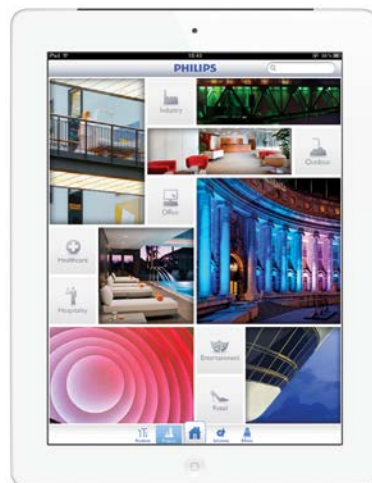
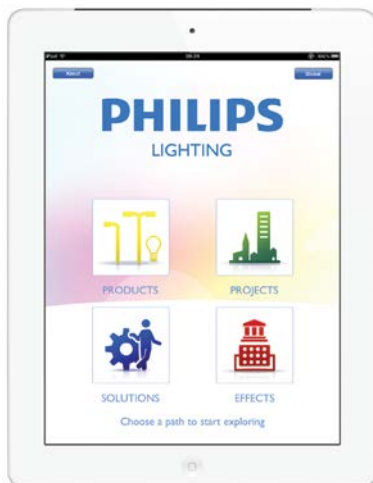



---

# Professional Luminaires











## PowerBalance 2.0

When it comes to office lighting, new opportunities are presented to invest in the latest technology, allowing for energy savings of up to 25% compared to a conventional 4x14W T5 fitting as well as reduced operational costs. At Philips, we've designed our PowerBalance luminaire with all the above factors in mind. Combined with a rated lifetime of 50,000 hrs, the PowerBalance offers impressive energy savings resulting in reduced operational costs, trumping its conventional T5 predecessors.



### Features and Benefits

- Advanced LED technology, offering efficacy and long lifetime
- Smart Pyramid Optics (SPO), ensuring excellent light control
- Choice of 3 lumen packages with 4000K colour temperature, ideal for office applications
- System efficiency of up to 114lm/W



Product ID	L (mm)	W (mm)	H (mm)
W300L1200	1197	297	75
W600L600	597	597	75

Dimensions in mm (Nominal)

POWERBALANCE 2.0			
Family name	PowerBalance 2.0	Driver	Integrated DALI driver
Model	RC600B	Dimmable	Compatible with DALI controllers
Lumen/ Watt	32W/ 3100lm 33W/ 3700lm 43W/ 4200lm	Installation	T-Bar recessed mounting
Correlated Colour Temperature (CCT)	4000K	IP rating	IP20
Colour Rendering Index (CRI)	80	Weight	6.5Kg
Flex and Plug	Yes	Colour of housing	Housing: post-painted steel. Optics: plastic
Lifetime L70*	50,000hrs	Application	Offices, Healthcare, Department stores
Unified Glare Ratio (UGR)	15	Accessories	n/a
Optics	Smart Pyramid Optics (SPO)	Suspension Height - min/max	n/a
		Maximum Run Length	n/a





## PowerBalance 2.0 continued

COMMERCIAL CODE	I2NC	DESCRIPTION
RC600B32W4KDREC	911401561111	RC600B LED31S/840 PSD W30L120 CAU
RC600B32W4KDSQ	911401555811	RC600B LED31S/840 PSD W60L60 CAU
RC600B32W4KDREA	911401561211	RC600B LED31S/840 PSD W30L120 AIR CAU
RC600B32W4KDSQA	911401555911	RC600B LED31S/840 PSD W60L60 AIR CAU
RC600B33W4KDREC	911401555711	RC600B LED35S/840 PSD W30L120 CAU
RC600B33W4KDSQ	911401561611	RC600B LED35S/840 PSD W60L60 CAU
RC600B33W4KDREA	911401561011	RC600B LED35S/840 PSD W30L120 AIR CAU
RC600B33W4KDSQA	911401561711	RC600B LED35S/840 PSD W60L60 AIR CAU
RC600B43W4KDREC	911401560711	RC600B LED40S/840 PSD W30L120 CAU
RC600B43W4KDSQ	911401561811	RC600B LED40S/840 PSD W60L60 CAU
RC600B43W4KDREA	911401560811	RC600B LED40S/840 PSD W30L120 AIR CAU
RC600B43W4KDSQA	911401561911	RC600B LED40S/840 PSD W60L60 AIR CAU



# SmartPanel LED

Philips SmartPanel is an affordable LED lighting solution for general office areas, providing energy savings of up to 20% compared with similar output T5 fittings.

With its ultra-slim design, SmartPanel is suitable for both recessed and suspended applications to cater to all tastes and trends.

Featuring a side-lit LED and high quality light guide, Smart Panel creates a uniform and clean look for any office application.

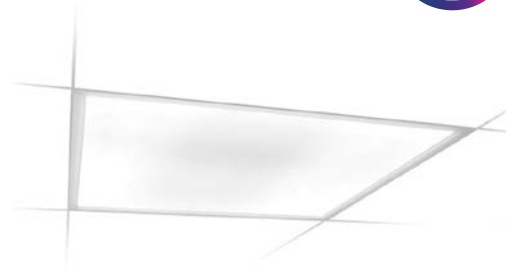

## Features and Benefits

- High System efficacy: 77lm/W for neutral white 4000K
- Improved working environment: High colour rendering (CRI>80); Excellent lighting uniformity
- Slim housing design: 14mm for housing height. 55mm with the driver height considered

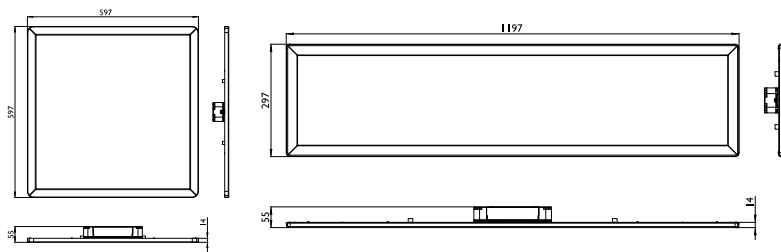

Product ID	L (mm)	W (mm)	H (mm)
RCI 60V Square	597	597	14/55
RCI 60V Rectangle	1197	297	14/55
Dimensions in mm (Nominal)			(H – including driver)

## SMARTPANEL LED

Family name	RCI60V
Lumen/Watt	2500lm/33W – 3x14W replacement 3400lm/45W – 2x54W replacement
Colour temp	Warm white 3000K / Neutral white 4000K
Colour Rendering Index	>80
Flex and Plug	Included
Lifetime L70*	30,000 Hours
Office compliant/UGR	<19
Louvre/Optics	Light guide with diffuser
Driver	Integrated driver

\* = When the fitting reaches 70% of full potential (new)

Dimmable	Compatible with DALI controllers
Installation	Recessed: Individual; lay in exposed ceiling grids Suspended: Individual; suspended mounting with steel-wire-suspension kit (optional) with power cord
Classification/IP rating	IP20
Colour/Materials	Housing; Frame: plastic Back cover: steel Light guide: PMMA Driver housing: Polycarbonate Trim Colour: White
Application	General lighting, Offices, Schools
Accessories	Suspension mounting kit (RCI60Z SMS PSU/ RCI60Z SMS PSD) Surface mounting kit (RCI60Z MB-SURF SQR/ RCI60Z MB-SURF REC)



## SmartPanel LED continued

COMMERCIAL CODE	I2NC	DESCRIPTION
RCI60V45W4KDSQ	911401509811	RCI60V LED34S/840 PSD W60L60 CAU
RCI60V45W4KDREC	911401509911	RCI60V LED34S/840 PSD W30L120 CAU
RCI60V45W4KFSQ	911401509411	RCI60V LED34S/840 PSU W60L60 CAU
RCI60V45W4KFREC	911401509611	RCI60V LED34S/840 PSU W30L120 CAU
RCI60V45W3KFSQ	911401510011	RCI60V LED34S/830 PSU W60L60 CAU
RCI60V45W3KFREC	911401510211	RCI60V LED34S/830 PSU W30L120 CAU
RCI60V45W3KDSQ	911401510411	RCI60V LED34S/830 PSD W60L60 CAU
RCI60V45W3KDREC	911401510511	RCI60V LED34S/830 PSD W30L120 CAU
RCI60V33W4KFSQ	911401509511	RCI60V LED25S/840 PSU W60L60 CAU
RCI60V33W4KFREC	911401509711	RCI60V LED25S/840 PSU W30L120 CAU
RCI60V33W3KFSQ	911401510111	RCI60V LED25S/830 PSU W60L60 CAU
RCI60V33W3KFREC	911401510311	RCI60V LED25S/830 PSU W30L120 CAU
RCI60ZSMSF	911401585301	RCI60Z SMS PSU
RCI60ZSMSD	911401585401	RCI60Z SMS PSD
RCI60ZSURFSQ	911401542211	RCI60Z MB-SURF SQR622x622x65
RCI60ZSURFREC	911401542311	RCI60Z MB-SURF REC1222x322x65



# CoreLine LED

CoreLine LED is a stylish range of high output LED luminaires suitable for general office and retail lighting applications. With a longlife LED platform, you can directly replace a conventional 4x18W and/or 2x36W fluorescent system and enjoy lower maintenance costs.



## Features and Benefits

- Up to 90lm/W system efficiency with significant energy savings than traditional T5 systems
- LPD>7W/m<sup>2</sup> with LEED green energy consumption certification of +5
- PC prism panel reduces glare
- Long lifetime of up to 50,000 hours

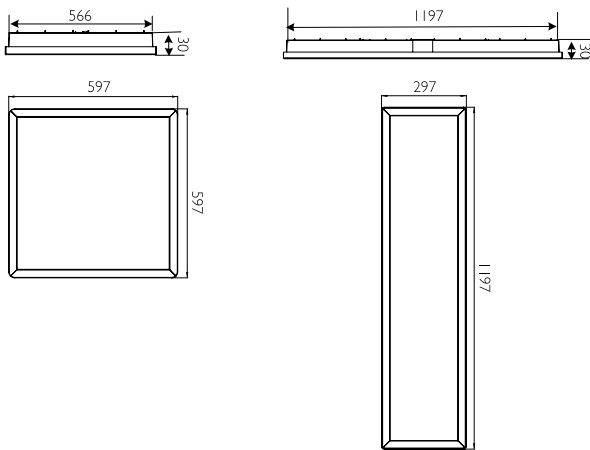

Product ID	L (mm)	W (mm)	H (mm)
RCI00C Rectangle ver.	1197	297	30
RCI00C Square ver.	597	597	30
SMI00C Rectangle ver.	1197	197	30
SMI00C Square ver.	597	597	30

Dimensions in mm (Nominal)

## CORELINE LED

Family Name	Coreline
Model	RCI00C - Recessed ver. SMI00C - Surface-mounted ver.
Lumen/ Watt	2600lm/31W - 2x28 / 4x14W T5 replacement 3700lm/40W - 3x28 / 2x35WT5 replacement
Lamp Colour	4000K
Colour Rendering Index (CRI)	80
Flex and Plug	No
Lifetime L70*	50,000 Hours
Unified Glare Ratio	19 - square ver 22 - rectangle ver
LOR	1.00
Louvre/Optics	Light guide with diffuser
Driver	Integrated driver
Dimmable	Compatible with DALI controllers

Installation	Recessed: Individual; lay in exposed ceiling grids Surface mounted
Classification/IP rating	IP20
IK Rating	n/a
Weight (kg)	3.0
Colour/Materials	Housing: Steel Light cover: Polycarbonate Driver box: Steel
Application	General lighting, Office, Corridors, Retail
Accessories	NA
Suspension Height - min/max	NA
Maximum Run Length	NA

\* = When the fitting reaches 70% of full potential (new)



## CoreLine LED continued

COMMERCIAL CODE	I2NC	DESCRIPTION
CORELINE LED RECESSED MOUNTED		
RCI00C3IW4KFSQ	911401568901	RCI00C LED25S/840 PSU W60L60
RCI00C3IW4KFREC	911401569001	RCI00C LED25S/840 PSU W30L120
RCI00C3IW4KDSQ	911401564301	RCI00C LED25S/840 PSD W60L60
RCI00C3IW4KDREC	911401568601	RCI00C LED25S/840 PSD W30L120
RCI00C42W4KFSQ	911401564201	RCI00C LED35S/840 PSU W60L60
RCI00C42W4KFREC	911401564101	RCI00C LED35S/840 PSU W30L120
RCI00C42W4KDSQ	911401568501	RCI00C LED35S/840 PSD W60L60
RCI00C42W4KDREC	911401568701	RCI00C LED35S/840 PSD W30L120
CORELINE LED SURFACE MOUNTED		
SMI00C3IW4KFREC	911401592601	SMI00C LED25S/840 PSU W20L120
SMI00C3IW4KFSQ	911401592701	SMI00C LED25S/840 PSU W60L60
SMI00C42W4KFSQ	911401592201	SMI00C LED35S/840 PSU W60L60
SMI00C42W4KFREC	911401592301	SMI00C LED35S/840 PSU W20L120
ACCESSORY		
RCI00CSUSPSET	911401562201	RCI00C Suspension set





# Smartform LED

Designed to fit in a wide range of ceiling types, this family of highly versatile modular and semi-modular luminaires can fulfill the majority of project requirements in most applications. SmartForm LED offers higher luminaire efficiency than conventional MLO (micro-lens optic) solutions, enabling significant energy savings. At the same time, its choice of optics ensures a range of inspiring light effects to bring office environments to life.



## Features and Benefits

- Continuous line and light beam models
- Office compliant (UGR19, CRI 80)
- Inspiring light effects
- High system efficacy with optics innovation
- Aesthetical and novel design with visually better ceiling integration
- Designed to fit in a wide range of ceiling types

### BBS411 & BBS415

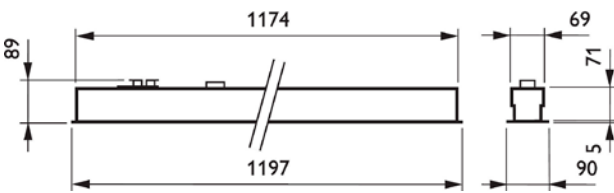

### BBS417

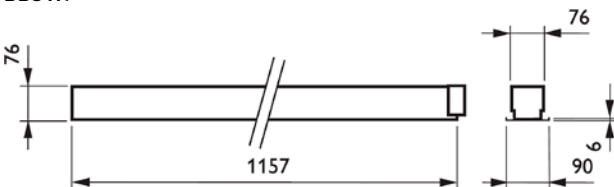

Product ID	L (mm)	W (mm)	H (mm)
BBS411	1197	90	89
BBS415	1197	90	89
BBS417	1157	90	76
Dimensions in mm (Nominal)		(H – including driver)	



# Smartform LED continued

SMARTFORM LED			
Family name	Smartform LED	Optics	LIN-PC: OLC micro-lens optic in polycarbonate cover MLO-PC: OLC micro-lens optic in polycarbonate cover O-PC: Opal optic in polycarbonate cover
Model	BBS411 - Light beam Slim BBS415 - Light beam BBS417 - Continuous Line	Driver	Integrated driver
Lumen/Watt	BBS411 - Light beam Slim MLO-PC: 1700lm/ 25W LIN-PC: 2000lm/ 25W BBS415 - Light beam MLO-PC: 1900lm/ 25W LIN-PC: 2000lm/ 25W MLO-PC: 3500lm/ 47W LIN-PC: 4200lm/ 47W BBS417 - Continuous Line MLO-PC: 1700lm/ 25W LIN-PC: 2000lm/ 25W O-PC: 1900lm/ 25W	Dimmable	Fixed output and DALI compatible
Correlated Colour Temperature (CCT)	3000K, 4000K	Installation	Recessed mounting
Colour Rendering Index (CRI)	80	IP rating	IP40
Flex and Plug	Not included	Weight	BBS411 & BBS415 - 4.5kg - 5kg BBS417 - 3.3kg
Lifetime L70*	50,000hrs	Colour of housing	White, Silver
Unified Glare Ratio (UGR)	19	Application	Retail, Hospitality, Offices, Schools
		Accessories	Mounting bracket, ZBS415 SMB End caps, ZBS417 EP-S-LED SET
		Suspension Height - min/max	n/a
		Maximum Run Length	n/a

\* = When the fitting reaches 70% of full potential (new)

COMMERCIAL CODE	I2NC	DESCRIPTION
SMARTFORM LED - CONTINUOUS LINE		
BBS41725W4KDMLO	910501965503	BBS417 LED24/840 PSD W9L120 MLO-PC PI
BBS41725W4KDO	910501965603	BBS417 LED24/840 PSD W9L120 O-PC PI
BBS41725W4KDLIN	910501965703	BBS417 LED24/840 PSD W9L120 LIN-PC PI
SMARTFORM LED - LIGHT BEAM SLIM		
BBS41125W4KDMLO	910501964603	BBS411 LED24/840 PSD W9L120 MLO-PC PI
BBS41125W4KDLIN	910501964803	BBS411 LED24/840 PSD W9L120 LIN-PC PI
SMARTFORM LED - LIGHT BEAM		
BBS41525W4KDMLO	910501963803	BBS415 LED24/840 PSD W15L120 MLO-PC PI
BBS41525W4KDLIN	910501964003	BBS415 LED24/840 PSD W15L120 LIN-PC PI
BBS41547W4KDMLO	910501964203	BBS415 LED48/840 PSD W15L120 MLO-PC PI
BBS41547W4KDLIN	910501964403	BBS415 LED48/840 PSD W15L120 LIN-PC PI



## SmartBalance LED

SmartBalance is clearly the next step in surface-mounted and suspended luminaires for the specification market. It not only offers increased energy efficiency, but is also visually appealing without being intrusive. And its design helps to minimize clutter on the ceiling and meets all relevant office norms.



### Features and Benefits

- Perfect combination of innovative design and performance
- Energy efficacy of up to 90 lm/W
- Compact, lightweight and unobtrusive
- Office compliant - UGR 19 and two levels of L65, namely 1500/3000 cd/m<sup>2</sup>
- Aesthetical and novel design with visually better ceiling integration
- Wireless DALI-controllable and emergency lighting options available
- Direct and indirect lighting options available to create the right light levels for visual comfort and performance
- Connect up to 3 luminaires with coupling accessories

### SM480C

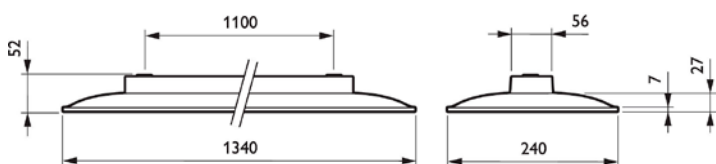

Product ID	L (mm)	W (mm)	H (mm)
SM480C	1340	240	52
SP480P/ SP482P	1340	240	50

Dimensions in mm (Nominal) (H – including driver)

### SP480P/SP482P

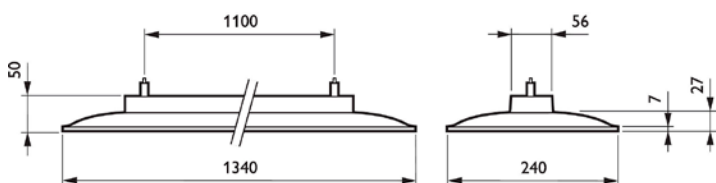





# SmartBalance LED continued

SMARTBALANCE LED		SMARTBALANCE LED	
Family name	SmartBalance	Driver	Integrated driver
Model	SM480C - Surface SP480P - Suspended SP482P - Direct/Indirect Suspended	Dimmable	Fixed output and DALI compatible
Lumen/Watt	ACC-MLO: 3500lm/ 40W AC/PC-MLO: 3000lm/ 41W Dir/Indir: 4050lm/ 48W	Installation	Surface and Suspended mounting
Correlated Colour Temperature (CCT)	3000K, 4000K	IP rating	IP40
Colour Rendering Index (CRI)	80	Weight	SM480C - 4.5kg SP480P - 4.65kg SP482P - 4.55kg
Flex and Plug	Not included	Colour of housing	White, Silver
Lifetime L70*	50,000hrs	Application	Retail, Hospitality, Offices, Schools
Unified Glare Ratio (UGR)	19	Accessories	Coupling pieces (SP480Z CP WH, SP480Z CP SI)
Optics	AC-MLO: OLC micro-lens optic made of acrylic cover ACC-MLO: OLC micro-lens optic made of clear acrylic cover PC-MLO: OLC micro-lens optic made of polycarbonate	Suspension Height - min/max	n/a
		Maximum Run Length	n/a

\* = When the fitting reaches 70% of full potential (new)

COMMERCIAL CODE	I2NC	DESCRIPTION
SMARTBALANCE LED - SURFACE MOUNTED		
SM480C41W3KDACC	910504084403	SM480C LED30S/830 PSD W24LI34 AC-MLO PI
SM480C41W3KDPC	910504084803	SM480C LED30S/830 PSD W24LI34 PC-MLO PI
SM480C40W4KDACC	910504084303	SM480C LED30S/840 PSD W24LI34 AC-MLO PI
SM480C40W4KDPC	910504084703	SM480C LED30S/840 PSD W24LI34 PC-MLO PI
SM480C41W3KDACC	910504084603	SM480C LED35S/830 PSD W24LI34 ACC-MLO PI
SM480C40W4KDACC	910504083603	SM480C LED35S/840 PSD W24LI34 ACC-MLO PI
SMARTBALANCE LED - SUSPENDED		
SP480P41W3KDACC	910504085003	SP480P LED30S/830 PSD W24LI34 AC-MLO SM2
SP480P40W4KDACC	910504084903	SP480P LED30S/840 PSD W24LI34 AC-MLO SM2
SP480P41W3KDACC	910504085203	SP480P LED35S/830 PSD ACC-MLO SM2 PI
SP480P40W4KDACC	910504083703	SP480P LED35S/840 PSD ACC-MLO SM2 PI
SP480P40W4KDPC	910504086303	SP480P LED30S/840 PSD W24LI34 PC-MLO SM2 PI SI
SMARTBALANCE LED - DIRECT/INDIRECT		
SP482P48W3KDACC	910504085403	SP482P LED40S/830 PSD W24LI34 AC-MLO SM2
SP482P48W4KDACC	910504085303	SP482P LED40S/840 PSD W24LI34 AC-MLO SM2
SP482P45W3KDACC	910504085603	SP482P LED40S/830 PSD ACC-MLO SM2 PI
SP482P43W4KDACC	910504083803	SP482P LED40S/840 PSD ACC-MLO SM2 PI
SP482P51W3KDPC	910504085803	SP482P LED40S/830 PSD W24LI34 PC-MLO SM2
SP482P49W4KDPC	910504085703	SP482P LED40S/840 PSD W24LI34 PC-MLO SM2
ACCESSORIES		
SP480ZCPWH	910403218203	SP480Z CP WH
SP480ZCPSI	910403218303	SP480Z CP SI



# Celino LED

Celino LED is a complete luminaire range that reflects the market trend towards miniaturisation and architectural integration, while delivering a significant advance in optical performance. Made of natural anodised aluminium, the housing of Celino LED is a mere 71mm wide and has die cast- aluminium end caps.



## Features and Benefits

- Compliance with latest office - lighting norm
- Complete luminaire range that reflects the trend to miniaturisation and architectural integration
- Excellent optical performance: optical covers for optimum visual comfort and efficiency
- Inspiring: aesthetical and novel design with visually better ceiling integration
- Comfort: spacious and pleasant environment with comfortable lighting appearance
- Efficient: high efficacy achieved with optics innovation

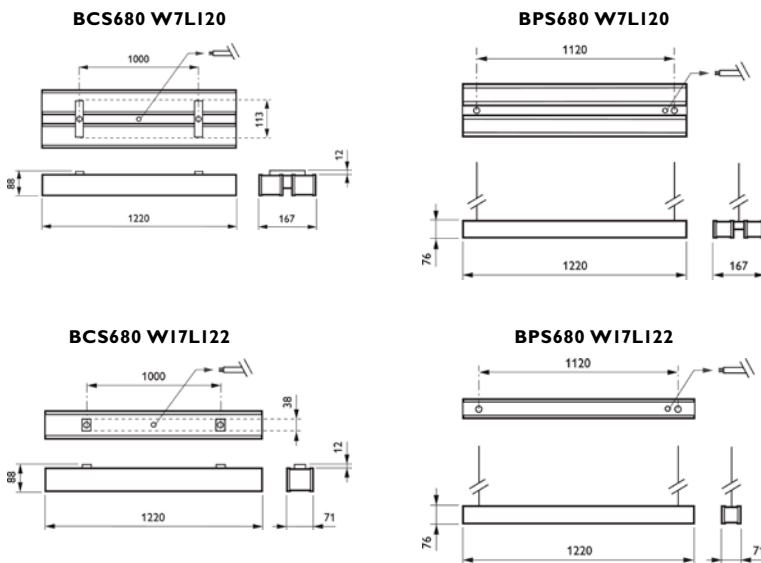

Product ID	L (mm)	W (mm)	H (mm)
BCS680 W7L120	1220	167	88
BPS680 W7L120	1220	167	76
BCS680 W17L122	1220	71	88
BPS680 W17L122	1220	71	76
Dimensions in mm (Nominal)			(H – including driver)



# Celino LED continued

CELINO LED			
Family name	Celino LED	Driver	Integrated driver
Model	BCS680 - Surface BPS680 - Suspended	Dimmable	Fixed output and DALI compatible
Lumen/Watt	LIN-PC: 2050lm/ 23W (3000K) LIN-PC: 2050lm/ 21.5W (4000K) LIN-PC: 4100lm/ 46W (3000K) LIN-PC: 4100lm/ 43W (4000K) MLO-PC: 1650lm/ 23W (3000K) MLO-PC: 1650lm/ 21.5W (4000K) MLO-PC: 3300lm/ 46W (3000K) MLO-PC: 3300lm/ 43W (4000K)	Installation	Surface and Suspended mounting
Correlated Colour Temperature (CCT)	3000K, 4000K	IP rating	IP40
Colour Rendering Index (CRI)	80	Weight	W7L120 - 4.2kg W17L120 -7.8kg
Flex and Plug	Not included	Colour of housing	Housing: natural anodised aluminium, End caps: die-cast aluminium
Lifetime L70*	50,000hrs	Application	Retail, Hospitality, Offices, Healthcare
Unified Glare Ratio (UGR)	19	Accessories	n/a
Optics	LIN-PC: OLC micro-lens optic in polycarbonate cover MLO-PC: OLC micro-lens optic in polycarbonate cover	Suspension Height - min/max	n/a
		Maximum Run Length	n/a

\* = When the fitting reaches 70% of full potential (new)

COMMERCIAL CODE	I2NC	DESCRIPTION
CELINO LED - SURFACE MOUNTED		
BSC68022W4KDMLO	910504074703	BCS680 LED24/840 PSD W7L122 MLO-PC
BSC68022W4KDLIN	910504074803	BCS680 LED24/840 PSD W7L122 LIN-PC
BSC68043W4KDMLO	910504074903	BCS680 LED48/840 PSD W17L122 MLO-PC
BSC68043W4KDLIN	910504075003	BCS680 LED48/840 PSD W17L122 LIN-PC
CELINO LED - SUSPENDED		
BPS68022W4KDMLO	910504075303	BPS680 LED24/840 PSD W7L122 MLO-PC SM2
BPS68022W4KDLIN	910504075403	BPS680 LED24/840 PSD W7L122 LIN-PC SM2
BSC68043W4KDMLO	910710101007	BPS680 LED48/840 PSD W17L122 MLO-PC SM2
BSC68043W4KDLIN	910710101001	BPS680 LED48/840 PSD W17L122 LIN-PC SM2
BPS68023W3KDMLO	910710101002	BPS680 LED24/830 PSD W7L122 MLO-PC SM2
BPS68023W3KDLIN	910710042296	BPS680 LED24/830 PSD W7L122 LIN-PC SM2





## LumiStone LED

LumiStone is a LED luminaire consisting of two smaller ellipses rather than the traditional single voluminous piece. The ellipses have soft curvatures and resemble smooth stones found in nature. The flexible light effects created with direct and indirect light make LumiStone the perfect choice for inspiring lighting designs. Thanks to its cutting edge LED technology, LumiStone is also highly energy efficient, delivering immediate savings on operational costs.



### Features and Benefits

- Inspiring design with elliptical modules
- Creates a truly inspiring environment with appealing design and indirect lighting
- Over 50% energy savings compared to a functional luminaire, and even more compared to decorative solutions
- Many variations thanks to innovative mounting options
- Choice of direct and direct/indirect lighting
- Office compliant for use in all office spaces

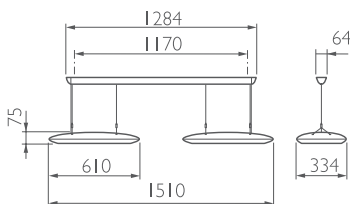

Product ID	L (mm)	W (mm)	H (mm)
SP524P/ SP526P	1510	334	75

Dimensions in mm (Nominal)

LumiStone LED continued

LUMISTONE LED			
Family name	LumiStone	Driver	Integrated driver
Model	SP524P - Direct SP526P - Direct/ Indirect	Dimmable	Fixed output and DALI compatible
Lumen/Watt	SP524P - Direct 4000lm/ 40W (3000K) 4000lm/ 38W (4000K) SP526P - Direct/ Indirect 3000lm/ 31W (3000K) 3000lm/ 29W (4000K)	Installation	Suspended mounting
Correlated Colour Temperature (CCT)	3000K, 4000K	IP rating	IP40
Colour Rendering Index (CRI)	80	Weight	SP524P - 6.15kg SP526P - 6.25kg
Flex and Plug	Not included	Colour of housing	White
Lifetime L70*	50,000hrs	Application	Retail, Hospitality, Offices
Unified Glare Ratio (UGR)	19	Accessories	Coupling pieces (SP480Z CP WH, SP480Z CP SI)
Optics	Poly-carbonate LED cup	Suspension Height - min/max	Between 20 and 150 cm from ceiling bar; cable stored in bar
		Maximum Run Length	n/a

\* = When the fitting reaches 70% of full potential (new)

COMMERCIAL CODE	I2NC	DESCRIPTION
LUMISTONE LED - DIRECT LIGHTING		
SP524P31W3KDWH	910504080403	SP524P 2xLED15S/830 PSD DCB WH
SP524P29W4KDWH	910504080603	SP524P 2xLED15S/840 PSD DCB WH
LUMISTONE LED - DIRECT/ INDIRECT LIGHTING		
SP524P40W3KDWH	910504080803	SP526P 2xLED20S/830 PSD DCB WH
SP524P38W4KDWH	910504081003	SP526P 2xLED20S/840 PSD DCB WH

# Sereno TBS 299

The TBS299 is a superior energy efficient solution that delivers excellent lighting performance and colour-rendering in any kind of interior application. With its sleek design and availability in 5 different lamp configurations, the TBS299 is the ideal recessed luminaire for all types of office spaces and public buildings.



## Features and Benefits

- Rippled louvre reflectors made from high quality pre-anodised aluminium
- External hinged connection device enables easy top installation without the need to detach louvres
- Patented BatWing profiled steel housing substantially enhances distribution uniformity
- Features a high frequency electronic ballast to ensure flicker-free start and low energy consumption
- Complete with flex and plug
- Package includes T5 4000K lamps
- UGR19 - Office norm compliant

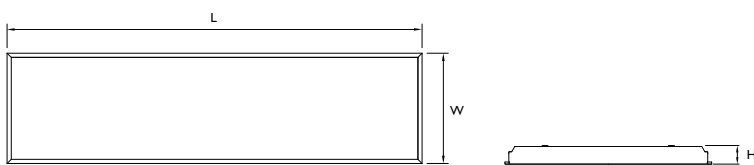

Product ID	L (mm)	W (mm)	H (mm)
TBS299/214	596	296	54
TBS299/314	596	596	54
TBS299/414	596	596	54
TBS299/228	1196	296	54
TBS299/328	1196	596	54

Dimensions in mm (Nominal)

TBS299		Louvre/Optics	Matt, ribbed cross louvres (M2)
Family name	TBS299	Gear/Ballast	HFP – High Frequency Performer
Lamp types	2 x 14W 3 x 14W 4 x 14W 2 x 28W 3 x 28W	Dimmable	Dali on request
Lamps included	Yes – Neutral White – 4000K	Installation	Recessed
Flex and Plug	Yes	Classification/IP rating	Class I, IP 20
Beam angle	n/a	Colour/Materials	Matt white - Post painted steel
Office compliant/UGR	Yes - UGR 19	Accessories	n/a

COMMERCIAL CODE	I2NC	DESCRIPTION
TBS299214W4KFM2	911401538201	TBS2992X14W840HFPM2W3
TBS299314W4KFM2	911401538301	TBS2993X14W840HFPM2W3
TBS299414W4KFM2	911401538401	TBS2994X14W840HFPM2W3
TBS299228W4KFM2	910403630654	TBS2992X28W840HFPM2W3
TBS299328W4KFM2	911401538501	TBS2993X28W840HFPM2W3

## Sereno TBS 528/869

The Philips TBS 528 and 869 are a range of recessed TL5 luminaires that feature superior optics with Philips patented 3 Dimensional Omni-directional Luminance Control (OLC). This feature provides excellent performance in terms of efficiency, uniformity and glare.

Dimming options available on request



### Main Applications:

- Conference rooms, Retail and department stores, Schools, Childcare services
- Service Areas (Restaurant, Cafes) Reception and public service areas
- General Office areas and corridors

### Choices of Optics:

- M8 for TBS528: Micro comfort optic, Matt finish, LOR up to 64%, UGR 16
- D8-H for TBS869: Micro high efficiency optic, Semi high gloss finish, LOR up to 86%, UGR 17

### Main Features:

- Quick external connection without having to remove louvres
- Easy replacement of lamps, only have to remove 1 reflector
- Ultra Flat only 47mm deep
- Perforated infill panel
- Complete with flex & plug
- T5 4000K lamps included

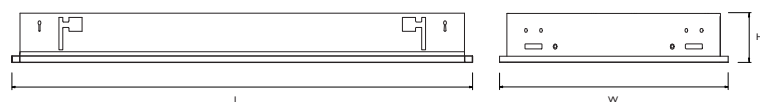

Product ID	L (mm)	W (mm)	H (mm)
2 x TL5-14W	595	295	47
3 x TL5-14W	595	595	47
4 x TL5-14W	595	595	47
2 x TL5-28W	1195	295	47
3 x TL5-28W	1195	595	47

Dimensions in mm (Nominal)



## Sereno TBS 528/869 continued

TBS528					
Family name	TBS528 TBS869		Louvre/Optics	TBS528 – Micro Comfort Optic – Matt Finish TBS869 – Micro high efficiency optic – Semi high gloss finish	
Lamp types	2 x 14W 3 x 14W 4 x 14W	2 x 28W 3 x 28W	Gear/Ballast	HFP – High Frequency Performer	
Lamps included	Yes – Neutral White 4000K			Dimmable	Dali on request
Flex and Plug	Yes			Installation	Recessed
Beam angle	n/a			Classification/IP rating	IP20
Office compliant/UGR	Yes – TBS528 – UGR16 Yes – TBS869 – UGR17		Colour/Materials	Housing: Post painted sheet steel in white	
			Accessories	n/a	

COMMERCIAL CODE	I2NC	DESCRIPTION
TBS 528		
TBS528214W4KFM8	910403390501	TBS5282X14W840HFPM8W3
TBS528228W4KFM8	910403390301	TBS5282X28W840HFPM8W3
TBS 869		
TBS8693144KFD8H	910403391901	TBS8693X14W840HFPD8HW3
TBS8694144KFD8H	911400699780	TBS8694X14W840HFPD8HW3
TBS8691284KFD8H	910403630652	TBS8691X28W840HFPD8HW3
TBS8692284KFD8H	911400699880	TBS8692X28W840HFPD8HW3
TBS869128WDD8H	910403630653	TBS8691X28WHFDD8HW3

## Modella TCS I25

Modella TCSI25 is a luminaire for TL-D and TL5 linear fluorescent lamps with an attractive design to suit all interiors. It comes with a choice of smooth, easy-to-clean opal or prismatic covers. The covers can be suspended from the end caps to allow easy lamp replacement without the need for any tools.



### Features and Benefits

- Luminaire for TL-D and TL5 fluorescent lamps with an attractive design that blends in perfectly with all interiors
- Choice of smooth, easy-to-clean opal or prismatic covers
- Covers can be suspended from the end caps for easy lamp replacement with no need to use any tools
- TL5 4000K lamps included
- Choice of opal or prismatic covers
- Tool-less lamp replacement
- Suitable for: Offices, Retail, Hospitality and Industry

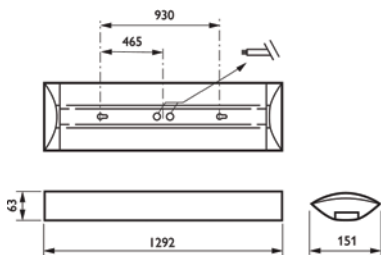

Product ID	L (mm)	W – fitting (mm)	W – mounting bracket (mm)
TCSI25	1292	151	63

Dimensions in mm (Nominal)

MODELLA			
Family name	TCSI25	Gear/Ballast	Integrated
Lamp types	2x28W 2x54W	Dimmable	n/a
Lamps included	Yes – Neutral White 4000K	Installation	Individual; screw ceiling mounting
Flex and Plug	n/a	Classification/IP rating	IP20
Beam angle	n/a	Colour/Materials	Housing: powder painted steel, white End Caps: plastic, white Cover: opal or prismatic, internally ribbed
Office compliant/UGR	n/a	Accessories	n/a
Louvre/Optics	Opal cover Prismatic cover		

COMMERCIAL CODE	I2NC	DESCRIPTION
TCSI252X28W4KO	910402425612	TCSI25 2Xtl5-28W/840 HFP Opal diffuser
TCSI252X28W4KP	910402425712	TCSI25 2Xtl5-28W/840 HFP Prismatic diffuser
TCSI252X54W4KO	910402435312	TCSI25 2Xtl5-54W/840 HFP Opal diffuser
TCSI252X54W4KP	910402435412	TCSI25 2Xtl5-54W/840 HFP Prismatic diffuser



## LuxSpace Gen III

Our highly energy-efficient LuxSpace family has now received a major upgrade, in the form of an improved system efficacy. The extremely low power consumption of this LED solution results in significant energy savings compared with traditional CFL downlights. There is also a range of different sizes and outputs, and an array of different accessories, ensuring maximum flexibility in customising the right light effect for your application. Best of all, this family of luminaires delivers specification grade performance, including a DALI dimming system, IP54 ingress protection (front part) and better glare control than ever before. These innovative downlights are ideal for applications in offices, shops, hotels and hospitals where an energy efficient general lighting solution is needed.



### Features and Benefits

- Features the latest LED technology to deliver high system efficacy, resulting in up to 80% energy savings compared with conventional CFL downlights.
- Realises specification grade standards in visual comfort, performance and consistent colour rendering:
  - Better colour rendering: CRI80;
  - Better colour consistency.
- Provides more flexibility with a full range and different accessories.
- Compact curved design gives the luminaire a professional look.

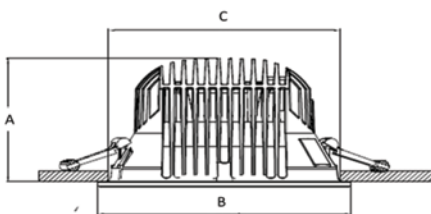

Product ID	A (mm)	B (mm)	C (mm)
Micro - DN478	71	ø137	ø125
Mini - DN488/ DN489	88.5	ø163	ø150
Compact - DN486/ DN487	88.5	ø163	ø150
Compact Power - DN498/ DN499	119.5	ø218.3	ø200

Dimensions in mm (Nominal)

### LUXSPACE GEN III

Family name	LuxSpace Gen III	Correlated Colour Temperature (CCT)	3000K, 4000K
Model	<b>UGR 22 Range</b> Micro - DN478 Mini - DN488 Compact - DN486 Compact Power - DN498 <b>UGR 19 Range</b> Mini - DN489 Compact - DN487 Compact Power - DN499	Colour Rendering Index (CRI)	80
Lumen/ Watt	<b>3000K</b> Micro - 8.5W/ 600lm Mini - 12W/ 960lm Compact - 18W/ 1450lm Compact Power -23W/ 1900lm <b>4000K</b> Micro - 8.5W/ 640lm Mini - 12W/ 1000lm Compact - 18W/ 1500lm Compact Power -23W/ 2000lm	Flex and Plug	Yes
		Lifetime L70*	50,000hrs
		Unified Glare Ratio (UGR)	19, 22
		Driver	External DALI driver

\* = When the fitting reaches 70% of full potential (new)



## LuxSpace Gen III continued

COMMERCIAL CODE	I2NC	DESCRIPTION
LUXSPACE 3 MICRO RECESSED DOWNLIGHT, UGR22		
DN4789W3KDWHG	911401800099	DN478 1xDLED-3000 PSD-E C WH CAU
DN4789W3KDWHM	911401800399	DN478 1xDLED-3000 PSD-E M WH CAU
DN4789W4KDWHG	911401800199	DN478 1xDLED-4000 PSD-E C WH CAU
DN4789W4KDWHM	911401800299	DN478 1xDLED-4000 PSD-E M WH CAU
LUXSPACE 3 MINI RECESSED DOWNLIGHT, UGR19		
DN48912W3KDWHG	911401801299	DN489 1xDLED-3000 PSD-E C WH CAU
DN48912W3KDWHM	911401801099	DN489 1xDLED-3000 PSD-E M WH CAU
DN48912W4KDWHG	911401801199	DN489 1xDLED-4000 PSD-E C WH CAU
DN48912W4KDWHM	911401801399	DN489 1xDLED-4000 PSD-E M WH CAU
LUXSPACE 3 MINI RECESSED DOWNLIGHT, UGR22		
DN48812W3KDWHG	911401800999	DN488 1xDLED-3000 PSD-E C WH CAU
DN48812W3KDWHM	911401800599	DN488 1xDLED-3000 PSD-E M WH CAU
DN48812W4KDWHG	911401800499	DN488 1xDLED-4000 PSD-E C WH CAU
DN48812W4KDWHM	911401800799	DN488 1xDLED-4000 PSD-E M WH CAU
LUXSPACE 3 COMPACT RECESSED DOWNLIGHT, UGR19		
DN48718W3KDWHG	911401802599	DN487 1xDLED-3000 PSD-E C WH CAU
DN48718W3KDWHM	911401802299	DN487 1xDLED-3000 PSD-E M WH CAU
DN48718W4KDWHG	911401802399	DN487 1xDLED-4000 PSD-E C WH CAU
DN48718W4KDWHM	911401802499	DN487 1xDLED-4000 PSD-E M WH CAU
LUXSPACE 3 COMPACT RECESSED DOWNLIGHT, UGR22		
DN48618W3KDWHG	911401801999	DN486 1xDLED-3000 PSD-E C WH CAU
DN48618W3KDWHM	911401802099	DN486 1xDLED-3000 PSD-E M WH CAU
DN48618W4KDWHG	911401801899	DN486 1xDLED-4000 PSD-E C WH CAU
DN48618W4KDWHM	911401802199	DN486 1xDLED-4000 PSD-E M WH CAU
LUXSPACE 3 COMPACT POWER RECESSED DOWNLIGHT, UGR19		
DN49923W3KDWHG	911401801599	DN499 1xDLED-3000 PSD-E C WH CAU
DN49918W3KDWHM	911401801799	DN499 1xDLED-3000 PSD-E M WH CAU
DN49918W4KDWHG	911401801699	DN499 1xDLED-4000 PSD-E C WH CAU
DN49918W4KDWHM	911401801499	DN499 1xDLED-4000 PSD-E M WH CAU
LUXSPACE 3 COMPACT POWER RECESSED DOWNLIGHT, UGR22		
DN49823W3KDWHG	911401802899	DN498 1xDLED-3000 PSD-E C WH CAU
DN49823W3KDWHM	911401802999	DN498 1xDLED-3000 PSD-E M WH CAU
DN49823W4KDWHG	911401802699	DN498 1xDLED-4000 PSD-E C WH CAU
DN49823W4KDWHM	911401802799	DN498 1xDLED-4000 PSD-E M WH CAU



## LuxSpace Gen III - Accessories



Drop glass frosted middle  
SG-FRC



Embedded frosted middle  
GF-HR



Drop glass mattel bezel  
SG-HR-FR



White adaptor ring  
CFRM WH



Drop glass opal finish  
SG-O



Grey adaptor ring  
CFRM GR



Embedded frosted glass  
GF



## LuxSpace Gen III - IP54

Our highly energy-efficient LuxSpace family has now received a major upgrade, in the form of an improved system efficacy. The extremely low power consumption of this LED solution results in significant energy savings compared with traditional CFL downlights. There is also a range of different sizes and outputs, and an array of different accessories, ensuring maximum flexibility in customising the right light effect for your application. Best of all, this family of luminaires delivers specification grade performance, including a DALI dimming system, IP54 ingress protection (front part) and better glare control than ever before. These innovative downlights are ideal for applications in offices, shops, hotels and hospitals where an energy efficient general lighting solution is needed.



### Features and Benefits

- Features the latest LED technology to deliver high system efficacy, resulting in up to 80% energy savings compared with conventional CFL downlights.
- Realises specification grade standards in visual comfort, performance and consistent colour rendering:
  - Better colour rendering: CRI80;
  - Better colour consistency.
- Provides more flexibility with a full range and different accessories.
- Compact curved design gives the luminaire a professional look.

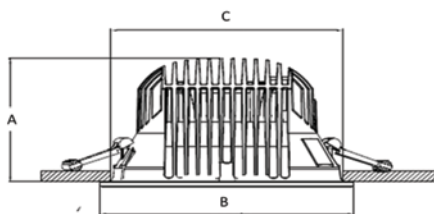

Product ID	A (mm)	B (mm)	C (mm)
Micro - DN478 PG	71	ø137	ø125
Mini - DN488 PG	88.5	ø163	ø150
Compact Power - DN498 PG	119.5	ø218.3	ø200

Dimensions in mm (Nominal)



## LuxSpace Gen III - IP54 continued

LUXSPACE GEN III - IP54			
Family name	LuxSpace Gen III - IP54	Unified Glare Ratio (UGR)	22
Model	Micro - DN478 PG Mini - DN488 PG Compact Power - DN498 PG	Driver	External Fixed driver
Lumen/ Watt	<b>3000K</b> Micro - 7W/ 600lm Mini - 10W/ 960lm Compact Power -20W/ 1900lm <b>4000K</b> Micro - 7W/ 640lm Mini - 10W/ 1000lm Compact Power -20W/ 2000lm	Dimmable	No, fixed output only
Correlated Colour Temperature (CCT)	3000K, 4000K	Installation	Recessed mounting with flexible spring clips
Colour Rendering Index (CRI)	80	IP rating	IP54 (front cover only)
Flex and Plug	Yes	Colour of housing	White
Lifetime L70*	50,000hrs	Application	Retail, Hospitality, Offices
		Accessories	Adaptor ring (White/Grey)
		Reflector	Glossy
		Suspension Height - min/max	n/a
		Maximum Run Length	n/a

\* = When the fitting reaches 70% of full potential (new)

COMMERCIAL CODE	I2NC	DESCRIPTION
LUXSPACE 3 MICRO RECESSED IP54 DOWNLIGHT		
DN4787W3KDWHGP	911401803299	DN478 1xDLED-3000 PSU-E C WH PG CAU
DN4787W4KDWHGP	911401803399	DN478 1xDLED-4000 PSU-E C WH PG CAU
LUXSPACE 3 MINI RECESSED IP54 DOWNLIGHT		
DN48810W3KDWHGP	911401803499	DN488 1xDLED-3000 PSU-E C WH PG CAU
DN48810W4KDWHGP	911401803599	DN488 1xDLED-4000 PSU-E C WH PG CAU
LUXSPACE 3 COMPACT POWER RECESSED IP54 DOWNLIGHT		
DN49820W3KDWHGP	911401803699	DN498 1xDLED-3000 PSU-E C WH PG CAU
DN49820W4KDWHGP	911401803799	DN498 1xDLED-4000 PSU-E C WH PG CAU



## LuxSpace Gen III Wall-wash

Our highly energy-efficient LuxSpace family has now received a major upgrade, in the form of an improved system efficacy. The extremely low power consumption of this LED solution results in significant energy savings compared with traditional CFL downlights. There is also a range of different sizes and outputs, and an array of different accessories, ensuring maximum flexibility in customising the right light effect for your application. Best of all, this family of luminaires delivers specification grade performance, including a DALI dimming system, IP54 ingress protection (front part) and better glare control than ever before. These innovative downlights are ideal for applications in offices, shops, hotels and hospitals where an energy efficient general lighting solution is needed.



### Features and Benefits

- Features the latest LED technology to deliver high system efficacy, resulting in up to 80% energy savings compared with conventional CFL downlights.
- Realises specification grade standards in visual comfort, performance and consistent colour rendering:
  - Better colour rendering: CRI80;
  - Better colour consistency.
- Provides more flexibility with a full range and different accessories.
- Compact curved design gives the luminaire a professional look.

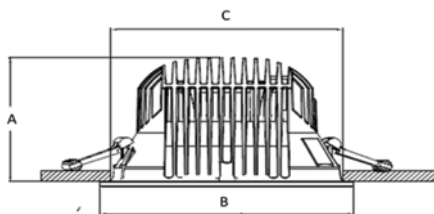

Product ID	A (mm)	B (mm)	C (mm)
Mini - DN488 M-A	88.5	ø163	ø150
Compact Power - DN498 M-A	119.5	ø218.3	ø200

Dimensions in mm (Nominal)





## LuxSpace Gen III Wall-wash continued

### LUXSPACE GEN III WALL-WASH

Family name	LuxSpace Gen III Wall-wash	Driver	External DALI driver
Model	Mini - DN488 M-A Compact Power - DN498 M-A	Dimmable	DALI Compatible
Lumen/ Watt	<b>3000K</b> Mini - 12W/ 960lm Compact Power -23W/ 1900lm <b>4000K</b> Mini - 12W/ 1000lm Compact Power -23W/ 2000lm	Installation	Recessed mounting with flexible spring clips
Correlated Colour Temperature (CCT)	3000K, 4000K	IP rating	IP20
Colour Rendering Index (CRI)	80	Colour of housing	White
Flex and Plug	Yes	Application	Retail, Hospitality, Offices
Lifetime L70*	50,000hrs	Accessories	Adaptor ring (White/Grey)
Unified Glare Ratio (UGR)	22	Reflector	Matt
		Suspension Height - min/max	n/a
		Maximum Run Length	n/a

\* = When the fitting reaches 70% of full potential (new)

COMMERCIAL CODE	I2NC	DESCRIPTION
LUXSPACE 3 MINI RECESSED WALL-WASH DOWNLIGHT		
DN48812W3KDWBMW	911401800899	DN488 1xDLED-3000 PSD-E M-A WH CAU
DN48812W4KDWBMW	911401800699	DN488 1xDLED-4000 PSD-E M-A WH CAU
LUXSPACE 3 COMPACT POWER RECESSED WALL-WASH DOWNLIGHT		
DN49823W3KDWBMW	911401803099	DN498 1xDLED-3000 PSD-E M-A WH CAU
DN49823W4KDWBMW	911401803199	DN498 1xDLED-4000 PSD-E M-A WH CAU



## LuxSpace Gen II - Surface Mounted

LuxSpace Surface-mounted is designed for general lighting applications in offices and retail outlets. It features the latest LED technology, resulting in low power consumption compared to a typical CFL downlight, and delivers consistent light output, stable colour performance and high colour rendering. It is available in Mini and Compact versions. All offer a compact look and feel, and a perfect fit. They are very easy to install, and their long lifetime means an end to the hassle of relamping.



### Features and Benefits

- Glare control (reflector optic)
- Good colour consistency and high colour rendering; extra sparkle
- Extremely long lifetime: more than five times longer than CFL lamps

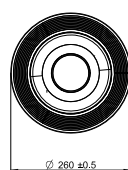
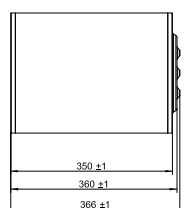
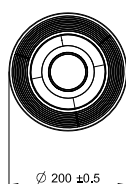
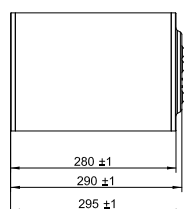

Product ID	Height (mm)	Cutout (mm)
Mini - BCS488	295	200
Compact - BCS498	366	260

Dimensions in mm (Nominal)



# LuxSpace Gen II - Surface Mounted continued

## LUXSPACE GEN II - SURFACE MOUNTED

Family Name	LuxSpace Gen II - Surface Mounted	Unified Glare Ratio (UGR)	22
Model	Mini - BCS488 Compact - BCS498	Driver	External Fixed or DALI driver
Lumen/ Watt	<b>3000K</b> Mini - 1000lm/ 13W Compact - 2000lm/ 27W <b>4000K</b> Mini - 1100lm/ 13W Compact - 2200lm/ 27W	Dimmable	Yes, DALI compatible dimming
Correlated Colour Temperature (CCT)	3000K, 4000K	Installation	Surface mounted
Colour Rendering Index (CRI)	80	IP rating	IP20
Flex and Plug	No	Colour of housing	White
Lifetime L70*	50,000 hrs	Application	Retail, Hospitality, Offices
		Accessories	N/A
		Reflector	Glossy
		Suspension Height - min/max	N/A
		Maximum Run Length	N/A

\* = When the fitting reaches 70% of full potential (new)

COMMERCIAL CODE	I2NC	DESCRIPTION
LUXSPACE MINI SURFACE MOUNTED DOWNLIGHT		
BCS48813W3KDWHG	911401535701	BCS488 C 1xDLED-3000 PSD-E C WH
BCS48813W4KDWHG	911401535001	BCS488 C 1xDLED-4000 PSD-E C WH
LUXSPACE COMPACT SURFACE MOUNTED DOWNLIGHT		
BCS49827W3KDWHG	911401535301	BCS498 C 1xDLED-3000 PSD-E C WH
BCS49827W4KDWHG	911401535401	BCS498 C 1xDLED-4000 PSD-E C WH



## GreenAccent Gen II

The new GreenAccent LED accent luminaire has a refined finish, and the 4 different mounting options make it possible to address an environment's accent lighting needs while retaining the same visual concept. With optimized service life in the segment and high energy efficiency, it allows the replacement of traditional metal vapour lamp systems with high quality lighting and faithful colour rendering.



### Features and Benefits

- Professional optical design to ensure beam quality and outstanding 'PUNCH' effect
- Constant colour consistency and colour homogeneity over the lifetime
- Equivalent to 35W, 70W CDM solution, energy saving up to 35%
- Optimized heat sink design, enabling 40k hrs long lifetime
- Multiple types to choose from, creating ideal shop lighting environments

RS280B

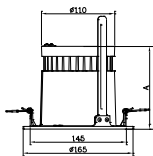

RS281B

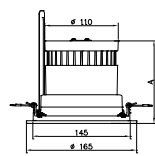

ST281C

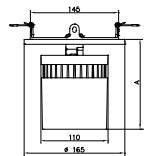

ST281T

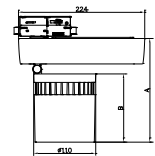

Product ID	Depth (mm)	Width (mm)	Cutout (mm)
RS280B 26.5W	125	145	ø165
RS280B 54W	120	145	ø165
RS281B 26.5W	125	145	ø165
RS281B 54W	120	145	ø165
ST281C 26.5W	147	110	ø165
ST281C 54W	142	110	ø165
ST281T 26.5W	184	110	ø110
ST281T 54W	179	110	ø110

Dimensions in mm (Nominal)

### GREENACCENT GEN II

Family Name	GreenAccent Gen II	Driver	External driver
Model	RS280B - Recessed Fixed RS281B - Recessed Adjustable ST281C - Semi-recessed ST281T - Track	Dimmable	Fixed output (Dali dimming available on request)
Lumen/ Watt	1750lm/ 26.5W (3000K) 1900lm/ 26.5W (4000K) 3700lm/ 54W (3000K) 3900lm/ 54W (4000K)	Installation	Recessed fixed, Recessed adjustable, Semi-Recessed, Track
Correlated Colour Temperature (CCT)	3000K, 4000K	IP rating	IP20
Colour Rendering Index (CRI)	80	Weight	RS280B/ RS281B - 1.2kg ST281C/ ST281T - 1.1kg
Flex and Plug	Not included (available on request)	Colour of housing	Recessed fixed/ Recessed adjustable - White only Semi-recessed/ Track - White, Black
Lifetime L70*	40,000hrs	Application	Retail, Hospitality, Offices
Unified Glare Ratio (UGR)	11 - 15	Accessories	Smart Tracks
Optics	Vacuum aluminium plating on PC reflector, 54W version - anti-reflection coating glass applied	Suspension Height - min/max	NA
		Maximum Run Length	NA

\* = When the fitting reaches 70% of full potential (new)





## GreenAccent Gen II continued

COMMERCIAL CODE	I2NC	DESCRIPTION
GREENACCENT II LED20 SEMI-RECESSED		
ST28IC27W3KFWHM	911401700062	ST28IC LED20/830 PSU-E MB WH
ST28IC27W3KFWHW	911401700072	ST28IC LED20/830 PSU-E WB WH
ST28IC27W3KFWHN	911401700052	ST28IC LED20/830 PSU-E NB WH
ST28IC27W3KFBKM	911401700122	ST28IC LED20/830 PSU-E MB BK
ST28IC27W3KFBKW	911401700132	ST28IC LED20/830 PSU-E WB BK
ST28IC27W3KFBKN	911401700112	ST28IC LED20/830 PSU-E NB BK
ST28IC27W4KFWHM	911401700092	ST28IC LED20/840 PSU-E MB WH
ST28IC27W4KFWHW	911401700102	ST28IC LED20/840 PSU-E WB WH
ST28IC27W4KFWHN	911401700082	ST28IC LED20/840 PSU-E NB WH
ST28IC27W4KFBKW	911401700162	ST28IC LED20/840 PSU-E WB BK
ST28IC27W4KFBKM	911401700152	ST28IC LED20/840 PSU-E MB BK
ST28IC27W4KFBKN	911401700142	ST28IC LED20/840 PSU-E NB BK
GREENACCENT II LED40 SEMI-RECESSED		
ST28IC54W3KFBKW	911401700532	ST28IC LED40/830 PSU-E WB BK
ST28IC54W3KFBKM	911401700522	ST28IC LED40/830 PSU-E MB BK
ST28IC54W3KFBKN	911401700472	ST28IC LED40/830 PSU-E NB BK
ST28IC54W3KFWHW	911401700452	ST28IC LED40/830 PSU-E WB WH
ST28IC54W3KFWHM	911401700442	ST28IC LED40/830 PSU-E MB WH
ST28IC54W3KFWHN	911401700412	ST28IC LED40/830 PSU-E NB WH
ST28IC54W4KFBKW	911401700512	ST28IC LED40/840 PSU-E WB BK
ST28IC54W4KFBKM	911401700492	ST28IC LED40/840 PSU-E MB BK
ST28IC54W4KFBKN	911401700502	ST28IC LED40/840 PSU-E NB BK
ST28IC54W4KFWHW	911401700422	ST28IC LED40/840 PSU-E WB WH
ST28IC54W4KFWHM	911401700462	ST28IC LED40/840 PSU-E MB WH
ST28IC54W4KFWHN	911401700432	ST28IC LED40/840 PSU-E NB WH
GREENACCENT II LED20 RECESSED FIXED		
RC280B27W3KFWHM	911401799601	RS280B LED20/830 PSU-E MB WH
RC280B27W3KFWHW	911401799701	RS280B LED20/830 PSU-E WB WH
RC280B27W3KFWHN	911401799501	RS280B LED20/830 PSU-E NB WH
RC280B27W4KFWHW	911401535311	RS280B LED20/840 PSU-E WB WH
RC280B27W4KFWHM	911401799901	RS280B LED20/840 PSU-E MB WH
RC280B27W4KFWHN	911401799801	RS280B LED20/840 PSU-E NB WH
GREENACCENT II LED40 RECESSED FIXED		
RC280B54W3KFWHM	911401700302	RS280B LED40/830 PSU-E MB WH
RC280B54W3KFWHW	911401700332	RS280B LED40/830 PSU-E WB WH
RC280B54W3KFWHN	911401700292	RS280B LED40/830 PSU-E NB WH
RC280B54W4KFWHW	911401700342	RS280B LED40/840 PSU-E WB WH
RC280B54W4KFWHM	911401700322	RS280B LED40/840 PSU-E MB WH
RC280B54W4KFWHN	911401700312	RS280B LED40/840 PSU-E NB WH



## GreenAccent Gen II continued

COMMERCIAL CODE	I2NC	DESCRIPTION
GREENACCENT II LED20 RECESSED ADJUSTABLE		
RC281B27W3KFWHM	911401799401	RS281B LED20/830 PSU-E MB WH
RC281B27W3KFWHW	911401700012	RS281B LED20/830 PSU-E WB WH
RC281B27W3KFWHN	911401700002	RS281B LED20/830 PSU-E NB WH
RC281B27W4KFWHM	911401700032	RS281B LED20/840 PSU-E MB WH
RC281B27W4KFWHW	911401700042	RS281B LED20/840 PSU-E WB WH
RC281B27W4KFWHN	911401700022	RS281B LED20/840 PSU-E NB WH
GREENACCENT II LED40 RECESSED ADJUSTABLE		
RC281B54W3KFWHW	911401700392	RS281B LED40/830 PSU-E WB WH
RC281B54W3KFWHM	911401700382	RS281B LED40/830 PSU-E MB WH
RC281B54W3KFWHN	911401700352	RS281B LED40/830 PSU-E NB WH
RC281B54W4KFWHW	911401700372	RS281B LED40/840 PSU-E WB WH
RC281B54W4KFWHM	911401700362	RS281B LED40/840 PSU-E MB WH
RC281B54W4KFWHN	911401700402	RS281B LED40/840 PSU-E NB WH
GREENACCENT II LED20 TRACK		
ST281T27W3KFWHM	911401700182	ST281T LED20/830 PSU-E MB IC WH
ST281T27W3KFWHW	911401700192	ST281T LED20/830 PSU-E WB IC WH
ST281T27W3KFWHN	911401700172	ST281T LED20/830 PSU-E NB IC WH
ST281T27W3KFBKM	911401700232	ST281T LED20/830 PSU-E MB IC BK
ST281T27W3KFBKW	911401700242	ST281T LED20/830 PSU-E WB IC BK
ST281T27W3KFBKN	911401700252	ST281T LED20/830 PSU-E NB IC BK
ST281T27W4KFWHW	911401700212	ST281T LED20/840 PSU-E WB IC WH
ST281T27W4KFWHM	911401700222	ST281T LED20/840 PSU-E MB IC WH
ST281T27W4KFWHN	911401700202	ST281T LED20/840 PSU-E NB IC WH
ST281T27W4KFBKW	911401700262	ST281T LED20/840 PSU-E WB IC BK
ST281T27W4KFBKM	911401700282	ST281T LED20/840 PSU-E MB IC BK
ST281T27W4KFBKN	911401700272	ST281T LED20/840 PSU-E NB IC BK
GREENACCENT II LED40 TRACK		
ST281T54W3KFBKM	911401700642	ST281T LED40/830 PSU-E MB IC BK
ST281T54W3KFBKW	911401700602	ST281T LED40/830 PSU-E WB IC BK
ST281T54W3KFBKN	911401700592	ST281T LED40/830 PSU-E NB IC BK
ST281T54W3KFWHM	911401700552	ST281T LED40/830 PSU-E MB IC WH
ST281T54W3KFWHW	911401700542	ST281T LED40/830 PSU-E WB IC WH
ST281T54W3KFWHN	911401700482	ST281T LED40/830 PSU-E NB IC WH
ST281T54W4KFBKM	911401700622	ST281T LED40/840 PSU-E MB IC BK
ST281T54W4KFBKW	911401700612	ST281T LED40/840 PSU-E WB IC BK
ST281T54W4KFBKN	911401700632	ST281T LED40/840 PSU-E NB IC BK
ST281T54W4KFWHM	911401700562	ST281T LED40/840 PSU-E MB IC WH
ST281T54W4KFWHW	911401700572	ST281T LED40/840 PSU-E WB IC WH
ST281T54W4KFWHN	911401700582	ST281T LED40/840 PSU-E NB IC WH



## GreenAccent Gen II continued

COMMERCIAL CODE	I2NC	DESCRIPTION
TRACK ACCESSORIES		
RCSI70IMBK	911400893780	RCSI70 3C LI000 BK
RCSI70IMGR	911400893880	RCSI70 3C LI000 GR
RCSI70IMWH	911400893980	RCSI70 3C LI000 WH
RCSI702MBK	911400894080	RCSI70 3C L2000 BK
RCSI702MGR	911400894180	RCSI70 3C L2000 GR
RCSI702MWH	911400894280	RCSI70 3C L2000 WH
ZCSI70ICPBK	911400894380	ZCSI70 3C ICP BK
ZCSI70ICPGR	911400894480	ZCSI70 3C ICP GR
ZCSI70ICPWH	911400894580	ZCSI70 3C ICP WH
ZCSI70LCPBK	911400894680	ZCSI70 3C LCP BK
ZCSI70LCPGR	911400894780	ZCSI70 3C LCP GR
ZCSI70LCPWH	911400894880	ZCSI70 3C LCP WH
ZCSI70TCPBK	911400894980	ZCSI70 3C TCP BK
ZCSI70TCPGR	911400895080	ZCSI70 3C TCP GR
ZCSI70TCPWH	911400895180	ZCSI70 3C TCP WH



## GreenSpace Gen III

GreenSpace is an optimised LED downlight. Featuring a simple yet robust integrated design and high system efficacy, it offers customers a sustainable solution with a return on investment within one to three years. It conforms to general lighting norms for offices, shops and other indoor applications. GreenSpace also offers very good colour rendering, while a diffuser cover ensures superior uniformity and glare control. Its long lifetime makes it a true 'fit and forget' solution. This optimised downlight can be used in environments requiring a 'green' general lighting solution, for instance offices, shops, hotels and hospitals.



### Features and Benefits

- Light efficacy of up to 93lm/w
- Uniform and diffused lighting effect
- Improved PMMA material; higher diffusion rate
- Superior heat sink design
- Superior solution for retrofitting
- Long lifetime: 50,000 hours

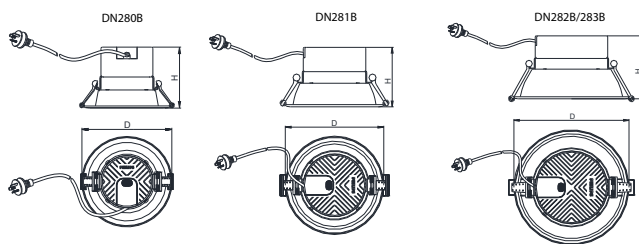

Product ID	Depth (mm)	Height (mm)	Cutout (mm)
DN280B (White)	139	96	ø105 - 110
DN280B (Aluminium)	121	94	ø105 - 110
DN281B (White)	187	103	ø150 - 155
DN281B (Aluminium)	170	103	ø150 - 155
DN282B/ DN283B (White/ Aluminium)	234	117	ø200 - 205
DN280Z Adaptor Ring (White)	138		
DN281Z Adaptor Ring (White)	185		
DN282Z/ DN283Z Adaptor Ring (White)	249		

Dimensions in mm (Nominal)

GREENSPACE GEN III			
Family Name	GreenSpace Gen III	Lifetime L70*	50,000hrs
Model	DN280B - Micro DN281B - Mini DN282B - Compact DN283B - Compact Power	Unified Glare Ratio (UGR)	≥23-25
Lumen/ Watt	<b>R-Series (White)</b> DN280B - 600lm/ 7W DN281B - 1050lm/ 11.6W DN282B - 1550lm/ 17.4W DN283B - 2100lm/ 23W <b>O-Series (Aluminium)</b> DN280B ALU - 600lm/ 7W DN281B ALU PR - 550lm/ 6W DN281B ALU - 1000lm/ 11.6W DN282B ALU - 1500lm/ 17.4W DN283B ALU - 2000lm/ 23W	Dimmable	Non-dimmable. Fixed output only.
Correlated Colour Temperature (CCT)	3000K, 4000K	Installation	Recessed mounting with flexible spring clips
Colour Rendering Index (CRI)	83	IP rating	IP20
Flex and Plug	Yes	Weight	DN280B - 0.18kg DN281B - 0.28kg DN282B/ DN283B - 0.38kg
Optics	MCPET high reflective film, anti fog, high permeable diffusion sheet	Colour of housing	White, Aluminium
Driver	Integrated driver	Application	Retail, Hospitality, Offices
		Accessories	Adaptor rings
		Suspension Height - min/max	NA
		Maximum Run Length	NA

\* = When the fitting reaches 70% of full potential (new)



## GreenSpace Gen III continued

COMMERCIAL CODE	I2NC	DESCRIPTION
GREENSPACE III MICRO DOWNLIGHT WHITE		
DN280B7W3KFWH	911401575811	DN280B 1xDLED-3000 PSU WH CAU
DN280B7W4KFWH	911401575911	DN280B 1xDLED-4000 PSU WH CAU
GREENSPACE III MINI DOWNLIGHT WHITE		
DN281B12W3KFWH	911401576011	DN281B 1xDLED-3000 PSU WH CAU
DN281B12W4KFWH	911401576111	DN281B 1xDLED-4000 PSU WH CAU
GREENSPACE III COMPACT DOWNLIGHT WHITE		
DN282B17W3KFWH	911401576411	DN282B 1xDLED-3000 PSU WH CAU
DN282B17W4KFWH	911401576511	DN282B 1xDLED-4000 PSU WH CAU
GREENSPACE III COMPACT POWER DOWNLIGHT WHITE		
DN283B23W3KFWH	911401576611	DN283B 1xDLED-3000 PSU WH CAU
DN283B23W4KFWH	911401576711	DN283B 1xDLED-4000 PSU WH CAU
GREENSPACE III MICRO DOWNLIGHT ALUMINIUM		
DN280B7W3KFALU	911401577211	DN280B 1xDLED-3000 PSU ALU G CAU
DN280B7W4KFALU	911401577311	DN280B 1xDLED-4000 PSU ALU G CAU
GREENSPACE III MINI DOWNLIGHT ALUMINIUM		
DN281B6W3KFALU	911401577411	DN281B 1xDLED-3000 PSU ALU PR CAU
DN281B6W4KFALU	911401577511	DN281B 1xDLED-4000 PSU ALU PR CAU
DN281B12W3KFALU	911401577611	DN281B 1xDLED-3000 PSU ALU G CAU
DN281B12W4KFALU	911401577711	DN281B 1xDLED-4000 PSU ALU G CAU
GREENSPACE III COMPACT DOWNLIGHT ALUMINIUM		
DN282B17W3KFALU	911401577811	DN282B 1xDLED-3000 PSU ALU G CAU
DN282B17W4KFALU	911401577911	DN282B 1xDLED-4000 PSU ALU G CAU
GREENSPACE III COMPACT POWER DOWNLIGHT ALUMINIUM		
DN283B23W3KFALU	911401578011	DN283B 1xDLED-3000 PSU ALU G CAU
DN283B23W4KFALU	911401578111	DN283B 1xDLED-4000 PSU ALU G CAU
GREENSPACE III ADAPTOR RINGS		
DN280Z138MMWH	911401700852	DN280Z AD Adaptor Ring
DN281Z185MMWH	911401700862	DN281Z AD Adaptor Ring
DN282Z249MMWH	911401700872	DN282Z AD Adaptor Ring
DN283Z249MMWH	911401700882	DN283Z AD Adaptor Ring





## Essential Downlight LED

The Essential LED downlight is the latest offering in the Philips 90mm downlight portfolio. Offering energy savings of up to 75%, long lifetime, and dimmability, this simple retrofit solution is perfect for both residential and commercial applications. With a low profile, and flush finish, the product is easy to install, and will look subtle in the ceiling space.



### Features and Benefits

- Fit the application - 3000K/ 4000K CCT, CRI80, high consistency
- White Rim - Fused with white ceiling
- Bright - 800 lm
- Saving - Only 12W power consumption, vs 50W halogen
- Longer lasting - 25k hours lifetime vs 3k hours of halogen
- 90mm cutout - Easily replace your halogen spotlight
- Plug and Play - Prewired with 1.5m flex and 3-pin plug
- High compatibility - Can work with selected leading/trailing edge dimmers

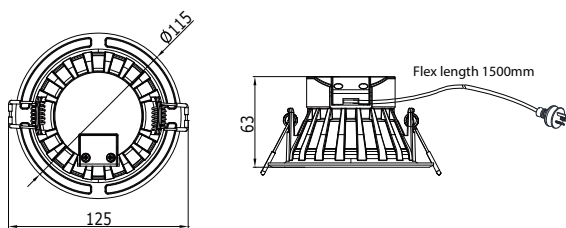

Product ID	Width (mm)	Depth (mm)	Cutout (mm)
DNI05B	115	63	ø92

Dimensions in mm (Nominal)

### ESSENTIAL DOWNLIGHT LED

Family Name	Essential Downlight LED	Driver	Integrated driver
Model	DNI05B	Dimmable	Selected Universal, Trailing/ Leading edge dimmers.
Lumen/ Watt	800lm/ 12W	Installation	Recessed
Lamp Colour	3000K, 4000K	IP rating	IP20
Colour Rendering Index (CRI)	80	Colour of housing	White
Flex and Plug	Yes	Application	Residential, Retail, Hospitality, Commercial
Lifetime L70*	25,000 hrs	Accessories	NA
Unified Glare Ratio (UGR)	n/a	Suspension Height - min/max	NA
Optics	100D	Maximum Run Length	NA

\* = When the fitting reaches 70% of full potential (new)

COMMERCIAL CODE	I2NC	DESCRIPTION
DNI05B12W3KDIM	911401589111	DNI05B 1x DLED/830 WH 100D
DNI05B12W4KDIM	911401589211	DNI05B 1x DLED/840 WH 100D



## SmartBright Mini Dimmable LED

Consuming just 11W of energy and designed to replace MRI16 halogen downlights, the new dimmable SmartBright Mini is a true fit and forget solution. It is compatible with a number of universal leading and trailing edge dimmers, has a long lifetime and offers up to 75% energy savings in 90mm downlight cutouts.



### Features and Benefits

- Fit the application - 3000K/ 4000K CCT, CRI80, high consistency
- White Rim - Fused with white ceiling
- High gloss reflector - Efficient and stylish
- Brighter - 700lm output, 10% brighter than standard MRI16 Halogen
- Saving - Only 11W power consumption, vs 50W halogen
- Longer lasting - 25k hours lifetime vs 3k hours of halogen
- 90mm cutout - Easily replace your halogen spotlight
- Plug and Play - Prewired with 1.2m flex and 3-pin plug
- High compatibility - Can work with your existing leading/trailing edge dimmers

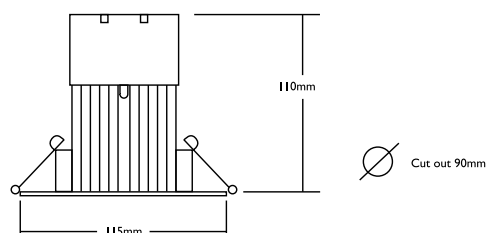

Product ID	Cutout (mm)	Diameter (mm)	Height (mm)
DNI01B	90	115	110

Dimensions in mm (Nominal)

### SMARTBRIGHT MINI DIMMABLE LED

Family Name	SmartBright Mini Dimmable LED	Dimmable	Selected Universal, Trailing/ Leading edge dimmers. Please refer to <a href="http://www.philips.com.au">www.philips.com.au</a> for dimming details.
Model	DNI01B	Installation	Recessed
Lumen/ Watt	700lm/ 11W	IP rating	IP20
Lamp Colour	3000K, 4000K	Weight	DNI01B - 0.47kg
Colour Rendering Index (CRI)	80	Colour of housing	White
Flex and Plug	Yes	Application	Residential, Retail, Hospitality, Commercial
Lifetime L70*	25,000 hrs	Accessories	NA
Unified Glare Ratio (UGR)	n/a	Suspension Height - min/max	NA
Optics	60D	Maximum Run Length	NA
Driver	Integrated driver		

\* = When the fitting reaches 70% of full potential (new)

COMMERCIAL CODE	I2NC	DESCRIPTION
DNI01B11W3KDIM	911401534611	DNI01B 1x DLED/830 WH 60D 1x
DNI01B11W4KDIM	911401534711	DNI01B 1x DLED/840 WH 60D 1x



## CoreLine ProSet

CoreLine ProSet is a high quality 90mm downlight, offering superb lifetime of 50,000 hours, and IP44 rating so that it can be used in bathrooms as well as other typical residential and commercial applications. With adjustable ring, this product offers fantastic versatility to direct the light exactly where you want to put it. Consuming only 13W of energy, this product will deliver up to 75% energy savings, with even further savings possible through dimmability.



### Features and Benefits

- Fit the application - 3000K/ 4000K CCT, CRI80, high consistency
- Fixed and Adjustable fittings, white finish
- High Output - 640lm output
- Saving - Only 13W power consumption, vs 50W halogen
- Long lasting - 50k hours lifetime vs 3k hours of halogen
- 90mm cutout - Easily replace your halogen spotlight
- Plug and Play - Prewired with 1.2m flex and 3-pin plug
- High compatibility - Extensive leading edge dimmer compatibility list
- IP44 - Applicable for Bathrooms

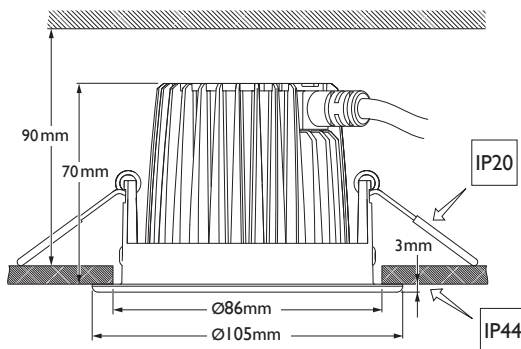

Product ID	Width (mm)	Height (mm)	Cut-out (mm)
RS121B	105	73	ø86

Dimensions in mm (Nominal)

### CORELINE PROSET DOWNLIGHT

Family Name	CoreLine ProSet Downlight	Dimmable	"Selected Leading edge dimmers. Please refer to <a href="http://www.philips.com.au">www.philips.com.au</a> for dimming details."
Model	RS121B - Adjustable	Installation	Recessed Adjustable
Lumen/ Watt	640lm/ 13W	IP rating	IP44
Lamp Colour	3000K, 4000K	Weight	RS121B - 0.33kg
Colour Rendering Index (CRI)	80	Colour of housing	White
Flex and Plug	Yes	Application	Residential, Retail, Hospitality, Commercial
Lifetime L70*	50,000 hrs	Accessories	NA
Unified Glare Ratio (UGR)	n/a	Suspension Height - min/max	NA
Optics	40D	Maximum Run Length	NA
Driver	Integrated driver		

\* = When the fitting reaches 70% of full potential (new)

COMMERCIAL CODE	I2NC	DESCRIPTION
RS121B13W3KDIM	91140157511	RS121B LED6-40-/830 PSR WH CAU
RS121B13W4KDIM	91140157511	RS121B LED6-40-/840 PSR WH CAU



# CoreLine Trunking

CoreLine Trunking solution offers a continuous line of light, creating uniformity across the intended space. The product is easy to install, with a simple starter pack per line of light, and easy access via a clever mount and clip device. The product is available in multiple lumen packages and lengths, as well as DALI dimmable option. The latest LED technology now means we can now achieve 100lm/w system efficacy, whilst achieving long lifetime of 50,000 hours. This product is suitable for many applications, especially retail and industry application.



## Features and Benefits

- Up to 54% more efficient than average conventional Trunking systems, with 100lm/W system efficiency
- Functional design with 4 dedicated beam shapes (Wide, Narrow, Medium, Double Asymmetric)
- Dimmable (DALI) for even more energy savings
- Comfortable light with up to 8000 lumen per 1.7m
- Highlights merchandise with a 'sparkling' effect
- One volume architecture for fast installation and less packaging waste

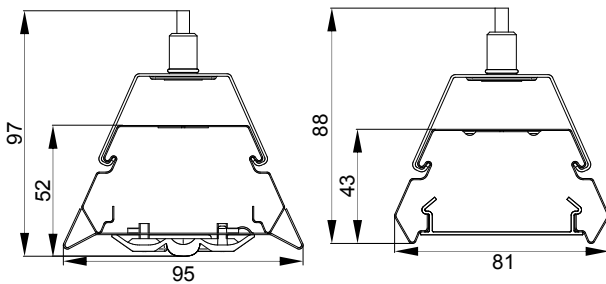

Product ID	Depth (mm)	Height (mm)	Cutout (mm)
LLI20X	95	97	3450
LLI21X	95	97	1725

Dimensions in mm (Nominal)

## CORELINE TRUNKING

Family Name	CoreLine Trunking
Model	LLI20X - 3.4m LLI21X - 1.7m
Lumen/ Watt	9000lm/ 90W 4500lm/ 45W
CCT	4000K
Colour Rendering Index (CRI)	>80
Flex and Plug	5 or 7 wire connection
Lifetime L70*	50,000hrs
Unified Glare Ratio (UGR)	n/a
Optics	NB/ MB/ WB/ DA30
Driver	Philips Xitanium Driver
Dimmable	PSU (Fixed), or PSD (Dali)

Installation	Surface/ Suspension Wire
IP rating	IP20
Weight	3400mm - 7.5kg 1700mm - 4.5kg
Colour of housing	White
Application	Industry, Retail
Accessories	Surface/ Suspension Mounting Bracket Starter Kit per aisle of light - Incl. starting and end cap, connector to mains, and first suspension Alternative accessories on request
Suspension Height - min/max	3m/ 12m
Maximum Run Length	NA

\* = When the fitting reaches 70% of full potential (new)



## GreenPerform LED Batten

GreenPerform LED Batten is a high quality LED batten and a high system efficacy that delivers significant energy savings of up to 50% as compared to conventional T8 battens. With a reliable and robust housing structure, this maximizes the endurance and contributes to its long lifetime.

With its flexible optics and mounting accessories, it is suitable for symmetrical, asymmetrical, direct and indirect lighting applications. It can be used in a wide variety of applications.



### Features and Benefits

- High quality LED batten equivalent to a 2x36W T8 or 2x28W T5
- System efficacy reaches 100lm/W, up to 50% energy saving compared to T8 Batten with same light level
- Integrated design, slim profile, easy to install
- Good colour uniformity and colour rendering (CRI>80)
- Reliable and robust housing structure, maximise the endurance over the life time
- Suitable for both direct and indirect lighting application with flexible optics and mounting accessories
- Provides for continuous line of light due to inline connector between battens, max.25 pcs in connection

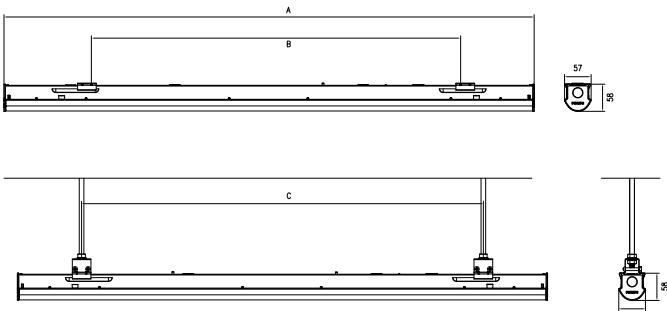

Product ID	A	B	C
BN208C LED20/L600	573	365±20	385±20
BN208C LED40/L1200	1135	823±20	843±20
BN209C LED40/L1200	1135	823±20	843±20

Dimensions in mm (Nominal)





# GreenPerform LED Batten continued

GREENPERFORM LED BATTEN				
Family name	BN208C Standalone – 600/1200mm	BN209C Trunkable – 1200mm	Driver	Philips Xitanium® Driver
Lumen/Watt	2000lm/20w – 2x18W T8 replacement 4000lm/40w – 2x36W T8 replacement	4000lm/40W – 2x36W T8 replacement	Dimmable	No
Lamp Colour	Neutral White 4000K		Installation	Surface / Suspension
Colour Rendering Index	>80		Classification/IP rating	IP20
Flex and Plug	n/a		Colour/Materials	Housing: 0.6mm SPCC Cover: PMMA
Lifetime L70*	50,000 hours		Accessories	Surface Mounting Bracket symmetric Surface Mounting Bracket asymmetric Suspension Pole Connection Block Connecting Cable Power Cable
Office compliant/UGR	n/a		Maximum Run Length	25 Fixtures
Louvre/Optics	Prismatic cover			

\* = When the fitting reaches 70% of full potential (new)

COMMERCIAL CODE	I2NC	DESCRIPTION
BN208C40W4K1200	911401568401	BN208C LED40/NW L1200 FR
BN208C40W6K1200	911401585601	BN208C LED40/CW L1200 FR
BN208C20W4K1200	911401565801	BN208C LED20/NW L1200 FR
BN208C20W4K600	911401566101	BN208C LED20/NW L600 FR
BN208C10W4K600	911401566601	BN208C LED10/NW L600 FR
BN209C40W4K1200	911401566901	BN209C LED40/NW L1200 FR
BN209C40W6K1200	911401586001	BN209C LED40/CW L1200 FR
BN209C20W4K1200	911401567401	BN209C LED20/NW L1200 FR
ACCESSORIES		
BY208ZMBA	911401567501	BY208Z MB-A
BY208ZMBS	911401567601	BY208Z MB-S
BY209ZMBA	911401567701	BY209Z MB-A
BY209ZMBS	911401567801	BY209Z MB-S
BY208ZSP	911401567901	BY208Z SP
BY208ZTB	911401568001	BY208Z TB
BY208ZC600P	911401568101	BY208Z C600-P
BY208ZC2	911401568201	BY208Z C-2
BY208ZC200P	911401568301	BY208Z C200-P



## SmartBright LED Batten Gen2

SmartBright LED Batten G2 is an affordable replacement for T5 and T8 battens in indirect lighting solutions, such as pelmet or cove lighting. The product comes in a variety of lengths, and an excellent lifetime of 30,000 hours. The product also comes with a plug in the packaging, so is easy for installation.



### Features and Benefits

- Patented glass diffuser: Better heat conduction, no embrittlement, no yellowing
- Longer life time: 30,000 hours
- Higher energy-efficiency : 79lm/w
- Lower TCO vs.TL5 batten triggered to replace conventional batten more easily
- Slim and narrow end cap designed for cove and shelf lighting
- 5 lengths, 3 colours, flexible, mix and match
- Power cable included for easier purchase



Product ID	Length (mm)	Width (mm)	Height (mm)
BN066C (600mm)	585.5	25.5	43
BN066C (1200mm)	1185.5	25.5	43

Dimensions in mm (Nominal)

### SMARTBRIGHT LED BATTEN GEN2

Family Name	GreenPerform Batten
Model	BN066C
Lumen/ Watt	1108lm / 14W 967lm / 12W 836lm / 10.8W 555lm / 7W 311lm / 4W
CCT	3000K, 4000K, 6500K
Colour Rendering Index (CRI)	80
Flex and Plug	Power Cable (included)
*Lifetime (L70@25°C)	30,000 Hrs
Unified Glare Ratio (UGR)	n/a
Optics	Diffused Glass

Driver	Integrated
Dimmable	PSU (Fixed)
Installation	Surface Mounted
IP rating	IP20
Colour of housing	White
Application	Shop Window, Cove, Shelf, Convenience Store, Freezer
Accessories	Spare Mounting bracket and screw Connection Cable (0.2m or 0.6m)
Suspension Height - min/max	NA
Maximum Run Length	10 Pieces

\* = When the fitting reaches 70% of full potential (new)

# TCW060 Fluorescent Waterproof Batten

Designed for use in demanding environments, TCW060 is an economical, compact waterproof luminaire. Dedicated versions are available for TL-D and TL5 lamps. Ingress-protected to a level of IP65 and operating solely on electronic gear, this is a competitive energy saving solution for wet spaces – at the same cost as an electromagnetic solution. A flexible ceiling clip facilitates easy installation and maintenance.



## Features and Benefits

- Economic waterproof luminaire
- Ingress protected to IP65, shockproof to IK08
- Dedicated dimensions for TL-D
- Adjustable ceiling clip for flexible installation

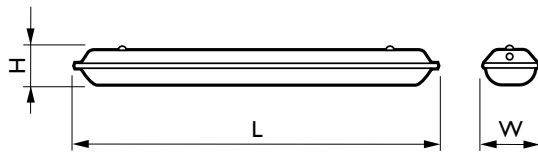

Product ID	L (mm)	W (mm)	H (mm)
TCW060 1xTL-D36W HF	1270	86	90
TCW060 2xTL-D36W HFP	1270	136	90
TCW060 2xTL-D58W HF	1570	136	90

Dimensions in mm (Nominal)

TCW060 FLUORESCENT WATERPROOF BATTEN			
Family name	TCW060	Connection	SI [Screw connection block]
Model	TCW060 1xTL-D36W HF TCW060 2xTL-D36W HFP TCW060 2xTL-D58W HF	Ingress protection code	IP65 [Dust penetration-protected, jet-proof]
Number of light sources	1, 2	Mech. impact protection code	IK08 [5 ] vandal-protected]
Lamp family code	TL-D [MASTER TL-D]	Colour	Grey
Lamp power	36W, 58W	Glow-wire test	650/5 [Temperature 650°C, duration 5s]
Kombipack	No	Country version	No
Gear	HF [Electronic high-frequency], HFP [HF Performer]	CE mark	CE [CE mark]
Optical cover/lens type	PCP [Polycarbonate prismatic]	Input voltage	220-240V
Emergency lighting	No		

COMMERCIAL CODE	I2NC	DESCRIPTION
TCW060136HFPFU	823807877301	TCW060 1xTLD-36W HFP FTB TE
TCW060236HFPFU	823807877401	TCW060 2xTLD-36W HFP FTB TE
TCW060258HFPFU	823807874401	TCW060 2xTLD-58W HFP FTB TE



## GreenPerform Waterproof Batten

GreenPerform LED Waterproof is a high quality luminaire with a high system efficacy that delivers significant energy savings of up to 50% as compared to conventional T8 batten. With a reliable and robust housing structure, this maximizes the endurance and contributes to its long lifetime.

It is suitable to be used in both direct and indirect lighting applications. This is due to its flexible optics and choice of symmetric or asymmetric mounting accessories that allows for a variety of different lighting applications.



### Features and Benefits

- Up to 95lm/W system efficacy, save over 50% energy by replacing T8 waterproof luminaires
- 50,000hr lifetime & IP65 & IK08 protection ensure ultimate reliability and endurance
- Comfortable light with high colour uniformity SDCM<3.5 , CRI>80
- Compact design & IP68 waterproof quick connector ease the installation

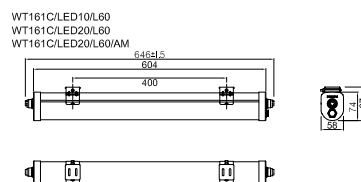
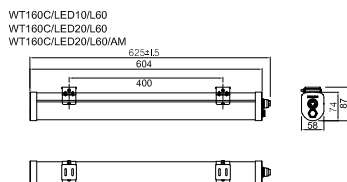
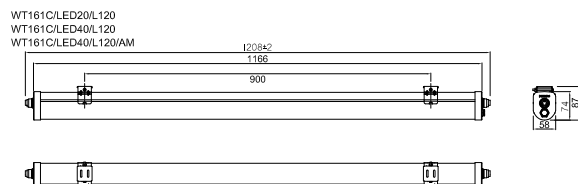
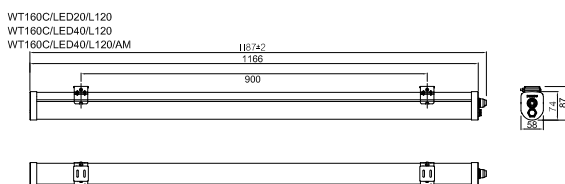
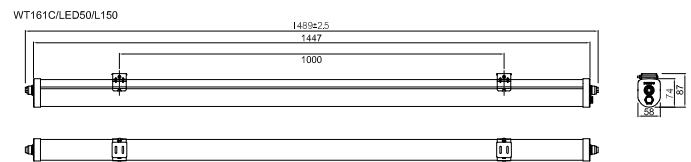
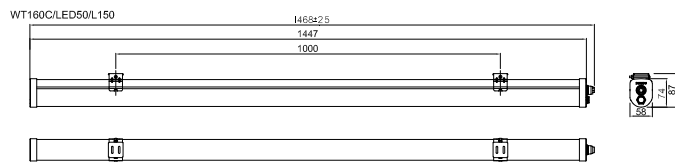



# GreenPerform Waterproof Batten continued

## GREENPERFORM WATERPROOF BATTEN

Family Name	GreenPerform Waterproof Batten	Driver	Philips Xitanium Driver
Model	WT160C - Standalone version WT161C - Trunkable version	Dimmable	PSU (Fixed)
Lumen/ Watt	4800lm/ 55W 3800lm/ 40W 1900lm/ 20W 1000lm/ 12W	Installation	Surface Mounted
CCT	4000K, 6500K	IP rating	IP65
Colour Rendering Index (CRI)	80	Weight	1500mm - 1.7kg 1200mm - 1.3kg 600mm - 0.7kg
Flex and Plug	No	Colour of housing	Green
Lifetime L70*	50,000hrs	Application	Industry, F&B, Parking, Semi Outdoor, Under Canopy, Underground
Unified Glare Ratio (UGR)	n/a	Accessories	Trunking Connector Cable (300mm)
Optics	Symmetrical wide beam (120°)	Suspension Height - min/max	NA
		Maximum Run Length	25 pcs trunking

\* = When the fitting reaches 70% of full potential (new)

COMMERCIAL CODE	I2NC	DESCRIPTION
WT160C10W4K600	911401511811	WT160C LED10 NW L600
WT160C10W6K600	911401511911	WT160C LED10 CW L600
WT161C10W4K600	911401512011	WT161C LED10 NW L600
WT161C10W6K600	911401512111	WT161C LED10 CW L600
WT160C20W4K600	911401512211	WT160C LED20 NW L600
WT160C20W6K600	911401512311	WT160C LED20 CW L600
WT161C20W4K600	911401512411	WT161C LED20 NW L600
WT161C20W6K600	911401512511	WT161C LED20 CW L600
WT160C20W4K1200	911401512611	WT160C LED20 NW L1200
WT161C20W4K1200	911401512711	WT161C LED20 NW L1200
WT160C20W6K1200	911401512811	WT160C LED20 CW L1200
WT161C20W6K1200	911401512911	WT161C LED20 CW L1200
WT160C40W4K1200	911401513011	WT160C LED40 NW L1200
WT160C40W6K1200	911401513111	WT160C LED40 CW L1200
WT161C40W4K1200	911401513211	WT161C LED40 NW L1200
WT161C40W6K1200	911401513311	WT161C LED40 CW L1200
WT160C50W4K1500	911401513411	WT160C LED50 NW L1500
WT160C50W6K1500	911401513511	WT160C LED50 CW L1500
WT161C50W4K1500	911401513611	WT161C LED50 NW L1500
WT161C50W6K1500	911401513711	WT161C LED50 CW L1500
WT161ZTB	911401527511	WT161Z TB





## CoreLine Waterproof Batten

CoreLine Waterproof LED is a direct replacement for traditional fluorescent waterproof luminaires, in terms of light performance, installation flexibility and length. With similar look and feel to traditional battens, this diffused luminaire will save up to 50% in energy, and will last 50,000 hours, hence reducing maintenance costs.



### Features and Benefits

- Up to 50% lower energy consumption compared to TL-D
- Reliable LED technology – maintenance free
- Direct substitute to conventional waterproofs in light performance, installation flexibility & length
- Substitute available for 2X18W/1X36W/2X36W/1X58W/2X58W TL-D
- Sleek design to create traditional look and feel
- Wide-beam light distribution
- Diffuser with optical element ensures visual comfort
- Ceiling-mounted bracket and suspension hooks included; installation can be made vandal-proof by additional screw fixation of mounting brackets

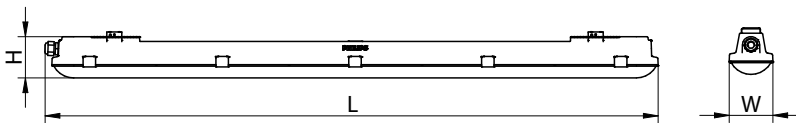

Model	W (mm)	H (mm)	L (mm)
2ft	87	82	661
4ft	87	82	1223
5ft	87	82	1504

Dimensions in mm (Nominal)



## CoreLine Waterproof Batten continued

CORELINE WATERPROOF BATTEN			
Family Name	CoreLine Waterproof Batten	Installation	Surface Mounted, Suspension Hook
Model	WT120C - Standalone version	IP rating	IP65
Lumen/ Watt	6000lm/ 57W 4000lm/ 41W 3400lm/ 29W 2200lm/ 23W 1800lm/ 19W	IK Rating	IK08
CCT	4000K	Weight	1500mm - 1.82kg 1200mm - 1.53kg 600mm - 0.93kg
Colour Rendering Index (CRI)	80	Colour of housing	Light Grey
Flex and Plug	No	Application	Industry, F&B, Parking, Semi Outdoor, Under Canopy, Underground
*Lifetime (L70)	50,000hrs	Accessories (Included)	Mounting bracket (2pcs), suspension hook (2pcs), anti-vandal screws (2pcs), grommet (2pcs), cable gland (2pcs)
Unified Glare Ratio (UGR)	UGR23	Suspension Height - min/max	NA
Optics	Symmetrical wide beam	Maximum Run Length	NA
Driver		* = When the fitting reaches 70% of full potential (new)	
Dimmable	PSU (Fixed)		

COMMERCIAL CODE	I2NC	DESCRIPTION
WT120C19W4K600	910500453335	WT120C LED18S/840 PSU L600
WT120C23W4K1200	910500453336	WT120C LED22S/840 PSU LI200
WT120C29W4K1500	910500453337	WT120C LED34S/840 PSU LI500
WT120C41W4K1200	910500453338	WT120C LED40S/840 PSU LI200
WT120C57W4K1500	910500453339	WT120C LED60S/840 PSU LI500



## Pacific LED Waterproof Batten

Pacific LED Waterproof batten is a high performance luminaire, replacing traditional fluorescent fittings. With comparable lumen outputs, Pacific LED will save up to 50% energy, and lasts 50,000 hours. Further savings can be achieved through DALI dimming, and comes in a variety of lengths and beam angles. There is also a chemical resistance option, and multiple wiring options.



### Features and Benefits

- Point-to-point replacement of high performance TL-D waterproof luminaires up to 2.58W
- Energy savings up to 50%, dimmable (DALI) for even more savings
- Significant lower maintenance cost due to high system lifetime
- Chemical resistance and impact resistance combined in one product optionally
- Multiple Beam angles, lengths, and wiring connections
- Easy installation

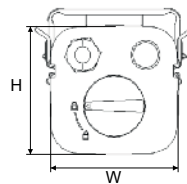
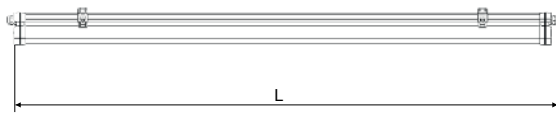

Model	W (mm)	H (mm)	L (mm)
2ft	96	96	721
4ft	96	96	1342
5ft	96	96	1642

Dimensions in mm (Nominal)

### PACIFIC LED WATERPROOF BATTEN

Family Name	Pacific LED G3	Installation	Surface Mounted
Model	WT460C - Standalone Version WT461C - Chemical Resistance Version	IP rating	IP66
Lumen/ Watt	6400lm/ 54W 4200lm/ 35W 3500lm/ 28W 2300lm/ 22W	IK Rating	IK08
CCT	4000K	Weight	1500mm - 3.9kg 1200mm - 3.4kg 600mm - 1.7kg
Colour Rendering Index (CRI)	80	Colour of housing	Clear with light grey
Flex and Plug	No	Application	Industry, F&B, Parking, Semi Outdoor, Under Canopy, Underground
Lifetime L70*	50,000hrs	Accessories	Flexible ceiling bracket, Suspension Hooks, Ceiling clips, Cable glands, End cap 3 or 5 pole connector, Polycarbonate tube
Unified Glare Ratio (UGR)	22	Suspension Height - min/max	NA
Optics	NB, WB, VWB	Maximum Run Length	NA
Driver	Philips Xitanium Driver		
Dimmable	PSD (DALI), PSU (Fixed)		

\* = When the fitting reaches 70% of full potential (new)

# Prolux T5 Highbay TPS 550

Ideal for factories, warehouses, distribution centres and light industry. Philips ProLux T5 highbay solution is a direct replacement for current HID highbay systems, helping you gain significant energy savings.

The combination of robust housing, high-reflectance material and specially designed reflectors add up to a high-efficiency luminaire that can help drive profitability by improving energy efficiency. For even more savings, combine with Philips Dynalite lighting controls.



## Features and Benefits

- Energy efficiency – delivering up to 45%\* energy savings compared to a typical HID Highbay solution, helping you to save more money with lower monthly power bills
- Excellent light quality – better vertical illuminance for rack application, better uniformity, more vivid colour rendering
- Easy maintenance – side ballast access for easy replacement of the ballast without touching the reflector
- Flexible installation – fulfill your unique needs with suspended, surface and pipe-mounted installation options as well as three beam angles (wide, medium and narrow) for various lighting applications
- Accessories – Polycarbonate cover (optional) and Wire Guard mesh cover (optional)

\* Compared to a one-to-one replacement with the current HID Highbay Lighting Solution

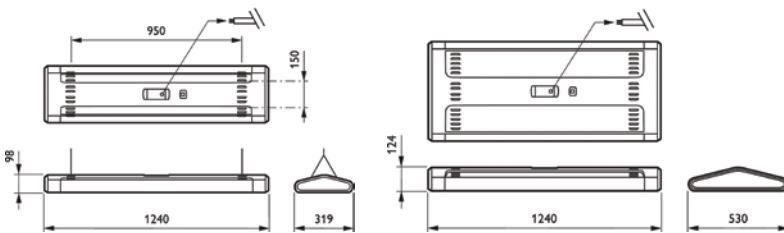

Product ID	L (mm)	W (mm)	H (mm)
TPS550 2 x 54W	1240	530	98
TPS550 4/6 x 54W	1240	319	124

Dimensions in mm (Nominal)

# Prolux T5 Highbay TPS 550 continued

TPS550 HIGHBAY			
Family name	TPS550	Dimmable	I-10v HFR dimmable (optional) DALI Dimming (optional)
Lamp types	2 x 54w 4 x 54w – replacement for 250W HPI 6 x 54w – replacement for 400W HPI	Installation	Suspension, Surface Mounted, Pipe Mounted Height: 6-12m
Lamps included	No	Classification/IP rating	IP20
Flex and Plug	Yes	Colour/Materials	Housing: Steel Optic: High reflectance aluminium (95% reflectance)
Beam angle	Narrow beam Medium beam Wide beam	Accessories	Transparent Protection cover – Steel Wire guard mesh cover – Steel Mounting plate (for pipe installation) – Steel Extension data cable for HFR version
Office compliant/UGR	No		
Louvre/Optics	High efficiency optic		
Gear/Ballast	HFP – High Frequency Performer (standard) HFR – I-10v dimmable (optional) HFR-D DALI (optional)		

COMMERCIAL CODE	I2NC	DESCRIPTION
TPS5506X54HFPNB	910403630507	TPS550 6xTL5-54W HFP NB W3
TPS5506X54HFPMB	910403630508	TPS550 6xTL5-54W HFP MB W3
TPS5506X54HFPWB	910403630509	TPS550 6xTL5-54W HFP WB W3
TPS5504X54HFPNB	910403630510	TPS550 4xTL5-54W HFP NB W3
TPS5504X54HFPMB	910403630511	TPS550 4xTL5-54W HFP MB W3
TPS5504X54HFPWB	910403630512	TPS550 4xTL5-54W HFP WB W3
TPS5502X54HFPNB	910403630513	TPS550 2xTL5-54W HFP NB W3
TPS5502X54HFPMB	910403630514	TPS550 2xTL5-54W HFP MB W3
TPS5502X54HFPWB	910403630515	TPS550 2xTL5-54W HFP WB W3
TPS5506X54HFRNB	910403630531	TPS550 6xTL5-54W HFR NB W3
TPS5506X54HFRMB	910403630532	TPS550 6xTL5-54W HFR MB W3
TPS5506X54HFRWB	910403630533	TPS550 6xTL5-54W HFR WB W3
TPS5504X54HFRNB	910403630535	TPS550 4xTL5-54W HFR NB W3
TPS5504X54HFRMB	910403630536	TPS550 4xTL5-54W HFR MB W3
TPS5504X54HFRWB	910403630537	TPS550 4xTL5-54W HFR WB W3
TPS5502X54HFRNB	910403630538	TPS550 2xTL5-54W HFR NB W3
TPS5502X54HFRMB	910403630540	TPS550 2xTL5-54W HFR MB W3
TPS5502X54HFRWB	910403630541	TPS550 2xTL5-54W HFR WB W3





# GreenPerform Highbay Gen2

Ideal for factories, warehouses, distribution centres, and light industrial. Philips GreenPerform LED highbay Gen2 is designed to replace 250W and 400W HID highbays, offering up to 60% energy savings, whilst delivering long lifetime, in often hard to reach maintenance areas. Gen2 version sees a reduction in glare by up to 20%, as well as a wide variety of light outputs, from 9,000 lm, all the way up 24,000 lm.



## Features and Benefits

- Best energy-efficiency : System efficacy>100lm/W, 1:1 replacement of 400/250W HPI
- Comfortable light: CRI increase to 85 for all colour temperature
- Optimal lighting effects: new light platform & optical design reduce 20% glare
- Versatile applications: multiple mounting options (hook/pipe/ bracket)
- Advanced control interface: 1~10V / DALI dimming option integrated for solution selling (selected models only)
- Robust & Reliable: IP65 protection and 50K hours system life time
- Wider Industry Application: Available in both Tempered Glass Cover and PC Cover
- Easy to Install: Equipped with 3m long power cord & IP65 connector
- Reduced Weight: Max 9.5 kg

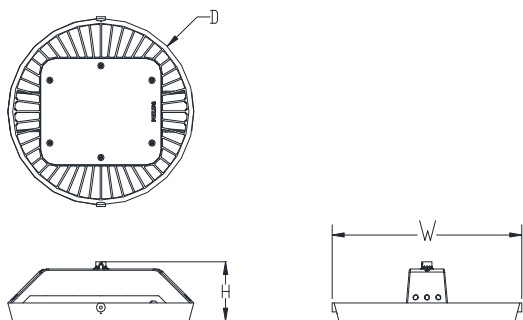

Model	W (mm)	D (mm)	H (mm)
BY687P	530	ø520	165
BY688P	466	ø457	158
BY689P	374	ø366	153

Dimensions in mm (Nominal)

## GREENPERFORM HIGHBAY GEN2

Family name	GreenPerform Highbay Gen2
Lumen/Watt	BY687P - 240W, 200W (Big size) BY688P - 160W, 140W (Medium size) BY689P - 100W, 90W (Small size)
Lamp Colour	24,000lm/ 240W 20,000lm/ 200W 16,000lm/ 160W 14,000lm/ 140W 10,000lm/ 100W 9,000lm/ 90W
CCT	4000K, 6500K
Colour Rendering Index (CRI)	85
Wiring	IP65 Connector
*Lifetime (L70)	50,000hrs
Unified Glare Ratio (UGR)	25
Optics	WB, NB, HRO

Driver	Philips Xitanium LED Driver
Dimmable	PSU (Fixed), PSR (1-10V selected), PSD (Dali selected)
Installation	Hook/ Pole/ Bracket
IP rating	IP65
IK Rating	IK07
Weight	BY687P - 9.5kg BY688P - 7kg BY689P - 5kg
Colour of housing	Silvery grey, high quality die-cast aluminium
Application	Industry, Commercial & Convention
Accessories	Mounting Bracket
Suspension Height - min/max	NA
Maximum Run Length	NA

\* = When the fitting reaches 70% of full potential (new)



## GreenPerform Highbay Gen2 continued

COMMERCIAL CODE	I2NC	DESCRIPTION
<b>BIG SIZE</b>		
BY687P240WL6KRW	911401568511	BY687P LED240/CW PSR S-WB L3000
BY687P240WL6KRN	911401568811	BY687P LED240/CW PSR S-NB L3000
BY687P240WL6KRH	911401569011	BY687P LED240/CW PSR S-HRO L3000
BY687P240WL4KRW	911401568911	BY687P LED240/NW PSR S-WB L3000
BY687P240WL4KRN	911401569111	BY687P LED240/NW PSR S-NB L3000
BY687P240WL4KRH	911401568711	BY687P LED240/NW PSR S-HRO L3000
BY687P200WL6KRW	911401568611	BY687P LED200/CW PSR S-WB L3000
BY687P200WL6KRN	911401569311	BY687P LED200/CW PSR S-NB L3000
BY687P200WL6KRH	911401569611	BY687P LED200/CW PSR S-HRO L3000
BY687P200WL4KRW	911401569511	BY687P LED200/NW PSR S-WB L3000
BY687P200WL4KRN	911401569411	BY687P LED200/NW PSR S-NB L3000
BY687P200WL4KRH	911401569211	BY687P LED200/NW PSR S-HRO L3000
BY617ZMB	911401568411	BY617Z MB
<b>MEDIUM SIZE</b>		
BY688PI60WL6KFW	911401567111	BY688P LED160 L3000/CW PSU S-WB
BY688PI60WL6KFN	911401567211	BY688P LED160 L3000/CW PSU S-NB
BY688PI60WL6KFH	911401567311	BY688P LED160 L3000/CW PSU S-HRO
BY688PI60WL4KFW	911401567411	BY688P LED160 L3000/NW PSU S-WB
BY688PI60WL4KFN	911401567511	BY688P LED160 L3000/NW PSU S-NB
BY688PI60WL4KFH	911401567611	BY688P LED160 L3000/NW PSU S-HRO
BY688PI40W6KRW	911401535411	BY688P LED 140/CW PSR S-WB
BY688PI40W6KRN	911401535711	BY688P LED 140/CW PSR S-NB
BY688PI40W4KRW	911401536111	BY688P LED 140/NW PSR S-WB
BY688PI40W4KRN	911401535811	BY688P LED 140/NW PSR S-NB
BY618ZMB	911401578801	BY618Z MB
<b>SMALL SIZE</b>		
BY689PI00WL6KFW	911401568311	BY689P LED100 L3000/CW PSU S-WB
BY689PI00WL6KFN	911401568111	BY689P LED100 L3000/CW PSU S-NB
BY689PI00WL6KFH	911401567911	BY689P LED100 L3000/CW PSU S-HRO
BY689PI00WL4KFW	911401568011	BY689P LED100 L3000/NW PSU S-WB
BY689PI00WL4KFN	911401567811	BY689P LED100 L3000/NW PSU S-NB
BY689PI00WL4KFH	911401567711	BY689P LED100 L3000/NW PSU S-HRO
BY689P90W6KFW	911401536811	BY689P LED90/CW PSU S-WB
BY689P90W6KFN	911401536911	BY689P LED90/CW PSU S-NB
BY689P90W4KFW	911401536311	BY689P LED90/NW PSU S-WB
BY689P90W4KFN	911401535911	BY689P LED90/NW PSU S-NB
BY619ZMB	911401578701	BY619Z MB



## GentleSpace Gen2

GentleSpace Gen2 represents the best in class LED highbay offering, perfect for replacing HID technology in factories, warehouses, distribution centres and light industrial. This state of the art LED luminaire delivers optimum performance in light output, lifetime, and functionality, with DALI dimming capability. GentleSpace Gen2 delivers up to 60% energy savings, whilst maximising architectural appeal and performance.



### Features and Benefits

- Up to 25k lumens - Fully equivalent to HPI250/400W high end conventional luminaires
- DALI dimmable with MDU option - Save even more energy costs
- CRI80: High quality of light
- 3.5 x more lifetime than conventional highbay
- Multiple beam angles - More applications can be fulfilled
- -30C - +45C - Wide operating temperature range
- 106-109 lm/W - Improved efficiency

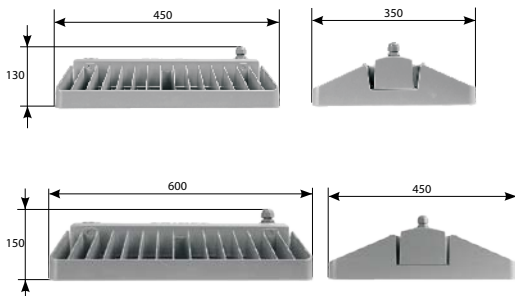

Model	Width (mm)	Length (mm)	Height (mm)
BY470P	350	450	130
BY471P	450	600	150

Dimensions in mm (Nominal)

### GENTLESPACE GEN2

Family Name	GentleSpace Gen2
Model	BY471P - 234W, 160W (Big Size) BY470P - 119W (Small Size)
Lumen/ Watt	25,000lm/ 234W 17,000lm/ 160W 13,000lm/ 119W
CCT	4000K
Colour Rendering Index (CRI)	85
Wiring	3m flex and external connector IP65
*Lifetime (L70)	70,000 hrs
Unified Glare Ratio (UGR)	22-25
Optics	WB, MB, NB, HRO
Driver	Philips Xitanium LED Driver

Dimmable	PSR (1-10V), PSD (Dali)
Installation	Suspension Wire/Bracket
IP rating	IP65
IK Rating	IK07
Weight	BY471P - 16.9kg BY470P - 9.8kg
Colour of housing	Silvery grey, high quality die-cast aluminium
Application	Industry, Commercial & Convention
Accessories	Mounting Bracket
Suspension Height - min/max	NA
Maximum Run Length	NA

\* = When the fitting reaches 70% of full potential (new)





## SmartBay Lowbay

Philips' new generation of LED Lowbay, SmartBay, delivers substantial energy saving in a simple way, by adopting a brand-new LED platform and optical technology. It has an optimal colour CRI and UGR to improve the comfort of lighting, satisfying the requirements of various applications such as factories, shopping malls and public areas. SmartBay is the ideal replacement solution for HPI, CDM and MH lamps.



### Features and Benefits

- Energy-efficiency: system efficacy > 95lm/W, 1:1 replacement of CDM or HPI, saving up to 69% energy
- Comfortable light: CRI >85, UGR <19 (with reflector), offering a comfortable lighting experience
- Super long life: 50,000 hours system lifetime
- Versatile applications : more than 5 mounting options and accessories, flexible for versatile indoor installations

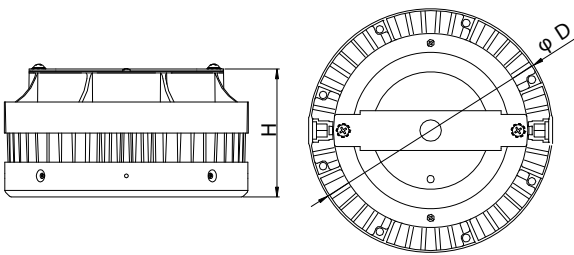

Model	Diameter (mm)	Height (mm)
BY268P	250	150
BY269P	132	102

Dimensions in mm (Nominal)

### SMARTBAY LOWBAY

Family Name	SmartBay Lowbay
Model	BY268P - Big Size BY269P - Small Size
Lumen/ Watt	8,200lm/ 85W 5,800lm/ 60W 3,800lm/ 40W
CCT	3000K, 4000K, 6500K
Colour Rendering Index (CRI)	85
*Lifetime (L70)	50,000 hrs
Unified Glare Ratio (UGR)	22-25
Optics	WB, NB (Needs reflector)
Driver	Philips Xitanium LED Driver

Dimmable	PSU (Fixed)
Installation	Hook/ Pole/ Bracket
IP rating	IP40
Weight	BY268P - 4.5kg BY269P - 2.5kg
Colour of housing	Silvery grey (Pantone 429U)
Application	Industry, Supermarket, Public Area, Shopping Mall
Accessories	Mounting Bracket, Reflector, Hook, Chain Kit, Pipe Kit
Suspension Height - min/max	NA
Maximum Run Length	NA

\* = When the fitting reaches 70% of full potential (new)





## Mini 300 Gen2

Designed for petrol-station canopies and low-bay applications, Mini 300 Gen2 is an ultra-efficient retrofit fixture that offers outstanding light quality, effective thermal management, and a very long lifespan.

Reduced maintenance, replacement and energy cost means a short payback period, making Mini 300 LED Gen2 a shining example of how businesses can save money by opting for green products. A movement detector combined with a daylight sensor enables further energy savings. Our Mini 300 LED gen2 app gives users control in ways that are simply not possible with other luminaires – for instance, reading status and managing lighting from the floor by laptop or Smartphone via Bluetooth.



### Features and Benefits

- Wireless management via Bluetooth from Smartphone or laptop
- Scheduler build in the luminaire to customize your settings
- Status and settings can be read from the floor (no more lift is needed to change settings of luminaire.)
- Instant LED light, long lifetime for lower maintenance cost
- Retrofit solution of 250W & 400W HPI (MPF) or 250W & 315W CDM (Mini300) or competitors
- Movement detector unit and daylight sensor combined for even more energy savings
- Very low weight makes it easy to install (only one person needed)
- Plug & Play
- Master & Slave to reduce number of luminaires with sensor (lower investment cost)
- Energy savings up to 85% compared to HPI systems

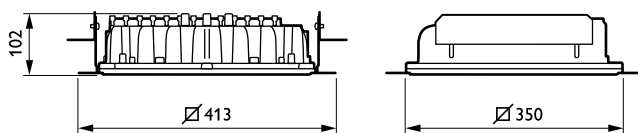

Model	Width (mm)	Length (mm)	Height (mm)
BBP400	350	350	102
BCS400	378	373	152

Dimensions in mm (Nominal)





## Mini 300 Gen2 continued

MINI 300 GEN2			
Family Name	Mini 300 GII	Dimmable	PSD (Dali)
Model	BBP400 - Recessed BCS400 - Surface Mounted	Installation	Recessed/ Surface Mounted
Lumen/ Watt	12,640lm/ 140W 11,147lm/ 121W 9,629lm/ 106W 8,095lm/ 94W 6,533lm/ 76W	IP rating	IP65
CCT	5700K	Weight	BBP400 - 9.1kg BCS400 - 8.6kg
Colour Rendering Index (CRI)	68	Colour of housing	Silvery grey - High quality die-casting aluminium
Wiring		Application	Petrol Stations, Industry, Warehouse, Public Areas
*Lifetime (L80)	70,000 hrs	Accessories	Ceiling Mounting Frame
Unified Glare Ratio (UGR)	22-25	SMARTS Options	Motion Detection Unit, Daylight Sensor, Scheduler Mode, Bluetooth, Master vs Slave units
Optics	PRM, PRW, PAM, A	Suspension Height - min/max	NA
Driver	Philips Xitanium LED Driver	Maximum Run Length	NA
		Maximum Run Length	NA

\* = When the fitting reaches 70% of full potential (new)

# Mini 300 HID

Mini 300 Cube is an extremely efficient low-glare luminaire specially designed for downlighting. The efficiency is achieved by a patented optic coating (which reflects 97% of the light). Mini 300 Cube delivers a uniform light distribution with an asymmetric or bi-directional beam creating outstanding illuminances in industrial and retail environments. The range comprises versions for recessed (DBP300), surface mounted (DCP300) and pole mounted (DGP300). Mini 300 is also available in LED versions (Mini 300 LED Gen 2) in high efficiency for substantial energy savings.



## Features and Benefits

- Creates a daylight impression with an extremely efficient low-glare luminaire specially designed for downlighting in canopies
- Daylight impression from an extremely efficient low-glare recessed luminaire specially designed for downlighting under canopies
- Uniform light distribution with an asymmetrical or bi-directional beam creating outstanding illuminance in industrial and retail environments
- Inviting atmosphere thanks to CDM-TD lamp with excellent colour rendering and white-coated reflector
- High efficiency thanks to a patented optic coating

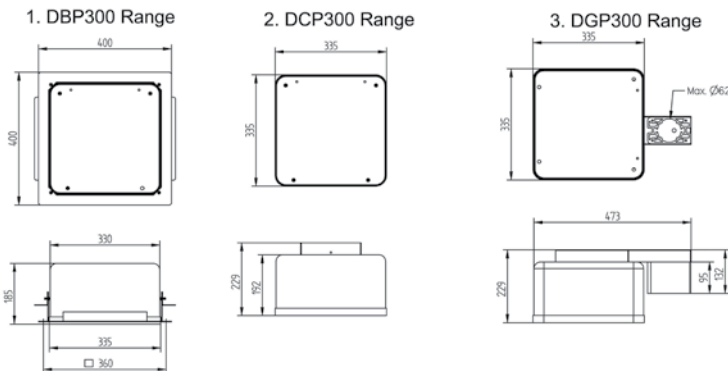

Model	Width (mm)	Length (mm)	Height (mm)
DBP300	400	400	185
DCP300	335	335	229
DGP300	335	473	229

Dimensions in mm (Nominal)

MINI 300 HID			
Family Name	Mini 300 HID	Driver	Integrated driver
Model	DCP300, DGP300, DBP300	Installation	Recessed
Lamp Type	CDM-TD, CDM-T	IP rating	IP65
Wattage	70W, 150W, 250W	Weight	7.5kg
Lamp Colour	3000K, 4000K	Colour of housing	White
Colour Rendering Index (CRI)	80, 90 (with CDM-TD lamp)	Application	Industrial, Petrol Stations, Under Canopy
Flex and Plug	No		
Optics	Asymmetrical, narrow beam (A-NB) Asymmetrical, medium beam (A-MB) Asymmetrical, wide beam (A-WB), not for CDM-T 250 W lamp version Symmetrical, wide beam (S-WB) Symmetrical, wide beam, bi-directional (S-WB-BD)		

## Mini 300 HID continued

COMMERCIAL CODE	I2NC	DESCRIPTION
DCP300MH70SWB	911401077980	DCP300 CDM-TD70W IC S-WB FG WH 230-240
DCP300MHI50AWB	911401077580	DCP300 CDM-TDI50W IC A-WB FG WH 230-240
DCP300MHI50SWB	911401078080	DCP300 CDM-TDI50W IC S-WB FG WH 230-240
DCP300MHI50SWBBD	911401077680	DCP300CDM-TDI50W IC S-WB-BD FG WH 230-240
DCP300MH250SWB	911401078180	DCP300 CDM-T250W IC S-WB FG WH 230-240
DCP300MH250SWBBD	911401077780	DCP300 CDM-T250W IC S-WB-BD FG WH230-240
DGP300MH70AWB	911401080680	DGP300 CDM-TD70W IC A-WB FG WH 230-240
DGP300MH70AMB	911401080880	DGP300 CDM-TD70W IC A-MB FG WH 230-240
DCP300MH70SWBBD	911401080380	DCP300 CDM-TD70W IC S-WB-BD FG WH 230-240
DCP300MH70AWB	911401081480	DCP300 CDM-TD70W IC A-WB FG WH 230-240
DGP300MH70ANB	911401081180	DGP300 CDM-TD70W IC A-NB FG WH 230-240
DGP300MHI50AWB	911401080780	DGP300 CDM-TDI50W IC A-WB FG WH 230-240
DGP300MHI50AMB	911401080980	DGP300 CDM-TDI50W IC A-MB FG WH 230-240
DGP300MHI50ANB	911401081280	DGP300 CDM-TDI50W IC A-NB FG WH 230-240
DGP300MH250AMB	911401081080	DGP300 CDM-T250W IC A-MB FG WH 230-240
DGP300MH250ANB	911401081380	DGP300 CDM-T250W IC A-NB FG WH 230-240
DBP300MH70SWBBD	911401078780	DBP300 CDM-TD70 WIC S-WB-BD FG WH 230-240
DBP300MH70SWB	911401081580	DBP300 CDM-TD70W IC S-WB FG WH 230-240
DBP300MH70AWB	911401079880	DBP300 CDM-TD70W IC A-WB FG WH 230-240
DBP300MHI50SWB	911401078980	DBP300 CDM-TDI50W IC S-WB FG WH 230-240
DBP300MHI50SWBBD	911401079080	DBP300CDM-TDI50W IC S-WB-BD FG WH230-240
DBP300MHI50AWB	911401079980	DBP300 CDM-TDI50W IC A-WB FG WH 230-240
DBP300MH250SWBBD	911401078580	DBP300 CDM-T250W IC S-WB-BD FG WH230-240
DBP300MH250SWB	911401078680	DBP300 CDM-T250W IC S-WB FG WH 230-240

## Metro

The Metro luminaire brings a fresh new light to your residential areas, and industrial estates. Metro's compact yet attractive housing easily blends in with your surroundings while making a significant contribution to a safer and more comfortable environment. It comes available with a choice of SON, HPL, CDM and PL-T lamps for a high light output as well as fully integrated gear and mounting brackets for swift and simple installation and maintenance.



### Features and Benefits

- Compact luminaire body, designed to accept a variety of lamps: SON, HPLN, CDM-ET and PL-T
- Quick and easy lamp replacement by removal of twist-lock bowl
- Maintenance of the control gear and lamp holder is via a single slideout gear/ lamp holder assembly
- Mounting bracket for easy and flexible installation
- Anti-vibration spring supplied for HID lamp versions

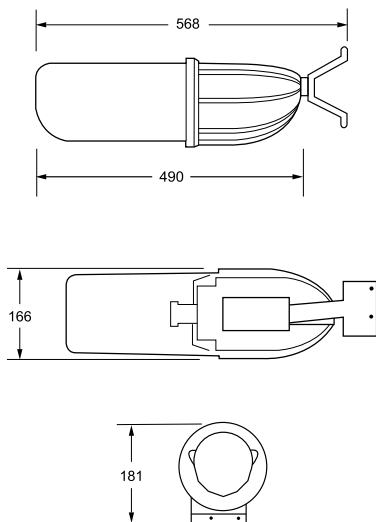

Model	Length (mm)	Width (mm)	Height (mm)
HGC007	568	166	181

Dimensions in mm (Nominal)

## Metro continued

METRO			
Family Name	Metro	Installation	Mounting Bracket (supplied)
Model	HGC007	IP rating	IP65
Lamp Types	SON, HPL, CDM, PL-T	Weight	3.5kg
Wattages	SON (70W) HPL (50W, 80W), CDM (70W), PL-T (18W, 32W)	Colour of housing	N/A
Lamp Colour	SON (2000K), HPL (4200K), CDM (4000K), PL-T (4100K)	Application	Residential streets, Area lighting, Footpaths, Conveyor lighting, General Mining lighting
Colour Rendering Index (CRI)	SON (25), HPL (45), CDM (>80), PL-T (>80)	Accessories	NA
Flex and Plug	No		
Optics	N/A		
Control Gear	Conventional, Electronic (PL-T 4P)		

COMMERCIAL CODE	I2NC	DESCRIPTION
HGC007SHPLN50	910401646280	METRO 50W HPLN LANTERN HPF C/W LAMP & BRACKET
HGC007SHPLN80	910401646380	METRO 80W HPLN LANTERN HPF C/W LAMP & BRACKET
HGC007SSON70H	910401646180	METRO 70W SON LANTERN HPF C/W LAMP & BRACKET
HGC007SPLT32	910401646680	METRO PLT 32W C/W LAMP & BRACKET
HGC007SESNOGEAR	910401647280	METRO ES LAMPHOLDER NO GEAR
HGC007SPLC18HK	910401646480	METRO PLC 18W C/W LAMP & BRACKET
HGC007MP70H	910401646780	METRO MINE C/W SON70W/I SPRNG FTB PC BOWL
HGC007MP80H	910401646880	METRO MINE C/W 80WMV SPRING PC BOWL
HGC007MP80HNL	823807881001	METRO MINE C/W 80WMV SPRING PC BOWL - NO LAMP
HGC007MCDM70	823807839801	METRO MINE C/W CDM70W SPRING FTB - NO LAMP
HGC007MSONI70	910401646980	METRO MINE C/W SON-I-70W - NO LAMP



# Metro LED

The Metro LED luminaire builds on the continued success of the conventional Metro fitting by offering an energy efficient light source for conveyor lighting, general mining lighting, residential streets, areas requiring security, footpaths, access ways and industrial lighting estates. Designed with die-cast aluminium housing and polycarbonate cover, it provides vibration, dust and heat resistant capabilities to meet harsh application environments. It uses the Philips LEDGINE LED platform to ensure long lifetime and reliability and offers significant energy savings when compared with conventional lamp systems.



## Features and Benefits

- Up to 70% energy savings compared to conventional HID Metro with 70W High Pressure Sodium lamp
- Ergonomic curve-shaped housing
- Vibration, dust and heat resistant
- High quality cool and neutral white light with high colour consistency

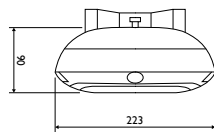
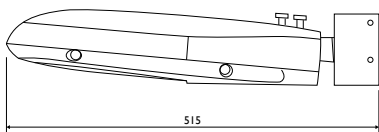

Model	Length (mm)	Width (mm)	Height (mm)
BGS007	515	223	90

Dimensions in mm (Nominal)

METRO LED			
Family Name	Metro LED	Driver	Integrated driver
Model	BGS007	Surge protection	10kV
Lumen/ Watt	2000 lm / 20W	Installation	Standard Metro mounting bracket (supplied)
Lamp Colour	4000K	Weight	3.5kg
Colour Rendering Index (CRI)	70 ± 5	Colour of housing	Grey
Flex cable	Yes - 3m	Application	General Mining areas / Conveyor Belts / Minor Roads
*Lifetime (L70)	50,000 hrs	Accessories	NA
Classifications	IP65, IK06, Class I	* = When the fitting reaches 70% of full potential (new)	
Optics	Symmetrical Beam		

COMMERCIAL CODE	I2NC	DESCRIPTION
BGS007204KS	911401641502	BGS007 LED20/NW 20W 220-240V SNE-V





# RoadStar

RoadStar was created to help those responsible for lighting our world succeed in their energy conservation goals. Through affordable optimal photometric performance the RoadStar gives all project owners the opportunity to meet their energy conservation goals without sacrificing performance, beauty or safety.



Built to last this versatile lighting solution was designed with an over 70,000 hour lifespan, to minimise maintenance requirements and maximise performance. Not having to deploy maintenance personnel to replace lamps and electrical components can save any user considerable time and money. The durable IP66 sealed construction, excellent thermal management and resistance to the elements, makes the RoadStar an extremely tough, lumen generating power house that simply cannot be outperformed.

## Features and Benefits

- Lifetime of over 70,000 hours
- Low maintenance cost: IP66 sealed lens ensures low maintenance with no need for internal cleaning, resulting in a lower total cost of ownership
- Make a statement with this beautifully designed housing to suit any city centre and provide a designer feel.
- Multiple lumen packages and optics to suit most roadway applications.

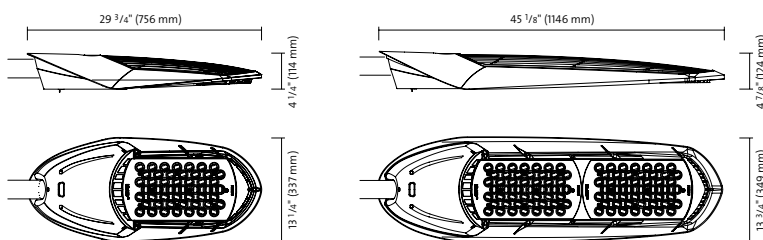

Product ID	L (mm)	W (mm)	H (mm)
GPLS	756	337	114
GPLM	1146	349	124

Dimensions in mm (Nominal)

ROADSTAR			
Family Name	RoadStar	Optics	LE2, LE3, LE4, LE5
Model	GPLS, GPLM	Driver	Integrated driver
Lumens	Up to 14,695 lumens	Installation	Pole mounted
Wattage	45W to 204W	Weight	GPLS (9.1kg), GPLM (14.1kg)
Lamp Colour	4000K	Colour of housing	Grey
Colour Rendering Index (CRI)	80	Application	Minor and major roads
Flex and Plug	No	Accessories	NA
*Lifetime (L70@25°C)	70,000 hrs	* = When the fitting reaches 70% of full potential (new)	



## GreenVision Xceed

GreenVision Xceed offers an affordable LED road lighting solution for both residential and major road applications. It offers 3 housing sizes and a range of beam optics to fully cater to different road configurations and conditions. It is designed to achieve better light uniformity and maximum spacing between poles, while ensuring sufficient light on the road. Its die-cast aluminium housing and Philips LEDGINE LED platform ensures long lifetime and reliability. Best of all, GreenVision Xceed offers up to 50% of energy savings when compared to conventional lamp systems.



### Features and Benefits

- Up to 50% energy savings with full compliance to road lighting safety standards
- Superior W/m<sup>2</sup> performance delivered through different optics for greater flexibility to fit different road applications
- High quality cool and neutral white light with high colour consistency
- Tool-less opening of gear compartment & gear tray replacement for ease of maintenance
- World class, approbated quality components (LEDs / Driver / etc.)

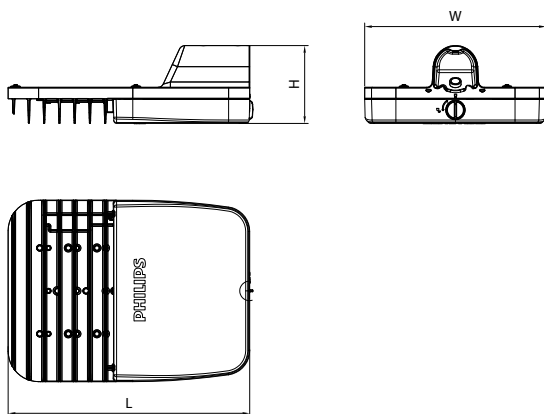

Model	L (mm)	W (mm)	H (mm)
BRP371	422	318	136
BRP372	522	318	136
BRP373	853	318	136

Dimensions in mm (Nominal)

### GREENVISION XCEED

Family Name	GreenVision Xceed	Optics	DNE, DME, DWE, DWV, DWP, DW
Model	BRP371/372/373	Driver	Integrated driver
Lumens	Up to 31,100 lumens	Surge Protection	10kV
Wattage	20W to 305W	Installation	Pole mounted
Lamp Colour	3000K, 4000K, 5700K	Weight	BRP371:6.5kg; BRP372:8kg; BRP373:14kg
Colour Rendering Index (CRI)	70 ± 5	Colour of housing	Grey
Flex and Plug	No	Application	Major & Residential roads
*Lifetime (L70@35°C)	50,000 hrs	Accessories	N/A
Classifications	IP66, IK08, Class I		

\* = When the fitting reaches 70% of full potential (new)



## GreenVision Xceed continued

COMMERCIAL CODE	DESCRIPTION
BRP371204KDWE	BRP371 LED20/NW 20W 220-240V
BRP371284KDWE	BRP371 LED30/NW 28W 220-240V
BRP371554KDWE	BRP371 LED53/NW 55W 220-240V
BRP371704KDWE	BRP371 LED70/NW 70W 220-240V
BRP371904KDWE	BRP371 LED87/NW 90W 220-240V
BRP3711054KDWE	BRP371 LED104/NW 105W 220-240V
BRP3721204KDWE	BRP372 LED122/NW 120W 220-240V
BRP3721404KDWE	BRP372 LED139/NW 140W 220-240V
BRP3721504KDWE	BRP372 LED157/NW 155W 220-240V
BRP3731754KDWE	BRP373 LED174/NW 175W 220-240V
BRP3731954KDWE	BRP373 LED192/NW 195W 220-240V
BRP3732104KDWE	BRP373 LED209/NW 210W 220-240V
BRP3732254KDWE	BRP373 LED226/NW 225W 220-240V
BRP3732404KDWE	BRP373 LED243/NW 240W 220-240V
BRP3732604KDWE	BRP373 LED260/NW 260W 220-240V
BRP3732754KDWE	BRP373 LED277/NW 275W 220-240V
BRP3732904KDWE	BRP373 LED294/NW 290W 220-240V
BRP3733054KDWE	BRP373 LED311/NW 305W 220-240V



## Tango LED

Tango LED is a general purpose LED floodlighting luminaire for various lighting applications, such as area lighting, billboard, façade, industry area, and other general applications. The Tango LED floodlight incorporates an LED light source, optical system, heat sink and driver into one compact housing. Its specially designed heat sink incorporates aesthetics and functionality whilst ensuring reliability and long lifetime. Tango LED takes advantage of all of these features and provides energy savings and a longer lifetime, bringing area lighting into a new era.



### Features and Benefits

- Energy saving: system efficacy reaches 90lm/w, which gives more than 40% of energy saving when compared to conventional floodlight
- Free from lamp replacement: Lifetime reaches 50,000 hours at L70, which requires no lamp replacement after installation
- Low maintenance cost: IP65 housing ensures low maintenance with no need for internal cleaning, resulting in a lower total cost of ownership
- Good reliability: Painted non-corrosive die-cast aluminium housing and steel bracket gives extra strength when the luminaire is installed in a rough environment
- Easy installation and maintenance: Universal “U” shape mounting bracket.

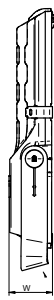
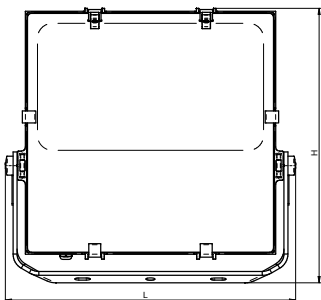

Model	L (mm)	W (mm)	H (mm)
BVP361	433	74	572
BVP363	587	74	572

Dimensions in mm (Nominal)



## Tango LED continued

TANGO LED			
Family Name	Tango LED	Optics	WB, MB, NB (BVP363 only)
Model	BVP361, BVP363	Driver	Integrated driver
Lumens	BVP361 (5,300/10,400/15,500 lumen), BVP363 (17,500/21,000/24,500/28,000 lumens)	Surge Protection	10kV
Wattage	BVP361 (55W, 105W, 155W), BVP363 (175W, 210W, 245W, 280W)	Installation	Universal Bracket
Lamp Colour	3000K, 4000K, 5700K	Weight	BVP361 (10.5kg), BVP363 (16kg)
Colour Rendering Index (CRI)	75	Colour of housing	Grey Aluminium
Flex and Plug	No	Application	Area lighting, billboard, façade, industry area, and other general applications.
*Lifetime (L70)	50,000 hrs	Accessories	N/A
Classifications	IP65, IK07, Class I		

\* = When the fitting reaches 70% of full potential (new)

COMMERCIAL CODE	I2NC	DESCRIPTION
BVP361554KAWB	911401655402	BVP361 LED53/NW 55W 220-240V AWB V
BVP361554KSWB	911401655502	BVP361 LED53/NW 55W 220-240V SWB V
BVP3611054KAWB	911401655602	BVP361 LED104/NW 105W 220-240V AWB V
BVP3611054KSWB	911401655702	BVP361 LED104/NW 105W 220-240V SWB V
BVP3611554KAWB	911401655802	BVP361 LED155/NW 155W 220-240V AWB V
BVP3611554KSWB	911401655902	BVP361 LED155/NW 155W 220-240V SWB V
BVP3632804KAWB	911401652402	BVP363 LED280/NW 280W 220-240V AWB V
BVP3632804KSWB	911401652502	BVP363 LED280/NW 280W 220-240V SWB V
BVP3632804KNB	911401652602	BVP363 LED280/NW 280W 220-240V NB V
BVP3632454KAWB	911401652702	BVP363 LED245/NW 245W 220-240V AWB V
BVP3632454KSWB	911401652802	BVP363 LED245/NW 245W 220-240V SWB V
BVP3632454KNB	911401652902	BVP363 LED245/NW 245W 220-240V NB V
BVP3632104KAWB	911401653002	BVP363 LED210/NW 210W 220-240V AWB V
BVP3632104KSWB	911401653102	BVP363 LED210/NW 210W 220-240V SWB V
BVP3632104KNB	911401653202	BVP363 LED210/NW 210W 220-240V NB V
BVP3631754KAWB	911401653302	BVP363 LED175/NW 175W 220-240V AWB V
BVP3631754KSWB	911401653402	BVP363 LED175/NW 175W 220-240V SWB V
BVP3631754KNB	911401653502	BVP363 LED175/NW 175W 220-240V NB V



## Tango G2 LED

Tango G2 LED is a general purpose mid-power LED floodlighting luminaire suitable for various lighting applications, including area lighting, billboard, façade, and other general applications. Similar to the Tango LED floodlight, the Tango G2 LED floodlight incorporates a mid-power LED light source, optical system, heat sink and driver into even smaller and lighter compact housing. Its specially designed heat sink incorporates aesthetics and functionality whilst ensuring reliability and long lifetime. Tango LED takes advantage of all of these features and provides an affordable energy efficient floodlighting solution.



### Features and Benefits

- Energy saving: system efficacy reaches 100lm/w which gives an energy saving of more than 40% when compared to conventional floodlighting.
- No need for lamp replacement: thanks to a lifetime that reaches 50,000 hours at L70.
- Low maintenance: IP65 housing ensures low maintenance with no need for internal cleaning, resulting in a lower total cost of ownership.
- Flexibility on lighting application: the symmetrical wide beam covers most lighting applications.
- Long-lasting: painted, non-corrosive die-cast aluminium housing and steel bracket gives extra strength when the luminaire is installed in harsh environments.
- Easy installation and maintenance: with a universal “U” shape mounting bracket and 300mm long tail, the Tango G2 is easy to install.

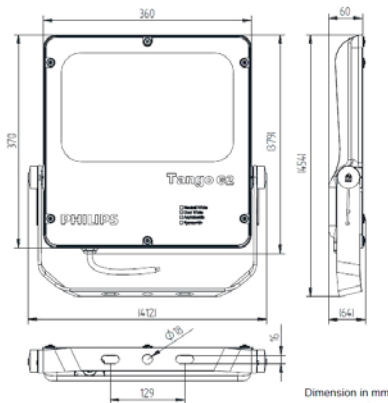

Product ID	L (mm)	W (mm)	H (mm)
BVP281	412	64	454

Dimensions in mm (Nominal)





# Tango G2 LED continued

TANGO G2 LED			
Family Name	Tango G2 LED	Optics	SWB
Model	BVP281	Driver	Integrated driver
Lumens	4,000lm, 8000lm, 12,000lm	Surge Protection	10kV
Wattage	40W, 80W, 120W	Installation	Universal Bracket
Lamp Colour	4000K, 6500K	Weight	6.5kg
Colour Rendering Index (CRI)	Min 80	Colour of housing	Grey Aluminium
Flex and Plug	No	Application	Area lighting, bill board, façade, industry area, and other general applications.
*Lifetime (L70@35°C)	50,000 hrs	Accessories	N/A
Classifications	IP65, IK07, Class I		

\* = When the fitting reaches 70% of full potential (new)

COMMERCIAL CODE	I2NC	DESCRIPTION
BVP281404KSWB	911401635202	BVP281 LED40/NW 40W 220-240V SWB
BVP281804KSWB	911401634102	BVP281 LED80/NW 80W 220-240V SWB
BVP2811204KSWB	911401634202	BVP281 LED120/NW 120W 220-240V SWB
BVP2814065KSWB	911401634602	BVP281 LED40/CW 40W 220-240V SWB
BVP2818065KSWB	911401634702	BVP281 LED80/CW 80W 220-240V SWB
BVP28112065KSWB	911401634802	BVP281 LED120/CW 120W 220-240V SWB

# OptiVision

An asymmetric luminaire for downlighting that combines a compact design with very high efficiency. It provides excellent spill-light control and limitation of glare and upward leakage of light. It accommodates metal-halide lamps for good colour rendering or high-pressure sodium lamps for economical operation. Available with narrow, medium and wide beams.



## Features and Benefits

- Excellent spill-light control; limitation of glare and upward leakage of light is secured by asymmetric optics that achieve peak intensity at 60° and a sharp cut-off of light at 80°
- Housing dust proof and waterproof to IP65; no internal cleaning required
- Integrated protractor scale for aiming
- The compact, low-weight luminaire, together with the low drag factor, enables savings on mast costs
- Specially designed heat fins to provide optimal working conditions for lamp and reflector system

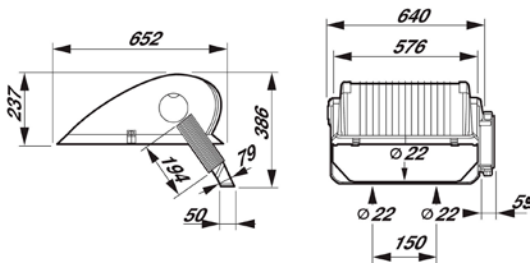

Product ID	L (mm)	W (mm)	H (mm)
MVP507	640	652	386

Dimensions in mm (Nominal)

OPTIVISION			
Family Name	OptiVision	Control Gear	Conventional (gear tray mounted or IP65 box) **
Model	MVP507	Installation	Floodlight mounting bracket
Lamp Type	SON-T, MHN-LA **	IP rating	IP65
Wattage	600W (SON-T), 1kW, 2kW (MHN-LA) **	Weight	17.3kg (excluding gear)
Lamp Colour	4200K/5600K (MHN-LA) **	Colour of housing	Silver
Colour Rendering Index (CRI)	80/90 (MHN-LA) **	Application	Sports Facilities / Industrial Areas / Car Parks
Flex and Plug	No	Accessories	NA
Optics	NB, MB, WB		

\*\* Please note that lamp and control gear are to be purchased separately.

COMMERCIAL CODE	I2NC	DESCRIPTION
MVP507MHIKWVB	910401647780	MVP507 MHN-LA1000W WB
MVP507SONTIKWVB	910401647680	MVP507 SON-T1000W WB
MVP507SONT600WB	910401647580	MVP507 SON-T1000W WB
MVP507MH2KWNB	823807803511	MVP507 MHN-LA2000W/400V/NB BK
MVP507MH2KWMB	823807803611	MVP507 MHN-LA2000W/400V/MB BK
MVP507MH2KWVB	823807803711	MVP507 MHN-LA2000W/400V/WB BK

# ArenaVision

Since it was first introduced in 1988, Philips ArenaVision has proven to be amongst the best floodlighting systems ever for sports lighting applications, most of which have to fulfill the highest specifications to enable television coverage of national and international events. With ArenaVision, the key disciplines of lamp, optic and gear design were brought together with a single mission: to create the best possible floodlight that will operate effectively for many years. ArenaVision MVF403 is ideal for indoor sports halls as well as many outdoor sports and other illumination uses. It comes with a variety of reflectors and lamps and offers a choice of optical systems.



## Features and Benefits

- Together with the unique oval optics, the MHN-SA 2000W lamp guarantees the highest possible system efficiency, low glare and optimal lighting levels on the field
- Built-in reflector reduces spill light and glare even further
- Rear opening access for easy lamp replacement
- Housing dust proof and waterproof to IP65; no internal cleaning required

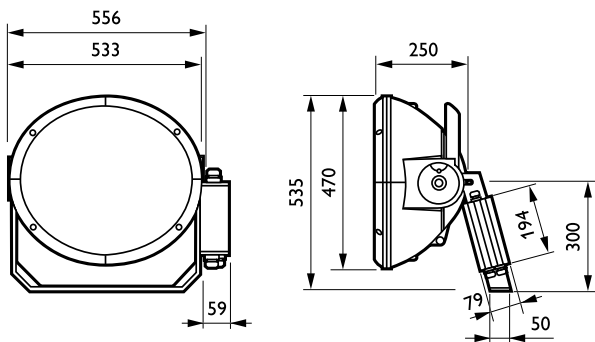

Product ID	L (mm)	W (mm)	H (mm)
MVF403	533	250	535

Dimensions in mm (Nominal)

ARENAVISON			
Family Name	ArenaVision	Control Gear	Conventional (gear tray mounted or IP65 box) **
Model	MVF403	Installation	Floodlight mounting bracket
Wattage	1kW, 2kW	IP rating	IP65
Lamp Colour	4200K/5600K **	Weight	13.7kg (excluding gear)
Colour Rendering Index (CRI)	80/90 **	Colour of housing	Silver
Flex and Plug	No	Application	Outdoor Sports Lighting / Indoor Sports Halls / Architectural floodlighting
Optics	A1, A2, A3, A4, A5, A6, A7	Accessories	N/A

\*\* Please note that lamp and control gear are to be purchased separately.

ArenaVision continued

COMMERCIAL CODE	I2NC	DESCRIPTION
MVF403MHIKWA1	911401054680	MVF403 C MHN-LAI000W 220-240V A1
MVF403MHIKWA2	911401054780	MVF403 C MHN-LAI000W 220-240V A2
MVF403MHIKWA3	911401054880	MVF403 C MHN-LAI000W 220-240V A3
MVF403MHIKWA4	911401054980	MVF403 C MHN-LAI000W 220-240V A4
MVF403MHIKWA5	911401055080	MVF403 C MHN-LAI000W 220-240V A5
MVF403MHIKWA6	911401055180	MVF403 C MHN-LAI000W 220-240V A6
MVF403MHIKWA7	911401055280	MVF403 C MHN-LAI000W 220-240V A7
MVF403MH2KWA1	910401642180	MVF403 MHN-SA2000W 380-415 CAT-A1 SI
MVF403MH2KWA2	910401642780	MVF403 MHN-SA2000W 380-415 CAT-A2 SI
MVF403MH2KWA3	910401642280	MVF403 MHN-SA2000W 380-415 CAT-A3 SI
MVF403MH2KWA4	910401642380	MVF403 MHN-SA2000W 380-415 CAT-A4 SI
MVF403MH2KWA5	910401642480	MVF403 MHN-SA2000W 380-415 CAT-A5 SI
MVF403MH2KWA6	910401642580	MVF403 MHN-SA2000W 380-415 CAT-A6 SI
MVF403MH2KWA7	910401642680	MVF403 MHN-SA2000W 380-415 CAT-A7 SI

# ComfortVision

ComfortVision is a high-efficiency, asymmetric floodlight, distributing a low-glare beam evenly and accurately. It can accommodate metal-halide lamps for good colour rendering or a high-pressure sodium lamp for economical performance. Available in medium- or narrow-beam versions, the floodlight accepts a single 1,000 or two 400 or 600W lamps. The twin-lamp version offers switching flexibility that permits tailoring to the user's needs while allowing energy savings. ComfortVision's rugged all-weather construction is designed for easy aiming, simple cleaning and speedy servicing.



## Features and Benefits

- Rugged, all-weather construction
- Single 1000 W or two switchable 400 or 600 W lamps
- Medium or narrow beam
- Adjustment range of  $\pm 12^\circ$  from the horizontal
- Universal mounting bracket

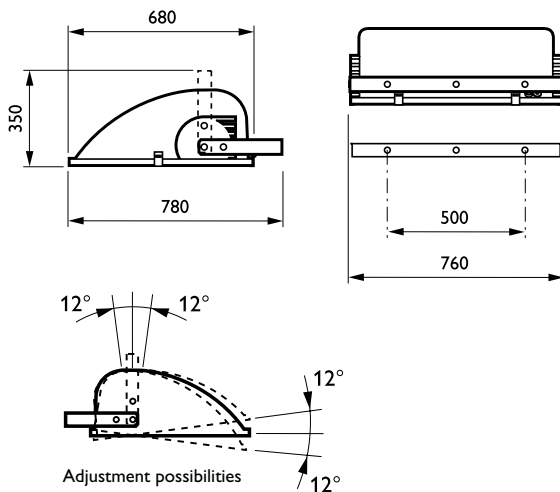

Product ID	L (mm)	W (mm)	H (mm)
SNFI 11	780	760	350

Dimensions in mm (Nominal)

# ComfortVision continued

COMFORTVISION			
Family Name	ComfortVision	Control Gear	Conventional (gear tray mounted or IP65 box) **
Model	SNF111	Installation	Floodlight mounting bracket
Lamp Types	SON-T	IP rating	IP65
Wattage	1kW, 2x400W **	Weight	23.5kg (excluding gear)
Lamp Colour	N/A **	Colour of housing	Silver
Colour Rendering Index (CRI)	N/A **	Application	Industrial Areas / Roundabouts / Car Parks / Sports Lighting / Airports
Flex and Plug	No	Accessories	N/A
Optics	NB, MB		

\*\* Please note that lamp and control gear are to be purchased separately.

COMMERCIAL CODE	I 2NC	DESCRIPTION
SNF111SON1KWNB	910403929112	SNF111 1xSON-T1000W NB SI
SNF111SON1KWMB	910403929212	SNF111 1xSON-T1000W MB SI
SNF1112SON400NB	910403929512	SNF111 2XSON-T400W NB SI
SNF1112SON400MB	910403929612	SNF111 2xSON-T400W MB SI



# ConTempo HID

The ConTempo floodlight has a registered design that blends well with contemporary outdoor environments. It has a rugged pressure die-casted aluminium housing with corrosion resistant powder coating. ConTempo also features an integrated energy saving copper ballast, electronic semi-parallel ignitor and capacitor. The unit has passed rigorous tests for dust and water ingress protection.



## Features and Benefits

- Rugged pressure die-casted aluminium housing with corrosion resistant powder coating
- Integrated energy saving copper ballast, electronic semi-parallel ignitor and capacitor
- Custom-designed peened anodised reflector for efficient symmetric and asymmetric optics
- Hinged toughened glass cover for easy operation
- Rigorously tested for dust and water ingress protection
- Ergonomic installation and maintenance mechanisms

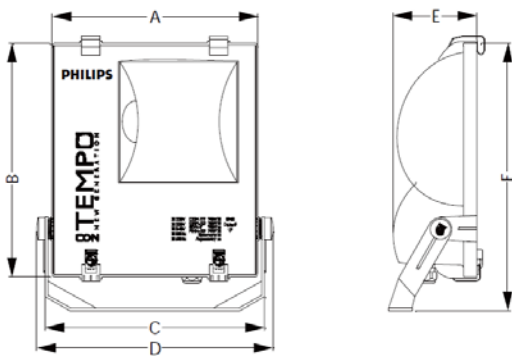

Product ID	D (mm)	E (mm)	F (mm)
RVP250	363	117	424
RVP350	460	137	476

Dimensions in mm (Nominal)

## CONTEMPO HID

Family Name	ConTempo HID	Control Gear	Conventional
Model	RVP250/350	Installation	Universal Bracket
Lamp Type	MHN-TD, HPI-T, SON-T	IP rating	IP65
Wattages	70W, 150W, 250W, 400W	Weight	RVP250 (4.7kg) , RVP350 (9.4kg)
Lamp Colour	MHN-TD (4200K), HPI-T (4500K), SON-T (2000K)	Colour of housing	Grey
Colour Rendering Index (CRI)	MHN-TD (80) , HPI-T (65) , SON-T (25)	Application	Area Lighting / Billboard / Façade / Industrial Areas / Other General
Flex and Plug	No	Accessories	N/A
Optics	Symmetrical, Asymmetrical		

## ConTempo HID continued

COMMERCIAL CODE	I2NC	DESCRIPTION
RVP250MH70TDKA	911401057480	RVP250 MHN-TD70W K IC 240V 50Hz A SP
RVP250MH70TDKS	911401056380	RVP250 MHN-TD70W K IC 240V 50Hz S SP
RVP250MHI50TDKA	911401057580	RVP250 MHN-TDI50W K IC 240V 50Hz A SP
RVP250MHI50TDKS	911401057180	RVP250 MHN-TDI50W K IC 240V 50Hz S SP
RVP350HPI250TKA	911401056980	RVP350 HPI-T250W K IC 240V 50Hz A SP
RVP350HPI250TKS	911401056580	RVP350 HPI-T250W K IC 240V 50Hz S SP
RVP350HPI400TKA	911401057080	RVP350 HPI-T400W K IC 240V 50Hz A SP
RVP350HPI400TKS	911401056680	RVP350 HPI-T400W K IC 240V 50Hz S SP
RVP250SON70TKA	911401057680	RVP250 SON-T70W K IC 240V 50Hz A SP
RVP250SON70TKS	911401057280	RVP250 SON-T70W K IC 240V 50Hz S SP
RVP250SON150TKA	911401057780	RVP250 SON-T150W K IC 240V 50Hz A SP
RVP250SON150TKS	911401057380	RVP250 SON-T150W K IC 240V 50Hz S SP
RVP350SON250TKA	911401056780	RVP350 SON-T250W K IC 240V 50Hz A SP
RVP350SON250TKS	911401057880	RVP350 SON-T250W K IC 240V 50Hz S SP
RVP350SON400TKA	911401056880	RVP350 SON-T400W K IC 240V 50Hz A SP
RVP350SON400TKS	911401056480	RVP350 SON-T400W K IC 240V 50Hz S SP

# Tango HID

Compact, sturdy floodlight complete with integral gear, particularly suited for surface lighting using metal halide or high-pressure sodium lamps. All-weather construction designed for simple cleaning and speedy servicing.



## Features and Benefits

- High-grade symmetrical or asymmetrical reflector projects a highly efficient light beam
- Wall, ceiling and surface mountings with wide range of adjustments for both down and up lighting
- Quick, easy access to lamp and gear, without affecting beam adjustment, through hinged front window with quick-release clips
- Housing dustproof and jetproof; no internal cleaning required

MMF383, SMF383

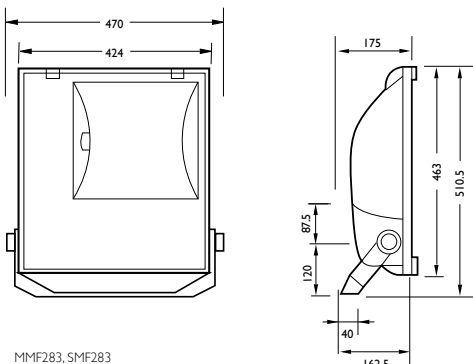

MMF283, SMF283

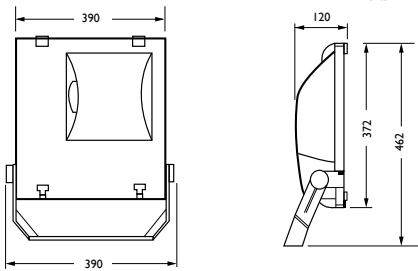

Product ID	L (mm)	W (mm)	H (mm)
MMF383, SMF383	470	175	510.5
MMF283, SMF283	390	120	462

Dimensions in mm (Nominal)

Tango HID continued

TANGO HID			
Family Name	Tango HID	Control Gear	Conventional
Model	Tango 2 (SMF283, MMF283), Tango 3 (SMF383, MMF383)	Installation	Universal Bracket
Lamp Types	MHN-TD, HPI-T, SON-T	IP rating	IP65
Wattages	70W, 150W, 250W, 400W	Weight	Tango 2 (7.6-9kg) Tango 3 (12.5 -14kg)
Lamp Colour	MHN-TD (4200K), HPI-T (4500K), SON-T (2000K)	Colour of housing	Black
Colour Rendering Index (CRI)	MHN-TD (80) , HPI-T (65) , SON-T (25)	Application	Area Lighting / Billboard / Façade / Industrial Areas / Other General
Flex and Plug	No	Accessories	N/A
Optics	Symmetrical, Asymmetrical		

COMMERCIAL CODE	I2NC	DESCRIPTION
MMF283MH70TDKS	91040333201	MMF283 MHN-TD70W Tango S K 240v 50hz
MMF283MHI50TDKS	91040333101	MMF283 MHN-TD150W Tango S K 240v 50hz
MMF383HPI250TKS	910403334201	MMF383 HPI-T250W Tango S K 240v 50hz
MMF383HPI400TKS	910403334401	MMF383 HPI-T400W Tango S K 240v 50hz
MMF383HPI400TKA	910403334501	MMF383 HPI-T400W Tango A K 240v 50hz
SMF283SON70TKS	910403336601	SMF283 SON-T70W Tango S K 240v 50hz
SMF383SON250TKS	910403333801	SMF383 SON-T250W Tango S K 240v 50hz
SMF383SON400TKS	910403334001	SMF383 SON-T400W Tango S K 240v 50hz
SMF383SON400TKA	910403334101	SMF383 SON-T400W Tango A K 240x 50hz

# HNF90I (Puma)

A versatile floodlight suitable for small to medium scale floodlighting for sports or similar areas. It offers good colour rendering with HPI-T metal halide lamps, or economical operation with SON-T high pressure sodium lamps. Robust and simple construction designed for easy aiming, quick maintenance and long service life.



## Features and Benefits

- Robust and simple construction designed for easy aiming, quick maintenance and long service life.
- Suitable for multiple applications including industrial areas and sports facilities.

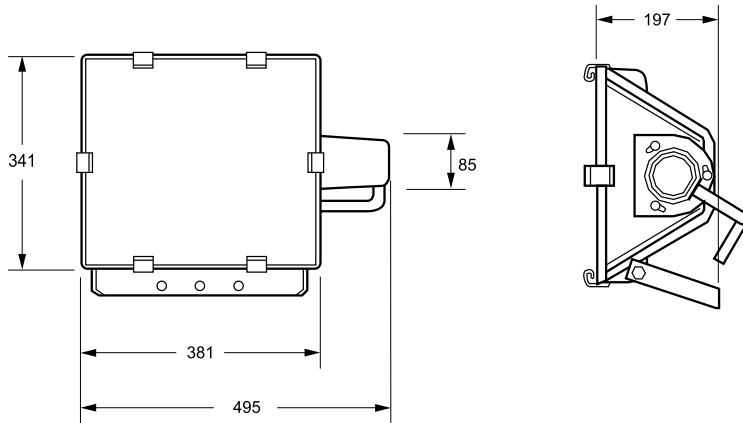

Product ID	L (mm)	W (mm)	H (mm)
HNF90I	495	197	341

Dimensions in mm (Nominal)

HNF90I (PUMA)			
Family Name	Puma	Control Gear	N/A
Model	HNF90I	Installation	Universal bracket
Wattage	N/A	IP rating	IP65
Lamp Colour	N/A	Weight	8kg
Colour Rendering Index (CRI)	N/A	Colour of housing	Silver
Flex and Plug	No	Application	Sports facilities / General areas / Industrial areas / Car Parks
Optics	NB, WB	Accessories	N/A

\* Please note fitting is supplied without lamp

COMMERCIAL CODE	I2NC	DESCRIPTION
HNF90IGRNB	911401040780	HNF90I NARROW FLOOD
HNF90IGRWB	911401040380	HNF90I WIDE FLOOD
HNF90IBLNB	911401040880	HNF90I NRW FLD - BLACK



## Mini Vandalite LED

Everyone wants to feel safe after dark, and yet we're also conscious of the need to save energy. The solution to this dilemma is here in the form of Mini Vandalite LED, a ceiling or wall-mounted security and amenity lighting luminaire. LED-based, it delivers low-energy lighting all night long. Its translucent bowl provides excellent light distribution for low-level lighting of walls, corridors and surroundings. The high reliability and longevity of LEDs means that neither lamp replacement nor maintenance is required during the luminaire's long service life, thus reducing costs. Mini Vandalite's robust, vandal-resistant construction makes it suitable for both outdoor and indoor applications.



### Features and Benefits

- Point to Point replacement of fluorescent bulkheads
- 12W (600 lm) and 17W (900 lm)
- 50 lm/W, Energy Savings up to 30%
- Compact and easy to install
- Life up to 50,000hrs (L70)
- IP65/IK10 robust design and vandal resistant construction
- Outdoor Residential / Security Lighting

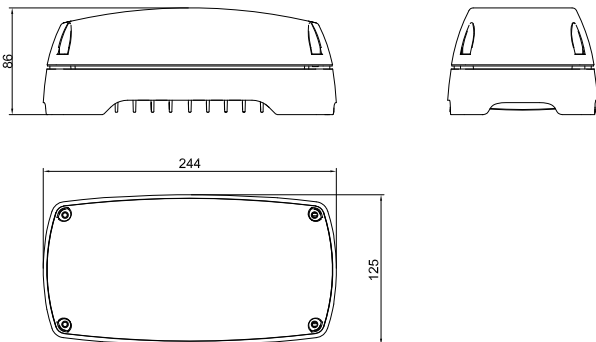

Product ID	L (mm)	W (mm)	H (mm)
BCW098	244	125	86

Dimensions in mm (Nominal)

\* = When the fitting reaches 70% of full potential (new)





## Mini Vandalite LED continued

MINI VANDALITE LED			
Family Name	Mini Vandalite	Dimmable	PSU (Fixed output)
Model	BCW098	Installation	Wall Mounted
Lumen/ Watt	900lm/ 17W 600lm/ 12W	IP rating	IP65
Lamp Colour	4000K	IK Rating	IK10
Colour Rendering Index (CRI)	85	Colour of housing	Dark grey, RAL 7043
Flex and Plug	Not included	Application	Residential, Security
*Lifetime (L70)	50,000hrs	Accessories	n/a
Unified Glare Ratio (UGR)	n/a	Suspension Height - min/max	NA
Optics	120D	Maximum Run Length	NA
Driver	Integrated driver		

COMMERCIAL CODE	I2NC	DESCRIPTION
BCW0986L12W4KF	911401704901	BCW098 LED6/NW
BCW0989L17W4KF	911401705001	BCW098 LED9/NW



## Twin Motion LED Sensor

The Philips LED motion sensor incorporates the latest in lighting technology with practical and user friendly features, including adjustable beam angles and sensor timer.

Designed as a total fit and forget solution, the LED motion and daylight sensor is the complete package with low energy usage and extra long life.



### Features and Benefits

- Low 2 x 7.5W LED adjustable beam angles
- Bright 5,000K colour temperature
- Up to 30,000 hours lifetime
- IP44 rated for outdoor use
- Powerful 1,000 lumens light output

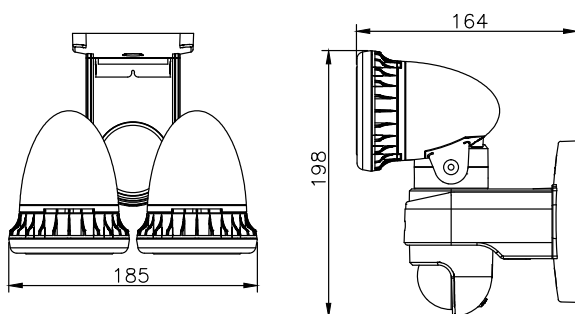

Product ID	L (mm)	W (mm)	H (mm)
EH313L	164	185	198

Dimensions in mm (Nominal)

### TWIN MOTION LED SENSOR

Family Name	Twin Motion LED Sensor	Dimmable	PSU (Fixed output)
Model	EH313L	Installation	Wall Mounted
Lumen/ Watt	EH313L - 1000lm/ 15W	IP rating	IP44
Lamp Colour	5000K	Weight	0.80kg
Colour Rendering Index (CRI)	80	Colour of housing	Black
Flex and Plug	Not included	Application	Residential Security
*Lifetime (L70)	30,000 hrs	Accessories	n/a
Unified Glare Ratio (UGR)	n/a	Suspension Height - min/max	NA
Optics	110D	Maximum Run Length	NA
Driver	Integrated driver		

### COMMERCIAL CODE

EH313LLED

### I2NC

919023001234

### DESCRIPTION

EH313L LED Twin Motion Sensor

## Vandalite

Vandalite is a surface mounted fluorescent luminaire that, as its name implies, is a tough, dust and watertight product for situations where semi-outdoor exposure and vandalism can be a problem. The Vandalite has an IP65 rating, being totally dustproof and waterproof. Its robust construction makes it virtually vandal-proof. The body is injection moulded, glass filled nylon for long life and added strength. The reflector is of pressed prepainted steel with integral gear and rota-lock lampholders for 1xTL5 14W lamp or with moulding and posts for 2xPL 18W or 1xPL 36W lamps.



### Features and Benefits

- Dust, water and impact protection
- Optimum light distribution and performance
- Easy installation and maintenance

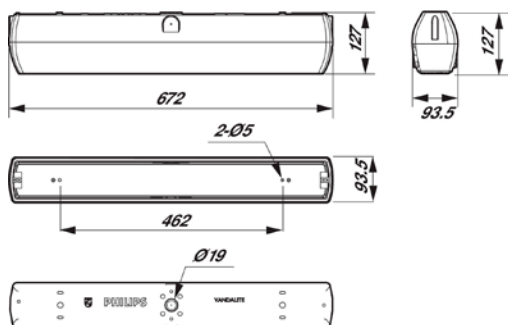

Product ID	L (mm)	W (mm)	H (mm)
TCW098 T5	672	93	126
TCW098 T8	672	93.5	127

Dimensions in mm (Nominal)

### VANDALITE

Family Name	Vandalite	Installation	Screw mounted
Model	TCW098	IP rating	IP65
Watt	14W (T5), 18W/36W (T8)	Weight	2kg
Lamp Colour	N/A	Application	Residential, Industrial, Commercial
Colour Rendering Index (CRI)	N/A	Accessories	N/A
Flex and Plug	No		
Driver	High Frequency Ballast/Conventional		

COMMERCIAL CODE	I2NC	DESCRIPTION
TCW098I14T5CL	910403630084	TCW098 1xTL5 14W K HFS CL
TCW098I14T5OP	910403630085	TCW098 1xTL5 14W K HFS OP
FCW09824CFLOP	911400606880	FCW098 IX Tornado 24W K O





---

# Consumer Luminaires











# LEDINO

## Giving light a new experience

Minimalist and elegant. Simple yet versatile. Philips Ledino injects a natural sense of purity and beauty into your home.

With a linear design and an integrated LED light source, it's ideal for the sophisticated living room, dining area or bedroom. And perfect for the savvy urbanite.

You'll enjoy natural white light adjustable to the preferred atmosphere, thanks to its state-of-the-art Power LEDs. Together, they give your interior a beautiful diffused white accent, and an energy-efficient light source that lasts up to 20,000 hours.

Time to feel right at home with the future.



### Tunable White

A simple key lets you choose between four different white light colour temperatures (3450, 3100, 2700, 2500 Kelvin) on selected fittings.



## 69092/31 Suspension Light



### 69092/31 SUSPENSION LIGHT

Colour/Finish	White, aluminium
IP rating	IP20
Lamp	LED 4 x 7.5W, 2700K
Dimensions (mm)	900 x 106 x MAX 1480 (adjustable height)
Commercial Code	69092/29/86 (2.7K)

## 69092/87 Suspension Light



### 69092/87 SUSPENSION LIGHT

Colour/Finish	Aluminium
IP rating	IP20
Lamp	LED 4 x 7.5W, 2700K
Dimensions (mm)	900 x 106 x MAX 1480 (adjustable height)
Commercial Code	69092/11/86 (2.7K)

## 69064/87 Wall Light



### 69064/87 WALL LIGHT

Colour/Finish	Grey
IP rating	IP20
Lamp	LED 1 x 2.5W, 4000K or 2700K
Dimensions (mm)	120 x 120 x 506
Commercial Code	69064/87/86 (4K) or 69064/99/86 (2.7K)

## 69070/31 Wall/Ceiling Light



### 69070/31 WALL/CEILING LIGHT

Colour/Finish	White
IP rating	IP20
Lamp	LED 1 x 7.5W, 4000K or 2700K
Dimensions (mm)	72 x 168 x 130
Commercial Code	69070/31/86 (4K) or 69070/29/86 (2.7K)

## 69072/31 Wall/Ceiling Light



### 69072/31 WALL/CEILING LIGHT

Colour/Finish	White
IP rating	IP20
Lamp	LED 2 x 7.5W, 4000K or 2700K
Dimensions (mm)	315 x 133 x 73
Commercial Code	69072/31/86 (4K) or 69072/29/86 (2.7K)



## 69074 Wall/Ceiling Light



### 69074 WALL/CEILING LIGHT

Colour/Finish	White
IP rating	IP20
Lamp	LED 4 x 7.5W, 4000K or 2700K
Dimensions (mm)	284 x 284 x 73
Commercial Code	69074/31/86 (4K) or 69074/29/86 (2.7K)

## 69080/87 Wall/Ceiling Light



### 69080/87 WALL/CEILING LIGHT

Colour/Finish	Grey
IP rating	IP20
Lamp	LED 1 x 7.5W, 4000K
Dimensions (mm)	136 x 132 x 102
Commercial Code	69080/87/86 (4K)

## 69082/87 Wall/Ceiling Light



### 69082/87 WALL/CEILING LIGHT

Colour/Finish	Grey
IP rating	IP20
Lamp	LED 2 X 7.5W, 4000K
Dimensions (mm)	185 x 503 x 58
Commercial Code	69082/87/86 (4K)

## 69084/87 Wall/Ceiling Light



### 69084/87 WALL/CEILING LIGHT

Colour/Finish	Grey
IP rating	IP20
Lamp	LED 4 x 7.5W, 4000K or 2700K
Dimensions (mm)	185 x 903 x 58
Commercial Code	69084/87/86 (4K) or 69084/99/86 (2.7K)

## 69089/31 Wall Light



### 69089/31 WALL LIGHT

Colour/Finish	White
IP rating	IP20
Lamp	LED 2 x 2.5W, 4000K or 2700K
Dimensions (mm)	95 x 127 x 55
Commercial Code	69089/31/86 (4K) or 69089/29/86 (2.7K)



# ESSENTIAL LED

## Slimline Ceiling Oyster Range

.....

The new Philips Essential LED Ceiling range delivers the advantages of LED technology in surface mount ceiling luminaires. These are an ideal replacement for older incandescent, ecohalogen or fluorescent based oysters. The LED light sources used are up to 75% more energy efficient versus traditional light sources<sup>1</sup>. Using LED allows a stylish slim line design only 50mm thick for a clean, unobtrusive installation.

LED deliver longer life than conventional light sources with up to 15,000 hours<sup>2</sup> of hassle free light delivered instantly in a soft uniform manner via durable, yellowing & chip resistant acrylic diffusers. The range offers a choice of 3 popular sizes and warm white or cool white colour temperatures.

1. Ultra efficient LED light source saves up to 75% energy vs. Philips EcoClassic halogen lamps with similar light output.
2. Up to 15,000 hours lifetime at 70% lumen maintenance in residential use.



## 30804 Slimline Ceiling Oyster 12W



### 30804 CEILING OYSTER 12W

Colour/Finish	White bezel
Lamp	LED 12W, 3000K or 5700K
Dimensions (mm)	290 x 290 x 50
Commercial Code	30804/61/46 (3K) or 30804/31/46 (5.7K)

## 30805 Slimline Ceiling Oyster 17W



### 30805 CEILING OYSTER 17W

Colour/Finish	White bezel
Lamp	LED 17W, 3000K or 5700K
Dimensions (mm)	350 x 350 x 50
Commercial Code	30805/61/46 (3K) or 30805/31/46 (5.7K)

## 30806 Slimline Ceiling Oyster 22W



### 30806 CEILING OYSTER 22W

Colour/Finish	White bezel
Lamp	LED 22W, 3000K or 5700K
Dimensions (mm)	380 x 380 x 50
Commercial Code	30806/61/46 (3K) or 30806/31/46 (5.7K)







# ROOMSTYLERS

---

Express your style with light

---

Understated, yet thoroughly distinct. The Philips Roomstylers contemporary collection blends effortlessly into any modern home décor, thanks to light fixtures that span a wide spectrum of colours and materials.

Available in both stand-alone and coordinated sets, the range includes wall and ceiling lights. All designed to give you the flexibility you need to complement your lifestyle.

## TCG701 Ceiling/Wall Light



### TCG701 CEILING/WALL LIGHT

Colour/Finish	White colour, sand blasted glass, steel
Lamp	E27, lamp not included
Dimensions (mm)	340 x 340 x 100
Commercial Code	30010/17/46

## TCG702 Ceiling/Wall Light



### TCG702 CEILING/WALL LIGHT

Colour/Finish	Nickel finish, sand blasted glass, steel
Lamp	E27, lamp not included
Dimensions (mm)	360 x 360 x 96
Commercial Code	30012/17/46

## TCG700 Ceiling/Wall Light



### TCG700 CEILING/WALL LIGHT

Colour/Finish	Gold finish, sand blasted glass, steel
Lamp	Lamp included
Dimensions (mm)	340 x 340 x 100
Commercial Code	30052/01/86

## TCG700 Ceiling/Wall Light



### TCG700 CEILING/WALL LIGHT

Colour/Finish	White, chrome finish, sand blasted glass, steel
Lamp	Lamp included
Dimensions (mm)	340 x 340 x 100
Commercial Code	30052/11/86

## TCG700 Ceiling/Wall Light



### TCG700 CEILING/WALL LIGHT

Colour/Finish	White colour, sand blasted glass, steel
Lamp	Lamp included
Dimensions (mm)	340 x 340 x 100
Commercial Code	30052/56/86

## QCG307 Ceiling/Wall Light



### QCG307 CEILING/WALL LIGHT

Colour/Finish	White, nickel finish, sand blasted glass
Lamp	E27, lamp not included
Dimensions (mm)	370 x 370 x 116
Commercial Code	70107/86/17

## QCG307 Ceiling/Wall Light



### QCG307 CEILING/WALL LIGHT

Colour/Finish	White colour, sand blasted glass
Lamp	E27, lamp not included
Dimensions (mm)	370 x 370 x 116
Commercial Code	70107/86/31

## QWG306 Wall Light



### QWG306 WALL LIGHT

Colour/Finish	White, glass and steel
Lamp	E27, lamp not included
Dimensions (mm)	265 x 95 x 255
Commercial Code	33710/30/86

## FWG301 Wall Light



### FWG301 WALL LIGHT

Colour/Finish	Beige, sand blasted glass with fabric
Lamp	E27, lamp not included
Dimensions (mm)	315 x 111 x 168
Commercial Code	33200/30/76

## QWG311 Wall Light



### QWG311 WALL LIGHT

Colour/Finish	Dark grey, steel and glass
Lamp	E27, lamp not included
Dimensions (mm)	401 x 103 x 90
Commercial Code	33206/93/86





# KIDSPLACE

---

## Fun spaces with light & colour

---

Light up a child's world with Philips Kidsplace – a specially designed collection of child-safe light fittings. Available in diverse designs with playful colours, they transform a child's bedroom into a magical wonderland.

Its wide range of ambient lighting gives a sense of cosiness and warmth, encouraging children to be themselves and have fun. Turning on the switch is like stepping into a make-believe world of a child's creative imaginings.

This collection is the perfect touch for a child to play, learn, create - a dream!

## QCG316 Ceiling Light



### QCG316 CEILING LIGHT

Colour/Finish	Mixed colour, glass, wood
IP rating	IP20
Lamp	E27, lamp not included
Dimensions (mm)	400 x 400 x 430
Commercial Code	40153/55/86

## QPG308 Suspension Light



### QPG308 SUSPENSION LIGHT

Colour/Finish	Mixed colour, steel, synthetics, wood
IP rating	IP20
Lamp	E27, lamp not included
Dimensions (mm)	185 x 234 x MAX 1500 (adjustable height)
Commercial Code	40279/55/86

## QCG310 Ceiling Light



### QCG310 CEILING LIGHT

Colour/Finish	Mixed colour, steel, satinated glass, wood
IP rating	IP20
Lamp	E27, lamp not included
Dimensions (mm)	300 x 300 x 135
Commercial Code	30110/55/56

## QCG311 Ceiling Light



### QCG311 CEILING LIGHT

Colour/Finish	Mixed colour, steel, satinated glass, wood
IP rating	IP20
Lamp	E27, lamp not included
Dimensions (mm)	300 x 300 x 135
Commercial Code	30111/55/86

## QCG315 Ceiling Light



### QCG315 CEILING LIGHT

Colour/Finish	Mixed colour, glass, steel, wood
IP rating	IP20
Lamp	E27, lamp not included
Dimensions (mm)	400 x 400 x 356
Commercial Code	30112/55/86



## QPG314 Suspension Light



### QPG314 SUSPENSION LIGHT

Colour/Finish	Mixed colour, wood, steel
IP rating	IP20
Lamp	E27, lamp not included
Dimensions (mm)	420 x 420 x MAX 1300 (adjustable height)
Commercial Code	40178/55/86

## QPG315 Suspension Light



### QPG315 SUSPENSION LIGHT

Colour/Finish	Mixed colour, steel, synthetics, wood
IP rating	IP20
Lamp	Ambiance E27, lamp included
Dimensions (mm)	267 x 267 x MAX 1200 (adjustable height)
Commercial Code	40204/55/86

## FPG302 Suspension Light



### FPG302 SUSPENSION LIGHT

Colour/Finish	Mixed colour, wood, steel
IP rating	IP20
Lamp	Ambiance E27, lamp included
Dimensions (mm)	470 x 130 x MAX 1250 (adjustable height)
Commercial Code	40429/55/86

## QPG313 Suspension Light



### QPG313 SUSPENSION LIGHT

Colour/Finish	Yellow, wood, synthetics
IP rating	IP20
Lamp	Ambiance E27, lamp included
Dimensions (mm)	380 x 110 x MAX 1050 (adjustable height)
Commercial Code	75500/86/34

## QPG316 Suspension Light



### QPG316 SUSPENSION LIGHT

Colour/Finish	Mixed colour, wood, synthetics
IP rating	IP20
Lamp	Ambiance E27, lamp not included
Dimensions (mm)	300 x 350 x MAX 1100 (adjustable height)
Commercial Code	78621/86/55

## 40229 Suspension Light



### 40229 SUSPENSION LIGHT

Colour/Finish	Mixed colour, wood
IP rating	IP20
Lamp	Ambiance E27, lamp included
Dimensions (mm)	320 x 270 x MAX 1500 (adjustable height)
Commercial Code	40229/55/86

## 40295 Suspension Light



### 40295 SUSPENSION LIGHT

Colour/Finish	Purple and pink, wood
IP rating	IP20
Lamp	Ambiance E27, lamp included
Dimensions (mm)	493.7 x 394.8 x MAX 1500 (adjustable height)
Commercial Code	40295/49/86

## 69112 Guidelight Bug



### 69112 GUIDELIGHT BUG

Colour/Finish	Red colour, synthetics
Switch	Motion sensor
Lamp	LED 2 x 0.06W included
Dimensions (mm)	105 x 80 x 105
Commercial Code	69112/32/46

## 69112 Guidelight Bee



### 69112 GUIDELIGHT BEE

Colour/Finish	Yellow colour, synthetics
Switch	Motion sensor
Lamp	LED 2 x 0.06W included
Dimensions (mm)	105 x 80 x 105
Commercial Code	69112/34/46



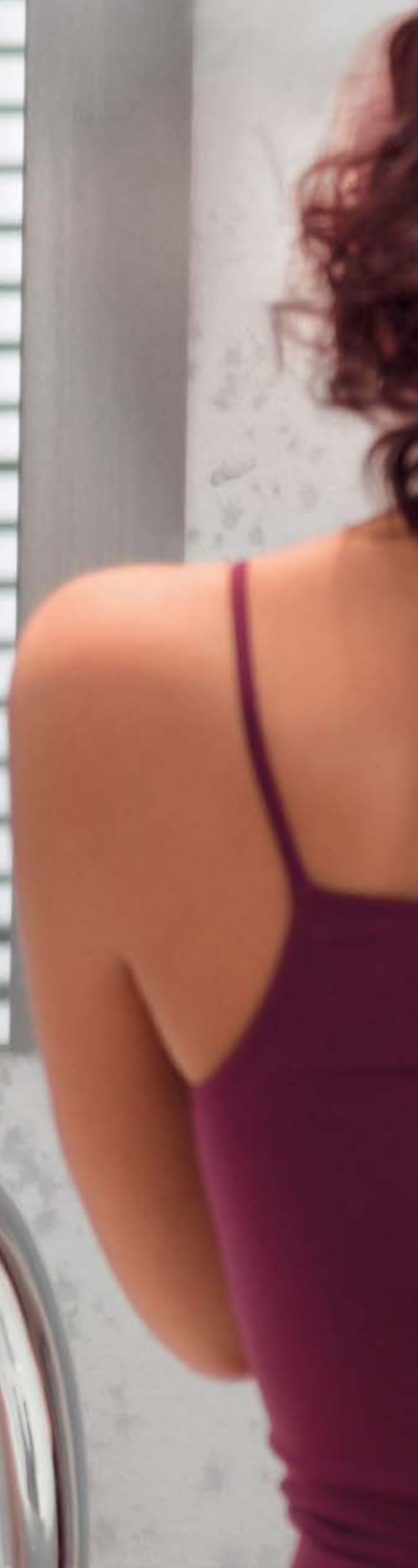





# Aquafit

---

## Turn your bathroom into a spa

---

Inspired by the beauty of water, Philips Aquafit turns your bathroom into a rejuvenating experience. You'll find bright task and general lighting imbued with style and functionality.

Apply make-up or shave effortlessly with tasteful task lights placed around your mirror. Or create a soothing ambience with basic illumination from our ceiling lights.

All products are specially designed with Ingress Protection (IP) rating, without compromising on brightness or style. Total peace of mind in your oasis of calm.

# The right light for the right area

Take note when choosing bathroom lighting as there are strict regulations concerning the type of light you can use. The following information is a guide to help you understand what light fittings can be placed where.

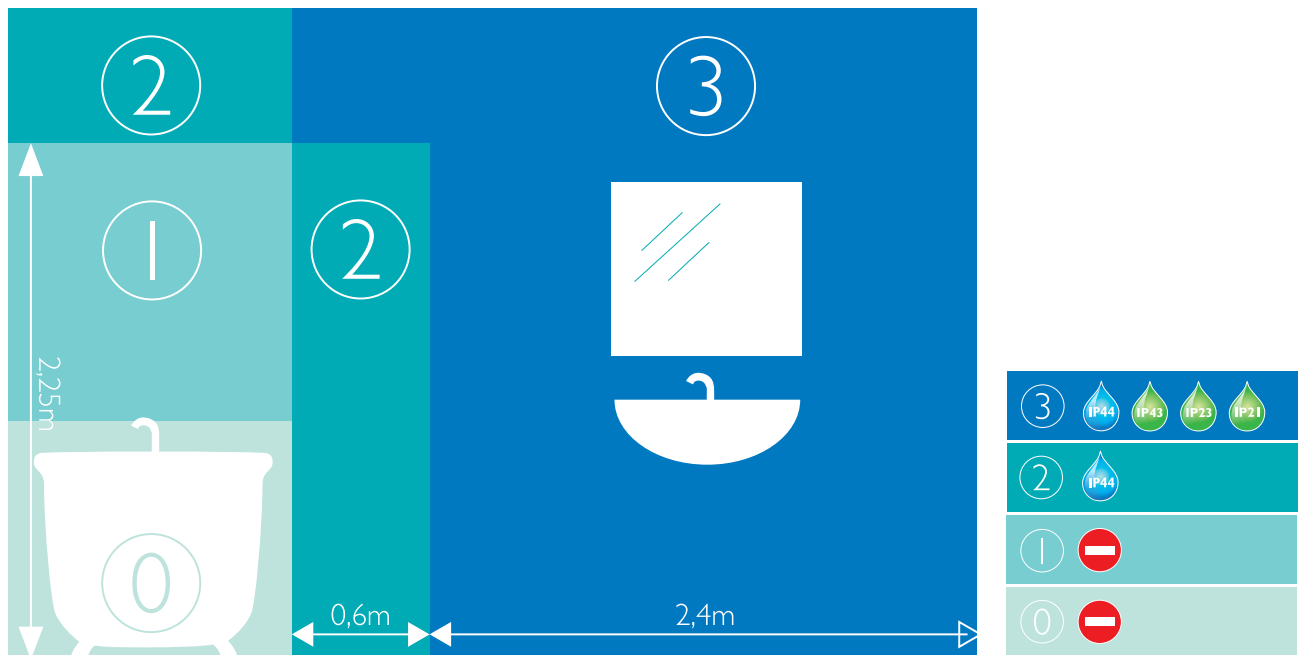

## Area 0 - I – Bathtub area

Philips does not recommend the use of any lighting fixtures in these areas.

## Area 2 – Ceiling and outside shower area

General lighting from luminaires installed on the ceiling can provide the illumination needed here.

### Safety requirement:

This area stretches to 0.6m outside the bath/shower and 2.25m above the floor. Since there is a risk of water accidentally splashing on the fitting, an IP rating of at least IP44 is required.

## Area 3 – Grooming area near vanity

This area requires bright shadow free light for task orientated activities like shaving or make up application.

### Safety requirement:

This area stretches beyond zone 2. As long as there is no chance of the fixture being splashed with water or steam, an IP21 rating is sufficient.

A higher IP rating can always be used to ensure added safety.



## QCZ800 Ceiling Light



### QCZ800 CEILING LIGHT

Colour/Finish	White colour, glass
IP rating	IP44
Lamp	E27, lamp not included
Dimensions (mm)	260 × 260 × 120
Commercial Code	32005/31/76

## QCZ806 Ceiling Light



### QCZ806 CEILING LIGHT

Colour/Finish	White colour, glass
IP rating	IP44
Lamp	E27, lamp not included
Dimensions (mm)	320 × 320 × 110
Commercial Code	32066/31/76

## QCZ802 Ceiling/Wall Light



### QCZ802 CEILING/WALL LIGHT

Colour/Finish	Chrome colour, steel with glass
IP rating	IP44
Lamp	E27, lamp not included
Dimensions (mm)	315 × 315 × 100
Commercial Code	32010/11/76

## QCZ802 Ceiling/Wall Light



### QCZ802 CEILING/WALL LIGHT

Colour/Finish	Nickel colour, steel with glass
IP rating	IP44
Lamp	E27, lamp not included
Dimensions (mm)	315 × 315 × 100
Commercial Code	32010/17/76

## 32047 Wall Light



### 32047 WALL LIGHT

Colour/Finish	Chrome colour, metal with glass
IP rating	IP44
Lamp	E14, lamp not included
Dimensions (mm)	202 × 100 × 163
Commercial Code	32047/11/66

## 32048 Wall Light



### 32048 WALL LIGHT

Colour/Finish	Chrome colour, metal with glass
IP rating	IP44
Lamp	E14, lamp not included
Dimensions (mm)	190 x 320 x 163
Commercial Code	32048/11/66

## 32049 Wall Light



### 32049 WALL LIGHT

Colour/Finish	Chrome colour, metal with glass
IP rating	IP44
Lamp	E14, lamp not included
Dimensions (mm)	190 x 500 x 163
Commercial Code	32049/11/66

## 32029 Wall Light



### 32029 WALL LIGHT

Colour/Finish	Chrome colour, metal with glass
IP rating	IP21
Lamp	E14, lamp not included
Dimensions (mm)	190 x 100 x 165
Commercial Code	32029/11/66

## 32030 Wall Light



### 32030 WALL LIGHT

Colour/Finish	Chrome colour, metal with glass
IP rating	IP21
Lamp	E14, lamp not included
Dimensions (mm)	190 x 320 x 165
Commercial Code	32030/11/66

## 32031 Wall Light



### 32031 WALL LIGHT

Colour/Finish	Chrome colour, metal with glass
IP rating	IP21
Lamp	E14, lamp not included
Dimensions (mm)	190 x 460 x 165
Commercial Code	32031/11/66

## 32032 Wall Light



### 32032 WALL LIGHT

Colour/Finish	Chrome colour, metal with glass
IP rating	IP21
Lamp	E14, lamp not included
Dimensions (mm)	218 x 100 x 200
Commercial Code	32032/11/66

## 32033 Wall Light



### 32033 WALL LIGHT

Colour/Finish	Chrome colour, metal with glass
IP rating	IP21
Lamp	E14, lamp not included
Dimensions (mm)	218 x 320 x 200
Commercial Code	32033/11/66

## 32035 Wall Light



### 32035 WALL LIGHT

Colour/Finish	Chrome colour, metal with glass
IP rating	IP21
Lamp	E14, lamp not included
Dimensions (mm)	241 x 100 x 247
Commercial Code	32035/11/66

## 32036 Wall Light



### 32036 WALL LIGHT

Colour/Finish	Chrome colour, metal with glass
IP rating	IP21
Lamp	E14, lamp not included
Dimensions (mm)	240 x 320 x 185
Commercial Code	32036/11/66

## 32044 Wall Light



### 32044 WALL LIGHT

Colour/Finish	Chrome colour, metal with glass
IP rating	IP21
Lamp	E14, lamp not included
Dimensions (mm)	196 x 100 x 167
Commercial Code	32044/11/66

## 32045 Wall Light



### 32045 WALL LIGHT

Colour/Finish	Chrome colour, metal with glass
IP rating	IP21
Lamp	E14, lamp not included
Dimensions (mm)	183 x 320 x 167
Commercial Code	32045/11/66

## 32046 Wall Light



### 32046 WALL LIGHT

Colour/Finish	Chrome colour, metal with glass
IP rating	IP21
Lamp	E14, lamp not included
Dimensions (mm)	185 x 500 x 167
Commercial Code	32046/11/66









# OUTERSTYLERS

---

## At home with nature

---

The Philips Outerstylers collection puts you right at home with the great outdoors. Water and weather-resistant, it illuminates your balcony or garden in style.

Designed to leave a lasting impression, you'll find a wide selection of outdoor lighting made from long-lasting materials. So your home – and the space it nestles in – exudes a beauty that's truly enduring.

Yet the collection does more than enhance your outdoor spaces. It ensures your pathways, steps and porches are well and safely lit, preventing accidents and protecting your family from intruders – without compromising on style or elegance.

For the perfect sanctuary, inside and out.



Designed for safety and long life

## EWS300 Wall Light



### EWS300 WALL LIGHT

Colour/Finish	Stainless steel finish. Stainless steel, synthetics, aluminium, 360° light output
IP rating	IP44
Lamp	E27, lamp not included
Dimensions (mm)	235 x 95 x 260
Commercial Code	17086/47/46

## EWP300 Wall Light



### EWP300 WALL LIGHT

Colour/Finish	Light Grey colour. Aluminium, synthetics
IP rating	IP44
Lamp	E27, lamp not included
Dimensions (mm)	356 x 93 x 75
Commercial Code	17130/87/46

## I7105 Wall Light



### I7105 WALL LIGHT

Colour/Finish	Light Grey, aluminium, synthetics
IP rating	IP44
Lamp	E27, lamp not included
Dimensions (mm)	113 x 290 x 130
Commercial Code	17105/87/46

## I7105 Wall Light



### I7105 WALL LIGHT

Colour/Finish	Anthracite, aluminium, synthetics
IP rating	IP44
Lamp	E27, lamp not included
Dimensions (mm)	113 x 290 x 130
Commercial Code	17105/93/46

## I7173 Wall Light



### I7173 WALL LIGHT

Colour/Finish	Inox, stainless steel, glass
IP rating	IP44
Lamp	E14, lamp not included
Dimensions (mm)	176 x 93 x 200
Commercial Code	17173/47/46





# LED DESK LAMPS

---

## Give your eyes a break

---

Breeze through long work sessions with the Philips range of desk lamps to assist with any of your task lighting needs.

The collection of Philips desk lamps are functional with a custom designed reflector which enables apt lighting, while the 2D flexibility lets you direct light along the vertical plane.





## Eyecare Black



### LED DESK LIGHT EYECARE BLACK

Colour/Finish	Black
Lamp	LED 5W, 6500K Dimmable
Commercial Code	69195/30/46

## Eyecare White



### LED DESK LIGHT EYECARE WHITE

Colour/Finish	White
Lamp	LED 5W, 6500K Dimmable
Commercial Code	69195/31/46

## Vane Blue



### LED DESK LIGHT VANE BLUE

Colour/Finish	Blue
Lamp	LED 7W, 6500K Collapsible 2D Swivel arm Dimmable – 3 step tap control
Dimensions (mm)	415 x 135 x 38
Commercial Code	31668/35/46

## Vane Pink



### LED DESK LIGHT VANE PINK

Colour/Finish	Pink
Lamp	LED 7W, 6500K Collapsible 2D Swivel arm Dimmable – 3 step tap control
Dimensions (mm)	415 x 135 x 38
Commercial Code	31668/28/46

## Vane Grey



### LED DESK LIGHT VANE GREY

Colour/Finish	Grey
Lamp	LED 7W, 6500K Collapsible 2D Swivel arm Dimmable – 3 step tap control
Dimensions (mm)	415 x 135 x 38
Commercial Code	31668/87/46







# LIVING COLORS

---

## Set the mood

---

Imagine a room with a personality that reflects your own. One that creates the perfect ambience. Dictated not by a mere coat of paint but the entire spectrum of the rainbow.

Want a little 'me' time? Try a soothing blue. Feeling light? Get cheery pink. Romance in the air? Turn passionate red.

All inspired by you.

## Living Colors Micro-White



### LIVING COLORS MICRO-WHITE

Colour/Finish	White
Lamp	LED 1 x 5W (creates 64 colours)
Dimensions (mm)	110 x 120 x 100
Commercial Code	70018/31/46

## Living Colors Iris-Black



### LIVING COLORS IRIS-BLACK

Colour/Finish	Black
Lamp	LED 1 x 10W (creates 16 million colours) Dimmable
Dimensions (mm)	218 x 218 x 225
Commercial Code	70999/30/46





---

# Lamps



ONS



## ClassicTone Candle

Decorative candle shaped lamps for chandeliers and ornamental wall bracket lighting. Use clear to add sparkle or frosted to give a softer effect.

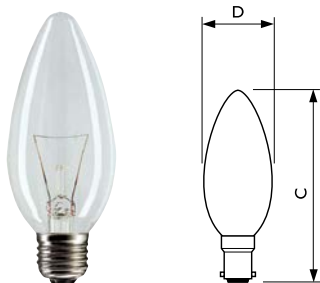

Product ID	Overall Length C max.	Diameter D max.
25W B15	98	35
25W B22	95	35
25W E14	100	35

Dimensions in mm

### CLASSICTONE CANDLE

Shortcode	Wattage (W)	Cap Base	Voltage	Bulb Shape	Luminous Flux Lamp (lm)	Average Lifetime (hrs)	Colour	Carton Qty
C35CL25W240VBC	25	B22	240V	B35	200	1000	Clear	50
C35FR25W240VBC	25	B22	240V	B35	205	1000	Frosted	50
C35CL25W240VSBC	25	B15	240V	B35	210	1000	Clear	50
C35FR25W240VSBC	25	B15	240V	B35	205	1000	Frosted	50
C35CL25W240VSES	25	E14	240V	B35	210	1000	Clear	100
C35FR25W240VSES	25	E14	240V	B35	210	1000	Frosted	100



## Classicitone Lustre

A small spherical lamp for many decorative applications. Available in clear or frosted in a range of bases.

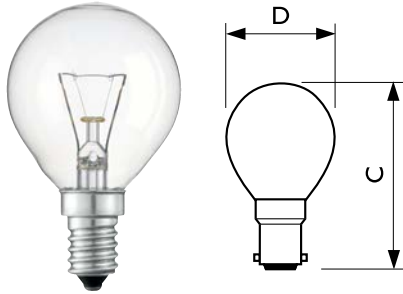

Product ID	Overall Length C max.	Diameter D max.
B15	76.5	45
B22	71.5	45
E14	78	45
E27	73	45

Dimensions in mm

### CLASSICTONE LUSTRE

Shortcode	Wattage (W)	Cap Base	Voltage	Bulb Shape	Luminous Flux Lamp (lm)	Average Lifetime (hrs)	Colour	Carton Qty
LCL25W240VBC	25	B22	240V	P45	200	1000	Clear	100
LFR25W240VBC	25	B22	240V	P45	210	1000	Frosted	100
LCL25W240VSBC	25	B15	240V	P45	210	1000	Clear	100
LFR25W240VSBC	25	B15	240V	P45	205	1000	Frosted	100
LCL25W240VES	25	E27	240V	P45	200	1000	Clear	100
LFR25W240VES	25	E27	240V	P45	210	1000	Frosted	100
LCL25W240VSES	25	E14	240V	P45	210	1000	Clear	100
LFR25W240VSES	25	E14	240V	P45	210	1000	Frosted	100

## Practitone Philinea

An elegant linear architectural lamp in an Argenta (white) finish. The Practitone has a specially positioned lamp base which allows installation in continuous strips of light. It is sold as a double peg (S14s) version.



Product ID	Overall Length C max.	Diameter D max.
35W	300	30
60W	500	30

Dimensions in mm

### PRACTITONE PHILINEA

Shortcode	Wattage (W)	Cap Base	Voltage	Bulb Shape	Luminous Flux Lamp (lm)	Average Lifetime (hrs)	Colour	Carton Qty
PHIL35W240VS14	35	S14s	240V	T30	270	1000	White	25
PHIL60W240VS14	60	S14s	240V	T30	420	1000	White	25

## Practitone Tubular

Small incandescent lamps for areas with limited space.

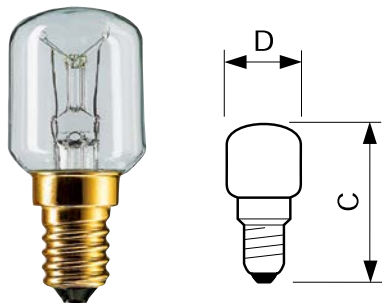

Product ID	Overall Length C max.	Diameter D max.
15W B15 PILOT	52	22
15W B22 PILOT	52	25
15W E14 PILOT	57	25
15W E14 OVEN	49	22
25W E14 OVEN	57	25
25W E27 OVEN	61	29

Dimensions in mm

### PILOT LAMPS

Shortcode	Wattage (W)	Cap Base	Voltage	Bulb Shape	Luminous Flux Lamp (lm)	Average Lifetime (hrs)	Colour	Unit	Carton Qty
T25I5W240VBCB2	15	B22	240V	T25	90	1000	Clear	SET	5
T25I5W240VSESB2	15	E14	240V	T25	115	1000	Clear	SET	5
T22I5W240VSBCEB	15	B15	240V	T25	90	1000	Clear	PCE	5

### OVEN LAMPS

Shortcode	Wattage (W)	Cap Base	Voltage	Bulb Shape	Luminous Flux Lamp (lm)	Average Lifetime (hrs)	Colour	Unit	Carton Qty
OVENI5W235VSESB	15	E14	230-240V	T22	90	1000	Clear	PCE	5
OVEN25W240VSESB	25	E14	230-240V	T25	172	1000	Clear	PCE	5
OVEN25W240VESB	25	E27	230-240V	T29	162	1000	Clear	PCE	5

# Partytone Coloured

Coloured decorative lamps with internally colour-coated bulb in standard A-shape. For use indoors and outdoors.



Product ID	Overall Length C max.	Diameter D max.
40W B22	95	55
Dimensions in mm		

## PARTYTONE COLOURED

Shortcode	Wattage (W)	Cap Base	Voltage	Bulb Shape	Luminous Flux Lamp (lm)	Average Lifetime (hrs)	Colour	Carton Qty
YE40W240VBC	40	B22	240V	A55	300	1000	Yellow	100
BL40W240VBC	40	B22	240V	A55	33	1000	Blue	100
GR40W240VBC	40	B22	240V	A55	110	1000	Green	100
RE40W240VBC	40	B22	240V	A55	80	1000	Red	100

## Floodlight PAR38 and PAR38 Colour

Made from hard pressed glass, making them suitable for indoor and outdoor applications.

Spot versions have a stippled front reflector producing a narrow homogenous beam.

Flood versions have a front refractor composed of prismatic elements, and are available in a coloured option.

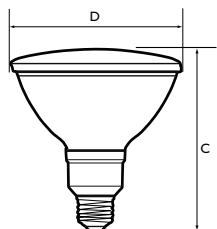

Product ID	Overall Length C max.	Diameter D max.
80W E27	137	122.5
120W E27	137	121
80W E27 Colour	137	122.5
80W E27 Anti Mosquito	137	121

Dimensions in mm

### FLOODLIGHT PAR38

Shortcode	Wattage (W)	Cap Base	Voltage	Bulb Shape	Beam Angle °	Luminous Intensity (cd)	Average Lifetime (hrs)	Carton Qty
PAR38FL80WES	80	E27	240V	PAR38	30	1800	2000	6
PAR38FL120WES	120	E27	240V	PAR38	30	3100	2000	6

### PAR38 COLOUR

Shortcode	Wattage (W)	Cap Base	Voltage	Bulb Shape	Average Lifetime (hrs)	Colour	Carton Qty
PAR38FLYE80WES	80	E27	240V	PAR38	1000	Yellow	6
PAR38FLGR80WES	80	E27	240V	PAR38	1000	Green	6
PAR38FLBL80WES	80	E27	240V	PAR38	1000	Blue	6
PAR38FLR80WES	80	E27	240V	PAR38	1000	Red	6

### PAR38 ANTI MOSQUITO

Shortcode	Wattage (W)	Cap Base	Voltage	Bulb Shape	Luminous Flux Lamp (lm)	Average Lifetime (hrs)	Carton Qty
PAR38FLAM80WES	80	E27	240V	PAR38	560	2000	6

## Reflector Ring Mirror

Reflector lamps based on advanced spotlighting technology. Used for display lighting in shops, hotels, restaurants and homes.

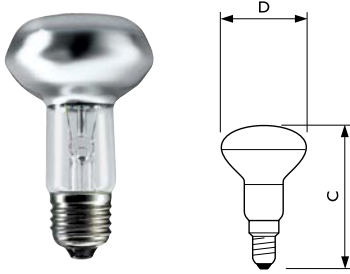

Product ID	Overall Length C max.	Diameter D max.
R39 E14	67	39
NR50 E14	86	50
NR63 E27	104.5	63
NR63 B22	103	63

Dimensions in mm

### REFLECTOR RING MIRROR

Shortcode	Wattage (W)	Cap Base	Voltage	Bulb Shape	Beam Angle °	Luminous Intensity (cd)	Average Lifetime (hrs)	Unit	Carton Qty
R3930W245VSES	30	E14	240V	R39	45	160	1000	PCE	30
R50SP40W230VSES	40	E14	240V	NR50	30	400	1000	PCE	30
R63SP40W240VES	40	E27	240V	NR63	30	420	1000	PCE	6
R63SP60W240VBC	60	B22	240V	NR63	30	750	1000	PCE	6
R63SP60W240VES	60	E27	240V	NR63	30	1050	1000	PCE	6
R63S60240ES2PK2	60	E27	240V	NR63	30	1050	1000	SET	12
R63S40240ES2PK2	40	E27	240V	NR63	30	1050	1000	SET	12

## Reflector Standard Floodline

Reflector lamps based on advanced spotlighting technology. Used for display lighting in shops, hotels, restaurants and homes.

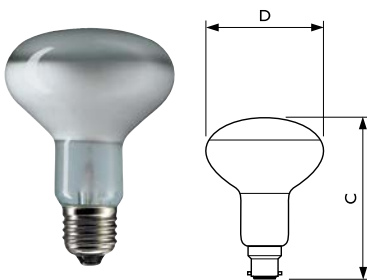

Product ID	Overall Length C max.	Diameter D max.
E80 B22	113	80
E80 E27	114.5	80

Dimensions in mm

### REFLECTOR STANDARD FLOODLINE

Shortcode	Wattage (W)	Cap Base	Voltage	Bulb Shape	Beam Angle °	Luminous Intensity (cd)	Average Lifetime (hrs)	Carton Qty
E8060W240VES	60	E27	240V	E80	80	270	1000	6
E80100W240VES	100	E27	240V	E80	80	530	1000	6
E8075W240VES	75	E27	240V	E80	80	360	1000	12
E80100W240VBC	100	B22	240V	E80	80	530	1000	6





# Masterline ES Dichroic

An advanced range of low voltage halogen dichroic lamps featuring the leading infrared reflecting technology for maximum energy savings. Masterline Energy Saving lamps feature a unique Philips patented burner method enabling higher efficiency with reduction of energy usage by up to 30%. The diamond backed dichroic reflector provides a precision beam of bright, white sparkling light. Lifetime 5,000 hours. Improved version featuring a single-ended burner and flat glass to match the look of standard dichroics.

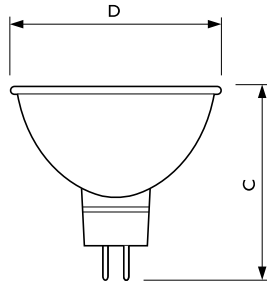

Product ID	Overall Length C max.	Diameter D max.
GU5.3	50.5	51
Dimensions in mm		

## MASTERLINE ES DICHROIC

Commercial Code	Wattage (W)	Cap Base	Voltage	Luminous Intensity (cd)	Average Lifetime (hrs)	Colour Temp (K)	Beam Angle °	Carton Qty
18132	20	GU5.3	12V	6500	5000	3000	50	20
18133	20	GU5.3	12V	1000	5000	3000	36	20
18136	30	GU5.3	12V	11000	5000	3000	36	20
18137	30	GU5.3	12V	750	5000	3000	60	20
18138	35	GU5.3	12V	13500	5000	3000	8	20
18139	35	GU5.3	12V	4400	5000	3000	24	20
18140	35	GU5.3	12V	2200	5000	3000	36	20
18141	35	GU5.3	12V	1050	5000	3000	60	20

## Brilliantline Pro Dichroic

A quality low voltage halogen reflector lamp consisting of a high pressure xenon gas filled burner, optically positioned in a Dichroic glass reflector. Designed to transmit heat through the back of the lamp and reflect light to the front, resulting in a “cool” beam. Brilliantline Pro lamps feature a high intensity beam with a clearly defined beam spread and have excellent lumen maintenance over their life. They come complete with front glass and the universal burning position. Lifetime 4,000 hours.



Product ID	Overall Length C max.	Diameter D max.
GU4	40	35.3
GU5.3	46	50.8

Dimensions in mm

### BRILLIANTLINE PRO DICHROIC

Commercial Code	Wattage (W)	Cap Base	Voltage	Luminous Intensity (cd)	Average Lifetime (hrs)	Colour Temp (K)	Beam Angle °	Carton Qty
I4612	20	GU5.3	12V	780	4000	3000	36	50
I4615	35	GU5.3	12V	3100	4000	3000	24	50
I4616	35	GU5.3	12V	1500	4000	3000	36	50
I4617	35	GU5.3	12V	700	4000	3000	60	50
I4625	20	GU4	12V	800	4000	3000	30	50
I4627	35	GU4	12V	1500	4000	3000	30	50

# Essential Plus Dichroic

Low voltage halogen reflector lamps, designed to provide crisp white light. Feature a “cool” beam dichroic reflector and UV block on the burner. The closed version offers additional protection from UV via the glass front. Ideally suited for general purpose display and domestic lighting. Lifetime 3,000 hours.

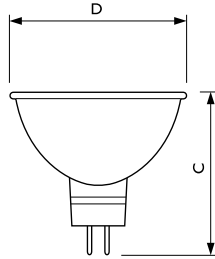

Product ID	Overall Length C max.	Diameter D max.
GU5.3	46	51

Dimensions in mm

## ESSENTIAL PLUS DICHROIC

Commercial Code	Wattage (W)	Cap Base	Voltage	Luminous Intensity (cd)	Average Lifetime (hrs)	Colour Temp (K)	Beam Angle °	Carton Qty
I3111	35	GU5.3	12V	1000	3000	3000	36	50
I3112	35	GU5.3	12V	400	3000	3000	60	50
I3121	35	GU5.3	12V	1000	3000	3000	36	10
I3122	35	GU5.3	12V	400	3000	3000	60	10
I3141	35	GU5.3	12V	1000	3000	3000	36	20
I3142	35	GU5.3	12V	400	3000	3000	60	20
I3161	35	GU5.3	12V	1000	3000	3000	36	30
I3162	35	GU5.3	12V	400	3000	3000	60	30
I3222	20	GU5.3	12V	550	3000	3000	36	50
I5121	35	GU5.3	12V	1500	4000	3000	36	20
I5122	35	GU5.3	12V	700	4000	3000	60	20

## Masterline III

Low voltage halogen reflector lamp with double-ended burner and high-purity aluminium reflector. It has a unique infra-red coated burner technology, and revolutionary compact precision burner for maximum performance of the infra-red reflecting coating. The ceramic filament shield reduces glare and improves beam shape. It has a flat profile, very tight beam pattern, and excellent glare control.

Increased lifetime (4,000 hours) ensures low maintenance costs.

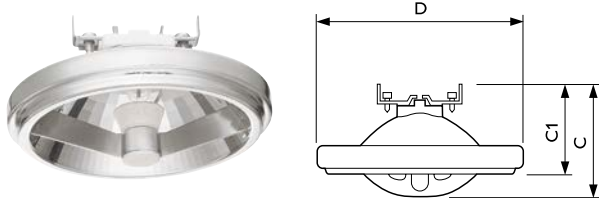

Product ID	Overall Length C max.	Overall Length C1 max.	Diameter D max.
30, 45, 60W	65	49	111
Dimensions in mm			

### MASTERLINE III

Commercial Code	Wattage (W)	Cap Base	Voltage	Luminous Intensity (cd)	Average Lifetime (hrs)	Colour Temp (K)	Beam Angle °	Carton Qty
MSTIII30WI2V8D	30	G53	12V	23000	4000	3000	8	6
MSTIII30WI2V24D	30	G53	12V	4000	4000	3000	24	6
MSTIII45WI2V8D	45	G53	12V	33000	4000	3000	8	6
MSTIII45WI2V24D	45	G53	12V	5300	4000	3000	24	6
MSTIII45WI2V45D	60	G53	12V	1900	4000	3000	45	6
MSTIII60WI2V8D	60	G53	12V	48000	4000	3000	8	6
MSTIII60WI2V24D	60	G53	12V	8500	4000	3000	24	6
MSTIII60WI2V45D	60	G53	12V	2800	4000	3000	45	6

# Essential Twistline Dichroic

A range of compact quartz halogen reflector lamps that offer a mains voltage look-alike to low voltage dichroic MRI6 lamps. The lamp can be connected directly to 240V mains supply eliminating the need for a transformer.

Featuring an aluminium reflector which directs most of the heat to the front to prevent overheating in the luminaire/ceiling space where ventilation is not adequate. Features a GU10 lamp base. Twistline provides a constant quality of light over lamp life and remains bright and shining.

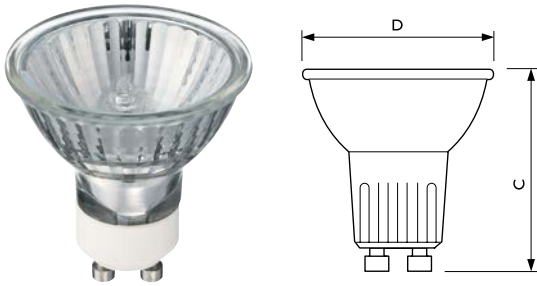

Product ID	Overall Length C max.	Diameter D max.
GU10	51	51

Dimensions in mm

## ESSENTIAL TWISTLINE DICHROIC

Commercial Code	Wattage (W)	Cap Base	Voltage	Luminous Intensity (cd)	Average Lifetime (hrs)	Colour Temp (K)	Colour	Beam Angle °	Carton Qty
ESSGU1050W	50	GU10	240V	400	2000	3000	40	60	50

## Essential Capsule

- Sturdy and compact
- Dimmable with a universal burning position
- For use in fixtures with protected front glass in accordance with IEC
- Low voltage – transformer required

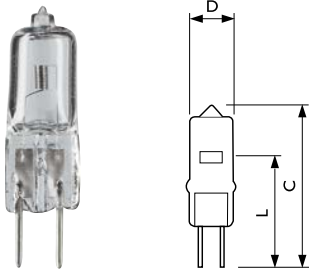

Product ID	Overall Length C max.	Diameter D max.	Overall Length L nom.
G4	32	9	22
GY6.35	44	12	30

Dimensions in mm

### ESSENTIAL CAPSULE

Commercial Code	Wattage (W)	Cap Base	Voltage	Luminous Flux Lamp (lm)	Average Lifetime (hrs)	Colour Temp (K)	Colour	Carton Qty
ESSCAP10W12VG4	10	G4	12V	100	2000	3000	Clear	10
ESSCAP20W12VG4	20	G4	12V	250	2000	3000	Clear	10
ESSCAP50W12VGY	50	GY6.35	12V	700	2000	3000	Clear	10



# Essential Capsule MV

Mains-voltage halogen capsule with G.9 base.

- UV block quartz glass
- G9 base for easy insertion and replacement
- Mains voltage so no transformer needed
- Easily dimmable
- General lighting in homes, hotels, bars and restaurants
- Ideal for use in small, lightweight, open luminaires
- Used in luminaires without front glass in accordance with IEC 598

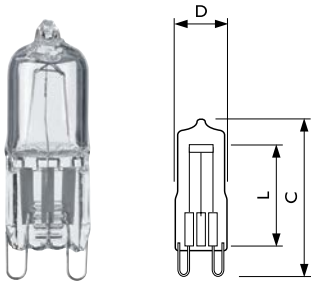

Product ID	Overall Length C max.	Diameter D max.
G9	44.6	12.75
Dimensions in mm		

## ESSENTIAL CAPSULE MV

Commercial Code	Wattage (W)	Cap Base	Voltage	Luminous Flux Lamp (lm)	Average Lifetime (hrs)	Colour Temp (K)	Carton Qty
ESSG940WFRB2	40	G9	240V	460	2000	2770	10
ESSG960WFRB2	60	G9	240V	790	2000	2800	10

## EcoClassic A55

New generation halogen-technology lamp to replace the standard GLS bulb. Offering the same shape, size, and dimming functions.

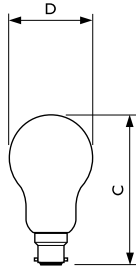

Product ID	C	D
A55	95.5	55

Dimensions in mm

### ECOCLASSIC A55

Commercial Code	Wattage (W)	Cap Base	Voltage	Luminous Flux Lamp (lm)	Average Lifetime (hrs)	Colour Temp (K)	Colour	Carton Qty
ECO28WE27A55CL	28	E27	240	340	2000	2900	Clear	100
ECO28WE27A55FR	28	E27	240	340	2000	2900	Frosted	100
ECO28WB22A55CL	28	B22	240	340	2000	2900	Clear	100
ECO28WB22A55FR	28	B22	240	340	2000	2900	Frosted	100
ECO42WE27A55CL	42	E27	240	630	2000	2900	Clear	100
ECO42WE27A55FR	42	E27	240	630	2000	2900	Frosted	100
ECO42WB22A55CL	42	B22	240	630	2000	2900	Clear	100
ECO42WB22A55FR	42	B22	240	630	2000	2900	Frosted	100
ECO53WE27A55CL	53	E27	240	850	2000	2900	Clear	100
ECO53WE27A55FR	53	E27	240	850	2000	2900	Frosted	100
ECO53WB22A55CL	53	B22	240	850	2000	2900	Clear	100
ECO53WB22A55FR	53	B22	240	850	2000	2900	Frosted	100
ECO70WB22A55CL	70	B22	240	1200	2000	2900	Clear	100
ECO70WB22A55FR	70	B22	240	1200	2000	2900	Frosted	100
ECO70WE27A55CL	70	E27	240	1200	2000	2900	Clear	100
ECO70WE27A55FR	70	E27	240	1200	2000	2900	Frosted	100

# EcoClassic Candle

New generation halogen-technology lamp to replace the standard GLS candle. Offering the same shape, size, and dimming functions.

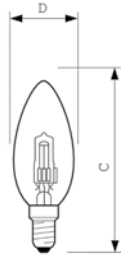

Product ID	C	D
Candle	95.5	36

Dimensions in mm

## ECOCLASSIC CANDLE

Commercial Code	Wattage (W)	Cap Base	Voltage	Luminous Flux Lamp (lm)	Average Lifetime (hrs)	Colour Temp (K)	Colour	Carton Qty
C35CL28W240VSES	28	E14	240	370	2000	2800	Clear	70
C35CL28W240VSBC	28	B15	240	370	2000	2800	Clear	70
C35FR28W240VSES	28	E14	240	370	2000	2800	Frosted	70
C35FR28W240VSBC	28	B15	240	370	2000	2800	Frosted	70
C35CL28W240VBC	28	B22	240	370	2000	2800	Clear	70
C35FR28W240VBC	28	B22	240	370	2000	2800	Frosted	70

## EcoClassic Lustre

New generation halogen-technology lamp to replace the standard GLS lustre. Offering the same shape, size, and dimming functions.

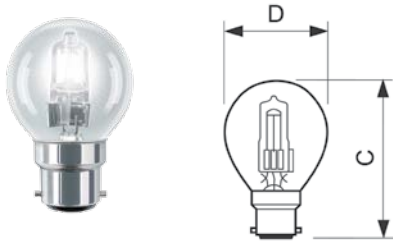

Product ID	C	D
Lustre	72.5	46

Dimensions in mm

### ECOCLASSIC LUSTRE

Commercial Code	Wattage (W)	Cap Base	Voltage	Luminous Flux Lamp (lm)	Average Lifetime (hrs)	Colour Temp (K)	Colour	Carton Qty
LCL28W240VBC	28	B22	240	370	2000	2800	Clear	100
LFR28W240VBC	28	B22	240	370	2000	2800	Frosted	100
LCL28W240VSBC	28	B15	240	370	2000	2800	Clear	100

# Plusline Pro – Compact / Small / Large

These high performance, general purpose, linear halogen lamps give perfect colour rendition. These lamps feature two arc prevention fuses built-in for added safety. The burning position is universal on the compact and small types. Used mainly for outdoor floodlighting applications.

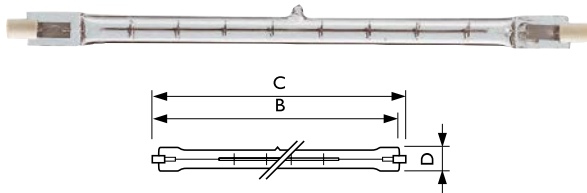
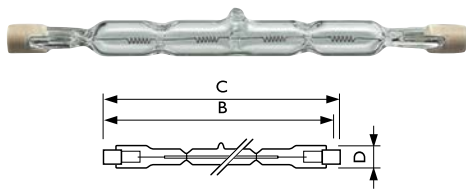
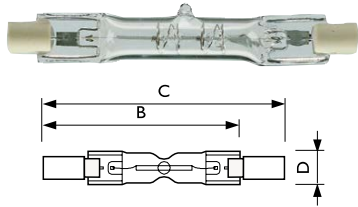

Product ID	Description	Overall Length B nom.	Diameter Length C max.	Overall Length D max.
100W	COMPACT	74.9	78.3	15
150W	COMPACT	74.9	78.3	15

Dimensions in mm

Product ID	Description	Overall Length B nom.	Diameter Length C max.	Overall Length D max.
200W	SMALL	114.2	117.6	12
300W	SMALL	114.2	117.6	12
500W	SMALL	114.2	117.6	12

Dimensions in mm

Product ID	Description	Overall Length B nom.	Diameter Length C max.	Overall Length D max.
1000W	LARGE	185.7	189.1	11
1500W	LARGE	250.7	254.1	11

Dimensions in mm

## PLUSLINE PRO – COMPACT / SMALL / LARGE

Commercial Code	Description	Wattage (W)	Luminous Flux Lamp (lm)	Cap Base	Voltage	Average Lifetime (hrs)	Colour Temp (K)	Carton Qty
DECOMP100WB	COMPACT	100	1550	R7s	240V	2000	2900	10
DECOMP150WB	COMPACT	150	2550	R7s	240V	2000	2900	10
DESMALL200WB	SMALL	200	3250	R7s	240V	2000	2900	10
DESMALL300WB	SMALL	300	5600	R7s	240V	2000	2900	10
DESMALL500WB	SMALL	500	9900	R7s	240V	2000	2900	10
DEBIG1000W	LARGE	1000	24200	R7s	240V	2000	2900	10
DEBIG1500W240V	LARGE	1500	36300	R7s	240V	2000	2900	10





# MASTER TL5 High Efficiency ECO

This extremely efficient TL5 lamp (tube diameter 16mm) saves considerable energy in quality T5 fittings. The TL5 HE Eco lamp offers excellent lumen maintenance and colour rendering. Application areas vary from offices and industry to schools and retail environments.

- Benefits:**
- Up to 10% energy saving with compatible Philips ballasts
  - The same quality of light as compared with MASTER TL5 HE lamps
  - All benefits of regular TL5 lamps

- Warnings and Safety:**
- Energy reduction is only achieved with current-controlled gear
  - The lamps operate with power-controlled gear, but in that case give more light output instead of using less energy.

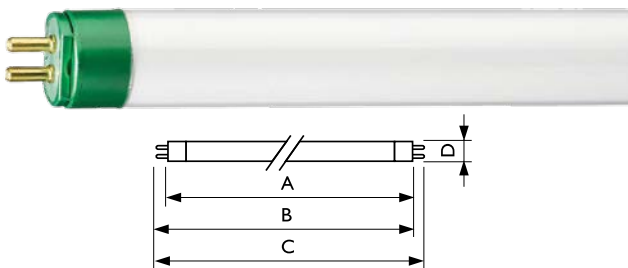

Product ID	A max.	B max.	C max.	D max.
14W → 13W	549.0	556.1	563.2	17
28W → 25W	1149.0	1156.1	1163.2	17
35W → 32W	1449.0	1456.1	1463.2	17

Dimensions in mm

## MASTER TL5 HIGH EFFICIENCY ECO

Shortcode	Wattage (W)	Cap Base	Luminous Flux Lamp (35°, lm)	Average Lifetime (hrs)	Colour Rendering Index (Ra)	Colour Temp (K)	Min Order Quantity	Carton Qty
TL513WECO830	13	G5	1350	25000	85	3000	40	40
TL513WECO840	13	G5	1350	25000	85	4000	40	40
TL525WECO830	25	G5	2900	25000	85	3000	40	40
TL525WECO840	25	G5	2900	25000	85	4000	40	40
TL525WECO865	25	G5	2700	25000	85	6500	40	40
TL532WECO830	32	G5	3650	25000	85	3000	40	40
TL532WECO840	32	G5	3650	25000	85	4000	40	40

## MASTER TL5 High Output ECO

This extremely efficient TL5 lamp (tube diameter 16mm) saves considerable energy by simple lamp-for-lamp replacement. The TL5 HO Eco lamp offers excellent lumen maintenance and colour rendering. Application areas vary from offices and industry to schools and retail environments.

- Benefits:**
- Up to 10% energy saving with compatible Philips ballasts
  - The same quality of light as compared with MASTER TL5 HO lamps
  - All benefits of regular TL5 lamps

- Warnings and Safety:**
- Energy reduction is only achieved with current-controlled gear
  - The lamps operate with power-controlled gear, but in that case give more light output instead of using less energy.

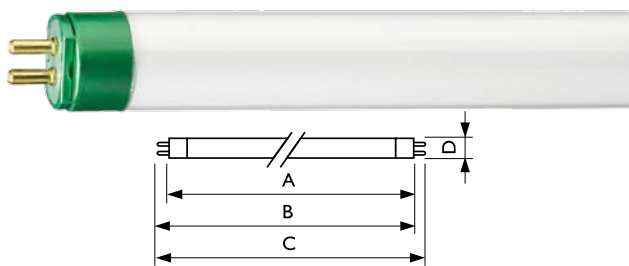

Product ID	A max.	B max.	C max.	D max.
49W → 45W	1449.0	1456.1	1463.2	17

Dimensions in mm

### MASTER TL5 HIGH OUTPUT ECO

Shortcode	Wattage (W)	Cap Base	Luminous Flux Lamp (35°, lm)	Average Lifetime (hrs)	Colour Rendering Index (Ra)	Colour Temp (K)	Min Order Quantity	Carton Qty
TL545WECO830	45	G5	4900	25000	85	3000	40	40
TL545WECO840	45	G5	4900	25000	85	4000	40	40
TL545WECO865	45	G5	4900	25000	85	6500	40	40

# MASTER TL5 High Efficiency

Low-pressure mercury discharge lamps with a tubular 16mm envelope. Specifically designed for operation with electronic gear, and suited for dimming. Optimal lighting efficiency at 35°C ambient temperature (compared with TL-D at 25°C). Allows use of more compact luminaires for lighting system minimalisation.

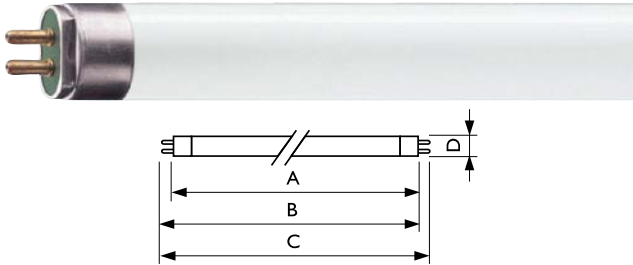

Product ID	A max.	B max.	C max.	D max.
14W	549.0	556.1	563.2	17
21W	849.0	856.1	863.2	17
28W	1149.0	1156.1	1163.2	17
35W	1449.0	1456.1	1463.2	17

Dimensions in mm

## MASTER TL5 HIGH EFFICIENCY

Shortcode	Wattage (W)	Cap Base	Luminous Flux Lamp (lm)	Average Lifetime (hrs)	Colour Rendering Index (Ra)	Colour Temp (K)	Min Order Quantity	Carton Qty
TL514W830HE	14	G5	1350	24000	85	3000	40	40
TL514W840HE	14	G5	1350	24000	85	4000	40	40
TL514W865HE	14	G5	1250	24000	85	6500	40	40
TL521W830HE	21	G5	2100	24000	85	3000	40	40
TL521W840HE	21	G5	2100	24000	85	4000	40	40
TL521W865HE	21	G5	1950	24000	85	3000	40	40
TL528W830HE	28	G5	2900	24000	85	3000	40	40
TL528W840HE	28	G5	2900	24000	85	4000	40	40
TL528W865HE	28	G5	2700	24000	85	6500	40	40
TL535W830HE	35	G5	3650	24000	85	3000	40	40
TL535W840HE	35	G5	3650	24000	85	4000	40	40
TL535W865HE	35	G5	3450	24000	85	6500	40	40

## MASTER TL5 High Output

Low-pressure mercury discharge lamps with a tubular 16mm envelope. Specifically designed for operation with electronic gear, and suited for dimming. Optimal lighting efficiency at 35°C ambient temperature (compared with TL-D at 25°C). Allows use of more compact luminaires for lighting system minimalisation.

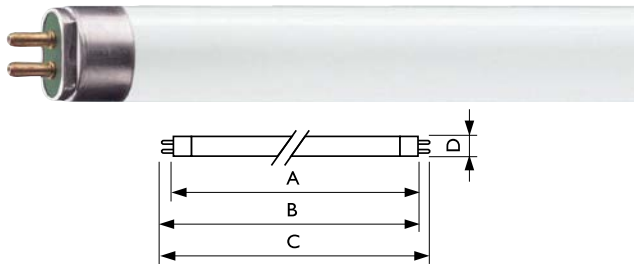

Product ID	A max.	B max.	C max.	D max.
24W	549.0	556.1	563.2	17
39W	849.0	856.1	863.2	17
49W	1449.0	1456.1	1463.2	17
54W	1149.0	1156.1	1163.2	17
80W	1449.0	1456.1	1463.2	17

Dimensions in mm

### MASTER TL5 HIGH OUTPUT

Shortcode	Wattage (W)	Cap Base	Luminous Flux Lamp (lm)	Average Lifetime (hrs)	Colour Rendering Index (Ra)	Colour Temp (K)	Min Order Quantity	Carton Qty
TL524W830HO	24	G5	1950	24000	85	3000	40	40
TL524W840HO	24	G5	1950	24000	85	4000	40	40
TL524W865HO	24	G5	1820	24000	85	6500	40	40
TL539W830HO	39	G5	3500	24000	85	3000	40	40
TL539W840HO	39	G5	3500	24000	85	4000	40	40
TL539W865HO	39	G5	3300	24000	85	6500	40	40
TL549W840HO	49	G5	4900	24000	85	4000	40	40
TL549W865HO	49	G5	4650	24000	85	6500	40	40
TL554W830HO	54	G5	5000	24000	85	3000	40	40
TL554W840HO	54	G5	5000	24000	85	4000	40	40
TL554W865HO	54	G5	4750	24000	85	6500	40	40
TL580W830HO	80	G5	7000	24000	85	3000	40	40
TL580W840HO	80	G5	7000	24000	85	4000	40	40

# MASTER TL5 HO Xtra

Low-pressure high-output mercury discharge lamps with a tubular 16mm envelope.

- Benefits:**
- Longer lifetime and fewer early failures mean lower maintenance costs and facilitate change from spot to group replacement
  - Allow system miniaturisation with maximum luminaire design freedom
  - Optimised for installations which need high luminous flux
  - Excellent lumen maintenance
  - Good colour rendering
- Features:**
- Significant reduction of early failures through advanced long life technology
  - Extra long lifetime and high reliability
  - Highly efficient 3-band fluorescent coating in combination with precoating
  - Maximum lumen output reached at approx. 35°C in free-burning position
  - Can be ignited from -15° to + 50°C
  - Low mercury dose
- Application:**
- Where maintenance costs are high, e.g. high ceilings or other hard to-reach locations
  - Department stores, supermarkets, warehouses, production halls and public areas like car parks and railway stations
- System:**
- Can be used with TL5 electronic gear

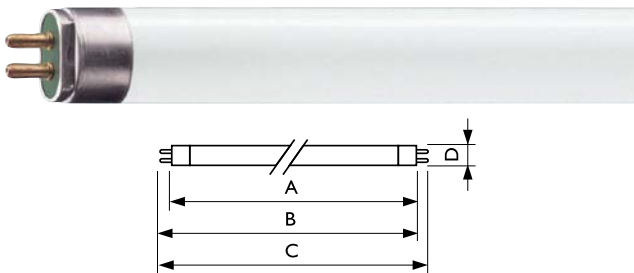

Product ID	A max.	B max.	C max.	D max.
49W	1449.0	1456.1	1463.2	17
54W	1149.0	1156.1	1163.2	17
80W	1449.0	1456.1	1463.2	17

Dimensions in mm

## MASTER TL5 HO XTRA

Shortcode	Wattage (W)	Cap Base	Luminous Flux Lamp (lm)	Average Lifetime (hrs)	Colour Rendering Index (Ra)	Colour Temp (K)	Min Order Quantity	Carton Qty
TL549W840 XTRA	49	G5	4900	45000	85	4000	20	20
TL549W865 XTRA	49	G5	4900	45000	85	6500	20	20
TL554W840 XTRA	54	G5	5000	45000	85	4000	20	20
TL554W865 XTRA	54	G5	5000	45000	85	6500	20	20
TL580W830 XTRA	80	G5	7000	45000	85	3000	20	20
TL580W840 XTRA	80	G5	7000	45000	85	4000	20	20

## MASTER TL5 HO TOP

This TL5 HO TOP lamp (Temperature Optimised Performance) offers a constant light level, independent of temperature fluctuations, making it an excellent solution for warm applications. The TL5 HO TOP can be operated on equivalent systems as MASTER TL5 HO. Excellent solution for warm applications, such as non air conditioned warehouses, wall washers, etc.

- Benefits:**
- Allows system miniaturisation with maximum luminaire design freedom
  - Lamp lengths enable easy fitting into ceiling module systems
  - Retrofit to current TL5 HO non-amalgam lamps
  - Optimised for installations which need high luminous flux, especially in hot (above 40°C) conditions
  - Constant lumen level over a wide temperature range (20-75°C) with excellent lumen maintenance
  - Good colour rendering

- Features:**
- Lumen output higher than 90% of maximum value at ambient lamp temperatures from 20 to 75°C due to amalgam-controlled operation
  - Allows dimming-down to 30% light output
  - Hot restrike and good run-up behaviour compared to high intensity discharge lamps due to auxiliary amalgams at both lamp ends
  - Can be ignited at temperatures from -15 to +75°C

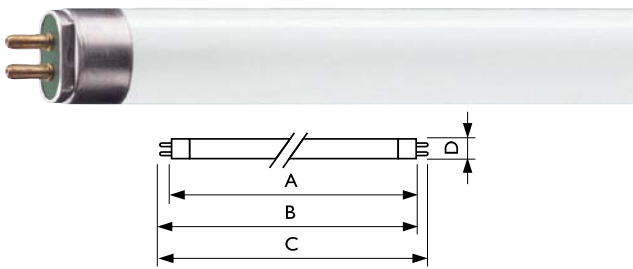

Product ID	A max.	B max.	C max.	D max.
54W	1149.0	1156.1	1163.2	17
80W	1449.0	1456.1	1463.2	17

Dimensions in mm

### MASTER TL5 HO TOP

Shortcode	Wattage (W)	Cap Base	Luminous Flux Lamp (lm)	Average Lifetime (hrs)	Colour Rendering Index (Ra)	Colour Temp (K)	Min Order Quantity	Carton Qty
TL554W840TOP	54	G5	5000	24000	85	4000	20	20
TL580W840TOP	80	G5	7000	24000	85	4000	20	20



# MASTER TL5 HO 90 Deluxe

Low-pressure mercury discharge lamps with high colour rendering.

- Benefits:**
- Allows system miniaturisation and maximum luminaire design freedom, with lamp lengths defined for easy fitting into ceiling module systems
  - Virtually constant lumen level with good lumen maintenance
  - Excellent colour rendering
- Features:**
- Highly efficient multi-band fluorescent coating in combination with precoating and high lamp load
  - Specifically designed for operation with electronic gear and well suited for dimming
  - Maximum light output reached at approx. 35°C in free-burning position if an electronic ballast without additional electrode heating is used
  - Can be ignited from -15 to +50°C
- Application:**
- Where a high colour recognition is needed: first aid and treatment rooms in hospitals, printing rooms, jewellery manufacturing, dentists, hairdressing, museums and shops

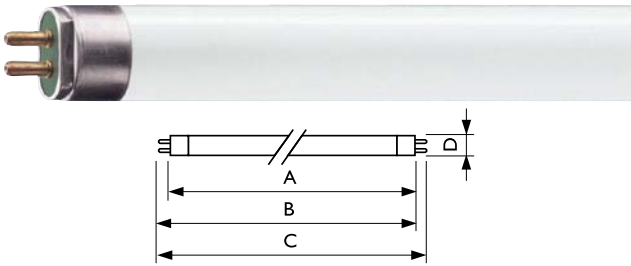

Product ID	A max.	B max.	C max.	D max.
24W	549.0	556.1	563.2	17
54W	1149.0	1156.1	1163.2	17

Dimensions in mm

## MASTER TL5 HO 90 DELUXE

Shortcode	Wattage (W)	Cap Base	Luminous Flux Lamp (lm)	Average Lifetime (hrs)	Colour Rendering Index (Ra)	Colour Temp (K)	Min Order Quantity	Carton Qty
TL524W940	24	G5	1600	24000	91	4000	20	20
TL524W950	24	G5	1600	24000	92	5000	20	20
TL554W940	54	G5	4300	24000	91	4000	20	20
TL554W950	54	G5	4300	24000	92	5000	20	20

## MASTER TL5 Circular

16mm tube diameter circular fluorescent lamps with a choice of various diameters.

- Benefits:**
- Slim 16mm tube allows creation of extremely flat luminaires
  - Allows appealing circular designs
  - High lamp efficacy
  - Good colour rendering
  - Temperature independent light output
  - Higher average system efficiency

- Features:**
- Perfect circular shape
  - Highly efficient 3-band fluorescent coating
  - Specifically designed for operation with electronic gear
  - Can be ignited from -15 to +50°C
  - Amalgam technology

- Application:**
- Brings the benefits of TL5 lighting to an even wider range of attractive applications
  - Suitable for a wide range of professional and semi-professional applications
  - Ideal for use in shops, offices and public areas with non-traditional layouts
  - Amalgam lamps have limited suitability for dimming applications.

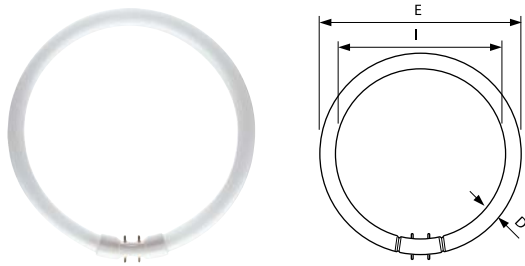

Product ID	D max.	E max.	I max.
22W	18	230	197
40W/55W	18	305	272
60W	18	379	346

Dimensions in mm

### MASTER TL5 CIRCULAR

Shortcode	Wattage (W)	Cap Base	Luminous Flux Lamp (lm)	Average Lifetime (hrs)	Colour Rendering Index (Ra)	Colour Temp (K)	Min Order Quantity	Carton Qty
TL5C22W830	22	2GX13	1800	12000	85	3000	10	10
TL5C22W840	22	2GX13	1800	12000	85	4000	10	10
TL5C40W830	40	2GX13	3300	12000	85	3000	10	10
TL5C40W840	40	2GX13	3300	12000	85	4000	10	10
TL5C55W830	55	2GX13	4200	12000	85	3000	10	10
TL5C55W840	55	2GX13	4200	12000	85	4000	10	10
TL5C60W840	60	2GX13	5000	12000	85	4000	10	10

# MASTER TL-D ALTO

The difference is green. The ALTO lamp, a green flagship product, features technology that employs a unique capsule injection dosing system that delivers significantly less mercury into each tube; now only two milligrams.

The lamps Next Generation triphosphor technologies ensures high light output, high lumen maintenance, and good colour rendering.

Features a distinct green end cap for easy identification for relamping. So make the switch to green!

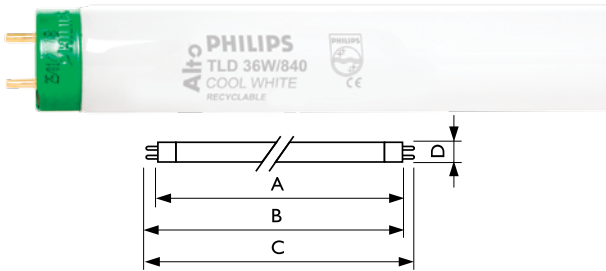

Product ID	A max.	B max.	C max.	D max.
18W	549.0	556.1	563.2	28
36W	1149.0	1156.1	1213.6	28
58W	1500.0	1504.7	1514.2	28

Dimensions in mm

## MASTER TL-D ALTO

Shortcode	Wattage (W)	Cap Base	Voltage	Luminous Flux Lamp (lm)	Average Lifetime EL (hrs)	Colour Rendering Index (Ra)	Colour Temp (K)	Min Order Quantity	Carton Qty
TLD18W830ALTO	18	G13	59	1350	20000	83	3000	25	25
TLD18W840ALTO	18	G13	59	1350	20000	82	4000	25	25
TLD18W850ALTO	18	G13	59	1310	20000	80	5000	25	25
TLD18W865ALTO	18	G13	59	1275	20000	80	6500	25	25
TLD36W830ALTO	36	G13	103	3250	20000	83	3000	25	25
TLD36W840ALTO	36	G13	103	3250	20000	82	4000	25	25
TLD36W850ALTO	36	G13	103	3170	20000	80	5000	25	25
TLD36W865ALTO	36	G13	103	3070	20000	80	6500	25	25
TLD58W830ALTO	58	G13	111	5150	20000	83	3000	25	25
TLD58W840ALTO	58	G13	111	5200	20000	82	4000	25	25
TLD58W850ALTO	58	G13	111	4950	20000	80	5000	25	25
TLD58W865ALTO	58	G13	111	4800	20000	80	6500	25	25

## MASTER TL-D Super 80

Next Generation triphosphor tubes with alternate wattages/lengths.

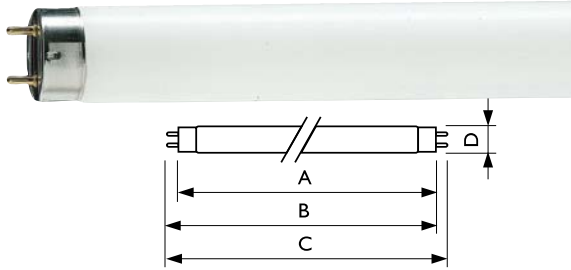

Product ID	A max.	B max.	C max.	D max.
30W	1199.4	1206.5	1213.6	28

Dimensions in mm

### MASTER TL-D SUPER 80

Shortcode	Wattage (W)	Cap Base	Voltage	Luminous Flux Lamp (lm)	Average Lifetime EM (hrs)	Colour Rendering Index (Ra)	Colour Temp (K)	Min Order Quantity	Carton Qty
TLD30W840	30	G13	98	2400	15,000	85	4000	25	25

## MASTER TL-D Xtreme

Next Generation triphosphor tube with long service life and fewer early failures. Xtreme (extremely long life) are suited for applications where maintenance costs are high; such as areas with high ceilings or difficult to reach areas (department stores, supermarkets, warehouses, halls, airports etc). The Xtreme lamps are also suited to areas that require minimum disruption due to relamping; such as production facilities and transport tunnels. Philips recommends Xtreme lamps in applications where users are looking for longer periods between group replacement of lamps. Features a distinct X-cap to identify as a long-life lamp.

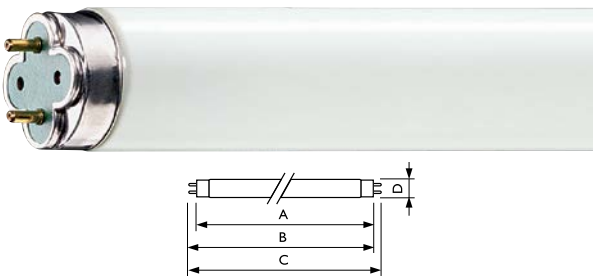

Product ID	A max.	B max.	C max.	D max.
18W	589.8	596.9	604	28
36W	1199.4	1206.5	1213.6	28
58W	1500.0	1507.1	1514.2	28

Dimensions in mm

### MASTER TL-D XTREME

Shortcode	Wattage (W)	Luminous Flux Lamp (lm)	Average Lifetime (hrs) EM	Average Lifetime (hrs) EL	Average Lifetime 24H Operation EL (hrs)	Colour Rendering Index (Ra)	Colour Temp (K)	Min Order Quantity	Carton Qty
TLD18W840XTRE	18	1330	47000	79000	92000	82	4000	25	25
TLD36W840XTRE	36	3250	47000	79000	92000	82	4000	25	25

# MASTER TL-D 90 Deluxe

TL-D 90 Deluxe tubes with a Colour Rendering Index (CRI) >90 are a direct retrofit for standard or TL-D Super 80 where there is a requirement for very good colour rendering. Achieve deeper, richer colours in situations including florists, hairdressers, fashion/departments stores, museums etc.

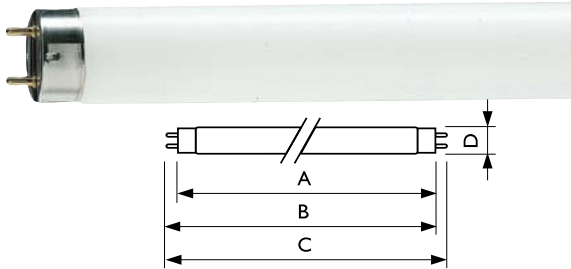

Product ID max.	A max.	B max.	C max.	D max.	E max.
18W	589.8	594.5	96.9	604	28
36W	1199.4	1204.7	1206.5	1213.6	28
58W	1500.0	1504.7	1507.1	1514.2	28

Dimensions in mm

## MASTER TL-D 90 DELUXE

Shortcode	Wattage (W)	Cap Base	Voltage	Luminous Flux Lamp (lm)	Average Lifetime (hrs)	Colour Rendering Index (Ra)	Colour Temp (K)	Min Order Quantity	Carton Qty
TLD18W865	18	G13	59	1150	15000	93	6500	10	10
TLD18W950	18	G13	59	1150	15000	93	5000	10	10
TLD36W940	36	G13	103	2800	15000	91	3800	10	10
TLD36W950	36	G13	103	2800	15000	93	5000	10	10
TLD58W930	58	G13	111	4350	15000	92	3000	10	10
TLD58W950	58	G13	111	4550	15000	93	5000	10	10

## MASTER TL-D Secura

Next Generation triphosphor tube with protective coating. Outer sleeve keeps glass and other lamp components together in case of accidental lamp breakage. Suited for use in areas with open food and beverage areas, production facilities, sports facilities, animal enclosures etc.

Features a distinct blue-ring to identify as protected tubes. MASTER TL-D Secura is HACCP Certified.

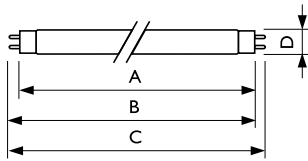

Product ID	A max.	B max.	C max.	D max.	E max.
36W	1199.4	1204.1	1206.5	1213.6	28

Dimensions in mm

### MASTER TL-D SECURA

Shortcode	Wattage (W)	Cap Base	Voltage	Luminous Flux Lamp (lm)	Average Lifetime (hrs)	Colour Rendering Index (Ra)	Colour Temp (K)	Min Order Quantity	Carton Qty
TLD36W840SECURA	36	G13	103	3200	15000	85	4000	25	25

## MASTER TL-D Food Pro (Butcher)

The colour 79 butcher tube. Next Generation triphosphor tube designed specifically for the presentation of fresh meat and poultry. Lamps emphasis the deep red colours such as those of meat, without the lamp having a red appearance.

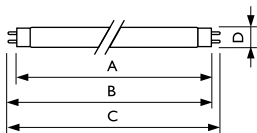

Product ID	A max.	B max.	C max.	D max.	E max.
18W	589.8	594.5	596.9	604	28
30W	894.6	899.3	901.7	908.8	28
36W	1199.4	1204.1	1206.5	1213.6	28

Dimensions in mm

### MASTER TL-D FOOD PRO (BUTCHER)

Shortcode	Wattage (W)	Cap Base	Luminous Flux Lamp (lm)	Average Lifetime (hrs)	Colour Rendering Index (Ra)	Colour Temp (K)	Min Order Quantity	Carton Qty
TLD18W79	18	G13	740	15000	74	3800	25	25
TLD30W79	30	G13	1300	15000	74	3800	25	25
TLD36W79	36	G13	1750	15000	74	3800	25	25



## TL-D Standard Colours

Low-wattage standard colour tubes with shorter length and moderate colour rendering.

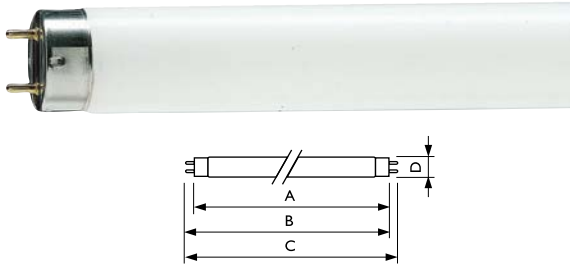

Product ID	A max.	B max.	C max.	D max.
10W	331.5	338.6	345.7	28
15W	437.4	444.5	451.6	28

Dimensions in mm

### TL-D STANDARD COLOURS

Shortcode	Wattage (W)	Cap Base	Luminous Flux Lamp (lm)	Average Lifetime (hrs)	Colour Rendering Index (Ra)	Min Order Quantity	Carton Qty
TLD10W33	10	G13	520	10000	60	25	25
TLD15W33	15	G13	960	10000	63	9	9

## TL-D Coloured

Philips TL-D COLOUR lamps is a complete portfolio of strong and brilliant colours ranging from 18W-58W. That means more freedom to create great ambiance.

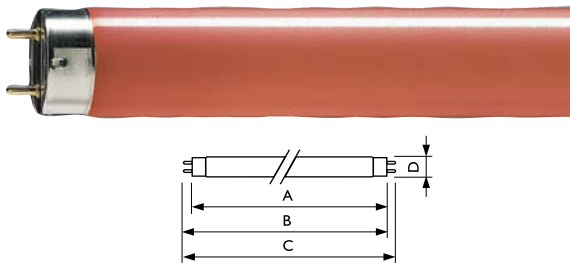

Product ID	A max.	B max.	C max.	D max.	E max.
18W	589.8	594.5	596.9	604	28
36W	1199.4	1204.1	1206.5	1213.6	28

Dimensions in mm

### TLD COLOURED

Shortcode	Colour	Wattage (W)	Cap Base	Luminous Flux Lamp (lm)	Min Order Quantity	Carton Qty
TLD18W18	Blue	18	G13	400	25	25
TLD18W17	Green	18	G13	1300	25	25
TLD18W16	Yellow	18	G13	660	25	25
TLD36W18	Blue	36	G13	970	25	25
TLD36W16	Yellow	36	G13	1580	25	25

## TL-E Circular Super 80

A range of simple, yet decorative shaped circular fluorescent lamps. To provide non-directional light in decorative or functional fittings.

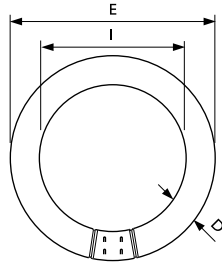

Product ID	D max.	E max.	I max.
22W	30.9	215.9	157.5
32W	30.9	304.8	246.1
40W	30.9	406.4	347.7

Dimensions in mm

### TL-E CIRCULAR SUPER 80

Shortcode	Wattage (W)	Cap Base	Luminous Flux Lamp (lm)	Average Lifetime (hrs)	Colour Rendering Index (Ra)	Colour Temp (K)	Min Order Quantity	Carton Qty
TLE22W840	22	G10q	1285	9000	85	4000	20	20
TLE22W865	22	G10q	1250	9000	85	6500	20	20
TLE32W840	32	G10q	2130	9000	85	4000	4	4
TLE32W865	32	G10q	2130	9000	85	6500	20	20
TLE40W865	40	G10q	3100	9000	85	6500	20	20

## TL Miniature

Miniature tubes with 16mm diameter. Suited to orientation or compact lighting applications, and where space is limited.

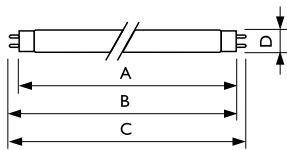

Product ID	A max.	B max.	C max.	D max.
6WTL	212.1	219.2	226.3	16
8WTL	288.3	295.4	302.5	16

Dimensions in mm

### TL MINIATURE

Shortcode	Wattage (W)	Cap Base	Luminous Flux Lamp (lm)	Average Lifetime (hrs)	Colour Rendering Index (Ra)	Colour Temp (K)	Min Order Quantity	Carton Qty
TL6W33	6	G5	280	10000	60	4100	25	250
TL8W33	8	G5	410	10000	60	4100	25	250

## TL-X XL Instant Start

Instant start safety lamps specifically designed for use in potentially explosive atmospheres. Internal ignition switch and nickel single pin caps. Must be used with explosion-proof ballasts in flameproof or increased safety fittings.

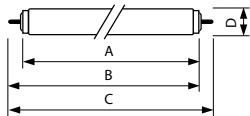

Product ID	A max.	B max.	C max.	D max.
20W	574	592.5	611	40.5
40W	1183.5	1202	1220.5	40.5

Dimensions in mm

### TL-X XL INSTANT START

Shortcode	Wattage (W)	Cap Base	Luminous Flux Lamp (lm)	Average Lifetime (hrs)	Colour Temp (K)	Min Order Quantity	Carton Qty
TLXXL20W33	20	FA6	1100	26000	4100	25	25
TLXXL40W33	40	FA6	2350	26000	4100	25	25

## Starter Switches

Premium quality 2-pin flame-retardant polycarbonate ignitors for starting of fluorescent lamps on conventional electromagnetic circuits.

Controlled preheating of the lamp filaments and sufficient pulse voltage for longer lamp life.

Features a radio-interference suppression capacitor.

S2 starters for ignition in single-circuit operation 110-130V and series operation 220-240V.

S10 starters for ignition in series operation 220-240V.

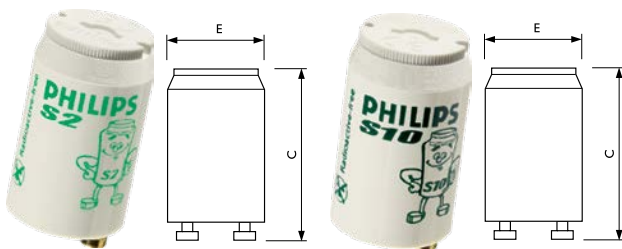

Product ID	Overall Length C max.	Diameter E max.
S2	40.3	21.5
S10	40.3	21.5

Dimensions in mm

### STARTER SWITCHES

Shortcode	Wattage (W)	Min Order Quantity	Carton Qty
S2	4-22	25	300
S10	4-65	25	300

## MASTER PL-R Eco

MASTER PL-R-Eco is an extremely efficient compact fluorescent lamp for downlight applications. It consists of six parallel tubes with a new innovative 'Twist and Lock' lamp base, designed for use with electronic gear.

- Benefits:**
- Optimal light and efficiency performance for short or long operation per switch in indoor downlighters
  - Up to 50% less energy consumption in application versus 18 and 26 W PL-C/T on EM gears for comparable lighting levels
  - Up to 25% less energy consumption in application versus 18 and 26 W PL-C/T on HF drivers for comparable lighting levels
  - Long life, sustainable light output and less early failures lead to less hassle and lower maintenance costs and facilitate the change from spot to group replacement
  - Easy lamp (re-)placement and stable fixation due to new twist and lock lampbase/holder

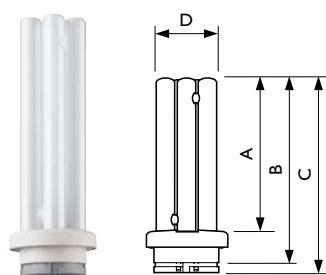

Product ID	A max.	B max.	C max.	D max.
14W	99.7	120.0	126.6	41.0
17W	121.7	142.0	148.6	41.0

Dimensions in mm

### MASTER PL-R ECO

Shortcode	Wattage (W)	Cap Base	Luminous Flux Lamp (lm)	Average Lifetime (hrs)	Colour Rendering Index (Ra)	Colour Temp (K)	Min Order Quantity	Carton Qty
PLR14W830	14	GRI4q-I	1200	24000	82	3000	10	10
PLR14W840	14	GRI4q-I	1200	24000	82	4000	10	10
PLR17W830	17	GRI4q-I	1500	24000	82	3000	10	10
PLR17W840	17	GRI4q-I	1500	24000	82	4000	10	10

## PL-C 2-PIN

PL-C lamps are compact, single ended fluorescent lamps. All require external control gear which normally comes complete with the luminaire. 2-pin (non-dimming) option.

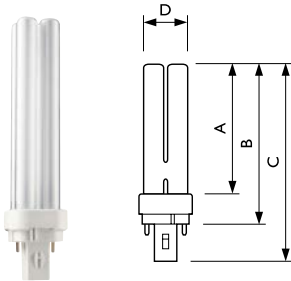

Product ID	Base Face to Base Face A max.	Insertion Length B max.	Overall Length C max.	Diameter D max.
10W	75.7	95	109.9	27.1
13W	97.5	117	131.9	27.1
18W	109.5	129	143.9	27.1
26W	130.7	150	164.9	27.1

Dimensions in mm

### PL-C 2-PIN

Shortcode	Wattage (W)	Cap Base	Luminous Flux Lamp (lm)	Average Lifetime (hrs)	Colour Temp (K)	Min Order Quantity	Carton Qty
PLC10W8402P	10	G24d-1	600	10000	4000	10	50
PLC13W8272P	13	G24d-1	900	10000	2700	10	50
PLC13W8302P	13	G24d-1	900	10000	3000	10	50
PLC13W8402P	13	G24d-1	900	10000	4000	10	50
PLC18W8272P	18	G24d-2	1200	10000	2700	10	50
PLC18W8302P	18	G24d-2	1200	10000	3000	10	50
PLC18W8402P	18	G24d-2	1200	10000	4000	10	50
PLC26W8302P	26	G24d-3	1800	10000	3000	10	50
PLC26W8402P	26	G24d-3	1800	10000	4000	10	50

## PL-C 4-PIN

PL-C lamps are compact, single ended fluorescent lamps. All require external control gear which normally comes complete with the luminaire. 4-pin (dimming) option.

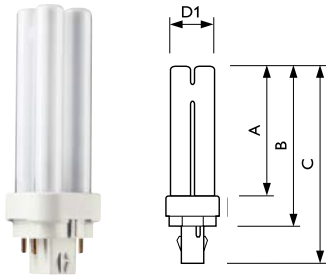

Product ID	Base Face to Base Face A max.	Insertion Length B max.	Overall Length C max.	Diameter DI max.
13W	97.5	117	131.9	27.1
18W	109.5	129	143.9	27.1
26W	130.7	150	164.9	27.1

Dimensions in mm

### PL-C 4-PIN

Shortcode	Wattage (W)	Cap Base	Luminous Flux Lamp (lm)	Average Lifetime (hrs)	Colour Rendering Index (Ra)	Colour Temp (K)	Min Order Quantity	Carton Qty
PLC13W8304P	13	G24q-1	900	10000	83	3000	10	50
PLC13W8404P	13	G24q-1	900	10000	82	4000	10	50
PLC18W8304P	18	G24q-2	1200	10000	83	3000	10	50
PLC18W8404P	18	G24q-2	1200	10000	82	4000	10	50
PLC26W8274P	26	G24q-3	1800	10000	83	2700	10	50
PLC26W8304P	26	G24q-3	1800	10000	83	3000	10	50
PLC26W8404P	26	G24q-3	1800	10000	82	4000	10	50

## MASTER PL-L 4-PIN

PL-L lamps have two parallel fluorescent tubes and a 4-pin base. Dimming possible on electronic gear.

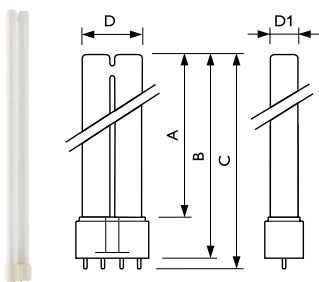

Product ID	Base Face to Base Face A max.	Insertion Length B max.	Overall Length C max.	Diameter D max.	Diameter DI max.
18W	194.2	220	226.0	37.7	18
36W	384.2	410	416.6	37.7	18
40W	509.2	535	541.6	37.7	18
55W	509.2	535	541.6	37.7	18

Dimensions in mm

### MASTER PL-L 4-PIN

Shortcode	Wattage (W)	Cap Base	Luminous Flux Lamp (lm)	Average Lifetime (hrs)	Colour Rendering Index (Ra)	Colour Temp (K)	Min Order Quantity	Carton Qty
PLL18W8304P	18	2G11	1200	15000	82	3000	25	25
PLL18W8404P	18	2G11	1200	15000	82	4000	25	25
PLL36W8404P	36	2G11	2900	15000	82	4000	25	25
PLL55W8304P	55	2G11	4800	20000	82	3000	25	25
PLL55W8404P	55	2G11	4800	15000	82	4000	25	25



## PL-S 2-PIN

PL-S lamps are compact, single ended fluorescent lamps, with two parallel tubes. They have either a 2-pin or 4-pin base incorporating a special instant starter and capacitor.

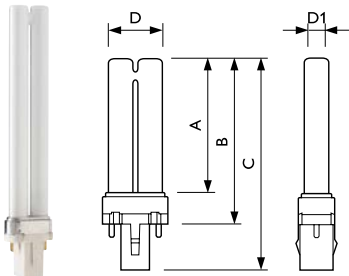

Product ID	Base Face to Base Face A max.	Insertion Length B max.	Overall Length C max.	Diameter D max.	Diameter DI max.
7W 2P	97	113	135.0	27.1	10
9W 2P	129	145	167.0	27.1	10
11W 2P	198	214	235.8	27.1	10

Dimensions in mm

### PL-S 2-PIN

Shortcode	Wattage (W)	Cap Base	Luminous Flux Lamp (lm)	Average Lifetime (hrs)	Colour Temp (K)	Min Order Quantity	Carton Qty
PLS7W8272P	7	G23	400	8000	2700	25	25
PLS7W8402P	7	G23	400	8000	4000	25	25
PLS9W8272P	9	G23	600	8000	2700	25	25
PLS9W8402P	9	G23	600	8000	4000	25	25
PLS11W8272P	11	G23	900	8000	2700	25	25
PLS11W8402P	11	G23	900	8000	4000	25	25

## PL-S 4-PIN

PL-S lamps are compact, single ended fluorescent lamps, with two parallel tubes. They have either a 2-pin or 4-pin base incorporating a special instant starter and capacitor.

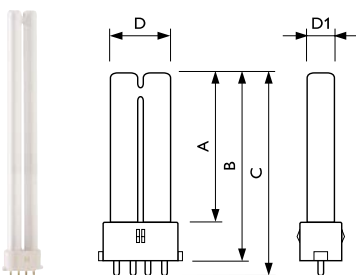

Product ID	Base Face to Base Face A max.	Insertion Length B max.	Overall Length C max.	Diameter D max.	Diameter DI max.
11W 4P	196	214	219.9	27.1	10

Dimensions in mm

### PL-S 4-PIN

Shortcode	Wattage (W)	Cap Base	Luminous Flux Lamp (lm)	Average Lifetime (hrs)	Colour Temp (K)	Min Order Quantity	Carton Qty
PLS11W8404P	11	2G7	900	8000	4000	25	50

## PL-T 2-PIN

PL-T lamps are compact, single ended fluorescent lamps. All require external control gear which normally comes complete with the luminaire.

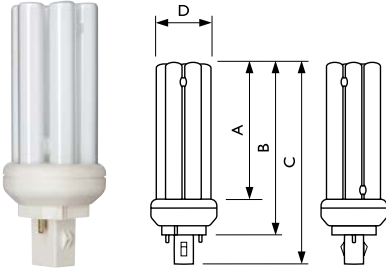

Product ID	Base Face to Base Face A max.	Insertion Length B max.	Overall Length C max.	Width D max.
26W	86.7	111.0	126.7	41.0

Dimensions in mm

### PL-T 2-PIN

Shortcode	Wattage (W)	Cap Base	Luminous Flux Lamp (lm)	Average Lifetime (hrs)	Colour Temp (K)	Min Order Quantity	Carton Qty
PLT26W8302P	26	Gx24d-3	1800	10000	3000	10	50
PLT26W8402P	26	Gx24d-3	1800	10000	4000	10	50

# PL-T TOP 4-PIN

PL-T TOP (Temperature Optimised Performance) energy saving compact fluorescent lamp. Compact long-arc low-pressure mercury discharge lamp envelope consists of 6 parallel narrow fluorescent tubes. Amalgam controlled operation.

- Benefits:**
- Optimal lighting performance for long periods of continuous operation
  - High temperature independency at higher application temperatures due to Amalgam technology
  - Long life and sustainable light output

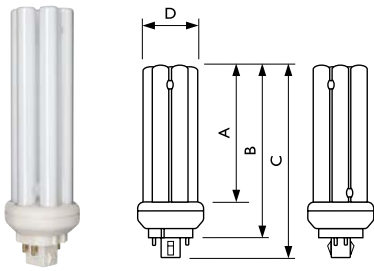

Product ID	Base Face to Base Face A max.	Insertion Length B max.	Overall Length C max.	Width D max.
18W	71.7	96.0	111.7	41.0
26W	86.7	111.0	126.7	41.0
32W	98.7	123.0	138.7	41.0
42W	120.7	145.0	160.7	41.0
57W	157.7	182.0	197.7	41.0

Dimensions in mm

## PL-T TOP 4-PIN

Shortcode	Wattage (W)	Cap Base	Luminous Flux Lamp (lm)	Average Lifetime (hrs)	Colour Rendering Index (Ra)	Colour Temp (K)	Min Order Quantity	Carton Qty
PLTT18W8304P	18	Gx24q-2	1200	13000	82	3000	10	50
PLTT18W8404P	18	Gx24q-2	1200	13000	82	4000	10	50
PLTT26W8304P	26	Gx24q-3	1800	13000	82	3000	10	50
PLTT26W8404P	26	Gx24q-3	1800	13000	82	4000	10	50
PLTT32W8304P	32	Gx24q-3	2400	13000	82	3000	10	50
PLTT32W8404P	32	Gx24q-3	2400	13000	82	4000	10	50
PLTT42W8304P	42	Gx24q-4	3200	13000	82	3000	10	50
PLTT42W8404P	42	Gx24q-4	3200	13000	82	4000	10	50
PLTT57W8404P	57	Gx24q-5	4300	13000	82	4000	10	50

## MASTER PL-T Xtra

Energy saving compact fluorescent lamp. Compact long-arc low-pressure mercury discharge lamp envelope consists of 6 parallel narrow fluorescent tubes.

- Benefits:**
- Extra long life
  - Longer lifetime and less early failures lead to less hassle and lower maintenance costs and facilitate the change from spot to group replacement
  - Optimal light performance for long operation per switch on

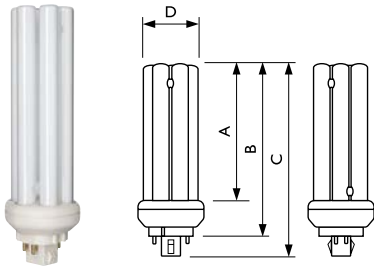

Product ID	Base Face to Base Face A max.	Insertion Length B max.	Overall Length C max.	Width D max.
42W	120.7	145.0	160.7	41.0
57W	157.7	182.0	197.7	41.0

Dimensions in mm

### MASTER PL-T XTRA

Shortcode	Wattage (W)	Cap Base	Luminous Flux Lamp (lm)	Average Lifetime (hrs)	Colour Rendering Index (Ra)	Colour Temp (K)	Min Order Quantity	Carton Qty
PLTXTRA42W8404P	42	GX24q-4	3050	33000	82	4000	50	50
PLTXTRA57W8404P	57	GX24q-5	4300	33000	82	4000	50	50

## PL-Q 2-PIN & 4-PIN Quadrant

PL-Q lamps are compact fluorescent lamps consisting of three double-bent parallel fluorescent tubes.

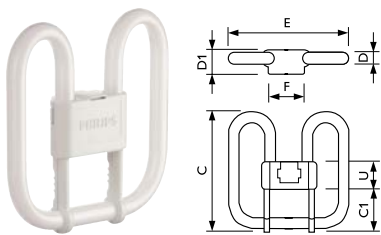

Product ID	Overall Length C max.	Diameter D max.	Diameter DI max.	Diameter E max.	Width F max.
16W	141.0	15.0	27.5	138.0	41.0
28W	207.0	24.0	33.0	205.0	41.0

Dimensions in mm

### PL-Q 2-PIN & 4-PIN QUADRANT

Shortcode	Wattage (W)	Cap Base	Luminous Flux Lamp (lm)	Average Lifetime (hrs)	Colour Temp (K)	Min Order Quantity	Carton Qty
PLQ16W8272P	16	GR8	1050	6000	2700	10	10
PLQ28W8274P	28	GR10q	2050	6000	2700	10	10
PLQ28W8404P	28	GR10q	2050	6000	4000	10	10



## Ambiance Lustre

Suitable for a wide variety of decorative lighting and situations, creating a very pleasant and relaxed atmosphere with a high degree of visual comfort.

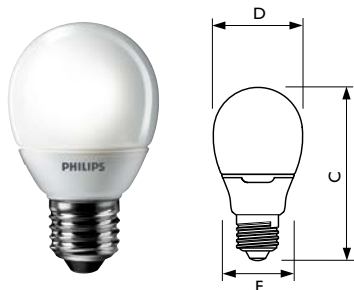

Product ID	Overall Length C max.	Diameter D max.	Width F max.
8W	97	56.5	48.5

Dimensions in mm

### AMBIANCE LUSTRE

Shortcode	Wattage (W)	Cap Base	Voltage	Luminous Flux Lamp (lm)	Average Lifetime (hrs)	Colour Temp (K)	Carton Qty
LST8WWWWSBC	8	B15	220-240V	370	6000	2700	6
LST8WWWWSBC	8	B22	220-240V	370	6000	2700	6
LST8WWWWSSES	8	E14	220-240V	370	6000	2700	6
LST8WWWWSSES	8	E27	220-240V	370	6000	2700	6



## Ambiance Candle

Suitable for a wide variety of decorative lighting and situations, creating a very pleasant and relaxed atmosphere with a high degree of visual comfort.

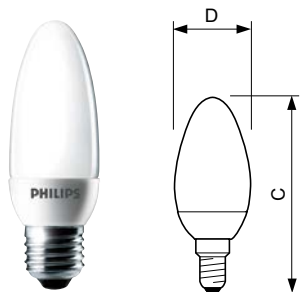

Product ID	Overall Length C max.	Diameter D max.
8W	119.5	41.5

Dimensions in mm

### AMBIANCE CANDLE

Shortcode	Wattage (W)	Cap Base	Voltage	Luminous Flux Lamp (lm)	Average Lifetime (hrs)	Colour Temp (K)	Carton Qty
CND8WWWVWBC	8	B15	220-240V	370	6000	2700	6
CND8WWWVWBC	8	B22	220-240V	370	6000	2700	6
CND8WWWVWSES	8	E14	220-240V	370	6000	2700	6

## Ambiance PAR38

Due to its shape, PAR38 is ideal to replace current incandescent PAR38 applications. Suited for use in shops, office, homes and outdoors\*.

\* For outdoor application, we suggest using this product with light fittings greater than IP54.

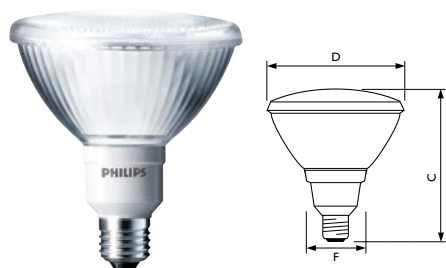

Product ID	Overall Length C max.	Diameter D max.	Width F max.
23W	140.2	122	43.5

Dimensions in mm

### AMBIANCE PAR38

Shortcode	Wattage (W)	Cap Base	Voltage	Luminous Flux Lamp (lm)	Average Lifetime (hrs)	Colour Temp (K)	Carton Qty
PAR23WWWVWES	23	E27	220-240V	1250	6000	2700	6
PAR23WCDLES	23	E27	220-240V	1200	6000	2700	6

## Genie

An energy saving stick-shape compact fluorescent lamp of a small size.

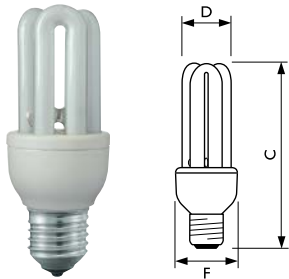

Product ID	Overall Length C max.	Diameter D max.	Width F max.
8W	105.5	35	44.4
11W	117	35	44.4
14W	132	35	44.4
18W	135	41	48.4

Dimensions in mm

GENIE							
Shortcode	Wattage (W)	Cap Base	Voltage	Luminous Flux Lamp (lm)	Average Lifetime (hrs)	Colour Temp (K)	Carton Qty
GENIE14WWWBC	14	B22	220-240V	840	8000	2700	6
GENIE14WWWES	14	E27	220-240V	840	8000	2700	6
GENIE14WCDLBC	14	B22	220-240V	790	8000	6500	6
GENIE14WCDLES	14	E27	220-240V	790	8000	6500	6
GENIE18WWWBC	18	B22	220-240V	1100	8000	2700	6
GENIE18WWWES	18	E27	220-240V	1100	8000	2700	6
GENIE18WCDLBC	18	B22	220-240V	1040	8000	6500	6
GENIE18WCDLES	18	E27	220-240V	1040	8000	6500	6

# Tornado

An energy saving twist-shape compact fluorescent lamp with optimal light distribution.

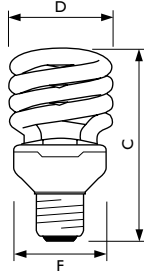

Product ID	Overall Length C max.	Diameter D max.	Width F max.
5W	80	47	40.5
8W	87	47	40.5
12W	94	47	40.5
15W	109	58	52.5
20W	114	62	52.4
24W	126	62	52.5

Dimensions in mm

## TORNADO

Shortcode	Wattage (W)	Cap Base	Voltage	Luminous Flux Lamp (lm)	Average Lifetime (hrs)	Colour Temp (K)	Carton Qty
TND5WWWES	5	E27	220-240V	300	8000	2700	6
TND5WWWBC	5	B22	220-240V	300	8000	2700	6
TND5WWWSES	5	E14	220-240V	300	8000	2700	6
TND5WCDLBC	5	E27	220-240V	285	8000	6500	6
TND5WCDLSES	5	E14	220-240V	280	8000	6500	6
TND8WWWES	8	E27	220-240V	500	8000	2700	6
TND8WWWBC	8	B22	220-240V	500	8000	2700	6
TND8WWWSES	8	E14	220-240V	500	8000	2700	6
TND8WCDLBC	8	B22	220-240V	475	8000	6500	6
TND8WCDLES	8	E27	220-240V	475	8000	6500	6
TND12WWWES	12	E27	220-240V	740	8000	2700	6
TND12WWWBC	12	B22	220-240V	740	8000	2700	6
TND12WWWSES	12	E14	220-240V	725	8000	2700	6
TND12WCDLBC	12	B22	220-240V	700	8000	6500	6
TND12WCDLES	12	E27	220-240V	700	8000	6500	6
TND12WCDLSES	12	E14	220-240V	690	8000	6500	6
TND15WWWES	15	E27	220-240V	950	8000	2700	6
TND15WWWBC	15	B22	220-240V	950	8000	2700	6
TND20WWWES	20	E27	220-240V	1250	8000	2700	6
TND20WWWBC	20	B22	220-240V	1250	8000	2700	6
TND20WCDLES	20	E27	220-240V	1200	8000	6500	6
TND20WCDLBC	20	B22	220-240V	1200	8000	6500	6
TND24WWWES	24	E27	220-240V	1550	8000	2700	6
TND24WWWBC	24	B22	220-240V	1550	8000	2700	6
TND24WCDLES	24	E27	220-240V	1450	8000	6500	6
TND24WCDLBC	24	B22	220-240V	1450	8000	6500	6

# The Basics of LED Technology





## LED

An LED (light emitting diode) is a semi-conductor device or chip that produces light when an electrical current is applied.

### What to remember:

LEDs are just one of many components – optics, housing, power sources, to name a few – used to create an LED fixture or lamp. When looking at claims about lifetime, efficiency and design, it is important to compare the specifications of the entire LED system as a whole not just the specifications of the individual system components.

## Efficiency and efficacy

The “efficacy” of a lighting fixture is usually expressed as the amount of light (in lumens) produced by a certain amount of electricity (in watts). Lighting fixture “efficiency” is the ratio of the total lumens exiting the fixture to the total lumens produced by the light source. Efficiency is also used to discuss the broader concept of using resources efficiently.

### What to remember:

It is important to note that the efficacy of the LEDs themselves is always greater than the efficacy of the LED fixture. This is caused by many factors including losses as light bounces off reflectors and passes through lenses. Make sure when specifying a light fixture that you are looking at the appropriate fixture data versus the LED source data.

## Lifetime

For traditional lighting sources lifetime is reported as “mean time to failure,” which means the average time it takes for some percentage of lamps (usually 50%) to fail completely. With an LED source, light output diminishes over time. Therefore for LED sources, lifetime typically refers to the useful life of the light output, which is referred to as lumen maintenance.

### What to remember:

The lifetimes of LED sources and traditional light sources are defined differently. For white LEDs, lifetime is referred to as the time after which 70% of the original light output remains, not when the source has completely burnt out.

## Low voltage versus line voltage

As opposed to the simplicity of direct line voltage feed, historically all LED fixtures required an external, low voltage power supply or transformer resulting in a more complex installation process than that of traditional fixtures. However, today direct line voltage LED fixtures are available.

### What to remember:

Some LED fixtures can accept direct line voltage. Philips has developed Powercore® technology specifically to increase efficiency, lower the overall cost, and ease installation of LED lighting systems by integrating power management directly into the fixture. Fixtures with Powercore technology can be plugged directly into a standard wall outlet or wired directly into a standard junction box, eliminating the need for external low-voltage power supplies that can complicate installation.

## Directionality

LEDs are directional sources. Traditional light sources (e.g. the incandescent bulb) emit light in all directions. In order to collect light and direct it onto the surface you are trying to illuminate, you must use lenses and reflectors, which absorb light and reduce the total output of the fixture.

### What to remember:

Because an LED source is already emitting the majority of light in a defined direction, it requires significantly less beam shaping optics, leading to a more efficient light fixture. A traditional source may produce more lumens than an LED source, but it may lose much of its light when passing through the required optics. It is important to consider total illuminance, measured in foot candles or lux, when making comparisons between light fixtures.

## Colour Rendering Index (CRI)

Colour Rendering Index (CRI), is a measure of the ability of a light source to render colors, compared to a reference source (incandescent or daylight), on a scale of up to 100, with 100 being identical to the reference source.

### What to remember:

The higher the CRI, the better the fixture's ability to show true colours.

## Sustainability

LED lighting is often linked to sustainability in the context of energy. But sustainability is a much larger concept, with energy efficiency being just one component. Sustainability takes into account environmental responsibility, including waste reduction, recyclability, materials and resources, and building and design practices themselves.

### What to remember:

LED lighting supports sustainable design in several ways: it can reduce energy consumption, it requires infrequent replacement (leading to less waste), and it contains no hazardous mercury. Some LED fixtures are designed to be disassembled more easily for recycling.



# LED Lamps Application Guide

Please read the following installation instructions very carefully when installing your Philips LED lamp.

- Always switch off power supply before commencing work.
- Operating temperature range of the lamp should be between -20°C and 45°C ambient. Over-heating can affect lamp performance.
- Only use in indoor applications and in open fixtures providing 10mm free air space.
- Ensure the fixture has the appropriate lamp-holder.
- Do not use or install the lamp in highly dusty or smoky environments. It is recommended that you install the lamp only after construction is completed.
- Input voltage should be +/-10% the amount stipulated in the specifications.
- Philips Dimmable LED lamps are only dimmable with compatible mix of transformers and dimmers, actual dimming performance depends on dimmer type (refer to the recommended dimmer & transformer list). Please note the different combinations based on the type of lamp and number of lamps.
- For LV MRI6 range the wiring length between lamp and transformer should be less than 1.5 metres.
- Not intended to use with emergency light fixtures or exit lights or DC transformers.
- Customer may notice a one second flicker during startup. This is normal and will not affect lamp performance and lifetime.
- Relative humidity in the installation should not exceed 80% Relative Humidity. Do not install in bathrooms, kitchens and wet areas. These lamps have no tolerance to water.
- Lamps must be protected from the ingress of salt air.
- Do not install the lamp close to medical equipment/televisions/studios/radio areas.
- Products are not subjected to more than total of 20,000 fast switches (time between "on" and "off" should be less than 10 minutes).
- Electrical installation in which the product operates must not be subjected to voltage fluctuations. The mains supply should have surge or over voltage protection equipment.
- It is also recommended that all lamps on one transformer share the same Philips brand.
- Approximate lifetimes are based on usage not exceeding 4,000 hrs/year.

For detailed information, please visit [www.philips.com.au/masterledlamps](http://www.philips.com.au/masterledlamps)







## LEDspot Mains Voltage GU10

This lamp is similar to a traditional GU10 halogen reflector lamp of 50W. It is ideal for a myriad of applications such as track lighting, general architectural and landscape lighting, display case fixtures and cabinet lighting.

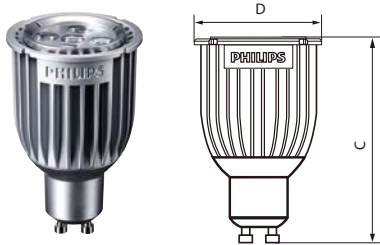

Product ID	Overall Length C max.	Diameter D max.
8W	80.5	50.2

Dimensions in mm

### LEDSPOT MAINS VOLTAGE GU10

Commercial Code	Wattage (W)	Cap Base	Voltage	Luminous Intensity (cd)	Total Lumen (lm)	Average Lifetime (hrs)	Colour Temp (K)	Beam Angle °	Min Order Quantity	Carton Qty	Dimmable
MLED8W27GU1025D	8	GU10	230-240V	1800	430	40000	2700	25	1	6	Yes
MLED8W27GU1040D	8	GU10	230-240V	900	430	40000	2700	40	1	6	Yes
MLED8W30GU1025D	8	GU10	230-240V	1900	450	40000	3000	25	1	6	Yes
MLED8W30GU1040D	8	GU10	230-240V	950	450	40000	3000	40	1	6	Yes
MLED8W40GU1025D	8	GU10	230-240V	1900	450	40000	4000	25	1	6	Yes
MLED8W40GU1040D	8	GU10	230-240V	950	450	40000	4000	40	1	6	Yes

### DIMMING COMPATIBILITY FOR MASTER LED GU10, 8W\* \*\* \*\*\*

#### DIMMER INFO

Brand	Type #	Load Type	Load
HPM	2000E	RL	2000W
HPM	2400E	RL	2400W
HPM	1000TMWE	RC	10-1000W
HPM	700TWE	RC	10-700W
Clipsal	31E800T	RC	800W
Clipsal	2031E2PUDR	RLC	25-450W
Clipsal	5852D2T1AA	RC	480W
Clipsal	5854DIT2AA	RC	240W
Clipsal	32/2400	RL	2400W
Clipsal	32/1000	RL	1000W
Clipsal	L5504D2A	RL	600W
Clipsal	L5504D2U	RLC	600W
HPM	Cat 250T	RC	250W
Clipsal	32V500	RL	500W
Clipsal	32E2CFLDM	RC	5-300W
Clipsal	32E450UDM	RLC	450W
Clipsal	32E450TM	RC	450W
Clipsal	32E450LM	RL	450W
Clipsal	3031H500MK	R	500W
HPM	Cat 400T	RC	10-400W
HPM	Cat 450P	RLC	450W

#### RESULTS

				Number of Lamps																	
				1	2	3	4	5	6	7	8	9	10	11	12	13	14	15	16	17	18
HPM	2000E	RL	2000W	•	•	•	•	•	•	•	•	•	•	•	•	•	•	•	•	•	•
HPM	2400E	RL	2400W	•	•	•	•	•	•	•	•	•	•	•	•	•	•	•	•	•	•
HPM	1000TMWE	RC	10-1000W	•	•	•	•	•	•	•	•	•	•	•	•	•	•	•	•	•	•
HPM	700TWE	RC	10-700W	•	•	•	•	•	•	•	•	•	•	•	•	•	•	•	•	•	•
Clipsal	31E800T	RC	800W	•	•	•	•	•	•	•	•	•	•	•	•	•	•	•	•	•	•
Clipsal	2031E2PUDR	RLC	25-450W	•	•	•	•	•	•	•	•	•	•	•	•	•	•	•	•	•	•
Clipsal	5852D2T1AA	RC	480W	•	•	•	•	•	•	•	•	•	•	•	•	•	•	•	•	•	•
Clipsal	5854DIT2AA	RC	240W	•	•	•	•	•	•	•	•	•	•	•	•	•	•	•	•	•	•
Clipsal	32/2400	RL	2400W	•	•	•	•	•	•	•	•	•	•	•	•	•	•	•	•	•	•
Clipsal	32/1000	RL	1000W	•	•	•	•	•	•	•	•	•	•	•	•	•	•	•	•	•	•
Clipsal	L5504D2A	RL	600W	•	•	•	•	•	•	•	•	•	•	•	•	•	•	•	•	•	•
Clipsal	L5504D2U	RLC	600W	•	•	•	•	•	•	•	•	•	•	•	•	•	•	•	•	•	•
HPM	Cat 250T	RC	250W	•	•	•	•	•	•	•	•	•	•	•	•	•	•	•	•	•	•
Clipsal	32V500	RL	500W	•	•	•	•	•	•	•	•	•	•	•	•	•	•	•	•	•	•
Clipsal	32E2CFLDM	RC	5-300W	•	•	•	•	•	•	•	•	•	•	•	•	•	•	•	•	•	•
Clipsal	32E450UDM	RLC	450W	•	•	•	•	•	•	•	•	•	•	•	•	•	•	•	•	•	•
Clipsal	32E450TM	RC	450W	•	•	•	•	•	•	•	•	•	•	•	•	•	•	•	•	•	•
Clipsal	32E450LM	RL	450W	•	•	•	•	•	•	•	•	•	•	•	•	•	•	•	•	•	•
Clipsal	3031H500MK	R	500W	•	•	•	•	•	•	•	•	•	•	•	•	•	•	•	•	•	•
HPM	Cat 400T	RC	10-400W	•	•	•	•	•	•	•	•	•	•	•	•	•	•	•	•	•	•
HPM	Cat 450P	RLC	450W	•	•	•	•	•	•	•	•	•	•	•	•	•	•	•	•	•	•

\* Dimmable to 10% with compatible mix of dimmers and transformers.  
Real dimming performance depends on dimmer type.

\*\* Please check with manufacturer on availability of transformers and dimmers in Australia.

\*\*\* Philips does not accept liability for compatibility as a result of changes in dimmer or transformer specifications.



## LEDspot Low Voltage MR11 – Non-dimmable

Philips 12V MASTER LED 4W MR11 is the latest in Philips' series of Low Voltage(12VAC) Halogen spot replacements. It also offers excellent accent light effect.



Product ID	Overall Length C max.	Diameter D max.
4W	40	34.6

Dimensions in mm

### LEDSPOT LOW VOLTAGE MR11 – NON-DIMMABLE

Commercial Code	Wattage (W)	Cap Base	Voltage	Luminous Intensity (cd)	Average Lifetime (hrs)	Colour Temp (K)	Beam Angle °	Min Order Quantity	Carton Qty
MLEDMR112700K24D	4	GU4	12V	580	25000	2700	24	1	12
MLEDMR114000K24D	4	GU4	12V	700	25000	4000	24	1	12

## LEDspot Low Voltage MR16 – Non-dimmable

Delivering a warm, halogen/incandescent-like accent beam, MASTER LEDspot MR16 non-dimmable lamp is an ideal retrofit solution for spot and general lighting applications where dimming is not required. It is particularly suited to public areas such as receptions, lobbies, corridors, stairwells and washrooms in the hospitality industry. These lamps provide an alternative to traditional GU5.3 halogen reflector lamps.

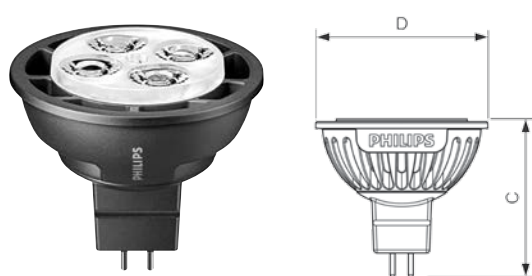

Product ID	Overall Length C max.	Diameter D max.
4W	47.8	50
6.5W	47.8	49.9

Dimensions in mm

\* Image guide only.

### LEDSPOT LOW VOLTAGE MR16 – NON-DIMMABLE

Commercial Code	Wattage (W)	Cap Base	Voltage	Luminous Intensity (cd)	Luminous Flex (lm)	Average Lifetime (hrs)	Colour Temp (K)	Beam Angle °	Min Order Quantity	Carton Qty
MLED4W2700K24D	4	GU5.3	12V	1000	210	45000	2700	24	1	10
MLED4W3000K24D	4	GU5.3	12V	1150	220	45000	3000	24	1	10
MLED6.5W27K24D	6.5	GU5.3	12V	2000	380	25000	2700	24	1	10
MLED6.5W30K24D	6.5	GU5.3	12V	2030	390	25000	3000	24	1	10
MLED6.5W27K36D	6.5	GU5.3	12V	1200	380	25000	2700	36	1	10
MLED6.5W30K36D	6.5	GU5.3	12V	1250	390	25000	3000	36	1	10



## LEDspot Low Voltage MR16 – Dimmable

Philips 12V MASTER LED Dimmable MR16 is the latest in Philips' series of low voltage (12VAC) Halogen spot replacements. Not only does it employ Philips patented solution offering compatibility with a variety of standard 12V Halogen electronic transformers and wall dimmers, it also delivers good beam intensity. The Philips MASTER LED 7W 12V Dimmable MR16 fits into most halogen lamp fittings.

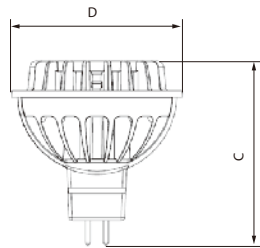

Product ID	Overall Length C max.	Diameter D max.
12V MASTER LED Dimmable MR16	54.5	50.5

Dimensions in mm

### LEDSPOT LOW VOLTAGE MR16 – DIMMABLE\*

Product Type	Voltage (V)	Power Watts (W)	Base	Power Factor	Lumen 90D cone (lm)	Total Lumen (lm)	Beam Angle	CCT (K)	Intensity (Cd)	Lifetime (Hrs)	CRI	Dimmable
MLED 7W27K24DIM	12	7	GU5.3	>0.7	380	350	24	2700K	1950	40,000	>80	Yes
MLED 7W3K24DIM	12	7	GU5.3	>0.7	380	350	24	3000K	1950	40,000	>80	Yes
MLED 7W4K24DIM	12	7	GU5.3	>0.7	400	380	24	4000K	2050	40,000	>80	Yes
MLED 7W27K36DIM	12	7	GU5.3	>0.7	380	350	36	2700K	1050	40,000	>80	Yes
MLED 7W3K36DIM	12	7	GU5.3	>0.7	380	350	36	3000K	1050	40,000	>80	Yes
MLED 7W4K36DIM	12	7	GU5.3	>0.7	400	380	36	4000K	1100	40,000	>80	Yes
MLED 7W27K60DIM	12	7	GU5.3	>0.7	380	350	60	2700K	360	40,000	>80	Yes
MLED 7W3K60DIM	12	7	GU5.3	>0.7	380	350	60	3000K	360	40,000	>80	Yes
MLED 7W4K60DIM	12	7	GU5.3	>0.7	400	380	60	4000K	380	40,000	>80	Yes

\* Refer to Dimming Compatibility table.



# LEDspot Low Voltage MRI6 – Dimming Compatibility

## DIMMING COMPATIBILITY FOR MASTER LED DIMMABLE MRI6 7W\*

		Dimmable*	TRANSFORMER									
			Brand	Osram			Tridonic			LONON	NVC	
DIMMER	Brand	Model	Without Dimmer	Redback 60VA	HTM 70	HTM 105	HTM 150	VIPER	Speedy	POSSUM	LNDET-50	ET60E
				1 lamp	1 lamp	1 lamp	2 lamps	1 lamp	1 lamp	1 lamp	1 lamp	1 lamp
			Pass	Pass	Pass	Pass	Pass	Pass	Pass	Pass	Pass	Pass
DIMMER	Clipsal	32E450UDM										
		32E450TM										
		32E2CFLDM										
		250Volt 500VA										
		KB3IRD400										
	LEGRAND	Arteor 400W										
	HPM	Cat 400L										
		Cat 400T										
	Philips	LRD8020										
	Lonon	NB6MB										
	TCL	V805I										
		A805I										
	TNC	Z62-M12										
	Dynamlite	DDMC802+DDLM102										
		DDMC802+DDTM102										
		DLE1205										
	PDL	624TMWH										
	KIWI	K004U										
		K005T										
	Panasonic	WEG57816										
WEG57813												

\*Philips does not accept liability for incompatibility as a result of changes in dimmer or transformer specifications.









## LEDbulb A60

The new MASTER LED A60 12W bulb delivers a dimmable glow effect similar to a 60W incandescent bulb for a welcoming, warm atmosphere, making it ideal for general lighting applications. Its innovative design radiates warm light in all directions, making it a good alternative to the incandescent lamp.



Product ID	Overall Length C max.	Diameter D max.
12W	109.6	61.5

Dimensions in mm

\* Image guide only.

### LEDBULB A60

Commercial Code	Wattage (W)	Cap Base	Voltage	Lumen Output (lm)	Average Lifetime (hrs)	Colour Temp (K)	Min Order Quantity	Carton Qty	Dimmable
MLED12WA60E27WW	12	E27	220-240V	806	25000	2700	1	6	Yes
MLED12WA60B22WW	12	B22	220-240V	806	25000	2700	1	6	Yes

### DIMMING COMPATIBILITY FOR MASTER LED A60 12W

Brand	Type #	Load	Operation Condition	Dimmer Features	Max no. of lamps
CLIPSAL	32E450LM	450W	220-240V, 50Hz	Leading edge	4 max



## LEDbulb A67

The unique remote phosphor technology utilised in the MASTER LED A67 13W bulb delivers soft white light similar to a 75W incandescent bulb ideal for general lighting appliances.

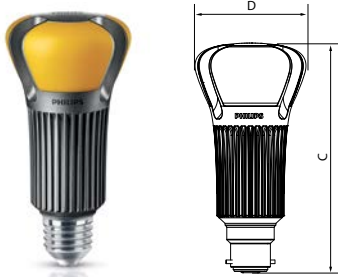

\* Image guide only.

Product ID	Overall Length C max.	Diameter D max.
13W	127	61

Dimensions in mm

### LEDBULB A67

Commercial Code	Wattage (W)	Cap Base	Voltage	Lumen Output (lm)	Average Lifetime (hrs)	Colour Temp (K)	Min Order Quantity	Carton Qty	Dimmable
MLED13WA67E27WW	13	E27	220-240V	1055	25000	2700	1	6	Yes
MLED13WA67B22WW	13	B22	220-240V	1055	25000	2700	1	6	Yes





## LED Decorative Candle

Delivering sparkling light effects, Novallure LED candle bulbs are ideal for general and decorative lighting in the hospitality industry, as well as in home environments. Mounted in full view in chandeliers, wall sconces or modern luminaires, the clear bulb fits existing fixtures with an E14 socket and is dimmable.

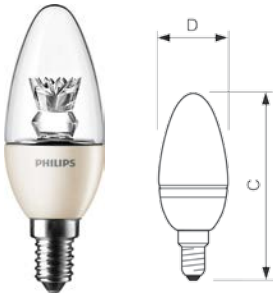

Product ID	Overall Length C max.	Diameter D max.
3.5W	113	39
4W	101	35

Dimensions in mm

### LED DECORATIVE CANDLE

Commercial Code	Wattage (W)	Cap Base	Voltage	Lumen Output (lm)	Average Lifetime (hrs)	Colour Temp (K)	Min Order Quantity	Carton Qty
MLED35W27KCLOT	3.5W	SES	230-240V	250	20000	2700	1	10
MLED4W3000K24D	4	SES	230-240V	250	20000	3000	1	10



## LEDspot PAR

With its robust design and warm-white beam of light, these new generation PAR lamps are ideal for general lighting and spot lighting in the hospitality industry. They are especially suitable for public areas such as lobbies, corridors, and stairwells. Compatible with existing fixtures with an E27 holder and designed for retrofit replacement of halogen lamps. The range includes an IP44-rated outdoor version PAR38 lamp.

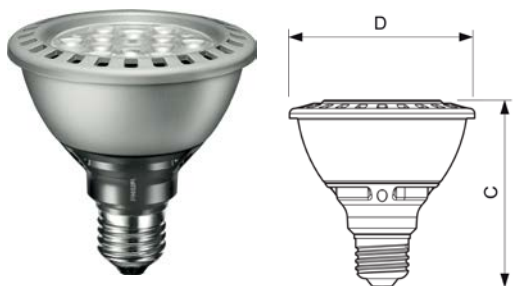

\* Image guide only.

Product ID	Overall Length C max.	Diameter D max.
12W	91	92
18W	133	122
17W	132.5	121.6

Dimensions in mm

### LEDSPOT PAR

Commercial Code	Wattage (W)	Cap Base	Voltage	Lumen Output (lm)	Average Lifetime (hrs)	Colour Temp (K)	Beam Angle °	Min Order Quantity	Carton Qty	Dimmable
ML9W27000K3025D	9.5	E27	220-240V	650	40000	2700	25	1	6	Yes
ML14W27000K3825D	14.5	E27	220-240V	900	40000	2700	25	1	6	Yes
ML17W27000K38OD	17	E27	220-240V	810	25000	2700	25	1	6	No

### DIMMING COMPATIBILITY FOR LEDSPOT PAR 9.5W PAR30\*

Dimmer Type	Brand	Type	Operating Voltage	Load	Max. Lamp Quantity
32E450LM	CLIPSAL	RL	220V, 50Hz	450W	3
			240V, 50Hz	450W	4
32E450UDM	CLIPSAL	RLC	220V/240V, 50Hz	450W	7
E303IHD	CLIPSAL	RLC	240V, 50Hz	40~600W	2

### DIMMING COMPATIBILITY FOR LEDSPOT PAR 14.5W PAR38\*

Dimmer Type	Brand	Type	Operating Voltage	Load	Max. Lamp Quantity
32E450LM	CLIPSAL	RL	220V, 50Hz	450W	3
			240V, 50Hz	450W	4
32E450UDM	CLIPSAL	RLC	220V/240V, 50Hz	450W	7
E303IHD	CLIPSAL	RLC	240V, 50Hz	40~600W	2

\* Please check with manufacturer on availability of dimmers in Australia.



## LEDspot AR111

Delivering a warm, halogen-like accent beam, MASTER LEDspot LV AR111 is an ideal retrofit solution for spot and general lighting applications in the hospitality and retail industry. It is particularly suitable for general lighting and creative accent lighting applications in shops, restaurants, hotels, and museums. The range includes dimmable versions.

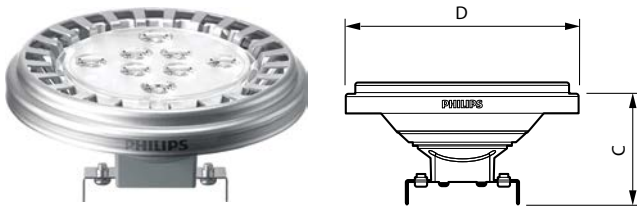

Product ID	Overall Length C max.	Diameter D max.
15W	58.6	111

Dimensions in mm

### LEDSPOT AR111

Commercial Code	Wattage (W)	Cap Base	Voltage	Lumen Output (lm)	Average Lifetime (hrs)	Colour Temp (K)	Beam Angle °	Min Order Quantity	Carton Qty	Dimmable
ML15WAR111WW24DM	15	G53	12V	830	45000	2700	24	1	6	Yes
ML15WAR111WW40DM	15	G53	12V	830	45000	2700	40	1	6	Yes

### DIMMING COMPATIBILITY FOR LEDSPOT LV AR111\*

	Brand	Model	Transformer compatibility	Clipsal	Clipsal	Clipsal	HPM	HPM
				32E450UD M 450W	32E450TM	32E450LM	Cat400L	Cat400T
Philips	ET-S60	I Lamp	Pass			•	•	•
OSRAM	ECO-ET105	I Lamp	Pass	•	•	•		•
	HTM I05/230-24	I Lamp	Pass	•	•	•		•

\* Please check with manufacturer on availability of transformers and dimmers in Australia.





## LEDtube

Philips MASTER LEDtube integrates a LED light source with a frosted cover design into the traditional linear fluorescent form. Philips MASTER LEDtube is an advanced alternative to the classic linear fluorescent lamp and is designed for multiple general lighting applications such as:

**Main Applications:** • Offices • Industrial • Parking lots • Railway stations • Warehouses • Supermarket/Shops  
• School • Hospital • Cold stores

Note: EPM 050 must be purchased separately with each Philips LEDtube.

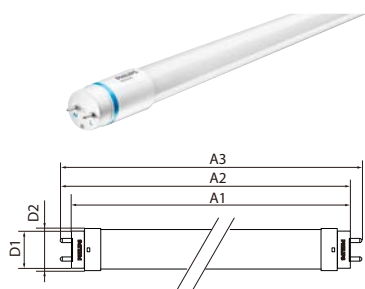

Product ID	Length	A1	A2	A3	CI	DI	D2
10W	600mm	588.5	595.5	602.5	-	25.68	28
15W	900mm	893.5	900.5	907.5	-	25.68	28
19W	1200mm	1198	1205	1212	-	25.68	28
24W	1500mm	1500	1507	1514	-	25.68	28

Dimensions in mm

### LEDTUBE

Commercial Code	Wattage (W)	Cap Base	Voltage	Lumen Output (lm)	Average Lifetime (hrs)	Colour Temp (K)	Min Order Quantity	Carton Qty
TLED10W4000KG13	10	G13	100-240V	825	40000	4000	10	10
TLED10W6500KG13	10	G13	100-240V	825	40000	6500	10	10
TLED15W4000KG13	15	G13	100-240V	1265	40000	4000	10	10
TLED15W6500KG13	15	G13	100-240V	1265	40000	6500	10	10
TLED16W4000KG13	16	G13	100-240V	1600	40000	4000	10	10
TLED16W6500KG13	16	G13	100-240V	1600	40000	6500	10	10
TLED20W4000KG13	20	G13	100-240V	2100	40000	4000	10	10
TLED20W6500KG13	20	G13	100-240V	2100	40000	6500	10	10
MLEDSTARTEMP050	-	-	-	-	-	-	10	10







## CorePro LEDtube

The CorePro LEDtube is an affordable LED solution suitable for replacing T8 fluorescent lamps on electromagnetic (Em) ballast installations. The product provides a natural lighting effect for use in general lighting applications.

**Main Applications:** • Car park • Warehouses • Signage

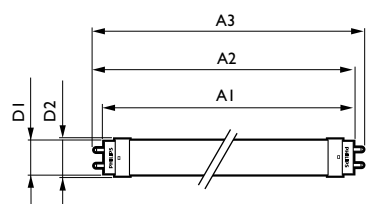

Product ID	Length	A1	A2	A3	CI	DI	D2
10W	600mm	588.5	595.5	602.5	-	25.68	28
15W	900mm	893.5	900.5	907.5	-	25.68	28
19W	1200mm	1198	1205	1212	-	25.68	28
24W	1500mm	1500	1507	1514	-	25.68	28

Dimensions in mm

### LEDTUBE

Commercial Code	Wattage (W)	Cap Base	Voltage	Lumen Output (lm)	Average Lifetime (hrs)	Colour Temp (K)	Min Order Quantity	Carton Qty
TLED10W4000KG13	10	G13	200-240V	800	TBC	4000	10	10
TLED10W6500KG13	10	G13	200-240V	800	TBC	6500	10	10
TLED20W4000KG13	20	G13	220-240V	1600	TBC	4000	10	10
TLED20W6500KG13	20	G13	220-240V	1600	TBC	6500	10	10

## Ceramic Metal Halide - Master CDM-T

Range of single-ended, compact, high-efficiency, discharge lamps with a stable colour over lifetime and a crisp, sparkling light. Long lamp life compared with incandescent and halogen lamps. Low heat output and UV-block for reduced fading risks. Available in small CDM-T, for use with ballast and ignitor or electronic gear.

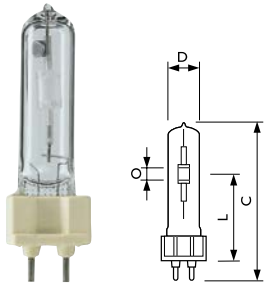

Product ID	Overall Length	Diameter	Light Centre Length	Arc Length
	C max.	D max.	L nom.	O nom.
20W	103	20	56	4
35W	103	20	56	5
70W	103	20	56	7
150W	110	20	56	9

Dimensions in mm

### MASTER CDM-T

Shortcode	Description	Wattage (W)	Cap Base	Luminous Flux	Average Lifetime (hrs)	Colour Temp (K)	Min Order Quantity	Carton Qty
CDMT20W830	MASTERC CDM-T 20W/830 G12 ICT/I2	20	G12	1800	12000	3000	1	12
CDMT35W942	MASTERC CDM-T 35W/942 G12 ICT/I2	35	G12	3150	12000	4200	1	12
CDMT70W942	MASTERC CDM-T 70W/942 G12 ICT/I2	70	G12	6600	12000	4200	1	12
CDMT150W942	MASTERC CDM-T 150W/942 G12 ICT/I2	150	G12	12000	12000	4200	1	12

## Master CDM-T Elite

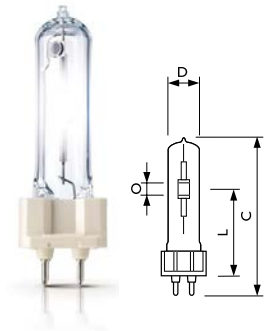

Product ID	Overall Length	Diameter	Light Centre Length	Arc Length
	C max.	D max.	L nom.	O nom.
35W	103	20	56	5
50W	103	20	56	6
70W	103	20	56	7
150W	110	20	56	9

Dimensions in mm

### MASTER CDM-T ELITE

Shortcode	Description	Wattage (W)	Cap Base	Luminous Flux	Average Lifetime (hrs)	Colour Temp (K)	Min Order Quantity	Carton Qty
CDMTEL35W930	MASTER CDM-T Elite 35W/930 G12 ICT/I2	35	G12	4000	15000	3000	1	12
CDMTEL35W942	MASTER CDM-T Elite 35W/942 G12 ICT	35	G12	3800	15000	4200	1	12
CDMTEL50W930	MASTER CDM-T Elite 50W/930 G12 ICT/I2	50	G12	5400	15000	3000	1	12
CDMTEL70W930	MASTERC CDM-T Elite 70W/930 G12 ICT/I2	70	G12	7500	15000	3000	1	12
CDMTEL70W942	MASTERC CDM-T Elite 70W/942 G12 ICT	70	G12	7500	15000	4200	1	12
CDMTEL150W930	MASTERC CDM-T Elite 150W/930 G12 ICT/I2	150	G12	15000	15000	3000	1	12

# Master CDM-T Elite Light Boost

MasterColour CDM-T/TC Light Boost puts an end to the stark choice of complete darkness or full-on brightness, as this breakthrough innovation enables you to vary light levels significantly by dimming or boosting, while still maintaining excellent quality of light.

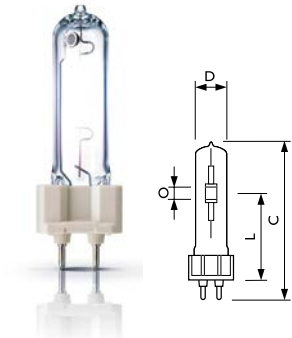

Product ID	Overall Length	Diameter	Light Centre	Arc Length
	C max.	D max.	L nom.	O nom.
70W	103	20	56	7

Dimensions in mm

## MASTER CDM-T ELITE LIGHT BOOST

Shortcode	Description	Wattage (W)	Cap Base	Luminous Flux	Average Lifetime (hrs)	Colour Temp (K)	Min Order Quantity	Carton Qty
CDMTLB70W930	CDM-T Elite Light Boost 70W/930 G12	70	G12	7650	15000	3000	1	12
CDMTLB70W942	CDM-T Elite Light Boost 70W/942 G12	70	G12	6500	15000	4200	1	12

# Master CDM-TC

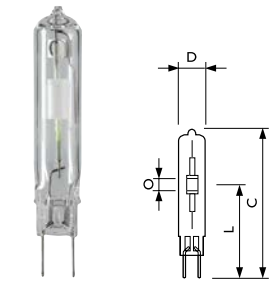

Product ID	Overall Length	Diameter	Light Centre Length	Arc Length
	C max.	D max.	L nom.	O nom.
20W	103	20	56	4
35W	103	20	56	5
70W	103	20	56	7

Dimensions in mm

## MASTER CDM-TC

Shortcode	Description	Wattage (W)	Cap Base	Luminous Flux	Average Lifetime (hrs)	Colour Temp (K)	Min Order Quantity	Carton Qty
CDMTC20W830	MASTERC CDM-TC 20W/830 G8.5 ICT/12	20	G8.5	1800	12000	3000	1	12
CDMTC35W942	MASTERC CDM-TC 35W/942 G8.5 ICT/12	35	G8.5	3000	12000	4200	1	12
CDMTC70W942	MASTERC CDM-TC 70W/942 G8.5 ICT/12	70	G8.5	6500	12000	4200	1	12

## Master CDM-TC Elite

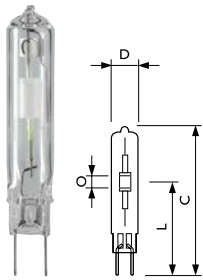

Product ID	Overall Length	Diameter	Light Centre Length	Arc Length
	C max.	D max.	L nom.	O nom.
35W	103	20	56	5
50W	103	20	56	6
70W	103	20	56	7

Dimensions in mm

### MASTER CDM-TC ELITE

Shortcode	Description	Wattage (W)	Cap Base	Luminous Flux	Average Lifetime (hrs)	Colour Temp (K)	Min Order Quantity	Carton Qty
CDMTCEL35W930	MASTER CDM-TC Elite 35W/930 G8.5 ICT/12	35	G8.5	4000	15000	3000	1	12
CDMTCEL35W942	MASTER CDM-TC Elite 35W/942 G8.5 ICT/12	35	G8.5	3700	15000	4200	1	12
CDMTCEL50W930	MASTER CDM-TC Elite 50W/930 G8.5 ICT/12	50	G8.5	5400	15000	3000	1	12
CDMTCEL70W930	MASTER CDM-TC Elite 70W/930 G8.5 ICT/12	70	G8.5	7650	15000	3000	1	12
CDMTCE70W942	MASTER CDM-TC Elite 70W/942 G8.5 ICT	70	G8.5	7400	15000	4200	1	12

## Master CDM-TC Elite Light Boost

MasterColour CDM-T/TC Light Boost puts an end to the stark choice of complete darkness or full-on brightness, as this breakthrough innovation enables you to vary light levels significantly by dimming or boosting, while still maintaining excellent quality of light.

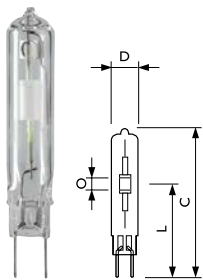

Product ID	Overall Length	Diameter	Light Centre Length	Arc Length
	C max.	D max.	L nom.	O nom.
70W	103	20	56	7

Dimensions in mm

### MASTER CDM-TC ELITE LIGHT BOOST

Shortcode	Description	Wattage (W)	Cap Base	Luminous Flux	Average Lifetime (hrs)	Colour Temp (K)	Min Order Quantity	Carton Qty
CDMTCL70W930	MC CDM-TC Elite Light Boost 70W/930 G8.5	70	G8.5	7650	15000	3000	1	12
CDMTCL70W942	MC CDM-TC Elite Light Boost 70W/942 G8.5	70	G8.5	6500	15000	4200	1	12



## Master CDM-TD

CDM-TD range of double-ended, compact, high-efficiency, discharge lamps with a stable colour over lifetime and a crisp, sparkling light. UV-block for reduced health and fading risks. Direct retrofit in place for quartz metal halide lamps providing lower operating costs, reduced heat output, and better light quality.

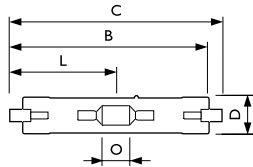

Product ID	Overall Length	Diameter	Light Centre Length	Arc Length
	C max.	D max.	L nom.	O nom.
CDMTD70W830	119.63	22		8
CDMTD70W942	119.63	22		7
CDMTD150W830	137.43	25		10
CDMTD150W942	137.43	25		10

Dimensions in mm

### MASTER CDM-TD

Shortcode	Description	Wattage (W)	Cap Base	Luminous Flux	Average Lifetime (hrs)	Colour Temp (K)	Min Order Quantity	Carton Qty
CDMTD70W830	MASTERC CDM-TD 70W/830 RX7s ICT/I2	70	RX7s	6500	15000	3000	1	12
CDMTD70W942	MASTERC CDM-TD 70W/942 RX7s ICT/I2	70	RX7s	6000	15000	4200	1	12
CDMTD150W830	MASTERC CDM-TD 150W/830 RX7s ICT/I2	150	RX7s	13250	15000	3000	1	12
CDMTD150W942	MASTERC CDM-TD 150W/942 RX7s ICT/I2	150	RX7s	14200	15000	4200	1	12

## MHN-TD

High pressure quartz metal halide gas discharge lamps in a compact linear tube which offers high performance together with high colour rendering. MHN-TD lamps require control gear to operate and have a recommended burning position of  $\pm 45$  degrees from the horizontal.

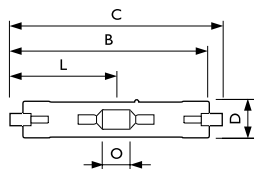

Product ID	Overall Length	Diameter	Light Centre Length	Arc Length	
	C max.	D max.	L nom.	O nom.	B nom.
70W	139	24	64.9	17.8	132
150W	139	24	64.9	17.8	132

Dimensions in mm

### MHN-TD

Shortcode	Description	Wattage (W)	Cap Base	Luminous Flux	Average Lifetime (hrs)	Colour Temp (K)	Min Order Quantity	Carton Qty
MHNTD70W730	MHN-TD 70W/730 RX7s ICT/I2	70	RX7s	6200	9000	3000	1	12
MHNTD70W842	MHN-TD 70W/842 RX7s ICT/I2	70	RX7s	5700	10500	4200	1	12
MHNTD150W730	MHN-TD 150W/730 RX7s ICT/I2	150	RX7s	13800	10500	3000	1	12
MHNTD150W842	MHN-TD 150W/842 RX7s ICT/I2	150	RX7s	12900	10500	4200	1	12

## CDM-/TP Medium Wattage Elite

Protected, high efficiency, discharge lamps with stable colour over lifetime and a crisp, sparkling light. Features double UV block quartz sleeves and a hard glass outer bulb for use in open fixtures, with reduced fading risks. Requires ballast and igniters, and a high current protection device for CDM-TP is mandatory (IEC 1167).

Electronic gear can be used to increase lamp-life, improve system efficacy, and offer flicker-free operation.

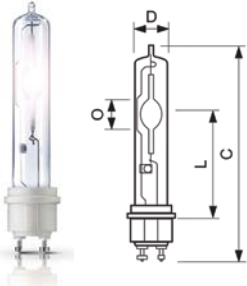

Product ID	Overall Length	Diameter	Light Centre Length	Arc Length
	C max.	D max.	L nom.	O nom.
210W	188	29	92	12.1
315W	188	29	92	14

Dimensions in mm

### CDMT/TP MW ELITE

Shortcode	Description	Wattage (W)	Cap Base	Luminous Flux	Average Lifetime (hrs)	Colour Temp (K)	Min Order Quantity	Carton Qty
CDMTPMWEL210W93	MASTERCLOUR CDM-TP MW Elite 210W/930 PGZX18 (P)	210	PGZX18	23100	27000	3000	12	12
CDMTPMWEL210W94	MASTERCLOUR CDM-TP MW Elite 210W/942 PGZX18 (P)	210	PGZX18	22100	30000	4200	12	12
CDMTPMWEL315W93	MASTERCLOUR CDM-TPMW Elite 315W/930 PGZX18 (P)	315	PGZX18	36200	30000	3000	12	12
CDMTPMWEL315W94	MASTERCLOUR CDM-TPMW Elite 315W/942 PGZX18 (P)	315	PGZX18	34700	30000	4200	12	12

## CDM-R Mini

Provides users with a compact, high-efficiency, discharge reflector lamp. Low operating costs, long-lamp life, UV block for reduced fading risk and a stable colour impression all benefit the shop owner. Low heat output and crisp, sparkling light, enhances the experience for shoppers and staff. Requires CDM electronic HID driver.

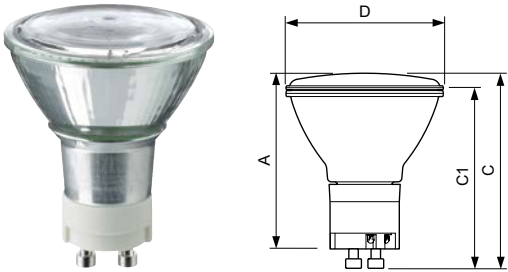

Product ID	A max.	C max.	Cl max.	D nom.	D max.
20W	59	65.4	60.9	50	50.7
35W	59	65.4	60.9	50	50.7

Dimensions in mm

### CDM-R MINI

Shortcode	Description	Wattage (W)	Cap Base	Luminous Intensity (cd)	Average Lifetime (hrs)	Colour Temp (K)	Min Order Quantity	Carton Qty
CDMRM20W83040	CDM-Rm 20W /830 40 Deg GX10	20	GX10	2100	15000	3000	1	12
CDMRM35W94215	CDM-Rm 35W /942 15 Deg GX10	35	GX10	12000	9000	4200	1	12
CDMRM35W94225	CDM-Rm 35W /942 25 Deg GX10	35	GX10	5500	9000	4200	1	12
CDMRM35W94240	CDM-Rm 35W /942 40 Deg GX10	35	GX10	2800	9000	4200	1	12

## CDM-R Mini Elite

The easy way to reflect more sparkle. The new Philips MasterColour CDM- R Mini Elite brings trusted quality to 50mm reflector lamps and with the superior output and colour stability to create the right atmosphere to match your customers retail brand and positioning.

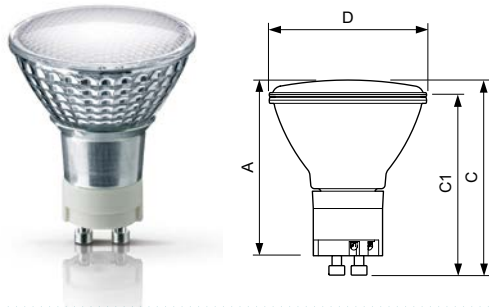

Product ID	A max.	C max.	Cl max.	D nom.	D max.
35W	59	65.4	60.9	50	50.7
50W	59	65.4	60.9	50	50.7

Dimensions in mm

### CDM-R MINI ELITE

Shortcode	Description	Wattage (W)	Cap Base	Luminous Intensity (cd)	Average Lifetime (hrs)	Colour Temp (K)	Min Order Quantity	Carton Qty
CDMRM35W93010	CDM-Rm Elite Mini 35W/930 10D	35	GX10	20000	12000	3000	1	12
CDMRM35W93025	CDM-Rm Elite Mini 35W/930 25D	35	GX10	8500	12000	3000	1	12
CDMRM35W93040	CDM-Rm Elite Mini 35W/930 40D	35	GX10	4400	12000	3000	1	12
CDMRME50W93060	CDM-Rm Elite Mini 50W/930 60D	35	GX10	3000	12000	3000	1	12
CDMRME50W93025	CDM-Rm Elite Mini 50W/930 25D	50	GX10	11500	12000	3000	1	12
CDMRME50W93040	CDM-Rm Elite Mini 50W/930 40D	50	GX10	7000	12000	3000	1	12

## CDM-R PAR 20

Provides users with a compact, high-efficiency, discharge reflector lamp. Low operating costs, long-lamp life, UV block for reduced fading risk and a stable colour impression all benefit the shop owner. Low heat output and crisp, sparkling light, enhances the experience for shoppers and staff.

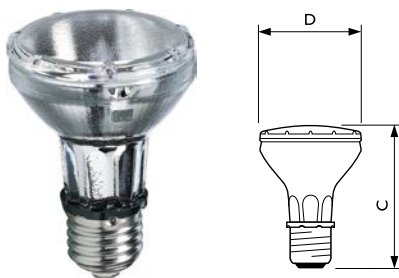

Product ID	Overall Length C max.	Diameter D max.
PAR20	95	65

Dimensions in mm

### CDM-R PAR 20

Shortcode	Description	Wattage (W)	Cap Base	Luminous Intensity (cd)	Average Lifetime (hrs)	Colour Temp (K)	Min Order Quantity	Carton Qty
CDMR35W8302010	CDM-R 35W /830 E27 PAR20 10D ICT/12	35	E27	23000	9000	3000	1	12
CDMR35W8302030	CDM-R 35W /830 E27 PAR20 30D ICT/12	35	E27	5000	9000	3000	1	12
CDMR35W9422010	CDM-R 35W /942 E27 PAR20 10D ICT/12	35	E27	21500	9000	4200	1	12
CDMR35W9422030	CDM-R 35W /942 E27 PAR20 30D ICT/12	35	E27	5000	9000	4200	1	12

## CDM-R PAR 30

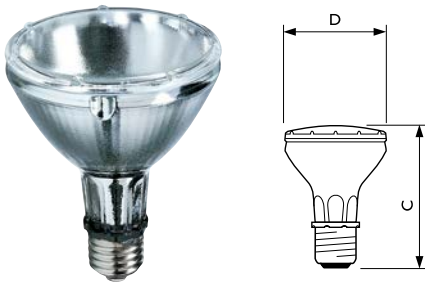

Product ID	Overall Length C max.	Diameter D max.
PAR30L	123	95

Dimensions in mm

### CDM-R PAR 30

Shortcode	Description	Wattage (W)	Cap Base	Luminous Intensity (cd)	Average Lifetime (hrs)	Colour Temp (K)	Min Order Quantity	Carton Qty
CDMR70W9423010	CDM-R 70W /942 E27 PAR30L 10D 1CT/6	70	E27	63000	12000	4200	1	12
CDMR70W9423030	CDM-R 70W /942 E27 PAR30L 30D 1CT/6	70	E27	13000	12000	4200	1	12
CDMR70W9423040	CDM-R 70W /942 E27 PAR30L 40D 1CT/6	70	E27	9000	12000	4200	1	12

## CDM-R PAR 30 Elite

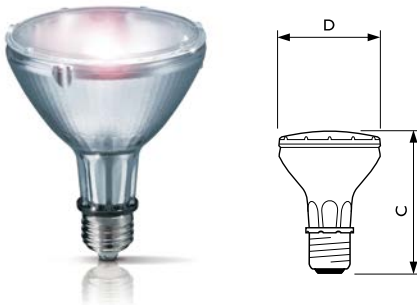

Product ID	Overall Length C max.	Diameter D max.
PAR30L	123	95

Dimensions in mm

### CDM-R PAR 30 ELITE

Shortcode	Description	Wattage (W)	Cap Base	Luminous Intensity (cd)	Average Lifetime (hrs)	Colour Temp (K)	Min Order Quantity	Carton Qty
CDMR35W93030	MC CDM-R Elite 35W/930 E27 PAR30L 30D	35	E27	7800	12000	3000	1	12
CDMR35W93010	MC CDM-R Elite 35W/930 E27 PAR30L 10D	35	E27	52000	12000	3000	1	12
CDMR70W93040	MC CDM-R Elite 70W/930 E27 PAR30L 40D	70	E27	10000	11000	3000	1	12
CDMR70W93030	MC CDM-R Elite 70W/930 E27 PAR30L 30D	70	E27	15000	11000	3000	1	12
CDMR70W93010	MC CDM-R Elite 70W/930 E27 PAR30L 10D	70	E27	70000	11000	3000	1	12

## CDM-R III

Offering the benefits of a Mastercolour PAR in the stylish look of a 111mm aluminium reflector lamp.

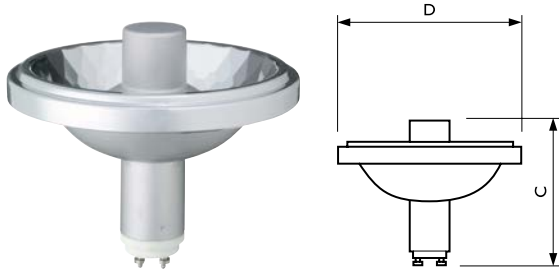

Product ID	Overall Length C max.	Diameter D max.
20W	95	111
35W	95	111
70W	95	111

Dimensions in mm

### CDM-R III

Shortcode	Description	Wattage (W)	Cap Base	Luminous Intensity (cd)	Average Lifetime (hrs)	Colour Temp (K)	Min Order Quantity	Carton Qty
CDMR11120W83024	MASTERC CDM-R111 20W/830 24D ICT/6	20	GX8.5	4500	9000	3000	1	6
CDMR11120W83010	MASTERC CDM-R111 20W/830 10D ICT/6	20	GX8.5	20000	9000	3000	1	6
CDMR11135W83040	MASTERC CDM-R111 35W/830 40D ICT/6	35	GX8.5	4000	11000	3000	1	6
CDMR11135W83024	MASTERC CDM-R111 35W/830 24D ICT/6	35	GX8.5	8500	11000	3000	1	6
CDMR11135W83010	MASTERC CDM-R111 35W/830 10D ICT/6	35	GX8.5	35000	11000	3000	1	6
CDMR11135W94240	MASTERC CDM-R111 35W /942 GX8.5 40D ICT/6	35	GX8.5	4000	9000	4200	1	6
CDMR11135W94224	MASTERC CDM-R111 35W /942 GX8.5 24D ICT/6	35	GX8.5	8500	9000	4200	1	6
CDMR11135W94210	MASTERC CDM-R111 35W /942 GX8.5 10D ICT/6	35	GX8.5	35000	9000	4200	1	6
CDMR11170W83040	MASTERC CDM-R111 70W/830 40D ICT/6	70	GX8.5	9000	9000	3000	1	6
CDMR11170W83024	MASTERC CDM-R111 70W/830 24D ICT/6	70	GX8.5	15000	9000	3000	1	6
CDMR11170W83010	MASTERC CDM-R111 70W/830 10D ICT/6	70	GX8.5	50000	9000	3000	1	6
CDMR11170W94240	MASTERC CDM-R111 70W /942 GX8.5 40D ICT/6	70	GX8.5	9000	11000	4200	1	6
CDMR11170W94224	MASTERC CDM-R111 70W /942 GX8.5 24D ICT/6	70	GX8.5	15000	11000	4200	1	6
CDMR11170W94210	MASTERC CDM-R111 70W /942 GX8.5 10D ICT/6	70	GX8.5	50000	11000	4200	1	6



# CosmoPolis Outdoor

New-generation ceramic metal halide lamps for outdoor lighting with white light, using a new lamp base and clear quartz outer bulb.

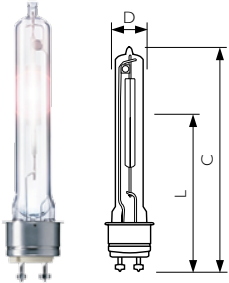

Product ID	Overall Length C max	Diameter D max.	Arc Length O	Light Centre Length L
45W	132	20	15	59
60W	132	20	14	59
90W	143	20	18	66
140W	147	20	20	66

Dimensions in mm

## COSMOPOLIS OUTDOOR

Shortcode	Description	Wattage (W)	Cap Base	Luminous Flux (lm)	Average Lifetime (hrs)	Colour Temp (K)	Min Order Quantity	Carton Qty
CPOTWEXTRA45W72	MST CosmoWh CPO-TW Xtra 45W/728 PGZ12	45	PGZ12	4950	30000	2800	12	12
CPOWHITE60W728	MASTER Cosmo CPOT White 60W/728 PGZ12	60	PGZ12	7200	30000	2800	1	12
CPOWHITE60W840	MASTER Cosmo CPOT White 60W/840 PGZ12	60	PGZ12	7020	16000	4000	12	12
CPOWHITE90W728	MASTER Cosmo CPOT White 90W/728 PGZ12	90	PGZ12	10450	30000	2800	12	12
CPOWHITE90W840	MASTER Cosmo CPOT White 90W/840 PGZ12	90	PGZ12	10350	15000	4000	12	12
CPOWHITE140W728	MASTER Cosmo CPOT White 140W/728 PGZ12	140	PGZ12	16500	24000	2800	1	12
CPOWHITE140W840	MASTER Cosmo CPOT White 140W/840 PGZ12	140	PGZ12	16100	15000	4000	1	12

## CDO-TT & CDO-ET Elliptical

The Mastercolour City range of high intensity discharge lamps feature a CDM Mastercolour discharge tube placed in a high pressure sodium lamp outer bulb. The result is a robust lamp which emits a pleasant light, with stable colour and excellent colour rendering (Ra>80), and which is compatible with a SON ballast and igniters.

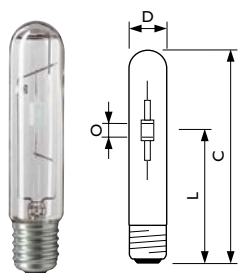

**CDO-TT**

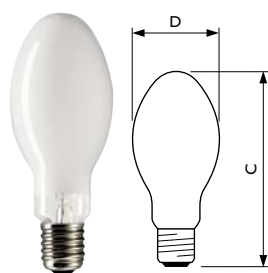

**CDO-ET**

Product ID	Overall Length C max.	Diameter D max.	Arc Length O	Light Centre Length L
CDOTT 70W	156	32.5	7	102
CDOTT 150W	211	48	9	135
CDOTT 250W	254	47	25.4	158
CDOTT 400W	279	47	32	175
CDOET 70W	156	71	NA	NA
CDOET 150W	230	91	NA	NA

Dimensions in mm

### CDO-TT & CDO-ET ELLIPTICAL

Shortcode	Description	Wattage (W)	Cap Base	Luminous Flux (lm)	Average Lifetime (hrs)	Colour Temp (K)	Min Order Quantity	Carton Qty
CDOTT70W828	MASTER CITYWH CDO-TT PLUS 70W/828 E27	70	E27	7500	16000	2800	12	12
CDOTT150W828	MASTER CITYWH CDO-TT PLUS 100W/828 E40	100	E40	10700	16000	2800	12	12
CDMTT400W840	MASTERC CITY CDM-TT 400W/840 E40 SLV/12	400	E40	34000	9000	4000	12	12
CDOET70W828	MASTER CITYWH CDO-ET PLUS 70W/828 E27	70	E27	7230	16000	2800	12	12
CDOET150W828	MASTER CITYWH CDO-ET PLUS 150W/828 E40	150	E40	15100	16000	2800	12	12

# HPI-T Quartz Metal Halide

Quartz metal halide lamps in tubular shape with clear outer bulb (HPI-T), or ovoid shape with coated outer bulb (HPI). Features unique 3-band technology for high luminous efficacy over a long lifetime. Metal halide gas discharge lamps designed to be suitable in retrofit applications, HPI(T) Plus lamps are compatible with high pressure sodium control gear as well as standard metal halide control gear. This makes it possible to enjoy the benefits of quality colour and exceptional performance without a costly gear upgrade for retrofit sodium systems. HPI(T) Plus offers a high lumen output, good efficacy and excellent colour rendition.

“S”- type for direct retrofit for HPL lamps, due to its internal ignitor

“P”- type is suitable for use in open luminaires

Lamps run on sodium and metal halide control gear

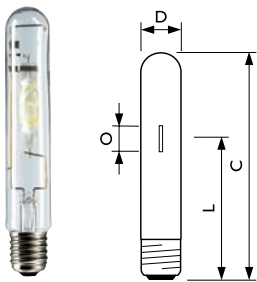

Product ID	Overall Length	Diameter D max.	Light Centre Length L max.	Arc Length
	C max.	D max.	L max.	O max.
250W	257	47	155	29
400W	286	47	172	40
1000W	382	66	240	80
2000W/380V	430	102	267	120
2000W/220V	430	102	290	89

Dimensions in mm

## HPI-T QUARTZ METAL HALIDE

Shortcode	Wattage (W)	Cap Base	Luminous Flux (lm)	Average Lifetime (hrs)	Colour Temp (K)	Min Order Quantity	Carton Qty
HPITPLUS250WGES	250	E40	25000	20000	4300	1	12
HPITPLUS400WGES	400	E40	42500	20000	4300	1	12
HPIT1000WGES	1000	E40	50000	10000	4300	1	4
HPIT2KW22VGES	2000	E40	189000	10000	4200	1	4
HPIT2KW380VGES	2000	E40	210000	10000	3800	1	4

## HPI PLUS Quartz Metal Halide

Energy saving compact fluorescent lamp. Compact long-arc low-pressure mercury discharge lamp envelope consists of 6 parallel narrow fluorescent tubes.

**Features:**

- Ovoid, internally white coated outer bulb.
- 3-band technology resulting in high luminous efficacy, both initially and over long lifetime.
- Available in cool white and daylight colour appearance demonstrating good colour stability.
- "S"- type for direct retrofit for HPL lamps.
- "P"- type for use without protective front shield.

**Luminaires:**

- HPI Plus BU-P and BUS-P suitable for use in open luminaires.
- For other HPI Plus lamps a protective front glass is required.

**System:**

- Can be run on HPI-gear as well as on SON-gear ("Plus"-concept). The results in both light output and colour temperature are different.
- HPI Plus BUS and BUS-P types require an HPL-gear and no ignitor.

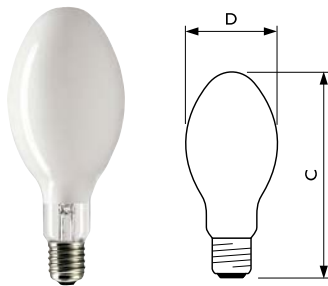

Product ID	Overall Length C max.	Diameter D max.
250W	226	91
400W	290	122

Dimensions in mm

### MASTER HPI PLUS OVOID COATED METAL HALIDE LAMPS (BASE UP,IGNITOR REQUIRED)

Shortcode	Description	Wattage (W)	Cap Base	Luminous Flux (lm)	Average Lifetime (hrs)	Colour Temp (K)	Min Order Quantity	Carton Qty
HPIP250WBUGES	HPI PLUS 250W BU E40.1CT/12	250	E40	20500	20000	4500	1	12
HPIP400WBUGES	HPI PLUS 400W BU E40.1CT/6	400	E40	32000	20000	4500	1	6

# HPI PLUS Quartz Metal Halide continued

## MASTER HPI PLUS OVOID COATED, (BASE UP, IGNITOR REQUIRED, PROTECTED)

Shortcode	Description	Wattage (W)	Cap Base	Luminous Flux (lm)	Average Lifetime (hrs)	Colour Temp (K)	Min Order Quantity	Carton Qty
HPIP250WBUPGES	MASTER HPI Plus 250W/745 BU-P E40 SLV/12	250	E40	18000	20000	4500	1	12
HPIP400WBUPGES	MASTER HPI Plus 400W/745 BU-P E40 SLV/6	400	E40	32500	20000	4500	1	6

## MASTER HPI PLUS OVOID COATED (BASE UP, SELF START, NO IGNITOR REQUIRED)

Shortcode	Description	Wattage (W)	Cap Base	Luminous Flux (lm)	Average Lifetime (hrs)	Colour Temp (K)	Min Order Quantity	Carton Qty
HPIP400WBUSGES	HPI-PLUS 400W BUS E40.1CT/6	400	E40	32500	20000	4500	1	6

## MASTER HPI PLUS OVOID COATED, (SELF START, NO IGNITOR REQUIRED, PROTECTED )

Shortcode	Description	Wattage (W)	Cap Base	Luminous Flux (lm)	Average Lifetime (hrs)	Colour Temp (K)	Min Order Quantity	Carton Qty
HPIP400WBUSPGES	MASTER HPI Plus 400W/745 BUS-P E40 SLV/6	400	E40	32500	20000	4500	1	6

## Metal Halide - Universal Operating Ovoid

Metal halide gas discharge lamps offer good luminous efficacy, good colour rendering and reliable long life. In an ovoid style, with coated outer-bulb, and operates at any position.

Low wattage lamps with extra quartz tube around discharge tube prevents risk of outer bulb shattering when abnormally operated or at end of life.

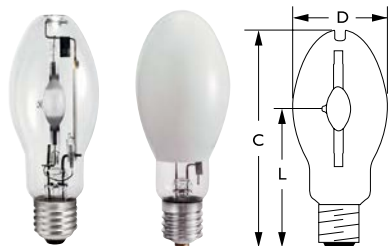

Product ID	Overall Length	Diameter	Light Centre Length
	C max.	D max.	L max.
70W/100W/150W	141	56	83

Dimensions in mm

### METAL HALIDE - UNIVERSAL OPERATING OVOID

Shortcode	Description	Type	Wattage (W)	Cap Base	Luminous Flux (lm)	Average Lifetime (hrs)	Colour Temp (K)	Min Order Quantity	Carton Qty
MH70W640PESCO	MH 70W/640 P E27 CO SLV/24	Coated	70	E27	5300	10000	4000	1	24
MH70W640PESCL	MH 70W/640 P E27 CL SLV/24	Clear	70	E27	5300	10000	4000	1	24
MH100W640PESCO	MH 100W/640 P E27 CO SLV/24	Coated	100	E27	8500	10000	4000	1	24
MH100W640PESCL	MH 100W/640 P E27 CL SLV/24	Clear	100	E27	8500	10000	4000	1	24
MH150W640PESCO	MH 150W/640 P E27 CO SLV/24	Coated	150	E27	13000	10000	4000	1	24
MH150W640PESCL	MH 150W/640 P E27 CL SLV/24	Clear	150	E27	13000	10000	4000	1	24



# Metal Halide - ArenaVision/OptiVision Lamps

MHN-SA/MHN-LA lamps with their excellent natural white colour, high luminous efficacy and compact size are designed to meet the demanding requirements of professional sports lighting and flood lighting applications.

Double pinch concept results in longer lifetime. Available in short arc (MHN-SA) and long arc (MHN-LA) versions.

## MHN-SA X830



## MHN-SA PSFC20

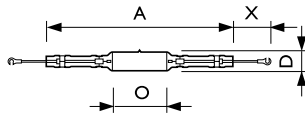

Product ID	Overall Length	Diameter	Light Centre Length	X nom.
	C max.	D max.	L max.	
1800W	294	40	405	35
2000W	364	40	108	58

Dimensions in mm

## METAL HALIDE - SHORT ARC

Shortcode	Description	Wattage (W)	Cap Base	Luminous Flux (lm)	Average Lifetime (hrs)	Colour Temp (K)	Min Order Quantity	Carton Qty
MHNSAI800W2309R	MASTER MHN-SA 1800W/956 X830R 230V UNP/I	1800	X830ROD	155000	5000	5600	1	4
MHNSAI800W4009P	MASTER MHN-SA 1800W/956 (P)SFC 400V UNP	1800	PSFC20-6	160000	5000	5600	1	4
MHNSAI800W2309P	MASTER MHN-SA 1800W/956 (P)SFC 230V UNP	1800	PSFC20-6	155000	5000	5600	1	4
MHNSA2KW4009R	MASTER MHN-SA 2000W/956 X830R 400V UNP	2000	X830ROD	200000	5000	5600	1	4

## MHN-LA 2000W



## MHN-LA 1000W

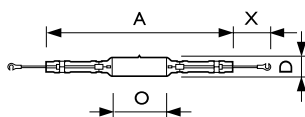

Product ID	Overall Length	Diameter	Light Centre Length	Arc Length
	C max.	D max.	L max.	O nom.
1800W/X830R	318	41	25	25
2000W/X830R	318	41	25	25
1800W (P) SFC	364	41	25	25

Dimensions in mm

## METAL HALIDE - LONG ARC

Shortcode	Description	Wattage (W)	Cap Base	Luminous Flux (lm)	Average Lifetime (hrs)	Colour Temp (K)	Min Order Quantity	Carton Qty
MHNLA1KW2309C	MASTER MHN-LA 1000W/956 X528/C 230V UNP	1000	X528	90000	-	5600	1	4
MHNLA1KW2308C	MASTER MHN-LA 1000W/842 X528/C 230V UNP	1000	X528	100000	10000	4200	1	4
MHNLA2KW4009C	MASTER MHN-LA 2000W/956 X528/C 400V UNP	2000	X528	190000	12000	5600	1	4
MHNLA2KW4008C	MASTER MHN-LA 2000W/842 X528/C 400V UNP	2000	X528	220000	12000	4200	1	4

## Sodium Lamps

High pressure sodium vapour lamps have a sintered aluminium oxide discharge tube enclosed in an internally coated outer bulb. They offer a long, reliable lifetime and have excellent lumen maintenance. SON lamps require control gear to operate and have a universal burning position.

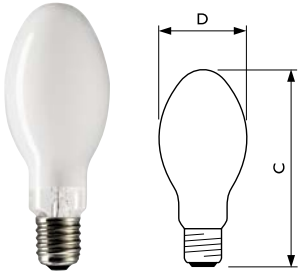

Product ID	C max.	D max.
50W, 70W	156	71
150W, 250W	226	91
400W	290	122

Dimensions in mm

SON									
Shortcode	Wattage (W)	Cap Base	Luminous Flux (lm)	Average Lifetime (hrs)	Colour Rendering Index (Ra)	Colour Temp (K)	Envelope	Min Order Quantity	Carton Qty
SON150WES	50	E27	3400	28000	25	2000	CO	1	24
SON170WES	70	E27	5600	28000	25	2000	CO	1	24
SON70WES	70	E27	5600	28000	25	2000	CO	1	24
SON150WGES	150	E40	14500	28000	25	2000	CO	1	12
SON250WGES	250	E40	27000	28000	25	2000	CO	1	12
SON400WGES	400	E40	48000	28000	25	2000	CO	1	12

## SON-T

High Pressure Sodium lamps with clear tubular outer bulb.

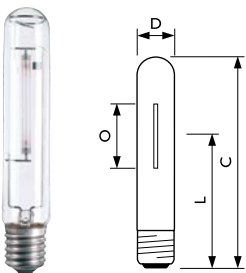

Product ID	C max.	D max.	L nom.	O nom.
150W	257	48	158	70
250W	257	48	158	70
400W	283	48	175	87
1000W	390	67	240	153

Dimensions in mm

SON-T									
Shortcode	Description	Wattage (W)	Cap Base	Luminous Flux (lm)	Average Lifetime (hrs)	Colour Rendering Index (Ra)	Colour Temp (K)	Min Order Quantity	Carton Qty
SONT150WGES	SON-T 150W E E40 SLV/12	150	E40	15000	28000	25	2000	1	12
SONT250WGES	SON-T 250W E E40 SLV/12	250	E40	28000	28000	25	2000	1	12
SONT400WGES	SON-T 400W E E40 SLV/12	400	E40	48000	28000	25	2000	1	12
SONT1000WGES	SON-T 1000W E E40 SLV/4	1000	E40	130000	16000	25	2000	1	4

# SON-T PIA

High pressure sodium lamp with clear tubular outer bulb, high output and long reliable lifetime.

SON-T PIA								
Shortcode	Description	Wattage (W)	Cap Base	Luminous Flux (lm)	Average Lifetime (hrs)	Colour Temp (K)	Min Order Quantity	Carton Qty
SONTPPLUS70WES	MASTER SON-T PIA PLUS 70W E E27 SLV/I2	70	E27	6600	28000	2000	1	12
SONTHGFRI100WGES	MASTER SON T APIA PLUS HG FREE 100W E40	100	E40	10000	38000	2100	1	12
SONTHGFRI150WGES	SON-T PIA HGFR 150W E40 SLV/I2	150	E40	18000	38000	2000	1	12
SONTHGFREE250G	MST SON-T APIA PLUS HG FREE 250W E40 ISL	250	E40	32200	38000	2100	1	12
SONTPPLUS400W	MASTER SON T PIA PLUS HG FREE 400W/E40	400	E40	56000	38000	2100	1	12
SONTPPLUS600WG	MST SON-T PIA PLUS 600W/220 E40 ISL/I2	600	E40	90000	30000	2000	1	12

# Sodium - High Pressure Tubular Agro

SON-T Agro lamp was specifically developed for use in the professional plant growing market. The lamp matches the lighting needs of many kinds of plants, both in respect of lighting level and in spectral composition of the light.

Suitable for use on SON control gear.

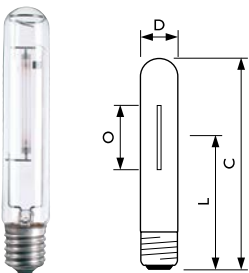

Product ID	Overall Length	Diameter	Light Centre Length	Arc Length
	C max.	D max.	L nom.	O nom.
400W AGRO	283	47	175	83
600W	283	47	174.2	126

Dimensions in mm

SON-T AGRO								
Shortcode	Description	Wattage (W)	Cap Base	Luminous Flux (lm)	Average Lifetime (hrs)	Colour Temp (K)	Min Order Quantity	Carton Qty
SONTAGRO400WGES	SON-T AGRO 400W E E40 SLV/I2	400	E40	48000	30000	2000	1	12

## Mercury - High Pressure Ovoid

High pressure mercury vapour lamps with a quartz discharge tube enclosed in an internally coated ovoid outer bulb. For indoor or outdoor applications. HPL-N lamps require control gear to operate and have a universal burning position.

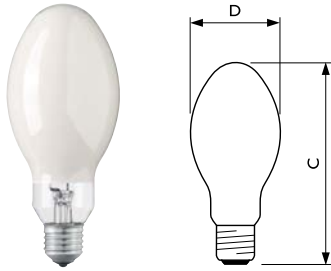

Product ID	Overall Length C max.	Diameter D max.
50W	130	56
80W	135	71
125W	171.5	76
250W	228	91
400W	290	121.5

Dimensions in mm

### HPL-N

Shortcode	Description	Wattage (W)	Cap Base	Luminous Flux (lm)	Average Lifetime (hrs)	Colour Temp (K)	Min Order Quantity	Carton Qty
HPLN50WES	HPL-N 50W E27 SG ICT/24	50	E27	1800	24000	4200	1	24
HPLN80WES	HPL-N 80W E27 SG ICT/24	80	E27	3700	24000	4200	1	24
HPLN125WES	HPL-N 125W E27 SG ICT/24	125	E27	6200	24000	4200	1	24
HPLN250WGES	HPL-N 250W E40 HG ICT/12	250	E40	12700	16000	4100	1	12
HPLN400WGES	HPL-N 400W E40 HG ICT/6	400	E40	22000	16000	3900	1	6
HPLN700WGES	HPL-N 700W/542 E40 HG CRP/6	700	E40	38500	12000	3900	1	6
HPLN1000WGES	HPL-N 1000W/542 E40 HG CRP/6	1000	E40	58500	12000	3900	1	6

## UV - Blacklight Blue

Low-pressure, mercury vapour, fluorescent lamps. These lamps have an inner envelope coated in a fluorescent powder emitting long wave UV radiation to excite luminescence.

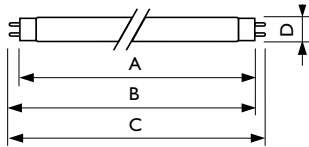

Product ID	Base to Base A	Insert Length B	Overall Length C max.	Diameter D max.
18W	589.8	596.9	604	28
36W	1199.4	1206.5	1213.6	28

Dimensions in mm

### UV - BLACKLIGHT BLUE

Shortcode	Wattage (W)	Cap Base	UV-A Radiation (W)	Min Order Quantity	Carton Qty
TLD18W108	18	G13	3.5	25	25
TLD36W108	36	G13	8.0	25	25





---

# Stand Alone Controls



# ToBeTouched

Simplicity Itself.

People working in busy office, school, shop, hospitality and health care environments don't have time to waste working out how to operate the lighting. Building upon the iconic design and user-friendliness of the colour ring used in LivingColours, the ToBeTouched range of intuitive user interfaces brings the same style and ease of interaction to professional lighting applications.

The dynamic “Light Wheel”, can change its appearance to visualise different light parameters including brightness, colour, saturation and colour temperature. The user can select which parameter to edit and the “Light Wheel” changes according to the selection. The “what you see is what you get” visualisation of the “Light Wheel” makes it intuitive and easy for the user to predict the result of his or her choice. The soft touch control and the dynamic light ring enriches the experience and adds an element of wonder.

ToBeTouched currently comprises four models. These range from a simple on/off switch, plus a version with dimming, through to a cool/warm white controller and a full-colour model.

Assisting the user with light, sound and colour feedback, these easy-to-install interfaces make operating a lighting system easy – and fun!



TOBETOUCHED		
Commercial Code	Description	Min Order Quantity
UID8520DIMDALI	UID8520 TOBETOUCHED DIM DALI	1
UID8523LIGHTBOOST	UID8523/00 CDM LIGHT BOOST CONTROLLER	1
UID8530CTDMX	UID8530 TOBETOUCHED COLOUR TEMPERATURE DMX	1
UID8540RGBDMX	UID8540 TOBETOUCHED COLOUR DMX	1
UIA8550TBTPSU	UIA8550 TOBETOUCHED POWER SUPPLY UNIT	1

## OccuSwitch DALI

The OccuSwitch DALI is a combined sensor and controller. It will dim and switch the lights in a room or area on occupancy and available daylight, with options for local override, parallel operation. A detachable wiring connector enables easy installation and mounting in the ceiling. Separate Wieland cables are available for an even easier, fast and trouble-free installation.



OCCUSWITCH DALI		
Commercial Code	Description	Min Order Quantity
LRM2070DALI	LRM2070/10 BASIC	1
LRM2080DALI	LRM2080/10 ADVANCED	1

## Occuswitch - LRM1000 Movement Detector

LRM1000 is a ceiling mountable 360 degree motion detector, with built in photo cell sensor and adjustable switch off delay (10sec - 5min), and is capable of switching 2000VA



OCCUSWITCH - LRM1000		
Commercial Code	Description	Min Order Quantity
LRM1000	LRM1000/00 OS Mov Det	1

## Occuswitch - LRM1010 Movement Detector Small

LRM1010 is a recessed surface mounted 360D motion detector, with a built in photo cell sensor and adjustable switch off delay (10sec - 5min). It is capable of switching 1000VA, and has an adjustable directional lense.



### OCCUSWITCH – LRM1010

Commercial Code	Description	Min Order Quantity
LRM1010	LRM1010/00 OS Mov Det Small	1

## Occuswitch - LRM1040 Movement Detector 180D Wall/Corner

LRM1040 is a wall or corner mounted 180D movement detector, with built in photo cell sensor and adjustable switch off delay (5sec - 12min). It is capable of switching 2000VA, and has selectable Auto/Off mode.



### OCCUSWITCH – LRM1040

Commercial Code	Description	Min Order Quantity
LRM1040	LRM1040/00 OS Mov Det Ip44 180Dgr	1

## Occuswitch - LRM1070 Movement Detector

LRM1070 is a movement detector with a built in lighting switch. The unit is designed for the automatic switching of light in indoor applications, with a light sensor range between 10 and 1000 lux. It comes with 360D movement detection, with built in photo cell sensor and adjustable switch of delay (1min - 30min). It is capable of switching 1380 VA, and can run parallel operation. The product also comes with an optional surface mount box accessory.

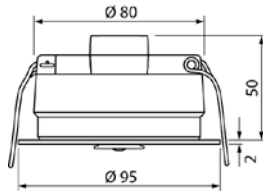

OCCUSWITCH - LRM1070		
Commercial Code	Description	Min Order Quantity
LRM1070	LRM1070/00 Sensr Mov Det St	1
LRH1070	LRH1070/00 Sensr Surface Box (to suit Occuswitch LRM1070/00)	1

## Highbay Sensor: High Bay 360° Occupancy Sensor

Philips LRM 2510 high bay occupancy sensor with Passive Infrared (PIR) technology operates on line voltage and switch loads directly without the need for power packs. They install to a junction box or fixture and have a detection pattern that covers the typical area of three fixtures.

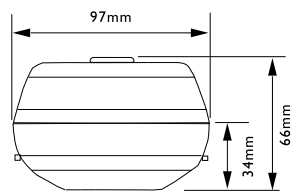

HIGHBAY SENSOR: HIGH BAY 360° OCCUPANCY SENSOR		
Commercial Code	Description	Min Order Quantity
LRM2510	LRM 2510/00 PIR HIGH BAY HV SENSR	15



---

# Electronic Control Gear







## HF Regulator Intelligent Touch & DALI for TL5, TL5 Eco, TLD and PLL

Intelligent high-frequency electronic dimming ballast, using DALI (Digital Addressable Lighting Interface according to IEC62386) or Touch and Dim push-button protocol for fluorescent lamps. Pre-empting upcoming legislation meeting AI BAT (Best Available Technology) requirements. With a special command you can retrieve the mains power consumption of the system, and with another command you can ask which lamp wattages are connected.

- Benefits:**
- Extremely low stand-by losses, controlled cut-off for dim levels above 80%, hybrid control dimming (current control at 100% and power control at 1%), combined with MASTER TL5 Eco for extra energy savings
  - HF operation improves light quality, lamp lifetime
  - Combined with controls, additional energy savings can be achieved
  - Compliant with European and Asian norms and suitable for emergency lighting systems
- Features:**
- The HF-R Intelligent recognises which lamp (T5 HE, HO, ECO or TL-D) is connected and is operated accordingly
  - Programmed start: flicker-free ignition < 1.0 second and striation free operation, no stroboscopic effects. Preheating the lamp electrodes enables the lamps to be switched on and off without reducing life
  - Smart power ensures constant light, independent of mains fluctuations and dimming from 1 to 100%
  - Stop circuit is activated within 5 seconds in the event of lamp failure (safety stop), and ballast resets automatically after lamp replacement

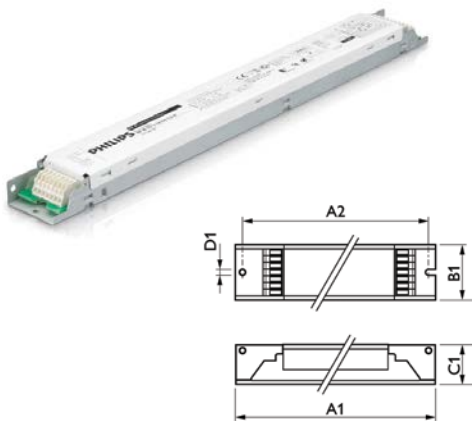

Product ID	A1 (Norm)	A2 (Norm)	B1 (Norm)	C1 (Norm)	D1 (Norm)
HF-Ri TD 1 35/49/80 TL5 E+	360.0	350.0	30.0	22.0	4.1
HF-Ri TD 1 28/35/49/54 TL5 E+	360.0	350.0	30.0	22.0	4.1
HF-Ri TD 2 28/35/49/54 TL5 E+	360.0	350.0	30.0	22.0	4.1
HF-Ri TD 1 14/21/24/39 TL5 E+	360.0	350.0	30.0	22.0	4.1
HF-Ri TD 2 14/21/24/39 TL5 E+	360.0	350.0	30.0	22.0	4.1
HF-Ri TD 3 14/24 TL5 E+ 195-240V 50/60Hz	360.0	350.0	39.0	22.0	4.2
HF-Ri TD 4 14/24 TL5 E+ 195-240V 50/60Hz	360.0	350.0	39.0	22.0	4.2

Dimensions in mm

# HF Regulator Intelligent Touch & DALI for TL5, TL5 Eco, TLD and PLL

continued

HF-Ri TD					
Shortcode	Description	Wattage (W)	Voltage	Min Order Quantity	Carton Qty
HFRI114/21/24/39	HF-Ri TD 1 14/21/24/39 TL5 TLD PLL	14/21/24/39	220-240V	1	12
HFRI214/21/24/39	HF-Ri TD 2 14/21/24/39 TL5 TLD PLL	14/21/24/39	220-240V	1	12
HFRI128/35/49/54	HF-Ri TD 1 28/35/49/54 TL5 TLD PLL	28/35/49/54	220-240V	1	12
HFRI228/35/49/54	HF-Ri TD 2 28/35/49/54 TL5 TLD PLL	28/35/49/54	220-240V	1	12
HFRI135/49/80	HF-Ri TD 1 35/49/80 TL5 TLD PLL	35/49/80	220-240V	1	12
HF-Ri TD 314/24	HF-Ri TD 314/24 TL5	14/24	220-240V	12	12
HF-Ri TD 414/24	HF-Ri TD 414/24 TL5	14/24	220-240V	12	12

Shortcode	T5 HE/T5 ECO HE				T5 HO/T5 ECO HO					TLD			PLL				
	14/13	21/19	28/25	35/32	24/20	39/34	54/50	49/45	80/73	18	36	58	24	36	40	55	80
HF-Ri TD 1 14/21/24/39 TL5 E+	•	•			•	•					•		•	•	•		
HF-Ri TD 2 14/21/24/39 TL5 E+	•	•			•	•					•		•	•	•		
HF-Ri TD 1 28/35/49/54 TL5 E+			•	•			•	•			•						•
HF-Ri TD 2 28/35/49/54 TL5 E+			•	•			•	•			•						•
HF-Ri TD 1 35/49/80 TL5 E+				•				•	•								•

## HF Regulator Touch & DALI for PL-R Eco

HF-Regulator II Touch DALI for PL-T, PL-C and PL-R lamps – Dimming: a next step in energy saving. Low stand-by losses, together with controlled dimming. HF operation improves light quality, lamp lifetime. Combined with controls, additional energy savings can be achieved.

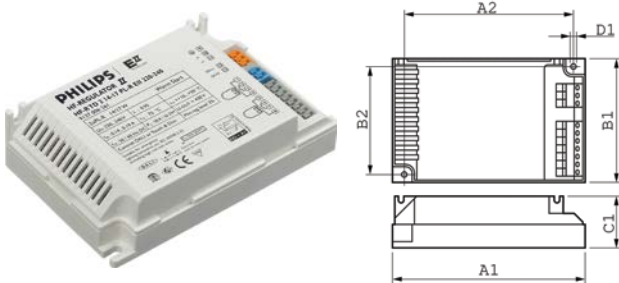

Product ID	Length A1	Fixing Hole Distance Length A2	Width B1	Height C1	Fixing Hole Diameter D1
HF-RTD 1 14-17 PL-R EII 123 111	79	33	4.5	?	

Dimensions in mm

### HF-RTD PL-R ECO

Shortcode	Description	Wattage (W)	Voltage	Min Order Quantity	Carton Qty
HFRTD1 14-17PLR	HF-RTD 1 14-17 PL-R EII 220-240V	14/17	220-240V	12	12
HFRTD2 14-17PLR	HF-R TD 2 14-17 PL-R EII 220-240V	14/17	220-240V	12	12

# HF Performer III (Fixed Output) for TL5, TL5 Eco and TLD

One of the most energy efficient fixed output (A2 BAT), slim, high frequency electronic ballast for fluorescent lamps. HF-operation reduces eye strain as caused by electromagnetic ballasts. Automatic restart (after voltage dip or lamp exchange) ensures easy operation and hassle free re-lamping.

- Key features:**
- Programmed, flicker-free, preheated start (< 1.0s)
  - 100,000 hour lifetime at Ta 50°C and over 100,000 on/off switches on one lamp
  - Automatic restart (after voltage dip or lamp exchange) ensures easy operation and hassle free re-lamping

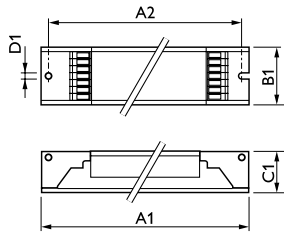

Product ID	Length A1	Fixing Hole Distance Length A2	Width B1	Height C1	Fixing Hole Diameter D1
TL5 I and 2x lamp	360	350	30	22	4.2
TL-D I and 2x lamp	280	265	30	28	4.2

Dimensions in mm

## TL5

Shortcode	Description	Wattage (W)	Voltage	Min Order Quantity	Carton Qty
HFP114-35TL5III	HF-P 1 14-35 TL5 HE III 220-240V 50/60Hz	14/21/28/35	220-240V	1	12
HFP214-35TL5III	HF-P 2 14-35 TL5 HE III 220-240V 50/60Hz	14/21/28/35	220-240V	1	12
HFP149TL5HOIII IDC	HF-P 149 TL5 HO III 220-240V 50/60Hz IDC	49	220-240V	1	12
HFP249TL5HOIII IDC	HF-P 249 TL5 HO III 220-240V 50/60Hz IDC	49	220-240V	1	12
HFP154/155TL5HO/PLLI IDC	HF-P 154/155 TL5 HO/PLL III 220-240V IDC	54/55	220-240V	1	12
HFP254/255TL5HO/PLLI IDC	HF-P 254/255 TL5 HO/PLL III 220-240V IDC	54/55	220-240V	1	12

## TL-D

Shortcode	Description	Wattage (W)	Voltage	Min Order Quantity	Carton Qty
HFP118TLD	HF-P 118 TL-D III 220-240V 50/60Hz IDC	18	220-240V	1	12
HFP136TLD	HF-P 136 TL-D III 220-240V 50/60Hz IDC	36	220-240V	1	12
HFP158TLD	HF-P 158 TL-D III 220-240V 50/60Hz IDC	58	220-240V	1	12
HFP218TLD	HF-P 218 TL-D III 220-240V 50/60Hz IDC	18	220-240V	1	12
HFP236TLD	HF-P 236 TL-D III 220-240V 50/60Hz IDC	36	220-240V	1	12
HFP258TLD	HF-P 258 TL-D III 220-240V 50/60Hz IDC	58	220-240V	1	12

## HF Selectalume II (Fixed Output) for TL5 and TLD

Affordable, reliable, high frequency electronic ballast for TL5 and TLD fluorescent lamps, ideal alternative for electromagnetic (EM) ballasts.

- Key features:**
- Energy efficient CELMA A2, savings of 25% energy compared to electromagnetic “C-type” ballasts
  - Robust design for 70,000 hour lifetime at Ta=50°C with >50,000 on/off switches on one lamp
  - Warm, flicker-free start
  - High power factor 0.98 with THD <10%
  - Automatic restart after voltage dip or lamp exchange

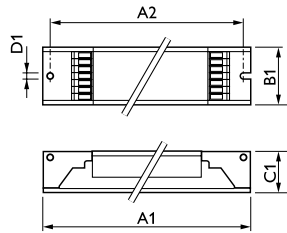

Product ID	Length A1	Fixing Hole Distance Length A2	Width B1	Height C1	Fixing Hole Diameter D1
TL5 I and 2x lamp	280	265	30	21.5	4.2
TL-D I and 2x lamp	280	265	30	28	4.2

Dimensions in mm

### TL5

Shortcode	Description	Wattage (W)	Voltage	Min Order Quantity	Carton Qty
HFS114-35TL5II	HF-S 114-21 TL5 II 220-240V	14/21	220-240V	1	12
HFS214TL5II	HF-S 214 TL5 II 220-240V	14	220-240V	1	12
HFS128-35TL5II	HF-S 128-35 TL5 II 220-240V	28/35	220-240V	1	12
HFS221-28TL5II	HF-S 221-28 TL5 II 220-240V	21/28	220-240V	1	12

### TLD

Shortcode	Description	Wattage (W)	Voltage	Min Order Quantity	Carton Qty
HFS118TLDII	HF-S 118 TL-D II 220-240V	18	220-240V	1	12
HFS218TLDII	HF-S 218 TL-D II 220-240V	18	220-240V	1	12
HFS136TLDII	HF-S 136 TL-D II 220-240V	36	220-240V	1	12
HFS236TLDII	HF-S 236 TL-D II 220-240V	36	220-240V	1	12



# HID-Primavision (Fixed output) Mini

Indoor one-piece electronic ballasts for optimum performance of 20W to 150W CDM discharge lamps. The benefits of electronic gear versus conventional gear are the elimination of lamp flicker, and increase in lamp life of up to 30%, and a reduction of colour shift and simple installation.

“I”- type Independent version, with strain relief, for stand-alone operation.

“S” - type Standard version, for in-fixture operation.

## “I” TYPE

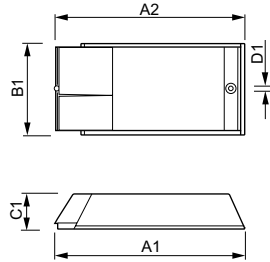

Product ID	Length A1	Fixing Hole Distance Length A2	Width B1	Height C1	Fixing Hole Diameter D1
HIDPVm I	190.0	154.0	43.3	30.0	-
HIDPVC 35/70 I	188.0	170.0	62.7	34.5	4.8
HIDPVC 100/150 I	223.9	206.0	82.7	34.2	4.8

Dimensions in mm

## “S” TYPE

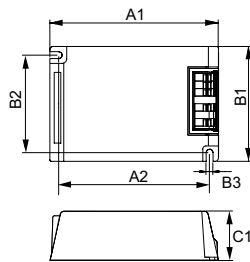

Product ID	Length A1	Fixing Hole Distance Length A2	Width B1	Fixing Hole Distance Width B1	Height C1	Fixing Hole Diameter D1
HIDPVm S	97.3	88.3	43.3	-	30.5	4.2
HIDPVC 35/70 S	109.6	98.5	74.4	63.7	32.2	4.9
HIDPVC 100/150 S	135.0	-	75.0	-	32.0	4.8

Dimensions in mm

## HID PRIMAVISION FOR CDM LAMPS

Shortcode	Description	Wattage (W)	Voltage	Min Order Quantity	Carton Qty
HIDPVmPGJ520w/S	HID-PV m PGJ5 20 /S CDM HPF 220-240V	20	220-240V	1	12
HIDPVmPGJ520W/I	HID-PV m PGJ5 20 /I CDM LPF 220-240V	20	220-240V	1	12
HIDPVmPGJ520WFP	HID-PV m PGJ5 20/FP CDM LPF 220-240V	20	220-240V	1	12
HIDPVm020SCDM	HID-PV m 20 /S CDM HPF 220-240V 50/60Hz	20	220-240V	1	12
HIDPVm020ICDM	HID-PV m 20 /I CDM HPF 220-240V 50/60Hz	20	220-240V	1	12
HIDPVm020FPCDM	HID-PV m 1x020/FP CDM HPF 220-240V	20	220-240V	1	12
HIDPVm035SCDM	HID-PV m 1x035/S CDM HPF 220-240V	35	220-240V	1	12
HIDPVm035ICDM	HID-PV m 1x035/I CDM HPF 220-240V	35	220-240V	1	12
HIDPVm035FPCDM	HID-PV m 1x035/FP CDM HPF 220-240V	35	220-240V	1	12

# HID-Primavision (Fixed output) continued

## “I & FP” TYPES

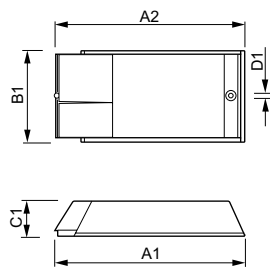

Product ID	Length A1	Fixing Hole Distance Length A2	Width B1	Height C1	Fixing Hole Diameter D1
HIDPVm I	190.0	154.0	43.3	30.0	-
HIDPVC 35/70 I	188.0	170.0	62.7	34.5	4.8
HIDPVC 100/150 I	223.9	206.0	82.7	34.2	4.8

Dimensions in mm

## “S” TYPE

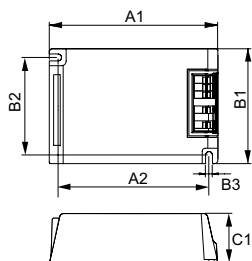

Product ID	Length A1	Fixing Hole Distance Length A2	Width B1	Fixing Hole Distance Width B1	Height C1	Fixing Hole Diameter D1
HIDPVm S	97.3	88.3	43.3	-	30.5	4.2
HIDPVC 35/70 S	109.6	98.5	74.4	63.7	32.2	4.9
HIDPVC 100/150 S	135.0	-	75.0	-	32.0	4.8

Dimensions in mm

## HID PRIMAVISION FOR CDM LAMPS

Shortcode	Description	Wattage (W)	Voltage	Min Order Quantity	Carton Qty
HIDPVC50/SCDM	HID-PV C 50 /S CDM 220-240V 50/60Hz	50	220-240V	1	12
HIDPVC50/ICDM	HID-PV C 50 /I CDM 220-240V 50/60Hz	50	220-240V	1	12
HIDPVC50/FP CDM	HID-PV C 50 /FP CDM 220-240V 50/60Hz	50	220-240V	1	12
HIDPVC100/S CDM	HID-PV C 100/S CDM - flex and plug	100	220-240V	1	12
HIDPVC100/I CDM	HID-PV C 100/I CDM - flex and plug	100	220-240V	1	12
HIDPVC100/FP CDM	HID-PV C 100/FP CDM - flex and plug	100	220-240V	1	12
HIDPVC150/S CDM	HID-PV C 150/S CDM - inbuilt application	150	220-240V	1	12
HIDPVC150/ICDM	HID-PV C 150/I CDM - independent/hard wired	150	220-240V	1	12
HIDPVC150/FP CDM	HID-PV C 150/FP CDM - flex and plug	150	220-240V	1	12
HIDPVSTRAIN	HID-STRAIN RELIEF	NA	NA	10	10

# HID-PrimaVision Economy (Fixed output)

## "I" TYPE

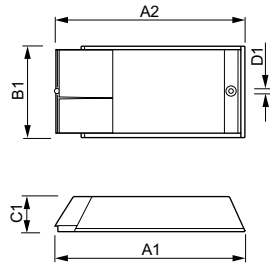

Product ID	Length A1	Fixing Hole Distance Length A2	Width B1	Height C1	Fixing Hole Diameter D1
HIDPVm I	190.0	154.0	43.3	30.0	-
HIDPVC 35/70 I	188.0	170.0	62.7	34.5	4.8
HIDPVC 100/150 I	223.9	206.0	82.7	34.2	4.8

Dimensions in mm

## "S" TYPE

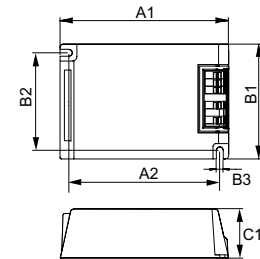

Product ID	Length A1	Fixing Hole Distance Length A2	Width B1	Fixing Hole Distance Width B1	Height C1	Fixing Hole Diameter D1
HIDPVm S	97.3	88.3	43.3	-	30.5	4.2
IDPVC 35/70 S	109.6	98.5	74.4	63.7	32.2	4.9
HIDPVC 100/150 S	135.0	-	75.0	-	32.0	4.8

Dimensions in mm

## HID PRIMAVISION FOR CDM LAMPS

Shortcode	Description	Wattage (W)	Voltage	Min Order Quantity	Carton Qty
HIDPVE35/S CDM	HID-PV E 35/S CDM - inbuilt application	35	220-240V	12	12
HIDPVE35/I CDM	HID-PV E 35/I CDM - Independent/hard wired	35	220-240V	12	12
HIDPVE35/FP CDM	HID-PV E 35/FP CDM - Flex & Plug	35	220-240V	12	12
HIDPVE70/S CDM	HID-PV E 70/S CDM - inbuilt application	70	220-240V	12	12
HIDPVE70/I CDM	HID-PV E 70/I CDM - Independent/hard wired	70	220-240V	12	12
HIDPVE70/FP CDM	HID-PV E 70/FP CDM - Flex & Plug	70	220-240V	12	12

## HID AspiraVision

AspiraVision DALI Compact (70W) for CDM Elite Light Boost – The electronic gear with brains. Dim and boost Elite Light Boost lamps for energy saving and attraction lighting. SOFTSTART allows installation with fewer circuit breakers. Loop Through allows faster, cost-efficient installation.

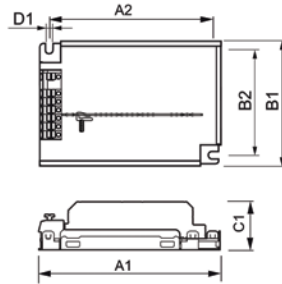

Product ID	A1	A2	B1	B2	C1	D1
HID-AV C DALI 70 /S CDM 220-240V 50/60Hz	110.0	98.5	75.0	-	32.3	4.5

Dimensions in mm

### HID ASPIRAVISION

Shortcode	Description	Wattage (W)	Voltage	Min Order Quantity	Carton Qty
HIDAVC70/S CDM	HID-AV C 70/S CDM - inbuilt application	70	220-240V	12	12
HIDAVC70/I CDM	HID-AV C 70/I CDM - independent/hard wired	70	220-240V	1	12
HIDAVC70/FP CDM	HID-AV C 70/FP CDM - flex and plug	70	220-240V	1	12

## HID PrimaVision Medium Wattage Elite Ballasts

HID-PrimaVision (Xtreme) for CDM Elite MW – Xtreme drivers for the highest reliability. Most efficient white-light system in the industry in its power range. Designed to minimise maintenance costs in outdoor lighting thanks to the 80,000-hour lifetime and integrated lightning protection. Same energy consumption and smooth driving of the lamp regardless of fluctuations in the mains voltage.

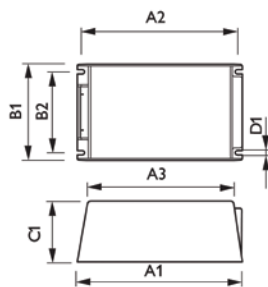

Product ID	A1	A2	B1	B2	C1	D1
HID-PV Xt 210 /S CDM 220-240V 50/60Hz	170.0	156.0	101.0	81.5	59.0	5.0

HID-PV 315 /S CDM 220-240V 50/60Hz	215.0	204.5	128.5	111.5	60.0	4.2
------------------------------------	-------	-------	-------	-------	------	-----

Dimensions in mm

### HID PV MW ELITE BALLASTS

Shortcode	Description	Wattage (W)	Voltage	Min Order Quantity	Carton Qty
HIDPVXT210/SCDM	HID-PV Xt 210 /S CDM 220-240V 50/60Hz	210	220-240V	12	12
HIDPV315/SCDM	HID-PV 315 /S CDM 220-240V 50/60Hz	315	220-240V	12	12

## HID PrimaVision for Mini White SON

PrimaVision SDW-TG (50W & 100W) for SDW-TG – High quality and robust performance. Optimal lamp performance thanks to minimal lamp power tolerance. Reduces colour differences between lamps and initial lumen spread. Performance is independent of mains voltage.

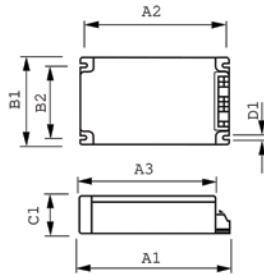

Product ID	A1	A2	B1	B2	C1	D1
HID-PV 50 /S SDW-TG 220-240V 50/60Hz	150.0	134.0	90.0	70.0	38.0	4.5
HID-PV 100 /S SDW-TG 220-240V 50/60Hz	150.0	134.0	90.0	70.0	38.0	4.5

Dimensions in mm

### HID PRIMAVISION FOR MINI WHITE SON

Shortcode	Description	Wattage (W)	Voltage	Min Order Quantity	Carton Qty
HIDPVC50SDWTG	HID-PV 50/S SDW-TG	50	220-240V	1	12
HIDPVC100SDWTG	HID-PV 100/S SDW-TG	100	220-240V	1	12
HID-STRAIN RELIEF	HID STRAIN RELIEF	N/A	N/A	10	10

## HID PrimaVision Xtreme for CPO

Compact, robust, outdoor, one-piece, electronic ballasts for CosmoPolis White (CPO-TW) lamps. Offering an energy-saving street and road light solution with extremely long life, and suitable for withstanding outdoor environments (storms, lightning strikes, etc.).

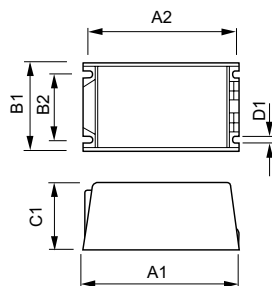

Product ID	A1	A2	B1	B2	C1	D1
HIDPV0	150	135.9	65	46.8	65	5

Dimensions in mm

### HID DYNAVISON DALI XTREME FOR CPO

Shortcode	Description	Wattage (W)	Voltage	Min Order Quantity	Carton Qty
HIDPVXt45/SCPO	HID-PV Xt 45/S CPO-TW	45	220-240V	12	12
HIDPVXt60/SCPO	HID-PV Xt 60/S CPO-TW	60	220-240V	12	12
HIDPVXt90/SCPO	HID-PV Xt 90/S CPO-TW	90	220-240V	12	12
HIDPVXt140/SCPO	HID-PV Xt 140/S CPO-TW	140	220-240V	12	12

## ET-S Halogen Transformer

A high frequency electronic transformer for operation with 12 volt halogen lamps. The ET-Standard transformer is uniquely compact and lightweight. It is also dimmable with approved leading and trailing edge dimmers. A range of benefits include short-circuit protection in the event of lamp failure, temperature protection, constant output voltage, and operates at a whisper (30dB).

Wire cross section on mains and lamp sides of terminals is 0.5 to 2.5mm<sup>2</sup>. Distance between lamp and transformer; minimum 20cm, maximum 2m. Distance from other transformers must be more than 25cm.

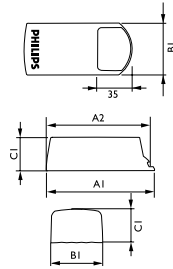

Product ID	A1	A2	B1	C1
ET-S	105	110	52	33.5
Dimensions in mm				

### ET-S HALOGEN TRANSFORMER

Shortcode	Description	Wattage (W)	Voltage	Min Order Quantity	Carton Qty
ETS60VA220240V	ET-S 60 220-240V 20-60VA	20-150	220-240V	1	50









---

# Technical Data







## The principles of LED technology

The basis for light generation inside a Light Emitting Diode (LED), a solid-state semiconductor, is the conversion of electrical energy directly into light.

On its most basic level this can be seen as an electron that moves from one material into another while losing an amount of energy. Due to the law of conservation of energy, this loss of energy needs to be converted and, inside a LED, this energy is converted into radiation energy composed of light in the visible part of the spectrum, and a bit of infrared radiation dissipated as heat.

The LED is comprised of two semiconductor regions, a positive electrically charged or p-region and a negative electrically charged or n-region, see Diagram 1. In the p-region there is a shortage of electrons and in the n-region a surplus of electrons. When voltage is applied across these two regions, current begins to flow and electrons move across the p-n junction, from the n-region into the p-region. The process of an electron moving through the p-n junction releases energy. The dispersion of this energy produces photons with visible wavelengths. The higher the energy released, the shorter the wavelength becomes. Low-energy photons will emit in the infrared part of the spectrum, and as the energy increases, the colour of the light will change from deep red, via yellow, green, cyan and blue to the ultra-violet part of the spectrum – in fact it follows the colours of the rainbow.

Diagram 1. LED composition with the electrically charged p- and n-regions and the p-n junction emitting light.

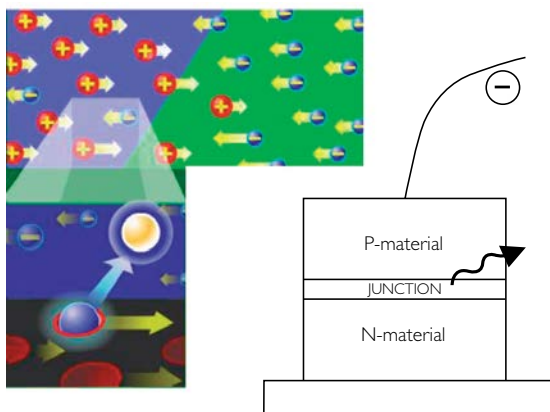
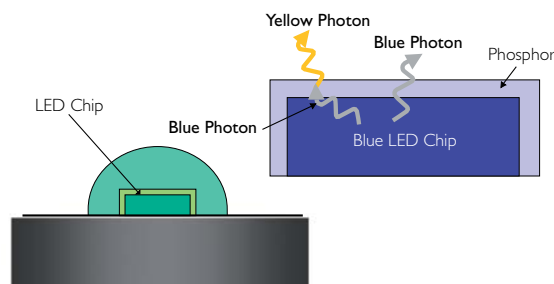

Diagram 2. White LED, the principle of white light generation.



### White light and RGB (red, green and blue)

A white LED consists of a blue LED chip and a yellow phosphor coating, see Diagram 2. The blue photons generated in the semiconductor chip can either pass the phosphor layer unaffected, or be converted into yellow photons. These two colours – blue and yellow – combine to produce white light.

It is also possible to generate white light with the aid of a red, green and blue LED. Such LED array systems are called RGB systems. Normally the RGB systems are used to make different colour effects. With a RGB system all colours of light within the colour triangle can be produced.

Graph. Colour triangle for a RGB system; all colours within the triangle can be reproduced.

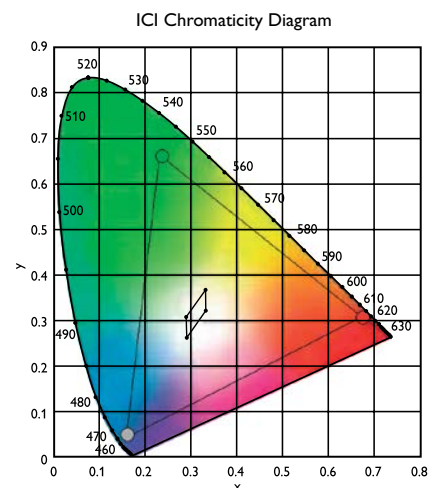



## Characteristics and benefits

On this page you will find an overview of the characteristics and benefits of LEDs. In the various indoor and outdoor applications different advantages will be important. Architectural applications will use the vivid colours and dynamic colour control, whereas the traffic signal market is focused on maximising energy savings and reducing maintenance costs to practically zero.

### In general:

- More energy-efficient than incandescent and halogen lamps
- Much longer life, up to 50,000 hours at 70 percent of lumen maintenance
- Reduced maintenance cost
- No unwanted IR or UV radiation in the beam of light, less risk of fading of colour pigments and textile
- Highly efficient low-cost plastic optics can be used

### Architecture/design:

- Design flexibility, hidden compact light sources
- Vivid saturated colours without the use of additional filters
- Directed light for increased system efficacy
- Robust, vibration-proof, solid-state lighting
- Less light pollution due to precise optical control

### Unique LED advantages:

- Dynamic colour control, white point adjustable
- Fully dimmable without colour variation
- Instant switch-on at full colour and full lighting level
- No transmission loss due to colour filters
- Install and forget for a long time

### Environment:

- No hazardous metals e.g. mercury in the light source
- Safety and low temperature:
- Low voltage DC operation
- Highly efficient in cold environment
- Cold start capability down to -40°C
- Sealed for life waterproof luminaires

## Value chain

The definition of levels of integration describes the road from LED chip to luminaire, with increasing complexity and value. Philips undertakes business activities at all levels of the value chain.

### Level 0. LED chip

Semiconductor chips are the basis for every LED and these are grown in complex wafer production equipment. The wavelength of the LED is defined according to the manufacturing process, the parameters and the tolerance.



## The principles of LED technology

### Level 1. LED component

Packaging is the next step. Here the thermal and optical properties are determined and the chip is connected to its package by means of bond wires for external connections.

### Level 2. LED array

A miniature printed circuit board is used to connect one or more LEDs, possibly together with driver electronics, and acts as a thermal interface between LEDs and heat sink.

### Level 3. LED module

A LED module combines heat sink, optics and separate driver in one module, ready to be installed in a luminaire.

A mono-colour traffic light source is an example of level 3. Three of these modules will be combined in a level-4 traffic signal head.

### Level 4. LED luminaire

A LED luminaire can be connected directly to the outside, mechanically and electrically. It houses, supplies power to and protects the LED array(s) from the environment while maintaining optimal operating conditions.

Philips LEDline is an example of a level-4 product.



				
<b>Level 0</b>	<b>Level 1</b>	<b>Level 2</b>	<b>Level 3</b>	<b>Level 4</b>
LED-Chip	LED or lamp	LED's on PCB	LED module with optics and driver	Luminaire

Table. Survey of levels of integration and LED products.

## LED lighting system

A LED lighting system comprises several components like a power supply, controller, control interface and luminaire/LED arrays/optics. In many cases one or more components are combined in one product for ease of installation. In other cases there might be a need for more flexibility in terms of system configuration and control. e.g. a power supply or control interface may be shared by a group of luminaires. Every single component is selected to fit the application demands.

## Lighting controls

The revolution of LED technology for lighting creates new possibilities in the application of lighting. In many applications the dynamic character of LED enables a lighting solution to create a unique experience. By using RGB colours or variation in colour temperature, all sorts of effects are made possible and can be specified for a particular lighting design or application, both indoor and outdoor. To enable these dynamic lighting solutions there is a need for lighting control systems that create the right experience for the customer. Philips provides a range of smart scene-setting lighting controllers that offers a reliable solution for any project, from simple colour selection at the push of a button or the turn of a wheel to fully automated, pre-programmed light control and/or multimedia integration.



## Colour characteristics of lamps

Lamps do not all emit light of the same colour. There is, for example, a striking difference between the pronounced amber light from standard sodium lamps and the white light from most other lamps. Even then, one white light is not the same as another. To select the right light source for the colour characteristics required, two separate parameters have to be considered, i.e. the colour temperature of the emitted light and its colour rendering.

### Colour temperature

Given that the colour of the light has an important influence on the colour impression of the area, the colour temperature of the light source plays an essential role. To enable an objective comparison of the colour impressions from various sources, subjective terms such as the popular words 'cool' and 'warm' are inadequate. A precise scale is required and given by the term 'correlated colour temperature'; the colour gradation of the light is compared with the light emitted by an intensely heated iron bar of which the temperature is known. In this way, the light colour can be specified by a value in kelvin (K). A low colour temperature represents warm, yellow, orange or red light and a high colour temperature cool, blue or violet light.

Four categories, as a practical guideline, are:

#### **2000 – 3000 K warm/cosy**

The colour from incandescent lamps, (compact) fluorescent lamps in the colours 827 and 927 and the SDW-T White SON lamp. Generally used for intimate and cosy environments where the emphasis is on a peaceful relaxing ambience.

#### **3000 – 4000 K warm/neutral**

The colour from halogen lamps, colour 830 and 930 (compact) fluorescent lamps and MASTERColour 830 lamps. Used in places where people are active, requiring a welcoming comfortable ambience.

#### **4000 – 5000 K neutral/cool**

The light colour from 840 and 940 fluorescent lamps as well as MASTERColour 942 and MHN metal halide lamps. Usually applied in commercial areas and offices where a look of cool efficiency is desired.

#### **5000 K and above daylight and cool daylight**

The light colour that best matches natural daylight, such as fluorescent colours 850, 865, 950 and 965.

### Colour rendering

The perception of surface colours, the colour rendering of the light, depends on the colour content of the incident light. The light emitted by a light source is composed of a mixture of colours, all in different intensities. A change in the colour mixture and intensity yields a different colour rendering.

Daylight incandescent lamps have fully natural colour rendering properties. The same is true for halogen lamps. The reason for this is the continuous spectrum of the sources, which is typical for filament lamps.

Most gas discharge sources, however, have an interrupted or line spectrum. This has an influence on the quality of their colour rendering properties, which vary from very poor, with SOX low-pressure sodium gas discharge lamps, to excellent, with the colour 90 De Luxe series fluorescent and MASTERColour 942 lamps.

When selecting a particular lamp type, a clear understanding of the colour rendering properties is essential.

A fair indication is given by the colour rendering index (CRI), which is a standardised scale with 100 as the maximum value. Colours are best shown under a light source with the highest colour rendering index. Incidentally, it is only worthwhile to compare CRI values of lamps of similar colour temperature.

## In practice, three colour rendering categories are normally found

### CRI between Ra 90 and 100.

- Excellent colour rendering properties.
- Applications are mainly those where correct colour appraisal is a critical task.

### CRI between Ra 80 and 90.

- Good colour rendering properties.
- Applications in areas where critical colour appraisal is not the primary consideration but where good rendition of colours is essential.

### CRI below Ra 80.

- Moderate to poor colour rendering properties.
- Applications in areas where the quality of colour rendering is of minor importance.

The choice in favour of a particular colour rendering class does, of course, depend on the demands that an application makes on a lamp.

For example, a CRI of Ra 60 is inadequate for shop lighting, but is qualified as good for functional road lighting.

Light colour	Colour temp. in kelvin	Type of lamp or lamp colour
Cool Daylight	17000 8000 6500	452 451 865, 965
Daylight	6000	
Cool White	5000 4500 4200	850, 950 HPI (-T) Plus 942, HPL-N, MHN
Neutral White	4000 3500 3400	840, 940 HPL Comfort
'Crisp' Warm White	3000 2900 2800 2700	Halogen 12V, 830, 930 Halogen Plusline Halogen PAR Incandescent, 827, 927
'Cosy' Warm White	2500 2150	SDW-T SON Comfort
Very Warm White	2000	SON PIA Plus

Indoor applications	CRI	Type of lamp or lamp colour
Excellent	100 92 90	Incandescent, halogen 12V, 230V 927, 930, 940, 950, 965 CDM 942
Good	83 82 80	SDW-T 451, 452, 827, 830, 840, 850, 865 CDM 830, SDW-T, MHN, QL
Moderate	75 70 69 65 60	54 25 HPI (-T) Plus SON Comfort 33
Insufficient	55 50	35, HPL Comfort 29
Poor	45 40 25	HPL-N SON Plus SON

## Areas of application

Correct light impressions and correct rendering of colours assists us in recognising our surroundings.

The colour climate of an artificially-lit space is determined by light colour temperature and colour rendering.

Room furnishings of wood and fabrics in warm colours require warm lighting in the colours 827 or 927.

For pleasing light the colours 830 and 930 are most suitable for many applications. The more business-like the interiors are, the cooler the light can be. Furniture using chromium, glass and marble, or in black and white, is emphasised by the neutral light colours 840 and 940. Colours 865 and 965 are best used in environments where there is a high daylight content.

For (compact) fluorescent lamps it is most economical to choose the colours 830 and 840 as they produce the highest light output. Colours 927, 930, 940 and 950, on the other hand, give the best colour rendering.

# Proper use of fluorescent lamps

Philips light colours	Special			Neutral white		Cool daylight		
	79	830	930	840	940	950	865	965
<b>Sales areas</b>								
Groceries								
Meat								
Textiles, leather								
Furniture, carpets								
Sports, games, stationery								
Photo, clocks and jewellery								
Cosmetics, hairdressing								
Flowers								
Bookshops								
<b>Industry</b>								
Workshops								
Electro mechanical assembly								
Textile manufacture								
Printing, graphical tasks								
Colour testing								
Paintshops								
Stores								
Plant nurseries								
<b>Offices, schools</b>								
Office areas								
Conference rooms								
Teaching areas								
Lobbies, corridors								
<b>Others</b>								
Dwellings								
Restaurants								
Museums								
Sport, multipurpose areas								
Hospital bedrooms								
Treatment rooms								



## Protection against ingress of solid objects, dust & moisture

The Ingress Protection system (IP) EN 60529, 1991 defines various degrees of protection against the ingress of foreign bodies, dust and moisture. The term 'foreign bodies' includes things like fingers and tools coming into contact with the electrical live parts of the product.

Both safety aspects (contact with live parts) and harmful effects on the function of the luminaire are defined. The exact testing method for luminaires for each IP classification is described in the standard EN 60598.

Some testing methods from EN 60529 were found to be inappropriate for luminaires and it must be noted that the specific conditions in an application may differ from the conditions during testing.

The designation to indicate the degree of protection consists of the characteristic letters IP followed by 2 digits indicating conformity with the conditions stated in the two tables. All Philips luminaires fulfil the minimum classification: IP20 (protected against finger contact with live parts), however a selection of luminaires, especially those for industrial and outdoor (road) applications, meet a higher IP classification. It is important to realise that the specification and safety of luminaires are only secured if the necessary maintenance is carried out according to the instructions of the manufacturer within the time schedules indicated.

### Protection against ingress of dust, solid objects and moisture

First number: Degree of protection against contact with external elements			Second number: Degree of protection against ingress of moisture		
First number	Description	Explanation	Second number	Description	Explanation
0	Non-protected	Not protected	0	Non-protected	Not protected against moisture
1	Hand-protected	Protected against solid objects exceeding 50mm in diameter	1	Drip-proof against vertical water drops	Water drips falling vertically shall have no harmful effect
2	Finger-protected	Protected against finger contact with live parts; and against solid objects exceeding 12mm in diameter	2	Drip-proof when tilted at angles of up to 15°	Water drips shall have no harmful effect
3	Tool-protected	Protected against contact with live parts by tools, wire or similar objects over 2.5mm thick; and protection against penetration of solid objects exceeding 2.5mm in diameter	3	Rain/spray-proof	Water falling at an angle of up to 60° shall have no harmful effect
4	Wire-protected	Protected against contact with live parts by tools, wire or similar objects over 1mm thick; protection against penetration of solid objects exceeding 1mm in diameter	4	Splash-proof	Splashing water from any direction shall have no harmful effect
5	Dust accumulation-protected	Complete protection against contact with live parts and against harmful accumulation of dust; some dust may penetrate but not to the extent that operation is impaired	5	Jet-proof	Water projected by a nozzle from any direction shall have no harmful effect. (Nozzle diameter 6.3mm, pressure 30kPa)
6	Dust penetration-protected	Complete protection against contact with live parts and against penetration of dust	6	Jet-proof	Water projected by a nozzle from any direction shall have no harmful effect. (Nozzle diameter 12.5mm, pressure 100kPa)
			7	Watertight	Watertight; temporary immersion in water under specified conditions of pressure and time possible without ingress of water in harmful quantities
			8	Pressure watertight	Pressure watertight; continuous submersion in water under specified conditions of pressure and time without ingress of water in harmful quantities

## Optics to suit all requirements

The optic in a luminaire is made up of the reflector and louvres, diffuser or refractor system that controls the light direction and beam pattern of the luminaire. It is an essential control device. It is therefore not surprising that Philips offers a wide variety of optics, each designed to perform a specific function.

Which optic is best for the practical situation in question?

The function of the area to be illuminated and the task to be performed usually determine the type of luminaire and optic you need, while the ceiling system often determines the dimensions and the way the luminaire is to be mounted. The luminaire-optic combination must fulfil the lighting requirements defined for each specific area and task. In addition, other requirements, such as image, efficiency and aesthetics, will influence the decision. Light distribution, direct and reflected glare control and efficiency are parameters that influence the performance of the lighting installation. These elements are described in the European standard EN 12464-1 (Light and lighting - Lighting of workplaces).

The following optic guide is comprised of optics for fluorescent luminaires with TL5 and TL-D lamps, grouped in the different optic dimensions (Micro, Mini, Midi and Maxi), for downlights with compact fluorescent lamps and for projectors with compact HID lamps.

The overview offers an indication of the optic description and performance. As the optical performance may vary with lamp type and number of lamps, please consult the photometric database via [www.lightingsoftware.philips.com](http://www.lightingsoftware.philips.com) in conjunction with calculation programmes like DIALUX and RELUX.

## Micro optics – New generation optics for TL5

Micro optics are the latest state-of-the-art in optical design and available for TL5 lamps only. The very slim-line optics, with an opening of only 55mm, are integrated in high-end luminaires. The aluminium optics with their curved underside enhance the aesthetic appearance and have an improved efficiency.

Micro optics are applied in innovative luminaire families like Arano, Celino and Savio, in slim-line and square luminaires.

### C8/D8

Performer micro optic made of high-quality standard aluminium, reflection  $\geq 83\%$ , available in high gloss (C) and semi-high gloss (D). Delta-shaped light distribution and all-round glare control.

LOR	up to 82%
UGR <sub>R</sub>	$\leq 19$
L	$< 1000\text{cd/m}^2$

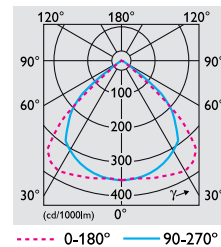

36

Medium beam rotationally symmetric optic for downlighting and accent lighting. Made of anodised aluminium with 99% reflection. Intensity varies greatly with lamp type and power. For accent and general lighting in areas where high-quality light sources are required.

LOR	up to 60%
$I_{max}$	approx. 1 kcd/klm

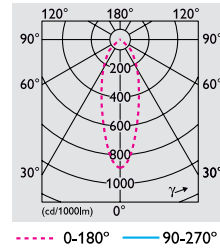

60

Wide-beam rotationally symmetric optic for down lighting. Made of anodised aluminium with 99% reflection. Intensity varies greatly with lamp type and power. For general lighting in retail areas, museums, hotels and lobby areas, in offices and public buildings.

LOR	up to 60%
$I_{max}$	approx. .75 kcd/klm

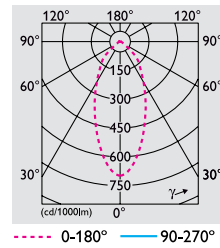



# Explanation of type numbers – example only

## Luminaires

The method used for type numbers is explained in the following. This explanation covers the major part of the type numbers.

For the precise choice of luminaire for a particular lighting assignment it is advisable to contact a representative of Philips Lighting.

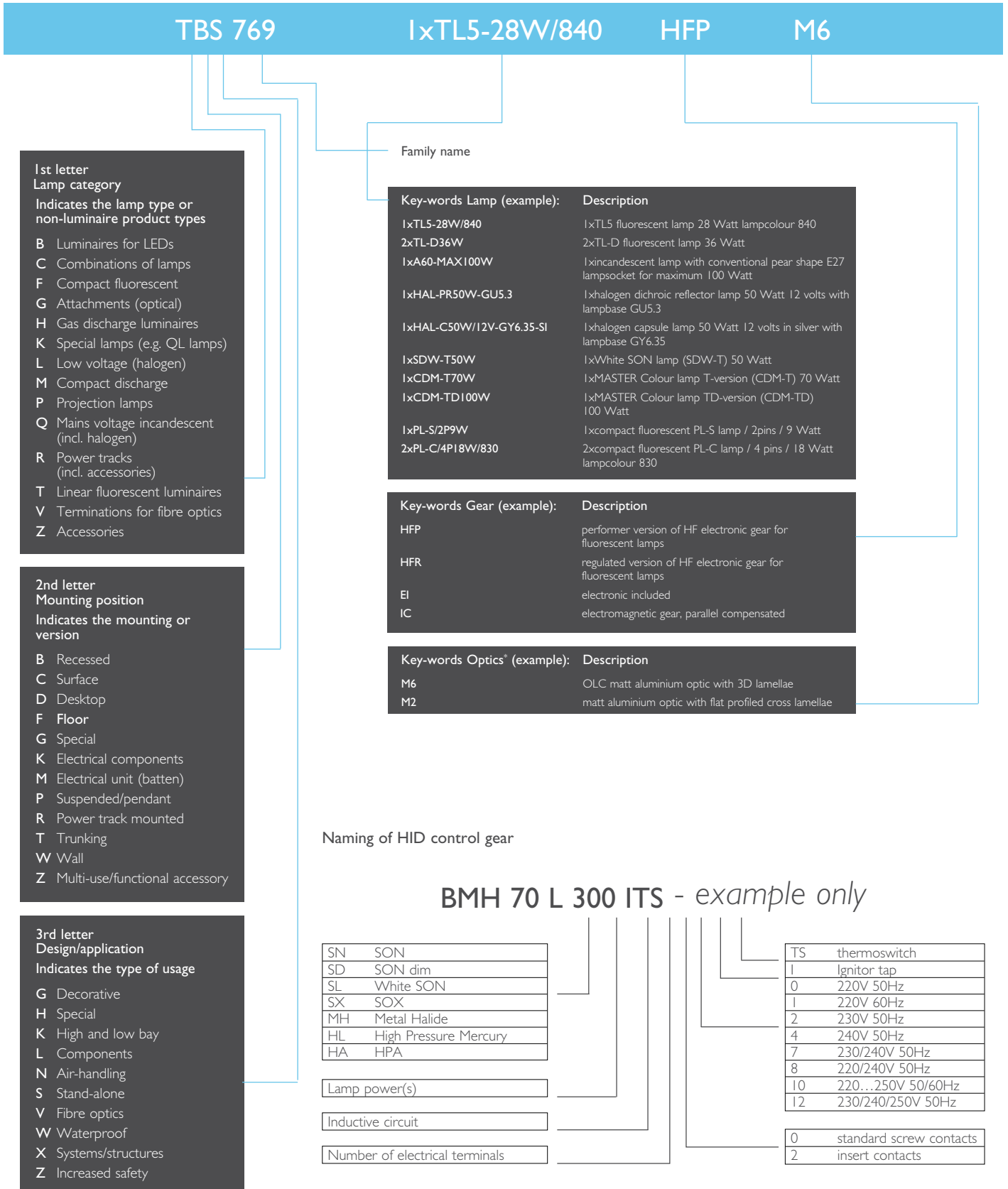

The next three digits in the designation indicate the family of luminaires.

## Lamp Characteristics

Efficacy of fluorescent lamp systems – typical examples:

Lamp type		Conventional gear	Electronic gear HFR, HFP, EBS or EBE
TL-D 18 W 4-lamp system	Lamp Ballast Total Lamp flux System efficacy Energy saving potential	4 x 18 W 14 W 86 W 4 x 1350 lumen 63 lumen/Watt	4 x 16 W 10 W 74 W 4 x 1400 lumen 76 lumen/Watt 16%
TL-D 36 W 1-lamp system	Lamp Ballast Total Lamp flux System efficacy Energy saving potential	36 W 8 W 44 W 3350 lumen 76 lumen/Watt	32 W 4 W 36 W 3200 lumen 89 lumen/Watt 22%
TL-D 58 W 1-lamp system	Lamp Ballast Total Lamp flux System efficacy Energy saving potential	58 W 11 W 69 W 5200 lumen 75 lumen/Watt	50 W 5 W 55 W 5000 lumen 89 lumen/Watt 26%
TL5 HE 14 W 4-lamp system	Lamp Ballast Total Lamp flux System efficacy	Not available	4 x 14 W 6 W 62 W 4 x 1350 lumen 87 lumen/Watt
TL5 HE 28 W 1-lamp system	Lamp Ballast Total Lamp flux System efficacy	Not available	28 W 4 W 32 W 2900 lumen 91 lumen/Watt
TL5 HO 49 W 1-lamp system	Lamp Ballast Total Lamp flux System efficacy	Not available	49 W 5 W 54 W 4900 lumen 91 lumen/Watt

### Colour temperature and colour rendering

Correct light colours and correct reproduction of colours assists us in recognising our surroundings. The colour climate of an artificially-lit space is determined by the light colour and the colour rendering. Room furnishings of wood and fabrics in warm or pastel colours require warm lighting in the colour /827 or /927.

The more business-like the interior is, the cooler the light can be. Furniture using chromium, glass and marble, or in black and white, is emphasised by the cool light colours /840 and /940.

#### Colour Rendering (Ra)

Colour rendering is the ability of a light source to reproduce colour. The light source is put over an 8-colour slide test, and the light source's ability to reproduce colour is tested. From this, it is rated on the CRI (Colour Rendering Index). E.g. The '8' in 840 indicates a colour rendering between 80-90.



Moderate:  
60 < Ra < 80

Good:  
80 ≤ Ra < 90

Excellent:  
Ra ≥ 90

#### Colour Temperature (K)

Colour temperature refers to the colour appearance of a light source. It is measured in degrees Kelvin (K). E.g. The '40' in 840 indicates a colour temperature of 4000K.



Warm

Cool







---

# Glossary of Terminology

### Average illuminance

Illuminance averaged over a specified surface.

Unit: lux (lx) = lm/m<sup>2</sup>

Symbol: E<sub>av</sub>

### Ballast

Electrical device used with discharge lamps for stabilising the current in the discharge.

### Beam spread

Angle in the plane through the beam axis over which the luminous intensity drops to a stated percentage (e.g. 50%) of its peak intensity.

### Brightness

Attribute of visual sensation according to which an area appears to emit more or less light. Brightness according to the definition is also an attribute of colour.

### Candela

The standard unit of light intensity, abbreviated to "cd", which is one lumen per steradian.

### CDM

See MASTERColour CDM.

### Colour appearance

General expression for the colour impression received when looking at a light source.

### Colour change

The facility to change the colour temperature of a lighting installation makes it possible to create a more comfortable working environment or to introduce dynamic lighting effects.

### Colour rendering

Ability of a light source to render colours naturally, without distorting the hues seen under a full spectrum radiator (like daylight or incandescent lamps). The colour rendering index (CRI) ranges from 0 to 100.

### Colour rendering index CRI

See Colour rendering.

Symbol: R<sub>a</sub>

### Colour temperature

Temperature in kelvin of a full spectrum radiator closest to the colour appearance of a light source at the same brightness.

Unit: kelvin, K

Symbol: T<sub>c</sub>

### Contrast C (between two parts of a visual field)

The relevant luminance difference between two parts in accordance with the formula:

$$C = \frac{L1 - L2}{L2}$$

Where the size of the two parts differs greatly and where:

L1 = luminance of the smallest part (object)

L2 = luminance of the largest part (background).

### DALI

Digital Addressable Lighting Interface, a standardised communication interface to regulate lighting levels and to switch electronic HFD ballasts on and off.

### Daylight linking

Using natural light saves energy and is beneficial to individual users. Daylight linking is a technique that regulates the light output of luminaires in accordance with daylight conditions, thus maintaining a constant level of indoor lighting and ensuring comfort at all times.

### Diffuser

Optical element used to mix light rays to improve uniformity or reduce glare. An opal cover is an example of a diffuser.

### Direct lighting

Lighting by means of luminaires with a light distribution such that 90 – 100% of the emitted luminous flux reaches the working plane directly, assuming that this plane is unbounded.

### Disability glare

Glare that impairs vision.

### Discharge lamp

Lamp in which the light is produced, directly or indirectly, by an electric discharge through a gas, a metal vapour or a mixture of several gases and vapours.

### Discomfort glare

Glare that causes discomfort without necessarily impairing vision.

### Dust-proof luminaire

Luminaire constructed so that dust of a specified nature and fineness cannot enter when it is used in a dust-laden atmosphere.

### Emergency lighting

Lighting provided for use when the supply to the normal lighting fails.

### Escape lighting

That part of emergency lighting provided to ensure that an escape route can be effectively identified and used in the case of failure of the normal lighting system.

### Flashed area

The light of a luminaire in a given direction. The area of the orthogonal projection of the luminous surface on a plane perpendicular to the specified direction.

### Fresnel lens or reflector

A Fresnel lens or reflector is an optical element of reduced height. By means of discrete steps, the basic shape is flattened yet the optical characteristics are retained.

### Glare

Condition of vision in which there is discomfort or a reduction in the ability to see significant objects, or both, due to an unsuitable distribution or range of luminance or to extreme contrast in space or time.

### Halogen lamp

Incandescent lamp in which the inclusion of halogens in the gas filling and a high-temperature quartz envelope promote the tungsten halogen cycle, permitting a higher filament temperature. The result is a higher colour temperature and a significantly extended life.

### Halogen HV

"High voltage" 230 - 240V halogen lamp, which does not require a ballast or a transformer.

### Halogen LV

"Low voltage" 6V, 12V or 24V halogen lamp. An electronic or electromagnetic transformer is required to operate low-voltage halogen lamps and is often integrated into the luminaire.

### HFR-DALI

Electronic regulating DALI ballast for various fluorescent lamps. With this new-style electronic ballast standard push-buttons can be used to dim the light output down to 3%. The lamp can also be switched on or off using the push-button control.

Ballast functions according to the DALI protocol.

### HFP PERFORMER

Electronic ballast for various fluorescent lamp types with warm-start principle. See also 'Specification data luminaires'.

### HFR 1-10V

Electronic regulating ballast for various fluorescent lamp types by which light dimming is possible. The main ranges of HFR ballasts allow step-less dimming down to 3%. See also 'Specification data luminaires'.

### Horizontal illuminance ( $E_{hor}$ )

Illuminance incident on the horizontal surface.

Unit: lux (lx) = lm/m<sup>2</sup>

Symbol:  $E_{hor}$

### HPI Plus lamp

Metal-halide high-intensity discharge lamp combining high luminous efficacy with white light of moderate colour rendering. Main indoor applications are big industrial halls and lighting of discount stores, hyper/supermarkets and DIY shops. HPI Plus lamps are usually applied in high-bay luminaires and floodlights.

### Illuminance

The luminous flux density at the surface being lit. The illuminance in the full summer sun is approx. 100,000 lux. Recommended illuminances for work places range from 200 lux for rough work to 2000 lux for detailed or critical work.

Unit: lux (lx) = lm/m<sup>2</sup>

Symbol: E

### Incandescent lamp

Lamp in which light is produced by means of an element heated to incandescence by the passage of an electric current.

### Indirect lighting

Lighting by means of luminaires with a light distribution such that not more than 10 per cent of the emitted luminous flux reaches the working plane directly, assuming that this plane is unbounded.

### Induction lighting refractor

Optical element used to concentrate light rays to focus or improve the direction of light. A prismatic cover is an example of a refractor.

### Infrared remote control

In offices and meeting rooms where the lighting requirement changes frequently, wireless infrared control offers the flexibility to set the lighting and change it at any time.

### Isocandela curve (diagram)

Curve traced on an imaginary sphere with the source at its centre and joining all adjacent points corresponding to those directions in which the luminous intensity is the same, or a plane projection of this curve.

### Isolux curve (diagram)

Locus of points on a surface where the illuminance has the same value.

### Jet-proof luminaire

Constructed to withstand a direct jet of water from any direction.

### LED

Light Emitting Diode used as a light source. Solid-state semiconductor device that converts electrical energy directly into light of a specific colour or white light.

### Light output ratio (LOR)

Ratio of the total light emitted by a luminaire to the total light output of the lamp(s) it contains measured at standard operating conditions.

### Low-pressure sodium lamp

Sodium vapour lamp in which the partial pressure of the vapour during operation does not exceed 5 Pa – for example: a SOX lamp.

### Lumen depreciation

The decline in the light output of a light source during its lifetime.

### Luminaire

Appliance that distributes, filters or transforms the light given by a light source (LED or lamp), and which contains all the necessary elements for fixing and protecting the light source(s) and facilitates their power supply and operating conditions.

### Luminance

The light intensity per square metre of apparent area of the light source, luminaire or illuminated surface. Where surfaces are lit, the luminance depends upon both lighting level and reflection characteristics of the luminous surface.

Unit: cd/m<sup>2</sup>

Symbol: L



### Luminous efficacy

The quantity of light that a light source emits per unit of electrical energy consumed. Notice that the luminous efficacy can be specified for a light source or for a lighting system (lamp and ballast).

The luminous efficacy of a system is lower than that of the light source.

Unit:  $lm/W$

### Luminous flux

The total light output emitted by a light source. Also the total light falling on a surface. The light output of a light source is measured in lumen.

Unit: lumen

Symbol:  $\phi$

### Luminous intensity

The luminous flux in a given direction, e.g. from a floodlight or projector.

Unit: candela ( $cd$ ) = one lumen per steradian

Symbol:  $I$

### Luminous intensity distribution diagram (table)

Luminous intensity shown in the form of a polar diagram, cartesian diagram or table, in terms of candelas per 1,000 lumens of lamp flux.

The diagram (table) for non-symmetrical light distributions gives the light distribution of a luminaire in at least two planes:

1. In a vertical plane through the longitudinal axis of the luminaire,
2. In a plane at right angles to that axis.

**Note:** The luminous intensity diagram (table) can be used:

- a. To provide a rough idea of the light distribution of the luminaire.
- b. For the calculation of illuminance values at a point.
- c. For the calculation of the luminance distribution of the luminaire.

### Lux

The standard unit of illuminance of a surface being lit. One lux equals one lumen per square metre.

### Maintained emergency lighting

Emergency lighting where the lamps are operated from the normal supply during standard conditions. In an emergency situation the emergency lamp (usually one lamp in luminaires of two or more lamps) remains in operation.

### Maintained illuminance (luminance)

Value below which the average illuminance on the specified surface is not allowed to fall. The maintained illuminance is specified at the end of the maintenance cycle, taking into consideration the maintenance factor.

It is one of the main specification elements for the lighting designer. In the various standards the maintained illuminance is specified for various activities.

Unit: lux

Symbol:  $E_m, L_m$

### Maintenance factor

Correction factor used in lighting design to compensate for the rate of lumen depreciation, caused by lamp ageing (lumen depreciation and lamp failure) and dirt accumulation (luminaire and environment).

It determines the maintenance cycle needed to ensure that illuminance does not fall below the maintained value.

### MASTERColour CDM lamp

Series of metal-halide discharge lamps with excellent colour rendering and a warm or neutral colour impression. MASTERColour lamps, also available as reflector lamps, are applied in projectors and downlights for shop and office applications.

### Mercury lamp

This High-intensity discharge lamp is used in industry and large public spaces. Higher quality light characteristics are obtained by applying metal-halide lamps.

### Metal-halide lamp

Single or double-ended discharge lamp for use in industry, public spaces and shops. Metal-halide lamps combine a natural white colour with a pleasant light and a high luminous intensity.

### Movement detection

Sensing of occupancy by movement detection ensures lights are activated only when needed and enables the lighting in a specific area to be controlled.

### Non-maintained emergency lighting

Emergency lighting where the emergency lighting lamps come into operation only when the power supply to normal lighting fails.

### Obtrusive light

Spill light which because of quantitative, directional and spectral attributes in a given context, gives rise to annoyance, discomfort, distraction or a reduction in the ability to see essential information.

### OLC

Omnidirectional Lighting Control, a Philips patented series of optics for TL5 and TL-D lamps offering optimal lighting efficiency in combination with excellent glare and luminance control all around the luminaire.

### Optic

A device that changes the direction of a beam of light, usually by reflection, diffusion or refraction by a lens. The optic may include louvres for reduction of glare.

### PL lamp

Single-ended compact fluorescent lamp in which the discharge tube is folded into two, four or six limbs. PL lamps are characterised by unusually high light output for their length. They are applied in compact luminaires for professional and domestic use. Also available with integrated ballast.

### Power factor

Ratio of the circuit power in watts over the product of the root-mean-square values of voltage and current. For sinusoidal waveforms, it is equal to the cosine of the angle of phase difference between voltage and current. For electronic ballasts the power factor is 0.95 so that no additional phase compensation is required.

### Refractor

Optical element used to concentrate light rays to focus or improve the direction of light. A prismatic cover is an example of a refractor.

### RGB

Red, green and blue, used to specify the colours of a light source.

### SDW-T

White SON or SDW-T lamps offer a high luminous efficacy in combination with warm-white light. The colour rendering is excellent. SDW-T lamps are applied in shops and public spaces where the atmosphere should be warm and cosy.

### Sky glow

The brightening of the night sky that results from the reflection of radiation (visible and non-visible), scattered from the constituents of the atmosphere (gas molecules, aerosols and particulate matter) in the direction of observation. It comprises two separate components as follows:

- Natural sky glow: That part of the sky glow which is attributable to radiation from celestial sources and luminescent processes in the earth's upper atmosphere.
- Man-made sky glow: That part of the sky glow which is attributable to man-made sources of radiation (e.g. outdoor electric lighting), including radiation that is emitted directly upwards and radiation that is reflected from the surface of the earth.

### Sodium lamp, SON lamp

High-pressure discharge lamp with a yellowish colour appearance and an extremely high efficiency. SON and SON Comfort lamps, with improved colour characteristics, are mainly applied in high-bay industrial applications.

### Solid-state lighting eg. LED

Description of a lighting device that does not contain moving parts or parts that can break, rupture, shatter, leak or contaminate the environment (such as a lamp).

### Spill light (stray light)

Light emitted by a lighting installation which falls outside the boundaries of the site for which the lighting installation is designed.

### Starter

Device for starting a discharge lamp, in particular a fluorescent lamp, that preheats the electrodes and/or causes a voltage surge in combination with the series ballast.

### Switching and dimming control

As more and more light sources can be dimmed economically, lighting controls need to provide both switching and light regulating capabilities.

### TL5

Linear double-ended fluorescent lamp with a diameter of 16mm. In combination with OLC optics and high-frequency ballasts the TL5 system offers a superb performance, both in terms of lighting technology and energy consumption.

### TL-D

Linear double-ended fluorescent lamp with a diameter of 26mm. Available in a range of colours and colour rendering characteristics.

### Threshold increment (TI)

The measure of disability glare expressed as the percentage increase in the contrast required between an object and its background for it to be seen equally well with a source of glare present.

**Note:** Higher values of TI correspond to greater disability glare.

### Uniformity ratio

Ratio of the minimum over the average illuminance for a specified area ( $E_{min}/E_{ave}$ ).

When defined as such, the uniformity ratio is also the ratio of the minimum over the maximum illuminance for a specified surface area ( $E_{min}/E_{max}$ ).

### Utilisation factor

Utilisation factor (UF) of a lighting installation represents the percentage of the luminous flux of the lamp(s) that reaches the defined working plane. UF can be seen as the efficiency of the lighting installation. UF is used to calculate the number of luminaires required.

### Vertical illuminance

Illuminance incident on the vertical surface.

Unit: lux (lx) = lm/m<sup>2</sup>

Symbol:  $E_{vert}$

### Visual guidance

The sum of the measures taken to give the user of a space an unambiguous and immediately recognisable picture of the course of the path ahead. Visual guidance is important in shops and other public buildings. The lighting designer takes the demands for visual guidance into consideration.



Contact Philips Customer Service:  
Ph: 1300 304 404  
Fax: (02) 9947 0363  
lightingsalesdesk@philips.com  
www.philips.com.au/lighting

Philips Lighting  
Sydney Office  
65 Epping Road, North Ryde NSW 2113  
Melbourne Office  
850 Lorimer Street, Port Melbourne VIC 3207  
Adelaide Office  
6 Hamra Drive, Export Park SA 5950  
Brisbane Office  
Building 5, 747 Lytton Road, Murarrie QLD 4172  
Perth Office  
114 Jersey Street, Jolimont WA 6014  
1300 304 404 (Toll Free - Local Only)  
www.philips.com.au/lighting



© 2014 Koninklijke Philips Electronics N.V.

All rights reserved. Reproduction in whole or in part is prohibited without the prior written consent of the copyright owner. The information presented in this document does not form part of any quotation or contract, is believed to be accurate and reliable and may be changed without notice. No liability will be accepted by the publisher for any consequence of its use. Publication thereof does not convey nor imply any license under patent or other industrial or intellectual property rights.

Document number: 919002151397

Release date: May 2014