



THORN STERLING And THORN NOMAD

Both these bikes are designed specifically for use with the **Rohloff EX hub** and **with suspension forks**

Prices may change at any time and we do not wish to waste resources; consequently the prices, in printed copies of this brochure <<< may no longer be correct. The current prices, given in the on line brochure, are correct and will always be honoured.

Issue 12 - Jan 2011



Nearing the summit of the 230Km climb of Paso Agua Negra, from sea level in Chile into Argentina at 4755m.

THORN FRONT SUSPENSION MTB AND TOURING BIKE

About Thorn

The business began as St John Street Cycles, in 1984 when Robin Thorn took over an almost defunct toy and cycle shop at 36 St John Street. He chose Bridgwater quite by chance – he was having holiday in the area from his home in Norfolk, and was amazed to see the number of people on bicycles in the town. In an instant the decision was made and the shop was leased that day.



Robin borrowed a small sum from his parents and worked all hours of the day and night to build up the business. He soon became a well-known figure with his oil-stained brown overall and wild hair and beard, often working on the pavement in the sunniest weather to draw further attention to his shop.

In 1989, the first employee was taken on – Andy Blance, a friend and very experienced australian rider.

In 1992, the first tentative moves were made into national advertising, concentrating on the touring and tandem markets, which were the particular interests of Robin and Andy. The emphasis had completely changed from cheap bikes to very high quality, specialist machines, though still often sold at a bargain price made possible by Robin's buying prowess.

In 1993, Robin decided to move up the road to number 91-93. The entire building front was gutted to give a modern, light, air-conditioned shop and a very superior workshop; the rear was left as a long single-storey brick store. St John Street Cycles was rapidly becoming known as one of the major touring and tandem suppliers in the country. We were gaining an extremely good reputation for the quality of our service and the breadth of our knowledge in the field.

In late 1995 we began to consider manufacturing our own bikes. We had become increasingly frustrated by the mistakes and missing features on the bikes we could buy and wanted to design what we considered to be the ideal touring bike and the ideal tandem. Andy used his wealth of experience and study of the subject to design the bikes, and the THORN brand was launched. The first bikes were so well received that we didn't even have to advertise them – they sold as quickly as we could get them made. At this point we set up our own frame shop and Andy designed complete ranges of Thorn bikes. Thorn quickly became established as a premier brand in the tandem touring market. At the same time, our mail order business and online store had been growing apace, and our internet site recognised as an industry best.

In 2000, the limited company Thorn Cycles Ltd. Was formed, with Robin and Helen Thorn as joint owners. St John Street Cycles remains as a trading name of the company.



(1) Robin and Andy back in 1992

(2) Robin 2007

(3) Andy 2007

Steel is real

High quality steel is the best possible material for a strong, comfortable, well equipped, long lasting frame... all our bikes are high quality **heat treated steel**... we would not wish to build our bikes with anything else and we would not wish to use anything else for our own cycling!

The final heat treatment process can double the cost of a steel cycle tube. Heat treatment significantly raises the UTS (ultimate tensile strength) which makes the tubes stronger and more resistant to cracking, it also makes the tubes more resistant to denting. It also greatly enhances steel's much talked of and easy to notice but hard to describe quality of "resilience". Because heat treatment is so expensive, the steel tubes used in most cycles are not heat treated. If a frame doesn't say "heat treated", you can be certain that the tubes won't be.

All the tubes used in Thorn frames are heat treated.

Cheap (thick-walled) aluminium frames are strong enough, they could have the fittings required on a touring bike but they are heavy and very uncomfortable.

Expensive (thin walled) aluminium frames are less uncomfortable and they are quite light but they can't have the fittings required for touring and they break! Dealing with a broken lightweight aluminium frame is easy...You recycle it into bottle tops!

Carbon fibre frames can be very lightweight and very durable...as long as you don't scratch them...a gouge in a carbon frame is a catastrophic failure waiting to happen. I'd have no hesitation using one for racing...

...if I raced!

and (especially) if somebody else was paying for it! It is difficult to manufacture a carbon frame with bosses...I don't know whether to laugh or cry, when I see a "cool" carbon road racing frame being used for lightweight touring...I see rattling mudguards, held on with cable ties, mega heavy alloy seat post-fitting (seat post breaking?) carriers with loads being carried, which are too high and too far back for stability...or I see no provision for luggage at all, with the rider looking like a cricket umpire, clothing tied around their waist...how cool is that...in both senses of the word?

I also frequently see the dangers and difficulties associated with toe overlap.

Titanium is two-thirds of the weight of steel...but even the top quality, cycle-specific tubes are much less stiff. To make a frame which is as stiff as a good,

Suss MTB and touring brochure Index.

- 1 Front cover.
- 2 About Thorn. Steel is real.
- 3 Sterling, a touring MTB
- 4 Disc brakes versus V brakes
- Full suss XTR Versus Sterling
- 5 Cost of running
- 6 Sterling frames and sizing
- 7 What the Sterling is and what it's not.
- 8, 9 Sterling Pukka Spec MTB
- 10 Sterling MTB spec
- 11 Sterling MTB Spec
- 12 Accessories
- 13 Collage
- 14 &15 Mt.-Tura Fork
- 16-18 Nomad Mk2.
- 19 Nomad Mk2 Sizing & matrix
- 20-21 On tour with a heavy duty Rohloff front suss touring bike
- 22 Order form, contact details set up dimensions.
- 23 Options and additions
- 24 Very special commuting bike

You couldn't have these fittings on an alloy or titanium frame



high quality steel frame, you have to use considerably more volume of material, which does not give that much of a weight saving! Many customers however want a weight saving with a Ti frame and they end up with a frame which is not stiff enough...this not only wastes energy...it can give a scary ride down steep hills!

Much of the titanium used today is not only of a very low grade but it is also "plain gauge" material, that is, it is not butted at all! If low grade steel frames can be nicknamed "gas pipe", perhaps these tubes should be called "nuclear reactor cooling pipe". Such tubes may be an improvement on "gas pipe" steel but they are far inferior to top quality steel, unless, of course, they are actually being used in a reactor!

They remind me of the story of "the Emperor's new clothes".

It is either impossible or extremely expensive to have the required fittings on a high quality butted Ti frame and furthermore, all such titanium frames, that we have known, have also broken! It is usually impossible to repair a cracked titanium frame. Perhaps there are some proper titanium frames, being made today, or which may be made in the future, that won't break...but we doubt it. We certainly wouldn't want to risk such a huge sum of money, when steel is almost as light, is much more durable and could be easily repaired if necessary, steel rides better, is relatively inexpensive and a steel frame can have all the fittings you require.



Steel is real!

THORN STERLING

A “Touring Mountainbike” by Andy Blance

The Thorn Sterling is, perhaps, the most multi-functional bike we have ever made. I designed it specifically for the Rohloff hub with the EX box. The frame may be used with a rear disc brake or a rear V brake.

I called it “Sterling” because it is designed for UK mud...not Californian hard pack! I also expect the bike to give “Sterling” service.

I have designed the Sterling to be a “Touring Mountainbike”. There are clearances for huge tyres (2.4”). Please note that, because its BB is higher than a typical road bike, it may also be used with narrow tyres (which lower the BB height considerably) on the road, without fear of grounding the pedals during spirited cornering.

The geometry is “suspension specific” and is designed for 100mm travel suspension forks. The Sterling is also suitable for use with 80mm travel forks but, on no account is it permissible to use forks, with more than 100mm travel .

A suspension-replacing steel fork is available for the Sterling. Our “Mt.-Tura fork” (see pages 14 and 15) replaces 80-100mm suspension forks, these provide the Sterling with a low cost and effective “alter-ego” as an impeccably handling touring, commuting or light weight expedition bike!

If you do not require either a suspension fork or disc brakes and you also never plan to use huge knobby tyres, we strongly advise you to consider one of our other Rohloff bikes. Please see the Raven Tour, Raven Sport Tour or Thorn Nomad Mk2 brochures.

If you are looking for a suspension ready heavy duty tourer, we have the ultimate bikes, the **THORN NOMAD Mk 2** and **NOMAD Mk2 S&S** on pages 16 to 21 of this brochure



When you look at the tyre clearance, the superb cable line to the EX box, the ISO disc mount, the Thorn dropouts, the curved reinforcing tubes and the beautiful TIG welding, we're sure that you will appreciate our attention to detail.

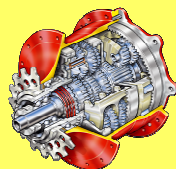

Rohloff equipped
14 speed internal hub gear
526% gear range in even 13.6% steps!



“V” brakes Vs Hydraulic discs.

There is no doubt that hydraulic disc brakes are preferable to V brakes in the deep, muddy conditions often found in UK mountainbiking. They are, however, very easily damaged (especially in transit) and a bent rotor is much more difficult to straighten than an “out of true” wheel. Indeed, if the rotor is warped enough, the wheel will not even turn! Don’t compare the 8 to 10mm thick, cast rotors, found on modern cars and motorcycles, with the 2mm thick, stainless steel plate, rotors found on bicycles.

For everything, apart from full-on mountainbiking, we prefer the simplicity, ruggedness and ease of maintenance of V brakes. We even prefer the “feel” of top quality V brakes. We have rims available, with a tungsten carbide braking surface, which provides fantastic braking combined with exceptional longevity.

Please don’t ask for a disc brake on steel forks, we simply won’t do it!

We use raked blades, these are exceptionally comfortable, they will withstand the forces of cycling (and have done so for generations) but raked forks will not withstand the forces generated by a disc brake, which are very different to the forces generated by V brakes, even at the same rate of retardation. We have seen 3 ways that other manufacturers have “accomplished” this, they all seem stupid to us

- (1) We have had customers complain that a well known custom builder’s raked steel forks have permanently bent under braking.
- (2) We have seen hideously uncomfortable, thick walled, straight blades used by another manufacturer, these forks don’t fail, but I expect that an owner’s hands and elbows soon would!
- (3) The most ridiculous “solution” of all, is a heavy left blade and lighter right blade. The different blades must have different elastic properties (isn’t that supposed to be the point?) and therefore the axle must twist, when a bump is hit. If the axle twists, then so must the front wheel. If the front wheel twists, then the bike consequently alters course.

Isn’t hitting bumps comfortably and safely the main function of a bicycle’s fork? Why compromise comfort and safety, in order to fit a brake, which is inferior, in the conditions that the steel fork will be used in?



Rohloff equipped Pukka hard tail Vs Full suss XTR equipped MTB

Please note, in the following comparison, both bikes are deemed to be used in severe conditions, for serious off road riding. No allowance has been made for any “gentle” miles of road use getting to and from the trails. With, less severe use, many more miles could be obtained from a transmission.

(1) Performance. *There is no doubt that a brand new, clean XTR groupset shifts really well...it will even shift under full load, whereas a Rohloff hub will balk at shifting, until you back off power. When you change gear with the XTR groupset, under full load, there is a loud “clunk”, as the change is made, this is the sound of expensive parts taking minute chunks out of each other...this kind of performance costs money, lots and lots and lots of money!*

You may not be able to change gear under full load but, with Rohloff, you can change gear without pedalling (this is great for covering the gear, which you would require, if you needed to resume pedalling, whilst going downhill.) Rohloff is great, if you lose traction and come to a halt up a steep, loose climb. Simply change up several gears and stand on the pedals, get the bike moving, without digging a hole with the rear tyre and then, once you are moving again, change down to a suitable gear for the gradient...try that with a derailleur! (well don’t actually!)

You can still change gear effortlessly, with Rohloff, in mud so thick, that all derailleur bikes have become very heavy and temperamental single speeds!

A decent full suss XC bike will certainly drop a hard tail on bumpy descents but (depending on the rider!!!) a high quality hard tail will take it all back (and more!) on the climbs and singletrack.

(2) Servicing. *A full suss bike requires a lot of maintenance to keep all its pivots properly serviced (this assumes that the pivots are serviceable) The derailleurs have to be cleaned and lubricated regularly, it all takes time. The rear shock needs servicing every 100 hours, if it’s a good one...if its not a good one, it isn’t worth having! The Rohloff hard tail needs its oil changing every 3000miles (5000Km), that takes 15 mins. It also needs its cables changing every 2 oil changes, this takes 30 mins and costs very little. It also needs to be hosed down occasionally. Both bikes need the same attention to forks and to discs.*

(3) Cost and cost of running. If you shop around at the end of the year, you may just be able to pick up a decent XTR full suss bike for the cost of one of our Pukka spec Rohloff-equipped Sterling bikes. **If you use it hard and cover 3000 off road miles a year**, you may be lucky and get 4 years out of a full suss frame. During that time you will have bought 11 XTR cassettes, 11 chains, 3 chainsets, you will have had your forks and shocks serviced 11 times each and you will have purchased 3 pairs of mechs and 1 set of STI shifters. You will have also spent a considerable sum on the suspension pivots.

If you were to have covered the same terrain on a Sterling you would have performed 4 oil changes and changed the gear wires once. If you used Rohloff chain and looked after it, you might be ready to bin the second one. You would be ready to replace the sprocket, chainring and gear shifter. You would have had your forks serviced 11 times and your Thudbuster, if you bought one, would be ready for the bin. Your forks would also be ready to bin. **Let's say that you buy new forks, sprocket, chain, chain ring, shifter, headset and BB unit, you now have a bike whose transmission runs more smoothly than it ever did, the hub will only be 10% of the way through its known service life, you still have a lifetime guarantee on the frame and you have new forks, it's like a new bike again but the derailleur owner is back to square one and needs to buy a new bike...and that's another two and a half grand more to find...sure they may recoup £500 on eBay for the old bike...there's always some mug!**

Ignoring the initial cost of the bike and the cost of tyres, rotors, brake servicing and pads.

You've spent £ 1191 to cover 12,000 miles off road on Rohloff and you still have a superb fully-serviced bike to ride.

The XTR full suss bike costs £7978 to cover the same distance, including the extra £2000 needed buy a new bike.

(4) Convenience and fun. There is no doubt that riding a full suss, XTR-equipped, MTB down hills is fun, as long as the frame is a good one. The Rohloff equipped Sterling certainly is great fun to ride too, it is very sharp and responsive.

In mucky conditions, the thought of taking a full suss, derailleur bike out for an hour, when it will take two hours to clean and service, is not appealing. You can take your Rohloff bike out and get it as mucky as you like and it will only require a 5 minute hose down and chain lube when you get back...**now that's convenience** and I guarantee that you will use the bike more frequently because of it...**and that's fun!**

“Sterling, the bike you can ride, between summers, without loosing your appetite”

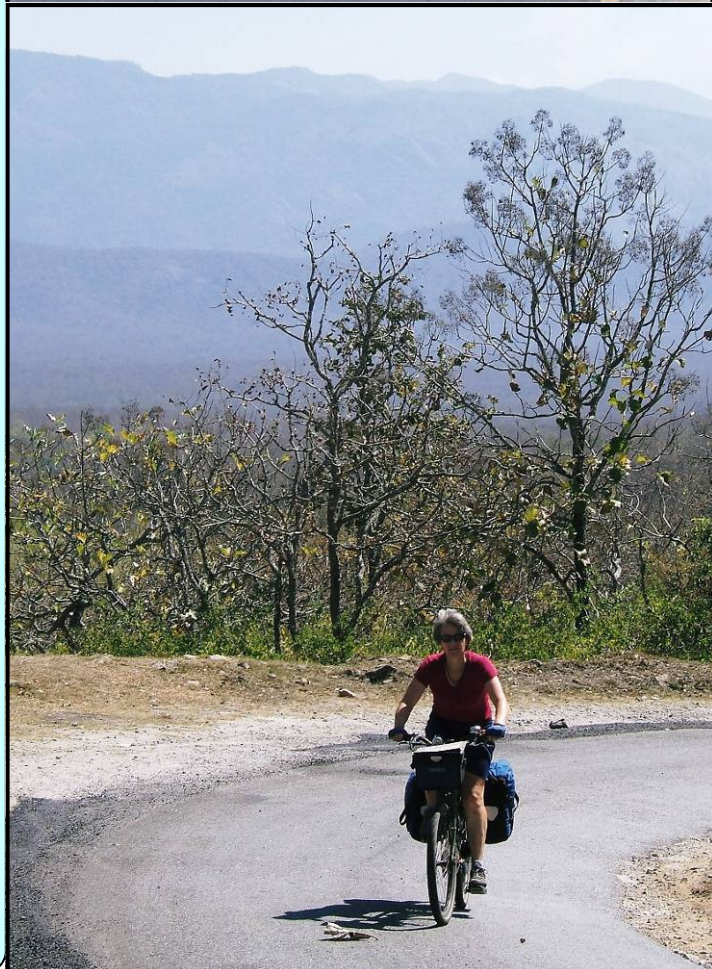

Frames and frame sizing

The Sterling frames are beautifully crafted from our own very high specification "THORN 858" tube set. Our tubes are seamless, as opposed to inferior tubes with a welded seam, they start life as a pierced billet of Japanese Cro-Mo. The tubes are then cold drawn, from the billet, into raw seamless tubes. These tubes are drawn further and they have both their ends thickened up (double butting). Finally, the tubes are heat treated, this operation costs as much as all the operations that have taken places so far, from ore to butted seamless tube. But it is the heat treating process which gives the tube its ultimate strength, resistance to dents and high resilience.



The Sterling frames have many brazed on fittings. They have a complete set of our own special cast stainless steel cable guides. (The brake cable/hose is routed along the top of the top tube, to avoid a guide causing injury if the bike has to be "shouldered". The gear cables run under the RHS of the down tube, under the BB and then under the LHS chain stay...this routing produces the fewest bends and allows the cables to directly enter the EX box, with the box sloping downward slightly to limit ingress of water and facilitate the draining of any that does find its way in)

The Sterling has removable V brake bosses and an ISO disc mount, allowing you the choice of type of brake. The Sterling has a reinforcing gusset under the down tube and a pair of curved reinforcing tubes, which distribute the forces fed into the LH seat stay by a rear disc. Such a tube has an effect on the rear end of the bike and, because there is no cassette (or mech) to prevent us, we have also fitted a reinforcing tube to the RHS to balance up the feel of the frame.

The Sterling has our own cast stainless steel, Rohloff-specific dropouts, with double eyelets. It also has our own foolproof eccentric BB, with stainless M8 x 0.75 bosses, for adjusting chain tension.

The Sterling is provided with a pair of stainless steel M5 bosses on its seat stays, for attaching a carrier and 3 stainless bosses (2 under the bridges and 1 at the back of the seat tube) for directly attaching mudguards, if required.

We have also provided a pair of Crud Catcher bosses under the down tube (the head tube has been "extended downwards" to allow clearance between the "Cruddie" and a suspension fork crown).

The Sterling also has 2 pairs of bottle bosses (down tube and seat tube) The down tube bottle bosses are attached very high on the tube to both allow the "Cruddie" to protect the bottle from muck and to leave the maximum space for shouldering the bike. (Note; shouldering the bike would not be possible if the seat tube bosses are used.)

Finally we have specified a cast stainless steel, forward facing, seat clamp with M6 screw, you can be certain that this will securely clamp the seat post.

As you can see, no effort has been spared, in order to make the Sterling a superbly functional machine, no matter how you decide to focus it.

The 2 sizes of Sterling can be seen below, larger, side on pics of the 3 sizes can be seen elsewhere in this brochure.
 Size 582 Small/Medium can be seen on page 11
 Size 590 Medium/Large can be seen on page 7



S/M



M/L



See sizing diagram on page 19



STERLING
 frames (in common with all our steel frames) have our "Original owner, lifetime warranty" against faulty materials or workmanship.



Thorn Sterling dimensions. (Please see diagram on page 19)

PLEASE NOTE that standover heights are measured with 2.1" tyres and a 100mm travel suspension fork, without any "sag". S/O at the front of the bike is measured from the ground to the furthestmost point that you could stand over the frame (not quite to the intersection with the head tube)...not everybody has legs long enough to manage this and those people must be confident in their own abilities to ride such a machine! Mid tube standover is, as the name suggests, from the ground to the top of the brake line, in the exact centre of the tube...you absolutely must have clearance here!

The M/L Sterling is the most popular size and it suits people from 5' 8" to 6'1". The size S/M is the smallest size I can make with 100mm travel forks and clearance for a Crud catcher, without using a bent top tube. It has an extremely steep slope, to allow the greatest number of people to be able to stand over the middle. It should suit people up to 5' 9"

(1) SIZE	(2) Actual Seat tube length C to C	SLOPE (1) - (2)	Virtual Top Tube	Chainstay	S/O at the front of the bike	Mid tube standover
582 Small/Med	340	242	580	430	840	745
590 Med/Large	410	180	608	436	870	805

WHAT THE STERLING IS.

The Sterling is an improvement on our original Rohloff equipped MTBs...the "Enduro" and the "Catalyst". The frame is lighter, the cable routing is better, there is even more clearance for UK mud (and clearance for tyres at least 2.4" wide!) The luggage carrying provision is improved, a standard Blackburn Mtn. carrier can be used with a rear disc brake and I have specified stainless steel for all the guides and fittings. Fiona and I have moved across the kit from our Raven Enduros onto Sterling frames to test them, I have no intention of moving it back...the ride is superb and a definite improvement! The Enduro climbed well...the Sterling is better. The Enduro descended superbly...the Sterling is better. I was expecting (and prepared for) a slight loss of nimbleness on singletrack...but no, the Sterling is even easier to thread through the trails. In spite of all these improvements and the huge losses of the Pound against the Euro (making the Rohloff hub much more expensive) the 2009 Sterling is slightly less expensive than the 2007 Enduro.

The Sterling is designed to excel in many different spheres and disciplines.

When the Sterling is being used to explore challenging off road routes, at home (the UK) and abroad, it is absolutely perfect and peerless and very economical to run! You could accurately describe it as it as a "long distance, lightweight touring, hard tail MTB"...but as the Sterling has a an exquisite, top quality seamless, cold drawn, double butted and heat treated Cro-Mo steel frame

...we'd prefer to call it...

"a Rohloff Equipped, Action-touring, Lightweight, Wilderness-Optimised, Resilient-tail, Long Distance, MTB"...
that's a bit of a mouthful...but when abbreviated to "REAL WORLD MTB" it sounds much better!

The Sterling can be used fully and enthusiastically, as an endurance-racing cross country MTB...riding as quickly as your skill levels and the terrain will allow. Unlike many of today's bikes, the Sterling will also carry a small amount of luggage, whilst travelling at such pace. Experience has shown that (especially over distance and even more especially in the event of a crash!) it is better not to carry any more than you need to on your back (just stick to water, money, mint cake and keys)...the sandwiches, waterproofs, fleece, first aid kit, space blanket and (especially) tools, are best carried in a small bag, securely attached to the top of a "Blackburn Mtn. rack"

The Sterling will also carry up to 15Kg over severe terrain, if required to do so, as long as you make allowances for such terrain by "riding light" and "floating" over bumps. This means that ultra-lightweight, alpine cycle-camping and "Polaris" events are well within the Sterling's remit. And, as it will do this, you can be absolutely certain that it will allow the "slightly overweight" to pootle around on bridleways and such like, possibly carrying a camera and tripod and whilst enjoying the simplicity and reliability of Rohloff, with the comfort of a proper suspension fork.

As mentioned earlier, I have designed a steel, suspension-replacing fork, (with all the fittings required for touring) for the Sterling. Such a fork allows the bike to be used in situations where suspension is not required...holidays which are too long for the service interval for the suspension fork or for day to day use...why wear out your suspension forks on journeys where they are a hindrance rather than a help?

With Mt.-Tura forks fitted, the Sterling can lead a double life as a lightweight adventure touring bike, or as an all-year, all-weather commuting day to day bike. (See page 14)

WHAT THE STERLING IS NOT.

*The Sterling is not designed to be used with forks with more than 100mm travel...**the use of forks with more than 100mm travel is expressly forbidden** and could result in sudden frame failure, with the consequent risk of serious injury or death.*

The Sterling is not designed for "taking big air" or for large drop-offs.

The Sterling is not designed to withstand heavy landings, especially repeated heavy landings, from poorly executed wheelies. (I'd hate to ride long distances on the bike that was designed to withstand such landings!)

The Sterling is not designed to be ridden by cyclists taller than 6' 1" (1855mm). The Sterling is made from fairly lightweight tubing and, being an off road machine, which is expected to have to soak up some punishment, it is therefore not suitable, as an MTB, for heavyweight riders. Maximum rider weight with full (15Kg) luggage carrying capacity is 13.5 stone (189lbs or 86Kg) Maximum rider weight with 2kg of luggage is 15 stone (210lbs or 95Kg)

Whilst the Sterling makes a superb bike for self-supported, cross-country, endurance-racing, I don't consider that it could ever be totally competitive in XC racing...unless the conditions were really,

incredibly, seriously muddy...but if you race to "take part" then it will do the job very nicely indeed!

If you are in with a chance of winning an XC race, somebody will surely be footing the bill for your kit and you won't be interested in the economical nature and potentially long service life of the Sterling!

The Sterling is multi-functional...but even it can't do everything and, even some of the things it can do, can be done in a superior fashion by one of our other bikes.

If you don't intend to use the Sterling's capacity for disc brakes, or it's capability of using a suspension fork and if you also never plan to use the Sterling's ability to swallow really fat tyres, then you would find the Thorn Raven Sport Tour a far superior machine than a V brake Sterling, with rigid forks running on 1.75" tyres.

If you don't intend to use discs or suspension but would like to use fat tyres and you also wish to carry quantities of luggage, you would be much better off looking at our Raven Tour or at our Nomad Mk2 and Nomad Mk2 S+S.

If you want to carry vast amounts of luggage over whatever terrain presents itself, I believe that there is only one bike in the world which can do this properly and you should look the suspension options on our Nomad Mk2.

We offer the Sterling in a choice of 3 different specifications, these are:-

- (1) Pukka MTB spec**
- (2) MTB spec**
- (3) Trekking Spec**

(1) Pukka MTB Spec

The idea behind the “Pukka MTB spec” Sterling is to not be afraid to spend money, where it will make a real difference.

I’m not talking of spending money to save a few grams on some shiny trick bits, which may, or may not, give good service. I’m talking of genuine improvements in either off road function or to service life.

Pukka spec Sterling, what you see is what you get!
Bike shown with upgrade to Rolls saddle



Note bike shown with 2010 colour fork, 2011 fork is white.

Bike shown is size M/L (590 Medium/Large)

Forks

We supply the “pukka MTB Spec” Sterling with the latest **Rock Shox Sid Team forks** in black. Having tried these forks, I had to have them on my own bike! I have to say that these are the best suspension forks I have ever used, for an XC hard tail (sorry, I mean resilient tail!) They have very comprehensive adjustments, which allow the rider to tune the forks to their preferred style of riding. The “dual air” system allows a rider to shape the response characteristics of the air spring, in addition to adjusting its spring rate. Now my Sid team forks are nicely “dialled in”, I find that I ride with the forks “wide open” most of the time off road. (The Quantock hills, where I do most of my riding, have very steep, rocky climbs, I have to ride these slowly and I prefer to do so in the saddle, with the forks wide open, the rocks are then much less likely to halt forward progress).

I have found (or have come very close to finding) an ideal setting, for my style, which means that I don’t have to keep messing with the forks for different sections of the trail. The “lockout” is a “soft lockout”, which can be incrementally adjusted, by increasing the compression damping. When locked out, the fork certainly doesn’t

“bob” and, if I ever forgot to unlock it, and started a fast downhill, it would open itself, once a pre-set bump threshold has been reached (mine are set quite low!) **These are seriously good forks but they do need servicing every 100 hours to maintain this level of performance.** (The **SID Team forks** are supplied with different colour decals, note the pink decals on Fiona’s Sterling!)

Brakes

We supply the Pukka MTB spec with **Hope Tech X2 callipers, Hope flip-flop levers, with Hope braided stainless hoses front and rear and 160mm rotors.** These brakes certainly have sufficient power for mountainbiking in steep hills. The rear brake is powerful enough to be able to lock the wheel up at any time (which is essential for safety, should it ever be necessary to “lay the bike down”) and, unless you used “freeride” or downhill tyres, it would be difficult to use more power than the 160mm front can supply. Hope brakes are easy to work on, very reliable and effective and, not only do Hope keep all the parts as spares, they also have comprehensive video instructions on their website!

Brake upgrade. If you ride really quickly, you may wish to consider an upgrade to 183mm Hope M4 (four pot) front brake, with a floating rotor .

You really could not need more stopping power! This brake is awesome and it is not needed on the rear for “normal” mountainbiking.

Crankset, BB and chainring

We supply the Pukka MTB spec with **Deore cranks**, which offer many of the features and benefits of the pro level, XTR chainset to the sports rider, at an affordable price point.

The Hollowtech II chainset features an external bottom bracket system which is a lightweight, rigid design that is incredibly strong and durable.

The default option is 170mm cranks on the S/M size Sterling and 175mm cranks on the M/L and L sizes.

All Sterlings are supplied

with one of our 7075 single chain rings...these rings are the highest quality obtainable and they are reversible...wear out one side of the teeth, then reverse the ring and wear out the other side...Rohloff is certainly cheap to run, after the initial purchase has been made!

There is a choice of ring size but you would need a good reason not to have the lowest permissible gearing (which is obtained with the default 38t ring) on a “Pukka MTB”

Chain

We fit a Sram 890 **8 speed chain** to the Pukka MTB spec Sterling. The 8 speed chain is slightly wider and will pass more easily over damaged teeth than the narrower 9sp chain would.

Wheels and Tyres

The Pukka MTB spec Sterling is equipped with a **Black Rohloff hub and a Black Hope Mono disc hub.** The black anodising on the Rohloff hub is of architectural quality, which is an expensive process. The black hubs are significantly less likely to suffer from oxidation than the brightly polished (but non anodised) silver hubs. The Hope mono disc hub is precision made with sealed cartridge bearings and a stepped heavy duty axle, which increases lateral



An underside shot of the Pukka spec Sterling, look at the beautiful cable routing!

these grips the most comfortable we have ridden with, they are also very high quality, last well and, very importantly for an MTB, they have a clamp which locks them tight onto the bars.

We also supply one of our own stems, we try and fit a black stem, when we can but the priority is given to providing the right length for the rider.

A micro adjustable reasonably lightweight seat post is included and a high quality Selle San Marco Rolls saddle is provided.

No MTB should be without a Crud catcher, especially if you ride where dogs are walked! (Where aren't they walked in the UK?)

Our frame not only has dedicated bosses, it also has sufficient headtube below the junction with the down tube to fit one and have it clear the fork crown!

Please note that none of our bikes include pedals, these have to be bought separately.

fork stiffness.

The hubs are laced and hand built, by a master wheel builder, into black Rigida disc bull rims, (which are very light for 31mm wide rims at 575g) using the highest available quality, double butted, stainless steel spokes.

The extra width of the rim gives excellent support to the tyres, resulting in a more positive "bite" and the opportunity to run lower pressures.

The standard tyres are 2.1" Panaracer Fire XC folding tyres. These offer superb grip in all conditions and have a low rolling resistance. Many MTB riders, myself included, have found the benefits of even fatter tyres (even better grip, lower pressures may be used without snakebite punctures, fat tyres roll better on bumpy ground and they are more comfortable). For this reason we offer the option of the Panaracer Rampage 2.35" tyres...I run these and they provide awesome grip. I am sure that they are often much more tyre than I need but I am more concerned with grip than I am with absolute speed.

Grip equals confidence, confidence equals speed and, personally speaking, damage to my anatomy slows me down considerably more than having a bit too much tyre! The wheels are fitted with top quality inner tubes with Presta valves...the ones you can actually get air into, with a mini pump, when it's all going "chests up"!

Bars, grips, stem, seat post, saddle, pedals and Crud catcher.

The Pukka MTB spec is supplied with Thorn MTB comfort riser bars, these do the job nicely and we don't believe that handlebars are a sensible place to try and save weight.

We have chosen to fit the Ergo GP-1 handlebar grips. Not only are



MTB Spec

The thinking behind the “MTB spec” is to provide a bike with a superb frame, a Rohloff hub, high quality suspension forks and disc brakes, that is capable of genuinely serious off road performance, for the least amount of money possible. This is a “no frills” package that really works superbly well.

There are no nasties like duff headsets, duff BBs, duff tyres or shoddily built wheels hidden in this package.

Forks

We supply the “MTB Spec” Sterling with the latest 100mm travel **Magura Menja air forks**, these are high quality forks, designed for long service intervals. Menja forks are designed to run smoothly and feature DLO, dynamic lock out, which means that the “sag height” is maintained when the forks are locked out., which gives the quicker steering that is desirable when on smooth surfaces.

Brakes

We supply the MTB spec with **160/160mm Shimano Deore hydraulic disc brakes**. Deore brakes are very reliable and low maintenance, indeed many hire centres insist on using these brakes. The Deore brakes certainly have adequate performance for **serious MTB use**.

Chain

We fit a **KMC Z610HX 3/32” single speed chain** to the MTB spec Sterling. This chain has bushless construction and thicker side plates, with mushroomed rivets.

Crankset, BB and chainring

We supply the MTB spec with our own **SJSC single chainset**, which includes one of our 7075 alloy rings (please see Pukka spec for details) This is a perfectly adequate and suitable chainset for serious use. The default option is to fit 170mm cranks on the S/M size Sterling and to fit 175mm cranks on the M/L and L sizes.

Please Note: The MTB spec comes with Magura Menja air fork.
Bike also shown with upgrade to Rolls saddle

Wheels and Tyres

The MTB spec Sterling is equipped with a **Silver Rohloff hub and a silver centre-lock Shimano Deore disc front hub**.

Apart from these items the wheel and tyre spec is the same as the Pukka spec. Please see Pukka spec for more details) The hubs are laced and hand built, by a master wheel builder, into black Rigida disc bull rims, using double butted, stainless steel spokes.

The standard tyres are 2.1” Panaracer Fire XC folding tyres. We offer the option of the Panaracer Rampage 2.35” tyres. The wheels are fitted with top quality inner tubes with Presta valves

Bars, grips, stem, seatpost, saddle, pedals and Crud catcher.

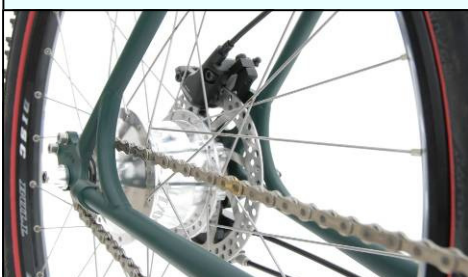

The MTB spec is supplied with Thorn MTB comfort riser bars, which are fitted with our anatomic cork grips, these are great to grab a handful of and are warm in cool weather and cool in hot

weather, the cork doesn't absorb moisture and they stay put! We also supply one of our own stems, we try and fit a black stem when we can. A micro adjustable reasonably lightweight seat post is included and a high quality Selle San Marco Rolls saddle is provided. We do not supply any of our bikes with pedals included in the price.

Recommended additions

Whilst we recommend the same additions to the MTB spec as we recommend with the Pukka spec, we realise that the idea of choosing the MTB spec, as opposed to the Pukka spec, is to keep costs down! Nevertheless, please note that a Crud Catcher is not standard issue with the MTB spec. (Please see Pukka spec for more details)

Alpine brake upgrade. If you plan to ride black routes in the Alps, or if you plan to haul huge amounts of luggage on the Nomad Mk2 upgrade, you may wish to consider an upgrade to 203mm Hope Tech V2 brakes, with floating ventilated rotors on the front and rear. You may not need more stopping power but you are likely to require the capacity to dump more heat! **NOTE.** The SID team forks (Pukka spec.) are prohibited from using such a large front brake. You can read a little more about this brake on page 17

**Tough,
Matt
Green
Powder
Coat
Finish**

Trekking Spec

The concept behind the "Trekking spec" is to provide a fully equipped on/off road bike for fun-packed on/off road, light touring. Our Trekking spec Sterling has an absolutely superb frame, a Rohloff hub, low-maintenance suspension forks with low (and easy) maintenance V brakes. This machine is capable of genuine off road performance...the extent of which is limited only by the choice of tyres.

Trekking spec Sterling, what you see is what you get!



Please Note:
The Trekking spec comes with Magura Menja air fork. Bike also shown with upgrade to Rolls saddle

Bike shown is size S/M (582 Small/Medium)

Forks

We supply the "Trekking Spec" Sterling with the latest 100mm travel **Magura Menja air forks**, these are high quality forks, designed for long service intervals. Menja forks are designed to run smoothly and feature DLO, dynamic lock out, which means that the "sag height" is maintained when the forks are locked out., which gives the quicker steering that is desirable when on smooth surfaces.

Brakes

We supply the Trekking spec with **Shimano Deore V brakes**, which are very reliable, require very low maintenance and have cartridge brake pads.

Crankset, BB and chainring

As with the MTB spec, we supply the Trekking spec Sterling with our own SJSC single chainset, which includes one of our 7075 alloy rings (please see Pukka spec for details) This is a perfectly adequate and suitable chainset for serious use.

The default option is to fit 170mm cranks on the S/M size Sterling and to fit 175mm cranks on the M/L

Chain

We fit a **KMC Z610HX 3/32" single speed chain** to the Trekking spec Sterling. This chain has bushless construction and thicker side plates, with mushroomed rivets.

Wheels and Tyres

The Trekking spec Sterling is equipped with a **Silver Rohloff hub and a silver Shimano Deore front hub. We have also chosen the superb Rigida Grizzly rims.** (Rigida Grizzly CSS rims are available as an upgrade. CSS rims have a tungsten carbide brake surface, which improves wet weather braking slightly but **increases rim life dramatically...you don't need discs to avoid worn out rims!** The CSS rims require special brake blocks, which we supply when the rims are upgraded. The wheels are laced and hand built, by a master builder, using double butted, stainless steel spokes.

The standard tyres are 2.0" Schwalbe Hurricane folding tyres, which roll very nicely on tarmac and have exceptional dry weather off road performance (wet off road conditions need to be treated with more care! But you would not wish to ride very far, on the road, on tyres which genuinely thrive in mud!). The wheels are fitted with top quality inner tubes with on the road with tyres Presta valves

Bars, grips, stem, seat post, saddle, mudguards, Cruddie, carrier and pedals.

Like the MTB spec, the Trekking spec Sterling is supplied with Thorn comfort riser bars, which are fitted with our anatomic cork grips, these are great to grab a handful of and are warm in cool weather and cool in hot weather, the cork doesn't absorb moisture and they stay put!

We also supply one of our own stems, we try and fit a black stem when we can.

A micro adjustable reasonably lightweight seat post is included and a high quality Selle San Marco Rolls saddle is provided.

A wide (65mm) SKS rear mudguard is fitted as standard along with a Crud catcher...this combination will keep most of the muck off you, without the hazard that front mudguard stays present, when being used off road, where loose sticks may abound. It also looks fairly cool too!

As you will have read, the Trekking Spec Sterling is designed as a light weight on/off road touring bike, we have fitted it with a Blackburn Mtn. Carrier and Profile cage, along with Thorn bottle as standard issue.

You still need to choose and purchase pedals however!

Recommended additions

The same additions as the Pukka spec are offered with the Trekking spec.

(Please see Pukka spec for more details)

Recommended additions

A Blackburn Mtn. carrier is a very lightweight and useful accessory. Not only can it carry 9Kg off road (should you want to) it gives you a great sense of security when hanging off the back of the saddle, with the seat of your pants hovering above the rear tyre!

I know (almost) everybody uses a hydration pack but an old-fashioned bottle lets you "pop out for an hour" (or take a sticky drink) with minimum fuss. The old profile cage was great...so great in fact that we got more made especially for us, very highly recommended, perhaps you want two?

A Thudbuster LT suspension seat post, setup to only react to large bumps, will allow you to practically keep up with high quality full suss XC bikes downhill (you'll drop them on the climbs!) The "strange at first but easy to get used to and then totally natural feeling" downwards and backwards movement of the Thudbuster maintains a fairly constant distance from backside to pedals, thus avoiding knee problems. It is highly advisable to use a "Lizard skin" cover to protect the pivots.



If you are looking at a Nomad Mk2 or if you plan to regularly carry the maximum 15Kg on the Sterling and if you ever plan to do it off road, you will need more than a Blackburn Mtn. carrier, you will need our Thorn Expedition heat-treated tubular Cro-Mo carrier and the adaptors to convert the dropout bosses from 2 x 5mm to 1 x 6mm. This adaptor also pushes the carrier and thus the heavy panniers out further, to clear the rear rotor. As the adaptors have to be hand tuned by our mechanics, to clear the IS disc mount, it's a good idea to order one of our carriers with the bike (or frame). If and only IF you are using the Mt.-Tura fork you may wish to consider our tubular heat-treated Cro-Mo Mk5 Lo-loader carrier. This is the strongest carrier on the market.

A computer is a nice thing to have, it not only gives you encouragement, it also allows you to know when servicing is due, the Cateye CC-MC100W wireless computer is easy to use and it is undoubtedly the most reliable on the market.

Perhaps you already have suitable pedals which you can use? If not you will require some.

SPD pedals give great control and are highly recommended for serious off road use. Shimano's M520 double sided SPD pedals allow you to try the system yourself very inexpensively. If you want to use conventional "flat" pedals, the best on the market are Shimano's

MX30DX pedals, these are double-sided and have raised adjustable and replaceable stainless set screws, to provide superb grip for your shoes, with minimum risk to your shins.



In some circumstances it makes great sense to generate your own electricity, to power up lights, which are bright enough for you to be able to see where you are going and/or to recharge GPS batteries. A Schmidt dynohub will give as much light as many 6w rechargeable systems, for very little effort. Whilst not perhaps bright enough for MTB riding, it certainly produces enough light for spirited riding, in country lanes, on moonless nights. We supply the dynohub built into a wheel and we supply it fully wired in to a Busch and Miller Lumotec switchable headlight. , we fit the headlight with an uprated bulb to provide even more light to see with! **Stop press.** The new lightweight Schmidt Son 20R will power up the amazing Edelux high power LED front light, when used with a 700c wheel. Not only is the hub significantly lighter, the Edelux light requires less power and therefore the small effort required to generate your own power is further reduced. The Edelux light makes it easier to ride in the pitch black lanes than with a 15w halogen bulb of an old fashioned rechargeable system. Real technological progress but at a really scary price!





multi
functionality

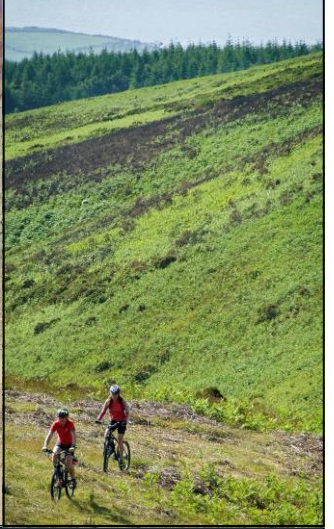

THORN Mt.-Tura fork.

How to, in effect, own two different Thorn Rohloff bikes for “just a little more” than the cost of one.

We have considerable experience in providing superbly handling, steel-framed, touring bikes, with steel forks. I designed the Sterling around a 100mm travel suspension fork. When I designed the frame, I also designed a fork, specifically for the Sterling, which could replace the suspension fork and turn it (the Sterling) into a beautifully handling, rigid touring bike.



Look at the length of available steerer!



For reasons of safety, we will not attach a disc brake to a steel fork, consequently the Mt.-Tura forks are supplied with V brake bosses (mounted behind the fork blades)

In addition to these, the Mt.-Tura fork has all the bosses you could need; it has a discrete dynamo boss, it has a set of four 6mm stainless bosses (for our heat treated, Cro-Mo, expedition Lo Loaders).

It has a pair of 6mm stainless mudguard bosses above the drop outs and a plate with a pair of 5mm bosses, set under the twin plate crown, to directly screw the mudguards to. The fork also has a 5mm stainless boss on the steerer, between the crown plates, to allow the secure mounting of a headlight in the most sensible place for it. I have rated the Mt.-Tura forks as being suitable for carrying up to 12.5Kg of luggage on each side!

I don't think that I would wish to carry 25Kg on the front of a bike, which only had 15Kg on the rear, for any great period of time (!) but there are many places (where those with an adventurous spirit, may wish to take a bike) that water is in short supply.

Apart from water, the kit you would need to survive, in

the extremes of heat and cold (such as are found in high mountain ranges and some deserts) need not weigh more than 15Kg, if it is chosen wisely. 15Kg is within the Sterling's capacity to carry at the rear and in a bar bag.

If the time comes, when a huge quantity of water needs to be carried, the Mt.-Tura forks give the Sterling this capacity. Closer to home, the week's shopping could be carried home in big bags at the front of a Sterling with Mt.-Tura forks, if they are equipped with our lo-loader carrier.



From Pukka disc MTB to a splendid lightweight adventure tourer (or back) in just 25 minutes! (Please see text)

25 Mins



Save money.

Top quality suspension forks cost about 12p per mile to run (5p depreciation and 7p in servicing costs) You need suspension if you want to ride off road (well you most certainly do if you want to ride at pace off road). But you don't need suspension if you are using the bike for general day to day duties, or if you are touring on the road and (probably) not on long tours, which would involve you having to service the forks whilst mid-tour!

Ideally you would have 2 or 3 Rohloff equipped bikes, each one specifically focused for a particular purpose! A few customers genuinely aspire to this but most want a bike that does it all. If you change the forks on your Sterling and fit the suspension forks only when you need to use them, you will save money and have a more appropriate bike to ride day to day.

If you have a V brake, already set up on the forks, complete with cable and lever and if you have a non-disc wheel with a road tyre mounted, it is possible to swap forks and brake levers in 5-10 minutes. (A mudguard, along with carrier, dynamo, light etc can have already been fitted to the fork)

A rear carrier, with mudguard already attached, could be mounted in 5 minutes...this would just leave you with the rear tyre to change to complete the transformation from "Pukka MTB" to "Super Tourer". If you cycle 4000 miles a year, it could take less than six months for this to be cost effective.

Mt.-Tura fork "kit A".

The cost of this kit varies, depending upon which spec Sterling it is fitted to. This is a kit which comprises of a Mt.-Tura fork (in the same colour as the frame) to which is mounted a Shimano Deore V brake and a 65mm wide SKS mudguard. The kit includes a hand built (with top quality stainless spokes) front, non-disc wheel (Rigida Grizzly on Deore) to which is mounted the tyre of your choice. Both disc specs include a Deore V brake lever and cable, the Trekking spec only requires the V brake and cable. The MTB spec needs an easily removable and (re-installable) handle bar grip to swap the lever, so this includes the upgrade to Ergon GP-1 grips.

Both disc specs require a front mudguard, whereas the Trekking spec already has a 65mm front guard left over from the fitting of the rear guard.

Mt.-Tura fork "kit B".

The cost of this kit also varies greatly depending upon which spec Sterling it is fitted to. This is a kit which comprises of a Mt.-Tura fork (in the same colour as the frame) to which is mounted a Shimano Deore V brake and a 65mm wide SKS mudguard. The kit includes a hand built (with top quality stainless spokes) front, non-disc wheel with tungsten carbide braking surface (Rigida Grizzly CSS on Deore) to which is mounted the tyre of your choice. Both disc specs include a Deore V brake lever, blue Swissstop brake pads for CSS rims and cable, the Trekking spec only requires the V brake, pads and cable. The MTB spec needs an easily removable and (re-installable) handle bar grip to swap the lever, so this includes the upgrade to Ergon GP-1 grips.

Both disc specs require a front mudguard, whereas the Trekking spec already has a 65mm front guard left over from the fitting of the rear guard.

Note Mt.-Tura kits on Trekking spec Sterlings.

It is not essential that a complete front wheel is purchased with the Mt.-Tura kits for the Trekking spec bikes. But it does save time, not having to keep swapping the tyres around. Swapping the front V brakes from fork to fork is also obviously possible but the brakes would certainly need to be adjusted to suit each different fork, this can often take an unexpected and considerable, amount of time!

How to avoid having to change the rear tyre, when performing the transformation.

Do you plan to alternate between some rides being "road rides" and other rides being "off road rides"?

Would you like the bike to be set up nicely for each situation, yet you don't have the time to keep swapping rear tyres over? A Schwalbe Marathon EX, or a Schwalbe Hurricane, rear tyre provides good rear grip both on the road and in Trekking situations.

Nevertheless, it is a huge advantage to have a specific front tyre, such as Marathon Supreme, for riding on road and a different, specific front tyre for riding off road, such as a Schwalbe Smart Sam Alpencross (or even more especially) a real, knobbly, mountainbike front tyre.



As there is no need to change the rear tyre, the swap between these 2 V brake set ups can be accomplished in under 5 minutes



THORN NOMAD MK2

The Nomad name.

The original Thorn Nomad was a ground breaking derailleur geared touring bike, which we produced between 1996 and 2004, it rapidly became the machine of choice for a great many expedition touring cyclists. It would be hard to find a corner of the world that has not been visited by one of our Nomads!

The Nomad had great strength and beautifully neutral handling, when heavily loaded. It was also very affordable!

Within a very short space of time, thousands of websites contained references to our bike. It was and still is, a much loved and highly regarded bike!

In 2002 I began to develop an expedition touring bike, which was designed, from the BB up, to use a Rohloff Speedhub. From our very first tour, Fiona and I realised that everything else was now out of date and that we never wished to have to use derailleur gears again! The poor old derailleur Nomad's number was up. I knew that we wouldn't want to produce such a bike for much longer but I most certainly **did** want to keep the name!

The process of development continued and, several years and several prototypes later, I genuinely felt that it would be impossible to make a better bike...I had the ultimate, field tested design for an expedition bike and now all I had to do was to somehow make it affordable!

The Nomad name lives on.

We re-introduced our "famous name", and the first Thorn Raven Nomad made its debut in 2007. The first batches were all equipped with S&S couplings and they were not designed for use with front suspension. These have sold very well and the bikes have proven themselves to be very robust and very durable.

Some people say that the bikes are heavy but I have had no complaints from any customer, who was looking for a true expedition touring bike.

Crashing down rocky trails, with huge loads or being thrown around by baggage handlers, is a sure way to test robustness and durability to their limits. There is no substitute for tube wall thickness, in these circumstances.

What would be the point of having an expedition frame built with tubes, which would lose all their structural integrity, once they had a big dent in them?



S&S couplings and S&S specific cable routing.



We give you the choice of where you fit the under the down tube bottle. You can fit it above the couplings, for quicker separation. Or you can straddle the coupling with it, which allows a bigger bottle and a lower Centre of Gravity but increases the time taken to separate.



The Thorn Nomad Mk2 now offered with a choice... with S&S couplings, or without.

Over the last few years, I have often wondered if some people were buying the Nomad S&S in spite of the couplings, rather than because of them.

The new **Nomad Mk2** is available both with S&S couplings and without them.

I'd always suggest that you have the bike with couplings. There are many upsides to having S&S couplings and only 3 downsides to them, as far as I can see, these are:-

(1) You have to check them every day, which is no big deal.

(2) They add about 500g to the frame, including the special cable guides and joiners.

(3) They do considerably more damage to your bank account, compared to the uncoupled Nomad.

One day it may be absolutely necessary, to make your bike into as small a package as the couplings allow, in order to avoid surcharges, or fit into a small vehicle.

This will certainly save you money and may, in extreme cases...

...allow you to save the bike!

The Mk2's frame fittings.

The Mk2 Nomad has a substantial, open ended gusset between the head tube and the down tube, if you hit a large obstruction, at speed, with a heavy load, you may be glad that we considered this to be a good idea, with or without suss forks!

The Nomad Mk2, has 3 stainless bottle cage bosses, 6mm carrier bosses, huge tyre clearances. It has stainless guides, stainless eccentric screws and bosses, it has our own stainless, Rohloff-specific dropouts and it has direct-fit mudguard mounts. It's got the lot! It has even got a rear ISO disc mount **and** removable V brake bosses.

The Nomad Mk 2 is now suspension compatible.

The Nomad Mk2 is designed to be compatible with suspension forks with 80 or 100mm of travel.

100mm forks are around 470mm long, by the time the "sag" has been set and the fork is riding on a rippled surface, it is around 435mm long. The Mk2 Nomad's geometry is designed to give superb handling with such a fork.

The Mk2 Nomad comes with its own super quality, steel twin plate crown Reynolds fork, which is 420mm long. This fork has the correct offset to allow the bike to give superb handling, with or without, a heavy load at the front.

With this fork, the BB height is ideal for a rigid bike. With a suss fork, it is also a "normal" height for a hard tail MTB.

I'd never set out on an intercontinental expedition with a suspension fork but Fiona and I both use a suss fork (with XTR V brakes) for our adventure holidays, in the Andes.

There are some front carriers on the market, which, apparently, work with suspension



The Nomad Mk2 frames weigh around 3Kg but, considering their great strength, they are very lightweight!

forks. We don't fit these to the bikes we send out, as the suss fork manufacturers do not give a warranty for their use. However, I believe that a suspension adventure touring bike should only have a very small weight on the front, otherwise it will "dive into holes". A lightly loaded bar bag and perhaps a couple of litres of water, on occasion (if you can contrive to fit the cages to your fork yourself) are all that I'd recommend.

If you fancy a Mk2 Nomad, built with a suspension fork, please decide upon which specification Sterling is most appropriate to your requirements and use that as a basis for your suspension Nomad.

For V brake bikes, please select "Sterling Trekking spec".

For spec with Shimano Deore hydraulic disc brakes, please select "Sterling MTB spec".

For Rockshox Sid Team forks and Hope hydraulic disc brakes, please select Pukka MTB spec.

We are sorry that this is not straightforward but we believe that most Mk2 Nomads will be purchased with the rigid fork, in the knowledge that a suss fork could be fitted (by the owner) if required, at a later stage.

If you are interested in a non-suspension Nomad Mk2, please look at the Nomad Mk2 brochure but, please note; the brochure you are currently reading is the only one which has options for suspension or for disc brakes. We have simply copied much of what you have just read into the Nomad Mk2 brochure!

Nomad Mk2 with suspension and with disc brakes.

At the time of writing, there are no disc brakes available, that I'd want to use on an adventure touring bike or (even more especially) on an expedition bike. I have incorporated the ISO disc mount to "future-proof" the bike.

If you are a big, heavy, powerful rider who is looking for a Rohloff equipped MTB for use in conditions where lighter riders are happy to use a 100mm travel hard tail, fear not, the Nomad Mk2 is certainly up to the task!

Ultimate disc brake.

If you are looking at the Nomad Mk2 as a heavy duty touring MTB, especially for use in alpine conditions, you may want to specify Hope ventilated rotors with tech V2 callipers; they are very expensive however, and you'll need to consider how to avoid damaging them in transit. The Hope Tech V2 callipers used in combination with the 203mm floating, ventilated rotors, are **the** brakes to have (at the time of writing) as far

as their ability to dissipate heat is concerned. We even recommend their use, as a third brake, on our tandems. There is no way that you could possibly need the awesome braking potential that these brakes offer and you could bend the stanchions on some forks if you tried. It is not at all unusual, with a loaded bike, under prolonged braking, on even a moderately long hill, for ordinary disc brakes to literally burn out! We are not saying that you couldn't burn these brakes out too, if the forces were great enough, for long enough but these brakes will dump the most heat of any brake that we have tried.

(Ventilated rotors have been used in motor sport for many years and many high quality road going vehicle have them. The ventilation does not refer to the holes drilled in them, it refers to the fact that the rotors are of twin skin construction and therefore present a considerably larger surface area to the air in order to dissipate heat.)

Enormous luggage carrying potential.

The Nomad Mk2 will carry in excess of 35Kg, over the most extreme terrain, on the rear carrier alone, as long as you specify our own Thorn Expedition carrier. Our carrier is made of aircraft quality, heat treated, tubular Cro-Mo and it is the strongest carrier on the market. Once again, we don't know whether to laugh or to cry when we see a titanium carrier which weighs 300g being touted as being capable of carrying 30Kg.

Yes it may support 30Kg but it won't carry such a load without swaying and I doubt if it would carry such a weight over rough surfaces for long! Our carrier could support 250Kg. (if you could balance 250Kg of grain on our carrier, you could gently push the bike along...if they were not so expensive to produce, we could sell millions in India!)

Choice of colour.

We offer the Mk2 Nomad in a choice of 2 tough power coat colours; super stealthy, sophisticated, Matt Black, or totally in your face "Tonka" yellow.

Our frames have a thorough rust proofing process applied before the super tough powder coated finish, it will take some knocks. Decals are applied and then the frame is given a clear coat of powder lacquer. "Conventional" touring wisdom says that black is a much less noticeable colour and why attract attention? Believe me, if you have a huge touring load and especially if you have a different skin colour to the locals, you'll attract attention, no matter what colour your bike is!

With a yellow bike though, a potential thief has to consider how inconspicuous they will be, when making off with your steed. If the worst happens, there may be much more chance of retrieving the bike again, if the bike is a different colour from all the local bikes, which often tend to be black. Don't choose the colour based upon not standing out, choose the colour you like yourself. Yellow certainly stands out in the holiday photos!

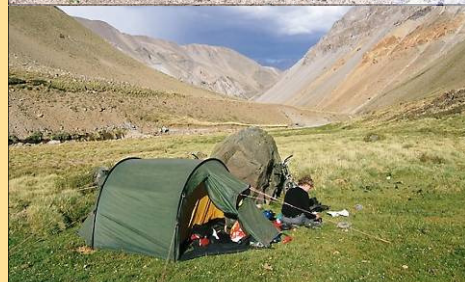

**Size
565L**



You can see above just how strong a colour the “totally in your face, Tonka Yellow” is.

The Bike above is based on the trekking spec Sterling. The changes to spec. include Expedition carrier, a Cateye opticube rear light, 2 extra Profile cages, a Brooks B17 saddle, Ergon grips and 2.25” Schwalbe Marathon Extreme tyres.

Below, you can see a worm’s eye view of the superb cable routing to the EX box on the Nomad Mk2. The stainless steel eccentric screws and bosses can also be seen.

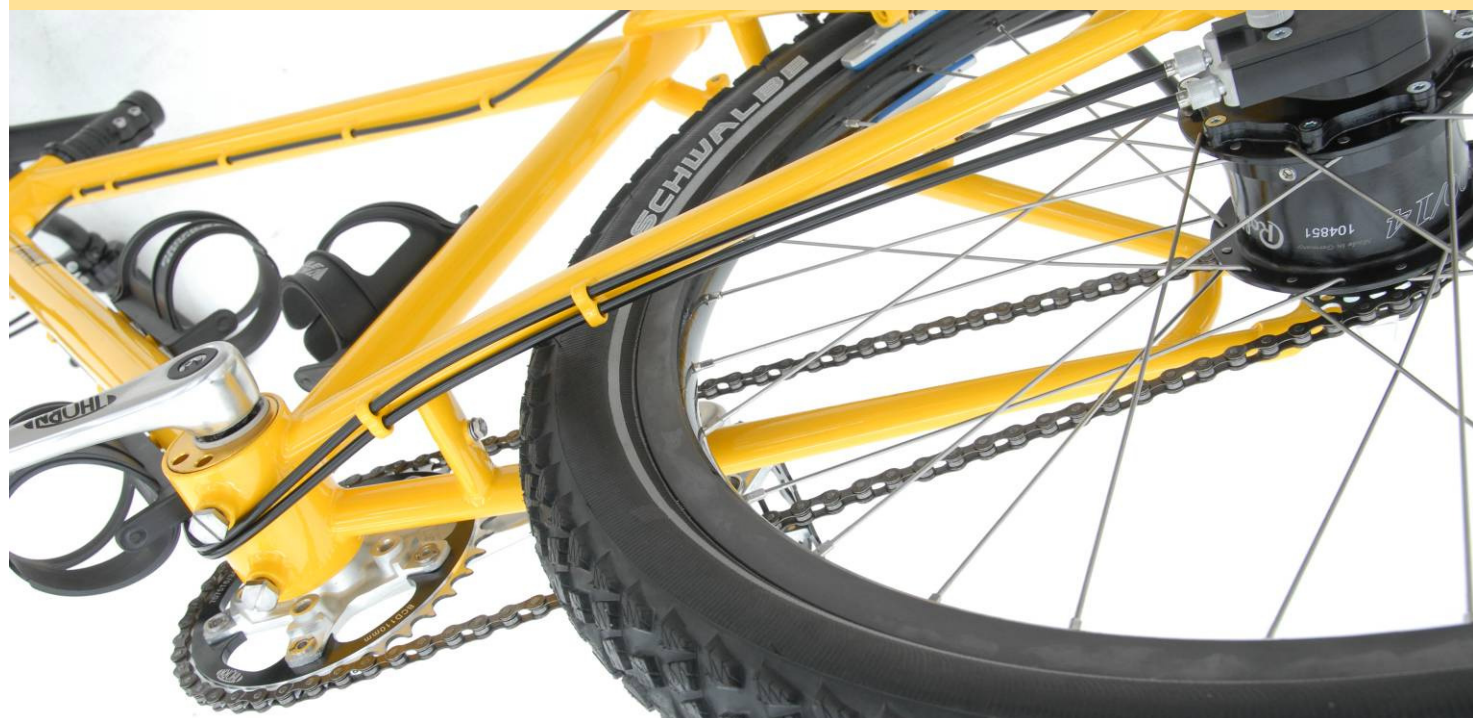

Sizes of Nomad Mk2.

(Please refer to the Matrix)

All sizes of the Mk2 have a fairly steeply sloping top tube. Especially when fitted with a suss fork and without the weight of a rider.

This steep slope is essential to provide the rider with a low enough top tube to be able to stand over it in the middle.

We call this mid tube standover height.

It is essential that you can stand over your bike at this point. (Long legged riders may even be able to straddle the bike, when equipped with suss forks, at the very front with clearance, this is fortuitous, rather than essential.)

Suss forks will "sag" when you sit on the saddle and they will sag even more when you pedal gently. We call this "normal ride height" but, please note that the forks will rise, the moment you jump off the saddle! You will see the dimensions in the matrix, it may be confusing to understand what the frame sizes mean.

One way that we size our bikes is to measure the seat tube, from the centre of the BB, to the intersection of where the centre line from the top tube would intersect with it, if the bike had a horizontal top tube. This is the "SIZE" in the matrix. We have some frames with medium length top tubes and other frames with long top tubes. This is the letter after the size (M or L).

When you take this information into consideration, along with the actual centre to

centre measurement of the seat tube, it gives you a good idea of what the rest of the frame is like.

We also give the "slope"...this is the difference between the size and the actual seat tube C to C.

We also subtitle the frames as simply **small, small/medium, medium, large and X large**, this refers to the height of the frame. The **small frame (510M)** has the shortest

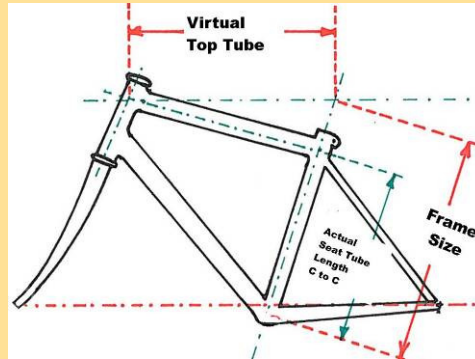

top tube, that we would use with a suss compatible bike. Please also note that we can't make an extra small suss frame. You'll notice that there are 2 medium size frames, with different length top tubes (565M and 565L). The 565M will suit most women from around 5'6" (1675mm), as well as many men from around 5' 8" (1725mm), who are looking for a more upright position. (Please note that the average woman, of a given height, has longer legs than the average man, of the same height. But please also note the use of the word "average", as this is not always the case!)

The Xtra Large frame (620L) is huge, it is the biggest frame we have ever made and will suit customers up to 6' 8" (2030mm). But, although the 620L has suspension compatible geometry, we do not know of a suspension fork, which has a long enough steerer to be used with this frame.

Our method is, believe it or not, what we consider to be the most sensible way of doing things. If you were to simply measure to the top of the actual seat tube, it wouldn't tell you much about the frame and the current MTB convention of calling things an, apparently random, measurement in inches only works, as long as all frames have a similar shape and as long as all manufacturers agree to this convention. I expect that we could call our 6 frame sizes 15", 16", 17", 17", 19", 19" and 21" If you come from an MTB background, it would make some sense.

Paradoxically, if you come from a traditional touring background, where frames were once measured centre to top, it would make more sense, if we called them 19", 21", 22.5", 23", 24.5", 24.5" and 26".

I hope that I have explained why we don't do either of these things, a 19" touring bike would be ludicrously small for someone who thought that they wanted a 19" MTB and a 21" MTB would be monstrously huge for the shorter than average man, who may ride a 21" touring bike!

Confused? Don't worry, a couple of phone calls, or emails to us, is all it will take to make certain that you get the correct size Nomad!

[1] SIZE (virtual seat tube length C to C)	[2] Actual Seat Tube length C to C	Slope [1] Minus [2]	Length of Head Tube	Virtual Top tube C to C	Chain Stay To centre of eccentric	Seat Angle with steel fork	Mid Tube Standover height With steel fork and 2.0" tyres	Stand Over Height at front of top tube with steel fork	Seat Angle At "Normal" ride height, with 100mm suss fork and 2.0" tyres	Mid Tube Standover (without rider) with 100mm suss fork and 2.0" tyres	Stand Over Height at front of top tube with suss fork (without rider)
510M (Small frame, Med top tube)	370	140	85	555	447	74.5	725	775	73.75	747	820
540L (Small/Medium frame, long top tube)	400	140	113	590	466	73	755	805	72.25	777	850
565M (Medium frame, med top tube)	400	165	139	575	453	73.5	745	815	73.25	767	860
565L (Medium frame long top tube)	415	150	139	605	466	73	775	825	72.25	797	870
590M (Large frame medium top tube)	445	145	166	585	466	73	800	845	72.25	822	890
590L (Large frame long top tube)	460	130	166	620	472	73	810	855	72.25	832	900
620L (Xtra large frame long top tube)	520	100	200	635	479	72.5	850	880	71.75 *see notes	872 *see notes	945 *see notes

Thorn Nomad Mk2 size matrix. Standover heights at front are measured 75mm back from headset.

*Please note size 620L's headtube is too long for the steerer of any suss fork steerer that we know of.

The joy of being on tour with the ultimate, heavy duty, suspension specific, adventure touring bike. *By Andy Blance.*

Fiona and I still use our prototype Nomads for our adventure touring holidays and for any cycling, which involves flying with the bike. They have taken us on the biggest adventures of our lives.

You could never accuse these bikes of being lightweight but I am convinced that they weigh significantly less than any other bikes of comparable strength!

We love these bikes so much that we have given them names, my bike is called Hector, Fiona's bike is called Bertha. Bertha is the final prototype for the Nomad Mk2

These bikes have long chainstays, having extra long chainstays means that we can carry (almost) all of the load at the back and it will sit inside the wheelbase, therefore we have bikes which handle superbly with medium/small to ultra heavy loads.

With suspension forks, you really do not want to be loading up the front of a bike...otherwise it nose-dives into every hole! This is not advertising hype, we actually ride these bikes hard!

We have crossed the Andes 22 times in the last 5 years. In doing so, we have climbed some of the biggest, wildest and most remote passes in the world.

Many of these crossings were 7 days between sources of supplies...the longest was 10 days. We are not superhuman or even super athletes, we are simply very stubborn and determined and we have the best kit in the world for these adventures. The finest kit is no substitute for determination but knowing that your bike can carry sufficient food and water without wasting your effort (and without breaking!) helps inspire confidence. Determination is born out of confidence and self awareness; survival also depends upon preparation and luck. The weather can change suddenly in mountains and having emergency water, several extra days' food and fuel, sufficient warm clothes and a strong tent, is literally the difference between having a good travel story to tell or never being able to tell a story again.

Sitting on the low parapet of a bridge in Chile, for a bite to eat. On the ripio (gravel roads), the bridge usually offer some respite from the dust and reveal a (previously hidden) view to distant mountains



On one of our trips, Fiona and I climbed out of the Atacama to 4,800m+ whilst carrying 50Kg each (mostly water) and, apart from 2l on the forks and our bar bags, all the weight was at the back. I can't say that the relentless climbing, in blazing sun, was easy but the bikes felt efficient and totally stable. We have also descended many of the most exhilarating trails in South America. The descent, on the old "road", from Uspallata to Mendoza, has 365 hairpin bends, many of which are off camber and with surfaces, which alternate between:- sand, gravel, corrugations, loose rocks or slick rock, with every bend. On one really steep section, on the outside edge of every second hairpin, there was a sheer, unfenced drop of hundred of meters. As usual, there was a little room for error but the consequences, of any major misreading of the trail,



As I explained to Fiona, whilst some may think that I am on holiday, it is obvious that, as “designer and test pilot”, I have to make absolutely certain that the bikes are up to their advertised job!

Please don't try this on a conventional, short wheelbase MTB...with your camping kit in a backpack, or in a trailer!

With their rigid steel forks fitted, H&B (Hector and Bertha) become “conventional” expedition touring (or travel) bikes and can carry any amount of weight, at the front, that may be required.

In 2008 we went on a (cheap) hotel based tour of Southern India's Western Ghats. H&B used their steel forks and 2.0” Schwalbe Marathon Supreme tyres to negotiate the broken tarmac. H&B certainly felt very comfortable, yes, of course they were totally overbuilt for such a trip; we could more easily have used Sterlings but we had no worries about these bikes being damaged in transit and of course, we didn't have to send the forks off, to be serviced, when we returned!



Hector on smoother road surfaces in India, with a relatively light load and steel forks.



were severe! It was sublime to be “right in the moment” and to carve a line through the obstacles, with 30+Kg of camping kit on the back, at speeds of up to 60Kph.

Yes, I may appear crazy but I prefer to think that I am a highly skilled rider, who was lucky enough to be riding the finest adventure touring bike ever made, on the most exhilarating “road”, yet to be encountered, in a lifetime of cycling!

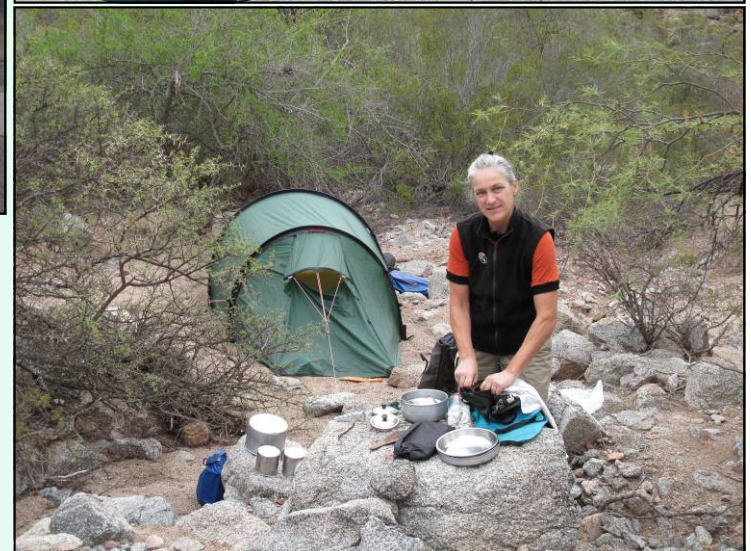

THORN STERLING ORDER FORM

- Frame only.....£399
 - Frame & Rohloff hub built into a wheel.....from £1399
 - Complete bike...Pukka MTB spec.....£2999
 - Complete bike...MTB spec.....£2499
 - Complete bike...Trekking spec.....£2299
 - Upgrade complete bike to Nomad Mk2 frame (inc. steel fork see note*)...+£100
 - U/G complete bike to Nomad Mk2 S&S frame (inc. steel fork see note*)...+£500
- Note* complete bike comes with the suss fork appropriate to chosen spec.
E.g. you get the Sid forks with Pukka spec and Menja forks with MTB or Trekking spec.

Any colour you like in industrial powder coat
(Please note that we can't fit decals other than self adhesive vinyl decals.) ...£250

Size and colour (please write)

Crank Length 170
175

Chain ring 38, 39, 40, 42, 44, 46
16t sprocket is standard and 38t ring is recommended for offroad use

Cut suspension fork steerer
Cut to default length
Default length varies with frame size, S/M length = 205mm, M/L length = 230mm, L length = uncut
Cut to different length, please specify

Handlebar stem length.
Equip cycle with default stem
Default stem length varies with frame size
S/M = 100mm 17 deg, M/L = 120mm 17 deg
L length = 130mm 17 deg.
Provide different length/angle, Please specify

Total sale price £_____ Deposit paid £_____ Card Cash Other

NOTES SPECIFIC TO THIS SALE

Invoice No _____
Male Female Title _____
First name _____
Surname _____
Address _____
Town _____
County _____
Country _____
Postcode _____
Telephone numbers.
Home _____
Work _____
Mobile _____
Email address _____@_____



Call on 01278 441 500
Email sales@thorncycles.co.uk
Online www.sjscycles.com

St John St Cycles,
Thorn Cycles Ltd,
91-93 St John St,
BRIDGWATER,
Somerset
TA6 5HX

PLEASE NOTE:- Occasionally some items become unavailable for long periods of time. We reserve the right to substitute items of similar (or greater) value, where there will be no adverse affect on function. No surcharge will be made for this

St John St Cycles is a trading style of Thorn Cycles Ltd
(Incorporated in England 4121096 -
registered office: St John St Cycles, 91-93 St John St,
Bridgwater, TA6 5HX)

Set up dimensions

Height = _____ mm Standover Height = _____ mm Shoe size =-

- Racing
- Sporty
- Relaxed
- Upright
- Dropped
- Straight
- Comfort
- Other

The dimensions below will enable us to set up your new bike exactly as your favourite machine. Please provide either "L" or "H"

If you don't have a "favourite machine" please provide all data requested above!

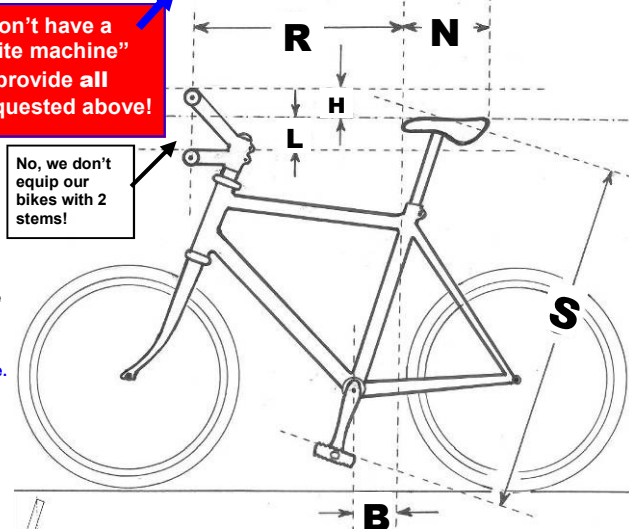

N = _____ mm
Overall saddle length & name of saddle.

S = _____ mm
Distance from top of pedal (with crank in line with seat tube) to the top of the saddle, measured along the seat tube.

L = _____ mm
Using a level straight edge; distance from top of the saddle to top of stem (with drops.)
Or to top of grips, with straight or comfort bars.
Bars are lower than saddle.

H = _____ mm
Using level straight edge; distance from top of saddle to top of stem (drop bars).
Or to top of grips, with straight or comfort bars.
Bars are higher than saddle.

B = _____ mm
Distance of plumb line behind BB, from saddle.

R = _____ mm
Distance from tip of saddle to a centre line through the handlebar grips. (Or to the straight tops of drop bars)
Please see diagram

Please note:
The dimensions that you send us must be accurate.
Please get somebody else to check your measurements.

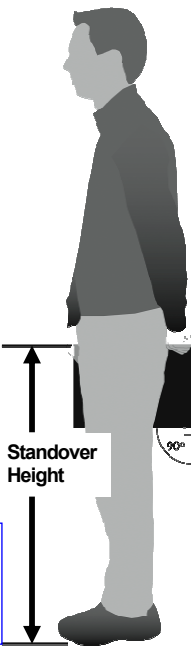

How standover height is to be measured.

- [1] Cycle shoes must be worn
- [2] Measure the distance from the ground to the top of a tube (or thick book) which is parallel to the ground.
- [3] Raise the tube (or book) as high as it will go, until contact with the crotch is made.

Standover height is NOT trouser length, trousers go down to the ankle...
...feet go down to the ground with shoes!

Upgrade or addition Please see text for details...this is the order that they appear in the text, starting from "Pukka spec"	Pukka MTB Spec	MTB Spec	Trekking Spec
Rock Shox Sid Team Forks.	Already supplied with this spec.	+ £200	No V brake mounts on SID fork
Hope Tech X2 hydraulic disc brakes inc Hope front hub.	Already supplied with this spec.	+ £190	Trekking is V brake spec
Hope Tech M4 four pot front calliper and 183mm floating rotor. Special price...Highly recommended	+£10	+ £200	
Shimano Deore cranks, 2 piece...external bearings black	Already supplied with this spec.	+£45	+£45
Sram PC 890 the best (8 speed chain) currently available	Already supplied with this spec.	+£22	+£20
Panaracer Rampage 2.35" folding tyre	+£10	+£10	+£10...but too much tyre for on/off road
Black Rohloff hub	Already supplied with this spec.	+£30	+£30
Upgrade to disc hub, to future proof Trekking spec	Already supplied with this spec.	Already supplied with this spec.	+£23
Easton EA30 riser bars, for those who don't wish to try our own superb Thorn Comfort riser bar	+£20	+£20	+£10...a bit wide for trekking
Thorn straight bars with "ski bend" bar ends and rubber grips	£ Zero	+£10	+£10
Thorn straight bars with Thorn ergo control bar ends and Ergon GP-1 handlebar grips	+£16	+£28	+£28
Ergon GP-1 handlebar grips	Already supplied with this spec.	+£12	+£12
Crud Catcher front "mudguard"	Already supplied with this spec.	+£10	Already supplied with this spec.
Blackburn Mtn. carrier...black supplied, silver needs requesting.	+£35	+£35	Already supplied with this spec.
Profile bottle cage and Thorn bottle (each)	+£11	+£11	Already supplied with this spec.
Thudbuster LT suspension seat post, inc protective neoprene "Lizard skin" cover	+£140	+£140	+£140
Schmidt dyno hub...silver	+£138	+£188	+£158 (non disc)
Schmidt dyno hub...black	+£149	+£199	+£188 (non disc)
Light and bracket for Schmidt dyno hub...various options are available	+£'s varies with choice	+£'s varies with choice	+£'s varies with choice
Thorn expedition heat treated Cro-Mo rear carrier	+£70	+£70	+£35
Cateye CC-MC 100W cordless computer set and fitted	+£40	+£40	+£40
Rigida CSS Grizzly rims, Deore levers and brakes and Swisstop blue pads. Strong and very hard wearing but fairly light weight rims.	Not applicable, these specs have disc brakes		+£99
Rigida CSS Andra 30 rims, Mega strong and very hard wearing...the ultimate touring rim. Levers, brakes and pads as above.			+£85
Shimano XTR V brakes, the best V brakes available.			+£175
65mm wide SKS rear mudguard	+£35	+£35	Already supplied with this spec.
THORN Mt.-Tura fork matt green Please Note that the Mt.-Tura fork is supplied in addition to the suspension fork.	Contact sales for a price		
Mt.-Tura fork Kit A please see page 14 of the brochure for details, standard rim...choose tyre			
Mt.-Tura fork Kit B please see page 14 of the brochure for details, CSS rim, & blue pads...choose tyre			
Thorn expedition Lo-Loaders for Mt.-Tura	+£70	+£70	+£70
Shimano (M520) double sided SPD pedals (inc cleats)	+£19	+£19	+£19
Shimano LX (M540) double sided SPD pedal (inc cleats) higher quality version of the above	+£45	+£45	+£45
Shimano MX30 DX double sided flat pedals great grip	+£66	+£66	+£66
Other pedals, please specify	+£'s varies with choice	+£'s varies with choice	+£'s varies with choice

THORN STERLING



'The most multi-functional bike we have ever made!...'

The bike shown above was built for a customer in Canada, he wanted a bike to ride to work all year round...he lives in the Rockies and his winter commute is in the dark at minus 30 degrees! He is very happy with his bike!

Copyright © 2010 Thorn Cycles Ltd. - All rights reserved

St John Street Cycles - Thorn Cycles Ltd. 91-93 St John Street - Bridgwater, Somerset TA6 5HX
01278 441 500 - sales@thorncycles.co.uk - www.sjscycles.com - www.thorncycles.co.uk
St John Street Cycles is a trading style of Thorn Cycles Ltd, incorporated in England - VAT no. 4121096

