

Introducing the
World's 1st Dedicated
ECO POS Printer



Star | POS Printing Solutions

Designed with **you** in mind...

star

www.StarAsia.com

Star Micronics, one of the world's largest printer manufacturers, has designed a portfolio of thermal and impact point-of-sale printers for use in a wide variety of applications. With over thirty years of manufacturing expertise and a highly-skilled R&D department, Star has not only developed printers which offer high performance and reliability, but introduced a number of unique profit-making features for the user without extra cost or extensive IT knowledge required.

The Star Difference

Star has extensively researched the needs of its users and is proud to be able to demonstrate The Star Difference in so many areas of its business, from creating the first splash-proof cover for hospitality, to providing the world's first dedicated ECO POS printer with power and paper saving tools as well as environmentally friendly packaging.

The market-leading TSP100 *futurePRNT* Series including low cost dedicated ECO, LAN and PoweredUSB models with a 4 year warranty including head and cutter epitomises Star Micronics' philosophy of providing more than our competitors at the right price. No other completely new range of printers has been so widely and so quickly accepted in such a competitive marketplace.

VALUE-ADDED HARDWARE DESIGNED FOR SPECIFIC APPLICATIONS

High Performance linked with Unmatched Versatility















Star Micronics' investment in all areas of the POS Printer "Build" has led to a range of reliable, versatile printers perfect for POS, Kiosk and hospitality use. Star's latest addition, the FVP10, encompasses all three applications making this front loading/receipt ejecting printer perfect for POS shelf or counter use as well as kiosk use; whilst the unique voice function adds a sophisticated profit-enhancing feature at no extra cost – yet another philosophy Star has used to grow its considerable market share with!

The Star Choice

Star Micronics' product philosophy has always been to give the customer a choice of products to meet their individual requirements. The wide range of choice available, encompassing on-demand ticketing and labelling printers as well as kiosk printers, is continually expanding.

The latest additions of new mobile printers as well as the revolutionary new low cost "complete" ECO receipt printer meet the demands of customers operating in a variety of environments including hospitality, retail, kiosk construction, ticketing, and labelling are effectively being met.

Typical Applications

	Mobile <ul style="list-style-type: none"> • S200 • S300 • S400 • T300 		Hospitality: Bar / Fast Food <ul style="list-style-type: none"> • TSP100 • TSP650 • FVP10 • TSP700II • SP700 		Retail Point of Sale <ul style="list-style-type: none"> • TSP100/TSP100II • TSP650 • FVP10 (Front paper exit) • TSP700II • TSP800II
	Pharmacy / Healthcare <ul style="list-style-type: none"> • TSP828 • TSP700II • HSP7000 • TSP650 • FVP10 		Hospitality: Kitchen <ul style="list-style-type: none"> • TSP100 • TSP100LAN • TSP650 • SP700 • SP500 		Supermarkets <ul style="list-style-type: none"> • TSP700II • FVP10 • TSP650 • TSP100 Series • SP700 / SP500
	Labelling / Warehouse <ul style="list-style-type: none"> • TSP828 • TSP800II • TSP700II • TUP542 • TUP942 		Hospitality: Delivery <ul style="list-style-type: none"> • TSP100 • TSP800II • FVP10 • SP700 • DP8340 		Transport <ul style="list-style-type: none"> • TSP800II/TUP500/900 • TSP700II • SP322 • SP298 • S400
	Ticketing <ul style="list-style-type: none"> • TSP700II (0.15mm) • TUP500 (0.15mm) • TSP650 • TSP800II (112mm wide) • TUP992 (112mm wide) 		Lottery & Gaming Kiosk <ul style="list-style-type: none"> • TSP1000 • TSP700II • FVP10 • SP298 • TSP800II (112mm) 		Kiosk Point of Sale <ul style="list-style-type: none"> • TSP700II • TSP650 • FVP10 • TUP500 • TUP900 / TSP800II
	Banking / ATM <ul style="list-style-type: none"> • TSP Thermal • HSP7000 • TUP500 • TUP900 		Laser A4 Replacement <ul style="list-style-type: none"> • TSP800II • TUP900 for Hotels, Retailers, Warehouses, Wholesalers		Kiosk A4 Replacement <ul style="list-style-type: none"> • TUP992 • TSP800II

KEY PRODUCT SUMMARY

		Page
Thermal POS Printers	4	6
Label & Ticketing Printers	5	7
		Matrix Impact & Hybrid Printers
		Kiosk / Terminal Printers

THERMAL PRINTERS

NEW TSP100 ECO	The World's 1st Dedicated ECO Printer with all <i>futurePRNT</i> advantages and NO extra costs	8-13
TSP100U/GT SERIES	Up to 250mm/second USB versions of the unique <i>futurePRNT</i> Series	8-13
TSP100LAN SERIES	Entry-Level Ethernet version of TSP100U with specialist LAN features	8-13
TSP100USB SERIES	The World's 1st Dedicated Entry level Powered USB Receipt Printer	8-13
NEW futurePRNT™ SOFTWARE	Details of Marketing and Installation Software included with TSP100, TSP700II and SP700 Printers	9/12
TSP650 SERIES	Low Cost, High Speed 150mm/second, Entry-Level Receipt Printers with Tear Bar or Autocutter	16-17
TSP700 II SERIES	250mm/second Multi-function Receipt Printer suitable for Labels, Barcodes, Tickets and Kiosk use	18-19
NEW TSP800II SERIES	Unique 112mm wide, 180mm/second Barcode, Label, Ticket & Receipt Printers	20-21
NEW TSP800RX	Unique 112mm wide, 180mm/second Receipt, Ticket & Label Printer with Media Security Feature	21
TSP1000 SERIES	Versatile Thermal Printer with 18cm Diameter Paper Roll and Stacker for up to 30 Tickets	23
NEW FVP10 SERIES	New 250mm/second Front Operating "Shelf" Printer with built-in Voice Communication	14-15

MATRIX PRINTERS

SP500 SERIES	Highly Sophisticated, Entry Level Receipt Printer (up to 7.5 lps) – New Interface Version for Ethernet and USB	28
SP700 SERIES	High Speed, "Drop-In & Print" Two Colour Matrix Receipt / Kitchen Printers (up to 8.9 lps)	26-27
SP298 SERIES	Reliable, Cost Effective Slip Printers (up to 3.1 lps)	24
DP8340 SERIES	Versatile, Wide (114mm), Mobile, Compact Receipt / Label Printers (up to 2 lps)	29

THERMAL / MATRIX HYBRID PRINTERS

HSP7000	Low Cost, 250mm/second, High Speed Thermal / Matrix Hybrid Printer	25
SCP700 SERIES	Thermal Label / Matrix Slip Combination Printer	24

KIOSK / TERMINAL EMBEDDED PRINTERS

Summary of Packaged and Open Frame Printers available from Star including:		7, 30-31
NEW TUP500 SERIES	220mm/second Open Frame, Modular Solution with New TUP500DP Compact Version	32
TUP900 SERIES	Versatile, Open Frame 80 – 112mm A4 Replacement Receipt, Ticket / Label Solution	33
NEW FVP10 SERIES	New 250mm/second Front Operating "Shelf" Printer with built-in Voice Communication	14-15

LABEL & TICKETING PRINTERS

Summary of Label & Ticketing Printers available from Star including:		5
TSP828 SERIES	Dedicated 112mm wide Label Thermal Printer with Automatic Label Peeler	22
TSP700 II SERIES	Multi-functional 250mm/second, up to 82.5mm wide Thermal Barcode, Label, Receipt and Ticket Printers	18-19
NEW TSP800II SERIES	Multi-functional 180mm/second, 112mm wide Thermal Barcode, Label, Receipt and Ticket Printers	20-21
NEW TUP500 / TUP900 SERIES	High Speed Open Frame Thermal Solutions (80 – 112mm wide MEDIA)	32-33
DP8340 SERIES	Versatile, Wide (114mm) Mobile, Label and Receipt Printer (up to 2 lps)	28
SCP700 SERIES	Thermal Label / Matrix Slip Combination Printer	24
NEW FVP10 SERIES	New 250mm/second Front Operating "Shelf" Printer with built-in Voice Communication	14-15

MOBILE PRINTERS

NEW SM-S200	Compact 58mm / 2" Pocket Size Mobile Printer with blue light LCD Display	34-35
NEW SM-S300	Lightweight 80mm / 3" Mobile Printer with 10 hour Battery Life	34-35
NEW SM-T300	Rugged, Dust & Splash Proof, 80mm / 3" Mobile Printer with 50mm Roll Diameter	34-35
NEW SM-S400	Compact, Wide format 112mm / 4" Mobile Printer with 11 hour Battery Life	34-35

REWRITE CARD PRINTERS

TCP300II	For high-speed Leuco rewritable card	36
TCP400	For standard 760 micron Leuco rewritable card	37
TCP300V	For stand alone usage with large LCD and "CF" data storage option	36

Star Support

Star Micronics continues to invest money and effort towards providing support for a wide selection of platforms with a full range of sophisticated printer drivers. Star's latest products demonstrate Star's determination to provide the best printers on the market with its new "intuitive" installation software for Microsoft applications including 64 bit support for Windows 7 and Vista as well as Microsoft® certification (WHQL).

Please call us if you need information on these, or any others.



JAVAPOS™











ESC/POS™

WHQL







Microsoft® Windows® XP

Thermal POS Printer Summary

The Star Printers Series	TSP100 ECO <i>futurePRNT</i>	TSP100U / GT <i>futurePRNT</i>	TSP100LAN & TSP100PUSB <i>futurePRNT</i>	TSP650	TSP700 II	TSP800 II	FVP10
							
	page 8-13	page 8-13	page 8-13	page 16-17	page 18-19	page 20-21	page 14-15
	Dedicated ECO Printers with Power & Paper Saving Tools	New, High Speed "All-in-the-Box" Thermal USB Receipt Printers	Dedicated LAN & Powered USB Thermal Printers	Thermal Receipt Printers	Thermal Barcode, Label & Receipt Printers	Thermal Barcode, Label, Ticket & Receipt Printers	New Thermal Front Operating Printers with Voice Tool
Max. Print Speed*	150mm/sec.	TSP100GT: 250mm/sec. TSP113U (Tear Bar): 125mm/sec.	125mm/sec.	150mm/sec.	250mm/sec.	180mm/sec.	250mm/sec.
Resolution	203 dpi	203 dpi	203 dpi	203 dpi	203 dpi 406 x 203 dpi selectable	203 dpi 406 x 203 dpi selectable	203 dpi 406 x 203 dpi selectable
Vertical Installation	Yes: Wall Mount Plate included Desk Boot option available	Yes: Wall Mount Plate included Desk Boot option available	Yes: Wall Mount Plate included Desk Boot option available	Yes: Wall Mount Plate included Desk Boot option available	Yes: Wall Mount Plate included Desk Boot option available	Yes: Wall Mount Kit option available	No: Unique, Flat Top, Shelf Mount option
Autocutter	Partial cut (guillotine) with 3mm default Top margin	Tear Bar and Partial (Guillotine) Autocutter models	Tear Bar and Partial (Guillotine) Autocutter models	Tear Bar and Partial (Guillotine) Autocutter models	Full or Partial cut (Guillotine)	Full or Partial cut (Guillotine)	Full or Partial cut (Guillotine)
Paper Width	80mm (58mm using guide provided)	80mm (58mm using guide provided)	80mm (58mm using guide provided)	80mm (58mm using guide provided)	82.5, 80, 58mm selectable (80mm standard with User Installable Paper Guide fitted)	112mm standard, 82.5 or 80mm options with User Installable Paper Guide option	58 ~ 80mm fully adjustable
Paper Thickness	0.065 ~ 0.085mm	0.065 ~ 0.085mm	0.065 ~ 0.085mm	0.065 ~ 0.085mm	0.065 ~ 0.15mm	0.065 ~ 0.15mm	0.065 ~ 0.15mm
Paper Roll (diameter)	83mm	83mm	83mm	83mm	100mm	100mm	83mm
No. of Copies	Auto Multi Copy Software Tool	Auto Multi Copy Software Tool	Auto Multi Copy Software Tool	Original only	Automatic 2nd Copy Raster feature	Automatic 2nd Copy Raster feature	Automatic 2nd Copy Raster feature
Print Width	50.8mm (58mm paper) 72mm (80mm paper)	50.8mm (58mm paper) 72mm (80mm paper)	50.8mm (58mm paper) 72mm (80mm paper)	72mm	80mm maximum	104mm	72mm
Interface	USB 2.0 Full Speed with cable supplied and "virtual" serial port emulator. Non Star WiFi / Bluetooth options	USB 2.0 Full Speed with cable supplied and "virtual" serial port emulator. Non Star WiFi / Bluetooth options	Powered USB model with "virtual" serial port (no cables included). Ethernet model (10/100baseT, UTP) with cable supplied and "virtual" serial port. Non Star WiFi / Bluetooth options	Parallel or Serial (USB & Ethernet options). Non Star WiFi / Bluetooth options	Serial, Parallel or USB as standard. Ethernet / 9pin Serial options. Non Star WiFi / Bluetooth options	RS232C or Bi-directional Parallel, with USB or Ethernet options. Non Star WiFi / Bluetooth options	Built-in USB as standard with 2nd port for Parallel, Serial, LAN or PUSB options. Non Star WiFi / Bluetooth options
Unique Ethernet Print on Disconnection Feature			TSP100LAN: Standard	Standard with IFBD-HE07 option	Standard with IFBD-HE07 option	Standard with IFBD-HE07 option	Standard with IFBD-HE07 & sub chassis option
Power Supply	Internal with Power Cable included	Internal with Power Cable included	TSP100 LAN: Internal TSP100PUSB: External All cables included	External option	External option	External option	External option
Reliability	60 million lines	60 million lines	60 million lines	60 million lines	60 million lines	37 million lines	60 million lines
Dimensions (W x D x H) mm	142 x 204 x 132	142 x 204 x 132	142 x 204 x 132	142 x 202 x 132	147 x 213 x 148	180 x 213 x 148	144 x 227.7 x 114
Additional Features	<p>TSP100 GT available with full gloss Piano Black or Ice White casing</p> <p>All other models available with standard Star White or Charcoal Grey casing</p> <p><i>Accessories supplied including:</i> Wall Mount Bracket, 58mm Paper Guide, Auto-Reverse Text Output Software, 1.8m Interface Cable, 1.8m Power Cable (Interface & Power cables not included with PUSB versions)</p> <p><i>Options:</i> Display Stand for vertical use and added protection, Splash Proof Cover</p>  <p><i>Display Stand for TSP100 & TSP650 Series</i></p>			<p>Tear Bar or Autocutter models</p> <p>Two Colour Capability</p> <p>Unique AutoLogo™ Coupon & Graphics Tool</p> <p>Splash Proof Cover option</p> <p>Wall Mount included</p> <p>Display Stand option for vertical use</p>	<p>Splash Proof Cover option</p> <p><i>futurePRNT</i> software Tools including Auto Text Reverse</p> <p>External Paper Feed</p> <p>Wall Mount Kit & Interface Cover included</p> <p>Flashing Blue or Green & Red Paper Exit Guide option</p>	<p>A4 replacement printer with Auto Scalable Raster driver for 112mm wide output and reduced CO2</p> <p>High paper capacity with 10cm roll diameter and external rear paper feed for larger capacity or high value media</p> <p>Up to 0.15mm thick media including tickets & labels</p> <p>New TSP800RX Media Secure version</p>	<p>True "Drop-In & Print" drawer style front paper loading & exit</p> <p>"Flat Shelf" opportunity for up to 7Kg</p> <p>Unique voice feature</p> <p>Splash resistant design with IPX1 certification</p> <p>Dual Interface option</p>

* True print speed with external data (not paper feed speed).

Label & Ticketing Printer Summary

The Star Printers Series	TSP700 II	TSP800 II	FVP10	TSP828	TUP592 TUP542	TUP992 TUP900	TSP1000
							
	page 18-19	page 20-21	page 14-15	page 22	page 32	page 33	page 23
	Thermal Barcode, Label & Receipt Printers	Thermal Barcode, Label, Ticket & Receipt Printers	New Thermal Front Operating Printers with Voice Tool	Dedicated Thermal Label Printers with Auto-Peeler	Modular, Open Frame Thermal Kiosk / Terminal Printers	Modular, Open Frame Thermal Kiosk / Terminal Printers	Thermal Printers with 30 Receipt / Ticket Stacker
Max. Print Speed*	250mm/sec.	180mm/sec.	250mm/sec.	150mm/sec.	220mm/sec.	150mm/sec.	180mm/sec.
Resolution	203 dpi 406 x 203 dpi selectable	203 dpi 406 x 203 dpi selectable	203 dpi 406 x 203 dpi selectable	203 dpi	203 dpi	203 dpi	203 dpi
No. of Columns	48 / 64 or 53 / 71 col depending on paper width	A4 print capability on 112mm paper with Auto Scaling software	48 / 64 or 53 / 71 col depending on paper width	up to 92 columns (driver dependent)	48 / 64 or 53 / 71 col depending on paper width	A4 print capability on 112mm paper with Auto Scaling software	48 / 64 or 53 / 71 col depending on paper width
Autocutter	Full or Partial cut (Guillotine)	Full or Partial cut (Guillotine)	Full or Partial cut (Guillotine)		Full or Partial (Guillotine) Full only with PR500 Presenter & TUP592	Full or Partial (Guillotine) Full only with PR900 Presenter & TUP992	Full Cut (Guillotine)
Paper Width	82.5, 80, 58mm selectable (80mm standard with User Installable Paper Guide fitted)	112mm standard, 82.5 or 80mm options with User Installable Paper Guide option	58 ~ 80mm fully adjustable	41 ~ 108mm thermal label 45 ~ 112mm thermal paper roll	45 ~ 82.5mm adjustable	80 ~ 112mm adjustable	45 ~ 82.5mm
Paper Thickness	0.065 ~ 0.15mm	0.065 ~ 0.15mm	0.065 ~ 0.15mm	0.19mm	0.065 ~ 0.15mm	0.065 ~ 0.15mm	0.065 ~ 0.15mm
Paper Roll (diameter)	100mm	100mm	83mm	110mm	150 / 250mm (option)	150 / 250mm (option)	180mm
Media Presentation	User selectable paper delivery options – cut & drop or optional paper exit guide	User selectable paper delivery options with mounting bracket option	Front output delivery with flat shelf mount bracket option	Auto-Peeler or Batch printing	Presenter with document capture. Flashing paper exit guide option	Presenter with document capture. Metal paper exit guide option	
Print Width	80mm maximum	104mm	72mm	104mm / 832 dots	80mm / 640 dots	104mm / 832 dots	80mm on 82.5mm wide paper
Interface	Serial, Parallel or USB as standard. Ethernet / 9pin Serial options. Non Star WiFi / Bluetooth options	RS232C or Bi-directional Parallel, with USB or Ethernet options. Non Star WiFi / Bluetooth options	Built-in USB as standard with 2nd port for Parallel, Serial, LAN or PUSB options. Non Star WiFi / Bluetooth options	USB, RS232C Serial, Parallel or Ethernet options. Non Star WiFi / Bluetooth options	Supplied without Interface. 9-pin or 25-pin Serial, Parallel, USB, Ethernet options	Supplied without Interface. 9-pin or 25-pin Serial, Parallel, USB options	Serial, Parallel or USB as standard. Ethernet option. Non Star WiFi / Bluetooth options
Unique Ethernet Print on Disconnection Feature	Standard with IFBD-HE07 option	Standard with IFBD-HE07 option	Standard with IFBD-HE07 & sub chassis option	Standard with IFBD-HE07 option	Standard with IFBD-HE07 option		Standard with IFBD-HE08 option
Power Supply	External option	External option	External option	External option	External option	External option	External option
Reliability	60 million lines	37 million lines	60 million lines	37 million lines	60 million lines	37 million lines	60 million lines
Dimensions (W x D x H) mm	147 x 213 x 148	180 x 213 x 148	144 x 227.7 x 114	180 x 213 x 157	TUP592: 160 x 234.1 x 179 TUP542: 160 x 185 x 179	TUP992: 192 x 249.3 x 179 TUP942: 190.7 x 199.1 x 179	161 x 306.5 x 249
Additional Features	Splash Proof Cover option <i>futurePRINT</i> software Tools including Auto Text Reverse External Paper Feed Wall Mount Kit & Interface Cover included Flashing Blue or Green & Red Paper Exit Guide option	A4 replacement printer with Auto Scalable Raster driver for 112mm wide output and reduced CO ₂ High paper capacity with 10cm roll diameter and external rear paper feed for larger capacity or high value media Up to 0.15mm thick media including tickets & labels New TSP800RX Media Secure version	True “Drop-In & Print” drawer style front paper loading & exit “Flat Shelf” opportunity for up to 7Kg Unique voice feature Splash resistant design with IPX1 certification Dual Interface option	Automatic label peeler included as standard Barcode support: Ladder & 2 Dimensional Windows™ Drivers on CD included with printer	Document Capture Near End Paper Sensor 25cm Paper Roll option Open Frame or Modular Solution for 45 to 82.5mm output Flashing Green or Red Paper Exit Guide option	Document Capture Near End Paper Sensor A4 to A6 Scalable Raster Driver 25cm Paper Roll option Open Frame or Modular Solution for 80 or 112mm output Metal Paper Exit Guide option	Unique Stacker for up to 30 tickets 3 Colour Case Versions High Capacity 18cm Paper Roll 2 Colour Print capability







* True print speed with external data (not paper feed speed).

Matrix Kitchen & Hybrid Printer Summary

The Star Printers Series	SP500	SP700	DP8340	SP298	HSP7000
	 page 28	 page 26-27	 page 26	 page 30	 page 25
	Low Cost, High Speed 9-pin Matrix Receipt Printers	High Speed, Easy-Load, Red / Black 9-pin Matrix Printers	9-pin, Red / Black Receipt / Label Matrix Printers	9-pin Matrix Slip Printers	World's Fastest Thermal / Matrix Slip Hybrid Printers
Max. Print Speed*	7.5 lps (16 column) 4.0 lps (42 column)	4.7 ~ 8.9 lps	2.0 lps	3.1 lps	Thermal: 250mm/sec. Matrix Slip: 4.82 ~ 8.9 lps
No. of Columns	76mm – 40 / 42 / 35 58mm – 30 / 32 / 26	42 / 35 col	40 col (48 or 60 col option)	42 col	Receipt: 48 or 64 Star Mode or ESC/POS™ Slip: 60 or 45 col
Autocutter	Tear Bar and Full / Partial (Guillotine) Autocutter Rewind models	Tear Bar and Full / Partial (Guillotine) Autocutter Rewind models	Tear Bar only	Slip Printer	Guillotine Partial Centre Cut
Paper Width	76, 57.5mm	76, 69.5, 58.5mm x 85mm roll diameter	114.3mm	up to 182mm	Thermal: 80, 76, 58mm Matrix: 68 ~ 230mm
Paper Thickness	0.07 ~ 0.10mm	0.065 ~ 0.085mm	0.07 ~ 0.09mm	0.09 ~ 0.20mm	Thermal: 0.065 ~ 0.085mm Matrix: 0.09 ~ 0.31mm
Paper Roll (diameter)	85mm	85mm	80mm	Slips only	83mm
No. of Copies	Original + 2	Original + 1 (2 ply) Original + 2 (3 ply)	Original + 1	Original + 2	Original + 3
Logo Store	Yes	Advanced Graphics Tool	No	No	Advanced Graphics Tool
Print Width	76mm ~ 63 or 60mm 58mm ~ 45mm	63mm	84.3mm	63mm	Receipt: 51, 68, 72 (default) mm Slip: max. 85.4mm
Interface	RS232C or Bi-directional Parallel	RS232, Parallel, USB 2.0 or without interface. Ethernet option. Non Star WiFi / Bluetooth options	RS232C or Parallel	RS232C or Bi-directional Parallel	RS232C or Parallel with LAN / USB / Powered USB options
Ink Ribbon	RC200B (Blk) RC2000D Laundry	RC700B (Blk) RC700BR (Blk / Red) RC700D Laundry	SF03B (Blk) SF03BR (Blk / Red)	RC200B (Blk) RC2000D Laundry	RC-7KB
Power Supply	Internal with Power Cable included	Internal with Power Cable included	230V AC Psu optional 12V DC input	External option	External option
Reliability	22 million lines	22 million lines	10 million lines	9 million lines	Thermal: 60 million lines Slip: 37 million lines
Dimensions (W x D x H) mm	140 x 225 x 163	160 x 245 x 152	202 x 200 x 98 (without paper holder)	180 x 190 x 138.5	186 x 296 x 177
Additional Features	6 position Black Mark Sensor as standard Vertical or Wall Mount option Near End Paper Sensor option Paper Rewind version Star Buzzer Alarm option	<i>Options include:</i> Black Mark Sensor Star Buzzer Alarm option Near End Sensor Vertical use Kit / Wall Mount Splash Resistant Case Design	Red / Black versions Friction or Sprocket versions Label versions Wall Mounting Bracket option	Auto Side Loading with instant top of form positioning Charcoal Grey or Star White Case Mobile Validation Printer Prescription Printer	Unique AutoLogo™ Coupon & Graphics Tool MICR & Non MICR versions Two Colour Thermal Receipts Drop-In Paper Loading Intelligent Front Loading

* True print speed with external data (not paper feed speed).

Kiosk / Terminal Printer Summary

The Star Printers Series	TUP592 TUP542	TUP500DP Option	TUP992 TUP900	TSP650	TSP700 II	TSP800 II	FVP10
							
	page 32	page 32	page 33	page 16-17	page 18-19	page 20-21	page 14-15
	Modular, Open Frame Thermal Kiosk / Terminal Printers	DP Chassis option for TUP500 Open Frame Printers	Modular, Open Frame Thermal Kiosk / Terminal Printers	Thermal Receipt Printers	Thermal Barcode, Label & Receipt Printers	Thermal Barcode, Label, Ticket & Receipt Printers	New Thermal Front Operating Printers with Voice Tool
Max. Print Speed*	220mm/sec.	220mm/sec.	150mm/sec.	150mm/sec.	250mm/sec.	180mm/sec.	250mm/sec.
Resolution	203 dpi	203 dpi	203 dpi	203 dpi	203 dpi 406 x 203 dpi selectable	203 dpi 406 x 203 dpi selectable	203 dpi 406 x 203 dpi selectable
No. of Columns	48 / 64 or 53 / 71 col depending on paper width	48 / 64 or 53 / 71 col depending on paper width	A4 print capability on 112mm paper with Auto Scaling software	48 or 64 col Star or ESC/POST™	48 / 64 or 53 / 71 col depending on paper width	A4 print capability on 112mm paper with Auto Scaling software	48 / 64 or 53 / 71 col depending on paper width
Autocutter	Full or Partial (Guillotine) Full only with PR500 Presenter & TUP592	Full or Partial (Guillotine) Full only with PR500 Presenter & TUP592	Full or Partial (Guillotine) Full only with PR900 Presenter & TUP992	Tear Bar and Partial (Guillotine) Autocutter models	Full or Partial cut (Guillotine)	Full or Partial cut (Guillotine)	Full or Partial cut (Guillotine)
Paper Width	45 ~ 82.5mm adjustable	45 ~ 82.5mm adjustable	80 ~ 112mm adjustable	80mm (58mm using guide provided)	82.5, 80, 58mm selectable (80mm standard with User Installable Paper Guide fitted)	112mm standard, 82.5 or 80mm options with User Installable Paper Guide option	58 ~ 80mm fully adjustable
Paper Thickness	0.065 ~ 0.15mm	0.065 ~ 0.15mm	0.065 ~ 0.15mm	0.065 ~ 0.085mm	0.065 ~ 0.15mm	0.065 ~ 0.15mm	0.065 ~ 0.15mm
Paper Roll (diameter)	150 / 250mm (option)	100mm	150 / 250mm (option)	85mm	100mm	100mm	83mm
Media Presentation	Presenter with document capture. Flashing paper exit guide option	Presenter with document capture. Flashing paper exit guide option	Presenter with document capture. Metal paper exit guide option	User selectable paper delivery options with mounting bracket included	User selectable paper delivery options with mounting bracket included & optional paper exit guide	User selectable paper delivery options with mounting bracket option	Front output delivery with flat shelf mount bracket option
Print Width	80mm / 640 dots	80mm / 640 dots	104mm / 832 dots	72mm	80mm maximum	104mm / 832 dots	72mm
Interface	Supplied without Interface. 9-pin or 25-pin Serial, Parallel, USB, Ethernet options	Supplied without Interface. 9-pin or 25-pin Serial, Parallel, USB, Ethernet options	Supplied without Interface. 9-pin or 25-pin Serial, Parallel, USB options	Parallel or Serial (USB & Ethernet options)	Serial, Parallel or USB as standard. Ethernet / 9pin Serial options	RS232C or Bi-directional Parallel, with USB or Ethernet options	Built-in USB as standard with 2nd port for Parallel, Serial, LAN or PUSB options
Unique Ethernet Print on Disconnection Feature	Standard with IFBD-HE07 option	Standard with IFBD-HE07 option		Standard with IFBD-HE07 option	Standard with IFBD-HE07 option	Standard with IFBD-HE07 option	Standard with IFBD-HE07 & sub chassis option
Power Supply	External option	External option	External option	External option	External option	External option	External option
Reliability	60 million lines	60 million lines	37 million lines	60 million lines	60 million lines	37 million lines	60 million lines
Dimensions (W x D x H) mm	TUP500 Mechanism: 135 x 101 x 103 Open Frame: 160 x 234.1 x 179	Mechanism: 135 x 101 x 103 Open Frame: 140 x 150 x 240	TUP900 Mechanism: 176.2 x 101 x 121 Open Frame: 192 x 249.3 x 179	142 x 202 x 132	147 x 213 x 148	180 x 213 x 148	144 x 227.7 x 114
Additional Features	Document Capture Near End Paper Sensor 25cm Paper Roll option Open Frame or Modular Solution for 45 to 82.5mm output Flashing Green or Red Paper Exit Guide option	Document Capture Near End Paper Sensor Open Frame or Modular Solution for 45 to 82.5mm output Flashing Green or Red Paper Exit Guide option	Document Capture Near End Paper Sensor A4 replacement printer with Auto Scalable Raster Driver for 112mm wide output and reduced CO ₂ 25cm Paper Roll option Metal Paper Exit Guide option	Tear Bar or Autocutter models Two Colour Capability Unique AutoLogo™ Coupon & Graphics Tool Splash Proof Cover option Wall Mount included Display Stand option for vertical use	Flashing Blue or Green & Red Paper Exit Guide option futurePRINT software Tools including Auto Text Reverse External Paper Feed Wall Mount Kit & Interface Cover included PC free Info / Sequential number Print Facility	A4 replacement printer with Auto Scalable Raster driver for 112mm wide output and reduced CO ₂ High paper capacity with 10cm roll diameter and external rear paper feed for larger capacity or high value media Up to 0.15mm thick media including tickets & labels New TSP800RX Media Secure version	True "Drop-In & Print" drawer style front paper loading & exit "Flat Shelf" opportunity for up to 7Kg Unique voice feature Splash resistant design with IPX1 certification Dual Interface option

* True print speed with external data (not paper feed speed).



The World's 1st Entry-Level Receipt Printer designed to reduce Global Warming and Operating Expenditure without costing you more.

- High quality, 203 dpi output at 150mm/second printing a 9cm receipt just 0.5 second slower than a more expensive, not so environmentally friendly 300mm/second printer
- Full speed USB interface with serial port emulator for legacy software
- Internal power supply with all set-up accessories in the box for convenience and reduced transport costs
- Market- leading installation and Retail Tools Software enabling more effective use of current POS set-up as well as lower maintenance and installation costs due to multiple printer Pre-Installation Tool. The TSP100 Series are the only printers in the world that never require taking out of the box before on-site installation
- All installation accessories in the box at purchase
- **NEW** industry-leading 4 year warranty on all *futurePRNT* Series including print head and cutter (Europe and South Africa)
- Fully tested for Energy Star certification

Use the TSP100 ECO guilt-free with the manufacturer's pre-paid Carbon Offset program with Certified Emission Reduction credits which will offset the CO₂ emissions emitted from the TSP100 manufacturing & disposal process and projected power consumption for up to 5 years (total 33.9Kg/unit). The CERs used will then be cancelled with the scheme as defined by the Kyoto Protocol.

See www.futurePRNT.com/ECO for more details including how to register and print off your Carbon Offset Certificate to show how your company is trying to minimise environmental damage, or access the ECO Impact Analysis Tool to work out how much money you could save using the TSP100 ECO printer.

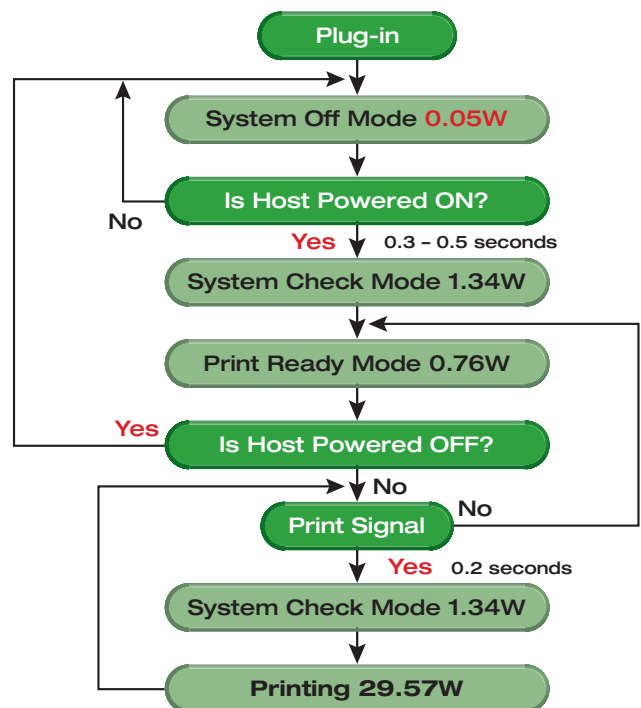

TSP100 ECO Power Management inspired by the cheetah, nature's greatest exponent of energy efficiency, **uses 40% less power than most.** This printer is so clever that there is no on/off switch as it is "power controlled" by connecting the power cable first and then the USB cable between Printer and the PC. In addition to mimicking the PCs own sleep mode, the printer has advanced sleep mode during periods of inactivity with less than 0.5 second wake up.

NEW TSP100 ECO futurePRNT Tools could reduce paper consumption by 70% or more.

Unique Partial Cut 3mm Default Top Margin

This is not rocket science, but so obvious and so necessary. Star's innovative and experienced engineering expertise has resulted in the TSP100 ECO being the only partial cut printer able to achieve a 3mm Top Margin saving 8mm of paper for every receipt printed.

Just calculate the savings yourself. Some competitors cannot even achieve an 11mm Top Margin, so please check this very carefully when comparing competitive POS printers.

Auto Reduction without changing original POS Software or simply "shrink" your 80mm receipt

The TSP100 ECO can automatically reduce receipts from an 80mm wide format to 58mm without changing the customer's original software set-up. Simply tick the required paper reduction in the ECO futurePRNT software and you can choose whether to reduce the receipt vertically or horizontally, or both to 72.5% horizontally and 50% vertically.



Reduce your receipts & paper usage without changing your current POS Software.



Receipts On Demand Printing

Once again Star has used the clever futurePRNT software to produce an **Operator Prompt** to ask the customer whether they need a receipt or not. The receipt can then be either cancelled or printed, perfect for low cost, consumable items such as newspapers, fast food etc. as the receipts are often left behind. All cancelled receipts can be saved graphically and be reviewed or reprinted. (Note: not all countries will allow this feature so the software may be modified on a regional basis).

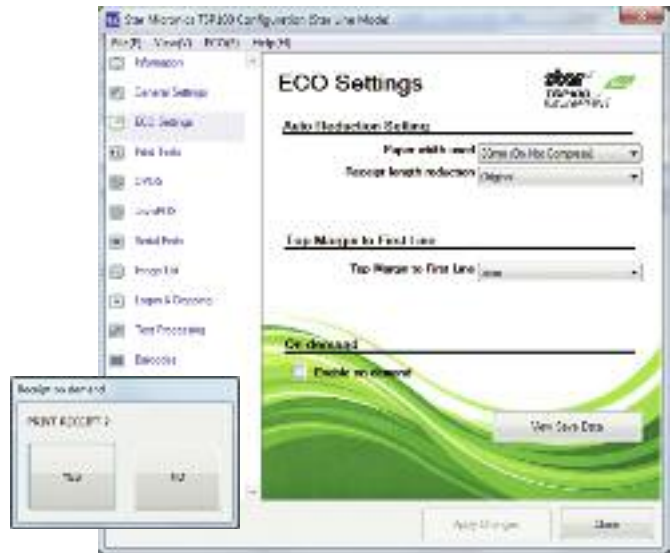

More details on www.futurePRNT.com



TSP100^{GT}/U futurePRINT Series

TSP100 USB models featuring speeds up to 250mm per second with traditional or new full gloss printer casing

TSP113GT 250mm/second Tear Bar version

TSP143GT 250mm/second Autocutter version

Models available in full gloss Piano Black and Ice White.

Large quantities can be ordered in traditional charcoal grey.

TSP113U 125mm/second Tear Bar version

Available in charcoal grey and Star white.

High performance 203 dpi receipt printers which have changed all the rules of POS printing and placed Star far ahead of its competitors with this unique software driven POS receipt range with obvious advantages for retail and hospitality. Star, the now true market leader was also the first to include:

Developers Kit with unique selectable Preview Tool. Details on page 12

- ★ Installation CD with Windows 7 and Vista™ WHQL operating and 64 bit support as well as other operating platforms such as Mac™, Linux™, POS for .NET etc.

■ **All installation accessories in the box at purchase**

- ★ Internal power supply with 1.8m power and USB cables
- ★ Wall mount kit for space saving operation with automatic receipt reversal for user comfort
- ★ Power switch cover & 58mm guide
- ★ Value Added software for Retailers including more than ten Receipt Redesign, Image & Easy Install Tools as well as a Software

- **NEW** 4 year warranty on all TSP100 printers including print head and cutter (Europe and South Africa)

- **Pre-Installation Set-up Tool** which means you do not have to take the printer out of the box before installation as all settings are held in .xml files on the PC. Contact Star for case studies of large retailers world-wide who have carried out installations of hundreds of printers literally over night



■ **Splashproof Cover and Vertical Printer Stand with A5 Retail Display opportunity**

Once again Star listened to its customers such as its global hospitality, fast-food partner in Germany and produced the first single station splashproof cover of its kind. This printer is so reliable that the only returns had previously been due to one chocolate milk shake and two fizzy drinks! This was remedied with the introduction of the splashproof cover.

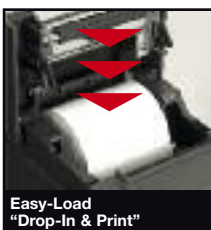

Easy-Load "Drop-In & Print"



Full speed USB interface with serial port emulator for legacy software



Robust, high speed guillotine cutter for increased reliability



Wall mount bracket included with printer at purchase

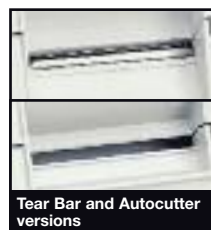

Tear Bar and Autocutter versions



Splash Proof Cover option for extra protection

NEW TSP100 Powered USB Printers

The World's 1st Dedicated Entry-Level Powered USB

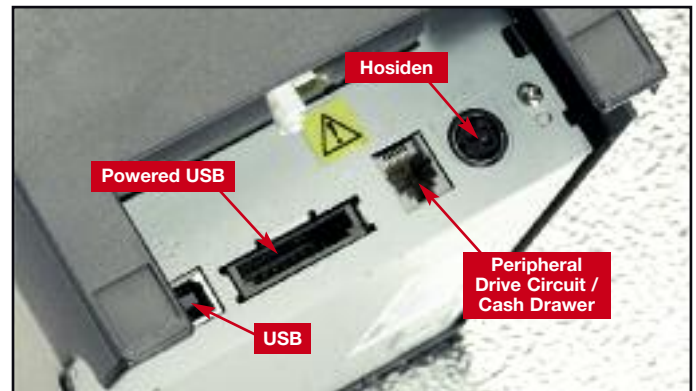

The printer is supplied with two port covers for use depending on configuration chosen.



Benefit from improved cable management and, more importantly, being able to cost-effectively use the same UPS on both your POS station and printer at the same price as a traditional printer.

USB is now the industry's preferred communication link between a PC and a printer; so what is the next logical step – to combine the power supply and interface to produce Powered USB. As a result, Star has developed the world's first dedicated entry-level Powered USB printers offering significant cost advantages over competitor products for all types of retailer.

As usual the POS market is in IT transition with the future looking at Powered USB terminal and peripherals. The key advantages include now being able to cost-effectively include UPS (Uninterrupted Power Supply) cover on both the PC and printer so that all transactions will be protected. The TSP100 PUSB is therefore perfect to replace any single station printer with a free-of-charge upgrade path when the retailer decides to follow the industry and use Powered USB POS Terminals at the same price as a traditional single station printer.

To replace a single station serial printer; set the printer up as indicated; change the interface cable to USB and create a Virtual Serial Port using the Star wizard included in the TSP100 *futurePRNT* configuration utility. Contact Star for the quick fix to replace a Parallel printer.



NEW TSP100LAN *futurePRNT*

Entry-Level Ethernet version of the TSP100 *futurePRNT*



Ethernet is now the connection method of choice for the new breed of IT managers in hospitality and retail environments requiring fast, long distance, reliable communication. However this extremely flexible choice of connection has always come with a cost. Star is now determined to change this with the introduction of the dedicated TSP100LAN *futurePRNT*.

Star *futurePRNT* is famous for its revolutionary software, quality hardware and entry-level price and the new TSP100LAN is no exception.

Simple, fast, reliable network connection using standard, low cost CAT 5 cabling combined with *futurePRNT*'s software and particularly simple installation procedures enhance the advantages of today's Ethernet.

Print on Disconnection Feature

The TSP100LAN will negotiate with any networked host and automatically print an error if the connection is lost due to PC / Hub failure or cable damage.

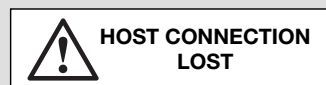

- Immediate warning to the remote location, that the printer is offline.
- Immediate warning to the POS that the printer is offline / missing.

The secret of Star's success with this ground-breaking product is a result of the investment that Star has put in time, effort and money into the software provided with this printer.



This software far exceeds installation tools normally provided, enabling users to install high volume, custom set-ups without even taking the printer out of its box.

Details can be found on www.futurePRNT.com



TSP100 Coupon Marketing Tool

Star's revolutionary new printer has taken customer motivation to new heights with this free-of-charge value-added software, which will work alongside your current system. The new Coupon Marketing Tool from Star will enable the automatic printing of coupons based on the retailer's pre-decided products or purchase values relevant to that transaction.

Seasonal fluctuations, overstock situations can all be addressed by the retailer determining certain "trigger action" key words. The simple wizard-driven software will "word-search" all receipts to ascertain the automatic output of relevant coupons or graphics.

The new **IMAGE IMPORT TOOL** simplifies the logo store set-up by eliminating the need for the usual image preparation work. An unlimited number of mono or colour jpgs, gifs and bmps can be accessed by the control panel, saved by name and even prepared for output with a choice of dither methods. There is no longer any need to pre-size or pre-save an image file as a mono bmp, as was so often required by other POS printers. The TSP100's unique **INSTALLATION SET-UP FACILITY** will allow PCs to be pre-installed (not necessarily with the printer connected) for multiple printer use across the whole store. The new **PRE-VIEW TOOL** provides retailers and system builders with the ability to pre-check the overall appearance of planned receipts by using the pre-view tool during set-up. This simple tool, again a rare facility in the POS world, will save much time.



The new **JOURNAL AND MULTI-COPY TOOL** from Star truly demonstrates the versatility of the Star TSP100 futurePRNT. Not only can the user now determine how many copies should be printed, but they can also specify the different text and graphics required per copy – perfect for DIY retailers, pizza delivery companies to name just a few of the users that will really appreciate this tool.

The flexibility of the journal tool will allow users to create an Electronic Journal of all transactions searchable by calendar date, which can be printed out at the end of day or week. All data is stored as a bitmap file (providing a true representation of all receipts and coupons printed).

Pre-Installation Set-Up Tool

Reduce multiple printer installation time using the .xml facility to save all printer settings on the PC!

All printer and futurePRNT™ software settings including logos, coupons, Auto-Text Reversal for vertical use etc. can all be easily pre-set using the included intuitive configuration software. These settings can then be distributed as a .xml file to all relevant PCs for mass system installations, so that there is now no need to remove the printer from the box before installation.

Auto-Text Reversal™



Receipt Re-Design Tool

This revolutionary new tool has been designed to work completely independently from your current POS software and will allow any user to literally re-design their receipts without changing their software. Legacy software can have embedded text and graphics which you may have always wanted to change. Now you can, with the new **RECEIPT CROPPING TOOL** crop unwanted sections, thus creating space for new graphics and text.

The unique Star Selectable **PRE-VIEW TOOL** will make this task even easier. Perhaps the most important element will be the **FONT REPLACEMENT TOOL** making the printer's resident fonts no longer relevant. This, along with the other tools mentioned, will be available from the printer's properties page and, when selected, will replace any non TrueType fonts featured on the receipt with a more attractive / effective font – all without affecting the speed of the printer.



*** Literally re-design your receipt without changing your software or becoming an IT expert. Crop out embedded text and images, add new profit-making messages and graphics.**

futurePRNT Specifications

TSP100 futurePRNT™ Series Summary

NEW TSP143 ECO

150mm/second Autocutter USB model

TSP113 GT

250mm/second USB Tear Bar model

TSP143 GT

250mm/second USB Autocutter model

TSP113 LAN

125mm/second Ethernet Tear Bar model

TSP143 LAN

125mm/second Ethernet Autocutter model

TSP113 PUSB

125mm/second PoweredUSB Tear Bar model

TSP143 PUSB

125mm/second PoweredUSB Autocutter model

TSP113 U

125mm/second USB Tear Bar model

futurePRNT™ Accessories



Splash Proof Cover for all models



Charcoal Grey Display Stand



Powered USB Cable for TSP100 Powered USB model only (Part No. 37999560)

Printer Method	Direct Thermal Line Printing
Traditional Print Speed	TSP100 ECO – 150mm/second TSP100U, TSP100PUSB, TSP100LAN – 125mm/second, TSP100GT – 250mm/second
Printer Case Colour	TSP143 ECO, TSP100U, TSP100LAN, TSP100PUSB Star White or Charcoal Grey. TSP100GT full gloss Piano Black or Ice White. Other colours available for larger volume orders.
Print Resolution	203 dpi (8 dots per mm)
Two Colour Print Capability	Red / Black, Blue / Black (special paper required)
No. of Columns (maximum)	Star Mode = 48. ESC/POS™ Font A 42 Font B 56
Character Set	ANK 95, 32 Int 128 Graphic plus Chinese, Japanese, Korean, Taiwanese
International Code Pages	Star Mode = 40 + 1 blank, ESC/POS™ Mode = 10 + 1 blank allowing an additional character page to be added
Barcodes	Extended barcode functionality – 9 versions including QR (PDF417 & Maxicode pending)
Line Spacing	3mm or 4mm + programmable
Paper Specifications:	
Width	80mm Standard, 58mm with guide fitted
Thickness / Weight	0.065mm – 0.085mm
Roll Diameter	up to 83mm
Easy-Load	“Drop-In & Print”
Paper Out Sensor	Standard
Maximum Print Width	80mm paper = 72mm, 58mm paper = 50.8mm
Top Margin	TSP100 ECO 3mm default with 11mm selectable option. All other TSP100 models 11mm
Autocutter	Guillotine (Partial Cut Only)
Logo Store Capacity	Unlimited
Drivers Available (CD-ROM with printer)	Windows® 7 32/64 Bit, Vista 32/64 Bit, XP 32 Bit, XP Embedded, CE, Server 2008 32/64 Bit, 98/ME/2000/NT4 (download only), WePOS, POSReady, OPOS™, POS for .NET, JavaPOS™, Virtual Serial Port, Linux™ CUPS, Mac OS X CUPS, StarIO SDK
Interface / Port:	All models feature a selectable “Virtual” Serial Port emulator
TSP100U / GT / ECO	USB 2.0 Full Speed with cable supplied
TSP100LAN	Ethernet (10/100BaseT, UTP) with cable supplied
TSP100 Powered USB	Combined Power and USB cable version (cables not supplied)
Emulation	Star Mode, ESC/POS™
Peripheral Drive Circuit	2 circuits (24V max.1A), 1 Compulsion input
Power Consumption	TSP100 ECO please see page 8 All other TSP100 models Average 1.6amp. Printing, 0.1 Amp. Standby.
Power Supply	Internal with power cable supplied (not TSP100PUSB)
Operating / Storage Conditions:	
Temperature	5°C to 45°C / -20°C to 60°C
Humidity	10% to 90% RH (without condensation)
Dimensions	142mm (W) x 204mm (D) x 132mm (H)
Weight:	
Autocutter Models (Guillotine)	TSP143U – 1.73Kg, TSP143GT – 1.76Kg, TSP143PUSB – 1.53Kg, TSP143LAN – 1.72Kg, TSP143 ECO – 1.72Kg
Tear Bar Models	TSP113U – 1.56Kg, TSP113GT – 1.59Kg, TSP113PUSB – 1.37Kg, TSP113LAN – 1.56Kg
Safety Standards	UL, C-UL, TÜV, FCC, VCCI, EN55022, CE
Reliability:	
MCBF	60 million lines
Print head	100km
Cutter (Guillotine)	1 million cuts
Accessories included with the printer	Wall Mount Bracket Auto-Reverse Text Output Software Vertical Upper Guide (TSP100 ECO only) 58mm Paper Guide 1.8m Interface Cable (not PUSB models) 1.8m Power Cable Installation CD and futurePRNT Retail Marketing and Set-up Software (Interface and Power cables not included with PUSB versions)
Options	Splash Proof Cover, Display Stand for Vertical Use Combined Power Supply / Powered USB cable for TSP100 PUSB Non Star WiFi / Bluetooth options

All available to work alongside your original software!!



“I can talk to your customers as well! See you soon...”

FVP10 Series

The NEW, Front Operating, Vocal Direct Thermal Printer

Given its significant expertise and experience in providing high-performance printing solutions for the worldwide retail market, Star has now developed another industry-first with the introduction of a unique front operating, multi-functional direct thermal printer with speech functionality.

Once again Star has shown that there is no compromise between functionality, cost and innovation providing this versatile printer with high-speed performance, paper saving features as well as a new method of user and printer interaction with the voice communication tool.

- High quality 203 dpi output with high print speeds of up to 250mm/second combined with fast, efficient throughput (406 x 203 double density selectable)
- High reliability – (60 million lines MCBF) Autocutter – 2 million cuts
- Tough and durable splash-proof casing with IPX1 certification and downwards angled paper exit to prevent liquid intake
- FVP10 platform printer. The square design, front operation and flat top provide a space-saving opportunity as objects up to 7Kg can be placed on top of the printer without interfering with its operation – chip and pin pads, graphic displays, scanners etc.
- Barcodes, receipts, labels & tickets can all be printed on media from 0.065 to 0.15mm in thickness with linear paper width adjustment from 58 to 80mm allowing for complete application functionality
- Dual interface facility with USB as standard and additional port for second plug-in options – Serial, Parallel, Ethernet, PoweredUSB
- Options include: PS60 Power supply, Wall / Shelf mount, Traditional and PoweredUSB interfaces as well as Cable Cover. (USB cable included in box at purchase with installation CD-ROM & power switch cover)



- The FVP10 is the only POS printer on the market to feature a unique drawer style front-loading system that offers true “Drop-In & Print” paper loading



Typical Applications

- **Retail**
 - High Speed • High Quality Graphics
 - Logos and Coupons
 - Increases Counter Space
- **Hospitality**
 - High Speed • Logos and Coupons
 - Increases Counter Space
 - Voice Enabled
- **Kiosk**
 - High Speed • High Reliability
 - Easy-Load
- **Kitchen**
 - Hygienic • Stainless Steel Mount
 - Easy Clean • Voice Enabled
- **Pharmacy Labelling**



The clean design "counter mounter"

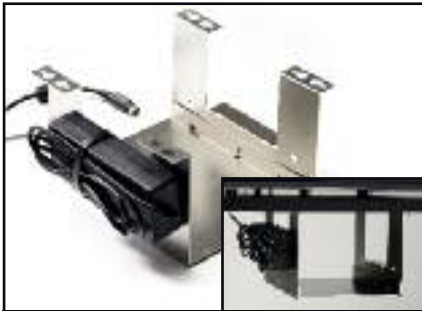

Shelf Mount option with power supply holder



Auto 80 to 58mm wide compression with up to 50% vertical length reduction as well



Reduce Paper Costs – contact Star if you need assistance.

All Star thermal printers can reduce any receipt length by up to 25% without reducing the font size



"Drop-In & Print" Easy Load



FVP10 "plug-in" 2nd interface option

Linux

JAVAPOS™

Compatible with

Designed for

WHQL

ESC/POS™

"Instinctive" compatibility with majority of POS operating platforms, with quality suite of drivers

FVP10 Printer Specifications

Printer Method	Direct Thermal Line Printing with drawer style paper loading and front paper exit
Print Speed	up to 250mm/second
Print Resolution (v x h)	203 x 203 dpi
Double Density Graphics	406 x 203 dpi (selectable)
Printer Case Design	Flat top platform printer with splashproof downward paper exit and IPX1 splash resistant certification
Print Width	up to 72mm
Automatic Compression Mode	72mm to 52mm (576 reduced to 384 pixels)
Paper Width	58 ~ 80mm fully adjustable
Media Type	Receipts, Tickets, Labels (Black Mark)
Thickness / Weight	0.065 ~ 0.15mm
Roll Diameter	83mm
Paper Loading	"Drop-In & Print" Easy Load
Reflective Black Mark Sensor	Standard
Paper End / Near End Sensor	Standard
Print Width	Max. 80mm wide = 72mm Min. 58mm wide = 52mm
No of Columns	48 / 64 columns
Top Margin	13mm default / 3mm selectable (full cut mode)
Barcodes	9 versions / PDF417 and QR (Maxicode option pending)
Voice Function	Internal speaker plus audio jack connector for external speaker if required
Sound Storage	Up to 5 minutes (13Mbit) Flash Rom with sound management software – up to 255 voice commands
Logo Store	4 Mbit Flash ROM with graphic management software. Up to 250 named logos text string activated
Superior Graphics Management	New high quality Image Import and Placement Software tool
Advanced Text Search facility	Trigger sounds, coupons and logos according to the receipt text
Flash ROM	32 Mbit (external) CG, Logo & Sound 4 Mbit (internal) PGM
Drivers (CD-ROM with printer)	Windows® 7 32/64 Bit, Vista 32/64 Bit, XP 32 Bit, XP Embedded, CE, Server 2008 32/64 Bit, OPOST™, JavaPOS™, Linux™ CUPS, Mac OS X CUPS, StarIO SDK
Emulations	Star Line Mode & ESC/POS™
Interface	Built-in USB as standard with 2nd port for – Parallel, Serial, Ethernet & PoweredUSB options. Non Star WiFi / Bluetooth options
Peripheral Drive Circuit	2 circuits (24V max. 1A) 1 compulsion input
Power Supply (PS60A-24B only)	External option with Hosiden connector Operating / Waiting – Average 1.56A / 0.12A
Dimensions (W x D x H) mm	144 x 227.7 x 114 144 x 316.2 x 114 with Cable Cover
Printer Reliability	60 million lines
Autocutter / Life	Partial cut – guillotine (full cut optional) up to 2 million cuts
Options (USB interface cable included in box with installation CD-ROM and power switch cover)	Parallel, Serial, Ethernet & PoweredUSB Non Star WiFi / Bluetooth options PS60 power supply (PS60A-24B only) Shelf mount frame, Interface cable cover



The clean design "counter mounter" – the perfect compact solution for retail and hospitality





TSP650 Series

High Spec, Fast, Entry-Level Receipt Printer

- High performance, entry-level receipt printer capable of printing at a non-hesitating 150mm per second with an outstanding data throughput
- High quality 203 dpi print quality with barcode capability including 2D for receipts, coupons and ticketing, etc.
- Easy-to-use AutoLogo™ marketing / stock management tool with the ability to configure / download up to 15 graphics or coupons without any expensive software changes or complicated set up procedures
- Start up accessories provided with printer include:
 - ★ Operating CD with a suite of drivers
 - ★ Wall mount plate with vertical kit including both horizontal and vertical mount paper near end sensors
 - ★ Paper guide for choice of 58mm or 80mm paper widths
 - ★ Power switch cover to prevent accidental switch off
 - ★ Start up paper roll
- TSP650 options include:
 - ★ Warning buzzer
 - ★ Power supply PS60
 - ★ USB and low cost Ethernet interfaces with Print on Disconnection feature
 - ★ Splash proof cover
 - ★ Charcoal grey display stand with in-store A5 graphics facility

Typical Applications

- Point-of-Sale
- Ticketing
- Retail
- Hospitality

- TSP651** Tear Bar Version
- TSP654** Autocutter Version

All models are available in charcoal grey or Star white, with either serial RS232C or parallel interfaces as standard. (USB and low cost Ethernet options are available for future upgrades)

AutoLogo™ - a valuable graphics utility from Star

AutoLogo™ is a Star POS Printer "side" feature working alongside existing POS software. It allows users to quickly and easily add logos or information / graphics to a receipt without affecting existing software.

Many retailers are prepared to "live" with their current receipt format as the benefits of changing the top logo or using the receipt for distributing information such as imminent sales or holiday closing times etc are outweighed by the cost and disturbance of major software changes. AutoLogo™ allows retailers to achieve these benefits without any IT upsets.





Optional charcoal grey display stand with in-store A5 graphics facility



Two colour output - red & black or blue & black



Tear Bar and Autocutter versions



High quality barcodes for coupons or tickets

Reduce Paper Costs
- contact Star if you need assistance.

All Star thermal printers can reduce any receipt length by up to 25% without reducing the font size.



"Drop-In & Print" Easy Load



Moulded desk boot for vertical operation



Splash Proof Cover option adds extra protection



Power Switch Cover



Wall mount plate included

JAVAPOS™

Compatible with **OPOS**

Windows 7 WHQL Mac Universal

ESC/POS™

Compatibility with most major operating systems

TSP650 Printer Specifications

Printer Method	Direct Thermal Line Printing
Print Speed	up to 150mm/second
Print Resolution	203 dpi
Two Colour Print Capability	Red / Black, Blue / Black (special paper required)
No. of Columns	48 / 64
Character Set	ANK 95, 32 Int 128 Graphic
International Code Pages	Star Mode = 40 + 1 blank, ESC/POS™ Mode = 10 + 1 blank allowing an additional character page to be added
Barcodes	9 versions / PDF417 option
Line Spacing	3mm or 4mm + Programmable
Paper Feed Speed	up to 150mm/sec.
Paper Specifications:	
Width	80mm standard / 58mm (paper guide)
Thickness / Weight	0.065 ~ 0.085mm
Roll Diameter	83mm
Easy-Load	"Drop-In & Print"
Paper End	Standard
Near End Sensor	Horizontal and vertical use
Maximum Print Width	80mm paper = 72mm, 58mm paper = 52mm
Top Margin	13mm default (11mm selectable via Memory Switch)
Autocutter (guillotine)	Partial cut (centre cut)
Logo Store	2 Mbit Flash ROM with graphic management software
Flash ROM	16Mbits
Drivers Available (CD-ROM with printer)	Windows® 7 32/64 Bit, Vista 32/64 Bit, XP 32 Bit, XP Embedded, CE, Server 2008 32/64 Bit, 98/ME/2000/NT4 (download only), OPOS™, JavaPOS™, Virtual Serial Port, Linux™ CUPS, Mac OS X CUPS, StarIO SDK
Interface Versions	Serial or Parallel with USB and low cost Ethernet options. Non Star WiFi / Bluetooth options
Emulation	Star Line Mode & ESC/POS™
Peripheral Drive Circuit	2 circuits (24V max. 1A), 1 Compulsion input
Power Consumption	Operating / Waiting - Average 1.7 / 0.15A Uses PS60 - 24V Psu with Hosiden connector
Operating Conditions:	
Temperature	5°C to 45°C
Humidity	10% ~ 90% RH (without condensation)
Storage Conditions:	
Temperature	-20 to 60°C
Humidity	10% ~ 90% RH
Dimensions	142 (W) x 202 (D) x 132 (H) mm
Weight	1.72 / 1.56Kg (Autocutter / Tear Bar version)
Safety Standards	UL, C-UL, TÜV, FCC, VCCI, EN55022, CE, Gost
Reliability:	
Printer	60 million lines (MCBF)
Autocutter (Guillotine)	1 million cuts
Options	Parallel (IFBD-HC03), Serial (IFBD-HD03), Ethernet (IFBD-HE07), USB (IFBD-HU05), Serial 9-pin (IFBD-HN03) Interfaces Non Star WiFi / Bluetooth options Wall & Vertical Mount Kits (basic wall mount kit supplied with printer) Charcoal grey display stand with in-store A5 graphics facility Splash Proof Cover, Buzzer

Star Choice to suit your budget

Once again, Star has produced a high spec., entry-level receipt printer which will happily slip into the majority of POS and Hospitality solutions. Producing fast, high quality receipts with the very latest, leading edge components, this printer takes data processing to a new level.

Only Star is able to offer such a huge range of single station POS printers and the TSP650 extends the choice to suit your budget.





TSP700II Series

High Speed Multi-functional Barcode, Label, Ticket and Receipt Printers

- Introducing the world's fastest single station receipt printer capable of producing barcodes, labels and tickets at a rapid 250mm per second
- Large paper roll diameter up to 100mm providing almost twice as much paper capacity
- "Drop-In & Print", easy paper loading. Literally drop a roll of paper into the printer, close the lid, and it's loaded!
- Full or partial cut autocutter (centre) MCBF 2 million cuts
- New splash resistant design with easy-clean curves for robust kitchen / bar use
- Available in Star white or Charcoal grey with serial, parallel, USB (WHQL certified) or no interface versions. User installable, low cost Ethernet option also available with Print on Disconnection feature
- Easy-to-use AutoLogo™ marketing / stock management tool with the ability to configure / download up to 15 graphics or coupons without any expensive software changes or complicated set up procedures
- Double Density (406 x 203 dpi) print resolution setting for high quality graphics and ID photos
- Compatibility with all major operating platforms with a quality suite of drivers including Microsoft WHQL certification for seamless USB integration

TSP700II Driver / Advanced Configuration utility

- The "Image List" allows users to name and even import multiple file types without having to use an external image editing utility. This is particularly useful for single users to prepare an image (size, shade, pixel output) and then test print it to check the final quality
- NV logo allows users to quickly and easily download logos to the printer
- Ability to change Memory Switches in an easy-to-use graphical user interface
- The new built-in Ethernet Set-up feature avoids having to download a separate utility
- The Virtual Serial Port allows communication over Ethernet or USB using software limited to serial output
- Auto-Text Reverse for vertical use is available from the Device settings menu in raster mode
- The Enable Value Add function allows users to use some futurePRINT features such as text processing and couponing. Please contact your reseller for more information

Typical Applications

- High Speed Receipt Printer
- Reliable Hospitality Printer with "Splash Proof" cover
- Barcode, Label & Ticket Printer with External Paper Feed Path and Black Mark Sensor
- Lottery Printer 82.5mm print width with 1st column printing
- Kiosk Printer with four position usage and external paper feed path

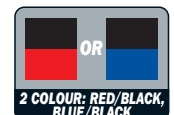
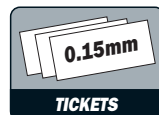



High speed, multi-functional printer, ideal for Labels, Barcodes, Receipts, Tickets and Kiosk

Reduce Paper Costs
- contact Star if you need assistance.

All Star thermal printers can reduce any receipt length by up to 25% without reducing the font size.



Splash Proof cover



Receipt Rotation Tool



Serial, Parallel and USB interface versions are available, plus a non interface version for use with Ethernet or WiFi



"Drop-In & Print" Easy Load



New Flashing Paper Exit Guide



TSP700II Snout Connection

Linux
JAVAPOS™
Compatible with OPOS
Windows 7 WHQL Mac Universal
ESC/POS™

Compatibility with most major operating systems

TSP700II Printer Specifications

Printer Method	Direct Thermal Line Printing
Print Speed	up to 250mm/second
Print Resolution (vertical x horizontal) Double Density graphics	203 x 203 dpi 406 x 203 dpi (selectable for ID photos etc.)
Print Density	7 step selection by memory switch or control command
Character Matrix	12 x 24 dots, 9 x 24 dots
Two Colour Print Capability	Red / Black, Blue / Black (special paper required)
No. of Columns (maximum)	48 / 64 or 53 / 71 (depends on Paper Width) incl. 1st column print for lottery applications
Character Set	ANK 95, 32 Int 128 Graphic
International Code Pages	Star Mode = 40 + 1 blank. ESC/POST™ Mode = 6 + 1 blank allowing an additional character page to be added
Barcodes	9 versions / PDF417, QR code
Line Spacing	3mm or 4mm + Programmable
Paper Feed Speed	up to 250mm/sec.
Paper Specifications: Width	80mm standard. 82.5 & 58mm also available by simply moving installed paper guide
Thickness / Weight	0.065 ~ 0.15mm
Roll Diameter	100mm
Easy-Load	"Drop-In & Print" or through rear slot for fanfold paper / tickets / labels
Paper End / Black Mark Sensor	Standard
Near End Sensors	Two sensors for horizontal or vertical use respectively
Maximum Print Width	80mm paper = 72mm, 82.5 paper = 80mm, 58 paper = 52mm
Top Margin	13mm default (3mm selectable via Memory Switch)
External Straight Paper Feed Path	Standard for larger paper rolls or fanfold paper / tickets / labels
Autocutter (guillotine)	Full or Partial cut selectable (centre cut) up to 2 million cuts
Logo Store	2 Mbit Flash ROMs with graphic management software
Flash ROM	16Mbits
Drivers Available (CD-ROM with printer)	Windows® 7 32/64 Bit, Vista 32/64 Bit, XP 32 Bit, XP Embedded, CE, Server 2008 32/64 Bit, 98/ME/2000/NT4 (download only), WePOS, POSReady, OPOS™, POS for .NET, JavaPOS™, Virtual Serial Port, Linux™ CUPS, Mac OS X CUPS, StarIO SDK
Interface Versions	Serial, Parallel, USB, Non-interface versions with low cost Ethernet "plug-in" option. Non Star WiFi / Bluetooth options
Emulation	Star Line Mode & ESC/POST™
Peripheral Drive Circuit	2 circuits (24V max. 1A), 1 Compulsion input
Power Consumption	Operating / Waiting – Average 1.8 / 0.15A Uses PS60 – 24V Psu with Hosiden connector
Operating / Storage Conditions: Temperature	5°C to 45°C / -20 to 60°C
Humidity	10% ~ 90% RH (without condensation) / 10% ~ 90% RH
Dimensions (without interface cover)	147 (W) x 213 (D) x 148 (H) mm / 1.75Kg
Safety Standards	UL, C-UL, TÜV, FCC, VCCI, EN55022, CE, Gost
Reliability: Printer	60 million lines (MCBF)
Autocutter (Guillotine)	2 million cuts
Options	Parallel (IFBD-HC03), Serial (IFBD-HD03), Ethernet (IFBD-HE07), USB (IFBD-HU05), Serial 9-pin (IFBD-HN03) Non Star WiFi / Bluetooth options New Flashing Paper Exit Guide, Wall & Vertical Mount Kits (basic wall mount kit supplied with printer) PS60 24V Power Supply, Splash Proof Cover, Buzzer

Accessories included in box with printer at purchase

New features included in the box at purchase: Driver CD, Wall & Vertical mount kits, Interface & Power switch covers



TSP800II Series

High Speed, Wide Format Barcode, Label, Receipt and Ticket Printer

- Versatile 180mm/sec. Barcode, Label, Receipt & Ticket Printer with Autocutter
- Unique 104mm / 4" print width – on paper stock up to 0.15mm thick. 82.5 and 80mm paper rolls can also be accommodated using the optional paper guide
- Internal or External Paper Feed Paths (external for large capacity or security applications)
- "Drop-In & Print", easy paper loading
- Two colour output when required with comparable running costs to other technologies – red / black or blue / black (special paper required)
- Compact Footprint (180 (W) x 213 (D) x 148 (H) mm) with vertical "Desk Boot" and Wall Mount options
- ESC/POST™ compatible in standard and "Super Large" mode
- Automatic scalable raster driver for immediate A4 reduction to virtual A6. Ideal for desktop replacement printer, internet café and kiosk use
- **Kiosk Information Terminal Printer**
Desk boot option & external paper feed path
- **Internet Printer**
Screen image reduction feature
- **Remote Printer**
- **Industrial Printer**
Data logging, journals – high capacity paper rolls
- **TSP847II** Non Interface
- **TSP847IIU** USB Interface
- **TSP847IID** Serial Interface
- **TSP847IIC** Parallel Interface
- User installable, low cost Ethernet option also available with Print on Disconnection feature

Typical Applications

- **High Quality POS Receipt Printer** with shelf edge labelling feature
- **Ticket / Label / Kiosk / Information Terminal Printer** with black mark sensor
- **Barcode Printer**

Automatic Page Scaling – A4 to virtual A6

The new **TSP800II Scalable Raster Driver** provides the ability to format a page or screen image in the same way as a standard PC printer and then print that image on 112mm wide paper up to 0.15mm thick. All this at up to 180mm/second, without the need for additional software!



 180mm per second HIGH SPEED	 EASY LOAD	 KIOSK PRINTER	 A4 → 50% RASTER SCALER FULL SCREEN GRAPHICS DOWN TO 112mm WIDE	 up to 0.15mm BARCODE, LABEL & TICKETS	 LOGO STORE 16 Mbit FLASH ROM	 BI-DIRECTIONAL STATUS CHECK	 OR 2 COLOUR: RED/BLACK, BLUE/BLACK
--------------------------------------------------	----------------------	--------------------------	---------------------------------------------------------------------------------------------------------	----------------------------------------------------------------	---------------------------------------------------	----------------------------------------	---------------------------------------------------------



High speed USB and Ethernet interface options (user installable)



Versatile 112mm output for all retail and kiosk environments



Unique kiosk printer for automatically scaled A4 to A6 output. (See the Star Kiosk brochure for further details)



External paper feed path for secure or high capacity applications



Wall mount and desk boot options



Barcodes, labels, receipts and tickets all from one model at speeds up to 150mm/second

TSP800 II / TSP800RX Printer Specifications

Printer Method	Direct Thermal Line Printing
Print Speed	up to 180mm/second
Print Resolution (vertical x horizontal)	203 x 203 dpi, 406 x 203 dpi (selectable for ID photos etc.)
Print Density	7 step selection by memory switch or control command
Two Colour Print Capability	Red / Black, Blue / Black (special paper required)
No. of Columns (maximum)	TSP800II: 104mm with A4 auto reduction software feature
International Code Pages	Star Mode = 40+1 blank. ESC/POS™ = 10+1 Blank allowing an additional character page to be added
Barcodes	9 versions / PDF417, QR code
Line Spacing	3mm or 4mm + Programmable
Paper Specifications:	
Width	TSP800II: 112mm standard, (82.5mm, 80mm with guide)
Thickness / Weight	0.065 ~ 0.15mm
Roll Diameter	100mm
Easy-Load	"Drop-In & Print" or through rear slot for fanfold paper / tickets / labels
Paper End / Black Mark Sensor	Standard
Near End Sensor	Horizontal position default
Maximum Print Width	up to 104mm
Top Margin	13mm default (3mm selectable via Memory Switch)
External Straight Paper Feed Path	Standard for larger paper rolls or fanfold paper / tickets / labels
Autocutter (guillotine)	Full or Partial cut selectable (centre cut) up to 2 million cuts
Logo Store	3.9Mbit Flash ROM with graphic management software
Flash ROM	16Mbits
Drivers Available (CD-ROM with printer)	Windows® 7 32/64 Bit, Vista 32/64 Bit, XP 32 Bit, XP Embedded, CE, Server 2008 32/64 Bit, 98/ME/2000/NT4 (download only), OPOS™, JavaPOS™, Linux™ CUPS, Mac OS X CUPS, Scalable Raster Driver, StarIO SDK
Interface versions	Serial, parallel, USB, Non-Interface versions with low cost Ethernet "plug-in" option. Non Star WiFi / Bluetooth options
Emulation	Star Line Mode & ESC/POS™ (Page mode supported)
Peripheral Drive Circuit	2 circuits (24V max. 1A), 1 compulsion input
Power Consumption	Operating / Waiting – 2.0 / 0.12A Uses PS60 – 24V with Hosiden connector
Operating / Storage Conditions:	
Temperature	5°C to 45°C / -20 to 60°C
Humidity	10% ~ 90% RH (without condensation) / 10% ~ 90% RH
Dimensions / Weight	180 x 213 x 148mm / 1.9Kg
Safety Standards	UL, C-UL, TÜV, FCC, VCCI, EN55022, CE, Gost
Reliability:	
Printer	37 million lines (MCBF)
Autocutter	2 million cuts
Options	Parallel (IFBD-HC03), Serial (IFBD-HD03), Ethernet (IFBD-HE07), USB (IFBD-HU05), Serial 9-pin (IFBD-HN03) Interfaces Non Star WiFi / Bluetooth options Wall & Vertical Mount Kits; Buzzer; PS60 24V Power Supply

TSP800RX – the Secure Printer



Introducing the new secure locking TSP800RX for extra media protection.

- Perfect for high value ticketing as well as other applications including the medical industry in the US and Middle East.
- Designed specifically to work with the latest electronic medical record (EMR) software, the TSP800RX is well known for its secure handling of specialised thermal prescription paper.

Visit www.StarAsia.com for further information.



Kensington Lock Slot to secure Printer

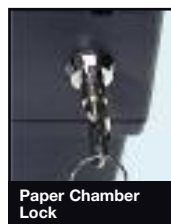

Paper Chamber Lock



Disabled Paper Feed Button for added Security



Specialist Prescription Printer

TSP828 Series

Dedicated Direct Thermal Label Printer with In-Built Automatic Label Peeler



- High speed, high resolution output
- Fully adjustable label widths
- Easy-Load
- Automatic label peeler as standard (can be easily disabled when required)
- Multiple Interface versions with user installable, low cost Ethernet option also available with Print on Disconnection feature
- Large capacity, 110mm diameter paper roll
- Star Line & Page Mode
- Barcode support: Ladder and 2 Dimensional
- Transmissive / or Reflective sensor for top of form recognition
- Paper End and Label Peeler sensors
- Windows™ Drivers on CD included with printer

Typical Applications

- Retail Point-of-Sale
- Shelf Labelling
- Inventory Control
- Product Labelling
- Shipping
- Couriers / Logistics
- Warehouse
- Mailing etc.

TSP828 Printer Specifications

Printer Method	Direct Thermal Line Printing	Drivers Available (CD-ROM with printer)	Windows® 7 32/64 Bit, Vista 32/64 Bit, XP 32 Bit, XP Embedded, CE, Server 2008 32/64 Bit, Linux™ CUPS, Mac OS X CUPS, StarIO SDK
Print Speed	up to 150mm/second / 35 lps @ 6 lpi (47 lps @ 8 lpi)	Interface Options	Parallel (IFBD-HC03), Serial (IFBD-HD03), Ethernet (IFBD-HE07), USB (IFBD-HU05)
Paper Feed Speed	150mm/second	Emulation	Star Line Mode / Page Mode
Resolution	203 dpi (8 dots / mm)	Reliability: Printer Print Head	MCBF 37 million lines 100km
Print Width	104mm maximum	Power Supply	External option PS60
Paper Specifications: Width	41 to 108mm (±0.5mm) thermal label 45 to 112mm (±0.5mm) thermal paper roll maximum 110mm	Operating Conditions	Temperature 5 ~ 45°C Humidity 10% to 90% RH (without condensation)
Roll Diameter	up to 0.19mm maximum	Storage Conditions (not including paper)	Temperature -20 ~ +60°C Humidity 10% to 90% RH (without condensation)
Thickness / Weight Paper Loading	"Drop-In & Print", Easy Load	Printer Dimensions	180 (W) x 213 (D) x 157 (H) mm Approx. 2Kg not including I/F board, paper roll etc.
Interface Versions	TSP828UN – Dual Interface version (USB / RS232C Serial) TSP828C – Parallel Interface version Non Star WiFi / Bluetooth options		

TSP1000 Series

Versatile, Low Cost Thermal Printers with Receipt / Ticket Stacker and 18cm Paper Roll



Unique stacker for up to 30 tickets / kitchen orders, with a software definable sensor for maintaining table priority etc.

- High speed output – up to 180mm per second
- “Drop-In & Print”, easy-load
- Large paper roll capacity (up to 180mm diameter) with adjustable paper low sensor
- Ticket Stacker fitted as standard (up to 30 tickets) with fitted sensor for software driven multiple or single ticket / kitchen order print out
- Guillotine cutter
- Multiple paper width (45 ~ 82.5mm adjustable)
- Two colour output available – red / black or blue / black (special paper required)
- Variable position, high quality black mark sensor
- Three colour versions – Cherry red & Star white, charcoal grey or Star white

Typical Applications

- **High Speed Ticket Printer** – with high capacity paper roll and ticket stacker for group / family tickets
- **Reliable Kitchen / Warehouse Picking Ticket Printer** – with stacker for multiple orders
- **Versatile Receipt Printer** – for high volume receipting where the receipts are usually left behind
- **Lottery Printer** – 82.5mm print width with 1st column printing

- TSP1043D** Serial Interface
- TSP1043C** Parallel Interface
- TSP1043U** USB Interface
- TSP1043** No Interface (interface option can be added)



“Drop-In & Print” Easy Load 18cm diameter paper roll

The high capacity 180mm diameter paper roll can provide over 3,000 9cm tickets / food orders

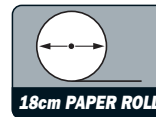
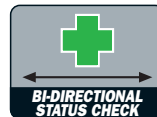
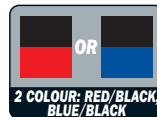
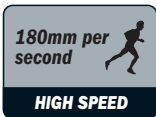

TSP1000 Printer Specifications

Printer Method	Direct Thermal Line Printing
Print Speed	up to 180mm per second / 57 lps
Print Resolution	203 dpi (8 dots per mm)
Two Colour Print Capability	Red / Black, Blue / Black (special paper required)
No. of Columns (maximum)	Star Mode = 40. ESC/POST™ Font A 42 Font B 64
Character Set	ANK 95, 32 Int 128 Graphic
International Code Pages	Star Mode = 40 + 1 blank, ESC/POST™ Mode = 10 + 1 blank allowing an additional character page to be added
Barcodes	9 versions / PDF417 option / QR code
Line Spacing	3mm or 4mm + programmable
Paper Specifications:	
Width	45 ~ 82.5mm (variable with 80mm default)
Thickness / Weight	0.065mm ~ 0.15mm
Roll Outer Diameter	180mm (dependant on paper weight)
Easy-Load	“Drop-In & Print”
Paper Out Sensor	Standard
Maximum Print Width	maximum 80mm
Left / Right Margin	0mm (left or right), 1st column print
Ticket Stacker	30 receipts / tickets maximum with ticket sensor
Ticket Length	50 ~ 300mm
Autocutter	Guillotine (Full Cut only)
Cutter position	Approx. 11mm distance between cutter and top of form
Logo Store Capacity	2 Mbit
Flash ROM / SRAM	2 x 8 Mbit plus 2 x 1 Mbit Static RAM

Drivers Available (CD-ROM with printer)	Windows® 7 32/64 Bit, Vista 32/64 Bit, XP 32 Bit, XP Embedded, CE, Server 2008 32/64 Bit, 98/ME/2000/NT4 (download only), WePOS, POSReady, POS for .NET, Virtual Serial Port, Linux™ CUPS, Mac OS X CUPS, StarIO SDK
Interface / Port	Full Speed USB (IFBD-HU06), Serial (IFBD-HD04) and Parallel (IFBD-HC04) as standard with Serial 9-pin (IFBD-HN04) and Ethernet (IFBD-HE08) options. Non Star WiFi / Bluetooth options
Emulation	Star Line & Page Mode, ESC/POST™
Peripheral Drive Circuit	2 circuits (24V max.1A), 1 Compulsion input
Power Consumption	Operating / Waiting – Average 2.0 / 0.1A Uses PS60 – 24V Psu with Hosiden connector
Power Supply	External option PS60
Operating Conditions:	
Temperature	5°C to 45°C
Humidity	10% to 90% RH (without condensation)
Storage Conditions:	
Temperature	-20°C to 60°C
Humidity	10% to 90% RH (without condensation)
Dimensions	161 (W) x 306.5 (D) x 249 (H) mm
Weight	3.0Kg
Safety Standards	UL, C-UL, TÜV, FCC, VCCI, EN55022, CE, CB
Reliability:	
MCBF	60 million lines
Print head	100km
Cutter (Guillotine)	1 million cuts



SP298 Series

Fast, Reliable, Cost Effective Matrix Impact Slip Printers

- Rugged bi-directional printer capable of graphics using a highly reliable 9-pin print head
- Up to 3.1 lines per second with bi-directional cheque mode
- High reliability with helix head drive 9 million lines Calculated Real Time MCBF / 2.5 million lines Traditional
- Epson TM-U295 compatible with same size footprint and interchangeable power supply

Typical Applications

Ideal for printing 'company branded' pre-printed multi-part slips / forms

- Hotels
- Restaurants
- POS
- Pharmacy Printer

SP298 MD Serial Version
SP298 MC Parallel Version

Unique AutoSide Loading™

The printer features unique paper AutoSide Loading making document loading quick, easy and reliable. The user can simply introduce a form into the side of the station and the printer performs automatic document clamping, instant top of form alignment, fast printing and selectable forward or reverse document eject.

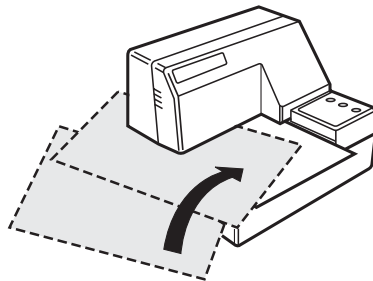

SCP700 Series

Thermal Receipt / Label & Impact Slip Combination Printer

- Pharmacy Printer – unique compact printer able to simultaneously print labels and prescriptions
- The SCP700 can be used in any environment where slips and / or labels need to be printed for product tracking – technical warranty departments etc.

SP298 & SCP700 Printer Specifications

SP298 / SCP700 Slip Printer		Drivers Available	
Printer Method	9-pin serial impact dot matrix with true descenders	Windows® 7 32/64 Bit, Vista 32/64 Bit, XP 32 Bit, 98/ME/2000/NT4 (download only), XP Embedded, Server 2008 32 Bit, StarIO SDK	
Print Speed	up to 3.1 lines per second	Agency Approvals	UL, C-UL, FCC, TÜV, CE, CB
Emulation	Star Mode & ESC/POS™ (Epson TM-U295)	SP298 Dimensions	180 (W) x 190 (D) x 138.5 (H) mm / 2.1Kg
Interface	Serial or Parallel (SCP700 dual interface – Serial with parallel option)	SCP700 Thermal Receipt / Label Printer	
Paper:		Print Method	Direct Thermal Line Printing
Copy Capability	Original + two copies	Print Speed	up to 50mm/second
Paper Width / Length	up to 182mm / 80 to 257mm	Printable Width	72mm
Margin Top / Bottom	5 / 14mm	Paper Width	80mm
Print Width	63mm	Thickness / Weight	0.06 to 0.085mm
Reliability	MCBF 9 million lines	Sensor	Paper Out, Near End (3 adjustable positions)
Head Life	70 million characters	Reliability	38 million lines
Power Supply	PS60 option 24V Psu with Hosiden connector	Autocutter (Guillotine)	Full or Partial 300,000 cuts Label Version Full Cut only
Ribbons	Black RC200B, 1.2 million characters RC2000D Laundry Ribbon		

HSP7000 Series

High speed, 203 dpi Thermal / Matrix Hybrid Combination Printer

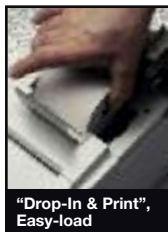

- High speed 250mm/second thermal receipt printer, combined with high speed 9-pin matrix cheque / validation printer
- High resolution 203 dpi output for fast, superior quality logo / barcode receipt output
- "Drop-In & Print", Easy-load
- Fast, easy and accessible ribbon replacement with cover sensor
- Auto status back for paper loading, sensor reporting etc.
- Easy-to-use AutoLogo™ marketing / stock management tool with the ability to configure / download graphics or coupons

Typical Applications

- **POS Printer**
Perfect for combined and accurate, high speed 203 dpi receipt and 9-pin cheque printing
- **Tough Record and Form Printer**
Fast, accurate form completion with high speed record output for Electronic and DIY retailers (for product warranties etc.)

- **HSP7543** Hybrid Combination without MICR
- **HSP7643** Hybrid Combination with top position MICR
- **HSP7743** Hybrid Combination with bottom position MICR

(MICR = Magnetic Ink Character Recognition, used in cheque-reading devices)

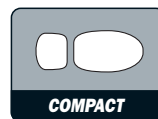
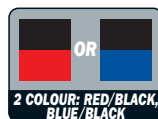
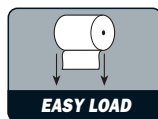
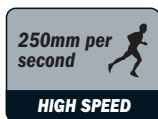

HSP7000 Printer Specifications

Print Speed:	
Thermal	up to 250mm/second
Matrix Slip	83 lps (3mm / line), 63 lps (4mm / line) up to 4.82 lps (40 columns) up to 8.9 lps (16 columns)
Dimensions / Weight	186 (W) x 296 (D) x 177 (H) mm / 4.6Kg
Emulation	Star Mode / ESC/POS™
Drivers Available (CD-ROM with printer)	Windows® 7 32/64 Bit, Vista 32/64 Bit, XP 32 Bit, XP Embedded, CE, Server 2008 32/64 Bit, 98/ME/2000/NT4 (download only), WePOS, POSReady, OPOS™, POS for .NET, JavaPOS™, Virtual Serial Port, Linux™ CUPS, Mac OS X CUPS, StarIO SDK
Interface	Parallel / Serial
Interface options	Full Speed USB (IFBD-HU06), Serial (IFBD-HD04), Parallel (IFBD-HC04), Ethernet (IFBD-HE08), Powered USB (IFBD-HPU04)
Safety Standards	UL, C-UL, TÜV, FCC Class A, CE, CB GOST, C-tick, AS standard, VCCI Class A, EN55022
RECEIPT STATION:	
Thermal	Direct Thermal
Resolution	203 dpi
Autocutter	Guillotine partial cut (centre)
Target Life	1.5 million cuts
Reliability	60 million lines
Paper:	
Paper Loading	"Drop-In & Print"
Roll Diameter	max. 83mm
Paper width / Print area	80 / 72mm (default) 76 / 68mm, 58 / 51mm

Paper Thickness (Receipt)	0.065 ~ 0.085mm
Near End Sensor	Yes
Paper Sensor	Yes
Cover Open Sensor	Yes
Barcodes	Yes
Two Colour Receipts	Red / Black, Blue / Black (special paper required)
MATRIX SLIP STATION:	
Print Direction	9-pin bi-directional, logic seeking
Reliability	37 million lines
No. of Columns	60 / 45 cols.
Print Area	max. 85.4mm
Paper Loading	Intelligent Front Loading
Paper Width	up to 230mm
Length	75 ~ 297mm
Thickness / Weight	1 part: 230mm wide: 0.09 ~ 0.15mm, 105mm wide: 0.09 ~ 0.20mm 4 part: 0.09 ~ 0.31mm
Ribbon	RC-7KB
Cheque Printing	Yes
Validation	Yes (max. 8 lines)
MICR Versions (Top / Bottom)	Yes (lower cost Non MICR version also available)
Options	Full Speed USB (IFBD-HU06), Serial (IFBD-HD04), Parallel (IFBD-HC04), Ethernet (IFBD-HE08), Powered USB (IFBD-HPU04) Interfaces PS60 Power Supply

SP700 Series

Advanced, High Speed Clamshell™ Receipt Printers



- High speed, 9-pin high quality printer
- “Drop-In & Print”, easy paper loading
- Flexible with different paper widths:
58mm / 70mm / 76mm
- Variety interface options fit different system needs
- Paper Check Window enables checking the remaining paper without opening the cover
- 18 Pin head allows printing Chinese Character in 1 pass
- New splash resistant design with easy-clean curves for robust kitchen / bar use
- Capable to print in two colors: Black and Red to highlight important information and print pleasant logos.
- Built-in power supply, no AC adapter is need
- Paper Guide, Switch Cover included as standard

- New **Graphics Management Tool** with a name and list facility for easy identification and use for up to 255 images. This tool will also facilitate multiple printer configurations **NEW**
- **Logo Store Driver Tool** can download multiple images (mono or colour in a variety of formats)

Typical Applications

- **Receipt Printer**
for POS systems that require reliability and speed
- **Hospitality**
Splash resistant cover. Buzzer alarm and wall mount option

Models

SP712

Tear Bar Printer

SP712R

Tear Bar Rewind Version

SP742

Autocutter Printer

SP742R

Autocutter Rewind Version

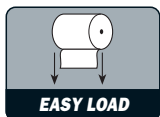

The New Star SP700 printers are enhanced not only in printing speed, but also in capability and reliability. It is a cost-efficient model which is ideal for restaurant, kitchen, retail and ticketing.

With SP700 series, you could print quality receipts and tickets at a faster speed than ever. SP700 printers incorporate with "Drop-in & print" paper loading design, in just 3 simple steps, you could change the paper roll easily and quickly.

To satisfy different requirements, SP700 series comes with 9-Pin or 18-Pin versions; Tear bar or Autocutter version. The 18-Pin version, SP717 and SP747 allows printing Chinese characters in one single pass, doubling Chinese character printing speed. Moreover, SP700 series provides variety of interface options, from traditional Parallel Interface to advanced Ethernet Interface, to integrate with different system configurations.

Star has improved not only the hardware features, but also the software capabilities making day-to-day usage so much easier. We always plan ahead, driver for next generation Windows OS - Windows 7 is ready for SP700 printers.

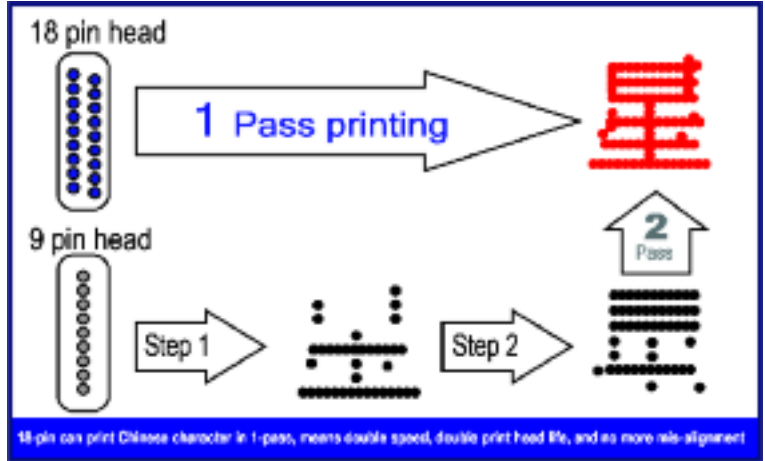

All models are available in Star White or Charcoal Grey with Serial / Parallel / USB (WHQL certified) or Ethernet interface.

SP700 Printer Specifications

Print Method	9 Pin Serial Impact Dot Matrix	Wall Mount Facility	Available on all models (up to 2 part paper)
Printer Versions: SP712 SP742	Tear Bar Mono and Red / Black Model Autocutter Mono and Red / Black Model (full or partial cut)	Paper Sensors	Paper End (Near End Sensor option – factory fit), black mark option
SP712 / 742 with rewind Interface Versions Interface Options	Tear Bar and Autocutter Rewind Models RS232, Parallel, USB 2.0, Without Interface USB (IFBD-HU06), Serial (IFBD-HD04) and Parallel (IFBD-HC04), Ethernet (IFBD-HE08), Serial 9-pin (IFBD-HN04) Non Star WiFi / Bluetooth options	Ribbon Life: RC700B RC700BR	3 million characters Black 1.5 million characters / Red 0.75 million characters
Print Speed	Capable of printing 13 x 20 line receipts per minute from 4.7 to 8.9 lps depending on number of columns	RC700D	Laundry Ribbon
Paper Feed Speed	Approx. 5.6 inches per second (@ continuous feed)	Data Buffer	8 Kbyte
Print Direction	Bi-directional, Logic Seeking	Program ROM	Flash Memory (16Mbit), NV bit image 256 Kbyte
Print font: Character Matrix Column capacity Character Size (mm) Character Set Code Pages Character Per Inch (CPI)	7 x 9 (Half dot) / 5 x 9 42 / 35 1.2 (W) x 2.42 (H) / 1.5 (W) x 2.42 (H) 95 Alphanumeric, 32 International 40 16.9 / 14.1	Emulation	Star Mode and ESC/POST™
Paper Loading	Drop-In & Print, Easy Load with see-through cover	Drivers Available (CD-ROM with printer)	Windows® 7 32/64 Bit, Vista 32/64 Bit, XP 32 Bit, XP Embedded, CE, Server 2008 32/64 Bit, 98/ME/2000/NT4 (download only), WePOS, POSReady, OPOST™, POS for .NET, JavaPOST™, Virtual Serial Port, Linux™ CUPS, Mac OS X CUPS, StarIO SDK
Paper Handling: Width with guide included	76mm (default), 69.5mm, 58mm (± 0.5) x 85mm roll diameter	Power Supply	INTERNAL Power Supply with power cable included
Thickness / Weight 1 ply Copy Capability 2 ply Copy Capability 3 ply	0.06 ~ 0.085mm Original + 1, 0.05 ~ 0.08 / piece, total less 0.14 Original + 2, 0.05 ~ 0.08 / piece, total less 0.20	D.K.D. Function	2 Drivers
		Reliability	MCBF 22 million lines
		Autocutter (Guillotine)	1 million cuts (full / partial cut)
		Overall Dimensions	160 (W) x 245 (D) x 152 (H) mm 160 (W) x 245 (D) x 183 (H) mm (rewind version)
		Weight	SP712: 2.96Kg, SP742: 3.18Kg, SP712R: 3.43Kg, SP742R: 3.65Kg
		EMI Standard	VCCI Class A, FCC Class A, CE
		Safety Standard	UL, C-UL, TÜV, CB, EN60950
		Options	Interfaces (see above), Black Mark Sensor, Buzzer, Wall mount / Vertical use kit

SP500 Series

Logic seeking SP500 Series offers an unbeatable price / performance ratio unmatched by any other manufacturer

- High speed, logic seeking, 9-pin quality matrix printer – up to 7.5 lps
- **NEW** non-interface version available for Ethernet and USB usage (IFBD-HE08 and IFBD-HU06)
- Competitively priced with unmatched feature per cost ratio
- “Drop-In & Insert” paper loading facility
- Adjustable 58 or 76mm paper widths
- Quality ticket output on media up to 0.10mm with 6 position Black Mark Sensor
- Spill-proof / Hygienic design for bar / kitchen environments with cable and power switch covers
- Space saving vertical or horizontal operation
- Wall mount option
- Internal universal power supply
- Journal / Rewind option (must be fitted by supplier)
- Compact footprint with internal power supply and vertical operation

Typical Applications

- Point of Sale
- Ticketing
- Hospitality
- Fiscal (requires local module)
- Kiosk

- SP512** Tear Bar Version
- SP542** Autocutter Version
- UP542** Kiosk Version



Vertical footprint:
163mm deep
by 140mm wide

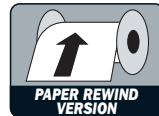

SP500 Printer Specifications

Printer Method	9 Pin Serial Dot Matrix
Print Speed	Approx. 7.5 lps (@ 16 col) or 4 lps (@ 42 col, 16.9 CPI)
Print Direction	Bi-directional, Logic Seeking
Paper Feed Speed	Approx. 33 lps (@ continuous feed)
Number of Columns	40 col / 42 col / 35 col (76mm paper) 30 col / 32 col / 26 col (58mm paper)
Character Matrix	7 x 9 (half dot) / 5 x 9
Character Set	95 alphanumeric, 46 International, 128 x 40 graphic
Code Pages	40 Code Pages
Program ROM	Flash Memory
Character per inch (CPI)	16.9 / 14.1
Character Size (mm)	1.2 (W) x 2.42 (H) / 1.5 (W) x 2.42 (H)
Paper Specifications:	
Width	76 ± 0.5mm or 57.5 ± 0.5mm (W) x 85mm (diameter)
Thickness / Weight 1 ply	0.07 ~ 0.10mm
Copy Capability 2 ply	Original +1, 0.05 ~ 0.08mm per ply (total less than 0.14)
Copy Capability 3 ply	Original +2, 0.05 ~ 0.08mm per ply (total less than 0.20)
Ribbon Life	1.2 million characters (RC200B)
Control Code	Star Mode / ESC/POS™ Emulation
Interface	Serial or Parallel. New Non-interface version for Ethernet (IFBD-HE08), USB (IFBD-HU06), Serial 9-pin (IFBD-HN04) usage

Data Buffer	2 KByte or 256 Byte
Reliability:	
Printer	22 million lines (CRT), 9 million lines (MCBF)
Autocutter	300,000 cuts (Full or Partial Cut) Guillotine
Drivers Available	Windows® 7 32/64 Bit, Vista 32/64 Bit, XP 32 Bit, XP Embedded, CE, Server 2008 32/64 Bit, 98/ME/2000/NT4 (download only), WePOS, POSReady, POS for .NET, Virtual Serial Port, StarIO SDK
Peripheral Driver	2 circuits, for driving solenoids etc. (24V max., 1A)
(D.K.D. Function)	1 compulsion input
EMI Standard	VCCI Class A, FCC Class A, CE Marking
Safety Standard	UL, C-UL, TÜV, CB
Black Mark Sensor	6 position as standard
Paper End Sensor	Standard
Additional Features	Fiscal Memory (Space Only) Power Switch Cover as standard
Overall Dimensions	140 (W) x 225 (D) x 163 (H) mm 140 (W) x 225 (D) x 210 (H) mm (rewind version)
Weight	2.0Kg (Tear Bar Model) 2.2Kg (Autocutter Model)
Options	Paper Near End Sensor Star Buzzer alarm Paper Rewind (Journal) – Distributor/Factory Fit Vertical Mount Paper Roll Holder WB-S500 Ethernet & USB options for SPECIAL SP500 version

DP8340 Series

Compact, Wide Format (114mm), Receipt / Record Printers



Unique 114mm wide report, receipt and data printer available for 12V or 24V usage in mobile, rugged or unattended environments.

- Reliable budget entry level printer with tear bar
- Up to 2 lines per second with a paper feed speed of 12 lps
- Black and red printing

- Separate 230V AC power supply with 12V DC output
- Wall mount option available

Typical Applications

- **Receipt Printer**
- **Record Printer** Data logging, Measuring equipment
- **Mobile Printing** 12 volt applications

- **Label Printing** Sprocket version
- **Graphics Version** details upon request

- **DP8340FD** Serial Friction, Black / Red
- **DP8340FC** Parallel Friction, Black / Red
- **DP8340SD** Serial Sprocket, Black / Red
- **DP8340SC** Parallel Sprocket, Black / Red

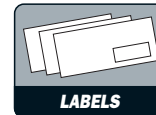
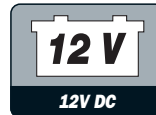
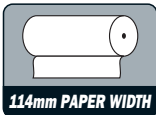

DP8340 Printer Specifications

Printer Method	9-pin serial impact dot matrix
Print Speed	up to 2 lines per second (bi-directional)
Number of Columns	40 (12 CPI) 48 or 60 column option
Print Area	84.3mm
Line Spacing	1/6"
Character Size	12 CPI
Character Set	ASCII 96 International and Symbol 64 Block graphics 64 IBM Special 83 & Block graphics 50 (available only on parallel interface) Download 10 (available only on parallel interface)
Character Matrix:	
Ordinary Characters	5 x 9 dots
Block Graphics	6 x 6 dots
IBM Block Graphic	6 x 8 dots (available only on parallel interface) Graphic Mode
Ink Ribbon	Black / Red (SF-03BR), Life 800,000 / 400,000 characters
Option	Black (SF-03B), Life 800,000 characters
Reliability	10 million lines Calculated Real Time MCBF 5 million lines MCBF (Traditional)
Print Head	70 million characters
Paper Feed Speed	12 lines per second

Paper:	
DP8340	Roll Paper (Width 4.5" / 114.3mm)
DP8340S	Sprocket Fanfold (Width 4.5" / 114.3mm)
Roll Diameter	Max. 3.15" (80mm)
Thickness / Weight	Max. 0.09mm
No. of Copies	One original + 1 copy
Operating Conditions	5°C to 40°C, 10% to 80% RH (w/o condensation)
Storage Conditions	-20°C to 70°C, 5% to 95% RH (w/o condensation)
Data Buffer	Approx. 1.5 KByte
Interface	Serial (RS232C) and 20 mA current loop or Parallel
Dimensions	202 (W) x 200 (D) x 98 (H) mm (w/o paper holder)
Weight	Approx. 1.9Kg
Drivers Available	OPOST™, Windows™ line mode with control font support
Peripheral Drive	RS232C – Internal output / Parallel – 1 internal & 1 external (no compulsion switch)
Options	Wall mount bracket; In-vehicle power cable
PS8340 Power Supply Unit	
Output	DC 12V ± 10% (max. 2A)
Dimensions	59 (W) x 117 (D) x 36 (H) mm
Weight	2.0Kg



Kiosk Print keep the w

Star innovation

From the world's busiest airports to the world's largest casinos, our kiosk solutions keep people moving and businesses booming. Star Micronics are the kiosk printing industry specialists with over three decades of knowledge and expertise and have, as a result, created the world's largest range of kiosk printers with unmatched versatility and specialist options designed specifically for the kiosk market.

Remote Firmware Update Capability

All of Star's latest thermal printers can be sent firmware updates remotely saving our customers time and money updating new resident printer features; new barcode types etc. as well as adding Star customer specific requirements. Contact Startech@Star-EMEA.com for more details.

Auto Recovery after Power Loss

This is a common issue for kiosks in some environments which is fortunately a thing of the past with Star's selectable auto recovery feature. This will ensure the printer resumes operation no matter at what point the power was lost during the printing cycle.

Actual Print Verification / Status

This is another hot topic which Star is happy to solve with their customers' system set-ups. Star printers are able to provide accurate status reports that verify when and whether a ticket has actually been printed, taken or retracted, giving peace of mind all round.

Star Operating Platform Support

It is well known that Star Micronics Drivers are the best in the industry due to the consistent investment, expertise and relationships developed with industry giants such as Microsoft and Apple and the UPOS committee. Not only do Star sophisticated drivers support industry standards from Windows 7 to Linux or POS for .NET, but Star is also prepared to supply source code for those kiosk builders who prefer to communicate directly with the printer's port thus providing flexibility at all levels. Mature Java-POS™ support has also been a top topic for kiosks for some time with Star's experience developed through so many installed applications.

The secret of success

The secret to Star's success in this marketplace is a result of its expertise being demanded by the Star customer which has led to the world's largest range of both encased, open frame modular and mechanism specialist thermal and matrix kiosk printing solutions.

Star's open frame printers are the perfect solution for those more sophisticated unattended applications while kiosk builders have a wide choice of encased

printers for simpler kiosk design. These are easier to adapt to meet customer's requirements from a design perspective.

Many kiosks are now an extension of the customer's original retail solution and, as such, benefit from the POS printer experience and specialist features included within the Star range. The same can be said for the majority of UK cinemas today, which gain from the speed, low cost and easy maintenance

of the Star TSP700II encased printer, as do other kiosk customers in Nigeria, Germany, South Africa, Scandinavia and the US, to name just a few countries serviced by Star Micronics.

Star's experience with installations around the world is virtually endless and all customers can and should take advantage of the hardware and software support available.

The Star difference

Star's specialist in-house OEM team have the technical knowledge and experience required to assist customers with every aspect of printer integration from customised printing solutions within restricted timescales to a vast range of operating platform drivers. Star has successfully installed specialist printing solutions into some of the world's largest kiosk applications including employment agencies, Internet stations, Mobile Phone Top-Up, In-Store Loyalty applications, Parking and Access Control, Ticketing and Information kiosks. **Full range details can be found on page 7 or please request the Star Kiosk brochure from www.StarAsia.com**

Printing Solutions that world in motion...

Save paper and money with Star's A4 to A6 Automatic Scaling Tool

The Automatic A4 to virtual A6 Scalable Tool is a perfect solution for Internet or product detail printouts, hotel chains wanting to reduce paper costs and environmental damage as well as any other type of customer wanting to combine a receipt printer with a back office printer for reporting. Premier Inn, the UK's fastest growing hotel chain could see this as invaluable tool in their network.



TSP800II



TSP700II



TSP650

NEW Flashing Paper Exit Guide option
now available for the TSP700II



TSP500



TUP500DP



TSP992

TUP500 Series

High Speed 220mm per second Kiosk Printing Solution available in Modular or Open Frame formats



TUP500 LED Flashing Paper Exit Guide



TUP500 Easy Paper Loading

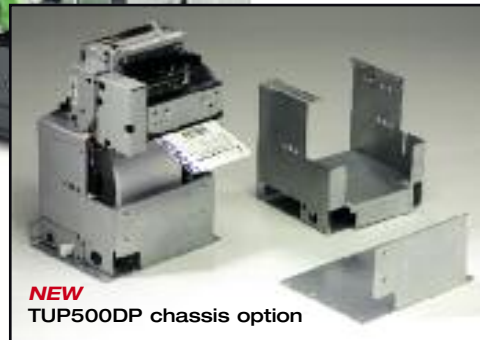

NEW TUP500DP chassis option

- Introducing the new superfast, versatile open frame / modular kiosk printing solution from Star Micronics. Featuring speeds up to 220mm/second (with standard 15cm paper roll) and a default speed of 180mm/second using the optional 25cm paper roll holder
- Adjustable 45 to 82.5mm paper width functionality with self centring width adjuster
- Barcodes receipts, tickets, labels (TUP542) etc. are all printed on media from 0.065mm to 0.15mm thick allowing for complete application functionality
- TUP500 options include:
 - 25cm paper roll holder for horizontal or vertical use (max. capacity 18cm in vertical mode)
 - Paper exit guide / snout with flashing LED attraction mode
 - **NEW** TUP500DP chassis option providing a more compact printer taking up to 25% less space with 10cm diameter paper roll
 - All models supplied without interface with low cost USB, Ethernet with "Print on Disconnection" feature as well as the traditional interface options



TUP500 Printer Specifications

Mechanism - TMP542 & Cutter	
Print Method	Direct Line Thermal Printing
Print Speed	up to 220mm per second
Printable Width	Max. 80mm with 1st column print
Top Margin	11mm (3mm selectable with reverse feed)
Print Resolution	8 or 16 x 8 dots / mm (203 or 406 x 203 dpi)
Paper Loading	Semi Automatic with easy "Lift & Tilt" Functionality
Paper Sensors	Black Mark / Paper End / Paper Low Sensors
Paper Specifications:	
Width	Min. 45mm to Max 82.5mm
Media	Thermal Paper Rolls
Two Colour Printing	Special thermal paper required
Thickness / Weight	0.065 ~ 0.15mm
Roll Diameter	15cm / 6" with 25.4cm / 10" option (RHU-T500)
Autocutter	Full Cut (Guillotine) – contact Star if Partial cut needed
Autocutter Life	up to 1 million cuts
Min. / max. Cut Length	TUP542: 25mm, TUP592: 75 ~ 300mm
Print Head Life	Max. 100 million pulses / 100 Km
Reliability	60 million lines MCBF
Mechanism Dimensions	TMP542: 135 (W) x 101 (D) x 103 (H) mm
Open Frame Dimensions	TUP592: 160 (W) x 234.1 (D) x 179 (H) mm
TUP500DP Dimensions	140 (W) x 150 (D) x 240 (H) mm
Without Presenter	TUP542: 160 (W) x 185 (D) x 179 (H) mm
Drivers Available	Windows® 7 32/64 Bit, Vista 32/64 Bit, XP 32 Bit, XP Embedded, CE, Server 2008 32/64 Bit, 98/ME/2000/NT4 (download only), OPOS™, JavaPOS™, Virtual Serial Port, Linux™ CUPS, Mac OS X CUPS, StarIO SDK

Interface	TUP500 Series supplied without interface
Interface Options	USB (IFBD-HU05), Ethernet (IFBD-HE07), Parallel (IFBD-HC03), Serial RS232C (IFBD-HD03), 9-pin Serial (IFBD-HN03)
Presenter Unit - PR500	
Paper Loop	Upper Side Loop
Presenter Function	Document Eject Document Capture (Timed or Software controllable)
Paper Thickness	0.065 ~ 0.15mm
Paper Length	75 to 300mm with Journal Mode for End-of-Day reporting
Paper Width	Min. 45mm to Max 82.5mm
Dimensions	135.1 (W) x 57 (D) x 76.3 (H) mm
Life	1 million receipts
Control Board - TBD500	
Flash ROM / SRAM	16 Mbit / 4 Mbit (2M x 2)
Logo Store	Enabled
Emulations	Star Line & Page Mode, ESC/POS™
Code Pages	Star Mode = 40 + 1 blank ESC/POS™ Mode = 10 + 1 blank
PS60 Power Supply Option	
Supply Voltage	24V DC, (59 (W) x 146 (D) x 32 (H) mm)
Input Voltage	100V (-10%) to 240V (+10%)
TUP500 Open Frame and Mechanism Options	
<ul style="list-style-type: none"> • USB, Ethernet, Parallel, Serial RS232C, 9-pin Serial interface • PS60 Power Supply • 25cm / 10" Paper Roll Holder (RHU-T500) • Large Roll Damper Roller Unit (DRU-T500B) • Paper Exit Guide (SNOUT-T500) – LED lit with Flashing Attraction Mode • Weight Bar (heavy weight paper use) – PR5 (included at purchase) 	
<i>Please contact Star for other options when installing the TMP500 Mechanism</i>	

TUP900 Series

80 – 112mm wide (A4 replacement) Open Frame / Modular Kiosk Printing Solution

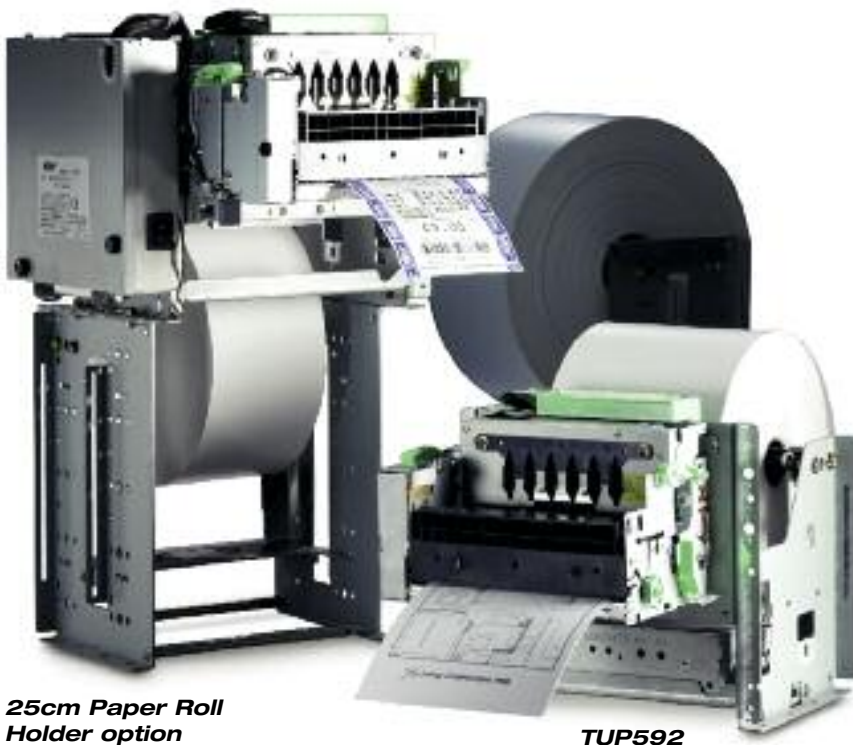

25cm Paper Roll Holder option

TUP592

- High speed, cost efficient 150mm/second quality thermal barcode, receipt, ticket and A4 kiosk printing solution for 80 to 112mm formats up to 0.15mm
- A4 to A6 automatic scalable raster driver for reduced, legible A4 or internet output on 112mm wide paper
- Adjustable horizontal or vertical mounted control panel with extended cable lengths
- Easy-load – simply lift and tilt the mechanism forward and insert the paper for automatic paper loading
- Multi-position adjustable near end paper sensor with 80cm of cable for use with the high capacity paper roll supply option
- TUP992 options include:
 - 25cm paper roll holder (15cm standard). Max. capacity 18cm when mounted below printer
 - Choice of interfaces
 - PS60 power supply

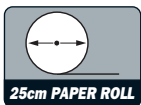
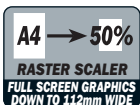
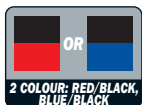

TUP900 Printer Specifications

Mechanism - TMP942 & Cutter	
Print Method	Direct Thermal Line Printing
Print Speed	up to 150mm per second
Top Margin	15mm (3mm selectable)
Print Resolution	8 x 8 dots / mm (203 x 203 dpi)
Paper Loading	Semi Automatic with easy "Lift & Tilt" Functionality
Paper Sensors	Black Mark / Paper End / Paper Low Sensors
Paper Specifications:	
Width	80 to 112mm
Media	Thermal Paper Rolls
Two Colour Printing	Special thermal paper required
Thickness / Weight	0.065 ~ 0.15mm
Roll Diameter	15cm / 6" with 25cm / 10" option (RHU-T900)
Autocutter	Full or Partial Cut (Guillotine) Full Cut only with Presenter PR900 and TUP992
Autocutter Life	up to 1 million cuts
Reliability	37 million lines MCBF
Mechanism Dimensions	TMP942: 176.2 (W) x 101 (D) x 121 (H) mm
Drivers Available	Windows® 7 32/64 Bit, Vista 32/64 Bit, XP 32 Bit, XP Embedded, CE, Server 2008 32/64 Bit, 98/ME/2000/NT4 (download only), WePOS, POSReady, OPOS™, POS for .NET, JavaPOS™, Virtual Serial Port, Linux™ CUPS, Mac OS X CUPS, Scalable Raster Driver, StarIO SDK
Interface	TUP900 Series supplied without interface
Interface Options	USB (IFBD-HU06), Parallel (IFBD-HC04), Serial (IFBD-HD04), Serial 9-pin (IFBD-HN04)
Presenter Unit - PR900	
Paper Loop	Upper Side Loop

Presenter Function	Document Eject Document Capture (Timed or Software controllable)
Paper Thickness	0.065 ~ 0.15mm
Paper Length	75 to 300mm
Paper Width	80 to 112mm
Life	1 million receipts
Control Board - TBD900	
Flash ROM / SRAM	2 x 8 Mbit plus 2 x 1 Mbit Static RAM
Logo Store	2 Mbit
Emulations	Star Line & Page Mode, ESC/POS™
Code Pages	Star Mode = 40 + 1 blank ESC/POS™ Mode = 10 + 1 blank
TUP992 Open Frame System	
Overall Dimensions	192 (W) x 249.3 (D) x 179 (H) mm / 2.84Kg
Printing Solution	All specifications for each module apply
PS60 Power Supply Option	
Supply Voltage	24V DC, (59 (W) x 146 (D) x 32 (H) mm)
Input Voltage	100V (-10%) to 240V (+10%)
TUP592 & TUP992	Open frame printer solution with moveable control panel and paper near end sensors via extended cables
TUP542 & TUP942	Non presenter version
TUP500 & TUP900	Modular components available (see tables)

Please visit www.StarAsia.com and watch our LIVE DEMO NOW!!

NEW

SM-S400



SM-T300

SM-T300DB
Bluetooth and
Serial without
Magnetic Stripe
Reader

SM-T301DB
Bluetooth with MSR

SM-T301DW
WiFi version with MSR



SM-S200



SM-S300

Mobile Printers

Fast, lightweight and small. Star's new range of wireless mobile printers provide easy-to-use printing solutions for delivery receipts; field service estimates, reports, parts lists; inventory management schedules; mobile point-of-sale receipting and sales orders to name just a few applications.

SM-S200

58mm Mobile Printer with Blue Light LCD Display

Sophisticated pocket size printer capable of producing high quality output at a fast 80mm/sec. with Bluetooth and Serial connections as well as a cover open sensor and power save facility



Blue Light Display



Easy Paper Loading

SM-T300

80mm rugged Mobile Printer with LCD display & WiFi version

Ultra rugged with IP54 dust / splash proof certification. Available with or without the magnetic stripe reader with Bluetooth and WiFi versions



LCD Display



Rugged Design

SM-S300

80mm Mobile Printer

Pocket size 80mm workhorse with an extended battery life of 10 hours with Bluetooth for wireless communication and Serial for printer settings and set-up



Magnetic Stripe Reader with Serial & Bluetooth



Easy Paper Loading



Wide 112mm Paper Width



Easy Paper Loading

SM-S400

112mm Mobile Printer

Wide, 104mm output for data filled service reports, delivery notes or law enforcement parking or motoring tickets in a compact case

Options available



Carrying Case for SM-S200



Car Charger



1-Bay Charger



4-Bay Battery Charger



Shoulder Strap for SM-T300

SM-S200 Printer Specifications

Print Method	Direct Line Thermal Printing	
Print Speed	80mm/sec	
Print Width	48mm / 2"	
Print Resolution	203 dpi	
Dimensions	80.5 (W) x 113.5 (D) x 46 (H) mm	
Weight	232g (with battery)	
Battery Duration	6 hour printing (5 minute intervals)	
AC Adaptor	4 hours full charge time	
Power Voltage	7.4V	
Paper:		
Media	Thermal Paper	
Loading Method	"Drop-In & Print"	
Width	58mm	
Thickness / Weight	0.06 ~ 0.07mm	
Roll Diameter	39mm	
Interface	Bluetooth (2.1), Serial	
Print Head Reliability	50km	
Barcode	Code39/93/128, JAN/EAN8, JAN/EAN13, EAN128, I2/5, KAN, UPC, CODABAR, PDF417, QR Code, DATA Matrix	
Drop Test	1m	
Operating System Support	Windows® 7 32/64 Bit, Vista 32/64 Bit, XP 32 Bit, Server 2008, 32/64 Bit, CE, StarIO SDK	
Magnetic Stripe Reader	Standard 1&2 Track (2&3 optional)	
Auto Power Down Mode	1-5 minutes configurable	
Characters per line	42	
Character Support	ANK, Simplified/Traditional Chinese, Arabic, Cyrillic, Russian, Turkish, Greek, Japanese, Persian, Latin 9 and others (upon request)	
Included	AC Charger, Battery Pack, Serial Cable, Sample Roll, Setup Sheet	
Options	4 Unit Battery Charger, Car Charger, Leather Case, Extra Battery Charger, Extra Battery Pack	

SM-T300 Printer Specifications

Print Method	Direct Line Thermal Printing	
Print Speed	75mm/sec	
Print Width	72mm / 3"	
Print Resolution	203 dpi	
Dimensions	120 (W) x 130.5 (D) x 58.4 (H) mm	
Weight	422g (with battery)	
Battery Duration	8 hour printing (5 minute intervals)	
AC Adaptor	4 hours full charge time	
Power Voltage	7.4V	
Paper:		
Media	Thermal Paper	
Loading Method	"Drop-In & Print"	
Width	80mm	
Thickness / Weight	0.06 ~ 0.07mm	
Roll Diameter	50mm	
Interface	Bluetooth & Serial / WiFi versions	
Print Head Reliability	50km	
Barcode	Code39/93/128, JAN/EAN8, JAN/EAN13, EAN128, I2/5, KAN, UPC, CODABAR, PDF417, QR Code, DATA Matrix	
Drop Test	1.5m	
Operating System Support	Windows® 7 32/64 Bit, Vista 32/64 Bit, XP 32 Bit, Server 2008, 32/64 Bit, CE, StarIO SDK	
Magnetic Stripe Reader	Standard 1&2 Track (2&3 optional)	
Auto Power Down Mode	1-5 minutes configurable	
Characters per line	64	
Character Support	ANK, Simplified/Traditional Chinese, Arabic, Cyrillic, Russian, Turkish, Greek, Japanese, Persian, Latin 9 and others (upon request)	
Included	AC Charger, Battery Pack, Serial Cable, Belt Clip, Sample Roll, Setup Sheet, IP54 Certified	
Options	4 Unit Battery Charger, Car Charger, Shoulder Strap, Extra Battery Charger, Extra Battery Pack	

SM-S300 Printer Specifications

Print Method	Direct Line Thermal Printing	
Print Speed	65mm/sec	
Print Width	72mm / 3"	
Print Resolution	203 dpi	
Dimensions	107.4 (W) x 88.5 (D) x 45 (H) mm	
Weight	269g (with battery)	
Battery Duration	10 hour printing (5 minute intervals)	
AC Adaptor	4 hours full charge time	
Power Voltage	7.4V	
Paper:		
Media	Thermal Paper	
Loading Method	"Drop-In & Print"	
Width	80mm	
Thickness / Weight	0.06 ~ 0.07mm	
Roll Diameter	38mm	
Interface	Bluetooth (2.1), Serial	
Print Head Reliability	50km	
Barcode	Code39/93/128, JAN/EAN8, JAN/EAN13, EAN128, I2/5, KAN, UPC, CODABAR, PDF417, QR Code, DATA Matrix	
Drop Test	0.9m	
Operating System Support	Windows® 7 32/64 Bit, Vista 32/64 Bit, XP 32 Bit, Server 2008, 32/64 Bit, CE, StarIO SDK	
Magnetic Stripe Reader	Standard 1&2 Track (2&3 optional)	
Auto Power Down Mode	1-5 minutes configurable	
Characters per line	64	
Character Support	ANK, Simplified/Traditional Chinese, Arabic, Cyrillic, Russian, Turkish, Greek, Japanese, Persian, Latin 9 and others (upon request)	
Included	AC Charger, Battery Pack, Serial Cable, Sample Roll, Setup Sheet	
Options	4 Unit Battery Charger, Car Charger, Extra Battery Charger, Extra Battery Pack	

SM-S400 Printer Specifications

Print Method	Direct Line Thermal Printing	
Print Speed	50mm/sec	
Print Width	104mm / 4"	
Print Resolution	203 dpi	
Dimensions	138.4 (W) x 88.5 (D) x 45.7 (H) mm	
Weight	321g (with battery)	
Battery Duration	11 hour printing (5 minute intervals)	
AC Adaptor	4 hours full charge time	
Power Voltage	7.4V	
Paper:		
Media	Thermal Paper	
Loading Method	"Drop-In & Print"	
Width	112mm	
Thickness / Weight	0.06 ~ 0.07mm	
Roll Diameter	38mm	
Interface	Bluetooth (2.1), Serial	
Print Head Reliability	50km	
Barcode	Code39/93/128, JAN/EAN8, JAN/EAN13, EAN128, I2/5, KAN, UPC, CODABAR, PDF417, QR Code, DATA Matrix	
Drop Test	0.9m	
Operating System Support	Windows® 7 32/64 Bit, Vista 32/64 Bit, XP 32 Bit, Server 2008, 32/64 Bit, CE, StarIO SDK	
Magnetic Stripe Reader	Standard 1&2 Track (2&3 optional)	
Auto Power Down Mode	1-5 minutes configurable	
Characters per line	92	
Character Support	ANK, Simplified/Traditional Chinese, Arabic, Cyrillic, Russian, Turkish, Greek, Japanese, Persian, Latin 9 and others (upon request)	
Included	AC Charger, Battery Pack, Serial Cable, Sample Roll, Setup Sheet	
Options	4 Unit Battery Charger, Car Charger, Extra Battery Charger, Extra Battery Pack	

Other Star Specialist Brochures available:

- Star Hospitality Printing Solutions
- Star Kiosk Printing Solutions
- Star Printer Mechanisms
- Star Visual Card Loyalty & Access Read / Write Systems

visit STAR at

www.StarAsia.com

Unit 1906, Enterprise Square Two, 3 Sheung Yuet Road, Kowloon Bay, Hong Kong
Tel: +852-2799 6682 Fax: +852-2798 5050 Email: info@StarAsia.com

All other trademarks, where used, are acknowledged. In accordance with Star's policy of continual product development, Star-Asia Technology Ltd., reserve the right to change or amend the specification and price of its products from time to time without prior notice.

