

CHAPTER 36

THE BEST CONTROL OR HOW TO PERMANENTLY AND SAFELY CONTROL ALL WOOD DESTROYING ORGANISMS

<http://www.pctonline.com/copesan/>

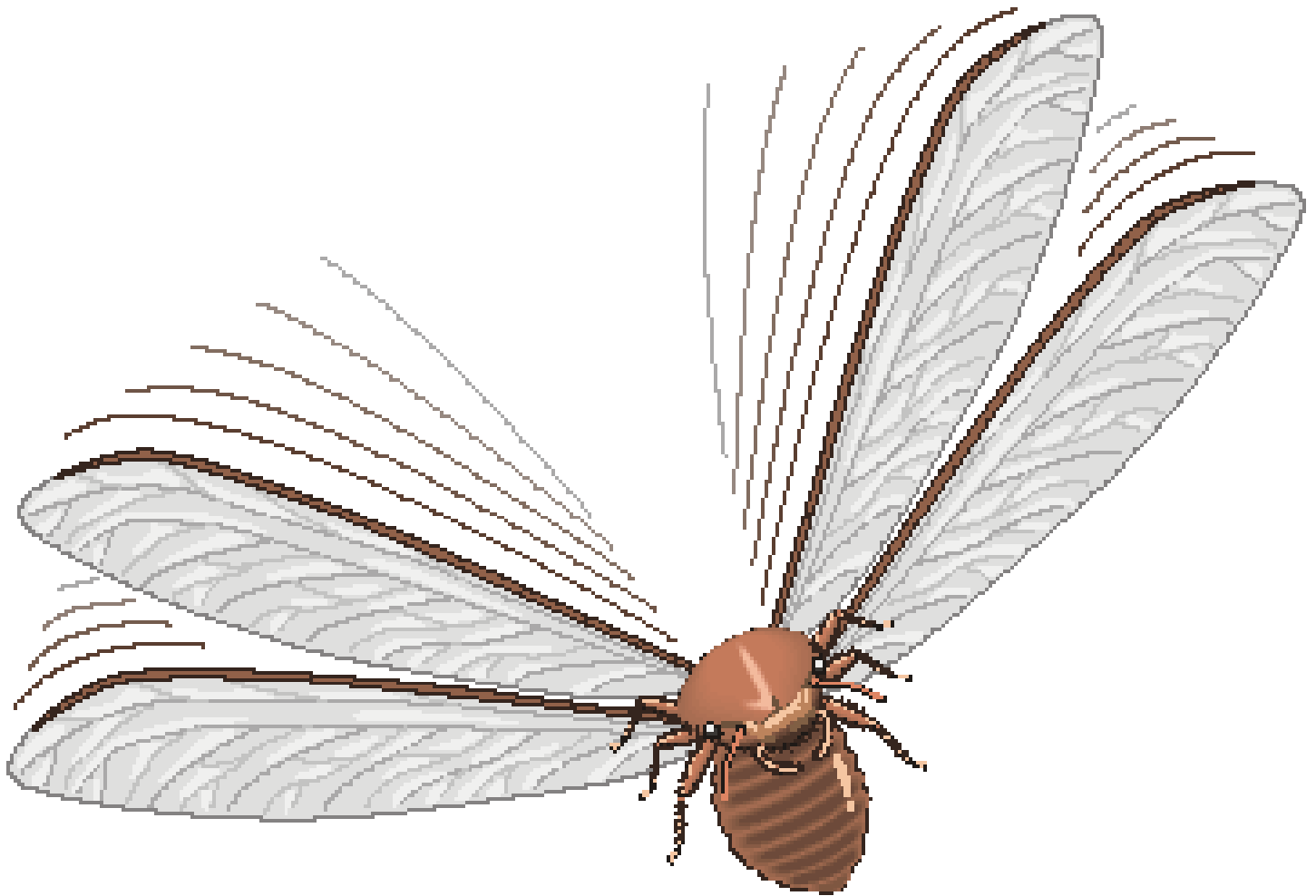

(without killing yourself)

The February 1999 issue of Pest Control magazine on page 18 quotes Dr. Austin Frishman as saying, “We know that termiticides alone will not solve most termite problems.” This chapter will show you how to safely solve them without using any volatile termiticide poisons.

At the time a live tree is cut down, nearly half its weight consists of water! The most destructive factor to wood in structures is excessive moisture, not wood destroying insects. Correct all moisture and humidity problems and you will also control almost all wood destroying insect problems without using any poisons. Use ventilation, moisture barriers, fans, air conditioners and/or dehumidifiers first, last and always.

FORWARD

Far more volatile, “registered,” synthetic pesticide poison is used to *control* termites than any other structural pest you will ever encounter. No volatile synthetic *residual* insecticide or economic poison is completely safe no matter what the *professional pest control industry* claims. The U. S. Environmental Protection Agency (EPA), when it *approves* one of the economic poisons, basically is **only** concerned with the harmful effects that occur from a single exposure of only the active ingredient by any route of entry or its **acute** toxicity expressed as its LD₅₀ or LC₅₀ value which is the lethal dose or concentration (relative amount) of only the active ingredient required to kill 50 % of a test population, e.g., male rats. LD₅₀ values are recorded in milligrams of active ingredient per kilogram of body weight of the test animal. LC₅₀ values are recorded in milligrams of active ingredient per volume of air or water. Both units are the same as parts per million (ppm) which compares to 1 minute in 2 years or 1 inch in 16 miles. *Inert* ingredients, metabolites, contaminants, synergistic effects and chronic exposures are not evaluated, even if they are more toxic or restricted than the active ingredient.

Most volatile, “registered” *residual* active ingredients have not even begun to be (thoroughly) evaluated regarding whether or not they are *sensitizers*, carcinogenic (cancer-causing), neuro-toxic and/or cause chronic (long-term) health effects. We simply do not know how many birth defects, miscarriages, breathing problems, memory losses, cancers, other sickness and deaths are caused by chronic (long-term) exposure to even minute amounts of these synthetic *residual* active ingredient poisons, but the danger is significant. Besides all the unknown personal hazards to the applicator and occupants of a building, we are also basically unaware of the long-term environmental hazards/contamination caused by the **total** toxic residual qualities of these economic poisons. No adequate studies have even been done on long term potable water and ambient air contamination caused by these toxins. We simply are unaware of how dangerous they are to us (much less future generations), especially if we are under 1 year old, over 60 years old, pregnant, chemically sensitive, have breathing problems and/or allergies. We have been told less than 1/5 oz. of chlorpyrifos will kill a full grown man.

Whenever you see a pesticide (poison) advertisement that shows an insect lying dead on its back with its legs waving in the air you, should immediately know that this has a very dangerous active ingredient that can and probably will adversely effect your cholinesterase levels and probably is a deadly nerve gas or neuro-toxin that should not be used in your home if at all possible.

Inert* ingredients in “registered” economic poisons or synthetic *residual* insecticides can even be more deadly to you and your family and contaminate far longer than the **active** ingredient, and yet they do not have to be tested (even acutely) or even listed on the label. Even your doctor will find it very difficult or even impossible to discover what these *inert* ingredients actually are. **Often the *inert* ingredient’s MSDS states it can not be used in the area or way (only the active ingredient) in the *registered* poison label says the poison can! I, therefore, believe no pesticide is legally or ethically registered in the U. S.!*

In January 1996, Pest Control magazine reported that Missouri Attorney General Jay Nixon announced Orkin Exterminating had agreed to a settlement worth an estimated \$7.7 million. Nixon said that in many of the estimated 7,000 homes Orkin failed to apply the original termite treatment according to label instructions....



In a Press release that was never officially issued Bob Butterworth, Florida’s Attorney General, and Bob Crawford, Commissioner of Florida’s Department of Agriculture and Consumer Services, noted up to 50,000 Floridians could be eligible for refunds or chemical retreatments with Terminix International Company Limited Partnership. “Terminix failed to fully treat properties for subterranean termites despite its promise to lay down a complete protective barrier against the destructive insects,” Crawford said. Terminix International is a \$900 million Service Master subsidiary and has a sister operation called Tru Green ChemLawn since 1991 per the March 1998 issue of

Pest Control Technology. Several years before, Connie Chung reported, Terminex had to redo 20,000 homes in Kentucky, was fined and had to set up a rather large trust fund. When Rocco DiLorenzo from Ace Pest Control in Fort Myers, FL wrote Pest Control Technology in their March issue expressing deep concern over their February cover displaying Terminix in such high regard, especially one which has had so many accusations of...improper treatments, he received the following partial comment, “For a company of Terminix’s size, with sales nearing \$1 billion and 11,000 employees, it’s inevitable that some termite treatments will be performed improperly.” (Who chooses which ones are “inevitable”?)

With the ever increasing and skyrocketing violence, asthma, heart arrhythmias or irregular heartbeats and/or heart attacks, cancer rates, pulmonary problems, health problems, neurological diseases and the rapidly accumulating data that exposes the toxic disruption of our endocrine systems that control all sexual traits, fertility and reproduction, all life as we know it is literally hanging in the balance. That is why we recommend you use mechanical alteration and only sodium borate and refuse to use any volatile, synthetic *residual* pesticide poisons. The EPA lists over 2,518 chemicals that it allows manufacturers to add to pesticide poison formulations as *inert* ingredients. *Inerts* can include antifreeze, wood alcohol, asbestos, solvents, stabilizers, emulsifiers and preservatives. Many synthetic *residual* pesticides are 80% to 99% *inert* ingredients. In addition, in some cases EPA allows pesticide poisons to be manufactured using *recycled* hazardous wastes or to contain contaminants such as DDT or dioxins. Forty of the *inert* ingredients allowed by EPA in pesticide formulations are also classified by EPA as *inerts* of toxicological concern. This means they are: probably human carcinogens, known animal carcinogens, brain or nervous system toxins, capable of causing other chronic effects or adverse reproductive effects, or acutely toxic at concentrations of one part per million or less to some tested species. Methyl bromide is an extremely toxic fumigant that is easily inhaled or absorbed through the skin. EPA considers methyl bromide so dangerous that it permits only certified pest control applicators to use products which contain it as an active ingredient. However, EPA has also classified methyl bromide as an *inert* ingredient, meaning that the pesticide manufacturers may add it to other pesticide poisons without even testing it or even listing it on the *registered* label! Therefore, the real dangers of these poisons is not currently accessible.

If you are chemically sensitive, we suggest you try Safe Solutions, Inc. food-grade diatomaceous earth, negative ion plates, termite predators, e.g., nematodes and/or mites, baits, antibiotics, salts, capsaicin, fans, enzymes, e.g., Safe Solutions, Inc. Enzyme Cleaner with Peppermint, dehumidifiers, rain gutters, proper grading, ventilation, moisture barriers, sand barriers and/or mechanical alteration, then if you still have any pockets of resistance the only natural chemical/pesticide we recommend that you use is called sodium borate; it is a naturally occurring material that has trace amounts of arsenic; TIM-BOR powder has no added inert ingredients; BORA-CARE liquid also contains ethylene glycol and water; IMPEL RODS are solid borate fungicide rods. In addition, we also recommend you use other non-toxic controls such as exclusion, mechanical alteration, temperature controls, biological controls, sanitation and other integrated pest management techniques. We are firmly committed to your safety and we will always attempt to help you permanently control your pest problems with the **least** amount of toxin possible! **ALWAYS FOLLOW THE LABEL DIRECTIONS!** There are 3 signal words (on any pesticide label) that are used to indicate its danger or acute toxicity:

SIGNAL WORD	RELATIVE TOXICITY	AMOUNT NEEDED TO KILL THE AVERAGE PERSON
1. Danger- Poison	Highly toxic	A taste to a teaspoonful
2. Warning	moderately toxic	A teaspoonful to a tablespoonful
3. Caution	Low-order toxicity (comparatively free from danger)	An ounce to more than a pint

See also the LD₅₀ Value Comparisons in Chapter 12. Note: The signal word for TIM-BOR, BORA-CARE and IMPEL RODS is "Caution". **There is no signal word for the use of predators (Dine-O-Mites) and/or negative ion plates such as purple plates or Earth Cards and/or salts or fans or Safe Solutions, Inc. Enzyme Cleaner with Peppermint or their food-grade DE, etc. because they are all food-grade or GRAS Pestisafes®.**

There are basically 2 types of *registered* pesticide poisons available:

- **Restricted Use** - For sale and use by licensed certified professional pest control operators and only to those under their direct supervision.
- **General Use** - For sales and use by anyone.

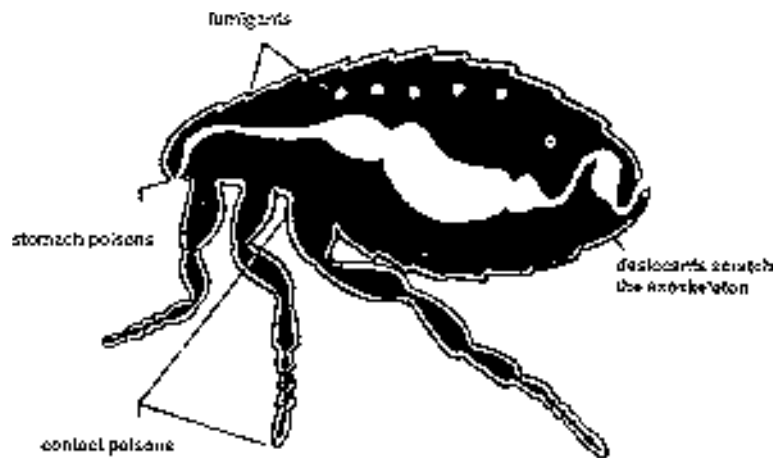

There are basically 4 types of “registered” pesticide poisons available for control of wood destroying organisms.

Types of “Registered” Insecticide Poisons or Pesticide Poisons:

- **Stomach pesticides** - The poison penetrates the insect through the digestive tract and kills it as the poison is absorbed through the gut. Boric acid and sodium borate are stomach poisons.
- **Contact pesticides** - The poison kills the insect through contact with any part of the body. Diazinon, pyrethrins, chlorpyrifos and dormant oils are examples of contact pesticide poisons. Sodium borate also kills fungi by direct contact.
- **Fumigant pesticides** - The poison penetrates the insect through its respiratory organs. These insecticides have the terrible ability to volatilize (become a gas or vapor) extremely rapidly. Methyl bromide, sulfuryl fluoride, aluminum phosphide, paradichlorobenzene and naphthalene are dangerous fumigant insecticide poisons.
- **Desiccant pesticides** - These insecticide poisons are dusts which scratch or scrape the outer layer of the exoskeleton causing the insect to lose body fluids and die from dehydration. Silica aerogel is an example.

The majority of poisons used can enter the insect body by more than one route. For example, a compound may function not only as a stomach insecticide but as a contact insecticide and/or a desiccant as well. Note: Just in California - each year about 9 million pounds of “registered” poisons are used to *control* structural pests.

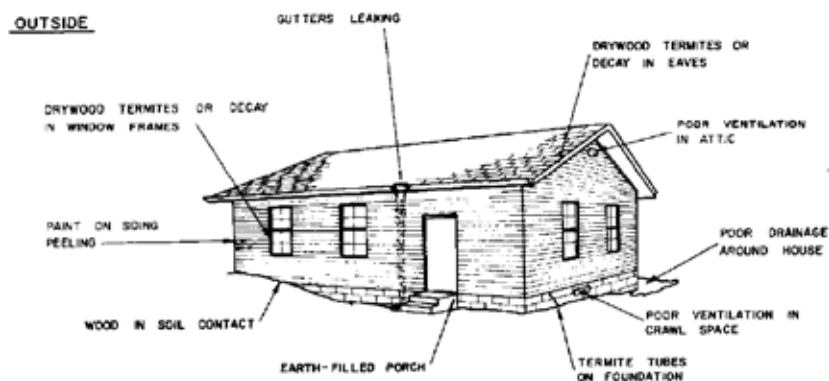

INITIAL COMMENTS

It is virtually impossible to calculate the total destruction caused by the attack of wood destroying insects and decay because much damage is never reported or recognized as damage caused by wood destroying organisms. In the early 1960's, it was estimated that the public spent approximately 1.5 billion dollars per year then to control/prevent and repair the damages caused by subterranean termites **alone**. The Associated Press noted in the Grand Rapids Press (March 8, 1998) that the NPCA estimated it cost \$2 billion yearly just to *treat* the problem. Because of inflation, poorly designed slab-on-ground construction and the greater use of concrete terraces next

to foundation walls, extremely higher costs) of (replacement) termiticides and the increased structural damage and incidence of attack; this, the Author believes, is due especially to the termite resistance to volatile, synthetic termiticide poisons and/or their shorter residual life spans; the highest estimate is now over \$3.5 billion yearly. Volatile, synthetic termite poisons simply do not control termites as well as proper construction, humidity reduction and/or non-volatile, least-toxic salts do.

In order for you to better understand your home's enemies and their characteristics, habits and life histories; recognize the damages; understand how they attack and enter your home; know what organisms are responsible for what damages; and how to permanently control them, and **permanently** prevent or stop their progress and damage) is the only reason for this chapter.

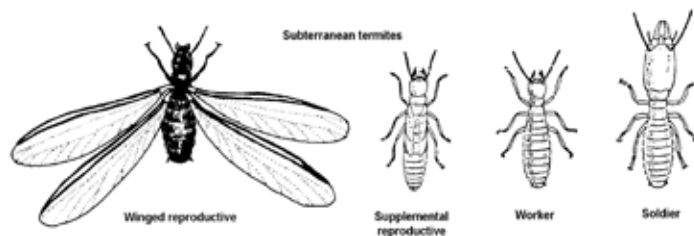

Please note that while most wood destroying insects and decay problems are currently are still trying to be *controlled* by the *professional* termite control industry using many different EPA *registered* volatile, synthetic *residual* termiticides (economic poisons), fumigants and treatment techniques, we will basically ignore all these *professional* poisons and techniques. In 1986 the industry's *Approved Reference Manual for the Control of Subterranean Termites* was *corrected* with a disclaimer that read, "NO CLAIM OR WARRANTY WHATEVER IS MADE OR IMPLIED THAT THE RECOMMENDATIONS METHODS OR PROCEDURES CONTAINED IN THIS PUBLICATION ENSURE SAFETY OR PREVENT INJURY OR PROPERTY DAMAGE." In addition (about the same time) it was proven that even when professional applicators exactly followed the (chlordane) termiticide label *some permanent* ambient air **contamination** of that cancer-causing chemical **always occurred!** Even then these very dangerous "termite" poisons that still are contaminating our homes did not give 100% termite control. The Author has found termites eating homes unfit for human habitation (due to termiticide contamination)! In addition to these major safety problems, the current termiticide poisons break down relatively quickly, especially in some soils and/or the termites are already resistant to most of them or will be shortly (and the labels basically allow/ensure continued *retreatments*), which will continue to cost you more and more money **and** create more and more contamination and give you less and less real termite control.

Pressure treated (wolmanized) wood is very expensive and, the Aauthor believes, very dangerous, (it is now being pulled off the market) and needs constant attention and is not very effective. We have found severe insect damage in pressure treated wood, including carpenter ants in a few months and termites in a few years. Pressure treating wood actually makes more porous and susceptible to water damage; sunlight rapidly grays pressure treated wood **unless you continually clean and treat it with more chemicals (poisons).**

Therefore, especially for the purposes of this manual, we will only recommend the use of predators and/or baits and/or sand and/or food-grade DE and/or salts and/or mechanical alteration and/or pestisafes® and/or lime and/or non-toxic negative ion plates and/or the least-toxic, non-volatile pesticide, sodium borate. Negative ion plates have been previously described. TIM-BOR, IMPEL RODS, JECTA and BORA-CARE are registered, non-volatile termiticides and insecticides (that **permanently** penetrate the wood) and are for use by professional pest control operators. TIM-BOR comes to you as a "pure" wettable powder and BORA-CARE comes to you as a liquid concentrate that also contains ethylene glycol and water. JECTA comes as an injectable borate gel spot treatment that can measure the amount injected into a small drilled hole. IMPEL RODS come as solid borate fungicide "sticks", rods or cylinders, 1/4" x 1/2", 1/3" x 1" and 1/2" x 2". They are inserted into pre-drilled holes which are then sealed with caulk or putty. Sodium borate is effective for the prevention of decay fungi (as a contact poison) and wood infesting insects, including all the wood boring beetles (anobiida, lyctidae, etc.), termites (subterranean, dry wood, damp wood, Formosan, etc.) and carpenter ants (as a stomach poison). In addition, it also acts as a fire retardant! Methods of application include injection, spray, fog, brush and dust. Sodium borate may be applied on or into all interior and exterior wood and all wood composites. The treatment is permanent even after cutting and finishing when it is protected from the rain inside and/or sealed outside and not in direct contact with the soil. THE IDEAL SITUATION WOULD BE TO APPLY SODIUM BORATE TO ALL THE SURFACES OF ALL THE (RAW) WOOD JUST BEFORE THE HOME IS (RE)FINISHED (DRY WALLED AND CARPETED). If you decide you want a *professional* to apply it for you, be sure they first **clean out** their rig and decontaminate all of the lines and the tank first.

What are the dangers? If you are **still** thinking about hiring someone to apply hundreds of gallons of some volatile, “registered” *residual* poison in your building - please only have them treat outside and spot treat inside only if absolutely necessary. **Be very careful**, especially if there is a well within 100’ of any **soil** treatment. Do not let anyone treat your home’s interior with any volatile *residual* termiticides, especially if you have heat ducts in your slab or have a crawl space that is used as a plenum air space or if you have unsealed cracks or expansion joints in your slab floor or foundation, or if your blocks are visually open on top, or if anyone in your home is over 60, under 1, pregnant, chemically sensitive, allergic or has any breathing problems. It was estimated that over 75% of all U. S. homes built prior to April, 1988 are **still** contaminated with significant levels of chlordane - do you really want **more** poison contamination? When you compare the typical organophosphate termiticide label with the agricultural label, you find **the** termite poison label allows the *professional* to apply **over 300 times** the amount of active ingredient **inside** your home than what is considered to be a *safe* application to an **acre** of ground **outside** and yet the same label states it is unsafe and illegal to apply this diluted poison inside a barn where the animals or birds will be used for food! Remember that before the introduction of any of these synthetic *residual* economic poisons called termiticides, homes and barns *miraculously* stood for centuries. It is far more important to protect your health than to *save* a few 2” x 4”s with synthetic, “registered” poisons that will continue to volatilize into your home for years and years and years!

Volatile, “registered” *residual* pesticide poisons or termiticide poisons supposedly kill or repel either by poisoning the soil or contacting the insect. This means contamination of nearby water sources and ambient air can occur and/or that toxic surface and ambient air contamination may be present for years after their labeled and *registered* application. Sodium borate is applied directly to the wood, thereby eliminating most potential soil, air or water contamination. Sodium borate penetrates throughout the wood and leaves no toxic surface residue. The sodium borate is left as micro-crystals of borate salt inside the wood which will not decompose or volatilize (vaporize) like volatile, synthetic *residual* pesticide poisons. This means the sodium borate will keep providing you broad spectrum protection (permanently) with little impact on our environment or your health. We suggest that you (re) design and construct your home and additions to minimize moisture uptake and retention by wood; use a dehumidifier; remove all branches that overhang or touch your home; correct all earth-wood contact points; repair all cracks and crevices; thoroughly caulk, screen paint and/or seal your home, and sometimes that you replace your porches, piers and stoops with sodium borate treated and sealed lumber. Since 1953 when non-volatile sodium borate was mandated in New Zealand to be used to treat and pretreat lumber and homes and buildings, there has never been any evidence of even one successful attack of wood destroying organism in New Zealand, no matter what the conditions. Compare this to the failure of toxic and volatile termiticide poisons routinely failing to protect our homes during the same time period and you need go no further with your choice of termiticide - but the poison *industry* and the *regulators* ignore little facts like these. In short, we will be discussing safer, better and more permanent pest control techniques.

“Registered” pesticide poisons are specifically made to kill; they do not protect - they attack our central nervous systems and other vital body centers. Poisoning symptoms are often mistaken for flu and other illness and vary with each person, but **acute or one time exposure to just the active ingredient symptoms** may include: feelings of discomfort, headache, flu-like symptoms, eye pain, nausea, vomiting, cramps, diarrhea, hives, chest tightness, difficult breathing, asthma-like attacks, sore nose, tongue or throat, burning skin or ears, rash, earaches or infections, excessive sweating or salivation, coughing, muscle pain, discomfort or twitching; seizures, temporary paralysis, tissue swelling, arthritis-like complaints, blurred or dim vision, numbness or tingling in hands or feet, incontinence, anorexia, anxiety, suicidal depression, irritability, angry outbursts, sleep disorders, hyperactivity, learning disability, fatigue, dizziness, unexplained fever, irregular heartbeat, heart attacks, elevated blood pressure, nose bleeds, menstrual irregularity, spontaneous bleeding, stroke, seizures, death; **chronic or long-term health problems** associated with even minute amounts of synthetic pesticide poisons include: lowered male fertility, miscarriage, birth defects, chemical sensitization, immune suppression; cancer; cataracts, blindness, liver and kidney dysfunction, memory loss, neurological damages and dysfunction; emotional problems, MCS, heart disturbances, death, etc.

The Environmental Protection Agency (EPA) has officially stated in court that **EPA “registration”** (and, therefore, labeled usage) **does not assure safety**. Current pesticide “registration” clearly is not designed to protect the public’s health; that is why the National Academy of Science (NAS) estimates that **1 out of 7 of us is already significantly impaired by “registered” pesticide poisons and other toxic chemicals**. The National Cancer Institute studies show children get leukemia 6 - 7 times more often when pesticides are used in or even around their homes, and farmers and pesticide applicators show similar increases in cancer when exposed to these

poisons. Drinking water in at least 39 states is already contaminated with these toxins. We clearly are already destroying/poisoning ourselves and the next generation!

The main toxicity of organophosphorus and carbamate active ingredients in volatile, synthetic pesticide poisons relates primarily to their function as cholinesterase inhibitors. Acetylcholinesterase is an enzyme involved in the normal function of certain nerves. Regulation of vital body processes such as breathing, speech, vision, pulse rate and function of the gastrointestinal tract, for example, are all controlled by nerves. Following a nerve impulse, the nerve or junction is returned to the normal state in the presence of an enzyme (acetylcholinesterase) and is again capable of carrying an impulse. The enzyme (acetylcholinesterase) prevents persistent "activation" of the nerve or function. Certain chemicals, including organophosphorus and many carbamate pesticide poisons, block the enzyme action (acetylcholinesterase), causing a series of nerve malfunctions.

Failure of the affected nerves to function properly causes:

Constriction of the pupil of the eye (miosis). Tightness of the chest. Increased bronchial (respiratory tract) secretions. Sweating. Tearing (lacrimation). Rapid pulse rate initially followed by a decrease in the pulse rate. Nausea, vomiting, abdominal pain and diarrhea. Involuntary urination. Muscle twitching. Cramps. increased salivation, etc.; a lethal dose of a cholinesterase-inhibiting organophosphorus compound is reported to produce death from respiratory failure (asphyxia). Generally, poisoning from cholinesterase-inhibiting organophosphorus or carbamate pesticides can be confirmed by measuring the cholinesterase activity of the blood plasma or red blood cells (erythrocytes). Persons exposed to organophosphorus or carbamate pesticides which interfere with normal nerve functions (inhibitors of the enzyme acetylcholinesterase) should consult a physician concerning the possibility of measuring blood cholinesterase activity as an estimate of exposure. Specific antidotes, available to the medical profession, are usually effective in countering the principal acute effect of organophosphorus and carbamate pesticides. This is why we only recommend the use of sodium borate, salts, negative ion plates or the intelligent pest management® techniques described in this manual.

SAND BARRIER: If you wish, you may also safely and permanently control subterranean termites with (7-10 mesh) sand either pre or post construction, but it would be far easier and more effective to apply this termite "shield" preconstruction.

The effective size of the particulate = 1 - 3 mm (1.7 - 2 mm preferred). Recommended minimum thickness = 6 inches; recommended minimum width = 24 inches. Expect to spend about \$1,000 minimum for the sand (delivered), not counting the labor for installation; note that the sand, typically referred to by suppliers as "sand-blasting sand", is not readily and inexpensively available everywhere. Research to date indicates that sand barriers are just as effective as volatile poison barriers, but last a lot longer and are environmentally stable. When detailing, wrap sand with geotextile filter fabric to prevent loss or contamination of sand barrier. In order to maintain the barrier, plan on using a covering over the sand barrier that is not too difficult to remove and reinstall. Table salt will also control termites permanently, but it is water soluble and attacks ferrous metals like nails.

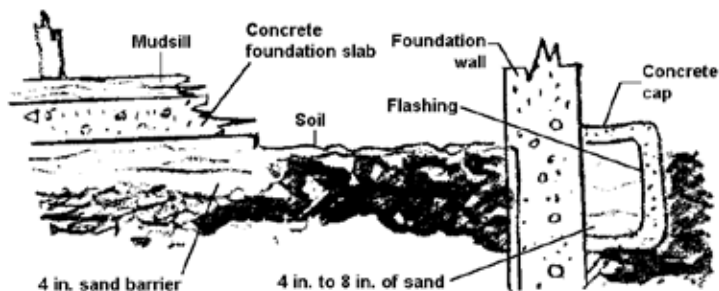

THE INSPECTION

A thorough, accurate yearly inspection is the most important part of any wood destroying organism control program and will ensure early detection of infestations and/or reinfestations before serious damage can occur. Before you even begin your inspection, completely read and understand this manual and become knowledgeable in the biology and habits of the various wood destroying organisms so you will know what to look for. Proper termite identification and a knowledge of the species' biology are the most essential elements in termite control. Then carefully and visually inspect all accessible areas, probe and/or sound all accessible structural members and wooden objects inside and outside your home. **Be sure you look under all rocks and patio stones for subterranean termites who are there looking for moisture and decaying organic matter.** In Florida and the south (and when baiting) check every 3 months.

Be sure to write down everything you find, i.e., type of infestations, damages, inaccessible areas, conditions conducive to infestation, construction problem (s), moisture problem (s), etc. and carefully record all of this on graph paper as a permanent record. Written notes and photographs, properly recorded and properly filed away, are the only things that do not forget.

Later in this chapter you will find a section, “What you will need to accurately inspect your home”. Please understand and follow this section very carefully. Only after a thorough inspection will you be ready to decide if any treatments and control techniques are necessary. Also refer to the chapter on inspections in the front of this manual. Methane gas is produced in large quantities by an active termite colony.

Remember to save and properly file the results of all of your inspections so that you can compare/monitor the conditions conducive to infestation, damages and other details with each passing year. Remember, you should conduct a thorough inspection at least once a year and should continue to visually monitor and photograph your home as you clean and conduct normal preventative maintenance on it. Remember to make a graph drawing of your home showing the view from above (a plan) and at least one view from the side (an elevation). This will help you find hidden and/or inaccessible areas you might otherwise overlook inside. Make several copies so you can use a fresh graph each time you inspect your home. If you decide to pay a professional to conduct these inspections for you, tell him in the beginning that **whoever you pay to conduct your inspections will not be allowed to perform any treatments.** This should ensure a more honest opinion on his part. Sometimes the professional will pound on the wall and then use a stethoscope (for hearing behind walls), drill holes into your wall and insert fiber-optic viewing scopes (for seeing behind walls) and/or bring in a methane gas detector and/or termite-detecting dogs (for smelling behind walls, ceilings and floors), but nothing beats a “live-in” inspector (you) who carefully and faithfully monitors your own home daily! Remember, **even if you find evidence of an active infestation there is no need to panic** and have some *professional* sell you a job **today** or lose your home tomorrow! While all wood destroying organisms can do some damage, there **always** is time to properly and thoroughly plan your control program and often there is no need for **any** poison *control*, especially volatile poisons. Your inspection, if done properly, will allow you to decide how you can best control your wood destroying insect infestations, whether you will use exclusion, mechanical alteration, baits, sodium borate, spot or overall applications, traps, heat or cold treatments, biological controls (e.g., mites, nematodes, antibiotics), sand, salt, dehumidifiers, fans, vents, air conditioning, vapor barriers, medication, Peladow®, borax, Safe Solutions, Inc. Peppermint Soap or Enzyme Cleaner, dusts (including food-grade DE), capsaicin, alternative boron products, sanitation or a combination of these or any other controls.

SODIUM BORATE HELPS WOOD BITE BACK

Imagine taking the very wood that termites, beetles, carpenter ants and fungi love to eat and destroy and turning it into the “bait” that kills them **permanently** and makes it more fire retardant! Borates were first used in Australia in 1938 against termites and powder post beetles. Since 1953 all construction lumber in New Zealand is treated with borates and there have been no problems with termites. In Hawaii where formosan subs are a major problem, borates are used in 90% of all construction. See borax/sodium borate caution at the end of the chapter. Note: Borax a/k/a hydrated sodium borate.



Your wildest dream has come true with the recent introduction of the powder pesticide, Tim-bor and the liquid pesticide, Bora-Care, from Nisus Corporation, web site: <http://www.nisuscorp.com>, and the solid fungicide, IMPEL RODS, from PoleCare, Inc., web site: <http://www.polecare.com/products.php>. Sodium borate penetrates into the wood and do not decompose or change with time. (They can leach out and should be sealed in if they are directly exposed to the elements.) They are odorless, easy to mix and handle and pose no significant risk to humans and animals. You can use them with confidence in homes with children and pets. Outside applications



can be sealed. In addition, applications of sodium borate does not harm the wood or change its appearance. Pressure treated wood on the other hand has a MSDS the Author does not like and he has found carpenter ants infesting a deck less than four months old. Pressure treating wood also does not even give it weather protection according to manufacturers. It actually makes wood more porous and susceptible to water damage! Sunlight also grays pressure treated wood and moisture promotes decay, mold and mildew growth.



While technically disodium tetrahydrate octaborate is a *new* product, its source is sodium borate, a mineral as old as the earth. In fact, boron compounds, or borates, were first shown to be toxic to wood destroying organisms more than 50 years ago and have been used extensively as a preservative for lumber in Australia, New Zealand, the Scandinavian countries and Europe. Now, following the decision by the United States Borax & Chemical Corporation and Nisus Corporation to market these chemicals as an insecticide/termicide and fungicide, they are available to PCO's in this country and, hopefully, directly to you, or you could simply try spraying Borax at a rate of 1 - 2 cups per gallon of hot water. There is also a sodium borate pesticide available from Arch Wood Protection, Inc, web site: <http://www.archchemicals.com/Fed/WOLW/Products/Preservative/Sillbor/default.htm> and still others will probably follow, but for our purposes the dust formula will be TIM-BOR, the liquid formula will be BORA-CARE and the solid slow-release sodium borate (fungicide) rods will simply be called IMPEL RODS.



Unfortunately BORA-CARE uses ethylene glycol, a potentially harmful chemical, as its carrier for the borate. Unlike other borates, termites do not have to eat BORA-CARE treated wood in order to die. All they have to do is come in contact with it, so you should see control results within a week or so. Please read a short history of sodium borates in Chapter 11.

Dr. NanYao Su, entomologist at the University of Florida's Fort Lauderdale Research & Education Center, originally predicted a decreasing role for the toxic and volatile synthetic *residual* poisons currently used in pest control. For example, he said, "the amount of soil termiticides we're spraying in the soil is tremendous, and the Author thinks this type of control technology will be phased out." New concepts hold promise, such as those he's developing with borates. Unlike soil treatments, which he terms "exclusion devices," intended only to keep the termites out but not decrease their numbers, "the use of sodium borate allows us to kill a large proportion of the population of termites." Soil treatments have a place, explains Su, but once that soil barrier is broken up or moved, termites will find a way in. But sodium borate allows termites to "come in and take the bait." While this may result in minor surface etching of the wood, no structural damage is done and the entire colony is killed, not simply removed to a new location. In New Zealand, wood destroying organisms had been a major problem until 1953 when soaking construction materials in a borate solution became mandatory. Since that time there has been no reported incidence of failure in homes treated with borate solutions! (When the University of Florida leased Dow their Sentricon system of baiting, Dr. Su may have changed his "recommendation".)



Sodium borate dissolves readily in hot water. The solution doesn't irritate the skin and isn't corrosive to most metals. It can also be safely and completely washed off skin with mild soap and water. There's no risk of absorption through unbroken skin either. The Author knows applicators who put their cut hands into dry sodium borate to heal the cuts. Yet, for all its safety, sodium borate is highly effective at controlling its target pests. There are also no dangerous solvents to use and there are no unknown *inert* ingredients either! When first applied, sodium borate coats the surface of the wood; then within minutes they begin to penetrate the surface and enter the wood. The sodium borate then begins to diffuse and move throughout the entire piece. How quickly this diffusing occurs depends on what kind of wood you have, its moisture content, your equipment and other environmental conditions. A key difference between sodium borate and traditional synthetic *residual* chemical termiticides is that rather than *treating* the soil or fumigating, sodium borate can be injected, sprayed, fogged or brushed

directly on/into bare wood. It penetrates into the wood so that more than just the surface is treated, and because sodium borate does not decompose or change with time, true long-term protection is provided. The product is ideal for wood that is not in contact with the ground and not exposed to rain or excessive standing water. Native subterranean termites are killed with only 1,000 ppm of boron in wood. Formosan termites are killed with 2,000 ppm of boron in wood. Dampwood and drywood termites are killed with 1,000 ppm of boron in wood. Where you have a steady, severe plumbing leak or moisture problem, it should be repaired before sodium borate is applied. Moisture is a key factor in the mode of action of sodium borate. **The higher the moisture content of the wood, the faster borate diffuses into it and the deeper its penetration.** In addition to treating the wood you can also treat sawdust, wood pellets, tongue depressors, scraps of wood, (rolls of) corrugated cardboard etc. with 3% or less sodium borate and use them as baits and/or *pre-baits*. **If you get some on glass, quickly remove the residue with soap and hot water.**

Take anobiid beetles, for example. Infestations usually occur in wood with a moisture content of 12% - 25%. With that level of moisture, the sodium borate is going to penetrate deeper into the wood than any of the other (synthetic *residual*) insecticides, and when it does that, it's more likely to kill more of the larvae. In the case of subterranean termites, the moisture content of the wood is higher because they bring soil moisture up to the wood. This means the borate will quickly diffuse wherever the termites are feeding. Borates don't operate the way synthetic *residual* insecticides do; they are not a quick contact killer. Instead, when you apply sodium borate as a remedial treatment, there's a chance adult beetles emerging from the wood won't even be killed, but if all the exposed wood is treated, the sodium borate will prevent all reinfestation. Lyctids, anobiids and old house borers are killed with only 800 ppm in the wood. So, while it may not totally prevent emergence, it actually gives better/safer/longer control and performance in the long run. Sodium borate controls and prevent a broad spectrum of wood destroying insects, including drywood and subterranean termites, anobiids, lyctids and carpenter ants. It also has been proven, both in the U. S. and abroad, that sodium borate controls decay fungi including brown, white and wet rot. Boron is an inherent fire retardant and Borax has been used for many years in the U. S. to protect cellulose (blown-in) insulation from insect and fungus attack and to make the ground-up or pulverized newspaper fire retardant. Use this material (add a little boric acid) as a termite bait in crawls and under porches, slabs, etc.

Wood freshly treated with sodium borate will appear slightly darker than untreated wood. After a day or so the treated wood will resume its original color. The treatment will also not adversely affect the painting, staining or gluing of the wood. Sodium borate is also a corrosion inhibitor so fasteners (nails, screws, etc.) made of steel and other ferrous (iron) metals should last even longer in sodium borate treated wood than they would in untreated wood. (The sodium borate solution may tarnish unpainted aluminum.) Because sodium borate is water soluble, freshly treated wood should be protected from rain and snow. Exterior surfaces should be sealed (covered) with a coat of water-resistant paint or stain. It is not necessary to seal interior wood surfaces except in situations involving repeated moisture contact (shower stalls, bath houses, hot tubs, etc.) Pretreat sawdust, pellets, virgin cardboard, pulverized newspapers (cellulose insulation) dowels, stakes, tongue depressors, pieces of wood etc. with antibiotics and/or sodium borate or borax and put them where termite workers will find them and kill the colony for you. **A LIFELONG INVESTMENT!**

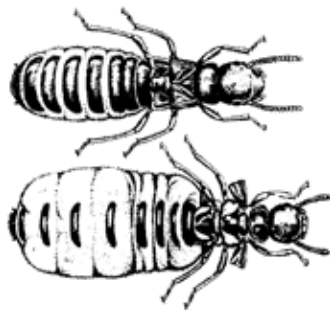

TERMITE LIFE CYCLE

SUPPLEMENTARY
REPRODUCTIVES

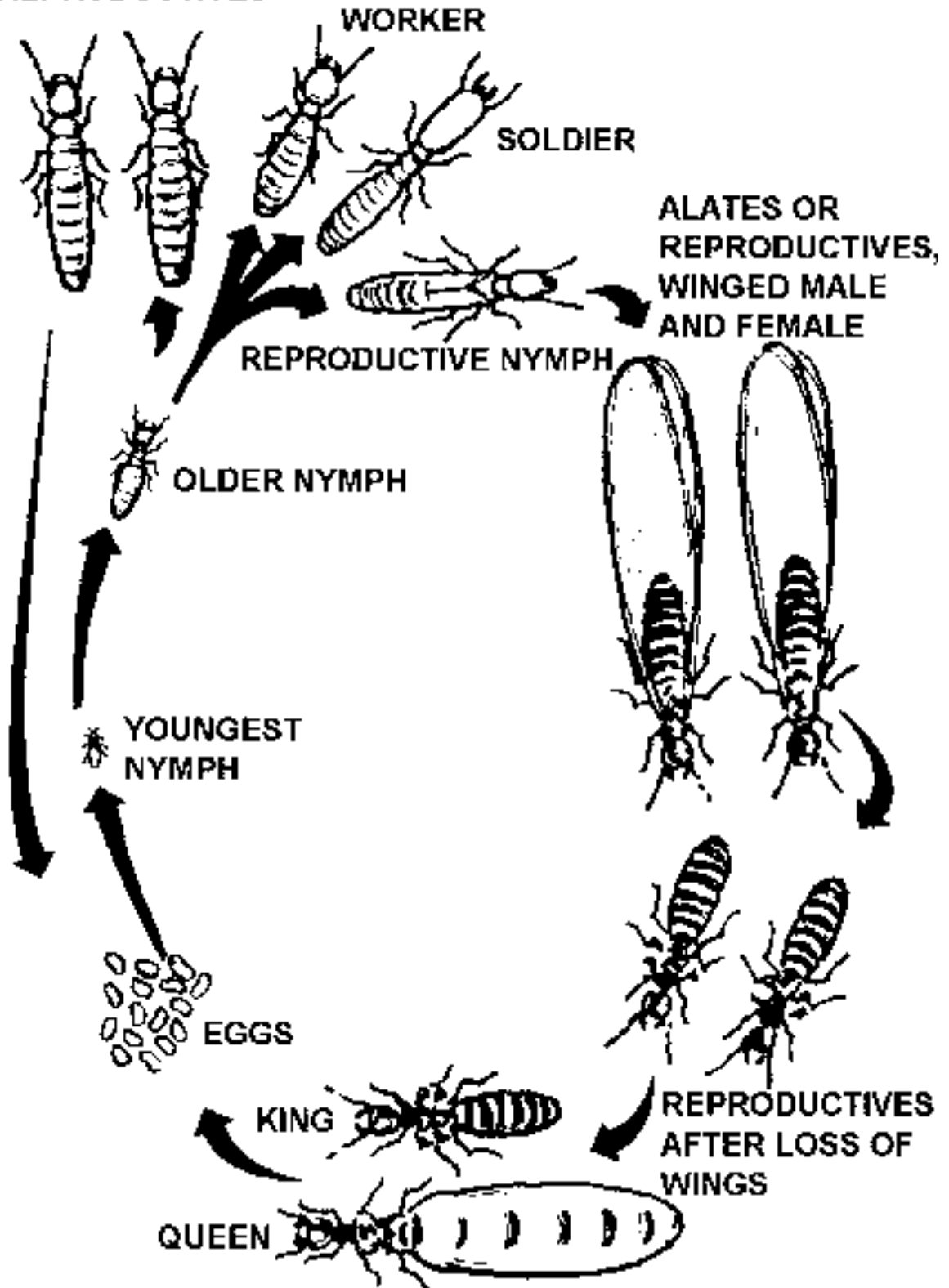

HOW YOU CAN DISTINGUISH ANTS FROM TERMITES

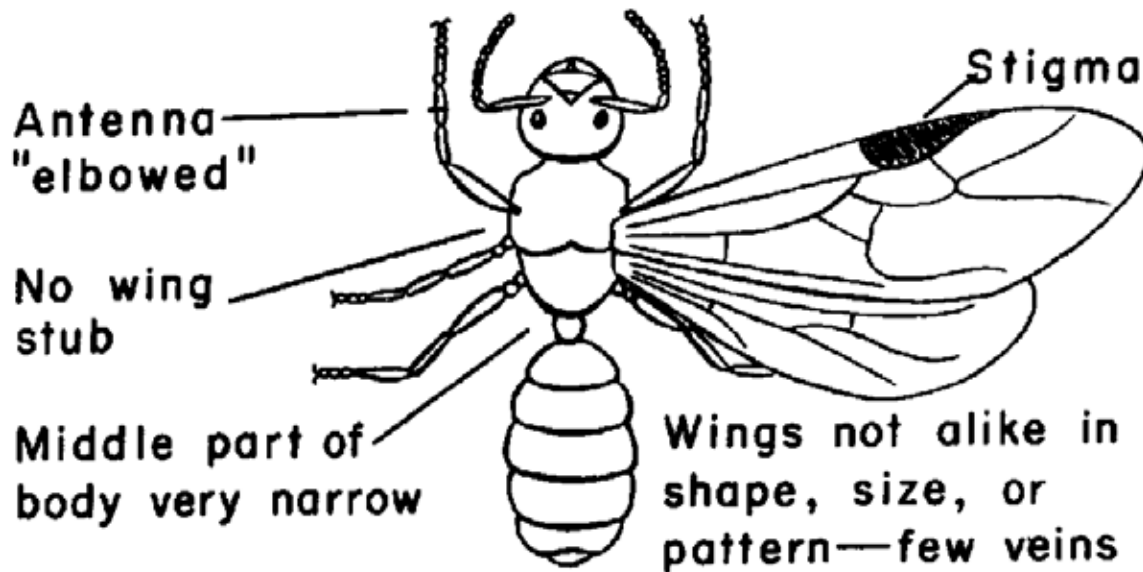

ANT

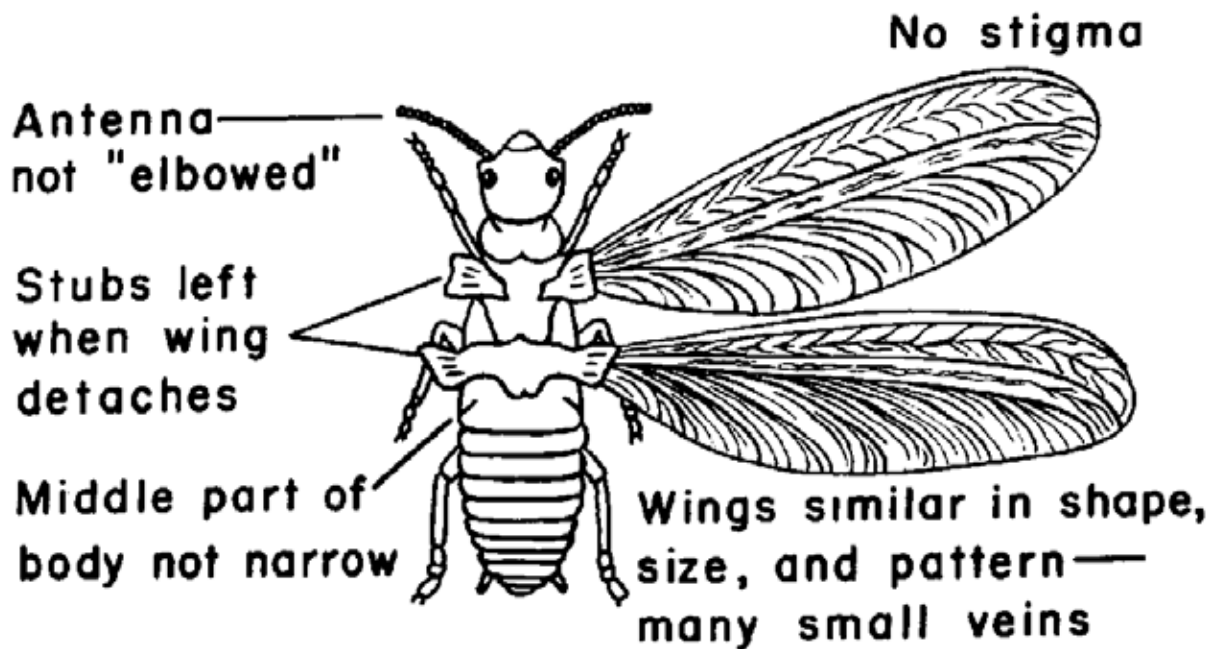

TERMITE

THE IDENTIFICATION, HABITS AND TREATMENT OF SUBTERRANEAN TERMITES AND OTHER WOOD DESTROYING ORGANISMS

SUBTERRANEAN (BELOW THE EARTH) TERMITES are in the animal kingdom, in the phylum Arthropoda, all arthropods have segmented bodies, jointed legs and a hard shell or exoskeleton) class Insecta, (insects) order Isoptera (termites, the word means “equal wings”) and (for our general purposes usually of the) genus *Reticulitermes* (some subterranean termites). In India Isoptera (termites) are used as aphrodisias and for sexual rejuvenation. The Romans named the termites that ate their structures “termes”, which means “wood worm.” They look like white maggots with legs. Average daily temperature and soil moisture are two of the most important factors for the distribution of termites in any ecosystem; control these and you control the termites. Subterranean termites cause about 95% of the termite related damage in the U. S. There are many species of subterranean termites of which *Reticulitermes flavipes* (Kollar) or the eastern subterranean termite is just one. Over 2,400 species of termites are described worldwide and about 56 termite species are found in the U. S. However, only 7-8 species of subterranean termites are truly economically important pests. Subterranean termite bodies are divided into a head, thorax and abdomen. The head includes a pair of antennae and mandibles or (“teeth”). The middle section or thorax, has 3 sections each with a pair of legs. Termites are primitive, soft-bodied, social insects closely related to cockroaches and they have chewing mouthparts. (Their hard, saw-toothed jaws work like horizontally-held scissors.) Termites sometimes damage living plants, but usually these “white ants or maggots” convert dead wood and other cellulose (the hard part of plants) materials to humus. Subterranean termites are the most destructive and economically important insect pests of wood and other cellulose products in the United States with the exception of Alaska. It is estimated that in just the U. S. over 600,000 homes are *treated* yearly with volatile, synthetic termiticide poisons to *control* termites. The subterranean termite leads a secret or hidden life searching for moisture, warmth and food. Subterranean termites are most active and eat the most in hot weather. We actually help termites survive by allowing them to use our homes as a food source and by centrally heating our homes in winter. Heated basements and slabs make it easier for the termites to remain above ground (in the north) to forage rather than trying to find a food source far below the cold surface of the ground. Termites have, obviously, a great economic impact on wood used in and around homes; in addition they also do considerable damage to utility poles, fence posts and similar items and occasionally to living plants. Termites develop from eggs which are laid by primary and supplementary reproductives and are cared for by other termites during an incubation period. They have incomplete or gradual metamorphosis (change in form), their life stages being egg, nymph (which undergo several molts) and three different forms of adults. The subterranean termites have relatively long life individual spans of 3 - 5 years. Every time a termite molts, it sheds the chitinous lining of its digestive tract (and all of the single-cell organisms contained therein) along with the rest of its exoskeleton; it must, therefore, obtain a drop of anal liquid from another termite to replenish these “digestive aids” each time it molts. Their primary means of communication is by their constant food sharing (trophallaxis) between members of the same colony by mouth-to-mouth food transfers. That is why slow acting poisons like borates (at low rates - that do not repel) or medications that destroy bacteria and these organisms, work so well in destroying termite colonies. **Termites are divided into two major groups; those who live below the earth and those that live above it; subterranean termites cause far more damage.**

Termites are social insects that live in highly organized colonies that range from 2,000 to 20 million members in number and can spread out a linear distance of 260 feet! If you could weigh all of the termites in the world, their combined weight would be twice the weight of all the human inhabitants. More than 90% of the termite population are in an immature life stage (workers) that can change into one or more of several other castes. While some subterranean colonies may integrate with another nearby termite colony, most colonies will, upon meeting another colony, begin to slaughter and eat each other, so we will basically consider subterranean termites to be (prejudiced) social insects that usually live in self-supporting, self-perpetuating and totally independent (family) colonies located in the ground, which is their most common source of moisture. Each colony is really a family made up entirely of descendants from the original surviving pair of termites. These colonies (social groups) are composed of many individuals in different stages of development and usually three different forms or divisions of labor or functional types (castes). Nearly all termites have soldier, worker and reproductive castes. Even though subterranean termites live below the ground surface, they usually feed above ground. All termites in a colony are genetically similar; any one of them (at the time of egg hatching) is capable of becoming a member of any

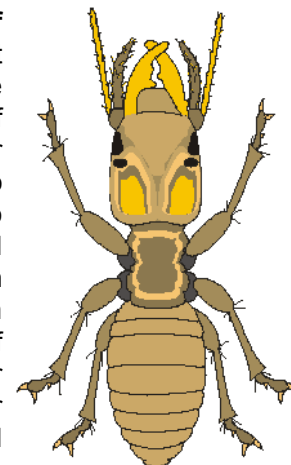

caste in the colony. **Do not assume that there is only one independent colony beneath your home; there may be several. Note: One colony can forage up to 3/4 of an acre or more.**

Deep inside their subterranean homes, relative humidity is nearly 100% and water loss through the cuticle is minimal. Control the moisture and you control the termites. Give them too much water for too long and they drown. They can escape drowning for awhile by entering a state of quiescence for up to several hours.

1. TERMITE REPRODUCTIVES are sexually active males and females (kings and queens), usually made up of either primary or secondary reproductives, both of which are fed by the workers. Some termite queens live to be 50 years old. A primary (high order) termite queen is stationary and grows over 100 times as big as the male reproductive and can be 2000 times bigger than the workers. She looks like a hot dog with a head. She can lay 100 million eggs in a lifetime, or about one every 3 seconds. The swarmers find new food sources so they can reconnect to the main colony that can cover an acre. Low order termite queens (e.g., *Reticulitermes*) are mobile and very multiple.

PRIMARY TERMITE REPRODUCTIVES (*swarmers*) are winged and begin all the new colonies by breeding and rearing the first group of workers. They are usually light tan (yellow-brown) to black in color with 4 equal-sized elongated (paddle-shaped), whitish, translucent wings with many fine veins (which are shed soon after flight); 3 pairs of legs, 1 pair of antennae and a large pair of eyes on their head. They mature in 2 - 3 years and can live for generations; with increased age the body of a functioning female reproductive may become greatly expanded with developing eggs and she will attain a size several times that of a worker or soldier. Queens live 15 - 30 years and lay up to 100 eggs per day. Flooding proves to the Author that these primary reproductives are not very important to the low-order colony. Swarmers usually die in a few hours if they cannot enter a suitable habitat.

SECONDARY TERMITE REPRODUCTIVES or supplementaries of both sexes have very short wings; the females take the place of the queen if she is injured or dies, or when the colony greatly increases in size. Supplementary females actually lay most of the eggs in a colony and can also migrate and start new colonies. They are extremely numerous and are only slightly pigmented and have short wing buds. There is a third type of reproductive replacements in some species which are **TERTIARY TERMITE REPRODUCTIVES**; they are not only wingless but also are unpigmented. Secondary reproductives will probably negate the control of termites using commercial *bait stations* alone - so use a termite system that attracts termites.

2. TERMITE SOLDIERS are sterile adult males and females and defend the termite colony against enemy intruders (primarily ants) and, like workers, only live a few years. They are unpigmented (gray or yellow-white) except for their enlarged, elongated, brown hard heads with two strong, smooth mandibles (mouthparts or jaws) and are wingless. Termite soldiers cannot eat wood and are also fed by the workers. Soldiers block openings and galleries of the nest with their larger heads and cut attackers in half with their mandibles (jaws). If intruders invade the galleries, both soldiers and workers attack following an odor (pheromone) trail. When an invader is injured, the healthy workers cover it (and wall off the colony) with fecal matter.

3. TERMITE WORKERS (sterile adults) and (older but sexually immature) nymphs (functional workers) are unpigmented (gray or yellow-white) and wingless individuals who groom the queens, eggs, nymphs, soldiers and each other, carve the nest, make channels through the soil and excavate tunnels through the wood, forage for food, construct and repair shelter tubes and other workings, chew and "eat" wood fragments so they can care for and feed the rest of the colony by regurgitating digested cellulose, termite workers prefer moist wood, cardboard and cork. Termite workers do not forage "randomly" and can chew through lead, copper and foam sheets, plastic pipe and swimming pool liners with ease because their "teeth" are harder than most chewing insects and their teeth are replaced at least 4 times during their lifetime (one set with each molt). Termite workers do all of the damage to your home and make up the most numerous members of established colonies. (They look like white maggots with legs.) Termite workers have a swarming mass of intestinal "symbionts" or microorganisms containing flagellated protozoans, amoebae, bacteria and fungi in their lower digestive tracts (guts), and these organisms contain enzymes which actually convert the cellulose into simple substances which the termites can digest. Kill the microflora with anti-biotics or antibacterial medications or the protozoans with copper, iron or sulfur or kill both with Flagyl® 250-375 ml., and you quickly starve and kill the entire termite colony. They can chew through 1/8" PVC pipe and pool liners in addition to your home, fence, shed, picnic table, deck and/or garage so *prebait* these areas with sodium borate treated lumber or sawdust (with honey and molasses) or pellets or dowel or stakes or seltzer water (DOT) moistened cardboard, or cellulose insulation treated with borax

and boric acid or DOT, etc. Subterranean termites will not forage in areas where upper level soil temperatures are too hot or cold or too salty. Workers use "thermal shadows" to scan and locate above-ground food sources (Ettershank et al. 1980). They are attracted to air with 1% carbon dioxide - about 1/10 the carbon dioxide found in your exhaled breath. Not all termites feed each day and feeding patterns follow obvious seasonal changes. **They prefer to eat chewed or digested food.**

The termite nymphs, after hatching, look like small adults without wings but are usually lighter in color. They increase gradually in size through a series of molts (shedding their external skeletons) and as they increase in size, color and age they take on adult characteristics. Wings, if they will eventually be present, start out on the surface of their bodies as wing buds.

A mature termite colony (a minimum of 3 - 4 years and as long as 8 - 10 years old) can produce large numbers of termite swarms. or winged primary reproductive adults (alates) which emerge (swarm) once every year at certain seasons of the year for colonizing flights (to establish new colonies) through openings (called swarming tubes or swarm castles) the workers make to the outside. At the end of their short, weak, fluttering flight, they break off their wings (a process known as "dealation") along a line of weakness near the base, wherever they've landed and, with a male (or 2-3) following a female, they move along like a train (for over an hour) until they find a hidden location (usually the soil under or near a piece of wood) to construct a small (royal) cell by excavating a chamber with their jaws; they enter and then seal the entrance; later they mate, reproduce and lay usually fewer than a hundred eggs the first year and rear the first group of workers (other forms of adults are generally produced with later egg laying). Occasionally subterranean termite colonies can be found living in a roof (or cross member) under the top (moist) surface. The queen can retain sperm for approximately 6 months before she needs to be refertilized by the "king", who lives with her for life. In a mature colony if these primary reproductive forms are injured or die, supplemental or secondary reproductives without color pigmentation or functional wings are created in large numbers. Swarming termite primary reproductives are the termites most often seen by you, and are usually much darker than the other members of the colony. All 4 wings are the same length and extend more than the length of the body beyond the tip of the abdomen. Environmental conditions such as the temperature, moisture both within and outside the colony, light conditions and even barometric pressure influence when this swarming occurs. As a general rule, termite swarms usually emerge on warm sunny days when the humidity is high (after a spring rain). They are particularly defenseless at this time and may die from heat or cold or drown in water or are eaten by their natural enemies. Each surviving subterranean pair (king and queen) personally care for the eggs and young nymphs through the first two instars (molts); then at the third instar these "stunted" youngsters become self-supporting and assume their duties and begin to develop into the various castes. In a colony of one million individuals, the original queen may only have laid 10,000 of the eggs, with supplementary reproductives laying the rest. According to Dr. Rudy Scheffrahn, a University of Florida researcher, the foraging range of *Reticulitermes* is about 1/4 acre and about 1 acre for the Formosan termite. Rudy suggests if termites are found above the second floor it is unlikely soil poisoning will control them. Subterranean termite damage has been estimated at \$1 to \$3 billion per year in the U.S.

Swarming termites (alates) often are confused with swarming ant reproductives. You must be able to distinguish between the two insects. Both have two pair of wings... termite wings, however, are all about the same size and are translucent. The back wings of ants are shorter and smaller than the front wings and they are transparent. Termites have straight bodies while ants have clearly noticeable pinched (thin) waists between the thorax and abdomen. Another clearly distinguishable difference is in the antennae...termites have straight antennae (that look like a string of little beads); ants have bent antennae (elbowed). Note: Carpenter ants differ from regular ants by having only one knob on their thin "waist" and the upper surface of the thorax is evenly rounded with all segments having a uniform appearance. They are usually larger and colored black, red, brown or some variation thereof. If you want to stop the swarm you can inject or spray ammonia water or diluted borax or diluted enzyme cleaner. **When you vacuum up all swarms during a swarm you can easily tell from where the (termite) infestation is coming.**

The Subterranean Termite and Its Environment

Subterranean termites are naturally vulnerable to a wide variety of environmental factors, i.e., temperature, humidity wood in direct or close proximity to the soil, soil type and moisture which restrict the colony to the soil as a source of moisture, but moisture is the primary condition conducive - so use a moisture meter! **Control the moisture and you control the termites!** They prefer sandy soil over a clay base, but can be found in

many types of soil. Termite activity slows down once the temperature drops below 50° F. They usually infest wood that has been previously infested with fungi and they prefer relative a humidity of 97.5%, so dry out the area and the wood! Their high moisture requirement means they will maintain contact with the soil and/or locate near areas where moisture collects. Subterranean termites may even eliminate their direct contact with the soil where an above-ground moisture source is available. Wood moisture content greater than 15% promotes above ground survival and greater than 20% can create actual termite colonization **above** the ground. Damp wood near tubs, sinks, toilets and leaking pipes, or wood kept damp by runoff water, e.g., roofs or gutters, are also prime locations for termite infestations. So repair all *leaks* and properly install and use visquine, vents, fans and dehumidifiers! Look for roof, window, door, faucet, sprinkler leaks, earth/wood contacts and faulty grading! The location(s), timing and estimated damage potential of an attack is unpredictable. **We have found foraging workers in wood and trees and cardboard when the ground was frozen!**

All the termite workers, soldiers, supplementary reproductives and nymphs are soft-bodied insects and tend to desiccate or lose water very rapidly when exposed to dry air or salt. (They will crawl up into wood to avoid floods.) Mud tubes are used by the termites when they pass over exposed areas. These mud tubes not only serve as a protective barrier against intrusion of ants, light and air movements, but are thought to conserve moisture, especially for the workers whose ectoskeletons (outer covering) are thinner than in most insects. Fans and dehumidifiers (alone) have solved ongoing termite retreatment problems when properly installed and maintained. Simple table salt, food-grade DE, borax, Peladow® or sodium borate will quickly and permanently control termites in the soil (crawl spaces, bath traps, etc.) and in the wood, but table salt will also attack and destroy ferrous metals like nails. Sodium borate and borax will not attack ferrous metals in the same way.

The warm, moist conditions and accumulation of (their liquid, not pelleted) fecal material found within the closed system of the termite colony/nest promote the growth of micro-organisms, particularly fungi; these “**fungus farms**” **provide the termites with the necessary source of protein, nitrogen and vitamins which are basic to termite growth. Termites are highly attracted to odors and carbon dioxide produced by wood-decaying fungi, so keep all of your wood dry and/or treated with sodium borate.**

The environment of a colony of termites is delicately balanced. A termite colony may have been slowly crowded out and abandoned because the fungi grew so fast the termites could not “keep up with it.” Sudden temperature changes (or other factors) result in the accumulation of liquid water within the galleries, and they may literally drown. Their most basic means of communication is through odor...chemical (pheromone) communication; however, air currents, touch, sound vibration of surfaces and antennal contacts are also basic termite communication tools. They cannot “hear” but feel noise (through their feet) outside the nest, and immediately react to “sound” when their nest is tapped.

WORKERS AND TERMITE SOLDIERS are blind. Except on their initial swarming/colonizing flight, **subterranean termites live a cryptobiotic life, which means they are always hidden and in the dark, in wood, in the soil, or in their passage ways (mud tubes).**



THE CAST-OFF WINGS found just after the termite swarming season are an almost sure sign of active termite infestation, but the presence of mud tubes on a foundation, hanging from a ceiling, between a sub-floor and the ground, along any structural member, or in debris under a structure, can be observed at any time of year. **Subterranean termites always make mud tubes.**

A MUD TUBE looks like a length of grayish-brown yarn. Mud tubes or foraging tubes can be found in large masses or singly with only a fraction of an inch being visible. They can be oval or flattened. In exposed areas, subterranean termites must protect themselves from the drying effects of the air, so the mud tubes or earthen shelter tubes they construct over the surface of foundation walls are a typical sign of subterranean termite infestation. Old abandoned mud tubes are not always distinguishable from active tubes. Break open the tube in one or more areas and check for live termites, or wait for several days to see if the shelter tube has been repaired. Termites can rebuild mud (or shelter) tubes at a surprising speed. Exner in 1953 noted a 1.2” tube was restored in 65 minutes. As a general rule, old mud is dry and brittle and breaks away easily. Fresh mud can be moister, stronger and is generally darker in color. The mud tubes are constructed by worker termites from particles of soil, wood and other debris held together with fecal material and salivary secretions. **A TYPICAL HIDDEN INFESTATION** is where subterraneans have entered a structure through a hollow block, void or a crack 1/32” wide leaving no

visible mud tubes. Because termites are normally hidden, it is necessary for you to sound all accessible structural members for hollow areas where termites may be working and then probe all of the hollow areas to check for termite infestation. Termites will eat wood right out to the paint, but they won't eat the paint or through the surface without patching the hole with "mud". The wood structural members closest to the soil, and therefore, the most likely to be severely damaged by termites, are the sills, joists, studs, girders and other important load-bearing members of your home's construction. Failure to stop termite attacks at this point can lead to sagging walls, leaking surfaces and wood decay. A real fancy schmancy way to bait termite tubes is to treat 13 - 15 sheets of a roll of white paper towels or a piece of (double) virgin cardboard with 1% - 3% sodium borate (or 2% - 5% boric acid or borax mixed in seltzer water with a "fizz"), then place it directly over the mud tube and cover it with a clear piece of plexiglass bolted to the surface with self-tapping screws. You can daily (visually) check the termites' progress and demise - while keeping kids and pets away from the bait. Use cellulose insulation treated with sodium borate or boric acid or borax to cover crawl space floors as a bait.

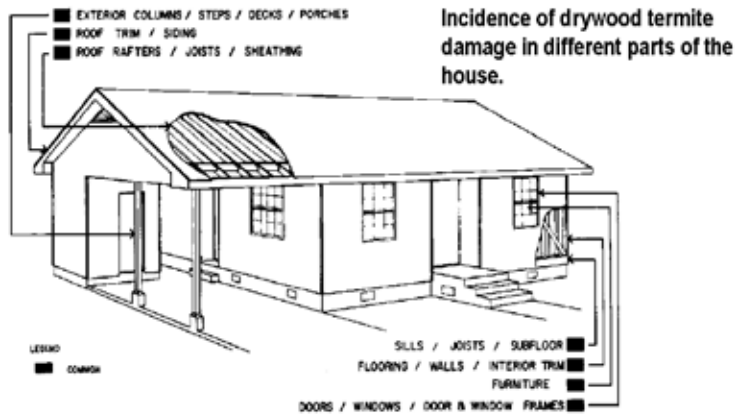

TERMITES can and will eat any plants or materials containing cellulose (especially most corrugated cardboard, foam, rotting wood, books, rose roots, cotton and other natural fabrics, canvas, paper and they try to eat plastic liners of pools, plastic pipe, etc.), but they are unable to digest the cellulose directly. Their digestion is aided by single-cell organisms in their digestive tracts (guts) which convert the cellulose into more simple substances that termites can digest. The exchange of food from the anus and the cannibalization of some unfortunate dead and/or dying individuals is the normal means by which these cellulose digesting protozoans, amoebae, bacteria and fungi are transferred from the older to younger members of the colony. If there are too many reproductives or soldiers for the good of the colony they will also be killed and consumed by the workers. If during grooming some members' thin integument (skin) is accidentally penetrated (pierced) this will trigger an immediate attack and the unfortunate individual is also consumed by the workers. They will also eat sodium borate-weakened members and spread the poison throughout the colony. They also damage but cannot digest other materials such as rubber, plastic, asphalt, metal, mortar, etc. They are attracted to rotting wood and foam and "fresh" seltzer water which all give off carbon dioxide. Also try (fresh) ballpoint pen ink!

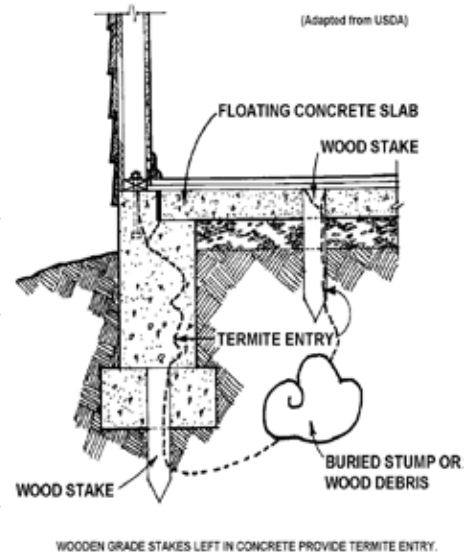

SUBTERRANEAN TERMITES OF NORTH AMERICA

Most termite damage which occurs in the United States is caused by subterranean termites although drywoods or damp woods or powder posts may be a greater local problem. Several termite species of the genus *Reticulitermes* comprise the most important and widespread group of subterranean termites. Their natural ranges are areas where the mean (average) temperatures is 50° F. but because of man's central heating they are now found throughout most areas of the northern states too. The subterraneans of the north (without central heating) generally cease their activity above the soil at approximately freezing (32° F.) and move downward 3 - 4 feet in the soil to escape the adverse weather conditions (Their body fluids do contain glycol so they normally do not freeze.). If treatments are undertaken for subterranean termites within 6 months after the first evidence of termite infestation occurs, very little structural damage is every likely to be a problem. (If Formosan subterranean termites are involved, control should be completed within a few months.) Sapwood (soft, new wood next to the bark) is most susceptible to subterranean termite attack. Usually only 2 - 4 feet of a 2x4 are destroyed (each year) by a mature colony of subterranean termites, but recently that figure was increased by Larry Pinto who wrote a colony of 60,000 subterranean termites (in some areas) can consume 12 inches of a 2x4 in 6 months.

A single mature colony may have from 250,000 to several million members.

Subterranean and tree nesting termites differ from the drywood and damp wood termites in that their colonies usually need to maintain direct contact with the moist soil in order to obtain enough water to survive. In a few cases, where the structural wood is sufficiently moist, some colonies are able to survive without ground contact. This secondary moisture source, however, is not common. The subterranean colony normally lives in a series of underground chambers and galleries from which they build mud tubes to their food source, i.e., your home. They prefer sandy soil over one with a heavy clay base.

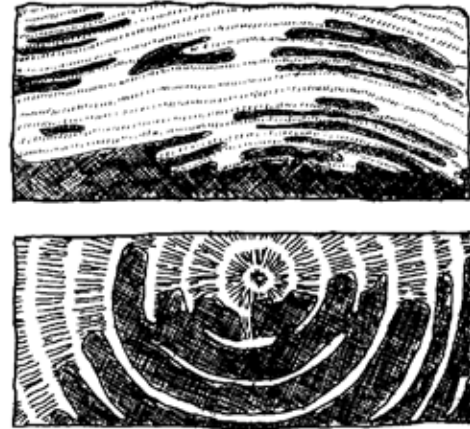

The damage that subterranean termites cause differs from the damage caused by other wood destroying organisms.

Termites usually eat only the soft layers of the annual rings in wood, following along the grain, and only penetrate the hard layers to get from one soft layer to another. (Look at the pictures.)

This frequently leaves a damaged piece of wood looking very much like the pages of a book. You further distinguish a subterranean termite infestation by the mud (grayish-brown cement) tubes that connect and/or line their excavated galleries (tunnels). Subterranean termites travel constantly from their nests in the ground to the above ground wood, or other cellulose-containing materials upon which they feed. They make these trips only inside the wood or inside other voids or inside the mud tubes which they construct. Single mud tubes, when they are built in the open, are about the diameter of an ordinary lead pencil. Subterranean termites, in fact all termites, may excavate the wood so that only a very thin shell is left on the surface between their galleries and the outside. When the shell is broken, subterraneans will cover the hole with the same "mud" with which they make their tubes. This mud is also frequently used to cover the openings between 2 joists so the termites can move about in a protected situation. If you find a tube put sodium borate treated wood or 1/2% (or less) borate treated corrugated cardboard or 12 - 15 sheets of white paper towels directly into or over it and break off the top of the tube, or directly sprinkle (lightly) treated sodium borate sawdust or pellets or cellulose insulation next to it and then cover with clear plexiglass (secured with bolts) so you can easily observe your control efforts carefully!

Because subterranean termites live in the ground, most of their damage is usually found near ground level. Termites normally invade most homes through underground roots or wood close to or in direct contact with the soil, particularly at porches, steps, flower boxes, planters or fences. **Make sure wood parts of your**

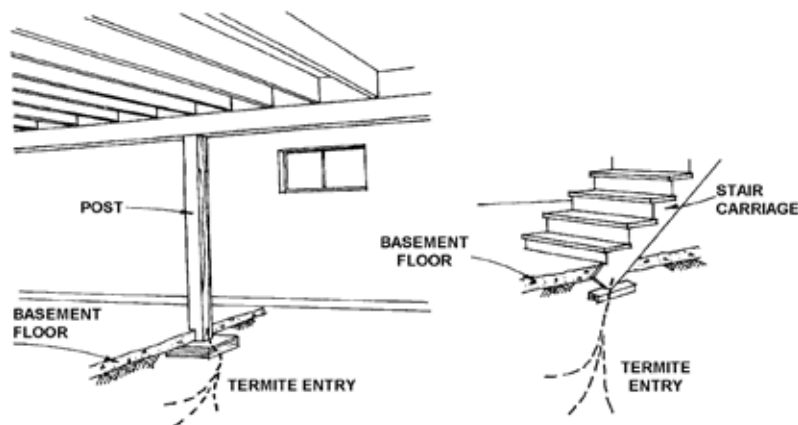

building are at least 8" above the soil. Worker termites come out of the soil at night (when temperatures and relative humidity levels permit) climb a blade of grass and thermally scan the surrounding area for food sources. Termite baits used to control them must be 1/2 in and 1/2 out of the ground and covered with transparent material (or left uncovered) so their thermal scan is not adversely affected. Examine thoroughly all of the lower levels of your home, i.e., the basement or crawl space walls, supporting piers, sill plates, floor joists and subfloors, etc. Poorly vented crawl spaces often create an area of high relative humidity where the joists absorb moisture and are more susceptible to termite attack. So properly vent crawl spaces and if necessary properly install and maintain

fans and dehumidifiers and/or prebait with sodium borate treated pellets or sawdust, or cellulose insulation, etc. Particular attention must also be paid any areas behind concrete steps, porches or concrete slabs where they join or abut your home. Especially note any cracks and/or expansion joints 1/32" or greater that would allow termites access under or into bricks, mortar or concrete and then into your wood. Most subterranean termite infestations take place behind the front or back porch or slab. If your home is under construction, be sure no (untreated) wood debris is allowed in any of the backfill, especially in the earth fill under all of your porches, steps and patios and/or pretreat the wood with sodium borate. If you want to *prebait* these areas use sodium borate treated cardboard or wood. Properly positioned, you should have termites in your baits within a week.

Historically, the basic principle in the control of subterranean termites was to deny them access to their food (cellulose) and/or to cut off the "ground contact" with their soil moisture. This was usually accomplished by mechanical alteration or poison treatment of infested areas. Deny them direct contact with food or moisture and they will die or direct them to 1% or less sodium borate treated cardboard/wood/cellulose insulation/white paper towels and they will also die. In many cases, simple structural modification, installing and maintaining dehumidifiers and/or pretreating with sodium borate may be all that is necessary to achieve effective control, e.g., correct or treat all earth-wood contacts and moisture problems and other conditions conducive to infestation. Be especially aware of all rigid foam board insulation installations (unless pretreated with sodium borate) they are easily attacked by termites.

Termite Bait Formulation: Proper bait formulation is based on the idea of a Preferred Food Source. They prefer chewed or digested food. Upon discovery, termites will actively and:

- Preferentially feed on the bait (don't think 50% acceptance is adequate; this needs to be much higher). They're not miracles: Putting a (poisoned) preferred food source (e.g., wood cardboard, paper, sawdust or cellulose powder) in the middle of the lawn is not going to work if the termites don't come across it. Proper placement and the bait station choice are very important. **Put baits where you see most activity and so they can find it, or add an attractant, e.g., brown rot fungus, CO₂ or other termites.**
- Try to recruit other termites to all of the bait stations. Baits may not be effective unless the first termites recruit other termites to feed on it. Termites clean themselves by licking or grooming one another - slow-acting toxicants and/or mites are easily spread throughout the entire colony in this way.
- When you add 25 - 100 "foreign" termites (with at least 2 healthy soldiers) to each of your cardboard bait stations, you will attract the local colony to your bait station very quickly.
- Carbon dioxide will also attract them, so put some foam in with your cardboard (boron) bait and/or moisten with (fresh) carbonated seltzer water. Add a little honey and molasses or aspartame.

Baits must be designed for continuous feeding; especially once the bait stations become focused sites in the termite's foraging network. All baits must be slow-acting (1% or less); if they kill too quick, termites will shut down that portion of the tube. Overall consumption of a bait: If they feed on the bait but never return, it's a cause for concern. You must make sure it's a viable food source. Use seltzer water (without chlorine) moistened virgin cardboard or white paper towels (with some foam to give off carbon dioxide) in shrink wrap if possible and 1% sodium borate (DOT) or less or boric acid or borax or nematode or mite predators or 250 ml Flagyl® or 1% protease enzyme or colloidal silver or 1/4% urea, 1/4% methylene blue or 1/2% red food color. You can increase the methylene blue concentration. What you should see happening is a great reduction of your bait over time - steady decline is a good sign, but immediate reduction after first consumption may not be good (they may have shut down and gone to something else). Bait station effectiveness relies on your proper monitoring, to make sure the station stays full with active ingredients. It is hard to get a feel for acceptance unless you inspect routinely. Wells, plenum air spaces and other environmental locations are good spots to test baits. The best commercial-strength bait is Not Nice to Termites® (but nice to people, homes and pets) monitoring stations and termite control stations may be available from Get Set, Inc. at 1-800-221-6188.

SOME DIFFERENT TREATMENT STRATEGIES FOR TERMITE BAITS:

Supplemental

- Control localized activity, supplement to soil or wood termiticide poisons that were previously applied.
- Monitor/service baits at 3 to 5 month intervals.

Remedial

- Control of active termite infestations, *stand alone*.
- Monitor/service termite baits at least at 2- to 3-month intervals.

Preventative

- An aid to prevention from termite attack.
- Monitor/service baits at least at 3- to 5-month intervals (place or use baits in heavy pressure areas or use them for monitoring).

SOME OF THE MORE COMMON SPECIES OF SUBTERRANEAN TERMITES:

A. ARID LAND *Reticulitermes tibialis* (Banks) - These are the most widely distributed of all the subterranean termites and you will find these subterraneans from western Mexico north to Oregon and Montana, east to Indiana and south to Texas, Missouri or Arkansas, and in more diverse habitats. They overlap with Pacific Coast termites but prefer the drier areas. All *Reticulitermes* make tubes, but not pellets. The heads of their soldiers are short, broad and yellow and they can be found naturally in the creosote bush and grease wood.

B. DESERT *Amitermes wheeleri* (Desneux) and *Heterotermes aureus* (Snyder) - Both termites are of a species of subterranean termites other than *Reticulitermes*. Only species among many DESERT termites that damage buildings, especially hardwoods, i.e., oak veneering; in nature they live in dead trees, stumps and cactus plants. You will find them in Texas, Arizona, Nevada and California. They both are strong nocturnal fliers, unlike most other subterranean termites. A third desert termite *Amitermes arizonensis* (Banks) is common in Southern California and infests citrus tree bark, but are normally not found in homes.

C. FORMOSAN *Coptotermes formosanus* (Shiraki) - Is still another species of subterranean in addition to those above. They are more common in the tropical regions and native to main land China; they have been spread to more temperate areas via shipment of infested wood from the Far East and Hawaii where they cause more damage than any other insect. Now considered firmly established in this continent, especially along the Gulf coasts including Texas, you will also find them in the southern Pacific and Atlantic coastal states, i.e., Florida and California and the lower Mississippi valley. *Coptotermes havilandi* was found in Miami in 1996, in Key West in 1999, and is now in the Florida Keys. *Coptotermes formosanus* is also in Orlando, Florida and is spreading. They cause up to \$300 million in damage annually in New Orleans. Swarming normally occurs between dusk and midnight and the alates are attracted to lights. The swarming flights can be quite large. They are one of the world's most vigorous and damaging termites because their queen can lay 1000 eggs a day (population development), the enormous size of their colonies (mature colonies may contain 2 - 3 million members), their larger individual size (Swarmers are up to 5/8" and have hairy wings; their more extensive tube and tunnel building, the rapidity with which new food sources are located and destroyed, the greater variety of materials attacked by them and their ability to find secondary moisture sources and to thrive without a direct ground connection. Formosan swarmers can and do reinfest buildings, especially when they fly upward and find wet wood. They can swarm in the spring and in the fall. Scientists have discovered that they have developed the ability to make a chemical pesticide to protect their nests against beetles and other nuisances, according to a report in the April 9 issue of Nature. Formosan termites apply the chemical naphthalene to their underground nests to ward off both pests and predators and to inhibit the growth of fungi that might otherwise destroy the colony, Louisiana State University researcher Jian

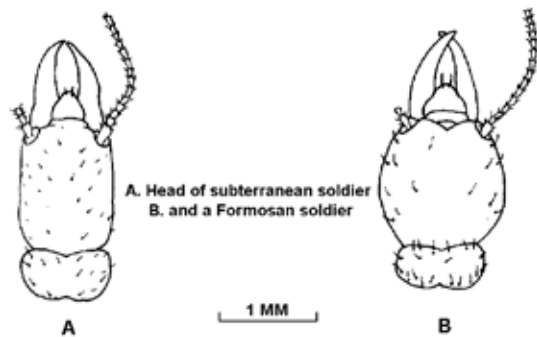

They cause up to \$300 million in damage annually in New Orleans. Swarming normally occurs between dusk and midnight and the alates are attracted to lights. The swarming flights can be quite large. They are one of the world's most vigorous and damaging termites because their queen can lay 1000 eggs a day (population development), the enormous size of their colonies (mature colonies may contain 2 - 3 million members), their larger individual size (Swarmers are up to 5/8" and have hairy wings; their more extensive tube and tunnel building, the rapidity with which new food sources are located and destroyed, the greater variety of materials attacked by them and their ability to find secondary moisture sources and to thrive without a direct ground connection. Formosan swarmers can and do reinfest buildings, especially when they fly upward and find wet wood. They can swarm in the spring and in the fall. Scientists have discovered that they have developed the ability to make a chemical pesticide to protect their nests against beetles and other nuisances, according to a report in the April 9 issue of Nature. Formosan termites apply the chemical naphthalene to their underground nests to ward off both pests and predators and to inhibit the growth of fungi that might otherwise destroy the colony, Louisiana State University researcher Jian

Chen and four colleagues report. The chemical, the active ingredient in mothballs, had never been found in the insect kingdom. Exactly how this is accomplished is unknown, but the chemical is inserted into the mixture of mud and chewed-up wood that termites use to build their homes. The compound becomes volatile over time and literally fumigates the next, repelling beetles and ants as well as larger predators such as squirrels, birds and bats, the researchers report. The soldiers have oval heads and their mandibles cross when closed. The soldiers exude a whitish, sticky, acidic substance from a gland in the conspicuously enlarged opening on the top of their heads which can “eat” through lead, plastics, mortar, plaster, etc. Other subterranean soldiers have oblong or rectangular heads. Formosans are able to create serious structural damage even in the first 8 - 10 years of your home's life. Most subterranean termites do not construct a clearly defined “nest”, but the Formosans often build above ground “carton” nests. In order to do so, they produce a rather hard material called carton which, though hard, has the appearance of a honeycomb bed sponge. Carton is composed of chewed wood, saliva, soil and fecal material, which functions to retain moisture and protect the Formosans from predators. An occupied carton nest is relatively moist and pliable; abandoned nests are dry and hardened like concrete. **Soak the occupied nests with sodium borate solution and Safe Solutions, Inc. Enzyme Cleaner.** They need at least 15% wood moisture content.

Professional control of Formosans historically has required specialized treatment which included greater concentrations of volatile, synthetic *residual* poisons, removing moisture sources above ground, injecting other volatile, synthetic *residual* poisons above ground, removal of all secondary nests from wall areas and even fumigation. This species will bite the legs off any sick termites they find so that the contagion cannot spread through their colonies. Their nests are often underground but can also fill cavities under fixtures, or can even be inside the walls of your home. Would you believe that medium-sized colony of Formosan termites (3 million or so) can eat ONE FOOT of a 2 x 4 in only TWO days! It takes an eastern or western subterranean termite colony of around 60,000 workers about six months or more to consume this amount of wood. If you are building, treat all structural wood members with sodium borate and *prebait* under the concrete slab with treated stakes pushed into the earth, or treated wood or pulverized newspaper, pellets, sawdust, cardboard and/or form boards using 1/2% to 1% disodium octaborate tetrahydrate. Extracts from the ant species *Ochetellus glaber* as well as piperidine from Red Imported ants and an alkanoid, pyrrolidine from Pharaoh ants, or the monoterpenoid alcohols, eugenol (found in cloves), geraniol (found in geraniums), citral, citronellal and/or nerol have all been used to kill Formosan subterranean termites - so you may wish to vacuum up a *good* supply of some of these ants and blend them in a blender with cloves to try an experimental spray in the soil and/or wood yourself. Eugenol which kills with its volatile fumes was the most toxic termite substance the University of Hawaii in Honolulu tested. PCO, the official magazine of the Florida Pest Control Association, noted in its February 1999 issue on page 19: “Dr. Gregg Henderson, LSU entomologist, reported that twice as many alates were found in 1998 than just a year before in South Louisiana — so much for ‘control’.” By 2005 Formosans caused more than \$1 billion per year in the USA, including repair costs.

Note: Another non-native subterranean species *Coptotermes havilandi* (Holmgren) was found in Miami in 1996 — their alates differ from Formosian alates in that they are dark brown on top and yellow brown underneath. The presence of white, half moon shaped *antennal spots* in front of each ocellus, is also characteristic of *C. havilandi* alates. The new invader is a destructive pest of wood and crops in Thailand, Malaysia, and Indonesia and is currently the major structural pest in the city of Sao Paulo, Brazil and its migration (north) is continuing. Soil treatments will not control this subterranean termite - use sodium borate and change the conditions conducive to infestation and/or soak the soil with a salt or sea water or enzymes/bacteria.

D. EASTERN SUBTERRANEAN *Reticulitermes flavipes* (Kollar) - Is the most common species of subterranean distributed in North America. You will find them from Canada south to Florida and west to Arizona and Utah. Swarms mainly in spring (February through June), occasionally in fall (September through November), but has been known to swarm all year long (especially when they are under heated slabs), depending on temperature, humidity and barometric pressure. Beside infesting homes they also infect living trees, shrubs, flowers and crops. They have no permanent “royal” cell, but can move to find the most favorable conditions. Workers live no more than two years, and generally number up to 250,000 per colony, but they can contain over a million. They may have tens of thousands of secondary reproductives. It takes several years to achieve a population of 50,000 or more foraging workers. They can not survive very long in soil with a Ph above 8.7 or below 2.3.

E. LIGHT SOUTHEASTERN *Reticulitermes hageni* (Banks) - You will find these “miniature” subterraneans from Washington, D.C. south to Florida and west into Texas and Kansas. Swarm August to October in the North;

October to February in Florida. Light tan or black swarmers that are extremely tiny.

F. PACIFIC COAST or WESTERN *Reticulitermes hesperus* (Banks) - Most destructive subterranean termite on the west coast of the U. S. You will find them from British Columbia south to western Mexico, east to Idaho and Nevada. Usually takes 4 years before swarmers with pale yellow-brown bodies and gray wings emerge from a colony. This termite excavates galleries in wood similar to those of the eastern subterranean termite, (spotting the wood with dirty, yellowish-brown fecal spots) but earthen shelter (mud) tubes are built less commonly. The heads of their soldiers are long, narrow and pale. Workers prefer soil temperatures between 84°-90° F., and are never found in soils above 104° F.

G. SOUTHEASTERN *Reticulitermes virginicus* (Banks) - You will find them in the same general areas as the light southeastern, but they have swarmers with black body color and they usually swarm earlier in spring (May and June) with some fall swarms in October and November. They will fight eastern subterranean immediately for dominance.

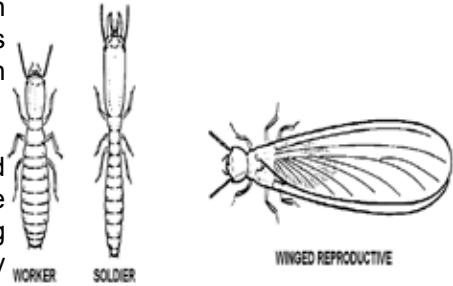

The poison “industry” notes more than 600,000 termite jobs are performed annually by 68,000 pest control operators using an average of 300 gallons of volatile, “registered” termiticide poison per home! Some states still demand that a maximum amount of poison be used no matter how small the infestation! Usually those states think they are *protecting* you by requiring the maximum allowable rate of poison be applied! Usually their *inspectors or regulators* have never done a termite job! Soil *residue* levels (and not the actual control of termites) are apparently the only way *they* can tell of a termite job was done *correctly* or not!

MANY, MANY HOMES HAVE BEEN CONTAMINATED AND MADE UNLIVABLE AND PEOPLE HAVE DIED OR HAVE BECOME VERY ILL BECAUSE OF THE ‘REGISTERED’ POISONS USED IN PROFESSIONAL TERMITE CONTROL. THE INDUSTRY’S PRINCIPLE OF CONVENTIONAL SUBTERRANEAN TERMITE CONTROL USUALLY WAS AND OFTEN STILL IS THE PLACEMENT OF POISON BARRIERS BETWEEN THE GROUND (where some termite colonies are) AND THE STRUCTURE THAT IS TO BE PROTECTED. THIS CAN BE DONE WITH TABLE SALT OR BAITS OR DONE MECHANICALLY, SUCH AS BY REMOVAL OF OR PRETREATMENT OF ALL EARTH-TO-WOOD CONTACTS WITH SODIUM BORATE, OR MORE COMMONLY BY THE INJECTION OF CHEMICAL POISON BARRIERS AND/OR WOOD TREATMENT, OR BY A COMBINATION OF THESE METHODS. SO YOU MUST SPECIFY WHICH TREATMENT AND CONTROL YOU WANT.

The first “registered” residual poison soil *treatments* ranged from an arsenic compound and the use of motor oil to the use of DDT. For the past 5 decades (since Hitler) the primary (only) “professional” strategy for *controlling* subterranean termites is/was to **try** to deny them access to a structure by poisoning the soil around and under it with volatile “registered” poisons that attacked our nervous system and/or caused us cancer! **Brilliant!** In the mid 1940s and until recently (when the Author helped get chlordane/heptachlor banned) most *professional* residual chemicals used for subterranean termite control were chlorinated hydrocarbons: chlordane, aldrin, dieldrin, heptachlor, pentachlorophenol. Today synthetic *residual* pesticides include an organophosphate or chlorpyrifos (Dursban TC), 2 permethrins (Dagnet and Torpedo), a carbamate (Ficam 2), a cypermethrin (Demon TC), a fenvalerate (Tribute) and a isofenphos (Pryfon). All of these synthetic *residual* organic insecticides are considered to be economic poisons and *residual* termiticides, but they all break down relatively quickly and, because they all volatilize, should be considered extremely dangerous, especially when treating inside (many times) to the maximum amount their labels allow. The Author personally has inspected homes so contaminated with termite poisons, the building had to be physically removed yet he found live termites **still** eating the wood! If you wish information on chemical soil poisoning, refer to the supplemental section at the rear of this chapter, “Soil Treatments or Poison Barriers.” If you would like a list of suspected health problems caused by any of these poisons, please refer to Chapter 13. Remember to ventilate damp areas, e.g., crawl spaces and basements, and/or use a dehumidifier and fans to obtain proper drying. Remove all visible termite tubes, especially those that connect the soil to the wood. The use of *Steinernema* and/or *Heterorhabditis* nematodes (which enter a host where they reproduce and infect it with bacteria), has not proven effective, especially in certain soil conditions and in the north, but sand barriers are being used with some success. Sodium borate has proven to be the best termiticide we have ever used, especially if used in combination with other IPM controls, e.g., dehumidifiers and

vents. Borax, sodium borate, salt, food-grade DE and Peladow® treated soil or wood will all control termites permanently unless they are all leached out. Table salt will also attack ferrous metals (nails), however.

Even the poison “industry” believes a “conventional” chemical (poison) treatment should involve the following basic steps: 1. mechanical alteration, 2. soil treating, 3. foundation treating, and 4. wood treating. Any given conventional termite control job may involve one, several or all of these steps, depending primarily upon the type of construction encountered. In most situations adequate control may be obtained without involving all 4 types of treatment, especially if you simply use borax, Peladow®, table salt, food-grade DE and/or sodium borate and/or some integrated pest control techniques.

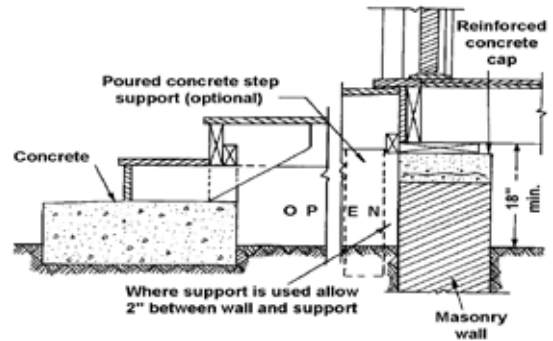

Subterraneans normally enter your home searching for food (any cellulose source) through roots or through wood in direct contact with the soil and/or by building mud (shelter) tubes over or inside foundation walls, piers, chimneys, etc. and/or through cracks or expansion joints in cement slabs and walls and/or via free-standing shelter tubes from the crawl or through some opening to the wood above.

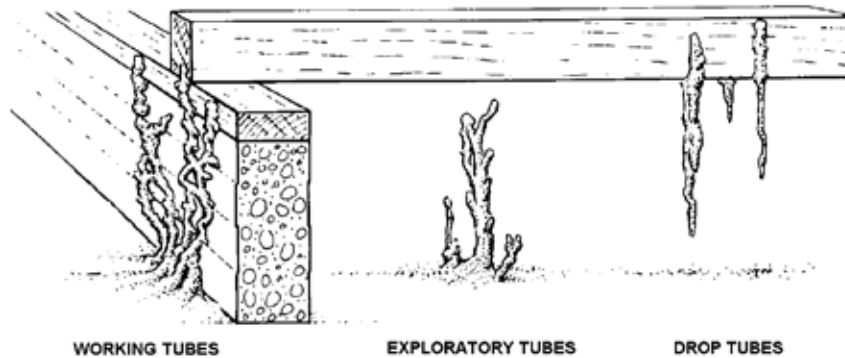

SUBTERRANEAN TERMITES CONSTRUCT FOUR TYPES OF TUBES OR TUNNELS. WORKING TUBES ARE CONSTRUCTED FROM NESTS IN THE SOIL TO WOODEN STRUCTURES, AND MAY BUILD TUBES AND TRAVEL UP CONCRETE OR STONE FOUNDATIONS. Break into these active (mud) shelter tubes or any active wood galleries and insert a 1% or less sodium borate treated block, cellulose insulation, sawdust/pellets, piece of wood or corrugated cardboard and/or tape or secure these objects over the exposed termite workings. We like to use several 1% or less treated pieces of cardboard covered with see through plexiglass - screwed into the wall, covering the area of the old tube - you can easily inspect to see if you need to *re bait*. **Moist baits work best, so periodically remove the plastic, add pieces of foam and mist the cardboard with seltzer water with a “fizz”.** SWARMING TUBES ARE EXTENSIONS OF THE WORKING TUBES. EXPLORATORY AND MIGRATORY TUBES ARISE FROM THE SOIL BUT DO NOT CONNECT TO WOOD STRUCTURES. **DROP TUBES** EXTEND FROM WOODEN STRUCTURES BACK TO THE SOIL, AND ARE TYPICALLY COMPRISED OF MORE SAWDUST THAN THE OTHER TYPES OF TUBES. Any object making contact between the soil and your home - insulation, trees, vines, brush, wood piles, weeds, roots, plumbing, etc. - can serve as a “bridge” or as a support for their mud tubes. If there is a good supply of soil moisture, or if there is high humidity in the crawl space or sub-slab areas of your home, or you have any roots or wood near or in the soil (and continual warmth) you can expect subterraneans to (eventually) do extensive damage to your home. Correct (any of) these conditions conducive to infestation and you greatly reduce the damage potential of termites.

Mechanical alteration consists of modifications of the structure such as introducing barriers of an impermeable or pressure-treated material; for example, concrete, metal, food-grade DE, wolmanized wood, etc. which will prevent the entry of termites; doors, windows, chimneys and roof valleys need to be adequately flashed; the removal of all cellulose debris; the elimination of all moisture problems near or in the structure; proper grading and gutters which will let water quickly drain away from your home; the establishment of sufficient ventilation of attics, crawl spaces, especially of the infested areas; adequate inspection of the entire structure, the breaking

of all earth-wood contacts (for example, roots, siding or foam insulation below grade level) and removing all porches and steps and replacing with sodium borate or pressure-treated wood “decks” or construct (open) treated wooden steps to your porch and prevent hidden termite entry. Drill holes in the wood or concrete where you see or suspect termite activity and insert sodium borate treated dowels the same size as the hole - these can be removed and visually inspected/replaced as necessary. See also the section on Intelligent Pest Management® Techniques. Whether done as a pretreatment or post construction control, the pest control industry has historically relied on volatile soil poisons to control subterranean termites. *Conventional* soil treating consists of the application of a volatile, “registered,” synthetic *residual* chemical poison such as chlorpyrifos, fenvalerate, permethrin or cypermethrin to the soil under and adjacent to a building to create an *impervious* barrier. Points where barriers can be established include along the inside and outside of the foundation, under slabs and around utility entrances. These synthetic *residual* chemical poisons usually contaminate the ambient air (the air you breathe) to some degree. **Because soil poisons break down quickly and can be rendered useless by any mechanical break or root in the treated soil,** we recommend you only use sodium borate (or food-grade DE on top of the soil) which we believe to be permanent and safer. NOTE: In some areas a “registered” *residual* chemical soil *treatment/barrier* is required by “law” (whether or not you want or need it **at the maximum poison rate allowed**) on all new construction! In such a case we still recommend sodium borate and/or food-grade DE be applied as a *supplemental* pretreatment to protect the wood in your home from those subterranean termites that may still penetrate chemical gaps occurring in termiticide-treated soil or that enter after the termiticide poison breaks down or there is a mechanical break or wherever there are plant roots through this “registered” *residual* soil “barrier”. **Remember, small roots or tiny cracks 0.03” or more in width permit the passage of termites!** See the supplemental section “Soil Treatments or Poison Barriers” at the end of this chapter. Someone ought to see who gets *perks or paybacks* from requiring the **maximum** use of volatile, synthetic, termiticide poisons that never will work as well as sodium borate and/or other Intelligent Pest Management® techniques!

Wood treating is the application of chemicals to wood to eliminate existing termite infestations or to make the wood impervious or permanently resistant to termites. You could easily inject a solution or dust of sodium borate, table salt, borax or Peladow® (especially with Safe Solutions Enzyme Cleaner with Peppermint) into the galleries with a hypodermic syringe, or dust them with food-grade DE in a bulb duster. You also pressure treat galleries with water and then pressure treat them with about 1 pint of *Steinernema carpocapsae* nematodes or inject a solution of Flagyl® or enzymes/bacteria.

Foundation treating is the (pressure) application of “registered” residual poisons to a foundation to try to make it impervious to termites. The intended purpose is to *permanently* poison the soil along the wall, but this can contaminate your ambient air (the air you breathe) when these synthetic *residuals* volatilize or pour through the cracks and expansion joints of your foundation and the poisons are never really *impervious*.

Pressure-treated wood is frequently used in the construction of buildings and can give effective control when it is used up to the ceiling level of the first floor, but **remember most pressure treated wood has dangerous levels of arsenic which is considered to be carcinogenic.** Spraying the “normal” synthetic *residual* poisons on wood already in place gives only a surface treatment and only rarely penetrates to the center of the wood. In badly damaged wood, wood treatment chemicals can be injected into the cavities made by termites. This gives you better control than a brush or spray application. Synthetic *residual* pesticides, i.e., Dursban TC, which is available in a pressurized solvent form has been injected for temporary control, but sodium borate can be safely injected or simply sprayed or you can apply dust to the surface several times) without creating any needless danger or toxic exposure to you and your family and once done correctly, control is virtually permanent. Note: The ant is the termite’s greatest natural enemy. **Quite often after a successful treatment of ants a previously hidden termite infestation is found.** Whichever treatment you do, be sure to scrape down all the termite mud tubes and reinspect in two more weeks; if they are repaired, spot retreat that area again and scrape down all the repaired mud tubes again and reinspect in two more weeks. **Continue to reinspect as needed.**

PREVENTION OF SUBTERRANEAN TERMITE ATTACK DURING CONSTRUCTION

The best and least expensive time to protect against subterranean termites is during the planning and construction of a building or addition. **Always remember moisture is the primary condition conducive to termite infestation! Correct this problem and you control the termites!** Carbon dioxide correctly used will attract termites, so sprinkle or moisten your baits with seltzer water or simply breathe into the stations.

Improper design and construction of buildings, resulting either from a lack of knowledge of or indifference to the termite problem create situations favorable to infestation. It is very important to use good building practices and sodium borate wood pretreatments during construction. You can also *prebait* by putting 1/2% sodium borate or borax treated wood or corrugated virgin cardboard or sawdust in areas normally attacked by termites, e.g., porch voids and crawl spaces and plumbing voids, under pool liners, etc. or drive treated stakes into the ground before pouring the cement.

Good Building Practices

The Building Site - All roots, stumps, foam board insulation and other wood debris should be removed from the building site or pretreated with sodium borate before or borax starting construction. Burying such debris will only increase the probability of an infestation. Wooden spreader sticks and grade stakes should be removed or pretreated with sodium borate before the concrete hardens. Form boards and scraps of lumber also should be removed or pretreated with sodium borate or borax before filling or backfilling around the completed foundation. Wood should not be buried beneath porches and steps. No scraps of lumber should be left on or beneath the soil surface or around the building after construction. Food-grade DE, enzymes/bacteria, borax, Peladow®, table salt or salt water sprays can be applied to or incorporated into the soil surface before the concrete is poured and/or sodium borate baits can be incorporated into the soil before the concrete is poured.

Termite colonies can develop in wood debris or soil and gain entrance into a building, particularly at the concrete entrance slabs of porches. Note: Masonry is so porous that it can carry water up to 8" into the structural wood!

Synthetic stucco or *exterior insulation and finish systems* or EIFS construction can create a very serious potential for water penetration by all openings into the building - which makes eliminating termites and/or fungi very difficult, especially with soil treatments or "registered," synthetic poison sprays.

To prevent an unfavorable moisture buildup in the soil beneath a building, the soil surface or grade around the building should be sloped so that surface water will quickly drain away from it. Gutters and downspouts attached to eaves can help remove water quickly. **If your don't have them, install them.** Where there are problems of poor surface drainage, e.g., flat sites or around buildings with basements, the use of drainage tile around the outside of the building foundation may also be helpful. Install a dehumidifier and fans where needed. **Install a dehumidifier and fans where needed.**

Basement Crawl and Pier (Crawl-space) Foundations - All foundations should be made as impervious to termite attack as humanly possible to protect all of the wood above. The proper construction of foundations is one of the most important measures that can be taken to protect against termites and should be considered very carefully. Crawl-space foundations may be rated in the decreasing order of relative resistance to penetration by termites as follows:

1. **Poured concrete wall and pier foundations that are easily inspected** (see the picture) and properly reinforced to prevent large shrinkage or settlement cracks. Cracks 0.03 inch or more in width permit the passage of termites. These can be baited with sodium borate or borax treated sawdust, cellulose insulation, virgin cardboard or pellets and then sealed. Baits that give off carbon dioxide work best.

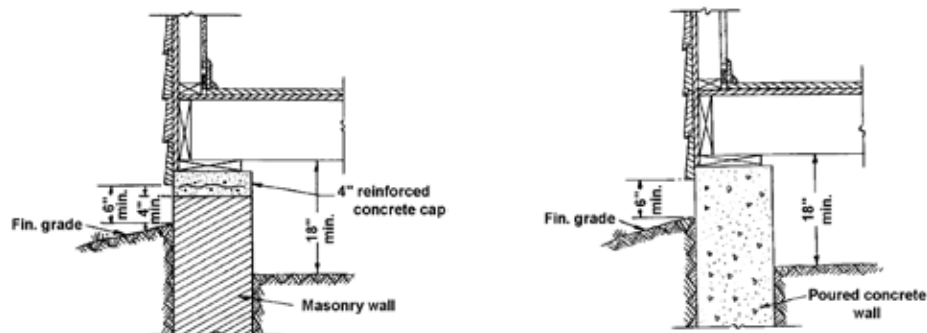

2. Hollow block or brick wall and pier foundations:

- Capped with a minimum of 4 inches of reinforced poured concrete.
- Capped with precast solid concrete blocks, all joints completely filled with cement mortar.
- Top course of hollow blocks and all joints completely filled with concrete. Where hollow blocks remain open no protection is provided unless all voids are chemically treated or all exposed wood is treated with sodium borate or borax.
- ½% sodium borate or borax treated (pine) sawdust or pellets or cellulose insulation to white paper towels can be added to the voids before capping them.

3. All wooden piers, or posts used for foundations or piers, should be either pressure-treated or treated with sodium borate and then sealed.

- A reinforced poured concrete cap on masonry walls or piers prevents hidden attack by termites. A minimum clearance of 18 inches under the floor joists will allow inspection for termite tubes or possible cracking of the cap. See the example on the right above.

Raised Porches and Terraces of Concrete or Masonry - Dirt-filled porches and terraces contribute to a large proportion of all termite infestations in buildings. Therefore, spaces beneath concrete porches, entrance platforms and similar raised units should not be filled with soil. Such spaces should be left open with access doors for inspection. If this cannot be done, or if the spaces beneath such raised units must be filled, leave at least 6 inches of clearance between soil and wood and treat all the wood with sodium borate and then seal. You can also prebait these areas with sodium borate treated sawdust, cellulose insulation, white paper towels and/or pieces of wood and/or soak the soil with salt water.

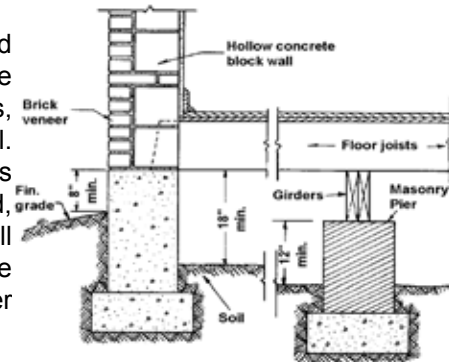

CLEARANCE BETWEEN WOOD AND SOIL - The outside finished grade should always be equal to or below the level of the soil underneath the structure, so that water is not trapped underneath the house and the foundation wall is exposed and can be inspected. Outside siding should not extend more than 2 inches below the top of foundation walls, piers and concrete caps and should be at least 6 inches above the outside grade. This will force termites into the open where their tunnels can be seen before they reach the wood. In crawl spaces the minimum clearance between the ground and the bottom of floor joists should be 18 inches; such clearances for beams and girders should be 12 inches. Where the superstructure of a building is masonry, **provide for adequate clearance** between wood and soil both outside and inside the building. Crawls can be prebaited with sodium borate treated sawdust or pellets or cardboard or foam or pulverized newspaper or sprayed with salt water or food-grade DE.

TERMITE BAITS - First attract a large number of termites with some carbon dioxide in seltzer water or beer or foam pieces that give off carbon dioxide and virgin corrugated cardboard (preformed termite tubes) or white paper towels or find active galleries or mud tubes. Then place/add a seltzer or beer moistened sodium borate, Flagyl®, borax or boric acid or colloidal silver bait (at 1% or less active ingredients - often less is better) Foraging termite workers will take the slow acting toxicant and orally transfer by trophallaxis (the poison) to the rest of the colony and act as your personal delivery agents. You should not use commercial 18% boric acid baits, it is better to make your own 1% or less baits by treating sawdust, wood pellets, cellulose insulation, corrugated cardboard, dowels, stakes or pieces of wood with 1% or less sodium borate or borax and place them in plumbing voids, crawl spaces, under slabs (preconstruction) and porches, under pool liners and/or anywhere you see or suspect termite activity. You can use 6-12" pieces of drainage pipes with holes in the side and a PVC cap on the top, or, better yet, rolled cardboard (and a little seltzer or beer or foam insulation to give off a little carbon dioxide) covered with shrink wrap. Include some "foreign" termites or foam insulation and wet the cardboard with carbonated seltzer to help attract the termites. Sometimes adding a little molasses and honey also helps attract and kill termites. Put a number of baits around and near your foundation - prebait with untreated material, e.g., rolled corrugated cardboard (preformed termite tubes), when you see termite worker activity replace (or treat) with 1% or less sodium borate (or borax) treated material. Be sure to reinspect and moisten or rebait as needed. Remember that feeding activity is often seasonal, so don't stop inspecting and/or periodically moistening your baits. Remember bait stations should be installed 12 inches away from the foundation walls in highly conducive

areas such as near air conditioners, spigots, downspouts, rocks, porches, fencing, woodpiles, stumps, mulched areas and low moist areas and no more than 20 feet from each other around the entire structure. **Be sure to keep the bait station in shrink wrap, level with the ground.**

TERMITE SHIELDS - Metal and or certain plastic termite shields are used to prevent hidden termite entry, particularly as a replacement for the concrete cap or other methods of sealing unit masonry foundations. If properly designed, constructed, installed and maintained, shields will force termites out into the open, revealing any tunnels constructed around the edge and over the upper service of the shield, but very few shields are properly constructed and installed and homeowners usually fail to inspect shields frequently enough to detect termite infestations. Therefore, termite shields are not currently recommended for detection and prevention of termite infestations. **If you use them, prebait the block voids (lightly) with sodium borate treated sawdust, pellets, cardboard, foam, cellulose insulation or white paper towels.**

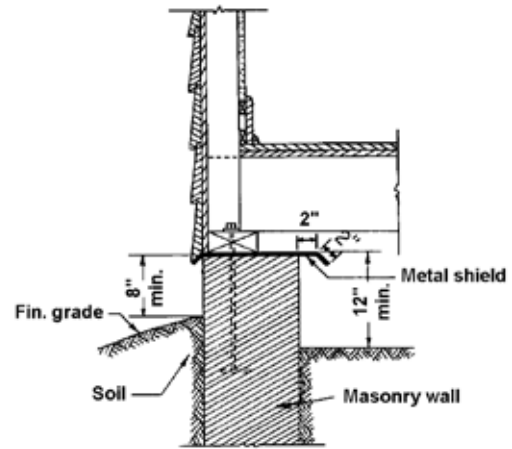

Termite shield over uncapped masonry wall showing **minimum clearance from ground** on both inside and outside foundation.

PROPER VENTILATION beneath Buildings - Ventilation openings in foundation walls beneath buildings with crawl spaces should be large enough and distributed so as to prevent dead air pockets and moisture from forming. Such pockets can give rise to humid conditions conducive to termite activity and wood decay. Openings placed within 10 feet of the corners of buildings usually give the best cross ventilation. The openings need not be placed on the front side of a building if unventilated areas can be avoided. The size and number of openings depend on soil moisture, atmospheric humidity and air movement. In general, the total area of ventilation openings should be at least 1/150th of the ground area beneath dwellings. Shrubbery should be kept far enough from the openings to permit free circulation of air, and far enough from the foundation to prevent roots from touching the foundation and to allow inspection of wall surfaces for the presence of termite tubes. Properly cover exposed soil with visquine or rolled roofing or pulverized newspaper, lightly mixed with DOT, borax and/or boric acid.

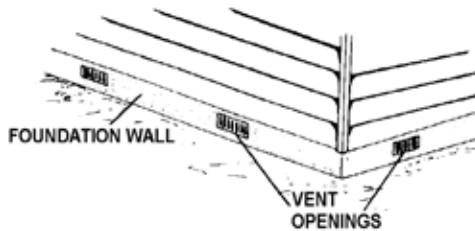

Wooden Porches and Steps - Porch supports, such as piers, adjacent to a building should be separated from the building proper by 2 inches to prevent hidden access by termites. Wooden steps should rest upon a concrete base or apron which extends at least 6 inches above the grade.

Construction of wooden steps of porch to prevent hidden termite attack - treat with borates!

Door Frames - Door frames or jambs should never extend into or through concrete slab floors.

Windows below Grade - Where window frames or other openings near or below outside grade are made of wood, the foundation wall surrounding the wood should be made impervious to termites. The bottom of the window well should be at least 5 inches below the nearest wood and/or all of the wood should be pretreated with sodium borate or borax.

Skirting between Foundation Piers - Where pier foundations are used, it is sometimes desirable to close the spaces between the piers with lattice or wooden skirting. If this is done, the woodwork should be separated from the piers and soil by at least 2 inches and/or use sodium borate treated lumber or pressure treated lumber.

Wood Used in Basements - should be pretreated with sodium borate or borax.

Partitions and Posts - Install wooden basement partitions, posts and stair carriages after the concrete floor is poured. They should never extend into or through the concrete. Concrete footings that extend at least 3 inches above the floor level should be used under wood posts, partitions, stair carriages and under heating units and

other load bearing points. Use reinforced concrete because the concrete may crack, providing entrance points for roots and termites. **Look anywhere two construction points come together; termites love these points!**

Basement Rooms - Termite infestations in finished basement rooms are very difficult to detect and control. Such situations exist commonly in finished basements where untreated wood floors and furring strips are used. The best way to prevent such infestations is to pretreat all of the wood with sodium borate or use pressure-treated lumber for wood screeds, subflooring and furring strips because of the danger of decay and infestation.

Girders, Sills and Joists - Wooden girders, sills and joists that are in or on foundation walls in basements should not be placed below the outside grade level. Termites may find hidden access to this wood and it may be subject to decay. Because of the difficulty of replacing girders, sills and joists, it is a good practice to use sodium borate or borax or pressure treated lumber for these structural members.

Water Pipes and Conduits - Keep all plumbing and electric conduits clear of the ground in crawl spaces. Suspend them from girders and joists where possible. Do not support them with wooden blocks or stakes connected to the ground because termites will tunnel through these wood supports or construct tubes over them to the sills, floors and joists above. Treat all of the exposed wood members with sodium borate or borax. Where pipes or steel columns penetrate concrete slabs or foundations walls, fill the spaces around them with either dense cement mortar or roofing grade coal-tar pitch. **Moisture is the primary conducive condition for termites - so use properly installed dehumidifiers, air conditioners and/or vents/fans.**

Humidity - At low humidity levels subterranean termites can survive for 15 days when they have access to moist soil. **As you reduce the humidity levels - wood damage and subterranean termite survival sharply decrease.** So properly install gutters, moisture barriers, vents, fans and dehumidifiers - and inject desiccants into galleries and/or apply salt, borax, sodium borate to the wood and/or soil if labeled.

CONCRETE SLAB-ON-GROUND FOUNDATION - One of the most susceptible types of construction, and one that often gives a false sense of security, is the concrete slab-on-ground foundation. Termites can easily gain access to the building over the edge of the slab, through expansion joints, openings around plumbing and cracks in the slab. Post construction infestations in buildings with this type of construction are very difficult to control, especially with synthetic *residual* termiticides. Because slab-on-ground construction is extremely susceptible to termite attack, and infestations are very difficult to control, treat all of the wood (especially all sole plates) before covering it with dry wall with sodium borate or borax for permanent control.

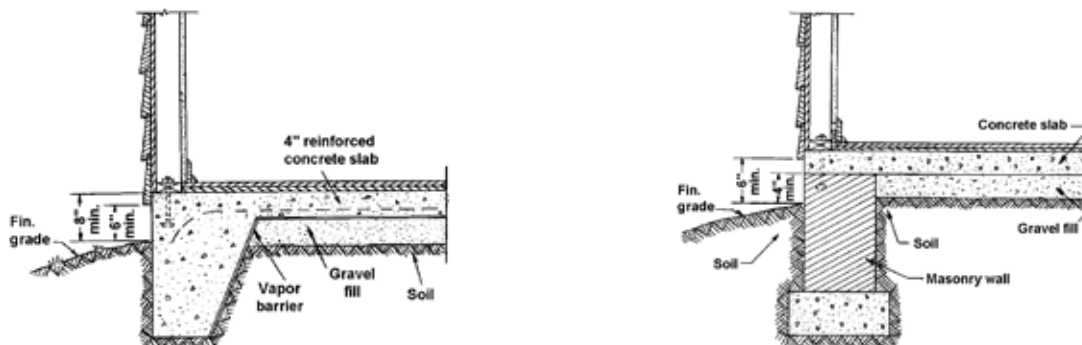

Do not leave any untreated foam insulation or wood such as forms, scraps, grade stakes or wood plugs in or beneath the slab or prebait them with sodium borate. Reinforce the slab at all points where it is likely to crack. Termites can penetrate some types of slabs more easily than others. **The monolithic type** provides the best protection against termites. In this type of construction the floor and the footing are poured in one continuous operation, eliminating joints or other structural features which permit hidden termite entry. Even so, treat all exposed wood with sodium borate. **Be sure you do not forget the bath trap in the bathroom behind the closet - if you simply put food-grade DE and/or salt water on the soil here you should not have a termite problem, unless it leaches away.**

Monolithic concrete slab-on-ground construction.

A second type is the suspended slab which extends completely across the top of the foundation. Here the slab and the foundation are constructed as independent units. This prevents hidden termite attack because even though a vertical crack may develop in the wall, termites still must tunnel over an exposed part of the concrete slab. The lower edge of the suspended slab should be open to view. With the monolithic and suspended slabs, the top of the slab should be at least 8 inches above grade. Treat all exposed wood with sodium borate or borax. Treat all cracks with borax or a salt, e.g., table salt and then seal them with silicone caulk.

Suspended concrete slab-on-ground construction.

A third type is the floating slab. It may either rest on a ledge of the foundation or be independent of it. In both instances the slab is in contact with the ground. This is the most hazardous of the three types of slabs because the slab edges come in contact with the foundation walls, and termites may gain hidden access to the wood through expansion joints. Properly treat all exposed wood with sodium borate or borax.

Floating concrete slab-on-ground construction: (A) edge of slab rests on ledge of the foundation; (B) slab rests entirely on the ground (floating).

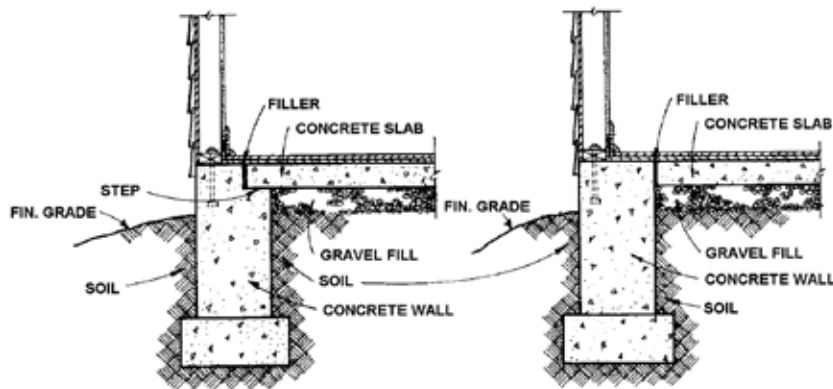

BASIC CHECKLIST FOR SUBTERRANEAN TERMITE PROBLEMS - Always remember moisture is the main problem - correct it ASAP.

1. **Cracks in concrete foundation** - These give termites hidden access to your home = Treat with borax or food-grade DE or a salt and/or bait with cardboard treated with sodium borate and then repair.
2. **Posts in concrete** - If they go all the way through the concrete to the soil underneath, they invite termite attack so remove and patch cement and/or treat twice with sodium borate.
3. **Earth-filled porches** - Soil should be at least 6 inches below the level of any wooden members = correct. Put sodium borate treated cellulose on top of the soil as *bait*. Use any of the *baits* I have suggested previously and/or soak the soil with salt water or borax.
4. **Form boards** - If left in place after construction is completed, they provide excellent termite food remove. Metabolites and carbon dioxide from fungal organisms in decaying wood in the soil actually draw subterranean termites to your property. So pretreat them with sodium borate or remove them.
5. **Leaking pipes or faucets** - They keep the wood or soil underneath continually moist = repair.
Moisture is the primary condition conducive to termite infestation.
6. **Shrubby near air vents** - Makes root bridges into your home or can block air flow which causes the air underneath your home to remain warm and moist - an ideal climate for termites so remove or at least severely trim back.
7. **Debris under and around your home** - Pieces of wood can support a new termite colony and permit termites to increase in number to the point that your home is eventually attacked = remove and/or pretreat with sodium borate so that the poisoned baits now become your first line of defense against termite attack - rather than your *weakest link*. Note: This will be extremely difficult because most back-fills are a combination of roots, bark, building debris, foam, clay, rock, dirt, etc.
8. **Low foundation walls or footings** - These permit wooden members to contact the soil - correct and/

or treat all exposed members with sodium borate or borax.

9. **Brick veneer covering foundation.** If the bond fails, termites have hidden entrance between exterior and foundation = repair or so, remove and/or treat with sodium borate or borax.
10. **Flower planters** - If built against the house, they allow direct access or root access to unprotected veneer, siding or cracked stucco, so remove or treat with sodium borate or borax.
11. **Wooden forms around drains** - Forms left in a hole in the slab where a drain enters the building also provide a direct route to inner walls = remove or treat with sodium borate or borax.
12. **Porch steps on ground** - Steps in contact with soil literally offer termites a personal stairway to your home remove and replace or treat with sodium borate or borax.
13. **Area around heating unit** - Soil here is kept warm year-round, which accelerates termite development = treat wood with sodium borate or borax and/or prebait.
14. **Paper collars around pipes** - Paper is made from wood, which is food for termites = remove and tar or treat with sodium borate or borax. **(They love white paper towels.)**
15. **Trellises** - If a trellis touches the soil and is connected to the house, it provides a direct link for termites from the soil to your home = remove or treat with sodium borate or borax and seal.
16. **Scrape down all the mud tubes or bait them;** if they are repaired after 2 weeks, rebait and/or spot retreat that area again and scrape down all the mud tubes again and recheck in 2 more weeks, etc.
17. **Pressure inject all galleries and cracks with water,** then pressure inject about a pint of *Steinernema carpocapsae* into the galleries a few hours later.

FOR PERMANENT SUBTERRANEAN TERMITE CONTROL USING SODIUM BORATE PLEASE TURN TO THE SECTION - Permanent Wood Destroying Organism Control.

NON-SUBTERRANEAN TERMITE WOOD-DESTROYING ORGANISMS

If you could understand everything about subterranean termites (and that's next to impossible), there still are dry wood, damp wood, tree nesting and powder post termites as well as the several wood boring beetles, fungi (decay), bees, wasps, weevils and ants that may be found destroying the wood in your home. You should be able to identify both old and live signs of infestations of these "home wreckers" too:

1. DRYWOOD TERMITES (Family - Kalotermitidae, Order - Isoptera) There are about 400 species of drywood termites classified worldwide, but only a handful are economically considered to be pests. All drywood termites live in wood that is moderately to extremely dry, especially in hot areas with high relative humidity. Drywood termites are found primarily in the Southern USA including the southwest. Their galleries are in dry, sound wood, usually very near the surface usually less than 3 mm from the wood surface. Trees and brush are the primary food source of drywood termites; when land is cleared these termites of necessity attack the homes built on the site. They require no contact with the soil or with any other (secondary) source of moisture. In most instances, drywoods extract enough water from the wood they feed upon and from the water that is formed during their digestion to live. They extract so much water from their (0.0394 inch) hexagonal fecal pellets that they are hard and dry like grains of sand. Drywood termites are most commonly recognized by their distinctive fecal pellets (piles) that are often the color of the wood they are feeding upon. They can inhabit new homes less than 5 years old. They can live in very dry, sound wood, require no moisture source or ground connection and create no mud tubes. The pictures in this section show a typical drywood termite soldier and drywood termite reproductive, the differences in drywood and dampwood termite fecal pellets, and carpenter ant fecal pellets, and a representative piece of wood showing a typical kick hole with a pile of fecal pellets. Swarmers generally enter your home at night (in the direction of the prevailing winds) through unscreened attic and foundation vents, shingle roofs or through cracks and crevices in or between exposed wood, joints and trim, particularly window sills and frames, bark crevices, knot holes and nail holes after leaving their nests in dead trees, utility poles, fence posts, firewood or other buildings nearby. They are attracted to light and initially wedge themselves into a narrow space so they can get a purchase (mechanical aid) on the exposed wood (on the exterior or interior) so they can more easily begin tunneling. Treat with sodium borate and then caulk, paint and screen these areas immediately. Drywood termite colonies develop at a slower rate than subterranean termites and usually number a few to 10,000 individuals at most and can be found in homes, furniture, dimension lumber, sash-and-door items, wood pulp/fiber



SOLDIER



REPRODUCTIVE

insulation boards, plywood, paper, cloth and any other products that contain cellulose. Since drywood termites live and feed inside sound wood, external damage signs may go undetected for years. Drywood termites eat the wood right up to the paint forming "blisters"; apply your probe here and seed-like fecal pellets will pour out. If you sound and hear hollow sounds, probe there too. Sometimes you may have to remove plaster to examine the framework or at least drill through the stucco or plaster into the framework to see if it is hollow (with pellets). Their swarmers (usually appear at night and are a light yellow-brown to dark brown or black in color) have winged veins with several distinct longitudinal veins with many cross-veins in the front edge of the wings (colored clear to smoky black). The subterranean swarmer has only 2 prominent longitudinal veins at the front edge of its translucent wings. Drywoods do not construct mud tubes, but you usually can find their fecal pellets. Inject and spray all termite infested wood with Safe Solutions Enzyme Cleaner with Peppermint and sodium borate or borax or food-grade DE or Flagyl® or colloidal silver. All cracks, crevices, holes and other openings should be thoroughly patched, screened or caulked to prevent drywood termite swarmers from entering your building. A mature colony may only have 3000 members. There is no true worker caste; the nymphs perform this function.

Note: Drywood termites do not survive in unheated structures, so turn off the heat.

COMMON SPECIES

A. The dark, western drywood termite, *Incisitermes* (formerly *Kaloterme*s) *minor* (Hagen) - You will find them from Washington south to California east to Arizona and Utah. In this area, it causes extensive damage to

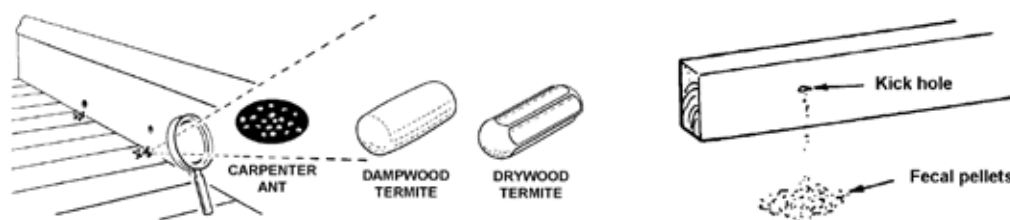

homes as well as to wooden derricks, piled lumber, furniture and telephone poles. They may infest any drywood portions of a home from its foundation plates to the roof, and they are the most destructive drywood termites in this Country. Small flights occur during April through July, frequently after rains. Winged adults are dark brown and about 1/2 inch long. The white, soft-bodied nymphs remain hidden in the galleries and are not seen unless the wood is broken open. Colony growth proceeds slowly.

B. The southern drywood termite, *Incisitermes schwarzi* (Banks), is found in southern Florida, occurring as far north as Pensacola. It infests woodwork, poles, dead trees, logs and stumps. There also is another occasional drywood termite found in the southern coastal area as of the Florida Keys, called *Neoterme*s *jouteli* (Banks), where it can infest moist foundation timbers, dead trees and logs in direct contact with the earth. Mating flights may occur throughout much of the year.

C. The light, southeastern drywood termite, *Incisitermes snyderi* (Light) - You will find these termites in woodwork and poles from South Carolina to Florida and west to Texas. It is the most injurious species of drywood termites in the east.

D. The dark, southeastern drywood termite, *Kaloterme*s *approximatus* (Snyder), occurs along the Gulf Coast west to New Orleans and on the Atlantic Coast north to southern Virginia. It attacks timbers in homes, dead trees, logs, posts and utility poles and living rosaceous trees in Florida. Their swarmers have a dark brown body color and grayish wings.

E. The light, western or desert drywood termite, *Marginiterme*s *hubbar*di (Banks), is found from California to Arizona. It is also referred to as the Southern Drywood Termite or Desert Drywood Termite. This termite is very similar in habits to the Western Drywood Termite but prefers even drier conditions and higher temperatures. It infests poles, posts and homes but also is (very rarely) found attacking natural wood, i.e., giant cacti and cottonwood. Their swarmers are light yellow with light wings and they fly at night, usually just after rain and they are attracted to lights.

F. Another species, the West Indian (furniture or drywood) termite or powder post termite (*Cryptotermes brevis*) is the most widespread drywood termite pest in the world and the most dangerous drywood termite species in Puerto Rico, the U. S. Virgin Islands, Pacific territories, Hawaii, Florida and Louisiana. In addition, infested furniture can sometimes be found in other states. For our purposes we will simply refer to them as powder post termites. High relative humidity creates “water poisoning” or death.

G. *Neotermes jouteli* (Banks) is found in the Florida keys, Cuba, Mexico, Panama and the West Indies. Largely limited to the Coastal zones (not more than ten miles or so from the shore line). They usually damage buildings with moist foundations. Usually they are found in organic debris laying on the ground.

Drywood termite infestations of homes are becoming more common as people move into the deserts. Unlike subterraneans, drywoods do not require any contact with soil. They establish their colonies and live in dry, sound wood. Structural timbers, woodwork, furniture, wooden derricks, telephone poles, lumber, roofing, etc. may be damaged seriously. In southern California and southern Florida, they are the most damaging termite pests. Drywoods have no “worker” caste; the nymphs perform all of the duties of “workers”. They only have (adult) reproductive and soldier castes. Usually, the first visual evidence of drywood termite infestations are piles of six-sided fecal pellets (generally referred to as “frass”) which usually have a resin or tea color. The first generation pellets are the same color as the wood, but they are saved and then reconsumed. These piles can be found below “kickout” holes made by the nymphs for the purpose of keeping the galleries (the eaten out areas in the wood) clean. NOTE: Drywood galleries are clean and go across the grain; subterranean galleries are “dirty” (filled with mud) and extend with the grain. Drywood excreta (pellets) are elongated, having 6 distinct concave (indented) sides and somewhat blunt (rounded) ends. Pellets are hard and dry and will scatter when “flicked” with your fingernail. Some fecal pellets and other debris can also be stored by the dry woods in unused chambers. When you find a “kickout or kick” hole, usually it will be closed up with a waxy substance (fecal pellets cemented together with body secretions) placed there by the nymphs to keep out intruders. This is where you should probe for signs of active infestation. **The presence of cast-off swarmer wings is another indication of drywood termite infestation.** The structure of wings will help you identify the species of termite - get some identification sheets from your local agriculture or extension agent. Drywood termites generally live in undecayed wood with a low moisture content.

Drywoods attack both the sapwood and heartwood of both hardwood and softwood; their entrance is (usually) initially made through an open crack, crevice, space or joint which they first enter before beginning to bore into your wood. Because they do infest furniture, they are shipped by man from one part of the country to another.

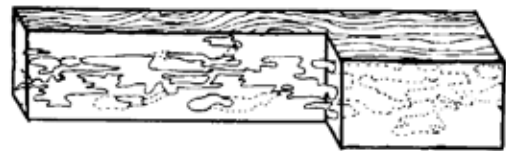

Even well established drywood colonies are usually localized and have only from 2000 to 3000 members; quite small when compared to subterranean colonies which may have millions of individual members.

DRYWOOD TERMITE CONTROL - Turn off the heat. Try to prevent their invasion with yearly caulking, 20-mesh screens over all foundation, soffit and ridge vents and covering raw wood with paint, varnish or some other sealant. Drywood termite infestations are not controlled with fumigation - the eggs hatch and restart the colony by cannibalizing the cadavers. Drywood termite colonies can be controlled by exposing them to subfreezing temperatures until the internal wall voids are cooled to minus 20° F. or colder; this can also be accomplished using applications of liquid nitrogen. This control was first approved in California in 1987, but it is very dangerous to the applicator. Drywood termite infestations can also be controlled by heating the home or infested part thereof until the internal temperature of the wood reaches 120° F. Once their galleries’ temperatures are quickly raised to 120° F. they die in approximately an hour - raise it quickly to 130° F. and they die in about 6 - 7 minutes. Drywood termite infestations can be physically removed, treated with the fungus *Metarhizium anisoplae* or they can also be treated with electro-guns, liquid nitrogen, or electricity, or microwaves, or by fumigation (structures sealed or “tarped”) then treated with sulfuryl fluoride (VIKANE) or methyl bromide, but these methods provide no residual protection and do not always control even the current infestations (especially if the floors are varnished or shellaced)! There was NO preventative/residual treatment against dry wood termites before sodium borate. Now you can safely and permanently remove them and/or prevent them all by yourself or have an Intelligent Pest Management® company foam/spray them inside the wall with sodium borate. Drywood termites do not like to be shaken; therefore, railroad ties and musical instruments that vibrate,

such as frequently used pianos are sometimes safe from their attack. If you put poison/dust on a few, the rest will die shortly because they constantly groom one another. You can also inject colonies with food-grade DE or diluted enzyme cleaner with peppermint and sodium borate or borax or boric acid or try a surface coat of liming wax (bees wax and titanium white) or inject Dine-O-Mites. You might even try aspartame solutions and/or Flagyl®.

FOR PERMANENT DRYWOOD TERMITE CONTROL USING SODIUM BORATE, PLEASE TURN TO THE SECTION - Permanent Wood Destroying Organism Control.

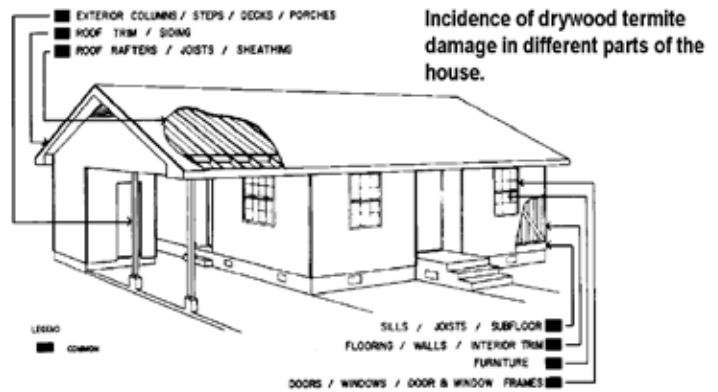

2. POWDER POST TERMITES (Kalotermitidae) - Powder post termites also live in dry wood, damaging structural timbers, wood work and floors as well as furniture. They normally enter wood through tiny openings and excavate galleries like dry wood termites, but their galleries are not kept clean but are frequently filled with fine powder. You can distinguish powder post termites from dry wood termites by their much smaller size and smaller fecal pellets. The tiny fecal pellets are ejected from the galleries and are frequently the first visual indication that powder post termites are destroying your wood.

Cryptotermes brevis (or tropical rough-headed powder post termite) is the species of powder post termite (do not confuse with powder post beetle) that is of any economic importance (they can attack your home, picture frames, wood work and/or furniture) in the U. S., although in nature there are other species. ***Cryptotermes brevis*** (Walker) is not native to the U. S. and has not yet been found here in any natural habitat. It can be shipped anywhere into the U. S. in wood furnishings and artifacts from Hawaii, Puerto Rico, the U. S. Virgin Islands and else where in the Caribbean, Central and South America, the Orient and South Africa. You may find them living **inside** buildings in southern coastal areas from Florida to Louisiana; they usually die out in cooler climates.

Powder post termites (*Cryptotermes spp.*) are so-named because of their “frass” or tiny fecal pellets which are constantly dropping.

The powder post termite soldier is the easiest to distinguish from the dry wood termite soldier. The head is distinctly concave and black or dark brown in color, as long as it is wide, is blunt nosed and rough in front, and its mandibles (jaws) point downward rather than forward and are not enlarged as in other termites. You can distinguish the alates (*swarmers*) by their wings because the median vein runs along the radius instead of continuing to the wing tip as it does in dry wood swarmers. This termite is very destructive to woodwork and furniture because it destroys the interior of wood, leaving only a paper-thin layer of wood or paint on the outside. Treatment for powder posts is the same as for dry woods. Try Safe Solutions Enzyme Cleaner with Peppermint and sodium borate or borax or food-grade DE or colloidal silver or Flagyl® if you want instant and permanent control.



FOR POWDER POST TERMITE CONTROL USING SODIUM BORATE, PLEASE TURN TO THE SECTION — Permanent Wood Destroying Organism Control.

ROTTEN WOOD, DAMP WOOD TERMITES (Kalotermitidae, Rhinotermitidae and Hodotermitidae) — Most rotten woods or damp woods are in the genus *Zootermopsis*, except the DESERT which is from the genus *Paraneotermes* and the FLORIDA which is in the genus *Prorhinotermes*. **This group contains some of our largest termites with bodies as much as one inch long and with swarmer wings of alates twice that length.** Although damp wood termites also do not require direct contact with the damp ground, they generally only infest logs and buildings that have (damp) earth-wood contacts. In order to obtain moisture, they do not live in dry wood, but infest wood that has a high degree of moisture content. They normally are associated with wood decay and do not construct mud tubes. Once they are established, some species can attack sound and relatively dry wood if they maintain direct contact with damp wood. Water tanks and homes on beaches are particularly vulnerable because of their high moisture content.

These termites cut openings into the wood and excavate large galleries, as do dry wood termites. They do not, however, keep their galleries clean. Their fecal pellets can be found throughout their tunnels, and many of the six-sided pellets are also thrown out of these galleries through small openings in the surface of the infested wood. Dampwood termites are noticeably larger than subterranean termites.

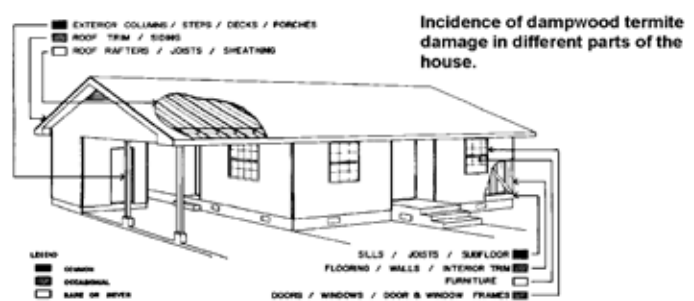

A. The desert damp wood termite, *Paraneotermes simplicicornis*, (Banks) which you may find on the border of the deserts in the southwestern states from Texas to California, differs from other damp wood termites by being occasionally “subterranean” in habit. It attacks only moist wood. This termite frequently attacks mesquite and the underground roots and parts of living shrubs and young trees and is particularly troublesome in residential areas and citrus groves. It can be found in untreated poles and fence posts and in baseboards, hardwood Doors and door frames of buildings. Flights occur in July and August in evenings after rains; all colonizing pairs can not enter wood above the ground and its colonies are always in wood that is partly or entirely buried in the ground. Produces distinctive black pellets shaped like bon-bons, but construct no mud tubes.

B. Florida damp wood termite, *Proprhinotermes simplex* (Hagen) - You may find them in Tampa and the extreme southeastern counties of Florida and in the Keys. They live naturally in damp but solid logs near salt water and they are a common pest of buildings in the limited area where they are found. They do not live in the earth, but they may infest logs beneath the soil. The eaten portion of the wood is replaced with a clay-like substance. **The decay damage is usually worse than the termite damage.**

C. The Pacific damp wood or rotten wood termite, *Zootermopsis angusticollis*, (Hagen) is our largest and most primitive and most destructive damp wood or rotten wood termite. Since moist but still structurally sound wood is attacked, this species could be more properly called a damp wood termite. They have no worker caste. The work of the colony is carried on by the nymphs (immature forms, up to 3/8-3/4” long) of the soldiers (up to 5/8-3/4” long) and reproductives. They occur most commonly in cool and humid coastal areas, but they have been found even up to 6,000 feet above sea level. You will find them from British Columbia south to Baja California. Damp woods also do not require direct contact with the soil in order to obtain moisture, but they do prefer sapwood that has a high degree of moisture content, and they also spread wood-decaying fungi. **The first control procedure always**



is to eliminate all sources of moisture problems (leaky roofs, “sweating” or leaking pipes, condensation, earth-wood contacts, improper drainage, etc.) and then to burn and replace the infested and damaged wood. A few infestations are found at lower altitudes in southern California, but you will usually only find them at higher elevations in the coastal mountain ranges. Along the West Coast, the frequency and severity of occurrence at lower elevations becomes more evident the farther north you go. The rotten wood termite is a major problem at low altitudes along the coastal areas of Washington and Oregon. Although called a rotten or damp wood termite, this species can live in dry, sound wood. Occasionally this termite is carried to other parts of the country in shipments of lumber, but it has not successfully established in these areas. Their tunnels are of many sizes and shapes and have a velvety appearance and are often covered with dried liquid feces. Throughout their tunnels you can also see small, hard, oval fecal pellets with a slight hexagonal shape.

Their swarms or “rainbugs” or winged reproductives (with wings up to 1” long) are light brown with dark brown leathery wings. Nymphs are white to cream colored with a darker abdomen. These termites swarm in relatively small numbers, 50 to 60, from a single colony. **Swarmers are attracted to light and are commonly seen around street lights at night.** The female excavates a nest, the male follows, the opening is sealed and the pair mates and creates a new colony.

D. There are several other damp wood termites which may be found occasionally in buildings, i.e., *Zootermopsis nevadensis* (Hagen). These, however, are not very common and are not described other than because of their high moisture requirements, damp wood termites most often are found in cool, humid areas along the coast and are typical pests of beach houses. The Nevada damp wood termite, however, occurs in the higher, drier mountainous areas of the Sierra, where it is an occasional pest of mountain cabins and other forest structures.

It also occurs along the northern California coast.

DAMP WOOD TERMITES excavate large galleries which are dirty, full of their fecal pellets that are usually hard and round at both ends. In very damp wood the pellets are often spherical or irregular, and stick to the sides of the galleries. In basically sound wood galleries follow the sapwood. In decayed wood their galleries are larger and pass through both heartwood and sapwood. **DAMP WOODS also have no worker caste.** Work is carried on by nymphs which eventually become soldiers or reproductives as determined by the queen. Try the electro-gun or try fumigating with a heat gun or liquid nitrogen or try spraying with Safe Solutions Enzyme Cleaner with Peppermint and sodium borate or borax or food-grade DE, which kill them on contact and can penetrate the wood and/or galleries with *fumigant* action. We have controlled damp wood termites in Florida using Glenn Gordon's termite elimination/attraction baiting system. **The best control is to eliminate moisture.**

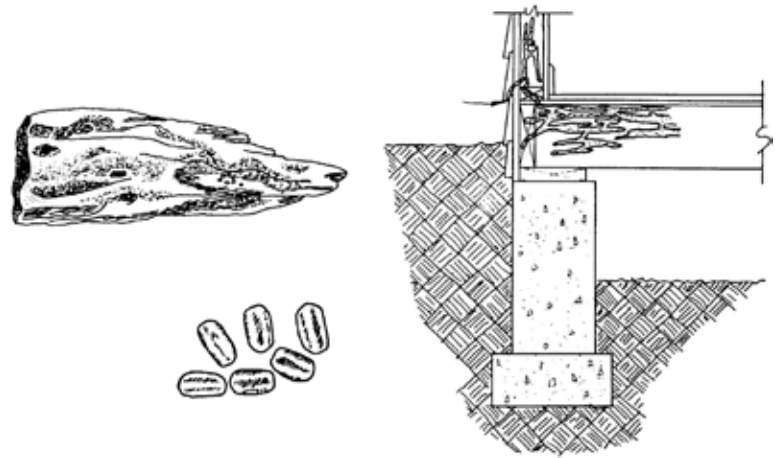

FOR ROTTEN WOOD OR DAMP WOOD TERMITE CONTROL USING SODIUM BORATE, PLEASE TURN TO THE SECTION Permanent Wood Destroying Organism Control.

4. TREE-NESTING (ARBOREAL) TERMITES are characterized by their habit of building several carton nests on tree surfaces, posts, in or on buildings or directly on the ground. All above ground nests are connected to the ground (like subterraneans) with a large (broad) shelter tube on surfaces below their nests. When it is extremely dry, these termites abandon their nests and return directly to the moist ground. The nests are very distinctive, being dark brown, globular or oval in shape and entirely covered with a fine (thin and brittle) outer shell. No one knows how individual colonies of reproductives, workers and soldiers are founded. They attack (generally older, poorly constructed) buildings in the U. S. Virgin Islands and Puerto Rico by extending their shelter (mud) tubes from the soil through foundation cracks and crevices or directly over the surface to reach wood; they can cause structural damage to buildings and stored lumber.

All of the tree-nesting termites belong to the most highly advanced family, Termitidae. The damaging species all belong to the same genus (or species), so they are described as a group.

Their reproductives are a little larger than subterranean species and have wings that are opaque instead of nearly transparent or translucent. There are two prominent longitudinal veins at the front of the wings, with no cross veins as in subterraneans. The veins in the hind portion of the wings, however, are pigmented and conspicuous instead of unpigmented as in most subterranean species. Their bodies are dark brown to black in color with wings to match. The reproductives swarm during the day in the spring.

The soldiers are quite distinctive and will, along with their carton nest, adequately serve to identify this type of termite. Their heads are rounded and drawn out in front into a long snout with an opening at the end. This type of soldier is called a nasute. Nasutes eject an irritating and sticky fluid (which entangles their foes) from the snout as their means of defense of the colony. They have very small mandibles or "teeth".

Most often, the signs of tree-nesting termite infestation will be very similar to those of the subterranean termites. Tree-nesting termites build shelter (mud) tubes of wood debris and fecal material which may be seen on surfaces and in crevices. The wood itself may be damaged very much like that attacked by subterranean termites. They more frequently tend to attack wood that has already been damaged by other termites or by fungi, but they will also infest sound timber. They apparently attack all types of wood. On rare occasions, you may find a nest constructed on a wall or in an attic space. You may simply soak the entire nest and tubes with diluted enzyme cleaner.

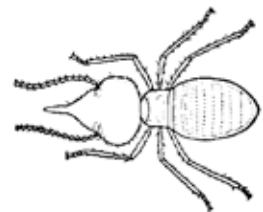

FOR TREE NESTING TERMITE CONTROL USING SODIUM BORATE, PLEASE TURN TO THE SECTION — Permanent Wood Destroying Organism Control.

(NON-SUBTERRANEAN) TERMITE TREATMENT

Conventional (temporary) treatment for drywood (damp wood, rotten wood or tree nesting) termites has usually consisted of fumigating the entire structure with a toxic gas or introducing a toxic liquid or dust into the excavated chambers or by treating with a safer electro-gun for temporary control, but sodium borate is the only way to achieve permanent control. You may inject, spray, brush, fog or pressure-treat with sodium borate or borax.

Fumigation is usually done with sulfuryl fluoride (Vikane) or methyl bromide gas. The entire building is tarped or tightly covered with a plastic cover and then the gas is introduced. Standard dosage for methyl bromide is 2 pounds per 1,000 cubic feet. The dosage of Vikane is determined by following instructions provided by the manufacturer. Vikane has the advantage of rapid and uniform dispersion within the temperature range for climates where these termites are normally found. Such fumigation, if ever done, should only be made by specialists thoroughly trained in the use of these gases which are extremely dangerous. Hopefully methyl bromide will finally be banned, as it destroys our ozone. In addition to the dangers, there is no residual control with any fumigant - so this expensive and dangerous temporary *control* work is continually required *as needed* - so properly use sodium borate or borax instead.



To prepare for use of a liquid synthetic *residual* pesticide poison or dust application, holes are drilled into the infested timbers through the termite galleries using a ½ inch drill in larger timbers and smaller drill holes elsewhere. Volatile, synthetic *residual* poisons like (liquid) Dursban TC can then be forced through these holes and dispersed through the galleries. The most commonly used *professional* dust is sodium fluosilicate; the desiccant dust, silica gel, is also used, especially in attics to reduce the rate of reinfestation. Technical grade boric acid (alone) also may be used, but be sure to follow the labeled instructions. The use of electro-guns and this drilling and injecting method will temporarily control localized infestations. Extensive infestations can be temporarily controlled by fumigation or permanently controlled with an overall treatment (and/or injection) of sodium borate. There are certain other disadvantages involved with the injection of conventional (synthetic *residual* pesticide) liquids into the galleries. There may be a fire hazard created if oil-based synthetic *residual* materials are used, and the injection of water-based synthetic *residual* materials (without sodium borate) in a wooden beam can create a favorable site for decay fungi and there are always toxicity problems to be considered to non-target species, i.e., people. You can also power inject food-grade DE, diluted Safe Solutions, Inc. Enzyme Cleaner with Peppermint and sodium borate or borax and/or colloidal silver at a rate of 2 oz. each per 1 qt. water to safely control these pests. After any liquids or dusts have been injected into the wood, the openings should be plugged with wooden dowels, corks, caulked or plastered.

Damp wood termite infestations can be controlled by the same methods as dry wood termites when they are in wood not in direct contact with the ground. Where there is direct ground contact, structural changes to eliminate these contacts or moisture problems may be necessary. Permanent control consists primarily of eliminating the moisture problem in the wood and replacing damaged and moist wood with pressure-treated wood or often simply treating with sodium borate. **Powder post termites can also be temporarily controlled** by injecting volatile, *residual* synthetic chemicals or pestisafes®, e.g., diluted enzyme cleaner and/or peppermint soap into their galleries or by fumigation **or permanently controlled by treating/injecting with sodium borate or borax.**

When non-subterranean termites infest furniture or homes, they can be fumigated or residual synthetic chemicals can be injected into their galleries by using a hypodermic syringe to inject a fumigant such as ethylene dibromide into their galleries or you could simply inject diluted sodium borate or borax. Either method has the advantage of getting the chemical inside the wood without disfiguring the surface of the furniture, but the sodium borate will control "them" forever. These infestations can also safely be (temporarily) controlled by putting the furniture in a chamber heated to 150° F. for 1½ hours, or for 4 hours in a chamber heated to 140° F. Kilns or special vaults equipped with heating units are used for this purpose. Cold may also be used safely to (temporarily) control these termites. In northern climates, simply place infested furniture and crates outdoors; large freezers can be used in warmer areas. Exposure at a temperature of 15° F. for 4 days will (temporarily) kill all the termites in the infested wood, or liquid nitrogen can be used. Homes can be tarped or areas of infestation can be temporarily treated by raising the temperature to 120° F. There are a number of other measures that could be used to help prevent non-subterranean termite infestations. All lumber, especially second-hand lumber, should be carefully inspected for evidence) of infestation and then treated with sodium borate or borax before being used. Infested lumber should be destroyed by burning or treated with sodium borate. All doors, windows, especially attic windows, and all ventilation openings should be screened with 20 mesh non-corrodible metal wire cloth. Screening will prevent the entrance of swarmer termites into areas where colonies can be established. Sodium borate or pressure-treated wood will also prevent attack. Lumber pressure treated with wood preservatives can also be purchased in many areas. Termite-resistant woods can also be used, certain kinds of redwood, cedar, cypress and longleaf pine, especially the heartwood give the greatest natural protection. Protection of exterior wood surfaces with paint also helps. Paint will fill many of the pores, cracks and openings used by termites to gain entrance. Large cracks and joints can be filled with putty or plastic wood. The use of steel, concrete, brick or stone in construction instead of wood offers excellent protection against non-subterranean termite attacks, but it will not prevent attack of the other wooden materials inside - unless all entryways are properly sealed and/or the wood is treated with sodium borate as a permanent preventative. If you are very chemically sensitive, try injecting nests with diluted Safe Solutions, Inc. Enzyme Cleaner with Peppermint and borax or sodium borate using a syringe.

FOR PERMANENT NON-SUBTERRANEAN TERMITE CONTROL USING SODIUM BORATE PLEASE TURN TO THE SECTION - Permanent Wood Destroying Organism Control.

5. CARPENTER ANTS - Are the most visible of our ants, being large ($\frac{1}{4}$ " - $\frac{3}{4}$ " long), with long legs and they bite! They are polymorphic, so there are workers of different sizes called *major*, *minor* and *intermediate*. The workers can emit a strong formic acid odor. There are both winged and unwinged queens, winged males and several sizes of unwinged (sterile) females. Various species of the family Formicidae occur throughout the U. S. with the most of them living in the midwestern and eastern states at elevations up to 9,000 feet. All carpenter ants of economic importance belong to the genus *Camponotus*, i.e., the black carpenter ant *Camponotus pennsylvanicus* (DeGeer) which is the most common carpenter ant in the east. They are completely black and the workers are from $\frac{1}{4}$ " to $\frac{1}{2}$ " long; *Camponotus laevigatus* (F. Smith) is also black; *Camponotus vicinus* (Mayr) is red and black; *Camponotus clarithorax* (Emery), *hyatti* (Henry) and *modoc* (Weeler) are all brownish-black; *modoc* is the red-legged carpenter ant found predominately in the northwest; *Camponotus ferrugineus* (Fab.) is called the red carpenter ant; *Camponotus novaeboracensis* (Fitch) or the New York carpenter ant is black with a deep maroonish-red thorax. You could also find *Camponotus abdominalis*, the Florida carpenter ant or the smallest carpenter ant *Camponotus nearcticus* (Emery). One specie will occur typically at high altitudes (above 9,000 feet) while another specie will be found near sea level. Carpenter ants differ from other ants because they usually only have one knob on their "waist" and the upper surface of their thorax is evenly rounded, with all segments having a uniform appearance. Because the ant is the termite's greatest enemy, a very extensive ant colony will appear to *control* a hidden termite infestation. Quite often after a successful (carpenter) ant control using synthetic *residual* pesticides a previously hidden/undetected termite infestation becomes visible. (This probably would not happen if the carpenter ant infestation was treated with sodium borate because that "ant" treatment would also control the termites - if it was done correctly/extensively.) Carpenter ants do not eat wood but simply carve, excavate or hollow out nesting galleries (living areas) in wood with the grain which resemble the galleries of termites, but they are entirely clean, contain no "mud", debris, fecal pellets or frass and have an almost sandpapered appearance. The presence of a colony is sometimes first noticed because the worker ants drop frass (sawdust-like debris) from wherever the nests are being made. The frass they create and remove as they make the galleries looks like "sawdust" (has the appearance of shavings from a rip saw), hence the name "carpenter" ant. (Note: Chisel-shaped marks indicate rodent gnawings.) For the most part, these galleries are in moist or unsound wood, although carpenter ants can and sometimes do burrow in sound wood. Some of the

harder layers of wood often remain as “walls” separating the many tunnels. At frequent intervals, openings are cut in these walls, providing a means for movement from gallery to gallery. Access to the outside will normally be through natural cracks or openings in your home or along telephone or electric lines. Sometimes, however, the ants cut special slit-like openings in the wood which are called “windows”. **(The black carpenter ant cannot successfully establish a colony in wood that has less than a 15% moisture content. = Use a dehumidifier, fans and/or desiccating dusts.) See Ant Chapter 15 for more pictures and more data.**

Carpenter ants will usually establish nests in a number of different locations. Outdoors the site may be in rotting portions of trees, in dead stumps, hollow logs, telephone poles, fence posts, boards or similar large pieces of wood lying on or buried in the ground. Wood that is moist, partially decayed (softened) or previously attacked by other insects, i.e., termites, powder post beetles, carpenter bees, etc. is preferred although cracks, crevices and other natural cavities may be used initially to get a carpenter ant nest started in sound wood. Carpenter ant colonies may be carried into your home in firewood or they may enter through cracks in your foundation, or crawl on branches that touch your home, or enter along electric, plumbing or telephone lines or through vents. **They are ingenious in finding the easiest access.** Ants usually move into your home to find food, or just after they have been seriously disturbed, i.e., when a hollow tree is broken open or a garage or neighboring home is torn down or a nearby building site is cleared. However, nests do occur indoors *normally* and may be found in hollow metal and wood doors, window sills, the substructure of porches, roofs, behind baseboards, fireplaces, wall voids, shingles or other natural hollow areas or voids, especially above windows and doors. Their “nest” may also be just under a box or in a hollow pipe with several hundred ants in it, or in some debris, or even out in the open! They have also been found nesting in upholstered furniture, under floors, between ceiling joints in an attic, behind chests and books, etc. It takes time, patience, imagination and often a stethoscope to locate all of their nests. Nests can also be detected in inaccessible voids by listening carefully for faint, dry, rustling or scratching sounds; the sound will increase if you tap (sound) near the nest. Exposure to the outside, leaks, condensation, poor air circulation and contact with the soil provide ideal nesting conditions for carpenter ants. They frequently nest around basements, foundations, roofs, porches, windows, doors and sink drains. Finding all of the nests can be difficult since nests are carefully hidden, but with patience you can locate all of their nests by observing the movement and trails of the workers, locating frass piles, checking moisture problem areas very closely, checking trees and all stored wood outside and, if necessary, removing the trim and baseboards inside. **Locate (and destroy) all carpenter ant nests, replace or repair all damaged or decayed wood and eliminate any moisture problems. Pick up and burn all dead wood, and remove any branches that touch or overhang your home. Correct all moisture problems. Look for nests in the insulation!**

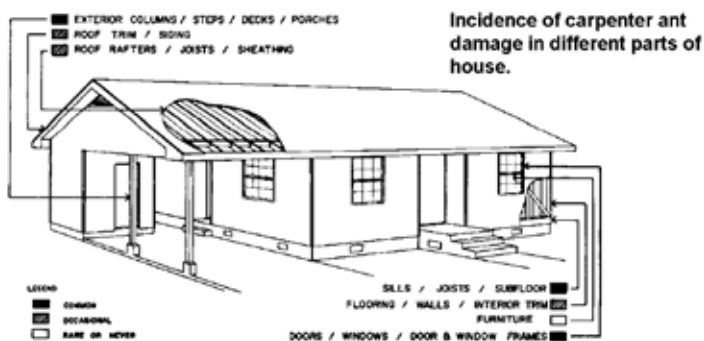

Carpenter ant



Carpenter ant damage to wood

As mentioned before, the (occupied) carpenter ant galleries are kept immaculately clean. Frass or the shredded wood fragments resulting from the excavations are carried from the nest and thrown outside. Conical piles of this frass, bits of soil and sand, portions of insects, dead ants and other debris sometimes build up beneath the “windows” or openings to the nest. This “sawdust” is not always evident, however, as the ants may dispose of it in a hollow portion of a tree, void areas in a structure or unused galleries within the nest.

Carpenter ant winged reproductive forms (simultaneously) swarm in the spring at which time new colonies are created. After mating all of the males quickly die. The colony is normally started by only one surviving

queen, who having selected or carved out a nest, then breaks off her wings and seals the entrance hole with a cement-like wood paste. Then she lays 15 - 20 cream colored eggs up to 1/8" in length. The queen personally cares for these first larvae and feeds them with a fluid secreted from her mouth. This liquid nourishment is derived from her stored fat and wing muscles. The minimae or first small (polymorphic) workers take 2 - 10 months to develop through the egg, larval and pupal stages; even though they are very small, they are hard working and immediately begin to feed the young and the queen, who now begins to only produce eggs. Subsequent generations create "major, intermediate and minor" workers. The pupal state is completed within tan or cream colored silken cocoons which often are incorrectly called "ant eggs". **There usually is only one (unwinged) queen and all of the workers are sterile (sexually undeveloped) females, but there may be more than one queen in a colony and the largest workers may also lay eggs but their eggs only produce male ants.** Usually if you find the nest and kill the queen or use (boric acid or sodium borate) light Karo syrup baits and kill the queen you kill the entire colony - so find the nest and/or bait. In general, soldiers are simply larger (female) workers who guard the nest, battle intruders, explore and forage for the young. However, these duties do overlap and some members of each caste are engaged in doing all jobs.

A carpenter ant colony is said to be mature whenever winged reproductives are formed. This normally occurs sometime after 2 to 6 years at which time the colony has grown to 2,000 to 3,000 or more individuals. Once this level is reached, it generally remains there due to the constant drain caused by producing 200 - 400 reproductive *swarmers* each year and the normal attrition of the workers. (Some colonies contain as many as 100,000 individuals.) They also may have multiple nest sites (primary for parent) and satellite nests) and they may shift from one site to another. The winged male and female forms may be produced at any time, but they usually develop in late summer. After spending the winter in the nest, they swarm in the spring or early summer. Carpenter ants produce "nature's antifreeze" or glycerol in their bodies when the temperature drops and can withstand tremendous cold. Freeze one in an ice cube tray by covering with Saran Wrap®...when the ice melts the ant will simply get up and walk away!

The carpenter ant eats a great variety of both animal and plant foods. One colony may have separate workers feeding on 1) Proteins 2) Pollen and 3) Carbohydrates - you must use baits with ½% or less sodium octaborate tetrahydrate and in hopefully all three kinds of foods, to obtain control. This ant will also feed on other insects both living and dead, and all of man's food supplies. Honeydew is a sweet food (sugary secretion) produced by aphids that is particularly attractive to these ants. In fact, because the carpenter ants will not normally eat the aphids that produce the honeydew, some people think the ants collect and herd aphids like we do cows, but at times they do kill the captured aphids and lap up their bodily juices. Many sweets and meats found in kitchens, garbage cans and storage areas are also fed upon by carpenter ants, including light Karo syrup, maple syrup, honey, jelly, sugar, meat, bread, grease and fat. Remember their favorite kinds of foods when you make sodium borate (less than 1%) or boric acid or food-grade DE (1% - 5%) baits. Increase the percentage of boric acid or sodium borate or DE if control is not reached in 3 months, to 5% - 15%, but try the least toxic baits first!

Foraging carpenter ant workers collect all of the food for the colony. The workers are polymorphic, i.e., the workers/subcastes vary in size from ¼" - ¾" in length. Worker ants can travel 100 yards (300 feet) from the nest for food and can be found throughout your home looking for food. These worker ants do not lay down scent trails like some other ants do and, as a result, workers may be found wandering all over with no particular trail leading to the nest. The food collected may be carried back to the nest, but more often it is simply swallowed where it is found, so make sure your baits are not too strong! Later it is simply regurgitated for use by the queen, developing larvae and non-foraging workers. Northern carpenter ants "hibernate" for the winter. In times of famine, eggs, larvae, pupae and even worker adults will be killed and cannibalistically eaten so the queen and a few opportunistic workers can survive.

Carpenter ants are of economic importance because of the tremendous damage they do to our buildings, the food they eat and contaminate and their unwanted movement inside and outside of our homes. Their nesting activities can weaken our homes, especially roofs and other moist areas. Unlike termites, ants have a complete metamorphosis: egg, larva, pupa and adult and while they do not avoid light they basically are "nocturnal" and usually are seen (on garbage cans) at night using a flashlight with a red lens.

CARPENTER ANT CONTROL — Find the nest(s)! Eliminate moisture problems!

Install negative ion plates. Inspection is the most important step. Once nests are located, control is relatively simple, requiring the labeled application of *residual* synthetic insecticide dust(s) or emulsion(s), or better yet using Safe Solutions Enzyme Cleaner with Peppermint and/or sodium borate (DOT) or borax, which will kill the ants on contact and can penetrate the wood and/or galleries with *fumigant action*. It is essential to destroy the queen in each colony. Outside nests can be destroyed with carbon dioxide, Safe Solutions, Inc. food-grade DE, steam cleaning, boiling, soapy water or diluted peppermint soap or enzyme cleaners, white vinegar and/or hot paraffin or aerosol foam insulation, but **BE CAREFUL NOT TO HURT YOURSELF! It is better to try sanitation, talcum powder and/or diluted Safe Solutions, Inc. Enzyme Cleaner (4 oz. per 3 gals. water) first. Complete control of carpenter ants depends a great deal upon your finding the all of their (parent and satellite) colonies or nests.** When carpenter ants are found in your building, either the colony is nesting within the building proper, or they are nesting somewhere outside your building and are merely entering to forage for food (so wipe up all spilled food immediately, store all food in tightly sealed containers, rinse your dishes after eating and store your garbage outside). **Elimination of the nest outside may be just as important as one already established inside your building because an entire colony may migrate from one nesting site to another**, i.e., from a tree outside to the structural timbers inside your building. Colonies are also established inside by newly fertilized females that fly in and/or are carried in by you in infested materials such as firewood. **Always make sure that branches are never allowed to touch or overhang your building and patch all wall cracks inside and outside and use a dehumidifier.** Inject desiccating dusts, e.g., talcum powder, medicated body powder, food-grade diatomaceous earth or silica aerogel, boric acid or dry sodium borate through small holes drilled into your wall voids. **Bait with commercially prepared (non-volatile) baits or make your own.**

As previously mentioned, a thorough inspection is the way to begin your carpenter ant control. The entire structure and all the grounds within 100 yards should be thoroughly inspected for nests since it is possible that more than 1 colony is present. The several steps to a successful inspection include interviews with your family, a thorough visual inspection indoors and outdoors and sound detection with your ear or a stethoscope wherever nests are suspected. Carpenter ants are most active on warm nights, particularly between 10 p.m. and 2 a.m., so conduct your inspection around midnight with a bright flashlight equipped with a yellow (best choice) or red filter to avoid disturbing the ants. Feed the worker ants a little dab of light Karo syrup, honey or mint jelly or insect fragments and follow them *home*. Sometimes when you turn a light on at night you will find large numbers in your sink seeking water; follow them back (along well established trails) to their nests using a red or yellow light.

Talking with your family and/or all of the occupants can get your inspection off on the right foot. Remember kids like looking at ants, so do not forget to talk to them. Discuss where the big black ants have been seen, where they are most prevalent, patterns of their movement and whether or not swarmers or *frass* (sawdust-like material) has been seen. If there is or has been a moisture problem in your home, it is important to know exactly where since carpenter ants love to attack these areas. To remove an ant swarm in your dish washer, simply run the machine, then pull the machine out and treat the exposed wood with sodium borate. **Then dust with Comet®, food-grade diatomaceous earth, or medicated powder or talcum powder or mop with Mop-up® or borax.**

The most important part of the indoor inspection is to look for moist or damp wood and nearby areas with high moisture readings. Critical areas include any small voids with high moisture, i.e., around plugged drain gutters, poorly fitted or damaged siding and Dashing, wood shingle roofs, hollow porch posts and columns and leaking doors and window frames. Other susceptible areas include any earth-wood contacts, areas of improper ventilation and wood scraps in (damp) crawl spaces or under (moist) dirt-filled slab porches. These all are ideal interior nesting sites for carpenter ants. **Don't forget to look in spider webs for dead carpenter ant workers and swarmers.**

CARPENTER ANT COLONIES

- Are usually found in damp areas or where a moisture problem, e.g., a leak, is or was present.
- An entire nest may move into newly stacked lumber pile in one night.
- Can also be found hollow bathroom or bedroom doors, hollow curtain or window shade rods, framed voids (rough openings) voids around doors and windows, tree stumps, fire wood and soffit areas.
- Colonies sometimes can be heard excavating wood within the structure at night.
- If disturbed, they may quickly move their nest to a more hidden location.
- Usually nest outside in hollowed out dead wood of trees.

- May travel into structures from overhanging tree limbs or utility lines that pass through tree branches.
- Stethoscopes are useful when searching structures for carpenter ant nests.

Carpenter ants are occasionally found in perfectly dry environments. Nests may be located in hollow trees, logs, interior doors and other small void areas, i.e., the space between the top of a door casing and the ceiling; often the wood is not galleried; the ants merely find and use the existing cavities or voids.

When inspecting for a nest indoors look for: (1) piles of sawdust or frass (wood debris) ejected from the colony, (2) “windows” or small openings in the wood, (3) worker ants foraging for food, (4) swarmers, (5) damaged wood, and outdoors look for: (6) trees that are rotting or have holes, and be sure to (7) look under boards, cans, leaves, pine needles and stones. Their frass or sawdust usually has a shredded quality and should not be confused with ordinary sawdust. This frass may be deposited in some void, i.e., between walls. “Windows” also may not be visible either because the ants can also use any available cracks. Ant foraging indoors is usually very minimal, especially during the day, since the ants usually look for food outdoors and are more active at night. Swarmers often become trapped and die around windows and in spider webs. A thorough inspection usually will reveal the above. The surface of damaged wood often appears solid, but by sounding the timbers, (hollow) damaged areas can be located and probed.

Carpenter ants can indicate hidden water problems because they usually only infest water damaged wood. Check for leaks around your windows and doors, plumbing fixtures and under shingles and make all necessary repairs. Keep your foods in tightly sealed containers or in the refrigerator. Most ants prefer sweets and fats. Practice good sanitation. Avoid leaving garbage, dirty dishes or food particles where they are accessible to ants. Caulk cracks and crevices in your building’s foundation and siding. Remove dead wood and rotted lumber, fire wood and stumps from around your home. Prune tree branches that touch or overhang your home to prevent carpenter ants from coming in. Ant bait can be prepared by mixing together 1/2 cup of grape or apple-mint jelly or honey or light Karo syrup, 1 tablespoon ground-up dried pet food and 1/2 teaspoon **or less** technical grade boric acid or sodium borate powder or borax or food-grade DE. Put 1 teaspoon of mix on a small piece of aluminum foil and place where ants are seen **but out of reach of pets and children.** Treat until ants are no longer found indoors, replacing bait as it becomes dry. If dead ants are found near bait, it’s too strong and more jelly should be added. Mix only enough bait for one application; **never store unused bait in the refrigerator or anywhere people, pets or wildlife can get to it!**

Outdoor inspection includes a thorough inspection of the exterior of your home or building and outbuildings as well as all of your grounds and trees. Carpenter ant workers forage extensively and may travel as far as 100 yards from their nest. They can forage individually so that a trail of any kind is not always detectable, but often they will follow the same, well established trail for years, wearing a 1/4” groove in the grass thatch. Carpenter ants commonly nest in trees and stumps and use branches and vines to travel from tree to tree and to gain access into your home. These ants may nest in living trees, but are usually found in knot holes, scars, dead, rotten and crotch areas. Stacks of firewood, logs and lumber are also potential nesting areas. As with the indoor inspection, it is very important to look closely at those areas on the outside of your home where a moisture problem exists or may have existed. Carpenter ant nests can often be found in wood where faulty drainage or some other defect has caused a moisture problem. Piles of frass near these timbers or near posts, lumber, stumps or trees indicate active nesting sites. Remove all dead wood and trim any branches that touch your home. When inspecting inside and outside look not only for carpenter ants, nests and frass (sawdust and partial ant bodies), but look, recognize and correct (if at all possible) potential food sources (garbage, dropped fruit, etc.) and any conditions favorable to their development or entry into your home.

Your ear (and a stethoscope) are often useful in locating carpenter ant nests. Sometimes you can hear them *chewing* at night, but an active colony will also produce a distinct, dry, rustling sound which intensifies when the colony is disturbed. The rustling sound, thought to be a form of communication, is made with the mandibles (jaws) striking the wood and is not caused by their excavation of the wood. This rustling noise is occasionally very loud, but usually cannot be detected except when conditions are very still. If a suspected nest is found, you should rap heavily on the wall or door and then press your ear or stethoscope to the surface in order to hear any sounds. **Sometimes nests can be located with gas detectors or trained dogs that sniff them out.**

True protection from carpenter ants requires destruction/elimination of all the queens in all of the colonies in and around your building. This often is difficult because ants can forage on one property and nest in yet

another. Where all the nests are not destroyed, control may be temporary at best (unless you use sodium borate); even if you see no more workers, eggs can hatch up to 9 months later and reinfest. **(Some ant colonies can survive even the deaths of 99% of their workers!)** The elimination of high moisture conditions is also a must for carpenter ant control and also helps to prevent future attacks by the ants as well as wood infesting fungi. Correct all moisture problems, i.e., leaky downspouts, faulty gutters, roofs, flashing around chimneys, showers, tubs, toilets, etc.

If entrances to the nest are found, they can be enlarged slightly so that aerosol foam insulation or synthetic (non-volatile) residual insecticides, dusts or sodium borate can be introduced. Care must be exercised in not creating conditions which will be favorable to fungi development, i.e., only aerosols containing foam insulation, boric acid or silica gel should be used because water-based synthetic residual poisons help cause decay. (Remember, sodium borate permanently prevents decay even when carried in water.) **A heat gun with 160° F. will quickly kill carpenter ants, but be careful not to start a fire.**

The insecticide or talcum or medicated body powder or food-grade DE should reach as many as possible of the areas inhabited or traveled by the ants. You can drill 1/4" or 3/8" holes at about 12" intervals in the infested walls and/or wood in order to reach all of the galleries of the nests). The spray or dust (including sodium borate, e.g., TIM-BOR which comes as a "dust" is best applied by using a nozzle that will fit tightly into these holes or a hypodermic syringe. The sprayer or duster should be of a type that will force the insecticide into the different chambers and galleries. The holes may then be sealed by hammering in dowels as plugs or small corks of appropriate size or caulked, plastered or simply sealed with petroleum jelly.

When it is impossible to find the nest(s), a more general treatment of the premises with boric acid, borax, negative ion plates, Safe Solutions, Inc. Peppermint Soap and/or Enzyme Cleaners or sodium borate may be necessary, but first deny access to the ants by sealing off all their entry points into your home, e.g., around telephone lines, dryer vents, electrical lines and plumbing, including all visible cracks and crevices. Correct all moisture problems, practice proper sanitation, remove all earth-wood contacts, firewood and branches that touch or overhang your home. Then try "baiting" the workers with honey or chopped-up yellow mealworms or frozen crickets - the workers will carry the "food" back to the nest, and you can follow and watch where they go. Then you can treat the nest(s) with dust and then caulk. You can also mark all visible workers on a graph - then plot a straight line to their nest(s) You can also bait with honey and cream and follow them back and remove the nest(s) and/or bait them with their preferred food, e.g., honey and/or a can of pet food or tuna fish sprayed with diluted 1% protease enzymes or 1% - 2% boric acid or borax. Later, if absolutely necessary, the outside of the foundation can be sprayed with a residual material as can the base of trees, fences, shrubs and other ant foraging areas. Baseboards and door frames in the home should be sprayed initially, and if there is a full basement or crawl space, the mud sill (the board that lies on the top of the foundations and any structural timbers between it and the subfloor should be sprayed so that a continuous film of borax or sodium borate is present. Unused attic areas should also be sprayed thoroughly. Remember that too much sodium borate or borax can be harmful to living plants. Always follow the label directions. The pest control industry has historically only used volatile, "registered," residual pesticide poison sprays (such as diazinon, chlordane, Dursban and malathion), or dusts, e.g., chlordane, diazinon, Dursban, Ficam, Sevin and/or propoxur, methoprene and hydramethylnon, and even fumigation or heating the wood to 120° F. or using an Electrogun® to (temporarily) control carpenter ant infestations. We never recommend the use of any volatile, synthetic residual sprays or dusts, especially if anyone in your home is over 60 years old or under 1 year old, pregnant, chemically sensitive or has any allergies or any breathing problems. We also never recommend fumigation. We do recommend the safe use of sodium borate and/or boric acid or borax, or baking soda or talcum powder or Comet® or aerosol foam insulation or enzyme cleaner or peppermint soap, but, remember, do not rely on any one alternative alone to control your carpenter ants; you should always: (1) trim all trees, branches and vegetation that touch or overhang your homes (2) remove all dead stumps, firewood and lumber piles within 50 feet of your home; (3) correct all moisture problems, e.g., improper grades, poorly vented attics and crawl spaces, leaking roofs and plumbing, cracked foundations and/or non-functioning rain gutters; (4) replace all decayed lumber with pressure treated wood (or treat with sodium borate); (5) remove all earth-wood contacts; (6) use inorganic mulches near your home rather than wood chips, etc.; (7) remove, trim or patch all holes and broken branches in all the trees near your home (8) and when (and if) you bring fire wood into your building, inspect it first and burn the uninfested, firewood as soon as possible....always discard (and burn) any infested firewood outside your building;



(9) routinely remove all leaf and pine needle debris from roofs and gutters; (10) seal and/or caulk all cracks and openings in the exterior (walls) of your building. **Don't forget to also read Chapter 15.**

FOR PERMANENT CARPENTER ANT CONTROL USING SODIUM BORATE, PLEASE TURN TO THE SECTION - Permanent wood destroying organism control.



6. LARGE CARPENTER BEES - You will find there are several species and subspecies; all have a complete metamorphosis and are from the family Anthophoridae, Genus *Xylocopa* spp.

Like carpenter ants, these bees are described by the word “carpenter” in their common name because of their boring activity in wood. They are distributed throughout the U. S.

Several species (from the sub-family Xylocepinae and the genus Xylocopa) of carpenter bees, occur in the U. S., the eastern carpenter bee, *Xylocopa virginica* (Linnaeus) (the most destructive carpenter bee) is found from Maine to Wisconsin and south to Florida and Texas. In Michigan they appear to be restricted to the southern half of the state. *Xylocopa micans* (Lepeleter) occur in the southeastern states. *Xylocopa orpifex* (Smith) (the mountain carpenter bee) is 1/2” - 2/3” and found in the western U. S. and southern California. The species *Xylocopa orpifex* is 1/2” to 2/3” long, both sexes are black and you will find the nests close together. *Xylocopa varipunctata* or valley carpenter bee, is found in the lower altitudes of California and Arizona. *Xylocopa varipuncta* (Patton) is 3/4” to 4/5” long, the female is metallic black and the males are colored tan. *Xylocopa californica* is most common in the western U. S. They are metallic blue or green with whitish hair on the pronotum; they are 1” to 1-1/4” in length. Carpenter bees are widespread in their distribution, but are seldom abundant in any given locality.

The adult carpenter bee usually looks like a common bumble bee. Carpenter bees are large (1/2” to 1-1/4” in length), robust and with a shiny, bluish-black abdomen. Bumble bees, on the other hand, have hairy abdomens that are mostly yellow. Bumble bees do not make holes in wood, carpenter bees do.

Carpenter bees usually attack soft, bare wood, i.e., trees, telephone poles, fence posts and unpainted, unvarnished or weathered timbers, shakes, beams, siding and logs (as in log cabins, garden furniture). The only visible external evidence of infestation is the entry hole, almost 1/2” in diameter and perfectly round, made by the female. Some sawdust-like frass (not fecal matter) may drop onto a surface below the entry hole. Try injecting holes with talcum powder or diluted Safe Solutions, Inc. peppermint soap or enzyme cleaners (with or without borax or sodium borate) at night.

Adults excavate nests in wood. Soft woods (pine, redwood, fir, cedar and spruce) are preferred, but they have also been found in hard woods (willow and oak). A “nest” usually consists of a round entrance hole (3/8” to 1/2 “ diameter by 1-1/2 “ - 2” deep) and a system of tunnels oriented along the grain of the wood. Carpenter bee tunnels usually turn at a right angle after penetrating an inch across the grain; then they usually follow the soft wood for as far as several feet (after years of use). If entry is from the end of a board, the tunnel does not turn but follows the grain straight in. The queen bees can carve up to 1/2 inch per day with their mandibles (jaws) when they make the entrance hole; they can, obviously, excavate the softer wood at a faster pace as they cut their tunnels with the grain.



Nests are located in porches, eaves, fascia boards, garages, sheds, carports, fences, window trim, lamp posts and other wood objects, usually on the southern or eastern areas of your buildings, etc. They tend to avoid wood that is painted, whitewashed or covered with bark. Unlike carpenter ants, who use nests in wood as a home for themselves, mother carpenter bees carve tunnels in wood only to rear their young. Beginning at the point farthest from the entry, females prepare a series of brood cells in the tunnels, providing each with food (“bee bread” - a mixture of pollen and nectar), an egg and a partition of chewed wood. Most females produce 6 to 8 young. The chamber is then sealed off with wood particles and the next chamber is made, and so on, to where the tunnel angles to the entry. The mother bee then leaves and never returns. The eggs hatch and the pollen is sufficient nourishment to bring the larvae to maturity. The larvae develop from May to August, emerging

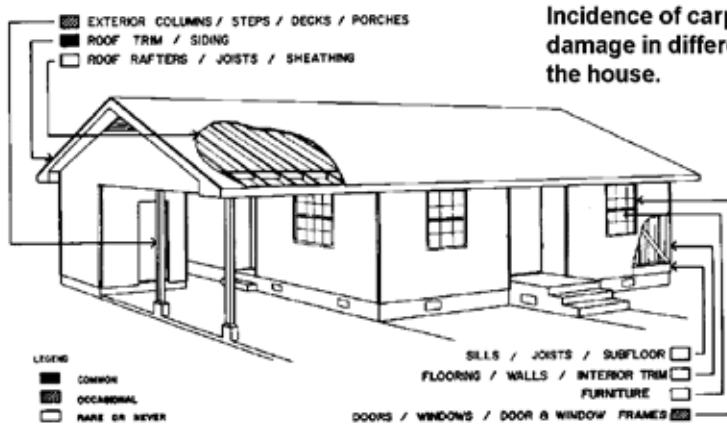

in September. The oldest bee, developing at the end of the tunnel, emerges first and must cut through all the partitions and crawl over the other developing bees. Normally, there is only one generation per year. Juvenile (unmated) adults of both sexes do overwinter in the tunnels. In Michigan, they become active when temperatures reach the 70's in the spring.

Mating, accompanied by a strange “bobbing dance” by the male, occurs in April. The carpenter bees clean and enlarge the nest. They seem to prefer this to establishing new nests. Some carpenter bee nests have been known to have been in continuous use for 14 years.

There are two principle concerns about the activities of carpenter bees. The first concern usually is over the danger of getting stung, but females (males can't sting) are very hesitant to sting, and usually must be aggravated or held or provoked before they sting. (Most solitary wasps and bees are this way; normally only colony dwellers are aggressive and attack and sting man.) Carpenter bees are not particularly important as pollinators.

The second concern deals with wood damage. It is generally more of an aesthetic problem since carpenter bees rarely nest in or damage the load bearing capacity of structural timbers. Damage is most severe in trim and decorative wood on the exterior or the building, i.e., window sills, siding, eaves, railings, outdoor furniture and fences. Other minor concerns include excrement stains, the buzzing flight of the adults, the noise of their nest construction, and the attraction of (hungry) woodpeckers. In addition to woodpeckers there are two species of bee flies (Diptera: Bombyliidae) that are natural enemies of the carpenter bee. The flies deposit their eggs in the entrance of the tunnel and the maggots parasitize the bee larvae.

The best preventative control is to keep exposed wood surfaces treated with sodium borate or borax and then well painted or varnished. These infestations are generally *professionally* controlled by injecting synthetic *residual* insecticide poison dust 5% or 10% Sevin (carbaryl) or by using synthetic *residual* poison sprays such as Baygon, Dursban or any contact spray directly into the entrances and then plugging them (in fall) with dowels or plastic wood or caulk, and then painting or varnishing the entire wood surface. You can get better, safer control by using TIM-BOR dust here too, or use a hypodermic syringe and inject a labeled liquid solution of sodium borate (DOT) or simply dust with boric acid or food-grade DE or talcum or medicated powder, put a *slug* of steel wool or copper wool into the entrance hole with sodium borate or boric acid on it or spray with Safe Solutions Enzyme Cleaner with Peppermint and/or borax.

OTHER WOOD DESTROYING ORGANISMS

Many other insects and decay fungi in addition to termites, ants and bees infest and seriously damage wood. Many of these, such as the various bark and ambrosia beetles and round and flatheaded borers, are usually found alive only in green or unseasoned wood. You should only be concerned with those insects and decay which can subsequently damage the seasoned lumber in your home. The next group of wood destroying organisms to be discussed are the wood boring beetles and various decay fungi. The wood boring beetle larvae excavate burrows in your wood. Observing the damage done by these insects is generally enough evidence for you to place the insects in their proper family, but positive identification to genus or species will usually require the examination of the insect itself. Wood decay and wood wasps will also be discussed; if you have any questions, please write or call your state entomologists or County Extension Service.

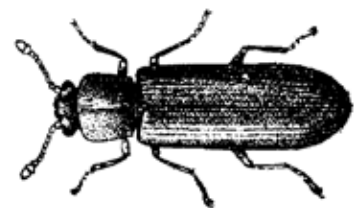

POWDER POST BEETLES

Various small beetles attack seasoned wood in buildings; they are usually first noticed when the powder-like sawdust (frass) is pushed out of tiny emergence holes in the infested wood. The term “powder post beetle”, used in pest control, applies to any of 3 closely related families within the family Bostrichoidea. This common name comes from the activities of the larval stages of these beetles because the larvae reduce timbers to a mass of very fine, powdery and/or pelleted frass held together by a thin outer shell of surface wood which is itself penetrated by numerous “exit” or emergence holes. The 1/12” to 1/3” long adults do not damage the wood; they are only reproductives. There are several differences in size, behavior and feeding habits among these pests which have led to the separation of three families. Although the members of the family Lyctidae are the only beetles which truly are powder post beetles the name is used to describe members of the families Anobiidae and Bostrichidae because of the similarity of their damages. These three are quite easy to distinguish - the true powder post beetles (Lyctidae) loosely fill their galleries with a very fine powder, similar in appearance to face powder; the false powder post beetles (Bostrichidae) tightly pack their galleries with a coarser boring dust, often containing small wood splinters or fragments and the death watch beetles (Anobiidae) fill their galleries with small pellets that are blunt at each end. The frass in the bostrichid and anobiid galleries is not only coarser than the lyctids, but it tends to stick together. All beetles belonging to the order Coleoptera which means “sheath wings” have chewing-type mouthparts in both the adult and larval stages. Most have four wings with the front pair (the elytra) thickened, leathery or hard and brittle, usually meeting in a straight line in the middle of their back, and (when at rest) covering the thin membranous hind wings used to fly.

The cost of just lyctid powder post beetle damage is said only second to that of subterranean termites. They do many millions of dollars’ worth of damage in the U. S. alone each year. These beetles infest and reinfest dry seasoned wood, until the interior of such wood, especially the sapwood, is completely riddled with holes or galleries and packed with frass. Many pin hole openings, exit holes, emergence holes, flight holes or “shot holes” as they are often called, perforate the surface of infested wood. The size of these holes will vary, depending upon which family and species of the beetles is involved. Both hardwoods and softwoods are infested, although the family Lyctidae only infests hard woods. The anobiid beetles actually are the most important pests of homes. Avoid buying furniture or wood products that have not been stained, varnished, or properly dried. Properly paint or varnish new wood items to seal pores and to prevent egg laying.

Powder post beetles are found infesting unfinished flooring, studs, girders and other wooden parts of buildings, firewood, lumber crating, paneling, furniture, tool handles, gun stocks and many other wood articles. Infestations can be caused by building with infested lumber, and bringing in infested firewood. Beetles often fly into crawl spaces beneath buildings and lay eggs in exposed wood there. The first evidence of infestation is usually piles of very fine sawdust or powder on or under infested wood and the small holes in the wood surface, but this evidence may not be visible for 3 months to 3 years or more, depending upon the species involved, environmental conditions and type of wood attacked. In hidden areas, i.e., inaccessible crawl spaces, serious damage may be done before the infestation is finally discovered.

If the surface of your wood looks as if it had been riddled by darts, buckshot or birdshot, chances are you have just discovered a powder post beetle infestation (unless someone actually threw darts repeatedly or has fired into it or has driven a lot of nails and then pulled them all out). Unlike termites, powder post beetles make their presence known by many visible exit holes in lumber. By probing these areas you may come upon galleries where the wood inside has been eaten out, checking the frass in the galleries will help you identify the beetle you are dealing with; if you find a specimen in there, put it in a bottle for your state extension entomologists, and send them a piece of damaged wood too. Before the female deposits her eggs to a piece of wood, **she first “tastes”** it to see if it contains enough starch and sugar to nourish her young. **If you prevent her from doing this with a wood coating of any kind (paint, floor fillers, varnish, wax, whitewash, etc.) she will not deposit her eggs!** So simply use sodium borate or paint or seal or varnish all exposed unfinished wood rather than routinely spraying volatile poisons!

Why are they called “exit” holes and not “entrance” holes?

After all, how did the insect first get into the wood? Powder post beetles deposit their eggs with an ovipositor (like a hypodermic needle) either by pushing them into the surface wood pores or by placing them in cracks and crevices in the wood (Anobiid beetles) or by boring into the wood and placing them directly in the wood (Bostrichid and Lyctid beetles). The eggs hatch and the larvae then begin to eat. “Mom” has long since gone; the larvae (her babies) cause all the structural damage. After they’ve done a lot of it, they pupate, become adults and, as such, emerge from wood (making exit holes). They then fly off and start new infestations. The more (filled) exit holes, the more active your infestations may be.

The exit holes of powder post beetles are all perfectly round, but they differ in size. The frass also differs in each family; so does their wood preference and their placement of eggs also differs. Please refer to “A Key to Damage Done By Wood Destroying Insects” which should also be helpful to you in identifying specific infestations.

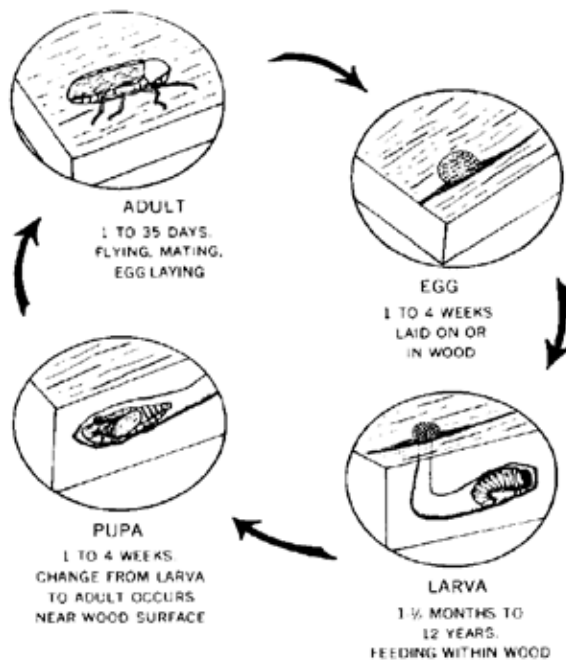

LYCTID OR TRUE POWDER POST BEETLES

Family - Lyctidae

Class - Insecta

Order - Coleoptera

Metamorphosis - Complete

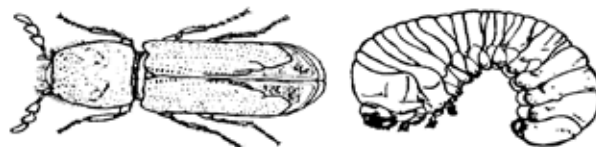

Adult lyctid beetles push their long and cylindrical eggs (20 - 50) into the open cracks, crevices and surface pores of wood usually with a moisture content from 10% - 20% and a starch content above 3%. Lyctid larvae bore into the wood as soon as they hatch and eat the sugar and starches found in the sapwood portion of the wood; they are white, grub-like, wrinkled with dark brown heads and mandibles. The front end of their body is larger than the back and bears 3 minute (but distinct) pairs of legs, the last pair of spiracles which are much larger than the others. They create large amounts of extremely fine powder, or excrement, hence the name.

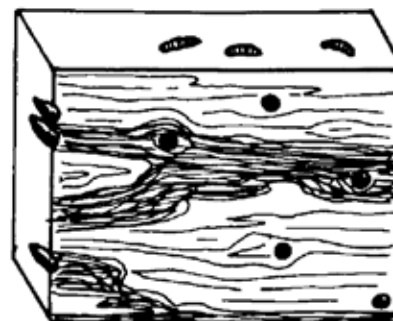
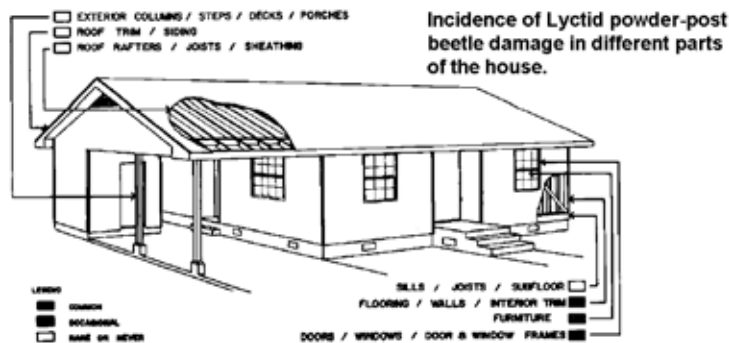

Mature larvae tunnel near to the surface of the wood and pupate. Adults bore round exit holes 1/32” to 1/16” in diameter through the surface of the wood soon after their metamorphosis is complete, quickly mate, fly away readily and usually hide during the day. Adult beetles usually drag along some fine, powdery wood dust out of the wood with them as they emerge. They are small, slender beetles, varying in size from 1/32” to 7/32” long and are flattened and reddish-brown to chestnut to black in color, and their heads are distinctly visible from above. The basal segment of the abdomen is quite long (as long as the second and third combined) and the antenna bears club consisting of only 2 segments.

There are certain similarities which indicate a close relationship between lyctid and bostrichid beetles. (At one time they were all placed in the family Bostrichidae.) Both are unable to digest cellulose and hemicellulose which form the cell walls and make up the bulk of the woody tissue (nor do they have any “partnership” with protozoa or bacteria that can); hence, this material passes through the digestive tract of their larvae virtually untouched and accounts for the large amounts of powdery frass left by the beetles. The chief source of their food is starch and other cell contents, e.g., sugars and proteins. Therefore, because heartwood is practically free of starch, it is immune to beetle infestation. Softwoods do not have pores (and usually have a low starch content) so they are also immune to lyctid infestation. In nature, these beetles breed in old dried wood branches and limbs. Since the carbohydrate content of wood is what is needed for the development of both of these beetles, it is advantageous to the pregnant females to find wood with a high starch content in which to lay their eggs. Lyctid females can actually select favorable wood by a so-called “tasting” process. Wood which has a low starch content (below 3%) and less than 8% or more than 32% moisture content is seldom infested. Lyctids are usually found infesting only the seasoned or partly seasoned sapwood (where the richest starches are found) of hard woods, especially those which have a higher moisture content, i.e., implement handles made of ash and hickory and flooring or furniture made from pecan, wild cherry, oak, maple, walnut and other hardwoods that have diffuse (large) pores, which are necessary for the female in egg laying. Ring porous hardwoods such as oak, ash and hickory are the most susceptible. Bamboo, which is attacked by some oriental lyctids, is technically classified as a grass. Occasionally bamboo furniture, baskets, screens, etc. may be infested. These beetles can complete a life cycle in one spring and summer season if temperature and moisture conditions are good, but they usually require a year or more when they are in wood in your home because of the dryness of your lumber. In an unoccupied or poorly heated building, they often reinfest available hardwood for many generations. Obviously, it helps to put a dehumidifier in your basement and, thereby, further reduce the moisture content of the wood and ambient air. If wood is slowly dried in temperatures below 100° F., starch depletion is speeded up and also is less susceptible to lyctid attack.

You can tell lyctid damage by the frass or extremely fine, flour-like powder falling from the emergence holes. The frass left by other wood borers almost always contains pellets and has a coarse texture or tendency to stick together. When inspecting for damage, be sure to distinguish old damage from active beetle infestations. Newly formed holes are light in color and clear in appearance; older ones are darker in color. This color change also is usually evident in the frass left by the beetles. In heavy beetle infestations there may also be even smaller circular emergence holes where small wasps which are parasitic on the beetle larvae have also emerged.

There are at least 66 known species of Lyctidae of which 35 are known to exist in the U. S., but for our purposes only 6 of these are of major importance. They are: *Lyctus brunneus* (Stephens) or “Brown powder post beetle”; they are reddish-brown in color with a prothorax wider in front than in back, with a shallow depression along the middle; they are frequently found in bamboo; *Lyctus cavicollis* (LeConte) or “Western lyctus beetle” is a slender, rusty, reddish-brown beetle that looks like the above except the punctures on the dorsum or striae are in double rows; *Lyctus linearis* (Goeze) or “European lyctus beetle” is dark brown in color and the elytra (thickened wing cases or forewings) have a single row of large, shallow punctures and are glossy, reddish-brown in color; *Lyctus opaculus* (LeConte); *Lyctus planicollis* (LeConte) or “Southern lyctus beetle” is basically black to dark brown; *Lyctus parallelipedus* (Melsh) or more correctly, *Trogoxylon parallelipedus* (Melsheimer) or “Velvety lyctus or Powder Post beetle” - they vary from rusty red to very dark brown - to black - and are covered with very fine yellow hairs. In addition to these established species, others, e.g., *Minthea rugicollis* (Walker), *Lyctoxylon japonum* (Reitter), *Trogoxylon prostomoides* (Gorham) and/or *Trogoxylon aequale* (Woll.), are periodically discovered (especially in maritime ports) infesting wooden items shipped into this country. But, from purely an economic standpoint, our two most important lyctid pests are the Southern lyctus beetle and the velvety powder post beetle. **Diluted Safe Solutions Enzyme Cleaner with Peppermint will kill them on contact; peppermint acts as like a fumigant and will even penetrate wood , but adding sodium borate or borax will also permanently take care of them all.** Piles of hard wood debris, dead branches, old lumber, etc. should not be allowed to accumulate in your storage areas but should be burned as soon as possible; **use a dehumidifier and/or fans.**

FALSE OR LARGE POWDER POST BEETLES
Family Bostrichidae

These beetles have also been called “branch and twig borers” because their natural habitat is in dead or dying branches of trees, particularly hardwoods. Adult bostrichid beetles bore directly into seasoned wood in lumber yards or your home in order to lay their slender eggs. The female bostrichids bore into the wood creating “egg tunnels” that expose the cross-grain, allowing them to insert the eggs directly into the wood’s pores. Mature (3/16” to 5/16” long) larvae are grub-like, bigger in front than in back and curved and wrinkled and lack hairs on their body, with 3 pairs of short but well-developed legs. Their mandibles are black and not toothed on the inner margin and their head is bent downwards.

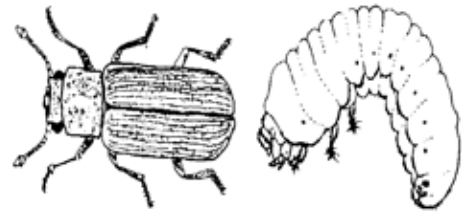

After metamorphosis, bostrichid adults also bore through the surface of the wood creating exit or emergence holes. Adults vary from 1/8” to 1” long, with a body that is cylindrical and their antenna bears a club of 3 distinct and separate segments. Their head is directed downward and is not visible from above because the thorax is usually noticeably roughened and forms a hood which obscures the head.

The members of this family are also unable to digest cellulose, and are basically dependent upon the starch content of the wood which they infest. There are a considerable number of species in this family and they infest a wide range of wood materials. They are most commonly encountered in the sapwood of hard woods, especially the ring porous woods, but some also infest the sapwood and become important pests in softwoods. Although primarily a pest of moist, seasoned wood, some species occasionally will be found in unseasoned or green wood.

Most bostrichids are larger than the other families of powder post beetles. Consequently, their egg tunnel entrances and exit holes are also larger (3/32” to 9/32” in diameter). These holes may not contain frass but the galleries do. The frass is meal-like, tightly packed, tends to stick together and contains no pellets.

The bamboo borer, *Dinoderus minutus* (Fabricius) is commonly shipped into the U. S. It is a small (about 1/8” long), cylindrical brown beetle that is a pest primarily of bamboo furniture, curtains and ornaments. It is also found in stored grain products, spices, drugs and dried bananas.

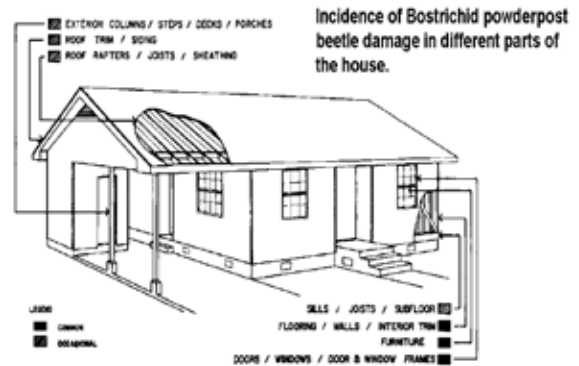

The black polycaon or *Polycaon stouti* (LeConte) is a larger, completely black beetle (about 1/2” to 7/8” long) usually found infesting hard wood lumber, furniture and other wood products on the Pacific Coast in the western U. S. Occasionally, it is found in other parts of the country in furniture that has been shipped from the West Coast. The adult differs from other members of the family in that the head is visible from above. Life cycle is about one year. Adults are nocturnal fliers (fly at night).

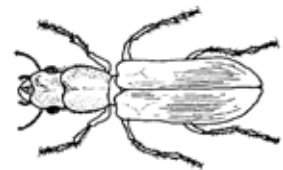

The lead-cable borer or short circuit beetle, *Scobicia declivis* (LeConte), is a cylindrical, reddish-brown beetle about 1/5” to 1/4” long with larvae feeding upon solid wood for about 9 months before pupating. However, the greatest damage is done (in June - August) by the reproductive adults boring 1/10” (egg laying) holes into the lead sheathing of exposed aerial telephone cables. Often the attacks are precipitated by forest fires, particularly oak forest fires - when those beetles may occur in large numbers. Wherever there are holes in the lead sheathing, moisture eventually enters and a short circuit results. Telephones may be out of use for several days. **Putting beef tallow (or grease) especially where the rings support the lead cable (sticks to and) suffocates the adult beetles when they try to bore into the lead there.** They also attack softwoods and hardwoods usually with the grain, and are “attracted” to newly painted homes, corks in wine bottles, wooden wine casks, plaster-board, plaster casts, living trees and plastic conduits.

The Red-shouldered shothole borer, *Xylobiops basilaris* (Say), is a cylindrical black beetle, about 1/4" long, with patches of red at the base of the elytra (thickened forewings that cover the hind wings). Although found in both furniture and structural timbers, the adults commonly emerge from dead or dying trees in such numbers that they become a nuisance. They are usually found in the Eastern U. S. where they attack any freshly cut and partially seasoned hardwood, log homes, arbors, rustic bridges, fences, furniture and cured oak, elm, hickory woods. Most of the larval boring is in soft wood.

Heterobostrychus aequalis (Waterhouse) is another typical species which is found in south Florida where it infests most any lumberyard lumber and paneling. They were recently introduced to this continent in wood products shipped from the Orient. They are commonly called Oriental wood borers.

There are several other bostrichids, e.g., *Stephanopachys rugosus* (Oliv.) and *S. substriatus* (Oliv.), that are occasionally found infesting homes, but they are not discussed and can all be controlled by properly applying sodium borate.

POWDER POST BEETLE CONTROL

Historically the poison industry has only used fumigation or volatile, synthetic residual poisons — You also could try to control powder post beetles by following these volatile poison labels, i.e., by spraying chlorpyrifos 42% EC on the infested (unfinished) wood in spring (and) summer. To time synthetic *residual* sprays with beetle emergence, glue a piece of white paper over a damaged area of infested wood. Then you will know when to begin your (re)treatments when tiny holes appear in the paper. However, in our opinion it is better and safer to treat with sodium borate at any time. Remember to only buy furniture or wood products that have been stained, painted, varnished and/or properly dried. **Properly install and use a dehumidifier, fans and/or vents in your basement/crawl space. Properly paint or varnish (new or raw) wood to seal the pores and prevent egg laying. Spray with Safe Solutions, Inc. Peppermint Soap and/or Enzyme Cleaners and DOT or borax or food-grade DE to kill them on contact and/or to penetrate the wood and/or galleries with a fumigant and residual action. We do not recommend the use of any volatile "registered" poisons!**

FOR PERMANENT POWDER POST BEETLE CONTROL USING TIM-BOR, PLEASE TURN TO THE SECTION — Permanent Wood Destroying Organism Control.

FURNITURE, TIMBER, DEATHWATCH BEETLES Family Anobiidae

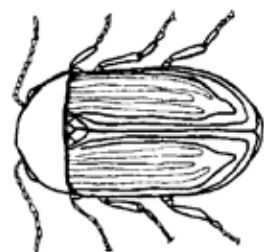

Adult anobiid beetles usually lay 50 - 100 eggs in the old emergence holes and in cracks and crevices of old, dry limbs, but they can also be found in structural members and furniture of your home or building, generally in the crawl spaces of older homes. As soon as they hatch, the larvae borrow into the wood where they live and tunnel for a year or more. When mature, they burrow toward the surface of the wood where they pupate for approximately 2 - 3 weeks. Emerging adults also bore round exit holes 1/16" to 1/8" in diameter through the surface of the wood and fly away after they complete their metamorphosis. Note: The eggs will not hatch if the relative humidity is not 45% or greater = **use a dehumidifier and fans and/or air conditioners!**

Mature larvae of anobiids are slightly curved, wrinkled and have tiny hairs on the body, with 3 pairs of short legs. Their mandibles are usually toothed on the inner edge. Larvae of the various species vary from 1/4" to 1/2" long. They usually infest sap wood in softwoods, but can and do infest hard woods and coniferous woods and even bore into the heartwood. They make small "granular" pellets rather than the flour-like powder the Lyctus beetles create. **They are the common pests of log homes.**

Adults are small beetles, usually 1/10" to 1/3" long. They vary in color from red-brown to almost black and are covered with fine yellow hairs. The widest point of the under surface of the thorax of most anobiid beetles is slightly forward of the base, which then tapers slightly backward and toward the midline, giving the thorax a sort of a rough, diamond-shaped outline. Their head is characteristically bent downward and is hidden by the pronotum (the section of the back between the head and wing covers) so that it cannot be seen from

above. They fly and are most active during early evening hours.

Some of the anobiids (unlike termites and other powder post beetles) are able to directly digest wood cellulose without the aid of protozoa. The growth of stain fungi within the galleries can serve as a source of protein and increases the rate of development of the larvae, but some species can complete their life cycle on cellulose alone because of the presence of an internal enzyme in their gut which digests the cellulose. Anobiids require at least 14% moisture; decay fungi need at least 24%, so properly install and use fans and/or air conditioners and/or dehumidifiers.

Anobiids infest all types of seasoned wood, although they prefer the sapwood of softwoods. Infestations are common in crawl spaces and basements (that are not properly vented and/or do not have dehumidifiers), where most exposed framing lumber is softwood, i.e., pine. Hardwood cabinets, furniture and interior wood work are also infested. Infestation is characterized by small, round holes on the surface with fine to coarse powder sifting from them; look closely and you may see bun-shaped pellets within the mass. (Two anobiid species that infest hard wood do not produce pellets.)

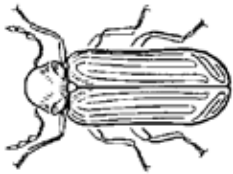

Their life cycle can be one or more years, depending upon the anobiid species involved and environmental conditions. Most adults emerge from April through July and will reinfest wood only if the moisture content of the wood is high enough = use a dehumidifier. In crawl spaces, reinfestation occurs most frequently where ventilation is poor and the resulting humidity is absorbed by the wood members. Attics and wall spaces are rarely infested because ventilation and temperature controls usually dry out these upper levels of your home. You usually find them in wood with 14% moisture content or higher — **lower this and you safely control these pests.**

There are three anobiids which are the most common and economically damaging - *Anobium punctatum* (DeGeer), the furniture beetle; *Xestobium rufovillosum* (DeGeer), the Death-watch beetle; known as *Euvrilleta peltata* (Harris) formerly known as *Xyletinus peltatus* (Harris). The furniture beetle is found principally in the eastern half of the U. S., and although named the furniture beetle, it is also found in structural members, but central heating and dehumidifiers will dry out the wood to a level that is not conducive to beetle development. The death-watch beetle is found throughout the U. S. It attacks building timbers in poorly ventilated areas where moisture tends to collect. Its common name is derived from the ticking sound that the adult makes inside infested wood that is audible in the hush and stillness of the night. The sound is actually a mating call. The mating signal is made by both sexes as they try to locate one another - the sound is produced by the *lover* striking its head on the surface upon which it stands. An old superstition said the sound was a signal that death was near, hence the name. *Euvrilletta peltata* is a serious pest in the Southeast and eastern U. S. It infests the sapwood (and heartwood) of both softwoods and hardwoods, especially crawl space timbers. Infestations tend to build to such proportions that serious loss of structural strength to sills, floor joists and subflooring areas and log homes occurs. The adult is a brown to reddish-brown beetle covered with fine yellow hairs.

There are more than 260 species in the family Anobiidae in the U. S., including the drug store beetle and cigarette beetle that are important pests of stored products, not wood. All the wood destroying species prefer wood with a high protein, low resin content that is slightly decayed or has a relatively high moisture content. Damp areas, i.e., unvented crawl spaces with moderate temperatures are ideal. They may attack plywood made with blood or casein glues; synthetic adhesives are toxic to the small larvae. In very old infestations you may also see very tiny round exit holes 1/32" in diameter made by parasite wasps whose larvae feed on the anobiid beetle larvae. **Damage from these beetles is usually greatest in the dampest regions of your home and should be just one more reason for you to use a dehumidifier, fans, air conditioners, and/or vents and borax or sodium borate.**

Other Anobiids include the Eastern death watch beetle, *Hemicoeles carinatus* (Say), the California deathwatch beetle, *Hemicoelus gibbicollis* (Le Conte), *Ernobius mollis* (L); *Priobium sericeum* (Say); *P. ruficornis* (Say) and *Ptilinus punctatum* (LeConte).

FOR POWDER POST BEETLE CONTROL USING SODIUM BORATE, PLEASE TURN TO THE SECTION — Permanent Wood Destroying Organism Control.

**ROUND HEADED BORERS OR “LONG -HORNED”
BEETLES OR CERAMBYCIDS**

Family - Cerambycidae

Class - Insecta

Order - Coleoptera

Metamorphosis - Complete

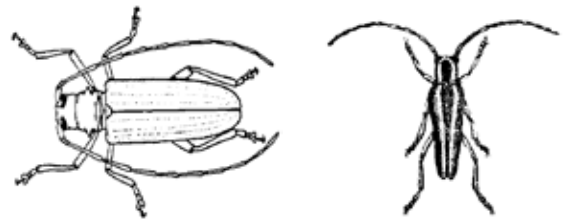

There are more than 1,200 known species of these beetles in the U. S., all of which lay their eggs in cracks

or crevices in bark or on the surface of rough-sawed timbers. Mature larvae are thin-skinned, large and grotesque wood borers, varying from 1/2” to 4” long, having deep folds between their abdominal segments (like a corrugated hose) somewhat cylindrical and have a large fairly cylindrical thorax, but sometimes their shape is like an ice cream cone, the head being vanilla. The larvae’s normal cylindrical shape normally produces similarly shaped burrows - hence the name round-headed borer (or larvae). The body is usually straight, long and narrow and whitish to a light cream color. The rear portion of the head usually is partly hidden so only the mandibles and mouth parts are clearly visible. The adults in the family Cerambycidae usually have very long, thin antennae - that may even be longer than their bodies - hence the name longhorned beetles. The two most important pests of buildings the (Old and New house borers), however, do not have particularly long antennae. All adult cerambycids do have large, strong toothed mandibles.

Adults are large, usually cylindrical, elongated beetles (from 1/4” to 3” long). Some species that attack hardwoods are brightly colored; they all have long, thin antennae and may have conspicuous markings on the wing covers. Because the antennae often are longer than the body, the adults are called “long-horned” beetles.

New House Borer - *Arhopalus productus* (LeConte) is usually found when you see exit holes in the subflooring, hardwood flooring, linoleum, plaster or plasterboard and roofing of new houses. You will find them outside in most of the Western U. S. and Canada, where they infest dead or dying coniferous (cone bearing) evergreens such as firs, pines, red cedar, spruce, etc., but especially Douglas fir. They usually attack trees previously damaged by a forest fire, apparently attracted by the smoke.

They always lay their eggs in deep crevices of bark. Eggs cannot be laid in seasoned structural lumber when the bark has been removed, so remove any bark found in your home. They make clean-cut oval emergence holes about 3/16” lengthwise, easily distinguishable from the round holes left by powder post beetles and wood wasps. Around their emergence holes you will find an accumulation of cuttings resembling a pile of cigarette tobacco.

They live about 2 years, but are usually only found in new homes during the first year because the drying-out wood becomes unsuitable for further larval development. Only full grown larvae will survive to maturity. Adult beetles are 7/8” to 1-1/4” long, narrow and black in color. Larvae are up to 1-5/8” long and ice cream cone-shaped.

There is no possibility of further structural danger from their infestations, and there is no need to treat. Most often, minor cosmetic repairs will correct the problem.

ASIAN LONGHORNED BEETLE - America under Siege by Alien Invaders

The U. S. Department of Agriculture’s (USDA) animal and Plant Health Inspection Services (APHIS) needs your help in preventing the spread of an Asian longhorned beetle (*Anoplophora glabripennis*) (Motschulsky); this native of China and Korea has become a formidable and serious pest of hardwood trees. There are known infestations of this terrible insect in the U. S. in the streets and parks of Chicago, New York City, Brooklyn, NY, and in Amityville, NY. This Asian longhorned beetle is extremely destructive to trees. It is known to attack healthy maple trees (including Norway, sugar, silver, red and others), horse chestnut, poplar, willow, elm, mulberry and black locust. It also may attack other hardwoods. In New York, the beetle appears to prefer maples and horse chestnuts. The large, bullet-shaped beetle is shining coal black with white spots and is about 1/2” long. On its head are very long, horn-shaped antennae (feelers) that are black with white rings and are longer than the insect itself. The plate-shaped feet are black with a whitish-blue upper surface. Telltale signs: The white, worm-like immature beetles bore into tree trunks and branches, causing heavy sap flow from wounds and coarse wood shavings and/or large sawdust accumulations at tree bases. A generation probably takes 1 - 2 years to complete.

Adult beetles leave round holes that are 3/8" or larger in the bark. Yellowing leaves and leaf drop and dead and/or dying branches and exit holes are other indicators that the pest is present. This information was found on the web and provided by Insect Identification Lab, Department of Entomology, Virginia Tech, Blacksburg, VA 24061-0319; <http://everest.ento.vt.edu/> New web site: <http://whizlab.isis.vt.edu/servlet/sf/ento//index.html>. By 2001, over 6000 infested trees were removed in New York and Chicago.

OLD HOUSE BORER

Class - Insecta

Order - Coleoptera

Family - Cerambycidae

Metamorphosis - Complete

The most destructive insect of this family is *Hylotrupes bajulus* (Linnaeus), the old house borer. It is a fairly common pest and its larvae hollow out extensive galleries in seasoned softwood (like the new house borer), but the old house borer can and does reinfest seasoned lumber and infest your home after construction. The old house borer requires seasoned, wide-grain wood of softwoods, e.g., pine, spruce and fir to which no paint or permanent finish has been applied, so paint or stain or finish any unfinished wood or lumber. Originally from Northern Europe. Because it is commonly found in (unburned) wooden boxes and packing crates and (untreated) prefabricated and log homes, eventually it will be found throughout the entire U. S., especially wherever there is an August mean temperature of about 73° F. You will find that it usually infests well-seasoned coniferous wood and (unseasoned) pine in newer structures and a few older buildings, usually in the eastern U. S. along the Atlantic Coast (more often in Maryland, Virginia and North Carolina), and as far west as Texas and Minnesota.

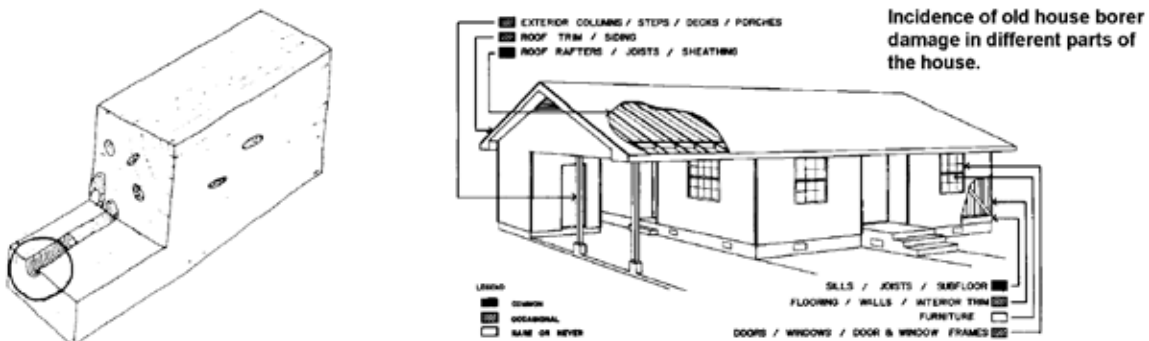

Slightly flattened adults are grayish-brown to black covered with gray or yellow-gray hairs on their heads and foreparts of their bodies and they are strong fliers. Females may be nearly an inch long while the males may be only about 3/8" in length in a white patch on the back elytra (pair of thickened forewings covering the hind wings). On the pronotum there are 2 black, shiny bumps, usually surrounded by long gray hairs, so they have an owl-like appearance. Usually 150 - 200 eggs are laid in a joint between two pieces of wood or into a crack, crevice or checkmark with an ovipositor. Antennae 1/3 the body length or more.

Their larvae are typical round-headed borers up to 1-1/4" long, thin-skinned and have 3 black eyespots (ocelli) in a row on each side of their oval heads and they live 2 to 12 years in the larval stage in seasoned softwood, although this can be even longer if environmental and nutritional conditions are not favorable. Their abdomen looks like it is made up of a series of large beads. Because they have a very long (hidden) life cycle and can conceivably infest the same piece of wood over and over, they could cause serious structural damage (e.g., to roof timbers) before the infestation is discovered. When nearly fully grown, old house borer larvae can be heard eating and tunneling from several yards away; this noise can be heard from spring to fall for many years. Usually the possibility of structural damage from 1 - 2 larvae is very slight, but the emotional impact on the homeowner is quite significant! Because the adults live only 8 - 16 days after leaving the exit holes and lay eggs in May - July, and their **larvae usually feed for years without breaking through the surface of the wood.** This means you must very carefully inspect and **sound** infested wood to find any galleries or visible boring dust. When the galleries are clean they often appear to have a wavy pattern like sand over which water was washed. If emergence holes are present, they will be broadly oval and about 1/4" to 3/4" in diameter, but there are only a few visible emergence holes for the first few years. Some periods of low temperature are needed for pupation to be completed. In fresh-cut log homes the larvae can complete their metamorphosis in two years.

Adult beetles typically emerge to mate in June, July and August. About 175 eggs per female are laid. The eggs hatch in about 9 days and immediately bore into the wood.

Even though the old house borer larvae are also able to digest cellulose directly (without the aid of yeast or protozoans) they still need some other cell contents, i.e., sugars, starches and protein, for development. They need a minimum of 0.2 % protein; this is usually found in the sapwood nearest the bark or in decayed wood where they can use some species of fungi for a protein source. They need to be in wood that has at least 10% moisture content, **so install and use fans, an air conditioner and/or a dehumidifier.** They prefer spruce, pine, hemlock and fir lumber.

As the infestation progresses (when the larvae are 3½ - 4½ years old) you can hear the larvae boring into the wood (several feet away), making a rhythmic ticking or rasping sound like a mouse gnawing. Sometimes the very fine, powdery frass (sometimes with barrel-shaped fecal pellets) is so great in one area it causes the thin surface to bulge out or “blister”....probe these areas.

There is a lot of evidence to indicate that in heated, well ventilated, occupied homes old house borers rarely reinfest beyond the first generation. It is not uncommon to find only a few boards are infested in an entire home, which could be surgically removed and replaced with sodium borate or borax treated wood. In spite of all this, a great deal of *professional treatment* (particularly fumigation) is routinely performed. Sodium borate should be used if you wish to permanently control both the fungi and larvae. **Properly install and maintain air conditioners, dehumidifiers, vents and/or fans.** Usually you can treat with sodium borate basically for peace of mind - occasionally to prevent structural damage.

Flat Oak Borer - *Smodicum cucujiforme*, is about 1/3” - 2/5” long, flattened and dull yellow in color. They are found in the Atlantic and Gulf Coast states and are common pests in oak and can reinfest.

Some other species of Cerambycids, e.g., the spined pine borer, black pine sawyer, four-spotted longhorn, black timberman, banded alder borer, nautical borer and others **can be found in nature** and may require treatment of the living ornamentals which they infest, but **do not use sodium borate or borax on them because too much can kill plants; follow the label directions exactly.** We are now working with antibiotics, colloidal silver, bacteria and enzymes systemically.

BARK AND TIMBER BEETLES

Family - Scolytidae



Bark and timber beetles of the family Scolytidae and of the genera *Dendroctonus* and *Ips* may also be of concern to you. The bark beetles excavate extensive galleries immediately beneath the bark and their eggs are deposited within these galleries. **The scored patterns of their tunnels distinguish the groups within this family and has given them the nickname “engraver beetles”.** The timber beetles excavate tunnels in solid wood. Some of them can derive nourishment directly from the infested wood. Others need to feed upon fungi which they grow within their galleries. These beetles are usually (but not always) associated with dead or dying trees or green wood. The damage remains in the wood after it is cut, but does not increase because the insects are unable to live in dry wood.

The bark beetles may infest log cabins, park shelters and similar structures made of rough-hewn wood in which the bark or small areas of bark are left in place. They may take 2 - 3 years to emerge from circular emergency holes 1/16” to 3/32” in diameter and are attracted by light. Other common sources of bark beetle infestations are fences, rustic lawn and porch furniture and firewood brought indoors during winter.



Timber beetles are sometimes troublesome when they emerge from improperly seasoned wood used in hard wood floors or paneling, but they **cannot reinfest** the dried wood or bark, and they cause no real loss of structural strength to the wood from which they emerged and, therefore, **need not be treated.**

The scolytids are small (1/16" - 1/4" long), cylindrical, robust beetles, usually brown, reddish-brown or black in color and have elbowed antennae that bear a large expanded club. The club usually appears to consist of a single segment which is much wider than the preceding segments. The larvae do not have legs and do not damage seasoned wood.

Another group of beetles belonging to this family and the family Platypodidae (the flat-footed ambrosia beetles) are the ambrosia beetles. Most of the scolytids are short and stubby and less than 1/8" long, while the platypodids are slender and about 3/8" long and do not consume the wood and throw out all of their frass, cleaning and widening the galleries for themselves and their larvae to freely move about as they feed on the fungus. They are so named because their larvae feed only on the ambrosia fungus which grows in their galleries in moist, unseasoned or green softwoods and hardwoods. The beetles introduce the fungus spores into their tunnels, and wherever the fungus grows, the wood is stained blue, black or dark brown, especially around their galleries, and circular emergence pinholes 1/50" to 1/8" in diameter. These stains indicate ambrosia beetle infestations. The damage is sometimes confused with powder post beetle damage even though the stains are very visible. It is important to know the difference because powder post beetles can reinfest wood in structures and ambrosia beetles cannot. If live ambrosia beetles are found indoors, the most likely source is new firewood. **Since their attack ends before or shortly after wood is brought indoors, no control is needed, unless the wood is constantly wet, i.e., wine casks or hot tubs.**

WHARF BORER

Nacerdus melanura (Linnaeus)

Family - Oedemeridae

Class - Insecta

Order - Coleoptera

Metamorphosis- Complete

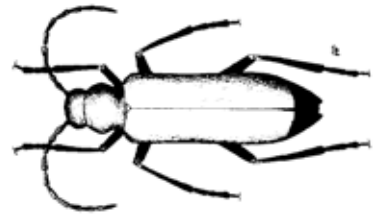

Wharf borers are usually about the size of a German roach and are usually found along the coastal areas of lakes, rivers and oceans. They can be a serious pest in pilings and wharves where the larvae excavate (dig out) extensive galleries, weakening the timbers and providing access for secondary infestation by rot/decay organisms. This pest may be found throughout most of the U. S. and Canada, in buildings in which poor drainage or faulty plumbing creates very moist wood, especially pilings and other earth-wood contacts, e.g., in wood lying on damp ground or wood that has been buried beneath the soil at construction sites.

The adult beetles are 1/4" - 9/16" long, bodies elongate, slender and soft-bodied and look like (narrow) long-horned beetles, but do not belong to the same family. They emerge from round exit or emergence holes approximately 1/4" in diameter. They may be yellow to red-brown with black tips on the leathery wing covers, each bearing lengthwise raised lines; legs and the underside of their bodies are black to brown. Antennae are about half the body length. The whole body is usually thickly covered with short, fine yellow hair. Adults emerge generally from April to July and are attracted to the light. The wharf borer larvae are usually cream colored with brown mouthparts and black mandibles and are more than 1" long, very narrow, cylindrical and covered with brown hairs. They bear a wart-like swelling on the upper side of the last 2 segments of the thorax and the first 2 segments of the abdomen and on the underside of the third and fourth segments of the abdomen.

You will find the wharf borer along the Atlantic and Pacific coasts and near the Great Lakes and elsewhere across the U. S. The larvae feed on wood which is already very wet and decayed, but their infestations further worsen the problem. Thousands of adults may suddenly emerge from the wood and create a nuisance in their attempt to escape the your home. Removal of debris and all earth-wood contacts is the best control in your home, e.g., crawl. Because they can reinfest docks or infested wood boats, it may be necessary to fumigate, inject food-grade DE, diluted peppermint soap with enzyme cleaner, use temperature controls on them, or simply replace the damaged wood with borax or sodium borate treated wood. Sodium borate or borax will kill them but it usually must be sealed in or it may leach out. You might try IMPEL RODS here as a fungicide that may also control (incidentally) the wharf borer.

FLATHEADED (OR METALLIC WOOD) BORERS OR BUPRESTIDS

Family - Buprestidae

Order - Melanophila

Metamorphosis - Complete

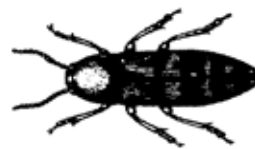

Active infestations of flatheaded borers are rarely seen in structures, but sapwood previously damaged by the larvae is often encountered. If adults (3/16" - 3/4" long) happen to emerge from their oval exit holes 1/8" to 1/2" in diameter within your home, they will not reinfest seasoned (dry or aged) wood; therefore, there is no reason to treat for them. The larvae of all species of (flatheaded) borers in trees and newly cut logs and can be distinguished by the well developed, flattened plates of the upper and lower surfaces of the prothorax. (The area behind the head is enlarged and flattened.)

Adults have short antennae and are flattened, hard-shelled and boat-shaped (wing tips come to a point at the rear rather than having a squared-off appearance). Adults usually have brilliantly metallic colors (some what iridescent) and they make handsome specimens. The scarab so often depicted in ancient Egyptian jewelry probably was a Buprestid. These beetles tend to be flat and their tunnels are broadly oval, tightly packed with fine frass, 3 times as wide as high, more like shallow etchings in the wood than the clearly oval and round tunnels of Cerambycids and the powder posts. Usually the elytra (thickened forewings that protect and cover the hindwings) are ridged or roughened. They are strong fliers and actively seek weak or injured trees to infest in the spring and summer months. Adults tunnel in under bark and lay eggs in "scorings" between the bark and the sapwood. After hatching the flattened larvae tunnel in and under the bark and eventually move into the sapwood and heartwood of dead or dying trees. The larvae (1" - 2" long) are white to yellow (cream-colored) grubs that have no legs or eyes, and are called "flat-headed" because of their very conspicuously widened thorax, just behind their dark and virtually unnoticeable head. Most common species are the Golden, *Dicerca* and the Green. Most buprestids feed until winter, pupate and emerge in the warmer months. They are stimulated and attracted by forest fires and/or heat and can be attracted to other burning materials. They have a tiny heat sensor on their underside that can detect infrared light emitted from forest fires over 30 miles away. The beetle then rapidly flies toward the blaze - seeking freshly burned wood in which to deposit eggs. *Buprestis lineata* (Linnaeus) is commonly found in log homes built with pine logs found in the southeastern and eastern U. S., i.e., white pine, loblolly pine, long leaf and pitch pine. Other flatheaded borers include: *Dicera homi* (Crotch), the Golden Buprestid or *Buprestis aurulenta* (Linnaeus) and the Green Buprestid or *Buprestis langli* (Mannerheim). Metallic wood boring beetles have been used as aphrodisias in China and to increase sexual desire and attractiveness.

INTELLIGENT PEST MANAGEMENT® CONTROL OF WOOD BORING BEETLES

If the damage was caused by one of the true powder post beetles, it will only be necessary to treat articles made of hard woods. In most cases, this will usually involve a thorough application of sodium borate (rather than "registered," volatile, synthetic pesticide poisons) to all visible hard wood surfaces.

If the infestation involves either bostrichid or anobiid beetles, softwoods as well as hardwoods will be eventually infested by the pest. Even if the infestation is only visible in hardwood flooring, it would still be advisable to treat (if possible) the softwood subflooring, etc.

The *professional* pest control *industry* has historically only used a number of volatile, synthetic *residual* insecticide poisons, i.e., 1% chlordane, 1% Dursban TC, coal tar creosote, 5% pentachlorophenol and even 0.5% lindane have all been used *professionally* for such *treatments*). **It was thought in the past that oil formulations resulted in better control because of greater penetration of the wood, but this is not the case.** In addition, oil solutions have the disadvantages of increasing the fire hazard, greater cost, greater health hazard and discomfort, and danger of damage to plants in and around the treatment area. Sodium borate or borax can safely and permanently replace any/all synthetic *residual* insecticide poison treatments here too. **The Author never recommends the use of any volatile, "registered," synthetic pesticide poisons.**

Most volatile, "registered," residual pesticide poisons (other than the non-volatile sodium borate or borax) will continue to volatilize and contaminate your ambient air as long as they are effective. The most difficult problem encountered in such treatments is getting the insecticide poison to the insects which are concealed and fairly well shielded in their burrows. Although a material with longer *residual* life would kill the beetles shortly after they emerge, it may be desirable to kill them in their tunnels so that they will not mar the

surface of the wood with emergence holes after metamorphosis. The best penetration into the tunnels might be obtained by using a fumigant, but the high cost and danger in handling these materials and the fact that they have no effective residual life stops us from ever recommending them, so we use the pestisafe® peppermint soap with DOT to reach in and “grab them”. *Residual* sprays should be applied with a cone or fan nozzle to obtain thorough coverage and applied at a low pressure to lessen splashing, or in the case of (non-volatile) sodium borate, simply brushed, fogged or sprayed on, injected or dusted in the voids and galleries.

In treating finished wood such as furniture or flooring, volatile, synthetic pesticide poisons have been historically used in an oil solution to try to avoid spotting. As a last resort, even with the oil solution, it is best to apply a small amount to an out-of-the-way area and allow it to dry before making a complete treatment because the oil itself may destroy some wood finishes. Therefore, keep all objects off treated areas for about 24 hours. Do not allow any surface to be walked on or handled until it is thoroughly dry. If there are only scattered patches of infestation, you can spot treat only the infested boards. Avoid over-treating where the oil solution runs off or puddles, particularly on hardwood floors which are laid over asphalt paper or asphalt-based mastic. The asphalt will be dissolved by excess oil and may bleed through the finished floor. Any excess solution should be wiped up immediately. Be careful not to mar the surface by the spray. Then try to seal the poison in. We prefer to use sodium borate or borax (in water) according to the labeled directions rather than any toxic, volatile, “registered,” synthetic *residual* pesticide) (in oil).

When it is difficult to apply a spray to control powder post beetles, the *industry* often resorts to fumigation, especially when the beetles have moved into walls and other inaccessible areas. In this case, the entire building is covered with gas-proof tarpaulins or light-weight plastic sheets, and fumigated with methyl bromide (2-1/2 lb. per 1000 cu. ft.) or sulfuryl fluoride. Detailed directions, as well as instruction, can be obtained from the manufacturers of the gas being used. We don't recommend their use for many reasons including safety and lack of residual effectiveness. **War gases and volatile, “registered” pesticide poisons and/or “registered” fumigants are similar in many respects. All are extremely poisonous to man.** Thoughts of chemical warfare are frightening, yet fumigants and volatile pesticide are often handled as though they were as harmless as water. Fumigants and many volatile, active ingredients in pesticide poisons are odorless, colorless, tasteless, deadly gases or chemical pesticide poisons that produce, or are applied as, toxic nerve gases or vapors. They all must be in the gaseous state before they can be *effective* as fumigants or volatile pesticide poisons. Fumigants, even compared with many synthetic pesticide poisons, have no residual or lingering effectiveness; i.e., the fumigated area is subject to reinfestation just as soon as the fumigant is aired out. Often the fumigation, even when done per the “registered” label, does not eradicate all of the current pest infestations. Many fumigators have told me so. All fumigants are quickly lethal (acutely toxic) to man and other warm-blooded animals at the same concentrations that are effective against insects. Fumigants diffuse as individual molecules in the gaseous state; the colder the day the longer the gas takes to kill the pest and decompose. Some present a fire hazard, permanently injure/corrode some items and all are extremely dangerous and require considerable training, skill and experience in order to even do a *temporary* control job *safely and effectively*. We feel it would be better and cheaper (especially in the long run) even if you have to remove the walls and completely spray or brush all of the exposed wood with non-volatile sodium borate or borax.

If the old house borer is to be controlled, the emphasis shifts entirely to treatment of softwoods only which this pest infests. Infestations of this beetle often involve extensive excavations, and larvae may be considerable distances from the original points of infestation. For this reason, the industry historically drilled into infested timbers and introduced volatile, synthetic *residual* chemicals under pressure to force the toxicant throughout the gallery system. Pentachlorophenol emulsion pastes have also been used, but repeated applications were often necessary to get the recommended amounts of poison into the wood. If the poison *industry* considers the infestation is too widespread for spot treating with volatile, *residual* sprays, fumigation may again be *necessary* for temporary *control*. Other long-horned beetles require no control. **Again, we only recommend the labeled use of sodium borate to gain safe, permanent (non-contaminating) control.**

The presence of ambrosia, bark and timber beetles is an incidental occurrence, and the number of beetles emerging is generally small. Such situations seldom require any treatment because reinfestation is rare, although **simply vacuuming up the emerging beetles** is sometimes desirable and/or **often all that is needed to control these pests.**

Buprestid beetles do not require control either because, like the long-horned beetles and bark beetles, they only attack dead or dying green trees, and if they do emerge after construction, **they will not reinfest the now seasoned wood.**

Wharf borer infestations have historically been *treated* with pentachlorophenol either alone or in combination with another poison. The fungicidal properties of this poison also helps combat the rot organisms which are usually associated with this insect; it usually is *professionally* injected into the infested wood under pressure and should always be covered with at least two coats of sealer. We believe that replacement of damaged lumber should be made only with sodium borate-treated lumber. The correction of moisture conditions in infested wood should be done before there is any use of any volatile insecticide poisons. (If you use sodium borate here, remember to follow the label and seal your treatment. Do not apply to wood in the ground or exposed to rain.) If emerging adults are creating a nuisance, simply vacuum them up.

When wood-boring beetles infest furniture or other movable articles, one of the most usual and rapid means of *professional* temporary control is vault fumigation. Infested articles are also wrapped and tarped and then fumigated if a vault is not available. Methyl bromide is the most commonly used fumigant. Another successful means of temporary but safe control is subjecting the infested materials to dry heat at 180° F. for 30 minutes. This type of treatment must be approached with caution since it may result in warping of the wood or damaging of the finish. Rustic furniture can be dipped in solutions of sodium borate or borax or simply sprayed 3 times to the point of runoff with sodium borate or borax (letting dry each time) and then sealed.

BARK BEETLES

Family - Scolytidae

Adults are small (1/16" - 7/16") bodies elongate, cylindrical, slender, usually brown, reddish or black with heads almost completely hidden from above. The 2 most common genera are *Dendroctonus* and *Ips*. There are many species.

Bark beetle adults lay eggs beneath the bark and larvae eat only near the surface of the sapwood. Often they are found in structures where some attic or crawl timbers may still have bark at the edges. Frass is fine, brownish-white sawdust. **Adults do not reinfest dry wood or bark** and, therefore, no control is necessary in structures except occasionally in log cabins or rustic furniture.

AMBROSIA BEETLES OR WOOD STAINERS

Families - Scolytidae and Platypodidae

So named because the larvae feed only on the fungi (*ambrosia*) which grows in moist, usually green wood. Adults bore directly into the wood for several inches, then construct egg chambers off each side of the tunnels. Because of the fungus on which they feed, galleries are stained the color of the fungus (dark blue, brown or black). These stains are the key to identification of these infestations), especially because the stains do not appear in powder post infestation. *Trypodendron lineatum* (Oliver) is most widely distributed in the U. S. and Canada. It is a pest of recently felled timber. **Ambrosias do not reinfest dried wood and should not be treated.**

FOR CONTROL OF ALL THE WOOD-BORING BEETLES USING SODIUM BORATE, PLEASE TURN TO THE SECTION - Permanent Wood Destroying Organism Control

WOOD WASPS (HORNTAILS)

Family - Siricidae

Wood wasps cause cosmetic damage to new structures by defacing finished surfaces, as the adults emerge from infested structural lumber. The exit holes of wood wasp adults are not found necessarily in the lumber originally infested - but in whatever materials the adult insects must penetrate in their attempts to leave the infested wood and fly away. Their frass (sawdust) looks like loose cigarette tobacco. These are not true wasps, although they may look like them and belong to the order Hymenoptera and are generally over an inch in length. The basic

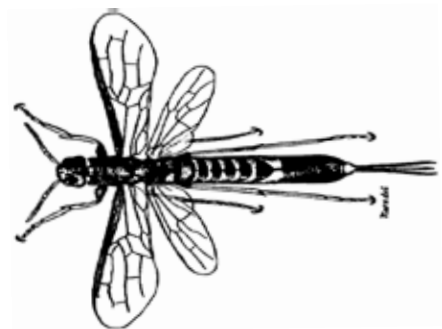

difference is that the wood wasp's thorax and abdomen are uniform in width and closely jointed (like a termite) while the true wasp's abdomen is joined to the thorax by a narrow petiole (like an ant). Wood wasps neither bite or sting. Adults (of the species which attack softwoods) are black or metallic dark blue or a combination of black with red and yellow; the last segment of the abdomen bears a "horn-like" projection; the female also bears a long, slender ovipositor there too. There are about 50 different species of horntails in the family Siricidae, approximately 20 of them occurring in the United States. They belong to four different genera, one of which infests hardwoods. Those in all of the other genera attack softwoods, and some are common pests of the coniferous trees we routinely use for construction. Larvae are cylindrical, creamy-white or yellow, slightly S-shaped and have a small horny spine on their rear end which they use to pack frass and to gain support by driving the spine into walls of galleries. Like many wood-attackers that do not reinfest seasoned wood, the horntail only infests dying trees, newly felled logs and freshly sawed lumber. The female uses her long ovipositor (egg placer) to insert several eggs deep into crevices of bark. Her larvae then make tunnels that curve and are up to 2 feet long into both sapwood and heartwood. Tunnels are tightly packed with coarse frass and cast skins (from molting). Life cycle is usually about 3 - 5 years.

Wood wasp infestations are usually found when you see the 1/4" holes (which normally appear within the first 3 years) left by emerging adults, holes in wood and in most any wood covering such as wallboard, plaster, carpeting, linoleum, hardwood flooring, etc. **Inasmuch as adults do not reinfest, no control is required** - usually only cosmetic damage repair or caulking is needed and/or for you to treat the fungi in the galleries with sodium borate and/or with diluted Safe Solutions, Inc. Enzyme Cleaners and/or borax.

Mating of wood wasps takes place in tree tops where the males congregate and remain, whereas after breeding the females have to descend to the lower levels to do their damage (Ovipositing).

WOOD-BORING WEEVILS of the family Curculionidae are sometimes called "snout beetles" because of the prolongation of their heads; they are small, hard-bodied, black or reddish-brown, cylindrical and from 1/8" to 1/5" long. Their wing covers are heavily pitted. Antenna elbowed and clubbed, club is 3-segmented and compact. Their larvae are whitish, grub-like, legless and about 1/8" long. Some wood-boring weevils infest seasoned wood that usually is slightly damp or partially decayed. Their damage is very similar to anobiid powder posts which also may be present in the same wood. Eggs are laid in holes excavated by the female or in cracks and crevices; after passing through a larval and pupal stage the adults emerge through raggedly-round 1/16" exit holes or elongated 1/32" to 1/12" irregularly-shaped holes. They attack plywood, hardwood and softwood. When severe both the sapwood and heartwood are honeycombed with galleries up to 1/16" in diameter made by feeding adults and larvae. Their frass is made up of very fine powder and tiny pellets packed in the galleries. Their damage is in direct proportion to the amount of dampness and decay that is present. **Use a dehumidifier and/or sodium borate or borax. Reduce the moisture content of the wood to below 20% - and you have safe control!**

AN OVERVIEW OF DAMAGE DONE BY WOOD DESTROYING INSECTS (DESTRUCTIVE STAGE)

Shape and size (inches) of exit/entry hole	Wood Type	Age of Wood Attacked	Appearance of Frass in Tunnels	Insect Type	Reinfest
round 1/50-1/8	softwood & hardwood	new	none present	ambrosia beetles	no
round 1/32-1/16	hardwood	new & old	fine, flour-like, loosely packed	lyctid beetles	yes
round 1/15-3/32	bark/sapwood interface	new	fine to coarse, bark colored, tightly packed	bark beetles	no
round 1/16-1/8	softwood & hardwood	new & old	fine powder and pellets, loosely packed; pellets may be absent and frass tightly packed in some hardwoods	anobiid beetles	yes
round 3/32-9/32	soft & hardwood (bamboo)	new	fine to coarse powder, tightly packed	bostrichid beetles	rarely
round 1/6-1/4	softwood	new	coarse, tightly packed	horntail, woodwasp	no
round 1/2	softwood	new & old	none present	carpenter bee	yes
round-oval 1/8-3/8	softwood & hardwood	new	coarse to fibrous, mostly absent	round-headed borer	no
oval 1/8-1/2	softwood & hardwood	new	sawdust-like, tightly packed	flat-headed borer	no
oval 1/4-3/8	softwood	new & old	very fine powder & tiny pellets tightly packed	old house borer	yes
flat oval 1/2 or more or irregular surface groove 1/8-1/2 wide	softwood & hardwood	new	absent or sawdust-like, coarse to fibrous; tightly packed	round or flat headed borer, wood machined after attack	no

SPECIFIC KEYS

1. In seasoned or processed wood, numerous small circular holes 1/32" - 1/16" resembling those made by birdshot or darts or nails appear on the surface of wood. If the wood splits open, many frass-filled tunnels can be seen, most of them running with the grain. Loose, floury sawdust in tunnels.

Various Powder Post Beetles

- a. Longitudinal, cylindrical galleries of various sizes (about 1/16" in diameter) and round exit holes 1/32" to 1/16" in diameter in the sapwood of newly seasoned porous hardwoods with a high starch content. (Common in poorly seasoned lumber.) Fine frass (flour or talc-like and packed) in tunnels but readily "powders out". No pellets in powder. Reinfests.

Family: Lyctidae (larva)

- b. Round exit holes vary from 3/32" to 9/32" in diameter in sapwood of seasoned hardwoods due to re-entrance as well as emergence of adult. Occasional tunnels going crosswise to the grain, but majority with the grain. Fine to coarse frass which tends to stick together and is tightly packed in 1/16" - 3/8" tunnels; few, if any, pellets. Usually in (newly) seasoned hard woods such as ash, oak and hickory; sometimes in softwoods. Rarely reinfests.

Family: Bostrichidae (larva)

- c. Round exit holes 1/16" to 1/8" in diameter. More advanced galleries running randomly across the grain. The fine to coarse frass is tightly or at least loosely packed in isolated clumps of different sizes and may consist in part of distinct elongated or bun-shaped pellets, usually gritty and loose in numerous 1/8" tunnels. In seasoned softwoods. Rarely in heartwood. Reinfests.

Family: Anobiidae (larva)

2. In either living trees, seasoned sapwood of softwoods and hardwoods, sometimes in the heartwood and in unseasoned logs and timber; occasional holes, round or slightly oval, 1/8" to 3/4" in diameter. Oval and rather extensive tunnels, mostly in the sapwood with usually coarse to fibrous sawdust or packed frass; frass may be mostly absent or it will be coarse and fibrous; these Cerambycidae do not reinfest, but can tunnel through plaster, felt, shingles, etc.

Roundheaded or Longhorned Beetles (larva)

- a. Usually heavy damage to sapwood of seasoned softwood, primarily pine, fir and spruce. Often only

visible evidence of injury is a few 1/4" to 3/4" diameter elongated and oval exit holes to the outside; oval tunnels packed with very fine powdery dust sometimes mixed with tiny (barrel-shaped) fecal pellets; galleries when clean have a rippled or wavy pattern like sand over which water was washed. Sometimes reinfests, especially in decay-softened wood.

Old House Borer (larva)

3. In living trees, rough timber (lawn furniture, log homes, etc.) tunnels are greatly flattened and winding, elongated or oval exit holes are 1/8" to 1/2" in diameter; also found in seasoned sapwood and heart wood of soft woods and hard woods. The frass is like tightly-packed sawdust and may contain light and dark material if found under the bark. These Buprestidae do not reinfest.

Flatheaded Wood Boring Beetles (larva)

4. In unseasoned bark or bark-covered sapwood, circular emergence holes 1/16" to 1/4" size. Inner side of bark (cambial layer) and surface of sapwood itself "engraved" with galleries. Their "frass" has a salt and pepper appearance. These Scolytidae do not reinfest.

Bark, Engraver and Timber Beetles (adults and larva)

5. Circular pin holes 1/50" to 1/8" in diameter and slender galleries usually centered in a dark streak or ring in unseasoned sapwood and heartwood of living hard woods and soft woods, freshly-cut logs and timber. The galleries normally have no frass, but if the infestation is active, there may be some very fine white, powdery frass and the exit holes and the areas around them are stained dark blue, brown or black by the action of fungi (called ambrosia). These Platypodidae and some Scolytidae do not reinfest and abandon wood below 30% moisture.

Ambrosia Beetles (larva)

6. No openings (or at best a few and then they are usually sealed over). Galleries are extensive and carved length-wise, usually in softwood and plastered or speckled with a hard, plastic-like "mud". Some chambers may be filled with *clay*. May also infest many different cellulose objects near or in contact with the soil. They reinfest.

Subterranean Termites (worker)

7. Wood often has distinct round openings to outside; when split open, it reveals very thorough excavations) of large, clean chambers or broad pockets connected by smooth (small) tunnels or galleries that cut across the wood grain through both the heartwood and sapwood. In unused portions of the galleries you will find numerous small fecal pellets (coarse, hard, sand-like). Each pellet has rounded ends and 6 flattened or concavely depressed sides with longitudinal ridges at angles between the 6 surfaces. They are formed by the pressure on the fecal matter in the termite's rectum where water is extracted and conserved. They reinfest.

Dry Wood Termites (nymph)

8. Usually in unsound, damp, partially decayed, softened or moist softwoods with extensive, entirely clean galleries which are of a polished, sandpapered appearance, often with rounded edges, and containing no frass or debris. Coarse sawdust or wood shavings may be found nearby.

Carpenter Ants (worker)

9. Weathered or unpainted softwoods with 3/8" to 1/2" round entrance holes on side, edge or end, leading into long tunnels and continue with the grain of the wood - from 1/2 to several feet long but usually 12" long with about 6 individual cells.

Carpenter Bee (adult)

10. Elliptical holes 3/16" to 1/4" in diameter, excavated from the outside in ward to a depth of about 1" or less. Sometimes the holes contain larval or pupal skins. In wood usually near stored food products.

Cadelle (larva)

11. Round holes 1/8" to 3/16" in diameter, excavated from the outside straight in ward. Depth varies from 1/2" to several inches. May contain pupae or cast skins. Holes often in end of grain.

Hide or Larder Beetles (larva)

12. Wet or decayed sapwood and hard wood of seasoned softwoods with large, irregular tunnels in the more sound portions of the wood; round exit holes 1/4" in diameter; frass shredded and moist. They reinfest.
Wharf Borer (larva)

13. Sapwood and heartwood of dead or dying trees, exit holes oval (3 times as wide as tall), galleries very flat and winding, tightly packed with frass, walls scarred with fine traverse lines. These Buprestidae do not reinfest.

Metallic Wood Borers (larva)

14. Sapwood and heartwood of both hard woods and softwoods that are slightly damp or decayed; emergence holes are raggedly round, elongated or irregularly shaped 1/32" to 1/12" in diameter; tunnels often appear honeycombed; frass is tightly-packed, very fine sawdust with very tiny fecal pellets. These Curculionidae do reinfest.

Wood-boring Weevils (adult & larva)

15. In earth-wood contacts or decayed wood, cracks and crevices may be sealed with fecal pellets and soft fecal matter. When the wood is relatively sound, galleries follow the annual rings with the sap wood eaten first; if seriously decayed the galleries will be larger and pass through both heartwood and sapwood; varied galleries round, oval and broad) with a velvety appearance, sometimes covered with dried fecal matter. They do reinfest.

Damp Wood, Rotten Wood Termites (nymph)

16. In living trees and unseasoned hardwood in living or dying trees or recently felled logs and firewood; holes variable sizes, round 1/32" to 1/8" exit holes and galleries free of frass, lined with a wood-colored substance and unstained are found. They do not reinfest.

Timber Worms (larva)

O. WOOD DECAY (Fungi is a Latin word meaning mushrooms; fungi is plural, fungus is singular) - A fungus is a plant that lacks chlorophyll and can not synthesize its own food. Wood decay in buildings is a problem where humidity is high and ventilation and/or drainage is inadequate, so use dehumidifiers and fans and improve drainage. Wood decay is the result of a fungus infection that can only grow in wood whenever the moisture content rises to over 20%, wood in basements and crawls usually has a moisture content of from 16% to 18%; using a dehumidifier can even lower this substantially. Decay fungi require a wood moisture content of about 30% for serious damage; the optimum temperature is usually from 70° to 85° F., but they can live favorably in temperature ranges of 50° - 100° F. So properly vent properly and install and maintain dehumidifiers. Note: Hydrated lime is not only a (non-volatile) caustic pesticide - it is also an excellent fungicide and is very inexpensive. **Use with great care!**

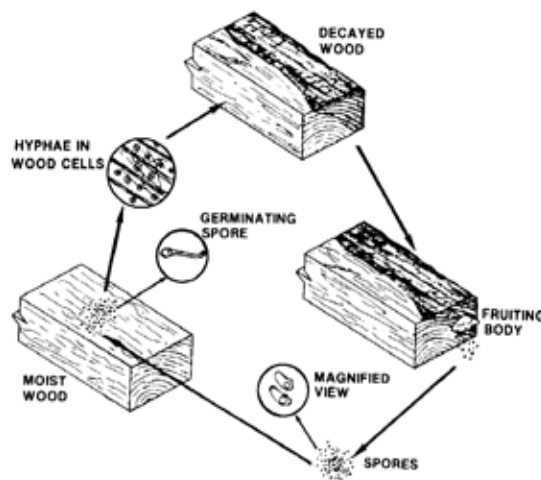

Decay fungi are living (minute) plants which have no chlorophyll, so they cannot produce food carbohydrates and, therefore, must use dead wood as their source of food. Food is taken from the wood by fungi through minute threads (called hyphae which combine into masses called mycelium) which the fungus sends into the wood. The body of the fungus, which remains visible on the wood surface, is called the fruiting body. When mature, these produce millions of minuscule seeds called spores which are always present in the air and the soil. Decay fungi need the moisture content of the wood to be over 28% to grow. It becomes dormant but not killed during periods of freezing temperatures. **Much of the damage blamed on termites is actually caused by fungus attack and both may easily be permanently controlled with sodium borate or borax.** **All fungi require moisture, oxygen, warmth and food.** Some fungi use only the starch and protein in wood and this does not weaken it structurally, i.e., surface molds (mildew fungi) and sapstain fungi. Others extract cellulose from the wood and thereby destroy the structural strength of wood, i.e., brown and white rots. Fungi also cannot live in water-saturated wood. To control fungi, however, it is best to eliminate all moisture problems

and badly damaged wood; replace the damaged wood with dry structurally sound wood. Treat all wood above ground with sodium borate or, if you insist, other wood preservatives such as a paraffin/varnish combination, copper or zinc naphthenate, TBT0 (bis-tributyl-tin oxide) or copper-8-quinolinolate. **If it will be exposed to the elements, apply a non-toxic water repellent and then paint the wood. Use fans and a dehumidifier.**

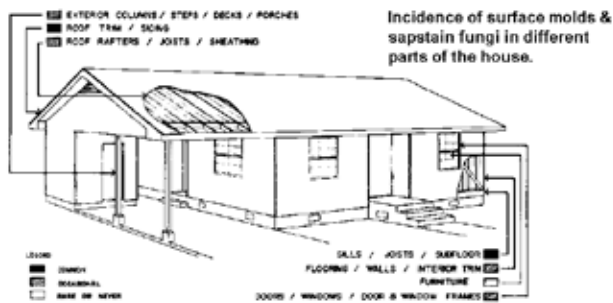

SURFACE MOLDS OR MILDEWS discolor the surface of wood with their own color which can be gray, green, black, yellow, pink or orange. The fungi is powdery in appearance and can be scraped off easily. Their spores (seeds) grow very quickly on moist wood (before it is seasoned or treated) while at the lumberyard or on the building site, or in a finished home. When the wood dries (to less than 20% moisture) the fungus dies but does not change its appearance, which clearly indicates that at some time the lumber was too moist. If you do not have a moisture meter, you must visually check for water leaks,

proper ventilation, etc., because if any of these conditions exist in your home it is open to attack by wood damaging fungi. If no such problems exist, you may assume that infection is dead or dormant or occurred prior to construction and does not need to be treated. **Use a dehumidifier, fans and/or air conditioning.**

SAPSTAIN (or BLUESTAIN) FUNGI are similar to surface molds, the visible difference being that the discoloration penetrates deep into the wood and the wood becomes blue, black or gray and will not scrape off. Sapstain does not structurally weaken the wood except for fiber products, e.g., chipboard.

(CUBICAL) BROWN ROT infection causes wood to darken and become brittle. The wood shrinks, warps and it cracks along as well as perpendicular to the grain causing a checkerboard appearance. Eventually the wood becomes dry, then powdery. Brown rot often is incorrectly called “dry rot”, which describes the appearance of the decayed wood, but “dry rot” only occurs when the wood is moist. Brown rots cause decay by extracting cellulose which is the main support of cell walls in wood, thus depriving it of strength, and is the most common form of wood decay. **Sodium borate will kill this rot with concentrations as low as 600 ppm or 0.3 per cent. Brown rot fungus growth attracts termites.**

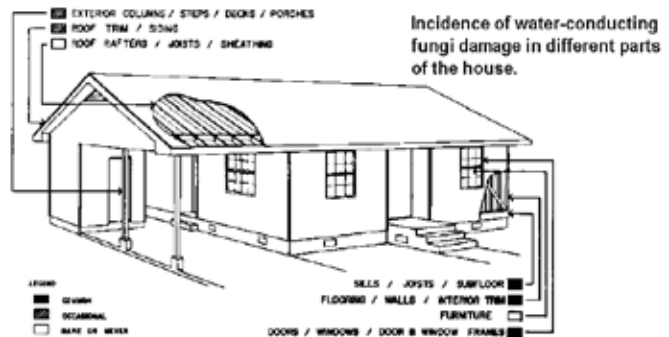
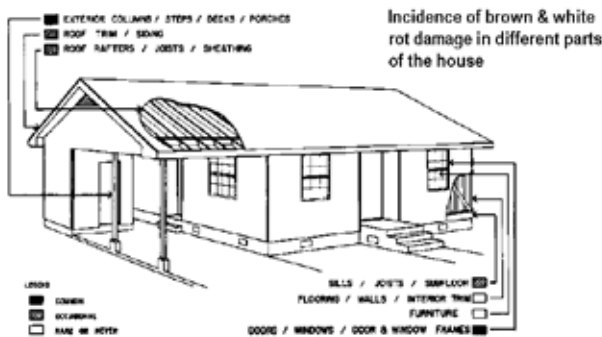

WATER-CONDUCTING FUNGI - Most fungi are able to survive only on moist wood and will not attack adjacent dry wood. There are, however, 2 kinds of brown rot fungi that are able to conduct water up to 30' in order to moisten normally dry wood then feed upon and destroy it.

***Poria incrassata* (Berk. &Curt.)** seriously damages mostly coniferous wood, (but the fungus is an omnivorous saprophyte that can attack and destroy virtually any commercial wood) and is most common in southeastern and western states. It produces the usual threads (mycelia) but they then form together in root-like strands that comprise or are called rhizomorphs (pronounced rise-o-morfs; rendered from Greek words that mean root-shaped). Rhizomorphs vary in color from white to brown to brownish-black as they age. They can be up to 1/4" thick. The rhizomorphs are water conductors which can “rise” or extend across bricks, stone, concrete, etc. in order to reach and attack dry wood, even up to the second and third floors of a building. When rhizomorphs reach wood, they flatten out over the surface of the wood in a mass of mycelia of which they are composed, first moistening the wood, then penetrating into it and causing decay. Wood so infected sometimes

may appear sound on the surface and yet be decayed within. Normally occurs in new or remodeled homes and can cause extensive damage within 2 - 3 years. Infested wood become very light in weight, and loses its structural strength - because of the loss or extraction of its cellulose by the fungal hyphae. It is our most destructive fungus, the term *dry rot* probably is derived from the appearance of the wood after the fungus is dead. **Control is simple: Break the connection between the source of the water and the structural member - the wood will then dry out and the fungus will die or treat the wood with sodium borate.**

***Merulius lacrymans* (Wulf.) is the second water conducting brown rot fungus and is commonly called the "tear fungus".** It appears in the northern states and Canada. It produces the same kind of decay (on coniferous woods) as *Poria incrassata*. The name *lacrymans* is Latin meaning "weeping" because this fungus produces numerous globules of water (tears) on the surface of the wood it infects. Treat with sodium borate.

SOFT ROT is a less severe form of wood decay. The fungi attack the surface and soften the wood inward. The wood must be very wet, i.e., buried in earth, under water, cooling towers or pulp wood chips.

WHITE ROT in wood causes it to be fibrous and spongy, considerably bleached of color, hence their name. The wood, however, will not shrink as with brown rot until the decay is well advanced. Like brown rot, they do extract the cellulose from the wood, which deprives it of its strength. 600 ppm of sodium borate will also control this rot.

WHITE-POCKET ROT or *Fomes pini* (Thore) is another rather common fungus that does not structurally weaken wood; it only attacks the heartwood of living trees. When wood from infected trees is seasoned, this fungus dies. Wood infected by white-pocket contains many small, white pockets. White-pocket rot can be found anywhere, but especially in softwood lumber from the West Coast. **White pocket rot fungi die when the wood is seasoned and dry - so, no control is necessary.**

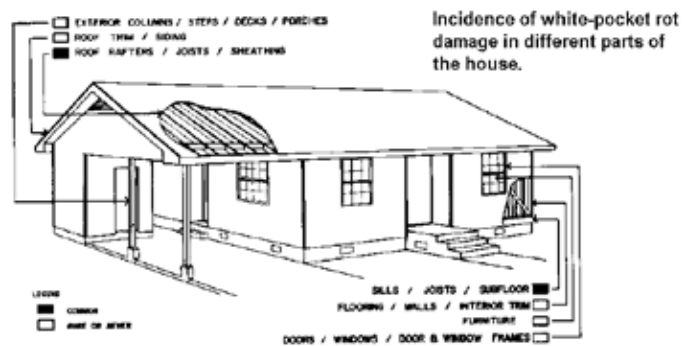

DECAY CONTROLS

- Build on a well drained site.
- Infected structural members should be replaced with sound, sodium borate, naturally resistant, or, as a last resort, pressure-treated wood. Try carefully using borax or hydrated lime if you can not get sodium borate.
- All earth-to-wood contacts and wood debris must be eliminated. Caulk all exterior joints.
- All visible sources of moisture must be corrected (i.e., plumbing and roofing leaks, siding problems, condensation, poor drainage, improper ventilation, grading, improperly installed gutters and downspouts, broken drain tiles, etc.).
- Proper adequate cross-ventilation should be provided in attics and crawl spaces. As a general rule of thumb for crawl spaces, at least 1 square foot of opening should be provided for every 25 lineal feet of foundation, so **use vents, fans and/or dehumidifiers**. See also "Correcting Moisture Problems." Use a moisture meter and check all exposed wood. Install a vapor barrier over 80% of the soil. Install air conditioning if necessary.

A less obvious source of moisture is when a your home is air conditioned or near a body of water. Moisture produced by mopping, washing clothes and dishes, breathing, showering, baths, baking, etc. can create moisture problems. A poorly vented crawl can produce over 12 gallons of water per day per 1,000 square feet! **When your crawl space has been properly vented and your drainage has been corrected and the problem of wet or damp soil persists, 4 - 6 mil sheets of polyethylene or rolled roofing can be installed over the soil under the house.** This vapor barrier catches soil condensation as it rises but before it reaches joists and subflooring, then returns the dampness to the ground. **Use a dehumidifier and fans.** Another source of moisture is the soil fill under a raised concrete porch, especially if construction timbers have been left in the fill. In such case it is may be necessary to first remove the fill and correct the earth-wood and moisture problems, before beginning any treatment. Once again, the first step to stop decay is to determine the source of moisture and eliminate it

if possible. **Properly install vapor barriers, vents, dehumidifiers and/or fans.**

All badly rotted woods should be removed and replaced with sound, dry lumber (treated with sodium borate) When it is not possible to eliminate the source of moisture entirely, the replacement lumber should only be pressure-treated. Plastic beams or pressure treated wood can also be used wherever the wood will contact the soil or be driven into the ground. **(The Author does not recommend arsenic treated wood.)**

Fungus infested wood has historically been *professionally* treated by the poison *industry* in place with preservative chemical poisons, i.e., tributyltin oxide, copper sulfate, coal tar creosote, zinc chloride and other chlorides, inorganic arsenicals, patented preservatives or pentachlorophenol in oil has been sprayed or brushed on to wood surfaces. **The Author does not recommend their use.** They all are usually applied in 2 or 3 separate coats and each treatment is made as heavy as possible without undue runoff. Penta was also applied as a water emulsion paste and one application was usually sufficient. Penta treatments should be carried out only when the wood is dry, otherwise the preservative will not penetrate the wood. It is very important to point out that even the “professional” application of synthetic *residual* fungicides or synthetic *residual* insecticides to fungus infested wood or soil will not (always) stop the wood decay. **Only by eliminating the moisture source can wood decay fungi be absolutely controlled.** Moisture must be eliminated and ventilation made adequate. If this cannot be done, then infested wood should be replaced with sound, pressure treated or sodium borate treated wood. **DRY WOOD WILL NEVER DECAY**, but the real question is not control but danger - the probable/ actual contamination of the ambient air and people by these volatile synthetic *residual* preservatives. This is not the case with sodium borate treatments which actually penetrate better when the wood is wet. It is very important to try to protect the interior parts of the timbers from decay if they should get wet again. In applying pentachlorophenol (even outside) you should be careful not to breathe the fumes and to protect your eyes and skin from contact with this toxic chemical. (While the State of Michigan (at the time of this writing) still allowed the use of pentachlorophenol and creosote, we do not recommend their use (especially inside) even if they are covered with two coats of sealer.) In fact, many applications of penta and creosote have already been severely restricted **nationally** and are really not available for general use. Therefore, we only recommend the use of sodium borate which can be sprayed, fogged, injected, placed in or brushed on and then sealed and should (permanently) control decay fungi - **follow the labeled directions. See also mold/fungi in Chapter 20.**

FOR CONTROL OF DECAY FUNGI USING SODIUM BORATE, PLEASE TURN TO THE SECTION — Permanent Wood Destroying Organism Control.

WHAT YOU WILL NEED TO ACCURATELY AND REGULARLY INSPECT YOUR HOME/BUILDING:

A. STEP LADDER - Never step on furniture or shelving to reach upper areas or an attic. Do not scratch floors or walls and furniture with ladder when you move it.

B. SOUNDING/PROBING TOOL - Use an ice pick or medium flat-head screwdriver sharpened to a cutting edge on a grinding wheel. Select one with a heavy plastic handle that is adequate for sounding suspicious surfaces or use a hammer. Sound carefully striking the wood surface with the handle) without harming or scratching the surfaces. Wherever you hear a dull, thudding sound, examining them further by gently probing the finished surfaces with the sharpened edge. You can be more aggressive (but not less careful) probing the unfinished structural members in the attic, basement and crawl space. Probe irregular surfaces and into what may be exit holes. Dry woods keep active galleries clean; if your probing an exit hole produces a stream of pellets, continue probing to where galleries are clean. That's where the live ones are. Always try to find all live infestations and all tubes and damage.

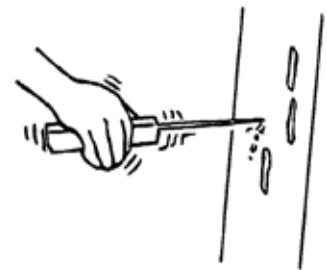

C. BRIGHT FLASH LIGHT & SPARE BATTERIES & BULBS - It's your most important tool and it's common sense to have spares handy rather than interrupt your inspection to run to the store. A very compact, bright light to use on any inspection is a scuba flashlight e.g., UKE4AA. Fiber-optic scopes can provide views of hard to inspect areas.

D. CLIPBOARD KIT- Pen, pencils, calculator, graph paper and scratch paper.

E. GLOVES - Keeps your hands cleaner, lessen the chances of splinters and cuts; cloth work gloves are satisfactory. **Always wear gloves** when turning over or moving firewood, boards, foam, rocks, stone or debris, especially where spiders, snakes and/or scorpions are common.

F. HARD HAT & KNEE PADS - (and often a dust mask for respirator) will further protect you, especially if you have allergies.

G. MAGNIFYING GLASS - The simple lens is enough to help identify wings, frass, galleries, grubs, etc.

H. COVERALLS - Put them on before crawling or entering any dirty areas (e.g., attics, crawls, etc.) and take them off and wash them immediately after your inspection, but shake out the dust/dirt outdoors rather than in your home.

I. MEASURING TAPE - Carefully make your measurements. With regard to measurements, use these formulae:

	L = length	W = width	H = height
1.		AREA (sq. ft.)	= L x W
2.		LINEAL FEET	= 2L x 2W
3.		VOLUME (cu. ft.)	= L x W x H

J. INSPECTION MIRROR - Saves hours. There are many areas that can only be seen with an inspection mirror. Flash your light into the mirror and it will illuminate most of the hidden areas and surfaces you need to see.

K. MOISTURE METER - Electrical resistance of wood decreases as its moisture content increases. Insert the two needles of the meter along the grain of the wood. The electrical resistance between the needles reads directly on the meter as the percentage of moisture content of the wood. A satisfactory meter has a range of 6% to 30% moisture content. The moisture content of structural lumber should be below 20%. When the temperature is below 70° F. or above 90° F. you must apply correction factors to the moisture reading as supplied with the meter. Especially check the soil moisture around or under the foundation to determine if constantly wet areas exist next to your home caused by faulty grade construction. Wood materials adjacent to swimming pools are very susceptible to wood destroying organism attack because of the moist conditions caused by splashed water. **Moisture control is the most critical element in the long-term control or management of most wood destroying insects including termites. If the moisture reading of any wood member is above 20%, you should check for and correct all moisture, drainage and ventilation problems. Use a dehumidifiers, fans and/or vents.**



L. HACK SAW BLADE — Gut through where you suspect there is earth-wood contact, e.g., a filled porch adjacent to the outer wall of an under crawl. The filled porch is noted from the outside, but it is inspected from inside the crawl space.

M. STETHOSCOPE — This will help you listen for the sounds of infestation. There are other listening devices, e.g., the acoustic emissions detector developed by DowElanco. The AE detector is supposedly sensitive enough to detect the localized chewing sounds of one termite.

N. ELECTRONIC GAS SNIFFER OR DETECTOR — Will detect gases, e.g., methane emitted by termites as they digest your home.

O. BORESCOPES AND FIBEROPTICS — A hole can be drilled and you can use these tools to usually see inside walls and other voids.

P. TERMITE DETECTING DOGS — Can be used to check for active termite infestations. Beagle dogs have also been trained to sniff out these gases.



HOW TO BEGIN YOUR HOME INSPECTION

If you or anyone has observed any wood destroying activity or moisture problems in your home or building, let that be the starting point of your inspection, but a thorough inspection of the entire structure must follow and be completed. A satisfactory view cannot be obtained from a distance greater than a few feet, so pull on your coveralls and commence the inspection inside your home. Examine every room of your home systematically for evidence of insect attack and decay damage. Sound, probe and listen wherever necessary. Sound all accessible timbers, probe suspicious areas and listen for hollow sounds of damaged wood or the sound of disturbed insects.

Visually inspect surfaces of walls, ceilings, floors, baseboards, wood trim, etc. for stains, discolorations, frass, slightly raised or blistered areas on paint and wallpaper that may hide insects or damage. Check for exit holes, swarmers and dropped wings; include all closets, nooks and crannies.



Thoroughly inspect around plumbing, shower stalls, tubs, sinks, windows, ceilings, doors and washing machines for water stains that may indicate moisture problems.

If there are any inaccessible areas or areas you can not enter because they are hidden, locked, obstructed, too narrow, too dangerous, too wet, covered with ceilings, snow, insulation, leaves, wall board, etc., **note them all on your report.**

Examine cracks around built-in cabinets, door and window frames. Pull out drawers, open drapes, raise blinds, carefully pull back curtains; look for tubes, frass and insect parts.

Usually carpeting and linoleum cannot be moved, but small throw **rugs can be moved** for a more thorough inspection of the floor areas.

Check behind and under all furniture. If you are not dirty, you did not really look very hard.

REPORT WHERE ALL THE PROBLEMS WERE FOUND.

1. **List all visible evidence of insects, frass, damage, tubes, etc. that indicate insect attack.**
2. **List all visible evidence of any moisture problems.**
3. **List all visible mildew and mold growth and wood decay.**
4. **List all cracks in the slab or foundation.**
5. **Note where ceilings, floors or roofs sag and/or are cracked or buckled.**
6. **Note all enclosed heat ducts, wells and enclosed sump pump locations.**
7. **Note all inaccessible, finished and/or furnished areas.**
8. **Note all areas that do not have a positive pitch around your home to keep water away.**

Inspections should note any risk of possible pesticide poison contamination. Enclosed (or nearby) heat ducts, wells, springs, cisterns, etc. can be contaminated by “registered” *residual* insecticide applications and if any of these are present in the area, subterranean termite control should be conducted with special care. Alternate methods of pest control using limited amounts of “registered” synthetic insecticides, or no volatile, synthetic insecticide poison at all, e.g., mechanical alteration and/or sodium borate, are preferable in sensitive areas or with sensitive people in order to avoid creating contamination problems.

ATTICS - Use your ladder to climb into the attic (if possible). Some of the attic space may be inaccessible because of insulation or storage, or large conduits. Check and note all visible tubes, frass, exit holes, insect parts, damage, etc. The attic is a good place to use your inspection mirror. If possible, inspect and sound: the roof rafters (they support roof sheathing); the roof sheathing (the roofing visible from the Attic); the ridge pole (top member to which rafters attach); the joists (to which ceiling below is attached); the top plates of all interior partitions (top member to which wall studs attach) and the wooden attic vents.

Check and note and then repair or correct all visible moisture sources such as “sweating” pipes or conduits, condensation, improper grading or venting and leaks.

Ascertain that the attic ventilation is adequate and not blocked.

Note: Be extremely careful or step only on the joists; to crawl on joists only; the surface between joists will not support you. You'll fall through to the room below.

AGAIN REPORT AND NOTE LOCATION OF ALL PROBLEM AREAS:

- 1. List all visual evidence of any and all insect attacks); identify insects and damages.**
- 2. List all visual evidence of any and all decay and/or rain see page.**
- 3. List all visual excessive moisture problems and their cause.**

CRAWL SPACES - Proceed to the crawl space if there is one, but first walk around your home from the outside, noting the locations) of earth-filled porches, planters, etc. that you will need to inspect from inside the crawl space. Note: salt water, borax, salt granules, rock salt, calcium chloride all will control termites/fleas in the dirt.

CAUTION: Often in the soil of crawl spaces you may find a tiny parasitic nematode called a hookworm. It has hooks on its mouthparts, attaches to linings of the small intestines of animals and man on which it feeds. It can cause a lethargic, anemic state if it attacks you internally. Numbers of them are passed from the body in fecal matter. Pets, especially dogs, that have access to crawl spaces under houses can pass hookworms which then leave their fecal matter and deposit themselves in the soil while awaiting another host (you). Attaching themselves to skin can cause itching and irritation referred to as "creeping eruption". These can usually be washed off without further problem. If somehow they pass from your hand or sleeve or cigarette or to food to your mouth, more unpleasant complications may result. There also may be other fungus, bacteria or diseases down there waiting for you, so we recommend that gloves, long sleeves and trousers tucked into your socks should be worn in any crawl spaces and everything should be washed when you finish. Hookworms appear more frequently from May to November. Other precautions include having enough light when crawling under a house, avoiding all electrical wiring (also applies in attics), not offending any rodents and/or reptiles whose privacy you may invade. Should this happen, back off quietly and quickly. **This is often the most unpleasant area to inspect, but this is also the main area where wood destroying insects and fungi cause extensive damage without being noticed and must be thoroughly inspected.**

Visually inspect and sound the entire subfloor (the flooring visible from under the house) for insect attack, surface molds, signs of decay and water stains. Use a moisture meter and record your findings.

Pay particular attention to chimneys, earth-filled porches, steps, decks and planters that touch the foundation wall and where the earth may contact wood sills or headers.

Closely examine and sound all of the wood under bathrooms, kitchens and laundry rooms for possible leaks.

Thoroughly inspect and sound all perimeter and interior walls, piers, chimney bases and pipes making contact with soil for evidence of insect infestation and decay.

Check and note any standing water and wet foundation walls. Determine the cause and correct the problems. Stored lumber, wood debris, form boards and tree stumps should not be left under your home; note them and correct or remove all of the problems. Be sure eavestroughs or gutters are properly functioning.

Vents from dryers, condensate lines from air conditioners should discharge outside the crawl area with drainage away from the structure; if they do not, note this and correct the problem (s). Be sure there is a minimum 18" clearance from the soil surface to the bottom of floor joists and that the soil is covered with a vapor barrier or note that this should be corrected as soon as possible.

Check if ventilation is adequate and functioning. A good rule of thumb is 1 square foot of vent per 25 running feet of foundation wall or see "Correcting Moisture Problems".

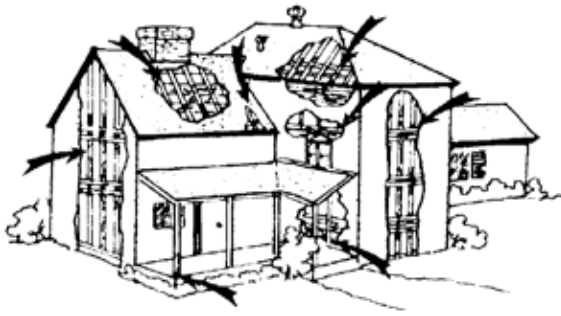

AGAIN, REPORT AND NOTE LOCATION OF ALL PROBLEM AREAS.

1. List all visual evidence of insect attacks; identify insects and damages.
2. List inadequate cross ventilation; note where additional vents should be added.
3. List all visual leaks and all improper drainage.
4. List standing water under house and its causes.
5. Note all earth-wood contacts.
6. Note any insufficient soil-to-wood clearances.
7. Note all visual evidence of decay.
8. Note all wood with a high moisture content, especially above 20%.

NOW GO OUTSIDE - and thoroughly inspect the exterior of your home.

- Check under all rocks and/or patio stones for subterranean termites.
- Note all inaccessible areas and type of foundations), construction type/style/materials.
- Check for all visible earth-wood contacts, all untreated wood, i.e., siding, sheathing, insulation, edging and/or veneer should terminate a minimum of 6" above the exterior grade level.
- Check wood structures such as garages, sheds, barns, fences, fence posts, trellises, wood debris, stored lumber, firewood, especially those that touch your home.
- Check for visible subterranean mud tubes running up exterior foundations walls to masonry block, adobe, frame, stucco or other veneer.
- Carefully observe your exterior grades, trellises, outbuildings, walks, patios, drainspouts, etc.
- Drainage should always be away from the structure.
- Note all branches that overhang or touch your buildings; these should all be removed.
- Open any exterior electrical meter or fuse boxes and look for fecal pellets.
- Examine wood siding, windows and frames, doors and frames, eaves, roof trim, wood soffits and fascia; any other wood items for insect attack, decay, mold and/or excessive moisture.
- Check gutters and downspouts for leaks and blockage.
- Sound any wood shingles at roof eaves and any other projection of the roof, e.g., dormers, cornices or wood trim work; probe wherever necessary.
- Note all cracked cement foundations; these should all be patched.
- Note all visual problems that interfered with your inspection, e.g., snow, ice, trash, toys, leaves, brush, clutter, etc.



AGAIN REPORT AND NOTE LOCATION OF ALL PROBLEM AREAS.

1. List all visual evidence of insect attacks; identify insects and damages.
2. Note all visual decay, and improper drainage, grades and moisture problems that need to be corrected.
3. List all stored firewood, lumber, debris, especially stacked next to your home and note that they are to be removed.
4. List all earth- wood contacts in all your structures and nearby materials.
5. Note all steps, decks, porches, flowerboxes, chimneys and masonry block walls touching your home.
6. Note all trees and shrubbery that need to be pruned/trimmed so you can enter the crawl space or because they block air flow to crawl vents or because they allow access of insects/fungi

into your home.

7. **Note any structural members that are less than 8" above grade that are not pressure-treated or sodium borate or borax treated wood.**
8. **List all veneer, siding, wood vent frames that are less than 6" above grade and are not pressure-treated wood or that need to be screened or repaired.**
9. **Note all loose siding and/or paint or stucco which is blistered or peeling and/or areas that have to be patched and/or repaired.**

COMPILING THE INSPECTION RESULTS

After completing the inspection, the next most important function is the accurate compilation and description of all the information, decay and infestations) you found.

If no decay or infestation of any kind has been discovered, keep your notes and properly install a dehumidifier and/or pretreat with sodium borate per the labeled instructions). Begin with accurate measurement of the structures involved. As a rule, begin measuring at the left corner of the front of the structure. Secure the end of the tape measure (put a screwdriver through the tape loop into the ground or otherwise secure the tape end of the structure with the "teeth" that are attached to the tape loop). Keep the tape taut and measure each exterior wall from corner to corner. Proceed all around the structures, noting locations of all crawl space vents, gas and water meters, raised porches, slabs on grade, obstructions, construction deficiencies, wells, telephone and plumbing lines, etc.

The sum of all the exterior outside measurements is called the lineal footage. For subterranean termite infestations, include the location and measurements of all piers and/or grade beams that support the structure. If the structure has crawl spaces, note their total area (square footage). If subterranean termites have been discovered and the construction is slab, it is important to note where the water main and plumbing is located in the structure and if there are any heating ducts in the slab.

THE GRAPH

The graph will permanently record and communicate the type of basic structure, all inaccessible areas, the dimensions and the condition of your home or building at the time you inspected it. Graph paper helps drawing a structure to scale, using a ratio of one small square to one lineal foot. Using the measurements you have taken of your home, you can accurately and easily reproduce its exact shape and relative size on the graph paper.

1. **Subterranean termite treatment historically takes place at the ground or foundation level in most cases.** Therefore, the graph should show the type of foundations, all inaccessible or problem areas and where they are located as well as where all the piers, grade-beams and any other structural details that may be involved in treatment (such as sunken living rooms, sunken bath tubs and even the exterior vents) to the crawl space area). Exterior foundation walls should be indicated on the graph. Slabs poured on grade (with no foundation), walks, garage door openings, planters, open carports should also be clearly drawn in. (Be sure to include any heat ducts enclosed in the slab areas.) Any interior access(es) to your crawl spaces should also be clearly indicated.
2. **Having drawn and identified all your home's or building's construction features, you should clearly note all of the information you have collected regarding infestation, damage and special hazards.** Note carefully where all decay and infestation was found, where swarmer wings were found and where any/all damage was found.
3. **Your finished graph should show** all of the pertinent structural features, the location of all signs of infestation, all structural and cosmetic damage and any hazards that may exist, i.e., earth-wood contacts, decay and moisture problems, etc.); in short, **all of the information that you so carefully gathered during your inspection.**

Now the graph can be used to determine the proper treatment procedure; if you need help in determining treatment, you should send us this graph with all of your findings.

ADDITIONAL COMMENTS REGARDING NON-SUBTERRANEAN TERMITE INSPECTIONS

Non-subterranean termites can be found in almost any part of your home or building and in any of your wood furnishings. When inspecting for damp wood and dry wood termites, you should not only look for visible damage, but also for the plugs in entrance and exit holes. While both kinds of termites can be found from cellar to attic dry wood termites are usually found in dry wood and damp wood termites are usually found in damp wood which has a considerable amount of moisture.

Initial infestations of dry wood termites are usually found close to the exterior of your home, especially where wood is joined together. Large, well-established infestations, however, frequently will extend over large areas including into the central areas of your home. You should routinely look for fecal pellets pushed out from the termite galleries. Soundings of wood should be made, the same as for subterranean termites. Tapping the wood will cause a hollow sound where there are internal galleries. Hollow wood can then be probed to discover termite damage. Dry wood termites often push their small fecal pellets out of the wood. The presence of these pellets is frequently the first indication that these termites are present. Other evidences of infestation include swarming flights of reproductive adults, shed wings and surface blisters where the galleries come close to the surface of the wood. Occasionally you may find shelter tubes of pellets cemented together or their cement like walls which partition off large chambers or close large openings in order to conserve humidity. Note: Shed non-subterranean termite wings have cross veins between the coastal vein, which forms the anterior margin of the wing, and the subcoastal vein, which is the second most anterior vein originating from the wing base. These cross veins are lacking in subterranean (Family Rhinotermitidae) termites. Remember to include all details. Albert Einstein once said, "God is also in the details." Dr. Einstein said this to explain why he went to such great lengths to prove his theories. **In all inspections for non-subterranean termites, a scale diagram or graph also should also be made indicating all places where termites or other wood destroying insects are present. Take some digital photos and date them.**

THE "REGISTERED" POISON LABEL

Federal law requires that all *registered* pesticide poisons must be applied strictly in accordance with labeling directions. Note: You legally may apply the material (poison) at less than the labeled rate. State law may ignore the federal law and demand you must apply the maximum labeled poison rate!

LABEL: Exactly what is printed on or attached to the product container itself.

(EXPANDED) LABELING: All the combined information that a manufacturer provides about the pesticide poison such as the label itself, training manuals, brochures, flyers, etc.

LEARN TO ACTUALLY READ THE LABEL - The label includes the:

BRAND NAME - Name given the product by the pesticide (poison) manufacturer.

COMMON NAME - Name used by all manufacturers and formulators rather than the complex chemical name (it is easier to identify), e.g., "Dursban or chlorpyrifos" rather than (O, O-diethyl- Of3,5, G-thrichloro-2-pyridinyl) phosphorothioate is the active ingredient's chemical name.

INGREDIENT STATEMENT - Lists only what active ingredients are in the "registered" poison, occasionally including the "inert" ingredients, but the latter need not be identified and could actually be more dangerous to you than the active ingredient.

NAME AND ADDRESS OF POISON MANUFACTURER - Required by law to be shown on all "registered" pesticide (poison) labels.

REGISTRATION & ESTABLISHMENT NUMBERS - Includes both the EPA *registration* number for only the active ingredient in the product (poison) and the number assigned to the factory that made the poison.

HUMAN HAZARD WARNINGS - Most "registered," synthetic *residual* pesticides, in order to control the target pests, are also toxic and hazardous to people. The degree of acute toxicity (but not the chronic toxicity) of only

the active ingredient in the pesticide poison can be sometimes determined by reading the:

SIGNAL WORD(S) - The appropriate signal (toxicity) word is set by law and must appear on the label.

<u>SIGNAL WORDS</u>	<u>TOXICITY</u>	<u>APPROXIMATE AMOUNT NEEDED TO KILL THE AVERAGE PERSON</u>
DANGER-POISON WARNING CAUTION	Highly toxic Moderately toxic Low-order toxicity	A taste to a teaspoonful A teaspoonful to a tablespoonful comparatively free from danger

SYMBOL - All highly toxic products will also have the “skull and crossbones” on the label in addition to the words **DANGER-POISON**.

CHILD HAZARD STATEMENT- All chemical products must prominently display this statement: **KEEP OUT OF REACH OF CHILDREN**.

ENVIRONMENTAL HAZARD - Wrong or careless use of “registered” pesticides (poisons) can cause undesirable effects on the environment. You must follow the precautions shown on any label.

PHYSICAL & CHEMICAL HAZARD STATEMENT - Includes (1) emergency first aid measures; (2) signs and symptoms of poisoning; (3) instructions to physician.

RESTRICTED USE - This usually designates “registered” pesticides (poisons) that can cause serious human injury or environmental damage even when used exactly as the label directs. The label will also designate that the product must only be used by *certified* or *professional* applicators and those under their direct supervision.

DIRECTIONS FOR USE - This is your best source for how to try to correctly apply the poison. Information includes (1) in what form the product can and should be applied; (2) how much to use; (3) where to apply the product; (4) when to apply the poison. (You may use less but never more than the EPA label allows, but in Michigan and some other states - you may not be able to use less than the label allows - even if you have only one termite!) It is against the law to use more, so you honestly cannot legally apply these *registered* volatile poisons in those states with Departments of Lunacy any more than you can drive at only 55 mph (no more and no less at any and all times)!

MISUSE STATEMENT - A reminder that it is a violation of federal law to use the *registered* poison’s active ingredient other than as the label directs. Note: You can not (legally/safely) use Dursban TC to treat a barn occupied by animals to be used for food purposes, but you may legally use it inside human crawl spaces as a surface application and directly on wood surfaces in basements, etc.! Confused? So are a lot of people.

TARGET INSECTS - Lists insects that may be controlled with the product. (You may legally use the poison to control other insects if their control is not expressly forbidden.)

STATEMENT OF STORAGE & DISPOSAL PRECAUTIONS - Self-explanatory and very important.

NET CONTENTS - Depending on the container, this will tell how much is in it. This can be expressed in gallons, pints, quarts, pounds or some other unit of measure.

PENALTIES



You, PERSONALLY, may break the law if you do not use a “registered” pesticide poison exactly as the current label directs. Even if you did not intend to break the law, you still may be subject to civil penalties and fined up to \$5,000. Remember, the labels constantly change and some “laws” say you must not use less and other “laws” say you must not use more than the label allows!

If you intentionally misuse a “registered” pesticide, you **PERSONALLY** are guilty of a criminal offense and, on conviction, can be fined up to \$25,000 and/or imprisoned for up to one year.

SYNTHETIC RESIDUAL PESTICIDE POISON COMMENTARY

Rachel Carson's 1962 book, *Silent Spring*, was quickly followed by the rise of environmentalists, and then in the early 1970's by the formation of the Environmental Protection Agency. **We helped remove some of the more persistent and deadly toxins**, but there are still many volatile poisons left that are misused and/or often applied simply “just to be sure” by some *professionals*. It is a very sad commentary that **many** years after Rachel Carson first warned the pest control *industry* of the dangers of using (and misusing) synthetic *residual* pesticides, **these professionals now use many, many times more of these dangerous toxins than they did back then - with no real reduction in insect pest problems!** Now the very rain is contaminated with these toxins and it is impossible to grow true organic foods! In 1965, 335 million pounds of synthetic pesticide poisons were applied just to crops; in 1989, 806 million pounds of poisons were applied just to crops. There are approximately 350 pesticide poison **active** ingredients *legally* allowed for use by the EPA on our crops - of this number approximately 20% or 70 or more are classified as *probable* or *possible* human carcinogens. In addition, there has been a tremendous increase in yard, home, governmental and commercial spraying of these toxins! Yet there is an ever increasing problem for the poison *industry* - more and more people do not want poisons or fumigants used in their homes! **Today we are still trying to help you manage your pests (without using any volatile pesticide poisons) in a safe and environmentally sound manner!**

Successful Intelligent Pest Management® Control - To be successful you must study your environment very carefully because it also may be the same environment your pest enemy lives in. **In killing them, do not hurt yourself!** Observe/know their habits, tracks, droppings, sounds, characteristics, peculiarities, feeding preferences, breeding habits, type of metamorphosis and activity periods. Become familiar with all of the various salts, baits, dehumidifiers, tactics, specialized tools, Pestisafes®, mechanical alterations, chemical formulations, techniques and procedures available to you and this knowledge will assure you of a permanent, safe kill. Thorough inspections, accurate records, exclusion techniques, proper sanitation, mechanical alterations), replacement of surgically removed decay and infestations) with pressure treated wood, trapping, environmental changes/controls, safe, natural chemical controls) - all these tools will aid you in permanently and safely destroying all of your enemy, his descendants and his habitat. The Author never recommends the use of any volatile, synthetic *residual* pesticide poisons because they simply do not control pests permanently and are dangerous to you and the environment. Use of sodium borate (or borax) treated wood is an additional safeguard against damage from termites and decay. For maximum protection, the wood should be pressure-impregnated with an approved (poison) chemical by a standard process or, better yet, simply and safely treated with sodium borates. Vacuum treatment gives adequate protection where conditions are less severe. Brush, spray or short-period soaks of volatile, “synthetic” poison treatments give limited protection above ground. Chemicals and their uses are given in (1) Federal Use Specification II-W-571d (current revision), (2) Standards of the American Wood Preservers' Association and (3) Standards of the National Woodwork Manufacturers' Association. Slow-growing heartwood of some native wood species is quite resistant to termites, but it is not immune nor is it as resistant as pressure-treated wood. **The following kinds and grades of lumber are considered the most resistant to native termites (but are not to be considered a termite barrier):**

1. **Foundation-grade California redwood**
2. **All-heart southern tide water red cypress**
3. **Very pitchy southern pine - “lightwood”**
4. **Heartwood of eastern red cedar (less resistant than the above)**

In addition, bald cypress, Arizona cypress, chestnut, black locust and walnut, redwood, Pacific yew and Osage orange are considered to be most resistant (but not impervious) to termite attack. **Consider food-grade DE, table salt, borax, Peladow® or sodium borate, or other salts, sanitation and structural control measures first, not only for prevention but also to control existing infestations.**

INTELLIGENT PEST MANAGEMENT® TECHNIQUES

Generally, buildings become infested because little or no effort was made during construction that would have made your home resistant to infestation. Correct all conditions conducive to infestation and/or decay. Remove

all wood, foam, roots, dead limbs and other debris, correct all earth-wood contacts; do not let branches touch or overhang your home; use a dehumidifier and treat/paint/varnish/seal all exposed wood. Note: All termites have relatively little resistance to drying out or extremes of either heat or cold. Changing these conditions even temporarily will wipe out the entire colony. The top of the exterior foundation should be at least 8" above the finished grade and should have at least 6" of foundation exposed below the siding in areas subject to some decay. A foundation height above grade of 12" - 18" should be maintained in areas where frequent hard rains can cause significant splash wetting of wood siding, sheathing ends or sills. In the crawl space at least 18 inches between joists and ground and 12 inches between ground and girders should be maintained. This will allow for crawl-space inspection. The need for ample (well vented) crawl space cannot be too strongly emphasized - a substructure that is difficult to reach will not receive adequate inspection. Establish new grades to provide good drainage. Replace heavily damaged wood with sound material or masonry or metal. Fill all voids, cracks or expansion joints in concrete, masonry or siding with caulk, cement grout, roofing-grade coal-tar pitch or rubberoid bituminous sealers. Correct all moisture problems, e.g., repair all eaves and downspouts, all leaking water outlets, etc. Provide adequate drainage. Think about structural modifications. Use only finished exterior wood. If you find shelter tubes, break them open or remove them. You can cover the tube and bait with several layers of non-volatile sodium borate treated cardboard or 12 - 16 sheets of white paper towels and then cover the cardboard/paper towels with clear plastic secured with self taping screws - so you can easily inspect (remoisten with seltzer water if necessary) and analyze/determine the need for additional treatment or drill into the wood and/or concrete and insert treated dowels, the same size as the hole or use sodium borate treated tongue depressors (through the tubes) secured with brads. Ant colonies and other predators like yellow jackets will also help control termites. You can also inject a slurry of food-grade diatomaceous earth under the slab to control termites. Remember, a mature colony of 60,000 subterranean termites will only eat the equivalent of 2' - 4' of a 2 x 4 each year. You can also bait or *prebait* with sodium borate treated stakes, sawdust pellets, cellulose insulation, white paper towels, (virgin) cardboard - with 25 - 100 "foreign" termites, woodscraps, tongue depressors, etc. in any/all areas you see or suspect termite activity - when the workers find your bait they will carry it back and kill the queen and the colony for you. **Bait Caution: Tobacco and/or smoke residue or volatile pesticides or solvents will repel termites (and other insects) from your baits.**

Structural modifications are used by many termite control specialists to prevent future termite damage. Wood up to 18" above the soil line should be treated with sodium borate or replaced with concrete or protected with barriers of metal or concrete. Examine other possible points of entry such as cracks in the foundation, wood posts through concrete in contact with the soil under the foundation, wet soil caused by excess watering or leaking pipes, wood soil contact where top soil is graded too high, porch steps in contact with the soil, shrubbery blocking air flow through vents, and all foam or form boards left in place under fill that provide termite food supply; either remove them or treat them with sodium borate or borax.

Damage-prone wood can also be replaced with naturally insect-resistant wood. (Those wood preservative poisons which work where wood is in contact with soil are usually arsenical compounds such as chromated copper arsenate (CCA). **These poisons are highly toxic and easily absorbed through the skin.**)

Another non-volatile control method consists of barriers made of 10 - 16 mesh sand. This size sand particle is too large for termites to push aside and not large enough for termites to crawl between. Sand is deposited in 20" bands around a structure and is blown in with a hose in areas under it. The sand barrier method is now considered an acceptable control measure by the City of Honolulu. Food-grade DE and/or crushed limestone granules are also being suggested as a permanent barrier under buildings.

CORRECTING MOISTURE PROBLEMS

Sufficient condensation to promote infestation and decay of sills, headers, joists and subflooring may result from winter condensation or that associated with summer air conditioning. Winter condensation and most of that associated with air conditioning can be prevented by keeping the crawl space dry with proper soil drainage, adequate ventilation, with a soil cover and/or a dehumidifier and fans. **Where drying is impossible, the use of pressure treated wood or sodium borate or borax may be necessary.**

Soil drainage - If the surface soil in the crawl space can be kept dusty dry by good drainage (and/or a dehumidifier and/or fan), the danger of condensation/infestation is small even if ventilation is substandard. Having a positive pitch around the exterior and putting a gravel barrier around the entire building will keep the soil drier and helps

prevent subterranean termite invasions.

Ventilation - Adequate, screened ventilation of the crawl space is your best, safest and cheapest safeguard against damage by decay fungi and wood destroying insects. Vent openings in the perimeter foundation should provide cross movement of air if they are placed uniformly around the perimeter and as near the corners as possible without materially reducing the strength of the wall. Near-corner positioning is desirable because dead air is the most common there. The total effective opening of the vents should be proportional to the size of the space; openings totaling 1/150 of the ground area are adequate. Accordingly, a crawl space of 900 square feet would require a total vent area of about 6 square feet.

Screening reduces the air flow through vents by 25% or more. To compensate for this the screened vent area should be about a third larger than the 1/150. Also, if vents are below the grade level, a somewhat larger size opening is needed. Shrubbery growing in front of vents can also materially reduce their effectiveness. All vents should be screened. Openings need not be placed on the front of the home, provided they can be arranged to prevent unventilated areas. These vent openings are effective against winter condensation, but not necessarily against summer condensation under air-conditioned buildings, especially in high humidity coastal areas. Also, since vents often are closed in cold weather, ventilation alone seldom can be relied on as a sole means of condensation control even in cold climates. For this reason ground covers were developed.

Ground covers - A good ground cover will effectively control condensation even when vents are closed during the winter. A cover should be used particularly where winter temperatures commonly are 50° F. or below and ground surfaces are usually damp, or where summer air conditioning is used over a damp crawl space.

A good ground cover will generally keep the substructure wood dry despite the damp ground. Even if the vent opening area is substantially less than recommended. A cover should not only have adequate vapor resistance, but also sufficient strength to permit some traffic on it, because it may be necessary to crawl on the cover while making inspections, repairing plumbing, heating ducts and electrical wiring, or to store materials. **Two inexpensive materials that have both vapor resistance and strength are 45-pound or heavier roll roofing and 6-mil polyethylene sheeting or visquine.** A 4-mil polyethylene film can also be used with a layer of sand or fine gravel on top to help reduce the chance of tearing the surface. **The strips of roll roofing or visquine should be overlapped slightly and should touch the foundation walls.** Special measures to limit escape of water vapor at the seams or edges are not necessary. The ground does not have to be perfectly flat; with time the cover will conform to moderate surface irregularities. If the crawl or basement is still damp, install a dehumidifier and/or fans and exhaust the moisture into a drain or outside the foundation walls.

Once you solve all moisture problems within, your lot should be properly graded to let water drain rapidly away from your home or building; in addition the gutters, downspouts and foundation drains should all guide water clear of your home or building. All doors, windows, roof valleys and chimneys need to be adequately flashed, all openings, cracks and crevices should be caulked or tuck pointed. All attic spaces should also be well vented to prevent accumulations of moisture; if possible the raw wood should be treated with sodium borate and sealed. Exterior walls should be fitted with vapor barriers when building and then maintained by properly caulking, staining, varnishing or painting. When building in very moist regions, the soil under a slab-based house should be shielded with a heavy polyethylene sheet before the concrete is poured. All branches and bushes should be removed that touch the building, overhang the roof or block the ventilation openings. Never store firewood inside or outside touching your home for any length of time. All earth-wood and foam insulation contacts should be removed. If necessary, remove all concrete porches and/or steps that touch the foundation wood and replace with pressure treated or sodium borate treated (open) wooden “decks”. Remember to properly ventilate all areas and/or use a dehumidifier and/or fans.

PERMANENT WOOD DESTROYING ORGANISM CONTROL- While ants continually move back and forth from the feeding source to the colony; termites move in groups from feeding source to feeding source. When termites run into poisoned soil they go in the opposite/other direction and hit the neighbor's home but, if hungry enough, they will persist until they find a root or until they penetrate (they can penetrate an untreated opening 1/64 of an inch!) the volatile, synthetic poison *barrier*. Given the weaknesses, dangers and limitations of “registered” poison *barriers*, we advise the use of sodium borate wood treatments, sanitation and moisture reduction. You may wish to add Safe Solutions, Inc. Enzyme Cleaner with Peppermint to your mix to aid the penetration of the

wood and/or galleries, but do not forget to provide proper ventilation and moisture control in your wood treatment program. They do not pass through properly salted (or borax) earth.

How do TIM-BOR®, IMPEL RODS®, BORA-CARE®, Guardian®, Shell Guard® or any of the sodium borates work? — The active ingredient in TIM-BOR, IMPEL RODS and BORA-CARE is disodium octaborate tetrahydrate (DOT), or simply sodium borate, which functions as a slow-acting stomach poison in insects and as a contact poison to decay fungi. Termites accumulate the active ingredient (DOT) while they are feeding. Since borates are slow-acting poisons, these termites can move throughout the colony and spread the insecticide by the feeding of nymphs, soldiers and reproductives, or by cannibalism when these termites die. Behavioral changes have also been observed. When termites die in a given area, the area is usually avoided by other termites. In addition, the wood treated with synthetic pesticide poisons is not the first choice of the termite and is avoided. **Please read and understand the proper labels before any treatment begins.** Sodium borates do not discolor wood, are odorless and do not vaporize, nor do they cause wood to absorb water or change equilibrium moisture content. Boric acid is toxic to insects, decay fungi and bacteria. It is generally cytotoxic and is an enzyme inhibitor and kills the microorganisms in the termite's gut, causing starvation.

Sodium borate treated wood also deters wood destroying beetles by killing larvae as they hatch from eggs laid on treated surfaces. If some larvae would survive long enough to penetrate the wood surface, they will soon die after ingesting treated wood. Existing larvae in the wood will pupate and the emerging adults will die when they chew through the treated wood. **Sodium borates are also herbicides, so be careful.**

Carpenter ants do not consume wood, but they can cause substantial and rapid damage by excavating cavities in wood for nesting. Sodium borate treated wood is very unpalatable, and is not excavated by carpenter ants. However, treated wood may not prevent or eliminate a carpenter ant infestation since the ants can penetrate construction features and avoid chewing treated wood. TIM-BOR powder or sodium borate solutions or foamed applications in wall voids and around conduit and plumbing lines and other openings will provide another level of control for these pests.

Decay fungi can infect and rapidly destroy wood where there are moisture problems. Some fungi can actively conduct moisture from the ground or a leak to wood of lower moisture content to expand the colonization of wood. **Sodium borate or borax is highly toxic to decay fungi and will kill the fungi present and/or protect against future infections.**

Application of sodium borate (should be applied only to bare wood or to wood surfaces where an intact water repellent barrier is not present) to **control wood destroying organisms must be part of an Intelligent Pest Management® (IPM) Strategy.** Problems which may have led to the infestation or that may do so in the future must be connected. This includes correcting moisture leaks, providing adequate ventilation and moisture barriers and removal of debris from crawl spaces. Sodium borate is an odorless, colorless protectorant with excellent residual activity; it is non-staining and has a low mammalian toxicity. TIM-BOR comes in a powder form, BORA-CARE comes in a liquid form with inactive ingredients of glycols and water. If you do not want to use glycols in your home, use the powder form. Borax, table salt and Peladow® and many other salts can be diluted and sprayed on wood and soil and will also give control but some may also attack all ferrous metals (nails).

GLYCOL ETHERS CAUTION

The Occupational Safety and Health Administration is close to publishing a proposed rule to control worker exposure to four glycol ethers based on potential hazards to workers' reproductive systems. The Agency is set to propose an exposure limit of 0.1 part per million for 2-methoxyethanol and its acetate and an exposure limit of 0.5 ppm for 2-ethoxyethanol and its acetate. The proposal would lower exposure limits for the substances, which are used as chemical intermediates, industrial coatings and solvents, and jet fuel additives, among other things. The Environmental Protection Agency had estimated between 200,000 and 350,000 workers could be exposed to unsafe levels of the glycol ethers. **Note: Ethylene glycol is the hazardous material in anti-freeze.**

The Journal of Pesticide Reform/Summer 1997 noted three alternative chemical treatment cautions, e.g., borate, hexaflumuron and sulfluramid.

BORATE CAUTION

The effects of boric acid on reproduction are particularly striking. In long-term (6-month and 2-year) studies with rats and mice, boric acid caused testicular atrophy, increased incidence of abnormal sperm, decreased sperm movement, and degeneration of sperm-producing structures. When fed to pregnant rats, boric acid reduced the weight of the offspring and increased the number of malformed offspring. The same effects were observed when boric acid was fed to pregnant mice. In addition, the number of fetal resorptions increased. (These are fetuses that stop developing in early pregnancy.) TIM-BOR®, Bora-care® or borax all are toxic to plants at higher than normal rates as is fertilizer.

HEXAFLUMURON CAUTION

Many standard tests are lacking for hexaflumuron: medium-term (subchronic) toxicity testing, delayed neurotoxicity testing, and tests for developmental or reproductive effects. Hexaflumuron is a mild skin and eye irritant. Eyes required a day to heal, while skin required a week. In long-term (chronic) feedings tests, hexaflumuron increased the incidence and severity of a liver cell abnormality. Hexaflumuron is very toxic to aquatic animals; concentrations of 0.1 parts per billion kill water fleas. It is persistent in soil, with a half-life (the time required to breakdown of half the amount applied) between 100 and 160 days.

SULFLURAMID CAUTION

EPA reports that “multiple exposures to relatively low doses of this “registered” pesticide poison can cause adverse reproductive and developmental effects in laboratory animals.” In addition, its toxicity to birds (when fed in the diet) is “high”. It is also toxic to aquatic animals. Rainbow trout are killed by concentrations of 2 parts per million, and water fleas by concentrations one-tenth as high.

After the initial treatment, inspections should be performed on a regular basis and additional preventative spray treatments of sodium borate (up to 4) can be made. Each additional treatment will increase the borate loading and penetration into the wood, making it more repellent to insects and permanently controlling fungi. There has been a study where Douglas fir was treated with BORA-CARE and TIM-BOR; there was a 100% mortality and a 2% loss of wood with BORA-CARE compared to a 60% mortality and 20% loss of wood with TIM-BOR after only 5 days of diffusion; both were exposed to attack from Formosan termites.

SPECIFICS FOR BORON APPLICATIONS - For initial absorbance wood should be dry; for penetration wood should be wet. **Glenn Gordon from Home Guard Pest Control, Inc. in Largo, Florida has developed the best (high pressure) application equipment the Author has never seen for the application of DOT - hopefully it will be on the general market soon.**

PRETREATMENT - One to two thorough applications of TIM-BOR or BORA-CARE (can be applied by spraying, brushing, injection or fogging) may be made to wood during construction. Brush, fog or spray applications of a sodium borate solution should be made to all accessible surfaces of bare wood: flooring, subflooring, sill plates, top plates, wall studs, trusses, rafters, roofing, plywood, etc. Application should be performed after framing and roofing are in place and before insulation and drywall are installed. Avoid spraying electrical components. Protect treated wood from excessive rain. Treat the sill plates, behind steps and porches and slabs very thoroughly. This is a good time to put some salt, treated baits or cellulose insulation under the slab.

PREVENTATIVE AND REMEDIAL TREATMENT USING SODIUM BORATE - You may wish to add a biodegradable dye to your solution to provide both visual satisfaction to the customer and to ensure you that proper application techniques were followed and to visually record what was treated. **Note: Sodium borates diffuse readily in wood with a moisture content of 20% or higher; at lower levels, borates do not diffuse readily. When the wood is very dry, spray twice with a 10% solution to aid in penetration, or carefully use BORA-CARE with glycols.**

Basement or Crawl Space Structure - Brush, fog or spray a sodium borate solution on all bare wood accessible in the flooring and subfloor. These measures will control an infestation even when certain parts of a gallery are not directly treated. Adequate measures must be taken to correct moisture problems (leaks, etc.) that may have led to and sustained the infestation. Treat the infested areas and areas behind porches, steps and slabs

very thoroughly. While borates are not yet labeled as soil treatment materials, the material that drips or that falls from the wood on to the crawl space dirt will prevent subterranean termites and roots from passing through this poisoned soil until it leaches out.

Attics - Brush, fog or spray sodium borate solutions to all accessible wood: rafters, trusses, top plates, ceiling joists, plywood, particle board, etc. Areas with known infestations can also be drilled and pressure injected when possible. This has also been a very effective technique in spot treating for control of drywood termites.

Exterior Wood - Sodium borate can be applied to bare siding, decks, trim or logs. Applications can be made by drilling the wood and injecting borates or by placing IMPEL-RODS within or by brush or spray or pressure injection techniques. Painted or sealed wood needs to be pressure treated or the sealing coat removed prior to application. Prepare "deck" surfaces with Deck-Prep. Following treatment, the exterior wood must be sealed to protect sodium borate from leaching out. Wood should be completely dry for at least 48 hours before a sealing coat (paint, varnish or waterproofing seal or if you use BORA-CARE, seal with Co-Pel) can be applied. When properly applied, sodium borate will not interfere with application of sealants. DO NOT apply any sodium borate in inclement weather. Sodium borates and/or borax can kill plants and roots at high volumes.

Mud Tubes, Powder, Pellets and/or Frass - **Be sure to scrape down and destroy all mud tubes or better still place a piece of treated wood e.g. a tongue depressor or Popsicle stick or cardboard (preformed termite tubes) sprayed with sodium borate and seltzer water into the tube and then knock down the tube above.** Note: If you treat several layers of cardboard to cover the tube and then cover the cardboard with clear plastic secured with self tapping screws, you can easily check the effectiveness of your baits. Drill holes in the wood and/or concrete and insert treated dowels the same size as the holes. Then saturate all exposed wood, especially the areas where the mud tubes were found (twice within a six-hour period). Subterranean termites are unable to construct new tubes on correctly treated wood (or concrete) and the "trapped" termites will shortly dehydrate and die. Reinspect in two weeks; if more mud tubes are found, scrape down the tubes again and spot retreat that area again and reinspect in two weeks. For non-subterranean termites, be sure to clean up all pellets, powder and frass and reinspect in two weeks; if there is fresh evidence, spot retreat those areas and again clean up the evidence of reinfestation and recheck in two months. **If you wish to treat inside walls, drill a 1" hole in the plaster board (etc.) about 8" - 12" up from the baseboard every 16" and inject the sodium borate solution to the studs and sole plates through the holes; then plug holes with plastic (insulation) plugs; if no reinfestation occurs in 2 years, seal the holes permanently with plaster. Remember to follow all of the current label directions completely.**

Cold Air Returns - Do not forget to treat the wood covered by cold air returns - one simple way is to remove the register upstairs, and then simply spray borates on the exposed wood.

TIM-BOR MIXING INSTRUCTIONS - Old Label - Always read the new label!

1. Please read the label thoroughly - then estimate the amount of TIM-BOR solution needed to complete the job. 7 - 10 gallons of solution are needed to cover 1,000 square feet of wood surface area. This amount can vary depending on the moisture content and species of wood. (Remember, 25 pounds of TIM-BOR is enough to cover (a minimum of) 2,500 square feet and 1 pound of DOT per gallon equals a 10% mix). **Never use surfactants/foam; they will impede diffusion.**
2. Using a slightly oversized container (bucket), fill to about 80 % of the final required volume, then add 1 lb. TIM-BOR powder per gallon of required solution while stirring. The remainder of the water is then added and the solution is agitated until all of the product has dissolved. Using this mix you should spray twice per the label. <http://www.nisuscop.com/pdfs/timborlabel.pdf>

EXAMPLE: Prepare 5 gallons of 10% TIM-BOR solution:

- A. Add 4 gallons of clear water to a 6-gallon bucket.
- B. Add 5 one lb. measures of TIM-BOR while gently stirring.
- C. Add enough water to bring the final volume to 5 gallons and continue to stir until all of the TIM-BOR has dissolved.

3. **If you mix 1½ pounds of TIM-BOR per gallon you only have to spray once.**
NOTE: BORA-CARE uses a 10% solution to treat firewood only and treats insects and decay with a 23% solution.

3. **LARGE TANKS:**
 (For paddle, jet, bypass and backflow agitation systems)

- A. Add water to about 80% of the final desired volume.
- B. Activate the agitation system or start the recirculating pump.
- C. Add the required amount of TIM-BOR in about 5 lb. portions or smaller. Do not allow large clumps of material to form; break them up with a paddle or with spray water from the recirculating system. Then continue to add more solid material.
- D. Add water to bring total volume to the desired amount. Continue to agitate the solution until all of the solids dissolve.
- E. Agitate the solution briefly at the beginning of each spray job or after the solution has been standing for an extended period.

TIPS:

- Hot/warm water will dissolve TIM-BOR and/or BORA-CARE more rapidly.
- Hand mixing with a paddle or with mechanical mixers will give excellent results.
- Oversized containers help prevent careless spills and minimizes splashing during mixing.

Adding TIM-BOR to water:

- a. Having hot water in the mixing container before adding TIM-BOR reduces dust and speeds the mixing process.
- b. Adding water to dry powder is not recommended. This tends to form lumps of material that dissolve slowly.

APPLICATION: SPRAY PROCEDURES (HAND OR PRESSURE SPRAYERS) (Can also be brushed or fogged on.) (Please read the individual labels.)

- 1. Spray wood evenly using a medium-to-coarse spray at low pressures (20 - 30 psi).
- 2. Ensure that all accessible wood surfaces are thoroughly wetted. Wood will absorb sodium borate, especially TIM-BOR solutions at different rates. Surfaces that absorb solution rapidly should be sprayed again. The following TIM-BOR table describes the best application scheme for each target organisms. Be sure to compare with the BORA-CARE label instructions; in either event, be sure to read and follow the specific labeled instructions.

ORGANISM	METHOD
Fungi	1 spray or for serious infestations 2 sprays 1 hour - 24 hours apart.
Anobiid Larvae	2 sprays 1 hour - 24 hours apart.
Termites	2 sprays 1 hour- 24 hours apart for remedial use. When accessible, drill and inject solution directly into wood where galleries or kickholes are detected. See INJECTION section for more detail. Treat sills and plates behind steps, chimneys, slabs and porches very thoroughly.
Formosan Subterranean Termites	2 sprays 6 hours - 24 hours apart. When accessible, drill and inject solution directly into wood where galleries or tubes are detected. See INJECTION section for more detail.
Preventative Application Against Wood Destroying Organisms	2 or more sprays 1 hour to 1 year apart. This treatment plan is intended only as part of an ongoing preventative maintenance and inspection plan.

In 1953 New Zealand required all construction lumber to be treated with borates; since that time there have been no problems with termites per Jeff Lloyd of the United Kingdom speaking at a CPCO meeting 3/18/98.

TIPS:

- Be sure to adequately treat all infested areas and the sills and plates behind slabs, chimneys, porches and steps very thoroughly per current label directions.
- Best results and penetration will be obtained with ambient temperatures above 55° F.
- Do not spray frozen wood!
- Do not spray painted or waterproofed surfaces.
- Do not spray or spill onto soil or foliage.
- Sodium borate will not damage concrete or masonry work but may leave white crystals on the surface after drying which will permanently prevent insect activity. These can be easily washed or brushed off.
- If you have an extremely thick piece of wood, soak a towel or sponge and leave it on the area. A cotton rope will *wick/siphon* the 10% mix out of the bucket directly onto the sill plate, timber, beam or whatever. Over a period of hours, the thickest wood can be adequately treated.
- Remoisten termite baits with seltzer water that has not lost its “fizz”.

PRESSURE INJECTING SODIUM BORATE - There is special (in-plant) equipment available or you will be able to do this manually with Home Guard’s equipment shortly.

SODIUM BORATE FOAM APPLICATIONS - You can also foam (or spray) interior walls with sodium borate mixes to control carpenter ants and/or termites.

EQUIPMENT - Spray system with operating pressure greater than 75 psi Whitmire injection tip, 1 inch (part #14-O384) hand drill, 1/8” or 7/16” drill bits.

Sodium borate dust and/or solutions (especially TIM-BOR is labeled and) can be directly injected into infested wood. The area treated includes the immediate accessible infestation and adjacent areas. This procedure is not an alternative to spraying, rather an adjunct to spraying when structural timbers thicker than 4 inches are infested. This procedure can also be performed on (drilled) painted and/or sealed wood.

1. Injection holes (7/16” or 1/8” in diameter) should be drilled in the area of suspected infestation. The holes should be drilled in a diamond pattern with the long axis along the grain and the holes spaced every 12” to 16”. Holes should be spaced 4” to 6” across the grain. When possible the wood should be treated one diamond pattern beyond the immediate area of visible infestation.
2. Drill the holes through the widest dimension available. Do not drill completely through the beam; leave about 3/4” undrilled. If the widest surface is not accessible, holes can be drilled in the narrower surface. The diamond pattern cannot be used, so drill holes 8” - 10” apart. All holes should be deeper than the injection tip. A longer injection tip should not be used.
3. Press and hold the injection tip firmly into each hole and inject solution until runoff is observed from other holes, galleries, kickholes, etc. When injecting solid wood, maintain the injection pressure for 15 to 60 seconds at each hole. Longer times give better penetration.
4. Release the trigger wait briefly and withdraw the injection tip. Excess solution can be absorbed with paper towels and collected for disposal (ordinary trash).

EXAMPLE: Treat an infestation in a structural beam with nominal 4” x 10” dimensions.

- A. Each hole is drilled approximately 3.25” deep in the diamond pattern shown.
- B. Solution is injected under pressure (75 - 150 psi) for 15 to 60 seconds in each hole.
- C. If a gallery is directly penetrated, solution should be injected until runoff is detected from other holes. Wood surrounding the gallery should also be pressure injected. Treat “one diamond” length beyond the suspected area of infestation when possible.

CARE OF SPRAY AND FOGGING EQUIPMENT

1. Sodium borate solutions are compatible with stainless steel, brass and all plastic components of spray equipment. Solutions should be mixed as needed and drained from equipment daily.
2. Equipment should be rinsed with clear water to flush remaining sodium borate out of equipment. The rinse should be saved and treated as clean water to make up future sodium borate solutions or disposed of according to local regulations.
3. Excess or unused solutions should not be left in spray equipment overnight or for extended periods of time. TIM-BOR solutions can be stored in sealed plastic containers for use in future applications. Keep these solutions from freezing and stored safely away.

TIPS:

- Store unused 10% TIM-BOR solutions in sealed plastic containers labeled as “Ready to Use” solution. BORA-CARE solutions must be all used within 24 hours.
- Previously stored 10% TIM-BOR solutions are completely miscible with freshly made solutions. Simply combine clear solutions.
- Some solids may form from solutions after prolonged exposure to cold (typically at temperatures below 40° F.), or if water has been allowed to evaporate over an extended period of time from a 10% solution. Bring cold solutions to room temperature and agitate until all solids re-dissolve.
- Do not use a solution with solids present.

FOGGING WITH BORA-CARE - Old Label

BORA-CARE is labeled to be applied by spraying, brushing or fogging on to exterior or interior wood surfaces. While the label normally does not require people to leave the home during treatment, the Author strongly suggests everyone does and then re-enter only after everything is completely dry and you have thoroughly aired out your home - especially if you fog! Please read and follow the labeled instructions and MSDS. Fogging inaccessible crawls, attics and other hard to reach areas with BORA-CARE per labeled instructions may provide adequate control.

THE AUTHOR DOES NOT RECOMMEND FOGGING!

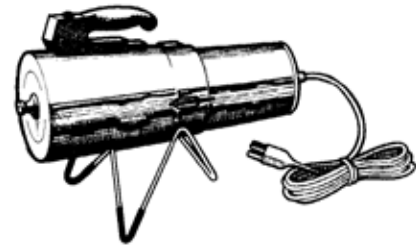

DUSTING TIM-BOR POWDER - Old Label

Wall voids and wood can effectively be protected from carpenter ants by power or hand dusting devices. Access can be through electric outlet boxes, switches, plumbing, etc. Dust TIM-BOR powder generously to coat surfaces with a thin powder. BORA-CARE would have to be injected as a liquid here as it does not come as a powder. **Don't forget to drill and dust block voids with TIM-BOR dust.**

TIPS:

- Use dust protection equipment for this application.
- Be sure to dust about and below fireblocks in certain types of wall construction.
- Areas to be dusted should be dry and not open to living areas below.

BORA-CARE MIXING INSTRUCTIONS AND ETHYLENE GLYCOL CAUTION:

The Nisus Corporation puts BORA-CARE (sodium borate, water and glycols) liquid concentrates in one gallon and two and one-half gallon containers that weigh 11.5 pounds per gallon. Simply read and follow the label directions and mix only the amount of solution you will need to spray your home or any part thereof. There is no need to “fiddle” with BORA-CARE because it mixes more readily with water and, unlike the powder form (TIM-BOR), there is no dust problem to be concerned about, but some people may want their sodium borate without ethylene glycols; ethylene glycol may cause congenital malfunctions (teratogenic) in mice and rats when

administered by garbage or in the drinking water during organogenesis, but it is not teratogenic when fed in the diet. Pre-existing kidney disorders may be aggravated by exposure to this material. Note: Ethylene glycol is the hazardous material in antifreeze. **Please read the MSDS and current label:** <http://www.nisuscorp.com/pdfs/boracarelabel.pdf>; <http://www.nisuscorp.com/pdfs/timbormsds.pdf>; the following is merely a small part thereof of an old MSDS/label. There are new techniques being developed all the time, e.g., foaming and pressure application, etc.

(Partial) Directions for BORA-CARE Use

It is a violation of federal law to use this product in a manner inconsistent with its labeling. BORA-CARE should be applied only to bare wood or to wood surfaces where an intact water repellent barrier is not present.

Mixing Instructions - Old Label

BORA-CARE is a concentrate which must be diluted with clean water before use. The use of warm water, if available, and an impeller-type mixer which can be used with an electric drill aids the dilution process.

Hand Sprayers: Mix a clean container and stir the diluted solution until completely uniform. Always mix in a separate container, then add solution to spray tank. Mixing BORA-CARE directly in a spray tank can block hoses and nozzles.

High Volume Pumping Systems: Add all of the dilution water to tank. Start recirculator, then slowly add BORA-CARE concentrate. Allow to mix until uniform. Use diluted BORA-CARE within 24 hours after mixing.

Do not leave unused solution under pressure or in tank overnight. Clean and/or flush equipment and lines with water after use.

Dilution Rates by Volume

<u>Parts Water</u>	<u>Parts BORA-CARE</u>	<u>% Disodium Octaborate Tetrahydrate</u>
1	1	23%
4	1 (for firewood only)	10%

Use a 1 to 1 BORA-CARE dilution ratio for subterranean and Formosan termites and for all other insects and decay fungi. On firewood, use a 4 part water to 1 part BORA-CARE dilution ratio.

Safe Handling Procedures - Old Label

The use of chemical splash goggles and solvent resistant gloves is advised. Spills and over-spray may be cleaned with a damp cloth or absorbed with appropriate materials.

When applying BORA-CARE in confined spaces, it is recommended that ventilation or an exhaust system be provided. If this is impractical, the use of a NIOSH approved respirator designed for protection from organic vapors is recommended. (Refer to the BORA-CARE Material Safety Data Sheet (MSDS) for additional health and safety information.) **We suggest you always read the newest MSDS's, labels and technical bulletins available.** <http://www.nisuscorp.com/pdfs/boracaremsds.pdf>

**Recommended Minimum Application Rates
Dimensional Lumber**

Lumber Size (inches)	1 gallon of diluted BORA-CARE will treat up to:	Minimum gallons of diluted BORA- CARE to treat 1000 lineal feet
1 x 4	1200 lineal feet	0.8
1 x 12	400	2.6
2 x 4	600	1.6
2 x 6	400	2.6
2 x 8	308	3.2
2 x 10	240	4.2
2 x 12	200	5.0
4 x 4	300	3.4
4 x 6	200	5.0
4 x 8	150	6.8
4 x 12	100	10.0
6 x 8	100	7.6
6 x 10	80	10.0
6 x 12	68	15.0

Panels, Siding and Plywood

Thickness (inches)	1 gallon of diluted BORA-CARE will treat up to:	Minimum gallons of diluted BORA- CARE to treat 1000 square feet
1/4	1,600 sq. ft.	0.6
3/8	1,067	1.0
1/2	800	1.2
3/4	533	1.8

NOTE: The numbers listed above are based on an application rate off gallon of diluted BORA-CARE to 400 board feet of wood. However, some wood surfaces may absorb more than the minimum application rate. 1 gallon of BORA-CARE concentrate yields 2 gallons of diluted solution, as applied.

USING IMPEL RODS AND JECTA - Old Label

Decks, porches, window and door frames, logs, timbers, fence and mail box posts, columns, roof trim and fascia and foundation areas can also be drilled and these solid borate fungicide rods or fluids can be placed within the hole for remedial or preventative treatment to structural areas already infiltrated by wood decay or vulnerable to possible attack. IMPEL Rods are odorless, environmentally safe and registered in all states including California. Drill the wood and insert the rods per the labeled instructions and then seal the holes with caulk or putty, or simply treat all the wood with sodium borate solutions as discussed previously. The rods come 1/4" x 1/2", 1/3" x 1" and 1/2" x 2" in length and width. <http://www.nisuscorp.com/pdfs/jectalabel.pdf>; <http://www.polecare.com/products.php>

USING SODIUM BORATE PRE-BAITS AND/OR BAIT - You can spray or soak cellulose insulation (pulverized newspaper) sawdust, wood pellets, blocks, wood scraps, corrugated cardboard, tongue depressors, etc. with 3% (or less) sodium borate and use these materials to *prebait*/bait any and all areas where you see or suspect you will have termite activity e.g. block voids, plumbing voids, under porches, in cracks, under pool liners, etc. Moisten with seltzer water (with fizz) and add a little honey and molasses later if nothing happens in 2 - 3 weeks.

SAFETY

1. TIM-BOR is a light powder and can generate dust. Use of a light-duty dust mask (such as 3M Model 5800) is recommended when mixing. (BORA-CARE comes as a liquid concentrate, IMPEL Rods come as solid rods.) Any type of glove will protect skin adequately. Eye protection and long sleeved shirts should always be worn.

2. Accidental Exposure: (Consult the Material Safety Data Sheet (MSDS) for more information.)

Skin	Wash with mild soap and water.
Eyes	Flush with tepid (warm) water for 15 minutes. If irritation persists, consult a physician.
Inhalation	Remove to fresh air.
Ingestion	TIM-BOR - Drink plenty of water. Induce vomiting and contact a physician or poison control center. BORA-CARE - Read MSDS; treat for exposure to glycols. Contains borates. Monitor electrolytes.

3. Wash hands after handling sodium borate concentrates and their solutions before eating, drinking or going to the bathroom.

STORAGE

1. TIM-BOR (powder) and IMPEL Rods (solid) should be stored in a dry place above ground where children and animals cannot gain access.
2. BORA-CARE concentrate and/or TIM-BOR ready-to-use 10% solutions should be stored in carefully labeled, sealed plastic containers and kept from freezing and where children and animals cannot gain access.
3. There is no fire hazard with BORA-CARE, TIM-BOR or its solutions or solid IMPEL Rods. They all act as fire retardants.

Prebaiting with Sodium Borate - Treat virgin cardboard or shredded paper towels or stakes or blocks with 1% or less sodium borate and place them as baits in the soil next to the foundation wall - place them 20 feet apart - inspect monthly - replace those that are eaten as needed - put a sodium borate treated 2x4 under the porch steps and foundation before you pour cement - place treated strips of wood or cardboard or sawdust or cellulose insulation on the ground before you install your pool liner. Follow the label directions. You can make sodium borate baits using flat or rolled (virgin) cardboard, sawdust and/or paper towels and/or pieces of wood, foam etc. There are commercial cellulose baits containing 18% boric acid, but we think this is too strong a mix and would like to suggest a 1% - 5% mix, but if you use the weaker bait be sure you use enough bait material. So if you are making your own sawdust bait and think it is too strong or that the sawdust absorbed too much sodium borate - mix in fresh/untreated sawdust and add a **little** honey and/or molasses. You can drill holes in wood and/or concrete and insert treated dowels (the same size) by the activity and replace as needed; you can make stakes and treat them per label directions and drive them into the dirt and *prebait* before you pour cement. Boric acid, borax, Flagyl® and other salts and antibiotics will also kill termites, but they are not so labeled.

ENVIRONMENTAL HAZARDS

Boron is an essential micronutrient for plant life; however, even 10% TIM-BOR or BORA-CARE solutions are concentrated enough to be phytotoxic to (kill) all foliage.

- **Do not carelessly spill or apply sodium borate to crop lands, ornamental plants, trees or lawns. Too much borate will kill plants, but remember sodium borate (Solubor®) is also sold as a fertilizer.**
- **Do not apply sodium borate to any body of water. Certain aquatic life forms are very sensitive to excess boron concentrations.**



If possible uses of these products have been mentioned here, it is not intended that the above-mentioned products be used to practice any applicable patent, whether mentioned in this bulletin or not, without procurement of a license, if necessary, from the owner, following investigation by the user.

NOTICE: THERE ARE NO EXPRESS WARRANTIES ON TIM-BOR OR BORA-CARE OR IMPEL RODS OR JECTA INSECTICIDES OR FUNGICIDES OR IMPLIED WARRANTIES OF MERCHANTABILITY OR FITNESS FOR A PARTICULAR PURPOSE WHICH EXTEND BEYOND THOSE SPECIFICALLY DESCRIBED HEREIN, OR IN SELLER'S SPECIFICATIONS, OR SELLER'S EPA APPROVED LABEL.

ON ALL PRODUCTS, AVOID PROLONGED INHALATION OR PROLONGED SKIN CONTACT. NOT FOR FOOD OR DRUG USE. READ MSDS AND ALL INSTRUCTIONS RELATING TO THE PRODUCTS BEFORE USE.

HEALTH HAZARD INFORMATION & LD₅₀ VALUE COMPARISONS

Criteria for cataloging pesticide products by toxicity established by federal regulation include the following categories based on the acute oral LD₅₀ of the product:

Highly toxic (Category I)	LD ₅₀ -	50	mg/kg or less
Moderately toxic (Category II)	LD ₅₀ -	50 - 500	mg/kg
Slightly toxic (Category III)	LD ₅₀ -	500 - 5000	mg/kg
Relatively non-toxic (Category III)	LD ₅₀ -	- 5000+	mg/kg

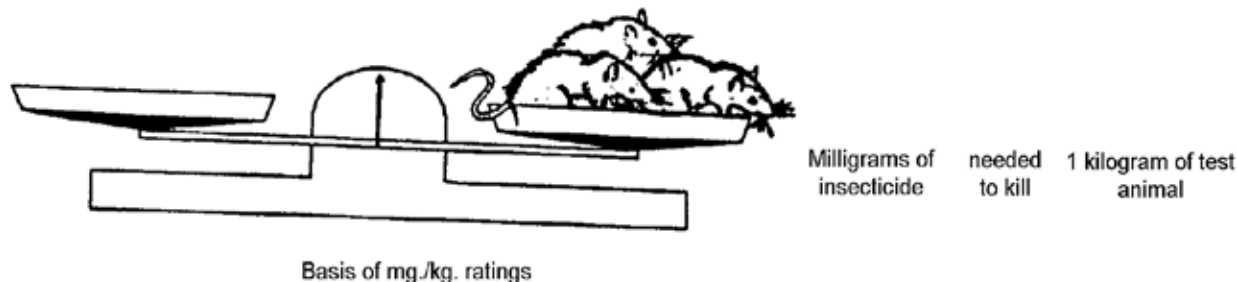

The TIM-BOR, IMPEL RODS and BORA-CARE labels have "CAUTION" for a signal word and TIM-BOR powder is 99% Disodium Octaborate Tetrahydrate that naturally contains trace amounts of arsenic. NOTE: This is the same active ingredient in solid IMPEL RODS and liquid BORA-CARE (which also has glycols and water) in the liquid concentrate. Vapor pressure is negligible and the National Fire Protection Association has rated the physical hazards of sodium borate as follows: Health - 0; flammability- 0; reactivity - 0. TIM-BOR has an LD₅₀ value (the relative amount of active ingredient required to kill 50% of a test population) of 2.55 gram/kg of body weight (in rats). BORA-CARE has an LD₅₀ value of 5000; sodium rates have not been shown to acutely irritate human skin, but it may be slightly irritating if you get some in your eyes; simply rinse them out (the effects of one-time exposure are reversible). Boric acid has not been shown to cause cancer, even with chronic overexposure. If you get some on your skin, simply wash with soap and water. If you get some in your eyes, flush with warm water for 15 minutes. If you find any irritation of your nose and throat or have inhaled any dust, go outside and breathe fresh air. If you swallowed any TIM-BOR and are conscious and alert, drink plenty of water and induce vomiting. If you swallowed any BORA-CARE, do not give anything by mouth; give syrup of ipecac or put fingers in the back of the throat and induce vomiting. Be sure to read the MSDS for either product. If you decide to use BORA-CARE, it does have glycols which evaporate quickly but could temporarily cause some problems to people who are chemically sensitive. **No one that is pregnant or that has skin, kidney, lung problems or is chemically sensitive should be allowed to apply even these chemicals (especially BORA-CARE) or should remain in the home during treatment. Please consult the MSDS and labels for further information.** If you have any persistent irritation or health concerns, consult a physician. NOTE: Boron is the element of which borax and boric acid are compounds. Individuals eat a certain amount of boron daily in their orange juice, all their vegetables, fruits (especially currants and raisins), breads and cereals. It is commonly present in blood in an average concentration of 0.14 mg/100 ml (range 0 - 0.77 mg/100 ml) but elevations in blood of 3.2 mg/100 ml have reportedly caused toxic manifestations. Some of the symptoms of boron or boric acid poisoning, namely diarrhea, vomiting, cramps, etc., may easily be confused with gastroenteritis and the attending physician may not suspect the true nature of the symptoms unless he/she is made aware of your

possible exposure to boron and/or boric acid. If BORA-CARE is used and any material is swallowed, treat for exposure to glycols and monitor electrolytes. Please read the MSDS and the "BORA-CARE mixing Instructions" section regarding the dangers of ethylene glycols. Note: The Manufacturer told me verbally that normally 90% of all the ethylene glycols will dissipate within 24 - 48 hours, but the higher the humidity the longer it will take for them to dissipate; increase the ventilation to lower the time. **BE CAREFUL! Please read the appropriate current MSDS and labels.**

Boric Acid or Borax or Sodium Borate Baits - Treat (per label directions) 2x4's, cellulose insulation (or pulverized newspapers) tongue depressors, blocks, cardboard, plywood, sawdust and/or other cellulose items and put them in crawl spaces, cracks and crevices, porch voids, plumbing voids, under pool liners and/or anywhere you anticipate a possible (or have a) termite attack. They will carry the bait back and kill the queen. Bushwacker® has a 18% boric acid bait for about \$20.00 for a pound. Properly *pretreating* with sodium borate will give you safer, longer *pretreatment* control than volatile, synthetic termiticides which break down after 5 years or less. You can make rolls (of sodium borate treated) corrugated cardboard to be placed in shrink wrap or a 12" section of 4" diameter PVC drain pipe (with the holes) capped with a PVC cap and placed neat the foundation every 20 feet or so around your building or cardboard boxes of glued and treated corrugated cardboard. You can attract "local" termites to your bait station by adding 25 - 100 "foreign" workers and at least 2 - 4 healthy soldiers to your bait stations. You can cover the cardboard with see-through plastic or Plexiglas, attached with self tapping screws. Termites love seltzer water, moistened (without chlorine) corrugated cardboard and will normally eat that instead of wood. Attract them to your baits with "foreign" termites, as they will war with one another. You can drill holes and insert treated dowels by termite activity, you can also treat stakes and drive them into the dirt and *prebait* before you pour the cement, etc. Borax, table salt, urea, Peladow® and other salts will safely control and/or stop termite activity in soils and wood, but they may also attack ferrous metals, e.g., nails. These salts will permanently control all wood destroying organisms until they are leached out. Borax and boric acid have been around for centuries, and their insecticidal properties have been known for some time. Stradivarius (1644-1737) used borates when making his violins.

THE GREATEST "SECRET" OF CONTROL



YOU SHOULD ONLY BE CONCERNED WITH REMOVING YOUR ENEMY ONCE AND FOR ALL - AS SAFELY AS POSSIBLE. Good luck, soldier; your enemy is now in your capable/caring hands. UTTERLY DESTROY ALL OF YOUR ENEMY, ITS BREEDING PLACES, FOOD AND WATER SUPPLIES. Leave nothing of them or their habitat left to return to trouble you. DO NOT LEAVE ANY "POCKETS OF RESISTANCE" that will allow your enemy to breed back (to their original level or even greater levels of infestation) and re-attack your home or buildings! Try to be smarter than your enemy!

LIFETIME CONTROL AND FINAL COMMENTS

Note: Borate termiticides must not be applied in any manner to the soil: Soil termiticide labels state you can not treat soil under or adjacent to any structure which contains a well or cistern; we do not advise the use of any volatile soil termiticides, especially under or adjacent to any part of a structure with a well or cistern (even if it is abandoned) located within ten feet of it. This distance is measured across the surface of the soil from the application area to where the well or cistern begins to descend vertically, OR applied in any manner to soil at or below the local water table.

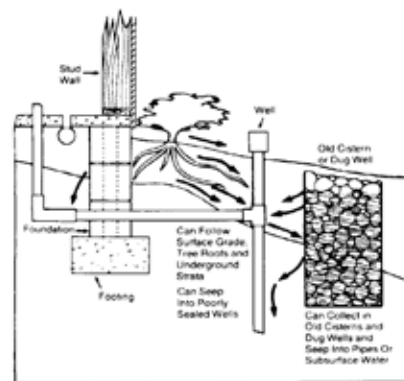

If you have any further questions on Intelligent Pest Management® techniques for wood destroying insect or decay controls or chemical choices, call a graduate of the Institute of Pest Management, Inc. during normal business hours and talk directly with Get Set, Inc. or contact us on the Web: <http://www.getipm.com>. Anytime you build or move into a new home or anytime you find any wood destroying organisms, or simply want to prevent them, you may call or write us. Remember that in California gloves, long sleeved shirts and eye protection are required whenever you apply any pesticide, no matter what the label requires. **Check your state's requirements.**

SUPPLEMENTAL SECTION

Initial Commentary: It is impossible in the Author's opinion to make a volatile, synthetic poison barrier so complete around and/or under an entire structure that termites cannot by persistent foraging be unable to find access either via a root or directly through or around this volatile, synthetic poison barrier. The Author has personally inspected homes so contaminated with these terrible termiticide toxins that people could not live there anymore - and these buildings were eventually hauled away to a toxic landfill - but until they were hauled away - the Author still found active termites eating the wood!

Harry Katz in [Pest Control Technology](http://www.pctonline.com/Article.aspx?article_id=40076), April, 1998 also noted: **THE "CONTINUOUS BARRIER" IS A CONTINUING MYTH** http://www.pctonline.com/Article.aspx?article_id=40076.

For half a century, the cornerstone of the pest control industry's procedure to control termites has been the placement of a continuous chemical (poison) barrier around and under a structure's foundation. This may turn out to be the April Fool's tale of the '90s. Many failures of termite jobs are not the fault of PCOs or of the termiticide. **Blame for some of the failures in termite jobs should rest with the regulatory community, which mandated label directions based on a flawed concept that creating a complete or continuous chemical barrier is repeatable and sustainable by using the application techniques as labeled.** Equating five-year efficacy in controlled lab tests with justification for a five-year warranty is unfair. It is unreasonable and materially deceptive by regulators to cite efficacy in controlled lab tests that use different application and distribution techniques and then claim that such demonstrates proof that the labeled use will provide equivalent control in field conditions.

The (poison) barrier was designed to prevent subterranean termites from entering the structure for food or leaving the structure for moisture in the soil. To ensure efficacy of termiticides, the Environmental Protection Agency need proof that the toxicant in the soil would persist for at least five years.

This was provided in federal testing agencies in Mississippi and other sites where soil and termiticide solution were premixed in a cement mixer and placed under concrete slabs to simulate home construction.

Termiticide labels mandated by the EPA suggest mixing the soil with the termiticide solution in a shallow ditch along the foundation, or rodding down into the backfill but not below the footing. Pavement was to be drilled at intervals, depending on the type of soil, according to some labels.

A UNIFORM DISTRIBUTION? It was a Myth Conception of the regulators, the pest control industry and the public that the distribution of the (poison) solution by rodding would be uniform and that the (poison) barrier would be a series of contiguous columns of treated soil that would bar entry by termites. Testing in the field did indeed prove the residual value of the toxicant. But, for obvious reasons, no label calls for mixing all the soil to the footing with termiticide in a cement mixer.

It is not likely that the backfill around a foundation is uniform enough to permit an even distribution of termiticide (poison) solution. Building debris, brickbats, hunks of clay, trash and other items make it virtually impossible for every cubic inch to be properly treated (thoroughly soaked with the termiticide POISON). Some areas get too much and some areas will, obviously, get too little or none at all. This is true even if the operator is extremely meticulous about measuring and calibrating the application. As a result, the termite colony has plenty of time to find these untreated areas and the foragers can and will find their 'windows of opportunity'.

While we do not usually recommend that you need or conduct any application of volatile, synthetic termiticide residual poison barriers, some states still demand all new construction be pretreated using these toxic chemicals and we, therefore, have included this section for your information. (Do not exceed 25 psi pressure.) Remember one simple fact - 98% of all subterranean termite infestations occur behind the porch or step - yet 98% of the termiticide poison is applied elsewhere!

Some of the Author's Personal Experience with "Professional" Termite "Control":

Thirty some years ago, the Author was one of the "good old boys" who applied chlordane/heptachlor (and/or Dursban) until he got a tumor or cyst the size of a golf ball on his right middle finger and decreased mentally so much he could not add up small amounts up change! After years of sauna detoxification, he can function, as long

as he avoids further contamination from any volatile, synthetic pesticide poisons. Just after the Author completed writing the first edition of **The Best Control**[®], an Intelligent Pest Management[®] manual of about a thousand pages. he went to Arizona to take several pesticide applicator exams. After flying into Phoenix, he stayed at a motel and awoke with a severe headache after 13 hours and discovered the motel had been *treated* for termites several times. Arizona has a law that owners be told of alternative controls, but another law mandates the only way a new home can be built is to have a **complete** soil *treatment* using only volatile synthetic termiticide poisons, and yet another mandate states the only way a building can be treated for subterranean termites is to use the **maximum** labeled rate of volatile synthetic termite poisons - any less amount of the volatile poisons - is fraud! the Author does not remember taking his exams on 8/26/94 - and pities the people of Arizona and other states that are controlled by poison applicators and *regulators* that do not care what the public wants or needs, but will instead *protect/pollute* them with the **maximum** labeled amount of dangerous, volatile, synthetic pesticide poisons they can! It is no wonder 1 out of every 7 Americans is already significantly impaired from their exposure to toxic materials, and currently the earth is experiencing the greatest rate of extinction since the age of the dinosaur!

On October 1, 1996, the EPA (due to the NPCA's lobbying efforts) noted that on 10/1/97, all termiticide product labels will state in EPA - approved label language, that (poison) applicators will be able to use their own discretion in determining what rate termiticides should be applied for post construction termiticides - PCO's will no longer be *responsible* for keeping construction workers away from construction sites that have been recently (poisoned) "treated". Instead of having to plug every (poison) treatment drill hole, even those that are inaccessible, (poison) applicators will (only) be required to plug the exterior holes and those in commonly occupied areas. (Poison) applicators will no longer have to wear (protective) moon suits for all termiticide applicators and lastly, (only) one technician, not two as called for in the draft, will be permitted to do post construction *treatments* involving a void in the foundation! Pest Control magazine noted this in January, 1997 - as the National Pest Control Association (NPCA) proudly proclaimed these facts/compromises and their logo as *Guardians of the environment!* Amazing!

USA TODAY - TUESDAY, MARCH 24, 1998 - 13A - THE FORUM

Scrutiny of pesticides comes none too soon

By Warren Getler

When Jacob Berkson, former deputy general counsel for the General Services Administration, had his house treated for termites 10 years ago, he could not have known that his life would be changed forever. He became chronically ill with headaches, nausea and memory loss. He moved out of his house. He wrote a book, *Canary's Tale*, about his encounter with organophosphate pesticides.

Symptoms of poisoning

Here are some persistent symptoms and signs reported in chronic organophosphate insecticide poisoning:

Blurred vision

Headaches

Muscle weakness

Lethargy/insomnia

Short-term memory loss

Confusion

Lowered intellectual scores

Depression

Source: Report by EPA epidemiologist Dr. Jerome

Blondell

The experience, he says, "devastated my life." And now, as regulators take a close look at these products, the Maryland resident warns: "If there's any doubt, you resolve doubt in favor of public safety and health."

Today the Environmental Protection Agency is holding a public meeting on a class of widely used household products that may be adversely affecting the lives of numerous Americans: the organophosphate pesticides (OPs) sprayed in millions of homes, schools, restaurants and offices and used extensively in agriculture as well.

The EPA last year curtailed the use of the nation's most widely used pesticide, Dursban. Now it also is seeking to determine whether the entire class of OPs should be reined in, or eliminated particularly for indoor use.

New scrutiny - The heightened scrutiny comes none too soon. The EPA has received thousands of reports of health-related incidents linked to OPs.

Other agencies also are focusing on the OP pesticides. The Pentagon has signaled concern that their use in the Gulf War may have contributed to the various neurological ailments reported by veterans. Dursban, diazinon and Malathion, all OPs, were widely used to contain desert flies and other pests. There's also concern that troops indiscriminately used unauthorized OPs acquired in Saudi Arabia and Kuwait, including a potent fly bait called Azamethiphos.

"We have grounds for concern. Prudence would suggest that we be particularly careful about the use of organophosphate pesticides," Pentagon Gulf War illness spokesman Bernard Rostker says. What's more, the National Institute for Occupational Safety and Health has launched an investigation into the health effects of Dursban among professionals who use it to combat termites and roaches. Dursban is sprayed in more than 20 million homes annually.

Under the new Food Quality Protection Act, the EPA must evaluate the safety of entire classes of pesticides, particularly when it comes to cumulative risks to children from direct exposure and via food and water.

Manufacturer vs. EPA - The EPA's growing concern over OPs has a history. Manufacturer DowElanco of Indianapolis was fined more than \$800,000 in 1995 for the late reporting of several hundred cases of alleged long-term injury from Dursban.

Last year, an EPA report on the chemical chlorpyrifos (the active, EPA-registered ingredient in Dursban) concluded on the basis of case reports that the compound "may be significant cause of chronic neurobehavioral effects." It said that "further study is needed to determine the prevalence and severity of these effects." Notably, the report's co-author, EPA epidemiologist Dr. Jerome Blondell, visited the Pentagon in January 1994 to warn about apparent parallels between reported longer-term symptoms of OP poisonings at home and those reported among Gulf vets.

DowElanco says the Blondell report is "seriously flawed" based on its own extensive studies, which it says prove Dursban is safe when used as labeled. Nonetheless, the company last year agreed to withdraw certain uses of Dursban: as an indoor fog, carpet spray or as pet flea dips and shampoos. The company can still sell the product for home crack-and-crevice spraying, termite applications and agricultural uses. It says it's pursuing additional safety research.



With serious safety questions being raised by no fewer than three federal agencies, it seems urgent that regulators take a very comprehensive look at these products.

Dr. Lynn Goldman, the EPA's pesticide administrator, says the Food Quality Protection Act provides a tougher safety standard. "The new standard is 'reasonable certainty at no harm. What it means in plain English," she adds, "is that in the case of a pesticide like chlorpyrifos, no one should get sick or suffer chronic neurological damage because of a legal use of this pesticide."

If infants, children and adults are being made chronically sick or disabled by routine exposures, then strong steps - perhaps an outright ban in closed-in environments - need to be taken. If people are being injured solely through misapplication by unqualified commercial applicators, then the flimsy state-by-state licensing and training procedures must be reformed. And, for consumers who want to buy these products off the shelf, the EPA will need to, as it says it will, change its labeling guidelines significantly. *Warren Getler, a Washington, D.C., journalist, specializes in science, environmental and national security issues.*

"Soil Treatments or Poison Barriers"

Before allowing any termiticide poison use in your home or property, please read the current label and MSDS available on the internet at numerous web sites (including that of the manufacturers); find some of these locations at: <http://www.ilpi.com/msds/> and/or try: <http://www.pctonline.com/msds/search.asp>

Volatile, "Registered" Residual Poisons - Poison treatment of the soil around and under the foundation is generally the *professionals'* prime method of *preventing* termite attack, but it should only supplement good building practices. Backfills normally are a combination of soil, clay, rock, building debris, foam insulation, roofing, concrete, roots, metal, plastic, etc. that seriously impede or prevent the "proper" disbursement of any termiticide poison *residue* throughout every cubic inch or foot of soil. The word "residue" is the poison industry's way of describing how long the contamination or volatilization of the poison will be found residing in your home, family and pets. Only as long as the poison is volatile (capable of contaminating) will it *control* your pests!

In the Mallis Handbook of Pest Control, 8th Edition, Dr. Michael Potter also noted that liquid termiticide (poison) dilutions tend to disperse randomly over the subslab fill resulting in inconsistent coverage and diversion from

target areas. Termites spend their lives looking for these “mistakes” or untreated pockets of soil to use to gain entrance to their (your home) food supply!

Volatile, ‘registered,’ synthetic *Residual* Soil Poisons - Volatile, synthetic insecticide poisoned soil still serves as one of the pest control industry’s most important means of isolating a building from termites. Soil treatment is supposedly most effective when done before and during construction of the foundation, especially when using concrete slab-on-ground construction. The *hidden* control problem is, we are building our homes over old farm fields, groves, and orchards where the termites have already been exposed to and have become resistant to every pesticide poison known to man. Then they are exposed to even more lawn care pesticide poisons and home and garden pesticide poisons - is it any wonder the termites are immune or already resistant (already equipped with cytochrome P450 enzymes) to make them impervious to the poison *industry’s* termite soil poisons? **Remember, virtually all “registered” pest control pesticide poisons are recycled - after they have already basically failed as “registered” agricultural poisons!**

Several volatile, synthetic *residual* pesticide poison formulations are currently “registered” with the EPA for poisoning soils to prevent or control subterranean termite infestations. Currently the most common volatile, synthetic termiticide poisons used are: chlorpyrifos (Dursban TC), cypermethrin (Demon TC), fenvalerate (Tribute), isofenphos (Pryfon 6) and permethrin (Dragnet or Torpedo). All of these volatile, synthetic *residual* insecticide poisons or termiticide poisons can be purchased by certified pesticide applicators and used only under their direct supervision, but chlorpyrifos can also be purchased and used by homeowners in some states. At least 6 of the currently *registered* volatile termiticide poisons are repellent to termites - which means termites simply avoid the *treated* (poisoned) soil and are funneled into roots or gaps in the poison “barrier.” **Several studies of soil termiticide residues in Texas show that after only 5 years, there is less than 10% of the initial application rates of all the currently registered termiticides tested (Gold et. al 1996) - so why would any sane person demand only the maximum labeled rate of these dangerous poisons be used?**

Preparation of Chemical Poison Solutions - A synthetic *residual* soil termiticide poison is considered “economical” when compared to the potential structural loss only and they are most easily prepared when purchased as a liquid concentrate. The concentrate is formulated according to the percentage, or weight in pounds per gallon, of the toxin it contains. Each concentrate contains an emulsifier to make it easier to mix in water and must be diluted before use. Label directions are provided on the container for diluting the concentrated solution to the desired strength. **The label should be followed carefully; however, even when properly applied at the labeled rates, these soil “barriers” are subject to degradation within several years and/or root penetration and/or mechanical breaks, especially when the soil is disturbed or covered and can contaminate you, your family, your ambient air and potable water supply for years!**

How long will these volatile poisons “protect” your home? For most uses, the recommended concentrations of the final dilutions are: Chlorpyrifos, 1.0 percent; cypermethrin, 0.25 to 0.5 percent; fenvalerate, 0.5 to 1.0 percent; isofenphos, 0.75 percent, and permethrin, 0.5 to 1.0 percent. **Remember, however, that the chemical barrier may be significantly reduced by many environmental factors, e.g., repellency, mechanical alteration, absorption, penetration, roots, soil type, pH, sunshine and/or rain and the poison industry admittedly knows little about these factors!** (For example, copper [pipes] in the ground causes chlorpyrifos not to control termites in those areas.) Many Gulfport efficacy studies demonstrate some (currently *registered*) termiticides demonstrate only a **2-3 years’ efficacy** and the ground-board efficacy test used a 1.0% application rate for pyrethroids, but no currently *registered* pyrethroid termiticide allows a 1.0% application rate, most are 0.5% or less and termites avoid soil poisoned with pyrethroids! Often a residual termiticide poison may not be effective but termites may not break through and it will appear that the termiticide poison is still effective. The bottom line is many products have use rates far below the rates tested in the Gulfport studies! Numerous studies have found the degradation of (all currently “registered”) synthetic termiticides are inevitable, particularly in exposed soils, on exterior perimeters, and/or will soon develop weak points in the *protective (poison) barrier*. Because the termite poison barriers now all break down so quickly - most *termiticide* poison manufacturers have added (yearly) perimeter *treatments* for *crickets* to their *registered termiticide* labels! **Way to go poison guys!** Note: Chlordane **was** labeled to be used at 8 times the rate needed to pass the Gulfport test. A 1/8% emulsion of chlordane or heptachlor gave 5 years of control in the Gulfport protocol, but the “registered” labeled rates for both of these carcinogens was 1%. At the November 1998 ESA and APS meeting in Las Vegas, Weste L. Osbring (USDA - ARS, 1600 SW 23rd Drive, Gainesville, FL 14565) reported that subterranean termite colonies (*Reticulitermes virginicus*) vary significantly in their ability to detoxify pesticide poisons. Cyclodienes, e.g., aldrin

and chlordane, detoxification rates can vary as 250%. Elimination of resistant colonies can take more than three times as much methoxychlor or DDT than susceptible ones. As poisoned termites die they decompose and produce acidic chemicals that can repel the other termites. One colony exhibited a three-fold tolerance ratio for chlorpyrifos.

The February, 1997, EPA Special Report on Environmental Endocrine Disruption: An Effects Assessment and Analysis noted on page 30 that this year, more than one-half a million Americans will succumb to cancer, making it the nation's second leading killer after cardiovascular disease. On page 92 the report noted some Endocrine Disruption Effects in wildlife from synthetic pesticide pyrethroids (various) including: Avian reproduction impaired, eggshell thinning; fish reproduction impaired. The report noted on page 21: While estrogenic effects have been cited as examples in this document, it is important to realize that any hormone has the potential of being disrupted in one way or another by an environmental agent, and similar considerations as for estrogenic effects apply. In other words we simply do not and will not know how dangerous these synthetic poisons are until it is too late for many of us. **Always avoid the use of any volatile, synthetic pesticide poisons!**

Termite Pheromones - All subterranean termites spray the tunnels they dig with pheromones so they can follow the scent from their nest to your home or building to find their food supply. Destroy that pheromone scent with orange oil and the termites simply cannot find their way to your property.

Termite Bait/Spray - The sugar analogue glucono delta-lactone (GDL), a naturally occurring organic acid used as a food additive, inhibits termites' immunity against pathogenic microorganisms that normally contaminate termite colonies.

Subterranean termites remain disease-free because of their constant grooming and the protective effect of a specific type of protein, known as gram-negative bacteria-binding proteins (GNBPs), present in termite saliva and fecal matter. These GNBPs naturally destroy both fungus and bacteria.

The addition of GDL to the colony, however, inhibits the fungus-fighting proteins from doing their job. Termites exposed to the GDL succumb to fungus/disease much faster than those who aren't exposed.

PMP 2009 Termite Report

USDA-FS Termiticide Report Termiticide Efficacy Results for 2008

By Drs. Terry Wagner, Joe Mulrooney, Thomas Shelton, and Chris Peterson • Contributors

The United States Department of Agriculture Forest Service (USDA-FS) evaluates candidate termiticides for federal and state registration. In 2008, the USDA-FS administered 33 agreements with product manufacturers as part of its ongoing Termiticide Testing Program.

Two termiticides were installed at the four national test sites in Florida (February), Arizona (April), Mississippi (June), and South Carolina (September). A third termiticide was installed in Mississippi and South Carolina. The number of

continued on page 30

Table 1. Number of years that termiticides remained effective in concrete slab (CS) and ground board (GB) tests at four field sites applying the EPA guideline and Florida efficacy rule.[†] Fractions of years occurred when products were installed out of cycle. Control = percentage of all untreated plots attacked over the life of the study.

% A.I.	Test	Arizona		Florida		Mississippi		South Carolina		FL SE States
		EPA	FL	EPA	FL	EPA	FL	EPA	FL	
Bifenthrin – Biflex TC (est. 1986)										
0.031	CS	0	9	4	11	2	5	2	4	4
0.062††	CS	16	16	22	22	7	7	10	16	10
0.125††	CS	10	15	9	22	2	7	22	22	9
0.25	CS	22	22	22	22	16	17	22	22	22
0.5	CS	6	22	22	22	18	22	22	22	22
0.031	GB	6	7	4	5	2	2	3	4	4
0.5	GB	10	11	14	21	12	15	8	11	14
Control	CS	52%		67%		52%		62%		-
Control	GB	67%		85%		77%		86%		-
Cypermethrin (est. 1982)										
0.125	CS	1	4	0.5	1.5	1	3	2	2	2
0.25††	CS	4	4	10.5	12.5	3	5	4	4	4
0.5††	CS	4	5	4.5	9.5	7	14	12	12	11.5
1.0	CS	8	10	7.5	21.5	6	15	12	16	15
1.0	GB	3	6	4.5	4.5	5	5	5	6	5
Control	CS	62%		65%		56%		65%		-
Control	GB	74%		76%		87%		90%		-
Permethrin – Dragnet (est. 1978)										
0.25	CS	8	10	2	2	1	2	0.5	0.5	1
0.5††	CS	13	19	4	4	5	6	4.5	4.5	4.5
1.0††	CS	15	15	15	25	5	8	10.5	11.5	10.5
1.0††	GB	9	11	6	6	2	3	0.5	3.5	3
Control	CS	50%		55%		60%		53%		-
Control	GB	43%		78%		86%		84%		-
Permethrin – Torpedo (est. 1980. Controls same as cypermethrin)										
0.25	CS	9	9	3	7	2	2	0.5	0.5	1.5
0.5††	CS	11	13	6	9	3	5	1.5	4.5	5
1.0††	CS	19	28	25	27	3	7	6.5	7.5	7
0.5††	GB	4	4	4	4	1	1	1.5	1.5	1.5
1.0††	GB	8	9	5	5	2	2	1.5	1.5	1.5

† EPA: Years with no penetration through treated soil in any plot.

FL: Years with no damage worse than ASTM 9 to test blocks in 90% or more of the plots per site.

FL SE States: Years with no damage worse than ASTM 9 to test blocks in 90% or more of the plots for all southeastern sites.

†† Registered rates.

Table 2. Number of years that termiticides remained effective in concrete slab (CS) and ground board (GB) tests at four field sites applying the EPA guideline and Florida efficacy rule.[†] Fractions of years occurred when products were installed out of cycle. Control = percentage of all untreated plots attacked over the life of the study.

% A.I.	Test	Arizona		Florida		Mississippi		South Carolina		FL SE States
		EPA	FL	EPA	FL	EPA	FL	EPA	FL	
Imidacloprid – Premise 75 WSP (est. 1992)										
0.025	CS	15	15	15	15	1	1	3	4	2
0.05††	CS	15	15	6	12	2	2	10	10	6
0.1††	CS	15	15	15	15	2	4	5	15	8
0.15	CS	15	15	15	15	3	4	5	15	5
0.2	CS	15	15	15	15	2	5	5	5	5
0.25	CS	15	15	12	15	2	2	8	9	8
0.3	CS	15	15	15	15	5	5	5	11	14
0.4	CS	15	15	12	15	5	9	5	14	15
0.1††	GB	3	7	2	2	1	1	2	2	2
0.2	GB	8	14	2	2	2	2	2	2	2
0.3	GB	5	6	2	2	2	2	1	2	2
0.4	GB	5	7	2	3	2	2	4	5	2
Control	CS	33%		77%		75%		36%		-
Control	GB	40%		95%		96%		70%		-
Fipronil – Termidor 80 WG (est. 1994)										
Only one treated GB plot has been attacked in 14 years, but due to the low attacks at untreated control plots and multiple products in the test site, it is impossible to evaluate treatment effects. For additional information, refer to the 2006 Termiticide Report (PC, February 2007, page 66).										
Control	CS	14%		19%		2%		3%		-
Control	GB	10%		6%		14%		11%		-
Fipronil – Termidor SC (est. 1999)										
0.06††	CS	9	9	8.5	8.5	8	9	8	8	8.5
0.125††	CS	9	9	8.5	8.5	8	9	9	9	8.5
0.25	CS	9	9	8.5	8.5	9	9	9	9	8.5
0.06††	GB	9	9	8.5	8.5	9	9	5	9	8.5
0.125††	GB	9	9	8.5	8.5	8	9	9	9	8.5
0.25	GB	0	9	2.5	8.5	2	2	9	9	8
Control	CS	2%		60%		81%		62%		-
Control	GB	48%		97%		82%		87%		-
Chlorfenapyr – Phantom (est. 1996)										
0.125††	CS	12	12	1	7	1	1	6	7	1
0.25††	CS	12	12	11	11	2	5	5	12	6
0.5	CS	12	12	12	12	4	4	12	12	12
0.75	CS	12	12	1	1	5	5	12	12	12
1.0	CS	12	12	12	12	5	7	8	8	7
2.0	CS	12	12	12	12	1	9	12	12	12
0.25††	GB	9	11	0	0	2	6	5	8	6
0.5	GB	5	10	1	8	4	4	12	12	5
0.75	GB	12	12	4	7	5	12	11	12	8
1.0	GB	8	12	9	11	5	11	11	11	11
2.0	GB	6	11	12	12	12	12	8	12	12
Control	CS	19%		58%		79%		49%		-
Control	GB	48%		85%		98%		96%		-

† EPA: Years with no penetration through treated soil in any plot.

FL: Years with no damage worse than ASTM 9 to test blocks in 90% or more of the plots per site.

FL SE States: Years with no damage worse than ASTM 9 to test blocks in 90% or more of the plots for all southeastern sites.

†† Registered rates.

“Registered” Rates and Methods of Applications - Old Label

The supposed objective of chemically *treating* soil with any “registered,” synthetic *residual* poison is to provide a continuous poison *protective barrier* in the soil surrounding the building foundation. The synthetic *residual* poison must be applied thoroughly and uniformly to block all routes of termite entry. This requires that all *registered* volatile poison treatments be applied around all expansion cracks, pipes and utility conduits that contact the soil or wood. Any of the previously mentioned volatile termiticide poisons may be temporarily effective, but remember they can and will also all volatilize into your home, especially through cracks and any other unsealed openings and termites are already resistant to many of them. The rates and methods of application change with the type of construction and the area to be *treated* as follows:

1. **Slab-on-ground Construction** - Soon after the dirt or gravel fill has been put in place and tamped, you may treat the fill with a volatile, synthetic *residual* poison before the concrete slab is poured. The synthetic *residual* poison may be applied either with a power sprayer or a tank-type garden sprayer using low pressure to avoid misting. Anyone who walks or drags a hose, etc. on your pretreat opens many “gaps” in the poison “barrier”.
 - a. Apply 1 gallon of diluted volatile poison per 10 square feet of area as an overall treatment under slab and attached slab porches, carport, garage and terrace where the fill soil or unwashed gravel.

Volatile, synthetic *residual* poison treatment of the fill material prior to pouring a concrete slab is used to try to prevent termite attack.

- b. Apply 1.5 gallons of volatile diluted poison per 10 square feet of area where the fill is washed gravel or other coarse absorbent material, such as cinder.
- c. Apply 4 gallons of volatile diluted poison per 10 linear feet to the fill in critical areas under the slab, such as along the inside of foundations walls, along both sides of interior partition walls and around plumbing.
- d. “Treat” voids in masonry blocks or foundations.* If voids are inaccessible, drill holes near the footing and inject the volatile poison to form a continuous barrier. Apply 2 gallons of diluted volatile poison per 10 linear feet of wall or foundation . Note: New York does not allow and we do not recommend that anyone treat these voids with volatile poisons. It is far better to fill them; if this is impossible, you can dig a trench along side the structure and place the soil on a waterproof tarp or visquine at least 6 mils thick); then treat the soil, allow the soil to dry a minimum of 4 hours and then replace the dry soil in the trench. Remember, the synthetic termiticide poisons are volatile and short-lived and roots pass through them and provide safe highways through the “protective” (poison) barrier for the termites.

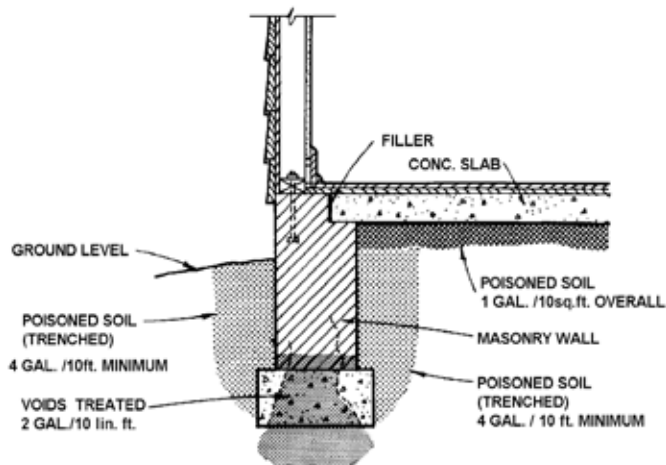

Caution: Application of volatile, synthetic *residual* poisons to slab construction. Do not treat inside structures that have intraslab or subslab air ducts or with plenum air systems.

***Drilling into the blocks and applying termiticide poisons inside them is prohibited in New York State.**

- e. After the slab is poured, dig a trench 6 to 8 inches wide along the outside of the foundation including porches and patio. Where the top of the footing is more than 12 inches deep and where large volumes of volatile, synthetic *residual* poison must be applied, make holes about 12 inches apart in the bottom of the trench to the top of the footing using a crow bar, metal rod or grouting rod. These holes will supposedly permit better distribution of the volatile, synthetic *residual* poison by providing access to the soil at depths below the trench. The holes may need to be closer together in hard-packed clay soils than in light sandy soils. Apply 4 gallons of diluted volatile, synthetic *residual* poison per 10 linear feet of trench for each foot of depth from grade to footing. Refill the trench and saturate the soil with synthetic *residual* poison. Finally, place a thin layer of untreated soil on top of the *treated* soil and cover with visquine or cement. **Note: Have someone inside to be sure no visible poison enters the structure.**

Application of a volatile poison to soil around the exterior foundation. **A 4" layer of untreated soil should be placed over the treated soil at completion.** (Some of the new volatile termiticide poison labels say this is no longer necessary - just leave the poison directly exposed to the degradation of sunlight and/or air!)

2. Crawl-space Houses - The soil under and around crawl-space homes should be treated as follows:

- a. Apply 4 gallons of diluted volatile, synthetic *residual* poison per 10 linear feet of trench along the inside of all foundation walls (including porches and patio) and along all sides of interior supports and plumbing. Note: Do not *treat* crawl spaces that will be used as plenum air spaces, or if the foundation (that extends below grade) has any holes, cracks, voids or is constructed of stone or rubble without mortar, you must first fill all of the holes, cracks or voids with mortar or other suitable permanent and impervious material prior to application of any volatile, synthetic residual "ground" poisons to prevent these poisons from freely moving into the structure. Note: If you do not wish to fill all the voids, cracks or holes in the foundation, or it is constructed of stone or rubble without mortar- you can also trench the soil next to the foundation, place it on a waterproof tarp or sheet of visquine (at least 6 mils thick), then *treat* the soil, allow the soil to dry a minimum of 4 hours and then replace the dry, poisoned soil in the trench after lining the trench with visquine before replacing the *treated* soil.

Application (via trenching and/or rodding) of volatile, synthetic *residual* poison to crawl-space construction. Soil *treatment*: (1) along outside and (2) interior perimeter foundation wall; (3) around pier and (4) plumbing. In New York you must (and we highly recommend everywhere) permanently seal the interior exposed soil with an impervious material such as an 18" wide ribbon of concrete immediately following the application. **BE SURE THE CRAWL SPACE IS PROPERLY VENTILATED BEFORE ANY VOLATILE POISON TREATMENT BEGINS.**

- b. Dig a trench 6 to 8 inches wide along the outside of the foundation including porches, patio, etc. Where the top of the footing is more than 12 inches below the surface, rod to the top of

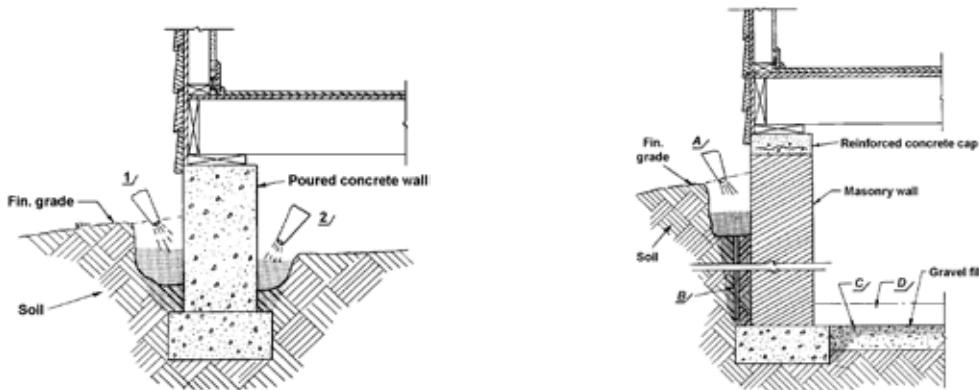

the footing. The holes may need to be closer together in hard packed clay soils than in light sandy soils. Apply 4 gallons of diluted volatile, synthetic *residual* poison per 10 linear feet of trench for each 12 inches of depth from grade to footing. After rodding, refill the trench and saturate the soil with volatile, synthetic *residual* poison. **Then place a thin layer of untreated soil on top of the treated soil.**

Application of volatile, synthetic *residual* poisons to soil in and around a house with a full basement; (A) *treatment* along outside of foundation, (B) rodding from bottom of trench to top of footing, (C) *treatment* of fill or soil beneath a concrete floor in basement, (D) concrete slab poured after volatile poison has been applied.

- c. Apply 1 gallon of volatile poison per 10 square feet of soil surface as an overall *treatment* only where the attached concrete platform and porches are on fill or ground.

3. **Basement Homes:** (See crawl space foundation notes!)

- a. *Treat* the soil under and around basement houses with volatile, synthetic *residual* poisons applied in the same manner as recommended for slab-on-ground construction.
- b. Voids in masonry foundations can be *treated* at or near the footing with 2 gallons of volatile, synthetic *residual* poison per 10 linear feet of wall. (Not legal in New York.)

4. **Other Types of Construction** - All volatile poison *treatments* should only be done according to the component parts, using the exact specifications on the label which apply to each.

Considerations when *Treating* New Construction - Be sure you understand the entire/current poison label and all appropriate state and federal "laws"! The type of soil encountered at the building site and the amount of moisture present in the soil just prior to treatment will have an effect on the acceptance of liquids at the recommended rates. Treatment is best accepted when the soil fill is damp but not excessively wet or dry. Excessively wet, there is a chance of runoff, and the volatile, synthetic *residual* poison will not penetrate the soil. In frozen or excessively dry soil the volatile, synthetic *residual* poison solution is repelled and puddling occurs which will result in poor distribution of the volatile termiticide poison and contamination problems. **Studies have now shown that some soil particles can hold onto the termiticide (poison) molecule so tightly that it is not released to affect the termite that comes in contact with the poisoned soil particle - this is called bioavailability. Couple this with the fact it is virtually impossible to achieve an equal distribution of the poison in the soil and that all these volatile poisons break down quickly and termites are repelled by these poisons and there are many manmade "gaps" and many roots in the soil and it is easy to explain why and how quickly so many termites can reenter the *treated* structure directly through the poison barrier.** In addition, you must add in these major termite control problems - native and/or subsequent resistance, microbial metabolism (by actinomycetes, fungi and bacteria) soil alkalinity, ultraviolet radiation, oxidation, hydrolisis, polymerization, leaching and volatilization, which all start working immediately to quickly render your volatile soil poison *barrier* not only useless, but dangerous! Remember that if you (or your *bankster*) request volatile, synthetic termiticide poisons - EPA still requires that the labeled rate (maximum amount) of volatile, synthetic poisons must be applied on your preventative termite poison *barrier* or pretreat - even though all of the *protective* poison will disappear basically in 5 years or less! **Remember, the "protective" poison barrier is quite thin and its continuity is routinely disrupted by termite treatment hoses, plumbing, inspectors, carpenters, cement contractors, etc.!** While all construction workers will have to leave when the "registered" poison is applied, they will be back to breathe and to "play" in the poisoned soil soon enough.

Mechanical breaks or the disturbance of *treated* soil breaks the continuity of the synthetic insecticide barrier and increases the possibility of termite penetration. The *treatment* of fill under slabs is probably less than 2 inches deep and the majority of the poison is in the top 0.75 inch; therefore, very little disturbance to the *treated* soil can be tolerated. **After all grading and other soil disturbance has been completed,** the final volatile poison *treatment* on the outside of foundations may be done. Protect a freshly treated slab foundation site with polyethylene sheeting or other waterproof material, unless the cement is to be poured the day of the treatment. This may prevent rain from washing the volatile, synthetic *residual* termiticide poisons into your well

or into the ground water.

Volatile termiticide poisons are **still** considered *stable* by EPA once they dry in the soil. Because the most commonly used volatile, synthetic *residual* termiticides are also considered to be insoluble in water, leaching is also not considered to be a problem. (Then how did the poison *industry* get them into the water solution in the first place? - especially dangerous are the new *foams* that freely force or move volatile poisons throughout the soil.) However, there is a major risk of contaminating a well or other water supply if these volatile, synthetic *residual* termiticide poisons are applied under pressure to nearby soil that either contains layers of gravel or tends to severely crack during periods of drought. Especially in these situations, the soil should never be *treated* with volatile, synthetic *residual* poisons. Remember, all these *new poisons* will quickly become or are already totally ineffective and useless, due to all the volatilization, roots, microbial degradation, mechanical breaks, moisture barriers, resistance, rain and/or sunlight, etc.

The February 1998 issue of Pest Control magazine had a termiticide pretreatment article by Dr. George Rotramel who studied 157 slab (monolithic) homes in the desert southwest - termites invaded more than half of these "pretreated" homes in this subdivision within a year of construction. There was no relationship between success or failure dependant on the time of year, the product used, the crew doing the work, or whether an inspector was present during the (poison) application. Failure rates (for all of the "registered" volatile, synthetic termiticide poisons) were just as high when an inspector was present to certify that the (pretreatment) work was being done according to label the "registered" directions! In my opinion you would have about the same or better *success* rate if you did nothing - but nothing would be safer and cheaper for the occupants!

Glenn Gordon's brother, Garry, found a living pine root under a slab; the pine tree was located way outside the previously treated termite treatment area; the termites had hollowed out the root and were using it as a roadway to enter and continued to eat the home no matter how often the soil had been competitively *treated* (poisoned)! Termites consistently use roots as routes of entry - even tiny palm tree roots are routinely used to gain access through the poisoned soil.

Pest Control magazine, July, 1998 issue noted on page 62 that 2 resolutions were passed during an annual builders' meeting attended by 17,000 people. In essence, the resolution said the builders do not want PCO's to use the full labeled rate (of poison) for pretreatment termiticide poisons and that builders were not going to guarantee "control" work done by PCO's. The builders are telling the EPA to back down from its ruling that maximum poison pretreatment rates must be used and that their concern is not about economics, but really about the health and safety of their customers and protecting the environment!

Naturally Resistant Woods - Untreated sapwood is usually highly susceptible to termites and has a short service life when termites are allowed access to it. However, the slow-growing heartwood of some wood species has varying degrees of termite resistance. This resistance is attributed to chemical components that are toxic and/or repellent to termites. The practice of using resistant woods in construction has been almost completely replaced in the U. S. by using volatile poisons to *protect* cheaper wood.

Precise ratings for termite resistance of heartwood are not possible because of differences within wood species. However, some of the most resistant species are: bald cypress, eastern red cedar, chestnut, Arizona cypress, black locust, redwood, osage orange, black walnut and Pacific yew. It should be noted that even the fungi most resistant wood cannot be considered a termite barrier. Termites are able to tube over resistant (and pressure treated) wood to attack susceptible wood. Only those parts actually constructed from such wood can be considered resistant. The use of resistant or sodium borate treated wood throughout a structure can be easily economically justified when termites, ants, beetles and decay are considered serious problems and permanent protection from them is desired.

Chemically Treated or Poisoned Woods - Chemically treated (poisoned) wood *safeguards* against both insects and decay. The degree of protection obtained depends on the kind of preservative, the penetration achieved, and the retention of the chemical in the wood. **If you use foam insulation - be sure it incorporates (or you add) disodium octaborate tetrahydrate (DOT) at least into the foam matrix.**

There is a difference in the treatability of various species and types of wood, and the harder heartwood resists *treatment* more than the softer sapwood.

By applying wood preservatives (poisons) at standard retention rates and assuring that the wood is satisfactorily penetrated, it is possible to increase the life of wood structures by at least five times. For maximum protection, the wood should be pressure-impregnated with an approved chemical (poison) by a standard process or treated with sodium borate per this manual and the labels. In less severe conditions, a vacuum treatment usually gives adequate protection. Brush, spray or short-period soak treatments using a preparation other than sodium borate only gives limited protection of wood above ground and should not be relied on to give long-term protection. **So use non-volatile sodium borate (or borax); it is safer and lasts longer.**

Some wood preservative chemicals and their uses are given in : (1) Federal Use Specification T T- W- 571 J, (2) Standard TI-49 of the American Wood Preservers Association, and (3) Standards of the National Woodwork Manufacturers' Association. As with the naturally resistant woods, termites are usually able to tube over some synthetically treated wood and attack untreated wood. Wherever insects and decay are major concerns, sodium borate treated wood should be used throughout a structure.

Ridding existing structures of termites and making them resistant to all future infestations are major problems in termite control. Generally, buildings become infested because little or no attention was given to the preventive measures during construction that would have made the structures resistant to termites. It is in such buildings that termites cause heavy losses each year.

When controlling termites in existing buildings, observe the same principles that are recommended for the prevention of infestations during the construction of new buildings. That is, eliminate all of the conditions favoring the development of termite colonies in the soil and permitting passage of termites to the wood within the building. Subterranean termites in the wooden parts of a building will die if they are unable to maintain contact with the soil or another source of moisture.

Inspection - Wooden structures that are in areas where subterranean termites occur should be inspected periodically for evidence of active infestation regardless of previous preventive or treatment measures. If no preconstruction measures were employed, the structure should be inspected more frequently. The best physical barriers can be breached by termites, and most (if not all) volatile, synthetic *residual* termiticide poisons will quickly become ineffective in stopping termites. The continuity of the volatile, synthetic *residual* chemical barrier may be easily broken, and maintenance or repair personnel may leave a termite-prone condition after working underneath or around your home. Anyone can inadvertently disturb the *treated* soil or place wood on the soil or against or under the building. If not cautious, you may overlook vegetation that has grown over or through the volatile, synthetic *residual* poison "barriers", providing new access for termites. Settlement cracks may occur in foundation walls or concrete slabs and again allow termite entrance. So prebait with sodium borate (or borax) treated sawdust or cellulose or cardboard or spray salt water and seal them all with silicon caulk.

With proper inspection, usually annually, very little termite damage should result before their discovery. Termites (other than Formosan) typically work slowly and can be detected and controlled before causing structural weakness to the timbers. **Although extreme haste is not required, once an infestation is discovered, some alterations or treatment should be completed within several months.**

Sanitation - Sanitation and structural control measures should be given consideration to control existing infestations. In addition to any poison treatment(s), the following control measures should be used:

1. Remove all wood, including form boards and other debris containing untreated cellulose or foam from underneath and adjacent to buildings with crawl spaces or pretreat/prebait it with sodium borate.
2. Remove exterior wooden structures, such as trellises, that connect the ground with the woodwork of the building or treat them with sodium borate and then seal them. Any wood remaining in contact with the soil should be treated with sodium borate and sealed. **Untreated foam insulation and plant roots will serve as highways for ongoing termite invasions.**
3. Replace heavily damaged (structurally weakened) sills, joists, flooring, etc. with sound borate treated wood. Where possible, remove all soil within 18 inches of floor joists and 12 inches of girders.

4. Fill voids, cracks or expansion joints in concrete masonry with sodium borate treated sawdust or cellulose or salt water and either cement or roofing-grade coal-tar pitch.
5. Provide adequate drainage and correct all moisture problems.
6. Provide access for inspection of vulnerable areas.
7. Provide adequate foundation ventilation. In some cases, a moisture barrier (visquine or similar material) placed on the soil can be used instead of providing additional ventilation.
8. Remember every plant you plant near the foundation, will have roots that provide termite bridges or breaches in and through your volatile, soil poison *barrier*.
9. **Since 1953 when (non-volatile) sodium borate was used to treat and pretreat lumber and homes and buildings in New Zealand there has been no evidence of even one single successful attack of wood destroying insects no mater what the conditions!**

Volatile, Synthetic Residual Poison Control - The maximum use of volatile, synthetic *residual* poisons used in the vain and dangerous attempt to prevent subterranean termite infestations are also used to *control* existing and (non-existing) infestations in buildings. The commonly used soil poisons, concentrations, rates of application, method of preparation and necessary precautions are discussed on the label. **NEVER ALLOW ANYONE TO COMPLETELY TREAT OR RETREAT YOUR BUILDING WITH THESE VOLATILE POISONS...ONLY ALLOW RETREATMENT OF THE REINFESTED OR DISRUPTED AREAS WITH SODIUM BORATE!**

The many variations in construction prevent a detailed discussion of exact procedures for chemical (poison) treatment in all situations. However, in applying treatments, **remember that the supposed purpose of volatile, synthetic termiticide poisons is to establish a “protective”, volatile poison barrier between termites in the soil and wood in the structure, but if the poison barrier is not complete and unbroken and undisturbed by mechanical breaks, etc., even later - termites will continually find a weak spot in the volatile poison barrier and break through.** Some procedures for *treatment* of existing buildings with volatile, synthetic pesticide poisons are as follows:

1. **Slab-on-ground Construction** - Termite infestations in buildings with a slab on the ground present serious control problems. It is difficult to form an effective volatile, synthetic *residual* poison barrier in the soil beneath such floors. One way to *treat* under the slab is to drill a series of vertical holes about 0.5 inch in diameter through the slab, particularly at the base of partition walls and other points where the termites may be entering . The distance between holes is determined by the type of soil or fill material and its moisture content. However, in most cases 18 inches is usually *recommended*. Be cause a *complete*, volatile poison barrier is necessary for this type of treatment to be effective, the volatile, synthetic *residual* poison injected into each hole must meet with that poison injected in adjacent holes. The “advantage” of vertical drilling and injecting is that the synthetic *residual* poisons will flood and cover the surface of the soil better. **Patch all cracks!**

Another way to treat under slabs with volatile, synthetic *residual* termiticide poisons is to drill horizontally through exterior foundations walls to the soil just beneath the slab and inject the volatile, synthetic *residual*poison in the holes with rods (**but we do not recommend this**). This method is more difficult and requires special equipment, and should properly be performed (if at all) by a professional pest control operator who cares. Be sure you hire a professional that will guarantee in writing you will not have any chemical contamination of your ambient air or potable water, and that his insurance actually covers you if there is any subsequent contamination. If they will not give this to you in writing, use only sodium borate. Extreme caution should be taken to prevent drilling into plumbing, electric conduits or heating ducts that may be imbedded in concrete. Injection of toxic, volatile termiticides into these areas must be avoided. Using synthetic *residual* poisons, treat along the outside of the foundation as thorough as possible, but be sure not to allow the volatile toxins to contaminate your well or home through (unpatched) foundation cracks.

Note: Air circulation ducts should be permanently filled and sealed before *treating* inside or treatment should only be made outside with any volatile, synthetic *residual* pesticides poisons.

2. **Crawl-space Construction** - The procedures used for pretreatment with volatile poison can also be used for termite control in existing buildings. G-d forbid!
3. **Basement Construction** - *Treat* the soil along the outside walls of basements with volatile termiticide poisons.
4. **Raised Porches, Terraces and Entrance Slabs** - Termite infestations frequently occur at porches, terraces and entrance platforms. The most satisfactory way to control infestations at these locations is to excavate the soil adjacent to the foundation wall, remove all wood debris and then either apply a volatile, synthetic *residual* poison to the soil as recommended, or treat all the wood with sodium borate and seal if necessary. Place an access panel over the opening to permit inspection. Alternatively, holes may be drilled either through the adjacent foundation wall from within the crawl space or basement, or through the entrance slab. Volatile, synthetic *residual* poisons can be injected to try to form a continuous barrier, or you can treat the wood with sodium borate or the soil with salts, borax, etc. and get permanent control.
5. **Buildings with Wells** - Where wells are located close to or within foundation walls, the same principles of termite control apply as are recommended for their prevention. However, greater care must be exercised when using volatile, synthetic *residual* poisons to form a "barrier." Although the presently used termiticide poisons are supposedly not very water soluble once they have dried on the soil, *treated* soil can be physically moved so as to carry the chemical (poison) directly into the well. **Be sure to follow the registered label exactly.**

Note: to correctly apply the maximum labeled amount of registered poison using the recommended pressure of 25 PSI it would take over a day to treat in most homes!

Fumigation Warning - Hazards of Illegal Applications

In Vol. 17 No. 2 NCAP noted hazards of illegal applications. On September 28, 1986 an elderly Virginia man, Hubert Watson, died of heart failure shortly after being brought to a hospital emergency room. It was not until three days later when his wife was admitted to the hospital after spending three days unable to get out of bed, and then died suddenly with similar symptoms, that doctors suspected that a toxin might be the cause. Autopsy showed high levels of fluoride in her blood. The following week, Orkin Extermination notified state officials that they had fumigated the house at the end of September.

In brief, here is the tragic sequence of events that ended the Watson's lives. Their house was fumigated on September 25, 1986. A security guard watched the house until the following morning so that no one would enter the house. Then the fumigation traps were removed, and fans ventilated the house for 2-1/2 hours. In midafternoon, the house was approved for reentry, and the Watsons returned home about 5:00. After several hours they left home to watch a football game, then returned to sleep. By the next day both were feeling ill, and the following day Hubert Watson died.

In the litigation that followed, testimony showed that Orkin had not monitored air levels of sulfuryl fluoride (as required by the Vikane label) before authorizing reentry. Also, Orkin employees did not remove a waterproof mattress cover from the Watsons' bed when ventilating the house. This meant that when the Watsons slept on the mattress it still contained a dangerous amount of sulfuryl fluoride. Orkin eventually pleaded guilty to violating the Federal Insecticide, Fungicide and Rodenticide Act (FIFRA) in this incident. The company was fined \$500,000 and placed on probation. A portion of the fine (\$150,000) was suspended providing that Orkin changed its procedures to follow the law.

The story did not end with the sentencing; five years later, Orkin and EPA were back in court. EPA had evidence that Orkin had committed 306 violations of pesticide laws, including 119 violations of the probation agreement, in 17 states since being placed on probation. At least 17 times, EPA wrote, "Orkin committed the same violations of fumigation safety requirements for which the company was convicted and sentenced." The story did not end with the sentencing; five years later, Orkin and EPA were back in court. EPA had evidence that Orkin had committed 306 violations of pesticide laws, including 119 violations of the probation agreement, in 17 states since being

placed on probation. At least 17 times, EPA wrote, "Orkin committed the same violations of fumigation safety requirements for which the company was convicted and sentenced."

"It's nothing short of scary the way the company was handling its business," said the District Court Judge who heard the case.

Hazards of Even *Legal* Applications Following the *Registered* Label

Two human health concerns arise when sulfuryl fluoride fumigations are conducted according to the label directions. First, some materials often used in homes absorb sulfuryl fluoride, then release it over long intervals. This means that people can be exposed for a prolonged periods. Second, the concentrations of sulfuryl fluoride currently considered *acceptable* for residents when they reenter their homes may not protect them against sulfuryl fluoride's neurotoxicity.

One "Last" Pesticide Warning

For virtually the Author's entire 30-year pest control career as President of Stroz Services, Inc. he was routinely told by the DOA *regulatory* people use to use the **maximum** amount of chlordane/heptachlor or some other volatile, termite **poison** the label allows or they would prosecute me for *fraud* - He wrote them continually to go ahead - arrest me.

The very same *regulators* constantly told the Author they would feel **safer** if he completely *retreated* (re-poisoned) all homes that were previously treated (poisoned) and still had **inactive** termite infestations, every time the home was sold, just like his *competitors* did - in order to **protect** the public! He is probably the only pest control operator in the U. S. who was indicted by the *regulators* for not applying enough of the volatile, cancer-causing chemicals chlordane/heptachlor! The Author refused repeatedly to apply the maximum labeled rate of this (or any other) terrible carcinogen! When he stopped even making spot applications of chlordane in 1983 - he was publicly ridiculed by both the poison *industry* and the *regulators*. But, when the *fat lady* finally sings - the song she sings is very sweet indeed!

On May 23, 1997, PANUPS announced, **Velsicol Ceases Production of Chlordane and Heptachlor.**

The Velsicol Chemical Corporation announced 5/17/97 that it is permanently ceasing production of the organo-chlorine insecticide poisons chlordane and heptachlor at its manufacturing facility in Memphis, Tennessee, and that it will not make its proprietary technology available to any other company for manufacture. The company estimates that it will sell out its remaining stocks before the end of 1997. Velsicol was the world's sole producer of these pesticides (poisons).

With one exception, chlordane and heptachlor have been prohibited for all uses in the U.S. since 1987 (heptachlor is used to kill fire ants in cable boxes). However, Velsicol has continued to produce the pesticide poisons for export. U.S. customs data show that at least 4,472,000 pounds of chlordane and 5,696,000 pounds of heptachlor were exported from the U.S. between 1991 and 1994 (these numbers may far understate the true quantities, since approximately 75% of pesticide (poison) exports go unnamed in customs records).

According to Velsicol, both pesticides (poisons) are used primarily for termite control in wooden structures and as soil insecticides in tropical regions worldwide. The company stated that over the last few years the products (poisons) have been used for major road building projects in Africa, for "protection of residential structures," in Northeastern Australia and Asia and for crop protection in South America.

The U.S. Environmental Protection Agency (EPA) classifies chlordane and heptachlor as "probable human carcinogens." They have also been linked with endocrine disruption, and they can persist in the environment for decades. One or both of these chemicals (poisons) are already banned or severely restricted in at least 70 countries!

In addition, chlordane and heptachlor are included on a list of persistent organic pollutants (POPs) that have been identified by the United Nations Environment Programme for possible international phaseouts on their

production and use. POPs are subject to long-range global transport and are highly persistent, semi-volatile, highly toxic and liable to bioaccumulate. Both pesticides (poisons) are currently included under the Prior Informed Consent (PIC) procedure, an international program, designed to notify governments about (and give them an opportunity to prevent) certain hazardous pesticide (poison) imports. PIC is currently voluntary, but governments are negotiating to make the procedure a legally binding instrument (the third International Negotiating Meeting on PIC will meet in Geneva, May 26-30, 1997).

In addition to problems stemming from use of these pesticides (poisons), the company's production practices have resulted in their release into the air and water surrounding its manufacturing plant in Tennessee, and the company is responsible for creating three sites on EPA's Superfund National Priorities lists of contaminated waste sites federally mandated for clean up due to environmental contamination. Numerous individuals have filed suits against the company for the contamination of their homes from their insecticides (poisons), and Congress between 1990 and 1992 deliberated legislation to ban their export.

Despite widespread international recognition that chlordane and heptachlor pose serious health and environmental risks, Velsicol's president and CEO, Arthur Sigel, said in the company's announcement, "we have always believed in the efficacy of these products (poisons), and the science that supports their continued use, but the economics no longer support continued manufacture." Sandra Marquardt, Program Director at Mothers & Others for a Liveable Planet and longtime advocate for a ban on the export of banned pesticides (poisons), stated that "Velsicol's production of these insidious insecticides (poisons) has left us with a toxic legacy that will persist for decades to come! This decision should have been made decades ago!"

Did the Michigan DOA *learn* - **no** - they and many other *regulators* **still** require the maximum amount of *registered* poison the label allows be applied on every job! The DOA again threatened the Author a few days after his *accidental* 11/5/95 fire, that totally destroyed our Stroz office and all of our (30 years worth) of records and research (and for which Auto Owners still had not finished reimbursing us at the time of this writing over 2-3/4 years later) for not using "enough volatile termiticide poison directly over a well - and for not having 3 years worth of records!" Also at the time of this writing, the Federal Trade Commission was entering the termite *market* to be sure "enough" poisons was being applied on termite pretreats (where you don't have termites); post-construction treatments where you actually have termites do not have to be treated at the maximum poison level - go figure! The whole poison industry defies any/all real logic! Couple this illogical situation with the fact the efficacy and degradation of all the current "registered", volatile, synthetic termiticide poisons has been extensively studied by the U. S. Department of Agriculture Forest Service, the University of Florida, Texas A & M University, the University of Hawaii and others who have all found that all of the current "registered" termiticide poisons very considerably in their repellency and their persistence in different geographic locations from site to site and even around the same *treated* building. Despite **maximum** rates of volatile poison application and even *ideal treatment* procedures, some poisons fail to provide 100% "protection" in one or more sites (e.g., Mississippi, Florida, South Carolina and Arizona) within 1 - 2 years and most fail to provide 100% "protection" beyond 5 years!

On 11/10/99 (Reuters) noted, Connecticut sues pest control firm:

HARTFORD, Conn., Nov 10 (Reuters) - Connecticut on Wednesday filed a lawsuit against Terminix International, the nation's biggest termite-control company, citing misuse of pesticides and falsification of records on "thousands" of occasions, state Attorney General Richard Blumenthal said.

Blumenthal alleged that the Memphis, Tenn.-based company broke Connecticut's pesticide-safety laws more than 5,800 times over the past four years and should be made to pay heavy fines.

Terminix, a unit of Downers Grove, Ill.-based ServiceMaster Co (NYSE:SVM - news), strongly denied any wrongdoing and said it will fight the suit.

The action, filed in Hartford Superior Court by the state of Connecticut and the state Department of Environmental Protection (DEP), seeks total fines of more than \$1 million.

"Terminix degraded the environment, defied the law, and endangered Connecticut citizens," Blumenthal said at a news conference.

“Overwhelming evidence established abysmal record keeping, shoddy work, sloppy application of hazardous chemicals, and substandard training for employees,” Blumenthal said. “Such flagrant, blatant abuses ought to bring serious and swift sanctions.”

Terminix called the allegations “meritless.”

“The state’s decision to file this lawsuit is inexplicable in that the DEP is already attempting to impose sanctions on Terminix through hearings, which have been proceeding since March of this year,” the company said in a written statement.

“Accordingly, it appears to Terminix that the DEP’s lawsuit is an attempt to reinvigorate a weak case and to intimidate Terminix into a settlement on terms which the DEP cannot obtain through the legal system.”

DINE-O-MITE Glenn Gordon from Home Guard Pest Control, Inc. in Largo, Florida, discovered and is working with two new predatory mites and a new nematode, to biologically attack and safely destroy termite infestation - the DINE-O-MITE! Both of these mites are actually “cruising” predators of termites that Glenn Gordon discovered dining on termites in Florida, and one has been named by the Author purely to describe them in this manual.

DINE-O-MITE, *Sarcoptes tyranasorus*, (Gordon-Tvedten)

Class - Aracnida

Order - Acavi

Family - Sarcoptidae

Body broadly oval, almost round in shape, with fine lines, microscopic in size - they look like grapes all over the infested termite. Unlike most predators, these mites seem to work as social groups. Adults create a biomass of dead termites and then young are raised thereon; you can visually see the breeding adults, but the first instar 6-legged larval stage must be seen under a 10x magnifier. Live termites are attracted to the biomass to become consumed by the second through sixth instars. The sixth molt also creates the breeding adults. They are excellent predators of all termites - but what a way to die! Glenn Gordon said he felt sorry for the termites, it would be like being attacked by dimes that slowly suck the life out of you. Termites groom themselves constantly to remove fungus and debris - but they can not or do not choose to remove this terrible little predator, which attaches itself like scale or a tick and continues to feed until the termite dies, then it detaches and finds another victim. Legs are short and not visible from above, while feeding, same coloration as termite workers. Most predator species are controlled or repelled by the termite’s ability to produce (the pesticide) naphthalene. These mites are arachnids and resistant to pesticides and are not controlled or repelled by naphthalene. They attack termites like little Tasmanian devils - unlike termites infested with Steinernematid nematodes (applied as a soil treatment) - the termite colony is apparently unaware of their presence and does not seal the infested members off to protect itself. Nor do the infested individuals remove them as they could easily do. Nematodes (lay in wait and) “ambush” termites, etc. and must be broadcast all over.

What person in his/her right mind would attempt to fly an airplane without first learning how to do so...the same holds true with those who would use volatile, synthetic pesticide poisons. The word is pesti-CIDES, not pesti-SAFES®. “Registered” pesticide poisons kill insects because they adversely effect a life process like respiration, digestion, reproduction, circulation and/or nerve reactions...a person would have to be foolish to think that volatile, synthetic poisons protect and do not harm or even kill exposed people and pets. The media has continued to focus on many environmental and human tragedies involving volatile, synthetic pesticide use and misuse and accidents. No volatile, synthetic termiticide or pesticide poisons, no matter how safe they are claimed to be, are ever totally non-toxic! Note: Sentricon’s wood originally was douglas fir. The Author believes it now is aspen. Neither of these woods are termite favorites.

Sadly, most of just the active ingredients in pesticides still have not been thoroughly evaluated regarding carcinogenic, chronic or neuro-toxic effects. Legally some companies can and do hire a technician today and have him *professionally* spraying to morrow. In addition, no current governmental regulatory agency voluntarily or routinely checks to see if the *professional’s* work has been done safely and/or correctly. Most *regulators* are only concerned that enough poison was applied and/or the *registered* label was followed. Most companies do not even provide their own men with “state of the art” information regarding detrimental environmental or personal hazards regarding the toxic qualities of the pesticides they use. “Some” companies do not even provide proper

safety equipment to protect their own people. For years many properties have been *treated just to be sure* even when there was/is no evidence of active infestation. Historically most regulators and customers have only been concerned if *enough* poison was used and if the *professional* left any *survivors*. The pest control company was almost forced to be sure *they got them all* and this put control as the one and only concern and left the applicator to choose the volatile poison, how much to use, and when and where to apply it. So the strongest, most volatile poisons were usually applied at the strongest possible mix! It has been estimated that less than 1% of those people poisoned will ever bother to report it. Even if they do, most will be told (without any testing) that their reactions or symptoms are not pesticide related!

Warning - Your safety depends upon you knowing how and where and when and if, to spot apply any of these volatile poisons that won't work for long, if at all!! We believe you should first learn of any and all known hazards and risks connected with the pesticides you will ultimately use in or on your property. Remember, if anyone is pregnant, elderly, under 1 year old, has chemical sensitivity, asthma or breathing problems they must leave for at least several days after your synthetic *residual* poison application! Be sure to use all of the proper safety equipment the Author or the label recommend or require. Everyone must be out of the property before you begin any pesticide related control program. All pets must also be out, all aquariums shut off and covered and all of the label instructions and our suggestions (written and/or oral) must be followed before safe re-entry is allowed. You should also post on your entrance a sign notifying everyone that pest control was done here and what poison was applied. The Author believes if you must error you must error on the side of safety and not on the side of control. The sad thing is these volatile poisons really don't even control termites! The Author believes that your safety if the most important consideration and that you should not create a worse problem for yourself than the pests you are attempting to control. Do not apply any volatile, "registered" pesticide poison unless there is an obvious need! Remember, you can always replace a 2 x 4 or even an entire building, but you can never replace anyone's life or anyone's health! Dr. Pete Lurker told the Author there was a command directive to make sure the interim evacuation level for chlordane contamination developed by Dr. Mike Livingston was kept as high as possible so that the interim level or "standard" would not require too much remediation or movement of Wright Patterson Air Force personnel. The federal government cannot and will not protect you and ours - only you can decide not to poison your home, water, air, pets, family and yourself. The state *regulators* want to be sure the maximum rate of synthetic termiticide poison is applied - that is the only way they know how to *judge* if the *treatment* was *correct*. For almost 60 years we have needlessly sprayed the whole earth with deadly nerve gases - yet very few people have said, "Enough! Stop the madness! Stop the use of volatile, synthetic pesticide poisons! Please stop killing us!" Join me now in stopping the use of pesticide nerve gases! Join the Author in closing down the pesticide poison industry who has produced and sprayed the toxic cloud of neurotoxins that are destroying our earth and us! In a November 1995 Pest Control Editorial, Jerry Mix noted Orkin, one of the largest pest control companies admitted it had a 65% turnover rate of termite technicians per year. By the way, the Author has seen many homes so contaminated with volatile, synthetic termiticide poisons no one could safely enter or drink the water, but the termites were still eating the home!

ALTERNATIVE INTELLIGENT PEST MANAGEMENT® TERMITE CONTROLS - Virtually any antimicrobial or antibiotic, e.g., Flagy® (250ml), when dissolved and soaked into cardboard, will quickly kill the entire termite colony when eaten, because the medicine kills all the microflora and protozoa in the termite's gut and the colony starves. Add virtually any salt or iron/sulfur or methylene blue (that contains copper) or colloidal silver to the wood and you either repel or sterilize termites. Glenn Gordon from Home Guard Pest Control Inc. in Largo, Florida is working with a predatory mite and *new* nematode and new sodium borate application equipment. Joe Tallon introduced liquid nitrogen, heat treatment and essential oils for drywood termite controls. The Author has always suggested sanitation, temperature controls, habitat reduction, changing the conditions conducive to infestations, dehumidifiers, fans, vents, metal termite shields, various predators, spot treatments and/or air conditioners in buildings, microwave, electroguns, stainless steel mesh, enzymes, aggregate or basaltic or (special) sand and other physical barriers and/or to simply use food-grade DE, amorphous silica, borax or calcium chloride, table salt (sodium chloride) under slabs and in crawls in order to control subterranean termites - table salt is, however, very corrosive to ferrous metals, e.g., nails, fasteners, wires and plumbing and it kills plants.

Electric charges and various baits and molds are also being used, e.g., hexaflumuron, widely used in Europe, Central and South America as a pesticide, interferes with a termite's life cycle by inhibiting its production of chitin; chitin is a hard material that makes up the insect's protective coating. As termites grow, they shed their old coats and develop new ones, but when they ingest bait laced with hexaflumuron, the chemical interferes with the coat exchange. They are said to become trapped between a partial new molt and the older shell, and die. A commercial product containing hexaflumuron (a chitin synthesis inhibitor), The University of Florida's Sentricon System[®] was the first termite bait product commercially available in the U. S.; it clearly will not be the last. In USA Today on Tuesday, August 25, 1998 entomologist, Nan-Yao Su of the University of Florida was quoted as saying, "No one weapon will suffice. You have to hit them with everything: bait barrier insecticides, nest removal and constant vigilance and it has to be on a massive scale. If I kill a colony in my back yard, down the road there's another colony. Unless there are community-wide programs, we'll just be going back and forth." (Please read the Author's notes about hexaflumuron in Chapter 14.) This termite baiting system has been patented by the University of Florida and licensed to DowElanco. But, termite resistance to the hexaflumuron in the Sentricon System [especially after the first year placement anniversary - due to previous exposures of sub-lethal doses of traditional pesticides; causing elevated enzyme (e.g., P450) levels] is bound to be a problem per Glenn Gordon. The in-ground delivery system, however, cannot be used against aerial colonies that have no connection to the ground and the system cannot be used easily when the soil is covered by concrete or asphalt. On 4/5/99 I had a phone conversation with Mel Edelstein of the Florida Certified Pest Control Operators who noted he had just returned from a pest control operators' conference sponsored by Pest Control Technology in Louisiana. Mel said PCOs had told him that in the French Quarter the Sentricon[®] System was in place virtually around every house, but no one there knew of any placement that had worked. In fact last year was the worst Formosan swarmer season ever and Sentricon[®] has been used there for years. Mel said there were about 250 PCOs from all over the U. S. at one meeting he attended and the discussion never got beyond bait stations and the fact insurance companies were not covering subsequent losses due to their lack of control. Soon to follow was American Cyanamid's hydramethylnon-based termite bait, targeted for registration in 1996. Cyanamid had entered a joint partnership with Drs. Barbara Thorne and James Traniello of Entomological Associates, Inc., who reportedly have developed a bait material that is likely to attract termites. Gary Curl, senior market manager at Cyanamid, notes that the key to success will be to develop a bait that termites are likely to feed on and that will stimulate the recruitment of nestmates. Thorne concurs, emphasizing that the biggest challenge in termite baiting is getting the termites to find the bait in the first place - an opinion shared by other researchers. The likelihood of termites finding any bait, will vary from one treatment site to the next, depending on such factors as termite foraging intensity, moisture, food availability and proper presentation. In the February 1998 issue of Pest Control Technology American Cyanamid pulled its Subterfuge termite bait due to variations in the formulation components.

Note: Not one of the commercial bait products currently available had yet to protect a single ground board or simulated slab in the "standard" USDA Forest Service field tests that attempt to show 5 years (termiticide) efficacy. When I wrote this chapter, all other termiticides *registered* then had supposedly met that EPA requirement of a 5-year residual life, but Roger E. Gold & Associates field tested various soil termiticides and found none were consistently effective for 5 years in Texas soil. In fact, per Harry Katz, they all were significantly degraded within a few months after application. The Gold group said if adequately distributed in the soil "the soil poisons may give" Texans at least 2 years of "control" in "most cases". In 1990, Bill Hawks of Wichita, KS wrote a warning that PCOs' and *regulators*' notion of a termite job was a dangerous "cartoon" and someday PCOs (who applied these soil poisons) would awake in the middle of a nightmare. **Welcome to the "registered" poison nightmare.** FMC Corporation is developing yet another termite bait, which contains sulfluramid as the active ingredient. The Company is also pursuing registration of a proprietary method of collecting and topically treating termites - with the intent of increasing the amount of slow-acting toxicant delivered to the colony. This approach is termed "Trap-Treat-Release" by its inventor, Dr. Timothy Myles of the University of Toronto. PCO's can expect to see many other novel ways of delivering bait or treatments to termites, including formulations that can be injected directly into termite galleries or foraging tunnels within the structure. You can also pressure inject water into the galleries, wait 2 - 4 hours and pressure inject *Steinernema carpocapsae* into the galleries and colony. **The Author is working on a bacteria/enzyme barrier.**

Premise 75 from Bayer uses a synthetic chloronicotinyl pesticide called imidacloprid to weaken termites so that naturally occurring organisms, e.g., *Trichoderma spp.*, a soil borne insect pathogen or fungal spores will infect and kill termites. Dozens of slow-acting compounds might be effective, provided they are formulated at the proper concentration and incorporated into a delivery system that is attractive to termites. By the end of the 1990s we were supposedly to have many bait formulations including naturally-derived "biotermiticides" produced from host-specific mites, fungi, nematodes, bacteria and, perhaps, viruses. EcoScience Corporation

and Terminex International had entered a joint development agreement for the microbial termiticide product (Bio-Blast), relying on the same green fungus technology, *Metarhizium anisopllae* [there are at least six species of this fungus infecting over 200 insect species in seven insect orders (Zimmerman 1993).] already developed for cockroaches (Bio-Path). EcoScience originally received an experimental use permit to test its new fungus product, Bio-Blast, on 1,000 termite infested homes in 10 states. It is generally available throughout the U. S. for use by any PCOs. A series of products are predicted to come from these efforts, the first being sprays and dusts for treating above-ground (galleries) infestations of subterranean and drywood termites. When injected into walls, feeding galleries or termite carton, conidia of the fungus rapidly disperses and germinates on the outer chitinous layer or "skin" of the pest, eliminating the structural (above-ground) infestation. Dr. Jeff Pinkham, EcoScience's director of regulatory affairs, anticipates registration of the sprayable fungus formulation in 1995, and the dust in 1996. Note: Bio-Blast® came on the market in Spring of 1997. But, remember, termites constantly groom themselves to remove any fungus that may start to grow on them, fungi are omnipresent in their damp, dark environments. Termites have been dealing with ways to stop the attack of fungi in their colonies for 300 million years. When termites are in their nest material, fungus will not grow - but once they leave, a white fungal mat grows overnight! Their own body emissions (naphthalene) stimulate, prevent or control fungus and/or ant invasions. While small, spot applications of sodium borate and/or the proper use of dehumidifiers have successfully controlled termites wherever we have used them, we do suggest you still remove all of the conditions conducive to infestation. Other choices - sandblasting size sand or granite particles several centimeters thick - too large for subterranean termites to carry or move or chew through and the space between each particle is too small to crawl through, can be used to safely and permanently stop termite penetration. Granitgard® from Australia, web site: <http://www.granitgard.com.au/>, is guaranteed 30 years! Another alternative is a sand barrier made from crushed (Hawaiian) basaltic rocks (1.7 to 2.4 mm in size). Stainless steel mesh, either under or over a vapor barrier has openings so small, termites can not pass (or chew) through. Australian tests on stainless steel mesh show it is not corroded after 11 years; U. S. tests in Florida, Arizona, Mississippi and South Carolina show it effectively controls termites for at least the 4 years it has been tested. Termi-Mesh Australia is trying to market stainless steel mesh in the U. S. We are just starting to field test Home Guard Bait Stations, Not Nice to Termites™ Bait Stations, Safe Solutions, Inc. Enzyme Cleaner, Dine-O-Mite™ predators, carbon dioxide, attractants and fumigants and sodium borate and/or boric acid *prebaits* and baits as termite control alternative techniques. We will let you know all the results from our field tests. Borox, urea, table salt, Flagyl®, calcium chloride, colloidal compounds, e.g., colloidal silver, 1% - 2% outdoor Scotch Gard® and many other salts will control all wood destroying insects in the soil and/or wood, but they may also destroy ferrous metals such as nails,, so be very careful how you use them. The December 1998 issue of Pest Control Technology noted in Harry Katz' editorial on termiticides the toxic (pretreatment) "barrier" under a slab is only 1/8 of an inch deep when properly applied according to the label. The "registered" poison is anything but a continuous "barrier" by the time workmen have left the site.

Why some baiting can be so effective: Subterranean termites feed one another by regurgitating and defecating the nutrients (and poison, antibiotics, sterilants, etc.) from their foraging to all of the other nestmates, in different locations, this oral-oral or anal-oral transfer of stomach contents is called trophallaxis. This process disperses your slow acting toxicants or antibiotics throughout the colony to the soldiers, queens, dependent castes and instars. If you provide sufficient attractive baits, your control chemical will be delivered throughout even a widely dispersed colony causing it to seemingly collapse "overnight". If your "toxin" has a feeding deterrence level, any bait station will probably be ineffective in truly controlling termites. The station I have been using literally attracts termites; once you have termites in one station, put some in all stations so the entire colony(s) can be quickly controlled. **Larger traps (cardboard bait stations)** without toxins have been used for many years to attract termites into the bait station and then the station can be physically removed. After a few months the colony can be seriously depleted. Then, after some more trapping, the colony collapses. Third world countries have used this trapping technique to control even Formosan termites.

The Journal of Pesticide Reform/Fall 1999 - Vol. 19, No. 3 had an article by Caroline Cox entitled: "Inert Ingredients in Pesticides: Who's Keeping Secrets?"

"Finally, inerts put people's health at risk. A recent incident in New York powerfully illustrates how complex (unregistered and untested) inerts' health impacts can be. In April of 1996, and again in August, Terminex International Co. treated the home of the Trimper family in Rotterdam for termites with an insecticide, probably Dursban TC. Dursban TC is a commonly used termiticide containing chlorpyrifos. The Trimpers had asked for another chlorpyrifos insecticide, Equity, but Terminex applied Dursban instead.

Following the second treatment, three-year-old Kyle Trimper became ill with unexplained high fevers and respiratory Problems. His parents were also ill, and his mother suffered two miscarriages during the following year. (Every time the Author sprayed Dursban he watched the gravid roaches abort!)

In early 1997, the family complained to the New York Department of Environmental Conservation about the lingering odors in their home, and the health problems Kyle was having. The agency came to their house, along with the Department of Health, and collected air samples several times. Because Terminex asserted the insecticide applied in the Trimper home was Equity, even though the applicator who had done the treatment admitted otherwise, the agencies looked at inert ingredients in the air of the Trimper's home. (This analysis for inerts as a part of an enforcement investigation is extremely rare.) Equity's inert ingredients are identified by Dow AgroSciences, its manufacturer, as "proprietary emulsifiers, proprietary solvents and propylene glycol." Dursban TC's inerts, according to Dow, are also proprietary, but include "xylene range aromatic solvent."

The air samples were in a word, frightening. The agencies (still) found a mixture of solvents, including benzene, toluene, ethylbenzene, xylenes, and trimethyl benzenes. The Department of Health analyzed the components of a sample of Dursban TC, and then compared it with what they found in the Trimper's house. The result "was a very close match." Can you imagine how bad it had to be right after the "treatment"?)

The benzene in the Trimper's house was particularly frightening. Benzene is "carcinogenic to humans," according to the International Agency for Research on Cancer because people who are exposed to it are at increased risk for leukemia. In laboratory studies it has caused tumors in multiple organs and also causes genetic damage. EPA classified benzene as "of toxicological concern" in 1987 and asked pesticide manufacturers to stop using it. By 1991 EPA had removed benzene from its list of pesticide inert ingredients because the agency believed that it was no longer being used. So why was it in the Trimper house? Because Dursban TC contains "a mix of petroleum distillates" according to EPA's Kerry Liefer. (Interesting name). And that mix contained (unregistered/unapproved) benzene.

The other Dursban inerts found in the Trimper's house are also hazardous. Toluene causes confusion, memory loss, nausea, and can harm unborn babies when their mothers are exposed. Trimethylbenzenes damage the nervous system and are irritating to the eyes. Xylenes cause headaches, nausea, confusion, kidney damage and fetal death.

The Trimper case is unlikely to be just an isolated incident since Dursban TC is one of the most widely used liquid termiticides in the U. S. However, when termite (and/or fire ant) treatments cause problems, attention almost always focuses (only) on the active ingredient. It is rare there's any consideration of inerts. As a result, it is impossible to know how often incidents like the Trimper's occur."

Why continue to use these dangerous, "registered" termiticide poisons? Especially when termites can be killed with so many different, safe and far more effective alternatives, including salt water. **Caution: Salt water will also destroy nails and other metals.**

What does Orkin call these dangerous, "registered" termiticide poisons? The Author noticed that the Spring 2000 t.v. ads for Orkin called the "registered" termiticide poisons they are shown applying as "directed liquid". **Caution: Ask to see the MSDS for "directed liquid".**

ANALYSIS
of
HOMEGUARD'S
SUBTERRANEAN TERMITE
COLONY ELIMINATION
SYSTEM
by
C. D. MAMPE, PhD.
DM ASSOCIATES
BRADENTON, FL

Introduction

Dear Mr. Buchner

Mr. Glen Gordon of HomeGuard Pest Control has requested that I review his termite control bait system to determine its efficacy, Attached is my review comments and analysis.

Based on available science, the HomeGuard system is as effective - if not more so - than existing commercial systems. This system has met the same standard of proof that was applied to other systems.

If a better standard of proof is developed, HomeGuard has requested that I re-review the available data to determine if the HomeGuard system continues to meet the standard.

I have worked with all of the existing commercial systems as a field development researcher. This puts me in a unique position to evaluate the HomeGuard system. My CV is also attached.

If you have any questions, I would be pleased to provide answers.

Sincerely,

C. D. Mampe, PhD.

Baits to control subterranean termites have been considered since the early 1960's. However, the efficacy of chlordane and related termiticides and the lack of suitable toxicants for baits stifled development for several decades.

With the loss of chlordane and related compounds and the heightened awareness of environmental concerns, interest in termite baits was renewed- Currently, there are three commercial systems available, Dow AgroScience's "Sentricon", FMC's "FirstLine and Ensystem's "Exterra", The FirstLine system employs a slow-acting toxicant (sulfluramide) while the other two systems employ growth regulators (hexaflumeron and diflubenzuron respectively). Both Dow AgroScience and Ensystem claim "colony elimination" while FMC claims "colony suppression".

All of the above three systems utilize in-ground monitors and, once termites locate the monitors, the toxicant is installed in the station.

The **HomeGuard** system is similar in concept except that predacious mites are introduced into the stations rather than a toxicant. In-ground stations (or traps) are employed — The design of the stations is such that subterranean termites are readily attracted to the stations - in fact, in this Writer's experience - the HomeGuard stations are more attractive than are the three commercial systems.

Proof of Efficacy

Subterranean termite bait systems are relatively new and research people are still debating how to measure efficacy of such baits. Two different systems have been considered.

Mark, release and recapture method - This system utilizes traps in the ground to capture termites. The termites are dyed and released. Traps are reinspected periodically. The number of marked compared to the number of unmarked termites is utilized to calculate the population size, This system is repeated during the control period until the colony size is reduced or eliminated.

This system has several limitations. The dyes utilized are toxic to termites- In addition, they do not remain in the termite indefinitely. Researchers (especially Forschler in Georgia and Thome in Maryland) have found that this system greatly over-estimated a population's size, While marking, releasing and recapturing termites can provide some information to research people, this system does not provide accurate information for evaluating bait efficacy.

Absence of termites method - The other method, which was employed by Dow AgroScience and eventually by others, consists of continued monitoring following bait acceptance until termites have been absent for a given period of time. Originally, Dow's Sentricon system set **two consecutive months** of no termite activity as a measure of colony elimination. Ensystem used **six consecutive months** of no termite activity for a standard of proof for colony elimination.

While this issue continues to be debated, the currently accepted "standard of proof" is six consecutive months of no termite activity in or on the building nor in any monitor,

Special considerations - Research is quickly learning that termite population are mobile and move into different territories on a regular basis. Therefore, it is to be expected that once a particular termite population is eliminated another may take its place, Forschler in Georgia is using DNA "footprints" to determine if renewed activity in a monitor is related to the original population or represents a new population, Even these studies are confounded as some - and perhaps many - termite populations are inter related and the DNA identifiers are not always exclusive.

It is also not unusual for a different species of termite to invade a territory once an existing species was been eliminated. R. virginicus often is found in a territory after the most common species, Reticulitermes flavipes, is eliminated. In such cases there is no doubt that a population was eliminated but replaced by another.

Analysis of the HomeGuard System

Data from HomeGuard are summarized in the attached Table. The table shows that eight of the twelve treated properties have had no termites in the traps nor in the structures for six consecutive months or more.

Two properties (Chapnick and Ciolli) have not had any termite activity for 4 months. The inspections are continuing but there is no reason to believe that any termites will be detected during the next two months.

Two properties (Horning and Lafferty) had no termite activity for several months but activity then reappeared- The original infestations of these two properties were the common Eastern subterranean termite, Reticulitermes flavipes. The termites which appeared in the traps several months after activity had ceased were R. virginicus, a related - species. This is further proof that the original populations of R. flavipes was eliminated.

You will note that in some cases no inspections were made for several months. HomeGuard has found from experience that once mites are introduced and termite activity ceases, inspections can be conducted quarterly. If activity returns between quarterly inspections, it has only been in traps and not in the structure. In addition, since the traps have clear caps, some homeowners inspect the traps themselves and will report any renewed activity to HomeGuard between scheduled inspections.

HomeGuard's standard of proof for colony elimination exceeds that of the termite bait industry - that after baits are consumed, no termite activity is found for a period of 6 months or more. The Sentricon system originally called for only two consecutive months of no activity. In addition, since the HomeGuard traps are much more attractive to termites than are the stations utilized by the three commercial systems, the standard of proof is more rigorous that it is for other systems utilizing less attractive traps.

BIOGRAPHY

C. Douglass Mampe

Dr. C. Douglass Mampe received his bachelor's degree in entomology from Iowa State University, master's degree from North Dakota State University and a Ph.D. from North Carolina State University. Upon completing his university education, he joined the staff of the National Pest Control Association (NPCA). During his 10 years there he was responsible for keeping abreast of all technical and regulatory actions related to the structural pest control industry. This included reviewing research proposals and overseeing research projects related to the biology and control of termites, cockroaches, commensal rodents and other related pests.



Mampe eventually left NPCA as its technical director and joined WesternTermite and Pest Control Inc., and its sister company Residex, a pest control industry supply house. He served as Western's technical director for six years and developed practical procedures for field operations. He eventually became general manager of Residex, which included developing new pesticide registrations and industry training programs, including certification training programs for a number of the northeastern and middle Atlantic states.

In 1980, Mampe started his own consulting firm for the urban and structural pest control industry. His firm provides technical consultation, training and training programs, evaluates new pesticides and equipment, custom develops personnel management programs and provides expert testimony.

Mampe served as editor of *NPCA's Approved Reference Procedures for Subterranean Termite Control*, and editor and co-author of the *Manual for Structural Wood Decay*. He writes a monthly column called "Answers" for *Pest Control* magazine. This column, which deals with a variety of questions, has consistently been one of the best read sections of the magazine since the column first appeared at the beginning of 1975.

Mampe is a member of the NPCA, Pi Chi Omega, the Entomological Society of America and a number of state pest control associations, He is currently licensed as a certified pesticide applicator in a number of northeastern states. In 1979, he was chosen "Pest Control Operator of the Year" by the New Jersey Pest Control Association for his contributions to the industry in that state. He is currently serving as a resource person for the United States House of Representatives Committee on Agriculture.

Doubt creates mountains... Faith removes them.
Vendi, vidi, vici = I came, I saw, I conquered. — Ceasar

Termites - Typical First Strikes by Housekeeping and Maintenance

Note: In all of the termite inspections the Author has made in his career, where he found evidence of subterranean termite infestations, 99% were located behind the front porch or a step leading outside. When a home is being built, most builders simply sweep the wood debris out one of these door openings and then cover the debris with concrete, making a perfect termite terrarium where it is dark, damp and never freezes. Before they put in the porch or step or slab, remove all of this debris or, better yet, treat it all with sodium borate or borax or incorporate food-grade DE in these areas.

1. Vacuum up all swarmers and/or place containers of water near the swarm area. Check all wood with a moisture meter. Push lollipops into the ground (stick first) wherever you find termite activity. The lollipops will attract ants that will attack and eat the termites.
2. Inject and soak all the damp and/or infested and/or exposed (unfinished) wood with ½ c. Safe Solutions Enzyme Cleaner with Peppermint and 1½ c. borax in 1 gal. hot water at least 3 times to the point of runoff.
3. Remove all earth/wood contacts, roots and foam board insulation. Termites hate sand.
4. Install and properly maintain dehumidifiers, vents, fans, eaves and downspouts.
5. Prebait with rolled cardboard moistened with an ice cube (with no chlorine) or some cold seltzer water that still has its “fizz” and ½% or less borax or sodium borate, or moistened with colloidal copper and Flagyl®.
6. Not Nice to Termites® (but nice to people, homes and pets) bait monitoring stations and termite predator mite stations may be obtained from Get Set, Inc. The monitoring stations should be placed near water sources like downspouts, leaking outdoor faucets and/or air conditioners or swamp coolers or under rotting logs, planters, shingles, rocks and/or stones. Add as many as you need until you get hits. Replace the hit ones with active stations (and transfer the termites). **Don't disturb active stations once feeding begins. Remember, termites forage in the top 4" of soil in the spring. In the summer they go deeper (especially in the South) and may avoid your traps!**
7. Termite workers have been given various cellulose products to eat in laboratory and field situations. We have observed they prefer to eat cardboard with brown rot and CO₂, white paper towels, processed cellulose, plywood, pine, citrus wood, sawdust, wood chips, untreated foam, etc. One of the least preferred soft wood for native species is douglas fir - they will eat oak first.
8. Termite baits can be made to attract termites by applying CO₂ and/or brown rot to them. A simple way to get the (brown rot) attractant is to put wet paper towels over a termite colony and collect the fecal droppings; then dilute in acetone and spray the mix on cardboard. Be sure to use the proper protection for the acetone. Flagyl 250 ml can be diluted and added to the bait station or sprayed directly on infested wood or cardboard (or dust a live mud tube with the powder). 1% sodium borate or borax or ¼% urea, ¼% methylene blue or ½% red food dye can be added to the baits.
9. Treat crawlspace spaces and cracks with diluted urea, borax or salt. Termites will avoid eugenol, orange oil, myrrh resins, clove oil, cinnamon oil, DE, urea, or salt treated soil, wood, cardboard, etc. You can also use Safe Solutions, Inc. food-grade diatomaceous earth as a barrier through which termites will not dig or inject it into galleries.
10. Before the vapor barrier is put down, apply a generous amount of food grade diatomaceous earth (DE) to the bare soil, especially around the footing and expansion cracks. Once the foundation is poured and set, apply more food grade DE along the outside perimeter, especially under the porches and steps.
11. If you still have visible termite activity, read the entire chapter.
12. Contact a graduate of the Institute of Pest Management, Inc.
13. It is interesting that our “government” tends to “register” poisons that do not work and to attack and/or discredit GRAS or non-toxic products that actually control pests.

Alternative Indian Termite Controls

1. Mixtures of lime and sulphur or orange oil orange oil, forked into the soil discourages termite attack.
2. Wood ash heaped around the base of the trunk has been recorded to prevent termite infestation of coffee bushes and date palms.
3. Cattle urine diluted at a rate of 1:6 with water can be poured down termite holes. This treatment should be repeated for a few days since the termites tried to open up.

4. Farmers mix red coloured clay with water to form a sticky paste. This paste is coated on the trunk and large twigs at the onset of monsoon when termite damage is severe. Fresh and young grafts are coated with cattle dung to protect them from termites. Combined use of the two methods effectively prevents infestations in small orchards.

Source : *Natural Crop Protection in the Tropics*

Boron - One of the most important functions boron serves is to keep the world green. All plants – from fields of cotton to groves of Douglas fir – depend on trace amounts of boron to thrive. Plants get the boron they need from the land and water supply; it's widely distributed throughout the environment as minerals called borates. People get the boron they need from plants; it's part of a healthy diet.

Although boron is essential for plants, and nutritionally important for humans – it also works to control insects and fungi. Boron in the form of sodium borate will also kill bacteria and plants at higher levels.

In treated wood, borates are:

- colorless and odorless so they maintain the physical appearance of wood products,
- non-volatile and robust so they don't evaporate or degrade during service,
- non-corrosive so many of the nails and metal fasteners used with untreated wood can also be used with borate treated wood,
- and will repel or kill cockroaches and other pests.

Borates work by interfering with the basic metabolic processes in wood destroying organisms, similar to their mode of action in controlling other insects such as ants and silverfish. Because the mode of action is fundamental, borate efficacy is broad spectrum, and target organisms do not develop resistance as they can with conventional pesticides. Boron's functionality is based on its ability to form complexes with various sugar alcohol compounds such as vitamins and co-enzymes. Reaction of borates with co-enzymes containing these molecules has been found to diminish the ability of organisms to process food and energy, causing the target organisms to "starve" and eventually die. **The best way to expose target organisms to borates is to treat their food source or immediate environment.**

When timber is exposed to moisture, decay fungi can infest and destroy wood. Using borate preservatives puts the wood destroying organism in constant and direct contact with the borates. As with insects, the borates in the treated wood interfere with the metabolic processes of decay fungi.

The levels used in pest applications pose no risk to people or pets. The fact is, people consume between one to three milligrams of borates as part of a healthy plant-based diet. Our bodies handle borates as they do any nutrient; by using what they need and excreting the rest. Borates do not bioaccumulate in humans or other mammals, and they are not absorbed through intact skin. Even among workers with higher than normal exposure to borates, studies show no negative health impacts over time. Trees need boron to grow.,

To read more on the ability of borate treated wood to provide control of non-wood destroying pests, see: <http://www.borax.com/wood/pdfs/SustainableWood.pdf> and/or <http://www.archchemicals.com/Fed/WOLW/Docs/Outdoor/WOW-5050.pdf>

Termites are called "social" cockroaches.

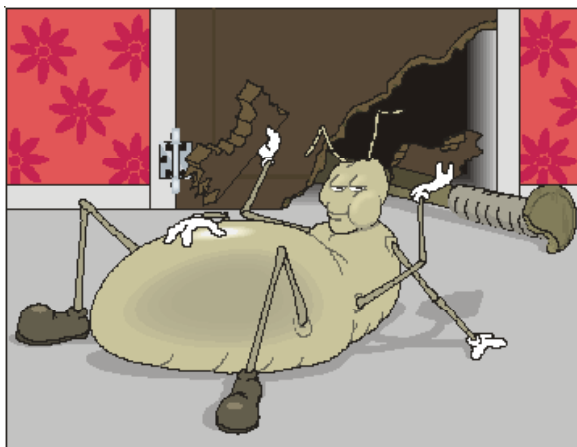

A person with a new idea is a crank until the idea succeeds. — Mark Twain

Government Regulations and Specifications - The U. S. “standard” railroad gauge (the distance between the rails) is 4 feet, 8.5 inches. That’s an exceedingly odd number. Why was that very unusual gauge used? Because that’s the way they built them in England and the U. S. railroads were built by English expatriates. Why did the English people build them like that? Because the first rail lines were built by the same people who built the pre-railroad tramways, and that’s the same gauge they used. So why did “they” use that strange gauge then? Because the people who built the tramways used the same jigs and tools that they used for building wagons, which used that exact wheel spacing. Okay! Why did the wagons use that odd wheel spacing? Well, if they tried to use any other spacing the wagons would break on some of the old, long distance roads, because that’s the same spacing of the old wheel ruts. So who built these old rutted roads? The first long distance roads in Europe were built by Imperial Rome for the benefit of their legions. These roads have been used ever since. And the ruts? The initial ruts, which everyone else had to match exactly for fear of destroying their wagons, they were first made by Roman war chariots. Since the war chariots were made for by Imperial Rome they were all alike in the matter of wheel spacing. Thus we finally have the answer to the original question: The United States “standard” railroad gauge of 4 feet, 8.5 inches derives from the original specification for an Imperial Roman army war chariot. Specs and Bureaucracies apparently live forever. So, the next time you are handed a government specification and wonder what horse’s posterior came up with it, you may be exactly right. Because the old Imperial Roman chariots were made to be just wide enough to accommodate the rear-ends of two war horses = or 4 feet 8.5 inches! **There’s an interesting extension to the story about railroad gauges and horses’ behinds:** When we see a space shuttle sitting on its launch pad, there are two big booster rockets attached to the sides of the main fuel tank. These are solid rocket boosters, or SRBs. The SRBs are made by Thiokol at their factory in Utah. The engineers who designed the SRBs might have preferred to make them a bit fatter, but the SRBs had to be shipped by train from the factory to the launch site. The railroad line from the factory had to run through a tunnel in the mountains. The SRBs had to fit through that tunnel. The tunnel is slightly wider than the railroad track, and the railroad track is about as wide as two horses’ behinds. So, the major design feature of what is arguably the world’s most advanced transportation system was determined over two thousand years ago by the width of a horse’s behind!

In the time of universal deceit, telling the truth is a revolutionary act. — George Orwell

The February 1999 issue of Pest Control had an article, “Pretreatment Problems Run Rampant.” Bob Kessler, President, Certified Pest Control Operators of Florida summed up the meeting for me with his comments, which the Author has noted in part: “The manufacturers have overstated the efficacy” and “With the current technology, there are some really inherent problems. We can use any chemical we want, but in more than half of the treatments that my company performed, conditions occurred that I had absolutely no control over. We’ve done soil treatments where the technician was 15 feet away from workers; as the guy is spraying, they’re digging trenches to get down to the plumbing they’re back filling. I’ve even seen the top three inches of soil stripped off within an hour of us doing a pretreat. I have to presume that hasn’t changed a great deal from when I got out of doing pretreats 15 years ago. I got out of the business because I had no faith in the treatment as it was. I really believe there’s got to be some other way of doing it. I’d like to have someone explain to me how in the world you could do a soil treatment and then have a half a dozen guys stomp all over that surface and then tell me that stuff is not disturbed.” Another comment the Author liked was that of Dr. Rudi Scheffrahn, Professor, University of Florida, who noted current (synthetic) termiticide poisons should last (only) three years with average application. Once again the Author asks, so why use these dangerous poisons?

Note: Pest control operators in southern Florida should be aware of a new termite invader there called the Asian subterranean termite (*Coptotermes gestroi*), which is very similar to the Formosan termite. It was first found near the Port of Miami in 1996, then in naval housing in Key West in 1999; it was originally named *Coptotermes havalandi*. The Asian alates are darker in color than the Formosan alates and the Asian soldiers exude a white, milky secretion from their heads when disturbed.

The April 2005 issue of Pest Control noted that the (pest control) industry research firm, Specialty Products Consultants LLC, reports an estimated \$1.2 billion is spent annually on termite treatments and renewals in the United States; the National Pest Management Association puts the figure at \$5 billion.

Selah!

The battle continues...stay tuned for updates. S.L.T.

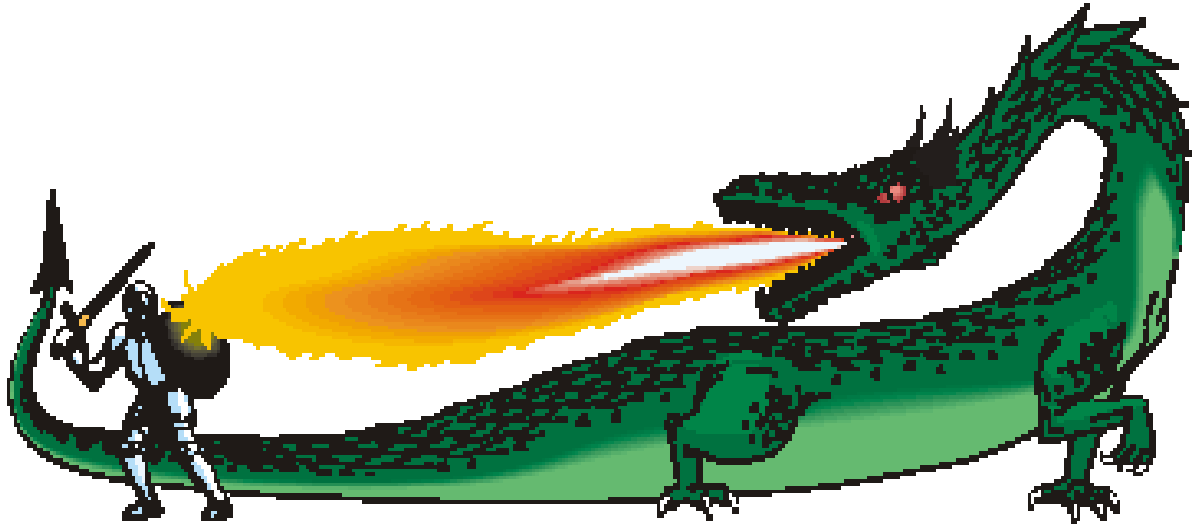

*Safe Solutions products may be purchased online at:

<http://www.safesolutionsinc.com>

or by telephone at:

1-888-443-8738.

