

Treibitsch

ELEKTROINSTALLATIONEN

Planung und Ausführung von Starkstrom- und Schwachstrom - Anlagenbau
8010 Graz, Klosterwiesgasse 52, Tel. 0316 / 81 19 81 , Fax DW 13

PREISLISTE

ohne MwSt

Inhaltsverzeichnis

	Seite		Seite
KABEL/LEITUNGEN		VERBINDUNGSMATERIAL	
Sat-Koaxkabel, Lautsprecherltg., Baustellenltg.	1	Fassungen, Coroplast, Nagelschellen	51
Drähte, Mantelleitungen	2	Kabelbinder, Spiralschlauch	52
PVC-Schlauchltg., Kabeltrommel-Abroller	3	Kabelverschraubung	53
Einziehhilfen / KATI-BLITZ	4	Cellpack: Verbindungsmuffe, Schrumpfschlauch	54
ROHRE u. ZUBEHÖR		VERTEILER u. SICHERUNGSMATERIAL	
Rohr und Zubehör	5, 6	Zählerverteiler	55
Klemmschellen, Kabelschutzrohr	7	Kleinverteiler	56, 57
Kabelschutzrohr, FMP vorverdr., Kabelabdeckpl.	8	Feuchtraumverteiler	57
Kabelwarnband	9	Baustromverteiler	58
KABELKANÄLE u. KABELRINNEN		EZ-Element, DIAZED-Sicherung, Passhülsen, Passschrauben	59
Elitec Kabelkanal, Installation-/Brüstungskanal	10, 11	Neozed-Sicherung u. Elemente, NH-Sicherung	
Elitec Verdrahtungskanal	12	LS-Automat AEG	60
OBO Kabeltragsysteme + Zubehör	13-19	LS-Automat Möller	61
Van Geel Kabeltragsysteme + Zubehör	20-23	LS-Automat Hager	62
Unterflursysteme OBO + Van Geel	24-27	LS-Automat Legrand	63
SCHALTER UND ABZWEIGDOSEN		FI-Schalter AEG / Hager / Legrand	64
Kaiser Hohlwanddosen, Fräser	28	FI-Schalter Moeller	65
GFI Hohlwand	29	Leitungsschutzschalter, Überspannungsschutz	66
Kaiser Betondosen + Zubehör	30	Verschienung	67
Abzweigdosen / Blitzement	31	Schütze, Motorschutzschalter	68
FEUCHTRAUM-MATERIAL		Raumthermostat, NH-Trenner, DRSTR-Zähler	69
FR-Schaltermaterial	32	Sicherungseinsätze Möller, Sicherungslasttrenn.	
FR Dosen ABOX ELT / Spelsberg / Sarel / OBO	33, 34	Treppenlicht, Stromstoß, Klingeltrafo, Fernschalter	70
STECKVORRICHTUNGEN		Schuko VE, Nachlaufrelais, Kippshalter	
Gummi-Schuko-Perilex-Klapp-Winkelstecker	35-37	Dämmerungs- u. Treppenlichtschalter Theben/Merten	71
Kabeltrommeln, Kleinverteiler	38	Schaltuhren Legrand / Theben / Hager	72
Wandverteiler Kunststoff + Vollgummi	39	Mini Relais und Sockel FINDER	73
Wandverteiler Vollgummi, Mobilverteiler Kunststoff	40	Relais, Stromstoß- u. Netzfreischalter Eitako	74
Mobilverteiler Kunststoff + Vollgummi	41	LEUCHTMITTEL	
Hängeverteiler, Aufroller	42	Standardlampen	76
CEE - PCE / Mennekes	43, 44	Kerzenform, Illulampen/Tropfenlampen (E14 + E27)	77
Tischverteiler, Verlängerungen, Zwischenschalter	45	Birnform, Ofen, Globe	78
E-Herd-Anschlußdosen, Dosenmuffen		Leuchtstofflampen	79
DIVERSE KLEMMEN		Leuchtstofflampen energiesparend / rund / U-förmig	80
Hauptleitungsklemme, Zählersteck/Reihenklemme	46, 47	TL5 - Röhren Osram / Philips	81
Dosenklemmen, Reihenklemmen		Infrarotreflektor, Linestra, Halopin ES, Halolux	82
Nulleiter- u. Pot-Schienen, Banderderdose,	48	Halopin, NV-Halogen GU5,3	83
Erdungsschellen, Montageband, FIXPIN, LSA-Plus		Halogen-Kaltlichtreflektorlampen, HiSpot, Twistline	84
LSA-Plus, LSA-Profil + Zubehör	49, 50	Alu, NV-Halogen GU5,3/G4/GU10, CFL Square	
		Halogenstäbe, NV-Halogen G4	85
		Halogen-Metalldampflampen	86
		Softone, Krypton, Argenta, Quecksilberdampf.	87
		Reflektorlampen, PAR38-Reflektorlampen	88
		Energiesparlampen	89-99

Inhaltsverzeichnis

	Seite
LEUCHTEN	
FR-Wannenleuchte, FR-Balken Thorn Aquaforce	101
Raster-Anbau/Einbauleuchten Thorn Punch + Quattro	102
Anbauleuchten Thorn TEFEM, LED Einbau-Downlights	103
Flutlichtlampen SonPak, Alu-Bay Thorn	104
Lichtleisten, Spiegelleuchten	105
Sensorleuchten, Halogen-Scheinwerfer	106
Einbaustrahler, Einbau-Downlights, LED-Spots	107
LED Einbau-/Wandeinbau-Spots	108
Elektr-Trafo	109
Vorschaltgeräte	110
Notleuchten, Notlicht-Einsätze	111, 112
Nurglasleuchten, Bebi-/Unilux	113
NETZWERK	
Schränke, Lüfter, Steckdosenleiste	114
Wandschränke u. Zubehör	115
Schrankleuchte, Paneele, Fachböden,	116
Patchpaneel, Kat5 Dosen, Patchkabel	117
Kat 5 + 6 Dosen, Patchpaneel Kat 6	118
Datenkabel Kat5 + 6, Erd/Datenkabel	119
ERDUNG / BLITZSCHUTZ	
	120-121
SAT-ANLAGEN	
Hirschmann-Triax	122-123
Delta	124-125
BEWEGUNGSMELDER	
Bewegungsmelder - BEG / Hager / Züblin	126
SPRECHANLAGEN	
Läutwerk, Gong	127
Fermax	128
Bticino	129
WERKZEUG	
	130

Abbildung	Art. Nr.	Bezeichnung	Kupferzahl kg/km	VE	per	Brutto €
-----------	----------	-------------	---------------------	----	-----	----------

SAT Koaxkabel

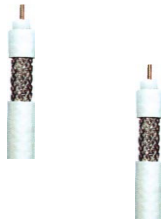

Heiru incl. Kupfer						exkl. Kupfer
464106	KAB	HTS100	Koax 1,0/5,5	100db	100	1000 368,20
464104	KAB	HTS100	Koax 1,0/5,5	100db	300	1000 368,20
464105	KAB	HTS100	Koax 1,0/5,5	100db	500	1000 368,20
Heiru incl. Kupfer						exkl. Kupfer
464108	KAB	HTS110	Koax 1,1/5,5	110db	100	1000 516,95
464109	KAB	HTS110	Koax 1,1/5,5	110db	300	1000 516,95

Lautsprecherleitung

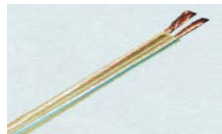

						exkl. Kupfer
008010	KAB	LS 2x0,75 TR	transparent		15	100 1000 292,86
464091	KAB	LS 2x1,5 TR	transparent HFL2x1,5		30	100 1000 778,59
464094	KAB	LS 2x2,5 TR	transparent HFL2x2,5		50	100 1000 1.145,73
464097	KAB	LS 2x4 TR	transparent HFL2x4		80	100 1000 1.776,62



						exkl. Kupfer
328877	KAB	F-VYDVY 4x0,5/1	Postmodemkabel		21	100 1000 693,03
328878	KAB	F-VYDVY 4x0,5/1	Postmodemkabel		21	250 1000 693,03
328881	KAB	F-VYDVY 4x0,5/1	Postmodemkabel		21	500 1000 693,03



						exkl. Kupfer
025441	KAB	750600+275	Videosystemkabel RG95 + 2x0,75 / 75Ohm / schwarz		38	100 1000 2.670,00

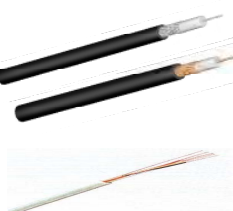

						exkl. Kupfer
334315	KAB	RG 58 C/U	Koaxkabel 50 OHM		19	100 1000 1.057,05
334325	KAB	RG 59 B/U	Koaxkabel 75 OHM		24	100 1000 1.007,46
334330	KAB	RG 59 B/U	Koaxkabel 75 OHM		24	500 1000 1.007,46
334328	KAB	RG 59 B/U	Koaxkabel 75 OHM		24	1000 1000 1.007,46
331347	KAB	J-Y(ST)Y2x2x0,8EIB	EIB BUS Leitung grün		21	1000 1000 864,69

PVC Baustellenleitung



						exkl. Kupfer
335482	KAB	XYMM-J 3x1,5	Baustellenl. gelb K 35		45	50 1000 1.346,59
335479	KAB	XYMM-J 3x1,5	Baustellenl. gelb K 35		45	100 1000 1.346,59
335496	KAB	XYMM-J 3x2,5	Baustellenl. gelb K 35		75	50 1000 2.717,13
335494	KAB	XYMM-J 3x2,5	Baustellenl. gelb K 35		75	100 1000 2.717,13
335507	KAB	XYMM-J 4x1,5	Baustellenl. gelb K 35		60	50 1000 1.719,18
335506	KAB	XYMM-J 4x1,5	Baustellenl. gelb K 35		60	100 1000 1.719,18
335515	KAB	XYMM-J 4x2,5	Baustellenl. gelb K 35		100	50 1000 3.296,98
335514	KAB	XYMM-J 4x2,5	Baustellenl. gelb K 35		100	100 1000 3.296,98
335521	KAB	XYMM-J 5x1,5	Baustellenl. gelb K 35		75	50 1000 2.255,89
335520	KAB	XYMM-J 5x1,5	Baustellenl. gelb K 35		75	100 1000 2.255,89
335540	KAB	XYMM-J 5x2,5	Baustellenl. gelb K 35		125	50 1000 4.152,37
335538	KAB	XYMM-J 5x2,5	Baustellenl. gelb K 35		125	100 1000 4.152,37
335553	KAB	XYMM-J 5x4	Baustellenl. gelb K 35		200	100 1000 6.584,38
335562	KAB	XYMM-J 5x6	Baustellenl. gelb K 35		300	100 1000 9.676,50

Baustellenleitungen können mit Aufdruck bestellt werden, ab 500m ist der Aufdruck kostenlos, unter 500m werden pauschal € 15,- ohne MwSt. verrechnet.
(€ 15,- vorgegebener Preis der Kabelindustrie)

Abbildung	Art. Nr.	Bezeichnung	Kupferzahl kg/km	VE	per	Brutto €
-----------	----------	-------------	---------------------	----	-----	----------

	Aufbau: 1 Kupferleiter, blank, eindrätig 2 Aderisolation aus Polyvinylchlorid (PVC)
---	--

**Ye 1,5
H07V-U**

330697	KAB H07V-U 1,5bl	PVC-Aderleitung	15	100	1000	131,22
330730	KAB H07V-U 1,5sw	PVC-Aderleitung	15	100	1000	131,22
330700	KAB H07V-U 1,5br	PVC-Aderleitung	15	100	1000	131,22
330710	KAB H07V-U 1,5gg	PVC-Aderleitung	15	100	1000	137,78
330736	KAB H07V-U 1,5vi	PVC-Aderleitung	15	100	1000	131,22
330724	KAB H07V-U 1,5or	PVC-Aderleitung	15	100	1000	131,22
330739	KAB H07V-U 1,5ws	PVC-Aderleitung	15	100	1000	131,22
330720	KAB H07V-U 1,5gr	PVC-Aderleitung	15	100	1000	131,22

**Ye 2,5
H07V-U**

330746	KAB H07V-U 2,5bl	PVC-Aderleitung	25	100	1000	212,29
330765	KAB H07V-U 2,5sw	PVC-Aderleitung	25	100	1000	212,29
330749	KAB H07V-U 2,5br	PVC-Aderleitung	25	100	1000	212,29
330755	KAB H07V-U 2,5gg	PVC-Aderleitung	25	100	1000	212,29

	Aufbau: 1 Kupferleiter, blank, eindrätig (IE) od. mehrdrätig (IM) 2 Aderisolation aus Polyvinylchlorid (PVC) 3 Aderumhüllung 4 Außenmantel aus Polyvinylchlorid (PVC), grau bzw. Sonderfarben
---	--

YM-J 3x1,5

333675	KAB NYM-J3x1,5RE 100m Ring		45	100	1000	684,18
333676	KAB NYM-J3x1,5RE 50m Ring		45	50	1000	684,18
333677	KAB NYM-J3x1,5RE 500m Trommel		45	500	1000	684,18

YM-J 3x2,5

333685	KAB NYM-J3x2,5RE 100m Ring		75	100	1000	1.225,73
333686	KAB NYM-J3x2,5RE 50m Ring		75	50	1000	1.225,73
333687	KAB NYM-J3x2,5RE 500m Trommel		75	500	1000	1.225,73

YM-J 4x1,5

333704	KAB NYM-J4x1,5RE 100m Ring		60	100	1000	875,02
333705	KAB NYM-J4x1,5RE 50m Ring		60	50	1000	875,02
333707	KAB NYM-J4x1,5RE 500m Trommel		60	500	1000	875,02

YM-J 5x1,5

333735	KAB NYM-J5x1,5RE 100m Ring		75	100	1000	1.042,43
333736	KAB NYM-J5x1,5RE 50m Ring		75	50	1000	1.042,43
333737	KAB NYM-J5x1,5RE 500m Trommel		75	500	1000	1.042,43

YM-J 5x2,5

333760	KAB NYM-J5x2,5RE 100m Ring		125	100	1000	1.866,38
333761	KAB NYM-J5x2,5RE 50m Ring		125	50	1000	1.866,38
333762	KAB NYM-J5x2,5RE 500m Trommel		125	500	1000	1.866,38

Abbildung	Art. Nr.	Bezeichnung	Kupferzahl kg/km	VE	per	Brutto €
-----------	----------	-------------	---------------------	----	-----	----------

H05VV-F(YMM) PVC - Schlauchleitung
A05VV-F



Aufbau:

- 1 Kupferleiter, blank, feindrähtig
- 2 Aderisolation aus Polyvinylchlorid (PVC)
Aderkennzeichnung nach HD 308 S2 (siehe Seite 265)
- 3 Außenmantel aus Polyvinylchlorid (PVC)

YMM-J 3x1,5	329655	KAB H05VV-F3G1,5	100m Ring	45	100	1000	859,61
	329658	KAB H05VV-F3G1,5	50m Ring	45	50	1000	859,61
	329661	KAB H05VV-F3G1,5	500m Trommel	45	500	1000	589,61
YMM-J 3x2,5	329679	KAB H05VV-F3G2,5	100m Ring	75	100	1000	1.472,29
	329680	KAB H05VV-F3G2,5	50m Ring	75	50	1000	1.472,29
	329683	KAB H05VV-F3G2,5	500m Trommel	75	500	1000	1.472,29
YMM-J 4x1,5	329710	KAB H05VV-F4G1,5	100m Ring	60	100	1000	1.086,61
	329712	KAB H05VV-F4G1,5	50m Ring	60	50	1000	1.086,61
	329715	KAB H05VV-F4G1,5	500m Trommel	60	500	1000	1.086,61
YMM-J 5x1,5	329751	KAB H05VV-F5G1,5	100m Ring	75	100	1000	1.319,45
	329752	KAB H05VV-F5G1,5	50m Ring	75	50	1000	1.319,45
	329756	KAB H05VV-F5G1,5	500m Trommel	75	500	1000	1.319,45
YMM-J 5x2,5	329769	KAB H05VV-F5G2,5	100m Ring	125	100	1000	2.247,60
	329770	KAB H05VV-F5G2,5	50m Ring	125	50	1000	2.247,60
	329774	KAB H05VV-F5G2,5	500m Trommel	125	500	1000	2.247,60



013349 CIM 142750

Kabeltrommel-Abroller aus pulverbesch. Stahlblech, mit Tragegriff und vier höhenverstellbaren, rutschfesten Gummifüßen, flache Aufrollrampe, mit zwei Tragwalzen, seitliche Trommelführungen, Tragwalzenabstand durch einfaches Umhängen beliebig variierbar

1 1

365,70

Aderkennzeichnung Kabel und Leitungen

Aktuelles Schema der Aderfarben gemäß Harmonisierungsdokument HD 308 S1				Neues Schema der Aderfarben gem. Harmonisierungsdokument HD 308 S2	
Kabel für bewegte Verlegung		Kabel für feste Verlegung		Kabel für alle Verlegungen	
mit grün-gelb	ohne grün-gelb	mit grün-gelb	ohne grün-gelb	mit grün-gelb	mit grün-gelb
2-polig					
blau braun			blau schwarz		blau braun
3-polig					
blau braun grün gelb	schwarz blau schwarz braun	schwarz blau schwarz grün gelb	blau braun schwarz	blau braun grün gelb	braun grau schwarz
4-polig					
blau braun schwarz grün gelb	schwarz blau schwarz braun	braun blau schwarz grün gelb	blau braun schwarz schwarz	schwarz braun grau grün gelb	braun grau blau schwarz
5-polig					
schwarz blau braun schwarz grün gelb	schwarz schwarz blau schwarz braun	schwarz braun blau schwarz grün gelb	schwarz blau braun schwarz schwarz	schwarz blau braun grau grün gelb	schwarz braun grau blau schwarz

Kati Blitz Einziehfedern Einziehhilfen

Abbildung	Art. Nr.	Bezeichnung	VE	per	Brutto €
-----------	----------	-------------	----	-----	----------



002805	NEU	RT2008	Einziehhilfe	1	1	327,00
---------------	------------	---------------	--------------	---	---	---------------

Wahlweise - in Verbindung mit einer Akkubohrmaschine oder durch ein integriertes Übersetzungsgetriebe, welches per Hand betätigt wird, erzeugt der RT 2008 einen einzigartigen Vortrieb der Einzugsfeder.



215350	DIE	KBCOMP20	Kati Blitz 20m 101820	1	100	10.760,00
215351	DIE	KBCOMP30	Kati Blitz 30m 101830	1	100	12.550,00
215352	DIE	KBCOMP50	Kati Blitz 50m 101850	1	100	14.870,00
215531	DIE	KBSERV	Service Set 101245	1	100	2.700,00
214874	DIE	KBAH/3	Anfangshülse 101012	1	100	775,00
214876	DIE	KBVB/3	Verbindungshülse 101011	1	100	494,00
214244	DIE	KATKLEB 30G	Kleber 30 Gramm 101027	1	100	970,00

Einziehfeder

RED PULL



289708	DUL	PELS 410 RED	Perlon 4mm / 10 Meter	1	1	12,93
289709	DUL	PELS 415 RED	Perlon 4mm / 15 Meter	1	1	17,01
289710	DUL	PELS 420 RED	Perlon 4mm / 20 Meter	1	1	21,12



289698	DUL	MEF 410	Stahl 4mm / 10 Meter	1	1	26,88
289699	DUL	MEF 415	Stahl 4mm / 15 Meter	1	1	37,86
289700	DUL	MEF 420	Stahl 4mm / 20 Meter	1	1	49,65



288305	CRA	C1511611	Kabelgloss (12 Stk. = VE) Gleitspray Cramolin 400 ml	12	1	25,20
029224	CEL	219647	EASY-GLIDE Kabelgleitmittel 1050 ml	1	1	21,90

Abbildung	Art. Nr.	Fabrikat	Bezeichnung	VE	per	Brutto €
-----------	----------	----------	-------------	----	-----	----------

FX-Schlauch in Ringen zu 50m bzw. zu 25m, > 320N

nach ÖNORM E 6544, gemäß ÖVE-EN 50086-2-2



214825	Dietzel	019856	FX20 HG	EN 2221	50 100	63,18
214826	Dietzel	019857	FX25 HG	EN 2221	50 100	85,43
214827	Dietzel	019858	FX32 HG	EN 2221	25 100	150,12
214828	Dietzel	019859	FX40 HG	EN 2221	25 100	208,44
214829	Dietzel	019860	FX50 HG	EN 2221	25 100	376,92
214830	Dietzel	019861	FX63 HG	EN 2221	25 100	585,36
276426	Pipelife	TXL 20	Flex leicht	EN 2221	50 100	63,18
276427	Pipelife	TXL 25	Flex leicht	EN 2221	50 100	85,43
276428	Pipelife	TXL 32	Flex leicht	EN 2221	25 100	150,12
276429	Pipelife	TXL 40	Flex leicht	EN 2221	25 100	208,44
276430	Pipelife	TXL 50	Flex leicht	EN 2221	25 100	376,92
276431	Pipelife	TXL 63	Flex leicht	EN 2221	25 100	585,36

FXP-TURBO in Ringen zu 50m bzw. zu 25m mit innenliegenden Profilwellen >750N

nach ÖNORM E 6544, gemäß ÖVE-EN 50086-2-2

Bei Sonderverlegung auch in diversen Farben lieferbar → FXP-Color



216632	Dietzel	083270	FXP-TURBO 20	EN 3341	50 100	113,40
216633	Dietzel	083271	FXP-TURBO 25	EN 3341	50 100	149,04
216634	Dietzel	083272	FXP-TURBO 32	EN 3341	25 100	260,28
216635	Dietzel	083273	FXP-TURBO 40	EN 3341	25 100	371,52
216636	Dietzel	083274	FXP-TURBO 50	EN 3341	25 100	665,28
216637	Dietzel	083275	FXP-TURBO 63	EN 3341	25 100	1.220,40
276129	Pipelife	PXM 20	Profiline Flex Mittel	EN 3341	50 100	113,40
276130	Pipelife	PXM 25	Profiline Flex Mittel	EN 3341	50 100	149,04
276131	Pipelife	PXM 32	Profiline Flex Mittel	EN 3341	25 100	260,28
276132	Pipelife	PXM 40	Profiline Flex Mittel	EN 3341	25 100	371,52
276133	Pipelife	PXM 50	Profiline Flex Mittel	EN 3341	25 100	665,28

Krallenmuffe



216452	Dietzel	080642	KM-TURBO 20 OR	Krallen Muffe	100 100	27,14
216453	Dietzel	080643	KM-TURBO 25 OR	Krallen Muffe	50 100	35,46
216760	Dietzel	085925	KM-TURBO 32 OR	Krallen Muffe	25 100	50,96
214931	Dietzel	020612	HM 40 OR	Haftmuffe orange	25 100	79,14
214932	Dietzel	020613	HM 50 OR	Haftmuffe orange	15 100	106,08
214933	Dietzel	020614	HM 63 OR	Haftmuffe orange	8 100	212,16
276081	Pipelife	ML 20	Flex Muffe	zugfest hellgrau	100 100	27,77
276082	Pipelife	ML 25	Flex Muffe	zugfest hellgrau	50 100	36,19
276083	Pipelife	ML 32	Flex Muffe	zugfest hellgrau	25 100	53,98
276084	Pipelife	ML 40	Flex Muffe	zugfest hellgrau	25 100	80,39
276085	Pipelife	ML 50	Flex Muffe	zugfest hellgrau	15 100	108,16
276086	Pipelife	ML 63	Flex Muffe	zugfest hellgrau	8 100	217,36
276385	Pipelife	TML 20	Steck-Haftmuffe	hellgrau	100 100	27,77
276386	Pipelife	TML 25	Steck-Haftmuffe	hellgrau	50 100	36,19
276387	Pipelife	TML 32	Steck-Haftmuffe	hellgrau	25 100	53,98
276388	Pipelife	TML 40	Steck-Haftmuffe	hellgrau	25 100	80,39
276389	Pipelife	TML 50	Steck-Haftmuffe	hellgrau	15 100	108,16
276390	Pipelife	TML 63	Steck-Haftmuffe	hellgrau	8 100	217,36

Abbildung	Art. Nr.	Bezeichnung	VE	per	Brutto €
-----------	----------	-------------	----	-----	----------

VRM-TURBO in Stangen zu 3m, einseitig aufgemufft, I-Rohr mit innenliegenden Profilwellen, > 320N

nach ÖNORM E 6543, gemäß ÖVE-EN 50086-2-1



216693	DIE 084196 VRM-TURBO 20	EN 2221	111	100	100,10
216694	DIE 084197 VRM-TURBO 25	EN 2221	57	100	150,70
216695	DIE 084198 VRM-TURBO 32	EN 2221	57	100	226,60
216696	DIE 084199 VRM-TURBO 40	EN 2221	21	100	325,60
216697	DIE 084200 VRM-TURBO 50	EN 2221	21	100	532,40
276399	PIP TRL 20M I-Rohr	EN 2221	111	100	100,10
276400	PIP TRL 25M I-Rohr	EN 2221	57	100	150,70
276401	PIP TRL 32M I-Rohr	EN 2221	57	100	226,60
276402	PIP TRL 40M I-Rohr	EN 2221	21	100	325,60
276403	PIP TRL 50M I-Rohr	EN 2221	21	100	532,40

UPRM-TURBO in Stangen zu 3m, einseitig aufgemufft, Panzerrohr mit innenliegenden Profilwellen, > 750N

nach ÖNORM E 6543, gemäß ÖVE-EN 50086-2-1



216699	DIE 084202 UPRM-TURBO 20	EN 3341	111	100	168,48
216700	DIE 084203 UPRM-TURBO 25	EN 3341	57	100	247,32
216701	DIE 084204 UPRM-TURBO 32	EN 3341	57	100	393,96
216702	DIE 084205 UPRM-TURBO 40	EN 3341	21	100	504,36
216703	DIE 084206 UPRM-TURBO 50	EN 3341	21	100	710,64
216704	DIE 084207 UPRM-TURBO 63	EN 3341	21	100	1.198,80
276405	PIP TRM 20M P-Rohr	EN 3341	111	100	168,48
276406	PIP TRM 25M P-Rohr	EN 3341	57	100	247,32
276407	PIP TRM 32M P-Rohr	EN 3341	57	100	393,96
276408	PIP TRM 40M P-Rohr	EN 3341	21	100	504,36
276409	PIP TRM 50M P-Rohr	EN 3341	21	100	710,64
276410	PIP TRM 63M P-Rohr	EN 3341	21	100	1.198,80

Klemmschelle für I-Rohr



216539	DIE 082178 CL 20 HG	Klemmschelle hellgrau	100	100	17,26
216545	DIE 082215 CL 25 HG	Klemmschelle hellgrau	100	100	26,10
216548	DIE 082219 CL 32 HG	Klemmschelle hellgrau	100	100	36,19
216551	DIE 082223 CL 40 HG	Klemmschelle hellgrau	50	100	48,67
216567	DIE 082596 CL 50 HG	Klemmschelle hellgrau	50	100	66,04
216570	DIE 082600 CL 63 HG	Klemmschelle hellgrau	25	100	124,80
276371	PIP TKSL 20	Klemmschelle hellgrau	100	100	17,26
276372	PIP TKSL 25	Klemmschelle hellgrau	100	100	26,10
276373	PIP TKSL 32	Klemmschelle hellgrau	100	100	36,19
276374	PIP TKSL 40	Klemmschelle hellgrau	50	100	48,67
276375	PIP TKSL 50	Klemmschelle hellgrau	50	100	66,04
276376	PIP TKSL 63	Klemmschelle hellgrau	25	100	156,52

Abbildung	Art. Nr.	Bezeichnung	VE	per	Brutto €
-----------	----------	-------------	----	-----	----------

Klemmschelle für Panzerrohr



216538	DIE 082177 CL 20 GR	Panzer-Klemmschelle grau	100	100	19,14
216544	DIE 082214 CL 25 GR	Panzer-Klemmschelle grau	100	100	28,60
216547	DIE 082218 CL 32 GR	Panzer-Klemmschelle grau	100	100	38,27
216550	DIE 082222 CL 40 GR	Panzer-Klemmschelle grau	50	100	51,79
216566	DIE 082595 CL 50 GR	Panzer-Klemmschelle grau	50	100	71,66
216569	DIE 082599 CL 63 GR	Panzer-Klemmschelle grau	25	100	168,48
276378	PIP TKSM 20	Reihenklemschelle grau	100	100	19,14
276379	PIP TKSM 25	Reihenklemschelle grau	100	100	28,60
276380	PIP TKSM 32	Reihenklemschelle grau	100	100	38,27
276381	PIP TKSM 40	Reihenklemschelle grau	50	100	51,79
276382	PIP TKSM 50	Reihenklemschelle grau	50	100	71,66
276383	PIP TKSM 63	Reihenklemschelle grau	25	100	168,48

Kabelschutzrohr KSR



Kabelschutzrohre aus PVC-hart (PVC-U), einseitig aufgemufft,
in Stangen zu 3m und 6m /normale Ausführung; Druckfestigkeit >450N

214061	DIE KSR 50 schwarz 3m	001729	1419	100	459,00
214062	DIE KSR 63 schwarz 3m	001730	891	100	572,40
214063	DIE KSR 75 schwarz 3m	001731	654	100	696,60
214064	DIE KSR 90 schwarz 3m	001732	414	100	988,20
214065	DIE KSR 110 schwarz 3m	001733	285	100	1.177,20

Kabelschutzrohr KSX / FXK



Kabelschutzrohre aus PVC-hart (PVC-U), inkl. Muffe
in Ringen zu 25m, leichte Ausführung; Druckfestigkeit >250N

214124	DIE FXK 50 schwarz	001984	25	100	259,20
214125	DIE FXK 65 schwarz	001985	25	100	329,40
214126	DIE FXK 80 schwarz	001986	25	100	459,00
214127	DIE FXK 100 schwarz	001987	25	100	604,80
214128	DIE FXK 125 schwarz	001988	25	100	1.101,60
275978	PIP KSX 50 schwarz		25	1	2,60
275979	PIP KSX 65 schwarz		25	1	3,30
275980	PIP KSX 80 schwarz		25	1	4,60
275974	PIP KSX 100 schwarz		25	1	6,05
275975	PIP KSX 125 schwarz		25	1	11,00

Kabelschutzrohr KSX-PE



Biegsame Vollwand-Kabelschutzrohre halogenfrei, glatt aus PE,
schlagfest (bisher für schwere mechanische Beanspruchung S-PE)

214152	DIE 002122 KSXPE 25	Kabelschutzrohr PE 25 3/4"	100	100	165,00
214153	DIE 002123 KSXPE 32	Kabelschutzrohr PE 32 1"	100	100	225,50
214154	DIE 002124 KSXPE 40	Kabelschutzrohr PE 40 5/4"	100	100	313,50

Abbildung	Art. Nr.	Bezeichnung	VE	per	Brutto €
-----------	----------	-------------	----	-----	----------

Kabelschutzrohr KSX-PEG

Kabelschutzrohr aus PE-hart (PE-HD), inkl. Muffe / inkl. kunststoffummantelten Metalleinziehdraht
Ø 0,8 mm; nach ÖNORM E6517, gemäß ÖVE-EN 50086-2-4, normale Ausführung: > 450N



215581	DIE 041925	FXKVR 50 sw inkl. Muffe	50	100	330,00
215291	DIE 032332	FXKVR 63 sw inkl. Muffe	50	100	410,00
215227	DIE 026353	FXKVR 75 sw inkl. Muffe	50	100	540,00
215562	DIE 041343	FXKVR 90 sw inkl. Muffe	50	100	620,00
215563	DIE 041344	FXKVR 110 sw inkl. Muffe	50	100	700,00
215587	DIE 041990	FXKVR 125 sw inkl. Muffe	50	100	1.070,00
215589	DIE 042514	FXKVR 160 sw inkl. Muffe	50	100	1.885,00

Kabelschutzrohr mit eingelegtem PA-Zugdraht, Ø 1,5mm, PE > 450N
inkl. Verbindungsmuffe / ÖVE EN50086



276007	PIP KSX-PEG50	KSR mit Zugdraht	50	1	3,30
276009	PIP KSX-PEG63	KSR mit Zugdraht	50	1	4,10
276011	PIP KSX-PEG75	KSR mit Zugdraht	50	1	5,40
276013	PIP KSX-PEG90	KSR mit Zugdraht	50	1	6,20
275994	PIP KSX-PEG110	KSR mit Zugdraht	50	1	7,00
275997	PIP KSX-PEG125	KSR mit Zugdraht	50	1	10,70
275999	PIP KSX-PEG160	KSR mit Zugdraht	50	1	18,85

FMP vorverdrahtet



- Einfache und schnelle Verlegung in einem Arbeitsgang
- Keine Einziehprobleme mehr in Beton, Estrich, Hohlwänden
- Verlegung durch 1 Person → spart Arbeitszeit & Geld
- Kein Baustopp im Winter

FMP bezogen Preise excl. CU

002784	GFI FMP20 + Ye 3x1,5	gnge-sw-blau	50	100	114,45
002766	GFI FMP20 + Ye 3x2,5	sw-blau-gnge	50	100	142,80
017772	GFI FMP20 + Ye 5x1,5	gnge-sw-bl-br-vio	50	100	144,90
017570	GFI FMP25 + Ye 5x2,5	gnge-sw-bl-br-vio	50	100	200,55

Kabelabdeckplatten



Achtung Kabel

Abmessungen:

215301	DIE KPL 120 032786	120 x 1000 mm	25	100	170,00
214819	DIE KPL 150 019441	150 x 1000 mm	25	100	235,00
214820	DIE KPL 250 019442	250 x 1000 mm	25	100	320,00
275768	PIP KAD 120AK	120 x 1000 mm	25	1	1,70
275771	PIP KAD 150AK	150 x 1000 mm	25	1	2,35
275776	PIP KAD 250AK	250 x 1000 mm	25	1	3,20

Achtung Starkstromkabel

Abmessungen:

215588	DIE KPL 120 042063	120 x 1000 mm	25	100	170,00
214169	DIE KPL 250 002275	250 x 1000 mm	25	100	320,00
275769	PIP KAD 120AST	120 x 1000 mm	25	1	1,70
275773	PIP KAD 150BEWAG	150 x 1000 mm	25	1	2,35
275779	PIP KAD 250AST	250 x 1000 mm	25	1	3,20
275780	PIP KAD 250BEWAG	250 x 1000 mm	25	1	3,20

Abbildung	Art. Nr.	Bezeichnung	VE	per	Brutto €
	006218	PIP LWBASTD	250m Ring	1000	1000 121,20
	276022	PIP LWB2AK "Achtung Kabel"	250m Ring	250	1 30,30
	214166	DIE LWB2 "Achtung Kabel"	002205	100	100 12,18
	276033	PIP LWB3AK "Achtung Kabel"	100m Ring	100	1 18,15
	214168	DIE LWB3 "Achtung Kabel"	002217	100	100 18,17
	214165	DIE LWB2 "Achtung Starkstromkabel"	002191	100	100 12,18
	276035	PIP LWB3AST "Achtung Starkstromkabel"	100m Ring	100	1 18,15
	214167	DIE LWB3 "Achtung Starkstromkabel"	002213	100	100 18,17
	276036	PIP LWB3AST-BEW "Achtung Starkstromkabel BEWAG"	100m Ring	100	1 18,15

Abbildung	Art. Nr.	Bezeichnung	VE	per m	Brutto €
-----------	----------	-------------	----	-------	----------

Minikanal

269814	ELI 14111	LFG 15x15 reinweiss RAL9010	80	1	1,40
269408	ELI 4110	LFG 15x15 braun RAL8014	80	1	1,40
269663	ELI 11026	LFG 15x30 reinweiss RAL9010	72	1	2,73
269002	ELI 1038	LFG 15x30 braun RAL8014	72	1	2,73
269718	ELI 11530	LFG 15x50 reinweiss RAL9010	50	1	4,37
269080	ELI 1531	LFG 15x50 braun RAL8014	50	1	4,37
269662	ELI 11025	LFG 20x20 reinweiss RAL9010	54	1	1,66
269001	ELI 1037	LFG 20x20 braun RAL8014	54	1	1,66
269665	ELI 11028	LFG 25x40 reinweiss RAL9010	40	1	3,78
269004	ELI 1040	LFG 25x40 braun RAL8014	40	1	3,78
269664	ELI 11027	LFG 30x30 reinweiss RAL9010	50	1	3,44
269003	ELI 1039	LFG 30x30 braun RAL8014	50	1	3,44
269666	ELI 11029	LFG 40x40 reinweiss RAL9010	24	1	4,52
269005	ELI 1041	LFG 40x40 braun RAL8014	24	1	4,52
269667	ELI 11030	LFG 40x60 reinweiss RAL9010	28	1	5,51
269674	ELI 11060 T	LFG 40x60T reinweiss RAL9010 m. TS	24	1	6,82
269006	ELI 1042	LFG 40x60 braun RAL8014	28	1	5,51
269013	ELI 1061 T	LFG 40x60T braun RAL8014 m. TS	24	1	6,82
269676	ELI 11072	LFG 40x90 reinweiss RAL9010	12	1	11,15
269015	ELI 1073	LFG 40x90 braun RAL8014	12	1	11,15
269710	ELI 11462	LFG 40x110 reinweiss RAL9010	12	1	13,69
269070	ELI 1463	LFG 40x110 braun RAL8014	12	1	13,69
269668	ELI 11031	LFG 60x60 reinweiss RAL9010	16	1	9,01
269007	ELI 1043	LFG 60x60 braun RAL8014	16	1	9,01
269669	ELI 11032	LFG 60x90 reinweiss RAL9010	16	1	13,31
269008	ELI 1044	LFG 60x90 braun RAL8014	16	1	13,31

Abbildung	Art. Nr.	Bezeichnung	VE	per m	Brutto €
-----------	----------	-------------	----	-------	----------



Installationskanal



269670	ELI 11033	60x110 reinweiß RAL9010	8	1	16,77
269671	ELI 11034	60x130 reinweiß RAL9010	10	1	20,99
269672	ELI 11035	60x150 reinweiß RAL9010	8	1	23,72
269673	ELI 11036	60x200 reinweiß RAL9010	8	1	31,29
269675	ELI 11066	60x230 reinweiß RAL9010	8	1	35,29

Brüstungskanal (Oberteil und Unterteil)



269832	ELI 14253	65x100 reinweiß RAL9010	8	1	21,19
269729	ELI 11746	65x130 reinweiß RAL9010	8	1	24,98
269728	ELI 11742	65x170 reinweiß RAL9010	8	1	33,44

Aufbodenkanal

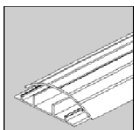

269430	ELI 4221	Aufbodenk. 18 x 75 gr	36	1	7,56
269431	ELI 4222	Aufbodenk. 18 x 75 br	36	1	9,67



269048	ELI 1261	Gerätedose blau	40	1	3,83
269052	ELI 1268	Gerätedose schwarz	48	1	3,18

LFG Trennsteg

269047	ELI 1260	Höhe 60mm LFG,FB	100	1	2,92
269066	ELI 1360	Höhe 40mm LFG,FB	100	1	2,86
269069	ELI 1456	Höhe 60mm LFG,BR,ALU	100	1	3,17

Abbildung	Art. Nr.	Bezeichnung	VE	per	Brutto €
-----------	----------	-------------	----	-----	----------



Verdrahtungskanal

Unterteil u. Oberteil

Nennmaß HxB (mm)

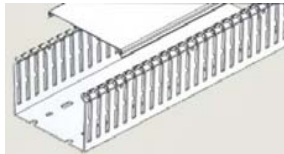

269097	ELI	1682	VK Special 16x16	100	1	3,01
269098	ELI	1683	VK Special 30x25	60	1	4,21

Höhe 40 mm

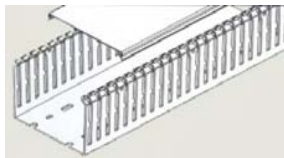

271159	ELI	N1684	VK Special 40x25	48	1	4,58
271160	ELI	N1685	VK Special 40x40	48	1	5,62
271161	ELI	N1686	VK Special 40x60	36	1	6,60

Höhe 60 mm



271162	ELI	N1687	VK Special 60x25	32	1	6,21
271168	ELI	N1696	VK Special 60x30	32	1	6,64
271163	ELI	N1688	VK Special 60x40	32	1	8,01
271164	ELI	N1689	VK Special 60x60	32	1	9,65
271165	ELI	N1690	VK Special 60x80	24	1	12,28
271166	ELI	N1691	VK Special 60x100	16	1	12,82
271167	ELI	N1692	VK Special 60x120	16	1	16,06

Höhe 80 mm

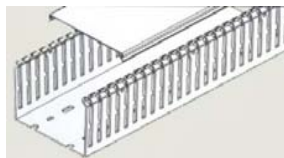

271154	ELI	N1677	VK Special 80x40	28	1	9,94
271155	ELI	N1678	VK Special 80x60	20	1	9,65
271156	ELI	N1679	VK Special 80x80	20	1	14,90
271157	ELI	N1680	VK Special 80x100	16	1	16,12
271158	ELI	N1681	VK Special 80x120	16	1	18,42

Höhe 100 mm

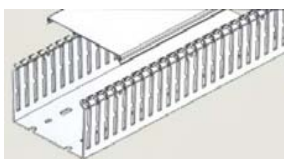

269101	ELI	1698	VK Special 100x60	24	1	17,91
269102	ELI	1699	VK Special 100x100	20	1	26,72

Abbildung	Art. Nr.	Bezeichnung	VE	per	Brutto €
-----------	----------	-------------	----	-----	----------

Kabelrinnen Stahlblech, sedimierverzinkt mit stabilisierender Lochprägung und gratfreier Leitungsauflage
L: 3000 mm, H: 60 mm, 1,1 kN bei 1,5 m Stützabstand, einfache Montage mittels CLICK-Verbindung



374968	OBO 6047611 RKSM 610	Breite 100 mm	3	1	17,25
374972	OBO 6047638 RKSM 620	Breite 200 mm	3	1	21,55
374974	OBO 6047654 RKSM 630	Breite 300 mm	3	1	26,90
374976	OBO 6047689 RKSM 640	Breite 400 mm	3	1	37,30
374978	OBO 6047719 RKSM 650	Breite 500 mm	3	1	46,05
374980	OBO 6047735 RKSM 660	Breite 600 mm	3	1	53,35

Verbinder - zu verwenden bei Zuschnitten und div. Formteilen



375321	OBO 6068154 RV 610	Verbinder 100mm	1	1	7,80
375323	OBO 6068170 RV 620	Verbinder 200mm	1	1	7,90
375324	OBO 6068189 RV 630	Verbinder 300mm	1	1	8,70
375325	OBO 6068197 RV 640	Verbinder 400mm	1	1	11,30
375326	OBO 6068200 RV 650	Verbinder 500mm	1	1	12,80
375327	OBO 6068219 RV 660	Verbinder 600mm	1	1	13,80

Schraubverbinder



375290	OBO 6067093 KU	Schraubverbinder	1	1	2,70
---------------	----------------	------------------	---	---	-------------

Zubehör für Kabelrinnensystem sedimierverzinkt 60mm Seitenhöhe



Bogen 90° kompl. mit Winkelverb.

374922	OBO 6043216 RB 90 610	60 x 100 mm	1	1	42,80
374923	OBO 6043224 RB 90 620	60 x 200 mm	1	1	50,70
374924	OBO 6043232 RB 90 630	60 x 300 mm	1	1	61,40
379832	OBO 7001290 RB 90 640	60 x 400 mm	1	1	66,80
379833	OBO 7001304 RB 90 650	60 x 500 mm	1	1	84,00
379834	OBO 7001312 RB 90 600	60 x 600 mm	1	1	97,50

Anbau-Abzweigstück kpl. mit 2 Winkelverb.



374909	OBO 6040403 RAA 610	60 x 100 mm	1	1	33,80
374911	OBO 6040438 RAA 620	60 x 200 mm	1	1	35,65
374912	OBO 6040446 RAA 630	60 x 300 mm	1	1	38,30
379851	OBO 7002394 RAA 640	60 x 400 mm	1	1	50,90
379852	OBO 7002416 RAA 650	60 x 500 mm	1	1	60,85
379853	OBO 7002432 RAA 660	60 x 600 mm	1	1	71,65

Eckverbinder (Kabelrinnen-Endstück verstellbar), bandverzinkt, DIN EN 10147



375309	OBO 6067972 REV 60	Eckverbinder 60 mm	1	1	10,00
379835	OBO 7001330 REV 610	60 x 100 mm	1	1	33,20
379836	OBO 7001332 REV 620	60 x 200 mm	1	1	39,55
379837	OBO 7001334 REV 630	60 x 300 mm	1	1	55,10
379838	OBO 7001336 REV 640	60 x 400 mm	1	1	64,20

Abbildung	Art. Nr.	Bezeichnung	VE	per	Brutto €
-----------	----------	-------------	----	-----	----------

Zubehör für Kabelrinnensystem sedimierverzinkt 60mm Seitenhöhe

Steigstück (Vertikalbogen 90° STEIGEND), bandverzinkt DIN EN 10147



379928	OBO 7007005 RBV 610 S	60 x 100 mm	1	1	26,30
379930	OBO 7007013 RBV 620 S	60 x 200 mm	1	1	34,40
379931	OBO 7007017 RBV 630 S	60 x 300 mm	1	1	51,90
379932	OBO 7007021 RBV 640 S	60 x 400 mm	1	1	68,70
379933	OBO 7007025 RBV 650 S	60 x 500 mm	1	1	75,40
379934	OBO 7007029 RBV 660 S	60 x 600 mm	1	1	98,95

Deckel f. Steigstück (Vertikalbogen 90° STEIGEND), Stahl, bandverzinkt



380349	OBO 7130805 DBV 100 S	60 x 100 mm	1	1	14,50
380351	OBO 7130813 DBV 200 S	60 x 200 mm	1	1	16,60
380352	OBO 7130817 DBV 300 S	60 x 300 mm	1	1	20,70
380353	OBO 7130821 DBV 400 S	60 x 400 mm	1	1	22,95
380354	OBO 7130825 DBV 500 S	60 x 500 mm	1	1	27,00
380355	OBO 7130829 DBV 600 S	60 x 600 mm	1	1	29,40

Fallstück (Vertikalbogen 90° FALLEND), bandverzinkt, DIN EN 10147



379936	OBO 7007055 RBV 610 F	60 x 100 mm	1	1	26,30
379938	OBO 7007063 RBV 620 F	60 x 200 mm	1	1	34,40
379939	OBO 7007067 RBV 630 F	60 x 300 mm	1	1	51,90
379940	OBO 7007071 RBV 640 F	60 x 400 mm	1	1	68,70
379941	OBO 7007075 RBV 650 F	60 x 500 mm	1	1	75,40
379942	OBO 7007079 RBV 660 F	60 x 600 mm	1	1	98,95

Deckel f. Fallstück (Vertikalbogen FALLEND), Stahl, bandverzinkt

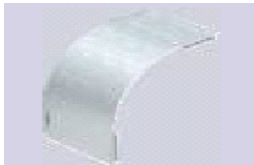

380357	OBO 7130852 DVB 100 F	60 x 100 mm	1	1	14,50
380359	OBO 7130860 DVB 200 F	60 x 200 mm	1	1	16,60
380360	OBO 7130864 DVB 300 F	60 x 300 mm	1	1	20,70
380361	OBO 7130868 DVB 400 F	60 x 400 mm	1	1	22,95
380362	OBO 7130872 DVB 500 F	60 x 500 mm	1	1	27,00
380363	OBO 7130876 DVB 600 F	60 x 600 mm	1	1	29,40

Deckel ungelocht für Kabelrinne und Kabelleiter, bandverzinkt, DIN EN 10147

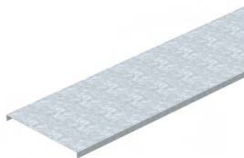

374994	OBO 6049150 DLKS 100 FS	100 x 3000 mm	3	1	11,80
374995	OBO 6049156 DLKS 200 FS	200 x 3000 mm	3	1	17,10
374996	OBO 6049162 DLKS 300 FS	300 x 3000 mm	3	1	22,15

375005	OBO 6052103 DRLU 100	100 x 3000 mm	3	1	11,10
375009	OBO 6052210 DRLU 200	200 x 3000 mm	3	1	18,65
375011	OBO 6052307 DRLU 300	300 x 3000 mm	3	1	27,10
375013	OBO 6052405 DRLU 400	400 x 3000 mm	3	1	39,10
375015	OBO 6052512 DRLU 500	500 x 3000 mm	3	1	55,80
375019	OBO 6052609 DRLU 600	600 x 3000 mm	3	1	67,75



375271	OBO 6065600 DKU	Deckelklammer universal	60	100	86,25
---------------	-----------------	-------------------------	----	-----	--------------

375267	OBO 6065540 DKL 60 VA	Deckelklammer 20 x 60	50	1	8,05
---------------	-----------------------	-----------------------	----	---	-------------

Abbildung	Art. Nr.	Bezeichnung	VE	per	Brutto €
-----------	----------	-------------	----	-----	----------

Zubehör für Kabelrinnensystem sedimierverzinkt 60mm Seitenhöhe

Reduzierwinkel Endabschlussblech



380161	OBO 7109105	RWEB 610 / auf 100 mm	1	1	11,80
380163	OBO 7109202	RWEB 620 / auf 200 mm	1	1	16,60
380164	OBO 7109296	RWEB 630 / auf 300 mm	1	1	18,65
380165	OBO 7109407	RWEB 640 / auf 400 mm	1	1	22,40
380166	OBO 7109504	RWEB 650 / auf 500 mm	1	1	27,30
380167	OBO 7109601	RWEB 660 / auf 600 mm	1	1	32,20

Deckel m. Drehriegelverschluss für BKS/BKS/SKS/DKS/IKS



375004	OBO 6052096	DRL 100 FS / 100 mm	3	1	16,90
375008	OBO 6052207	DRL 200 FS / 200 mm	3	1	26,45
375010	OBO 6052304	DRL 300 FS / 300 mm	3	1	35,65
375012	OBO 6052401	DRL 400 FS / 400 mm	3	1	48,75
375014	OBO 6052509	DRL 500 FS / 500 mm	3	1	63,80
375018	OBO 6052606	DRL 600 FS / 600 mm	3	1	75,10



375195	OBO 6062067	TSG 60 FS / Trennsteg Höhe 60 mm für Schraubbefestigung	3	1	8,90
---------------	-------------	---	---	---	-------------



375203	OBO 6062288	TSG 60 S / Trennsteg U-Profil 60 mm, 3 m lang, FS, Schnellbefestigung mit Anker TSG	3	1	8,90
---------------	-------------	---	---	---	-------------



375204	OBO 6062296	ANK. TSG / Anker f. Trennsteg U-Profil, FS	1	100	23,40
---------------	-------------	--	---	-----	--------------

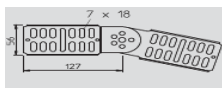

380062	OBO 7082010	RGV 60 / Gelenk-Verbinder SH 60 mm FS zur Herstellung von Bögen 90°, T-Stücken	1	1	6,20
---------------	-------------	--	---	---	-------------

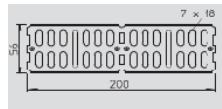

375292	OBO 6067115	RWVL 60 FS / Verbinder 200 mm f. Kabelrinne 60 mm FS	1	1	3,90
---------------	-------------	--	---	---	-------------



380096	OBO 7084757 MP	Montageplatte zur Befestigung von FR-Dosen an Kabelrinnen	1	1	6,75
---------------	----------------	---	---	---	-------------



379426	OBO 6356109 DB	Deckenbügel	1	1	4,70
---------------	----------------	-------------	---	---	-------------



375367	OBO 6072905 KSB	Kantenschutz f. Blech 1-2 mm	10	1	8,20
---------------	-----------------	------------------------------	----	---	-------------

Abbildung	Art. Nr.	Bezeichnung	VE	per	Brutto €
-----------	----------	-------------	----	-----	----------

Montagesysteme

Leichtes Montagesystem

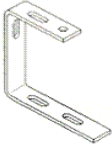

374589	OBO 6015394 LW 100	L-Winkel 100	1	1	7,35
374590	OBO 6015396 LW 200	L-Winkel 200	1	1	11,45
374591	OBO 6015398 LW 300	L-Winkel 300	1	1	16,70
379499	OBO 6363980 UB 100	Uni-Bügel 100 FT	1	1	8,70
379500	OBO 6363982 UB 200	Uni-Bügel 200 FT	1	1	12,30
379501	OBO 6363984 UB 300	Uni-Bügel 300 FT	1	1	25,50

Wandausleger 1,2 kN



379773	OBO 6424716 MWA 12/11	110 mm FS	1	1	4,80
379774	OBO 6424732 MWA 12/21	210 mm FS	1	1	6,60
379775	OBO 6424740 MWA 12/31	310 mm FS	1	1	7,65
379776	OBO 6424759 MWA 12/41	410 mm FS	1	1	12,15

Wandausleger 1,5 kN



379723	OBO 6420656 AW 15/11	110 mm FT	1	1	6,50
379725	OBO 6420680 AW 15/21	210 mm FT	1	1	8,90
379726	OBO 6420710 AW 15/31	310 mm FT	1	1	10,30
379727	OBO 6420745 AW 15/41	410 mm FT	1	1	15,95
379728	OBO 6420788 AW 15/51	510 mm FT	1	1	22,85
379730	OBO 6420826 AW 15/61	610 mm FT	1	1	25,30

Wandausleger 3kN



379700	OBO 6419704 AW 30/11	110 mm FT	1	1	7,30
379702	OBO 6419720 AW 30/21	210 mm FT	1	1	9,75
379703	OBO 6419747 AW 30/31	310 mm FT	1	1	12,50
379704	OBO 6419763 AW 30/41	410 mm FT	1	1	18,30
379705	OBO 6419798 AW 30/51	510 mm FT	1	1	23,75
379706	OBO 6419828 AW 30/61	610 mm FT	1	1	27,40

Hängestiel einfach C1 (41x21 mm) m. geschweißter Kopfplatte, tauchfeuerverzinkt, innenverzahntes Schienenprofil, DIN EN ISO 1461



379299	OBO 6342650 C1-200	L = 200 mm	1	1	19,00
379300	OBO 6342652 C1-300	L = 300 mm	1	1	23,00
379301	OBO 6342654 C1-400	L = 400 mm	1	1	26,10
379302	OBO 6342656 C1-500	L = 500 mm	1	1	28,00
379303	OBO 6342658 C1-600	L = 600 mm	1	1	30,10
379304	OBO 6342660 C1-800	L = 800 mm	1	1	37,20
379305	OBO 6342664 C1-1000	L = 1000 mm	1	1	42,75
379306	OBO 6342666 C1-1200	L = 1200 mm	1	1	48,75
033832	OBO 1124579 SKC 40	Schutzkappe f. C1-Stiel	100	100	130,90

Abbildung	Art. Nr.	Bezeichnung	VE	per	Brutto €
-----------	----------	-------------	----	-----	----------

Montagesysteme



Hängestiel doppelt C2 (2x41x21 mm) mit geschweißter Kopfplatte, tauchfeuerverzinkt, innenverzahntes Schienenprofil, DIN EN ISO 1461

379307	OBO 6342672	C2-200 L = 200 mm	1	1	25,45
379308	OBO 6342673	C2-300 L = 300 mm	1	1	33,60
379309	OBO 6342674	C2-400 L = 400 mm	1	1	40,20
379310	OBO 6342675	C2-500 L = 500 mm	1	1	44,85
379311	OBO 6342676	C2-600 L = 600 mm	1	1	51,00
379312	OBO 6342678	C2-800 L = 800 mm	1	1	66,50
379313	OBO 6342680	C2-1000 L = 1000 mm	1	1	75,85
379314	OBO 6342681	C2-1200 L = 1200 mm	1	1	87,85

379328	OBO 6342706	C2 Schutzkappe f. Hängestiel	100	100	279,10
381848	OBO 8181907G	HKV 8 mit Mutter und Schraube vz	100	100	292,00

Hängestiel C 41x41 mm, verzahnt, 3-seitig gelocht



379315	OBO 6342683	C41/0200 F 200 mm, galvanisch verzinkt, DIN 50961	1	1	15,95
379316	OBO 6342684	C41/0300 F 300 mm, galvanisch verzinkt, DIN 50961	1	1	20,20
379317	OBO 6342685	C41/0400 F 400 mm, galvanisch verzinkt, DIN 50961	1	1	24,50
379318	OBO 6342686	C41/0500 F 500 mm, galvanisch verzinkt, DIN 50961	1	1	27,90
379319	OBO 6342688	C41/0800 F 800 mm, galvanisch verzinkt, DIN 50961	1	1	38,50
379327	OBO 6342703	C41/1000 F 1000 mm, tauchfeuerverzinkt, DIN EN ISO 1461	1	1	46,75
379321	OBO 6342692	C41/1200 F 1200 mm, galvanisch verzinkt, DIN 50961	1	1	55,05

Hängestiel US 5K mit angeschweißter Kopfplatte, 50x50 mm, galvanisch verzinkt, DIN 50961







379333	OBO 6343841	US 5 K 020 200 mm	1	1	19,15
379335	OBO 6343843	US 5 K 030 300 mm	1	1	21,40
379336	OBO 6343845	US 5 K 040 400 mm	1	1	23,70
379337	OBO 6343847	US 5 K 050 500 mm	1	1	26,55
379338	OBO 6343849	US 5 K 060 600 mm	1	1	29,00
379340	OBO 6343853	US 5 K 080 800 mm	1	1	39,20
379342	OBO 6343857	US 5 K 100 1000 mm	1	1	44,25
379344	OBO 6343861	US 5 K 120 1200 mm	1	1	49,35

Steigetrasse/Steigeleiter für Bügelschellen 2056U, bandverzinkt



mittelschwer mit CPS-Sprosse, Höhe 60 mm, Länge 6 Meter, DIN EN 10147

374542	OBO 6010620	SLL 620 CP B: 200 mm	6	1	38,50
374543	OBO 6010622	SLL 630 CP B: 300 mm	6	1	40,50
374544	OBO 6010624	SLL 640 CP B: 400 mm	6	1	42,30
374545	OBO 6010626	SLL 650 CP B: 500 mm	6	1	44,75
374546	OBO 6010628	SLL 660 CP B: 600 mm	6	1	47,80
374701	OBO 6019617	WB 30/75 Wandbügel	1	1	4,45

Abbildung	Art. Nr.	Bezeichnung	VE	per	Brutto €
Kabelleitern gelocht, 60 mm Seitenhöhe, mit VS-Sprosse, bandverzinkt DIN EN 10147					
	377237	OBO 6208627 LG 620 VS	200 mm, für Bügelschelle 2055	6 1	31,70
	377238	OBO 6208630 LG 630 VS	300 mm, für Bügelschelle 2056	6 1	33,65
	377239	OBO 6208633 LG 640 VS	400 mm, für Bügelschelle 2056	6 1	35,65
	377240	OBO 6208636 LG 650 VS	500 mm, für Bügelschelle 2056	6 1	39,20
	377241	OBO 6208639 LG 660 VS	600 mm, für Bügelschelle 2056	6 1	40,50
	377253	OBO 6208800 LLV 60 FS	Längsverbinder f. Kabelleiter bandverzinkt, 60x150 mm	1 1	4,45
	377257	OBO 6208840 LVG 60	Längsverbinder f. Kabelleiter bandverzinkt, 64x150 mm	1 1	4,45
	377260	OBO 6208851 LWV 60 FS	Winkelverbinder f. Kabelleiter bandverzinkt, 60x200 mm	1 1	5,50
	377264	OBO 6208895 LWVG 60	Winkelverbinder f. Kabelleiter bandverzinkt, 64x200 mm	1 1	5,50
	377266	OBO 6208908 LGV 60 FS	Gelenkverbinder f. Kabelleiter bandverzinkt, 60x210mm	1 1	10,75
	377269	OBO 6208941 LGVG 60	Gelenkverbinder f. Kabelleiter bandverzinkt, 64x210mm	1 1	10,75
	377460	OBO 6222536 SKH 60	Schutzkabel f. Kabelleiter Höhe 60 mm, gelb, Polyäthylen	1 1	1,40
	Zubehör für Kabelleitern				
	377431	6221076 LKS 40 FS	Klemmstück 40x22 mm bandverzinkt	50 1	1,00
	377432	6221084 LKS 40 FT	Klemmstück 40x22 mm tauchfeuerverzinkt	1 1	1,25
377435	6221122 LKS 60/4 FT	Klemmstück 60x30x4 mm tauchfeuerverzinkt	1 1	1,90	

BBS-Schellen 1K = Pohlschellen











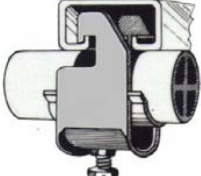
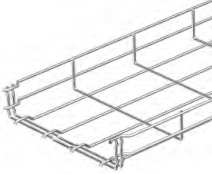

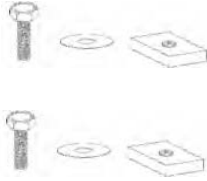

 	370901	OBO 1175122	8-12 / K12AC	1 100	206,00
	370902	OBO 1175165	12-16 / K16AC	1 100	208,90
	370903	OBO 1175211	16-22 / K20AC	1 100	219,20
	370904	OBO 1175289	22-28 / K28AC	1 100	254,20
	370905	OBO 1175343	28-34 / K32AC	1 100	301,45
	370906	OBO 1175408	34-40 / K40AC	1 100	344,10
	370907	OBO 1175467	40-60 / K44AC	1 100	377,90
	370908	OBO 1175521	46-52 / K52AC	1 100	405,45
	370909	OBO 1175580	52-58 / K56AC	1 100	447,00
	370910	OBO 1175645	58-64 / K64AC	1 100	470,50

Abbildung	Art. Nr.	Bezeichnung	VE	per	Brutto €
Gitterrinnen galvanisch verzinkt, 60 mm Seitenhöhe					
	374355	OBO 6001442 GRM 55/100 B: 100 mm	3	1	14,40
	374357	OBO 6001446 GRM 55/200 B: 200 mm	3	1	16,95
	374359	OBO 6001448 GRM 55/300 B: 300 mm	3	1	20,50
	374360	OBO 6001450 GRM 55/400 B: 400 mm	3	1	24,45
	374362	OBO 6001452 GRM 55/500 B: 500 mm	3	1	32,60
	374363	OBO 6001454 GRM 55/600 B: 600 mm	3	1	35,75
Zubehör für Gitterrinnen					
	374653	OBO 6016634 GSV 34 FT Stoßstellenverbinder FT für Bogensegmente	25	1	1,50
Montagezubehör					
	379551	OBO 6406122 FRSB 6x12 Flachrundschräube mit Kombimutter M6x12, feuerverzinkt, DIN 267, Teil 10	100	100	21,35
	379557	OBO 6406157 FRSB 6x15 Flachrundschräube mit Kombimutter M6x15, feuerverzinkt, DIN 267, Teil 10	100	100	23,40
	379764	OBO 6424548 FCM Schnellbefestigung M6x12, feuerverzinkt, DIN 267, Teil 10	1	100	23,50
	381848	OBO 8181907G HKV 8G Hängestiel-Konsolenverbinder best. aus: Schraube M8x20, Karosseriescheibe M8, Schrägmutter SM8 ACHTUNG: wird zukünftig ersetzt durch: Art.Nr. 1148946	1	1	2,92
	381849	OBO 8181911G HKV 10 Hängestiel-Konsolenverbinder best. aus: Schraube M10, Karosseriescheibe M10, Schrägmutter SM10	1	1	3,46
Mittenabhängung f. Kabelrinne, Stahl bandverzinkt					
	379448	OBO 6358705 MAH 60/100 B: 100 mm	1	1	10,00
	379450	OBO 6358713 MAH 60/200 B: 200 mm	1	1	11,30
	379451	OBO 6358717 MAH 60/300 B: 300 mm	1	1	12,25
	379434	OBO 6357504 TPB 100 Trapezbefestigung	1	1	5,40
	379644	OBO 6418244 SKS 10x110 Sechskantschraube M10x110	1	1	2,00
	373029	OBO 3141233 2078 Gewindestange M10 3000mm	1	100	1.825,75
	379607	OBO 6410103 12005 Gewindemuffe M10	1	100	437,00
	373289	OBO 3400107 DIN934 Sechskantmutter M10	100	100	30,60
	373318	OBO 3403165 964 Unterlegscheibe M10 d=30mm	100	100	20,50
	370619	OBO 1123671 A8G2/1,8 Ankerschiene gelocht, 10,5x30mm, 2000x40x22, bandverzinkt, DIN EN 10147	2	100	1.262,40
	370618	OBO 1123668 A8U2/1,8 Ankerschiene ungelocht, 2000x40x22, bandverzinkt, DIN EN 10147	2	100	1.162,40
	370538	OBO 1115669 2069 GTPL Hutschiene gelocht	2	100	777,85
	370537	OBO 1115650 2069 GTP Hutschiene ungelocht	2	100	558,50

Sehr geehrte Kunden!

Da sich bei vielen Produkten Preise täglich ändern, sind unsere Preise als Richtpreise anzusehen und wir behalten uns Preisänderungen vor.











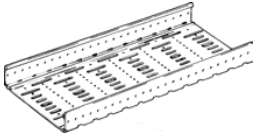

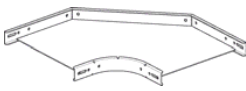

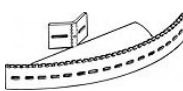

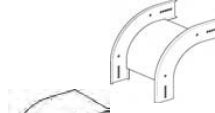



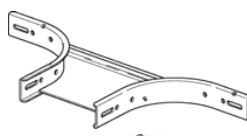

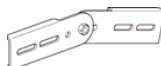
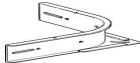
Abbildung	Art. Nr.	Bezeichnung	VE per	Brutto €
Kabelrinnen Stahlblech, sedimierverzinkt				
L: 3000 mm, H: 60 mm				
	433541	VAN 8210710 Kabelrinne	Breite 100 mm 3 100	1.021,20
	433542	VAN 8210720 Kabelrinne	Breite 200 mm 3 100	1.360,30
	433543	VAN 8210730 Kabelrinne	Breite 300 mm 3 100	1.802,50
	433538	VAN 8210640 Kabelrinne	Breite 400 mm 3 100	3.030,70
	433539	VAN 8210650 Kabelrinne	Breite 500 mm 3 100	3.950,30
	433713	VAN 8230000 Schnellkupplung (schraublos)	1 100	196,30
	433670	VAN 8216230 Stossleiste 300 mm svz	1 100	1.129,60
	433671	VAN 8216240 Stossleiste 400 mm svz	1 100	1.192,30
	433672	VAN 8216250 Stossleiste 500 mm svz	1 100	1.266,40
	433583	VAN 8212610 Bogen 90° B100H60 svz	1 100	2.517,40
	433584	VAN 8212620 Bogen 90° B200H60 svz	1 100	3.249,90
	433585	VAN 8212630 Bogen 90° B300H60 svz	1 100	4.074,80
	433586	VAN 8212640 Bogen 90° B400H60 svz	1 100	4.740,80
	433587	VAN 8212650 Bogen 90° B500H60 svz	1 100	6.716,70
	433590	VAN 8212710 Deckel Bogen 90° B100 svz	1 100	1.892,70
	433591	VAN 8212720 Deckel Bogen 90° B200 svz	1 100	2.957,40
	433592	VAN 8212730 Deckel Bogen 90° B300 svz	1 100	3.663,90
	433597	VAN 8212810 Eckstück verstellbar B100H60 svz	1 100	2.496,00
	433598	VAN 8212820 Eckstück verstellbar B200H60 svz	1 100	3.034,50
	433599	VAN 8212830 Eckstück verstellbar B300H60 svz	1 100	4.226,80
	433604	VAN 8212910 Deckel Eckstück verstellbar 100 svz	1 100	1.255,70
	433605	VAN 8212920 Deckel Eckstück verstellbar 200 svz	1 100	1.783,40
	433624	VAN 8214010 Fallstück 90° B100H60 svz	1 100	2.757,30
	433625	VAN 8214020 Fallstück 90° B200H60 svz	1 100	3.047,50
	433626	VAN 8214030 Fallstück 90° B300H60 svz	1 100	3.577,60
	433631	VAN 8214110 Deckel Fallstück 90° B100 svz	1 100	1.999,60
	433632	VAN 8214120 Deckel Fallstück 90° B200 svz	1 100	3.169,70
	433633	VAN 8214130 Deckel Fallstück 90° B300 svz	1 100	4.030,50
	433638	VAN 8214210 Steigestück 90° B100H60 svz	1 100	2.685,50
	433639	VAN 8214220 Steigestück 90° B200H60 svz	1 100	2.952,00
	433640	VAN 8214230 Steigestück 90° B300H60 svz	1 100	3.577,60
	433645	VAN 8214310 Deckel Steigestück 90° B100 svz	1 100	2.019,40
	433646	VAN 8214320 Deckel Steigestück 90° B200 svz	1 100	3.199,50
	433569	VAN 8212010 Abzweigstück horiz. B100H60 svz	1 100	2.787,80
	433570	VAN 8212020 Abzweigstück horiz. B200H60 svz	1 100	3.740,20
	433571	VAN 8212030 Abzweigstück horiz. B300H60 svz	1 100	4.360,40
	433572	VAN 8212040 Abzweigstück horiz. B400H60 svz	1 100	5.389,30
	433576	VAN 8212110 Deckel Abzweigstück horiz. B100 svz	1 100	1.858,30
	433577	VAN 8212120 Deckel Abzweigstück horiz. B200 svz	1 100	2.712,20
	433717	VAN 8230200 Gelenkstück H60 svz	1 100	812,70

Abbildung	Art. Nr.	Bezeichnung	VE	per	Brutto €
	433719	VAN 8230500 Universal Anbaustück	1	100	2.540,30
	433551	VAN 8211110 Deckel Kabelrinne 100 L2000mm svz	2	100	894,40
	433552	VAN 8211120 Deckel Kabelrinne 200 L2000mm svz	2	100	1.381,70
	433553	VAN 8211130 Deckel Kabelrinne 300 L2000mm svz	2	100	1.841,50
	433743	VAN 8236000 Haltefeder Deckel Edelstahl	50	100	69,30
	433722	VAN 8231100 Trennprofil A L3000mm svz	3	100	644,20
	433724	VAN 8231300 Anker für TP-A schraublos svz	1	100	73,70
	433723	VAN 8231201 Trennwand L-Profil H49mm L3m	3	100	660,70
	431421	LEG 8200100 Sperrzahnschraube M6x10	100	100	11,70
	431422	LEG 8200200 Sperrzahnmutter M6	100	100	8,10
	431434	LEG 8302101 Kantenschutz PVC UV-beständig	1	100	362,20

Universelles Tragsystem für Kabelrinnen und Kabelleitern







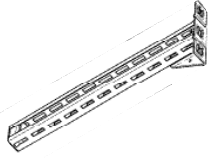
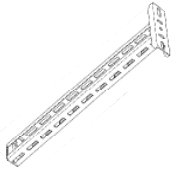
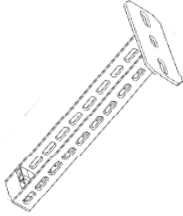

	434738	VAN 8766102 Stiel C40, 200	1	100	1.265,00
	434739	VAN 8766103 Stiel C40, 300	1	100	1.273,30
	434740	VAN 8766104 Stiel C40, 400	1	100	1.449,60
	434741	VAN 8766105 Stiel C40, 500	1	100	1.617,60
	434742	VAN 8766106 Stiel C40, 600	1	100	2.203,90
	434743	VAN 8766107 Stiel C40, 700	1	100	2.465,70
	434744	VAN 8766108 Stiel C 40, 800	1	100	2.725,20
	434746	VAN 8766110 Stiel C 40, 1000	1	100	3.218,50
	433933	VAN 8306100 Schutzkappe C40/22 (A8), gelb	1	100	343,00
	434706	VAN 8716403 Hängestiel U50 240Nm svz L300	1	100	1.272,90
	434707	VAN 8716404 Hängestiel U50 240Nm svz L400	1	100	1.383,10
	434708	VAN 8716405 Hängestiel U50 240Nm svz L500	1	100	1.589,20
	434709	VAN 8716406 Hängestiel U50 240Nm svz L600	1	100	1.969,60
	434713	VAN 8716410 Hängestiel U50 240Nm svz L1000	1	100	2.870,80
	434750	VAN 8766403 Hängestiel U55 300 3,5kN 320Nm tfvz	1	100	2.143,40
	434751	VAN 8766404 Hängestiel U55 400 3,5kN 320Nm tfvz	1	100	2.517,10
	434752	VAN 8766405 Hängestiel U55 500 3,5kN 320Nm tfvz	1	100	2.796,30
	434753	VAN 8766406 Hängestiel U55 600 3,5kN 320Nm tfvz	1	100	3.075,50
	434757	VAN 8766410 Hängestiel U55 1000 3,5kN 320Nm tfvz	1	100	4.240,60
	434762	VAN 8766503 Hängestiel U60 780Nm tfvz L300	1	100	2.725,20
	434763	VAN 8766504 Hängestiel U60 780Nm tfvz L400	1	100	3.080,00
	434764	VAN 8766505 Hängestiel U60 780Nm tfvz L500	1	100	3.432,60
	434765	VAN 8766506 Hängestiel U60 780Nm tfvz L600	1	100	3.851,00
	434766	VAN 8766507 Hängestiel U60 780Nm tfvz L700	1	100	4.148,30
	434767	VAN 8766508 Hängestiel U60 780Nm tfvz L800	1	100	4.582,60
	434769	VAN 8766510 Hängestiel U60 780Nm tfvz L1000	1	100	5.208,30
	434771	VAN 8766512 Hängestiel U60 780Nm tfvz L1200	1	100	5.925,50

Abbildung	Art. Nr.	Bezeichnung	VE	per	Brutto €
Universelles Tragsystem für Kabelrinnen und Kabelleitern					
	434718	VAN 8717110 Konsole leicht 100 0,75kN svz	1	100	527,10
	434720	VAN 8717120 Konsole leicht 200 0,75kN svz	1	100	565,00
	434721	VAN 8717130 Konsole leicht 300 0,75kN svz	1	100	697,00
	434722	VAN 8717210 Ausleger 100 1500N svz	1	100	494,10
	434723	VAN 8717220 Ausleger 200 1500N svz	1	100	626,10
	434724	VAN 8717230 Ausleger 300 1500N svz	1	100	802,00
	434725	VAN 8717240 Ausleger 400 1500N svz	1	100	909,70
	434726	VAN 8717250 Ausleger 500 1500N svz	1	100	1.192,30
	434818	VAN 8767310 Wandkonsole schwer 3kN, 70-100	1	100	1.004,00
	434819	VAN 8767320 Wandkonsole schwer 3kN, 200	1	100	1.099,30
	434820	VAN 8767330 Wandkonsole schwer 3kN, 300	1	100	1.460,90
	434821	VAN 8767340 Wandkonsole schwer 3kN, 400	1	100	1.553,30
	434822	VAN 8767350 Wandkonsole schwer 3kN, 500	1	100	1.902,00
	426823	LEG 616007 Befestigungsset M8x20 tfvz	1	100	73,50
	426825	LEG 616009 Befestigungsset M10x20 tfvz	1	100	116,50
	426826	LEG 616010 Befestigungsset M10x25 tfvz	1	100	121,40
	434702	VAN 8715110 Stielkonsole leicht 600 N, 70-100 für Stiel C40	1	100	527,10
	434703	VAN 8715120 Stielkonsole leicht 600 N, 200 für Stiel C40	1	100	565,00
	434704	VAN 8715130 Stielkonsole leicht 600 N, 300 für Stiel C40	1	100	697,00
	431443	LEG 8313070 Torbandschraube 8x35 DIN603	100	100	34,00
	431438	LEG 8313013 Schrägmutter M8 C40x22 glatt	100	100	81,10
	431439	LEG 8313020 Sechskantschraube M8X20	100	100	22,50
	431440	LEG 8313030 K-Scheibe M8 8,4x25x2	100	100	9,70
	431428	LEG 8200402 Beilagscheibe M10	100	100	6,20
	431423	LEG 8200300 Sechskantmutter M10 (934.10)	100	100	15,70
	431425	LEG 8200302 Sechskantmutter M8 vz	100	100	8,60
		433699	VAN 8219310 STR 100 Einlegebügel H=157, 600N	1	100
433700		VAN 8219320 STR 200 Einlegebügel H=157, 600N	1	100	1.796,40
433701		VAN 8219330 STR 300 Einlegebügel H=157, 600N	1	100	2.427,30
433702		VAN 8219340 STR 400 Einlegebügel H=157, 600N	1	100	3.974,70
434069		VAN 8317501 TR-100 UNI-Einlegebügel 400N	1	100	662,10
434070		VAN 8317502 TR-100/100 UNI-Einlegebügel 400N	1	100	933,30
434071		VAN 8317503 TR-100/200 UNI-Einlegebügel 400N	1	100	1.123,50
431420		LEG 8191000 Befestigungsset M6	100	100	22,40
433694		VAN 8219210 ELB Einlegebügel-Z- 100	1	100	570,80
433695	VAN 8219220 ELB Einlegebügel-Z- 200	1	100	796,60	
433696	VAN 8219230 ELB Einlegebügel-Z- 300	1	100	950,10	
433729	VAN 8232100 Deckenbügel	1	100	240,00	

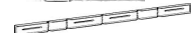
Abbildung	Art. Nr.	Bezeichnung	VE	per	Brutto €
-----------	----------	-------------	----	-----	----------

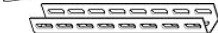
Universelles Tragsystem für Kabelrinnen und Kabelleitern

	431431	LEG 8234200	Gewindestange M10x3000 vz	3	100	339,10
	433739	VAN 8235000	Montageplatte mit Schnellkupplung svz	1	100	389,10
	433953	VAN 8312101	Reduzier/Endstück 100-300H60 svz	1	100	1.282,40
	433954	VAN 8312102	Reduzier/Endstück 400-600H60 svz	1	100	1.744,50
	434778	VAN 8766530	Profil U60 tfvzL3000	3	100	11.141,40
	434781	VAN 8766560	Kopfplatte U60 tfvz6000N	1	100	3.310,00
	431448	LEG 8399802	Ankerschiene A8 ungel. 2000mm svz	2	100	981,30
	431450	LEG 8399902	Ankerschiene A8 gel. 2000mm svz	2	100	1.044,30

Kabelleiter GLO-4 sedimierverzinkt

	435123	VAN 8311132P	Kabelleiter H60 B200 L3m svz Sprosse	3	100	2.988,10
	435124	VAN 8311133P	Kabelleiter H60 B300 L3m svz Sprosse	3	100	3.089,00
	435126	VAN 8311134P	Kabelleiter H60 B400 L3m svz Sprosse	3	100	3.189,80
	435127	VAN 8311135P	Kabelleiter H60 B500 L3m svz Sprosse	3	100	3.369,50
	433955	VAN 8312112	Innenbogen 200	1	100	8.202,80
	433956	VAN 8312113	Innenbogen 300	1	100	8.445,10
	433957	VAN 8312114	Innenbogen 400	1	100	10.291,50
	433958	VAN 8312115	Innenbogen 500	1	100	10.619,50
	434055	VAN 8313180	Schnellkupplung H60 svz	1	100	435,60
	434154	VAN 8367030	Klemmstück 60-100	25	100	116,70
	435165	VAN 8319632P	Steigeleiter H60 B200 L3m svz Sprosse	3	100	3.531,70
	435166	VAN 8319633P	Steigeleiter H60 B300 L3m svz Sprosse	3	100	3.753,10
	435167	VAN 8319634P	Steigeleiter H60 B400 L3m svz Sprosse	3	100	3.731,10
	434053	VAN 8313160	Wandbügel 80x56	1	100	216,90
	434051	VAN 8313140	Eckverbinder H60 svz	1	100	980,00
	434052	VAN 8313150	Gelenkkupplung H60 svz	1	100	908,80

Gitterrinne Cablofil sedimierverzinkt







	435216	VAN CM000061	CF 54/50 BS EZ	3	100	1.373,20
	435221	VAN CM000071	CF 54/100 BS EZ	3	100	1.546,10
	435231	VAN CM000091	CF 54/200 BS EZ	3	100	2.104,30
	435236	VAN CM000101	CF 54/300 BS EZ	3	100	2.864,60
	435535	VAN CM558081	VerbindungsKIT KITASSTR EZ	1	100	170,40
	435548	VAN CM558241	Schnellverbinder EDRN	1	100	577,30
	435563	VAN CM558340	Faslock S	25	100	236,50
	435560	VAN CM558320	Faslock XL	25	100	236,50
	435417	VAN CM556100	Konsole CSN 100 GS	1	100	769,20
	435423	VAN CM556120	Konsole CSN 200 GS	1	100	1.073,10
	435426	VAN CM556130	Konsole CSN 300 GS	1	100	1.333,80
	435433	VAN CM556300	Deckenkonsole CSNC 100 GS	1	100	1.730,50
	435439	VAN CM556320	Deckenkonsole CSNC 200 GS	1	100	1.996,20
	435442	VAN CM556330	Deckenkonsole CSNC 300 GS	1	100	3.028,70

Abbildung	Art. Nr.	Bezeichnung	VE	per	Brutto €
-----------	----------	-------------	----	-----	----------



Unterflursysteme



381489	OBO 7410034	UZD350-3 Unterflur-Zug- und -Abzweigdose / Estrichhöhe 70-125mm	1	1	146,10
---------------	-------------	---	---	---	---------------

381491	OBO 7410047	UZD115170/350-3 Unterflur-Zug- und -Abzweigdose / Estrichhöhe 115-170mm	1	1	160,60
---------------	-------------	---	---	---	---------------

381493	OBO 7410056	UZD165220/350-3 Unterflur-Zug- und -Abzweigdose / Estrichhöhe 165-220mm	1	1	176,80
---------------	-------------	---	---	---	---------------



380666	OBO 7400505	DUG350-3/4 Montagedeckel Nenngröße 4	1	1	45,65
---------------	-------------	--------------------------------------	---	---	--------------

380667	OBO 7400509	DUG350-3/6 Montagedeckel Nenngröße 6	1	1	45,65
---------------	-------------	--------------------------------------	---	---	--------------

380668	OBO 7400513	DUG350-3/9 Montagedeckel Nenngröße 9	1	1	45,65
---------------	-------------	--------------------------------------	---	---	--------------

380679	OBO 7400549	DUG350-3R9 Montagedeckel Nenngröße rund 9	1	1	45,65
---------------	-------------	---	---	---	--------------



381210	OBO 7406712	ZES4U Revisionsabdeckung Nenngröße 4, grau, RAL7011	1	1	32,30
---------------	-------------	---	---	---	--------------

381214	OBO 7406744	ZES6U Revisionsabdeckung Nenngröße 6, grau, RAL7011	1	1	35,50
---------------	-------------	---	---	---	--------------

381218	OBO 7406760	ZES9U Revisionsabdeckung Nenngröße 9, grau, RAL7011	1	1	44,15
---------------	-------------	---	---	---	--------------



380949	OBO 7405196	GES4U Geräteeinsatz für Unterflurmontage in Kanalsystem f. Teppich/PVC / Nenngröße 4, grau, RAL7011, Deckeltiefe 5mm	1	1	50,25
---------------	-------------	--	---	---	--------------

380959	OBO 7405308	GES6U Geräteeinsatz für Unterflurmontage in Kanalsystem f. Teppich/PVC / Nenngröße 6, grau, RAL7011, Deckeltiefe 5mm	1	1	67,85
---------------	-------------	--	---	---	--------------

380971	OBO 7405388	GES9U Geräteeinsatz für Unterflurmontage in Kanalsystem f. Teppich/PVC / Nenngröße 9, grau, RAL7011, Deckeltiefe 5mm	1	1	85,40
---------------	-------------	--	---	---	--------------

380996	OBO 7405528	GESR9U Geräteeinsatz für Unterflurmontage in Kanalsystem f. Teppich/PVC / Nenngröße rund 9, grau, RAL7011, Deckeltiefe 5mm	1	1	89,70
---------------	-------------	--	---	---	--------------



381523	OBO 7410246	RKSNUZD350/4VS20 / nivellierbare Kassetten f. Parkett/Steinböden m. Schnurablass / Nenngröße 4 / V2A / Kassettentiefe 20mm	1	1	533,00
---------------	-------------	--	---	---	---------------

381524	OBO 7410250	RKSNUZD350/4VS25 / nivellierbare Kassetten f. Parkett/Steinböden m. Schnurablass / Nenngröße 4 / V2A / Kassettentiefe 25mm	1	1	549,00
---------------	-------------	--	---	---	---------------

381527	OBO 7410264	RKSNUZD350/9VS20 / nivellierbare Kassetten f. Parkett/Steinböden m. Schnurablass / Nenngröße 9 / V2A / Kassettentiefe 20mm	1	1	639,60
---------------	-------------	--	---	---	---------------

381528	OBO 7410268	RKSNUZD350/9VS25 / nivellierbare Kassetten f. Parkett/Steinböden m. Schnurablass / Nenngröße 9 / V2A / Kassettentiefe 25mm	1	1	658,80
---------------	-------------	--	---	---	---------------

381576	OBO 7410544	NW350-3QK Nivellierwinkel-Set / ACHTUNG: Die Nivellierwinkel sind immer separat zu bestellen!	1	1	30,80
---------------	-------------	--	---	---	--------------

Abbildung	Art. Nr.	Bezeichnung	VE	per	Brutto €
-----------	----------	-------------	----	-----	----------



Unterflursysteme



381515	OBO 7410200	RKNUZD3/4VS20 / nivellierbare Blindkassetten f. Parkett/Steinböden / Nenngröße 4 / V2A / Kassettentiefe 20mm	1	1	410,00
381516	OBO 7410204	RKNUZD3/4VS25 / nivellierbare Blindkassetten f. Parkett/Steinböden / Nenngröße 4 / V2A / Kassettentiefe 25mm	1	1	422,30
381519	OBO 7410218	RKNUZD3/9VS20 / nivellierbare Blindkassetten f. Parkett/Steinböden / Nenngröße 9 / V2A / Kassettentiefe 20mm	1	1	492,00
381520	OBO 7410222	RKNUZD3/9VS25 / nivellierbare Blindkassetten f. Parkett/Steinböden / Nenngröße 9 / V2A / Kassettentiefe 25mm	1	1	506,75
381576	OBO 7410544	NW350-3QK Nivellierwinkel-Set / ACHTUNG: Die Nivellierwinkel sind immer separat zu bestellen!	1	1	30,80



380935	OBO 7405100	GES2DB / Geräteinsatz f. Doppel/Hohlböden / Nenngröße 2, grau RAL7011 / Deckeltiefe 5mm	1	1	37,70
380943	OBO 7405164	GES4DB / Geräteinsatz f. Doppel/Hohlböden / Nenngröße 4, grau RAL7011 / Deckeltiefe 5mm	1	1	50,25
380953	OBO 7405260	GES6DB / Geräteinsatz f. Doppel/Hohlböden / Nenngröße 6, grau RAL7011 / Deckeltiefe 5mm	1	1	67,85
380965	OBO 7405348	GES9DB / Geräteinsatz f. Doppel/Hohlböden / Nenngröße 9, grau RAL7011 / Deckeltiefe 5mm	1	1	85,40



381192	OBO 7406570	RKSN4VS20 / nivellierbare Kassetten f. Parkett/Steinböden m. Schnuranschluss DB/HB / Nenngröße 4 / V2A / Kassettentiefe 20mm	1	1	553,00
381193	OBO 7406574	RKSN4VS25 / nivellierbare Kassetten f. Parkett/Steinböden m. Schnuranschluss DB/HB / Nenngröße 4 / V2A / Kassettentiefe 25mm	1	1	569,00
381196	OBO 7406598	RKSN9VS20 / nivellierbare Kassetten f. Parkett/Steinböden m. Schnuranschluss DB/HB / Nenngröße 9 / V2A / Kassettentiefe 20mm	1	1	659,60
381197	OBO 7406602	RKSN9VS25 / nivellierbare Kassetten f. Parkett/Steinböden m. Schnuranschluss DB/HB / Nenngröße 9 / V2A / Kassettentiefe 25mm	1	1	678,80



381146	OBO 7406370	RKN4VS20 / nivellierbare Blindkassetten f. Parkett/Steinböden DB/HB / Nenngröße 4 / V2A / Kassettentiefe 20mm	1	1	430,00
381147	OBO 7406374	RKN4VS25 / nivellierbare Blindkassetten f. Parkett/Steinböden DB/HB / Nenngröße 4 / V2A / Kassettentiefe 25mm	1	1	442,30
381150	OBO 7406386	RKN9VS20 / nivellierbare Blindkassetten f. Parkett/Steinböden DB/HB / Nenngröße 9 / V2A / Kassettentiefe 20mm	1	1	512,00
381151	OBO 7406390	RKN9VS25 / nivellierbare Blindkassetten f. Parkett/Steinböden DB/HB / Nenngröße 9 / V2A / Kassettentiefe 25mm	1	1	526,75



381827	OBO 7429131	MT3/45/2-1 Gerätebecher f. 3 Geräte Modul 45 f. Nenngr. 2, 4 und 6	1	1	7,10
381829	OBO 7429139	MT4/45/2-2 Gerätebecher f. 4 Geräte Modul 45 f. Nenngr. 9	1	1	7,85
381315	OBO 7407584	LP45 Blindabdeckung einer Montageöffnung Modul 45	1	1	1,80
381287	OBO 7407280	GB2/3TW Gerätebecher-Trennsteg	1	1	1,10
381830	OBO 7429150	MT3/45 Modulträger f. Modul 45-Geräte	1	1	3,95
381831	OBO 7429154	MT4/45 Modulträger f. Modul 45-Geräte	1	1	4,40

Sehr geehrte Kunden!

Da sich bei vielen Produkten Preise täglich ändern, sind unsere Preise als Richtpreise anzusehen und wir behalten uns Preisänderungen vor.

Abbildung	Art. Nr.	Bezeichnung	VE	per	Brutto €
-----------	----------	-------------	----	-----	----------



Unterflursysteme

	381021	OBO 7405708	GESRN2USB Geräteinsatz m. Schutzrahmen, vernickelt f. UZD/UDL	1	1	173,95
	381017	OBO 7405660	GESRMS2USB Geräteinsatz m. Schutzrahmen, Altmessing f. UZD/UDL	1	1	211,30
	381014	OBO 7405632	GESRK2USB Geräteinsatz m. Schutzrahmen, Altkupfer f. UZD/UDL	1	1	211,30
	381011	OBO 7405596	GESRC2USB Geräteinsatz m. Schutzrahmen, verchromt f. UZD/UDL	1	1	211,30
	381022	OBO 7405721	GESRSM2USB Geräteinsatz m. Schutzrahmen, matt schwarz f. UZD/UDL	1	1	331,35
	381020	OBO 7405688	GESRN2UAB Geräteinsatz m. Anlegerahmen, vernickelt f. UZD/UDL	1	1	173,95
	381016	OBO 7405656	GESRMS2UAB Geräteinsatz m. Anlegerahmen, Altmessing f. UZD/UDL	1	1	211,30
	381013	OBO 7405628	GESRK2UAB Geräteinsatz m. Anlegerahmen, Altkupfer f. UZD/UDL	1	1	211,30
	381010	OBO 7405592	GESRC2UAB Geräteinsatz kpl. mit Anlegerahmen für UZD/UDL verchromt	1	1	211,30
	381024	OBO 7405723	GESRSM2UAB Geräteinsatz m. Anlegerahmen, matt schwarz f. UZD/UDL	1	1	331,35
	381019	OBO 7405676	GESRN2HS Geräteinsatz m. Schutzrahmen, vernickelt f. DB/HB	1	1	180,10
	381015	OBO 7405644	GESRMS2HS Geräteinsatz m. Schutzrahmen, Altmessing f. DB/HB	1	1	217,00
	381012	OBO 7405620	GESRK2HS Geräteinsatz m. Schutzrahmen, Altkupfer f. DB/HB	1	1	217,00
	381009	OBO 7405584	GESRC2HS Geräteinsatz m. Schutzrahmen, verchromt f. DB/HB	1	1	217,00
	381023	OBO 7405722	GESRSM2HS Geräteinsatz f. Schutzrahmen, matt schwarz f. DB/HB	1	1	291,35
	381467	OBO 7408558	UDL2-120/70 Unterflur-Auslassdose f. GESRM2 135x157x70, bandverzinkt	1	1	96,90
	381468	OBO 7408562	UDL2-120/80 Unterflur-Auslassdose f. GESRM2 135x157x80, bandverzinkt	1	1	106,20
	381320	OBO 7407624	MPR2/2C Montageplatte f. 2RJ45-Anschlussbuchsen	1	1	27,15
	381323	OBO 7407634	MPR2XD Montageplatte für eine XLR Buchse Ø 24mm	1	1	40,40
	381818	OBO 7427000	UDHOME4V/V Geräteinsatz komplett mit Schukosteckdose, 200x200mm	1	1	421,00
	381819	OBO 7427004	UDHOME4VU 95-125mm VA mit 2 Gerätebecher GB2	1	1	415,60
	376033	OBO 6117343	ASMC5G/S Anschlussmodul SNAP-IN Kat5 geschirmt	1	1	8,85
	376034	OBO 6117345	ASMC6G/S Anschlussmodul SNAP-IN Kat6 geschirmt	1	1	15,10

Sehr geehrte Kunden!

Da sich bei vielen Produkten Preise täglich ändern, sind unsere Preise als Richtpreise anzusehen und wir behalten uns Preisänderungen vor.

Abbildung	Art. Nr.	Bezeichnung	VE	per	Brutto €
-----------	----------	-------------	----	-----	----------



Unterflursysteme

Einbaugeräte-Systeme Modul 45



375948	OBO 6117041	SKSD33RW1 / Steckd. 1fach reinweiss 33°	1	1	10,25
375949	OBO 6117043	SKSD33OR1 / Steckd. 1fach orange 33°	1	1	10,25
375950	OBO 6117045	SKSD33GN1 / Steckd. 1fach grün 33°	1	1	10,25
375953	OBO 6117052	SKSD33RW2 / Steckd. 2fach reinweiss 33°	1	1	16,50
375954	OBO 6117054	SKSD33OR2 / Steckd. 2fach orange 33°	1	1	16,50
375955	OBO 6117056	SKSD33GN2 / Steckd. 2fach grün 33°	1	1	16,50
375958	OBO 6117063	SKSD33RW3 / Steckd. 3fach reinweiss 33°	1	1	26,30
375959	OBO 6117065	SKSD33OR3 / Steckd. 3fach orange 33°	1	1	26,30
375960	OBO 6117067	SKSD33GN3 / Steckd. 3fach grün 33°	1	1	26,30
376025	OBO 6117315	DM45RM/S / Datentechnik-Modul reinweiss, schräger Auslass	1	1	8,10
376031	OBO 6117337	ASM C5 / Anschlussmodul Kat5 ungeschirmt	1	1	15,66
376029	OBO 6117325	ASM C5 G / Anschlussmodul Kat5 geschirmt	1	1	15,30
376032	OBO 6117341	ASM C6 / Anschlussmodul Kat6 ungeschirmt	1	1	29,13
376030	OBO 6117329	ASM C6 G / Anschlussmodul Kat6 geschirmt	1	1	25,65
376082	OBO 6117589	ANT 45 / Antennensteckdose SAT reinweiss	1	1	37,10

Unterflursystem GVG-5

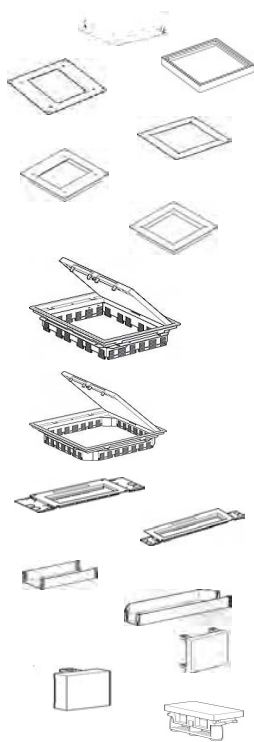

434221	VAN 8434000	Universaldose GVG-5 H56-140mm	30	100	11.208,40
434223	VAN 8434060	Aufstockrahmen H35mm Alu	60	100	2.648,10
434212	VAN 8430741	Basisdeckel 3mm rechteckig	6	100	2.184,80
434213	VAN 8430742	Basisdeckel 3mm quadratisch	6	100	2.184,80
434215	VAN 8430751	Aufnahmedeckel rechteckig f. Markierrand	6	100	4.634,80
434216	VAN 8430752	Aufnahmedeckel quadratisch f. Markierrand	6	100	4.634,80
434298	VAN 8453801	Deckelsatz rechteckig RAL 7011	6	100	7.382,60
434309	VAN 8454801	Deckelsatz rechteckig Alu T	6	100	9.006,90
434312	VAN 8454811	Deckelsatz rechteckig Alu Markierrand	6	100	9.806,00
434299	VAN 8453802	Deckelsatz quadratisch RAL 7011	3	100	7.410,90
434310	VAN 8454802	Deckelsatz quadratisch Alu T	3	100	10.118,90
434313	VAN 8454812	Deckelsatz quadratisch Alu Markierrand	3	100	10.917,90
434319	VAN 8455031	Montageplatte M45 3-fach	10	100	483,40
434320	VAN 8455032	Montageplatte M45 4-fach	10	100	614,40
434315	VAN 8455001	Abdeckdose klein	150	100	479,10
434316	VAN 8455002	Abdeckdose groß	100	100	551,30
425725	VAN 074392	Blindplatte 45x45 RAL9010	10	100	237,60
425724	VAN 074391	Blindplatte 22,5x45 RAL9010	10	100	149,00
434317	VAN 8455006	Zugentlastungsset	10	100	186,10

Sehr geehrte Kunden!

Da sich bei vielen Produkten Preise täglich ändern, sind unsere Preise als Richtpreise anzusehen und wir behalten uns Preisänderungen vor.











Abbildung	Art. Nr.	Bezeichnung	VE per	Brutto €
	294489 KAI 9073-01	Hohlwanddose 120 inkl. Deckel ✓ Höhe 65 mm, großer Verdrahtungsraum, ✓ für 2 Stromkreise durch Trennwand 9073-20, für Klemmen bis 4mm ² ✓ Aufnahme für Normschiene TS 35 z.B. für Reihenklemme ✓ Leitungs- oder Rohreinführungen bis max.25mm durch Universal-Öffnungsschneider herstellbar	10 100	766,76
	294470 KAI 9063-01	Hohlwanddose 65 mm	25 100	122,01
	009093 KAI 9063-31	Hohlwanddose 65 mm ✓ Fräsloch 68mm, für Plattenstärke 7-35mm	25 100	122,01
	294473 KAI 9064-01	Geräte-Verbindungsdose ✓ Fräsloch 68mm, für Plattenstärke 7-35mm	25 100	152,93
	294463 KAI 9062-02	Hohlwanddose 2 fach ✓ Fräsloch 2x68mm, für Plattenstärke 7-35mm ✓ für 2 Geräte-Einsätze oder 1 Blockeinsatz ✓ auch als Geräte-Verbindungsdose einsetzbar ✓ zur Stromkreistrengung Trennwand 9062-22 einsetzen	10 100	351,30
	294518 KAI 9195-91	Hohlwandkasten 107x107 ✓ Fräsloch 4x 35mm, (107x107x53), für Klemmen bis 4mm ✓ für 2 Stromkreise Trennwand 9195-20 einsetzen	10 100	646,86
	294523 KAI 9196-91	Hohlwandkasten 165x165 ✓ Fräsloch 4x68mm (165x165x72), für Klemmen bis 16mm ² ✓ für 2 Stromkreise Trennwand 9196-20 einsetzen	10 100	1.609,25
	294032 KAI 1083-10	Multi - 2000 Fräser ✓ mit Randversenker und Platinauswerfer, Fräsloch 68mm, Frästiefe 36mm	1 100	9.823,81
	294043 KAI 1083-70	Multi - 2000 HM Fräser ✓ Fräskrone und Randversenker hartmetallbestückt, Fräsloch 68mm, Frästiefe 36mm	1 100	20.825,64
	294026 KAI 1082-20	Bi-Metall-Fräser ✓ passend für Bohrmaschine 13mm Bohrfutter ✓ Fräsloch 120mm, Frästiefe 40mm - stufenweise tiefer möglich	1 100	15.724,41

Abbildung	Art. Nr.	Bezeichnung	VE per	Brutto €
	215081	DIE HWD65 Hohlwanddose orange 021196	25 100	178,00
	215082	DIE HWAD65 Hohlwanddose tief orange 021197	10 100	225,00
	215083	DIE HWDZ65 Hohlwanddose 2fach orange 021198	10 100	323,00
	215084	DIE HWAK100 Abzweigk. Hohlwand + Deckel or. 021199	10 100	504,00
	215940	DIE HWAD120 Hohlwandd. 120mm o.Deckel 064609	5 100	440,00
	215942	DIE HWARD120 Deckel zu HWAD120 064612	5 100	241,00
	019161	GFI HWDV 35 Hohlwanddose orange 35mm	25 100	207,00
	019158	GFI HWD 47 Hohlwanddose orange 47mm	20 100	178,00
	019159	GFI HWD 61 Hohlwanddose orange 61mm	20 100	225,00
	019160	GFI HWDD 47 Hohlwanddose 2fach orange	10 100	323,00
	019162	GFI HWD 107 Hohlwanddose 107x107+Deckel	10 100	504,00
	els spelsberg			
	276167	PIP SP-92005001 HW 050 Gerätedose 1f.	10 100	116,00
	276166	PIP SP-92003501 HW 035 Flachdose 35mm tief	10 100	180,00
	276168	PIP SP-92006501 HW 065 Geräteverbindungsdose	10 100	145,00
	Abzweigkasten			
	276188	PIP SP-92800101 HWK 1 107x107x53	10 100	616,00
	276189	PIP SP-92800201 HWK 2 165x165x65	10 100	1.530,00
	276190	PIP SP-92800301 HWK 3 235x205x72	10 100	4.870,00
	276177	PIP SP-92512001 Hohlwanddose 120Ømm inkl. Deckel	10 100	748,00

Abbildung	Art. Nr.	Bezeichnung	VE per	Brutto €
	294207 KAI 1248-50	Beton-Deckendose 45°	10 100	213,52
	294210 KAI 1249-50	Beton-Deckendose 45°	10 100	161,98
		<ul style="list-style-type: none"> ✓ Einbauhöhe 55 mm (2 - teilig) ✓ 4 Markierungen für Kabel und Rohre bis 25 mm ✓ mit Metallmutter M 5 für Leuchtenhaken (Hakenlänge min. 55mm + Putzstärke) ✓ A - Auslassöffnung 35 mm ✓ B - Auslassöffnung 60 mm 		
	294159 KAI 1202-04	Wand-Deckenkrümmer 30°	30 100	148,30
		<ul style="list-style-type: none"> ✓ Einbauhöhe 62mm ✓ 3-teilig, komplett mit End- u. Übergangsstülle ✓ für Rohr, Außen-Ø 20mm 		
	294161 KAI 1202-34	Wand-Deckenkrümmer 30°	15 100	295,56
		<ul style="list-style-type: none"> ✓ Einbauhöhe 62mm ✓ 3-teilig, komplett mit End- u. Übergangsstülle ✓ für Rohr, Außen-Ø 25mm 		
	294211 KAI 1255-40	Gerätedose 2-teilig	10 100	144,73
		<ul style="list-style-type: none"> ✓ Einbauhöhe 53mm ✓ 4 Schraubdome z. Gerätebef. Abstand 60mm ✓ 2 Markierungen für Kabel u. Rohre bis Ø 25mm 		
	294282 KAI 1290-40	Gehäuse f. NV-Leuchten	10 100	695,24
		<ul style="list-style-type: none"> ✓ Einbauhöhe incl. Frontteil 133 mm ✓ Durchmesser 130 mm ✓ für starre und kardanbefestigte Leuchten ✓ max. Einbauhöhe 105 mm ✓ Lampenleistung max. 50 Watt ✓ für Decken ab 16 cm 		
	294283 KAI 1290-41	Gehäuse mit Trafotunnel	10 100	1.782,80
		<ul style="list-style-type: none"> ✓ 2-teilig ✓ Durchmesser 130 mm ✓ Tunnel für 1 elektronischen Trafo bis 105 VA (schlanke Bauform) ✓ mit Trennwand zwischen Primär/Sekundärbereich 		
	294291 KAI 1290-51	1290-51 Universal-Frontteil	10 100	407,05
		<ul style="list-style-type: none"> ✓ variabler Deckenauslass ✓ Farbe schwarz für (mm) 40, 45, 50, 55, 60, 68, 75, 80, 85, 90, 95, 100 ✓ Einsatz von elektronischen Sicherheitstrafo erst ab Öffnung 68mm 		
	294288 KAI 1290-47	Deckenauslass 68x68	10 100	407,05
		<ul style="list-style-type: none"> ✓ für Deckenauslass 68 ✓ Leuchtenblende min. 75 mm 		

Abbildung	Art. Nr.	Bezeichnung	VE	per	Brutto €
					
	424141	LEG 031301 Mauerdose MD 65	250	100	18,80
	424144	LEG 031306 Putzdeckel rund rot	250	100	12,40
	425924	LEG 089207 Mauerdose Galea GMD70	250	100	25,90
	425929	LEG 089212 Signaldeckel für GMD70	250	100	10,90
	425923	LEG 089206 Combi Dose BCD 65 NEU	250	100	15,40
	424142	LEG 031303 Abzweigdose VD 70	250	100	17,60
	424143	LEG 031304 Dosend. UD70D Fixspanne	250	100	16,00
	424145	LEG 031307 Signaldeckel rot SD 2	200	100	33,70
	425922	LEG 089205 Schalterdose VSD 65 R	250	100	28,20
	425925	LEG 089208 Gerätedose VSD 80	50	100	77,70
	425926	LEG 089209 Geräted. 2fach GD 2	100	100	50,50
	425927	LEG 089210 Geräted. 3fach GD 3	100	100	84,50
	424146	LEG 031311 Unterteil KD 75	100	100	33,60
	424150	LEG 031321 Randdeckel D 75	100	100	32,50
	424151	LEG 031322 Unterteil KD 100	100	100	42,00
	424152	LEG 031326 Randdeckel D 100	100	100	39,90
	424153	LEG 031331 Unterteil KD 150	50	100	145,80
	424154	LEG 031336 Randdeckel D 150	100	100	99,70
	215004	DIE AK/U80 Abzweigkasten Unterteil 020924	100	100	55,20
	214982	DIE AK/RD80 Randdeckel PVC weiss 020857	100	100	72,60
	215005	DIE AK/U100 Abzweigkasten Unterteil 020925	100	100	77,00
	214013	DIE AK/RD100 Randdeckel PVC weiss 000735	100	100	90,90
	215006	DIE AK/U150 Abzweigkasten Unterteil 020926	50	100	235,00
	214014	DIE AK/RD150 Randdeckel PVC weiss 000737	100	100	246,00
	215007	DIE AK/U200 Abzweigkasten Unterteil 020927	20	100	846,00
	214015	DIE AK/RD200 Randdeckel PVC weiss 000739	80	100	349,00
	215000	DIE ASD70 o.D. Abzweig-Schalterdose 70 020912	100	100	41,20
BLITZ-ZEMENT					
	013876	IMP Blitzzement 25 Kilo - Sack	25	per kg	1,14
	010397	IMP Blitzzement 5 Kilo - Sack	5	per kg	1,77
	023019	SIK Blitzmörtel 10 Kilo - Kübel	10	Kübel	28,50

Abbildung	Art. Nr.	Bezeichnung	VE	per	Brutto €
-----------	----------	-------------	----	-----	----------

Feuchtraum-Aufputz



229244	BER 307605	Wechselschalter	10	1	9,19
229451	BER 507605	Taster	10	1	10,73
229382	BER 474005	Schuko-Steckdose	10	1	7,62
229423	BER 477505	SK-Steckdose 2f. waagr.	10	1	18,10
229419	BER 477005	SK-Steckdose 2f. senkr.	10	1	18,10
229426	BER 478005	Kombination Wechsel-	10	1	19,52



legrand		Plexo™ IP55			
425539	LEG 069709	Universal Aus/Wechselschalter grau	10	100	852,40
425542	LEG 069714	Serienschalter grau	5	100	1.396,30
425546	LEG 069719	Taster 1-pol. Schließer grau	10	100	853,20
425564	LEG 069746	Schuko-Steckd. + Wechselsch. grau	10	100	1.795,40
425555	LEG 069730	Schuko-Steckdose 1fach AP	10	100	680,80
425561	LEG 069742	Schuko-Std. AP 2f. waagr.	10	100	1.618,50
425562	LEG 069743	Schuko-Std. AP 3fach	5	100	2.894,80
425563	LEG 069744	Schuko-Std. AP 2f. senkr.	5	100	1.618,50



361634	JUN 805W	Serienschalter grau	1	1	14,35
361641	JUN 806W	Wechselschalter grau	1	1	8,76
361675	JUN 820W	Schuko-Steckdose 1fach grau	1	1	7,26
361689	JUN 822W	Schuko-Steckdose 2fach grau waagr.	1	1	17,25
361685	JUN 8220W	Schuko-Steckdose 2fach grau senkr.	1	1	17,57
361697	JUN 831W	Taster 1-pol. Schließer grau	1	1	9,55
361725	JUN 876W	Schuko-Steckd. + Wechselsch. grau	1	1	19,52

Feuchtraum-Unterputz



478080	POP 633217	FR-Steckdose u.P. mit Deckel perlweiss RAL1013, IP44	10	1	5,62
004694	ABL 1471460	ALU-Schuko-Steckdose m. Deckel IP41 Unterteil-Thermoplast m. 2xM20	6	1	66,60
228132	BER 1884	Dichtungsring	10	1	0,87
228059	BER 1328	Rahmen 1fach weiss	10	1	5,91
228060	BER 1329	Rahmen 2fach weiss	10	1	6,95
228061	BER 1330	Rahmen 3fach weiss	10	1	12,96
228608	BER 132809	Rahmen 1fach polarweiss	10	1	5,91
228610	BER 132909	Rahmen 2fach polarweiss	10	1	6,95
228612	BER 133009	Rahmen 3fach polarweiss	10	1	12,96
228286	BER 4715	SK-Steckdose m. Klappdeckel weiss	10	1	9,63
229351	BER 471509	SK-Steckdose m. Klappdeckel pws	10	1	9,63
228288	BER 4718	SK-Steckd. kpl. m. Rahmen weiss	10	1	16,89
229355	BER 471809	SK-Steckd. kpl. m. Rahmen pws	10	1	16,89
228072	BER 1550	Wippe weiss	10	1	5,56
228867	BER 155009	Wippe polarweiss	10	1	5,56
228075	BER 1553	Wippe Kontroll- o. beleuchtet weiss	10	1	6,27
228876	BER 155309	Wippe Kontroll- o. beleuchtet pws	10	1	6,27



Abbildung	Art. Nr.	Bezeichnung	VE	per	Brutto €
-----------	----------	-------------	----	-----	----------

spelsberg e-term



ABOX - Serie Verbindungsdosen leer ohne Klemmstein

schlagfest, flammwidrig, selbstdichtende Membraneinführungen, großer Anschlußraum, IP65, grau, ohne Klemmen

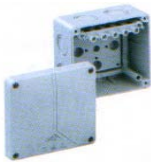

312953	SPE	ABOX 060 L	110x110x67 leer	80690701	2	100	784,58
312956	SPE	ABOX 100 L	140x140x79 leer	81091001	2	100	1.027,62
312959	SPE	ABOX 160 L	180x180x91 leer	81691001	1	100	1.673,62

ABOX - Serie Verbindungsdosen mit Klemmstein

schlagfest, flammwidrig, selbstdichtende Membraneinführungen, großer Anschlußraum, IP65, grau, m. Schraubklemmen



312977	SPE	ABOX 060 B	110x110x67 best. grau	80640701	2	100	1.108,64
312955	SPE	ABOX 100 B	140x140x79 best. grau	81041001	2	100	1.556,36
312958	SPE	ABOX 160 B	180x180x91 best. grau	81641001	1	100	2.601,04

Abzweigdosen IP 55 m. grauem Deckel aufschraubbar, Temp. -5° bis +60°C



								per Stück
005107	ELC	400C3 / CE3	ET003 / 80x80x50	88988108	1/140	1	1,78	
005108	ELC	400C4 / CE4	ET005 / 100x100x50	88988204	1/60	1	3,43	
005109	ELC	400C4R / CE5	ET007 / 120x75x50	88988300	1/100	1	3,81	
005110	ELC	400C5 / CE6	ET008 / 150x110x70	88988406	1/44	1	5,77	
005111	ELC	400C6 / CE7	ET009 / 190x145x70	88988502	1/25	1	8,47	
005112	ELC	400C7 / CE8	ET011 / 240x190x110	88988605	1/12	1	13,83	
005113	ELC	400C8 / CE9	ET012A / 300x220x120	88702879	1/7	1	35,78	
005106	ELC	400C9 / CE10	ET014A / 380x300x120	88702908	1/5	1	40,73	

Abzweigdosen IP 65, Wände glatt, grauer Deckel, Temp. -5° bis +60°C



								per Stück
005115	ELC	410C4R / CEL5	ET007PL / 120x75x50	88703230	1/126	1	3,59	
005116	ELC	410C5 / CEL6	ET008PL / 150x110x70	88987505	1/47	1	5,50	
005117	ELC	410C6 / CEL7	ET009PL / 190x145x70	88987608	1/28	1	7,63	
005118	ELC	410C7 / CEL8	ET010PL / 240x190x70	88987704	1/14	1	12,18	
005119	ELC	410C8 / CEL9	ET012APL / 300x220x120	88702850	1/7	1	24,91	
009332	ELC	410C9 / CEL10	ET014APL / 380x300x120	88702885	1/5	1	35,11	

Abbildung	Art. Nr.	Bezeichnung	VE per	Brutto €
-----------	----------	-------------	--------	----------

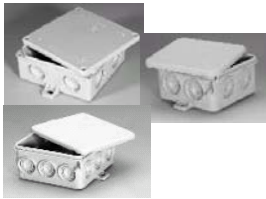

e-term

479309	ELT FK 75M	FR Dose 88x88 92000139	5 100	136,50
479031	ELT FD 7	FR Dose 75x75 88653105	50 100	80,52
479032	ELT FD 12	FR Dose 90x90 88653201	50 100	106,29

SAREL



247117	SAR 05004	80x80x45 halogenfrei	10 1	1,32
247118	SAR 05005	105x105x55 halogenfrei	5 1	3,73

spelsberg

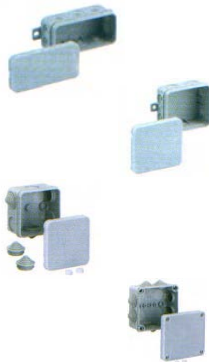

312835	SPE MINI 25 leer	89x43x37 grau IP54	40 100	108,73
	31090801	Einführung 10+2		
312927	SPE SD 7 leer	75x75x37 grau IP55	60 100	103,19
	33290701	Einführung 7+3		
312937	SPE I 12 leer	85x85x37 grau IP55	60 100	114,06
	33291201	Einführung 12+3		
312950	SPE HP 80	85x85x42 leer grau IP55	50 100	174,82
	32298001	Einführung 7xPG16		
312920	SPE HP 100	113x113x58 leer grau IP55	40 100	400,82
	32690001			

legrand®



426091	LEG 092104	65x65x40 grau	5 100	165,70
	Plexo-Dose	mit 7 Stufen-Einführungen		
426093	LEG 092126	80x80x45 grau	5 100	185,70
	Plexo-Dose	mit 7 Stufen-Einführungen		
426094	LEG 092136	105x105x55 grau	5 100	394,40
	Plexo-Dose	mit 7 Stufen-Einführungen		

OBO BETTERMANN



371506	OBO T25 2007029	Ø 80x51mm lichtgrau (RAL7035)	1 100	278,75
371507	OBO T40 2007045	90x90x52 mm lichtgrau (RAL7035)	1 100	374,40
371508	OBO T60 2007061	114x114x57 mm lichtgrau (RAL7035)	1 100	655,20
371509	OBO T100 2007077	151x117x67 mm lichtgrau (RAL7035)	1 100	925,60
371510	OBO T160 2007093	190x150x77 mm lichtgrau (RAL7035)	1 100	1.300,00
371511	OBO T250 2007109	240x190x95 mm lichtgrau (RAL7035)	1 100	1.747,20
371512	OBO T350 2007125	285x201x120 mm lichtgrau (RAL7035)	1 100	2.901,60

Abbildung	Art. Nr.	Bezeichnung	VE	per	Brutto €	
	000338	ABL 2206110	Perilexkupplung ws	10	1 22,45	
	000339	ABL 2407110	Perilexwinkelstecker ws	10	1 13,85	
	000340	ABL 2421110	Perilexsteckdose UP ws	10	1 14,50	
	000341	ABL 2441860	Perilex FR Std. AP gr.	5	1 20,15	
	000342	ABL 2451510	Perilex FR Std. UP ws. m. D.	10	1 25,85	
	000343	ABL 2491010	Perilex Steckd. AP ws.	5	1 11,60	
	 	021505	ABL 2429090	Perilex Vollgummistecker	10	1 22,60
		021506	ABL 2489090	Perilex Vollgummikupplung	10	1 32,15
		021803	ABL 1419170	PVC Stecker ORANGE	10	1 6,50
		021496	ABL 1419190	Stecker Gummi klein	20	1 5,40
	021497	ABL 1429190	Stecker Vollgummi	20	1 5,45	
	021499	ABL 1479090	Kupplung Gummi klein	10	1 9,05	
	021870	ABL 1479070	PVC Kupplung ORANGE	10	1 10,80	
	021491	ABL 1129190	Kupplung Vollgummi	10	1 6,35	
	002848	ABL 1473190	Kupplung 3fach Gummi	5	1 46,05	
	021493	ABL 1176110	Kupplung weiss Stand.	10	1 4,30	
	021501	ABL 1679060	PVC-Kupplung grau	20	1 8,80	
	021490	ABL 1116110	Schukostecker weiss	50	1 2,25	
	021495	ABL 1418060	PVC-Stecker grau	20	1 3,80	
	021804	ABL 1107110	Winkel Schukostecker	20	1 2,65	
	021805	ABL 1001075	Winkel Schukost. m.Schalter	20	1 10,45	

Stecker Kupplungen Perilex PVC Gummi Schutzkontakt

Abbildung	Art. Nr.	Bezeichnung	VE	per	Brutto €
	425282	LEG 050265 Schalenklappstecker firnweiß	50	100	125,90
	425283	LEG 050266 Schalenklappstecker firnweiß seitliche Einführung	20	100	155,30
	425297	LEG 051350 Winkelstecker weiß	100	100	310,50
	425299	LEG 051352 Winkelstecker grau	100	100	310,50
	435940	LEG 050363 Schalenkupplung firnweiß	10	100	222,40
		erst ab September 2009 lieferbar!!! Ersatz:			
	021493	ABL 1176110 Kupplung weiss Stand.	10	1	4,30
	425291	LEG 050321 Gummistecker	40	100	278,00
	425303	LEG 051364 Gummikupplung	30	100	456,30
	266904	PCE 0511-s Schutzkontaktstecker Gummi 2p+E 240V IP44 spritzwassergeschützt	10	1	2,26
	266910	PCE 05622-s Schutzkontaktstecker Vollgummi 2p+E 240V IP44 spritzwassergeschützt	10	1	4,57
	266905	PCE 0512-s Schutzkontaktstecker Gummi 2p+E 240V IP44 spritzwassergeschützt	10	1	3,37
	266911	PCE 05811-s Schutzkontakt-Winkelstecker Gummi 2p+E 240V IP44 spritzwassergeschützt	10	1	6,47
	266912	PCE 05812-s Schutzkontakt-Winkelstecker Vollgummi 2p+E 240V IP44 spritzwassergeschützt	10	1	7,26
	267297	PCE 2510-s Schutzkontaktkupplung Gummi 2p+E 240V IP20	10	1	3,72
	267314	PCE 25621-s Schutzkontaktkupplung m. Deckel + Band Vollgummi 2p+E 240V IP44	10	1	6,49
	267315	PCE 25622-s Schutzkontaktkupplung m. Klappdeckel Vollgummi 2p+E 240V IP44	10	1	6,96
	267304	PCE 2520-s Schutzkontaktkupplung Vollgummi 2p+E 240V IP20	10	1	5,00
	267305	PCE 2521-s Schutzkontaktkupplung m. Schnappdeckel Vollgummi 2p+E 240V IP44	10	1	6,28
	267307	PCE 2522-s Schutzkontaktkupplung m. Klappdeckel Vollgummi 2p+E 240V IP44	10	1	7,11

Abbildung	Art. Nr.	Bezeichnung	VE	per	Brutto €
	267309 PCE 25311-s	3-Wege Kupplung Gummi mit Schnapdeckel 2p+E 240V, IP44	1	1	27,53
	267312 PCE 25322-s	3-Wege Kupplung Vollgummi mit Klappdeckel 2p+E 240V IP44	1	1	30,33
	267310 PCE 25311-s5	3-Wege Kupplung Gummi mit Deckel u. 5pol. Anschlussklemme 2p+E 240V,IP44	1	1	31,72
	267313 PCE 25322-s5	3-Wege Kupplung Vollgummi mit Klappd. u. 5pol. Anschlussklemme 2p+E 240V,IP44	1	1	34,86
	266667 PCE 980901315684	3-Wege Kupplung Gummi IP44 m. 1,5m Kabel 3G1,5 H07RN-F m. Stecker 2p+E 240V	1	1	38,41
	266669 PCE 980905315581	Schutzkontakt-Verlängerungsleitung K35 IP44 m. mont. Gummistecker + 3-Wege-Kuppl. m. Schnapdeckel, 5m Baust.ltg. K35 N07V3V3-F 3G1,5	1	1	43,25
	266709 PCE 980925315551	Schutzkontakt-Verlängerungsleitung K35 IP44 m. mont. Gummistecker + kuppl. m. Schnapdeckel, 25m Baust.ltg. K35 N07V3V3-F 3G1,5	1	1	54,16
	266715 PCE 980925325551	Schutzkontakt-Verlängerungsleitung K35 IP44 m. mont. Gummistecker + kuppl. m. Schnapdeckel, 25m Baust.ltg. K35 N07V3V3-F 3G2,5	1	1	76,95
	266730 PCE 980925515111	CEE-Verlängerungsleitung K35 IP44 m. mont. CEE-Stecker + CEE-Kuppl. 16A 5p 400V, 25m Baust.ltg. K35 N07V3V3-F 5G1,5	1	1	79,71
	266736 PCE 980925525111	CEE-Verlängerungsleitung K35 IP44 m. mont. CEE-Stecker + CEE-Kuppl. 16A 5p 400V, 25m Baust.ltg. K35 N07V3V3-F 5G2,5	1	1	111,25
	266720 PCE 980925504211	CEE-Verlängerungsleitung K35 IP44 m. mont. CEE-Stecker + CEE-Kuppl. 32A 5p 400V, 25m Baust.ltg. K35 N07V3V3-F 5G4	1	1	165,41
	266724 PCE 980925506211	CEE-Verlängerungsleitung K35 IP44 m. mont. CEE-Stecker + CEE-Kuppl. 32A 5p 400V, 25m Baust.ltg. K35 N07V3V3-F 5G6	1	1	237,41
	266482 PCE 9805210	Handgeräteleitung PUR H07BQ-F 2x1 orange 5m + Konturenst.	1	1	14,26
	266480 PCE 9803215	Handgeräteleitung PUR H07BQ-F 2x1,5 orange 3m + Konturenst.	1	1	11,95
	266483 PCE 9805215	Handgeräteleitung PUR H07BQ-F 2x1,5 orange 5m + Konturenst.	1	1	18,91
	266484 PCE 9805310	Handgeräteleitung PUR H07BQ-F 3x1 orange 5m + Schutzkontaktst.	1	1	17,76
	266481 PCE 9803315	Handgeräteleitung PUR H07BQ-F 3x1,5 orange 3m + Schutzkontaktst.	1	1	13,85
	266485 PCE 9805315	Handgeräteleitung PUR H07BQ-F 3x1,5 orange 5m + Schutzkontaktst.	1	1	21,89







Abbildung	Art. Nr.	Bezeichnung	VE	per	Brutto €
	266292 PCE 9275394	Kabeltrommel aus hochwert. Kst. m. unzerbrechl. Tragegriff, m. Thermoschutzschalter, 3 SK-Steckd. m. selbstschl. Klappd. 16A 250V, 25m Baust.ltg. K35 N07V3V3-F 3G1,5	1	1	168,38
	266293 PCE 9275394	Kabeltrommel aus hochwert. Kst. m. unzerbrechl. Tragegriff, m. Thermoschutzschalter, 3 SK-Steckd. m. selbstschl. Klappd. 16A 250V, 40m Baust.ltg. K35 N07V3V3-F 3G1,5	1	1	188,06
	266268 PCE 9270140	Kabeltrommel aus Spezial-Gummi Ø 310, m. unzerbrechl. Tragegriff aus Kst., m. Thermoschutzschalter u. Spannungsanzeige, 4 SK-Steckd. m. selbstschl. Klappd. 16A 250V LEER	1	1	118,82
	266275 PCE 9270156	Kabeltrommel aus Spezial-Gummi Ø 310, m. unzerbrechl. Tragegriff aus Kst., m. Thermoschutzschalter u. Spannungsanzeige, 4 SK-Steckd. m. selbstschl. Klappd. 16A 250V, 25m Baust.ltg. K35 N07V3V3-F 3G1,5	1	1	179,74
	266282 PCE 9270175	CEE-Kraftstrom-Kabeltrommel aus Spezial-Gummi Ø 310, m. unzerbrechl. Tragegriff aus Kst., m. Thermoschutzschalter 3phasig, 1 CEE-Dose 16A 5p 400V, 3 SK-Steckd. m. selbstschl. Klappd. 16A 250V LEER	1	1	170,93
	266283 PCE 9270180	CEE-Kraftstrom-Kabeltrommel aus Spezial-Gummi Ø 310, m. unzerbrechl. Tragegriff aus Kst., m. Thermoschutzschalter 3phasig, 1 CEE-Dose 16A 5p 400V, 3 SK-Steckd. m. selbstschl. Klappd. 16A 250V, 25m Baust.ltg. K35 N07V3V3-F 5G2,5	1	1	298,02
	266335 PCE 9430409	Kunststoff-Kompaktverteiler Baureihe ST. ANTON , 3 SK-Steckd. 16A 250V m. selbstschl. Klappd., 1,5m H07RN-F 3G1,5 + Gummi-SK-Stecker 16A 250V	1	1	40,78
	266356 PCE 9430451	Kunststoff-Kompaktverteiler Baureihe ST. ANTON , 2 CEE-Dosen 16A 5p 400V, 1 SK-Steckd. 16A 250V m. selbstschl. Klappd., 1 CEE-Phasenwender-Gerätestecker 16A 5p 400V	1	1	39,54
	266357 PCE 9430452	Kunststoff-Kompaktverteiler Baureihe ST. ANTON , 1 CEE-Dose 16A 5p 400V, 2 SK-Steckd. 16A 250V m. selbstschl. Klappd., 1 CEE-Phasenwender-Gerätestecker 16A 5p 400V	1	1	41,15
	266358 PCE 9430453	Kunststoff-Kompaktverteiler Baureihe ST. ANTON , 3 CEE-Dosen 16A 5p 400V, 1 CEE-Phasenwender-Gerätestecker 16A 5p 400V	1	1	41,15





Abbildung	Art. Nr.	Bezeichnung	VE	per	Brutto €
	266171 PCE 9014120	Kunststoff-Wandverteiler ungesichert Baureihe SCHWAZ , HxBxT = 249x189x110mm, 2 CEE-Dosen 16A 5p 400V, 4 SK-Steckd. 16A 250V, Leitungseinführung 1xM20 oben	1	1	109,03
	266441 PCE 9605151	Kunststoff-Wandverteiler 6TE Baureihe LECH , HxBxT = 230x130x152mm, 1 CEE-Dose 16A 5p 400V, 2 SK-Steckd. 16A 250V, 1 LS 16A 3p-C, 2 LS 16A 1p-C, Leitungseinführung: 1xM25 Anbauverschr. oben, 2xM25 vorgeprägte Leit.einf. unten	1	1	138,41
	266192 PCE 9036151	Kunststoff-Wandverteiler 10TE Baureihe ANIF , HxBxT = 320x222x140mm, 2 CEE-Dosen 16A 5p 400V, 3 SK-Steckd. 16A 250V, 2 LS 16A 3p-C, 3 LS 16A 1p-C, Leitungseinführung: 1xM25 Anbauverschr. oben, 1xM25 Blindverschr. unten	1	1	273,58
	266193 PCE 9036510	Kunststoff-Wandverteiler 10TE Baureihe ANIF , HxBxT = 320x222x140mm, 1 CEE-Dose 32A 5p 400V, 1 CEE-Dose 16A 5p 400V, 3 SK-Steckd. 16A 250V, 1 LS 16A 3p-C, 3 LS 16A 1p-C, 1 FI therm. 40A/4/0,03A, Leitungseinführung: 1xM32 Anbauverschr. oben, 1xM32 Blindverschr. unten	1	1	338,24
	266195 PCE 9040110	Kunststoff-Wandverteiler 12TE Baureihe MOLLN , HxBxT = 397x330x167mm, 2 CEE-Dosen 16A 5p 400V, 3 SK-Steckd. 16A 250V, 2 LS 16A 3p-C, 3 LS 16A 1p-C, 1 FI therm. 40A/4/0,03A, Leitungseinführung: 1xM25 Anbauverschr. oben, 1xM25 Blindverschr. unten	1	1	405,78
	266197 PCE 9040785	Kunststoff-Wandverteiler 16TE Baureihe MOLLN , HxBxT = 397x330x167mm, 1 CEE-Dose 32A 5p 400V, 1 CEE-Dose 16A 5p 400V, 4 SK-Steckd. 16A 250V, 1 LS 32A 3p-C, 1 LS 16A 3p-C, 4 LS 16A 1p-C, 1 FI therm. 40A/4/0,03A, Leitungseinführung: 1xM32 Anbauverschr. oben, 1xM32 Blindverschr. unten	1	1	430,99
	265117 PCE 9040680	Kunststoff-Wandverteiler 16TE Baureihe MOLLN , HxBxT = 397x330x167mm, 1 CEE-Dose 32A 5p 400V, 2 CEE-Dose 16A 5p 400V, 4 SK-Steckd. 16A 250V, 1 LS 32A 3p-C, 2 LS 16A 3p-C, 4 LS 16A 1p-C, 1 FI therm. 40A/4/0,03A (3TE), Leitungseinführung: 1xM32 Anbauverschr. oben, 1xM32 Blindverschr. unten	1	1	489,50
	266178 PCE 9027680	Kunststoff-Wandverteiler 16TE Baureihe SÖLL , HxBxT = 509x297x186mm, 1 CEE-Dose 32A 5p 400V, 2 CEE-Dose 16A 5p 400V, 4 SK-Steckd. 16A 250V, 1 LS 32A 3p-C, 2 LS 16A 3p-C, 4 LS 16A 1p-C, 1 FI therm. 40A/4/0,03A, Leitungseinführung: 1xM32 Anbauverschr. oben, 1xM32 Blindverschr. unten	1	1	648,17

Abbildung	Art. Nr.	Bezeichnung	VE	per	Brutto €
	266237	PCE 9222150 Kunststoff-Wandverteiler 16TE Baureihe SALZBURG , HxBxT = 370x298x203(153)mm, 2 CEE-Dose 16A 5p 400V, 3 SK-Steckd. 16A 250V, 2 LS 16A 3p-C, 3 LS 16A 1p-C, 1 FI therm. 40A/4/0,03A, 1 Klemmblock 5p 25mm ² , Leitungseinführung: 1xM25 Anbauverschr. oben	1	1	552,32
	266239	PCE 9227550 Kunststoff-Wandverteiler 16TE Baureihe SALZBURG , HxBxT = 370x298x203(153)mm, 1 CEE-Dose 32A 5p 400V, 1 CEE-Dose 16A 5p 400V, 3 SK-Steckd. 16A 250V, 1 LS 32A 3p-C, 1 LS 16A 3p-C, 3 LS 16A 1p-C, 1 FI therm. 40A/4/0,03A, 1 Klemmblock 5p 25mm ² , Leitungseinführung: 1xM32 Anbauverschr. oben	1	1	559,20
	266203	PCE 9210144 Kunststoff-Wandverteiler 16TE Baureihe KLAGENFURT , HxBxT = 330x210x132(82)mm, 1 CEE-Dose 16A 5p 400V, 2 SK-Steckd. 16A 250V, 1 LS 16A 3p-C, 2 LS 16A 1p-C, 1 FI therm. 40A/4/0,03A, 1 VC-Klemmblock 10mm ² , Leitungseinführung: 1xM25 Verschr. unten	1	1	420,00
	266251	PCE 9240038 Kunststoff-Wandverteiler 16TE Baureihe BRUCK , HxBxT = 370x370x203(153)mm, 2 CEE-Dosen 32A 5p 400V, 2 CEE-Dosen 16A 5p 400V, 4 SK-Steckd. 16A 250V, 1 LS 32A 3p-C, 2 LS 16A 3p-C, 4 LS 16A 1p-C, 1 FI therm. 40A/4/0,03A, 1 Klemmblock 5p 25mm ² , Leitungseinführung: 1xM32 Anbauverschr. unten	1	1	740,00
	266181	PCE 9030010 Kunststoff-Mobilverteiler ungesichert Baureihe IMST , HxBxT = 200x197x197mm, 2 CEE-Dosen 16A 5p 400V, 4 SK-Steckd. 16A 250V, CEE-Gerätestecker 16A 5p 400V	1	1	86,78
	266183	PCE 9030020 Kunststoff-Mobilverteiler ungesichert Baureihe IMST , HxBxT = 200x197x197mm, 2 CEE-Dosen 16A 5p 400V, 5 SK-Steckd. 16A 250V, 2m Kabel 5G2,5 m.CEE-Stecker 16A 5p 400V	1	1	120,04
	266180	PCE 9030004 Kunststoff-Mobilverteiler ungesichert Baureihe IMST , HxBxT = 200x197x197mm, 2 CEE-Dosen 16A 5p 400V, 5 SK-Steckd. 16A 250V, 1 FI therm. 40A/4/0,03A - über alle Ausgänge, 2m Kabel 5G2,5 m.CEE-Stecker 16A 5p 400V	1	1	232,98
	266188	PCE 9030614 Kunststoff-Mobilverteiler ungesichert Baureihe IMST , HxBxT = 200x197x197mm, 1 CEE-Dose 32A 5p 400V, 1 CEE-Dose 16A 5p 400V, 2 SK-Steckd. 16A 250V, 1 LS 16A 3p-C, 1 LS 16A 1p-C, 1 FI therm. 40A/4/0,03A - über alle Ausgänge, 2m Kabel 5G4 m.CEE-Stecker 32A 5p 400V	1	1	257,16

Abbildung	Art. Nr.	Bezeichnung	VE per	Brutto €
	266346 PCE 9430429	Übergangs-Steckvorr. Kst. Baureihe ST. ANTON Eingang: 1,5m h07RN-F 5G1,5, 1 CEE-Dose 16A 5p 400V, Ausgang: 3 SK-Steckd. 16A 250V	1 1	50,66
	266397 PCE 9440151	Vollgummi-Mobilverteiler ungesichert Baureihe STEYR , HxBxT = 72x430x115mm, 2 CEE-Dosen 16A 5p 400V, 3 SK-Steckd. 16A 250V, 2m Kabel 5G2,5 m. CEE-Stecker 16A 5p 400V	1 1	151,21
	266388 PCE 9437430	Übergangs-Steckvorr. Kst. Baureihe ST. ANTON Eingang: 1 CEE-Phasenwender-Gerätestecker 16A 5p 400V, Ausgang: 1 CEE-Dose 32A 5p 400V	1 1	46,07
	266382 PCE 9436432	Reduzier-Steckvorr. Kst. Baureihe ST. ANTON Eingang: 1 CEE-Phasenwender-Gerätestecker 32A 5p 400V, Ausgang: 1 CEE-Dose 32A 5p 400V, 1 LS 16A 3p-C	1 1	99,05
	266408 PCE 9474494	Vollgummi-Mobilverteiler Baureihe SPITZ m. Absicherung , HxBxT = 320x320x320mm, 3 CEE-Dosen 16A 5p 400V, 4 SK-Steckd. 16A 250V, 2 LS 16A 1p-C, 1 FI therm. 40A/4/0,03A, 2m Kabel 5G2,5 m. CEE-Strecker 16A 5p 400V	1 1	432,64
	266399 PCE 9474080	Vollgummi-Mobilverteiler Baureihe SPITZ m. Absicherung , HxBxT = 320x320x320mm, 1 CEE-Dose 32A 5p 400V, 2 CEE-Dosen 16A 5p 400V, 3 SK-Steckd. 16A 250V, 1 LS 16A 3p-C, 3 LS 16A 1p-C, 1 FI therm. 40A/4/0,03A, 2m Kabel 5G6 m. CEE-Strecker 32A 5p 400V	1 1	515,00
	266415 PCE 9500020	Vollgummi-Mobilverteiler Baureihe KREMS m. Absicherung , HxBxT = 285x 400x238mm, 2 CEE-Dosen 32A 5p 400V, 4 CEE-Dosen 16A 5p 400V, 6 SK-Steckd. 16A 250V, 1 LS 32A 3p-C, 2 LS 16A 3p-C, 3 LS 16A 1p-C, 1 FI therm. 63A/4/0,03A, 1 CEE-Gerätestecker 63A 5p 400V	1 1	948,90
	266069 PCE 061523	Kabelbrücke kpl. m. Einsatz, m. strukt. Oberfläche, 4 Reflektoren, Bef. auf dem Boden ist aufgrund d. hohen Eigengewichtes d. Kabelbrückensatzes nicht notwendig, beliebig bis zur gewünschten Breite aneinanderreihbar, Abm.: LxBxH = 600x800x80mm, Gewicht: 29,4 kg, Kabelkanäle: 15/35/55mm je Stück	1 1	153,05
	266070 PCE 061525	Kabelbrücke kpl. m. Einsatz, m. strukt. Oberfläche, 4 Reflektoren, Bef. auf dem Boden ist aufgrund d. hohen Eigengewichtes d. Kabelbrückensatzes nicht notwendig, beliebig bis zur gewünschten Breite aneinanderreihbar, Abm.: LxBxH = 600x800x80mm, Gewicht: 29,4 kg, Kabelkanäle: 15/35/55mm je Stück / mit Deckel 5 Kanäle LxBxH = 600x800x60mm	1 1	184,25
	265114 PCE 9033008	Kunststoff-Hängeverteiler ungesichert m. 4 Ringschrauben u. Ankergriff, Baureihe PEGASUS , HxBxT = 230x140x140mm, 4 SK-Steckd. 16A 250V, 1 VC-Klemme 3p (230V Zugang), Leitungseinführung: 1xM20 Anbauerschraubung oben	1 1	102,67
	268739 PCE 9033-1	Hängeset	1 1	17,50











Abbildung	Art. Nr.	Bezeichnung	VE	per	Brutto €
	265113 PCE 9033005	Kunststoff-Hängeverteiler ungesichert m. 4 Ringschrauben u. Ankergriff, Baureihe PEGASUS , HxBxT = 230x140x140mm, 1 CEE-Dose 16A 5p 400V, 3 SK-Steckd. 16A 250V, 1 VC-Klemme 5p, Leitungseinführung: 1xM25 Anbauerschraubung oben	1	1	110,17
	268739 PCE 9033-1	Hängeset	1	1	17,50
	265115 PCE 9033073	Kunststoff-Hängeverteiler ungesichert m. 4 Ringschrauben u. Druckluftvariante, Baureihe PEGASUS , HxBxT = 230x140x140mm, 4 SK-Steckd. 16A 250V, 1 VC-Klemme 3p (230V Zugang), Leitungseinführung: 1xM20 Anbauerschraubung oben, 1x Druckluftschnellverschluss 2-fach 1/2"	1	1	233,40
	268739 PCE 9033-1	Hängeset	1	1	17,50
	265116 PCE 9034003	Kunststoff-Mobilverteiler ungesichert m. Tragegriff u. Standfuss, Baureihe PEGASUS , HxBxT = 220x140x140mm, 2 CEE-Dosen 16A 5p 400V, 2 SK-Steckd. 16A 250V, Leitungseinführung: 2m Kabel H07RN-F 5G2,5 m. CEE-Stecker 16A 5p 400V	1	1	134,36
	266058 PCE 42170	Kabelaufroller JUNIOR 230 10m 3G1,5 BxHxT = 130x270x295mm, Gehäuse aus bruchf. Kst., m. Überlastschutz u. abschaltb. Blockiervorr., m. Wand- u. Deckenbef., Nennleistung: 2000W, abgerollt 10m Kabel H05VV-F 3G1,5 m. SK-Stecker + -Kupplung, TÜV-GS-geprüft	1	1	254,70
	266060 PCE 42175	Kabelaufroller MASTER 400 10m 5G1,5 BxHxT = 170x310x330mm, Gehäuse aus bruchf. Kst., m. Überlastschutz u. abschaltb. Blockiervorr., m. Wand- u. Deckenbef., Nennleistung: 3000W, abgerollt 10m Kabel H05VV-F 5G1,5 m. CEE-Stecker + -Kupplung 16A 5p 400V, TÜV-GS-geprüft	1	1	573,11
	266112 PCE 740060	LED-Akku-Handstableuchte m. Ladestation, Schutzart IP43, Schutzkl. II, 30 LEDs, druckf. Gehäuse, Betriebsdauer bis zu 6 Std. (Dauerbetrieb), NiMH-Akku, austauschbar, versenk. Henkel aus Kst. Akku-Ladestation, Wandmontage mögl.	1	1	101,43
	266119 PCE 783109	Arbeitsleuchte GLADIATOR 2x36W, ohne Akku, IP54, BxHxT = 300x320x115mm, mit 1 SK-Steckd., 5m Zuleitung H07RN-F 3G1,5, Lampenlichtstrom 2800 lm je Lampe, mittlere Lebensdauer 8000h	1	1	217,80

Abbildung	Art. Nr.	Bezeichnung	VE per	Brutto €
-----------	----------	-------------	--------	----------



	267206	PCE 215-6tt	CEE Kupplung 5 x 16A TURBO TWIST	10 1 5,87
	267247	PCE 225-6tt	CEE Kupplung 5 x 32A TURBO TWIST	10 1 7,82
	267177	PCE 213-6tt	CEE Kupplung 3 x 16A TURBO TWIST	10 1 5,72
			schraublos	
	266819	PCE 015-6tt	CEE Stecker 5 x 16A TURBO TWIST	10 1 4,56
	266866	PCE 025-6tt	CEE Stecker 5 x 32A TURBO TWIST	10 1 6,53
	266788	PCE 013-6tt	CEE Stecker 3 x 16A TURBO TWIST	10 1 4,30
			schraublos	
	267060	PCE 115-6	CEE Wanddose 5 x 16A TWIST	10 1 6,15
	267111	PCE 125-6	CEE Wanddose 5 x 32A TWIST	10 1 8,23
	267061	PCE 115-6tt	CEE Wanddose 5 x 16A TURBO TWIST	10 1 6,15
	267112	PCE 125-6tt	CEE Wanddose 5 x 32A TURBO TWIST	10 1 8,23
	267024	PCE 113-6tt	CEE Wanddose 3 x 16A TURBO TWIST	10 1 6,00
	267062	PCE 115-6ttk	CEE Wanddose 5 x 16A TURBO TWIST klein	10 1 6,47
	267113	PCE 125-6ttk	CEE Wanddose 5 x 32A TURBO TWIST klein	10 1 8,65
	267025	PCE 113-6ttk	CEE Wanddose 3 x 16A TURBO TWIST klein	10 1 6,29
	267956	PCE 7015-6	Phasenwender 16A 5p. TWIST	10 1 14,99
	267962	PCE 7025-6	Phasenwender 32A 5p. TWIST	10 1 17,98
	266975	PCE 1050-0b	Maschinensteckdose blau Schraubkontakt	10 1 4,31
	267003	PCE 109-0b	Maschinensteckdose blau schraubloser Kontakt	10 1 5,31
	266992	PCE 106-0	Aufputzgehäuse blau f. SK-Sreckd. m. Flansch 50x50, IP44	10 1 4,31
	268224	PCE 9215-6	Wandsteckdose 16A 5p. COMBO	10 1 16,60
	268233	PCE 9225-6	Wandsteckdose 32A 5p. COMBO	10 1 40,02
	267418	PCE 315-6	CEE Anbaudose gerade 5x16A IP44	10 1 12,95
	267419	PCE 315-6F7	CEE Anbaudose gerade 5x16A IP44 für Kabelkanaleinbau	10 1 12,95
	268169	PCE 810-00	CEE Zwischenflansch	10 1 9,35
	269048	ELI 1261	Gerätedose blau	40 1 3,83
	<u>Alternative zu 315-6F7 + 810-00 + ELI 1261:</u>			
	481552	WAL 410VS	CEE Anbaudose gerade 5x16A IP44 für Kabelkanaleinbau	10 1 56,30



Abbildung	Art. Nr.	Bezeichnung	VE per	Brutto €
 				
	299980	MEN AM15 CEE Kupplung 5 x 16A PRO TOP	10 1	9,60
	300027	MEN AM16 CEE Kupplung 5 x 32A PRO TOP	10 1	13,75
	300098	MEN AM180 CEE Kupplung 3 x 16A PRO TOP	10 1	10,55
	299836	MEN AM13 CEE Stecker 5 x 16A PRO TOP	10 1	8,30
	299891	MEN AM14 CEE Stecker 5 x 32A PRO TOP	10 1	11,45
	299964	MEN AM148 CEE Stecker 3 x 16A PRO TOP	10 1	9,10
	299601	MEN AM1 CEE Wanddose 5 x 16A	10 1	8,95
	300192	MEN AM2 CEE Wanddose 5 x 32A	10 1	12,40
	299758	MEN AM1178 CEE Wanddose 3 x 16A	10 1	9,90
	300833	MEN AM4125 CEE UP Steckdose 5 x 16A	5 1	19,00
	300819	MEN AM4105 CEE AP Steckdose 5 x 16A	5 1	21,35
	300585	MEN AM3319 Phasenwender 5 x 16A	10 1	19,05
	300587	MEN AM3322 Phasenwender 5 x 32A	10 1	22,95
	299692	MEN AM11031 Maschinensteckdose 	10 1	4,15
	299680	MEN AM10906 Übergangskasten 1 pol.	1 1	47,45
	299681	MEN AM10907 Übergangskasten 2 pol.	1 1	52,35
	268187	PCE 885-6v CEE Unterputz-Steckdose 5 x 16A 400V ws	1 1	19,56
	268189	PCE 895-6v CEE Unterputz-Steckdose 5 x 32A 400V ws	1 1	26,50
	268183	PCE 8830v UP SK-Steckdose 16A 2p+E 230V ws	1 1	21,11
	268181	PCE 865-6v CEE Aufputz-Steckdose 16Av5p 400V ws	1 1	21,42
	268374	PCE 901025 Absperrschloss, Zyl. + Schlüssel, gleichsperrend	1 1	27,63
	266569	PCE 96061552 Wandsteckdose COMBO-POL m. Anbaudose schräg, 1 CEE-Dose 16A 5p 400V, 2 SK-Steckd. (abges. m. 10A Sich.), IP44	1 1	52,73
	266578	PCE 96062552 Wandsteckdose COMBO-POL m. Anbaudose schräg, 1 CEE-Dose 32A 5p 400V, 2 SK-Steckd. (abges. m. 10A Sich.), IP44	1 1	71,26

Abbildung	Art. Nr.	Bezeichnung	VE	per	Brutto €
	005534	GFI Tischverteiler 2 fach + Kabel weiss	10	1	11,70
	478135	GFI Tischverteiler 3 fach + Kabel weiss	10	1	4,80
	005599	GFI Tischverteiler 3 fach + Kabel braun	10	1	6,00
	005763	GFI Tischverteiler 4 fach + Kabel weiss	10	1	9,30
	470862	GFI Tischverteiler 6 fach + Kabel weiss	10	1	8,70



Tischverteiler mit Befestigungslaschen

	005533	GFI Tischverteiler 2 fach ohne Kabel weiss	60	1	4,35
	005556	GFI Tischverteiler 3 fach ohne Kabel weiss	60	1	3,60
	005749	GFI Tischverteiler 4 fach ohne Kabel weiss	60	1	6,60
	470879	GFI Tischverteiler 5f. + Kabel + Schalter ws.	10	1	11,10
	470864	GFI Tischverteiler 6f. + Kabel + Schalter ws.	10	1	13,50

Steckdosenverteiler für eine Schalterdose



  	478019	POP 507655 3 fach Steckdose	10	1	12,68
	478083	POP 653277 2 fach Steckdose	10	1	10,46
	006055	GFI Verlängerung Kabel 3x1 / 2 Meter	1	1	6,20
	006051	GFI Verlängerung Kabel 3x1 / 3 Meter	1	1	7,80
	006057	GFI Verlängerung Kabel 3x1 / 4 Meter	1	1	9,30
	006052	GFI Verlängerung Kabel 3x1 / 5 Meter	1	1	10,20
	006058	GFI Verlängerung Kabel 3x1 / 10 Meter	1	1	18,00
	001674	GFI Schnurschalter Schnurschalter braun	1	1	3,90
	001673	GFI Schnurschalter Schnurschalter weiß	1	1	3,90
	001675	GFI Schnurschalter Schnurschalter gold	1	1	3,90
001672	GFI Schnurschalter Schnurschalter schwarz	1	1	3,90	

e-term **legrand**

  	424163	LEG 031483 Geräteanschld. 5x2,5	10	100	575,90
	424165	LEG 031489 Geräteanschld. 5x6	10	100	1.514,80
	000720	ABL 2505110 Geräteanschld. 5x2,5	10	1	8,00
	479003	ELT LDV80 BR Deckendose 80mm2 88569101	20	100	100,38
	479002	ELT LDV80 WS Deckendose 80mm2 88569002	20	100	100,38

Dosenmuffe FDM

* wasserdicht IP 68 * wieder offenbar * UV-beständig * für Steuerungs- und Versorgungsleitungen * rasch und sicher Erdkabel verbinden * eine defekte Freileitung instandsetzen * Schutzklasse 2, bis 1000V * ÖVE-geprüft * tausendfach bewährt bei der Telekom

	002682	FRD FDM1 Dosenmuffe 4x6-14mm	10	1	19,25
	002931	FRD FDM2 Dosenmuffe 4x6-25mm	6	1	31,50
	008085	FRD FDM3 Dosenmuffe 1x10-42mm	1	1	92,60
	478788	ELT PG13,5 Würgenippel 88230507	100	100	7,19
	478785	ELT PG16 Würgenippel 88230103	100	100	9,51

Sehr geehrte Kunden!

Da sich bei vielen Produkten Preise täglich ändern, sind unsere Preise als Richtpreise anzusehen und wir behalten uns Preisänderungen vor.

Abbildung	Art. Nr.	Bezeichnung	VE	per	Brutto €
-----------	----------	-------------	----	-----	----------

Hauptleitungsabzweigklemmen



295502	KLE	2645/1S	1polig 2x16mm ²	4	100	416,25
---------------	-----	----------------	----------------------------	---	-----	---------------

295512	KLE	3549/1	1polig 2x25mm ²	4	100	803,20
---------------	-----	---------------	----------------------------	---	-----	---------------

295516	KLE	4540/1S	1polig 2x50mm ²	2	100	2.567,90
---------------	-----	----------------	----------------------------	---	-----	-----------------



295504	KLE	2645/4S	4polig je Pol 2x16mm ²	1	100	772,20
---------------	-----	----------------	-----------------------------------	---	-----	---------------

295506	KLE	2648/4S	4polig / 3 Pole 2x16 mm ² / 1 Pol 6x16 mm ² PE/N	1	100	1.081,00
---------------	-----	----------------	--	---	-----	-----------------

295505	KLE	2645/5S	5polig je Pol 2x16mm ²	1	100	1.152,55
---------------	-----	----------------	-----------------------------------	---	-----	-----------------



295514	KLE	3549/4S	4polig je Pol 2x25mm ²	1	100	2.088,85
---------------	-----	----------------	-----------------------------------	---	-----	-----------------

295515	KLE	3549/5	5polig je Pol 2x25mm ²	1	100	2.981,10
---------------	-----	---------------	-----------------------------------	---	-----	-----------------



005501	POL	HAK2524	2polig 25mm ² grau / 2x2 Eingänge, 2x2 Ausgänge / Montage horizontal / 2080205	1	1	9,76
---------------	-----	----------------	---	---	---	-------------



005504	POL	HAK2548	4polig 25mm ² grau / 4x2 Eingänge, 4x2 Ausgänge / Montage horizontal (vertikal durch Verdrehen d. Klemnteils) / 2080408	1	1	15,50
---------------	-----	----------------	--	---	---	--------------



005502	POL	HAK25410	4polig 25mm ² grau / 4x2 Eingänge, 3x2 Ausgänge / Montage horizontal (vertikal durch Verdrehen d. Klemnteils) / 2080409	1	1	12,09
---------------	-----	-----------------	--	---	---	--------------



005503	POL	HAK25510	5polig 25mm ² grau / 5x2 Eingänge, 5x2 Ausgänge / Montage horizontal (vertikal durch Verdrehen d. Klemnteils) / 2080504	1	1	23,14
---------------	-----	-----------------	--	---	---	--------------

Zählersteckklemmen



129042	HAG	KJ01Z	Stifte 2 pol. AC	10	1	2,25
---------------	-----	--------------	------------------	----	---	-------------

215631	DIE	8040/07	Stifte 4 pol. 057312	10	100	436,04
---------------	-----	----------------	----------------------	----	-----	---------------

129048	HAG	KJ04Z	Plombierdeckel 2 pol.	10	1	11,90
---------------	-----	--------------	-----------------------	----	---	--------------

215625	DIE	8040/40 (60228)	Plombierdeckel 4 pol. 056938	10	100	1.104,63
---------------	-----	------------------------	------------------------------	----	-----	-----------------

129051	HAG	KJ10S	Zählersteckklemme 2 p.	10	1	33,10
---------------	-----	--------------	------------------------	----	---	--------------

215622	DIE	8040 (AT 416)	Zählersteckklemme 4 p. 056935	10	100	3.684,51
---------------	-----	----------------------	-------------------------------	----	-----	-----------------

Reihenklemmen



478766	ELT	EKL0 88166865	12polig 2,5mm ²	10	100	138,48
---------------	-----	----------------------	----------------------------	----	-----	---------------

479137	ELT	EKL1 88716109	12polig 4mm ²	10	100	135,20
---------------	-----	----------------------	--------------------------	----	-----	---------------

479144	ELT	EKL2 88718299	12polig 6mm ²	10	100	284,54
---------------	-----	----------------------	--------------------------	----	-----	---------------

478765	ELT	EKL3 88166827	12polig 16mm ²	10	100	473,24
---------------	-----	----------------------	---------------------------	----	-----	---------------

479143	ELT	EKL4 88717947	12polig 25mm ²	10	100	1.179,78
---------------	-----	----------------------	---------------------------	----	-----	-----------------

478821	ELT	DKR2G 88302702	Dosenkl. 12polig 3x2,5mm ²	10	100	144,10
---------------	-----	-----------------------	---------------------------------------	----	-----	---------------

Abbildung	Art. Nr.	Bezeichnung	VE	per	Brutto €
-----------	----------	-------------	----	-----	----------

Dosenklemmen



476133	WAG 273101	5 x 0,75 - 1,5	100	100	27,50
476136	WAG 273104	3 x 1,0 - 2,5	100	100	27,90
476137	WAG 273105	5 x 1,0 - 2,5	100	100	36,30
476138	WAG 273108	8 x 0,75 - 1,5	100	100	56,40



476065	WAG 243211	Steckverbinder; für EIB-Anwendungen; Steckklemm-Anschluss, dunkelgrau und rot verrastet / 8 Klemmstellen / 2 Potenziale	50	100	81,90
---------------	------------	---	----	-----	--------------



476033	WAG 222412	Verbindungsklemme 2x4 mm ² ; 2-Leiter-Klemme; mit Betätigungshebeln; max. Dauergebrauchstemperatur 85 °C; CAGE CLAMP®-Anschluss	100	100	50,70
---------------	------------	--	-----	-----	--------------



476034	WAG 222413	Verbindungsklemme 3x4 mm ² ; 3-Leiter-Klemme; mit Betätigungshebeln; max. Dauergebrauchstemperatur 85 °C; CAGE CLAMP®-Anschluss	40	100	57,90
---------------	------------	--	----	-----	--------------



476035	WAG 222415	Verbindungsklemme 5x4 mm ² ; 5-Leiter-Klemme; mit Betätigungshebeln; max. Dauergebrauchstemperatur 85 °C; CAGE CLAMP®-Anschluss	50	100	96,00
---------------	------------	--	----	-----	--------------



476063	WAG 243204	MICRO-Verbindungs-dosenklemme 4x0,6-0,8mm; dunkelgrau; 4-Leiter-Klemme; Steckklemm-Anschluss	100	100	34,20
---------------	------------	--	-----	-----	--------------



476064	WAG 243208	MICRO-Verbindungs-dosenklemme 8x0,6-0,8mm; dunkelgrau; 8-Leiter-Klemme; Steckklemm-Anschluss	50	100	56,70
---------------	------------	--	----	-----	--------------

Weidmüller



352556	WEI 1746430000	Dosenklemme 3x2,5	100	100	12,69
352558	WEI 1746450000	Dosenklemme 5x2,5	100	100	14,73
352559	WEI 1746460000	Dosenklemme 8x2,5	100	100	37,24

Reihenklemmen



350896	WEI 1010000000	WPE 2,5 gnge	100	100	369,45
350897	WEI 1010100000	WPE 4 gnge	100	100	376,35
350899	WEI 1010200000	WPE 6 gnge	50	100	441,75
350900	WEI 1010300000	WPE 10 gnge	50	100	476,70
350901	WEI 1010400000	WPE 16 gnge	50	100	660,30
350902	WEI 1010500000	WPE 35 gnge	25	100	883,95



350944	WEI 1020000000	WDU 2,5 dunkelbeige	100	100	113,25
350950	WEI 1020080000	WDU 2,5 blau	100	100	113,25



350952	WEI 1020100000	WDU 4 dunkelbeige	100	100	132,00
350957	WEI 1020180000	WDU 4 blau	100	100	132,00



350958	WEI 1020200000	WDU 6 dunkelbeige	100	100	177,90
350962	WEI 1020280000	WDU 6 blau	100	100	177,90
350963	WEI 1020300000	WDU 10 dunkelbeige	50	100	212,70
350967	WEI 1020400000	WDU 16 dunkelbeige	50	100	266,70
350128	WEI 0383560000	EW 35 Endwinkel	50	100	64,50

Abbildung	Art. Nr.	Bezeichnung	VE	per	Brutto €	
	478781	ETE NSCH 8X8	Nulleiterschiene 88229509	1	100	1.334,00
	478802	ETE NSCHT2	Nulleiterschienenenträger 88233008	50	100	77,41
	295595	KLE 651N/7	Nulleiterklemme 7p. 2020228	10	100	162,35
	295593	KLE 651N/12	Nulleiterklemme 12p. 2020229	10	100	257,00
	295594	KLE 651N/15	Nulleiterklemme 15p. 2020230	10	100	432,60
	295598	KLE 651S/7	Schutzleiterklemme 7p. 2020231	10	100	162,35
	295596	KLE 651S/12	Schutzleiterklemme 12p. 2020232	10	100	257,00
	295597	KLE 651S/15	Schutzleiterklemme 15p. 2020233	10	100	432,60
	006728	ULB 1780	Banderderanschlußdose	10	100	594,00
	478945	ETE POT 16/25	Potentialausgleichsschiene 88461307 / 2020301	5	100	1.150,00
	373477	OBO 5015073	Potentialausgleichsschiene	5	1	11,50
	295860	KLE 309	Potentialausgleichsschiene	5	100	612,00
	370618	OBO 1123668 A8U2/1,8	Ankerschiene ungelocht, 2000x40x22, bandverzinkt, DIN EN 10147	2	100	1.162,40
	370619	OBO 1123671 A8G2/1,8	Ankerschiene gelocht, 10,5x30mm, 2000x40x22, bandverzinkt, DIN EN 10147	2	100	1.262,40
	000017	GFI SIB 54118	Montageband gelocht 13,5x0,7 / Loch- Ø 5,5mm / Rolle à 10 m in Kassette	1	1	13,20
	373010	OBO 3105024	Dübel 18mm FIX PIN	100	100	23,40
	295887	KLE 37 / 0	Erdungsschelle 1/8 bis 3/8 "	10	100	230,90
	295888	KLE 37 / 1	Erdungsschelle 3/8 bis 1/5 "	10	100	277,55
	295890	KLE 37 / 4	Erdungsschelle 3/8 bis 4 "	10	100	372,15
	478946	ETE EB1 88461403	Erdungsschelle 3/8 bis 1/5 " 2020417	10	100	277,55
	478947	ETE EB2 88461509	Erdungsschelle 3/8 bis 4 " 2020418	10	100	372,15

Anschluss- u. Verbindungsmodule LSA-PLUS- und LSA-PROFIL-Module d. Baureihe 2

LSA- PLUS-Anschlussleiste 2/10 m. parallelem Prüfabgriff bzw. Überspannungsschutzabgriff



018004	KRO 6089100202	LSA Plus Anschlussleisten 2/10 Kabelseite oben, ohne Farbcode / Bedruckung: rangierseitig 1.....0 / zum Aufrasten auf Montagebügel 2/10 / Gehäusefarbe grau	10	1	18,30
---------------	-----------------------	---	----	---	--------------

Abbildung	Art. Nr.	Bezeichnung	VE per	Brutto €
-----------	----------	-------------	--------	----------

LSA-Profil Anschlussleiste 2/10 → **Achtung: für Profilschienen!**



KRONE



020483	KRO 6089112002	LSA Profil Anschlussleisten 2/10 ohne Farbcode / Bedruckung: rangierseitig 1.....0 / universell zu installieren auf: Profilstangen (75mm Abstand für 8 DA-Module), Montagebügel 2/10, Hutschienen (in Verbindung mit d. Hutschienenadapter 64612013-00), Gehäusefarbe grau	10 1	16,50
028108	KRO 6089112102	LSA Profil Trennleiste 2/10 ohne Farbcode / Bedruckung: rangierseitig 1.....0	10 1	21,60

LSA-Profil-Erddrahtleiste 2/34

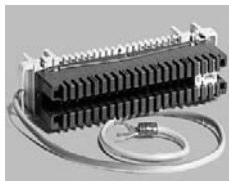

023329	KRO 6089210801	LSA Profil Erddrahtleiste 2/34 Farbe: grün/gelb; 500mm lang	10 1	37,80
---------------	----------------	--	------	--------------

LSA-PLUS-Trennleiste 2/10

Trennleiste zu 8 DA bzw. 10 DA m. Trennstelle z. Öffnen d.
Leitungsweges, Prüfmöglichkeit gezielt in beide Richtungen oder
Stecken v. Staffelschutz-Elementen



023680	KRO 6089110202	LSA PLUS Trennleiste 2/10 ohne Farbcode / Bedruckung: rangierseitig 1.....0 / zum Aufrasten auf Montagebügel 2/8 bzw. 2/10 / Gehäusefarbe cremeweiss	10 1	22,50
024236	KRO 6089110206	LSA PLUS Trennleiste 2/10 ohne Farbcode / Bedruckung: rangierseitig 0.....9 / zum Aufrasten auf Montagebügel 2/8 bzw. 2/10 / Gehäusefarbe cremeweiss	10 1	22,50

LSA-PLUS-Erddrahtleiste



Zum lötf-, schraub- u. abisolierfreien Verbinden von Erdbeidrähten
an einem Erdanschluss. Bis zu 38 Erdbeidrähte anschließbar. Zum
Aufrasten auf Montagebügel 2/10. Gehäusefarbe rot.

022714	KRO 6089201700	LSA - PLUS Erddrahtleiste 2/38 mit Erddraht und Ringkabelschuh für M4 / 38-polig, ca. 250mm lang	10 1	37,80
---------------	----------------	--	------	--------------

Abbildung	Art. Nr.	Bezeichnung	VE per	Brutto €
-----------	----------	-------------	--------	----------

Montagewanne



KRONE

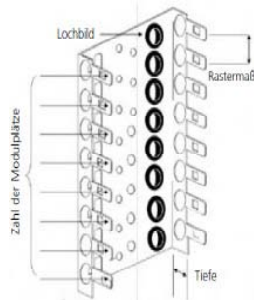

020489	KRO 6050312203	für 3 Module Tiefe 22mm LSA Montagebügel T22	1 1	11,79
020488	KRO 6050312205	für 5 Module Tiefe 22mm LSA Montagebügel T22	1 1	18,90
018005	KRO 6050312210	für 10 Module Tiefe 22mm LSA Montagebügel T22	1 1	37,80
000541	KRO 6050315011	für 11 Module Tiefe 50mm LSA Montagebügel T50	1 1	51,99
021847	KRO 6050315050	für 50 Module Tiefe 50mm LSA Montagebügel T50	1 1	236,25

Leergehäuse - Tür m. Vorreiber - ohne Montagewanne!



023423	KRO 6436100120	Leergehäuse f. 3 Module (2/10) Kronection-Box H170 x B140 x T75	1 1	38,40
018867	KRO 6406100120	Leergehäuse f. 5 Module (2/10) Kronection-Box H215 x B215 x T75	1 1	46,20
018003	KRO 6437100120	Leergehäuse f. 10 Module (2/10) Kronection-Box H320 x B215 x T75	1 1	70,80

BOX incl. Trennleiste

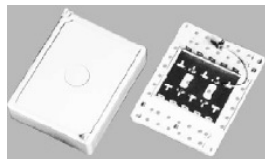

004758	KRO 6429107800	Miniverteiler 201D + 1LSA-PLUS Trennleiste 2/10 Connection Box 201D H170 x B120 x T43	1 1	70,50
---------------	----------------	--	-----	--------------

Anlegewerkzeug



Das Standardwerkzeug f. alle Daten-, Informations- u. Fernmeldeverkabelungen. Anwendbar f. sämtl. LSA-PLUS-Baureihen sowie RJ45-Buchsen u. Highband. Zur Anschaltung v. Leiterdurchmessern (0,35 - 0,9mm) u. Aderdurchmessern (0,7 - 2,6mm). Bei Beschaltung einer zweiten Ader im Kontakt wird der Sensor abgeschaltet (Aderspez. u. Anzahl d. Adern sind abh. v. verw. Anschlusstechnik). Die Schere kann abgeschaltet werden, um ein Durchschleifen eines Potentials auf benachbarte Kontakte zu ermögl.

017472	KRO 6417205501	LSA-PLUS-Anlegewerkzeug	1 1	117,00
---------------	----------------	-------------------------	-----	---------------

Abbildung	Art. Nr.	Bezeichnung	VE	per	Brutto €
-----------	----------	-------------	----	-----	----------

ELECTROPLAST 



M. SCHURRER & CO.
Ges.m.b.H.



003838	ELP 110S04 + 115-04	Fassung E 27 Steckfassung	50	100	164,44
003839	ELP 110-04	Fassung E 27 sw / 110SW	50	100	176,17
003840	ELP 110-06	Fassung E 27 ws / 110WS	50	100	224,53
003847	ELP 140-04	Fassung E 14 sw / 140SW	50	100	141,85
003848	ELP 140-06	Fassung E 14 ws / 140WS	50	100	188,18
000084	ELP 110-15 (110-04)	Baustellenfassung mit Leuchtenklemme 15cm lang	50	100	423,96
003902	ELP 5010	Fassung E 27 Messing	50	100	355,68
003903	ELP 50126001	Fassung+Ring E27 met.	50	100	413,71
	SCH 10M färbig	Coroplast färbig braun, schwarz, violett, gelb, grün, blau, orange, rot,weiß, grau, transparent	20	100	94,58
006090	SCH 10M grün/gelb	Coroplast grün/gelb	20	100	111,02
006148	SCH 504/5/250	Infrarot Wärmestrahler 5m Z.	1	1	20,50

 **legrand**®



424169	LEG 031525	Nagelschelle 6 mm grau	1000	100	3,60
424170	LEG 031526	Nagelschelle 7 mm grau	1000	100	4,20
424171	LEG 031527	Nagelschelle 8 mm grau	1000	100	4,20
424172	LEG 031528	Nagelschelle 9 mm grau	1000	100	5,40
424182	LEG 031552	Nagelschelle 3 mm weiss	2000	100	2,90
424183	LEG 031553	Nagelschelle 4 mm weiss	2000	100	3,30
424184	LEG 031554	Nagelschelle 5 mm weiss	2000	100	3,30
424185	LEG 031555	Nagelschelle 6 mm weiss	1000	100	3,60
424186	LEG 031556	Nagelschelle 7 mm weiss	1000	100	4,20
424187	LEG 031557	Nagelschelle 8 mm weiss	1000	100	4,20

Abbildung	Art. Nr.	Bezeichnung	VE	per	Brutto €
-----------	----------	-------------	----	-----	----------

haupa®

Kabelbinder *NATUR* -40 °C bis 85 °C

259596	HAU 262502	Kabelbinder 100 x 2,5	100	100	0,76
259598	HAU 262504	Kabelbinder 142 x 2,5	100	100	1,65
259600	HAU 262506	Kabelbinder 203 x 2,5	100	100	1,85
259602	HAU 262508	Kabelbinder 142 x 3,2	100	100	1,72
259604	HAU 262510	Kabelbinder 292 x 3,6	100	100	3,67
259606	HAU 262512	Kabelbinder 190 x 4,8	100	100	3,54
259608	HAU 262516	Kabelbinder 203 x 4,6	100	100	3,63
259610	HAU 262518	Kabelbinder 250 x 4,8	100	100	5,33
259611	HAU 262520	Kabelbinder 310 x 4,8	100	100	5,79
259615	HAU 262532	Kabelbinder 380 x 7,6	100	100	16,16
259616	HAU 262536	Kabelbinder 450 x 8,0	50	100	25,86

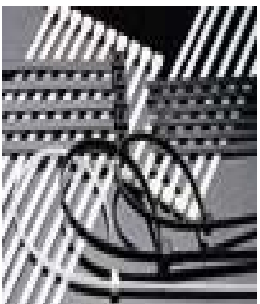
Kabelbinder *SCHWARZ* -40 °C bis 85 °C, UV-beständig

259623	HAU 262602	Kabelbinder 100 x 2,5 sw	100	100	0,87
259624	HAU 262604	Kabelbinder 142 x 2,5 sw	100	100	1,68
259625	HAU 262606	Kabelbinder 203 x 2,5 sw	100	100	2,04
259628	HAU 262610	Kabelbinder 292 x 3,6 sw	100	100	4,41
259629	HAU 262616	Kabelbinder 203 x 4,6 sw	100	100	4,17
259630	HAU 262618	Kabelbinder 250 x 4,8 sw	100	100	6,13
259631	HAU 262620	Kabelbinder 310 x 4,8 sw	100	100	6,64
259632	HAU 262622	Kabelbinder 368 x 4,8 sw	100	100	8,67
259635	HAU 262632	Kabelbinder 380 x 7,6 sw	100	100	18,59
259637	HAU 262638	Kabelbinder 610 x 9,0 sw	50	100	29,11

Klebesockel für Kabelbinder

259586	HAU 262160	Klebesockel 19x19mm, bis 3,6 mm <i>NATUR</i>	100	100	11,71
259588	HAU 262162	Klebesockel 28x28mm, bis 4,8 mm, <i>NATUR</i>	100	100	14,01

Spiralband

478817	ELT SP4 88253407	4-20mm transparent	25	100	28,98
479233	ELT SP9 88916673	12-50mm transparent	25	100	52,38
479244	ELT SP15 88943079	15-80mm transparent	25	100	76,60
479242	ELT SPN4 88940200	4-20mm schwarz	25	100	28,98
479228	ELT SPN9 88913600	12-50mm schwarz	25	100	52,38
479241	ELT SPN15 88940104	15-80mm schwarz	25	100	76,60

Abbildung	Art. Nr.	Bezeichnung	VE	per	Brutto €
-----------	----------	-------------	----	-----	----------

M. SCHURRER & CO.
 Ges.m.b.H.

Kabelverschraubung *Kunststoff Perfect*

005991	JAC 50007PA	PG 7	100	100	68,90
005992	JAC 50009PA	PG 9	100	100	69,70
005993	JAC 50011PA	PG 11	100	100	85,32
005994	JAC 50013PA	PG 13,5	100	100	94,58
005995	JAC 50016PA	PG 16	50	100	103,76
005996	JAC 50021PA	PG 21	50	100	150,11
005997	JAC 50029PA	PG 29	25	100	287,67
005998	JAC 50036PA	PG 36	10	100	1.064,27

Kabelverschraubung *Metall metrisch*

011531	JAC 50612M	M12x1,5	100	100	200,53
011532	JAC 50616M	M16x1,5	100	100	222,16
007936	JAC 50620M	M20x1,5	100	100	289,01
008125	JAC 50625M	M25x1,5	50	100	507,16
008161	JAC 50632M	M32x1,5	25	100	875,28
008230	JAC 50640M	M40x1,5	10	100	1.231,32

Kabelverschraubung *Kunststoff metrisch*

002975	JAC 50612 PA7001	M12x1,5	100	100	65,24
011546	JAC 50616 PA7001	M16x1,5	100	100	75,50
011551	JAC 50620 PA7001	M20x1,5	100	100	101,80
011559	JAC 50625 PA7001	M25x1,5	100	100	154,45
011564	JAC 50632 PA7001	M32x1,5	25	100	304,70
011588	JAC 50640 PA7001	M40x1,5	10	100	663,05
003113	JAC 50650 PA7001	M50x1,5	5	100	1.552,30
005783	JAC 50663 PA7001	M63x1,5	5	100	2.114,52

Abbildung	Art. Nr.	Bezeichnung	VE per	Brutto €
-----------	----------	-------------	--------	----------

CELLPACK

Verbindungsmuffe



290695	CEL M0	4 x 6 6-15mm	1 1	19,50
290696	CEL M1	4 x 16 9-22mm	1 1	27,00
290709	CEL M2	4 x 25 17-30mm	1 1	42,00
290711	CEL M3	4 x 70 25-42mm	1 1	80,00
290649	CEL EG143	Giessharz 143ml G0	1 1	15,00
290652	CEL EG286	Giessharz 286ml G1	1 1	19,90
290654	CEL EG464	Giessharz 464ml G2	1 1	27,30

Verbindungsmuffe Typ: SMH 4



290863	CEL SMH41,5-6	4 x 1,5 - 4 x 6	1 1	8,50
290862	CEL SMH41,5-16	4 x 1,5 - 4 x 16	1 1	10,50
290871	CEL SMH46-25	4 x 6 - 4 x 25	1 1	12,50
290866	CEL SMH416-50	4 x 16 - 4 x 50	1 1	20,50
290869	CEL SMH425-95	4 x 25 - 4 x 95	1 1	29,00
290867	CEL SMH425-150	4 x 25 - 4 x 150	1 1	35,00
290876	CEL SMH495-300	4 x 95 - 4 x 300	1 1	49,00

Warmschrumpfschlauch in Abrollboxen



290776	CEL SB 2,4 - 1,2 SW	schwarz / 15m	1 1	18,00
290798	CEL SB 3,2 - 1,6 SW	schwarz / 15m	1 1	18,00
290806	CEL SB 4,8 - 2,4 SW	schwarz / 10m	1 1	18,00
290819	CEL SB 6,4 - 3,2 SW	schwarz / 10m	1 1	18,00
290833	CEL SB 9,5 - 4,8 SW	schwarz / 10m	1 1	18,00
290755	CEL SB 12,7-6,4 SW	schwarz / 8m	1 1	18,00
290769	CEL SB 19,1 - 9,5 SW	schwarz / 4m	1 1	18,00
290789	CEL SB 25,4-12,7SW	schwarz / 7m	1 1	18,00

Schrumpfschlauch mit Klebebeschichtung

L = Länge



461227	3M 43134221 MDT-A 12/3	12 - 3 mm / L = 1000mm	1 1	8,60
461228	3M 43134222 MDT-A 19/6	19 - 6 mm / L = 1000mm	1 1	11,20
461229	3M 43134223 MDT-A 27/8	27 - 8 mm / L = 1000mm	1 1	13,55
461230	3M 43134224 MDT-A 32/7,5	32 - 7,5 mm / L = 1000mm	1 1	14,40
461231	3M 43134225 MDT-A 38/12	38 - 12 mm / L = 1000mm	1 1	15,90
461232	3M 43134226 MDT-A 50/18	50 - 18 mm / L = 1000mm	1 1	23,05

Abbildung	Art. Nr.	Bezeichnung	VE per	Brutto €
-----------	----------	-------------	--------	----------



211360	MOE 276135	USTR331150W	1 1	443,91
Verteiler MUR " LEER " weiß				

019558	MOE ONST3 11503ZN	AP Verteiler komplett	1 1	741,01
Verteiler MUR " LEER " weiß OHNE RÜCKWAND! 770710548				

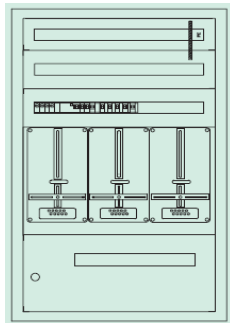

209156	MOE U-STR-3/1150-3Z-B-WX	260429	1 1	706,29
---------------	--------------------------	--------	-----	---------------

MUR Verteiler weiss, bestückt mit:

1 Stk	MOE PFIM404003XG	4 pol. 40 Amp. 30 MA
1 Stk	MOE SPC-S-3+1 Set	Übersp.ableiter 3+1
3 Stk	MOE PLSMB16	1 pol. 16 Amp.
2 Stk	MOE PLSMC161N	1 pol. 16 Amp. + NL.
3 Stk	MOE PLSMB131N	1 pol. 13 Amp. + NL.
1 Stk	MOE 7D763	Nulleiterdurchführung



212421	MOE U-STR3-3/1150-3Z-B-W/X	283444	1 1	1.118,14
---------------	----------------------------	--------	-----	-----------------

Mürz Verteiler MÜRZ weiss, bestückt mit:

1 Stk	MOE PFIM404003XG	4 pol. 40 Amp. 30 MA
1 Stk	MOE SPC-S-3+1 Set	Übersp. Ableiter-Set
1 Stk	MOE Z-FW-LP	Wiedereinschaltgerät
3 Stk	MOE PLSMB16	1 pol. 16 Amp.
2 Stk	MOE PLSMC161N	1 pol. 16 Amp. + NL.
3 Stk	MOE PLSMB131N	1 pol. 13 Amp. + NL.



Vollisolierter Zählerverteiler Steiermark

278547	ELS ST3C30AP	Aufputz-Verteiler	1 1	502,00
3-reihig, 3 Zählerplätze				

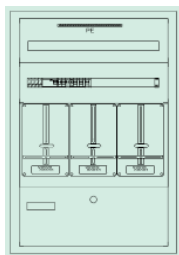

Burgenland-Verteiler

211355	MOE 276130	U-BR-3/3/1150W	1 1	521,63
Burgenland-Verteiler " LEER " weiß				



Abbildung	Art. Nr.	Bezeichnung	VE per	Brutto €
-----------	----------	-------------	--------	----------



Kleinverteiler UP - UPV VOLTA IP30 QuickConnect

131321	HAG	Alt: VU12BN Neu: VU12AT	1-reihig mit Tür 12 PLE	1 1	78,23
131324	HAG	Alt: VU24BN Neu: VU24AT	2-reihig mit Tür 24 PLE	1 1	100,75
131327	HAG	Alt: VU36BN Neu: VU36AT	3-reihig mit Tür 36 PLE	1 1	117,35
131331	HAG	Alt: VU48BN Neu: VU48AT	4-reihig mit Tür 48 PLE	1 1	152,91

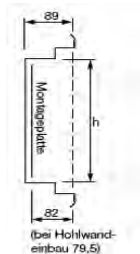
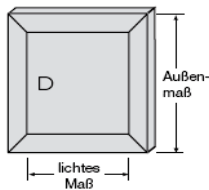

	1-reihig	2-reihig	3-reihig	4-reihig
Innenmaß h	245	370	495	620
Nischenmaße H x B x T flache Ausführung	317 x 330 x 90 317 x 330 x 72	442 x 330 x 90 442 x 330 x 72	567 x 330 x 90 567 x 330 x 72	692 x 330 x 90 692 x 330 x 72
Ausschnittmaße H x B x T Hohlwandeinbau flache Ausführung	307 x 312 x 88 307 x 312 x 72	432 x 312 x 88 432 x 312 x 72	557 x 312 x 88 552 x 312 x 72	682 x 312 x 88 682 x 312 x 72
Montageplattenmaße H x B x T	200 x 265 x 2,5	325 x 265 x 2,5	450 x 265 x 2,5	575 x 265 x 2,5

Blendrahmenmaße:	1-reihig	2-reihig	3-reihig	4-reihig
Außenmaß H x B	336 x 348	461 x 348	586 x 348	711 x 348
Lichtes Maß H x B	276 x 288	401 x 288	526 x 288	651 x 288

Blendrahmenhöhe: Standardausführung = 9 mm, flache Ausführung = 25 mm



Hohlwandverteiler - HWV VOLTA IP30 1x12PLE QuickConnect

131303	HAG	Alt: VH12BN Neu: VH12AT	1-reihig mit Tür 12 PLE	1 1	87,71
131306	HAG	Alt: VH24BN Neu: VH24AT	2-reihig mit Tür 24 PLE	1 1	105,49
131309	HAG	Alt: VH36BN Neu: VH36AT	3-reihig mit Tür 36 PLE	1 1	116,16
131313	HAG	Alt: VH48BN Neu: VH48AT	4-reihig mit Tür 48 PLE	1 1	164,76



Kleinverteiler AP - APV GAMMA, Österreich

128505	HAG	GD213D	2-reihig 26 PLE	1 1	48,50
128507	HAG	GD313D	3-reihig 39 PLE	1 1	61,84

Kleinverteiler AP - APV VOLTA IP30 QuickConnect

131279	HAG	VA12BN	1-reihig 12 PLE	1 1	34,37
131282	HAG	VA24BN	2-reihig 24 PLE	1 1	65,19
131285	HAG	VA36BN	3-reihig 36 PLE	1 1	84,16
131289	HAG	VA48BN	4-reihig 48 PLE	1 1	100,75

Maße in mm

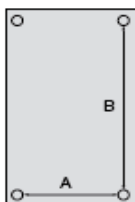

	1-reihig	2-reihig	3-reihig	4-reihig
Außenmaße H x B x T	245 x 305 x 96,5	370 x 305 x 96,5	515 x 305 x 96,5	640 x 305 x 96,5
Höhe oberer Anschlussraum	127,5	127,5	147,5	147,5
Höhe unterer Anschlussraum	112,5	112,5	112,5	112,5



131281	HAG	VA12T	Stahlblechtür f. VA12BN	1 1	14,40
131284	HAG	VA24T	Stahlblechtür f. VA24BN	1 1	17,90
131287	HAG	VA36T	Stahlblechtür f. VA36BN	1 1	22,10
131291	HAG	VA48T	Stahlblechtür f. VA48BN	1 1	26,60













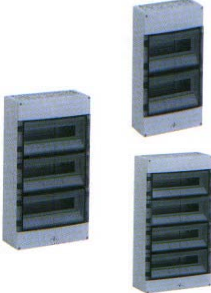

Abbildung	Art. Nr.	Bezeichnung	VE per	Brutto €
	Kleinverteiler AP - OPAL IP30 weiss mit Tür 			
	244048	SDR 10891	1-reihig 13 TE	1 1 39,84
	244049	SDR 10892	2-reihig 26 TE	1 1 51,92
	244050	SDR 10893	3-reihig 39 TE	1 1 66,40
	244051	SDR 10894	4-reihig 52 TE	1 1 88,14
	Miniverteiler AP 			
	128499	HAG GD 102N	2 PLE ohne Klemme 55x160	1 1 6,70
	128500	HAG GD 104N	4 PLE ohne Klemme 110x180	1 1 9,10
	128501	HAG GD 106N	6 PLE ohne Klemme 146x180	1 1 9,30
	128502	HAG GD 108N	8 PLE ohne Klemme 182 x180	1 1 10,40
	Kleinverteiler AP weiss 			
	312690	SPE AK 09 / 73540901	1r. / 9 TE, 200x200x122	1 100 3.762,98
	312686	SPE AK 12 / 73541201	1r. / 12 TE, 250x200x122	1 100 5.116,80
	312687	SPE AK 14 / 73541401	1r. / 14 TE, 300x300x142	1 100 6.619,86
	312691	SPE AK 28 / 73542801	2r. / 28 TE, 450x300x142	1 100 10.372,18
	312692	SPE AK 42 / 73544201	3r. / 42 TE, 600x300x142	1 100 14.284,40
	312693	SPE AK 56 / 73545601	4r. / 56 TE, 750x300x142	1 100 18.761,60
	Kleinverteiler Mini Pragma L / AP weiss ohne Tür 			
	244006	SDR 10227	1-reihig 12TE	1 1 31,35
	244007	SDR 10228	2-reihig 24TE	1 1 38,67
	244008	SDR 10229	3-reihig 36TE	1 1 52,25
	Kleinverteiler Mini Pragma L / UP weiss ohne Tür			
	244045	SDR 10676	1-reihig 12TE	1 1 43,68
	244046	SDR 10677	2-reihig 24TE	1 1 49,15
	244047	SDR 10678	3-reihig 36TE	1 1 70,99
	Türen f. Mini Pragma L / AP und UP weiss (RAL9003)			
	244039	SDR 10571	1-reihig	1 1 6,27
	244042	SDR 10580	2-reihig	1 1 8,36
	244043	SDR 10581	3-reihig	1 1 10,45
	Feuchtraum-Aufputz-Verteiler 			
	014258	GFI FR AP 1-reihig	610316 12 Module	1 1 59,70
	014259	GFI FR AP 2-reihig	610317 24 Module	1 1 80,70
	014260	GFI FR AP 3-reihig	610318 36 Module	1 1 108,00
	Unterputz-Kleinverteiler mit Stahlblechtür flach 			
	211056	MOE 275512	KLV-U 1-14F 14TE	1 1 77,71
	211057	MOE 275513	KLV-U 2-28F 28TE	1 1 100,45
	211058	MOE 275514	KLV-U 3-42F 42TE	1 1 117,07
	211059	MOE 275515	KLV-U 4-56F 56TE	1 1 156,43
	211105	MOE 275650	KLV-U-HWBFS	1 1 9,73





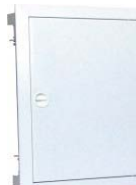



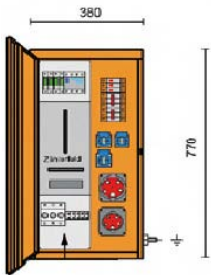

Abbildung	Art. Nr.	Bezeichnung	VE per	Brutto €
	266654	PCE 690002454	1	1.123,12
	266655	PCE 690006342	1	1.224,20
	266662	PCE 7570010185	1	90,40
	265192	PCE 690008518	1	2.316,40
	266658	PCE 69010637	1	2.749,66
	003584	DIE EVM0251EE1SK Baustromverteiler 12 2 x Kraft 1 x Schuko ohne Gestell	1	825,00
	215444	DIE 035543 Untergestell BSV-Zwerg	1	5.233,00

Abbildung	Art. Nr.	Bezeichnung	VE	per	Brutto €
	462604	SIC EZII Sicherungssockel DII 25A 500V 1p	15	100	348,40
	462606	SIC EZIII Sicherungssockel DIII 63A 500V 1p	15	100	558,10
	462516	SIC Abd. 40x90 Sich. sockel DII 1p EZII	30	100	93,60
	462518	SIC Abd. 50x90 Sich. sockel DIII 1p EZIII	30	100	114,40
	462602	SIC KII Schraubkappe Porzellan DII 25A	50	100	84,30
	462603	SIC KIII Schraubkappe Porzellan DIII 63A	30	100	116,80

DZ Sicherungseinsatz DII + DIII 500V gG

	462531	SIC GL6A Schmelzeinsatz 6 A	25	100	63,90
	462522	SIC GL10A Schmelzeinsatz 10 A	25	100	44,30
	462523	SIC GL16A Schmelzeinsatz 16 A	25	100	44,30
	462524	SIC GL20A Schmelzeinsatz 20 A	25	100	51,00
	462525	SIC GL25A Schmelzeinsatz 25 A	25	100	51,00
	462527	SIC GL35A Schmelzeinsatz 35 A	25	100	84,30
	462529	SIC GL50A Schmelzeinsatz 50 A	25	100	91,90
	462530	SIC GL63A Schmelzeinsatz 63 A	25	100	91,90
		SIC PH6A - 50A Passhülse Neozed	50	100	47,60
	462598	SIC PS6A Passschraube 6 A	25	100	44,30
	462589	SIC PS10A Passschraube 10 A	25	100	44,30
	462590	SIC PS16A Passschraube 16 A	25	100	44,30
	462591	SIC PS20A Passschraube 20 A	25	100	44,30
	462592	SIC PS25A Passschraube 25 A	25	100	44,30
	462594	SIC PS35A Passschraube 35 A	25	100	89,80
	462596	SIC PS50A Passschraube 50 A	25	100	89,80
	462597	SIC PS63A Passschraube 63 A	25	100	89,80

Neozedpatrone





	462549	SIC NEO6A D01 6A	10	100	73,50
	462534	SIC NEO10A D01 10A	10	100	54,10
	462538	SIC NEO16A D01 16A	10	100	54,10
	462539	SIC NEO20A D02 20A	10	100	68,10
	462540	SIC NEO25A D02 25A	10	100	68,10
	462543	SIC NEO35A D02 35A	10	100	96,30
	462545	SIC NEO50A D02 50A	10	100	96,30
	462548	SIC NEO63A D02 63A	10	100	96,30
	462537	SIC NEO 16A Schraubkappe Porz. D01 HGR	20	100	98,40
	462546	SIC NEO 63A Schraubkappe Kst. D02 DGR	20	100	103,00
	462554	SIC SN2-1K NEO Sich. sockel D02 63A 1p	15	100	503,40
	462555	SIC SN1-3K NEO Sich. sockel D01 16A 3p	5	100	978,60
	462556	SIC SN2-3K NEO Sich. sockel D02 63A 3p	5	100	1.280,20
		SIC NH Gr. 00 / 10A, 16A, 20A, 25A, 32A, 35A, 50A, 63A, 80A	3	1	3,77
		SIC NH Gr. 00 / 100A, 125A	3	1	3,77
		SIC NH Gr. 1 / 50, 63, 80, 100, 125, 160A	3	1	7,81
		SIC NH Gr. 1 / 200A und 250A	3	1	12,72
		SIC NH Gr. 2 / 50A, 63A, 80A, 100A, 125A,	3	1	9,41
		SIC NH Gr. 2 / 160A, 200A, 250A	3	1	9,41
		SIC NH Gr. 2 / 300A, 315A, 355A, 400A	3	1	21,37

Abbildung	Art. Nr.	Bezeichnung	VE per	Brutto €
-----------	----------	-------------	--------	----------

LS-Schalter 1polig

003528	AEG	566743	EP101B13	13 Amp. B 10 kA	12	1	18,90
003545	AEG	566744	EP101B16	16 Amp. B 10 kA	12	1	17,90
003509	AEG	566756	EP101C6	6 Amp. C 10 kA	12	1	34,20
003510	AEG	566757	EP101C10	10 Amp. C 10 kA	12	1	29,50
003516	AEG	566758	EP101C13	13 Amp. C 10 kA	12	1	29,50
003517	AEG	566759	EP101C16	16 Amp. C 10 kA	12	1	29,50
003518	AEG	566760	EP101C20	20 Amp. C 10 kA	12	1	29,50
003520	AEG	566761	EP101C25	25 Amp. C 10 kA	12	1	33,80
003522	AEG	566762	EP101C32	32 Amp. C 10 kA	12	1	34,20

LS-Schalter 1polig + N

003857	AEG	566903	EP101B13N	13 Amp. B 10 kA	6	1	44,50
003858	AEG	566904	EP101B16N	16 Amp. B 10 kA	6	1	43,50
003546	AEG	566916	EP101C6N	6 Amp. + NL C 10 kA	6	1	60,00
003547	AEG	566917	EP101C10N	10 Amp. + NL C 10 kA	6	1	55,20
003548	AEG	566918	EP101C13N	13 Amp. + NL C 10 kA	6	1	55,20
003549	AEG	566919	EP101C16N	16 Amp. + NL C 10 kA	6	1	55,20
003553	AEG	566920	EP101C20N	20 Amp. + NL C 10 kA	6	1	55,20

LS-Schalter 3polig → LS-Schalter **B-Charakteristik zu den selben Preisen erhältlich!**

003614	AEG	566838	EP103C13	13 Amp. C 10 kA	4	1	107,00
003704	AEG	566839	EP103C16	16 Amp. C 10 kA	4	1	107,00
003739	AEG	566840	EP103C20	20 Amp. C 10 kA	4	1	107,00
003740	AEG	566841	EP103C25	25 Amp. C 10 kA	4	1	120,00
003782	AEG	566842	EP103C32	32 Amp. C 10 kA	4	1	121,00

LS-Schalter 3polig+N → LS-Schalter **B-Charakteristik zu den selben Preisen erhältlich!**

003783	AEG	566958	EP103C13N	13 Amp. + NL C 10 kA	3	1	135,00
003794	AEG	566959	EP103C16N	16 Amp. + NL C 10 kA	3	1	135,00
003814	AEG	566960	EP103C20N	20 Amp. + NL C 10 kA	3	1	135,00
008080	AEG	566961	EP103C25N	25 Amp. + NL C 10 kA	3	1	135,00
002863	AEG	566962	EP103C32N	32 Amp. + NL C 10 kA	3	1	135,00

LS-Schalter 1polig + N / 1TE = 17,5mm

003217	AEG	692758	EPC61NB16	1 TE 6KA B16+N	12	1	27,30
006726	AEG	692796	EPC61NC16	1 TE 6KA C16+N	12	1	37,10

Abbildung	Art. Nr.	Bezeichnung	VE per	Brutto €
-----------	----------	-------------	--------	----------

LS-Schalter 1polig

207758	MOE	244704	PLSMB10	10 Amp. B	12	1	25,59
207759	MOE	244706	PLSMB13	13 Amp. B	12	1	12,11
207760	MOE	244708	PLSMB16	16 Amp. B	12	1	12,11
207773	MOE	244730	PLSMC10	10 Amp. C	12	1	27,92
207774	MOE	244732	PLSMC13	13 Amp. C	12	1	14,20
207775	MOE	244734	PLSMC16	16 Amp. C	12	1	14,20
207776	MOE	244735	PLSMC20	20 Amp. C	12	1	30,42
207777	MOE	244736	PLSMC25	25 Amp. C	12	1	31,33

LS-Schalter 1polig + N

207796	MOE	244773	PLSMB101N	10 Amp. + NL. B	8	1	39,68
207797	MOE	244775	PLSMB131N	13 Amp. + NL. B	8	1	23,44
207798	MOE	244777	PLSMB161N	16 Amp. + NL. B	8	1	23,44
207807	MOE	244796	PLSMC101N	10 Amp. + NL. C	8	1	43,57
207808	MOE	244798	PLSMC131N	13 Amp. + NL. C	8	1	26,44
207809	MOE	244800	PLSMC161N	16 Amp. + NL. C	8	1	26,44

LS-Schalter 3polig

207879	MOE	244974	PLSMB133	13 Amp. B	1	1	60,55
207880	MOE	244976	PLSMB163	16 Amp. B	1	1	60,55
207893	MOE	245000	PLSMC133	13 Amp. C	1	1	67,05
207894	MOE	245002	PLSMC163	16 Amp. C	1	1	67,05
207895	MOE	245003	PLSMC203	20 Amp. C	1	1	113,43
207896	MOE	245004	PLSMC253	25 Amp. C	1	1	118,76

LS-Schalter 3polig + N

207915	MOE	245043	PLSMB133N	13 Amp. + NL. B	1	1	75,14
207916	MOE	245045	PLSMB163N	16 Amp. + NL. B	1	1	75,14
207929	MOE	245069	PLSMC133N	13 Amp. + NL. C	1	1	83,44
207930	MOE	245071	PLSMC163N	16 Amp. + NL. C	1	1	83,44
207931	MOE	245072	PLSMC203N	20 Amp. + NL. C	1	1	138,11
207932	MOE	245073	PLSMC253N	25 Amp. + NL. C	1	1	144,27

Abbildung	Art. Nr.	Bezeichnung	VE	per	Brutto €
-----------	----------	-------------	----	-----	----------

LS-Schalter 1polig



129575	HAG MBN 113	1 pol. 13 Amp.B	12	1	11,84
129576	HAG MBN 116	1 pol. 16 Amp.B	12	1	11,84
129681	HAG MCN 113	1 pol. 13 Amp.C	12	1	13,88
129682	HAG MCN 116	1 pol. 16 Amp.C	12	1	13,88

LS-Schalter 1polig + N



129615	HAG MBN 513	1 pol. 13 Amp. + NL.B	6	1	22,96
129616	HAG MBN 516	1 pol. 16 Amp. + NL.B	6	1	22,96
129741	HAG MCN 513	1 pol. 13 Amp. + NL.C	6	1	25,92
129742	HAG MCN 516	1 pol. 16 Amp. + NL.C	6	1	25,92

LS-Schalter 3polig



129711	HAG MCN 313	3 pol. 13 Amp.C	4	1	65,84
129712	HAG MCN 316	3 pol. 16 Amp.C	4	1	65,84
129713	HAG MCN 320	3 pol. 20 Amp.C	4	1	63,97
129714	HAG MCN 325	3 pol. 25 Amp.C	4	1	71,66
129715	HAG MCN 332	3 pol. 32 Amp.C	4	1	83,17

LS-Schalter 3polig + N



129756	HAG MCN 613	3 pol. 13 Amp. + NL.C	3	1	81,90
129757	HAG MCN 616	3 pol. 16 Amp. + NL.C	3	1	81,90
129758	HAG MCN 620	3 pol. 20 Amp. + NL.C	3	1	83,17
129759	HAG MCN 625	3 pol. 25 Amp. + NL.C	3	1	89,57

LS-Schalter 2polig (1TE = 17,5mm)



129807	HAG MKN 513	1 pol. 13 Amp. + NL.B	12	1	24,82
129808	HAG MKN 516	1 pol. 16 Amp. + NL.B	12	1	24,82
129819	HAG MLN 513	1 pol. 13 Amp. + NL.C	12	1	28,02
129820	HAG MLN 516	1 pol. 16 Amp. + NL.C	12	1	28,02

Abbildung	Art. Nr.	Bezeichnung	VE per	Brutto €
-----------	----------	-------------	--------	----------

LS-Schalter 1polig

423459	LEG 006859	LS 10 C 1pol. 13A	1 100	1.165,80
423460	LEG 006860	LS 10 C 1pol. 16A	1 100	1.189,70
423461	LEG 006861	LS 10 C 1pol. 20A	1 100	2.299,30

LS-Schalter 1polig + N

423468	LEG 006898	LS 10 C 1pol. + N 10A	1 100	3.816,20
423469	LEG 006899	LS 10 C 1pol. + N 13A	1 100	1.743,40
423470	LEG 006900	LS 10 C 1pol. + N 16A	1 100	1.743,40
423471	LEG 006901	LS 10 C 1pol. + N 20A	1 100	3.504,50

LS-Schalter 3polig

423499	LEG 006939	LS 10 C 3pol. 13A	1 100	5.807,00
423500	LEG 006940	LS 10 C 3pol. 16A	1 100	5.757,10
423501	LEG 006941	LS 10 C 3pol. 20A	1 100	8.834,60
423502	LEG 006942	LS 10 C 3pol. 25A	1 100	9.131,80

LS-Schalter 3polig + N

423509	LEG 006979	LS 10 C 3pol. + N 13A	1 100	6.788,80
423510	LEG 006980	LS 10 C 3pol. + N 16A	1 100	6.730,60
423511	LEG 006981	LS 10 C 3pol. + N 20A	1 100	8.050,20
423512	LEG 006982	LS 10 C 3pol. + N 25A	1 100	9.824,80

Abbildung	Art. Nr.	Bezeichnung	VE	per	Brutto €
-----------	----------	-------------	----	-----	----------

AEG



003815	AEG 604202	FI40/0,03-2	2 pol	40 Amp.	30 mA	1	1	70,00
003818	AEG 604208	FI40/0,03-4	4 pol	40 Amp.	30 mA	1	1	79,20
003834	AEG 604210	FI63/0,03-4	4 pol	63 Amp.	30 mA	1	1	261,00



003836	AEG 604335	FIC40/0,1-4F	4 pol	40 Amp.	100 mA	1	1	138,00
---------------	------------	---------------------	-------	---------	--------	---	---	---------------

F= thermisch absicherbar



003837	AEG 604121	FPS440/100	4 pol	40 Amp.	100mA	S	1	1	151,00
003842	AEG 604122	FPS440/300	4 pol	40 Amp.	300 mA	S	1	1	151,00
003841	AEG 604125	FPS463/100	4 pol	63 Amp.	100 mA	S	1	1	179,00
003832	AEG 604325	FIG40/0,03-4F	4 pol	40 Amp.	30 mA	G	1	1	255,00
003835	AEG 604327	FIG63/0,03-4F	4 pol	63 Amp.	30 mA	G	1	1	282,00

011968	AEG 608983	LSFIC13/0,03	FI LS	13A	0,03A	6KA	1	1	118,00
006200	AEG 608984	LSFIC16/0,03	FI LS	16A	0,03A	6KA	1	1	118,00

hager

NEU ALT

127080	HAG CDC240D	CD240A	2 pol	40 A.	0,03 A		1	1	126,61
---------------	-------------	--------	-------	-------	--------	--	---	---	---------------



127082	HAG CDC440Y	CD441A	4 pol	40 A.	0,03 A		1	1	131,15
---------------	-------------	--------	-------	-------	--------	--	---	---	---------------

127101	HAG CEC440D	CE440A	4 pol	40 A.	0,1 A		1	1	126,61
---------------	-------------	--------	-------	-------	-------	--	---	---	---------------

127129	HAG CJG441D	CJ441A	4 pol	40 A.	0,03 A G		1	1	159,94
---------------	-------------	--------	-------	-------	----------	--	---	---	---------------



127135	HAG CNA440D	CP440A	4 pol	40 A.	0,1 A S		1	1	217,46
---------------	-------------	--------	-------	-------	---------	--	---	---	---------------

127131	HAG CJG463D	CJ463A	4 pol	63 A.	0,03 A G		1	1	185,54
---------------	-------------	--------	-------	-------	----------	--	---	---	---------------



127024	HAG ADA963D	AD036C	FI / LS	13 Amp.	C 0,03A		1	1	164,03
---------------	-------------	--------	---------	---------	---------	--	---	---	---------------

legrand



423677	LEG 008994	FI 4pol.	40A	30mA			1	100	11.414,50
---------------	------------	----------	-----	------	--	--	---	-----	------------------

423678	LEG 008995	FI 4pol.	63A	30mA			1	100	17.669,20
---------------	------------	----------	-----	------	--	--	---	-----	------------------

423681	LEG 009000	FI 4pol.	40A	100mA			1	100	9.951,50
---------------	------------	----------	-----	-------	--	--	---	-----	-----------------

423683	LEG 009001	FI 4pol.	63A	100mA			1	100	14.889,90
---------------	------------	----------	-----	-------	--	--	---	-----	------------------

423687	LEG 009006	FI-S 4pol.	40A	100mA			1	100	21.272,50
---------------	------------	------------	-----	-------	--	--	---	-----	------------------

423701	LEG 009045	FI-G 4pol.	40A	30mA			1	100	13.896,60
---------------	------------	------------	-----	------	--	--	---	-----	------------------

423702	LEG 009046	FI-G 4pol.	63A	30mA			1	100	21.409,60
---------------	------------	------------	-----	------	--	--	---	-----	------------------



Abbildung	Art. Nr.	Bezeichnung	VE per	Brutto €
	206918	MOE 235569 PFIM40201	2 pol. 40 Amp. 100 mA / bedingt stoßstromfest	1 1 115,03
	206917	MOE 235568 PFIM402003	2 pol. 40 Amp. 30 mA / bedingt stoßstromfest	1 1 125,14
	206968	MOE 235625 PFIM402003G	2 pol. 40 Amp. 30 mA / stoßstromfest G-Typ	1 1 165,35
	206931	MOE 235584 PFIM404003	4 pol. 40 Amp. 30 mA / bedingt stoßstromfest	1 1 140,61
	206932	MOE 235585 PFIM40401	4 pol. 40 Amp. 100 mA / bedingt stoßstromfest	1 1 128,91
	206980	MOE 235641 PFIM40401SA	4 pol. 40 Amp. 100 mA / selektiv + stoßstromfest 5kA, pulsstromsensitiv, Typ S/A	1 1 276,34
	206970	MOE 235627 PFIM404003G	4 pol. 40 Amp. 30 mA / stoßstromfest G-Typ	1 1 177,07
	206972	MOE 235629 PFIM40401G	4 pol. 40 Amp. 100 mA / stoßstromfest G-Typ	1 1 210,49
	206935	MOE 235588 PFIM634003	4 pol. 63 Amp. 30 mA / bedingt stoßstromfest	1 1 350,56
	206936	MOE 235589 PFIM63401	4 pol. 63 Amp. 100 mA / bedingt stoßstromfest	1 1 277,81
	206973	MOE 235630 PFIM634003G	4 pol. 63 Amp. 30 mA / stoßstromfest G-Typ	1 1 425,94
	206982	MOE 235645 PFIM63401SA	4 pol. 63 Amp. 100 mA / selektiv + stoßstromfest 5kA, pulsstromsensitiv, Typ S/A	1 1 403,86
		206986	MOE 235737 PFIM404003X	4 pol. 40 Amp. 30 mA / bedingt stoßstromfest 250A
206987		MOE 235738 PFIM40401X	4 pol. 40 Amp. 100 mA / bedingt stoßstromfest 250A	1 1 218,17
206989		MOE 235740 PFIM40401XSA	4 pol. 40 Amp. 100 mA / selektiv + stoßstromfest 5kA, pulsstromsensitiv, Typ S/A	1 1 315,25
206991		MOE 235742 PFIM404003XG	4 pol. 40 Amp. 30 mA / stoßstromfest G-Typ	1 1 315,74
207010		MOE 235875 PFHM404003G	4 pol. 40 Amp. 30 mA / stoßstromfest G-Typ	1 1 327,12
207011		MOE 235876 PFHM634003G	4 pol. 63 Amp. 30 mA / stoßstromfest G-Typ	1 1 506,86
	207014	MOE 235879 PFHM40401S	4 pol. 40 Amp. 100 mA / selektiv + stoßstromfest 5kA, Typ S	1 1 326,83
	207016	MOE 235881 PFHM63401S	4 pol. 63 Amp. 100 mA / selektiv + stoßstromfest 5kA, Typ S	1 1 449,10
	207360	MOE 238696 PKNM131NB003	FI-LS 13 Amp. 1+Npolig / bedingt stoßstromfest Typ AC	1 1 158,55
	207380	MOE 238768 PKNM161NB003	FI-LS 16 Amp. 1+Npolig / bedingt stoßstromfest Typ AC	1 1 158,55
	207370	MOE 238708 PKNM131NC003	FI-LS 13 Amp. 1+Npolig / bedingt stoßstromfest Typ AC	1 1 173,81
	207390	MOE 238780 PKNM161NC003	FI-LS 16 Amp. 1+Npolig / bedingt stoßstromfest Typ AC	1 1 173,81
	207377	MOE 238717 PKNM131NC003G	FI-LS 13 Amp. 1+Npolig / stoßstromfest	1 1 195,42
	207397	MOE 238789 PKNM161NC003G	FI-LS 16 Amp. 1+Npolig / stoßstromfest	1 1 195,42













Abbildung	Art. Nr.	Bezeichnung	VE per	Brutto €
Überspannungsableiter steckbar 335VAC				
	208137	MOE 248176 SPC-S-20/335/1	1pol. 1x20kA 12 1	56,80
	208139	MOE 248178 SPC-S-20/335/3	3pol. 3x20kA 1 1	170,41
	208140	MOE 248179 SPC-S-20/335/4	4pol. 4x20kA 12 1	227,21
	208155	MOE 248194 SPCS 3+1 Set Ableiterklasse C	1 1	262,15
	208154	MOE 248193 SPCS 3+1 ohne Verschienung 3pol. + 1pol.	1 1	241,30
	205473	MOE 105195 SPB- 3+1 Ableiterklasse B+C TN-S/TT-Set 3+1pol.	1 1	485,97
	373734	OBO 5094618 Übersp. Ableiter 1pol. V20-C/1-280 gem. ÖVE/ÖNORM E8001-1§18	1 1	48,70
	373736	OBO 5094624 Übersp. Ableiter 3pol. V20-C/3-280 gem. ÖVE/ÖNORM E8001-1§18	1 1	139,40
	373747	OBO 5094656 Übersp. Ableiter 3pol.+N V20-C/3+NPE gem. ÖVE/ÖNORM E8001-1§18	1 1	183,90
	373701	OBO 5093627 Kombi-Ableiter 3pol. V 50-B+C/3 gem. ÖVE/ÖNORM E8001-1§18	1 1	282,95
	373703	OBO 5093654 Kombi-Ableiter 3pol.+N V50-B+C/3+NPE gem. ÖVE/ÖNORM E8001-1§18	1 1	373,80
	208099	MOE PLHTC20V 248102 Leitungsschutzsch. 20A	12 1	68,47
	208100	MOE PLHTC25V 248103 Leitungsschutzsch. 25A	12 1	68,47
	208101	MOE PLHTC32V 248104 Leitungsschutzsch. 32A	12 1	72,17
	208102	MOE PLHTC40V 248105 Leitungsschutzsch. 40A	12 1	74,18
	208103	MOE PLHTC50V 248106 Leitungsschutzsch. 50A	12 1	83,55
	208104	MOE PLHTC63V 248107 Leitungsschutzsch. 63A	12 1	85,98
	212892	MOE LHSPA 750853401 Ausschaltsperr	1 100	245,00
	212891	MOE LHSPE 750853301 Einschaltsperr	1 100	245,00
				
	245018	MERLIN 18903 C120B Leitungsschutzsch. 20A	12 1	42,97
	245019	MERLIN 18904 C120B Leitungsschutzsch. 25A	12 1	48,74
	245020	MERLIN 18905 C120B Leitungsschutzsch. 32A	12 1	56,22
	245021	MERLIN 18906 C120B Leitungsschutzsch. 40A	12 1	63,73
	245022	MERLIN 18907 C120B Leitungsschutzsch. 50A	12 1	75,00
	245023	MERLIN 18908 C120B Leitungsschutzsch. 63A	12 1	85,39
	246220	MERLIN 60704 C120B Bestätigungssperrkappe	12 100	402,00

Abbildung	Art. Nr.	Bezeichnung	VE per	Brutto €
<div style="display: flex; justify-content: space-around; align-items: center;"> <div style="text-align: center;">  </div> <div style="text-align: center;">  </div> <div style="text-align: center;">  </div> </div>				
	209267	MOE 263942 ZVL1N/36	Anschlußwinkel	36 1 0,85
	209270	MOE 263945 ZVL2L3/36	Anschlußwinkel	36 1 0,85
	209273	MOE 263948 ZVN1,5TE/36	Anschlußwinkel	36 1 0,85
	209281	MOE 263956 ZVSS	Sammelschiene 1m	1 1 7,36
	209283	MOE 263958 ZVADP	Abdeckung 1m	1 1 7,72
	210998	MOE 275410 AP45	Abd. Vorzählerteil 45mm	2 1 7,26
	211000	MOE 275413 NBP1000	Blindstreifen 45 mm	1 1 2,12
	003161	POL 1320401 NBP1000	Blindstreifen 45 mm	1 1 5,10
	208205	MOE 248267 ZD63	Nulleiterdurchführung	1 1 7,49
		209924	MOE 271060 ZGV10/3P3TE	Verschiebung
209928		MOE 271064 ZGV16/3P3TE	Verschiebung	1 1 70,90
	006433	AEG N10EP	Nulleiterschiene 10 A f. 1m verdr. für AEG Serie EP	1 1 22,50
	006409	AEG 3LP10EP	Sammelsch. 3pol. f. 1m verdr. für AEG Serie EP	1 1 44,70
	000054	AEG EP	Endkappe	1 1 0,54
	129024	HAG KDR463B	Phasenschiene 4polig 56 Mod.	1 1 64,17
	129231	HAG KZN024	Endkappe f. KDR463B 4polig	1 1 0,55

Abbildung	Art. Nr.	Bezeichnung	VE per	Brutto €
-----------	----------	-------------	--------	----------

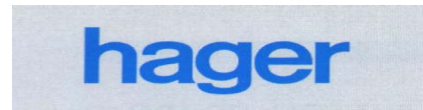

125271	BUJ P1W16 400V	Pumpenschutz FR Geh.	1 1	82,00
125356	BUJ R2540 230V	Heizungsschutz 25A 4p.	6 1	33,18
125367	BUJ R4040 230V	Heizungsschutz 40A 4p.	6 1	68,70
125346	BUJ R2020 230V	Heizungsschutz 20A 2p.	6 1	27,09
127292	HAG ES220	Schütz 25 A. 2S o. Umschalter	12 1	41,20
127293	HAG ES220A	Schütz 25 A. 2S m. Umschalter	12 1	41,16
127305	HAG ES420	Schütz 25 A. 4S o. Umschalter	6 1	49,30
127309	HAG ES440	Schütz 40 A. 4S o. Umschalter	1 1	101,60
127314	HAG ES463	Schütz 63 A. 4S o. Umschalter	1 1	130,60
247255	TEL GC2520M5	Inst.schütz 25A 2S 230/240V	1 1	24,28
247263	TEL GC2540M5	Inst.schütz 25A 4S 230/240V	1 1	24,93
247274	TEL GC4040M5	Inst.schütz 40A 4S 220/230V	1 1	59,27

Motorschutzschalter

Art. Nr. AEG











007853	AEG MBS25	0,25 - 0,4A	254180	1	51,60
005977	AEG MBS25	0,4 - 0,63A	254189	1	54,90
000058	AEG MBS25	0,63 - 1A	254198	1	61,70
000059	AEG MBS25	1 - 1,6A	254209	1	61,70
000061	AEG MBS25	1,6 - 2,5A	254220	1	61,70
000062	AEG MBS25	2,5 - 4A	254231	1	61,70
000063	AEG MBS25	4 - 6,3A	254244	1	61,70
005978	AEG MBS25	6,3 - 10A	254256	1	71,80
000060	AEG MBS25	10 - 16A	254266	1	71,80
012198	AEG MBS25	16 - 20A	254275	1	77,60
010004	AEG MBS25	20 - 25A	254282	1	92,20
008375	AEG IIP55	Motorschutz-Gehäuse	254435	1	14,30

Sehr geehrte Kunden!

Da sich bei vielen Produkten Preise täglich ändern, sind unsere Preise als Richtpreise anzusehen und wir behalten uns Preisänderungen vor.

Raumthermostat NH-Trenner Zählertafel Moeller Sicherungseinsatz

Abbildung	Art. Nr.	Bezeichnung	VE	per	Brutto €
	315178 THE 7050001	Raumthermostat 1 Öffner, 230VAC/50Hz mit Netz-Ein/Aus-Schalter, IP30, 5-30°C RAL9010	1	1	29,45
	315174 THE 7010001	Raumthermostat 1 Öffner, 230VAC/50Hz, IP30, 5-30°C RAL9010	1	1	24,72
	315175 THE 7020001	Raumthermostat 1 Öffner, mit Nachtabsenkung, 230VAC/50Hz, IP30, 5-30°C RAL9010	1	1	28,92
	007199 ABB 1SEP201428R0001	NH-Trenner 000 100A	1	1	41,90
	007210 ABB 1SEP101890R0002	NH-Trenner 000 160A	1	1	51,10
	006149 SCH DSTZ380/40R	Drehstromz. 40A 201040S	1	1	53,00
	033933 B&W DVH3113	Zähler 3PH dir. 65A EC310	1	1	417,00
	006155 SCH WSTZ220/40R	Wechselstromz.40A 101040S	1	1	14,10
	015514 ULB 2394	Zählertafel grau	1	1	19,50
	022348 ULB 2395	Zählertafel schwarz	1	1	20,10
	208176 MOE ZSLSNEOZ3 248234	Lasttrennsch. 3pol. 63A	1	1	59,23

Sicherungseinsatz



	209879 MOE ZSLSB20 268989	20A 1VE = 3Stk.	1	1	22,54
	209880 MOE ZSLSB25 268990	25A 1VE = 3Stk.	1	1	22,54
	209881 MOE ZSLSB35 268991	35A 1VE = 3Stk.	1	1	22,54
	209882 MOE ZSLSB50 268992	50A 1VE = 3Stk.	1	1	22,54
	209883 MOE ZSLSB63 268993	63A 1VE = 3Stk.	1	1	22,54
	006389 AEG LD023 544333	Sicherungslasttrennsch. 3pol. 63A / durch einlegen in Schubladensystem	4	1	86,30
	462514 HGM 4863063	Sichlastsch. 3pol. 63A	1	1	77,18

Abbildung	Art. Nr.	Bezeichnung	VE per	Brutto €
Treppenlichtautomat				
	003851 AEG 666518	PLTSE(F) Treppenlichtaut. elektronisch	12 1	43,50
	014624 AEG 666212	PLS16 1051 Stromstosschalter 230V VE	12 1	28,10
	127258 HAG	EPN510 Fernschalter 1S 16A 230V	12 1	24,90
	130189 HAG	SN016 Schukosteckdose 16A 250V VE	4 1	17,70
	127243 HAG	EMN001 Treppenlichtzeitsch. 1PLE	6 1	37,50
	130127 HAG	SB116 Ausschalter 1 x 16A	12 1	13,40
	205152 MOE	101064 Treppenlichtzeitschalter TLE	12 1	48,13
	209510 MOE	266875 Schukosteckdose VE ZSD230	4 1	13,22
	209415 MOE	265262 Stromstoßschalter VE ZS230S	12 1	25,67
	422829 LEG	003701 Rex 800 EM Plus Stand.- Treppenlicht-Zeitschalter 0,5-10Min.	1 100	2.618,00
	423044 LEG	004707 Rex 800 Plus Treppenlicht- Zeitschalter 0,5-12 Min. m. Vorwarnfunktion + Nulldurchgangsschaltung, autom. 3/4-Leiter-Anschlusskennung	1 100	3.846,70
	423043 LEG	004704 Rex 800 Multi wie 004707 zusätzl. sep. Steuerungseing. 8-230V AC/DC u. Multifunktional	10 100	4.522,10
	422860 LEG	004015 Fernschalter Lexic 1-pol. 16A 230V	10 100	2.431,50
	425260 LEG	049843 LuxoRex Dämmerungsschalter AP stufenlos einstellb. 5-1000Lux 230V	1 100	7.943,00
	425221 LEG	049107 Stromstoßschalter 1pol. Doseneinbau	10 100	2.126,30
	425223 LEG	049230 Duftyrex elektron. Nachlaufrelais 3/6/12min. 230V Doseneinb.	10 100	4.072,20
	244256 SCG	15213 Klingeltrafo 8-12V VE	6 1	35,46
	299005 MAI	225800 Nachlaufrelais 220-240V 8-14min	1 1	15,26
	298891 MAI	VZ6 Nachlaufrelais 6min	1 1	35,20
	298892 MAI	VZ12 Nachlaufrelais 12min	1 1	35,20
	298893 MAI	VZ24C Nachlaufrelais 1,5-24min	1 1	47,30

Sehr geehrte Kunden!

Da sich bei vielen Produkten Preise täglich ändern, sind unsere Preise als Richtpreise anzusehen und wir behalten uns Preisänderungen vor.

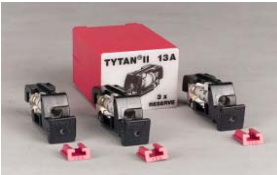
Abbildung	Art. Nr.	Bezeichnung	VE per	Brutto €
-----------	----------	-------------	--------	----------

Dämmerungsschalter Verteilereinbau



315330	THE LUNA 112	mit separatem Lichtfühler 2 Helligkeitsbereiche 2-35Lux, 35-2000Lux ca. 80Sek. Ein-/Ausschaltverzögerung	1 1	136,84
315025	THE LUNA 110	VE m. sep. Lichtfühler	1 1	115,59
315037	THE LUNA 126	max.1000W	1 1	41,28
315038	THE LUNA 127	max.2300W mit einstellbarer Ein-/Ausschaltverzögerung	1 1	58,85

Treppenlicht Zeitschalter



315005	THE ELPA 8	45 x 17,5 x 60mm 1-7 MIN, 3- u. 4-Leiteranschluß, max. 2300W für Glühlampe oder Halogenlast	1 1	33,08
315004	THE ELPA 6	0,5-20 MIN, 3 u. 4 Leiteranschluß, max. 3600W, für Glühlampe oder Halogenlast	1 1	35,18

Dämmerungsschalter



117021	MER 544829	Dämmerungsschalter bis 2300VA/Halogen bis 2000W, Bereich 3-2000Lux (ohne Schaltverzögerung)	1 1	62,00
117023	MER 544894	Dämmerungsschalter bis 2300VA/Halogen bis 2000W, Bereich 3-2000Lux (mit Schaltverzögerung)	1 1	70,11
470593	REV 2591	Tages-Zeitschaltuhr	1 1	7,50
470595	REV 2594	digitale Zeitschaltuhr Tag/Wo.progr.	1 1	17,70

Abbildung	Art. Nr.	Bezeichnung	VE	per	Brutto €
-----------	----------	-------------	----	-----	----------

Steckreiter-Schaltuhren



SYN 168 h/SUL 188 h

315055	THE SYN 168 H	24 Std. / 15 Min. / 30 Min.	1	1	39,44
315066	THE SUL 188 H	24 Std. mit Gangreserve	1	1	83,09
315068	THE SUL 188 HW	24 Std. / 7 Tage mit Gangreserve	1	1	121,43

Segment-Schaltuhren



SYN 161 h/SUL 181 H

315054	THE SYN 161 H	24 Std. / 30 Min. / 30 Min.	1	1	39,60
315065	THE SUL 181 H	24 Std. mit Gangreserve	1	1	81,67

Digitale Schaltuhren



TR 610 top2

315153	THE TR 610 top2	1 Kanal, 28 Speicherplätze	1	1	82,67
315156	THE TR 612 top2	2 Kanäle, 42 Speicherplätze	1	1	114,86



047 61

422831	LEG 003705	EcoRex D11 Wochen-Schaltuhr 1-Kanal 16A	1	100	7.873,60
423066	LEG 004761	AlphaRex D21 Wochen-Schaltuhr 1-Kanal 16A	1	100	8.239,30
423075	LEG 004771	AlphaRex D22 Wochen-Schaltuhr 2-Kanal 16A	1	100	11.393,90

Analoge Schaltuhren



037 53

037 30

047 52

422836	LEG 003730	Microrex T11 1TE	1	100	4.215,50
422838	LEG 003740	Microrex QT11 Lexic	1	100	8.569,80
422845	LEG 003752	Microrex T31 Lexic o. Gangres.	1	100	4.215,50
422846	LEG 003753	Microrex QT31 Lexic 100h Gangr.	1	100	8.569,80
423064	LEG 004753	Microrex T31 Su/Wi Tag	1	100	8.391,60
423065	LEG 004758	Microrex W31 Su/Wi Woche	1	100	9.683,50

Tagesuhr



NEU / ALT

127211	HAG EH210 / EH110	analog 3TE ohne Gangreserve	1	1	37,80
127212	HAG EH211 / EH111	analog 3TE mit Gangreserve	1	1	76,30
127196	HAG EG010	digital 1TE mit Gangreserve	1	1	64,80

Digitale Wochenschaltuhr 2 TE + Programmierschlüssel



127198	HAG EG103	mit Gangreserve 1 Kanal	1	1	82,40
127203	HAG EG203	mit Gangreserve 2 Kanal	1	1	106,00

Abbildung	Art. Nr.	Bezeichnung	VE per	Brutto €
-----------	----------	-------------	--------	----------

Industrie-Steckrelais

013699	FIN 60.12.8.230.0040	8 pol. 230 V AC	10 1	11,51
013698	FIN 60.12.8.024.0040	8 pol. 24 V AC	10 1	10,77
013700	FIN 60.12.9.024.0040	8 pol. 24 V DC	10 1	10,77
013703	FIN 60.13.8.230.0040	11 pol. 230 V AC	10 1	11,82
013702	FIN 60.13.8.024.0040	11 pol. 24 V AC	10 1	11,09
013704	FIN 60.13.9.024.0040	11 pol. 24 V DC	10 1	11,09
007151	FIN 60.13.8.012.0040	11 pol. 12 V AC	10 1	11,09
011595	FIN 60.13.9.012.0040	11 pol. 12 V DC	10 1	11,09

Socket (Schraubfassung) blau







013701	FIN 9002 / 90.72	Socket 8 polig	10 1	4,81
013705	FIN 9003 / 90.73	Socket 11 polig	10 1	5,44

Miniatur-Steckrelais

011150	FIN 55.34.8.012.0040	4 Wechsler 12V AC	10 1	8,58
011151	FIN 55.34.9.012.0040	4 Wechsler 12V DC	10 1	8,58
013694	FIN 55.34.8.024.0040	4 Wechsler 24V AC	10 1	8,58
013696	FIN 55.34.9.024.0040	4 Wechsler 24V DC	10 1	8,58
013695	FIN 55.34.8.230.0040	4 Wechsler 230V	10 1	9,41

Socket (Schraubfassung) blau

013697	FIN 9404 / 94.84.1	Socket für Minirelais	10 1	5,33
---------------	---------------------------	-----------------------	------	-------------

Abbildung	Art. Nr.	Bezeichnung	VE	per	Brutto €
	314620 ELT 21100030 S12-100-230V	1 Schließer, 16A 230V AC Stromstoßschalter elektromechanisch Reiheneinbaugerät mit Handbetätigung und Schaltstellungsanzeige / Steuerleistungsbedarf nur 5-6 Watt	10	1	21,30
	314834 ELT 91100030 S91-100-230V	1 Schließer, 10A 230V AC Stromstoßschalter elektromechanisch f. Doseneinbau mit Handbetätigung u. Schaltstellungsanzeige / kein Stand-by-Verlust / Steuerspannung 230V AC / Glühlampenlast 2300W / Steuerleistungsbedarf nur 4-5W	10	1	22,00
	314765 ELT 23100830 TLZ12-8E-230V	Multifunktions-Treppenlicht-Zeitschalter elektronisch 1 Schließer, 16A 230V AC Zeiteinstellung bis 30 Min, nachschaltbar, Zeitverlängerung mit Mehrfachasten (bis zu 3-fach), Dauerlicht (60 Min) und Ausschaltlogik mit Taster, Ausschaltvorwarnung zuschaltbar zusätzl. Modus für Energiesparlampen (ESL), automatische Erkennung 3-/4-Leiter-Schaltung, Doppelanschlüsse für Taster und Lampe (oben und unten), Versorgungs- und Steuerspannung 230V AC, Glühlampen 2300W, ESL 200W Stand-by-Verlust nur 0,5W, Kontaktschaltung mit Nulldurch- gang, Glimmlampenstrom bis 50 mA <u>Zusatzfunktionen integriert:</u> ES: Stromstoßschalter ER: Relais ESV: Stromstoßschalter mit Zeitfunktion (bis 120 Min) EIN mit Taster, AUS mit Taster oder Zeit inkl. Dauerfunktion (120 Min)	10	1	30,90
	314701 ELT 22100231 FR12.1-230	selbstlernender Netzfreischalter Reiheneinbaugerät, unterbricht die Stromversorgung nach Abschaltung, bis zu einer Stromaufnahme von 200mA sind Kleinverbraucher zulässig. Die Grundlast (Grenzwert) wird vom FR12.1.230 automatisch eingelernt.	10	1	87,00
	314757 ELT 23001005 MFZ12DX-UC	Multifunktions-Zeitrelais 1 Wechsler 10A Reiheneinbaugerät, Versorgungs- u. Steuerspannung 8-230V UC Zeitbereich von 0,1 sec. bis 40 Std., 1 Wechsler potentialfrei, Schaltzustandsanzeige mit LED (AUS - blinken - EIN), Kontaktschaltung mit Nulldurchgang (bei 230V), Stand-by-Verlust nur 0,4W bistabiles Relais <u>18 Funktionen:</u> AV = Ansprechverzögerung RV = Rückfallverzögerung ARV = Ansprech- u. Rückfallverzögerung IA = impulsgesteuerte Ansprechverzögerung (zB autom. Türöffner) EW = Einschaltwischer AW = Ausschaltwischer TI = Tatgeber mit Impuls beginnend TP = Taktgeber mit Pause beginnend ON = Dauer EIN	10	1	57,90

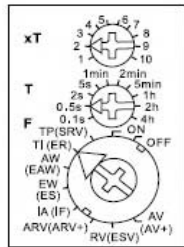
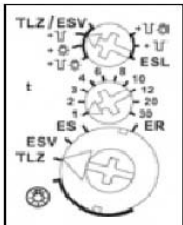

AV+ = Additive Ansprechverzögerung	ESV = Stromstoßschalter m. Rückfallverzögerung und Ausschaltvorwarnung
ARV+ = Additive Ansprech- u. Rückfallverzögerung	ES = Stromstoßschalter
IA = impulsgesteuerte Ansprechverzögerung (zB autom. Türöffner)	EAW = Einschalt- u. Ausschaltwischer
IF = Impulsformer	ER = Relais
ES = Stromstoßschalter	SRV = Stromstoßschalter mit Rückfallverzögerung
EW = Einschaltwischer	OFF = Dauer AUS



Der Wechsel zu energieeffizienter Beleuchtung

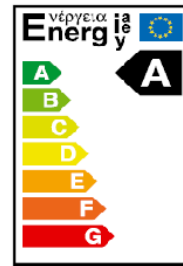

Zeitplan für den Auslauf ineffizienter Glühlampen

jeweils ab September		2009	2010	2011	2012	2013	2014	2015	2016
Glühlampen	klar	15W	15W	15W	Auslauf aller klaren Glühlampen				
		25W	25W	25W					
		40W	40W	40W					
		60W	60W	60W					
		75W	75W	75W					
		100W	100W	100W					
Glühlampen	matt	Matte Lampen durch Energiesparlampen mit Energieeffizienzklasse A ersetzen							

■ Erlaubt Achtung: Alle Wattagen sind indikativ. Der bestimmende Faktor ist der Lichtstrom (Lumen)
■ Auslauf Lampen dürfen nicht mehr in den Verkehr gebracht werden. Alle Lagerbestände dürfen noch aufgebraucht werden.

Zeitplan für den Auslauf ineffizienter Leuchtstofflampen

jeweils ab April	2010	2012	2015	2017
Leuchtstofflampen - T0 und T5** - TL-D U-Form - TL-D Ringform	Auslauf aller ineffizienten Leuchtstofflampen durch Mindesteffizienz (lm/W) und RA > 80 (Lichtfarben 33-640, 54-765)			
T12		Auslauf aller ineffizienten Leuchtstofflampen durch Mindesteffizienz (lm/W) und RA > 80 (Lichtfarben 33-640, 54-765)		
Leuchten mit KVGVVG				Auslauf ineffizienter Leuchten mit KVGVVG***

■ Erlaubt Achtung: Alle Wattagen sind indikativ. Der bestimmende Faktor ist der Lichtstrom (Lumen)
■ Auslauf Lampen/Leuchten mit KVGVVG dürfen nicht mehr in den Verkehr gebracht werden. Alle Lagerbestände dürfen noch aufgebraucht werden.

Zeitplan für den Auslauf ineffizienter Halogenlampen

jeweils ab September		2009	2010	2011	2012	2013	2014	2015	2016		
Halogenlampen	klar	5W	5W	5W	5W	5W	5W	5W	5W		
		10W	10W	10W	10W	10W	10W	10W	10W		
		20W	20W	20W	20W	20W	20W	20W	20W		
		35W	35W	35W	35W	35W	35W	35W	35W		
		50W	50W	50W	50W	50W	50W	50W	50W		
		75W	75W	75W	75W	75W	75W	75W	75W		
		100W	100W	100W	100W	100W	100W	100W	100W		
		230V	25W	25W	25W	25W	25W	25W	25W	25W	
			40W	40W	40W	40W	40W	40W	40W	40W	
			60W	60W	60W	60W	60W	60W	60W	60W	
Halogenlampen	klar	75W	75W	75W	75W	75W	75W	75W	75W		
		100W	100W	100W	100W	100W	100W	100W	100W		
		150W	150W	150W	150W	150W	150W	150W	150W		
		200W	200W	200W	200W	200W	200W	200W	200W		
		300W	300W	300W	300W	300W	300W	300W	300W		
		500W	500W	500W	500W	500W	500W	500W	500W		
			+750W	+750W	+750W	+750W	+750W	+750W	+750W	+750W	
		Halogenlampen	matt	Auslauf aller matten Halogenlampen (Hochvolt – G9, E14, E27 Sockel – Niedervolt – G4, GY6,35 Sockel)							

■ Erlaubt Achtung: Alle Wattagen sind indikativ. Der bestimmende Faktor ist der Lichtstrom (Lumen)
■ Auslauf Lampen dürfen nicht mehr in den Verkehr gebracht werden. Alle Lagerbestände dürfen noch aufgebraucht werden.

Zeitplan für den Auslauf ineffizienter Hochdruckentladungslampen

jeweils ab April	2010	2012	2015	2017
Natriumdampflampen		Auslauf aller ineffizienten Natriumdampflampen		
Natriumdampfaustauschlampen		Auslauf aller ineffizienten Natriumdampfaustauschlampen		
Quecksilberdampflampen		Auslauf aller ineffizienten Natriumdampfaustauschlampen		
Metallhalogenentladungslampen		Auslauf aller ineffizienten Metallhalogenentladungslampen		Auslauf weiterer Typen

■ Erlaubt Achtung: Alle Wattagen sind indikativ. Der bestimmende Faktor ist der Lichtstrom (Lumen)
■ Auslauf Lampen dürfen nicht mehr in den Verkehr gebracht werden. Alle Lagerbestände dürfen noch aufgebraucht werden.

Sehr geehrte Kunden!

Da sich bei vielen Produkten Preise täglich ändern, sind unsere Preise als Richtpreise anzusehen und wir behalten uns Preisänderungen vor.

Typenvergleich Leuchtmittel

Internationale Bezeichnung	Osram	Philips	GE	Sylvania	Radium	Produktbeschreibung
HME Highpressure Mercury Elliptic	HQL	HPL-N	H	HSL-BW	HRL	Quecksilberhochdrucklampen
HSE High pressure sodium elliptic	NAV-E	SON	SON/E	SHP	RNP-E	Natriumhochdrucklampen elliptisch
HST High pressure sodium tubular	NAV-T	SON-T	SON/T	SHP-T	RNP-T	Natriumhochdrucklampen tubular
HST-DE Highpr. sodium tub. Double-Ended	NAV-TS		LU/TD, Lucalox-TD			Natriumhochdr. 2seitig gesockelt sofortige Wiederezündung2
HIE High pressure iodium elliptic	HQI-E	HPI	MBI (F)	HSI (MP)	HRI-E	Halogen-Metaldampflampe elliptisch
HIT High pressure iodium tubular	HQI-T	HPIT, MHNT, CDMT	MBI/T	HSI-T	HRI-T	Halogen-Metaldampflampe tubular
HIT-DE High pr. Iodium tub. Double-Ended	HQI-TS	HPIT, MHNTD	MQI, HGMI/D2	HSI-TD	HRI-TS	Halogenmetallp. 2seitig gesockelt sofortige Wiederezündung2
T26 (T8) Leuchtstofflampe 26mm	L/	TL-D/	F/	F/	NL/	z.B. L 36W 21 Watt / Lichtfarbe
T38 (T12) Leuchtstofflampe 38mm	L/	TL/	F/	F/	NL/	z.B. L 58W 21 Watt / Lichtfarbe
T16 (T5) Leuchtstofflampe 16mm	FH, FQ	TL5HE, TL5HO				z.B. FH 14 W 66 Watt / Lichtfarbe
TC-S S... single - 1 Bogen	Dulux-S	PL-S	Biax-S, FBX/	LYNX CF-S	Ralux	5-11W 2-Stiftsockel mit eingeb. Starter, Sockel G23
TC-D D... double - 2 Bögen	Dulux-D	PL-C	Biax-D, FDBX	LYNX CF-D	Ralux duo	10-26W 2-Stiftsockel mit eingeb. Starter, Sockel G24d-1 bis d3
TC-T T... tripple - 3 Bögen	Dulux-T	PL-T	Biax-T, FTBX	LYNX CF-T	Ralux trio	18-42W 18 u. 26W kompatibel m. TC-D, Sockel GX24d-2 bis d3
TC-L L...long	Dulux-L	PL-L	Biax-L, FBX	LYNX CF-L	Ralux long	18-55W 4-Stiftsockel 2G11
TC-S/E	Dulux-S/E	PL-S /4p.	Biax-S 4p. FBX 4p.	LYNX CF-SE	Ralux / E	5-11W 4-Stiftsockel 2G7
TC-D/E	Dulux-D/E	PL-C /4p.	Biax-D 4p. FDBX 4p.	LYNX- CF-DE	Ralux duo/E	10-26W 4-Stiftsockel Sockel G24q
TC-T/E	Dulux-T/E	PL-T /4p.	Biax-T 4p. FTBX 4p.	LYNX- CF-TR	Ralux trio/E	18-32 (42) W Sockel GX24q-2 bis 3
TC-F F...flat	Dulux-F			LYNX-F	Ralux twin	18-36W 4-Stiftsockel 2G10, elektr. Daten wie TC-L 18-36W
TC-DD	F.. 2D		2-D Lampen			z. B. F 16 2D Lichtfarbe 2 oder 4 PIN
QR-CB 35 / FTA-FFG	Decostar 35		Precise MR11			NV-Halogenlampe offener Reflektor
FTB			M52 10°			NV-Halogenlampe 20W 10° Superspot
FTC			M51 17°			NV-Halogenlampe 20W 20° Spot
FTD			M62 30°			NV-Halogenlampe 20W 30° Flood
FTE			M65 10°			NV-Halogenlampe 35W 10° Superspot
FTF			M66 20°			NV-Halogenlampe 35W 20° Spot
FTG						NV-Halogenlampe 35W 30° Flood
	41894SP					NV-Halogenlampe 50W 10°
	41894WFL 38°					NV-Halogenlampe 50W 40°
QR-CB-C 35, FTA/C, FTG/C	Decostar 35S	STANDARDline	Precise MR11			NV-Halogenlampe geschlossener Reflektor
FTB/C	44890SP 10°	12300	M252 10°			NV-Halogenlampe 20W 10° Superspot
FTC/C	44890FL 24°		M251 17°			NV-Halogenlampe 20W 20° Spot
FTD/C	44890WFL 38°	12302	M262 30°			NV-Halogenlampe 20W 30° Flood
FTE/C	44892SP 10°	12312	M265 8°			NV-Halogenlampe 35W 10° Superspot
FTF/C	44892FL 24°		M266 20°			NV-Halogenlampe 35W 20° Spot

Sehr geehrte Kunden!

Da sich bei vielen Produkten Preise täglich ändern, sind unsere Preise als Richtpreise anzusehen und wir behalten uns Preisänderungen vor.

Typenvergleich Leuchtmittel

Internationale Bezeichnung	Osram	Philips	GE	Sylvania	Radium	Produktbeschreibung
FTG/C	44892WFL 38°	12314				NV-Halogenlampe 35W 35° Flood
QR-CB 51						offener Reflektor
ESX	41860SP		M68 11°			NV-Halogenlampe 20W 12° Narrow Spot
BBF			M94 24°			NV-Halogenlampe 20W 24° Flood (Spot)
BAB	41860WFL		M36 36°			NV-Halogenlampe 20W 38° Wideflood (Flood)
FRB			M71 8°			NV-Halogenlampe 35W 8° Narrow Spot (Very Narrow Spot)
FMT						NV-Halogenlampe 35W 12° Spot (Narrow Spot)
Frau			M70 18°			NV-Halogenlampe 35W 24° Flood (Spot)
FMW			M81 38°			NV-Halogenlampe 35W 38° Wideflood (Flood)
EXT	41870SP		M49 10°			NV-Halogenlampe 50W 12° Spot (Narrow Spot)
EXZ			M50 21°			NV-Halogenlampe 50W 24° Flood (Spot)
ENL						NV-Halogenlampe 50W 28° Narrow Flood
EXN	41870WFL		M58 38°			NV-Halogenlampe 50W 38° Wideflood (Flood)
FNV			M80 60°			NV-Halogenlampe 50W 60° Very Wideflood (Wide Flood)
EYF			M60 12°			NV-Halogenlampe 75W 10° Narrow Spot
FNW			M82 18°			NV-Halogenlampe 75W 20° Spot
EYC			M61 38°			NV-Halogenlampe 75W 40° Wideflood
	Decostar 51S	ACCENTline				geschlossener Reflektor
ESX/C	44860SP	32010 12°	M268			NV-Halogenlampe 20W 10° Narrow Spot
BBF/C			M294			NV-Halogenlampe 20W 20° Spot
BAB/C	44860WFL 38°	32036 36°	M236			NV-Halogenlampe 20W 40° Wideflood
	44860VWFL					NV-Halogenlampe 20W 60° Very Wideflood
FRB/C	44865SP	33510 10°	M271			NV-Halogenlampe 35W 10° Narrow Spot
FRA/C	44865FL 24°		M270			NV-Halogenlampe 35W 20° Spot
FMW/C	44865WFL 38°	33536 36°	M281			NV-Halogenlampe 35W 40° Wideflood
	44865VWFL					NV-Halogenlampe 35W 60° Very Wideflood
EXT/C	44870SP	35010 12°	M249			NV-Halogenlampe 50W 10° Narrow Spot
EXZ/C	44870FL 24°		M250			NV-Halogenlampe 50W 20° Spot
EXN/C	44870WFL 38°	35036 36°	M258			NV-Halogenlampe 50W 40° Wideflood
FNV/C	44870VWFL		M280			NV-Halogenlampe 50W 60° Very Wideflood
EYF/C	44880SP		M260			NV-Halogenlampe 65W 10° Narrow Spot
FNW/C			M282			NV-Halogenlampe 65W 20° Spot
EYC/C	44880WFL 38°		M261			NV-Halogenlampe 65W 40° Wideflood
EXN/C	44880VWFL					NV-Halogenlampe 65W 60°

Sehr geehrte Kunden!

Da sich bei vielen Produkten Preise täglich ändern, sind unsere Preise als Richtpreise anzusehen und wir behalten uns Preisänderungen vor.

Art. Nr.	Bezeichnung	Sockel	Farbe	VE	per	Brutto €
----------	-------------	--------	-------	----	-----	----------

Standardlampen



Abmessungen:

L= 91 mm

ø = 50 mm

007726	15W 230V	E27	klar	50	100	110,00
016463	15W 230V	E27	matt	50	100	123,00
007733	25W 240V	E27	klar	50	100	90,00
007715	25W 240V	E27	matt	50	100	98,00
007716	40W 240V	E27	klar	50	100	90,00
007717	40W 240V	E27	matt	50	100	98,00
007718	60W 240V	E27	klar	50	100	90,00
007719	60W 240V	E27	matt	50	100	98,00
007720	75W 240V	E27	klar	50	100	102,00
007721	75W 240V	E27	matt	50	100	110,00
007712	100W 240V	E27	klar	50	100	102,00
007713	100W 240V	E27	matt	50	100	110,00

Art. Nr.	Bezeichnung	Sockel	Farbe	VE	per	Brutto €
----------	-------------	--------	-------	----	-----	----------

Standardlampen



Abmessungen:

L= 97 mm

ø = 55 mm

106121	15W 230V	E27	klar	50	100	163,00
106140	15W 230V	E27	matt	50	100	182,00
106124	25W 230V	E27	klar	50	100	138,00
106142	25W 230V	E27	matt	100	100	150,00
106127	40W 230V	E27	klar	50	100	138,00
106144	40W 230V	E27	matt	100	100	150,00
106130	60W 230V	E27	klar	50	100	138,00
106147	60W 230V	E27	matt	100	100	150,00
106134	75W 230V	E27	klar	50	100	157,00
106149	75W 230V	E27	matt	100	100	169,00
106116	100W 230V	E27	klar	50	100	157,00
106136	100W 230V	E27	matt	100	100	169,00

Art. Nr.	Bezeichnung	Sockel	Farbe	VE	per	Brutto €
----------	-------------	--------	-------	----	-----	----------

Standardlampen



Abmessungen:

L= 97 mm

ø = 55 mm

239632	15W 230V	E27	klar	50	100	136,07
239634	15W 230V	E27	matt	50	100	152,39
239599	25W 230V	E27	klar	50	100	110,72
239604	25W 230V	E27	matt	100	100	120,93
239600	40W 230V	E27	klar	50	100	110,72
239605	40W 230V	E27	matt	100	100	120,93
239601	60W 230V	E27	klar	50	100	110,72
239606	60W 230V	E27	matt	100	100	120,93
239602	75W 230V	E27	klar	50	100	126,12
239607	75W 230V	E27	matt	100	100	136,33
239603	100W 230V	E27	klar	50	100	126,12
239608	100W 230V	E27	matt	100	100	136,33

Art. Nr.	Bezeichnung	Socket	VE	per	Brutto €
----------	-------------	--------	----	-----	----------

Standardlampen



Abmessungen:

L= 104 mm
 ø = 35 mm



007575	15W 230V E14 klar	91624	100	100	144,00
007576	15W 230V E14 matt	91346	100	100	153,00
007589	25W 240V E14 klar	90478	100	100	128,00
017393	25W 240V E14 matt	91680	100	100	136,00
007591	40W 240V E14 klar	91673	100	100	128,00
007592	40W 240V E14 matt	91682	100	100	136,00
007593	60W 240V E14 klar	91677	100	100	149,00
007594	60W 240V E14 matt	91683	100	100	157,00

Illuzierlampen / Tropfenlampen

Abmessungen:

L= 80 mm
 ø = 45 mm



007524	15W 230V E14 klar	92002	100	100	144,00
001577	15W 230V E14 matt	92003	100	100	153,00
007560	25W 240V E14 klar	19775	100	100	128,00
007561	25W 240V E14 matt	19777	100	100	136,00
007562	40W 240V E14 klar	19782	100	100	128,00
007563	40W 240V E14 matt	19778	100	100	136,00
007878	60W 240V E14 klar	19784	100	100	149,00
017066	60W 240V E14 matt	19786	100	100	157,00

Abmessungen:

L= 74 mm
 ø = 45 mm



001578	15W 230V E27 klar	91917	100	100	237,00
014736	15W 230V E27 matt	90569	100	100	274,00
007540	25W 230V E27 klar	90564	100	100	237,00
007543	25W 230V E27 matt	91994	100	100	257,00
001579	40W 230V E27 klar	90565	100	100	237,00
007547	40W 230V E27 matt	90567	100	100	257,00

Art. Nr.	Bezeichnung	Socket	VE	per	Brutto €
----------	-------------	--------	----	-----	----------

Standardlampen



Abmessungen:

L= 104 mm
 ø = 35 mm



106151	15W 230V E14 klar	100	100	207,00
106164	15W 230V E14 matt	100	100	219,00
106152	25W 230V E14 klar	100	100	188,00
106165	25W 230V E14 matt	100	100	200,00
106156	40W 230V E14 klar	100	100	188,00
106168	40W 230V E14 matt	100	100	200,00
106160	60W 230V E14 klar	100	100	213,00
106173	60W 230V E14 matt	100	100	225,00

Illuzierlampen / Tropfenlampen

Abmessungen:

L= 80 mm
 ø = 45 mm



106179	15W 230V E14 klar	100	100	207,00
106191	15W 230V E14 matt	100	100	219,00
106181	25W 230V E14 klar	100	100	188,00
106193	25W 230V E14 matt	100	100	200,00
106185	40W 230V E14 klar	100	100	188,00
106196	40W 230V E14 matt	100	100	200,00
106189	60W 230V E14 klar	100	100	213,00
106199	60W 230V E14 matt	100	100	225,00

Abmessungen:

L= 74 mm
 ø = 45 mm



106180	15W 230V E27 klar	100	100	375,00
106192	15W 230V E27 matt	100	100	387,50
106183	25W 230V E27 klar	100	100	375,00
106195	25W 230V E27 matt	100	100	387,50
106187	40W 230V E27 klar	100	100	375,00
106198	40W 230V E27 matt	100	100	387,50

Art. Nr.	Bezeichnung	Socket	VE	per	Brutto €
----------	-------------	--------	----	-----	----------

Standardlampen



Abmessungen:

L= 100 mm
 ø = 35 mm



239029	15W 230V E14 klar	100	100	178,15
239015	15W 230V E14 matt	100	100	189,16
239009	25W 230V E14 klar	100	100	157,72
239016	25W 230V E14 matt	100	100	167,93
239011	40W 230V E14 klar	100	100	157,72
239007	40W 230V E14 matt	100	100	167,93
239014	60W 230V E14 klar	100	100	184,11
239017	60W 230V E14 matt	100	100	194,34

Illuzierlampen / Tropfenlampen

Abmessungen:

L= 78 mm
 ø = 45 mm



239018	15W 230V E14 klar	100	100	178,15
239024	15W 230V E14 matt	100	100	189,16
239020	25W 230V E14 klar	100	100	157,72
239026	25W 230V E14 matt	100	100	167,93
239022	40W 230V E14 klar	100	100	157,72
239028	40W 230V E14 matt	100	100	167,93
239166	60W 230V E14 klar	100	100	184,11
239172	60W 230V E14 matt	100	100	194,34

Abmessungen:

L= 73 mm
 ø = 45 mm



239019	15W 230V E27 klar	100	100	299,17
239025	15W 230V E27 matt	100	100	319,78
239021	25W 230V E27 klar	100	100	299,17
239027	25W 230V E27 matt	100	100	319,78
239023	40W 230V E27 klar	100	100	299,17
239006	40W 230V E27 matt	100	100	319,78

Art. Nr.	Bezeichnung	Farbe	VE	per	Brutto €
----------	-------------	-------	----	-----	----------

Birnenlampen



Abmessungen:

	15W	25W
L (mm) =	54	57
ø (mm) =	26	28



007302	15W 230V	E14	klar	10	100	196,00
013773	15W 230V	E14	matt	10	100	196,00
007304	25W 230V	E14	klar	10	100	196,00

Backofenlampen

Abmessungen:

	15W	25W	40W
L (mm) =	50	60	80
ø (mm) =	22	28	28

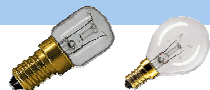

007659	15W 230V	E14	klar	10	100	282,00
010394	25W 230V	E14	klar	10	100	282,00
007908	40W 230V	E14	klar	10	100	282,00

Globelampen E27

Abmessungen:

	G80	G95	G120
L (mm) =	119	138	170
ø (mm) =	80	95	120



007486	G80 40W 230V	opal	10	100	418,00
007487	G80 60W 230V	opal	10	100	418,00
007485	G80 100W 230V	opal	10	100	418,00
007491	G95 40W 230V	opal	10	100	468,00
007494	G95 60W 230V	opal	10	100	468,00
007488	G95 100W 230V	opal	10	100	468,00
007482	G125 40W 230V	opal	10	100	572,00
007483	G125 60W 230V	opal	10	100	572,00
007480	G125 100W 230V	opal	10	100	572,00

Art. Nr.	Bezeichnung	Farbe	VE	per	Brutto €
----------	-------------	-------	----	-----	----------

Birnenlampen



Abmessungen:

L (mm) =	57
ø (mm) =	26



107670	15W 230V	E14	klar	10	100	269,00
107672	15W 230V	E14	matt	10	100	269,00
107671	25W 230V	E14	klar	10	100	269,00
107673	25W 230V	E14	matt	10	100	269,00

Backofenlampen

Abmessungen:

	15W	40W
L (mm) =	50	80
ø (mm) =	22	45



107664	15W 230V	E14	klar	10	100	378,00
107664	40W 230V	E14	matt	10	100	378,00

Globelampen E27

Abmessungen:

	G80	G95	G120
L (mm) =	119	142	175
ø (mm) =	80	95	120



106033	G80 40W 230V	opal	10	100	624,00
106034	G80 60W 230V	opal	10	100	624,00
106032	G80 100W 230V	opal	10	100	624,00
106037	G95 40W 230V	opal	10	100	689,00
106038	G95 60W 230V	opal	10	100	689,00
106035	G95 100W 230V	opal	10	100	689,00
106028	G120 40W 230V	opal	10	100	845,00
106029	G120 60W 230V	opal	10	100	845,00
106026	G120 100W 230V	opal	10	100	845,00

Art. Nr.	Bezeichnung	Farbe	VE	per	Brutto €
----------	-------------	-------	----	-----	----------

Birnenlampen



Abmessungen:

	1)	2)
L (mm) =	54	57
ø (mm) =	17	25



239079	15W 230V	E14 1)	klar	10	100	243,56
239119	15W 230V	E14 2)	matt	10	100	243,56
239084	25W 230V	E14 2)	klar	10	100	243,56
239085	25W 230V	E14 2)	matt	10	100	243,56

Backofenlampen

Abmessungen:

	15W	25W	40W
L (mm) =	49	57	78
ø (mm) =	22	25	45

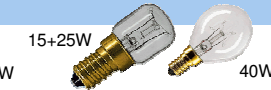

239076	15W 230V	E14	klar	10	100	349,38
239080	25W 230V	E14	klar	10	100	349,38
239064	40W 230V	E14	klar	10	100	349,38

Globelampen E27

Abmessungen:

	G80	G95	G120
L (mm) =	125,5	147	172,5
ø (mm) =	80	95	120



239068	G80 40W 230V	opal	10	100	525,43
239069	G80 60W 230V	opal	10	100	525,43
239070	G95 40W 230V	opal	10	100	587,81
239071	G95 60W 230V	opal	10	100	587,81
239074	G95 100W 230V	opal	10	100	587,81
239072	G120 60W 230V	opal	10	100	717,87
239073	G120 100W 230V	opal	10	100	717,87

Art. Nr.	Bezeichnung	Type	VE	per	Brutto €
----------	-------------	------	----	-----	----------

Leuchtstofflampen



Abmessungen:

ø = 26mm

Länge: 18W 590mm
 36W 1200mm
 58W 1500mm

29 / 830 = warmweiss

33 / 840 = kaltweiss

007352	18W	33	F18W	35098	25	100	283,00
007399	36W	33	F36W	35099	25	100	283,00
007428	58W	33	F58W	29570	25	100	379,00

007355	18W	830	F18W	93319	25	100	553,00
007357	18W	840	F18W	93317	25	100	553,00
007402	36W	830	F36W	39105	25	100	553,00
007404	36W	840	F36W	16856	25	100	553,00
007431	58W	830	F58W	93334	25	100	626,00
007433	58W	840	F58W	93333	25	100	626,00

Art. Nr.	Bezeichnung	Type	VE	per	Brutto €
----------	-------------	------	----	-----	----------

Leuchtstofflampen



Abmessungen:

ø = 26mm

Länge: 18W 590mm
 36W 1200mm
 58W 1500mm

31 / 830 = Warmton

20-640 / 21-840 = kaltweiss (hellweiss)

107111	18W	20-640	L18W	25	100	380,00
107169	36W	20-640	L36W	25	100	380,00
107219	58W	20-640	L58W	25	100	500,00

107121	18W	31-830	L18W	25	100	625,00
107125	18W	21-840	L18W	25	100	625,00
107182	36W	31-830	L36W	25	100	625,00
107187	36W	21-840	L36W	25	100	625,00
107229	58W	31-830	L58W	25	100	710,00
107233	58W	21-840	L58W	25	100	710,00

Art. Nr.	Bezeichnung	Type	VE	per	Brutto €
----------	-------------	------	----	-----	----------

Leuchtstofflampen



Abmessungen:

ø = 28mm

Länge: 18W 604mm
 36W 1213,6mm
 58W 1514,2mm

830 = Warmton

33-640 / 840 = kaltweiss (neutralweiss)

240235	18W	33-640	TL-D	25	100	327,06
240237	36W	33-640	TL-D	25	100	327,06
240239	58W	33-640	TL-D	25	100	439,50

240114	18W	830	TL-D	25	100	652,93
240115	18W	840	TL-D	25	100	652,93
240122	36W	830	TL-D	25	100	652,93
240123	36W	840	TL-D	25	100	652,93
240126	58W	830	TL-D	25	100	739,86
240127	58W	840	TL-D	25	100	739,86

Art. Nr.	Bezeichnung	VE	per	Brutto €
----------	-------------	----	-----	----------

energiesparende Leuchtstofflampen Lumilux Energiesaver



Abmessungen:

ø = 26mm

Länge: 32W 1200mm 830 = Warmton
51W 1500mm 840 = kaltweiss (hellweiss)

107740	32W	830	25	100	1.680,00
107741	32W	840	25	100	1.680,00
107742	51W	830	25	100	1.905,00
107743	51W	840	25	100	1.905,00

Art. Nr.	Bezeichnung	VE	per	Brutto €
----------	-------------	----	-----	----------

energiesparende Leuchtstofflampen Master TLD-Eco



sense and simplicity



Abmessungen:

ø = 28mm

830 = warmweiss

Länge: 32W 1200mm 840 = neutralweiss
51W 1500mm 865 = kaltweiss (cool daylight)

239547	32W	830	TLD-ECO	25	100	1.632,31
239548	32W	840	TLD-ECO	25	100	1.632,31
239549	32W	865	TLD-ECO	25	100	1.632,31
239550	51W	830	TLD-ECO	25	100	1.849,65
239551	51W	840	TLD-ECO	25	100	1.849,65
239552	51W	865	TLD-ECO	25	100	1.849,65

Leuchtstofflampen kreisförmig (rund)



Rohrdurchmesser 16 mm

nur für EVG-Betrieb 830 = Warmton

Sockel 2GX13 840 = hellweiss

106661	22W	830	FC	ø = 225mm	12	100	3.570,00
106662	22W	840	FC	ø = 225mm	12	100	3.570,00
106665	40W	830	FC	ø = 300mm	12	100	3.760,00
106666	40W	840	FC	ø = 300mm	12	100	3.760,00
106669	55W	830	FC	ø = 300mm	12	100	4.040,00
106670	55W	840	FC	ø = 300mm	12	100	4.040,00

Leuchtstofflampen kreisförmig (rund) Master TL5 Circular



Rohrdurchmesser 14-18 mm

830 = warmweiss

Sockel 2GX13 840 = neutralweiss

240166	22W	830	ø = 230mm	10	100	3.741,64
240170	22W	840	ø = 230mm	10	100	3.741,64
240167	40W	830	ø = 305mm	10	100	3.941,57
240171	40W	840	ø = 305mm	10	100	3.941,57
240175	55W	830	ø = 379mm	10	100	4.248,68
240172	55W	840	ø = 379mm	10	100	4.248,68

Leuchtstofflampen kreisförmig (rund) BASIC



Rohrdurchmesser 29 mm

Sockel 2GX13 640 = hellweiss

107143	22W	640C	ø = 216mm	12	100	1.835,00
107163	32W	640C	ø = 305mm	12	100	1.835,00
107207	40W	640C	ø = 406mm	12	100	1.835,00

Leuchtstofflampen kreisförmig (rund) TL-E Circular



Rohrdurchmesser 26,2-30,9 mm

Sockel 2GX13 33-640 = neutralweiss

239987	22W	33-640	ø = 215,9mm	12	100	1.871,18
239990	32W	33-640	ø = 304,8mm	12	100	1.871,18
239567	40W	33-640	ø = 406,4mm	12	100	1.871,18

Leuchtstofflampen U-förmig

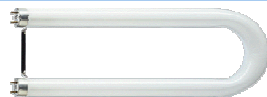

Rohrdurchmesser 26 mm

640 = hellweiss

107112	18W	640U	L = 310 mm	24	100	2.680,00
107170	36W	640U	L = 607 mm	12	100	2.680,00
107220	58W	640U	L = 765 mm	12	100	3.080,00

Leuchtstofflampen U-förmig TL-DU

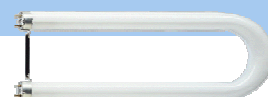

Rohrdurchmesser 23-27 mm

33-640 = neutralweiss

240521	18W	33-640	L = 310 mm	24	100	2.651,83
240522	36W	33-640	L = 607 mm	12	100	2.651,83
240523	58W	33-640	L = 759 mm	12	100	2.960,96

Art. Nr.	Bezeichnung	VE	per	Brutto €
----------	-------------	----	-----	----------

FQ - Leuchtstofflampen



TL5 Rohrdurchmesser 16 mm

830 = Warmton

840 = hellweiss

Länge:

106724	24W	830 HO	549mm	40	100	1.460,00
106727	24W	840 HO	549mm	40	100	1.460,00
106739	39W	830 HO	849mm	40	100	1.545,00
106742	39W	840 HO	849mm	40	100	1.545,00
106747	49W	830 HO	1449mm	40	100	1.640,00
106748	49W	840 HO	1449mm	40	100	1.640,00
106758	54W	830 HO	1149mm	40	100	1.640,00
106761	54W	840 HO	1149mm	40	100	1.640,00
106772	80W	830 HO	1449mm	40	100	1.825,00
106775	80W	840 HO	1449mm	40	100	1.825,00

Art. Nr.	Bezeichnung	Länge	VE	per	Brutto €
----------	-------------	-------	----	-----	----------

TL5 - Leuchtstofflampen



mittlere Lebensdauer 20.000 h

Warmstart EVG nach IEC

höherer Lichtstrom als Master TL5 HE Lampen

100% recycelbar

TL5 Rohrdurchmesser 17 mm

830 = warmweiss

840 = neutralweiss

Länge:



240156	24W	830 HO	549mm	40	100	1.575,00
240157	24W	840 HO	549mm	40	100	1.575,00
240158	39W	830 HO	849mm	40	100	1.708,15
240159	39W	840 HO	849mm	40	100	1.708,15
240154	49W	830 HO	1449mm	40	100	1.776,78
240155	49W	840 HO	1449mm	40	100	1.776,78
240182	54W	830 HO	1149mm	40	100	1.872,95
240183	54W	840 HO	1149mm	40	100	1.872,95
240272	80W	830 HO	1449mm	40	100	1.968,23
240273	80W	840 HO	1449mm	40	100	1.968,23

FH - Leuchtstofflampen

TL5 Rohrdurchmesser 16 mm

830 = Warmton

840 = hellweiss

Länge:



106676	14W	830 HE	549mm	40	100	1.135,00
106678	14W	840 HE	549mm	40	100	1.135,00
106684	21W	830 HE	849mm	40	100	1.280,00
106686	21W	840 HE	849mm	40	100	1.280,00
106692	28W	830 HE	1149mm	40	100	1.135,00
106694	28W	840 HE	1149mm	40	100	1.135,00
106701	35W	830 HE	1449mm	40	100	1.280,00
106703	35W	840 HE	1449mm	40	100	1.280,00

TL5 - Leuchtstofflampen

TL5 Rohrdurchmesser 17 mm

830 = warmweiss

840 = neutralweiss

Länge:



240146	14W	830 HE	549mm	40	100	1.229,37
240147	14W	840 HE	549mm	40	100	1.229,37
240148	21W	830 HE	849mm	40	100	1.382,58
240149	21W	840 HE	849mm	40	100	1.382,58
240150	28W	830 HE	1149mm	40	100	1.229,37
240151	28W	840 HE	1149mm	40	100	1.229,37
240152	35W	830 HE	1449mm	40	100	1.382,58
240153	35W	840 HE	1449mm	40	100	1.382,58

Leuchtstofflampen

Rohrdurchmesser 38 mm

20-640S = kaltweiss

Länge:

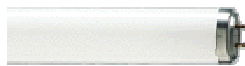

107139	20W	20-640S	590mm	25	100	520,00
107208	40W	20-640S	1200mm	25	100	520,00
107249	65W	20-640S	1500mm	25	100	615,00

Leuchtstofflampen

TL RS

Rohrdurchmesser 40,5 mm

33-640 = neutralweiss

Länge:

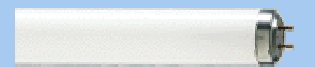

240289	20W	33-640	604mm	25	100	478,35
240290	40W	33-640	1213,6mm	25	100	478,35
240291	65W	33-640	1514,2mm	25	100	478,35

Starter



107679	ST 151	4-22W	25	100	107,00
107677	ST 111	4-80W	25	100	99,00
107681	ST 173	Schnellst. 15-32W	25	100	590,00
107685	ST 171	Schnellst. 30-80W	25	100	590,00

Starter



240229	S2	4-22W	25	100	109,61
240233	S10	4-65W	25	100	99,90

Infrarotlampe Linestra Halopin / Halolux

Abbildung	Art. Nr.	Bezeichnung	VE	per	Brutto €
-----------	----------	-------------	----	-----	----------



003414	LTV 29922	Röhre 40W E14 klar 26x80mm (für Dunstabzug)	10	100	363,40
---------------	-----------	--	----	-----	---------------



007554	GEL IR150WRT	Infrarotrefl. 150W rot 91372	9	100	812,00
---------------	--------------	------------------------------	---	-----	---------------

Linestra



007600	GEL LIN 35W	35W 2-sockelig	25	100	564,00
---------------	-------------	----------------	----	-----	---------------

007603	GEL LIN 60W	60W 2-sockelig	25	100	679,00
---------------	-------------	----------------	----	-----	---------------

010607	IBV 940135-100	Linestra-Set 35W weiss	1	100	1.390,00
---------------	----------------	------------------------	---	-----	-----------------

006528	IBV 940160-100	Linestra-Set 60W weiss	1	100	1.710,00
---------------	----------------	------------------------	---	-----	-----------------

Halopin Energy Saver



105588	OSR 66733ES	33W (= 40W) klar G9 230V 2.000 h / Länge = 43mm / Ø = 14mm	10	100	767,35
---------------	-------------	--	----	-----	---------------

Halolux



105390	OSR 64472	60W E27 klar	1	100	1.431,70
---------------	-----------	--------------	---	-----	-----------------

105396	OSR 64474	75W E27 klar	1	100	1.431,70
---------------	-----------	--------------	---	-----	-----------------

105400	OSR 64476	100W E27 klar	1	100	1.431,70
---------------	-----------	---------------	---	-----	-----------------

105406	OSR 64478	150W E27 klar	1	100	1.431,70
---------------	-----------	---------------	---	-----	-----------------



105391	OSR 64472 IM	60W E27 matt	1	100	1.431,70
---------------	--------------	--------------	---	-----	-----------------

105397	OSR 64474 IM	75W E27 matt	1	100	1.431,70
---------------	--------------	--------------	---	-----	-----------------

105401	OSR 64476 IM	100W E27 matt	1	100	1.431,70
---------------	--------------	---------------	---	-----	-----------------

105407	OSR 64478 IM	150W E27 matt	1	100	1.431,70
---------------	--------------	---------------	---	-----	-----------------



105392	OSR 64472 BT	60W klar E27	1	100	648,90
---------------	--------------	--------------	---	-----	---------------

105402	OSR 64476 BT	100W klar E27	1	100	648,90
---------------	--------------	---------------	---	-----	---------------

105408	OSR 64478 BT	150W klar E27	1	100	648,90
---------------	--------------	---------------	---	-----	---------------

Halolux Ceram



105382	OSR 64466	25W klar B15d	1	100	1.163,90
---------------	-----------	---------------	---	-----	-----------------

105384	OSR 64467	40W klar B15d	1	100	1.163,90
---------------	-----------	---------------	---	-----	-----------------

105386	OSR 64469	60W klar B15d	1	100	1.163,90
---------------	-----------	---------------	---	-----	-----------------

105394	OSR 64473	75W klar B15d	1	100	1.163,90
---------------	-----------	---------------	---	-----	-----------------

105398	OSR 64475	100W klar B15d	1	100	1.163,90
---------------	-----------	----------------	---	-----	-----------------



105383	OSR 64466 AM	25W matt B15d	1	100	1.163,90
---------------	--------------	---------------	---	-----	-----------------

105385	OSR 64467 AM	40W matt B15d	1	100	1.163,90
---------------	--------------	---------------	---	-----	-----------------

105387	OSR 64469 AM	60W matt B15d	1	100	1.462,60
---------------	--------------	---------------	---	-----	-----------------

105395	OSR 64473 AM	75W matt B15d	1	100	1.462,60
---------------	--------------	---------------	---	-----	-----------------

105399	OSR 64475 AM	100W matt B15d	1	100	1.462,60
---------------	--------------	----------------	---	-----	-----------------

Art. Nr.	Bezeichnung	Socket	VE	per	Brutto €
----------	-------------	--------	----	-----	----------

Halopin mit Sockel



Abmessungen:

L= 43 mm

ø = 14 mm



105586	25W 230V G9	66725	10	100	767,35
105587	25W 230V G9	66725 AM	10	100	824,00
105589	40W 230V G9	66740	10	100	768,38
105590	40W 230V G9	66740 AM	10	100	824,00
105582	60W 230V G9	66660	10	100	767,35
105583	60W 230V G9	66660 AM	10	100	824,00
105584	75W 230V G9	66675	10	100	767,35
105585	75W 230V G9	66675 AM	10	100	824,00

Art. Nr.	Bezeichnung	Socket	VE	per	Brutto €
----------	-------------	--------	----	-----	----------

Halopin mit Sockel



Abmessungen:

L= 52 mm

ø = 13 mm



031351	25W 230V G9	96673	10	100	809,00
031352	25W 230V G9	96671	10	100	883,00
031353	40W 230V G9	96674	10	100	809,00
031354	40W 230V G9	96675	10	100	883,00
031355	60W 230V G9	96676	10	100	809,00
031356	60W 230V G9	96677	10	100	883,00
031357	75W 230V G9	96678	10	100	809,00
031358	75W 230V G9	96679	10	100	883,00

Halogen Niedervolt Lampen Lebensdauer 3.000h

Abmessungen:

L= 45 mm

ø = 51 mm



105102	20W 12V GU5,3 38° 44860WFL	20	100	381,00
105104	35W 12V GU5,3 38° 44865WFL	20	100	381,00
105108	50W 12V GU5,3 38° 44870WFL	20	100	381,00

Halogen Niedervolt Lampen Lebensdauer 3.000h

Abmessungen:

L= 46 mm

ø = 51 mm



239764	20W 12V GU5,3 36° 32036	60	100	452,04
239765	35W 12V GU5,3 36° 33536	60	100	452,04
239766	50W 12V GU5,3 36° 35036	60	100	452,04

Halogen-Kaltlichtreflektorlampe
NV-Halogen
Hispot / Twistline Alu
CFL Square

Abbildung	Art. Nr.	Bezeichnung	VE	per	Brutto €
-----------	----------	-------------	----	-----	----------

Halogen-Kaltlichtreflektorlampe / MR 16 Start / GU5,3 / geschlossen
GE Lighting

031344	GEL 38006	20W 12V 36° 230V	10	100	405,00
031345	GEL 38007	35W 12V 36° 230V	10	100	405,00
031346	GEL 38011	50W 12V 36° 230V	10	100	405,00

Kaltlicht-Reflektorlampen m. Abdeckscheibe 51mm Ø
DECOSTAR 51 ENERGY SAVER
ENERGY SAVER
OSRAM

105185	OSR 48860 ES WFL	12V 20W 36° GU5,3	20	100	978,50
105189	OSR 48865 ES WFL	12V 35W 36° GU5,3	20	100	978,50
105193	OSR 48870 ES WFL	12V 50W 36° GU5,3	20	100	978,50

35mm Ø Niedervolt Halogenlampen Lebensdauer 2.000h
OSRAM

105109	OSR 44888WFL	12V 10W 36° GU4	10	100	545,90
105111	OSR 44890WFL	12V 20W 36° GU4	10	100	545,90
105113	OSR 44892WFL	12V 35W 36° GU4	10	100	545,90

Halopar ohne Trafo 230 Volt, Lebensdauer 2.000h GU10
OSRAM

105555	OSR 64820FL	HI-SPOT 35W + Alu-Reflektor	10	100	875,50
105558	OSR 64824FL	HI-SPOT 50W + Alu-Reflektor	10	100	875,50

Hispot GU10 240 Volt
GE Lighting

021635	GEL 10859	20MR16/230/FL 20W	10	100	1.160,00
021636	GEL 10857	35MR16/230/FL 35W	10	100	1.160,00
021637	GEL 92730	50MR16/230/FL 50W	10	100	1.160,00

Twistline Alu 2000 230 Volt 40° GU10

240202	PHL 18087	25W / Höhe: 51mm	10	100	1.082,49
239811	PHL 18044	50W / Höhe: 51mm	10	100	1.082,49

CFL Square

106104	OSR F16 2D827 2P	2D Lampen 16W 2 Stifte	20	100	1.640,00
106105	OSR F16 2D827 4P	2D Lampen 16W 4 Stifte	20	100	1.640,00
106108	OSR F28 2D827 2P	2D Lampen 28W 2 Stifte	20	100	2.400,00
106109	OSR F28 2D827 4P	2D Lampen 28W 4 Stifte	20	100	2.400,00

Art. Nr.	Bezeichnung	VE	per	Brutto €
----------	-------------	----	-----	----------

Halogenstäbe



Länge (mm):

007505	100W	r7S	78	10	100	750,00	
007507	150W	r7S	78	10	100	750,00	
007508	150W	r7S	117	10	100	710,00	
007867	200W	r7S	78	10	100	750,00	
030534	200W	r7S	117	230V	10	100	710,00
030532	300W	r7S	117	230V	10	100	513,00
030531	500W	r7S	117	10	100	496,00	
007506	1000W	r7S	189	10	100	1.262,00	
007509	1500W	r7S	254	10	100	1.498,00	
007511	2000W	r7S	331	10	100	1.814,00	

Halogen Niedervolt Lampen

Abmessungen:

	G4	G4	GY6,35
	5W	10/20W	25/35/50W
L (mm) =	31	30	44
ø (mm) =	10	10	12



007645	5W	G4	12V	M9	20	100	225,00
007616	10W	G4	12V	M11	20	100	225,00
007633	20W	G4	12V	M47	20	100	225,00
007641	20W	GY6,35	12V	M76	20	100	243,00
007646	35W	GY6,35	12V	M95	20	100	243,00
007632	50W	GY6,35	12V	M32	20	100	243,00

Art. Nr.	Bezeichnung	VE	per	Brutto €
----------	-------------	----	-----	----------

Halogenstäbe HALOLINE UV-Stop



Länge (mm):

105506	60W	r7S	74,9	64688	20	100	824,00
105507	100W	r7S	74,9	64690	20	100	824,00
105509	150W	r7S	74,9	64695	20	100	824,00
105511	150W	r7S	114,2	64696	20	100	772,50
105512	200W	r7S	114,2	64698	20	100	772,50
105513	300W	r7S	114,2	64701	20	100	566,50
105515	500W	r7S	114,2	64702	20	100	566,50
105530	1000W	r7S	185,7	64740	12	100	1.390,50

Halogen Niedervolt Lampen Halostar Standard UV-Stop

Abmessungen:

	10W	20W	35W	50W
L (mm) =	33	33	44	44
ø (mm) =	9,5	9,5	12	12



105357	10W	G4	12V	64415	40	100	216,30
105363	20W	G4	12V	64425	40	100	216,30
105367	35W	GY6,35	12V	64432	40	100	216,30
105372	50W	GY6,35	12V	64440	40	100	216,30

Art. Nr.	Bezeichnung	VE	per	Brutto €
----------	-------------	----	-----	----------

Halogenstäbe Plusline kurz und Standard



Länge (mm):

239859	60W	r7S	78,3	10	100	857,24
239117	100W	r7S	78,3	10	100	857,24
239118	150W	r7S	78,3	10	100	857,20
239851	200W	r7S	78,3	10	100	812,20
239856	200W	r7S	117,6	10	100	812,20
239857	300W	r7S	117,6	10	100	586,57
239858	500W	r7S	117,6	10	100	586,57
239853	1000W	r7S	189,1	10	100	1.443,80
239854	1500W	r7S	254	10	100	1.714,62

Halogen Niedervolt Lampen Capsuleline

Abmessungen:

	10W	20WG4	20W	35W	50W
L (mm) =	31	32	44	44	44
ø (mm) =	9	8,8	12	12	12



239721	10W	G4	12V	3284	100	100	257,15
239700	20W	G4	12V	13078	100	100	257,10
239705	20W	GY6,35	12V	13104	100	100	279,75
239704	35W	GY6,35	12V	13103	100	100	279,75
239703	50W	GY6,35	12V	13102	100	100	279,75

Art. Nr.	Bezeichnung	VE	per	Brutto €
----------	-------------	----	-----	----------

Halogen-Metall dampflampen Rx7S

Lebensdauer: 15.000 h



030978	CMH70TD UVC 830 warmweiss	12	100	6.625,92
030979	CMH70TD UVC 942 neutralweiss	12	100	6.625,92
030980	CMH150 TD UVC 830 warmweiss	12	100	7.058,48
030981	CMH150 TD UVC 942 neutralweiss	12	100	7.058,48

Halogen-Metall dampflampen Rx7S Arcstream

Lebensdauer: 9.000 h

000224	ARC70/TD/UVC/730 34530	12	100	4.195,00
002927	ARC70/TD/UVC/742 34536	12	100	4.195,00
000272	ARC150/TD/UVC/730 34527	12	100	4.320,00
016122	ARC150/TD/UVC/742 34535	12	100	4.320,00

keramische Halogen-Metall dampflampen G12 ConstantColor CMH

830 = warmweiss
 942 = neutralweiss



022576	35T UVC 830 / 43272	12	100	8.476,00
022688	70T UVC 830 / 20005	12	100	8.476,00
022757	70T UVC 942 / 20013	12	100	8.476,00
022758	150T UVC 830 / 20012	12	100	10.189,00
022762	150T UVC 942 / 20014	12	100	10.189,00

Art. Nr.	Bezeichnung	VE	per	Brutto €
----------	-------------	----	-----	----------

Halogen-Metall dampflampen Rx7S Ceramic Powerball HCI-TS



Abmessungen:

L (mm) = 70W (114,2) 150W (132)
 ø (mm) = 70W (21) 150W (24)

Lebensdauer: 15.000 h

106872	70W 830 WDL warmweiss	12	100	6.520,00
106873	70W 942 NDL neutralweiss	12	100	6.520,00
106868	150W 830 WDL warmweiss	12	100	6.945,00
106869	150W 942 NDL neutralweiss	12	100	6.945,00

Halogen-Metall dampflampen Rx7S Powerstar HQI-TS UV-reduziert



Abmessungen:

L (mm) = 70W (114,2) 150W (132)
 ø (mm) = 70W (20) 150W (23)

Lebensdauer: 9.000 h

106962	70W WDL warmweiss	12	100	4.870,00
106961	70W NDL neutralweiss	12	100	4.870,00
106950	150W WDL warmweiss	12	100	5.000,00
106949	150W NDL neutralweiss	12	100	5.000,00

Halogen-Metall dampflampen G12 Keramik-Powerball HCI-T

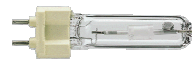

Abmessungen:

L (mm) = 35W+70W (100) 150W (105)
 ø (mm) = 35W+70W (19) 150W (25)

106851	35W 830 WDL warmweiss	12	100	9.350,00
106853	35W 942 NDL neutralweiss	12	100	9.350,00
106854	70W 830 WDL warmweiss	12	100	9.350,00
106856	70W 942 NDL neutralweiss	12	100	9.350,00
106847	150W 830 WDL warmweiss	12	100	11.250,00
106848	150W 942 NDL neutralweiss	12	100	11.250,00

Halogen-Metall dampflampen

Art. Nr.	Bezeichnung	VE	per	Brutto €
----------	-------------	----	-----	----------

Halogen-Metall dampflampen Rx7S MasterColour CDM-TD



Abmessungen:

L (mm) = 70W (119,63) 150W (137,43)
 ø (mm) = 70W (22) 150W (25)

Lebensdauer: 15.000 h

239338	70W 830 warmweiss	12	100	6.884,33
239351	70W 942 neutralweiss	12	100	6.884,33
239339	150W 830 warmweiss	12	100	7.333,76
239353	150W 942 neutralweiss	12	100	7.333,76

Halogen-Metall dampflampen Rx7S MHN-TD

Abmessungen:

L (mm) = 70W (119,63) 150W (137,43)
 ø (mm) = 70W (21) 150W (24)

Lebensdauer: 9.000 h

240317	70W 842 neutralweiss	12	100	5.234,39
240006	70W 730 warmweiss	12	100	5.234,39
240318	150W 842 neutralweiss	12	100	5.385,18
239324	150W 730 warmweiss	12	100	5.385,18

Halogen-Metall dampflampen G12 MasterColour CDM-T

Lebensdauer: 12.000 h

Abmessungen:

L (mm) = 35W+70W (103) 150W (110)
 ø (mm) = 20

239330	35W 830 warmweiss	12	100	10.619,86
239468	35W 942 neutralweiss	12	100	10.619,86
239331	70W 830 warmweiss	12	100	10.619,86
239343	70W 942 neutralweiss	12	100	10.619,86
239337	150W 830 warmweiss	12	100	11.873,12
239352	150W 942 neutralweiss	12	100	11.873,12

Art. Nr.	Bezeichnung	Socket	Farbe	VE	per	Brutto €
----------	-------------	--------	-------	----	-----	----------

Softone Standard Bellalux



Abmessungen:

L= 97 mm
ø = 55 mm



106052	25W 230V	E27	Bellalux	100	100	208,00
106053	40W 230V	E27	Bellalux	100	100	208,00
106054	60W 230V	E27	Bellalux	100	100	208,00
106055	75W 230V	E27	Bellalux	100	100	234,00
106051	100W 230V	E27	Bellalux	100	100	234,00

Art. Nr.	Bezeichnung	Socket	Farbe	VE	per	Brutto €
----------	-------------	--------	-------	----	-----	----------

Softone Standard



Abmessungen:

L= 95 mm
ø = 55 mm



239656	25W 230V	E27	weiss	30	100	201,33
239658	40W 230V	E27	weiss	30	100	201,33
239652	60W 230V	E27	weiss	30	100	201,33
239660	75W 230V	E27	weiss	30	100	201,33
239654	100W 230V	E27	weiss	30	100	201,33

Krypton Superlux



ø / L (mm)

107691	40W 230V	E27	50 / 88	100	100	276,00
107692	60W 230V	E27	50 / 88	100	100	276,00
107083	75W 230V	E27	60 / 105	100	100	311,00
107082	100W 230V	E27	60 / 105	100	100	311,00

Argenta Superlux softwhite



ø / L (mm)

239030	40W 230V	E27	50 / 91	60	100	275,02
239031	60W 230V	E27	50 / 91	60	100	275,02
239048	75W 230V	E27	50 / 91	60	100	291,43
239049	100W 230V	E27	60 / 104	60	100	291,43

**Quecksilberdampf Lampen HQL und HQL DeLuxe,
verbesserte Farbqualität**



ø / Länge (mm)

106974	50W E27	HQL	50 / 130	40	100	890,00
106979	80W E27	HQL	70 / 156	40	100	890,00
106966	125W E27	HQL	75 / 170	40	100	1.030,00
106969	250W E40	HQL	90 / 226	12	100	3.120,00
106971	400W E40	HQL	120 / 290	12	100	4.285,00

106973	50W E27	HQL DeLuxe	55 / 130	40	100	1.020,00
106978	80W E27	HQL DeLuxe	70 / 156	40	100	1.020,00
106965	125W E27	HQL DeLuxe	75 / 170	40	100	1.255,00

**Quecksilberdampf Lampen Comfort und neutralweiss,
verbesserte Farbqualität**



ø / Länge (mm)

239240	50W E27	HPL-N	56 / 130	10	100	897,75
239241	80W E27	HPL-N	71 / 155	10	100	897,75
239242	125W E27	HPL-N	76 / 173	10	100	1.047,22
239247	250W E40	HPL-N	91 / 228	10	100	3.193,17
239245	400W E40	HPL-N	121,5 / 290	10	100	4.389,99

239248	50W E27	HPL-C	56 / 130	10	100	1.047,22
239249	80W E27	HPL-C	71 / 155	10	100	1.047,22
239250	125W E27	HPL-C	76 / 173	10	100	1.296,72

Die Qual der Wahl bei der Auswahl des richtigen Produkts?

Lassen Sie sich nicht ins



bringen!

Rufen Sie uns



(ohne) an!

Wir beraten Sie gerne!

Art. Nr.	Bezeichnung	VE	per	Brutto €
----------	-------------	----	-----	----------

Reflektorlampen



Abmessungen:

	R39	R50	R63	R80	R95		
L (mm) =	64	86	103	115	131		
ø (mm) =	39	50	63	80	95		
007672	R39	30W	E14	240V	100	100	390,00
007673	R50	25W	E14	240V	50	100	257,00
030460	R50	40W	E14	240V	40	100	257,00
007683	R63	40W	E27	240V	40	100	267,00
007684	R63	60W	E27	240V	40	100	267,00
007686	R80	40W	E27	240V	40	100	267,00
007691	R80	60W	E27	240V	40	100	267,00
007692	R80	75W	E27	240V	40	100	348,00
007685	R80	100W	E27	240V	40	100	348,00
007695	R95	75W	E27	240V	32	100	456,00
007693	R95	100W	E27	240V	32	100	456,00

PAR38 - Reflektorlampen

Abmessungen:

L (mm) =	140						
ø (mm) =	122						
007671	80W	SP	E27	Spot	12	100	828,00
000094	100W	SP	E27	Spot	12	100	911,00
007664	60W	FL	E27	Flood	12	100	828,00
007667	80W	FL	E27	Flood	12	100	828,00
007660	120W	FL	E27	Flood	12	100	911,00

Art. Nr.	Bezeichnung	VE	per	Brutto €
----------	-------------	----	-----	----------

Reflektorlampen



Abmessungen:

	R39	R50	R63	R80	R95		
L (mm) =	67,5	86,5	105	116	140		
ø (mm) =	39	50	63	80	95		
106215	R39	30W	E14	230V	25	100	528,00
106216	R50	25W	E14	230V	25	100	348,00
106217	R50	40W	E14	230V	25	100	348,00
106223	R63	40W	E27	230V	25	100	360,00
106224	R63	60W	E27	230V	25	100	360,00
106233	R80	40W	E27	230V	25	100	360,00
106230	R80	60W	E27	225V	25	100	360,00
106232	R80	75W	E27	225V	25	100	450,00
106229	R80	100W	E27	225V	25	100	450,00
107747	R95	75W	E27	230V	24	100	600,00
106236	R95	100W	E27	230V	24	100	600,00

PAR38 - Reflektorlampen 240V

Abmessungen:

L (mm) =	139						
ø (mm) =	122						
106209	80W	SP	E27	Spot	12	100	1.157,00
106206	120W	SP	E27	Spot	12	100	1.287,00
106208	60W	FL	E27	Flood	12	100	1.157,00
106209	80W	FL	E27	Flood	12	100	1.157,00
106207	120W	FL	E27	Flood	12	100	1.287,00

Art. Nr.	Bezeichnung	VE	per	Brutto €
----------	-------------	----	-----	----------

Reflektorlampen



Abmessungen:

	R39	R50	R63	R80	R95		
L (mm) =	67	86	104,5	116	139		
ø (mm) =	39	50	63	80	95		
239075	R39	30W	E14	230V	30	100	441,22
239100	R50	25W	E14	230V	30	100	290,97
239101	R50	40W	E14	230V	30	100	290,97
239089	R63	40W	E27	230V	30	100	290,97
239090	R63	60W	E27	230V	30	100	290,97
239154	R80	40W	E27	230V	30	100	290,97
239155	R80	60W	E27	230V	30	100	290,97
239150	R80	75W	E27	230V	30	100	394,19
239151	R80	100W	E27	230V	30	100	394,19
239152	R95	75W	E27	230V	30	100	516,27
239153	R95	100W	E27	230V	30	100	516,27
239032	R80	40W	E27	Philux	30	100	262,83
239033	R80	60W	E27	Philux	30	100	262,83
239034	R80	75W	E27	Philux	30	100	290,97

PAR38 - Reflektorlampen

Abmessungen:

	1)	2)					
L (mm) =	137	137					
ø (mm) =	121	122,5					
239682	80W	SP	E27	1) Spot	12	100	947,72
239679	120W	SP	E27	2) Spot	12	100	1.042,57
239677	60W	FL	E27	1) Flood	12	100	947,72
239678	80W	FL	E27	2) Flood	12	100	947,72
239676	120W	FL	E27	2) Flood	12	100	1.042,57

Art. Nr.	Bezeichnung	Type	VE	per	Brutto €
----------	-------------	------	----	-----	----------

Energiesparlampe



Glühlampenform Electronic Decor T2/T3 Standard (6000 h) FLE/GLS/T2

000635 8W E27 827 45850 10 100 **1.170,00**

000624 8W E14 827 45848 10 100 **1.170,00**

000636 12W E27 827 45837 10 100 **1.170,00**

000625 12W E14 827 45835 10 100 **1.170,00**

000638 15W E27 827 45831 10 100 **1.380,00**

028885 20W E27 827 40158 10 100 **1.380,00**

Art. Nr.	Bezeichnung	Type	VE	per	Brutto €
----------	-------------	------	----	-----	----------

Energiesparlampen



→ EL CL

Dulux EL Classic A (EL CL) & Dulux EL (EL) 10.000 h

106455 7W E27 827 EL CL 10 100 **1.650,00**

106451 10W E27 827 EL CL 10 100 **1.650,00**

106452 15W E27 827 EL CL 10 100 **1.650,00**

106453 20W E27 827 EL CL 10 100 **1.650,00**



Duluxstar Mini Globe DSTAR MIGL / 827 warmwhite / 220-240V

106362 5W E14 $\phi = 62\text{mm}$ L = 100mm 10 100 **980,00**

106363 5W E27 $\phi = 62\text{mm}$ L = 96mm 10 100 **1.050,00**

106364 7W E14 $\phi = 62\text{mm}$ L = 100mm 10 100 **980,00**

106365 7W E27 $\phi = 62\text{mm}$ L = 96mm 10 100 **1.050,00**

106360 11W E27 $\phi = 72\text{mm}$ L = 111mm 10 100 **1.050,00**

106361 15W E27 $\phi = 80\text{mm}$ L = 121mm 10 100 **1.050,00**

Art. Nr.	Bezeichnung	Type	VE	per	Brutto €
----------	-------------	------	----	-----	----------

Energiesparlampen



PL-Electronic Ambiance (12.000 h) & Softone ESaver 8yr (8.000 h)

240217 5W E27 827 Softone 6 100 **1.262,18**

240218 8W E27 827 Softone 6 100 **1.262,18**

240462 9W E27 827 PL-E 6 100 **1.713,26**

239835 12W E27 827 PL-E 6 100 **1.713,26**

240219 12W E27 827 Softone 6 100 **1.262,18**

239836 16W E27 827 PL-E 6 100 **1.713,26**

240220 16W E27 827 Softone 6 100 **1.262,18**

239837 20W E27 827 PL-E 6 100 **1.713,26**

240221 20W E27 827 Softone 6 100 **1.262,18**

239834 23W E27 827 PL-E 6 100 **1.713,26**

Art. Nr.	Bezeichnung	Type	VE	per	Brutto €
----------	-------------	------	----	-----	----------

Energiesparlampen



Abmessungen:

E14	E27
ø (mm) =	45 46
L (mm) =	100 103



Electronic Decor T2 Spherical (6.000 h) Illu FLE/SPH/T2

000581	5W	E14	827	88839	8	100	1.350,00
000596	5W	E27	827	73386	10	100	1.350,00
000597	7W	E14	827	88842	8	100	1.440,00
000598	7W	E27	827	73396	10	100	1.440,00



Electronic Decor T2 Candle (6.000 h) / Kerze FLE/CDL/T2

000633	5W	E14	827	73406	10	100	1.350,00
000648	5W	E27	827	88852	10	100	1.350,00
000649	7W	E14	827	73411	10	100	1.440,00
000650	7W	E27	827	88855	10	100	1.440,00

Art. Nr.	Bezeichnung	VE	per	Brutto €
----------	-------------	----	-----	----------

Energiesparlampen



Duluxstar Mini Ball DSTAR MIBA / 827 warmwhite

106358	5W	E27	ø = 45mm	L = 96mm	10	100	880,00
106359	7W	E27	ø = 45mm	L = 96mm	10	100	880,00
106356	11W	E27	ø = 60mm	L = 111mm	10	100	880,00
106357	15W	E27	ø = 60mm	L = 121mm	10	100	880,00



Dulux EL Classic B / 827 Interna

106456	5W	E14	ø = 37mm	L = 99,5mm	10	100	2.100,00
106457	7W	E14	ø = 42,5mm	L = 117mm	10	100	2.100,00
106458	9W	E14	ø = 42,5mm	L = 117mm	10	10	2.100,00

Energiesparlampen

Art. Nr.	Bezeichnung	VE	per	Brutto €
----------	-------------	----	-----	----------

Energiesparlampen



Softone Esaver 8yr Mini (SOFT ES 8YR TRL Mini) / 827 warmweiss

240925	8W	E14	ø = 45mm	L = 80mm	10	100	1.099,00
240924	8W	E27	ø = 45mm	L = 85mm	10	100	1.099,00



Softone Esaver Kerze 8yr / 827 warmweiss

240222	5W	E14	ø = 45,8mm	L = 128,2mm	6	100	1.487,56
240223	8W	E14	ø = 45,8mm	L = 128,2mm	6	100	1.487,56
240224	12W	E14	ø = 46,8mm	L = 135,2mm	6	100	1.487,56

Art. Nr.	Bezeichnung	Type	VE	per	Brutto €
----------	-------------	------	----	-----	----------

Energiesparlampen **GE Lighting**



Electronic Biax Extra-Mini T3 / 827 (15.000 h)					
000295	9W	E14	ø = 42mm L = 116mm	43342	6 100 1.462,00
000296	9W	E27	ø = 42mm L = 115mm	43343	6 100 1.349,00
000298	11W	E14	ø = 42mm L = 116mm	43352	6 100 1.462,00
000305	11W	E27	ø = 42mm L = 115mm	43353	6 100 1.349,00
000318	15W	E27	ø = 42mm L = 128mm	43364	6 100 1.349,00
000328	20W	E27	ø = 42mm L = 143mm	43370	6 100 1.349,00
Electronic Biax Extra-Mini QBX / 827 (15.000 h)					
000329	20W	E27	ø = 49mm L = 137mm	23017	10 100 1.349,00
000330	23W	E27	ø = 49mm L = 151mm	23106	10 100 1.462,00

Art. Nr.	Bezeichnung	Type	VE	per	Brutto €
----------	-------------	------	----	-----	----------

Energiesparlampen **OSRAM**



Dulux EL Longlife (DEL LL) / 827 (15.000 h)					
106312	3W	E14	ø = 30mm L = 115mm	10 100	1.550,00
106313	5W	E14	ø = 36mm L = 119mm	10 100	1.430,00
106337	5W	E27	ø = 36mm L = 113mm	10 100	1.430,00
106314	7W	E14	ø = 36mm L = 113mm	10 100	1.430,00
106338	7W	E27	ø = 36mm L = 119mm	10 100	1.430,00
106296	11W	E14	ø = 45mm L = 126mm	10 100	1.430,00
106297	11W	E27	ø = 45mm L = 117mm	10 100	1.430,00
106300	15W	E27	ø = 45mm L = 128mm	10 100	2.010,00
106303	20W	E27	ø = 45mm L = 145mm	10 100	2.010,00
106306	23W	E27	ø = 58mm L = 173mm	10 100	1.550,00
106309	30W	E27	ø = 58mm L = 180mm	10 100	2.110,00

Energiesparlampen

Art. Nr.	Bezeichnung	Type	VE	per	Brutto €
----------	-------------	------	----	-----	----------

Energiesparlampen **PHILIPS** sense and simplicity



Master PL Electronic / 827 (15.000 h)					
239531	5W	E14	ø = 26mm L = 118mm	10 100	1.534,87
239530	5W	E27	ø = 26mm L = 115mm	10 100	1.496,84
239534	8W	E14	ø = 26mm L = 123mm	10 100	1.534,87
239532	8W	E27	ø = 26mm L = 120mm	10 100	1.496,84
239538	11W	E14	ø = 26mm L = 145mm	10 100	1.534,87
239535	11W	E27	ø = 26mm L = 142mm	10 100	1.496,84
240356	15W	E27	ø = 39,8mm L = 126,2mm	6 100	1.534,87
240357	20W	E27	ø = 39,8mm L = 137,2mm	6 100	1.534,87
240358	23W	E27	ø = 39,8mm L = 152,2mm	6 100	1.534,87
239958	27W	E27	ø = 39,8mm L = 174,2mm	6 100	1.534,87
240212	33W	E27	ø = 39,8mm L = 196,2mm	6 100	1.534,87

Sehr geehrte Kunden!

Da sich bei vielen Produkten Preise täglich ändern, sind unsere Preise als Richtpreise anzusehen und wir behalten uns Preisänderungen vor.

Art. Nr.	Bezeichnung	Type	VE	per	Brutto €
----------	-------------	------	----	-----	----------

Energiesparlampen **GE Lighting**



Electronic Biax T3 Mini / 827 (10.000 h)

000876	9W	E14	L = 115mm	88697	10	100	870,00
000875	9W	E27	L = 117mm	88695	10	100	870,00
000877	11W	E14	L = 126mm	88706	10	100	870,00
000874	11W	E27	L = 126mm	72689	10	100	870,00

000878	15W	E27	L = 140mm	72688	10	100	870,00
---------------	-----	-----	-----------	-------	----	-----	---------------

000879	20W	E27	L = 153mm	88718	10	100	870,00
---------------	-----	-----	-----------	-------	----	-----	---------------



Electronic Biax T4 Sensor FLE15TBX SENZ / 827 / 220-240V (6.000 h)

000331	15W	E27	$\phi = 55\text{mm}$ L = 148mm	45299	10	100	3.570,00
---------------	-----	-----	-----------------------------------	-------	----	-----	-----------------

Art. Nr.	Bezeichnung	Type	VE	per	Brutto €
----------	-------------	------	----	-----	----------

Energiesparlampen **OSRAM**



ECO Dulux EL / 827 (10.000 h)

106448	8W	E14	$\phi = 36\text{mm}$	L = 114mm	10	100	1.110,00
106449	8W	E27	$\phi = 36\text{mm}$	L = 113mm	10	100	1.040,00

106438	12W	E14	$\phi = 45\text{mm}$	L = 126mm	10	100	1.110,00
---------------	-----	-----	----------------------	-----------	----	-----	-----------------

106439	12W	E27	$\phi = 45\text{mm}$	L = 117mm	10	100	1.040,00
---------------	-----	-----	----------------------	-----------	----	-----	-----------------

106441	16W	E27	$\phi = 45\text{mm}$	L = 128mm	10	100	1.040,00
---------------	-----	-----	----------------------	-----------	----	-----	-----------------

106444	21W	E27	$\phi = 45\text{mm}$	L = 145mm	10	100	1.040,00
---------------	-----	-----	----------------------	-----------	----	-----	-----------------



Dulux EL Sensor (DEL LL SENS) / dimmbar / Vario / 827

106340	11W	E27	SEN	$\phi = 45\text{mm}$ L = 123mm	6	100	2.430,00
---------------	-----	-----	-----	-----------------------------------	---	-----	-----------------

106341	15W	E27	SEN	$\phi = 45\text{mm}$ L = 129mm	10	100	2.430,00
---------------	-----	-----	-----	-----------------------------------	----	-----	-----------------

106294	20W	E27	DIM	$\phi = 58\text{mm}$ L = 158mm	10	100	2.600,00
---------------	-----	-----	-----	-----------------------------------	----	-----	-----------------

106343	20W	E27	VAR	$\phi = 45\text{mm}$ L = 145mm	6	100	2.050,00
---------------	-----	-----	-----	-----------------------------------	---	-----	-----------------

Energiesparlampen

Art. Nr.	Bezeichnung	Type	VE	per	Brutto €
----------	-------------	------	----	-----	----------

Energiesparlampen **PHILIPS** sense and simplicity



PL-Electronic / 827 (10.000 h)

239950	12W	E27	$\phi = 38,7\text{mm}$	L = 118,9mm	15	100	1.227,22
---------------	-----	-----	------------------------	-------------	----	-----	-----------------

239951	16W	E27	$\phi = 38,7\text{mm}$	L = 126,6mm	15	100	1.227,22
---------------	-----	-----	------------------------	-------------	----	-----	-----------------

239952	20W	E27	$\phi = 38,7\text{mm}$	L = 144,2mm	15	100	1.227,22
---------------	-----	-----	------------------------	-------------	----	-----	-----------------

239953	23W	E27	$\phi = 38,7\text{mm}$	L = 155,2mm	15	100	1.227,22
---------------	-----	-----	------------------------	-------------	----	-----	-----------------



Master PL-E Automatic (AUTO) & Master PL-E Dimmable (DIMM) / 827 (15.000 h)

240884	11W	E27	AUTO	$\phi = 51\text{mm}$ L = 141mm	6	100	1.999,00
---------------	-----	-----	------	-----------------------------------	---	-----	-----------------

240885	15W	E27	AUTO	$\phi = 51\text{mm}$ L = 141mm	6	100	1.999,00
---------------	-----	-----	------	-----------------------------------	---	-----	-----------------

240916	20W	E27	DIMM	$\phi = 40\text{mm}$ L = 147mm	6	100	2.499,00
---------------	-----	-----	------	-----------------------------------	---	-----	-----------------

Art. Nr.	Bezeichnung	VE	per	Brutto €
----------	-------------	----	-----	----------

Energiesparlampen



827 = warmweiss
830 = Warmton
840 = kaltweiss

Abmessungen:

	10W	13W	18W	26W
Ø (mm) =	27	27	27	27
L (mm) =	110	138	153	172

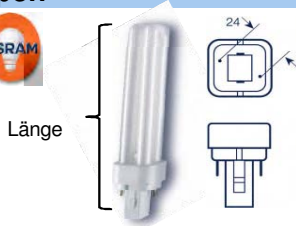

Dulux D 2Pin

f. konventionelle Vorschaltgeräte (KVG)

106409	10W	827 DD	G24d1	10	100	910,00
106410	10W	830 DD	G24d1	10	100	910,00
106411	10W	840 DD	G24d1	10	100	910,00
106413	13W	827 DD	G24d1	10	100	910,00
106414	13W	830 DD	G24d1	10	100	1.000,00
106415	13W	840 DD	G24d1	10	100	1.000,00
106416	18W	827 DD	G24d2	10	100	1.125,00
106417	18W	830 DD	G24d2	10	100	1.125,00
106418	18W	840 DD	G24d2	10	100	1.125,00
106420	26W	827 DD	G24d3	10	100	1.300,00
106421	26W	830 DD	G24d3	10	100	1.300,00
106422	26W	840 DD	G24d3	10	100	1.300,00

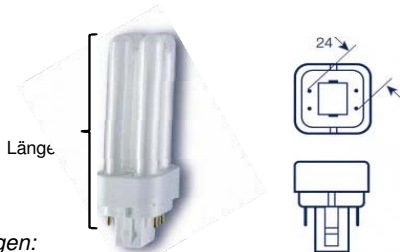

Abmessungen:

	10W	13W	18W	26W
Ø (mm) =	27	27	27	27
L (mm) =	103	131	146	165

Dulux D/E 4Pin

f. elektr. Vorschaltgeräte (EVG) + Dimmerbetrieb

106424	10W	827 DDE	G24q1	10	100	1.000,00
106425	10W	830 DDE	G24q1	10	100	1.000,00
106426	10W	840 DDE	G24q1	10	100	1.000,00
106427	13W	827 DDE	G24q1	10	100	1.080,00
106428	13W	830 DDE	G24q1	10	100	1.080,00
106429	13W	840 DDE	G24q1	10	100	1.080,00
106431	18W	827 DDE	G24q2	10	100	1.210,00
106432	18W	830 DDE	G24q2	10	100	1.210,00
106433	18W	840 DDE	G24q2	10	100	1.210,00
106434	26W	827 DDE	G24q3	10	100	1.425,00
106435	26W	830 DDE	G24q3	10	100	1.425,00
106436	26W	840 DDE	G24q3	10	100	1.425,00

Art. Nr.	Bezeichnung	VE	per	Brutto €
----------	-------------	----	-----	----------

Energiesparlampen



827 = Warmton Extra
830 = warmweiss
840 = neutralweiss

Abmessungen:

	10W	13W	18W	26W
Ø (mm) =	27,1	27,1	27,1	27,1
L (mm) =	116,4	138,4	150,4	171,4

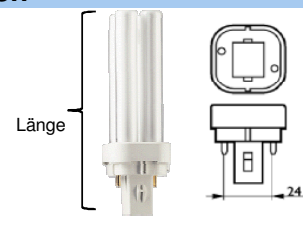

Master PL-C 2Pin

f. konventionelle Vorschaltgeräte (KVG)

240265	10W	827 G24d1	10	100	1.014,75
240266	10W	830 G24d1	10	100	1.014,75
240250	10W	840 G24d1	10	100	1.014,75
240076	13W	827 G24d1	10	100	1.111,69
240077	13W	830 G24d1	10	100	1.111,69
240078	13W	840 G24d1	10	100	1.111,69
240079	18W	827 G24d2	10	100	1.261,78
240080	18W	830 G24d2	10	100	1.261,78
240081	18W	840 G24d2	10	100	1.261,78
240082	26W	827 G24d3	10	100	1.450,27
240083	26W	830 G24d3	10	100	1.450,27
240084	26W	840 G24d3	10	100	1.450,27

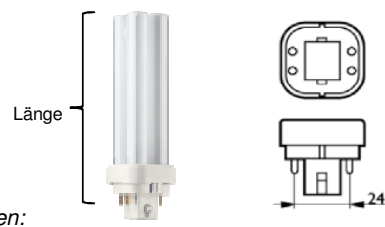

Abmessungen:

	10W	13W	18W	26W
Ø (mm) =	27,1	27,1	27,1	27,1
L (mm) =	108,9	130,9	142,9	163,9

Master PL-C 4Pin

f. elektr. Vorschaltgeräte (EVG) + Dimmerbetrieb

240086	10W	827 G24q1	10	100	1.111,69
240090	10W	830 G24q1	10	100	1.111,69
240091	10W	840 G24q1	10	100	1.111,69
240087	13W	827 G24q1	10	100	1.208,50
240092	13W	830 G24q1	10	100	1.208,50
240093	13W	840 G24q1	10	100	1.208,50
240088	18W	827 G24q2	10	100	1.353,33
240094	18W	830 G24q2	10	100	1.353,33
240095	18W	840 G24q2	10	100	1.353,33
240089	26W	827 G24q3	10	100	1.595,10
240096	26W	830 G24q3	10	100	1.595,10
240097	26W	840 G24q3	10	100	1.595,10

Kompaktleuchtstofflampen

Art. Nr.	Bezeichnung	VE per	Brutto €
----------	-------------	--------	----------

Kompaktleuchtstofflampen



827 = warmweiss
830 = Warmton
840 = kaltweiss

Länge

Abmessungen:

	7W	9W	11W
Ø (mm) =	27	27	27
L (mm) =	137	167	237

Dulux S 2Pin

für konventionelle Vorschaltgeräte (KVG)

106526	7W	827	DS	G23	10	100	480,00
106527	7W	830	DS	G23	10	100	480,00
106528	7W	840	DS	G23	10	100	480,00
106533	9W	827	DS	G23	10	100	480,00
106534	9W	830	DS	G23	10	100	480,00
106535	9W	840	DS	G23	10	100	480,00
106518	11W	827	DS	G23	10	100	520,00
106519	11W	830	DS	G23	10	100	520,00
106520	11W	840	DS	G23	10	100	520,00

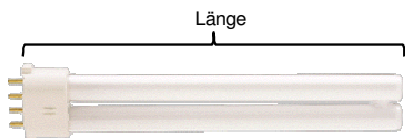

Abmessungen:

	7W	9W	11W
Ø (mm) =	27	27	27
L (mm) =	114	144	214

Dulux S/E 4Pin

f. elektr. Vorschaltgeräte (EVG) + Dimmerbetrieb

106543	7W	827	DSE	2G7	10	100	560,00
106544	7W	830	DSE	2G7	10	100	560,00
106545	7W	840	DSE	2G7	10	100	560,00
106546	9W	827	DSE	2G7	10	100	560,00
106547	9W	830	DSE	2G7	10	100	560,00
106548	9W	840	DSE	2G7	10	100	560,00
106538	11W	827	DSE	2G7	10	100	650,00
106539	11W	830	DSE	2G7	10	100	650,00
106540	11W	840	DSE	2G7	10	100	650,00

Art. Nr.	Bezeichnung	VE per	Brutto €
----------	-------------	--------	----------

Kompaktleuchtstofflampen



sense and simplicity



827 = Warmton Extra
830 = warmweiss
840 = neutralweiss

Länge

Abmessungen:

	7W	9W	11W
Ø (mm) =	28	28	28
L (mm) =	135	167	235,8

Master PL-S 2Pin

für konventionelle Vorschaltgeräte (KVG)

239494	7W	827	G23	10	100	531,33
239495	7W	830	G23	10	100	531,33
239496	7W	840	G23	10	100	531,33
239500	9W	827	G23	10	100	531,33
239501	9W	830	G23	10	100	531,33
239502	9W	840	G23	10	100	531,33
239506	11W	827	G23	10	100	580,23
239507	11W	830	G23	10	100	580,23
239508	11W	840	G23	10	100	580,23

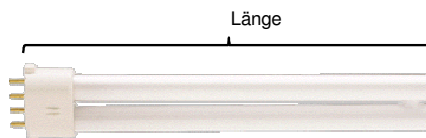

Abmessungen:

	7W	9W	11W
Ø (mm) =	28	28	28
L (mm) =	113	145	214

PL-S 4Pin

f. elektr. Vorschaltgeräte (EVG) + Dimmerbetrieb

239497	7W	827	2G7	10	100	628,26
239498	7W	830	2G7	10	100	628,26
239499	7W	840	2G7	10	100	628,26
239503	9W	827	2G7	10	100	628,26
239504	9W	830	2G7	10	100	628,26
239505	9W	840	2G7	10	100	628,26
239509	11W	827	2G7	10	100	725,08
239510	11W	830	2G7	10	100	725,08
239511	11W	840	2G7	10	100	725,08

Art. Nr.	Bezeichnung	Type	VE	per	Brutto €
----------	-------------	------	----	-----	----------

Energiesparlampen



Electronic Decor T2 Spiral FLE/HLX/T2 (8.000 h) / 827					
000652	8W	E14	$\phi = 46\text{mm}$ L = 101mm	72711	8 100 1.050,00
000653	8W	E27	$\phi = 46\text{mm}$ L = 87mm	72712	8 100 1.050,00
000287	12W	E14	$\phi = 53\text{mm}$ L = 100mm	72714	6 100 1.050,00
000654	12W	E27	$\phi = 53\text{mm}$ L = 100mm	72715	6 100 1.050,00
000655	15W	E27	$\phi = 54\text{mm}$ L = 100mm	72717	6 100 1.170,00
000656	20W	E27	$\phi = 60\text{mm}$ L = 118mm	88680	6 100 1.260,00
000762	23W	E27		88686	6 100 1.350,00

Art. Nr.	Bezeichnung	Type	VE	per	Brutto €
----------	-------------	------	----	-----	----------

Energiesparlampen



Duluxstar Mini Twist (DSTARMITW) ¹⁾ & Duluxstar Twist (DTWIST) ²⁾ / 6.000 h / Lichtfarbe 827 (Interna)					
106373	5W	E14	¹⁾ $\phi = 35\text{mm}$ L = 92mm		10 100 995,00
106374	5W	E27	¹⁾ $\phi = 40\text{mm}$ L = 75mm		10 100 995,00
106377	8W	E14	¹⁾ $\phi = 35\text{mm}$ L = 101mm		10 100 995,00
106378	8W	E27	¹⁾ $\phi = 46\text{mm}$ L = 83mm		10 100 995,00
106369	11W	E14	¹⁾ $\phi = 40\text{mm}$ L = 107mm		10 100 995,00
106370	11W	E27	¹⁾ $\phi = 46\text{mm}$ L = 91mm		10 100 995,00
106398	13W	E27	²⁾ $\phi = 46\text{mm}$ L = 116mm		10 100 995,00
106400	21W	E27	²⁾ $\phi = 54\text{mm}$ L = 123mm		10 100 995,00
106402	24W	E27	²⁾ $\phi = 54\text{mm}$ L = 132mm		10 100 995,00

Art. Nr.	Bezeichnung	Type	VE	per	Brutto €
----------	-------------	------	----	-----	----------

Energiesparlampen







827 = Warmton-Extra
 865 = cool daylight

Tornado Esaver 8yr (8.000 h) / 230-240V					
240861	5W	E14	$\phi = 47\text{mm}$ L = 92mm	T2 827	6 100 899,00
240850	5W	E27	$\phi = 47\text{mm}$ L = 80mm	T2 827	6 100 899,00
240862	8W	E14	$\phi = 47\text{mm}$ L = 99mm	T2 827	6 100 899,00
240863	8W	E14	$\phi = 47\text{mm}$ L = 99mm	T2 865	6 100 899,00
240851	8W	E27	$\phi = 47\text{mm}$ L = 87mm	T2 827	6 100 899,00
240852	8W	E27	$\phi = 47\text{mm}$ L = 87mm	T2 865	6 100 899,00
240864	12W	E14	$\phi = 47\text{mm}$ L = 106mm	T2 827	6 100 899,00
240865	12W	E14	$\phi = 47\text{mm}$ L = 106mm	T2 865	6 100 899,00
240853	12W	E27	$\phi = 47\text{mm}$ L = 94mm	T2 827	6 100 899,00
240854	12W	E27	$\phi = 47\text{mm}$ L = 94mm	T2 865	6 100 899,00
240855	15W	E27	$\phi = 58\text{mm}$ L = 109mm	T3 827	6 100 899,00
240856	15W	E27	$\phi = 58\text{mm}$ L = 109mm	T3 865	6 100 899,00
240857	20W	E27	$\phi = 63\text{mm}$ L = 114mm	T3 827	6 100 899,00
240858	20W	E27	$\phi = 63\text{mm}$ L = 114mm	T3 865	6 100 899,00
240859	23W	E27	$\phi = 63\text{mm}$ L = 127mm	T3 827	6 100 899,00
240860	23W	E27	$\phi = 63\text{mm}$ L = 127mm	T3 865	6 100 899,00

Sehr geehrte Kunden!

Da sich bei vielen Produkten Preise täglich ändern, sind unsere Preise als Richtpreise anzusehen und wir behalten uns Preisänderungen vor.

Abbildung	Art. Nr.	Bezeichnung	VE per	Brutto €	
Halolux Energy Saver (HALOLUX ES) 2.000 h					
	105437	OSR 64542 FR ES A	28W E27 matt / Ø 55mm / Länge = 96mm	20 100 360,50	
	105433	OSR 64542 ES A	28W E27 klar / Ø 55mm / Länge = 96mm	20 100 360,50	
	105442	OSR 64543 FR ES A	42W E27 matt / Ø 55mm / Länge = 96mm	20 100 360,50	
	105439	OSR 64543 ES A	42W E27 klar / Ø 55mm / Länge = 96mm	20 100 360,50	
	105443	OSR 64544 ES A	52W E27 klar / Ø 55mm / Länge = 96mm	20 100 350,00	
	105444	OSR 64544 FR ES A	52W E27 matt / Ø 55mm / Länge = 96mm	20 100 350,00	
	105447	OSR 64547 ES A	70W E27 klar / Ø 56mm / Länge = 96mm	20 100 350,00	
	105448	OSR 64547 FR ES A	70W E27 matt / Ø 56mm / Länge = 96mm	20 100 350,00	
		105438	OSR 64542 FR ES B	28W E14 matt Kerzenform / Ø 35mm / Länge = 98mm	20 100 463,50
		105434	OSR 64542 ES B	28W E14 klar Kerzenform / Ø 35mm / Länge = 98mm	20 100 463,50
	105445	OSR 64545 ES R50	28W E14 / Ø 55mm / Länge = 85mm	20 100 463,50	
	105446	OSR 64546 ES R63	42W E27 / Ø 63mm / Länge = 105mm	20 100 463,50	

Dulux EL Facility / Lichtfarbe 827



Ideal für den Einsatz an Abschaltautomatik und Bewegungsmeldern sowie in Treppenhäusern. Extra lange mittlere Lebensdauer von 15.000 Stunden*. Unbegrenzt oft schaltbar über die gesamte Lebensdauer. Schneller Lichtstromanlauf durch QUICK START-Schaltung nach dem Einschalten. Uneingeschränkt einsetzbar für Gleichspannungsanwendungen (176...310 V) sowie im Notstrombetrieb. Für alle Anwendungen im Haushalt und Gewerbe (z.B. Hotels, Gastronomie, Facility-Management), wo Energiesparlampen oft geschaltet werden müssen

106332	OSR DEL LL FCY 10W	E14 / Ø 45mm / L = 126mm	10 100 1.790,00
106333	OSR DEL LL FCY 10W	E27 / Ø 45mm / L = 117mm	10 100 1.650,00
106334	OSR DEL LL FCY 14W	E27 / Ø 45mm / L = 123mm	10 100 1.650,00
106335	OSR DEL LL FCY 18W	E27 / Ø 45mm / L = 137mm	10 100 1.650,00

Dulux EL Reflector / Lichtfarbe 827 / 15.000 h



106318	OSR DEL REFL 15W	E27 / Ø = 102mm / L = 143mm	10 100 2.575,00
106319	OSR DEL REFL 20W	E27 / Ø = 117,5mm / L = 161mm	10 100 2.575,00

Abbildung	Art. Nr.	Bezeichnung	VE per	Brutto €
-----------	----------	-------------	--------	----------

Mini-Lynx Kompakt Fast-Start T2 / 827 / 6.000 h



000670	SYL 0031001	5W / E14 / Ø = 38 mm / L = 86 mm	10 100	1.099,00
000730	SYL 0031003	5W / E27 / Ø = 38 mm / L = 86 mm	10 100	1.099,00
280158	SYL 0031019	7W / E14 / Ø = 38 mm / L = 92 mm	10 100	1.110,00
280159	SYL 0031021	7W / E27 / Ø = 38 mm / L = 92 mm	10 100	1.099,00
280160	SYL 0031023	9W / E14 / Ø = 38 mm / L = 97 mm	10 100	1.120,00
280161	SYL 0031025	9W / E27 / Ø = 38 mm / L = 97 mm	10 100	1.099,00
280152	SYL 0031029	11W / E27 / Ø = 38 mm / L = 102 mm	10 100	1.099,00
280155	SYL 0031037	15W / E27 / Ø = 43 mm / L = 117 mm	10 100	1.099,00

Mini-Lynx Kompakt Fast-Start Spiral T2 / 827 / 6.000 h



280229	SYL 0031005	8W / E14 / Ø = 40 mm / L = 92 mm	10 100	1.099,00
280230	SYL 0031007	8W / E27 / Ø = 40 mm / L = 92 mm	10 100	1.099,00
280226	SYL 0031009	12W / E27 / Ø = 40 mm / L = 97 mm	10 100	1.099,00
280227	SYL 0031013	15W / E27 / Ø = 40 mm / L = 117 mm	10 100	1.099,00

Mini-Lynx Kompakt GLS T2 / 827 / 6.000 h



280135	SYL 0024961	7W / E27 / Ø = 60 mm / L = 116 mm	10 100	1.190,00
280127	SYL 0024962	11W / E27 / Ø = 60 mm / L = 127 mm	10 100	1.190,00
280130	SYL 0031073	15W / E27 / Ø = 60 mm / L = 130 mm	10 100	1.190,00
280132	SYL 0031079	18W / E27 / Ø = 60 mm / L = 130 mm	10 100	1.190,00
001102	SYL 0031070	22W / E27 / Ø = 60 mm / L = 135 mm	10 100	1.420,00

Mini-Lynx Kompakt Candle T2 / 827 / 6.000 h



280193	SYL 0031085	5W / E14 / Ø = 38 mm / L = 100 mm	10 100	1.290,00
280195	SYL 0031089	7W / E14 / Ø = 38 mm / L = 100 mm	10 100	1.290,00
280196	SYL 0031091	7W / E27 / Ø = 38 mm / L = 100 mm	10 100	1.290,00
280197	SYL 0031095	9W / E14 / Ø = 38 mm / L = 111 mm	10 100	1.290,00
280199	SYL 0031097	9W / E27 / Ø = 38 mm / L = 111 mm	10 100	1.290,00

Mini-Lynx Kompakt Ball T2 / 827 / 6.000 h



280231	SYL 0031055	5W / E14 / Ø = 45 mm / L = 89 mm	10 100	1.090,00
280232	SYL 0031118	7W / E14 / Ø = 45 mm / L = 89 mm	10 100	1.090,00
280233	SYL 0031057	7W / E27 / Ø = 45 mm / L = 89 mm	10 100	1.090,00
280234	SYL 0031061	9W / E14 / Ø = 46 mm / L = 89 mm	10 100	990,00
280236	SYL 0031063	9W / E27 / Ø = 46 mm / L = 84 mm	10 100	990,00

Mini-Lynx T Fast-Start Economy T3 / 827 / 6.000 h



280181	SYL 0024722	5W / E14 / Ø = 37 mm / L = 101 mm	10 100	920,00
280182	SYL 0024725	5W / E27 / Ø = 37 mm / L = 98 mm	10 100	899,00
280183	SYL 0024734	7W / E14 / Ø = 37 mm / L = 111 mm	10 100	920,00
280185	SYL 0024737	7W / E27 / Ø = 37 mm / L = 108 mm	10 100	899,00
280186	SYL 0024746	9W / E14 / Ø = 48 mm / L = 95 mm	10 100	920,00
280188	SYL 0024749	9W / E27 / Ø = 48 mm / L = 92 mm	10 100	899,00
280163	SYL 0024759	11W / E14 / Ø = 48 mm / L = 99 mm	10 100	920,00
280166	SYL 0024762	11W / E27 / Ø = 48 mm / L = 96 mm	10 100	899,00
280169	SYL 0024772	15W / E27 / Ø = 48 mm / L = 116 mm	10 100	899,00
280172	SYL 0024779	18W / E27 / Ø = 48 mm / L = 124 mm	10 100	899,00
280175	SYL 0024786	20W / E27 / Ø = 48 mm / L = 136 mm	10 100	899,00
280178	SYL 0024793	23W / E27 / Ø = 48 mm / L = 149 mm	10 100	899,00

Art. Nr.	Bezeichnung	Type	VE	per	Brutto €
----------	-------------	------	----	-----	----------

Energiesparlampen **GE Lighting**



ø = mm Länge mm

Electronic BIAx Globe Elegance (FLE) 10.000 h						
003339	11W	E27	120	126	6	100 1.230,00
007461	15W	E27	120	152	6	100 1.230,00
027935	20W	E27	120	180	6	100 1.230,00
008346	23W	E27	120	181	6	100 1.330,00

Art. Nr.	Bezeichnung	Type	VE	per	Brutto €
----------	-------------	------	----	-----	----------

Energiesparlampen **OSRAM**



Dulux EL Longlife Globe (DEL LL GL) / 827 (15.000 h)						
106316	15W	E27	ø = 120mm	L = 167mm	10	100 2.430,00
106317	20W	E27	ø = 120mm	L = 190mm	10	100 2.430,00
Dulux EL Globe (DEL GL) 10.000 h						
106459	16W	E27	ø = 120mm	L = 167mm	10	100 1.300,00
019500	21W	E27	ø = 120mm	L = 167mm	10	100 1.300,00

Energiesparlampen

Art. Nr.	Bezeichnung	Type	VE	per	Brutto €
----------	-------------	------	----	-----	----------

Energiesparlampen **PHILIPS** sense and simplicity



PL Electronic Globe / 827 (12.000 h)						
239838	16W	E27	ø = 121mm	L = 182,1mm	6	100 2.761,21
239839	20W	E27	ø = 121mm	L = 182,1mm	6	100 2.761,21
239840	23W	E27	ø = 121mm	L = 182,1mm	6	100 2.761,21
Softone 8yr Globe (8.000 h)						
240443	9W	E27	ø = 95mm	L = 153,1mm	4	100 1.394,63
240444	12W	E27	ø = 95mm	L = 153,1mm	4	100 1.394,63
240445	16W	E27	ø = 121mm	L = 182,1mm	4	100 1.394,63
240446	20W	E27	ø = 121mm	L = 182,1mm	4	100 1.394,63

Sehr geehrte Kunden!

Da sich bei vielen Produkten Preise täglich ändern, sind unsere Preise als Richtpreise anzusehen und wir behalten uns Preisänderungen vor.

Art. Nr.	Bezeichnung	Type	VE	per	Brutto €
----------	-------------	------	----	-----	----------

Energiesparlampen



Electronic Decor T2 GU 10 Reflektor / 827 (6.000 h)

000880	7W GU10	73454	10	100	1.770,00
000657	9W GU10	88858	10	100	1.770,00



Electronic Decor T2 Reflektor R50 / 827 (6.000 h)

000706	7W E27	88846	10	100	1.770,00
	$\varnothing = 50\text{mm}$ L = 91mm				
000721	7W E14	88845	10	100	1.770,00
	$\varnothing = 50\text{mm}$ L = 91mm				

Electronic Decor T2 Reflektor R63 / 827 (6.000 h)

000722	11W E27	88849	10	100	2.010,00
	$\varnothing = 63\text{mm}$ L = 105mm				
000723	11W E14	88848	10	100	2.010,00
	$\varnothing = 63\text{mm}$ L = 105mm				

Electronic PAR38 / 827 (8.000 h)

000034	23W E27	88692	6	100	2.910,00
	$\varnothing = 121\text{mm}$ L = 154mm				

Art. Nr.	Bezeichnung	Type	VE	per	Brutto €
----------	-------------	------	----	-----	----------

Energiesparlampen



Duluxstar Target Spot Reflektor DSTAR R50 / 827

106367	7W E14	88845	6	100	1.670,00
	$\varnothing = 50\text{mm}$ L = 91mm				

Duluxstar Target Spot Reflektor DSTAR R63 / 827

106368	11W E27	88849	6	100	2.050,00
	$\varnothing = 63\text{mm}$ L = 105mm				



Duluxstar PAR38 (DSTAR PAR38) / 827 (6.000 h)

106366	20W E27	88692	6	100	1.670,00
	$\varnothing = 122\text{mm}$ L = 137mm				

Energiesparlampen

Art. Nr.	Bezeichnung	Type	VE	per	Brutto €
----------	-------------	------	----	-----	----------

Energiesparlampen



Downlighter ES 8yr R50 GU10 / 827

240928	7W GU10	88858	6	100	1.099,00
	$\varnothing = 50\text{mm}$ L = 82mm				



Downlighter ES 6yr/8yr / Reflektor R50 / 827

240927	7W E14	88845	6	100	1.099,00
	$\varnothing = 50,8\text{mm}$ L = 97mm				

Downlighter ES 6yr/8yr / Reflektor R63 / 827

240406	11W E27	88849	6	100	1.605,39
	$\varnothing = 65\text{mm}$ L = 126mm				



Downlighter ES PAR38 / Reflektor / 827

240866	20W E27	88692	6	100	1.990,00
	$\varnothing = 120\text{mm}$ L = 135mm				
240867	23W E27	88692	6	100	1.990,00
	$\varnothing = 120\text{mm}$ L = 135mm				

Bei uns erhältlich:



Abbildung	Art. Nr.	Bezeichnung	VE	per	Brutto €
-----------	----------	-------------	----	-----	----------

Feuchtraum-Wannenleuchte mit Acryl-Wanne, IP65, grau
SLI SYLVANIA

014855	SYL PROOF PRO2	1x18W mit VVG	0045700	1	1	52,70
006142	SYL PROOF PRO2	1x36W mit VVG	0045701	1	1	52,70
006143	SYL PROOF PRO2	1x58W mit VVG	0045702	1	1	79,30
006144	SYL PROOF PRO2	2x36W mit VVG	0045703	1	1	24,90
006145	SYL PROOF PRO2	2x58W mit VVG	0045704	1	1	92,70
003389	SYL PROOF PRO2	1x18W mit EVG	0045710	1	1	106,00
003376	SYL PROOF PRO2	1x36W mit EVG	0045711	1	1	106,00
003381	SYL PROOF PRO2	1x58W mit EVG	0045712	1	1	142,30
003384	SYL PROOF PRO2	2x36W mit EVG	0045713	1	1	118,20
003388	SYL PROOF PRO2	2x58W mit EVG	0045714	1	1	156,00

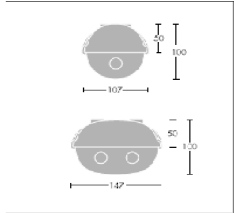
THORN
LumExpress
Feuchtraum-Wannenleuchte AQUAFORCE II IP65 Schutzklasse I T26/G13

238361	THO 96503020	1x36W VVG		1	1	50,70
238362	THO 96503043	1x58W VVG		1	1	53,70
029670	THO 96503091	2x36W VVG (96503089)		1	1	74,70
238363	THO 96503112	2x58W VVG		1	1	77,70
234100	THO 96503024	1x36W EVG		1	1	96,80
234102	THO 96503047	1x58W EVG		1	1	106,30
234104	THO 96503093	2x36W EVG		1	1	124,60
234106	THO 96503116	2x58W EVG		1	1	141,30
236424	THO 96503167	Kettenbefestigung 10St.		1	1	4,90
235462	THO 96503158	Edelstahlverschlüsse (Set)		1	1	19,00

Feuchtraum-Balken ohne Abdeckung SURF2
THORN
 Lighting people and places

Freistrahkende Feuchtraumleuchte aus glasfaserverstärktem Polyester-Schichtstoff, schockgeprüft.

238388	THO 96002975	1x36W IND L = 1265mm		1	1	46,50
238389	THO 96002976	1x58W IND L = 1565mm		1	1	56,70
238033	THO 96002988	1x36W EVG L = 1265mm		1	1	95,80
238034	THO 96002986	1x58W EVG L = 1565mm		1	1	101,70

Abbildung	Art. Nr.	Bezeichnung	VE per	Brutto €
-----------	----------	-------------	--------	----------

THORN

LumExpress

Rasteranbauleuchte PUNCH IP21 Schutzklasse I T26/G13



Schlanke Rasteranbauleuchte in unaufdringlichem Design. Gleiche Gehäusegröße für ein- und zweilampige Version. Satinierter Aluminiumraster oder HSC-Spiegelraster. Gehäuse aus Stahlblech, weiß, Endkappen aus ABS-Kunststoff. Deckenmontage über Schlüssellochbohrungen und Schlitzscheiben.

PUNCH, Aluminium-Raster matt, parallel kompensiert

238376	THO 96002300	1x58W	1	1	105,90
008092	THO 96002301	2x36W	1	1	105,90
238378	THO 96002302	2x58W	1	1	120,60
017189	THO 96006481	4x18W	1	1	166,80

PUNCH, HSC-Spiegelraster, parallel kompensiert

238375	THO 96002303	1x58W	1	1	183,00
016589	THO 96002304	2x36W	1	1	183,00
238377	THO 96002305	2x58W	1	1	230,40
002328	THO 96102545	4x18W	1	1	231,60

PUNCH, HSC-Spiegelraster, EVG

237796	THO 96006464	1x58W	1	1	246,20
237799	THO 96006470	2x36W	1	1	246,20
237801	THO 96006476	2x58W	1	1	256,10
237803	THO 96102699	4x18W	1	1	328,20

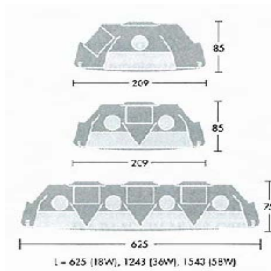

Rastereinbauleuchte QUATTRO T8 Modul 625 IP20 Schutzklasse I T26/G13

Einzeleuchte, Modul 625, Gehäuse Stahlblech weiß, Aluminiumraster matt oder HSC-Spiegelraster. Geeignet für sichtbare und verdeckte Trageschienensysteme bzw. Gipskartondecken. Lieferung inkl. Befestigungszubehör.



Quattro, Aluminium-Raster matt satiniert

237840	THO 96009926	2x36W EVG	1	1	256,90
237844	THO 96009982	4x18W EVG	1	1	284,50

Quattro, HSC-Spiegelraster

237841	THO 96009928	2x36W EVG	1	1	360,70
237845	THO 96009983	4x18W EVG	1	1	371,20

Abbildung	Art. Nr.	Bezeichnung	VE	per	Brutto €
-----------	----------	-------------	----	-----	----------



Anbauleuchte DIREKT / TEFEM T5



Flache T5 Anbau- (direkt strahlend) bzw. Pendelleuchte (direkt/indirekt strahlend) aus Stahlblech weiß, in ästhetisch gekrümmter Form und mit HSC-Spiegelraster. Inkl. Leuchtmittel (4000 K). Pendelleuchte wird komplett mit Seilabhängung geliefert (Deckenbefestigung/Baldachin sind separat zu bestellen).

238055	THO 96204015	LUM 2x49W DMB LI840	1	1	247,70
238059	THO 96204014	LUM D/I 2x49W DMB LI840	1	1	257,50

DMB = HSC-Spiegelraster / LI840 = inkl. Leuchtmittel Lichtfarbe 840 / D/I = direkt/indirekt strahlend

TEFEM Zubehör

235151	THO 96003414	Deckenbefestigung	1	1	6,10
235148	THO 96236614	Baldachin weiss	1	1	13,10

Einbau-Downlight Base LED



Ohne Dekor-Innenring



Das neue Base LED-Downlight ist für den Betrieb an Netzspannung geeignet und lässt sich - dank Schutzart IP44 - vielseitig einsetzen. Die Leuchte zeichnet sich vor allem durch die leistungsfähigen XLamp®-LEDs sowie durch bahnbrechende Farbmichentechnologie aus. Base LED ist sehr einfach zu installieren. Jedes Downlight verfügt über 2 Befestigungsfedern für eine korrekte Ausrichtung an der Decke. Der glatte weiße Frontring wirkt unauffällig an der Decke und für dekorative Zwecke sind verschiedenfarbige Innenringe verfügbar: mattweiss, mattkupfer oder satinsilber. Des weiteren gibt es Anbauversionen in verschiedenen Ausführungen. Das Downlight verfügt über die Schutzart IP44 (Schutz gegen Spritzwasser), d.h. es kann in Feuchträumen wie etwa Badezimmern installiert werden. Base LED eignet sich ideal für viele Gewerbe- oder Wohnbereiche - Korridore, Treppenhäuser, Bars, Restaurants - kurzum, überall dort, wo die Leuchten über lange Betriebsdauer verfügen und ein einladenes aber wirtschaftliches Beleuchtungskonzept wünschenswert ist.

234237	THO 96107294	BaseLED Einbau 165 MRE 1x12W LED L927	1	1	227,20
234238	THO 96107303	BaseLED Einbau 165 MRE 1x12W LED L935	1	1	227,20

BaseLED Zubehör

234241	THO 96107296	BaseLED 165 WHI Bezel Ring mattweiss	1	1	27,10
234239	THO 96107297	BaseLED 165 WHI Bezel Ring mattkupfer	1	1	27,10
234240	THO 96107298	BaseLED 165 WHI Bezel Ring satinsilber	1	1	27,10

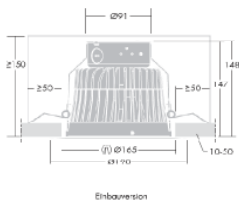

Dekor-Innenring in mattweiß



Dekor-Innenring in mattkupfer



Dekor-Innenring in satinsilber

Abbildung	Art. Nr.	Bezeichnung	VE per	Brutto €
-----------	----------	-------------	--------	----------

Flutlichtleuchte SonPak LX asymmetrisch strahlend

THORN

Flutlichtleuchte in 3 Baugrößen für Hochdruck-Entladungslampen zwischen 40 und 400 Watt; Gehäuse in schwarz (RAL 9005). Sonpack LX7 aus glasfaserverstärktem Kunststoff, Frontabdeckung aus schlagfestem Polycarbonat. Sonpak LX 15/25/40 aus pulverbeschichtetem Aluminiumdruckguss mit 5 mm dickem, gehärteten Frontglas. Beide mit asymmetrisch strahlenden Reflektoren, umfangreiches Zubehör erhältlich. Lieferung inkl. Leuchtmittel. IP65 Schutzklasse I



237964	THO 96231761	SonPak LX 70W HSE-I A/S E27	1	1	134,10
---------------	---------------------	-----------------------------	---	---	---------------

237963	THO 96231763	SonPak LX 70W HIT-DE RX7s	1	1	201,10
---------------	---------------------	---------------------------	---	---	---------------

(Tiefe 103/Breite 268/Höhe 385)



237952	THO 96231765	SonPak LX 150W HST E40	1	1	256,50
---------------	---------------------	------------------------	---	---	---------------

237950	THO 96231767	SonPak LX 150W HIT E40	1	1	256,50
---------------	---------------------	------------------------	---	---	---------------

(Tiefe 125/Breite 335/Höhe 400)



033637	THO 96201062	Ersatzleuchtmittel für 96231767	1	1	126,00
---------------	---------------------	---------------------------------	---	---	---------------

237956	THO 96231769	SonPak LX 250W HST E40	1	1	278,30
---------------	---------------------	------------------------	---	---	---------------

237960	THO 96231773	SonPak LX 400W HST E40	1	1	292,80
---------------	---------------------	------------------------	---	---	---------------

237955	THO 96231771	SonPak LX 250W HIT E40	1	1	278,30
---------------	---------------------	------------------------	---	---	---------------

237959	THO 96231775	SonPak LX 400W HIT E40	1	1	292,80
---------------	---------------------	------------------------	---	---	---------------

Hallenreflektorleuchte ALU-BAY m. Aluminiumreflektor HIE/HSE E40



234009	THO 96502955	Alu-Bay 1x250W	1	1	177,90
---------------	---------------------	----------------	---	---	---------------

234011	THO 96502966	Alu-Bay 1x400W	1	1	199,50
---------------	---------------------	----------------	---	---	---------------

237889	THO 96502963	Schutzglas IP65 zu Alu-Ref.	1	1	29,90
---------------	---------------------	-----------------------------	---	---	--------------

234003	THO 96502964	Abdeckung zu PC-Ref. 250W	1	1	18,30
---------------	---------------------	---------------------------	---	---	--------------

234004	THO 96502965	Abdeckung zu PC-Ref. 400W	1	1	28,60
---------------	---------------------	---------------------------	---	---	--------------

Abbildung	Art. Nr.	Bezeichnung	VE	per	Brutto €
-----------	----------	-------------	----	-----	----------

THORN



Systemleuchte aus Stahlblech weiß, Stirnseiten aus Kunststoff mit integrierter Fassung, beidseitig um 90° verstellbar, **inkl. Leuchtmittel (3000K)**. IP20 Schutzklasse I

006015	THO 96004200	AS18	Lichtleiste 18 W L=613	1	1	50,70
006017	THO 96004201	AS30	Lichtleiste 30 W L=918	1	1	54,30
238365	THO 96004202	AS36	Lichtleiste 36 W L=1223	1	1	57,00



Dekorative Lichtleiste IP40 aus Stahlblech weiß mit Schalter, Lampenabdeckung aus Polycarbonat, B: 37mm H: 64mm **inkl. Leuchtmittel (4000K)**. IP40 Schutzklasse I

238381	THO 96004948	ST15WS	Stylo 15 W weiß L=485	1	1	55,80
238382	THO 96004949	ST18WS	Stylo 18 W weiß L=637	1	1	55,80
238383	THO 96004950	ST30WS	Stylo 30 W weiß L=942	1	1	58,20
238384	THO 96004951	ST36WS	Stylo 36 W weiß L=1246	1	1	63,30
238386	THO 96004993	ST58WS	Stylo 58 W weiß L=1546	1	1	78,90



Dekorative Lichtleiste IP40 aus Stahlblech weiß mit Schalter, Lampenabdeckung aus Polycarbonat, B: 37mm H: 64mm **inkl. Leuchtmittel (4000K)**. IP40 Schutzklasse I mit EVG

238006	THO 96503681	ST18WEVG	Stylo 18 W weiß L=637	1	1	90,10
238007	THO 96503682	ST30WEVG	Stylo 30 W weiß L=942	1	1	101,00
238008	THO 96503683	ST36WEVG	Stylo 36 W weiß L=1246	1	1	111,80
238009	THO 96503684	ST58WEVG	Stylo 58 W weiß L=1546	1	1	119,30



Spiegelleuchte IP44 (Ausführung mit Schalter IP23) aus Stahlblech weiß, Lampenabdeckung aus Acryl, **inkl. Leuchtmittel (2700K)**. IP44/23 Schutzklasse I

013205	THO 96004696	BK118	weiss	1	1	87,00
002329	THO 96004695	BK118U	mit Schuko-Steckdose	1	1	104,40
013186	THO 96004795	BK118BRS	mit SSDO + Schalt.	1	1	109,80
002332	THO 96007720	BK118HF	mit EVG	1	1	138,60

ibv Mini-Lichtleiste Serie 970

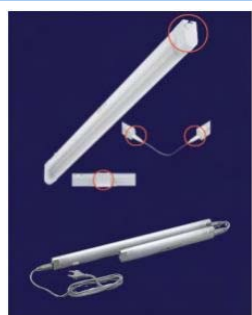

mit Schalter, Anschlußleitung 180cm, Eurostecker u. Verbindungsleitung 14cm. EVG und komplett inkl. Leuchtmittel T5. Geringe Bauform, enorme Lichtkraft, besonders geeignet zum Unterbau an Schränken und Möbeln, die Leuchte kann problemlos erweitert werden - durch einfaches Zusammenstecken (Kopf-an-Kopf-Montage) oder durch das im Lieferumfang enthaltene Verbindungskabel (Eck-Montage). Wandmontage ergibt eine Aufbauhöhe von 22mm. Max. 12 Leuchten können miteinander verbunden werden. Montage stehend oder liegend möglich - Click-Fix-Montage, separate Befestigung. Farbe weiß. Breite: 28mm, Höhe: 43mm

021083	IBV 970008-100	8W	Länge = 312mm	1	1	23,70
021320	IBV 970013-100	13W	Länge = 541mm	1	1	26,70
021343	IBV 970021-100	21W	Länge = 873mm	1	1	38,70
021437	IBV 970028-100	28W	Länge = 1173mm	1	1	47,70
021643	IBV 970035-100	35W	Länge = 1473mm	1	1	53,70

Lumilux-Combi mit Kabel und Stecker



105599	OSR 72011 W	18W weiss	L=621 B=21 H=50mm	4	100	3.100,00
105600	OSR 72016 W	30W weiss	L=926 B=21 H=50mm	4	100	3.690,00
105601	OSR 72021 W	36W weiss	L=1231 B=21 H=50mm	4	100	3.880,00

OSRAM

Lumilux-Combi mit Festanschluß



105627	OSR 72106 W	10W weiss	L= 501 B=30 H= 50mm	4	100	2.970,00
105629	OSR 72111 W	18W weiss	L= 621 B=30 H=50mm	4	100	3.100,00
105632	OSR 72116 W	30W weiss	L= 926 B=30 H=50mm	4	100	3.690,00
105635	OSR 72121 W	36W weiss	L=1231 B=30 H=50mm	4	100	3.880,00

Luminestra



105769	OSR 73071 W	8W	L= 342 B=70 H=20mm	4	100	3.470,00
105772	OSR 73081 W	13W	L= 555 B=70 H=20mm	4	100	2.690,00

Abbildung	Art. Nr.	Bezeichnung	VE per	Brutto €
Sensorleuchten				
	460032 ZUB 2710	Cerclampe 360 PL Schaltleistung: 2x 9W PL (G-23) E-Bereich: 360°/max. 7m. 5-300 Lux, Zeitverzögerung: 20 Sek.-10Min., nur für Innenmontage, Größe: 290x290x90mm	1 1	65,00
	460033 ZUB 2720	Cerclampe 360 E Schaltleistung: 3x E14 (40W) E-Bereich: 360°/max 7m. 5-300 Lux, Zeitverzögerung: 5 Sek.-15 Min., nur für Innenmontage, Größe: 300x300x130mm	1 1	65,00
	324423 RZB 211344.002.19	FLAT BASIC (Abd. aus Glas) Decken-/Wandleuchte m. HF-Sensor 360° (nicht für Energiesparlampen) D370, Ø 262, H118 mm / A60/2x60W / IP43 Deckenmont. IP44 Wandmont. / Unterteil Kst. weiss / erfasst jeden Punkt im Raum (1 bis 8 Meter Ø / empf. Montagehöhe 2,5m / Einschaltdauer v. 5sec. bis 15min. einstell-bar / Ansprechbarkeit v. 2 bis 2000 Lux einstell-bar / werkzeugloser Lampenwechsel	1 1	123,59
	324690 RZB 221126.002.1.19	FLAT POLYMERO (Abd. aus PMMA) Decken-/Wandleuchte m. HF-Sensor 360° (nicht für Energiesparlampen) D305, Ø 262, H115 mm / A60/60W / IP43 Deckenmont. IP44 Wandmont. / Unterteil Kst. weiss / erfasst jeden Punkt im Raum (1 bis 8 Meter Ø / empf. Montagehöhe 2,5m / Einschaltdauer v. 5sec. bis 15min. einstell-bar / Ansprechbarkeit v. 2 bis 2000 Lux einstell-bar / werkzeugloser Lampenwechsel	1 1	100,07
	460020 ZUB 2320	Globelampe 200 klar weiß	1 1	65,00
	460019 ZUB 2310	Globelampe 200 klar schwarz	1 1	65,00
	460022 ZUB 2340	Globelampe 200 opal weiß	1 1	65,00
	460021 ZUB 2330	Globelampe 200 opal schwarz	1 1	65,00
	014589 ZUB 8060S	500 Watt Scheinwerfer weiss	1 1	20,00
	014571 ZUB 8050S	500 Watt Scheinwerfer schwarz	1 1	20,00
		Schutzart: IP 54 / inkl. Leuchtmittel		
	460276 ZUB 8110P	150 Watt Scheinwerfer schwarz	1 1	15,00
	460277 ZUB 8120P	150 Watt Scheinwerfer weiss	1 1	15,00
		Schutzart: IP 55 / inkl. Leuchtmittel		
	002410 HAL 1021	Fluter 1000 W schwarz IP55	1 1	101,70
	002411 HAL 1022	Fluter 1500 W schwarz IP55	1 1	113,70
Scheinwerfer mit Sensor				
	014025 ZUB 1020	PRO 500/220 weiss 500W	1 1	144,00

Sehr geehrte Kunden!

Da sich bei vielen Produkten Preise täglich ändern, sind unsere Preise als Richtpreise anzusehen und wir behalten uns Preisänderungen vor.

Abbildung	Art. Nr.	Bezeichnung	VE	per	Brutto €
-----------	----------	-------------	----	-----	----------

Einbaustrahler
HALE

002446	HAL 3405	weiß schwenkbar	1	1	8,40
002448	HAL 3407	Gold schwenkbar	1	1	10,41
002447	HAL 3406	Chrom schwenkbar	1	1	10,41



002443	HAL 3400	weiß starr	1	1	4,80
002445	HAL 3402	Gold starr	1	1	6,99
002444	HAL 3401	Chrom starr	1	1	6,99

Einbaustrahler f. Lochausschnitt 68mm m. Bayonettverschluss

-NI Nickel gebürstet

MY-6800 rund, 30° schwenkbar, Schutzklasse III

031749	LEU MY-6800-NI	Nickel gebürstet	1	1	6,90
031750	LEU MY-6800-C	chrom	1	1	6,90
031751	LEU MY-6800-G	Gold	1	1	6,90
031752	LEU MY-6800-MB	Messing brüniert	1	1	6,90
031753	LEU MY-6800-W	weiß	1	1	5,50



-NI Nickel gebürstet

MY-6810 quadratisch, 30° schwenkbar, Schutzklasse III

031754	LEU MY-6810-NI	Nickel gebürstet	1	1	8,80
031755	LEU MY-6810-C	chrom	1	1	8,80
031756	LEU MY-6810-ALU	alugrau	1	1	8,60

MY-6820 quadratisch, 30° schwenkbar, alugrau m. Glas satin, Schutzklasse III

031757	LEU MY-6820-ALU	alugrau	1	1	9,60
--------	-----------------	---------	---	---	-------------

LED-Spots

030853	BAR 60511315	LED-Spot 12VAC/DC 3,1W Gu5,3 weiß	1	1	18,90
026147	BAR 60511326	LED-Spot 12VAC/DC 3,1W Gu5,3 warmweiß	1	1	18,90
029867	BAR 60521315	LED-Spot 3,1W GU10 weiß	1	1	18,90
029237	BAR 60521326	LED-Spot 3,1W GU10 warmweiß	1	1	18,90



105947	OSR 80327	PARATHOM 5W GU10 100-240V PAR16 kaltweiß / Länge: 56mm Ø 50mm	10	100	5.250,00
105948	OSR 80328	PARATHOM 5W GU10 100-240V PAR16 warmweiß / Länge: 56mm Ø 50mm	10	100	5.250,00

DecoLED Outdoor (Ersatz für Weihnachtsbeleuchtung und Party-Lichterketten)

239901	PHL DECO LED	Tropfenlampe 1Watt kaltweiß E27 / Länge: 100mm Ø 50mm	10	100	1.453,00
239902	PHL DECO LED	Tropfenlampe 1Watt weiß E27 / Länge: 100mm Ø 50mm	10	100	1.453,00

Abbildung	Art. Nr.	Bezeichnung	VE	per	Brutto €
-----------	----------	-------------	----	-----	----------

Netzteil für LED1 12V=



031310	SLV 470507	Netzteil 12W für LED Gu5,3 / LxBxH: 85x40x23mm	1	1	24,90
003158	SLV 470508	Netzteil 60W für LED Gu5,3 / LxBxH: 182x88x35mm	1	1	119,00

LED für den Innenbereich



EYELEDS rund für die Innenanwendung, Einbau-Ø 45mm, Einbautiefe 6,5mm, IP67, blendfrei, belastbar bis 285kg, nur 0,3W Stromverbrauch, Lichtfarbe: weiß, Gehäuse Edelstahl

292985	INS 90011001	LED einzeln	1	1	132,75
292707	INS 90011003	LED-Kette 3 Stück	1	1	371,25
292712	INS 90011005	LED-Kette 5 Stück	1	1	596,25
292717	INS 90011008	LED-Kette 8 Stück	1	1	936,00
292722	INS 90011020	LED-Kette 20 Stück	1	1	2.070,00

Zubehör (unbedingt erforderlich):

292996	INS 91000010	Netzgerät m. Stecker f. 10 LED's	1	1	87,75
292995	INS 91000040	Netzgerät UP für 40 LED's	1	1	155,25

Einbauspot mit Power-LED



Serie Luxor mit 40° Ausstrahlungswinkel wurde speziell für den Austausch von Halogenspots entwickelt. Der LED-Innenteil ist drehbar. 2,5W / Gehäuse: silber metallic

297568	LUM LT 05420NW	Lichtfarbe: naturweiß / 3800K, 130lm / Ø 52mm, T: 25mm	1	1	89,34
297571	LUM LT 05420WW	Lichtfarbe: warmweiß / 2900K, 125lm / Ø 52mm, H: 25mm	1	1	89,34
297566	LUM LT 05420CW	Lichtfarbe: coolweiß / 6000K, 180lm / Ø 52mm, H: 25mm	1	1	89,34

Alu-Dekorplatte zu Einbauspot (ohne LED-Einbauspot) / Serie Luzern / Modulares System mit Aluminium Dekorplatte, dimmbar, je nach verwendetem Netzteil mit Phasenabschnittdimmer oder 1-10V Potentiometer.

297525	LUM LT 05300 S1	1-fach silber metallic LxB: 80x80mm / Einbau-Ø 0,55mm	1	1	14,28
297517	LUM LT 05300 RT2	2-fach silber metallic LxB: 80x142mm / Einbaumaße: LxB: 55x117mm	1	1	32,07
297520	LUM LT 05300 RT3	3-fach silber metallic LxB: 80x204mm / Einbaumaße: LxB: 55x180mm	1	1	43,89

297505	LUM LT 05021 NS	Netzteil dimmbar (max. 5 LED-Spots) 230V-12,5VA 700mA f. 2 Lampen	1	1	87,87
297506	LUM LT 05202	2-fach-Weiche mit 2 m Kabel (bei 3 Lampen)	1	1	10,47
297507	LUM LT 05211	4-fach-Weiche mit 1 m Kabel (bei 4-5 Lampen)	1	1	12,39

Wandeinbau-Spot mit Power-LED



Serie Lugo in sieben verschiedenen Lichtfarben, ideal zur Beleuchtung bei Stiegenaufgängen udgl. 2,5W / Abmessungen: LxBxT: 90x90x40mm

297533	LUM LT 05310NW	Lichtfarbe: naturweiß / 3800K, 130lm	1	1	72,33
297535	LUM LT 05310WW	Lichtfarbe: warmweiß / 2900K, 125lm	1	1	72,33
297531	LUM LT 05310CW	Lichtfarbe: coolweiß / 6000K, 180lm	1	1	72,33
297508	LUM LT 05285	Wandeinbaugehäuse Metall	1	1	12,39
001620	LUM LT 05280	Wandeinbaugehäuse Kunststoff	1	1	13,50

Abbildung	Art. Nr.	Bezeichnung	VE per	Brutto €
-----------	----------	-------------	--------	----------

HALE

OSRAM

PHILIPS

sense and simplicity



010253	HAL 0600	Trafo PF60 20-50W	1 1	25,50
002405	HAL 0601	Trafo PF75 20-80W	1 1	26,70
009819	HAL 0602	Trafo PF105 20-105W	1 1	32,70
009849	HAL 0603	Trafo PF150 50-150W	1 1	45,00
012118	HAL 0604	Trafo PF200 50-200W	1 1	63,00
012117	HAL 0606	Trafo PF250 75-250W	1 1	81,00



002401	HAL 0993	Trafo PF300 300W	1 1	117,00
002403	HAL 0880	Mini 60 VA Cody 93x33x19	1 1	24,00



107012	OSR HTM70	Trafo Maus 70 VA	1 100	2.730,00
107010	OSR HTM105	Trafo Maus 105 VA	1 100	3.100,00
107011	OSR HTM150	Trafo Maus 150 VA	1 100	4.690,00



240664	PHL Primaline ETS	Trafo Maus 70 VA	1 100	4.664,73
240665	PHL Primaline ETS	Trafo Maus 105 VA	1 100	5.396,92
240666	PHL Primaline ETS	Trafo Maus 150 VA	1 100	8.254,80



002433	HAL 2053	Fassung f. Halogenl.	1 100	270,00
---------------	-----------------	----------------------	-------	---------------



003846	ELP 12600 Z	Fassung f. HI-Spot GU 10 / 230V	1 100	204,54
---------------	--------------------	---------------------------------	-------	---------------

Abbildung	Art. Nr.	Bezeichnung	VE per	Brutto €
-----------	----------	-------------	--------	----------

elektronisches Vorschaltgerät 230/240V nicht dimmbar

OSRAM



107551	OSR	QTP8 1x18	L=360/B=30/H=30mm	20 100	2.640,00
107552	OSR	QTP8 1x36	L=360/B=30/H=30mm	20 100	2.640,00
107553	OSR	QTP8 1x58	L=360/B=30/H=30mm	20 100	2.640,00
107554	OSR	QTP8 2x18	L=423/B=30/H=30mm	20 100	3.010,00
107555	OSR	QTP8 2x36	L=423/B=30/H=30mm	20 100	3.010,00
107556	OSR	QTP8 2x58	L=423/B=30/H=30mm	20 100	3.010,00



Abmessungen LxBxH: 234x40x28mm Lochabstand: 220mm **TRIDONIC.ATCO**

478630	TRD	PC1x18WT8PRO	Art. Nr. 22176093	10 100	3.360,00
478638	TRD	PC1x36WT8PRO	Art. Nr. 22176108	10 100	3.360,00
478631	TRD	PC1x58WT8PRO	Art. Nr. 22176094	10 100	3.360,00

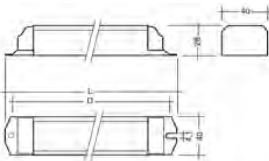

478637	TRD	PC2x18T8PRO	Art. Nr. 22176107	10 100	3.960,00
478639	TRD	PC2x36T8PRO	Art. Nr. 22176109	10 100	3.960,00
478632	TRD	PC2x58T8PRO	Art. Nr. 22176095	10 100	3.960,00

verlustarmes Vorschaltgerät 230/240V

TRIDONIC.ATCO



478596	TRD	EC18LC501K	18W L=151mm	10 100	590,00
Art. Nr. 22115859					

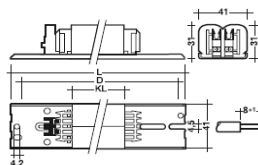

478597	TRD	EC36LC501K	36W L=151mm	10 100	590,00
Art. Nr. 22115862					

478598	TRD	EC058C501K	58W L=191mm	10 100	1.090,00
Art. Nr. 22115907					

Elektronische Vorschaltgeräte EVG TL-T5 nicht dimmbar

Helvar



			Länge x Breite x Höhe			
000856	HELVAR	EL 1x14-35s	280x30x21mm	10	1	33,00
000855	HELVAR	EL 1x24s	280x30x21mm	10	1	33,00
012711	HELVAR	EL 1x54s	280x30x21mm	10	1	33,00
003201	HELVAR	EL 2x14-35s	360x30x21mm	10	1	39,00
032641	HELVAR	EL 2x39/36s	360x30x21mm	10	1	39,00
033275	HELVAR	EL 3/4x14s	360x30x21mm	10	1	50,40

Abbildung	Art. Nr.	Bezeichnung	VE	per	Brutto €
-----------	----------	-------------	----	-----	----------

Notlicht mit Bereitschaftsschaltung



289007	BEL 1938	6 Watt / 1 Stunde	1	1	62,30
289008	BEL 1941	6 Watt / 3 Stunden	1	1	72,70
288970	BEL 1325	8 Watt / 1 Stunde	1	1	78,95
289012	BEL 1968	8 Watt / 3 Stunden	1	1	84,15

Notlicht Dauer- und Bereitschaftsschaltung

289013	BEL 1970	8 Watt / 1 Stunde	1	1	103,90
289014	BEL 1972	8 Watt / 3 Stunden	1	1	114,30

Notlicht-Einsätze



304177	REG 10-GR.032	Notlichteinsatz 3h	1	1	191,40
304178	REG 10-GR.033	Notlichteinsatz 1h	1	1	143,40



238239	THO 96502953	Voyager E T16 E3NM L535 NM Bereitschaftsschaltung IP65	1	1	93,90
238238	THO 96502952	Voyager E T16 E3m L535 M Dauer- /Bereitschaftsschaltung IP65	1	1	112,50
238336	THO 96009794	Voyager Slimline Notlichteinsatz 1x18-58W T23 E3M IP20	1	1	254,10



238237	THO 96502954	Voyager E EXIT T16 E3M (Dauer/Bereitschaft) L535 (inkl. Leuchtmittel), inkl. Piktogramm / LxBxT: 392x190x60mm	1	1	167,70
238240	THO 96235709	Voyager E Double 1x8W / Economy / E3M (Dauer/Bereitschaft), inkl. Piktogramm	1	1	157,50



288945	BEL 12500	6W 1h Bereitschaftsschaltung	1	1	49,85
288947	BEL 12506	8W 3h Dauer u. Bereitsch.	1	1	97,70

Leuchtstofflampe f. Notleuchten







107256	OSR L8W/640EL	16mm Durchm., 288mm lang	1	100	850,00
---------------	---------------	--------------------------	---	-----	---------------



Abbildung	Art. Nr.	Bezeichnung	VE	per	Brutto €
LED - Notleuchte Dauer-/Bereitschaftsschaltung					REGIOLUX
		Erkennungsweite 18 Meter, inkl. Piktogrammfolien-Set, IP 54, Schutzklasse II, 8x SMD LED weiss			
	000231	REG 50-EVA-ULTLED-W LED 3h Wandmontage	1	1	190,50







		Erkennungsweite 18 Meter, inkl. Piktogrammfolien-Set, IP 54, Schutzklasse II, 8x SMD LED weiss			
	000238	REG 50-EVA-ULTLED-D LED 3h Deckenmontage	1	1	190,50



LED - Notleuchte Dauer-/Bereitschaftsschaltung					REGIOLUX
		Erkennungsweite 18 Meter, inkl. Piktogrammfolien-Set, IP 54			
	304249	REG 50-EVA-ULTIMO-W 1x8W 3h Wandmontage	1	1	209,70
		Erkennungsweite 18 Meter, inkl. Piktogrammfolien-Set, IP 54, Montagezubehör zur Aufnahme von Ketten - Seilpendelaufhängung beiliegend			
	304248	REG 50-EVA-ULTIMO-D 1x8W 3h Deckenmontage	1	1	209,70

Sicherheitsleuchte Serie RILUX IP40				
	247656	OVA 37029	8/1 NC / 8 Watt / 1 h / G5 inkl. Piktogr. / Bereitschaft	1 1 151,48
	247657	OVA 37030	8/3 NC / 8 Watt / 3 h / G5 inkl. Piktogr. / Bereitschaft	1 1 138,41
	247660	OVA 37071E	8SA/SE/1NC / 8 Watt / 1 h	1 1 206,50
	247661	OVA 37072E	8SA/SE/3NC / 8 Watt / 1h	1 1 218,30
	247767	OVA 50224	Piktogramm-Set (li-re-nach unten)	1 1 4,58

Einzelbatterieleuchten S8 Professionell mit Leuchtstofflampe für manuellen Funktionstest				
	425440	LEG 066000	8 Watt / 1 h / Bereitschaft	1 100 7.738,50
	425443	LEG 066003	8 Watt / 3 h / Bereitschaft	1 100 9.009,20

Piktogrammetiketten selbstklebend plastifiziert für S8 und G5				
	426963	LEG 660865	Pfeil links 310x112mm	5 100 300,30
	426964	LEG 660866	Pfeil rechts 310x112mm	5 100 300,30
	426965	LEG 660867	Pfeil nach unten 310x112mm	5 100 300,30

Einzelbatterieleuchten mit Leuchtstofflampe				
	425382	LEG 061702	6 Watt / 1 h / Bereitschaft	1 100 3.849,50
	425384	LEG 061708	6 Watt / 1 h / Bereitschaft/Dauer	1 100 7.002,90
	425385	LEG 061711	6 Watt / 3 h / Bereitschaft	1 100 4.796,00

Piktogrammetiketten selbstklebend plastifiziert				
	000519	LEG 060964	Pfeil nach unten 225x90mm	1 100 309,60
	000556	LEG 060990	Pfeil links 225x90mm	1 100 309,60
	425375	LEG 060991	Pfeil rechts 225x90mm	1 100 309,60

Nurglasleuchten FR-Leuchten Anbauleuchten

Abbildung	Art. Nr.	Bezeichnung	VE per	Brutto €
	003865 ELP 19042-04	Opalglas 195 x 195	1 1	29,43
	003853 ELP 17031	Opalglas rund 200	1 1	21,27
	003868 ELP 19061	Opalglas rund 300	1 1	40,31

Glasbefestigung durch DKN (Druck-Kipp-Nurglasleuchten)-System, werkzeuglose Glasbefestigung: leichter Druck der Glasränder auf die Haltefeder löst beim Aufsetzen den Kipp- und Haltemechanismus aus, werkzeugloses Öffnen bei Lampenwechsel, Halterung nach Glasmontage nicht sichtbar, Haltefedern gleichen Glasrandtoleranzen aus.

	317005 RZB 10120.002	Nurglasleuchte Serie DKN Classic Abdeckung Glas opal seidenglanz, mundgeblasen Unterteil Metall verzinkt, Glühlampe 60W E27, Schutzart IP40, Schutzkl.1, D=250mm, H=105mm	1 1	19,64
	317035 RZB 10320.002	Nurglasleuchte Serie DKN Kreis Abdeckung Glas opal seidenglanz, mundgeblasen Unterteil Metall verzinkt, Glühlampe 60W E27, Schutzart IP 20/40, Schutzkl.1, D=250mm, H=100mm	1 1	29,30
	317055 RZB 10420.002	Nurglasleuchte Serie DKN Quadrat Abdeckung Glas opal seidenglanz, mundgeblasen Unterteil Metall verzinkt, Glühlampe 60W E27, Schutzart IP 40, Schutzkl.1, 235mm, H=100mm	1 1	33,55

Kunststoffleuchte Serie Flat Polymero IP44



Unterteil Kunststoff weiß, Abdeckung Kunststoff PMMA, opal, Schutzart: IP43
Deckenmontage, IP44 Wandmontage, werkzeugloser Lampenwechsel / schlagzäh

318062 RZB 221023.002.1	D310, H115 / A60/75W	1 1	47,99
---------------------------------------	----------------------	-----	--------------

FR-Leuchten



478004 POP 008916	Bebilux 60W SLK grau = 60401	1 1	5,33
478082 POP 640291	Bebilux 60W MK grau = 60415	1 1	6,57
478123 POP 688736	Unilux 100W MK grau = 60419	1 1	11,57
425360 LEG 060459	Plexo rund 100W FR	10 100	2.136,80

Abbildung	Art. Nr.	Bezeichnung	VE per	Brutto €
-----------	----------	-------------	--------	----------



Xpatch 19 " Netzwerkschrank IP 30 Standard Line (Type NWS-...)

Komplett montiert, Rahmen zerlegbar, passive Belüftung, vorbereitet für aktive Belüftung (inkl. Bodenabdeckung mit Filtereinschub, Dachblech m. Abdeckung) einflügelige Glastür mit Dreipunkt-Schwenkhebelvorrichtung, RAL 7035, Zierblende RAL 5021, staubdichte Kabeleinführung oben und unten, 19"-Profil vorne und hinten, Erdungssets (3Stk.) und Erdungsschiene, Sockel 100mm mit Kiemen, Nivellierfüße, 20 Stk. Schrauben u. Käfigmuttern, 2 Seitenwände, Rückwand.



209253	MOE 263794	600/600/1180-23HE	1 1	1.656,79
209254	MOE 263795	600/600/1625-33HE	1 1	1.754,80
209256	MOE 263798	600/600/2025-42HE	1 1	1.841,33
209257	MOE 263801	600/800/2025-42HE	1 1	1.941,91
209259	MOE 263804	800/800/2025-42HE	1 1	2.071,65
209905	MOE 269017	800/800/2025-42HE	1 1	2.228,17
209904	MOE 269016	800/1000/2025-42HE	1 1	2.153,93

- 1) mit rückseitiger, einflügeliger Metalltür (anstelle Rückwand)
- 2) mit Schwenkrahmen symetrisch (anstelle 19" Profil vorne und hinten)



208466	MOE 255003	Einbaulüfter	1 1	97,35
208863	MOE 255418	1-Schließer / Thermostat	1 1	49,74

19" Steckdosenleiste

208846	MOE 255398	7-fach	1 1	117,19
---------------	-------------------	--------	-----	---------------



Steckdosenleiste

208848	MOE 255401	6-fach	1 1	49,57
---------------	-------------------	--------	-----	--------------



Überspannungsschutz-Steckdosenleiste mit Schalter

212425	MOE 283449	19" 7fach	1 1	130,35
212427	MOE 283461	6fach	1 1	99,55

Abbildung	Art. Nr.	Bezeichnung	VE	per	Brutto €
-----------	----------	-------------	----	-----	----------



Xpatch 19 " Wandschrank IP 30 Standard Line (Type NWS-...)

2-teilig mit Glastür und Zylinderschloss, RAL 7035, Festrahmen mit versetzbaren 19" Schienen, Kabeldurchführung hinten, oben und unten, staubgeschützte Kabeleinführung durch Büstenleiste, 20 Stk. Schrauben und Käfigmuttern.



B / T / H mm					
209242	MOE 263782	600x400x500 / 09 HE	1	1	431,65
209243	MOE 263783	600x400x634 / 12 HE	1	1	458,99
209244	MOE 263784	600x500x900 / 15 HE	1	1	499,35
209903	MOE 269014	600/500/900 / 18 HE	1	1	518,94
205729	MOE 108899	600/600/1034 / 21 HE	1	1	805,96

Xpatch 19 " Wandschrank IP 30 Basic Line (Type NWE-...)

2-teilig mit Glastür und Zylinderschloss, RAL 7035, Festrahmen mit versetzbaren 19" Schienen, Kabeldurchführung hinten, oben und unten, staubgeschützte Kabeleinführung durch Büstenleiste, 16 Stk. Schrauben und Käfigmuttern.



B / T / H mm					
212568	MOE 285756	570/310/347-6HE	1	1	360,74
212569	MOE 285757	570/410/347-6HE	1	1	379,46
212570	MOE 285758	570/410/480-9HE	1	1	398,57
212571	MOE 285759	570/410/613-12HE	1	1	423,82
212572	MOE 285800	570/510/747-15HE	1	1	461,08
212573	MOE 285801	570/510/880-18HE	1	1	479,17

Xpatch Belüftung für 19 " Wandgehäuse Standard Line (Type NWS-...)



212472	MOE 285130	Filterlüftblech	1	1	36,57
212473	MOE 285131	bestückt	1	1	208,00

*) bestückt mit 2 Einbaulüfter, 1 Thermostat, 1 Lüfterverdrahtung

Xpatch 19 " Netzwerkschrank IP 30 Basic Line (Type NCE-...)

komplett montiert, einflügelige Glastür, Dachblech mit Lüftungsschlitzen, RAL 7035, staubdichte Kabeleinführung oben, 19" Profil vorne und hinten, Erdungsset (1 Stk.), Nivellierfüße, 20 Stk. Schrauben und Käfigmuttern, 2 Seitenwände, Rückwand



B / T / H mm					
212574	MOE 285802	600/600/1180-23HE	1	1	1.262,58
212576	MOE 285804	600/600/2025-42HE	1	1	1.433,10
212578	MOE 285806	800/800/2025-42HE	1	1	1.598,90

Zubehör Sockel 100mm mit Kiemen

207633	MOE 240401	NCE-SOK/6601 / 600x600	1	1	115,35
207636	MOE 240404	NCE-SOK/8802 / 800x800	1	1	121,32

Abbildung	Art. Nr.	Bezeichnung	VE	per	Brutto €
-----------	----------	-------------	----	-----	----------

MOELLER 



Schrankleuchte mit Schalter, Steckdose, Magnethalterung

208806 MOE **255355** NWS-SRL/ST/MG 1 1 **145,37**

19" Schrankleuchte mit Schalter

212471 MOE **285129** NWS-SRL/S/19 1 1 **142,82**

208865 MOE **255420** NWS-TKT Türkontakt 1 1 **84,17**

Halbzylinder mit Schlüssel NWS-HZ. Inkl. 2 Schlüssel, gleichschließend

208658 MOE **255195** NWS-HZ/2SL/GS 1 1 **29,27**

Xpatch 19 " Fachböden für Festeinbau, Befestigung vorne



208486 MOE **255023** NWS-FFE/19/2HE/T180 Tiefe 180mm,2HE 1 1 **42,60**

205510 MOE **106080** NWS-FFE/19/2HE/T250 Tiefe 250mm,2HE 1 1 **44,35**

208487 MOE **255024** NWS-FFE/19/2HE/T400 Tiefe 400mm,2HE 1 1 **48,22**

Xpatch 19 " Fachböden für Festeinbau, Befestigung vorne und hinten

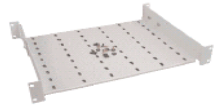

208482 MOE **255019** NWS-FFD/19/2HE/T400 Tiefe 400mm,2 HE 1 1 **56,71**

208483 MOE **255020** NWS-FFD/19/2HE/T600 Tiefe 600mm,2 HE 1 1 **68,22**

208484 MOE **255021** NWS-FFD/19/2HE/T740 Tiefe 740mm,2 HE 1 1 **77,58**

Xpatch 19 " Fachböden für Festeinbau ausziehbar



208478 MOE **255015** NWS-FAD/19/2HE/T400 Tiefe 400mm, 2HE 1 1 **164,78**

208479 MOE **255016** NWS-FAD/19/2HE/T600 Tiefe 600mm, 2HE 1 1 **233,48**

208480 MOE **255017** NWS-FAD/19/2HE/T740 Tiefe 740mm, 2HE 1 1 **242,06**

Xpatch Rangierpanel zur horizontalen Kabelführung



208492 MOE **255029** NWS-FP/KFB/M/1HE 1 1 **21,00**

Rangierbügel vertikal für 19" für Schrankbreite 800mm



208721 MOE **255258** NWS-RGB/MO/O/SB 1 1 **8,79**

Rangierbügel vertikal für 19" Wandgehäuse und Schrankbreite 600mm

208317 MOE **254852** NWS-19/S/RGB/V/VD 1 1 **7,97**

Abbildung	Art. Nr.	Bezeichnung	VE	per	Brutto €
-----------	----------	-------------	----	-----	----------



Xpatch 19 " Telefon Patchpanel 1 HE



207055	MOE 237030	DNW-PPL/19H1/25RJ45/TEL/U/00	1	1	159,77
207056	MOE 237031	DNW-PPL/19H1/50RJ45/TEL/U/00	1	1	217,01

Xpatch 19 " Telefon Patchpanel 1 HE (CAT 5e oder CAT 6) geschirmt



207052	MOE 237027	DNW-PPL/19H1/24RJ45/5E/S/00 24-fach RJ45 CAT5e	1	1	178,07
207054	MOE 237029	DNW-PPL/19H1/24RJ45/6/S/00 24-fach RJ45 CAT 6	1	1	417,30

Xpatch Datendosen 2xRJ45 (CAT 5e oder CAT 6) geschirmt 80x80



207057	MOE 237032	DNW-DD80/2RJ45/5E/S/BG cremefärbig CAT 5e	1	1	19,60
207058	MOE 237033	DNW-DD80/2RJ45/5E/S/WS reinweiß CAT 5e	1	1	19,60
207059	MOE 237034	DNW-DD80/2RJ45/6/S/BG cremefärbig CAT 6	1	1	45,95
207060	MOE 237035	DNW-DD80/2RJ45/6/S/WS reinweiß CAT 6	1	1	45,95

Xpatch Patchkabel CAT 5e, Geflecht und Folie geschirmt, PVC grau



207099	MOE 237146	DNW-PC/0050/RJ45/RJ45/5E/CSUTP/GR/PV 0,5m	1	1	1,54
207100	MOE 237147	DNW-PC/0100/RJ45/RJ45/5E/CSUTP/GR/PV 1,0m	1	1	2,90
207102	MOE 237149	DNW-PC/0200/RJ45/RJ45/5E/CSUTP/GR/PV 2,0m	1	1	3,79
207103	MOE 237154	DNW-PC/0300/RJ45/RJ45/5E/CSUTP/GR/PV 3,0m	1	1	4,49
207104	MOE 237164	DNW-PC/0500/RJ45/RJ45/5E/CSUTP/GR/PV 5,0m	1	1	5,86

Xpatch Patchkabel CAT 6, 2xS-Folie geschirmt, LSOH, grau



207146	MOE 237277	DNW-PC/0100/RJ45/RJ45/6/CSTP/GR/LS 1,0m	1	1	10,17
207148	MOE 237279	DNW-PC/0200/RJ45/RJ45/6/CSTP/GR/LS 2,0m	1	1	11,85
207149	MOE 237281	DNW-PC/0300/RJ45/RJ45/6/CSTP/GR/LS 3,0m	1	1	13,54
207150	MOE 237283	DNW-PC/0500/RJ45/RJ45/6/CSTP/GR/LS 5,0m	1	1	16,90

KAT5E Patchkabel grau, foliengeschirmt mit 2x RJ45-Stecker, vergossene Hauben mit Knickschutz



010284	ASS AMCSS80005	Patchkabel 0,5 Meter	10	1	1,35
011716	ASS AMCSS80010	Patchkabel 1 Meter	10	1	1,95
005957	ASS AMCSS80020	Patchkabel 2 Meter	10	1	2,67
005955	ASS AMCSS80030	Patchkabel 3 Meter	10	1	4,80
005956	ASS AMCSS80050	Patchkabel 5 Meter	10	1	5,40
013650	ASS AMCSS80100	Patchkabel 10 Meter	10	1	10,20
011955	ASS AMCSS80150	Patchkabel 15 Meter	10	1	13,50
006978	ASS AMCSS80200	Patchkabel 20 Meter	10	1	18,30
009083	ASS AMCSS80300	Patchkabel 30 Meter	10	1	28,50

Patchkabel auch in Farben rot, gelb, blau

(ausgenommen 20m und 30m)



021084	ASS AM08/8SRS	Stecker RJ45 CAT5	10	1	1,77
021085	ASS AMOT8/8	Knickschutztüle für Stecker AM08/8SRS	10	1	0,36
019850	ASS AM06/8-8RS	Stecker RJ45 CAT6	10	1	2,40

Abbildung	Art. Nr.	Bezeichnung	VE	per	Brutto €
Kat5E Patchpanel					
	001948	ASS APAN-5-24S 24-fach Ports, 1 HE	1	1	117,00
Kat6 Patchpanel					
	011159	ASS APAN-6-16S 16-fach Ports, 1HE	1	1	132,00
	022437	ASS APAN-6-24S 24-fach Ports, 1 HE	1	1	177,00
Kat3 Patchpanel					
	020236	ASS A-ISPAN-25G 25-fach Ports, 1 HE	1	1	117,00
	024024	ASS A-ISPAN-50G 24-fach Ports, 1 HE	1	1	135,00
 Rutenbeck Fernmeldetechnik					
CAT6 Datendose RJ45 2x8p.					
	305758	RUT 13810207 weiß	1	1	19,70
CAT6 Datendose RJ45 2x8p.					
	305770	RUT 13811207 reinweiß	1	1	19,70
UAE Anschlußdose 2 x RJ 45 KAT5+ vollgeschirmt mit Rahmen 80x80mm und Zentralstück 50x50mm, für Stecker RJ12 und RJ45					
	305734	RUT 13510207 Datendose weiss	1	1	19,50
	305753	RUT 13511207 Datendose polarweiss	1	1	19,50
UAE Anschlußdose 1 x RJ 45 KAT5+ vollgeschirmt mit Rahmen 80x80mm und Zentralstück 50x50mm, für Stecker RJ12 und RJ45					
	305733	RUT 13510203 Datendose weiss	1	1	17,00
	305752	RUT 13511203 Datendose polarweiss	1	1	17,00
UAE Anschlußdose 2 x RJ 45 KAT5+ vollgeschirmt mit Rahmen 80x80mm und Zentralstück 50x50mm, f. Stecker RJ12 ubd RJ45					
CAT6 Datendose RJ45 2x8p.					
	022220	ASS DN-9005-N Datendose weiss	1	1	14,70
CAT5 Datendose RJ45 2x8p.					
	022677	ASS DN-9002-N Datendose polarweiss	1	1	11,70

Abbildung	Art. Nr.	Bezeichnung	VE	per	Brutto €
-----------	----------	-------------	----	-----	----------

UC 300

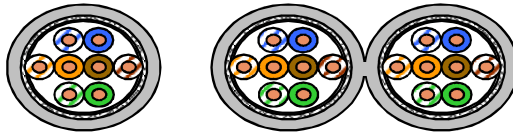

Datenkabel UC 300 HS24 SF/UTP CAT 5e

mit Folienschirm u. Geflechschirm 4 x 2 x 0,51 AWG 24 FRNC

CU Zahl

021625	KAB	UC 300 HS 244 P	CAT 5e	grau	27	100	1000	750,00
021627	KAB	UC 300 HS 242x4P	CAT 5e	Duplex grau	54	100	1000	1.590,00

UC 400

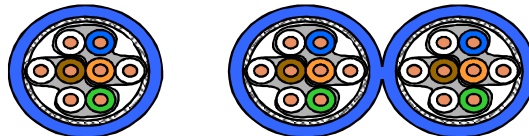

Datenkabel UC 400 HS23/1 S/FTP CAT 6

mit Folienschirm u. Geflechschirm 4 x 2 x 0,56 AWG 23 FRNC

CU Zahl

021628	KAB	UC 400 HS 234 P	CAT 6	blau	34	100	1000	960,00
021629	KAB	UC 400D HS 232x4P	CAT 6	Duplex blau	68	100	1000	1.920,00

UC 900

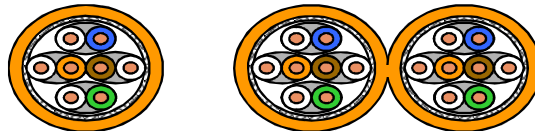

Datenkabel UC 900 HS23/1 S/FTP CAT 7

mit Folienschirm u. Geflechschirm 4 x 2 x AWG 23 FRNC

CU Zahl

021630	KAB	UC 900 HS 234 P	CAT 7	orange	26	100	1000	1.050,00
021631	KAB	UC 900D HS 232x4P	CAT 7	Duplex orange	52	100	1000	2.250,00

UC 900

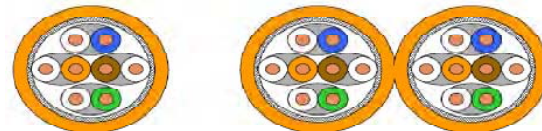

Erdkabel/Datenkabel UC 900 SS23 S/FTP CAT 7 PE

mit Folienschirm u. Geflechschirm 4 x 2 x AWG 23

CU Zahl

011938	KAB	UC 900 SS 23	CAT 7	orange	75	100	1000	1.950,00
---------------	-----	--------------	-------	--------	----	-----	------	-----------------

UC 1200

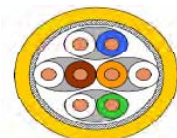

Datenkabel UC 1200 HS23/4P FRNC-B S/FTP CAT7

mit Folienschirm u. Geflechschirm 4 x 2 x AWG 23 FRNC

CU Zahl

019452	KAB	UC 1200 HS 234 P	CAT 7	gelb	28	100	1000	1.350,00
---------------	-----	------------------	-------	------	----	-----	------	-----------------

Achtung: Preise exkl. Kupferzuschlag

Abbildung	Art. Nr.	Bezeichnung	VE	per	Brutto €
	214620	DIE 006821 Runddraht RD10fv 10mm / 1kg = 1,62m	50	1000	<i>Preis auf Anfrage</i>
	214621	DIE 006845 Erdungs-Bandeisen EBE 30x3fv 1 kg = ca. 1,40m	50	1000	<i>Preis auf Anfrage</i>
	001441	DEH 849018 Runddraht D8 ALU weich 20 kg = 148m	20	1000	<i>Preis auf Anfrage</i>
	010657	DEH 869010 Runddraht D10 NIRO V4A 50 kg = 80m	50	1000	<i>Preis auf Anfrage</i>
	263056	DEH 620001 Schlagspitze 20mm Stahl fvz.	100	1	2,55
	263073	DEH 625001 Schlagspitze 25mm Stahl fvz.	50	1	2,90
	263063	DEH 620015 Anschlussschelle 20mm	20	1	5,80
	263080	DEH 625015 Anschlussschelle 25mm	20	1	6,25
	263070	DEH 620151 Tiefenerder 20mm Stahl fvz.	10	1	27,05
	263086	DEH 625151 Tiefenerder 25mm Stahl fvz.	10	1	37,25
	263093	DEH 635150 Profilstaberder 1,5m Stahl fvz.	5	1	33,05
	263094	DEH 635200 Profilstaberder 2,0m Stahl fvz. Profil A 50x50x3 m. Bohrung	5	1	43,55
	214595	DIE ESP1500 Erdspiess 1.500mm	1	100	1.460,00
	006499	Profil Ø 16mm m. Bohrung			
Erdeinführungsstange kpl. mit Trennstück und Anschluß					
	262939	DEH 480150 Stahl tauchfz. 1,5m Set	1	1	25,30
	262987	DEH 556125 Densoband 50mm	24	1	11,55
	262988	DEH 556130 Densoband 100mm	12	1	22,55
	262001	DEH 100100 Fangstange 1.000mm Stahl fvz.	10	1	16,25
	262272	DEH 206109 Dachleitungsstütze Niro m. Clip	25	1	6,80
Dachleitungsstütze für Ziegeldächer					
	262278	DEH 206219 L=335mm Niro, Rd 8mm/H=20mm	50	1	3,70
	262280	DEH 206229 L=475mm Niro, Rd 8mm/H=20mm	50	1	4,35
Dachleitungsstütze für Schieferdächer					
	262227	DEH 204089 L=205mm K/grau, Rd8mm/H=16mm	50	1	3,10
Dachleitungsstütze für Wellplattendach					
	262181	DEH 202015 6-10mm St/tZn,	50	1	1,85
Leitungshalter für Rd 8mm, mit Holzschraube					
	262376	DEH 274160 Niro m. Holzschr. u. K-Dübel D 8mm	50	1	2,95
	262365	DEH 263118 St/tZn Holzschraubengew. Spitze 100mm	50	1	3,65
	262408	DEH 276006 Abdeckscheibe K/grau	100	1	0,25
	262409	DEH 276007 Abdeckscheibe K/braun	100	1	0,25









Abbildung	Art. Nr.	Bezeichnung	VE	per	Brutto €
	Leitungshalter für Rd 8mm zum Einschlagen				
	262349	DEH 260108 Stahl tauchfeuerverz. 100mm Vierkant	50	1	2,20
	262354	DEH 260158 Stahl tauchfeuerverz. 150mm Vierkant	50	1	2,35
	262305	DEH 207019 Niro - Clip f. Rd8mm Niro	50	1	1,05
	262514	DEH 338000 Dachrinnenanschl. Klemme St. fvz.	25	1	3,45
	262516	DEH 338007 Dachrinnenanschluss - Klemme CU	25	1	8,35
	Regenrohrschelle mit 2-Schraubenüberleger				
	262825	DEH 421100 verzinkt 100mm	10	1	2,80
	262827	DEH 421120 verzinkt 120mm	10	1	4,25
	Falzklemme, Klemme drehbar, Falzstärke = max. 10mm				
	262558	DEH 365050 St/tZn Rd 8mm	50	1	4,55
	Falzklemme, Falzstärke = max. 6mm				
	262545	DEH 365000 Zinkdruckguss Rd 8mm	50	1	4,00
	262544	DEH 363010 Endstück Zinkdruckguss	50	1	4,65
	262541	DEH 347201 Klemmschuh Rd 7-10mm	50	1	3,25
	Erdungsfestpunkt				
	262907	DEH 478011 m. Anschlussgew. M10/M12	1	1	20,65
	MV-Klemme				
	262624	DEH 390050 Rd 8-10mm Stahl verz.	50	1	2,10
	262626	DEH 390057 Rd 8-10mm Kupfer	50	1	5,50
	262627	DEH 390059 Rd 8-10mm Niro	50	1	4,70
	262625	DEH 390051 Rd 8-10mm Alu	50	1	2,35
	262619	DEH 385202 Verbindungsuffe Stahl verz.	50	1	2,90
	Kreuzklemme ohne Zwischenplatte				
	262489	DEH 314300 M6 / Rd8-10 / Rd8-10	50	1	2,75
	262436	DEH 301000 KS-Verbinder Stahl verzinkt	100	1	2,80
	262906	DEH 476100 Revisionstür 200x140 Stahl verzinkt	10	1	12,60
	262847	DEH 450000 Trennm. Rd8-10/16mm Zinkdr.	50	1	4,10

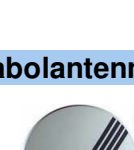

Abbildung	Art. Nr.	Bezeichnung	VE	per	Brutto €
	287336	TRI AE 75 S Ausseneinheit <i>SINGLE</i>	1	1	69,00
		1 Stk. <i>FESAT78</i> Parabolantenne 80cm			
		1 Stk. <i>CS300</i> Uni Single		981000705	
	287337	TRI AE 75 T Ausseneinheit <i>TWIN</i>	1	1	89,00
		1 Stk. <i>FESAT 78</i> Parabolantenne 80cm			
		1 Stk. <i>CS320</i> Uni Twin		981000706	
	287347	TRI AE 75 Q Ausseneinheit <i>QUATTRO</i>	1	1	105,00
		1 Stk. <i>FESAT78</i> Parabolantenne 80cm			
		1 Stk. <i>CS404</i> Quattro LNC		981000772	

Parabolantenne

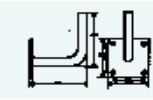
	287288	TRI FESAT85 hellgrau (lichtgrau) 85cm 96504001	1	1	98,00
	287289	TRI FESAT85 dunkelgrau (schiefergrau) 85cm 965040011	1	1	98,10
	287291	TRI FESAT85 ziegelrot 85cm 965040023	1	1	98,10
	010189	TRI FESAT95K - SET 95cm Alu	1	1	150,70
	287108	TRI GHV820 Hausanschluß-Verstärker 940019061	1	1	153,00
	287233	TRI KOK3N Koaxkupplung 947546100	10	1	2,30
	287234	TRI KOKWI3 Koaxwinkelkupplung 947548100	10	1	3,30
	287230	TRI KOS3N Koaxstecker 947539100	10	1	2,30
	287232	TRI KOSWI3 Koaxwinkelstecker 947544100	10	1	3,30
	287216	TRI KVFC01 Kabelverbinder 947374001	10	1	2,30
	287217	TRI KVFC02F Kabelverbinder 947387001	10	1	2,30
	287309	TRI MPO11 Antennenverstärker m. Netzteil 981000023	1	1	73,80
	287215	TRI RFC75 Abschlusswiderstand 947373001	1	1	1,00
	287044	TRI STEMA 42/200 steckbares Standrohr 811077102	1	1	46,40
287045	TRI STEMA 42/300 steckbares Standrohr 811077103	1	1	65,00	
287047	TRI STEMA 50/200 steckbares Standrohr 813775102	1	1	55,60	
287048	TRI STEMA 50/300 steckbares Standrohr 813775103	1	1	74,00	
	464263	HEI WIMA 250/50 Winkelmast 25cm Wandabstand	1	1	17,09
	464264	HEI WIMA 350/50 Winkelmast 35cm Wandabstand	1	1	17,88
	464265	HEI WIMA 450/50 Winkelmast 45cm Wandabstand	1	1	19,57
	287402	TRI SATKAB1,5 Sat-Anschlusskab.1,5m 981000900	1	1	4,40
	287403	TRI SATKAB3 Sat-Anschlusskab. 3m 981000901	1	1	6,00
	287407	TRI TVK1,5 TV-Empfängerkabel 1,5m 981000906	1	1	3,00
	287408	TRI TVK3 TV-Empfängerkabel 3m 981000907	1	1	4,20
	287409	TRI TVK5 TV-Empfängerkabel 5m 981000908	1	1	5,70

Sehr geehrte Kunden!

Da sich bei vielen Produkten Preise täglich ändern, sind unsere Preise als Richtpreise anzusehen und wir behalten uns Preisänderungen vor.

Abbildung	Art. Nr.	Bezeichnung	VE	per	Brutto €
	287199	TRI VFC0421 Verteiler 2fach 947355101	1	1	7,90
	287200	TRI VFC0631 Verteiler 3fach 947356101	1	1	12,00
	287201	TRI VFC0741 Verteiler 4fach 947357101	1	1	14,00
	287273	TRI VFC1061SF Verteiler 6fach 947741002	1	1	32,40
	287240	TRI VFC0421SF Verteiler 2fach 947568001	1	1	12,00
	287043	TRI BEG42U Befestigungsschelle 810971100	1	1	5,30
	287041	TRI BEG50U Befestigungsschelle 810909100	1	1	6,10
	287492	TRI ECO CKR504 4-fach Multischalter 940187001	1	1	110,40
	287493	TRI ECO CKR506 6-fach Multischalter 940188001	1	1	143,60
	287494	TRI ECO CKR508 8-fach Multischalter 940189001	1	1	172,60
	287495	TRI ECO CKR512 12-fach Multischalter 940190001	1	1	216,00
	287496	TRI ECO CKR516 16-fach Multischalter 940191001	1	1	288,60
	287499	TRI ECO CKR904 Multischalter 9 in 4 940225001	1	1	216,10
	287501	TRI ECO CKR908 Multischalter 9 in 8 940227001	1	1	288,20

Empfangssysteme 40mm



287151	TRI CS300S Uni Single 1 Teiln. 940251001	1	1	10,90
287152	TRI CS320T Uni Twin 2 Teiln. 940252001	1	1	32,80
287153	TRI CS400QT Uni Quattro SQ44 940253001	1	1	32,80

Empfangssystem + Multischalter



287154	TRI CS404QS QUATTRO GLQD40 940254001	1	1	47,80
287155	TRI CS408OS 8 fach / 8 Teilnehmer 940255001	1	1	140,80

287034	TRI DAB42-2 Dichtungsmanschette 601025101	1	1	7,30
287035	TRI DAB50-2 Dichtungsmanschette 601026101	1	1	9,40
287038	TRI DAB52-3N Bleiziegel 601131101	1	1	32,40
287051	TRI MAKA15 Standrohrkappe f. Rohr 32-60mm 910231100	1	1	5,80
287057	TRI MF63 Standrohrfuss f. 30-60mm 910781100	1	1	17,80



287349	TRI EDA3902F Sat Einzeldose 981000822	1	1	9,90
287131	TRI FS01 Einzeldose Kabel TV 940115001	1	1	13,80
287144	TRI FS07 Durchgangsdose TV 940158001	1	1	18,20
464187	HEI MX 600AAP Sat Einzeld. AP Gehäuse	1	1	6,41
464230	GFI TDU310 Einsatz Telefondose UP	1	1	16,19
287350	TRI GEDA3911P Durchgangsdose Sat 981000823	1	1	11,50



287168	TRI ES6 Erdungsschiene 942234101	1	1	16,20
---------------	---	---	---	--------------



287074	TRI FESA815N37 Antenne K21-37 15dB 910862601	1	1	140,80
---------------	--	---	---	---------------



287083	TRI FM30 Antenne f. UKW 910906002	1	1	51,80
---------------	---	---	---	--------------

Abbildung	Art. Nr.	Bezeichnung	VE per	KAP €
-----------	----------	-------------	--------	-------



Parabolantenne



031822	DELTA SAT65W	65cm, weiß	1	1	59,00
031823	DELTA SAT75DB	75cm, dunkelbraun	1	1	74,00
031824	DELTA SAT75G	75cm, graphit	1	1	74,00
031825	DELTA SAT75W	75cm, weiß	1	1	74,00
031826	DELTA SAT75Z	75cm, ziegelrot	1	1	74,00
031827	DELTA SAT85DB	85cm, dunkelbraun	1	1	99,00
031828	DELTA SAT85G	85cm, graphit	1	1	99,00
031829	DELTA SAT85W	85cm, weiß	1	1	99,00
031830	DELTA SAT85Z	85cm, ziegelrot	1	1	99,00



031803	DELTA BK226	Hausanschluß-Verstärker	1	1	69,00
---------------	--------------------	-------------------------	---	---	--------------



000279	DELTA NG1880	Universal-Stecker-Netzteil 18V	1	1	35,00
---------------	---------------------	--------------------------------	---	---	--------------



031815	DELTA FC60	F-Stecker 6,0mm	10	1	0,50
031816	DELTA FC70	F-Stecker 7,0mm	10	1	0,50
031817	DELTA FCB1HQ	F-Verbinder Buchse-Buchse HQ	10	1	1,90



031842	DELTA FHHM40	Feedadapter 40mm f. Fuba u. Hirschmann	1	1	23,90
031843	DELTA FHHI	Feedadapter 40mm f. Hirschmann Hit-SAT-Serie 75/85	1	1	23,90



031818	DELTA AMS50/200	steckbares Standrohr	1	1	49,90
031819	DELTA AMS50/300	steckbares Standrohr	1	1	69,90



031820	DELTA DSP90	Dachsparrenhalter 90cm Rohr	1	1	149,90
---------------	--------------------	-----------------------------	---	---	---------------



031821	DELTA MZ50	Mastzubehör-Set 50mm best. aus: Mastfuß, Mastschelle, Bleiziegel, Manschette, Mastkappe	1	1	69,00
---------------	-------------------	---	---	---	--------------

Abbildung	Art. Nr.	Bezeichnung	VE per	KAP €
-----------	----------	-------------	--------	-------



031804	DELTA VT0224	Verteiler 2-fach 5-2200MHz	1 1	9,90
031805	DELTA VT0324	Verteiler 3-fach 5-2200MHz	1 1	11,90
031806	DELTA VT0424	Verteiler 4-fach 5-2200MHz	1 1	15,90
031807	DELTA VT0286	Verteiler 2-fach 5-862MHz	1 1	5,90
031808	DELTA VT0386	Verteiler 3-fach 5-862MHz	1 1	7,90
031809	DELTA VT0486	Verteiler 4-fach 5-862MHz	1 1	9,90



031810	DELTA MTF0486	Multitaps 4-fach 862MHz	1 1	16,90
031811	DELTA MTF0686	Multitaps 6-fach 862MHz	1 1	19,90
031812	DELTA MTF0886	Multitaps 8-fach 862MHz	1 1	24,90
031813	DELTA MTF1286	Multitaps 12-fach 862MHz	1 1	49,90
031814	DELTA MTF1686	Multitaps 16-fach 862MHz	1 1	59,90



031839	DELTA SUM928	Uni-Einkabelsystem 2x8TLN	1 1	1.290,00
031840	DELTA SUM918	Uni-Einkabelsystem 1x8TLN	1 1	990,00
031841	DELTA SUM518	Uni-Einkabelsystem 1x8TLN	1 1	549,00



031836	DELTA MS54N	4-fach Multischalter	1 1	89,00
031837	DELTA MS56N	6-fach Multischalter	1 1	109,00
031838	DELTA MS58N	8-fach Multischalter	1 1	129,00



000175	DELTA SUM514K	Sat-Channel-Router- Kaskadengerät, bis zu 4 Receiver anschließbar	1 1	199,00
000274	DELTA SUM516K	Sat-Channel-Router- Kaskadengerät, bis zu 6 Receiver anschließbar	1 1	199,00

Empfangssysteme 40mm



031831	DELTA UC21	Uni Single 1 Teiln.	1 1	9,90
031832	DELTA UC22	Uni Twin 2 Teiln.	1 1	33,90
031833	DELTA UC44	Uni Quattro	1 1	33,90
031834	DELTA UC44S	Uni Quattro Switch	1 1	49,90
031835	DELTA IDLP40	Unicable-LNB	1 1	129,00

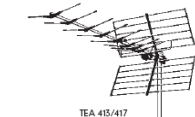

031801	DELTA TEA413	UHF-Fernsehantenne 13dB	1 1	69,00
---------------	---------------------	-------------------------	-----	--------------



031802	DELTA FM3	Antenne f. UKW	1 1	49,00
---------------	------------------	----------------	-----	--------------

Sehr geehrte Kunden!

Da sich bei vielen Produkten Preise täglich ändern, sind unsere Preise als Richtpreise anzusehen und wir behalten uns Preisänderungen vor.

Abbildung	Art. Nr.	Bezeichnung	VE	per	Brutto €
-----------	----------	-------------	----	-----	----------



288023	BEG 91001	Luxomat-Melder 140° weiss LC140WS	1	1	44,60
288031	BEG 91021	Luxomat-Melder 140° schwarz LC140SW	1	1	44,60

288024	BEG 91002	Luxomat-Melder 200° weiss LC200WS	1	1	59,90
288032	BEG 91022	Luxomat-Melder 200° schwarz LC200SW	1	1	59,90



288054	BEG 92002	Luxomat-Melder 230° weiss m. Unterkriechschutz	1	1	114,00
288191	BEG 97002	Luxomat-Melder 230° weiss m. Unterkriechschutz	1	1	120,85
288052	BEG 92000	IR-RC-Fernbedienung inkl. Batterie f. 97002	1	1	19,90



288083	BEG 92150	AP-Präsenzmelder 360° Master weiss	1	1	114,00
288094	BEG 92165	AP-Präsenzmelder 360° Master weiss (Einbau f. Zwischend.)	1	1	116,00
288084	BEG 92152	AP-Präsenzmelder Slave 360° weiss	1	1	99,50
288110	BEG 92190	AP-Präsenzmelder 360° weiss Deckeneinbau	1	1	76,00

Bewegungsmelder



288025	BEG 91008	280° weiss, Eckmontage	1	1	89,00
---------------	-----------	------------------------	---	---	--------------



244553	SCG 16974	Bewegungsmelder CDM 180 180° 230V 50Hz Reichweite: 12m	1	1	53,19
---------------	-----------	---	---	---	--------------



460229	ZUB 25000	Infra Garde 360° Plus	1	1	80,00
---------------	-----------	-----------------------	---	---	--------------



460234	ZUB 25070	Swiss Garde 360° Präsenz UP 2-Kanal weiß	1	1	125,00
---------------	-----------	--	---	---	---------------



460053	ZUB 3120	Infra Garde 270° Eckmontage ws.	1	1	60,00
---------------	----------	---------------------------------	---	---	--------------



460054	ZUB 3220	Infra Garde 180° UP	1	1	55,00
---------------	----------	---------------------	---	---	--------------

Abbildung	Art. Nr.	Bezeichnung	VE per	Brutto €
-----------	----------	-------------	--------	----------

Läutwerk / Gong



425192	LEG 041219	Läutwerk AP 8V weiss	10 100	1.132,90
425193	LEG 041221	Läutwerk AP 220V weiss	10 100	1.533,60



425203	LEG 041605	Gong Mini Lido AP firnweiss	1 100	1.516,90
425204	LEG 041606	Gong Zweiton 220V weiss	1 100	1.648,00



425205	LEG 041615	Funkgong ALTI 3-Ton-Melodie, Reichweite 100m freies Gelände	1 100	11.395,30
---------------	------------	---	-------	------------------



292153	GRO 43300	Mistral 300 Funkgong-Set (Sender + Empfänger), Reichweite 200m, 13fache Rufunterscheidung	1 1	106,10
---------------	-----------	---	-----	---------------



292149	GRO 43150	Elektronik-Gong Croma 50 für Batteriebetrieb m. 4x1,5V LR14/C (Babyzelle) / Batterie nicht im Lieferumfang / 3-fache Rufunterscheidung / 3 Sounds / weiß/silbergrau	1 1	26,85
---------------	-----------	---	-----	--------------



292174	GRO 44179	Gong 569-230V / 2-Klang / max. 80dB(A) / Achtung! Nur geeignete 230V-Taster verwenden!	1 1	20,45
---------------	-----------	---	-----	--------------



292120	GRO 24082	Aufputz-Läutwerk LTW 1171A 12V AC / 12V~/0,38A / max. 85 dB(A)	1 1	13,95
---------------	-----------	--	-----	--------------



213686	MOE 103164	Funk-Paket CPAD-00-28 / 1x Schaltaktor 230VAC/8A / 1x Taster 1fach komplett, PR20, weiss / 2x Klebestreifen für Taster	1 1	128,00
---------------	------------	--	-----	---------------

Abbildung	Art. Nr.	Bezeichnung	VE per	Brutto €
-----------	----------	-------------	--------	----------



Audio - Türsprechanlagen - Set



		Einfamilienhaus-Set UP-Türstat.		
347157	FER 3500	Alu-silber	1 1	129,35
347548	FER 35000	Alu-weiß	1 1	129,35
347163	FER 3602	Einfamilienhaus-Set UP-Türstat. mit Codeschloß Alu-silber	1 1	299,40
347159	FER 3502	Einfamilienhaus-Set UP-Türstat. m. Infomodul Alu-silber	1 1	157,50
347182	FER 5356	AP-Einfamilien-Set 2-Draht-Neox silber	1 1	120,00
347482	FER 8929	AP-Einfamilien-Set f. Briefkasten o. Türstation	1 1	107,50
347170	FER 4900	UP-Türst. City-Line 2-Draht-Bus	1 1	339,00
347158	FER 3501	Zweifamilienhaus-Set UP-Türstat. Alu-silber	1 1	175,00
347549	FER 35010	Zweifamilienhaus-Set UP-Türstat. Alu-weiß	1 1	175,00
347558	FER 36041	Zweifamilienhaus-Set UP-Türstat. Alu-silber m. Codeschloß	1 1	327,40
347183	FER 5357	AP-Türstation Neox, silber	1 1	141,00



Haustelefon weiß, mit elektronischem Ruf
Türstation auch mit Code-Tastatur (2 verschiedene Codes)
zum Öffnen der Haustür oder Garagentor, schalten v. Licht etc.
oder mit beleuchtetem Namensschild für Hausnummer,
Öffnungszeiten usw.
Lautstärke von Mikrofon imd Lautsprecher stufenlos
getrennt einstellbar

Video - Einfamilien-Set



347155	FER 3340	UP-Türstat. schwarz/weiß Monitor, Alu-silber	1 1	605,00
347154	FER 3330	UP-Türstat. Color, Alu-silber	1 1	1.068,40
347171	FER 4933	UP-Türstat. City-Line Color 2-Draht- Bus o. Koax	1 1	927,00
347156	FER 3365	Zweifamilien-Set UP-Türstation schwarz/weiß Alu-silber	1 1	1.045,00

Abbildung	Art. Nr.	Bezeichnung	VE per	Brutto €
-----------	----------	-------------	--------	----------

Audio - Türsprechanlagen - Set



420415	BTI	367211	Einfamilienhaus-Set Sfera Modular / Swing 2-Draht Alu UP	1 1	305,03
420416	BTI	367212	Einfamilienhaus-Set Sfera Modular / Swing 2-Draht weiss UP	1 1	305,03
420417	BTI	367221	Zweifamilienhaus-Set Sfera Modular / Swing 2-Draht Alu UP	1 1	348,60
420418	BTI	367222	Zweifamilienhaus-Set Sfera Modular / Swing 2-Draht weiss UP	1 1	348,60
420043	BTI	313311	Einfamilienhaus-Set Sfera Modular / Sprint analog Alu UP	1 1	134,88
420044	BTI	313321	Zweifamilien-Set Sfera Modular / Sprint analog Alu UP	1 1	174,30
420033	BTI	100024	Einfamilienhaus-Set Sfera Modular / Sprint analog m. Codelock Alu UP	1 1	357,94
420439	BTI	368111	Einfamilienhaus-Set Linea Metall / Swing 2-Draht Alugussgehäuse, vandalensicher AP	1 1	286,35
420440	BTI	368121	Zweifamilienhaus-Set Linea Metall / Swing 2-Draht Alugussgehäuse, vandalensicher AP	1 1	333,04
420435	BTI	368011	Einfamilienhaus-Set Linea 2000 / Swing analog Alu AP	1 1	104,50
420437	BTI	368021	Zweifamilienhaus-Set Linea 2000 / Swing analog Alu AP	1 1	149,00

Video - Türsprechanlagen - Sets Video 2-Draht



420431	BTI	367711	Einfamilienhaus-Set Sfera Monoblock / Pivot Station 2-Draht Inox UP	1 1	1.300,00
420442	BTI	368311	Einfamilienhaus-Set Sfera Monoblock / Pivot Station 2-Draht, mit Memory Inox UP	1 1	1.350,00
420432	BTI	367721	Zweifamilienhaus-Set Sfera Monoblock / Pivot Station 2-Draht Inox UP	1 1	1.900,00
420445	BTI	368511	Einfamilienhaus-Set Sfera Monoblock / Pivot Display 2-Draht Inox UP	1 1	1.111,17
420446	BTI	368521	Zweifamilienhaus-Set Sfera Monoblock / Pivot Display 2-Draht Inox UP	1 1	1.530,77
420447	BTI	369111	Einfamilienhaus-Set Sfera Modular / Swing 2-Draht Alu UP	1 1	931,26
420448	BTI	369121	Zweifamilienhaus-Set Sfera Modular / Swing 2-Draht Alu UP	1 1	1.216,99
420433	BTI	367811	Einfamilienhaus-Set Linea Metall / Pivot Station 2- Draht Alugussgehäuse, vandalensicher AP	1 1	1.200,00
420441	BTI	368211	Einfamilienhaus-Set Linea Metall / Pivot Station 2- Draht, mit Memory, Alugussgehäuse, vandalensicher AP	1 1	1.250,00
420434	BTI	367821	Zweifamilienhaus-Set Linea Metall / Pivot Station 2- Draht Alugussgehäuse, vandalensicher AP	1 1	1.800,00
420443	BTI	368411	Einfamilienhaus-Set Linea Metall / Pivot Display 2- Draht Alugussgehäuse, vandalensicher AP	1 1	836,02
420444	BTI	368421	Zweifamilienhaus-Set Linea Metall / Pivot Display 2- Draht Alugussgehäuse, vandalensicher AP	1 1	1.185,24
420427	BTI	367511	Einfamilienhaus-Set Linea Metall / Swing 2-Draht Alugussgehäuse, vandalensicher AP	1 1	1.111,17
420428	BTI	367521	Zweifamilienhaus-Set Linea Metall / Swing 2-Draht Alugussgehäuse, vandalensicher AP	1 1	1.530,77

Sehr geehrte Kunden!

Da sich bei vielen Produkten Preise täglich ändern, sind unsere Preise als Richtpreise anzusehen und wir behalten uns Preisänderungen vor.

Abbildung	Art. Nr.	Bezeichnung	VE	per	Brutto €
-----------	----------	-------------	----	-----	----------



	258888 HAU 220168	Lehrlingskoffer Start	1	1	385,44
---	-------------------	-----------------------	---	---	---------------

Werkzeugkoffer für den Auszubildenden aus schwarzem Rindsleder

Inhalt:

Black Line Seitenschneider 165mm, Abisolierzange 165mm
5 VDE Elektriker Schraubendreher 2,5x 75, 3x100, 4x100, 5,5x125, 6,5x150mm
VDE Kreuzschlitz Schraubendreher Gr. 1 und Gr. 2
Kabelmesser 1teilig, PUK-Taschensäge, Pinsel, Gipsmulde, Spachtel 40mm
Elektriker-Meißel 10x250mm, Spannungsprüfer - Klinge 50mm,
Steinmeißel 300mm, Schlosserhammer 300g, Fäustel 1000g

	258885 HAU 220153	Werkzeugkoffer Basic	1	1	493,38
--	-------------------	----------------------	---	---	---------------

Hartschalenkoffer schwarz, 2 Werkzeugtafeln, eine mit Dokumententasche, Bodenschale mit variablen Trennstegen, 19 Werkzeuge

Inhalt:

Black Line Telefonzange 200mm, Kombizange 155mm
Black Line Seitenschneider 165mm, Abisolierzange 165mm
5 VDE Elektriker Schraubendreher 2,5x 75, 3x100, 4x100, 5,5x125, 6,5x150mm
2 VDE Kreuzschlitz Schraubendreher PH Gr. 1 und PH Gr. 2
Kabelmesser 1teilig, PUK-Taschensäge, Schlosserhammer 300g,
Elektriker-Meißel 10x250mm, Spannungsprüfer - Klinge 50mm,
Maßstab 2m, Malerspachtel

Kabelschneider



	354323 WEI 9002650000	KT8 / für Kabel bis 8mm Ø	1	1	28,68
---	-----------------------	---------------------------	---	---	--------------

	354324 WEI 9002660000	KT12 / für Kabel bis 12mm Ø	1	1	32,33
---	-----------------------	-----------------------------	---	---	--------------

	355014 WEI 9202040000	KT45R / für Kabel bis 45mm Ø	1	1	209,74
---	-----------------------	------------------------------	---	---	---------------