



A Century of Product Integrity

hydraulic  
& mechanical  
equipment catalog



**INTRODUCTION**  
pages 1 - 5



**power pumps**

Index ..... 1  
 Company Overview ..... 2-3  
 Safety Tips ..... 4-5



**cylinders**

Introduction ..... 6 - 7  
 Proper Size and Selection ..... 8 - 9  
 Spring Return ..... R Series 5-100 Tons..... 10 - 11  
 Spring Return ..... RLS Series 10-100 Tons..... 12  
 Spring Return ..... RFS Series 5-150 Tons..... 13  
 Pull Cylinder S/A ..... RP Series 2-5 Tons..... 14  
 Pull Cylinder D/A..... RDP Series 10-100 Tons ..... 15  
 Center Hole S/A..... RC Series 12-100 Tons..... 16  
 Center Hole D/A ..... RCD Series 30-500 Tons ..... 17  
 Load Return ..... RLR Series 30-1000 Tons ..... 18 - 19  
 Locknut Load Return ..... RLN Series 30-1000 Tons ..... 20 - 21  
 Double Acting ..... RDA Series 10-1000 Tons ..... 22 - 23  
 Pancake Locknut..... CLP Series 60-500 Tons..... 24  
 Steel Cylinder Accessories..... 25  
 Alum. Spring Return ..... RAS Series 30-150 Tons ..... 26  
 Alum. Locknut ..... RAL Series 50-150 Tons..... 27  
 Alum. S/A Center Hole ..... RAC Series 30-60 Tons ..... 28  
 Alum. D/A Center Hole ..... RACD Series 30-150 Tons ..... 29



**hand pumps**

Introduction ..... 30 - 31  
 Proper Size & Selection ..... 32 - 33  
 Compact Steel..... 34  
 Lightweight Aluminum..... 35  
 Heavy Duty..... 36  
 Special Application..... 37  
 Ultra High Pressure Aluminum ..... 38  
 Ultra High Pressure Accessories..... 39  
 Pump & Cylinder Sets - Steel & Aluminum..... 40 - 41

Introduction ..... 42 - 43  
 Proper Size & Selection..... 44 - 45  
 G1 Series Electric ..... 46 - 47  
 G3 Series Electric ..... 48 - 49  
 G4 Series Electric ..... 50 - 51  
 G5 Series Electric ..... 52 - 53  
 G6 Series Electric ..... 54 - 55  
 G5 Series Air ..... 56 - 57  
 G4 Series Gas..... 58 - 59  
 G6 Series Gas..... 60 - 61  
 G Series Accessory Kits ..... 62 - 63  
 Compact Pumps - Air over Hydraulic ..... 64 - 65



**accessories**

Introduction ..... 66 - 67  
 Proper Selection..... 68 - 69  
 2 & 3 Way Control Valves..... 70  
 4 Way Control Valves ..... 71  
 In Line System Valves ..... 72  
 High Pressure Manifolds..... 73  
 1/4" NPTF Couplers..... 74  
 3/8" NPTF Couplers..... 75  
 NPTF Fittings and Oil..... 76  
 Analog & Digital Gauges ..... 77  
 High Pressure Hoses..... 78 - 79

# TABLE OF CONTENTS



## bolting

Introduction .....	80 - 81
Proper Size & Selection .....	82 - 83
G1 Series Lightweight Bolting Pump .....	84
G3 Series Heavy Duty Bolting Pump .....	85
G5 Series Heavy Duty Bolting Pump .....	86
G5 Series Heavy Duty Air Bolting Pump.....	87
WT Series Torque Wrenches - Square Drive .....	88
Torque Wrenches - Square Drive Accessories .....	89
WX Series Torque Wrenches - Low Clearance .....	90 - 91



## presses

Introduction .....	114 - 115
Proper Size & Selection .....	116 - 117
H-Frame Bench 10 & 15 Tons.....	118
H-Frame 10 Tons .....	119
H-Frame 25 & 30 Tons.....	120
H-Frame 55 Tons .....	121
H-Frame 100 Tons .....	122
H-Frame 150 - 200 Tons .....	123



## lifting jacks

Introduction .....	92 - 93
Proper Size & Selection .....	94 - 95
HJ Series Hand Jacks .....	96
TJH Series Toe Jacks - Heavy Duty.....	97
B Series Air Lifting Bags .....	98 - 99
Air Bag Accessories .....	100 - 101



## mechanical

Introduction .....	124 - 125
Proper Size & Selection .....	126 - 127
RJ Series Ratchet Jacks .....	128 - 129
CR Series Reel Jacks .....	130 - 131
Push / Pull Jacks .....	132
JJ Series Super Jacks.....	133
SJ Series Screw Jacks.....	134
Screw & Cap Assemblies.....	135
44 Series Tank Jacks .....	136
SER Series Loadbinder Jacks .....	137
PJ Series Planer Jacks.....	138
S Series Spreader Jacks .....	139
RS Series Roof Support.....	140 - 141
RS Series Roof Support Base .....	142 - 143
SE & BE Series Trench Braces .....	144 - 145
Lever Bar & Accessories.....	146



## hydraulic tools

Introduction .....	102 - 103
Proper Size & Selection .....	104 - 105
Single Acting Punch - 35 Tons.....	106 - 107
S Series Hydraulic Spreaders GAT'R Jaw.....	108
SF Series Hydraulic Spreaders - 5 Tons .....	109
NS Series Nut Splitters .....	110
Maintenance Kit .....	111
Maintenance Kit - Components .....	112 - 113

## MISCELLANEOUS pages 147 - 148

System Arrangements .....	147
Conversion Chart.....	148

All Simplex Product Dimensions are subject to change without notice. Please consult your Simplex Representative for verification of critical specifications, or email: [info@tksimplex.com](mailto:info@tksimplex.com)

All Simplex Products are warranted against defects in material and workmanship. Any Simplex Product proven defective will be repaired or replaced at no charge. Contact your authorized Simplex Service Center or visit the Simplex Support Center at: [www.tksimplex.com](http://www.tksimplex.com)



# Introduction

Quality Since 1899



## Positioning & Lifting Equipment Specialists

### Corporate Office ►

The Simplex office includes sales, marketing, technical service and engineering resources, assuring that any customer questions can be addressed seamlessly and in a timely manner.



### Manufacturing ►

The latest in manufacturing CNC technology is used to improve product availability along with providing service excellence in the competitive market we share.



### Quality Control ►

Simplex sets the highest standards in maintaining quality by utilizing the latest CMM quality control technology to assure consistent quality is maintained across all product lines. All Simplex vendors are held to the same high quality standards that Simplex has come to expect. All Simplex products meet or exceed ANSI/ASME B30.1 safety standards where applicable.



## Positioning & Lifting Equipment Specialists



### ◀ Products

Designed and manufactured to withstand the rugged environments of the worldwide industrial market. Simplex offers a wide variety of high pressure hydraulic and mechanical products which are widely used in the mining, construction, manufacturing / MRO, fabricating, energy, power generation and shipbuilding markets.



### ◀ System Arrangements

To assist our customers in selecting the proper components, Simplex offers System Development assistance to assure the correct products are used for your particular application. Contact the sales office for details.

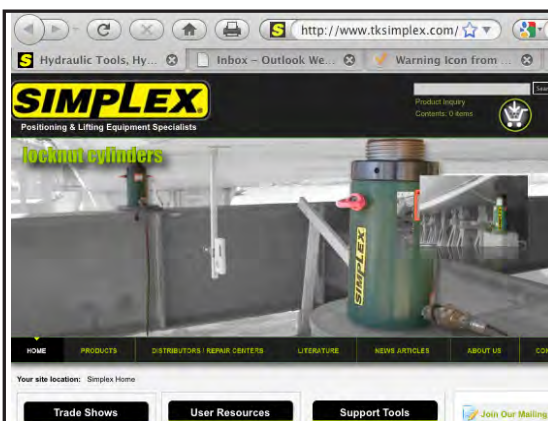

### ◀ Corporate Website

To keep up with the demand of the "information now" lifestyle, our website incorporates the latest interactive technology that will keep you engaged throughout your online experience. This website can be used from simply inquiring about the product line, to fully gradeable on-line training. This technology is a frontrunner in the industry.

*(Please refer to inside back cover for more detailed information on our website).*

# Safety Tips

**SIMPLEX**

## 1. Choose The Right Ram.

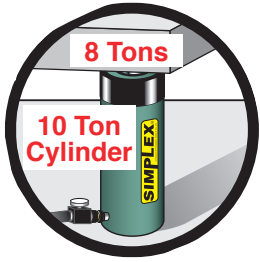

You must know the weight of what you intend to lift and choose a ram with at least 20% more capacity. Be aware of possible load shift requiring more capacity at any particular lifting point.

## 2. Inspect All System Components.

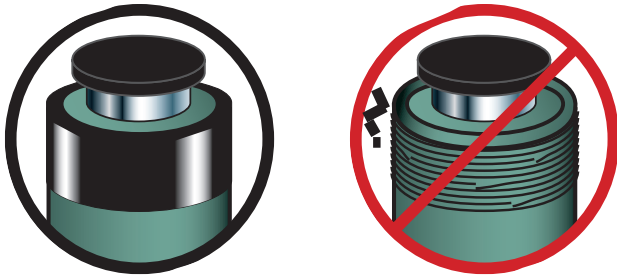

Check each component before you set up your hydraulic system. Do not use damaged or worn components. Turn them in for repair or replacement.

## 3. Safety Instructions.



Read all warning labels and instructions. Operating instructions must be understood before using equipment. Never remove labels from equipment. Replace missing, worn, or damaged labels. Always wear safety goggles and protective clothing when using hydraulic equipment.

## 4. Each Jack Or Ram Must Be Fully Supported At The Base.

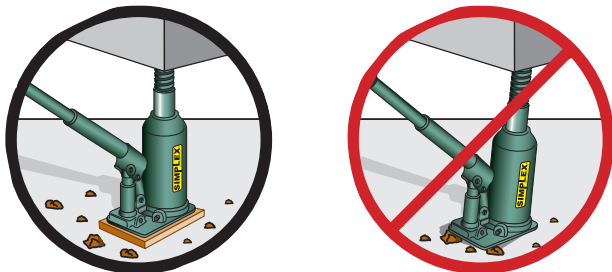

Every jack or ram, whether used individually or in a system, should be completely supported on a solid, firm, non-sliding foundation capable of supporting the load.

## 5. Fill Oil Reservoirs With Cylinder Retracted.

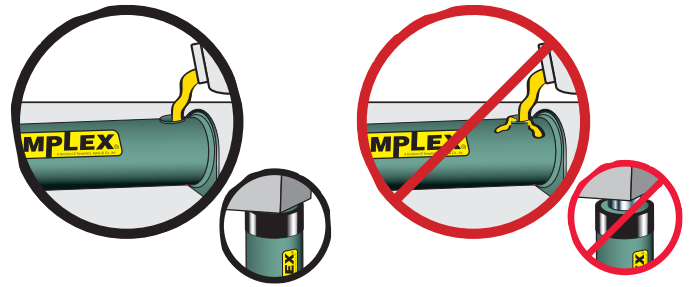

Only fill pump to recommended level, and fill only when connected cylinder is fully retracted.

## 6. Know How Your Hydraulics Work.

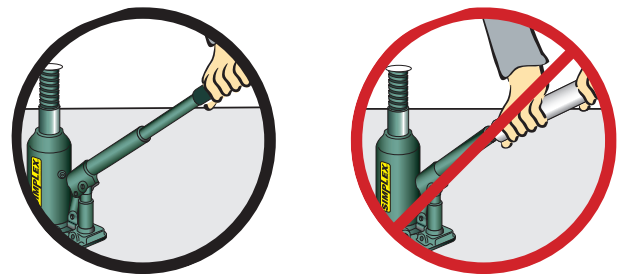

Do not use extensions or cheater bars on hydraulic jacks or hand pumps to raise a load.

## 7. Center The Load On The Lifting Point.

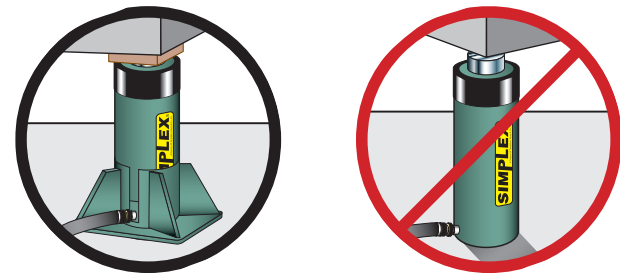

The load must be centered on the ram, or equally distributed on multiple rams. Off center loading can result in the ram slipping out and loss of the load.

## 8. When Using Multiple Rams, Distribute The Load Evenly.

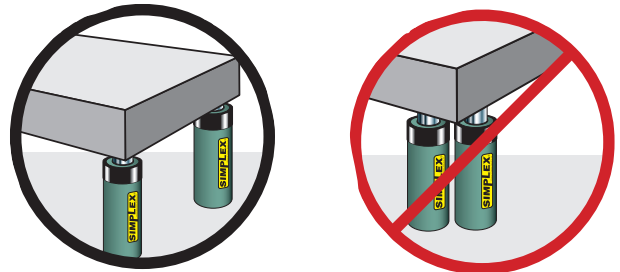

For multiple ram lifts, you must be able to determine the location and number of lifting points that will allow the load to be evenly distributed to all the rams. Size, center of gravity, and load geometry must be considered in order to correctly determine load balance.

**9. Block Or Crib Your Load As It Raises.**

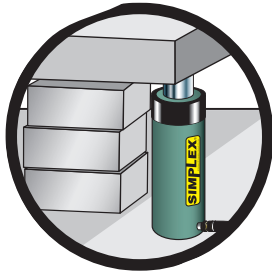

Place blocking or cribbing under the loads as you raise it. Each time you raise it higher, insert more blocking. Position yourself in a manner that will keep you clear of the load, and will not allow your hands or other body parts between the load and the cribbing.

**10. Do Not Use Rams As Permanent Supports.**

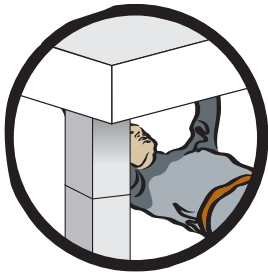

Hydraulic rams are not meant to be used as permanent supports, but are designed to lift and lower. If you need to hold the load for any length of time, cribbing or Simplex locknut cylinders should be used.

**11. Hydraulic Connections.**

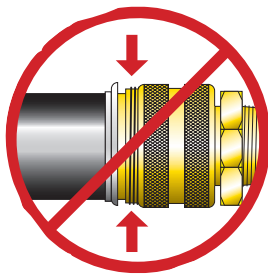
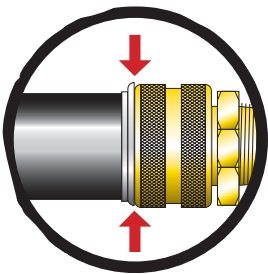

When making connections with quick couplers, make sure the couplings are fully engaged. Threaded connections such as fittings, gauges, etc. must be securely tightened and leak free. Never use excessive tightening force that may distort the fittings or strip the thread profile.

**12. Avoid Extreme Heat Or Weld Spatter.**

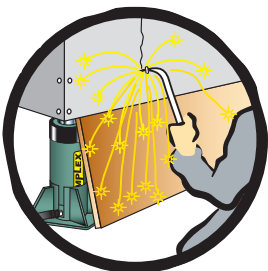

Weld spatter will damage plunger rods and hoses. Hydraulic fluid can ignite if vaporized or exposed to high temperatures.

**13. Hydraulic Disconnections.**

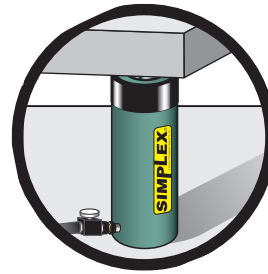

Never attempt to disconnect hydraulic hoses, fittings or couplers under pressure. Unload the ram, open the release screw on the hand pump and shift or open all hydraulic controls several times. If system includes a gauge, double check the gauge to insure pressure has been completely released.

**14. Do Not Carry Or Drag Pumps And Rams By Their Hoses.**

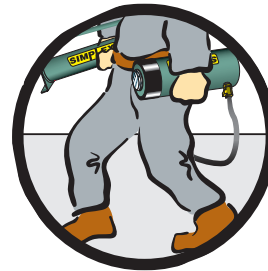

Dragging or carrying rams or pumps by a connected hose can damage the couplers and hoses. Using damaged couplers and hoses can be dangerous.

**15. Keep Hydraulic Hoses Free Of Obstructions.**



Do not drop sharp or heavy objects on hose. Keep hose out of heavy traffic areas. This will cause internal damage to hose wire strands. Applying pressure to a damaged hose may cause it to rupture. Avoid sharp bends and kinks when routing hydraulic hoses.



# CYLINDERS





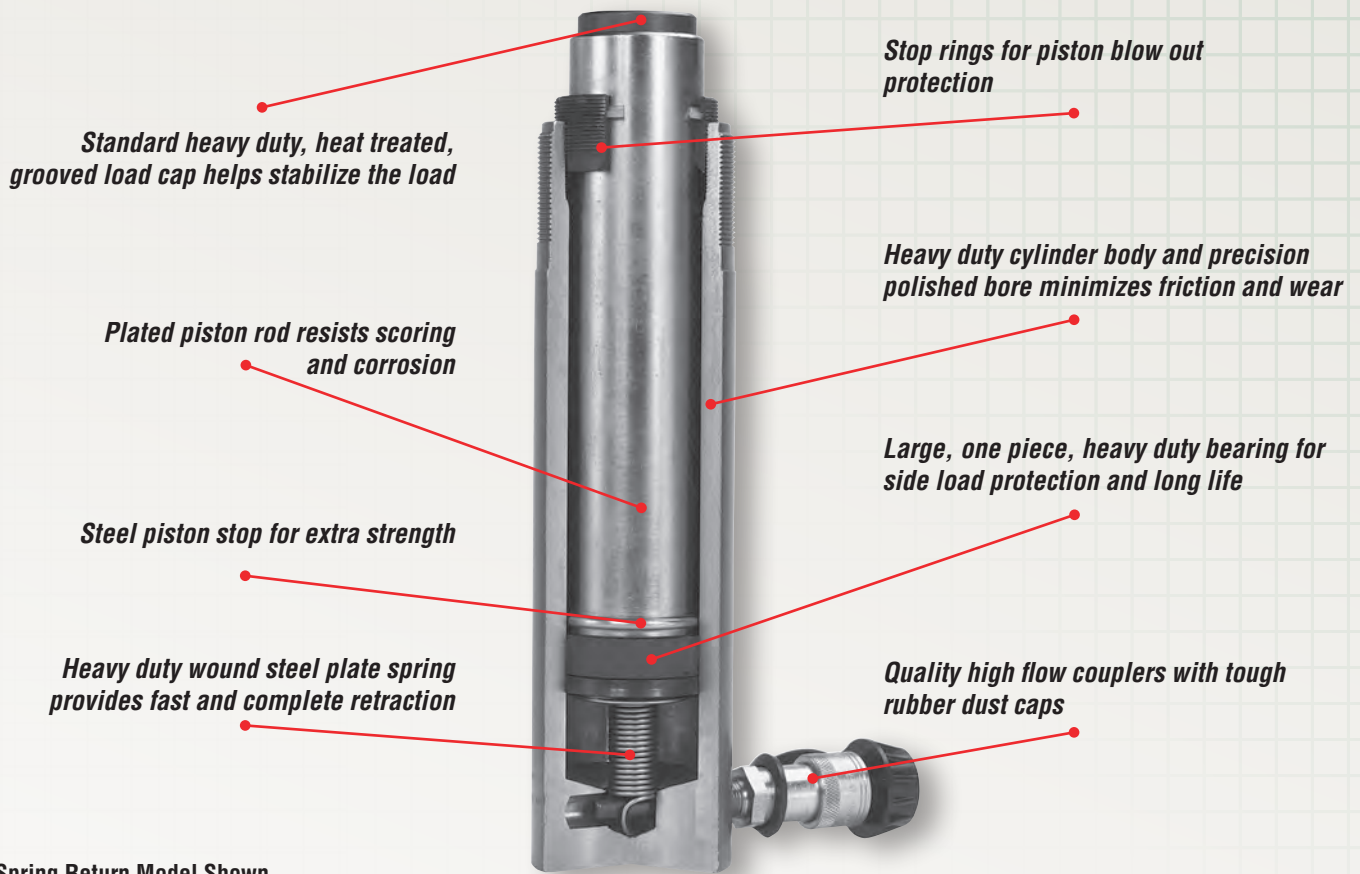

Spring Return Model Shown

**SIMPLEX CYLINDER PRODUCT LINE OVERVIEW****► Wide Variety**

Simplex offers the widest selection of cylinder styles, tonnages and strokes to match your specific requests.

**► Built for Rugged Industrial/Construction Use**

All Simplex cylinders meet ANSI/ASME B30.1 SAFETY STANDARDS. Stop rings, plated pistons and heavy duty construction provide trouble free operation and long life.

**► Standard Design Elements**

Cylinders are designed for 10,000 psi operating pressure which offers a smaller footprint and greater force.

**► Versatile Fixturing**

Threaded collars and internal plunger threads withstand full loading for maximum flexibility in fixturing.

**► Piston Blow-Out Protection**

All Simplex cylinders (*excluding CLP Series*) incorporate a positive piston stop to limit piston travel at the end of the stroke, and allows the cylinder to be operated at full stroke. Piston stops add strength and safety to your cylinder.

**► Protection from Contamination**

Polyurethane wipers clean the rod surface during retraction, protecting the inner cylinder assembly from dirt, moisture and other contaminants.

# CYLINDERS

Proper Size & Selection

**SIMPLEX**

## Single Acting



Single acting cylinders are hydraulically driven in one direction. These cylinders are used in many general purpose applications when retract speed is not a requirement. This cylinder type requires a pump source with a single acting valve for proper operation.

Both Spring Return and Load Return cylinders are constructed and operated in a similar manner, but function differently on the return.

- ▶ *Spring Return cylinders are hydraulically extended, but utilize a spring for retraction assistance.*
- ▶ *Load Return cylinders are hydraulically extended and retracted by the load or other external forces.*
- ▶ *Simplex 3 Way, 3 Position Suc-O-Matic valve can draw hydraulic oil out of any single acting cylinder. In the retract position, the valve generates enough suction to fully retract any single acting load return cylinder automatically.*

## Double Acting



Double acting cylinders are hydraulically driven in both directions. These cylinders are used in many general purpose applications where retraction speed is required or the mechanical forces required for return is not available. This cylinder type requires a pump source with a 4 way valve for proper operation.

- ▶ *Oil entering the advance port exerts pressure on the bottom plunger face raising the piston upward and oil on the retract side exits the retract port.*
- ▶ *When oil is pumped into the retract port, it exerts pressure on the top plunger face causing the plunger to retract and oil exits the advance port.*
- ▶ *A safety relief is installed on the retract side of all Simplex double acting cylinders to prevent over-pressurization in the event the retract line has been blocked.*

## Center Hole



Center hole cylinders are available in both single and double acting styles. These cylinders are primarily used for pushing and pulling applications. Both styles have a center tube that allows a rod or cable to pass through the cylinder and assist in tensioning / pulling applications.

Both single acting and double acting center-hole cylinders are constructed and operated in a similar manner to their standard counterparts.

- ▶ *Single acting center-hole cylinders utilize a spring for retraction. This cylinder type requires a pump source with a 3 way valve for proper operation.*
- ▶ *Double acting center-hole cylinders are hydraulically extended and retracted. This cylinder type requires a pump source with a 4 way valve for proper operation.*

**Force & Speed Calculations**

**Flow:** Created by the pump source.

**Pressure:** Generated by resistance to flow and pressure from the pump source. This resistance is usually the result of a load.

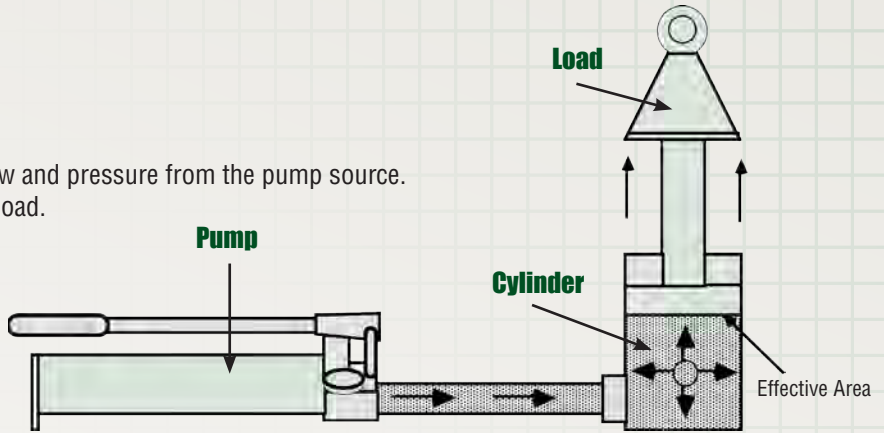

**Force:** The amount of force a hydraulic cylinder can generate is equal to hydraulic pressure times the effective area of the cylinder. (**Effective area is the surface area of the piston face in square inches.**) For multiple cylinder systems, multiply the effective area times the number of cylinders times pressure to determine system force.

**Formula for Calculation of Output Force:**

$$\frac{\text{psi} \times \text{Cylinder Effective Area} \times \text{No. of Cylinders}}{2,000} = \text{TONS}$$

**Speed:** When using a “power pump” the speed at which your cylinder will lift is determined by dividing the pump’s flow by the cylinder’s effective area.

**Formula for Calculation of Lifting Speed:**

$$\frac{\text{Pump Flow Per Minute}}{\text{Cylinder Effective Area} \times \text{No. of Cylinders}} = \frac{\text{in./min.}}{\text{Piston Travel}}$$

**Simplex Cylinders At A Glance Chart**

Cylinder Series	Description/Applications	Cylinder Type	Plunger Type	Capacity (Tons)	Strokes (in)	Page No.(s)
<i>R</i>	General Purpose Spring Return For Fast Retraction	Single Acting	Solid	5 - 100	.62 - 14.38	10-11
<i>RAS</i>	Lightweight, General Purpose Spring Return			30 - 150	2 - 10	26
<i>RAL</i>	Lightweight Load Holding Locknut Spring Return			50 - 150	2 - 10	27
<i>CLP</i>	Low Profile Locknut			60 - 500	1.97 - 1.79	24
<i>RAC</i>	Lightweight Center Hole Spring Return		Double Acting	Center Hole	30 - 60	3 - 6
<i>RACD</i>	Lightweight Center Hole	30 - 150			2 - 10	29
<i>RLS</i>	Low Height Spring Return	Single Acting	Solid	10 - 100	1.5 - 2.25	12
<i>RFS</i>	Very Low Height Spring Return			5 - 150	.44 - .62	13
<i>RP</i>	Pull Cylinder Spring Return			2 - 5	5 - 5.5	14
<i>RLN</i>	Mechanical Load Holding / Locknut Load Return			30 - 1,000	2 - 12	20-21
<i>RC</i>	Single Acting Center Hole		Double Acting	Center Hole	12 - 100	.31 - 6.13
<i>RCD</i>	Double Acting Center Hole	30 - 646			3 - 10	17
<i>RDP</i>	Double Acting Pull Cylinder	Solid		Solid	10 - 100	6
<i>RDA</i>	Double Acting Controlled Retraction / Fast Cycling		10 - 1,000		2 - 24	22-23

cylinders

# STEEL CYLINDERS

R Series - Spring Return



R556 Shown



### COLLAR THREADS

Standard Collar Threads on all models (except R50) for easy fixturing.



### HOSES - pages 78 - 79

Heavy duty and thermo plastic hydraulic hoses to meet your requirements and safety factor.



### GAUGES - page 77

Improve your system visibility and safety by adding an inline hydraulic gauge to your circuit.



### POWER PUMPS - pages 43 - 65

Simplex offers a wide variety of lightweight power pumps to fit any application.

- Capacity Range ..... ▶ **5 - 100 Tons**
- Stroke Range ..... ▶ **.62 - 14.38 In.**
- Maximum Pressure ..... ▶ **10,000 PSI**

- ▶ HD internal spring for fast retract assistance.
- ▶ Heat treated load caps are standard.
- ▶ Stop ring for piston blow-out protection.
- ▶ Plated piston resists scoring & corrosion.
- ▶ High flow couplers are plated to resist corrosion.
- ▶ Rod wiper protects inner cylinder from dirt.

cylinders

### Standard Base Mounting Holes R51 through R10010 Cylinders

Model	Bolt Circle (in)	Thread (in)	Thread Depth (in)
5 Ton*	1	.25 - 20 UNC	.56
10 Ton	1.56	.31 - 18 UNC	.50
15 Ton	1.88	.38 - 16 UNC	.50
25 Ton	2.31	.5 - 13 UNC	.75
30 Ton	----	----	----
55 Ton	3.75	.5 - 13 UNC	.75
75 Ton	----	----	----
100 Ton	5.5	.75 - 10 UNC	1.00

\* R50 Base Mounting hole 7/32 through x 23/64 "C" bore (1/4" depth).

*This R10010 is used to press the drive shaft into a large industrial fan during standard maintenance. When combined with a Simplex power pump, this job was completed quickly and safely. ▼*

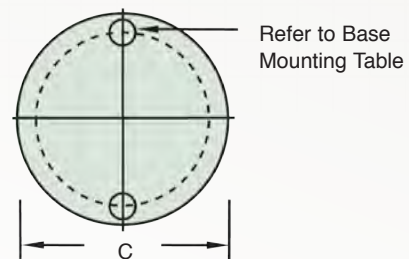
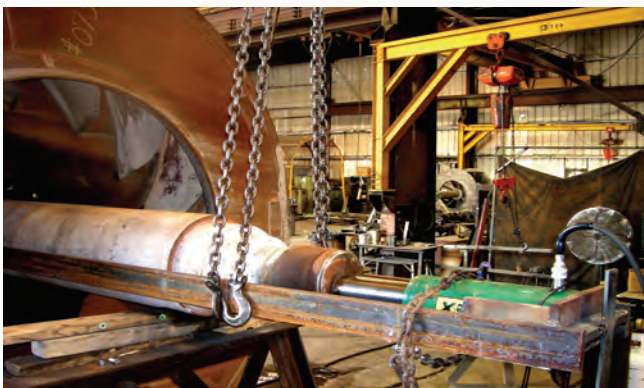

# STEEL CYLINDERS

R Series - Spring Return

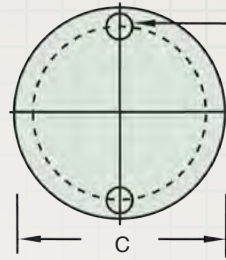
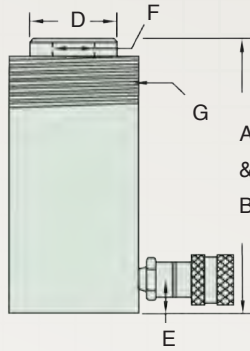

Model	Cap. (Tons)	Stroke (in)	Oil Cap. Req'd (cu in)	Ram Bore Dia. (in)	Effect Area (sq. in.)	Pres. @ Cap (psi)	A		C	D	E	F		G		Wgt. (lbs)
							Min. Height (in)	Ext. Height (in)	Body O.D. (in)	Piston O.D. (in)	Base to Port C/L (in)	Piston I.D. Thrds (in)	Piston Threads Depth (in)	Collar Threads (in)	Collar Threads Lgth (in)	
R50	5	0.62	0.6	1.13	0.99	10,000	1.62	2.24	2 5/8	1.00	0.75	---	---	---	---	2.5
R51	5	1.13	0.99	1.13	0.99	10,000	4.37	5.50	1 1/2	1.00	0.75	.75 --16	0.75	1.5 -- 16	1.13	2.3
R53	5	3.13	2.98	1.13	0.99	10,000	6.52	9.65	1 1/2	1.00	0.75	.75 --16	0.75	1.5 -- 16	1.13	3.3
R55	5	5.13	4.97	1.13	0.99	10,000	8.52	13.65	1 1/2	1.00	0.75	.75 --16	0.75	1.5 -- 16	1.13	4.1
R57	5	7.18	6.96	1.13	0.99	10,000	10.75	17.93	1 1/2	1.00	0.75	.75 --16	0.75	1.5 -- 16	1.13	5.3
R59	5	9.18	9.07	1.13	0.99	10,000	12.83	22.01	1 1/2	1.00	0.75	.75 --16	0.75	1.5 -- 16	1.13	6.1
R101	10	1.03	2.3	1.69	2.24	8,945	3.50	4.53	2 1/4	1.50	0.75	---	---	2.25 -- 14	1.13	4
R102	10	2.19	4.18	1.69	2.24	8,945	4.78	6.97	2 1/4	1.50	0.75	1 -- 8	0.75	2.25 -- 14	1.13	5.1
R104	10	4.19	9.2	1.69	2.24	8,945	6.78	10.97	2 1/4	1.50	0.75	1 -- 8	0.75	2.25 -- 14	1.13	7.2
R106	10	6.00	13.7	1.69	2.24	8,929	9.78	15.78	2 1/4	1.50	0.75	1 -- 8	0.75	2.25 -- 14	1.13	9.8
R108	10	8.00	17.89	1.69	2.24	8,929	11.78	19.78	2 1/4	1.50	0.75	1 -- 8	0.75	2.25 -- 14	1.13	12
R1010	10	10.00	22.65	1.69	2.24	8,929	13.78	23.78	2 1/4	1.50	0.75	1 -- 8	0.75	2.25 -- 14	1.13	14
R1012	10	12.00	26.84	1.69	2.24	8,929	15.78	27.78	2 1/4	1.50	0.75	1 -- 8	0.75	2.25 -- 14	1.06	15
R1014	10	14.00	31.31	1.69	2.24	8,929	17.78	31.78	2 1/4	1.50	0.75	1 -- 8	0.75	2.25 -- 14	1.06	18
R152	15	2.13	6.28	2.00	3.14	9,554	5.83	7.96	2 3/4	1.63	0.75	1 -- 8	1.00	2.75 -- 16	1.19	9
R154	15	4.13	12.57	2.00	3.14	9,554	7.83	11.96	2 3/4	1.63	0.75	1 -- 8	1.00	2.75 -- 16	1.19	11
R156	15	6.38	19	2.00	3.14	9,554	10.69	17.07	2 3/4	1.63	1.00	1 -- 8	1.00	2.75 -- 16	1.19	15
R1510	15	10.38	31.4	2.00	3.14	9,554	14.69	25.07	2 3/4	1.63	1.00	1 -- 8	1.00	2.75 -- 16	1.19	21
R1514	15	14.38	44	2.00	3.14	9,554	18.69	33.07	2 3/4	1.63	1.00	1 -- 8	1.00	2.75 -- 16	1.19	26
R251	25	1.00	5.16	2.56	5.16	9,690	5.50	6.50	3 1/2	2.25	1.00	1.5 -- 16	1.13	3.31 -- 12	1.93	13
R252	25	2.00	10.31	2.56	5.16	9,690	6.50	8.50	3 1/2	2.25	1.00	1.5 -- 16	1.13	3.31 -- 12	1.93	14
R254	25	4.00	20.63	2.56	5.16	9,690	8.50	12.50	3 1/2	2.25	1.00	1.5 -- 16	1.13	3.31 -- 12	1.93	18
R256	25	6.19	32.23	2.56	5.16	9,690	10.75	16.94	3 1/2	2.25	1.00	1.5 -- 16	1.13	3.31 -- 12	1.93	22
R258	25	8.19	42.55	2.56	5.16	9,690	12.75	20.94	3 1/2	2.25	1.00	1.5 -- 16	1.13	3.31 -- 12	1.93	27
R2510	25	10.19	52.86	2.56	5.16	9,690	14.75	24.94	3 1/2	2.25	1.00	1.5 -- 16	1.13	3.31 -- 12	1.93	31
R2512	25	12.19	63.18	2.56	5.16	9,690	16.75	28.94	3 1/2	2.25	1.00	1.5 -- 16	1.13	3.31 -- 12	1.93	36
R2514	25	14.19	73.49	2.56	5.16	9,690	18.75	32.94	3.5	2.25	1.00	1.5 -- 16	1.13	3.31 -- 12	1.93	39
R308	30	8.25	53.6	2.88	6.49	9,245	15.25	23.50	4	2.25	2.25	1.5 -- 16	1.00	3.31 -- 12	1.93	40
R552	55	2.00	22.08	3.75	11.04	9,960	6.94	8.94	5	3.13	1.38	---	---	5 -- 12	2.81	33
R554	55	4.00	44.16	3.75	11.04	9,960	8.94	12.94	5	3.13	1.38	---	---	5 -- 12	2.81	42
R556	55	6.19	69	3.75	11.04	9,960	11.06	17.25	5	3.13	1.38	---	---	5 -- 12	2.81	51
R5513	55	13.25	146.3	3.75	11.04	9,960	18.26	31.51	5	3.13	1.38	---	---	5 -- 12	2.81	83
R756	75	6.06	95.4	4.50	15.90	9,430	11.31	17.37	5.75	3.75	1.19	---	---	5.75 -- 12	1.75	65
R7513	75	13.06	208	4.50	15.90	9,430	19.38	32.44	5.75	3.75	1.19	---	---	5.75 -- 12	1.75	130
R1006	100	6.63	137	5.13	20.63	9,695	14.06	20.69	7	4.13	1.62	---	---	6.87 -- 12	1.75	90
R10010	100	10.25	212	5.13	20.63	9,695	17.69	27.94	7	4.13	1.62	---	---	6.87 -- 12	1.75	110

Cylinders

# STEEL CYLINDERS

RLS Series - Low Profile Spring Return



RLS201 Shown



## SIMPLEX CYLINDERS

Cylinder design specifications meet or exceed ANSI /ASME B30.1 Safety Standards.



## POWER PUMPS - pages 43 - 65

Simplex offers a wide variety of lightweight power pumps to fit any application.



## GAUGES - page 77

Improve your system visibility and safety by adding an inline hydraulic gauge to your circuit.



## COUPLERS - pages 74 - 75

High flow quick disconnect couplers provide a quick change to a variety of pumps.

**Capacity Range** .....▶ **10 - 100 Tons**

**Stroke Range** .....▶ **1.5 - 2.44 In.**

**Maximum Pressure** .....▶ **10,000 PSI**

- ▶ Compact low-profile design.
- ▶ HD spring for fast retraction.
- ▶ Grooved plunger to stabilize the load.
- ▶ Stop ring for piston blow-out protection.
- ▶ Rod wiper protects inner cylinder from dirt.
- ▶ Plated piston to resist scoring & corrosion.

Simplex RLS Series provides the ideal fit and force required for most bridge lifting and pier cap maintenance jobs. ▼

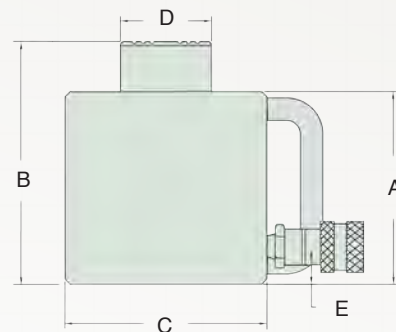

Model	Cap. (tons)	Stroke (in)	Oil Cap. Req'd (cu. in.)	Ram Bore Dia. (in)	Effect Area (sq in)	Pressure @ Cap. (psi)	A	B	C	D	E	Wgt. (lbs)
							Min. Ht. (in)	Ext. Ht. (in)	Body O.D. (in)	Piston O.D. (in)	Base to Port C/L (in)	
RLS101	10	1.5	3.4	1.68	2.24	8,940	3.47	4.97	2.75	1.5	.68	9
RLS201	20	1.75	7.8	2.38	4.43	9,030	3.87	5.62	3.62	2	.68	11
RLS302	30	2.44	15.8	2.87	6.49	9,250	4.62	7.06	4	2.62	.75	15
RLS502	50	2.38	22.8	3.5	9.62	10,400	4.81	7.19	4.87	2.75	.93	24
RLS1002	100	2.25	44.2	5	19.63	10,200	5.56	7.81	6.5	3.62	1.25	50



RFS20 Shown



**THINK SAFETY**

Please refer to pages 4&5 for a complete list of safety tips and recommendations.



**HOSES - pages 78 - 79**

Heavy duty and thermo plastic hydraulic hoses to meet your requirements and safety factor.



**HAND PUMPS - pages 31 - 41**

Simplex carries the widest variety of Hand Pumps for specific applications.

- Capacity Range** .....▶ **5 - 150 Tons**
- Stroke Range** .....▶ **.44 - .62 In.**
- Maximum Pressure** .....▶ **10,000 psi**

- ▶ Plated piston to resist scoring & corrosion.
- ▶ Low profile, high tonnage design.
- ▶ Rod wiper protects inner cylinder from dirt.

Simplex RFS Series cylinders provide the ideal fit and force required for most bridge lifting and pier cap maintenance jobs. ▼



Model	Base Mounting Hole Dimensions (in)
R50	.22 through x .36 C' Bore (.25 Deep)
RFS10	.28 through x .42 C' Bore (.31 Deep)
RFS20	.39 through x .62 C' Bore (.39 Deep)

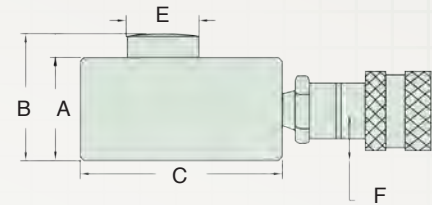

Refer to Base Mounting Table

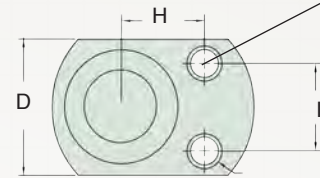

Model	Cap. (tons)	Stroke (in)	Oil Cap. Req'd (cu.in.)	Ram Bore Dia. (in)	Effective Area (sq.in.)	Pressure @ Cap. (psi)	A	B	C	D	E	F	H	I	Wgt. (lbs)
							Min. Ht. (in)	Extended Ht. (in)	Body Length (in)	Body Width (in)	Piston O.D. (in)	Base to Port C/L (in)	Width	Width	
R50	5	.62	.6	1.13	.99	10,000	1.62	2.25	2.56	1.62	1	.75	1	1.13	2.5
RFS10	10	.44	1	1.68	2.24	8,940	1.68	2.13	3.25	2.19	.75	.75	1.34	1.41	3.3
RFS20	20	.44	1.9	2.38	4.43	9,030	2.03	2.47	4	3	1.13	.75	1.56	1.93	6
RFS30	30	.5	3.2	2.87	6.49	9,250	2.31	2.81	4.5	3.75	1.38	.75	---	---	8.5
RFS50	50	.62	6	3.5	9.62	10,400	2.62	3.25	5.5	4.5	1.75	.75	---	---	14.3
RFS75	75	.62	10	4.5	15.90	9,440	3.13	3.75	6.5	5.5	2.13	.75	---	---	24.5
RFS100	100	.62	12.3	5	19.63	10,200	3.38	4	7	6	2.5	.75	---	---	31
RFS150	150	.56	17.2	6.25	30.66	9,785	3.93	4.5	8.5	7.5	3	.93	---	---	50.5

cylinders

# STEEL CYLINDERS

RP Series - Single Acting Pull Cylinder



### THINK SAFETY

Please refer to pages 4&5 for a complete list of safety tips and recommendations.



### GAUGES - page 77

Improve your system visibility and safety by adding an inline hydraulic gauge to your circuit.



### POWER PUMPS - pages 43 - 65

Simplex offers a wide variety of lightweight power pumps to fit any application.

RP55 Shown

- Capacity Range ..... ➤ **2 - 5 Tons**
- Stroke Range ..... ➤ **5 - 5.5 In.**
- Maximum Pressure ..... ➤ **10,000 PSI**

- ▶ Designed for pulling & tensioning applications.
- ▶ High strength, all steel construction.
- ▶ Chrome plated piston rod resists corrosion.
- ▶ Spring loaded piston rod automatically extends when pressure is released.
- ▶ Rod wiper protects inner cylinder from dirt.

The RP55 pull cylinder and a G5 Air Pump was needed to position structural I-Beams for welding. ▼



Clevis Dimensions

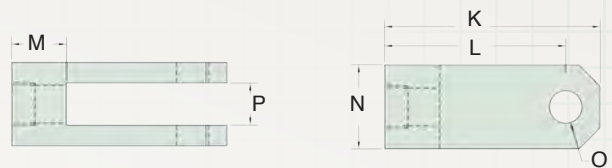

Pull Cylinder Dimensions

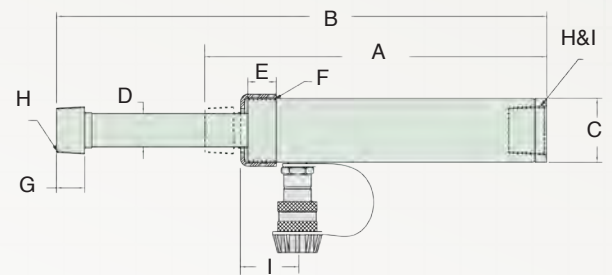

Optional Accessories

Model	K (in)	L (in)	M (in)	N (in)	O (in)	P (in)
RPC25	5.13	4.31	1.31	2	.75	1
RPC55	6	5	1.5	2.5	.87	1.5

Both models include adapter and clevis.

Model	Capacity (tons)	Stroke (in)	Oil Cap. Required (cu.in.)	Pressure @ Capacity (psi)	A	B	C	D	E	F	G	H	I	Wgt. (lbs)
					Min. Height (in)	Extended Height (in)	Body O.D. (in)	Piston O.D. (in)	Collar Thread (in)	Collar Thread Length (in)	Piston Adapter (in)	NPTF Thread (in)	Cylinder To Port (in)	
RP25	2	5	2.8	7,250	9.56	14.56	1.75	.75	1.5-16	1	1	.75-14	1.68	4
RP55	5	5.5	6.2	8,850	11.87	17.38	2.25	1.19	2.25-14	1	1.38	1.25-11.5	1.68	11

cylinders





# STEEL CYLINDERS

RDP Series - Double Acting Pull Cylinder



RDP506 Shown



### HOSES - pages 78 - 79

Heavy duty and thermo plastic hydraulic hoses to meet your requirements and safety factor.



### COUPLERS - pages 74 - 75

High flow quick disconnect couplers provide a quick change to a variety of pumps.



### GAUGES - page 77

Improve your system visibility and safety by adding an inline hydraulic gauge to your circuit.



### IN-LINE VALVES - page 72

Maximize control and safety with our in-line valves.

- Capacity Range ..... ► **10 - 100 Tons**
- Stroke Range ..... ► **6 In.**
- Maximum Pressure ..... ► **10,000 PSI**

- Hard chrome plated steel piston rods resist corrosion.
- Ideal for joining steel plates for welding.
- Useful for the fabrication industry as well as cable tensioning.
- Double acting cylinder provides quick & full retraction.

The Simplex RDP506 is used by this manufacturer of heavy steel cables. ▼

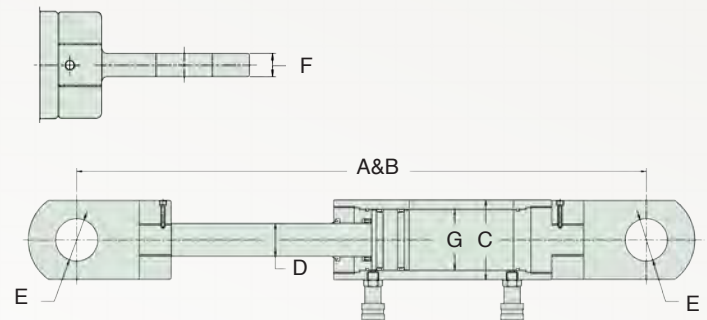

Model	Cap. (tons)	Stroke (in)	Oil Cap. Req'd. (cu. in.)	Effect Area (sq in)	A	B	C	D	E	F	G	Wgt. (lbs)
					Closed Dimensions (in)	Open Dimensions (in)	Body O.D. (in)	Piston O.D. (in)	Clevis Hole Diameter (in)	Clevis Width (in)	Bore Diameter (in)	
RDP106	10	6	11.5	2.4	21.1	27.1	3.34	1.57	1.18	.78	2.36	30.8
RDP306	30	6	16.56	6.6	26.3	32.3	4.53	1.89	2.36	.98	3.46	63.8
RDP506	50	6	25.9	11.7	25.2	31.2	6.10	2.36	2.75	1.77	4.53	99
RDP1006	100	6	30.38	22.2	29.1	35.1	7.80	2.56	3.15	1.97	5.91	193.6

cylinders

# STEEL CYLINDERS

RC Series - Single Acting Center Hole

**SIMPLEX**



RC603A Shown

**Capacity Range** ..... ➤ **12 - 100 Tons**  
**Stroke Range** ..... ➤ **.31 - 6.13 In.**  
**Maximum Pressure** ..... ➤ **10,000 PSI**

➤ Induction hardened piston rod for added strength eliminating the need for a loadcap.

*Twenty - four RC121A cylinders were used so repairs could be made to the roof of the Mission San Juan Capistrano. ▼*



## CENTER HOLE

Corrosion resistant technology on the piston rod and retaining nut extends cylinder life.



## GAUGES - page 77

Improve your system visibility and safety by adding an inline hydraulic gauge to your circuit.



## MANIFOLDS - page 73

The ideal solution in obtaining precise control when operating multiple cylinders.

### Base Mounting Hole Dimensions

Model	Bolt Circle (in)	Thread (in)	Thread Depth (in)
RC120A	2.00	5/16 - 18 UNC	.25
RC121A	NO TAPPED HOLES		
RC123A	2.00	5/16 - 18 UNC	.50
20 Ton	3.25	3/8 - 16 UNC	.37
30 Ton	3.63	3/8 - 16 UNC	.62
60 Ton	5.13	1/2 - 13 UNC	.55
RC1003A	7.00	5/8 - 11 UNC	.75

• Refer to Base Mounting Table

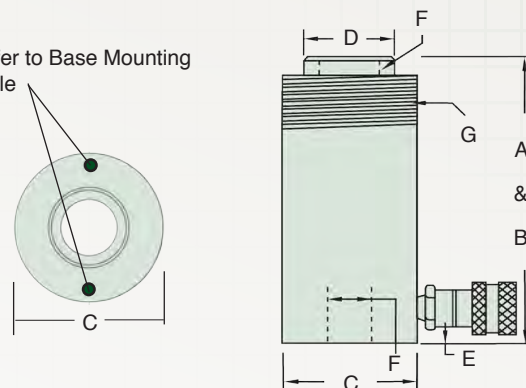

Model	Cap. (tons)	Stroke (in)	Oil Capacity Required (cu. in.)	Effect Area (sq. in.)	Pres. @ Cap. (psi)	A	B	C	D	E	F	G		Wgt. (lbs)
						Minimum Height (in)	Extended Height (in)	Body O.D. (in)	Piston O.D. (in)	Base to Port C/L (in)	Center Hole Diameter (in)	Collar Threads (in)	Collar Thread Length (in)	
RC120A	12	0.31	.86	2.76	8,695	2.2	2.5	2.75	1.38	0.38	.77	2 3/4-16	1.19	3.5
RC121A	12	1.63	4.5	2.76	8,695	4.75	6.38	2.75	1.38	0.98	.77	2 3/4-16	1.19	6.5
RC123A	12	3	8.3	2.76	8,695	7.25	10.25	2.75	1.38	0.98	.77	2 3/4-16	1.19	10
RC202A	20	2	9.46	4.73	8,456	6.42	8.42	3.88	2.12	0.75	1.06	3 7/8-12	1.50	17
RC206A	20	6.10	28.67	4.73	8,456	12.09	18.09	3.88	2.12	0.75	1.06	3 7/8-12	1.50	31
RC302A	30	2.5	18.05	7.22	8,310	7.03	9.53	4.5	2.5	0.85	1.31	4 1/2-12	1.66	24
RC306A	30	6.13	44.23	7.22	8,310	13	19.13	4.5	2.5	1.00	1.31	4 1/2-12	1.66	48
RC603A	60	3	38.29	12.73	9,426	9.75	13.25	6.26	3.62	1.25	2.12	6 1/4-12	1.91	62
RC606A	60	6	76.41	12.73	9,426	12.75	18.75	6.26	3.26	1.25	2.12	6 1/4-12	1.91	78
RC1003A	100	3	62	20.60	9,694	10	13	8.38	5	1.50	3.11	8 3/8-12	2.38	132



# STEEL CYLINDERS

RCD Series - Double Acting Center Hole



RCD307A Shown

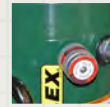

### RELIEF VALVE

Relief valve prevents damage in case of over pressurization.



### COUPLERS - pages 74 - 75

High flow quick disconnect couplers provide a quick change to a variety of pumps.



### POWER PUMPS - pages 43 - 65

Simplex offers a wide variety of lightweight power pumps to fit any application.

**Capacity Range** ..... ➤ **30 - 500 Tons**  
**Stroke Range** ..... ➤ **3 - 10.13 in.**  
**Maximum Pressure** ..... ➤ **10,000 PSI**

- ▶ Design allows for both push & pull forces.
- ▶ Induction hardened piston rod for added strength eliminating the need for a loadcap.
- ▶ Performance Nitride/QPQ corrosion resistant technology on the piston rod and retaining nut for extended cylinder life.

Base Mounting Hole Dimensions

Model	Bolt Circle (in)	Thread (in)	Thread Depth (in)
30 Ton	3.63	3/8 - 16 UNC	.62
60 Ton	5.12	1/2 - 13 UNC	.55
100 Ton	7.00	5/8 - 11 UNC	.75

• Refer to Base Mounting Table

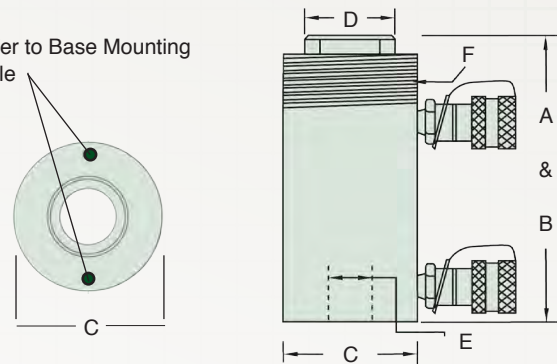

Model	Push Capacity (tons)	Pull Capacity (tons)	Stroke (in)	Oil Capacity Required (cu.in.)	Push Effect Area (sq.in.)	Pres. @ Cap. (psi)	A	B	C	D	E	F		Wgt. (lbs)
							Minimum Height (in)	Extended Ht. (in)	Body O.D. (in)	Piston O.D. (in)	Center Hole Dia. (in)	Collar Threads (in)	Collar Threads Length (in)	
RCD307A	36	24	7	50.55	7.22	8,310	13	20	4.5	2.5	1.31	4 1/2-12	1.66	48
RCD6010A	64	42	10.12	128.94	12.73	9,426	17.25	27.37	6.26	3.62	2.13	6 1/4-12	1.91	101
RCD1003A	103	68	3	61.88	20.63	9,694	10	13	8.38	5.0	3.13	8 3/8-12	2.38	135
RCD1006A	103	68	6	123.76	20.63	9,694	13.50	19.50	8.38	5.0	3.13	8 3/8-12	2.38	175
RCD10010A	103	68	10.13	208.84	20.63	9,694	18.12	28.25	8.38	5.0	3.13	8 3/8-12	2.38	235
RCD1505	150	---	5	78	31.6	9,491	13.13	18.13	10	6	3.13	---	---	240
RCD2006C	246	---	6	172	49.3	10,000	16.25	22.25	12	8	4.13	---	---	385
RCD3006C	434	---	6	296	91.5	10,000	18.75	24.75	15	9.5	4.25	---	---	720
RCD5006C	646	---	6	463	129.3	10,000	21.5	27.5	17.75	12	5.25	---	---	1230

cylinders

# STEEL CYLINDERS

RLR Series - Load Return



RLR1006 Shown



## SWIVEL LOAD CAP

5° swivel load caps on 30-100 ton models help stabilize the load.



## HOSES - pages 78 - 79

Heavy duty and thermo plastic hydraulic hoses to meet your requirements and safety factor.



## GAUGES - page 77

Improve your system visibility and safety by adding an inline hydraulic gauge to your circuit.



## POWER PUMPS - pages 43 - 65

Simplex offers a wide variety of lightweight power pumps to fit any application.

**Capacity Range** .....▶ **30 - 1000 Tons**

**Stroke Range** .....▶ **6 - 12 In.**

**Maximum Pressure** .....▶ **10,000 PSI**

- ▶ Large bearings resist side load.
- ▶ Plated piston to resist scoring & corrosion.
- ▶ Stop ring for piston blow-out protection.
- ▶ Custom strokes and capacities up to 1,500 tons available, contact factory.
- ▶ Swivel Eye Bolts are used 100 tons and up.

## Design Construction - 150+ Tons

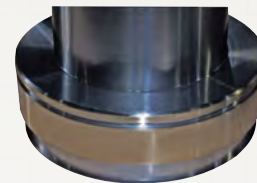

## Piston Flange

A thick bronze inlay on the piston flange virtually eliminates scoring of cylinder bore while offering the best protection against accidental side loading. (150 Tons and up)

A ten cylinder system, using RLR40012 cylinders, is used to lift the bed of this dragline so that maintenance can be performed on the rollers. ▼



# STEEL CYLINDERS

RLR Series - Load Return

• Note: 100 Ton Models Have Eyebolts For Positioning

## 30 - 100 Tons

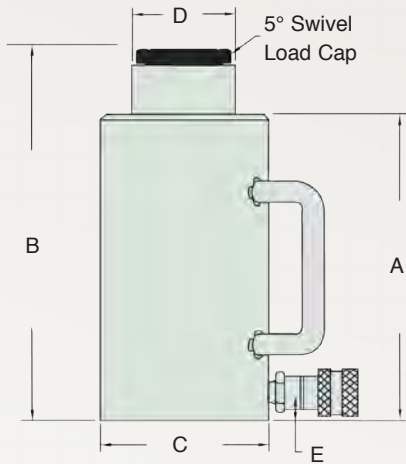

## 150 - 1000 Tons

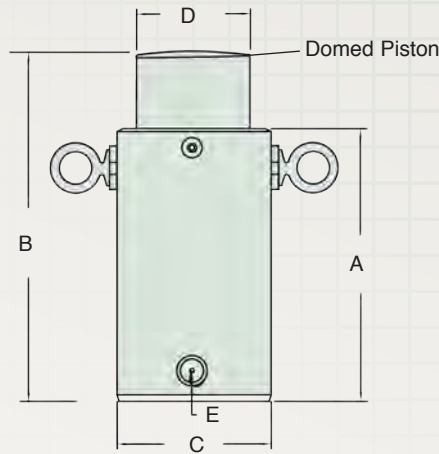

Model	Cap. (tons)	Stroke (in)	Oil Cap. Required (cu. in.)	Ram Bore Diameter (in)	Effective Area (sq in)	Pressure @ Capacity (psi)	A		B		C		D		E		Wgt. (lbs)
							Min. Ht. (in)	Ext. Ht. (in)	Body O.D. (in)	Piston O.D. (in)	Base to Port C/L (in)						
RLR306	30	6	38.9	2.87	6.49	9,240	9.38	15.38	4	2	.75					32	
RLR502	50	2	22.1	3.75	11.05	9,054	5.44	7.44	5	3	.78					30	
RLR506	50	6	66.3	3.75	11.05	9,054	9.44	15.44	5	3	.78					55	
RLR5010	50	10	133	3.75	11.05	9,054	13.44	23.44	5	3	.78					92	
RLR1006	100	6	118	5	19.63	10,200	10.56	16.56	6.38	3.38	1.25					90	
RLR10010	100	10	196	5	19.63	10,200	14.56	24.56	6.38	3.38	1.25					126	
RLR1502	150	2	66.4	6.25	30.68	9,778	7	9	9	5.56	1.25					117	
RLR1506	150	6	199	6.25	30.68	9,778	11	17	9	5.56	1.93					189	
RLR15012	150	12	398	6.25	30.68	9,778	17	29	9	5.56	1.93					297	
RLR2002	200	2	88.4	7.25	41.28	9,054	8	10	10	6.56	2.06					184	
RLR2006	200	6	265	7.25	41.28	9,054	12	18	10	6.56	2.06					282	
RLR20012	200	12	530	7.25	41.28	9,054	18	30	10	6.56	2.06					429	
RLR3002	300	2	120	8.75	60.13	9,978	11.5	13.5	12	7.81	2.44					277	
RLR3006	300	6	361	8.75	60.13	9,978	13.75	19.75	12	7.81	2.44					405	
RLR30012	300	12	722	8.75	60.13	9,978	19.75	31.75	12	7.81	2.44					597	
RLR4002	400	2	174	10.5	86.59	9,238	11.5	13.5	14	6.56	3					455	
RLR4006	400	6	520	10.5	86.59	9,238	15.5	21.5	14	6.56	3					612	
RLR40012	400	12	1040	10.5	86.59	9,238	21.5	33.5	14	6.56	3					842	
RLR5002	500	2	208	11.5	103.87	9,628	12.62	14.62	16	10.31	3.19					627	
RLR5006	500	6	623	11.5	103.87	9,628	16.62	22.62	16	10.31	3.19					855	
RLR50012	500	12	1246	11.5	103.87	9,628	22.62	34.62	16	10.31	3.19					1197	
RLR6002	600	2	246	12.5	122.71	9,778	13.5	15.5	17.5	11.31	3.5					655	
RLR6006	600	6	738	12.5	122.71	9,778	17.5	23.5	17.5	11.31	3.5					902	
RLR60012	600	12	1476	12.5	122.71	9,778	23.5	35.5	17.5	11.31	3.5					1273	
RLR8002	800	2	330	14.5	165.13	9,690	14.44	16.44	18	13.31	4.13					997	
RLR8006	800	6	991	14.5	165.13	9,690	18.44	24.44	18	13.31	4.13					1256	
RLR80012	800	12	1982	14.5	165.13	9,690	24.44	36.44	18	13.31	4.13					1644	
RLR10002	1000	2	402	16	201.06	9,950	16.13	18.13	21	14.93	4.25					1523	
RLR10006	1000	6	1206	16	201.06	9,950	20.13	26.13	21	14.93	4.25					1883	
RLR100012	1000	12	2412	16	201.06	9,950	26.13	38.13	21	14.93	4.25					2423	

# STEEL CYLINDERS

RLN Series - Locknut Load Return



RLN1006 Shown



## SWIVEL EYE BOLTS

Swivel Eye Bolts are used on 100 tons and up.



## HOSES - pages 78 - 79

Heavy duty and thermo plastic hydraulic hoses to meet your requirements and safety factor.



## GAUGES - page 77

Improve your system visibility and safety by adding an inline hydraulic gauge to your circuit.



## POWER PUMPS - pages 43 - 65

Simplex offers a wide variety of lightweight power pumps to fit any application.

**Capacity Range** .....▶ **30 - 1000 Tons**

**Stroke Range** .....▶ **2 - 12 In.**

**Maximum Pressure** .....▶ **10,000 PSI**

- ▶ Lock nuts offer extended load holding.
- ▶ Stop ring for piston blow-out protection.
- ▶ 5° swivel load caps on 30-100 ton models for side load protection.
- ▶ Custom strokes and capacities up to 1,500 tons available, contact factory.

## Design Construction - 200+ Tons



### Acme Screw

Class 2 ACME Thread offers high strength & ease to move lock-nut into position for load holding.

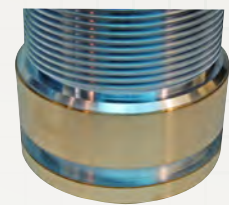

### Piston Flange

A thick bronze inlay on the piston flange virtually eliminates scoring of cylinder bore while offering the best protection against accidental side loading. (200 Tons and up)

Simplex RLN1006 cylinders are used to lift and hold this large generator for routine maintenance during an annual outage at this power plant. ▼



# STEEL CYLINDERS

RLN Series - Locknut Load Return

• Note: 100 Ton Models Have Eyebolts For Positioning

## 30 - 100 Tons

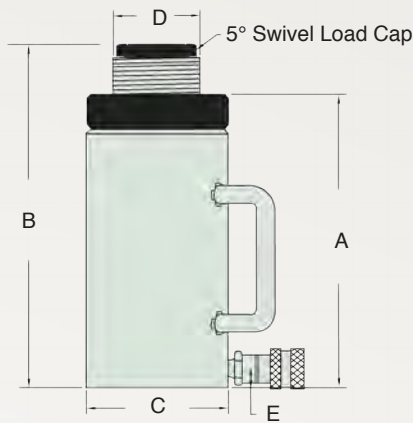

## 150 - 1000 Tons

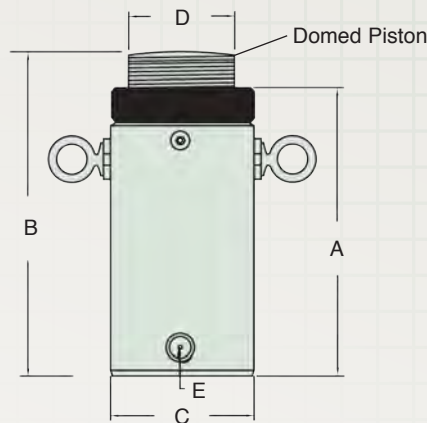

Model	Cap. (tons)	Stroke (in)	Oil Cap. Required (cu. in.)	Ram Bore Diameter (in)	Effect Area (sq. in.)	Pressure @ Cap. (psi)	A	B	C	D	E	Wgt. (lbs)
							Minimum Height (in)	Extended Height (in)	Body O.D. (in)	Piston O.D. (in)	Base to Port C/L (in)	
RLN302	30	2	13	2.87	6.49	9,240	6.38	8.38	4	2.44	.75	21
RLN306	30	6	38.9	2.87	6.49	9,240	10.38	16.38	4	2.44	.75	35
RLN502	50	2	22.1	3.75	11.05	9,054	6.75	8.75	5	3.19	.78	38
RLN506	50	6	66.2	3.75	11.05	9,054	10.75	16.75	5	3.19	.78	63
RLN5010	50	10	133	3.75	11.05	9,054	14.75	24.75	5	3.19	.78	100
RLN1002	100	2	40	5	19.63	10,200	8	10	6.38	4.31	1.25	87
RLN1006	100	6	118	5	19.63	10,200	12	18	6.38	4.31	1.25	132
RLN10010	100	10	196	5	19.63	10,200	16	26	6.38	4.31	1.25	202
RLN1502	150	2	66.4	6.25	30.68	9,780	8	10	8.5	5.56	1.93	149
RLN1506	150	6	199	6.25	30.68	9,780	12.25	18	8.5	5.56	1.93	221
RLN15012	150	12	398	6.25	30.68	9,780	18	30	8.5	5.56	1.93	311
RLN2002	200	2	88.4	7.25	41.28	9,054	9.5	11.5	10	6.56	2.06	233
RLN2006	200	6	265	7.25	41.28	9,054	13.5	19.5	10	6.56	2.06	332
RLN20012	200	12	530	7.25	41.28	9,054	19.5	31.5	10	6.56	2.06	479
RLN3002	300	2	120	8.75	60.13	9,978	11.5	13.5	12	7.81	2.44	357
RLN3006	300	6	361	8.75	60.13	9,978	15.5	21.5	12	7.81	2.44	485
RLN30012	300	12	722	8.75	60.13	9,978	21.5	33.5	12	7.81	2.44	677
RLN4002	400	2	174	10.5	86.59	9,238	13.81	15.81	14	9.31	3	520
RLN4006	400	6	520	10.5	86.59	9,238	17.81	23.81	14	9.31	3	675
RLN40012	400	12	1040	10.5	86.59	9,238	23.81	25.81	14	9.31	3	905
RLN5002	500	2	208	11.5	103.87	9,628	14.75	16.75	16	10.31	3.19	927
RLN5006	500	6	623	11.5	103.87	9,628	18.75	24.75	16	10.31	3.19	1041
RLN50012	500	12	1246	11.5	103.87	9,628	24.75	36.75	16	10.31	3.19	1383
RLN6002	600	2	246	12.5	122.79	9,778	15.62	17.62	17.5	11.31	3.5	985
RLN6006	600	6	738	12.5	122.79	9,778	19.62	25.62	17.5	11.31	3.5	1232
RLN60012	600	12	1476	12.5	122.79	9,778	27.62	39.62	17.5	11.31	3.5	1603
RLN8002	800	2	330	14.5	165.13	9,690	16.93	18.93	18	13.31	4.13	1148
RLN8006	800	6	991	14.5	165.13	9,690	21.93	27.93	18	13.31	4.13	1407
RLN80012	800	12	1982	14.5	165.13	9,690	27.93	39.93	18	13.31	4.13	1795
RLN10002	1000	2	402	16	201.06	9,950	19.62	21.62	21	14.81	4.25	1818
RLN10006	1000	6	1206	16	201.06	9,950	23.62	29.62	21	14.81	4.25	2178
RLN100012	1000	12	2412	16	201.06	9,950	29.62	41.62	21	14.81	4.25	2718

Cylinders

# STEEL CYLINDERS

RDA Series - Double Acting

**SIMPLEX**



RDA10006 Shown - with optional o/c valve (sold separately)

**Capacity Range** .....▶ **10 - 1000 Tons**  
**Stroke Range** .....▶ **2 - 24 In.**  
**Maximum Pressure** .....▶ **10,000 PSI**

- ▶ Collar threads designed for full load (10-200 tons).
- ▶ Removable load cap for flexibility and safety.
- ▶ Stop ring for piston blow-out protection.
- ▶ Plated piston to resist scoring & corrosion.
- ▶ Large bearings resist side load.
- ▶ Rod wiper protects inner cylinder from dirt.
- ▶ Custom strokes and capacities up to 1,500 tons available, contact factory.

Maintenance crews relied on Simplex RDA15018 cylinders to help lift, transport and launch a U.S. Navy research ship from dry dock to the ship's launch site. ▼



**POWER PUMPS - pages 43 - 65**  
Simplex offers a wide variety of lightweight power pumps to fit any application.



**HOSES - pages 78 - 79**  
Heavy duty and thermo plastic hydraulic hoses to meet your requirements and safety factor.



**GAUGES - page 77**  
Improve your system visibility and safety by adding an inline hydraulic gauge to your circuit.



**MANIFOLDS - page 73**  
The ideal solution in obtaining precise control when operating multiple cylinders.

## Design Construction - 200+ Tons

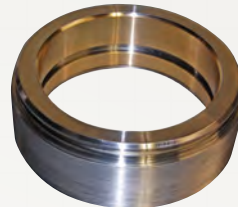

**Bronze Inlay**  
Thick bronze inlay on the inner diameter of the retaining nut protects the piston rod.

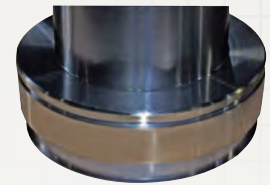

**Piston Flange**  
A thick bronze inlay on the piston flange virtually eliminates scoring of cylinder bore while offering the best protection against accidental side loading. (200 Tons and up)



# STEEL CYLINDERS

RDA Series - Double Acting

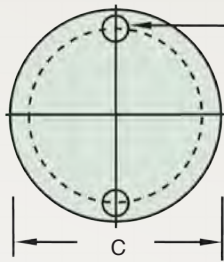

Refer to Base Mounting Table

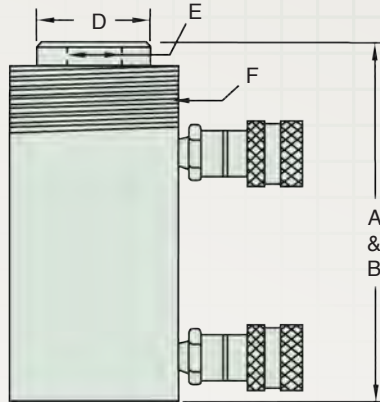

Base Mounting Hole Dimensions

Model	Thread		Bolt Circle Diameter (in)
	Size (in)	Depth (in)	
55 Ton	.62 -11	.75	3.75
100 Ton	.62 -11	1	4.25
150 Ton	1-8	1.38	5
200 Ton	1-8	1.13	5

Model	Push Cap. (tons)	Pull Cap. (tons)	Stroke (in)	Oil Cap. Req'd. (cu.in.)	Ram Bore Dia. (in)	Push Effect Area (sq. in)	Pull Effect Area (sq.in)	Pres. @ Cap. (psi)	A		C	D	E		F		Wgt. (lbs)
									Min. Ht. (in)	Ext. Ht. (in)			Piston O.D. (in)	Piston I.D. Thrds. (in)	Piston Thrd. Depth (in)	Collar Thrds. (in)	
RDA1010	10	4	10	22	1.68	2.23	.80	8,960	16.13	26.13	2.87	1.38	1-8	1	2.25-14	1.06	28
RDA308	30	12.5	8.13	34	2.87	6.51	3	9,250	15.75	23.75	4	2.13	1.5-16	1	3.31-12	1.93	40
RDA3014	30	12.5	14.5	91	2.87	6.51	3	9,250	21.62	36.13	4	2.13	1.5-16	1	3.31-12	1.93	64
RDA556	55	17	6.13	46	3.75	11.05	3.4	9,955	13.13	19.25	5	3.13	1-12	1.5	5-12	1.75	68
RDA5512	55	17	12	92	3.75	11.05	3.4	9,955	19.13	31.13	5	3.13	1-12	1.5	5-12	1.75	114
RDA5524	55	17	24	184	3.75	11.05	3.4	9,955	31.62	55.62	5	3.13	1-12	1.5	5-12	1.75	201
RDA1006	100	45	6.06	77	5.25	21.65	9.08	9,239	13.87	19.93	7	4	3.25-12	2.5	7-12	2.5	140
RDA10012	100	45	12	151	5.25	21.65	9.08	9,239	19.87	31.87	7	4	3.25-12	2.5	7-12	2.5	187
RDA1506	150	67	6.06	120	6.5	33.18	13.55	9,041	15.44	21.5	8.5	5	3.5-12	2.75	8.5-12	2.19	218
RDA15012	150	67	12	236	6.5	33.18	13.55	9,041	21.5	33.5	8.5	5	3.25-12	2.75	8.5-12	2.19	295
RDA2002	200	72	2	66	7.5	44.18	15.91	9,054	11.44	13.44	10	6	---	---	9.75-12	1.87	232
RDA2006	200	72	6	170	7.5	44.18	15.91	9,054	15.44	21.44	10	6	---	---	9.75-12	1.87	315
RDA20013	200	72	13	368	7.5	44.18	15.91	9,054	22.44	35.44	10	6	---	---	9.75-12	1.87	440
RDA3002	355	51.5	2	101	9.5	70.9	20.62	10,000	13.25	15.25	12	8	---	---	---	---	277
RDA3006	355	51.5	6	302	9.5	70.9	20.62	10,000	17.25	23.25	12	8	---	---	---	---	441
RDA30012	355	51.5	12	605	9.5	70.9	20.62	10,000	23.25	35.25	12	8	---	---	---	---	688
RDA4002	565	123	2	127	12	113	49.48	10,000	12.38	14.38	14.5	9	---	---	---	---	530
RDA4006	565	123	6	382	12	113	49.48	10,000	16.62	22.62	14.5	9	---	---	---	---	670
RDA40012	565	123	12	762	12	113	49.48	10,000	22.87	34.87	14.5	9	---	---	---	---	880
RDA5002	664	135	2	156	13	132	54.19	10,000	16.5	18.5	16	10	---	---	---	---	722
RDA5006	664	135	6	471	13	132	54.19	10,000	20.5	26.5	16	10	---	---	---	---	953
RDA50012	664	135	12	942	13	132	54.19	10,000	26.5	38.5	16	10	---	---	---	---	1300
RDA6002	600	110	2	158	12.5	122.71	44.17	10,000	15	17	17	10	---	---	---	---	917
RDA6006	600	110	6	472	12.5	122.71	44.17	10,000	19	25	17	10	---	---	---	---	1188
RDA60012	600	110	12	944	12.5	122.71	44.17	10,000	25	37	17	10	---	---	---	---	1595
RDA8002	800	130	2	226	14.5	165.13	52.03	9,690	16	18	18.5	10	---	---	---	---	1166
RDA8006	800	130	6	991	14.5	165.13	52.03	9,690	21.5	27.5	18.5	10	---	---	---	---	1461
RDA80012	800	130	12	1,360	14.5	165.13	52.03	9,690	26	38	18.5	10	---	---	---	---	1776
RDA10002	1000	75	2	354	17	227	50.27	8,810	16	18	21	15	---	---	---	---	1558
RDA10006	1000	75	6	1,071	17	227	50.27	8,810	20	26	21	15	---	---	---	---	2058
RDA100012	1000	75	12	2,142	17	227	50.27	8,810	27	39	21	15	---	---	---	---	2808

cylinders

# STEEL CYLINDERS

CLP Series - Pancake Locknut



CLP-1002 Shown



### EASE OF POSITIONING

Lock Ring Bars & Eye Bolts on all models.



### OVER TRAVEL PROTECTION

Single acting load return with overload protection port.



### HOSES - pages 78 - 79

Heavy duty and thermo plastic hydraulic hoses to meet your requirements and safety factor.



### POWER PUMPS - pages 43 - 65

Simplex offers a wide variety of lightweight power pumps to fit any application.

Capacity Range .....▶ **60 - 500 Tons**

Stroke Range .....▶ **1.77 - 1.97 In.**

Maximum Pressure .....▶ **10,000 PSI**

- ▶ Extra low profile to fit into tight spaces.
- ▶ 5° swivel load caps on all models.
- ▶ Locknut design provides positive mechanical load hold.

Simplex CLP Series cylinders are designed specifically for lifting and load holding where space is at a minimum. ▼

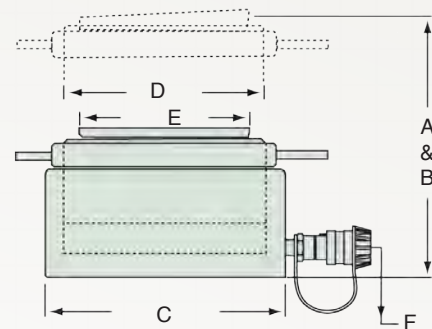

Model	Cap. Tons	Stroke (in)	Oil Cap. Required (cu.in.)	Ram Bore Dia. (in)	Effective Area (sq.in.)	A	B	C	D	E	F	Wgt. (lbs)
						Min. Ht. (in)	Ext. Ht. (in)	Body O.D. (in)	Piston O.D. Thread (mm)	Saddle Diameter (in)	Base to Port (in)	
CLP-602	60	1.97	26.4	4.1	13.4	4.9	6.7	5.5	105 X 6	3.8	.8	33
CLP-1002	100	1.97	43.7	5.3	22.2	5.4	7.2	6.9	135 X 6	5	.8	57
CLP-1502	150	1.77	58.7	6.5	33.1	5.8	7.8	8.7	165 X 6	5.9	1.1	97
CLP-2002	200	1.77	77.8	7.5	49.9	6.1	8.1	9.6	190 X 6	7.1	1.2	125
CLP-2502	250	1.77	99.7	8.5	56.3	6.3	8.3	10.8	215 X 6	7.9	1.3	165
CLP-4002	400	1.77	157.1	10.6	88.7	7	9	13.8	270 X 8	9.9	1.5	297
CLP-5002	500	1.77	194	11.8	109.6	7.6	9.6	15.8	300 X 8	11.2	1.9	418

### Cylinder Bases

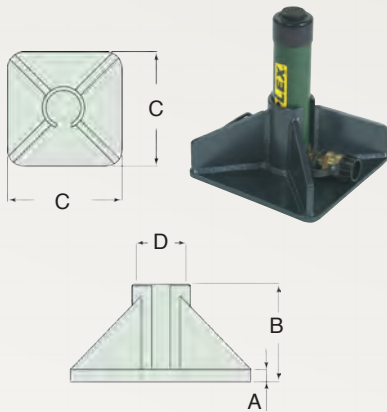

Model	A	B	C	D
BA10	.39	4.72	9.06	2.28
BA25	.63	4.96	11.02	3.39

BA10 for R102 through R1014  
BA25 for R252 through R2514

### Cylinder Load Caps



Model	Type of Cylinder
18347	Used on R5 Series
18348	Used on R10 & R15 Series
85525	Used on R25 Series
85525	Used on R30 Series
85546	Used on R55 Series
85546	Used on R75 Series
85546	Used on R100 Series
18348	Used on RDA10 Series
85525	Used on RDA30 Series
88390	Used on RDA55 Series
18323	Used on RDA100 Series
18326	Used on RDA150 Series
87721	Used on RDA200 Series

### Tilt Saddles

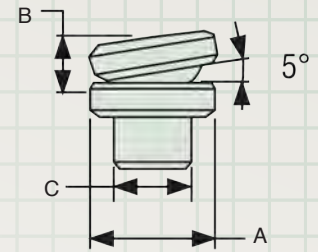

Model	A	B	C
ATS10	1.38	.59	.88
ATS25	1.97	.83	1.4
ATS100	2.82	1.55	---

ATS10 for R102 through R1014  
ATS25 for R251 through R2514

ATS100 for R-Series 55, 75 and 100 ton cylinders

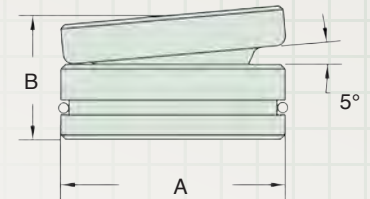

### Mounting Blocks For R5 Series Cylinders

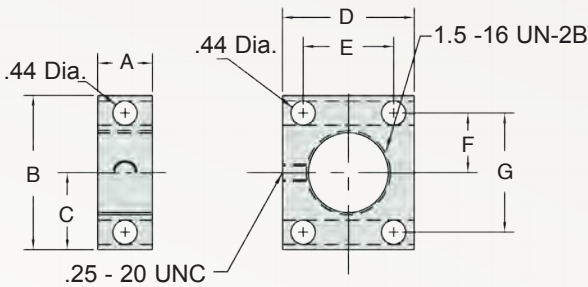

Model	A	B	C	D	E	F	G
BR5	.99	2.75	1.38	2.36	1.62	1.06	2.12

### Mounting Blocks

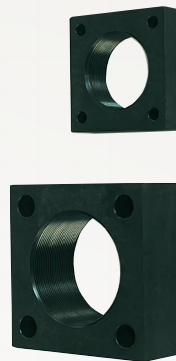

### Mounting Blocks For R10, R15 & R25 Series Cylinders

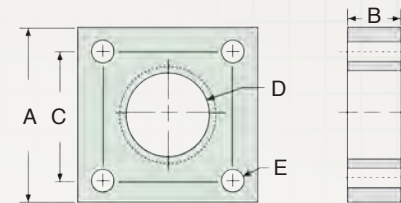

Model	A (in)	B (in)	C (in)	D (in)	E (in)
BR10	3.5	1	2.63	2.25-14 UN-2B	.34
BR15	3.5	1	2.63	2.75-16 UN-2B	.34
BR25	5	2	3.66	3.93-12 UN-2B	.66

cylinders

For R-Series 5, 10, 15 & 25 ton cylinders

Model	A	B	C	D	E	F
BCR5	1.12	1.74	.56	.63	.62	.76
BCR10	1.69	2.44	1	.88	1	1.12
BCR15	1.69	2.44	1	.88	1	1.12
BCR25	2.25	2.82	1.5	1.26	1.25	1.37

### Piston Clevis

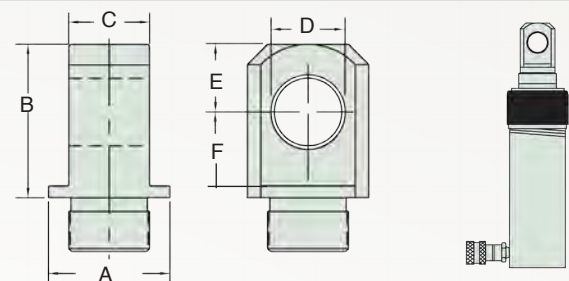

For R-Series 10, 15 & 25 ton cylinders

Model	A	B	C	D	E	F	G (under cut)
BC10	2.5	2.88	1	.88	1	1.38	.25
BC15	3	2.88	1	.88	1	1.38	.25
BC25	3.75	3.38	1.5	1.26	1.25	1.53	.25

### Base Clevis

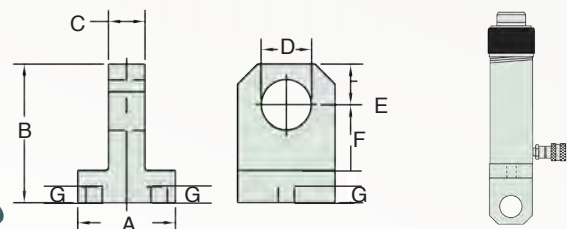

# ALUMINUM CYLINDERS

RAS Series - Spring Return



RAS306B Shown



### TECHNICAL COATING REDUCES WEAR

Corrosion resistant technology on the piston rod and retaining nut extends cylinder life.



### CARRYING HANDLES

2 carrying handles on models RAS10010B, RAS1506B & RAS15010B for ease of mobility.



### GAUGES - page 77

Improve your system visibility and safety by adding an inline hydraulic gauge to your circuit.



### POWER PUMPS - pages 43 - 65

Simplex offers a wide variety of lightweight power pumps to fit any application.

Capacity Range ..... ➤ **30 - 150 Tons**

Stroke Range ..... ➤ **2 - 10 In.**

Maximum Pressure ..... ➤ **10,000 PSI**

- Half the weight of steel cylinders.
- Heavy duty spring for fast & full retraction.

The RAS302B spring return cylinder along with a P32 aluminum hand pump is easy to carry and position in tight places. ▼

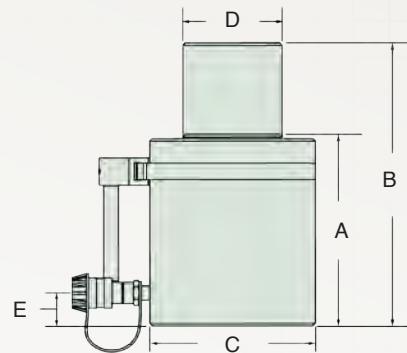

Model	Cap. (tons)	Stroke (in)	Oil Cap. Req'd (cu. in.)	Effect Area (sq. in)	A		C	D	E		Wgt. (lbs)
					Min. Ht. (in)	Ext. Ht. (in)			Body O.D. (in)	Piston O.D. (in)	
RAS302B	30	2	13	6.5	6.5	8.5	4.5	2.5	1.5	14	
RAS306B	30	6	39	6.5	10.5	16.5	4.5	2.5	1.5	18	
RAS502B	50	2	22.1	11	6.5	8.5	5.5	3.13	1.5	13	
RAS504B	50	4	44.2	11	8.5	12.5	5.5	3.13	1.5	17	
RAS506B	50	6	66.2	11	10.5	16.5	5.5	3.13	1.5	28	
RAS5010B	50	10	110.4	11	14.5	24.5	5.5	3.13	1.5	36	
RAS1002B	100	2	41.2	20.7	6.5	8.5	8	4.25	1.5	40	
RAS1004B	100	4	82.4	20.7	8.5	12.5	8	4.25	1.5	45	
RAS1006B	100	6	123.7	20.7	10.5	16.5	8	4.25	1.5	50	
RAS10010B	100	10	206	20.7	14.5	24.5	8	4.25	1.5	68	
RAS1502B	150	2	61.4	30.7	6.5	8.5	10	4.87	1.5	58	
RAS1506B	150	6	184.1	30.7	10.5	16.5	10	4.87	1.5	86	
RAS15010B	150	10	306.8	30.7	14.5	24.5	10	4.87	1.5	110	

cylinders



# ALUMINUM CYLINDERS

RAL Series - Locknut Spring Return



RAL502 Shown



### EXTENDED LOAD HOLDING

Locknuts offer extended load holding for safe and secure operation.



### CARRYING HANDLES

2 carrying handles on models RAL10010, RAL1506 & RAL15010 for ease of mobility.



### HOSES - pages 78 - 79

Large selection of standard, heavy duty and thermo plastic hydraulic hoses to meet your requirements and safety factor.



### GAUGES - page 77

Improve your system visibility and safety by adding an inline hydraulic gauge to your circuit.

**Capacity Range** ..... ► **50 - 150 Tons**

**Stroke Range** ..... ► **2 - 10 In.**

**Maximum Pressure** ..... ► **10,000 PSI**

- Technical coating reduces wear & corrosion.
- Carrying handles standard on all models.

Simplex 150 ton aluminum locknut spring return cylinders are used to lift this large crane for routine maintenance on bearings. ▼

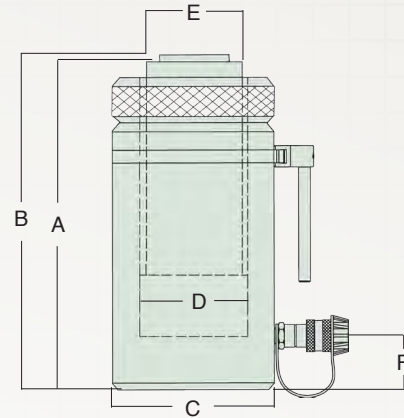

Model	Cap. (tons)	Stroke (in)	Oil Cap. Required (cu.in.)	Effect Area (sq.in.)	A	B	C	D	E	F	Wgt. (lbs)
					Min. Ht. (in)	Ext. Ht. (in)	Body O.D. (in)	Cyl. Bore Dia. (in)	Piston O.D. (in)	Base to Port C/L (in)	
RAL502	50	2	21.65	11.04	8.13	10.13	5.5	3.75	3.13	1.5	20
RAL504	50	4	43.3	11.04	10.13	14.13	5.5	3.75	3.13	1.5	25
RAL506	50	6	64.92	11.04	12.13	18.13	5.5	3.75	3.13	1.5	30
RAL5010	50	10	108.2	11.04	16.13	26.13	5.5	3.75	3.13	1.5	40
RAL1002	100	2	40.51	20.68	8.38	10.38	8	5.13	4.25	1.5	45
RAL1004	100	4	81	20.68	10.38	14.38	8	5.13	4.25	1.5	55
RAL1006	100	6	121.5	20.68	12.38	18.38	8	5.13	4.25	1.5	64
RAL10010	100	10	202.5	20.68	16.38	26.38	8	5.13	4.25	1.5	82
RAL1502	150	2	60.6	30.68	8.38	10.38	10	6.25	5	1.5	65
RAL1506	150	6	181.8	30.68	12.38	18.38	10	6.25	5	1.5	101
RAL15010	150	10	303	30.68	16.38	26.38	10	6.25	5	1.5	156

cylinders

# ALUMINUM CYLINDERS

RAC Series - Single Acting Center Hole



RAC303 Shown

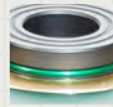

### CENTER HOLE

Chrome plated center hole for extra protection.



### CARRYING HANDLE

Carrying handles standard on all models.



### HOSES - pages 78 - 79

Heavy duty and thermo plastic hydraulic hoses to meet your requirements and safety factor.



### GAUGES - page 77

Improve your system visibility and safety by adding an inline hydraulic gauge to your circuit.

Capacity Range ..... ► **30 - 60 Tons**

Stroke Range ..... ► **3 - 6 In.**

Maximum Pressure ..... ► **10,000 PSI**

- Half the weight of steel cylinders.
- Heavy duty spring for fast & full retraction.
- Technical coating reduces wear & corrosion.
- Stop rings for piston blow-out protection.
- Rod wiper protects inner cylinder from dirt.

The Simplex RAC306A 30 ton single acting aluminum center hole cylinder is used to pull pins from off road equipment. ▼

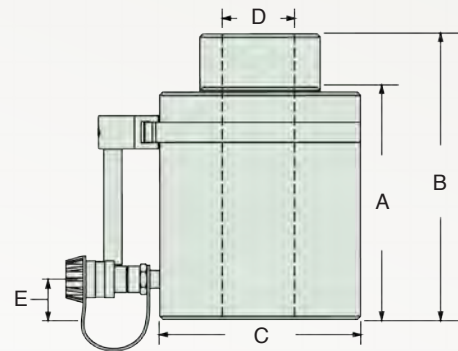

Model	Cap. (tons)	Stroke (in)	Oil Cap. Required (cu.in.)	Effect Area (sq.in)	A	B	C	D	E	Wgt. (lbs)
					Minimum Height (in)	Extended Height (in)	Body O.D. (in)	Center Hole (in)	Base to Port C/L (in)	
RAC303	30	3	22	7.21	8.75	11.75	5.5	1.19	1	22
RAC306A	30	6	44	7.21	11.75	17.75	5.5	1.19	1	30
RAC603	60	3	37	12.3	10.13	13.13	7.5	2.13	1	42
RAC606	60	6	74	12.3	13.25	19.25	7.5	2.13	1	55



# ALUMINUM CYLINDERS

RACD Series - Double Acting Center Hole



RACD306 Shown



### RELIEF VALVE

Safety pressure relief valve feature protects from over pressurization.



### CARRYING HANDLES

2 carrying handles on models RACD1002 & RACD15010 for ease of mobility.



### POWER PUMPS - pages 43 - 65

Simplex offers a wide variety of lightweight power pumps to fit any application.

- Capacity Range ..... ► **30 - 150 Tons**
- Stroke Range ..... ► **2 - 10 In.**
- Maximum Pressure ..... ► **10,000 PSI**

- Technical coating reduces wear & corrosion.
- Steel piston for protection against load damage.
- Chrome plated sleeve for extra protection.
- Stop rings for piston blow-out protection.
- Rod wiper protects inner cylinder from dirt.

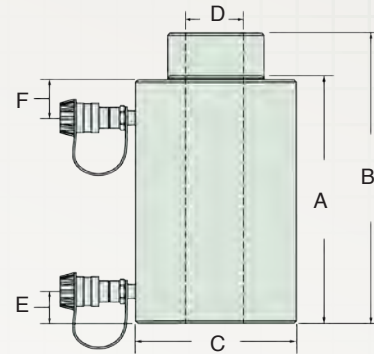

cylinders

Model	Cap. (tons)	Stroke (in)	Oil Cap. Required (cu.in.)		Effect Area (sq.in.)		A	B	C	D	E	F	Wgt. (lbs)
			Push	Pull	Push	Pull	Min. Ht. (in)	Ext. Ht. (in)	Body O.D. (in)	Center Hole Dia. (in)	Base to Port C/L (in)	Collar to Port C/L (in)	
RACD302	30	2	14.34	6.5	6.35	3.25	7	9	5.5	1.5	1.75	1.75	20
RACD306	30	6	43.02	19.5	6.35	3.25	11	17	5.5	1.5	1.75	1.75	28
RACD3010	30	10	71.7	32.5	6.35	3.25	15	25	5.5	1.5	1.75	1.75	35
RACD502	50	2	21.71	6.86	10.3	3.43	7	9	7.5	2.13	1.75	1.75	33
RACD504	50	4	43.44	13.72	10.3	3.43	9	13	7.5	2.13	1.75	1.75	41
RACD506	50	6	65.16	20.58	10.3	3.43	11	17	7.5	2.13	1.75	1.75	49
RACD5010	50	10	108.6	34.3	10.3	3.43	15	25	7.5	2.13	1.75	1.75	65
RACD1002	100	2	41.52	15.6	20.28	7.8	10	12	11	3.5	2.5	2.5	85
RACD1004	100	4	83.04	31.2	20.28	7.8	12	16	11	3.5	2.5	2.5	105
RACD1006	100	6	124.56	46.8	20.28	7.8	14	20	11	3.5	2.5	2.5	120
RACD10010	100	10	206.6	78	20.28	7.8	18	28	11	3.5	2.5	2.5	155
RACD1502	150	2	61.26	17.96	31.47	9	10	12	12	3.5	2.5	2.5	101
RACD1506	150	6	183.73	53.98	31.47	9	14	20	12	3.5	2.5	2.5	141
RACD15010	150	10	306.3	89.82	31.47	9	18	28	12	3.5	2.5	2.5	180

hand pumps

# HAND PUMPS





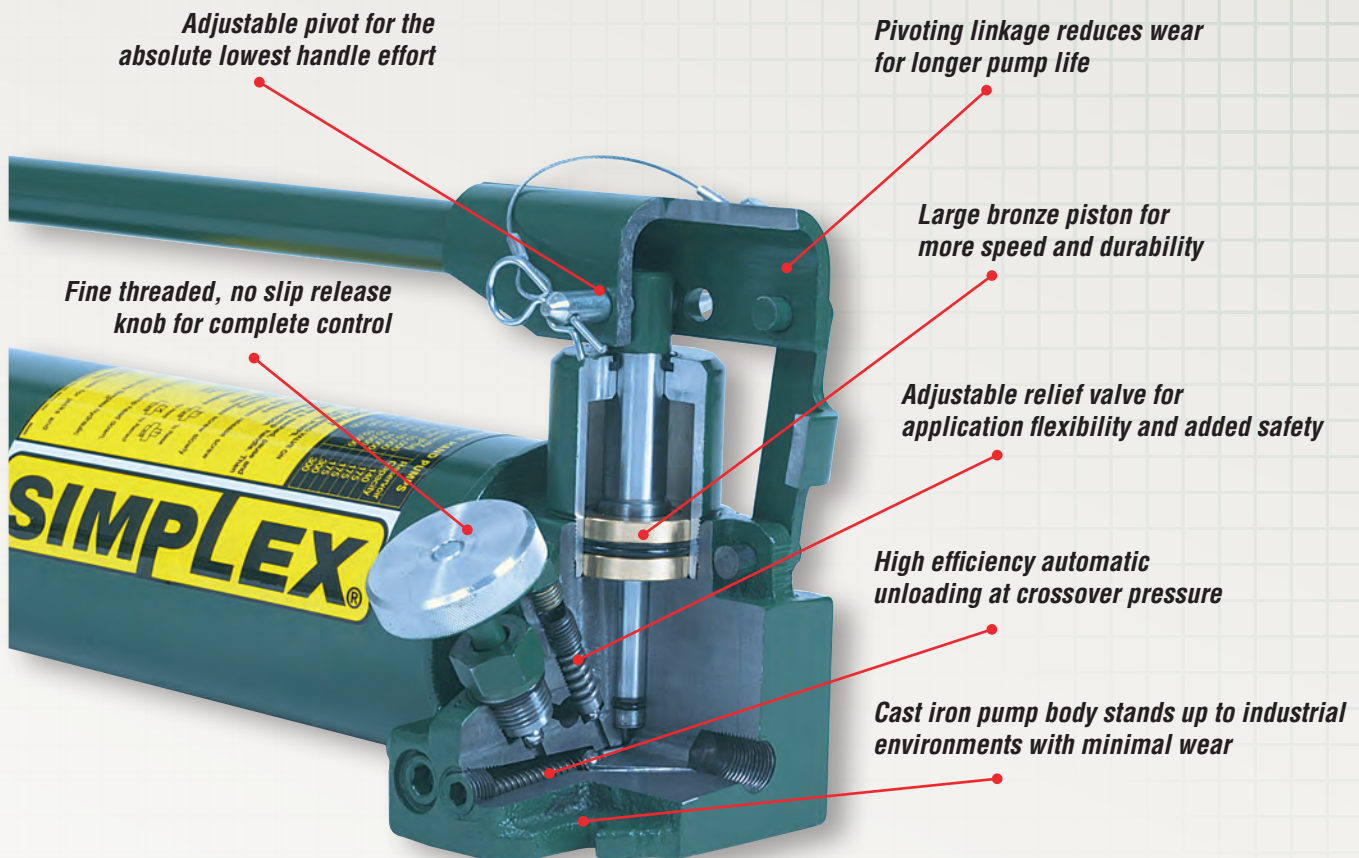

P140 Model Shown

**SIMPLEX HAND PUMP PRODUCT OVERVIEW****► Wide Variety**

Simplex offers the widest selection of hand pump styles, reservoir sizes, and flow rates to meet your everyday needs. Each pump has specific features that make certain models better suited for particular jobs. Select a hand pump with features that best fit your application.

**► Built for Rugged Industrial/Construction Use**

Shipyards, steel mills, construction sites and weld shops can be rough environments for hand pumps. Simplex's all metal and aluminum designs withstand real world conditions and applications.

**► Total Control of Hand Pump Operation**

Simplex release valves have a fine pitch screw and large valve handle for maximum control. Check ball valve design is more reliable than needle valves, and less costly to repair.

**► Lowest Handle Effort**

Simplex hand pumps have low, back saving handle efforts to reduce operator fatigue & back injury.

**► Optimal Oil Displacement Per Stroke**

More oil per stroke means less handle strokes per job. Simplex pumps have the highest available oil displacement per stroke, in many cases reducing the number of handle strokes as much as 50%.

**► Easy To Use / Built To Last**

Pivot linkage provides uniform handle effort at all points along the arc of the pump handle stroke. The pivot reduces piston side loading for longer pump life. Some pump models have four-way valves for use with double-acting cylinders.

# HAND PUMPS

Proper Size & Selection

**SIMPLEX**

## Portable Hand Pumps



Single & two speed compact hand pumps deliver a constant flow to smaller cylinders or hydraulic powered tools regardless of load. Ideal when durability as well as portability are important.

## Aluminum Hand Pumps



Aluminum hand pumps are the perfect choice when a light weight pump is required. The alloy construction resists corrosion and stands up to heat, welding sparks and other environments where composite pumps may not be suited.

## Heavy Duty Hand Pumps



Heavy duty, two speed hand pumps in the low pressure stage deliver a high volume of oil per stroke for fast cylinder speed. Once the load is engaged, the pump automatically switches to the high pressure stage.

## Specialty Hand Pumps



Specialty hand pumps are perfect for OEM applications or as emergency backup pumps. The pumps were designed to fit in tight spaces and are ideal for fixed bolt down applications.

## Hi-Flow Hand Pumps With Large Reservoirs

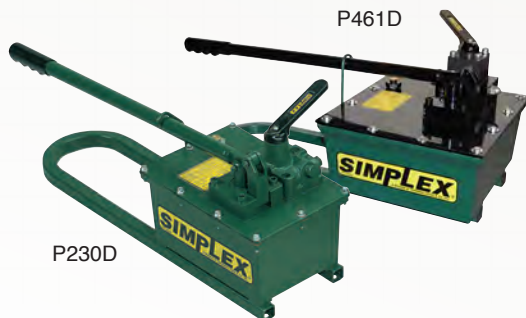

Heavy duty hand pumps with 4 way valves are used to power double-acting cylinders or tools.

## Configured Sets

Standard hand pump and single acting cylinder configuration.



**Sizing The Proper Hand Pump To Your Cylinder**

Once you have selected your cylinder, find the required reservoir capacity in the cylinder specification chart, and choose a hand pump with at least 10% more reservoir capacity per cylinder.

**Example**

An R256 cylinder (page 11) has a required oil capacity of 32.2 cu. in. The P42 hand pump (page 34) with a reservoir capacity of 45 cu.in. can pump this cylinder to its full stroke. If two R256 cylinders are to be raised, use a P140 with a reservoir capacity of 175 cu.in. .25" I.D. hose requires .6 cu. in. oil per foot. .38" I.D. hose requires 1.3 cu. in. per foot.

**Type Of Cylinders**

Most hand pumps are designed to operate single-acting cylinders. Hand pumps with 4-way valves can operate double-acting cylinders.

**Quick Reference Chart**

Use this chart to match the appropriate size hand pump to your single-acting Simplex cylinders. Match your cylinder capacity (across the top) with the cylinder strokes listed (in the left hand column). The intersecting box will give you the recommended hand pump for general applications.

Cylinder Stroke (in)	Cylinder Capacity (Tons)										
	5 Ton	10 Ton	15 Ton	20 Ton	25 Ton	30 Ton	50/55 Ton	60 Ton	75 Ton	100 Ton	150 Ton
1	P22/P32	P22/P32	----	P41A/P71	P42/P72	P42/P72	P42/P72	----	P42/P72	P42/P72	P42/P72
2	----	P22/P32	P42/P72	P42/P72	P42/P72	P42/P72	P42/P72	----	----	P82A/P140	P140
3	P22/P32	----	----	----	----	----	----	P82A/P140	----	----	----
4	----	P22/P32	P42/P72	----	P42/P72	----	----	----	----	----	----
5	P22/P32	----	----	----	----	----	----	----	----	----	----
6	----	P42/P72	P42/P72	----	P42/P72	P82A/P140	P82A/P140	----	P82A/P140	P230	P230
7	P42/P72	----	----	----	----	----	----	----	----	----	----
8	----	P42/P72	P42/P72	----	P82A/P140	P82A/P140	----	----	----	P230	P300
9	P42/P72	----	----	----	----	----	----	----	----	----	----
10	----	P42/P72	P42/P72	----	P82A/P140	----	----	----	----	P230	P461
12	----	P42/P72	----	----	P82A/P140	----	----	----	----	----	----
13	----	----	----	----	----	----	P230	----	----	----	----
14	----	P42/P72	P82A/P140	----	P82A/P140	----	----	----	----	----	----

*For higher speeds, use power pumps to operate multiple cylinder systems or long stroke cylinders over 50 tons.*

**Hand Pump / Cylinder Speed Chart**

Use this chart to determine the number of full pump handle strokes required to extend a Simplex cylinder 1". You may take handle stroke per inch and multiply it by the cylinder stroke to determine the number of strokes required to fully extend the cylinder.

Cylinder Stroke (in)	Strokes Per 1" of Cylinder Travel	Cylinder Capacity (Tons)									
		5 Ton	10 Ton	15 Ton	20 Ton	25 Ton	30 Ton	50/55 Ton	60 Ton	75 Ton	100 Ton
P41A/P71	NO LOAD	7	15	21	31	34	43	73	88	106	137
	LOAD	7	15	21	31	34	43	73	88	106	137
P20/P42/P32/P82A	NO LOAD	2	3	4	6	7	8	14	17	20	26
	LOAD	7	15	21	31	34	43	73	88	106	137
P72/P30	NO LOAD	2	3	4	6	7	8	13	16	18	23
	LOAD	7	15	21	31	34	43	73	88	106	137
P140/P300	NO LOAD	1	1	2	2	2	3	5	5	6	8
	LOAD	4	10	14	22	22	27	46	58	66	86
P230/P461	NO LOAD	1	1	1	1	1	1	2	2	2	3
	LOAD	3	8	11	16	18	22	38	45	54	70

hand pumps

# HAND PUMPS

P Series - Compact Steel



P82A, P41A & P22 Shown

**Reservoir Capacity** ..... ➤ **20 - 134 cu.in.**  
**Weight** ..... ➤ **10 - 24 lbs.**  
**Maximum Pressure** ..... ➤ **10,000 PSI**

- ▶ Large 3/8" pressure port for maximum flow.
- ▶ Low handle effort for easy operation.
- ▶ Single and two speed models.
- ▶ Two-speed operation (P82A) for fast and easy operation.
- ▶ Vent free reservoir eliminates spills (P41A).
- ▶ All steel construction, chrome plated plunger and wiper system for durable, long lasting performance.



## GAUGES - page 77

Improve your system visibility and safety by adding an inline hydraulic gauge to your circuit.



## COUPLERS - pages 74 - 75

High flow quick disconnect couplers provide a quick change to a variety of pumps.



## HOSES - pages 78 - 79

Heavy duty and thermo plastic hydraulic hoses to meet your requirements and safety factor.

With its compact footprint, the Simplex P22 hand pump is perfect for fixed mounting. ▼

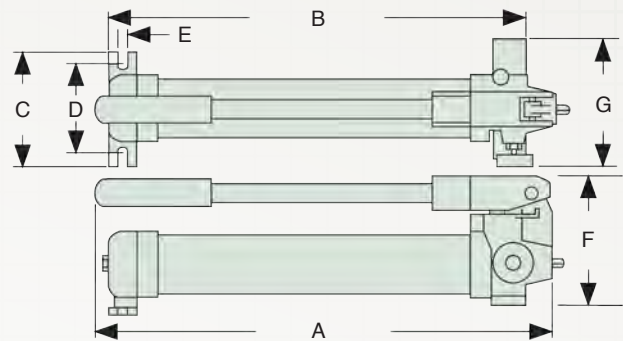

Model	Speed	Pressure Rating (PSI)	Oil Volume Per Stroke (cu.in.)		Usable Oil Capacity (cu.in.)	A	B	C	D	E	F	G	Wgt. (lbs)
			1st Stage	2nd Stage		(in)	(in)	(in)	(in)	(in)	(in)	(in)	
P20	2	1st Stage 200 2nd Stage 2,850	.79	.16	20	14.23	11.08	2.62	1.5	.59	5.59	5.39	10
P22	2	1st Stage 200 2nd Stage 10,000	.23	.06	20	14.23	11.08	2.62	1.5	.59	5.06	4.92	10
P41A	1	10,000	----	.16	40	23.03	18.28	5.25	---	---	4.69	4.00	13
P42	2	1st Stage 200 2nd Stage 10,000	.79	.16	45	25.64	20.86	3.54	---	---	5.75	5.39	19
P82A	2	1st Stage 350 2nd Stage 10,000	.99	.15	134	21.97	19.50	5.75	4.76	.31	6.88	7.00	24

hand pumps



P32 & P72 Shown



**PRECISION GRIP RELEASE KNOB**

Precise load lowering with large knob and fine pitched threads.



**SIMPLEX CYLINDERS - pages 7 - 29**

Cylinder design specifications meet or exceed ANSI /ASME B30.1 Safety Standards.



**IN-LINE VALVES - page 72**

Maximize control and safety with our in-line valves.



**POWER PUMPS - pages 43 - 65**

Simplex offers a wide variety of lightweight power pumps to fit any application.

- Reservoir Capacity** ..... ➤ **30 - 70 cu.in.**
- Weight** ..... ➤ **8 - 11 lbs.**
- Maximum Pressure** ..... ➤ **10,000 PSI**

- All aluminum construction makes these pumps extremely light weight and easy to handle.
- 25% faster per stroke than comparative pumps means less work for operator.

*This P32 provided the power and control to lift this 10 ton CNC machine during routine maintenance. ▼*

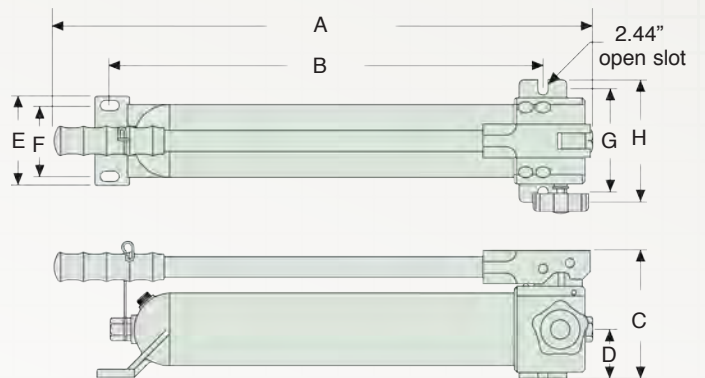

Model	Speed	Pressure Rating (PSI)	Oil Volume Per Stroke (cu.in.)	Usable Oil Capacity (cu.in.)	A (in)	B (in)	C (in)	D (in)	E (in)	F (in)	G (in)	H (in)	Wgt. (lbs)
P30	2	1st Stage 200	.91	30	17.13	11.81	5.55	2	5.51	4.25	4.25	5.5	8
		2nd Stage 3,000	.19										
P32	2	1st Stage 200	.43	30	17.13	11.81	5.55	2	5.51	4.25	4.25	5.5	8
		2nd Stage 10,000	.06										
P71	1	10,000	.14	70	24.60	19.35	5.55	2	5.51	4.25	4.25	5.5	10
P71V*	1	10,000	.14	70	24.60	19.35	5.55	2	5.51	4.25	4.25	5.5	10
P72	2	1st Stage 200	.91	70	24.60	19.35	5.55	2	5.51	4.25	4.25	5.5	11
		2nd Stage 10,000	.19										

\*Viton Seals

# HAND PUMPS

P Series - Heavy Duty Steel



P140 & P461D Shown

**Reservoir Capacity** ..... ➤ **175 - 460 cu.in.**  
**Weight** ..... ➤ **26 - 61 lbs.**  
**Maximum Pressure** ..... ➤ **10,000 PSI**

- ▶ Heavy duty, metal construction for durability.
- ▶ High displacements of oil per stroke.
- ▶ Adjustable handle effort / dual pivot points.
- ▶ Low, back saving handle effort.
- ▶ External adjustable relief valves.

US recovery teams needed to dismantle and remove a downed Navy aircraft, they used Simplex P140D hand pumps. ▼



## THINK SAFETY

Please refer to pages 4&5 for a complete list of safety tips and recommendations.



## COUPLERS - pages 74 - 75

High flow quick disconnect couplers provide a quick change to a variety of pumps.



## IN-LINE VALVES - page 72

Maximize control and safety with our in-line valves.



## GAUGES - page 77

Improve your system visibility and safety by adding an inline hydraulic gauge to your circuit.



### P140 & P300 Series

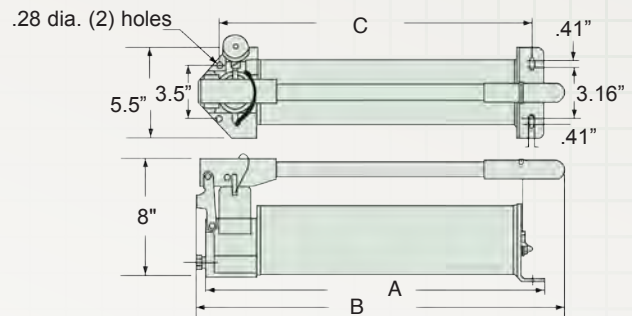

### P230 & P461 Series

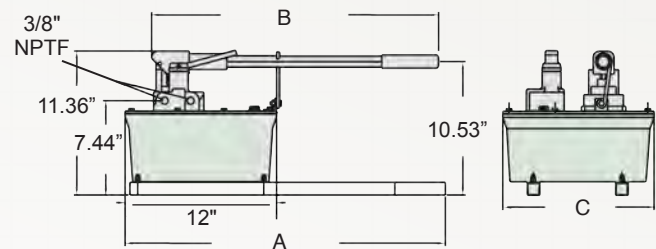

Model	Tool Type	Pressure Rating (PSI)	Oil Volume Per Stroke (cu. in.)		Usable Oil Capacity (cu. in.)	A	B	C	Wgt. (lbs)
			1st Stage	2nd Stage		(in)	(in)	(in)	
P140	Single Acting	1st Stage 400 2nd Stage 10,000	2.8	.24	175	24.81	27.25	23.31	26
P230			7.7	.3	230	25.38	22.75	9	49
P300			2.8	.24	300	28.5	31	26.5	37
P461			7.7	.3	460	25.38	22.75	12	61
P140D	Double Acting	1st Stage 400 2nd Stage 10,000	2.8	.24	175	29.5	31.5	23.31	30
P230D			7.7	.3	230	25.38	22.75	9	49
P461D			7.7	.3	460	25.38	22.75	12	61

hand pumps



P10004A & P1606A Shown

- Volume Per Stroke** ..... ► **.30 - 4.56 Cu.In.**
- Weight** ..... ► **9 - 20 Lbs.**
- Pressure Range** ..... ► **750 - 12,000 PSI**

- Ideal for fixed applications when pumps need to be bolted in place.
- P1000A Series offers a swivel pump head for flexible fixturing.
- Wide range of operating pressures to select from.

*This P10006A is used as an auxiliary pump to position scaffolding for fabrication of the docking system for a new airline hangar. ▼*



**SIMPLEX CYLINDERS - pages 7 - 29**

Cylinder design specifications meet or exceed ANSI /ASME B30.1 Safety Standards.



**COUPLERS - pages 74 - 75**

High flow quick disconnect couplers provide a quick change to a variety of pumps.

**P1000A Series**

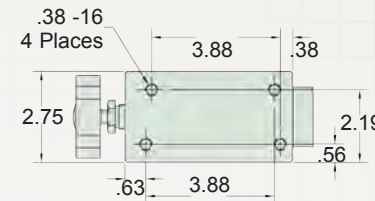
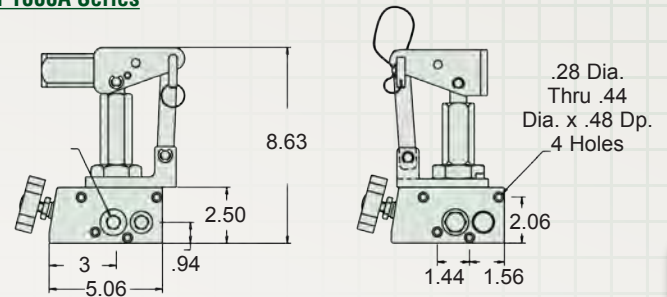

**P160A Series**

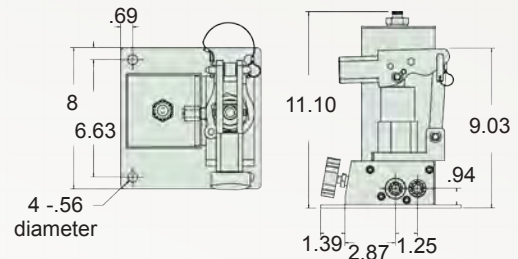

hand pumps

Model	Usable Reservoir Capacity (cu.in.)	Operating Pressure (PSI)	Volume per Stroke (cu.in. )	Maximum Handle Effort (lbs)	Weight (lbs)
P1603A	148	12,000	.30	108	20
P1604A	148	6,500	.53	104	20
P1606A	148	3,000	1.33	108	20
P10003A	---	12,000	.30	108	9
P10004A	---	6,500	.53	104	9
P10006A	---	3,000	1.33	108	9
P10008A	---	1,000	2.11	106	11
P100012A	---	750	4.56	79	11

# HAND PUMPS

P Series - Ultra High Pressure Aluminum



P60 Shown



### THINK SAFETY

Please refer to pages 4&5 for a complete list of safety tips and recommendations.



### SPRING LATCH

An easy to use spring latch handle provides quick carrying mobility.

- ▶ Reservoir Capacity ..... **60 Cu.In.**
- ▶ Weight ..... **10 Lbs.**
- ▶ Maximum Pressure ..... **40,000 PSI**

- ▶ 40,000 psi maximum pressure.
- ▶ 60 cu. in. reservoir provides more usable oil capacity.
- ▶ Large pressure release knob, fine threaded for added control.
- ▶ Lower handle effort provides less operator fatigue.
- ▶ Slotted front mounting hole offers flexibility.

### Pressure Port Details

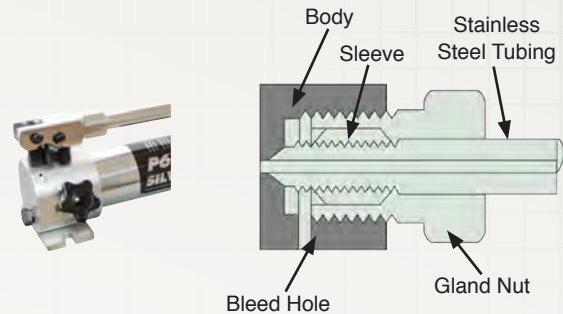

### ▲ Cone Seal

High pressure fitting seal on a cone surface does not require pipe sealer. The gland nut holds the sleeve and tube to provide 40,000 psi seal.

Ideal for lab testing, the P60 offers safe and easy operation for applications requiring up to 40,000 psi. ▼

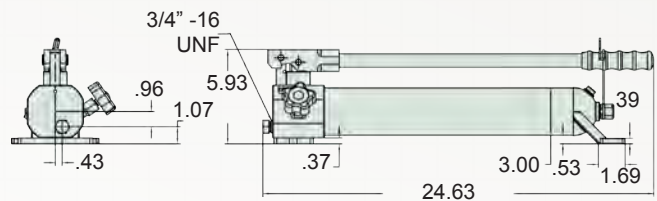









Model	Usable Reservoir Capacity (cu.in.)	Pressure Rating (PSI)		Oil Volume Per Stroke (cu.in.)		Handle Effort (lbs)	Weight (lbs)
		1st Stage	2nd Stage	1st Stage	2nd Stage		
P60	60	200	40,000	.86	.04	90	10

hand pumps



Note: .25" cone fittings use .56" - 18 threads, .38" cone fittings use .75" - 16 . \* Actual tubing lengths are .75" less than nominal size shown. These dimensions make distance between centers of valves and fittings multiple of 4" spaces.

### P60 ULTRA HIGH PRESSURE ACCESSORIES

Model	Item No.	Connection
 Gland Nut Plug	UH1	.38" Cone
 Elbow	UH2	.38" Cone
 Tee	UH3	.38" Cone Side
 Gauge Adapter	UH4	.38" Cone Side / .25" Cone Gauge Port
 Coupling	UH5	.38" Cone
 Gland Nut with Sleeve	UH6	.38" Cone
 Gauge Connector	UH7	.25" Cone
 Gauge	UH8	0 - 40,000 psi (2,760 Bar) Ultra High Pressure Gauge
 Tubing	UH9 UH10 UH11	4" Tube, O.D. .38" * 8" Tube, O.D. .38" * 12" Tube, O.D. .38" *

# PUMP & CYLINDER SETS

ST & STL Series - Steel & Aluminum Configurations



ST106A Set Shown

- Capacity Range** ..... ► **10 - 100 Tons**
- Stroke Range** ..... ► **1.5 - 14.25 In.**
- Maximum Pressure** ..... ► **10,000 PSI**

hand pumps

- All steel or aluminum construction.
- Each set comes with a 6' hose equipped with a high flow coupler, gauge and gauge adapter.
- Cylinders can be used in upright, inverted or horizontal position.
- Heavy duty spring for fast and full cylinder retraction.
- Maximum control and safety is provided with the pressure gauge.
- Optimal performance provided with matched pump and cylinder.

Each Set Includes The Following:

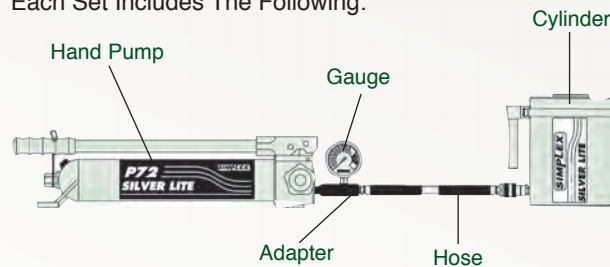

Eliminate the hassle of matching the right pump to the right cylinder by ordering our pre-matched pump & cylinder sets. ▼

Pump and cylinder sets are ideal for shop equipment servicing, such as this scrap metal receptacle requiring maintenance. ▼





## Steel Hand Pumps

STL306 Set Shown

### Center Hole Cylinder Sets

Model	Capacity (tons)	Stroke (in)	Closed Height (in)	Included in Set				
				Cylinder Model	Pump Model	Hose	Gauge	Gauge Adapter
ST302HCA	30	2.5	7.03	RC302A	P42	HCA6	GTH12	GA1
ST306HCA	30	6.13	13	RC306A	P82A	HCA6	GTH12	GA1

### Low Profile Cylinder Sets

Model	Capacity (tons)	Stroke (in)	Closed Height (in)	Included in Set				
				Cylinder Model	Pump Model	Hose	Gauge	Gauge Adapter
ST101A	10	1.5	3.47	RLS101	P42	HCA6	GT5	GA1
ST201A	20	1.75	3.87	RLS201	P42	HCA6	GT20	GA1
ST302A	30	2.44	4.62	RLS302	P42	HCA6	GT30	GA1
ST502A	50	2.38	4.81	RLS502	P42	HCA6	GT20	GA1
ST1002A	100	2.25	5.56	RLS1002	P82A	HCA6	GT20	GA1

### General Purpose Cylinder Sets

Model	Capacity (tons)	Stroke (in)	Closed Height (in)	Included in Set				
				Cylinder Model	Pump Model	Hose	Gauge	Gauge Adapter
ST102A	10	2.19	4.78	R102	P42	HCA6	GT5	GA1
ST106A	10	6	9.78	R106	P42	HCA6	GT5	GA1
ST1010A	10	10	13.78	R1010	P42	HCA6	GT5	GA1
ST252A	25	2	6.5	R252	P42	HCA6	GT25	GA1
ST254A	25	4	8.5	R254	P42	HCA6	GT25	GA1
ST256A	25	6.19	10.75	R256	P82A	HCA6	GT25	GA1
ST2514A	25	14.19	18.75	R2514	P82A	HCA6	GT25	GA1
ST556A	55	6.19	11.06	R556	P82A	HCA6	GT25	GA1

## Aluminum Hand Pumps

### Silver Lite Aluminum Spring Return Sets

Model	Capacity (tons)	Stroke (in)	Closed Height (in)	Included in Set				
				Cylinder Model	Pump Model	Hose	Gauge	Gauge Adapter
STL302	30	2	6.5	RAS302B	P72	HCA6	G5	GA1
STL306	30	6	10.5	RAS306B	P72	HCA6	G5	GA1
STL502	50	2	6.5	RAS502B	P72	HCA6	G5	GA1
STL504	50	4	8.5	RAS504B	P72	HCA6	G5	GA1
STL1002	100	2	6.5	RAS1002B	P72	HCA6	G5	GA1

### Silver Lite Aluminum Spring Return Center Hole Sets

Model	Capacity (tons)	Stroke (in)	Closed Height (in)	Included in Set				
				Cylinder Model	Pump Model	Hose	Gauge	Gauge Adapter
STL303HC	30	3	8.75	RAC303	P72	HCA6	G5	GA1
STL306HC	30	6	11.75	RAC306	P72	HCA6	G5	GA1
STL603HC	60	3	10.13	RAC603	P72	HCA6	G5	GA1

power pumps

# POWER PUMPS



*Tough permanent magnet motors are easily maintained*

*Balanced eccentric shaft and oil bath lubrication provides smooth, quiet performance*

*2nd stage piston pump modular design reduces down time*

*Self priming 1st stage gear pump*

*Electronic advancements offer reliable power control*

*"User Friendly" external relief adjustment on all Simplex valves*

*Durable, lightweight alloy pump housing*

*"Heat Exchanger Ready" unloading port improves cooling efficiencies*

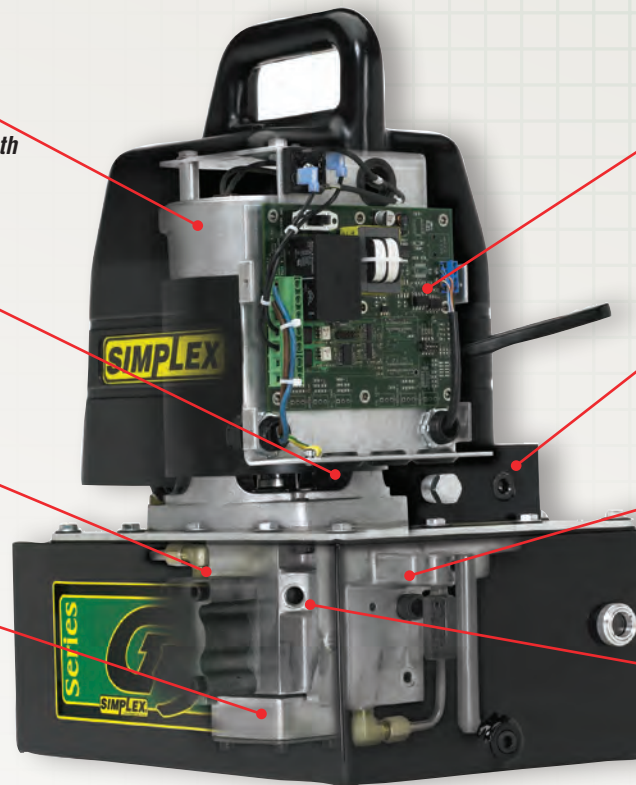

G5 Power Pump Shown

## SIMPLEX POWER PUMP PRODUCT LINE OVERVIEW

### ► Wide Variety

Simplex offers a large selection of pump platforms, valve styles, reservoir sizes, accessories & controls to meet your everyday needs.

### ► Maximum Flexibility

External adjustable pressure relief valves for variable pressure settings, plus many interchangeable control valves and reservoirs for a wide range of applications. Dual Voltage & Dual Hertz electric motors for applications requiring alternate power sources.

### ► Built for Long Life & Continuous Duty

Unified chassis provides high strength, fewer potential leak points and solid construction for severe duty.

### ► High Performance / Fast Cycle Times

Crossover pressure up to 2,000 psi. Provides high, first stage flows well into the work cycle. This extra power provides higher speeds in Prestressing, Bending, Crimping, Compressing & Post-Tensioning applications.

### ► Cool Running & Dependable Performance

High first stage performance is achieved through field proven Gear Pump technology. In addition to gear pumps, an unloading valve passes full power to the second stage once crossover pressure is reached. No power is lost and less heat is generated.

### ► Quiet Operation

Low motor RPM, internally lubricated bearings, and close coupled motor mounting make these pumps among the quietest on the market. (Approximately 80dba at 10,000 psi.)

# POWER PUMPS

Proper Size & Selection

**SIMPLEX**

## G1 Power Pumps 19 Cu.In. / Min. @ 10,000 Psi



An intermittent .5 hp power pump that is best suited to power small to medium size tools or cylinders. It's very lightweight, portable and works well for crimping, cutting, pressing, punching and bending applications.

## G5 Power Pumps 55 Cu.In. / Min. @ 10,000 Psi



Continuous duty 1.5 hp electric and 3 hp air power pumps are perfect for medium size tools and cylinders on construction sites, ship and rail yards and other field applications. It's the perfect choice for production and lifting applications due to its reservoir sizes and valve options.

## G3 Power Pumps 46 Cu.In. / Min. @ 10,000 Psi



A 1.13 hp continuous duty power pump that is best suited to power small to medium tools and cylinders. Ideal for systems that require high performance, large oil capacities with lightweight portability.

## G6 Series Power Pumps 100 Cu.In. / Min. @ 10,000 Psi



Continuous duty 3 hp electric and 5.5 hp gasoline pumps are ideal for medium to large size tools and cylinders. The high flow rate runs multiple cylinders for heavy lifting, high tonnage and large positioning jobs and applications effectively.

## G4 Power Pumps 55 Cu.In. / Min. @ 10,000 Psi







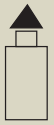

Continuous duty 1.5 hp electric and 4 hp gasoline pumps are best suited for medium size tools and cylinders. It's a perfect choice for clamping, holding, positioning and lowering and lifting applications due to its reservoir sizes and valve options.

## Compact Air Foot Pumps 11 Cu.In. / Min. @ 10,000 Psi



An intermittent portable foot controlled pump best suited for pressing, production and shop tool applications. Runs effectively on 10CFM @ 60-150 PSI.

Basic Valve Configurations For Pumps							
Pump Application	Valve Type	Valve Function			Works With Cylinder Type		
							
		Advance	Hold	Retract	Single-Acting Load RTN	Single-Acting Spring RTN	Double-Acting
<b>Dump pumps</b> are ideal for crimping, pressing or cutting applications. Switching motor "on" builds pressure, switching motor "off" dumps pressure.	Dump Valve	●	---	●	●	●	---
<b>Manual valve pumps</b> are ideal for general applications. Directional control is accomplished by manually shifting a control valve.	2 Way	●	---	●	●	●	---
	*3 Way	●	●	●	●	●	---
	4 Way	●	●	●	---	---	●
<b>Solenoid valve pumps</b> are ideal for production/automation applications. Directional control is accomplished via solenoid w/pendant.	2 Way	●	---	●	---	●	---
	*3 Way	●	●	●	●	●	---
	4 Way	●	●	●	---	---	●

\* 3 Way Models Include Suc-O-Matic Feature

Simplex pumps are the world's only 10,000 psi pumps to offer a new standard in pump construction and reliability. Close coupled motor and the one piece chassis combine to offer a rigid unit with minimal flex and wear characteristics.

The chassis, field proven gear pumps, replaceable piston bores and ball seats, higher crossovers, and quality motors are just a few of the extras incorporated in all Simplex pumps.

Use the speed chart (right) and select the right size pump to obtain the cylinder speed you desire.

For multiple cylinder system speeds, divide the inches per minute by number of cylinders in the system.

Cylinder Capacity (Tons)		Inches Per Minute				
		G1 Series	G3 Series	G4/G5 Series	G6 Series	
10	Loaded	9	9	24	45	76
	Unloaded	104	169	169	200	290
20/25	Loaded	4	4	10	20	33
	Unloaded	50	75	75	132	132
30	Loaded	3	3	8.5	16	26
	Unloaded	39	60	60	104	104
50/55	Loaded	2	2	5	9	15
	Unloaded	23	35	35	61	61
60/75	Loaded	1.5	1.5	3.5	6	10
	Unloaded	16	24	24	43	43
100	Loaded	1	1	3	5	8.5
	Unloaded	13	19	19	34	34
150	Loaded	.5	.5	1.75	3	5
	Unloaded	7	11	11	20	20
200	Loaded	.38	.38	1	2	4
	Unloaded	5	8	8	15	15

$$\frac{\text{Inches Per Minute}}{60} = \text{Cylinder Speed In Seconds}$$

# POWER PUMPS

G1 Series - Electric



Model Shown G1121

- Reservoir Capacity** .....▶ **1 Gallon**
- Flow @ Rated Pressure** .....▶ **19 cu.in./min.**
- Maximum Pressure** .....▶ **10,000 PSI**

- ▶ Powered by a 115V - 60HZ, .5 hp universal motor (14,640 rpm).
- ▶ Low startup voltage, draws 10 amps at full load (230V models available).
- ▶ Two-speed pump operation provides fast tool performance.
- ▶ External adjustable relief standard on all models.

With its mobility and power, the G1 power pump with a low profile locknut cylinder was the perfect choice for adjusting loaded shelving racks in this warehouse. ▼

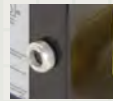

## SITE GAUGE

Metal reservoir site gauge for easy viewing of oil level.



## COUPLERS - pages 74 - 75

High flow quick disconnect couplers provide a quick change to a variety of pumps.



## IN-LINE VALVES - page 72

Maximize control and safety with our in-line valves.



## HOSES - pages 78 - 79

Heavy duty and thermo plastic hydraulic hoses to meet your requirements and safety factor.



## SUC-O-MATIC VALVE

The 3 position / 3 way "Suc-O-Matic" valve draws hydraulic oil out of any single acting cylinder with full retraction regardless of weak springs or mounting.

Performance Chart

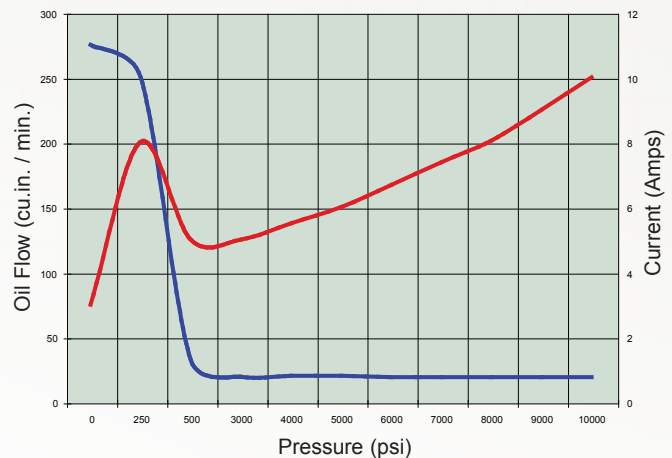

power pumps



# POWER PUMPS

G1 Series - Electric

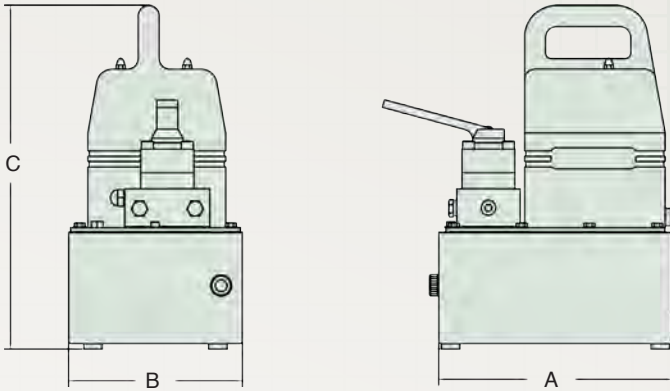

Reservoir (Gallons)	A	B	C
	(in)	(in)	(in)
1 Plastic	10.52	8.08	15.95
1 Metal	11.00	8.17	16.17

Model	Pressure Rating (psi)		Output Flow (cu.in. / min.)		Motor Spec.		Valve Type	Pendant Control	Usable Oil	Weight (lbs)
	1st Stage	2nd Stage	1st Stage	2nd Stage	(vac)	(amps)				
G1100	400	10,000	250	19	115	10	DUMP	MOTOR	1	30
G1101	400	10,000	250	19	115	10	DUMP	MOTOR	1	32
G1121	400	10,000	250	19	115	10	2W, 2P	MOTOR	1	33
G1131	400	10,000	250	19	115	10	3W, 3P	MOTOR	1	34
G1141	400	10,000	250	19	115	10	4W, 3P	MOTOR	1	34

\* For 230 VAC pump use "2" in the 3rd character of the model number. Motor specifications 0,37 kw single phase, 5 amps @ 230 VAC.

\* Motor pendant is standard on all models.

power pumps

## Additional Pump Configurations

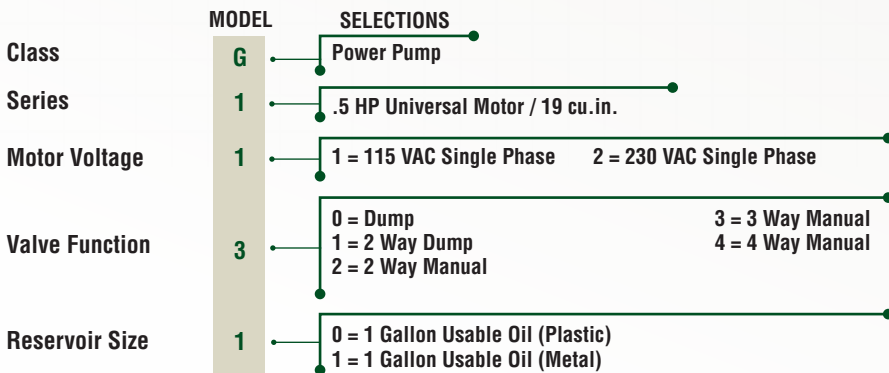

# POWER PUMPS

G3 Series - Electric

**SIMPLEX**



G3132 Shown

**Reservoir Capacity** ..... ➤ **1 - 10 Gallons**  
**Flow @ Rated Pressure** ..... ➤ **46 cu.in./min.**  
**Maximum Pressure** ..... ➤ **10,000 PSI**

- ▶ Powered by a 115V - 60Hz, 1.13 hp universal motor (21,000 rpm).
- ▶ Low startup voltage, draws 16 amps at full load (230V models available).
- ▶ Equipped with a 15' remote power controlled pendant.
- ▶ Reservoirs available in 1 - 10 gallons; welded steel design.
- ▶ Ideal for use with small, mid sized hydraulic cylinders or tools.

A Simplex G3 power pump was used at a testing facility to pressurize manifolds for leaks. ▼

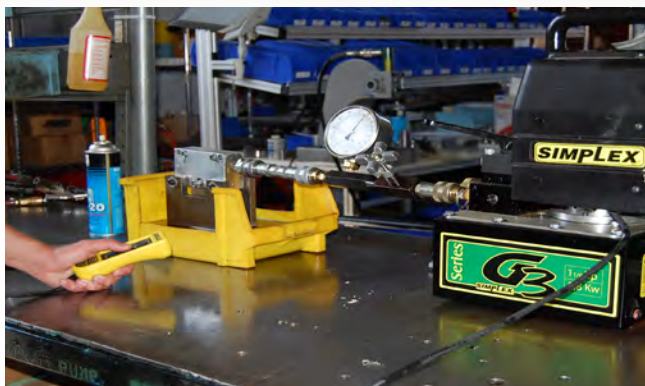

## CYLINDERS - pages 7 - 29

Cylinder design specifications meet or exceed ANSI /ASME B30.1 Safety Standards.



## COUPLERS - pages 74 - 75

High flow quick disconnect couplers provide a quick change to a variety of pumps.



## MANIFOLDS - page 73

The ideal solution in obtaining precise control when operating multiple cylinders.



## HOSES - pages 78 - 79

Heavy duty and thermo plastic hydraulic hoses to meet your requirements and safety factor.

power pumps



## SUC-O-MATIC VALVE

The 3 position / 3 way "Suc-O-Matic" valve draws hydraulic oil out of any single acting cylinder with full retraction regardless of weak springs or mounting.

Performance Chart

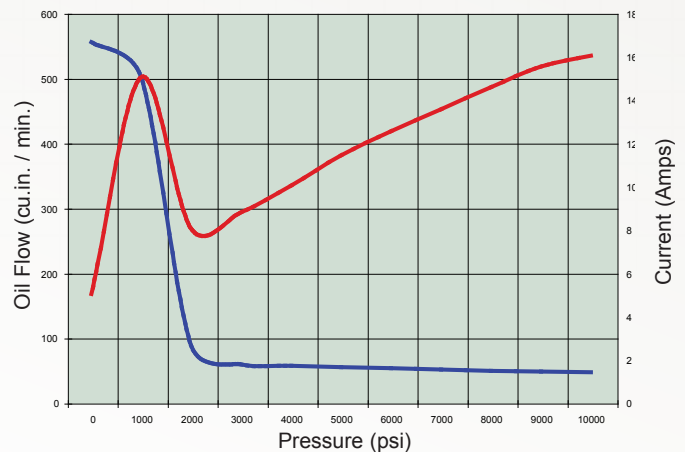

# POWER PUMPS

G3 Series - Electric

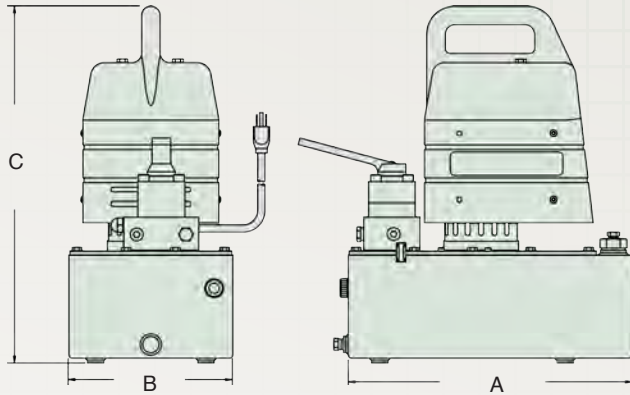

Reservoir (Gallons)	A	B	C
	(in)	(in)	(in)
1	11.00	8.19	18.75
1.5	15.13	8.75	19
2.5	17	9.75	19
5	25.10	11.75	18.75
10	25.10	11.75	23



Model	Pressure Rating (psi)		Output Flow (cu.in./min.)		Motor Spec.		Valve Type	Pendant Control	Usable Oil	Weight (lbs)
	1st Stage	2nd Stage	1st Stage	2nd Stage	(vac)	(amps)				
G3100	1,100	10,000	525	46	115	16	Dump	Motor	1	38
G3101	1,100	10,000	525	46	115	16	Dump	Motor	1	45
G3102	1,100	10,000	525	46	115	16	Dump	Motor	1.5	50
G3121	1,100	10,000	525	46	115	16	2W, 2P	Motor	1	45
G3122	1,100	10,000	525	46	115	16	2W, 2P	Motor	1.5	52
G3131	1,100	10,000	525	46	115	16	3W, 3P	Motor	1	48
G3132	1,100	10,000	525	46	115	16	3W, 3P	Motor	1.5	53
G3133	1,100	10,000	525	46	115	16	3W, 3P	Motor	2.5	63
G3162	1,100	10,000	525	46	115	16	3W, 3P	Motor / Solenoid	1.5	57
G3163	1,100	10,000	525	46	115	16	3W, 3P	Motor / Solenoid	2.5	67
G3141	1,100	10,000	525	46	115	16	4W, 3P	Motor	1	48
G3142	1,100	10,000	525	46	115	16	4W, 3P	Motor	1.5	53
G3143	1,100	10,000	525	46	115	16	4W, 3P	Motor	2.5	63
G3172	1,100	10,000	525	46	115	16	4W, 3P	Motor / Solenoid	1.5	57
G3173	1,100	10,000	525	46	115	16	4W, 3P	Motor / Solenoid	2.5	67

\* For 230 VAC pump use "2" in the 3rd character of the model number. Motor specifications 0,8 kw single phase, 10 amps @230 VAC.

## Additional Pump Configurations

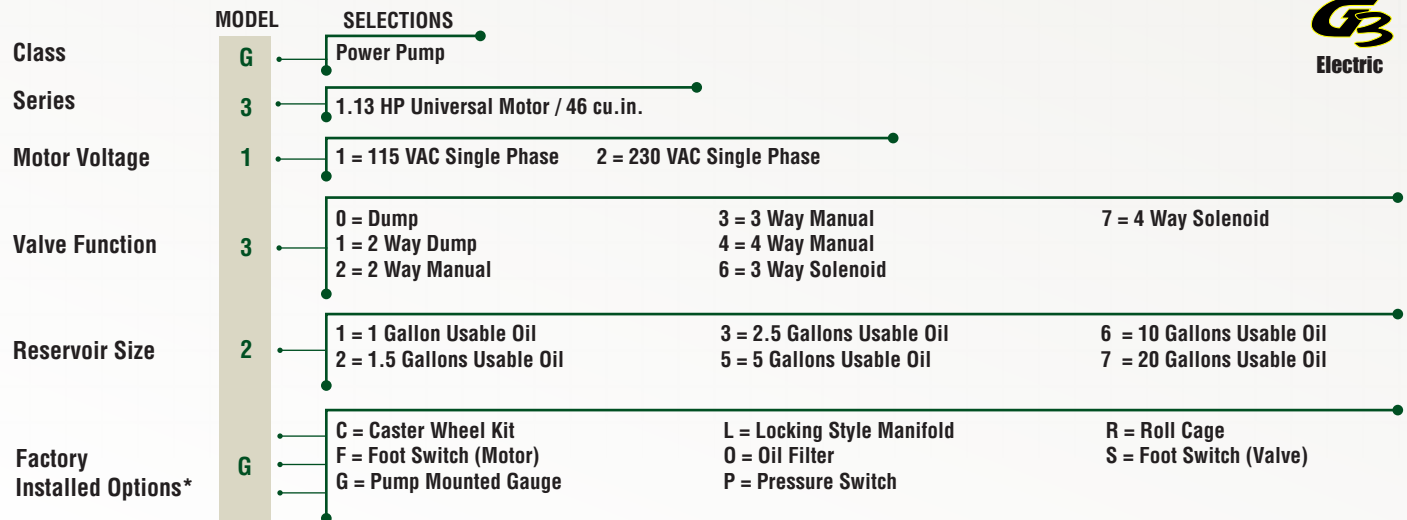

- \* If pump model consists of more than 3 options, contact factory. \* Motor pendant is standard on all models.
- \* Gauge will not be protected by roll cage when a 5 gallon or larger reservoir is ordered.
- \* Roll cage not available on 10 & 20 gallon reservoir.
- \* Caster wheel kit not available on 5,10 & 20 gallon reservoirs.
- \* Oil filter not available on dump, 2 way dump & 2 way manual.

power pumps

# POWER PUMPS

G4 Series - Electric

**SIMPLEX**

**G4**  
Electric



G4173 Shown

**Reservoir Capacity** ..... ➤ **1.5 - 20 Gallons**  
**Flow @ Rated Pressure** ..... ➤ **55 cu.in./min.**  
**Maximum Pressure** ..... ➤ **10,000 PSI**

- ▶ Powered by a 115V - 60Hz, 1.5 hp induction motor (1,725 rpm).
- ▶ Low startup voltage, draws amps at full load (230V models available).
- ▶ High performance two-stage pump provides higher cross-over pressure for faster cycle times and equipment operation.
- ▶ Ideal for use with mid sized hydraulic cylinders.

The Simplex G4 power pump along with the S3000A spreader was used to pry apart the rusted doors on this steel shipping container. ▼



**MANIFOLDS - page 73**

The ideal solution in obtaining precise control when operating multiple cylinders.



**COUPLERS - pages 74 - 75**

High flow quick disconnect couplers provide a quick change to a variety of pumps.



**GAUGES - page - 77**

Improve your system visibility and safety by adding an inline hydraulic gauge to your circuit.



**CYLINDERS - pages 7 - 29**

A large selection of steel and aluminum cylinders to meet every need.



**SUC-O-MATIC VALVE**

The 3 position / 3 way "Suc-O-Matic" valve draws hydraulic oil out of any single acting cylinder with full retraction regardless of weak springs or mounting.

**Performance Chart**

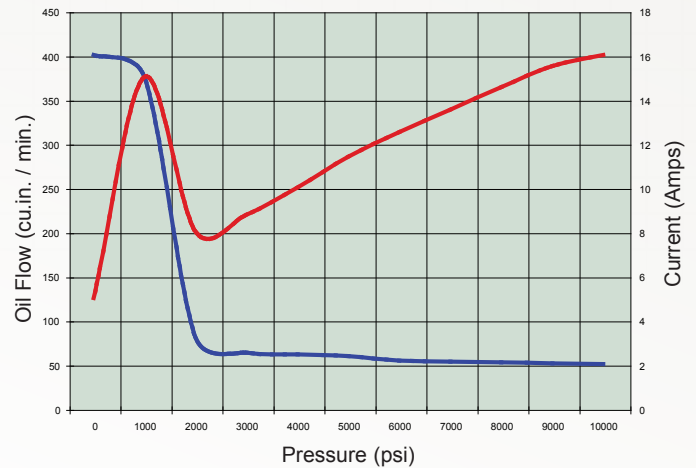

power pumps

# POWER PUMPS

G4 Series - Electric

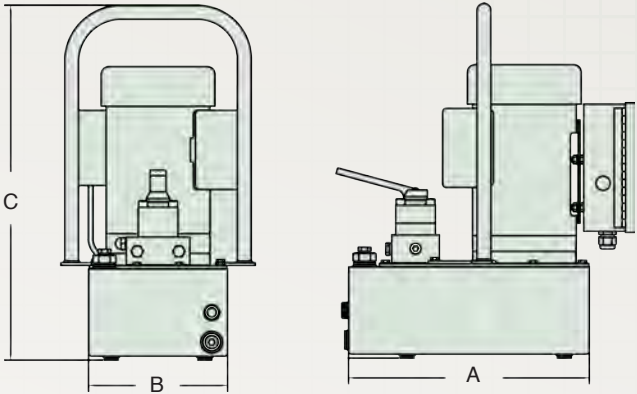

Reservoir (Gallons)	A	B	C
	(in)	(in)	(in)
1.5	15.13	8.75	22.34
2.5	17	9.75	22.34
5	25.10	11.75	21
10	25.10	11.75	25.25
20	28	19.6	25.25

Model	Pressure Rating (psi)		Output Flow (cu.in./min.)		Motor Spec.		Valve Type	Pendant Control	Usable Oil	Weight (lbs)
	1st Stage	2nd Stage	1st Stage	2nd Stage	(vac)	(amps)				
G4102	1,100	10,000	400	55	115	16	Dump	Motor	1.5	38
G4103	1,100	10,000	400	55	115	16	Dump	Motor	2.5	45
G4122	1,100	10,000	400	55	115	16	2W, 2P	Optional Motor	1.5	52
G4132	1,100	10,000	400	55	115	16	3W, 3P	Optional Motor	1.5	53
G4133	1,100	10,000	400	55	115	16	3W, 3P	Optional Motor	2.5	63
G4162	1,100	10,000	400	55	115	16	3W, 3P	Motor / Solenoid	1.5	57
G4163	1,100	10,000	400	55	115	16	3W, 3P	Motor / Solenoid	2.5	67
G4142	1,100	10,000	400	55	115	16	4W, 3P	Optional Motor	1.5	53
G4143	1,100	10,000	400	55	115	16	4W, 3P	Optional Motor	2.5	63
G4172	1,100	10,000	400	55	115	16	4W, 3P	Motor / Solenoid	1.5	57
G4173	1,100	10,000	400	55	115	16	4W, 3P	Motor / Solenoid	2.5	67

\* For 230 VAC pump use "2" in the 3rd character of the model number. Motor specifications 1,1 kw single phase, 10 amps @ 230 VAC.

### Additional Pump Configurations

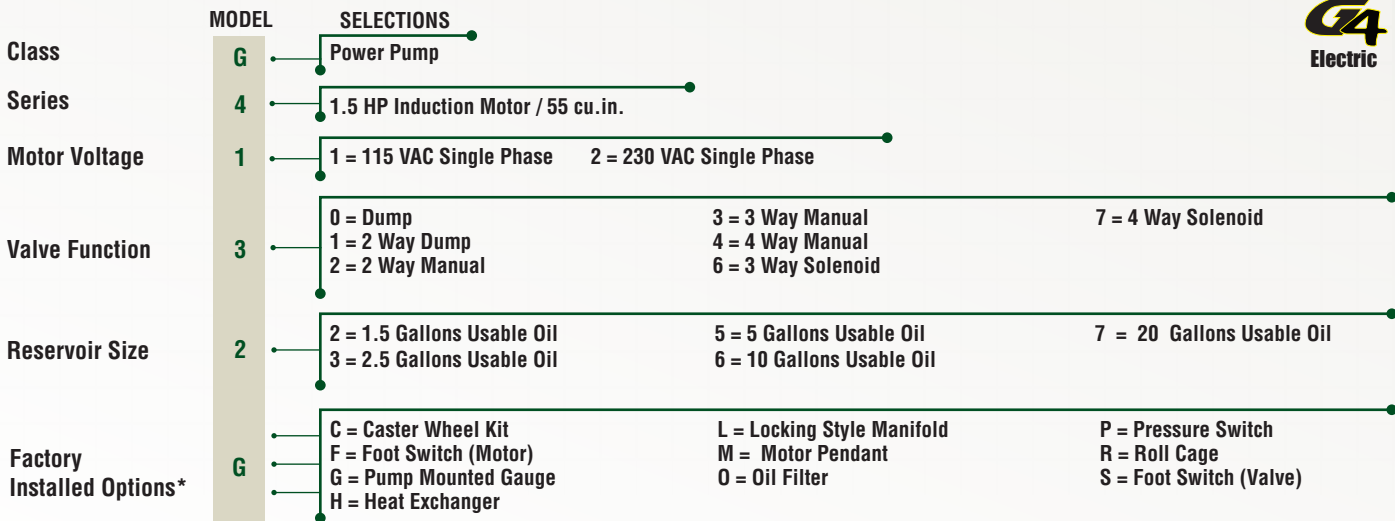

\* If pump model consists of more than 3 options, contact factory.  
 \* Gauge will not be protected by roll cage when a 5 gallon or larger reservoir is ordered.  
 \* Roll cage not available on 10 & 20 gallon reservoir.  
 \* Caster wheel kit not available on 5,10 & 20 gallon reservoirs.  
 \* Oil filter not available on dump, 2 way dump & 2 way manual.

power pumps



# POWER PUMPS

G5 Series - Electric



G5132G Shown

- Reservoir Capacity** .....▶ **1.5 - 20 Gallons**
- Flow @ Rated Pressure** .....▶ **55 cu.in./min.**
- Maximum Pressure** .....▶ **10,000 PSI**

- ▶ Powered by a 115V - 60Hz, 1.5 hp permanent magnet motor (3,000 rpm).
- ▶ Low startup voltage, draws 18 amps at full load (230V models available).
- ▶ High performance two-stage pump provides higher cross-over pressure for faster cycle times and equipment operation.
- ▶ Reservoirs available in 1.5 - 20 gallons; welded steel design.
- ▶ Ideal for use with mid to large sized hydraulic cylinders or tools.
- ▶ Comes standard with 15' pendant.

The G5 power pump coupled with a 50 ton Simplex cylinder are used daily to position bearings in the assembly processing section of the plant. ▼



## THINK SAFETY

Please refer to pages 4&5 for a complete list of safety tips and recommendations.



## HOSES - pages 78 - 79

Heavy duty and thermo plastic hydraulic hoses to meet your requirements and safety factor.



## GAUGES - page 77

Improve your system visibility and safety by adding an inline hydraulic gauge to your circuit.



## IN-LINE VALVES - page 72

Maximize control and safety with our in-line valves.



## SUC-O-MATIC VALVE

The 3 position / 3 way "Suc-O-Matic" valve draws hydraulic oil out of any single acting cylinder with full retraction regardless of weak springs or mounting.

Performance Chart

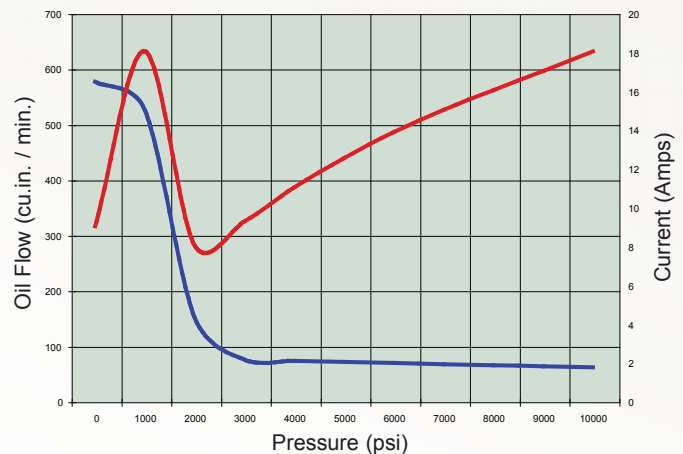

# POWER PUMPS

G5 Series - Electric

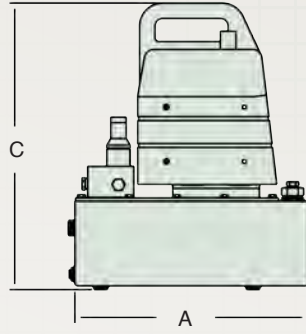
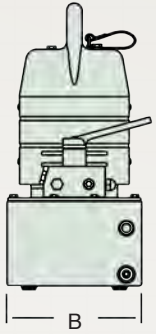

Reservoir (Gallons)	A	B	C
	(in)	(in)	(in)
1.5	15.13	8.75	18.59
2.5	17	9.75	18.59
5	25.10	11.75	18.59
10	25.10	11.75	22.84
20	28	19.60	22.84



Model	Pressure Rating (psi)		Output Flow (cu.in./min.)		Motor Spec.		Valve Type	Pendant Control	Usable Oil	Weight (lbs)
	1st Stage	2nd Stage	1st Stage	2nd Stage	(vac)	(amps)				
G5102	1,100	10,000	550	55	115	18	Dump	Motor	1.5	64
G5103	1,100	10,000	550	55	115	18	Dump	Motor	2.5	74
G5122	1,100	10,000	550	55	115	18	2W, 2P	Motor	1.5	64
G5123	1,100	10,000	550	55	115	18	2W, 2P	Motor	2.5	74
G5132	1,100	10,000	550	55	115	18	3W, 3P	Motor	1.5	67
G5133	1,100	10,000	550	55	115	18	3W, 3P	Motor	2.5	77
G5135	1,100	10,000	550	55	115	18	3W, 3P	Motor	5	115
G5162	1,100	10,000	550	55	115	18	3W, 3P	Motor / Solenoid	1.5	71
G5163	1,100	10,000	550	55	115	18	3W, 3P	Motor / Solenoid	2.5	81
G5165	1,100	10,000	550	55	115	18	3W, 3P	Motor / Solenoid	5	119
G5142	1,100	10,000	550	55	115	18	4W, 3P	Motor	1.5	67
G5143	1,100	10,000	550	55	115	18	4W, 3P	Motor	2.5	77
G5145	1,100	10,000	550	55	115	18	4W, 3P	Motor	5	115
G5172	1,100	10,000	550	55	115	18	4W, 3P	Motor / Solenoid	1.5	71
G5173	1,100	10,000	550	55	115	18	4W, 3P	Motor / Solenoid	2.5	81
G5175	1,100	10,000	550	55	115	18	4W, 3P	Motor / Solenoid	5	119

\* For 230 VAC pump use "2" in the 3rd character of the model number. Motor specifications 1,1 kw single phase, 10 amps @ 230 VAC.

## Additional Pump Configurations

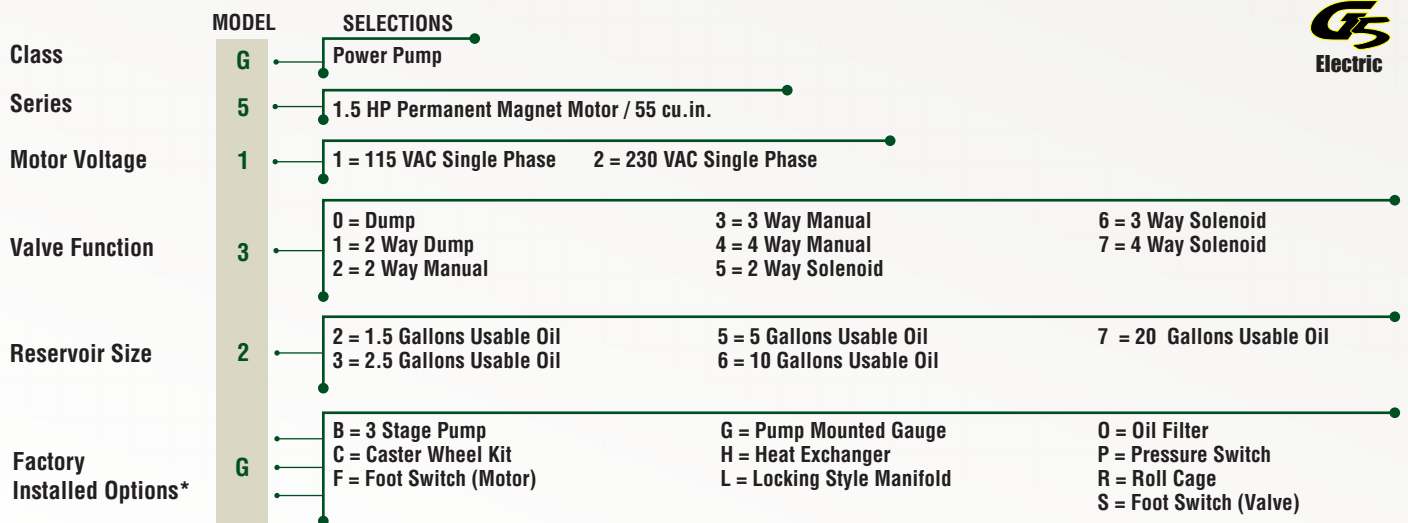

- \* If pump model consists of more than 3 options, contact factory.
- \* Gauge will not be protected by roll cage when a 5 gallon or larger reservoir is ordered.
- \* Roll cage not available on 10 & 20 gallon reservoir.
- \* Caster wheel kit not available on 5, 10 & 20 gallon reservoirs.
- \* Oil filter not available on dump, 2 way dump & 2 way manual.
- \* Motor pendant is standard on all models.

power pumps



# POWER PUMPS

G6 Series - Electric

**SIMPLEX**

**G6**  
Electric



G6335 Shown

**Reservoir Capacity** .....▶ **5 - 40 Gallons**  
**Flow @ Rated Pressure** .....▶ **100 cu.in./min.**  
**Maximum Pressure** .....▶ **10,000 PSI**

- ▶ Two-stage pump operation provides fast tool performance.
- ▶ Ideal for use with mid to large sized hydraulic cylinders or tools.
- ▶ Powered by a multi-voltage, 3 phase, 3 hp AC motor (3450 rpm); low startup voltage draws 9.5 amps (230v) at full load.
- ▶ Perfect fit for production and multi-cylinder lift systems.
- ▶ Quiet running, only (80dba).

The G6 Series Electric pump can power a variety of Simplex tools while withstanding the daily wear and tear in this steel fabricating shop. ▼



## HOSES - pages 78 - 79

Heavy duty and thermo plastic hydraulic hoses to meet your requirements and safety factor.



## COUPLERS - pages 74 - 75

High flow quick disconnect couplers provide a quick change to a variety of pumps.



## GAUGES - page 77

Improve your system visibility and safety by adding an inline hydraulic gauge to your circuit.



## CYLINDERS - pages 7 - 29

A large selection of steel and aluminum cylinders to meet every need.



## SUC-O-MATIC VALVE

The 3 position / 3 way "Suc-O-Matic" valve draws hydraulic oil out of any single acting cylinder with full retraction regardless of weak springs or mounting.

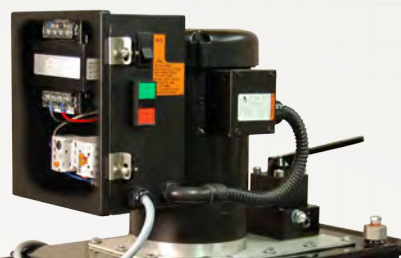

▶ Deluxe Starter Box is equipped on all models.

## Performance Chart

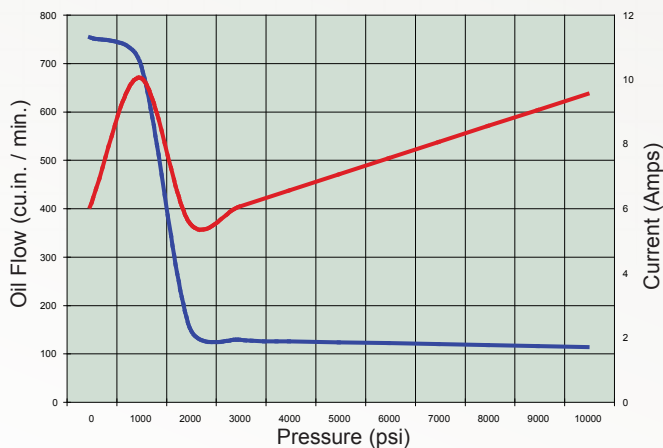



# POWER PUMPS

G6 Series - Electric

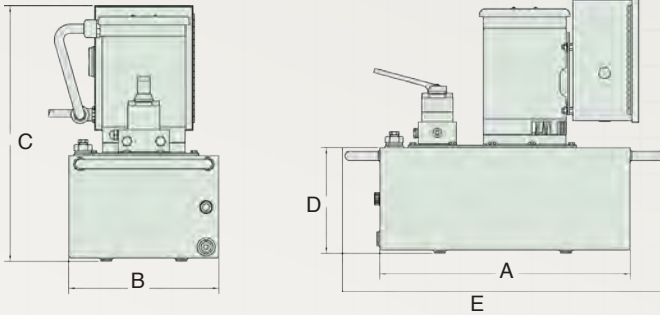

Reservoir (Gallons)	A	B	C	D	E
	(in)	(in)	(in)	(in)	(in)
5	19.62	11.75	20.52	8.46	25.10
10	19.62	11.75	24.76	12.71	25.10
20	23.50	19.60	24.51	12.46	28
40	36	24	24.7	12.25	41.5

Model	Pressure Rating (psi)		Output Flow (cu.in./min.)		Motor Spec.		Valve Type	Pendant Control	Usable Oil	Weight (lbs)
	1st Stage	2nd Stage	1st Stage	2nd Stage	(vac)	(amps)				
G6335	1,500	10,000	750	100	230	9.5	3W, 3P	----	5	162
G6336	1,500	10,000	750	100	230	9.5	3W, 3P	----	10	217
G6336L	1,500	10,000	750	100	230	9.5	3W, 3P (L)	----	10	218
G6365	1,500	10,000	750	100	230	9.5	3W, 3P	Solenoid	5	165
G6366	1,500	10,000	750	100	230	9.5	3W, 3P	Solenoid	10	220
G6366L	1,500	10,000	750	100	230	9.5	3W, 3P (L)	Solenoid	10	221
G6346	1,500	10,000	750	100	230	9.5	4W, 3P	----	10	210
G6347	1,500	10,000	750	100	230	9.5	4W, 3P	----	20	311
G6347L	1,500	10,000	750	100	230	9.5	4W, 3P (L)	----	20	312
G6375	1,500	10,000	750	100	230	9.5	4W, 3P	Solenoid	5	165
G6376	1,500	10,000	750	100	230	9.5	4W, 3P	Solenoid	10	220
G6376L	1,500	10,000	750	100	230	9.5	4W, 3P (L)	Solenoid	10	221

(L) = Lock Valve Manifold

- \* For 230 VAC pump use "3" in the 3rd character of the model number. Motor specifications 2,2 kw 3 phase, 10 amps @ 230 VAC.
- \* For 380 VAC pump use "4" in the 3rd character of the model number. Motor specifications 2,2 kw 3 phase, 5.8 amps @ 380 VAC.
- \* For 460 VAC pump use "5" in the 3rd character of the model number. Motor specifications 2,2 kw 3 phase, 4.7 amps @ 460 VAC.
- \* For 575 VAC pump use "6" in the 3rd character of the model number. Motor specifications 2,2 kw 3 phase, 3.8 amps @ 575 VAC.

## Additional Pump Configurations

MODEL	SELECTIONS
Class	<b>G</b> Power Pump
Series	<b>6</b> 3 HP / 3 Phase / 100 cu.in.
Motor Voltage	<b>3</b> 3 = 230 VAC, 3 Phase 4 = 380 VAC, 3 Phase 5 = 460 VAC, 3 Phase 6 = 575 VAC, 3 Phase
Valve Function	<b>3</b> 2 = 2 Way Manual 3 = 3 Way Manual 4 = 4 Way Manual 6 = 3 Way Solenoid 7 = 4 Way Solenoid
Reservoir Size	<b>5</b> 5 = 5 Gallons Usable Oil 6 = 10 Gallons Usable Oil 7 = 20 Gallons Usable Oil 8 = 40 Gallons Usable Oil
Factory Installed Options *	<b>C</b> F = Foot Switch (Motor) G = Gauge (Integrated) H = Heat Exchanger L = Locking Style Manifold M = Motor Pendant O = Oil Filter P = Pressure Switch S = Foot Switch (Valve)



\* If pump consists of more than 3 options, consult factory.  
\* Oil filter not available on 2 way manual.

# POWER PUMPS

G5 Series - Air

**SIMPLEX**



G5733 Shown

**Reservoir Capacity** ..... ➤ **1.5 - 20 Gallons**  
**Flow @ Rated Pressure** ..... ➤ **55 cu.in./min.**  
**Maximum Pressure** ..... ➤ **10,000 PSI**

- ▶ Powered by a rotary air vane, 3 hp motor (3,000 rpm).
- ▶ Equipped with a filter-lubricator assembly, air muffler and carry handlebar on all models.
- ▶ Precision designed valve offers reliability and secure load holding; external adjustable relief standard on all models.
- ▶ Ideal for use with mid sized hydraulic cylinders or tools.

*The power and dependability of the G5 Air Power Pump is the perfect solution for any job where electric and gasoline powered tools are not suitable. ▼*

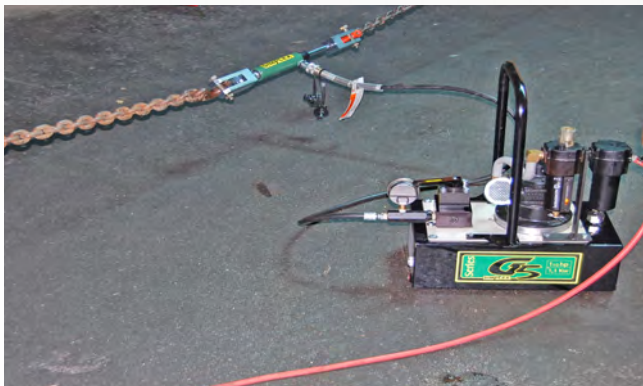

## MANIFOLDS - page 73

The ideal solution in obtaining precise control when operating multiple cylinders.



## COUPLERS - pages 74 - 75

High flow quick disconnect couplers provide a quick change to a variety of pumps.



## GAUGES - page 77

Improve your system visibility and safety by adding an inline hydraulic gauge to your circuit.



## CYLINDERS - pages 7 - 29

A large selection of steel and aluminum cylinders to meet every need.



## SUC-O-MATIC VALVE

*The 3 position / 3 way "Suc-O-Matic" valve draws hydraulic oil out of any single acting cylinder with full retraction regardless of weak springs or mounting.*

**Performance Chart**

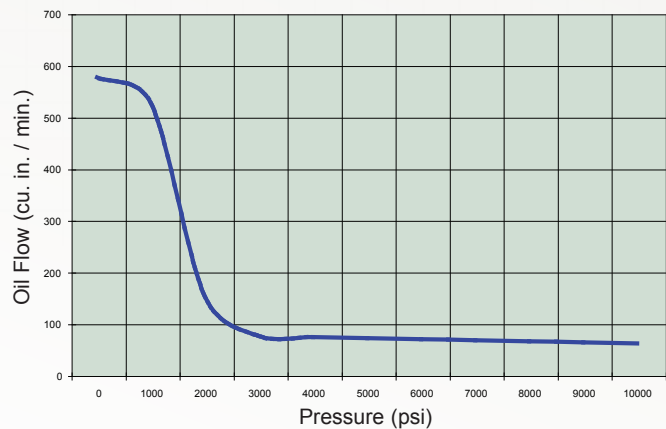

# POWER PUMPS

G5 Series - Air

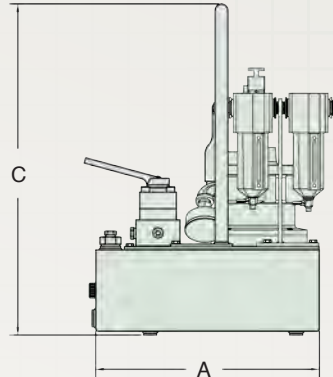
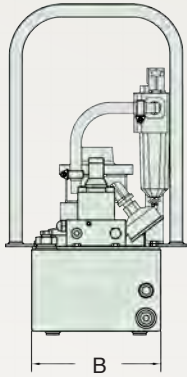

Reservoir (Gallons)	A (in)	B (in)	C (in)
1.5	15.13	8.75	22.34
2.5	17	9.75	22.34
5	25.10	11.75	20.52
10	25.10	11.75	24.77
20	28	19.62	26.69

Model	Pressure Rating (psi)		Output Flow (cu.in. / min.)		Motor Spec.		Valve Type	Pendant Control	Usable Oil	Weight (lbs)
	1st Stage	2nd Stage	1st Stage	2nd Stage	(psi)	(cfm)				
G5732	1,100	10,000	700	55	90	50	3W, 3P	----	1.5	50
G5735	1,100	10,000	700	55	90	50	3W, 3P	----	5	108
G5762	1,100	10,000	700	55	90	50	3W, 3P	Solenoid	1.5	52
G5765	1,100	10,000	700	55	90	50	3W, 3P	Solenoid	5	110
G5742	1,100	10,000	700	55	90	50	4W, 3P	----	1.5	50
G5745	1,100	10,000	700	55	90	50	4W, 3P	----	5	108
G5772	1,100	10,000	700	55	90	50	4W, 3P	Solenoid	1.5	52
G5775	1,100	10,000	700	55	90	50	4W, 3P	Solenoid	5	110

power pumps

## Additional Pump Configurations

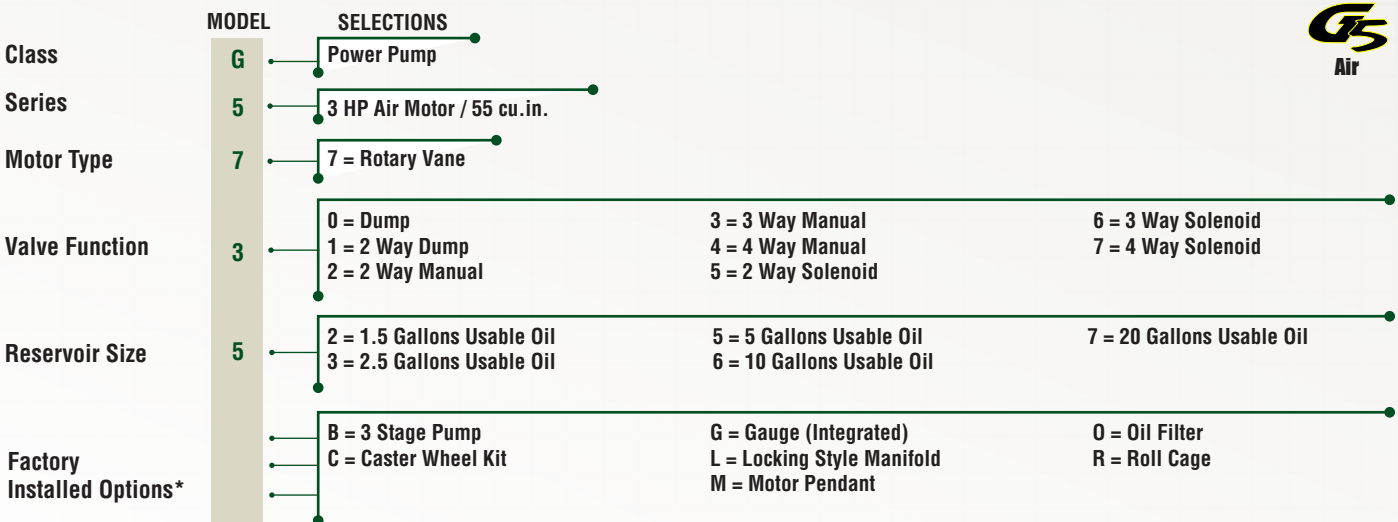

\* If pump model consists of more than 3 options, contact factory.  
 \* Gauge will not be protected by roll cage when a 5 gallon or larger reservoir is ordered.  
 \* Roll cage not available on 10 & 20 gallon reservoir.  
 \* Caster wheel kit not available on 5, 10 & 20 gallon reservoirs.  
 \* Oil filter not available on dump, 2 way dump & 2 way manual.

# POWER PUMPS

G4 Series - Gas

**SIMPLEX**



G4833 Shown

- Reservoir Capacity** ..... ➤ **1.5 - 20 Gallons**
- Flow @ Rated Pressure** ..... ➤ **50 cu.in./min.**
- Maximum Pressure** ..... ➤ **10,000 PSI**

- ▶ Powered by a 127 c.c. Briggs & Stratton® gas motor.
- ▶ High performance two-stage pump provides higher cross-over pressure for faster cycle times and equipment operation; 50 cubic inches / minute @ 10,000 PSI.
- ▶ Reservoirs available in 1.5 - 20 gallons; welded steel design.
- ▶ Ideal for use with mid sized hydraulic cylinders or tools.

The location to repair this dock foundation needed the versatility of the G4 gas power pump. ▼



## MANIFOLDS - page 73

The ideal solution in obtaining precise control when operating multiple cylinders.



## COUPLERS - pages 74 - 75

High flow quick disconnect couplers provide a quick change to a variety of pumps.



## GAUGES - page 77

Improve your system visibility and safety by adding an inline hydraulic gauge to your circuit.



## IN-LINE VALVES - page 72

Maximize control and safety with our in-line valves.



## SUC-O-MATIC VALVE

The 3 position / 3 way "Suc-O-Matic" valve draws hydraulic oil out of any single acting cylinder with full retraction regardless of weak springs or mounting.

Performance Chart

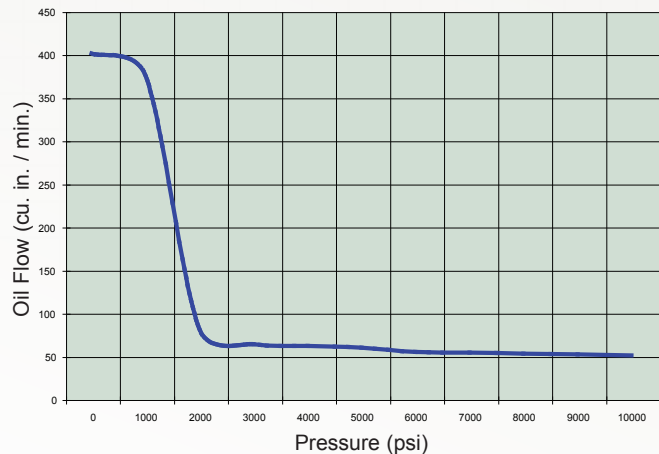

# POWER PUMPS

G4 Series - Gas

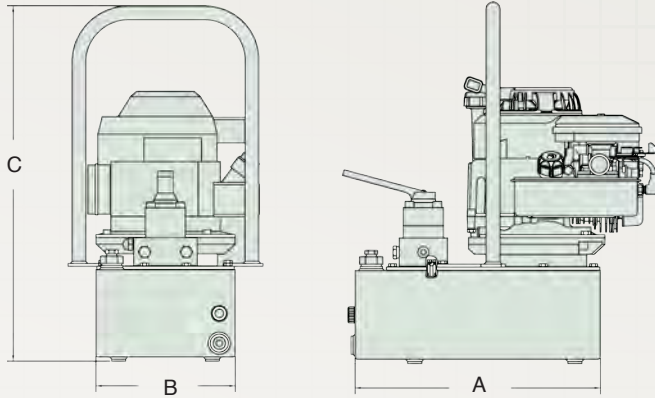

Reservoir (Gallons)	A	B	C
	(in)	(in)	(in)
1.5	15.13	8.75	22.34
2.5	17	9.75	22.34
5	25.10	11.75	19.54
10	25.10	11.75	23.97
20	28	19.60	22.84

Model	Pressure Rating		Output Flow		Motor B&S	Valve Type	Usable Oil	Weight (lbs)
	1st Stage	2nd Stage	1st Stage	2nd Stage				
G4833	1,100	10,000	400	50	127 c.c.	3W, 3P	2.5	53
G4835	1,100	10,000	400	50	127 c.c.	3W, 3P	5	108
G4843	1,100	10,000	400	50	127 c.c.	4W, 3P	2.5	53
G4845	1,100	10,000	400	50	127 c.c.	4W, 3P	5	108

## Additional Pump Configurations

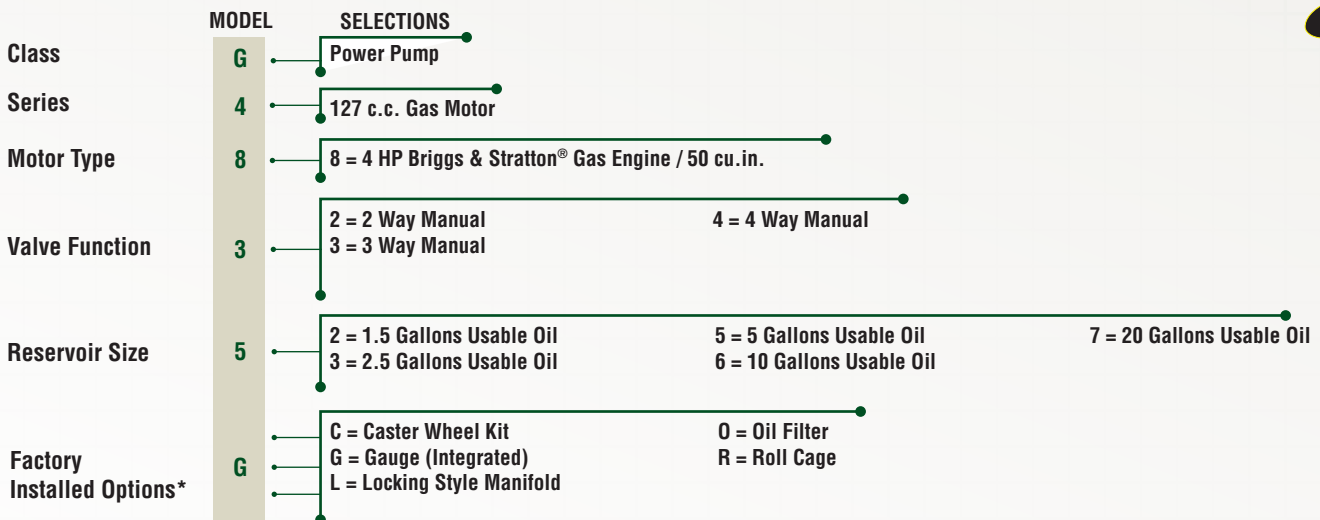

\* If pump model consists of more than 3 options, contact factory.  
 \* Gauge will not be protected by roll cage when a 5 gallon or larger reservoir is ordered.  
 \* Roll cage not available on 10 & 20 gallon reservoir.  
 \* Caster wheel kit not available on 5, 10 & 20 gallon reservoirs.  
 \* Oil filter not available on dump, 2 way dump & 2 way manual.

power pumps

# POWER PUMPS

G6 Series - Gas

**SIMPLEX**

**G6**  
Gas



G6843 Shown

**Reservoir Capacity** ..... ➤ **2.5 - 20 Gallons**  
**Flow @ Rated Pressure** ..... ➤ **100 cu.in./min.**  
**Maximum Pressure** ..... ➤ **10,000 PSI**

- ▶ Powered by a 163 c.c. Honda® gas motor.
- ▶ High performance two-stage pump provides higher cross-over pressure for faster cycle times and equipment operation.
- ▶ Ideal for use with mid to large sized hydraulic cylinders or tools.
- ▶ Reservoirs available in 2.5 - 20 gallons; welded steel design.
- ▶ Precision designed valve offers reliability and secure load holding.

The G6 Series Gas pump can withstand the most rugged environments without ever compromising performance. ▼



**HOSES - pages 78 - 79**

Heavy duty and thermo plastic hydraulic hoses to meet your requirements and safety factor.



**COUPLERS - pages 74 - 75**

High flow quick disconnect couplers provide a quick change to a variety of pumps.



**GAUGES - page 77**

Improve your system visibility and safety by adding an inline hydraulic gauge to your circuit.



**IN-LINE VALVES - page 72**

Maximize control and safety with our in-line valves.



**SUC-O-MATIC VALVE**

The 3 position / 3 way "Suc-O-Matic" valve draws hydraulic oil out of any single acting cylinder with full retraction regardless of weak springs or mounting.

**Performance Chart**

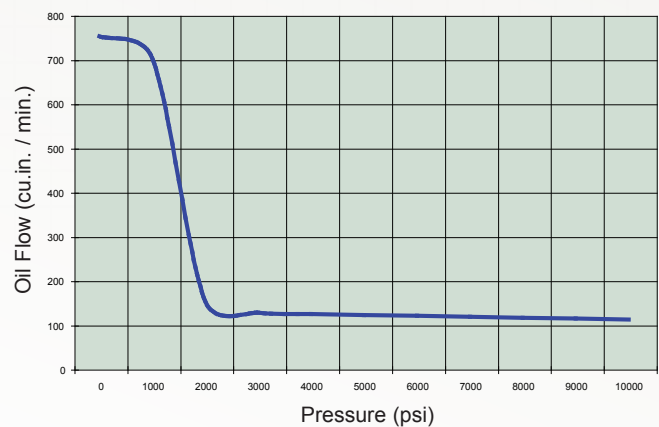

power pumps

# POWER PUMPS

G6 Series - Gas

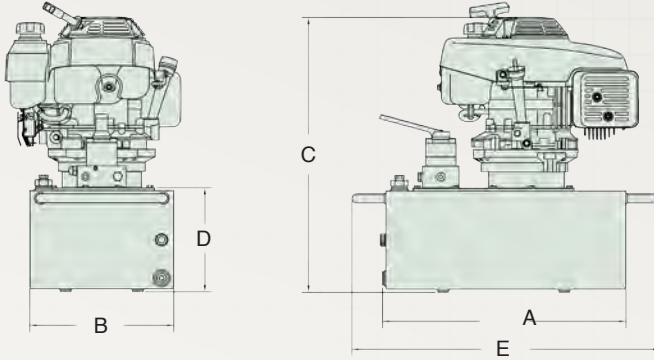

Reservoir (Gallons)	A	B	C	D	E
	(in)	(in)	(in)	(in)	(in)
2.5	17	9.75	19.86	5.71	----
5	19.60	11.75	22.36	8.46	25.10
10	19.60	11.75	26.61	12.71	25.10
20	23.50	19.60	26.36	12.46	28

28 x 22.68 x 18.75 Roll Cage Dimensions for 2.5 gallon.

Model	Pressure Rating (psi)		Output Flow (cu.in./ min.)		Motor Spec	Valve Type	Usable Oil	Weight (lbs)
	1st Stage	2nd Stage	1st Stage	2nd Stage				
G6833	1,200	10,000	750	100	163 c.c.	3W, 3P	2.5	68
G6835	1,200	10,000	750	100	163 c.c.	3W, 3P	5	123
G6843	1,200	10,000	750	100	163 c.c.	4W, 3P	2.5	68
G6845	1,200	10,000	750	100	163 c.c.	4W, 3P	5	123

## Additional Pump Configurations

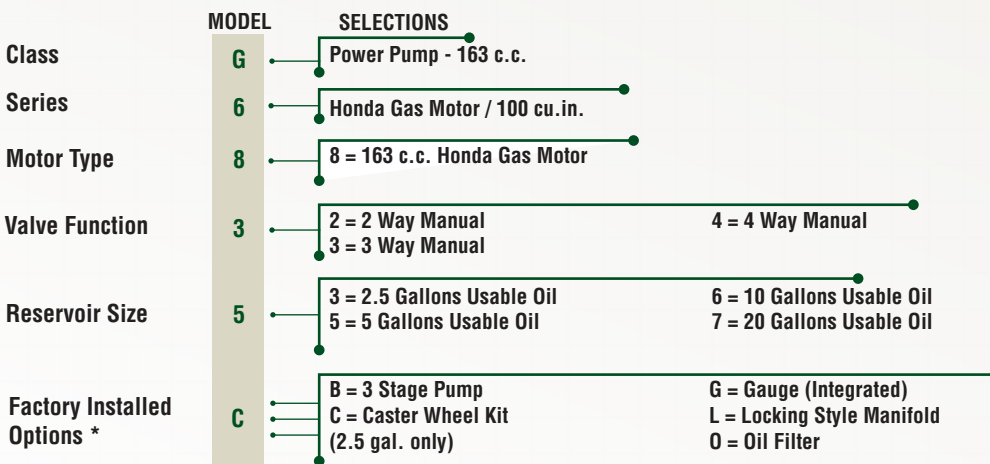

power pumps

\* For reservoirs over 20 gallon capacity, please contact factory.  
 \* If pump model consists of more than 3 options, contact factory.  
 \* Oil filter not available with 2 way manual.

# POWER PUMPS

G Series - Accessory Kits



**Order # G07-3M, G07-3S  
G07-4M, G07-4S**

3M = 3 Way Manual  
4M = 4 Way Manual  
3S = 3 Way Solenoid  
4S = 4 Way Solenoid

Monitor Pressure In The System By Incorporating An Integrated Pressure Gauge.

## Integrated Pressure Gauge Kit

	Includes
* Shcs .38-16 X 2.5 .....	4
Gauge Shroud Mounting .....	2
* Gauge Bracket Manual .....	1
* BHCS 10-24 X .50 316SS.....	4
Manifold Assembly.....	1
* Valve Handle Assembly.....	1
Gauge Shroud Assembly.....	1
Instruction Sheet G07 .....	1
<b>* Extra Components In Manual 3 Or 4 Way Gauge Kit *</b>	



**Order # G02**

Hands free pump control can be achieved with the 15 ft. cord Foot Switch.

## Foot Switch Kit

	Includes
Foot Switch .....	1
18-3 Power Cord .....	15 Foot Cord
Spade Terminal .....	3
Instruction Sheet G02.....	1



**Order # G03**

Protect your G Series pump from jobsite mishaps with a lightweight industrial grade Roll Cage.

## Roll Cage Kit

	Includes
.25" Fender Washer .....	4
HHCS .25 - 20 X .75 W/Nylon S.S .....	4
Roll Cage .....	1
Instruction Sheet G03.....	1



**Order # G04 - 115  
(FOR 115 VOLT)  
G04 - 230  
(FOR 230 VOLT)**

Avoid pump overheating and costly repairs from long work periods with a coil induction Heat Exchanger.

## Heat Exchanger Kit - 115 Volt / 230 Volt

	Includes
Heat Exchanger Assembly G5 115V .....	1
Bulkhead Elbow .38" Flare Tube .....	2
Swivel Fitting .....	1
Elbow .25" NPT To .38" Flare Tube .....	1
Tube Heat Exchanger Pump To Cover Plate .....	1
Tube Heat Exchanger Cover Plate To Tank .....	1
Standoff Heat Exchanger .....	4
BHCS .25-20 X 3/8 .....	4
Hex Nut .25-20 Plated .....	4
O-Ring .44 X .62 .....	2
Ring Terminal .25" .....	1
Cover Plate Standard .....	1
Cover Plate Torque Wrench .....	1
Instruction Sheet G04.....	1

power pumps





**Order # G05**

Protect your system from unwanted contaminants with an easy to install **External Filter Kit**.

**External Filter Kit**

	Includes
Filter Block W/ Relief Assembly .....	1
Roll Pin .13 X .38 Lg .....	1
SHCS .38-16 X 5.25 .....	1
SHCS .38-16 X 6.25 .....	4
Instruction Sheet G05.....	1



**Order # G01**

Provide a safe distance from large loads with a handy 15 ft. heavy duty **Pendant Control Kit**.

**Pendant Motor Control Kit**

	Includes
Pendant Assembly .....	1
Membrane Switch Label .....	3
Decal Pendant Instruction .....	1
Simplex Decal .....	1
Instruction Sheet G01.....	1



**Order # G06**

Give your G Series pump mobility with heavy duty **Swivel Casters** for easier movement on tough terrain.

**Caster Kit**

	Includes
Caster Strip .....	2
Swivel Caster .....	4
Acorn Nut .38 - 16 Plated .....	4
FHCS .25 - 20 X .75 Length .....	4
Instruction Sheet G06.....	1

**\* Mounts Only To A: 1 - 1.5 - 2.5**

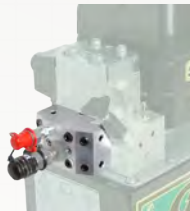

**Order # WMT4**

Run Up To 4 Different Tools To Add Versatility To Your G Series Pump With A **Multiport Adapter Kit**.

For Torque Wrench Pumps Only.

**Multi-Port Adapter Kit**

	Includes
Multi-Port Adapter Block .....	1
Valve Adapter Multiport Assembly .....	2
Pipe Plug .13" Flush W/ Coating .....	4
SHCS .25 - 20 X 2" Length .....	2
Hex Pipe Plug .25" W/ Coating.....	1
Instruction Sheet WMT4.....	1

# POWER PUMPS

Compact Foot Pumps - Air over Hydraulic



Air over Hydraulic



Air Foot Pump Family Shown

**Usable Oil Capacity** .....▶ **90 - 460 Gallons**  
**Weight** .....▶ **18.5 - 41 lbs.**  
**Maximum Pressure** .....▶ **10,000 psi**

- ▶ 3 position non-slip, diamond grip treadle for safe advance, hold & retract operation.
- ▶ Quiet operation - 85 dba @ 10,000 psi for in-house production.
- ▶ Rugged all metal construction.
- ▶ High quality rubber gasket seals.
- ▶ Integrated non-spill vent / oil level indicator.

**DETENT CLIP**  
 Pedal can be used to reduce operator strain by locking in the release position.

**NON-SKID FEET**  
 Four mountable non-skid rubber feet can be used to make your pump stationary.

**FOOT PEDAL**  
 A non-slip diamond plate texture gives the user safe and controlled foot pivoting action.

**SERVICE KITS**  
 A large selection of serviceable part kits are offered to reduce operating costs and down time.

## GA9 Series Cutaway View



Engineers selected the Simplex air pump when reliable 10,000 psi power was needed to run this production line fixture. ▼



Performance Chart

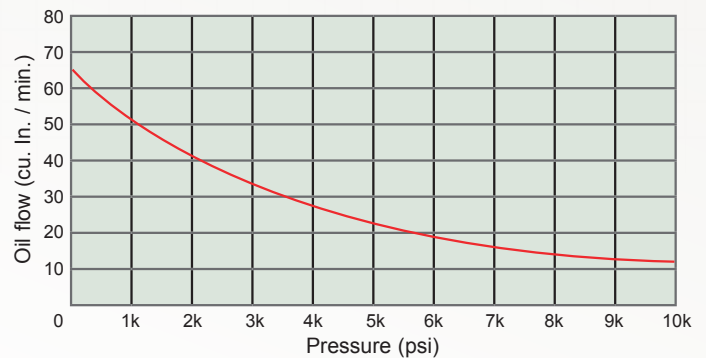

power pumps

# POWER PUMPS

Compact Foot Pumps - Air over Hydraulic



## GA9 - 90 cu. in. Reservoir

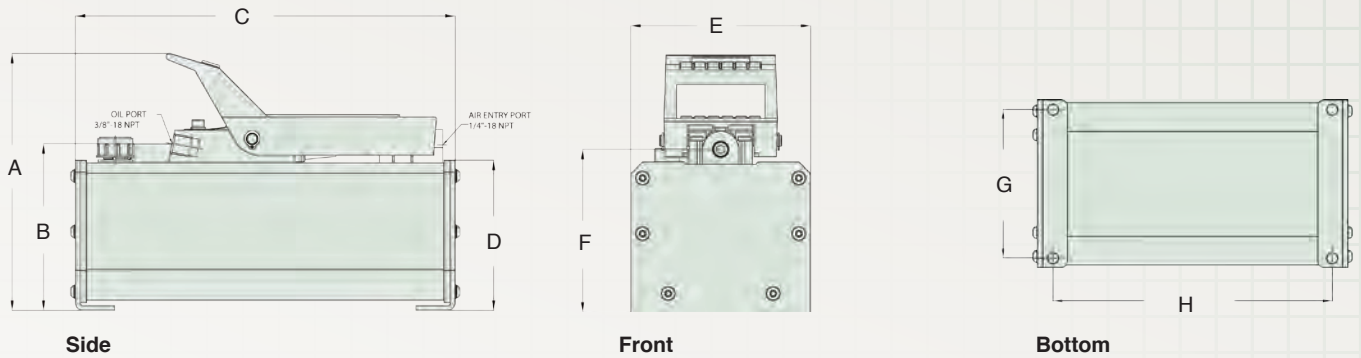

## GA9 - 230 / 460 cu. in. Reservoir

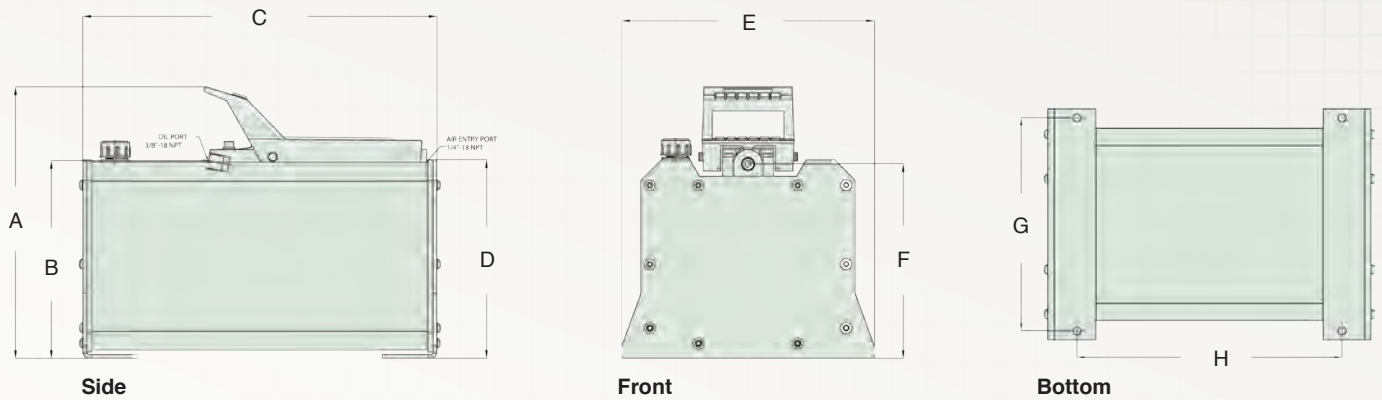

Model	Tool Type	Control	Usable Oil Capacity (cu. in.)	Oil Flow @ 0 psi (cu. in.)	Oil Flow @ 10,000 psi (cu. in.)	Operating Air Pressure Range (psi)	Weight (lbs)	Reservoir Sizes						Mounting Holes	
								A	B	C	D	E	F	G	H
GA90	S/A	Foot Pedal	90	68	11	60 - 150	18.5	8.38	5.32	10.69	4.81	5.81	5.25	5.01	9.27
GA9230	S/A	Foot Pedal	230	68	11	60 - 150	32.6	11.88	7.94	10.63	7.94	9.84	7.88	9.05	11.29
GA9460	S/A	Foot Pedal	460	68	11	60 - 150	41	11.88	7.94	14.06	7.94	9.84	7.88	9.05	11.29
GA90R	S/A	Pendant	90	68	8	60 - 150	23.5	8.38	5.32	10.69	4.81	5.81	5.25	5.01	9.27
GA9230R	S/A	Pendant	230	68	8	60 - 150	37.6	11.88	7.94	10.63	7.94	9.84	7.88	9.05	11.29
GA9230D	D/A	Valve	230	68	11	60 - 150	31.6	11.88	7.94	10.63	7.94	9.84	7.88	9.05	11.29
GA9460D	D/A	Valve	460	68	11	60 - 150	41	11.88	7.94	14.06	7.94	9.84	7.88	9.05	11.29

# SYSTEM ACCESSORIES



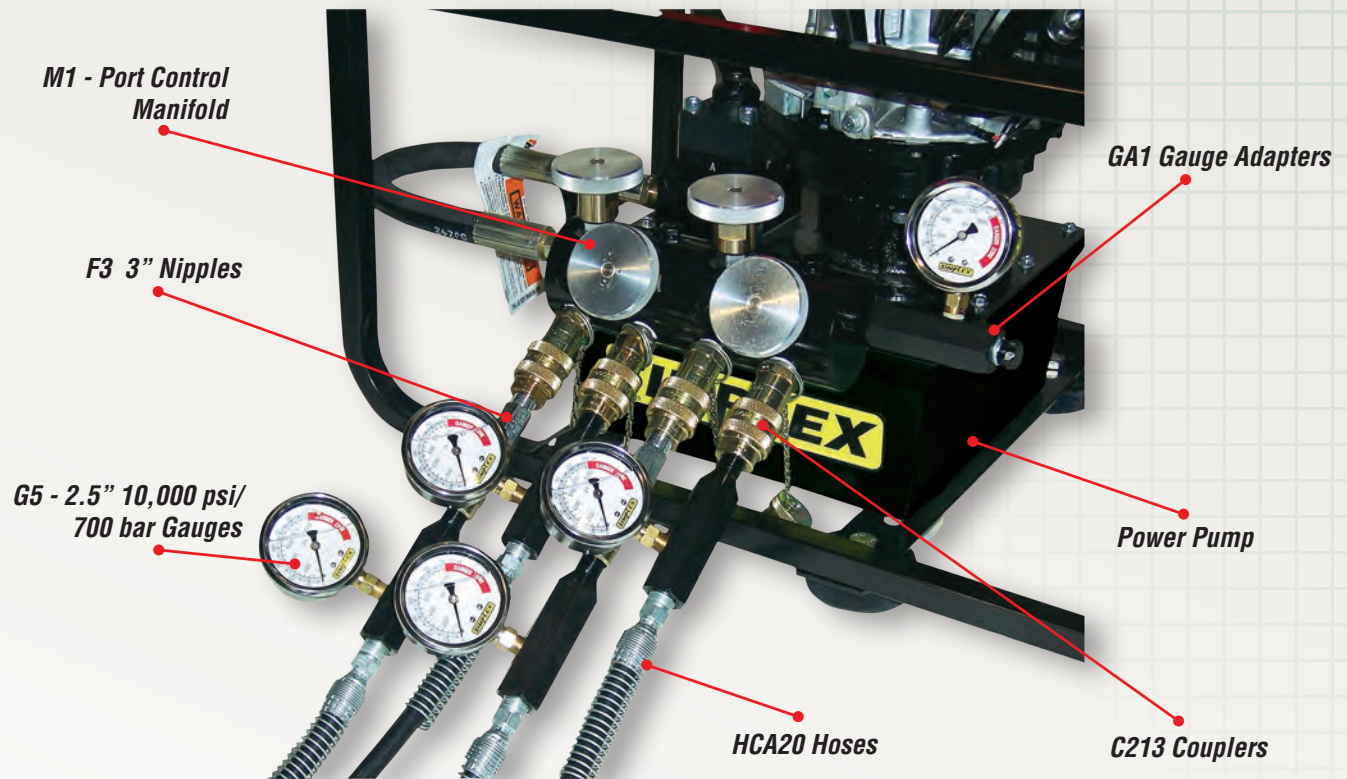

Pump with 4 Port Manifold Shown

## SIMPLEX SYSTEM ACCESSORY OVERVIEW

### ► Increase Your System Visibility

Monitor your system pressure and load by incorporating SIMPLEX liquid filled gauges in your hydraulic circuit. Also, SIMPLEX offers digital gauges to meet any demanding requirement for accuracy.

### ► Increase Your System Control

Take advantage of the wide selection of configured inline system valves to maximize individual tool speed for safe and efficient control.

### ► Load Holding

Add additional backup safety with the SIMPLEX V10E or V10EC load holding valve at each cylinder. Whether you need to throttle down the load or free flow in one direction, these compact and highly effective valves offer the flexibility and additional control needed at any jobsite.

### ► Flexibility

Select from a large assortment of SIMPLEX forged 10,000 psi fittings to customize your plumbing configurations to your individual requirements.

### ► Easy Setup

Simplify transport and setup of system arrangement with SIMPLEX 10,000 psi hydraulic hoses configured with quick disconnect couplers.

# SYSTEM ACCESSORIES

Proper Selection



## 2, 3 And 4 Way Control Valves



The 2 and 3 way valves are used to operate single acting cylinders and tools. The 4 way version is used to operate double acting cylinders or tools.

## In-Line Valves

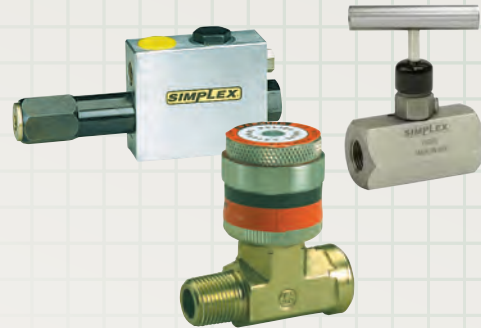

Maximize the control and safety factor of your system arrangement with our in-line valves.

## Manifolds

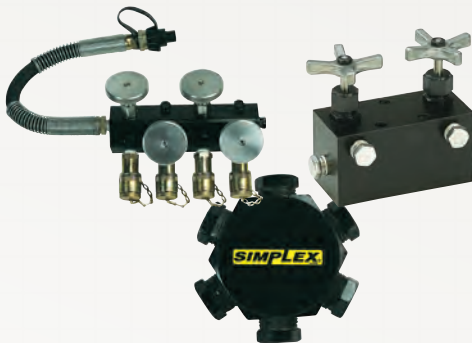

Manifolds are the central component of your system arrangement. Precision control needle valves and 3/8" ports are standard. Manifolds can be connected together to accommodate any size system.

## Couplers / Fittings



These couplers & fittings provide maximum fluid flow and are plated to resist corrosion. The no-spill style coupler is utilized where safety and environmental needs are a demand.

## Gauges



These analog and digital gauges give the operator a window to the system. Select from PSI or tonnage readings to meet your specific requirements. Simplex high pressure gauges offer reliability along with durability.

## Hoses



HD rubber and non-conductive thermo-plastic style hoses are ideal for demanding and continuous operation with up to a 4:1 safety factor.

### Detailed example of a 1 point lift, manually driven with check valve

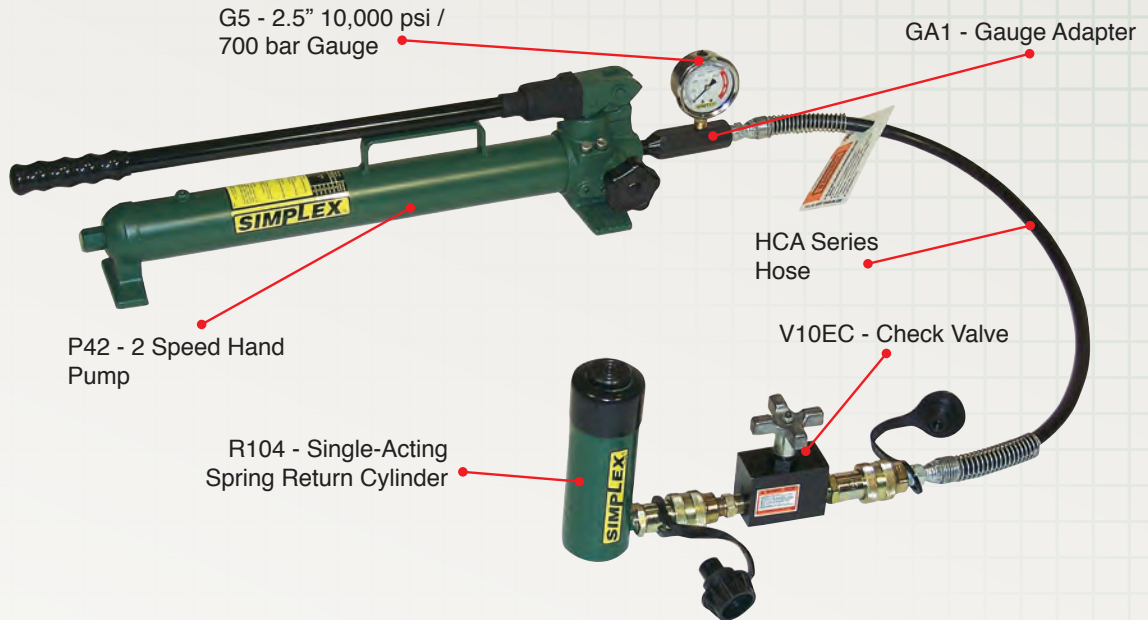



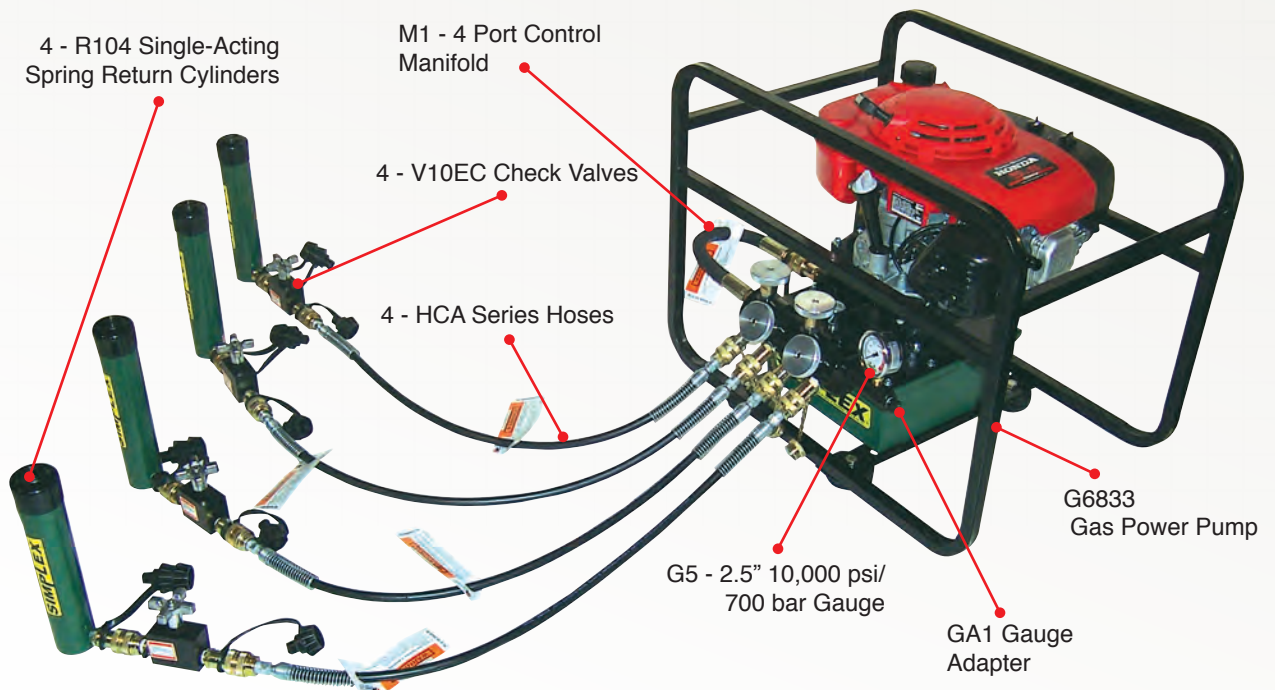







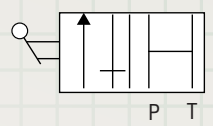
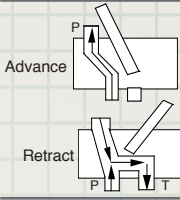

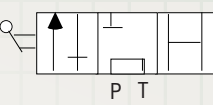
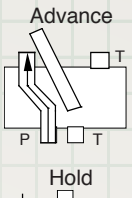
### Detailed example of a 4 point lift, gas driven with M1 manifold & check valves

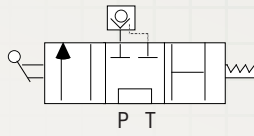
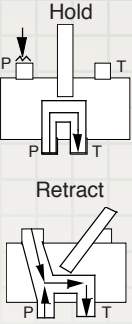

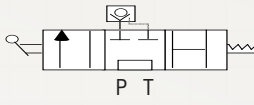
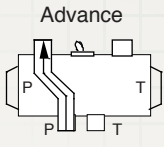
# SYSTEM ACCESSORIES

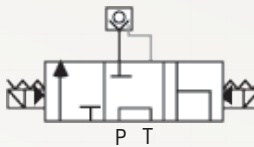
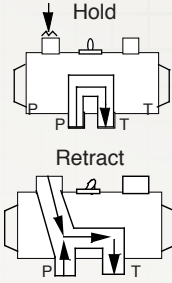

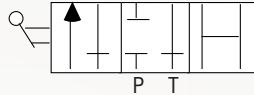
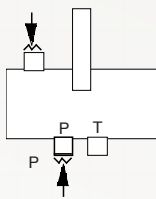

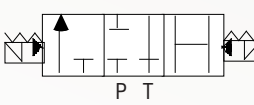
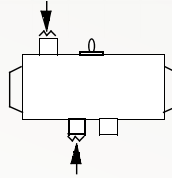



## 2 & 3 Way Control Valves

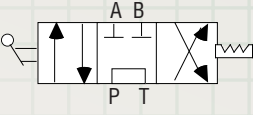
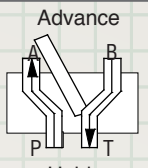
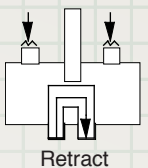
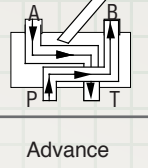

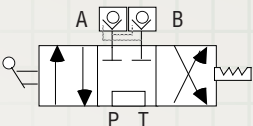
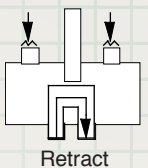
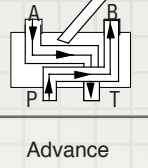

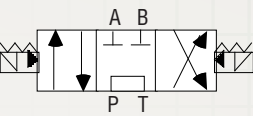
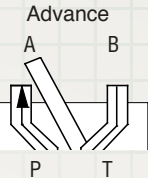
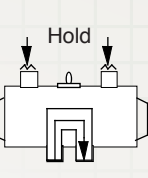
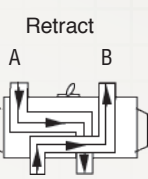
Model	Description	Hydraulic Schematic	Functional Flow Schematic
 VP2	Pump mounted, 2 position, 2 way valve is ideal for pressing, punching, crimping, staking or pulling applications when load holding is not needed.		
 VP3	Pump mounted, 3 position, 3 way valve is commonly used with single-acting cylinders for lifting applications or production work. The center position holds the load with the pump motor on or off.		
 VPL3	Pump mounted, 3 position, 3 way valve is the same as VP3, but with a built in pilot check valve. The VPL3 provides positive load holding in the center position, and will not allow pressure drop while shifting. Recommended for prestressing, post tensioning and precision holding applications.		
 VPS31	Pump mounted, electric solenoid actuated, 3 position, 3 way valve with remote pendant switch allows remote operation of system directional control. <b>For 230V, Use Model Number VPS32</b>		
 VPSL31	Pump mounted, electric solenoid actuated, 3 position, 3 way valve with remote pendant switch is the same as the VPS3, but with a built in pilot operated check valve. The VPSL31 provides positive load holding in the center position, and will not allow pressure drop while shifting. <b>For 230V, Use Model Number VPSL32</b>		
<b>Remote Mounted Valves - For Single Acting Cylinders &amp; Tools</b>			
 VRM3 & VR3CC	VRM3 is remote mounted, manual valve, 3 position, 3 way tandem center. <b>(reference VP3 schematic)</b> VR3CC is remote mounted, manual valve, 3 position, 3 way closed center.		
 VRS31 & VRS31CC	VRS31 is remote mounted, solenoid valve, 3 position, 3 way tandem center. <b>(reference VPS31 schematic)</b> <b>For 230V, Use Model Number VRS32</b> VRS31CC is remote mounted, solenoid valve, 3 position, 3 way closed center. <b>For 230V, Use Model Number VRS32CC</b>		

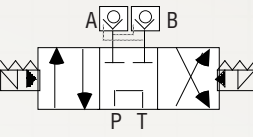
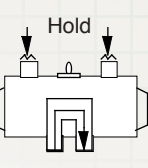
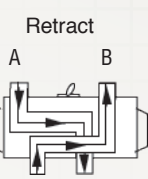
accessories

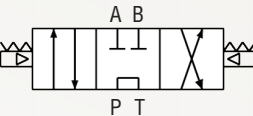
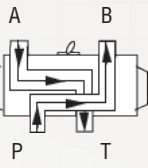

Model	Description	Hydraulic Schematic	Functional Flow Schematic
	<b>VP4</b> Pump mounted, 3 position, 4 way valve is used with double-acting cylinders and tools. This valve controls direction of oil for advancing, holding & retracting. The center position holds the load with the pump motor running or off.		 Advance  Hold  Retract
	<b>VPL4</b> Pump mounted, 3 position, 4 way valve is the same as VP4, but with a built in pilot check valve. The VPL4 provides positive load holding in the center position, and will not allow pressure drop while shifting. Recommended for prestressing and precision holding applications.		 Retract 
	<b>VPS41</b> Pump mounted, electric solenoid actuated, 3 position, 4 way valve with remote pendant switch. Same as VP4, but allows remote operation of directional control. <i>For 230V, Use Model Number VPS42</i>		 Advance  Hold  Retract
	<b>VPSL41</b> Pump mounted, electric solenoid actuated, 3 position, 4 way valve with remote pendant switch functions the same as VPS41, but with a built in pilot operated check valve. The VPSL41 provides positive load holding in the center position, and will not allow pressure drop while shifting. <i>For 230V, Use Model Number VPSL42</i>		 Retract 
	<b>VPA4</b> Pump mounted, air solenoid actuated, 3 position, 4 way valve with remote pendant switch. Same as VP4, but allows remote operation of directional control.		

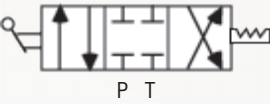
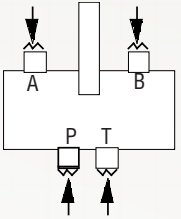

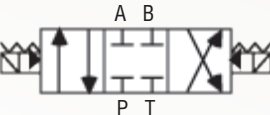
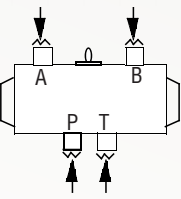





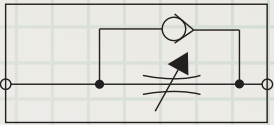

**Remote Mounted Valves - For Double Acting Cylinders & Tools**

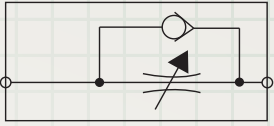
	<b>VR4 &amp; VR4CC</b> VR4 is remote mounted, manual valve, 3 position, 4 way tandem center. <b>(reference VP4 schematic)</b> VR4CC is remote mounted, manual valve, 3 position, 4 way closed center.	<b>VR4CC</b> 	
	<b>VRS41 &amp; VRS41CC</b> VRS41 is remote mounted, solenoid valve, 3 position, 4 way tandem center. <b>(reference VPS41 schematic)</b> <i>For 230V, Use Model Number VRS42</i> VRS41CC is remote mounted, solenoid valve, 3 position, 4 way closed center. <b>(reference VPS41 schematic)</b> <i>For 230V, Use Model Number VRS42CC</i>	<b>VRS41CC</b> 	

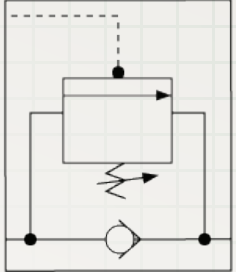



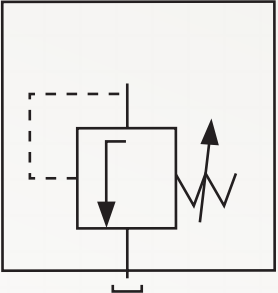

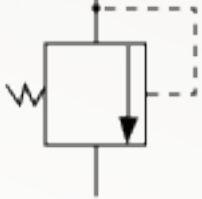

# SYSTEM ACCESSORIES

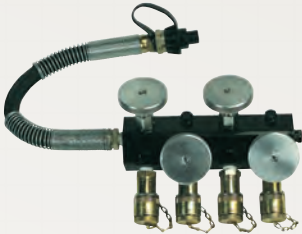
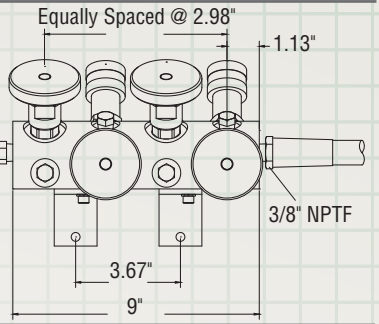
## In-Line System Valves

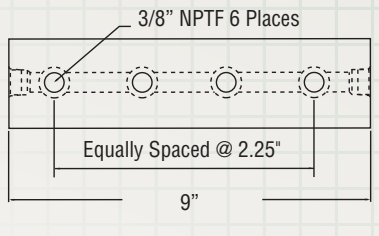

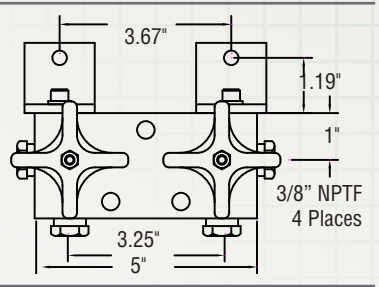
Model	Description	Hydraulic Schematic
	<p><b>Check Valve</b> automatically locks load in raised position as plunger is being extended. Protects against dropping the load due to pressure loss. Required for multiple cylinder lifting from one source. (Includes F1 - 3/8" porting Hex Nipple).</p>	
	<p><b>Check Valve</b> is a V10E with polarized high flow couplers for direct, rapid mounting to cylinder couplers.</p>	
	<p><b>Over Center Check Valve</b> can be mounted at the cylinder to hold the load in the event of system failure. Unlike other piloted check valves, the V2 provides controlled retraction without "chatter". <b>Note: When used in multiple cylinder systems, contact Simplex for minimum pump requirements.</b></p>	
	<p><b>Shut-Off Valve</b> is a needle-type valve for sustained load-holding and flow control. Use for positive shut-off or throttling. (3/8" porting NPTF)</p>	
	<p><b>In-line Adjustable Relief Valve</b> is for in-line mounting into hydraulic systems. Accurately controls maximum pressure from 800 to 10,000 psi. Turn handle until gauge indicates desired working pressure - tighten lock nut. Valve automatically opens and bypasses excess flow from system when preset pressure is reached. (Includes tubing &amp; fittings).</p>	
	<p><b>Safety Relief Valve</b> threads into top port of double-acting cylinders, or inline on hydraulic systems, for protection against over pressurizing. Pressure rating is set to 10,500 psi. (3/8" porting NPTF) 3/8"m - 3/8" f</p>	

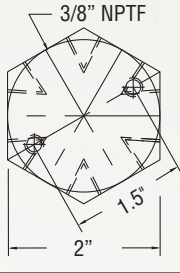
accessories

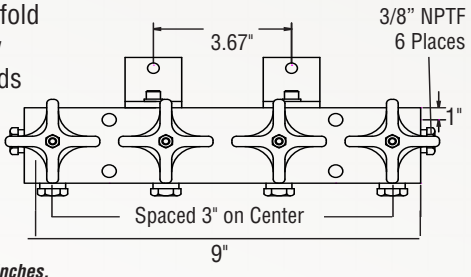
Model	Description	Technical Specifications
	<p><b>Pump Mounted 4 Cylinder Control Manifold Kit:</b> The M1 control manifold incorporates (4) station shut-off/flow control valves, 18" hose, gauge port, (4) high flow couplers and pump mounting hardware. Two or more manifolds can be coupled together for larger systems.  <b>For replacement hose order #89521</b></p> <p><i>All dimensions in inches.</i></p>	
	<p><b>Pump Mounted 4 Cylinder Manifold Kit:</b> The M2 manifold includes 18" hose and pump mounting hardware. Two or more manifolds can be coupled together for larger systems.  <b>For replacement hose order #89521</b></p> <p><i>All dimensions in inches.</i></p>	
	<p><b>Pump Mounted 2 Cylinder Control Manifold Kit:</b> The M2A control manifold incorporates (2) station shut-off/flow control valves. Two or more manifolds can be coupled together for larger systems.</p> <p><i>All dimensions in inches.</i></p>	
	<p><b>6 Port Inline Hex Manifold:</b> The M3 inline hex manifold features (6) - 3/8" NPTF threaded ports &amp; mounting holes.</p> <p><i>All dimensions in inches.</i></p>	
	<p><b>Pump Mounted 4 Cylinder Control Manifold Kit:</b> The M4A control manifold incorporates (4) station shut-off/flow control valves. Two or more manifolds can be coupled together for larger systems.</p> <p><i>All dimensions in inches.</i></p>	



# SYSTEM ACCESSORIES

## 1/4" NPTF Couplers





### 1/4" NPTF HIGH - FLOW COUPLERS

For use on smaller tools, pumps and any tool with 1/4" threads. These couplers are plated to resist corrosion. Cylinder Half Couplers have male 1/4" NPTF threads; Hose Half Couplers have female 1/4" NPTF threads.

Model	Description
 CT201	Ram Coupler Half with Dust Cap
 CT202	Hose Coupler Half with Dust Cap
 CT200	Ram & Hose Coupler Set with 2 Dust Caps





### 1/4" NPTF FLUSH FACE / NO SPILL COUPLERS - FOR BOLTING PRODUCTS

Unique flush face design features push to connect operation with an auto lock sleeve on the CT211, and non-spill "dry" disconnect operation. Easy cleaning minimizes system contamination. This coupler should be used wherever oil spillage constitutes a safety or environmental hazard. Couplers have 1/4" NPTF threads.

Model	Description
 CT210	Hose Coupler Half with Dust Cap
 CT211	Ram Coupler Half with Dust Cap
 CT212	Coupler Complete with 2 Dust Caps





### 3/8" NPTF HIGH - FLOW COUPLERS

These premium grade couplers provide maximum fluid flow and are plated to resist corrosion. Cylinder Half Couplers have male 3/8" NPTF threads & high strength rubber dust caps; Hose Half Couplers have female 3/8" NPTF threads.

Model	Description
 C213	Hose Coupler Half with Dust Cap
 C211	Ram Coupler Half with Dust Cap
 C209	Coupler Set Complete with 2 Dust Caps
 CR215	Dust Cap

### 3/8" NPTF FLUSH FACE / NO SPILL COUPLERS









Unique flush face design features push to connect operation with a sleeve lock, and non-spill "dry" disconnect operation. Easy cleaning minimizes system contamination. This coupler should be used wherever oil spillage constitutes a safety or environmental hazard. Couplers have 3/8" NPTF threads.

Model	Description
 C513	Hose Coupler Half
 C511	Ram Coupler Half
 C509	Coupler Set Complete with 2 Dust Caps
 C515 C516	Dust Cap Ram Half Dust Cap Hose Half

# SYSTEM ACCESSORIES

NPTF Fittings & Oil

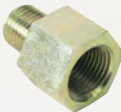

Model	Description	Model	Description
 F1	<b>Hex Nipple</b> 3/8" M NPTF Threads	 F10	<b>Reducer Fitting</b> 3/8" M to 1/4" F NPTF Threads
 F3	<b>3" Nipple</b> 3/8" M NPTF Threads	 F11	<b>Tee</b> 3/8" F NPTF Threads
 F6	<b>6" Nipple</b> 3/8" M NPTF Threads	 F13	<b>Coupling</b> 3/8" F NPTF Threads
 F7	<b>90° Elbow</b> 3/8" F NPTF Threads	 F15	<b>Cross Fitting</b> 3/8" F NPTF Threads
 F9	<b>90° St. Elbow</b> 3/8" M - 3/8" F NPTF Threads	 F17	<b>Reducer Fitting</b> 1/4" M to 3/8" F NPTF Threads

All fittings above are rated for 10,000 psi, and are engraved for added safety and readability.

## Gauge Adapter



GA1

Gauge Adapter Simplifies Your Connection Point

## Simplex Hydraulic Oil

Special, high pressure formulated, premium grade oil for all Simplex hydraulic products. High viscosity index ensures maximum lubricity over a wide range of operating temperatures.









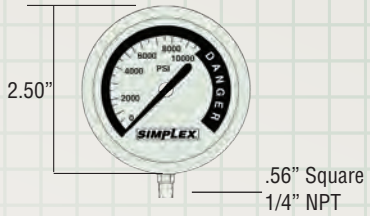

Model	Hydraulic Oil Quantity
A01	1 Gallon
A05	5 Gallons
A055	55 Gallons

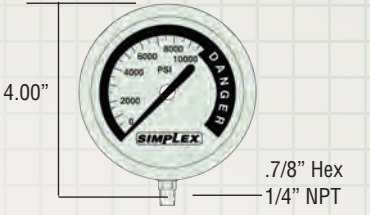
### Viscosity Index - 100 Minimum

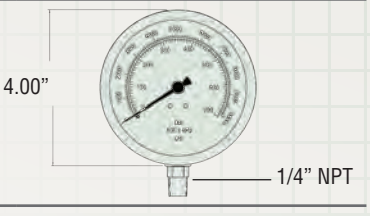
Vis, Ssu @ 100° F -	150 - 155
Vis, Ssu @ 210° F -	45 - 50
Vis, Ssu @ 0° F -	< 15,000
Pour Point -	-50° F
Flash Point -	400° F
Analine Point -	204.8° F

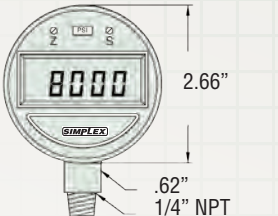
Includes: Anti-Foam, Anti-Rust And Low Temperature Additives

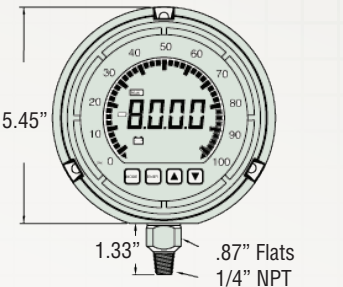
Model	Description	Dimensions
 <p><b>G5</b></p> <ul style="list-style-type: none"> <li>▶ Liquid filled dampens needle vibration.</li> <li>▶ Reads both PSI and Bar</li> <li>▶ 1% full scale accuracy.</li> <li>▶ 500 psi increment up to 10,000 PSI</li> <li>▶ Stainless steel casing.</li> </ul>	 <p>2.50" .56" Square 1/4" NPT</p>	
 <p><b>G6</b></p> <ul style="list-style-type: none"> <li>▶ 10,000 psi to 15,000 psi warning zone.</li> <li>▶ The calibrated scale reads from 0-10,000 psi</li> <li>▶ Reads both PSI and Bar</li> <li>▶ Liquid filled dampens needle vibration.</li> <li>▶ 1% full scale accuracy.</li> <li>▶ Large easy to read 4" face.</li> <li>▶ Rubber blowout plugs for safety.</li> <li>▶ Stainless steel casing.</li> </ul>	 <p>4.00" .7/8" Hex 1/4" NPT</p>	
 <p><b>G7</b></p> <ul style="list-style-type: none"> <li>▶ 10,000 psi to 15,000 psi warning zone.</li> <li>▶ The calibrated scale reads from 0-10,000 psi</li> <li>▶ Reads both PSI and Bar</li> <li>▶ Liquid filled dampens needle vibration.</li> <li>▶ 1% full scale accuracy.</li> <li>▶ Large easy to read 4" face.</li> <li>▶ Standard on all Simplex Torque Wrench Pumps.</li> </ul>	 <p>4.00" 1/4" NPT</p>	
 <p><b>GD1</b></p> <ul style="list-style-type: none"> <li>▶ Designed for high cycle pressure applications</li> <li>▶ Self powered Lithium batteries.</li> <li>▶ Full 4 digit display.</li> <li>▶ + / - .25% full scale accuracy.</li> <li>▶ 10 million cycle life minimum.</li> <li>▶ Stainless steel sensor that is vibration &amp; shock resistant.</li> <li>▶ The calibrated scale reads from 0-10,000 psi</li> </ul>	 <p>2.66" .62" 1/4" NPT</p>	
 <p><b>GD2</b></p> <ul style="list-style-type: none"> <li>▶ .75" characters and 270° bar graph "analog" readout.</li> <li>▶ Splash proof phenolic housing.</li> <li>▶ + / - .25% full scale accuracy.</li> <li>▶ Keypad enable/disable of peak high or peak low hold.</li> <li>▶ Stainless steel sensor that is vibration &amp; shock resistant.</li> <li>▶ The calibrated scale reads from 0-10,000 psi</li> </ul>	 <p>5.45" 1.33" .87" Flats 1/4" NPT</p>	

accessories

### Scaled Tonnage Gauges For Simplex Cylinders









Model	Cylinder Tonnage	Face Diameter	Applicable Cylinder Series
GT5	5, 10, 15	4"	R5, R10, R15, RFS10, RLS101, RDA1010
GT20	20, 50	4"	RLS201, RLS502, RLS1002, RFS20, RFS50, RFS100
GT25	25, 55, 100	4"	R25, R55, RDA55, R100
GT30	30, 50, 100	4"	R308, RLS302, RFS30, RLN30, RLN50, RLN100, RLR306, RLR50, RLR100
GT100	150, 200	4"	RDA100, RDA200, RFS150, RLN150, RLN200, RLR150, RLR200
GT150	100, 150, 200	4"	RDA150
GTH12	12, 20, 30	4"	RC12, RC20, RC30, RCD30
GTH60	60, 100, 150	4"	RC60, RC1003, RCD6010, RCD100, RCD1505

# SYSTEM ACCESSORIES

## High Pressure Hoses









**HA & HCA Industrial Grade .25" I.D.** series hoses are rated at 10,000 psi operating pressure and 20,000 psi minimum burst pressure. This hose is the recommended choice for hand pump & cylinder sets, as well as a wide range of other intermittent applications. ▼

Model	Length (ft)	Hose Ends		I.D. (in)
HA3	3	 3/8" NPTF Male	 3/8" NPTF Male	.25"
HA6	6			
HA10	10			
HA20	20			
HA36	36			
HA50	50			
HCA3	3	 3/8" NPTF Male	 C213 Coupler*	
HCA6	6			
HCA10	10			
HCA20	20			
HCA36	36	 C213 Coupler*	 C213 Coupler*	
HCA50	50			

\*All hoses with couplers includes CR215 Dust Cap.

**High Flow HD & HDC .38" I.D.** series hoses are recommended to achieve higher retraction speeds and minimal flow restrictions. These heavy duty hoses are rated at 10,000 psi with a minimum burst pressure of 30,000 psi. ▼





Model	Length (ft)	Hose Ends		I.D. (in)
HD3	3	 3/8" NPTF Male	 3/8" NPTF Male	.38"
HD6	6			
HD10	10			
HD20	20			
HD50	50			
HDC3	3	 3/8" NPTF Male	 C213 Coupler*	
HDC6	6			
HDC10	10			
HDC20	20			
HDC50	50	 C213 Coupler*	 C213 Coupler*	

\*All hoses with couplers includes CR215 Dust Cap.

accessories









**Non-Conductive Thermo Plastic HR & HRC** series hoses are for those special applications where non-conductivity is a must. The HR & HRC series hose operates at 10,000 psi working and 40,000 psi burst, (4:1 safety factor). Light weight and durable, the multi-layered design complies with M.H.I. I.J.100 hose specifications. Orange in color, the HR and HRC are easily identified from standard conductive hoses. ▼

Model	Length (ft)	Hose Ends		I.D. (in)
HR3	3	 3/8" NPTF Male	 3/8" NPTF Male	.25"
HR6	6			
HR10	10			
HR20	20			
HRC3	3	 3/8" NPTF Male	 C213 Coupler*	
HRC6	6			
HRC10	10			
HRC20	20			





\*All hoses with couplers includes CR215 Dust Cap.

**Thermo-Plastic HP & HPC** series hoses are recommended for demanding applications. Along with their distinctive green color, the HP & HPC series hoses boast a 10,000 psi working, 40,000 psi minimum burst, (4:1 safety factor) and a tough polyurethane outer cover that resists abrasion and wear. Well suited for continuous duty, the reinforced polyester and carbon steel wire design contributes to low volume expansion, minimized fatigue and enhanced system efficiencies. ▼

Model	Length (ft)	Hose Ends		I.D. (in)
HP3	3	 3/8" NPTF Male	 3/8" NPTF Male	.25"
HP6	6			
HP10	10			
HP36	36			
HP50	50			
HPC3	3	 3/8" NPTF Male	 C213 Coupler*	
HPC6	6			
HPC10	10			
HPC20	20			
HPC36	36	 C213 Coupler*	 C213 Coupler*	
HPC50	50			

\*All hoses with couplers includes CR215 Dust Cap.

**Heavy Duty HE & HEC** series hoses are for demanding and continuous duty applications that require 10,000 psi working and 40,000 psi burst, (4:1 safety factor) but where rubber coated, steel wire braid design is preferred. These hoses are well suited in operating temperatures up to 150° F. ▼

Model	Length (ft)	Hose Ends		I.D. (in)
HE6	6	 3/8" NPTF Male	 3/8" NPTF Male	.25"
HE10	10			
HE20	20			
HEC6	6	 3/8" NPTF Male	 C213 Coupler*	
HEC10	10			
HEC20	20			

\*All hoses with couplers includes CR215 Dust Cap.

bolting

# BOLTING PRODUCTS

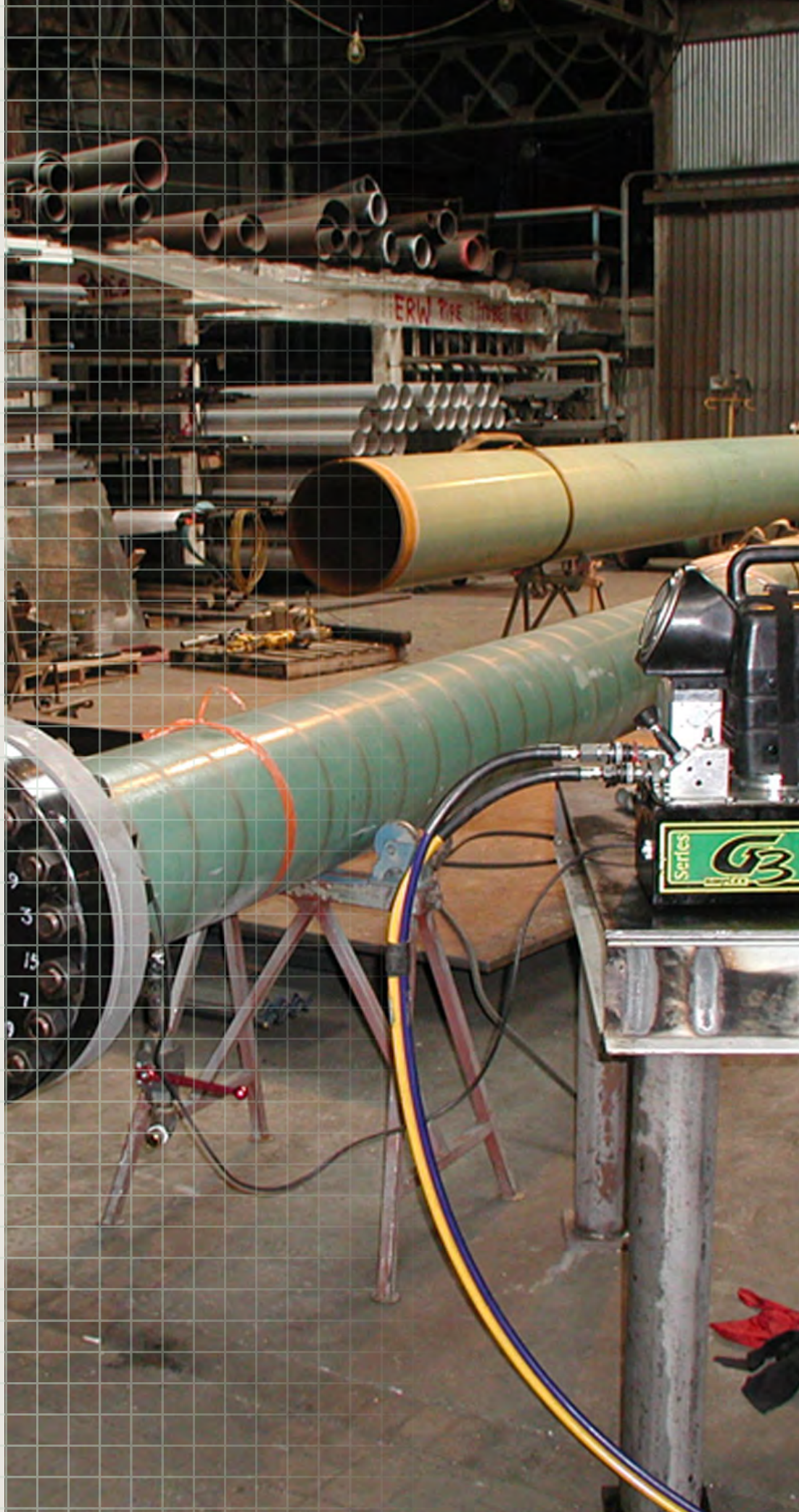

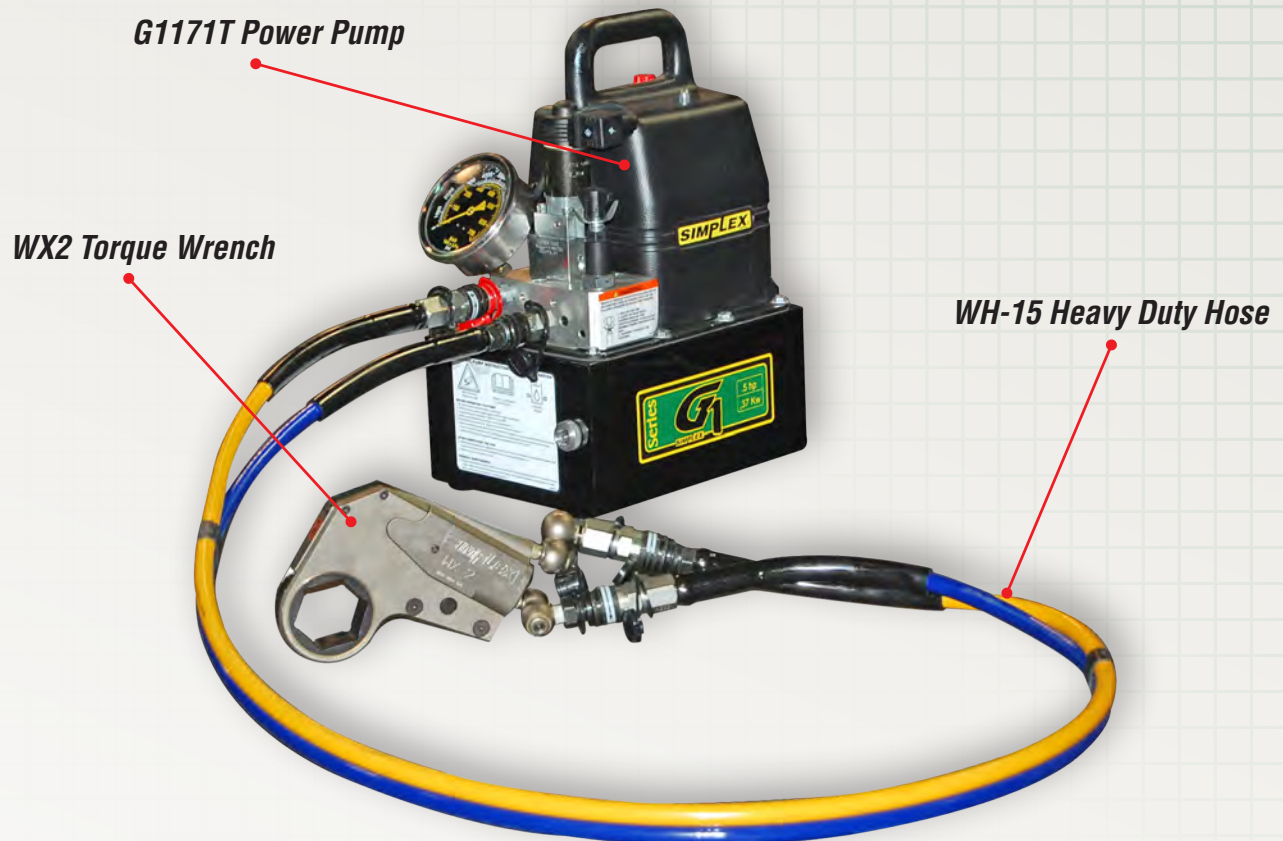

Standard Bolting Model Shown

## SIMPLEX BOLTING PRODUCTS OVERVIEW

### ► Bolting Features

Simplex offers a wide variety of hydraulic torque wrenches available in square drive design or low clearance wrenches. These tools are the most versatile in the business. Optional attachments and accessories are available to complement both style wrenches.

### ► WT-Series Square Drive Wrenches

The Simplex square drive wrench combines strength and simplicity to handle the toughest bolting jobs. Simplex square drive wrenches come with a push through drive in the .75", 1" and 1.5" models, eliminating pulling the drive out of a wrench to change drive direction. The WT-Series wrenches can react off the wrench body for close quarter applications. Several optional accessories are available.

### ► WX-Series Low Clearance Wrenches

Simplex Low Clearance wrenches are the flattest wrenches available, utilizing a patented low height piston. The Simplex WX series wrenches fit in places competitive wrenches cannot. The low clearance wrenches have a wide choice of links available in .06" increments. Metric sizes are also available. Several optional accessories are available such as hex reducers, hex to square drive adaptors and different reaction arms.

### ► Bolting Accessories

Simplex torque wrench pumps are available in both electric and air power. Simplex electric pumps are smooth running, continuous duty pumps with permanent magnet motors that will start and run under full load on as little as 60VAC. An integrated auto shut-off switch, along with a steel reservoir, keeps the oil and pump cool and helps prevent pump breakdown. Hoses are twin style with a 4:1 safety factor and the pump mounted gauge reads out in 100 psi increments.

# BOLTING PRODUCTS

Proper Size & Selection

**SIMPLEX**

## G1 Bolting Pump

19 cu.in. / min. @ 10,000 psi



*An intermittent .5 hp pump that is best suited to power small size torque wrenches. It's easy to transport and very lightweight.*

Starting weight @ 36 lbs.

## G5 Bolting Pump

55 cu.in. / min. @ 10,000 psi



*A continuous duty 1.5 hp pump that is best suited for medium to large torque wrenches.*

Starting weight @ 75 lbs.

## G3 Bolting Pump

46 cu.in. / min. @ 10,000 psi



*A continuous duty 1.13 hp pump that is best suited to power small to medium torque wrenches. Ideal for systems that require high performance, with lightweight portability.*

Starting weight @ 57 lbs.

## G5 Bolting Pump - Air

55 cu.in. / min. @ 10,000 psi



*A continuous duty air pump that is best suited for medium to large size torque wrenches. The high flow rate runs multiple tools efficiently.*

Starting weight @ 75 lbs.

## Bolting Wrenches

Square Drive & Low Clearance Wrenches

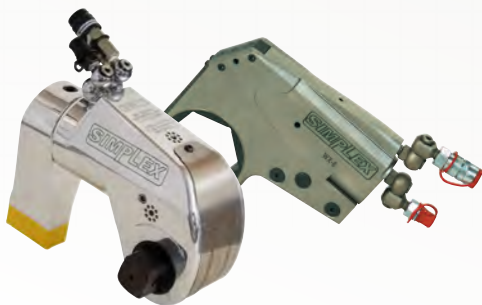

*Simplex offers a wide variety of hydraulic wrenches available in lightweight square drive design or the flat low clearance design. Optional attachments and accessories are available for both style wrenches to simplify your task.*

## Hoses & Manifolds



*A complete set of high performance, high pressure hose styles and sizes are available to fit any application, along with an 8 port manifold allowing the user the ability to use up to four tools at once.*

## Selecting The Bolting System



### Selecting The Proper Pump

All SIMPLEX bolting pumps are configured specifically for bolting applications. Each “turnkey” power pump includes polarized couplers, external adjustable relief valve, pump mounted gauge and optional multi-port manifold for multiple tools. When selecting a power pump, consider the power requirements; air, 115 vac or 230 vac, 2nd stage hydraulic flow, pump operating / interval time, number of tools being operated and weight. Refer to the internal pages for details.



### Selecting The Proper Hose

All SIMPLEX hoses are thermo-plastic, banded together, color coded and polarized for plug and play operation. Lengths are available in 15, 20 and 40 feet. Each bolting hose has a 4:1 safety factor that provides you with the flexibility to meet any project requirement.



### Selecting The Proper Tool

A hydraulic torque wrench is a tool used to precisely set the hydraulic torque of a fastener such as a nut or bolt. Our hydraulic torque wrenches are available in a square drive and low profile design. Consider the amount of torque, footprint requirements and reaction area when selecting your wrench.

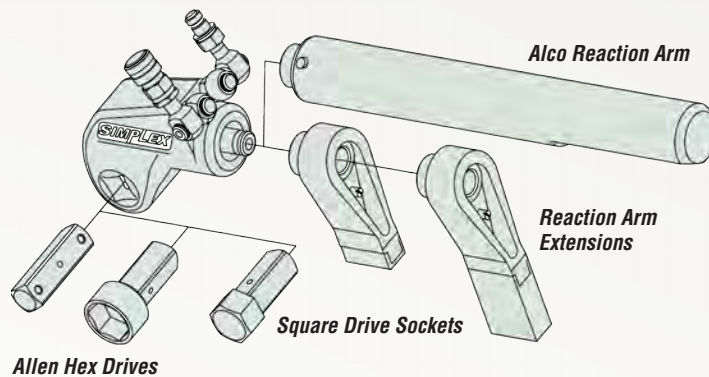

### WT Series Square Drive Wrench

Simplex square drive wrenches come with a push through drive in the .75", 1" and 1.5" models, eliminating pulling the drive out of a wrench to change drive direction. The WT Series wrenches can react off the wrench body for close quarter applications. Several optional accessories such as Alco Reaction Arms, extensions and sockets are available for your specific needs.

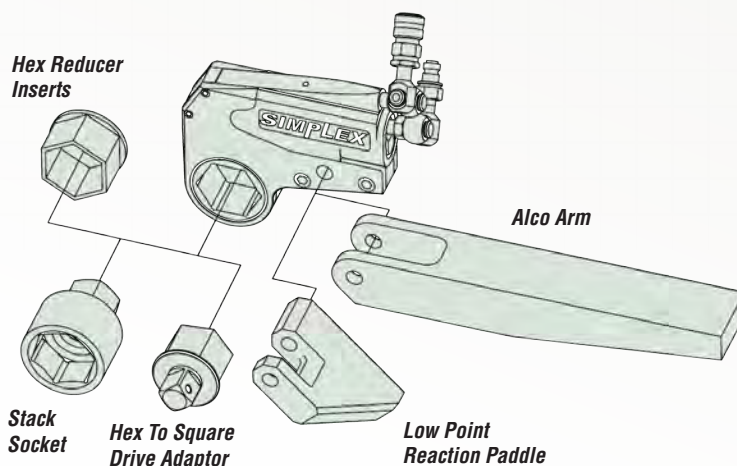

### WX Series Low Clearance Wrench

Simplex low clearance wrenches fit in places that competitive style wrenches cannot. The low clearance wrenches have a wide choice of links available in .06" increments. Several optional accessories are available such as hex reducers, hex to square drive adaptors and different reaction arms.

# BOLTING PUMPS

G1 Series - Electric

**SIMPLEX**



G1171T Shown



**THINK SAFETY**

Please refer to pages 4&5 for a complete list of safety tips and recommendations.



**TORQUE WRENCHES - pages 88 - 91**

Torque wrenches available in lightweight square drive, or low clearance wrenches.



**TORQUE HOSES - page 89**

Heavy duty, thermo-plastic torque wrench hoses to meet your requirements.

- Reservoir Capacity** .....▶ **1 Gallon**
- Weight** .....▶ **36 lbs.**
- Maximum Pressure** .....▶ **10,000 PSI**

- ▶ Light weight bolting pump equipped with an integrated gauge, adjustable relief and 15' remote power controlled pendant.
- ▶ Powered by a 115V - 60Hz, .5 hp universal motor (14,640 rpm).
- ▶ Low startup voltage, draws 10 amps at full load (230V model available).
- ▶ Two-speed pump operation provides fast tool performance.

The G1 bolting pump along with a WX series low clearance torque wrench was used to tighten the footing of this support tower. ▼

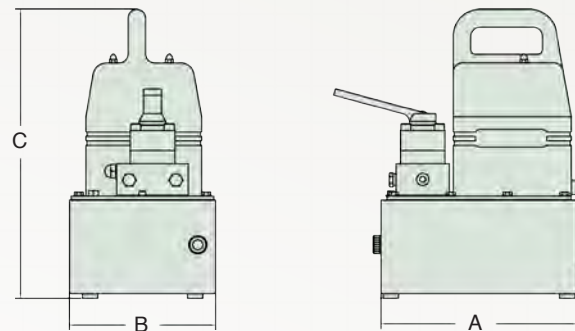

Reservoir (Gallons)	A	B	C
	(in)	(in)	(in)
1 (metal)	11	8.17	16.17

\* For 230 VAC pump use "2" in the 3rd character of the model number. Motor specifications 0,37 kw single phase, 5 amps @ 230 VAC.

Model	Pressure Rating (psi)		Output Flow (cu.in./min.)		Motor Spec.		Valve Type	Pendant Control	Usable Oil (Gallon)	Weight (lbs)
	1st Stage	2nd Stage	1st Stage	2nd Stage	(vac)	(amps)				
G1171T	400	10,000	250	19	115	10	4W, 2P	Motor / Solenoid	1	36

bolting



G3171T Shown

- Reservoir Capacity** ..... ➤ **1 - 2.5 Gallons**
- Weight** ..... ➤ **57 - 69 lbs.**
- Maximum Pressure** ..... ➤ **10,000 PSI**

- ▶ Heavy Duty bolting pump is ideal for use with small to mid-sized torque wrenches.
- ▶ High performance two-stage pump provides higher cross-over pressure for faster cycle times and tool operation; 46 cubic inches / minute @ 10,000 PSI.
- ▶ Powered by a 115V - 60Hz, 1-1/8 hp universal motor.

The ease of operation and mobility from the G3 bolting pump was needed to repair the massive chuck on this CNC machine. ▼



**TORQUE HOSES - page 89**

Heavy duty, thermo-plastic torque wrench hoses to meet your requirements.



**TORQUE WRENCHES - pages 88 - 91**

Torque wrenches available in lightweight square drive, or low clearance wrenches.

**G3 Bolting Pump Factory Installed Options**

For ordering, add option letter to end of the model number.

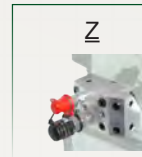

Multi-Port Manifold

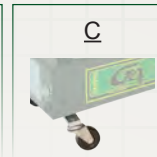

Caster Kit



Roll Cage

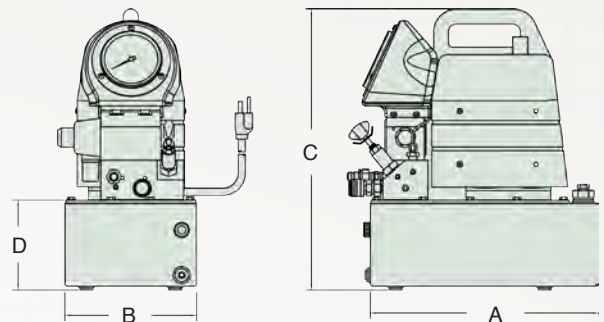

Reservoir (Gallons)	A	B	C	D
	(in)	(in)	(in)	(in)
1.5	15.13	8.75	19	5.96
2.5	17	9.75	19	5.96

\* For 230 VAC pump use "2" in the 3rd character of the model number. Motor specifications 0,8 kw single phase, 10 amps @ 230 VAC.

Model	Pressure Rating (psi)		Output Flow (cu.in./min.)		Motor Spec.		Valve Type	Pendant Control	Usable Oil (Gallons)	Weight (lbs)
	1st Stage	2nd Stage	1st Stage	2nd Stage	(vac)	(amps)				
G3171T	1,100	10,000	525	46	115	16	4W, 2P	Motor / Solenoid	1	57
G3172T	1,100	10,000	525	46	115	16	4W, 2P	Motor / Solenoid	1.5	62
G3173T	1,100	10,000	525	46	115	16	4W, 2P	Motor / Solenoid	2.5	69

bolting

# BOLTING PUMPS

G5 Series - Electric

**SIMPLEX**



G5172T Shown

**Reservoir Capacity** ..... ➤ **1.5 - 2.5 Gallons**  
**Weight** ..... ➤ **75 - 85 lbs.**  
**Maximum Pressure** ..... ➤ **10,000 PSI**

- ▶ Heavy Duty bolting pump configuration is ideal for use with mid to large sized torque wrenches.
- ▶ Powered by a 115V - 60Hz, 1-1/2 hp permanent magnet motor (3,000 rpm); low startup voltage, draws 18 amps at full load (230V models available).
- ▶ High performance two-stage pump provides higher cross-over pressure for faster cycle times and tool operation.

*The G5 pump had the flexibility and power to be instrumental in the construction of the blade section on this wind turbine. ▼*



## TORQUE HOSES - page 89

Heavy duty, thermo-plastic torque wrench hoses to meet your requirements.



## TORQUE WRENCHES - pages 88 - 91

Torque wrenches available in lightweight square drive, or low clearance wrenches.

## G5 Bolting Pump Factory Installed Options

For ordering, add option letter to end of the model number.

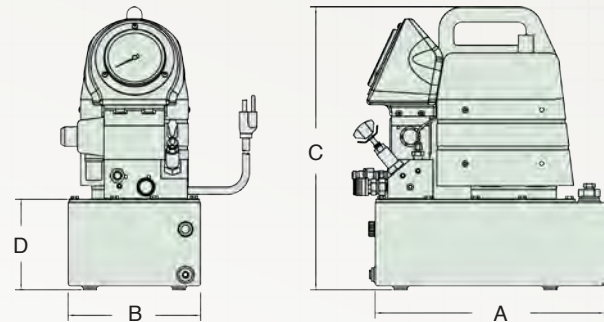
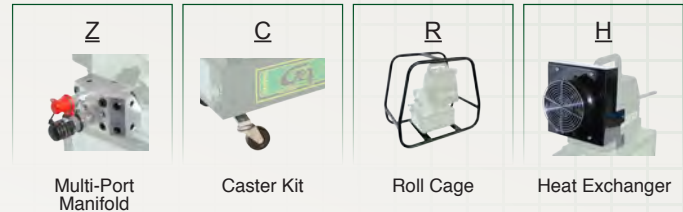

Reservoir (Gallons)	A	B	C	D
	(in)	(in)	(in)	(in)
1.5	15.13	8.75	19	5.96
2.5	17	9.75	19	5.96

Larger capacities available upon request.

\* For 230 VAC pump use "2" in the 3rd character of the model number. Motor specifications 1,1 kw single phase, 10 amps @ 230 VAC.

Model	Pressure Rating (psi)		Output Flow (cu.in./min.)		Motor Spec.		Valve Type	Pendant Control	Usable Oil (Gallons)	Weight (lbs)
	1st Stage	2nd Stage	1st Stage	2nd Stage	(vac)	(amps)				
G5172T	1,200	10,000	500	55	115	18	4W, 2P	Motor / Solenoid	1.5	75
G5173T	1,200	10,000	500	55	115	18	4W, 2P	Motor / Solenoid	2.5	85





G5772T Shown

**Reservoir Capacity** ..... ➤ **1.5 - 2.5 Gallons**  
**Weight** ..... ➤ **75 - 85 lbs.**  
**Maximum Pressure** ..... ➤ **10,000 PSI**

- ▶ Powered by a rotary air vane, 3 hp motor (3,000 rpm).
- ▶ Equipped with a filter-lubricator assembly, air muffler, adjustable relief and 12' remote controlled pendant on all models.
- ▶ High performance two-stage pump provides higher cross-over pressure for faster cycle times and tool operation; 55 cubic inches / minute @ 10,000 PSI.

A Simplex G5 Air pump is used with a WT-2 to remove the shroud on this steel cutter. ▼



**TORQUE HOSES - page 89**

Heavy duty, thermo-plastic torque wrench hoses to meet your requirements.



**TORQUE WRENCHES - pages 88 - 91**

Torque wrenches available in lightweight square drive, or low clearance wrenches.

**G5 Air Bolting Pump Factory Installed Options**

For ordering, add option letter to end of the model number.

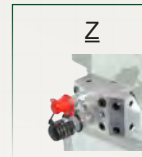

Multi-Port Manifold

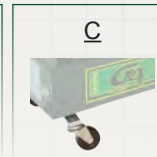

Caster Kit



Roll Cage

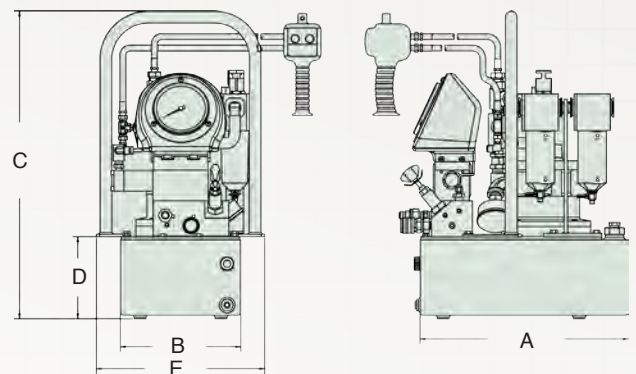

Larger capacities available upon request.

Reservoir (Gallons)	A	B	C	D	E
	(in)	(in)	(in)	(in)	(in)
1.5	15.13	8.75	22.34	5.96	12.24
2.5	17	9.75	22.34	5.96	13.24

Model	Pressure Rating (psi)		Output Flow (cu.in./min.)		Motor Spec.		Valve Type	Pendant Control	Usable Oil (Gallons)	Weight (lbs)
	1st Stage	2nd Stage	1st Stage	2nd Stage	(psi)	(cfm)				
G5772T	1,200	10,000	700	55	90	50	4W, 2P	Motor / Solenoid	1.5	75
G5773T	1,200	10,000	700	55	90	50	4W, 2P	Motor / Solenoid	2.5	85

bolting

# TORQUE WRENCHES

WT Series - Square Drive



WT2, WT3 & WT5 Shown

**Maximum Torque @ 10,000 psi** ▶ **27,200 Ft. Lbs.**  
**Square Drive Range** .....▶ **.75 - 2.5 In.**  
**Maximum Pressure** .....▶ **10,000 PSI**

- ▶ Hardened alloy square drive provides long life.
- ▶ No reaction pawl eliminates tool lockup.
- ▶ 27 degree stroke for high performance & speed.
- ▶ Push through square drive switches from tighten to loosen instantly.
- ▶ No leak couplers that swivel on double axis for ease of operation.
- ▶ Anti-Backlash mechanism prevents tool from back-driving.

## THINK SAFETY

Please refer to pages 4&5 for a complete list of safety tips and recommendations.



## BOLTING PUMPS - pages 81 - 87

Torque wrench pumps are available in both electric and air power.



## TORQUE HOSES - page 89

Heavy duty, thermo-plastic torque wrench hoses to meet your requirements.



*Lightweight, easy to use and reliable - The WT-5 torque wrench is used to certify flange assemblies in this fabricating shop. ▼*

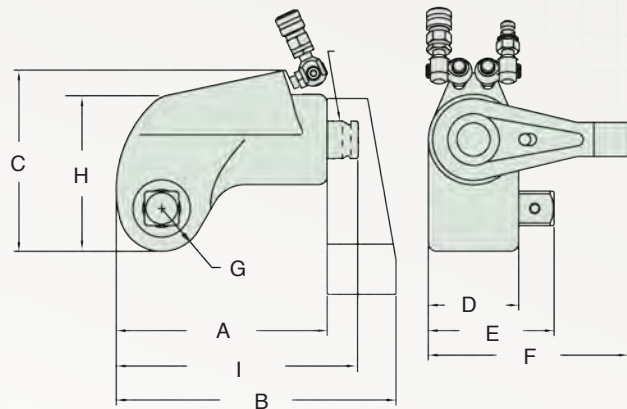
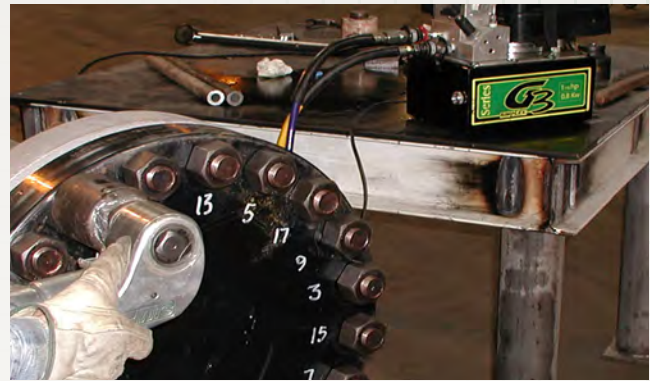

Model	A	B	C	D	E	F	G	H	I	Wgt. (lbs.)	Output (ft./lbs.)	Square Drive (in)	Available Socket Size (in)	Available Socket Size (mm)
	Length (in)	Length (in)	Height (in)	Width (in)	Width (in)	Width (in)	Radius (in)	Height (in)	Length (in)					
WT-2	4.68	6.10	4.20	2	2.76	4.42	.98	3.42	5.32	3.9	1,270	.75	.5 - 2.38	13 - 60
WT-3	6.10	8.10	5.30	2.62	3.68	5.81	1.30	4.54	6.68	9	3,330	1	.75 - 4.5	19 - 114
WT-5	8	10.74	6.99	3.61	5.06	7.98	1.70	6.05	9.48	19	7,170	1.5	1.31 - 5.38	33 - 137
WT-10	9.21	12.21	7.79	3.93	5.43	8.72	1.95	6.70	10.36	29	11,010	1.5	1.31 - 5.38	33 - 137
WT-27	12.29	16.29	10.19	5.26	7.73	11.63	2.43	8.82	13.87	70	27,200	2.5	1.62 - 9.25	41 - 235

bolting



**Sockets For .75", 1" And 1.5" Drive Wrenches**

Model Number for .75" Drive WT-2	Socket Size (in)	Model Number for 1" Drive WT-3	Socket Size (in)	Model Number for 1" Drive WT-3	Socket Size (in)	Model Number for 1" Drive WT-3	Socket Size (in)	Model Number for 1.5" Drive WT-5 & 10	Socket Size (in)	Model Number for 1.5" Drive WT-5 & 10	Socket Size (in)
WST1212	.75 x .75	WST1612	1 x .75	WST1633	1 x 2.06	WST1654	1 x 3.38	WST2422	1.5 x 1.38	WST2443	1.5 x 2.68
WST1213	.75 x .81	WST1613	1 x .81	WST1634	1 x 2.13	WST1655	1 x 3.44	WST2423	1.5 x 1.44	WST2444	1.5 x 2.75
WST1214	.75 x .87	WST1614	1 x .87	WST1635	1 x 2.19	WST1656	1 x 3.5	WST2424	1.5 x 1.5	WST2445	1.5 x 2.81
WST1215	.75 x .93	WST1615	1 x .93	WST1636	1 x 2.25	WST1657	1 x 3.56	WST2425	1.5 x 1.56	WST2446	1.5 x 2.87
WST1216	.75 x 1	WST1616	1 x 1	WST1637	1 x 2.31	WST1658	1 x 3.62	WST2426	1.5 x 1.62	WST2447	1.5 x 2.93
WST1217	.75 x 1.06	WST1617	1 x 1.06	WST1638	1 x 2.38	WST1659	1 x 3.68	WST2427	1.5 x 1.68	WST2448	1.5 x 3
WST1218	.75 x 1.13	WST1618	1 x 1.13	WST1639	1 x 2.44	WST1660	1 x 3.75	WST2428	1.5 x 1.75	WST2449	1.5 x 3.06
WST1219	.75 x 1.19	WST1619	1 x 1.19	WST1640	1 x 2.5	WST1661	1 x 3.81	WST2429	1.5 x 1.81	WST2450	1.5 x 3.13
WST1220	.75 x 1.25	WST1620	1 x 1.25	WST1641	1 x 2.56	WST1662	1 x 3.87	WST2430	1.5 x 1.87	WST2451	1.5 x 3.19
WST1221	.75 x 1.31	WST1621	1 x 1.31	WST1642	1 x 2.62	----	----	WST2431	1.5 x 1.93	WST2452	1.5 x 3.25
WST1222	.75 x 1.38	WST1622	1 x 1.38	WST1643	1 x 2.68	----	----	WST2432	1.5 x 2	WST2453	1.5 x 3.31
WST1223	.75 x 1.44	WST1623	1 x 1.44	WST1644	1 x 2.75	----	----	WST2433	1.5 x 2.06	WST2454	1.5 x 3.38
WST1224	.75 x 1.5	WST1624	1 x 1.5	WST1645	1 x 2.81	----	----	WST2434	1.5 x 2.13	WST2455	1.5 x 3.44
WST1225	.75 x 1.56	WST1625	1 x 1.56	WST1646	1 x 2.87	----	----	WST2435	1.5 x 2.19	WST2456	1.5 x 3.5
WST1226	.75 x 1.62	WST1626	1 x 1.62	WST1647	1 x 2.93	----	----	WST2436	1.5 x 2.25	WST2457	1.5 x 3.56
WST1227	.75 x 1.68	WST1627	1 x 1.68	WST1648	1 x 3	----	----	WST2437	1.5 x 2.31	WST2458	1.5 x 3.62
WST1228	.75 x 1.75	WST1628	1 x 1.75	WST1649	1 x 3.06	----	----	WST2438	1.5 x 2.38	WST2459	1.5 x 3.68
WST1229	.75 x 1.81	WST1629	1 x 1.81	WST1650	1 x 3.13	----	----	WST2439	1.5 x 2.44	WST2460	1.5 x 3.75
WST1230	.75 x 1.87	WST1630	1 x 1.87	WST1651	1 x 3.19	----	----	WST2440	1.5 x 2.5	----	----
WST1231	.75 x 1.93	WST1631	1 x 1.93	WST1652	1 x 3.25	----	----	WST2441	1.5 x 2.56	----	----
WST1232	.75 x 2	WST1632	1 x 2	WST1653	1 x 3.31	----	----	WST2442	1.5 x 2.62	----	----

**Allen Hex Drive For WT Series Wrenches**

Model	Wrench Model	Allen Hex Size (in)	Maximum Torque (ft.-lbs)
WA-1208	WT-2	.5	395
WA-1210	WT-2	.62	740
WA-1212	WT-2	.75	1,270
WA-1214	WT-2	.87	1,270
WA-1216	WT-2	1	1,270
WA-1610	WT-3	.62	740
WA-1612	WT-3	.75	1,330
WA-1614	WT-3	.87	2,070
WA-1616	WT-3	1	3,100
WA-1618	WT-3	1.13	3,330
WA-1620	WT-3	1.25	3,330
WA-2414	WT-5	.87	2,070
WA-2416	WT-5	1	3,100
WA-2418	WT-5	1.13	4,355
WA-2420	WT-5	1.25	6,275
WA-2422	WT-5	1.38	7,170
WA-2424	WT-5	1.5	7,170
WA-2420-10	WT-10	1.25	6,275
WA-2422-10	WT-10	1.38	7,750
WA-2424-10	WT-10	1.5	10,500
WA-2426-10	WT-10	1.62	10,500
WA-2428-10	WT-10	1.75	10,500
WA-4024	WT-27	1.5	10,500
WA-4026	WT-27	1.62	13,280
WA-4028	WT-27	1.75	16,230
WA-4030	WT-27	1.87	27,200
WA-4032	WT-27	2	27,200
WA-4036	WT-27	2.25	27,200

**Alco Reaction Arms**



Model	Length (in)
WT2-ALCO	18
WT3-ALCO	22.25
WT5-ALCO	21
WT10-ALCO	23.5
WT27-ALCO	----

**Reaction Arm Extensions**



Model	Length (in)
WT3-EX1	1
WT3-EX2	2
WT3-EX3	3
WT5-EX1	1
WT5-EX2	2
WT5-EX3	3
WT10-EX1	1
WT10-EX2	2
WT10-EX3	3

**Torque Wrench Hoses**



Model	Length (ft)	Hose Type
WH-15	15	15' Blue & Yellow Duplex Hose w/ Quick Disconnect Couplers
WH-20	20	20' Blue & Yellow Duplex Hose w/ Quick Disconnect Couplers
WH-40	40	40' Blue & Yellow Duplex Hose w/ Quick Disconnect Couplers

bolting

# TORQUE WRENCHES

WX Series - Low Clearance Wrenches

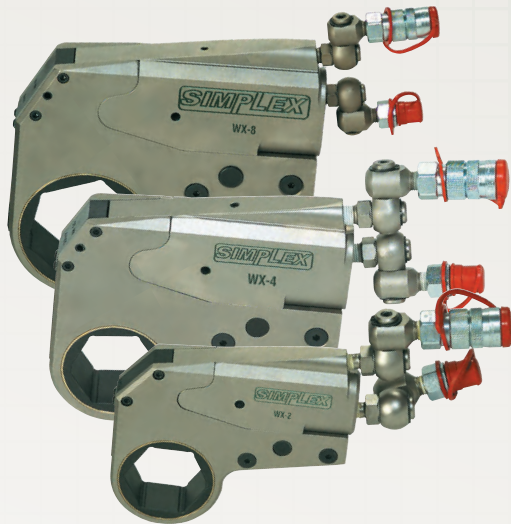

WX2, WX4 & WX8 Shown

**Maximum Torque @ 10,000 psi** ▶ **35,600 Ft. Lbs.**  
**Tool Width** .....▶ **1.25 - 3.24 In.**  
**Maximum Pressure** .....▶ **10,000 PSI**

- ▶ Patented piston design for lower profile.
- ▶ Quick and easy interchangeable links requiring no tools.
- ▶ Accurate to within + / - 3%.
- ▶ Slim nose radius for tight spaces.
- ▶ Plated wrenches resist corrosion.

The WX-4 in-line reaction coupled with an ALCO arm was the perfect solution for this bolting application. ▼



## THINK SAFETY

Please refer to pages 4&5 for a complete list of safety tips and recommendations.



## BOLTING PUMPS - pages 81 - 87

Torque wrench pumps are available in both electric and air power.



## TORQUE HOSES - page 89

Heavy duty, thermo-plastic torque wrench hoses to meet your requirements.



## OPTIONAL WX - SERIES ACCESSORIES

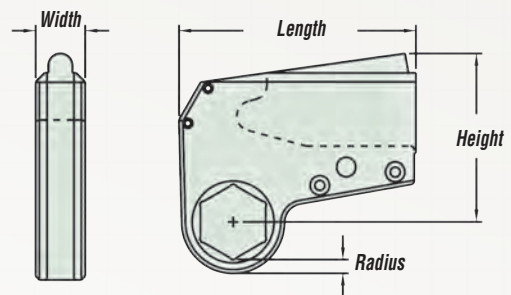
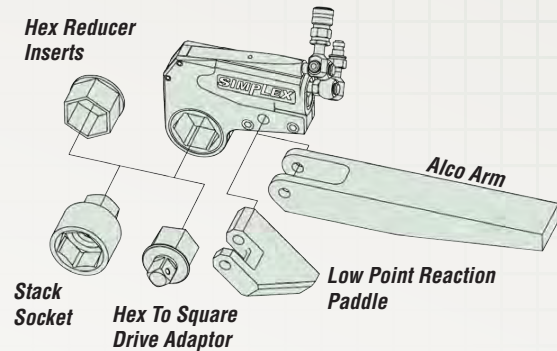

\*Weight on Links will vary by size.

Model	Length (in)	Height (in)	Radius (in)	Max. Tool Width (in)	Output (ft./lbs.)	Weight (lbs.)
WX-2	5.67	4	.36	1.25	1,930	3.5
WX-4	7.80	5.60	.46	1.63	3,950	6
WX-8	9.80	7	.54	2.05	8,630	11.7
WX-16	12.93	7.58	.65	2.5	16,600	16
WX-32	15.30	10.90	.93	3.24	35,600	26

Available Link Sizes (in./mm)		*Weight (lbs.)
From	To	
.75" / 19mm	2.56" / 65mm	2.5 - 3.5
1" / 25mm	3.13" / 80mm	5.4 - 7.6
1.87" / 50mm	4" / 105mm	11.9 - 14.5
2.62" / 65mm	4.62" / 115mm	21 - 28
3.13" / 80mm	6.13" / 155mm	29 - 39.5

# TORQUE WRENCHES

## WX Series - Low Clearance Wrenches

### Wrench Handle



▲ Optional Wrench Handle - Order # WCH-1 Handles are available for the WX-8, WX-16 & WX-32. The handle can be screwed on either side of the wrench or on top of the wrench.

### WX Drive Unit



▲ Select a WX drive unit that will give you the amount of torque you are looking for.

### WXL Hex Link



▲ Couple your WX drive unit with the WXL hex link that you will need. See chart below for specific WXL link.

Accessories are available in imperial and metric sizes.

Model Number For WX-2 Links	Hex Size (in)	Model Number For WX-4 Links	Hex Size (in)	Model Number For WX-4 Links	Hex Size (in)	Model Number For WX-8 Links	Hex Size (in)	Model Number For WX-8 Links	Hex Size (in)	Model Number For WX-16 Links	Hex Size (in)	Model Number For WX-32 Links	Hex Size (in)	Model Number For WX-32 Links	Hex Size (in)
WXL2-12	.75	WXL4-16	1	WXL4-43	2.68	WXL8-30	1.87	WXL8-57	3.56	WXL16-42	2.62	WXL32-50	3.13	WXL32-87	5.44
WXL2-13	.81	WXL4-17	1.06	WXL4-44	2.75	WXL8-31	1.93	WXL8-58	3.62	WXL16-43	2.68	WXL32-51	3.19	WXL32-88	5.5
WXL2-14	.87	WXL4-18	1.13	WXL4-45	2.81	WXL8-32	2	WXL8-59	3.68	WXL16-44	2.75	WXL32-52	3.25	WXL32-89	5.56
WXL2-15	.93	WXL4-19	1.19	WXL4-46	2.87	WXL8-33	2.06	WXL8-60	3.75	WXL16-45	2.81	WXL32-53	3.31	WXL32-90	5.62
WXL2-16	1	WXL4-20	1.25	WXL4-47	2.93	WXL8-34	2.13	WXL8-61	3.81	WXL16-46	2.87	WXL32-54	3.38	WXL32-91	5.68
WXL2-17	1.06	WXL4-21	1.31	WXL4-48	3	WXL8-35	2.19	WXL8-62	3.87	WXL16-47	2.93	WXL32-55	3.44	WXL32-92	5.75
WXL2-18	1.13	WXL4-22	1.38	WXL4-49	3.06	WXL8-36	2.25	WXL8-63	3.93	WXL16-48	3	WXL32-56	3.5	WXL32-93	5.81
WXL2-19	1.19	WXL4-23	1.44	WXL4-50	3.13	WXL8-37	2.31	WXL8-64	4	WXL16-49	3.06	WXL32-57	3.56	WXL32-94	5.87
WXL2-20	1.25	WXL4-24	1.5	----	----	WXL8-38	2.38	----	----	WXL16-50	3.13	WXL32-58	3.62	WXL32-95	5.93
WXL2-21	1.31	WXL4-25	1.56	----	----	WXL8-39	2.44	----	----	WXL16-51	3.19	WXL32-59	3.68	WXL32-96	6
WXL2-22	1.38	WXL4-26	1.62	----	----	WXL8-40	2.5	----	----	WXL16-52	3.25	WXL32-60	3.75	WXL32-97	6.06
WXL2-23	1.44	WXL4-27	1.68	----	----	WXL8-41	2.56	----	----	WXL16-53	3.31	WXL32-61	3.81	WXL32-98	6.13
WXL2-24	1.5	WXL4-28	1.75	----	----	WXL8-42	2.62	----	----	WXL16-54	3.38	WXL32-62	3.87	----	----
WXL2-25	1.56	WXL4-29	1.81	----	----	WXL8-43	2.68	----	----	WXL16-55	3.44	WXL32-63	3.93	----	----
WXL2-26	1.62	WXL4-30	1.87	----	----	WXL8-44	2.75	----	----	WXL16-56	3.5	WXL32-64	4	----	----
WXL2-27	1.68	WXL4-31	1.93	----	----	WXL8-45	2.81	----	----	WXL16-58	3.62	WXL32-65	4.06	----	----
WXL2-28	1.75	WXL4-32	2	----	----	WXL8-46	2.87	----	----	WXL16-60	3.75	WXL32-66	4.13	----	----
WXL2-29	1.81	WXL4-33	2.06	----	----	WXL8-47	2.93	----	----	WXL16-62	3.87	WXL32-68	4.25	----	----
WXL2-30	1.87	WXL4-34	2.13	----	----	WXL8-48	3	----	----	WXL16-64	4	WXL32-70	4.38	----	----
WXL2-31	1.93	WXL4-35	2.19	----	----	WXL8-49	3.06	----	----	WXL16-66	4.13	WXL32-72	4.5	----	----
WXL2-32	2	WXL4-36	2.25	----	----	WXL8-50	3.13	----	----	WXL16-68	4.25	WXL32-74	4.62	----	----
WXL2-33	2.06	WXL4-37	2.31	----	----	WXL8-51	3.19	----	----	WXL16-70	4.38	WXL32-76	4.75	----	----
WXL2-34	2.13	WXL4-38	2.38	----	----	WXL8-52	3.25	----	----	WXL16-72	4.5	WXL32-78	4.87	----	----
WXL2-35	2.19	WXL4-39	2.44	----	----	WXL8-53	3.31	----	----	WXL16-74	4.62	WXL32-80	5	----	----
WXL2-36	2.25	WXL4-40	2.5	----	----	WXL8-54	3.38	----	----	----	----	WXL32-82	5.13	----	----
WXL2-37	2.31	WXL4-41	2.56	----	----	WXL8-55	3.44	----	----	----	----	WXL32-84	5.25	----	----
WXL2-38	2.38	WXL4-42	2.62	----	----	WXL8-56	3.5	----	----	----	----	WXL32-86	5.38	----	----

lifting jacks

# LIFTING JACKS



All Simplex Air Bags have a maximum working pressure of 116 PSI.

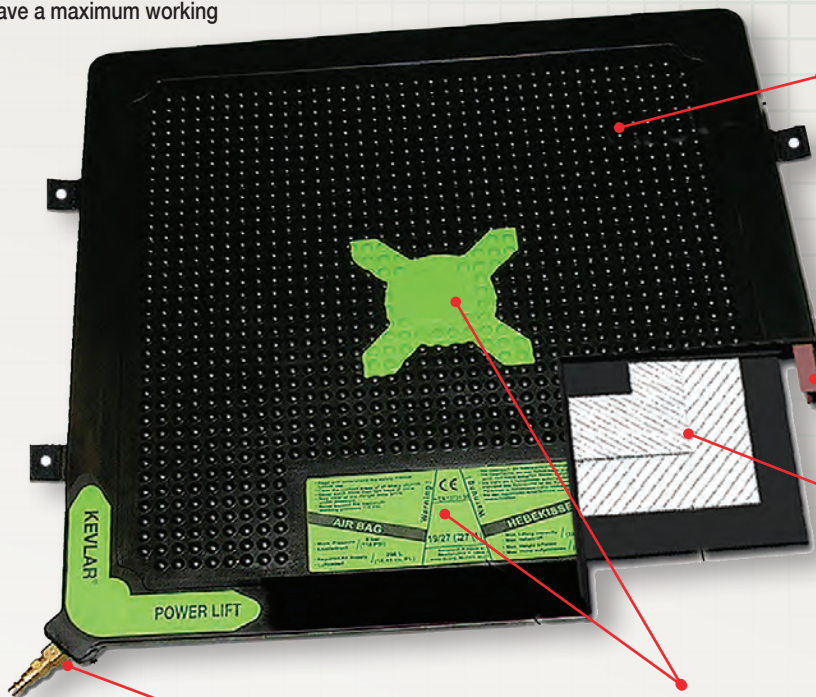

*Load contact surface (top and bottom) has molded positive gripping, interlocking, convex rubber dimples.*

*Reinforced edge protects the bag where damage often occurs.*

*Patented Kevlar® reinforced diagonal crosshatch pattern.*

*Interchangeable couplers. Compatible (or adaptable) with all other air bag types.*

*Centering cross, pressure limitations, capacities, and important safety warnings are brightly colored and bonded to the rubber for long life.*

Heavy Duty Air Bag Shown

## SIMPLEX LIFTING JACK PRODUCT LINE OVERVIEW

### ► Something for Every Job

From the thinnest of air lifting bags to the widest assortment of controls, Simplex heavy duty air lifting bags provide a solution to the most unique and specialized application.

### ► General Maintenance

From factory maintenance to portable tool chests, Simplex hand jacks are the standard utility tools for all maintenance applications.

### ► Self Contained Mobile Force

From structural movers to plant maintenance crews, Simplex Toe Jacks offer high capacities in a broad range of lifting.

# LIFTING JACKS

Proper Size & Selection

**SIMPLEX**

## Hydraulic Hand Jacks

### 2 Through 100 Ton Hydraulic Hand Jacks

Simplex 2 through 100 ton capacity all purpose jacks are ideal for use in general industrial applications, and are used extensively in maintenance, construction and material handling. The versatility of the Simplex bottle jack has made it a favorite in shipyards, factories, oil fields, mines & general industries.



lifting jacks

## Hydraulic Toe Jacks

### 2 Through 10 Ton Hydraulic Toe Jacks

Simplex hydraulic toe jacks are the solution to all of your low clearance lifting problems. Choose from the widest variety of self contained toe jacks in the industry. Capacities range from 2 through 10 tons. The Simplex TJH2 is a 2 ton self-contained toe jack utilizing .62" minimum toe height and over 4" of travel.





**Air Lifting Bags**

**1.1 Through 74.1 Tons Air Lifting Bags**

Thin, powerful & light weight, Simplex Air Bags are the answer to the toughest industrial applications. Starting with a minimum height of 1.1", Simplex lifting bags offer high capacity for clearances too small for most conventional jacks. They are ideal for use in railroads, construction, mining, shipyards and industrial applications that require safe, reliable lifting, spreading, bending or pushing. Simplex air lifting bags are manufactured with neoprene & Kevlar reinforced construction and are safer, stronger and more reliable than other bags on the market.



**Lifting Capacity and Height Guidelines**

When selecting the proper air bag arrangement, consider size and lift requirements. The amount of contact surface is a direct relationship to force output. It's important to consider the lifting height when sizing the proper air bag. As an air lifting bag inflates (increasing convexity), contact surface is reduced, which lowers the lifting capacity.

Air bags stacked on top of each other will increase the lifting height, but not the overall air bag capacity. Lifting capacity depends on the size of the air bag surface in contact with the lower surface of the object to be lifted. In order to choose the proper size air bag, reference the performance graph on page 98.

Example below demonstrates a typical 44 ton two air bag system arrangement.

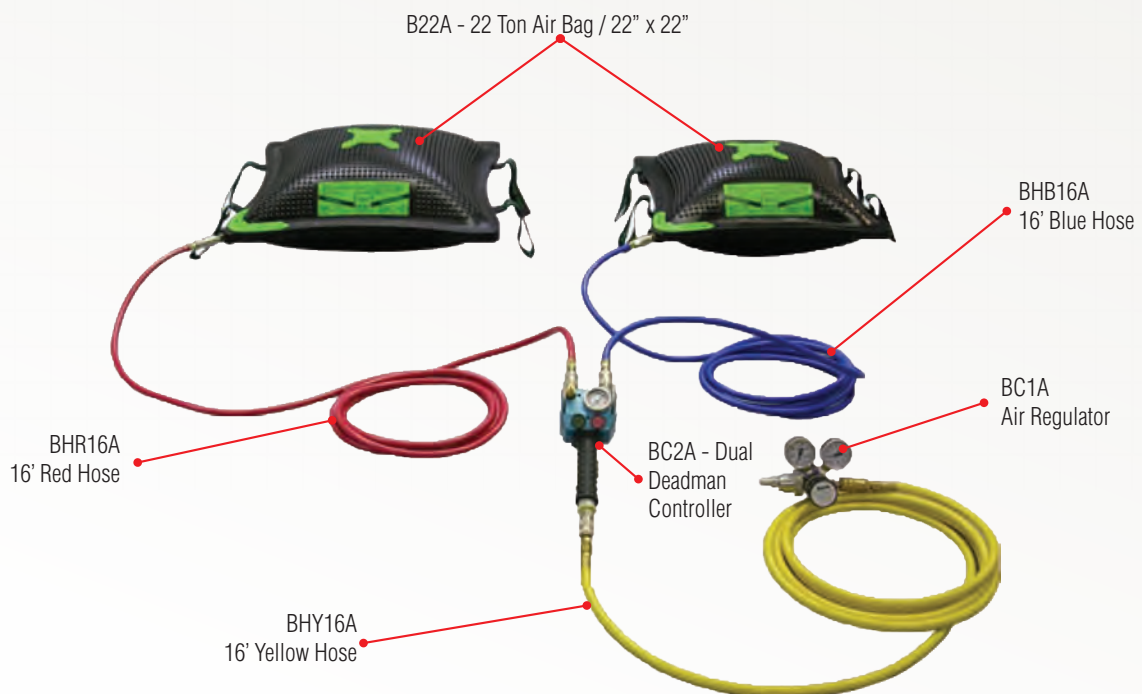

Lifting Jacks

# LIFTING JACKS

HJ Series - Hand Jacks



HJ Family Shown

**Capacity Range** ..... ➤ **2 - 100 Tons**  
**Stroke Range** ..... ➤ **3.38 - 6.68 In.**  
**Weight** ..... ➤ **5 - 194 Lbs.**

- ▶ Drop forged base and rugged welded housing construction.
- ▶ All models include over travel protection.
- ▶ Grooved saddles help prevent load slippage.
- ▶ Super low profile versions available in 12 & 22 ton capacities.
- ▶ Piston rods are chrome plated to resist corrosion.

**THINK SAFETY**  
 Please refer to pages 4&5 for a complete list of safety tips and recommendations.

**CARRYING HANDLE**  
 Conveniently located handle at the top of higher tonnage jacks makes positioning quick and easy.

**SCREW EXTENSIONS**  
 2 through 22 ton models include screw extensions for quick setup.

Various applications are suitable for the hydraulic HJ Series hand Jack, ranging from spreading, leveling, lifting and holding. ▼



◀ All Hand Jacks come equipped with a 3 piece Lever Bar set to accommodate space limitations.



lifting jacks

Model	Capacity (tons)	Stroke (in)	Minimum Height (in)	Extended Screw Ht. (in)	Maximum Height (in)	Base Area (in)	Piston Diameter (in)	Maximum Handle Effort (lbs)	Weight (lbs)
HJ2	2	4.5	7.13	2	13 5/8	4.33 x 2.56	.75	64	5
HJ3	3	4.5	7.5	2.38	14.38	4.53 x 2.83	.87	64	7
HJ5	5	4.75	7.87	2.75	15.38	5.59 x 3.22	1.25	48	8
HJ8	8	4.75	7.87	2.75	15.38	5.94 x 3.54	1.38	69	13
HJ12	12	5.87	9.5	3.13	18.5	6.53 x 4.17	1.62	73	20
HJ12/LP	12	3.75	6.75	3	13.5	6.53 x 4.17	1.62	73	15
HJ22	22	6.38	10.62	----	17	7.17 x 5.03	2.13	73	30
HJ22/LP	22	3.38	7.13	1.62	12.13	7.17 x 5.03	2.13	73	24
HJ35	35	6.38	11	----	17.38	7.56 x 5.59	2.5	69	45
HJ55	55	6.68	12	----	18.75	9.33 x 7.40	3.25	73	97
HJ100	100	5.75	12	----	17.72	12.52 x 10.43	4.90	93	194



TJH Family Shown

**Capacity Range** .....▶ **2 - 10 Tons**  
**Stroke Range** .....▶ **4.44 - 9 In.**  
**Weight** .....▶ **18 - 85 Lbs.**

- ▶ Self-contained models for maximum versatility.
- ▶ Low toe heights fit in tight clearances.
- ▶ The lowest handle effort for easy operation.
- ▶ The lowest weights for reduced back injuries.
- ▶ Swivel sockets for access in close quarters. (TJH5 & TJH10 only).



**THINK SAFETY**

Please refer to pages 4&5 for a complete list of safety tips and recommendations.



**PISTOL GRIP**

TJH109LS comes equipped with an ergonomic pistol grip for rapid advancement to load.



**TOE LIFT**

Toe Lifts are rated at maximum capacity on all models.

*Its small footprint and ease of mobility make the TJH10 perfect for lifting a variety of equipment when space and clearance are at a premium. ▼*



Lifting Jacks



◀ **TJH2, TJH5 and TJH10** Toe Jacks come equipped with a 3 piece Lever Bar set to accommodate space limitations.

◀ **TJH109LS** Toe Jack comes equipped with a solid one piece Lever Bar.

Note: Lever Bars are included with all models.

Model	Capacity (tons)	Stroke (in)	Minimum Height (in)		Base Area (in)	Maximum Handle Effort (lbs)	Method Of Return	Weight (lbs)
			Toe (in)	Cap (in)				
TJH2	2	4.44	.62	9.25	4.92 x 7	51	Load	18
TJH5	5	4.62	1	11.75	7.25 x 10.62	33	Spring	53
TJH10	10	5.87	1.25	13.13	9.5 x 11.25	38	Spring	85
TJH109	10	9	2.25	22	6.5 x 10	80	Spring	56
TJH109LS	10	9	2.17	16.13	6 x 9	73	Spring	41

# LIFTING JACKS

B Series - Air Lifting Bags



B Series Shown



### THINK SAFETY

Please refer to pages 4&5 for a complete list of safety tips and recommendations.



### DUAL DEADMAN CONTROLLER - pages 100 - 101

Used for precise inflation and deflation control.



### Y CONNECTOR - pages 100 - 101

Allows control of two bags from one single fitting controller.

- Capacity Range .....▶ **1.1 - 74.1 Tons**
- Lifting Height .....▶ **2.7 - 20 In.**
- Maximum Pressure .....▶ **116 psi**

- ▶ 11 models with capacities ranging from 1.1 through 74.1 tons.
- ▶ Simplex air bags operate on standard shop air up to 116 psi.
- ▶ All models include 2 ply Kevlar with neoprene.
- ▶ Wide variety of safety controllers for single & multiple bag systems.
- ▶ Light weight makes the Simplex air bags easy to set up.
- ▶ B22A through B74A bags come with side holes for attaching bags together.

Durability and strength makes Simplex Air Lifting Bags the perfect solution to raise these collapsed concrete slabs for repair. ▼



### Lifting Bag Performance

B1A Through B6A Air Bag Chart

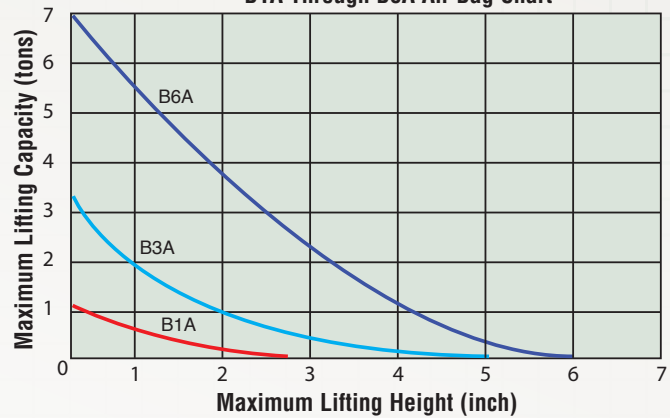

B11A Through B74A Air Bag Chart

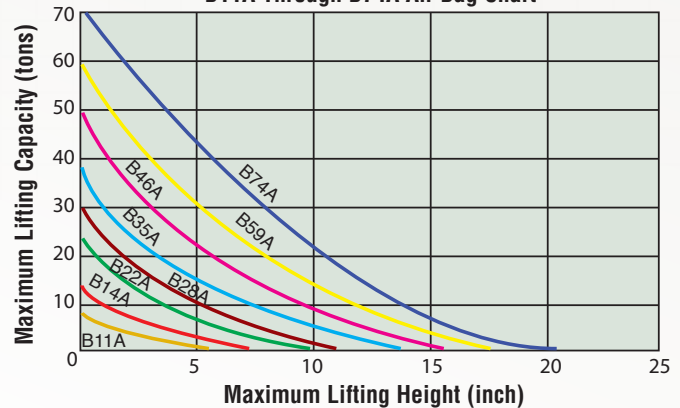

lifting jacks

# LIFTING JACKS

## B Series - Air Lifting Bags

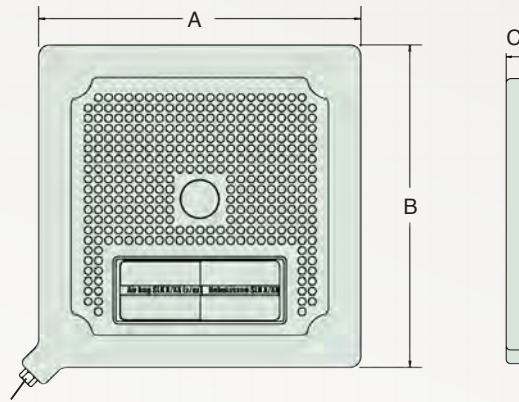
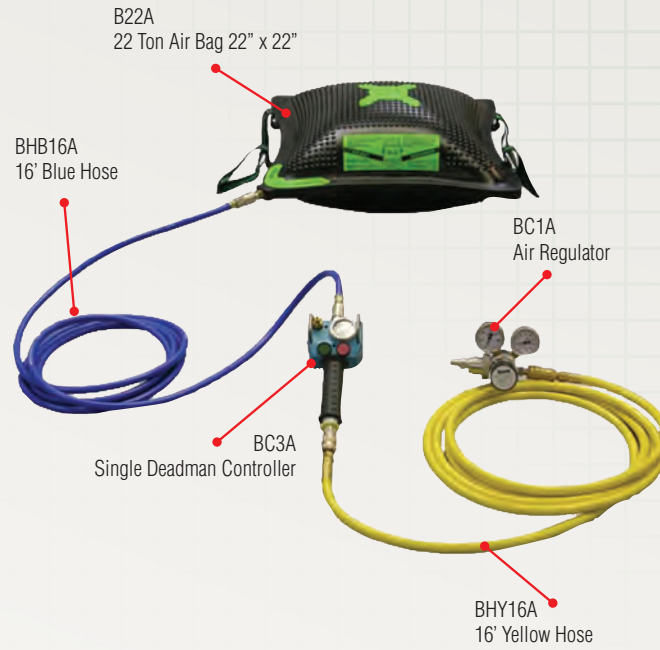

1/4" - 18 NPTF





Model	Capacity (tons)	Maximum Lifting Height (in)	A	B	C	Air Required @ 116 PSI (cu.ft.)	Maximum Burst Pressure (PSI)	Weight (lbs)
			Length (in)	Width (in)	Thick (in)			
B1A	1.1	2.7	6	6	1.1	.18	464	1.32
B3A	3.1	5.1	9	9	1.1	.53	464	2.8
B6A	6.4	5.9	12	12	1.1	1.48	464	5.3
B11A	10.8	7.0	15	15	1.1	3.04	464	8.8
B14A	14.2	8.6	18	18	1.1	5.37	464	11.6
B22A	22.7	10.6	22	22	1.1	10.45	464	17.8
B28A	27.7	11.8	24	24	1.2	14.7	464	24.6
B35A	35.3	14.1	27	27	1.2	21.9	464	29.9
B46A	46.4	16.5	31	31	1.2	32.5	464	40.1
B59A	58.8	17.7	35	35	1.2	46.8	464	49.6
B74A	74.1	20	36	36	1.2	53.1	348	55.8

Lifting Jacks





# LIFTING JACKS

B Series - Air Bag Accessories

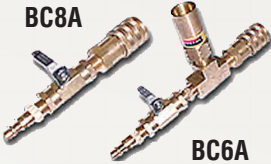

Model	Description
	<p>Industrial duty, color coded <b>Supply Hoses</b> allows the user to coordinate the lift properly and safely.</p> <p><b>BHR16A - 16' Red Hose</b>  <b>BHR32A - 32' Red Hose</b>  <b>BHB16A - 16' Blue Hose</b>  <b>BHB32A - 32' Blue Hose</b>  <b>BHY16A - 16' Yellow Hose</b>  <b>BHY32A - 32' Yellow Hose</b></p>
	<p><b>BC12</b></p> <p><b>Deluxe Dual Deadman Controller</b> used for precise inflation and deflation control. Built in safety relief valves prevent over inflation with the pressure sensitive toggles.</p>
	<p><b>BC2A</b></p> <p><b>Dual Deadman Controller</b> with pressure gauge and pressure relief valves. Control two bags from one air source. Reliable over extreme temperature range.</p>
	<p><b>BC3A</b></p> <p><b>Single Deadman Controller</b> with pressure gauge and pressure relief valves. Reliable over extreme temperature range.</p>

lifting jacks

Model	Description
	<p><b>BC9A</b></p> <p><i>Y Connector</i> allows control of 2 bags from one single fitting controller.</p>
	<p><b>BC8A</b> <b>BC6A</b></p> <p><i>In-Line Control Shut Off and Relief Valves</i> enable the user to disconnect a hose without deflating the bag.</p>
	<p><b>BC11</b></p> <p><i>Dual Safety Controller</i> with pressure gauge and pressure relief valve. Cost effective and reliable over a wide range of control applications.</p>
	<p><b>BC1A</b></p> <p><i>Pressure Regulator Controller</i> is a diaphragm type single stage regulator with high pressure air tank compatibility.</p>
	<p><b>BC4A</b></p> <p><i>Single Safety Controller</i> with pressure gauge and pressure relief valve. Cost effective and easy to use.</p>

hydraulic tools

# HYDRAULIC TOOLS

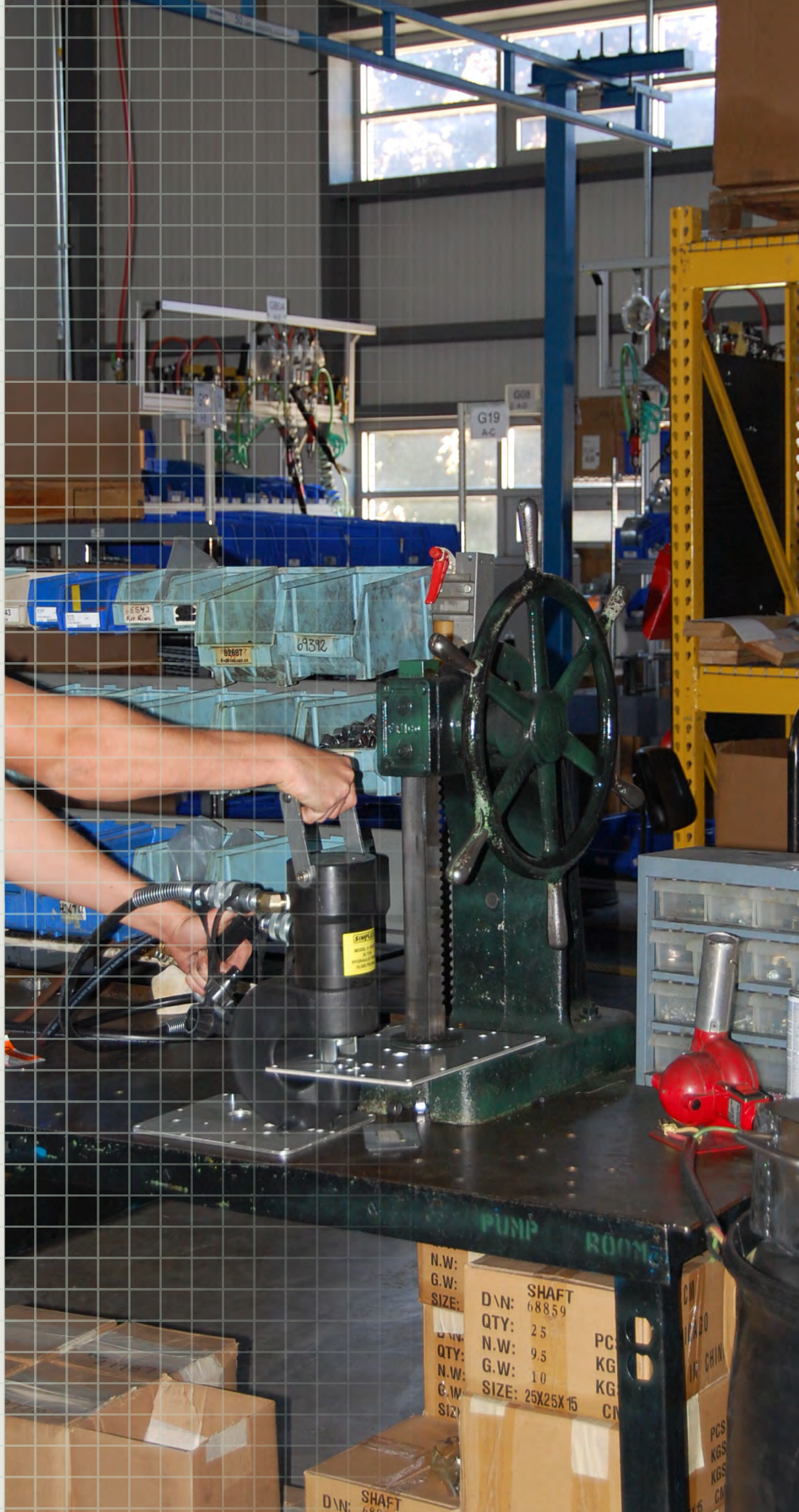



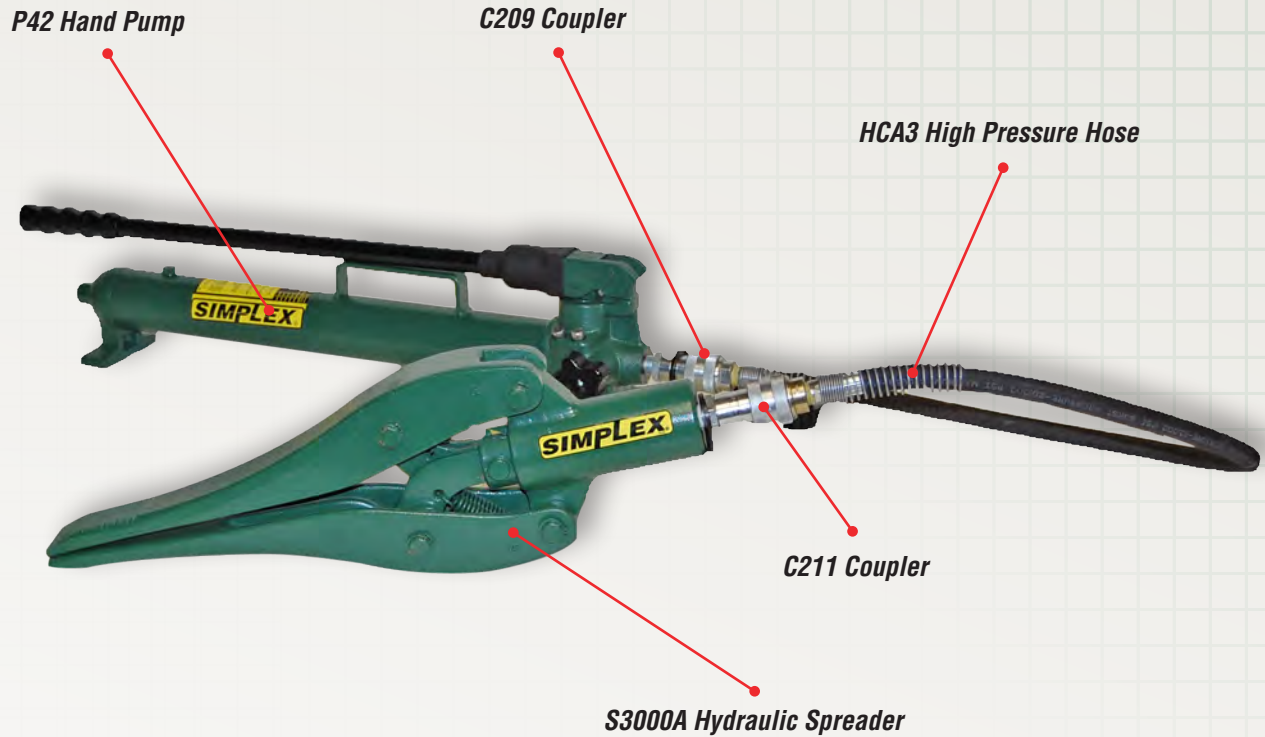

S3000A Spreader with a P42 Hand Pump

## SIMPLEX HYDRAULIC TOOLS PRODUCT LINE OVERVIEW

### ► Specialty Tools

Whether it's a construction site or production fabrication, Simplex single acting 35 ton portable punch offers fast and effective solutions.

### ► Spreaders

From flange spreading to emergency rescue, Simplex can supply a suitable solution in hydraulic or mechanical spreading.

### ► Configured to Meet a Broad Range of Requirements

Whether it's collision repair, general maintenance or specialized spreading, clamping or holding, Simplex maintenance kits come complete with the largest assortment of attachments.

# HYDRAULIC TOOLS

Proper Size & Selection

**SIMPLEX**

## Hydraulic Nut Splitters

*Simplex nut splitters fit up to 8 nut sizes and offer greater value and versatility. The specifically designed head fits all A.P.I. and ANSI flanges and cuts hex, square and 12 point nuts. You can easily calibrate the cutting chisel so only the nut is cut without damaging the bolt or stud. Simplex splitters will cut the hardest nuts, up to grade 8 and 2H (ASTMA 194/2H), Brinell hardness 248-325.*



hydraulic tools

## Hydraulic Spreaders

*The Simplex S2000A (1 ton) and S3000A (.75 ton capacity) spreaders are the perfect fit for close clearance jobs. The SF5 spreader offers 5 tons of spreading force with a .13" starting clearance. It is one of Simplex's most versatile tools for spreading.*



**Single Acting Portable Punch**

*Simplex 35 Ton Single-Acting Portable Punch mounted motor control handle (included with SPH35A) provides easy operation and greater operator safety. Punches and dies are interchangeable with competitive punches.*

**Hydraulic Maintenance Kits**

*The Simplex MK106 Maintenance Kit provides a complete assortment of attachments that greatly expands the range of applications. Using these various attachments allows you to custom build spreaders, straightening tools, clamps and a wide variety of other problem solving maintenance tools.*



# HYDRAULIC TOOLS

SPH Series - Single Acting Punch



SPH35A Shown



### HOSES - pages 78 - 79

Heavy duty and thermo plastic hydraulic hoses to meet your requirements and safety factor.



### GAUGES - page 77

Improve your system visibility and safety by adding an inline hydraulic gauge to your circuit.



### POWER PUMPS - pages 43 - 65

Simplex offers a wide variety of lightweight power pumps to fit any application.

- Capacity ..... ► **35 Tons**
- Maximum Thickness ..... ► **.5 In.**
- Maximum Pressure ..... ► **10,000 PSI**

- Industrial grade, single acting, spring return design.
- Punches holes in material up to .5" thick mild steel.
- All models come equipped with a heavy duty steel case, providing tool and die organization along with ease of transport.
- Large selection of square, rounded and oblong dies and punches are offered to complete a wide variety of applications.

Simplex offers a punch mounted motor control so that work can be performed safely and more productively as shown in this fabricating shop. ▼



\* "M" = METRIC DIE SET

Model	Punch	Steel Case	Punch & Die Set	Pump	Pump Voltage	Hose	Weight Punch Only (lbs.)
SPH35A	SPH35A	Yes	----	----	----	----	32
SPH35SA	SPH35A	Yes	DS-44, DS-56, DS-69, DS-81	----	----	----	32
SPH35SPA - 115	SPH35A	Yes	DS-44, DS-56, DS-69, DS-81	G1101F	115	HCA6	32
SPH35SPA - 230	SPH35A	Yes	DS-44, DS-56, DS-69, DS-81	G1201F	230	HCA6	32
*SPH35MA	SPH35A	Yes	DS-38, DS-44, DS-53, DS-69	----	----	----	32
*SPH35MPA - 115	SPH35A	Yes	DS-38, DS-44, DS-53, DS-69	G1101F	115	HCA6	32
*SPH35MPA - 230	SPH35A	Yes	DS-38, DS-44, DS-53, DS-69	G1201F	230	HCA6	32

hydraulic tools



SPH35SPA Kit Shown

# HYDRAULIC TOOLS

SPH Series - Single Acting Punch

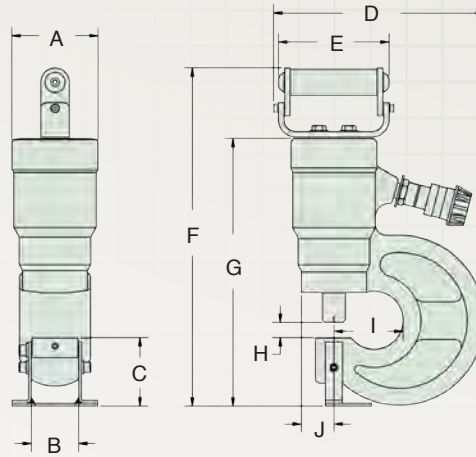

**Punch Dimensions**

	A	B	C	D	E	F	G	H	I	J
<b>Imperial</b>	3.75	2.06	2.97	9.16	4.81	14.66	11.6	.66	3	1.42
<b>Metric</b>	95.25	52.32	75.43	232.66	122.17	372.36	294.64	16.76	76.2	36.06

### QUALITY OF STEEL REFERENCE TABLE

- A: Mild A-7
- B: Boiler Plate
- C: Structural A-36
- D: Struct Corten (ASTM A242)

- E: Cold Rolled C-1018
- F: Hot Rolled C-1050
- G: Hot Rolled C-1095
- H: Hot Rolled C-1095 Annealed

- I: Stainless Annealed
- J: Stainless 304 Hot Rolled
- K: Stainless 316 Cold Rolled

Contact Factory for additional dimensions.

Hole Type	Punch Model	Die Model	Punch & Die Set	Bevel Punch & Die Set for I-Beams	Bevel Punch & Die Set for U-Beams	Hole Size		Bolt Size		A	B	C	D	E	F	G	H	I	J	K
						(in)	(mm)	(in)	(mm)	*Maximum Metal Thickness To Be Punched (in.)										
Round	DP-31	DD-31	DS-31	DSB-31	---	.31	7.9	.25	---	.31	.31	.25	.25	.25	.25	.13	.19	.25	.25	.25
Round	DP-38	DD-38	DS-38	DSB-38	---	.38	9.5	.31	M8	.38	.38	.31	.31	.31	.31	.19	.25	.31	.31	.31
Round	DP-44	DD-44	DS-44	DSB-44	DSBU-44	.44	11.1	.44	M10	.44	.44	.38	.38	.38	.31	.19	.31	.31	.31	.31
Round	DP-53	DD-53	DS-53	DSB-53	DSBU-53	.53	13.5	.44	M12	.50	.50	.44	.44	.44	.38	.25	.31	.38	.38	.38
Round	DP-56	DD-56	DS-56	DSB-56	---	.56	14.3	.5	---	.50	.50	.50	.44	.50	.44	.25	.38	.44	.44	.44
Round	DP-69	DD-69	DS-69	DSB-69	DSBU-69	.69	17.5	.62	M16	.50	.50	.50	.44	.50	.40	.25	.31	.40	.40	.40
Round	DP-78	DD-78	DS-78	---	---	.78	19.8	---	M18	.50	.50	.50	.44	.50	.38	.25	.31	.38	.39	.38
Round	DP-81	DD-81	DS-81	---	---	.81	20.6	.75	---	.50	.50	.50	.44	.50	.31	.19	.31	.31	.31	.31
Square	DP-45	DD-45	DS-45	---	---	.31	7.9	.25	---	.31	.31	.25	.25	.25	.25	.13	.19	.25	.25	.25
Square	DP-54	DD-54	DS-54	---	---	.38	9.5	.31	M8	.38	.38	.31	.31	.31	.31	.19	.25	.31	.31	.31
Square	DP-63	DD-63	DS-63	---	---	.44	11.1	.38	M10	.44	.44	.38	.38	.38	.31	.19	.31	.31	.31	.31
Square	DP-72	DD-72	DS-72	---	---	.50	12.7	.44	M12	.50	.50	.44	.44	.44	.38	.25	.31	.38	.38	.31
Oblong	DP-10	DD-10	DS-10	---	---	.31 x .75	7.9 x 19	.25	---	.31	.31	.25	.25	.25	.25	.13	.19	.25	.25	.25
Oblong	DP-12	DD-12	DS-12	---	---	.38 x .75	9.5 x 19	.19	M8	.38	.38	.31	.31	.31	.31	.19	.25	.31	.31	.31
Oblong	DP-18	DD-18	DS-18	---	---	.44 x .75	11.1 x 19	.38	M10	.44	.44	.38	.38	.38	.31	.19	.31	.31	.31	.31
Oblong	DP-25	DD-25	DS-25	---	---	.50 x .75	12.7 x 19	.44	M12	.50	.50	.44	.44	.44	.38	.25	.31	.38	.38	.38

hydraulic tools

# HYDRAULIC TOOLS

S Series - Hydraulic Spreaders



S2000A and S3000A Shown

## HOSES - pages 78 - 79



Heavy duty and thermo plastic hydraulic hoses to meet your requirements and safety factor.

## GAUGES - page 77



Improve your system visibility and safety by adding an inline hydraulic gauge to your circuit.

## HAND PUMPS - pages 31 - 41



Handpump design specifications meet or exceed ANSI /ASME B30.1 Safety Standards.

hydraulic tools

- Capacity Range ..... ► **.75 - 1 Tons**
- Weight ..... ► **5 - 25 Lbs.**
- Spread Range ..... ► **.38" - 11.5"**

- Closed narrow ends starting at .38".
- Large spreading range up to 11.5".
- Return spring assists the jaws to the closed position.
- Durable all metal construction to withstand any tough environment.
- Quality high flow coupler for fast tool setup.

### S2000A

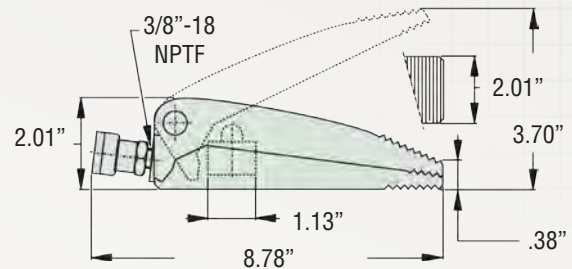

### S3000A

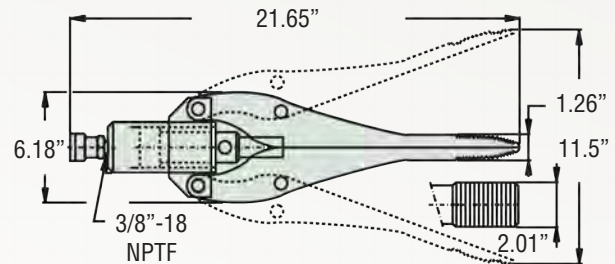

The Simplex S2000A spreader was used to remove this rusted anchor plate from a brick wall for mortar patching to begin. ▼



Model	Capacity (tons)	Pressure @ Capacity (PSI)	Oil Capacity Required (cu.in.)	Weight (lbs)	Width (in)	Suggested Hand Pump
S2000A	1	10,000	.61	5	2.01	P42
S3000A	.75	10,000	3.91	25	2.01	P42



SF5 Shown

**Capacity** ..... ► **5 Tons**  
**Weight** ..... ► **17 Lbs.**  
**Spread Range** ..... ► **.13 - 3 In.**

- 5 tons of spreading force.
- .13" through 3" spreading capability.
- Jaws open parallel.
- Will not drift or creep-down.
- All metal construction.

Boasting 5 tons of spreading force and 3 inches of operational lift, the SF5 is the most versatile tool for heavy equipment maintenance. ▼



**GAUGES - page 77**

Improve your system visibility and safety by adding an inline hydraulic gauge to your circuit.



**HOSES - pages 78 - 79**

Heavy duty and thermo plastic hydraulic hoses to meet your requirements and safety factor.



**HAND PUMPS - pages 31 - 41**

Handpump design specifications meet or exceed ANSI /ASME B30.1 Safety Standards.



**POWER PUMPS - pages 43 - 65**

Simplex offers a wide variety of lightweight power pumps to fit any application.



◀ SF5 Spreaders are used in pairs to spread the flanges equally for general maintenance and repair.

hydraulic tools

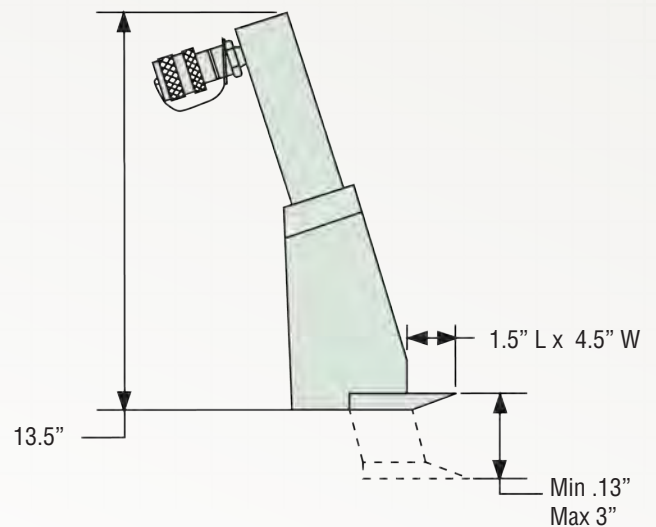

Model	Capacity (tons)	Oil Capacity Required (cu.in.)	Pressure @ Capacity (PSI)	Weight (lbs)	Spread		Suggested Hand Pump
					Min. (in)	Max. (in)	
SF5	5	5	10,000	17	.13	3	P22

# HYDRAULIC TOOLS

NS Series - Nut Splitters

**SIMPLEX**



NS Series Shown

## HOSES - pages 78 - 79



Heavy duty and thermo plastic hydraulic hoses to meet your requirements and safety factor.

## COUPLERS - pages 74 - 75



High flow quick disconnect couplers provide a quick change to a variety of pumps.

## POWER PUMPS - pages 43 - 65



Simplex offers a wide variety of lightweight power pumps to fit any application.

- Nut Range** ..... ► **.5 - 2.93 In.**
- Weight** ..... ► **1.8 - 75.1 Lbs.**
- Maximum Pressure** ..... ► **10,000 PSI**

- Cuts hardened nuts up to grade 8 & 2H.
- Replacement chisel and set screws included.
- Cuts any shape nut.
- Cuts nuts from .5" to 2.93".
- Rugged carrying case included.

Refineries, steel mills and power plants rely heavily on Simplex nut splitters for removing stubborn or rusted nuts easily and safely. ▼

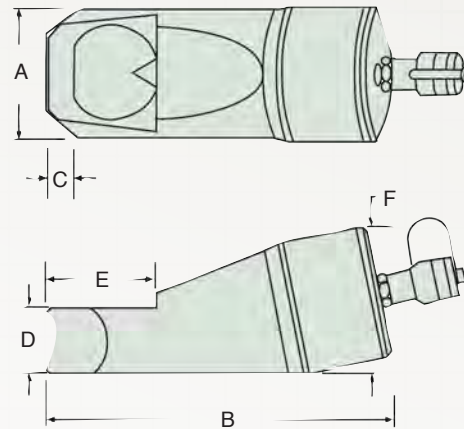

Model	Stud Diameter (in)	Nut A/F (in)	A (in)	B (in)	C (in)	D (in)	E (in)	F (in)	Wgt. (lbs.)	Suggested Hand Pump
NS1319	.25 - .44	.5 - .75	1.57	4.76	.28	.75	1.14	1.93	1.8	P42 / P72
NS1924	.44 - .56	.75 - .93	2.13	5.77	.39	.98	1.57	2.42	4.4	P42 / P72
NS2432	.56 - .75	.93 - 1.25	2.52	7	.51	1.18	2.05	2.99	6.6	P42 / P72
NS3241	.75 - 1	1.25 - 1.62	2.97	8.09	.63	1.42	2.56	3.38	9.7	P42 / P72
NS4150	1 - 1.25	1.62 - 2	3.70	9.61	.83	1.77	3.00	4.17	18	P140
NS5060	1.25 - 1.5	2 - 2.38	4.17	10.60	.94	2.13	3.62	4.90	26	P140
NS6075	1.5 - 1.87	2.38 - 2.93	6.26	14.37	1.06	2.95	4.37	7.20	75.1	P140

hydraulic tools





MK106 Shown



**THINK SAFETY**

Please refer to pages 4&5 for a complete list of safety tips and recommendations.



R106 is rated at 10 tons at 10,000 psi. When using attachments or extensions do not exceed 5,000 psi (5 tons) reading on the gauge. Accessories & extensions are only rated at 5 tons. S2000A Spreader has an operating capacity of 1 ton.

**Capacity** .....▶ **10 Tons**  
**Weight** .....▶ **84 Lbs.**

- ▶ Set includes a Simplex hand pump, cylinder, hose, gauge and gauge adapter.
- ▶ Heavy duty case included.
- ▶ Rated at 5 tons when attachments are used.
- ▶ Quick lock and threaded adaptors included.
- ▶ Order as a set or individual components.



◀ Add collar toe and flat base to build custom spreader or toe jack.



◀ Extensions, custom heads and adapters allow you to create tools that solve hundreds of problems. Simplex MK106 kits are used extensively for collision repair.



◀ Add a V-base and flat base for special spreading, holding and bending jobs.







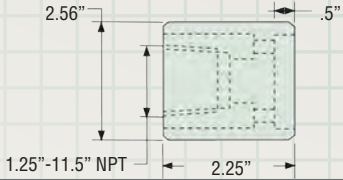

hydraulic tools

Model	Capacity (tons)	Cylinder	Hand Pump	Hose	Gauge	Gauge Adapter	Attachments	Spreader	Box	Weight (lbs)
MK106	10	R106	P42	HCA6	G5	GA1	MK-4 thru MK-20	S2000A	MK-21	84

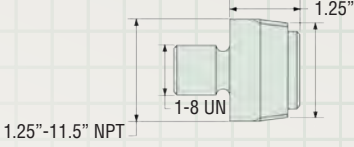
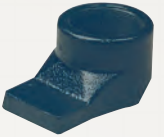
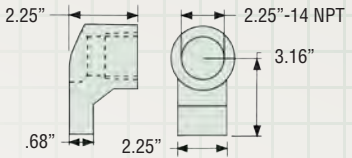
# HYDRAULIC TOOLS

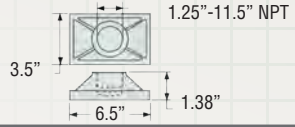
MK Series - Kit Components

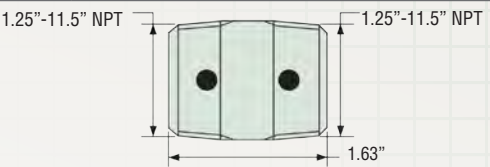
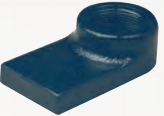
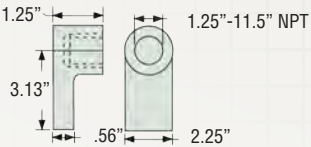

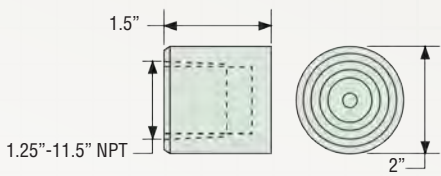







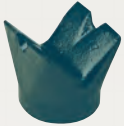
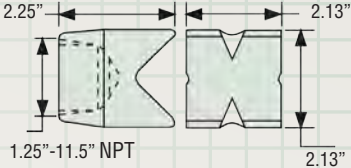

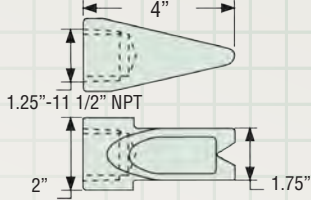

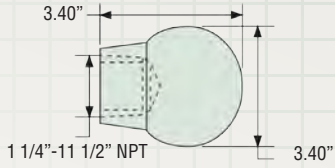

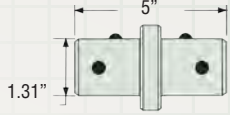

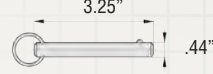
Model	Description	Dimensions
 MK-4	<b>Base Attachment</b> (Qty. 1)	
 MK-5	<b>Threaded Adaptor</b> (Qty. 1)	
 MK-6	<b>Collar Toe</b> (Qty. 1)	
 MK-7	<b>Flat Base</b> (Qty. 1)	
 MK-8	<b>Threaded Connector</b> (Qty. 1)	
 MK-9	<b>Threaded Plunger Toe</b> (Qty. 1)	
 MK-10	<b>Grooved Saddle</b> (Qty. 1)	

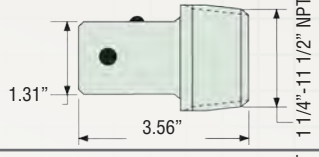
hydraulic tools

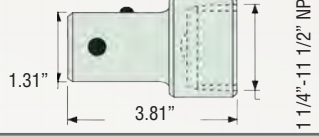

Maintenance Kit - MK106

Model	Description	Dimensions
 <p><b>MK-11</b></p>	<p><b>90° V-Base</b> (Qty. 1)</p>	
 <p><b>MK-12</b></p>	<p><b>Wedge Head</b> (Qty. 1)</p>	
 <p><b>MK-13</b></p>	<p><b>Flex Head</b> (Qty. 1)</p>	
 <p><b>MK-14</b></p>	<p><b>Lock On Connector</b> (Qty. 3)</p>	
 <p><b>MK-15</b></p>	<p><b>Lock Pin</b> (Qty. 4)</p>	
 <p><b>MK-16</b></p>	<p><b>Male Lock On Adapter</b> (Qty. 1)</p>	
 <p><b>MK-17</b></p>	<p><b>Female Lock On Adapter</b> (Qty. 1)</p>	
<b>Extensions and Box</b>		
 <p><b>MK-18</b></p>	<p><b>5 Inch Extension Pipe</b> (Qty. 1)</p>	
 <p><b>MK-19</b></p>	<p><b>10 Inch Extension Pipe</b> (Qty. 1)</p>	
 <p><b>MK-20</b></p>	<p><b>18 Inch Extension Pipe</b> (Qty. 1)</p>	
 <p><b>MK-21</b></p>	<p><b>Wooden Box</b> (Qty. 1)</p>	

hydraulic tools

\* All components are included in the MK106 Maintenance Kit.  
\* All components can be ordered separately.

presses

# HYDRAULIC PRESSES

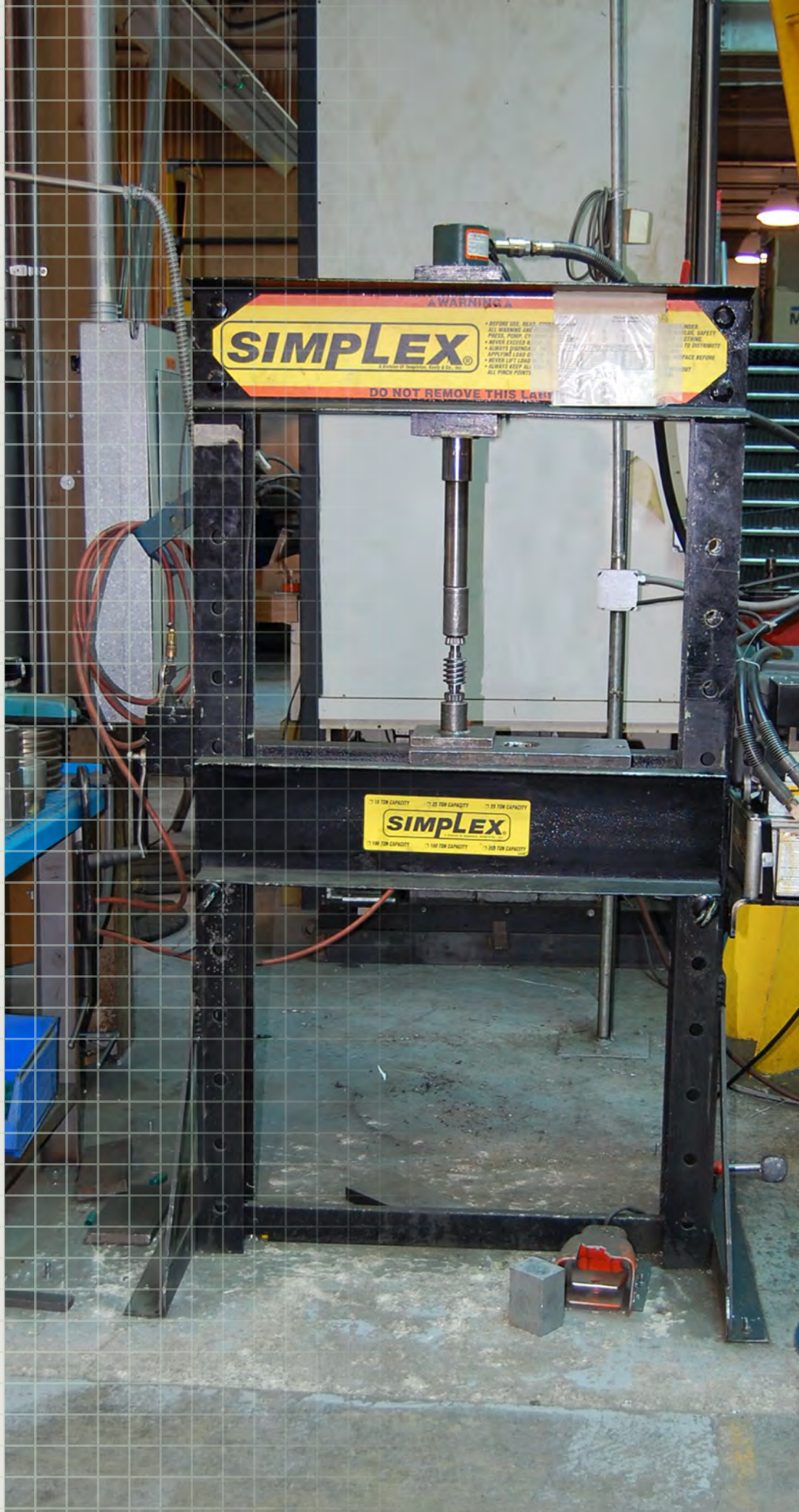

*Double pinned & welded construction for strength & safety*

*Friction brake winch for easy adjustment of work bed. Will not drop if handle is released*

*Maximum daylight for larger jobs & easy loading*

*Adjustable work bed for maximum flexibility*

*Rigid frame under full load*

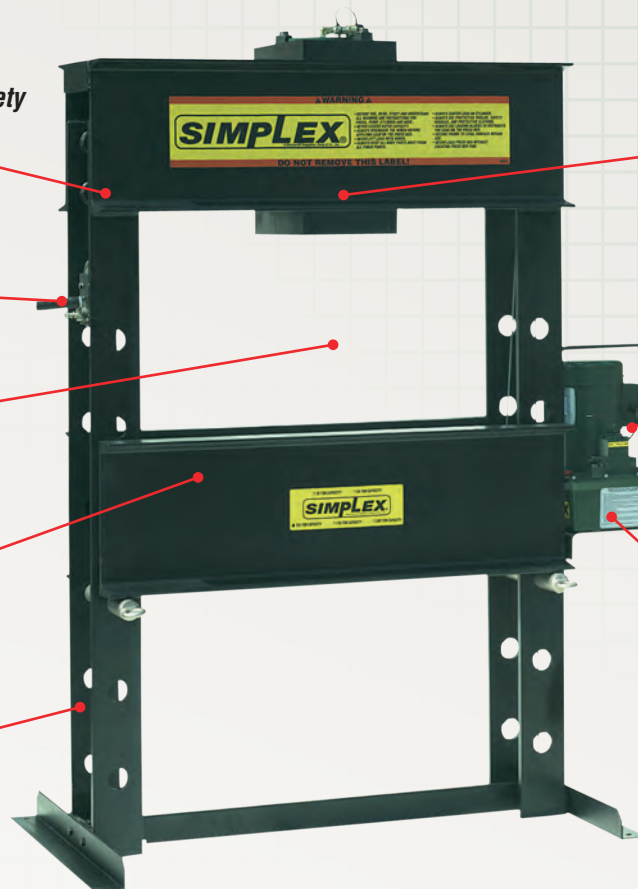

*Moveable work head allows movement across the entire length of the top cross bar*

*All electric pumps on 25 through 200 ton presses come standard with remote pendant control*

*Wide choice of electric, air or manual power sources*

IES10010 H Frame Press

## SIMPLEX HYDRAULIC PRESSES PRODUCT LINE OVERVIEW

### ► Wide Variety

Simplex offers presses with capacities from 10 through 200 tons. Choose from a wide range of pressing, cylinder strokes & styles, and your choice of Simplex manual or power pumps. Choose from a variety of H-Frame designs.

### ► Heavy Duty Construction/ Built for Safety

Simplex presses do not rely on “bolt together” construction for strength. Simplex H-Frames employ double pinned and heavy duty welded construction. This construction provides a frame that is **rigid** and provides an extra margin of safety.

### ► Maximum Flexibility

All Simplex H-Frame Presses include a moveable work head that easily rolls across the entire length of the top cross bar. This allows the pressing force to be positioned at any point of the press bed. The adjustable work bed can be raised or lowered to accommodate a wide variety of jobs.

### ► Maximum Daylight

Simplex presses have large work areas that accommodate larger jobs and makes loading and unloading easier. Open sides have large clearances for loading work through the side daylight.

### ► Easy To Use

H-Frame (25 ton & up) includes a friction brake winch that adjusts the bed height effortlessly and will not drop the bed if the handle is released (no kick back). The wide choice of pumps & valves provides a variety of controls. Moveable work head incorporates rollers for easy positioning.

### ► Custom Build Your Press

Along with many standard models, you can build custom presses by ordering the press without a pump. Order any Simplex pump & pump mounting kit separately to meet your requirements.

# HYDRAULIC PRESSES

Proper Size & Selection

**SIMPLEX**

## Selecting A Hydraulic Press

*SIMPLEX Hydraulic H-frame presses are accepted in many industries because of their wide range of use. They are able to produce significant force, ranging from 10 through 200 tons. Hydraulic presses provide force through the use of fluid pressure on a piston by means of manual or powered pumping element. The power source provides the ability for infinite adjustment of stroke, speed, length and pressure while staying within the limits of press capacity. Refer to the individual presses for packaged systems.*

## Principal Parts To Review When Selecting A Press

**Throat Clearance** - The distance from the vertical centerline of the ram to the frame member at the back of the bed. The distance measures the largest diameter piece that can be positioned with the part centerline under the center of the ram.

**Daylight** - The vertical clearance from the top of the bed to the underside of the ram in its peak position upwards. It shows the maximum vertical capacity of the press.

**Work Height** - The distance from the floor to the bolster.

## Simplex Hydraulic Presses

presses



### Bench

*Only Simplex offers Bench Presses with up to 15 ton capacities, moveable work heads and adjustable beds for maximum flexibility. For small production jobs, the adjustable bed eliminates wasted time approaching the work. IBP1010 & IBP1510 presses include a 10" stroke cylinder.*



### Floor H - Frame

*Simplex H-Frame Presses can be used professionally for assembly or straightening work up to 200 tons. They are also excellent for testing work pieces. H-Frame presses are robust and built to last. The frame is made of welded steel sections and the hydraulic system is excellent for precision work with the height of the work table easy to adjust and the cylinder head moveable.*

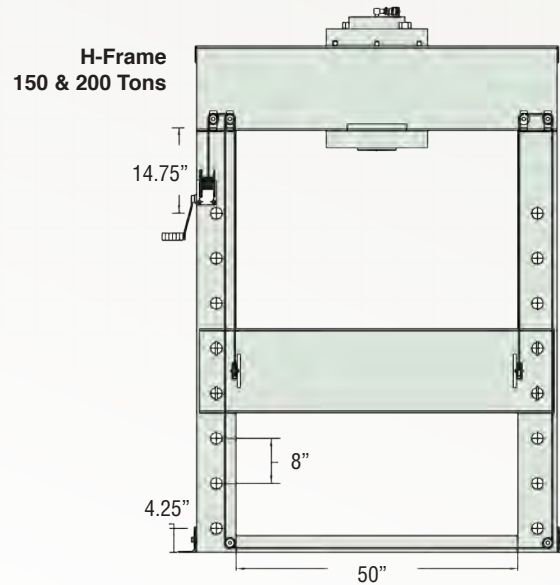
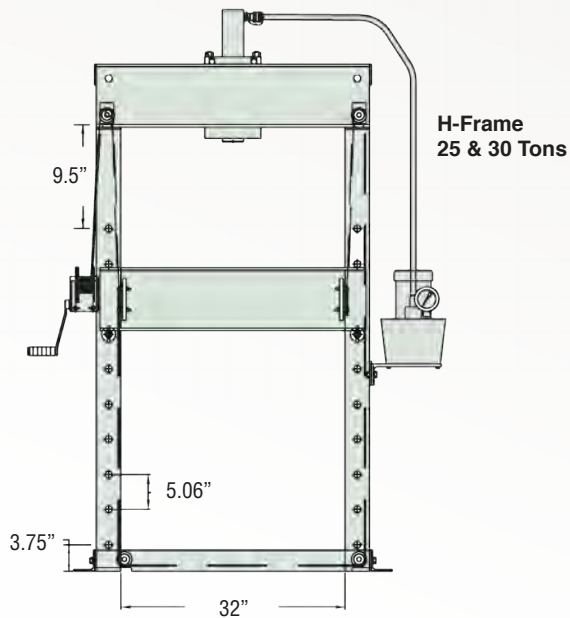
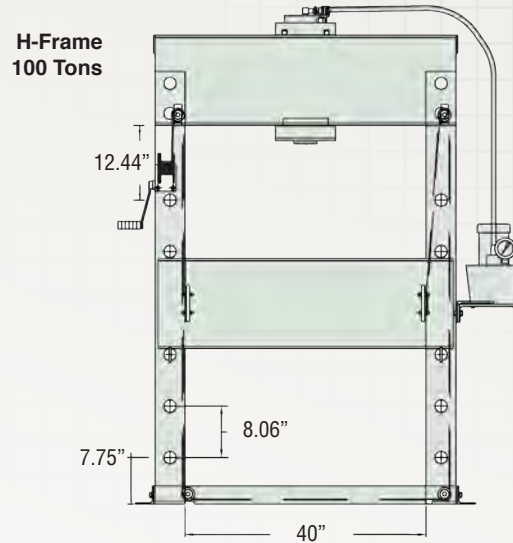
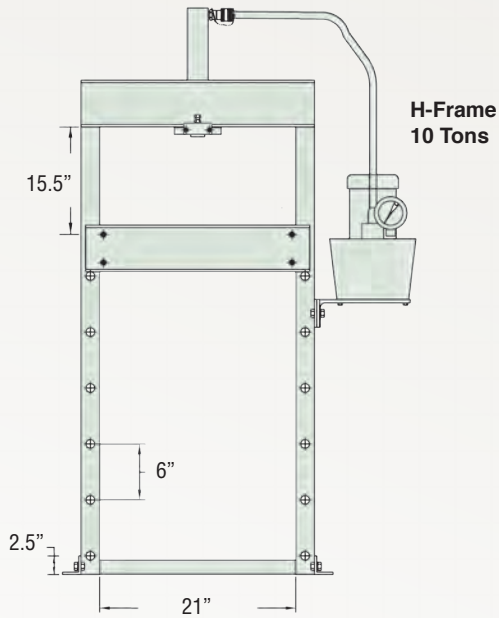
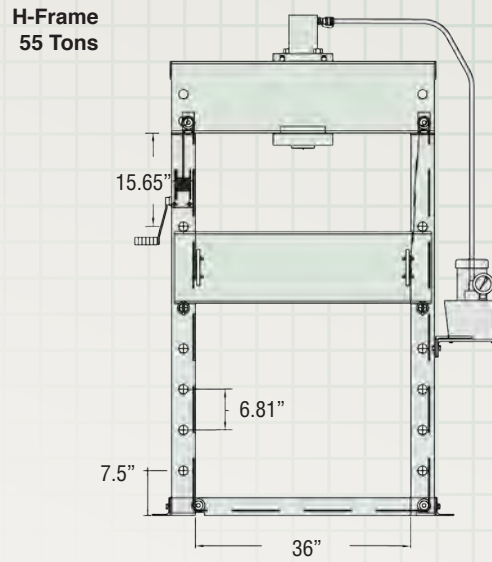
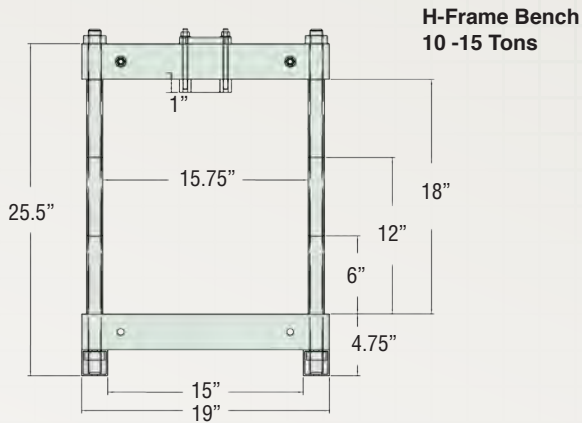

presses

# HYDRAULIC PRESSES

10-15 Ton - H Frame Bench



Model IBP1010



### HOSES - pages 78 - 79

Heavy duty and thermo plastic hydraulic hoses to meet your requirements and safety factor.



### COUPLERS - pages 74 - 75

High flow quick disconnect couplers provide a quick change to a variety of pumps.



### POWER PUMPS - pages 43 - 65

Simplex offers a wide variety of lightweight power pumps to fit any application.

**Capacity** ..... ► **10 - 15 Tons**

**Stroke** ..... ► **10 In.**

**Maximum Pressure** ..... ► **10,000 PSI**

- 10 or 15 ton capacities.
- Adjustable bed with large daylight.
- Moveable work head.
- Wide variety of power sources.

Simplex bench mounted press frame simplified the work so it can be performed safely and more productively. ▼

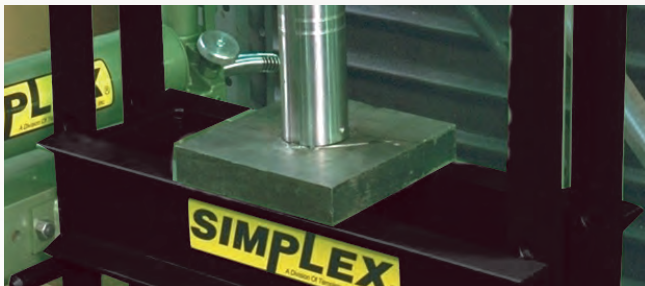

Contact Factory for additional dimensions.

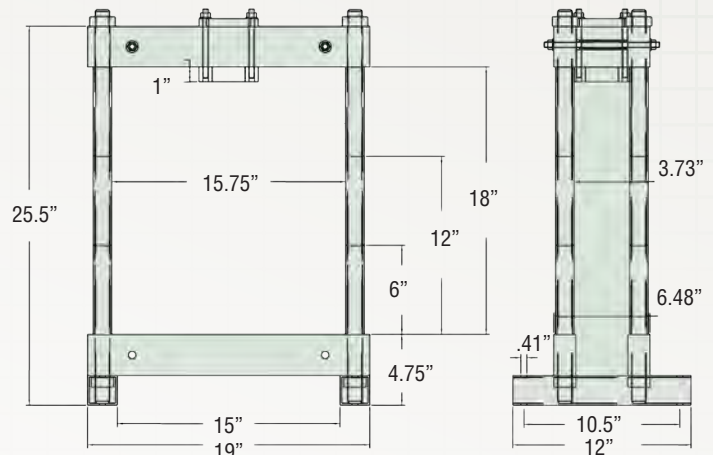

Model Number with Cylinder	Capacity (tons)	Type	Ram	Stroke (in)	Model Number w/o Cylinder	Weight (lbs)
IBP1010	10	S/A	R1010	10	IBP10	142
IBP1510	15	S/A	R1510	10.38	IBP15	150

Products listed below are ordered separately.

Capacity (tons)	Suggested Hand Pump	Suggested Electric Pump	Suggested Hose	Suggested Gauge	Gauge Adapter	Weight (lbs)
10	P42	G1121	HCA6	G6	GA1	130
15	P42	G1121	HCA6	G6	GA1	130

presses





Model IMS1010



**SIMPLEX HAND PUMPS - pages 31 - 41**

Hand pump design specifications meet or exceed ANSI /ASME B30.1 Safety Standards.



**HOSES - pages 78 - 79**

Heavy duty and thermo plastic hydraulic hoses to meet your requirements and safety factor.



**SIMPLEX CYLINDERS - pages 7 - 29**

Cylinder design specifications meet or exceed ANSI /ASME B30.1 Safety Standards.



**GAUGES - page 77**

Improve your system visibility and safety by adding an inline hydraulic gauge to your circuit.

- Capacity** ..... ► **10 Tons**
- Stroke** ..... ► **10 - 10.13 In.**
- Maximum Pressure** ..... ► **10,000 PSI**

- Single or double acting models available.
- Large daylight with open sides for easy loading.
- Heavy duty welded construction.
- Moveable work head for maximum versatility.
- IES Series comes with motor pendant control.

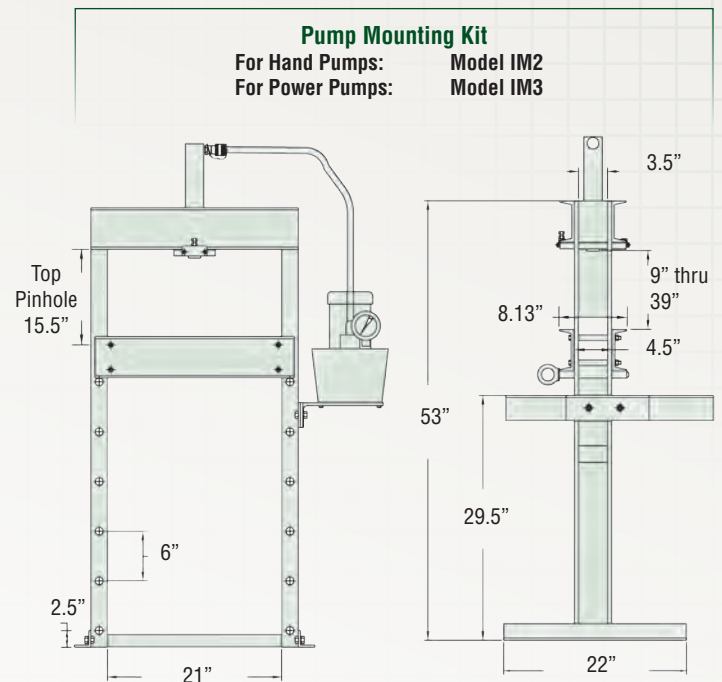

presses

Model Number Without Pump	Model Number With Pump	Type of Cylinder	Cylinder Stroke (in)	Type of Pump	Pump Model	Operation	Speed (in/min) * Indicates Inches per Stroke		Weight With Pump (lbs)	Weight Without Pump (lbs)
							Advance	Pressing		
----	<b>IAS1010</b>	R1010 Single Acting 10 Ton Capacity	10	Air Powered	GA90	Advance Hold Retract	31	4.5	202	172
<b>IS1010</b>	<b>IES1010</b>		10	Electric Powered	G1121		104	9	204	172
----	<b>IMS1010</b>		10	Manual	P42		.38*	.06*	208	172
<b>IDD1010</b>	<b>IED1010</b>	RDA1010 D/A	10	Electric Powered	G1141		104	9	226	188
----	<b>IMD1010</b>	10 Ton Capacity	10	Manual	P140D		1.25*	.10*	236	188

# HYDRAULIC PRESSES

25-30 Ton - H Frame



Model IES256

## HOSES - pages 78 - 79



Heavy duty and thermo plastic hydraulic hoses to meet your requirements and safety factor.

## COUPLERS - pages 74 - 75



High flow quick disconnect couplers provide a quick change to a variety of pumps.

## POWER PUMPS - pages 43 - 65



Simplex offers a wide variety of lightweight power pumps to fit any application.

- Capacity Range ..... ➤ **25 - 30 Tons**
- Stroke ..... ➤ **6.25 - 14.25 In.**
- Maximum Pressure ..... ➤ **10,000 PSI**

- ▶ Large daylight with open sides for easy loading.
- ▶ Wide choice of pumps & pressing cylinders.
- ▶ Includes tonnage gauge.
- ▶ IES & IED Series comes with pendant control.
- ▶ Moveable work head for maximum versatility.
- ▶ Adjustable work bed with friction brake winch.

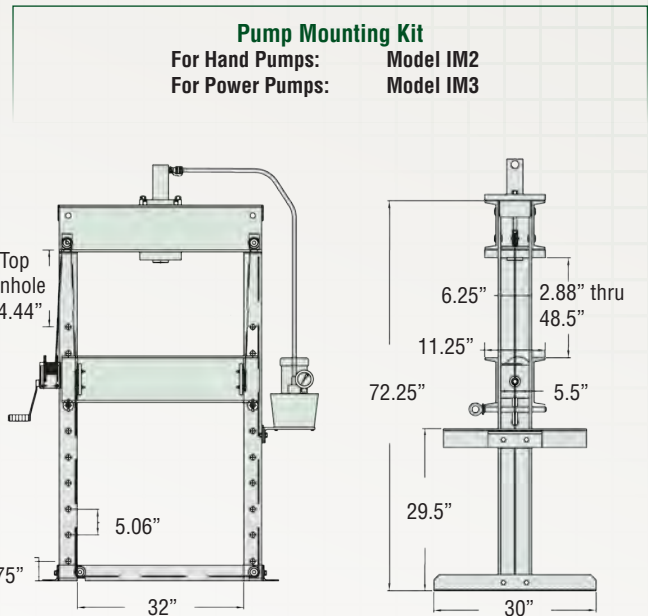

Model Number Without Pump	Model Number With Pump	Type of Cylinder	Cylinder Stroke (in)	Type of Pump	Pump Model	Operation	Speed (in/min) * Indicates Inches Per Stroke		Weight With Pump (lbs)	Weight Without Pump (lbs)
							Advance	Pressing		
----	<b>IAS256</b>	R256/ R2514 Single Acting 25 Ton Capacity	6.25	Air	GA90	Advance Hold Retract	14	2	417	----
----	<b>IAS2514</b>		14.25	Air	GA90		14	2	433	----
<b>IS256</b>	<b>IES256</b>		6.25	Electric	G1121		50	4	419	387
<b>IS2514</b>	<b>IES2514</b>		14.25	Electric	G1121		50	4	435	403
----	<b>IMS256</b>		6.25	Manual	P82A		.15*	.03*	423	----
----	<b>IMS2514</b>		14.25	Manual	P82A		.15*	.03*	439	----
<b>ID3014</b>	<b>IED3014</b>	RDA3014	14.25	Electric	G4172		40	3	462	428
----	<b>IMD3014</b>	RDA3014	14.25	Manual	P140D		.43*	.04*	458	----

presses



# HYDRAULIC PRESSES

55 Ton - H Frame



Model IES556



### THINK SAFETY

Please refer to pages 4&5 for a complete list of safety tips and recommendations.



### HOSES - pages 78 - 79

Heavy duty and thermo plastic hydraulic hoses to meet your requirements and safety factor.



### SIMPLEX CYLINDERS - pages 7 - 29

Cylinder design specifications meet or exceed ANSI /ASME B30.1 Safety Standards.



### GAUGES - page 77

Improve your system visibility and safety by adding an inline hydraulic gauge to your circuit.

- Capacity ..... ► **55 Tons**
- Stroke ..... ► **6.25 - 13.25 In.**
- Maximum Pressure ..... ► **10,000 PSI**

- Large daylight with open sides for easy loading.
- Adjustable work bed with friction brake winch.
- Moveable work head for maximum versatility.
- Rigid frame under full load.
- IED & IES Series are equipped with a pendant control.

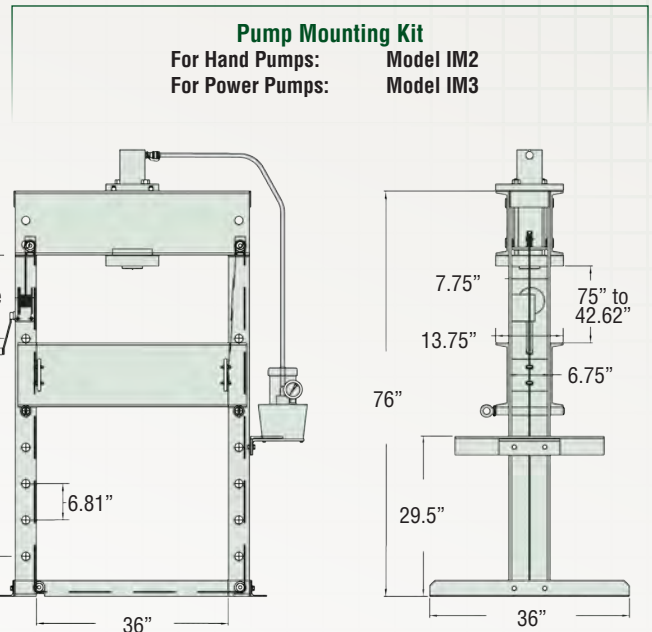

presses

Model Number Without Pump	Model Number With Pump	Type of Cylinder	Cylinder Stroke (in)	Type of Pump	Pump Model	Operation	Speed (in/min) * Indicates Inches per Stroke		Weight With Pump (lbs)	Weight Without Pump (lbs)
							Advance	Pressing		
IS556	IES556	R556 S/A	6.25	Electric Powered	G1121	Advance Hold Retract	23	2	707	675
IS5513	IES5513	R5513 S/A	13.25		G1121		23	2	735	703
ID556	IED556	RDA556 D/A	6.13		G4172		35	5	748	710
ID5512	IED5512	RDA5512 D/A	12		G4172		35	5	793	755
----	IMS556	R556 S/A	6.25	Manual	P82A		.07*	.02*	711	----

# HYDRAULIC PRESSES

100 Ton - H Frame



Model IES1006



### HOSES - pages 78 - 79

Heavy duty and thermo plastic hydraulic hoses to meet your requirements and safety factor.



### SIMPLEX CYLINDERS - pages 7 - 29

Cylinder design specifications meet or exceed ANSI /ASME B30.1 Safety Standards.



### POWER PUMPS - pages 43 - 65

Simplex offers a wide variety of lightweight power pumps to fit any application.

- Capacity Range ..... ➤ **100 Tons**
- Stroke ..... ➤ **6.06 - 12 In.**
- Maximum Pressure ..... ➤ **10,000 PSI**

- ▶ Moveable work head for maximum versatility.
- ▶ Wide choice of pumps & pressing cylinders.
- ▶ Includes tonnage gauge.
- ▶ IED & IES Series comes with pendant control.
- ▶ Choose double-acting presses for fast retraction.
- ▶ Adjustable work bed with friction brake winch.

A machine shop needed to straighten forgings prior to machining and the Simplex 100 ton H Frame press was a perfect fit for the job. ▼

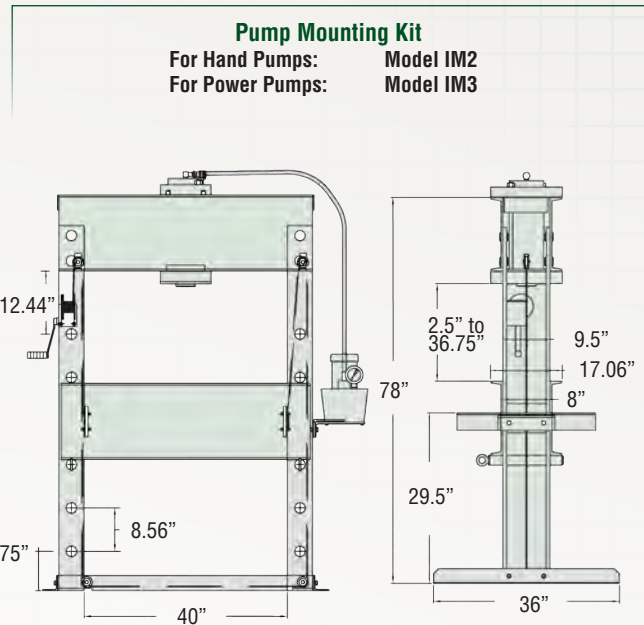

Model Number Without Pump	Model Number With Pump	Type of Cylinder	Cylinder Stroke (in)	Type of Pump	Pump Model	Operation	Speed (in/min)		Weight With Pump (lbs)	Weight Without Pump (lbs)
							Advance	Pressing		
IS1006	IES1006	R1006 S/A	6.62	Electric Powered	G4163	Advance Hold Retract	19	2.75	1558	1470
IS10010	IES10010	R10010 S/A	10.25		G4163		19	2.75	1578	1490
ID1006	IED1006	RDA1006 D/A	6.06		G4173		19	2.75	1620	1532
ID10012	IED10012	RDA10012 D/A	12		G4173		19	2.75	1655	1567

presses



Model ID15012



**THINK SAFETY**

Please refer to pages 4&5 for a complete list of safety tips and recommendations.



**HOSES - pages 78 - 79**

Heavy duty and thermo plastic hydraulic hoses to meet your requirements and safety factor.



**POWER PUMPS - pages 43 - 65**

Simplex offers a wide variety of lightweight power pumps to fit any application.



**GAUGES - page 77**

Improve your system visibility and safety by adding an inline hydraulic gauge to your circuit.

- Capacity** ..... ► **150 - 200 Tons**
- Stroke** ..... ► **12 - 13 In.**
- Maximum Pressure** ..... ► **10,000 PSI**

- Large daylight with open sides for easy loading.
- Adjustable work bed with friction brake winch.
- Rigid frame under full load.
- IED Series comes with pendant control.
- Includes tonnage gauge.
- Presses ordered with pumps include remote pendant control and large 5 gallon reservoir.

*Rail car repair shops are constantly faced with large jobs, these applications require a reliable and safe high tonnage press. ▼*

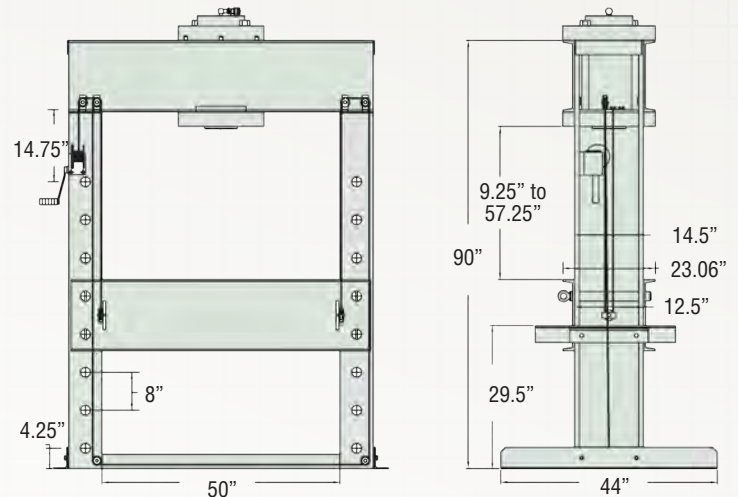
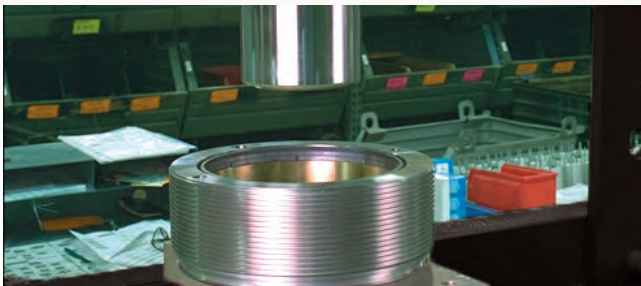

Model Number Without Pump	Model Number With Pump	Type of Cylinder	Cylinder Stroke (in)	Type of Pump	Pump Model	Operation	Speed (in/min)		Weight With Pump (lbs)	Weight Without Pump (lbs)
							Advance	Pressing		
ID15012	IED15012	RDA15012 D/A	12	Electric Powered	G6375	Advance Hold Retract	20	4.5	3035	2839
ID20013	IED20013	RDA20013 D/A	13				14	3.5	3180	2984

presses

# MECHANICAL JACKS



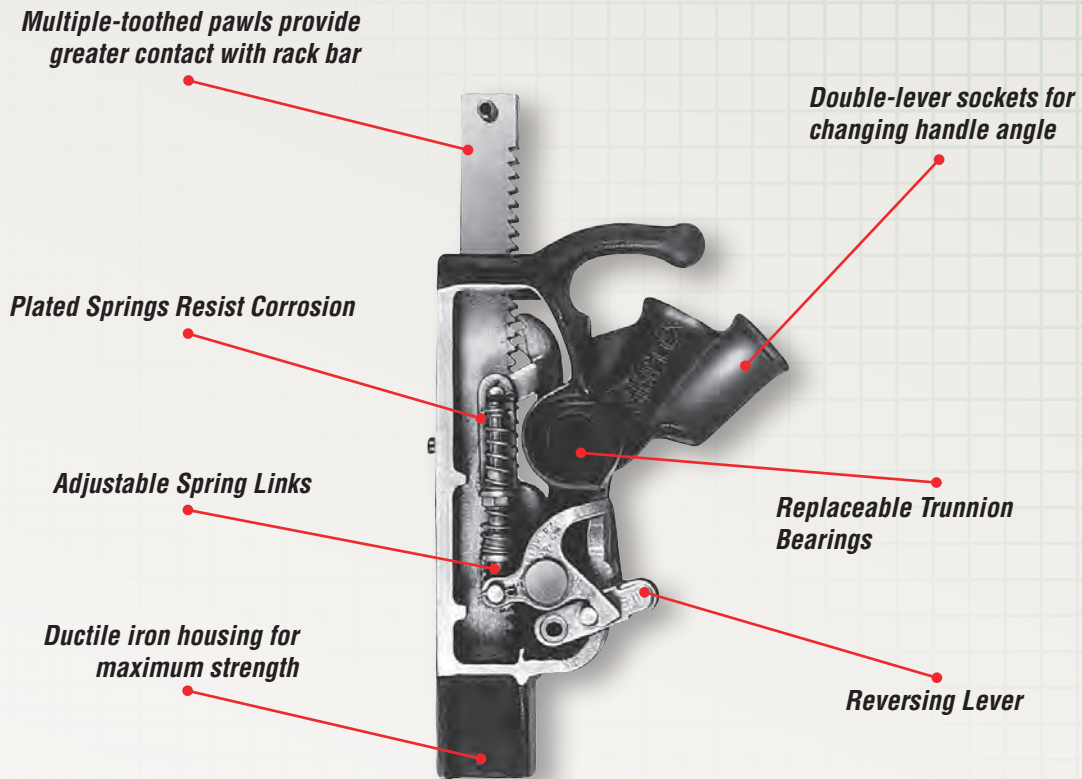

Ratchet Model Jack Shown

**SIMPLEX MECHANICAL JACKS PRODUCT LINE OVERVIEW****► The Industry Standard**

With over a century of experience in designing and manufacturing mechanical jacks, Simplex is the undisputed market leader that has set the standard for high quality and reliability in the mechanical jack industry.

**► The Widest Selection**

Only Simplex can offer a full range of Ratchet Jacks, Screw Jacks, Superjacks, Push/Pull Jacks and Mine Roof Supports to fit a broad range of applications and use.

**► Unsurpassed Quality**

Simplex Jacks have proven to withstand the toughest application and use in today's market. Each Jack component is carefully inspected and assembled by highly skilled assemblers and tested to meet or exceed ANSI B30.1 Safety Standards.

**► Value and Service**

Simplex stands behind every mechanical jack we sell with a NO SMALL PRINT WARRANTY supported by our global network of Industrial Distributors and Authorized Service Centers.

# MECHANICAL JACKS

Proper Size & Selection

**SIMPLEX**

## Methods Of Mechanical Force

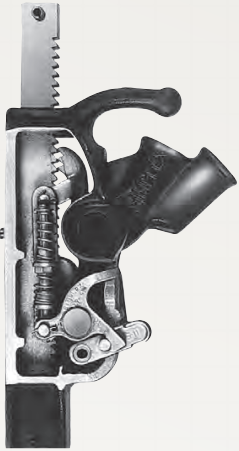

### Ratchet Jacks

◀ Ratcheting mechanism used to create leverage for movement.



### Screw Jacks

◀ Mechanical advantage is gained by using a specialized Acme threaded screw.

## Points To Review When Selecting A Mechanical Jack

### Determine the Proper Jack for your Application

Ratchet jacks are designed for lifting and positioning up to 15 tons. For higher tonnage applications, you should consider using our Superjacks for lifting and sustaining up to 50 tons. For all sustaining load applications, consider the screw jack as a suitable solution up to 24 tons.

### Handle Effort

Reference each table within this section to determine the amount of handle effort required for an application. Each model number specifies the amount of force required per ton. Also consult your local codes, safety standards or contracts that may specify maximum allowable handle effort per user. Proper jack sizing is required to maintain reasonable handle effort.

### Lift and Height of Jack

The available clearance under the load often determines which jack should be used. For the greatest versatility, select a jack that has the longest available stroke, but still fits under the load. The ratchet jack toe can be used in very low clearance situations where other products are not suited.

### Travel Speed

Ratchet jacks provide greatest travel per stroke, but accommodate lighter loads. Superjacks provide greater lifting capacity with less movement per stroke.

### Portability

If ease of portability is a factor, consider lightweight Ratchet Jack models: RJA1022, RJA1538, or Superjack models: JJA1510C, JJA2510C, JJA2515C, JJA3510D, JJA5010B.



**Ratchet Jacks** are ideal for mills and factory maintenance, oil fields, shipyards, farms, machinery riggers, construction contactors, mining operators, bridge and rail car repair and heavy-duty industrial maintenance. These are the most versatile, general-purpose jacks available. Rugged construction permits safe, efficient lifting, lowering, skidding, moving, sustaining and leveling with the important SIMPLEX feature that provides full lift capacity on the toe or on the cap.



**Super Jacks** are used for inspecting and renewing journal brasses, bridge, tank and structural steel erectors, presses, shipbuilding and all industries where powerful, all-position jacks are required. These jacks will hold the load indefinitely and offer heat treated, alloy steel forgings, bronze nuts, ball bearings, positive shoulder stops and high gear ratios. The ratchet mechanisms are fully enclosed to protect them from the elements.



**Screw Jacks** are suitable for house movers, leveling, supporting, shop and factory maintenance, riggers, locomotive repairs, drillers and farm applications. Malleable housings are lighter and unbreakable. A hardened, large chrome-moly ball floating cap centers the load automatically and reduces friction by 88%. The steel cap is constructed of corrugated, drop-forged steel with a self-leveling 9 degree float.



**Push-Pull Jacks** are essential for any maintenance repair or production work in all types of shops and field applications. Loadbinder Jacks are used on the construction of bridges and concrete and steel engineering projects. Gravity type pawl is used on boats and barges.



**Trench Braces & Roof Supports** are designed for putting up cross timbers and steel beams, aligning steel mine cars, a temporary prop in connection with loading equipment, pulling up and removing slack in power cables and pulling and pushing conveyor lines and controlling the tail piece.



# MECHANICAL JACKS

RJ Series - Ratchet Jacks



Models: RJ84A, RJ85A, RJ1017 & RJ86A

**Capacity Range** .....▶ **5 - 20 Tons**  
**Stroke Range** .....▶ **7 - 21.25 In.**  
**Maximum Toe Height Range** .....▶ **1.62 - 2.25 In.**

- ▶ Multiple-tooth pawls for strength & safety.
- ▶ Large base ensures a firm foundation.
- ▶ Drop-forged, alloy steel, heat-treated components.
- ▶ Plated springs to resist corrosion.
- ▶ Double-lever sockets for jacking in close quarters.
- ▶ The RJA1538 pole jack is designed for pole pulling applications. Chain and I-Beam are ordered separately.



### THINK SAFETY

Please refer to pages 4&5 for a complete list of safety tips and recommendations.



### CE COMPLIANT

Our Jack design specifications meet or exceed ANSI /ASME B30.1 Safety Standards.



### CARRYING HANDLE

Carrying handles make the positioning and transporting of the 10, 15 and 20 ton ratchet jacks simple.

mechanical



RJA1022

RJ22B

RJ24A

RJ2029



RJA1538  
Pole Jack

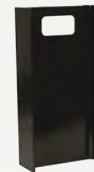

IB1538  
I-Beam Base



CHA1538  
Alloy Chain

*Its large lifting and holding capacity and heavy-duty housing, makes the RJ Series Jacks universal tools on any jobsite. ▼*



Model	Jack Housing Material	Support Capacity (tons)	Lifting Capacity (tons)	Handle Effort per Ton (lbs)
RJ84A	Steel	5	5	32
RJ85A				32
RJ86A				32
RJ1017		10	10	30
RJ22B				30
RJ24A		20	15	32
RJ2029	32			
RJA1022	Aluminum	10	10	30
RJA1538		15	8	32

# MECHANICAL JACKS

RJ Series - Ratchet Jacks

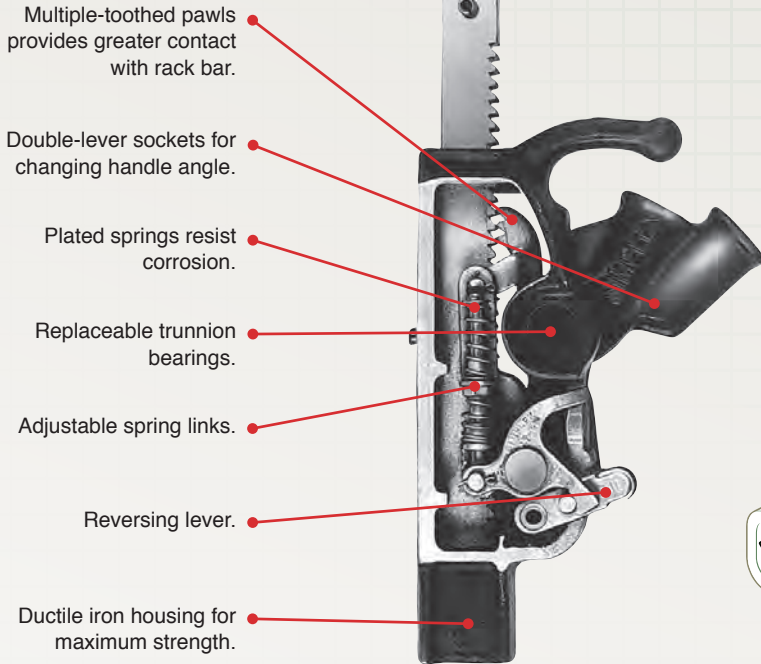

Multiple-toothed pawls provides greater contact with rack bar.

Double-lever sockets for changing handle angle.

Plated springs resist corrosion.

Replaceable trunnion bearings.

Adjustable spring links.

Reversing lever.

Ductile iron housing for maximum strength.



## RECOMMENDED LEVER BARS

Please refer to page 146 for additional details.

Ratchet Jack Model	Lever Bar Model
<i>RJ84A</i>	SLB36
<i>RJ85A</i>	SLB36
<i>RJ86A</i>	SLB36
<i>RJ1017</i>	SLB60
<i>RJ22B</i>	SLB60
<i>RJ24A</i>	SLB70
<i>RJ2029</i>	SLB70
<i>RJA1022</i>	SLB60
<i>RJA1538</i>	SLB70

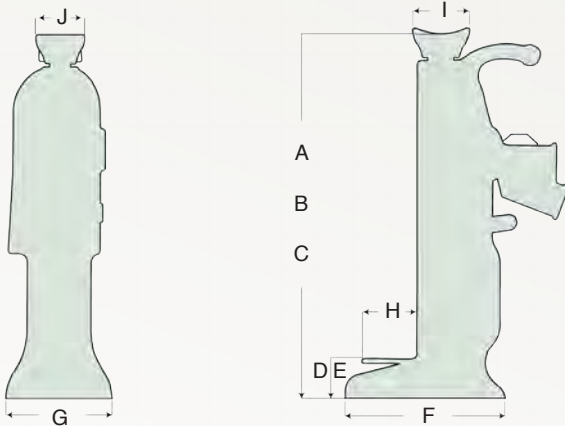

Dimensions (in)										Weight (lbs)	Model
A	B	C	D	E	F	G	H	I	J		
Minimum Height	Maximum Height	Stroke	Toe Minimum Height	Toe Maximum Height	Base Length	Base Width	Toe Length	Cap Length	Cap Width		
14	21	7	1.75	8.75	7.38	5	2.5	2.62	2.31	28	<i>RJ84A</i>
17	27	10	1.75	11.75	7.38	5	2.5	2.62	2.31	30	<i>RJ85A</i>
20	33	13	1.75	14.75	7.38	5	2.5	2.62	2.31	35	<i>RJ86A</i>
17.25	26.75	9.5	1.62	11.13	8.75	6	2.4	2.87	2.62	40	<i>RJ1017</i>
21.62	33.62	12	2	14	10.25	6.5	2.4	3	2.5	70	<i>RJ22B</i>
23.25	36	12.75	2.25	15	10.25	8	2.62	3.5	2.87	93	<i>RJ24A</i>
28	46	18	2.25	20.25	11	8	2.62	3.5	2.87	104	<i>RJ2029</i>
21.62	33.62	12	2	14	10.25	6.5	2.4	3	2.5	42	<i>RJA1022</i>
37.62	59.13	21.25	---	---	8.13	8.25	---	---	---	62	<i>RJA1538</i>

mechanical

# MECHANICAL JACKS

CR Series - Reel Jacks



CR321B Reel Jacks

**Capacity Range** ..... ➤ **5 - 20 Tons**  
**Stroke Range**..... ➤ **9.5 - 11.5 In.**  
**Minimum Height Range** ..... ➤ **21 - 34.5 In.**

- ▶ Double-lever sockets for jacking in close quarters.
- ▶ Multiple-tooth pawls for strength & safety.
- ▶ Drop-forged, alloy steel, heat-treated components.
- ▶ Adjustable spring links for added serviceability.
- ▶ Plated springs to resist corrosion.
- ▶ Precision machining throughout.
- ▶ Steel lever bars sold separately.



### THINK SAFETY

Please refer to pages 4&5 for a complete list of safety tips and recommendations.



### CE COMPLIANT

Our Jack design specifications meet or exceed ANSI /ASME B30.1 Safety Standards.



### CARRYING HANDLES

Convenient center mounted carrying handle makes this jack easy to position and move.



### LAMINATED BASE

Treated laminated hardwood base provides solid support along with durability.

*The large wooden bases and low handle efforts on these Reel Jacks enhance safety and reduce operator fatigue. ▼*



CR320B



CRA1029R

Model	Capacity / Pair		Handle Effort per Tons (lbs)	Stroke (in)	Dimensions (in)					
	Side Hooks (tons)	Top Hooks (tons)			A	B	C	C <sup>1</sup>	C <sup>2</sup>	C <sup>3</sup>
					Minimum Height	Maximum Height	Minimum Height			
CR320B	5	10	72	9.5	20.75	30.25	15.25	---	---	---
CR321B	10	20	48	14	34.50	48.50	9.25	15.63	22.00	28.38
CRA1029R			40	11.63	31.13	42.75	24.87	---	---	---
CRA1029L			40	11.63	31.13	42.75	24.87	---	---	---

mechanical

# MECHANICAL JACKS

CR Series - Reel Jacks



Two CR321B Reel Jacks are used to support this cable spool for line feeding.

CR320B

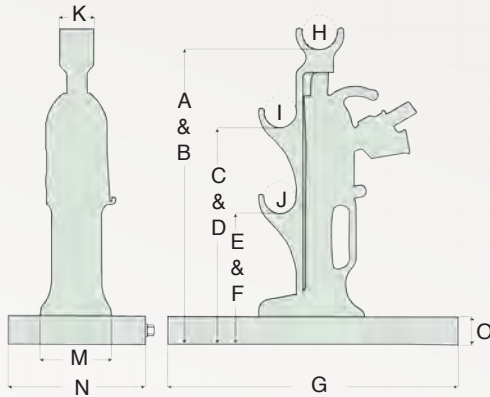

CR321B

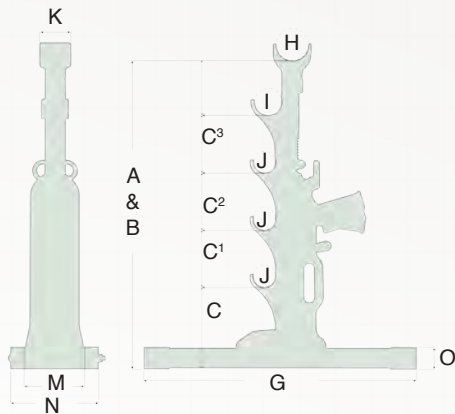

## RECOMMENDED LEVER BARS

Please refer to page 146 for additional details.

Reel Jack Model	Lever Bar Model
CR320B	SLB36
CR321B	SLB60
CRA1029R	SLB60
CRA1029L	SLB60

CRA1029R & CRA1029L

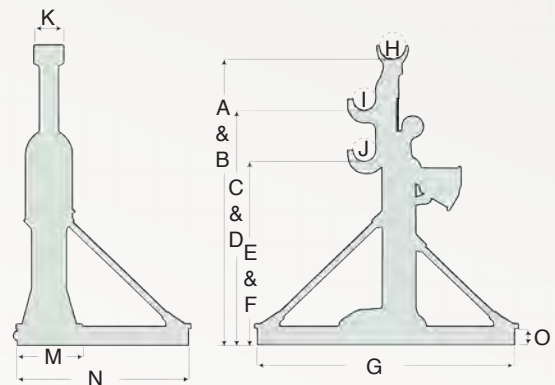

Dimensions (in)											Weight (lbs)	Model
D	E	F	G	H	I	J	K	M	N	O		
Maximum	Minimum	Maximum	Length	Diameter	Diameter	Diameter	Width	Length	Width	Height		
24.75	9.25	18.75	20.38	2.62	2.25	2.25	2.38	5.00	9.38	2.00	51	CR320B
---	---	---	30.37	3.63	3.00	2.38	3.50	6.50	9.75	2.50	125	CR321B
36.50	18.87	30.50	30.00	3.12	2.62	2.62	3.50	6.62	7.50	2.25	86	CRA1029R
36.50	18.87	30.50	30.00	3.12	2.62	2.62	3.50	6.62	7.50	2.25	86	CRA1029L

mechanical

# MECHANICAL JACKS

PP Series - Push / Pull Jacks



Model: PP610



Model: PP61015



### THINK SAFETY

Please refer to pages 4&5 for a complete list of safety tips and recommendations.



### CE COMPLIANT

Our Jack design specifications meet or exceed ANSI /ASME B30.1 Safety Standards.



### RECOMMENDED LEVER BARS

Please refer to page 146 for additional details.

Push/Pull Jack Model	Lever Bar Model
PP610	SLB24
PP61015	SLB24

- Centered Capacity ..... ► **10 Tons**
- Weight ..... ► **5 - 13 Lbs.**
- Screw Diameter ..... ► **1.25 In.**

- Used for pushing, pulling, holding and more.
- Ideal for weld shops.
- End nuts are designed to permit the use of chains with eye hooks.
- Suitable for adjusting forms, dampers, fixtures and flues.
- Incorporates 1.25-6 ACME 2G Class, right and left hand.

A Simplex PP610 is used to separate these I-Beams for proper bridge repair operation and maintenance. ▼

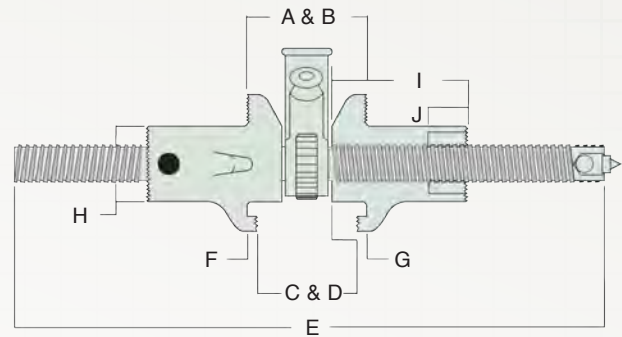

Model	Dimensions (in)									
	A	B	C	D	E	F	G	H	I	J
	Minimum	Maximum	Minimum	Maximum	Length	Length	Length	Length	Length	Length
PP610	3.38	8.13	2.87	7.62	10	.31	.31	2.38	3.19	1.25
PP61015	----	----	----	----	10	----	----	----	----	----

Model	Centered Capacity (tons)	Hook/Toe Offset Load Capacity (tons)	Travel (in)	Handle Effort per ton (lbs)	Screw Diameter (in)	Weight (lbs)
PP610	10	2	4.5	15	1.25	13
PP61015	10	2	----	15	1.25	5

mechanical



Models: JJA2515C, JJ2510C

- Capacity Range** ..... ► **15 - 50 Tons**
- Stroke Range** ..... ► **4 - 9 In.**
- Minimum Height** ..... ► **10.25 - 15 In.**

- Ratcheting screw jack design.
- Holds the load indefinitely, and will not creep down.
- Positive shoulder stop for safety.
- Available with aluminum or ductile iron housing.
- Ball bearings for smooth operation and low handle effort.



**THINK SAFETY**

Please refer to pages 4&5 for a complete list of safety tips and recommendations.



**CE COMPLIANT**

Our Jack design specifications meet or exceed ANSI /ASME B30.1 Safety Standards.



**REVERSAL RATCHET**

Raise or lower the load precisely with the reversal ratchet socket with quick spin handle.



**RECOMMENDED LEVER BARS**

Please refer to page 146 for additional details.

Super Jack Model	Lever Bar Model
JJ2510C	SLB36
JJ3510D	SLB36
JJ5010B	SLB56
JJA1510C	SLB36
JJA2510C	SLB36
JJA2515C	SLB36
JJA3510D	SLB36
JJA5010B	SLB56

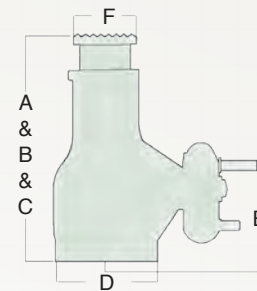

Model	Jack Housing Material	Capacity (tons)	Dimensions (in)						Handle Effort Per Ton (lbs)	Weight (lbs)
			A	B	C	D	E	F		
			Minimum Height	Maximum Height	Stroke	Base Diameter	Socket	Cap Diameter		
JJ2510C	Steel	25	10.25	15.25	5	5.5	7.5	3.13	6	43
JJ3510D		35	10.25	15.25	5	5.5	7.5	3.13	6	44
JJ5010B		50	10.31	14.31	4	7.25	8.81	3.93	4	80
JJA1510C	Aluminum	15	10.25	15.25	5	5.5	7.5	2.38	6	38
JJA2510C		25	10.25	15.25	5	5.5	7.5	3.13	6	34
JJA2515C		25	14.87	23.87	9	5.5	7.5	3.13	6	43
JJA3510D		35	10.25	15.25	5	5.5	7.5	3.13	5	34
JJA5010B		50	10.31	14.31	4	7.25	8.81	3.93	4	61

mechanical

# MECHANICAL JACKS

SJ Series - Screw Jacks



Mechanical Screw Jack Family Shown

**Capacity Range** .....▶ **12 - 24 Tons**  
**Stroke Range** .....▶ **3.75 - 14.25 In.**  
**Minimum Height** .....▶ **9.62 - 23 In.**

- ▶ Ductile and malleable bodies for added strength.
- ▶ Positive welded stop for safety.
- ▶ Supports loads indefinitely, and will not creep down.
- ▶ Carry handle for ease of transport.
- ▶ Four holes for easy positioning of lever bar.
- ▶ 9° tilt saddle assists in centering load point.



### THINK SAFETY

Please refer to pages 4&5 for a complete list of safety tips and recommendations.



### CE COMPLIANT

Our Jack design specifications meet or exceed ANSI /ASME B30.1 Safety Standards.



### RECOMMENDED LEVER BARS

Please refer to page 146 for additional details.

\* Lever Bars Sold Separately

Screw Jack Model	Lever Bar Model
<i>SJ156</i>	SLB24
<i>SJ158</i>	SLB24
<i>SJ1512</i>	SLB24
<i>SJ208</i>	SLB35
<i>SJ2010</i>	SLB35
<i>SJ2012</i>	SLB35
<i>SJ258</i>	SLB42
<i>SJ2512</i>	SLB42
<i>SJ2518</i>	SLB42

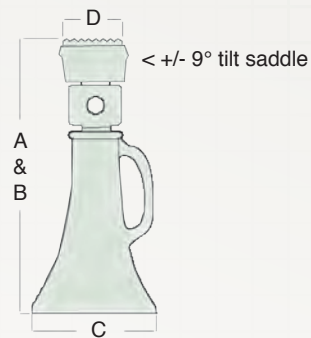

Model	Sustaining Capacity (tons)	Dimensions (in)				Handle Effort Per Ton (lbs)	Weight (lbs)
		A	B	C	D		
		Closed Height	Stroke	Base Diameter	Cap Diameter		
<i>SJ156</i>	12	9.63	3.75	4.75	2.88	15	10
<i>SJ158</i>		11.63	5.75	5.5	2.88	15	12
<i>SJ1512</i>		15.75	9.75	6.25	2.88	15	16
<i>SJ208</i>	20	11.88	5	6	3.13	15	17
<i>SJ2010</i>		13.75	7	6.5	3.13	15	20
<i>SJ2012</i>		15.75	9	6.75	3.13	15	24
<i>SJ258</i>	24	13	4.25	6.5	3.25	15	28
<i>SJ2512</i>		17	8.25	7.25	3.25	15	37
<i>SJ2518</i>		23	14.25	8.5	3.25	15	52





▲ The shoulder nut is placed into piping, fixtures or other fixed forms supplied by the user.



SCN15 & SC156 Shown



**THINK SAFETY**

Please refer to pages 4&5 for a complete list of safety tips and recommendations.



**RECOMMENDED LEVER BARS**

Please refer to page 146 for additional details.

\* Lever Bars Sold Separately

Screw & Cap Model	Lever Bar Model
SC156	SLB24
SC158	SLB24
SC1512	SLB24
SC208	SLB35
SC2010	SLB35
SC2012	SLB35
SC258	SLB42
SC2512	SLB42
SC2518	SLB42

- Sustaining Capacity** ..... ► **12 - 24 Tons**
- Thread Pitch Range** ..... ► **1.5 - 2.5 in.**
- Weight Range** ..... ► **5.5 - 29.25 Lbs.**

- Holds the load indefinitely without creep down.
- The shoulder nut is placed into piping or other fixed form, and the screw & cap assembly is threaded through it.

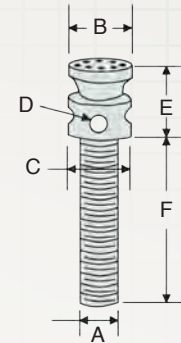
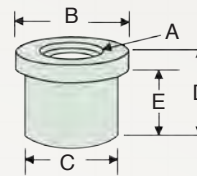

Model	Sustaining Capacity (tons)	Dimensions (in)						Weight (lbs)
		A	B	C	D	E	F	
		Modified Acme Thread Diameter - Pitch A (Thread) (in)	Width	Diameter	Width			
SC156	12	1.5 - 3	2.87	2.25	.87	3.75	5.68	5.5
SC158		1.5 - 3	2.87	2.25	.87	3.75	7.68	6.25
SC1512		1.5 - 3	2.87	2.25	.87	3.75	11.68	7.75
SC208	20	2 - 2.5	3.13	2.87	.93	4	7.56	10.5
SC2010		2 - 2.5	3.13	2.87	.93	4	9.56	12
SC2012		2 - 2.5	3.13	2.87	.93	4	11.56	13.5
SC258	24	2.5 - 2.5	3.25	3.25	1.81	5	7.81	16.75
SC2512		2.5 - 2.5	3.25	3.25	1.81	5	11.86	21.75
SC2518		2.5 - 2.5	3.25	3.25	1.81	5	17.81	29.25
<b>Shoulder Nuts</b>								
SCN15	---	1.5 - 3	3	2.41	3	2.25	---	3.25
SCN20	---	2 - 2.5	4	3	3.25	2.25	---	5
SCN25	---	2.5 - 2.5	5	3.93	4	3	---	11

mechanical

# MECHANICAL JACKS

44 Series - Tank Jacks



Tank Jack Family Shown



**CE COMPLIANT**

Our Jack design specifications meet or exceed ANSI /ASME B30.1 Safety Standards.

Model	Order Number	Base Dia. "A" (in)	Base Height "B" (in)	Min. Height "C" (in)	Max. Height "C" (in)	Weight (lbs)
4406	03820	5.75	4	6	8	10
4410	03840	6	8	10	12	12
4414	03860	6.5	12	14	16	17
4418	03880	8	16	18	20	26
4846	03993	-----	-----	-----	-----	2.5

- Capacity ..... ➔ **7.5 Tons**
- Stroke ..... ➔ **2 In.**
- Minimum Height ..... ➔ **6 - 18 In.**

- ▶ Supports and levels verticle, bottom, or side opening filter and storage tanks.
- ▶ Rated capacity for all models is 15,000 lbs.
- ▶ Screw operation provides infinite adjustment for exact tank leveling and gravity flow.

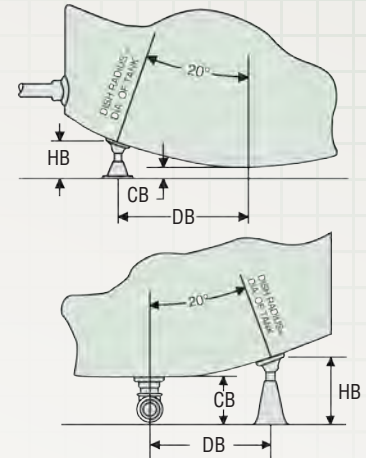
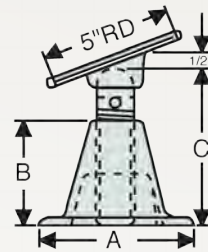

Use the installation data charts, with accompanying drawings, to determine the size and number of jacks your application will require.

Model	Tank Dia. (ft-in)	Pipe Dia. (in)	"DB" (in)	"HB" (in)	"CB" (in)	Quantity Required	
						Under 12 Ft.	Over 12 Ft.
<b>For Side Pipe Connections</b>							
4406	3-6	---	14	6.5	4	4	4
4406	4-0	---	16	6.38	3.5	4	4
4406	4-6	---	18	6.75	3.5	4	4
4406	5-0	---	20	7.13	3.5	4	4
4406	5-6	---	22	7.5	3.5	4	4
4406	6-0	---	24	6	1.5	4	4
4406	6-6	---	26	6.13	1.5	4	4
4406	7-0	---	28	6.5	1.5	4	6
4406	7-6	---	30	6.87	1.5	4	6
4406	8-0	---	32	7.25	1.5	6	8
4406	8-6	---	34	7.62	1.5	6	8
4406	9-0	---	36	8	1.5	6	8
4410	9-6	---	38	10.38	3.5	8	8
4410	10-0	---	42	10.75	3.5	8	8

Model	Tank Dia. (ft-in)	Pipe Dia. (in)	"DB" (in)	"HB" (in)	"CB" (in)	Quantity Required	
						Under 12 Ft.	Over 12 Ft.
<b>For Bottom Pipe Connections</b>							
4410	3-6	2	14	10.5	8	4	4
4410	4-0	2.5	16	11.87	9	4	4
4410	4-6	2.5	18	12.25	9	4	4
4414	5-0	2.5	20	14.62	11	4	4
4414	5-6	2.5	22	15	11	4	4
4414	6-0	3	24	16.38	12	4	4
4414	6-6	3	26	14.62	10	4	4
4418	7-0	4	28	18.25	13.25	4	6
4418	7-6	4	30	18.62	13.25	4	6
4418	8-0	4	32	19	13.25	6	8
4418	8-6	5	35	20	14	6	8
4418	9-0	5	37	19.5	13	6	8
4418	9-6	5	39	20	13	8	8
4418	10-0	6	41	21	14	8	8



SER20 & SER30 Shown

- Capacity** .....▶ **20 Tons**
- Travel Range** .....▶ **14 - 38 In.**
- Barrel Range** .....▶ **18 - 42 In.**
- Weight** .....▶ **57 - 92 Lbs.**

- ▶ 20 ton capacity models are used for connecting river barges, pulling forms and steel plates.
- ▶ Ideal for bridge construction and steel engineering projects.
- ▶ Equipped with spring activated pawl and 26 in. integrated handle.
- ▶ Can be used in “push” or “pull” applications.



**THINK SAFETY**

Please refer to pages 4&5 for a complete list of safety tips and recommendations.



**CE COMPLIANT**

Our Jack design specifications meet or exceed ANSI /ASME B30.1 Safety Standards.

*The Loadbinder Jack was used to secure a tractor for transporting. The heavy duty construction makes this jack useful for many applications.* ▼

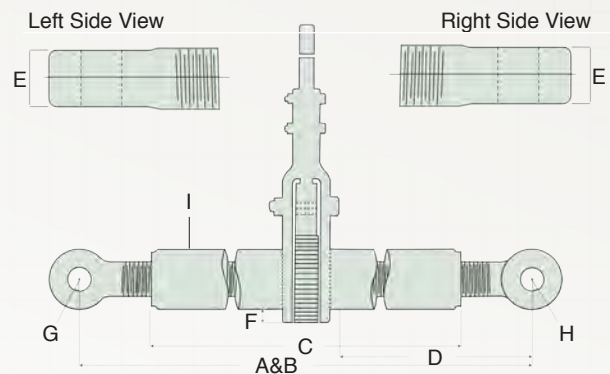

Model	Travel Length (in)	Screw Diameter (in)	Dimensions (in)									Weight (lbs)
			Eye to Eye		Barrel Length	Left / Right Screw Length	Left / Right Screw Eye Thickness	Ratchet Socket Length	Inner Diameter Left / Right Screw Eye	Radius	Pipe Barrel Outside Diameter	
			Minimum	Maximum								
SER10	14	2	23	37	18	11	2	.75	1.31	1.75	3.5	57
SER20	20	2	29	49	24	14	2	.75	1.31	1.75	3.5	66
SER30	26	2	35	61	30	17	2	.75	1.31	1.75	3.5	74
SER40	38	2	47	85	42	23	2	.75	1.31	1.75	3.5	92

mechanical

# MECHANICAL JACKS

PJ Series - Planer Jacks



Models: PJ1P, PJ2P & PJ4P



### THINK SAFETY

Please refer to pages 4&5 for a complete list of safety tips and recommendations.



### CE COMPLIANT

Our Jack design specifications meet or exceed ANSI /ASME B30.1 Safety Standards.

The notched base and swivel socket cap makes the versatile Planer Jack the perfect choice for repair & maintenance. ▼



- Sustaining Capacity** .....▶ **2 - 8 Tons**
- Weight** .....▶ **1.5 - 12 Lbs.**
- Operable Rise** .....▶ **1-4 In.**

- ▶ Side locking screw keeps the jack extended and prevents lowering due to vibration.
- ▶ Screw operation provides countless adjustments for exact leveling.
- ▶ Ideal jack for leveling plane beds, millers and machinery.
- ▶ Ball and socket cap swivels to center load forces.
- ▶ Notched base fastens easily to machine beds.

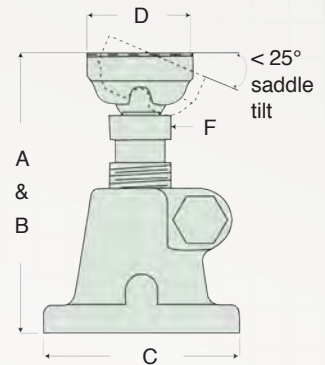
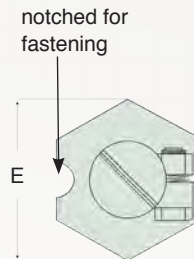

Model	Sustaining Capacity (tons)	Operable Rise (in)	Dimensions (in)						Weight (lbs)
			A	B	C	D	E	F	
			Minimum Height	Maximum Height	Across Flats	Cap Diameter	Across Points	Hex Across Flats	
PJ1P	2	1	2.75	3.75	2.38	1.25	2.75	.75	1.5
PJ2P	4	1.5	3.75	5.25	3.13	1.68	3.62	1	3
PJ3P	6	2.25	5.25	7.5	4	2.06	4.62	1.25	6
PJ4P	8	4	7.5	11.5	5.38	2.5	6.19	1.5	12

mechanical



Model: S3A



**THINK SAFETY**

Please refer to pages 4&5 for a complete list of safety tips and recommendations.



**CE COMPLIANT**

Our Jack design specifications meet or exceed ANSI /ASME B30.1 Safety Standards.



**LOAD CAP**

Steel serrated load cap prevents the load from possible slippage.

- Sustaining Capacity** ..... ► **3 Tons**
- Operable Rise** ..... ► **1 In.**
- Weight** ..... ► **3.3 Lbs.**

- Perfect for close quarters and tight spaces.
- Supports 3 tons and has a 1 in. stroke for adjustments.
- Closed height of 3 in.
- Serrated cap rotates and prevents load slippage.

*The S3A, with its low profile and small footprint was the perfect solution to level the bed of this milling machine. ▼*

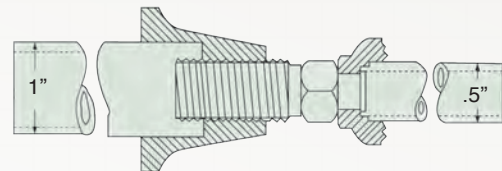
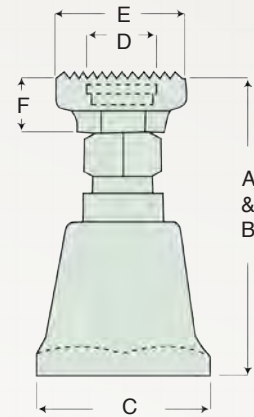

▲ The spreader jack can easily be extended by fitting a 1 in. diameter pipe in the cap well and a .5 in. diameter pipe in the housing well.

Model	Sustaining Capacity (tons)	Operable Rise (in)	Dimensions (in)						Weight (lbs)
			A	B	C	D	E	F	
			Minimum Height	Maximum Height	Base	Well Diameter	Cap Width	Cap Height	
S3A	3	1	3	4	2	.84	1.5	.68	3.25

mechanical

# MECHANICAL JACKS

RS Series - Roof Support

**SIMPLEX**



Models: 09618, RS139AS78114

<b>Stroke</b> .....	▶	<b>36 In.</b>
<b>Minimum Height</b> .....	▶	<b>66 - 78 In.</b>
<b>Maximum Height</b> .....	▶	<b>102 - 114 In.</b>

- ▶ The 9225A family is a ratcheting style roof support rated at 4 tons sustaining capacity.
- ▶ The 139A family is a screw extension type roof support rated at 5 tons sustaining capacity.
- ▶ Aluminum alloy housing and base makes this unit lightweight and portable (A9225 Family).
- ▶ Holds the load indefinitely without creep down.



## THINK SAFETY

Please refer to pages 4&5 for a complete list of safety tips and recommendations.



## CARRYING HANDLE

Integrated welded handle for ease of transport and positioning.

## Head Styles



### E Type Head

For all standard work.  
Dimension between flanges: 8.13"



### F Type Head

For use with electrical wiring.  
Dimension between flanges: 10.25"



### S Type Head

36 square inches in support area.

This RS Series Roof Support was used to support a horizontal I-Beam while weld work was being done on the verticle I-Beam. ▼



# MECHANICAL JACKS

RS Series - Roof Support

S Style Head

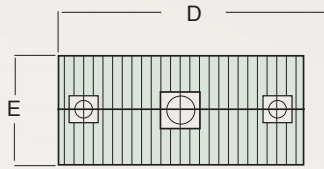

E & F Style Head

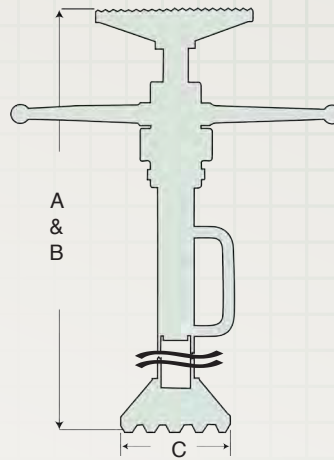
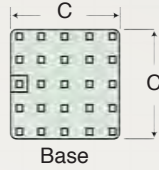
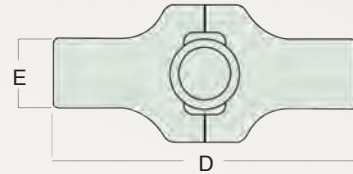

Dimensions (in)								
Model	Order Number	Stroke (in)	A	B	C	D	E	Weight (lbs)
			Minimum Height (in)	Maximum Height (in)	Base (in)	Head Length (in)	Head Width (in)	
<b>Complete Unit Ratchet Lever Series - A9225 Family</b>								
E	09602	20	39	59	7.38	8.13	2	29
F	09603	20	39	59	7.38	10.25	2	29
S	09620	20	39	59	7.38	9	4	29
E	09606	26	45	71	7.38	8.13	2	33
F	09607	26	45	71	7.38	10.25	2	33
S	09621	26	45	71	7.38	9	4	33
E	09610	38	57	95	7.38	8.13	2	36
F	09611	38	57	95	7.38	10.25	2	36
S	09622	38	57	95	7.38	9	4	36
E	09614	38	69	107	7.38	8.13	2	39
F	09615	38	69	107	7.38	10.25	2	39
S	09623	38	69	107	7.38	9	4	39
E	09616	38	75	113	7.38	8.13	2	42
F	09617	38	75	113	7.38	10.25	2	42
S	09624	38	75	113	7.38	9	4	42
E	09618	38	88	126	7.38	8.13	2	48
F	09619	38	88	126	7.38	10.25	2	48
S	09625	38	88	126	7.38	9	4	48
<b>Complete Unit Screw Extension Series - 139A Family</b>								
E	09802	24	42	66	6	8.13	2	50
F	09803	24	42	66	6	10.25	2	50
S	09820	24	42	66	6	9	4	50
E	09806	30	48	78	6	8.13	2	52
F	09807	30	48	78	6	10.25	2	52
S	09821	30	48	78	6	9	4	52
E	09814	36	66	102	6	8.13	2	58
F	09815	36	66	102	6	10.25	2	58
S	RS139AS66102	36	66	102	6	9	4	58
E	09818	36	78	114	6	8.13	2	64
F	09819	36	78	114	6	10.25	2	64
S	RS139AS78114	36	78	114	6	9	4	64

mechanical

# MECHANICAL JACKS

RS Series - Roof Support Base & Head Assembly

**SIMPLEX**



**Head Assembly**  
Model 09267



**Base Assembly**  
Model 09220

- Stroke** .....▶ **15 In.**
- Sustaining Capacity** .....▶ **8 - 16 Tons**
- Maximum Extended Height** .....▶ **73 - 93 In.**

Maximum pipe length recommendations are based upon the following conditions:

- ▶ Fully extended assemblies loaded to maximum rated capacity.
- ▶ Head and base securely fixed to prevent lateral movement.
- ▶ A round base (ordered separately) is available to fit the 2" pipe.
- ▶ All models incorporate a lever nut handle.
- ▶ The 8 ton models are available with either FS or S style heads.
- ▶ The 16 ton model is available with FS style head only.



## THINK SAFETY

Please refer to pages 4&5 for a complete list of safety tips and recommendations.



## CE COMPLIANT

Our Jack design specifications meet or exceed ANSI /ASME B30.1 Safety Standards.

## Head Styles



**S Type Head**  
36 square inches in support area.



**FS Type Head**  
For support with wooden or rubber cap pieces.



▲ The A9225, page 141, RS Series Roof Support is perfect for added safety and support for a wide range of mining applications.



# MECHANICAL JACKS

RS Series - Roof Support Base & Head Assembly

## Optional Pipe Specifications

Simplex head assemblies are designed for roof support in mines and other areas where ceiling heights vary greatly. Use your own pipe to custom build a support for nearly any application.

- ▶ The 8 ton MS-9 models use 2" schedule 40 pipe with a minimum yield strength of 35,000 psi.
- ▶ The 16 ton MS-17 model requires 2" schedule 80 pipe with a minimum yield strength of 48,000 psi / 16 ton model.



FS Type Head

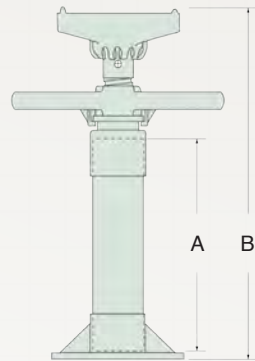

09267 & 09309

S Type Head

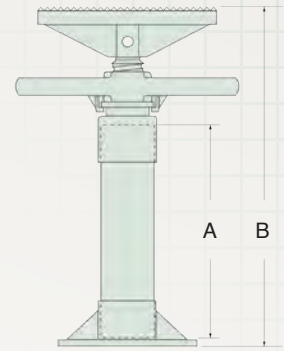

09233

Dimensions (in)		
Model	"A" Minimum Pipe Length	"B" Minimum Closed Height
MS9L-FS	20 1/2	27
MS9L-S	20 5/8	25 1/2
MS17L-FS	21 3/4	28 3/4

Model	Order Number Domestic	Head Style	Sustaining Capacity (tons)	Stroke (in)	*Maximum Pipe Length (in)	Maximum Extended Height (in)	Dimension Between Flanges (in)	Weight (lbs)
MS9L-FS	09267	FS	8	15	51.75	73	5.75	19
MS9L-S	09233	S	8	15	73.25	93	---	19
MS17L-FS	09309	FS	16	15	46.25	68	5.75	34
Base MB-17	09220	----	----	----	----	----	----	6

# MECHANICAL JACKS

SE & BE Series - Trench Braces



Screw & Butt Ends Sold Separately



### THINK SAFETY

Please refer to pages 4&5 for a complete list of safety tips and recommendations.



### CE COMPLIANT

Our Jack design specifications meet or exceed ANSI /ASME B30.1 Safety Standards.

Simplex SE Series Trench Braces are used to shore up the walls of this trench for the repair work of underground water pipes. ▼



- Adjustable Range.....▶ **7 - 10 In.**
- Pipe Size .....▶ **1.5 - 2 In.**
- Lever Length .....▶ **9.5 - 11 in.**

- ▶ Provides an efficient, economical protection against cave-ins and costly re-digging in construction & maintenance.
- ▶ Ball socket joints tilt for added safety on angular mounting.
- ▶ Holes on each end facilitates mounting to wood members.

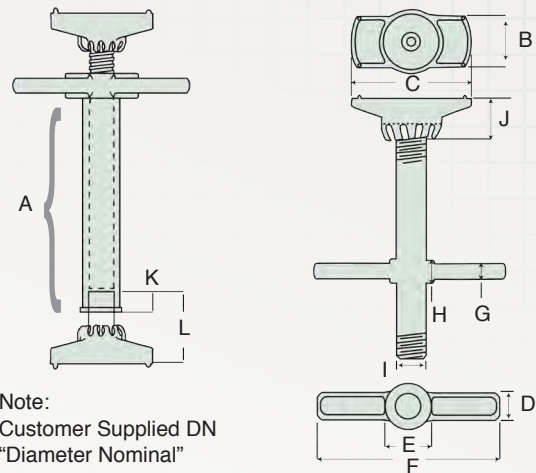

Note:  
Customer Supplied DN  
"Diameter Nominal"  
1.5 in. or 2 in. pipe.

Dimensions assume the use of both screw & butt ends together as an assembly.

Model (Screw End)	Adjust Range (in)	Pipe Size (in)	Dimensions (in)											
			A	B	C	D	E	F	G	H	I	J	K	L
			Minimum Pipe Length	Width	Length	Lever Width	Lever Diameter O.D.	Lever Length	Lever Height	Lever Nut Height	Screw Diameter O.D.	Height	I.D. Butt End Height	Collar Height
SE12	7	1.5	12	2.44	5.75	1.25	2.13	9.5	.68	1.13	1.38	2.44	----	----
SE16	10	1.5	16	2.44	5.75	1.25	2.13	9.5	.68	1.13	1.38	2.44	----	----
SE18	10	2	18	2.75	7.5	1.5	2.68	11	.81	1.38	1.87	3	----	----
Model (Butt End)	Screw Ends to be used with Butt End													
BE25	SE12 / SE16		----	2.44	----	----	----	----	----	----	----	----	1.5	3.87
BE35	SE18		----	2.75	----	----	----	----	----	----	----	----	1.93	4.87

mechanical

Simplex Trench Braces provide efficient, economical protection against cave-ins and costly redigging in construction and utility maintenance. Braces extend by turning the lever nut handle. The ball socket joints tilt for added safety on angular mounting. Holes on each end facilitate mounting to wood members.



Simplex trench braces are designed for use with standard schedule 40 pipe. Screw end models SE-12, SE-16 and butt end model BE-25 use 1 1/2" diameter pipe. Model SE-18 and butt end BE-35 use 2" diameter pipe. Pipe should be cut to length based on the chart below and drawing in Fig. 1.

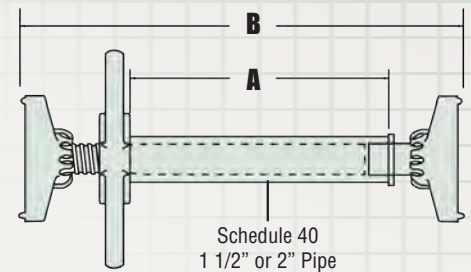
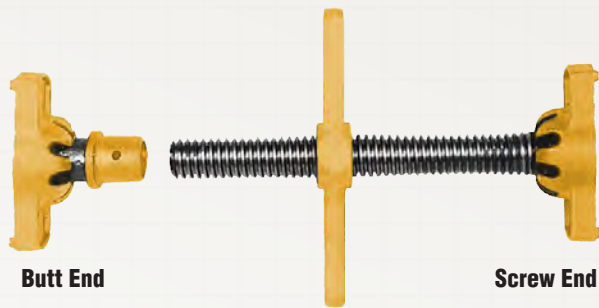

(Fig. 1) All Trench Brace Models

**Quick Reference Timber / Trench Brace Equivalency Tables\***

The following charts are based on OSHA Timber/Trench Brace Charts\* which do not consider transverse loading conditions.

Trench Depth (ft)	Horizontal Spacing (ft)	Cross Brace			Vertical Spacing (ft)	Wales		Uprights (in)			
		Width of Trench (ft)				Size (in)	Vertical Spacing (ft)	Max. Allowable Horizontal Spacing (ft)			
		up to 4	up to 6	up to 8				4'	5'	6'	8'
<b>Soil Type - A <math>P^a = 25 \times H + 72</math> psf (2ft. Surcharge)</b>											
5 to 10	up to 6	SE12 SE16	SE12 SE16	SE18	4	---		---	---	2"x 6"	---
	up to 8	SE12 SE16	SE12 SE16	SE18	4	---		---	---	---	2"x 6"
	up to 10	SE18	SE18	SE18	4	8 x 8	4	---	2"x 6"	---	---
	up to 12	SE18	SE18	---	4	8 x 8	4	---	---	2"x 6"	---
10 to 15	up to 6	SE12 SE16	SE12 SE16	SE18	4	---		---	---	3"x 8"	---
	up to 8	SE18	SE18	---	4	8 x 8	4	2"x 6"	---	---	---
<b>Soil Type - B <math>P^a = 45 \times H + 72</math> psf (2ft. Surcharge)</b>											
Trench Depth (ft)	Horizontal Spacing (ft)	Cross Brace			Vertical Spacing (ft)	Wales		Uprights (in)			
		Width of Trench (ft)				Size (in)	Vertical Spacing (ft)	Max. Allowable Horizontal Spacing (ft)			
		up to 4	up to 6	3'							
5 to 10	up to 6	SE-18	SE-18		5	6 x 8	5	2"x 6"			

# ACCESSORIES

Lever Bars & Accessories



## STEEL LEVER BARS & ACCESSORIES

<i>Model</i>	<b>Description</b>	<b>Length (in)</b>	<b>Diameter (in)</b>	<b>Weight (lb)</b>
<b>SLB24</b>	Round Lever Bar	24	.75	4
<b>SLB35</b>	Round Lever Bar	36	.81	6
<b>SLB36</b>	Round Lever Bar	36	1	8
<b>SLB42</b>	Round Lever Bar	42	1.13	12
<b>SLB56</b>	Round (Tapered) Lever Bar	56	1.14	16
<b>SLB60*</b>	Chisel Point Lever Bar	60	1.25	17
<b>SLB70</b>	Chisel Point Lever Bar	72	1.25	20
<b>IB1538</b>	I - Beam Base	20	---	44
<b>CHA1538</b>	Heavy Duty Chain	84	.62	29

\* Note: The SLB60 lever bars can be interchangeable with the SLB70 model, resulting in lower handle efforts.

## 1 POINT LIFT, MANUALLY DRIVEN WITH CHECK VALVE

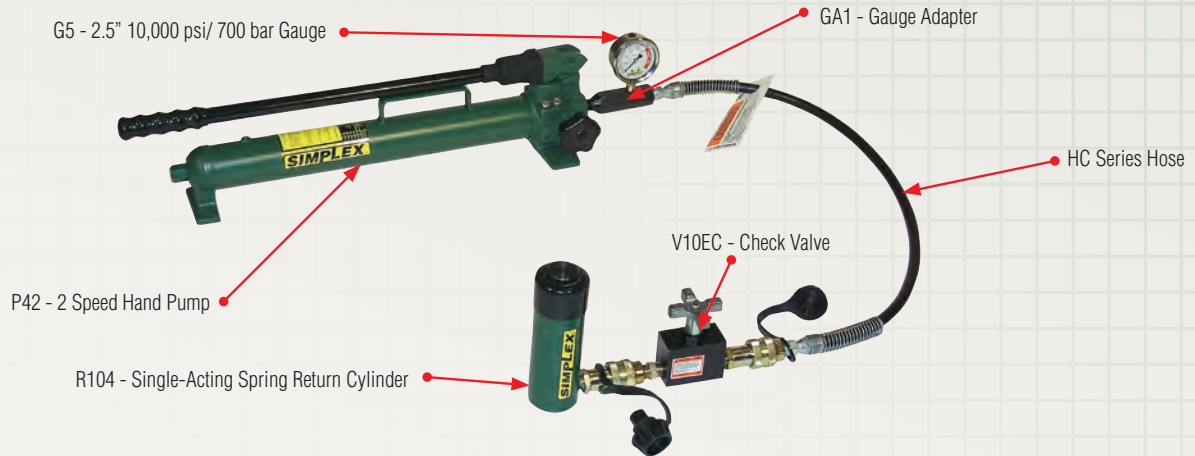

## 2 POINT LIFT, AIR DRIVEN WITH INDIVIDUAL CYLINDER CONTROL

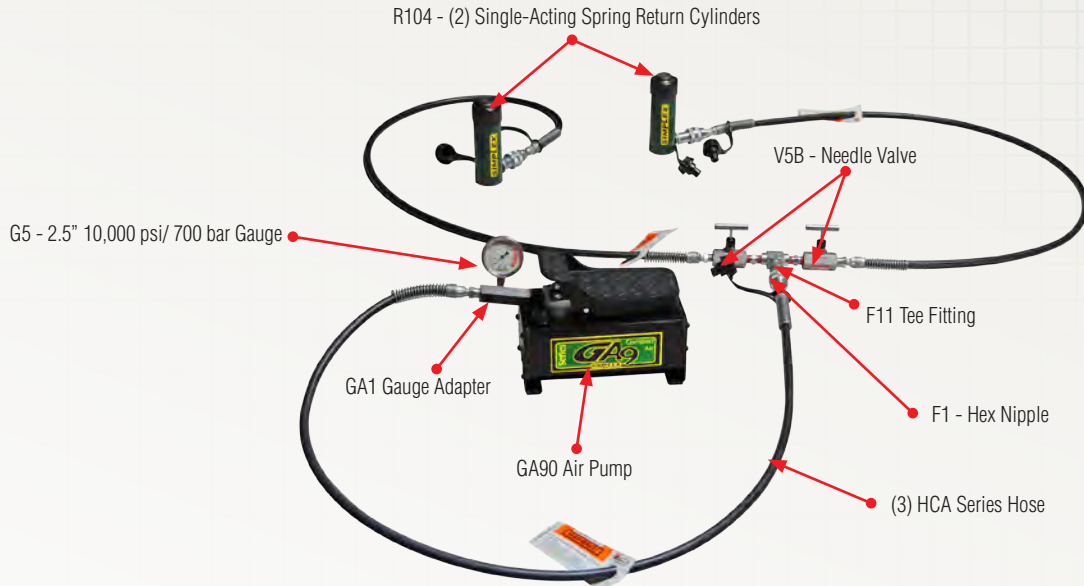

## 4 POINT LIFT, GAS DRIVEN WITH M1 MANIFOLD & CHECK VALVES

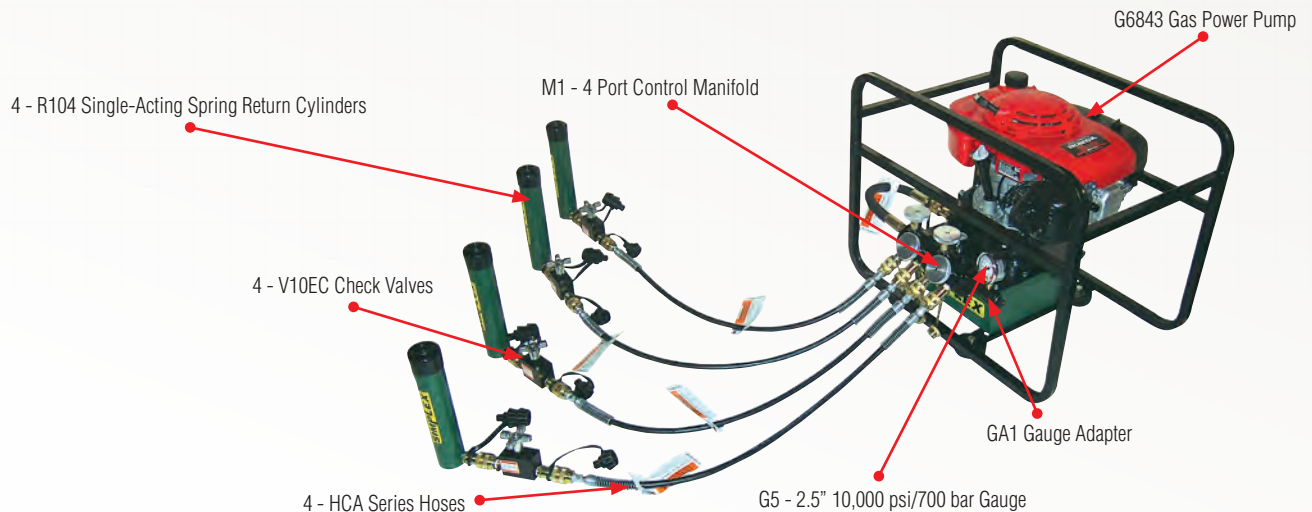

# CONVERSION CHART



Fractions	Inches	Millimeters	Fractions	Inches	Millimeters
1/64	.07	.39	33/64	.52	13.10
1/32	.03	.79	17/32	.53	13.49
3/64	.05	1.19	35/64	.55	13.89
1/16	.06	1.59	9/16	.56	14.29
5/64	.08	1.98	37/64	.58	14.68
3/32	.09	2.38	19/32	.59	15.08
7/64	.10	2.78	39/64	.61	15.49
1/8	.13	3.17	5/8	.62	15.88
9/64	.14	3.57	41/64	.64	16.27
5/32	.16	3.97	21/32	.65	16.67
11/64	.17	4.37	43/64	.67	17.07
3/16	.19	4.76	11/16	.68	17.46
13/64	.20	5.16	45/64	.70	17.86
7/32	.22	5.56	23/32	.72	18.26
15/64	.23	5.95	47/64	.73	18.65
1/4	.25	6.35	3/4	.75	19.05
17/64	.27	6.75	49/64	.77	19.45
9/32	.28	7.14	25/32	.78	19.84
19/64	.30	7.54	51/64	.80	20.24
5/16	.31	7.94	13/16	.81	20.64
21/64	.33	8.33	53/64	.83	21.03
11/32	.34	8.73	27/32	.84	21.43
23/64	.36	9.13	55/64	.86	21.83
3/8	.38	9.53	7/8	.87	22.23
25/64	.39	9.92	57/64	.89	22.62
13/32	.41	10.32	29/32	.90	23.02
27/64	.42	10.72	59/64	.92	23.42
7/16	.44	11.11	15/16	.93	23.81
29/64	.45	11.51	61/64	.95	24.20
15/32	.47	11.91	31/32	.97	24.60
31/64	.48	12.30	63/64	.98	25.00
1/2	.5	12.70	1.00	1.00	25.40

1 psi	= .069 bar
1 bar	= 14.7 psi
1 kPa	= .145 psi
1 cu. in.	= 16.39 cu./cm
1 cu./cm	= .061 cu./in.
1 liter	= 61.02 cu. in.
1 liter	= .264 gallon
1 U.S. gallon	= 3.78 liters
1 lbs.	= .4536 kg
1 kg	= 2.205 lbs.

1 Metric Ton	= 2,205 lbs.
1 Metric Ton	= 1,000 kg`
1 Ton (Short)	= 2,000 lbs.
1 Ton (Short)	= 907.18 kg
1 Inch	= 2.54 cm
1 Inch	= 25.4 mm
1mm	= .039 in.
1 sq. in.	= 6.452 cm/sq.
1 cm/sq.	= .155 sq. in.
1 Meter	= 39.37 in.

1 Horsepower	= .735 kW
1 Nm	= .73756 ft.lbs.
1 Ft. lbs.	= 1.355818
Centigrade	= 5/9 (F-32)
Fahrenheit	= 9/5 (C+32)

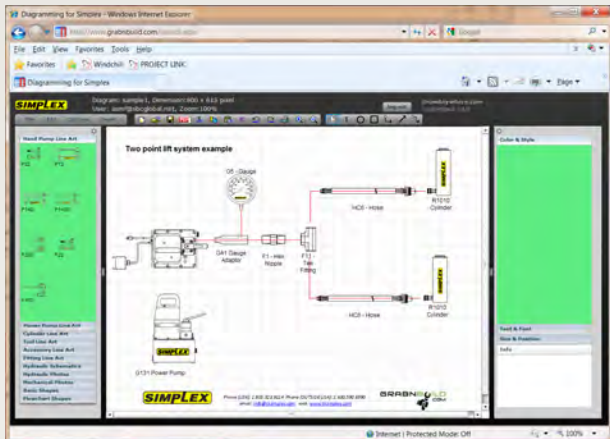

## Build Your Own System Arrangement



Simply grab and drag a full color or lineart image from the library to the artboard and visually create the system arrangement you desire. The artboards can then be saved to your own folder for future use. A great tool for detailing the specific components which comprise your system.

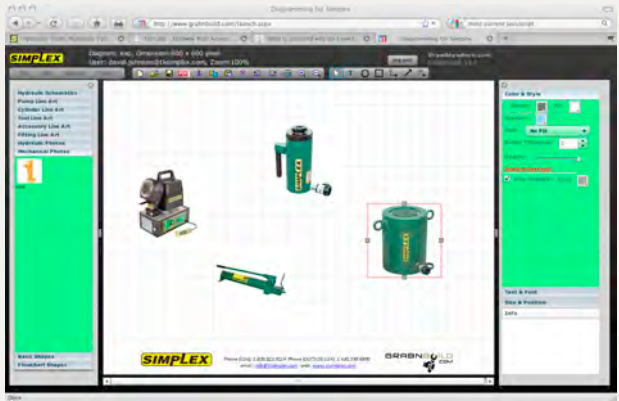

**▲ BUILD A SYSTEM USING LINEART**

**GRABNBUILD**  

**.COM**

**BUILD A SYSTEM USING FULL COLOR IMAGES**

**Competitive Cross Reference**

**Quickly convert your competitive part number to a Simplex product.**

**X-COMPETITOR EFFORT**

Database Disclaimer: Simplex has made every attempt to provide an accurate cross over to another manufacturer's part number. Simplex does not guarantee that equivalent products listed below will match the exact specifications of the competitive products. For additional details, please contact our Technical Support group.

Please enter a full or partial competitor part number to list Simplex's replacement model number(s), and then click on our part number to retrieve full product detail specifications. If the part number is not listed in our database, a quick web form will appear, just simply fill it out and we will respond quickly to your request.

Check off which category best fits your competitor model number - this option is optional, but will assist us in recommending your cross reference results.

**Support Tools:**

- Cylinders
- Hand Pumps
- Power Pumps
- Specialty Tools
- Equipment Kits
- Air Bags
- Mechanical Products
- Presses
- System Accessories
- Hand Jacks
- Valves

Competitor Part No:

## Competitive Cross Over Tool

Enter a full or partial competitor part number to list Simplex's replacement model number(s), and then click on our part number to retrieve full product detail specifications. If the part number is not listed in our database, a quick web form will appear, just simply fill it out and we will respond quickly to your request.

**Pressure to Tonnage Conversion**

**Work smarter, not harder by quickly generating your Pressure to Tonnage Conversion Table in Imperial & Metric Units.**

Once you select your Simplex cylinder model or entered your data manually, our Convert Engine will generate a data reference table in imperial and metric units.

You will be able to instantly view, print or email a your results data table.

**Complete this form for instant results!**

Error or Select Model Number: #1312

If Model number is manually entered, then enter Effective Area in sq. in. 2.25

## Pressure to Tonnage Conversion Tool

Work smarter, not harder by quickly generating your Pressure to Tonnage Conversion Table in Imperial & Metric Units.

Once you select your Simplex cylinder model or entered your data manually, our Convert Engine will generate a data reference table in imperial and metric units.



A Century of Product Integrity

hydraulic  
& mechanical  
equipment catalog



UNITED STATES HOME  
OFFICE

777 Oakmont Lane, Ste. 800  
Westmont, IL 60559  
Phone: 1 (630) 590-6990  
Fax: 1 (630) 590-6955  
Toll Free: 1 (800) 323-9114  
Email: sales@tksimplex.com  
www.tksimplex.com

*Distributed By:*

Canada

canada@tksimplex.com

Europe

europe@tksimplex.com

Asia & Pacific Rim

asiapacific@tksimplex.com

Mexico

mexico@tksimplex.com

South & Central America

latinamerica@tksimplex.com

Middle East

mid east@tksimplex.com

South Africa

southernafrica@tksimplex.com

Please Visit Us On:



TK Simplex



TKSimplex1

