

# HP® COLOR LASERJET CP5225

## TONER CARTRIDGE REMANUFACTURING INSTRUCTIONS



HP CP5225 TONER CARTRIDGE

# REMANUFACTURING THE HP COLOR LASERJET ENTERPRISE CP5225 SERIES TONER CARTRIDGES

By Mike Josiah and the Technical Staff at UniNet



First released in January 2011, the 5225 series of color laser printers are based on a 20 ppm (black and color), wide format (A3) 600 x 600 dpi engine, 3600 dpi with RET. (35ppm for the CP 4520 and 42ppm for the CP4525).

The 5225 cartridges are all-in-one types that consist of the toner supply, drum, and waste chamber. Like a few of the other newer high volume HP Color laser printers, the cartridges in this series do not fit into a pull out tray. All four cartridges are stacked in line front to back, and fit directly into the printer. Note also that the drum faces up, not down when placed in the printer. Because of this machine layout, we will take a moment and run through the printer theory before we get started.

These cartridges are basically a rectangular shaped, that come with a toner seal and a snap-on drum cover across the bottom to protect the drum. This cover also separates the developer roller from the drum so that when the cartridge is stored, the developer roller does not become flattened. These printers also have a separate waste bottle to collect the waste toner from the ITB (image transfer belt). These cartridges also use chips that's need to be replaced each cycle.

## PRINTERS BASED ON THE CP5225 ENGINE

HP Color LaserJet CP 5225n  
HP Color LaserJet CP 5225dn

## CARTRIDGES USED IN THESE MACHINES

<b>CE740A (black)</b>	<b>7,000 pages</b>	<b>\$208.82 list*</b>
<b>CE741A (cyan)</b>	<b>7,300 pages</b>	<b>\$367.82 list*</b>
<b>CE743A (magenta)</b>	<b>7,300 pages</b>	<b>\$367.82 list*</b>
<b>CE742A (yellow)</b>	<b>7,300 pages</b>	<b>\$367.82 list*</b>
<b>CE745A (toner collection unit)</b>		<b>\$18.00 list*</b>

\*Pricing in U.S. American Dollars, current as of May 2011.

**HP CP5225 COLOR PRINTING THEORY**

The color toner cartridge printing process happens in a series of stages or steps. For the purpose of this article, we will call them stages. Shown is the basic layout of the cartridges and how they relate to one-another and the printer. The laser units are on the bottom, the cartridges are at an angle, and the ITB is on top.

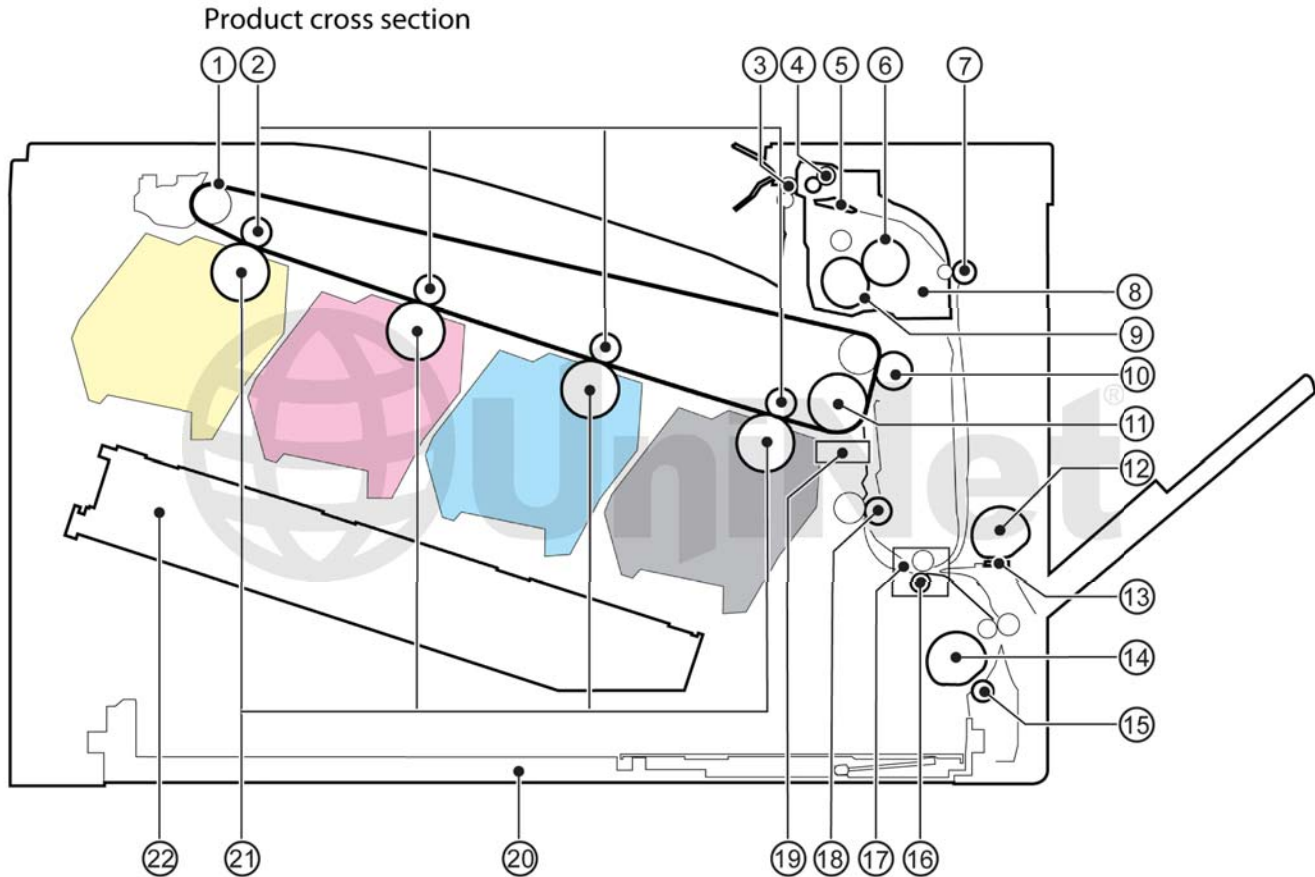

Item	Description
1.	ITB
2.	Primary transfer roller
3.	Delivery roller
4.	Duplex reverse roller (duplex models only)
5.	Duplex flapper (duplex models only)
6.	Pressure roller
7.	Duplex feed roller (duplex models only)
8.	IFuser
9.	Fuser sleeve
10.	Secondary transfer roller
11.	ITB drive roller

Item	Description
12.	MP tray pickup roller
13.	MP tray separation pad
14.	Cassette pickup roller
15.	Cassette separation roller
16.	Feed roller
17.	Media sensor
18.	Registration roller
19.	Registration density sensor
20.	Cassette
21.	Photosensitive drum
22.	Laser/scanner assembly

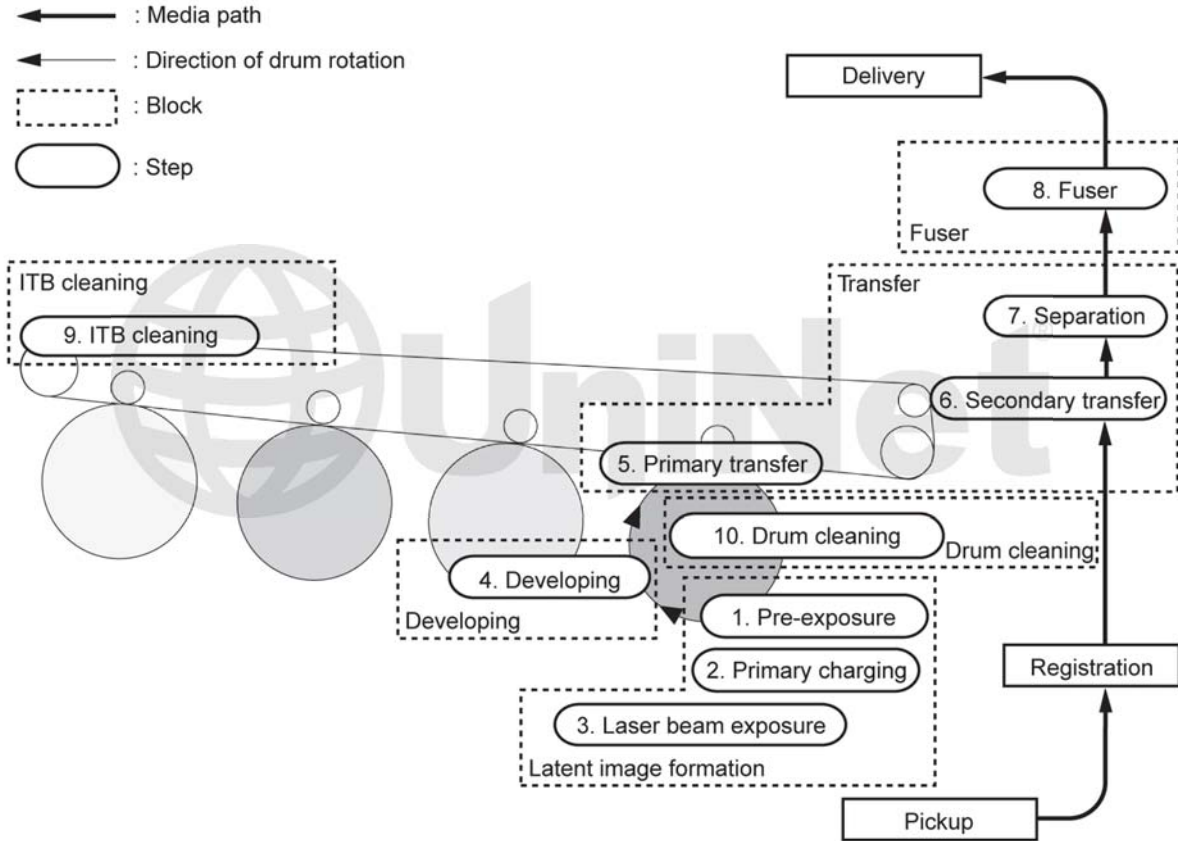

Shown here is the complete image formation process.

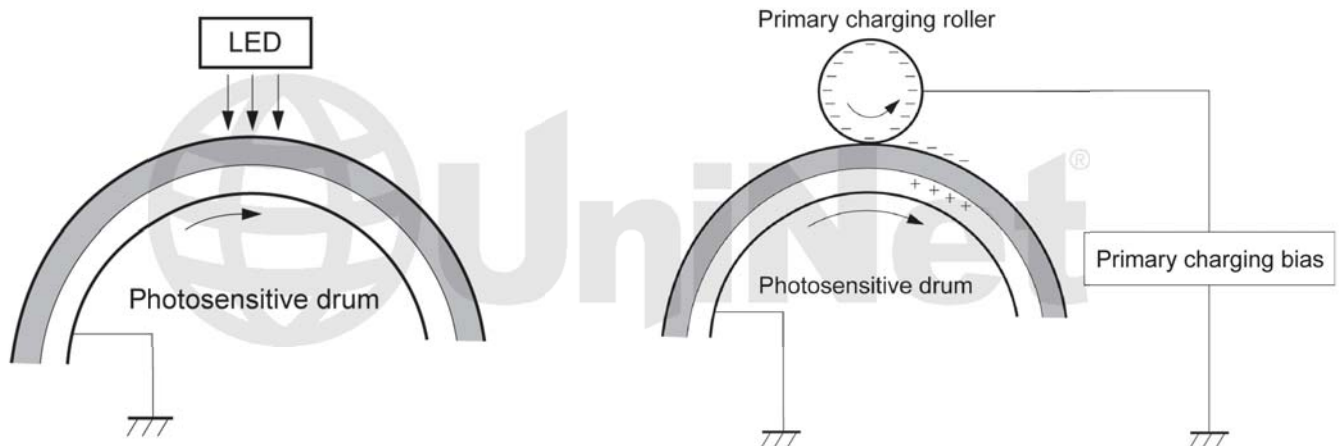

In the **first** stage, light from the pre-exposure LED strikes the drum to remove any residual charges from the drums surface.

Then the primary charge roller (PCR) places a uniform negative DC voltage on the OPC drum surface.

The amount of the negative DC voltage placed on the drum is controlled by the printer's intensity setting.

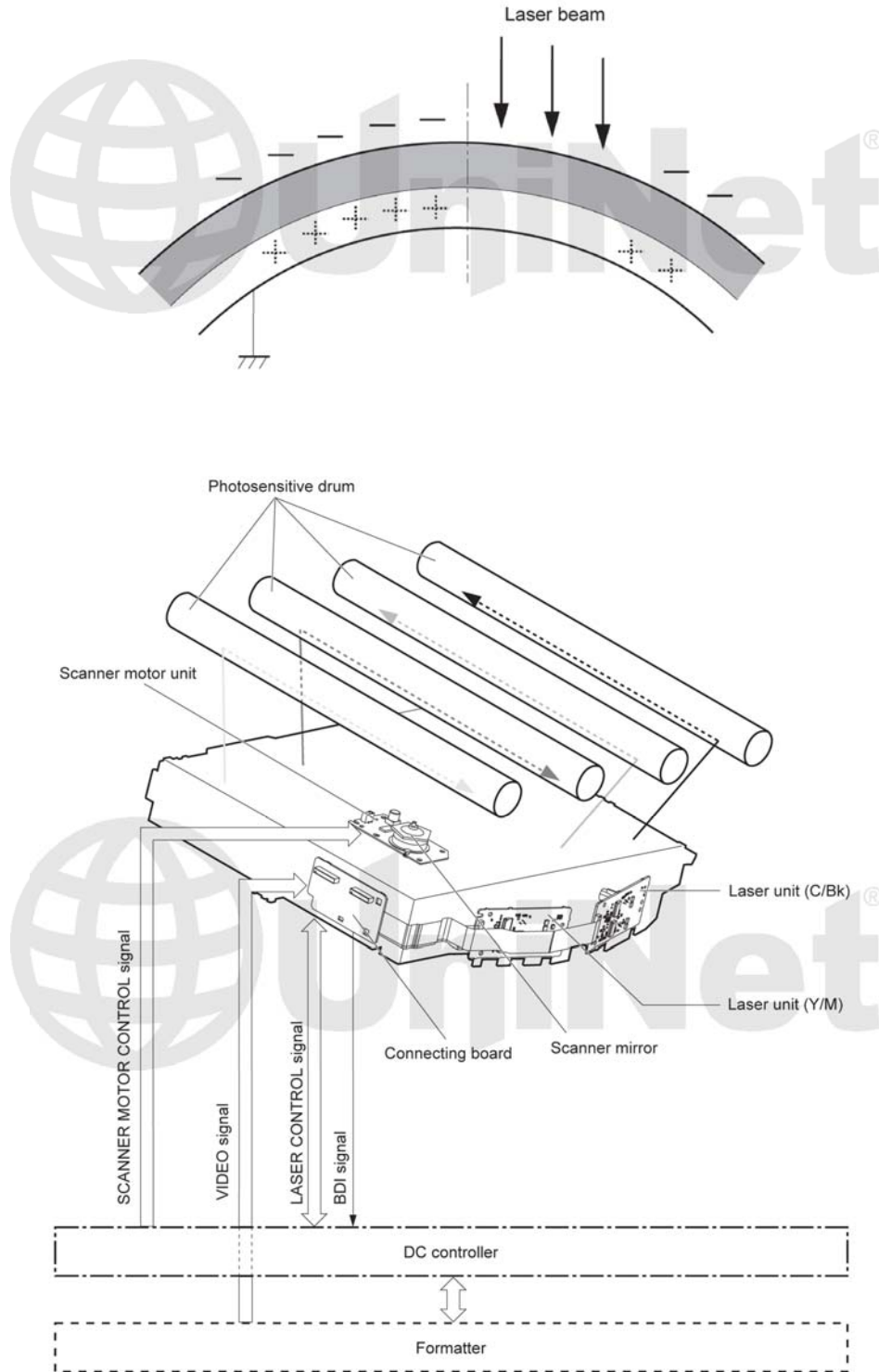

In the **second** stage, a laser beam is fired onto a rotating mirror (called the scanner). As the mirror rotates, the beams are reflected into a set of focusing lenses. The beams then strike the drums surface, reducing the negative charge and leaving a latent electrostatic image on the drum. The areas where the lasers did not strike the drum will retain the higher negative charge. These machines have gone back to using just one laser/scanner unit for all four colors.

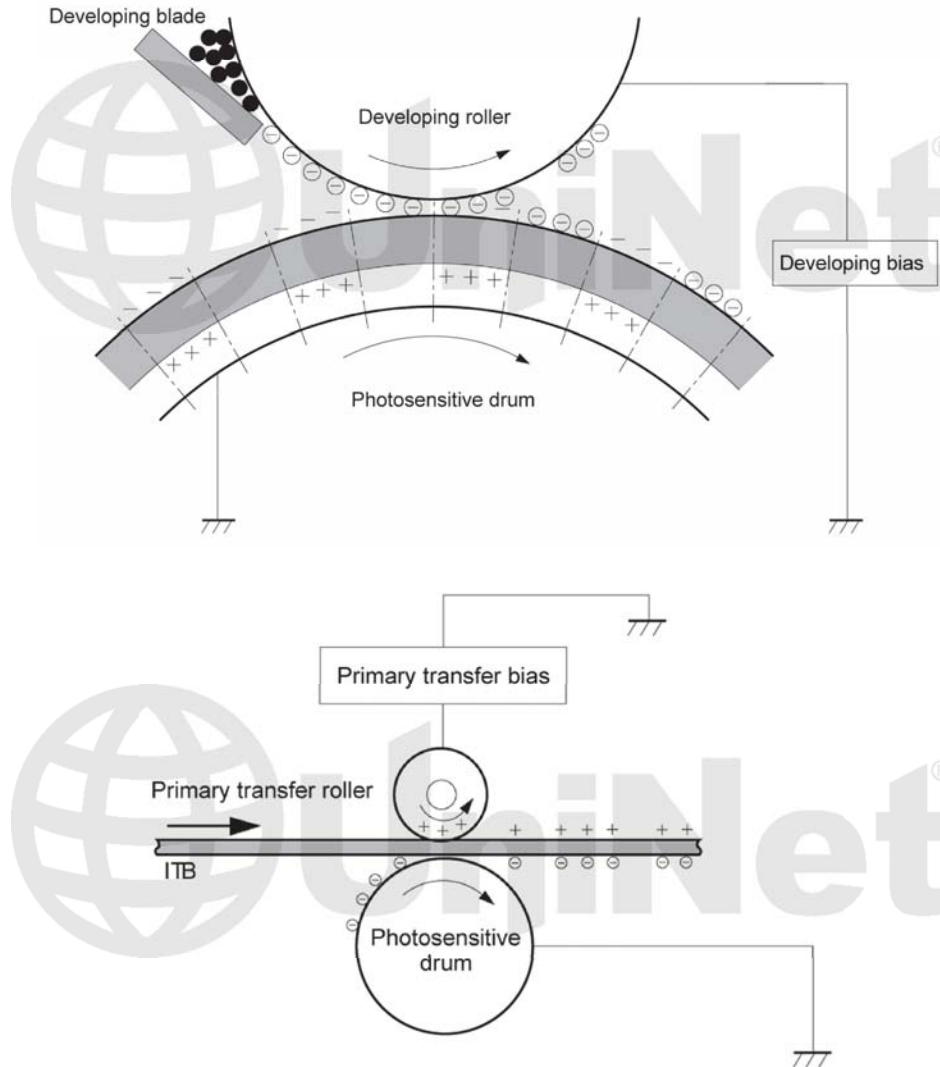

The **third** or developing stage is where the toner is developed on the drum by the developing section (or supply chamber), which contains the toner particles. The development stage is actually made up of two steps: toner charging, and the actual development. In the toner charging stage, the toner stirring blade turns inside the hopper. As it turns, friction causes a negative potential to develop on the toner. In addition, a foam feed roller brings the toner to the developer roller and also places a negative charge on the toner. These two charges help ensure a uniform charge on the toner. Once the toner is properly charged, the toner will coat the developer roller. The toner is also held onto and attracted to the developer roller by another negative DC bias voltage. This voltage is controlled by the printer's intensity setting and causes either more or less toner to be attracted by the developer roller. This in turn will either increase or decrease the print density. The amount of toner on the developer roller is controlled by the doctor blade, which uses pressure to keep the amount of toner on the roller constant. As the laser exposed areas of the OPC drum approach the developer roller, the toner particles are attracted to the drum's surface due to the opposite voltage potentials of the toner, and laser exposed areas of the OPC drum.

The **fourth** stage is the transfer stage. This is where there are some large differences from monochrome printers and also from other color lasers. In the primary transfer stage, the transfer roller which is located directly opposite each OPC drum, places a positive DC bias charge on the back of the ITB or image transfer belt. Each toner cartridge has a separate transfer charge roller. The image is transferred from the drum directly to the ITB. This process is repeated for each color cartridge in the following order: yellow, magenta, cyan, and black. At the same time, the paper is moving between the secondary transfer roller and the ITB. As the ITB passes the secondary transfer roller, the positive charge is picked up, and draws the negatively charged toner off the belt and onto the paper. Note that this entire process is upside down from most previous HP engines. The ITB and transfer rollers are on top of the OPC drum, not underneath it.



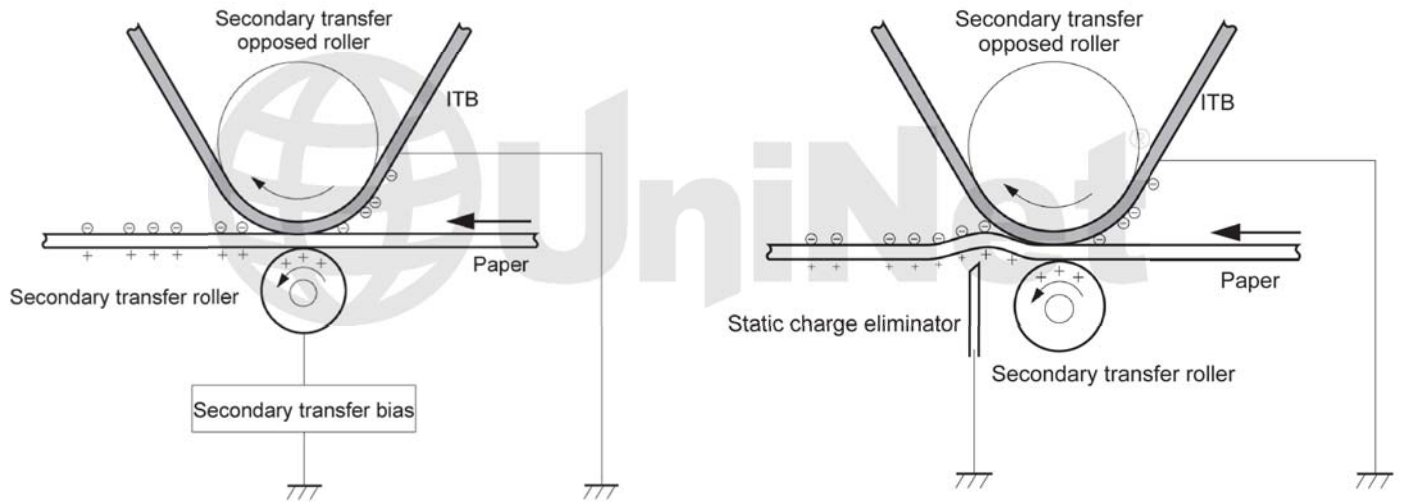

The paper separates from the ITB belt as the belt turns back down to start the process again. The static charge on the back of the paper is decreased with static charge eliminator. This helps stabilize the paper feed, and also prevents toner flares (spots) under low temperature and low humidity conditions.

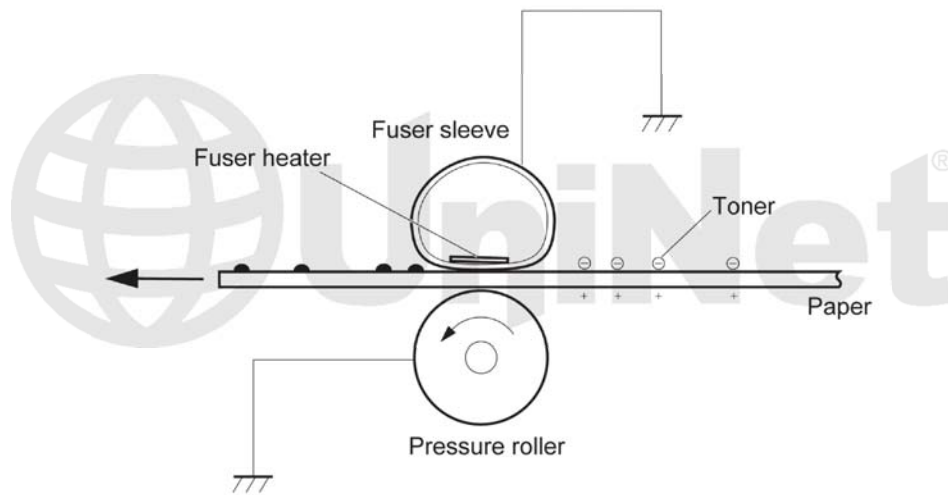

In the **fifth** stage, the image is then fused onto the paper by the fuser assembly. The fuser assembly is comprised of the upper heating assembly and lower pressure roller. The lower pressure roller presses the page up into the upper heating assembly which then melts the toner into the paper. This heating assembly consists of a flexible sleeve with a ceramic heating coil inside. This type of fuser affords “instant on” fusing with little to no wait time, and low power consumption.

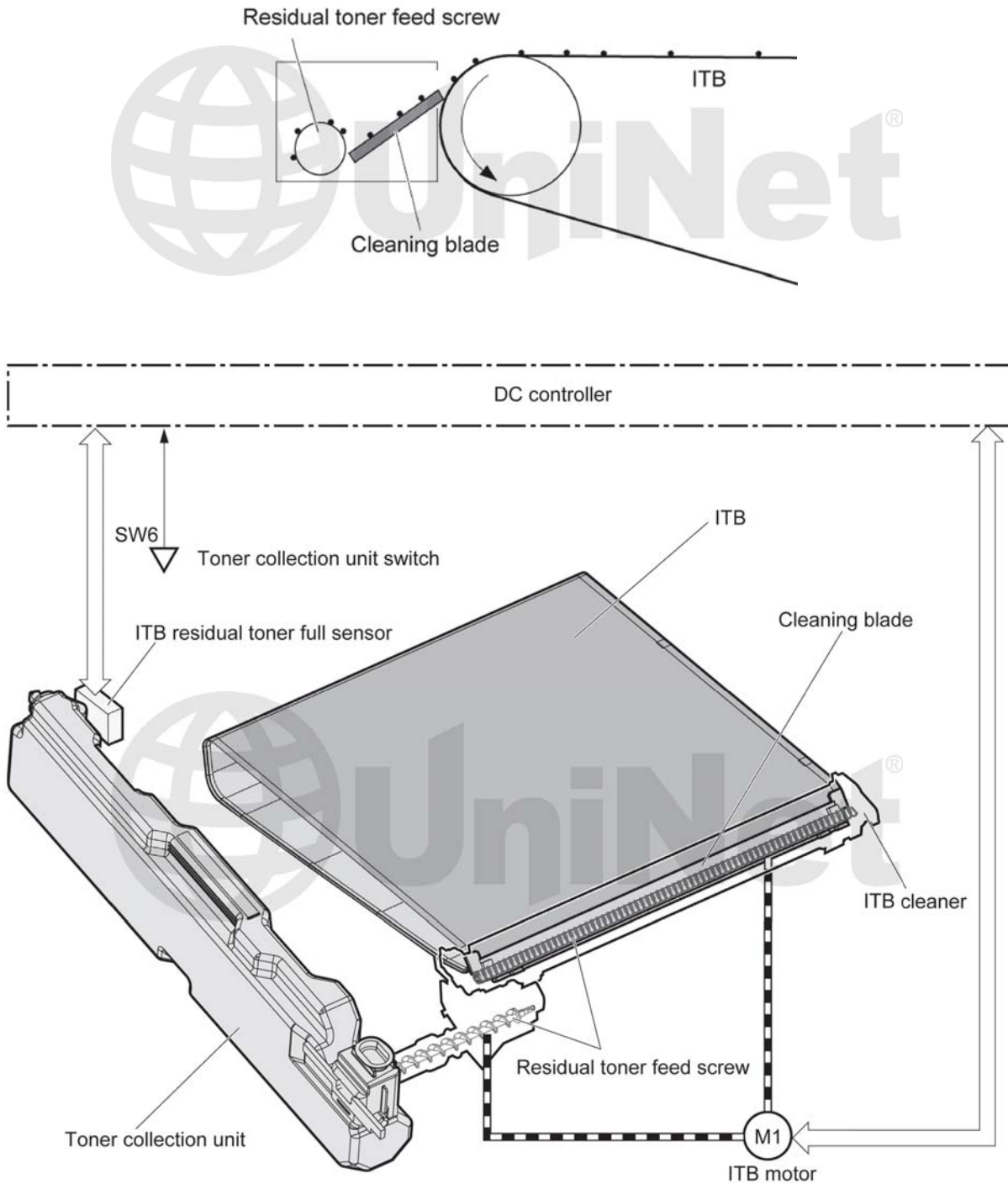

### ITB CLEANING

The ITB is cleaned by the ITB cleaning blade. The ITB wiper blade scrapes off the residual toner and an auger moves the toner to the toner collection box.



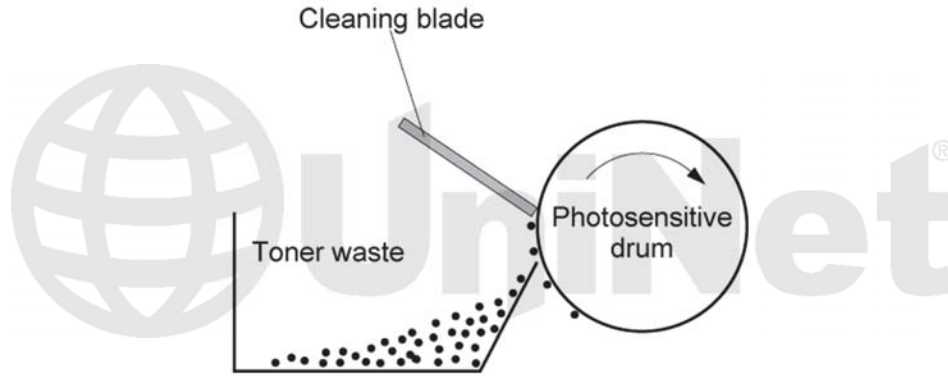

**OPC DRUM CLEANING**

The drum is cleaned after the image is transferred to the paper by the wiper blade. This part is fairly standard; the wiper blade scrapes the toner off the drum, and the recovery blade guides it into the waste chamber.

These printers can print in full color or in black-only modes. To print in the black only mode, the printer disengages the developer rollers in the cyan, magenta, and yellow cartridges. This process also takes place with the primary transfer rollers and the ITB belt.

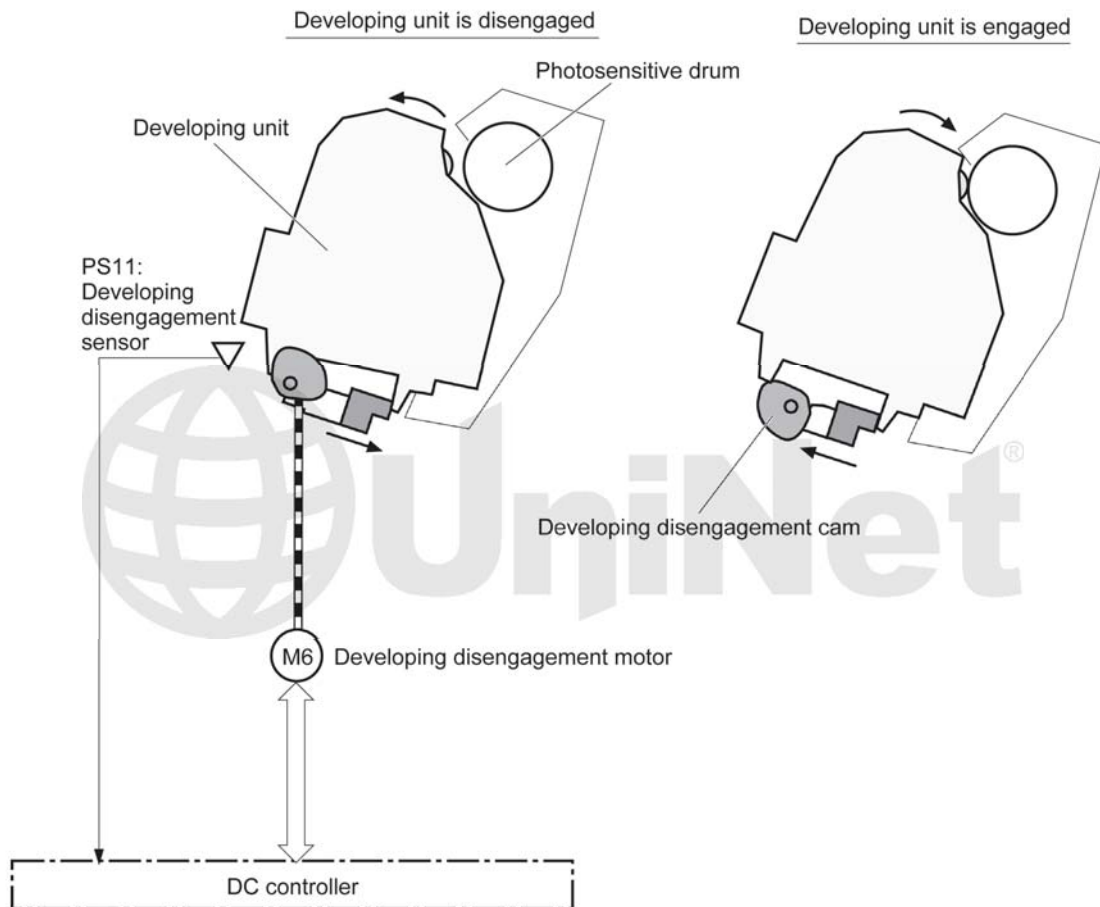

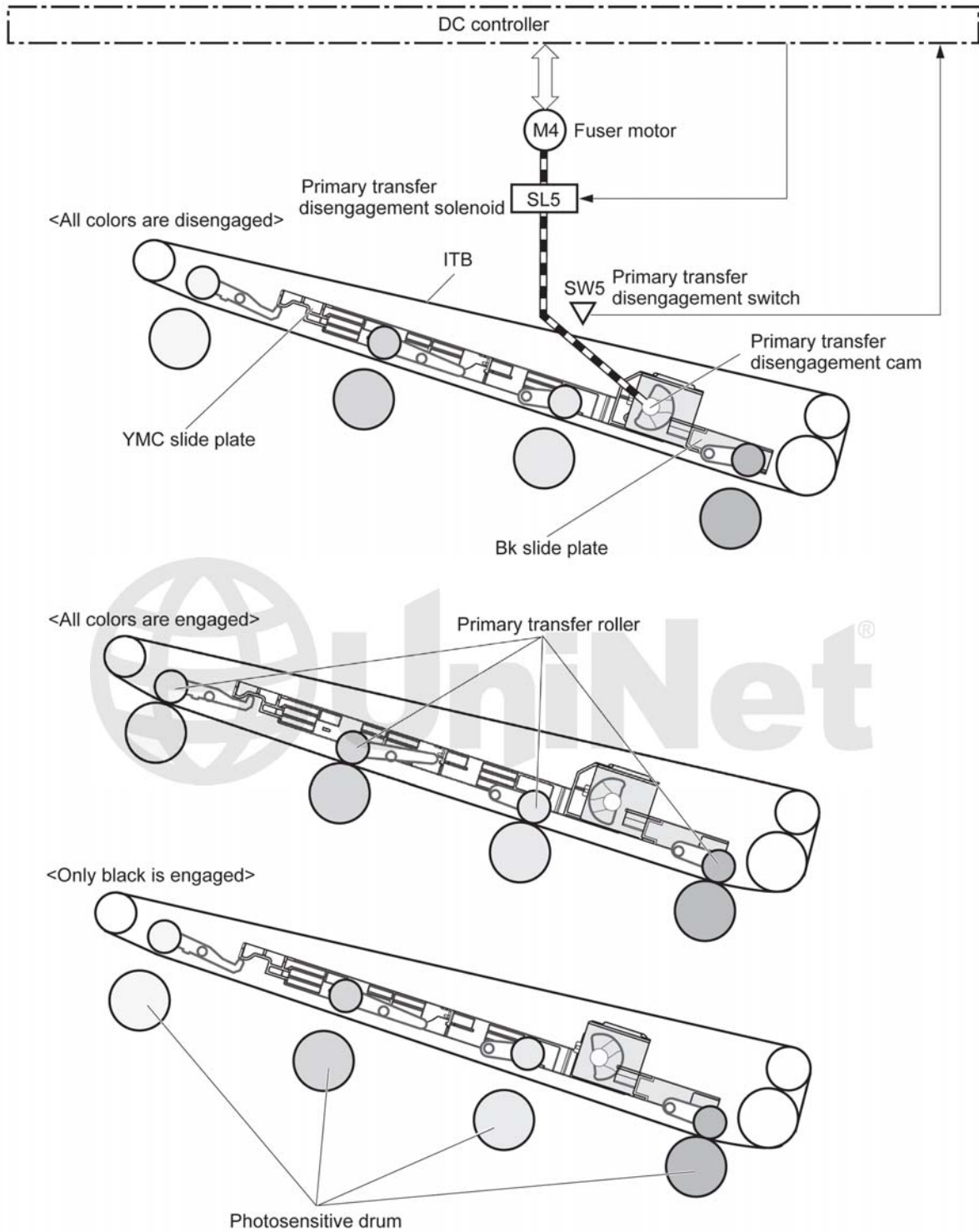

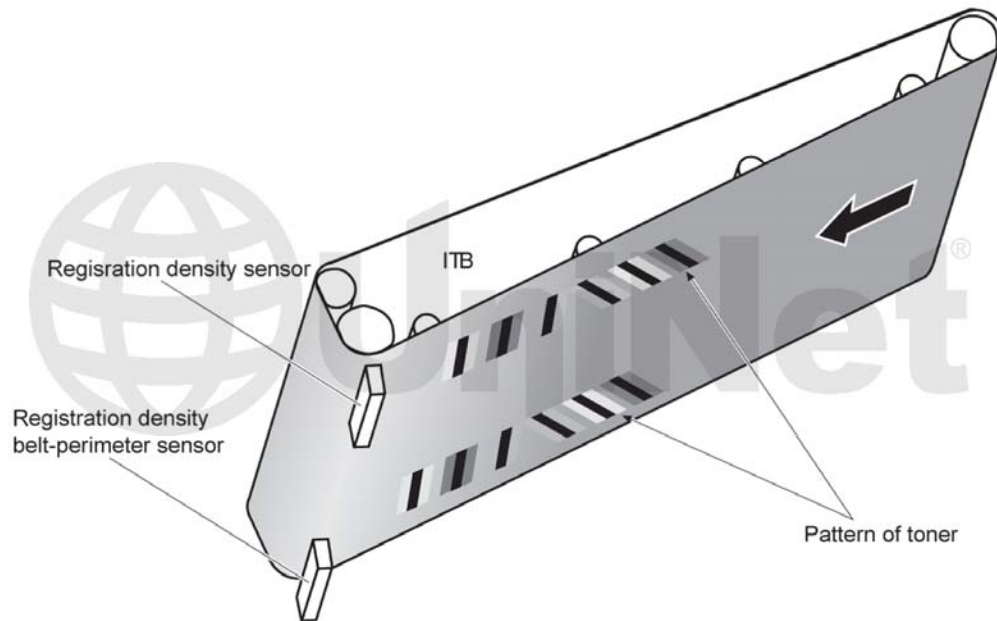

### PRINTER CALIBRATION

At the start of all this is the cartridge detection process, toner level detection, and then the calibration cycle. The printer will calibrate itself whenever the printer is turned on (within 15 minutes), when a new toner cartridge is installed and after 48 hours of run time. Calibration consists of a solid block and halftone of each color being printed to the ITB. As the printed areas get to the top of the belt, a sensor will detect them, measure the density, and adjust the printer accordingly. All of the calibration time settings are user controllable.

Taking test prints, cartridge troubleshooting as well as minor printer troubleshooting will be covered at the end of this article.

### REQUIRED TOOLS

1. Toner approved vacuum
2. A small screwdriver (common style)
3. A Phillips head screwdriver
4. Needle nose pliers

### SUPPLIES REQUIRED

1. Dedicated color toner for use in CP5225
2. New replacement chip
3. New long life drum for use in CP5225
4. New wiper blade
5. New toner feed roller (optional)
6. New PCR (optional)
7. New doctor blade (optional)
8. Drum cover
9. Lint-free cloths
10. Conductive grease

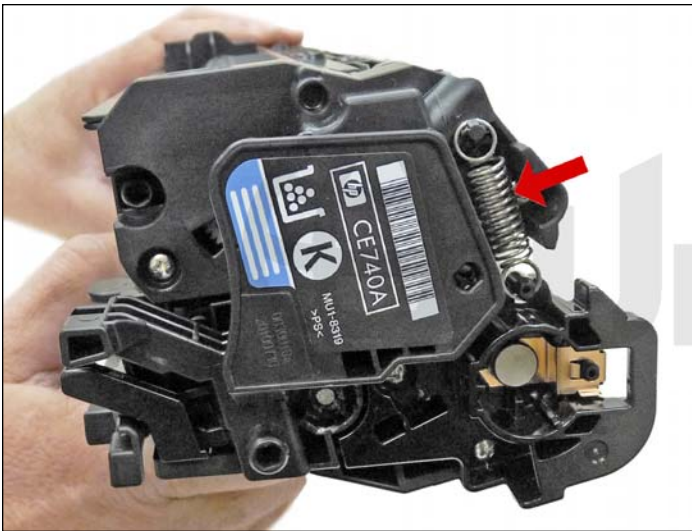

1. The pins in these cartridges are stepped. In other words the outside is thicker than the inside. To remove the pins, you must carefully shave the plastic away from the pins.

First, remove the spring from the label side of the cartridge.



2. With a razor knife, carefully shave the plastic from the heads of the hinge pins on both sides of the cartridge.



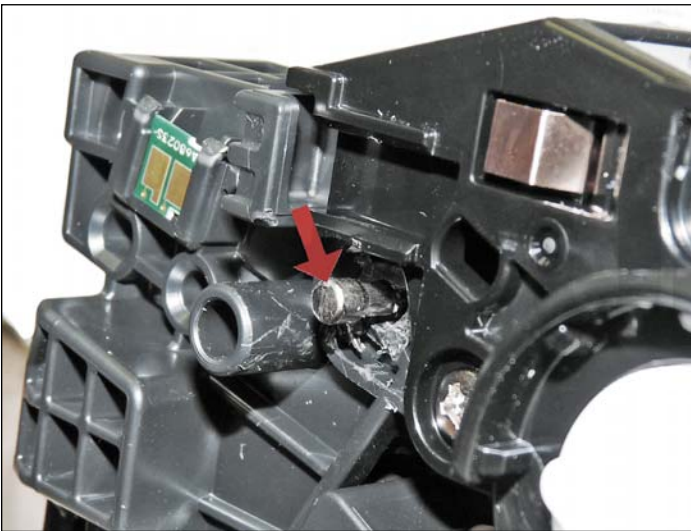

3. Remove the pins with flush cutting wire cutters.

The smaller pin fits on the contact side of the cartridge, the long pin on the label or gear side.

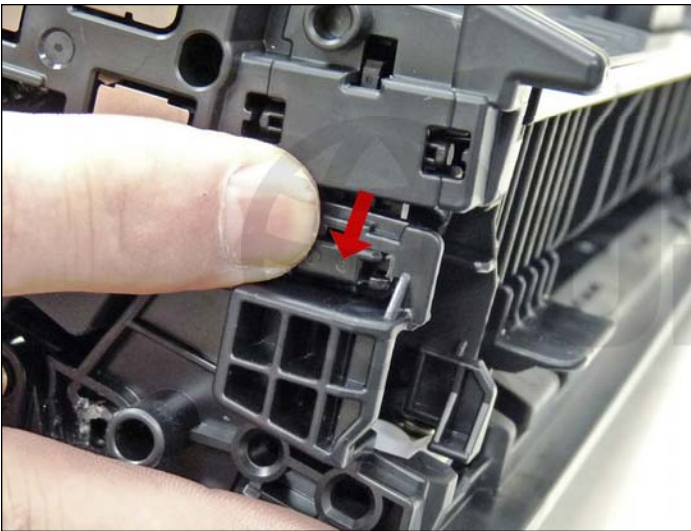

4. On the gear side, press in on the plastic locking mechanism.



5. On the opposite side, lift up on the black lever.

Lift the two halves apart.

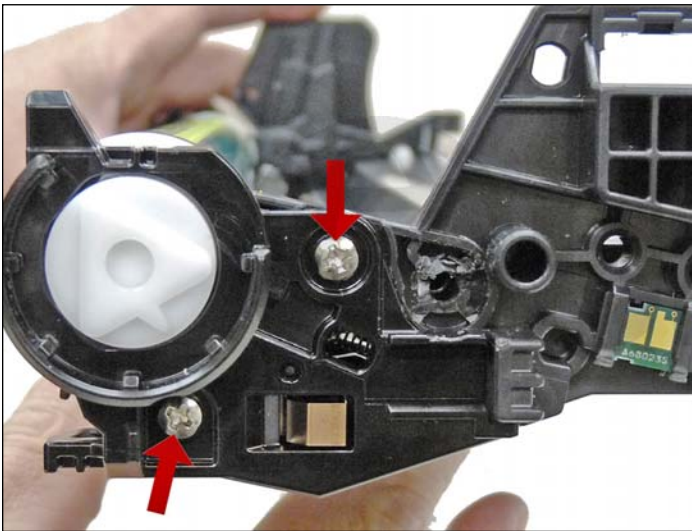

6. On the waste chamber, remove the two screws from the drum gear end cap.

Press in on the tab as shown and remove the end cap.

There is no need to remove the opposite side end cap.



7. Remove the drum.

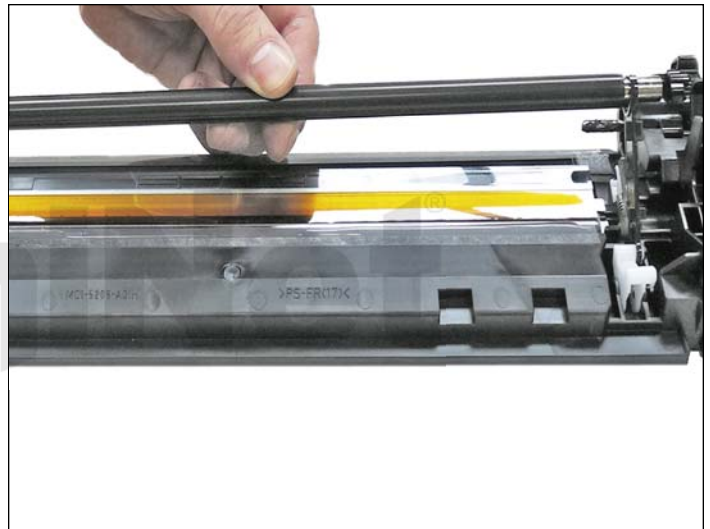

8. Remove the PCR by lifting up on the black and white PCR locking arms. Remove the PCR, the arms will stay in place.



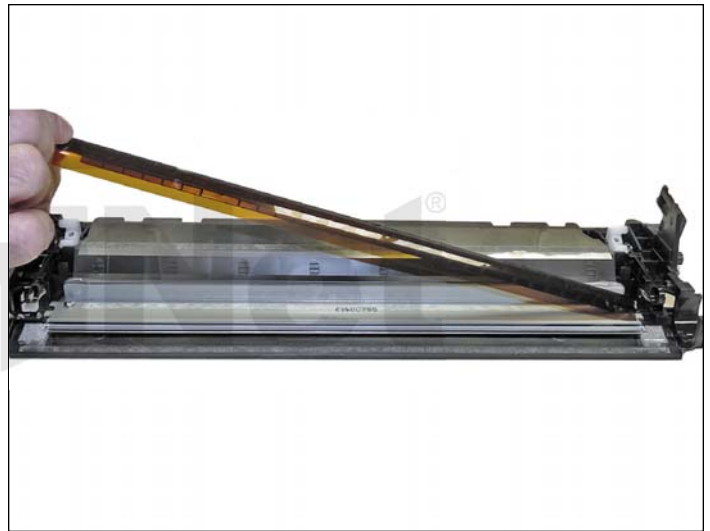
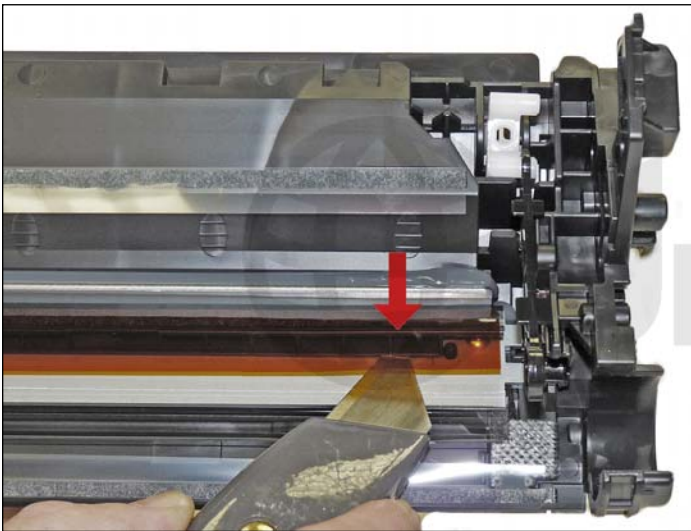

9. To remove the wiper blade, the amber film assembly needs to be removed.

Slide a razor knife under the plastic mounting bar, and remove the assembly.

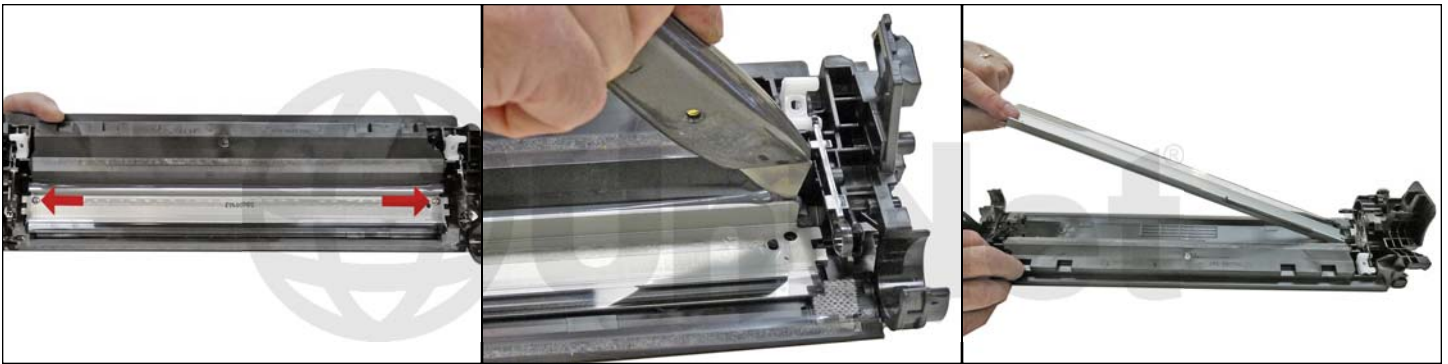

10. Remove the two screws from the wiper blade. Slide the razor knife along the back edge of the blade to release it from the glue. Remove the wiper blade. Clean out all the waste toner from the chamber. Try not to get any toner on the wiper blade seal if possible.

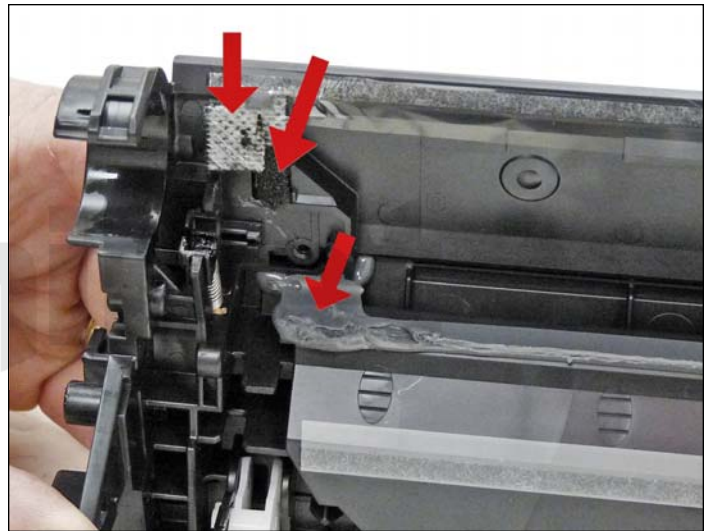
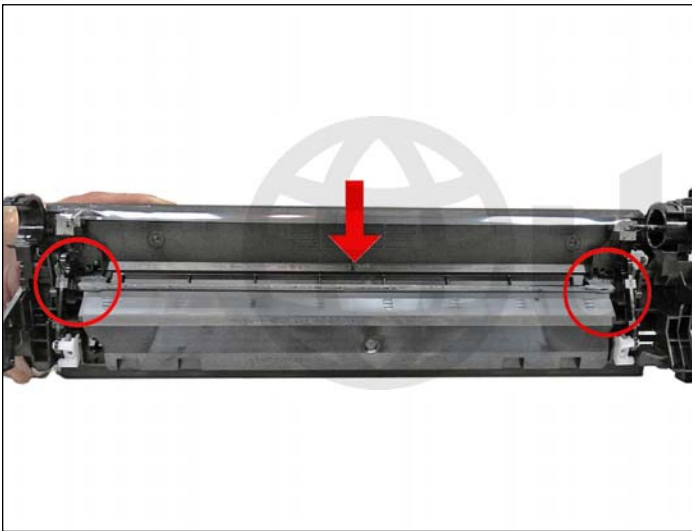

11. Clean the felt seals on each end of the wiper blade. If the wiper blade glue has toner on it, clean it off with alcohol and a foam swab. If it does not become sticky again, it needs to be removed and a good silicone caulk used to seal the blade off. GE 100% silicone and Phenoseal are two good brands for this.

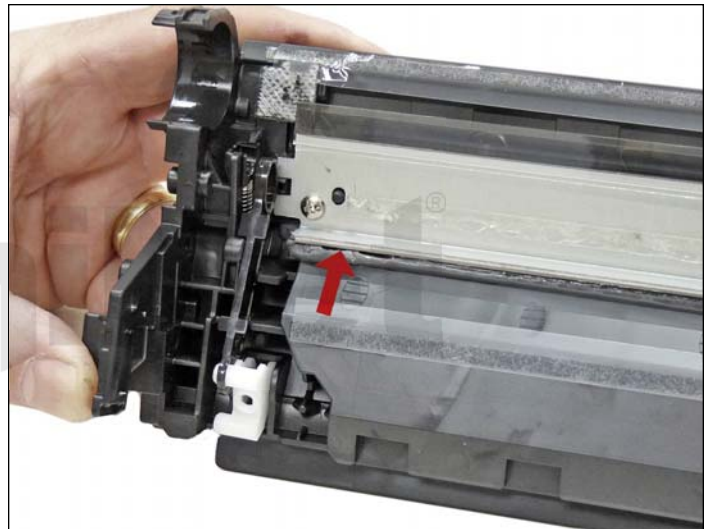

12. Install the new wiper blade and two screws.

If you removed the wiper blade glue, seal the back edge of the blade with the silicone now.



13. The amber film assembly is held in place with double sided tape. If this is not sticking or a new wiper blade is being used, replace the tape. Replace the film assembly.



14. Clean the PCR with your preferred cleaner and install in the cartridge with the PCR holders. Make sure you lock the locking arms in place.

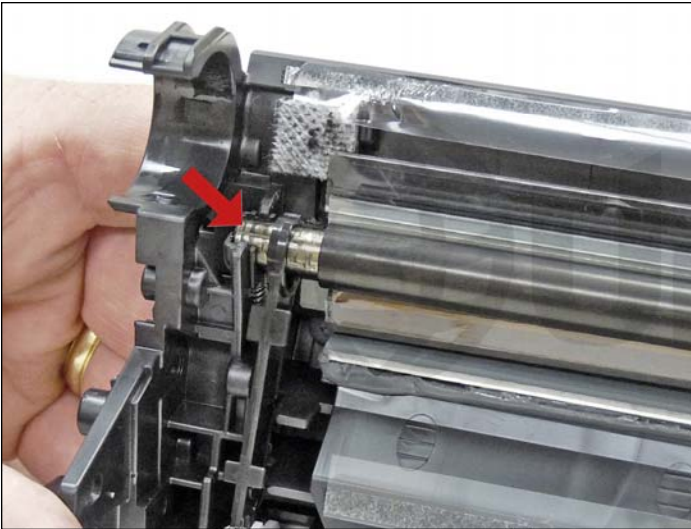

15. Place conductive grease on the black holder side of the shaft.



16. Install the drum (short hub side) onto the long drum ground/axle pin. Make sure there is conductive grease on the drum ground/axle pin.



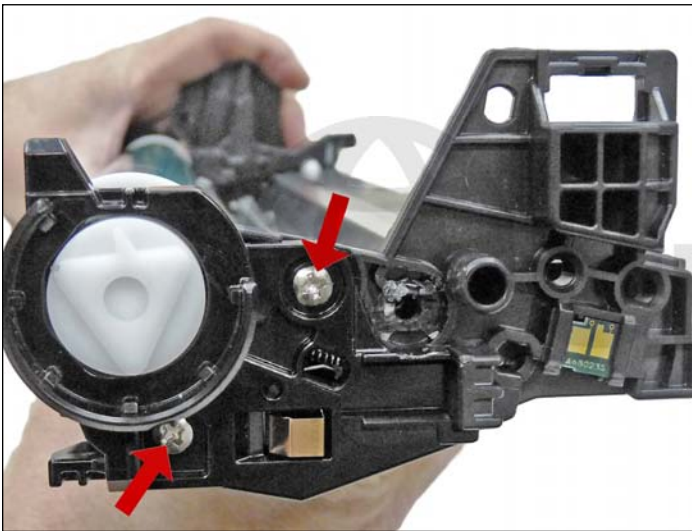

17. Install the end cap and two screws. Place a small amount of white lithium grease on the drum hub. Place the waste chamber aside.

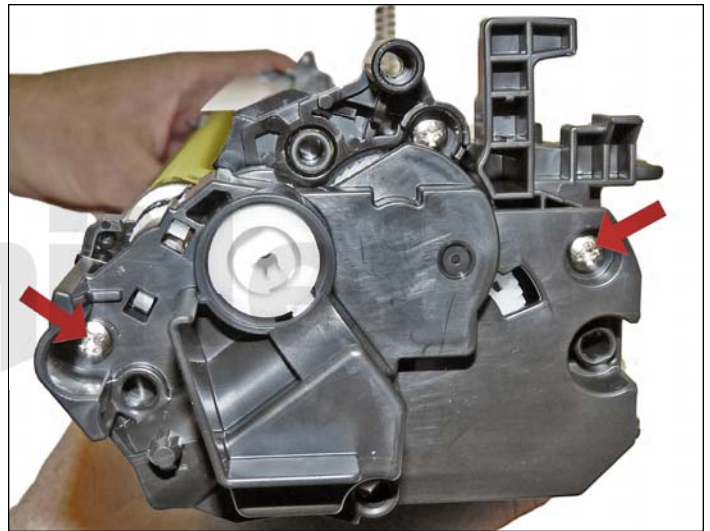

18. On the supply chamber, remove the two screws from the gear side end cap.



19. Pry up on the small tab and remove the end cap.



20. Remove the seal take-up gear.

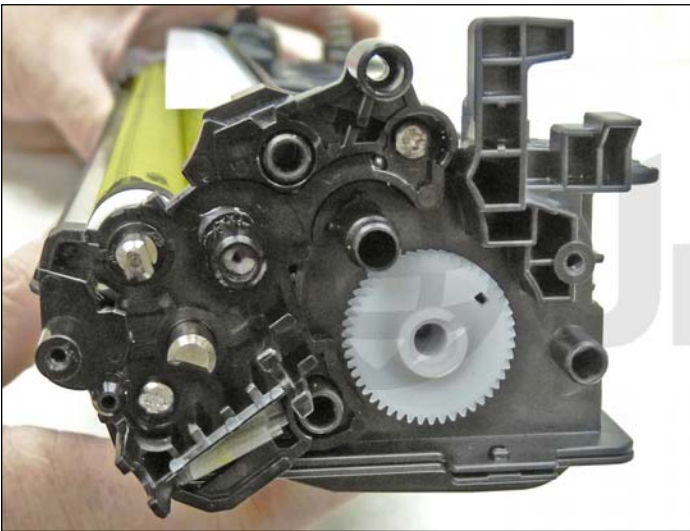

21. Remove all the gears as shown except for the mixing blade gear and the sealing strip gear. The mixing blade gear is attached to the mixing blade inside the hopper and is very difficult to re-attach properly.

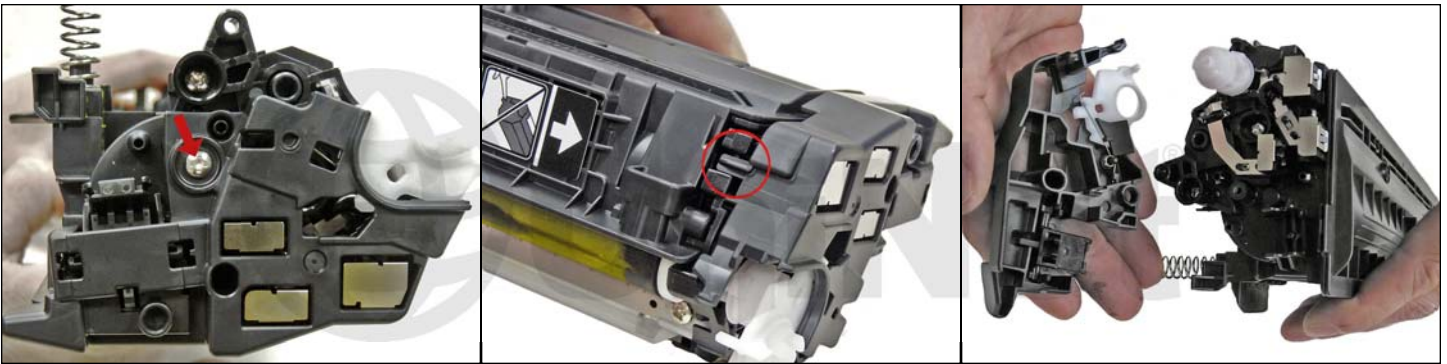

22. On the contact side, remove the screw, pry up on the small tab and remove the end cap.

Watch out for the developer gear assembly.

This is a three piece gear set that may come with the end cap.



23. Remove the triple developer roller drive gear(s).

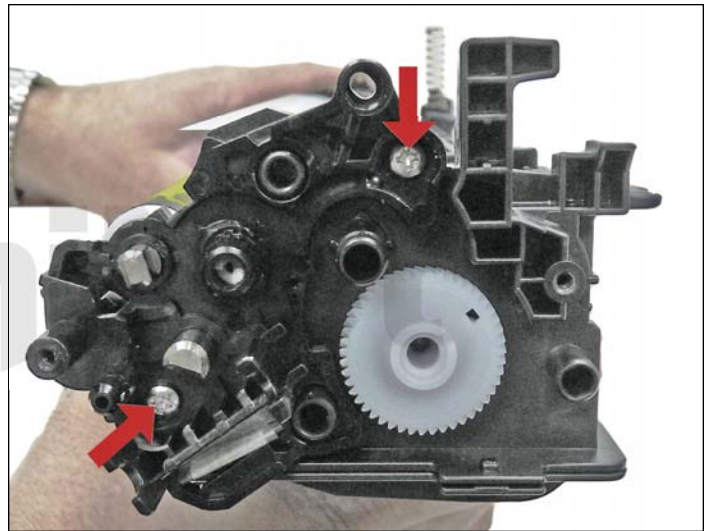

24. On the gear side inner end cap, remove the two screws and end cap.



25. Remove the developer roller.

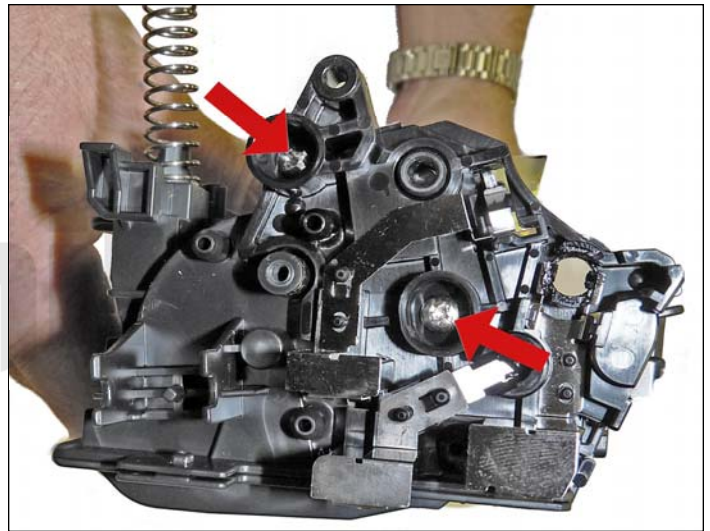

26. Remove single screw and contact side inner end cap.





27. Remove the two screws from the doctor blade and start to lift the blade up.

There is glue on either end of the blade.

As you lift the blade up, slice the glue away from the blade, with the razor knife.

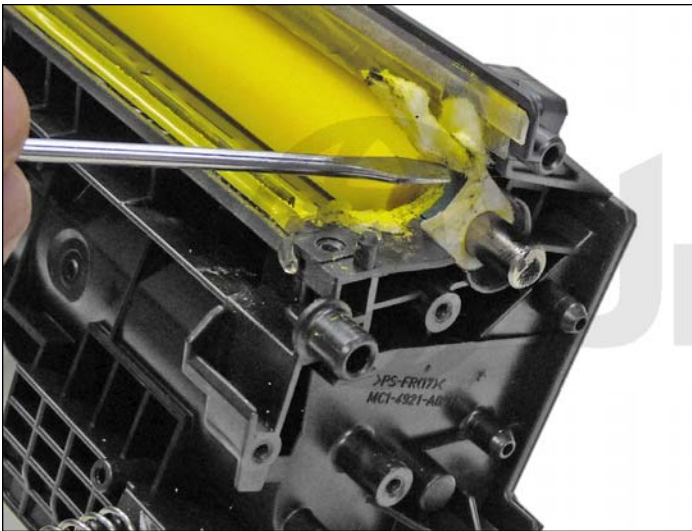

28. On the right side of the chamber, lift up the felt developer roller seal. Lift it from the front side and lay it over the back.

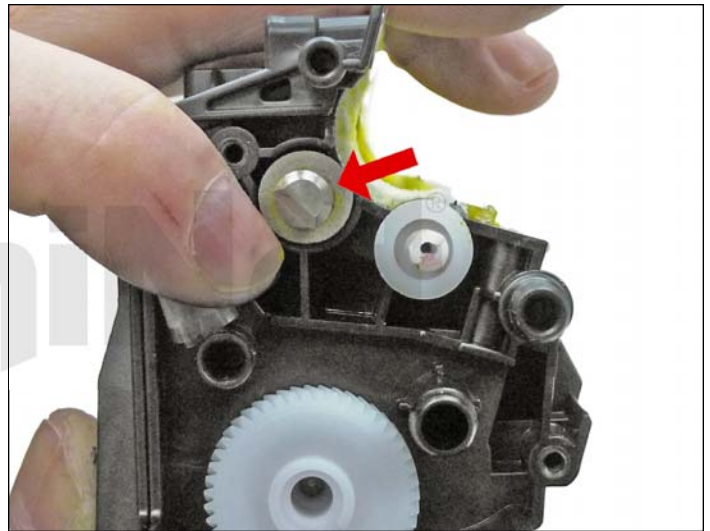
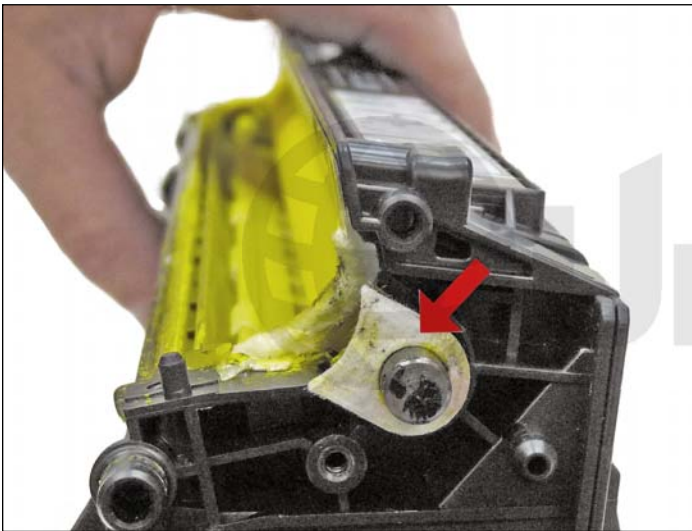

29. Remove the felt washers from both sides of the feed roller.

There is a gray felt washer on the gear side and a white felt washer on the contact side.

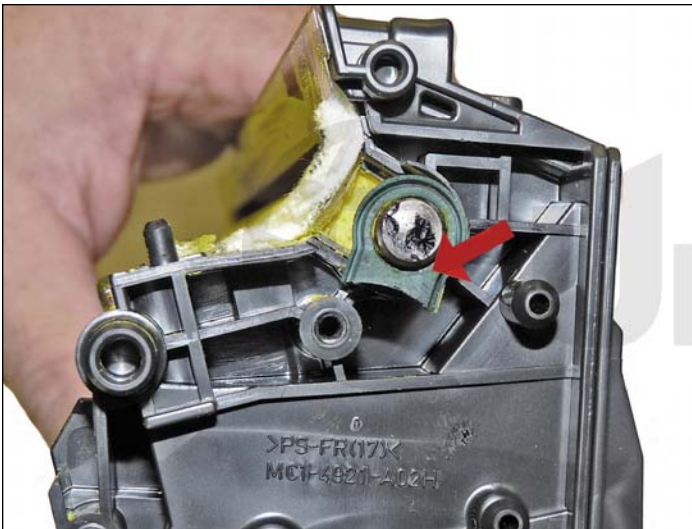

30. Pry out the rubber feed roller bushing from the right side.



31. Remove the feed roller.



32. Clean out the remaining toner and fill with the correct color of dedicated toner for use in CP5225.



33. When a seal is available, you will first need to remove the auger drive gear and remove the auger so that you have access to the seal area. Install the seal onto the seal rails. Pull the release tape off 1" at a time and press the seal in place as you go. Install the auger and auger drive gear. Make sure the drive gear is positioned as shown.



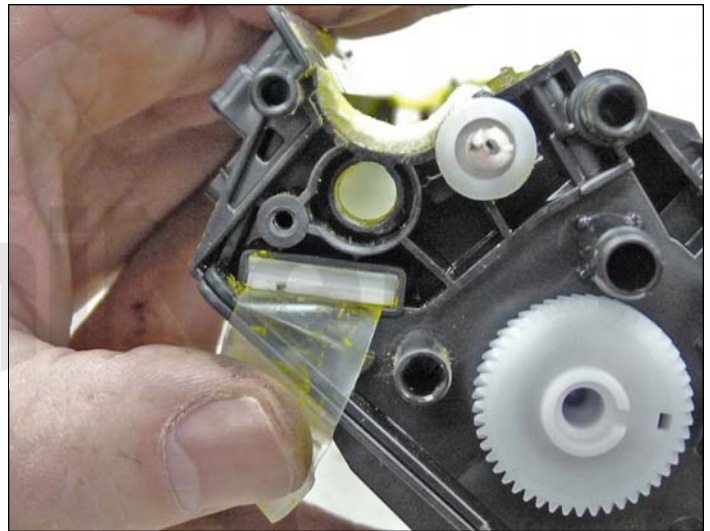

34. Remove the seal port and slide the seal pull tab through the slot.

Install the seal port.



35. Install the feed roller and rubber bushing, with the keyed end to the gear side.

UniNet®

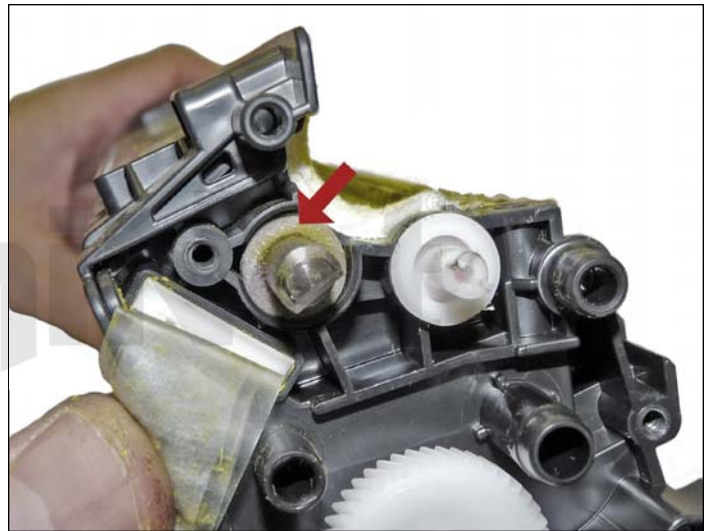

36. Install the feed roller felt washers.

Place the gray seal to the gear side, and the white to the contact side.

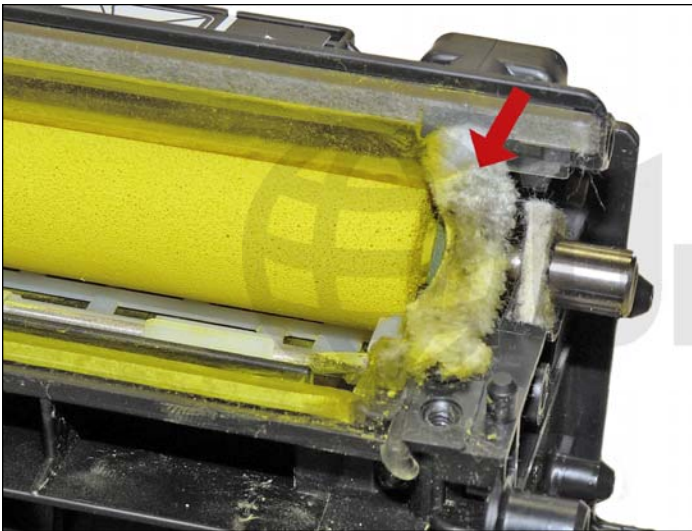

37. Press the developer roller felt seal back in place. Make sure it fits under the retaining blade. If the glue is not sticking, place a very small bead of 100% adhesive silicon to lock it in place.

DO NOT get the silicon on the top of the felt! This felt has a tendency to curve when re-installed. The picture shown is NOT the correct way. Make sure the felt is straight or it will leak.



38. Gap the blade to 1.6 mm. You may have to modify your gapping gauge to fit. Install the doctor blade and two screws. Make sure the sticky seals on either end of the blade seal correctly. If the material is no longer sticky clean it with alcohol or replace it with a small amount of silicon.

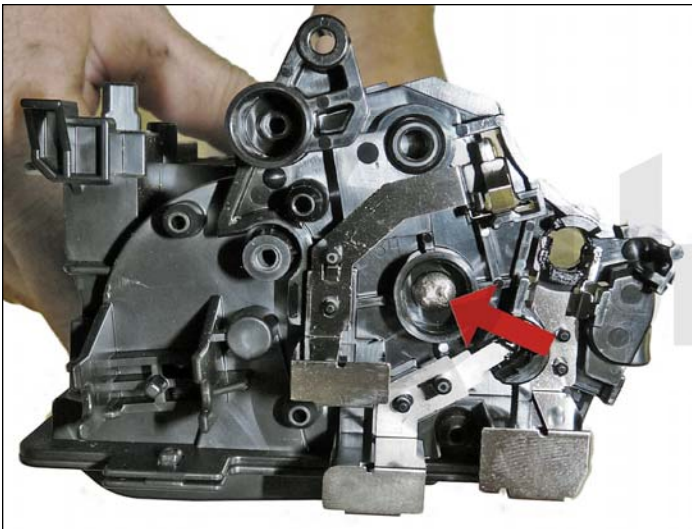

39. Clean the contacts and replace the conductive grease on the inner contact end cap. Install the inner contact end cap and screw.



40. Install the cleaned developer roller. Do not use any chemicals to clean this. A lint-free cloth works fine. Place the keyed end to the gear side and conductive grease on the contact side.



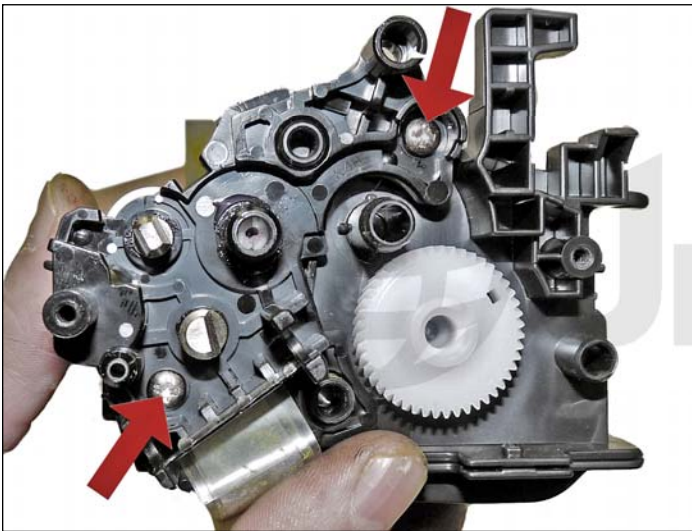

41. Install the inner gear end cap and two screws.

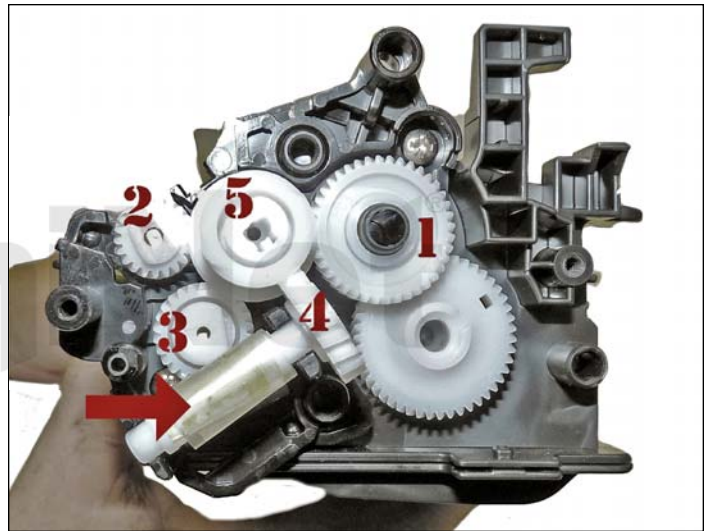

42. Install the gears in the order shown. If you installed a seal, slide the seal end through the take up gear and wrap the loose end tight on the roller.

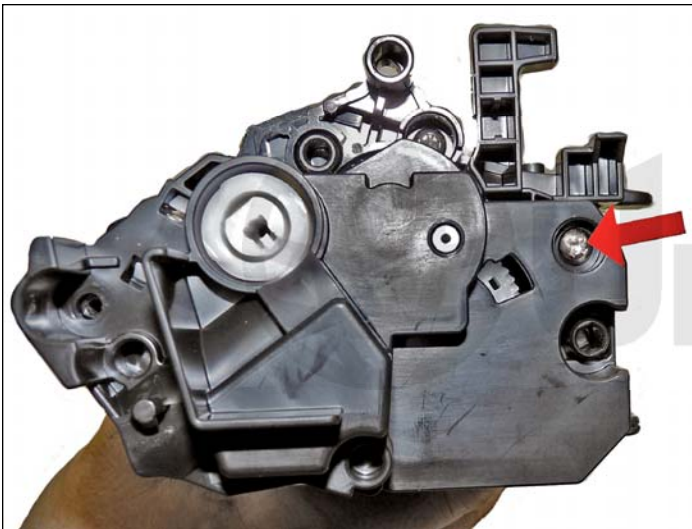

43. Install the outer gear end cap and screws.

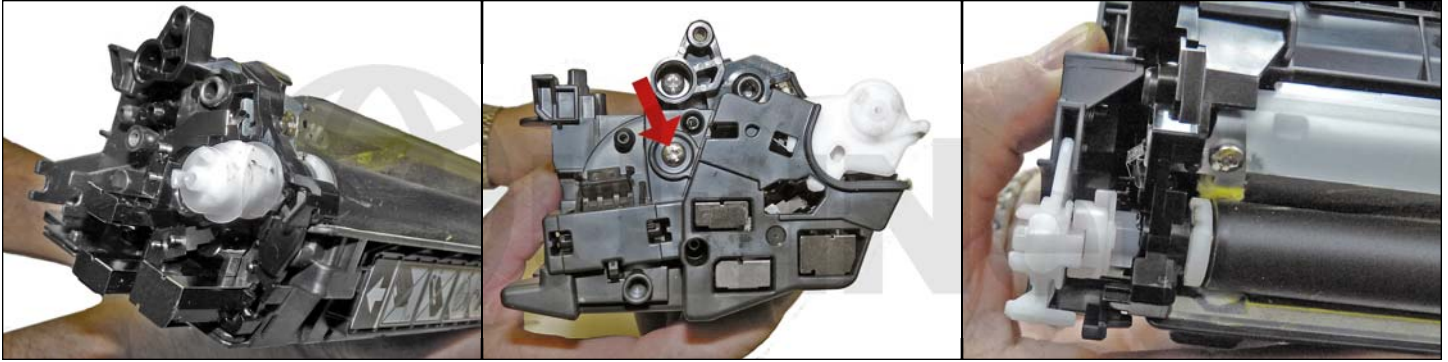

44. Place the triple gear on the developer roller shaft, and fit into the spring assembly on the end cap.

Install the end cap and install the two screws.



45. Place the two halves together with contact side first.

On the gear side, press the lever in place.

On the contact side snap the lock up into the end cap.





46. Install the two pins, with the large pin to the label or gear side of the cartridge.



47. Install the spring.



48. Remove and replace the chip.



49. If the new replacement chip is loose in the slot.

Close off the top edges with small amounts of hot glue.



50. Install the drum cover on to the cartridge.

## TAKING TEST PRINTS

### Print Quality Troubleshooting Pages:

1. Press the HOME button
2. Open the following menus: ADMINISTRATION, TROUBLESHOOTING, PRINT QUALITY PAGES
3. Press the DOWN arrow until "PRINT PQ TROUBLESHOOTING PAGES" appears on the display
4. Press OK

### Diagnostics Page:

1. Press the HOME button
2. Open the following menus: ADMINISTRATION, TROUBLESHOOTING, PRINT QUALITY PAGES
3. Press the DOWN arrow until "DIAGNOSTIC PAGE" appears on the display
4. Press OK

## REPETITIVE DEFECT CHART

<b>Primary charge roller:</b>	<b>35.0 mm</b>
<b>Developer roller sleeve:</b>	<b>42.0 mm</b>
<b>Primary transfer roller:</b>	<b>50.0 mm</b>
<b>Secondary transfer roller:</b>	<b>60.0 mm</b>
<b>OPC drum:</b>	<b>94.0 mm</b>
<b>Fuser sleeve:</b>	<b>76.0 mm</b>
<b>Fuser pressure roller:</b>	<b>79.0 mm</b>



### **CALIBRATE NOW**

Sometimes the only way to fix print quality issues is to force a calibration:

1. Press the HOME button
2. Press the DOWN arrow until DEVICE MAINTENANCE appears on the display
3. Press OK
4. Press the DOWN arrow until CALIBRATION/CLEANING appears on the display
5. Press OK
6. Press the DOWN arrow until FULL CALIBRATE or QUICK CALIBRATE appears on the display
7. Press OK

Use the FULL CALIBRATE if the colors are misaligned or blurry.

Use the QUICK CALIBRATE if the colors are wrong, too dark or light, or if highlights are missing.

### **PRINT DENSITY SETTINGS**

There are actually multiple sub settings that can be set under DENSITY.

As you can see, these settings can get a little intense and complicated.

#### **Highlights:**

Highlights are colors that are nearly white.

To darken highlight colors, increase the highlights setting.

This adjustment does not affect midtone or shadow colors.

#### **Midtones:**

Midtones are colors that are halfway between a white and solid density.

To darken midtone colors, increase the midtone setting.

This adjustment does not affect highlight or shadow colors.

#### **Shadows:**

Shadows are colors that are nearly a solid density.

To darken shadow colors, increase the shadows setting.

This adjustment does not affect highlight or midtone colors.