

TENSILE TESTING

Principles of Tensile Testing:

Three ways to carryout tensile test:

- 1. CRE:** Rate of increase of specimen length is uniform with time (the load measuring mechanism moves a negligible distance).
- 2. CRL:** Rate of increase of the load is uniform with time and rate of extension is dependent on the load-elongation characteristics of the specimen.
- 3. CRT:** Pulling one clamp at a uniform rate and the load is applied through the other clamp. Which moves appreciably to actuate a load measuring mechanism so that the rate of increase of either load or elongation is usually not constant.

CRE V/S CRL:

- ➡ With CRE principle, maximum load reaches before 3 sec., and rest of the time the specimen remains at higher load (initially very high rate of loading).
- ➡ For CRL, initial extension was very low and afterwards very high extension with small time (very high extension rate)
- ➡ So, nature of the curves of same specimen under two different principles will be different.
- ➡ If specimen length increase in a CRE machine, the rate of loading will decrease.

a) Pendulum Lever Principle (CRT):

M=Mass of pendulum and its C.G. is at R distance from the pivot

For extensible material, $v > u$

Click on Image to run the animation

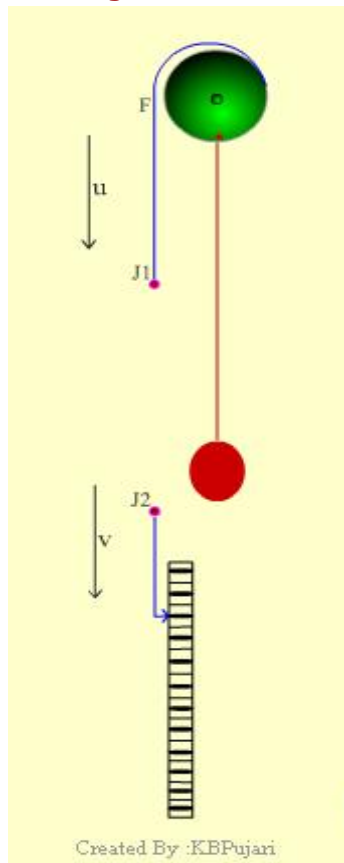

Assuming the specimen is in extensible,

Taking moments about pivot,

$$F \cdot r = Mg \cdot x = Mg \cdot R \sin \theta, \quad R, M, g, r, \text{ are constants}$$

$$F \propto \sin \theta, \quad F \text{ is tension in the specimen}$$

Machine rate of loading (μ)

Increase in the load per unit increase in the displacement of upper jaw (J1)

The displacement of upper jaw (**J1**)= $rd\theta$

$$dF/d\theta = (MgR/r)\cos\theta, \quad dF/rd\theta = \mu = (MgR/r^2)\cos\theta$$

MgR/r^2 is constant for a particular m/c and known as "**standard machine rate of loading**" or μ_0

Ratio of μ at start and at 45° is (**1:0.707**), i.e. $\cos 0^\circ : \cos 45^\circ$

Time rate of loading (L):

Rate at which the load on the specimen increases with respect to time

VDT = $rd\theta$ (For inextensible specimen)

$$d\theta/dt = v/r$$

$$L = df/dt = (dF/d\theta) \times (d\theta/dt) = (MgR\cos\theta/r) \times (v/r)$$

$$= (MgRv/r^2) \times \cos\theta = \mu \cdot v$$

$$L \propto \cos\theta$$

L changes throughout the test, maximum at $\theta=0^\circ$ (at start) and minimum (i.e. 0) at $\theta = 90^\circ$

Some considerations in Pendulum Principle:

(i) Inertia Effect :

Overthrow at end and at start also (extension without showing any load)

(ii) Effect of specimen extension:

$$\text{Time to break } (\tau) = \frac{F_{\max}}{\mu_0} + e$$

$$\mu_0 = \text{Force / unit length} \quad v$$

e = extension (length)

v = velocity of lower jaw

(iii) Scale :

$$\text{Force } (F) \propto \sin\theta,$$

This relationship causes uneven scale spacing. The calibration marks are close at start and gradually becoming more wide.

Or

By eccentric top pulley for evenly spaced scales.

b) Stelometer (CRL):

- Capable of measuring strength as well as elongation of fibre bundle.
- Works with Pendulum lever principle .
- The loading of the specimen is carried out by a pendulum system, which is mounted in such a way that it rotates about its **C.G.**
- It eliminates the inertia effects associated with normal pendulum principle.
- The beam and pendulum start in a vertical position but the **C.G.** of beam is such that when it is released the whole assembly rotates.
- The speed of rotation is controlled by adjusting the dashpot.

The stelometer

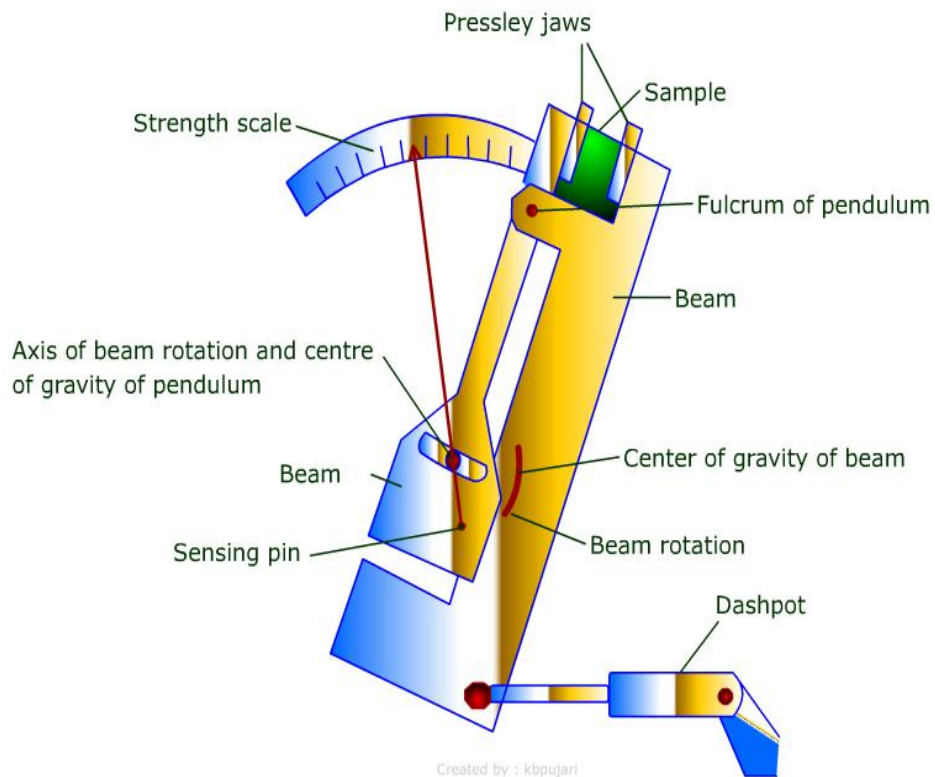

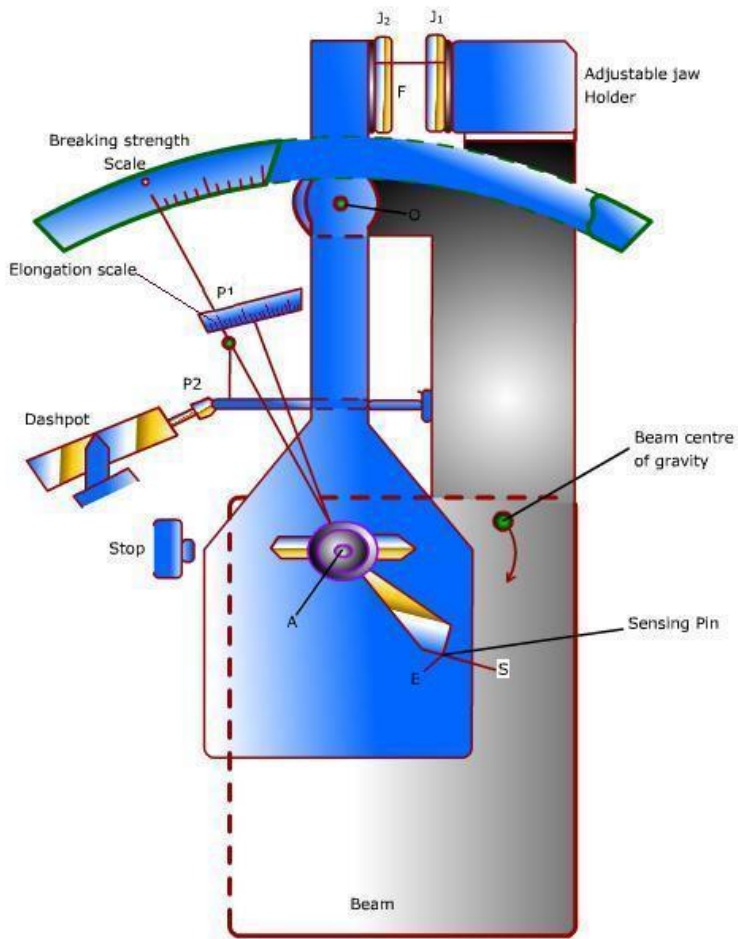

The Stelometer

Created by : kbpujan

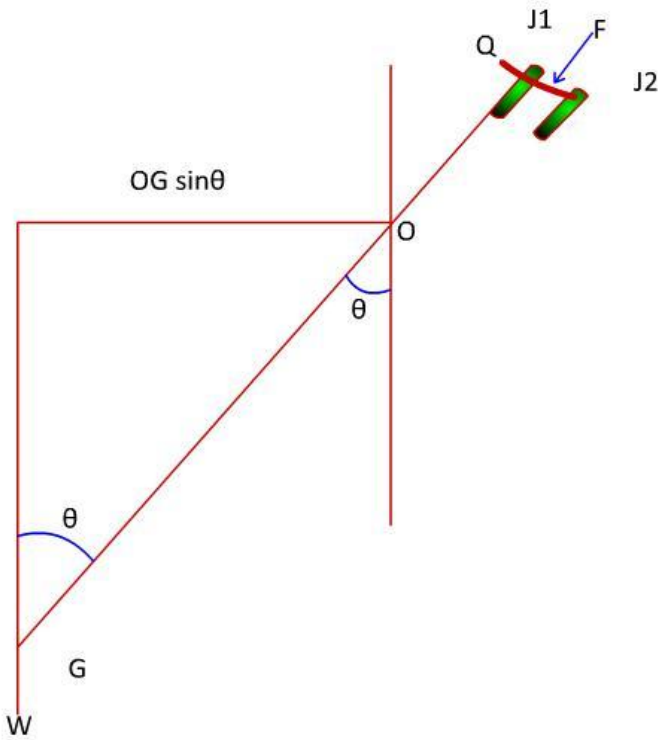

For Extensible Material:

μ_0 = std. m/c rate of loading

i.e. increasing in load per unit time displacement of J1

Time to break (T) = (Total movement of J2)/ v

$$= (\text{Movement of J1} + \text{Elongation of Specimen})/v$$

$$= (F_{max}/\mu_0 + e)/v$$

Assumptions:

- e: Linear load – extension curve
- μ_0 : Neglecting the effect of changes in θ

Example– Let extension at break - 7%

Gauge length - 8inch

Breaking load - 220gm

Std. Machine rate of loading, μ_0 - 1100gm/in

Rate of traverse - 2.28 inch/min

Calculate time of break

$$T = \left[\left\{ \frac{220}{1100} + 8 \times 0.07 \right\} / 2.28 \right] \times 60 \text{ sec}$$

$$= 20 \text{ sec}$$

$$F \times OQ = W \times OG \sin \theta$$

Clockwise moment **Anticlockwise moment**

$$F = \left(\frac{W \cdot OG}{OQ} \right) \sin \theta$$

$$F \propto \sin \theta$$

- Load on fibre bundle is proportional to "sin θ "
- The geometry of the system is so designed that the angular velocity of the beam is such that "sin θ " varies at an approximately constant rate.
- So, the rate of loading is constant (by adjusting the dashpot we can set it to 1 kg/sec).
- The % elongation is indicated by pointer P2, suspended from P1. The elongation scale is driven by sensing pin.
- If no elongation – both pointer P1 and elongation scale will move simultaneously, so P2 will be at zero
- If elongation is there – the scale will lag behind and thus the difference will show the elongation %.

c. The beam balance principle:

$$P \times BC = F \times AC$$

The load on the specimen 'P' can be varied by changing **F**, or

by changing the **distance from fulcrum**,

keeping **F** constant.

1. Pressley Fibre strength tester:

- ▶ The beam AB is pivoted at O.

- ▶ When B rises, the clamp C1 moves upwards.
- ▶ Initially the beam have a slight inclination of a few degree to the horizontal.
- ▶ The heavy rolling weight (W) when released from the catch, it rolls down the beam.
- ▶ A 'O increases until the fibres break.
- ▶ As soon as the break occurs, the arm AO drops and the brake arrangement stops the carriage instantly.
- ▶ The distance A'O is the measure of breaking force. The scale is directly graduated on the beam AB.

$$\text{Pressley Index (PI)} = \frac{\text{Breaking load in pound}}{\text{Bundle wt. in mg}}$$

$$\text{Tensile strength (g/tex)} = 5.36 \times PI$$

Schematic diagram of pressley fibre strength tester

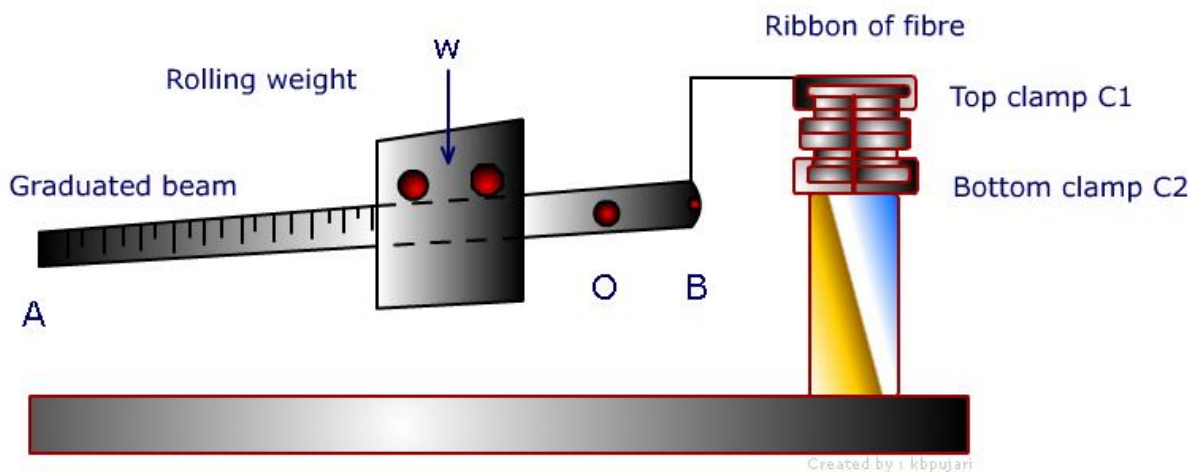

- ▶ The load on specimen ($P \propto A'O$), so the rate of loading is governed by the speed of rolling of wt. In normal condition the velocity gradually increase as it roll down and thus the rate of loading increases throughout the test. (*neither CRE nor CRL*)
- ▶ If we can control the velocity of rolling wt. by a specially made device, we can achieve CRL test condition.
- ▶ In **HVI**, this principle is used.

d. Loading by spring (both CRL and CRE):

The instrument is used for single fibre or fine yarns

(i) To test with CRL condition:

Motor M1 runs continuously

- As motor M1 starts, the H1 moves upwards at a constant speed.
- The spring extends and load is applied on the specimen at a constant rate.
- The extension of specimen will cause the leaf spring to touch upper contact C2, which starts the motor M2 and H2 moves down for a short period. This cycle continues until the specimen breaks
- S is helical spring ($\text{force} \propto \text{extension}$)

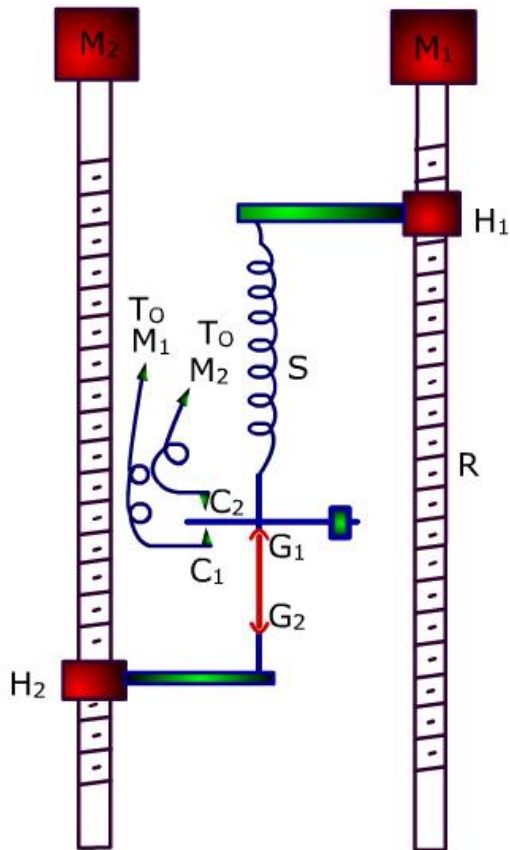

Schematic diagram of the cambridge Extensometer

created by : kbpujan

- G1 and G2 are the sample grips
- The upper grip G1 is connected to a leaf spring, which has a restricted movement between the electrical contacts C1 and C2.

(ii) To test with CRE condition:

Motor M2 runs continuously

The M1 starts and stops intermittently, as described above.

Used for single fibre and fine yarns.

Recording of Load – Extension (for CRL):

- A chart is mounted on a vertical cylinder.
- Movement of H1 measures the load, therefore the pen moves vertically along with H1.
- The motor M2, which runs only when the specimen extension is being taken up, also rotates the chart cylinder, angular movement of the cylinder being proportional to the extension.

Similar for CRE

e. Inclined plane principle (CRL):

Click on Image to run the animation

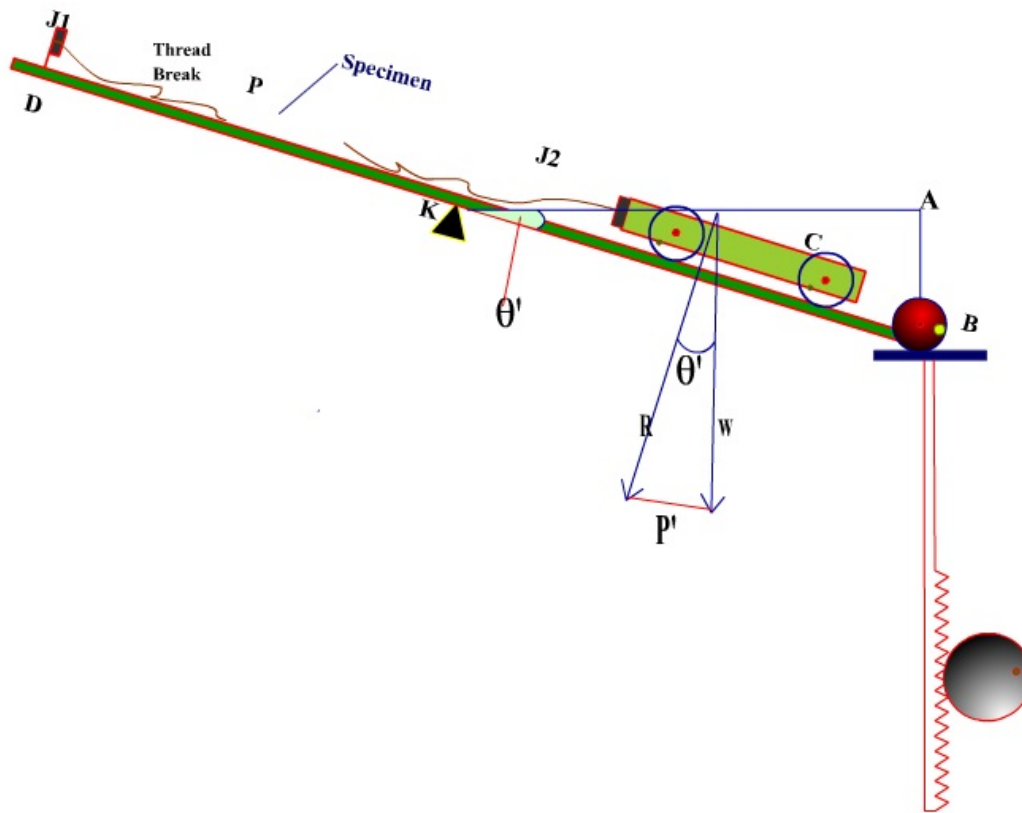

- ✓ The plane DB is tilted by dropping B at constant rate.

$$P = W \sin\theta$$

$$P \propto \sin\theta$$

In ΔABK , $\sin \theta = AB/KB$. Since for particular machine KB is constant, $\sin \theta \propto AB$. If AB is increased at constant rate, $\sin\theta$ will also increase at a constant rate.

- ✓ So, CRL condition is achieved.
- ✓ Extension of the specimen will not affect the rate of loading, the carriage merely rolling further down the plane.

f. Ballistic or impact principle:

- Measures 'work of rupture' of a specimen instead of max. breaking force.
- Potential energy at point **1**, $W \times h_1$.
- When pendulum is released, it swings downward and when it is nearly vertical, it begins to pull on the specimen (at **2**)
 - ✓ Breaks the specimen and rises to position **3**.

Work of rupture = $W (h_1 - h_2)$ in lbs

- 'K' is known as *centre of percussion of the pendulum*. it is a point on the axis of pendulum where a force may be applied without causing a reaction about the fulcrum.

Click on Image to run the animation

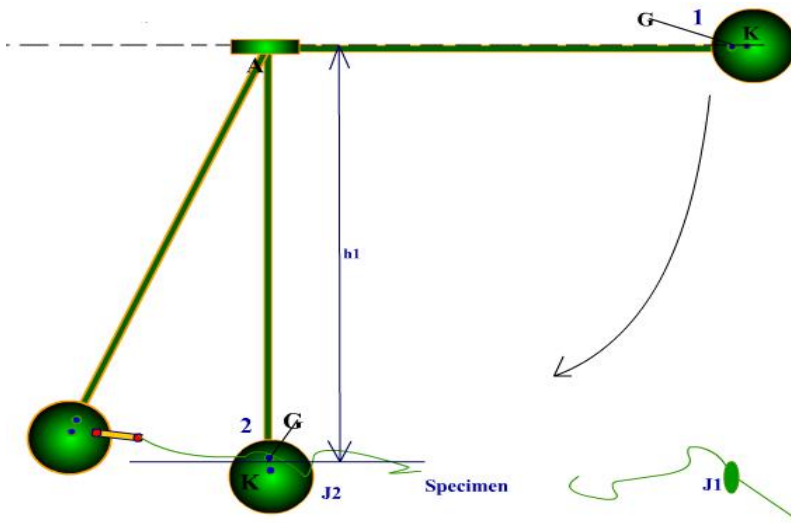

g. Strain gauge principle (Load Transducer):

Most of the modern tensile testers work on this principle.

- ▶ When the beam bends the length of upper face (AB) increases and lower face (CD) decreases and (NL) remains unchanged.
- ▶ Resistance wire (R) cemented on AB also expand and thus the value of resistance changes.
- ▶ **Convert this value of change in resistance to load value (applied on specimen)**
- ▶ Two resistance wires are placed on upper and other two are on lower surface. (To form a *Wheatstone Bridge*).

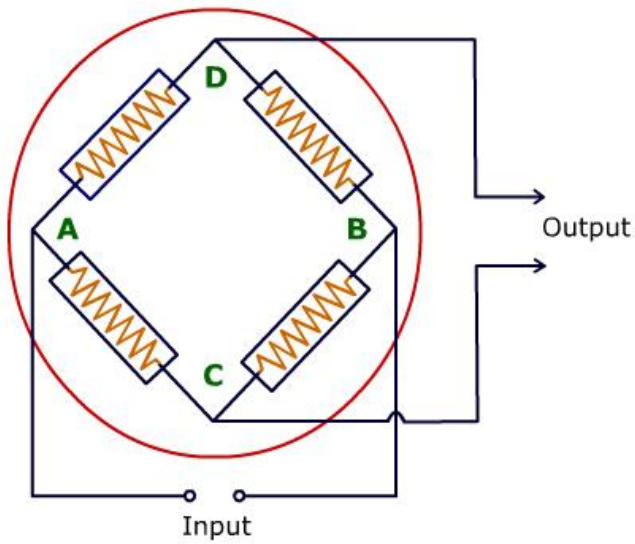

Four resistance in the load cell connected in the form of a wheatstone bridge

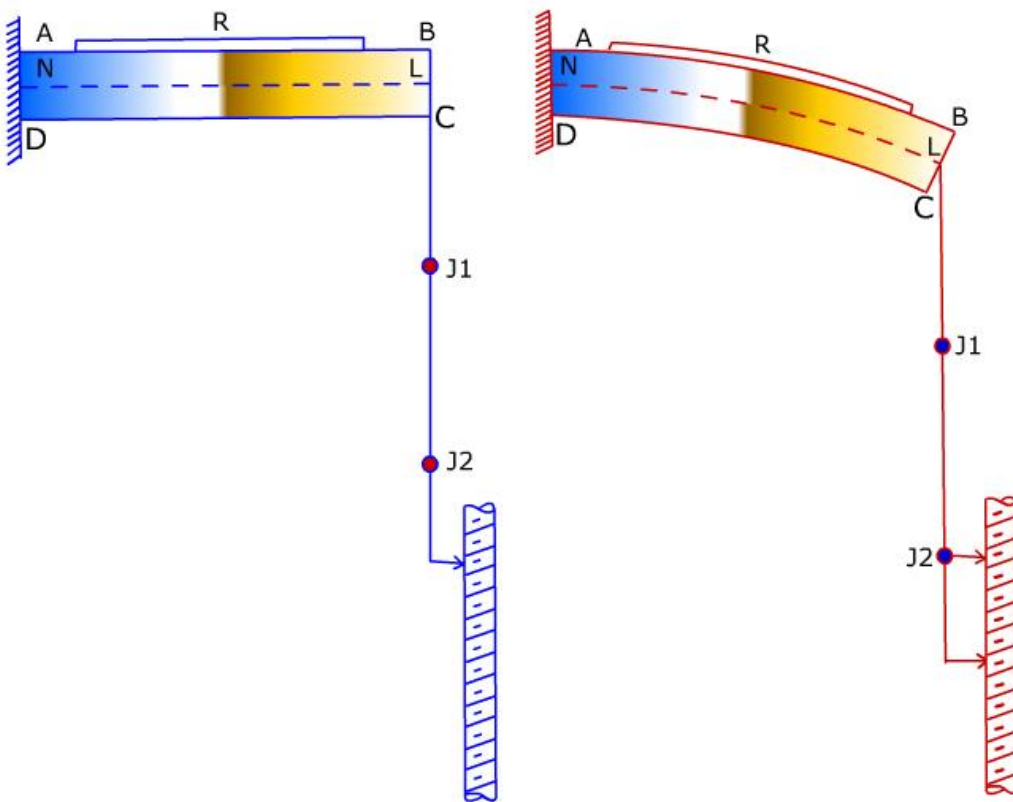

THE STRAIN GAUGE PRINCIPLE

Created by : kbpujari

- With the beam un-deflected, no voltage across CD, when a voltage is applied across AB. The bridge is 'balanced'.
- When load is applied, the deflection occurs and the values of the resistances change and a voltage is produced across CD, i.e., which is proportional to the load.

Advantages:

- ▶ Free from inertia errors and friction.
- ▶ The deflection of the end of the beam is very small, and thus it is tests under 'CRE' condition.
- ▶ Versatility in the type of instrument (yarn, fibre, fabrics, wide speed and load range, etc.)

Disadvantages:

- ▶ Expert technician is required for maintenance and repair.
- ▶ Chances of 'drift' in electronic circuits.
- ▶ High initial cost.

Instron tensile tester, UTM, Tensorapid, Zwick, Statimat and various other modern tensile testing instruments work in this principle.

h. Constant tension winding tests:

- ▶ It provides conditions somewhat similar to actual processing of yarn during winding, warping, sizing etc.
- ▶ The test is closer to actual running condition.
- ▶ A, B fixed pulleys and P movable pulley
- ▶ Under static conditions the tension of the loop will be 0.5L (uniform throughout the loop)
- ▶ The tension imposed on the yarn will cause it to stretch. "e" be the extension per unit length, $v = u (1 + e)$
- ▶ Necessary means are required to adjust the input and output velocity.
- ▶ The tension required to get the std. breakage rate

✓ Breakage rate and applied tension.

✓ Experimental data shows that

$n_1 = \text{Breaks}/1000 \text{ yard}$

At t_1 tension imposed on the yarn will cause it to stretch "e" be the extension per unit length,

$v = u (1 + e)$

Necessary means are required to adjust the input and output velocity.

Standard breakage rate is "8 breaks per 1000yard of yarn".

The tension required to get the standard break rate.

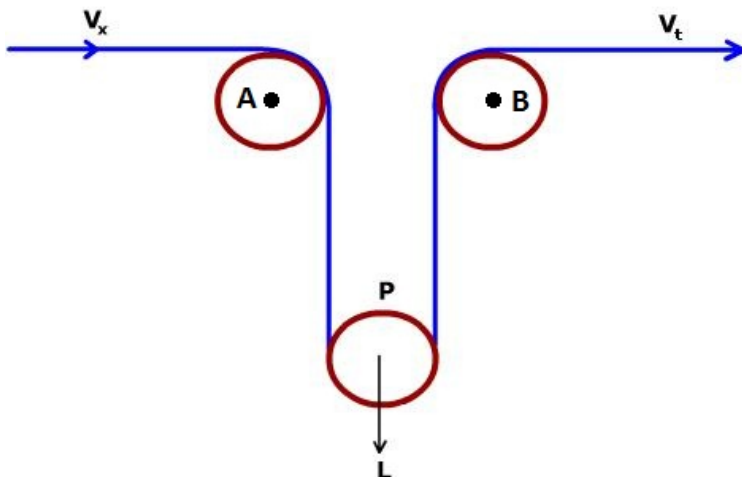

The constant-tension winding test principle

Breakage rate, applied tension and single thread strength:

Experimental data shows that

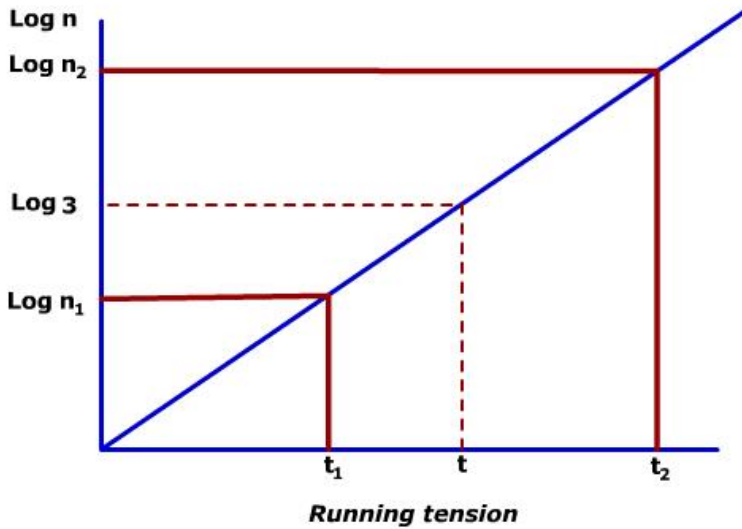

$n_1 =$ Bks/1000 yard at tension t_1 , and

$n_2 =$ Bks/1000 yard at tension t_2 .

Slope of the graph therefore, $\frac{\log n_2 - \log n_1}{t_2 - t_1} = \text{constant (c)}$

If 't' tension required to produce 'x' Bks/1000 yds, then

$$\text{Or, } t = t_1 + (t_2 - t_1) \left(\frac{\log x - \log n_1}{\log n_2 - \log n_1} \right)$$

So, we can calculate the tension required (t) to have certain breakage rate and vice versa, if we know these values at certain level.

Breakage rate, applied tension and single thread strength:

Single thread strength:

Empirical equation

$$T = \bar{x} - K\sigma$$

Dynamic mode T = Tension required to produce "n" breaks/1000yard

Static mode = Mean single yarn strength

$\sigma =$ S. D. of single yarn strength.

Factor 'K' depends on "n" and also change with test length of single thread tensile test.

In B.S. Handbook, the 1st estimate of tension required to produce 8 breaks/1000 yard is,

$$T = \text{Avg. Single yarn strength} \times \left(1 - \frac{CV \% \text{ of single yarn strength}}{30} \right)$$

$$= \bar{X} \left(1 - \frac{6}{x} \times \frac{100}{30} \right) = \bar{X} - 3.30$$

K = 3.3., with 20" test length and 8 breaks/1000 yard.

Application of constant – tension winding test:

Results obtained may serve as a guide to the behaviour of yarn in subsequent processing i.e. forecast of probable end-breakage rates.

- Comparison of yarn quality

	Yarn A	Yarn B	Yarn C
Count	60.2	61.0	60.8
CSP	2255	2170	2216
Single Yarn Strength	150.5	147.3	148.5
Breaks/1000 yard	18.6	6.8	21.5

YARN STRENGTH:

(i) Single yarn strength:

Instron, Uster etc. 500mm gauge length and speed adjusted so that the time to break is 20 ± 3 sec.

(ii) Skein Method (Lea Strength):

Advantages:

- ➡ It tests a long length of yarn in one test.
- ➡ Yarn is expected to break at its weak spots, so give more realistic strength values.
- ➡ Same hank can be used to measure yarn count.

Disadvantages:

- ➡ Result depends on friction between yarn and also between yarn and hook.
- ➡ No measure of strength variability.

FABRIC TENSILE STRENGTH

Fabric tensile strength depends upon

- ▶ Raw material.
- ▶ Yarn strength (twist: more twist for more strength)
- ▶ Fabric construction (*weave*: plane weave is stronger than floats-satin, sateen which are weaker, *Density*: low density cause weave slippage which result in seam slippage).
- ▶ Finish applied (resin finish improves weave slippage).
- ▶ Adverse of "finishing" process.

Measurement of fabric tensile strength

1. Strip Test: (British) BS 2576:

- ➡ In this method a fabric strip is extended to its breaking point by a suitable mechanical means which can record the breaking load and extension.
- ➡ Five fabric samples both in warp and weft direction are prepared with each not containing the same longitudinal threads.
- ➡ Samples are prepared 60mm x 300mm and then frayed to get 50mm wide specimen.
- ➡ The rate of extension is set to 50mm/min and gauge length is 200mm. pretension is 1% of the probable breaking load.

Click on Image to run the animation-1

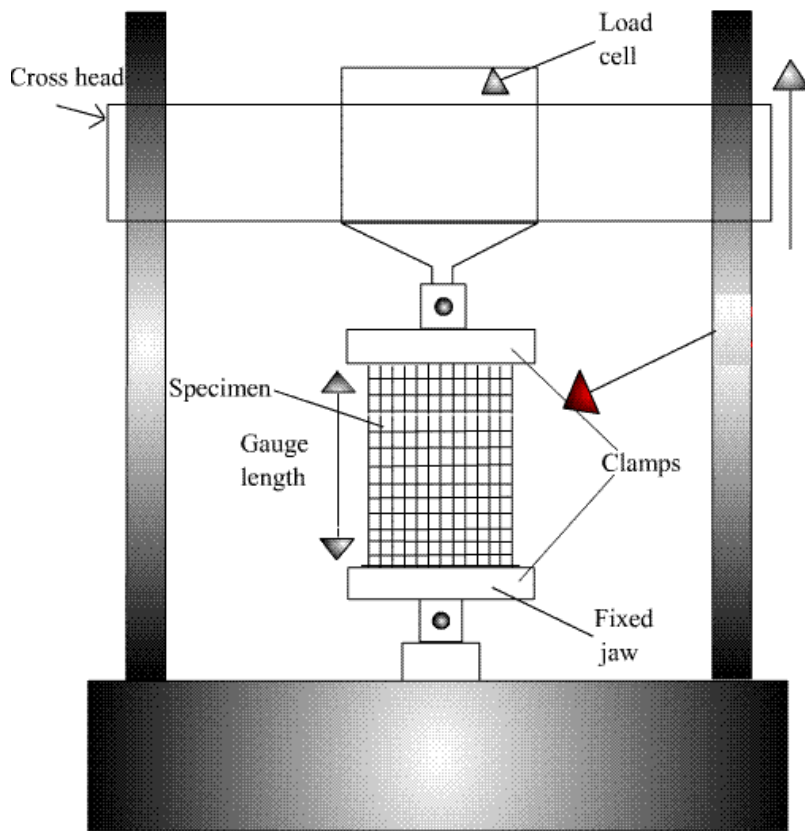

The apparatus for a fabric tensile test

- Any breaks that occur within 5mm of the jaws or at loads substantially less than the average should be rejected.
- The mean breaking force and mean extension % of initial length are reported.
- Samples are cut (60mm x 300mm) parallel to warp/weft.
- Frayed the threads from both sides of the width to bring down to 50mm wide.
- For heavily milled fabrics, no fraying is done (50mm x 300mm).

2. Grab Test: (U.S) ASTM D1682:

- The grab test uses jaw faces which are considerably narrower than the fabric, so avoiding the need to fray the fabric to width and hence making it a simpler and quicker test to carry out.
- The sample used is 100mm x 150mm jaws are 25mm square which stress only the central 25mm of the fabric.
- A line is drawn 37.5mm from the edge of fabric to assist it in clamping so the same set of threads are clamped in both jaws.
- The gauge length is 75mm and speed is adjusted so that the sample is broken in $20 \pm 3s$.

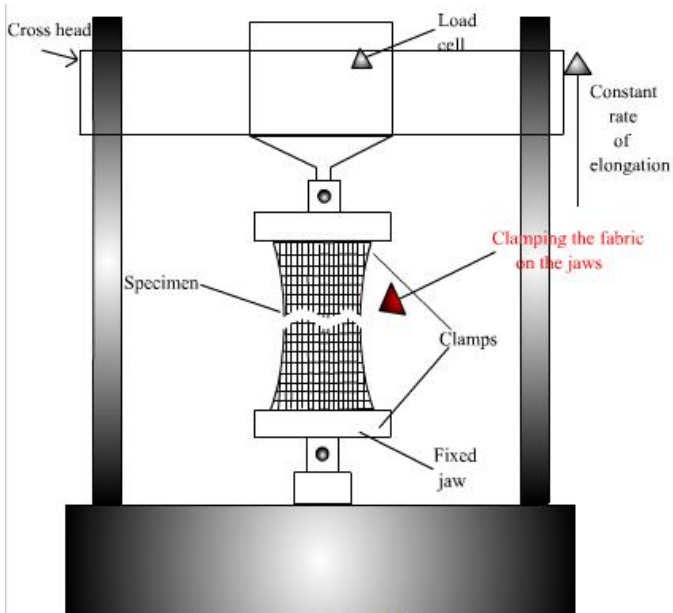

The apparatus for a fabric tensile test

- In this test, there is a certain amount of assistance from yarns adjacent to the central stressed area so that the strength measured is higher than for a 25mm frayed strip test.
- Fundamentally different from strip test.
- Jaw faces are considerably narrower than fabric. No need to fray the fabric.
- Simpler and quicker method.

3. USTER TENSORAPID (CRE Principle):

- For tensile testing of single and ply yarn.
- Testing of slivers, leas and fabrics is also possible.
- Force measurements up to 1000N without exchanging the force transducer.
- The *clamping force*, the yarn tensioners and the suction-off of the yarn can be programmed.
- All numerical and graphical results are displayed on a video screen. (Histogram, L-E curve, tables, etc.)
- Package creel for the automatic measurement up to 20 packages.
- Calling-up of test parameters of frequently tested yarn types from the memory (up to 40).
- *Pneumatically-actuated yarn clamps* ; the clamp pressure is programmable.
- Electronic elongation measurement.
- Test speed – Continuously adjustable between 50 and 5000mm/min.
- Test length.
 - > With horizontal position of clamps, continuously adjustable between 200 and 1000mm.
 - > With vertical position of clamps, continuously adjustable between 100 and 1000mm.
- Self test - Automatic calibration check for accuracy through inspection.