

# Vixen®

## Instruction Manual for Vixen **PORTA MOUNT**



PORTA MOUNT

\*This manual is prepared in common with all the PORTA mount series telescopes. You may occasionally find descriptions in the text not relevant to your model. The manual explains usage of the PORTA mount by mainly using pictures of the PORTA A80Mf by way of example.

\*Be sure to refer to an instruction manual of the optical tube assembly unit, if available, in conjunction with this manual.

**Read carefully the instructions before use, and follow them precisely.**

\*Always keep the instruction manual near your mount or telescope to enable any operational queries to be easily answered.

\*This instruction manual describes necessary precautions for the safe use of the product to prevent yourself and others from possible injuries as well as damages to the equipment. Only use the mounting/telescope after you are completely sure that you understand all the features.



## **WARNING!**

**Never look directly at the sun with your naked eyes or through any telescope or its finder scope or guiding scope. Permanent and irreversible eye damage may result.**

## **Cautions**

- ⊗ Do not leave the telescope's optical tube uncapped in daytime. It may cause a fire by sunlight passing through the objective lens or mirror of the optical tube or finder scope.
- ⊗ Do not use the product while transporting or walking, where injuries could arise from collision with objects or stumbling or falling.
- ⊗ Keep caps, desiccant, or vinyl packing materials away from children, to avoid danger of swallowing or suffocation.

## **General Cautions on Handling and Storage**

- ⊗ Do not leave the mounting or telescope inside a car in the scorching sun or, in front of any heat sources, particularly radiators of high temperature.
- ⊗ When cleaning, do not use organic solvents such as paint thinners or similar cleaners.
- ⊗ Prevent the product from being exposed to rain, water droplets, heavy dew, mud or sands.
- ⊗ Avoid touching any lens or mirror surface directly with fingers. If the lens or mirror becomes dirty with fingerprints or general smears, gently wipe it using commercially available lens cleaner and lens cleaning paper or consult your dealer.
- ⊗ Blow off dust on lens or mirror using commercially available blower brush.
- ⊗ For storage, keep in a dry place, where it is not exposed to the direct rays of the sun.

**Preface -----Page 2**

**⚠ Warning! -----Page 1**

**Table of Contents -----Page 2**

**Before Use -----Page 3**

◎ **Parts List -----Page 3**

◎ **Parts Description -----Page 3**

◎ **Specifications-----Page 4**

◎ **Optical Tubes -----Page 4**

**Preparation -----Page 5**

**I Setting up the Tripod/Attaching the Slow Motion Handles -----Page 5**

**II Preparation for Mounting the Optical Tube -----Page 5**

**III Mounting the Optical Tube -----Page 6**

**IV Attaching the Eyepiece -----Page 6**

**V-1 Attaching the Finder Scope (PORTA 80Mf and PORTA R130Sf)-----Page 7**

**V-2 Attaching the Finder Scope (PORTA A70Lf) -----Page 7**

**V-3 Attaching the Finder Scope (PORTA Telescopes with the Dot Finder)---Page 8**

**VI Balancing the Optical Tube -----Page 8**

**Basic Operation-----Page 9**

**I Quick Slewing Motion -----Page 9**

**II Fine Motion and Tracking -----Page 9**

**III Terrestrial Viewing-----Page 9**

**IV-1 Aligning the Finder Scope (PORTA A80Mf and PORTA R130Sf) ---Page10**

**IV-2 Aligning the Finder Scope (PORTA A70Lf) -----Page11**

**IV-3 Aligning the Finder Scope (PORTA Telescopes with the Dot Finder) ---Page11**

**Adjustments-----Page12**

**I Adjusting the Altitude/Azimuth Slewing Motion-----Page12**

**II Adjusting the Altitude Handle Position -----Page12**

**III Adjusting the Azimuth Handle Position-----Page13**

**Observation-----Page14**

**Observing the Moon-----Page14**

## ◎ Parts List

The PORTA altazimuth mount and tripod box contains the parts listed below. Make sure that your shipment contains all the parts.

### Contents of the PORTA

- ① PORTA Mount and Aluminum Tripod Legs Set
  - ② 4mm Allen Wrench (for adjusting tension of altitude/azimuth motion)
  - ③ 3/16" Allen Wrench (for attaching the dovetail block)
  - ④ Altitude/Azimuth Slow Motion Handles
  - ⑤ Accessory Tray
- Instruction Manual (This booklet.)

For contents other than the above parts (instruments such as optical tubes), refer to a list on a facing page.

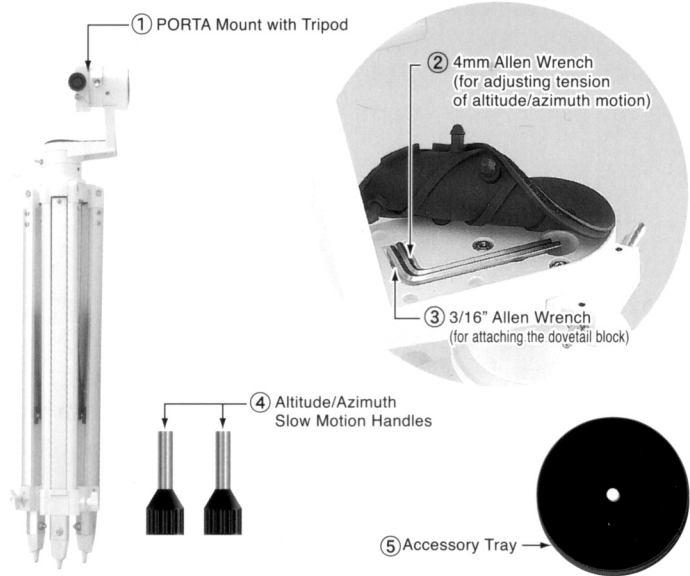

## ◎ Parts Descriptions

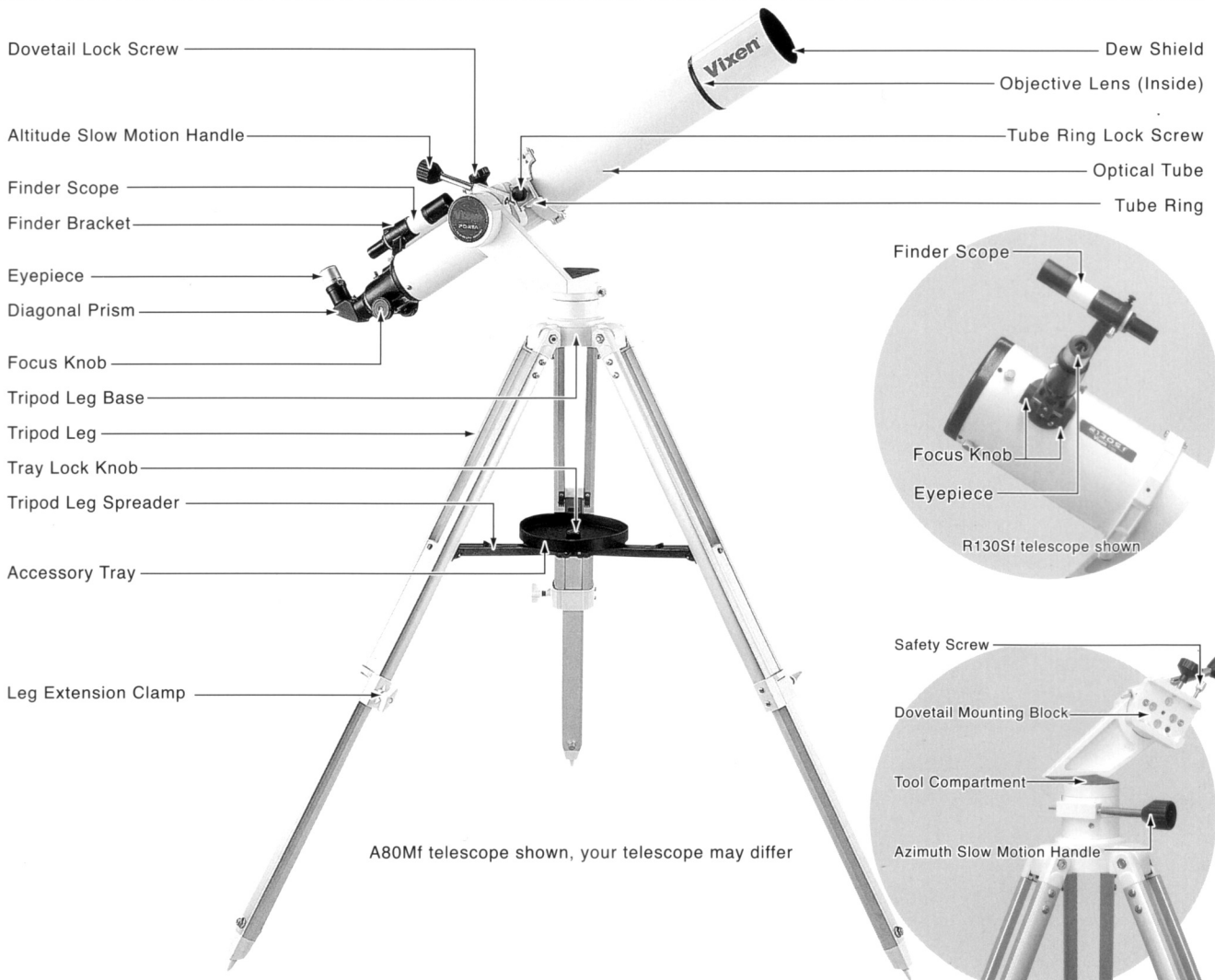



## ⊙ Specifications

Mount	Altazimuth Mount
Altitude (Vertical) Motion	Whole-circle Fine Motion (120-tooth) and Quick Slewing Motion
Azimuth (Horizontal) Motion	Whole-circle Fine Motion (120-tooth) and Quick Slewing Motion
Optical Tube Attachment	Dovetail Tube Plate Attachment System with Safety Screw
Max. Loading Weight	About 5 Kgs.
Tripod	Two-section Aluminum Legs with Accessory Tray
Adjustable Length	Adjustable from 90cm to 130cm in length
Total Weight (Inc. Tripod)	5.5 Kgs.

The PORTA altazimuth mount features simple altitude (vertical) and azimuth (horizontal) motion controls designed to easily point a telescope tube to the object you want to view.

## ⊙ Optical Tubes (Your optical tube may differ.)

Model	A80M	R135S	A70Lf	A80Mf	R130Sf	ED80Sf	ED100Sf
Objective Design	Achromatic Lens	Parabolic Mirror	Achromatic Lens	Achromatic Lens	Parabolic Mirror	Apochromatic	Apochromatic
Effective Aperture	80mm	135mm	70mm	80mm	130mm	80mm	100mm
Focal Length	910mm	720mm	900mm	910mm	650mm	600mm	900mm
Focal Ratio	f/11.4	f/5.3	f/12.9	f/11.4	f/5.0	f/7.5	f/9.0
Light Gathering Power	131x	372x	100x	131x	345x	131x	204x
Resolving Power	1.45"	0.86"	1.66"	1.45"	0.89"	1.45"	1.16"
Limiting Magnitude	11.3	12.4	11.0	11.3	12.3	11.3	11.8
Drawtube Diameter	64mm	38mm	40mm	44.5mm	40mm	64mm	64mm
Threads on Focusing Tube	60mm, 42mm	36.4mm	42mm	42mm	42mm	60mm, 42mm	60mm, 42mm
Eyepiece Push-fit	50.8mm, 31.7mm	31.7mm	31.7mm	31.7mm	31.7mm	50.8mm, 31.7mm	50.8mm, 31.7mm
Optical Tube Length	915mm	710mm	865mm	860mm	572mm	570mm	880mm
Optical Tube Diameter	90mm	155mm	76mm	90mm	160mm	100mm	100mm
Optical Tube Weight	2.5 Kgs	3.7 Kgs	1.9 Kgs	2.5 Kgs	4.0 Kgs	3.4 Kgs	3.7 Kgs
Finder Scope	Dot Finder	Dot Finder	6x24mm	6x30mm	6x30mm	9x50mm	9x50mm
Eyepiece (Lower Power)	PL20 (46x)	PL20 (36x)	PL20 (45x)	PL20 (46x)	PL20 (33x)	-	-
Eyepiece (Higher Power)	PL6 (152x)	PL6 (120x)	PL6.3 (143x)	PL6.3 (144x)	PL6.3 (103x)	-	-
Flip Mirror	⊙	-	-	-	-	⊙	⊙
Diagonal Prism	-	-	⊙	⊙	-	-	-
Tube Rings	⊙	⊙	⊙	⊙	⊙	⊙	⊙
Dovetail Tube Plate System	⊙	⊙	⊙	⊙	⊙	⊙	⊙

⊙ = Supplied

## I Setting Up the Tripod / Attaching the Slow Motion Handles

- ① Stand the tripod on an even and solid ground. Adjust the height of the tripod as the occasion demands.

※ To change the height, loosen the leg extension clamp of each tripod leg. Be sure to tighten all the leg extension clamps securely after adjusting the height of the tripod.



- ② Pull the tripod legs apart until the tripod leg spreader has been fully extended to let the tripod stand by itself

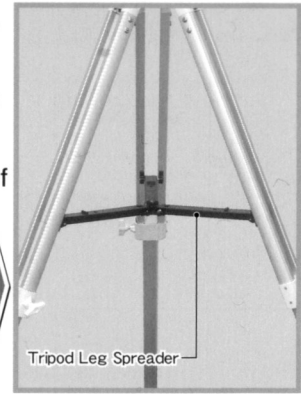
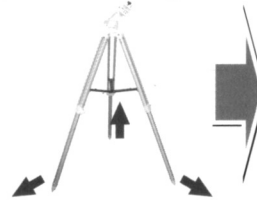

- ③ Take off the tray lock knob at the center of the tripod leg spreader and reveal the screw bolt.

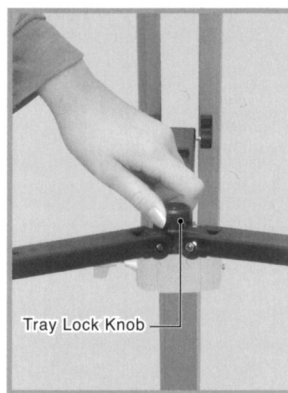

- ④ Place the accessory tray over the tripod leg spreader and position it so the screw bolt on the tripod leg spreader fits the matching hole at the center of the accessory tray. Then, fix the accessory tray with the tray lock knob.

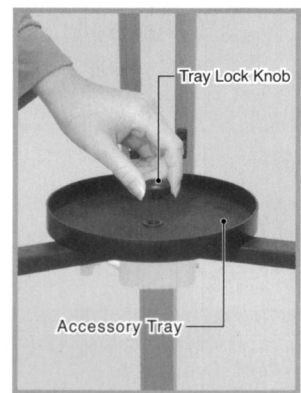

- ⑤ Attach the slow motion control handles onto each of the worm shafts for altitude adjustment and azimuth adjustment on the mount. Orient the metal sleeve so that the dent on the sleeve goes to the flat portion of the worm shaft. Slide the metal sleeve on the slow motion handle over the worm shaft.

※ There are two altitude worm shafts, one on either side of the altitude slow motion unit, and there are another two azimuth worm shafts on the azimuth slow motion unit. Use whichever one you find more convenient.

※ The two slow motion handles are the same and you can use whichever for altitude slow motion control or for azimuth slow motion control.

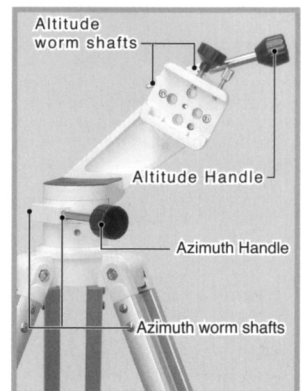
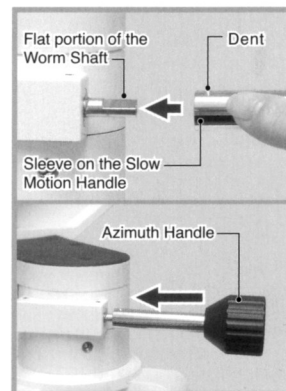

## II Preparation for Mounting the Optical Tube

- ① Turn the dovetail mounting block by hand so that the dovetail lock screw is on top.

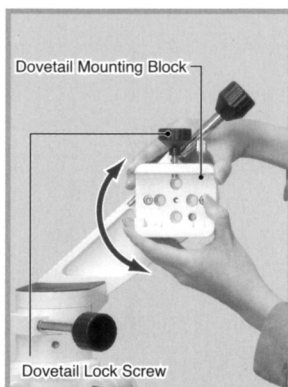

- ② Loosen both the dovetail lock screw and safety screw until the tips of these screws no longer extend into the inner part of the adapter block.

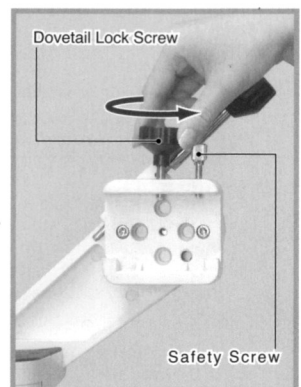

# Mounting Tele Vue Telescopes on PORTA Mount

If you are mounting a Tele Vue telescope onto the Porta Mount, install the adapter block AVT-1011 on the telescope mount ring or adjustable dovetail-balancing bar. The AVT-1011 is included with Tele Vue scopes sold with Porta Mount and is also available from your Tele Vue dealer.

From behind the telescope, rotate the ring mount so the adapter threads are on the right. Attach the adapter block with notch facing up.

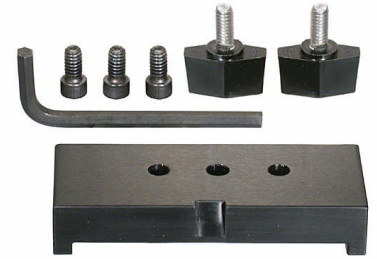

# Mounting Vixen Field Scopes on PORTA Mount

If you are mounting a Vixen Geoma field scope onto the Porta Mount, install the adapter block AVT-1011 on the base of the field scope. Lay the field scope on its side with the eyepiece end to your left and objective lens to the right. Place the smooth face of the adaptor block (notched edge up) against the mounting base of the field scope. With one hand, align the left-most hole on the adapter block with the left-most threaded hole on the field scope base. With the other hand, insert one of the supplied socket head cap screws (small screws) through the hole and drive it in with the supplied Allen key. Tighten firmly.



Follow the instructions in the **Preparation** section of the Porta Mount manual to setup the tripod and mount the field scope. Then loosen the silver locking thumbscrew on the spotting scope and rotate the scope body so that the eyepiece is facing up. In order to get the smoothest motion from your Porta Mount, follow the directions in the **Adjustments** section of the Porta Mount manual to adjust the altitude/azimuth slewing motion.

Tips to prevent the field scope from slipping off the adapter block:

- Make sure the socket head cap screw on the adapter block is tight.
- Adjust the tension on both axis (**Adjustments** section) so the field scope moves easily without binding and stays in position when you remove your hand. Photographers should do this adjustment with their imaging equipment attached.

## III Mounting the Optical Tube

Attach the dovetail mounted scope into the dovetail mounting block of the PORTA mount, tighten the dovetail lock screw onto the dovetail tube plate, centering notch until snug.

※ Next, tighten the small chrome safety screw onto the adapter until snug.

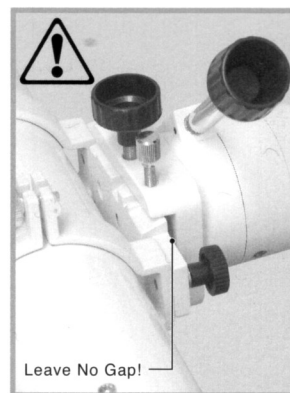
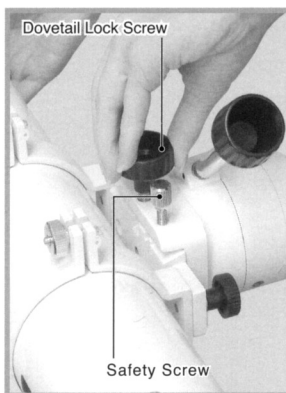
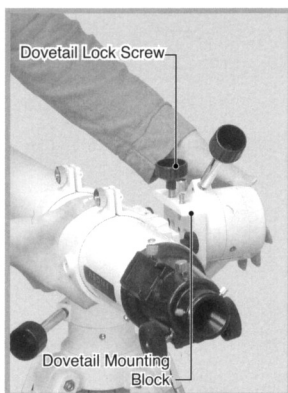

### **WARNING !**

Optical tube assemblies are seriously damaged if dropped. Tighten the dovetail lock screw securely. The safety screw should also be screwed in completely.

### **WARNING !**

Make sure that the dovetail tube plate is flat against the dovetail mounting block. Tightening the dovetail lock screw with a gap between these parts may result in the telescope unexpectedly falling off.

## IV Attaching the Eyepiece

(For other PORTA telescopes, refer to instruction manuals supplied with them.)

### Composition Chart of Visual Observation with the A80M

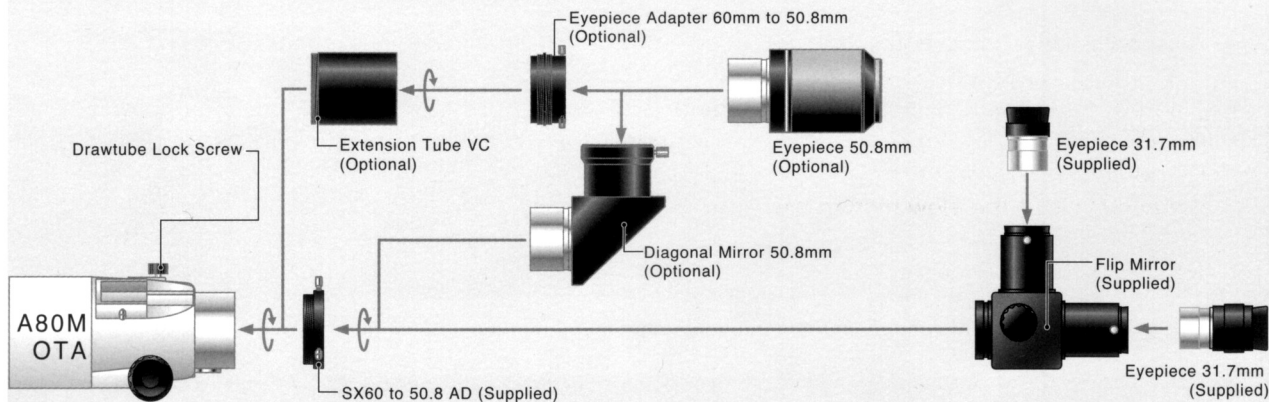

### Composition Chart of Visual Observation with the R135S

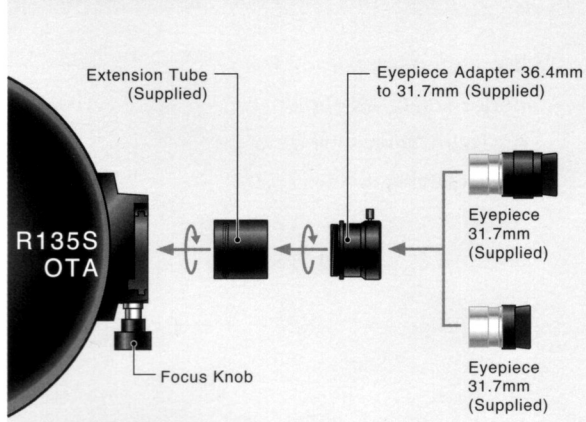

### Composition Chart of Visual Observation with the A70Lf, A80Mf or R130Sf

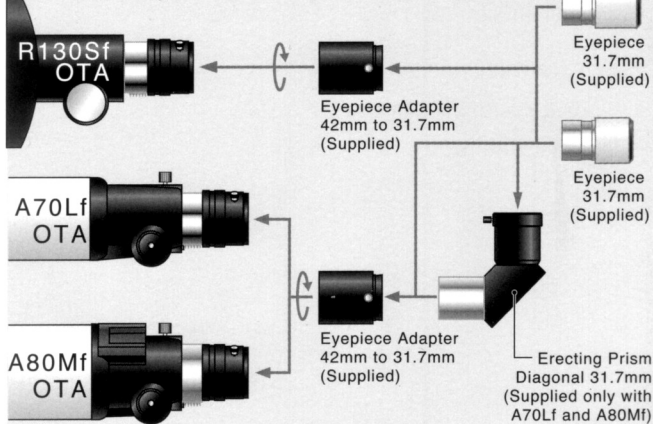



## V-1 Attaching the Finder Scope (PORTA A80Mf and PORTA R130Sf)

- ① Back out the adjustment screws on the finder bracket to allow passage of the finder scope. (Make sure the adjustment screws do not fall off the bracket.)

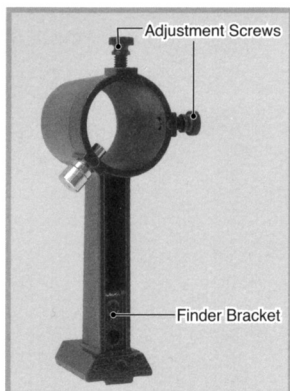

Slide the rubber O-ring onto the eyepiece end of the finder. There are two grooves on the finder tube. Position the O-ring on the narrow groove at the middle of the finder tube.

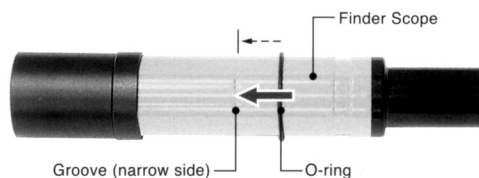

- ② Pull up the fixed stud on the bracket ring and pull it so that the finder tube slides into the bracket ring from its eyepiece end.

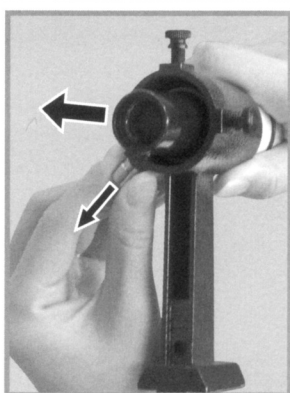

Release the fixed stud at the position that the wide groove on the finder tube is underneath the stud.

- ③ Tighten the two adjustment screws so that the finder scope is aligned as shown in the figure.

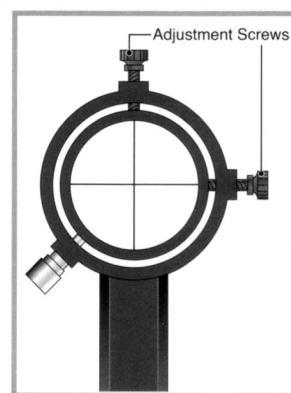

- ④ Loosen the finder bracket lock thumbscrew on the telescope.

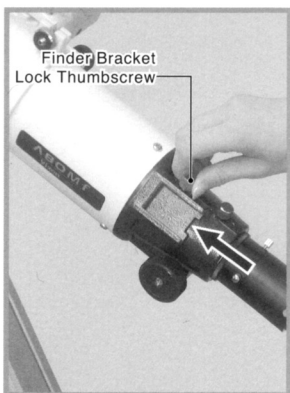

- ⑤ Attach the finder bracket as shown in the figure, tighten the finder bracket lock thumbscrew securely.

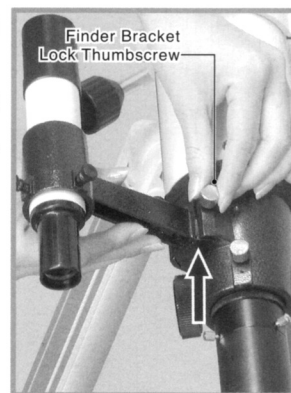

## V-2 Attaching the Finder Scope (PORTA A70Lf)

- ① Take off the two finder bracket fixing screws on the telescope.

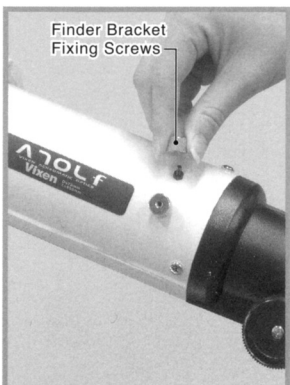

- ② Attach the bracket on the finder scope as shown in the figure, tighten the finder bracket fixing screws securely.

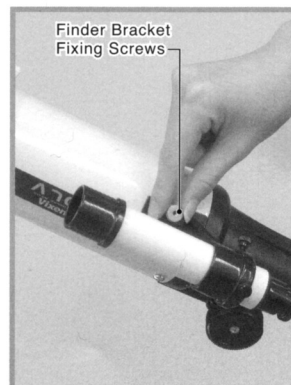

### V-3 Attaching the Finder Scope (PORTA Telescopes with the Dot Finder)

- ① Loosen the chrome finder bracket lock thumbscrew on the telescope.

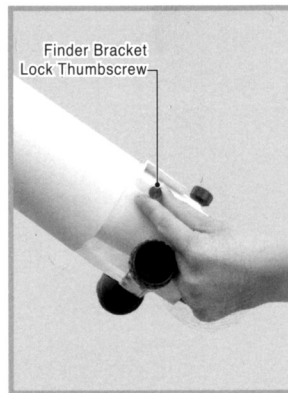

- ② Attach the bracket on the dot finder as shown in the figure, tighten the finder bracket lock thumbscrew securely.

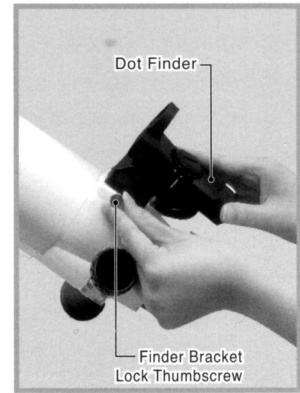

### VI Balancing the Optical Tube

If the optical tube moves because of unbalance, shift it to the center of balance.

With the optical tube in the horizontal position, hold the optical tube and loosen slightly the tube ring lock knobs so the optical tube can slide. Grasping the optical tube, rotate it on the altitude axis. If it feels overweighed on one end, slide the optical tube toward the other end. Repeat until the optical tube is balance. Tighten the tube ring lock knobs before proceeding.

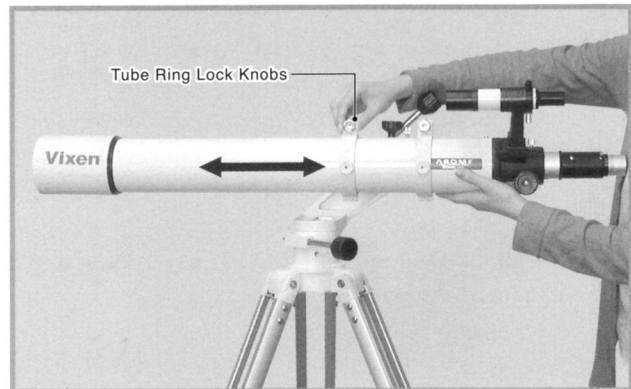



## I Quick Slewing Motion

You can quickly move the telescope toward the desired target by grasping the tube and moving it in altitude or azimuth. Do this to center the target in the finder and then fine-tune the position in the eyepiece by following the steps below.

⚠ Do not swing the Telescope by pulling or pushing the altitude or azimuth slow motion handles. Doing so may bend the worm shaft or even cause the shaft ends to break off.

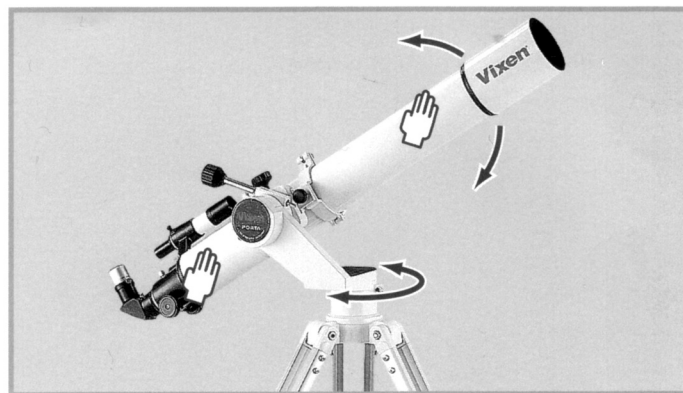

## II Fine Motion and Tracking

For fine target positioning, rotate the altitude or azimuth slow motion handles in either direction while looking at the target through the eyepiece. The PORTA mount will rotate the telescope smoothly into position.

On an alt-azimuth mount, it is best to put celestial targets at the edge of field and allow the motion of the Earth to drift them across the field of view while observing. This will allow for steadier views and less manual tracking.

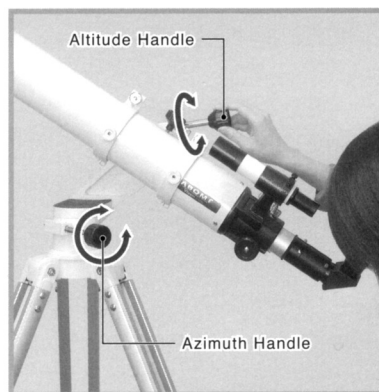

### Hint

At high power, it is hard to follow celestial target in the field of view of the telescope by pushing / pulling the mount by hand.

The altitude and azimuth handles allow smooth slow motion control of the telescope in order to search for and track objects.

## III Terrestrial Viewing

Beginners may have difficulty assembling and operating a telescope and PORTA mount on the first night of astronomical observation. We recommend following the instructions in this manual in daytime first. Try observing landscape in order to understand the movements of the PORTA mount and the field of view of your finder scope and telescope.

## IV-1 Aligning the Finder Scope (PORTA A80Mf and PORTA R130Sf)

- ① Choose a conspicuous target in the distance and place the target in the center of a field of view of the telescope.

In the illustration, a distant Vixen tower is brought into the center of the field of view of the telescope.

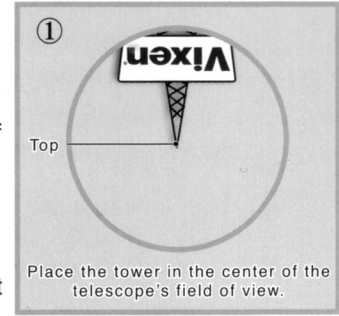

- ② Next, look through the finder scope. You should probably find the same target somewhere within the finder's field of view.

In the illustration, the tower is seen in the upper right of the finder's field of view. The finder scope has cross-hairs.

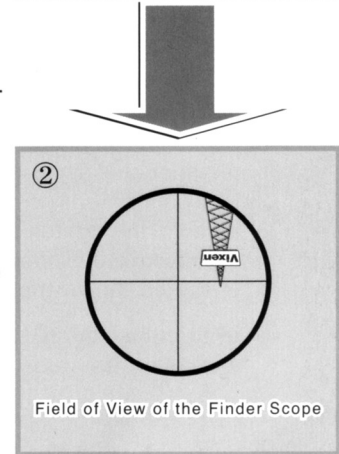

- ③ Align the optical axis (field of view) of the finder scope with the optical axis (field of view) of the telescope. Adjust the finder scope by loosening or tightening the adjustment screws A and B until the target is in the same position, in the center of the cross hairs.

In the illustration, the top of the tower is in the center of the cross hairs.

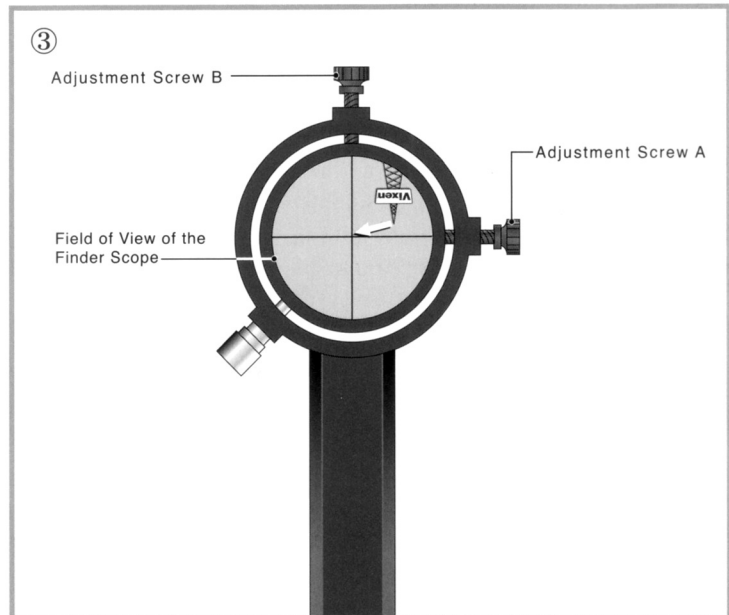

Example : The top of the tower can be moved toward the center of the cross hairs by loosening the adjustment screw A and tightening the adjustment screw B.

## IV-2 Aligning the Finder Scope (PORTA A70Lf)

- 1 Choose a conspicuous target in the distance and place the target in the center of a field of view of the telescope.

In the illustration, a distant Vixen tower is brought into the center of the field of view of the telescope.

- 2 Next, look through the finder scope. You should probably find the same target somewhere within the finder's field of view.

In the illustration, the tower is seen in the upper right of the finder's field of view. The finder scope has cross-hairs.

- 3 Align the optical axis (field of view) of the finder scope with the optical axis (field of view) of the telescope. Adjust the finder scope by loosening two adjustment screws and tightening the remaining one adjustment screw until the target is in the same position, in the center of the cross hairs.

In the illustration, the top of the tower is in the center of the cross hairs.

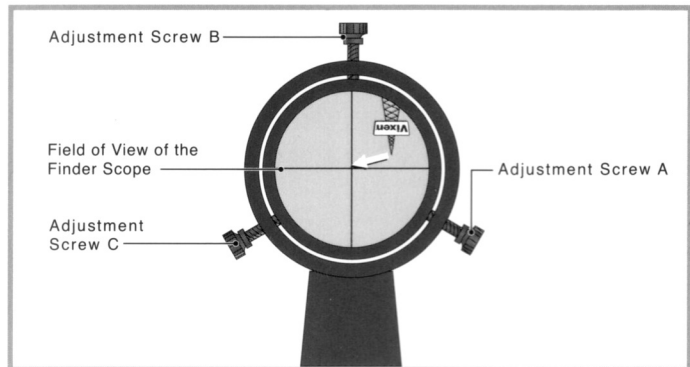
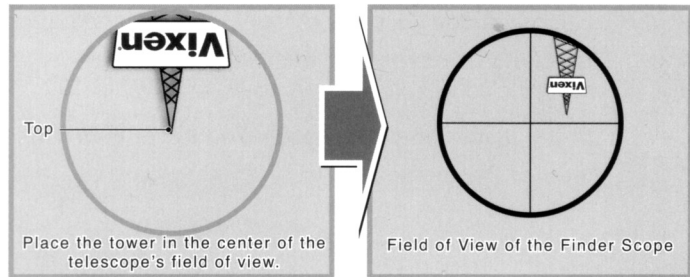

Example : The top of the tower can be moved toward the center of the cross hairs by loosening the adjustment screw A, B and tightening the adjustment screw C.

## IV-3 Aligning the Finder Scope (PORTA Telescopes with Dot Finder)

- 1 Choose a conspicuous target in the distance and place the target in the center of a field of view of the telescope.

In the illustration, a distant Vixen tower is brought into the center of the field of view of the telescope.

- 2 Turn on the dot finder by turning the brightness adjusting dial on the dot finder. There are graduations on the dial from 0 to 11. Set the dial at 11. The intensity of the brightness can be varied from 1 (faint) to 11 (strong).

- 3 You will see a red dot in the center of the field of view of the dot finder when you look along the white guideline.

- 4 Align the optical axis (field of view) of the dot finder with the optical axis (field of view) of the telescope.

Loosen the alignment clamp on the dot finder and move the upper portion of the dot finder by holding its front end until the red dot is in the same position as the target in the center of the field of view of the telescope. Then, tighten the alignment clamp.

In the illustration, the top of the tower is on the red dot in the field of view of the dot finder.

- 5 Set the brightness adjusting dial at 0 to turn off after using the dot finder. The dot finder comes with a CR2032 battery. When you install a new battery, remove the top cover of the brightness adjusting dial by unscrewing it with a coin or the like.

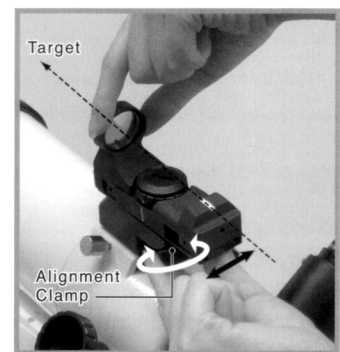
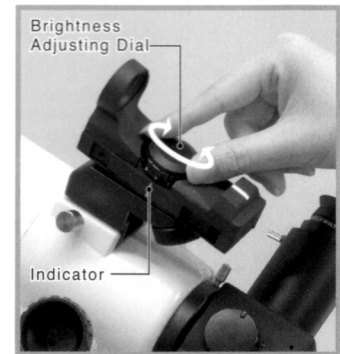
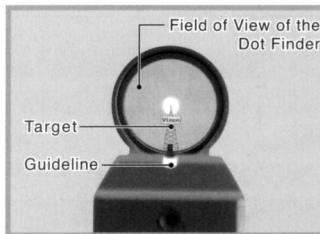
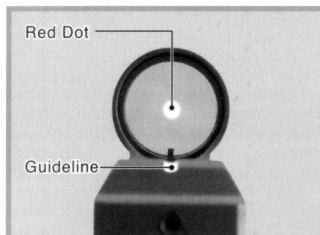
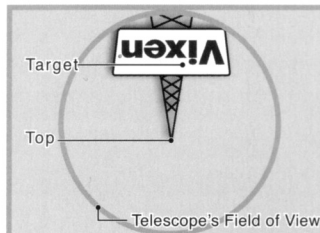

## I Adjusting the Altitude/Azimuth Slewing Motion

Test the motion smoothness of the PORTA Mount with a balanced scope by moving the telescope tube by hand in altitude and azimuth (without using the alt-azimuth handles). Depending on the length and weight of the telescope, you may find too much or too little resistance to the motion. This resistance may also change with use. Directions here are to adjust this motion tension to your preference.

- 1 Peel back the rubber cover on the mount base and remove the 4mm (smaller) Allen wrench

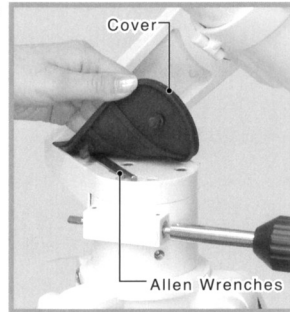

- 2 Locate the Allen screws that control the tension of the altitude or azimuth motion in the picture at right. These screws are recessed on the stationary part of each axis assembly.

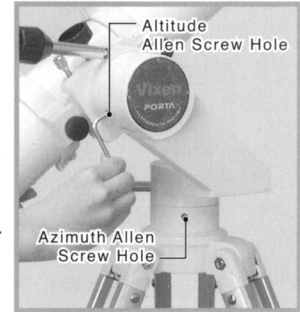

Adjust tension by rotating the screws and testing the motion by pushing/pulling on the tube.

## II Adjusting the Altitude Handle Position

You can change the orientation of the altitude handle relative to the optical tube to suit your observing preference. You may also wish to do this to avoid confusing it with the dovetail lock screw knob.

- 1 Put the scope in a horizontal position, grasp it with one hand, back off the safety screw and dovetail lock screw.



- 2 Peel back the rubber cover on the base of the mount and select the 3/16" (larger) Allen wrench.

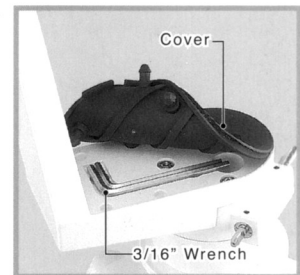

- 3 Locate the two large Allen head screws holding the dovetail mounting block onto the altitude axis plate. Grasp the dovetail block and back out the screws with the Allen wrench.

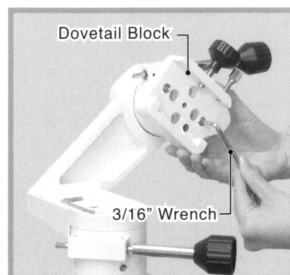

- 4 Remove the dovetail block from the mount. Note the outer ring of threaded holes pairs on the altitude axis plate. These will be used to reorient the dovetail block.

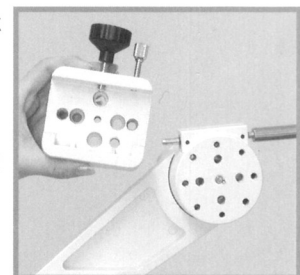

- 5 Reorient the altitude axis to place the altitude handle in a desired position as shown in the figure right. Match the dovetail block with an outer pair of three-aded holes on the altitude axis plate.



- 6 Attach the dovetail block with the previously removed Allen screws. Put the Allen wrench back to the tool compartment on the mount base.

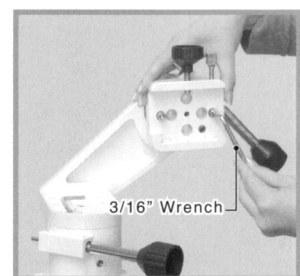

## III Adjusting the Azimuth Handle Position

You can change the orientation of the azimuth handle relative to the optical tube to suite your observing preference. You may wish to do this to avoid obstructing the optical tube.

- ① Put the scope in a horizontal position, grasp it with one hand, back off the safety screw and dovetail lock screw to remove the optical tube.



- ② Pull the rubber cover on the base of the mount and select the 3/16" (larger) Allen wrench.

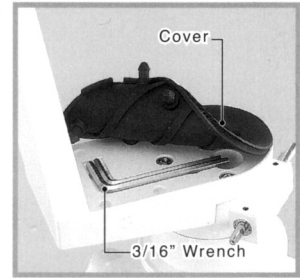

- ③ Locate the four Allen head screws holding the base of the altitude unit on the azimuth axis. Grasp the arm of the altitude unit and back out the screws with the Allen wrench.

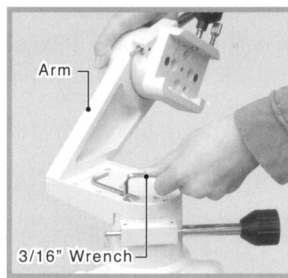

- ④ Remove the altitude unit from the azimuth axis plate on the tripod base. Note the outer ring of the threaded hole pairs on the azimuth axis plate. These will be used to reorient the altitude unit.

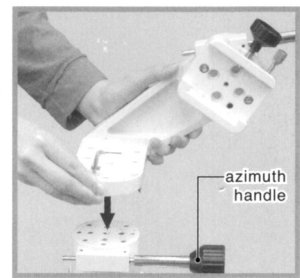

Reorient the azimuth axis to place the azimuth handle in a desired position as shown in the figure right. Match the altitude unit with an outer pair of threaded holes on the azimuth axis plate.

- ⑤ Attach the altitude unit with the previously removed Allen screws.

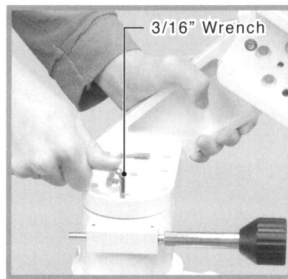

- ⑥ Put the Allen wrench back to the tool compartment on the mount base. Attach the optical tube.

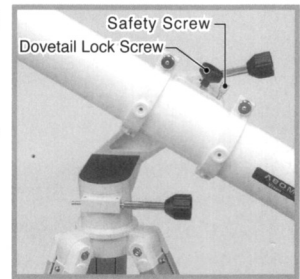



## Observing the Moon

With the finder scope aligned and the eyepiece attached, you are ready to use the PORTA telescope for your celestial observation in the night sky. Let's begin by observing a bright and easy-to-find object, the Moon, and then proceed to finding planets and dark objects easily visible at moderate power.

Bright and easy-to-find objects

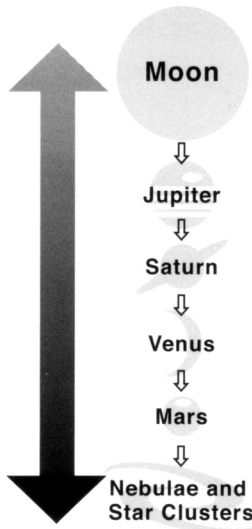

Dark celestial objects

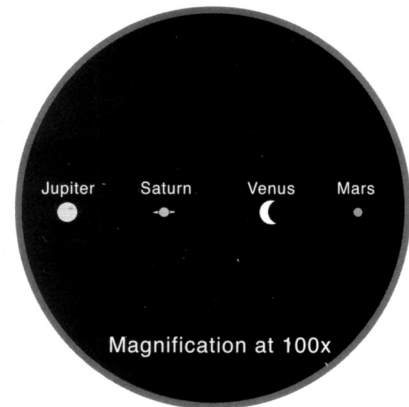
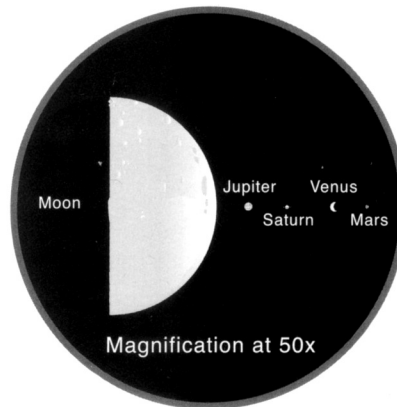

Above : What you can expect to see when viewing at a different magnification.

- ① Point your PORTA telescope at the Moon by slewing the telescope tube by hand. Locate the Moon in the finders cope (or the dot finder). Center the Moon in the finder using the slow motion handles.

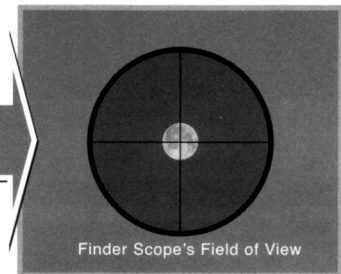
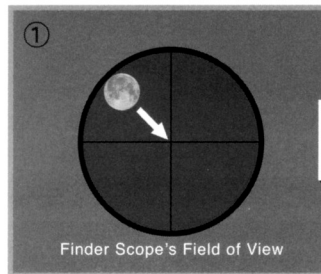

- ② Look through the telescope with an eyepiece of low magnification and the Moon will be there. Focus the telescope on the Moon by turning the focus knob.

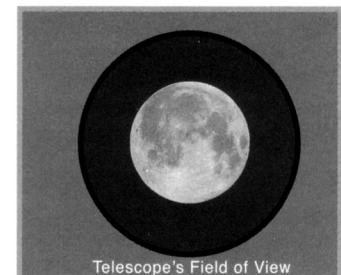
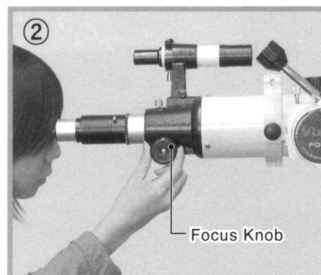

- ③ Try using a different eyepiece to change the magnification.

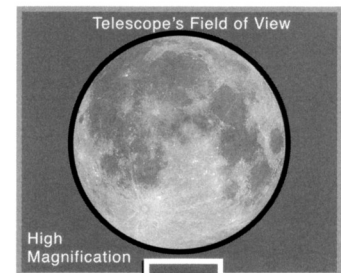
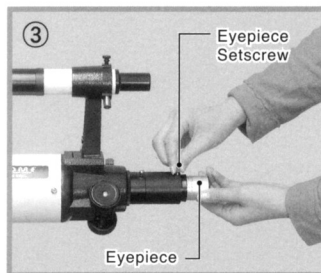

- ④ The Moon (stars and other celestial objects as well) appears to move out of the file of view while looking through the telescope due to the Earth's rotation. The higher the magnification, the faster the movement. Turn the slow motion handles on the PORTA mount to bring the Moon into the center of the field of view again.

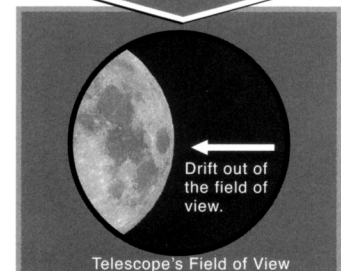
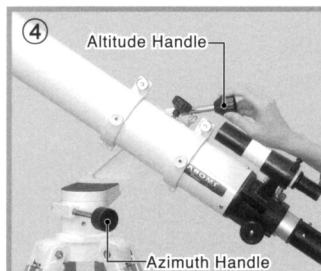



## **Vixen North America**

A Division of Tele Vue Optics, Inc.  
32 Elkay Dr.  
Chester, NY 10918.

[www.VixenAmerica.com](http://www.VixenAmerica.com)  
(845) 469-8660

---

**Vixen Co., Ltd.** 5-17-3 Higashitokorozawa, Tokorozawa, Saitama 359-0021, Japan  
<http://www.vixen.co.jp> Phone +81-4-2944-4141(International)  
Fax +81-4-2944-9722(International)

**Vixen Europe GmbH** Siemensring 44c, D-47877 Willich, Germany  
<http://www.vixen-europe.com> Phone 02154 / 8165-0  
Fax 02154 / 8165-29

53#-11-(9000)-1S-80(EMM)