

# ZOOLOGICA

Originalabhandlungen aus dem Gesamtgebiet der Zoologie

Gegründet 1888 von R. Leuckart, C. Chun, fortgesetzt von W. Kükenthal, R. Hesse, W. E. Ankel

Herausgegeben von F. Schaller ▪ Wien

45. Band

3. Lieferung

Heft 133

---

GEORG SCHEER

Hessian State Museum, Darmstadt, F.R. Germany

and

C. S. GOPINADHA PILLAI

Central Marine Fisheries Research Institute, Cochin/India

## Report on the Stony Corals from the Red Sea

With 5 Figures in the Text and 41 Plates



E. Schweizerbart'sche Verlagsbuchhandlung  
(Nägele u. Obermiller) ▪ Stuttgart 1983

## Contents

	page
I. Introduction . . . . .	1
1. Research work on reef corals and coral reefs in the Red Sea . . . . .	1
2. Provenance and localities of the corals . . . . .	7
3. Annotations on the synonymy lists . . . . .	16
II. Systematic description of the collected corals . . . . .	17
1. Suborder Astrocoeniina . . . . .	17
Family Thamnasteriidae . . . . .	17
Genus Psammocora . . . . .	17
Family Astrocoeniidae . . . . .	20
Genus Stylocoeniella . . . . .	20
Family Pocilloporidae . . . . .	21
Genus Stylophora . . . . .	21
Genus Seriatopora . . . . .	26
Genus Pocillopora . . . . .	29
Genus Madracis . . . . .	31
Family Acroporidae . . . . .	32
Genus Astraeopora . . . . .	32
Genus Acropora . . . . .	33
Genus Montipora . . . . .	48
2. Suborder Fungiina . . . . .	59
Superfamily Agariciaceae . . . . .	59
Family Agariciidae . . . . .	59
Genus Pavona . . . . .	59
Genus Leptoseris . . . . .	65
Genus Gardineroseris . . . . .	69
Genus Pachyseris . . . . .	70
Family Siderastreidae . . . . .	72
Genus Siderastrea . . . . .	72
Genus Coscinaraea . . . . .	73
Superfamily Fungiaceae . . . . .	74
Family Fungiidae . . . . .	74
Genus Cycloseris . . . . .	74
Genus Fungia . . . . .	78
Genus Ctenactis . . . . .	85
Genus Herpolitha . . . . .	87
Genus Podabacia . . . . .	87
Superfamily Poriticae . . . . .	88
Family Poritidae . . . . .	88
Genus Alveopora . . . . .	88
Genus Goniopora . . . . .	91
Genus Porites . . . . .	96
3. Suborder Faviina . . . . .	103
Family Faviidae . . . . .	103
Subfamily Faviinae . . . . .	103
Genus Caulastrea . . . . .	103
Genus Erythrastrea . . . . .	104
Genus Favia . . . . .	105

Genus Favites	113
Genus Goniastrea	119
Genus Platygyra	122
Genus Leptoria	126
Genus Oulophyllia	127
Genus Hydnophora	127
Subfamily Montastreinae	129
Genus Diploastrea	129
Genus Leptastrea	130
Genus Cyphastrea	133
Genus Echinopora	135
Genus Plesiastrea	138
(Genus Montastrea)	139
Family Trachyphylliidae	139
Genus Trachyphyllia	139
Family Rhizangiidae	140
Genus Culicia	140
Genus Phyllangia	141
Family Oculinidae	141
Genus Galaxea	141
(Genus Acrhelia)	143
Family Merulinidae	143
Genus Merulina	143
Family Mussidae	144
Genus Cynarina	144
Genus Lobophyllia	145
Genus Acanthastrea	147
Genus Blastomussa	149
(Genus Parascolymia)	151
Family Pectiniidae	151
Genus Mycedium	151
Genus Echinophyllia	152
Genus Oxypora	153
4. Suborder Caryophyllina	154
Superfamily Caryophylliicae	154
Family Caryophylliidae	154
Subfamily Caryophyllinae	154
Genus Caryophyllia	154
Genus Trochocyathus	155
Genus Deltocyathus	156
Genus Polycyathus	156
Genus Heterocyathus	157
Subfamily Desmophyllinae	158
Genus Dactylotrochus	158
Subfamily Parasmiliinae	159
Genus Parasmilia	159
Genus Solenosmilia	160
Genus Dasmosmilia	160
Subfamily Eusmiliinae	160
Genus Euphyllia	161
Genus Pleorogyra	162
Genus Physogyra	163
Genus Gyrosmilia	163
Superfamily Flabellicae	164
Family Flabellidae	164
Genus Flabellum	164
Genus Rhizotrochus	164
Genus Javania	165

5. Suborder Dendrophylliina . . . . .	166
Family Dendrophylliidae . . . . .	166
Genus Balanophyllia . . . . .	167
Genus Rhizopsammia . . . . .	169
Genus Dendrophyllia . . . . .	170
Genus Tubastraea . . . . .	173
Genus Turbinaria . . . . .	176
III. Annex . . . . .	178
Acknowledgments . . . . .	178
Abstract . . . . .	179
Zusammenfassung . . . . .	180
Bibliography . . . . .	181
Index for the systematic part . . . . .	190
Plates	

## I. Introduction

### 1. Research work on reef corals and coral reefs in the Red Sea

The first to mention corals of the Red Sea was Thomas SHAW, who travelled through Tunisia, Algeria, Egypt, Syria and the Sinai Peninsula, and who in his "Travels or observations relating to several parts of Barbary and the Levant" described 24 corals of Et Tur (1738, German edition 1765). From these one can recognize *Platygyra*, *Favia*, *Goniastrea*, *Acropora*, *Stylophora* and *Tubipora*, but his Latin descriptions are not sufficient for an identification at a species level. A fragment of *Fungia agariciformis* is figured in BRUCKMANN's "Lapides fungiformes maris rubri" (1748).

But the real research work on Red Sea corals started with Peter FORSKÅL. He was a member of a Danish expedition called the "Arabiske Rejse" under Carsten NIEBUHR and collected amongst other things corals near Suez, Djiddah, Al Luhayyah and Al Mukha in 1762/63. In 1763 he died of Malaria at Yarim in Yemen. His collections were taken to Copenhagen, and his results "Descriptiones Animalium . . ." were posthumously published by C. NIEBUHR in 1775. FORSKÅL described 26 coral species, 14 of which are still at the Zoological Museum of the University in Copenhagen. Few of these corals were figured 1776 in FORSKÅL's "Icones Rerum Naturalium . . .".

One of the participants of the Egypt expedition of the French army under NAPOLEON I in 1799–1801 was Jules-César SAVIGNY who summarized his observations in his "Description de l'Égypte" and included illustrations of some corals on the "planches d'histoire naturelle" in 1805–1812. The explanatory notes relating to the plates were written by Victor AUDOUIN (1826, 2nd ed. 1828).

Among the invertebrates of the Red Sea which Eduard RUEPPELL brought home from his first travel in Northern Africa (1822–1827) were three actinias of Et Tur from the Gulf of Suez which he described in 1828 together with F. S. LEUCKART, and some corals of the genus *Fungia*, published by LEUCKART in 1841. The other corals, which RUEPPELL had collected have never been treated.

In 1820–1826 Christian Gottfried EHRENBERG and Friedrich Wilhelm HEMPRICH travelled in the countries bordering the Red Sea on behalf of the Berlin Academy of Sciences. On this occasion they collected 376 corals of 62 species near Suez, Et Tur and in the Gulf of Aqaba in 1823. HEMPRICH died at Massawa in 1825. EHRENBERG published a systematic description of the corals in 1834. In 1954 STRESEMANN reported on the two friends' travel on the basis of letters.

Although Charles DARWIN himself did not tour the Red Sea he nevertheless described its reefs in his book "The structure and distribution of coral reefs" (1842). In this book he relies mainly on EHRENBERG's report on coral reefs (1834a) and on personal information given by Captain MORESBY who participated in a survey of the Red Sea.

A number of coral species of the Red Sea, including also those collected by the Frenchman BOTTA in the first half of the 19th century, are described in the works of Henry MILNE EDWARDS and Jules HAIME, especially in the three volumes of "Histoire Naturelle des Coralliaires" (1857 and 1860), published shortly after the death of HAIME (1856).

One should also mention the "Reise von Cairo nach Tor" by Eugen RANSONNET-VILLEZ. His report (1863) shows for the first time coloured illustrations of the underwater scenery of the coral banks there. His coral collection is located in Vienna.

An extremely valuable contribution towards expanding the knowledge of Red Sea corals was made by Carl Benjamin KLUNZINGER. He worked as a medical doctor at Al-Qusayr (Koseir) in Egypt on the Red Sea from 1864 to 1869 and again from 1872 to 1874. In 1872 he described a "Zoologische Excursion"

to a coral reef, and in 1877 he published a book "Bilder aus Oberägypten, der Wüste und dem Rothen Meere" reporting on coral reefs in chapter 6. In the second and third parts of his "Korallthiere des Rothen Meeres", published in 1879, he gave a systematic description of the reef corals that he had collected. For the first time in this work photos of corals were published in which details can be recognized with the aid of a magnifying glass. The first part which was published in 1877 deals with the rest of the Anthozoans, that is especially Alcyonacea, Gorgonacea and Actiniaria. In 1880 KLUNZINGER wrote "Über das Wachstum der Korallen". Some of KLUNZINGER's duplicates are in the old collection of the Hessisches Landesmuseum Darmstadt together with other corals from the Red Sea, they are included in the present report. More details about KLUNZINGER are given by W. KLAUSEWITZ (1964) in his introduction to KLUNZINGER's fishes of the Red Sea.

The opening of the Suez Canal in 1869 allowed easier access to the Red Sea. In 1873 Ernst HAECKEL visited the coral reefs of Et Tur. Full of enthusiasm he wrote about them in his book "Arabische Korallen" (1876). His collection was evaluated by G. v. KOCH in "Anatomie der Orgelkoralle" (1874) and "Anatomie von *Stylophora digitata*" (1877), and by F. BRUEGGEMANN in "Neue Korallen-Arten aus dem Rothen Meere und von Mauritius" (1878).

In 1885/86 L. FAUROT went on an extensive expedition into the Gulf of Aden and to the island Kamaran in the Red Sea off the Yemenite coast. In 1888 he reported on the reefs and corals found there, one of which he described as a new species in 1894.

In 1887 Johannes WALTHER from Jena travelled to the Sinai Peninsula, and in his book "Die Korallenriffe der Sinaihalbinsel" (1888) he wrote in detail about the reefs, both living and fossile, especially along the Western side.

In the following years major synoptical works were published that also included Red Sea corals. Some of them are:

- |                 |  |
|-----------------|--|
| F. BRUEGGEMANN: | Notes on stony corals (1877 and 1877a)   |
| A. ORTMANN:     | Studien über Systematik und geographische Verbreitung der Steinkorallen (1888) |
|                 | Steinkorallen vor der Südküste Ceylons (1889)                                  |
|                 | Korallenriffe von Dar-es-Salaam (1892)   |
| H. REHBERG:     | Neue und wenig bekannte Korallen (1892)  |
| G. BROOK:       | The Genus <i>Madrepora</i> (1893)  |
| H. M. BERNARD:  | The Genus <i>Turbinaria</i> . The Genus <i>Astraeopora</i> (1896)              |
|                 | The Genus <i>Montipora</i> (1897)  |
| L. DOEDERLEIN:  | Die Korallengattung <i>Fungia</i> (1902)                                       |
| H. M. BERNARD:  | The Genus <i>Goniopora</i> (1903)  |
|                 | The Genus <i>Porites</i> (Indo-Pacific Region) (1905)                          |

In 1895/96 and in 1897/98 the Austrian ship "Pola" under the expedition leader Franz STEINDACHNER went to the Red Sea. The vast coral collection was evaluated by Emil von MARENZELLER in his important works "Riffkorallen" and "Tiefseekorallen" in 1906. The collection of reef corals, comprising 750 specimens, included about half of the then known Red Sea corals as well as 7 new species and 5 first records.

One should also mention the publications of Charles GRAVIER, Paris, who in 1904 collected corals in the Bay of Tadjoura in the Gulf of Aden in the immediate vicinity of the Strait of Bab el Mandeb, for example "Les récifs de coraux et les madréporaires de la baie de Tadjourah" (1911). Already in 1907 T. W. VAUGHAN published "Some madreporarian corals from French Somaliland, East Africa, collected by Dr. Charles GRAVIER".

Further important works that treat with Red Sea corals were written by G. MATTHAI: "A revision of the recent colonial *Astraeidae* . . ." (1914) and "A monograph of the recent meandroid *Astraeidae*" (1928), and by C. J. van der HORST: "Madreporaria *Fungida*" (1921), "Agariciidae" (1922) and "Eupsammidae" (1922a).

The Englishman Cyril CROSSLAND contributed essentially to the history of coral research in the Red Sea. After visiting the East African coral reefs, he studied the Sudanese coastal zone and made his first travel for collecting purposes in 1904–1905. He let J. S. GARDINER have his corals, collected at Zanzibar and between Dongonab and Suakin for treatment, on which GARDINER reported in 1909. Now CROSSLAND became director of the Sudan Pearl Fishery and kept this until 1922. After participating in a South Pacific expedition from the Panama region to the Galapagos and Marquesas Islands and after visiting

Tahiti more than once, he founded the Marine Biological Station at Al Ghardaqa in 1930 and remained its first director until 1938. His great knowledge of coral reefs and corals is reflected in the reports on "Marine biology of the Sudanese Red Sea" (1907-1911). His book "Desert and water gardens of the Red Sea", published in 1913, deals in its second part with corals and coral reefs.

In 1933-34 the Egyptian research vessel "Mabahiss" took the John MURRAY expedition to the Indian Ocean. The "Introduction and list of stations" published by the expedition leader Lt.-Col. R. B. SEYMOUR SEWELL in 1935 indicates at which places of the Red Sea work was done during the outbound voyage. The deep sea corals dredged during this travel were evaluated by J. S. GARDINER & P. WAUGH (1938, 1939). Then, in the winter of 1934/35, the University of Cairo could use the "Mabahiss" for an expedition through the northern Red Sea. C. CROSSLAND, 1936, and A. F. MOHAMED, 1940, gave brief reports on the expedition. In a more detailed report on this travel CROSSLAND wrote on "Some coral formations" (1939).

The Marine Biological Station of Ghardaqa has produced many scientific papers, but only comparatively few deal with corals. Some of them are: C. CROSSLAND "The Marine Biological Station at Ghardaqa" (1935); "Coral faunas of the Red Sea and Tahiti" (1935a); "The coral reefs at Ghardaqa" (1938); G. C. L. BERTRAM "Breakdown of coral at Ghardaqa" (1937); Peggy WAUGH "Red Sea *Turbinaria* and *Astraeopora*" (1936); S. R. HICKSON "The species of the genus *Acabaria* in the Red Sea" (1940); H. A. F. GOHAR "The place of the Red Sea between the Indian Ocean and the Mediterranean" (1954); D. B. E. MAGNUS "Zur Ökologie einer nachtaktiven Flachwasser-Seefeder" (1966).

After returning from Egypt CROSSLAND dealt with a collection of T. A. STEPHENSON "Reef corals of the South African coast", which could be published not before 1948, and he revised "FORSKÅL's collection of corals in the Zoological Museum of Copenhagen (1941). Moreover, he worked on the corals collected during the Great Barrier Reef Expedition in 1928/29. This his most comprehensive work could not be published till after World War II and after his death in 1943. In this work "Madreporaria, Hydrocorallinae, Heliopora and Tubipora" (1952) CROSSLAND named 181 coral species, 54 of which from the Red Sea.

In 1949 Hans HASS, the pioneer of skin diving and underwater photography, who had introduced independent skin diving as a scientific aid into marine biology (HASS, 1948), dived alone on the coral reefs off Port Sudan. He wrote his book "Manta, Teufel im Roten Meer" about it (1952). In the following year, 1950, he produced the film "Abenteuer im Roten Meer" during an expedition.

In 1953 a group of Italian skin divers under the scientific leadership of Francesco BASCHIERI SALVADORI made an expedition on the vessel "Formica" to the Red Sea. They collected corals off the Sudanese coast near Massawa and above all in the Dahlak Archipelago, that were evaluated by Lucia ROSSI in "Madreporari, Stolonifera e Milleporini" (1954). She described 48 coral species, to which a further species was added in 1955.

W. D. NESTEROFF and A. GUILCHER worked on the coral reefs of the Farsan Bank in 1955. Their results are based on field work done during the "Calypso" expedition. The corals collected at that occasion were identified by M. PICHON, but they were not published.

In 1957 the second "Xarifa" expedition 1957/58, led by Hans HASS, went through the Red Sea on its way to the Indian Ocean. During different stops in the northern, central and southern parts of the Red Sea coral reefs were investigated and corals were collected. On pages 14-26 of his book "Expedition ins Unbekannte" (1961) HASS reports on that part of the expedition. A first report on the reefs and coral genera found in the Red Sea was written by G. SCHEER in 1971: "Coral reefs and coral genera in the Red Sea and Indian Ocean". The corals collected near the Sarso Islands were published by SCHEER (1967) together with those collected by W. SCHAEFER and W. KLAUSEWITZ at Sarso during the "Meteor" expedition 1964. All corals of the "Xarifa" expedition are dealt with in the present report.

In 1962 the Wingate Reef near Port Sudan was the destination of a "Korallen-Expedition des Hessischen Landesmuseums Darmstadt nach Port Sudan am Roten Meer" with the purpose of collecting material for a coral reef to be built in one of the display rooms of the museum. The leader of the expedition, Georg SCHEER, reported about it in 1962, and in 1964 he described in "Bemerkenswerte Korallen aus dem Roten Meer" some corals that had not been found there before as well as a new species. The corals collected at the Wingate Reef are also dealt with in the present report.

In 1962 and 1963 Hans MERGNER of the University of Bochum visited the Red Sea to study hydroid

growth on some coral reefs. In a first paper he wrote in 1967 on "Die ökologischen Gegebenheiten der untersuchten Riffgebiete ..." near Port Sudan, Suakin and Djiddah.

Something spectacular also happened in 1963. Chaques-Yves COUSTEAU built an "underwater village" comprising two housing units, one garage for a diving boat and a tool-shed at the Sha'ab Roumi Reef north of Port Sudan. Divers lived and worked under water in the houses for up to six weeks. A star-shaped house, the "Starfish", with an atmosphere of compressed air stood on telescope legs in a depth of 10 metres. From here the "aquanauts" could dive down to 60 metres. The second house, the "Rocket", was anchored in a depth of 26 metres and contained an oxygen-helium mixture allowing diving down to 110 metres. Accounts on this experiment were written by the well-known underwater photographer L. SILLNER "Ein kleiner Sprung ins große Meer" (1968) and by J.-Y. COUSTEAU & P. DIOLÉ in their book "Life and death in a coral sea" (1970; German edition: "Korallen, bedrohte Welt der Wunder", 1971). In 1976 P. DIOLÉ & A. FALCO wrote in greater detail about this adventure called "Précontinent II".

L. BERRY, A. J. WHITEMAN & S. V. BELL worked on the geomorphology of the raised coral reefs of Sudan in 1962, and they wrote about it in 1966.

During the German "Meteor" Expedition 1964/65 a group of biologists led by Sebastian GERLACH was dropped near the Sarso Islands in 1964. In 1967 S. GERLACH reported about this research project, W. KLAUSEWITZ about "Physiographische Zonierung der Saumriffe von Sarso" and W. SCHAEFER in 1969 about "Sarso, Modell der Biofacies-Sequenzen im Korallen-Bereich des Schelfs". The corals collected there were evaluated, as mentioned before, by G. SCHEER in 1967. A group of geologists, G. EINSELE, H. GENSER & F. WERNER, wrote on "Horizontal wachsende Riffplatten am Süd-Ausgang des Roten Meeres" (1967).

In the U.S. National Museum of Natural History, Washington, corals collected in the thirties mainly on the reefs around the Marine Biological Station Ghardaqa are housed together with a collection of H. A. FEHLMANN from 1965 from the same localities on occasion of the International Indian Ocean Expedition, and a few corals from Dongonab, collected by C. CROSSLAND in the years 1904 to 1914. Most of these corals were sent for identification to the Museum at Darmstadt, they are part of the present report.

In 1965 to 1968 the sports teacher János HÓLLOSI from Neu-Ulm and a group of SCUBA divers brought big coral collections from the northern Red Sea and from Massawa to the Hessisches Landesmuseum Darmstadt. These coral specimens are included in the present report.

In the four years from 1964 to 1967 the brothers Helmut and Günther FLEISSNER prepared a documentation on life in a coral reef near the Island of Shadwan and at the coast between Ghardaqa and Koseir. They also produced a film in colour which was shown on German television in 1968. The FLEISSNERS wrote on their work and their film in 1968 and 1971.

In 1968 the "Cambridge Coral Starfish Research Group" settled in Port Sudan to study, above all, the ecology of the "Crown of Thorns" *Acanthaster planci* in the surrounding reefs. R. ORMOND & A. CAMPBELL published a final report in 1974. In 1972 the group built a platform on Towartit Reef which provided room for several persons to work and sleep (HEAD & ORMOND, 1978). Later on G. BEMERT & R. ORMOND wrote a book on Red Sea coral reefs (1981).

At the same time the Marine Laboratory was founded at Suakin whose first director became Peter VINE, a member of the Cambridge group, and whose present director — since 1980 — is Michael MASTALLER from the University of Bochum. In 1973 and 1974 another member of the Cambridge group, Stephen M. HEAD, was engaged in collecting corals with special regard to the ecological conditions. He reported in 1978 on a new species and he could use his extraordinarily comprehensive material, more than 1200 specimens with 124 species of 52 genera, for his doctorate thesis in 1980. Some years ago (1977) VINE & HEAD wrote about the coral growth on COUSTEAU's underwater garage at Sha'ab Roumi.

In 1974 the National Council for Research in Khartoum was concerned with enlarging the already existing Institute of Oceanography at Port Sudan (SCHROEDER 1974). According to the plans of its director Johannes H. SCHROEDER who was nominated to this office in 1978, it is to comprise a new institute in the vicinity of the harbour and the field stations at Dongonab and on Sanganeb Reef. This institute made a first contribution towards coral research in the Red Sea through an extensive coral collection from Sanganeb Reef in 1979, which Prof. SCHROEDER handed over for identification to the Darmstadt Museum. These corals are considered in the present report, too.



Already in 1970 Dietrich D. KUEHLMANN of the Museum für Naturkunde in Berlin visited Massawa and Port Sudan to collect corals. This was followed in 1976 by a four-month stay at Al Hudayah and Port Sudan to study the dependence of coral associations on ecological factors. During that time KUEHLMANN also collected corals and dived down to 70 m at Wingate Reef. The coral collection has not been evaluated yet, but a few corals are dealt with in this report.

Mention should be made of a large-scale coral collecting expedition to the Wingate Reef near Port Sudan and to the Island Djebel Zuqur in the south of the Red Sea in 1976, organized by the Meeresmuseum Stralsund and led by Sunnfried STREICHER, on MS "Eichsfeld", a merchant vessel of the German Democratic Republic. The course of the expedition "Acropora 76" was described by S. STREICHER ("90 Tage im Roten Meer"), its objectives ("Ein Riffturm soll es sein") and the corals ("Korallen") and coral reefs ("Im Riff") were described by G. SCHULZE (all 1977). A comprehensive report of the expedition was published by S. STREICHER in his book "90 Tage im Korallenriff" (1980). In 1979 a second expedition "Acropora 79" was made to the island of Umm-al-Sciara off the Ethiopian harbour Assab with the purpose of collecting further material. An impressive coral reef was built and is on display at the Meeresmuseum Stralsund, whereas the vast coral collection has not been evaluated so far. A general review of both expeditions was given by the Meeresmuseum Stralsund in 1981.

Besides The Marine Biological Station at Ghardaqa in Egypt a second centre of marine research developed at the northern end of the Gulf of Aqaba. As early as 1936 scientists of the Hebrew University in Jerusalem started to study the Red Sea fauna. After the State of Israel was founded in 1948 it became necessary to make use of the nutritional resources of the Red Sea to supply the population with food. In 1950 the town of Eilat was founded, whose harbour constantly increased in importance. The cooperation between the Department of Fisheries of the Government and the Universities of Jerusalem and Tel Aviv resulted in an intensive exploration of the litoral marine fauna of the Sinai Peninsula.

This cooperation was highlighted by the two South Red Sea Expeditions of 1962 and 1965 to the region of the Dahlak Archipelago northeast of Massawa. O. H. OREN reported in 1962 on the first, C. LEWINSON & L. FISHELSON in 1967 on the second expedition. A. WAINWRIGHT described in 1965 the coral reef communities of the first expedition. Both expeditions brought home large coral collections which were identified by J. W. WELLS and M. PICHON, though not published. In 1968 H. BOSCHMA wrote on "The Milleporina and Stylasterina of the Israel South Red Sea Expedition" and J. VERSEVELDT on Octocorallia (Stolonifera and Alcyonacea) in 1965.

To provide a home for research and teaching a provisional marine biological station in tents and waggons was set up south of Eilat in the fifties, which was also open to scientists of other countries. In 1965/66 a first course on tropical marine biology for students and young scientists was organized by MAMBO (Mediterranean Association of Marine Biology and Oceanology). In 1968 an urgently needed modern research institute could be opened south of Eilat whose first director was Heinz STEINITZ. H. FENTON & H. STEINITZ wrote on Israel's marine biological research in 1967, the Marine Biological Laboratory was reported on in an anonymous paper of the Hebrew University of Jerusalem in 1968, and in 1969 by G. v. WAHLERT and W. KLAUSEWITZ, one of the first foreign visitors (1968) to the new station. Shortly afterwards (in May 1968) H. FEUSTEL of the Hessisches Landesmuseum Darmstadt went to Eilat and brought home from there a small collection of corals, which are mentioned in the present report.

The "Hebrew University - Smithsonian Institution Joint Program" whose main objective was to study the "Lessepsian migration", the migration of organisms from the Red Sea into the Mediterranean through the Suez Canal, started in 1967 and lasted several years. The most important results, the story of the programme and the collecting tasks were described by F. D. POR, H. STEINITZ, J. FERBER & W. ARON in 1972. They also described the different habitats and marked them on maps, and indicated the registration numbers. In the course of this programme also corals were collected, mainly in the Gulf of Aqaba, but also in the Gulf of Suez and some in the Red Sea at the south tip of the Sinai Peninsula. Prof. Dr. POR sent us the corals for evaluation, however, a manuscript completed in 1974 (SCHEER & PILLAI) could not be published. These corals are therefore dealt with in the present report.

From 1968 to 1971 the Tel Aviv University, too, collected corals along the coasts of the Sinai Peninsula in the Gulf of Aqaba and in the Gulf of Suez. These corals were sent to us for identification by Prof. Dr. FISHELSON. Some corals were also sent to Dr. PICHON who gave us his list of names. All these corals are part of the present report.

At that time a further team met, consisting of members of the Hebrew University of Jerusalem (Z. REISS), the University of Basel (L. HOTTINGER), the University of Copenhagen (H. J. HANSEN) and the University of Utrecht (C. W. DROOGER) to study the Foraminifera of the Gulf of Aqaba. In 1971 Georg SCHEIDEGGER and in 1973 Peter WETTSTEIN, both participants from Basel, collected corals, which WETTSTEIN began to identify at the Landesmuseum Darmstadt. However, he could not complete his work as he lost his life in a tragic accident. Prof. Dr. HOTTINGER gave us the corals for evaluation, these have been included in the present paper. In his report on the distribution of the larger Foraminifera in the Gulf of Eilat (1977) L. HOTTINGER indicated on maps and additional profiles the habitats and registration numbers which are also applicable to the corals.

A modernization of the port of Eilat and an intensive development of its technical facilities started in 1965. A new oil port was built, and it frequently happened that oil was spilt during pumping operations. In the greatly extended main port phosphate and other fertilizers were loaded into ships. Due to the open transport of the minerals large quantities were often seized by the wind and blown into the sea, where they sank onto the coral reefs. The influence of such pollution as well as other adverse factors were dealt with by L. FISHELSON, 1973, and Y. LOYA, 1975. Further papers discussed "Ecological and biological phenomena influencing coral-species composition" (L. FISHELSON, 1973a) and "Recolonization of Red Sea corals" (Y. LOYA, 1976).

Of the many scientific papers that were produced in the Marine Biological Laboratory, only some shall be mentioned which deal with corals and coral reefs. The GOREAUS, while working on coral calcification, discovered a new commensal mytilid which lives in *Fungia* (T. F. GOREAU, N. I. GOREAU, T. SOOT-RYEN & C. M. YONGE, 1969). B. F. SPIRO dealt with "Ultrastructure and chemistry of the skeleton of *Tubipora musica*" (1970) and "Diagenesis of some scleractinian corals" (1971). In the same year Y. LOYA & L. B. SLOBODKIN reported on "The coral reefs of Eilat". The work contains a list of the corals found which were identified by J. W. WELLS. Another paper of Y. LOYA (1974) dealt with "Community structure and species diversity of hermatypic corals at Eilat". In both publications the authors used for the first time their new method of "line transects" parallel to the coast for the quantitative investigation of coral reefs, a method which is generally accepted today. This and other methods were described by Y. LOYA also in 1978. Further papers of Y. LOYA deal with "*Stylophora pistillata*" and "Skeletal regeneration" (both 1976). Other aspects of *Stylophora pistillata* were treated in papers of J. J. SOHN (1977), B. RINKEVICH & Y. LOYA (1979), and P. G. FALKOWSKI & Z. DUBINSKY (1981). S. RICHMAN, Y. LOYA & L. B. SLOBODKIN reported on "The rate of mucus production by corals" (1975). In 1970 L. FISHELSON wrote about "non-scleractinian anthozoans", M. GRASSHOFF published in 1976 a paper on "Gorgonaria aus den Riffen von Eilat" and J. VERSEVELDT & J. COHEN described "Some new species of Octocorallia" (1971). J. VERSEVELDT reported on Alcyonacea in 1970 and 1974 and together with Y. BENAYAHU in 1972.

H. MERGNER of the University of Bochum studied the coral reefs near Eilat and compared them and other Red Sea reefs with those of South India and Jamaica (1971). H. SCHUHMACHER, also from Bochum, investigated the octocoral *Acabaria* (1973) and the first settlement of corals and other organisms on piers and support pillars over a longer period. He wrote several papers about it, the last in 1977. Moreover he studied the adaptation of Fungiids to different sedimentation and ground conditions (1979). This list of publications from the Marine Biological Laboratory is by far not complete.

It should still be mentioned that H. SCHUHMACHER in his book "Korallenriffe" (1976) dealt with the Red Sea in a section of the chapter "Indopazifische Riffregion".

A systematic study of the corals in the Gulf of Aqaba by Maya WIJSMAN-BEST of the Rijksmuseum van Natuurlijke Historie in Leiden resulted in a first paper on the genera *Cyphastrea*, *Leptastrea*, *Echinopora* and *Diploastrea* (1980).

Mention shall also be made to reports from the Biological Institute of the University Stuttgart: "Eilat und das Riff" with articles on reef areas, reef forms, reef zonation, Scleractinia, Actiniaria, Antipatharia, and many other subjects. (Exkursionsbericht I, edit. K. KOEHLER, U. KULL & P. SCHMID, 1980. Exkursionsbericht II, edit. P. SCHMID & K. KOEHLER, 1981).

While G. M. FRIEDMAN in 1966 described a fossile coastal reef near Eilat and A. GUILCHER reported on "Les rivages coralliens de l'est et du sud de la presqu'île du Sinai" (1979), H. MERGNER & H. SCHUHMACHER investigated in a comprehensive and very detailed work the "Morphologie, Ökologie und Zonie-

rung von Korallenriffen bei Aqaba" (1974), that is on the Jordanian side of the Gulf near the 1973 founded Marine Science Station south of the town of Aqaba. The work also contains a list of the found corals. These investigations were supplemented by H. MERGNER & A. SVOBODA (1977) with eco-functional analyses of seasonal changes in the population of reef organisms and biological productivity measurements. Finally a detailed quantitative analysis of a reef lagoon area 5 by 5 metres was carried out (H. MERGNER, 1979), followed by the investigation of the coral community of a fore reef area 5 by 5 metres in a depth of 10 to 12 metres (H. MERGNER & H. SCHUHMACHER, 1981). A part of the corals found there were given to one of us (Sch.) for identification, some of them are mentioned in the present report.

On the invitation of the Jordanian Government a French group, led by M. PICHON and J. JAUBERT, worked at the young and still incomplete Marine Science Station near Aqaba in 1978. The Science Reports of the group which have not been published yet, contain the results of the coral reef studies and a first inventory of the corals living there.

In 1977 and 1979 the "Saudi-Sudanese Commission for the Exploitation of the Red Sea Resources" together with PREUSSAG, Hannover (Fed. Rep. Germany), made two expeditions, Meseda I and II, to investigate metal-containing sediments in the Atlantis-II-Deep in the central Red Sea (**Metalliferous Sediments Atlantic-II-Deep**). A further aim was to find out by means of ecological investigations how damage through sea pollution could be avoided when exploiting the sediments. As part of these investigations the benthos was explored and some corals were gathered which, however, are not yet evaluated. A first report on these Meseda I and II cruises was published by H. THIEL (1980).

Since 1971 Hans W. FRICKE of the Max Planck Institut für Verhaltensphysiologie in Seewiesen has worked on animal behaviour in the Gulf of Aqaba. His observations, especially on fish but also on shrimps, brittle stars, sea urchins, crinoids and sea anemones resulted in numerous publications. He summarized many of his experiences in his book "Bericht aus dem Riff" (1976). But all investigations in a coral reef suffer from the fact that the length of stay under water with aqualungs is limited, whereas the surfacing periods are disproportionately long due to the decompression. This can be improved considerably when the diver can live under water. Therefore FRICKE built the underwater house "Neritica", which proved to be an important instrument for the exploration of coral reefs. In April 1978 FRICKE's underwater-house was placed on a coral reef 10 m deep near Eilat in the Gulf of Aqaba, and in Juni 1978 the first 12-day diving excursion was carried through. In 1978 and 1979 FRICKE reported on the "Neritica", and in 1980 on "Control of different mating systems in a coral reef fish ..." by experimental alteration of the size of the *Stylophora* coral habitat. A treatise of H. FRICKE & E. VARESCHI on the "bubbles" of *Plerogyra sinuosa* as photosynthetic organs is in press.

FRICKE's last spectacular enterprise was diving with the submersible "Geo" to control the distribution of corals in greater depths. From August to December 1981 he undertook many diving trips in the Gulf of Aqaba as far as 200 metres deep. Some of the corals collected on this occasion are incorporated in the present work. FRICKE published a first report on his deep-diving operations in 1982. Another paper of FRICKE, together with H. SCHUHMACHER, about the depth limits of Red Sea stony corals is in press.

## 2. Provenance and localities of the corals

The present material consists of different collections from various institutes and individuals as listed in Table 1. The different localities, from Pos. 1 to 4, 10 and 15, are shown in Fig. 1, the rest in Fig. 2.

### A. Corals from non-resident Institutes

#### 1. The Hebrew University Jerusalem

(Under "Material" in the systematical part: Jerus. SLR)

During the Hebrew University – Smithsonian Institution Joint Program, between 1967 and 1970, members of the Department of Zoology of the Hebrew University Jerusalem collected corals at the following localities, 381 of which are included in the present publication.

Table 1

	Institute: Collector	Year	Locality	Number of collect.		
				corals	spec.	gen.
1	The Hebrew University Jerusalem, Department of Zoology: Prof. Dr. H. STEINITZ, Prof. Dr. F. D. POR, and co-workers	1967 to 1970	Gulf of Suez, Gulf of Aqaba, South tip of Sinai Peninsula	381	82	41
2	Tel Aviv University, Zoology Department: Prof. Dr. L. FISHELSON, and co-workers	1967 to 1972	Gulf of Suez, Gulf of Aqaba, South tip of Sinai Peninsula	565	103	48
3	Universität Basel, Geolog.-paläontologisches Institut: Prof. Dr. L. HOTTINGER, Dipl. Geol. P. WETTSTEIN	1971 1973	Eilat, Fara'un Island, Dahab, El Kura	214	76	39
4	Universität Bochum, Institut f. Spez. Zoologie:					
a	Prof. Dr. H. MERGNER, Dr. H. MASTALLER	1977	Aqaba	14	7	5
b	Dr. H. SCHUHMACHER	1979	Eilat, Sanganeb Reef	6	6	4
5	U.S. National Museum of Natural History: Washington: A. H. FEHLMANN, C. CROSSLAND	1907– 1914 1933– 1935, 1965	Ghardaqa, Dongonab	111	54	23
6	Museum für Naturkunde Berlin, Zoologisches Museum: Dr. D. KUEHLMANN	1976	Wingate Reef off Port Sudan	23	10	6
7	Institute of Oceanography, Port Sudan: Prof. Dr. J. SCHROEDER, and co-workers	1979	Sanganeb Reef	108	71	37
8	Marine Research Laboratory, St. Petersburg (Florida): Mrs. Kay TALLEY	1975	Djiddah	16	14	10
9	Rijksmuseum van Natuurlijke Historie, Leiden		Red Sea	1	1	1
10	Deep-diving Projects: Prof. Dr. H. FRICKE	1981	Gulf of Aqaba	40	19	12
11	Hessisches Landesmuseum, Zoologische Abteilung, Darmstadt: Old collection, including 33 duplicates from KLUNZINGER		Koseir, Massawa	56	37	21
12	2nd Xarifa Expedition: Dr. G. SCHEER	1957	Northern and Central Red Sea, Sarso Islands	179	67	30
13	HLM Expedition to Port Sudan: Dr. G. SCHEER, and co-workers	1962	Wingate Reef	140	54	29
14	Diving Expeditions: Sports teacher J. HOLLOSI	1965 to 1968	Northern Red Sea, Massawa	198	57	28
15	Eilat Expedition: Dr. H. FEUSTEL	1968	Eilat	15	13	11
16	Others:					
a	Prof. Dr. I. EIBL-EIBESFELDT	1963	Sanganeb Reef	4	4	3
b	Prof. Dr. W. SCHAEFER	1964	Sarso Island	1	1	1
c	Prof. Dr. D. MAGNUS	1964	Ghardaqa	1	1	1
d	D. PASCHKE	1981	El Hibeiq	1	1	1
Altogether				2074	194	70
of these hermatypic corals				1976	161	51
ahermatypic corals				98	33	19

Gulf of Aqaba:	
Wadi Masri	SLR 1988
Fara'un Island	1064–1076, 1198–1261
Wadi Treibe	1384
Marsa Murach	285, 352–399, 1275, 1400, 1401
El Hamira	2287
Marsa el Muqeibla	1165–1192
Ras el Burqa	1984
El Kura	448–533
Marsa Abu Zabad	643–680
El Gharqana	1457–1601, 2290–2385.
Gulf of Suez:	
Ras el Misalla	SLR 2221–2251, 2938, 3040, 3050
Ras Matarma	2176, 2203, 3009, 3010
Abu Zanima	1828, 1850
El Bilaiyim	1746, 1777, 2744, 2838
Abu Durba	1809
Et Tur	784, 798, 823–859, 2103–2158.
Northern Red Sea:	
Ras Nasrani	SLR 1649–1658
Ras Muhammad	804–822, 1926–1928.

Further corals were collected during the Circum-Sinai Cruise in 1967:

Gulf of Aqaba:	
off Ras el Burqa	SLR 946 (230 m).

During the Gulf of Eilat – Deep Sea Cruise in 1968:

Gulf of Aqaba:	
SE of Ras Masri	SLR 1727 (280 fath.; 29° 29' N, 34° 54' 30" E).

During the Gulf of Eilat and Red Sea Cruise in 1969:

Gulf of Suez:	
off Et Tur	SLR 1269 (12 m; 28° 09' 30" N, 33° 36' 15" E), 1270 (40 m; 28° 09' N, 33° 30' E).

Northern Red Sea:	
Sharm el Moiya	SLR 2172 (36 m).

All these localities are listed in POR, STEINITZ, FERBER & ARON, 1972 (p. 484–487, 509–511).

## 2. Tel Aviv University

(Under "Material" in the systematical part: T. Aviv NS)

From 1967 to 1972 the Zoology Department of the University of Tel Aviv made a number of cruises, during which corals were collected at the following localities (the numbers in brackets after some field numbers indicate depths). 565 corals are included in the present report.

Gulf of Aqaba:	
Eilat	NS 231–1461, 2997 (21–25 fath.), 2998, 3066 (10 m), 3069 (10 m), 5061, 5062 (15 m), 5396–5430, 6062–6066, 6067 (20 m), 6068, 6103 and 6104 (25 m), 6105, 6106, 6107–6109 (25 m), 6110–6279, 6280–6284 (25 m), 6285–6343, 8371–8375, 9281, 9282, 9284–9286, 9288 (60 m), 9289 (30 m), 9290–9304, E47/1–E57/190
Taba	3063, 3064
Marsa Murach	1914–1934, 3067
Wassit	4889–4909
Dahab	1881–1897, 1898 (10 m), 3199, 3202–3205, 4843, 4848, 4910, 4911 (10 m), 4912– 4943, 4954–5012
Ras Atantur	4802–4842, 4845, 4846, 4849–4885, 4953, 5123
Shurat el Manqata	1841–1855, 1935–1938, 5124
Marsa Abu Zabad	E57/227.

Gulf of Suez:	
Ras Matarma	NS 8390–8411, 8424–8434, 8441–8447
El Bilaiyim	8202–8216, 8453–8685
Et Tur	1899–1902, 1903 (15 m), 1904–1907, 1908 (15 m), 1909–1913, 2244, 3206–3208, 5882–5892
Ras el Kanisa	8191–8201, 8376–8388, 8416–8423, 8435–8439, 8448–8450.
Northern Red Sea:	
Marsa el At	NS 4945–4952, 5127, 9283, 9287 (40 m)
Marsa Bareika	5949, 6070
Ras Muhammad	1859–1869, 1870 (20 m), 1871 (10 m), 1872–1878, 3198, 3200, 5930–5933, 5934 (10 m), 5935–5945, 5946 (10 m), 5947, 5948.

### 3. Universität Basel

(Under "Material" in the systematical part: Basel PW)

In connection with the Hebrew University – Smithsonian Institution Joint Program a research program on the Foraminiferida of the Gulf of Aqaba was initiated by Z. REISS of the Hebrew University Jerusalem. This program was joined by L. HOTTINGER of the University of Basel, H.-J. HANSEN of the University of Copenhagen and C. W. DROOGER of the University of Utrecht.

One of the members of the 1971 and 1973 SCUBA diving excursions, leading to a depth of 60 m, was Peter WETTSTEIN, a student of Prof. HOTTINGER, who collected corals at various places. In HOTTINGER (1977) maps and profiles of the investigated areas are shown in Figs. 14, 16 and 18; the numbers of the localities for the collection of foraminifera marked therein are also valid for the corals with the addition of PW 71 and PW 73 for the operations of 1971 and 1973.

A total of 214 corals were collected at the following localities:

Eilat, near Marine Biological Laboratory (MBL):	
Moses Rock north of MBL, lower side, profile 1; 8 m	PW 71 358, 359
Terrace in front of MBL, new settlement on beach rock and dead corals, profile 2	
localities 112, 113, 130; 1–10 m	73 501–518
locality 130; 6 m	73 524–534, 550, 551
6–8 m	73 587–592
locality 129; 40 m	71 305–329, 73 547–549
40–43 m	73 519–523
40–45 m	73 583–585
40–50 m	73 610
locality 037; 50–55 m	73 566–582
locality 128; 60 m	71 303, 73 620, 623
Lighthouse south of Eilat, from shade area under projecting patch reef, profile 3	
locality 205; 4 m	73 613, 614
6–8 m	73 608, 609
Fara'un Island (Coral Island):	
North east of island	
locality 303; 40 m	PW 73 611, 612
East side of island, fringing reef,	
between localities 040 and 043; 1–4 m	73 594
South tip of island, profile 7	
localities 040, 048; 10–20 m	73 557–561
locality 135; 40 m	71 330–356
South side of island	
locality 341, shade; 7 m	73 542–545
light; 18–22 m	73 541
shade; 20 m	73 536
South of island	
Halophila-lawn, locality 169; 45 m	71 360
fringing reef, shade area, loc. 362; 1–3 m	73 597–607
coral hillock, locality 366; 40 m	73 596
fringing reef, shade area, loc. 176; 5–10 m	73 554, 555, 562
Halophila-lawn, locality 007; 16 m	73 563
Dahab – El Kura	
Lighthouse, profile C	
locality 384; 25 m	PW 73 647

Bay of El Kura, outer reef, south tip	
depth not indicated	73 693–697
above locality 398; 4–6 m	73 587–692
locality 398; 8–10 m	73 683–686
locality 397; 20 m	73 680–682
locality 395; 46 m	73 675
Patch reefs off south tip	
locality 399; 0–5 m	73 699–709
locality 393; 20–22 m	73 629–637
locality 392; 30–33 m	73 638–642
Lagoon, patch reefs	
locality 150; 2–5 m	73 648–659
locality 190; 4–6 m	73 660
Lagoon, west rim; 0.5–1 m	73 661–668
Lagoon, east rim	
locality 380; without depth	73 669, 670

#### 4. Universität Bochum

- a) In 1977 Prof. Dr. H. MERGNER, Dr. H. SCHUHMACHER and Dr. M. MASTALER studied a fore reef area in a depth of 10 to 12 m near Aqaba (MERGNER & SCHUHMACHER, 1981). They gave one of us (Sch.) some (93 specimens) of the collected corals for identification. Of these corals the Hessisches Landesmuseum (HLM) Darmstadt could keep 13 specimens (6 species of 4 genera). They were classified under "HLM EC 1352–1364" together with a further coral "HLM EC 1391", and considered in the present report.
- b) From 1973 to 1976 Dr. H. SCHUHMACHER did experimental work on the adaptability of *Fungia* to sedimentation, both in the laboratory and at reefs near Eilat (SCHUHMACHER, 1979). He worked with 4 species of the genus *Cycloseris* and 8 species of the genus *Fungia* from the Gulf of Aqaba. Of these, 4 species are included in the present report under the numbers "Schuhmacher 2/1, 2/2, 2/4, 2/10", moreover one from Aqaba and one from Sanganeb Reef under "Schuhmacher 83 and 123" resp.

#### 5. U.S. National Museum of Natural History, Washington D. C.

(Under "Material" in the systematic part: USNM Wa)

A comprehensive collection of Red Sea corals in the USNM Washington contains corals from reefs near Ghardaqa collected in the thirties, and corals collected by H. A. FEHLMANN near Ghardaqa in 1965. Moreover, there are corals from Dongonab from the years 1904, 1907 and 1914, undoubtedly collected by C. CROSSLAND. As the corals were not identified they were handed over to one of us (Sch.) to work on them, and 111 specimens were sent to Darmstadt.

##### Northern Red Sea:

Various reefs near Ghardaqa Wa 1–54, 56–61, 63–72, 74–80, 82–87, 90, 92–109.

##### Central Red Sea:

Dongonab 55, 62, 73, 81, 88, 89, 91.

#### 6. Museum für Naturkunde der Humboldt-Universität Berlin, Zoologisches Museum

(Under "Material" in the systematical part: Berlin ZMB)

In 1976 Dr. D. KUEHLMANN collected a large amount of corals during his ecological studies at the Wingate Reef near Port Sudan. He dived to a depth of 70 m. 21 of these corals were sent to the HLM in Darmstadt to be studied by us, together with two further specimens of EHRENBERG, ZMB 600 and 1058.

The Wingate Reef corals come from different depths:

15–22 m	ZMB 7028, 7029
20–30 m	7011, 7012
22–35 m	7006, 7017, 7027
25–35 m	7021, 7023 (= EC 1383)
30 m	7009
30–40 m	7007, 7013, 7014, 7016, 7020, 7022, 7026 (= EC 1382)

40–50 m 7008, 7015, 7018 (= EC 1381)  
60–70 m 7019

Three of these corals could be incorporated in the Darmstadt collection, now having the numbers EC 1381–1383.

#### 7. Institute of Oceanography, Port Sudan

(Under "Material" in the systematical part: P. Sud. Sa)

In 1979 the director of the institute, Prof. Dr. J. SCHROEDER, and his co-workers gathered a large amount of corals at the Sanganeb Reef of Port Sudan, which he handed over to the Landesmuseum Darmstadt to be identified by one of us (Sch.) and to be kept here.

The 108 corals come from the following localities of the Sanganeb Reef:

Barrier, middle/south lagoon; 1–4 m	Sa 1–9
Patch reef in south lagoon; 3–5 m	10–16, 18
Lagoon side of W-rim at beacon, at knick point; 2–3 m	19–24
Lagoon side of W-rim at beacon, south of gap; 1–6 m	25–33
Lagoon side of E-rim at beacon; 1–2 m	34–36
Reef ridge in north lagoon; 2–6 m	37–48
South lagoon, 10–16 m step; 10–15 m	49–58, 58a, 59–66
Southern fore reef, near vertical cliff; 5–11 m	67–74, 79–86, 86a, 87–90
South barrier of north lagoon; 3–14 m	91, 92, 95–109, 109a, 110–112.

#### 8. Marine Research Laboratory, St. Petersburg (Florida)

In the years 1975 and 1976 Kay TALLEY, the wife of a diplomat, collected corals near Djiddah on the Saudi-Arabian coast. The collection is in the Marine Research Laboratory in St. Petersburg (Florida) where Dr. W. JAAP is responsible for it. The corals were identified by J. W. WELLS, W. JAAP and G. SCHEER. Some of these corals were handed over to the Hessisches Landesmuseum, Darmstadt, and two specimens were brought by Mrs. TALLEY personally.

Altogether there are 16 specimens labelled as follows:

HLM EC 1325, 1326, 1368–1378, 1378a, 1379, 1380.

#### 9. Rijksmuseum van Natuurlijke Historie, Leiden

Van der HORST (1921:64) mentions six specimens of *Fungia repanda* from the Red Sea that are kept at the Leiden Museum. One of these corals could be studied by courtesy of Dr. M. WIJSMAN-BEST. The specimen is mentioned in the present report under "Leiden 9507". The exact locality is unknown.

#### 10. "Geo" Deep-diving Projects

From August to December 1981 Prof. Dr. H. FRICKE made a great number of diving excursions with his submersible "Geo". He gave part of the collected corals to the Hessisches Landesmuseum Darmstadt. 40 specimens are included in the present report. The numbers behind "Fri" refer to the numbers of the diving trips.

Gulf of Aqaba:

Eilat lighthouse	9. 9. 1981	Fri 41 (110 and 130 m)
	16. 9. 1981	45 (125 m)
	18. 9. 1981	46 (152 m)
	21. 9. 1981	49 (135 m)
aquarium	4. 9. 1981	34 ( 92 m)
	6. 9. 1981	37 (150 m)
Marine Biological Labor.	17. 8. 1981	17 ( 52 m)
	23. 8. 1981	24 (128 m)
	24. 8. 1981	25 ( 65 m)
	26. 8. 1981	31 ( 67 m)
	1. 9. 1981	32 ( 73 m)
	23. 9. 1981	51 (164 and 170 m)



Northern Red Sea:		
Ras Umm Sidd	11. 11. 1981	Fri 78 (138 m)
	11. 12. 1981	115 (115 m)
Sharm esh Sheikh	18. 11. 1981	86 ( 90 m)
	23. 11. 1981	92 ( 97, 105 and 126 m)
	25. 11. 1981	94 ( 55 m)
	7. 12. 1981	109 ( 95 m)
	10. 12. 1981	114 ( 95 m)
Little Marsa, 4 miles south of Sharm esh Sheikh	16. 11. 1981	82 ( 91 m)

## B. Corals from the Hessisches Landesmuseum Darmstadt

(Under "Material" in the systematical part: HLM EC, unless otherwise stated)

### 11. Old Collection of HLM

The Museum possesses an old coral collection to which some specimens were added from the former Dr. WEBER-SULZER collection from Winterthur (Switzerland). A total of 56 corals are from the Red Sea. They include 33 duplicates from KLUNZINGER from Koseir, which the Museum purchased from him through the dealer in natural history specimens Gustav SCHNEIDER from Basel in 1889.

The localities are:

Northern Red Sea:	
Koseir	HLM EC 50-78, 144-164
Southern Red Sea:	
Massawa	HLM EC 166
Red Sea:	
locality not mentioned	HLM EC 167-171

### 12. 2nd Xarifa Expedition 1957/58

(Under "Material" in the systematical part: HLM X2:)

During the second expedition by Dr. Hans HASS on the research vessel "Xarifa", Dr. G. SCHEER collected corals (a total of 179 specimens) at the following places:

Gulf of Suez:	
Ras Shukheir on a very broad, flat platform, which gradually descended towards the sea	X2: 1 - 1-8
Northern Red Sea:	
Gubal Island at Bluff point; 9 m	X2: 2 - 1-35
at a wreck; 15 m	3 - 1-49
Ghardaqa, at the pier	5 - 1,2
Central Red Sea:	
Reef south of Mayetib Island near Makaua Island	X2: 7 - 1-3
Shaab Anbar, inner reefs of the northern atoll-like reef	8 - 1-6
Southern Red Sea:	
Sarso Island, fringing reef in NE; 3-5 m	X2: 9 - 1-30
Sarad Sarso Island, fringing reef in NW; 2-5 m	10 - 1-17
Small islet at the south of Sarad Sarso	13 - 1-11.

The reefs are described and some profiles are given in SCHEER (1971).

### 13. HLM Expedition to the Wingate Reef 1962

(Under "Material" in the systematical part: HLM RM)

A diagrammatic cross-section through the Wingate Reef off Port Sudan is figured in SCHEER (1971). Corals were collected by Dr. G. SCHEER and the members of the expedition on the reef flat (2 to 4 m deep), on the steep drop of the reef, and on a terrace in a depth of 10 to 15 m, altogether 140 specimens.

The main purpose of the expedition was to bring home corals to build and display a coral reef in the Museum.

14. Collections of János Hóllosi

Between 1965 and 1968 the sports teacher Janos HOLLOSI, Neu Ulm, undertook several SCUBA diving expeditions into the Red Sea, during which he collected corals. He handed over 198 specimens to the Hessisches Landesmuseum, Darmstadt.

Northern Red Sea:

Ras Muhammad, 1967	HLM EC 430, 434, 435
Shadwan Island, 1967	420-421 (3 m), 425 (5 m), 429 (10 m), 431 + 433 (15-16 m)
Ras Abu Suma, 1968	465-488
Safaga Island, 1967	432
1968	492-504

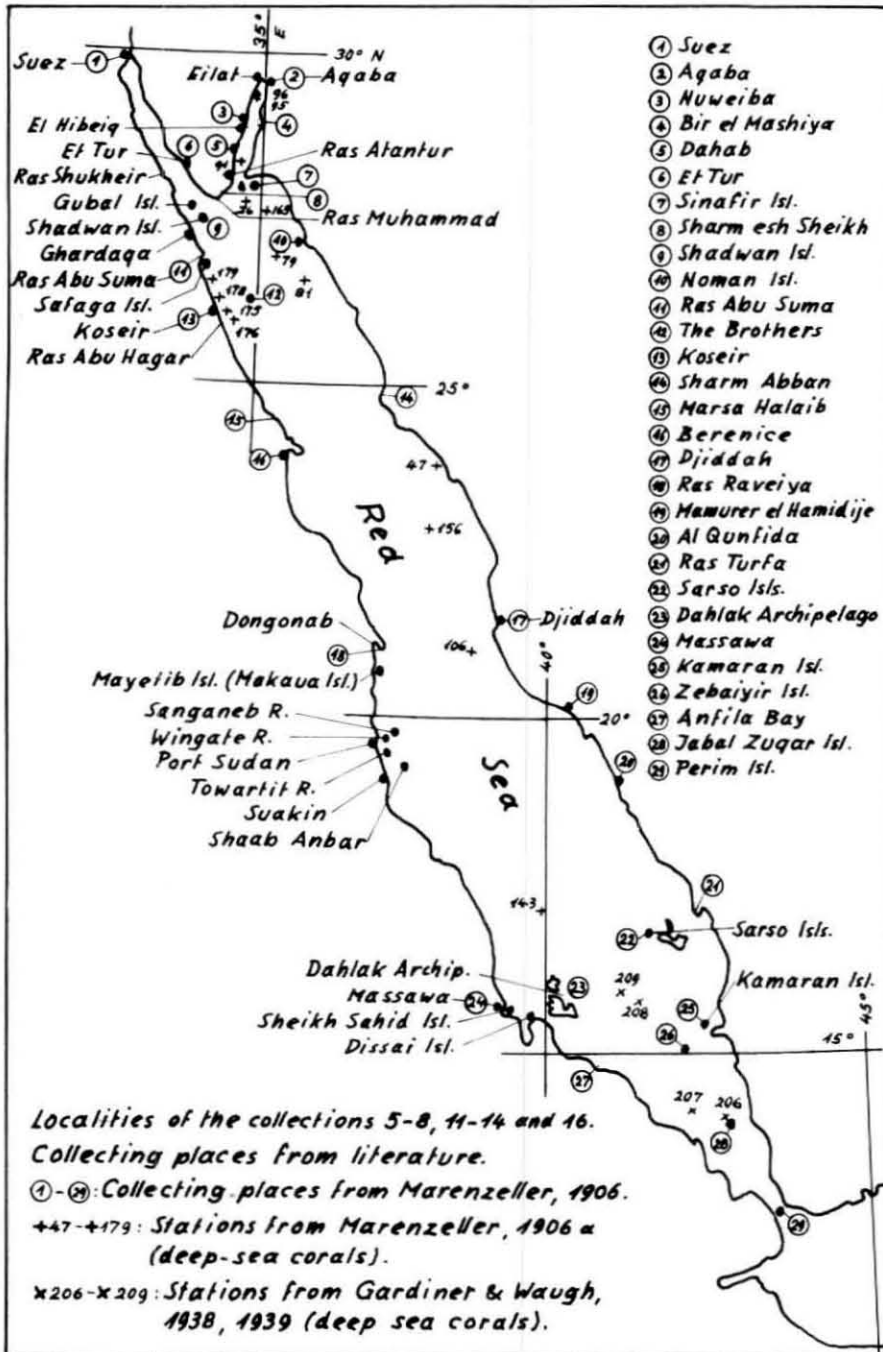

Fig. 1. Red Sea with localities of collections.

near Koseir, 1967	419+424 (3 m), 423 (2-10 m), 422 (6 m), 428 (20 m in grottos)
Ras Abu Hagar, 1966	276-319
1968	506-522
Without specific locality, 1965	245-249
Southern Red Sea:	
Massawa, Archico Bay, 1965	EC 341-350, 352, 353, 355-359, 362-369, 373-379, 387-393, 402-404,
depth not indicated	412, 414, 416
2 m	360, 372, 411
3-5 m	351, 354, 394, 395, 396-401, 405-407
5 m and more	408-410 (5 m), 380-386 (5-10 m), 370 + 371 (6 m), 413a-c (6-8 m),
	415 (8 m), 361 (10 m)
Massawa, Archico Bay, 1967	427 (3-10 m), 426 (3-20 m).

15. Collection Dr. Feustel from Eilat 1968

Dr. H. FEUSTEL, now chief curator of the Zoological Department of the Hessisches Landesmuseum Darmstadt, has brought along a collection of 15 specimens from the reefs at Eilat. They are considered in the present report under HLM EC 449-463.

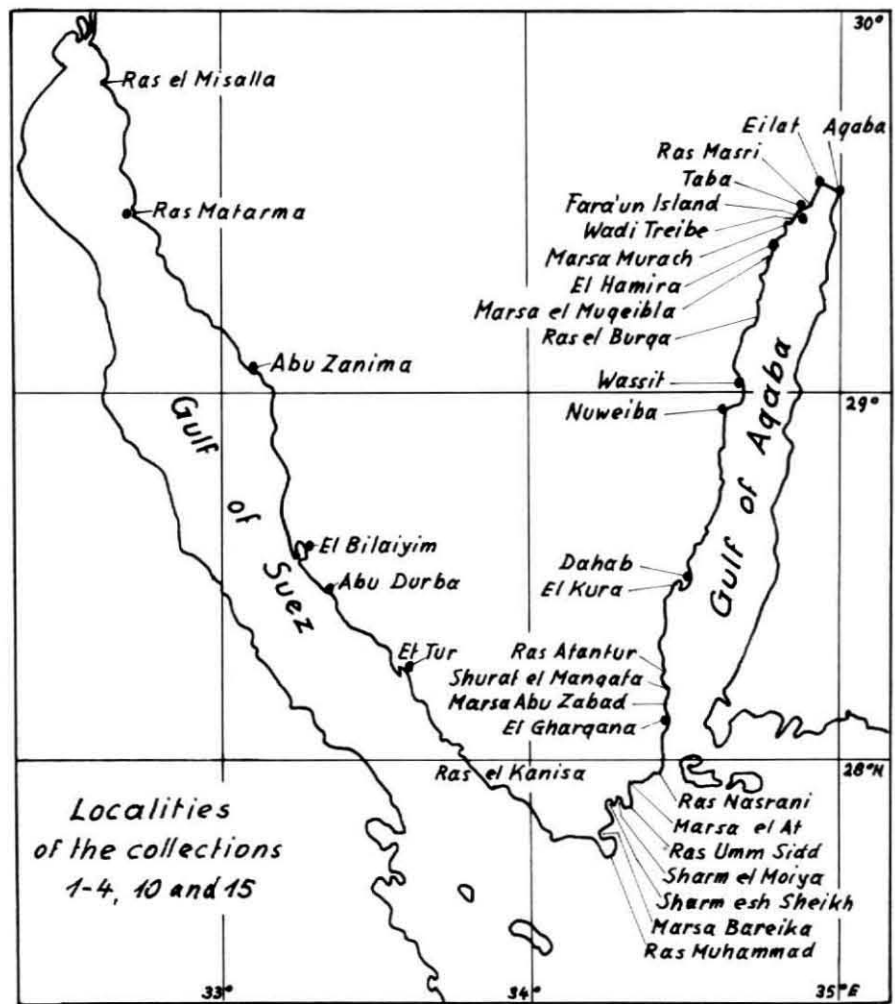

Fig. 2. Gulf of Suez and Gulf of Aqaba with localities of collections.

## 16. Other small collections

- |   |            |
|---|------------|
| a) Prof. Dr. I. EIBL-EIBESFELDT, Max Plank Institut für Verhaltensphysiologie, Seewiesen: Sanganeb Reef, 1963 | EC 132–135 |
| b) Prof. Dr. W. SCHAEFER, Forschungsinstitut Senckenberg, Frankfurt a. M.: Sarso Island, 1964                 | EC 251     |
| c) Prof. Dr. D. MAGNUS, Technische Hochschule, Darmstadt: Ghardaqa  | EC 1351    |
| d) Stud. Ref. D. PASCHKE, Universität Stuttgart: El Hibeiq, 1981  | Pa 81/209  |

## 3. Annotations on the synonymy lists

The literature quoted in the synonymy lists for the different species was chosen according to the following criteria:

1. First descriptions.
2. Works dealing exclusively with Red Sea corals, even if they only contain lists of species. They are:
 

AUDOUIN (and SAVIGNY), 1826 (1828)	v. MARENZELLER, 1906, 1906a
BRUEGGEMANN, 1878	MERGNER, 1979
CROSSLAND, 1941	MERGNER & SCHUHMACHER, 1974, 1981
FORSKAL, 1775	ROSSI, 1954
HAECKEL, 1876	SCHEER, 1964, 1967
HEAD, 1978, 1980	SCHUHMACHER, 1979
KLUNZINGER 2 and 3, 1879	WAUGH, 1936.
LOYA & SLOBODKIN, 1971	
3. Works that among other corals also deal with Red Sea corals, as for instance:
 

BERNARD, 1896, 1897, 1903, 1905	GARDINER & WAUGH, 1938, 1939
BROOK, 1895	v. d. HORST, 1922, 1922a
CROSSLAND, 1952	MATTHAI, 1914, 1928
DOEDERLEIN, 1902	MILNE EDWARDS (& HAIME), 1857, 1860
EHRENBERG, 1834	ORTMANN, 1888
FAUROT, 1888	WIJSMAN-BEST, 1980.
GARDINER, 1909	
4. Works in which the Red Sea is mentioned as area of distribution, and works with comprehensive descriptions and pictures. Here are some examples:
 

CHEVALIER, 1971, 1975	VAUGHAN, 1907, 1918
DANA, 1846	VERON & PICHON, 1976, 1980
FAUSTINO, 1927	VERON, PICHON & WIJSMAN-BEST, 1977
HOFFMEISTER, 1925	WALLACE, 1978
PILLAI & SCHEER, 1976	WELLS, 1954
SCHEER & PILLAI, 1974	WIJSMAN-BEST, 1972.

The authors attempted to consider and to evaluate as many works as possible in which Red Sea corals are mentioned.

## II. Systematic description of the collected corals

Phylum Coelenterata FREY and LEUCKART, 1847

Subphylum Cnidaria HATSCHKE, 1888

Class Anthozoa EHRENBERG, 1834

Subclass Zoantharia de BLAINVILLE, 1830

Order Scleractinia BOURNE, 1900

1. Suborder Astrocoeniina VAUGHAN and WELLS, 1943

Family **Thamnasteriidae** VAUGHAN and WELLS, 1943

The only living representative of this family, *Psammocora*, is known from Red Sea by five species.

Genus *Psammocora* DANA, 1846

Type species: *Pavona obtusangula* LAMARCK, 1816.

Generic characters: Encrusting, explanate, ramose or massive. Well developed thecal wall absent. Septa ramifying at the periphery, confluent between calices, often petaloid. Low collines often present between the row of calices. Columella styliform.

For details of the various subgenera of this genus reference may be made to WELLS (1956) and VERON & PICHON (1976).

Synopsis of *Psammocora* from Red Sea:

A. Corallum ramose.

1. Branches digitiform or nodular. Corallites in series, about 1 mm. Septa in two cycles, alternating in thickness. Columella styliform. . . . . *P. contigua*

B. Corallum encrusting or massive.

2. Corallites 1 to 2 mm in diameter. Corallum mostly massive, irregularly covered with high and continuous ridges. Corallites without true walls, but with rows of synapticulae. 10 to 12 septa reach the columella. Septal margin and sides densely granulated. Columella consists of several spines. . . . . *P. nierstraszi*

3. Corallites 2 to 3 mm in diameter, mostly in short series between more or less well-developed, irregularly curved ridges. About 12 septa reach the columella, which consists of few papillae. The wall ("false wall" after GARDINER) has on both sides rows of very conspicuous synapticulae, giving a characteristic aspect to the corallum, even to the naked eye. . . . . *P. profundacella*

4. Corallites polygonal, 3 to 4 mm in diameter, enclosed in distinct fossae or short valleys circumscribed by low acute collines. Septa ramifying at the collines. Columella styliform, surrounded by a set of paliform lobes. . . . . *P. baimeana*

5. Distance between corallite centres 3 to 5 mm. 12 to 18 septa, the principal ones mostly thickened and markedly projecting. Septa and septo-costae clearly visible to the naked eye. Columella consists of several papillae. . . . . *P. explanulata*

*Psammocora contigua* (ESPER), 1795

(Plate 1, Figs. 1, 2)

<i>Madrepora</i>	<i>contigua</i>	1797, ESPER, 81; pl. 66 (Type locality not known).
<i>Psammocora</i>	<i>contigua</i>	1925, HOFFMEISTER, 45; pl. 5/1a-2b. 1936, YABE, SUGIYAMA & EGUCHI, 59; pls. 44/5, 6, 8; 45/2, 3, 6. 1948, MATTHAI, 187; pl. 10/41-43. 1952, CROSSLAND, 165; pls. 15/4,5; 17/3. 1974, SCHEER & PILLAI, 449. 1976, PILLAI & SCHEER, 19 (synonymy). 1976, VERON & PICHON, 22; figs. 13-22 (synonymy). 1980, HEAD, 148, 441.
	<i>divaricata</i>	1905, GARDINER, 952, pl. 92/20, 21.
	<i>frondosa</i>	1872, VERRILL, 384.
	<i>gonagra</i>	1879, KLUNZINGER 3, 80; pl. 9/1. 1918, VAUGHAN, 141; pl. 59/1. 1922, v. d. HORST, 426. 1967, SCHEER, 422.
	<i>planipora</i>	1860, MILNE EDWARDS (& HAIME), 220. 1879, KLUNZINGER 3, 80. 1906, v. MARENZELLER, 90. 1921, v. d. HORST, 85 (synonymy).
	<i>plicata</i>	1846, DANA, 346; pl. 25/2.
	<i>ramosa</i>	1886, QUELCH, 128; pl. 6/6-6b.
	<i>vaughani</i>	1936, YABE, SUGIYAMA & EGUCHI, 60; pl. 41/6, 7.

ESPER's type of this species, which we have studied, is a small specimen about 35 mm in height. The top branches are 15 to 20 mm broad. The corallites are ill-formed and the distinction between major and minor septa very slight. This is apparently a young portion of a colony.

X2:9-8 is a fairly large colony. The corallites are 1 mm in diameter and are very conspicuous grading to a condition described by KLUNZINGER (1879) for his *gonagra* (Type No. 2183 in Berlin Museum). The primary septa are thicker than the second cycle and are club-shaped. The surface coenenchyme between the rows of calices are often slightly elevated. EC 169 is a free-lying colony. The branches are small, very thin, irregular, nodular. The calices are not well formed, and in this regard the specimen resembles the type.

**Material:** HLM, X2:9-8 (Sarso Isl.); EC 169 (Rotes Meer).

**Distribution:** Red Sea; Persian Gulf; Seychelles; Aldabra; Madagascar; Inhaca Isl. (SE Africa); Réunion; Mauritius; Chagos; Maldives; Lakshadweep; Southeast India; Ceylon; Andamans; Strait of Malacca; East Indies; Philippines; Palau Isls.; Great Barrier Reef; Solomon Isls. (GUPPY, 1885, as *P. planipora*); Marshall Isls.; Funafuti (Ellice Isls.); Fiji Isls.; Samoa; Cook Isls. (STODDART & PILLAI, 1973); Tahiti.

**Remarks:** Recently VERON & PICHON (1976) have shown, that *P. gonagra*, *P. vaughani* and *P. divaricata* along with *P. ramosa* are all but skeletal variants of *P. contigua*. These authors also list *P. planipora* and *P. frondosa* as doubtful synonyms. *P. planipora* is the same as *P. contigua*, and this is proved by a good suit of specimens from Solomon Islands (PILLAI, STODDART & MORTON, in preparation). *P. frondosa* VERRILL is the same as *P. plicata* DANA. The type is No. 217 in U.S. National Museum, Washington. It shows no noteworthy difference from otherwise typical specimens of *P. contigua* studied from elsewhere.

*Psammocora nierstraszi* v. d. HORST, 1921

(Plate 1, Figs. 3, 4)

<i>Psammocora</i>	<i>nierstraszi</i>	1921, v. d. HORST, 86; pl. 2/3, 4 (Type locality: Sumbawa). 1954, WELLS, 410; pl. 157/7, 8. 1971, LOYA & SLOBODKIN, 122. 1976, VERON & PICHON, 25; figs. 23, 24. 1980, HEAD, 148, 441.
	<i>samoensis</i>	1925, HOFFMEISTER, 46; pl. 5/3a-c.

We have only one specimen in our material, which we put to this species. It is a small piece, only 5 cm long, but it shows the typical characters. The corallites are small, they are not arranged in well-defined series, and the ridges are irregular and comparatively high.

Material: Northern R. S.: T. Aviv NS 5127 (Marsa el At).

Distribution: Red Sea; Aldabra; Maldives; Indonesia; Great Barrier Reef; Marshall Isls.; Samoa (type locality of *P. samoensis*).

Remarks: *P. nierstraszi* is very near to *P. superficialis* and *P. profundacella*, but more specimens of this rare species are needed to decide definitely upon its affinity.

*Psammocora profundacella* GARDINER, 1898

(Plate 1, Figs. 5, 6)

<i>Psammocora profundacella</i>	1898, GARDINER, 537; pl. 45/3 (Type locality: Funafuti).
	1918, VAUGHAN, 142; pl. 59/4, 4a.
	1936, YABE, SUGIYAMA & EGUCHI, 60; pl. 45/1, 4, 5, 7, 8.
	1948, CROSSLAND, 196.
	1955, NEMENZO, 24; pl. 6/1.
	1976, VERON & PICHON, 35, figs. 41–44.
<i>superficialis</i>	1898, GARDINER, 537; pl. 45/2 (Type locality: Funafuti).
	1976, VERON & PICHON, 27; figs. 25, 26 (synonymy).
<i>samoensis</i>	1955, NEMENZO, 26; pl. 6/5.

We have four specimens before us, two of them were collected by Dr. KUEHLMANN, Berlin, on the Wingate Reef. The striking holes around the corallites or along a series of some corallites, being caused by the synapticulae, give the corallum its unmistakable appearance.

Material: Central R. S.: P. Sud. Sa 20 (3 m), 53 (10 m) (Sanganeb Reef). Berlin ZMB 7008 (40–50 m), 7027 (22–35 m, Wingate Reef).

Distribution: Red Sea; Gulf of Aden; Southeast Africa (Moçambique, Inhaca Isl., Durban); Mauritius; Andamans; Philippines; Taiwan; Japan; Caroline Isls.; Great Barrier Reef; Funafuti (Ellice Isls.); Samoa; Fanning Isls.

Remarks: We consider *P. superficialis* and *P. profundacella* as synonymous, we cannot find any reasonable difference which justifies their separation. This is the first record of this species in the Red Sea.

*Psammocora baimeana* MILNE EDWARDS and HAIME, 1851

(Plate 1, Figs. 7, 8)

<i>Psammocora baimeana</i>	1860, MILNE EDWARDS (& HAIME), 221 (Type locality: Seychelles).
	1879, KLUNZINGER 3, 81; pl. 9/5.
	1898, GARDINER, 536; pl. 45/1.
	1918, VAUGHAN, 141; pl. 59/2, 2a.
	1948, MATTHAI, 198; pls. 15/2; 16/6–8.
	1964, SCHEER, 453.
	1976, VERON & PICHON, 34; figs. 39, 40 (synonymy).
	1980, HEAD, 148, 441.

We have examined six specimens of this species, one of them was collected by Dr. KUEHLMANN, Berlin, on the Wingate Reef. The largest has 11 cm in greater spread with a thickness of 7.5 cm. All are submassive. The corallites are either single or in short series of 3 to 5 in short valleys of low, acute collines. The axial fossa is about 1 mm in diameter. 12 septa reach the columella, but on the collines they ramify (30 to 40). Columella styliform, 6 to 8 paliform lobes present.

Material:

Gulf of Suez: Jerus. SLR 823 (Et Tur).

Gulf of Aqaba: Basel PW 73 612a (Fara'un Isl., 40 m, attached to *Leptoseris explanata*).

Northern R. S.: HLM EC 50, 152 (Koseir, duplicates from KLUNZINGER), 153 (Koseir).

Central R. S.: Berlin ZMB 7007 (Wingate R., 30–40 m).

Distribution: Red Sea; Seychelles; South Africa; Lakshadweep; Cocos-Keeling Isls.; Java; Great Barrier Reef; Solomon Isls.; Marshall Isls.; Funafuti (GARDINER, 1898); COOK Isls. (STODDART & PILLAI, 1973); Tahiti.

Remarks: Though the present species seems to be well defined, it appears to display reasonable skeletal variations. It may be that *P. profundacella*, *P. superficialis* and *P. nierstraszi* form a single species with *P. haimeana*, an opinion which was already expressed by MATTHAI (1948:187). VERON & PICHON (1976) have figured the type of *P. profundacella*, and their description and discussion on the skeletal variation of *P. profundacella* suggest that it is not clearly separable from *P. haimeana*. *P. superficialis* is also closely related and forms along with *P. nierstraszi* and *P. samoensis* a single series broken only on possible skeletal variations. However, we list *P. profundacella* and *P. nierstraszi* separate in this work, since the material we have examined is not sufficient enough to give positive evidence to our concept.

*Psammocora explanulata* v. d. HORST, 1922

(Plate 1, Fig. 9)

*Psammocora explanulata* 1922, v. d. HORST, 426; pl. 32/7, 8 (Type locality: Providence Isl.).  
1954, WELLS, 410; pl. 157/9, 10.  
1976, VERON & PICHON, 28; figs. 27-32.  
1980, HEAD, 148, 442.

We could examine on specimen, collected by Dr. KUEHLMANN, Berlin, on the Wingate Reef in a depth of about 30 m.

Material: Central R. S.: Berlin ZMB 7009 (Wingate Reef, 30 m).

Distribution: Red Sea; Amirantes; Providence Isl.; Réunion; Great Barrier Reef; Marshall Isls.

Remarks: This is the first record of this species in the Red Sea.

Family *Astrocoeniidae* KOBY, 1890

*Stylocoeniella* is the only Indo-Pacific genus of this family. Two species of *Stylocoeniella* are described in literature, viz *S. armata* and *S. guentheri*. Both are represented in the Red Sea.

Genus *Stylocoeniella* YABE and SUGIYAMA, 1935

Type species: *Porites armata* EHRENBERG, 1834 = *Stylocoenia hanzawai* YABE & SUGIYAMA, 1933.

Generic characters: Encrusting, surface with or without gibbositities. Calices 0.5 to 1.4 mm in diameter with two cycles of septa and a styliform columella. Septa dentate. Intercalicular areas with prominent spines. Surface spiny.

The two hitherto known species differ in the size of the calices and the degree of development of septa.

Synopsis of the two species of *Stylocoeniella*:

1. Calices 0.8 to 1.4 mm in diameter. 12 nearly equal septa. Intercalicular elevations are granulated spines. . . . . *S. armata*
2. Calices 0.5 to 1 mm. Only 6 septa prominent, second cycle of septa weakly developed. Intercalicular elevations are styliform pillars. . . . . *S. guentheri*

*Stylocoeniella armata* (EHRENBERG), 1834

(Plate 2, Fig. 1)

*Porites armata* 1834, EHRENBERG, 343 (Type locality: Red Sea).  
*Stylophora armata* 1857, MILNE EDWARDS (& HAIME), 138.  
1879, KLUNZINGER 2, 66; pl. 8/12.



		1906, v. Marenzeller, 77.
<i>Stylocoeniella</i>	<i>armata</i>	1954, WELLS, 409; pl. 96/1-4 (synonymy).
		1976, VERON & PICHON, 41; fig. 50.
		1980, HEAD, 147, 441.
<i>Porites</i>	<i>astreaoides</i>	1834, EHRENBERG, 343.
	(non <i>astreaoides</i> )	1816, LAMARCK, 269).
<i>Stylophora</i>	<i>ehrenbergi</i>	1857, MILNE EDWARDS (& HAIME), 139.
<i>Stylocoeniella</i>	<i>banzawai</i>	1935, YABE & SUGIYAMA, 105; pl. 15/1-6.

We have no specimen of this species in our collection, we can only mention the samples of EHRENBERG, KLUNZINGER, MARENZELLER and recently HEAD from Red Sea.

**Distribution:** Red Sea; Madagascar; Inhaca Isl.; Chagos; Malvan; W-coast of India (PILLAI unpubl.); Cocos-Keeling Isls.; Japan; Palau Isls.; Great Barrier Reef; Marshall Isls.; Cook Isls. (STODDART & PILLAI, 1973); Society Isls.

**Remarks:** The type of *Porites astreaoides* EHRENBERG from Red Sea is No. 600 in the Berlin Museum. It is a small piece of 4 cm in length. A projecting rod-like columella and two well-developed cycles of septa and well cut-out calices are evidently visible. At the periphery of the corallum coenenchymal elevations are seen, though rare. This specimen can surely be referred to the present species.

#### *Stylocoeniella guentheri* (BASSETT-SMITH), 1890

(Plate 2, Fig. 2)

<i>Stylophora</i>	<i>guentheri</i>	1890, BASSETT-SMITH, 362.
<i>Stylocoeniella</i>	sp.	1964, WELLS, 1103; pl. 296/6, 7.
	<i>guentheri</i>	1966a, WELLS, 203; figs. 1-10.
		1976, VERON & PICHON, 38; figs. 45-49.

*S. guentheri* was found by Dr. D. KUEHLMANN from the Museum für Naturkunde, Berlin, in the deeper waters of the Wingate Reef off Port Sudan. One is a specimen with a length of 6.6 cm. Calices 0.6 to 1 mm in diameter. Septa in two distinct cycles, only the six main septa reach the styliform columella. The intercorallite elevations are prominent and clearly related to one of the primary septa.

**Material:** Central R. S.: Berlin ZMB 7011, 7012 (Wingate R., 20-30 m).

**Distribution:** Red Sea; Madagascar; Maldives; Macclesfield Bk.; Taiwan; Great Barrier Reef; Niwetok Atoll.

**Remarks:** This is the first report of this species from Red Sea.

#### Family Pocilloporidae GRAY, 1842

Key to the genera of the family Pocilloporidae from the Red Sea:

A. Coenenchyme close to the thecal wall rises in the form of half a canoe.

1. Corallum ramose, branches thin or broad. Corallites conspicuous, arranged all over the branches (i.e. necessarily not in regular rows). Septa and columella prominent. . . . . *Stylophora*

2. Corallum ramose, branches generally thin (3 to 8 mm). Corallites arranged in regular longitudinal rows along the long axis of the branches. Septa and columella poorly developed. . . . . *Seriatopora*

B. Coenenchyme close to the thecal wall does not rise in the form of half a canoe.

3. Coenenchyme rises into the form of prominent verrucae. Septa and columella poorly developed. . . . . *Pocillopora*

4. Corallites polygonal, septa in cycles of 8 or 10, well developed. Surface coenenchyme level. . . . . *Madracis*

#### Genus *Stylophora* SCHWEIGGER, 1819

Type species: *Madrepora pistillata* ESPER, 1795.

The generic characters of this genus are already summarized. *Stylophora* is very rich in the Red Sea, both in number of species and in the coverage of the reef surfaces. A large number of species of

this genus are described by past authors, many of them based on ecological variants. Recent investigations have provided a better understanding of the species problem, and many earlier described species are now regarded only as synonyms. In the present work we recognize six species of *Stylophora* from Red Sea of which two, viz *S. kueblmanni* and *S. mamillata*, we provisionally name as new to science.

Synopsis of *Stylophora* discussed in this work:

A. Corallum ramose.

1. Branches moderately large, digitiform or palmate. Corallites average 1 mm, conspicuous. First cycle of septa prominent, second cycle less developed. The upper wall of the corallites project in the form of half a canoe. . . . . *S. pistillata*
2. Branches low, colony tufted. Branches digitiform or expanded at the tip. Corallites 0.5 to 0.8 mm in diameter. The thecal wall projecting on all sides in the form of a ring. . . . . *S. danae*
3. Branches thin, general appearance that of *Seriatopora*. Calices 0.5 to 0.75 mm. Wall equally but only slightly elevated. . . . . *S. subseriata*
4. Corallum pedicellate, branches thin, arranged in many layers. Corallite wall slightly projecting at the upper half only. Branches often flattened and coalescent. . . . . *S. kueblmanni*

B. Corallum knobby, lobed or encrusting.

5. Corallum knobby, lobed or with thick branches. Surface with large verruciform structures similar to those of *Pocillopora*. . . . . *S. wellsi*
6. Corallum encrusting. Surface with mamillate hillocks. Calices 0.4 to 0.6 mm in diameter. Only six septa well developed. Intercalicular elevations are prominent hoods. . . . . *S. mamillata*

*Stylophora pistillata* (ESPER), 1795

(Plate 2, Figs. 3–5)

<i>Madrepora</i>	<i>pistillata</i>	1797, ESPER, 73; pl. 60 (Type locality: Eastindian Seas).
<i>Porites</i>	<i>pistillata</i>	1834, EHRENBERG, 339.
<i>Sideropora</i>	<i>pistillata</i>	1846, DANA, 517.
<i>Stylophora</i>	<i>pistillata</i>	1857, MILNE EDWARDS (& HAIME), 134 (synonymy). 1879, KLUNZINGER 2, 62; pls. 7/3; 8/2. 1888, FAUROT, 119 (var. <i>elongata</i> KLUNZ.). 1906, v. MARENZELLER, 77; pls. 26/94–99; 29/94a–98a. 1954, ROSSI, 28. 1967, SCHEER, 422. 1971, LOYA & SLOBODKIN, 122. 1974, MERGNER & SCHUHMACHER, 265. 1976, PILLAI & SCHEER, 20. 1976, VERON & PICHON, 66; figs. 133–150 (synonymy). 1980, HEAD, 148, 442.
<i>Pocillopora</i>	<i>andreosyi</i>	1828, AUDOUIN (and SAVIGNY), 55; pl. 4/3.
<i>Millepora</i>	<i>alcicornis</i>	1775, FORSKAL, 137.
	<i>damicornis</i>	1775, FORSKAL, 137.
<i>Stylophora</i>	<i>dendritica</i>	1964, NEMENZO, 206; pl. 5/1, 2.
<i>Porites</i>	<i>digitata</i>	1834, EHRENBERG, 340.
<i>Stylophora</i>	<i>digitata</i>	1857, MILNE EDWARDS (& HAIME), 135 (synonymy). 1897, KLUNZINGER 2, 61; pls. 7/5; 8/1. 1888, FAUROT, 119 (var. <i>coalescens</i> DANA). 1941, CROSSLAND, 56. 1879, KLUNZINGER 2, 64; pls. 7/14; 8/19.
	<i>elongata</i>	1879, KLUNZINGER 2, 64; pls. 7/14; 8/19.
	<i>expanda</i>	1964, NEMENZO, 206; pl. 6/3.
<i>Sideropora</i>	<i>mordax</i>	1846, DANA, 518; pl. 49/1, 1a, b.
<i>Stylophora</i>	<i>mordax</i>	1918, VAUGHAN, 81; pl. 25/1, 1a, 2, 2a, b. 1954, WELLS, 411; pl. 96/5. 1974, SCHEER & PILLAI, 11 (synonymy). 1976, PILLAI & SCHEER, 20.
	<i>nana</i>	1964, NEMENZO, 206; pl. 6/1, 2.
	<i>palmata</i>	1857, MILNE EDWARDS (& HAIME), 137. 1879, KLUNZINGER 2, 63; pls. 7/6; 8/11.

		1971, LOYA & SLOBODKIN, 122.
<i>prostrata</i>		1879, KLUNZINGER 2, 62; pls. 7/8; 8/7.
		1971, LOYA & SLOBODKIN, 122.
<i>septata</i>		1898a, GARDINER, 996; pl. 62/1.
		1952, CROSSLAND, 108; pl. 2/5.
<i>sinitica</i>		1878, BRUEGGEMANN, 396; pl. 7/3.
		1879, KLUNZINGER 2, 65.

The treatment of the species adopted here is that of MARENZELLER (1906), according to whom *S. palmata*, *S. digitata* and *S. prostrata* of KLUNZINGER and *S. sinitica* BRUEGGEMANN are all skeletal variants of *S. pistillata*. PILLAI & SCHEER (1976) suggested that *S. mordax* is the same as *S. palmata*, which was later confirmed by VERON & PICHON. These authors have also included *S. sinitica* and *S. septata* under the synonymy of *S. pistillata*. We add *S. nana*, *S. expanda* and *S. dendritica*, all of NEMENZO (1964) from the Philippines.

*S. pistillata* is one of the most common species of the Red Sea, as far as we can suggest by the great number of specimens we have in our collection. A large number of specimens were examined, including ESPER's type, which display two major skeletal variations as follows: 1. The branches are either slender or digitiform or palmate; 2. the calices range from 0.5 mm at the older parts of the branches to 1.25 mm at the growing edges; the hoods may or may not be well developed. The species is well described in literature and it is unnecessary to go into the details again.

Material:

Gulf of Suez:	Jerus.	SLR	2133-1, 5, 2158-3, 5 (Et Tur).
	T. Aviv	NS	8403, 8443 (Ras Matarma); 8204, 8210, 8211, 8216, 8453, 8454, 8456, 8460, 8677 (El Bilaiyim); 8419, 8421 (Ras el Kanisa).
	HLM	X2:	1-3, 1-4 (Ras Shukheir).
Gulf of Aqaba:	Jerus.	SLR	1256-1 (Fara'un Isl.); 380-1-3 (Marsa Murach); 452-2, 3 (El Kura); 655, 668-1, 2, 680 (Marsa Abu Zabad).
	T. Aviv	NS	1242, 1267 (Eilat); 1932 (Marsa Murach); 4893, 4901 (Wassit); 4803 (Ras Atantur); 1846 (Shurat el Manqata).
	Basel	PW	73 648, 651, 681 (El Kura, 20 m).
Northern R. S.:	HLM	EC	449 (Eilat); 1364 (Aqaba).
	T. Aviv	NS	4947 (Marsa el At).
	HLM	X2:	2-4 (Gubal Isl., 9 m).
	HLM	EC	420, 421 (Shadwan Isl.); 492 (Safaga Isl.); 276-281, 506, 507 (Ras Abu Hagar); 419, 423 (Koseir).
	HLM	EC	168, 171 (without local.).
Central R. S.:	USNM	Wa	1, 2, 3 (Ghardaqa).
	P. Sud.	Sa	8, 16 (Sanganeb R.).
	HLM	RM	1, 2, 2a, 3, 52, 53, 54, 55 (Wingate R.).
Southern R. S.:	HLM	X2:	8-1 (Shaab Anbar).
	HLM	X2:	9-7, 9-12, 10-3, 10-4 (Sarso Isl.).
		EC	251 (Sarso Isl.); 166, 341, 342, 344-349 (Massawa).

Distribution: Widely distributed in the Indopacific from Red Sea to Fiji and Samoa, but not known from the Southeast coast of India.

*Stylophora danae* MILNE EDWARDS and HAIME, 1850

(Plate 2, Figs. 6, 7)

<i>Stylophora</i>	<i>danae</i>	1857, MILNE EDWARDS (& HAIME), 138 (Type locality: Singapore).
		1927, FAUSTINO, 90; pl. 10/6.
		1964, NEMENZO, 205; pl. 4/2.
	<i>erythraea</i>	1906, v. MARENZELLER, 75; pl. 27/100-105.
		1911, GRAVIER, 27; pls. 1/1-3; 11/44.
		1941, CROSSLAND, 56; pls. 10, 11.

- 1948, CROSSLAND, 181.  
 1980, HEAD, 148, 442.  
*cellulosa*(?) 1886, QUELCH, 56; pl. 1/2, 2a-c.

This species is represented in the collection by several specimens. Many of them are found attached to the branches or roots of mangrove plants. They are caespitose with short branches rising to almost uniform heights. The calicular wall is equally elevated on all sides of the corallite at the upper parts of the branches. Down below sometimes the wall is raised only as a hood. Six narrow septa are present in most of the calices. The coenenchyme looks smoother than in *S. pistillata*. A columella is present.

Material:

- Gulf of Suez: Jerus. SLR 2221-1, 2, 2251, 2938-2, 5 (Ras el Misalla); 2176-6 (Ras Matarma); 1746-1-3, 1777, 2744, 2833-1, 2 (El Bilaiyim); 784, 838-1-3, 2140-1, 2 (Et Tur).  
 T. Aviv NS 8408 (Ras Matarma); 8674 (El Bilaiyim); 1899 (Et Tur).  
 Gulf of Aqaba: Jerus. SLR 1256-2 (Fara'un Isl.); 452-1 (El Kura); 1457-1-3, 1495, 2290, 2337-1-6 (El Gharqana).  
 T. Aviv NS 1845 (Shurat el Manqata).  
 Basel PW 73 504, 505 (Eilat); 73 664-667 (El Kura).  
 Northern R. S.: HLM EC 465 (Ras Abu Suma).  
 Central R. S.: P. Sud. Sa 88 (Sanganeb R., 10 m).  
 Southern R. S.: HLM X2: 13-11 (Sarso Isl.).

Distribution: Red Sea; East coast of Africa; Sulu Sea; Philippines.

Remarks: CROSSLAND (1941, 1948) felt that *S. erythraea* MARENZELLER could be the same as *S. danae*. We agree that they are one and the same. VERON & PICHON (1976) thought that *S. cellulosa* QUELCH is referable to the synonymy of *S. pistillata*. However an examination of the type of *S. cellulosa*, kept in British Museum (Natural History), shows that it is more related to *S. danae* than to *S. pistillata*. The major distinction of *danae* from *pistillata* is that in the former the thecal wall is equally elevated on all sides while in *pistillata* only the upper part of the corallite wall has a hood.

*Stylophora subseriata* (EHRENBERG), 1834

(Plate 2, Fig. 8)

- |                   |                   |  |
|-------------------|-------------------|--|
| <i>Porites</i>    | <i>subseriata</i> | 1834, EHRENBERG, 340 (Type locality: Red Sea).       |
| <i>Stylophora</i> | <i>subseriata</i> | 1857, MILNE EDWARDS (& HAIME), 137.                  |
|                   |                   | 1879, KLUNZINGER 2, 65; pls. 7/10; 8/14.             |
|                   |                   | 1906, v. MARENZELLER, 74; pls. 26/90-93; 29/90a-93a. |
|                   |                   | 1954, ROSSI, 29.                                     |
|                   |                   | 1967, SCHEER, 422.                                   |
|                   |                   | 1976, PILLAI & SCHEER, 21.                           |

EHRENBERG's types in the Berlin Museum are Nos. 1045 and 1046. KLUNZINGER has redescribed this species, which has a strong superficial resemblance to some specimens of *Seriatopora*. MARENZELLER's description of this species is based on a good suite of specimens, which enabled him to illustrate the skeletal variation. The present collection includes 14 specimens which are all thin-stemmed. The calices are more or less 0.5 to 0.6 mm in diameter. The upper walls of the corallites project slightly, especially at the distal parts of the branches. Lower walls level. First cycle of septa visible but rudimentary. Surface coenenchyme solid, closely echinulate. Branches 4 to 8 mm in thickness, branchlets 3 to 4 mm, tips of branches blunt. In the lower parts of some of the branches the corallite walls are equally but little elevated. In some corallites a columella is visible.

RM 56 from Wingate Reef is almost typical. The branches look smooth. The corallites are very much crowded. The hoods are little developed. Septa and columella not conspicuous.

PW 71 316 and 71 317 resemble each other. They have branches up to 1 cm thick. The corallites are wide spread. The upper rim of the wall projecting. Septa and columella conspicuous at the older parts of the branches. The corallites range from 0.5 to 0.7 mm in diameter, thus grade towards *S. pistillata*. In fact these specimens are intermediate between the two species mentioned here.

## Material:

Gulf of Aqaba:	Jerus.	SLR	387 (Marsa Murach); 1165 (Marsa el Muqeibla); 533-2 (El Kura); 2385 (El Gharqana).
	T. Aviv	NS	6111, 6284 (30 m) (Eilat).
	Basel	PW	71 316, 317 (Eilat, 40 m); 73 633, 634 (El Kura, 20 m).
Central R. S.:	P. Sud.	Sa	102 (Sanganeb R., 8 m).
	HLM	EC	135 (Sanganeb R.).
	HLM	RM	56 (Wingate R.).
Southern R. S.:	HLM	EC	343 (Massawa).

Distribution: Red Sea; Persian Gulf; Madagascar; Mauritius (FAURE, 1977); Maldives; not known from the Pacific.

*Stylophora kuehlmanni* new species

(Plate 3, Figs. 1-4)

There are many specimens of *Stylophora* among the collections of Dr. KUEHLMANN in the Museum of Natural Science at Berlin from Wingate Reef near Port Sudan from a depth of 25 to 50 m. This appears to be a hitherto undescribed species and we venture to name it. The following are the details.

Corallum prostrate, pedicellate; larger colonies are up to 25 cm in greater spread. Branches 4 to 5 mm thick, repeatedly dividing, often reticulately coalescent, underside mostly flattened. Branches arranged in several layers as in some corymbose species of *Acropora*. Branchlets 2 to 3 mm thick, apices tapering. Odd branches have a remarkable resemblance to *Anacropora*.

Corallites 0.4 to 0.5 mm in diameter, 1 to 2 mm apart. Septa six, subequale, not exsert or only very slightly projecting above the thecal rim. The directive septa unite each other dividing the fossa into two equal compartments. Columella styliform, projecting. In older parts of the branches the thecal rim is not projecting, but at the distal parts the upper rim of the wall projects in the form of half-a-canoe. Surface minutely but closely echinulate. Coral solid in section.

## Material:

Northern R. S.:	HLM	Fri	94-1 (Sharm esh Sheikh, 55 m).
Central R. S.:	Berlin	ZMB	7013 (holotype, cross-section of branches oval, Wingate R., 30-40 m).
		ZMB	7015 (40-50 m), 7017 (22-35 m), 7019 (60-70 m), paratypes, cross-section oval, Wingate R.).
		ZMB	7014, 7016 (paratypes, cross-section circular, Wingate R., 30-40 m).
	HLM	EC	1381 (paratype, cross-section oval, Wingate R., 40-50 m, = Berlin ZMB 7018).
		EC	1382 (paratype, cross-section circular, Wingate R., 30-40 m, = Berlin ZMB 7026).

Remarks: As to the thin branches and the size and nature of calices the present species is very near to *S. subseriata*. But the flattened coalescent branches are unlike any of the specimens of *subseriata* we have examined. Further the present specimens have a very different look. We do not know whether these specimens are deep water ecomorphs of *S. subseriata*.

The species is named after its first collector Dr. D. H. KUEHLMANN, the well-known reef student.

The same species was also found by Prof. FRICKE diving with his submersible "Geo".

*Stylophora wellsii* SCHEER, 1964

(Plate 3, Figs. 5-7)

<i>Stylophora</i>	<i>wellsii</i>	1964, SCHEER, 613; figs. 1-5 (Type locality: Red Sea).
		1971, LOYA & SLOBODKIN, 122.
		1980, HEAD, 148, 442.
	<i>bassii</i>	1967, SCHEER, 422; figs. 1-3.

The type of *S. wellsi* is housed in the Naturmuseum Senckenberg Frankfurt (SMF 1033), also one paratype, the other paratypes are in the Hessisches Landesmuseum Darmstadt (HLM).

The following are the details of this species as described originally by one of us (SCHEER). The branches are thick, heavy, up to 4 cm thick and 7 cm long. The corallum possesses verruciform structures similar to those of *Pocillopora*. Calices 0.8 to 1.2 mm in diameter, closely placed. Septa six, upper half of septa project into the fossa and then descend vertically down to meet the columella. Columella present in older calices. Coenosteum spiny. The thecal rim is not elevated but level with the surrounding coenenchyme.

*Stylophora bassi* SCHEER, 1967, is based on a single specimen from Sarso Island (holotype X2:10–17 in the Hessisches Landesmuseum Darmstadt). This specimen also has verruciform projections characteristic of *S. wellsi*. But it has slender branches almost resembling *S. pistillata*. Further samples are required to assess its relationship, but we feel that *S. bassi* falls within the range of skeletal variations of *S. wellsi*, particularly in the presence of verrucae.

The present species is unique among the living representatives of the genus in the possession of calicle-bearing verrucae that suggests its evolutionary affinity with *Pocillopora*. It is near *Stylophora verrucosa* GERTH, 1923, from the Tertiary beds of Borneo.

Material:

Gulf of Aqaba:	T. Aviv	NS	4837 (Ras Atantur).
	Basel	PW	73 641 (El Kura, 30 m).
Northern R. S.:	USNM	Wa	4 (Ghardaqa).
Central R. S.:	P. Sud.	Sa	31 (Sanganeb R.).
	HLM	RM	12, 13, 13a, 57–60, 93, 104–111 (Wingate R.).
Southern R. S.:	HLM	X2:	10–17 ( <i>S. bassi</i> , Sarso Isl.).

Distribution: Red Sea.

*Stylophora mamillata* new species

(Plate 4, Figs. 1–3)

The following is a generalized description of this species based on material collected by Dr. D. KUEHLMANN from Wingate Reef, Port Sudan, outer reef (25 to 40 m deep), and preserved in the Museum für Naturkunde, Humboldt University, Berlin.

Corallum encrusting, thin, 5 to 8 cm in greater spread. Surface rises into mamillary hillocks, 2 to 5 mm high and 5 to 8 mm in diameter. Distance between adjacent projections 2 to 8 mm. Under the lens the surface of the corallum reveals closely set echinulations. In some cases 2 to 5 spines run together forming a short ridge.

Calices 0.4 to 0.6 mm in diameter, openings rounded, look like deep punctures. Primary septa conspicuous, project to half radius circle, nonexsert or only slightly so. They descend vertically to join a pillar-like columella. Second cycle of septa very small or rudimentary.

Intercorallite areas with prominent hoods at nearly each calyx, facing at different directions. The width of the hoods comes up to twice the diameter of the calices. Some of the hoods are 0.5 to 0.6 mm high so that the entrance to the calyx lies laterally and cannot be seen from above.

Material:

Central R. S.:	Berlin	ZMB	7020 (holotype, Wingate R., 30–40 m).
		ZMB	7021 (25–35 m), 7022 (30–40 m), (paratypes, Wingate R.).
	HLM	EC	1383 (paratype, Wingate R., 25–35 m, = Berlin ZMB 7023).

Genus *Seriatopora* LAMARCK, 1816

Type species: *Seriatopora subulata* LAMARCK, 1816.

Generic characters: Ramose, branches slender, often coalescent. Coenenchyme solid. Corallites arranged in longitudinal rows parallel to the long axis of the branches. Septa and columella rudimentary. Thecal rim rises in the form of hoods.

KLUNZINGER (1879) discussed five species of *Seriatopora* from Red Sea, viz. *S. octoptera* (EHRENBERG), *S. caliendrum* (EHRENBERG), *S. lineata* (LINNAEUS), *S. spinosa* MILNE EDWARDS & HAIME and *S. angulata* KLUNZINGER. In this work we recognize only three species of *Seriatopora* as occurring in Red Sea. *S. lineata* (EHRENBERG, ? non LINNAEUS) and *S. spinosa* being merged with *S. bystrix* (= *S. angulata*).

The following is a summary of the characteristics of the various species discussed herein.

1. Main branches 4 to 6 mm thick. Branches coalescent, branchlets spreading or ascending, tips pointed, intercorallite spaces rounded or flat. Upper wall of the corallites raised up in the form of half a canoe. Primary septa moderately developed. . . . . *S. bystrix*
2. Branches 3 to 4 mm thick, coalescent, longer than in *bystrix*, branchlets obtuse at the tip. Corallites close together, upper wall of the corallites only slightly projecting, generally not half a canoe shaped. The directive septa join together forming a middle ridge at the bottom of the calicular fossa. . . . .  
. . . . . *S. caliendrum*
3. Corallum generally cespitose, branches 4 to 8 mm thick, branchlets digitiform, tips blunt, obtuse, winged. Corallite wall uniformly risen all around. Calices 0.5 to 0.6 mm in diameter, crowded. . . . .  
. . . . . *S. octoptera*

#### *Seriatopora caliendrum* EHRENBERG, 1834

(Plate 4, Fig. 4)

<i>Seriatopora</i>	<i>caliendrum</i>	1834, EHRENBERG, 347 (Type locality: Red Sea).
		1860, MILNE EDWARDS (& HAIME), 313.
		1879, KLUNZINGER 2, 70; pls. 7/12; 8/3.
		1906, v. MARENZELLER, 80; pls. 28/113, 114; 29/113a, 114a.
		1967, SCHEER, 423.
		1971, LOYA & SLOBODKIN, 122.
		1974, MERGNER & SCHUHMACHER, 265.
		1976, VERON & PICHON, 63; figs. 118-130 (synonymy).

We are assigning two specimens in our collection to this species after having examined EHRENBERG's types in Berlin Museum (Nos. 1039, 1040, 1041, 1042). The salient features of this species were already summarized. The branches in the present specimens are thin, only 3 to 4 mm in diameter, coalescent. Calices 0.5 to 0.6 mm in diameter, septa rudimentary. The calicular wall slightly elevated at the upper half. Surface finely echinulate.

#### Material:

Gulf of Aqaga: T. Aviv NS 9304 (Eilat).  
Northern R. S.: HLM X2: 3-18 (Gubal Isl., 15 m).

Distribution: Red Sea; Gulf of Aden (GRAVIER, 1911); Philippines; Ryukyu Isls. (YABE & SUGIYAMA, 1941); Palau Isls.; Great Barrier Reef.

#### *Seriatopora octoptera* EHRENBERG, 1834

(Plate 4, Figs. 5, 6)

<i>Seriatopora</i>	<i>octoptera</i>	1834, EHRENBERG, 347 (Type locality: Red Sea).
		1846, DANA, 521.
		1860, MILNE EDWARDS (& HAIME), 313.
		1879, KLUNZINGER 2, 70; pls. 7/7; 8/4.
		1927, FAUSTINO, 93; pl. 11/1, 2.
		1964, NEMENZO, 199; pl. 1/1.

This "eightwinged" *Seriatopora* is characterized, according to KLUNZINGER, as follows: Caespitose, spreading, branches dichotomous. Main divisions rounded in outline, about 5 mm thick; branchlets cylindrical, upper branchlets 2 mm in diameter, 2 to 6 mm long. Calices 0.5 to 0.75 mm in diameter, close together, not in regular rows. Thecal rim equally but slightly raised on all sides of the corallites. Surface coenenchyme spiny. In between the rows of calices, at the distal parts of the branchlets, there are 8 to 10 wing-like expansions, hence the specific name *octoptera*.

The five specimens we have examined agree in their characteristics given above. The species has a superficial resemblance to *Stylophora subseriata*, but its calicular characters are different.

Material:

Gulf of Suez: Jerus. SLR 2133-3, 2148-1, 2 (Et Tur).  
Northern R. S.: HLM EC 157 (Koseir).  
USNM Wa 7 (Ghardaqa).

Distribution: Red Sea; Singapore (DANA); Sulu Sea; Philippines.

Remarks: The three species, *S. octoptera*, *lineata* and *caliendrum*, are all characterized by wing-like expansions at the branch tips, their differences according to KLUNZINGER are mainly in the thickness of branches and in the number of wings. According to MARENZELLER (1906) *S. lineata* (LINNAEUS, 1758) is not a *Seriatorpora*, and EHRENBERG misidentified this species. In the Berlin Museum we could compare EHRENBERG's type of *octoptera* (No. 1043) with his specimen of *lineata* (No. 1038), and we believe that the Red Sea species described under *lineata* is only a *hystrix* along with *S. spinosa* and *subulata* (No. 1037 in Berlin Museum).

*Seriatorpora hystrix* DANA, 1846

(Plate 4, Figs. 7, 8)

<i>Seriatorpora</i>	<i>hystrix</i>	1846, DANA, 521; pl. 49/3, 3a, b (Type locality: Red Sea). 1974, SCHEER & PILLAI, 11 (synonymy). 1976, VERON & PICHON, 58; figs. 99-118 (synonymy). 1980, HEAD, 148, 443.
	<i>angulata</i>	1879, KLUNZINGER 2, 73; pl. 10/4. 1906, v. MARENZELLER, 78; pls. 28/107-112; 29/107a-112a, 115. 1918, VAUGHAN, 74; pl. 20/3, 4. 1954, WELLS, 412; pl. 67/3-7. 1954, ROSSI, 28. 1967, SCHEER, 423. 1971, LOYA & SLOBODKIN, 122. 1974, MERGNER & SCHUHMACHER, 265.
	<i>lineata</i>	1834, EHRENBERG, 347. 1879, KLUNZINGER 2, 71; pls. 7/9; 8/5 (synonymy).
	<i>ocellata</i>	1877, BRUEGGEMANN, 421.
	<i>spinosa</i>	1860, MILNE EDWARDS (& HAIME), 312. 1877, BRUEGGEMANN, 421. 1879, KLUNZINGER 2, 72; pls. 7/15; 8/6 (synonymy). 1971, LOYA & SLOBODKIN, 122.
	<i>subulata</i>	1834, EHRENBERG, 346. 1876, HAECKEL, 45; pl. 2/9.

SCHEER & PILLAI (1974) discussed the differences between *S. hystrix* and *S. angulata*, but pointed out that they could be only geographical variants of one species. VERON & PICHON (1976) seem to have convincing proof for their identity. EHRENBERG's specimen of *subulata* is No. 1037 in Berlin which, according to KLUNZINGER, is a synonym of *S. spinosa* MILNE EDWARDS & HAIME, while *S. subulata* LAMARCK is a doubtful synonym of *S. lineata* (L.). According to MARENZELLER (1906) the specific name *lineata* is not applicable to any species of *Seriatorpora*, since *Millepora lineata* LINNAEUS is not a *Seriatorpora*. No. 2130 in the Berlin Museum is the type of *S. angulata* KLUNZINGER, a careful comparison with this and *S. subulata* has shown not much variation. We feel that these two specimens belong to a single species, and all these represent skeletal variants of one species, to which the specific name *hystrix* is applied.

There is a good suite of specimens in the present collection. Two of the specimens, SLR 829 and RM 61, agree to *spinosa* as described by KLUNZINGER and several could be referred to his *angulata*. One, X2:10-11 from Sarso Island, is typical *hystrix*.

Material:

Gulf of Suez: Jerus. SLR 829 (Et Tur).  
Gulf of Aqaba: Jerus. SLR 1252-1-3 (Fara'un Isl.); 384 (Marsa Murach); 667 (Marsa Abu Zabad).



	T. Aviv	Ns	6109 (Eilat, 25 m).
	Basel		(without No and locality).
Northern R. S.:	HLM	X2:	3-17, 24, 25 (Gubal Isl., 15 m).
	HLM	EC	282 (Ras Abu Hagar).
	USNM	Wa	5, 6 (Ghardaqa).
Central R. S.:	P. Sud.	Sa	1 (Sanganeb R.).
	HLM	RM	4, 4a, 61 (Wingate R.).
Southern R. S.:	HLM	X2:	10-11 (Sarso Isl.).

Distribution: Widely distributed from Red Sea along the East coast of Africa to Fiji, but not known from Lakshadweep or the Southeast coast of India.

### Genus *Pocillopora* LAMARCK, 1816

Types species: *Pocillopora acuta* LAMARCK, 1816.

Generic characters: Ramose or subramose. Coenosteum solid. Surface with verrucae bearing calices. Septa and columella as a rule poorly developed.

Within the genus the various species described in literature appear to be not well defined, the characteristics of most of the so-called species being that of the genus. The growthform, size of branches and verrucae, degree of development of septa and columella and coenenchymal ornamentation are all subjected to wide variation due to macro and micro habitats. When we understand the skeletal variations within the species as a result of future studies on reef, it is likely that many of the described species turn out to be only skeletal variants.

Previous records of *Pocillopora* from Red Sea include *P. favosa*, *P. hemprichi* and *P. danae* (WELLS in LOYA & SLOBODKIN, 1971). We consider (PILLAI & SCHEER, 1976) *P. favosa* EHRENBERG the same as *P. damicornis*. *P. hemprichi* and *P. danae*, we agree with VERON & PICHON (1976), are only skeletal variants of *P. verrucosa*. These two species known from Red Sea can be separated as follows:

1. Corallum cespitose, branches rounded at the base, more or less 1 cm in diameter, tips digitiform or expanded. Verrucae irregular, scattered. Calices more or less 1 mm in diameter. Septa and columella moderately developed. . . . . *P. damicornis*
2. Branches expanding towards the top, flat, broad. Verrucae 4 to 7 mm high and thick, ascending. Corallites polygonal, 1 to 1.5 mm in length. Septa and columella poorly developed. . . . *P. verrucosa*

### *Pocillopora damicornis* (LINNAEUS), 1758

(Plate 4, Fig. 9)

<i>Millepora</i>	<i>damicornis</i>	1758, LINNAEUS, 791 (Type locality: Asiatic Ocean).
<i>Pocillopora</i>	<i>damicornis</i>	1846, DANA, 527; pl. 49/7, 7a.
		1888, FAUROT, 119.
		1925, HOFFMEISTER, 15; pl. 1/1 (synonymy).
		1936, YABE, SUGIYAMA & EGUCHI, 12; pl. 4/3-5.
		1974, SCHEER & PILLAI, 13 (synonymy).
		1976, PILLAI & SCHEER, 21.
		1976, VERON & PICHON, 41; figs. 52-68 (synonymy).
		1980, HEAD, 148, 443.
	<i>bulbosa</i>	1834, EHRENBERG, 351.
		1846, DANA, 527; pl. 49/6, 6a.
		1936, YABE, SUGIYAMA & EGUCHI, 13; pls. 5/4; 7/1.
	<i>cespitosa</i>	1846, DANA, 525; pl. 49/5, 5a.
		1936, YABE, SUGIYAMA & EGUCHI, 13; pls. 5/3; 7/2.
	<i>favosa</i>	1834, EHRENBERG, 351.
		1876, HAECKEL, 45; pl. 2/8.
		1879, KLUNZINGER 2, 68; pls. 7/2; 8/10.
		1906, v. MARENZELLER, 77.
		1954, ROSSI, 30.
		1967, SCHEER, 423.

In two earlier papers (1974 and 1976) we suggested that *P. favosa* from the Red Sea is only a skeletal variant of *P. damicornis*. The present study, especially the examination of EHRENBERG's types of *P. favosa* in the Berlin Museum (Nos. 1022 and 1024), strengthens our earlier opinion. *P. suffruticosa* VERRILL and *P. pulchella* BRUEGGEMANN also belong here.

In the light of the recent work by VERON & PICHON a few additional remarks on the synonymy of this species become necessary. These authors list *P. brevicornis* and *P. acuta* (the type of the genus) under the synonymy of *P. damicornis*. *P. acuta* as figured by MILNE EDWARDS & HAIME (1860) is distinct from *P. damicornis* in the absence of well developed verrucae. It has a superficial resemblance to *Seriatopora* in growthform (see PILLAI & SCHEER, 1976, pl. 1/2). We prefer for the present to keep *P. acuta* separate from *P. damicornis*. *P. brevicornis* is likely to be a stunted growth of *P. verrucosa* or *P. meandrina*. It is unlikely to be the same as *P. damicornis*. The growthform and nature of verrucae are not in agreement with those of *P. damicornis*. QUELCH's (1886) *P. acuta* from the Challenger Expedition is represented by two specimens in BMNH (N. 1886. 12. 9. 32 form Banda and No. 1886. 12. 9. 35 from Mactan Island). These are only *P. damicornis* and not referable to *P. acuta*. GARDINER's (1897) specimen of *P. suffruticosa* from Funafuti is in the Zoology Museum of the Cambridge University. It is nothing but a true representation of *P. damicornis* as well as QUELCH's *suffruticosa* from Tongatabu (BMNH 1886. 12. 8. 30). *P. paucistellata* QUELCH, 1886, is represented by two slender branches in BMNH (type 1886. 12. 9. 29). The corallites are about 1 mm in diameter. Septa and columella are not visible. Verrucae not prominent. These branches appear to be only a variant of *P. damicornis*.

Material:

Gulf of Aqaba:	Jerus.	SLR	1988 (Ras Masri); 1254 (Fara'un Isl., 30 m); 366, 396-1, 2 (Marsa Murach); 1169 (Marsa el Muqeibla); 489-1, 4 (El Kura); 671, 678 (Marsa Abu Zabad).
	T. Aviv	NS	1933 (Marsa Murach); 4892 (Wassit).
	Basel	PW	73 683 (El Kura, 8-10 m).
	HLM	EC	1363 (Aqaba).
Northern R. S.:	USNM	Wa	8, 9 (Ghardaqa).
	HLM	EC	424 (Koseir).
Central R. S.:	HLM	RM	5 (Wingate R.).
	HLM	X2:	8-8 (Shaab Anbar).
Southern R. S.:	HLM	X2:	9-30 (Sarso Isl.).

Distribution: Red Sea along the East coast of Africa (CROSSLAND, 1948) throughout Indo-Pacific as far east as Gulf of California.

*Pocillopora verrucosa* (ELLIS and SOLANDER), 1786

(Plate 4, Fig. 10)

<i>Pocillopora</i>	<i>verrucosa</i>	1846, DANA, 529; pl. 50/3, 3a (synonymy). 1918, VAUGHAN, 77; pl. 23/1, 2, 2a. 1936, YABE, SUGIYAMA & EGUCHI, 14; pl. 3/3, 4. 1954, WELLS, 413; pl. 98/5, 6. 1976, PILLAI & SCHEER, 23 (synonymy). 1976, VERON & PICHON, 48; figs. 69-79 (synonymy). 1980, HEAD, 148, 443.
	<i>bemprichi</i>	1834, EHRENBERG, 352. 1879, KLUNZINGER 2, 69; pls. 7/1; 8/13. 1906, v. MARENZELLER, 78. 1954, ROSSI, 30; pl. 1/1, 2. 1971, LOYA & SLOBODKIN, 122. 1974, MERGNER & SCHUHMACHER, 265.
	<i>danae</i>	1864, VERRILL, 59. 1918, VAUGHAN, 77; pl. 22/1, 1a, 2. 1971, LOYA & SLOBODKIN, 122. 1974, MERGNER & SCHUHMACHER, 265. 1976, PILLAI & SCHEER, 22 (synonymy).

In a recent paper VERON & PICHON (1976) have merged *P. danae* and *P. hemprichi* with *P. verrucosa*, a conclusion with which we agree after an examination of the present suite of specimens, moreover we have seen EHRENBERG's types of *P. hemprichi* in Berlin Museum (Nos. 591, 860, 861, 1026). However, *P. elegans* and *P. meandrina*, both of which VERON & PICHON refer to the synonyms of *P. verrucosa*, look distinct. The nature of verrucae and details of calices are different. In *meandrina* the verrucae are spreading and more uniform than in *verrucosa* (PILLAI, STODDART & MORTON, in preparation). We have many specimens of broad branched *Pocillopora* before us, all of which we place under a single species. The following are the details of some of them, chosen to show the skeletal variation.

RM 6. An entire colony 12 cm in greater spread. Branches 4 to 5 cm broad at the top. Growing tips without verrucae. Lateral verrucae about 4 mm thick, 4 to 6 mm long, appressed, ascending. Calices deep, without septa and columella, diameter 1 to 1.25 mm.

EC 466. Caespitose with many branches arising from a small base. Branches 2 to 3 cm broad at the top. Growing tips with or without verrucae. Verrucae ascending, scattered. Resembles *hemprichi* as figured by KLUNZINGER.

RM 62. A large colony about 25 cm in greater spread. Branches up to 8 cm broad at the top, flattened. Verrucae 2 to 3 mm thick, 3 to 4 mm long, a little spreading ( $40^\circ$ ). This specimen grades towards *P. meandrina* var. *nobilis* particularly in the presence of smaller and more uniform verrucae.

SLR 489 is represented by two clumps. The basal parts of branches rounded, expanded towards the top. Growing edges of the branches about 2 cm broad. Verrucae very conspicuous, crowded, 5 to 6 mm long, about 4 mm thick. Calices average 1 mm in length with 12 moderately developed septa. This is typical of the form described as *P. danae*.

The specimens described above as well as many others present in the collection apparently look like a heterogeneous assemblage. But they all essentially have the following characters: 1. flat broad branches (sometimes basal parts rounded); 2. verrucae large, ascending, 4 to 6 mm in length, 3 to 4 mm thick; 3. corallites polygonal, deep, more or less 1 mm in length with poorly developed septa. The calices are more or less rounded at the older parts of the branches with better representation of the septa.

#### Material:

Gulf of Aqaba:	Jerus.	SLR	489-2, 3 (El Kura).
	T. Aviv	NS	4964 (Dahab); 4822 (Ras Atantur).
	HLM	EC	450 (Eilat).
Northern R. S.:	HLM	X2:	2-5 (Gubal Isl., 9 m).
	HLM	EC	466, 467 (Ras Abu Suma); 51 (Koseir, duplic. from KLUNZINGER); 283, 284 (Ras Abu Hagar).
	USNM	Wa	10-12 (Ghardaqa).
Central R. S.:	P. Sud.	Sa	7, 30 (Sanganeb R.).
	HLM	EC	1368 (Djiddah).
	HLM	RM	6, 62, 112 (Wingate R.).
	HLM	X2:	8-9 (Shaab Anbar).

Distribution: Red Sea; East coast of Africa (TALBOT, 1965); Aldabra (ROSEN, 1971); Madagascar (PICHON, 1964); Mauritius; Chagos; Southeast coast of India; Ceylon; Andamans; Cocos-Keeling Isls.; Singapore; Philippines (NEMENZO, 1964); Taiwan; Palau Isls.; Caroline Isls.; Great Barrier Reef; Solomon Isls.; Marshall Isls.; Fiji; Cook Isls. (STODDART & PILLAI, 1973); Tahiti.

#### Additional remarks to *Pocillopora*:

EHRENBERG (1834: 353) mentions from Red Sea *Pocillopora polymorpha*, but after MILNE EDWARDS & HAIME (1860: 308) this is only *Nullipora polymorpha*, a calcareous alga.

#### Genus *Madracis* MILNE EDWARDS and HAIME, 1849

Type species: *Madracis asperula* MILNE EDWARDS and HAIME, 1850.

Generic characters: Ramose or submassive. Calices polygonal or rounded, well defined. Septa in cycles of 8 or 10. Columella styliform.

The first record of this genus from Red Sea is that of MARENZELLER (1906a) from the deep waters in the northern part of Gulf of Aqaba (Stat. 95, 168 m, and 96, 350 m). He described the collected material under the new specific name *interjecta*.

In August 1981 Prof. H. FRICKE undertook his first deep-diving project with his submersible "Geo" in the Gulf of Aqaba near the spot where MARENZELLER had dredged. He found extensive reefs of *Madracis interjecta*, and has handed over three specimens (two of them consisting of several fragments) to the Darmstadt Museum.

*Madracis interjecta* v. MARENZELLER, 1906

(Plate 5, Figs. 1-3)

*Madracis interjecta* 1906a, v. MARENZELLER, 20; pl. 2/3 (Type locality: Red Sea, Gulf of Aqaba).

Corallum tangled, coalescent, with tufted or dendroid excrescences. Branches often long and thin; main branches 6 to 7 mm in diameter, twigs only 2 to 3 mm.

Corallites circular or slightly oval, 2 mm in diameter, at stumpy parts of the corallum on verruciform elevations. Distance between corallites on long branches 3 to 5 mm. Ten equal septa, strongly exsert, dropping off vertically in the calyx to a solid plate, about 1 mm in diameter, with a central well developed styliform and mostly compressed columella. Interseptal loculi are clearly visible. In some calices very small and inconspicuous septa of higher cycles are present. Pali not present.

Coenenchyme solid and more or less spinulose. At stouted parts of the corallum spines are numerous, often forming a ring around a corallite or polygonal rows between crowded corallites.

Dried fragments of the corallum are reddish.

Fri 49-1 is dendroid, 18 cm long, and broken in seven pieces. A great part of the corallum is dead, but young colonies, some only with one corallite, have settled on it.

Fri 49-2 consists of eight long and thin branches. Three of them are about 8 cm long with a diameter of 5 to 7 mm. The others are shorter and thinner, diameter 2 to 4 mm.

Fri 49-3 is a contorted mass of thin and mostly dead branches. Corallum about 6 cm long.

Material: Gulf of Aqaba: HLM Fri 49-1, 49-2, 49-3 (Eilat, lighthouse, 135 m deep).

Distribution: Known only from Red Sea.

Family **Acroporidae** VERRILL, 1902

The three genera *Acropora*, *Montipora* and *Astraeopora* of this family are present in Red Sea; *Anacropora*, the other living representative, hitherto being not recorded from this area. The above three genera can be separated as follows:

A. Axial corallites present.

Corallum ramose, encrusting or palmate. Radial corallites projecting or immersed. Septa in two cycles. Coenosteum porous. . . . . *Acropora*

B. Axial corallites absent.

1. Corallum encrusting, massive, ramose or foliaceous. Corallites small, generally wall not projecting. Septa in two cycles. Surface coenenchym glabrous, faveolate, papillate or tuberculate. Coenosteum porous. . . . . *Montipora*

2. Corallum encrusting or massive. Corallite walls projecting or level. Thecal wall solid. Septa conspicuous. Surface spiny. . . . . *Astraeopora*

Genus *Astraeopora* de BLAINVILLE, 1830

Type species: *Astrea myriophthalma* LAMARCK, 1816.

Generic characters: Colonial, encrusting, explanate, pulvinate or massive. Corallite walls level to projecting. Septa in 2 to 3 cycles. Columella poorly developed. Surface spiny.

The genus is known from Red Sea by a single species, *A myriophthalma*, which displays wide skeletal variation.

*Astraeopora myriophthalma* (LAMARCK), 1816

(Plate 5, Figs. 4, 5)

<i>Astrea</i>	<i>myriophthalma</i>	1816, LAMARCK, 260 (Type locality not known).
<i>Astraeopora</i>	<i>myriophthalma</i>	1860, MILNE EDWARDS (& HAIME), 168, pl. E2/4, 4a.
		1896, BERNARD, 87; pls. 25; 26; 33/9.
		1879, KLUNZINGER 2, 52; pl. 5/31.
		1918, VAUGHAN, 146; pl. 60/5, 5a.
		1936, WAUGH, 927.
		1954, WELLS, 431; pl. 141/3-6.
		1971, LOYA & SLOBODKIN, 123.
		1974, MERGNER & SCHUHMACHER, 264.
		1976, PILLAI & SCHEER, 34 (synonymy).
		1980, HEAD, 148, 445.
	<i>arenaria</i>	1896, BERNARD, 90; pls. 29; 33/11.
	<i>ehrenbergi</i>	1896, BERNARD, 92; pl. 33/15.
		1906, v. MARENZELLER, 74.
	<i>pulvinaria</i>	1888, ORTMANN, 160.
<i>Phyllopora</i>	<i>leptostoma</i>	1834, EHRENBERG, 338.
	<i>sphaerostoma</i>	1834, EHRENBERG, 338.

The present specimens have the following general characteristics: Encrusting, pulvinate. Full-grown corallites 1.5 mm in diameter, level to 3 mm exsert. Septa very narrow at the top of the wall, getting broader below and reaching the centre of the axial fossa.

Material:

Gulf of Eilat:	Jerus.	SLR	672 (Abu Zabad).
	T. Aviv	NS	1336-1, 2 (Eilat); 4939, 4988, 5007 (Dahab).
Northern R. S.:	USNM	Wa	21, 101 (Ghardaqa).
	HLM	EC	156 (Koseir).

Distribution: Red Sea eastward to Fanning Isl.

Genus *Acropora* OKEN, 1815

Type species: *Millepora muricata* LINNAEUS, 1758.

Generic characters: Ramose, rarely encrusting or massive. Tips of branches with an axial corallite that buds off numerous projecting radial corallites of different forms. Surface coenenchyme reticulate, spinose or pseudocostate. Septa in two cycles. Columella absent.

The genus is one of the most common and abundant reef-builders of the Indo-Pacific and Atlantic. More than 250 species are described. It is one of the most taxonomically difficult genera. Recently several workers have realized the importance of the skeletal variation in this genus within the species, that has resulted in a marked reduction of the number of species and thus of better understanding of the synonymy. BROOK (1893) arranged 212 of his species under ten subgenera and another eight species as "Species incertae sedis", making a total of 220 species known under the genus. Though many subsequent authors have not fully adopted the subgenera of BROOK, the arrangement of species was mostly after him. BROOK's subgenera are still a useful tool in the taxonomy of this genus.

The present authors are fully aware of the limitations of a key or synopsis of the various species as an aid in the determination of species of *Acropora*. The comparative nature of the characteristics assigned to many species in the past and the bewildering ecological and geographical variations of skeleton within the species put constraints on the practical applicability of the keys. This is the case with many genera of scleractinia, particularly those with several species described. We sincerely believe that few species can be safely named without the aid of good illustrations or the type as well as a clear judgement from the part of the worker on possible skeletal variations derived from a first-hand information of the ecological

conditions. However, we give below a synopsis of the species of *Acropora* hitherto known from Red Sea, with a view to minimize the description of the species to save space.

Synopsis of *Acropora* from Red Sea:

- A. Corallum arborescent. Branches 1 to 2 cm thick, long (5–10 cm). Axial corallites tubular, thin or thick-walled with 12 septa.
1. Branches without coalescence. Axials 3 to 3.5 mm in diameter, 2 mm exsert. Radials tubular, ascending or spreading, 2 to 4 mm long, 2 mm thick. Septa 12. . . . . *A. valenciennesi*
  2. Main branches sometimes prostrate, coalescent. Axials 2 to 2.5 mm in diameter and exsert. Radials chiefly immersed and labellate. A set of proliferous corallites with a rosette of labellate corallites scattered at regular intervals. . . . . *A. pharaonis*
  3. Growthform similar to (1). Axials 3 to 4 mm in diameter. Wall about 1 mm thick. Radials labellate, thick-walled, openings directed at different directions. Immersed corallites are few. Radials 2 to 4 mm long and 2 to 3 mm broad. . . . . *A. nobilis*
  4. Caespitose or tufted, subarborescent. Tips of branches tapering. Stems thinner than in (1). Axials 2 to 3 mm in diameter and exsert. Radials tubular, spreading, compressed from side to side, 2 to 4 mm in length, 2 mm thick. Septa only six in the radials. . . . . *A. haimeii*
- B. Corallum caespitose or corymbose. Axials tubular, thin walled with normally six septa. Radials nariform without the inner wall well-developed, normally with six septa.
5. Caespitose, low. Branches 2 to 5 cm long, 8 to 10 mm thick with slightly tapering tips. Axials 1.5 to 2 mm thick and exsert. Radials nariform, ascending, outer wall sometimes compressed at the tip; 1.5 to 2.5 mm long and broad. Opening oval. . . . . *A. nasuta*
  6. Corymbose, main branches prostrate and coalescent. Branchlets 2 to 5 cm long, 4 to 10 mm thick. Axials 1.5 to 2 mm and exsert with a large rounded opening. Radials spreading, labellate, with thick rounded tips, 2 to 3 mm long and broad. . . . . *A. corymbosa*
  7. Growthform similar to (6). Branchlets 2 to 4 mm thick, 2 to 4 cm long, in groups of 2 to 5. Axials 2 to 3 mm thick and exsert. Radials ascending, often appressed, 2 to 4 mm long, lips thin, not rounded. Width of radials generally 2 mm. . . . . *A. hyacinthus*
  8. Branches 8 to 12 mm thick, 4 to 7 cm long without much coalescence. Axials 3 to 3.5 mm thick, 3 to 8 mm exsert, thin-walled. Radials conspicuous, uniform, nariform with a flared out large oval opening. Length average 4 mm, 2.5 to 3 mm broad. Septa 12. . . . . *A. eurystoma*
- C. Corallum caespitose with thick, short digitiform branches with obtuse pices and thick-walled large axial corallites.
9. Branches 1 to 2 cm thick, up to 10 cm high, little subdividing. Axials 3 to 6 mm broad, 1 to 2 mm exsert, thick-walled. Radials labellate or nariform, ascending or spreading, 2 to 4 mm long and broad. . . . . *A. humilis*
- D. Corallum caespitose or caespito-corymbose with thick branches that suddenly taper at the tip to a conspicuous conical axial corallite. Radials nariform or bursiform or thick labellate. Surface mostly echinulate.
10. Peripheral branches prostrate and coalescent. Axials 2 to 3 mm at the tip. Radials nariform, appressed, 3 to 5 mm long and 2 to 3 mm thick, arranged in longitudinal rows along the long axis of the branches. Immersed corallites numerous at the basal parts. . . . . *A. variabilis*
  11. Caespito-arborescent. Axials 2 to 3 mm at the tip, about 6 mm below. Projecting radials nariform, inner wall absent, thin-walled, widely scattered, 2 to 3 mm thick and long. Below most radials subimmersed. . . . . *A. squarrosa*
  12. Caespito-corymbose with thick digitiform branches with tapering tips. Axials 4 mm at the top, 6 mm at the base. Radials conspicuous, uniform, equidistant, bursiform, 3 to 4 mm thick and long. Surface highly echinulate. Immersed corallites very few. . . . . *A. hemprichi*
  13. Caespito-arborescent, branches 1 to 2 cm thick, up to 10 cm high. All crowded. Axials 4 mm thick with 12 septa. Radials tubular, ascending or tubo-nariform, mostly uniform in size, 3 to 4 mm long, 1.5 to 2 mm thick with six septa; a few are proliferous. . . . . *A. forskali*
  14. Corallum prostrate, reticulate, coalescent, sometimes pedicellate. Upper branchlets 2 to 3 cm high. Axials 2 to 4 mm thick and high. Radials nariform, 2 to 3 mm broad and high. Lower part of the branches with verruciform and immersed ones. . . . . *A. granulosa*

E. Corallum subarborescent with slender branches with radiating short, thin branches and long tubular radials, giving a bottlebrush appearance to the corallum.

15. Subarborescent. Main branches up to 1 cm thick, with numerous radiating branchlets. Axials 2 to 3 mm thick and up to 5 mm long, thin-walled. Radials half-tubular or nariform, 3 to 4 mm long, 1 to 2 mm thick. Proliferous radials are tubular and up to 8 mm long. . . . . *A. capillaris*

*Acropora valenciennesi* (MILNE EDWARDS and HAIME), 1860

(Plate 5, Figs. 6, 7)

<i>Madrepora</i>	<i>valenciennesi</i>	1860, MILNE EDWARDS (& HAIME), 137 (Type locality: Ceylon). 1893, BROOK, 46.
	<i>multicaulis</i>	1893, BROOK, 48; pl. 3.
<i>Acropora</i>	<i>multicaulis</i>	1906, v. MARENZELLER, 53; pls. 17/54, 55, 18/54a, 55a. 1954, ROSSI, 49; pls. 5/3; 7/4. 1967, SCHEER, 426.

One of our specimens is referable to this species. The corallum is repeatedly dividing, tufted arborescent with thick branches. Total height of the colony 25 cm. Tips of branches slightly tapering. Branches 7 to 10 cm long, 1 to 1.5 cm thick. Axial corallites 3 to 3.5 mm thick, 2 to 3 mm exsert; septa 12, directives fused. Radials tubular, both proliferous and non-proliferous, former develop to branchlets. Non-proliferous ones 2 mm thick, 2 to 4 mm long, ascending or only slightly spreading, close together, smaller ones intercalated. At the basal parts of the branches a few are subimmersed. Septa 12, wall striated, base echinulate. Coenosteum striated and echinulate. Coral dense in section.

Material: Southern R. S.: HLM X2: 10-1 (Sarso Isl.).

Distribution: Red Sea; East Africa; Ceylon; Rameswaram (type locality of *A. multicaulis*); Torres Strait (BROOK).

Remarks: MILNE EDWARDS & HAIME (1860) did not illustrate this species, but gave only a short description which was amplified by BROOK. One of us (PILLAI) received good photographs of the type of *M. valenciennesi* from Paris Museum and examined the type of *A. multicaulis* in BMNH. There seems to be no major difference between these two except that in BROOK's species the radials are ascending at the distal parts of the branches, while in *valenciennesi* they are spreading throughout. However, the type of *valenciennesi* also shows ascending radials at the distal parts of the branches. The other details as well as the growthform are similar. We take the two species mentioned here as one and the same. Some of the radials have a strong resemblance to thick-stemmed specimens of *A. formosa*. But the dimensions of the axials of these two differ. Further field studies are required to ascertain their relationship.

*Acropora pharaonis* (MILNE EDWARDS and HAIME), 1860

(Plate 5, Fig. 8; Plate 6, Fig. 1)

<i>Madrepora</i>	<i>pharaonis</i>	1860, MILNE EDWARDS (& HAIME), 143 (Type locality: Red Sea). 1893, BROOK, 58 (synonymy). 1911, GRAVIER, 73; pl. 10/42, 43 (synonymy).
<i>Acropora</i>	<i>pharaonis</i>	1906, v. MARENZELLER, 35; pls. 4-8/10-18; 9/10a-17a. ? 1918, VAUGHAN, 106; pls. 69/1-5; 70/1, 2, 2a. non 1950, WELLS, 36 (= <i>A. intermedia</i> ). 1954, ROSSI, 46. 1967, SCHEER, 424. 1976, PILLAI & SCHEER, 25; pl. 3/1, 2.
<i>Madrepora</i>	<i>arabica</i>	1860, MILNE EDWARDS (& HAIME), 145. 1893, BROOK, 66 (synonymy).
	<i>ebrenbergi</i>	1860, MILNE EDWARDS (& HAIME), 143. 1893, BROOK, 48.
	<i>laxa</i> (LAM.)	1876, HAECKEL, 45; pl. 2/7. 1893, BROOK, 46 (non EHRENBERG).
	<i>microcyathus</i>	1879, KLUNZINGER 2, 22; pls. 3/3; 4/19; 9/17.

	<i>pustulosa</i>	1860, MILNE EDWARDS (& HAIME), 144 (non KLUNZINGER).
	<i>scandens</i>	1879, KLUNZINGER 2, 26; pls. 2/6; 3/2; 4/31; 9/21.
<i>Acropora</i>	<i>scandens</i>	1971, LOYA & SLOBODKIN, 123.
		1974, MERGNER & SCHUHMACHER, 264.
<i>Madrepora</i>	<i>spinulosa</i>	1879, KLUNZINGER 2, 23; pls. 2/8; 4/11; 9/18.
	<i>subtilis</i>	1897, KLUNZINGER 2, 28; pls. 2/7; 4/4; 9/22.
<i>Heteropora</i>	<i>prolifera</i>	1834, EHRENBERG, 336.

A large number of specimens of this highly variable species has been examined, among them KLUNZINGER's types of *M. microcyathus* (No. 2220) and *M. scandens* (No. 2125) and EHRENBERG's specimens of *Heteropora prolifera* (Nos. 886 and 887) in the Berlin Museum. We give below a short generalized description.

Corallum semi-arborescent, branches thick (up to 2 cm, SLR 809), branchlets numerous, coalescent. Some of the specimens are prostrate with thinner branches (8 to 10 mm, SLR 2169). Axial corallites 2 to 3 mm in diameter, 1 to 1.5 mm exsert, wall thick and costulate. Septa generally six, in some cases only the directives are prominent. Prominent radials tubular, chiefly proliferous, placed at a distance of 4 to 5 mm each other with a rosette of buds. Between the proliferous corallites there are many labellate ones. Truly immersed corallites are few, though they are present at the older parts of the branches. In the radials generally only the directives of the first cycle of septa are visible. Wall of the radials vermiculate. Corallum dense in section.

The above is only a generalized description of this species. There is wide range of skeletal variation particularly in the general appearance of the corallum. A large collection certainly looks heterogeneous, but the nature of the radials and their distribution is characteristic.

#### Material:

Gulf of Suez:	Jerus.	SLR	3009-2 (Ras Matarma); 2169-2, 2170-1 (Et Tur).
	T. Aviv	NS	8391, 8406, 8407, 8411, 8427, 8432, 8433, 8444, 8446 (Ras Matarma); 8457 (El Bilaiyim); 8196 (Ras el Kanisa).
Gulf of Aqaba:	Jerus.	SLR	645-1, 2 (Marsa Abu Zabad).
	T. Aviv	NS	4891, 4906 (Wassit); 4918, 4920, 4961 (Dahab); 1848 (Shurat el Manqata).
Northern R. S.:	Jerus.	SLR	809 (Ras Muhammad).
	T. Aviv	NS	4945 (Marsa el At); 1860 (Ras Muhammad).
	HLM	X2:	2-10 (Gubal Isl.).
		EC	468, 469 (Ras Abu Suma); 493 (Safaga Isl.); 57 (Koseir, duplic. from KLUNZINGER); 287, 509, 510 (Ras Abu Hagar); 1351 (Ghardaqa).
Central R. S.:	HLM	X2:	7-3 (Mayetib Isl.); 8-14 (Shaab Anbar).
	P. Sud.	Sa	110, 112 (Sanganeb R.).
	HLM	RM	113 (Wingate R.).

**Distribution:** It seems that this species is hitherto undoubtedly recorded only from the Red Sea, African Coast, Maldives and Minicoy (PILLAY, 1971). SEWELL (1935) mentioned its presence at Rameswaram, but one of the authors (PILLAI), though collecting corals there for several years, has not come across this in Gulf of Mannar or Palk Bay.

**Remarks:** In spite of the large number of illustrations given by VAUGHAN (1918) of his Cocos-Keeling Islands specimens along with a lengthy discussion on variation, it is not convincing that VAUGHAN's material really belongs to this Red Sea species.

The same is the case with WELL's (1950) material. There is one specimen in USNM (No. 44 314) which is one of WELL's from Cocos-Keeling Islands labelled *A. pharaonis*. This specimen does not belong to the present species and is probably only *A. intermedia*.

### *Acropora nobilis* (DANA), 1846

(Plate 5, Figs. 9, 10)

<i>Madrepora</i>	<i>nobilis</i>	1846, DANA, 481; pl. 40/3 (Type locality: Singapore).
		1864, VERRILL, 40.
		1893, BROOK, 135.



<i>Acropora</i>	<i>nobilis</i>	1925, HOFFMEISTER, 59; pl. 11/1, 2. 1932, THIEL, 126; pl. 20/2. 1974, PILLAI & SCHEER, 453; fig. 3c.
<i>Madrepora</i>	<i>canalis</i>	1886, QUELCH, 150; pl. 9/2, 2a, b.
<i>Acropora</i>	<i>eminens</i>	1906, v. MARENZELLER, 56; pls. 24/78; 18/78a.
	<i>luzonica</i>	1902, VERRILL, 231, pls. 36c/4; 36f/9.
<i>Madrepora</i>	<i>robusta</i> ?	1846, DANA, 475; pl. 39/3.
	<i>secunda</i>	1893, BROOK, 30.

According to MARENZELLER (1906) *A. eminens* is the only true arborescent *Acropora* occurring in Red Sea. A thick-branches clump before us is placed under this species. The branches are 2 to 2.5 cm thick, apices little tapering. Axial corallites 3 to 4 mm in diameter at the top, 1 to 1.5 mm exsert. Septa 12. Radials labellate, inner wall not developed, outer spreading, thick-walled; 2 to 2.5 mm broad, 2 to 4 mm long, openings directed at different directions. Between the larger radials a few smaller labellate subim-mersed corallites are seen.

Material:

Central R. S.: P. Sud. Sa 26 (Sanganeb R.).  
Southern R. S.: HLM EC 350 (Massawa).

Distribution: Red Sea; Ceylon; Southeast coast of India; Andamans; Malacca; Singapore (type locality of *A. secunda*); Philippines (type locality of *A. canalis*); Great Barrier Reef; Solomon Is.; Samoa.

Remarks: An examination of several specimens of this species, collected from Gulf of Mannar by PILLAI, has shown that *A. secunda* (BROOK) and *A. nobilis* (DANA) are one and the same. *A. canalis* and *A. luzonica*, both originally described from Philippines, also fall within the skeletal range of *A. nobilis*. It is very interesting to note that NEMENZO's very extensive treatise of *Acropora* (1967) does not include either of these, though he mentions *A. nobilis*. FAUSTINO (1927) felt that *A. canalis* resembles *A. nobilis*.

One of the present specimens is from Massawa, the same locality from where MARENZELLER (1906) described his *A. eminens*. Examination of large suite of specimens of *A. nobilis* has led to the conclusion that *A. eminens* is the same as *A. nobilis*, any difference between the types being purely accountable on geographic variations. There are not many valid criteria with which these two could be separated.

In the light of the recent work of WALLACE (1978) a few additional comments become necessary. She merged *Madrepora nobilis* DANA with *M. formosa*. We disagree with this view. DANA's type of *M. nobilis* in USNM is certainly different from his *M. formosa*. The nature of the axials and radials of these two are conspicuously different and they are easily separable. If we merge such widely separate forms as one and the same, all the species in *Acropora* as accepted at present become superfluous and invalid. WALLACE also refers *A. luzonica* to *A. aspera*. We do agree that *A. aspera*, *A. hebes* and *A. manni* belong to a single species, but *A. luzonica* is probably more related to *A. nobilis*.

*Acropora baimeii* (MILNE EDWARDS and HAIME), 1860

(Plate 6, Figs. 2, 3)

<i>Madrepora</i>	<i>baimeii</i>	1860, MILNE EDWARDS (& HAIME), 151 (Type locality: Red Sea). 1879, KLUNZINGER 2, 21; pls. 1/9; 5/4; 9/16. 1893, BROOK, 77 (synonymy).
<i>Acropora</i>	<i>baimeii</i>	1906, v. MARENZELLER, 51; pl. 16/45-48. 1918, VAUGHAN, 163, pls. 66/4, 5; 70/3, 3a, b. 1952, CROSSLAND, 207; pls. 33/1; 35/1. 1954, ROSSI, 48. 1967, NEMENZO, 82; pl. 25/1. 1978, WALLACE, 293; pls. 70; 71. 1980, HEAD, 148, 444.

The present specimens are either cespitose or tufted arborescent. It is unnecessary to go into the details of these specimens. They agree to earlier descriptions of KLUNZINGER and MARENZELLER.

EC 53 is one of KLUNZINGER's duplicates from Koseir. It is semiarborescent, attached to the dead branch of another *Acropora*. The nariform radials are 1.5 to 2 mm long; the axials are up to 3 mm in diameter. Apices of branches tapering.

## Material:

- Gulf of Suez: Jerus. SLR 2144-2 (Et Tur).  
 Gulf of Aqaba: Jerus. SLR 1248 (Fara'un Isl.); 461-1, 3, 4 (El Kura).  
 Northern R. S.: HLM EC 494-496 (Safaga Isl.); 53 (Koseir, duplic. from KLUNZINGER);  
 286 (Ras Abu Hagar).  
 Central R. S.: HLM RM 115 (Wingate R.).  
 Southern R. S.: HLM EC 351 (Massawa).

Distribution: Red Sea; Mauritius; Maldives; Ceylon; Singapore; Philippines; Great Barrier Reef; Fiji.

*Acropora nasuta* (DANA), 1846

(Plate 6, Figs. 4, 5)

<i>Madrepora</i>	<i>nasuta</i>	1846, DANA, 453; pl. 34/2 (Type locality: Fiji). 1893, BROOK, 73 (synonymy).
<i>Acropora</i>	<i>nasuta</i>	1971, LOYA & SLOBODKIN, 123. 1978, WALLACE, 297; pl. 78 (synonymy).
<i>Madrepora</i>	<i>cymbicyathus</i>	1893, BROOK, 86 (synonymy).
<i>Acropora</i>	<i>cymbicyathus</i>	1925, HOFFMEISTER, 63; pl. 13/2a, b. 1954, WELLS, 425; pl. 124/5-7.
<i>Madrepora</i>	<i>disticha</i>	1893, BROOK, 84; pl. 33/D.
	<i>effusa</i>	1893, BROOK, 76 (synonymy).

NS 1286 is caespitose. The radials and axials are more or less typical as described by BROOK. NS 1281, represented by two branches, are referable to *var. crassilabia*. The corallum is caespito-corymbose, branches 8-10 mm thick, slightly tapering at the top. Axial corallites 1.5 to 2 mm thick, 1 to 1.5 mm exsert; septa six, poorly developed. Radials ascending, 1.5 to 2.5 mm long. 1.5 to 1.75 mm broad, tip of the outer wall slightly tapering in the form of half a canoe or nariform. Opening oval. Immersed corallites few. Corallites become smaller and verruciform at the basal parts of the branches. Wall solid and echinulate. Dense in section.

NS 4889 is a large entire caespitose corallum with a solid base giving rise to numerous branches 2 to 5 cm high bearing branchlets 1 to 2 cm long and 5 to 8 mm thick. Radials nariform, average 2 mm long and wide. There are two cycles of septa in both the axials and radials. Coenenchyme echinulate.

Material: Gulf of Aqaba: T. Aviv NS 1281, 1286, 1357 (Eilat); 4889 (Wassit).

Distribution: Red Sea; Diego Garcia (type locality of *A. disticha*); Maldives; Lakshadweep (PILLAI unpubl.); Ceylon; East Indies; Philippines (NEMENZO, 1967); Great Barrier Reef; Solomon Is.; Marshall Is., (WELLS, 1954); Samoa; Tahiti.

Remarks: WALLACE (1978) has already merged *A. effusa* (BROOK = ? DANA) and *A. cymbicyathus* with *A. nasuta*, with which the present authors agree. Examination of a fair suite of specimens of this species from the lagoon reef flat of Kiltan Island in the northern Lakshadweep has convinced PILLAI that *A. disticha* (BROOK) also belongs to this species. BROOK's description of DANA's *effusa* shows not much variation from *A. nasuta*. DANA's description of his *effusa* is short and no figure of this in existence. The type is said to be lost. In these circumstances no meaningful purpose will be served by merely retaining a specific name like *effusa*, particularly in a genus like *Acropora*.

*Acropora corymbosa* (LAMARCK), 1816

(Plate 6, Fig. 6; Plate 7, Figs. 1-3)

<i>Heteropora</i>	<i>corymbosa</i>	1834, EHRENBERG, 336.
<i>Madrepora</i>	<i>corymbosa</i>	1879, KLUNZINGER 2, 24; pls. 2/2, 2a, b; 4/1; 8/21; 9/19. 1893, BROOK, 97 (synonymy, type locality: Indian Ocean). 1911, GRAVIER, 70; pl. 9/38.
<i>Acropora</i>	<i>corymbosa</i>	1906, v. MARENZELLER, 32; pls. 1-2/1-8; 3/1a-8a, 9. 1918, VAUGHAN, 171; pl. 67/1.

		1925, HOFFMEISTER, 62; pl. 13/1a-c.
		1932, THIEL, 121; pls. 18/2; 19/2.
		1954, ROSSI, 48; pl. 6/1.
		1954, WELLS, 420; pls. 116/3-6; 117/1, 2.
		1967, SCHEER, 424.
		1971, LOYA & SLOBODKIN, 123.
		1974, MERGNER & SCHUHMACHER, 264.
		1980, HEAD, 148, 443.
<i>Madrepora</i>	<i>cytherea</i>	1879, KLUNZINGER 2, 25; pls. 2/4a, b; 4/2; 9/20.
	(non <i>cytherea</i> )	1846, DANA, 441; pl. 32/3a, b.)

*A. corymbosa* and *A. hyacinthus* are said to be common in Red Sea as is the case in several other parts of the Indo-Pacific. Young colonies of these are often very difficult to separate, especially in view of the wide skeletal variation displayed. However, fully developed adult coralla of these two species differ in the following respects:

	<i>A. corymbosa</i>	<i>A. hyacinthus</i>
Radials about 2 or more mm in diameter, labellate, round-lipped, spreading 45 to 60°, length average 2 mm.		Radials about 1.5 mm in diameter, appressed, ascending lips not always rounded, length 2 to 4 mm.

We have studied EHRENBERG's specimens in Berlin Museum (Nos. 882 and 884). The present material includes many coralla which we place under *A. corymbosa*, they are either entire colonies or parts of vase-form ones.

We are following MARENZELLER (1906) in merging KLUNZINGER's *cytherea* (non DANA's *cytherea*) with *A. corymbosa*. KLUNZINGER reports on long- and thin-lipped calices of his *cytherea* (2, 1879, pl. 9, fig. 20b). We have found, as MARENZELLER, transitional forms between *A. corymbosa* and KLUNZINGER's *cytherea*, for example EC 134 and also some specimens in the collection SCHUHMACHER. Another coral, SCHUHMACHER No. 83, shows a great many of calices with long and acute lips.

Material:

Gulf of Suez:	Jerus. SLR	2249-2, 2938-1, 3040 (Ras el Misalla); 2144-1, 2158-1, 2 (Et Tur).
	T. Aviv NS	8425 (Ras Matarma).
Gulf of Aqaba:	Jerus. SLR	1064 (Fara'un Isl.); 389b (Marsa Murach); 450-1, 2 (El Kura).
	T. Aviv NS	231, 232, 1280-1, 2, 1342, 1367 (Eilat); 4909 (Wassit); 4827 (Ras Atantur); 5124 (Shurat el Manqata).
Northern R. S.:	USNM Wa	13 (Ghardaqa)
	HLM EC	425 (Shadwan Isl.); 54 (Koseir, duplicate from KLUNZINGER); 285, 508 (Ras Abu Hagar).
Central R. S.:	P. Sud. Sa	28 (Sanganeb R.).
	Schuhmacher	83 (Sanganeb R.).
	HLM EC	134 (Sanganeb R.); 1369 (Djiddah).
	RM	7, 63, 114 (Wingate R.).
Southern R. S.:	HLM X2:	9-9 (Sarso Isl.).

Distribution: Red Sea, throughout Indo-Pacific as far east as Tuamotu Archipelago.

*Acropora hyacinthus* (DANA), 1846

(Plate 6, Fig. 7; Plate 7, Fig. 4)

<i>Madrepora</i>	<i>hyacinthus</i>	1846, DANA, 444; pl. 32/2 (Type locality: Fiji).
		1893, BROOK, 107 (synonymy).
<i>Acropora</i>	<i>hyacinthus</i>	1925, HOFFMEISTER, 64; pls. 13/3; 14/1a-d.
		1954, WELLS, 421; pls. 118/3, 4; 120/3-5.
		1971, LOYA & SLOBODKIN, 123.
		1976, PILLAI & SCHEER, 29.
		1978, WALLACE, 288; pls. 63; 64A-C; 65; 66/A, B (synonymy).
<i>Madrepora</i>	<i>arcuata</i>	1893, BROOK, 102; pl. 12.
	<i>armata</i>	1893, BROOK, 68; pl. 4/A, B.

	<i>bifaria</i>	1893, BROOK, 110; pl. 30/A.
	<i>conferta</i>	1886, QUELCH, 164; pl. 10/3, 3a-c.
<i>Acropora</i>	<i>conferta</i>	1954, WELLS, 420; pls. 115/3-5; 116/1, 2.
<i>Madrepora</i>	<i>cytherea</i>	1846, DANA, 441; pl. 32/3a, b.
		1893, BROOK, 99 (synonymy).
<i>Acropora</i>	<i>cytherea</i>	1978, WALLACE, 289; pls. 63; 64/A, D; 66/C, D; 67 (synonymy).
		1980, HEAD, 148, 444.
<i>Madrepora</i>	<i>delicatula</i>	1893, BROOK, 109; pl. 28/D, E.
<i>Acropora</i>	<i>diomedea</i>	1906, VAUGHAN, 69; pls. 7/1, 1a; 8/2, 3.
<i>Madrepora</i>	<i>kenti</i> ?	1893, BROOK, 110; pl. 11/B.
	<i>latistella</i> ?	1893, BROOK, 112; pl. 9/B.
	<i>patula</i>	1893, BROOK, 111; pl. 9/E.
	<i>pectinata</i>	1893, BROOK, 95; pl. 27/D, E.
	<i>reticulata</i>	1893, BROOK, 68; pl. 4/a, b.
<i>Acropora</i>	<i>reticulata</i>	1954, WELLS, 422; pls. 110/4-6; 114/1-6.
		1976, PILLAI & SCHEER, 28; pl. 7/1.
<i>Madrepora</i>	<i>symmetrica</i>	1893, BROOK, 94; pl. 15.
	<i>thurstoni</i>	1893, BROOK, 200; pl. 35/A.

The above list of synonyms is drawn up based on earlier workers as well as a study of this species in the field from South India and Lakshadweep by PILLAI along with a critical examination of BROOK's material in BMNH, and USNM specimens of WELLS (1954) and HOFFMEISTER (1925). WALLACE 1978 separated *A. cytherea* from *A. hyacinthus*, though earlier workers merged them. *A. cytherea* can be a sturdy form of *hyacinthus*, particularly a form developed as a result of muddy condition as seen in Palk Bay along the Indian coast. *Acropora conferta* is a form shaped in clear waters in deeper habitats, and we agree with WALLACE that it is the same as *A. hyacinthus*. One of us (PILLAI) reached this conclusion as early as 1974 while studying this species in Kiltan Island in Lakshadweep. The type of *Madrepora symmetrica* BROOK is an abnormal growth of *A. hyacinthus* probably from a shallow muddy habitat. The type of *M. thurstoni* (BMNH 88.11.25.9) from Rameswaram (kept among the exhibits in 1970 in BMNH) is an entire colony with a thick base from which branches arise. It is only an extreme variation of forma *cytherea*. *A. kenti* and *A. bifaria* are listed by CROSSLAND (1952) under the synonymy of *A. hyacinthus*, though WALLACE (1978) felt that they belong to *A. eurystoma* (vide infra). The types of these two are nearer to *A. hyacinthus* than to *A. eurystoma* and we think that these two should also be placed along with the present species. Yet another species discussed by CROSSLAND (1952) under *hyacinthus* is *A. capillaris* (KLUNZINGER). *A. capillaris* is distinct from *hyacinthus* and we treat it separately.

#### Material:

Gulf of Suez:	HLM	X2:	1-1 (Ras Shukheir).
Gulf of Aqaba:	Jerus.	SLR	492-2 (El Kura).
	T. Aviv	NS	4907 (Wassit); 4960 (Dahab); 4846, 4953, 5123 (Ras Atantur).
Northern R. S.:	Jerus.	SLR	819a (Ras Muhammad).
	T. Aviv	NS	1865 (Ras Muhammad).
	USNM	Wa	19 (Ghardaqa).
Central R. S.:	P. Sud.	Sa	29 (Sanganeb R.).
	HLM	RM	66 (Wingate R.).
		X2:	8-26 (Shaab Anbar).

Distribution: Red Sea throughout Indo-Pacific as far east as Tuamotu Archipelago.

#### *Acropora humilis* (DANA), 1846

(Plate 7, Figs. 5, 6)

<i>Madrepora</i>	<i>humilis</i>	1846, DANA, 483; pls. 31/4; 41/4.
<i>Acropora</i>	<i>humilis</i>	1925, HOFFMEISTER, 60; pl. 11/4.
		1954, WELLS, 425; pls. 100/1; 126/1-6; 127/3, 4; 128/3-5 (synonymy).
		1954, ROSSI, 50.
		1967, SCHEER, 424; figs. 4, 5.
		1971, LOYA & SLOBODKIN, 123.
		1974, MERGNER & SCHUHMACHER, 264.

		1976, PILLAI & SCHEER, 32.
		1978, WALLACE, 300; pls. 81; 82; 83.
		1980, HEAD, 148, 444.
<i>Heteropora</i>	<i>abrotanoides</i>	1834, EHRENBERG, 337 (non LAMARCK).
<i>Madrepora</i>	<i>calamaria</i>	1893, BROOK, 154; pl. 23/A, B.
	<i>canaliculata</i>	1879, KLUNZINGER 2, 12; pls. 1/3; 4/10; 9/8. 1893, BROOK, 151.
<i>Acropora</i>	<i>digitifera</i>	1952, CROSSLAND, 207; pl. 35/2. 1978, WALLACE, 301; pl. 84/A-C.
<i>Madrepora</i>	<i>erythraea</i>	1879, KLUNZINGER 2, 14; pls. 3/5; 4/8; 9/10. 1893, BROOK, 157.
<i>Acropora</i>	<i>erythraea</i>	1954, ROSSI, 51; pls. 6/2; 8/1, 2. 1967, SCHEER, 424.
<i>Madrepora</i>	<i>gemmifera</i>	1893, BROOK, 142; pl. 21.
<i>Acropora</i>	<i>gemmifera</i>	1918, VAUGHAN, 177; pl. 77/1-3.
<i>Heteropora</i>	<i>bempricbi</i>	1876, HAECKEL, 45; pl. 2/6.
<i>Madrepora</i>	<i>ocellata</i>	1879, KLUNZINGER 2, 9; pls. 1/7; 4/14; 9/5. 1889, ORTMANN, 505.
<i>Acropora</i>	<i>ocellata</i>	1906, v. MARENZELLER, 52; pls. 18/81a; 24/81.
<i>Madrepora</i>	<i>pallida</i>	1879, KLUNZINGER 2, 10; pls. 9/6; 10/A.
	<i>paxilligera</i>	1893, BROOK, 74 (synonymy).
	<i>plantaginea</i>	1816, LAMARCK, 279 (non DANA). 1860, MILNE EDWARDS (& HAIME), 149. 1893, BROOK, 156 (synonymy).
	<i>platycyathus</i>	1893, BROOK, 153.
	<i>pyramidalis</i>	1879, KLUNZINGER 2, 12; pls. 1/2; 2/3; 4/6; 9/7; 10/B. 1893, BROOK, 150.
	<i>scherzeriana</i>	1878, BRUEGGEMANN, 397; pl. 8/a, b. 1879, KLUNZINGER 2, 9.
<i>Acropora</i>	<i>scherzeriana</i>	1906, v. MARENZELLER, 41; pls. 12/27-31; 13/27a, 29a, 31a, 32-35; 18/28a. 1918, VAUGHAN, 176; pl. 75/1-4.
<i>Heteropora</i>	<i>seriata</i>	1834, EHRENBERG, 337.
<i>Madrepora</i>	<i>seriata</i>	1860, MILNE EDWARDS (& HAIME), 152. 1893, BROOK, 149 (synonymy).
	<i>vagabunda</i>	1879, KLUNZINGER 2, 15; pls. 1/4; 4/9; 9/11.

WELLS (1954) gave an exhaustive treatment of the species and adopted DANA's specific name *humilis* to this species. LAMARCK's name *plantaginea* appears to be not used by any author since BROOK for any of the *Acropora*. BROOK stated that LAMARCK's types of *Madrepora plantaginea* include several specimens of which one was selected by MILNE EDWARDS & HAIME (1860) and described. MARENZELLER (1906) examined this and remarked that it is a very irregularly developed specimen and is similar to *A. scherzeriana*. One of us (PILLAI) received a good series of photographs of LAMARCK's type in Paris through Professor LEVI in 1969. A critical examination of these photographs shows that *Madrepora plantaginea* is more or less the same as *M. humilis* DANA. But we are not adopting it here because the specific name *humilis* is in continuous use since HOFFMEISTER, 1925, both in taxonomical and ecological works. A reversion to LAMARCK's name would cause more confusion than convenience.

EHRENBERG's *Heteropora seriata* is No. 889 in the Berlin Museum. A recent study of this fair-seized colony showed that it is not at all separable from other forms described under various names, but belonging to *A. humilis*. The same can be applied to EHRENBERG's *Heteropora abrotanoides* (Nos. 894, 895 and 896 in the Berlin Museum). KLUNZINGER's *Madrepora erythraea* is represented by a more slender form with cespitose corallum. We do not think, that *A. erythraea* is genetically different from *A. humilis*. The type of *Madrepora paxilligera* is USNM 249. One of us (PILLAI) studied this species in 1977 and feels that it also falls within the skeletal range of *A. humilis*. We have also studied KLUNZINGER's specimens of *M. canaliculata* (No. 2129), *ocellata* (2114), *pallida* (2128, 2225), *pyramidalis* (2115, 2116) and *vagabunda* (2145, 2224) in the Berlin Museum.

The present collection includes several specimens. They display a wide range of skeletal variation in the thickness of branches and in the size of the radials. However, they fit into the general description of this species given by WELLS (1954).

## Material:

Gulf of Suez:	Jerus.	SLR	2221-3, 2249-1 (Ras el Misalla); 2158-4 (Et Tur).
	T. Aviv	NS	1900 (Et Tur).
	HLM	X2:	1-2 (Ras Shukheir).
Gulf of Aqaba:	Jerus.	SLR	461-2 (El Kura).
	T. Aviv	NS	1274, 1284, 1285, 1366 (Eilat); 1895 (Dahab); 4840, 4850, 4856, 4857, 4873 (Ras Atantur).
	Basel	PW	73 684 (El Kura).
Northern R. S.:	HLM	EC	451 (Eilat).
	T. Aviv	NS	1861 (Ras Muhammad).
	USNM	Wa	99 (without locality, presumedly Ghardaqa).
	HLM	EC	145 (Koseir, duplicate from KLUNZINGER under <i>pyramidalis</i> ); 511, 512, 513 (Ras Abu Hagar).
Central R. S.:	P. Sud.	Sa	111 (Sanganeb R.).
	HLM	RM	64, 65, 68 (Wingate R.).
		X2:	8-2, 8-20 (Shaab Anbar).
Southern R. S.:	HLM	EC	353 (Massawa).

Distribution: Wide spread and common species. Red Sea eastward to Tuamotu and Hawaii (GRIGG, WELLS & WALLACE, 1981).

Remarks: We have added *A. digitifera* to the synonymy list. WALLACE (1978:301) has pointed out that "On the Great Barrier Reef, where *A. digitifera* occurs with *A. humilis*, some colonies cannot be definitely assigned to one or other species on morphological grounds".

*Acropora eurystoma* (KLUNZINGER), 1879

(Plate 7, Fig. 7)

<i>Madrepora</i>	<i>eurystoma</i>	1879, KLUNZINGER 2, 16; pls. 1/8; 4/7a, b; 9/12 (Type locality: Red Sea). 1893, BROOK, 137.
<i>Acropora</i>	<i>eurystoma</i>	1906, v. MARENZELLER, 51. 1971, LOYA & SLOBODKIN, 123. 1974, MERGNER & SCHUHMACHER, 264. 1973, PILLAI, VINE & SCHEER, 458. 1976, PILLAI & SCHEER, 30; pl. 8/3.
<i>Madrepora</i>	<i>anthocercis</i>	1893, BROOK, 106; pl. 13/C.
	<i>dilatata</i>	1893, BROOK, 81.
	<i>macrostoma</i>	1893, BROOK, 105; pl. 19/B.
<i>Acropora</i>	<i>pagoensis</i>	1925, HOFFMEISTER, 71.
	<i>tenuis?</i>	1978, WALLACE, 294; pls. 72, 73. 1980, HEAD, 148, 444.

The following is a generalized description of the present specimens. Corymbose, main branches up to 1 cm thick bearing 2 to 4 branchlets. Axial corallites 3 to 3.5 mm in diameter at the top with a large rounded opening. Wall thin, exsert to 3 mm. Septa 12, primaries larger than the secondaries, often meeting at the centre of the axial fossa. Radials ascending generally outer wall at 45°, nariform, uniform in size, about 4 mm in length, 2.5 to 3 mm in diameter at the top. A few of the larger radials are half tubular and proliferous. Some radials at the basal parts of the branches are subimmersed. There are two cycles of deep-seated septa in the radials. Wall striated, porous.

## Material:

Gulf of Aqaba:	Jerus.	SLR	1261 (Fara'un Isl.); 492-1 (El Kura); 645-3 (Marsa Abu Zabad).
	T. Aviv	NS	1236 (Eilat).
	Basel	PW	73 506 (Eilat).
Northern R. S.:	T. Aviv	NS	1866 (Ras Muhammad).
	USNM	Wa	14, 15 (Ghardaqa).
Central R. S.:	P. Sud.	Sa	5 (Sanganeb R.).

HLM RM 8, 67 (Wingate R.)  
 HLM X2: 8-22 (Shaab Anbar)

Distribution: Red Sea; Seychelles; Diego Garcia; Maldives; Philippines; Great Barrier Reef.

Remarks: WALLACE (1978) included *A. kenti*, *A. bifaria*, *A. dilatata*, *A. macrostoma* and *A. anthocercis* under the synonymy of *A. tenuis* along with *A. eurystoma*. DANA's *tenuis* is not so far figured. WALLACE may be right in merging *A. eurystoma* with *tenuis* DANA. However, we call it *eurystoma*, pending further confirmation. *A. kenti* and *A. bifaria* are more related to *A. hyacinthus* than to *A. eurystoma*. Yet another species, which is a probable synonym of this species, is *Acropora pagoensis* HOFFMEISTER, 1925. The type of *M. coronata* REHBERG was lost during World War II. However, the figures (REHBERG, 1892) clearly indicate its similarity to some of the specimens we have identified here as *A. eurystoma*.

*Acropora variabilis* (KLUNZINGER), 1879

(Plate 8, Figs. 1, 2)

<i>Madrepora</i>	<i>variabilis</i>	1879, KLUNZINGER 2, 17; pls. 1/10; 2/1, 5; 5/1, 3; 9/14 (Type locality: Red Sea). 1893, BROOK, 161.
<i>Acropora</i>	<i>variabilis</i>	1906, v. MARENZELLER, 49; pl. 15/40-44. 1918, VAUGHAN, 181; pl. 80/2, 3, 3a, b. 1952, CROSSLAND, 222; pl. 38/1, 6. 1954, WELLS, 428; pls. 128/1, 2; 130/1, 2. 1954, ROSSI, 52. 1964a, SCHEER, 458. 1971, LOYA & SLOBODKIN, 123. 1974, MERGNER & SCHUHMACHER, 264. 1974, SCHEER & PILLAI, 23; pl. 8/2 (synonymy). 1976, PILLAI & SCHEER, 31. 1978, WALLACE, 299; pl. 80/C, D. 1980, HEAD, 148, 445.

Caespito-corymbose, peripheral branches sometimes prostrate. Main branches possess several branchlets 8 to 10 mm in diameter, 2 to 5 cm long. Apices tapering with a large axial corallite 2.5 to 3 mm in diameter at the top, more at the base. Radial corallites nariform, half tubular, appressed, arranged in longitudinal rows along the long axis of the branches; tips curved, beaked. Openings small but oval. Between the prominent radials there are a few subimmersed corallites. Length of the radials 3 to 5 mm, diameter about 2 mm or more. Wall porous in young, compact in older cases, finely echinulate. Surface coenenchyme reticulate and closely echinulate.

We have seen in Berlin Museum KLUNZINGER's types of his forma *pachyclados* (No. 2118), forma *leptoclados* (No. 2119) and forma *caespitofoliata* (No. 2120). A good suite of specimens before us illustrate the skeletal variation within the species. EC 58, 144 and 146 from Koseir are some of KLUNZINGER's duplicates. X2:8-22 is a corymbose corallum, the underside of the base has branchlets similar to that of the upper side. The branchlets bear numerous proliferations. The radial corallites are tubular or nariform with subimmersed ones intercalated. Larger radials up to 5 mm long and 2.5 mm thick. SLR 645-4 is part of a corymbose corallum with prostrate peripheral branches with flattened underside. The tubular radials at the flattened area of the branches are appressed. This has a strong resemblance to the one figured by MARENZELLER in his plate 15, figure 41a.

Material:

Gulf of Suez:	T. Aviv	NS	8202 (El Bilaiyim); 3207 (Et Tur).
Gulf of Aqaba:	Jerus.	SLR	533-1 (El Kura); 645-4 (Marsa Abu Zabad).
	T. Aviv	NS	1893 (Dahab).
	Basel	PW	73 649, 695 (El Kura).
	HLM	EC	1352 (Aqaba).
Northern R. S.:	HLM	EC	58, 144, 146 (Koseir, duplicates from KLUNZINGER).
Central R. S.:	HLM	EC	1370 (Djiddah).
	HLM	EC	133 (Sanganeb R.).

Distribution: Red Sea; Maldives; Ceylon; Andaman and Nicobar Isls.; Mergui Archipelago; Cocos-Keeling Isls.; Philippines; Great Barrier Reef; Solomon Isls.; Marshall Isls.; Fiji; Samoa; Tuamotu Archipelago.

*Acropora squarrosa* (EHRENBERG), 1834

(Plate 8, Figs. 3, 4)

<i>Heteropora</i>	<i>squarrosa</i>	1834, EHRENBERG, 336.
<i>Madrepora</i>	<i>squarrosa</i>	1879, KLUNZINGER 2, 13; pls. 2/9; 4/12; 9/9 (Type locality: Red Sea). 1893, BROOK, 65 (synonymy).
<i>Acropora</i>	<i>squarrosa</i>	1906, v. MARENZELLER, 46; pl. 14/36-39. 1918, VAUGHAN, 184; pl. 83/2, 2a, b. 1954, WELLS, 427; pl. 129/1, 2. 1954, ROSSI, 52. 1967, SCHEER, 424. 1974, MERGNER & SCHUHMACHER, 264. 1976, PILLAI & SCHEER, 31. 1978, WALLACE, 312; pls. 98, 99, 100 (part).
<i>Madrepora</i>	<i>cancellata</i>	1893, BROOK, 166; pl. 32/C.
	<i>rousseaui</i>	1860, MILNE EDWARDS (& HAIME), 138. 1893, BROOK, 171.
<i>Acropora</i>	<i>rousseaui</i>	1906, v. MARENZELLER, 52; pls. 17/53; 18/53a.

Material:

Gulf of Aqaba:	Jerus.	SLR	1264 (Fara'un Isl.); 1184 (Marsa el Muqeibla).
	T. Aviv	NS	1266, 1283 (Eilat); 3064 (Taba).
Northern R. S.:	USNM	Wa	20 (Ghardaqa).
	HLM	EC	289, 290, 291 (Ras Abu Hagar).
Southern R. S.:	HLM	X2:	13-6 (Sarso Isl.).
		EC	352 (Massawa).

Distribution: Red Sea; Seychelles; Maldives; Philippines; Great Barrier Reef; Murray Isls.; Marshall Isls.; Tahiti.

Remarks: The type of *A. rousseaui* is not hitherto figured. However, MARENZELLER gave a figure of this species. One of our specimens (X2:13-6) is a semiarborescent clump with radiating branchlets that are tapering at the tips. The details of the corallites agree to MARENZELLER's description of *A. rousseaui*. We take *A. rousseaui* as the same as *A. squarrosa*.

WALLACE (1978) merged *A. murrayensis* with the present species, probably following VAUGHAN's (1918) suggestion. It seems that *A. murrayensis* is more related to *A. rosaria* than to *A. squarrosa*. In both the coenenchymal ornamentation is the same. However, the growthform of typical *squarrosa* seems to be different from that of *A. murrayensis*. There are seven specimens in the collection of Berlin Museum labelled *Heteropora squarrosa* which belong to EHRENBERG (Nos. 869, 870, 871, 872, 873, 875 and 898). Among these 871 is only *A. corymbosa* and 898 is similar to the type of *A. forskalii* and not *A. squarrosa*. Another specimen with the same No. 898 is labelled at present *Heteropora forskalii*, but this specimen is only *A. squarrosa*.

*Acropora bempriichi* (EHRENBERG), 1834

(Plate 8, Figs. 5, 6)

<i>Heteropora</i>	<i>bempriichi</i>	1834, EHRENBERG, 33 (Type locality: Red Sea).
<i>Madrepora</i>	<i>bempriichi</i>	1879, KLUNZINGER 2, 6; pls. 1/11; 4/17; 9/1. 1893, BROOK, 173 (synonymy).
<i>Acropora</i>	<i>bempriichi</i>	1906, v. MARENZELLER, 39; pls. 10; 11 (synonymy). 1954, ROSSI, 54. 1967, SCHEER, 424.



		1971, LOYA & SLOBODKIN, 123.
		1974, MERGNER & SCHUHMACHER, 264.
		1980, HEAD, 148, 444.
<i>Madrepora</i>	<i>klunzingeri</i>	1893, BROOK, 148 (synonymy).
	<i>obtusata</i>	1879, KLUNZINGER 2, 7; pls. 1/5; 4/18a, b; 8/20; 9/2.
	<i>pustulosa</i>	1879, KLUNZINGER 2, 8; pls. 1/1; 4/15; 9/4. (non MILNE EDWARDS & HAIME, 1860).
	<i>variolosa</i>	1879, KLUNZINGER 2, 8; pls. 1/6; 4/16; 9/3.

We have a good suite of specimens of this species. They are tufted arborescent with branches 1 to 2 cm thick with branchlets more or less 1 cm thick, 4 to 7 cm long. Axial corallites conical, 3 to 4 mm thick at the top, below at the base up to 6 mm. Opening small, rounded, about 1 mm in diameter, primary septa well developed, secondaries not fully represented. Radial corallites bursiform, uniform, rarely with smaller ones in between, 3 to 4 mm thick and long. Primary septa present, second cycle incomplete. Surface closely echinulate.

EHRENBERG's type is No. 856 in Berlin Museum. EC 56 is from Koseir and is one of KLUNZINGER's duplicates, labelled *Madrepora hemprichi*. EC 55 from Koseir, also a KLUNZINGER specimen and labelled *M. obtusata*, as well as KLUNZINGER's types of *obtusata* (No. 2113 in Berlin Museum), *variolosa* (No. 2111) and *pustulosa* (No. 2112) show no major variation in the details of the corallites. The main differences in the present suite of specimens are in the size of the radials. X2:10-9 is part of an arborescent branch. The radials are only 2 mm in length and width, though essentially bursiform.

Material:

Gulf of Aqaba:	Jerus.	SLR	1257 (Fara'un Isl.); 362-1-5 (Marsa Murach); 1183-1, 2 (Marsa el Muqeibla); 643-1, 2 (Marsa Abu Zabad); 2385-1 (El Gharqana).
	T. Aviv	NS	234, 1339, 1370, 1372 (Eilat); 1931 (Marsa Murach); 4890 (Wassit); 4991, 4992 (Dahab).
	Basel	PW	73 650, 661, 662, 687 (Dahab); 2 sp. without No and locality).
	HLM	EC	452 (Eilat).
Northern R. S.:	Jerus.	SLR	1927 (Ras Muhammad).
	T. Aviv	NS	3200 (Ras Muhammad).
	USNM	Wa	18 (Ghardaqa).
	HLM	X2:	2-13, 3-5 (Gubal Isl.)
	HLM	EC	52, 55, 56 (Koseir, duplic. from KLUNZINGER).
Central R. S.:	P. Sud.	Sa	2 (Sanganeb R.).
	HLM	RM	9, 10, 10a (Wingate R.).
Southern R. S.:	HLM	X2:	10-9 (Sarso Isl.).

Distribution: Red Sea; East coast of Africa; Mascarene Archipelago; Maldives; Minicoy (PILLAI, 1971); Ceylon (BROOK); Great Barrier Reef; Solomon Isls.

*Acropora forskali* (EHRENBERG), 1834

(Plate 9, Fig. 1)

<i>Heteropora</i>	<i>forskalii</i>	1834, EHRENBERG, 337 (Type locality: Red Sea).
<i>Madrepora</i>	<i>forskali</i>	1860, MILNE EDWARDS (& HAIME), 150. 1879, KLUNZINGER 2, 17; pls. 3/6; 5/2; 9/13. 1893, BROOK, 170.
<i>Acropora</i>	<i>forskali</i>	1906, v. MARENZELLER, 51; pls. 17/51, 52; 18/51a, 52a. 1954, ROSSI, 53. ? 1976, PILLAI & SCHEER, 30; pl. 8/1, 2.

The present collection includes a few specimens that we place under this species. The corallum is apparently caespito-corymbose. Branches 10 to 12 mm thick bearing smaller branchlets, tips obtuse. Axial corallites about 4 mm in diameter, openings about 1 mm. Septa 12, primaries almost meeting at the centre of the fossa. Radial corallites nariform, ascending, 1.5 to 2 mm thick, 3 to 4 mm long. A few larger and proliferous. At the base of the branches the radials are smaller and subimmersed. Radials have generally six septa.

## Material:

Gulf of Suez: Jerus. SLR 3009-1 (Ras Matarma).

Northern R. S.: USNM Wa 16 (Ghardaqa).

Distribution: Red Sea; Persian Gulf.

Remarks: The present authors (PILLAI and SCHEER, 1976) described and figured a specimen from Maldives under the present specific name. However, a comparison with the types in Berlin Museum (Nos. 897 and 899) makes us think that we have been mistaken in the determination. The Maldivian specimen is probably only *A. elseyi*. No. 898 in Berlin Museum labelled *Heteropora forskalii* is only *Acropora squarrosa*. But another specimen with the same number (898), labelled *H. squarrosa*, is similar to *A. forskali*. *Acropora cerealis* (DANA, non BROOK) is very near to *A. forskali*. Their relationship remains to be ascertained.

*Acropora granulosa* (MILNE EDWARDS and HAIME), 1860

(Plate 8, Figs. 7, 8)

<i>Madrepora</i>	<i>granulosa</i>	1860, MILNE EDWARDS (& HAIME), 156 (Type locality: Réunion).
		1893, BROOK, 189.
<i>Acropora</i>	<i>granulosa</i>	1978, WALLACE, 313; pls. 101, 102 (synonymy).
<i>Madrepora</i>	<i>clavigera</i>	1893, BROOK, 183; pl. 9/A, A'.
<i>Acropora</i>	<i>clavigera</i>	1952, CROSSLAND, 226; pls. 40/2; 42/3.
	<i>eibli</i>	1976, PILLAI & SCHEER, 32; pl. 10/1,2.
	<i>massawensis</i>	1906, v. MARENZELLER, 54; pls. 17/49, 50; 18/49a, 50a (Type locality: Red Sea).
		1954, ROSSI, 53; pls. 5/2; 8/3, 4.
<i>Madrepora</i>	<i>rayneri</i>	1893, BROOK, 191; pl. 8/A.
<i>Acropora</i>	<i>rayneri</i>	1954, WELLS, 431; pls. 134/6; 137/1,2.
<i>Madrepora</i>	<i>speciosa</i>	1886, QUELCH, 163; pl. 10/1, 1a, b.

The present identification is based on WALLACE (1978). The corallum is prostrate, main branches flattened, at the underside with a few immersed corallites. Branchlets at the upper side short, thick and tapering, sometimes with thick conical axials. Axial corallites generally thick, 2 to 3 mm in diameter and just so long, rarely up to 5 mm exsert. At the underside a few twigs with appressed beaked radials are present. Radials nariform, 2 to 3 mm long and broad, a few are larger. On the main branches a few radials are verruciform and subimmersed. Primary septa visible, deep-seated both in the axials and radials. Openings rounded, small. The surface is closely and profusely echinulate. The species is characterized by prostrate, coalescent corallum with short upper branchlets, prominently exsert axials and nariform radials with a profusely echinulate coenenchymal surface.

## Material:

Gulf of Aqaba: Basel PW 71 315, 306 (Eilat, 40 m), 73 610 (Eilat, 45-50 m);  
73 564 (Fara'un Isl.); 1 sp. without No and locality.

HLM EC 1353-1355 (Aqaba).

Northern R. S.: USNM Wa 17 (Ghardaqa).

Central R. S.: HLM EC 1371 (Djiddah).

Distribution: Red Sea; Mascarene Archipelago; Réunion; Maldives; Minicoy; Nicobar Is.; China Sea; Great Barrier Reef; Marshall Islands; Fiji; Tahiti.

Remarks: The type of this species is not yet figured. WALLACE (1978) gives good illustrations of various specimens she collected. She has already merged *A. speciosa* and *A. clavigera* with *A. granulosa*. It seems *A. tenella* (BROOK), *A. rambleri* (BASSETT-SMITH) and *A. confraga* (QUELCH) are falling within the skeletal range of this species. We (PILLAI & SCHEER, 1976) described a new species from Maldives, viz. *A. eibli*. However, it seems that *A. eibli* is also a variant of *A. granulosa*. *A. massawensis* MARENZELLER from Red Sea, as far as we could judge from his description and figures, is only corymbose growth of the present species.

*Acropora capillaris* (KLUNZINGER), 1879

(Plate 9, Figs. 2, 3)

*Madrepora capillaris* 1879, KLUNZINGER 2, 29; pls. 3/4; 4/13; 9/23 (Type locality: Red Sea).  
1893, BROOK, 80.

X2:8–21 from Shaab Anbar is almost typical as described by KLUNZINGER. A part of his type is No. 2317 in Berlin Museum. Our specimen is only a piece of a subarborescent colony with two main branches arising from a small base. Total height 16 cm. Branchlets numerous, radiating, 1.5 to 3 cm long, 3 to 6 mm thick. The tips of branchlets tapering to an axial corallite, 2 to 2.5 mm in diameter and just as much exsert. The corallum has a bottle-brush appearance as in *A. echinata*. Radial corallites half-tubular or nariform, inner wall almost undeveloped, outer wall ascending, placed at 45°, 1 to 1.5 mm in diameter, 1 to 3 mm long. A few of the radials are tubular and proliferous and are up to 5 mm long. Primary septa well developed, directives very broad. Second cycle of septa spiny. Surface striated and echinulate. Older parts of the corallum pitted. Dense in section.

Another specimen (EC 288) is entire with many branches arising from a base. The radial corallites are tubular in many cases and proliferous, 4 to 6 mm long.

## Material:

Gulf of Suez: T. Aviv NS 8416, 8423 (Ras el Kanisa).  
Gulf of Aqaba: Jerus. SLR 1249 (Fara'un Isl.).  
T. Aviv NS 3063 (Taba).  
Basel PW 73 611 (Fara'un Isl., 40 m).  
Northern R. S.: HLM X2: 2–16 (Gubal Isl.).  
HLM EC 288 (Ras Abu Hagar).  
Central R. S.: HLM EC 1372 (Djiddah).  
P. Sud. Sa 27 (Sanganeb R.).  
HLM RM 11 (Wingate R.).  
HLM X2: 8–13, 8–21 (Shaab Anbar).

Distribution: Red Sea.

Remarks: CROSSLAND (1952) felt that *A. capillaris* groups with *A. byacanthus*. But these are two distinct forms, and *A. capillaris* is near *A. echinata* in growth form.

Additional remarks to further *Acropora* species from Red Sea mentioned in literature:

*Madrepora bottae* 1893, BROOK, 139.

BROOK gives with "?" *Madrepora pharaonis* MILNE EDWARDS & HAIME, 1860, 143 (part), as synonym, but states that the specimen, although labelled "*pharaonis*", "is so unlike the types of that species, that it seems improbable MILNE EDWARDS would have included it under that name". The species is not figured and its position is uncertain.

*Madrepora tuberculosa* 1888, FAUROT, 119.

BROOK (1893:55) puts this coral with a "?" to *M. tuberculosa* MILNE EDWARDS & HAIME, 1860, 135. "The position of this species is uncertain" (BROOK), the type is lost and no figure exists.

*Madrepora valida* DANA 1893, BROOK, 168.

BROOK gives as synonym *M. verrucosa* and refers to FAUROT 1888, 119, with "?" and mentions as locality "? Red Sea". However, *M. verrucosa* from FAUROT was not recorded from Red Sea but from Gulf of Aden. Therefore *M. valida* is no Red Sea coral.

*Madrepora superba* 1897, KLUNZINGER 2, 19.

KLUNZINGER quoted EHRENBERG's *Heteropora laxa* (non LAMARCK) as synonym of his *M. superba* and mentioned that this coral, though the label shows the Red Sea as locality, could come from the Westindies, because a Westindian shell was found between the branches.

BROOK (1893:25) put *H. laxa* as well as *M. superba* in the synonymy of *M. muricata* forma *cervicornis* from the Westindies. Now *M. superba* was found by MOEBIUS (1880) at Mauritius and by FAUROT (1888) in the Gulf of Aden; other Indopacific corals, e.g. *M. secunda* from Singapore, referred to by ORTMANN (1888), did not scarcely differ from *cervicornis*. For that reason BROOK stated: "It has there-

fore seemed advisable to regard all as variations of one species, common to the Atlantic and Indo-Pacific Oceans”.

MARENZELLER (1901:122) refused BROOK's "prekäre Theorie der Ubiquität" and gave another interpretation in the description of his new species *Acropora eminens* (1906:56). He shared BROOK's opinion that KLUNZINGER's *M. superba* is *M. muricata* from the Westindies. He supposed that EHRENBURG's specimens of *H. laxa* were lost in course of time and only a label remained, which was placed on an *Acropora* where it does not belong. MARENZELLER stated: "Durch diese Aufklärung wird der Annahme, *A. muricata* lebe auch im Roten Meere, der Boden entzogen."

We do not agree neither with MARENZELLER nor with BROOK, but rather suppose KLUNZINGER's specimen of his *M. superba* comes really from Red Sea. After a comparison with other arborescent species we consider it as related to *Acropora nobilis*.

Because the types of *M. superba* and *H. laxa* could not be found in the Museum at Berlin, the position of *M. superba* is still uncertain.

*Heteropora laxa* 1834, EHRENBURG, 334.

Here we agree with BROOK and put this species provisionally to *Acropora cervicornis*.

#### Genus *Montipora* de BLAINVILLE, 1830

Type species: *Montipora verrucosa* QUOY & GAIMARD, 1833.

Generic characters: Encrusting, massive, foliaceous or ramose. Axial corallite absent. Corallites more or less 1 mm in diameter, fundamentally without elevated thecal wall. Septa in two cycles. A true columella absent.

BERNARD (1897) arranged the 142 species dealt with by him under four major heads, based on the nature of the surface coenenchyme, as to glabrous, foveolate, papillate and tuberculate. Among these truly glabrous forms of *Montipora* are hitherto not recorded from Red Sea. The following is an artificial key to the 12 species of *Montipora* known from Red Sea and discussed herein.

#### Synopsis of *Montipora* from Red Sea:

- A. Surface coenenchyme swells up either in the interstices or around the calices as ramparts or foveolations.
  1. Corallum encrusting or submassive. Calices 0.7 to 1 mm in diameter, surrounded by foveolations. Septa 12. . . . . *M. venosa*
- B. Interstitial coenenchyme forms conical, nipple-shaped or rounded projections as papillae, which remain either single or run together.
  - I. Corallum massive or encrusting. Surface with or without nodular coalescent branches.
    - a) Papillae irregular, three or four fuse to form excrescences.
      2. Individual papillae 1 to 1.5 mm thick and high. 3 to 5 papillae fuse to form small excrescences bearing calices; in between the coenenchym is smooth. Calices 0.6 to 0.7 mm. . . . . *M. spumosa*
      3. Papillae more or less 1 mm in height and thick. They fuse to form sharp crests. Interstices with flame-like small papillae. Calices average 0.5 mm, inconspicuous. Surface without nodular branches. . . . . *M. tuberculosa*
      4. Individual papillae 1 to 1.5 mm thick and 2 to 3 mm high. Often fuse to form ridges. Some areas with foveolations. Calices 0.6 to 0.7 mm, hidden from view. . . . . *M. monasteriata*
    - b) Papillae more regular, nipple-shaped or rounded with or without fusion forming ridges.
      5. Papillae nipple-shaped. Individual ones occupy the entire interstices. On branches, when developed, they unite to form ridges 2 to 3 mm high. Calices 0.6 to 0.8 mm in diameter with a wall. Septa six. . . . . *M. verrucosa*
      6. Papillae bursiform or rounded, 3 to 7 mm in diameter and height, often run together to form meandroid ridges. Calices very conspicuous, more or less 1 mm. . . . . *M. meandrina*

II. Corallum essentially ramose with or without coalescence.

7. Branches fuse to form close-set inverted cone-shaped columns. At the sides of the columns papillae absent. On the top of the columns papillae squeeze out, prominent ones 2 to 3 mm thick and high. Calices 0.6 to 0.7 mm. . . . . *M. edwardsi*
8. Top of branches flattened. Corallum short. Papillae form a labellate lower wall to the corallite. Calices 1 mm in diameter with 12 septa. . . . . *M. spongiosa*
9. A crowded cluster of stunted branches. Papillae inconspicuous, but form labellate lower wall to the corallite. Calices 0.5 to 0.7 mm, about 1 mm apart. The coral looks highly spinulose under the lens. . . . . *M. gracilis*
10. Arborescent. Papillae 1 to 2 mm, conical, either in close proximity to calyx or occupying the interstices. 2 to 3 of them may often fuse together. . . . . *M. circumvallata*
- C. Interstices with flame-like or grain-like frosted tubercles, sometimes in close proximity with calices.
11. Encrusting, surface with close-set gibbosities. Tubercles short, rounded at the top. Calices 0.6 to 0.8 mm, appear as projecting. . . . . *M. stilosa*
12. Foliaceous, surface with lobulations or a crowded cluster of coalescent branches. Tubercles often fuse to form low ridges. Calicular rim looks elevated. . . . . *M. ebrenbergi*

A. Foveolate species of *Montipora*.

Corallum encrusting or submassive, calices surrounded by foveolations.

*Montipora venosa* (EHRENBERG), 1834

(Plate 9, Figs. 4, 5)

<i>Porites</i>	<i>venosa</i>	1834, EHRENBERG, 342 (Type locality: Red Sea).
<i>Montipora</i>	<i>venosa</i>	1897, BERNARD, 69; pl. 32/15 (synonymy).
		1906, v. MARENZELLER, 63; pls. 21/66-68; 23/66a-68a.
		1907, BEDOT, 274; pls. 46/260-262; 47/263-266.
		1918, VAUGHAN, 153; pl. 63/3.
		1925, HOFFMEISTER, 50; pl. 6/2a, b.
		1952, CROSSLAND, 188; pls. 26/5; 27/5; 28/7.
		1954, ROSSI, 45.
		1971, LOYA & SLOBODKIN, 123.
		1974, SCHEER & PILLAI, 27; pl. 11/4.
		1980, HEAD, 148, 446.
	<i>colei?</i>	1954, WELLS, 437; pl. 146/1, 2.
<i>Manopora</i>	<i>planiuscula</i>	1846, DANA, 507; pl. 47/3, 3a.
<i>Montipora</i>	<i>verrucosa</i>	1897, KLUNZINGER 2, 35; pls. 5/14, 15; 6/10; 10/7 (non LAMARCK).

Corallum encrusting or hillocky. Calices about 1 mm (EC 470) or only 0.7 mm (EC 471), conspicuous, placed in deep funnel-like depressions formed of coenenchymal foveolations around the well cut-out wall. Individual papillae almost absent. They almost run together to form low ridges. Septa 12, primaries subequal fuse together to form a pseudo-columella. Surface of the corallum with gibbosities, rarely with conical projecting papillae. Surface under the lens reveals a spiny reticulum.

Material:

Gulf of Suez:	T. Aviv	NS	8384, 8685 (Ras el Kanisa).
Gulf of Aqaba:	T. Aviv	NS	1885, 4976, 4996 (Dahab); 4836 (Ras Atantur).
	Basel	PW	73 528 ? (Eilat, 6 m).
Northern R. S.:	T. Aviv	NS	1876 (Ras Muhammad).
	USNM	Wa	31 (Ghardaqa).
	HLM	EC	470, 471 (Ras Abu Suma); 60 (duplicate from KLUNZINGER as <i>verrucosa</i> ), 148 (Koseir).

Distribution: Red Sea; Persian Gulf; Gulf of Mannar; Nicobar Islands; East Indies; Great Barrier Reef; Marshall Is.; Fiji; Samoa; Cook Is.

Remarks: BERNARD (1897) opined that the specimens described by KLUNZINGER from Red Sea under the names *M. verrucosa* and *M. tuberculosa* are the same as *M. venosa*. However, a closer study of KLUNZINGER's duplicate in HLM and of EHRENBERG's type of *venosa* (No. 952) in Berlin Museum shows

that KLUNZINGER's *M. tuberculosa* is more or less similar to *M. monasteriata* (FORSKAL), while his *M. verrucosa* corresponds with *M. venosa*.

DANA's type of *Manopora planiuscula* (USNM No. 311) is a fragment about 5 cm in greater spread, but its similarity to EHRENBERG's type of *venosa* is evident.

The type of *M. colei* WELLS (USNM 44744) is likely to be an ecomorph of *M. venosa*.

## B. Papillate species of *Montipora*.

### I. Corallum massive or encrusting with or without nodular branches.

#### a) Papillae irregular.

### *Montipora spumosa* (LAMARCK), 1816

(Plate 9, Figs. 6, 7)

<i>Porites</i>	<i>spumosa</i>	1816, LAMARCK, 273 (Type locality: not recorded).
<i>Montipora</i>	<i>spumosa</i>	1897, BERNARD, 71; pls. 8/1; 11; 32/16 (synonymy). 1907, BEDOT, 277; pl. 48/267-270. 1918, VAUGHAN, 154; pl. 63/2, 2a. 1950, WELLS, 41. 1969, PILLAI, 419.
<i>Manopora</i>	<i>erosa</i>	1846, DANA, 504; pl. 46/5, 5a.
<i>Montipora</i>	<i>lanuginosa</i>	1897, BERNARD, 75; pls. 13; 32/20.
	<i>lobulata</i>	1897, BERNARD, 76; pls. 14; 16/1; 33/1. 1971, LOYA & SLOBODKIN, 123.

There is a submassive corallum in the present collection, the surface rises into small lobulations bearing calices and papillae. Edges of the corallum creeping. Calices on an average 0.6 mm in diameter, 1 mm apart, like irregular punctures not well cut out from the surrounding coenenchyme. Septa 6, directives larger. Papillae about 1 to 2 mm thick and high on level regions, fused forming clusters on lobulations. The specimen resembles the one figured by BERNARD in his plate 14 under the name *lobulata*.

#### Material:

Gulf of Aqaba: T. Aviv NS 1276, 1-4 (small fragments, Eilat); 1922 (Marsa Murach).

Distribution: Red Sea; Mauritius (type locality of *M. lanuginosa*); Diego Garcia; Gulf of Mannar; Cocos-Keeling Is.; East Indies; Great Barrier Reef; Lacépède Is. (NW Australia); Fiji (type locality of *M. erosa*); Cook Is. (STODDART & PILLAI, 1973).

Remarks: The first record of *M. spumosa* from Red Sea is that of WELLS in LOYA & SLOBODKIN (1971, as *lobulata*). The present specimens agree in every respect with *M. lanuginosa* as described and figured by BERNARD. A careful comparison of the British Museum specimens labelled by BERNARD as *M. spumosa*, *M. lanuginosa* and *M. lobulata* showed that there exists practically little difference among them to warrant separation.

The type of *Manopora erosa* DANA is USNM 308. It is a fragment but its identity with *M. spumosa* is clear. BERNARD treated *M. erosa* along with his glabrous forms.

### *Montipora tuberculosa* (LAMARCK), 1816

(Plate 9, Fig. 8)

<i>Porites</i>	<i>tuberculosa</i>	1816, LAMARCK, 272 (non KLUNZINGER), (Type locality not known).
<i>Montipora</i>	<i>tuberculosa</i>	1897, BERNARD, 112 (synonymy). 1889, ORTMANN, 498. 1925, HOFFMEISTER, 51; pl. 6/3a-c. 1954, WELLS, 436; pls. 144/3, 4; 146/8. 1971, LOYA & SLOBODKIN, 123. 1974, MERGNER & SCHUHMACHER, 265. 1980, HEAD, 149, 446.
	<i>conicula</i> ?	1954, WELLS, 436; pl. 146/3, 4.
	<i>sinensis</i> ?	1897, BERNARD, 109; pls. 19/3; 33/11. 1976, PILLAI & SCHEER, 35.

The history of the record of *M. tuberculosa* from Red Sea is as follows. KLUNZINGER described and figured specimens under the present specific name. However, as correctly pointed out by BERNARD, KLUNZINGER's *tuberculosa* is not the same as *M. tuberculosa* of LAMARCK. According to MARENZELLER (1906) KLUNZINGER's *tuberculosa* corresponds with *M. monasteriata* (FORSKAL), a fact that was confirmed by GRAVIER (1911). Again in 1971 WELLS listed (in LOYA & SLOBODKIN) *M. tuberculosa* from Gulf of Eilat.

Our present identification is based on HOFFMEISTER's treatment of *M. tuberculosa*. The specimens which we place under this species are all encrusting forms with a surface at places rising to small gibbositities. Calices range from 0.3 to 0.5 mm in diameter, inconspicuous, like pin-holes. Septa 12, crowded, filling the fossa. Papillae (better called tubercles?) 0.75 to 1 mm in thickness and height. Papillae often fuse together to form crests as described by HOFFMEISTER. In one of the specimens (SLR 399-2) the corallites are up to 0.7 mm in diameter.

The species is characterized by an encrusting corallum with small calices, crowded septa, small papillae often fusing to form small crests.

Material:

Gulf of Aqaba:	Jerus.	SLR	399-1, 2 (Marsa Murach); 491 (El Kura).
	T. Aviv	NS	4896, 4899 (Wassit); 1892b, 4934 (Dahab).
Northern R. S.:	USNM	Wa	30 (Ghardaqa).
	HLM	X2:	2-33 (Gubal Isl., 9 m).
Central R. S.:	P. Sud.	Sa	71 (Sanganeb R., 6 m).
	HLM	RM	20, 20a (Wingate R.).
	HLM	X2:	8-5 (Shaab Anbar).

Distribution: Red Sea; Aldabra; Mascarenes (FAURE, 1977); Maldives; Southeast India (PILLAI, 1972); Japan; Marshall Isls.; Samoa.

Remarks: *M. sinensis* BERNARD is possibly based on a young corallum of the present species.

The type of *M. conicula* WELLS, 1954 (type USNM 44742) is an encrustation with many tube-dwelling animals on it, which have altered the morphology. It is not far away from *M. tuberculosa*, also recorded from Marshall Islands.

*Montipora monasteriata* (FORSKAL), 1775

(Plate 10, Figs. 1, 2)

<i>Madrepora</i>	<i>monasteriata</i>	1775, FORSKAL, 133 (Type locality: Red Sea).
<i>Montipora</i>	<i>monasteriata</i>	1860, MILNE EDWARDS (& HAIME), 208.
		1897, BERNARD, 137.
		1906, v. MARENZELLER, 61; pl. 22/76.
		1941, CROSSLAND, 34; pl. 6 (synonymy).
		1971, LOYA & SLOBODKIN, 123.
		1974, MERGNER & SCHUHMACHER, 265.
		1980, HEAD, 149, 446.
	<i>tuberculosa</i>	1879, KLUNZINGER 2, 32; pls. 5/13; 6/4; 10/4 (non LAMARCK).

FORSKAL's original material has been redescribed by CROSSLAND (1941) discussing the synonymy to a great length. The present identification is based on CROSSLAND. It is not necessary to go into details since it is rather difficult for us to give a better treatment of this species than CROSSLAND. One of our specimens (RM 70) is submassive due to repeated encrustation. The calices, which are hidden from view by the overgrowing papillae, are 0.6 to 0.7 mm in diameter with 12 septa. The papillae remain either single (1 to 1.5 mm thick at the base and up to 3 mm high) or three to five of them unite to form short ridges.

Material:

Gulf of Aqaba:	T. Aviv	NS	1254, E55/548w (Eilat); 4818 (Ras Atantur).
Northern R. S.:	HLM	EC	61 (Koseir, duplicate from KLUNZINGER as <i>tuberculosa</i> ), 147 (Koseir).
Central R. S.:	HLM	RM	21, 21a, 70 (Wingate R.).
	P. Sud.	SA	24 (Sanganeb R.).

Distribution: Red Sea; Gulf of Mannar (PILLAI, 1972).

Remarks: BERNARD (1897) felt that KLUNZINGER's *Montipora tuberculosa* (non LAMARCK) is the same as *M. venosa*. But both MARENZELLER (1906) and CROSSLAND (1941) regarded it to correspond with *M. monasteriata*. KLUNZINGER (1879) actually was uncertain of FORSKAL's species, and what he described under *M. monasteriata* is only *M. circumvallata* of EHRENBERG (MARENZELLER, 1906).

Two of the specimens in HLM, EC 61 and 147 (locality Koseir, EC 61 is a duplicate from KLUNZINGER), are labelled *M. tuberculosa*. They are encrusting forms. The calices are about 0.5 to 0.6 mm in diameter. The papillae are small, about 1 mm in height and thickness with the characteristic fusion among themselves. These specimens are also referable to *M. monasteriata*. In none of the present specimens the upward branches are developed.

B. I. b) Papillae nipple-shaped or rounded, single or forming short ridges.

*Montipora verrucosa* (LAMARCK), 1816

(Plate 10, Figs. 3, 4)

<i>Porites</i>	<i>verrucosa</i>	1816, LAMARCK, 271 (non KLUNZINGER).
<i>Montipora</i>	<i>verrucosa</i>	1897, BERNARD, 103; pl. 19/2 (synonymy). 1901, STUDER, 417. 1907, VAUGHAN, 160; pls. 53-59. 1911, GRAVIER, 88; pl. 12/53. 1952, CROSSLAND, 193. 1954, WELLS, 438; pls. 143/6, 7; 147/3. 1967, NEMENZO, 18; pl. 5/2. 1971, LOYA & SLOBODKIN, 123.
	<i>capitata</i>	1886, QUELCH, 176.

EC 245 is a crowded cluster of branches. Calices very inconspicuous, 0.5 mm in diameter, six septa. Papillae uniform in size, conical, only 1.5 mm thick and high. Occasionally the papillae run together.

EC 358 is a fresh growth on a dead initial encrustation. The upper surface has small nodular and digitiform gibbositities. Papillae occupy the entire intercalicular area, 1.5 to 2 mm thick and high, rarely two or three of them run together. Calices 0.5 mm in diameter with six well-developed septa.

EC 391 is a branching corallum attached to a colony of *Synarea*. The details of calices and papillae are similar to those of EC 358.

Material:

Northern R. S.: USNM Wa 32, 33, 102 (Ghardaqa).

HLM EC 245 (without exact locality).

Southern R. S.: HLM EC 358, 391a (attached to *Porites iwayamaensis*) (Massawa).

Distribution: Red Sea; Somaliland; Aldabra (ROSEN, 1971); Madagascar (PICHON, 1964); Réunion (FAURE, 1977); Gulf of Mannar (PILLAI, 1972); Philippines; Great Barrier Reef; Marshall Is.; Fiji; Fanning Isl.; Hawaii.

*Montipora meandrina* (EHRENBERG), 1834

(Plate 10, Figs. 5, 6)

<i>Porites</i>	<i>maeandrina</i>	1834, EHRENBERG, 342 (Type locality: Red Sea).
<i>Montipora</i>	<i>maeandrina</i>	1897, BERNARD, 100; pl. 19/1 (synonymy). 1906, v. MARENZELLER, 64; pl. 22/72. 1954, ROSSI, 45; pl. 7/1-3. 1971, LOYA & SLOBODKIN, 123.
	<i>danae</i>	1897, BERNARD, 101; pl. 20 (synonymy). 1954, WELLS, 438; pl. 147/1, 2. 1967, NEMENZO, 38; pl. 12/3. 1971, LOYA & SLOBODKIN, 123. 1974, MERGNER & SCHUHMACHER, 265. 1976, PILLAI & SCHEER, 35. 1980, HEAD, 149, 446.



*rus* 1860, MILNE EDWARDS (& HAIME), 209.  
1879, KLUNZINGER 2, 36; pls. 5/5; 6/9; 10/8.  
1888, ORTMANN, 155.

Several specimens in the present material are referable to this species. The growthform varies as to encrusting, plate-like, massive with hillocks or even branching.

NS 4922 is part of a submassive corallum with a surface rising to hillocks. The papillae run together for considerable distance enclosing corallites between the valleys. The ridges thus formed are 4 to 6 mm thick and high. A few papillae remain free and are conical or rounded in shape. Calices about 1 mm in diameter with 12 septa.

SLR 381 (also SLR 1187 and PW 71 342) are thick digitiform or flattened branches up to 9 mm in height and 2.5 mm in width. The papillae run together. The primary septa often fuse at the centre of the calicinal fossa.

SLR 1176 is an encrusting growth with surface rising to small gibbosities. Papillae 3 to 4 mm thick and up to 7 mm high. SLR 353 is a circular disc-shaped specimen with a greater spread of 20 cm. It is formed of repeated encrustations. The papillae mostly remain single and are more or less similar to *M. danae* BERNARD.

The outstanding feature of this species are the large papillae which generally run together to form ridges and valleys enclosing conspicuous large calices. In general the calices are deep, open and about 1 mm in diameter, but in some specimens (SLR 1176) they are smaller, 0.7 mm only. In one specimen, Wa 103 from USNM, the papillae are not developed at all. It is a massive growth.

Material:

Gulf of Suez:	T. Aviv	NS	8380, 8418 (Ras el Kanisa).
Gulf of Aqaba:	Jerus.	SLR	1245* (Fara'un Isl.); 353*, 381 (Marsa Murach); 1176, 1187 (Marsa el Muqeibla); 487-1, 2 (El Kura); 654-2, 3*, 656 (Marsa Abu Zabad).
	T. Aviv	NS	1246*, 8371 (Eilat); 1923, 3067 (Marsa Murach); 4903 (Wassit); 4910, 4922, 4969 (Dahab).
	Basel	PW	73 516, 73 550 (Eilat); 71 341, 71 342 (40m), 73 545 (7m) (Fara'un Isl.); 73 638 (El Kura, 30-33 m).
	HLM	EC	1359-1362 (Aqaba).
Northern R. S.:	Jerus.	SLR	2172-1* (Sharm el Moya).
	USNM	Wa	51a (attached to <i>Porites lutea</i> ), 103 (Ghardaqa).
	HLM	X2:	2-33 (Gubal Isl., 9 m).
Central R. S.:	P. Sud.	Sa	14, 57 (14 m), 58a (15 m, attached to <i>Gyrosmilium interrupta</i> ), 59 (13 m) (Sanganeb R.).
	HLM	RM	69 (Wingate R.). (*f. <i>danae</i> )

Distribution: The known distribution of *M. meandrina* is limited to Red Sea and Somaliland. However, forma *danae* is widely known from the Indo-Pacific.

Remarks: From a close and critical study of the material at hand as well as of several others labelled as *danae* from different parts of the Indian Ocean we are of the opinion that *M. danae* MILNE EDWARDS & HAIME is the same as *M. meandrina*. The difference is mainly in the growthform and in the size of the calices. However, there are specimens in the present material that show characters intermediate between the two. It is also worth mentioning that some specimens of *M. meandrina* show a tendency towards branching forms grading in *M. spongiosa*, though retain conspicuous papillae. The relationship of *M. meandrina* to *M. spongiosa* is still an open question.

B. II. Papillate *Montipora* with ramose or tufted branching coralla.

*Montipora edwardsi* BERNARD, 1897

(Plate 10, Figs. 7, 8)

<i>Montipora</i>	<i>edwardsi</i>	1897, BERNARD, 78; pls. 8/3; 33/14 (Type locality: Red Sea).
	<i>confusa</i>	? 1967, NEMENZO, 14; pl. 3/1, 2.
	<i>multilobata</i>	? 1860, MILNE EDWARDS & HAIME, 214 (after BERNARD).

We have examined one specimen from the collection of USNM that we place under this species. At first we thought that it is an extreme form of *Montipora divaricata*. However, its similarity to BERNARD's type of *M. edwardsi* in BMNH is very clear. The following are the details of this specimen.

Ramose, several crowded branches from a narrow base, lower part dead, living zone 3 to 5 cm from top. Base of branches narrow (1 cm), rounded, upper portions expanded, coalescent, but there is no column formation as in the type. At the top they are all fused into a platform giving rise to tiny branchlets (papillae) 0.5 to 1 cm high. Greater spread of the colony 16 cm, total height 12 cm. Calices 0.6 to 0.7 mm in diameter, 1 to 1.5 mm apart, a well defined wall absent. Primary septa conspicuous, the directives often fuse together. Second cycle of septa spiny, 2 to 4 in number. Lower down the branches the surface coenenchyme is mostly glabrous, while at the top both foveolations and papillae-like structures become conspicuous at the distal parts. In many cases the papillae occupy half of the lower wall of the corallite. The papillae are well formed at the top of the corallum where the branches fuse to form a level platform. Under the lens the coenenchyme reveals plate-like granules with secondary spinules.

Material:

Northern R. S.: USNM Wa 22 (Ghardaqa).

Distribution: Red Sea; Taiwan (KAWAGUTI, 1953); Philippines ?.

Remarks: *M. confusa* NEMENZO appears to be not far away from *M. edwardsi*. It is very likely that they are one and the same. We have seen only one specimen of *M. edwardsi* and we are unable to give further comments.

*Montipora spongiosa* (EHRENBERG), 1834

(Plate 10, Figs. 9, 10)

<i>Porites</i>	<i>spongiosa</i>	1834, EHRENBERG, 339 (Type locality: Red Sea).
<i>Montipora</i>	<i>spongiosa</i>	1879, KLUNZINGER 2, 38; pls. 5/10; 6/3; 10/10 (synonymy). 1892, ORTMANN, 657. 1897, BERNARD, 86.

One of our specimens, EC 293, is only part of a corallum with ramose, coalescent branches. The proximal parts of the branches flattened, almost plate-like, distal parts with digitiform branchlets. Calices conspicuous, deep and open, more than 1 mm in diameter, 1 to 2 mm apart. First cycle of septa thickened, directives fuse at the middle, secondaries 2 to 4. The septa are very clearly visible to the naked eye. The papillae are developed at the underside of the corallites, and in some cases they resemble the labellate radials of some *Acroporae*. The surface under the lens reveals a closely set reticulum with fine echinulations. Washed and dried coral yellow.

EC 294 is a flattened, plate-like part of a corallum. The papillae are better developed than in EC 293. Another specimen, Wa 28 from USNM, has a total height of 15 cm, composed of flattened branches with digitiform branchlets. Some of the papillae are mammiform and are confined to the lower part of the wall. Other details as in EC 293.

Material:

Gulf of Aqaba: T. Aviv NS 6339 cf. (Eilat).

Northern R. S.: USNM Wa 28 (Ghardaqa).

HLM EC 293, 294 (Ras Abu Hagar).

Distribution: Red Sea. GRAVELY (1927) mentioned the occurrence of this species in Gulf of Mannar as very common. However, the species that are common in his collection at present are only *M. divaricata* and *M. digitata*. *M. spongiosa* is not seen there.

Remarks: The species is well defined. The conspicuous corallites with well developed thick septa are marked features that easily distinguish it from *M. circumvallata*. EHRENBERG's type in Berlin Museum has the No. 930.

*Montipora gracilis* KLUNZINGER, 1879

(Plate 10, Figs. 11, 12)

<i>Montipora</i>	<i>gracilis</i>	1879, KLUNZINGER 2, 37; pls. 5/12; 6/7; 10/9 (Type locality: Red Sea). 1897, BERNARD, 85.
------------------	-----------------	--

There are two specimens in the present collection. They are composed of crowded clusters of repeatedly dividing branches, that undergo fusion. The lower part is dead, total height in one 8 cm, in the other only the living zone is preserved and is 4 cm high. Calices 0.5 to 0.75 mm in diameter. Septa 12, primaries subequal. Calices about 1 mm apart. The wall at the lower half of the corallite projects in the form of papillae. Under the lens the coenenchyme reveals a fine reticulum with slender spines that give a rough appearance to the coral.

Material:

Gulf of Suez: T. Aviv NS 8678, 8684 (El Bilaiyim).

Distribution: Red Sea; Cook Islands (STODDART & PILLAI, 1973).

Remarks: The present specimens agree to the type in Berlin Museum (No. 2137). It is very likely that the present species is only a skeletal variation of *M. circumvallata*. The absence of free papillae is the major difference from *M. circumvallata* as is pointed out by KLUNZINGER.

*Montipora circumvallata* (EHRENBERG), 1834

(Plate 11, Figs. 1, 2)

<i>Porites</i>	<i>circumvallata</i>	1834, EHRENBERG, 339 (Type locality: Red Sea).
<i>Montipora</i>	<i>circumvallata</i>	1897, BERNARD, 87 (synonymy).
		1906, v. MARENZELLER, 62; pls. 21/70; 23/70a.
		1967, SCHEER, 426.
		1980, HEAD, 148, 446.
<i>Madrepora</i>	<i>abrotanoides</i>	1828, AUDOUIN (& SAVIGNY), 55; pl. 4/4.
<i>Montipora</i>	<i>abrotanoides</i>	1897, BERNARD, 110 (synonymy).
<i>Porites</i>	<i>crista galli</i>	1834, EHRENBERG, 340.
<i>Montipora</i>	<i>crista galli</i>	1860, MILNE EDWARDS (& HAIME), 211.
		1879, KLUNZINGER 2, 34; pls. 5/6; 6/1; 10/5.
		1897, BERNARD, 84.
		1967, NEMENZO, 17; pl. 5/1.
	<i>densa</i> ?	1906, v. MARENZELLER, 62; pl. 21/69, 69a.
	<i>monasteriata</i>	1879, KLUNZINGER 2, 34; pls. 5/9; 6/2; 10/6 (non FORSKAL).
	<i>nudiceps</i>	1879, KLUNZINGER 2, 33.

The material we place under this species superficially looks like a heterogeneous assemblage. In general the growthform is ramose, but some are arborescent and others are tufted cespitose with coalescent branches, sometimes fusing to semi-solid masses. We take a few examples to describe the skeletal variation.

EC 357 is semi-arborescent with a total height of 12 cm and greater spread of 18 cm. The main branch divides to form many branches, upper branchlets either digitiform or a little flattened as in some specimens of *M. divaricata*. The calices at the lower branches and main divisions small, average 0.5 mm in diameter, but larger and more conspicuous at the distal parts of the branches, where they are 0.7 to 0.8 mm in diameter. Septa in two cycles, primaries often meet at the centre of the fossa. The lower part of the calices possesses projecting papillae either in the form of a crescent or in some cases they form a ring around the calyx, 1 to 1.5 mm thick and high. The papillae resemble the labellate corallites of some *Acroporae*, particularly *A. millepora*. At certain parts the papillae are free, that is without close relation to calices, and they are conical, 1 to 2 mm thick at the base and just so in height. Two or three such papillae may fuse to form excrescences bearing calices, giving a rough appearance to the branch surface.

EC 356 is also arborescent. But in this specimen the papillae are sometimes up to 3 mm thick and high. At the lower part of the main divisions papillae are not developed and the surface looks smooth.

These two specimens differ from others in the collection in having arborescent coralla with well developed papillae. They agree in several respects to BERNARD's description of *M. abrotanoides*.

NS 8405 has a cespitose corallum with branches expanding towards the top and fusing each other to form flat plates. The top of the branches bears smaller crispate branchlets. Calices 0.5 to 0.6 mm in diameter, 1 to 1.5 mm apart; septa 12. At the older parts of the branches papillae are not well formed. In younger parts the lower wall of the corallites project, giving a nariform appearance. They are 1 to 1.5 mm in height and thickness at the base.

NS 8398 is only part of a colony. It is a fused mass of branches in the form of an inverted cone, almost similar to BERNARD's *M. edwardsi*. The sides of the cone are mostly smooth. The papillae are very conspicuous at the top of the cone, between them minute calices (0.3 to 0.5 mm) are seen.

Material:

Gulf of Suez:	T. Aviv	NS	8398, 8399, 8405 (Ras Matarma); 8462 (El Bilaiyim); 8198 (Ras el Kanisa).
Gulf of Aqaba:	Jerus.	SLR	379 (Marsa Murach).
	T. Aviv	NS	1351, 6343 (Eilat); 1934 (Marsa Murach).
Northern R. S.:	USNM	Wa	105 (Ghardaqa).
	HLM	EC	422 (Koseir); 246, 247 (without exact locality).
Southern R. S.:	HLM	X2:	13-2, 3, 4 (Sarso Isl.).
		EC	356, 357, 359 (Massawa).
Without local.:	HLM	EC	167 (Red Sea).

Distribution: Red Sea; Philippines.

Remarks: The following species with arborescent or tufted corallum and papillae are known from Red Sea: *M. abrotanoides*, *M. circumvallata* (EHRENBERG's type in Berlin Museum is No. 931), *M. crista galli*, *M. densa*, *M. edwardsi*, *M. gracilis*, *M. nudiceps* and *M. spongiosa*. Among these *M. spongiosa* has large corallites that are wide apart with foveolate coenenchyme along with papillae. The affinity of *M. spongiosa* as far as the calicular details are concerned is more with *M. meandrina*. In fact some of the specimens which we place under *M. meandrina* could form a link between *M. spongiosa* and *meandrina*. Only further observations in the field will settle their status. *M. abrotanoides* (= *M. nudiceps* DANA) is a little known species. BERNARD's description is positively fitting with some of our specimens described here, and we take this as the same as *M. circumvallata*. MARENZELLER (1906) has already merged *M. crista galli* with *M. circumvallata*. We put also with some doubts MARENZELLER's *M. densa* (No. 4486 in Berlin Museum) to the present species. We have described two specimens under the name *gracilis* maintaining the distinction pointed out by KLUNZINGER. However, it is likely that *M. gracilis* should fall within the skeletal range of *M. circumvallata*. Yet another species that merits consideration here is *M. edwardsi* BERNARD. Though we have recognized it here as valid species, its status is not beyond doubt. *M. edwardsi* could be an extreme form of growth of *M. circumvallata*. The squeezing out of the papillae at the top of the fused cones in *M. edwardsi*, which BERNARD stresses very much, can be due to the fusion of the growing edges of the branches, whereas the papillae are better developed in *M. circumvallata*.

NEMENZO (1967) described some new species closely related to *M. circumvallata* from the Philippine waters, such as *M. coalita*, *M. hirsuta*, *M. inconstans*, *M. malampaya* and *M. strigosa*. The differences among themselves appear to be only mere skeletal variations which should be expected in two different coralla of the same species. We think all the above mentioned species of NEMENZO are only variations of one species which is the same as *M. circumvallata*, though we have not studied any of his type specimens.

C. Tuberculate species of *Montipora*.

*Montipora stilosa* (EHRENBERG), 1834

(Plate 11, Figs. 3-7)

<i>Porites</i>	<i>stilosa</i>	1834, EHRENBERG, 342 (Type locality: Red Sea).
<i>Manopora</i>	<i>stilosa</i>	1846, DANA, 500.
<i>Montipora</i>	<i>stilosa</i>	1860, MILNE EDWARDS (& HAIME), 211.
		1879, KLUNZINGER 2, 30; pls. 5/7; 6/5; 10/1.
		1888, ORTMANN, 156.
		1897, BERNARD, 115.
		1974, MERGNER & SCHUHMACHER, 265.
		1980, HEAD, 149, 447.

The type of this species is No. 951 in Berlin Museum. EC 59 in HLM is from Koseir, one of KLUNZINGER's duplicates labelled *M. stylosa*. It is an encrustation. EC 292 is about 18 cm in greater spread. The surface rises into hillocks or gibbositities. SLR 648 is a multi-layered encrustation.

In general the calices range from 0.6 to 0.8 mm in diameter, more than 1 mm apart. Septa in two cycles, directives very broad. The rims of the calices are a little elevated, a feature well stressed by KLUNZINGER. The tubercles are small, grain-like, those close to the calices being slightly larger than those of the interstices. There are 6 to 8 tubercles around the calices, bases of which are fused, with their tips remaining free. The tubercles have no definite relation with the calices. The grain-like tubercles in the interstices give a rough look to the coral. In fact the tubercles are thickened in some specimens and grade towards papillae (as applied by BERNARD), and in this respect this species is an intermediate or transitional stage between papillate and tuberculate *Montipora*.

The outstanding features of this species are the encrusting corallum with small (2 to 3 cm high and thick) gibbositities, grain-like rounded tubercles and distant calices.

One of our specimens (NS 5003) is an encrustation with lobulations. The calices are 0.6 to 0.7 mm in diameter and are 1.5 to 3 mm apart. The second cycle of septa is incomplete. The tubercles are in the form of papillae about 1 mm high, 1.5 to rarely 2 mm thick at the base and scattered. There are not so many tubercles around the calices as is usual in this species. We at first took this specimen to be a hitherto undescribed species. However, we refrain from naming it, since we are not fully aware of the skeletal variation within *M. stilosa*. But we feel that there is sufficient justification to call it by a new variety name *eilatensis*.

Material:

Gulf of Aqaba:	Jerus.	SLR	352 (Marsa Murach); 648 (Marsa Abu Zabad); 2385-4 (El Gharqana).
	T. Aviv	NS	1238-1-3, 1245, 1259-1, 2* (Eilat); 3202, 4965, 5003*, 5010 (Dahab); 4855 (Ras Atantur).
	Basel	PW	73 526 (Eilat).
	HLM	EC	1356-1358 (Aqaba).
Northern R. S.:	USNM	Wa	29, 104 (Ghardaqa).
	HLM	EC	59 (duplicate from KLUNZINGER), 149 (Koseir), 292 (Ras Abu Hagar).
Central R. S.:	HLM	EC	1378a (attached to <i>Favia laxa</i> , Djiddah). (*var. <i>eilatensis</i> )

Distribution: Red Sea.

*Montipora ehrenbergi* VERRILL, 1872

(Plate 11, Figs. 8, 9)

<i>Montipora</i>	<i>ehrenbergii</i>	1872, VERRILL, 386 (in DANA's Corals and Coral Islands). 1925, HOFFMEISTER, 52; pl. 7/1. 1927, FAUSTINO, 253; pl. 81/1, 2. 1967, NEMENZO, 36; pl. 12/1.
	<i>erythraea</i>	1906, v. MARENZELLER, 58; pls. 22/73, 74; 23/73a, 74a. 1952, CROSSLAND, 193; pls. 24/2-4; 27/1, 2. 1954, ROSSI, 44. 1967, NEMENZO, 39; pl. 12/1. 1971, LOYA & SLOBODKIN, 123. 1974, MERGNER & SCHUHMACHER, 265. 1980, HEAD, 149, 447.
<i>Porites</i>	<i>foliosa</i>	1834, EHRENBERG, 341 (non PALLAS), Type locality: Red Sea).
<i>Montipora</i>	<i>foliosa</i>	1860, MILNE EDWARDS (& HAIME), 212.
	<i>solanderi</i>	1897, BERNARD, 152; pl. 29. 1967, NEMENZO, 41.
	<i>trabeculata</i>	1897, BERNARD, 148; pls. 27/2; 34/9.
	<i>tuberosa</i>	1879, KLUNZINGER 2, 32; pls. 5/8; 6/6; 10/3 (synonymy). 1897, BERNARD, 136. 1967, SCHEER, 426; fig. 6.
	<i>villosa</i>	1879, KLUNZINGER 2, 31; pls. 5/11; 6/8; 10/2. 1897, BERNARD, 116.

This species is very well represented in the collection by means of several specimens from different localities. We give below a general description of the species based on the present suite of material.

Corallum explanate in young stage, foliaceous in adult, folia arranged one above the other in the form of a rosette. Upper side of the folia level in young stage, rising to gibbositities or digitiform branches up to 10 cm high. Branches 2 to 5 cm thick either remain single or undergo fusion to form a cluster. Generally the surface coenenchyme looks rough due to the presence of excrescences with prominent tubercles. Calices on an average 0.75 mm in diameter, rarely 1 mm, a diameter apart. Conspicuous, look elevated due to the presence of fused tubercles around. Septa in two cycles, primaries larger than the secondaries. Tubercles slender, tips pointed, 2 mm high, about 1 mm thick, around the calices they fuse to form a tube elevating the fossa a little bit. The tubercles at the interstices are slightly shorter than those associated with the calicular wall. The surface of the coral has a rough appearance. At the periphery of the folium the tubercles run together to form short wavy ridges.

**Material:**

Gulf of Suez:	Jerus.	SLR	3050 (Ras el Misalla).
	T. Aviv	NS	8390, 8392, 8393 (Ras Matarma); 8458, 8464, 8466, 8467, 8468 (El Bilaiyim); 8201 (Ras el Kanisa).
Gulf of Aqaba:	T. Aviv	NS	8374 (Eilat).
Northern R. S.:	USNM	Wa	23, 24, 25, 26, 27, 27a (Ghardaqa).
	HLM	EC	248 (without exact locality).
Southern R. S.:	HLM	X2:	9-5 (Sarso Isl.).
		EC	354, 355, 426 (Massawa).
Central R. S.:	HLM	EC	1373-1375 (Djiddah).

**Distribution:** Red Sea; East Africa; Mauritius; Rodriguez; Java; Philippines; Great Barrier Reef, Solomon Islands; Fiji; Samoa.

**Remarks:** From a study of the material mentioned above along with BERNARD's types in BMNH we have drawn up the above list of synonyms. Between KLUNZINGER's *M. tuberosa* and *M. villosa* (both based on EHRENBERG's *Porites foliosa*, Berlin Museum Nos. 945, 948, 949) there is little difference except in the development of branches. The type of *M. tuberosa* (Berlin No. 945) is exactly similar to some of our present specimens which could be placed along with *M. erythraea*. *M. solanderi* BERNARD is a foliaceous corallum, where the upward growth of branches has not fully taken place. The relationship of this upward growth of branches has not fully taken place. The relationship of this species to *M. foliosa* is similar to that of *Echinopora horrida* to *E. lamellosa*. We do not think that *M. erythraea* MARENZELLER is separable from *M. foliosa* of EHRENBERG (non PALLAS). The first available name to this species is *ebrenbergi*, mentioned already by BERNARD (1897) under his *M. tuberosa*.

Additional remarks to further species of *Montipora* mentioned from Red Sea in literature:

In his recent treatise on the corals of the Sudanese Red Sea HEAD (1980) reports on three more *Montipora* species:

*Montipora granulosa* BERNARD, 1897

<i>Montipora</i>	<i>granulosa</i>	1879, BERNARD, 21; pls. 1/2; 31/3. 1952, CROSSLAND, 181; pls. 25/1, 4; 27/4. 1954, WELLS, 434; pl. 142/1, 2. 1980, HEAD, 148, 445.
------------------	------------------	---

Eight specimens, mainly from deep water. This is the first record for the Red Sea.

*Montipora effusa* (DANA), 1846

<i>Montipora</i>	<i>effusa</i>	1897, BERNARD, 144; pls. 25/2; 27/1. 1974, MERGNER & SCHUHMACHER, 265. 1980, HEAD, 149, 447.
------------------	---------------	--

Two specimens.

*Montipora verrilli* VAUGHAN, 1907

*Montipora*      *verrilli*      1907, VAUGHAN, 168; pls. 63/2, 2a, b; 64/1, 1a.  
 1954, WELLS, 438; pls. 145/3, 5; 148/1, 2; 179/4.  
 1980, HEAD, 149, 447.

This is the first Red Sea record.

Another species, *Montipora granulata* BERNARD, 1897, is listed by LOYA & SLOBODKIN (1971: 123) and MERGNER & SCHUHMACHER (1974: 265) in their checklists without descriptions and figures. HEAD (1980: 447) assumes that *M. granulata* (not *granulosa*) is a junior synonym of EHRENBERG'S *M. stilosa*.

LOYA & SLOBODKIN (1971: 123) list also *M. composita* CROSSLAND (1952: 195; pls. 28/1, 5; 29/1, 3, 4). HEAD supposes (1980) that this species is close to *M. verrilli* VAUGHAN.

## 2. Suborder Fungiina VERRILL, 1865

## Superfamily Agariciidae GRAY, 1847

## Family Agariciidae GRAY, 1847

Synopsis of the genera of Agariciidae considered herein:

- A. Corallum encrusting, foliaceous, columnar or ramose, uni- or bifacial. Corallite centres well distinct. Septo-costae confluent between centres with serrated or beaded edges. Columella styliform. Thecal wall usually not projecting. . . . . *Pavona*
- B. Corallum encrusting or foliaceous, unifacial. Corallites distinct, wall projecting on one side of the calyx. Septo-costae confluent between calices. A central mother calyx often visible around which secondary calices are arranged. . . . . *Leptoseris*
- C. Corallum encrusting, unifacial, hydnochoroid with long valleys and collines. Columella lamellar. Septa close together, continuous over the collines. . . . . *Pachyseris*
- D. Corallum encrusting or massive. Corallites polygonal, deep, wall acute. Septa of higher cycles join those of lower ones, before the latter unite with a central styliform columella situated at the centre of a small circular axial fossa. . . . . *Gardineroseris*

Genus *Pavona* LAMARCK, 1801

Type species: *Madrepora cristata* ELLIS & SOLANDER, 1786 (= *Madrepora cactus* FORSKAL, 1775).

Generic characters: Hermatypic, encrusting, columnar, foliaceous or branching, bifacial or unifacial. Calicular wall not differentiated. Septa confluent between adjacent centres with beaded or serrated edges and granular sides. Septa alternating in size. Columella styliform or compressed.

Key to the identification of *Pavona* from Red Sea:

- A. Corallum explanate, encrusting getting massive.
1. Distance between calicinal centres 2 to 4 mm. Septo-costae strikingly alternating. . . . . *P. explanulata*
- B. Corallum foliaceous or encrusting, getting massive.
2. Surface with collines arranged in longitudinal or meandroid rows, or surface hydnochoroid. . . . . *P. varians*
- C. Corallum foliaceous.
- I. Unifacial, attached by one edge.
3. Surface with acute collines, arranged in longitudinal and transverse series. . . . . *P. yabei*

- II. Bifacial.
4. Fronds up to 10 mm thick, very broad, non-crispate. Ambulacra flat. Carinae may or may not be developed. . . . . *P. decussata*
5. Fronds up to 5 mm thick, edges crispate, curled. Septo-costae low, larger and smaller ones may or may not alternate. Carinae not conspicuous. . . . . *P. cactus*
- D. Corallum columnar.
6. Corallites projecting at lower part of the corallum, mostly rounded. . . . . *P. maldivensis*
- E. Corallum branching.
7. Branches stout, keeled, angular. Carinae acute. . . . . *P. divaricata*

*Pavona explanulata* (LAMARCK), 1816

(Plate 11, Figs. 10, 11)

<i>Agaricia</i>	<i>explanulata</i>	1816, LAMARCK, 244 (Type locality: Indian Ocean).
<i>Lophoseris</i>	<i>explanulata</i>	1860, MILNE EDWARDS (& HAIME), 69; pl. D11/2a, b.
<i>Pavonia</i>	<i>explanulata</i>	1879, KLUNZINGER 3, 74; pl. 9/8.
<i>Pavonia</i>	<i>explanulata</i>	1922, v. d. HORST, 418; pl. 31/9.
		1971, LOYA & SLOBODKIN, 123.
		1976, PILLAI & SCHEER, 39; pl. 16/3 (synonymy).
		1980, HEAD, 149, 449.
	<i>cf. explanulata</i>	1980, VERON & PICHON, 17; figs. 26-34; 732, 733 above.
	<i>gardineri</i> ?	1922, v. d. HORST, 420; pl. 31/5, 6.
		1971, LOYA & SLOBODKIN, 123.

KLUNZINGER (1879) recorded this species from Red Sea, later on LOYA & SLOBODKIN (1971) and HEAD (1980) have collected it. We could study three specimens from the Maldives but only one from the Red Sea, found at the Sanganeb Reef in a depth of seven meters.

After LAMARCK's description (1816) *P. explanulata* is expanded and partly encrusting. But KLUNZINGER (1879) states that the colonies are flat, encrusting or elevated in gibbositities, and his fig. 8, pl. 9, shows such a hillocky growthform. This specimen comes very near to *P. maldivensis*, whose skeletal variations are discussed in detail by GARDINER (1905). It needs further work to prove if these two species are identical.

*P. gardineri* HORST (1922) is not far from *P. explanulata* and might turn out to be one and the same. The calicular characters of *P. explanulata* and *P. clavus* DANA are very similar, particularly in the alternating broad and narrow septa, but the two species differ in growthform.

Material:

Central R. S.: P. Sud. Sa 99 (Sanganeb R.).

Distribution: Red Sea; Aldabra; Madagascar (PICHON, 1964); Mascarenes (FAURE, 1977); Maldives; Ceylon; Andamans (PILLAI, 1972); Cocos-Keeling Isls.; Funafuti (Ellice Isls.).

*Pavonia varians* VERRILL, 1864

(Plate 12, Figs. 1, 2)

<i>Pavonia</i>	<i>varians</i>	1864, VERRILL, 55 (Type locality: Hawaii).
<i>Pavonia</i>	<i>varians</i>	1922, v. d. HORST, 419; pl. 31/3,4.
		1952, CROSSLAND, 162; pls. 13/1, 2; 14/4.
		1964, SCHEER, 428.
		1971, LOYA & SLOBODKIN, 123.
		1974, SCHEER & PILLAI, 29 (synonymy).
		1976, PILLAI & SCHEER, 40.
		1980, VERON & PICHON, 26; figs. 47-54; 735.
		1980, HEAD, 149, 448.
<i>Pavonia</i>	<i>percarinata</i>	1883, RIDLEY, 258.
<i>Lophoseris</i>	<i>repens</i>	1878, BRUEGGEMANN, 395; pl. 7/1.
<i>Pavonia</i>	<i>repens</i>	1879, KLUNZINGER 3, 75; pl. 9/3.
		1905, GARDINER, 946; pl. 90/9-11.



The species is one of the easily identifiable *Pavona* by virtue of its strongly developed longitudinal, sinuous or hydno-phoroid collines. The present skeletons display very little range of variation in the details of the calices and septal numbers.

Material:

- Gulf of Aqaba: Jerus. SLR 393 (Marsa Murach); 1984-4 (Ras el Burqa); 654-1 (Marsa Abu Zabad).  
 T. Aviv NS 4808 (Ras Atantur).  
 Basel PW 73 551 (Eilat); 73 607 (Fara'un Isl.); 73 660a (attached to *Porites solida*),  
 73 701 (El Kura).  
 Northern R. S.: HLM X2: 2-31, 3-2 (15 m) (Gubal Isl.).  
 EC 164 (Koseir).  
 Central R. S.: P. Sud Sa 81, 89, 103 (Sanganeb R.).  
 HLM RM 78, 80a (attached to *Favia laxa*) (Wingate R.).  
 X2: 8-10, 8-16, 8-17 (Shaab Anbar).

Distribution: Red Sea eastward throughout Indo-Pacific to Panama.

*Pavona yabei* PILLAI and SCHEER, 1976

(Plate 12, Fig. 3)

- |                   |              |   |
|-------------------|--------------|---|
| <i>Pavona</i>     | <i>yabei</i> | 1976, PILLAI & SCHEER, 39; pl. 16/1, 2 (Type locality: Maldives). |
| <i>Leptoseris</i> | <i>yabei</i> | 1980, VERON & PICHON, 62; figs. 104-114; 743, 744.                |

There are five specimens from Red Sea that we place under this species. They show no major structural variation from the holotype described by us. The coralla are unifacial, underside with ridges. The longitudinal and transverse collines are acute and well developed. However, they differ from the type in having less developed columellar styles.

Material:

- Gulf of Aqaba: Jerus. SLR 666-1-3 (Marsa Abu Zabad).  
 T. Aviv NS 1852 (Shurat al Manqata).  
 Basel PW 71 329 (Eilat, 40 m).

Distribution: Red Sea; Maldives; Great Barrier Reef (VERON & PICHON, 1980).

*Pavona decussata* (DANA), 1846

(Plate 12, Fig. 4)

- |                   |                  |  |
|-------------------|------------------|--|
| <i>Pavonia</i>    | <i>decussata</i> | 1846, DANA, 329; pl. 22/4 (Type locality: Fiji). |
| <i>Pavona</i>     | <i>decussata</i> | 1921, v. d. HORST, 74.                           |
|                   |                  | 1925, HOFFMEISTER, 40; pl. 4/1 (synonymy).       |
|                   |                  | 1936, YABE, SUGIYAMA & EGUCHI, 56; pl. 39/4-6.   |
|                   |                  | 1952, CROSSLAND, 161.                            |
|                   |                  | 1967, SCHEER, 428; fig. 8.                       |
|                   |                  | 1971, LOYA & SLOBODKIN, 123.                     |
|                   |                  | 1973, PILLAI & SCHEER, 469.                      |
|                   |                  | 1980, VERON & PICHON, 13; figs. 16-25; 731.      |
|                   |                  | 1980, HEAD, 149, 448.                            |
| <i>Pavonia</i>    | <i>angularis</i> | 1879, KLUNZINGER 3, 72; pl. 9/7.                 |
|                   |                  | 1906, v. MARENZELLER, 89; pls. 23/80a; 24/80.    |
|                   | <i>crassa</i>    | 1846, DANA, 331; pls. 23/2; 24/1.                |
|                   |                  | 1924, MATTHAI, 54.                               |
| <i>Lophoseris</i> | <i>cristata</i>  | 1860, MILNE EDWARDS (& HAIME), 66.               |
| <i>Pavonia</i>    | <i>lata</i>      | 1846, DANA, 330; pl. 23/1.                       |
|                   |                  | 1924, MATTHAI, 54; pls. 7/6; 8/1.                |
| <i>Pavona</i>     | <i>lata</i>      | 1974, PILLAI & SCHEER, 457; fig. 4a.             |

EC 361 is a fairly large colony, 17 cm in spread. The lower part is dead. Fronds about 3 mm thick at the growing edge, getting to 8 mm at the base. Width 4 to 5 cm. Tops of adjacent fronds united by transverse connections. Carinae present at certain places. Calices arranged in irregular rows; distance between adjacent columella centres 1.5 to 2.5 mm; 14 to 18 septo-costae around the fossa, alternating in height; septa edges and sides granular. Distance between adjacent rows of calices 2 to 3 mm.

X2: 10–14 is a cluster of folia, fronds only 1.5 cm wide. The details of calices as in EC 361. In both the specimens the ambulacra are flat.

Material:

Southern R. S.: HLM EC 361 (Massawa).

X2: 10–14 (Sarso Isl.).

Distribution: Red Sea; Somaliland; Madagascar; Rodriguez (as *P. lata*); Réunion; Gulf of Mannar (PILLAI, 1972); Cocos-Keeling Isls.; Andamans (MATTHAI, 1924); Mergui Archipelago; Str. of Malacca; East Indies; Philippines; Palau Isls.; Caroline Isls.; Great Barrier Reef; Fiji; Samoa.

Remarks: VAUGHAN (1918) thought *P. angularis* and *P. laxa* of KLUNZINGER are the same as *P. danai* MILNE EDWARDS & HAIME, while HORST (1921) only identified *laxa* with *danai* and considered *P. angularis* a synonym of *P. decussata*. HOFFMEISTER (1925) merged *P. danai* with *P. decussata*, a course which helped VAUGHAN and HORST in uniformity. CROSSLAND (1941), while writing on FORSKAL's corals, felt that *decussata* and *danai* are different and agreed that FORSKAL's *cactus* is the same as *P. danai* (vide infra). We feel *P. angularis* is more or less the same as *P. decussata*, while *P. danai* is the same as *P. cactus*.

DANA's types of *P. crassa* (USNM 222 and 223) differ from his *P. lata* (type USNM 194) in the possession of thicker and heavier fronds. In both the ambulacra are flat without conspicuous carinae. *P. decussata* is said to differ from *lata* and *crassa* in the presence of better developed carinae. However, in *P. crassa* are signs of carinae similar to that of *P. decussata*. From a study of a good suite of specimens of foliaceous *Pavona* from various parts of the Indo-Pacific we are tempted to believe that *P. crassa* and *P. lata* are only skeletal variants of *P. decussata*.

*Pavona cactus* (FORSKAL), 1775

(Plate 12, Figs. 5, 6)

<i>Madrepora</i>	<i>cactus</i>	1775, FORSKAL, 134 (Type locality: Red Sea).
<i>Pavonia</i>	<i>cactus</i>	1834, EHRENBERG, 329.
		1879, KLUNZINGER 3, 73; pl. 9/2.
		1906, v. MARENZELLER, 90; pl. 23/77.
<i>Pavona</i>	<i>cactus</i>	1918, VAUGHAN, 136; pl. 56/1, 1a (= <i>formosa</i> DANA).
		1936, YABE, SUGIYAMA & EGUCHI, 56; pl. 41/1–3.
		1967, SCHEER, 427.
		1980, VERON & PICHON, 8; figs. 5–15; 730.
		1980, HEAD, 149, 447.
<i>Lophoseris</i>	<i>cactus</i>	1860, MILNE EDWARDS (& HAIME), 68.
<i>Pavona</i>	<i>danai</i>	1918, VAUGHAN, 136; pl. 55/2; 56/2, 2a.
		1941, CROSSLAND, 41; pl. 7.
		1952, CROSSLAND, 161.
		1954, ROSSI, 42.
		1967, SCHEER, 427.
		1974, MERGNER & SCHUHMACHER, 265.
		1980, HEAD, 149, 448.
<i>Pavonia</i>	<i>decussata</i>	1927, FAUSTINO, 204; pl. 67/2, 3 (same specimen as VAUGHAN's figs. 2, 2a of pl. 56).
<i>Pavonia</i>	<i>praetorta</i>	1846, DANA, 325; pl. 22/5, 5a.
<i>Pavona</i>	<i>praetorta</i>	1921, v. d. HORST, 76 (synonymy).
		1936, YABE, SUGIYAMA & EGUCHI, 58; pls. 41/8; 42/8, 9; 44/2.
		1955, NEMENZO, 14; pl. 2/2.
<i>Pavonia</i>	<i>venusta</i>	1846, DANA, 326.
<i>Pavona</i>	<i>venusta</i>	1918, VAUGHAN, 136.
		1922, v. d. HORST, 418; pl. 31/1, 2.
		1967, SCHEER, 427; fig. 7.

EC 360 is a corallum with a greater spread of 12 cm. Fronds bifacial, larger ones up to 6 cm broad at the middle; summits divided, curled, growing edges thin (1 mm), maximum thickness at the base 4 mm. Calices arranged in series, distance between adjacent columella centres 1 to 1.5 mm, distance between series 3 to 4 mm. Calices shallow, 16 to 18 septo-costae around, strikingly alternating; edges of septa minutely serrated, sides granular. In older calices a central solid style represents the columella. Ambulacra flat or slightly rounded.

SLR 375 is represented by three specimens probably parts of the same corallum. The fronds are only 1 to 2 cm wide with a thickness of 1 mm at the tip getting to 5 mm at the basal parts. Carinae developed at places. Calices on an average 1 mm in diameter, septa range between 20 to 30 around a fossa. Columella a compressed style.

Material:

Gulf of Aqaba: Jerus. SLR 375-1-3 (Marsa Murach).  
 Northern R. S.: HLM EC 249 (without exact locality).  
 Central R. S.: P. Sud. Sa 65 (Sanganeb R., 11 m).  
 Southern R. S.: HLM X2: 9-20 (*venusta*), 10-8 (Sarso Isl.).  
 EC 360, 427 (Massawa).

Distribution: A wide spread species from Red Sea throughout Indian Ocean and in the Pacific as far East as Tahiti.

Remarks: FORSKAL's type of *Madrepora cactus* is a semifossilized specimen found on the Red Sea coast (CROSSLAND, 1941) and is the same as *Lophoseris danai* MILNE EDWARDS & HAIME. CROSSLAND (1941) considered FORSKAL's *M. cactus* as different from EHRENBERG's *P. cactus* (Nos. 813-816 in Berlin Museum) and he proposed to name FORSKAL's specimen as *danai* and to provide the other *cactus* corals with the authorship of EHRENBERG and the description of KLUNZINGER. In 1952 CROSSLAND wrote (p. 162): "It would be correct to suppress the name *cactus* altogether, but this would cause much confusion". In the present work we are treating *P. danai* as the same as *P. cactus*.

VAUGHAN (1918) grouped *P. cactus*, *P. praetorta*, *P. venusta*, *P. formosa*, *P. knorri* and *P. muelleri* (= *P. obtusangula* EHRENBERG, 1834) into that characterized by "Fronds crispate, summits divided into relatively narrow, more or less curled lobes. Without carinae". From a comparative study of a good collection of *Pavona* from Solomon Islands it was felt that *P. venusta* and *P. praetorta* are one and the same. In the present specimens also certain fronds have alternating high and low septa as is the case in *P. venusta*. In fact, *P. venusta* is intermediate between *P. cactus* and *P. formosa*.

*Lophoseris muelleri* MILNE EDWARDS & HAIME is based on *Pavonia obtusangula* EHRENBERG (non LAMARCK). The type locality is not known and the type appears to be not preserved in Berlin Museum. It is said to resemble *P. cactus* but with wider fronds. We feel that the specific name *muelleri* as applied to *Pavonia* should become obsolete particularly in the absence of the type and a good illustration.

*P. cactus* is separated from *P. decussata* in the presence of thinner fronds that are lobed at the summit. Calices are smaller in *P. cactus*, further carinae are not developed. *P. formosa* (DANA) could be a skeletal variant. The type of *P. formosa* has broader (5 cm) fronds than in *P. cactus*. VAUGHAN's pl. 56, figs. 1, 1a shows *formosa*, which he puts to *cactus*.

*Pavona maldivensis* (GARDINER), 1905

(Plate 12, Figs. 7, 8)

<i>Siderastrea</i>	<i>maldivensis</i>	1905, GARDINER, 935; pl. 89/1-3 (Type localities: Minicoy, Maldives).
<i>Pavona</i>	<i>maldivensis</i>	1948, MATTHAI, 182; pls. 6/20; 7/26; 12/47. 1974, SCHEER & PILLAI, 31; pl. 12/3-5. 1976, PILLAI & SCHEER, 38; pl. 17/1. 1980, VERON & PICHON, 33; figs. 59-60; 737.
	<i>lilacea</i>	1936, YABE, SUGIYAMA & EGUCHI, 58; pl. 46/3-6 (non KLUNZINGER).
<i>Pavona</i> ( <i>Pseudo-</i> <i>columnastrea</i> )	<i>pollicata</i>	1954, WELLS, 443; pl. 153/1-3. 1976, PILLAI & SCHEER, 40; pl. 15/4.

GARDINER (1905) has fully discussed the skeletal variation within a single corallum of this species. The present authors discussed (1976) further material from Maldives. There are five specimens before us which we assign to the present species. The following are details of some of the specimens.

SLR 357-1 looks massive, columnar, formed of repeated overgrowth. Calices on an average 2 mm in diameter, 2 mm apart, rounded, level at the top of the corallum, but projecting to 1 mm at the growing basal parts. In a fully grown calyx there are 18 to 34 septa at various parts of the corallum, they are confluent from calyx to calyx. A single upright style represents the columella.

EC 514 is plate-like, apparently growing in a horizontal position. Two thick columns are fused together to form a plate-like structure. The basal part is narrower than the top. Total height 16 cm, maximum thickness 2 cm. Corallites not projecting at the top of the columns but up to 1 mm elevated at the basal parts of the corallum. Calices rounded, 2.5 to 3 mm in diameter. Total number of septa 30 to 40. Columella styliform.

PW 73 314 is composed of a cluster of branches similar to *P. pollicata* WELLS. It is infested by Vermite tubes. Height of branches (columns) 6 to 9 cm, width 1 to 2 cm, about the same thickness at the top. Corallites close together at the top of the columns, 1.5 to 2 mm in diameter with 18 to 20 septa. Wall not projecting. At the sides and lower part of the corallum the corallites are wide apart, neatly rounded, wall only slightly projecting or level. Septa alternating, total number up to 30.

Material:

Gulf of Aqaba; Jerus. SLR 357-1 (Marsa Murach).  
 Basel PW 71 314 (Eilat, 40 m).  
 Northern R. S.: HLM EC 514 (Ras Abu Hagar).  
 Central R. S.: P. Sud. Sa 87, 97 (Sanganeb R.).

Distribution: Red Sea; Seychelles; Maldives; Minicoy; Nicobars; East Indies; Palau Isls.; Marshall Isls.; Tahiti.

Remarks: We have several specimens from Red Sea, Maldives and Nicobars, that we could study. We have also studied some specimens in Cambridge University, Zoology Museum, discussed by MATTHAI (1948). It seems to us, that *P. pollicata* and *P. maldivensis* are only growthforms as considered by MATTHAI (1948), though WELLS (1954) named part of MATTHAI's material as *pollicata* under subgenus *Pseudocolumnastrea*. In the present specimens, though in some cases they fully agree to WELLS' figure of his *pollicata*, we have not observed any paliform lobes that are characteristic of the subgenus *Pseudocolumnastrea*. Therefore we believe that *P. (Pseudocolumnastrea) pollicata* should be synonymized with *P. maldivensis* (GARDINER).

*Pavona divaricata* LAMARCK, 1816

(Plate 21, Figs. 4, 5)

<i>Pavonia</i>	<i>divaricata</i>	1816, LAMARCK, 240 (Type locality: Indian Ocean). 1846, DANA, 327, pl. 22/6.
<i>Pavona</i>	<i>divaricata</i>	1922, v. d. HORST, 419. 1924, MATTHAI, 55. 1925, HOFFMEISTER, 38; pl. 2/3a, b. 1936, YABE, SUGIYAMA & EGUCHI, 56; pl. 40/4. 1964, SCHEER, 616; figs. 6, 7. 1974, PILLAI & SCHEER, 457; fig. 3b. 1980, HEAD, 149, 448.
<i>Tichoseris</i>	<i>angulosa</i>	1889, ORTMANN, 515; pl. 14/7.
<i>Pavona (Poly- astra)</i>	<i>venosa var. arbuscula</i>	1939, UMBGROVE, 48; pl. 15/1-5.

The occurrence of *P. divaricata* in the Red Sea was first reported by SCHEER (1964) from the Wingate Reef, Port Sudan. More specimens were later obtained and on the whole we have seven specimens that we place under this species. The corallum is branching, branches 1 to 1.5 cm broad at the top, narrower at the base, height varies from 1 to 3 cm, apices acute. Carinae well developed, sharp. Calices 1 to 1.5 mm in diameter, rarely 2 mm, arranged in rows. 14 to 20 septa within a calyx, slightly alternating in size; edges and sides granular. Ambulacra thick, rounded at the top. The above description is based on RM 47.

Material:

Gulf of Aqaba: Jerus. SLR 1247-1 (Fara'un Isl.).  
 T. Aviv NS 6106 (Eilat).  
 Basel PW 73 654 (El Kura).  
 Central R. S.: HLM EC 1376 (Djiddah).  
 P. Sud. Sa 11 (Sanganeb R.).  
 HLM RM 47, 47a (Wingate R.).

**Distribution:** Red Sea; Mascarene Archipelago; Gulf of Mannar (PILLAI, 1972); Ceylon (ORTMANN); Str. of Malacca; Singapore; East Indies; Great Barrier Reef; Ponape (Caroline Is.); Rotuma; Marshall Is.; Fiji Is.; Tongatabu (Tonga Is.).

**Remarks:** Field study of a large colony of this species from Krusadai Island in the Gulf of Mannar has convinced one of us (PILLAI), that *P. venosa* var. *arbuscula* UMBGROVE is only a growthform of this species. The type of *Tichoseris angulosa* ORTMANN can very well be a worn-out portion of the basal encrustation of *P. divaricata*.

Additional remarks on the genus *Pavona*:

The first record of *P. clavus* (DANA) from the Red Sea is that of LOYA & SLOBODKIN (1971), but they have not described nor figured it. Later on HEAD (1980) collected two further specimens of this species which he describes as approaching *P. explanulata*.

Several other specimens were provisionally identified as *P. cf. diffluens* by HEAD (1980). He writes that better specimens are required to confirm the specific characters.

Genus *Leptoseris* MILNE EDWARDS & HAIME, 1849

**Types species:** *Leptoseris fragilis* MILNE EDWARDS & HAIME, 1849.

**Generic characters:** Hermatypic; encrusting, foliaceous or ramose, unifacial. Secondary calices often arranged around a central mother calyx. Lower wall of the corallites a little projecting. Septa close together, confluent between calices. Intercorallite area, i. e. between the rows of calices, flat or slightly convex, rarely collines developed.

Recently the genus received a revision by Zena DINESEN (1980). The genus is known from Red Sea by seven species.

Synopsis of *Leptoseris* from Red Sea:

A. Corallum encrusting, plate- or saucer-shaped or foliaceous.

I. Septocostae strongly alternating.

1. First order septocostae dentate; second order sometimes with smaller denticles, but frequently non-dentate. . . . . *L. scabra*
2. First and second order septocostae non-dentate. . . . . *L. explanata*

II. Septocostae equal or subequal. Margin of septocostae non-dentate, more or less granulated.

a) Corallum with collines parallel to the margin.

3. Collines prominent, often intersected by ridges . . . . . *L. mycetoseroides*
4. Collines only feebly developed. Calices small. . . . . *L. tenuis*

b) Corallum without such collines.

5. Calices distinct, sometimes in more or less concentric rows. . . . . *L. hawaiiensis*
6. Only few calices in the centre of the corallum. . . . . *L. fragilis*

B. Corallum erect and branched.

7. Branches 1 to 2 cm broad. Corallites projecting. . . . . *L. gardineri*

*Leptoseris scabra* VAUGHAN, 1907

<i>Leptoseris</i>	<i>scabra</i>	1907, VAUGHAN, 139; pl. 41/1, 1a, 2 (Type locality: Hawaii).
		1954, WELLS, 444; pl. 155/1, 2.
		1976, PILLAI & SCHEER, 40 (pars); pl. 17/4.
		1980, VERON & PICHON, 48; figs. 83-91, 739.
		1980, DINESEN, 194; pls. 8/1-3; 9/1-3.
		1980, HEAD, 149, 449.

We have no specimen of this species in our collection. But HEAD has found two samples in a depth of 50 m. He states (pers. comm.): "Septocostae unequal, dentate". On grounds of this description we include the species into the Red Sea corals, though we could not study HEAD's specimens.

**Distribution:** Red Sea; Réunion; Mauritius; Chagos Archipelago; Maldives; Houtman Abrolhos Isls.; Palau Isls.; Great Barrier Reef; Solomon Isls.; Marshall Isls.; Hawaii; Tahiti.

**Remarks:** From the Maldivic specimens, mentioned by PILLAI & SCHEER (1976: 40), only X2: 76-4 and 76-6 are *L. scabra*, the other three specimens are *L. explanata*.

*Leptoseris explanata* YABE and SUGIYAMA, 1941

(Plate 13, Figs. 1-4)

<i>Leptoseris</i>	<i>explanata</i>	1941, YABE & SUGIYAMA, 75; pl. 63/3-3e (Type locality: Palau Islands). 1980, VERON & PICHON, 42; figs. 71-82, 738.
	<i>glabra</i>	1980, DINESEN, 200; pls. 15/1-3; 16/1-3.
	cf. <i>hawaiiensis</i>	1941, YABE & SUGIYAMA, 75; pl. 62/3-3d.
	<i>scabra</i>	1948, MATTHAI, 192; pl. 4/11.

In our collection are ten specimens of this species. Fri 34-1 and Fri 86-1, which we received from Prof. FRICKE, and which he has collected with his submersible "Geo" in depths of 92 and 90 m respectively, are thin plates of 150 and 91 mm resp. in length. SLR 383, PW 73 609a and Sa 90 are thin saucer-shaped pieces with diameters of 27, 65 and 100 mm respectively. PW 73 583 is part of a bigger corallum. It is the end of a branch about 10 mm thick and 40 mm broad, which bifurcates at the margin. The sides of the branch are turned over and have overgrown the backside. PW 71 330 is an entire specimen, 12 cm in greater spread. The periphery divides into lobes. Cylindrical hollow processes, 2.5 cm high and 2 cm thick, are seen at the peripheral part. The coral looks in growthform like VAUGHAN's *tubulifera* = *L. hawaiiensis*.

**Material:**

Gulf of Aqaba:	Jerus.	SLR	383 (Marsa Murach); 665 (Marsa Abu Zabad).
	Basel	PW	73 583 (Eilat, 40-45 m); 73 609a, 73 612, 71 330 (Fara'un Isl., 40 m).
	HLM	Fri	34-1 (Eilat, aquarium, 92 m).
Northern R. S.:	HLM	Fri	86-1 (Sharm esh Sheikh, 90 m).
Central R. S.:	P. Sud.	Sa	90, 96 (Sanganeb R.).

**Distribution:** Red Sea; Réunion; Houtman Abrolhos Isls.; Palau Isls.; Great Barrier Reef; Solomon Isls.

**Remarks:** The holotype of *L. explanata* is figured by YABE & SUGIYAMA (1941) and by VERON & PICHON (1980, figs. 80 and 81). The latter authors state that the type specimen resembles deep-water specimens of their present series, and that "it differs substantially from the rest of the series in having smaller corallites and less prominent septo-costae". This and the occasional presence of dentate sections of the septocostae may have induced DINESEN to put *L. explanata* under *L. scabra* and to establish a new species, *L. glabra*. She included in that VERON & PICHON's specimens of *L. explanata*, but she has not excluded the type specimen of *L. explanata*, figured by the latter.

We agree with VERON & PICHON in using the name *explanata* for *Leptoseris* specimens with strongly alternating and non-dentate septocostae.

*Leptoseris mycetoseroides* WELLS, 1954

(Plate 13, Figs. 5, 6)

<i>Leptoseris</i> ?	<i>mycetoseroides</i>	1954, WELLS, 445; pl. 153/4-6 (Type locality: Bikini Atoll).
<i>Leptoseris</i>	<i>mycetoseroides</i>	1980, VERON & PICHON, 57; figs. 99-103, 741. 1980, DINESEN, 197; pls. 11/1-3; 12/1-3; 13/1-3.
<i>Agariciella</i>	<i>mycetoseroides</i>	1980, HEAD, 149, 451.
<i>Leptoseris</i>	<i>incrustans</i>	1922, v. d. HORST, 422; pl. 32/3, 4.
<i>Agaricia</i> ?	<i>minicoiensis</i>	1936, YABE, SUGIYAMA & EGUCHI, 55; pl. 42/5-7.

We refer three specimens to this species, viz. SLR 1250, PW 71 323 and X2: 8-11. All show the typical appearance with collines and intersecting ridges.

## Material:

- Gulf of Aqaba: Jerus. SLR 1250 (Fara'un Isl.).  
 Basel PW 71 323 (Eilat, 40 m).  
 Central R. S.: HLM X2: 8-11 (Shaab Anbar).

Distribution: Red Sea; Madagascar; Réunion; Mauritius; Saya de Malha; Chagos Archipelago; Houtman Abrolhos (W. Australia); Indonesia; Philippines; Japan; Great Barrier Reef; Solomon Isls.; Marshall Isls.

*Leptoseris tenuis* v. d. HORST, 1921

(Plate 13, Figs. 7-13)

- |                   |                |   |
|-------------------|----------------|---|
| <i>Leptoseris</i> | <i>tenuis</i>  | 1921, v. d. HORST, 83; pl. 5/9, 10 (Type locality: Paternoster Islands).<br>1922, v. d. HORST, 422.<br>1941, YABE & SUGIYAMA, 74; pls. 62/4-4c, 5, 5a; 64/1.<br>1980, VERON & PICHON, 65; figs. 115-120, 742. |
|                   | <i>foliosa</i> | 1980, DINESEN, 199; pl. 14/1-3.   |

We owe two specimens, Fri 82-1 and 92-1 (the latter consisting of two pieces) to Prof. FRICKE, which he has collected with his submersible "Geo" 91 and 97 m deep resp. Both are foliaceous fragments of bigger specimens with encrusting bases.

In the outer lobe-shaped part of Fri 82-1 collines are quite distinct, but in the middle part they are only feebly developed. No radiating ridges are present. The corallites are very small and superficial, often elliptical and in rows parallel to the margin. Septocostae are equal, straight, with granulated, rounded margins, about 20 to 25 in 5 mm.

In Fri 92-1 the collines are inconspicuous. Corallites are in short rows. Columella in elliptical corallites mostly elongated.

Another sample, NS 4948, is only a small fragment of a foliaceous specimen. The collines are very distinct so that the piece resembles *L. mycetoseroides*, but intersecting ridges are not present.

A second specimen which resembles *L. mycetoseroides*, Sa 95, is part of a plate-like corallum and is comparatively thick. But we think it belongs to *L. tenuis* despite its conspicuous collines.

## Material:

- Northern R. S.: T. Aviv NS 4948 (Marsa el At).  
 HLM Fri 92-1 (Sharm esh Sheikh, 97 m); 82-1 (little marsa 5 sm south of Sharm esh Sheikh, 91 m).  
 Central R. S.: P. Sud. Sa 95 (Sanganeb R.).

Distribution: Red Sea; Amirante Isls.; Providence Isl.; Saya de Malha; Paternoster Isls.; Great Barrier Reef; Solomon Isls.

Remarks: First record of this species in the Red Sea.

*Leptoseris hawaiiensis* VAUGHAN, 1907

(Plate 14, Figs. 1, 2)

- |                   |   |  |
|-------------------|---|--|
| <i>Leptoseris</i> | <i>hawaiiensis</i>                            | 1907, VAUGHAN, 137; pls. 39/1, 2; 40/1, 2 (Type locality: Molokai Isl., Hawaii).<br>1954, WELLS, 444; pl. 154/3, 4.<br>1980, VERON & PICHON, 52; figs. 92-98, 740.<br>1980, DINESEN, 193; pls. 4/4; 5/1-3; 6/1-4; 7/1-3. |
|                   | non cf. <i>hawaiiensis</i><br><i>tubifera</i> | 1941, YABE & SUGIYAMA, 73; pl. 63/3-3d.<br>1907, VAUGHAN, 141; pls. 42/3; 43/1.  |

We have only one specimen which we owe to Prof. FRICKE, who has obtained it by diving with his submersible "Geo" to a depth of 95 m. It is only a fragment, foliaceous and very thin. The corallites are circular with raised rims and directed upwards, diameter 2 to 3 mm; irregularly scattered or in short concentric rows. No collines present. Septocostae equal, usually straight, with delicately granulated but acute margins, about 25 in 5 mm. Columella well developed.

## Material:

- Northern R. S.: HLM Fri 114-1 (Sharm esh Sheikh, 95 m).

**Distribution:** Red Sea; Amirante Isls.; Mascarene Isls.; Chagos Archipelago; Maldives; Andamans; Thailand; Borneo; Indonesia; Philippines; Palau Isls.; Great Barrier Reef; Marshall Isls.; Hawaii; Tahiti.

**Remarks:** We put, in accordance with DINESEN (1980), *L. tubulifera* VAUGHAN to the present species. The tubuliferous expansions are not of any specific value, they are only growthforms, occurring also in *L. scabra* and *L. explanata*. It is uncertain, for lack of any description or figure, to which species *L. tubulifera* in LOYA & SLOBODKIN (1971) belongs.

HEAD states in his Ph. D. Thesis (1980: 449), that figures 9 and 10, plate 4, in MATTHAI, 1948, are incorrectly named *L. hawaiiensis*. He places this specimen together with seven others he has found at the reefs off Port Sudan (one is figured on his plate IV-1 and 1a) in the new genus *Craterastrea* as new species *C. levis*. An account on it is in press.

*Leptoseris fragilis* MILNE EDWARDS & HAIME, 1849

(Plate 14, Figs. 3-6)

<i>Leptoseris</i>	<i>fragilis</i>	1849, MILNE EDWARDS & HAIME, 72 (Type locality: Réunion).
		1854, ROUSSEAU, 123; pl. 29/1, 1a-h.
		1860, MILNE EDWARDS (& HAIME), 76.
		1948, MATTHAI, 192; pl. 4/5, 6.

The holotype of this species, No. 470 in the Paris Museum, is lost. CHEVALIER (in litt.) had it still at hand when writing his D. Sc. Thesis (1961). Now only four small "paratypes", also collected by ROUSSEAU 1841 at Réunion, are present (No. 468) in the collection MILNE EDWARDS in Paris. Already DINESEN (1980: 186) has supposed that these belong to *Coscinaraea*, and we agree with her. But we cannot agree that she omits *L. fragilis*. There is a very good picture of this species in ROUSSEAU, 1854, pl. 29, fig. 1. A specimen of exactly the same appearance was given to us by Prof. FRICKE, who has collected it with his submersible "Geo" in a depth of 110 m off Eilat. Another specimen was found in a depth of 128 m.

The specimen from FRICKE is a rounded thin plate. In the centre are three corallites on a hillock with 20, 24 and 28 septa respectively. The columella is a solid oval boss. The spicostae, about 35 in 10 mm, are equal, mostly straight, sometimes flexuous, and between the corallites and over other raised areas very contorted. Margins non-dentate. The specimen has a diameter of about 8 cm. FRICKE told us, that all specimens he had seen during his deep-divings had about the same size.

**Material:**

Gulf of Aqaba: HLM Fri 41-1 (Eilat, lighthouse, 110 m).  
Fri 24-1 (Eilat, Mar. Biol. Lab., 128 m).

**Distribution:** Red Sea; Réunion; Maldives.

**Remarks:** We feel that some of the references to *L. fragilis* in literature cannot be correct.

*Leptoseris gardineri* v. d. HORST, 1921

(Plate 14, Fig. 7)

<i>Leptoseris</i>	<i>gardineri</i>	1921, v. d. HORST, 82.
		1976, PILLAI & SCHEER, 40.
		1980, VERON & PICHON, 40; figs. 67-70 (synonymy).
		1980, DINESEN, 196; pl. 10/1-3.
		1980, HEAD, 149, 449.
<i>Folioseris</i>	<i>papyracea</i>	1892, REHBERG, 26; pls. 2/8; 4/2 (non <i>papyracea</i> DANA).
<i>Leptoseris</i>	<i>papyracea</i>	1905, GARDINER, 947; pl. 92/23.

Included in the material, collected by Prof. FRICKE with his submersible "Geo", is also *L. gardineri*. It is a small fragment about 55 mm wide, consisting of a bifurcating, flat branch; the two twigs also have branchlets. Corallites 2 to 4 mm in diameter with distinct thecal rims. Back side of the branches smooth with fine striations.

*L. gardineri* is similar to *L. papyracea* (DANA), but the latter is much smaller with superficial corallites.



## Material:

Northern R. S.: HLM Fri 109-1 (Sharm esh Sheikh, 95 m).

Distribution: Red Sea; Maldives; Indonesia; Palau Isls.; Great Barrier Reef; Marshall Isls.; Fiji; Samoa.

Genus *Gardineroseris* SCHEER and PILLAI, 1974

Type species: *Agaricia* (*Undaria*) *planulata* DANA, 1846.

Generic characters: Encrusting, tending to become massive. Cerioid with solid acute walls. Calices polygonal, mono- to tristomodaeal. Corallites 4 to 6 mm in diameter when monostomodaeal, 2 to 4 mm deep. Septa numerous, higher cycles unite with the lower cycles before the latter unite with a styliform columella placed in the centre of a small axial fossa. Septa subequal in thickness, arrangement more or less as in *Siderastreidae*.

The genus is known to include a single species, *G. planulata*. 1901 VERRILL has given the first figure of the species. In 1905 GARDINER established a new species *Agaricia ponderosa* with a variety *minikoiensis*. YABE, SUGIYAMA & EGUCHI (1936) separated the two, but their *Agaricia ? minikoiensis* is identical with *Leptoseris mycetoseroides*. MA (1937) placed *A. minikoiensis* in a new subgenus *Agariciella*. WELLS (1936) pointed out that *planulata*, *ponderosa* and var. *minikoiensis* are one and the same and placed them to *Pavona*, subgenus *Polyastra*. UMBGROVE (1939) believed he could separate *planulata* and *ponderosa* on grounds of small differences in the columella.

In the following years the name *ponderosa* was used: *Pavona p.* by MATTHAI (1948), *Pavona* (*Polyastra*) *p.* by DURHAM (1962), *Agariciella p.* by ROSEN (1971) and by LOYA & SLOBODKIN (1971), and finally *Gardineroseris p.* by SCHEER & PILLAI (1974). HEAD (1980) used again *Agariciella p.*, while VERON & PICHON (1980) returned to the older name *planulata*. The present authors think that *ponderosa* and *planulata* are the same, and that *planulata* has priority.

While proposing the generic name we made two statements which are unscientific, and we take this opportunity to correct them. First, the septal arrangement of *Gardineroseris* is more like *Siderastreidae* than *Thamnastreidae*. Second, we made a statement to the effect that WELLS' (1956) inclusion of *Agariciella* MA, 1937, in *Leptoseris* is incorrect. We regret this mistake, WELLS is fully justified.

*Gardineroseris planulata* (DANA), 1846

(Plate 14, Figs. 8, 9)

<i>Agaricia</i>	<i>planulata</i>	1846, DANA, 338.
<i>Asteroseris</i>	<i>planulata</i>	1901, VERRILL, 156, pl. 27/8, 8a.
<i>Pavona</i> ( <i>Polyastra</i> )	<i>planulata</i>	1936, WELLS, 549; pl. 10/1-3.
<i>Gardineroseris</i>	<i>planulata</i>	1980, VERON & PICHON, 68; figs. 121-125; 745.
<i>Agaricia</i>	<i>ponderosa</i>	1905, GARDINER, 937; pl. 89/5, 6.
	var. <i>minikoiensis</i>	1905, GARDINER, 938; pl. 90/7.
<i>Agaricia</i> ?	<i>ponderosa</i>	1936, YABE, SUGIYAMA & EGUCHI, 55; pls. 27/5; 38/1; 52/1.
<i>Pavona</i>	<i>ponderosa</i>	1948, MATTHAI, 182; pl. 6/18, 19, 21-24.
<i>Pavona</i> ( <i>Polyastra</i> )	<i>ponderosa</i>	1962, DURHAM, 50; fig. 5.
<i>Agariciella</i>	<i>ponderosa</i>	1971, ROSEN, 111.
		1971, LOYA & SLOBODKIN, 123.
<i>Gardineroseris</i>	<i>ponderosa</i>	1974, SCHEER & PILLAI, 32; pl. 15/1, 2.
		1976, PILLAI & SCHEER, 41.
<i>Agariciella</i>	<i>ponderosa</i>	1980, HEAD, 149, 451.

Corallum encrusting, edges free thus looking like a folium. Underside wherever free is covered by an epitheca, which stops about 5 mm from the growing edge. Corallites 5 to 7 mm in greater length, polygonal, with equal depth. Septa generally about 70, but up to 100 in a large calyx, subequal at the wall; higher cycles unite with the immediate lower cycle. 14 to 17 septa reach the columella. Axial fossa about 0.5 mm in diameter, sometimes filled by a styliform columella. Sides of septa minutely granulated.

## Material:

Gulf of Aqaba: T. Aviv NS 6065 (Eilat).

Central R. S.: P. Sud. Sa 48 (Sanganeb R.).

Distribution: Red Sea; Aldabra; Madagascar; Mascarene Archipelago; Maldives; Lakshadweep; Nicobar Is.; Philippines; Japan; Great Barrier Reef; Marshall Is.; Fanning Isl.; Tahiti; Cocos Isl. (East Pacific, DURHAM 1962).

Genus *Pachyseris* MILNE EDWARDS and HAIME, 1849Type species: *Agaricia rugosa* LAMARCK, 1801.

Generic characters: Unifacial or rarely bifacial. Surface with concentric or irregular, low collines enclosing broken or continuous lamellar columella. Calices ill-defined. Septa narrow, closely placed, continuous over the collines, 18 to 30 per cm length of colline. Septal edges dentate.

Synopsis of *Pachyseris* described herein:

1. Surface rises to irregular hillocks. Collines discontinuous, height of collines 3 to 5 mm. Columella lamellate, well developed. Septa about 20 per length of colline. . . . . *P. rugosa*
2. Corallum more or less plate-like, surface level. Collines concentrically arranged, very low (1 to 2 mm). Septa up to 30 per cm length of colline. Top of collines mostly rounded. Columella moderately developed. . . . . *P. speciosa*

*Pachyseris rugosa* (LAMARCK), 1801

(Plate 15, Figs. 1, 2)

<i>Pachyseris</i>	<i>rugosa</i>	1932, THIEL, 93; pls. 15/1, 2; 21/3, 4 (synonymy). 1936, YABE, SUGIYAMA & EGUCHI, 63; pls. 39/1, 2; 43/1-3, 5. 1937, MA, 151; pl. 90/2. 1971, LOYA & SLOBODKIN, 123. 1974, SCHEER & PILLAI, 33 (synonymy). 1980, VERON & PICHON, 76; figs. 131-137; 747.
	<i>carinata</i>	1921, v. d. HORST, 89; pl. 5/3. 1925, HOFFMEISTER, 37.
	<i>gemmae</i>	1955, NEMENZO, 19; pl. 4/1, 3.
<i>Undaria</i>	<i>monticulosa</i>	1872, VERRILL, 383 (in DANA: Corals and coral islands).
<i>Pachyseris</i>	<i>torresiana</i>	1918, VAUGHAN, 132; pl. 55/1, 1a. 1952, CROSSLAND, 164.
	<i>valenciennesi</i>	1860, MILNE EDWARDS (& HAIME), 86. 1921, v. d. HORST, 88; pl. 5/2. 1971, LOYA & SLOBODKIN, 123. 1976, PILLAI & SCHEER, 41; pl. 17/2, 3.

We place three specimens from the Red Sea collections under this species. The collines are broken up, i. e. they are not long and continuous, irregularly swollen to form short hillocks. The distinguishing features of this species are already summarized.

## Material:

Gulf of Aqaba: T. Aviv NS 9289 (Eilat, 30 m).

Basel PW 71 319 (Eilat, 40 m).

Northern R. S.: HLM EC 428 (Koseir).

Distribution: Red Sea eastward to Tuamotu Archipelago. Fairly wide-spread though not common anywhere.

Remarks: *P. valenciennesi* is based on *Agaricia rugosa* DANA (non LAMARCK) and is the same as *P. monticulosa* (VERRILL), 1872. The type is USNM 218. A careful study of this by PILLAI shows that it has not many features that will differentiate it from *P. rugosa* (LAMARCK) reported by different workers.

PILLAI & SCHEER (1976) reported specimens from Maldives under the name *P. valenciennesi*. These have rougher surfaces with higher hillocks than usual forms of *P. rugosa*. However, further studies have shown that there is not much reason for separating these two.

*Pachyseris gemmae* NEMENZO, 1955, is a positive synonym of *P. rugosa*. We recognize *P. speciosa* as valid species in the present work also. But one of our specimens, NS 9289, in fact shows intermediate features to ascertain their relationship. It is very likely that *P. speciosa* may also prove to be the same as *P. rugosa*.

*Pachyseris speciosa* (DANA), 1846

(Plate 15, Figs. 3, 4)

<i>Agaricia</i>	<i>speciosa</i>	1846, DANA, 337; pl. 21/7 (Type locality: East Indies).
<i>Pachyseris</i>	<i>speciosa</i>	1918, VAUGHAN, 131; pl. 54/3, 3a, 4, 4a.
		1974, SCHEER & PILLAI, 34; pl. 16/1, 2 (synonymy).
		1980, VERON & PICHON, 82; figs. 138–143; 748.
		1980, HEAD, 149, 451.
	<i>clementei</i>	1955, NEMENZO, 18; pl. 3/1–3.
	<i>involuta</i>	1878, STUDER, 644; pl. 3/11a–c.
		1921, v. d. HORST, 88; pl. 3/6.
<i>Agaricia</i>	<i>levicollis</i>	1846, DANA, 338; pl. 22/2.
<i>Pachyseris</i>	<i>levicollis</i>	1922, v. d. HORST, 427.
		1925, HOFFMEISTER, 36.
		1974, SCHEER & PILLAI, 34; pl. 16/3, 4.
		1976, PILLAI & SCHEER, 41.

The following are the major characters of the specimens of *Pachyseris* that we identify with the present species: Corallum explanate, unifacial, edges 3 to 5 mm thick, up to 1 cm at the central part. Collines lengthy, arranged concentrically. Surface level without any gibbositities unlike in *P. rugosa*. Height of collines more or less 1 mm. Distance between centres of valleys 3 to 4 mm. Septa thin, crenelated. Columella solid, discontinuous.

Material:

Gulf of Aqaba:	Jerus.	SLR	373 (Marsa Murach); 1186 (Marsa el Muqeibla); 663–1, 2 (Marsa Abu Zabad); 2385–2 (El Gharqana).
	T. Aviv	NS	3205 (Dahab); 1938 (Shurat al Manqata).
	Basel	PW	73 582, 73 620 (Eilat, 50–60 m).
Northern R. S.:	T. Aviv	NS	5949 (Marsa Bareika).
Central R. S.:	P. Sud.	Sa	92 (Sanganeb R.).
	HLM	RM	32 (Wingate R.).

Distribution: Red Sea; East Africa; Aldabra; Mauritius; Cargados; Saya de Malha; Chagos; Maldives; Nicobar Is.; Mergui Archipelago; East Indies (type locality of *P. involuta*); Philippines (type locality of *P. clementei*); Palau Is.; Great Barrier Reef; Marshall Is.; Samoa; Tahiti.

Remarks: SCHEER & PILLAI (1974) have already pointed out the existence of specimens that are intermediate in characters between *P. levicollis* and *P. speciosa*. There is one specimen among the collection of Madras Government Museum (No. 7394) from Pilai Island. It is labelled *P. speciosa* by the late Prof. G. MATTHAI. The collines are only 1.5 mm high with a solid columella which is continuous as in some specimens of *P. levicollis*. This is a connecting specimen between the two species.

*P. involuta* STUDER is similar to *P. levicollis* except for the fact that the calices are located higher upon the collines rather than at the middle of the valleys. This is only due to flattening of the collines caused by some special habitat. But for this it is the same as *P. speciosa*.

*P. clementei* NEMENZO differs from *P. speciosa* only in a vesiculate underside. We do not think that this character alone will justify a separate species name for this Philippine specimen.

Family *Siderastreidae* VAUGHAN and WELLS, 1943

Key to the genera of the family from Red Sea:

1. Encrusting or massive. Corallites cerioid, polygonal; wall formed of several layers of synapticulae. Budding extratentacular. Corallite wall well defined. . . . . *Siderastrea*
2. Encrusting to massive. Corallite wall not well defined. Calices single or in short series thus meandroid confluent. Budding intratentacular, mono- to tristomodaeal. . . . . *Coscinaraea*

Genus *Siderastrea* de BLAINVILLE, 1830

Type species: *Madrepora radians* PALLAS, 1766.

Generic characters: Submassive or encrusting. Corallites cerioid, wall thin, corallites polygonal. Septa uniting, two rows of synapticulae visible within the calyx. Septal edges dentate, sides granular. Columella small, papillary.

KLUNZINGER (1879) described two species of *Siderastrea* from Red Sea viz. *S. savignyana* and *S. lilacea*. The distinction between these two is minor. HORST (1922) felt that these two are one and the same. (Though his specimens, described 1921, did not belong to *S. savignyana* but are only *Pseudosiderastrea tayami*.) We agree with HORST (1922) that the two Red Sea species of *Siderastrea* belong to a single species, as described below.

*Siderastrea savignyana* MILNE EDWARDS and HAIME, 1850

(Plate 15, Figs. 5, 6)

<i>Astraea</i>	<i>savignyana</i>	1857, MILNE EDWARDS (& HAIME), 508 (Type locality: Red Sea).
<i>Siderastraea</i>	<i>savignyana</i>	1879, KLUNZINGER 3, 77.
		1922, v. d. HORST, 423.
		1954, ROSSI, 42.
		1980, HEAD, 150, 451.
<i>Astraea</i>	<i>galaxea</i>	1828, AUDOUIN (& SAVIGNY), 57; pl. 5/1.
<i>Siderastraea</i>	<i>lilacea</i>	1879, KLUNZINGER 3, 77; pls. 9/6; 10/16a, b.
		1971, LOYA & SLOBODKIN, 123.
	<i>pulchella</i> ?	1888, FAUROT, 119.
	<i>savignyi</i>	1892, REHBERG, 24.

SLR 832 and SLR 856-2 are thick encrustations. Maximum thickness about 1.5 cm. Calices polygonal, 3 to 4 mm in length, 2 to 2.5 mm wide, about 1.5 mm deep. Total septa 30 to 35 in a fully grown calyx, of equal thickness at the wall. Higher cycles unite to the lower, 12 septa unite the columella. Septal edges with subequal dentation. Intercorallite wall about 1 mm thick, often with a sharp ridge at the middle.

EC 362 is a massive, free lying colony. The intercorallite wall only 0.5 mm in thickness. 4 to 6 papillary projections are seen around the central columella style. Other details as already described.

## Material:

Gulf of Suez: Jerus. SLR 832, 856-2 (Et Tur).  
 Gulf of Aqaba: Basel PW 71 355 (Fara'un Isl., 40 m).  
 Southern R. S.: HLM EC 362 (Massawa).

Distribution: Red Sea; East Africa.

Remarks: ORTMANN's (1889) *Siderastraea sphaeroidalis*, which he mentioned 1892 from Red Sea under the name *S. savignyana*, belongs, according to v. d. HORST (1922: 420), to *Pavona clavus*.

Another *Siderastrea* from Red Sea, reported by FAUROT (1888), is *S. pulchella* MILNE EDWARDS & HAIME. We put this coral to *S. savignyana*, because the latter is the only species of *Siderastrea* known from Red Sea.

Genus *Coscinaraea* MILNE EDWARDS and HAIME, 1848

Type species: *Astrea monile* FORSKAL, 1775.

The generic characters are already summarized. In Red Sea the single species of this genus, that is known to occur, displays bewildering skeletal variation, that one may be tempted to make three or four "species" from a good collection of specimens. However, we name all our specimens as *C. monile*.

*Coscinaraea monile* (FORSKAL), 1775

(Plate 15, Figs. 7, 8)

<i>Madrepora</i>	<i>monile</i>	1775, FORSKAL, 133 (Type locality: Red Sea).
<i>Coscinaraea</i>	<i>monile</i>	1879, KLUNZINGER 3, 79; pls. 9/4; 10/17a, b (synonymy).
		1892, ORTMANN, 651.
		1906, v. MARENZELLER, 90; pl. 24/83.
		1907a, VAUGHAN, 260; pls. 23/1, 2; 24/1-3.
		1922, v. d. HORST, 423.
		1924, MATTHAI, 57; pl. 7/1.
		1941, CROSSLAND, 30; pl. 5 (lower fig.).
		1971, LOYA & SLOBODKIN, 123.
		1974, MERGNER & SCHUHMACHER, 264.
		1976, PILLAI & SCHEER, 42.
		1980, HEAD, 150, 451.
	<i>donnani</i>	1905, GARDINER, 950; pl. 90/12.
<i>Meandrina</i>	<i>labyrinthica</i>	1828, AUDOUIN (& SAVIGNY), 58; pl. 5/4.
<i>Astraea</i>	<i>maeandrina</i>	1834, EHRENBERG, 322.
<i>Coscinaraea</i>	<i>meandrina</i>	1860, MILNE EDWARDS (& HAIME), 204 (synonymy).
		1889, ORTMANN, 495.
	<i>ostreaeformis</i>	1922, v. d. HORST, 424; pl. 32/5, 6; and figs. 1, 2 on p. 425.

We select representative specimens to describe the skeletal variations displayed:

NS 8683 is an encrustation over a dead colony of the same species. Corallites 5 to 7 mm in diameter, all monostomodaal, deep (1 to 2 mm), 5 to 6 mm apart. This specimen agrees to GARDINER's description of *C. donnani* from the Maldives.

NS 4898 is hemispherical, thick. Corallites mono- or distomodaal, i. e. with very short valleys with not more than two columella centres running together. This specimen exactly and in detail resembles FORSKAL's type figured by CROSSLAND (1941).

Other four specimens (EC 158, 497, SLR 828 and NS 5396) possess long meandriform valleys with up to 15 small calicinal centres in an uninterrupted valley. These might agree to *C. meandrina* (EHRENBERG) which is the same as *Meandrina labyrinthica* AUDOUIN (& SAVIGNY). A good representation of this form is found in MATTHAI's (1924) plate 7, fig. 1.

PW 73 575 looks very peculiarly. It was collected from a depth of 50 m. The calices are very shallow, arranged in long superficial valleys. The collines between the valleys are not more than 2 mm high. The septa are very thin and close-set. The septal dentation and granules at the sides are very fine. The coral has a smooth appearance when compared with other specimens. It is a thin encrustation over a dead layer. This specimen almost approaches *C. ostreaeformis* HORST from the deep water of Providence Island. The present specimen as well as the holotype of *C. ostreaeformis* are only deepwater ecomorphs of *C. monile*.

## Material:

Gulf of Suez:	Jerus.	SLR	828 (Et Tur).
	T. Aviv	NS	8205, 8206, 8682, 8683 (El Bilaiyim).
Gulf of Aqaba:	Jerus.	SLR	398 (Marsa Murach).
	T. Aviv	NS	5396, 5429 (Eilat); 4898, 4904 (Wassit).
	Basel	PW	71 324, 73 573, 73 575 (Eilat, 40-55 m); 71 347 (Fara'un Isl., 40 m).
Northern R. S.:	USNM	Wa	34, 35 (Ghardaqa).
	HLM	EC	497 (Safaga Isl.); 158 (Koseir, duplicate from KLUNZINGER).
Central R. S.:	P. Sud.	Sa	92 (Sanganeb R.).

Distribution: Red Sea; Somaliland; Providence Isls.; Aldabra; Réunion; Mauritius; Maldives; Palk Bay; Ceylon; Mergui Archipelago (DUNCAN, 1889).

Superfamily **Fungiicae** DANA, 1846

Family **Fungiidae** DANA, 1846

Key to the genera of the family Fungiidae from Red Sea:

- A. Corallum discoidal, axial fossa short and monocentric, free at adult stage.
1. Corallum not more than 5 cm in diameter. Disc imperforate. Costae and septa with small grain-like teeth. . . . . *Cycloseris*
  2. Corallum larger than in 1., sometimes oval. Septa and costae prominently dentate. Rarely secondary mouths are developed at the oral side. . . . . *Fungia*
- B. Corallum elongate, with a long axial furrow, free at adult stage.
3. The axial furrow mono- or polycentric. Septa alternating in size. Septa of lower cycles run uninterrupted from the axial furrow to the periphery of the corallum. No lateral calices. . . . . *Ctenactis*
  4. The axial furrow always polycentric. Septa short, those originating from the axial fossa never reach the periphery of the corallum. Lateral calices present. . . . . *Herpolitha*
- C. Corallum foliaceous, plate- or bowl-shaped, and fixed in adult stage.
5. Secondary calices numerous. . . . . *Podabacia*

Genus *Cycloseris* MILNE EDWARDS and HAIME, 1849

Types species: *Fungia cyclolites* LAMARCK, 1801.

Generic characters: Solitary in adult stage. Discoidal or in diaseris form. Corallum imperforate. Very young stages in some species hexagonal. Costal granulation well developed. Adult ones generally attain a size of more or less 5 cm in diameter.

The six species discussed in this work can be separated as follows:

- A. Corallum flat, thin. Scar of attachment often visible.
- a) First two cycles of septa increase in height towards the centre of the disc and become highly exsert around the axial fossa.
    1. Septa comparatively thin, edges of septa sharp. Costae regularly radiating from the centre. . . . . *C. patelliformis*
    - b) First two cycles of septa moderately increasing in height around the fossa. Costae low, at the marginal part of the disc more distinctive.
      2. Septa comparatively thick, edges of septa rounded. . . . . *C. doederleini*
      3. Septa thin, edges of septa lacerated. . . . . *C. cf. erosa*
- B. Corallum conical thick. Scar of attachment in most cases not visible. Major septa exsert.
- a) Costae alternating in size.
    4. Corallum in cycloseris or diaseris form. Disc increasing in thickness towards the centre. Septa thickened, edges blunt, sides highly granular. Columella papillary. . . . . *C. distorta*
    5. Corallum perceptibly oval, underside concave. . . . . *C. cyclolites*
  - b) Costae equal in size.
    6. Corallum circular, underside flat or slightly concave. . . . . *C. costulata*

*Cycloseris patelliformis* (BOSCHMA), 1923

(Plate 16, Fig. 1)

- |                   |  |
|-------------------|--|
| <i>Fungia</i>     | <i>patelliformis</i> 1923, BOSCHMA, 136; pl. 9/9, 11, 13-16a.<br>1925, BOSCHMA, 192; pl. 5/12-14, 21.<br>1952, CROSSLAND, 154; pl. 16/1. |
| <i>Cycloseris</i> | <i>patelliformis</i> 1954, WELLS, 447; pl. 157/1-3.  |

- 1974, SCHEER & PILLAI, 35; pl. 17/4.  
 1980, VERON & PICHON, 115; figs. 184–187.  
*Fungia patella* (pars) 1902, DOEDERLEIN, 65; pls. 1; 2; 5/1, 2. (non 1879, KLUNZINGER 3, 61).

The present collections include more than 50 specimens which we place under this species. They range from 3 to 40 mm in diameter. They are all circular, flat discs. Underside in young stages flat, but in some adult ones slightly arched. Septa thin, edges microscopically serrated, sides granular. The primary cycle of septa most exsert around the axial fossa, followed by the secondaries. A central scar of attachment is visible at the aboral side in many cases. Costae radiate from the centre of the disc to the periphery. In some specimens they are of equal height throughout the length, but in some cases they become less elevated to the centre than at the periphery of the disc.

**Material:**

- Gulf of Aqaba: T. Aviv NS 5405 (Eilat, 30 specimens, 3 to 10 mm in diam.), 5412 (Eilat, 22 specimens, 10 to 20 mm in diam.); 5416 (Eilat, 2 broken pieces of large forms), 5422 (Eilat, 2 small specimens, 5 mm in diam.), 2997, 9296 (Eilat).  
 Basel PW 73 552 (without exact locality); 1 specimen without No and locality.

**Distribution:** Red Sea eastward to Samoa and Hawaii.

**Remarks:** *C. patelliformis* is very near to *C. vaughani* (BOSCHMA), but in the former species the costae are of equal height, whilst the latter has alternating costae towards the periphery, every fourth or eighth is more prominent.

WELLS (1954: 447) gives for the occurrence of *C. vaughani* among other localities also Red Sea with (?). We think that he refers here to *F. patella* from Gulf of Aden, mentioned by VAUGHAN, 1907a, and GRAVIER, 1911.

So far as we could find out, *C. patelliformis* was not yet reported from Red Sea.

*Cycloseris doederleini* (v. MARENZELLER), 1906

(Plate 16, Figs. 2–4)

- Fungia doederleini* 1906, v. MARENZELLER, 88; pl. 21/71, 71a (Type locality: Red Sea).  
 (non 1941, YABE & SUGIYAMA).  
 1971, LOYA & SLOBODKIN, 123.  
*Cycloseris doederleini* 1979, SCHUHMACHER; figs. 19 (left), 20 (left).  
 1980, HEAD, 150, 452.

We have three young specimens in our collection and one from Dr. SCHUHMACHER, which we put to this species. Most of them resemble very much the one figured by MARENZELLER (1906).

**Material:** Gulf of Aqaba: Basel PW 71 318 (Eilat, 40 m); 73 571, 572 (Eilat, 50–55 m).  
 SCHUHMACHER No. 2/1 (Eilat).

**Distribution:** Red Sea.

**Remarks:** MARENZELLER has shown his specimen to DOEDERLEIN, who puts it between *patella* and *distorta* (DOEDERLEIN in litt. in MARENZELLER 1906). *F. doederleini* belongs definitely to the genus *Cycloseris*, though it resembles *Fungia granulosa*. But the latter has a greater diameter in adult stage, and its septa are thinner.

*C. doederleini* comes very near to *C. tenuis*, but more material is needed to prove their identity.

*Cycloseris cf. erosa* (DOEDERLEIN), 1901

(Plate 16, Figs. 5–7)

- Fungia erosa* 1902, DOEDERLEIN, 73; pls. 4/1–1b; 5/4, 4a.  
 1921, v. d. HORST, 58.  
 1941, YABE & SUGIYAMA, 76; pl. 65/4–4d.  
*Cycloseris erosa* 1980, VERON & PICHON, 113; figs. 178, 179.

We could study only one specimen from Dr. SCHUHMACHER from Gulf of Aqaba assigned to *C. marginata*. After a careful comparison with related species and the original descriptions of *C. marginata*, *C.*

*tenuis*, *C. patelliformis* and *C. vaughani* we came to the conclusion that the rare and not well-known species *C. erosa* is next to the present specimen, which we describe as follows:

Corallum round, 35 mm in diameter. Upper surface slightly convex, underside flat. Margin very thin and slightly undulating. Septa unequal, also at the margin; all are thin, only those of the first two cycles are a little thickened at the fossa. The septa of the fourth cycle decrease suddenly in height towards the mouth, those of higher cycles lower gradually. The lower parts of septa unite with those of next higher cycles and finally reach the fossa. Septal margins are sharp with irregular dentations, lacerated by slits and perforated by slit-like holes. Sides of septa with granules, lower parts of septa strongly granulated.

Marginal part of costae laminar and thin, every fourth a little more prominent with irregularly arranged small denticles. Towards the centre costae continue as rows of granules. A scar of attachment present.

Material: Gulf of Aqaba: SCHUHMACHER No. 2/2 (Eilat).

Distribution: Red Sea; Indonesia, Japan, Great Barrier Reef.

Remarks: *Cycloseris erosa* was hitherto not known from Red Sea.

### *Cycloseris distorta* (MICHELIN), 1843

(Plate 16, Figs. 8–11)

<i>Fungia</i>	<i>distorta</i>	1902, DOEDERLEIN, 74; pls. 3; 5/3, 3a (synonymy). 1906, v. MARENZELLER, 88. 1909, GARDINER, 268. 1923, BOSCHMA, 142; pl. 9/10. 1925, BOSCHMA, 203; pl. 6/55–64.
<i>Cycloseris</i>	<i>distorta</i>	1954, WELLS, 447. 1976, PILLAI & SCHEER, 43. 1980, HEAD, 150, 452.
<i>Diaseris</i>	<i>distorta</i>	1909, HARRISON & POOLE, 901; pl. 85/2b, 3a. 1979, SCHUHMACHER, 210. 1980, VERON & PICHON, 121; figs. 194–196.

SLR 395–13 is more or less a flat disc (*cycloseris* form) with a greater diameter of 45 mm. Underside flat. Costae a little more pronounced at the periphery than at the central part of the disc. Major septa thickened, wavy, edges entire, sides granulose.

SLR 1400 and 1401 are *diaseris* forms, the former with 7 petaloid divisions at the periphery, and the latter with 3 divisions. Costae alternating in height, covered by small spines. Septa of subequal height throughout the length. Edges look blunt, sides heavily granular.

Material:

Gulf of Aqaba: Jerus. SLR 1400–1, 2, 1401–1–3, 395–13 (Marsa Murach).  
T. Aviv NS 9303 (Eilat).

Distribution: Red Sea eastward to Tahiti.

### *Cycloseris cyclolites* (LAMARCK), 1801

<i>Fungia</i>	<i>cyclolites</i>	1902, DOEDERLEIN, 77; pls. 4/7–9; 5/5, 5a (synonymy). 1909, GARDINER, 270. 1925, BOSCHMA, 205; pls. 5/24; 6/25–48. 1927, FAUSTINO, 171; pl. 46/4, 5. 1952, CROSSLAND, 153. 1954, ROSSI, 42.
<i>Cycloseris</i>	<i>cyclolites</i>	1879, KLUNZINGER 3, 71. 1941, YABE & SUGIYAMA, 76; pls. 64/2–4c, 8–9d; 65/1–3a. 1974, SCHEER & PILLAI, 35; pl. 17/1, 2 (synonymy). 1979, SCHUHMACHER, 210; figs. 3 (left), 27 (left). 1980, VERON & PICHON, 108; figs. 171–174, 753. 1980, HEAD, 150, 452.

We have no specimen in our collections, but the species was reported by several workers from Red Sea.

The corallum is rounded, sometimes slightly oval, high and equally arched. The underside is more or less concave with distinct, thin and very low costae, costal teeth poorly developed. The major costae



reach the centre of the disc. A scar of attachment is not always visible. The first two cycles of septa stand very high around the axial fossa. Septal edges minutely toothed, sides with granules arranged in transverse rows.

**Distribution:** Red Sea; Ceylon; Tuticorin (PILLAI, 1972); Andamans, Nicobars; Mergui Archipelago; East Indies; China Sea; Philippines; Honshu; Palau Isls.; New Britain.

*Cycloseris costulata* (ORTMANN), 1889

(Plate 17, Figs. 1–5)

<i>Fungia</i>	<i>costulata</i>	1889, ORTMANN, 519; pl. 14/8 (Type locality: Ceylon). 1902, DOEDERLEIN, 81; pls. 4/2, 2a; 5/7, 7a. 1909, GARDINER, 271; pl. 35/9. 1976, PILLAI & SCHEER, 42. 1979, SCHUHMACHER, 212. 1980, VERON & PICHON, 110; figs. 175–177.
<i>Cycloseris</i>	<i>cyclolites</i>	1905, GARDINER, 944 (pars); pl. 91/19. 1921, v. d. HORST, 59 (pars); pl. 2/5.
<i>Fungia</i>	<i>doederleini</i>	1941, YABE & SUGIYAMA, 77; pl. 66/9–9d (non v. MARENZELLER, 1906).

We do not have this species in our collection, we could only study one specimen from Dr. SCHUHMACHER.

The disc is round, 48 mm in diameter, 20 mm high with an unusual thick margin. The central part is elevated and arched around the fossa. First two cycles of septa are clearly exsert towards the fossa, also the third cycle is still exsert. At the periphery the septa are equal. Septa of six cycles are present with some members of the seventh. Septa of higher orders unite with those of the fifth cycle, which get suddenly lower and rise again towards the fossa, but do not reach the former level. The dents, caused in this manner, form a conspicuous ring with a diameter of about 32 mm. Septa of the fourth cycle stop suddenly before reaching the fossa. Septal margins have very small irregular denticles.

Costae of the underside with very small, secondarily frosted spines are equal, distinct and laminar. They extend as rows of granules to the centre, which is a rounded hillock of about 20 mm diameter. It has no sharp boundary, a scar of attachment is not visible.

**Material:** Gulf of Aqaba: SCHUHMACHER No. 2/4 (Eilat).

**Distribution:** Red Sea; Mozambique; Seychelles (WIJSMAN-BEST, FAURE & PICHON, 1980); Maldives; Ceylon; Palau Isls.; Bismarck Archipelago; Great Barrier Reef.

**Remarks:** YABE & SUGIYAMA (1941) felt that *F. costulata* DOEDERLEIN, which is in reality a true *Cycloseris*, is not the same as *F. costulata* ORTMANN, 1899, and proposed a new name *F. doederleini* to DOEDERLEIN's specimens. We do not know exactly, if ORTMANN's and DOEDERLEIN's material belong to a single species or not. However, it may be pointed out that the specific name *doederleini*, as applied by YABE & SUGIYAMA, is preoccupied by MARENZELLER's (1906) *Fungia doederleini*.

Additional remarks on further species of *Cycloseris*, reported from Red Sea:

*Cycloseris marginata* (BOSCHMA), 1923

<i>Fungia</i>	<i>marginata</i>	1923, BOSCHMA, 141; pls. 9/8, 8a; 10/24–26 (Type locality: Paternoster Islands).
<i>Cycloseris</i>	<i>marginata</i>	1974, SCHEER & PILLAI, 35; pl. 17/4. 1979, SCHUHMACHER, 210; figs. 4 (left), 21. 1980, VERON & PICHON, 118; figs. 192, 193.

SCHUHMACHER (1979: 236) mentioned, besides the one we identified as *C. cf. erosa*, four more specimens of this species. VERON & PICHON (1980) say that *C. marginata* was recorded from the Red Sea. They surely refer to SCHUHMACHER, because no other worker has reported on this species from Red Sea.

*Fungia patella* (ELLIS and SOLANDER), 1786

<i>Fungia</i>	<i>patella</i>	1902, DOEDERLEIN, 65; pls. 1; 2; 5/1, 2 (synonymy).
---------------	----------------	---

1909, GARDINER, 267, 269.  
1921, v. d. HORST, 57; pl. 1/1.

In his "Table showing the recent species of *Fungia* with their distribution" GARDINER (1909: 267) mentioned *F. patella* from Red Sea. Already DOEDERLEIN (1902) placed a long list of species in the synonymy of *F. patella*, and BOSCHMA in his report on "*Fungia patella*" (1923: 133) stated: "The chief object of this paper is to demonstrate that in the *Fungia patella* of different authors a number of distinct species are to be distinguished". Since BOSCHMA (1923) *F. patella* is split up and does not exist any more.

The three specimens of *F. patella*, mentioned by GARDINER (1909: 270), do not come from the Red Sea. Under "localities" of *F. patella* he does not list the Red Sea. Hence the exact specific status of GARDINER's specimens is uncertain. The present authors have not studied his material.

### Genus *Fungia* LAMARCK, 1801

Type species: *Madrepora fungites* LINNAEUS, 1758.

Generic characters: Solitary (rarely with secondary calices in some specimens), free in adult stage; discoidal or oval, flat or convex. Septa numerous, dentate. Costae prominent with blunt or sharp spines. Disc sometimes perforate. For the details of the characters of the subgenera of *Fungia* reference may be made to WELLS (1966).

Salient features of *Fungia* reported from Red Sea:

- A. Corallum oval, thick and heavy (Subgenus *Pleuractis*). Wall irregularly and only in older specimens perforate.
1. Corallum flat or arched. Septa minutely dentate. Tentacular lobes prominent. Costae clearly distinguishable with numerous short spines. . . . . *F. scutaria*
  2. Central part of the corallum strongly arched. Septa unequal. Septal edges sharp, dentated or lacerated. Costae consisting of rows of granules. On the upper side mostly additional centres present. . . . . *F. moluccensis*
- B. Corallum circular.
- a) Costae cyclically unequal, but all with spines or granules (Subgenus *Verrillofungia*).
    3. Corallum flat or convex. Septa wavy, major ones thickened, with mostly granular edges and sides. Costal spines tuberculate, with fusion among themselves. Wall perforate. Septal fusion conspicuous, similar to *Cycloseris*. . . . . *F. granulosa*
    4. Corallum flat, comparatively thick, up to 30 cm in diameter. Septa unequal in height. Spines of lower order costae sharp, larger towards the centre of the disc, often swollen at the base. Wall perforate. . . . . *F. repanda*
    5. Corallum flat or arched, even saucer-shaped. Costae with numerous small, granulose spines. Wall imperforate. . . . . *F. concinna*  - b) Only those costae, corresponding to lower cycles of septa, with long, echinulate spines. Costae of higher orders smooth (Subgenus *Danafungia*).
    6. Corallum flat or arched, up to 30 cm in diameter. Septa unequal; lower order septa markedly exsert around the central fossa. Sometimes tentacular lobes present. Spines of lower order costae long and coarse. Wall perforate. . . . . *F. danai*
    7. Corallum flat, thick. Septa of lower orders markedly thicker. Septal margins strongly and irregularly dentate. Lower cycles of costae with large, bifurcated teeth. Wall perforate. . . . . *F. scruposa*
    8. Corallum flat or slightly arched. Septal teeth better developed and more uniform than in 6. Costal spines larger towards the periphery than at the centre of the disc, bifurcated and swollen at the base. Wall imperforate. . . . . *F. horrida*
    9. Corallum generally flat, often irregularly contorted. Septa of lower cycles markedly exsert. Septal dentations regular of moderate size. Lower cycles of costae well developed with numerous conical spines. Wall imperforate. . . . . *F. klunzingeri*

- c) All costae with equally developed tall spines (Subgenus *Fungia*).  
 10. Corallum flat or arched. Septa with triangular dentations. Spines of costae awl-like, smooth.  
 Wall perforate or solid. . . . . *F. fungites*

*Fungia scutaria* LAMARCK, 1801

(Plate 17, Figs. 6, 7)

<i>Fungia</i>	<i>scutaria</i>	1801, LAMARCK, 370. 1876, HAECKEL, 45; pl. 2/1. 1879, KLUNZINGER 3, 65. 1902, DOEDERLEIN, 91; pl. 8/1-8 (synonymy). 1909, GARDINER, 272; pl. 34/8. 1954, ROSSI, 41. 1971, LOYA & SLOBODKIN, 123. 1974, MERGNER & SCHUHMACHER, 264. 1974, SCHEER & PILLAI, 36 (synonymy). 1976, PILLAI & SCHEER, 43. 1979, SCHUHMACHER, 227; fig. 23. 1980, VERON & PICHON, 159; figs. 264-268 (synonymy). 1980, HEAD, 150, 453.
	<i>dentigera</i>	1841, LEUCKART, 48; pl. 3/1, 2. 1860, MILNE EDWARDS (& HAIME), 17. 1879, KLUNZINGER 3, 64. 1892, ORTMANN, 653.
	<i>gravis</i>	1955, NEMENZO, 62; pl. 10/1, 2.
	<i>oabensis</i>	1902, DOEDERLEIN, 97; pl. 9/3-5.
	<i>placunaria</i>	1879, KLUNZINGER 3, 64; pls. 7/1; 8/6 (No. 2529 from Koseir in Berlin Museum).

18 specimens, all with the characteristic tentacular lobes on the septa are placed under this species. SLR 1258-2 is an attached stage with a greater diameter of 3 cm.

Material:

Gulf of Aqaba:	Jerus.	SLR	1258-1, 2 (Fara'un Isl.); 395-10 (Marsa Murach).
	T. Aviv	NS	228, 1248, 1249, 6280, 9302 (Eilat).
	Basel	PW	73 557, 558, 559, 560, 561 (Fara'un Isl.).
Northern R. S.:	HLM	X2:	2-29 (Gubal Isl.).
	USNM	Wa	44 (Ghardaqa).
Central R. S.:	P. Sud.	Sa	105 (Sanganeb R.).
	HLM	RM	16, 16a (Wingate R.).

Distribution: Red Sea; East Africa; Aldabra; Réunion; Chagos; Maldives; Lakshadweep; Ceylon; Andaman and Nicobar Isls.; Cocos-Keeling Isls.; East Indies; Philippines; Japan; Palau Isls.; Caroline Isls.; Solomon Isls.; New Caledonia (CHEVALIER, 1968); Marshall Isls.; Hawaii; Fanning Isls.; Cook Isls. (STODDART & PILLAI, 1973); Tuamotu Archipelago.

Remarks: *F. oabensis* (DOEDERLEIN, 1902) from Hawaii is said to have a heavy corallum with the costal spines greatly developed and irregularly swollen. We do not think that this is of specific value. *F. gravis* (NEMENZO, 1955) is again only a skeletal variation. These two are positive synonyms of *F. scutaria*.

*Fungia moluccensis* v. d. HORST, 1919

(Plate 17, Figs. 8, 9; Plate 18, Fig. 1)

<i>Fungia</i>	<i>moluccensis</i>	1919, v. d. HORST, 65; pl. 1 (Type locality: Moluccas). 1921, v. d. HORST, 60; pl. 2/1, 2. 1925, BOSCHMA, 210; pls. 6/49; 7/75, 76; 10/128. 1980, VERON & PICHON, 165; figs. 273-282, 756.
	<i>somervillei</i>	1924, MATTHAI, 41 (pars); pl. 9/3. 1974, SCHEER & PILLAI, 37; pl. 18/1, 2. 1979, SCHUHMACHER, 212; fig. 3 (right).

We have only one specimen before us, which we owe to Dr. SCHUHMACHER, who has collected this species for the first time in the Red Sea at Eilat.

The corallum is elongated and oval, 12 cm long and 6.5 cm broad. The central part of the upper surface is very arched along the axial fossa, which is 5.5 cm in length. Here the height of the corallum is about 4 cm. Septa are unequal, at the marginal part of the corallum irregularly fusing together. Edges of projecting septa dentate to lacerate, the lower ones of higher orders granulate. Costae heavily granulated with knob-like papillae, only at the periphery unequal. Lateral sides of upper surface with numerous secondary calices, which give a contorted appearance to the corallum.

**Material:** Gulf of Aqaba: SCHUHMACHER No. 2/10 (Eilat).

**Distribution:** Red Sea; Nicobar Is.; Mergui Archipelago; Philippines; Moluccas; Great Barrier Reef.

**Remarks:** *F. moluccensis* has some resemblance to *Cycloseris somervillei* GARDINER, 1909, with which it can be confounded. *C. somervillei* does not occur in the Red Sea.

### *Fungia granulosa* KLUNZINGER, 1879

(Plate 18, Fig. 2)

<i>Fungia</i>	<i>granulosa</i>	1879, KLUNZINGER 3, 65; pls. 7/3; 8/3 (Type locality: Red Sea).
		1902, DOEDERLEIN, 108; pl. 11/1-1b.
		1906, v. MARENZELLER, 89.
		1909, GARDINER, 276.
		1921, v. d. HORST, 63; pl. 1/8.
		1974, MERGNER & SCHUHMACHER, 264.
		1979, SCHUHMACHER, 214, fig. 5; 225, figs. 19 (centre), 20 (centre).
		1980, VERON & PICHON, 156; figs. 257-263.
		1980, HEAD, 150, 453.
<i>Strombodes</i>	<i>bemprichii</i> ?	1834, EHRENBERG, 211.

The following is a generalized description of the species based on the present collections. Young as usual attached. Disc of adults rounded, 8 to 10 mm thick, slightly elevated around the axial fossa. Under-side flat or arched. Greater diameter up to 8 cm. Axial fossa in large specimens about 2 cm long.

Two of the specimens (NS 9300 and 9301) are with secondary mouths (1 and 8 respectively), each with a columellar centre. This feature is not mentioned either by KLUNZINGER or by DOEDERLEIN, though the latter author's figure shows clearly one.

Major septa thick, wavy, subequal in thickness. All septa of the same height at the periphery of the corallum. At the junction of the lower and higher cycles of septa the latter at first a little low, but suddenly spring up to the level of the former. Septal edges entire, i. e. without any well developed teeth, though in some cases they are granular. In thin septa the edges are microscopically serrated. Septal sides profusely granular. Columella fills the entire bottom of the axial fossa, looks solid to the naked eye. Costae very thin, extend to the centre of the disc, but mostly represented by a row of fine rounded grains. In older specimens the grains fuse to form irregular swellings. But for these neither ridges nor teeth are developed at the lower side. In NS 9299 the grains representing costae do not extend to the centre of the disc, where it is smooth.

**Material:**

Gulf of Suez:	Jerus.	SLR	859 (Et Tur).
Gulf of Aqaba:	Jerus.	SLR	395-8, 9 (Marsa Murach).
	T. Aviv	NS	9297, 9299, 9300, 9301 (Eilat).
	Basel	PW	73 585 (Eilat).
Central R. S.:	P. Sud.	Sa	109, 109a (Sanganeb R.).
	HLM	RM	75 (Wingate R.).

**Distribution:** Red Sea; Philippines; Moluccas; Great Barrier Reef.

**Remarks:** The type of *Strombodes bemprichii* EHRENBERG is No. 608 in the Museum of Berlin. As already pointed out by KLUNZINGER it is a young *Fungia* in its attached stage. It is rather difficult to judge its identity with *F. granulosa*.

*Fungia repanda* DANA, 1846

(Plate 18, Figs. 3–5)

<i>Fungia</i>	<i>repanda</i>	1846, DANA, 295; pl. 19/1–3 (Type locality: Fiji). 1902, DOEDERLEIN, 115; pls. 12/4, 5; 13/1–3, 5–7. 1921, v. d. HORST, 64. 1941, YABE & SUGIYAMA, 78; pls. 73/2–3d; 74/2–2e; 75/3–3b. 1976, PILLAI & SCHEER, 44 (synonymy). 1980, VERON & PICHON, 146; figs. 239–244 (synonymy).
---------------	----------------	--

The species is characterized by its very unequally high septa, by the protruding main costae with elongated, granulated spines, by the smaller higher order costae with shorter spines or granules, and by the strongly perforated wall.

We have no specimen in our collections, but we include this species into our report because v. d. HORST (1921: 64) mentioned 6 specimens from Red Sea in the Museum Leiden: "The specimens from Red Sea are undoubtedly *F. repanda*, and the locality, Red Sea, can be vouched for". Dr. WIJSMAN-BEST has sent us one of these specimens (Museum Leiden No. 9507) and we can confirm the identification as *F. repanda*. Neither EHRENBERG (1834) nor KLUNZINGER (1879), MARENZELLER (1906), CROSSLAND (1952) or one of the more recent authors till HEAD (1980) has found this species in the Red Sea. Only VERON & PICHON (1980) mention it from Red Sea.

DOEDERLEIN (1902) writes that the original of *F. agariciformis* var. *discooides* EHRENBERG from the Museum in Berlin belongs to *F. repanda*. We have examined the type, No. 764, and regard it as *F. fungites*. Attached to the corallum is a label: "764. *Fungia fungites* L. var. *agariciformis*. DOEDERLEIN 1900 bestimmt."

Distribution: Red Sea; Indian Ocean; in the Pacific as far east as Tuamotu Archipelago.

*Fungia concinna* VERRILL, 1864

(Plate 18, Figs. 6–8)

<i>Fungia</i>	<i>concinna</i>	1864, VERRILL, 50 (Type locality: Zanzibar). 1902, DOEDERLEIN, 113; pls. 12/1–3; 13/4. 1909, GARDINER, 276. 1954, ROSSI, 40. 1974, SCHEER & PILLAI, 39. 1980, VERON & PICHON, 150; figs. 245–250 (synonymy). 1980, HEAD, 150, 452.
	<i>plana</i>	1902, DOEDERLEIN, 111; pl. 11/2–5. 1906, v. MARENZELLER, 89.

EC 363 has a disc-shaped corallum with a slightly convex surface. The concave underside is raised in the middle. The greater diameter of the corallum is 12.5 cm. Septal teeth uniform in size, about 10 in 10 mm length of septum. Costae become faint towards the central part of the disc. Costal teeth small, those of the larger costae up to 1 mm high and thick, larger ones bifurcating. Disc imperforate.

X2: 2–8 is a smaller, flat piece with 9 cm in diameter. Septa with smaller dentations. Parallel to the septal margins wavy lines recognizable.

X2: 3–9 is a saucer-shaped corallum with a longer diameter of 13.5 cm. The major septa stand above the higher cycles. The teeth on septa are poorly developed, septal edges lock entire to the naked eye. Sides of septa granular, near the margins with wavy lines. The costae corresponding to the major septa are very conspicuous. Teeth on costae faint at the central part of the corallum. This specimen differs from other ones in the nature of septal edges, it approaches *F. plana* STUDER.

*F. concinna* is near to *F. repanda*, but the major distinction between these two is the perforated wall of the latter, whilst *F. concinna* is unperforated.

## Material:

Northern R. S.: HLM X2: 2–8, 3–9 (Gubal Isl.).  
Southern R. S.: HLM EC 363 (Massawa).

Distribution: Red Sea; Zanzibar; Seychelles; Chagos Archipelago; Andamans; Nicobars; Singapore; Java; Philippines; Japan; Celebes; Banda Sea; Great Barrier Reef; Caroline Isls.; Marshall Isls.; Samoa; Tahiti; Tuamotu Archipelago.

*Fungia danai* MILNE EDWARDS and HAIME, 1851

(Plate 19, Figs. 1, 2)

<i>Fungia</i>	<i>danai</i>	1860, MILNE EDWARDS (& HAIME), 11; pl. D10/1. 1902, DOEDERLEIN, 129; pls. 14/3, 3a; 15/3, 4a; 16/5, 5a; 18/1-4a. 1927, FAUSTINO, 181; pls. 57/1, 2; 58/2, 3. 1932, THIEL, 78; pl. 9/2, 3. 1941, YABE & SUGIYAMA, 79; pl. 74/1-1d. 1976, PILLAI & SCHEER, 43 (synonymy). 1980, VERON & PICHON, 134; figs. 214-217.
	<i>echinata</i>	1846, DANA, 294; pl. 18/8, 9.
	<i>lobulata</i>	1889, ORTMANN, 520; pl. 15/9.

We have one specimen, which we refer to this species. The piece is broken, and only one half is present. Diameter of the disc 13 cm.

Septa are very unequal, the lower order septa are markedly exsert, especially around the central fossa. The margins of the septa are rather regularly dentate, about 6 teeth per cm, which appear thickened due to ridges vertically to the septal edges. Between the higher order septa synapticulae are clearly visible. No tentacular lobes present.

Undersurface with very unequal costae. Those of the lower orders with tall spines, often echinulate at the tips, sometimes bifurcating or branching. Centre of the disc also covered with such spines. Between the lower order costae mostly two of higher orders, which are rounded and smooth and separated by long slit-like perforations.

The upper surface of our specimen is very similar to that of *F. repanda*, but the costae prove its affinity to subgenus *Danafungia*. The undersurface with only two smooth costae between the spinuous ones of lower orders point at *F. scruposa*, but the regular septal dentations belong to *F. danai*.

Material:

Northern R. S.: HLM EC 429 (Shadwan Isl.).

Distribution: Red Sea; Madagascar; Seychelles; Maldives; Minicoy; South India; Ceylon; Andamans; Mergui Archipelago; Singapore; Indonesia; Philippines; Japan; Great Barrier Reef; New Caledonia; Fiji; Tahiti.

Remarks: This is the first record of *F. danai* from Red Sea.

*Fungia scruposa* KLUNZINGER, 1879

(Plate 19, Figs. 3, 4)

<i>Fungia</i>	<i>scruposa</i>	1879, KLUNZINGER 3, 63; pls. 7/2; 8/1 (Type locality: Red Sea). 1902, DOEDERLEIN, 133; pl. 19/1-3. 1906, v. MARENZELLER, 89. 1941, YABE & SUGIYAMA, 79; pls. 75/4, 4a; 76/1-1b. 1954, ROSSI, 40. 1979, SCHUHMACHER, 210. 1980, VERON & PICHON, 137; figs. 222-225. 1980, HEAD, 150, 452.
---------------	-----------------	---

The following is a description of the present specimen EC 515: Disc more or less rounded, slightly arched. Greater diameter 10.5 cm. Disc flat, not elevated around the axial fossa, highly perforated. Axial fossa 1.75 cm long, deep, the major septa (12) vertically descend into the bottom of the fossa. Major septa subequal in height. 2 to 3 subsidiary septa between two major septa can be seen at the periphery of the disc. Septal teeth conspicuous, lacerated, irregular, very thin, less than 1 mm thick, 1 to 2.5 mm high, turning to either side of the septum, closely placed, secondarily frosted; all together giving a rough look to the coral.

Costae correspond to septa, major costae 2 to 3 mm high and thick at the periphery of the disc, low and thin at the centre. Costal teeth 2 to 3 mm high, pointed at the tip, larger ones bifurcated, 1 to 2 mm thick at the base. Two almost complete rings of ridges formed by coenenchymal deposition bridge all costae at the underside.

PW 73 606 is a dead coral piece covered with calcareous algae and with three attached small and very young *Fungiae*, which we put with a query to *F. scruposa*.

**Material:**

Gulf of Aqaba: Basel PW 71 305 (juv., Eilat, 40 m); 73 606 (? , juv., Fara'un Isl.).  
 Norther R. S.: HLM EC 515 (Ras Abu Hagar).

**Distribution:** Red Sea; East Indies (v. d. HORST, 1921); Japan; Great Barrier Reef.

**Remarks:** The major distinctions between the present species and *F. horrida* are in the highly lacerated and irregular teeth and the better perforation at the undersurface of *F. scruposa*. More specimens are to be examined to ascertain the relationship of these two forms.

*Fungia horrida* DANA, 1846

(Plate 19, Figs. 5, 6)

<i>Fungia</i>	<i>horrida</i>	1846, DANA, 298; pl. 19/7 (Type locality: Fiji). 1902, DOEDERLEIN, 122; pl. 14/1, 1a. 1906, v. MARENZELLER, 89. 1909, GARDINER, 267. 1924, MATTHAI, 44; pls. 9/2; 10/6. 1925, BOSCHMA, 66; pl. 12/4, 6. 1979, SCHUHMACHER, 210. 1980, VERON & PICHON, 139; figs. 226–230 (synonymy). 1980, HEAD, 150, 452.
	<i>fieldi</i>	1909, GARDINER, 277; pls. 33/3, 4; 34/7.
	<i>madagascariensis</i>	1906a, VAUGHAN, 831; pls. 72; 73; 74/3.
	<i>valida</i>	1879, KLUNZINGER 3, 62; pl. 8/7, 8 (non VERRILL, 1864).

The present specimens are either arched or flat. One of our specimens (SLR 1226) is an attached stage. The adult specimens have prominent septal dentations characteristic of this species. A specimen from USNM (Wa 43), which we examined, is a circular flat disc with a greater diameter of 18 cm. Axial fossa only 3 cm long and 0.5 cm wide. It agrees to KLUNZINGER's description of *F. valida* (non VERRILL). There are 3 to 4 large teeth per cm length of septum.

**Material:**

Gulf of Aqaba: Jerus. SLR 1226 (juv., Fara'un Isl.); 395–1 (Marsa Murach).  
 T. Aviv NS 6160 (juv.), 9294 (Eilat).  
 Northern R. S.: USNM Wa 43 (Ghardaqa).  
 HLM X2: 2–26 (? , juv., Gubal Isl.).  
 Central R. S.: P. Sud. Sa 104 (Sanganeb R.).

**Distribution:** Red Sea; Madagascar; East Indies; Philippines; Great Barrier Reef; Fiji; Tahiti.

**Remarks:** The difference between *F. horrida* and *F. valida* VERRILL (type locality: Zanzibar) is slight. According to DOEDERLEIN (1902) KLUNZINGER's *F. valida* is only *F. horrida* and not conspecific with that of VERRILL.

The type of *F. fieldi* GARDINER (1909) in the Zoological Museum of Cambridge University is a disc-shaped corallum with every fourth septum broader than the intervening ones. The costal spines are swollen, the larger ones are up to 7 mm high.

The type of *F. madagascariensis* VAUGHAN (1906a) is USNM 21141, a very heavy specimen, which shows little variation from *F. fieldi* and *F. valida*.

It appears to the present authors that all the species mentioned here are skeletal variants of one and the same species which should be called *F. horrida*.

*Fungia klunzingeri* DOEDERLEIN, 1901

(Plate 19, Figs. 7, 8)

<i>Fungia</i>	<i>klunzingeri</i>	1901, DOEDERLEIN, 358 (Type locality: Red Sea).
		1902, DOEDERLEIN, 124; pls. 15/1, 1a; 16/4 (? , juv.).
		1909, GARDINER, 267.
		1979, SCHUHMACHER, 225; figs. 19 (right), 20 (right).
		1980, VERON & PICHON, 144; figs. 234–235.

We have six specimens which we assign to this species. Two are slightly arched and four are flat discs with unequal septa and short central fossae. The septa of lower cycles are markedly exsert. Edges of septa with regular, more or less triangular dentations. Costae corresponding to lower cycles of septa well developed, laminar with numerous spines. They are separated by lower and shorter costae without spines. Underside not perforated.

NS 3069 is a contorted specimen with a greater diameter of 7.5 cm. The higher order costae bear only few thin spinulose spines, sometimes arborescent or confluent.

X2: 3–29 is a flat disc with a diameter of 18 cm. Septa are regularly dentate with about 4 teeth per cm. Costae corresponding to lower order septa very prominent, laminar with coarse spines, which are very spinulose, tufted or arborescent. Centre of the disc only granulated. Scar of attachment present.

## Material:

Gulf of Suez:	Jerus.	SLR	841–1, 2 (Et Tur).
Gulf of Aqaba:	T. Aviv	NS	3069, 9295 (Eilat).
	Basel	PW	73 584 (Eilat, 40–45 m).
Northern R. S.:	HLM	X2:	3–29 (Gubal Isl.).
Central R. S.:	HLM	RM	74 (Wingate R.).

Distribution: Red Sea; Great Barrier Reef.

*Fungia fungites* (LINNAEUS), 1758

(Plate 20, Figs. 1–5)

<i>Madrepora</i>	<i>fungites</i>	1758, LINNAEUS, 793 (Type locality: Red Sea).
		1775, FORSKAL, 134.
		1776, FORSKAL, 14; pl. 42/1–3.
<i>Fungia</i>	<i>fungites</i>	1902, DOEDERLEIN, 136; pls. 20–25 (synonymy).
		1906, v. MARENZELLER, 89.
		1941, CROSSLAND, 40.
		1954, ROSSI, 41.
		1967, SCHEER, 428.
		1971, LOYA & SLOBODKIN, 123.
		1974, MERGNER & SCHUHMACHER, 264.
		1974, SCHEER & PILLAI, 38 (synonymy).
		1976, PILLAI & SCHEER, 44.
		1979, SCHUHMACHER, 234; figs. 26, 27 (right).
		1980, VERON & PICHON, 129; figs. 206–213, 755, 757 (synonymy).
		1980, HEAD, 150, 452.
	<i>agariciformis</i>	1834, EHRENBERG, 272.
		1841, LEUCKART, 42; pl. 4/1–4.
	<i>confertifolia</i>	1860, MILNE EDWARDS (& HAIME), 10.
	<i>patella</i>	1860, MILNE EDWARDS (& HAIME), 7.
		1879, KLUNZINGER 3, 61; pls. 7/4; 8/2 (synonymy).
		1888, FAUROT, 119.
		1889, ORTMANN, 519.
	<i>tenuifolia</i>	1860, MILNE EDWARDS (& HAIME), 9.

There is a good number of specimens in the present collections. They range from early attached stage to fully developed ones. The species display wide skeletal variation. We have made no attempt to identify the various varieties recognized by DOEDERLEIN. We have also seen EHRENBERG's types of his *F. agariciformis*, Nos. 764, 768 and 769 in the Museum Berlin.



## Material:

Gulf of Suez:	Jerus.	SLR	2250-1-8 (Ras el Misalla); 827, 2103-1, 2 (Et Tur).
	T. Aviv	NS	8434, 8441, 8442 (Ras Matarma); 8191 (Ras el Kanisa).
Gulf of Aqaba:	Jerus.	SLR	1253 (Fara'un Isl.); 395-6, 11 (Marsa Murach); 1181 (Marsa el Mueibla); 454 (El Kura); 662-1, 2 (Marsa Abu Zabad).
	T. Aviv	NS	9291, 9292, 9293, 9298 (Eilat).
	HLM	EC	453 (Eilat).
Northern R. S.:	T. Aviv	NS	1862 (Ras Muhammad).
	USNM	Wa	36, 37, 38, 39, 40, 41, 42 (juv.), 42a (Ghardaqa).
	HLM	EC	472 (Ras Abu Suma); 63 (Koseir, duplicate from KLUNZINGER); 295 (Ras Abu Hagar).
Central R. S.:	P. Sud.	Sa	18 (Sanganeb R.).
	HLM	RM	15, 73, 116, 122 (Wingate R.).
Southern R. S.:	HLM	X2:	9-4, 9-16, 9-21, 9-25 (Sarso Isl.).
		EC	364 (Massawa).

**Distribution:** Red Sea; Somaliland (GRAVIER, 1911); East Africa; Seychelles; Chagos; Maldives; Minicoy; Andaman and Nicobar Isls.; Singapore; Java; Timor; Banda; Amboina; Philippines; Japan; Palau Isls.; Caroline Isls.; Great Barrier Reef; Solomon Isls.; Marshall Isls.; Samoa; Tuamotu Archipelago.

**Remarks:** FORSKAL (1775: 134) mentioned a further specimen, different from *Madrepora fungites*, one foot long and 5 inches broad, with large lamellar teeth. CROSSLAND (1941: 40) opined that this could only be *Herpolitha limax*. However, we believe that FORSKAL had *Ctenactis echinata* at hand, which occurs in the Red Sea more frequently than *H. limax*.

Additional remarks to genus *Fungia*:

GARDINER (1909: 278) reported on four specimens of *Fungia acutidens* STUDER, collected by CROSSLAND in the reefs of Suakin. We could not examine these specimens, therefore we mention this species, previously known solely from New Ireland and doubtfully from Tahiti, only in an appendix.

CROSSLAND (1952) mentioned the occurrence of *F. paumotensis* STUTCHBURY in the Red Sea. His own specimen does not come from there and it is, after his own words, an abnormal specimen. We believe that CROSSLAND's note depend on a misunderstanding. Also VERON & PICHON (1980) report on *F. paumotensis* from the Red Sea. We do not know to which authority they refer, no other author has ever published *F. paumotensis* from the Red Sea. The next locality, where *F. paumotensis* was found, is Aldabra (ROSEN, 1971).

Genus *Ctenactis* VERRILL, 1864

**Type specimen:** *Madrepora echinata* PALLAS, 1766.

**Generic characters:** Corallum elongate with a long, mono- to polystomatous axial furrow. Septa unequal in height with coarse, elongate-compressed, large, spinose teeth. Costae reduced, unequal, represented by strongly spinose, arborescent spines. The genus is monospecific.

WELLS (1966) has put *Fungia echinata* into the new subgenus *Ctenactis*, and he has established a new genus, *Herpetoglossa*, homeomorphic with *Fungia* (*Ctenactis*), with the same septo-costal structures and containing one species, *H. simplex* (GARDINER). The main difference between these two forms consists in the development of several calicinal centres in the axial furrow of *H. simplex*. Wells considers *Herpetoglossa* as a very recent polystomatous derivative of *Fungia* (*Ctenactis*).

But nearly all authors agree, that *F. (Ctenactis) echinata* can be polycentric, too. Already EHRENBERG (1834: 274) had the varieties *platystoma* and *polystoma*. Then KLUNZINGER (3, 1879: 66), DOEDERLEIN (1902: 104), GARDINER (1909: 274), MATTHAI (1924: 42), BOSCHMA (1925: 216), THIEL (1932: 67), CROSSLAND (1952: 152) write that septa of opposite sides fuse at the axial fossa and divide it in secondary centres, at least the tendency for dividing is present. Also VERON & PICHON (1980: 171) state that *F. echinata* "may have rarely one, very rarely two, secondary centres". It is not applicable to separate specimens with null, one or two secondary centres as *F. echinata* from those with three and more under the name *H. simplex*.

Also the extension of the axial fossa to either ends of the corallum in *H. simplex*, as GARDINER (1905) assumes, is no specific character. There are specimens with shorter fossa and, on the other hand, specimens of *F. echinata* with long extending grooves.

BOSCHMA (1925) supposes that *H. simplex* has smaller costal spines and stronger granulated septa of higher orders than *F. echinata*. After VERON & PICHON (1980) the two forms differ in the following way: "Adult *H. simplex* are always polycentric, have more numerous, less alternating septa with triangular rather than lobate tentations with a thickened axial rod, and more numerous costal spines." We believe that all these differences are lying within the skeletal variability.

Therefore we propose to put together the two forms and to raise the subgenus *Ctenactis* again into the rank of a genus, as already recommended by VERRILL (1864).

*Ctenactis echinata* (PALLAS), 1766

(Plate 20, Figs. 6–9)

<i>Madrepora</i>	<i>echinata</i>	1766, PALLAS, 284 (Type locality: Indian Ocean).
<i>Haliglossa</i>	<i>echinata</i>	1834, EHRENBERG, 274 (No. 780 in Museum Berlin).
<i>Ctenactis</i>	<i>echinata</i>	1864, VERRILL, 51.
<i>Haliglossa</i>	<i>echinata</i>	1879, KLUNZINGER 3, 67.
<i>Fungia</i>	<i>echinata</i>	1902, DOEDERLEIN, 101; pl. 10/1–5 (synonymy). 1906, v. MARENZELLER, 63. 1954, ROSSI, 41. 1967, SCHEER, 428. 1971, LOYA & SLOBODKIN, 123. 1974, SCHEER & PILLAI, 37 (synonymy). 1976, PILLAI & SCHEER, 43. 1979, SCHUHMACHER, 210. 1980, VERON & PICHON, 169; figs. 283–289. 1980, HEAD, 150, 453.
<i>Herpetolithas</i>	<i>ebrenbergii</i>	1841, LEUCKART, 52; pl. 2/1–3.
<i>Fungia</i>	<i>ebrenbergii</i>	1860, MILNE EDWARDS (& HAIME), 14. 1889, ORTMANN, 521.
<i>Haliglossa</i>	<i>pectinata</i>	1879, KLUNZINGER 3, 66.
<i>Herpetolithas</i>	<i>rueppellii</i>	1841, LEUCKART, 54; pl. 1/1–3.
<i>Herpolitha</i>	<i>simplex</i>	1905, GARDINER, 943; pl. 91/13. 1925, BOSCHMA, 223; pl. 7/68–70. 1955, NEMENZO, 76; pl. 14/2, 4.
<i>Herpetoglossa</i>	<i>simplex</i>	1966, WELLS, 241. 1980, VERON & PICHON, 173; figs. 290–293.

There are 24 specimens of this species in the present collections. All pieces have an elongate shape with an axial furrow extending more or less over the entire length of the corallum. The largest specimen before us is 28 cm long. In one of the specimens (RM 72) the corallum is four-lobed. The axial fossa extends to all the four arms.

After the combination of *Fungia echinata* and *Herpetoglossa simplex* the present species is easily to identify by virtue of the characteristic form, the septal dentation and the costal spines. The axial furrow can be monocentric or polycentric by fusion of opposite septa.

Material:

Gulf of Aqaba:	Jerus.	SLR	395–2, 3, 4, 5, 7, 1275 (Marsa Murach).
	T. Aviv	NS	230, 9290 (Eilat); 1883 (Dahab).
Northern R. S.:	T. Aviv	NS	1868 (Ras Muhammad).
	HLM	X2:	3–38 (Gubal Isl.)
		EC	473 (Ras Abu Suma); 62 (Koseir, duplicate from KLUNZINGER); 296 (Ras Abu Hagar).
Central R. S.:	P. Sud.	Sa	12 (Sanganeb R.).
	HLM	RM	14, 17, 17a, 72 (Wingate R.).
Southern R. S.:	HLM	X2:	10–5, 10–13 (Sarso Isl.).
		EC	365, 366, 367 (Massawa).

**Distribution:** A wide-spread species from Red Sea along the east coast of Africa throughout the Indo-Pacific as far east as Tahiti and Hawaii.

Genus *Herpolitha* ESCHSCHOLTZ, 1826

Type specimen: *Madrepora limax* ESPER, 1795.

Generic characters: DUNCAN (1884: 145) defined the genus thus: "The corallum is free, long, narrow, and compound. The upper surface has calices of two kinds — one set occupy a long central axial line and are multilamellar, and the other set are placed irregularly, have few lamellae, and are small. The septo-costal rays are long and stout, and alternately thick and thin, and all are entire. No rays reach from the axial furrow to the circumference. The base is concave, perforated and echinulated. Synaptacula regular, numerous, oblique, tall, and wanting here and there. Columella trabecular."

*Herpolitha limax* (ESPER), 1795

(Plate 21, Fig. 1)

<i>Madrepora</i>	<i>limax</i>	1797, ESPER, 77; pl. 63.
<i>Herpetolitha</i>	<i>limax</i>	1860, MILNE EDWARDS (& HAIME), 24 (synonymy). 1889, ORTMANN, 518.
<i>Herpolitha</i>	<i>limax</i>	1909, GARDINER, 284; pls. 38/20–23; 39/24, 25. 1921, v. d. HORST, 67 (synonymy). 1971, LOYA & SLOBODKIN, 123. 1974, MERGNER & SCHUHMACHER, 265. 1974, SCHEER & PILLAI, 39 (synonymy). 1976, PILLAI & SCHEER, 45. 1979, SCHUHMACHER, 210. 1980, VERON & PICHON, 178; figs. 294–299. 1980, HEAD, 150, 453.
	<i>crassa</i>	1918, VAUGHAN, 129; pls. 53/1, 1a; 54/1.
	<i>foliosa</i>	1879, KLUNZINGER 3, 68; pl. 8/4, 5. 1906, v. MARENZELLER, 89. 1909, GARDINER, 282; pls. 36/14, 15; 37.
<i>Haliglossa</i>	<i>foliosa</i>	1834, EHRENBERG, 275 (No. 789 in Museum Berlin).
	<i>interrupta</i>	1834, EHRENBERG, 275 (No. 785 in Museum Berlin).
	<i>limacina</i>	1834, EHRENBERG, 275.
	<i>stellaris</i>	1834, EHRENBERG, 275.

We have five specimens in the present collections. RM 76 and 77 are elongated, the former with a total length of 18.5 cm and the latter 13 cm. The axial fossa in both the specimens do not extend to the extremities. The secondary calices on the surface are conspicuous.

PW 73 629 is a regenerated specimen. It has three lobes, the axial fossa extends to all the three.

**Material:**

Gulf of Aqaba: Basel PW 73 629 (El Kura, 20 m).  
Northern R. S.: T. Aviv NS 5947 (Ras Muhammad).  
Central R. S.: P. Sud. Sa 91 (Sanganeb R.).  
HLM RM 76, 77 (Wingate R.).

**Distribution:** Red Sea; Indian Ocean; in the Pacific as far east as Cook Isls. (STODDART & PILLAI, 1973), Tahiti and Tuamotu Archipelago.

Genus *Podabacia* MILNE EDWARDS and HAIME, 1849

Type specimen: *Madrepora crustacea* PALLAS, 1766.

Generic characters: Colonial fungiid with a foliaceous corallum attached at the adult stage. Underside costate. Secondary calices arranged around a large central mother calyx. Septo-costae confluent.

*Podabacia crustacea* (PALLAS), 1766

(Plate 21, Figs. 2, 3)

<i>Madrepora</i>	<i>crustacea</i>	1766, PALLAS, 291.
<i>Podabacia</i>	<i>crustacea</i>	1860, MILNE EDWARDS (& HAIME), 20.
		1905, GARDINER, 942; pl. 90/8.
		1936, YABE, SUGIYAMA & EGUCHI, 64; pl. 47/1-6.
		1952, CROSSLAND, 156; pls. 12/1; 13/3.
		1964, SCHEER, 618; fig. 8.
		1971, LOYA & SLOBODKIN, 123.
		1980, VERON & PICHON, 197; figs. 324-327.
		1980, HEAD, 150, 453.

The occurrence of this genus and species in Red Sea was first reported by SCHEER (1964), who has already described and figured his material RM 102. It is part of a corallum 17 mm thick at the broken edge. The older part of the corallum imperforate, but at the periphery it is perforated.

NS 4919 is an entire cup-shaped corallum with a greater diameter of 12.5 cm. The cup has a depth of 6.5 cm. The attachment was somehow lost at the time of collection, but a narrow base is present. Corallum porous. The growing edges are 3 to 3.5 mm thick. The central mother calyx is 7 mm in diameter. Secondary calices 5 to 7 mm apart with 12 to 18 septa. Septa alternating in height and thickness, edges dentate, sides granular. Costae extend from the periphery to the base, but they are faint at the central part of the corallum where their course is marked by granules.

## Material:

Gulf of Aqaba:	Jerus.	SLR	649, 670 (Marsa Abu Zabad).
	T. Aviv	NS	4912, 4917, 4919 (Dahab); 1841a, 1935, 1936 (Shurat el Manqata).
	Basel	PW	71 303 (60 m), 71 358 (Eilat); 73 691 (El Kura).
Northern R. S.:	T. Aviv	NS	1870 (Ras Muhammad).
Central R. S.:	P. Sud.	Sa	85 (Sanganeb R.).
	HLM	RM	102 (Wingate R.).

Distribution: Red Sea; Réunion (FAURE, 1977); Maldives; Ceylon; Singapore; Philippines; Japan; Great Barrier Reef; Marshall Isls.; Samoa; Tuamotu Archipelago.

## Superfamily Poriticae GRAY, 1842

## Family Poritidae GRAY, 1842

The family Poritidae is represented in the Red Sea by three genera viz. *Porites*, *Goniopora* and *Alveopora*. Among these the genus *Porites* is the most abundant and often a major reef builder as is the case elsewhere in the Indo-Pacific.

Key to the genera of the family *Poritidae* discussed herein:

- A. Septa spiny, 1 to 3 cycles, generally not joined to a columella. Corallum highly porous, very light. . . . . *Alveopora*
- B. Septa and columella well developed. Corallum moderately porous.
1. Septa fundamentally in three cycles. Calices more than 2 mm in diameter. . . . . *Goniopora*
2. Septa fundamentally in two cycles. Corallites generally less than 2 mm in diameter. . . . . *Porites*

Genus *Alveopora* de BLAINVILLE, 1830

Type species: *Madrepora daedalea* FORSKAL, 1775.

Generic characters: Explanate, columnar, submassive or ramose. Septa composed of thin spines, 2 to 3 cycles. Columella ill-formed. Wall highly porous.

The genus *Alveopora* urgently needs a revision. We have found in literature 19 species reported from Indo-Pacific, mostly single specimens, or known only from one locality. The usual distinction of the

species is based on size of corallites and number of septal spines. The latter criterion is not always unequivocal, size and number of the spines change within one species.

We have tried to separate the species on grounds of shape of corallum and size of corallites.

Key to the species considered herein:

- A. Corallum globular, knob-like.  
 1. Corallites 2 to 2.5 mm in diameter. Septal spines in two cycles. . . . . *A. daedalea*  
 B. Corallum columnar, plate-like or lobate.  
 2. Corallites polygonal, 1 to 1.5 mm in diameter. Septal spines in two cycles. . . . . *A. verrilliana*  
 3. Corallites rounded, neighbouring walls often separated. Corallites 1.5 mm in diameter. Septal spines in two cycles, second cycle short. . . . . *A. ocellata*  
 C. Corallum branching.  
 4. Corallites 2.5 to 4 mm in diameter. Septal spines in two cycles. . . . . *A. mortenseni*  
 5. Corallites 1 to 2 mm in diameter. Septal spines in two cycles, second cycle short. . . . . *A. viridis*

*Alveopora daedalea* (FORSKAL), 1775

(Plate 21, Figs. 6, 7)

<i>Madrepora</i>	<i>daedalea</i>	1775, FORSKAL, 133 (Type locality: Red Sea). 1776, FORSKAL, 12; pl. 37/B (?).
<i>Porites</i>	<i>daedalea</i>	1834, EHRENBERG, 341.
<i>Alveopora</i>	<i>daedalea</i>	1860, MILNE EDWARDS (& HAIME), 194. 1879, KLUNZINGER 2, 47; pl. 5/25, 26. 1906, v. MARENZELLER, 67. 1941, CROSSLAND, 32. 1967, SCHEER, 430. 1971, LOYA & SLOBODKIN, 124. 1974, MERGNER & SCHUHMACHER, 264. 1976, PILLAI & SCHEER, 53; pl. 22/1. 1980, HEAD, 151, 455.
<i>Alcyonella</i>	<i>savignyi</i>	1828, AUDOUIN (& SAVIGNY), 53; pl. 3/4 (1-12).
<i>Porites</i>	<i>clavasia</i>	1828, AUDOUIN (& SAVIGNY), 56; pl. 4/6 (1-3).

We have seven specimens from Red Sea before us that display considerable skeletal variation. The growth form is essentially knob-like with diameters up to 60 mm, usually less. Corallites polygonal, 2 to 2.5 mm in diameter. Septal spines in two cycles, primaries larger than the secondaries, extending horizontally to the centre and often meeting and tangling in the deeper parts of the fossae.

Material:

- Gulf of Suez: Jerus. SLR 1828 (Abu Zanima).  
 T. Aviv NS 8404, 8447 (Ras Matarma); 8376 (Ras el Kanisa).  
 Gulf of Aqaba: T. Aviv NS 1937 (Shurat el Manqata).  
 Northern R. S.: HLM EC 170 (without locality).  
 Southern R. S.: HLM X2: 10-16 (Sarso Isl.).

Distribution: Red Sea; Mauritius; Maldives; East India; Samoa.

*Alveopora verrilliana* DANA, 1872

(Plate 21, Fig. 8; Plate 22, Figs. 1, 2)

<i>Alveopora</i>	<i>verrilliana</i>	1872, DANA, 77, with fig. 1907, VAUGHAN, 217; pl. 91/3, 3a. 1925, HOFFMEISTER, 81. 1939, UMBGROVE, 59; pls. 5/4; 18/2, 3.
	<i>daedalea</i>	1846, DANA 512; pl. 48/4.

The following are the details of the specimens studied: EC 304 is a compressed columnar growth with a total height of 70 mm and a uniform width of about 30 mm. Thickness 20 mm. Corallites polygonal,

1 to 1.5 mm in greater diameter or length and same depth. Primary septal spines almost reach the centre of the fossa, where they sometimes fuse. Secondaries spiny, one third to half the length of the primaries.

EC 305 is encrusting, thick, explanate. Underside epithecate, upper side with hillocky growths. Greater spread 80 mm, thickness 8 to 10 mm, in the middle part 20 mm. Corallites polygonal. Details of septal spines as in EC 304.

EC 1377 and PW73 519 are thin, foliaceous lobes, 3 to 5 mm thick and 100 and 35 mm broad respectively. Underside and those parts of the flattened branches, which are not living, covered with epitheca. Corallites 1 to 1.5 mm, very flat; walls often incomplete. Surface showing a very ragged appearance. Septal spines in two cycles, secondaries shorter.

**Material:**

Gulf of Suez: T. Aviv NS 8424 (Ras Matarma).  
 Gulf of Aqaba: Basel PW 73 519 (Eilat, 40–43 m).  
 Northern R. S.: HLM EC 304, 305 (Ras Abu Hagar).  
 Central R. S.: HLM EC 1377 (Djiddah).  
 P. Sud. Sa 54 (Sanganeb R.).

**Distribution:** Red Sea; Mauritius; Java Sea; Philippines; Samoa; Hawaii.

*Alveopora ocellata* WELLS, 1954

(Plate 22, Figs. 3, 4)

*Alveopora ocellata* 1954, WELLS, 456; pl. 164/5–7 (Type locality: Bikini Atoll).

We have only one specimen, which we put to this species. Corallum flat, expanded, greater length 55 mm. Underside covered by a thin epitheca. Corallites round, about 1.5 mm in diameter. Walls of neighbouring corallites partly united, but often separated and then linked by spines and synapticulae. Septal spines in two cycles. First cycle spines well developed, extending horizontally to the centre of the fossa. The inner ends of the spines are a little thickened and do not meet. Second cycle of spines short, acute, sometimes incomplete.

**Material:**

Gulf of Aqaba: T. Aviv NS 6282 (Eilat).

**Distribution:** Red Sea; Bikini Atoll.

**Remarks:** This is the first record of this species from Red Sea.

It is curious that this species has not been found any more since WELLS (1954). It is likely that *A. superficialis* PILLAI & SCHEER, 1976, from the Maldives represents a deep-water ecomorph of *A. ocellata*, which again can be closely related to *A. verrilliana*. More specimens are required to prove their relationship.

*Alveopora mortenseni* CROSSLAND, 1952

(Plate 22, Figs. 5–7)

*Alveopora mortenseni* 1952, CROSSLAND, 235; pl. 49/1, 3, 4 (Type locality: Great Barrier Reef).  
 1976, PILLAI & SCHEER, 53; pl. 22/1.  
 1977, FAURE, 11.

We assign six specimens to this species. NS 2244, PW (without No) and Fri 31–1 are branching, SLR 3010 is the broken end of a branch. Only the ends of the branches are living, the branches themselves are covered with epitheca. The corallites are rounded to polygonal, in a few specimens some are elongated. The diameter of the corallites is 2.5 to 3.5 mm, few corallites can have as much as 4.5 mm. Septal spines in two cycles, in bigger corallites also spines of the third cycle present. In the upper parts of the calices the spines are short, lower down in the fossa they are elongated, confluent and forming a columella-like network. Between the corallites many buds are developing.

**Material:**

Gulf of Suez: Jerus. SLR 3010 (Ras Matarma).  
 T. Aviv NS 2244 (Ras el Misalla).

Gulf of Aqaba: Basel PW without No and locality.  
 HLM Fri 17-1 (52 m), 31-1, 2 (67 m) (Eilat, Mar. Biol. Lab.).

Distribution: Red Sea; Réunion; Mauritius; Rodriguez; Maldives; Great Barrier Reef.

Remarks: CROSSLAND (1952) mentioned that Dr. MORTENSEN has trawled this species from a depth of 30 fms. near the lighthouse at Ashrafi Island at the entrance to the Gulf of Suez.

*Alveopora viridis* QUOY and GAIMARD, 1833

(Plate 22, Figs. 8-11)

<i>Alveopora</i>	<i>viridis</i>	1833, QUOY & GAIMARD, 240; pl. 20/1-4 (Type locality: New Ireland).
		1860, MILNE EDWARDS (& HAIME), 194.
		1939, UMBGROVE, 59; pl. 18/4, 5.
	cf. <i>viridis</i>	1966, WELLS & SPENCER DAVIES, 49.
	<i>viridis</i>	1972, PILLAI, 205.

We have three specimens before us. NS 9282-1 is a short branch, 9 mm in diameter at the broken end, and about 50 mm long. The branch is covered with epitheca and bears three rounded knobs with corallites, but these are already dead and begin to calcify. Corallites 1.5 mm in diameter. Septal spines in two cycles, primaries meet each other only in the deeper parts of the fossa, secondaries much shorter. The specimen was collected by N. GUNDERMAN in a depth of 60 m.

From the same locality comes a small piece, NS 9282-2, the broken end of a branch. Sides covered with epitheca, above a cap of living corallites. Corallites up to 2 mm in diameter. Septal spines as in the former specimen.

Also SLR 355 is the broken end of a branch. Size of corallites and septal spines as in NS 9282-2.

Material:

Gulf of Aqaba: Jerus. SLR 355 (Marsa Murach).  
 T. Aviv NS 9282-1, 2 (Eilat, 60 m).

Distribution: Red Sea; Maldives; South India; Java Sea; New Ireland.

Remarks: This is the first record of this species from Red Sea.

Additional remarks to the genus *Alveopora*:

HEAD (1980) has reported of one specimen of *A. superficialis* found in a depth of 30 m at Harvey Reef off Port Sudan. He gives no description or figure, but regards his observation as first record of this species from Red Sea.

The corallum of *A. superficialis* is explanate; corallites 1.5 to 1.75 mm in diameter, polygonal to rounded, superficial. Septal spines in two cycles, thin and hair-like. Primaries extending to the centre, forming a columella-like network. Secondaries shorter, but often reaching this "columella". *A. superficialis* was described by PILLAI & SCHEER (1976) from the Maldives.

Genus *Goniopora* de BLAINVILLE, 1830

Type species: *Goniopora pedunculata* de BLAINVILLE, 1830.

Generic characters: Encrusting, massive or columniform. Corallites polygonal or rounded. Septa fundamentally in three cycles.

Synopsis of the species of *Goniopora* from Red Sea:

A. Corallites 3 to 7 mm in diameter.

I. Calices 3 to 5 mm deep, sometimes less.

1. Corallum hemispherical or club-shaped, calices 4 to 7 mm in diameter. Wall thin and highly porous. Septa narrow, vertically descending. Columella tangle present. . . . . *G. stokesi*
2. Corallum massive or columnar. Calices 3 to 5 mm in diameter, wall thickened. Septa in three cycles, extending to columella. Columella trabecular, pali present. . . . . *G. planulata*

- II. Calices not more than 1 mm deep.
3. Corallum explanate, massive or columnar. Calices 5 to 7 mm in diameter, Septa mostly 24, subequal. Slit-like interseptal loculi very conspicuous. . . . . *G. tenella*
- B. Corallites less than 3 mm in diameter.
4. Corallum submassive. Calices 2 to 3 mm in diameter, oval or rounded, 1 mm deep. Third cycle of septa incomplete. Columella very well developed. . . . . *G. minor*
5. Corallum columnar. Calices neatly polygonal, average 2 mm in length rarely 2.5 mm, shallow. Septa begin a little below the summit of the wall. Columella conspicuous. Septal teeth often conspicuous. . . . . *G. savignyi*
6. Corallum columnar or nodular. Colonies generally small. Calices 1.5 to 2 mm in diameter, about 1 mm deep. Third cycle of septa incomplete, primaries very conspicuous with prominent pali. . . . . *G. klunzingeri*

*Goniopora stokesi* MILNE EDWARDS & HAIME, 1851

(Plate 22, Figs. 12-14)

<i>Goniopora</i>	<i>stokesi</i>	1860, MILNE EDWARDS (& HAIME), 192 (synonymy). 1907a, VAUGHAN, 263; pl. 28/1, 2. 1907, BEDOT, 264; pls. 43/240, 241, 243, 245; 44/246, 247. 1927, FAUSTINO, 287; pl. 96/2, 3. 1955, NEMENZO, 45; pl. 9/2. 1974, SCHEER & PILLAI, 41; pl. 19/3, 4 (synonymy). 1976, PILLAI & SCHEER, 47.
	<i>Java Sea 1</i>	1903, BERNARD, 75, pl. 8/4.
	<i>Maldives 4</i>	1903, BERNARD, 89; pls. 7/6; 13/9.

There are two specimens in the collections which we place under this species. Both were free at the time of collection and with wrinkled thick epitheca at the underside. NS 1461 is hemispherical, 7.5 mm in greater spread, underside flat. NS 1460 is club-shaped, lower part dead, the living zone confined to a cap-like structure at the top. In both the calices are polygonal, 4 to 5.5 mm in length. Wall very thin. Septa narrow, three cycles, arranged in typical gonioporoid fashion. Columella large, convex.

Material:

Gulf of Aqaba: T. Aviv NS 1460, 1461 (Eilat).

Distribution: Red Sea; East Africa; Seychelles; Maldives; South India (PILLAI, 1972); Nicobar Isls.; Mergui Archipelago; Java; Singapore; Philippines.

*Goniopora planulata* (EHRENBERG), 1834

(Plate 23, Figs. 1, 2)

<i>Astraea</i>	<i>planulata</i>	1834, EHRENBERG, 319 (Type locality: Red Sea).
<i>Goniopora</i>	<i>planulata</i>	1879, KLUNZINGER 2, 45; pls. 5/24; 8/23 (synonymy). 1888, ORTMANN, 159. 1892, ORTMANN, 655. 1954, ROSSI, 54; pl. 10/2. 1967, SCHEER, 428. 1971, LOYA & SLOBODKIN, 124. 1974, MERGNER & SCHUHMACHER, 265. 1976, PILLAI & SCHEER, 49; pl. 19/3. 1980, HEAD, 150, 454.
	<i>columna</i>	1846, DANA, 570; pl. 56/5, 5a, b. 1876, HAECKEL, 16; fig. 13 (= DANA, 1872, fig. p. 52). 1974, SCHEER & PILLAI, 40; pl. 19/1, 2 (synonymy).
	<i>djiboutiensis</i>	1907a, VAUGHAN, 263; pls. 26; 27/2. 1972, PILLAI, 204.
	<i>duofaciata</i>	1932, THIEL, 134; pl. 20/1 (synonymy). 1973, PILLAI, VINE & SCHEER, 459.



- 1976, PILLAI & SCHEER, 48 (synonymy).  
*lobata* 1860, MILNE EDWARDS (& HAIME), 191.  
 1948, CROSSLAND, 200; pl. 12 (upper fig.); 13 (lower fig.).  
 1952, CROSSLAND, 232; pl. 47/1-3.  
 1956, STEPHENSON & WELLS, 27.  
*Red Sea 1* 1903, BERNARD, 100; pls. 8/1, 2; 13/12.  
*Red Sea 2 ?* 1903, BERNARD, 101.

We describe below representative specimens from our collections to illustrate the variation displayed in this species:

RM 51 is part of a columnar specimen 9 cm high. Corallites 4 to 5 mm in diameter, polygonal. Calices rounded, wall 0.5 to 0.7 mm thick. Calices 2 to 3 mm deep at the top of the corallum, shallow (1 mm) at the basal part. Septa in three cycles, united, in deeper calices they descent steeply, edges dentate. Columella formed of septal fusion, better developed in shallow calices. Pali present only in shallow older calices, not to be seen in deep calices at the top of the column.

X2: 13-8 is also columnar. Lower part dead. Corallites on an average 4 mm in diameter, wall 0.5 mm. Depth of calices 2.5 to 2 mm. Columella well developed. Six pali present at the junction of septa, top of pali blunt, granular.

NS 1908 is a thick columnar growth 15 cm high and 8 cm thick. The living zone is confined to the upper 4 cm. Corallites 2 to 3 mm in diameter and deep. Septa very narrow at the top of the wall, edges dentate as in other cases. Columella occupy half of the bottom of the calyx, composed of a layer of trabeculae. Pali not visible at the top of the corallum, but a set of six narrow pali is seen in older calices. The details of the corallites mostly agree to BEDOT's (1907) description of *G. lobata*, but the growth-form is typical as described for *G. planulata*.

EC 154 is one of KLUNZINGER's duplicates from Koseir. It is massive, the calices at the top of the corallum are eroded. At the base they are 3 to 4 mm in diameter. Columella well developed. Six pali moderately developed in some of the calices.

Material:

- Gulf of Suez: Jerus. SLR 840, 856-1, 2146a-c (Et Tur).  
 T. Aviv NS 1908 (Et Tur).  
 Gulf of Aqaba: Jerus. SLR 1076-1 (Fara'un Isl.); 677-2 (Marsa Abu Zabad).  
 T. Aviv NS 257, E55/548 o (Eilat); 1894, 4924 (Dahab).  
 Northern R. S.: Jerus. SLR 814-1, 2 (Ras Muhammad).  
 HLM X2: 3-1 (Gubal Isl.).  
 EC 154 (Koseir, duplicate from KLUNZINGER).  
 USNM Wa 47 (Ghardaqa).  
 Central R. S.: P. Sud. Sa 49 (Sanganeb R.).  
 HLM EC 1378 (Djiddah).  
 RM 51 (Wingate R.).  
 X2: 8-4 (Shaab Anbar).  
 Southern R. S.: HLM X2: 13-8 (Sarso Isl.).

Distribution: Red Sea eastward to Fiji.

Remarks: KLUNZINGER (1879) merged *G. lobata* and *G. columna* with *G. planulata*, but BEDOT (1907) and CROSSLAND (1948) treated *lobata* separate from *G. planulata*. According to UMBGROVE (1939) *G. columna* is also distinct from *G. planulata*, differing mainly in the development of pali. SCHEER & PILLAI (1974) followed UMBGROVE and kept *G. columna* distinct from *G. planulata*. However, from a study of the present specimens along with our material from Nicobars and Maldives we are convinced that *G. columna* and *G. lobata* are only variants of *G. planulata* as considered by KLUNZINGER. We have specimens displaying intermediate characters. *G. djiboutiensis* VAUGHAN is also not separable from *G. planulata*. And another species we consider as belonging here is *G. duofaciata*. It is very likely that *G. minor* CROSSLAND (vide infra) is a variant of *G. planulata*. However, we describe this species separate below.

*Goniopora tenella* (QUELCH), 1886

(Plate 23, Figs. 3, 4)

<i>Tichopora</i>	<i>tenella</i>	1886, QUELCH, 189; pl. 11/1, 1a.
<i>Goniopora</i>	<i>tenella</i>	1927, FAUSTINO, 283; pl. 95/1, 2.
		1971, LOYA & SLOBODKIN, 123.
		1974, PILLAI & SCHEER, 458; fig. 7d.
		<i>Philippines 1</i> 1903, BERNARD, 67; pl. 4/9.

The present specimen is about 15 cm long and 12 cm high and possesses three knobs joined with each other by an epitheca, which covers a great part of the intermediate surface. Corallites polygonal, wall 0.5 to 1.5 mm in thickness, reticulate. Calices rounded, 5 to 6 mm, sometimes 7 mm in diameter, very shallow, less than 1 mm deep. Mostly 24 subequal septa, the tertiaries somewhat shorter, almost all joint to the columella which is a prominent mass of filamentous reticulum, projecting nearly to the level of the wall, 3 to 3.5 mm in diameter. The slit-like, regular interseptal loculi between the 24 septa are very conspicuous.

## Material:

Central R. S.: Berlin ZMB 7006 (Wingate R., 22–35 m).

Distribution: Red Sea; Strait of Malacca; Philippines.

*Goniopora minor* CROSSLAND, 1952

(Plate 23, Figs. 5, 6)

<i>Goniopora</i>	<i>minor</i>	1952, CROSSLAND, 233; pl. 48/1, 3 (Type locality: Great Barrier Reef).
		1955, NEMENZO, 51; pl. 8/5.
		1956, STEPHENSON & WELLS, 27.
		1973, PILLAI, VINE & SCHEER, 459.
		1976, PILLAI & SCHEER, 48.

Corallum submassive with a greater spread of 6 cm and a thickness of 4 cm. Lower part dead. Calices 2 mm in diameter, about 1.5 mm deep, rounded. Wall about 1 mm thick. Two cycles of septa well developed, tertiaries not seen in many calices, but in some older ones a few of the third cycle present. Four to six septa are very broad and run over the columella, which occupies most of the bottom of the calyx. Pali not seen on calices of the top of the corallum, but 4 to 6 of them are seen on older calices.

## Material:

Gulf of Aqaba: HLM EC 454 (Eilat).

Distribution: Red Sea; Seychelles; Maldives; Minicoy; Ceylon (PILLAI unpubl.); Great Barrier Reef; Philippines.

*Goniopora savignyi* DANA, 1846

(Plate 23, Figs. 7, 8)

<i>Goniopora</i>	<i>savignyi</i>	1846, DANA, 570 (Type locality: Red Sea).
		1860, MILNE EDWARDS (& HAIME), 191.
		1879, KLUNZINGER 2, 45; pls. 5/23; 8/24.
		1888, ORTMANN, 159.
		1971, LOYA & SLOBODKIN, 123.
		(non 1973, PILLAI, VINE & SCHEER, 459).
		1980, HEAD, 150, 454.
	<i>malaccensis</i> ?	1878a, BRUEGGEMANN, 548.
	<i>Red Sea 3</i>	1903, BERNARD, 101.
<i>Astrea</i>	<i>spec.</i>	1828, AUDOUIN (& SAVIGNY), 57; pl. 5/2.

The following description is based on EC 394. Columnar, lower part dead. The top of the coral has four branches (columns), 2 to 3 cm high and thick. Tip flattened in one but obtuse in others. Total height of the coral 10.5 cm, greater spread 7 cm. Corallites polygonal, calices 2 to 2.5 mm long, 1 to 1.5 mm deep at the top of the columns, but shallower at the sides. Wall 0.5 mm thick, composed of a single row

of grains, looks like interrupted. Septa in three cycles, close set, third cycle of varying numbers, all septa start a little below the summit of the wall and on the wall their course is marked by 1 or 2 denticles. Septa unite to form a loose reticulum with upward processes representing the columella. Pali as a rule absent on the top of the corallum, but 6 to 8 paliform lobes are seen in shallow calices at the sides of the columns.

Material:

Northern R. S.: USNM Wa 46 (Ghardaqa).

Southern R. S.: HLM EC 394, 395 (Massawa).

Distribution: Red Sea, but probably more wide-spread.

Remarks: The characteristic features of the present species are the columnar growthform, shallow polygonal calices, and irregularity in the development of the third cycle of septa. The columella is formed of the irregular fusion of the septal ends. Pali are absent. *G. minor* has almost the same sized calices, but they are mostly oval and the growthform seems to be fundamentally different. In *G. savignyi* it is mostly columnar while in *G. minor* it is submassive.

PILLAI, VINE & SCHEER (1973) reported on two specimens from Seychelles under *G. savignyi*. However, a reexamination of these specimens reveals many notable differences from the Red Sea material we have at hand. In the Seychelles specimens the corallites are neatly polygonal, the septa are in three complete cycles, straight with 2 to 3 well-formed frosted teeth. In these respects they are similar to the one described by BERNARD (1903) from Mauritius and seem to be not conspecific with *G. savignyi* from Red Sea.

*G. malaccensis* BRUEGGEMANN (see BERNARD, 1903, p. 80 and 81) is closely related to *G. savignyi* if not identical.

*Goniopora klunzingeri* v. MARENZELLER, 1906

(Plate 24, Figs. 1, 2)

<i>Goniopora</i>	<i>klunzingeri</i>	1906, v. MARENZELLER, 67. 1980, HEAD, 150, 454.
	<i>lichen</i>	1879, KLUNZINGER 2, 46; pl. 5/22 (Type locality: Red Sea). 1971, LOYA & SLOBODKIN, 123.
	<i>Red Sea 5</i>	1903, BERNARD, 104.

There are two coralla before us, both small encrustations over dead layers of the same species. The surface rises into small nodular gibbositities. Corallites 1.5 to 2 mm in diameter, less than 1 mm deep. Wall looks solid at the top with a row of mural denticles. Thickness of the wall 0.5 mm. Primary and secondary cycles of septa conspicuous, former larger. Third cycle of septa of varying numbers, in many cases wholly depressed. Cycle not fully present in any case. Septa very narrow at the wall, descending steep. Columella poorly developed, sometimes absent with an open axial fossa. Pali six, conspicuous, frosted.

Material:

Gulf of Aqaba: T. Aviv NS 1338 (Eilat).

Northern R. S.: USNM Wa 48 (Ghardaqa).

Distribution: Red Sea.

Remarks: BERNARD (1903) has already shown that *G. lichen* MILNE EDWARDS & HAIME (= *Porites lichen* DANA) is not a *Goniopora* but is only a *Porites* as originally described by DANA (1846). KLUNZINGER (1879) described a *Goniopora* from Red Sea as *G. lichen*. Since the specific name *lichen* is not applicable, MARENZELLER (1906) proposed the new specific name *klunzingeri* to this.

Additional remarks to the genus *Goniopora*:

BERNARD (1903: 102) mentioned a further species of Red Sea, i. e. *Goniopora Red Sea 4*. He stated that it is near *Rhodaraea gracilis* MILNE EDWARDS & HAIME, 1860. We could not examine BERNARD's specimen, therefore we quote it only in this appendix.

Still another species shall be mentioned here, *Goniopora somaliensis* VAUGHAN, recorded by HEAD, 1980, pp. 150, 454, in only one specimen from Harvey Reef off Port Sudan. The first specimen of this

species was found by GRAVIER in the Gulf of Aden (French Somaliland) and described by VAUGHAN, 1907a, and GRAVIER, 1911. WELLS, 1952, has reported on three more specimens from Bikini Atoll.

Genus *Porites* LINK, 1807

Type species: *Porites polymorphus* LINK, 1807.

Generic characters: Colonial, encrusting, massive, columnar or ramose. Calices polygonal or circular, 1 to 2 mm in diameter, 1 to 1.5 mm deep. Wall thin with mural denticles. Septa in two cycles, arranged as four lateral pairs, a dorsal directive and a ventral triplet. Pali, synapticalae and columella present.

Synopsis of *Porites* from Red Sea:

- A. Little or no coenenchyme between the corallites. Calices polygonal, wall thin.
- I. Corallum massive or columnar with or without undulations on the surface.
- a) Septa of the ventral triplet remain free at their ends.
1. Corallites 1.5 mm in length, polygonal; wall thin; septal dentation and pali poorly developed. . . . . *P. solida*
- b) Septa of the ventral triplet unite at the ends to form a trident.
2. Calices more or less 1 mm in diameter; wall zig-zag or straight. Mural and septal denticles well developed. Pali 8, of which 5 or 6 are larger. . . . . *P. lutea*
3. Corallum always columnar, high. Calices 1.5 to 1.75 mm in length, polygonal. Septal denticle only one or even absent. Pali 5 to 8. Wall straight. . . . . *P. columnaris*
- II. Corallum encrusting, explanate, small.
4. Corallites and calices circular, more or less 1 mm in diameter. 1 to 5 calices may run together without any intervening wall. Wall highly thickened with many frosted denticles giving a rough appearance to the coral. Septa often bifurcate over the wall. . . . . *P. echinulata*
5. Calices like deep punctures. Primary septa well developed, deep-seated, steeply descending. Pali absent. Columella a prominent single style. . . . . *P. punctata*
- III. Corallum ramose.
6. Branches digitiform or only little compressed at the top. Corallites polygonal, 1.5 to 1.75 mm in length, very shallow. Ventral triplet forms a trident. Pali poorly developed. . . . . *P. nodifera*
7. Branches thick, compressed or flabellate. Corallites 1.25 to 1.5 mm in length, 1.5 mm deep. Ventral triplet free. Five pali often prominent. . . . . *P. compressa*
- B. Surface coenenchyme between the corallites rises to form conical or lengthy ridges enclosing valleys and small rounded calices.
- I. Corallum ramose.
8. Branches digitiform, 1 to 1.5 cm thick. Calices 0.5 to 0.6 mm in diameter, very shallow. Pali present. . . . . *P. (Synaraea) iwayamaensis*
- II. Corallum massive.
9. Surface with gibbositities. Details of calices mostly as in 8. . . . . *P. (Synaraea) undulata*
- A. Species without coenenchym between the corallites.
- I. Massive species of *Porites*.
- a) The ventral triplet does not fuse to form a trident.

*Porites solida* (FORSKAL), 1775

(Plate 24, Figs. 3, 4)

<i>Madrepora</i>	<i>solida</i>	1775, FORSKAL, 131 (Type locality: Red Sea).
<i>Porites</i>	<i>solida</i>	1879, KLUNZINGER 2, 42; pls. 5/21; 6/14 (synonymy). 1892, ORTMANN, 655. 1906, v. MARENZELLER, 65.

	1918, VAUGHAN, 191; pl. 84/3, 3a.
	1941, CROSSLAND, 21; pls. 1-3, 4 (upper and lower fig.; pl. 4, lower fig., is not <i>P. lutea</i> , it is the same picture as pl. 3, lower fig., and represents <i>P. solida</i> No. 21).
	1948, CROSSLAND, 202; pl. 14 (upper fig.).
	1952, CROSSLAND, 242.
	1954, ROSSI, 55.
	1967, SCHEER, 428.
	1974, MERGNER & SCHUHMACHER, 265.
	1974, SCHEER & PILLAI, 42.
	1976, PILLAI & SCHEER, 50.
	1980, HEAD, 150, 454.
<i>alveolata</i>	1860, MILNE EDWARDS (& HAIME), 178.
	1879, KLUNZINGER 2, 43; pl. 5/20.
	1971, LOYA & SLOBODKIN, 124.
<i>arenosa</i>	1797, ESPEER, 80; pl. 65.
	1860, MILNE EDWARDS (& HAIME), 180.
	1879, KLUNZINGER 2, 43.
	1948, CROSSLAND, 202; pls. 11 (lower fig.); 14 (lower fig.).
<i>conglomerata</i>	1834, EHRENBURG, 341 (No. 937 in Berlin Museum).
(non <i>conglomerata</i> )	1846, DANA.
	1860, MILNE EDWARDS (& HAIME), 179.
	1888, FAUROT, 119.
<i>fragosa</i> ?	1846, DANA, 536; pl. 55/9, 9a.
	1954, WELLS, 454; pl. 171 (synonymy).
<i>murrayensis</i>	1918, VAUGHAN, 192; pl. 84/4, 4a, b, 5.
<i>Red Sea 1</i>	1905, BERNARD, 236; pl. 33/7.
<i>Red Sea 8</i>	1905, BERNARD, 242.

CROSSLAND (1941) has discussed FORSKAL's types, and VAUGHAN (1918) has given a good description of this species. We mention here only the skeletal variation displayed in the present material.

The corallum is always massive. The surface is smooth or with gibbosities or may develop lobulations.

The calices are polygonal, deep or very shallow. In polygonal calices the wall is thin. But in many cases the wall is thickened and the calices are rounded as seen in *P. murrayensis*.

When the septal and mural elements are thickened they display granulations.

Pali 4 to 5, moderately developed or not visible. But in some rounded shallow calices five pali are very conspicuous along with the septal denticles between them and the wall.

Columella mostly a single style, but in some cases it is represented by a compact mass incorporating the septal ends.

#### Material:

Gulf of Aqaba:	Jerus.	SLR	650-2 (Marsa Abu Zabad).
	T. Aviv	NS	247, 6108 (Eilat).
	Basel	PW	73 501 (Eilat); 73 659, 660, 693, 706 (El Kura).
	HLM	EC	455, 456, 457 (Eilat).
Northern R. S.:	USNM	Wa	52 (Ghardaqa).
	HLM	X2:	2-7 (Gubal Isl.).
		EC	479 (Ras Abu Suma); 64, 65 (Koseir, duplicates from KLUNZINGER).
Central R. S.:	P. Sud.	Sa	4 (Sanganeb R.).
	HLM	RM	18, 117 (Wingate R.).
Southern R. S.:	HLM	EC	368, 369, 370, 371, 374 (Massawa).

Distribution: Red Sea; Zanzibar; Natal; Madagascar; Seychelles; Réunion; Mauritius; Maldives; Lakshadweep; South India; Sri Lanka; Andaman and Nicobar Isls.; Mergui Archipelago; Cocos-Keeling Isls., Philippines; Great Barrier Reef; Marshall Isls.

Remarks: BERNARD (1905) has already pointed out the similarity of *P. alveolata* by KLUNZINGER to *P. solida*. We have not examined MILNE EDWARDS & HAIME's type of *P. alveolata*. However, the specimens described by KLUNZINGER (1879) are not separable from *P. solida*.

*P. murrayensis* VAUGHAN is only a skeletal variation of the present species. Some of our specimens certainly show gradation towards *P. murrayensis*.

*P. fragosa* DANA may also belong to a variant of *P. solida*, though we have no convincing proof for such a conclusion.

A. I. b) Massive or columnar species in which the triplet of the septa forms a trident.

*Porites lutea* MILNE EDWARDS and HAIME, 1851

(Plate 24, Fig. 5, 6)

<i>Porites</i>	<i>lutea</i>	1860, MILNE EDWARDS (& HAIME), 180. 1879, KLUNZINGER 2, 40; pl. 5/16. 1888, FAUROT, 119. 1892, ORTMANN, 654. 1918, VAUGHAN, 198; pl. 88/1, 1a, b (synonymy; type locality: Fiji). 1925, HOFFMEISTER, 73; pl. 21/2a-c, 3. 1941, CROSSLAND, 24; pl. 4 (middle fig.) (No. 30 on pl. 5, upper fig., is named <i>P. lutea</i> , but No. 30 is <i>P. solida</i> as shown on pl. 4, upper fig.). 1954, ROSSI, 55. 1954, WELLS, 452; pls. 165/1, 2; 166/5, 6; 167/1-7. 1971, LOYA & SLOBODKIN, 124. 1974, MERGNER & SCHUHMACHER, 265. 1974, SCHEER & PILLAI, 43 (synonymy). 1976, PILLAI & SCHEER, 50.
	<i>conglomerata</i>	1846, DANA, 561; pl. 55/3, 3a (No. 683 USNM).
	(non <i>conglomerata</i> )	1816, LAMARCK and 1860, MILNE EDWARDS & HAIME).
	<i>baddoni</i>	1918, VAUGHAN, 197; pl. 87/1, 1a, b.
	<i>Red Sea 2</i>	1905, BERNARD, 238; pl. 33/8a, b.
	<i>somaliensis</i>	1911, GRAVIER, 80; pl. 11/46-48. 1967, SCHEER, 429; figs. 9, 10. 1974, MERGNER & SCHUHMACHER, 265. 1980, HEAD, 150, 455.
	<i>stephensoni</i>	1952, CROSSLAND, 238; pl. 50/3, 4.
	<i>tenuis</i> ?	1907, VAUGHAN, 212; pl. 90/1, 1a. 1974, PILLAI & SCHEER, 459.

Corallum invariably massive. Surface rises into small gibbositities. Calices polygonal, generally 1 mm in length (in SLR 1255 they are 1.5 mm). Wall zig-zag or straight, thin or slightly thickened. Mural denticles well developed. Often a median ridge is present on the intercorallite wall. Septa 12, the ventral triplet forms a trident. Pali 8 in number, those of the four lateral pairs of septa generally subequal and larger. One or two septal denticles between the pali and the wall. Columella a single style.

Material:

Gulf of Suez:	Jerus.	SLR	2938-3 (Ras el Misalla); 835, 2175 (Et Tur).
	T. Aviv	NS	8397, 8400, 8402, 8410 (Ras Matarma); 8207 (El Bilaiyim); 8388, 8439 (Ras el Kanisa).
	HLM	X2:	1-8 (Ras Shukheir).
Gulf of Aqaba:	Jerus.	SLR	1255 (Fara'un Isl.); 354-1, 2 (Marsa Murach); 1984-1, 2, 3, 5 (Ras el Burqa); 449-1-5 (El Kura); 650-1, 658 (Marsa Abu Zabab).
	T. Aviv	NS	3066 (Eilat); 4902 (Wassit); 1889, 4983, 4999 (Dahab); 4820 (Ras Atantur); 1853 (Shurat el Manqata).
	Basel	PW	73 658, 73 668 (El Kura); 1 ex. without No.
Northern R. S.:	Jerus.	SLR	804, 806-1, 2, 810, 811, 820, 821 (Ras Muhammad).
	USNM	Wa	49, 50, 51 (Ghardaqa).
	HLM	X2:	2-22, 3-34, 3-42 (Gubal Isl.).
		EC	474-478 (Ras Abu Suma); 66 (Koseir, duplicate from KLUNZINGER); 297, 300, 302, 303, 516-520 (Ras Abu Hagar).
Central R. S.:	HLM	RM	19, 19a (Wingate R.).
Southern R. S.:	HLM	X2:	9-2, 13-7 (Sarso Isl.).
		EC	372 (Massawa).

Distribution: Wide-spread from Red Sea into the Indo-Pacific up to Fiji, Samoa and Cook Isls.

Remarks: *P. somaliensis* is said (VAUGHAN, 1918) to differ from *P. lutea* in the possession of straight walls and better developed granulations. However, *P. baddoni*, a synonym of *P. lutea* (WELLS, 1954), has

straight walls. From the examination of the present specimens as well as several from South India (PILLAI) we are of the opinion that *P. somaliensis* has no separate status.

The type of *P. tenuis* is No. 407 in USNM. The type locality is marked Loo Choo. It is a small specimen. The growthform and calicular characters show not much variation from *P. lutea*. True, the calices on the average are slightly larger than in normal specimens of *P. lutea*, however, there seems to be little reason for its separation from *P. lutea*.

*Porites columnaris* KLUNZINGER, 1879

(Plate 24, Figs. 7, 8)

<i>Porites</i>	<i>columnaris</i>	1879, KLUNZINGER 2, 41; pls. 5/19; 8/22 (Type locality: Red Sea). 1888, FAUROT, 119. 1888, ORTMANN, 157. 1954, ROSSI, 57; pl. 9/3.
	<i>Red Sea 5</i>	1905, BERNARD, 240; pl. 33/9.

We have five specimen before us that we place under this species. They all show the typical columnar growth characteristic of this species. The following details are based on EC 373 from Massawa.

Columnar, total height 43 cm with a maximum thickness of 12 cm at mid height. Top narrow and a little flattened. Lower part dead with a fresh overgrowth. Surface irregularly humpy. Calices 1.25 to 1.75 mm in length, polygonal, moderately deep (less than 1 mm). Wall thin, wavy, often interrupted. Septa start a little below the summit of the wall, the lower triplet forms a trident. Septal denticles poorly developed, but in some calices a denticle between the wall and the outer synapticalae present. The inner synaptical ring complete above with a ring of pali visible. Pali 5 to 8 in different calices, those of the lateral pairs of septa larger than others. The pali on the lateral pair of the ventral triplet least developed. Columella a compressed style to which fused ends of septa are united by 5 to 6 radii. Interseptal loculi wider than the septa, oval when viewed from above.

Material:

Northern R. S.: HLM EC 151 (Koseir); 298, 301 (Ras Abu Hagar).  
Southern R. S.: HLM EC 373, 376 (Massawa).

Distribution: Known only from Red Sea.

Remarks: The details of the calices of this species is very similar to *P. lutea*, particularly in the wavy (zig-zag) wall and the development of pali. The major distinction is in the growthform.

A. II. *Porites* species with encrusting or small coralla.

*Porites echinulata* KLUNZINGER, 1879

(Plate 25, Figs. 1, 2)

<i>Porites</i>	<i>echinulata</i>	1879, KLUNZINGER 2, 43; pl. 5/18 (Type locality: Red Sea). 1892, ORTMANN, 655.
	<i>mayeri</i>	1918, VAUGHAN, 196; pl. 86/1, 1a (synonymy). 1971, LOYA & SLOBODKIN, 124.
	<i>Red Sea 7</i>	1905, BERNARD, 241.

We refer seven specimens to this species which are all larger as KLUNZINGER mentioned. BERNARD (1905) felt that KLUNZINGER's material could possibly be a young stage that got attached to other corals. However, the details of the calices of the present specimens agree with those of KLUNZINGER's. At first we identified our material with *P. mayeri*. But we find little difference to warrant the separation of *P. mayeri* from *P. echinulata*.

EC 430 is an explanate, thick plate-like corallum. The edges are free, central part thicker than the growing edges. Surface with small lobulations. Corallites rounded, on an average 1 mm in diameter. On several places 5 to 7 calices run together without intervening wall as is the case in *P. lichen*. Wall thickened in some cases up to 1 mm, looks very much granular due to the presence of mural granulations resembling

spines. Septa 12, very well developed, sometimes thickened. The outer ends of septa sometimes bifurcate (note KLUNZINGER compared this species with *Psammocora*) and merge into the mural denticles. The pali on the four pairs of lateral septa are well developed and often stand above the level of the columella style.

X2: 2-35 and 3-33 are massive though small coralla, nodular at the surface. The calices are 1.5 to 1.75 mm in diameter with highly thickened wall. The calyx has a funnel-shaped appearance. X2: 3-30 is a small encrustation, 50 mm in diameter.

Material:

Gulf of Aqaba: Basel PW 73 574 (Eilat, 50-55 m).  
 Northern R. S.: T. Aviv NS 1871 (Ras Muhammad).  
 HLM EC 430 (Ras Muhammad, 30 m); 498 (Safaga Isl.).  
 X2: 2-35, 3-30, 3-33 (Gubal Isl.).

Distribution: Red Sea; Murray Isls.

*Porites punctata* (KLUNZINGER), 1879

<i>Porites</i>	<i>punctata</i>	1834, EHRENBERG, 342.
<i>Stylaraea</i>	<i>punctata</i>	1879, KLUNZINGER 2, 44; pl. 5/27 (synonymy). 1952, CROSSLAND, 236; pl. 50/2.
<i>Porites</i>	<i>arenacea</i>	1834, EHRENBERG, 343.
	<i>Red Sea 9</i>	1905, BERNARD, 243.

Corallum small, encrusting, all reported specimens less than 20 mm in greater diameter. Calices more or less 1 mm in diameter, rounded, deep. Septa very narrow (as seen in EHRENBERG's *P. arenacea*), the primaries are larger than the second cycle. Wall thick and echinulate. Pali absent. Columella styliform, prominent.

KLUNZINGER adds that this species has resemblance to *Stylophora armata* (= *Stylocoeniella armata*) but differs in the absence of pali.

Material: The present collections do not include any specimen of this species. The only one we have studied is EHRENBERG's type of *P. arenacea* in Berlin Museum (No. 956).

Distribution: Red Sea; Great Barrier Reef.

Remarks: Both MILNE EDWARDS & HAIME (1860) and BERNARD (1905) merged *Stylaraea* with *Porites*, but KLUNZINGER and CROSSLAND treated *Stylaraea* as a distinct genus. The specific name *punctata* was first applied by LINNAEUS (1758) and later by ESPER (1797). KLUNZINGER (1879) attributed the authorship to LINNAEUS as adopted by MILNE EDWARDS & HAIME. CROSSLAND wrote (1952: 236): "The species is generally attributed to LINNAEUS and ESPER, but to go behind KLUNZINGER is to land in the quagmire described by BERNARD which I do not propose to enter (BERNARD, 1905, p. 11, and under *Porites Red Sea 9* and *P. Molluccas 1*, pp. 161 and 243). To alter the attribution to KLUNZINGER is the only way to find footing without adding to the confusion by giving a new name". In the present work, following CROSSLAND, we attribute the authorship of this species to KLUNZINGER, but agree with MILNE EDWARDS and HAIME and BERNARD that *Stylaraea* is not to be separated from *Porites*.

A. III. Branching species of *Porites*.

*Porites nodifera* KLUNZINGER, 1879

(Plate 25, Figs. 3, 4)

<i>Porites</i>	<i>nodifera</i>	1879, KLUNZINGER 2, 41; pls. 5/17; 6/13 (Type locality: Red Sea). 1892, ORTMANN, 655. 1954, ROSSI, 57; pl. 9/1, 2. 1967, SCHEER, 430. 1980, HEAD, 151, 455.
	<i>clavaria</i>	1834, EHRENBERG, 341.
	<i>Red Sea 3</i>	1905, BERNARD, 239.



The following description is based on EC 380. Corallum ramose, branches subdividing two to three times. Total height of the corallum 18 cm. Lower portion dead. Living layer extend from 5 to 6 cm from top to bottom. Topmost branches 5 to 6 cm long, 12 to 20 mm broad at the tip, tip a little flattened (compressed), rounded (obtuse) or rarely digitiform. Calices polygonal, 1.25 to 1.75 mm in length, shallow but not superficial; wall thin, mural denticles not very conspicuous, wall wavy and interrupted at places. Septa begin a little below the summit of the wall, the ventral triplet fused together, edges with 2 or 3 denticles, which are small and lacerated. Pali very poorly developed, better to seen under a lens, 4 to 6 in numbers. Columella looks solid, a central style standing below the level of the lateral pairs of pali. Septa steeply descending from the wall. Interseptal loculi thinner than the septa. Neither the pali nor the septal denticles in this species are conspicuous anywhere.

**Material:**

Southern R. S.: HLM X2: 13-1 (Sarso Isl.).  
EC 377-386 (Massawa).

**Distribution:** Recorded only from Red Sea.

*Porites compressa* DANA, 1846

(Plate 25, Figs. 5, 6)

*Porites compressa* 1846, DANA, 553; pl. 53/5, 5a (Type locality: Fiji).  
1907, VAUGHAN, 174; pls. 67; 68/3 (numer. addit. figs. of various formae on pls. 68-78).  
1955, NEMENZO, 31.  
1967, PILLAI, 122; pl. 1/3.  
1973, PILLAI & SCHEER, 471.  
1974, PILLAI & SCHEER, 459; fig. 6c.

The present specimen, EC 375, is an entire colony with a total height of 27 cm and a greater spread of 32 cm. The growthform is similar to VAUGHAN's forma *conjungens* (1907: 179, pl. 71, figs. 2, 2a) in having "ascending irregularly constricted nodulose columns, rising from a ramose base". Total height of columns 10 to 15 cm with branches at the top, fused below. Living zone extends to half the height. Tip of columns mostly compressed, 2 to 5 cm broad, 1.5 to 2 cm thick. Corallites polygonal, 1.25 to 1.75 mm in length, mostly 1.5 mm, 1 mm deep. Wall thin, straight or a little zig-zag with a single row of denticles. Septa thin, interseptal loculi wider than septa, the ventral triplet does not fuse to form a trident. Between the palus and the wall a frosted septal denticle present, often higher than the palus. Palar formula rarely complete. Five pali, those of the ventral directive and the lateral pairs of septa prominent and equal in height, a sixth one often seen on the dorsal directive. A more or less complete ring of synapticulae present below the pali. Columella styliform, joined to the fused ends of septa by radii. Septa and mural elements granular.

EC 299 is a branch and differs from EC 375 in having very shallow calices.

**Material:**

Northern R. S.: HLM EC 299 (Ras Abu Hagar).  
Southern R. S.: HLM EC 375 (Massawa).

**Distribution:** Red Sea; Mascarene Archipelago; Gulf of Mannar; Str. of Malacca; Philippines; Palau Islands (EGUCHI, 1938); Hawaii.

**Remarks:** This seems to be the first record of this species from Red Sea.

B. Species with coenenchyme between the corallites: Subgenus *Synaraea* VERRILL, 1864.

I. Corallum ramose.

*Porites (Synaraea) iwayamaensis* EGUCHI, 1938

(Plate 25, Figs. 7, 8)

*Porites iwayamaensis* 1938, EGUCHI, 385.  
*Por. (Syn.) iwayamaensis* 1954, WELLS, 455; pl. 170/3-5 (synonymy).  
1974, PILLAI & SCHEER, 459; fig. 7b.  
*Porites Caroline Islands 3* 1905, BERNARD, 94; pls. 9/5; 12/1-3.

The following is a generalized description of the present specimens: Branching, main divisions narrower at the base (1 to 1.5 cm thick) than at the top. At the distal divisions the branches widen to form palmate expansions with irregular digitiform branchlets that undergo fusion. In one of the specimens (EC 391) the top of the branches fuse to form a platform with closely set nodular branchlets 0.5 to 1 cm thick and high. Lower part of the coralla mostly dead. At the proximal parts of the branches the surface coenenchyme does not form ridges, instead possesses many papillae-like swellings 1 to 3 mm high and thick at the base. Between these papillae-like structures the coenenchyme is smooth with pinhole-like calices. At the distal part of the branches the coenenchyme forms ridges (1 mm high), in between enclosing rows of calices.

Calices 0.6 to 0.7 mm in diameter, circular, flush with the surface, touching each other or up to 0.5 mm apart, crowded at the lower part of the corallum, but arranged in longitudinal rows at the upper half. Septa 12, the ventral triplet forms a trident, the outer ends of septa merge with the echinulations on the surface coenenchyme. Septal dentation not visible. Pali generally six, of which five, i. e. those of the lateral pairs of septa and the one on the ventral directive, are subequal, rising above the level of the wall. In younger calices the axial fossa is open, but in old ones it is with a central styliform columella. The surface of the coral covered by fine, close-set echinulations.

**Material:**

Northern R. S.: HLM EC 150 (Koseir, as *Montipora villosa*).

Southern R. S.: HLM EC 387-393 (Massawa).

**Distribution:** Red Sea; Aldabra; Réunion; Str. of Malacca; Marshall Isls.; Caroline Isls. But certainly more wide-spread when the synonyms are fully known.

**Remarks:** *Synaraea convexa* VERRILL and *S. iwayamaensis* are probably one and the same. It is very likely that species such as *P. (Syn.) horizontalata* HOFFMEISTER, 1925, and *P. (Syn.) faustinoi* HOFFMEISTER, 1925, are based on basal or initial encrustations of a ramose *Synaraea* and as such are not valid species. There is practically very little difference between the specimens we described (PILLAI & SCHEER, 1976) from Maldives as *Synaraea convexa* and the present specimens, except for the thinner stems of the latter.

B. II. Species with coenenchyme, corallum massive.

*Porites (Synaraea) undulata* KLUNZINGER, 1879

(Plate 25, Figs. 9, 10)

<i>Synaraea</i>	<i>undulata</i>	1879, KLUNZINGER 2, 46; pls. 5/30; 6/12 (Type locality: Red Sea). 1888, ORTMANN, 158.
<i>Porites</i>	<i>undulata</i>	1906, v. MARENZELLER, 66; pl. 22/75. (non 1925, HOFFMEISTER, 79).
<i>Por. (Synaraea)</i>	<i>undulata</i>	1941, CROSSLAND, 42; pls. 8, 9. 1971, LOYA & SLOBODKIN, 124. 1973, PILLAI, VINE & SCHEER, 460. 1980, HEAD, 151, 455.
<i>Synaraea</i>	<i>lutea</i>	1879, KLUNZINGER 2, 49; pls. 5/29; 7/4. 1888, ORTMANN, 158.
<i>Porites</i>	<i>Red Sea 4</i>	1905, BERNARD, 239.
	<i>Red Sea 6</i>	1905, BERNARD, 241.
<i>Madrepora</i>	<i>rus</i>	1775, FORSKAL, 135.
<i>Montipora</i>	<i>rus</i>	1897, BERNARD, 140.

Massive, some are columnar, surface undulating, ridges 1 to 3 mm high and thick, enclosing rows of calices. Calices circular, 0.5 to 0.6 mm in diameter, shallow, superficial, close together. Septa 12, ventral triplet often fused. Pali six, moderately prominent. Columella styliform, rises to the level of pali. Surface coenenchyme echinulate.

**Material:**

Gulf of Aqaba: Jerus. SLR 361, 385 (Marsa Murach); 653-1, 2, 677 (Marsa Abu Zabad).

T. Aviv NS 6068 (Eilat); 1851 (Shurat el Manqata).

	Basel	PW	73 655, 73 656, 73 680 (20 m) (El Kura).
Northern R. S.:	Jerus.	SLR	805, 816-1, 2 (Ras Muhammad).
	T. Aviv	NS	1859 (Ras Muhammad).
	HLM	EC	155 (Koseir).
Central R. S.:	P. Sud.	Sa	10, 73 (Sanganeb R.).
Distribution: Red Sea; Seychelles (PILLAI, VINE & SCHEER, 1973).			

Additional remarks to the genus *Porites*:

LOYA & SLOBODKIN (1971) mention *P. studeri* from the Gulf of Eilat. This species was described after one single small specimen (VAUGHAN, 1907: 210, pl. 88, figs. 2, 2a) from Hawaii. A second specimen was found at Bikini Atoll (WELLS, 1954: 454, pl. 171, fig. 3). LOYA & SLOBODKIN have neither described nor figured their specimen, which was identified by WELLS. We have some doubt about the occurrence of this rare deepwater coral *P. studeri* in the Red Sea, therefore we do not incorporate it in our report, but mention it only in this appendix.

HAED, 1980, reported on two other species of the Red Sea. The first is *P. lichen* DANA. He mentioned that this species possibly may be a deep-water ecomorph of *P. solida*.

The second species, found by HEAD, is *P. andrewsi* VAUGHAN. He has collected it only within Port Sudan lighthouse fringing reef lagoon.

3. Suborder Faviina VAUGHAN and WELLS, 1943

Family Faviidae GREGORY, 1900

Subfamily Faviinae GREGORY, 1900

Recently VERON, PICHON & WIJSMAN-BEST (1977) have summarized the taxonomic history of this family and its subfamilies. VAUGHAN & WELLS (1943) included two subfamilies under Faviidae, viz Faviinae and Montastreinae, to which WELLS (1956) added Agathiphylliinae (the former family Agathiphylliidae, 1943) and Trachyphylliinae. The major distinction between Faviinae and Montastreinae as given by VAUGHAN & WELLS is that in the former budding is intratentacular, while in the latter it is extratentacular. However, some of the genera like *Plesiastrea* and a few species of *Favia*, which were included in Faviinae, have also extratentacular budding. CHEVALIER (1971) pointed out this and dispensed Faviinae and Montastreinae. He further elevated Trachyphylliinae to the status of a family Trachyphyllidae (CHEVALIER, 1975). CHEVALIER was followed by VERON, PICHON & WIJSMAN-BEST and is followed in the present work, but we maintain the two subfamilies.

Genus *Caulastrea* DANA, 1846

Type species: *Caulastrea furcata* DANA, 1846.

Generic characters: Phaceloid, branches diverging, with or without fusion. Corallites mostly monocentric, oval or circular; di- to tricentric conditions may be present. Wall thin. Septa alternating in size, exsert, edges dentate. Columella poorly developed. Costae conspicuous, extend to the base of the branches.

The genus *Caulastrea* was not previously recorded from Red Sea. The present specimens were collected by the late Peter WETTSTEIN, who has also labelled them. We accept his identification and report them below.

*Caulastrea tumida* MATTHAI, 1928

(Plate 26, Figs. 1, 2)

*Caulastrea tumida* 1928, MATTHAI, 275; pl. 72/5, 6 (Type locality: Great Barrier Reef).  
1936, YABE, SUGIYAMA & EGUCHI, 19; pls. 10/6, 7; 13/1, 2.

1939, UMBGROVE, 25; pl. 2/1.

1976, PILLAI & SCHEER, 54; pl. 24/2.

1977, VERON, PICHON & WIJSMAN-BEST, 18; figs. 13-15.

PW 71 333 is an entire colony with a greater spread of 10 cm and a total height of only 5 cm. The branches are short, 3 to 3.5 cm long each, main division with 2 or 3 monocentric corallites. Corallites rounded or a little elongated, 12 to 15 mm in diameter, 4 to 5 mm deep. Total number of septa 40 to 44, excluding a set of spiny ones. Major septa exsert, exsert ends vertical, 1.5 mm. Septa broader below, edges of septa dentate. Subsidiary septa unite to the major ones, the last tooth often forms a paliform lobe. Septa slightly swollen at the wall, sides granular.

PW 71 351 is a young colony with 9 monostomodaeal corallites. The colony is phaceloid, but the branches are shorter than in PW 71 333. Corallites oval or elongated, larger ones up to 20 mm in diameter. Larger septa up to 2 mm exsert.

**Material:**

Gulf of Aqaba: Basel PW 71 333, 351 (Fara'un Isl., 40 m).

**Distribution:** Red Sea; Madagascar; Maldives; Philippines; Japan; Bonin Isls.; NW-Australia; Great Barrier Reef; New Caledonia (?).

**Remarks:** This is the first record of this species and genus from Red Sea.

Genus *Erythraostrea* PICHON, SCHEER and PILLAI

**Type species:** *Erythraostrea flabellata* PICHON, SCHEER & PILLAI.

**Generic characters:** Phaceloid, branches flabellate, compressed, epithecate. Wall thin. Calices meandering, valleys short or long and sinuous, 5 to 10 mm wide, 4 to 5 mm deep. Columella centres distinct, formed of septal fusion, adjacent ones linked by indistinct lamellae. Septa exsert vertically, edges dentate. Costae very conspicuous, extend to the base of the flabellate branches, often linked by transverse ridges.

*Erythraostrea* is similar to *Caulastrea* in the details of septa and columella characters, but differs in having a very distinct growthform as well as long and sinuous valleys. In having flabellomeandroid coralla with columella centres linked by lamellae this genus resembles *Trachyphyllia*. But the septal nature as well as the form of the corallum are entire distinct, the septa have no inner lobe, a characteristic of *Trachyphylliidae*. The present genus certainly belongs to *Faviidae*, and its closest relative is *Caulastrea*.

*Erythraostrea flabellata* PICHON, SCHEER and PILLAI, in press.

(Plate 26, Figs. 3, 4)

*Erythraostrea flabellata* (? 1983), PICHON, SCHEER & PILLAI, in press.

Wa 75 is composed of two flabellate branches with a total height of 12 cm. Width at the top 8 cm, at the base 2.5 cm. The two branches are compressed, thickness at the mid-height 10 mm. An epitheca covers most of the surface, except the extreme top. Wall 0.5 to 0.75 mm thick. Costae correspond to major septa, elevated, extend to the base of the branch. There are many transverse ridges connecting the costae. Each branch bears a single valley. Valleys sinuous, 7.5 and 3 cm respectively, when measured straight. Width of valleys 5 to 9 mm at different parts, depth 5 to 6 mm.

Septa alternating in size, secondaries spiny, 6 to 8 major septa per cm length of wall. Major septa exsert to 2 mm, exsert part vertical, rounded at the top. Septa broader at the upper half, thinner below; a constriction is visible at the mid-length, but there is no paliform lobe. Broader parts of septa with microscopic serrations at the edges, lower down with 2 to 3 teeth. Sides of septa granular. Adjacent septa sometimes fusing together. Columella centres distinct, trabecular; major septa unite with the columella. Adjacent centres on an average 1 cm apart, linked by weakly developed lamellae.

NS 6062 is represented by a single compressed branch with a total height of 4.5 cm. It bifurcates at the top and has two valleys, 5 and 2 cm long respectively. Width of valleys 8 to 11 mm, depth 5 mm. The major septa a little thickened at the wall, the subsidiaries are better developed than in Wa 75 and fuse to

the sides of the major ones. The columella centres are 3 to 4 mm in diameter with twisted trabeculae.

NS 6063 possesses two valleys 4.5 and 5 cm long. There are 12 to 14 septa per cm length of wall. Major septa exsert to 1.5 mm. Columella centres are not visibly linked by any lamellae. Other details as in Wa 75.

Material:

Gulf of Aqaba: T. Aviv NS 6062, 6063 (Eilat, paratypes).

Northern R. S.: USNM Wa 75a, b (Ghardaqa, paratypes).

Genus *Favia* OKEN, 1815

Type species: *Madrepora fragum* ESPER, 1795.

Generic characters: Encrusting, massive or columnar. Plocoid. Corallites and calices polygonal or circular. Wall projecting with well developed intercorallite areas. Coenosteum costate. Septa alternating in width with dentate edges.

Synopsis of the species of *Favia* known from Red Sea:

1. Corallum columnar or massive. Corallites 2 to 4 mm in diameter. Septa 24 to 28. Major septa with paliform lobes. . . . . *F. stelligera*
2. Corallum massive. Corallites 4 to 6 mm in diameter. Wall exsert. Septa 30 to 35. Asexual reproduction by both fission and extratentacular budding. . . . . *F. laxa*
3. Corallum massive, hillocky. Corallites 7 to 9 mm in diameter. Septa 18 to 24, very uniform in size, with a distinct crown of paliform lobes. A second set of septa very indistinct. Costae correspond to all septa, very regular. . . . . *F. belianthoides*
4. Corallum massive, rounded, flat or encrusting. Corallites 5 to 11 mm in diameter, often oval up to 8 x 11 mm in spread. Septa 18 to 36. Paliform lobes mostly present. . . . . *F. pallida*
5. Corallum hemispherical. Corallites rounded, 8 to 12 mm in diameter. Septa 24 to 35. Walls exsert. Budding occasionally at the side of corallites. . . . . *F. amicorum*
6. Corallum encrusting or submassive. Corallites rounded, oval or elongated. Greater diameter 10 to 16 mm, 4 to 5 mm deep. Septa 25 to 40. Exo- and endothelial vesicles well developed. Perithecal costae prominent. . . . . *F. speciosa*
7. Corallum massive, flat or rounded. Corallites circular, oval or distorted, 10 to 20 mm in diameter. Septa range from 30 to 60, of which half the number meet the columella. Peritheca 2 to 5 mm thick. Corallite walls generally very little exsert. . . . . *F. favus*
8. Corallum explanate, very light. Corallites and calices polygonal, 15 to 17 mm long, 2 to 3 mm deep. Septa 24 to 32. Exsert ends of septa vertical, not arched. Septa subhorizontal. Wall exothecal, blisterly. Costae not visible. Asexual reproduction by marginal fission. . . . . *F. wisseli*
9. Corallum flat or dome-shaped. Corallites large, 18 to 20 mm in diameter, mostly circular. Wall sometimes projecting. Septa 50 to 60. . . . . *F. rotundata*

*Favia stelligera* (DANA), 1846

(Plate 26, Figs. 5, 6)

<i>Orbicella</i>	<i>stelligera</i>	1846, DANA, 216; pl. 10/9a-e (Type locality: Fiji).
<i>Favia</i>	<i>stelligera</i>	1918, VAUGHAN, 101; pls. 34/2, 3; 35/1-4 (synonymy).
		1952, CROSSLAND, 128.
		1967, SCHEER, 430.
		1971, LOYA & SLOBODKIN, 124.
		1971, CHEVALIER, 162; pls. 18/2; 19/2 (synonymy).
		1972, WIJSMAN-BEST, 24; pl. 4/3.
		1974, SCHEER & PILLAI, 44 (synonymy).
		1976, PILLAI & SCHEER, 55.
		1977, VERON, PICHON & WIJSMAN-BEST, 20; figs. 16-22.
		1980, HEAD, 151, 456.

	<i>acropora</i>	1914, MATTHAI, 102; pls. 25/1, 3; 26/4(?); 33/1 (synonymy).
	<i>lobata</i>	1857, MILNE EDWARDS (& HAIME), 434; pl. D8/3. 1879, KLUNZINGER 3, 31; pls. 3/9; 10/8. 1888, ORTMANN, 173.
<i>Orbicella</i>	<i>lobata</i>	1906, v. MARENZELLER, 87.
<i>Favia</i>	<i>pseudostelligera</i>	1971, CHEVALIER, 169; pls. 18/3, 7; 19/1 (synonymy).

18 specimens are placed under this species. They all show the typical hillocky growth. The corallites (except in X2: 3-22) range from 2.5 to 3 mm in diameter with a total of 20 to 24 septa. In X2: 3-22 the corallites are 3 to 5 mm in diameter, the total septa range from 24 to 36, thus agreeing to *F. pseudostelligera*. In all the specimens the calices are circular, wall only slightly projecting, and they are generally not more than 1 mm deep. Other details agree to MATTHAI's (1914) description of his *F. acropora* (= *stelligera*).

Material:

Gulf of Aqaba:	T. Aviv	NS	E55/548f (Eilat); 4979 (Dahab).
	Basel	PW	71 359 (Eilat); 73 708 (El Kura); 71 357 (without locality).
Northern R. S.:	USNM	Wa	57, 58 (Ghardaqa).
	HLM	X2:	3-22, 40, 41 (Gubal Isl.).
		EC	481 (Ras Abu Suma); 306, 307 (Ras Abu Hagar).
Central R. S.:	P. Sud.	Sa	36 (Sanganeb R.).
	HLM	RM	48, 88, 89 (Wingate R.).
Southern R. S.:	HLM	X2:	10-15 (Sarso Isl.).

Distribution: Red Sea; Aldabra (ROSEN, 1971); Madagascar (PICHON, 1964); Chagos; Maldives; Lakshadweep; Gulf of Mannar (PILLAI, 1972); Ceylon; Nicobar Isls.; Cocos-Keeling Isls. (VAUGHAN, 1918); East Indies (UMBGROVE, 1939); Japan (YABE, SUGIYAMA & EGUCHI, 1936); Palau Isls.; Great Barrier Reef (CROSSLAND, 1952); New Hebrides; New Caledonia; Marshall Isls. (WELLS, 1954); Fiji; Samoa; Fanning Isls.; Hawaii; Cook Isls. (STODDART & PILLAI, 1973); Tahiti (CROSSLAND, 1931); Tuamotu Archipelago.

*Favia laxa* (KLUNZINGER), 1879

(Plate 26, Figs. 7, 8)

<i>Orbicella</i>	<i>laxa</i>	1879, KLUNZINGER 3, 49; pls. 5/3; 10/9a, b (Type locality: Red Sea). 1906, v. MARENZELLER, 87.
<i>Favia</i>	<i>laxa</i>	1914, MATTHAI, 99; pls. 24/5, 6; 37/2. 1972, WIJSMAN-BEST, 25; pl. 4/4. 1974, WIJSMAN-BEST, 256; pl. 4/2. 1974, MERGNER & SCHUHMACHER, 264. 1977, VERON, PICHON & WIJSMAN-BEST, 23, figs. 23-27, 415. 1980, HEAD, 151, 456.
<i>Plesiastrea</i>	<i>laxa</i>	1971, LOYA & SLOBODKIN, 124.
<i>Favia</i>	<i>ananas</i> ?	1914, MATTHAI, 98; pls. 10/2, 4; 25/7 (synonymy).

We have seven specimens before us which we assign to this species. Two of them (RM 80 and PW 73 694) show almost similar details and are described together. Submassive, hemispherical. Corallites circular or elongated. Calices 4 to 6 mm in greater diameter, elongated ones showing signs of division. Wall elevated 1 to 2 mm. Distance between adjacent corallites 3 to 4 mm, depth 2 to 3 mm. Intercorallite grooves often visible. Total septa 28 to 32, of which 18 to 20 fuse with the columella. Larger septa with a paliform lobe. Generally only two subsidiary septa turn towards a major septum. Larger septa up to 1 mm exsert, edges dentate, sides granular. Costae conspicuous, those of the opposite sides unite at the middle of the intercorallite furrow over a transverse ridge.

PW 71 354 is encrusting. The corallites and calices are neatly rounded, average 6 mm in diameter, wall 2 mm exsert, adjacent corallites 4 to 5 mm apart. Peritheca with blisters. Septa 35 to 40, 13 to 20 reach the columella. Septa exsert and slightly swollen at the wall. Paliform lobes prominent. Columella 2 to 3 mm in diameter, composed of closely twisted trabeculae to which major septa join. Costae unite at the middle of the intercorallite area. In none of the specimens fully developed buds are preserved.

We have also studied KLUNZINGER's type of *Orbicella laxa* from Koseir, No. 2193 in Berlin Museum.

Material:

Gulf of Aqaba: Basel PW 71 354 (Fara'un Isl., 40 m); 73 694 (El Kura).  
 Northern R. S.: HLM X2: 3-19, 22 (Gubal Isl.).  
 Central R. S.: HLM EC 1379 (Djiddah).  
 P. Sud. Sa 55 (Sanganeb R.).  
 HLM RM 80 (Wingate R.).

Distribution: Red Sea; Réunion (FAURE, 1977); Great Barrier Reef; Solomon Isls. (PILLAI, STODDART & MORTON, unpubl.).

Remarks: STEPHENSON & WELLS (1956) felt that *F. laxa* along with *F. wakayana* and *F. vacua* could be synonyms of *Plesiastrea versipora*. The presence of extratentacular buds in *F. laxa* as pointed out by KLUNZINGER (1879) suggests its affinity to *Plesiastrea*. The possibility of *F. laxa* being a geographical variant of *P. versipora* cannot be overlooked.

MATTHAI's (1914) *F. ananas* is represented by one specimen (BMNH 27. 5. 12. 163) from Red Sea. It is about 58 mm in greater spread. Only 8 to 10 septa reach the columella and the septal edges have poorly developed teeth. MATTHAI adds that in *F. ananas* the asexual reproduction is by means of division, while in *F. laxa* both division and gemmation occurs. It is very likely that this specimen may fall within the skeletal range of *F. laxa*.

*Favia belianthoides* WELLS, 1954

(Plate 26, Figs. 9, 10)

*Favia belianthoides* 1954, WELLS, 458; pl. 174/2-6 (Type locality: Bikini Atoll).  
 1974, WIJSMAN-BEST, 257; pl. 4/3.  
 1980, HEAD, 151, 456.

We have only one specimen before us, collected by Prof. SCHROEDER at the Sanganeb Reef in a depth of about 15 m. It has a hillocky growthform, about 70 mm high and with a diameter of 80 mm at the base. The corallites are nodular, elevated, and considerably far apart. Diameter of corallites 7 to 9 mm, diameter of the inner calices 3 to 4 mm. Septa 18 to 24 in number, all reach the columella and terminate in paliform lobes, forming a prominent crown. Margins of septa finely dentate. A second set of septa alternate with the principals and are very indistinct in the calices. Costae correspond to all septa and are equal in size and very regularly crenellate.

Material:

Central R. S.: P. Sud. Sa 64 (Sanganeb R., 10-16 m).

Distribution: Red Sea; Molucca Sea; Solomon Isls.; Marshall Isls.

Remarks: A specimen from Solomon Islands was identified by one of us (PILLAI, in 1970) as *F. belianthoides*, which was later sent to Dr. Maya WIJSMAN-BEST. She compared this with KLUNZINGER's type of *Orbicella laxa* (personal communication) and opined the Solomon specimen matches *F. laxa* in every respect. She merged these two species (WIJSMAN-BEST, 1972), but later separated them again (1974). Also VERON, PICHON & WIJSMAN-BEST (1977) stated that *F. laxa* and *F. belianthoides* are not synonymous with each other.

*Favia pallida* (DANA), 1846

(Plate 27, Figs. 1, 2)

*Astraea pallida* 1846, DANA, 224; pl. 10/12, 13a-e.  
 1876, HAECKEL, 19; fig. 16 (= DANA, 1872, figs. p. 64).  
*Favia pallida* 1918, VAUGHAN, 105; pl. 38/1-7.  
 1971, CHEVALIER, 105; pls. 10/1-4, 6, 7; 13/4, 5; 14/1-3; 17/1, 2.  
 1972, WIJSMAN-BEST, 18; pl. 2/3, 4.  
 1974, MERGNER & SCHUHMACHER, 264.  
 1974, SCHEER & PILLAI, 45.

- 1976, PILLAI & SCHEER, 55.  
 1977, VERON, PICHON & WIJSMAN-BEST, 33; figs. 46–55, 422, 423 (synonymy).  
 1980, HEAD, 151, 456.  
*doreyensis* 1914, MATTHAI, 84; pls. 9/1, 3; 22/8, 9; 32/2–4 (synonymy).  
 1971, LOYA & SLOBODKIN, 124.  
*bululensis* 1914, MATTHAI, 87; pls. 9/6; 22/6; 35/1.  
*rotulosa* 1834, EHRENBERG, 319.

We have three specimens from Gulf of Aqaba and one from Sanganeb Reef before us, which we refer to this species. All are globular with rounded corallites up to 10 mm in diameter and oval ones up to 8 x 11 mm; they are separated by intercorallite furrows.

Material:

Gulf of Aqaba: Jerus. SLR 488–1, 2, 3 (El Kura).

Central R. S.: P. Sud. Sa 72 (Sanganeb R.).

Distribution: Red Sea eastward as far as Tuamotu Archipelago.

Remarks: As we have pointed out already (PILLAI & SCHEER, 1976), we follow VAUGHAN (1918) in treating *F. bululensis* with *F. pallida*. One of us (PILLAI, 1972) has shown that in a large suit of specimens a gradation from those with smaller corallites and less septa (forma *bululensis*) to the typical form occurs.

EHRENBERG's type of *F. rotulosa* is No. 737 in Berlin Museum, it is shown by MATTHAI, 1914, pl. 35, fig. 1.

*Favia amicornum* (MILNE EDWARDS and HAIME), 1849

(Plate 27, Figs. 3, 4)

- Parastrea amicornum* 1849, MILNE EDWARDS (& HAIME), 171; pl. 9/9 (1848) (new name for *Astrea ananas* QUOY & GAIMARD, 1833, 207; pl. 16/6, 7; non LAMARCK).  
*Favia amicornum* 1857, MILNE EDWARDS (& HAIME), 431.  
 1972, WIJSMAN-BEST, 21; pl. 3/3, 4.  
 1974, WIJSMAN-BEST, 255; pl. 3/1, 2.  
*amicornum* (complex) 1977, VERON, PICHON & WIJSMAN-BEST, 32; figs. 37–44, 420 (left), 421.  
*amicornum* 1980, WIJSMAN-BEST, FAURE & PICHON, 615.  
 1980, DITLEV, 63; figs. 63, 64, 276.  
 1981, MERGNER & SCHUHMACHER, 343.

By kindness of Dr. SCHUHMACHER we got a specimen (EC 1386) from Aqaba, and we could examine another specimen from the same place, both identified by Dr. WIJSMAN-BEST as *F. amicornum*, and reported on in MERGNER & SCHUHMACHER (1981). We have in our collection another four specimens, which we put to this species.

All colonies are small and hemispherical, greatest diameter 80 mm. Underside epithecate. Corallites exsert, rounded, on an average 9 mm in diameter. Budding not only intratentacularly, but occasionally also at the sides of the corallites. Septa rather thin and of even height, 24 to 40 in number, average 29 to 30, regularly dentate. No palis. Columella small, trabecular. Costae well developed, equal, strongly dentate or beaded.

Material:

Gulf of Aqaba: Basel PW 71 348, 352 (Fara'un Isl., 40 m); 73 636 (20–22 m), 73 640 (30–33 m) (Eilat).

SCHUHMACHER No. 123 (Aqaba, 10–12 m).

HLM EC 1386 (Aqaba, 10–12 m).

Distribution: Red Sea; Mozambique; Seychelles; Malacca; Great Barrier Reef; New Caledonia; Tongatabu.

Remarks: MATTHAI (1914:79) and CHEVALIER (1971:147) consider *F. amicornum* as synonymous with *F. favus*. But CHEVALIER's var. *exserta* of *F. speciosa* (p. 120, pl. 10, fig. 5) could be *F. amicornum*.



*Favia speciosa* (DANA), 1846

(Plate 27, Figs. 5-7)

<i>Astraea</i>	<i>speciosa</i>	1846, DANA, 220; pl. 43/1, 2 (Type locality: East Indies).
<i>Favia</i>	<i>speciosa</i>	1918, VAUGHAN, 103; pls. 36/1-4a; 37/1-4a. 1952, CROSSLAND, 127. 1954, ROSSI, 31. 1967, SCHEER, 430. 1971, LOYA & SLOBODKIN, 124. 1971, CHEVALIER, 117; pls. 10/5, 8; 11/1, 3, 4, 6; 12/3; 13/1-3; 14/4; 15/1, 2; 17/8; 18/1; 38/4, 5 (synonymy). 1972, WIJSMAN-BEST, 16; pl. 1/1-4. 1974, MERGNER & SCHUHMACHER, 264. 1974, SCHEER & PILLAI, 47; pls. 21/2; 22/1, 2 (synonymy). 1976, PILLAI & SCHEER, 55. 1980, HEAD, 151, 456.
	<i>cavernosa</i>	1879, KLUNZINGER 3, 26; pl. 3/4 (non FORSKAL).
	<i>clouei</i>	1914, MATTHAI, 89; pls. 10/6; 23/1, 2, 5; 25/2; 34/1 (synonymy).
	<i>okeni</i>	1857, MILNE EDWARDS (& HAIME), 430. 1906, v. MARENZELLER, 85.
	<i>tubulifera</i>	1879, KLUNZINGER 3, 28; pls. 3/6; 10/2. (No. 2169 in Berlin Museum).
<i>Madrepora</i>	<i>uva</i>	1797, ESPER, 32; pl. 43/1, 2 (Type locality: Chinese Seas).
<i>Favia</i>	<i>uva</i>	1834, EHRENBERG, 318.

There are 27 specimens of this species in the present material. Some of them agree to KLUNZINGER's description of *Favia tubulifera* and the others to his *F. cavernosa*.

The species is characterized by an encrusting or submassive corallum which is generally very light. Corallites and calices oval or elongated, 10 to 18 mm in length, 8 to 14 mm wide, 4 to 7 mm deep. Peritheca 2 to 4 mm thick. Corallites level to projecting up to 4 mm. Interior and intercorallite areas with a heavy deposition of endothelial vesicles. Septa 32 to 40, of which half reach the columella. Septa exert with dentate edges, upper part steeply descending. Columella trabecular. Costae prominent, thin, with toothed edges. Multiplication by equal or unequal fission. According to MATTHAI (1914: 89) the outstanding features of this species are the "light corallum, perithecal costae, open calices, and thin septa".

## Material:

Gulf of Suez:	T. Aviv	NS	8422 (Ras el Kanisa).
Gulf of Aqaba:	Jerus.	SLR	390, 392 (Marsa Murach).
	T. Aviv	NS	1240, 1279-1, 2, 9284 (Eilat); 4973 (Dahab).
	Basel	PW	71 310, 311, 322 (Eilat, 40 m); 73 642 (30-33 m), 675 (45 m), 685 (8-10 m) (Fara'un Isl.).
Northern R. S.:	USNM	Wa	56 (Ghardaqa).
	HLM	X2:	3-15, 27, 46 (Gubal Isl.).
Central R. S.:	P. Sud.	Sa	50 (Sanganeb R.).
	HLM	EC	132 (Sanganeb R.).
	HLM	RM	42, 90 (Wingate R.).
		X2:	8-18 (Shaab Anbar).
Southern R. S.:	HLM	X2:	10-2 (Sarso Isl.).

Distribution: Red Sea eastward to Tuamotu Archipelago.

Remarks: MATTHAI (1914) adopted the specific name *clouei* of VALENCIENNES to this species, which according to VAUGHAN (1918) is a nomen nudum and the same as *F. speciosa* (DANA).

MATTHAI merged EHRENBERG's (1834) *Favia uva* with his *clouei* stating that ESPER's (1797) *Madrepora uva*, with which EHRENBERG identified his material, is only a *Dichocoenia* (MATTHAI, 1914: 89). We have ESPER's type, labelled *Madrepora uva*, before us, which is certainly referable to *F. speciosa*. It seems that the first name applied to this species is *uva* ESPER. However, the specific name *speciosa* DANA was in continuous use since more than 135 years.

*Favia fava* (FORSKAL), 1775

(Plate 27, Figs. 8, 9)

<i>Madrepora</i>	<i>fava</i>	1775, FORSKAL, 132 (Type locality: Red Sea).
<i>Favia</i>	<i>fava</i>	1914, MATTHAI, 79; pls. 9/2; 20/1-6; 21/1-8; 22/1-5; 32/1; 36/1, 2 (synonymy). 1941, CROSSLAND, 27. 1952, CROSSLAND, 125. 1954, ROSSI, 31. 1967, SCHEER, 430. 1971, LOYA & SLOBODKIN, 124. 1971, CHEVALIER, 138; pls. 11/5, 7-9; 13/6-9; 15/3; 16/1, 2; 23/2 (synonymy). 1972, WIJSMAN-BEST, 13; pl. 2/1, 2. 1974, SCHEER & PILLAI, 46 (synonymy). 1976, PILLAI & SCHEER, 56. 1977, VERON, PICHON & WIJSMAN-BEST, 24; figs. 28-36, 416 (left)-419, 420 (right) (synonymy). 1980, HEAD, 151, 456.
<i>Favia</i>	<i>aspera</i>	1857, MILNE EDWARDS (& HAIME), 439.
	<i>bertbolleti</i>	1857, MILNE EDWARDS (& HAIME), 431. 1914, MATTHAI, 94 (pars); pl. 23/4.
<i>Madrepora</i>	<i>cavernosa</i>	1775, FORSKAL, 132.
<i>Favia</i>	<i>clouei</i>	1879, KLUNZINGER 3, 29.
	<i>danae</i>	1918, VAUGHAN, 108; pl. 39/1, 1a. 1924, MATTHAI, 12; pl. 1/2 (= 8 on the inverted plate).
<i>Astraea</i>	<i>deformis</i>	1834, EHRENBERG, 320 (non LAMARCK).
<i>Favia</i>	<i>denticulata</i>	1834, EHRENBERG, 318. 1857, MILNE EDWARDS (& HAIME), 428. 1879, KLUNZINGER 3, 27.
	<i>ebrenbergi</i>	1879, KLUNZINGER 3, 29; pls. 3/5, 7, 8; 10/1, 1a. 1888, ORTMANN, 172. 1889, ORTMANN, 526. 1892, ORTMANN, 660.
<i>Favites</i>	<i>ebrenbergi</i>	1976, PILLAI & SCHEER, 57 (synonymy).
<i>Favia</i>	<i>geoffroyi</i>	1857, MILNE EDWARDS (& HAIME), 423.
	<i>magnistellata</i>	1948, CROSSLAND, 185.
	<i>savignyi</i>	1857, MILNE EDWARDS (& HAIME), 437. 1906, v. MARENZELLER, 82; pl. 25/84-89.
	<i>versipora</i>	1834, EHRENBERG, 317 (non LAMARCK). (Nos. 720 and 721 in Berlin Museum.)

The material before us, 45 specimens, display considerable variation that we refer under separate facies.

Facies I. As representative PW 73 566. Submassive, base narrower than top, epitheca present. Calices oval or distorted, 10 to 12 mm long, 8 to 10 mm wide, 6 to 7 mm deep. Intercorallite walls 4 to 6 mm thick. Corallite wall not elevated. Septa 40 to 50, thin, sloping, 0.5 mm exsert. 15 to 18 septa reach the columella, others turn towards adjacent major septa. Septal edges with 10 to 15 close-set denticles. Costae correspond to septa, stop at the middle of the intercorallite wall; teeth close-set and similar to those of septa. The corallum has a spiny look due to the narrow septal and costal serration. This facies is similar to MARENZELLER's *Favia savignyi*.

Facies II. Representative NS 8417. The growthform and size of calices similar to facies I, but the intercorallite walls are 2 to 3 mm thick only. The thecal wall project to 1 mm. Major septa up to 1 mm exsert.

Facies III. Representative X2: 13-5. Massive. Corallites polygonal, 10 to 15 mm long, 8 to 10 mm broad, up to 10 mm deep. Wall fused, 1 to 1.5 mm thick, interrupted at places. Septa of equal width from top to bottom. Major septa exsert to 1 mm. Differs from the other two facies in the fused wall and deeper calices.

Facies IV. Representative RM 82. Massive. Calices oval or elongated, 8 to 10 mm long, 5 to 8 mm broad, 4 to 5 mm deep. Wall fused. Thecal wall not elevated. Total septa 30 to 40. Major septa 0.5 mm exsert. Paliform lobes visible as in all other specimens. The calices are smaller and shallower than in any of the above facies mentioned.

## Material:

Gulf of Suez:	T. Aviv	NS	1912 (Et Tur); 8417 (Ras el Kanisa).
Gulf of Aqaba:	Jerus.	SLR	367-1, 2 (Marsa Murach); 457 (El Kura); 664 (Marsa Abu Zabad).
	T. Aviv	NS	263, 266, 267, 268, 1337-1, 2 (Eilat); 1891, 3204, 4848, 4958, 4959, 4971, 4989 (Dahab); 4817, 4833, 4841, 4885 (Ras Atantur).
Northern R. S.:	Basel	PW	73 566, 569, 576 (Eilat, 50-55 m).
	USNM	Wa	53, 54 (Ghardaqa).
	HLM	EC	482 (Ras Abu Suma); 432 (Safaga (Isl.)); 67 (Koseir, duplicate from KLUNZINGER); 308 (Ras Abu Hagar).
Central R. S.:	USNM	Wa	55 (Dongonab).
	P. Sud.	Sa	23, 62, 108 (Sanganeb R.).
	HLM	RM	81, 82, 118 (Wingate R.).
Southern R. S.:		X2:	8-15 (Shaab Anbar).
	HLM	X2:	9-23, 13-5 (Sarso Isl.).
		EC	396 (Massawa).

Distribution: Red Sea eastward to Fanning Isls. A wide-spread Indo-Pacific species.

*Favia wisseli* new species

(Plate 28, Figs. 1-3)

One specimen collected during the 2<sup>nd</sup> Xarifa Expedition does not fit into any of the species of *Favia* known to the present authors. Though there is only one specimen, its characters are very remarkable that we are describing it under a new specific name.

Description of the holotype: Corallum submassive, but very light. The entire surface with endo- and exothecal vesicles, so that the coral looks blistery as in *Favia speciosa*. The intercorallite walls, though appearing fused, make holes when pressed, thus showing that the area is filled only with exothecal vesicles and the fusion is not complete and the wall not solid. Peritheca 1 to 2 mm thick. Corallites polygonal, calices polygonal, the latter 15 to 17 mm long and wide, 2 to 3 mm deep. Calicular wall not elevated, level. Total number of septa 24 to 32, all septa almost equally exsert, exsert ends not arched. Septa stop at the middle of the intercorallite area or look like confluent from corallite to corallite. The edges of the septa remain in its entire length almost above the level of the thecal rim, in other words the septa are not sloping. Septa thin, interseptal loculi double the thickness of septa. 12 to 15 septa extend to the centre of the axial fossa and fuse to form a columella. Columella poorly developed. Septal edges with 2 to 3 teeth at the upper half which are lacerated. At the lower half the septal edges with minute granulations similar to those on the sides. Asexual reproduction by marginal fission by fusion of two major septa from either side. Costae not visible.

## Material:

Central R. S.:	HLM	X2:	8-24 (holotype, collected 7. 11. 1957, Shaab Anbar, inner reef, 6 m deep).
----------------	-----	-----	--

Remarks: In the lightness of the corallum and in the excessive deposition of endothecal vesicles the present species is similar to *Favia speciosa*. However, the neatly polygonal corallites with highly porous peritheca and non-development of costae are unlike to *F. speciosa*. The nature of septa is also different. The thecal wall is not at all exsert in *F. wisseli*. It is unlikely that the present species is based on an extreme variant of *F. speciosa*.

The species is named in memory of Klaus WISSEL, a member of the 2<sup>nd</sup> Xarifa Expedition, who died on 7. 11. 1957 under water, while photographing corals at Shaab Anbar in the Red Sea.

*Favia rotundata* VERON, PICHON and WIJSMAN-BEST, 1977

(Plate 27, Figs. 10, 11)

<i>Favites</i>	<i>rotundata</i>	1977, VERON, PICHON & WIJSMAN-BEST, 64; figs. 110-112, 436-438 (Type locality: Swain Reef, Great Barrier Reef).
----------------	------------------	---

<i>flexuosa</i>	1954, WELLS, 459 (pars); pl. 175/2.
	1971, CHEVALIER, 219 (pars); pl. 21/5.
	1972, WIJSMAN-BEST, 36 (pars); pl. 8/2.
	1976, PILLAI & SCHEER, 52 (pars); pls. 25/2; 26/1.
<i>virens</i>	1952, CROSSLAND, 130 (pars); pl. 6/1.

Several previous authors have described specimens of this species under the name *Favites flexuosa*. VERON et al. (1977) separated *F. rotundata* from the older species on the ground that "it is always sub-plocoid, whereas *F. flexuosa* is cerioid, and has larger, more rounded corallites".

PW 73 705 was labelled by the late Peter WETTSTEIN as *F. flexuosa*, and this specimen resembles very much the one PILLAI & SCHEER (1976) described from Maldives as *F. flexuosa*. Greater spread 10 cm; thick, encrusting. Corallites and calices rounded, calices 17 to 20 mm in diameter, up to 5 mm deep; smaller calices about 12 mm in diameter. Intercorallite area 5 to 8 mm thick, wall little projecting. Total number of septa in a large calyx about 48, of which 18 to 20 major ones reach the columella. Subsidiaries turn towards and fuse with the sides of the major ones. Septa a little exsert at the wall, sloping within the calyx, edges with 8 to 10 teeth. Paliform lobes not developed. Columella looks solid with a set of curly upward directed trabeculae. Costae about 1 mm high, edges with teeth, join at the middle of the intercorallite wall over a shallow groove.

PW 71 353 is a fresh overgrowth on a dead corallum. Corallites and calices rounded, larger ones more or less 15 mm in diameter, 3 to 5 mm deep. Intercorallite wall 4 to 6 mm thick. Thecal wall up to 2 mm exsert. Total number of septa 44 to 55, septa much thickened at the wall (0.75 to 1 mm), close together, slightly exsert. Septal teeth two or three only, much swollen, seen only at the upper half of the septum. There is a very deep cleft at the lower two-thirds of major septa with a conspicuous paliform lobe. In shallow calices the pali rise to the level of the thecal rim. Columella trabecular. Septocostae without any teeth, those of the opposite side meet at the intercorallite groove. This specimen differs from PW 73 705 in the excessive thickness of the septa at the wall, development of pali and non-development or absence of costal teeth. Further, the thecal wall is elevated.

A third specimen, NS 8450, is submassive. The calices are polygonal or oval with the wall thickened to 4 mm. Calices 15 to 20 mm in greater diameter, up to 5 mm deep. Intercorallite groove present. Corallite wall not exsert. Total septa 35 to 40, slightly swollen at the wall, lower one-third of the septum broader than the upper two-thirds with a cleft and palus. Other details as already described.

#### Material:

Gulf of Suez:	T. Aviv	NS	8448, 8450 (Ras el Kanisa).
Gulf of Aqaba:	T. Aviv	NS	4985 (Dahab).
	Basel	PW	73 705 (El Kura); 71 353 (Fara'un Isl., 40 m).
Central R. S.:	P. Sud.	Sa	52 (Sanganeb R.).

**Distribution:** Red Sea; Maldives; Great Barrier Reef; New Caledonia. The species probably occurs in many other parts of the Indo-Pacific.

**Remarks:** This appears to be the first record of the species from the Red Sea.

We put this species under the genus *Favia* due to its plocoid appearance. But we agree with VERON, PICHON & WIJSMAN-BEST (1977: 20) that the distinction between *Favia* and *Favites* is not at all clear.

#### Additional remarks to further *Favia* species mentioned from Red Sea:

HAECKEL (1876) has figured a coral under the name *Heliastreaa forskaliana* MILNE EDWARDS & HAIME on his pl. 2, fig. 3. But we consider *H. forskaliana* as a synonym of *Echinopora gemmacea*, which HAECKEL has correctly shown under this name on pl. 2, fig. 5. However, HAECKEL's *H. forskaliana* represents a *Favia*. It is difficult to decide which species HAECKEL had on hand, perhaps *Favia speciosa*.

*Favia matthai* VAUGHAN, 1918. MERGNER & SCHUHMACHER (1974) have reported this species from Gulf of Aqaba, which is otherwise not known from Red Sea. They have given no description and no figure, therefore we do not incorporate this species in our report, but mention it only in this appendix.

*Favia valenciennesi* (MILNE EDWARDS & HAIME, 1849). The only authors, who mention this species from Red Sea, are MATTHAI (1924: 14) and CROSSLAND (1952: 126), both referring to MATTHAI's *Favia bertholleti* (1914: 94). MATTHAI on his part refers to *Parastrea bertholleti* VALENCIENNES in the Paris Museum, redescribed by MILNE EDWARDS & HAIME (1857: 431) as *Favia bertholleti* with the

addition: "Habite la mer Rouge". However, the type comes from the Seychelles (MATTHAI 1914, pl. 23, fig. 4). After having reexamined the type CHEVALIER is convinced (1971: 148 and 161), in accordance with ROSEN (1968), that it is only *Favia favius*. *Favia valenciennesi* does not occur in the Red Sea.

#### Genus *Favites* LINK, 1807

Type species: *Madrepora abdita* ELLIS & SOLANDER, 1786.

Generic characters: Encrusting to massive, sometimes the surface rising to hillocks and branches. Corallites cerioid, calices polygonal. Major septa of equal width at the thecal wall, often without developed paliform lobes. Asexual reproduction by mono- to tristomodaeal intratentacular budding, permanent condition monostomodaeal (but polycentric condition is found in *F. bennettiae* VERON, PICHON & WIJSMAN-BEST, 1977).

#### Synopsis of *Favites* from Red Sea:

1. Corallum submassive, hemispherical, surface level. Corallites polygonal, wall acute at the top. Corallites 12 to 16 and up to 20 mm long and up to 10 mm deep. Septa very narrow with equidistant serration at the edges. Pali conspicuous on major septa. . . . . *F. peresi*
2. Corallum massive, hillocky. Corallites polygonal, 10 to 14 mm long and 7 to 10 mm broad, 4 to 7 mm deep. Intercorallite wall thick (1 to 2 mm). Calices rounded with up to 60 septa. One side of the corallites more elevated. Septal teeth well-formed. . . . . *F. abdita*
3. Corallum usually massive, sometimes encrusting or with hillocks. Corallites up to 20 mm long, 14 mm broad and 7 mm deep. Septa up to 50. Septal teeth secondarily frosted, giving a spiny look to the coral. Major septa exsert and often continuous over the wall. . . . . *F. complanata*
4. Corallum massive or encrusting. Corallites 18 to 22 mm long, about 15 mm wide, 10 mm deep. Intercorallite wall 2 to 3 mm thick. Septa up to 75, steeply descending, narrow at the wall. Paliform lobes absent. Septa unite at the top of the intercorallite wall. . . . . *F. flexuosa*
5. Corallum encrusting or explanate. Corallites polygonal, 8 to 10 mm long, 6 to 8 mm broad, 4 to 5 mm deep. Calices oval or circular. Septa 28 to 40. Exsert parts of septa generally stop at the middle of the intercorallite wall with a groove. . . . . *F. halicora*
6. Corallum massive, rounded. Corallites polygonal, wall thin and acute at the top. Corallites 5 to 8 mm in length, and about 3 to 4 mm deep. Septa 24 to 36 with feebly developed dentation. No paliform lobes. . . . . *F. acuticollis*
7. Corallum encrusting, massive or hillocky. Corallites polygonal, 5 to 8 mm long and wide, 3 to 5 mm deep. Wall thickened up to 2 mm with a median raised thin ridge. Calices polygonal, oval or rounded. Septa 24 to 36. Major septa with paliform lobes. . . . . *F. pentagona*

#### *Favites peresi* FAURE and PICHON, 1978

(Plate 28, Figs. 4, 5)

*Favites peresi* 1978, FAURE & PICHON, 107; pls. 1-5 (Type locality: Madagascar).  
1980, HEAD, 151, 457.

The following is a generalized description of the specimens we have examined. Corallum massive, hemispherical or expanding towards the top from a narrow base, in some cases the colonies are found unattached. An epitheca often visible at the underside. Corallites cerioid, polygonal, tetra- or pentagonal, 12 to 16 mm long (in specimen NS 1325 they are 20 mm long and 10 mm deep), 8 to 12 mm broad, 3 to 8 mm deep. Wall acute at the summit, getting thicker towards the bottom. Septal number varies according to the size of the calices, for example a calyx 16 x 11 mm has a total of 55 septa and another 11 x 8 mm has 36 septa excluding a set of rudimentary ones. Septa close-set of equal width throughout the length, steeply descending, 14 to 18 septa meet the columella. Two subsidiaries from either side generally turn towards the central major septum before the latter unites with the columella. At the point of fusion of

septa there is a well developed palus, 14 to 18 of them forming a ring over the columella. Edges of septa with 12 to 14 equidistant, frosted, microscopic denticles, septal sides smooth. Columella oval or circular in outline, 2 to 3 mm in diameter, formed of closely twisted trabeculae. Septa very narrow, in many cases their course is better marked by a row of septal teeth. Often one side of the corallite wall is more elevated than the other side.

Material:

- Gulf of Aqaba: Jerus. SLR 660 (Marsa Abu Zabad).  
 T. Aviv NS 1353 (Eilat).  
 Basel PW 71 313 (40 m), 73 570 (50–55 m) (Eilat); 73 635 (20–22 m),  
 639 (30–35 m), 703 (El Kura); 1 ex. without No.
- Northern R. S.: HLM X2: 2–6, 3–4 (Gubal Isl.).
- Central R. S.: P. Sud. Sa 39 (Sanganeb R.).  
 HLM EC 1325 (Djiddah).  
 RM 40, 40a (Wingate R.).

Remarks: The general features of this species are more or less similar to *F. abdita*, particularly form and size of the corallites. However, the details of the septa seem to be the major distinction. Further, the corallite wall is more acute in *F. peresi* than in *F. abdita*. The crown of well developed paliform lobes suggests its affinity with *Goniastrea*, but the septa are of equal width throughout their length as in *Favites*.

The following specimens in HLM are paratypes, designated by FAURE & PICHON (1978): X2: 2–6, EC 1325 and RM 40a.

*Favites abdita* (ELLIS and SOLANDER), 1786

(Plate 28, Fig. 6)

<i>Madrepora</i>	<i>abdita</i>	1786, ELLIS & SOLANDER, 162; pl. 50/2 (Type locality unknown).
<i>Astraea</i>	<i>abdita</i>	1834, EHRENBURG, 321.
<i>Favia</i>	<i>abdita</i>	1914, MATTHAI, 91; pls. 9/5; 29/1–4; 25/2 (synonymy).
<i>Favites</i>	<i>abdita</i>	1918, VAUGHAN, 109; pl. 40/1–5. 1948, CROSSLAND, 189. 1952, CROSSLAND, 129. 1971, LOYA & SLOBODKIN, 124. 1971, CHEVALIER, 178; pls. 9/2; 18/4, 5, 8; 19/4; 20/1, 3, 7; 23/1, 3; 24/1 (synonymy). 1972, WIJSMAN-BEST, 33; pl. 7/1, 2. 1974, MERGNER & SCHUHMACHER, 264. 1974, SCHEER & PILLAI, 48. 1976, PILLAI & SCHEER, 56. 1977, VERON, PICHON & WIJSMAN-BEST, 54; figs. 90–96, 432, 433. 1980, HEAD, 151, 457.
<i>Prionastraea</i>	<i>gibbosa</i>	1897, KLUNZINGER 3, 40; pl. 4/10. 1888, ORTMANN, 173. 1889, ORTMANN, 528.
	<i>profundicella</i>	1888, FAUROT, 119.

One of the present specimens is a foliaceous growth. Others are massive. Generally the corallites are 10 to 12 mm in length, polygonal, 7 to 9 mm in width. The depth varies from 3 to 7 mm in different coralla. Total number of septa up to 60, of which 18 to 20 reach the columella. Other details of this species as described by MATTHAI (1914).

Material:

- Gulf of Aqaba: T. Aviv NS 6118, 6119 (Eilat); 5001, 5009 (Dahab); 4872, 4877, 4880 (Ras Atantur).  
 HLM EC 459 (Eilat).
- Northern R. S.: USNM Wa 59 (Ghardaqa).  
 HLM X2: 2–19 (Gubal Isl.).
- Central R. S.: P. Sud. Sa 66 (Sanganeb R.).

Distribution: Red Sea eastward into the Indo-Pacific up to Fanning Isl. A fairly common and wide-spread species.

*Favites complanata* (EHRENBERG), 1834

(Plate 28, Fig. 7)

<i>Favia</i>	<i>complanata</i>	1834, EHRENBERG, 317 (Type locality: Red Sea). 1857, MILNE EDWARDS (& HAIME), 443. 1914, MATTHAI, 109; pl. 30/1-3.
<i>Favites</i>	<i>complanata</i>	1954, ROSSI, 32. 1967, SCHEER, 432. 1971, CHEVALIER, 190; pls. 20/2, 6; 24/2, 3 (synonymy). 1974, MERGNER & SCHUHMACHER, 264. 1977, VERON, PICHON & WIJSMAN-BEST, 65; figs. 118-121, 442. 1980, HEAD, 151, 457.
<i>Gonistraea</i>	<i>halicora</i>	
	var. <i>obtusa</i>	1879, KLUNZINGER 3, 33; pl. 4/1.
<i>Astraea</i>	<i>bemprichii</i>	1834, EHRENBERG, 320.
<i>Prionastraea</i>	<i>bemprichi</i>	1857, MILNE EDWARDS (& HAIME), 521.
<i>Favia</i>	<i>bemprichii</i>	1914, MATTHAI, 110 (pars); pl. 36/3.
<i>Prionastraea</i>	<i>spinosa</i>	1879, KLUNZINGER 3, 39; pls. 4/7; 10/5. 1888, ORTMANN, 174. 1892, ORTMANN, 662.
<i>Astraea</i>	<i>tesserifera</i>	1834, EHRENBERG, 321.
<i>Prionastraea</i>	<i>tesserifera</i>	1857, MILNE EDWARDS (& HAIME), 517. 1879, KLUNZINGER 3, 37; pl. 4/9. 1889, ORTMANN, 527.
	<i>vasta</i> , var.	
	<i>superficialis</i>	1879, KLUNZINGER 3, 38; pl. 4/8.

The following description is based on RM 43: Corallum encrusting; corallites polygonal, cerioid, mostly pentagonal, 15 to 18 mm long, 10 to 14 mm broad, 4 to 5 mm deep. Wall acute at the top, about 1 mm thick, one side of the corallite more elevated than the other. There are 22 to 25 major septa in a large calyx with an equal number of subsidiary septa. 18 to 20 septa reach the columella. Septa wide apart, upper two-thirds narrower than the lower part. Major septa with a paliform lobe. Septa exert to 1 mm, those of the opposite side generally fusing at the top of the wall. Septal edges with 6 to 9 teeth, some of them are frosted giving a spiny look to the coral. Columella 2 to 3 mm in diameter, formed of septal ends. Subsidiary septa unite with the sides of the major septa.

## Material:

Gulf of Aqaba:	T. Aviv	NS	256, 262, 1341-1, 2, 9286 (Eilat); 5005, 5012 (Dahab); 4838 (Ras Atantur).
	Basel	PW	73 689 (El Kura).
Northern R. S.:	USNM	Wa	61, 63 (Ghardaqa).
	HLM	X2:	3-39 (Gubal Isl.).
		EC	521 (Ras Abu Hagar).
Central R. S.:	USNM	Wa	60, 62 (Dongonab).
	P. Sud.	Sa	74 (Sanganeb R.).
	HLM	RM	43 (Wingate R.).

Distribution: Red Sea; Japan (YABE, SUGIYAMA & EGUCHI, 1936); Great Barrier Reef; New Caledonia; Tuamotu Archipelago.

Remarks: CHEVALIER (1971) has already listed *Astraea bemprichii* and *Prionastraea spinosa* as synonyms of *Favites complanata*. However, it may be noted that MATTHAI's *bemprichii* is not the same as *Astraea bemprichii* EHRENBERG, though MATTHAI has figured the type (pl. 36, fig. 3). MATTHAI's material includes several specimens in BMNH labelled *Favia bemprichii*. These were recently examined by PILLAI & STODDART (in prep.) and were found to contain at least two species. Most of his specimens are referable to *Acanthastrea bemprichii*. VERON, PICHON & WIJSMAN-BEST (1977) placed *Astraea bemprichii* under *Favites abdita*. This is, however, erroneous. EHRENBERG's type of *A. bemprichii* is No. 735 in Berlin Museum. It is an entire hemispherical corallum with polygonal corallites up to 14 mm long. It is very similar to *F. complanata*. KLUNZINGER's figured type of *Prionastraea spinosa* is No. 2154 in Berlin. The calices are slightly smaller than in typical *complanata*, but its identity with *F. complanata* is evident.

*Favia vasta* var. *superficialis* KLUNZINGER (No. 2192 in Berlin Museum) and *Goniastreaa balicora* var. *obtusa* also belong to *F. complanata*.

*Favites flexuosa* (DANA), 1846

(Plate 28, Fig. 8)

<i>Astraea</i>	<i>flexuosa</i>	1846, DANA, 227; pl. 11/6, 6a-c (Type locality: Fiji).
<i>Favites</i>	<i>flexuosa</i>	1936, YABE, SUGIYAMA & EGUCHI, 32; pl. 20/1. 1939, UMBGROVE, 29. 1971, CHEVALIER, 219 (pars); pls. 22/2, 6; 23/9; 26; 27/2 (synonymy). 1977, VERON, PICHON & WIJSMAN-BEST, 61; figs. 102-109, 435. 1980, HEAD, 151, 457.
<i>Favia</i>	<i>favosa</i>	1914, MATTHAI, 112; pl. 28/2 (synonymy). 1924, MATTHAI, 18; pls. 1/1; 2/2, 3, 7-9.
<i>Prionastreaa</i>	<i>vasta</i>	1879, KLUNZINGER 3, 38; pls. 4/12; 10/4a, b (non pl. 4/8). 1888, ORTMANN, 173. 1892, ORTMANN, 662.
<i>Favia</i>	<i>vasta</i>	1914, MATTHAI, 108; pl. 27/3, 5, 6.
<i>Favites</i>	<i>vasta</i>	1971, CHEVALIER, 229; pls. 22/3; 25/4 (synonymy).
	<i>virens</i>	1952, CROSSLAND, 130; pl. 6/2 (non pl. 6/1). 1954, ROSSI, 32; pl. 2/1, 2. 1971, LOYA & SLOBODKIN, 124. 1976, PILLAI & SCHEER, 57; pl. 24/3 (synonymy).

The present species is represented by eight specimens. The following details are based on NS 5886: Corallum submassive, corallites cerioid, polygonal, wall 2 to 2.5 mm thick. Length of calices 15 to 22 mm (generally 17 to 18 mm), width 13 to 15 mm, depth 8 to 10 mm. Total number of septa in a calyx 18 to 15 mm is 75, including all the subsidiaries. Septa not swollen at the wall, steeply descending, of equal width from top to bottom. Edges with 8 to 10 slender and long horizontal teeth. Septa only slightly exsert, those of the opposite side fuse at the middle of the intercorallite wall over a thin vertical ridge. Paliform lobes not seen. 20 to 25 septa reach the columella. 3 to 4 subsidiary septa unite with a major one before the latter meets the columella. A few septa reach the septa without fusion. Columella concave, 4 to 5 mm in diameter, with curly, upward trabeculae. Asexual reproduction by marginal fission.

Material:

Gulf of Suez:	T. Aviv	NS	5884, 5885, 5886 (Et Tur).
Gulf of Aqaba:	Jerus.	SLR	364-1 (Marsa Murach).
	T. Aviv	NS	4956 (Dahab).
	Basel	PW	73 591 (Eilat); 73 553 (without locality).
Central R. S.:	P. Sud.	Sa	19 (Sanganeb R.).

Distribution: Red Sea; Maldives; Nicobar Isls.; East Indies; Philippines; Japan; Great Barrier Reef; New Caledonia; Solomon Isls.; Marshall Isls.; Fiji; Cook Isls.

*Favites balicora* (EHRENBERG), 1834

(Plate 29, Figs. 1, 2)

<i>Astraea</i>	<i>balicora</i>	1834, EHRENBERG, 321 (Type locality: Red Sea).
<i>Prionastreaa</i>	<i>balicora</i>	1857, MILNE EDWARDS (& HAIME), 517.
<i>Goniastreaa</i>	<i>balicora</i>	
	var. <i>acuta</i>	1879, KLUNZINGER 3, 33 (pars); pl. 4/2 (non var. <i>obtusa</i> ).
	<i>balicora</i>	1888, ORTMANN, 173. 1906, v. MARENZELLER, 86.
<i>Favia</i>	<i>balicora</i>	1914, MATTHAI, 106; pl. 26/3, 5-7 (synonymy).
<i>Favites</i>	<i>balicora</i>	1918, VAUGHAN, 110; pl. 41/1-3. 1948, CROSSLAND, 190. 1952, CROSSLAND, 128. 1971, LOYA & SLOBODKIN, 124.



- 1971, CHEVALIER, 197; pls. 20/4; 21/3; 22/4; 23/5, 6; 25/1, 2.; 28/1 (pl. 20/5 and 21/1 represent probably *Favites complanata*).  
 1974, SCHEER & PILLAI, 49.  
 1976, PILLAI & SCHEER, 57.  
 1977, VERON, PICHON & WIJSMAN-BEST, 59; figs. 97–101, 434 (synonymy).  
 1980, HEAD, 151, 457.  
 ? *chimensis* 1972, WIJSMAN-BEST, 31; pl. 5/4.  
 1974, MERGNER & SCHUHMACHER, 264.

This is a species which shows wide skeletal variation, and in fact, some of the specimens are close to *F. abdita* and others to *F. complanata*. However, typical forms are separable on reasonably safe grounds. We place 16 specimens from the present collection under this species. Superficially they present a heterogeneous assemblage. The following are the details:

RM 45 is submassive, explanate with a greater spread of 12 cm. Corallites polygonal to hexagonal, 8 to 10 mm long, 6 to 8 mm broad, 4 to 5 mm deep. Calices oval or rarely polygonal. Septa 28 to 40 in different calices, not including the spiny ones intercalated. Septa thin, interseptal loculi wider than the thickness of the septa. Septa exsert, narrower at the upper half than at the lower, edges with 8 to 10 teeth, the last tooth simulating a palus. Septa of the adjacent corallites scarcely meet over the intercorallite wall. Columella oval or circular in outline, composed of closely twisted trabeculae to which 14 to 20 major septa unite. Subsidiary septa unite with the sides of the major ones. Asexual reproduction by unequal fission.

EC 480 resembles MATTHAI's (1914) plate 26, fig. 6. It is submassive, corallites and calices oval or circular. Thecal rim slightly projecting with deep intercorallite furrows. Wall 1 to 1.5 mm thick. Larger calices up to 12 mm in diameter. EC 458 resembles EC 480 but has thinner intercorallite walls (less than 1 mm).

X2: 9–3 is encrusting. Corallites and calices polygonal, calices 8 to 10 mm long but very shallow, depth 2 to 3 mm. Major septa have only 5 to 6 teeth.

PW 71 339 is a massive growth. Both the calices and the corallites are circular or oval, very shallow. The paliform lobes in this specimen are very well developed, forming a conspicuous ring around the columella.

Material:

- |                 |         |     |  |
|-----------------|---------|-----|--|
| Gulf of Aqaba:  | T. Aviv | NS  | 9285 (Eilat); 4931, 4984 (Dahab).  |
|                 | Basel   | PW  | 71 339 (Fara'un Isl., 40 m).   |
|                 | HLM     | EC  | 458 (Eilat).   |
| Northern R. S.: | USNM    | Wa  | 64, 65, 66 (Ghardaqa).   |
|                 | HLM     | EC  | 480 (Ras Abu Suma); 69, 71, 161 (Koseir, EC 71 duplicate from KLUNZINGER as <i>Goniastrea balicora</i> ); 309 (Ras Abu Hagar). |
| Central R. S.:  | HLM     | RM  | 45 (Wingate R.).   |
| Southern R. S.: | HLM     | X2: | 9–3 (Sarso Isl.).  |

Distribution: Red Sea eastward into the Indo-Pacific as far east as Samoa and Loyalty Isls. For various localities see CHEVALIER, 1971.

*Favites acuticollis* (ORTMANN), 1889

(Plate 29, Fig. 3)

- |                    |                      |  |
|--------------------|----------------------|--|
| <i>Prionastrea</i> | <i>acuticollis</i>   | 1889, ORTMANN, 528; pl. 16/11 (Type locality: Ceylon). |
| <i>Favites</i>     | <i>acuticollis</i>   | 1971, CHEVALIER, 205; pls. 21/2; 23/4.                 |
|                    |                      | 1972, WIJSMAN-BEST, 32; pl. 6/4.                       |
|                    | <i>yamanarii</i>     |  |
|                    | var. <i>profunda</i> | 1939, UMBROVE, 31; pl. 4/2–4.                          |

One specimen is placed under this species. The polygonal corallites are 5 to 6 mm in length. Wall fused. Corallites penta- to hexagonal, calices rounded or oval, 3 to 4 mm deep. Septa 24 to 32, subequal, close together; edges with frosted dentation. Septa continuous over the wall or alternating with those of adjacent corallites. Columella trabecular. Paliform lobes not developed.

## Material:

Gulf of Aqaba: Jerus. SLR 356-2 (Marsa Murach).

Distribution: Red Sea; Chagos Archipelago (ROSEN, 1971); Ceylon; Indonesia; New Hebrides; New Caledonia.

Remarks: VERON, PICHON and WIJSMAN-BEST (1977) are treating *F. acuticollis* under *F. chinensis*. But *F. chinensis* differs from *F. acuticollis* in having bigger corallites with intercorallite grooves between them.

*Favites pentagona* (ESPER), 1794

(Plate 29, Fig. 4)

<i>Madrepora</i>	<i>pentagona</i>	1797, ESPER, 23; pl. 39/1, 2 (Type locality: Eastindian Seas).
<i>Prionastraea</i>	<i>pentagona</i>	1888, ORTMANN, 174.
		1889, ORTMANN, 529.
		1892, ORTMANN, 662.
		1879, KLUNZINGER 3, 41; pls. 4/11; 10/6a, b.
<i>Favia</i>	<i>pentagona</i>	1914, MATTHAI, 95 (pars); pls. 10/5; 24/2, 3 (synonymy), non pls. 24/4; 36/4.
<i>Favites</i>	<i>pentagona</i>	1918, VAUGHAN, 112; pl. 42/1, 2.
		1948, CROSSLAND, 188; pl. 6/lower fig.
		1971, LOYA & SLOBODKIN, 124.
		1971, CHEVALIER, 215; pls. 21/6, 7; 23/7; 25/3.
		1972, WIJSMAN-BEST, 27; pl. 5/1, 2.
		1974, MERGNER & SCHUHMACHER, 264.
		1977, VERON, PICHON & WIJSMAN-BEST, 68; figs. 122-127, 439-441 (synonymy).
		1980, HEAD, 151, 458.
<i>Aprastraea</i>	<i>deformis</i>	1904, GARDINER, 773; pl. 63/31.

We know only ESPER's description and figures of this species. According to that the corallites are of different size and form, usually polygonal, mostly pentagonal, 6 to 8 mm in diameter. Septa 30 to 36, alternating in length. 12 to 16 reach the columella and bear paliform lobes.

A specimen without label in the ESPER collection was designated by WIJSMAN-BEST (1972: 28) as *F. pentagona*. But it has characteristics which we attribute now to *F. melicerum*.

EC 68 is a specimen, collected by KLUNZINGER at Koseir. Corallum flat, surface irregular. Corallites cerioid, polygonal, 6 to 7 mm long and 5 to 6 mm broad. Calices polygonal, rounded or oval. Wall up to 1 mm, edges acute. Septa continuous over the wall, larger ones fusing with smaller ones of the opposite side. Septa 24 to 35 in number, 12 to 17 reaching the columella, the remaining ones very small. Paliform lobes conspicuous. Edges of septa finely dentate.

X2: 1-7 is an encrusting specimen with somewhat smaller corallites as in EC 68, on an average 4 x 6 mm, or 5 mm in diameter. Dentation of septa stronger, paliform lobes very distinct.

NS 5889 has a hillocky growthform, corallites 6 to 9 mm in length. On flattened parts calicular structures correspond with the above description. The corallites at the hillocks have more exsert and stronger dentate septa, thus the paliform lobes become inconspicuous.

SLR 824, NS 8676 and NS 1913 are intermediate forms between EC 68 and NS 5889.

## Material:

Gulf of Suez: Jerus. SLR 824 (Et Tur).

T. Aviv NS 8676 (El Bilaiyim); 1913, 5889 (Et Tur).

HLM X2: 1-7 (Ras Shukheir).

Gulf of Aqaba: T. Aviv NS 1352-1, 2 (Eilat); 4825, 4845, 4868, 4884 (Ras Atantur).

Northern R. S.: USNM Wa 67 (Ghardaqa).

HLM EC 68 (Koseir, duplicate from KLUNZINGER as *Prionastraea pentagona*).

Distribution: Red Sea; East Africa (Natal coast); Maldives; Ceylon; Indonesia; Taiwan; Japan; Caroline Is.; New Caledonia.

Remarks: KLUNZINGER (1879), MATTHAI (1914) and CHEVALIER (1971) felt that *Astraea melicerum* EHRENBERG, 1834, is the same as *Madrepora pentagona* ESPER and adopted the latter specific

name for this species. But VAUGHAN (1918) separated them and was followed by WIJSMAN-BEST (1972), PILLAI & SCHEER (1976) and VERON, PICHON & WIJSMAN-BEST (1977).

ESPER's type of *M. pentagona* as well as EHRENBERG's type of *A. melicerum* are lost. Therefore details in the structure of the two corals probably never can be compared with each other. MATTHAI (1914) knew EHRENBERG's type and has figured it (pl. 36, fig. 4). But he, too, did not have ESPER's *M. pentagona* on hand.

We follow VAUGHAN (1918) with some doubt and keep the two species separate. But we cannot incorporate *Favites melicerum* into the present work, because the species was not found in the Red Sea. Also EHRENBERG's type is from an unknown locality.

### Genus *Goniastrea* MILNE EDWARDS and HAIME, 1848

Type species: *Astrea retiformis* LAMARCK, 1816.

Generic characters: Encrusting, massive, cerioid or meandering. Wall solid. Septa of equal thickness at the wall, broader below with a shelf and conspicuous paliform lobes. Columella trabecular. Asexual reproduction by mono- to tristomodaal intratentacular budding.

Many species of this genus are described from the Indo-Pacific. VERON, PICHON & WIJSMAN-BEST (1977) recognized seven species from East Australia which cover all the Indo-Pacific forms. However, the present authors think that there are not more than three valid species in the genus. We consider *G. solida* (= *G. edwardsi*) and *G. retiformis* as one; all the species described in literature with mono-, di- to tristomodaal forms and larger calices than in *retiformis* as another, viz *G. pectinata*, and possibly a third with meandering valleys, viz *G. australensis*.

*G. palauensis* YABE, SUGIYAMA and EGUCHI, 1936, is in all probability a *Favites*.

Key to the species of *Goniastrea* considered herein:

- A. Corallites generally monocentric, rarely with two to three centres running together.
1. Corallites average 4 mm in length, polygonal, septa in three cycles. . . . . *G. retiformis*
  2. Corallites 6 to 10 mm in diameter, up to 10 mm deep, rarely with polycentric calices. . . . .  
 . . . . . *G. pectinata*
- B. Corallites meandering with long sinuous valleys.
3. Width of valleys 6 to 8 mm. . . . . *G. australensis*

### *Goniastrea retiformis* (LAMARCK), 1816

(Plate 29, Figs. 5, 6; Plate 30, Fig. 1)

<i>Astrea</i>	<i>retiformis</i>	1816, LAMARCK 2, 265 (Type locality not recorded).
<i>Goniastrea</i>	<i>retiformis</i>	1857, MILNE EDWARDS (& HAIME), 446.
		1879, KLUNZINGER 3, 36; pl. 4/5.
		1889, ORTMANN, 527.
		1892, ORTMANN, 661.
		1906, v. MARENZELLER, 86.
		1914, MATTHAI, 118; pls. 10/3; 31/1-5; 33/3; 38/2, 4 (synonymy).
		1952, CROSSLAND, 133.
		1967, SCHEER, 432.
		1971, LOYA & SLOBODKIN, 124.
		1971, CHEVALIER, 231; pls. 28/2-5; 29/1, 2, 8 (synonymy).
		1972, WIJSMAN-BEST, 38; pl. 8/3.
		1974, MERGNER & SCHUHMACHER, 265.
		1974, SCHEER & PILLAI, 50.
		1976, PILLAI & SCHEER, 59.
		1977, VERON, PICHON & WIJSMAN-BEST, 79; figs. 145-150, 174, 449.
		1980, HEAD, 152, 458.
	<i>edwardsi</i>	1971, CHEVALIER, 240; pls. 27/2; 28/6, 7; 29/5, 6 (synonymy).
		1977, VERON, PICHON & WIJSMAN-BEST, 80; figs. 151-156, 173 (synonymy).

	<i>favus</i>	1879, KLUNZINGER 3, 85; pls. 4/4; 10/7. 1888, ORTMANN, 173. 1906, v. MARENZELLER, 86.
<i>Plesiastrea</i>	<i>baeckeli</i>	1878, BRUEGGEMANN, 396; pl. 7/2a, b.
<i>Goniastrea</i>	<i>solida</i>	1857, MILNE EDWARDS (& HAIME), 444. 1914, MATTHAI, 117; pls. 10/1; 28/3, 4; 31/6; 33/4; 38/3 (synonymy).
<i>Astraea</i>	<i>spongia</i>	1834, EHRENBERG, 320.

During the present work we studied eight specimens of this species from Red Sea. RM 91 is almost typical as described by MATTHAI (1914). The corallites are polygonal, 3 to 4 mm long, 2 to 3 mm broad. Wall solid but acute (0.5 mm thick). 8 to 11 major septa, each with a large paliform lobe unite to the columella. The alternating subsidiary septa are small.

The rest of the specimens shows almost the same details. The polygonal corallites are 4 to 5 mm long, about 4 mm broad. The intercorallite walls are up to 1 mm thick. 12 to 14 septa reach the columella. In some calices the pali are very conspicuous on the major septa, but in others they are poorly developed. These specimens agree to *Goniastrea solida* as described by MATTHAI (= *G. parvistella* VAUGHAN and *G. edwardsi* CHEVALIER).

Material:

Gulf of Aqaba:	HLM	EC	461 (Eilat).
Central R. S.:	P. Sud.	Sa	6, 45 (Sanganeb R.).
	HLM	RM	84, 85, 86, 91 (Wingate R.).
Southern R. S.:	HLM	X2:	9-19 (Sarso Isl.).

Distribution: A common and widespread Indo-Pacific species recorded from almost all reefs from Red Sea to Samoa.

Remarks: One of us reached the conclusion as early as 1969, based on a field study of this species from Minicoy (PILLAI, 1971) where it is abundant in lagoon often forming extensive shoals, that *G. solida* MATTHAI is only a skeletal variation of *G. retiformis*. According to VAUGHAN (1918) MATTHAI's *G. solida* should be *G. parvistella* (DANA). CHEVALIER (1971) opined that *G. parvistella* is the same as *G. retiformis*, while *G. solida* is the same as *G. edwardsi*. VERON, PICHON & WIJSMAN-BEST (1977) placed *G. parvistella* under the synonymy of *G. edwardsi* and recognized the latter as valid species. We do agree that some specimens could be labelled *G. edwardsi* which shows variations from *G. retiformis*. However, we do not believe that they are genetically different. These are only skeletal variations.

*Goniastrea pectinata* (EHRENBERG), 1834

(Plate 29, Figs. 7, 8; Plate 30, Figs. 2, 3)

<i>Astraea</i>	<i>pectinata</i>	1834, EHRENBERG, 320 (Type locality: Red Sea).
<i>Goniastrea</i>	<i>pectinata</i>	1897, KLUNZINGER 3, 34; pl. 4/6. 1906, v. MARENZELLER, 86. 1914, MATTHAI, 120; pls. 28/6; 37/1 (synonymy). 1952, CROSSLAND, 135. 1954, ROSSI, 33; pl. 2/3. 1967, SCHEER, 432. 1971, LOYA & SLOBODKIN, 124. 1971, CHEVALIER, 246 (pars); pls. 27/3, 4; 30/1, 3, 4, 6; 32/1 (synonymy). 1972, WIJSMAN-BEST, 41; pl. 9/1-3. 1974, MERGNER & SCHUHMACHER, 265. 1974, SCHEER & PILLAI, 50. 1976, PILLAI & SCHEER, 58. 1977, VERON, PICHON & WIJSMAN-BEST, 87; figs. 168-172, 450. 1980, HEAD, 152, 458.
	<i>aspera</i>	1977, VERON, PICHON & WIJSMAN-BEST, 83; figs. 157-163 (synonymy).
	<i>equisepia</i>	1959, NEMENZO, 101; pl. 10/1.
	<i>favulus</i>	1972, WIJSMAN-BEST, 10; pl. 9/4.
cf. <i>favulus</i>		1977, VERON, PICHON & WIJSMAN-BEST, 86; figs. 164-167.
	<i>incrustans</i>	1889, DUNCAN, 11; pl. 1/19, 20. 1924, MATTHAI, 21; pls. 2/4; 11/4.

- mantonae* 1952, CROSSLAND, 136; pl. 7/1, 2.  
*planulata* 1914, MATTHAI, 121; pls. 28/5; 31/7, 8 (synonymy).  
*regularis* 1971, CHEVALIER, 267; pls. 29/4; 33/1.

We have a large number of specimens of this most highly variable species in the present collection, which has caused the unnecessary multiplication of species in the past.

The present material contains specimens that could be placed in *pectinata* (typica), *planulata* or *aspera* as described by earlier authors. We give figures to illustrate the gradation from one to another in the present suite of specimens.

Material:

- Gulf of Suez: HLM X2: 1-5 (Ras Shukheir).  
 Gulf of Aqaba: Jerus. SLR 356-1, 359-1, 2 (Marsa Murach); 448, 541 (El Kura).  
 T. Aviv NS E58/548d (Eilat); 4897 (Wassit); 1886, 3188, 4954 (Dahab).  
 Basel PW 71 326 (40 m), 73 579 (50-55 m) (Eilat); 73 542 (Fara'un Isl.); 73 631 (20-22 m), 73 653, 73 690 (El Kura).  
 Northern R. S.: T. Aviv NS 9283 (Marsa el At).  
 USNM Wa 68, 69, 70, 106 (Ghardaqa).  
 HLM X2: 2-21, 32 (9 m), 3-16, 31, 35, 47 (15 m) (Gubal Isl.).  
 EC 483 (Ras Abu Suma, 15 m); 499 (Safaga Isl.).  
 Central R. S.: P. Sud. Sa 80, 84, 107 (Sanganeb R.).  
 HLM RM 41, 44, 83 (Wingate R.).  
 X2: 8-3, 6, 25 (Shaab Anbar).

Distribution: Widely distributed from Red Sea into the Indo-Pacific to Cook Isls. (STODDART & PILLAI, 1973).

Remarks: We do not believe in taking minor skeletal variations such as the nature of pali, or comparative thickness or thinness of the wall, or shallowness of calices in *Goniastrea* as valid criteria for separation of species. From a study of several specimens of *Goniastrea* from different parts of Indo-Pacific including the types of many, we feel that the various species in our list of synonyms are all but skeletal variations of one species, viz *G. pectinata*. When we accept *G. planulata* as a positive synonym of *G. pectinata*, there is little reason to separate forms like *G. mantonae*, *G. favulus* and *G. incrustans*. The disagreement of recent authors such as CHEVALIER (1971), WIJSMAN-BEST (1972, 1976), PILLAI & SCHEER (1976) and VERON et al. (1977) on the list of synonyms of *Goniastrea* is a clear indication of the lack of specific criteria for the separation of closely related forms of the species.

*Goniastrea australensis* (MILNE EDWARDS and HAIME), 1857

(Plate 30, Figs. 4, 5)

- Prionastrea* *australensis* 1857, MILNE EDWARDS (& HAIME), 520 (Type locality: Great Barrier Reef).  
*Goniastrea* *australensis* 1972, WIJSMAN-BEST, 43; pl. 10/1-3.  
 1977, VERON, PICHON & WIJSMAN-BEST, 92; figs. 176-182, 451.  
 1980, HEAD, 152, 458.  
*benbami* 1917, VAUGHAN, 277; pls. 18/1, 2; 19/11; 20/1.  
 1918, VAUGHAN, 116.  
 1952, CROSSLAND, 136; pl. 8/2.  
 1955, ROSSI, 1; fig. p. 3.  
*columella* 1948, CROSSLAND, 191; pls. 8; 10/upper fig.  
*pectinata* 1971, CHEVALIER, 246 (pars), var. *benbami*: pls. 30/2; 31/6; 32/2; var. *columella*: pl. 30/5.  
*seychellensis* 1948, CROSSLAND, 190; pl. 6/upper fig.  
 1973, PILLAI, VINE & SCHEER, 461; pl. 3/1.

Material:

- Northern R. S.: HLM X2: 2-28 (Gubal Isl., 9 m).

Distribution: Red Sea; Natal coast, SE-Africa; Seychelles; Ceylon; Great Barrier Reef; Kermadec Isls. (type locality of *G. benbami*); New Caledonia.

Remarks: *G. australensis* is characterized by a meandering corallum. *G. columella* and *G. benbami* are similar in characters. CROSSLAND (1948) described specimens from East Africa under the name *G.*

*seychellensis*, which was later followed by PILLAI, VINE & SCHEER (1973). WIJSMAN-BEST (1972) opined that *Prionastrea seychellensis* MILNE EDWARDS & HAIME is a *Favites*, according to MATTHAI (1914) it is near to *Favia fava*. CHEVALIER (1971) merged *Goniastrea australensis* with *G. pectinata*, but VERON et al. (1977) kept them separate. The only major distinction between these two are in the form of the corallites, that is, in *G. pectinata* majority of the calices is monocentric. However, it may be noted that many specimens of *G. planulata* (= *pectinata*) have meandering valleys, though shorter than in *G. australensis*.

More about *G. seychellensis* see under the following "Additional remarks".

#### Additional remarks to the genus *Goniastrea*:

*Prionastrea seychellensis* MILNE EDWARDS & HAIME, 1849, 132.

MILNE EDWARDS and HAIME's type of *Prionastrea seychellensis* is, according to CHEVALIER (1971: 189) a badly preserved specimen. Therefore the opinion of different authors about the taxonomic position of this species is very heterogeneous.

KLUNZINGER (1879) named it *Goniastrea seychellensis*; his fig. 3, pl. 4, has much resemblance to fig. 6 (above), pl. 6, of CROSSLAND (1948), which we put to *Goniastrea australensis*. FAURE & PICHON (1978) have examined the type of CROSSLAND's figured specimen and consider it as different from MILNE EDWARDS and HAIME's type.

ORTMANN has mentioned *Goniastrea seychellensis* three times (1888, 1889 and 1892) from Red Sea. In 1888 he gave this name to a *Goniastrea halicora* in the Strassbourg Museum, one of KLUNZINGER's duplicates, which were acquired by several museums. We have in HLM such a duplicate, too, EC 71, which we list under *Favites halicora*.

MATTHAI (1914: 122) had no doubt that *Prionastrea seychellensis* and EHRENBERG's *Astraea deformis* belong together, and he referred them with a query to *Favia fava* (1914: 80). CHEVALIER (1971) supposed *Prionastrea seychellensis* is related to *Favites abdita*, and afterwards WIJSMAN-BEST (1972) and VERON, PICHON & WIJSMAN-BEST (1977) put it definitely to *Favites abdita*.

Two specimens of *Prionastrea seychellensis* in BMNH were placed to *Favites peresi* by FAURE & PICHON (1978). These authors have located in the Paris Museum another specimen of this name with a number of BMNH and labelled as holotype from the Seychelles, which they put to *Favia fava*.

Because of this diversity of opinions it is not possible to give a generally valid synonymy of *Prionastrea*, or *Goniastrea* resp., *seychellensis*. Due to this uncertainty it may be the best to suppress the specific name *seychellensis* in connection with any faviid coral.

*Goniastrea hombroni* (ROUSSEAU), 1854, 122; pl. 28/3, 3a.

SCHEER (1967, 432, figs. 11, 12) has reported *Goniastrea hombroni* from the Red Sea (X2: 9-19). He referred to *Favia hombroni* by GARDINER (1904, 771; pl. 62/27) and MATTHAI (1914, 107; pls. 26/1, 2; 33/2). Later on SCHEER & PILLAI (1974, 51; pl. 24/1-4) added *G. hombroni* from the Nicobar Islands. But all these forms do not belong to *hombroni* sensu ROUSSEAU. His *Parastraea hombronii* (1854) is identical with *Favia stelligera*, stated by ROSEN (1971, 80) who refers to WELLS, and by CHEVALIER (1971, 162 and 168), and confirmed from WIJSMAN-BEST (1977, 20). *P. hombronii* and *F. stelligera* have rounded calices separated from each other, whereas the above mentioned forms are cerioid with polygonal calices, whose septa continue from one calyx to the other. We put these forms for the present to *Goniastrea retiformis*, and therefore we have listed X2: 9-19 under "Material" of this species.

#### Genus *Platygyra* EHRENBERG, 1834

Type species: *Madrepora (Platygyra) lamellina* EHRENBERG, 1834, = *Madrepora daedalea* ELLIS & SOLANDER, 1786.

Generic characters: Massive, meandroid, valleys enclosed between thin, perforated, acute collines. Width of valleys 5 to 7 mm, depth about so much. Monocentric corallites sometimes present. Septa slightly exsert, continuous over the wall; edges dentate. Columella trabecular, continuous.

Key to the species of *Platygyra* from Red Sea:

- A. Valleys mostly lengthy and sinuous, sometimes short, rarely monocentric.
1. Width of valleys 5 to 7 mm, depth 5 to 8 mm. Septa slightly exsert. Collines generally perforated. .... *P. daedalea*
- B. Valleys mostly short with 2 to 3 centres or monocentric, 3 to 4 mm wide and equally deep. Wall imperforate.
2. Septa thin, little exsert. Wall acute at the top. .... *P. sinensis*
3. Septa thickened at the wall, exsert, with frosted teeth. Wall of uniform thickness from top to bottom, 1.5 to 2 mm. .... *P. crosslandi*

*Platygyra daedalea* (ELLIS & SOLANDER), 1786

(Plate 30, Fig. 6)

<i>Madrepora</i>	<i>daedalea</i>	1876, ELLIS & SOLANDER (non FORSKAL), 163; pl. 46/1 (Type locality: Indian Ocean).
<i>Coeloria</i>	<i>daedalea</i>	1928, MATTHAI, 24; pls. 1/1, 2; 5/1-8; 6/1, 7, 8; 8/4; 12/1; 44/3; 48/1; 54/6; 63/3; 68/5 (synonymy).
		1952, CROSSLAND, 148; pls. 11/1; 12/2.
<i>Platygyra</i>	<i>daedalea</i>	1972, WIJSMAN-BEST, 46; pl. 11/1, 2.
		1975, CHEVALIER, 122; pls. 7/1, 4, 5; 8/1-8; 10/1-6; 11/3-6; 40/10, 11 (synonymy).
		1977, VERON, PICHON & WIJSMAN-BEST, 98; figs. 190-196, 453, 454 (synonymy).
		1980, HEAD, 152, 459.
<i>Coeloria</i>	<i>arabica</i>	1879, KLUNZINGER 3, 17; pls. 2/1-4; 9/10a-c.
<i>Maeandrina</i>	<i>arabica</i>	1888, ORTMANN, 171.
		1889, ORTMANN, 523.
<i>Coeloria</i>	<i>astraeiformis</i>	1857, MILNE EDWARDS (& HAIME), 417.
		1879, KLUNZINGER 3, 19.
		1888, FAUROT, 119.
<i>Favia</i> (?)	<i>astraeiformis</i>	1928, MATTHAI, 276; pls. 44/2a, b; 45/1.
<i>Coeloria</i>	<i>astraeiformis</i>	1952, CROSSLAND, 147.
	<i>bottai</i>	1857, MILNE EDWARDS (& HAIME), 414.
	<i>esperii</i>	1857, MILNE EDWARDS (& HAIME), 417.
		1879, KLUNZINGER 3, 19; pl. 2/6.
	<i>forskaelana</i>	1857, MILNE EDWARDS (& HAIME), 414.
	<i>forskaliana</i>	1888, FAUROT, 119.
	<i>klunzingeri</i>	1928, MATTHAI, 47; pls. 34/4; 56/4.
<i>Maeandra</i>	<i>labyrinthica</i>	1834, EHRENBERG, 323.
<i>Madrepora</i>	<i>labyrinthiformis</i>	1775, FORSKAL, 132.
<i>Coeloria</i>	<i>labyrinthiformis</i>	1857, MILNE EDWARDS (& HAIME), 412.
		1876, HAECKEL, 45; pl. 2/4.
<i>Maeandra</i>	<i>lamellina</i>	1834, EHRENBERG, 323.
<i>Coeloria</i>	<i>lamellina</i>	1857, MILNE EDWARDS (& HAIME), 415.
		1888, FAUROT, 119.
<i>Maeandra</i>	<i>lamellina</i>	1906, v. MARENZELLER, 81.
<i>Coeloria</i>	<i>lamellina</i>	1928, MATTHAI, 37; pls. 6/2-6; 7/1-8; 8/1-3, 5, 6; 34/1; 53/5; 54/1; 56/2, 3, 5, 7; 65/1-3; 66/3; 71/7 (synonymy).
		1941, CROSSLAND, 28.
		1952, CROSSLAND, 149.
		1954, ROSSI, 33.
<i>Platygyra</i>	<i>lamellina</i>	1956, STEPHENSON & WELLS, 35 (synonymy).
		1967, SCHEER, 432.
		1971, LOYA & SLOBODKIN, 124.
		1972, WIJSMAN-BEST, 45; pl. 10/4.
		1973, PILLAI, VINE & SCHEER, 461.
		1974, MERGNER & SCHUHMACHER, 265.
		1974, PILLAI & SCHEER, 460; fig. 6b.
		1974, SCHEER & PILLAI, 51.
		1976, PILLAI & SCHEER, 59.
		1977, VERON, PICHON & WIJSMAN-BEST, 103; figs. 197-200, 455, 456 (synonymy).
		1980, HEAD, 152, 459.
<i>Coeloria</i>	<i>leptoticha</i>	1879, KLUNZINGER 3, 20.

			1892, ORTMANN, 660.
	<i>pachycheila</i>		1879, KLUNZINGER 3, 15; pl. 1/6.
<i>Platygyra</i>	<i>rustica</i>		1936a, WELLS, 104.
			1967, SCHEER, 432.
			1971, LOYA & SLOBODKIN, 134.
<i>Coeloria</i>	<i>subdentata</i>		1857, MILNE EDWARDS (& HAIME), 413.
<i>Platygyra</i>	<i>subdentata</i>		1971, LOYA & SLOBODKIN, 124.

We have a large number of specimens from Red Sea that we place under this species. Instead of trying to describe individual specimens we give below the major skeletal variations displayed.

**Length and depth of valleys:** Rarely monostomodaecal, length 1 to 10 cm, straight or sinuous. Width 5 to 7 mm, depth 5 to 8 mm. Interrupted or extending from one edge to other of the corallum.

**Collines:** Mostly acute at the top, perforated, getting thicker (2 mm) towards the base. In some coralla the top of collines a little thickened and less perforated.

**Septa:** Generally steep at the wall, only slightly exsert, only slightly broader below than at the top; alternating in size; edges dentate, the last tooth the largest. Septal sides granular. Exsert part arched or vertical, maximum exsertness 1.5 mm.

**Columella:** Trabecular, continuous. In some cases columella not visible, the bottom of the valleys being filled with endothelial vesicles. In many cases the columella is highly thickened and looks lamellar. Then the collines are also thickened, obtuse at the top and little perforated, thus simulating *Leptoria* condition.

**Material:**

Gulf of Suez:	Jerus.	SLR	1809 (Abu Durba); 831 (Et Tur).
	T. Aviv	NS	1904, 5888 (Et Tur); 8438 (Ras el Kanisa).
Gulf of Aqaba:	Jerus.	SLR	371, 386 (Marsa Murach); 458-1-3 (El Kura).
	T. Aviv	NS	269, 292, 294, 1263, E47/1, 4, E55/548h (Eilat); 1914 (Marsa Murach); 4895 (Wassit); 4941, 4955, 4993, 4995 (Dahab); 4810, 4812, 4816, 4830, 4832, 4871, 4879 (Ras Atantur).
	Basel	PW	73 692 (Dahab).
	HLM	EC	462 (Eilat).
Northern R. S.:	T. Aviv	NS	3198 (Ras Muhammad).
	USNM	Wa	71, 72 (Ghardaqa).
	HLM	X2:	3-8, 14, 20, 21, 26, 37, 43 (Gubal Isl.).
		EC	484 (Ras Abu Suma); 500 (Safaga Isl.); 72 (Koseir, duplicate from KLUNZINGER as <i>Coeloria arabica</i> ); 311, 312 (Ras Abu Hagar).
Central R. S.:	P. Sud.	Sa	34, 40, 41, 42 (Sanganeb R.).
	HLM	RM	33, 33a, 34, 35, 35a, 37, 37a, 38, 38a, 39, 39a, 92, 119 (Wingate R.).
Southern R. S.:	HLM	X2:	9-14, 15, 22, 29, 30 (Sarso Isl.).
		EC	399-402 (Massawa).

**Distribution:** Widely distributed from Red Sea into the Pacific as far east as Samoa and Cook Isls.

**Remarks:** The nomenclatural history of this species is lengthy, a résumé of it is given by CHEVALIER (1975). MATTHAI (1928) in his monograph kept *Coeloria daedalea* and *C. lamellina* separate. WELLS (1936: 104) stated that the name *daedalea* ELLIS & SOLANDER is preoccupied by FORSKAL's *Madrepora daedalea* which is *Alveopora daedalea*, and hence not available to *Platygyra*. He proposed the next available name *Meandrina rustica* DANA. However, CROSSLAND (1952: 148) argued vehemently against such changes of nomenclature and adopted the specific name *daedalea* to *Coeloria rustica*, from which he separated *Coeloria lamellina* as the more abundant species in the Red Sea. In 1956 STEPHENSON and WELLS merged *Platygyra lamellina* and *daedalea* together with *rustica*, *sinensis* and other species and adopted the specific name *lamellina* of EHRENBERG.

Recently WIJSMAN-BEST (1972 and 1976) and VERON, PICHON & WIJSMAN-BEST (1977) followed MATTHAI (1928) and separated again *P. lamellina* from *P. daedalea*, though CHEVALIER (1975) felt they are one and the same with the name *daedalea*.

In two earlier communications the present authors (SCHEER & PILLAI 1974 and PILLAI & SCHEER 1976) followed STEPHENSON and WELLS and named the species as *lamellina*. But we made no attempt



to separate *daedalea* from *lamellina*, since we maintained, as in the present work, that the two are only growthforms of one and the same species, which we name now with the older *daedalea*.

We add here *Coeloria klunzingeri* MATTHAI 1928 from Red Sea to the synonymy of *P. daedalea*. The type of *klunzingeri* is BMNH 28.3.1.4. It is only a fragment probably from the peripheral part of a larger corallum. There are two specimens in BMNH from the collection of Great Barrier Reef Expedition (GBR 132 and 172, i. e. BMNH 1934.5.14.86 and 87), labelled *C. daedalea* by the late Prof. G. MATTHAI. CROSSLAND (1952) made no mention of these specimens. The peripheral parts of these two specimens have valleys filled with endothecal vesicles and resemble exactly the type of *C. klunzingeri* MATTHAI.

*Platygyra sinensis* (MILNE EDWARDS and HAIME), 1848

(Plate 30, Fig. 7)

<i>Coeloria</i>	<i>sinensis</i>	1857, MILNE EDWARDS (& HAIME), 416 (Type locality: Mers de la Chine).
<i>Platygyra</i>	<i>sinensis</i>	1954, WELLS, 462; pl. 175/3.
		1972, WIJSMAN-BEST, 48; pl. 11/3.
		1975, CHEVALIER, 144; pls. 9/1, 2, 4, 5, 7, 8; 11/1, 2; 12/1-3 (synonymy).
		1976, WIJSMAN-BEST, 55; pl. 6/3.
		1977, VERON, PICHON & WIJSMAN-BEST, 105; figs. 201-206, 457.
		1980, HEAD, 152, 459.
<i>Coeloria</i>	<i>ceylonica</i>	1883, RIDLEY, 256.
<i>Platygyra</i>	<i>ryukyuensis</i>	1936, YABE, SUGIYAMA & EGUCHI, 38; pl. 28/3-5.
<i>Maeandra</i>	<i>stricta</i>	1918, VAUGHAN, 120; pl. 45/3, 3a.

There are three specimens all massive, that we assign to the present species. Corallites mostly monostomodaecal, polygonal, 3 to 5 mm long and 3 to 4 mm wide. A few larger ones are up to 10 mm long. Wall thin, acute at the top but solid, that is without perforations. Septa very little exsert, lower one-third of the septum broader than the upper part. Septal edges finely dentate, sides granular.

Material:

Central R. S.: USNM Wa 73 (Dongonab).

Southern R. S.: HLM EC 397, 398 (Massawa).

Distribution: Red Sea; East Africa; Maldives; Lakshadweep; Ceylon (RIDLEY, 1883); Christmas Isls.; Andamans (MATTHAI, 1924); Mergui Archipelago; Singapore; China Sea; Philippines; Japan; Palau Isls.; Caroline Isls.; New Guinea; Great Barrier Reef; Solomon Isls. (PILLAI, STODDART & MORTON, in prep.); Loyalty Isls.; Fiji; Samoa.

Remarks: MATTHAI (1928) merged *P. sinensis* with *P. daedalea*, which was followed by STEPHENSON & WELLS (1956). However, an examination of MATTHAI's material in BMNH shows that actually none of his specimens is referable to *P. sinensis*. But there is one specimen from Solomon Islands (GUPPY collection) in BMNH labelled by MATTHAI as *Favia schnideri* with a remark on the reverse of the label that it might belong to a new genus. This specimen is discussed by PILLAI, STODDART & MORTON (not yet published) and is referable to the present species. MATTHAI (1928: 228) stated that the type of *Coeloria ceylonica* RIDLEY is missing. However, PILLAI could locate it in BMNH. Though the type is a small specimen it is closely related to *P. sinensis*.

WIJSMAN-BEST (1972) opined that *C. klunzingeri* MATTHAI and *P. ryukyuensis* are one and the same (the latter a synonym of *P. sinensis*). However, we consider *P. klunzingeri* as a skeletal variant of *P. daedalea*.

*Platygyra crosslandi* (MATTHAI), 1928

(Plate 30, Figs. 8, 9)

<i>Coeloria</i>	<i>crosslandi</i>	1928, MATTHAI, 48; pls. 47/1, 2; 56/8 (Type locality: Red Sea).
-----------------	-------------------	---

The following description is based on SLR 652. Corallum massive, columnar, total height 15 cm, lower part dead, living zone confined to the upper 9 cm. Valleys short with a few circumscribed corallites. Length of valleys up to 2 cm, width 4 to 6 mm, depth on an average 4 mm. Collines thick, imperforate. Septa continuous over the wall, major septa highly thickened at the wall, exsert. Edges of septa with

teeth. Teeth secondarily frosted which gives a rough appearance to the corallum. Columella very poorly developed with occasional grain-like thickenings.

Material:

Gulf of Aqaba: Jerus. SLR 652 (Marsa Abu Zabad).  
 Basel PW 71 320, 321, 325 (Eilat, 40 m).  
 Central R. S.: P. Sud. Sa 106 (Sanganeb R.).

Distribution: Red Sea.

Remarks: The species is similar to *P. sinensis* in having short valleys as well as monostomodaecal corallites. However, the wall in *P. crosslandi* is much more thickened. The major distinction is in the exsert, swollen septa and frosted septal teeth which gives a spiny and rough look.

Genus *Leptoria* MILNE EDWARDS and HAIME, 1848

Type species: *Madrepora pbrygia* ELLIS & SOLANDER, 1786.

Generic characters: Massive, meandroid with long and sinuous valleys. Average width and depth of valleys 4 mm. Collines low and solid. Columella lamellar, thin, continuous or sometimes interrupted.

The genus is represented by only a single living species in the Indo-Pacific as described below.

*Leptoria pbrygia* (ELLIS and SOLANDER), 1786

(Plate 30, Figs. 10, 11)

<i>Madrepora</i>	<i>pbrygia</i>	1786, ELLIS & SOLANDER, 162; pl. 48/2 (Type locality: Pacific).
<i>Leptoria</i>	cf. <i>pbrygia</i>	1888, ORTMANN, 172.
	<i>pbrygia</i>	1918, VAUGHAN, 117, pls. 45/4, 5; 46/1-3.
<i>Platygyra</i>	<i>pbrygia</i>	1928, MATTHAI, 112; pls. 1/3; 10/5-7, 9; 11/5, 6; 12/3, 6; 49/1, 2; 50/1; 65/4 (synonymy).
<i>Leptoria</i>	<i>pbrygia</i>	1952, CROSSLAND, 150.
<i>Platygyra</i>	<i>pbrygia</i>	1954, ROSSI, 33.
<i>Leptoria</i>	<i>pbrygia</i>	1971, LOYA & SLOBODKIN, 124.
		1972, WIJSMAN-BEST, 50; pl. 12/4.
		1974, SCHEER & PILLAI, 52.
		1975, CHEVALIER, 110; pls. 6/6,7; 39/9; 40/1-3 (synonymy).
		1976, PILLAI & SCHEER, 60.
		1977, VERON, PICHON & WIJSMAN-BEST, 115; figs. 223-226, 460.
		1980, HEAD, 152, 459.
<i>Madrepora</i>	<i>gracilis</i>	1846, DANA, 261; pl. 14/6, 6a, b.
<i>Leptoria</i>	<i>gracilis</i>	1879, KLUNZINGER 3, 13; pls. 2/5; 9/11.
		1888, ORTMANN, 172.
		1889, ORTMANN, 525.
<i>Platygyra</i>	<i>gracilis</i>	1928, MATTHAI, 122; pls. 10/8; 12/4 (synonymy).

The characters of the species are the same as those of the genus. The present specimens show no noteworthy variations to warrant special mention.

Material:

Gulf of Aqaba: Jerus. SLR 363 (Marsa Murach).  
 T. Aviv NS 4802, 4831, 4835 (Ras Atantur).  
 Central R. S.: HLM RM 36, 36a (Wingate R.).

Distribution: Seychelles; Aldabra; Mauritius; Maldives; Lakshadweep; SE-India; Ceylon; Nicobar Isls.; Cocos-Keeling Isls.; Christmas Isl.; Singapore; China Sea; Philippines; Japan; Palau Isls.; Caroline Isls.; Great Barrier Reef; Solomon Isls.; New Caledonia; Marshall Isls.; Rotuma; Samoa (HOFFMEISTER, 1925); Cook Isls. (STODDART & PILLAI, 1973); Society Isls.

Remarks: We agree with WIJSMAN-BEST (1972) and CHEVALIER (1975) that *L. gracilis* is the same as *L. pbrygia*. A study of MATTHAI's material in BMNH shows no reasonable criteria with which these can be separated.

Genus *Oulophyllia* MILNE EDWARDS and HAIME, 1848

Type species: *Meandrina crispa* LAMARCK, 1816.

Generic characters: Massive, meandroid. Valleys wider and deeper than in *Platygyra*, 10 to 20 mm wide, up to 10 mm deep. Collines thin and acute, perforated. Columella centres distinct, circular in outline, linked by lamellae.

MATTHAI (1928) in his revision of the genus considered two species under this genus, viz *O. crispa* and *O. aspera*. Subsequent authors maintained this distinction. But VERON, PICHON & WIJSMAN-BEST (1977) with the aid of a series of specimens from East Australia were able to show that *O. crispa* and *O. aspera* represent a single species. Thus the genus is to be treated as monospecific. The present authors are in full agreement with the list of synonyms given by VERON et al. (1977).

The genus was first recorded from Wingate Reef by SCHEER (1964), later on it was found at the Sanganeb Reef, and now HEAD (1980) has added some more specimens from the reefs off Port Sudan.

*Oulophyllia crispa* (LAMARCK), 1816

(Plate 31, Fig. 1)

<i>Meandrina</i>	<i>crispa</i>	1816, LAMARCK 2, 247 (Type locality: Indian Ocean?).
<i>Oulophyllia</i>	<i>crispa</i>	1928, MATTHAI, 257; pls. 19/1, 2; 25/2; 71/1, 3 (synonymy). 1936, YABE, SUGIYAMA & EGUCHI, 42; pls. 25/6; 34/4. 1952, CROSSLAND, 147. 1964, SCHEER, 618; fig. 9. 1972, WIJSMAN-BEST, 49; pl. 11/4. 1976, PILLAI & SCHEER, 59. 1976, WIJSMAN-BEST, 56; pl. 7/2. 1977, VERON, PICHON & WIJSMAN-BEST, 118; figs. 227–237, 447 (right), 461 (synonymy). 1980, HEAD, 151, 458.
<i>Ulophyllia</i>	<i>aspera</i>	1886, QUELCH, 88; pl. 3/5–5b.
<i>Oulophyllia</i>	<i>aspera</i>	1928, MATTHAI, 258; pl. 18/5. 1974, SCHEER & PILLAI, 49; pl. 23/1, 3. 1975, CHEVALIER, 160; pls. 13/2, 3; 40/4–8; 41/1–3.
<i>Ulophyllia</i>	<i>bonbourei</i>	1911, GRAVIER, 49; pls. 4/25, 26; 5/27, 28.
	<i>cellulosa</i>	1886, QUELCH, 89; pl. 3/6–6c.
<i>Coeloria</i>	<i>cooperi</i>	1904, GARDINER, 762; pl. 60/9.
	<i>gigantea</i>	1936, YABE, SUGIYAMA & EGUCHI, 37; pls. 22/1, 2; 34/3.
<i>Coelogyra</i>	<i>levis</i>	1959, NEMENZO, 109; pl. 8/2.
<i>Coeloria</i>	<i>magna</i>	1904, GARDINER, 763; pl. 60/7, 8.

As already pointed out the collections from Red Sea include only two specimens of this species in Hessian State Museum, one already described and figured by SCHEER (1964). The valleys are about 10 mm wide. Collines perforated at the top. Septa narrow at the wall and steeply descending. The columella centres are well defined, a major difference from similar sized specimens of *Platygyra daedalea*. Lower part of septa broader than the upper part. Edges serrated.

## Material:

Central R. S.: P. Sud. Sa 67 (Sanganeb R.).  
HLM RM 87 (Wingate R.).

Distribution: Red Sea; East Africa (v. MARENZELLER, 1901); Réunion; Mauritius; Rodriguez (FAURE, 1977); Chagos; Maldives; Nicobar Isls.; Singapore; East Indies (type locality of *O. aspera*); Philippines; Japan; Palau Isls.; Caroline Isls.; Great Barrier Reef; New Caledonia; Marshall Isls.

Genus *Hydnophora* FISCHER de WALDHEIM, 1807

Type species: *Madrepora exesa* PALLAS, 1766.

Generic characters: Submassive, explanate, foliate or subramose. Surface with conical or elongated monticules bearing septa. Columella trabecular.

Synopsis of the species from Red Sea:

1. Corallum submassive. Monticules 2 to 5 mm in height and basal thickness, with 6 to 10 septa. . . . . *H. microconus*
2. Corallum massive, explanate or subramose. Monticules conical or elongated, conical ones 5 to 10 mm in height and basal thickness. . . . . *H. exesa*

*Hydnophora microconus* (LAMARCK), 1816

(Plate 31, Figs. 2, 3)

<i>Monticularia</i>	<i>microconus</i>	1816, LAMARCK 2, 251 (Type locality: l'Océan des Grandes-Indes; type is lost).
<i>Hydnophora</i>	<i>microconus</i>	1879, KLUNZINGER 3, 21; pls. 3/1; 9/12 (synonymy).
	<i>microconus</i>	1888, ORTMANN, 172.
	<i>microconus</i>	1892, ORTMANN, 660.
	<i>microconus</i>	1918, VAUGHAN, 122; pl. 47/3, 3a.
		1928, MATTHAI, 144; pls. 2/8, 9; 16/5-9; 17/1, 2, 4-6; 49/5 (synonymy).
		1952, CROSSLAND, 151.
		1971, LOYA & SLOBODKIN, 124.
		1972, WIJSMAN-BEST, 53; pl. 12/3.
		1974, MERGNER & SCHUHMACHER, 265.
		1974, SCHEER & PILLAI, 52.
		1975, CHEVALIER, 167; pls. 16/1; 40/9, 12; 41/10 (synonymy).
		1976, PILLAI & SCHEER, 61.
		1977, VERON, PICHON & WIJSMAN-BEST, 135, figs. 255-256.
		1980, HEAD, 152, 459.

The following details of this species are based on KLUNZINGER: Monticules 3 to 4 mm high and thick (at the base), smaller ones 2 mm, conical or cylindrical, a few compressed and in the latter case up to 6 mm long. Septa thin, vertical, sides granular, edges dentate, the teeth better developed at the lower part. Septa subequal with occasional smaller ones, 8 to 10 septa on a monticule, on smaller ones only 5. Monticules thickened towards the base. Columella formed of the fusion of septal ends from adjacent monticules. The top of monticules 3 to 5 mm apart.

One of our specimens, EC 159, is explanate with a greater spread of 25 cm. The surface with two hilly growths. Details as already described. EC 484 is massive, the monticules 4 to 5 mm high and wide. RM 24a is again massive, the monticules are small, only 2 to 3 mm thick and high.

Material:

Gulf of Aqaba:	T. Aviv	NS	251, 1243-1, 2 (Eilat), 4843 (Dahab); 4834, 4853 (Ras Atantur).
	Basel	PW	73 600 (Fara'un Isl.).
Northern R. S.:	USNM	Wa	74 (Ghardaqa).
	HLM	EC	484 (Ras Abu Suma); 159 (Koseir).
Central R. S.:	P. Sud.	Sa	35 (Sanganeb R.).
	HLM	RM	24a (Wingate R.).
Southern R. S.:	HLM	EC	403 (Massawa).

Distribution: Wide-spread from Red Sea to Samoa in the Pacific.

*Hydnophora exesa* (PALLAS), 1766

(Plate 31, Figs. 4, 5; Plate 33, Fig. 12)

<i>Madrepora</i>	<i>exesa</i>	1766, PALLAS, 290 (Type locality: Indian Ocean).
<i>Hydnophora</i>	<i>exesa</i>	1928, MATTHAI, 140; pls. 14/5; 15/1, 2; 16/1-4; 17/3 (synonymy).
		1972, WIJSMAN-BEST, 51; pl. 13/1-4.
		1974, SCHEER & PILLAI, 52.
		1974, MERGNER & SCHUHMACHER, 265.
		1975, CHEVALIER, 175; pls. 14/1-6; 16/2-6; 18/1; 41/4 (synonymy).
		1976, PILLAI & SCHEER, 60.
		1976, WIJSMAN-BEST, 57; pl. 8/1.
		1977, VERON, PICHON & WIJSMAN-BEST, 129; figs. 247-254 (synonymy).

		1980, HEAD, 152, 460.
<i>Madrepora</i>	<i>contignatio</i>	1775, FORSKAL, 134.
<i>Hydnophora</i>	<i>contignatio</i>	1879, KLUNZINGER 3, 22; pls. 3/2, 3; 9/12a-c (synonymy). 1888, ORTMANN, 172. 1906, v. MARENZELLER, 81; pls. 23/82a; 24/82. 1928, MATTHAI, 155; pls. 15/3; 17/7-9; 18/1-3, 6; 46/2 (synonymy). 1941, CROSSLAND, 39. 1971, LOYA & SLOBODKIN, 124.
	<i>ebrenbergi</i>	1857, MILNE EDWARDS (& HAIME), 423; pl. D5/2.
	<i>grandis</i>	1904, GARDINER, 764; pl. 60/11.
	<i>gyrosa</i>	1857, MILNE EDWARDS (& HAIME), 423. 1879, KLUNZINGER 3, 23.
	<i>lobata</i>	1857, MILNE EDWARDS (& HAIME), 421. 1879, KLUNZINGER 3, 20. 1889, ORTMANN, 525.
	<i>maldivensis</i>	1904, GARDINER, 765; pl. 60/12.
	<i>tenella</i>	1886, QUELCH, 96; pl. 5/8, 8a.

We have a good suit of specimens before us which show marked skeletal variations, particularly in the form of growth and in the length and thickness of monticules. They are encrusting, explanate, with free edges and foliate, some are fan-shaped, or they show subramose coralla.

Material:

Gulf of Suez:	Jerus.	SLR	834 (Et Tur).
	T. Aviv	NS	8395, 8426, 8429 (Ras Matarma); 3208 (Et Tur); 8381, 8382, 8435 (Ras el Kanisa).
Gulf of Aqaba:	T. Aviv	NS	1365, 5061, 5062, E55/548b (Eilat); 4943 (Dahab); 1855 (Shurat el Manqata).
	Basel	PW	73 554, 555, 596 (40 m) (Fara'un Isl.); 73 702, 709 (Dahab); 1 ex. without No.
Northern R. S.:	USNM	Wa	107 (Ghardaqa).
	HLM	X2:	2-18, 25 (Gubal Isl., 9 m); 3-44 (Gubal Isl., 15 m).
Central R. S.:	HLM	EC	1326 (Djiddah).
	P. Sud.	Sa	9, 100 (Sanganeb R.).
	HLM	RM	23, 24 (Wingate R.).

Distribution: Red Sea; East Africa (GRAVIER, 1911); Aldabra; Mauritius; Rodriguez; Chagos; Maldives; South India; Ceylon; Cocos-Keeling Isls.; Andaman and Nicobar Isls.; Mergui Archipelago; East Indies; China Sea; Philippines; Taiwan; Japan; Palau Isls.; Caroline Isls.; New Guinea; Great Barrier Reef; New Caledonia; Marshall Isls.; Ellice Isls.; Fiji; Samoa.

Subfamily *Montastreinae* VAUGHAN and WELLS, 1943

Genus *Diploastrea* MATTHAI, 1914

Type species: *Astrea heliopora* LAMARCK, 1816.

Generic characters: "Corallum encrusting or massive. Corallites circular, not projecting. Walls fused and perforate, hence perithea almost absent. Calices shallow. Septa in not less than two orders, the first two entocoelic, each consisting of twelve septa, exsert, much thickened towards their outer ends. Columella formed of twisted trabeculae from septal margins. Calicular dissepiments oblique" (MATTHAI, 1914: 72).

The genus is monospecific.

*Diploastrea heliopora* (LAMARCK), 1816

(Plate 31, Fig. 6)

<i>Astrea</i>	<i>heliopora</i>	1816, LAMARCK 2, 1816, 265 (Type locality: Australia).
<i>Diploastrea</i>	<i>heliopora</i>	1914, MATTHAI, 72; pls. 20/7, 8; 34/9.

- 1918, VAUGHAN, 143; pl. 59/5, 5a.  
 1925, HOFFMEISTER, 47.  
 1936, YABE, SUGIYAMA & EGUCHI, 54; pl. 11/5, 6.  
 1952, CROSSLAND, 166.  
 1964, SCHEER, 618; fig. 10.  
 1973, PILLAI, VINE & SCHEER, 461.  
 1974, SCHEER & PILLAI, 53.  
 1975, CHEVALIER, 60; pls. 3/3, 4, 6, 8; 38/7-9, 12 (synonymy).  
 1976, PILLAI & SCHEER, 61.  
 1977, VERON, PICHON & WIJSMAN-BEST, 153, figs. 295-297.  
 1980, HEAD, 152, 460.  
 1980, WIJSMAN-BEST, 259; pl. 5/4.  
*Orbicella minikoensis* 1904, GARDINER, 774; pl. 63/35.  
 1907a, VAUGHAN, 252 (synonymy).

One of us (SCHEER, 1964) has already reported on the occurrence of this species in Red Sea, based on a specimen collected from Wingate Reef. Additional collections from Gulf of Suez and Gulf of Aqaba received by the authors, do not contain this species. The genus is rare in Red Sea. The species displays little skeletal variations.

Material:

Central R. S.: HLM RM 71 (Wingate R.).  
 X2: 8-12 (Shaab Anbar).

Distribution: Red Sea eastward to Samoa. The genus is very common and abundant in Minicoy, but was not observed in northern Lakshadweep such as Kiltan Atoll. It is also not known from Ceylon and Gulf of Mannar along the Indian coast.

Genus *Leptastrea* MILNE EDWARDS and HAIME, 1848

Type species: *Leptastrea roissyana* MILNE EDWARDS and HAIME, 1848.

Generic characters: Corallum encrusting or massive, plocoid. Corallites polygonal or cylindrical. Intercorallite grooves present. Coenosteum solid. Costae generally stop at the middle of the intercorallite groove. Columella with papillary projections.

Synopsis of the species from Red Sea:

1. Corallites 2 to 4 mm in diameter. Thecal wall projecting. Calices mostly circular. Septa in three cycles, those of first cycle distinctly larger and more exsert than the other ones. . . . . *L. bottae*
2. Corallites rounded or polygonal, sometimes slightly elongated, 3 to 5 mm long. Septa in four cycles, nearly all of first two cycles equally developed. Septal sides and edges granular. Columella in form of a vertical ridge along the long axis of the calices. . . . . *L. transversa*
3. Corallites unequal, often irregular in form, 3 to 8 mm long. Wall thickened, not exsert. Septa in four cycles or more, septal edges finely dentate. Columella composed of papillary processes. . . . *L. purpurea*

*Leptastrea bottae* (MILNE EDWARDS and HAIME), 1849

(Plate 31, Figs. 7, 8)

- Cyphastraea bottai* 1857, MILNE EDWARDS (& HAIME), 486; pl. D7/1 (Type locality: Red Sea).  
*Leptastrea bottai* 1879, KLUNZINGER 3, 44; pls. 5/9; 10/13a, b.  
 1888, ORTMANN, 175.  
*Orbicella bottai* 1904, GARDINER, 777; pl. 63/36.  
*Leptastrea bottae* 1918, VAUGHAN, 94; pl. 31/3, 4 (synonymy).  
 1948, CROSSLAND, 185.  
 1952, CROSSLAND, 116; pls. 1/4; 2/2, 3.  
 1971, LOYA & SLOBODKIN, 124.  
 1974, MERGNER & SCHUHMACHER, 265.

<i>bottai</i>	1975, CHEVALIER, 54; pls. 2/8, 9; 3/5; 38/4, 5, 11 (synonymy).
cf. <i>bottae</i>	1977, VERON, PICHON & WIJSMAN-BEST, 155; figs. 298–302, 466.
<i>bottae</i>	1980, HEAD, 152, 461.
	1980, WIJSMAN-BEST, 246; pl. 2/3–6 (synonymy).
<i>immersa</i>	1879, KLUNZINGER 3, 47; pl. 6/1.
	1892, ORTMANN, 163.
	1918, VAUGHAN, 96; pl. 31/2, 2a, b.
<i>inaequalis</i>	1879, KLUNZINGER 3, 45; pl. 5/6.
<i>solida</i>	1914, MATTHAI, 69; pls. 17/8, 9; 18/3–6, 8; 19/5, 6 (synonymy).
	1974, MERGNER & SCHUHMACHER, 265.

The present specimens are all massive. Corallites projecting to 2 mm, usually less, close together, on an average 3 mm in diameter. Calices circular or oval. Septa in three cycles, out of which the first two cycles reach the columella. Primary septa the largest, about 0.5 mm exsert. Exsert ends slightly arched. Edges of septa with conspicuous serrations. Columella with 4 to 5 upright papillate processes that merge with the paliform lobes of the primary cycle of septa.

Material:

Gulf of Aqaba:	Jerus.	SLR	394 (Marsa Murach); 486 (El Kura).
	T. Aviv	NS	1881, 4968, 4970, 4990, 5002 (Dahab); 4811, 4849 (Ras Atantur).
	Basel	PW	73 587, 592 (Eilat).
Northern R. S.:	HLM	EC	73 (Koseir, duplicate from KLUNZINGER).
Central R. S.:	P. Sud.	Sa	22 (Sanganeb R.).

Distribution: Red Sea; Somaliland, Natal (CROSSLAND, 1948); Réunion; Chagos; Maldives; Lakshadweep; Cocos-Keeling Isls.; Philippines (Faustino, 1927); China Sea; Great Barrier Reef; New Caledonia; Marshall Isls.; Ellice Isls.; Tahiti (QUELCH, 1886).

Remarks: CHEVALIER (1975) has pointed out the similarities of *L. immersa* to *L. bottae*. The type of *L. immersa* KLUNZINGER is No. 2178 in Berlin Museum. The corallites in this are not projecting. Calices are oval with 6 to 8 major septa uniting to the columella. This specimen resembles the one figured by VERON, PICHON & WIJSMAN-BEST (1977, figs. 298 and 299), which is the type of *L. bottae* (MILNE EDWARDS & HAIME). The above authors have also pointed out that the specimens figured by many later authors under the name *L. bottae* have little similarity to the type of *Cyphastrea bottae*. However, we stress that the type of *L. immersa* KLUNZINGER is very similar to *Cyphastrea bottae* of MILNE EDWARDS & HAIME as figured by VERON et al.

WIJSMAN-BEST, 1980, states, that the figures 298 and 299 in VERON et al. (1977) represent *L. transversa* and not *L. bottae*. She shows the second specimen in the Paris Museum as the holotype of *L. bottae* (1980, pl. 2, fig. 4). However, we cannot find out any difference between these two specimens, especially in the arrangement of the septa.

*Leptastrea transversa* KLUNZINGER, 1879

(Plate 31, Figs. 9, 10)

<i>Leptastrea</i>	<i>transversa</i>	1879, KLUNZINGER 3, 46; pl. 6/2 (Type locality: Red Sea).
		1888, ORTMANN, 175.
		1918, VAUGHAN, 94; pl. 31/1, 1a.
		1952, CROSSLAND, 115; pl. 54/1–3.
		1964, SCHEER, 461.
		1971, LOYA & SLOBODKIN, 124.
		1974, MERGNER & SCHUHMACHER, 265.
		1974, SCHEER & PILLAI, 53.
		1975, CHEVALIER, 50; pls. 2/6, 7; 3/1; 38/10 (synonymy).
		1976, PILLAI & SCHEER, 61.
		1977, VERON, PICHON & WIJSMAN-BEST, 162; figs. 311–318, 468.
		1980, HEAD, 152, 461.
		1980, WIJSMAN-BEST, 249; pl. 3/3, 4 (synonymy).
	<i>roissiyana</i>	1914, MATTHAI, 67; pls. 8/1–3; 17/4; 18/1; 19/1, 2; 37/4.

This species is represented by two specimens among the material we examined from Red Sea. One is massive, the other encrusting. Corallites polygonal, calices polygonal or oval, when the walls are thickened. Greater diameter (length) of calices 2 to 3.5 mm, wall thickened up to 1 mm with a conspicuous intercorallite groove in the middle. Septa in three cycles, the first two cycles join the columella; all septa exsert, slightly swollen at the theca, at first sloping and then vertically descending; edges mostly entire or with microscopic serrations; sides granular. Columella composed of vertical papillary structures that are arranged in a line along the middle of the long axis of the calices forming a partition to either ends of which the two directive septa of the first cycle unite.

Material:

Gulf of Aqaba: Basel PW 73 631a (Dahab, 20–22 m, encrusting on a *Goniastrea pectinata*).  
Central R. S.: HLM RM 94 (Wingate R.).

Distribution: A common and widespread species from Red Sea to Tahiti. Often found in all localities where *L. purpurea* occurs.

*Leptastrea purpurea* (DANA), 1846

(Plate 31, Figs. 11, 12)

<i>Astrea</i>	<i>purpurea</i>	1846, DANA, 239; pl. 12/10a–c (Type locality: Fiji).
<i>Leptastrea</i>	<i>purpurea</i>	1918, VAUGHAN, 91; pl. 30/1–3 (synonymy). 1948, CROSSLAND, 184 (var. <i>roissiana</i> ). 1952, CROSSLAND, 115; pls. 1/5; 3/3. 1971, LOYA & SLOBODKIN, 124. 1975, CHEVALIER, 37; pls. 2/3, 4; 3/2; 37/11, 12; 38/1–2; 42/6 (synonymy). 1977, VERON, PICHON & WIJSMAN-BEST, 158; figs. 303–310, 467. 1980, HEAD, 152. 461. 1980, WIJSMAN-BEST, 248; pl. 3/1, 2 (synonymy).
	<i>ebrenbergana</i>	1857, MILNE EDWARDS (& HAIME), 494; pl. D7/4 (Type locality: Red Sea). 1888, ORTMANN, 175. 1914, MATTHAI, 68; pls. 17/5, 6; 18/2, 7; 19/3, 4; 34/8 (synonymy). 1952, CROSSLAND, 115; pls. 1/5; 3/3.
	<i>pruinosa</i>	1952, CROSSLAND, 116; pl. 3/1.

There are three specimens of this species among the material we received from USNM, two from Gulf of Aqaba and two from the old collection of HLM. These specimens are in general agreement with MATTHAI's description of *L. ebrenbergana*.

Material:

Gulf of Aqaba: T. Aviv NS 4977 (Dahab); 4861 (Ras Atantur).  
Northern R. S.: USNM Wa 76, 77, 78 (Ghardaqa).  
HLM EC 70, 74 (Koseir, duplicates from KLUNZINGER, the latter labelled *L. ebrenbergiana*).

Distribution: Wide-spread from Red Sea to Hawaii.

Remarks: SCHEER & PILLAI (1974) have pointed out the difficulties in separating specimens of *L. transversa* and *L. purpurea* in some cases. It has also been noticed by PILLAI (unpubl.) from South Indian reefs that in some coralla both *purpurea* and *transversa* conditions may coexist at different parts. Their major distinction lies in the dentation of the septa and in the nature of the columella. All the authors since MATTHAI (1914) have told these two species separate. However, it is with hesitation that we separate them. *L. transversa* could very well be a skeletal form of *L. purpurea*.

The type of *L. pruinosa* CROSSLAND in BMNH is a minute colony. Both CHEVALIER (1975) and VERON et. al. (1977) had many specimens which these authors assign to *L. pruinosa*. According to VERON, PICHON & WIJSMAN-BEST "This species is as difficult to differentiate from *L. purpurea* as the latter is form *L. transversa*" (p. 165). However, they differentiate them on the basis of behaviour and colouration of polyps. After a study of the type of *L. pruinosa* PILLAI, STODDART & MORTEN (unpubl.) felt that it is the same as *L. purpurea*.



Genus *Cyphastrea* MILNE EDWARDS and HAIME, 1848

Type species: *Astrea microphthalma* LAMARCK, 1816.

Generic characters: Encrusting, massive or ramose. Corallites circular, level or projecting, 1 to 3 mm in diameter. Septa in three cycles. Coenosteum spiny. Columella trabecular.

Key to the species of *Cyphastrea* from Red Sea:

1. Corallites 1 to 1.5 mm in diameter. Ten septa generally unite with the columella. Third cycle of septa incomplete. . . . . *C. microphthalma*
2. Corallites 1.5 to 2.5 mm in diameter. First two cycles of septa unite with the columella. Third cycle of septa in full complement. . . . . *C. serailia*

*Cyphastrea microphthalma* (LAMARCK), 1816

(Plate 32, Figs. 1, 2)

<i>Astrea</i>	<i>microphthalma</i>	1816, LAMARCK 2, 261 (Type locality: Nouvelle-Hollande).
<i>Cyphastrea</i>	<i>microphthalma</i>	1914, MATTHAI, 43; pls. 7/6; 12/4-9; 13/1, 2, 7; 34/4 (synonymy).
		1941, CROSSLAND, 46.
		1952, CROSSLAND, 118.
		1954, ROSSI, 34.
		1971, LOYA & SLOBODKIN, 124.
		1974, MERGNER & SCHUHMACHER, 264.
		1974, SCHEER & PILLAI, 54 (synonymy).
		1975, CHEVALIER, 9; pls. 1/1; 37/2-7.
		1976, PILLAI & SCHEER, 61.
		1977, VERON, PICHON & WIJSMAN-BEST, 176; figs. 350-356.
		1980, HEAD, 152, 460.
		1980, WIJSMAN-BEST, 243; pl. 1/4.
	<i>aspera</i>	1886, QUELCH, 107; pl. 4/3, 3a.
<i>Explanaria</i>	<i>galaxia</i>	1834, EHRENBERG, 306.
<i>Cyphastrea</i>	<i>savignyi</i>	1857, MILNE EDWARDS (& HAIME), 485.
		1879, KLUNZINGER 3, 51; pl. 5/7.
		1906, v. MARENZELLER, 87.
	<i>serailia</i>	1879, KLUNZINGER 3, 52; pls. 5/4; 10/12a, b.

We have a fair suite of specimens of the present species. Most of them are typical as described by MATTHAI (1914) with calices ranging from 1 to 1.5 mm in diameter and with solid coenosteum. Mostly ten, rarely nine or eleven septa unite the columella, the total number of septa range from 18 to 22, mostly 20. In very few cases all the tertiaries are developed.

Four of the present specimens deserve special mention, particularly in view of their peculiar corallites. PW 71 344 and SLR 1172 are small encrustations. The corallites are projecting, mammiform, basal thickness 2 to 4 mm, less at the top. Total height 3 to 4 mm. Calices circular or oval, 1 to 1.5 mm in diameter. Distance between adjacent corallites 2 to 5 mm. Calices shallow. Total septa 20, of which 10 of the larger ones unite the columella. Costae extend over the wall, marked by a row of fine spines. The intercorallite area is blistered.

X2: 2-27 is a submassive hemispherical corallum with a greater spread of 4 cm. The corallites are projecting, but they are not conical in outline. Septa 10 plus 10. Costae very conspicuous forming ridges along the wall.

The fourth specimen, PW 73 548, has corallites resembling X2: 2-27, but the calices are larger, up to 2 mm in diameter. Septa 9 plus 9, or 10 plus 10. Coenosteum very solid and spiny.

Though these four specimens are apparently different in the form of corallites from the typical specimens of *microphthalma* we have studied, we do not think that these specimens should be treated separate. The nature and details of calices and septa show no difference from *C. microphthalma*. In having conical elevated calices they approach to a condition of *C. japonica*, but the latter has a typical ramose growth.

## Material:

- Gulf of Suez: Jerus. SLR 830, 837, 2134 (Et Tur).  
 T. Aviv NS 8672, 8675, 8679 (El Bilaiyim).
- Gulf of Aqaba: Jerus. SLR 1172-1, 2 (Marsa el Muqeibla); 651 (Marsa Abu Zabad).  
 T. Aviv NS E51/173b, 55/548m, 1361 (Eilat); 1915 (Marsa Murach); 1898, 4934a  
 (together with *Montip. tuberculosa*), 4987 (Dahab).  
 Basel PW 73 502, 507, 509, 535, 548 (40 m) (Eilat); 71 344 (Fara'un Isl., 40 m);  
 73 637 (20-22 m), 652, 686 (El Kura).
- Northern R. S.: T. Aviv NS 1878 (Ras Muhammad).  
 USNM Wa 79, 80, 82 (Ghardaqa).  
 HLM X2: 2-27 (Gubal Isl.).  
 EC 501 (Safaga Isl.); 75 (Koseir, duplicate from KLUNZINGER as *C. serailia*);  
 160 (Koseir); 522 (Ras Abu Hagar).
- Central R. S.: USNM Wa 81 (Dongonab).  
 P. Sud. Sa 37, 61, 98 (Sanganeb R.).  
 HLM X2: 8-7 (Shaab Anbar).
- Southern R. S.: HLM EC 404 (Massawa).

Distribution: Red Sea eastward to Tahiti.

Remarks: In the Museum at Berlin we could study EHRENBERG's types of *Explanaria galaxia*, Nos. 715, 718, 719 and 945. An examination of KLUNZINGER's duplicates of his *serailia* (No. 2185 in Berlin Museum and EC 75 in HLM) showed clearly that it is in reality *C. microphthalmia*.

*Cyphastrea serailia* (FORSKAL), 1775

(Plate 32, Fig. 3)

- |                    |                    |  |
|--------------------|--------------------|--|
| <i>Madrepora</i>   | <i>serailia</i>    | 1775, FORSKAL, 135 (Type locality: Red Sea).                 |
| <i>Cyphastrea</i>  | <i>serailia</i>    | 1888, ORTMANN, 175.  |
|                    |                    | 1914, MATTHAI, 39; pls. 7/4; 11/1-9; 38/1, 5 (synonymy).     |
|                    |                    | 1941, CROSSLAND, 46.   |
|                    |                    | 1952, CROSSLAND, 118.  |
|                    |                    | 1971, LOYA & SLOBODKIN, 124.                                 |
|                    |                    | 1975, CHEVALIER, 18; pls. 1/2-9; 2/1 (synonymy).             |
|                    |                    | 1977, VERON, PICHON & WIJSMAN-BEST, 169; figs. 330-341.      |
|                    |                    | 1980, HEAD, 152, 460.  |
|                    |                    | 1980, WIJSMAN-BEST, 240; pl. 1/1, 2.                         |
| <i>Madrepora</i>   | <i>chalcidicum</i> | 1775, FORSKAL, 136 (Type locality: Red Sea).                 |
| <i>Cyphastrea</i>  | <i>chalcidicum</i> | 1879, KLUNZINGER 3, 52; pls. 5/8; 10/11a-c.                  |
|                    |                    | 1888, ORTMANN, 174.  |
|                    |                    | 1892, ORTMANN, 663.  |
|                    |                    | 1914, MATTHAI, 41; pls. 7/1, 5; 12/1-3; 14/1 (synonymy).     |
|                    |                    | 1941, CROSSLAND, 46.   |
|                    |                    | 1952, CROSSLAND, 117.  |
|                    |                    | 1971, LOYA & SLOBODKIN, 124.                                 |
|                    |                    | 1974, MERGNER & SCHUHMACHER, 264.                            |
|                    |                    | 1976, PILLAI & SCHEER, 62.                                   |
|                    |                    | 1977, VERON, PICHON & WIJSMAN-BEST, 173; figs. 342-349, 473. |
|                    |                    | 1980, HEAD, 152, 460.  |
|                    |                    | 1980, WIJSMAN-BEST, 242; pl. 1/3.                            |
|                    |                    | 1959, NEMENZO, 116; pl. 15/1.                                |
| <i>Solenastrea</i> | <i>forskaelana</i> | 1857, MILNE EDWARDS (& HAIME), 497.                          |
| <i>Cyphastrea</i>  | <i>gardineri</i>   | 1914, MATTHAI, 48; pls. 13/4, 5; 34/5.                       |
| <i>Solenastrea</i> | <i>gibbosa</i>     | 1857, MILNE EDWARDS (& HAIME), 496.                          |
| <i>Cyphastrea</i>  | <i>gibbosa</i>     | 1879, KLUNZINGER 3, 54.                                      |
| <i>Solenastrea</i> | <i>bemprichana</i> | 1857, MILNE EDWARDS (& HAIME), 495.                          |
| <i>Cyphastrea</i>  | <i>bemprichana</i> | 1879, KLUNZINGER 3, 54.                                      |
|                    | <i>maldivensis</i> | 1904, GARDINER, 780.   |
|                    | <i>ocellina</i>    | 1907, VAUGHAN, 103; pls. 25/4, 5, 5a; 26/1.                  |
|                    | <i>suvadivae</i>   | 1914, 45; pls. 7/7; 13/3; 34/6.                              |
| <i>Porites</i>     | <i>spec.</i>       | 1828, AUDOUIN (& SAVIGNY), 56; pl. 4/5.                      |

## Material:

- Gulf of Suez: T. Aviv NS 1905 (Et Tur); 8437 (Ras el Kanisa); 8673 (El Bilaiyim).  
 Gulf of Aqaba: Jerus. SLR 357-2 (Marsa Murach).  
 T. Aviv NS 250 (Eilat); 4923 (Dahab); 4863 (Ras Atantur).  
 HLM EC 463 (Eilat).  
 Northern R. S.: USNM Wa 83, 84 (Ghardaqa).  
 HLM X2: 2-24 (Gubal Isl.).  
 EC 502 (Safaga Isl); 76 (Koseir, duplicate from KLUNZINGER as *chalcidicum*), 77, 162, 163 (Koseir); 313, 314 (Ras Abu Hagar).

Distribution: Wide spread from Red Sea to Hawaii.

Remarks: The genus *Cyphastrea* is one of the easily detectable genera of faviids with comparatively small number of species from the Indo-Pacific. Since MATTHAI's classical revision of this genus in 1914 there was general agreement among various authors on the species recognized by MATTHAI, till WELLS (1954) doubtfully referred *C. gardineri* MATTHAI to the synonymy of *C. serailia*. This was followed by CHEVALIER (1975), who added *C. suvadivae* and *C. chalcidicum* to the synonyms of *C. serailia*, along with *C. japonica* YABE, SUGIYAMA & EGUCHI, 1936. However, VERON, PICHON & WIJSMAN-BEST (1977) took a different view from that of CHEVALIER. According to them *C. chalcidicum* and *C. japonica* are valid, and *C. gardineri* is more related to *C. microphthalma* than to *C. serailia*. These authors had more than 200 specimens between *C. serailia* and *C. chalcidicum*, probably the largest number of specimens examined by any worker on the genus. The major distinction between *C. chalcidicum* and *C. serailia* is in the thicker primary septa and costae of the latter, while in *C. chalcidicum* they are subequal (VAUGHAN, 1918: 87). A critical perusal of the large number of figures given by VERON et al. (1977) (for example compare figures 335, 339 and 342) shows forms linking these two species, and lends credentials to CHEVALIER's (1975) contention that *C. serailia* and *C. chalcidicum* are one and the same. The present authors also agree, that some specimens could be labelled as *C. chalcidicum* on the criteria already pointed out, but feel that CHEVALIER is correct.

One of the specimens in HLM, EC 1349 from Kaneohe Bay, Hawaii, is labelled *C. ocellina*. It is an encrustation with crowded, irregular hillocks on the surface. The corallites are 1.5 mm in diameter, slightly exsert, with 12 septa reaching the columella. The first cycle of septa is thicker and more exsert than the second cycle. We agree with CHEVALIER that *C. ocellina* is the same as *C. serailia* and the former only a geographical variant. In fact one of our specimens from Red Sea has similar growthform as this Hawaiian specimen with larger (2 mm) corallites.

As already pointed out by VERON, PICHON & WIJSMAN-BEST (1977) *C. conferta* NEMENZO (1959) shows no marked variation from *C. serailia*.

*C. japonica* which is considered by CHEVALIER (1975) as a synonym of *C. serailia* has a distinct growthform, which is more or less ramose with projecting cylindrical or conical corallites. However, we may point out that we have described in this work specimens with conical elevated corallites as *C. microphthalma*. This shows that the form of the corallites in this genus is subjected to variation and may not be taken as a sure criterion for separation of species.

In the present work we have not made any attempt to separate our specimens into *C. serailia* and *C. chalcidicum*, all being reported under the former name.

Genus *Echinopora* LAMARCK, 1816

Type species: *Madrepora lamellosa* ESPER, 1795.

Generic characters: Encrusting, submassive, foliaceous, ramose and fruticose. Coenosteum with spines on surface, that fuse to form short ridges extending between corallites. Corallites 4 to 7 mm in diameter, level or projecting up to 6 mm. Septal edges dentate. Columella trabecular.

Key to *Echinopora* from Red Sea:

1. Corallum foliaceous, sometimes with branches. Corallites 3 to 4 mm in diameter, about 1 mm exsert. 12 to 16 septa reach the columella. . . . . *E. lamellosa*

2. Corallum encrusting, submassive, fruticose or subfoliate. Corallites 5 to 7 mm in diameter and up to the same amount projecting. Primary septa much exsert. . . . . *E. gemmacea*

*Echinopora lamellosa* (ESPER), 1795

(Plate 32, Figs. 4, 5)

<i>Madrepora</i>	<i>lamellosa</i>	1797, ESPER, 65; pl. 58/1, 2 (Type locality not recorded).
<i>Echinopora</i>	<i>lamellosa</i>	1914, MATTHAI, 50; pls. 8/6; 14/2-6; 15/1; 16/6 (synonymy). 1959, MA, 63; pls. 246/1; 247/1-3; 250/2; 264/2. 1971, LOYA & SLOBODKIN, 124. 1974, SCHEER & PILLAI, 54 (synonymy). 1975, CHEVALIER, 69; pls. 5/3; 6/1; 39/1-6. 1976, PILLAI & SCHEER, 62. 1977, VERON, PICHON & WIJSMAN-BEST, 183; figs. 366-374, 474, 475. 1980, WIJSMAN-BEST, 252; pl. 3/5, 6 (synonymy). 1980, HEAD, 152, 462.

PW 73 544 is a young entire foliaceous corallum with a greater spread of 8 cm. Growing edges very thin, less than 1 mm thick. Corallites 3 to 4 mm in diameter, about 1 mm deep. Wall more exsert on one side than on the other, according to the incidence of light, maximum elevation 2 mm. Total number of septa 28 to 32 in various calices, 12 to 16 reach the columella. Primary cycle of septa the largest. Perithecal costae, extending from corallite to corallite, are finely granulated with occasional spines.

SLR 1164 is composed of some thin foliaceous fragments (2 mm thick). The corallites are up to 3 mm exsert. The costae are thicker at the base of the corallites than at the top. The notable feature of this species is the delicate development of perithecal costae. To the naked eye the surface looks nearly smooth, but under a lens it appears striated by the costae, which bear minute grains.

Material:

Gulf of Aqaba:	Jerus.	SLR	1244-1, 2, 3, 4 (Fara'un Isl.); 1164 (Marsa el Muqeibla).
	T. Aviv	NS	1882 (Dahab); 1849 (Shurat el Manqata).
	Basel	PW	73 544 (Fara'un Isl.).
Central R. S.:	P. Sud.	Sa	70 (Sanganeb R.).

Distribution: Red Sea; Somaliland (GRAVIER, 1911); Seychelles; Madagascar; Mauritius; Chagos; Maldives; northern Lakshadweep; Southeast India; Ceylon; Andaman and Nicobar Isls.; Mergui Archipelago; East Indies (UMBGROVE, 1939); China Sea; Philippines (NEMENZO, 1959); Palau Isls. (YABE, SUGIYAMA & EGUCHI, 1936); Great Barrier Reef; Solomon Isls.; New Caledonia; Loyalty Isls.; Marshall Isls.; Fiji; Samoa.

Remarks: The species was first reported from Red Sea by MA (1959); then by LOYA & SLOBODKIN (1971) and WIJSMAN-BEST (1980). Our specimen PW 73 544 resembles very much *Echinopora glabra* CHEVALIER (1975).

MATTHAI (1914) merged doubtfully *E. horrida* with *E. lamellosa*, but CHEVALIER (1975) treated them distinct. Though the branching growthform of *Echinopora* is not common in the Indian Ocean in general, it seems that such growth is very common in Australian waters including the Solomon Islands. It is very likely that *E. horrida* is the same as *E. lamellosa*.

*Echinopora gemmacea* (LAMARCK), 1816

(Plate 32, Figs. 6-9; Plate 33, Fig. 1)

<i>Explanaria</i>	<i>gemmacea</i>	1816, LAMARCK, 256 (Type locality: Indian Ocean ?).
<i>Echinopora</i>	<i>gemmacea</i>	1876, HAECKEL, 45; pl. 2/5. 1914, MATTHAI, 54; pls. 14/9; 15/5; 16/5, 7, 8; 17/2, 3; 37/5 (synonymy). 1941, CROSSLAND, 51. 1954, ROSSI, 34; pl. 3. 1967, SCHEER, 432. 1971, LOYA & SLOBODKIN, 124. 1974, MERGNER & SCHUHMACHER, 264.

		1975, CHEVALIER, 81; pls. 4/1–7; 6/2 (synonymy).
		1977, VERON, PICHON & WIJSMAN-BEST, 187; figs. 375–382.
		1980, HEAD, 152, 461.
		1980, WIJSMAN-BEST, 253; pl. 4/1, 2 (synonymy).
	<i>carduus</i>	1879, KLUNZINGER 3, 57; pls. 6/5; 10/14 (No. 2174 in Berlin Museum).
		1888, ORTMANN, 175.
<i>Madrepora</i>	<i>concamerata</i>	1775, FORSKAL, 136.
<i>Echinopora</i>	<i>concamerata</i>	1879, KLUNZINGER 3, 57; pl. 6/6.
	<i>ebrenbergi</i>	1857, MILNE EDWARDS (& HAIME), 625.
		1879, KLUNZINGER 3, 56; pls. 6/7, 9; 10/15.
		1888, ORTMANN, 176.
		1906, v. MARENZELLER, 88.
<i>Heliastraea</i>	<i>forskaelana</i>	1857, MILNE EDWARDS (& HAIME), 457; pl. D5/3a–c.
		1888, FAUROT, 119.
<i>Orbicella</i>	<i>forskalana</i>	1879, KLUNZINGER 3, 48.
		1906, v. MARENZELLER, 87.
<i>Echinopora</i>	<i>forskaliana</i>	1980, WIJSMAN-BEST, 258; pl. 5/2, 3.
	<i>fruticulosa</i>	1879, KLUNZINGER 3, 55; pl. 6/4.
		1906, v. MARENZELLER, 88.
<i>Stephanocora</i>	<i>bemprichii</i>	1834, EHRENBERG, 300 (No. 749 in Berlin Museum).
<i>Explanaria</i>	<i>bemprichii</i>	1834, EHRENBERG, 306 (Nos. 746, 747, 748 in Berlin Museum).
<i>Echinopora</i>	<i>bemprichi</i>	1857, MILNE EDWARDS (& HAIME), 623.
		1892, ORTMANN, 663.
	?	<i>hirsutissima</i> 1980, WIJSMAN-BEST, 255; pl. 4/3, 4.
<i>Orbicella</i>	<i>mammillosa</i>	1879, KLUNZINGER 3, 49; pls. 5/5; 10/10a–c.
<i>Plesiastrea</i>	<i>mammillosa</i>	1971, LOYA & SLOBODKIN, 124.
<i>Echinopora</i>	<i>solidior</i>	1857, MILNE EDWARDS (& HAIME), 626.
		1904, GARDINER, 782; pl. 63/38.

This species is very common in Red Sea, and the present collections include many specimens, better described under different sections because of their wide skeletal variations in growthform and nature and size of the corallites.

**Facies 1.** Explanate, with thin and free edges, thickened at the central part. EC 406 is part of a corallum. At the fracture it is 2 cm thick, growing edges only 2 mm. NS 1903 is a chip probably from the central part of the corallum, it is 12 cm thick. The corallites average 4 mm in diameter, only 1 mm exsert. The fourth cycle of septa more or less complete. Third cycle of septa unite with the secondaries. Depth of calices 2 to 3 mm. The corallites are approaching to a condition of *E. lamellosa*, but the thick submassive growth is unlike. Further specimens of facies 1: SLR 370; EC 316, 318.

**Facies 2.** Encrusting and tending to become submassive as in facies 1, but the corallites are wide apart, swollen at the base (8 to 10 mm), narrower at the top (6 to 7 mm), with a height of 5 to 7 mm. Septal teeth not very conspicuous. Costae extend to the middle of the perithecal region, supplied with numerous serrations. This is similar to *Orbicella mammillosa* KLUNZINGER. Some specimens of facies 2: PW 73 585; X2:2–15, 3–11, 3–12, 3–36; EC 503; RM 28; X2:13–9, 13–10.

**Facies 3.** Corallum foliaceous, similar to *E. lamellosa*. Underside sometimes with buds, forming secondary colonies as described for *E. lamellosa* (BOSCHMA, 1928). Corallites 5 to 6 mm in diameter, one side of the wall slightly more elevated than the other. Primary septa highly exsert. Perithecal spines very conspicuous. Some examples: EC 317, 431; X2:9–1; EC 407–409 with buds.

**Facies 4.** PW 73 697 is a foliaceous corallum, upper surface with a crowded cluster of subdividing digitiform branches, 1 to 1.5 cm thick and 3 to 5 cm high, bearing branchlets terminating in a corallite. Corallites 4 to 6 mm in diameter, exsert to 3 mm on the foliaceous base but up to 5 mm on the branches. First two cycles of septa highly exsert (1.5 mm), septal and costal dentation secondarily frosted. The growthform is similar to *E. horrida*.

**Facies 5.** Irregularly branching, fruticose. Corallites 7 to 8 mm in diameter at the top, 2 to 3 mm exsert. Primary cycle of septa most exsert. All our samples of this facies are broken from the base, and such it is difficult to say what kind of basal attachment they had in the field. Some specimens of this facies: SLR 2138; X2:2–3, 2–9; RM 26, 101; EC 410.

**Facies 6.** Massive, columnar with hillocks resembling some specimens of *Favia stelligera*. NS 8192 has a total height of 11 cm with a thickness of 12 cm at mid-height. Corallites crowded, 4 to 4.5 mm in

diameter, wall little elevated, touching to 5 mm apart. Primary septa about 1 mm exsert with one or two frosted teeth at the exsert part. Costae are represented by 2 to 3 spines on the wall, beyond that the perithecal costae are indistinct or they are sunk. But in one specimen their course is marked by low spines. Further examples of this facies: X2:2-14; EC 315, 486, 487.

Material:

- Gulf of Suez: Jerus. SLR 826, 833, 839, 2138, 2141, 2143, 2149 (Et Tur).  
 T. Aviv NS 1903, 3206 (Et Tur); 8192 (Ras el Kanisa).  
 HLM X2: 1-6 (Ras Shukheir).
- Gulf of Aqaba: Jerus. SLR 1065-1, 2 (Fara'un Isl.); 369-1, 2, 370, 372, 378, 389a, 391 (Marsa Murach); 2287 (El Hamira); 1171 (Marsa el Muqeibla); 453 (El Kura); 644 (Marsa Abu Zabad).  
 T. Aviv NS 6341, 8373, 8375 (Eilat); 1924, 1925 (Marsa Murach); 1897, 4921, 4932, 4938, 4966, 4986 (Dahab); 4807, 4842, 4881, 4882 (Ras Atantur); 1854 (Shurat el Manqata).  
 Basel PW 73 585, 597 (Fara'un Isl.); 73 697 (El Kura).
- Northern R. S.: Jerus. SLR 813 (Ras Muhammad).  
 USNM Wa 85, 86, 87, 108, 109 (Ghardaqa).  
 HLM X2: 2-3, 9, 14, 15, 3-11, 12, 36 (Gubal Isl.).  
 EC 431 (Shadwan Isl.); 486, 487 (Ras Abu Suma); 503 (Safaga Isl.); 78 (Koseir, duplicate from KLUNZINGER as *E. ebrenbergi*); 315, 316, 317, 318, 319 (Ras Abu Hagar).
- Central R. S.: HLM EC 1380 (Djiddah).  
 P. Sud. Sa 13, 21, 33, 43, 60, 69, 79 (Sanganeb R.).  
 USNM Wa 88, 89 (Dongonab).  
 HLM RM 25, 25a, 26, 27, 28, 28a, 101 (Wingate R.).  
 X2: 8-23 (Shaab Anbar).
- Southern R. S.: HLM X2: 9-1, 13-9, 10 (Sarso Isl.).  
 EC 405, 406, 407, 408, 409, 410 (Massawa).

Distribution: Red Sea; East Africa; Seychelles; Madagascar (PICHON, 1964); Réunion; East Indies (UMBGROVE, 1939); New Caledonia; Loyalty Isls.; Great Barrier Reef.

Remarks: It is interesting to note that the present set of specimens displays a wide range of skeletal variations particularly in the growthform. Specimens with highly exsert primary septa and very conspicuous costal spines resemble *E. hirsutissima*. The foliaceous growth with miniature colonies at the underside is similar to that reported for *E. lamellosa* by BOSCHMA (1928) and BOSCHMA & VERWEY (1930). The frond with upward digitiform branches is similar to *E. horrida*. The specimens with protruding, conical corallites correspond to *Orbicella mammillosa* KLUNZINGER and to *E. forskaliana* (MILNE EDWARDS & HAIME) from WIJSMAN-BEST (1980).

These all show that the growthform in this genus is subjected to much variation within the species, that this alone is not a reliable specific criterion. We are convinced that, besides *E. lamellosa*, all other *Echinopora* forms from Red Sea, listed in the synonymy, belong to only one species, to *E. gemmacea*.

Genus *Plesiastrea* MILNE EDWARDS and HAIME, 1848

Type specimen: *Astrea versipora* LAMARCK, 1816.

Generic characters: Corallum rounded, flat or encrusting. Plocoid with circular corallites of about 3 mm in diameter, produced by extratentacular budding. In front of all major septa are true palis, arranged in form of two crowns in most of the calices. This is the most striking character of the genus.

*Plesiastrea versipora* (LAMARCK), 1816

(Plate 33, Figs. 2-5)

<i>Astrea</i>	<i>versipora</i>	1816, LAMARCK, 264 (Type locality: Indian Ocean).
<i>Plesiastrea</i>	<i>versipora</i>	1857, MILNE EDWARDS (& HAIME), 490; pl. D7/5.
<i>Favia</i>	<i>versipora</i>	1914, MATTHAI, 103; pls. 23/3; 25/5, 6, 9; 37/3.
<i>Orbicella</i>	<i>versipora</i>	1918, VAUGHAN, 85; pl. 28/1.
<i>Plesiastrea</i>	<i>versipora</i>	1971, CHEVALIER, 295; pls. 33/4; 34/3.
		1974, PILLAI & SCHEER, 44.
		1977, WIJSMAN-BEST, 93; pl. 4/1-4.
		1977, VERON, PICHON & WIJSMAN-BEST, 149; figs. 284-294 (synonymy).
		1980, HEAD, 151, 456.

VERON, PICHON & WIJSMAN-BEST (1977) mention under "Distribution" of the species also Red Sea. We don't know who is the informant for this statement, because no other worker before has reported the species from Red Sea. Therefore HEAD (1980), who has found two specimens on a fringing reef off Port Sudan, writes this is "the first record for the Red Sea". We have got one specimen from D. PASCHKE of the University of Stuttgart, which he has collected in the Gulf of Aqaba.

## Material:

Gulf of Aqaba: Stuttg. Pa 81/209 (El Hibeiq).

Distribution: Red Sea; Western Indian Ocean; Cocos-Keeling Isls.; China Sea to Taiwan and Ryukyu Isls.; Celebes; Palau Isls.; Great Barrier Reef; Mariana Isls.; Caroline Isls.; Marshall Isls.; New Caledonia; Fiji Isls.

Additional remarks to another genus of Subfamily *Montastreinae*:

Genus *Montastrea* de BLAINVILLE, 1830

The history of the two genera *Montastrea* and *Plesiastrea* in systematical respect is discussed in detail by WIJSMAN-BEST (1977). MATTHAI (1914) united the two genera with *Favia*. VAUGHAN & WELLS (1943) put *Plesiastrea* into Subfamily Faviinae and *Montastrea* into Montastreinae, the latter genus confined to the Atlantic region. WIJSMAN-BEST (1972:11) excluded *Plesiastrea* from Faviinae and incorporated it into Montastreinae because of its dominant extratentacular budding. In contrary to WELLS (1956), CHEVALIER (1971) opined that *Montastrea* occurs also in the Indo-Pacific region. CHEVALIER united the two species *M. annuligera* and *M. curta*, but WIJSMAN-BEST (1977) separated them in her revision of the two above mentioned genera.

*Montastrea annuligera* (MILNE EDWARDS & HAIME), 1849, is very similar, if not identical, to *Plesiastrea versipora*, only the paliform lobes are less distinct. Under "Material" WIJSMAN-BEST (1977) refers to specimens from Red Sea in the collection SCHUHMACHER (University Bochum). We state this without comments.

## Family Trachyphylliidae VERRILL, 1901

Genus *Trachyphyllia* MILNE EDWARDS and HAIME, 1848

Type species: *Turbinolia geoffroyi* AUDOUIN, 1826.

Generic characters: Corallum trochoid in young stage, flabello-meandroid in adult; young ones attached, later sometimes becoming free. Calices long, compressed. Septa close together, exsert, edges dentate, lower half with a deep cleft and a conspicuous paliform lobe. Columella trabecular, linked by lamellae. Costae subequal, exsert and with subequal teeth.

The genus is represented by a single species in Red Sea.

*Trachyphyllia geoffroyi* (AUDOUIN), 1826

(Plate 33, Figs. 6, 7)

<i>Turbinolia</i>	<i>geoffroyi</i>	1828, AUDOUIN (& SAVIGNY), 54; pl. 4/1 (Type locality: Gulf of Suez).
<i>Trachyphyllia</i>	<i>geoffroyi</i>	1857, MILNE EDWARDS (& HAIME), 341. 1876, HAECKEL, 45; pl. 2/2.
<i>Antillia</i>	<i>geoffroyi</i>	1877a, BRUEGGEMANN, 308. 1879, KLUNZINGER 3, 12.
<i>Trachyphyllia</i>	<i>geoffroyi</i>	1888, FAUROT, 119. 1892, ORTMANN, 663.
<i>Antillia</i>	<i>geoffroyi</i>	1906, v. MARENZELLER, 81.
<i>Trachyphyllia</i>	<i>geoffroyi</i>	1928, MATTHAI, 97; pls. 22/1-11; 23/1, 2, 5; 60/1; 62/1-3, 7, 8, 11 (synonymy). 1952, CROSSLAND, 101. 1974, SCHEER & PILLAI, 55; pl. 24/5, 6. 1975, CHEVALIER, 201; pl. 7/2, 3 (synonymy). 1977, VERON, PICHON & WIJSMAN-BEST, 207; figs. 407-413.
	<i>amarantum</i>	1924, MATTHAI, 26; pl. 5/2.
	<i>constricta</i> ,	
	var. <i>maldivensis</i>	1904, GARDINER, 785; pl. 59/4, 5.

PW 73 532 is young, turbinate with a narrow base. Greater diameter 20 mm, lesser 11 mm. Costae extend to the base. PW 71 360 is attached on a gastropod shell. The calyx has a constriction from side to side. PW 73 563 is only part of a flabellate corallum. In all the three specimens the septa are exsert. Pali-form lobes are conspicuous. Septal edges with equal, close-set serrations, sides granular. Granules arranged transverse to the long axis of septum. Each row corresponds to a septal tooth. Columella composed of a closely placed set of trabeculae.

## Material:

Gulf of Aqaba: T. Aviv NS 2998, 5414, 5421 (Eilat).

Basel PW 73 532 (Eilat); 71 360 (45 m), 73 563 (16 m) (south of Fara'un Isl.).

Distribution: Red Sea; East Africa (HARRISON & POOLE, 1909); Seychelles (unpubl.); Maldives; Nicobar Isls.; East Indies; China Sea; Philippines; Japan; Great Barrier Reef; New Caledonia.

Family *Rhizangiidae* d'ORBIGNY, 1851Genus *Culicia* DANA, 1846

Type species: *Dendrophyllia rubeola* QUOY & GAIMARD, 1833 = *Culicia stellata* DANA, 1846 (genoelectotype, WELLS, 1936).

Generic characters: Colonies small, reptoid corallites getting separated from the stolons at a later stage. Calices small (3 to 5 mm), shallow. First cycle of septa prominent, exsert, lobate, upper half with entire edges. Pali absent. Columella well developed.

The genus is very inconspicuous on the reef due to the small size of the corallum as well as the coral-lites. It is generally seen attached to the underside of other corals. The genus is known by a single species from Red Sea, originally described by KLUNZINGER as new, viz *Cylicia cuticulata*.

*Culicia rubeola* (QUOY and GAIMARD), 1833

(Plate 33, Fig. 8, 9)

<i>Dendrophyllia</i>	<i>rubeola</i>	1833, QUOY & GAIMARD, 97; pl. 15/12-15 (Type locality: New Zealand).
<i>Culicia</i>	<i>rubeola</i>	1954, WELLS, 464; pl. 185/4-6 (synonymy). 1971, CHEVALIER, 93; pl. 3/6.
<i>Cylicia</i>	<i>cuticulata</i>	1879, KLUNZINGER 2, 74; pls. 5/28; 8/16; 10/15.



<i>Culicia</i>	<i>cuticulata</i>	1980, HEAD, 152, 462.
<i>Angia</i>	<i>smithi</i>	1857, MILNE EDWARDS (& HAIME), 177.
<i>Culicia</i>	<i>stellata</i>	1846, DANA, 377; pl. 28/5, 7.
	<i>spec.</i>	1974, SCHEER & PILLAI, 55.

The present collection does not include any specimen of this species. But Dr. ZIBROWIUS has kindly provided us with photographs of KLUNZINGER's type of *Cylicia cuticulata*, No. 4122 in the Paris Museum.

The following details are based on KLUNZINGER (1879). Reptoid, older corallites isolated. Corallites 2 to 5 mm in diameter, 1 to 4 mm high, calices mostly rounded. Depth of calyx 0.5 to 1.5 mm. Total number of septa 30 to 36, alternating in size. The septal teeth merge with a trabecular columella. An epitheca is visible. The living polyps are said to be pink or carmine in colour.

Distribution: Red Sea; Mascarene Archipelago; Gulf of Mannar (PILLAI, 1972); West coast of India (Goa); Nicobar Is.; Mergui Archipelago; Cocos-Keeling Is. (WELLS, 1950); Singapore (DANA, 1846); Taiwan; Marshall Is.; New Caledonia; New Zealand (RALPH & SQUIRES, 1962); Fiji; Tuamotu Archipelago.

#### Genus *Phyllangia* MILNE EDWARDS and HAIME, 1848

Type specimen: *Phyllangia americana* MILNE EDWARDS & HAIME, 1849.

Generic characters: Colonial, colony formation by extratentacular budding from reptoid stolon-like expansions. First and second cycle septa exsert, nondentate. Third cycle septa with lobes near the columella. Columella consisting of few curly ridges.

#### *Phyllangia spec.*

(Plate 33, Figs. 10, 11)

We have only one specimen at hand, collected by Prof. FRICKE with his submersible "Geo" in a depth of 115 m. The colonial specimen consists of two corallites different in size. The bigger one is about 15 mm high. The outside is densely covered by bryozoans, serpulids and a small shell, only the thecal margin with costae is visible. The calyx measures 13 by 11 mm. Septa in four complete cycles with an incomplete fifth. The first cycle septa are most prominent and exsert. They are rounded above and descend steeply to the columella. Second cycle septa less prominent, less exsert and narrower. Most of the third cycle septa with lobes near the columella. Columella consists of some curled leaves, to which the ends of the first three cycles of septa join. The smaller corallite has 5 mm in diameter with four complete cycles of septa, and is connected with the mother corallite by coenosteum with thin slats and deep furrows.

#### Material:

Northern R. S.: HLM Fri 115-2 (Ras Umm Sidd, 115 m).

Remarks: ZIBROWIUS supposes that our specimen belongs to the genus *Phyllangia*. It is not identical with species we know from literature. Moreover, we do not know what the coral really looks like when it is not densely overgrown. Further specimens would be needed for an exact identification. We shall therefore not attempt to name the coral and merely record this as the first evidence of the genus *Phyllangia* from the Red Sea. Both of KLUNZINGER's *Phyllangia* species belong to the genus *Polycyathus*.

#### Family Oculinidae GRAY, 1847

#### Genus *Galaxea* OKEN, 1815

Type species: *Madrepora fascicularis* LINNAEUS, 1758.

Generic characters: Plocoid, massive, corallites projecting, calices circular, oval or distorted. Coenosteum non-costate, vesicular. Septa in 2 to 5 cycles, exsert, exsert ends vertical, edges entire. Columella poorly developed.

Key to the species of *Galaxea* from Red Sea:

1. Corallum explanate, massive or columnar. Corallites 7 to 15 mm in diameter, up to 10 mm exsert; oval, circular or polygonal and distorted. Septa in 4 to 5 cycles, depending on the size of the calyx. . . . . *G. fascicularis*
2. Corallum explanate. Corallites circular, not more than 3 mm in diameter, 2 to 3 mm exsert. Septa in 2 to 3 cycles, primaries and rarely a few of the secondaries reach the columella. . . . . *G. astreata*

*Galaxea fascicularis* (LINNAEUS), 1758

(Plate 34, Figs. 1, 2)

<i>Madrepora</i>	<i>fascicularis</i>	1758, LINNAEUS, 796 (Type locality: African Ocean).
<i>Antbophyllum</i>	<i>fasciculare</i>	1834, EHRENBERG, 313 (Berlin Museum Nos. 622, 623).
<i>Galaxea</i>	<i>fascicularis</i>	1857, MILNE EDWARDS (& HAIME), 227.
		1879, KLUNZINGER 2, 78.
		1888, FAUROT, 119.
		1892, ORTMANN, 663.
		1914, MATTHAI, 59; pls. 8/4; 16/4; 34/3; 38/6 (synonymy).
		1941, CROSSLAND, 40 and 52; pl. 10.
		1952, CROSSLAND, 122.
		1954, ROSSI, 35.
		1967, SCHEER, 433.
		1971, LOYA & SLOBODKIN, 124.
		1971, CHEVALIER, 58; pls. 4/2, 7; 5/1-4; 6/3, 8; 7/1, 2; 8/1-6; 9/1; 37/1, 2 (synonymy).
		1974, MERGNER & SCHUHMACHER, 264.
		1974, SCHEER & PILLAI, 56 (synonymy).
		1976, PILLAI & SCHEER, 63.
		1980, VERON & PICHON, 204; figs. 336 (left)-346, 761, 762.
		1980, HEAD, 152, 462.
	<i>antbophyllites</i>	1894, FAUROT, 114; fig. 1.
<i>Madrepora</i>	<i>divergens</i>	1775, FORSKAL, 136 (= <i>M. organum</i> FORSKAL, semifossil specimens).
<i>Galaxea</i>	<i>divergens</i>	1906, v. MARENZELLER, 80.
	<i>hexagonalis</i>	1904, GARDINER, 783.
	<i>irregularis</i>	1857, MILNE EDWARDS (& HAIME), 229; pl. D2/2a, b.
		1879, KLUNZINGER 2, 78; pl. 7/11.
		1888, ORTMANN, 167.
		1888, FAUROT, 119.
		1906, v. MARENZELLER, 80.
	<i>lawisiana</i>	1959, NEMENZO, 82; pl. 2/2.

The present specimens agree to KLUNZINGER's description of *Galaxea fascicularis* and *irregularis*.

Material:

Gulf of Suez:	Jerus.	SLR	2139 (Et Tur).
	T. Aviv	NS	8401, 8431 (Ras Matarma).
Gulf of Aqaba:	Jerus.	SLR	382 (Marsa Murach); 1243 (Fara'un Isl.); 459 (El Kura); 646 (Marsa Abu Zabad).
	Basel	PW	73 632 (El Kura, 20-22 m).
Northern R. S.:	USNM	Wa	90, 92 (Ghardaqa).
	HLM	X2:	2-1 (Gubal Isl.).
		EC	488 (Ras Abu Suma).
Central R. S.:	USNM	Wa	91 (Dongonab).
	P. Sud.	Sa	44 (Sanganab R.).
	HLM	RM	31, 95, 96, 120 (Wingate R.).
Southern R. S.:	HLM	X2:	10-6, 12 (Sarso Isl.).
		EC	411 (Massawa).

Distribution: A wide spread species from Red Sea to Samoa.

Remarks: The species is well described in literature. A recent good account of it is found in CHEVALIER (1971). GARDINER (1904) and subsequently MATTHAI (1914) described specimens of

*Galaxea* from Maldives under the specific name *hexagonalis*. One of GARDINER's specimens is No. 1927. 5. 12. 220 in BMNH. It is represented by isolated corallites. It shows no noteworthy variation from other specimens labelled *G. fascicularis*. The hexagonal nature of the corallites, which MILNE EDWARDS and HAIME stressed, is not evident in the Maldivian specimens. The type of *G. hexagonalis* MILNE EDWARDS & HAIME from the Philippines is reported to be lost. It is very likely that *hexagonalis* is based on forms resembling *G. irregularis* of KLUNZINGER (= *G. lawisiana* of NEMENZO). No figure of *G. hexagonalis* is in existence.

After CROSSLAND (1941: 52) FORSKAL's two type specimens of *Madrepora divergens* (and also *M. organum*) are semifossil specimens and belong to *G. fascicularis*.

*Galaxea astreata* (LAMARCK), 1816

<i>Caryophyllia</i>	<i>astreata</i>	1816, LAMARCK, 227 (Type locality: Indian Ocean ?).
<i>Galaxea</i>	<i>astreata</i>	1971, CHEVALIER, 75; pls. 3/5; 4/3; 5/5, 6; 6/1; 7/3-6, 8.
	cf. <i>astreata</i>	1980, VERON & PICHON, 201; figs. 328-336 (right), 759, 760.
	<i>lamarcki</i>	1857, MILNE EDWARDS (& HAIME), 225 (after LAMARCK in Red Sea). 1879, KLUNZINGER 2, 77. 1914, MATTHAI, 64; pls. 13/6; 16/1; 34/2 (synonymy). 1976, PILLAI & SCHEER, 63.
	<i>longissima</i>	1857, MILNE EDWARDS (& HAIME), 226. 1879, KLUNZINGER 2, 78 (after MILNE EDWARDS & HAIME in Red Sea).
<i>Sarcinula</i>	<i>organum</i>	1816, LAMARCK, 223 (Type locality: Red Sea).

KLUNZINGER (1879) listed this species from Red Sea on the authority of LAMARCK, but neither he himself nor EHRENBERG had any material collected. This species is also not found in the present collection nor appears to have been collected by any other worker from Red Sea.

According to MATTHAI (1914) the species has corallites 2 to 3 mm in diameter, 2 to 4 mm apart, projecting to a maximum of 2 mm, of equal thickness from top to bottom. Perithecal vesicles large, about 2 mm in diameter. Septa in three cycles, but the third cycle is generally incomplete. Primaries larger, exsert, invariably reach the columella, sometimes along with a few of the second cycle. Costae not conspicuous.

Distribution: Red Sea; Saya de Malha; Chagos; Maldives; New Caledonia (CHEVALIER, 1971).

Remarks: The type of *G. astreata* (LAMARCK) is figured by CHEVALIER (1971, pl. 3, fig. 5) and he has adopted, after having located LAMARCK's type, the specific name *astreata* instead of *lamarcki* of MILNE EDWARDS and HAIME and later of MATTHAI (1914).

Additional remarks to another genus of family Oculinidae:

Genus *Acrbelia* MILNE EDWARDS and HAIME, 1849

CROSSLAND (1939: 24) wrote: "For the present it can be said that the only genera with which I was familiar in Dongonab (Lat. 21° N.) which I do not find near Ghardaqa (Lat. 27° 17' N.) are *Acrobelia* and *Euphyllia*". This is the only reference to *Acrbelia*, no one else has found or mentioned this genus from the Red Sea.

Family Merulinidae VERRILL, 1866

Genus *Merulina* EHRENBERG, 1834

Type species: *Madrepora ampliata* ELLIS & SOLANDER, 1786.

Generic characters: Corallum explanate and thin, often rising into short hillocks or irregular branches. Valleys and collines always straight, never sinuous, spreading by repeated forking. Calices in

rows or separated by transverse partitions of the valleys. Septa continuous over collines, septal margins coarsely toothed.

*Merulina cf. ampliata* (ELLIS and SOLANDER), 1786

(Plate 34, Figs. 3–5)

<i>Madrepora</i>	<i>ampliata</i>	1786, ELLIS & SOLANDER, 157; pl. 41/1, 2. 1797, ESPER, 98; pl. 77/1–3.
<i>Merulina</i>	<i>ampliata</i>	1834, EHRENBERG, 238. 1846, DANA, 272; pls. 15/1, 1a–e, 2, 2a; 16/1. 1928, MATTHAI, 127; pls. 1/4–6; 13/1–8; 59/3, 4; 67/3 (synonymy). 1952, CROSSLAND, 151. 1975, CHEVALIER, 208; pls. 18/2–5; 19/1; 20/1–4; 41/11. 1976, PILLAI & SCHEER, 64. 1980, VERON & PICHON, 216; figs. 358–374; 764.
<i>Merulina</i>	<i>sp. nov.</i>	1980, HEAD, 153, 463; pl. IV–2a, b, 3.

EHRENBERG's *M. ampliata* (1834: 328) in the Museum in Berlin is from an unknown locality. KLUNZINGER (1879) and MARENZELLER (1906) have not found this species. First MATTHAI (1928) reports on one specimen from Red Sea but without giving details. CROSSLAND (1952) also mentions one specimen from Red Sea (the same as MATTHAI ?), "in the North a small scrap, probably semi-fossil". Therefore CHEVALIER (1975) writes "Inconnue en Mer Rouge". But VERON & PICHON (1980) state again Red Sea in their "Distribution" of the species.

HAED (1980) figures for the first time specimens of a *Merulina* from the Red Sea. But he assigns it to a new species, because it differs from *M. ampliata* in having broader collines, wider valleys and, especially in flat portions of the corallum, isolated calices.

The same characters we have found on specimens from Sanganeb Reef, which we received from Prof. J. SCHROEDER, Port Sudan. The most conspicuous feature are the calices in explanate parts of the corallum, which are separated from each other in the valleys by broad transverse partitions rising to level of collines. Only at the periphery of the corallum the valleys are continuous.

MATTHAI (1928: 132) has described a similar specimen with single and some "distomodaeal" corallites from Sumatra under his *M. ampliata*. We also group our specimens provisionally to *M. ampliata*.

Material:

Gulf of Aqaba: Jerus. SLR 1191 (Marsa el Muqeibla).

Central R. S.: P. Sud. Sa 56, 63 (Sanganeb R.).

Distribution: Red Sea and Western Indian Ocean to Tonga and Samoa in the Pacific.

Remarks: HEAD (1980) wrote that a full account of his new species is in preparation. In the meantime this account is in press. He has named his species *M. scheeri*.

Family **Mussidae** ORTMANN, 1890

Synopsis of the genera of Mussidae from Red Sea:

1. Corallum solitary. Septa exsert, arched and swollen at the theca. Only the lower outer part of the major septa has teeth. . . . . *Cynarina*
2. Corallum tufted, ramose, phaceloid. Corallites 10 to 25 mm in diameter, monostomodaeal or in short or longer valleys. Septa thickened. . . . . *Lobophyllia*
3. Corallum massive, plocoid. Corallites 10 mm and more. Mono- to tristomodaeal. . . . . *Acantastrea*
4. Corallum branching, phaceloid or encrusting, cerioid. Corallites 4 to 13 mm. Septa typically mussid in two or three cycles. . . . . *Blastomussa*

Genus *Cynarina* BRUEGGEMANN, 1877

Type species: *Cynarina savignyi* BRUEGGEMANN, 1877.

Generic characters: Solitary, free or fixed, turbinate or saucer-shaped. Calyx subcircular. Septa in five cycles. Major septa highly exsert and arched, swollen at the theca; upper part of these septa entire and lobulate, lower outer part with teeth. A conspicuous set of pali present. Costae distinct.

*Cynarina lacrymalis* (MILNE EDWARDS and HAIME), 1848

(Plate 34, Fig. 6)

<i>Caryophyllia</i>	<i>lacrymalis</i>	1848, MILNE EDWARDS & HAIME, t. 11:238; t. 10: pl. 8/1, 1a (Type locality: Philippines; after CHEVALIER, 1975, type is lost).
<i>Cynarina</i>	<i>lacrymalis</i>	1964a, WELLS, 376; pls. 20/1-5; 21/1-6 (synonymy). 1975, CHEVALIER, 293; pls. 26/2, 3; 27/6 (synonymy). 1976, PILLAI & SCHEER, 64; pl. 28/1, 2. 1980, VERON & PICHON, 238; figs. 396-401, 770.
<i>Caryophyllia</i>	<i>cf. carduus</i>	1828, AUDOUIN (& SAVIGNY), 54; pl. 4/2.
<i>Sclerophyllia</i>	<i>margariticola</i>	1879, KLUNZINGER 3, 4; pl. 1/12. 1907a, VAUGHAN, 258. 1911, GRAVIER, 42; pl. 11/45. 1924, MATTHAI, 33.
<i>Cynarina</i>	<i>savignyi</i>	1877a, BRUEGGEMANN, 305. 1879, KLUNZINGER 3, 4. 1952, CROSSLAND, 137; pl. 4/1, 2.

There are six specimens in the present collection. The largest is 55 mm in greater diameter. The primary septa are the thickest and most exsert in majority of specimens, but in one (NS 6071) the first two cycles are subequal. The number of teeth range from 3 to 5. Pali very conspicuous in primary septa. The edges of septa of higher cycles have serrations representing teeth, these septa are not swollen as those of lower cycles. Two to three cycles of septa unite with the columella. Columella composed of closely twisted trabeculae. The specimens are cornuate (NS 6071) or saucer-shaped. The base is narrower than the top.

We have also seen KLUNZINGER's type of *Sclerophyllia margariticola*, No. 2181 in Berlin Museum.

Material:

Gulf of Aqaba: Jerus. SLR 364-2 (Marsa Murach); 1241 (Fara'un Isl.).  
T. Aviv NS 6071, 6114, 6116 (Eilat).  
Basel PW 73 573a (Eilat, 50-55 m, juv., attached to *Coscinaraea monile*).

Distribution: Red Sea; Madagascar; Maldives; Ceylon; India (the locality of the Indian Museum specimen, reported by MATTHAI, 1924, is not known); Borneo; China Sea (BASSET-SMITH, 1890); Philippines; Japan; Great Barrier Reef; New Caledonia; Loyalty Isls.; Kermadec Isls.

Genus *Lobophyllia* de BLAINVILLE, 1830

Type species: *Madrepora corymbosa* FORSKAL, 1775.

Generic characters: Phaceloid. Corallites monocentric or in longish valleys, 15 mm in diameter to 5 or 7 cm in length and 10 to 20 mm wide. Septa thick, highly exsert with large teeth. Columella centres distinct, adjacent ones in a valley linked by lamellae.

MATTHAI (1928) in his revision of *Lobophyllia* recognized three species, viz *L. corymbosa*, *L. costata* and *L. hemprichii*. CROSSLAND (1931) made a critical examination of the genus in Tahiti and felt that all the above mentioned species can be growthforms of one and the same. However, 1952 he separated *L. corymbosa* from *L. hemprichii*. It is interesting to note that specimens, labelled by MATTHAI as *L. costata*, were reported by CROSSLAND as *L. hemprichii*, which shows that these two great workers could not agree on the determination due to lack of any definite distinguishing features between *L. costata* and *L. hemprichii*. STEPHENSON & WELLS (1956) also felt that all of MATTHAI's "valid" species may represent a single good species. However, in this work we regard *L. corymbosa* and *L. hemprichii* as separate. *L. costata* is not separable on any sound basis.

Key to the species of *Lobophyllia* from Red Sea:

1. Corallites mostly monocentric, but with occasional di- or tricentric valleys. . . . . *L. corymbosa*

2. Corallites in the form of long valleys. Monocentric branches rare. Major septa highly thickened. . . . .  
 . . . . . *L. hemprichii*

*Lobophyllia corymbosa* (FORSKAL), 1775

(Plate 34, Figs. 7, 8)

<i>Madrepora</i>	<i>corymbosa</i>	1775, FORSKAL, 137 (Type locality: Red Sea).
<i>Caryophyllia</i>	<i>corymbosa</i>	1834, EHRENBERG, 315.
<i>Mussa</i>	<i>corymbosa</i>	1857, MILNE EDWARDS (& HAIME), 333. 1879, KLUNZINGER 3, 6; pl. 1/4, 9. 1906, v. MARENZELLER, 81.
<i>Lobophyllia</i>	<i>corymbosa</i>	1928, MATTHAI, 210; pls. 24/5; 25/5-8; 26/4; 27/1, 2; 57/5, 8; 58/1; 60/4, 6; 62/4, 5; 64/4; 68/1; 71/5, 6 (synonymy). 1941, CROSSLAND, 53. 1952, CROSSLAND, 147; pl. 9/3. 1954, ROSSI, 35. 1967, SCHEER, 433. 1971, LOYA & SLOBODKIN, 125. 1974, MERGNER & SCHUHMACHER, 265. 1974, SCHEER & PILLAI, 57. 1975, CHEVALIER, 231; pls. 21/1-4; 41/5, 6, 12 (synonymy). 1976, PILLAI & SCHEER, 65. 1980, VERON & PICHON, 274; figs. 472-475, 791 (right), 792, 793 (synonymy). 1980, HEAD, 153, 463.

Several branches and 2 monostomodaecal young specimens represent this species. Height of branches up to 16 cm. Corallites mostly monocentric, 20 to 22 mm in greater diameter, others with two or three centres forming valleys 3 to 4 cm long, 2 to 2.5 cm wide. Septa alternating thick and thin, major ones 1 to 1.5 mm thick, 3 mm exsert. Upper tooth 2 to 3 mm high, vertical. Columella centres well formed.

EHRENBERG's types in Berlin Museum are the Nos. 644, 1060 and 1061.

Material:

Gulf of Suez:	Jerus.	SLR	836-1-4, 2133-4, 2145 (Et Tur).
	T. Aviv	NS	1906, 5882, 5883, 5887 (Et Tur).
Gulf of Aqaba:	Jerus.	SLR	365-1, 2 (Marsa Murach); 1190 (Marsa el Muqeibla).
	T. Aviv	NS	1343-1, 2, 1349, 6103, 6107, E57/190 (Eilat); 1927 (Marsa Murach); 4911 (Dahab).
	Basel	PW	71 308 (40 m), 73 514 (Eilat); 73 598 (Fara'un Isl.); 73 670 (El Kura).
Northern R. S.:	T. Aviv	NS	1874 (Ras Muhammad).
	USNM	Wa	93 (Ghardaqa).
	HLM	X2:	2-11, 17, 3-7 (Gubal Isl.).
Central R. S.:	P. Sud.	Sa	25 (Sanganeb R.).
	HLM	RM	30 (Wingate R.).
Southern R. S.:	HLM	X2:	9-10, 10-10 (Sarso Isl.).

Distribution: Red Sea eastward to Tahiti. While this genus and species is abundant in Minicoy it is rare in northern Lakshadweep and is so far not recorded from the fringing reefs of southeast India.

*Lobophyllia hemprichii* (EHRENBERG), 1834

(Plate 34, Fig. 9)

<i>Manicina</i>	<i>hemprichii</i>	1834, EHRENBERG, 325 (Type locality: Red Sea).
<i>Mussa</i>	<i>hemprichi</i>	1857, MILNE EDWARDS (& HAIME), 337. 1879, KLUNZINGER 3, 8; pl. 1/3, 5.
<i>Lobophyllia</i>	<i>hemprichii</i>	1928, MATTHAI, 221; pls. 28/5, 6; 29/2-4; 34/6; 54/8; 58/3; 60/5; 66/2; 71/4 (synonymy). 1952, CROSSLAND, 143; pls. 10/1, 2; 30/1, 2. 1967, SCHEER, 433. 1971, LOYA & SLOBODKIN, 125.

			1974, MERGNER & SCHUHMACHER, 265.
			1975, CHEVALIER, 259; pls. 22/3; 23/3 (synonymy).
			1980, VERON & PICHON, 266; figs. 457-471, 785-790, 791 (left), (synonymy).
<i>Mussa</i>	<i>costata</i>		1846, DANA, 179; pl. 7/2.
<i>Lobophyllia</i>	<i>costata</i>		1928, MATTHAI, 216; pls. 24/6; 27/3; 28/1-4; 29/1; 34/5; 47/8; 54/9; 57/6; 58/2; 60/2; 62/15 (synonymy).
			1954, ROSSI, 36.
			1967, SCHEER, 433.
			1975, CHEVALIER, 246; pls. 21/5; 22/1, 2, 4; 23/1, 2; 24/2, 3 (synonymy).
<i>Caryophyllia</i>	<i>cristata</i>		1834, EHRENBERG, 315 (type specimen No. 647 in Berlin Museum).
<i>Mussa</i>	<i>cristata</i>		1857, MILNE EDWARDS (& HAIME), 335.
			1879, KLUNZINGER 3, 8; pl. 1/2, 11.
			1888, FAUROT, 119.
	<i>distans</i>		1879, KLUNZINGER 3, 7; pl. 1/1, 7.

The species is characterized by long, wide valleys, very thick major septa, and conspicuous septal teeth. Monocentric corallites are rare.

Material:

Gulf of Aqaba:	Jerus.	SLR	674 (Marsa Abu Zabad).
	T. Aviv	NS	1842 (Shurat al Manqata); 4925 (Dahab).
	Basel	PW	71 307 (40 m), 73 515, 523 (40-43 m, Eilat); 73 612b (Fara'un Isl., 40 m, together with <i>Leptoseris explanata</i> ), 71 336, 338, 340, 356, 594b (Fara'un Isl.); 73 682 (El Kura, 20 m).
Northern R. S.:	T. Aviv	NS	6070 (Marsa Bareika).
	HLM	X2:	3-3, 13 (Gubal Isl.).
Central R. S.:	P. Sud.	Sa	3, 51, 68 (Sanganeb R.).
	HLM	RM	29, 121 (Wingate R.).
		X2:	8-19 (Shaab Anbar).
Southern R. S.:	HLM	X2:	9-13, 24 (Sarso Isl.).
		EC	412 (Massawa).

Distribution: Red Sea eastward to Samoa (HOFFMEISTER, 1925).

Remarks: It has already been stated that in a large collection it is difficult to delimit *L. costata* and *L. hemprichii*, though extreme forms could be labelled as *L. costata* or *L. hemprichii*. However, we feel that in the present suite of material the gradation from *L. costata* to *L. hemprichii* is complete, and we think that these two are only one and the same.

Genus *Acanthastrea* MILNE EDWARDS and HAIME, 1848

Type species: *Acanthastrea spinosa* MILNE EDWARDS & HAIME, 1848 (= *Astraea echinata* DANA, 1846).

Generic characters: Submassive, plocoid. Corallites polygonal or circular, mono- to tristomodaeal, 10 to 25 mm long, 10 to 15 mm broad and deep. Septa swollen at the wall, with conspicuous, thickened, mussid teeth. Columella trabecular.

Synopsis of the species of *Acanthastrea* from Red Sea:

1. Corallites monostomodaeal, polygonal, rounded when the wall is excessively thickened. Calices 10 to 25 mm long, 10 to 15 mm broad, up to 15 mm deep. Septa range up to 50, depending on the size of the calyx. Septal teeth more or less 1 mm in height and thickness. . . . . *A. echinata*
2. Corallites mono- to tristomodaeal, in the latter case forming short valleys as in *Symphyllia*. Septa alternating in thickness, 7 to 10 septa per cm length of valley. Teeth 1 to 3 mm high and often thick. . . . . *A. erythraea*

*Acanthastrea echinata* (DANA), 1846

(Plate 35, Figs. 1, 2)

<i>Astraea</i>	<i>echinata</i>	1846, DANA, 229; pl. 12/1, 1a, b (Type locality: Fiji).
<i>Acanthastrea</i>	<i>echinata</i>	1918, VAUGHAN, 125; pls. 50/2, 2a; 51/1, 2. 1952, CROSSLAND, 141; pls. 8/1, 3; 9/1, 2. 1954, WELLS, 467; pl. 175/4, 5 (synonymy). 1971, LOYA & SLOBODKIN, 125. 1975, CHEVALIER, 313; pls. 29/1, 2, 4; 30/1, 3; 31/1, 2, 6 (synonymy). 1976, PILLAI & SCHEER, 65. 1980, VERON & PICHON, 253; figs. 432-439, 776-778. 1980, HEAD, 153, 463.
<i>Astrea</i>	<i>dipsacea</i>	1828, AUDOUIN (& SAVIGNY), 57; pl. 5/3. 1834, EHRENBERG, 321 (type specimens in Berlin Museum: Nos. 722, 725, 755, 756).
<i>Favia</i>	<i>dipsacea</i>	1948, CROSSLAND, 186; pl. 5.
<i>Acanthastrea</i>	<i>grandis</i>	1857, MILNE EDWARDS (& HAIME), 502. 1879, KLUNZINGER 3, 43.
<i>Favia</i>	<i>hemprichii</i>	1914, MATTHAI, 110 (pars); pl. 27/1, 2, 4 (non pl. 36/3), (non <i>Astraea hemprichii</i> EHRENBERG).
<i>Acanthastrea</i>	<i>hirsuta</i>	1857, MILNE EDWARDS (& HAIME), 502. 1879, KLUNZINGER 3, 42; pl. 5/1, 2.
<i>Favia</i>	<i>hirsuta</i>	1914, MATTHAI, 100; pl. 24/7, 8 (synonymy).
<i>Acanthastrea</i>	<i>rotundoflora</i>	1975, CHEVALIER, 325; pls. 29/3; 31/7.

There are seven specimens of this species in the present collection. The corallites are polygonal or rounded, calices mostly rounded, oval or drawn out and distorted. The intercorallite walls range from 2 to 7 mm in different coralla.

Two of the specimens, NS 4975 and PW 73 704, have rounded corallites and calices with excessively thickened intercorallite walls. These specimens are almost the same as the one described by CHEVALIER (1975) as *A. rotundoflora*. Though our suite of specimens is composed only of a small number of specimens, it illustrates the gradation from typical *echinata* to *rotundoflora*, and we have little hesitation to refer the latter to the synonyms of *A. echinata*.

## Material:

Gulf of Suez:	T. Aviv	NS	8670 (El Bilaiyim).
Gulf of Aqaba:	T. Aviv	NS	1264 (Eilat); 1890, 4975, 5006 (Dahab).
	Basel	PW	73 704 (El Kura).
	HLM	EC	460 (Eilat).

Distribution: Red Sea; Southeast Africa (Natal coast); Seychelles; Aldabra (ROSEN, 1971); Madagascar; Mauritius; Chagos; Maldives; Minicoy (GARDINER 1904); China Sea; Bonin Isls.; Great Barrier Reef; New Caledonia; Loyalty Isls.; Marshall Isls.; Ellice Isls.; Fiji; Cook Isls. (STODDART & PILLAI, 1973); Tuamotu Archipelago.

*Acanthastrea erythraea* (KLUNZINGER), 1879

(Plate 35, Figs. 3, 4)

<i>Isophyllia</i>	<i>erythraea</i>	1879, KLUNZINGER 3, 10; pls. 1/10; 9/9 (Type locality: Red Sea).
(non <i>Mussa</i> )	<i>erythraea</i>	1911, GRAVIER, 47; pl. 4/24).
<i>Symphyllia</i>	<i>erythraea</i>	1980, HEAD, 153, 466; pl. IV-4.

KLUNZINGER's type of *Isophyllia erythraea* is No. 2171 in the Berlin Museum. The longest valley is 40 mm. The nature of septa resembles those of *Lobophyllia*, i. e. they are swollen. Thicker and thinner ones alternate, the larger ones about 1.5 mm thick. Secondary septa do not reach the columella. The larger teeth on major septa up to 3 mm high, and there are about 5 such large teeth on a large septum. The uppermost tooth is vertical. The type is intermediate in characters between *Acanthastrea* and *Symphyllia*, the latter genus being hitherto not recorded from Red Sea, though SCHEER (1971) has mentioned it. Now HEAD (1980) has established anew the genus *Symphyllia* in the Red Sea.



Description of RM 97: Massive, expanding as it grows from a narrower base. Surface level. Greater diameter 17 cm, lesser 10 cm. Total height 10 cm. Corallites mono- to tristomodaal. Single corallites 20 to 25 mm long, 10 to 12 mm broad, 10 to 12 mm deep. Wall (peritheca), excluding the septa, 3 to 5 mm thick, broader below than at the top. Larger and smaller septa alternate, 7 to 10 septa per cm length of valley. Larger septa 0.75 mm thick, 1 to 1.5 mm exsert, those of the opposite sides usually fuse over the wall and look continuous. On a large septum there are 6 to 8 teeth, 1 to 2 mm high, the uppermost vertical, tips of teeth pointed. On the thin septa there are 6 to 10 serrations. Sides of septa smooth. Columella 3 to 5 mm in diameter, composed of closely twisted trabeculae, which most of the major septa unite with. Subsidiary septa turn towards and fuse to the sides of the major ones. Adjacent centres of columella in polycentric calices are linked by thin lacerated lamellae. Septa broader at the top than below, a little swollen at the wall. Wall and inside of calices with endothelial vesicles. At the periphery of the corallum costae corresponding to septa are visible.

Material:

Central R. S.: HLM RM 97 (Wingate R.).  
Berlin ZMB 7028, 7029 (Wingate R., 15–22 m).

Distribution: Red Sea. But probably more wide-spread when the synonymy is fully known.

Remarks: KLUNZINGER has stated that the species is very near to *Isophyllia spinosa* of the Atlantic and West Indian waters. We have carefully compared our *A. erythraea* with a specimen of *I. sinuosa* (= *I. spinosa*) from West Indies (X1:155–4 of HLM). The major distinctions are in the thicker wall and alternating swollen septa and larger teeth of the Red Sea species. MATTHAI (1914) did not make any reference to this species, though he (1928:236) stated that *Isophyllia erythraea* of KLUNZINGER is not an *Isophyllia* but is more related to *Favia hirsuta* (= *A. echinata*).

There are two other species that merit consideration here, viz *Symphyllia simplex* CROSSLAND (1948, 192, pl. 7) and *Acanthastrea billae* WELLS (1955, 15, pl. 2, figs. 2, 3). *S. simplex* and *A. billae* are more or less the same. *A. erythraea* seems to differ from these mainly in the polystomodaal nature of some of the corallites, approaching to a condition of *Symphyllia*. It is likely that all three species mentioned here constitute a single species. But more material must be certainly studied to settle the synonymy.

Genus *Blastomussa* WELLS, 1968

Type species: *Bantamia merleti* WELLS, 1961.

Generic characters: (adapted from WELLS, 1968) Colonial, encrusting or phaceloid with erect cylindrical branches, formed by extratentacular budding from edge zone. Septa stout, mussoid, with a low rounded lobate tooth.

HEAD (1978) divided the genus into two subgenera, *Blastomussa* with phaceloid coralla and *Ceriomorpha* with encrusting coralla. The genus is known to have three species, all three are reported from the present collection.

Synopsis of *Blastomussa* from Red Sea:

A. Corallum branching, phaceloid.

1. Corallites 5 to 7 mm in diameter. Height of branches up to 30 mm. Septa in two complete cycles with a set of incomplete tertiaries. . . . . *B. merleti*
2. Corallites 9 to 13 mm in diameter. Branches up to 50 mm high. Septa in three complete cycles with an incomplete set of the fourth cycle. . . . . *B. wellsi*

B. Corallum encrusting, cerioid.

3. Calices range from 4 to 8 mm in diameter. Corallum often with gaps between the corallites. . . . .  
. . . . . *B. loyae*

*Blastomussa merleti* (WELLS), 1961

(Plate 35, Figs. 5, 6, 10, 11)

*Bantamia merleti* 1961, WELLS, 189; figs. 1–4 (Type locality: New Caledonia).

- Blastomussa merleti* 1973, WIJSMAN-BEST, 154.  
 1975, CHEVALIER, 327; pls. 29/6; 30/5-7.  
 1978, HEAD, 634, fig. 1a.  
 (non 1968, WELLS, 276; figs. 4, 5).  
 1980, VERON & PICHON, 234; figs. 393-394, 767.  
 1980, HEAD, 153, 466.

The four samples in the present collection include several specimens ranging from single corallites to small phaceloid colonies, 4 cm high and up to 3 cm spread. Corallites cylindrical, an epitheca stops 1 mm from the top of the wall. Adjacent corallites 3 to 6 mm apart, diameter 4 to 5 mm. Wall about 0.5 mm thick. Calices shallow (1 mm). Septa in three cycles, primaries larger than secondaries, and these larger than tertiaries. Primaries exsert to 1.5 mm. Edges either entire or in higher cycles with 2 to 3 serrations. Septa swollen at the wall, exsert part with a deep cleft, above which the septum narrows, so that it has a beaked appearance. Sides of septa granular. Two cycles of septa reach the columella. Columella composed of thickened trabeculae with 1 to 3 upright processes. These processes are arranged in some calices in a longitudinal row forming a vertical ridge. Costae conspicuous at the top of the branch, below covered by an epitheca. The above details are based on PW 71 349.

Material:

- Gulf of Aqaba: T. Aviv NS 9281 (Eilat, 60 m).  
 Basel PW 71 349a, b (Fara'un Isl., 40 m).  
 Northern R. S.: T. Aviv NS 5946 (Ras Muhammad, 10 m).

Distribution: Red Sea; Aldabra (ROSEN, 1971); Madagascar; Great Barrier Reef; New Caledonia.

*Blastomussa wellsi* WIJSMAN-BEST, 1973

(Plate 35, Figs. 7, 8, 10, 11)

- Blastomussa wellsi* 1973, WIJSMAN-BEST, 154; figs. 1, 2 (Type locality: New Caledonia).  
 1975, CHEVALIER, 333; pls. 29/5; 31/3-5.  
 1978, HEAD, 634; fig. 1b.  
 1980, VERON & PICHON, 236; figs. 395, 768, 769.  
*merleti* 1968, WELLS, 276; figs. 4, 5.

One specimen in the collection differs from *B. merleti* mainly in the size of the corallites, nevertheless we name it *B. wellsi*. Whether it is the normal growth of *B. merleti*, and the type of the latter a stunted growth is not proved in the field. WELLS (1968) took this form with larger corallites only as *B. merleti*, but WIJSMAN-BEST (1973) separated it. WIJSMAN-BEST was followed by CHEVALIER (1975), HEAD (1978) and VERON & PICHON (1980). We do not have sufficient material to illustrate the gradation, but we feel that probably *B. merleti* and *B. wellsi* could be one and the same.

The following are the details of the present specimen: Corallum fasciculate, formed of extratentacular budding. Total height of the colony 4.5 cm. Corallites rounded or elongated, diameter 8 to 10 mm, shallow, epithecate. Septa in three complete cycles, exsert to 2 mm. At the mid-length of a septum there is a deep cleft with a conspicuous lobe. The first two cycles of septa are subequal and reach the columella. Septal edges serrated, sides granular. Columella in details resembles that of *B. merleti*.

Material:

- Gulf of Aqaba: Basel PW 73 567 (Eilat, 50-55 m).

Distribution: Red Sea; Great Barrier Reef; New Caledonia.

Remarks: This is the first record of this species from Indian Ocean and Red Sea.

*Blastomussa loyae* HAED, 1978

(Plate 35, Figs. 9-11)

- Blastomussa loyae* 1978, HEAD, 636, figs. 1c, d; 2 (Type locality: Sudanese Red Sea).  
 1980, HEAD, 153, 446.

Corallum encrusting, thin, greater spread 5 cm, thickness at the broken edge 1 cm. At the underside, particularly at the periphery, the fasciculate nature of the corallites can be seen. Surface level, intercorallite wall fused, with occasional oval or circular gaps, where the fusion of the thecal wall is incomplete. Corallites oval, penta- or hexagonal, 4 to 6 mm in diameter, about 1.5 mm deep. Intercorallite wall 1 to 1.5 mm thick. Septa generally in two cycles, in larger corallites a set of spiny tertiaries visible. The first two cycles subequal, exsert to 1 mm. Exsert ends vertical, edges microscopically serrated. Septa have a deep cleft, without conspicuous paliform lobes. Septa thickened at the wall, sides granular. Columella similar to that of *B. merleti*. 10 to 12 septa reach the columella. An epitheca is visible at the underside of the corallum.

**Material:**

Gulf of Aqaba: T. Aviv NS 6067 (Eilat, 20 m).

**Distribution:** Known only from Red Sea.

**Remarks:** *Blastomussa loyae* is a very well defined species. The major distinctions from the two other *Blastomussa* species are the growthform and the details of the corallites and septa. Head placed this species under a subgenus *Ceriomorpha*.

Additional remarks to another genus of the family Mussidae:

Genus *Parascalymia* WELLS, 1964

HEAD (1980: 153, 466) reports on six specimens of *P. vitiensis* from the reefs off Port Sudan. We have not seen these specimens, but we know the close similarity of the species with young stages of *Lobophyllia*, therefore we mention this unusual observation only with some doubts.

Family **Pectiniidae** VAUGHAN and WELLS, 1943

The family is represented by five genera, viz *Mycedium*, *Echinophyllia*, *Oxypora*, *Pectinia* and *Physophyllia*, all of them are very closely related. The generic status of some of these are not beyond doubt. *Pectinia* and *Physophyllia* are hitherto not known from Red Sea, the other three are discussed in this work.

Synopsis of the genera of Pectiniidae from Red Sea:

1. Corallum explanate or foliaceous. Corallites nariform, i. e. the wall raised up only on one side. . . . . *Mycedium*
2. Growthform similar to *Mycedium*, but the corallite wall is little raised up, if projecting, then equally on all sides. A central mother calyx often visible. . . . . *Echinophyllia*
3. Corallum foliaceous. Folia contorted, growing edges with slitlike perforations. Corallites without projecting wall. . . . . *Oxypora*

Genus *Mycedium* OKEN, 1815

Type species: *Madrepora elephantotus* PALLAS, 1766.

Generic characters: Colonial, explanate, growing edges rising to form thin folia. Corallites 6 to 12 mm in diameter, only one side of the wall projecting (up to 8 mm), i. e. they are nariform. Sometimes part of the corallites cylindrical. Coenosteum costate.

*Mycedium elephantotus* (PALLAS), 1766

(Plate 36, Figs. 1, 2)

<i>Madrepora</i>	<i>elephantotus</i>	1766, PALLAS, 290 (Type locality: Indian Ocean).
<i>Mycedium</i>	<i>elephantotus</i>	1940, UMBGROVE, 290; pl. 28/1. 1954, ROSSI, 36; pl. 4/1, 2. 1975, CHEVALIER, 337; pls. 33/3; 34/4; 35/2-4; 36/3; 42/3 (synonymy). 1980, VERON & PICHON, 320; figs. 564-582, 811-813. 1980, HEAD, 153, 468.
	<i>aspera</i>	1924, MATTHAI, 58; pls. 3/5; 7/2.
	<i>explanatum</i>	1901, VERRILL, 136; pl. 29/1.
	<i>okeni</i>	1860, MILNE EDWARDS (& HAIME), 75; pl. D12/1. 1924, MATTHAI, 58; pl. 3/6.
	<i>tenuicostatum</i>	1901, VERRILL, 137; pl. 29/2, 2a-c.
<i>Phyllastraea</i>	<i>tubifex</i>	1846, DANA, 270; pl. 16/4.
<i>Mycedium</i>	<i>tubifex</i>	1936, YABE, SUGIYAMA & EGUCHI, 49; pl. 37/3, 4. 1971, LOYA & SLOBODKIN, 125. 1974, MERGNER & SCHUHMACHER, 265. 1974, SCHEER & PILLAI, 59; pl. 27/4, 5. 1976, PILLAI & SCHEER, 68; pls. 31/2; 32/1.

The present specimens include young entire colonies as well as parts of larger coralla. In some of the specimens (for example SLR 807 and 808) the surface has small humpy projections, probably a reaction to the presence of boring polychaetes. The costae on such hillocks are more thickened than in normal forms. Corallites range from 6 to 10 mm in diameter and up to 10 mm in height in different coralla. Septa in three cycles. Costae confluent, edges with rounded granules.

Material:

Gulf of Suez:	T. Aviv	NS	5891, 5892 (Et Tur).
Gulf of Aqaba:	Jerus.	SLR	373-1-4 (Marsa Murach); 1185, 1188, 1192 (Marsa el Muqeibla); 676-1, 2 (Marsa Abu Zabad).
	Basel	PW	73 547 (40 m), 580 (50-55 m) (Eilat); 71 334 (40 m); 73 541 (18-22 m) (Fara'un Isl.); 73 647 (Dahab, lighthouse); 1 ex. without No.
Northern R. S.:	Jerus.	SLR	807-1, 2, 808, 818 (Ras Muhammad).
	T. Aviv	NS	4952 (Marsa el At); 1869 (Ras Muhammad).
	HLM	X2:	2-34, 3-10 (Gubal Isl.).
		EC	433 (Shadwan Isl.).
Central R. S.:	P. Sud.	Sa	46, 47 (Sanganeb R.).
Southern R. S.:	HLM	EC	413a (Massawa).

Distribution: Red Sea; Aldabra; Mauritius (FAURE, 1977); Maldives; South India; Nicobar Isls.; Mergui Archipelago; Singapore; East Indies (UMBROVE, 1939); China Sea; Philippines; Palau Isls.; Great Barrier Reef; New Caledonia; New Hebrides; Solomon Isls.; Marshall Isls.; Fiji; Tahiti.

Remarks: In agreement with WELLS (1955) and CHEVALIER (1975) we unite MATTHAI's *M. aspera* as well as *M. okeni* MILNE EDWARDS & HAIME, *M. explanatum* (VERRILL), *M. tenuicostatum* (VERRILL) and *M. tubifex* (DANA) with *M. elephantotus*.

Genus *Echinophyllia* KLUNZINGER, 1879

Type species: *Madrepora aspera* ELLIS & SOLANDER, 1786.

Generic characters: Colonial, explanate, underside costate. Corallites 7 to 10 mm in diameter, wall not at all, a little or sometimes more projecting, opening of the calices upward directed. A central mother calyx often present. Septo-costae confluent. Coenosteum vesicular. Columella conspicuous.

CHEVALIER (1975) has discussed four species, *E. aspera*, *E. echinata*, *E. glabra* and *E. rugosa*. VERON & PICHON (1980) include only *E. aspera* and *E. echinata* in *Echinophyllia* and add *E. orpbeensis* and *E. echinoporoides* to it. They replace *E. glabra* in the genus *Oxypora* and consider *E. rugosa* as a possible synonym of *O. lacera*.

*Echinophyllia aspera* (ELLIS and SOLANDER), 1786

(Plate 36, Figs. 3, 4)

<i>Madrepora</i>	<i>aspera</i>	1786, ELLIS & SOLANDER, 156; pl. 39 (Type locality: Eastindian Ocean).
<i>Echinophyllia</i>	<i>aspera</i>	1879, KLUNZINGER 3, 69; pl. 6/8.
<i>Oxyphyllia</i>	<i>aspera</i>	1936, YABE, SUGIYAMA & EGUCHI, 50; pls. 36/1-4; 38/5, 6.
<i>Echinophyllia</i>	<i>aspera</i>	1954, WELLS, 467; pl. 176/1-5.
		1971, LOYA & SLOBODKIN, 125.
		1974, MERGNER & SCHUHMACHER, 264.
		1975, CHEVALIER, 357; pls. 32/1-3; 33/2; 34/1-3 (synonymy).
		1976, PILLAI & SCHEER, 67; pl. 30/1, 2.
		1980, VERON & PICHON, 298; figs. 516-520, 800-802.
		1980, HEAD, 153, 466.

This species is very well represented in our collection by 24 specimens. From our samples it seems that the species is very common in the Gulf of Aqaba. Corallum encrusting or explanate, edges raised up to form foliaceous growth. Calices 8 to 10 mm in diameter or in some cases smaller, only 5 to 6 mm in diameter. Corallites generally level or the wall elevated up to 3 mm. Openings directed upwards (a major distinction from *Mycedium*). Septa 10 to 15 per calyx, all exsert, major septa with frosted teeth. Columella formed of the fusion of septal ends. Septo-costae confluent, supplied by conspicuous spines.

In some of our specimens (PW 71 327, 328, 73 536, Sa 86) the septo-costae are thickened and elevated near the wall up to 10 mm, so that many excrescences are formed everywhere, which gives a peculiar look to the coral. They certainly differ from typical forms, but we do not think there is any justification for their separation.

Two specimens, PW 73 568 and 603, have more or less protruding calices. They resemble *E. aspera* var. *sugiyamai*. This variety together with *E. aspera* var. *tosaensis* has got the new name *E. orpheensis* by VERON & PICHON, 1980. But we are not sure whether our material belongs really to the new species, therefore we leave it in *E. aspera*.

Another specimen, PW 73 623, is explanate and thin with a central mother calyx. It resembles *E. echinata* (SAVILLE-KENT), but we do not separate it from *E. aspera*.

We received a small fragment, Fri 25-1, from Prof. FRICKE, collected with his submersible "Geo" in a depth of 65 m, which looks like CHEVALIER's var. *undulata* (1975: 363, pl. 32/3 and 34/3). Another small specimen, Fri 92-2, is very thin.

## Material:

Gulf of Suez:	Jerus.	SLR	2154 (Et Tur).
	T. Aviv	NS	8193 (Ras el Kanisa).
Gulf of Aqaba:	Jerus.	SLR	1189 (Marsa el Muqeibla).
	T. Aviv	NS	1916 (Marsa Murach).
	Basel	PW	73 613 (lighthouse), 71 327, 328 (40 m), 73 549 (40 m), 568, 581 (50-55 m), 623 (60 m) (Eilat); 73 536 (20 m), 71 335 (40 m) (Fara'un Isl.); 73 602, 603 (south of Fara'un Isl.); 1 ex. without No.
Northern R. S.:	HLM	Fri	25-1 (Eilat, Mar. Biol. Lab., 65 m); 92-2 (Sharm esh Sheikh, 105 m).
	T. Aviv	NS	1877 (Ras Muhammad).
	USNM	Wa	94, 95, 96 (Ghardaqa).
	HLM	X2:	3-28 (Gubal Isl.).
Central R. S.:	P. Sud.	Sa	86, 101 (Sanganeb R.).
Southern R. S.:	HLM	EC	413b (Massawa).

Distribution: Red Sea; Seychelles, Aldabra; Madagascar (PICHON, 1964); Réunion; Maldives; Ceylon (DANA, 1846); Mergui Archipelago; East Indies; Taiwan (KAWAGUTI, 1953); Japan; Great Barrier Reef; Solomon Isls.; New Caledonia; Marshall Isls.; Tahiti.

Genus *Oxypora* SAVILLE-KENT, 1871

Type species: *Trachypora lacera* VERRILL, 1864.

Generic characters: Corallum foliaceous, thin, contorted, with slit-like perforations. Corallites shallow, without well-developed thecal wall. Septa in two cycles, septal edges with strong lacerated teeth. Columella trabecular.

*Oxypora lacera* (VERRILL), 1864

(Plate 36, Figs. 5, 6)

<i>Trachypora</i>	<i>lacera</i>	1864, VERRILL, 53 (Type locality: Singapore).
<i>Echinophyllia</i>	<i>lacera</i>	1905, GARDINER, 949; pl. 93/26.
<i>Oxypora</i>	<i>lacera</i>	1936, YABE, SUGIYAMA & EGUCHI, 53; pls. 29/6, 7; 37/1, 2.
		1954, WELLS, 468; pl. 177/7, 8.
		1954, ROSSI, 37; pls. 5/1; 6/3.
		1975, CHEVALIER, 384; pls. 34/6; 35/1 (synonymy).
		1976, PILLAI & SCHEER, 68.
		1980, VERON & PICHON, 314; figs. 546–558, 807–810.
		1980, HEAD, 153, 468.
	<i>titiziamensis</i>	1936, YABE, SUGIYAMA & EGUCHI, 53; pls. 29/4, 5; 34/5; 59/7.

The following is VERRILL's original description of this species (1864: 53): "Broadly explanate and gibbous, thin, with many irregular openings near the margin. Below coarsely and irregularly ribbed or costate, the principal costae very thick, prominent, strongly echinate, the spines irregular, lacerately lobed, smaller intermediate costae scarcely spinose. Upper surface covered by rather loose, very unequal septo-costal plates, which are deeply and irregularly divided into strong lacerate spines; the plates are nearly parallel, except close to the polyp centres, where they bend abruptly and unite with the columella. The spines around the centres are large and stout, often broad at the ends; centres irregularly scattered, from half an inch to an inch distant."

We had the opportunity to study a good number of specimens of *Oxypora* both from Maldives and Red Sea, which enables us to understand the skeletal variations. We are of the opinion that *O. titiziamensis* is nothing but a skeletal variant of the older species. The perforations of the corallum and the nature of the costal dentation are characters that are subjected to variation in different coralla. In general younger specimens have more perforations than the older ones. In older coralla the perforations get secondarily filled.

Material:

Gulf of Aqaba:	Jerus.	SLR	1167 (Marsa el Muqeibla).
Northern R. S.:	Jerus.	SLR	822 (Ras Muhammad).
	T. Aviv	NS	9287 (Marsa el At); 1867, 1869a (Ras Muhammad).
	HLM	X2:	3–6 (Gubal Isl.).
Central R. S.:	P. Sud.	Sa	32 (Sanganeb R.).
Southern R. S.:	HLM	EC	413c (Massawa).

Distribution: Red Sea; Madagascar (PICHON, 1964); Réunion; Maldives; Singapore; China Sea; Japan; Palau Isls.; Amboina; Great Barrier Reef; New Caledonia; Loyalty Isls.; Marshall Isls.

4. Suborder Caryophylliina VAUGHAN and WELLS, 1943

Superfamily Caryophylliicae GRAY, 1847

Family Caryophylliidae GRAY, 1847

Subfamily Caryophylliinae GRAY, 1847

Genus *Caryophyllia* LAMARCK, 1801

Type species: *Madrepora cyathus* ELLIS & SOLANDER, 1786

Generic characters: Solitary, rarely in fused masses or clusters, turbinate or cornuate, free or fixed. Calices circular or elliptical. Columella fasciculate. Septa in distinct cycles. Pali conspicuous in one crown. Costae present.

Synopsis of *Caryophyllia* known from Red Sea:

1. Corallum in fused clusters with a narrow base or peduncle. Calices 12 to 28 mm in diameter. Septa in four cycles with a few of the fifth, 13 to 17 septa highly exsert and arched. Pali 12 to 15. . . . . *C. paradoxus*
  2. Corallum solitary, cornuate. Calices up to 20 mm in diameter, height up to 40 mm. Septa in four cycles, 12 septa are larger and more exsert. Pali 12, large. . . . . *C. sewelli*
- The present collection does not include any of these deep-water species.

*Caryophyllia paradoxus* ALCOCK, 1898

*Caryophyllia paradoxus* 1898, ALCOCK, 14; pl. 1/2, 2a-c (Type locality: off Travancore, Kerala, West coast of India).  
1938, GARDINER & WAUGH, 181.

GARDINER & WAUGH (1938) have recorded this species from the southern part of the Red Sea from a depth of 366 m (Stat. 209).

Distribution: Red Sea; Westcoast of India.

*Caryophyllia sewelli* GARDINER and WAUGH, 1938

*Caryophyllia sewelli* 1938, GARDINER & WAUGH, 180; pl. 2/3 (Type locality: Red Sea).  
*sp. (?)* 1974, ZIBROWIUS, 755; pls. 1/11; 2/1.

*Caryophyllia sewelli* was described by GARDINER & WAUGH (1938) from the southern Red Sea from a depth of 366 m (Stat. 209). ZIBROWIUS (1974) states that a specimen in Senckenberg Museum (No. 521), collected by the "Valdivia" near St. Paul in the southern Indian Ocean, which he describes under *Caryophyllia sp.*, has great resemblance to *C. sewelli*. He supposes that his specimen belongs to a suite of the same "Valdivia" station, which MARENZELLER (1904) has published as *C. arcuata*.

Distribution: Red Sea; ? St. Paul Isl.

Genus *Trochocyathus* MILNE EDWARDS and HAIME, 1848

Type species: *Turbinolia mitrata* GOLDFUSS, 1827.

Generic characters: Solitary, turbinate, fixed or free. Pali present in all septa except the last cycle, arranged in two crowns. Columella spongy or crispate.

Synopsis of *Trochocyathus* known from Red Sea:

1. Corallum cylindro-conical or very short, often with a broad base of attachment. Diameter 5 to 8 mm (up to 11 mm after ALCOCK, 1902), height about 11 mm, (after ALCOCK up to 20 mm). Septa in four complete cycles. Pali 24 in two crowns. Columella consists of several (after ALCOCK of a large number of) small pinnacles. (After MARENZELLER, 1906a). . . . . *T. virgatus*
2. Corallum small, flat, slightly elliptical. Greater diameter 4 to 7 mm, height 2 to 3 mm. Septa in three complete cycles with some of the fourth. Pali before all septa, except the last cycle, in one or two crowns. Columella consists of several stout papillae. (After VAUGHAN, 1907). . . . . *T. oabensis*

*Trochocyathus virgatus* ALCOCK, 1902

*Trochocyathus virgatus* 1902, ALCOCK, 16; pl. 2/13 (Type locality: Sulu Sea).  
1906a, v. MARENZELLER, 21; 2/4.  
1927, FAUSTINO, 82; pl. 7/10.  
1964, WELLS, 112; pl. 1/8-10.

MARENZELLER (1906a) recorded this species from central and northern Red Sea and from Gulf of Aqaba at depths of 610 to 978 m. One specimen in the present collection from a depth of 280 fms. is

turbinate with a narrow base. The calyx is 5 mm in diameter. Epitheca absent. Total septa 48, of which 12 are subequal and maximum exsert. Costae very conspicuous. The pali and columella are damaged in this specimen, so that the details cannot be made out. According to ALCOCK there are 24 pali arranged in two crowns opposite to first three cycles of septa. The columella is composed of about 40 upright pillars clearly distinguished from the pali.

**Material:**

Gulf of Aqaba: Jerus. SLR 1727 (southeast of Ras Masri, 280 fathoms).

**Distribution:** Red Sea (MARENZELLER's stations: 47, 79, 91, 106, 156, 175, 176, 178); Sulu Sea; Philippines; Queensland.

*Trochocyathus oabensis* VAUGHAN, 1907

*Trochocyathus oabensis* 1907, VAUGHAN, 72; pl. 6/5, 5a, 6, 6a (Type locality: Hawaii).  
1938, GARDINER & WAUGH, 188.

GARDINER & WAUGH (1938) reported a specimen from southern Red Sea under the present name, hence its inclusion in this work.

**Distribution:** Red Sea (Stat. 207, 375 m); Hawaii.

**Remarks:** The species is more related to *Deltocyathus* in growthform than to *Trochocyathus*. VAUGHAN (1907) stated that it "bears the same relation to the discoid Trochocyathi that Diasheris does to Fungia".

Genus *Deltocyathus* MILNE EDWARDS and HAIME, 1848

**Type species:** *Turbinolia italicus* MICHELOTTI, 1838.

**Generic characters:** Solitary, discoid to patellate, free. Pali opposite all but least cycle, frequently uniting in deltas. Columella papillose on surface.

*Deltocyathus minutus* GARDINER and WAUGH, 1938

*Deltocyathus minutus* 1938, GARDINER & WAUGH, 198; fig. 5.

GARDINER & WAUGH have found this species in the southern Red Sea at three stations in depths of 256 to 366 m (Stat. 7, 206, 209).

Corallum a flattened disc when young, growing to an inverted dome-shape. Diameter of calyx 1.2 to 5 mm. Septa in three cycles, sometimes half of the fourth cycle present. Septa of the third cycle joining the second-ones.

**Distribution:** Red Sea.

Genus *Polycyathus* DUNCAN, 1876

**Type species:** *Polycyathus atlanticus* DUNCAN, 1876.

**Generic characters:** Corallum in small clusters formed by external budding, the young-ones attached to the mother corallite. Details of corallites similar to *Paracyathus*. Pali in several crowns merging with the columellar pillars. Septa exsert and arched. Differs from *Paracyathus* in the colonial nature of the corallum.

Synopsis of *Polycyathus* known from Red Sea:

1. Corallites usually 3 to 5, but up to 7 mm in diameter, height up to 10 mm. Septa in four cycles, sometimes the fourth incomplete. Pali before most of the septa of the first three cycles. Columella consists of numerous papillae. . . . . *P. fuscomarginatus*



2. Corallum with buds on the sides of a mother calyx, showing a bushy appearance. Seize of bushes up to 5 cm. Calices up to 15 mm, compressed forms 8 to 21 mm. Septa in four cycles, sometimes some of the fifth present. Pali before the septa of the first three cycles. Columella consists of about 20 small upstanding rots. (After GARDINER & WAUGH, 1938). . . . . *P. conceptus*

*Polycyathus fuscomarginatus* KLUNZINGER, 1879

(Plate 36, Figs. 7, 8)

*Phyllangia fuscomarginata* 1979, KLUNZINGER 2,75; pls. 8/18; 10/17 (Type locality: Koseir, Red Sea).  
1980, HEAD, 152, 462.  
*pallida* 1879, KLUNZINGER 2, 76; pls. 8/17; 10/16.

Corallum in small clusters usually attached to other corals, rarely with isolated calices. Corallites narrower at the base than at the top. Greater diameter 3 to 5 mm (up to 7 mm according to KLUNZINGER), up to 10 mm high and about 2 mm deep. Epitheca not seen. Wall costate. Septa in four cycles, the fourth in several calices incomplete. The first two cycles larger than the others. All septa exsert and arched. Upper half of the septa with entire edges, lower down serrated, the last tooth forming a palus, that merge with the papillose columella. Sides of septa granular. The colour of septa and inside the fossa is generally mild chocolate with white edges of the septa, or most of the calicular structures are white.

Material:

Gulf of Aqaba: Basel PW 73 614-1a (Eilat, attached to *Rhizopsammia wettsteini*); 73 597a  
(Fara'un Isl., attached to *Echinopora gemmacea*).  
Northern R. S.: T. Aviv NS 5934 (Ras Muhammad, 10 m).

Distribution: Red Sea.

Remarks: KLUNZINGER separated his *Phyllangia fuscomarginata* and *P. pallida* mainly based on the colour of the corallum. However, examination of the present material along with the type in Berlin (No. 2143) has convinced us, he was dealing with a single species. *Phyllangia* is mainly a West Indian and Atlantic genus. KLUNZINGER's *Phyllangia* (non MILNE EDWARDS & HAIME) should be correctly placed under *Polycyathus*. *Polycyathus andamanensis* ALCOCK, 1893 (type No. 5971/6 in Indian Museum Calcutta) is very similar to *P. fuscomarginatus* and could be a synonym.

*Polycyathus conceptus* GARNINER and WAUGH, 1938

*Paracyathus conceptus* 1938, GARDINER & WAUGH, 184; pl. 4/8, 9 (Type localities: Maldives and Red Sea).  
1962, RALPH & SQUIRES, 7; pl. 2/3, 4.  
1964, WELLS, 113; pl. 1/11, 12.

GARDINER & WAUGH (1938) have reported this species from the southern Red Sea at a depth of 732 to 805 m (Stat. 208), therefore we include it in the present work.

Distribution: Red Sea; Queensland; New Zealand.

Remarks: This species is characterized by a corallum in the form of bushy clumps, formed by extratentacular budding, and thus it is more related to *Polycyathus* than to *Paracyathus*, the latter with a solitary corallum. For details reference may be made to the authors listed above.

Genus *Heterocyathus* MILNE EDWARDS and HAIME, 1848

Type species: *Heterocyathus aequicostatus* MILNE EDWARDS & HAIME, 1848.

Generic characters: Solitary. Attached to a gastropod shell with a symbiotic sipunculid in the living condition. Costae conspicuous and extending to the base. Pali opposite to all septa. Columella papillary.

*Heterocyathus aequicostatus* MILNE EDWARDS and HAIME, 1848

(Plate 36, Fig. 9)

<i>Heterocyathus aequicostatus</i>	1848, MILNE EDWARDS & HAIME, 324; pl. 10/8 (Type locality: unknown).
	1904a, GARDINER, 105; pl. 3/1-43 (synonymy).
	1905, BOURNE, 193 and 213; figs. 2, 3; pls. 3/12-18; 4/19-21.
	1906, v. MARENZELLER, 90.
	1909, HARRISON & POOLE, 898, pl. 85/1a-f.
	1927, FAUSTINO, 83; pl. 8/1-7.
	1974, SCHEER & PILLAI, 61; pl. 28/3, 4 (synonymy).
<i>heterocostatus</i>	1938, GARDINER & WAUGH, 187.
<i>oblongatus</i>	1892, REHBERG, 9; pl. 2/1, 2.
<i>parasiticus</i>	1872, SEMPER, 255; pl. 20/17a-c.
<i>philippinensis</i>	1872, SEMPER, 254; pl. 20/12-14.
<i>pulchellus</i>	1892, REHBERG, 8; pl. 1/7a, b.
<i>wood-masoni</i>	1893, ALCOCK, 141; pl. 5/4, 4a.

Solitary, enclosing a gastropod shell. Basal part laterally with some small openings of the commensal sipunculid (for details see FEUSTEL, 1966). Height up to 10 mm. Diameter of the calyx up to 12 mm. Calices circular or oval, shallow (1 to 2 mm). Septa in five cycles. Primaries and secondaries subequal, or the primaries may be more thickened and forming a six-rayed star. All septa exsert, primaries the maximum. Edges of larger septa entire, those of higher cycles serrated. Three cycles of septa reach the columella, others unite with the lower cycles. Pali present before the first four cycles of septa, those of the primaries are the largest and bi- or trilobed. Costae correspond to septa, those of the primary and secondary septa prominent. Edges of costae granular.

The present samples are all small (2 to 9 mm in diameter), some are only attached to gastropods and the latter are not enclosed at the base of the coral. The same is reported by GARDINER & WAUGH (1938) of their *H. heterocostatus* from southern Red Sea (depth 375 m, Stat. 207), which we consider as synonymous with *H. aequicostatus*.

## Material:

Gulf of Aqaba: T. Aviv NS 1355, 5409, 5415, 5423 (Eilat), (each No. comprehends several specimens).

Distribution: Red Sea; East Africa; Persian Gulf; Maldives; Gulf of Mannar along the Indian coast; Ceylon; Andamans; Nicobars; Mergui Archipelago; China Sea; Philippines; Japan; Eastern Pacific.

Remarks: The type of *H. wood-masoni* ALCOCK is No. 5958/9 in the Indian Museum Calcutta. The distinguishing feature of this is the prominence of the primary septa, forming a six-rayed star. SCHEER & PILLAI (1974) had many specimens from the Nicobars (near the type locality of *H. wood-masoni*), in some of them this feature is very conspicuous (see pl. 28, fig. 3 of SCHEER & PILLAI). We feel that this is only a skeletal variation, and *H. wood-masoni* has no separate status.

Subfamily **Desmophyllinae** VAUGHAN and WELLS, 1943Genus *Dactylotrochus* WELLS, 1954

Type species: *Tridacophyllia cervicornis* MOSELEY, 1881.

Generic characters: Solitary. Columella absent. Wall with two or more fingerlike prolongations.

*Dactylotrochus cervicornis* (MOSELEY), 1881

(Fig. 3; Pl. 40, Fig. 4, centre)

<i>Tridacophyllia cervicornis</i>	1881, MOSELEY, 183; pl. 10/2, 2a-c, 3, 3a (Type locality unknown).
<i>Dactylotrochus cervicornis</i>	1954, WELLS, 470; pl. 178/1-3.
<i>Tridacophyllia primordialis</i>	1899, GARDINER, 168; pl. 19/7.

We have only six very small and young specimens before us, which are attached separately to the substratum between a *Dendrophyllia*, collected by Prof. FRICKE with his submersible "Geo" in a depth of 138 m. Four of the specimens have two striking prolongations of the wall, facing each other, whereas a fifth shows four extensions, two bigger ones lying opposite and two smaller ones perpendicular to them. One additional specimen shows the beginning of an outgrowth.

All specimens are very small, about 6 mm from tip to tip of the extensions and about 6 mm high. Septa in three cycles, very thin, those which are prolonged to the tips are somewhat thicker. No columella. Costae represented only by a few very fine granules. (Fig. 3, see also plate 40, fig. 4, centre.)

We do not believe that our specimens are a new species. We are convinced that they represent juvenile stages of *D. cervicornis*. But further collections should confirm this interpretation.

Material:

Northern R. S.: HLM Fri 78-2a-f (Ras Umm Sidd, 138 m, attached to *Dendrophyllia* cf. *cornigera*).

Distribution: Red Sea; Philippines; Tizard Bank; Marshall Isls.; Loyalty Isls.

Remarks: This is the first record of this rare species for the Red Sea. We are thankful that Dr. ZIBROWIUS has drawn our attention to the hidden specimens.

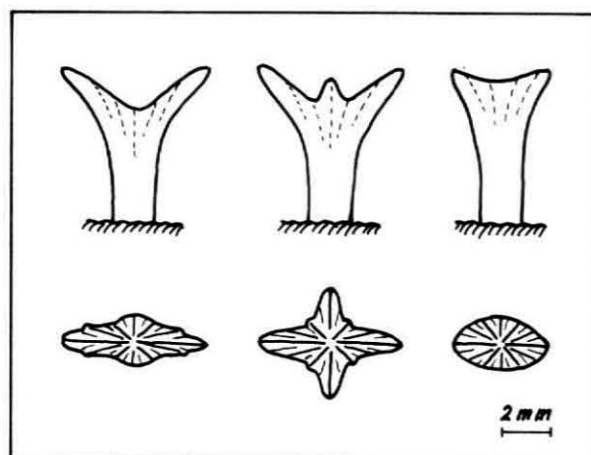

Fig. 3. *Dactylotrachus cervicornis* (diagrammatic sketch).

Subfamily **Parasmiliinae** VAUGHAN and WELLS, 1943

Genus *Parasmilia* MILNE EDWARDS and HAIME, 1848

Type species: *Madrepora centralis* MANTELL, 1822.

Generic characters: Solitary, fixed, trochoid. Columella spongy. Paliform lobes absent.

*Parasmilia fecunda* (POURTALÈS), 1871

<i>Coelosmilia</i>	<i>fecunda</i>	1871, POURTALÈS, 21; pls. 1/12; 3/4, 5; 6/14, 15 (Type locality: Straits of Florida).
<i>Anomocora</i>	<i>fecunda</i>	1878, STUDER, 641; pl. 2/9a-e.
<i>Parasmilia</i>	<i>fecunda</i>	1878, LINDSTROEM, 21.
		1904, v. MARENZELLER, 311; pl. 15/5.
		1939, GARDINER & WAUGH, 229.

GARDINER & WAUGH (1939) have recorded this species from the southern Red Sea at a depth of 366 m (Stat. 209). Calices very long, up to 70 mm, and conical, up to 9 mm in diameter. The numerous secondary corallites are no external buds, but are of sexual origin.

Distribution: Red Sea; off Sumatra; West Indies; Atlantic.

Remarks: ZIBROWIUS (1980: 133 under "Remarques") doubts about the identity of the Red Sea specimens with POURTALÈS' *Coelosmilia* (= *Coenosmilia* = *Parasmilia*) *fecunda*.

Genus *Solenosmilia* DUNCAN, 1873

Type species: *Solenosmilia variabilis* DUNCAN, 1873.

Generic characters: DUNCAN (1873: 327) defined the genus thus: "The corallum is bush-shaped; and the corallites, which rarely unite, are cylindrical and bifurcate. The terminal calices are produced by a bi-gemination; and their fossae and columellae are in common. The tissue between the new calices is usually costulate, and that over the rest of the corallum granular and without any epitheca. The calices increase by fissiparity, and form occasionally short series. Septa numerous, and not very exsert. Dissepiments common".

*Solenosmilia variabilis* DUNCAN, 1873

<i>Solenosmilia</i>	<i>variabilis</i>	1873, DUNCAN, 328; pl. 42/11-18 (Type localities: East coast of Portugal and Gulf of Cadiz). 1881, MOSELEY, 181; pl. 9/1-5. 1904a, v. MARENZELLER, 310; pl. 15/4, 4a. 1939, GARDINER & WAUGH, 229. 1974, ZIBROWIUS, 768 (synonymy). 1980, ZIBROWIUS, 143; pl. 75/A-N.
	<i>jeffreysi</i>	1898, ALCOCK, 27; pl. 3/3, 3a, b.

GARDINER & WAUGH (1939) recorded this species from southern Red Sea from a depth of 366 m (Stat. 209), hence its inclusion in the present work. We had no opportunity to study any material.

The following details of the species are based on ALCOCK (1898). Dendroid, calices projecting, the terminal calyx shows incomplete fission with a common fossa and columella. Diameter of the corallites about 4 mm, so much deep, elliptical or polygonal. Septa in three complete cycles with a few of the fourth. All septa narrow, only slightly projecting, cycles not conspicuously demarcated. Septal faces granular, edges straight or wavy. Columella composed of thin, twisted processes. Costae rugiform at the distal part of the corallite, weak below.

Distribution: Red Sea; Natal; South Africa; Persian Gulf; West coast of India; Southeast Australia; North and South Atlantic; Antilles.

Remarks: According to ZIBROWIUS (1974) *S. jeffreysi* ALCOCK, originally described from the West coast of India, is the same as the Atlantic species *S. variabilis*.

Genus *Dasmosmilia* POURTALÈS, 1880

Type species: *Trochosmilia lymani* POURTALÈS, 1871.

Generic characters: "Turbinate or trochoid, commonly increasing by parricidal budding. Paliform lobes before all but last cycle. Columella formed by mingling of inner lobes" (WELLS, 1956: F 429).

*Dasmosmilia valida* v. MARENZELLER, 1906

<i>Dasmosmilia</i>	<i>valida</i>	1906a, v. MARENZELLER, 18; pl. 2/2, 2a, b (Type locality: Red Sea).
--------------------	---------------	---

We have no specimen in the present collection. But MARENZELLER (1906a) has collected this species in the northern Red Sea at a depth of 490 m (Stat. 179). For details reference may be made to him.

Distribution: Red Sea.

Subfamily *Eusmiliinae* MILNE EDWARDS and HAIME, 1857

Synopsis of the genera of *Eusmiliinae*:

1. Corallum mainly phaceloid with diverging branches. Corallites mono-centric or in valleys. Septa little exsert. Columella absent. . . . . *Euphyllia*

2. Corallum mainly flabelloid with long valleys, 15 to 25 mm wide and deep. Septa highly exsert, edges entire. Columella absent. Series separated into independent flabellate branches. . . . . *Plerogyra*
3. Corallum mainly meandroid, details as in *Plerogyra*, but series closely united by walls. . . . . *Physogyra*
4. Corallum explanate, pedunculate, meandroid. Valleys 6 to 10 mm wide. Collines thin with a middle-groove. . . . . *Gyrosmilia*

### Genus *Euphyllia* DANA, 1846

Type species: *Caryophyllia glabrescens* CHAMISSO & EYSENHARDT, 1821.

Generic characters: Phaceloid, branches free throughout the length, diverging. Corallites monocentric (20 to 30 mm in diameter) or forming valleys, very deep. Septa very thin, slightly exsert, edges entire, sides smooth. Columella absent.

With regard to the list of synonyms of the several species a far-reaching agreement exists between the different authors as VAUGHAN (1918), MATTHAI (1928), CHEVALIER (1971) and VERON & PICHON (1980). The only greater difference is the position of *E. turgida*. MATTHAI considers it as a particular species, VAUGHAN and CHEVALIER put it to *E. fimbriata*, and VERON & PICHON to *E. glabrescens*.

The present authors agree with this latter opinion, because *E. glabrescens* and *E. turgida* are mostly phaceloid with mono-, di- or tristomodaeal corallites. On the other hand, *E. fimbriata* is mainly phacello-flabellate with more or less long meandroid valleys. Moreover another phenomenon justifies this decision, too.

VERON & PICHON (1980) subdivide the genus *Euphyllia* in two subgenera: 1. *Euphyllia* with *E. (E.) glabrescens* and *E. (E.) cristata*, and 2. *Fimbriaphyllia* with the new species *E. (F.) divisa* and *E. (F.) ancora* instead of *E. fimbriata*. They make the interesting statement, that these two new species can be distinguished only by the tentacles of their polyps and that, in this regard, they are unique in scleractinian taxonomy. *E. (F.) divisa* has long tentacles, thick at their base and dividing and branching with light caps. The polyps of *E. (F.) ancora* have long tentacles with pale caps which are curved or crescentic in shape, whereas the tentacles of *E. (E.) glabrescens* (including *E. turgida*) and *E. (E.) cristata* are long and tubular with white ends.

### *Euphyllia glabrescens* (CHAMISSO and EYSENHARDT), 1821

(Plate 37, Figs. 1–3)

<i>Caryophyllia</i>	<i>glabrescens</i>	1821, CHAMISSO & EYSENHARDT, 269; pl. 33/1A, B (Type locality: Raddak Isl., Australia).
<i>Euphyllia</i>	<i>glabrescens</i>	1904, GARDINER, 759.
		1918, VAUGHAN, 82; fig. 1; pl. 26/2, 3. 3a.
		1928, MATTHAI, 174; pls. 3/17–21; 4/2/5; 4/4/4; 6/2/9 (synonymy).
		1952, CROSSLAND, 104; pl. 2/6.
		1971, CHEVALIER, 26; pls. 1/3; 3/3.
		1974, SCHEER & PILLAI, 61.
		1976, PILLAI & SCHEER, 69.
		1980, VERON & PICHON, 342; figs. 606–610, 822 (top right), 823.
	<i>laxa</i>	1911, GRAVIER, 31; pl. 2/5–8.
	<i>turgida</i>	1846, DANA, 166; pl. 6/4.
		1904, GARDINER, 759.
		1928, MATTHAI, 177; pls. 40/2; 52/2; 59/2 (synonymy).
		1976, PILLAI & SCHEER, 70.

One specimen in the present collection was labelled by the late Peter WETTSTEIN as *E. turgida*. The specimen was collected by N. GUNDERMAN at a depth of 60 m. It is represented by four corallites, two of them separate and the others a branch with two corallites. The general appearance is similar to the one from Mauritius, figured by MATTHAI (1928, pl. 52, fig. 2) under *E. turgida*. All the corallites are monostomodaeal and range from 19 to 30 mm in greater diameter. The wall is very thin. There are 7 to 10 septa per cm length of the wall, of which 4 to 5 are larger than the others. Major septa about 1.7 mm exsert, not swollen at the wall. At the bottom of the calyx they turn left or right and extend to the centre of the

axial fossa. Costae visible as fine striations at the distal part of the corallites.

We received another specimen from Prof. FRICKE, who has collected it with his submersible "Geo" in a depth of 73 m.

Material:

Gulf of Aqaba: T. Aviv NS 9288 (Eilat, 60 m).

HLM Fri 32-1 (Eilat, Mar. Biol. Lab., 73 m).

Distribution: Red Sea; Saya de Malha; Maldives; Ceylon (ORTMANN, 1889); Mergui Archipelago (DUNCAN, 1889); Singapore; Philippines (NEMENZO, 1960); Japan (YABE, SUGIYAMA & EGUCHI, 1936); Palau Isls.; Great Barrier Reef; New Caledonia; Rotuma.

Remarks: The first reference to *Euphyllia* from the Red Sea is by CROSSLAND (1939: 24). He wrote in a footnote: "The genus *Euphyllia* has not hitherto been recorded from the Red Sea, but I have a clear recollection of it at Dongonab". In 1952 CROSSLAND repeated (p. 105) under *E. fimbriata*: "It occurs in the central Red Sea", and in a footnote: "This is the first record from the Red Sea. I especially noticed it at Dongonab, being attracted by the difference between its polyps and those of *Lobophyllia*. The living colonies resemble each other, but the polyps of the former show their tentacles by day (or at least in the early morning) when those of the latter are retracted". But CROSSLAND gave no description, and nobody else has reported on this genus. Therefore we think our specimen is the first described and figured *Euphyllia* from the Red Sea.

Genus *Plerogyra* MILNE EDWARDS and HAIME, 1848

Type species: *Euphyllia sinuosa* DANA, 1846 (= *Plerogyra laxa* MILNE EDWARDS & HAIME, 1849).

Generic characters: Colonial, forming thick branches, looking submassive. Corallites in long sinuous valleys. Septa exsert to 10 mm, edges and sides smooth. Columella absent.

*Plerogyra sinuosa* (DANA), 1846

(Plate 37, Figs. 4, 5)

<i>Euphyllia</i>	<i>sinuosa</i>	1846, DANA, 168 (Type locality: East Indies).
<i>Plerogyra</i>	<i>sinuosa</i>	1928, MATTHAI, 184; pls. 40/3; 41/3; 42/6; 47/5; 48/8 (synonymy).
		1936, YABE, SUGIYAMA & EGUCHI, 18; pls. 9/5, 6; 11/4.
		1967, SCHEER, 433; fig. 13.
		1971, CHEVALIER, 44; pls. 1/5; 2/2; 37/3, 6.
		1971, LOYA & SLOBODKIN, 125.
		1974, MERGNER & SCHUHMACHER, 265.
		1974, SCHEER & PILLAI, 62; pl. 28/5.
		1976, PILLAI & SCHEER, 70; pls. 28/5; 29/1.
		1980, VERON & PICHON, 362; figs. 638-643, 832-834.
		1980, HEAD, 153, 468.

Valleys range from 10 to 15 cm in length and 15 to 25 mm in width. The major septa are 5 to 8 mm exsert. In some cases (SLR 1247-2) the septa are more thickened at the mid-length than at the top and bottom. Other details as described by MATTHAI (1928), which need no repetition.

Material:

Gulf of Aqaba: Jerus. SLR 1247-2 (Fara'un Isl.); 358 (Marsa Murach); 673 (Marsa Abu Zabad).

T. Aviv NS 6104 (25 m), E51/183 (Eilat).

Basel PW 71 357 (40 m), 73 562 (Fara'un Isl.).

Northern R. S.: HLM X2: 3-45, 49 (Gubal Isl., 15 m).

Southern R. S.: HLM X2: 10-7 (Sarso Isl.).

Distribution: Red Sea; Madagascar; Chagos; Maldives; Nicobars; Malacca; Singapore; Northwest Australia; Philippines; Palau Isls.; Great Barrier Reef; New Caledonia; Marshall Isls.

Genus *Physogyra* QUELCH, 1884

Type species: *Physogyra aperta* QUELCH, 1884 = *Plerogyra lichtensteini* MILNE EDWARDS & HAIME, 1851.

Generic characters: Colonial, branches closely united with their walls. Endotheca highly versicular. Calices in long sinuous valleys. Septa exsert, edges and sides smooth. Columella absent.

*Physogyra lichtensteini* (MILNE EDWARDS & HAIME), 1851

<i>Plerogyra</i>	<i>lichtensteini</i>	1857, MILNE EDWARDS (& HAIME), 205.
<i>Physogyra</i>	<i>lichtensteini</i>	1928, MATTHAI, 186; pls. 63/1; 65/8 (synonymy).
		1936, YABE, SUGIYAMA & EGUCHI, 18; pl. 8/6.
		1954, WELLS, 471; pl. 178/4.
		1971, CHEVALIER, 51; pls. 1/2; 3/1, 2; 37/4.
		1976, PILLAI & SCHEER, 71; pl. 32/2.
		1980, VERON & PICHON, 366; figs. 645–652.
		1980, HEAD, 153, 468.

The genus *Physogyra* is present in the Gulf of Aden with *P. gravieri* and *P. somaliensis* (see VAUGHAN, 1907a), but was not known from the Red Sea. Now for the first time HEAD (1980) has found two specimens of *Physogyra* near Port Sudan, which are not identical with the Gulf of Aden specimens, therefore he designated them as *P. lichtensteini*.

We have no specimen in our collection.

Distribution: Red Sea; Madagascar; Gulf of Thailand; Celebes; Banda Sea; Taiwan; Ryukyu Isls.; Palau Isls.; Great Barrier Reef; New Caledonia; Marshall Isls.

Genus *Gyrosmlia* MILNE EDWARDS and HAIME, 1851

Type species: *Manicina interrupta* EHRENBERG, 1834.

Generic characters: Explanate, pedunculate, surface convex, meandroid. Valleys radiating from the centre, 6 to 10 mm wide, 6 to 8 mm deep. Collines 2 to 3 mm thick with a middle shallow groove, except at the ends. Calicinal centres well defined. Septa 10 to 14 per cm length of collines, larger and smaller ones alternating. Septa exsert (1 to 1.5 mm), exsert parts arched or truncated, edges entire; septa of the opposite side stop at the groove. Septa turn right or left within the valley. Columella absent. Costae present at the periphery of the corallum.

The genus is monospecific.

*Gyrosmlia interrupta* (EHRENBERG), 1834

(Plate 37, Figs. 6–8)

<i>Manicina</i>	<i>interrupta</i>	1834, EHRENBERG, 325 (Type locality: Red Sea, No. 618 in Berlin Museum).
<i>Gyrosmlia</i>	<i>interrupta</i>	1857, MILNE EDWARDS (& HAIME), 203.
		1879, KLUNZINGER 3, 2; pl. 1/8.
		1928, MATTHAI, 188.
		1971, LOYA & SLOBODKIN, 125.
		1974, MERGNER & SCHUHMACHER, 265.
		1980, HEAD, 153, 468.

The characters of this species are those of the genus. The only existing figure appears to be that of KLUNZINGER. We give additional figures of the present material. There are eleven specimens before us. They are all comparatively small, the largest is 11 cm in greater spread (PW 73 522) and is explanate. It shows repeated encrustation. The corallum is very light. PW 71 312 is also explanate with a greater spread of 9 cm. NS 8199 is 8 cm in greater spread. It has a very narrow cylindrical attachment, 5 mm in diameter at the broken site. At the underside costae are prominent. In PW 73 590 the costae are broken up

into short ridges with granules. PW 73 508 is a young colony, 15 mm in spread, with a very narrow attachment, 2 mm in diameter.

**Material:**

- Gulf of Suez: T. Aviv NS 8199 (Ras el Kanisa).  
 Gulf of Aqaba: T. Aviv NS 293, 1239, 1278, E56/55 (Eilat); 1919 (Marsa Murach).  
                   Basel PW 71 312 (40 m), 73 508, 522 (40–43 m), 590 (Eilat).  
 Central R. S.: P. Sud. Sa 58 (Sanganeb R.).

**Distribution:** Red Sea; Aldabra (ROSEN, 1971); Réunion, Mauritius (FAURE, 1977).

Superfamily **Flabellicae** BOURNE, 1905

Family **Flabellidae** BOURNE, 1905

Genus *Flabellum* LESSON, 1831

**Type species:** *Flabellum pavonium* LESSON, 1831.

**Generic characters:** Solitary, free or fixed in the early stage, compressed and fan-shaped. Calicular fossa elongated, deep. Septa very numerous, edges entire, straight or wavy, sides smooth or granular. Columella feeble, sometimes absent, when present papillary.

The only records of this coral genus from Red Sea appears to be those of GARDINER & WAUGH (1938), who have mentioned *F. rubrum* and *F. crateriformis* from a depth of 366 m in the southern part of the Red Sea. The latter species is similar to *Rhizotrochus* (vide infra) in having rootlets from the basal part of the corallite.

*Flabellum crateriformis* (ALCOCK), 1893

*Rhizotrochus crateriformis* 1894, ALCOCK, 170; pl. 8/1, 2 (Type locality: Bay of Bengal).  
 1898, ALCOCK, 24.

*Flabellum crateriformis* 1938, GARDINER & WAUGH, 174.

The following details are based on ALCOCK (1894, 1898). Cornuate, bent or often bowl-shaped. Wall thin and fragile, slightly epithecate. Calices circular or compressed, ratio of length to breadth 5:3. The theca is marked by faint longitudinal and transverse striations. A few rootlets in the form of cylindrical processes stand out at wide angles. Septa narrower at the wall, wider below, so that the first three cycles have the appearance of paliform lobes. Edges of septa entire, sides granular. Three cycles of septa unite to a feeble columella. "The principal septa sunken below the calicular margin give this species a remarkable appearance" (ALCOCK, 1898).

**Distribution:** Red Sea; Bay of Bengal, Indian coast.

**Remarks:** GARDINER & WAUGH (1938) have reported this species from southern Red Sea (Stat. 209, 366 m).

**Additional remarks to genus *Flabellum*:**

GARDINER & WAUGH (1938: 174) mention seven dead specimens as *F. rubrum* from the southern Red Sea at a depth of 366 m (Stat. 209). After SQUIRES (1963: 11) this identification is not correct. As GARDINER and WAUGH give no figure nor description, we can only state these records.

Genus *Rhizotrochus* MILNE EDWARDS and HAIME, 1848

**Type species:** *Rhizotrochus typus* MILNE EDWARDS & HAIME, 1848.

**Generic characters:** Turbinate or compressed, fixed with numerous basal or lateral rootlets. Columella absent. Septal characters similar to *Flabellum*. Epitheca present.



VAUGHAN & WELLS (1943) and WELLS (1956) consider *Rbizotrochus* as synonymous with *Monomyces*, which has only one additional rootlet. ZIBROWIUS (1974a: 22) states that "le nombre de racines ne justifie pas une séparation générique de ces formes". But we separate again the two genera on grounds of the number of its rootlets and feel us in accordance with ZIBROWIUS (personal communication, 1982), who has revised his former opinion.

We could not locate EHRENBERG's type of *Monomyces anthophyllum* in the Museum in Berlin.

### *Rbizotrochus typus* MILNE EDWARDS and HAIME, 1848

(Plate 38, Figs. 1-4)

*Rbizotrochus typus* 1848, MILNE EDWARDS & HAIME, 282; pl. 8/16 (Type locality: Singapore).  
1906a, v. MARENZELLER, 23; pl. 2/5.

MARENZELLER (1906a) was the first, who reported this species from the northern and southern Red Sea from depths of 780 and 212 m respectively (Stat. 165 and 143). We have four specimens before us, collected by Prof. FRICKE with his submersible "Geo" in depths of 130 and 152 m in the Gulf of Aqaba near Eilat.

The biggest one, Fri 41-2, measures 68 x 47 mm, the height of the conical part of the corallum is 35 mm. Number of septa 180, the sixth cycle is nearly complete. Septal margins smooth, lateral faces granular. Septa non-exsert. Columella only very feebly indicated. 16 recognizable rootlets, tubular, mostly broken. The three other specimens are somewhat smaller but similar in every respect. Septa fewer in numbers. No trace of columella.

#### Material:

Gulf of Aqaba: HLM Fri 41-2, 3, 4 (130 m), 46-1 (152 m) (Eilat, lighthouse).

Distribution: Red Sea; Singapore.

Remarks: During the Meseda I Expedition in October 1977 the research ship "Sonne" has trawled two dead specimens of *Rbizotrochus typus* at Station 66 (21°25, 20'N and 21°26, 70'N, both 37°45, 20'E) in depths of 1135 and 1043 m.

### Genus *Javania* DUNCAN, 1876

Type species: *Javania insignis* DUNCAN, 1876.

Generic characters: Solitary or in small clusters. Corallites attached by a pedicel which expands to form a circular or compressed calyx. Major septa exsert with entire or serrated edges. Columella absent. Epitheca present. Costae corresponding to the first two cycles of septa very prominent.

VAUGHAN & WELLS (1943) and WELLS (1956) treated *Javania* as a synonym, and DUNCAN (1884) as a subgenus of *Desmophyllum* EHRENBERG. However, CHEVALIER (1961) gave it the original generic status and showed that it is more related to the genus *Flabellum*. ZIBROWIUS in his revision of the genus *Javania* (1974a) confirmed the belonging of *Javania* to the family Flabellidae.

### *Javania insignis* DUNCAN, 1876

(Fig. 4; Plate 37, Figs. 9-12)

*Javania insignis* 1876, DUNCAN, 435; pl. 39/11-13 (Type locality: Japan).  
1906a, v. MARENZELLER, 23; pl. 2/6.  
*Desmophyllum insignis* 1968, EGUCHI, C41; pl. C9/4-9.  
*Javania insignis* 1974a, ZIBROWIUS, 8; pl. 1/1-6.

This species was first mentioned from the northern Red Sea by MARENZELLER (1906a) from a depth of 825 m (Stat. 81). Prof. FRICKE has collected in the Gulf of Aqaba with his submersible "Geo" two specimens, which we have before us. He reported that he has seen many of these corals in a brilliant white in living condition.

Fri 51-1 is an older specimen with a height of 35 mm, height of the conical part 20 mm. Measurements of the calyx 24 x 18 mm. 69 septa, fifth cycle incomplete. Margin of septa entire, sides granular. No columella. Costae corresponding to lower cycle septa very prominent near the margin of the wall.

The end of the corallum is hollow, also in the side is an opening. A view from below into the hole shows the end of the conical part of the real coral provided with 12 rootlets. The original coral is surrounded by an overcoat of calcareous deposits (Fig. 4) which turns into an epitheca.

The second specimen, Fri 51-2, is a younger form. Calyx 13 to 10 mm, 58 septa, no columella. At the outer side lines of growth are visible parallel to the margin of the wall. the outer calcareous deposits form an encrusting foot, which embraces a round, dead branch of another coral.

**Material:**

Gulf of Aqaba: HLM Fri 51-1 (164 m), 51-2 (170 m) (Eilat, Mar. Biol. Lab.).

**Distribution:** Red Sea; Madagascar; Japan.

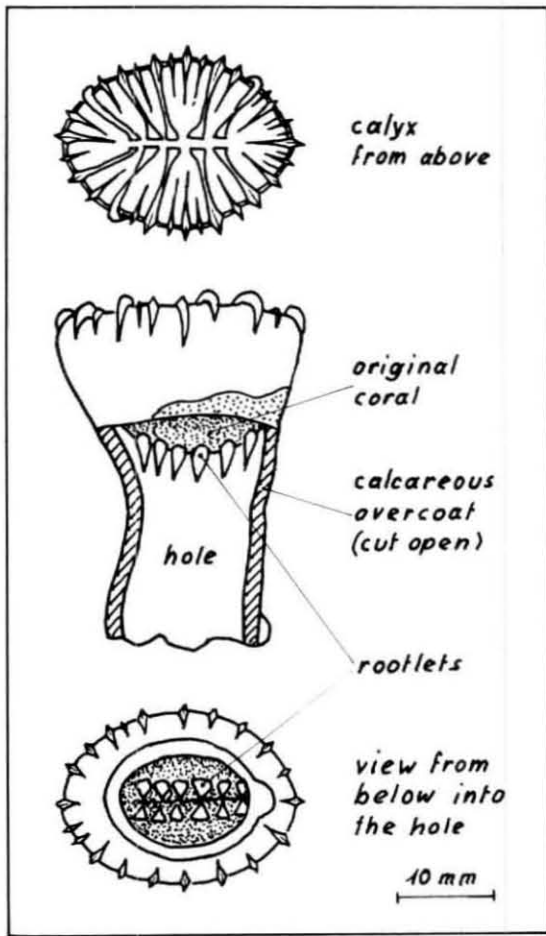

Fig. 4. *Jvania insignis* (diagrammatic sketch).

5. Suborder Dendrophylliina VAUGHAN and WELLS, 1943

Family **Dendrophylliidae** GRAY, 1847

Key to the genera of the family Dendrophylliidae from Red Sea (after VAUGHAN & WELLS, 1943):

- A. Septa arranged according to POURTALES plan in epebic state.
  - 1. Corallum solitary or in clusters, occasionally with buds. . . . . *Balanophyllia*
  - 2. Corallum forming small colonies by extratentacular and stoloniferous budding. . . . *Rhizopsammia*
  - 3. Corallum colonial, tufted or dendroid. . . . . *Dendrophyllia*

- B. Septa appearing normal in ephebic state.
4. Corallites united only basally. Corallum plocoid to dendroid. . . . . *Tubastraea*
  5. Corallites united nearly to their summits, separated by extensive coenenchyme. Corallum plocoid.  
 . . . . . *Turbinaria*

Genus *Balanophyllia* SEARLES WOOD, 1844

Type species: *Balanophyllia calyculus* SEARLES WOOD, 1834.

Generic characters: Solitary, rarely with buds, fixed; trochoid, cornuate, pedunculate or with a broad base. Wall porous. Costae correspond to septa. Septa undergo fusion according to POURTALÈS plan. Columella spongy, projecting or level.

Three species of *Balanophyllia*, viz. *B. rediviva* MOSELEY, *B. gemmifera* KLUNZINGER and *B. diffusa* HARRISON & POOLE were formerly recorded from Red Sea. We add a fourth, which we designate with some hesitation as *B. cumingii* MILNE EDWARDS & HAIME.

Synopsis of the species of *Balanophyllia* known from Red Sea:

1. Corallites solitary, occasionally with buds. Calyx 8 to 11 mm in diameter, depth about 6 to 8 mm. Septa in four complete cycles with an incomplete fifth. Columella elongated, about 5 mm long. Epitheca present. . . . . *B. rediviva*
2. Corallites solitary or in clusters, about 20 mm high, with external buds. Calyx 4 to 6 mm, up to 8 mm in diameter; depth about equivalent to the diameter. Septa in four complete cycles. Major septa thicker and exsert. Columella small. Epitheca present. . . . . *B. gemmifera*
3. Corallites solitary or in clusters, about 20 to 30 mm high, with external buds. Calyx elliptical, 13 by 10 mm, up to 18 by 15 mm; depth less than half the diameter. Septa in five cycles, first two cycles equal and somewhat exsert. Columella well developed, spongy, often extending between the septa of the first two cycles. Epitheca absent. . . . . *B. diffusa*
4. Corallites in small colonies, about 20 mm high. Calyces elliptical, about 17 by 13 mm in diameter; depth more than half the diameter. Septa in five cycles, the fifth incomplete. . . . . *cf. B. cumingii*

*Balanophyllia rediviva* MOSELEY, 1881

*Balanophyllia rediviva* 1881, MOSELEY, 193; pl. 15/10–12 (Type locality: Kei Island).  
 1906a, v. MARENZELLER, 14; pl. 2/1, 1a.  
 1922a, v. d. HORST, 111.

MARENZELLER (1906a) has recorded this species from the deep waters (490 and 900 m, Stat. 179 and 76 resp.) of the northern Red Sea. We have no specimen in our collection.

Distribution: Red Sea; East Indies.

*Balanophyllia gemmifera* KLUNZINGER, 1879

(Plate 38, Figs. 5–7)

*Balanophyllia gemmifera* 1879, KLUNZINGER 2, 55; pls. 8/8a–c; 10/11a–d (Type locality: Koseir, Red Sea; type species No. 2141 in Berlin Museum).  
 1906, v. MARENZELLER, 74.  
 1926, v. d. HORST, 50; pl. 3/8, 9.  
 1971, LOYA & SLOBODKIN, 125.  
 1974, MERGNER & SCHUHMACHER, 265.  
 1980, HEAD, 153, 470.

Corallites solitary or in small clusters formed by several individuals, often with buds at the side. Total height up to 20 mm. Corallites narrower at the base than at the top. Calices rounded or oval, larger ones up to 8 mm in diameter, very deep. Septa in four complete cycles with a few septa of the fifth cycle.

Primaries and secondaries unite with the columella without any fusion. The fifth, fourth and third unite and reach the columella. Septa very little exsert, steeply descending. Primaries and secondaries thickened at the wall, a little broader above than below. Edges of major septa entire, those of higher cycles serrated. Septa perforate behind. Septal sides granular. Columella in a large corallite less than 1 mm broad and about half the diameter of the calyx long, not projecting, suggesting septal fusion. Costae with rows of rounded granules extend to the base of the corallites, which is mostly covered by a thin epitheca.

Material:

- Gulf of Aqaba: Jerus. SLR 647 (Marsa Abu Zabad).  
 T. Aviv NS E55/149 I, 55/156, 55/213 (Eilat); 1844 (Shurat al Manqata); E57/227 (Marsa Abu Zabad).  
 Northern R. S.: Jerus. SLR 1658 (Ras Nasrani).  
 T. Aviv NS 5931 (Ras Muhammad).  
 Central R. S.: P. Sud. Sa 86a (Sanganeb R.).  
 HLM RM 98 (Wingate R.).

Distribution: Red Sea; Seychelles.

Remarks: *Rhodopsammia affinis* (SEMPER, 1872) is very near to the present species. The major difference seems to be in the nature of the columella. i. e. in *R. affinis* it is projecting, while in *B. gemmifera* it is small and level. KLUNZINGER (1879) obviously has not consulted SEMPER's work (1872), as far as one can understand from the list of literature cited by KLUNZINGER. Another species that might ultimately prove to be similar to the present species is *Dendrophyllia serpentina* VAUGHAN, 1907.

*Balanophyllia diffusa* HARRISON and POOLE, 1909

- Balanophyllia diffusa* 1909, HARRISON & POOLE, 906; pl. 85/4a, b (Type locality: Hastings Harbour, Mergui Archipelago).  
 1939, GARDINER & WAUGH, 239; pls. 1/3, 2/4.

This species was recorded from the Red Sea for the first time by GARDINER & WAUGH (1939) from a depth of 366 m (Stat. 209) in the southern part.

Distribution: Red Sea; Maldives; Mergui Archipelago.

Remarks: ZIBROWIUS supposes (pers. comm.) that *B. diffusa* sensu GARDINER & WAUGH is different from the typical form of HARRISON & POOLE.

cf. *Balanophyllia cumingii* MILNE EDWARDS and HAIME, 1848

(Plate 38, Figs. 8, 9)

- Balanophyllia cumingii* 1848, MILNE EDWARDS & HAIME, 87; pl. 1/8 (Type locality: Philippines).  
 1905, BOURNE, 209; pl. 2/7, 7a.  
 1939, GARDINER & WAUGH, 238; pl. 1/1.  
 1968, EGUCHI, C51; pl. C21/7, 8.  
*Rhodopsammia ovalis* 1872, SEMPER, 262; pl. 19/9a, b.

We have one specimen, collected by Prof. FRICKE with his submersible "Geo" in a depth of 138 m, that we place near *B. cumingii*. It consists of two living corallites which seem to be budding out of a now dead corallite. At the base of the broken mother corallite are two smaller ones, now dead and decayed. The two living corallites are about 20 mm high, at the base 10 mm in diameter, the calices measure 17 by 13 mm, depth of calices 9 and 12 mm resp. The longer sides of the calices nearly parallel.

The first two cycle septa are nearly equal, they are perforated towards the thecal ends, and they descend steeply to the columella. Edges of septa sharp, sides covered with granules and fine striations parallel to the margin. The higher cycle septa are narrower and serrated. The tertiaries reach the columella, too; the quarternaries are complete in number and join more or less down to the tertiaries; the septa of the incomplete fifth cycle join to the fourth.

The base of the living corallites is covered with a very thin and inconspicuous epitheca. The costae are covered with short spines, the narrow furrows between them consist of rows of perforations.

We have found no other coral which agrees better to our specimen than BOURNE's *B. cumingii* and SEMPER's *Rhodopsammia ovalis*. After SEMPER the polyps are provided "mit gelben Tentakeln und brillant orangefarbenem Mund". FRICKE described the colour of the polyps as yellow with red oral discs.

Material:

Northern R. S.: HLM Fri 78-3 (Ras Umm Sidd, 138 m).

Distribution: Red Sea; Ceylon; Philippines.

Remarks: If our identification proves correct, this is the first record of the species from the Red Sea.

The taxonomic position of *Balanophyllia* is in a poor state. Many of the so-called species are described on the strength of a single or a limited number of specimens, and many are certainly only ecomorphs or geographical variants. A revision of the genus is most desirable.

Genus *Rhizopsammia* VERRILL, 1869

Type species: *Rhizopsammia pulchra* VERRILL, 1869.

Generic characters: Small colonies, formed by extratentacular budding and by stolon-like expansions, from which new corallites develop. Septa according to POURTALES plan, no paliform lobes, columella spongy, wall porous.

*Rhizopsammia wettsteini* new spec.

(Plate 39, Figs. 1-4)

We have two specimens before us, which we adjoin with some hesitation to the genus *Rhizopsammia*. Both are small colonies formed by extratentacular budding and with stolons bearing young corallites.

The corallites are about 10 mm high, the calices are almost round, 7 to 10 mm in diameter, the largest calyx measuring 11.5 by 10.5 mm. The corallites have a smaller diameter at their base.

Columella loosely packed and spongy. Septa in four complete cycles, fifth and sixth cycle incomplete. Septa of the first two cycles almost identical, sloping downwards from the edge to the columella, which makes the calices appear wide and open. Edges of first two cycle septa irregularly dentate or frayed, only in very few cases are the edges intact. Septa perforated. Sides covered with granules and striations vertically to edge. Septa of higher orders are even more irregularly frayed and perforated. The quarternaries unite beneath the short tertiaries and join the columella. Moreover, they are joined to the first and second septa at the upper margin of the calyx by a spongy network of septa fringes, which makes these twelve points appear thicker. This is particularly evident on the first cycle septa.

Costae, especially in the upper part of the corallite, not clearly visible with numerous granules, often forming reticular ridges, interspersed with numerous perforations.

PW 73 614-1 consists of a principal calyx with two secondary calices on one side. Two ribbed stolons branch out from this colony, one of which has developed a daughter corallite at the end, the upper portion of which is missing. Some specimens of *Polycyathus fuscomarginatus* settle on the substrate supporting the colony.

PW 73 614-2 is also a small colony comprising three corallites with two stolons, each with a small daughter corallite.

The most striking features of *R. wettsteini* are the porosity and sponginess of the coral and its wide open calices.

Material:

Gulf of Aqaba: Basel PW 73 614-1, 2 (Eilat).

Remarks: *Rhizopsammia wettsteini* is named after the late Peter WETTSTEIN, who collected corals in the Gulf of Aqaba as part of Prof. HOTTINGER's work on Foraminifera in 1971 and 1973. His accidental death occurred in December 1975 before he could complete the identification of his corals.

Genus *Dendrophyllia* de BLAINVILLE, 1830

Type species: *Madrepora ramea* LINNAEUS, 1758.

Generic characters: Colonial, ramose, tufted or arborescent, dendroid. Colony formation by extratentacular budding. Corallites cup-shaped. Wall costate, porous. Septa undergo fission according to POURTALÈS plan. Columella spongy, often honeycomb-shaped.

Earlier records of *Dendrophyllia* from Red Sea include *D. micranthus*, which we now group with *Tubastraea*, and *D. fistula*, a deep-water species. A further species, *D. arbuscula*, is described in the present work. Prof. FRICKE could add four more species, *D. horsti*, *D. robusta*, *D. cf. cornigera* and *D. cf. minuscula*, collected during deep-water diving trips with the submersible "Geo".

Synopsis of the *Dendrophyllia* species known from Red Sea:

## A. Corallum elongated, ramose.

1. Main corallite long, vermiform. Subsidiary corallites thinner, arranged irregularly, twisted. . . . *D. fistula*
2. Corallum dendroid. Subsidiary corallites short, arranged regularly, thinner than main corallite. . . . *D. cf. minuscula*

## B. Corallum tufted.

## I. Colony relatively small. Calices almost round.

3. Calices up to 8 mm in diameter. Corallites up to 15 mm high. . . . *D. arbuscula*
4. Calices up to 11 mm in diameter. Corallites up to 25 mm high. Columella strikingly compact and vaulted upwards. . . . *D. horsti*

## II. Colony relatively large. Calices more or less oval.

5. Calyx dimensions up to 14 by 11 mm. Height of corallites up to 30 mm. . . . *D. cf. cornigera*
6. Calyx dimensions up to 24 by 16 mm. Height of corallites up to 40 mm. Theca of adult corallites strikingly thick. . . . *D. robusta*

*Dendrophyllia fistula* (ALCOCK), 1902

<i>Balanophyllia fistula</i>	1902, ALCOCK, 42; pl. 5/36, 36a (Type locality: Sulu Sea).
<i>Thecopsammia fistula</i>	1906a, v. MARENZELLER, 16; pl. 1/a-h.
<i>Dendrophyllia fistula</i>	1939, GARDINER & WAUGH, 237.
	1954, WELLS, 472; pl. 180/1-3.
	1964, WELLS, 116; pl. 2/4, 5.

The following details of this species are taken from the authors listed above. Corallum composed of long slender corallites of mostly uniform thickness with buds in different angles. Surface of the vermiform corallites with or without an epitheca. Calices oval, 7 by 6 mm (in the type) up to 10 by 8 mm in diameter. Septa in four cycles, not exsert. Primaries are largest, the fourth cycle slightly larger than the third, the former uniting with the latter. First three cycles of septa reach a spongy, deep-seated columella. Septa thickened at the wall. Outer side of corallites costate.

The only record of this deep-water species from the Red Sea is that of MARENZELLER (1906a), who mentioned its occurrence at depths of 490 (Stat. 179), 720 (Stat. 178) and 900 m (Stat. 76) in the northern part.

Distribution: Red Sea; Maldives; Japan; Queensland; Marshall Isls.

*Dendrophyllia cf. minuscula* BOURNE, 1905

(Plate 39, Figs. 5-10)

<i>Dendrophyllia minuscula</i>	1905, BOURNE, 213; pl. 2/11, 11A (Type locality: Ceylon).
	1922a, v. d. HORST, 103; pl. 8/30.

Prof. FRICKE with his submersible "Geo" collected at two places a remarkable *Dendrophyllia* which we cannot identify unequivocally and which we group with *D. minuscula*. It could, however, also be a deep-water ecomorph of another *Dendrophyllia* species. The branchlets collected are fragments of colonies 30 to 40 cm large, and clearly belong to two different forms.

(1) The branchlets collected at Sharm esh Sheikh at a depth of 126 m are slender. The daughter corallites are up to 8 mm long, relatively dispersed and more or less on the same plane. The costae of the corallites and branchlets, on which they are located, are narrow and feature a series of fine teeth.

(2) In contrast, the specimens collected near Eilat in a depth of 150 m are more compact, the daughter corallites are closer together and are arranged all around the branch, measuring up to 5 mm only. The costae of the corallites and branchlets are irregular. A dominant feature are the furrows separating the costae with numerous short or elongated perforations.

The calices of both forms measure 3 to 4.5 mm in diameter, are slightly oval and occasionally somewhat hexagonal. The first three septa cycles are complete, the septa of the second cycle relatively short, the fourth and fifth cycles are incomplete.

**Material:**

Gulf of Aqaba: HLM Fri 37-1 (Eilat, Aquarium, 150 m).

Northern R. S.: HLM Fri 92-3 (Sharm esh Sheikh, 126 m).

**Distribution:** Red Sea; Ceylon; Kei Isls. (Banda Sea).

**Remarks:** This is the first time that this species has been recorded in the Red Sea.

Dr. ZIBROWIUS has kindly shown us some specimens of an unidentified *Dendrophyllia* from South Africa, very similar to ours and perhaps of the same species. But further investigations will be required to clarify the relationship of all these *Dendrophyllia* specimens.

*Dendrophyllia arbuscula* v. d. HORST, 1922

(Plate 40, Figs. 1-3)

*Dendrophyllia arbuscula* 1922a, v. d. HORST, 105; pl. 8/6 (Type locality: Kei Islands and Dammer Island, Banda Sea).  
1968, EGUCHI, C55; pl. C21/5, 13.  
1974, SCHEER & PILLAI, 64; pl. 29/4, 5.  
1976, PILLAI & SCHEER, 71.

The present specimens are all tufted dendroid colonies with corallites radiating from a central stem. Maximum height 3.5 cm. Corallites, when fully formed, measure 7 to 8 mm in diameter at the top, with a maximum height of 15 mm from the stem. Adult ones feature small buds at their sides. Depth of calices 5 to 6 mm. Wall very thin. Septa in four complete cycles with a set of the fifth, arranged according to POURTALÈS plan. The first two cycles join the columella. Septa of the third cycle are short and mostly free. Those of the fifth link to the fourth, and the latter in turn form pairs and unite with the columella. Septa of the first two cycles are serrated. Septa with perforations. Columella trabecular, projecting. Inter-costal spaces thinner than the costae.

**Material:**

Gulf of Suez: Jerus. SLR 856-3 (Et Tur).

Gulf of Aqaba: Jerus. SLR 1384-2 (Wadi Treibe).

T. Aviv NS 1368-1, 2, E52/23 (Eilat).

Northern R. S.: T. Aviv NS 5930 (Ras Muhammad).

HLM X2: 3-48 (1, 2) (Gubal Isl.); 5-2 (Ghardaqa).

Central R. S.: HLM X2: 7-1 (Mayetib Isl.).

**Distribution:** Red Sea; Maldives; Nicobar Isls.; East Indies; Japan.

*Dendrophyllia horsti* GARDINER and WAUGH, 1939

(Plate 39, Figs. 11, 12)

*Dendrophyllia horsti* 1939, GARDINER & WAUGH, 237; pl. 2/5, 6 (Type locality: Ari Atoll, Maldives).

We have two specimens in our material, which were collected by Prof. FRICKE with his submersible "Geo" at depths of 125 and 115 m. The most striking characteristic of this species is the dense oval columella which is vaulted upwards.

Fri 45-2 is a colony, about 40 mm high, with seven corallites. Two are always of about the same age and sprout from the axial corallite. Length of corallites 15 to 25 mm, diameter of the calices up to 11 mm, slightly longer than broad. Septa in four complete cycles. First cycle septa join at the thecal rim with the neighbouring fourth and form six exsert groups. The fourth cycle septa unite shortly before meeting the columella. Third cycle septa are the shortest. The costae are equal with little projection.

The second specimen, Fri 115-1, consists of a corallite of about 25 mm length with two buds, one is broken, the other about 10 mm long. The diameters of the two calices are 8 and 6 mm. Both corallites are damaged, but we believe that the specimen belongs to the species under consideration.

**Material:**

Gulf of Aqaba: HLM Fri 45-2 (Eilat, lighthouse, 125 m).

Northern R. S.: HLM Fri 115-1 (Ras Umm Sidd, 115 m).

**Distribution:** Red Sea; Maldives.

**Remarks:** Prof. FRICKE reported in a private conversation that this species is very abundant at great depths. It was found for the first time in the Red Sea.

*Dendrophyllia cf. cornigera* (LAMARCK), 1816

(Plate 40, Figs. 4, 5)

<i>Caryophyllia</i>	<i>cornigera</i>	1816, LAMARCK, 228 (Type locality: Indian Ocean ?).
<i>Dendrophyllia</i>	<i>cornigera</i>	1860, MILNE EDWARDS (& HAIME), 118.
		1904, v. MARENZELLER, 313; pl. 18/21.
		1920, GRAVIER, 104; pl. 12/186-192.
		1926, v. d. HORST, 44.
		1980, ZIBROWIUS, 172; pl. 87/A-J.

One colony, 18 by 14 cm, has been brought up, collected by Prof. FRICKE with his submersible "Geo" at a depth of 138 m. The largest part of this colony is dead and overgrown with calcareous algae. The branches coming from a thick stem bear 14 living corallites, 15 to 25 mm long (the largest 30 mm). The calices are somewhat oval with diameters from 10-12 by 8-10 mm, the largest calyx measuring 14 by 11 mm. Septa in four cycles. Columella well developed. Costae covered with granules separated by numerous rows of perforations.

Although it was not possible to identify this *Dendrophyllia* with absolute accuracy it can provisionally be grouped with *cornigera*, as most of its features are similar to this species.

**Material:**

Northern R. S.: HLM Fri 78-1 (Ras Umm Sidd, 138 m).

**Distribution:** Mediterranean; Atlantic; South Africa; Red Sea; Amirantes; Providence Isl.; Maldives; Arafura Sea.

**Remarks:** *Dendrophyllia subcornigera* YABE & SUGIYAMA from Japan, described and figured in EGUCHI 1968, C64, pl. C32, figs. 3, 4, is very similar to the present specimen.

ZIBROWIUS (1980) assumes that all references to *D. cornigera* outside the Mediterranean and the Atlantic are based on incorrect identifications. He writes: "Certaines indications sur une plus large répartition (sinon le cosmopolitisme) de *D. cornigera* semblent s'expliquer par des confusions avec d'autres espèces". Only a comprehensive revision of the genus *Dendrophyllia* can clarify this relationship.

Until more accurate information is available we shall assume the species to be new for the Red Sea.

*Dendrophyllia robusta* (BOURNE), 1905

(Plate 40, Figs. 6, 7)

<i>Lobosammia</i>	<i>robusta</i>	1905, BOURNE, 212; pl. 2/10, 10A (Type locality: Ceylon).
<i>Dendrophyllia</i>	<i>robusta</i>	1939, GARDINER & WAUGH, 235.



Three specimens of this species are available, collected by Prof. FRICKE with his submersible "Geo" at a depth of 125 m. The larger one, Fri 45-1, 20 cm long and 15 cm high, has 12 living corallites at the ends of the branches. The rest of the bushy colony is covered with calcareous algae, bryozoans, serpulids, shells and so on. The calices are oval and measure up to 24 by 16 mm. Septa in five cycles, first two cycles subequal, edges sloping down vertically to the spongy columella. Edges of the higher orders of septa denticulated. Wall thick. Costae fine with perforated furrows. The smaller specimen, Fri 45-3, corresponds to that shown in BOURNE (1905, pl. 2, fig. 10). The third specimen, Fri 45-4, one living and one dead corallite, is attached to the substrate which bears *D. horsti* (Fri 45-2).

Material:

Gulf of Aqaba: HLM Fri 45-1, 3, 4 (Eilat, lighthouse, 125 m).

Distribution: Red Sea; South coast of Arabia; Ceylon.

Remarks: We cannot agree with GARDINER & WAUGH (1939) who consider *D. klunzingeri* (HORST, 1926, figured in HORST, 1922a, pl. 8, fig. 21, as *D. coccinea*) as identical to the present species. This is the first record of *D. robusta* occurring in the Red Sea.

Genus *Tubastraea* LESSON, 1834

Type species: *Tubastraea coccinea* LESSON, 1834.

Generic characters: Subplocoid to dendroid, budding from edge zone or from the base of the corallite. Corallites united by feebly costate coenosteum. Living tissue red to orange or black to dark green.

Remarks: BOSCHMA (1953) has expatiated in detail upon *Tubastraea*. However, we feel in accordance with ZIBROWIUS (in WIJSMAN-BEST, FAURE & PICHON, 1980: 621), when he states that the genus *Tubastraea* is badly known and has to be revised urgently. Therefore we consider the following synopsis of the genus, based on the growthform, not as a definite one.

Synopsis of *Tubastraea* from the Red Sea.:

- A. Corallum subplocoid. Budding from the coenosteum between the corallites.
1. Corallites 8 to 10 mm in diameter, up to 12 mm high, 5 to 6 mm deep. Septa in three cycles, the first two well developed, scarcely exsert. Columella small, to which the first two cycles unite. Polyps reddish. . . . . *T. aurea*
- B. Corallum subdendroid. Budding from the edge zone of corallites.
2. Budding mostly basally. Corallites 8 to 10 mm in diameter, up to 15 mm high, seldom 20 mm. Septa in four cycles, the fourth mostly incomplete. Septa of the first two cycles reach the more or less well developed columella. Polyps brown. . . . . *T. diaphana*
  3. Budding mostly marginally or laterally. Corallites 8 to 12 mm in diameter, 15 to 30 mm high. Septa in four complete cycles, those of the third and fourth cycle inconspicuous. Columella well developed. Polyps orange red. . . . . *T. coccinea*
- C. Corallum dendroid.
4. Branches 10 to 20 mm thick, repeatedly dividing, with lateral corallites. Corallites 5 to 8 mm in diameter, 10 to 15 mm long. Septa in three cycles, the tertiaries sometimes incomplete and inconspicuous. Columella more or less developed. Polyps blackish. . . . . *T. micranthus*

*Tubastraea aurea* (QUOY and GAIMARD), 1833

(Plate 40, Fig. 8)

<i>Lobophyllia aurea</i>	1833, QUOY & GAIMARD, 195; pl. 15/7-11 (Type locality: Society Islands).
<i>Dendrophyllia aurea</i>	1926, v. d. HORST, 46; pl. 2/1-4, 8a, b, 9a, b.
<i>Tubastraea aurea</i>	1953, BOSCHMA, 112-117; pls. 9/5, 6; 10/2, 6; 11/2, 4-6; 12/1-6. 1968, EGUCHI, C68; pls. C16/5, 6; C17/17; C26/2, 3 (synonymy). 1976, PILLAI & SCHEER, 72. 1980, HEAD, 172, 470.

	<i>coccinea</i>	1834, LESSON, 515; pl. 1.
<i>Coenopsammia</i>	<i>ebrenbergiana</i>	1860, MILNE EDWARDS (& HAIME), 127. 1879, KLUNZINGER 2, 56; pl. 8/9. 1889, ORTMANN, 512. 1906, v. MARENZELLER, 74.
<i>Dendrophyllia</i>	<i>manni</i>	1907, VAUGHAN, 156; pl. 46/6, 6a, 7, 7a.
<i>Coenopsammia</i>	<i>willeyi</i>	1899, GARDINER, 359; pl. 34.

The characters of the species are already summarized under the synopsis of *Tubastraea*. Though we have some colonies of *Tubastraea* in the present collection, only one seems to be referable to this species.

Material:

Gulf of Aqaba: Jerus. SLR 1384-1 (Wadi Treibe).

Distribution: Red Sea; Madagascar (PICHON, 1964); Chagos; Maldives; Gulf of Mannar (PILLAI, 1972); Ceylon; Mergui Archipelago; Cocos-Keeling Isls.; Singapore; East Indies; Japan; Great Barrier Reef; Loyalty Isls.; Fanning Isls.; Society Isls.; Hawaii Isls.

Remarks: We consider, with other authors, *Dendrophyllia manni* and *Coenopsammia willeyi* as synonym with *Tubastraea aurea*. Already VAUGHAN (1918: 144) wrote: "I should not be surprised if large suites of specimens showed that *D. aurea*, *D. danae*, *D. manni* and *D. willeyi* were variants of the same species".

Another species of *Tubastraea* is *T. tenuilamellosa* (MILNE EDWARDS & HAIME). BOSCHMA (1953: 110) writes: "it is by no means certain that *T. tenuilamellosa* is specifically distinct from *T. aurea*, because the characters on which distinction is based are subject to variation". When the two species prove to be the same, then *T. aurea* extends its distribution to Galapagos, Gulf of California and Westindies, and becomes one of the few cosmopolitan corals.

CAIRNS (1979: 205) states that from the western Atlantic shallow-water ahermatypic scleractinia "only one species is circumtropical, *Tubastraea coccinea*". It seems that CAIRNS gives priority to *T. coccinea* before *T. aurea*. In Table 4 (1979: 207) he mentions "*Tubastraea coccinea* LESSON, 1831" instead of 1834 as usual, but he gives no reference for LESSON, 1831.

*Tubastraea diaphana* (DANA), 1846

(Fig. 5; Plate 41, Figs. 1-4)

<i>Dendrophyllia</i>	<i>diaphana</i>	1846, DANA, 389; pl. 27/3 (Type locality: Singapore). 1872, VERRILL, 384. 1918, VAUGHAN, 144; pl. 60/2, 2a, 3, 3a. 1925, HOFFMEISTER, 48.
----------------------	-----------------	--

We refer most of our *Tubastraea* colonies with some doubts to this species. It differs from *T. aurea* mainly in the elevation of the corallites (10 to 20 mm) and the greater depth of calices, in the mostly subdendroid form of budding and in the colour of the living tissue. One of us (SCHEER) has examined DANA's type, No. 180 in the U.S. National Museum (Fig. 5).

Material:

Gulf of Aqaba: T. Aviv NS 254, E56/257 (Eilat).

Northern R. S.: HLM X2: 3-23 (Gubal Isl.).

Central R. S.: HLM RM 50-1, 2, 50a (Wingate R.).

Distribution: Red Sea; Cocos-Keeling Isls.; Singapore; Great Barrier Reef (STEPHENSON & WELLS, 1956); Fiji (QUELCH, 1886); Samoa (HOFFMEISTER, 1925).

Remarks: BOSCHMA (1953: 113) expresses the opinion, that "*Dendrophyllia diaphana* DANA in all probability is a young colony of *Tubastraea aurea* (QUOY & GAIMARD)". However, we consider the species as different from *T. aurea* and report it for the first time from the Red Sea.

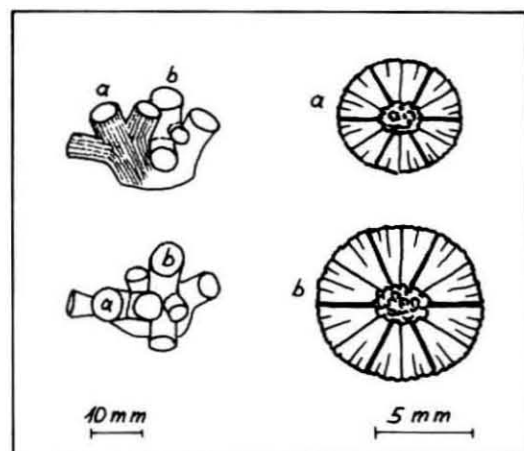

Fig. 5. *Dendrophyllia diaphana* DANA, Type USNM 180 (according to a rough drawing made at the USNM in 1974).

*Tubastraea coccinea* (EHRENBERG), 1834

(Plate 41, Figs. 5, 6)

<i>Oculina</i>	<i>coccinea</i>	1834, EHRENBERG, 304 (Type locality: Red Sea).
<i>Coenopsammia</i>	<i>coccinea</i>	1879, KLUNZINGER 2, 57; pl. 10/12a, b. 1906, v. MARENZELLER, 74.
<i>Dendrophyllia</i>	<i>coccinea</i>	1980, HEAD, 172, 470.

We have no specimen of this species in our collection, but Dr. KUEHLMANN of the Museum für Naturkunde Berlin has kindly sent us EHRENBERG's type No. 1058, which is shown on plate 41, fig. 5. Characteristic for this species are the long corallites, up to 30 mm and the buds near the calicinal margin.

Material: Red Sea: Berlin ZMB 1058.

Distribution: Red Sea.

Remarks: Most of the species, described as *coccinea* in literature, do not correspond with EHRENBERG's type No. 1058 and KLUNZINGER's description.

*Dendrophyllia coccinea* DANA (1846: 388, pl. 27, fig. 4, = *D. danai* VERRILL, 1872) is a real *Dendrophyllia* because of the septal arrangement according to POURTALÈS plan, and therefore it cannot belong to *Tubastraea*. One of us (SCH.) has studied the type specimen No. 182 in the U.S. National Museum.

*Dendrophyllia coccinea* v. d. HORST (1922a: 107, pl. 8, fig. 21) was altered in *D. klunzingeri* by v. d. HORST (1926).

*Dendrophyllia coccinea* v. d. HORST (1926: 45, pl. 3, figs. 1–3) differs in several aspects from the present species: (1) The septa are arranged according to POURTALÈS plan, therefore it cannot be a *Tubastraea*. (2) The calices are considerably deeper than stated in KLUNZINGER (on an average 13.3 mm instead of 5 mm). (3) The costae are narrower than the intercostal furrows and they have a sharp edge. According to KLUNZINGER the ribs are flat, broad and densely covered with little grains and with narrow furrows in between.

BOSCHMA (1953: 113) states: "*Dendrophyllia coccinea* DANA is conspecific with *Oculina coccinea* EHRENBERG". Considering the criteria already mentioned this cannot be true.

Also figures 1–3 on plate 30 in SCHEER & PILLAI (1974) cannot represent *T. coccinea* (EHRENBERG).

We do not know which form HEAD (1980) has in mind when talking about his *T. coccinea*.

Considering all these examples it can only be repeated that the genus *Tubastraea* requires urgently a revision.

*Tubastraea micranthus* (EHRENBERG), 1834

(Plate 41, Figs. 7, 8)

<i>Oculina</i>	<i>micranthus</i>	1834, EHRENBERG, 304 (type locality unknown).
<i>Coenopsammia</i>	<i>micranthus</i>	1879, KLUNZINGER 2, 58; pls. 7/13; 10/13 (No. 2131 in Berlin Museum). 1888, ORTMANN, 161.

<i>Dendrophyllia micranthus</i>	1922a, v. d. HORST, 101 (synonymy). 1926, v. d. HORST, 43; pl. 2/6, 7. 1952, CROSSLAND, 171; pls. 55/1; 56/1. 1954, ROSSI, 43; pl. 2/4. 1974, SCHEER & PILLAI, 63; pl. 29/3. 1980, HEAD, 153, 470.
<i>Tubastraea micrantha</i>	1971, LOYA & SLOBODKIN, 125. 1974, MERGNER & SCHUHMACHER, 265.
<i>Coenopsammia nigrescens</i>	1860, MILNE EDWARDS (& HAIME), 129; pl. E2/2a, b.
<i>Dendrophyllia nigrescens</i>	1846, DANA, 387; pl. 30/1, 1a-f (should be pl. 27). 1918, VAUGHAN, 143; pl. 60/1, 1a.

This arborescent species is represented in our material by several broken branches. The pieces are 10 to 15 cm high with a thickness of 12 to 17 mm at the main division. Main branches repeatedly dividing. Corallites 5 to 6 mm in diameter, height 10 to 12 mm. Calices circular, corallites slightly expanding towards the top. Depth 4 to 5 mm. Septa in three cycles, the tertiaries sometimes incomplete. There is no visible fusion of septa. Primaries larger than secondaries. Third cycle often small. Twelve septa reach the columella. Columella poorly developed. Costae conspicuous with transverse connections.

Material:

Gulf of Aqaba:	Jerus.	SLR	376-1-8 (Marsa Murach); 1384-3 (Wadi Treibe); 1168-1-6 (Marsa el Muqeibla).
	T. Aviv	NS	1369 (Eilat).
Northern R. S.:	Jerus.	SLR	817-1-3, 819b, 1926-1, 2 (Ras Muhammad).
	HLM	EC	434 (Ras Muhammad).
		X2:	5-1 (Ghardaqa).
Central R. S.:	HLM	X2:	7-2 (Mayetib Isl.).
	P. Sud.	Sa	82, 83 (Sanganeb R.).

Distribution: Red Sea; Seychelles; Aldabra; Mauritius; Maldives; Ceylon; Nicobar Isls.; Cocos-Keeling Isls.; Philippines; Japan; Palau Isls.; Great Barrier Reef; Fiji.

Remarks: v. d. HORST (1922a) states that "there is no real difference between the species of DANA (*nigrescens*) and that of EHRENBERG (*micranthus*)". But CROSSLAND (1952) regards the two species as quite distinct and gives differences between them. We follow v. d. HORST, until the genus has got a thorough revision. We agree with ROSEN (1979) that *Dendrophyllia micranthus* "is now regarded as a *Tubastraea*", but it should be considered whether MILNE EDWARDS and HAIME's generic name *Coenopsammia*, also used by KLUNZINGER, could be reintroduced.

#### Genus *Turbinaria* OKEN, 1815

Type species: *Madrepora crater* PALLAS, 1766.

Generic characters: Colonial, explanate, crateriform, submassive or foliaceous. Corallites united by a porous coenosteum. Surface with a well defined system of ridges and furrows. Corallites range from 2 to 10 mm in diameter. Columella well developed.

EHRENBERG (1834) reported *Turbinaria cinerascens* from Red Sea. KLUNZINGER (1879) regarded *T. mesenterina* LAMARCK as synonym to *T. cinerascens* and added *T. conica*. Moreover BERNARD (1896) listed *T. aspera* from Red Sea. Subsequently MARENZELLER (1906) reported *T. ehrenbergi* and *T. tenuis*. However, WAUGH (1936) made a field study of the *Turbinaria* of the Red Sea, which enabled her to state that all the above mentioned six species of *Turbinaria*, reported from Red Sea, are one and the same, viz *T. mesenterina*. The present specimens, numbering 30, display wide skeletal variation, but we treat them under a single species as follows.

#### *Turbinaria mesenterina* (LAMARCK), 1816

(Plate 41, Figs. 9, 10)

*Explanaria mesenterina* 1816, LAMARCK, 255 (Type locality: Indian Ocean; shown on pl. 19, fig. 60 in MARENZELLER, 1906).

<i>Turbinaria</i>	<i>mesenterina</i>	1860, MILNE EDWARDS (& HAIME), 166; pl. E1/1a, b. 1879, KLUNZINGER 2, 50; pl. 6/11. 1896, BERNARD, 57; pls. 15; 32/10 (synonymy). 1936, WAUGH, 913; pls. 1; 2/2, 2a, 3; figs. 1–6. 1941, CROSSLAND, 50. 1954, ROSSI, 44. 1967, SCHEER, 433. 1974, MERGNER & SCHUHMACHER, 265. 1976, PILLAI & SCHEER, 73. 1980, HEAD, 172, 470.
	<i>aspera</i>	1896, BERNARD, 56; pls. 15; 32/9.
<i>Explanaria</i>	<i>cinerascens</i>	1834, EHRENBERG, 306 (No. 967 in Berlin Museum).
<i>Turbinaria</i>	<i>conica</i>	1879, KLUNZINGER 2, 51; pl. 6/15. 1896, BERNARD, 58. 1906, v. MARENZELLER, 71; pl. 19/56–59.
	<i>ebrenbergi</i>	1906, v. MARENZELLER, 70; pl. 20/61–64.
<i>Madrepora</i>	<i>incrustans</i>	1775, FORSKAL, 135. 1776, FORSKAL, 12; pl. 37/C (?).
<i>Cyphastraea</i>	<i>incrustans</i>	1879, KLUNZINGER 3, 53.
<i>Turbinaria</i>	<i>sp.</i>	1971, LOYA & SLOBODKIN, 125.
	<i>tenuis</i>	1906, v. MARENZELLER, 72; pl. 20/65, 65a.

The present specimens show considerable variation in growthform and calicular characters, that we give below a general description.

**Growthform:** Encrusting, nodular (NS 4900), explanate and thin (X2: 9–18) with a narrow attachment, or explanate and thick with a broad attachment base (RM 22); foliaceous with thin edges (X2: 9–17), or the edges forming curled cylindrical or funnel-shaped structures.

**Corallites:** Circular, projecting, conical (PW 73 589) or level (RM 99). Diameter 2.5 to 3 mm at the top, 5 mm at the base. Height up to 5 mm. Shallow or up to 1 mm deep.

**Septa:** Generally 18 to 20, in some large calices up to 24. Subequal, projecting to half radius circle, or narrow and steeply descending in some of the conical corallites. All the septa reach the columella.

**Columella:** Conspicuous, either plate-like with a vertical ridge or projecting, conical, honeycomb-shaped.

**Coenenchyme:** Very finely echinulate, spines very closely set, ridge and furrow system conspicuous.

**Material:**

Gulf of Aqaba:	Jerus.	SLR	456–1, 2 (El Kura).
	T. Aviv	NS	243, 1364–1, 2, E52/24 (Eilat); 4900 (Wassit); 4933 (Dahab).
	Basel	PW	73 517, 589, 608a, c (Eilat); 1 exempl. without No.
Northern R. S.:	USNM	Wa	97, 98 (Ghardaqa).
	HLM	EC	435 (Ras Muhammad); 504 (Safaga Isl.).
		X2:	2–2, 12, 20 (Gubal Isl.).
Central R. S.:	P. Sud.	Sa	38 (Sanganeb R.).
	HLM	RM	22, 99 (Wingate R.).
Southern R. S.:	HLM	X2:	9–17, 18, 27, 28 (Sarso Isl.).
		EC	414, 415, 416 (Massawa).

**Distribution:** Red Sea; Somaliland; Rodriguez; Maldives; Northern Lakshadweep (PILLAI, unpubl.); Carolina Isls.; Marshall Isls.

### III. Annex

#### Acknowledgments

We are indebted to authorities, institutes, museums and numerous individuals without whose help the present work could not have been written. SCHEER thanks the Hessische Kultusminister Wiesbaden and the Hessische Landesmuseum Darmstadt for the possibility to organize an expedition to the Red Sea in 1962 with the purpose of collecting corals. Furthermore, he expresses his thanks to Prof. Dr. Hans HASS, head of the 2nd Xarifa Expedition 1957/58 for the opportunity to participate in this expedition, which gave him the chance to collect corals in various parts of the Red Sea. PILLAI gratefully acknowledges the award of a fellowship by the Alexander von Humboldt Foundation, Bonn—Bad Godesberg, which enabled him to work on the Red Sea corals together with SCHEER at the Hessische Landesmuseum Darmstadt in 1978/79. He is thankful to the Director, Central Marine Fisheries Research Institute Cochin, for permission to undertake this work. He thanks the authorities of the Museum, especially Dr. H. FEUSTEL, head of the Zoological Department, for the unreserved help and facilities provided during his tenure there.

We, the authors, wish to express our sincere gratitude to our colleagues who most willingly sent us their valuable coral collections. We received large collections from: Prof. Dr. F. D. POR, The Hebrew University Jerusalem, Department of Zoology; Prof. Dr. L. FISHELSON, Tel Aviv University, Zoology Department; Prof. Dr. L. HOTTINGER, Universität Basel, Geologisch-Paläontologisches Institut; Dr. K. RUETZLER, U.S. National Museum of Natural History, Washington; Prof. Dr. J. SCHROEDER, Institute of Oceanography, Port Sudan; J. HÖLLOSI, sports teacher, Neu-Ulm.

Further collections were received from: Prof. Dr. H. MERGNER, Universität Bochum, Institut für Spezielle Zoologie; Dr. D. H. H. KUEHLMANN, Museum für Naturkunde Berlin, Zoologisches Museum; Prof. Dr. H. FRICKE, Max-Planck-Institut für Verhaltensphysiologie, Seewiesen; Dr. W. JAAP, Marine Research Laboratory, St. Petersburg (Florida); Dr. H. FEUSTEL, Hessisches Landesmuseum Darmstadt, Zoologische Abteilung.

We got small collections and single corals from: Dr. H. SCHUHMACHER, Universität Bochum, Institut für Spezielle Zoologie; Prof. Dr. I. EIBL-EIBESFELDT, Max-Planck-Institut für Verhaltensphysiologie, Seewiesen, Forschungsstelle für Humanethologie; Prof. Dr. W. SCHAEFER †, Forschungs-Institut Senckenberg, Frankfurt a. M.; Prof. Dr. D. B. E. MAGNUS, Technische Hochschule Darmstadt, Zoologisches Institut; Stud. Ref. D. PASCHKE, Universität Stuttgart, Biologisches Institut; Dr. M. WIJSMAN-BEST, Rijksmuseum van Natuurlijke Historie, Leiden.

Moreover, we are grateful to all those who contributed to the completing of this work by making helpful suggestions, additions and comments, and by putting at our disposal photos and comparative material, including types. We want to mention: Dr. J.-P. CHEVALIER †, Muséum Nationale d'Histoire Naturelle, Paris; Dr. S. M. HEAD, University of Oxford, Department of Zoology; Prof. Dr. LEVI, Muséum Nationale d'Histoire Naturelle, Paris; Stud. Ref. D. PASCHKE, Universität Stuttgart, Biologisches Institut; Prof. Dr. M. PICHON, James Cook University of North Queensland, Townsville; Dr. H. SCHUHMACHER, Universität Bochum, Institut für Spezielle Zoologie; Prof. Dr. J. W. WELLS, Cornell University Ithaca; Dr. H. ZIBROWIUS, Station Marine d'Endoume, Marseille.

Our special thanks go to Dr. D. KUEHLMANN and Mrs. K. KUEHLMANN, Museum für Naturkunde Berlin, who showed us their EHRENBERG and KLUNZINGER types and who gave us the opportunity to look at the corals KUEHLMANN himself had collected in the Red Sea. We thank Mrs. V. KOPSKE, the photographer of the Berlin Museum, for valuable coral photos.

For providing literature on the subject we are grateful to: Dr. Z. DINESEN, Australian Institute of

Marine Science, Cape Ferguson; Dr. H. DITLEV, University of Aarhus, Institute of Genetics and Ecology; Prof. Dr. Y. LOYA, Tel Aviv University, Zoology Department; Prof. Dr. H. MERGNER, Universität Bochum, Institut für Spezielle Zoologie; Dr. B. R. ROSEN, British Museum (Natural History) London; Dr. J. E. N. VERON, Australian Institute of Marine Science, Cape Ferguson; Dr. C. WALLACE, James Cook University of North Queensland, Townsville; Dr. M. WIJSMANN-BEST, Rijksmuseum van Natuurlijke Historie, Leiden.

In addition, we are thankful to: Mrs. A. SCHEER, Darmstadt, for assistance in compiling the Index, thorough text revision and assistance in reading the proofs; Mrs. U. DOERKEN-SCHEER and Mrs. M. EBINGER, Bornheim, for translating various parts of the manuscript; W. KUMPF, Hessisches Landesmuseum Darmstadt, for taking photos of part of the corals, and for making all enlargements, assisted by E. MANTHEI; H. MUELLER, Darmstadt, for the graphic design of the tables.

Finally, we thank the Alexander von Humboldt Stiftung for subsidizing the printing costs of this work.

### Abstract

A historical survey on Red Sea coral research covers the period from the first coral illustration of T. SHAW (1738) to H. FRICKE's submersible, which he used in 1981 to dive down to a depth of 200 m and to collect corals. The research work proper started with P. FORSKÅL (1775). In 1834 C. G. EHRENBERG published the results of a trip to the Red Sea which he had made together with F. W. HEMPRICH. C. B. KLUNZINGER who had lived in Koseir for many years and who recorded the results of his work in three volumes (1879), probably made the most valuable contribution on Red Sea corals. Another important contribution on the coral fauna of the Red Sea came from E. v. MARENZELLER who also was the first to describe deep sea corals (1906). C. CROSSLAND, too, head of the Sudan Pearl Fishery and founder and first director of the Marine Biological Station Ghardaqa (1922–1938), made valuable contributions to coral research.

From 1968 to the 70ies the Cambridge Coral Starfish Research Group in Port Sudan also dealt with the corals of the local reefs (HEAD, 1980). In 1968 Israel's Marine Biological Laboratory was founded in Eilat in the north of the Gulf of Aqaba, an institution which produced a lot of contributions to coral research (e.g. LOYA & SLOBODKIN, 1971). Last but not least, there are the fundamental works of H. MERGNER and H. SCHUHMACHER (1974–1981) on the investigation of the coral reefs near Aqaba.

In addition to the corals collected in the Red Sea by G. SCHEER 1957 and 1962 and by H. FEUSTEL 1968, the Hessische Landesmuseum Darmstadt received sizeable coral collections from the Universities of Jerusalem, Tel Aviv and Basel, from the U.S. National Museum of Natural History Washington, from the Institute of Oceanography Port Sudan, and from diving expeditions of the sports teacher J. HÓLLOSI. Further collections came from the Universität Bochum, from the Museum für Naturkunde, Berlin, from the Marine Research Laboratory St. Petersburg (Florida), and from H. FRICKE's deep-diving projects. Moreover, the Hessische Landesmuseum Darmstadt also possesses an old coral collection including 33 duplicates from KLUNZINGER. A special chapter of the Introduction consists of a tabular summary of the collections, listing the locations — which are also marked on maps —, the inventory numbers and mentioning depth data.

The systematic part of the present report deals with altogether 2074 corals that were ascribed to 194 species from 70 genera. Of these, 161 species from 51 genera with 1976 specimens are reef corals. The remainder, 33 species from 19 genera with 98 specimens are ahermatypic corals. All 194 species are described, their affinities discussed, and information is given about their geographical distribution. 176 species are figured. Four species are described as new to science, and 22 species were found for the first time in the Red Sea.

### Zusammenfassung

Ein historischer Überblick über die Erforschung der Korallen des Roten Meeres reicht von den ersten Korallenabbildungen von T. SHAW (1738) bis zu H. FRICKE's Unterwasserboot, mit dem er 1981 bis 200 m Tiefe tauchte und Korallen sammelte. Die eigentliche Forschungsarbeit begann mit P. FORSKÅL (1775). 1834 veröffentlichte C. G. EHRENBERG die Ergebnisse einer zusammen mit F. W. HEMPRICH unternommenen Reise ans Rote Meer. Den wohl wichtigsten Beitrag über die Korallen des Roten Meeres lieferte C. B. KLUNZINGER, der viele Jahre in Koseir lebte und die Ergebnisse seiner Arbeit in drei Bänden (1879) niederlegte. Ein weiterer wichtiger Beitrag über die Korallenfauna des Roten Meeres stammt von E. v. MARENZELLER, der auch erstmals Tiefseekorallen beschrieb (1906). Auch C. CROSSLAND, Leiter der Sudan Pearl Fishery und Gründer und erster Direktor der Marine Biological Station Ghardaqa (1922 bis 1938), trug wesentlich zur Korallenforschung bei.

Von 1968 bis in die 70er Jahre befaßte sich die Cambridge Coral Starfish Research Group in Port Sudan auch mit den Korallen der dortigen Riffe (HEAD, 1980). In Eilat im Norden des Golfes von Aqaba wurde 1968 Israel's Marine Biological Laboratory gegründet, aus dem viele Beiträge zur Korallenforschung hervorgingen (z. B. LOYA & SLOBODKIN, 1971). Erwähnt seien schließlich noch die grundlegenden Arbeiten von H. MERGNER und H. SCHUHMACHER (1974–1981) zur Erforschung von Korallenriffen bei Aqaba.

Außer den von G. SCHEER 1957 und 1962 und den von H. FEUSTEL 1968 im Roten Meer gesammelten Korallen erhielt das Hessische Landesmuseum Darmstadt noch umfangreiche Korallensammlungen von den Universitäten Jerusalem, Tel Aviv und Basel, vom U.S. National Museum of Natural History Washington, vom Institute of Oceanography Port Sudan und von den Tauchexpeditionen des Sportlehrers J. HÓLLOSI. Weitere Sammlungen kamen von der Universität Bochum, vom Museum für Naturkunde Berlin, vom Marine Research Laboratory St. Petersburg (Florida) und von H. FRICKE's Tieftauchunternehmungen. Außerdem besitzt das Hessische Landesmuseum Darmstadt noch eine alte Korallensammlung, in der auch 33 Duplikate von KLUNZINGER sind. In einem besonderen Kapitel der Einleitung sind die Sammlungen tabellarisch zusammengestellt, die Fundorte aufgeführt und in Karten eingetragen, die Inventarnummern der gesammelten Korallen erwähnt und Tiefenangaben gemacht.

Insgesamt standen für den systematischen Teil des vorliegenden Berichts 2074 Korallen zur Verfügung, die 194 Arten aus 70 Gattungen zugeordnet werden konnten. Von diesen waren 161 Arten aus 51 Gattungen mit 1976 Exemplaren Riffkorallen. Der Rest, 33 Arten aus 19 Gattungen mit 98 Exemplaren waren ahermatypische Korallen. Alle 194 Arten werden beschrieben, ihre Verwandtschaftsverhältnisse erörtert und ihre geographische Verbreitung angegeben. 176 Arten sind abgebildet. Vier Arten werden neu beschrieben und 22 Arten erstmals im Roten Meer festgestellt.



## Bibliography

- ALCOCK, A. (1893): On some newly-recorded corals from the Indian seas. — Journ. Asiat. Soc. Bengal 62, II (Natur. Hist.), 138–149, pl. 5.
- (1894): Natural history notes from H. M. Indian marine survey steamer "Investigator". Ser. 2, No. 9. An account of the deep sea collection made during the season 1892–93. — Journ. Asiat. Soc. Bengal 62, II (Natur. Hist.), 169–184, pls. 8, 9.
- (1898): An account of the deep-sea Madreporaria collected by the Royal Indian marine survey ship "Investigator". — Calcutta (Indian Museum), 1–29, pls. 1–3.
- (1902): Report on the deep-sea Madreporaria of the Siboga-Expedition. — Monogr. Siboga-Exped. 16a, 1–52, pls. 1–5.
- AUDOUIN, V. (& SAVIGNY, J.-C.) (1828): Explication sommaire des planches de polypes de l'Égypte et de la Syrie, publiées par Jules-César SAVIGNY. — In "Description de l'Égypte", Paris 1826, 225–244; 2. edit. 1828, 40–58 (explic. of pls. 1–5).
- BASCHIERI SALVADORI, F. (1953): Spedizione Subacquea Italiana nel Mar Rosso. Ricerche Zoologiche. I. Parte narrativa. — Riv. Biolog. Colon. 13, 5–23.
- BASSET-SMITH, P. W. (1890): Report on the corals from Tizard and Macclesfield Banks, China Sea. — Ann. Mag. Natur. Hist., 6th ser., 6, 353–374, 443–458.
- BEDOT, M. (1907): Madréporaire d'Amboine. — Rev. Suisse Zool. 15, 143–292, pls. 5–50.
- BEMERT, G. & ORMOND, R. (1981): Red Sea Coral Reefs. Marine Animals. — London, 192 pp.
- BERNARD, H. M. (1896): The genus *Turbinaria*; the genus *Astraeopora*. — Cat. Madrep. Corals Brit. Mus. London 2, 106 pp., 33 pls.
- (1897): The genus *Montipora*; the genus *Anacropora*. — Cat. Madrep. Corals Brit. Mus. London 3, 192 pp., 34 pls.
- (1903): The genus *Goniopora*. — Cat. Madrep. Corals Brit. Mus. London 4, 206 pp., 14 pls.
- (1905): *Porites* of the Indo-Pacific region. — Cat. Madrep. Corals Brit. Mus. London 5, 303 pp., 35 pls.
- BERRY, L., WHITEMAN, A. J. & BELL, S. V. (1966): Some radiocarbon dates and their geomorphological significance, emerged reef complex of the Sudan. — Zeitschr. Geomorphol. NF 10, 119–143.
- BERTRAM, G. C. L. (1937): Some aspects of the breakdown of coral at Ghardaqa, Red Sea. — Proc. Zool. Soc. London 1936, 1011–1026.
- BLAINVILLE, H. M. D. de (1830): Les Madrépores. — Dictionnaire des Sciences natur. 60, 297–364 (Strasbourg, Paris).
- BOSCHMA, H. (1923): The Madreporaria of the Siboga Expedition. IV: Fungia patella. — Monogr. Siboga-Exped. 16d, 129–148, pls. 9, 10.
- (1925): Madreporaria I. Fungidae. (Papers from Dr. Th. MORTENSEN's Pacific Expedition 1914–16, XXVIII). — Videnskab. Meddel. Dansk Naturhist. Foren. København 79, 185–259, pls. 5–11.
- (1928): An unusual manner of budding: *Echinopora lamellosa* (ESPER). (Papers from Dr. Th. MORTENSEN's Pacific Expedition 1914–16, XLI). — Videnskab. Meddel. Dansk Naturhist. Foren. København 85, 1–6, pl. 1.
- (1953): On specimens of the coral genus *Tubastraea*, with notes on phenomena of fission. — Stud. Fauna Curaçao and other Carribb. Islands 4, 109–119, pls. 9–12.
- (1968): The Milleporina and Stylasterina of the Israel South Red Sea Expedition. (Rep. Isr. S. Red Sea Exped. 29). — Bull. Sea Fish. Res. Stat. Haifa 49, 8–14.
- BOSCHMA, H. & VERWEY, J. (1930): The occurrence of stalked buds in the coral *Echinopora lamellosa* (ESPER). — Treubia 12, 129–132, pls. 1–5.
- BOURNE, G. C. (1905): Report on the solitary corals collected by Prof. HERDMAN, at Ceylon, in 1902. — Rep. to Governm. of Ceylon on Pearl Oyster Fisheries of Gulf of Manaar, Suppl. Rep. 29, 187–242, pls. 1–4.
- BROOK, G. (1893): The genus *Madrepora*. — Cat. Madrep. Corals Brit. Mus. London 1, 212 pp., 35 pls.
- BRUCKMANN, F. E. (1748): Lapidés fungiformes maris rubri, & Dendrites Abachiensis. — Acta Phys.-Med. Acad. Caes. Leopold.-Francisc. Natur. curios. exhib. Ephemer. . . . 8, 217–220, pls. 3, 4 (Nürnberg).
- BRUEGGEMANN, F. (1877): Notes on stony corals in the collection of the British Museum. II. Remarks on the species of *Seriatopora*. — Ann. Mag. Natur. Hist., 417–421.
- (1877a): Notes on stony corals in the collection of the British Museum. III. A revision of the recent solitary Mussaceae. — Ann. Mag. Natur. Hist., 300–313.
- (1878): Neue Korallen-Arten aus dem Rothen Meer und von Mauritius. — Abh. Naturw. Ver. Bremen 5, 395–400, pls. 7, 8.
- (1878a): Über einige Steinkorallen von Singapore. — Abh. Naturw. Ver. Bremen 5, 539–549.
- CAIRNS, S. D. (1979): The deep-water Scleractinia of the Caribbean Sea and adjacent waters. — Stud. Fauna Curaçao and other Carribb. Islands 57, 341 pp., 40 pls.
- CHAMISSO, A. v. & EYSENHARDT, K. W. (1821): De animalibus quibusdam e classe vermium Linneana, in circumnavigatione terrae, auspiciante Comite N. ROMANZOFF, duce Ottone de KOTZEBUE, annis 1815–1818 peracta, observatis. — Nova Acta Phys.-Med. Acad. Caes. Leopold.-Carol. Natur. curios. 10, 343–374, pls. 24–33.
- CHEVALIER, J.-P. (1961): Recherches sur les madréporaires et les formations récifales miocènes de la Méditerranée occidentale. — (Dr. Sci. Thes.). Mém. Soc. Géol. France, N. S., 40, 562 pp., 203 figs., 26 pls.

- (1968): Les récifs actuels de Maré. – Exped. Franç. Récifs Corall. Nouvelle-Calédonie 3, 57–83, pl. 1.
- (1971): Les scléactiniaires de la Mélanésie Française (Nouvelle-Calédonie, Iles Chesterfield, Iles Loyauté, Nouvelle Hébrides). – Exped. Franç. Récifs Corall. Nouvelle-Calédonie 5, 301 pp., 182 figs., 38 pls.
- (1975): Les scléactiniaires de la Mélanésie Française (Nouvelle-Calédonie, Iles Chesterfield, Iles Loyauté, Nouvelle Hébrides). 2me Part. – Exped. Franç. Récifs Corall. Nouvelle-Calédonie 7, 407 pp., 253 figs., 42 pls.
- COUSTEAU, J.-Y. & DIOLÉ, P. (1970): Life and death in a coral sea. German edit.: Korallen. Bedrohte Welt der Wunder. – München/Zürich 1971, 304 pp., 162 figs.
- CROSSLAND, C. (1907): Reports on the marine biology of the Sudanese Red Sea. II. Narrative of the expedition. – Journ. Linn. Soc. London 31, 3–10, pl. 1.
- (1907a): Reports on the marine biology of the Sudanese Red Sea. IV. The recent history of the coral reefs of the mid-west shores of the Red Sea. – Journ. Linn. Soc. London, 31, 14–30, pl. 4.
- (1911): Reports on the marine biology of the Sudanese Red Sea. XVIII. A physical description of Khor Dongonab, Red Sea. – Journ. Linn. Soc. London 31, 265–286, pls. 28–34.
- (1913): Desert and water gardens of the Red Sea. – Cambridge, 158 pp., 40 pls.
- (1931): The reduced building-power and other variation in the astrean corals of Tahiti, with a note on *Herpetolitha limax* and *Fungia* spp. – Proc. Zool. Soc. London, 351–392, pls. 1–22.
- (1935): The Marine Biological Station of the University of Egypt at Ghardaqa (Hurghada) on the Red Sea. – Bull. Fac. Sci. Egypt. Univ. 3, 1–26, pls. 1–4.
- (1935a): Coral faunas of the Red Sea and Tahiti. – Proc. Zool. Soc. London, 499–504, pls. 1–3.
- (1936): The Egyptian exploration of the Red Sea. – Nature 137, 712–713.
- (1938): The coral reefs at Ghardaqa, Red Sea. – Proc. Zool. Soc. London, Ser. A, 108, 513–521.
- (1939): Some coral formations. Reports on the preliminary expedition for the exploration of the Red Sea in the R.R.S. "Mabahith" (Dec. 1934–Febr. 1935), Chapt. III. – Publ. Mar. Biol. Stat. Ghardaqa (Red Sea) 1, 21–35, pl. 2.
- (1941): On FORSKÅL's collection of corals in the Zoological Museum of Copenhagen. – Skr. Univ. Zool. Mus. København 1, 1–63, pls. 1–12.
- (1948): Reef corals of the South African coast. – Ann. Natal Mus. 11, 169–205, pls. 5–14.
- (1952): Madreporaria, Hydrocorallinae, Heliopora and Tubipora. – Sci. Rep. Great Barrier Reef Exped. 1928–29, 6, 85–257, pls. 1–56.
- DANA, J. D. (1846): Zoophytes. – U.S. Exploring Expedition during the years 1838–1848 under the command of Charles WILKES, U.S.N., 7, 740 pp., 61 pls., Philadelphia (1846–1848, Atlas 1849).
- (1872): Corals and Coral Islands. – London, 398 pp.
- DARWIN, C. (1842): The structure and distribution of coral reefs. – London, 214 pp.
- DINESEN, Z. D. (1980): A revision of the coral genus *Leptoseris* (Scleractinia: Fungiina: Agariciidae). – Mem. Queensl. Mus. 20, 181–235, pls. 1–16.
- DIOLÉ, P. & FALCO, A. (1976): Les mémoires de FALCO, chef plongeur de la Calypso. – Paris, 294 pp.
- DITLEV, H. (1980): A field guide to the reef-building corals of the Indo-Pacific. – Rotterdam, 291 pp., 390 figs.
- DOEDERLEIN, L. (1901): Die Korallen-Gattung *Fungia*. – Zool. Anz. 24, 351–360.
- (1902): Die Korallengattung *Fungia*. – Abh. Senckenberg. Naturforsch. Ges. 27, 1–162, pls. 1–25.
- DUNCAN, P. M. (1873): A description of the Madreporaria dredged up during the expedition of H.M.S. "Porcupine" in 1860 and 1870. – Trans. Zool. Soc. London 8, 303–344, pls. 39–49.
- (1876): Notices of some deep-sea littoral corals from the Atlantic Ocean, Caribbean, Indian, New-Zealand, Persian Gulf, and Japanese & C. Seas. – Proc. Zool. Soc. London, 428–442, pls. 38–41.
- (1884): A revision of the families and genera of the sclerodermic Zoantharia MILNE EDWARDS & HAIME, or Madreporaria (*M. rugosa* excepted). – Journ. Linn. Soc. London 18, 1–204.
- (1889): On the Madreporaria of the Mergui Archipelago collected for the Trustees of the Indian Museum, Calcutta, by Dr. John ANDERSON, F.R.S., Superintendent of the Museum. – Journ. Linn. Soc. London, Zool., 21, 1–25, pl. 1.
- DURHAM, J. W. (1962): Corals from the Galapagos and Cocos Islands. – Proc. Californ. Acad. Sci., 4th ser., 32, 41–56, 9 figs.
- EGUCHI, M. (1938): A systematic study of the reef-building corals of the Palao Islands. – Stud. Palao Tropic. Biol. Stat. 3, 325–390.
- (1968): The hydrocorals and Scleractinian corals of Sagami Bay. – Tokyo, 1–53, pls. 1–36 (Hydrocorals); C1–C80, pls. C1–C33 (Scleract.).
- EHRENBERG, C. G. (1834): Beiträge zur physiologischen Kenntniss der Corallenthiere im allgemeinen, und besonders des rothen Meeres, nebst einem Versuch zu physiologischen Systematic derselben. – Phys. Abh. Königl. Akad. Wissensch. Berlin aus d. Jahre 1832, 225–380.
- (1834a): Über die Natur und Bildung der Corallenbänke des rothen Meeres. – Phys. Abh. Königl. Akad. Wissensch. Berlin aus d. Jahre 1832, 381–432.
- EINSELE, G., GENSER, H. & WERNER, F. (1967): Horizontal wachsende Riffplatten am Süd-Ausgang des Roten Meeres. – Senckenberg. leth. 48, 359–379, 3 pls.
- ELLIS, J. & SOLANDER, D. (1786): The natural history of many curious and uncommon Zoophytes, collected from various parts of the globe. – London, 208 pp., 63 pls.
- ESPER, E. J. C. (1791): Die Pflanzenthiere in Abbildungen nach der Natur mit Farben erleuchtet nebst Beschreibungen. 1. Theil. – Nürnberg, 320 pp., Madrep. pls. 1–31 (p. 1–96 publ. 1788, p. 97–192 publ. 1789, p. 193–320 publ. 1790).
- (1797): Fortsetzungen der Pflanzenthiere in Abbildungen nach der Natur mit Farben erleuchtet nebst Beschreibungen. 1. Theil. – Nürnberg, 230 pp., Madrep. pls. 32–83 (p. 1–65 publ. 1794, p. 65–116 publ. 1795, p. 117–168 publ. 1796, p. 169–230 publ. 1797).

- FALKOWSKY, P. G. & DUBINSKY, Z. (1981): Light-shade adaptation of *Stylophora pistillata*, a hermatypic coral from the Gulf of Eilat. — *Nature* **289**, 172–174.
- FAURE, G. (1977): Annotated check list of corals in the Mascarene Archipelago, Indian Ocean. — *Atoll. Res. Bull.* No. **203**, 1–26.
- FAURE, G. & PICHON, M. (1978): Description de *Favites peresi*, nouvelle espèce de Scléactiniaire hermatypique de l'océan Indien (Cnidaria, Anthozoa, Scleractinia). — *Bull. Mus. Nat. Hist. Natur. Paris*, 3e sér., No **513**, Zool. **352**, 107–127.
- FAUROT, L. (1888): Rapport à M.le Ministre de l'Instruction Publique sur une Mission dans la Mer Rouge (Ile de Kamarane) et dans le Golfe d'Aden (Aden et Golfe de Tadjoura). — *Arch. Zool. Expér. et Génér.*, 2me sér., **6**, 117–133.
- (1894): Description du *Galaxea anthophyllites*, nouvelle espèce de polypier de la Mer Rouge. — *Bull. Zool. France* **19**, 114–116.
- FAUSTINO, L. A. (1927): Recent Madreporaria of the Philippine Islands. — *Monogr. Bur. Sci. Manila* **22**, 310 pp., 100 pls.
- FENTON, H. & STEINITZ, H. (1967): Eilat — a natural marine research laboratory. — *Ariel, Rev. Arts Sci. Israel*, **20**, 61–72.
- FEUSTEL, H. (1966): Anatomische Untersuchungen zum Problem der *Aspidosiphon-Heterocyathus*-Symbiose. — *Verh. Dtsch. Zool. Ges. Jena* 1965, 131–143.
- FISHELSON, L. (1970): Littoral fauna of the Red Sea: The population of non-scleractinian anthozoans of shallow waters of the Red Sea (Eilat). — *Mar. Biol.* **6**, 106–116.
- (1973): Ecology of coral reefs in the Gulf of Aqaba (Red Sea) influenced by pollution. — *Oecologia* **12**, 55–67.
- (1973a): Ecological and biological phenomena influencing coral species composition on the reef tables at Eilat (Gulf of Aqaba, Red Sea). — *Mar. Biol.* **19**, 183–196.
- FLEISSNER, H. & G. (1968): Filmexpedition nach Schadwan. — *Delphin* **15**, No. **4**, 17–18.
- (1971): The coral gardens of Shadwan. — *Symp. Zool. Soc. London* **28**, 535–539.
- FORSKÅL, P. (1775): Descriptiones Animalium, avium, amphibiorum, piscium, insectorum, vermium, quae in itinere orientali observavit Petrus FORSKÅL. Post mortem auctoris edidit Carsten NIEBUHR. — *Haunia*, 164 pp. (Corallia: p. 131–139).
- (1776): Icones Rerum Naturalium, quas in itinere orientali depingi curavit Petrus FORSKÅL. Post mortem auctoris edidit Carsten NIEBUHR. — *Haunia*, 15 pp., 43 pls. (Madrep. only pls. 37, 41, 42).
- FRICKE, H. W. (1976): Bericht aus dem Riff. Ein Verhaltensforscher experimentiert im Meer. — *München/Zürich*, 254 pp., 87 figs.
- (1978): Und über mir die Fische. — *Geo* (**12**), 106–128.
- (1979): Neritica: a shallow water habitat in the Red Sea. — *H. STEINITZ Mar. Biol. Lab. Elat, Rep.* **7**, 45–50.
- (1980): Control of different mating systems in a coral reef fish by one environmental factor. — *Anim. Behav.* **28**, 561–569.
- (1982): Vorstoss an die Grenze des Lichts. — *Geo* (**2**), 8–26.
- FRICKE, H. W. & SCHUHMACHER, H. (in press): The depth limits of Red Sea stony corals: an ecophysiological problem. — *Mar. Ecology*.
- FRICKE, H. W. & VARESCHI, E. (in press): A scleractinian coral with "photosynthetic organs": *Plerogyra sinuosa* DANA. — *Mar. Ecology*.
- FRIEDMAN, G. F. (1966): A fossil shoreline reef in the Gulf of Eilat (Aqaba). — *Israel Journ. Earth Sci.* **14**, 86–90.
- GARDINER, J. S. (1897): On some collections of corals of the family Pocilloporidae from the S. W. Pacific Ocean. — *Proc. Zool. Soc. London*, 941–953, pls. 56, 57.
- (1898): On the fungid corals collected by the author in the South Pacific. — *Proc. Zool. Soc. London*, 525–539, pls. 43–45.
- (1898a): On the turbinolid and oculinoid corals collected by the author in the South Pacific. — *Proc. Zool. Soc. London*, 994–1000, pl. 62.
- (1899): On the solitary corals collected by Dr. A. WILLEY. — In WILLEY, A.: Zoological results based on material from New Britain, New Guinea, Loyalty Islands, and elsewhere, collected 1895–1897. — *Cambridge*, pt. 2, 161–170, pls. 19, 20.
- (1899a): On the anatomy of a supposed new species of *Coenopsammia* from Lifu. — *WILLEY's Zool. Res.* **4**, 357–380, pl. 35.
- (1904): Madreporaria. Pt. II. Astreaeidae. — *Fauna and Geography of the Maldive and Laccadive Archipelagoes* **2**, 758–790, pls. 59–64.
- (1904a): The turbinolid corals of South Africa, with notes on their anatomy and variation. — *Mar. Invest. South Africa* **3**, 97–129, pls. 1–3.
- (1905): Madreporaria. Pt. III. Fungida; pt. IV. Turbinolidae. — *Fauna and Geography of the Maldive and Laccadive Archipelagoes* **2**, 933–957, pls. 89–93.
- (1909): The madreporarian corals. I. The family Fungiidae. With a revision of its genera and species and an account of their geographical distribution. — *Trans. Linn. Soc. London*, 2nd ser., *Zool.*, **12**, 257–290, pls. 33–39.
- GARDINER, J. S. & WAUGH, P. (1928): The flabellid and turbinolid corals. — *Sci. Rep. John MURRAY Exped. 1933–34*, **5**, No. **7**, 167–202, pls. 1–8.
- (1939): Madreporaria excluding Flabellidae and Turbinolidae. — *Sci. Rep. John MURRAY Exped. 1933–34*, **6**, No. **5**, 225–242, pls. 1, 2.
- GERLACH, S. A. (1967): Bericht über den Forschungsaufenthalt der Litoralgruppe auf der Insel Sarso (Rotes Meer). — "Meteor"-Forschungsergebn., Reihe D, 2–6.
- GOHAR, H. A. F. (1954): The place of the Red Sea between the Indian Ocean and the Mediterranean. — *Hidrobiol. Publ. Hydrobiol. Res. Inst. Fak. Sci. Univ. Istanbul*, Ser. B, **2**, 47–82.
- GOREAU, T. F., GOREAU, N. J., SOOT-RYAN, T. & YONGE, C. M. (1969): On a new commensal mytilid (Mollusca: Bivalva) opening into the coelenteron of *Fungia scutaria* (Coelenterata). — *Journ. Zool., London*, **158**, 171–195.
- GRASSHOFF, M. (1976): Gorgonaria aus den Riffen von Eilat, Rotes Meer. (Cnidaria: Anthozoa). — *Senckenberg. biol.* **57**, 155–165.
- GRAVELY, F. H. (1927): The littoral fauna of Krusadai Island and neighbouring localities. Suborder Scleractinia (Corals). — *Bull. Madras Governm. Mus., N.S., Natur. Hist. Sect.*, **1**, 41–51.
- GRAVIER, CH. (1911): Les récifs de coraux et les madréporaires de la Baie de Tadjourah (Golfe d'Aden). — *Ann. Inst. Océanogr., (Anc. Sér.)*, **2**, 1–99, pls. 1–12.
- (1920): Madréporaires provenant des campagnes des yachts Princesse-ALICE et Hirondelle II (1893–1913). — *Résult. Camp. Sci. ALBERT I*, **55**, 1–125, pls. 1–16.

- GRIGG, R. W., WELLS, J. W. & WALLACE, C. (1981): *Acropora* in Hawaii. Part 1. History of the scientific record, systematics, and ecology. — *Pacif. Sci.* 35, 1–13.
- GUILCHER, A. (1955): Géomorphologie de l'extrémité septentrionale du Banc Farsan (Mer Rouge). — *Ann. Inst. Océanogr., N. S.*, 30, 55–100, pls. 1–21.
- (1979): Les rivages coralliens de l'est et du sud de la presqu'île du Sinai. — *Ann. Geograph.* 88, 393–418.
- HAECKEL, E. (1876): Arabische Korallen. Ein Ausflug nach den Korallenbänken des Rothen Meeres und ein Blick in das Leben der Korallenthiere. — Berlin, 48 pp., 5 pls., 20 figs.
- HARRISON, R. M. & POOLE, M. (1909): Marine Fauna from the Mergui Archipelago, Lower Burma, collected by Jas. J. SIMPSON and R. M. RUDMOSE-BROWN, University of Aberdeen: Madreporaria. — *Proc. Zool. Soc. London*, 897–912, pls. 85, 86.
- HASS, H. (1948): Beitrag zur Kenntnis der Reteporiden mit besonderer Berücksichtigung der Formbildungsgesetze ihrer Zoarien und einem Bericht über die dabei angewandte neue Methode für Untersuchungen auf dem Meeresgrund. — *Zoologica* 101, 126 pp., 10 pls., 63 figs.
- (1952): Manta, Teufel im Roten Meer. — Berlin, 180 pp., 79 figs.
- (1961): Expedition ins Unbekannte. — Berlin/Frankfurt/Wien, 167 pp., 231 figs.
- HEAD, S. M. (1978): A cerioid species of *Blastomussa* (Cnidaria, Scleractinia) from the central Red Sea, with a revision of the genus. — *Journ. Natur. Hist.* 12, 633–639.
- (1980): The ecology of corals in the Sudanese Red Sea. Chapt. 4: The corals of the Sudanese Red Sea. Append. IV: Taxonomic notes and identification criteria for the corals. — Thesis Cambridge University, 142–181; 441–471.
- (in press): A new species of *Merulina* and a new genus and species of siderastreid coral from the Red Sea. — *Journ. Natur. Hist.*
- HEAD, S. M. & ORMOND, R. F. G. (1978): A platform as a base for coral reef studies. — In *Coral reefs: research methods*. Edit. STODDART, D. R. & JOHANNES, R. E., UNESCO Monograph. Ocean Meth. 5, 109–118.
- Hebrew University of Jerusalem (1968): The Marine Biological Laboratory at Eilat. — Eilat, 5 pp.
- HICKSON, S. R. (1940): The species of the genus *Acabaria* in the Red Sea. — *Publ. Mar. Biol. Stat. Ghardaqa* 2, 3–22.
- HOFFMEISTER, J. E. (1925): Some corals from American Samoa and the Fiji Islands. — *Pap. Dept. Mar. Biol. Carnegie Inst. Washington* 22, 1–90, pls. 1–23.
- HORST, C. J. v. d. (1919): A new species of *Fungia*. — *Zool. Meded. Rijks Mus. Natuurl. Hist. Leiden* 5, 65, pl. 1.
- (1921): The Madreporaria of the Siboga Expedition. II. Madreporaria Fungida. — *Monogr. Siboga-Exped.* 16b, 1–46, pls. 1–6.
- (1922): The Madreporaria of the Siboga Expedition. III. Eupsammidae. — *Monogr. Siboga-Exped.* 16c, 99–127, pls. 7, 8.
- (1922a): Madreporaria: Agariciidae (Percy SLADEN Trust Expedition to the Indian Ocean in 1905, 7). — *Trans. Linn. Soc. London*, 2nd ser. Zool., 18, 417–429, pls. 31, 32.
- (1926): Madreporaria: Eupsammidae (Percy SLADEN Trust Expedition to the Indian Ocean in 1905, 8). — *Trans. Linn. Soc. London*, 2nd ser. Zool., 19, 43–53, pls. 2, 3.
- HOTTINGER, L. (1977): Distribution of larger Peneroplidae, Borelis and Nummulitidae in the Gulf of Elat, Red Sea. — *Utrecht Micro-palaeontol. Bull.* 15, 35–109.
- KAWAGUTI, S. (1953): Coral fauna of the Island of Botal Tobago, Formosa, with a list of corals from the Formosan waters. — *Biol. Journ. Okayama Univ.* 1, 185–210, pls. 1–4.
- KLAUSEWITZ, W. (1964): Die Erforschung der Ichthyofauna des Roten Meeres. — In KLUNZINGER, C. B.: *Synopsis der Fische des Rothen Meeres*. Weinheim, Reprint, V-XXXVI.
- (1967): Die physiographische Zonierung der Saumriffe von Sarso. — "Meteor" *Forschungsergebn.*, Reihe D, H. 2, 44–68.
- (1969): Eilat, ein neues meeresbiologisches Institut am Roten Meer. — *Natur und Museum* 99, 117–124.
- KLUNZINGER, C. B. (1872): Zoologische Excursion auf ein Korallenriff des Rothen Meeres bei Kasser. — *Zeitschr. Ges. f. Erdkde. Berlin* 7, 20–56.
- (1877): Die Korallthiere des Rothen Meeres. 1: Die Alcyonarien und Malacodermen. — Berlin, 98 pp., 8 pls.
- (1877a): Bilder aus Oberägypten, der Wüste und dem Rothen Meere. — Stuttgart, 400 pp.
- (1879): Die Korallthiere des Rothen Meeres. 2: Die Steinkorallen. 1. Abschn.: Madreporaceen und Oculinaceen. — Berlin, 88 pp., 10 pls.
- (1879): Die Korallthiere des Rothen Meeres. 3: Die Steinkorallen. 2. Abschn.: Astreaeaceen und Fungiaceen. — Berlin, 100 pp., 10 pls.
- (1880): Über das Wachsthum der Korallen, insbesondere ihre Vermehrung durch Ableger und über Wachsthumstörungen. — *Württ. Naturwiss. Jahresh.*, 62–71.
- KOCH, G. v. (1874): Anatomie der Orgelkoralle (*Tubipora Hemprichii* EHRENBERG). — Jena, 26 pp., 2 pls.
- (1877): Mittheilungen über Coelenteraten. Anatomie von *Stylophora digitata* PALLAS. — *Jenaische Zeitschr. Naturwiss.* 11, 375–381, pl. 22.
- KOEHLER, K., KULL, U. & SCHMID, P. (1980): Eilat und das Riff. Ein Exkursionsbericht aus Israel. — *Arb. u. Mitt. Biol. Inst. Univ. Stuttgart* 3, 108 pp.
- LAMARCK, J. B. P. A. de (1816): *Histoire naturelle des animaux sans vertèbres*. Tome 2. — Paris, 568 pp.
- LESSON, R. P. (1834): Zoophytes. — In *Voyage aux Indes orientales par le nord de l'Europe pendant 1825–1829 de Ch. BELANGER*, *Zool.*, 505–519, pls. 1, 2 (Paris).
- LEUCKART, F. S. (1841): *Observationes Zoologicae de Zoophytis Coralliis, speciatim de genere Fungia*. — *Freiburg i. Br.*, 61 pp., 4 pls.
- LEWINSON, C. & FISHELSON, L. (1967): The second Israel South Red Sea Expedition, 1965, (General Report). — *Israel Journ. Zool.* 16, 59–68.

- LINDSTROEM, G. (1877): Contributions to the actinology of the Atlantic Ocean. — K. Svensk. Vetensk.-akad. Handl. 14, 1–26, 3 pls.
- LINNAEUS, C. (1758): Systema Naturae, Tomus 1 (Regnum animale). — Holmia, Edit. 10, 824 pp.
- LOYA, Y. (1972): Community structure and species diversity of hermatypic corals at Eilat, Red Sea. — Mar. Biol. 13, 100–123.
- (1975): Possible effects of water pollution on the community structure of Red Sea corals. — Mar. Biol. 29, 177–185.
- (1976): Recolonization of Red Sea corals affected by man-made perturbations and natural catastrophies. — Ecology 57, 278–298.
- (1976a): The Red Sea coral *Stylophora pistillata* is an r strategist. — Nature 259, 478–480.
- (1976b): Skeletal regeneration in a Red Sea scleractinian coral population. — Nature 261, 490–491.
- (1978): Plotless and transect methods. — In Coral reefs: research methods. Edit. STODDART, D. R. & JOHANNES, R. E.; UNESCO Monogr. Ocean Meth. 5, 197–217.
- LOYA, Y. & SLOBODKIN, L. B. (1971): The coral reefs of Eilat (Gulf of Eilat, Red Sea). — Symp. Zool. Soc. London 28, 117–139.
- MA, T. Y. H. (1937): On the growth rate of reef corals and its relation to sea water temperature. — Paleontol. Sinica, Ser. B, 16, 1–226, pls. 1–100.
- (1959): Effect of water temperature on growth rate of reef corals. — Oceanogr. Sinica, 2nd ser. priv. res. publ., spec Vol. 1, 1–116, pls. 1–320.
- MAGNUS, D. B. E. (1966): Zur Ökologie einer nachtaktiven Flachwasser-Seefeder (Octocorallia, Pennatularia) im Roten Meer. — Veröff. Inst. Meeresforsch. Bremerhaven, Sonderb. II, 369–380.
- MARENZELLER, E. v. (1901): Ostafrikanische Steinkorallen. Gesammelt von Dr. STUHLMANN 1888 und 1889. — Mitt. Naturhist. Mus. Hamburg 18, 117–134, 1 pl.
- (1904): Steinkorallen. Wissensch. Ergebn. dtsch. Tiefsee-Exped. „Valdivia“ 1898–1899, 7, 263–318, pls. 14–18.
- (1906): Riffkorallen. (Exped. „Pola“ in das Rote Meer 1895/96–1897/98). — Denkschr. Math.-Naturwiss. Kl. Kaiserl. Akad. Wiss. Wien 80, 27–97, pls. 1–29.
- (1906a): Tiefseekorallen. (Exped. „Pola“ in das Rote Meer 1895/96–1897/98). — Denkschr. Math.-Naturwiss. Kl. Kaiserl. Akad. Wiss. Wien 80, 13–25, pls. 1, 2.
- MATTHAI, G. (1914): A revision of the recent colonial *Astraeidae* possessing distinct corallites. (Percy SLADEN Trust Expedition to the Indian Ocean in 1905, 6, No. 1). — Trans. Linn. Soc. London, 2nd ser. Zool., 17, 1–140, pls. 1–28.
- (1924): Report on the madreporarian corals in the collection of the Indian museum, pt. 1. — Mem. Indian Mus. Calcutta 8, 1–59, 11 pls.
- (1928): A monograph of the recent meandroid *Astraeidae*. — Cat. Madrep. Corals Brit. Mus. London 7, 288 pp., 72 pls.
- (1948): On the mode of growth of the skeleton in fungid corals. — Phil. Trans. Roy. Soc. London, Ser. B, 233, 177–195, pls. 3–14.
- Meeresmuseum Stralsund (1981): „Acropora 1976 und 1979“, zwei meeresbiologische Sammelreisen ins Rote Meer. — Meer und Museum 2, 1–72.
- MERGNER, H. (1967): Über den Hydroidenbewuchs einiger Korallenriffe des Roten Meeres. — Zeitschr. Morph. Ökol. Tiere 60, 35–104.
- (1971): Structure, ecology and zonation of Red Sea coral reefs (in comparison with South Indian and Jamaican reefs). — Symp. Zool. Soc. London 28, 141–161.
- (1979): Quantitative ökologische Analyse eines Rifflagenareals bei Aqaba (Golf von Aqaba, Rotes Meer). — Helgoländ. wiss. Meeresunters. 32, 476–507.
- MERGNER, H. & SCHUHMACHER, H. (1974): Morphologie, Ökologie und Zonierung von Korallenriffen bei Aqaba (Golf von Aqaba, Rotes Meer). — Helgoländ. wiss. Meeresunters. 26, 238–358.
- (1981): Quantitative Analyse der Korallenbesiedlung eines Vorriffareals bei Aqaba (Rotes Meer). — Helgoländ. wiss. Meeresunters. 34, 337–354.
- MERGNER, H. & SVOBODA, A. (1977): Productivity and seasonal changes in selected reef areas in the Gulf of Aqaba (Red Sea). — Helgoländ. wiss. Meeresunters. 30, 383–399.
- MILNE EDWARDS, H. & HAIME, J. (1848): Recherches sur les polypiers. Mém. 2: Monographie des Turbinolides. — Ann. Sci. Natur., 3e sér., 9, 211–344, pls. 7–10.
- (1848a): Recherches sur les polypiers. Mém. 3: Monographie des Eupsammides. — Ann. Sci. Natur., 3e sér., 10, 65–114, pl. 1.
- (1848/1849): Recherches sur les polypiers. Mém. 4: Monographie des Astréides. — Ann. Sci. Natur., 3e sér., 10 (1948b), 209–320, pls. 5–9; 11 (1849), 233–312; 12 (1849a), 95–197.
- (1849b): Mémoires sur les polypiers appartenant à la famille des Oculinides, au groupe intermédiaire des Pseudastréides et à la famille des Fongides. — C. R. hebdom. Séanc. Acad. Sci. Paris 29, 67–73.
- (1850): Recherches sur les polypiers. Mém. 5: Monographie des Oculinides. — Ann. Sci. Natur., 2e sér., 13, 63–110, pls. 3–4.
- (1850a): Recherches sur les polypiers. Mém. 6: Monographie des Fongides. — Ann. Sci. Natur., 3e sér., 15, 73–144.
- (1851): Recherches sur les polypiers. Mém. 7: Monographie des Poritides. — Ann. Sci. Natur., 3e sér., 16, 21–70, pl. 1.
- (1851a): Monographie des polypiers fossiles des terrains paléozoïques précédée d'un tableau général de la classification des polypes. — Arch. Mus. Nat. Hist. Natur. Paris 5, 1–505, pls. 1–20.
- MILNE EDWARDS, H. (& HAIME, J.) (1857a): Histoire naturelle des coralliaires. Tome 1. — Paris, 326 pp., 10 pls.
- (1857): Histoire naturelle des coralliaires. Tome 2. — Paris, 633 pp., 10 pls.
- (1860): Histoire naturelle des coralliaires. Tome 3. — Paris, 560 pp., 11 pls.
- MOEBIUS, K. (1880): Eine Reise nach der Insel Mauritius im Jahre 1874–75. — In MOEBIUS, K., RICHTERS, F. & v. MARTENS, E.: Beiträge zur Meeresfauna der Insel Mauritius und der Seychellen, 1–65.
- MOHAMED, A. F. (1940): The Egyptian exploration of the Red Sea. — Proc. Roy. Soc. London, B, 128, 306–316.
- NEMENZO, F. (1955): Systematic studies on Philippine shallow water Scleractinians. I: Suborder Fungiida. — Natur. Appl. Sci. Bull. Univ. Philipp. 15, 3–84, pls. 1–14.

- (1958/59): Systematic studies on Philippine shallow water Scleractinians. II: Suborder Faviida. — *Natur. Appl. Sci. Bull. Univ. Philipp.* **16**, 73–135, pls. 1–24.
- (1960): Systematic studies on Philippine shallow water Scleractinians. III: Suborder Caryophylliidae. — *Natur. Appl. Sci. Bull. Univ. Philipp.* **17**, 207–213, pls. 1, 2.
- (1964): Systematic studies on Philippine shallow water Scleractinians. V: Suborder Astrocoeniidae (pars). — *Natur. Appl. Sci. Bull. Univ. Philipp.* **18**, 193–223, pls. 1–12.
- (1967): Systematic studies on Philippine shallow water Scleractinians. VI: Suborder Astrocoeniidae (*Montipora* and *Acropora*). — *Natur. Appl. Sci. Bull. Univ. Philipp.* **20**, 1–141 (text), 143–223 (= pls. 1–40).
- NESTEROFF, W. D. (1955): Les récifs coralliens du Banc Farsan Nord (Mer Rouge). — *Ann. Inst. Océanogr.* **30**, 46 pp., 21 pls.
- OKEN, L. (1815): *Lehrbuch der Naturgeschichte*, 3. Theil: Zoologie; 1. Abth.: Fleischlose Thiere; 2. Kl., 1. Zunft: Erdkorallen, Steinkorallen. — Jena, 59–74, pl. 2.
- OREN, O. H. (1962): The Israel South Red Sea Expedition. — *Nature* **194**, 1134–1137.
- ORMOND, R. F. G. & CAMPBELL, A. C. (1974): Formation and breakdown of *Acanthaster planci* aggregations in the Red Sea. — *Proc. 2nd Internat. Coral Reef Sympos.* **1**, Brisbane, 595–619.
- ORTMANN, A. (1888): Studien über Systematik und geographische Verbreitung der Steinkorallen. — *Zool. Jahrb., Syst. Geogr. Biol. Thiere*, **3**, 143–188, pl. 6.
- (1889): Beobachtungen an Steinkorallen von der Südküste Ceylons. — *Zool. Jahrb., Syst. Geogr. Biol. Thiere*, **4**, 493–590, pls. 11–18.
- (1890): Die Morphologie des Skeletts der Steinkorallen in Beziehung zur Koloniebildung. — *Zeitschr. wiss. Zool.* **50**, 278–316, pl. 11.
- (1892): Die Korallriffe von Dar-es-Salaam und Umgegend. — *Zool. Jahrb., Syst. Geogr. Biol. Thiere*, **6**, 631–670, pl. 29.
- PALLAS, P. S. (1766): *Elenchus Zoophytorum*. XI: Madrepora. — *Hagae Comitum*, 274–336.
- PICHON, M. (1964): Contribution à l'étude de la répartition des Madréporaires sur le récif de Tuléar, Madagascar. — *Rec. Trav. Stat. Mar. Endoume-Marseille*, fasc. hors. sér., suppl. **2**, 79–203.
- PICHON, M., SCHEER, G. & PILLAI, C. S. G. (in press): *Erythrastraea flabellata* n.gen., n.sp., a new hermatypic scleractinian coral from Red Sea. (Cnidaria, Anthozoa; Scleractinia). — *Bull. Brit. Mus. (N. H.), Zool. London*.
- PILLAI, C. S. G. (1967): Corals. — *Central Marine Fisheries Research Institute, Cochin, 20th Anniversary Souvenir*, 121–124.
- (1971): The distribution of shallow-water stony corals at Minicoy Atoll in the Indian Ocean with a check-list of species. — *Atoll Res. Bull.* **141**, 1–12.
- (1972): Stony corals of the seas around India. — *Proc. Symp. Corals and Coral Reefs 1969. Symp. Mar. Biol. Ass. India* **5**, 191–216.
- PILLAI, C. S. G. & SCHEER, G. (1973): Bemerkungen über einige Riffkorallen von Samoa und Hawaii. — *Zool. Jahrb., Syst. Ökol. Geogr. Tiere* **100**, 466–476.
- (1974): On a collection of Scleractinia from the Strait of Malacca. — *Proc. 2nd Intern. Coral Reef Sympos.* **1**, Brisbane, 445–464.
- (1976): Report on the stony corals from the Maldive Archipelago. — *Zoologica* **126**, 1–83, pls. 1–32.
- PILLAI, C. S. G., STODDART, D. R. & MORTON, J. E. (in prep.): The scleractinian corals from British Solomon Islands.
- PILLAI, C. S. G., VINE, P. J. & SCHEER, G. (1973): Bericht über eine Korallensammlung von den Seychellen. — *Zool. Jahrb., Syst. Ökol. Geogr. Tiere* **100**, 451–465.
- POR, F. D., STEINITZ, H., FERBER, J. & ARON, W. (1972): The biota of the Red Sea and the eastern Mediterranean (1967–1972). A survey of the marine life of Israel and surroundings. — *Israel Journ. Zool.* **21**, 459–523.
- POURTALES, L. F. de (1871): Deep-sea corals. — *Illustr. Cat. Mus. Compar. Zool. Harvard Coll.*, **4**, 93 pp., 8 pls.
- QUELCH, J. J. (1886): Report on the reef-corals collected by H. M. S. CHALLENGER during the years 1873–76. — *Rep. Sci. Res. Voy. H. M. S. CHALLENGER, Zool.*, **16**, 1–203, pls. 1–12.
- QUOY, J. R. C. & GAIMARD, J. P. (1833): Zoophytes. — *Voyage de découvertes de l'Astrolabe ...*, *Zool.* **4**, 175–254, pls. 14–20.
- RALPH, P. M. & SQUIRES, D. F. (1962): The extant scleractinian corals of New Zealand. — *Zool. Publ. Vict. Univ. Wellington* **29**, 1–19, 8 pls.
- RANSONNET-VILLET, E. v. (1863): Reise von Kairo nach Tor zu den Korallenbänken des rothen Meeres. — Wien, 34 pp., 4 pls.
- REHBERG, H. (1892): Neue und wenig bekannte Korallen. — *Abh. Naturwiss. Ver. Hamburg* **12**, 1–50, pls. 1–4.
- RICHMAN, S., LOYA, Y. & SLOBODKIN, L. B. (1975): The rate of mucus production by corals and its assimilation by the coral reef copepod *Acartia negligens*. — *Limnol. Oceanogr.* **20**, 918–923.
- RIDLEY, S. O. (1883): The coral-fauna of Ceylon, with descriptions of new species. — *Ann. Mag. Natur. Hist.*, ser. **5**, **11**, 250–262.
- RINKEVICH, B. & LOYA, Y. (1979): The reproduction of the Red Sea coral *Stylophora pistillata*. I. Gonads and planulae. — *Mar. Ecol. Progr. Ser.* **1**, 133–144.
- ROSEN, B. R. (1971): Appendix to BARNES, J. et al., Morphology of the reef front of Aldabra: Provisional check list of corals collected during The Royal Society Expedition to Aldabra, phase 6. — *Symp. Zool. Soc. London* **28**, 109–114.
- (1979): Check list of recent coral records from Aldabra (Indian Ocean). — *Atoll Res. Bull.* **233**, 1–24.
- ROSSI, L. (1954): Madreporari, Stoloniferi e Milleporini (Spediz. Subacquea Ital. nel Mar Rosso). — *Riv. Biol. Colon.* **14**, 23–72, pls. 1–10.
- (1955): Sulla presenza in Mar Rosso di *Goniastrea benhami* VAUGH. (Madreporaria). — *Doriana. Suppl. Ann. Mus. Civ. Stor. Natur. "G. Doria"* **2**, No. 63, 1–4.
- ROUSSEAU, L. (1854): Zoophytes. — *Voyage au pôle Sud et dans l'Océanie sur les corvettes l'Astrolabe et la Zélée ...*, *Zool.*, **5**, 119–124, pls. 27–29.
- RUEPPELL, E. & LEUCKART, F. S. (1828): Atlas zu der Reise im nördlichen Afrika von Eduard Rüppell. Neue wirbellose Thiere des rothen Meeres. — Frankfurt a. M., 47 pp., 12 pls.

- SAVIGNYI, J.-C. (1805–1812): Ordre des planches d'histoire naturelle et autres, publiées dans la "Description de l'Égypte". – Hist. natur., Zool., 2, Polypes. Paris, pls. 1–14.
- SAVILLE KENT, W. (1871): On some new and little known species of madrepores, or stony corals, in the British Museum collection. – Proc. Zool. Soc. London, 275–286, pls. 23–25.
- SCHAEFER, W. (1969): Sarso, Modell der Biofacies-Sequenzen im Korallenriff-Bereich des Schelfs. – Senckenberg. marit. [1], 50, 153–164.
- SCHAEFER, G. (1962): Korallen-Expedition des Hessischen Landesmuseums Darmstadt nach Port Sudan am Roten Meer. – Jenaer Rundsch. 7, 223–234.
- (1964): Bemerkenswerte Korallen aus dem Roten Meer. – Senckenberg. biol. 45, 612–620.
  - (1964a): Korallen von Abd-el-Kuri. – Zool. Jahrb. Syst. 91, 451–466.
  - (1967): Korallen von den Sarso-Inseln im Roten Meer. – Senckenberg. biol. 48, 421–436.
  - (1971): Coral reefs and coral genera in the Red Sea and Indian Ocean. – Symp. Zool. Soc. London 28, 329–367.
- SCHAEFER, G. & PILLAI, C. S. G. (1974): Report on the Scleractinia from the Nicobar Islands. – Zoologica 122, 1–75, pls. 1–33.
- (1974a): Taxonomic studies on some hermatypic corals from the Red Sea, collected by the Hebrew University of Jerusalem. – Unpubl. Manusc., 74 pp., 11 pls.
- SCHMID, P. & KOEHLER, K. (1981): Eilat und das Riff. Exkursionsbericht aus Israel: II. – Arb. u. Mitt. Biol. Inst. Univ. Stuttgart 4, 131 pp.
- SCHROEDER, J. (1974): The Institute of Oceanography in the Democratic Republic of the Sudan. – Report to the "National Council for Research", Manusc., Berlin, 1–13.
- SCHUHMACHER, H. (1973): Morphologische und ökologische Anpassungen von *Acabaria*-Arten (Octocorallia) im Roten Meer an verschiedene Formen der Wasserbewegung. – Helgoländ. wiss. Meeresunters., 25, 461–472.
- (1976): Korallenriffe. Ihre Verbreitung, Tierwelt und Ökologie. – München, Berlin, Wien, 275 pp., 127 col. pict., 79 black-white pict., 28 figs.
  - (1977): The initial phases in reef development, studied at artificial reef types off Eilat (Red Sea). – Helgoländ. wiss. Meeresunters. 30, 400–411.
  - (1979): Experimentelle Untersuchungen zur Anpassung von Fungiiden (Scleractinia, Fungiidae) an unterschiedliche Sedimentations- und Bodenverhältnisse. – Int. Rev. ges. Hydrobiol. 64, 207–243.
- SCHULZE, G. (1977): Ein Riffturm soll es sein. – Poseidon, 210–213.
- (1977a): Im Riff. – Poseidon, 456–461.
  - (1977b): Korallen. – Poseidon, 507–511.
- SEARLES WOOD, W. (1844): Descriptive catalogue of the zoophytes from the Crag. – Ann. Mag. Natur. Hist. 13, 10–21.
- SEYMOUR SEWELL, R. B. (1935): Introduction and list of stations. – Sci. Rep. John MURRAY Exped. 1, No. 1, 1–41.
- SHAW, T. (1738): Travels or observations relating to several parts of Barbary and the Levant. – Oxford, German edition (1765): Reisen oder Anmerkungen verschiedene Theile der Barbarey und der Levante betreffend. – Leipzig, 382–384: Die Corallen in dem rothen Meere. – 404–406: Appendix de Coralliis et eorum affinibus.
- SILLNER, L. (1968): Ein kleiner Sprung ins große Meer. – Stuttgart, 88 pp.
- SOHN, J. J. (1977): Changes in morphology and abundance of *Stylophora pistillata* and *Acropora variabilis* (Anthozoa, Hexactinaria) with respect to depth at Elat, Red Sea. – Int. Rev. ges. Hydrobiol. 62, 157–160.
- SPIRO, B. F. (1970): Ultrastructure and chemistry of the skeleton of *Tubipora musica* LINNÉ. – Bull. Geol. Soc. Denmark 20, 279–284, pls. 1, 2.
- (1971): Diagenesis of some scleractinian corals from the Gulf of Elat, Israel. – Bull. Geol. Soc. Denmark 21, 1–10, pls. 1–3.
- SQUIRES, D. F. (1963): *Flabellum rubrum* (QUOY and GAIMARD). – Mem. New Zealand Oceanogr. Inst. 20, 1–41, 3 pls.
- STEPHENSON, W. & WELLS, J. W. (1956): The corals of Low Isles, Queensland. – Pap. Univ. Queensland, Zool., 1, 1–59, pls. 1–7.
- STODDART, D. R. & PILLAI, C. S. G. (1973): Coral reefs and reef corals in the Cook Islands, South Pacific. – In FRASER, R. (comp.): Oceanography of the South Pacific 1972, New Zealand Commiss. for UNESCO, Wellington, 475–483.
- STREICHER, S. (1977): 90 Tage im Roten Meer. – Poseidon, 145–151.
- (1980): 90 Tage im Korallenmeer. – Rostock, 192 pp., 155 figs.
- STRESEMANN, E. (1954): HEMPRICH und EHRENBERG. Reisen zweier naturforschender Freunde im Orient, geschildert in ihren Briefen aus den Jahren 1819–1826. – Abh. Dtsch. Akad. Wiss. Berlin, Kl. Math. u. Naturwiss., Nr. 1, 1–177.
- STUDER, T. (1878): Übersicht der Steinkorallen aus der Familie der Madreporaria aporosa, Eupsamma und Turbinarina, welche auf der Reise S. M. S. Gazelle um die Erde gesammelt wurden. – Monatsber. Königl. Preuss. Akad. Wiss. Berlin f. 1827, 625–655, pls. 1–4.
- (1901): Madreporarier von Samoa, den Sandwich-Inseln und Laysan. – Zool. Jahrb., Abt. Syst., Geogr., Biol. Tiere, 14, 388–428, pls. 23–31.
- TALBOT, F. H. (1965): A description of the coral structure of Tutia reef (Tanganyika Territory, East Africa) and its fish fauna. – Proc. Zool. Soc. London 145, 431–470.
- THIEL, H. (1980): Benthic Investigations of the deep Red Sea. – Cour. Forsch. Inst. Senckenberg 40, 1–35.
- THIEL, M. E. (1932): Madreporaria. Zugleich ein Versuch einer vergleichenden Oekologie der gefundenen Formen. – Mém. Mus. Roy. d'Hist. Natur. Belg., Hors Sér., 2, 1–177, pls. 1–21.
- UMBGROVE, J. H. F. (1939): Madreporaria from the Bay of Batavia. – Zool. Meded. Rijksmus. Natuurl. Hist. Leiden 22, 1–64, pls. 1–18.
- (1940): Madreporaria from the Togian reefs (Gulf of Tomini, North-Celebes). – Zool. Meded. Rijksmus. Natuurl. Hist. Leiden. 22, 265–310, pls. 21–35.

- VAUGHAN, T. W. (1906): Madreporaria. Reports on the scientific results of the Exped. to the Eastern tropical Pacific ... by the ... "Albatross". — Bull. Mus. Comp. Zool. Harvard Coll. **50**, 61–72, pls. 1–10.
- (1906a): Three new Fungiae, with a description of a specimen of *Fungia granulosa* KLUNZINGER and a note on a specimen of *Fungia concinna* VERRILL. — Proc. U.S. Nat. Mus. **30**, 827–832, pls. 67–74.
- (1907): Recent Madreporaria of the Hawaiian Islands and Laysan. — Bull. Smithson. Inst. U.S. Nat. Mus. **59**, 1–427, pls. 1–96.
- (1907a): Some madreporarian corals from French Somaliland, East Africa, collected by Dr. Charles GRAVIER. — Proc. U.S. Nat. Mus. **32**, 249–266, pls. 17–28.
- (1917): Some corals from Kermadec Islands. — Trans. Proc. New Zealand Inst. f. 1916, **49**, 275–279, pls. 17–20.
- (1918): Some shoal-water corals from Murray Island (Australia), Cocos-Keeling Islands, and Fanning Islands. — Pap. Dep. Mar. Biol., Carnegie Inst. Washington (Publ. 213) **9**, 49–234, pls. 20–93.
- VAUGHAN, T. W. & WELLS, J. W. (1943): Revision of the suborders, families, and genera of the Scleractinia. — Spec. Pap. Geol. Soc. America **44**, 363 pp., pls. 1–51.
- VERON, J. E. N. & PICHON, M. (1976): Scleractinia of Eastern Australia. I. — Monogr. Ser. Austral. Inst. Mar. Sci. **1**, 1–86, 166 figs.
- (1980): Scleractinia of Eastern Australia. III. — Monogr. Ser. Austral. Inst. Mar. Sci. **4**, 1–443, 857 figs.
- VERON, J. E. N., WIJSMAN-BEST, M. & PICHON, M. (1977): Scleractinia of Eastern Australia. II. — Monogr. Ser. Austral. Inst. Mar. Sci. **3**, 1–233, 469 figs.
- VERRILL, A. E. (1864): List of the polyps and corals sent by the Museum of Comparative Zoology to other institutions in exchange, with annotations. — Bull. Mus. Compar. Zool. Harvard Univ. **1**, 29–60.
- (1868): Notes on the Radiata in the Museum of Yale College. No. 6. Review of the corals and polyps of the west coast of America. Order Madreporaria. — Trans. Connecticut Acad. Arts. Sci. **1**, 500–546, pls. 9, 10.
- (1877): Names of species in the author's report on Zoophytes. — In DANA, J. D.: Corals and Coral Islands. London, 379–388.
- (1901): Variations and nomenclature of Bermudian, West Indian and Brazilian reef corals, with notes on various Indopacific corals. — Trans. Connecticut Acad. Arts. Sci. **11**, 63–168, pls. 10–35.
- (1902): Notes on corals of the genus *Acropora* (Madrepora LAMARCK) with new descriptions and figures of types, and of several new species. — Trans. Connecticut Acad. Arts. Sci. **11**, 207–266, pls. 36–36f.
- VERSEVELDT, J. (1963): Report on the Octocorallia (Stolonifera and Alcyonacea) of the Israel South Red Sea Expedition, 1962, with notes on other collections from the Red Sea. — Bull. Sea Fish. Res. Stat. Haifa **40**, 28–48.
- (1970): Report on some Octocorallia (Alcyonacea) from the western Red Sea. — Israel Journ. Zool. **19**, 209–229.
- (1974): Alcyonacea (Octocorallia) from the Red Sea, with a discussion of a new *Sinularia* species from Ceylon. — Israel Journ. Zool. **23**, 1–37.
- VERSEVELDT, J. & BENAYAHU, Y. (1978): Description of an old and five new species of Alcyonacea from the Red Sea. — Zool. Meded. **53**, 58–74.
- VERSEVELDT, J. & COHEN, J. (1971): Some new species of Octocorallia from the Gulf of Eilat (Red Sea). — Israel Journ. Zool. **20**, 53–67.
- VINE, P. J. & HEAD, S. M. (1977): Growth of corals on Commander COUSTEAU's underwater garage at Shaab Rumi (Sudanese Red Sea). — Jeddah Nature Journ., 6–18.
- WAHLERT, G. v. (1969): Eilat — ein neuer Name in der Meeresforschung. — Naturwiss. Rdsch. **22**, 530–536.
- WAINWRIGHT, S. A. (1965): Reef communities visited by the Israel South Red Sea Expedition, 1962. — Bull. Sea Fish. Res. Stat. Haifa **38**, 40–53.
- WALLACE, C. (1978): The coral genus *Acropora* (Scleractinia: Astrocoeniina: Acroporidae) in the central southern Great Barrier Reef province. — Mem. Queensland Mus. **18**, 273–319, pls. 43–103.
- WALTHER, J. (1888): Die Korallenriffe der Sinaihalbinsel. — Abh. math.-phys. Cl. Königl. Sächs. Gesellsch. Wissensch. **14**, 439–506, 8 pls.
- WAUGH, P. (1936): The variation and species of Red Sea *Turbinaria* and *Astraeopora* with a discussion of the genera. — Proc. Zool. Soc. London, 919–929, 2 pls.
- WELLS, J. W. (1936): The madreporarian genus *Polyastra* EHRENBERG. — Ann. Mag. Natur. Hist. (ser. 10), **18**, 549–552, pls. 9, 10.
- (1936a): The nomenclature and type species of some genera of recent and fossil corals. — Americ. Journ. Sci., 5th ser., **31**, 97–134.
- (1950): Reef corals from the Cocos-Keeling Atoll. — Bull. Raffles Mus. Singapore **22**, 19–52, pls. 9–14.
- (1954): Recent corals of the Marshall Islands. — Geol. Surv. Prof. Pap. 260-I, 385–486, pls. 94–185.
- (1955): Recent and subfossil corals of Moreton Bay, Queensland. — Pap. Univ. Queensland, Dep. Geol., **4** (n. s.), No. 10, 1–18, pls. 1–3.
- (1956): Scleractinia. — In MOORE, R. C.: Treatise on Invertebrate Paleontology; Part F: Coelenterata, 328–444.
- (1961): Notes on Indo-Pacific scleractinian corals, pt. 3. A new reef coral from New Caledonia. — Pacif. Sci. **15**, 189–191.
- (1964): Ahermatypic corals from Queensland. — Pap. Univ. Queensland, Zool., **2**, 107–121.
- (1964a): The recent solitary mussid scleractinian corals. — Zool. Meded. Rijksmus. Natuurl. Hist. Leiden **39**, 375–384, pls. 20–23.
- (1966): Evolutionary development in the scleractinian family Fungiidae. — Symp. Zool. Soc. London **16**, 223–246.
- (1966a): Notes on Indo-Pacific scleractinian corals, pt. 4. A second species of *Stylocoeniella*. — Pacif. Sci. **20**, 203–205.
- (1968): Notes on Indo-Pacific scleractinian corals, pt. 6. Further note on *Bantamia merleti* WELLS. — Pacif. Sci. **22**, 275–276.
- WELLS, J. W. & SPENCER DAVIES, P. (1966): Preliminary list of stony corals from Addu Atoll. — Atoll Res. Bull. **116**, 43–55.
- WIJSMAN-BEST, M. (1972): Systematics and ecology of New Caledonian Faviinae (Coelenterata — Scleractinia). — Bijdr. Dierkunde **42**, 1–90, pls. 1–14.
- (1973): A new species of the Pacific coral genus *Blastomussa* from New Caledonia. — Pacif. Sci. **27**, 154–155.
- (1974): Biological results of the SNELLIUS Expedition. XXV. Faviidae collected by the SNELLIUS Expedition. I. — Zool. Meded. Rijksmus. Natuurl. Hist. Leiden **48**, 249–261, pls. 1–4.



- (1976): Biological results of the SNELLIUS Expedition. XXVII. Faviidae collected by the SNELLIUS Expedition. II. – Zool. Meded. Rijksmus. Natuurl. Hist. Leiden 50, 45–63, pls. 1–8.
  - (1977): Indo-Pacific coral species belonging to the subfamily Montastreinae VAUGHAN & WELLS, 1943 (Scleractinia – Coelenterata), pt. I. – Zool. Meded. Rijksmus. Natuurl. Hist. Leiden 55, 235–263, pls. 1–5.
- WIJSMAN-BEST, M., FAURE, G. & PICHON, M. (1980): Contribution to the knowledge of the stony corals from the Seychelles and Eastern Africa. – Rev. Zool. Afric. 94, 600–627, pls. 9–12.
- YABE, H. & SUGIYAMA, T. (1935): *Stylocoeniella*, a new coral genus allied to *Stylocoenia* and *Astrocoenia*. – Japan. Journ. Geol. Geogr. 12, 103–105, pl. 15.
- (1941): Recent reef-building corals from Japan and the South Sea Islands under the Japanese Mandate. II. – Sci. Rep. Tôhoku Imp. Univ., 2nd ser. (Geol.), spec. Vol. 2, 67–91, pls. 60–104.
- YABE, H., SUGIYAMA, T. & EGUCHI, M. (1936): Recent reef building corals from Japan and the South Sea Islands under the Japanese Mandate. I. – Sci. Rep. Tôhoku Imp. Univ., 2nd ser. (Geol.), spec. Vol. 1, 1–66, pls. 1–59.
- ZIBROWIUS, H. (1974): Scléactiniaires des îles Saint Paul et Amsterdam (Sud de l'Océan Indien). – Tethys (1973) 5, 747–778.
- (1974a): Révision du genre *Javania* et considérations générales sur les Flabellidae (Scléactiniaires). – Bull. Inst. Océanogr. 71, No. 1429, 1–48, pls. 1–5.
  - (1980): Les Scléactiniaires de la Méditerranée et de l'Atlantique nord-orientale. – Mém. Inst. Océanogr. 11, 1–227 (texte), 229–284 (annexes), pls. 1–107.

## Index for the systematic part

(Boldfaced figures refer to species treated in detail)

- abdit*a, *Astraea* 114  
*Favia* 114  
*Favites* 113, **114**, 115, 117, 122  
*Madrepora* 113, 114  
*abrotanoides*, *Heteropora* 41  
*Madrepora* 55  
*Montipora* 55  
*Acanthastr(a)ea* 144, 147  
*echinata* **148**, 149  
*erythraea* **148**  
*grandis* 148  
*hemprichii* 115  
*hillae* 149  
*hirsuta* 148  
*rotundoflora* 148  
*spinosa* 147  
*Acr(o)helia* 143  
*acropora*, *Favia* 106  
*Acropora* 32, 33  
*anthocercis* 43  
*aspera* 37  
*bifaria* 40, 43  
*canalis* 37  
*capillaris* 34, 40, 47  
*cerealis* 46  
*cervicornis* 48  
*clavigera* 46  
*conferta* 40  
*confraga* 46  
*corymbosa* 34, **38**, 44  
*cymbicyathus* 38  
*cytherea* 39, 40  
*digitifera* 41  
*dilatata* 43  
*diomedea* 40  
*disticha* 38  
*echinata* 47  
*effusa* 38  
*eibli* 46  
*elseyi* 46  
*eminens* 37, 48  
*erythraea* 41  
*eurystoma* 34, 40, **42**  
*formosa* 35  
*forskali* 34, 44, **45**  
*gemmafera* 41  
*granulosa* 34, **46**  
*haimei* 34, 37  
*hebes* 37  
*hemprichi* 34, **44**  
*humilis* 34, 40  
*hyacinthus* 34, **39**, 43, 47  
*intermedia* 36  
*kenti* 40, 43  
*luzonica* 37  
*macrostoma* 43  
*manni* 37  
*massawensis* 46  
*millepora* 55  
*multicaulis* 35  
*muricata* 48  
*murrayensis* 44  
*nasuta* 34, **38**  
*nobilis* 34, **36**, 48  
*ocellata* 41  
*pagoensis* 42  
*pharaonis* 34, 35  
*rambleri* 46  
*rayneri* 46  
*reticulata* 40  
*rosaria* 44  
*rousseaui* 44  
*scandens* 36  
*scherzeriana* 41  
*secunda* 37  
*speciosa* 46  
*squarrosa* 34, **44**, 46  
*tenella* 46  
*tenuis* 42  
*valenciennesi* 34, 35  
*variabilis* 34, 43  
*Acroporidae* 32  
*acuta* (var.), *Goniastrea* 116  
*Pocillopora* 29, 30  
*acuticollis*, *Favites* 113, 117  
*Prionastraea* 117  
*acutidens*, *Fungia* 85  
*aequicostatus*, *Heterocyathus* 157, **158**  
*affinis*, *Rhodopsammia* 168  
*Agaricia explanulata* 60  
*levicollis* 71  
*minicoiensis* 66, 69  
*planulata* 69  
*ponderosa* 69  
*rugosa* 70  
*speciosa* 71  
*Agariciella mycetoseroides* 66  
*ponderosa* 69  
*agariciformis*, *Fungia* 81, 84  
*Agariciidae* 59  
*alcicornis*, *Millepora* 22  
*Alcyonella savignyi* 89  
*alveolata*, *Porites* 97  
*Alveopora* 88  
*daedalea* **89**, 124  
*mortenseni* **89**, **90**  
*ocellata* **89**, **90**  
*superficialis* 90, 91  
*verrilliana* **89**, 90  
*viridis* **89**, 91  
*amarantum*, *Trachyphyllia* 140  
*americana*, *Phyllangia* 141  
*amicorum*, *Favia* 105, **108**  
*Parastrea* 108  
*ampliata*, *Madrepora* 143, 144  
*Merulina* **144**  
*Anacropora* 32  
*ananas*, *Astrea* 108  
*Favia* 106  
*ancora*, *Euphyllia* 161  
*andamanensis*, *Polycyathus* 157  
*andreossi*, *Pocillopora* 22  
*andrewsi*, *Porites* 103  
*Angia smithi* 141  
*angularis*, *Pavonia* 61  
*angulata*, *Seriatopora* 28  
*angulosa*, *Tichoseris* 64  
*annuligera*, *Montastrea* 139  
*Anomocora fecunda* 159  
*anthocercis*, *Acropora* 43  
*Madrepora* 42  
*anthophyllites*, *Galaxea* 142  
*Anthophyllum fasciculare* 142  
*anthophyllum*, *Monomyces* 165  
*Antillia geoffroyi* 140  
*aperta*, *Physogyra* 163  
*Aphrastraea deformis* 118  
*arabica*, *Coeloria* 123  
*Madrepora* 35  
*Maeandrina* 123  
*arbuscula*, *Dendrophyllia* 170, 171  
 (var.), *Pavonia* 64  
*arcuata*, *Caryophyllia* 155  
*Madrepora* 39  
*arenacea*, *Porites* 100  
*arenaria*, *Astraeopora* 33  
*arenosa*, *Porites* 97  
*armata*, *Madrepora* 39  
*Porites* 20  
*Stylocoeniella* 20, 100  
*Stylophora* 20, 100  
*aspera*, *Acropora* 37  
*Cyphastrea* 133  
*Echinophyllia* 152, **153**  
*Favia* 110  
*Goniastrea* 120  
*Madrepora* 152, 153  
*Mycedium* 152  
*Oulophyllia* 127  
*Oxyphyllia* 153  
*Turbinaria* 177  
*Ulophyllia* 127  
*asperula*, *Madracis* 31  
*Asteroseris planulata* 69  
*Astr(a)ea abdit*a 114  
*ananas* 108  
*deformis* 110, 122  
*dipsacea* 148  
*echinata* 147, 148  
*flexuosa* 116  
*galaxea* 72  
*halicora* 116  
*heliopora* 179  
*hemprichi(i)* 115  
*maeandrina* 73  
*melicerum* 118  
*monile* 73  
*myriophthalma* 32, 33, 133  
*pallida* 107  
*pectinata* 120  
*planulata* 92  
*purpurea* 132  
*retiformis* 119  
*savignyana* 72  
*speciosa* 109  
*spongia* 120  
*tesserifera* 115  
*versipora* 138, 139  
*astraeiformis*, *Coeloria* 123  
*Favia* 123  
*astraeoides*, *Porites* 21  
*Astraeopora* 32  
*arenaria* 33  
*ehrenbergi* 33  
*myriophthalma* 33  
*pulvinaria* 33  
*astrea*, *Caryophyllia* 143  
*Galaxea* 142, **143**  
*Astrocoeniina* 17  
*Astrocoeniidae* 20  
*atlanticus*, *Polycyathus* 156  
*aurea*, *Dendrophyllia* 173  
*Lobophyllia* 173  
*Tubastraea* 173  
*australensis*, *Goniastrea* 119,

- 121, 122  
*Prionastraea* 121
- Balanophyllia* 166, 167  
 calyculus 167  
 cumingii 167, 168  
 diffusa 167, 168  
 fistula 170  
 gemmifera 167  
 rediviva 167
- Bantamia merleti* 149, 150  
*benhami*, *Goniastrea* 121  
*bennettiae*, *Favites* 113  
*bertholleti*, *Favia* 110, 112  
*Parastrea* 112
- bifaria*, *Acropora* 40, 43  
*Madrepora* 40
- Blastomussa* 144, 149  
*loyae* 149, 150  
*merleti* 149, 150  
*wellsi* 149, 150
- bonhourei*, *Ulophyllia* 127  
*bottae(i)*, *Coeloria* 123  
*Cyphastraea* 130  
*Leptastrea* 130  
*Madrepora* 47  
*Orbicella* 130
- brevicornis*, *Pocillopora* 30  
*bulbosa*, *Pocillopora* 29
- cactus*, *Lophoseris* 62  
*Madrepora* 59, 62  
*Pavona* 60, 62
- calamaria*, *Madrepora* 41  
*caliendrum*, *Seriatopora* 27, 28  
*calyculus*, *Balanophyllia* 167  
*canaliculata*, *Madrepora* 41  
*canalis*, *Acropora* 37  
*Madrepora* 37
- cancellata*, *Madrepora* 44  
*capillaris*, *Acropora* 35, 40, 47  
*Madrepora* 47
- capitata*, *Montipora* 52  
*carduus*, *Caryophyllia* 145  
*Echinopora* 137
- carinata*, *Pachyseris* 70  
*Caroline Isl.* 3 *Porites* 101
- Caryophyllia* 154  
*arcuata* 155  
*astreata* 143  
*carduus* 145  
*cornigera* 172  
*corymbosa* 146  
*cristata* 147  
*glabrescens* 161  
*lacrymalis* 145  
*paradoxus* 155  
*sewelli* 155
- Caryophylliidae* 154  
*Caryophylliina* 154
- Caulastrea* 103  
*furcata* 103  
*tumida* 103
- cavernosa*, *Favia* 109  
*Madrepora* 110
- cellulosa*, *Stylophora* 24  
*Ulophyllia* 127
- centralis*, *Madrepora* 159
- cerealis*, *Acropora* 46
- Ceriomorpha* (subgen.) 149, 151
- cervicornis*, *Acropora* 48  
*Dactylotrachus* 158  
 (form.), *Madrepora* 47  
*Tridacophyllia* 158
- cespitifoliata* (f.), *Madrepora* 43
- cespitosa*, *Pocillopora* 29
- ceylonica*, *Coeloria* 125
- chalcidicum*, *Cyphastrea* 134  
*Madrepora* 134
- chinensis*, *Favites* 117, 118
- cinerascens*, *Explanaria* 177
- circumvallata*, *Montipora* 49, 52, 54, 55  
*Porites* 55
- clavaria*, *Porites* 100
- clavasia*, *Porites* 89
- clavigera*, *Acropora* 46  
*Madrepora* 46
- clavus*, *Pavona* 60, 65, 72
- clementei*, *Pachyseris* 71
- clouei*, *Favia* 109, 110
- coalita*, *Montipora* 56
- coccinea*, *Coenopsammia* 175  
*Dendrophyllia* 173, 175  
*Oculina* 175  
*Tubastraea* 173, 174, 175
- Coelogyra levis* 127
- Coeloria arabica* 123  
*astraeiformis* 123  
*bottai* 123  
*ceylonica* 125  
*cooperi* 127  
*crosslandi* 125  
*daedalea* 123  
*esperii* 123  
*forskaelana* 123  
*forskaliana* 123  
*gigantea* 127  
*klunzingeri* 123, 125  
*labyrinthiformis* 123  
*lamellina* 123  
*leptoticha* 123  
*magna* 127  
*pachychila* 123  
*rustica* 124  
*sinensis* 125  
*subdentata* 123
- Coelosmilia fecunda* 159
- Coenopsammia coccinea* 175  
*ehrenbergiana* 174  
*micranthus* 175  
*nigrescens* 176  
*willey* 174
- colei*, *Montipora* 49
- columella*, *Goniastrea* 121
- columna*, *Goniopora* 92
- columnaris*, *Porites* 96, 99
- complanata*, *Favia* 115
- Favites* 113, 115, 117
- composita*, *Montipora* 59
- compressa*, *Porites* 96, 101
- concamerata*, *Echinopora* 137  
*Madrepora* 137
- conceptus*, *Paracyathus* 157  
*Polycyathus* 157
- concinna*, *Fungia* 78, 81
- conferta*, *Acropora* 40  
*Cyphastrea* 134  
*Madrepora* 40
- confertifolia*, *Fungia* 84
- confraga*, *Acropora* 46
- confusa*, *Montipora* 53
- conglomerata*, *Porites* 97, 98
- conica*, *Turbinaria* 177
- conicula*, *Montipora* 50
- constricta*, *Trachyphyllia* 140
- contignatio*, *Hydnophora* 129  
*Madrepora* 129
- contigua*, *Madrepora* 18  
*Psammocora* 18
- convexa*, *Synaraea* 102
- cooperi*, *Coeloria* 127
- cornigera*, *Caryophyllia* 172  
*Dendrophyllia* 170, 172
- coronata*, *Madrepora* 43
- corymbosa*, *Acropora* 34, 38, 44  
*Caryophyllia* 146  
*Heteropora* 38  
*Lobophyllia* 145, 146  
*Madrepora* 38, 145, 146  
*Mussa* 146
- Coscinaraea* 68, 72, 73  
*donnani* 73  
*meandrina* 73  
*monile* 73  
*ostreaeformis* 73
- costata*, *Lobophyllia* 145, 147  
*Mussa* 147
- costulata*, *Cycloseris* 74, 77  
*Fungia* 77
- crassa*, *Herpolitha* 87  
*Pavonia* 61
- crassilabia* (var.), *Madrepora* 38
- crater*, *Madrepora* 176
- Craterastrea* 68  
*levis* 68
- crateriformis*, *Flabellum* 164  
*Rhizotrochus* 164
- crispa*, *Meandrina* 127  
*Oulophyllia* 127
- crista galli*, *Montipora* 55  
*Porites* 55
- cristata*, *Caryophyllia* 147  
*Euphyllia* 161  
*Lophoseris* 61  
*Madrepora* 59  
*Mussa* 147
- crosslandi*, *Coeloria* 125  
*Platygyra* 123, 125
- crustacea*, *Madrepora* 87, 88  
*Podabacia* 88
- Ctenactis* 74, 85  
*echinata* 85, 86
- Culicia* 140  
*cuticulata* 141  
*rubeola* 140  
*stellata* 140, 141
- cumingii*, *Balanophyllia* 167, 168
- curta*, *Montastrea* 139
- cuticulata*, *Culicia* 140  
*Cylicia* 140
- cyathus*, *Madrepora* 154
- cyclolites*, *Cycloseris* 74, 76, 77  
*Fungia* 74, 76
- Cycloseris* 74  
*costulata* 74, 77  
*cyclolites* 74, 76, 77  
*distorta* 74, 76  
*doederleini* 74, 75  
*erosa* 74, 75, 77  
*marginata* 75, 77  
*patelliformis* 74, 76  
*somervillei* 80  
*tenuis* 75, 76  
*vaughani* 75, 76
- Cylicia cuticulata* 140
- cymbicyathus*, *Acropora* 38  
*Madrepora* 38
- Cynarina* 144  
*lacrymalis* 145  
*savignyi* 144, 145
- Cyphastr(a)ea* 133  
*aspera* 133  
*bottai* 130  
*chalcidicum* 134  
*conferta* 134  
*gardineri* 134  
*gibbosa* 134  
*hemprichana* 134  
*incrusters* 177  
*japonica* 133, 135  
*maldivensis* 134  
*microphthalmia* 133, 135  
*ocellina* 134  
*savignyi* 133  
*serailia* 133, 134  
*suvadivae* 134
- cytherea*, *Acropora* 39  
*Madrepora* 39, 40
- Dactylotrachus* 158  
*cervicornis* 158
- daedalea*, *Alveopora* 89, 124  
*Coeloria* 123  
*Madrepora* 88, 89, 122, 123  
*Platygyra* 123, 125, 127  
*Porites* 89
- damicornis*, *Millepora* 22, 29  
*Pocillopora* 29
- danae*, *Dendrophyllia* 174  
*Favia* 110  
*Montipora* 52

- Pocillopora 30  
 Stylophora 22, 23  
 Danafungia (subgen.) 78  
 danai, Fungia 78, 82  
 Lophoseris 63  
 Pavona 62  
 Dasmosmilia 160  
 valida 160  
 decussata, Pavon(i)a 60, 61, 62  
 deformis, Aphrastraea 118  
 Astraea 110, 122  
 delicatula, Madrepora 40  
 Deltocyathus 156  
 minutus 156  
 dendritica, Stylophora 22  
 Dendrophyllia 166, 170  
 arbuscula 170, 171  
 aurea 173  
 coccinea 173, 175  
 cornigera 170, 172  
 danae 174, 175  
 diaphana 174  
 fistula 170  
 horsti 170, 171  
 klunzingeri 173, 175  
 manni 174  
 micranthus 176  
 minuscula 170  
 nigrescens 176  
 robusta 170, 172  
 rubeola 140  
 serpentina 168  
 subcornigera 172  
 willeyi 174  
 Dendrophylliidae 166  
 Dendrophylliina 166  
 densa, Montipora 55  
 denticulata, Favia 110  
 dentigera, Fungia 79  
 Desmophyllum insignis 165  
 diaphana, Dendrophyllia 174  
 Tubastraea 173, 174  
 Diaseris distorta 76  
 Dichocoenia 109  
 diffluens, Pavona 65  
 diffusa, Balanophyllia 167, 168  
 digitata, Montipora 54  
 Porites 22  
 Stylophora 22  
 digitifera, Acropora 41  
 dilatata, Acropora 43  
 Madrepora 42  
 diomedae, Acropora 40  
 Diploastrea 129  
 heliopora 129  
 dipsacea, Astrea 148  
 Favia 148  
 discoides (var.), Fungia 81  
 distans, Mussa 147  
 disticha, Acropora 38  
 Madrepora 38  
 distorta, Cycloseris 74, 76  
 Diaseris 76  
 Fungia 75  
 divaricata, Montipora 54, 55  
 Pavona 60, 64  
 Psammocora 18  
 divergens, Galaxea 142  
 Madrepora 142  
 divisa, Euphyllia 161  
 djiboutensis, Goniopora 92  
 doederleini, Cycloseris 74, 75  
 Fungia 75, 77  
 donnani, Coscinaraea 73  
 doreyensis, Favia 108  
 duofaciata, Goniopora 92  
 echinata, Acanthastrea 148, 149  
 Acropora 47  
 Astraea 147, 148  
 Ctenactis 85, 86  
 Echinophyllia 152, 153  
 Fungia 82, 85, 86  
 Haliglossa 86  
 Madrepora 85, 86  
 Echinophyllia 151, 152  
 aspera 152, 153  
 echinata 152, 153  
 echinoporoides 152  
 glabra 152  
 lacera 154  
 orpheensis 152, 153  
 rugosa 152  
 sugiyamai (var.) 153  
 tosaensis (var.) 153  
 undulata (var.) 153  
 Echinopora 135  
 carduus 137  
 concamerata 137  
 ehrenbergi 137  
 forskaliana 137  
 fruticulosa 137  
 gemmacea 112, 136  
 glabra 136  
 hemprichi 137  
 hirsutissima 137  
 horrida 136, 137, 138  
 lamellosa 135, 136, 137  
 solidior 137  
 echinoporoides, Echinophyllia 152  
 echinulata, Porites 96, 99  
 edwardsi, Goniastrea 119  
 Montipora 49, 53, 56  
 effusa, Acropora 38  
 Madrepora 38  
 Montipora 58  
 ehrenberg(i)ana, Coenopsammia 174  
 Leptastrea 132  
 ehrenberg(i), Astraopora 33  
 Echinopora 137  
 Favia 110  
 Favites 110  
 Fungia 85  
 Herpetolithas 85  
 Hydnothophora 129  
 Madrepora 35  
 Montipora 49, 57  
 Stylophora 21  
 Turbinaria 177  
 eibli, Acropora 46  
 eilatensis (var.), Montipora 57  
 elegans, Pocillopora 31  
 elephantotus, Madrepora 151, 152  
 Mycedium 151  
 elongata, Stylophora 22  
 elseyi, Acropora 46  
 eminens, Acropora 37, 48  
 equisepta, Goniastrea 120  
 erosa, Cycloseris 74, 75, 77  
 Fungia 75  
 Manopora 50  
 erythraea, Acanthastrea 148  
 Acropora 41  
 Isophyllia 148  
 Madrepora 41  
 Montipora 57  
 Mussa 148  
 Stylophora 23  
 Symphyllia 148  
 Erythraea 104  
 flabellata 104  
 esperi, Coeloria 123  
 Euphyllia 160, 161  
 ancora 161  
 cristata 161  
 divisa 161  
 fimbriata 161, 162  
 glabrescens 161  
 laxa 161  
 sinuosa 162  
 turgida 161  
 eurystoma, Acropora 34, 40, 42  
 Madrepora 42  
 exesa, Hydnothophora 128  
 Madrepora 127, 128  
 expanda, Stylophora 22  
 Explanaria cinerascens 177  
 galaxia 133  
 gemmacea 136  
 hemprichii 137  
 mesenterina 176  
 explanata, Leptoseris 65, 66, 68  
 explanatum, Mycedium 152  
 explanulata, Agaricia 60  
 Lophoseris 60  
 Pavon(i)a 59, 60, 65  
 Psammocora 17, 20  
 exserta (var.), Favia 108  
 fasciculare, Anthophyllum 142  
 fascicularis, Galaxea 142  
 Madrepora 141, 142  
 faustinoi, Porites 102  
 Favia 105  
 abdita 114  
 acropora 106  
 amicorum 105, 108  
 ananas 106  
 aspera 110  
 astraeiformis 123  
 bertholleti 110, 112  
 cavernosa 109  
 clouei 109, 110  
 complanata 115  
 danae 110  
 denticulata 110  
 dipsacea 148  
 doreyensis 108  
 ehrenbergi 110  
 exserta (var.) 108  
 favosa 116  
 favus 105, 108, 110, 113, 122  
 geoffroyi 110  
 halicora 116  
 helianthoides 105, 107  
 hemprichii 115, 148  
 hirsuta 148, 149  
 hombroni 122  
 hululensis 108  
 laxa 105, 106, 107  
 lobata 106  
 magnistellata 110  
 matthai 112  
 okeni 109  
 pallida 105, 107  
 pentagona 118  
 pseudostelligera 105  
 rotulosa 108  
 rotundata 105, 111  
 savignyi 110  
 schnideri 125  
 speciosa 105, 108, 109, 112  
 stelligera 105, 122, 137  
 superficialis (var.) 116  
 tubulifera 109  
 uva 109  
 vacua 107  
 valenciennesi 112  
 vasta 116  
 versipora 110, 139  
 wakayana 107  
 wisseli 105, 111  
 Faviidae 103  
 Faviina 103  
 Favites 113  
 abdita 113, 114, 115, 117, 122  
 acuticollis 113, 117  
 bennettiae 113  
 chinensis 117, 118  
 complanata 113, 115, 117  
 ehrenbergi 110  
 flexuosa 111, 113, 116  
 halicora 113, 116, 122  
 melicerum 118  
 pentagona 113, 118  
 peresi 113, 122  
 profunda (var.) 117  
 rotundata 111

- vasta 116  
virens 111, 116  
yamanarii 117  
favosa, Favia 116  
Pocillopora 29  
favulus, Goniastrea 120  
favus, Favia 105, 108, 110, 113, 122  
Goniastrea 120  
Madrepora 110  
fecunda, Anomocora 159  
Coelosmilia 159  
Parasmilia 159  
fieldi, Fungia 83  
Fimbriaphyllia (subgen.) 161  
fimbriata, Euphyllia 161, 162  
fistula, Balanophyllia 170  
Dendrophyllia 170  
Thecopsammia 170  
flabellata, Erythraea 104  
Flabellidae 164  
Flabellum 164  
crateriformis 164  
pavonium 164  
rubrum 164  
flexuosa, Astraea 116  
Favites 112, 113, 116  
foliosa, Haliglossa 87  
Herpolitha 87  
Leptoseris 67  
Montipora 57  
Porites 57  
Folioseris papyracea 68  
formosa, Acropora 35  
Madrepora 37  
Pavona 63  
forskaelana, Coeloria 123  
Heliastrea 137  
Solenastrea 134  
forskali(i), Acropora 34, 44, 45  
Heteropora 44, 45  
Madrepora 45  
forskali(iana), Coeloria 123  
Echinopora 137  
Heliastrea 112  
Orbicella 137  
fragilis, Leptoseris 65, 68  
fragosa, Porites 97  
fragum, Madrepora 105  
frondosa, Psammocora 18  
fruticulosa, Echinopora 137  
Fungia 74, 78  
acutidens 85  
agariciformis 81, 84  
concinna 78, 81  
confertifolia 84  
costulata 77  
cyclolites 74, 76  
danai 78, 82  
dentigera 79  
distorta 75, 76  
discoides (var.) 81  
doederleini 75, 77  
echinata 82, 85, 86  
ehrenbergi 86  
erosa 75  
fieldi 83  
fungites 79, 81, 84  
granulosa 75, 78, 80  
gravis 79  
horrida 78, 83  
klunzingeri 78, 84  
lobulata 82  
madagascariensis 83  
marginata 77  
moluccensis 78, 79  
oahensis 79  
patella 74, 75, 77, 84  
patelliformis 74  
paumotensis 85  
placunaria 79  
plana 81  
repanda 78, 81, 82  
scruposa 78, 82  
scutaria 78, 79  
somervillei 79  
tenuifolia 84  
valida 83  
Fungiidae 74  
Fungiina 59  
fungites, Fungia 79, 81, 84  
Madrepora 78, 84  
furcata, Caulastrea 103  
fuscomarginata, Phyllangia 157  
fuscomarginatus, Polycyathus 156, 157, 169  
galaxea, Astrea 141  
Galaxea 142  
anthophyllites 72  
astrea 142, 143  
divergens 142  
fascicularis 142  
hexagonalis 142  
irregularis 142  
lamarcki 143  
lawisiana 142  
longissima 143  
galaxia, Explanaria 133  
gardineri, Cyphastrea 134  
Leptoseris 65, 68  
Pavona 60  
Gardineroseris 59, 69  
planulata 69  
ponderosa 69  
gemmacea, Echinopora 112, 136  
Explanaria 136  
gemmae, Pachyseris 70  
gemmafera, Acropora 41  
Balanophyllia 167  
Madrepora 41  
geoffroyi, Antillia 140  
Favia 110  
Trachyphyllia 140  
Turbinolia 139, 140  
gibbosa, Cyphastrea 134  
Prionastrea 114  
Solenastrea 134  
gigantea, Coeloria 127  
glabra, Echinophyllia 152  
Echinopora 136  
Leptoseris 66  
glabrescens, Caryophyllia 161  
Euphyllia 161  
gonagra, Psammocora 18  
Goniastrea 119  
acuta (var.) 116  
aspera 120  
australensis 119, 121, 122  
benhami 121  
columella 121  
edwardsi 119  
equiseta 120  
favulus 120  
favus 119  
halicora 115, 116, 122  
hombrovi 122  
incrustans 120  
mantonae 121  
obtusa (var.) 115  
palauensis 119  
parvistella 120  
pectinata 119, 120, 121  
planulata 121  
regularis 121  
retiformis 119, 122  
seychellensis 121, 122  
solida 119  
Goniopora 88, 91  
columna 92  
dijiboutiensis 92  
duofaciata 92  
Java Sea 1 92  
klunzingeri 92, 95  
lichen 95  
lobata 93  
maleccensis 94  
Maldives 4 92  
minor 92, 93, 94, 95  
pedunculata 91  
Philippines 1 94  
planulata 91, 92  
Red Sea 1 93  
Red Sea 2 93  
Red Sea 3 94  
Red Sea 4 95  
Red Sea 5 95  
savignyi 92, 94  
somalensis 95  
stokesi 91, 92  
tenella 92, 94  
gracilis, Leptoria 126  
Madrepora 126  
Montipora 49, 54, 56  
Platygyra 126  
Rhodaraea 95  
grandis, Acanthastrea 148  
Hydnophora 129  
granulata, Montipora 59  
granulosa, Acropora 34, 46  
Fungia 75, 78, 80  
Madrepora 46  
Montipora 58  
gravieri, Physogyra 163  
gravis, Fungia 79  
guentheri, Stylocoeniella 20, 21  
Stylophora 21  
gyrosa, Hydnophora 129  
Gyrosmlia 163, 163  
interrupta 163  
haddoni, Porites 98  
haeckeli, Plesiastrea 120  
haimeana, Psammocora 17, 19  
haimei, Acropora 34, 37  
Madrepora 37  
halicora, Astraea 116  
Favia 116  
Favites 113, 116, 122  
Goniastrea 115, 116, 122  
Prionastrea 116  
Haliglossa echinata 86  
foliosa 87  
interrupta 87  
limacina 87  
pectinata 86  
platystoma (var.) 85  
polystoma (var.) 85  
stellaris 87  
hanzawai, Stylocoenia 20  
Stylocoeniella 21  
hassi, Stylophora 25  
hawaiiensis, Leptoseris 65, 66, 67  
hebes, Acropora 37  
helianthoides, Favia 105, 107  
Heliastrea forskaliana 112  
forskaelana 137  
heliopora, Astrea 129  
Diploastrea 129  
hemprichana, Cyphastraea 134  
Solenastrea 134  
hemprichi(i), Acanthastrea 115  
Acropora 34, 44  
Astraea 115  
Echinopora 137  
Explanaria 137  
Favia 115, 148  
Heteropora 41, 44  
Lobophyllia 145, 146  
Madrepora 44  
Manicina 146  
Mussa 146  
Pocillopora 30  
Prionastrea 115  
Stephanocora 137  
Strombodes 80  
Herpetoglossa simplex 85, 86  
Herpetolitha limax 87  
Herpetolitha ehrenbergii 86  
rueppellii 86  
Herpolitha 74, 87  
crassa 87

- foliosa 87  
 limax 85, 87  
 simplex 86  
 heterocostatus, *Heterocyathus* 158  
*Heterocyathus* 157  
   aequicostatus 157, 158  
   heterocostatus 158  
   oblongatus 158  
   parasiticus 158  
   philippinensis 158  
   pulchellus 158  
   wood-masoni 158  
*Heteropora* abrotanoides 41  
   corymbosa 38  
   forskali(i) 44, 45  
   hemprichi(i) 41, 44  
   laxa 47, 48  
   prolifera 36  
   seriata 41  
   squarrosa 44, 46  
*hexagonalis*, *Galaxea* 142  
*hillae*, *Acanthastrea* 149  
*hirsuta*, *Acanthastrea* 148  
   *Favia* 148, 149  
   *Montipora* 56  
*hirsutissima*, *Echinopora* 137  
*hombroni(i)*, *Favia* 122  
   *Goniastrea* 122  
   *Parastraea* 122  
*horizontalata*, *Porites* 102  
   *Synaraea* 102  
*horrida*, *Echinopora* 136, 137, 138  
   *Fungia* 78, 83  
*horsti*, *Dendrophyllia* 170, 171  
*hululensis*, *Favia* 108  
*humilis*, *Acropora* 34, 40  
   *Madrepora* 40  
*hyacinthus*, *Acropora* 34, 39, 43, 47  
   *Madrepora* 39  
*Hydnophora* 127  
   contignatio 129  
   ehrenbergi 129  
   exesa 128  
   grandis 129  
   gyrosa 129  
   lobata 129  
   maldivensis 129  
   microconos 128  
   tenella 129  
*hystris*, *Seriatopora* 27, 28  
  
*immersa*, *Leptastrea* 131  
*inaequalis*, *Leptastrea* 131  
*inconstans*, *Montipora* 56  
*incructans*, *Cyphastrea* 177  
   *Goniastrea* 120  
   *Leptoseris* 66  
   *Madrepora* 177  
*insignis*, *Desmophyllum* 165  
   *Javania* 165  
  
*interjecta*, *Madracis* 32  
*intermedia*, *Acropora* 36  
*interrupta*, *Gyrosmlia* 163  
   *Haliglossa* 87  
   *Manicina* 163  
*involuta*, *Pachyseris* 71  
*irregularis*, *Galaxea* 142  
*Isophyllia* erythraea 148  
   *sinuosa* 149  
   *spinosa* 149  
*italicus*, *Turbinolia* 156  
*iwayamaensis*, *Porites* 96, 101  
   *Synaraea* 96, 101  
  
*japonica*, *Cyphastrea* 133, 135  
*Javania* 165  
   *insignis* 165  
*Java Sea 1*, *Goniopora* 92  
*jeffreyi*, *Solenosmlia* 160  
  
*kenti*, *Acropora* 40, 43  
   *Madrepora* 40  
*klunzingeri*, *Coeloria* 123, 125  
   *Dendrophyllia* 173, 175  
   *Fungia* 78, 84  
   *Goniopora* 92, 95  
   *Madrepora* 45  
   *Platygyra* 125  
*knorri*, *Pavona* 63  
*kuehlmanni*, *Stylophora* 22, 25  
  
*labyrinthica*, *Maeandra* 123  
   *Meandrina* 73  
*labyrinthiformis*, *Coeloria* 123  
   *Madrepora* 123  
*lacera*, *Echinophyllia* 154  
   *Oxypora* 152, 154  
   *Trachypora* 153, 154  
*lacrymalis*, *Caryophyllia* 145  
   *Cynarina* 145  
*lamarcki*, *Galaxea* 143  
*lamellina*, *Coeloria* 123  
   *Madrepora* 122  
   *Maeandra* 123  
   *Platygyra* 123  
*lamellosa*, *Echinopora* 135, 136, 137  
   *Madrepora* 135, 136  
*lanuginosa*, *Montipora* 50  
*lata*, *Pavon(i)a* 61  
*laticella*, *Madrepora* 40  
*lawisiana*, *Galaxea* 142  
*laxa*, *Euphyllia* 161  
   *Favia* 105, 106, 107  
   *Heteropora* 47, 48  
   *Madrepora* 35  
   *Orbicella* 106, 107  
   *Pavona* 62  
   *Plerogyra* 162  
   *Plesiastrea* 106  
*Leptastrea* 130  
   *bottae(i)* 130  
   *ehrenberg(i)ana* 132  
   *immersa* 131  
   *inaequalis* 131  
   *pruinosa* 132  
   *purpurea* 130, 132  
   *roissiana* 130, 131  
   *solida* 131  
   *transversa* 130, 131, 132  
*leptocladus* (f.), *Madrepora* 43  
*Leptoria* 126  
   *gracilis* 126  
   *phrygia* 126  
*Leptoseris* 59, 65  
   *explanata* 65, 66, 68  
   *foliosa* 67  
   *fragilis* 65, 68  
   *gardineri* 65, 68  
   *glabra* 66  
   *hawaiiensis* 65, 66, 67  
   *incructans* 66  
   *mycetoseroides* 65, 66, 67, 69  
   *papyracea* 68  
   *scabra* 65, 66, 68  
   *tenuis* 65, 67  
   *tubulifera* 66, 67  
   *yabei* 61  
*leptostoma*, *Phyllopora* 33  
*leptoticha*, *Coeloria* 123  
*levicollis*, *Agaricia* 71  
*Pachyseris* 71  
*levis*, *Coelogyra* 127  
   *Craterastrea* 68  
*lichen*, *Goniopora* 95  
   *Porites* 95, 99, 103  
*lichtensteini*, *Physogyra* 163  
   *Plerogyra* 163  
*lilacea*, *Pavona* 63  
   *Siderastrea* 72  
*limacina*, *Haliglossa* 87  
*limax*, *Herpetolitha* 87  
   *Herpolitha* 85, 87  
   *Madrepora* 87  
*lineata*, *Millepora* 28  
   *Seriatopora* 28  
*lobata*, *Favia* 106  
   *Goniopora* 93  
   *Hydnophora* 129  
   *Orbicella* 106  
*Lobophyllia* 144, 145  
   *aurea* 173  
   *corymbosa* 145, 146  
   *costata* 145, 147  
   *hemprichii* 145, 146  
*Lobopsammia* robusta 172  
*lobulata*, *Fungia* 82  
   *Montipora* 50  
*longissima*, *Galaxea* 143  
*Lophoseris* cactus 62  
   *cristata* 61  
   *danai* 63  
   *explanulata* 60  
   *muelleri* 63  
   *repens* 60  
*loyae*, *Blastomussa* 149, 150  
  
*lutea*, *Porites* 96, 98, 99  
   *Synaraea* 102  
*luzonica*, *Acropora* 37  
*lymani*, *Trachosmlia* 160  
  
*macrostoma*, *Acropora* 43  
   *Madrepora* 42  
*madagascariensis*, *Fungia* 83  
*Madracis* 21, 31  
   *asperula* 31  
   *interjecta* 32  
*Madrepora* abdita 113, 114  
   *abrotanoides* 55  
   *ampliata* 143, 144  
   *anthocercis* 42  
   *arabica* 35  
   *arcuata* 39  
   *armata* 39  
   *aspera* 152, 153  
   *bifaria* 40  
   *bottae* 47  
   *cacuts* 59, 62  
   *calamaria* 41  
   *canaliculata* 41  
   *canalis* 37  
   *cancellata* 44  
   *capillaris* 47  
   *cavernosa* 110  
   *centralis* 159  
   *cervicornis* (f.) 47  
   *cespitifoliata* (f.) 43  
   *chalcidicum* 134  
   *clavigera* 46  
   *concamerata* 137  
   *conferta* 40  
   *contignatio* 129  
   *contigua* 18  
   *coronata* 43  
   *corymbosa* 38, 145, 146  
   *crassilabia* (var.) 38  
   *crater* 176  
   *cristata* 59  
   *crustacea* 87, 88  
   *cyathus* 154  
   *cymbicyathus* 38  
   *cytherea* 39, 40  
   *daedalea* 88, 89, 122, 123  
   *delicatula* 40  
   *dilatata* 42  
   *disticha* 38  
   *divergens* 142  
   *echinata* 85, 86  
   *effusa* 38  
   *ehrenbergi* 35  
   *elephantotus* 151, 152  
   *erythraea* 41  
   *eurystoma* 42  
   *exesa* 127, 128  
   *fascicularis* 141, 142  
   *favus* 110  
   *formosa* 37  
   *forskali* 45  
   *fragum* 105

- fungites 78, 84  
 gemmifera 41  
 gracilis 126  
 granulosa 46  
 haimei 37  
 hemprichi 44  
 humilis 40  
 hyacinthus 39  
 incrustans 177  
 kenti 40  
 klunzingeri 45  
 labyrinthiformis 123  
 lamellina 122  
 lamellosa 135, 136  
 latistella 40  
 laxa 35  
 leptoclados (f.) 43  
 limax 87  
 macrostoma 42  
 microcyathus 35  
 monasteriata 51  
 monile 73  
 multicaulis 35  
 muricata 47  
 nasuta 38  
 nobilis 36  
 obtusata 45  
 ocellata 41  
 organum 143  
 pachyclados (f.) 43  
 pallida 41  
 patula 40  
 paxilligera 41  
 pectinata 40  
 pentagona 118  
 pharaonis 35, 47  
 phrygia 126  
 pistillata 21, 22  
 plantaginea 41  
 platycyathus 41  
 pustulosa 36, 45  
 pyramidalis 41  
 radians 72  
 ramea 170  
 rayneri 46  
 reticulata 40  
 robusta 37  
 rousseaui 44  
 rus 102  
 scandens 36  
 scherzeriana 41  
 secunda 37, 47  
 serailia 134  
 seriata 41  
 solida 96  
 speciosa 46  
 spinulosa 36  
 squarrosa 44  
 subtilis 36  
 superba 47  
 symmetrica 40  
 thurstoni 40  
 tuberculosa 47  
 uva 109  
 vagabunda 41  
 valenciennesi 35  
 valida 47  
 variabilis 43  
 variolosa 45  
 verrucosa 47  
 Maeandra labyrinthica 123  
 lamellina 123  
 stricta 125  
 Maeandrina arabica 123  
 m(a)eandrina, Astraea 73  
 Coscinaraea 73  
 Montipora 48, 52, 56  
 Pocillopora 30, 31  
 Porites 52  
 magna, Coeloria 127  
 magnistellata, Favia 110  
 malaccensis, Goniopora 94  
 malampaya, Montipora 56  
 maldivensis, Cyphastraea 134  
 Hydnothraea 129  
 Pavona 60, 63  
 Siderastrea 63  
 (var.), Trachyphyllia 140  
 Maldives 4, Goniopora 92  
 mamillata, Stylophora 22, 26  
 mammillosa, Orbicella 137  
 Plesiastrea 137  
 Manicina hemprichii 146  
 interrupta 163  
 manni, Acropora 37  
 Dendrophyllia 174  
 Manopora erosa 50  
 planiuscula 49  
 stilosa 56  
 mantonae, Goniastrea 121  
 margariticola, Sclerophyllia 145  
 marginata, Cycloseris 75, 77  
 Fungia 77  
 massawensis, Acropora 46  
 matthai, Favia 112  
 mayeri, Porites 99  
 Meandrina crispa 127  
 labyrinthica 73  
 rustica 124  
 melicerum, Astraea 118  
 Favites 118  
 merleti, Bantamia 149, 150  
 Blastomussa 149, 150  
 Merulina 143  
 ampliata 144  
 scheeri 144  
 Merulinidae 143  
 mesenterina, Explanaria 176  
 Turbinaria 176  
 micrantha, Tubastraea 176  
 micranthus, Coenopsammia 175  
 Dendrophyllia 176  
 Oculina 175  
 Tubastraea 173, 175  
 microconos, Hydnothraea 128  
 Monticularia 128  
 microcyathus, Madrepora 35  
 microphthalma, Astrea 133  
 Cyphastrea 133, 135  
 millepora, Acropora 55  
 Millepora alaicornis 22  
 damicornis 22, 29  
 lineata 28  
 muricata 33  
 minicoiensis, Agaricia 66, 69  
 Orbicella 130  
 Pavona 69  
 minor, Goniopora 92, 93, 94, 95  
 minuscula, Dendrophyllia 170  
 minutus, Deltocyathus 156  
 mitrata, Turbinolia 155  
 Moluccas 1, Porites 100  
 moluccensis, Fungia 78, 79  
 monasteriata, Madrepora 51  
 Montipora 48, 50, 51, 55  
 monile, Astrea 73  
 Coscinaraea 73  
 Madrepora 73  
 Monomyces anthophyllum 165  
 Montastrea 139  
 annuligera 139  
 curta 139  
 Monticularia microconos 128  
 monticulosa, Pachyseris 70  
 Undaria 70  
 Montipora 32, 48  
 abrotanoides 55  
 capitata 52  
 circumvallata 49, 52, 54, 55  
 coalita 56  
 colei 49  
 composita 59  
 confusa 53  
 conicula 50  
 crista galli 55  
 danae 52  
 densa 55  
 digitata 54  
 divaricata 54, 55  
 edwardsi 49, 53, 56  
 effusa 58  
 ehrenbergi 49, 57  
 eilatensis (var.) 57  
 erythraea 57  
 foliosa 57  
 gracilis 49, 54, 56  
 granulata 59  
 granulosa 58  
 hirsuta 56  
 inconstans 56  
 lanuginosa 50  
 lobulata 50  
 malampaya 56  
 meandrina 48, 52, 56  
 monasteriata 48, 50, 51, 55  
 multilobata 53  
 nudiceps 55  
 rus 53, 102  
 sinensis 50  
 solanderi 57  
 spongiosa 49, 53, 54, 56  
 spumosa 48, 50  
 stilosa 49, 56, 59  
 strigosa 56  
 trabeculata 57  
 tuberculosa 48, 49, 50, 51  
 tuberosa 57  
 venosa 48, 49, 52  
 verrilli 59  
 verrucosa 48, 49, 52  
 villosa 57  
 mordax, Sideropora 22  
 Stylophora 22  
 mortenseni, Alveopora 89, 90  
 muelleri, Lophoseris 63  
 Pavona 63  
 multicaulis, Acropora 35  
 Madrepora 35  
 multilobata, Montipora 53  
 muricata, Acropora 48  
 Madrepora 47  
 Millepora 33  
 murrayensis, Acropora 44  
 Porites 97  
 Mussa corymbosa 146  
 costata 146  
 cristata 146  
 distans 146  
 erythraea 148  
 hemprichi 146  
 Mussidae 144  
 Mycedium 151  
 aspera 151  
 elephantotus 151  
 explanatum 151  
 okeni 151  
 tenuicostatum 151  
 tubifex 151  
 mycetoseroides, Agariciella 66  
 Leptoseris 65, 66, 67, 69  
 myriophthalma, Astraeopora 33  
 Astrea 32, 33  
 nana, Stylophora 22  
 nasuta, Acropora 34, 38  
 Madrepora 38  
 nierstraszi, Psammocora 17, 18,  
 20  
 nigrescens, Coenopsammia 176  
 Dendrophyllia 176  
 nobilis, Acropora 34, 36, 48  
 Madrepora 36  
 (var.), Pocillopora 31  
 nodifera, Porites 96, 100  
 nudiceps, Montipora 55  
 Nullipora polymorpha 31  
 oahensis, Fungia 79  
 Trochocyathus 155, 156  
 oblongatus, Heterocyathus 158  
 obtusa (var.), Goniastrea 115  
 obtusangula, Pavona 17, 63

- obtusata, Madrepora 45  
 ocellata, Acropora 41  
   alveopora 89, 90  
   Madrepora 41  
   Seriatorpora 28  
 ocellina, Cyphastrea 134  
 octoptera, Seriatorpora 27  
 Oculina coccinea 175  
   micranthus 175  
 Oculinidae 141  
 okeni, Favia 109  
   Mycedium 152  
 Orbicella bottai 130  
   forskalana 137  
   laxa 106, 107  
   lobata 106  
   mammillosa 137  
   minicoiensis 130  
   stelligera 105  
   versipora 139  
 organum, Madrepora 143  
   Sarcinula 143  
 orpheensis, Echinophyllia 152,  
   153  
 ostreaeformis, Coscinaraea 73  
 Oulophyllia 127  
   aspera 127  
   crispa 127  
 ovalis, Rhodopsammia 168  
 Oxyphyllia aspera 153  
 Oxypora 151, 153  
   lacera 152, 154  
   titiziamensis 154  
  
 pachychila, Coeloria 124  
 pachyclados (f.), Madrepora 43  
 Pachyseris 59, 70  
   carinata 70  
   clementei 71  
   gemmae 70  
   involuta 71  
   levicollis 71  
   monticulosa 70  
   rugosa 70, 71  
   speciosa 70, 71  
   torresiana 70  
   valenciennesi 70  
 pagoensis, Acropora 42  
 palauensis, Goniastrea 119  
 pallida, Astraea 107  
   Favia 105, 107  
   Madrepora 41  
   Phyllangia 157  
 palmata, Stylophora 22  
 papyracea, Folioseris 68  
   Leptoseris 68  
 Paracyathus conceptus 157  
 paradoxus, Caryophyllia 155  
 Parascolymia 151  
   vitiensis 151  
 parasiticus, Heterocyathus 158  
 Parasmilia 159  
   fecunda 159  
  
 Parastr(a)ea amicorum 108  
   bertholleti 112  
   bombronii 122  
 parvistella, Goniastrea 120  
 patella, Fungia 75, 77, 84  
 patelliformis, Cycloseris 74, 76  
   Fungia 74  
 patula, Madrepora 40  
 paucistellata, Pocillopora 30  
 paumotensis, Fungia 85  
 Pavon(i)a 59  
   angularis 61  
   arbuscula (var.) 64  
   cactus 60, 62  
   laxa 60, 65, 72  
   crassa 61  
   danai 62  
   decussata 60, 61, 62  
   diffluens 65  
   divaricata 60, 64  
   explanulata 59, 60, 65  
   formosa 63  
   gardineri 60  
   knorri 63  
   lata 61  
   laxa 62  
   lilacea 63  
   maldivensis 60, 63  
   minicoiensis 69  
   muelleri 63  
   obtusangula 17, 63  
   percarinata 60  
   planulata 69  
   pollicata 63  
   ponderosa 69  
   praetorta 62  
   repens 60  
   varians 59, 60  
   venosa 64  
   venusta 62  
   yabei 59, 61  
 pavonium, Flabellum 164  
 paxilligera, Madrepora 41  
 pectinata, Astraea 120  
   Goniastrea 119, 120, 121  
   Haliglossa 86  
   Madrepora 40  
 Pectiniidae 151  
 pedunculata, Goniopora 91  
 pentagona, Favia 118  
   Favites 113, 118  
   Madrepora 118  
   Prionastraea 118  
 percarinata, Pavonia 60  
 peresi, Favites 113, 122  
 pharaonis, Acropora 34, 35  
   Madrepora 35, 47  
 philippinensis, Heterocyathus  
   158  
 Philippines 1, Goniopora 94  
 phrygia, Leptoria 126  
   Madrepora 126  
   Platygyra 126  
  
 Phyllangia 141  
   americana 141  
   fuscomarginata 157  
   pallida 157  
   spec. 141  
 Phyllastraea tubifex 152  
 Phyllopora leptostoma 33  
   sphaerostoma 33  
 Physogyra 161, 163  
   aperta 163  
   gravieri 163  
   lichtensteini 163  
   somalienis 163  
 pistillata, Madrepora 21, 22  
   Porites 22  
   Sideropora 22  
   Stylophora 22, 24, 26  
 placunaria, Fungia 79  
 plana, Fungia 81  
 planipora, Psammocora 18  
 planiuscula, Manopora 49  
 plantaginea, Madrepora 41  
 planulata, Agaricia 69  
   Asteroseris 69  
   Astraea 92  
   Gardineroseris 69  
   Goniastrea 121  
   Goniopora 91, 92  
   Pavona 69  
   Polyastra 69  
   Undaria 69  
 platycyathus, Madrepora 41  
 Platygyra 122  
   crosslandi 123, 125  
   daedalea 123, 125, 127  
   gracilis 126  
   klunzingeri 125  
   lamellina 123  
   phrygia 126  
   rustica 123  
   ryukyuensis 125  
   sinensis 123, 125, 126  
   subdentata 123  
 platystoma (var.), Haliglossa 85  
 Plerogyra 161, 162  
   laxa 162  
   lichtensteini 163  
   sinuosa 162  
 Plesiastrea 138  
   haeckeli 120  
   laxa 106  
   mammillosa 137  
   versipora 107, 139  
 Pleuractis (subgen.) 78  
 plicata, Psammocora 18  
 Pocillopora 21, 29  
   acuta 29, 30  
   andreossi 22  
   brevicornis 30  
   bulbosa 29  
   caespitosa 29  
   damicornis 29  
   danae 30  
   elegans 31  
   favosa 29  
   hemprichi 30  
   meandrina 30, 31  
   nobilis (var.) 31  
   paucistellata 30  
   polymorpha 31  
   pulchella 30  
   suffruticosa 30  
   verrucosa 29, 30  
 Pocilloporidae 21  
 Podabacia 74, 87  
   crustacea 88  
 pollicata, Pavona 63  
 Polyastra arbuscula (var.) 64  
   planulata 69  
   ponderosa 69  
 Polycyathus 156  
   andamanensis 157  
   atlanticus 156  
   conceptus 157  
   fuscomarginatus 156, 157,  
   169  
   polymorpha, Nullipora 31  
   Pocillopora 31  
   polymorphus, Porites 96  
   polystoma (var.), Haliglossa 85  
   ponderosa, Agaricia 69  
   Agariciella 69  
   Gardineroseris 69  
   Pavona 69  
   Polyastra 69  
 Porites 88, 96  
   alveolata 97  
   andrewsi 102  
   arenacea 100  
   arenosa 97  
   armata 20  
   astraeoides 21  
   Caroline Islands 3, 101  
   circumvallata 55  
   clavaria 100  
   clavasia 89  
   columnaris 96, 99  
   compressa 96, 101  
   conglomerata 97, 98  
   crista galli 55  
   daedalea 89  
   digitata 22  
   echinulata 96, 99  
   faustinoi 102  
   foliosa 57  
   fragosa 97  
   haddoni 98  
   horizontalata 102  
   iwayamaensis 96, 101  
   lichen 95, 99, 102  
   lutea 96, 98, 99  
   maeandrina 52  
   mayeri 99  
   Molluccas 1 100  
   murrayensis 97  
   nodifera 96, 100



- pistillata 22  
 polymorphus 96  
 punctata 96, 100  
 Red Sea 1 97  
 Red Sea 2 98  
 Red Sea 3 100  
 Red Sea 4 102  
 Red Sea 5 99  
 Red Sea 6 102  
 Red Sea 7 99  
 Red Sea 8 97  
 Red Sea 9 100  
 solida 96, 102  
 somaliensis 98  
 spongiosa 54  
 spumosa 50  
 stephensoni 98  
 stilosus 56  
 studeri 102  
 subseriata 24  
 tenuis 98  
 tuberculosa 50  
 undulata 96, 102  
 venosa 49  
 verrucosa 52
- Poritidae** 88  
 praetorta, Pavona 62  
 primordialis, Tridacophyllia 158  
**Prionastraea acuticollis** 117  
 australensis 121  
 gibbosa 114  
 halicora 116  
 hemprichi 115  
 pentagona 118  
 profundicella 114  
 seychellensis 122  
 spinosa 115  
 superficialis (var.) 115  
 tesserafer 115  
 vasta 115, 116  
 profunda (var.), Favites 117  
 profundicella, Psammocora 17, 19, 20  
 profundicella, Prionastraea 114  
 prolifera, Heteropora 36  
 prostrata, Stylophora 23  
 pruinosa, Leptastrea 132  
**Psammocora** 17  
 contigua 17, 18  
 divaricata 18  
 explanulata 17, 20  
 frondosa 18  
 gonagra 18  
 haimeana 17, 19  
 nierstraszi 17, 18, 20  
 planipora 18  
 plicata 18  
 profundicella 17, 19, 20  
 ramosa 18  
 samoensis 18, 19, 20  
 superficialis 19, 20  
 vauhani 18  
**Pseudocolumnastrea** (subgen.) 63  
 Pseudosiderastrea tayami 72  
 pseudostelligera, Favia 106  
 pulchella, Pocillopora 30  
 Siderastraea 72  
 pulchellus, Heterocyathus 158  
 pulchra, Rhizopsammia 169  
 pulvinaria, Astraeopora 33  
 punctata, Porites 96, 100  
 Stylaraea 100  
 purpurea, Astrea 132  
 Leptastrea 130, 132  
 pustulosa, Madrepora 36, 45  
 pyramidalis, Madrepora 41  
 radians, Madrepora 72  
 rambleri, Acropora 46  
 ramea, Madrepora 170  
 ramosa, Psammocora 18  
 rayneri, Acropora 46  
 Madrepora 46  
 rediviva, Balanophyllia 167  
 Red Sea 1, Goniopora 93  
 Porites 97  
 Red Sea 2, Goniopora 93  
 Porites 98  
 Red Sea 3, Goniopora 94  
 Porites 100  
 Red Sea 4, Goniopora 95  
 Porites 102  
 Red Sea 5, Goniopora 95  
 Porites 99  
 Red Sea 6, Porites 102  
 7, Porites 99  
 8, Porites 97  
 9, Porites 100  
 regularis, Goniastrea 121  
 repanda, Fungia 78, 81, 82  
 repens, Lophoseris 60  
 Pavonia 60  
 reticulata, Acropora 40  
 Madrepora 40  
 retiformis, Astrea 119  
 Goniastrea 119, 122  
**Rhizangiidae** 140  
 Rhizopsammia 166, 169  
 pulchra 169  
 wettsteini 169  
 Rhizotrochus 164  
 crateriformis 164  
 typus 164, 165  
 Rhodaraea gracilis 95  
 Rhodopsammia affinis 168  
 ovalis 168  
 robusta, Dendrophyllia 170, 172  
 Lobopsammia 172  
 Madrepora 37  
 roissiana, Leptastrea 130, 131  
 rosaria, Acropora 44  
 rotulosa, Favia 108  
 rotundata, Favia 105, 111  
 Favites 111  
 rotundiflora, Acanthastrea 148  
 rousseaui, Acropora 44  
 Madrepora 44  
 rubeola, Culicia 140  
 Dendrophyllia 140  
 rubrum, Falbellum 164  
 rueppellii, Herpetholithas 86  
 rugosa, Agaricia 70  
 Echinophyllia 152  
 Pachyseris 70, 71  
 rus, Madrepora 102  
 Montipora 53, 102  
 rustica, Coeloria 124  
 Meandrina 124  
 Platygyra 124  
 ryukyuensis, Platygyra 125  
 samoensis, Psammocora 18, 19, 20  
 Sarcinula organum 143  
 savigniana, Astraea 72  
 Siderastr(a)ea 72  
 savignyi, Alcyonella 89  
 Cynarina 144, 145  
 Cyphastrea 133  
 Favia 110  
 Goniopora 92, 94  
 Siderastraea 72  
 scabra, Leptoseris 65, 66, 68  
 scandens, Acropora 36  
 Madrepora 36  
 scheeri, Merulina 144  
 scherzeriana, Acropora 41  
 Madrepora 41  
 schnideri, Favia 125  
 Sclerophyllia margaritcola 145  
 scrupeosa, Fungia 78, 82  
 scutaria, Fungia 78, 79  
 secunda, Acropora 37  
 Madrepora 37, 47  
 septata, Stylophora 23  
 serailia, Cyphastrea 133, 134  
 Madrepora 134  
 seriata, Heteropora 41  
 Madrepora 41  
**Seriopora** 21, 26  
 angulata 28  
 caliendrum 27, 28  
 hystrix 27, 28  
 lineata 28  
 ocellata 28  
 octoptera 27  
 spinosa 28  
 subulata 26, 28  
 serpentina, Dendrophyllia 168  
 sewelli, Caryophyllia 155  
 seychellensis, Goniastrea 121, 122  
 Prionastraea 122  
**Siderastrea** 72  
 lilacea 72  
 maldivensis 63  
 pulchella 72  
 savigniana 72  
 savignyi 72  
 sphaeroidalis 72  
**Siderastreidae** 72  
 Sideropora mordax 22  
 pistillata 22  
 simplex, Herpetoglossa 85, 86  
 Herpolitha 86  
 Symphyllia 149  
 sinaitica, Stylophora 23  
 sinensis, Coeloria 125  
 Montipora 50  
 Platygyra 123, 125, 126  
 sinuosa, Euphyllia 162  
 Isophyllia 149  
 Plerogyra 162  
 smithi, Angia 141  
 solanderi, Montipora 57  
**Solenastrea forskaelana** 134  
 gibbosa 134  
 hemprichana 134  
**Solenosmilia** 160  
 jeffreyi 160  
 variabilis 160  
 solida, Goniastrea 120  
 Leptastrea 131  
 Madrepora 96  
 Porites 96, 103  
 solidior, Echinopora 137  
 somaliensis, Goniopora 95  
 Physogyra 163  
 Porites 98  
 somervillei, Cycloseris 80  
 Funiga 79  
 speciosa, Acropora 46  
 Agaricia 71  
 Astraea 109  
 Favia 105, 108, 109, 111, 112  
 Madrepora 46  
 Pachyseris 70, 71  
 sphaeroidalis, Siderastraea 72  
 sphaerostoma, Phillopora 33  
 spinosa, Acanthastraea 147  
 Isophyllia 149  
 Prionastraea 115  
 Seriatopora 28  
 spinulosa, Madrepora 36  
 spongiosa, Astraea 120  
 spongiosa, Montipora 49, 53, 54, 56  
 Porites 54  
 spumosa, Montipora 48, 50  
 Porites 50  
 squarrosa, Acropora 34, 44, 46  
 Heteropora 44, 46  
 Madrepora 44  
 stellaris, Haliglossa 87  
 stellata, Culicia 140, 141  
 stelligera, Favia 105, 122, 137  
 Orbicella 105  
 Stephanocora hemprichii 137  
 stephensoni, Porites 98  
 stilosa, Manopora 56  
 Montipora 49, 56, 59

- Porites 56  
 stokesi, Goniopora 91, 92  
 stricta, Maeandra 125  
 strigosa, Montipora 56  
 Strombodes hemprichi 80  
 studeri, Porites 103  
 Stylaraea punctata 100  
 Stylocoenia hanzawai 20  
 Stylocoeniella 20  
   armata 20, 100  
   guentheri 20, 21  
   hanzawai 20, 21  
 Stylophora 21  
   armata 20, 100  
   cellulosa 24  
   danae 22, 23  
   dendritica 22  
   digitata 22  
   ehrenbergi 21  
   elongata 22  
   erythraea 23  
   expanda 22  
   guentheri 21  
   hassi 25  
   kuelhmanni 22, 25  
   mamillata 22, 26  
   mordax 22  
   nana 22  
   palmata 22  
   pistillata 22, 24, 26  
   prostrata 22  
   septata 22  
   sinaitica 22  
   subseriata 22, 24, 25, 28  
   verrucosa 26  
   wellsi 22, 25  
 subcornigera, Dendrophyllia 172  
 subdentata, Coeloria 124  
   Platygyra 124  
 subseriata, Porites 24  
   Stylophora 22, 24, 25, 28  
 subtilis, Madrepora 36  
 subulata, Seriatopora 26, 28  
 suffruticosa, Pocillopora 30  
 sugiyamai (var.), Echinophyllia 153  
 superba, Madrepora 47  
 superficialis, Alveopora 90, 91  
   (var.), Favia 115  
   (var.), Prionastraea 115  
   Psammocora 19, 20  
 suvadiva, Cyphastrea 134  
 symmetrica, Madrepora 40  
 Symphyllia erythraea 148  
   simplex 149  
 Synaraea convexa 101  
   faustinoi 101  
   horizontalata 102  
   iwayamaensis 101  
   lutea 102  
   undulata 102  
 tayami, Pseudosiderastrea 72  
 tenella, Acropora 46  
   Goniopora 92, 94  
   Hydnophora 129  
   Tichopora 94  
 tenuicostatum, Mycedium 152  
 tenuifolia, Fungia 84  
 tenuilamellosa, Tubastraea 174  
 tenuis, Acropora 42  
   Cycloseris 75, 76  
   Leptoseris 65, 67  
   Porites 98  
   Turbinaria 177  
 tessera, Astraea 115  
   Prionastraea 115  
 Thamnasteriidae 17  
 Thecopsammia fistula 170  
 thurstoni, Madrepora 40  
 Tichopora tenella 94  
 Tichoseris angulosa 64  
 titiziamensis, Oxypora 154  
 torresiana, Pachyseris 70  
 tosaensis (var.), Echinophyllia 153  
 trabeculata, Montipora 57  
 Trachyphyllia 139  
   amarantum 140  
   constricta 140  
   geoffroyi 140  
   maldivensis (var.) 140  
 Trachyphylliidae 139  
 Trachypora lacera 153, 154  
 transversa, Leptastrea 130, 131, 132  
 Tridacophyllia cervicornis 158  
   primordialis 158  
 Trochocyathus 155  
   oahensis 155, 156  
   virgatus 155  
 Trochosmilium lymani 160  
 Tubastraea 167, 173  
   aurea 173, 174  
   coccinea 173, 174, 175  
   diaphana 173, 174  
   micrantha 176  
   micranthus 173, 175  
   tenuilamellosa 174  
 tuberculosa, Madrepora 47  
   Montipora 48, 49, 50, 51  
   Porites 50  
 tuberosa, Montipora 57  
 tubifex, Mycedium 152  
   Phyllastraea 152  
 tubulifera, Favia 109  
   Leptoseris 66, 67  
 tumida, Caulastrea 103  
 Turbinaria 167, 176  
   aspera 177  
   conica 177  
   ehrenbergi 177  
   mesenterina 176  
   tenuis 177  
 Turbinolia italicus 156  
   geoffroyi 139, 140  
   mitrata 155  
   turgida, Euphyllia 161  
   typus, Rhizotrochus 164, 165  
 Ulophyllia aspera 127  
   bonhourei 127  
   cellulosa 127  
 Undaria monticulosa 70  
   planulata 69  
 undulata (var.), Echinophyllia 153  
   Porites 96, 102  
   Synaraea 96, 102  
 uva, Favia 109  
   Madrepora 109  
   vacua, Favia 107  
   vagabunda, Madrepora 41  
   valenciennesi, Acropora 34, 35  
   Favia 112  
   Madrepora 35  
   Pachyseris 70  
   valida, Dasmosmilium 160  
   Fungia 83  
   Madrepora 47  
   variabilis, Acropora 34, 43  
   Madrepora 43  
   Solenosmilium 160  
   varians, Pavon(i)a 59, 60  
   variolosa, Madrepora 45  
   vasta, Favia 116  
   Favites 116  
   Prionastraea 115, 116  
   vaughani, Cycloseris 75, 76  
   Psammocora 18  
   venosa, Montipora 48, 49, 52  
   Pavona 64  
   Porites 49  
   venusta, Pavona 62  
   verrilli, Montipora 59  
   verrilliana, Alveopora 89, 90  
   Verrillofungia (subgen.) 78  
   verrucosa, Madrepora 47  
   Montipora 48, 49, 52  
   Pocillopora 29, 30  
   Porites 52  
   Stylophora 26  
   versipora, Astrea 138, 139  
   Favia 110, 139  
   Orbicella 139  
   Plesiastrea 107, 139  
   villosa, Montipora 57  
   virens, Favites 112, 116  
   virgatus, Trochocyathus 155  
   viridis, Alveopora 89, 91  
   vitiensis, Parascolymia 151  
   wakayana, Favia 107  
   wellsi, Blastomussa 149, 150  
   Stylophora 22, 25  
   wettsteini, Rhizopsammia 169  
   willeyi, Coenopsammia 174  
   Dendrophyllia 174  
   wisseli, Favia 105, 111  
   wood-masoni, Heterocyathus 158  
   yabei, Leptoseris 61  
   Pavona 59, 61  
   yamanarii, Favites 117

JOURNAL, CENTRAL MARINE FISHERIES  
RESEARCH INSTITUTE, ERNAKULAM  
COCHIN-392016, INDIA

# Plates

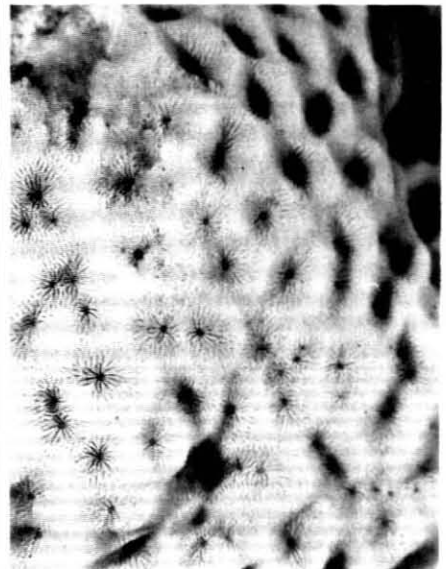
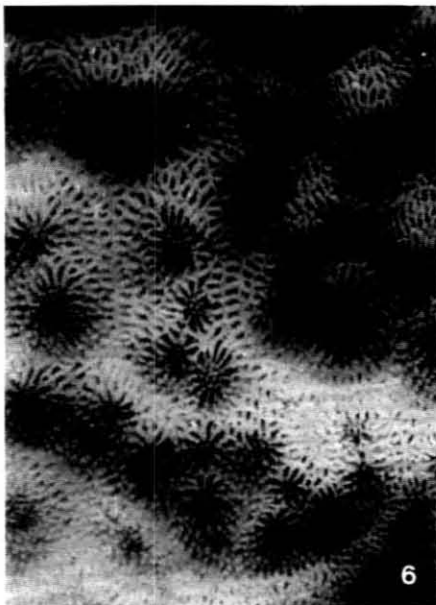
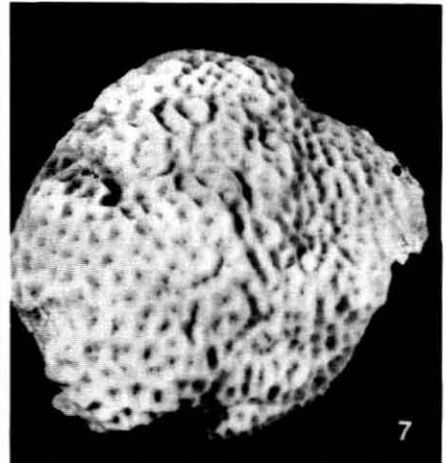
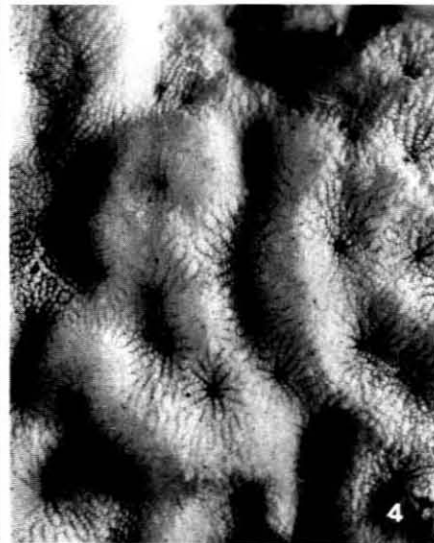

Figs. 1, 2. *Psammocora contigua* (X2:9-8, x0.5, x2).

Figs. 3, 4. *Psammocora nierstraszi* (NS 5127, x1.3, x4.9).

Figs. 5, 6. *Psammocora profundacella* (Sa 20, x1, x5.3).

Figs. 7, 8. *Psammocora haimeana* (ZMB 7007, x0.8, x2.7).

Fig. 9. *Psammocora explanulata* (ZMB 7009, x2.6).

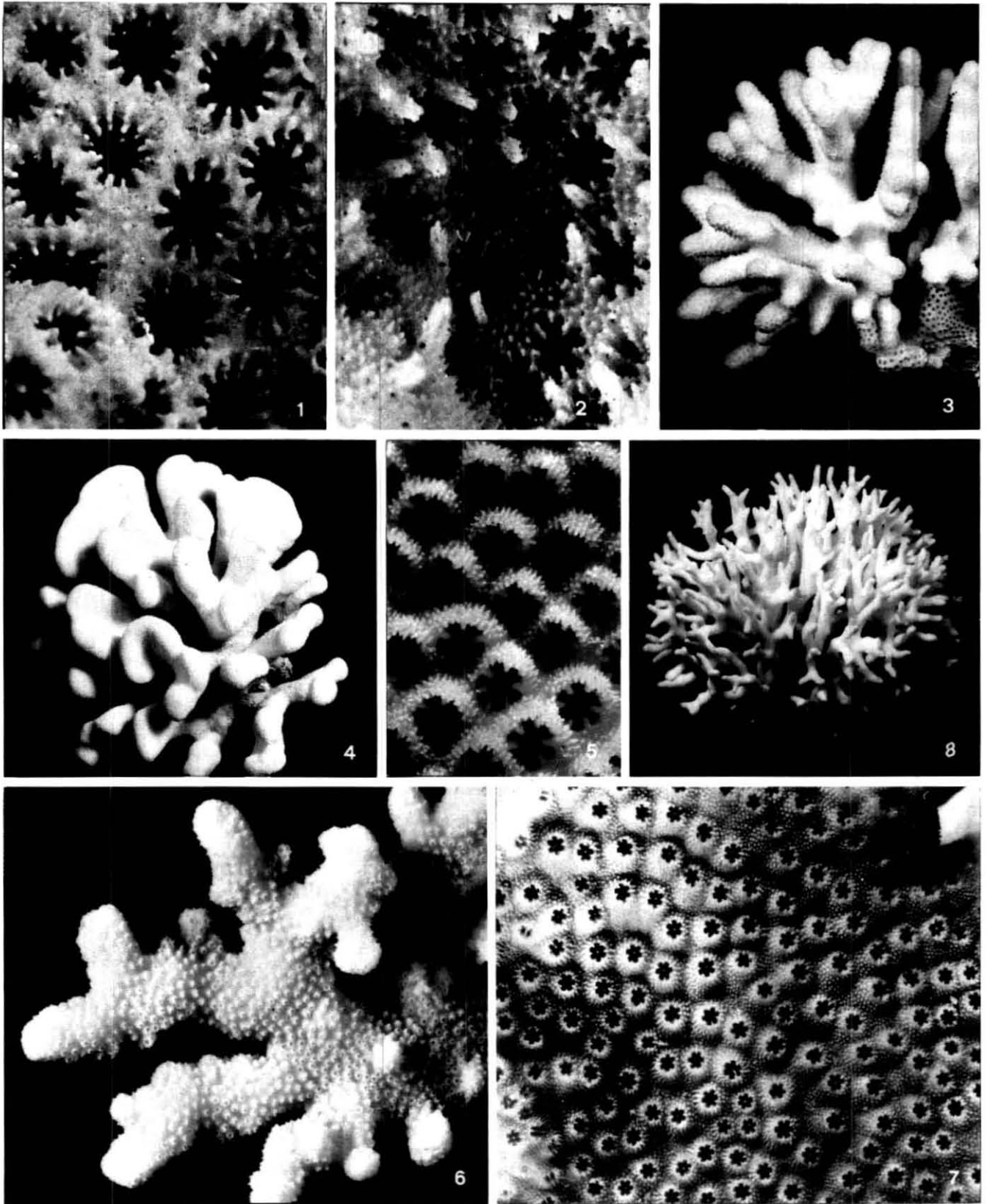
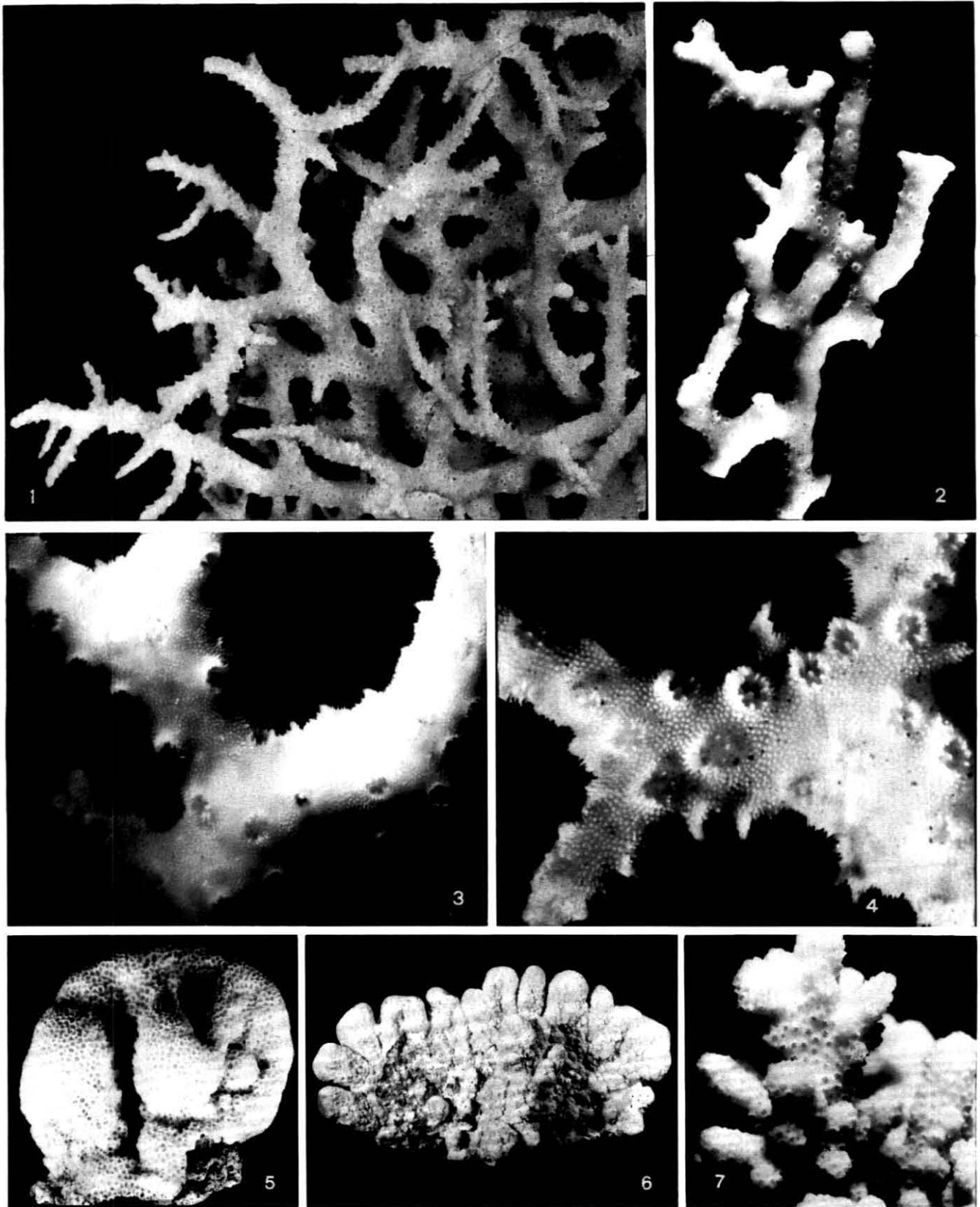

Fig. 1. *Stylocoeniella armata* (ZMB 600, x11.5, phot. V. KOPSKE).  
Fig. 2. *Stylocoeniella guentheri* (ZMB 7012, x13, phot. V. KOPSKE).

Figs. 3–5. *Stylophora pistillata* (3: EC 420, x0.7; 4, 5: RM 52, f. *mordax*, x0.4, x10).  
Figs. 6, 7. *Stylophora danae* (Sa 88, x1.5).  
Fig. 8. *Stylophora subseriata* (RM 56, x0.5).



Figs. 1-4. *Stylophora kuehlmanni* (1: ZMB 7013, x1, phot. V. KOPSKE; 2: EC 1381b, x1.65; 3: EC 1381d, x6.4; 4: EC 1382, x10).

Figs. 5-7. *Stylophora wellsi* (5: RM 13a, x1; 6: RM 60, x0.25; 7: X2:10-17, f. hassi, x1.9).

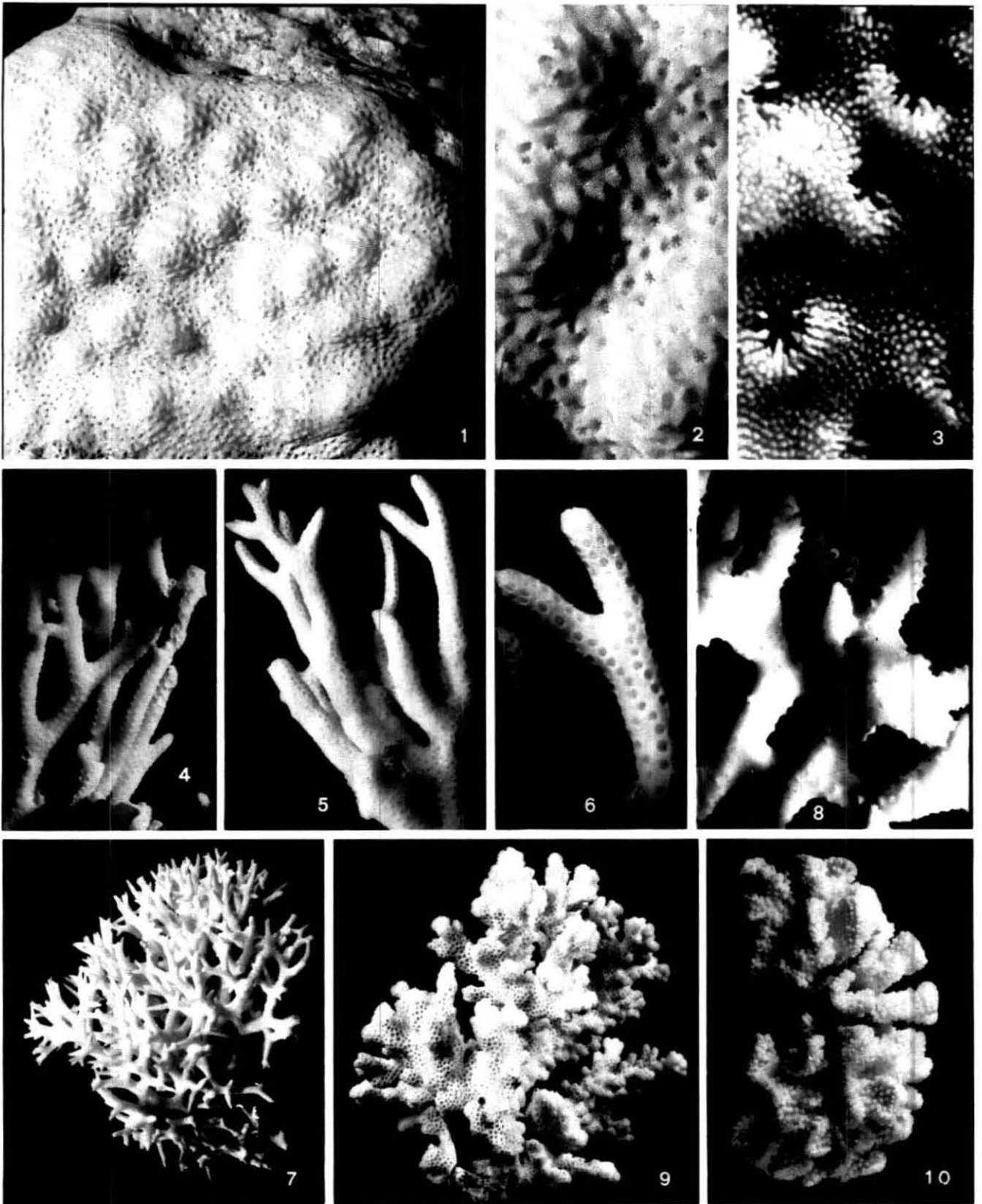

Figs. 1-3. *Stylophora mamillata* (1, 2: ZMB 7020, x1.4, x4.3; 3: EC 1383, x18).

Fig. 4. *Seriatopora caliendrum* (NS 9304, x1.2).

Figs. 5, 6. *Seriatopora octoptera* (SLR 2148-2, x1.2, x2.8).

Figs. 7, 8. *Seriatopora hystrix* (7: X2:10-11, x0.6; 8: X2:3-25, x1.8).

Fig. 9. *Pocillopora damicornis* (SLR 396-1, x0.6).

Fig. 10. *Pocillopora verrucosa* (RM 62, x0.3).

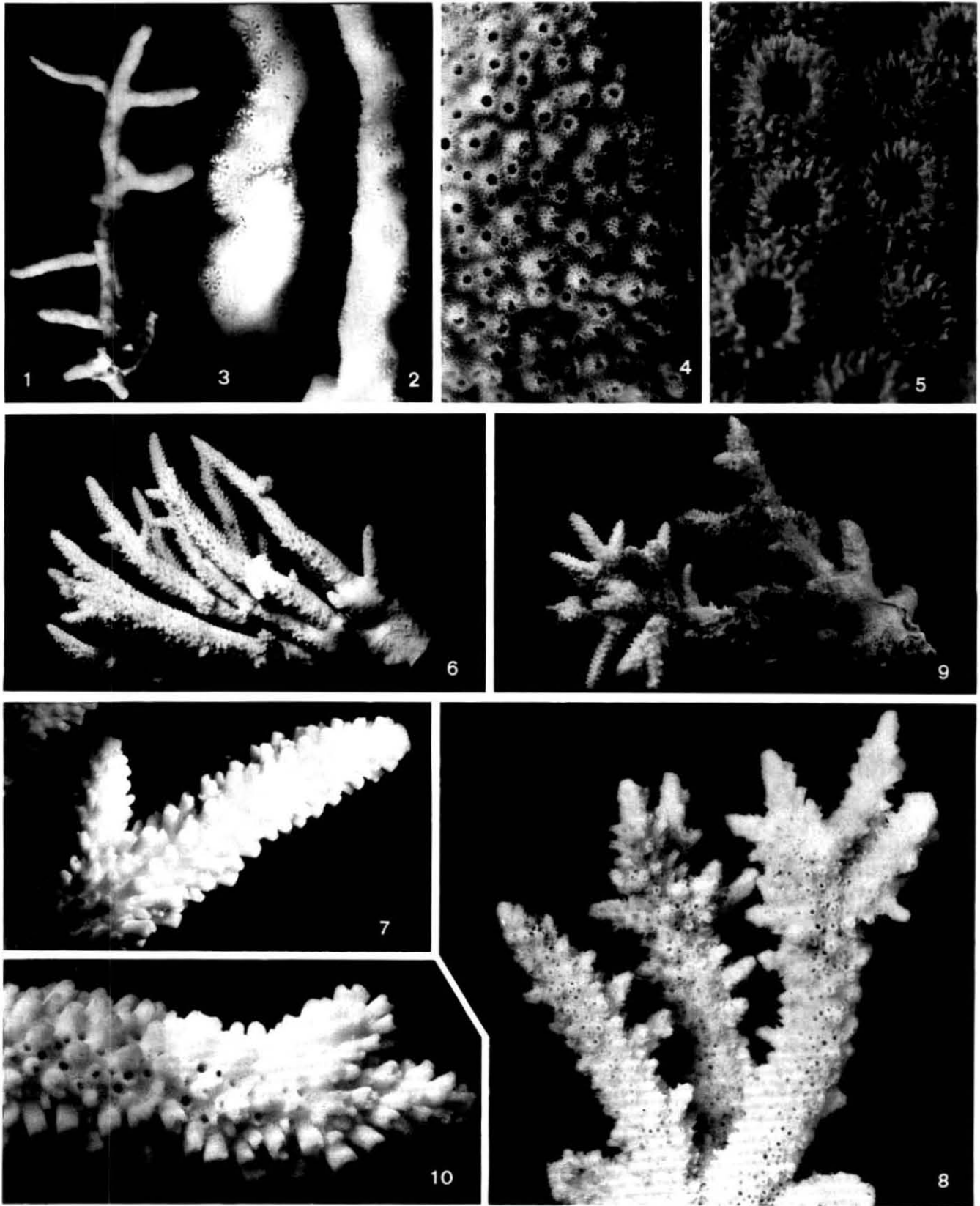

Figs. 1—3. *Madracis interjecta* (1: Fri 49—2a, x0.75; 2: Fri 49—2c, x2.3; 3: Fri 49—1a, x2.2).

Figs. 4, 5. *Astreopora myriophthalma* (4: SLR 672, x1; 5: Wa 101, x5, phot. U.S.N.M.).

Figs. 6, 7. *Acropora valenciennesi* (X2:10—1, x0.33, x1.3).

Fig. 8. *Acropora pharaonis* (SLR 809, x1).

Figs. 9, 10. *Acropora nobilis* (EC 350, x0.33, x1.5).



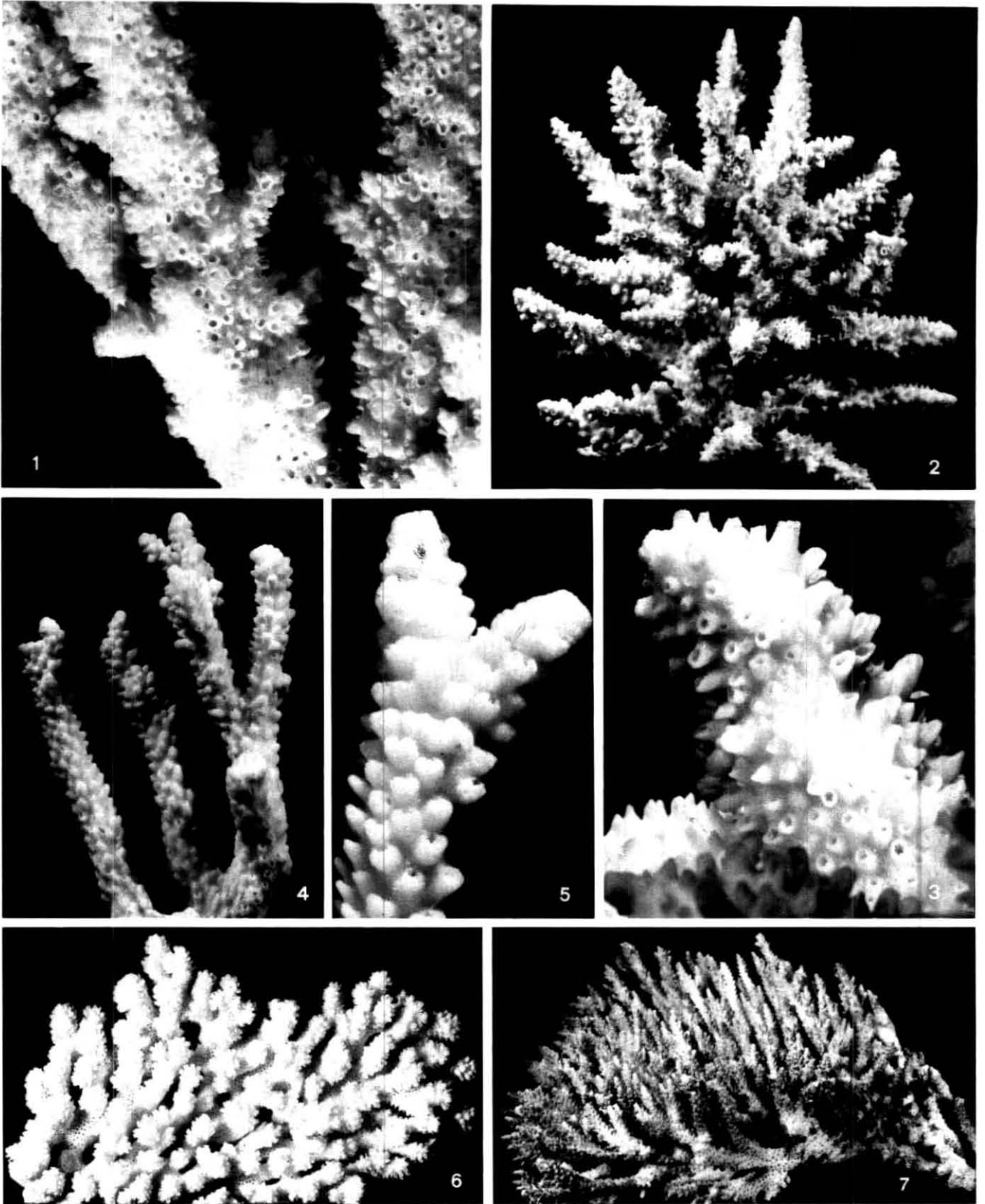
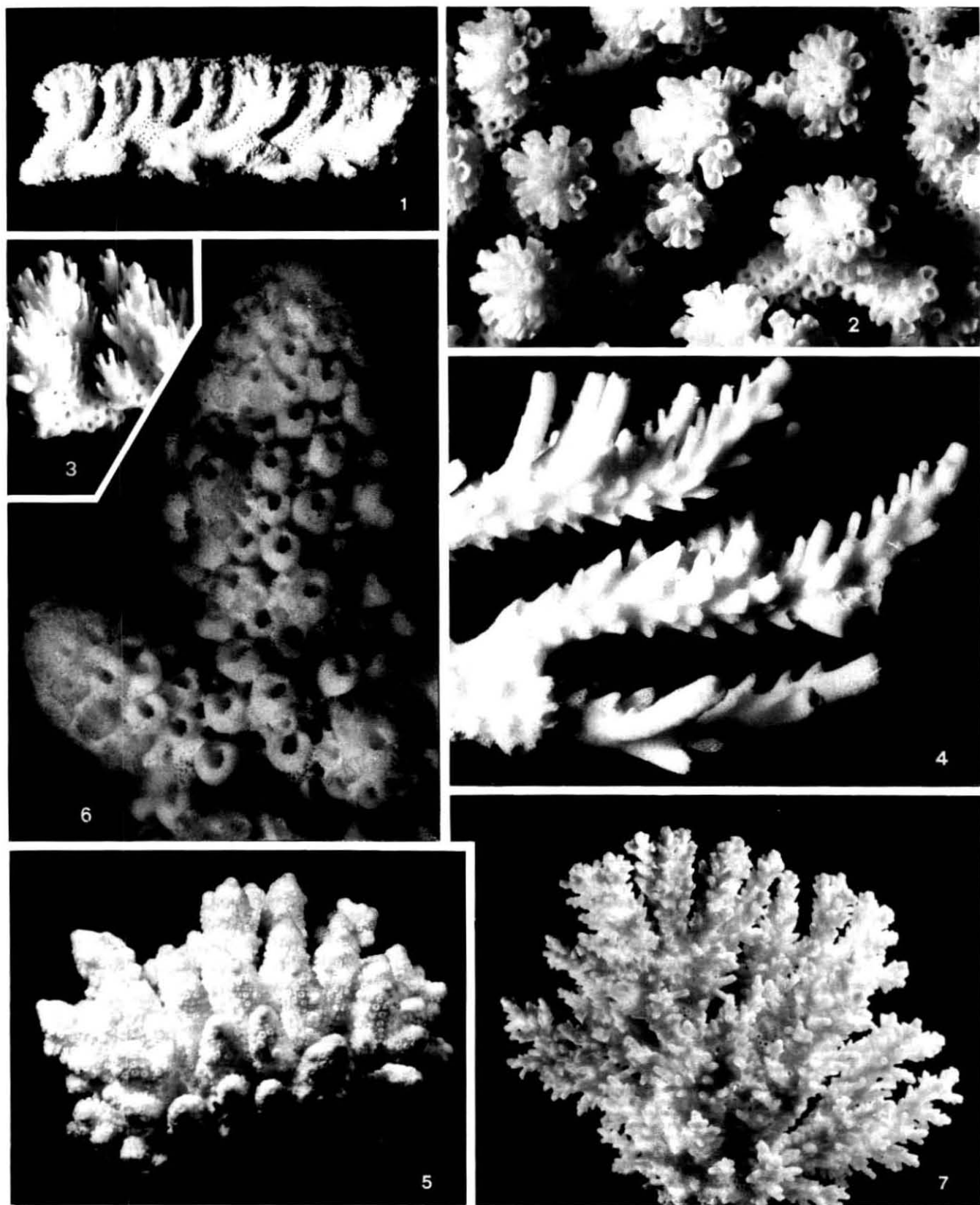

Fig. 1. *Acropora pharaonis* (NS 1860, x2).  
Figs. 2, 3. *Acropora haimeii* (2: EC 496, x0.7; 3: EC 286, x2).  
Figs. 4, 5. *Acropora nasuta* (NS 1281, x1, x3).

Fig. 6. *Acropora corymbosa* (Sa 28, x0.4).  
Fig. 7. *Acropora hyacinthus* (Sa 29, x0.4).



Figs. 1, 2. *Acropora corymbosa* (Sa 28, x0.5, x2).  
Fig. 3. *Acropora corymbosa* f. *cytherea* sensu KLUNZINGER (SCHUHMACHER 83, x1.5).

Fig. 4. *Acropora hyacinthus* (Sa 29, x2.5).  
Figs. 5, 6. *Acropora humilis* (5: RM 65, x0.5; 6: NS 1861, x3).  
Fig. 7. *Acropora eurystoma* (RM 67, x0.5).

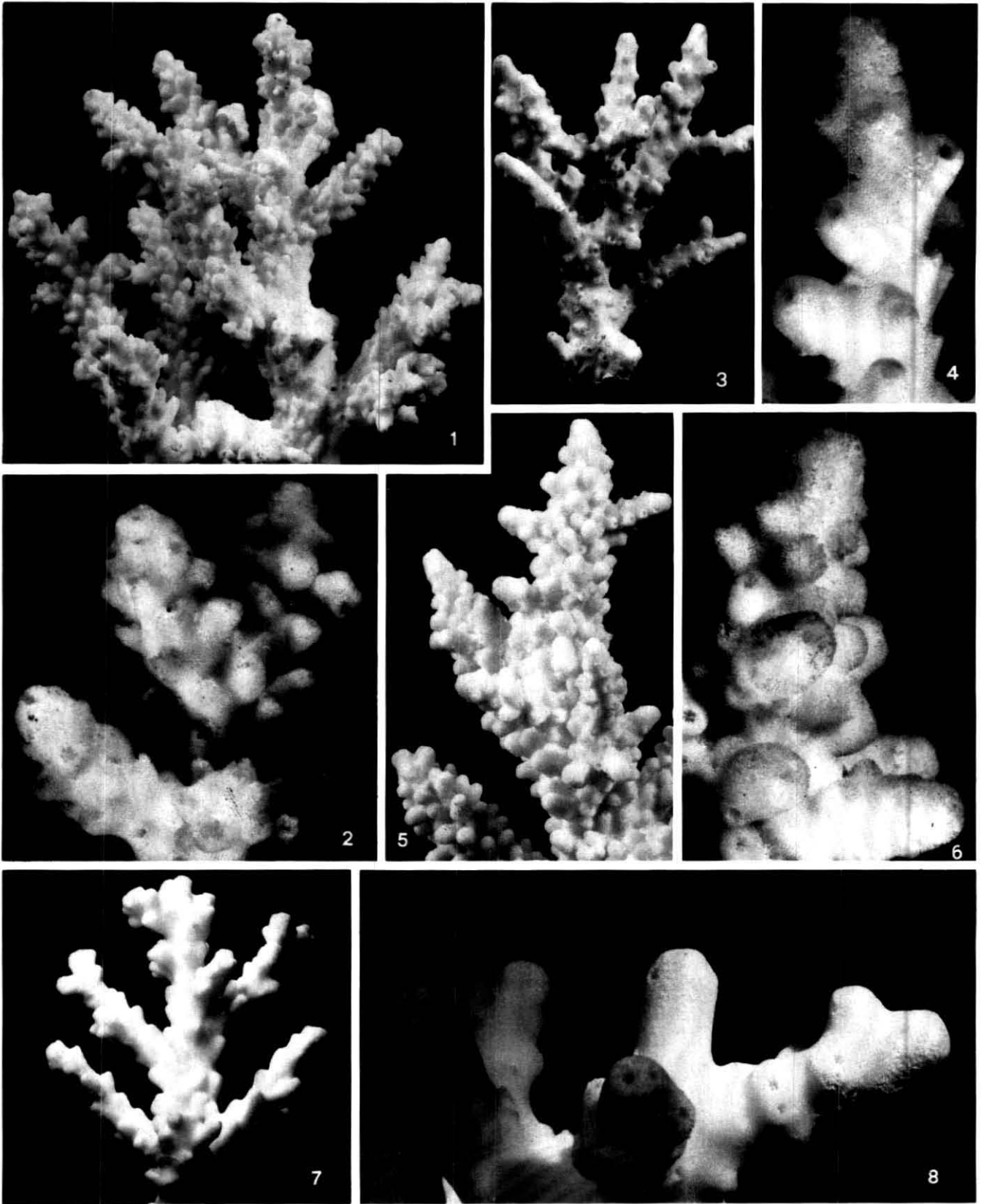

Figs. 1, 2. *Acropora variabilis* (NS 1893, x1, x3).

Figs. 3, 4. *Acropora squarrosa* (3: NS 1283, x1; 4: NS 3064, x3.6).

Figs. 5, 6. *Acropora hemprichi* (NS 1931, x1, x3).

Figs. 7, 8. *Acropora granulosa* (7: PW 71 306, x1; 8: PW 73 564, x3).

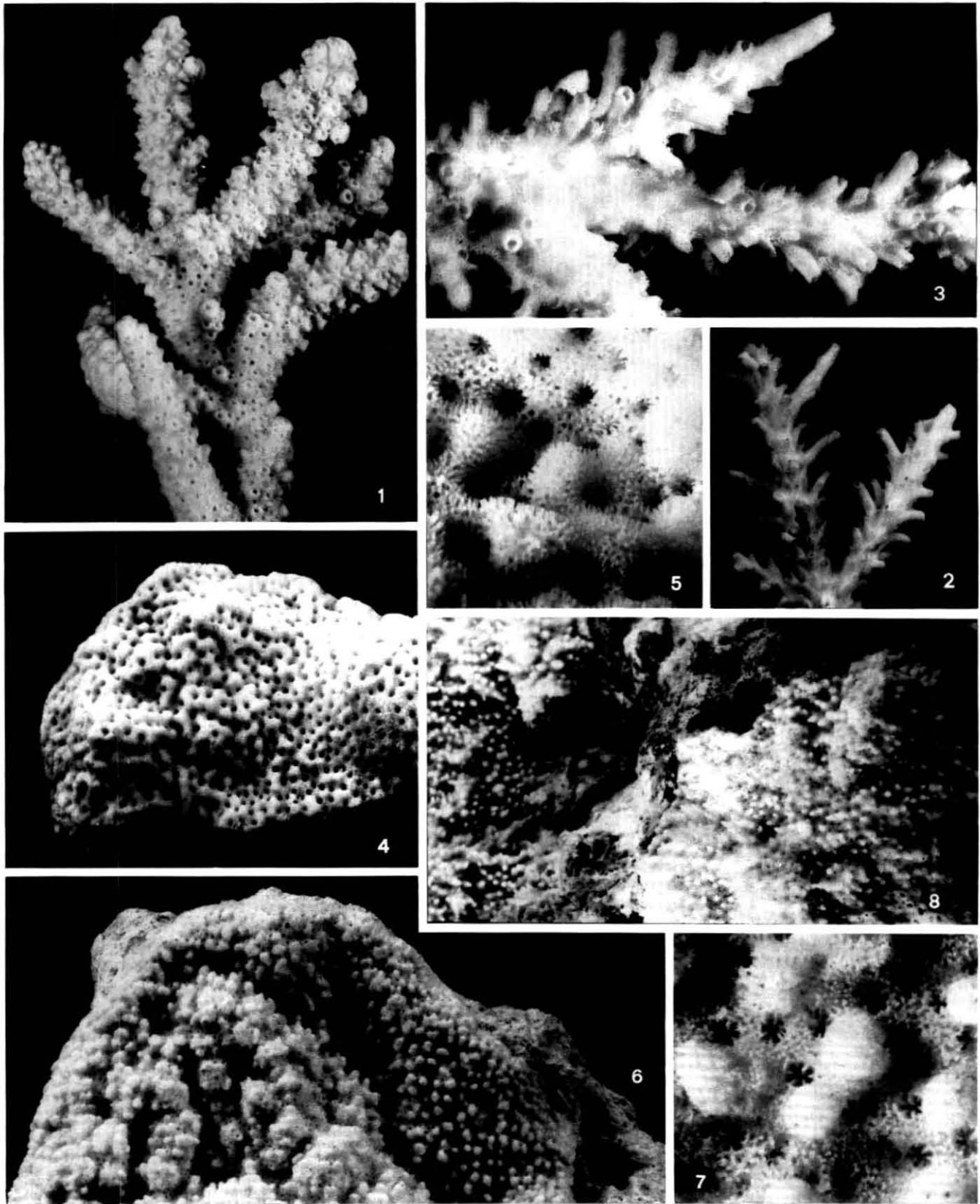

Fig. 1. *Acropora forskali* (SLR 3009-1, x1).

Figs. 2, 3. *Acropora capillaris* (2: SLR 1249, x1; 3: NS 3063, x2).

Figs. 4, 5. *Montipora venosa* (NS 1885, x1, x5).

Figs. 6, 7. *Montipora spumosa* (NS 1922, x1, x6.3).

Fig. 8. *Montipora tuberculosa* (SLR 399-1, x1.2).

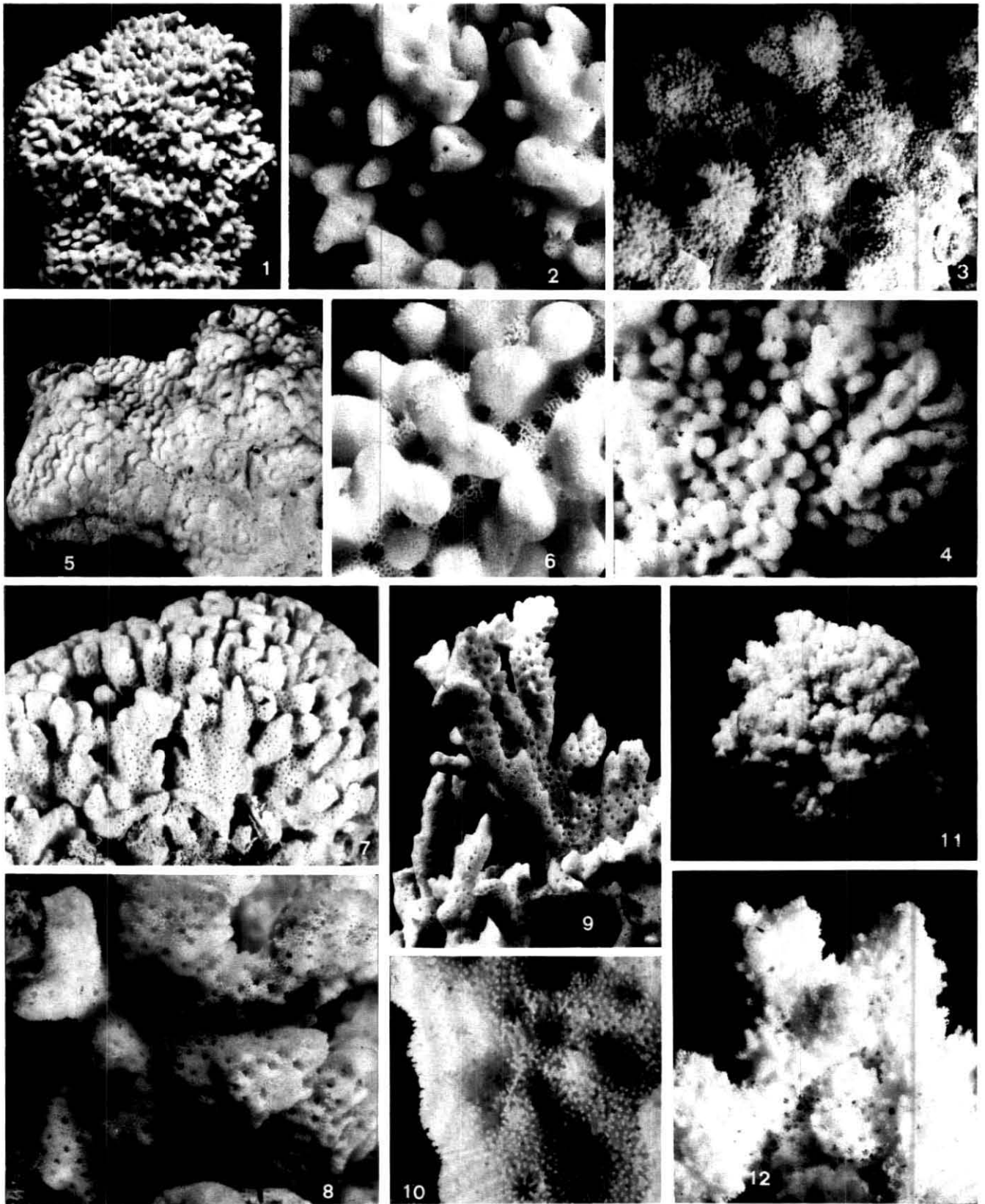

Figs. 1, 2. *Montipora monasteriata* (RM 21a, x1, x3.6).  
 Figs. 3, 4. *Montipora verrucosa* (3: Wa 102, x0.5, phot. U.S.N.M.;  
 4: EC 358, x2.7).  
 Figs. 5, 6. *Montipora meandrina* (5: RM 69, x0.5; 6: Sa 59, x3).

Figs. 7, 8. *Montipora edwardsi* (Wa 22, x0.7, x2.5).  
 Figs. 9, 10. *Montipora spongiosa* (NS 6339, x1, x6.3).  
 Figs. 11, 12. *Montipora gracilis* (NS 8678, x0.6, x2.8).

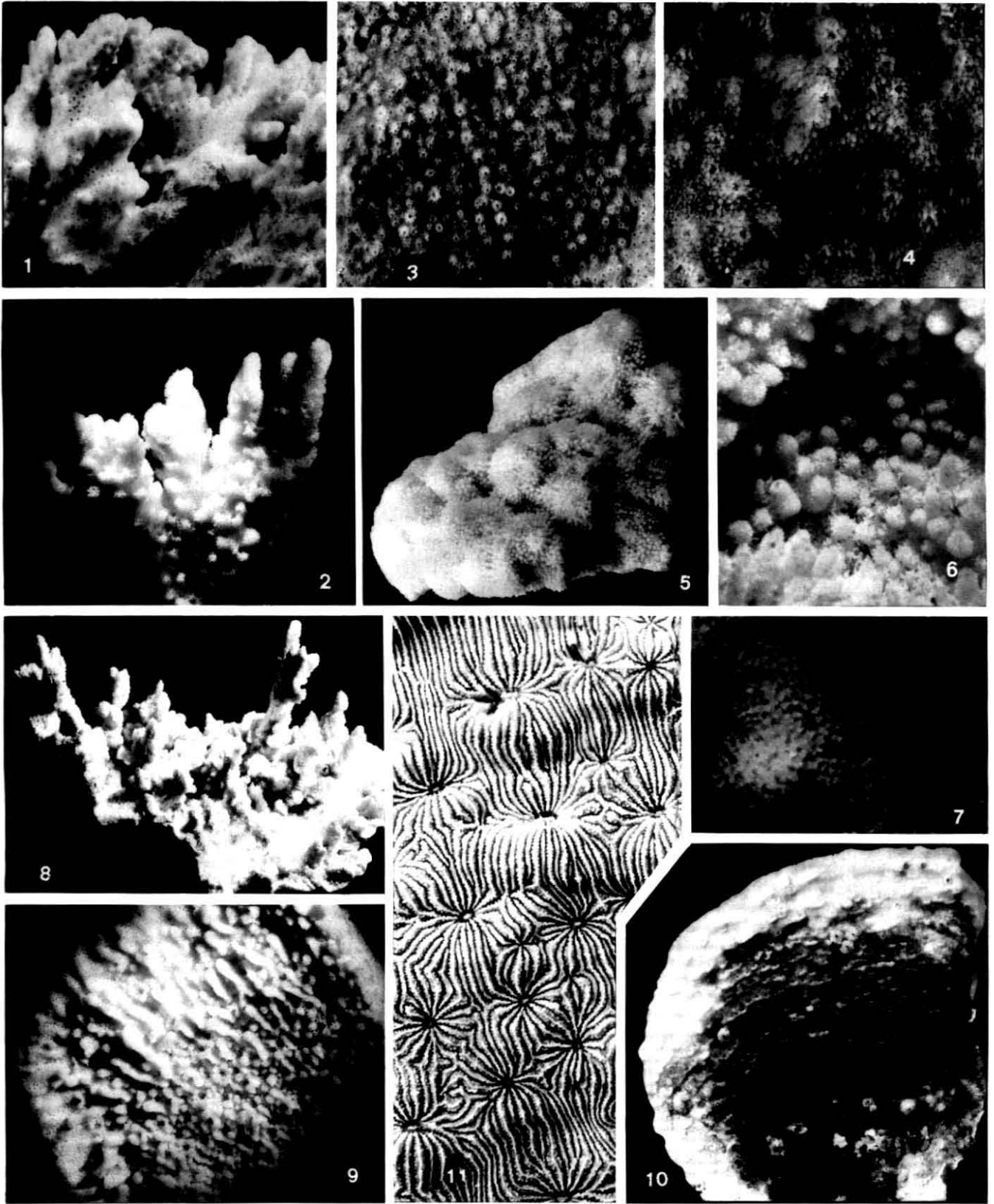

Figs. 1, 2. *Montipora circumvallata* (1: SLR 379, x1; 2: EC 356, x2).  
Figs. 3-7. *Montipora stilosa* (3, 4: SLR 648, x0.9, x2.3; 5, 6: NS 1245, x0.9, x6.3; 7: var. *eilatensis*, NS 5003, x6.3).

Figs. 8, 9. *Montipora ehrenbergi* (8: X2:9-5, x0.45; 9: EC 355; x2.4).  
Figs. 10, 11. *Pavona explanulata* (Sa 99, x0.5, x5).

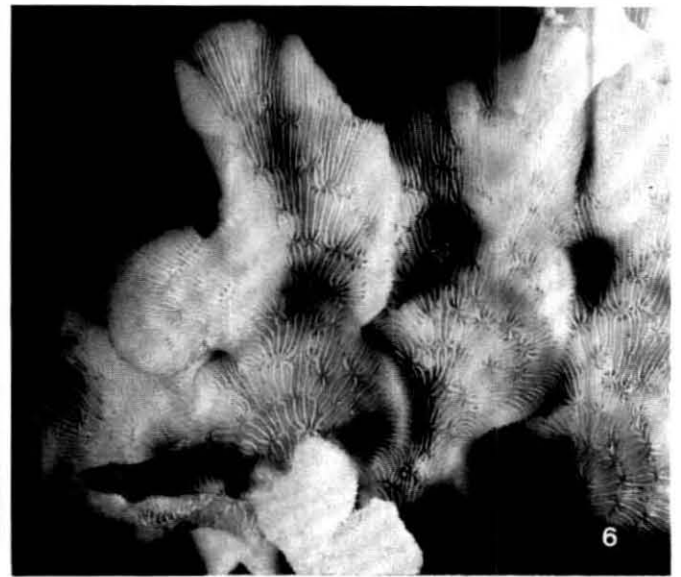
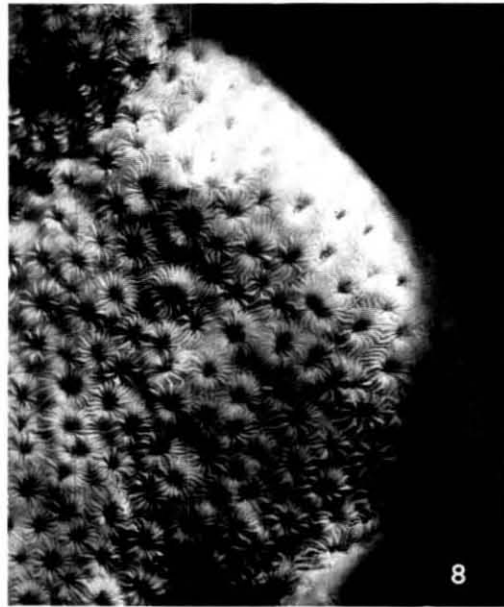
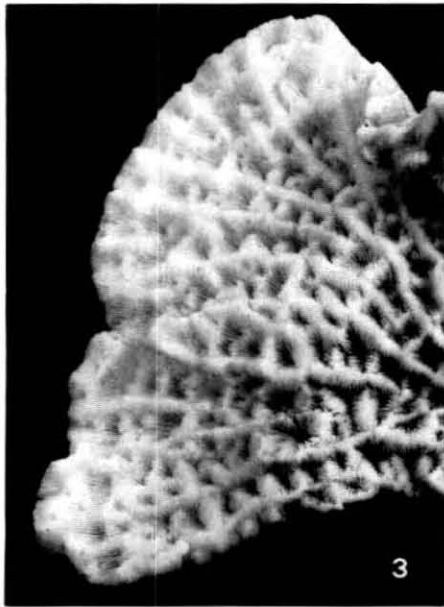
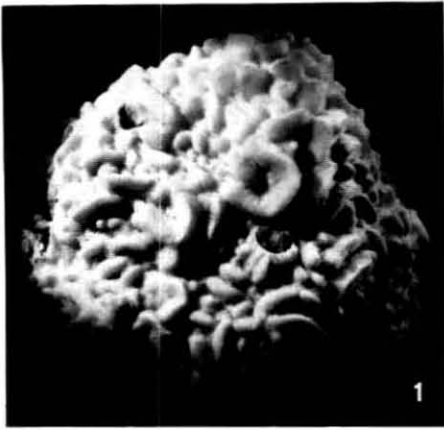

Figs. 1, 2. *Pavona varians* (PW 73 607, x1, x2.3).  
Fig. 3. *Pavona yabei* (SLR 666-1, x1).  
Fig. 4. *Pavona decussata* (X2:10-14, x1.1).

Figs. 5, 6. *Pavona cactus* (X2:9-20, x0.75, x2.5).  
Figs. 7, 8. *Pavona maldivensis* (7: PW 71 314, x0.5; 8: EC 514, x2).

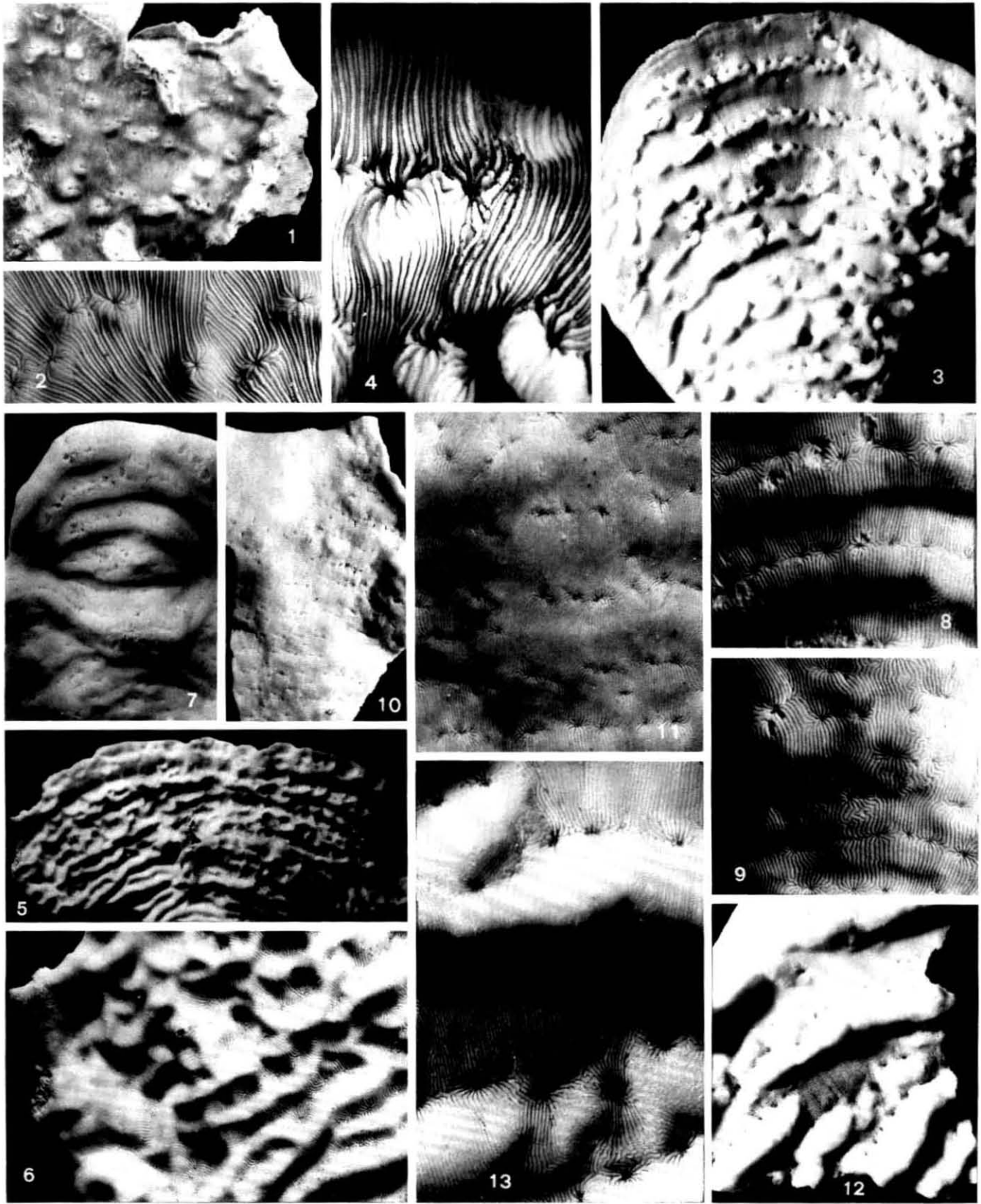

Figs. 1-4. *Leptoseris explanata* (1, 2: Fri 34-1, x0.7, x2.2; 3: Sa 96, x0.7; 4: Sa 90, x2.5).

Figs. 5, 6. *Leptoseris mycetoseroides* (X2:8-11, x0.7, x2).

Figs. 7-13. *Leptoseris tenuis* (7, 8, 9: Fri 82-1, x1, x3, x3; 10, 11: Fri 92-1, x1, x3; 12, 13: Sa 95, x0.85, x2.3).



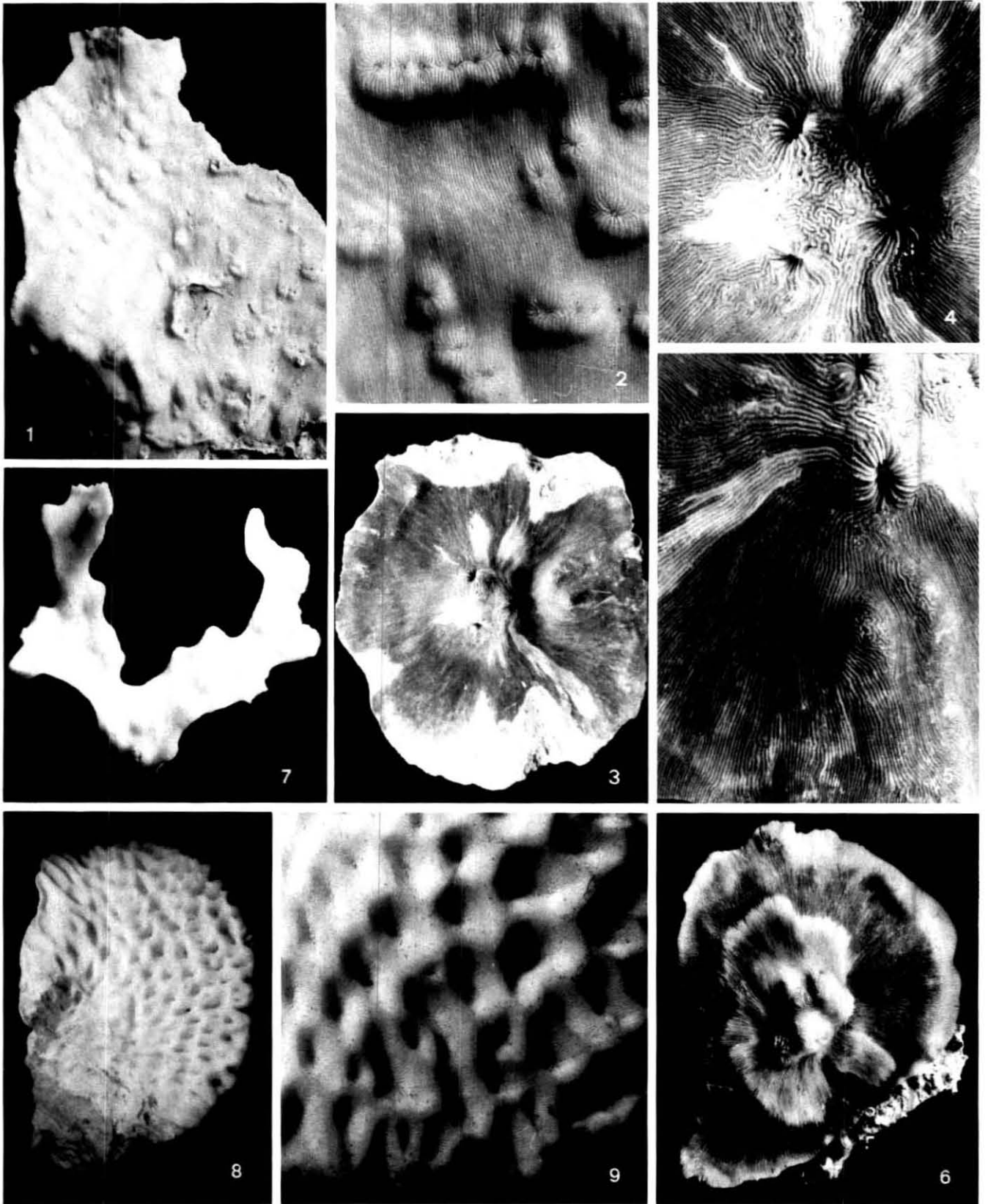

Figs. 1, 2. *Leptoseris hawaiiensis* (Fri 114-1, x1, x3).

Figs. 3-6. *Leptoseris fragilis* (3, 4, 5: Fri 41-1, x0.75, x2, x2.1; 6: Fri 24-1, x0.9).

Fig. 7. *Leptoseris gardineri* (Fri 109-1, x1).

Figs. 8, 9. *Gardineroseris planulata* (NS 6065, x0.8, x2.7).

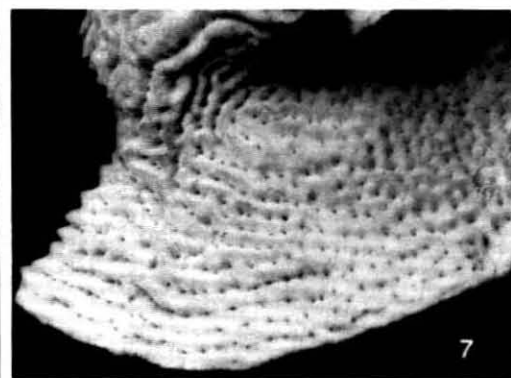
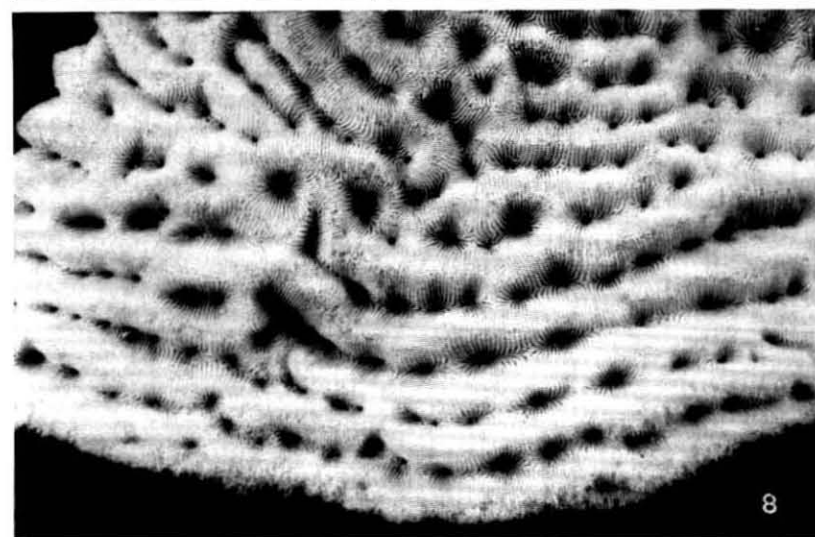
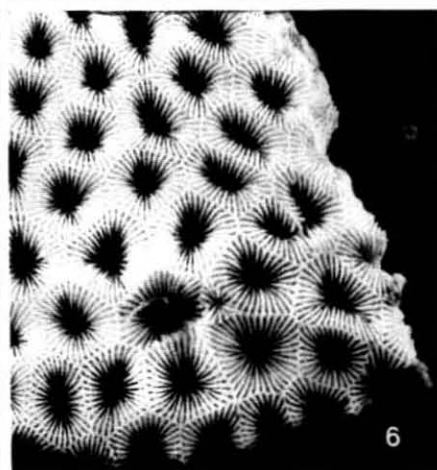
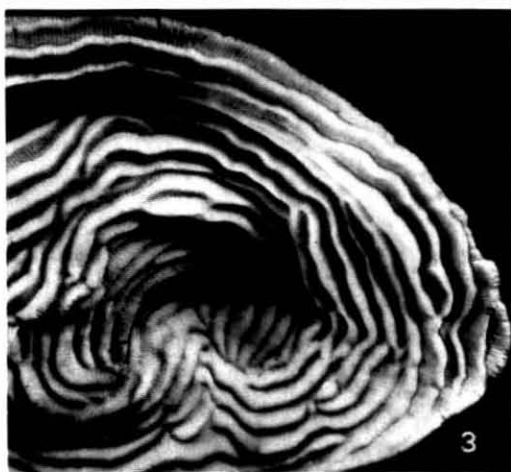
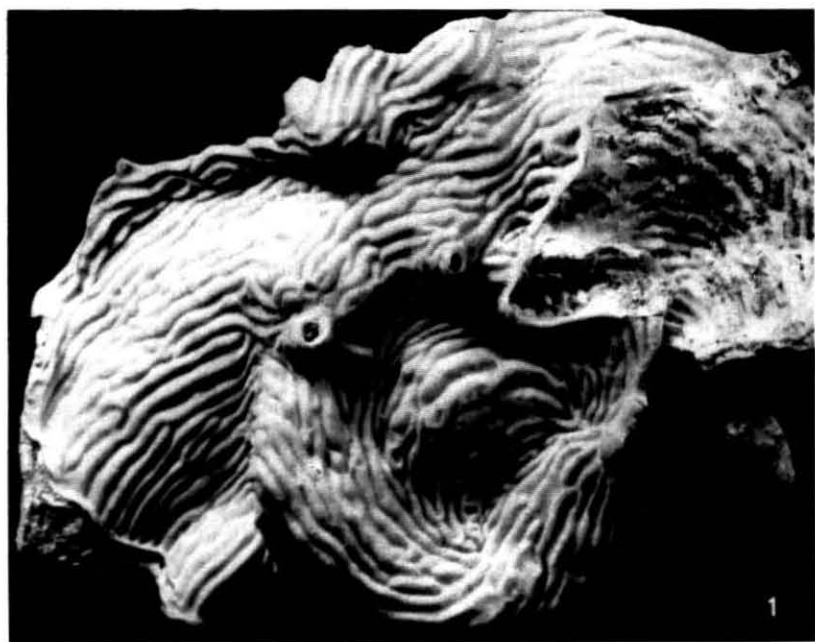

Figs. 1, 2. *Pachyseris rugosa* (NS 9289, x0.6, x2).  
Figs. 3, 4. *Pachyseris speciosa* (RM 32, x1, x2).

Figs. 5, 6. *Siderastrea savignyana* (SLR 832, x1, x3).  
Figs. 7, 8. *Coscinaraea monile* (SLR 398, x0.5, x1.4).

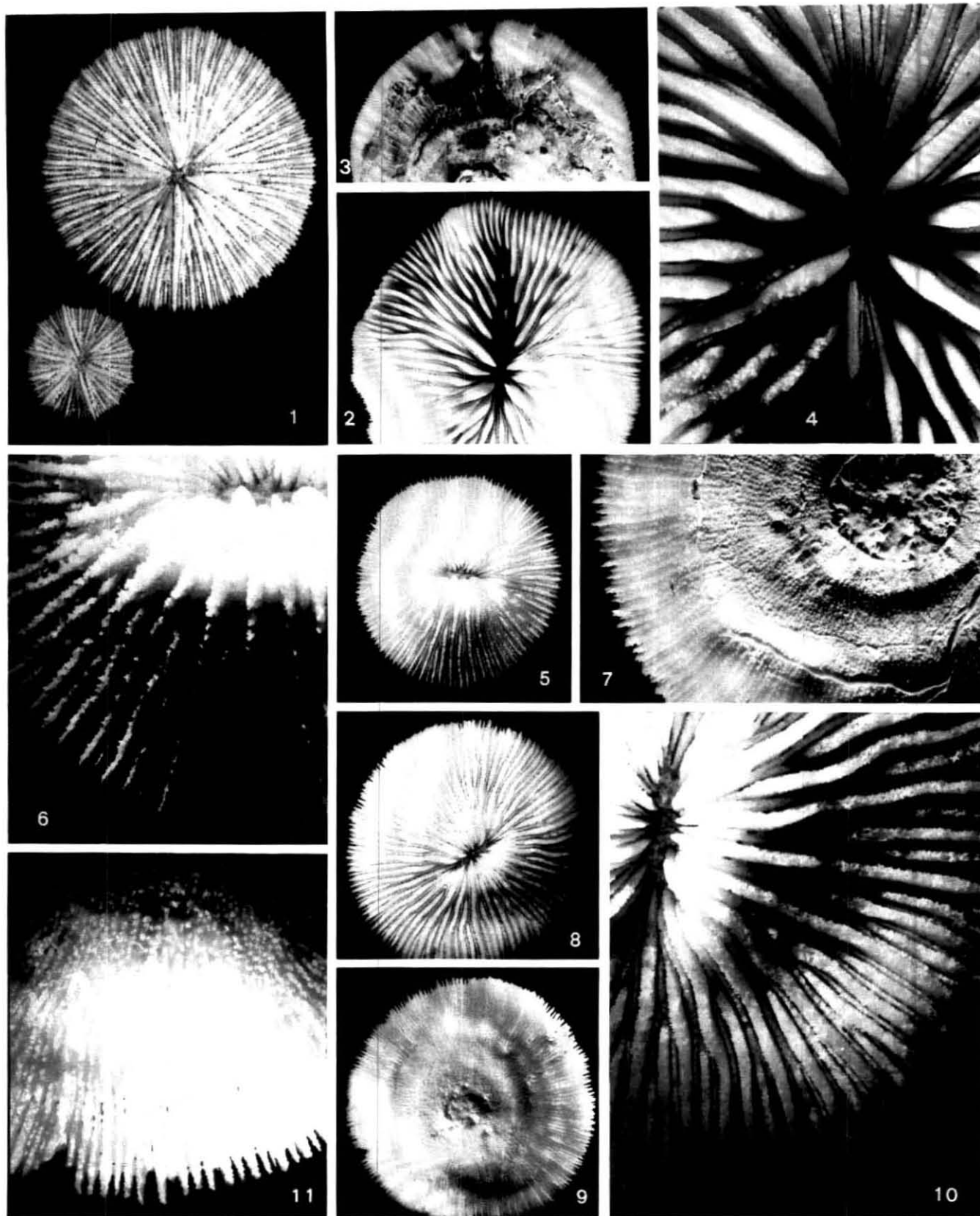
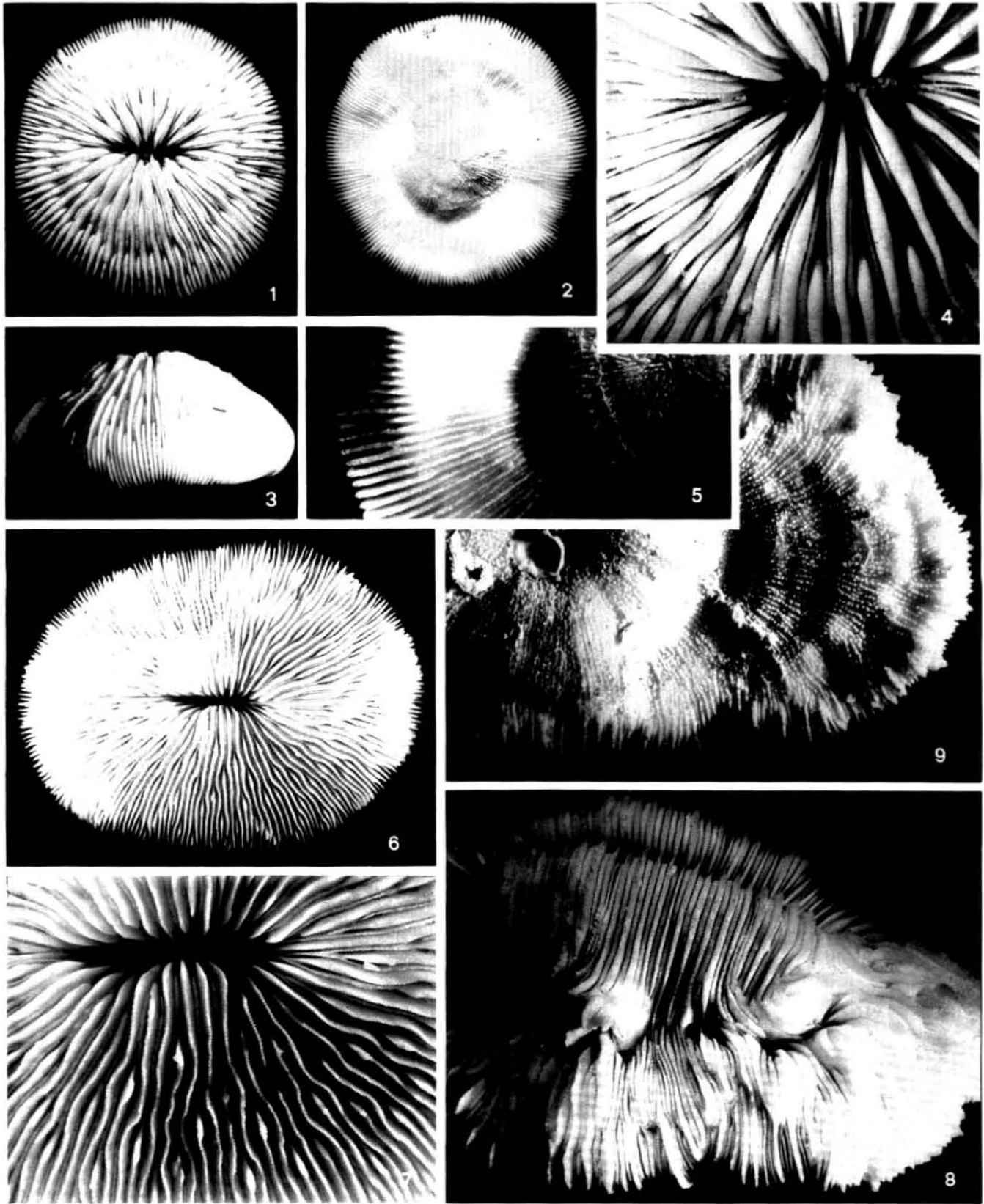

Fig. 1. *Cycloseris patelliformis* (NS 5405, below NS 5412, both x2.6).

Figs. 2-4. *Cycloseris doederleini* (SCHUHMACHER 2/1, x1, x1, x3).

Figs. 5-7. *Cycloseris cf. erosa* (SCHUHMACHER 2/2, x1, x3, x3).

Figs. 8-11. *Cycloseris distorta* (SLR 395-13, x1, x1, x3, x3).



Figs. 1–5. *Cycloseris costulata* (SCHUHMACHER 2/4; 1, 2, 3: x1, 4: x2.6, 5: x2.4).

Figs. 6, 7. *Fungia scutaria* (X2:2–29, x0.8, x1.9).

Figs. 8, 9. *Fungia moluccensis* (SCHUHMACHER 2/10; 8: x1.25, 9: x1.2).

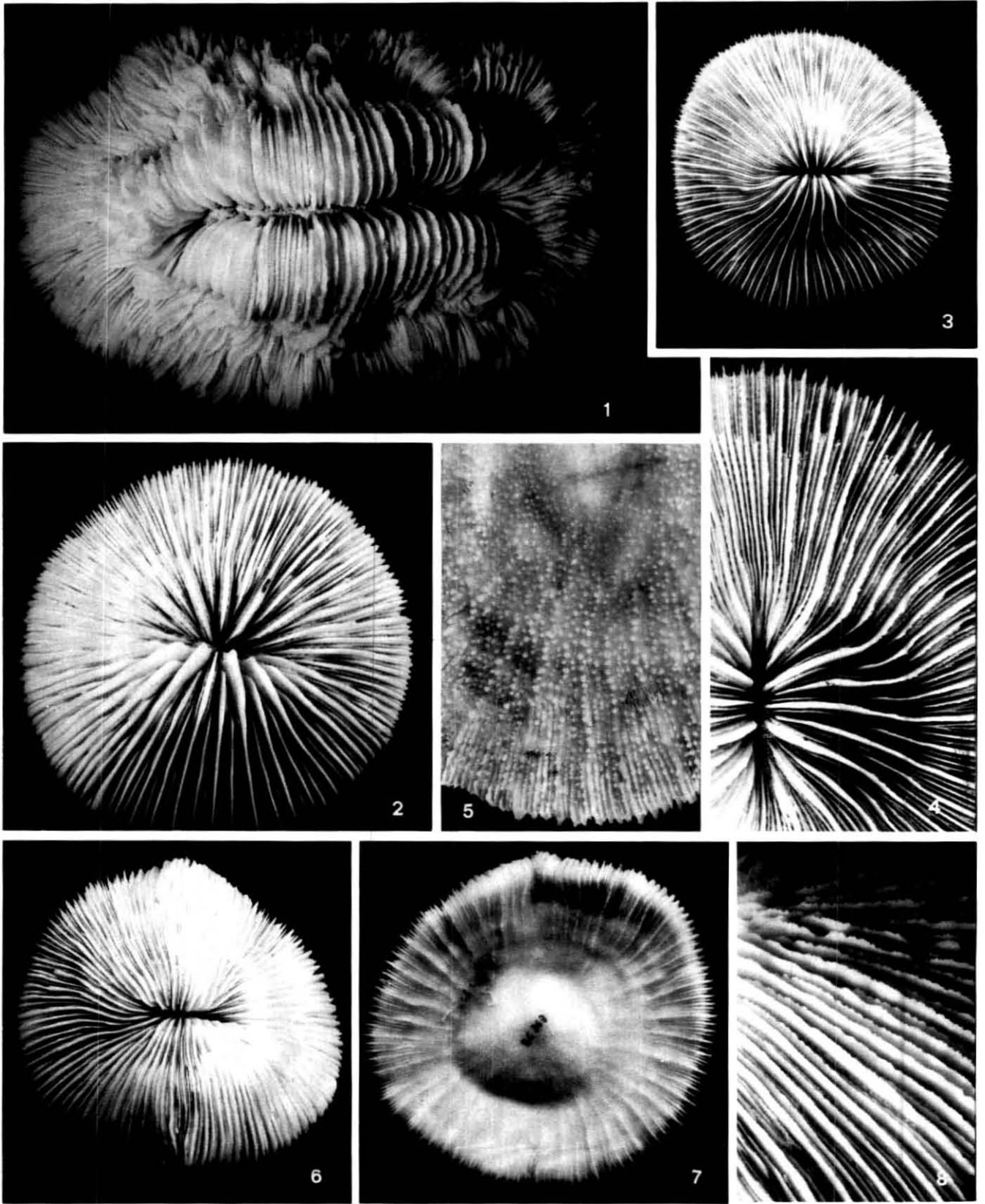
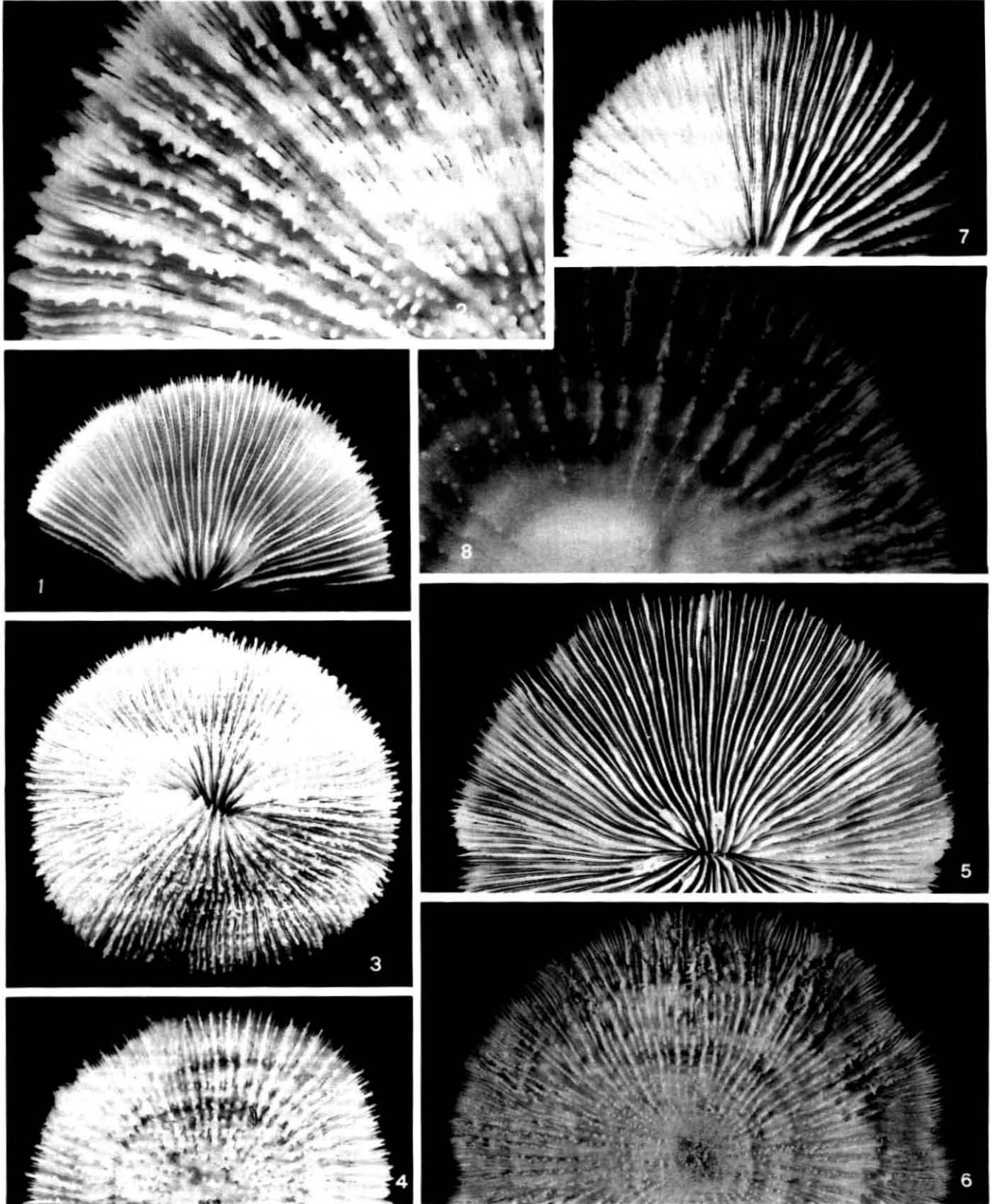

Fig. 1. *Fungia moluccensis* (SCHUHMACHER 2/10,  $\times 1$ ).  
Fig. 2. *Fungia granulosa* (SLR 859,  $\times 1$ ).

Figs. 3–5. *Fungia repanda* (Leiden 9507,  $\times 0.6$ ,  $\times 1.6$ ,  $\times 1.6$ ).  
Figs. 6–8. *Fungia concinna* (EC 363,  $\times 0.5$ ,  $\times 0.5$ ,  $\times 1$ ).



Figs. 1, 2. *Fungia danai* (EC 429,  $\times 0.5$ ,  $\times 1.5$ ).  
Figs. 3, 4. *Fungia scruposa* (EC 515,  $\times 0.6$ ,  $\times 0.6$ ).

Figs. 5, 6. *Fungia horrida* (Wa 43,  $\times 0.5$ ,  $\times 0.5$ ).  
Figs. 7, 8. *Fungia klunzingeri* (RM 74,  $\times 0.7$ ,  $\times 1.5$ ).

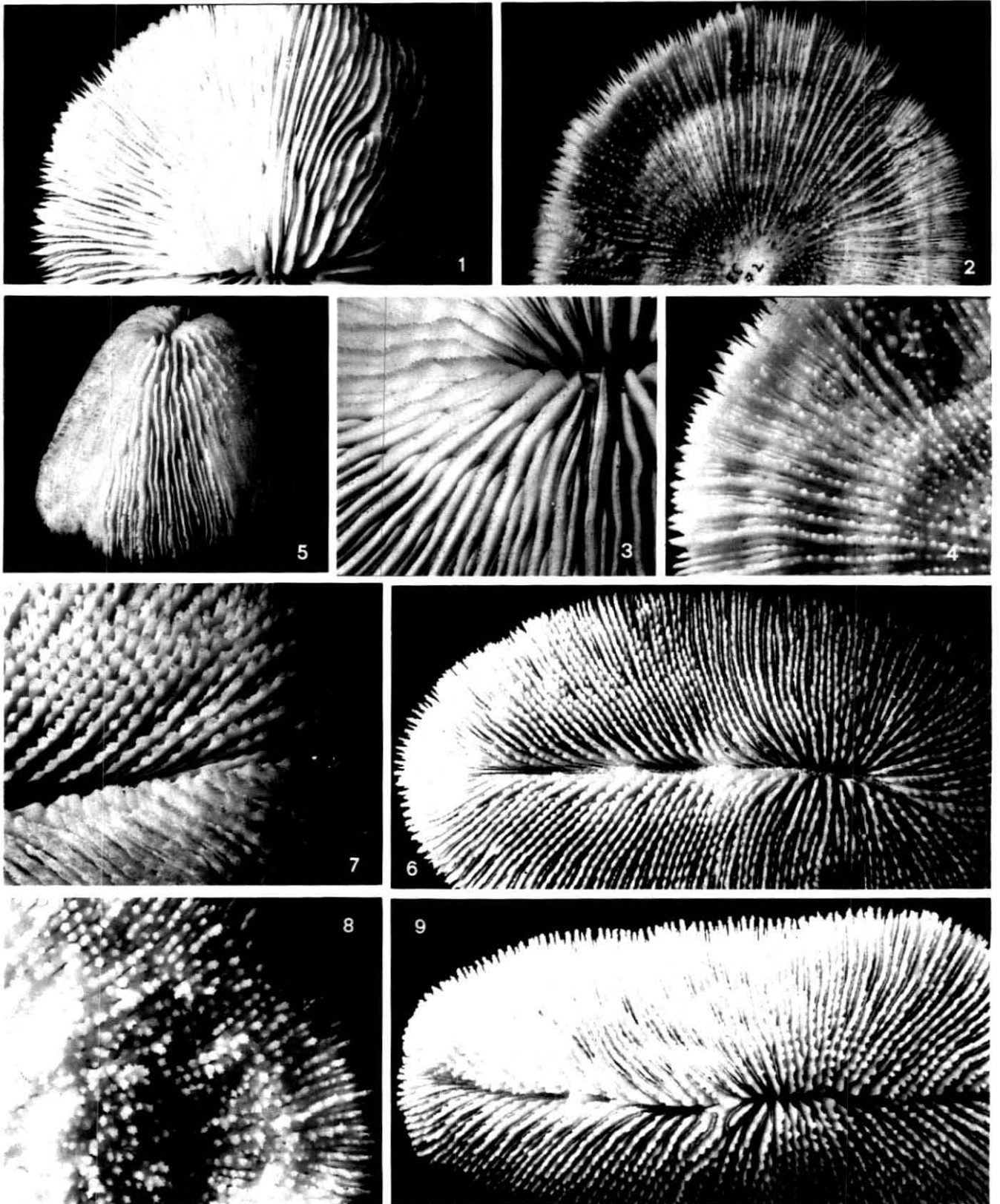

Figs. 1-5. *Fungia fungites* (1-4: EC 472, x0.8, x1.4; 5: RM 122, x0.6).

Figs. 6-9. *Ctenactis echinata* (6, 8: RM 17, x0.8, x1.9; 9: RM 17a, x0.8).

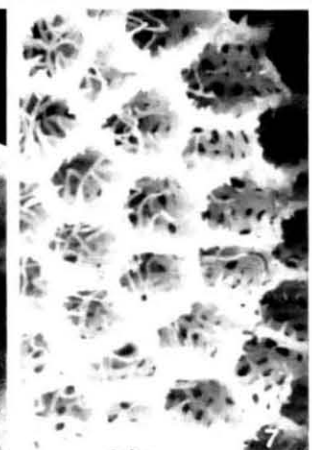
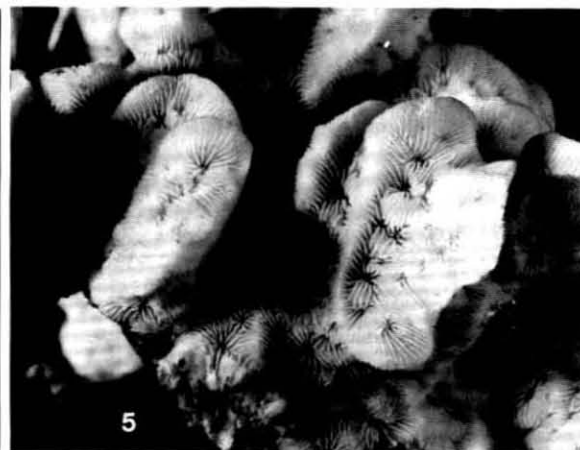
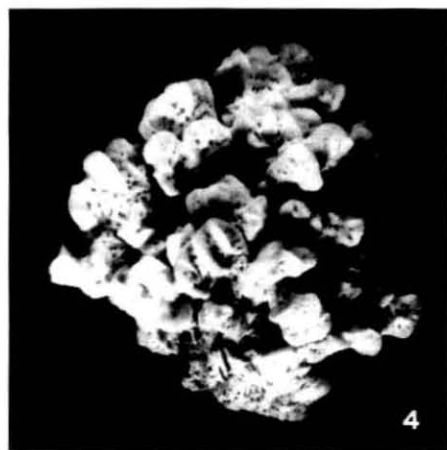
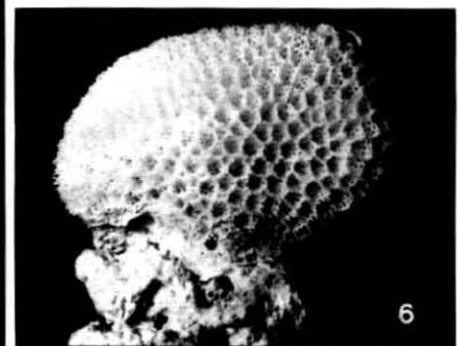
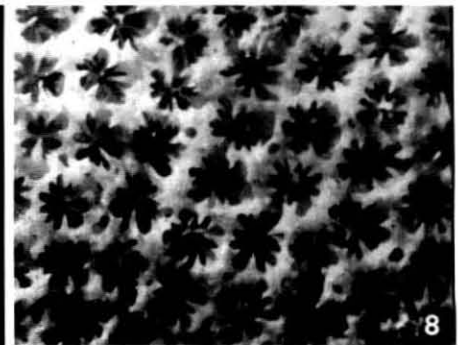
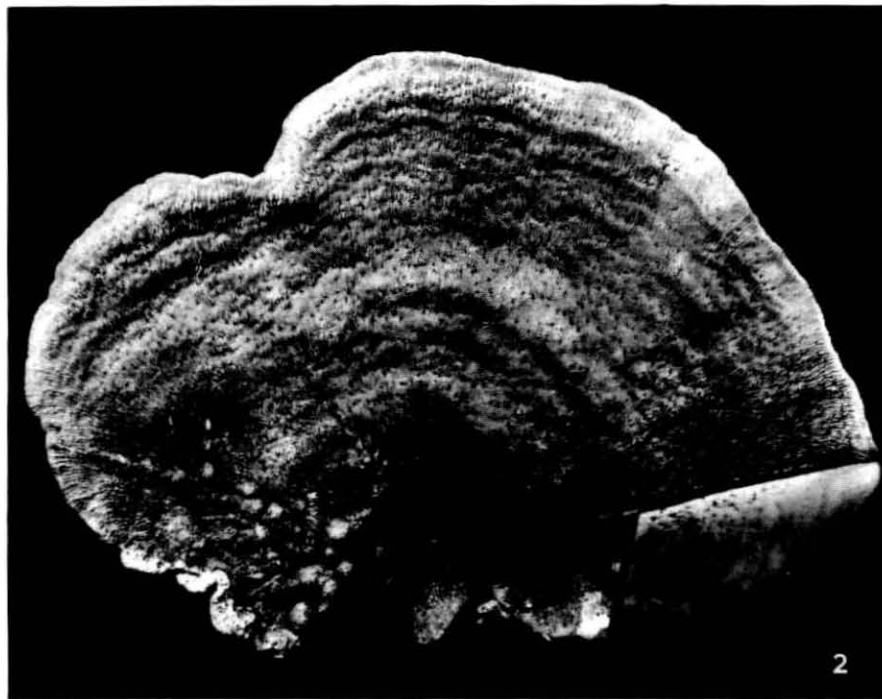
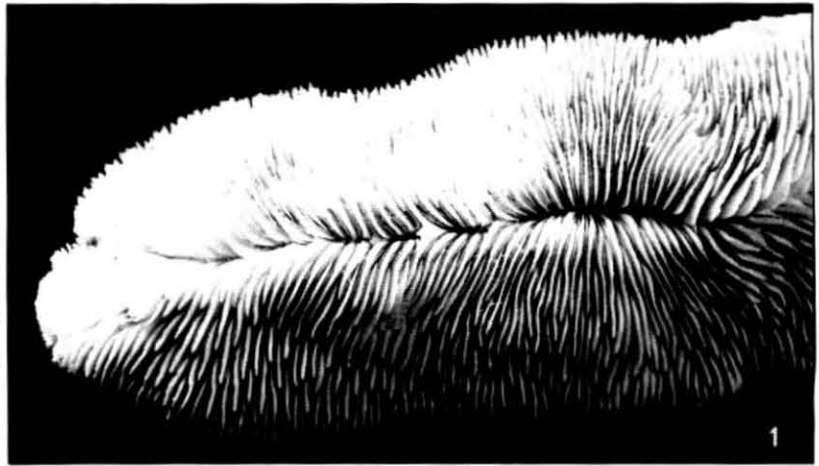
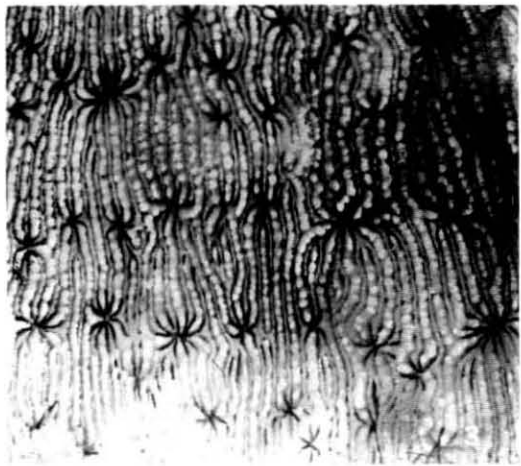
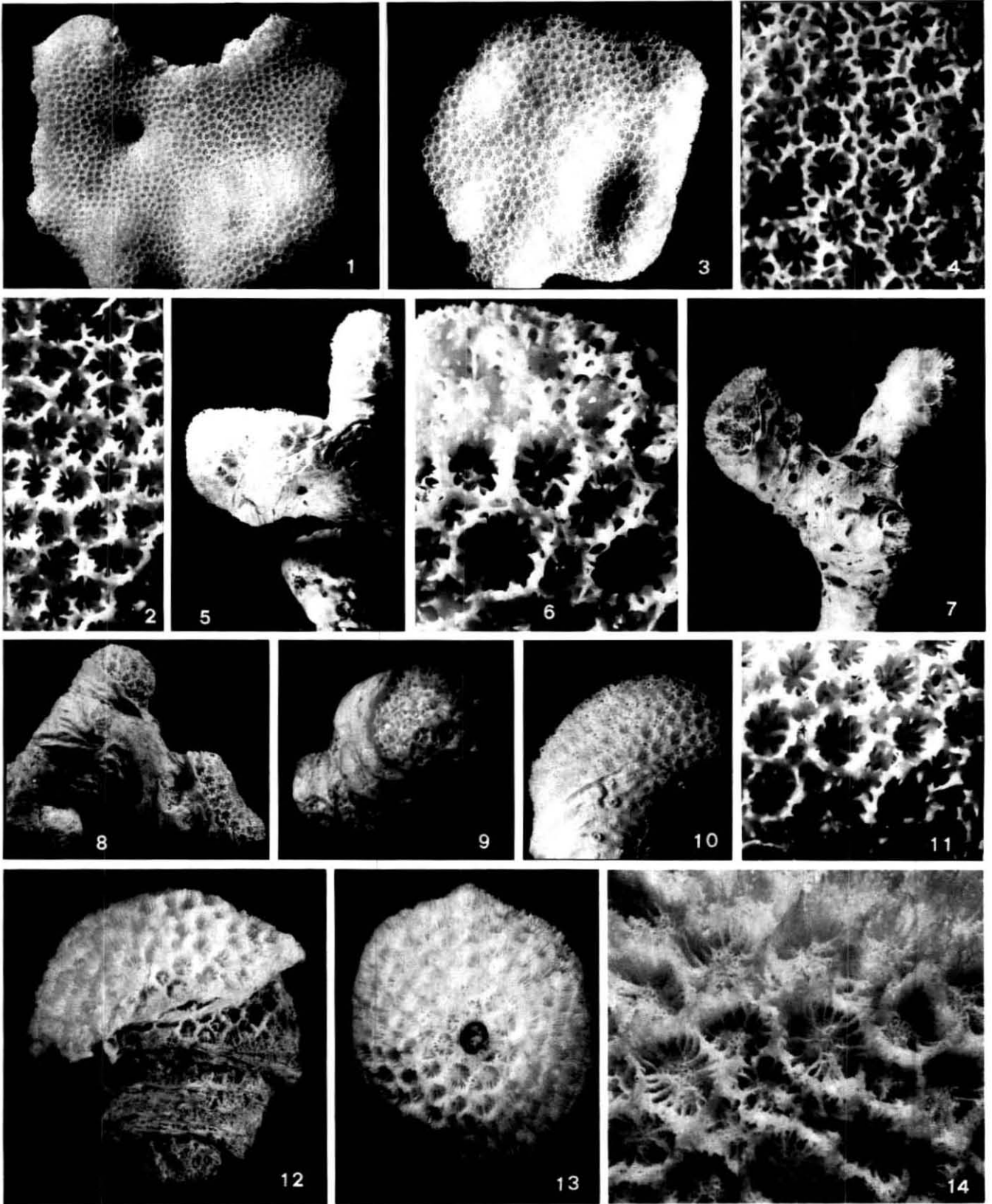

Fig. 1. *Herpolitha limax* (RM 76, x0.8).  
Figs. 2, 3. *Podabacia crustacea* (RM 102, x0.3, x1.8).  
Figs. 4, 5. *Pavona divaricata* (RM 47, x0.7, x1.9).

Figs. 6, 7. *Alveopora daedalea* (NS 8376, x1, x5).  
Fig. 8. *Alveopora verrilliana* (EC 304, x5).





Figs. 1, 2. *Alveopora verrilliana* (EC 305, x1, x5).

Figs. 3, 4. *Alveopora ocellata* (NS 6282, x1, x5).

Figs. 5-7. *Alveopora mortenseni* (5, 6: Fri 17-1, x1, x5; 7: Fri 31-1, x1).

Figs. 8-11. *Alveopora viridis* (8: NS 9282-1, x1; 9: NS 9282-2, x2; 10, 11: SLR 355, x1.3, x5).

Figs. 12-14. *Goniopora stokesi* (NS 1460, x1, x1, x3).

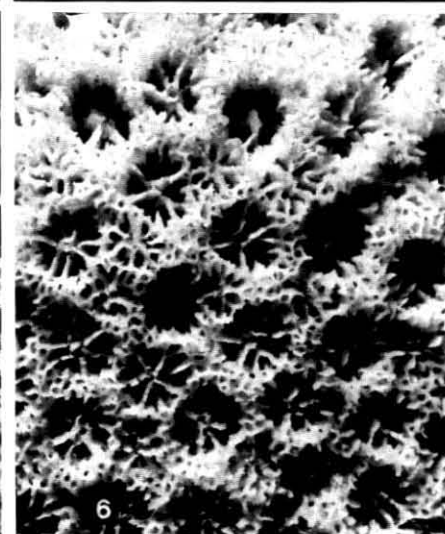
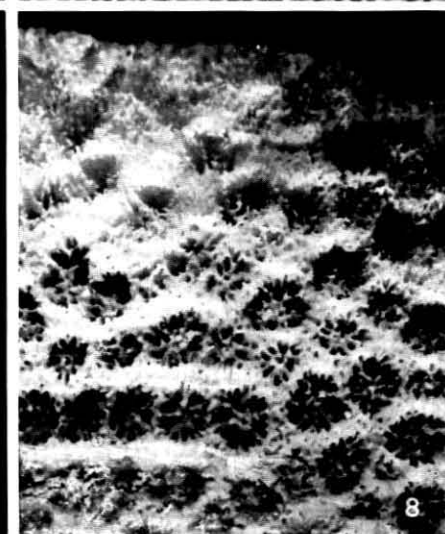
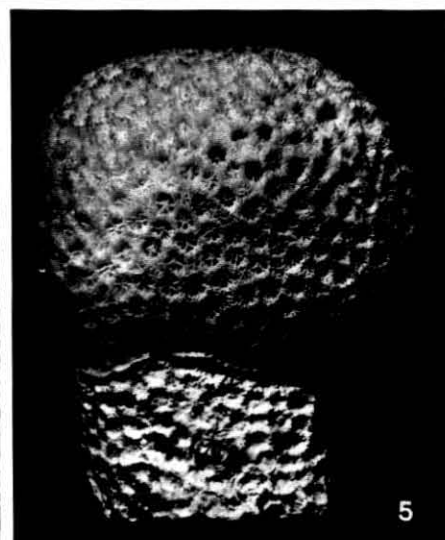
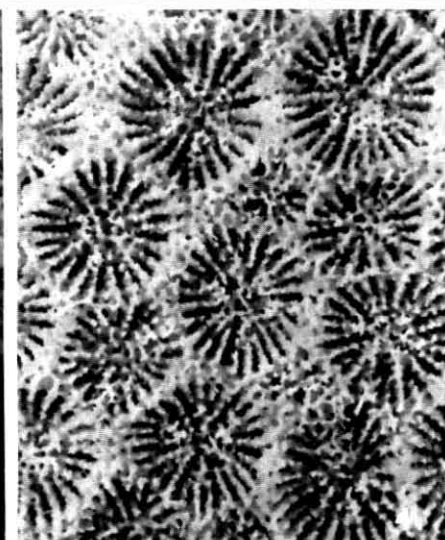
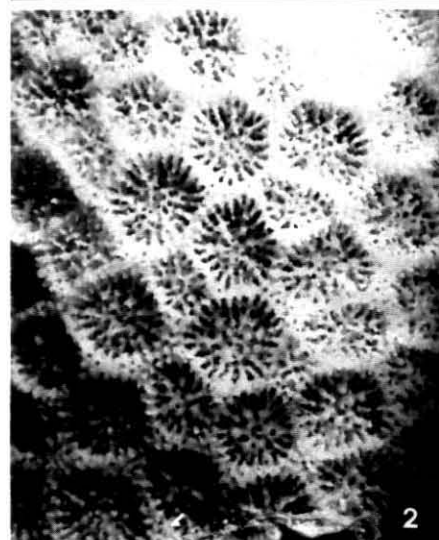
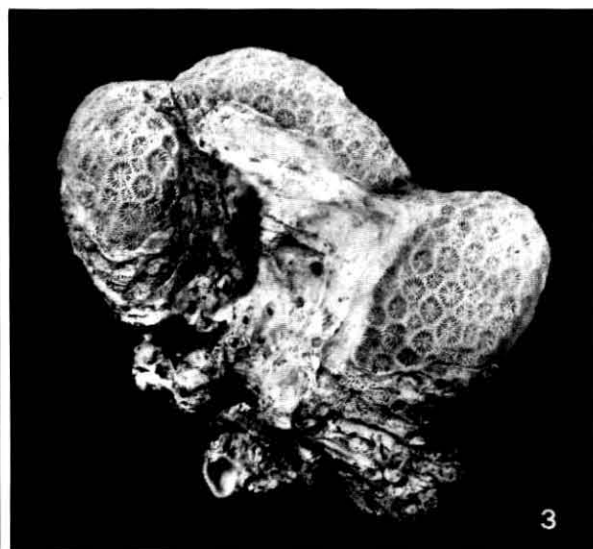
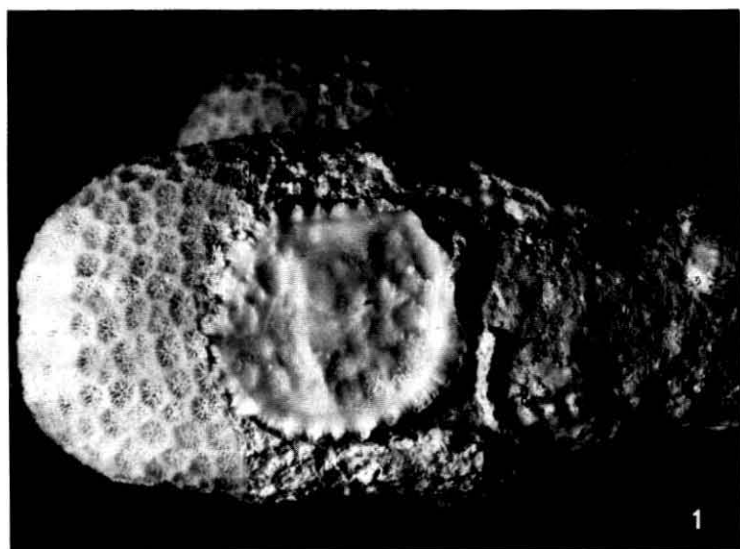

Figs. 1, 2. *Goniopora planulata* (X2:3-1, x1, x3).

Figs. 3, 4. *Goniopora tenella* (ZMB 7006, x0.5, x3).

Figs. 5, 6. *Goniopora minor* (EC 454, x1, x3).

Figs. 7, 8. *Goniopora savignyi* (Wa 46, x0.6, x3).

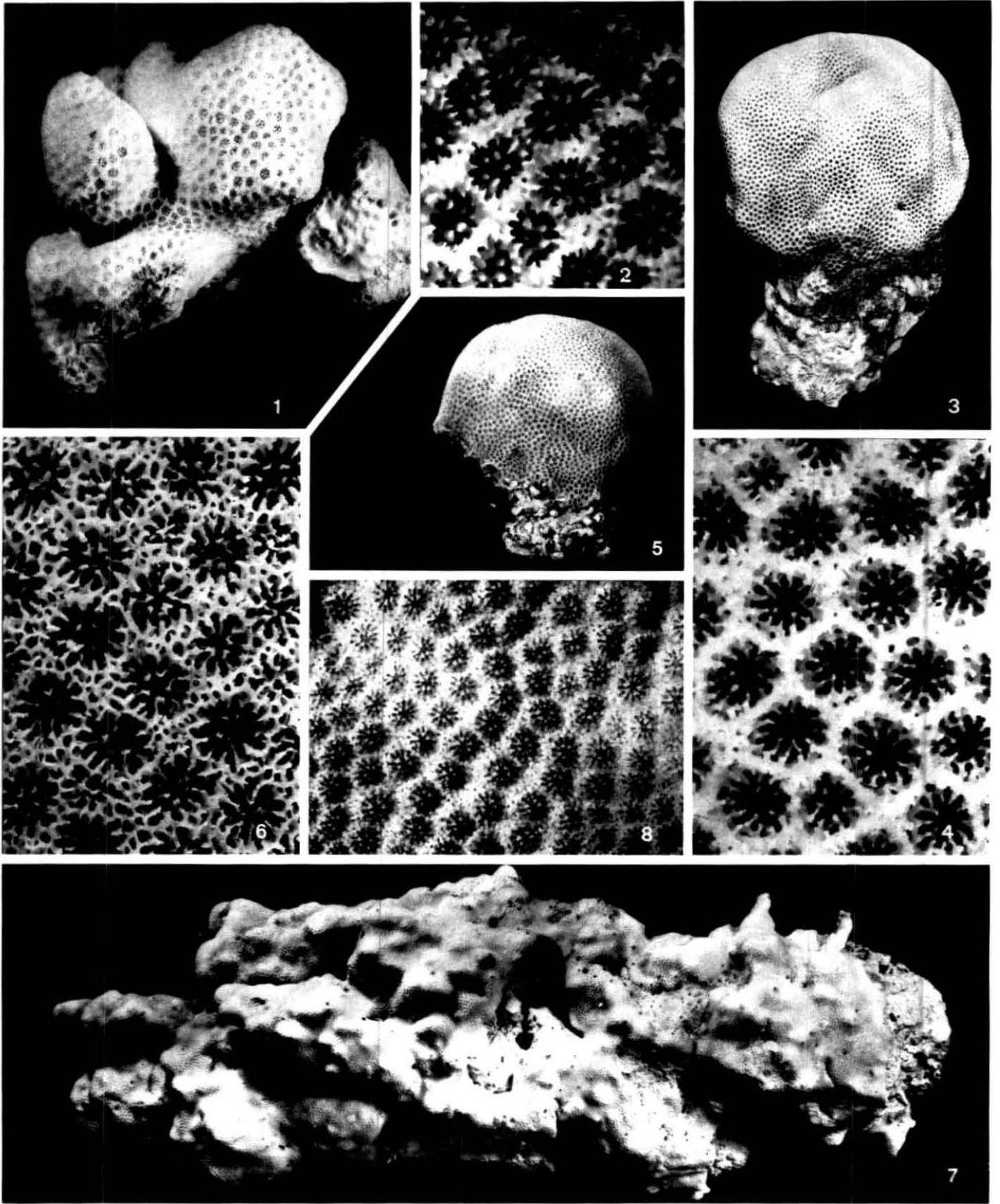

Figs. 1, 2. *Goniopora klunzingeri* (NS 1338, x1, x5).  
Figs. 3, 4. *Porites solida* (RM 18, x0.6, x10).

Figs. 5, 6. *Porites lutea* (RM 19, x0.75, x10).  
Figs. 7, 8. *Porites columnaris* (EC 373, x0.4, x5).

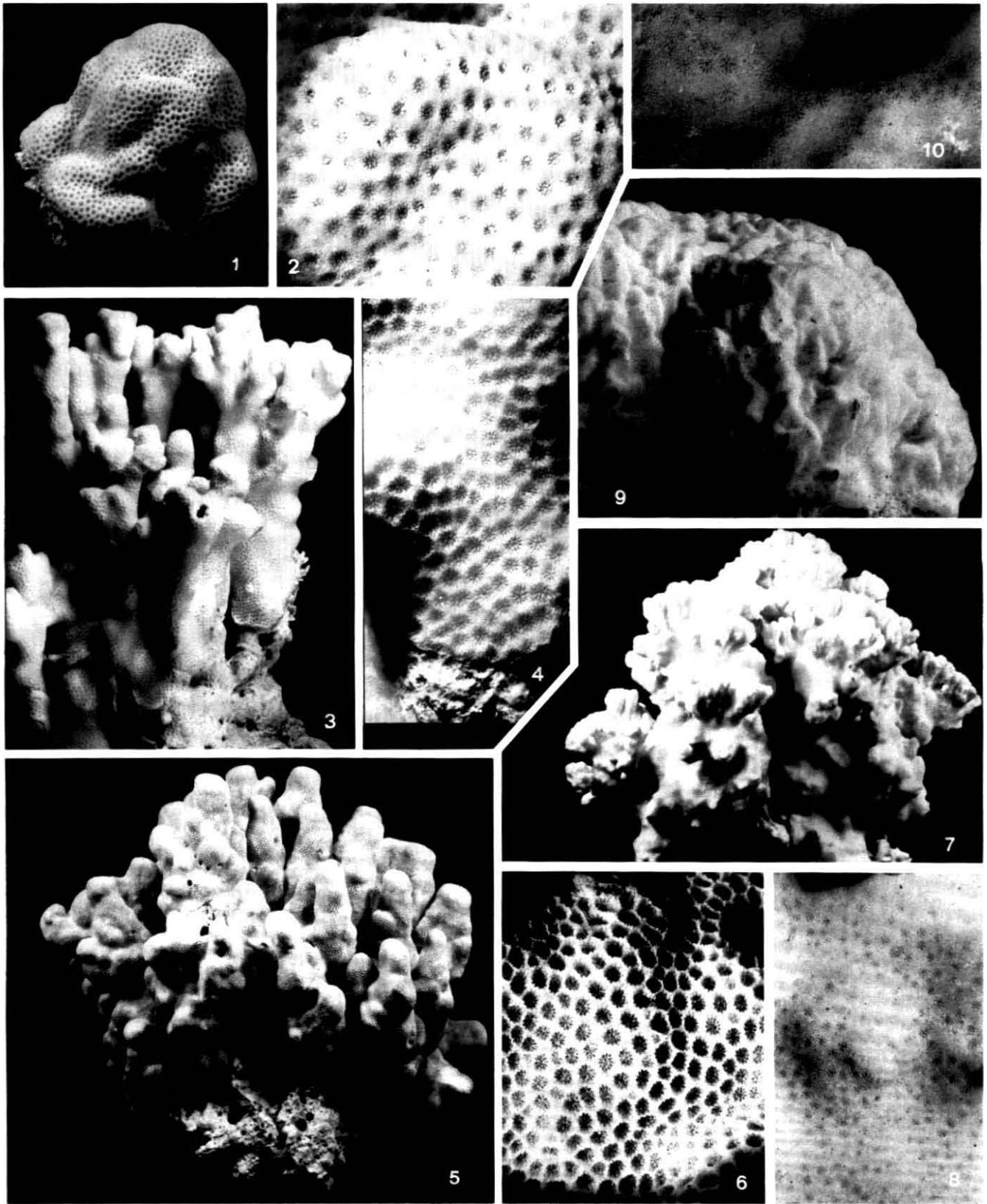

Figs. 1, 2. *Porites echinulata* (X2:3-33, x0.7, x3).

Figs. 3, 4. *Porites nodifera* (EC 380, x0.5, x3).

Figs. 5, 6. *Porites compressa* (EC 375, x0.3, x3).

Figs. 7, 8. *Porites* (*Synaraea*) *iwayamaensis* (EC 390, x0.5, x3).

Figs. 9, 10. *Porites* (*Synaraea*) *undulata* (NS 1859, x1, x4).

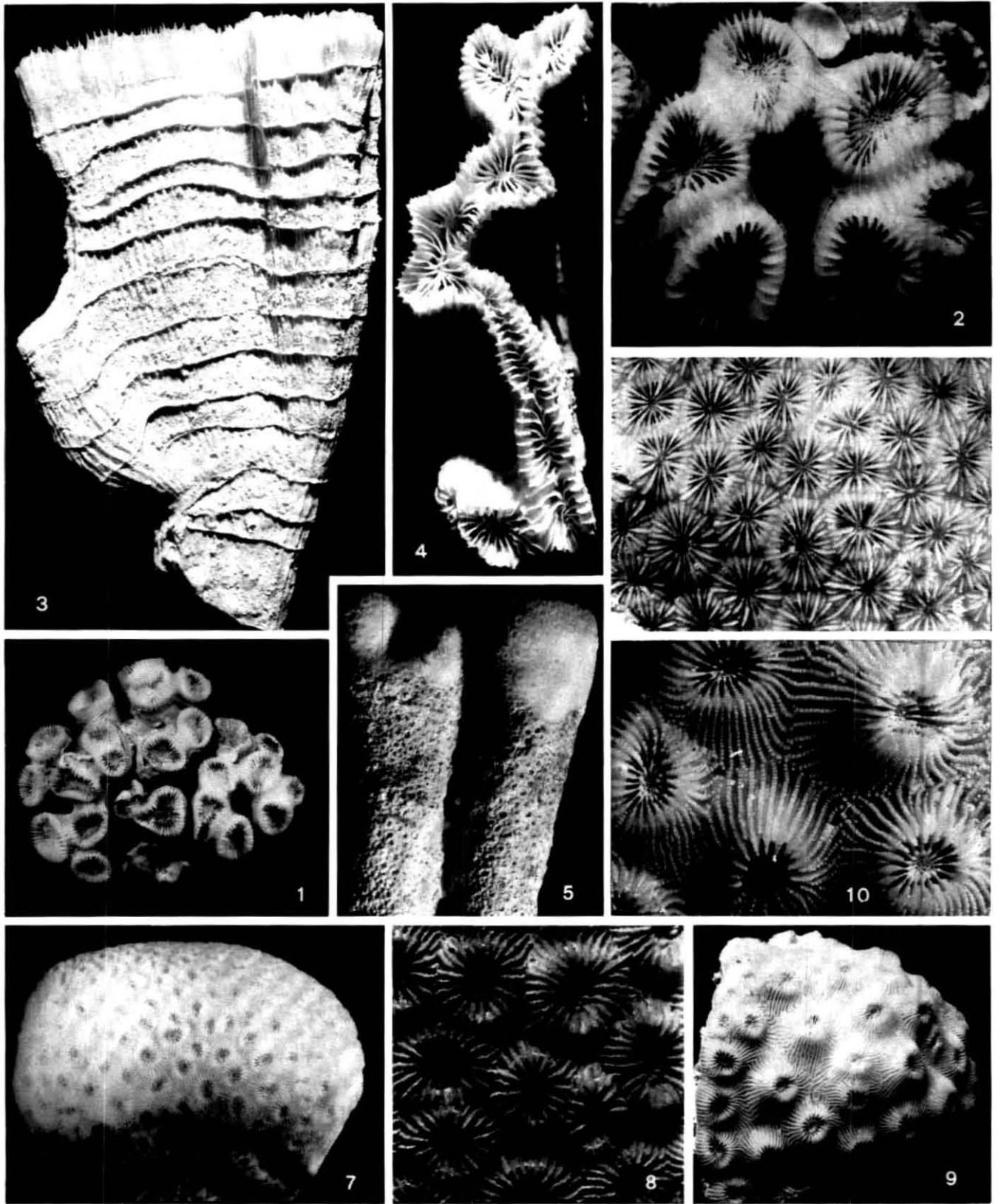

Figs. 1, 2. *Caulastrea tumida* (PW 71 333, x0.5, x1.5).  
Figs. 3, 4. *Erythrastrea flabellata* (Wa 75a, 3: x0.9, 4: x1.3).  
Figs. 5, 6. *Favia stelligera* (5: PW 71 357, x0.5; 6: X2:3-22, x2.5).

Figs. 7, 8. *Favia laxa* (RM 80, x0.7, x2.7).  
Figs. 9, 10. *Favia helianthoides* (Sa 64, x0.7, x2.5).

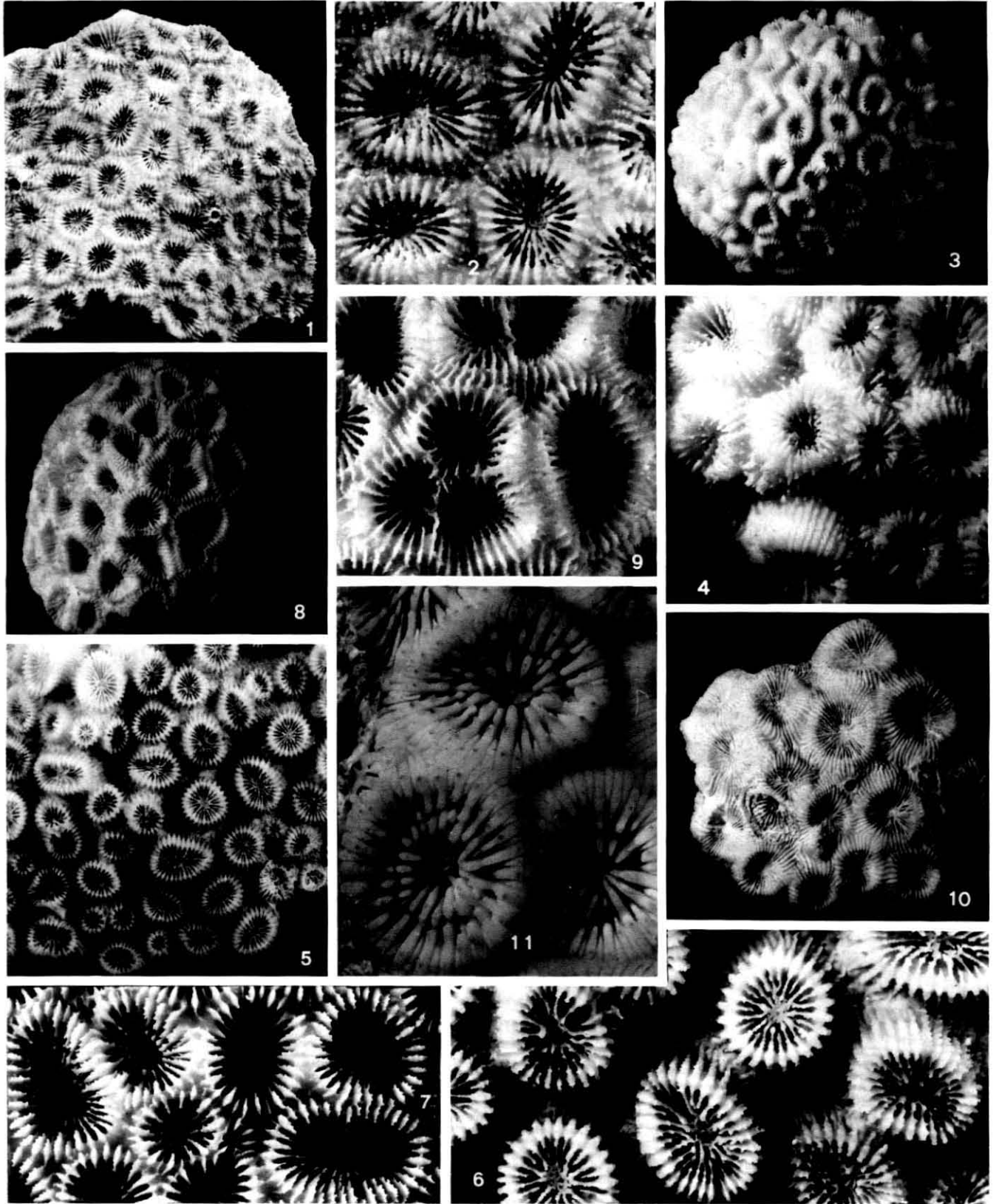

Figs. 1, 2. *Favia pallida* (Sa 72, x0.7, x2).  
Figs. 3, 4. *Favia amicorum* (SCHUHMACHER 123, x0.7, x2).  
Figs. 5-7. *Favia speciosa* (5, 6: SLR 390, x0.7, x2; 7: EC 132, x2).

Figs. 8, 9. *Favia fava* (NS 8417, x0.7, x2).  
Figs. 10, 11. *Favia rotundata* (10: PW 73 705, x0.6; 11: PW 71 353, x2).

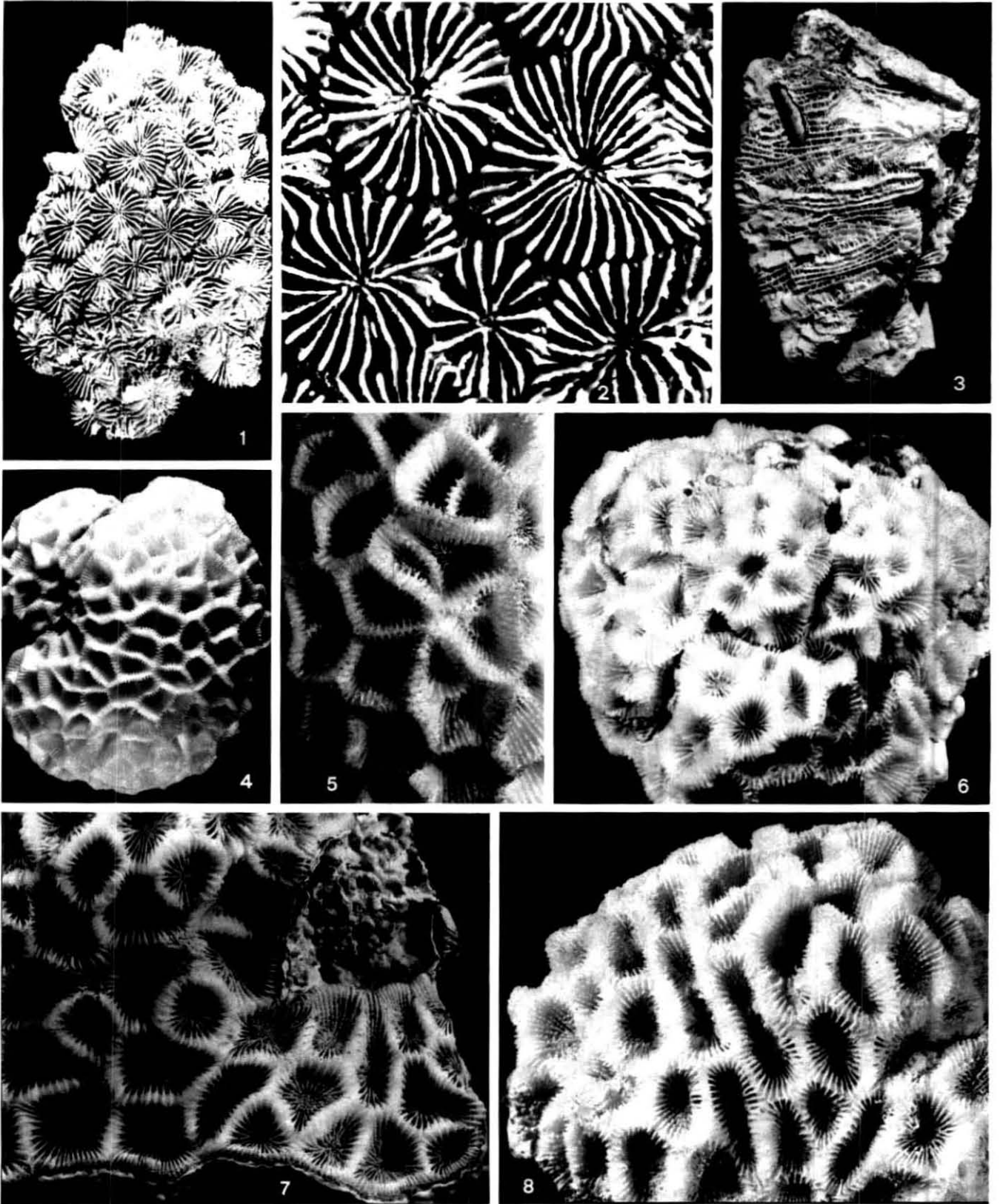

Figs. 1-3. *Favia wisseli* (X2:8-24, x0.6, x2, x0.6).  
Figs. 4, 5. *Favites peresi* (RM 40, x0.6, x1.5).  
Fig. 6. *Favites abdita* (EC 459, x1).

Fig. 7. *Favites complanata* (NS 4838, x1).  
Fig. 8. *Favites flexuosa* (NS 5884, x1).

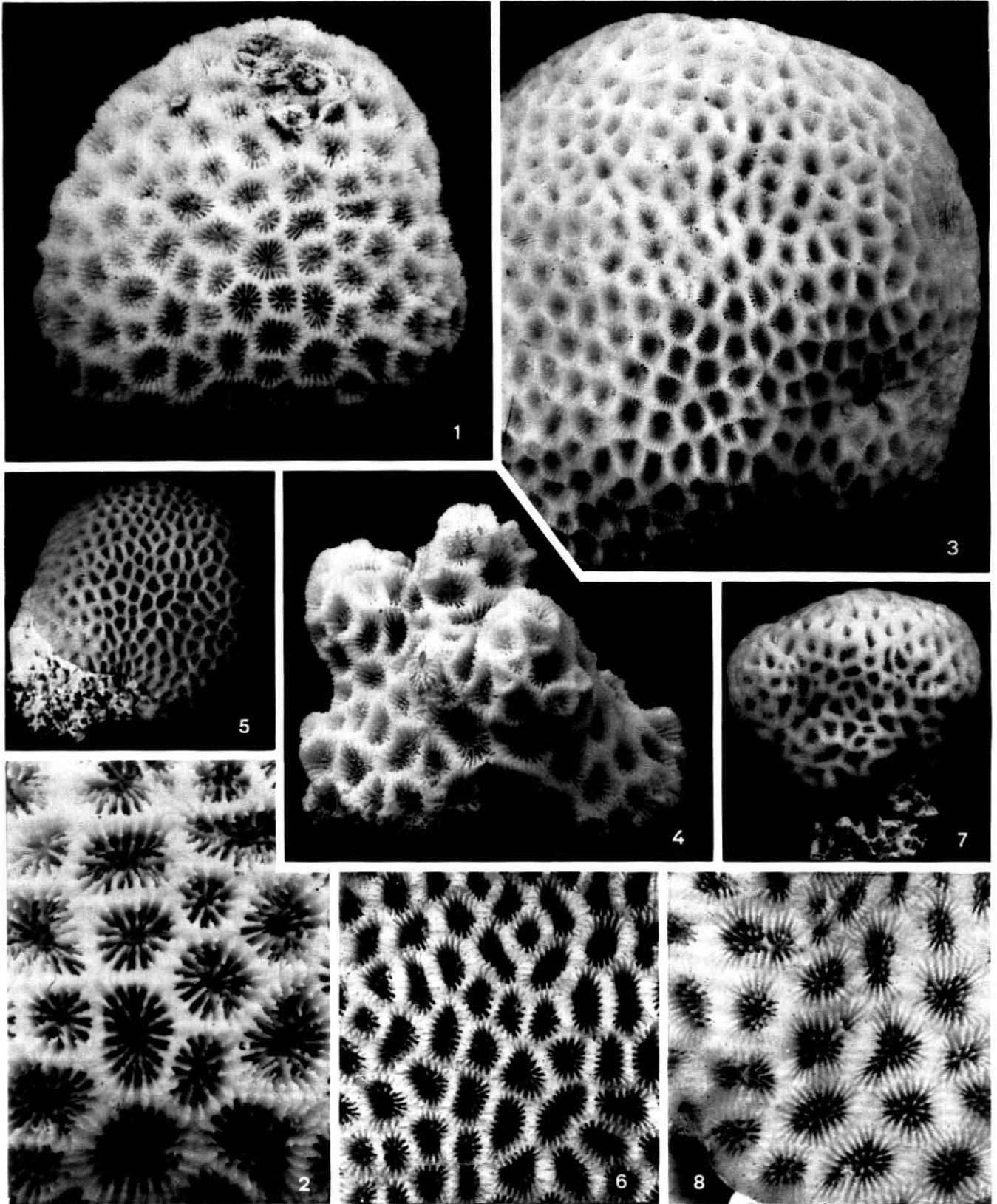

Figs. 1, 2. *Favites halicora* (NS 4984, x1, x2.3).  
Fig. 3. *Favites acuticollis* (SLR 356-2, x1).  
Fig. 4. *Favites pentagona* (NS 1913, x1.1).

Figs. 5, 6. *Goniastrea retiformis* (RM 84, x0.7, x2).  
Figs. 7, 8. *Goniastrea pectinata* (SLR 359-2, x0.7, x2).



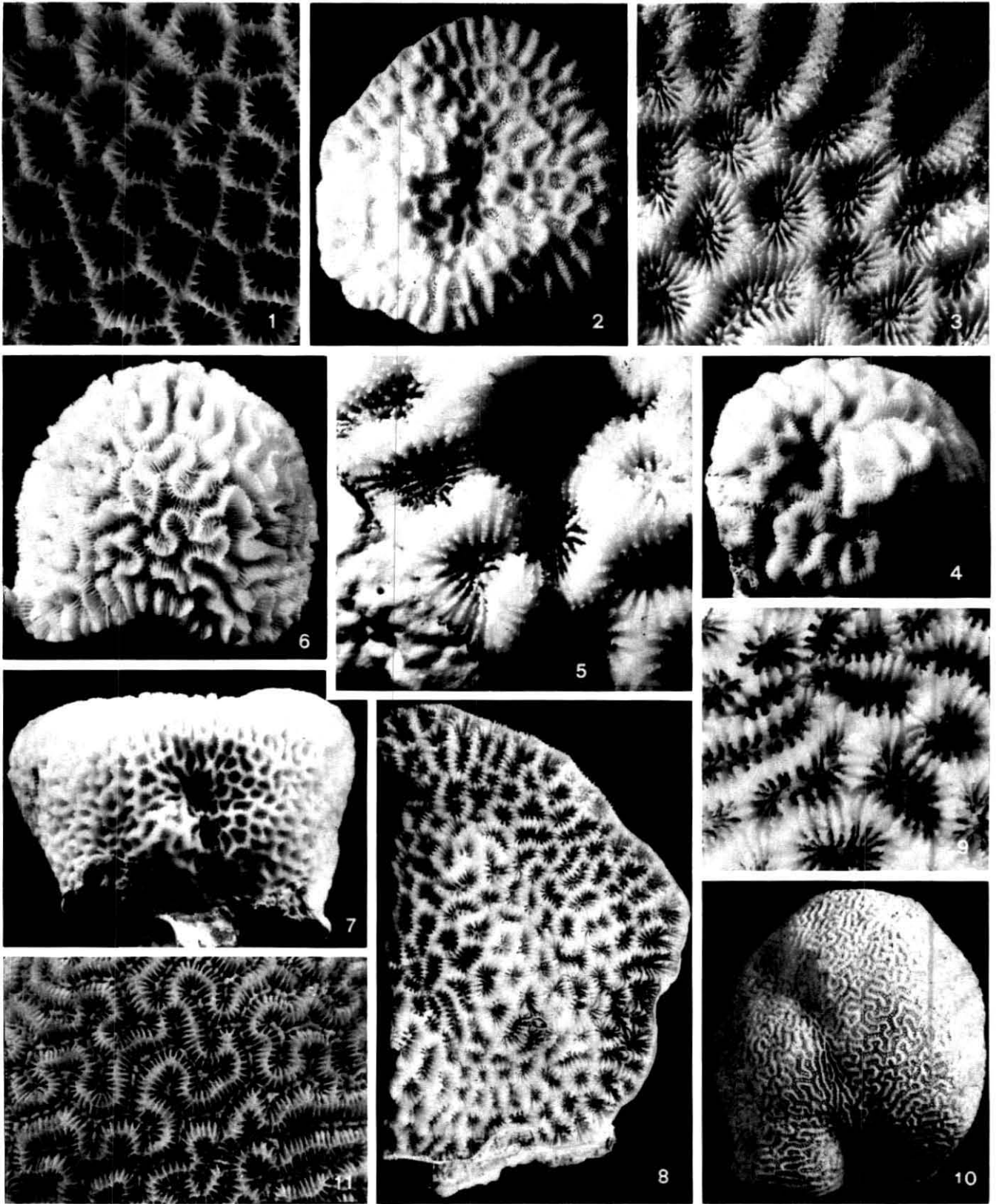

Fig. 1. *Goniastrea retiformis* (X2:9-19, x3).  
Figs. 2, 3. *Goniastrea pectinata* (PW 73 542, x0.5, x2).  
Figs. 4, 5. *Goniastrea australensis* (X2:2-78, x0.7, x2).  
Fig. 6. *Platygyra daedalea* (X2:9-29, x0.7).

Fig. 7. *Platygyra sinensis* (EC 398, x0.7).  
Figs. 8, 9. *Platygyra crosslandi* (Sa 106, x0.7, x2.9).  
Figs. 10, 11. *Leptoria phrygia* (RM 36a, x0.5, x2).

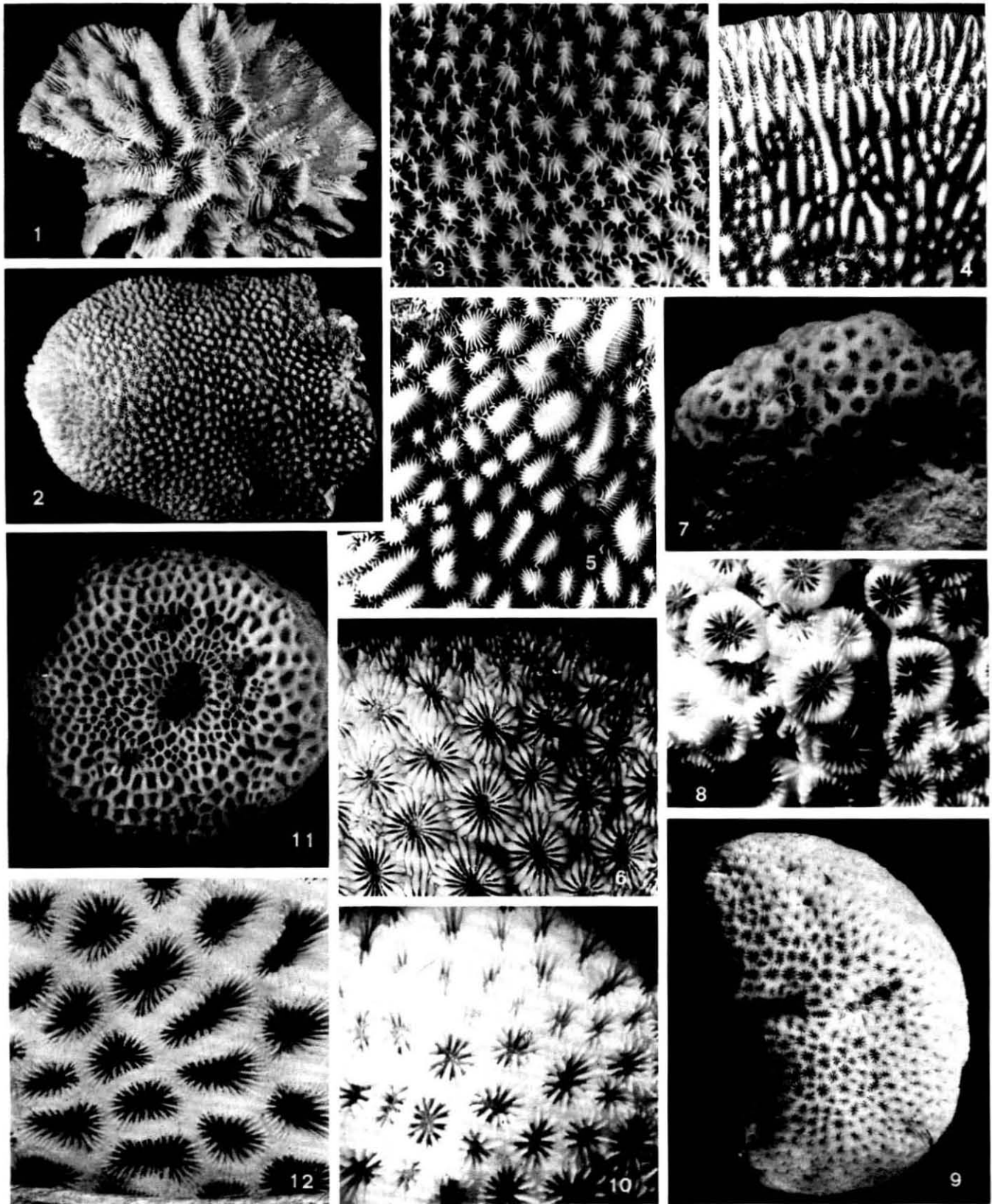

Fig. 1. *Oulophyllia crisa* (RM 87, x0.7).

Figs. 2, 3. *Hydnophora microconos* (RM 24a, x0.3, x1.8).

Figs. 4, 5. *Hydnophora exesa* (RM 23, x0.6, x1.1).

Fig. 6. *Diploastrea heliopora* (RM 71, x1.3).

Figs. 7, 8. *Leptastrea bottae* (NS 4970, x1, x3).

Figs. 9, 10. *Leptastrea transversa* (RM 94, x1, x3).

Figs. 11, 12. *Leptastrea purpurea* (Wa 78, x0.7, x3).

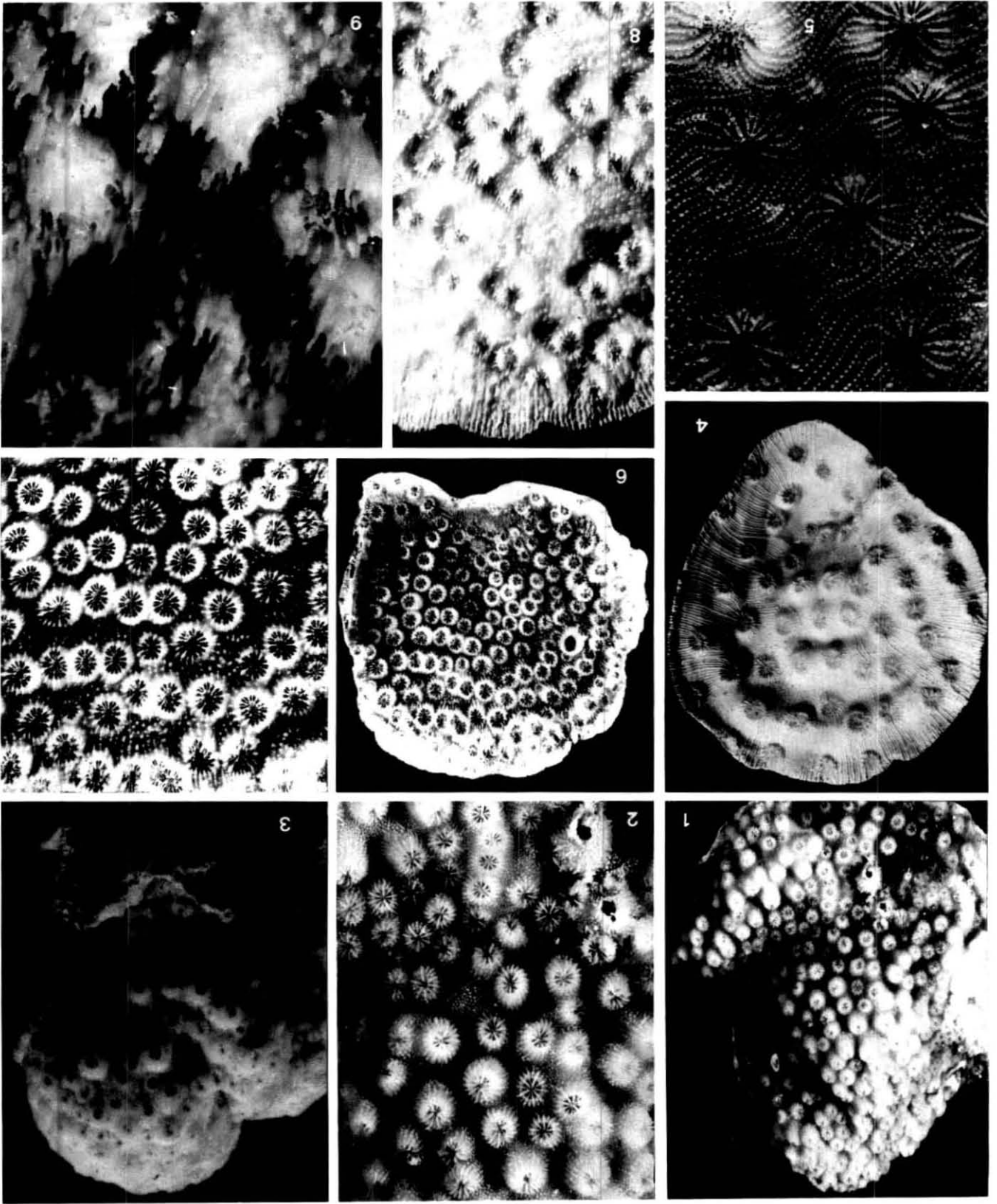

Figs. 1, 2. *Cyphastrea micropophthalma* (Sa 98, x1, x2,+).

Fig. 3. *Cyphastrea scutellata* (SLR 357-2, x1,2).

Figs. 4, 5. *Echinopora lamellosa* (+; PW 73 544, x0,8; 5: Sa 70, x2,8).

Figs. 6-9. *Echinopora gemmacea* (6, 7: RM 25, x0,5, x1; 8, 9: Sa 33, x1, x3,3).

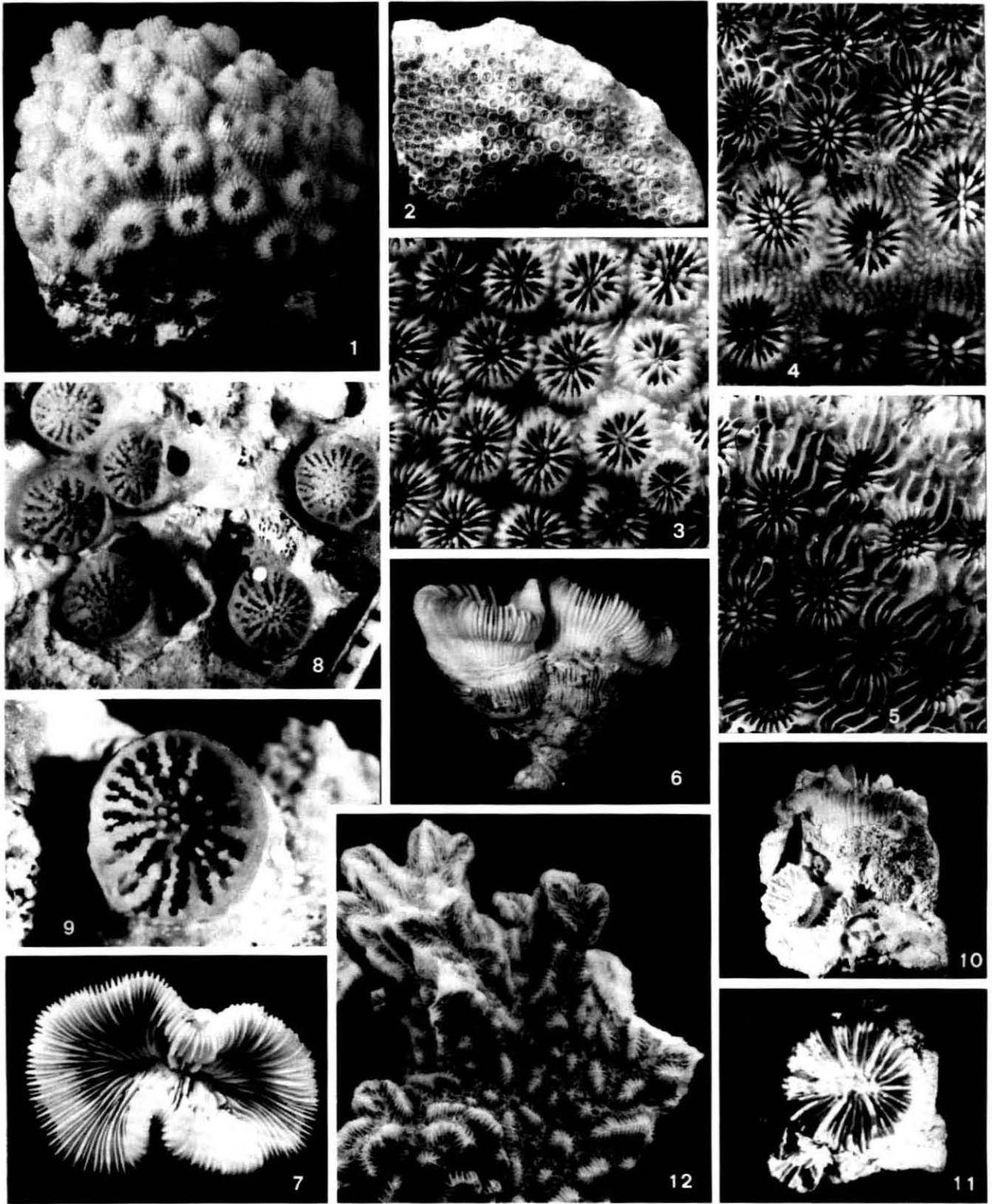

Figs. 1. *Echinopora gemmacea* (X2:2-15, x1).  
 Figs. 2-5. *Plesiastrea versipora* (Pa 81/209; 2: x0.7; 3-5: x3).  
 Figs. 6, 7. *Trachyphyllia geoffroyi* (PW 71 360, x0.7).

Figs. 8, 9. *Culicia rubeola* (Paris, coll. KLUNZINGER 4122, x5, x11, phot. H. ZIBROWIUS).  
 Figs. 10, 11. *Phyllangia* spec. (Fri 115-2, x2).  
 Fig. 12. *Hydnophora exesa* (SLR 834, x1.1).

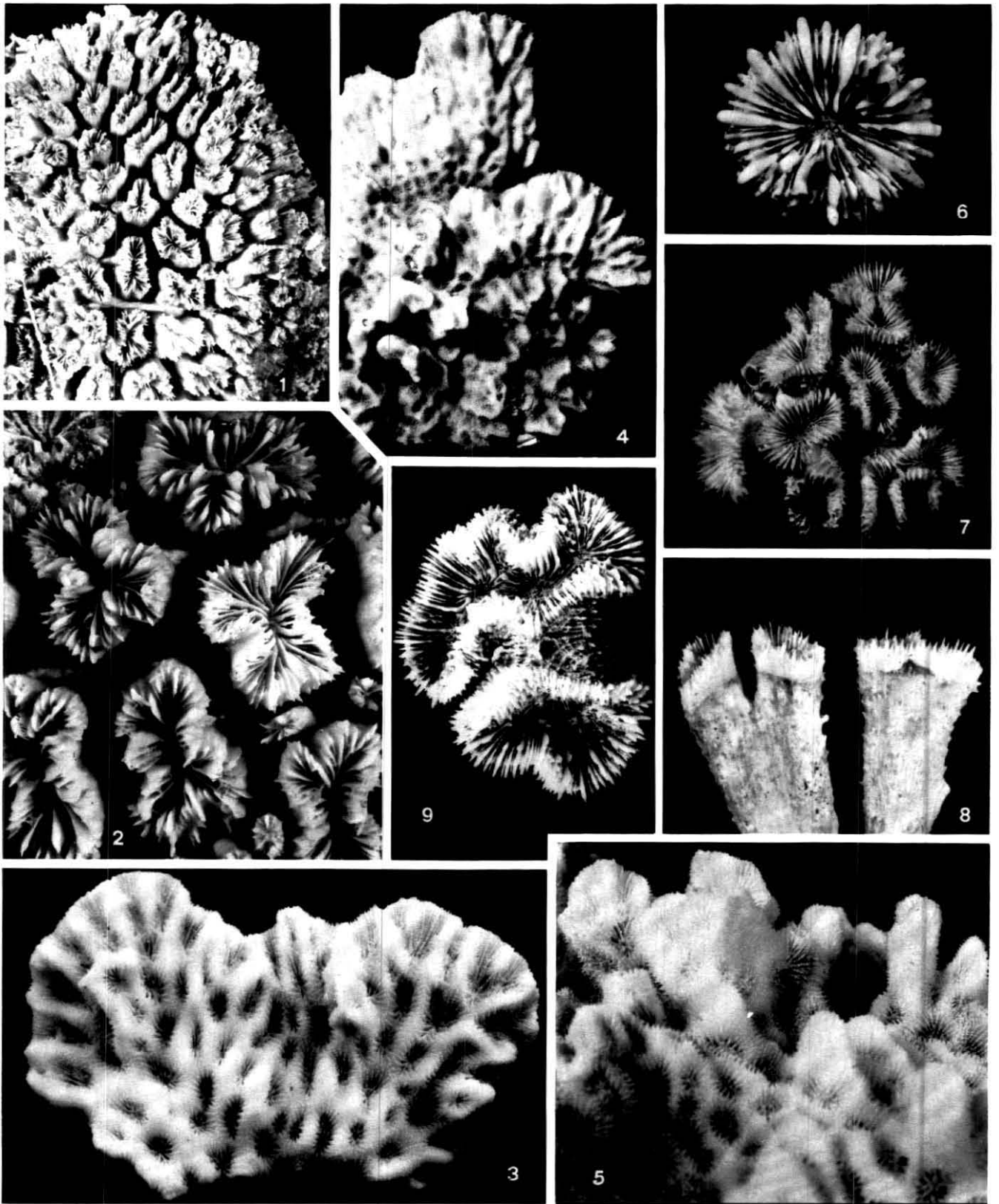

Figs. 1, 2. *Galaxea fascicularis* (Wa 92, x0.7, x2.1).

Figs. 3–5. *Merulina cf. ampliata* (3: SLR 1191, x1.2; 4, 5: Sa 56, x0.5, x1.1).

Fig. 6. *Cynarina lacrymalis* (NS 6116, x1.1).

Figs. 7, 8. *Lobophyllia corymbosa* (7: X2:9–10, x0.5; 8: RM 30, x0.5).

Fig. 9. *Lobophyllia hemprichi* (SLR 674, x0.5).

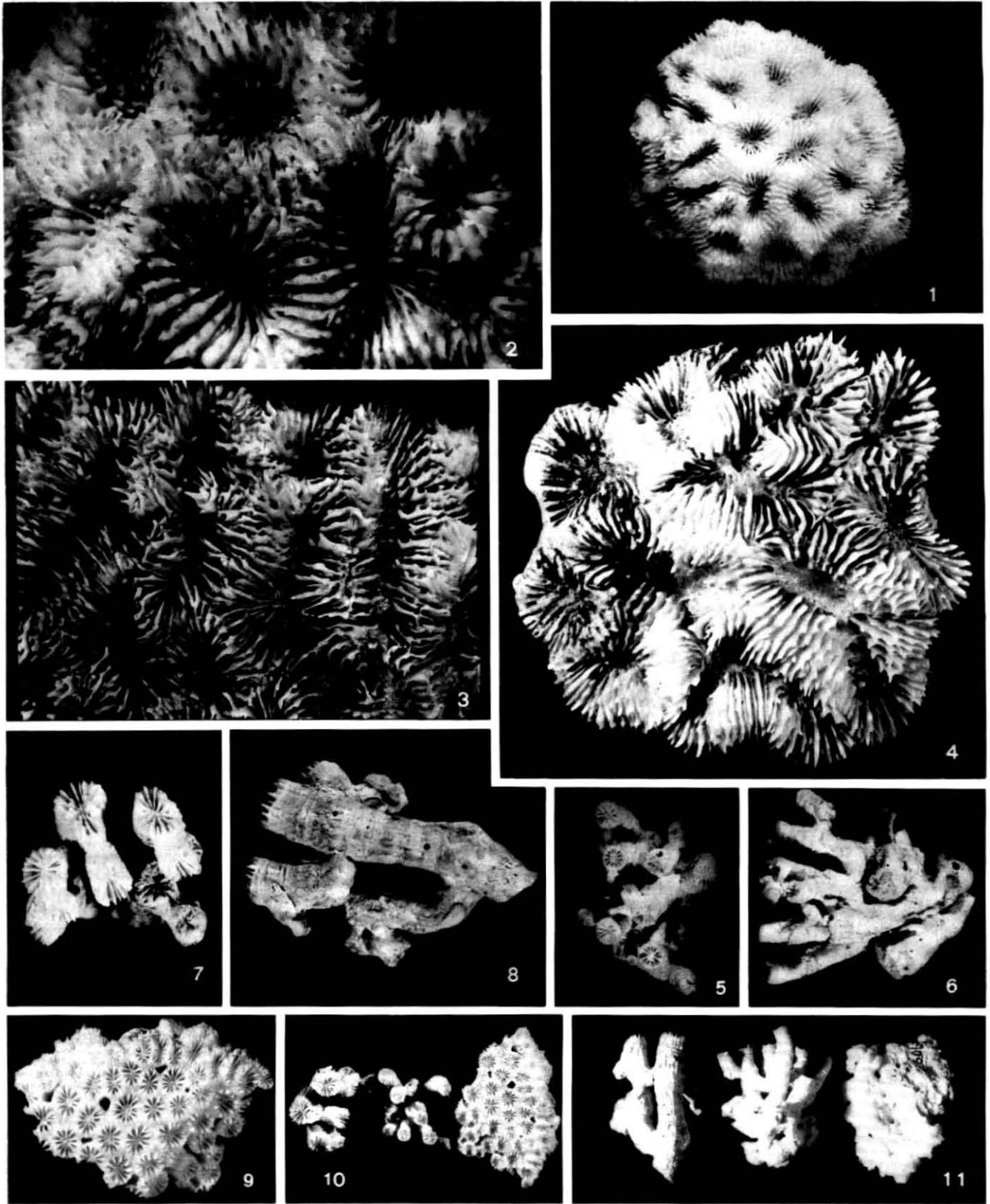

Figs. 1, 2. *Acanthastrea echinata* (EC 460, x0.7, x2).  
Figs. 3, 4. *Acanthastrea erythraea* (3: RM 97, x1; 4: ZMB 7028, x1).  
Figs. 5, 6. *Blastomussa merleti* (PW 71 349a, x1).

Figs. 7, 8. *Blastomussa wellsi* (PW 73 567, x1).  
Fig. 9. *Blastomussa loyae* (NS 6067, x0.9).  
Figs. 10, 11. *Blastomussa wellsi*, *merleti*, *loyae* (x0.5).

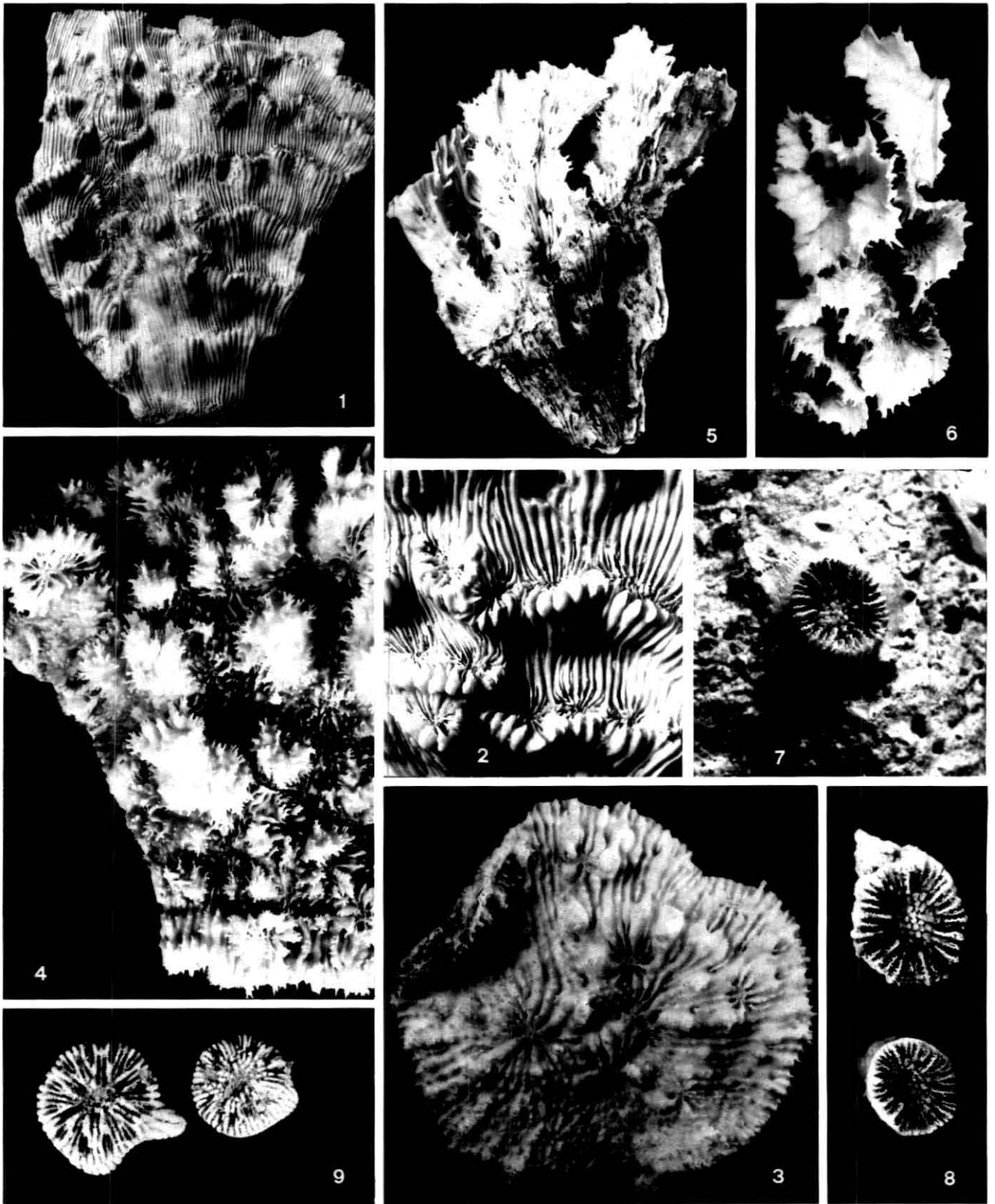

Figs. 1, 2. *Mycedium elephantotus* (Sa 47, x0.4, x1).  
Figs. 3, 4. *Echinophyllia aspera* (3: SLR 1189, x1.2; 4: Sa 86, x1.2).  
Figs. 5, 6. *Oxypora lacera* (SLR 1167, x0.6).

Figs. 7, 8. *Polycyathus fuscomarginatus* (7: PW 73 597, x4; 8: NS 5934, x3.6).  
Fig. 9. *Heterocyathus aequicostatus* (NS 5415, x2.5).

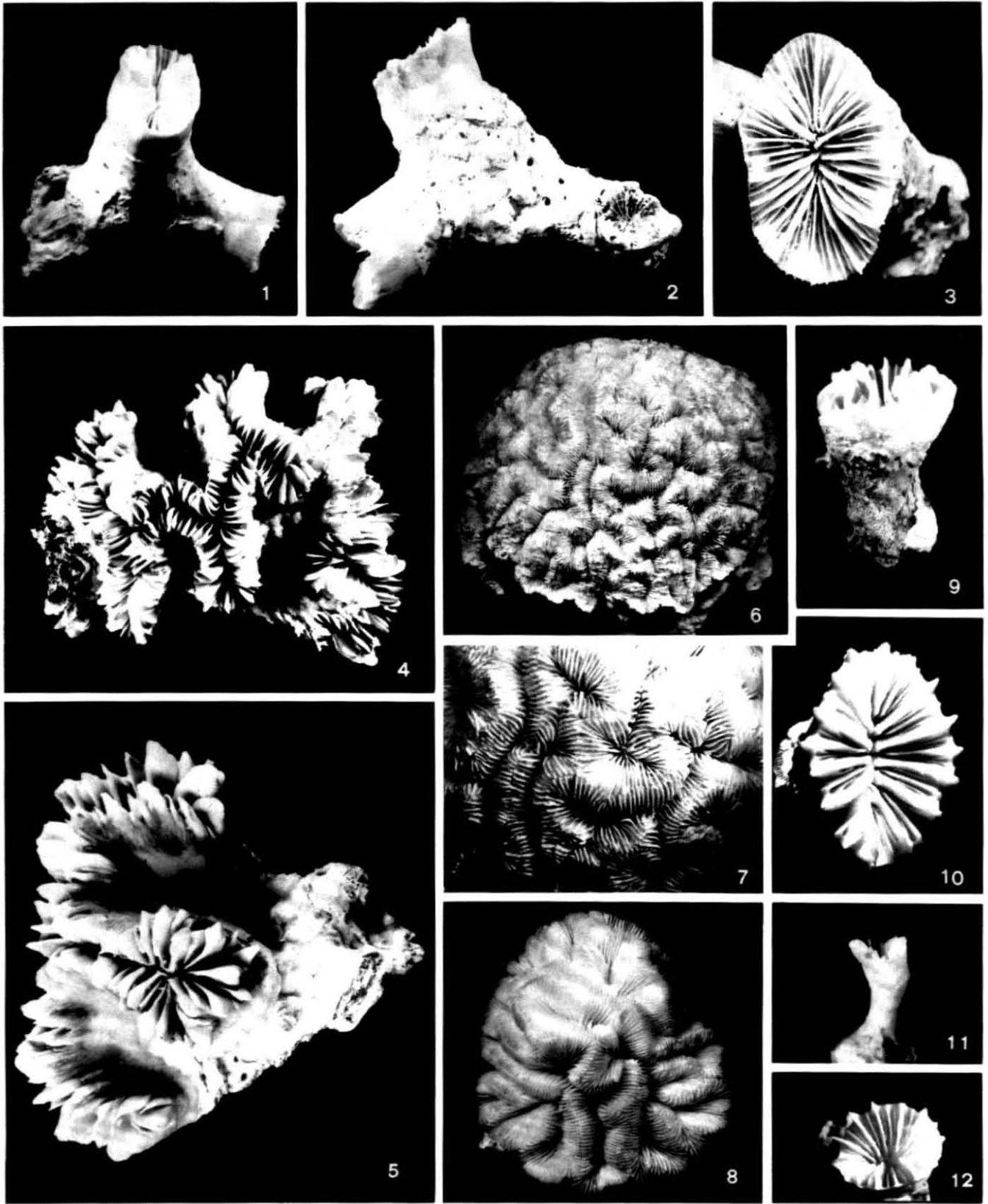

Figs. 1-3. *Euphyllia glabrescens* (1: NS 9288, x0.7; 2, 3: Fri 32-1, x0.7, x1).

Figs. 4, 5. *Plerogyra sinuosa* (4: X2:10-7, x0.5; 5: SLR 1247-2, x0.9).

Figs. 6-8. *Gyrosmilia interrupta* (6, 7: PW 73 522, x0.5, x1.1; 8: PW 73 590, x0.8).

Figs. 9-12. *Javania insignis* (9, 10: Fri 51-1, x1, x1.6; 11, 12: Fri 51-2, x0.9, x1.5).



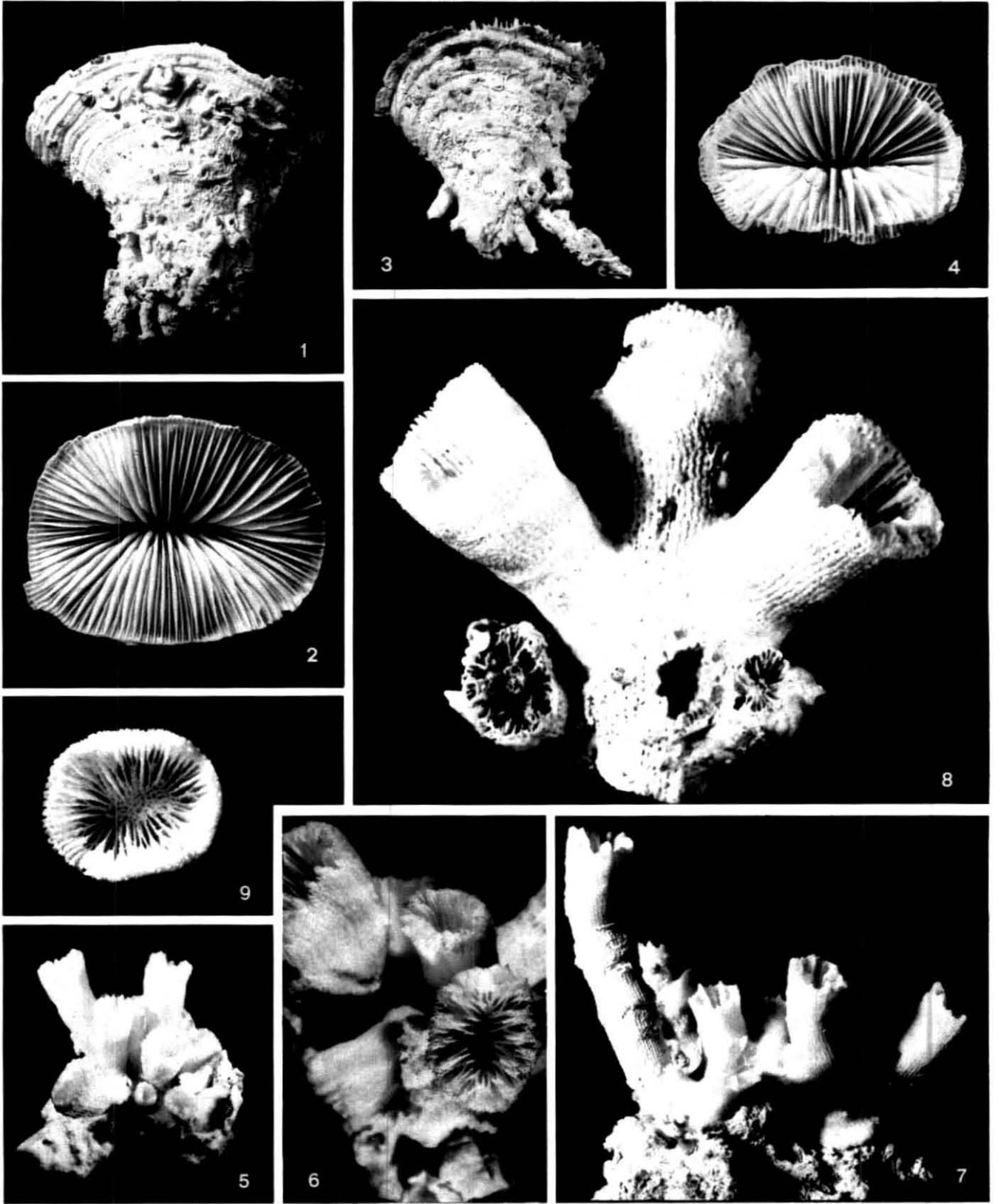

Figs. 1-4. *Rhizotrochus typus* (1, 2: Fri 41-2, x0.8; 3: Fri 41-4, x1; 4: Fri 46-1, x1).

Figs. 5-7. *Balanophyllia gemmifera* (5, 6: RM 98, x1.2, x2.9; 7: Sa 86a, x1.7).

Figs. 8, 9. cf. *Balanophyllia cumingii* (Fri 78-3, x2).

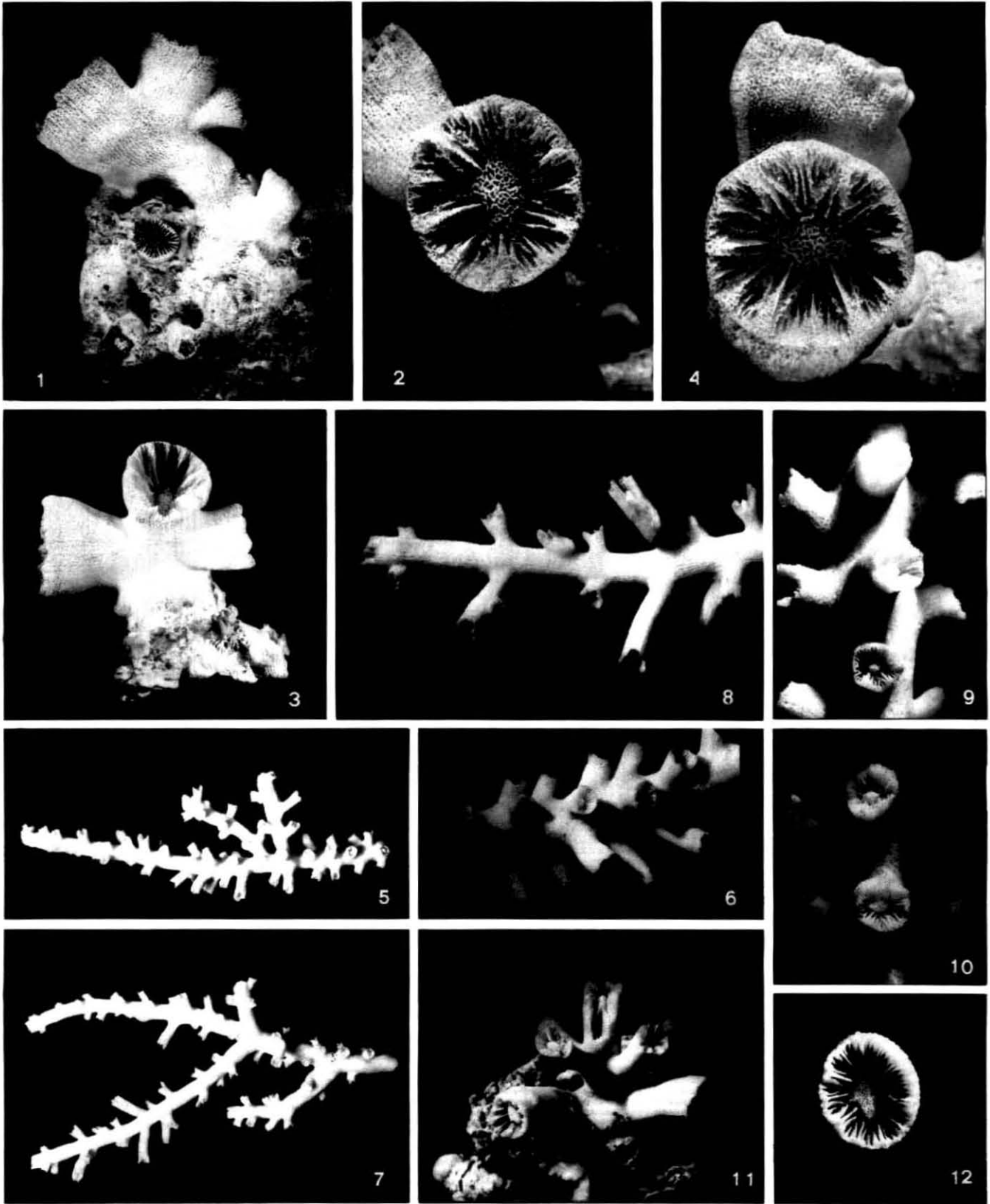

Figs. 1-4. *Rhizopsammia wettsteini* (1, 2: PW 73 614a, x1.8, x3.2; 3, 4: PW 73 614b, x1.6, x3.2).

Figs. 5-10. *Dendrophyllia cf. minuscula* (5, 6, 9, 10: Fri 37-1; 5: x0.5; 6: x1.5; 9: x2.2; 10: x2.4; 7, 8: Fri 92-3, x0.5, x1.5).

Figs. 11, 12. *Dendrophyllia horsti* (Fri 45-2, x0.5, x2).

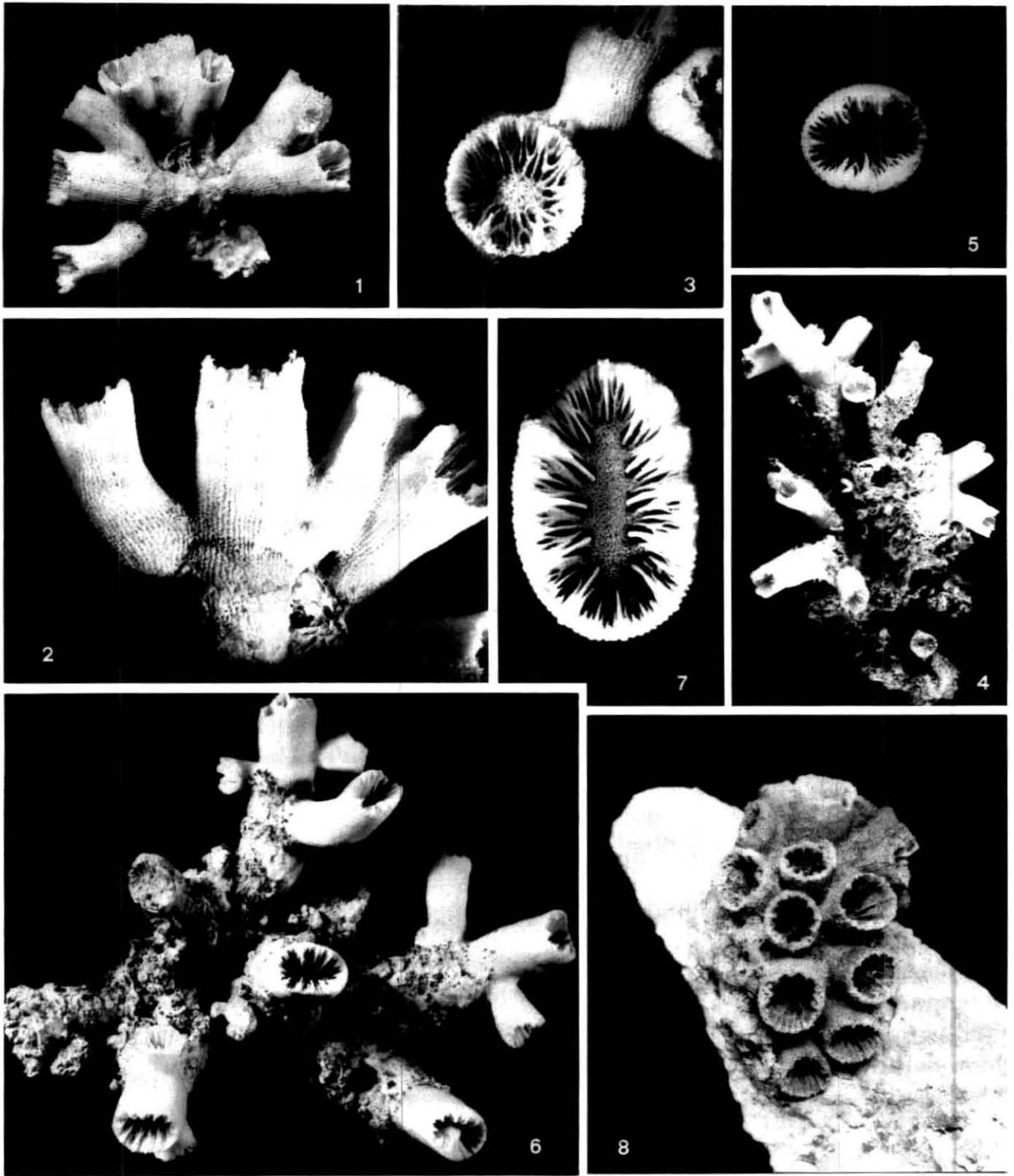

Figs. 1-3. *Dendrophyllia arbuscula* (X2:3-48, 1; 1: x1.2; 2: x2.4; 3: x2.5).

Figs. 4, 5. *Dendrophyllia* cf. *cornigera* (Fri 78-1, x0.5, x2). (In the centre of Fig. 4 three specimens of *Dactylotrachus cervicornis*).

Figs. 6, 7. *Dendrophyllia robusta* (Fri 45-1, x0.5, x2).

Fig. 8. *Tubastraea aurea* (SLR 1384-1, x1).

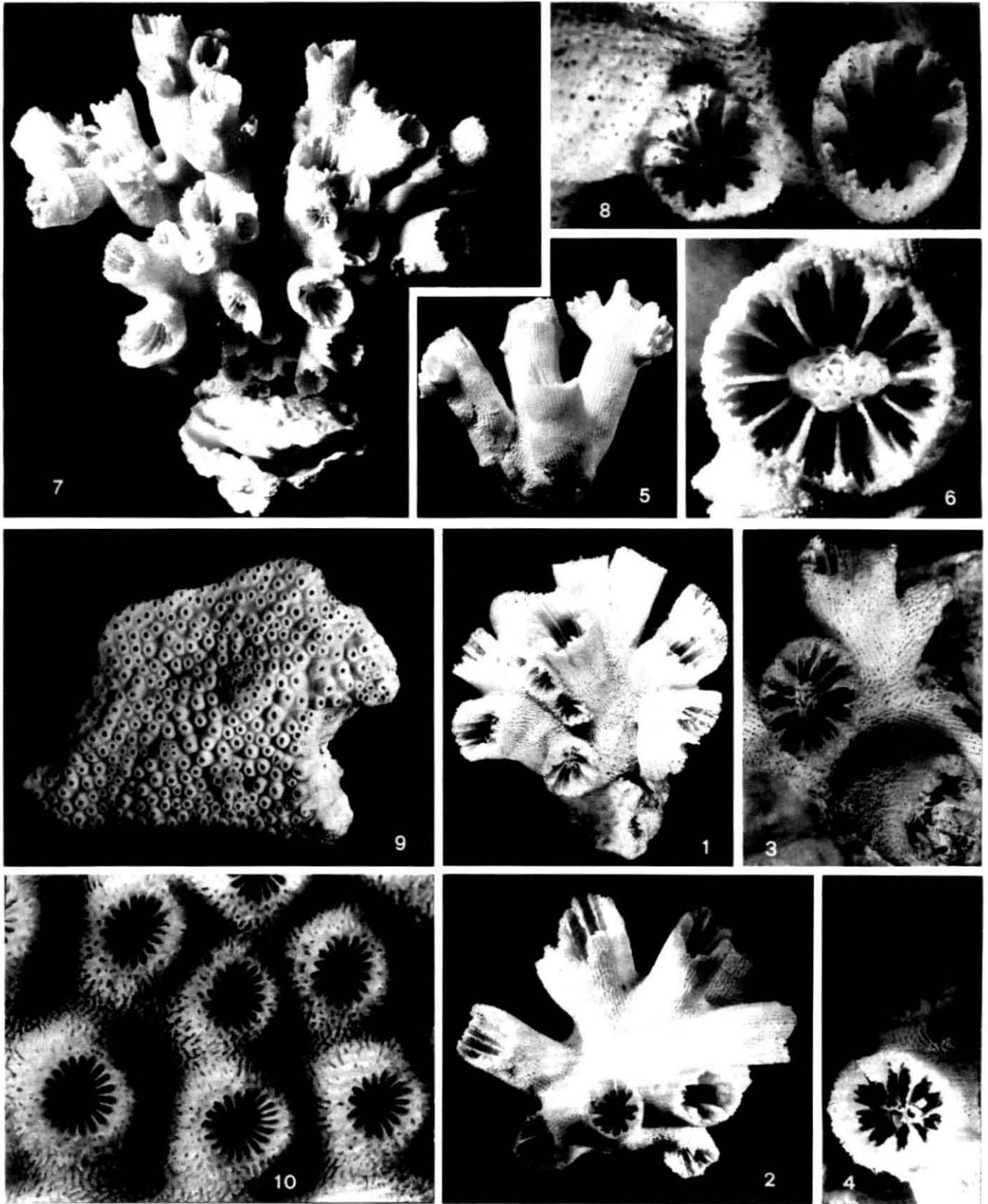

Figs. 1-4. *Tubastraea diaphana* (1, 4: RM 50a, x1.2, x2.5; 2: X2:3-23, x1.2; 3: RM 50-1, x2.5).

Figs. 5, 6. *Tubastraea coccinea* (ZMB 1058, x1.2, x4.9).

Figs. 7, 8. *Tubastraea micranthus* (Sa 83, x1.1, x4.5).

Figs. 9, 10. *Turbinaria mesenterina* (RM 22, x0.6, x6).