

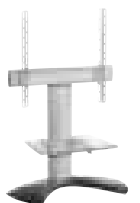

DEALER

CATALOGUE

2007



CHANGING PERSPECTIVES

INVENTING THE FUTURE

The consumer electronics market continues to develop at a rapid pace. To maintain your competitive edge as a dealer, you need to offer your customers the latest must-have products, month after month, year after year. But how? By working with a partner that understands the market and can provide you with a constant stream of unique and innovative products. Vogel's is the expert in supports for audio and video equipment. We have been specialising in this area for over 30 years. Our strategic focus on systematic innovation and high quality design has enabled us to produce winner after winner for this demanding market.

Winning design

Vogel's invests heavily in its in-house design and engineering department and that has resulted in many award-winning designs over the years. That tradition continues today. In just the last few months, two of our newest products received highly regarded design awards. Vogel's Click & Switch projector mounting system from the Evolution 6000 Series received the iF Product Design Award 2007. The iF award is one of the world's most well known trademarks for outstanding design. This global recognition puts Vogel's in the top tier of manufacturers. Vogel's new EPC 6545 projector ceiling solution and Mighty Brighty won the coveted 'CES Innovations Award 2007 Honoree' as well. The CES is the biggest consumer electronics trade show in the US.

Fast gains in 2006

In 2006, our insight and understanding of the consumer electronics market enabled us to identify some of its most important new trends, quickly develop new products and bring them to market. We introduced new product categories in 2006. Amongst these, our Mighty Brighty Projection Screen Paint, which is an exciting addition to our successful line of projector supports for the Home Cinema market.

New horizons for 2007

The year 2007 promises to be even more exciting. We anticipate a huge growth in manual and electronic supports for screens and in supports for very large screens. Vogel's has a long history in developing extremely stable, high quality supports for large format screens and the professional market. We will draw upon this experience to rapidly produce inventive new solutions for large screens in the consumer market. Furthermore, a headrest support for portable DVD players has been developed. DVDock will take us into the new category of in-car entertainment. We will also continue to add new internet applications as a way of reducing costs and improving communication with our sales partners and customers.

Working together, we can help each other build a successful future.

Gerdi Vogels
Managing Director



Universal solutions for every home and every TV

On the ground, on the wall or ceiling, on a table or as furniture. Vogel's offers a wide variety of solutions. And in all of these areas we provide innovations that you can easily sell.

Expanding our Home Cinema assortment

Vogel's was one of the first to take advantage of the tremendous growth in Home Cinema projectors with its highly popular Evolution 6000 Series Click & Watch projector mounts. We expanded our assortment with Mighty Brighty Projection Screen Paint. It was introduced in 2006 and has been very well received in the market. Mighty Brighty is a very convenient and cost-effective alternative to expensive stand-alone and built-in projection screens. We will continue to add innovative products in this fast-growing market.



Growing and gaining market share

The Vogel's Evolution 6000 Series LCD/Plasma wall supports continue to gain popularity with retailers and customers. Vogel's is still gaining market share compared to our competitors and is the leading brand in the flat display support market. Vogel's furniture assortment also offers many high quality choices to consumers and sales in this area are doing well.

Gearing up for in-car entertainment with DVDock

Vogel's enters a new product category with DVDock, a new headrest support for portable DVD players that are used for in-car entertainment. It offers a sturdy and stylish alternative to the flimsy and unattractive bags that are usually provided with portable DVD's. Vogel's DVDock is made of robust materials that will stand up to intensive use and it looks great with any style car.

EVOLUTION

Innovations from Vogel's	4
Partnership with Vogel's	6
Universal trends and Vogel's	8
Vogel's internet	10
Spotlights	12
DVDock - LCD Headrest Support	NEW 14
6000 Series	16
6000 Series - LCD/TFT and Plasma wall supports	18
6000 Series - accessories	21
LCD/TFT supports	22
LCD/Plasma stands	23
Large Screens	24
Large LCD/Plasma wall supports	26
Large LCD/Plasma accessories	27
Projection	NEW 28
Mighty Brighty - Projection Screen Paint	31
6000 Series - Projector modules and connector	32
Loudspeaker supports	34
Loudspeaker stands	36
TV wall supports and turntables	38

ORIGINAL

About Vogel's Original	39
LCD/TFT and Plasma wall supports	41
LCD floor stand	45
Projector supports	46
TV Wall supports and accessories	47
Loudspeaker support and stand	49
Microwave holder	49

FURNITURE

Furniture	50
-----------	----

PROFESSIONAL

Professional	52
--------------	----

GENERAL

Evolution and Original marketing support	54
Specifications and index	56
6000 Series - Explanation of icons	58

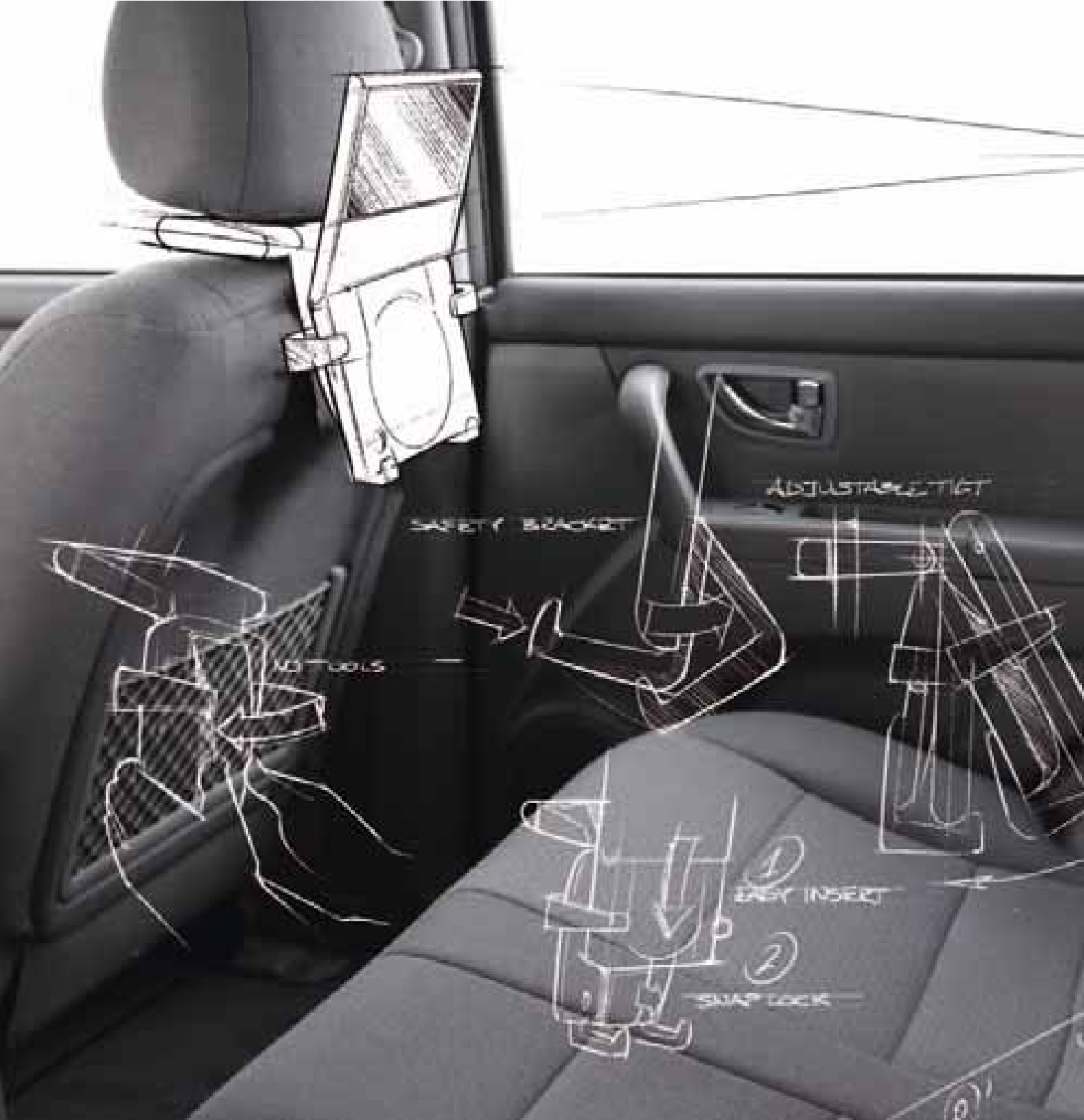

The birth of a new product

CAD models, mockups and prototypes are made to thoroughly test every aspect of the design

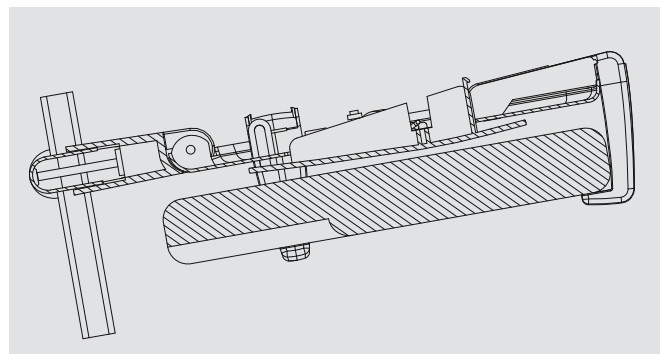

EUROPEAN DESIGN BY VOGEL'S

In today's highly competitive marketplace, the most successful companies are those that can anticipate what their customers will want. That requires insight into new market trends and an ability to quickly design and develop products that will meet these new needs. From the very start, Vogel's has had a clear strategic focus on in-house product design, development and engineering and we have always invested heavily in these areas. This has enabled us time and time again to identify new opportunities and quickly bring them to market before our competitors.

Some of our famous firsts include:

- The first and most successful loudspeaker support in the world, the BEK 100 (1973)
- The first universal LCD/Plasma adapter (2001)
- The first flat display supports with gas springs/shocks (2002)
- The first aluminium flat display supports (2002)
- The first LCD/TFT audio-visual modular concept (2002)
- The first aluminium projector support (2003)
- The first Projection Screen Paint which you can adapt at home to every situation (2006)

How has Vogel's achieved so many firsts?

We keep our pulse on market developments

Vogel's has a strong marketing department that has a close relationship with our business partners and end customers. They help keep us up-to-date on the latest developments and trends in our markets. In addition, we carry out independent research and visit all relevant trade shows and events to identify new market opportunities. This provides valuable input for our strategic product decisions.

Dedicated industrial design department

Over the last 30 years, our large team of industrial designers and engineers has built up highly specialised knowledge about consumer preferences, materials, functional requirements, ergonomics, and manufacturing processes for designing support products. Our experts provide valuable technical input on the feasibility of new designs before starting a project. They then use advanced tools, such as CAD models and mockups, to test and fine-tune key design aspects. This expertise helps us find new ways of doing things and helps us apply proven methods to new situations. Our specialists also work with an extensive network of suppliers to ensure the fastest and most cost-effective manufacturing methods.

We deliver products at affordable price points

Vogel's products are made of high quality materials, yet they are also affordable because we invest heavily in high volume production methods. Our industrial designs incorporate these production cost advantages and enable us to manufacture our products at affordable price points.

Vogel's industrial designers and engineers each contribute a different perspective and skill to come up with the most innovative solution

EUROPE

 AM ZigZag Shahen Tsarukyan	 AT H.F. Dollmann	 AZ Azel Azerbaijan Electronics	 BE Lucodex NV Kim Aerts	 BG Vigo	 CH Telion AG Stephan Hartmann	 CY M.Michael & Stavrou Electronics	 CZ EasyAV s.r.o. Daniel Pavelka	 DE Fa Schnepel GmbH & Co KG Kai Schnepel	 DK Rudolph Schmidt A/S (Auroragrup) Tommy Nielsen	 EE Sandman Group
 HR Dacco D.O.O. Darko Vekic	 HU Steelbird	 IE Hi Fidelity Marketing	 IS Television Centre Ltd.	 IT Pozzi Italia s.r.l.	 LT Ogmios Pulsas Ltd. Edividas Prateika	 LU Lucodex NV Kim Aerts	 LV Latsat Ltd.	 MT YAL Home and Electronics Adrian Galea	 NL Havoned B.V. Ruud Schaay	 NO D.S.K. (Auroragrup) Jan Einar Ervik
 SK TT- Thais Trading	 SL Technotop	 SR Av Max Group Dragan Trajkovic	 TR Aztek Technoloji Ürünleri	 UA Dumka						

AMERICAS

 AN Bootchand's Curacao	 BR Linear Audio	 CA Precor Consumer Electronics
 CL Audio plus	 MX Embodiment S.A. de C.V.	 US Audiovox
 VZ JVG Hogar C.A.		

AFRICA

 TN Epsilon 3	 ZA Radionics Distributors Ltd.
-------------------------	--

PARTNERSHIP WITH VOGEL'S

Vogel's has chosen to work with an indirect and independent distribution channel that has exclusive representation in each country or region where Vogel's products are sold. We are committed to this business model and fully support our importers who represent us locally. As a dealer, you should always contact your local Vogel's importer directly for information about Vogel's products and applications. They can also provide you with sales and marketing support tools. Any questions you might have about the Vogel's product assortment or organisation should be routed through your local Vogel's importer as well. See pages 58, 59 for more detailed information

				
ES ANMI Andreu & Miriam SA	FI FI Teletarvike Jarvinen Oy (Auroragroup) Juha Järvinen	FR D.A.M. Igor Briaud	GB BBG Distribution Ltd	GR Kinotechniki
				
PL Arkas Sp. Z o.o.	PT Fimofer Filipe Ferreira	RO VOG- Design Trade S.R.L.	RU Optima Ltd.	SE Orto Connex AB (Auroragroup) Hasse Sjölin

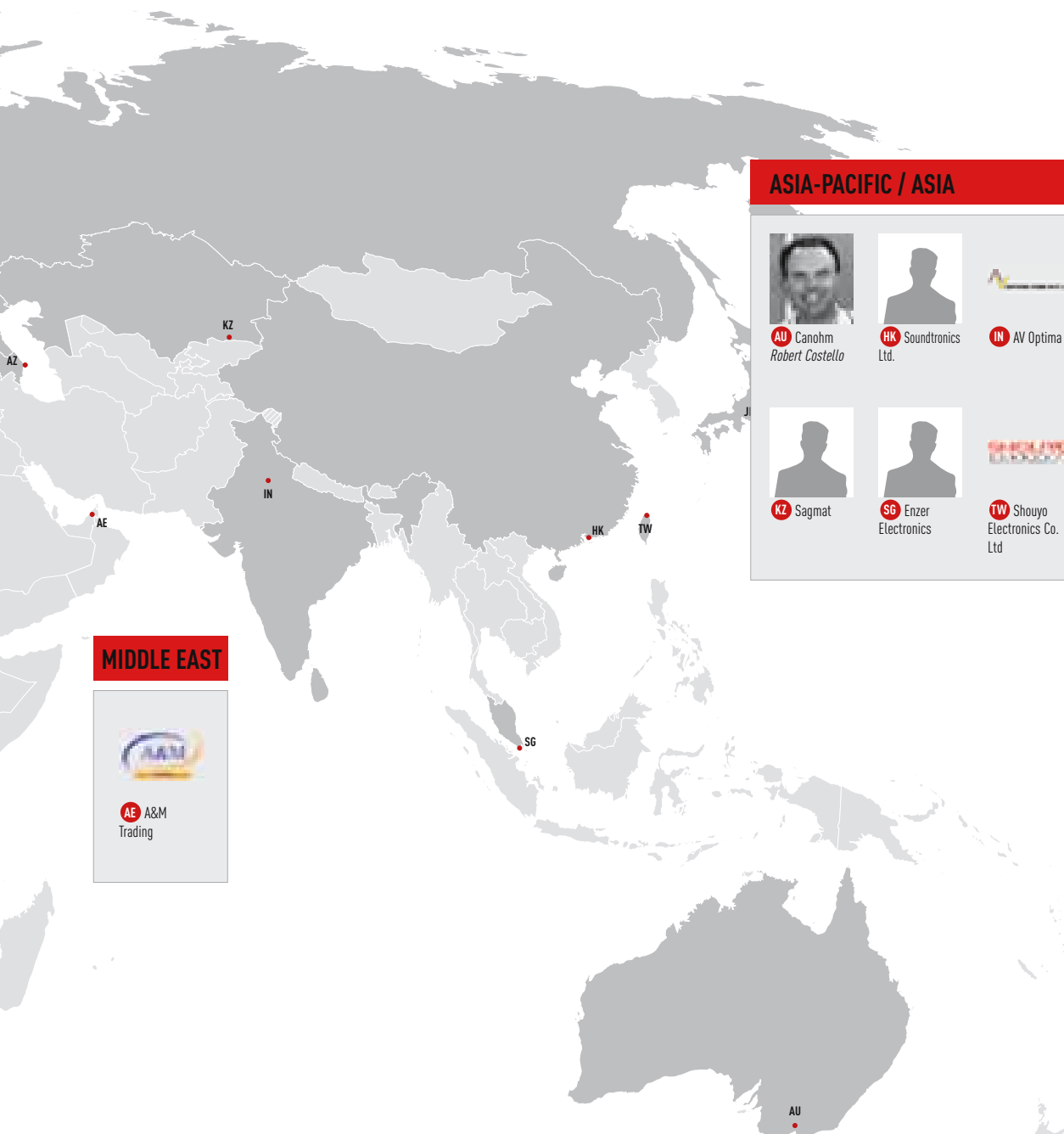

ASIA-PACIFIC / ASIA

			
AU Canohm Robert Costello	HK Soundtronics Ltd.	IN AV Optima	JP Osscreen CO. Ltd.
			
KZ Sagmat	SG Enzer Electronics	TW Shouyo Electronics Co. Ltd	

MIDDLE EAST



AE A&M
Trading

Flat Panel Worldwide

Source: DTC Worldwide, 2006

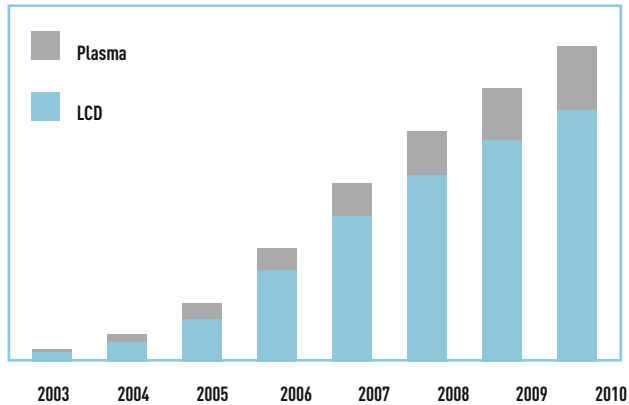

Screen Sizes EMEA

Source: DTC Worldwide, 2006

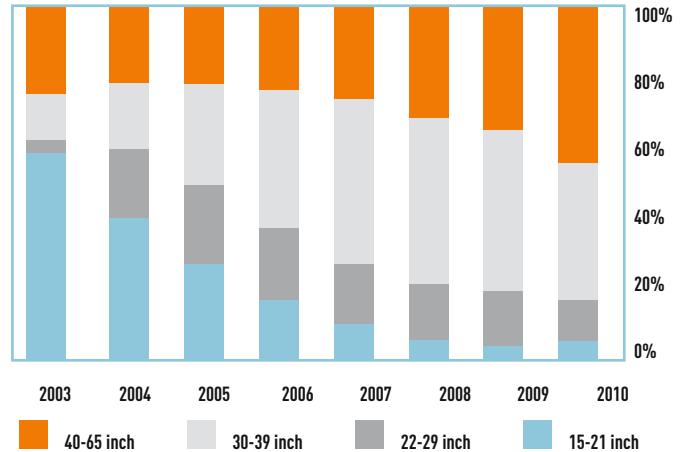

GROW WITH THE FLAT MARKET AND HOME PROJECTION

Flat panel continues to grow and diversify

The flat display market continues to grow and change. Medium-size and large screens are the fastest growing volume segments. And consumers want to turn and position their LCD/Plasma for better viewing. Flat displays are now being carried along to use in public transportation, cars and airplanes. Luckily, Vogel's is changing right alongside you.

Take advantage of the flat display boom

Sales are booming. In fact, flat display sales are expected to account for 90% of all TV sales by 2007. At Vogel's, we anticipated this growth and the new consumer demands when we began developing the Evolution 6000 Series. Now we have just the products you need to take advantage of this dynamic market.



VESA COMPATIBLE

VESA is the worldwide standard for mounting LCD/Plasma screens. The VESA logo tells you, at a glance, which screen complies with the VESA standard so you always get a perfect match. All Vogel's mounts for LCD and plasma screens are VESA compatible. Vogel's has developed a special interface for some of the models that are not VESA compliant.

A few screens still do not have a VESA standard mounting. Vogel's has developed an additional interface (EFA 6875, suitable for EFW 6205, EFW 6225 and EFW 6245) for some of the screens which are not VESA compliant.

Please check our website www.flatscreenfitter.com for information on the specific support that fits a screen.

VESA classification applicable to Vogel's products:

Innovative solutions

The Evolution 6000 Series support system offers a unique range of movement and set of innovative features that make it truly stand out from conventional supports. Its Smart Range provides the most advanced solutions for every size of flat display and for every price class - all in one modular system with the same stylish design. Vogel's DVDock is our newest addition. It is a stable and stylish headrest support for portable DVD players that are used for backseat entertainment in cars.

New demand for Home Cinema projection

One of the fastest growing segments in the Home Cinema market is projectors for home use. Good quality projectors are now available for under € 1,000 and we are seeing a clear shift in demand. There is a huge increase in sales of projectors for home use. Vogel's has a great deal of experience in this area from its professional market and recently introduced several important innovations to serve this market, including the Click & Switch projector mounting solution and Mighty Brightly Projection Screen Paint.

- **VESA MIS-D:**
 - 12-22.9" screen size
 - mounting holes 75 x 75 / 100 x 100 mm

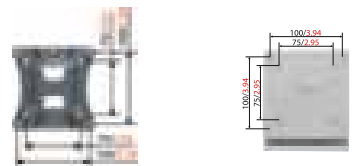

- **VESA MIS-E:**
 - 23-30.9" screen size
 - mounting holes 200 x 100 mm / 200 x 200 mm

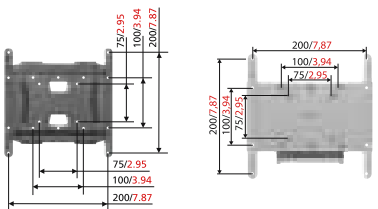

- **VESA MIS-F:**
 - ≥ 31" screen size
 - mounting holes in variable pattern
 - horizontal max. 700 mm
 - vertical max. 450 mm on flat back

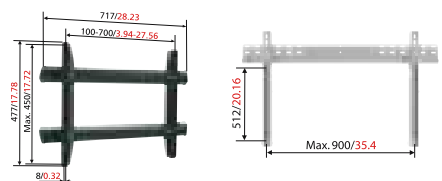



WHAT DOES TÜV MEAN FOR YOU

For consumers, the 'GS' certification mark provides extra certainty about the safety of their Vogel's product. All Vogel's products have been thoroughly tested beforehand. The GS certification mark is handed out by the TÜV. TÜV is an independent certification body for products and production processes. They carry out quality and safety tests.

Virtually all Vogel's products have the GS certification mark. Vogel's undergoes this voluntary certification to give consumers extra proof of the safety of their Vogel's product.

Vogel's products are put through an accelerated endurance test. This test simulates the daily cycle of normal use for a product that a consumer would carry out over a 10 year period. Consumer products are also put through an overload test. The overload test for Vogel's Professional products is extra heavy, because these products are used in public areas.



Test situations at Vogel's

SEGMENTATION & POSITIONING

To meet the needs to the Retail and Consumer Electronic markets, two lines of Vogel's products have been sold for years. Each line is designed with its own concept and target audience. Choose for yourself one or two lines depending on your own market demand and opportunities. Vogel's makes it easy for you to succeed on different levels.

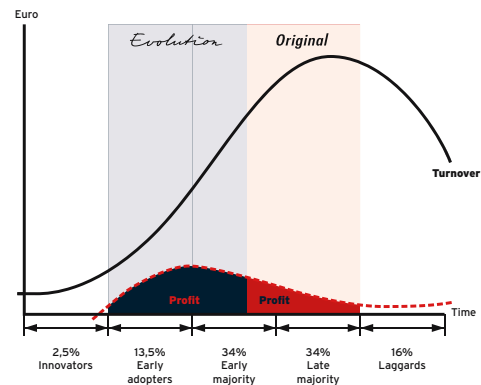

Vogel's Evolution Line is the most sophisticated and innovative range of entertainment supports you will find today. Based on the latest developments and styling and made of durable materials, they are designed to adapt to your space. Vogel's Evolution is designed for individuals who are looking for outstanding easy to use products, that enhance the quality of their entertainment experience.

Vogel's Original Line is the most practical range of entertainment supports that enhance the daily use of your audio and video equipment. Vogel's Original is designed for people who enjoy their life and want to move to the next level of usability and comfort.



VOGEL'S INTERNET APPLICATIONS ARE WORKING FOR YOU



Internet: www.vogels.com

Vogel's internet site

Vogel's internet site makes it easy for you and your customers to quickly locate the information that you need. The site is available in 6 different languages to make it more accessible. It provides information about all products and has a Store locator for the U.S. and The Netherlands (other countries on request). The site also has a few special sections that provide valuable information for consumers.



Home Cinema Planner

Customised Home Cinema Planner

Screen & Support advice application

Vogel's Home Cinema Planner can be customised for each importer or retailer in your own language and with your own housestyle elements. This example shows the customised site for our importer, the Aurora Group in Scandinavia. With this application, consumers can design their own living room layout using our standard graphic elements. They can try out different viewing positions, screen sizes and layouts for their room to see what screen and support work best for their situation. They can also ask for advice about screen size and features of support products.



Consumer Products

Customised Consumer On-line Product catalogue

Vogel's complete consumer catalogue can now be customised for each importer and dealer, in six languages with your own housestyle elements. This example shows the customised catalogue for our importer, Fa Schnepel GmbH & Co KG in Germany. Consumers can quickly find the right support for their needs. With all specifications and accessories. Also useful for dealers who want to quickly look something up.

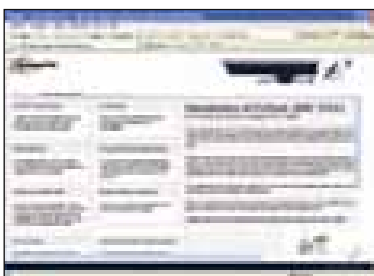

Information Store

Information Store to support your business

Extranet

This site, informationstore.vogels.com, was created to support local marketing and sales activities.

Press site

A new press portal is now available, press.vogels.com, for members of the trade and general press. They can use it to access specific company and product information from Vogel's. Members of the press must first register and they can then access all information.



Press site

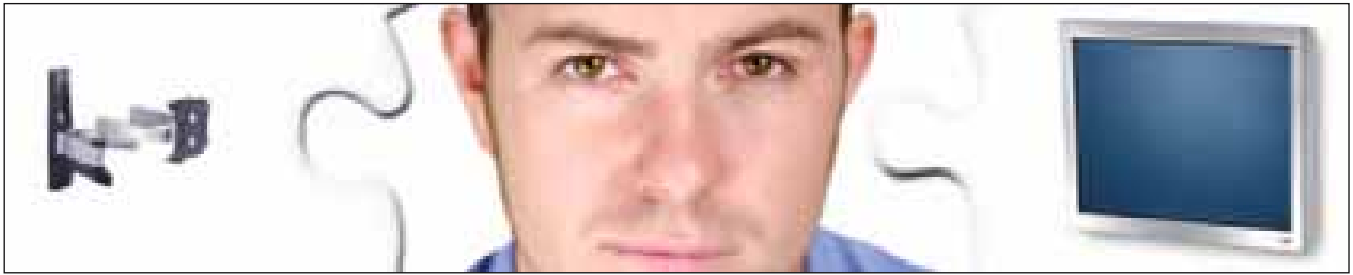

Quickly find the product that fits your flat screen

At www.flatscreenfitter.com we will tell you the Vogel's supports that fit each brand of flat screen TV. Consumers can find the exact support that fits their favourite TV. And you as dealer can make sure that you sell the right support for the right TV.

To do this, the Vogel's team maintains a complete database with all of the A brands of flat screen TVs that are available. All hole patterns are measured, whether they are VESA compatible or not. We also track all of the trends in the flat screen area.

Interfaces

Some televisions are not VESA compatible. Models that do not fit the standard supports can be mounted using an interface. This allows the support and screen to be attached to each other. These interfaces are available from our importers.

Customised Home Cinema Tips

Vogel's Home Cinema tips booklet can now be customised in your language and with your housestyle elements. Contact your local Vogel's importer for more information.

When you are considering buying Home Cinema equipment, you can spend days surfing the web to find information about all the aspects of creating a Home Cinema experience. What flat screen technology is best for your situation? What size should you go for? Is projection an option? What are the most important ergonomics for TV viewing? Or you can go to one independent resource (sponsored by Vogel's) to find the answers to all of these questions and more: www.homecinematips.com. On demand it is possible to create a branded booklet, like we did for the MediaMarket retailer.

This web site is an initiative of Vogel's. But you will not find any Vogel's products on this site. Over the years, Vogel's has amassed a wealth of practical insights about creating the ideal Home Cinema and we created this site to provide an objective source of information for consumers.

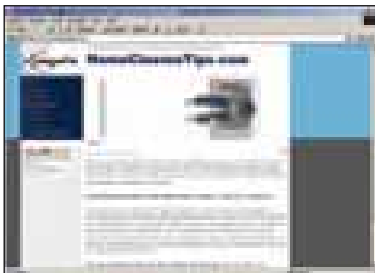

Customised Flatscreenfitter

Vogel's offers several tools for importers and dealers to support sales of Vogel's solutions. Some of these tools are customised versions of the Flatscreenfitter. They come in On-line and Off-line Flatscreenfitter versions, in printed publications and in e-tailer versions. Contact your local Vogel's Importer for more information.

On-line Flatscreenfitter

Vogel's offers an On-line Flatscreenfitter that can be integrated within your corporate website or intranet and is available in two versions:

- Universal On-line Flatscreenfitter: contains all Vogel's products, brands and types of LCD/Plasma screens. See example from the Aurora Group.
- Branded On-line Flatscreenfitter: can be edited to display only the brands and LCD/Plasma types that you sell and shows only Vogel's solutions available in your shops.

For more information, please contact marketing@vogels.com.

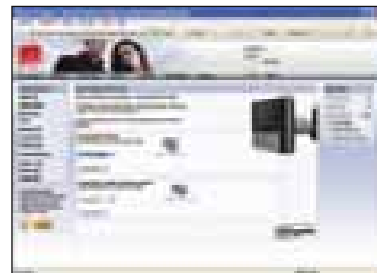

Flatscreenfitter



DVDock - LCD Headrest support EMC 5000

- Universal via adjustable arms to ensure a perfect fit for portable DVD player
- Tilt function (forward or backwards) to eliminate reflections and get the best viewing angle

See page 15 for more detailed information

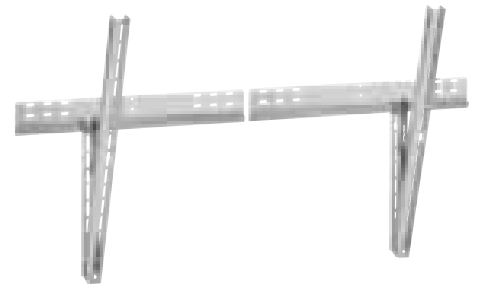

LCD/Plasma wall support XL - PFW 185

- Universal – complies with VESA MIS-F
- Tilt function 0-5-10-15°

See page 26 for more detailed information

PROJECTOR SUPPORTS



Projector wall solution - EPW 6565

- Reversible mounting, possible to mount the projector facing either straight up or upside down
- Universal, fits virtually every projector

See pages 32, 33 for more detailed information



Projector table solution - EPT 6525

- Tilt, turn & roll feature to easily position the projected image
- Universal, fits virtually every projector



Ceiling solution - EPC 6545

- Adjust & secure feature to lock the projector in position
- Ceiling cover included to hide cables and support when not in use

MIGHTY BRIGHTY PROJECTION SCREEN PAINT



Projection Screen Paint - MPW 10

Ready to use paint that creates a projection screen on your wall.

See page 31 for more detailed information



Projection Screen Paint - MPW 20

Create the optimal screen, with the best brightness and reflection for your projector and lighting situation. Everything you need to create a tailor-made projection screen of up to 6 m² with a dark border on your wall.



Projection Screen Paint - MPW 30

Turn your complete wall into the optimal projection screen that looks like a normal wall when not in use. We call this the Invisible Wall Solution because when you are not using your screen you simply remove the magnetic dark border and all you see is a normal white or light grey wall.

IN THE SPOTLIGHT

Vogel's makes a wide range of support products and accessories for the Audio/Video world. We would like to highlight a few of our special products that clearly stand out in their market.

ORIGINAL



LCD wall support – VFW 365

- Turn & tilt function guarantees optimal viewing position
- Cable Inlay System (CIS®) – all cables cleverly concealed

See page 45 for more detailed information

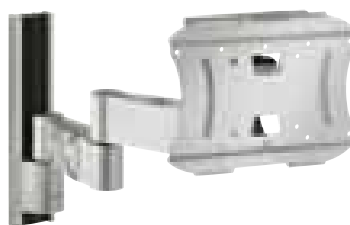

LCD wall supports - VFW 232 / 332 / 432

- One, two or three pivot points
- Tilt and turn functions guarantee optimal viewing position
- Pre-assembled LCD support simplifies mounting

See page 42 for more detailed information



Loudspeaker stand - VLS Glass

- Stylish glass base with stainless steel top plate
- Choice of three speaker - mounting options - suitable for most brands of surround speakers

See page 36 for more detailed information

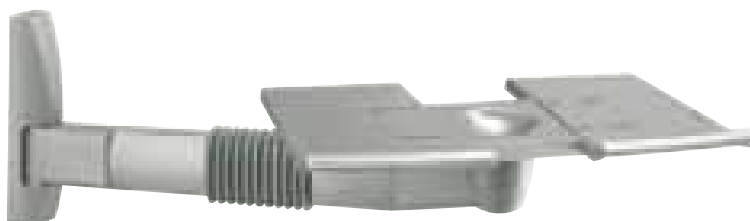

TV wall supports - TVB 2200 / 2250 / 2375

- Two or three turning points
- Cable Inlay System (CIS®) - all cables cleverly concealed

See page 47 for more detailed information

PROFIT FROM THE PORTABLE DVD MARKET

The revolution in portable audio devices (MP3 players) was just the start. Now it's time for portable video: sales of portable DVD players are growing fast and this growth is expected to continue.

Most of these players are attached to headrests for "backseat" entertainment in passenger cars. This is usually done with flimsy bags that are difficult to install. They are very unstable, unattractive to look at and make a car look cheap and tacky.

Vogel's DVDock™ is the perfect solution to address this problem and fills a big gap in the market. It's easy to mount, easy to use and has a stylish design that enhances any car interior. It's the right product, at the right time, at the right price.

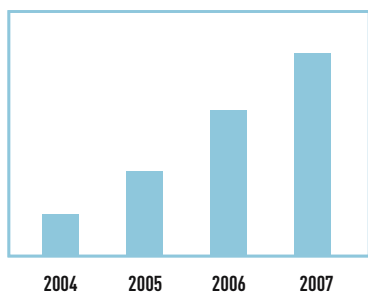

Fast market growth of portable DVD players in Europe

Easy install

Easy install with only an Allen key. Also cable connections and control buttons stay easily accessible



PROFITABLE SUPPORT

Vogel's has developed marketing materials to support you in selling this product. It includes special Point of Sale material that is designed to clearly stand out and attract the attention of your customers. Vogel's will carry out an international press campaign for trade and consumer press. Information about the DVDock™ can be found on the Vogel's web site: www.vogels.com/dvdock.



The DVDock™ packaging has a double-facing design, one dark side and one light side, so you can create an eye-catching checkerboard display. Comes with Eurolock to hang the packaging.



The self-selling display with a top card in 5 languages holds four DVDock™ products and clearly communicates the most important selling arguments to customers. Limited Edition.

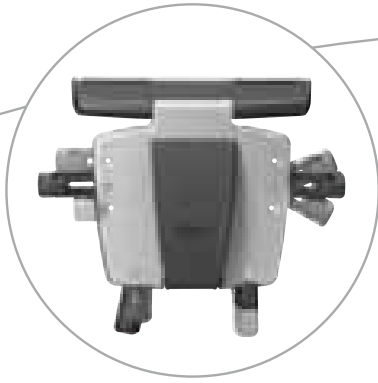

Universal (adjustable arms)

Universal via adjustable arms to ensure a perfect fit for portable DVD player



Easy placement, quick release

Quick release system to easy place or remove portable DVD player



Tilt

Tilt function to eliminate reflections and get the best viewing angle.

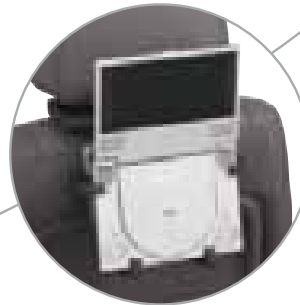

For clamshell and tablet type players

EMC 5000 LCD Headrest support

NEW

- Universal via adjustable arms to ensure a perfect fit for portable DVD player
- Quick release system to easy place or remove portable DVD player
- Easy install with only an Allen key. Also keeps cable connections and control buttons easily accessible
- Tilt function to eliminate reflections and get the best viewing angle

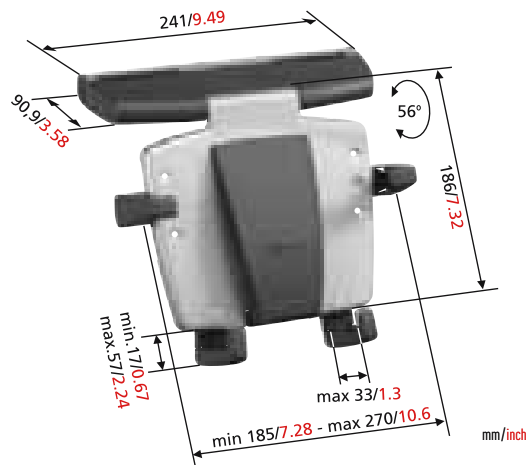
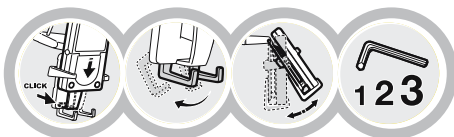

	18.5-27 cm 7.3-10.6"
	Max. 1.5 kg 3.3 lbs

Type nr.			
EMC 5000	28-27 cm / 7.3-10.6"	1.5 kg / 3.32 lbs	
Visit www.vogels.com for more information.			

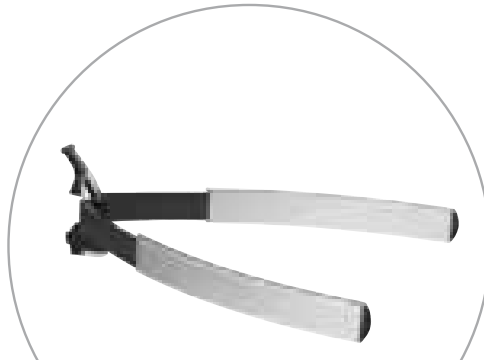

EFA 6825
Audio/DVD support



EFW 6245
LCD wall support



EFA 6835
Column system
(Audio/DVD support not included)



HIGHLIGHTS

- **Smart Range**

fits virtually every screen size and functionality

- **Modular system**

to organise your flat screen, A/V equipment, speakers and cables

- **Smart Movement Mechanism (SMM™)**

to position your screen with a fingertip while protecting your screen and wall

- **Advanced Cable Inlay System (AdvanCIS™)**

to easily place and manage cables for your TV and A/V equipment

- **Easy install**

requires very little effort to mount your flat screen on the wall

AMOUNT OF MOVEMENT

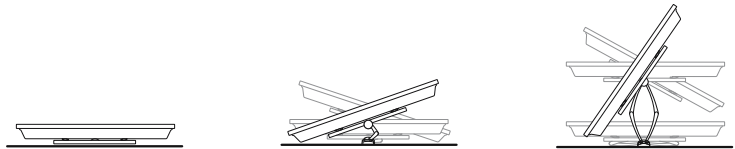

		FIXED	ADJUSTABLE	OPTIMALLY ADJUSTABLE
 <p>EFA 6830 EFA 6835 EFA 6840 Column system 23 / 63 / 93 cm (Audio/DVD support not included)</p>				
	35 - 56 cm 14 - 22"			
 <p>EFA 6825 Audio/DVD support</p>				
	57 - 81 cm 23 - 32"			
 <p>EFA 6825 Audio/DVD support</p>				
	77 - 108 cm 31 - 42"			
<p>Specifications to be communicated upon availability products.</p>				
				

In Autumn 2007, Vogel's will be introducing new wall supports for large screens.

EFW 6105 LCD/TFT wall support



35-56 cm
14-22"

Max.

12 kg
26 lbs

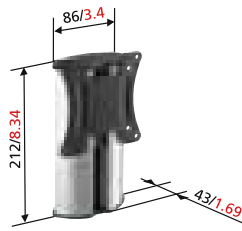

mm/inch

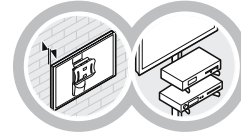

- Close to the wall, while leaving sufficient room for air circulation
- Universal - complies with VESA MIS-D, 100, C and VESA MIS-D, 75, C
- Pre-assembled - install in just 3 easy steps

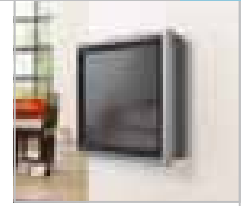

EFW 6125 LCD/TFT wall support



35-56 cm
14-22"

Max.

3-12 kg
6-26 lbs

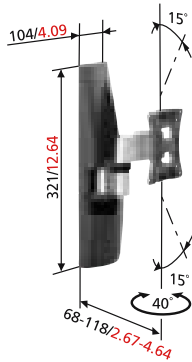

mm/inch

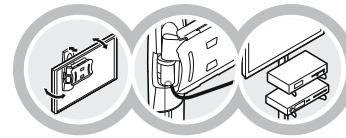

- Tilt and turn functions guarantee optimal viewing position
- Universal - complies with VESA MIS-D, 100, C and VESA MIS-D, 75, C
- Pre-assembled - install in just 3 easy steps



EFW 6145 LCD/TFT wall support



35-56 cm
14-22"

Max.

3-12 kg
6-26 lbs

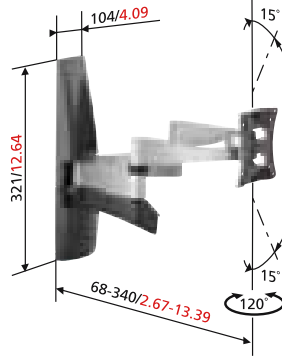

mm/inch



- Tilt, turn and reach functions guarantee optimal viewing position
- Universal - complies with VESA MIS-D, 100, C and VESA MIS-D, 75, C
- Unique Screen Protection System (SPS™) which protects both screen and wall
- Pre-assembled - install in just 3 easy steps



EFW 6205 LCD wall support



- Close to the wall, while leaving sufficient room for air circulation
- Universal - complies with VESA MIS-D, 100, C, VESA MIS-D, 75, C and VESA MIS-E, C
- Strips included for 200x200 VESA mounting holes*
- Pre-assembled - install in just 3 easy steps

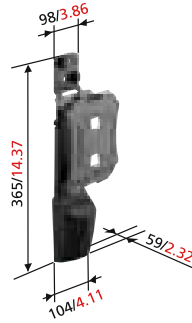
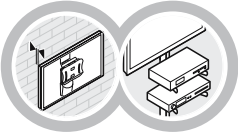

mm/inch



57-81 cm
23-32"

Max.

25 kg
55 lbs



EFW 6225 LCD wall support



- Tilt and turn functions guarantee optimal viewing position
- Universal - complies with VESA MIS-D, 100, C, VESA MIS-D, 75, C and VESA MIS-E, C
- Strips included for 200x200 VESA mounting holes*
- Pre-assembled - install in just 3 easy steps

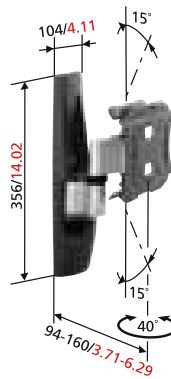
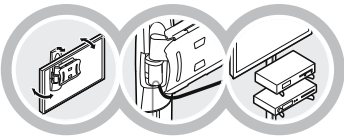

mm/inch



57-81 cm
23-32"

Max.

10-25 kg
22-55 lbs



EFW 6245 LCD wall support



- Tilt, turn and reach functions guarantee optimal viewing position
- Universal - complies with VESA MIS-D, 100, C, VESA MIS-D, 75, C and VESA MIS-E, C
- Strips included for 200x200 VESA mounting holes*
- Unique Screen Protection System (SPS™)**

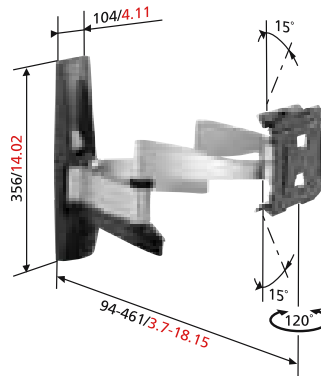

mm/inch



57-81 cm
23-32"



Max.

10-25 kg
22-55 lbs



**SPS™ max. 900 mm/35.4" screen width

* For other mounting holes (MIS-F) use EFW 6205, EFW 6225, EFW 6245 in combination with EFA 6875

-  77-165 cm
31-65"
-  Max.
70 kg
154 lbs
- 
- 

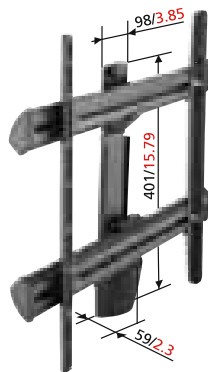

mm/inch

EFW 6305 LCD/Plasma wall support

- Close to the wall, while leaving sufficient room for air circulation
- Universal - complies with VESA MIS-F, 700, 450
- Pre-assembled - install in just 3 easy steps

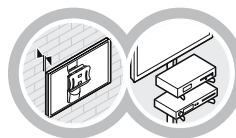

-  77-108 cm
31-42"
-  Max.
15-45 kg
33-99 lbs
- 
- 

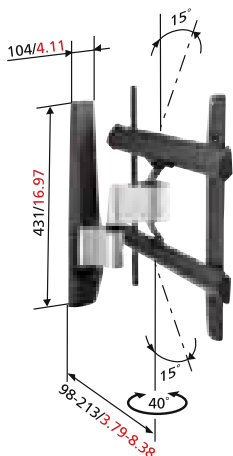

mm/inch

EFW 6325 LCD/Plasma wall support

- Tilt and turn functions guarantee optimal viewing position
- Universal - complies with VESA MIS-F, 700, 450
- Pre-assembled - install in just 3 easy steps

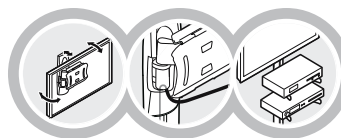

-  77-108 cm
31-42"
-  Max.
15-45 kg
33-99 lbs
- 
- 

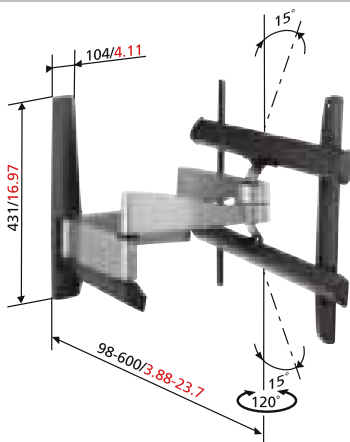



mm/inch

EFW 6345 LCD/Plasma wall support

- Tilt, turn and reach functions guarantee optimal viewing position
- Universal - complies with VESA MIS-F, 700, 450
- Unique Screen Protection System (SPS™) which protects both screen and wall
- Pre-assembled - install in just 3 easy steps



Type nr.		 Max.		VESA	Fixed	Adjustable	Optimally adjustable	Distance to wall	SPS™	CIS®
EFW 6105	35-56 cm / 14-22"	12 kg / 26 lbs	●	MIS-D	✓			4.3 cm / 1.7"		✓
EFW 6125	35-56 cm / 14-22"	3-12 kg / 6-26 lbs	●	MIS-D		✓		6.8-11.8 cm / 2.7-4.7"		✓
EFW 6145	35-56 cm / 14-22"	3-12 kg / 6-26 lbs	●	MIS-D			✓	6.8-34 cm / 2.7-13.4"	✓	✓
EFW 6205	57-81 cm / 23-32"	25 kg / 55 lbs	●	MIS-D / E (+ 200x200 mm)	✓			5.9 cm / 2.3"		✓
EFW 6225	57-81 cm / 23-32"	10-25 kg / 22-55 lbs	●	MIS-D / E (+ 200x200 mm)		✓		9.4-16 cm / 3.7-6.3"		✓
EFW 6245	57-81 cm / 23-32**	10-25 kg / 22-55 lbs	●	MIS-D / E (+ 200x200 mm)			✓	9.4-46.1 cm / 3.7-18.1"	✓*	✓
EFW 6305	77-165 cm / 31-65"	70 kg / 154 lbs	●	MIS-F	✓			5.9 cm / 2.3"		✓
EFW 6325	77-108 cm / 31-42"	15-45 kg / 33-99 lbs	●	MIS-F		✓		9.8-21.3 cm / 3.9-8.4"		✓
EFW 6345	77-108 cm / 31-42"	15-45 kg / 33-99 lbs	●	MIS-F			✓	9.8-60 cm / 3.9-23.6"	✓	✓

* SPS™ max. 900 mm / 35.4" screen width

Visit www.vogels.com for more information.

EFA 6825 Audio/DVD support

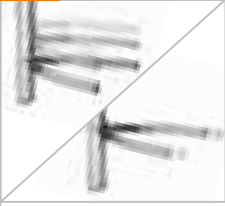

- Can be positioned at any height in the column
- Adjustable arms, which are equipped with an anti-slip edge, fit a wide range of A/V equipment sizes
- Combine with EFA 6830 / 6835 / 6840 to store A/V equipment
- Pre-assembled - install in just 1 easy step.

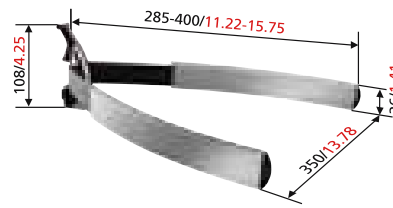
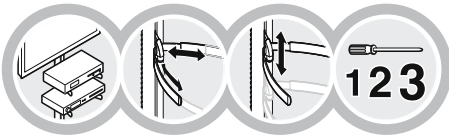

mm/inch

Max.

10 kg
22 lbs



EFA 6830 / 6835 / 6840 Column system



- 23 cm / 9.06" - 63 cm / 24.8" - 93 cm / 36.6"
- Flexible and unique AdvanCIS™ - easily hide and guide cables at any height
- Combine with EFA 6825 to store A/V equipment
- Pre-assembled - install in just 1 easy step

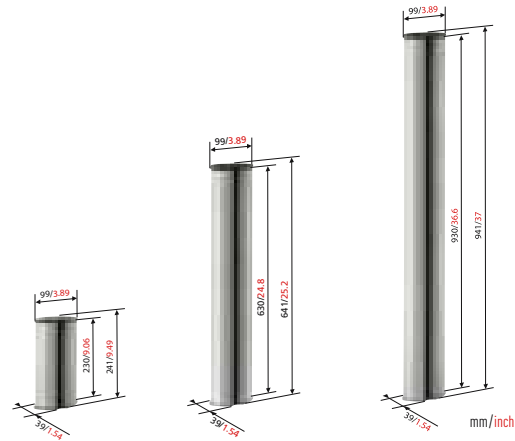
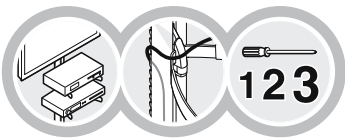

mm/inch

Max.

max 1x/3x/4x
EFA 6825



EFA 6875 Universal LCD adapter

- Universal - complies with VESA MIS-F, 450, 300
- Suitable for EFW 6205, 6225 and 6245 LCD supports, should only be used for Non-VESA compatible LCD screens

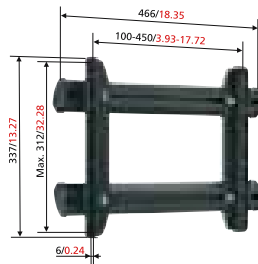

mm/inch



57-81 cm
23-32"

Max.

10-25 kg
22-55 lbs



EFA 6895 Studadapter

- Suitable for LCD/Plasma wall supports 6000 Series

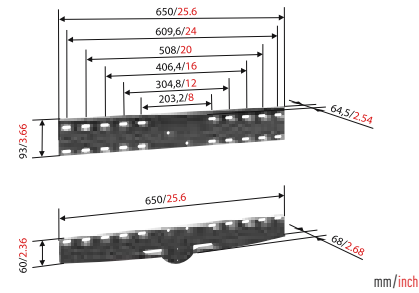

mm/inch



Type nr.	↑	↗	Max.	🔧	VESA
EFA 6825			10 kg / 22 lbs	●	VESA
EFA 6830	23 cm / 9.06"		max 1 x EFA 6825	●	
EFA 6835	63 cm / 24.8"		max 3 x EFA 6825	●	
EFA 6840	93 cm / 36.6"		max 4 x EFA 6825	●	
EFA 6875		57-81 cm / 23-32"	10-25 kg / 22-55 lbs	●	MIS-F
EFA 6895		Suitable for 6000 Series		●	

Visit www.vogels.com for more information.

EFW 1130 LCD/TFT desk + wall support

-  **25-61 cm**
10-24"
-  **Max.**
10-15 kg
22-33 lbs
- 
- 

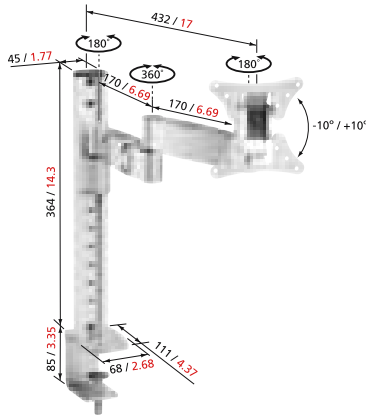

mm/inch

- For PC and TV use
- Choice of desk or wall mounting solution
- Adjustable height (from 20-43 cm / 7.87"-16.9")
- Cable Inlay System (CIS®) - all cables cleverly concealed and guided
- Tilt, turn & reach functions guarantee optimal viewing position
- Spacesaving - free up space on your desk
- Universal - complies with VESA MIS-D, 100, C and MIS-D, 75, C



EFK 1325 LCD under cabinet support

-  **25-38 cm***
10-15"
-  **Max.**
5 kg
11 lbs
- 
- 

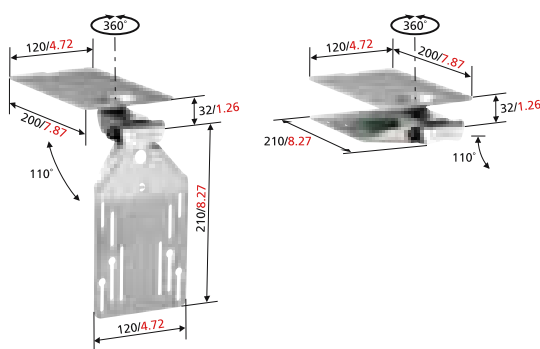





* depending on application

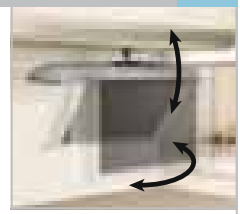





mm/inch

- Universal - complies with VESA MIS-D, 100, C and MIS-D, 75, C
- Max. 15" screen, depending on application
- Tilt, turn & fold functions guarantee optimal viewing position
- Spacesaving - useful for small spaces in the kitchen or in a bookcase
- Lock function



Type nr.		 Max.	Pivot points		VESA	CIS®	TILT
EFW 1130	25-61 cm / 10-24"	wall 15 kg / 33 lbs + desk 10 kg / 22 lbs	3		MIS-D	✓	+/- 10°
EFK 1325	25-38 cm / 10-15" *	5 kg / 11 lbs	1		MIS-D		

* depending on application

Type nr.		 Max.	Pivot points		VESA	CIS®
EFF 1140	63-107 cm / 25-42"	45 kg / 99 lbs	1		MIS-F	✓
EFA 0040	Suitable for EFF 1140 (Max. 2)	10 kg / 22 lbs				
EFT 2240	63-103 cm / 25-40"	30 kg / 66 lbs	1		MIS-F	✓
EFT 2265	104-165 cm / 41-65"	70 kg / 154 lbs	1		MIS-F	✓

Visit www.vogels.com for more information.

EFF 1140 LCD/Plasma floorstand



- Universal - complies with VESA MIS-F, 670, 510
- Turn function guarantees optimal viewing position
- CIS® and safetyglass shelf (adjustable in height & depth)
- One shelf included. Additional shelf is optional (EFA 0040), max. 2 (max. 20 kg)

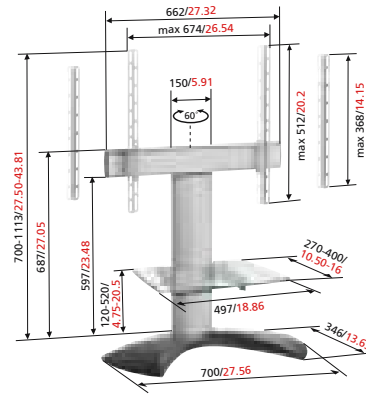

mm/inch



63-107 cm
25-42"



45 kg
99 lbs



EFA 0040 A/V multi support



- Suitable for LCD/Plasma floorstand EFF 1140
- Can be positioned at any height in the column
- Maximum 2 A/V multi supports
- Glass shelf adjustable in depth, fits a wide range of A/V equipment sizes
- Tempered safety glass shelf

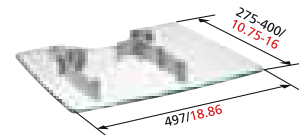

mm/inch



10 kg
22 lbs



EFT 2240 LCD/Plasma table stand



- Universal - complies with VESA MIS-F, 570, 360
- Turn function guarantees optimal viewing position
- Sturdy design and construction provides extra stability
- Cable Inlay System (CIS®) - all cables cleverly concealed

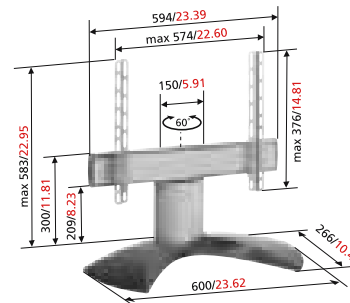

mm/inch



63-103 cm
25-40"



30 kg
66 lbs



EFT 2265 LCD/Plasma table stand



- Universal - complies with VESA MIS-F, 670, 510
- Turn function guarantees optimal viewing position
- Sturdy design and construction provides extra stability
- Cable Inlay System (CIS®) - all cables cleverly concealed

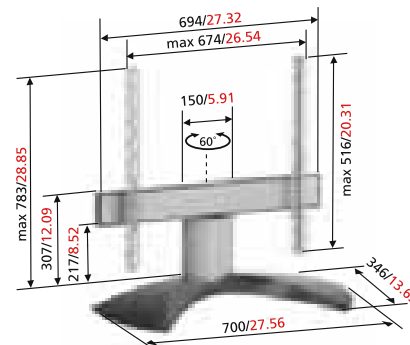

mm/inch



104-165 cm
41-65"



70 kg
154 lbs





HUGE GROWTH IN BIG SCREEN TVS

Flat displays are getting bigger and bigger in the home. The large LCD/Plasma segment is becoming more popular than ever. Even though the largest commercially available display today is 83" that will probably grow to LCD and plasma screens as large as 103". New developments in digital television and Home Cinema are driving this demand and we expect this trend to continue and increase in the future. The major display manufacturers are already moving into the 60" plus market and that will create a need for larger wall mounts in the home.

With our extensive experience in the professional market, Vogel's can help you profit from this growing market. The stylish and elegant design of our supports complements the most sophisticated interior. Our products are built to exact specifications from the most durable materials available, including high quality, solid steel and aluminium alloy frames. Vogel's high quality supports for oversized flat screens are TÜV certified which guarantees enduring strength and value. Our Vogel's Professional products are supplied in neutral white packaging.



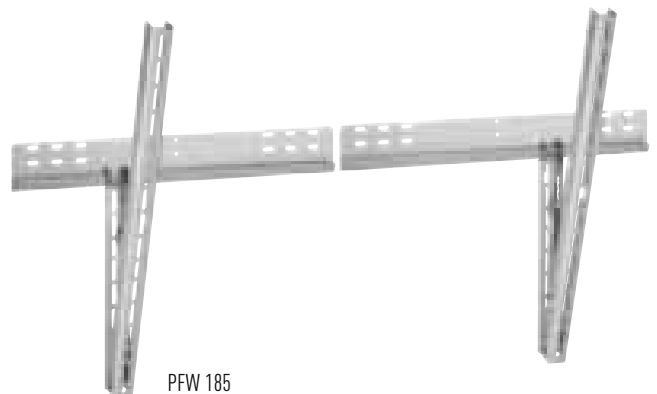

Largest and strongest support

Vogel's has the largest and strongest support for this market. The new PFW 185 LCD/Plasma support can be used to support extra large flat displays in the most demanding professional environments for home use. It provides stable and secure support for LCD/Plasma screens from 55" to 103".



PFW 185



-  140-262 cm
55-103"
-  Max.
40-300 kg
88-660 lbs
- 
- 

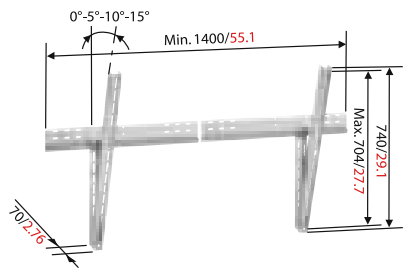

mm/inch

PFW 185 LCD/Plasma wall support

- Pre-assembled - install in just 1 easy step
- Tilt function 0-5-10-15°
- Universal - complies with VESA MIS-F

-  63-165 cm
25-65"
-  Max.
70 kg
154 lbs
- 
- 

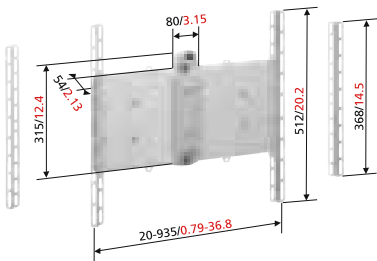

mm/inch

EFW 2001 LCD/Plasma wall support

- Universal - complies with VESA MIS-F, 930, 500
- Fixed to the wall
- Minimum distance to the wall 54 mm (2.13")



-  63-165 cm
25-65"
-  Max.
70 kg
154 lbs
- 
- 

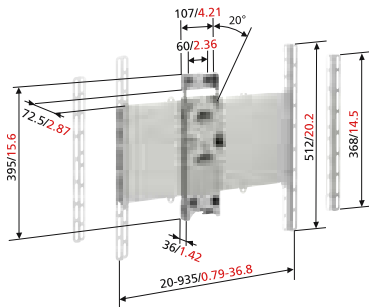

mm/inch

EFW 2004 LCD/Plasma wall support

- Universal - complies with VESA MIS-F, 930, 500
- Tilt function
- Minimum distance to the wall 73 mm (2.87")



-  63-165 cm
25-65"
-  Max.
70 kg
154 lbs
- 
- 

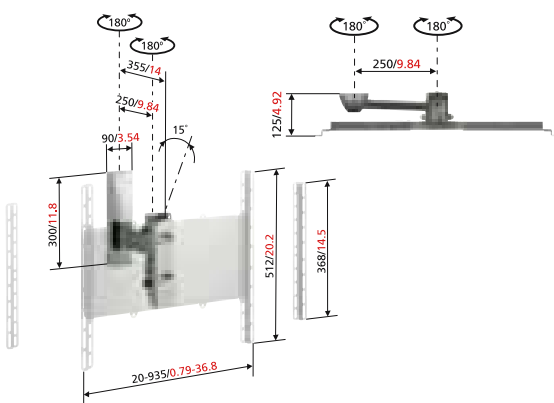

mm/inch

EFW 2009 LCD/Plasma wall support

- Universal - complies with VESA MIS-F, 930, 500
- Turn & tilt function guarantees optimal viewing position
- Cable Inlay System (CIS®) - all cables cleverly concealed
- Modular system - combine the wall support with cable covers and multi support to store A/V equipment

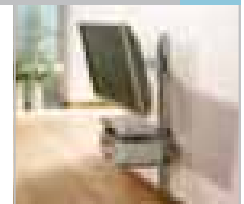

PFA 9017 Double stud adapter

- Suitable for EFW 2004

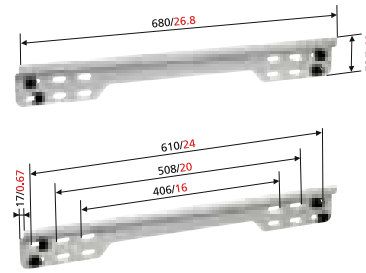

mm/inch



EFA 8001 Double stud adapter

- Suitable for EFW 2001 and 2009



mm/inch



Type nr.				VESA	Adjustability	Distance to wall	TILT
PFW 185	140-262 cm / 55-103"	40-300 kg / 88-660 lbs	●	MIS-F	tilt	5.2 cm / 2.05"	15°
EFW 2001	63-165 cm / 25-65"	70 kg / 154 lbs	●	MIS-F	fixed	5.4 cm / 2.13"	
EFW 2004	63-165 cm / 25-65"	70 kg / 154 lbs	●	MIS-F	tilt	7.3 cm / 2.87"	20°
EFW 2009	63-165 cm / 25-65"	70 kg / 154 lbs	●	MIS-F	turn, tilt	12.5-35.6 cm / 4.92-14.0"	15°
PFA 9017	Suitable for EFW 2004		●				
EFA 8001	Suitable for EFW 2001 and EFW 2009		●				

Visit www.vogels.com for more information.

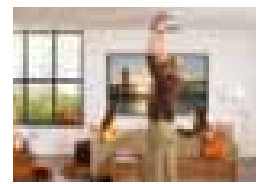

Click & Enjoy



Click & Entertain

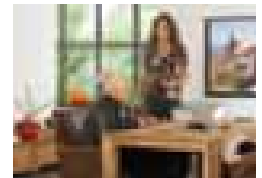

Click & Share

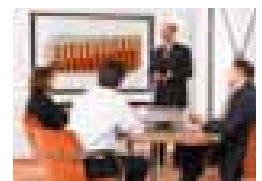

Click & Go



EPW 6565
Projector wall solution



EPC 6545
Projector ceiling solution



EPT 6525
Projector table solution



EPA 6505
Projector connector

CLICK & SELL

Get ready for the new kid in town!

Home Cinema Projection is coming to the home. As prices continue to go down and quality goes up, consumer demand will climb as well. It's clear that initial buyers will be early adopters. Many of them will be opinion leaders who will have a strong influence on future buyers. They have higher expectations for convenience and prefer complete solutions. This is a great opportunity for selling projectors with complementary supports.

Increase your sales

Vogel's versatile projector mounting solution can increase your sales revenues. It is a complete solution that includes a universal connector that fits the separate ceiling mount, wall mount and table mount. You can sell the connector and one mount for initial sales and mention the fact that other mounts are available for other areas in the house. This creates easy return sales. Each product sold has very high margins so you can quickly boost your income.

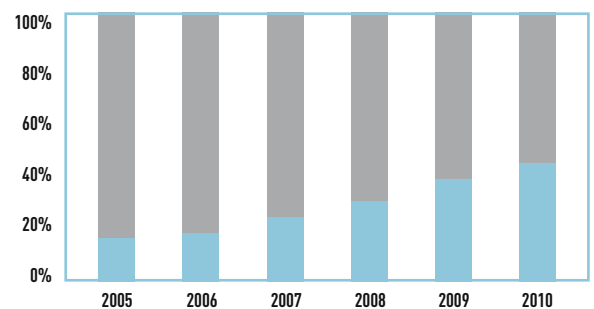
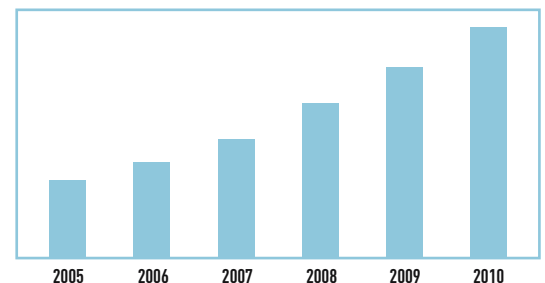

Projector Worldwide

Source: DTC Worldwide, 2006

Professional
Consumer

CLICK & SWITCH

Create multiple viewing environments with just 1 projector!

The Click & Switch system enables you to mount your projector on the ceiling, wall or on a table using the same basic set of components. Simply click your projector on to the universal connector and then attach it to the projector ceiling mount, wall mount or table. Easily store it when not in use by just unclicking it. No screwdriver is needed to detach it.

Mount your projector on the ceiling, wall or table with the Versatile Vogel's Click & Switch line of projector supports. Its universal design enables you to use your projector in every room. Mount your projector in any location, using the same basic set of components. Now you can easily enjoy your projector – wherever you like.

	TABLE	CEILING	WALL
MODULE	 EPT 6520	 EPC 6540	 EPW 6560
CONNECTOR	 EPA 6505		
SOLUTION	 EPT 6525	 EPC 6545	 EPW 6565

Table Solution

The EPT 6525 lets you easily position your projector anywhere on a table or shelf without resorting to a wobbly stack of books. Once in place, you simply position the projected image on a screen or wall for viewing. The rubber anti-slip pads prevent sliding and protect your furniture from scratches. The Table Solution can also be permanently attached to prevent theft.



Ceiling Solution

The EPC 6545 lets you mount your projector to the ceiling. The Adjust & Secure feature enables you to lock the projector into position. When not in use, simply remove your projector and hide the cables and support from sight using the ceiling cover provided.

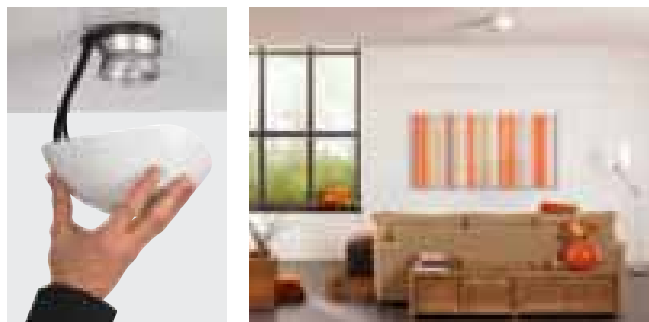

Wall Solution

The EPW 6565 lets you mount your projector on the wall with style. The module can be combined with the column system (EFA 6830 / 6835 / 6840) and Audio/DVD support (EFA 6825) from the Vogel's 6000 Series. The Audio/DVD support keeps your audio/visual equipment out of the way. The Wall Solutions flexible horizontal arm can be reversed so that you can mount your projector facing either straight up or upside down for the best projection at any height.



International Award Winner



2006 SEL3CTION
THE DUTCH DESIGN AWARDS

VOGEL'S HELPS YOU SELL A COMPLETE PROJECTOR SOLUTION

MIGHTY BRIGHTY®

Another innovation from 



Create your own projection screen in 4 easy steps

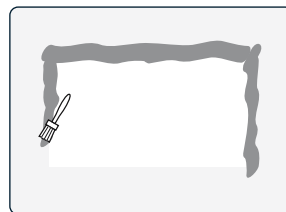

- 1 Define the exact size and location of your screen. Apply the MagneCoat on the border of your screen.

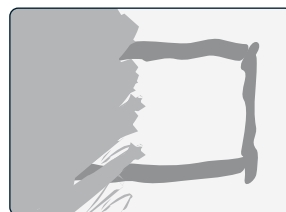

- 2 Mix and apply BaseCoat to the wall

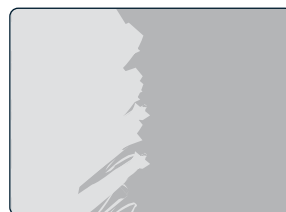

- 3 Mix and apply TopCoat to the wall

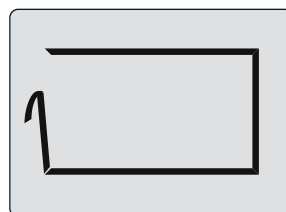

- 4 Add the MagneBorder around your screen. And easily remove it when you are not using your screen! Enjoy the Enormous Fun of Mighty Brighty

Mighty Brighty is a new and unique concept for creating the perfect projection screen right on a normal wall. Consumers just paint it on, sit back and enjoy. Always exactly the right size and format (4:3, 16:9, etc.). Always exactly flat and straight. Always exactly the right screen surface for the type of projector, projector position and the amount of light in the room. Plus it's invisible when the projector is not being used (MPW 30 only).

Consumers have more choices than ever when it comes to creating the ultimate Home Cinema experience. One option is a projector solution: buying a high quality projector and projection screen to create the big screen experience. But there are many decisions that a consumer needs to make if you are going to make the sale. Vogel's now gives you all the tools you need to sell a complete solution to your customers.

- High quality projector display: use the Vogel's special projector display to demonstrate how it works
- Click & Switch projector solution: so you can use your projector on a wall, ceiling or table – wherever, however you want
- Mighty Brighty Projection Screen Paint: a low cost alternative for expensive screens that lets you create the perfect projection screen right on a normal wall



"Now you can enjoy your Home Cinema experience with 40% higher Contrast and at least 20% higher Brightness compared to a normal white wall"

(Tested by Konica Minolta)

MPW 10 Standard Screen

NEW



Pre-mixed highly reflective paint to easily apply a standard projection screen of up to 5 m² on your wall or board.

Contains

- 1 litre BaseCoat (Light Grey)
- 1 litre TopCoat (Brightness / Gain 1.1)



330 cm
130"



5 m²
54 sq.ft.

MPW 20 Tailor-made Screen & Border

NEW



Everything you need to create a tailor-made projection screen of up to 6 m² with a dark border on your wall. It comes with paint for your wall and additional paint components (ContrastBooster and BrightnessBooster) to easily create the perfect screen surface for your situation. In addition, magnetic paint and magnetic borders are included to easily place (and remove!) a dark border around your screen. This border greatly heightens the contrast perception of images on the screen.

- Contains** • 1.4 litre BaseCoat • 0.1 litre ContrastBooster for BaseCoat • 0.9 litre TopCoat • 0.1 litre BrightnessBooster for TopCoat • 0.4 litre MagneCoat • 10 metres / 32.8 ft. of MagneBorder (width 5,5 cm / 2.2") • Also includes all necessary tools



343 cm
135"



6 m²
64 sq.ft.

MPW 30 Invisible Wall Solution

NEW



Same as the MPW 20, except this version has everything you need to paint the entire wall so you do not see the edges of the projection screen. We call this the Invisible Wall Solution because when you are not using your screen you simply remove the magnetic dark border and all you see is a normal white or light grey wall. Nobody sees that it is also an excellent projection screen.

- Contains** • 2.3 litres BaseCoat • 0.2 litre ContrastBooster for BaseCoat • 1.8 litres TopCoat • 0.2 litre BrightnessBooster for TopCoat • 0.4 litre MagneCoat • 10 metres / 32.8 ft. of MagneBorder (width 7,7 cm / 3.0") • Also includes all necessary tools



343 cm
135"



11 m²
118 sq.ft.

	16:9		Paint tools	ContrastBooster & BrightnessBooster	MagneBorder 10 m. / 32.8 ft.	Invisible Wall Solution
MPW 10	330 cm / 130"	5 m ² / 54 sq.ft.		Pre-mixed		
MPW 20	343 cm / 135"	6 m ² / 64 sq.ft.	✓	✓	Width 5.5 cm / 2.2"	
MPW 30	343 cm / 135"	11 m ² / 118 sq.ft.	✓	✓	Width 7.7 cm / 3.0"	✓

Visit www.vogels.com for more information.

Max.
10 kg
22 lbs

● Must be combined with EPA 6505

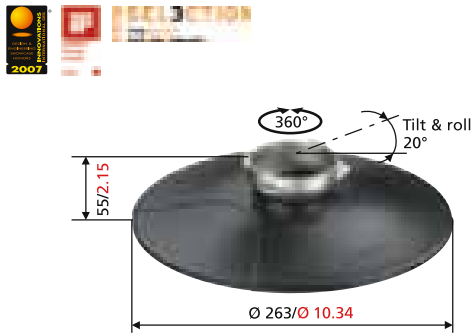

mm/inch

NEW

EPT 6520 Projector table module

- Part of the Vogel's Click & Switch system
- Tilt, turn & roll feature to easily position the projected image

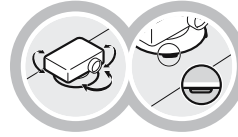
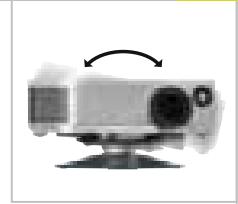

Max.
10 kg
22 lbs

● Must be combined with EPA 6505

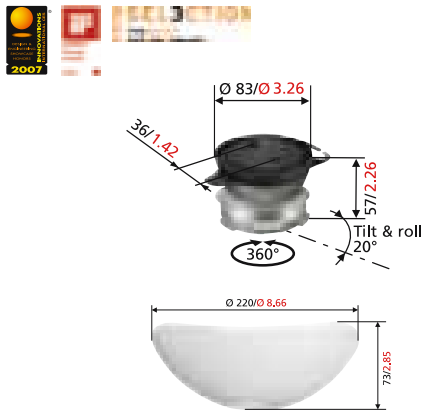

mm/inch

NEW

EPC 6540 Projector ceiling module

- Part of the Vogel's Click & Switch system
- Ceiling cover included to hide cables and support when not in use
- Adjust & secure feature to lock the projector in position

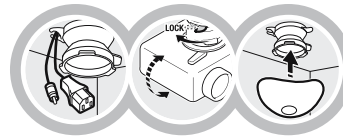

Max.
10 kg
22 lbs

● Must be combined with EPA 6505



mm/inch

NEW

EPW 6560 Projector wall module

- Part of the Vogel's Click & Switch system
- Part of the modular system of the 6000 Series
- Reversible mounting possible to mount the projector facing either straight up or upside down

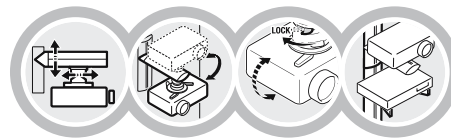
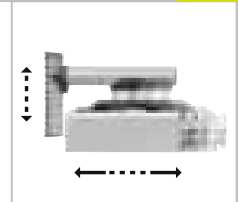

Max.
10 kg
22 lbs

● Must be combined with EPT 6520 and/or EPC 6540 and/or EPW 6560



mm/inch

NEW

EPA 6505 Projector connector

- Part of the Vogel's Click & Switch system
- Universal, fits virtually every projector weighing up to 10 kg
- Universal padlock possible to prevent against theft



EPT 6525 Projector table solution

NEW

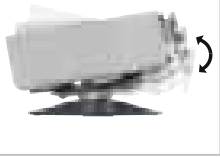

- Part of the Vogel's Click & Switch system
- Tilt, turn & roll feature to easily position the projected image
- Universal, fits virtually every projector

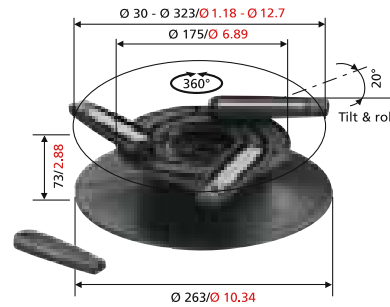
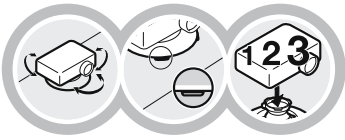

Complete projector table solution (EPT 6520 and EPA 6505)

mm/inch

Max.

10 kg
22 lbs



EPC 6545 Projector ceiling solution

NEW



- Part of the Vogel's Click & Switch system
- Ceiling cover included to hide cables and support when not in use
- Adjust & secure feature to lock the projector in position
- Universal, fits virtually every projector

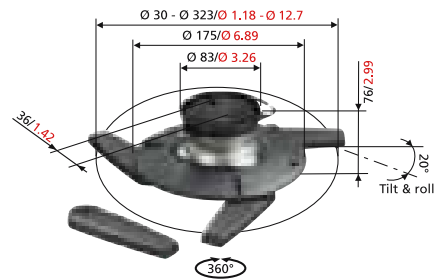
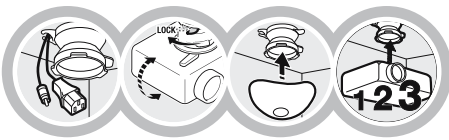

Complete projector ceiling solution (EPC 6540 and EPA 6505)

mm/inch

Max.

10 kg
22 lbs



EPW 6565 Projector wall solution

NEW

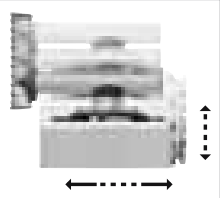

- Part of the Vogel's Click & Switch system
- Part of the modular system of the 6000 Series
- Reversible mounting possible to mount the projector facing either straight up or upside down
- Universal, fits virtually every projector

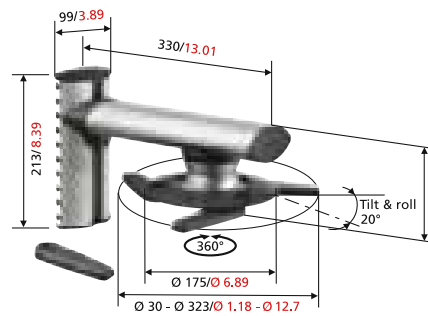
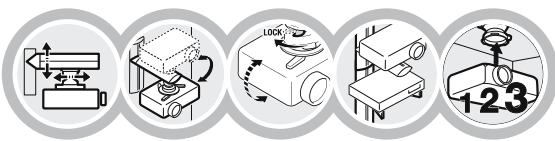

Complete projector wall solution (EPW 6560 and EPA 6505)

mm/inch

Max.

10 kg
22 lbs



Type nr.	Max.		CIS®	Click & Switch system	Solution			Fits column modular system 6000 Series (EFA 6830 / 6835 / 6840)	
					Module				Connector
					Table	Ceiling	Wall		
EPA 6505	10 kg / 22 lbs	●		✓			✓		
EPT 6520	10 kg / 22 lbs	●		✓	✓				
EPT 6525	10 kg / 22 lbs	●		✓	✓				
EPC 6540	10 kg / 22 lbs	●	✓	✓		✓			
EPC 6545	10 kg / 22 lbs	●	✓	✓		✓			
EPW 6560	10 kg / 22 lbs	●	✓	✓			✓	✓	
EPW 6565	10 kg / 22 lbs	●	✓	✓			✓	✓	

Visit www.vogels.com for more information.

VLB 1015 Centre speaker support (1x)

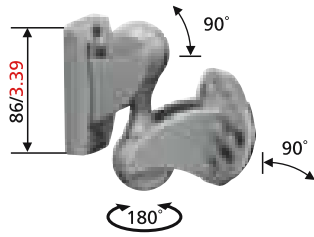

- For centre speaker
- Tilt and turn functions guarantee optimal listening position



Max.

1.5 kg
3.3 lbs



mm/inch

VLB 1025 Loudspeaker support (2x)

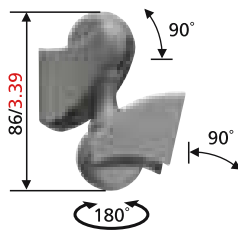

- For surround speakers
- Mountable on wall, (sloping) ceiling or under cabinet
- Tilt and turn functions guarantee optimal listening position

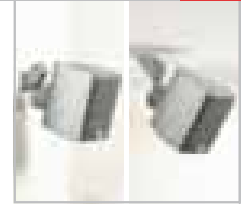

Max.

1.5 kg
3.3 lbs



mm/inch

Surround speaker support 5-pack



- Complete all-in-one solution for surround speaker set - two front, two rear and one centre speaker
- Includes VLB 1025 (4) and VLB 1015 (1)
- Tilt and turn functions guarantee optimal listening position
- Improves home cinema sound and reduces clutter
- Mountable on wall, ceiling or under cabinet

Max.

1.5 kg
3.3 lbs



mm/inch

VLB 50 Loudspeaker wall support (2x)

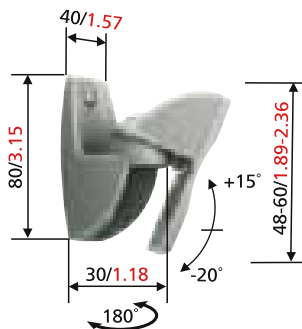

- For surround speakers and smaller hi-fi speakers <5 kg/11 lbs
- Tilt and turn functions guarantee optimal listening position
- Available in different colours



Max.

5 kg
11 lbs



mm/inch

VLB 100 Loudspeaker wall support (2x)



- Ideal for so-called bookshelf/standmount Hi-Fi speakers (<25 kg/55 lbs)
- Variable tilt angle
- Simple attachment system

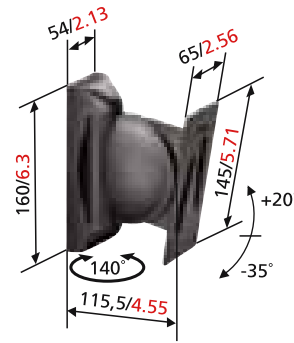

mm/inch

Max.

25 kg
55 lbs



VLB 200 Loudspeaker wall support (2x)



- Ideal for so-called bookshelf/standmount Hi-Fi speakers (<20 kg/55 lbs)
- No screws required, due to the clamping construction

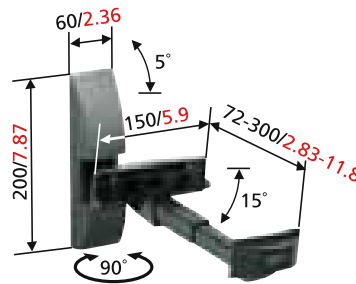

mm/inch

Max.

20 kg
44 lbs



Type nr.	Max.		Mounting	CIS®
VLB 1015	1.5 kg / 3.3 lbs	●	wall, ceiling	
VLB 1025	1.5 kg / 3.3 lbs	●	wall, ceiling	
VLB 5-pack	1.5 kg / 3.3 lbs	●	wall, ceiling	
VLB 50	5 kg / 11 lbs	● ● ○	wall	
VLB 100	25 kg / 55 lbs	●	wall	✓
VLB 200	20 kg / 44 lbs	●	wall	✓

Visit www.vogels.com for more information.

VLS 107 Loudspeaker stand (2x)

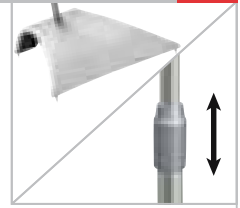

- Adjustable in height for personal preference
- Ideal for Home Cinema front & surround speakers <1,5 kg/3.3 lbs
- Cable Inlay System (CIS®) - all cables cleverly concealed
- Spiked feet for optimal acoustic performance (rubber feet included for delicate floors)
- Choice of three speaker-mounting options - suitable for most brands of surround speakers
- Easy mounting



mm/inch



60-104 cm
24-41"



1.5 kg
3.3 lbs



VLS 115 Loudspeaker stand (2x)

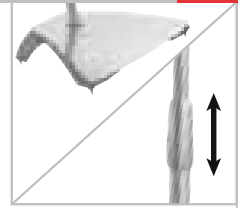

- Stylish base with stainless steel top plate
- Adjustable in height for personal preference
- Ideal for Home Cinema front & surround speakers <1,5 kg/3.3 lbs
- Cable Inlay System (CIS®) - all cables cleverly concealed
- Spiked feet for optimal acoustic performance (rubber feet included for delicate floors)
- Choice of three speaker-mounting options - suitable for most brands of surround speakers
- Easy mounting

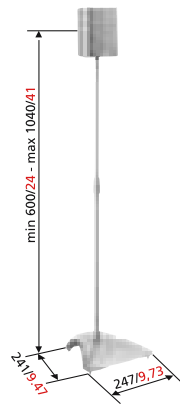

mm/inch



60-104 cm
25-41"



1.5 kg
3.3 lbs



VLS Glass Loudspeaker stand (2x)

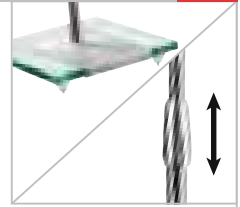

- Stylish glass base with stainless steel top plate
- Adjustable in height for personal preference
- Ideal for Home Cinema front & surround speakers <1,5 kg/3.3 lbs
- Cable Inlay System (CIS®) - all cables cleverly concealed
- Spiked feet for optimal acoustic performance (rubber feet included for delicate floors)
- Choice of three speaker-mounting options - suitable for most brands of surround speakers
- Easy mounting

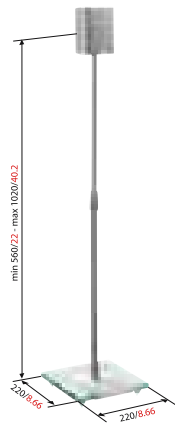

mm/inch



56-102 cm
22-40.2"



1.5 kg
3.3 lbs



VLS 120 Loudspeaker stand (2x)

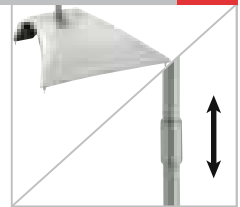

- Adjustable in height for personal preference
- Ideal for somewhat larger surround speakers <3 kg/7 lbs
- Cable Inlay System (CIS®) - all cables cleverly concealed
- Spiked feet for optimal acoustic performance (rubber feet included for delicate floors)
- Choice of various speaker-mounting options - suitable for most brands of surround speakers
- Easy mounting

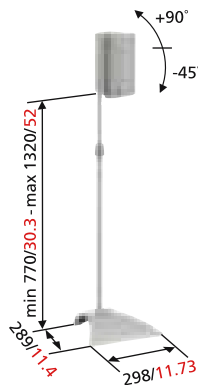

mm/inch



77-132 cm
31-52"



3 kg
7 lbs



VLS 45 Loudspeaker stand (2x)

- Ideal for so-called bookshelf/standmount Hi-Fi speakers (<25 kg/55 lbs)
- Cable Inlay System (CIS®) - all cables cleverly concealed
- Spiked feet for optimal acoustic performance (rubber feet included for delicate floors)
- Easy mounting

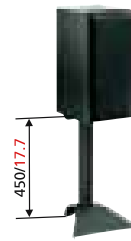

mm/inch



45 cm
18"



25 kg
55 lbs



VLS 60 Loudspeaker stand (2x)

- Ideal for so-called bookshelf/standmount Hi-Fi speakers (<25 kg/55 lbs)
- Cable Inlay System (CIS®) - all cables cleverly concealed
- Spiked feet for optimal acoustic performance (rubber feet included for delicate floors)
- Easy mounting



mm/inch



60 cm
24"



25 kg
55 lbs



Type nr.	I ↑↑	Max.		Flexible height	CIS®
VLS 107	60-104 cm / 24-41"	1.5 kg / 3.3 lbs	●	✓	✓
VLS 115	60-104 cm / 24-41"	1.5 kg / 3.3 lbs	●	✓	✓
VLS Glass	56-102 cm / 22-40.2"	1.5 kg / 3.3 lbs	●	✓	✓
VLS 120	77-132 cm / 31-52"	3 kg / 7 lbs	● ●	✓	✓
VLS 45	45 cm / 18"	25 kg / 55 lbs	●		✓
VLS 60	60 cm / 24"	25 kg / 55 lbs	●		✓

Visit www.vogels.com for more information.

TVB 2225 TV wall support

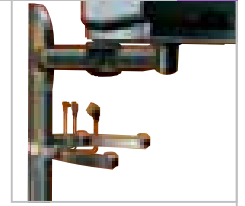

- 3 turning points to create optimal viewing angle
- Can be combined with Vogel's Evolution audio/video accessories
- Cable Inlay System (CIS®) - all cables cleverly concealed
- Available in silver and anthracite

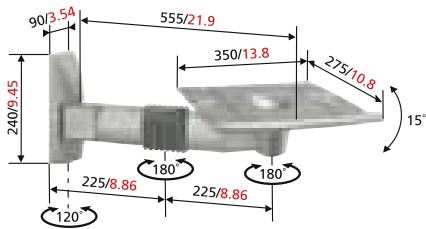

mm/inch



35-48 cm
14-19"



25 kg
55 lbs



TVB 2350 TV wall support



- 3 turning points to create optimal viewing angle
- Can be combined with Vogel's Evolution audio/video accessories
- Cable Inlay System (CIS®) - all cables cleverly concealed
- Available in silver and anthracite

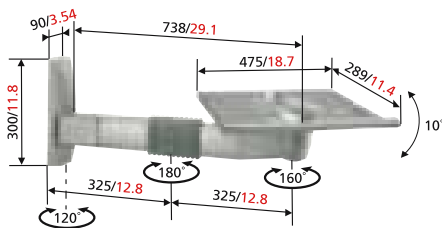

mm/inch



51-63 cm
20-25"



60 kg
132 lbs



Type nr.			Pivot points		Modulair systeem	CIS®	TILT
TVB 2225	35-48 cm / 14-19"	25 kg / 55 lbs	3		✓	✓	15°
TVB 2350	51-63 cm / 20-25"	60 kg / 132 lbs	3		✓	✓	10°

Visit www.vogels.com for more information.

TV TURNTABLES

TVS 2025 / 2032 TV Turntable



∅ 25 / 32 cm
10 / 13"



50 / 100 kg
110 / 220 lbs

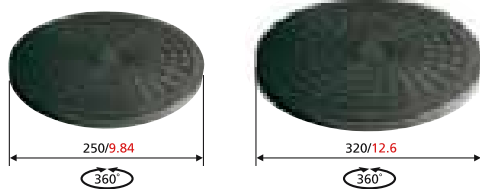

mm/inch

Type nr.				
TVS 2025	∅ 25 cm / 10"	50 kg / 110 lbs		360°
TVS 2032	∅ 32 cm / 13"	100 kg / 220 lbs		360°

Visit www.vogels.com for more information.



BEST VALUE FOR THE MONEY









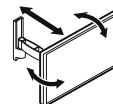
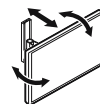
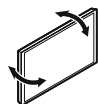
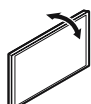
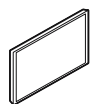

Vogel's Original product line offers consumers the best value for their money on a wide range of basic solutions that are practical and functional. All with Vogel's outstanding quality and durability.

This range of proven products enables you as a retailer to create more differentiation in your store. Plus, it gives you more cross-selling opportunities in a whole new customer segment, sensitive for a certain price point. The basic range of flat display supports fits most LCD/Plasma screens. This proposition should make it easier for you to satisfy every type of customer, while improving your margins.

All products from this budget line are included in the Flatscreen fitter website. See www.flatscreenfitter.com for more information.



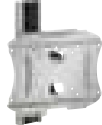
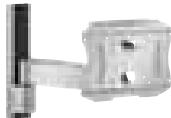
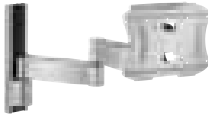
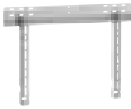

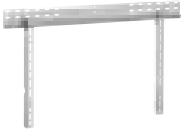
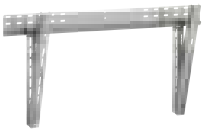
	FIXED	TILT	TILT & TURN	ADJUSTABLE	OPTIMALLY ADJUSTABLE
25 - 66 / 77 cm 10 - 26 / 30"	 VFW 030	 VFW 130	 VFW 226	 VFW 326	 VFW 426
57 - 81 cm 23 - 32"	 VFW 032	 VFW 132	 VFW 232	 VFW 332	 VFW 432
66 - 107 cm 26 - 42"	 VFW 040	 VFW 140		 VFW 365	
103 - 165 cm 40 - 65"	 VFW 065	 VFW 165			

- **Robust.** Each product is solidly constructed from the most durable materials available, including high quality, solid steel and aluminium alloy frames -all with scratch protection.
- **Long-lasting.** All supports are guaranteed for five years of rigorous daily use.
- **Easy installation.** Mounting is clear and fast thanks to drill template and simple instructions.
- **Versatility.** A wide range of sizes and models are available to fit every layout and decor.

Compact product range

- LCD/Plasma supports
- Projector supports
- TV supports
- Loudspeaker support and stand
- Microwave holder

Original packaging

- Designed with impact
- Outstanding colours
- Product is clearly shown
- Compact and modular format
- Self selling packaging
- Self explanatory icons and USPs



VFW 226 LCD/TFT wall support



- One pivot point
- Universal - complies with VESA MIS-D, 100, C and MIS-D, 75, C
- Tilt and turn functions guarantee optimal viewing position
- Pre-assembled LCD/TFT support simplifies mounting

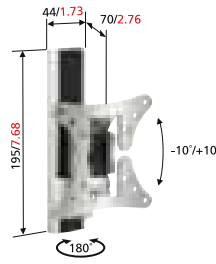

mm/inch



25-66 cm
10-26"

Max.

15 kg
33 lbs



VFW 326 LCD/TFT wall support

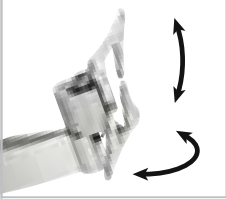

- Two pivot points
- Universal - complies with VESA MIS-D, 100, C and MIS-D, 75, C
- Tilt and turn functions guarantee optimal viewing position
- Cable clips for guiding your cables
- Pre-assembled LCD/TFT support simplifies mounting
- Buffer rings prevent damage to display and wall

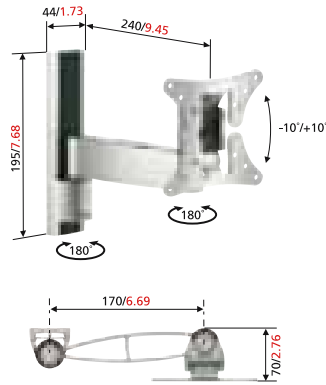

mm/inch



25-66 cm
10-26"

Max.

15 kg
33 lbs



VFW 426 LCD/TFT wall support



- Three pivot points
- Universal - complies with VESA MIS-D, 100, C and MIS-D, 75, C
- Tilt, turn and reach functions guarantee optimal viewing position
- Cable clips for guiding your cables
- Pre-assembled LCD/TFT support simplifies mounting
- Buffer rings prevent damage to display and wall

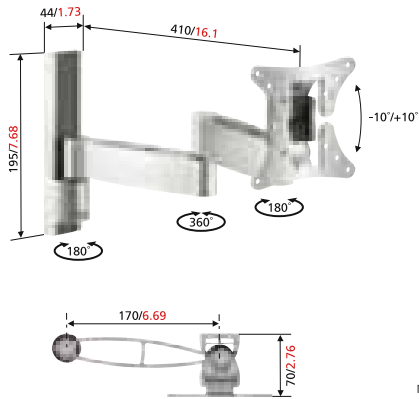

mm/inch



25-66 cm
10-26"

Max.

15 kg
33 lbs



ORIGINAL

VFW 232 LCD wall support



- One pivot point
- Tilt and turn functions guarantee optimal viewing position
- Universal - complies with VESA MIS-D, 100, C, MIS-D, 75, C and VESA MIS-E, C
- Additional strips for VESA MIS-E 200x200 mm
- Spacesaving- free up space in your room
- Pre-assembled LCD support simplifies mounting

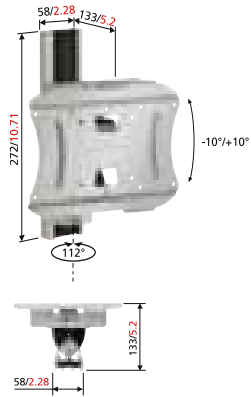

mm/inch

VFW 332 LCD wall support

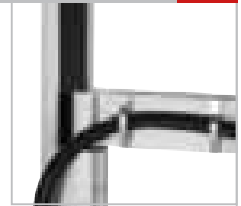

- Two pivot points
- Tilt, turn and reach functions guarantee optimal viewing position
- Universal - complies with VESA MIS-D, 100, C, MIS-D, 75, C and VESA MIS-E, C
- Additional strips for VESA MIS-E 200x200 mm
- Cable clips for guiding your cables
- Spacesaving- free up space in your room
- Buffer rings prevent damage to display and wall
- Pre-assembled LCD support simplifies mounting

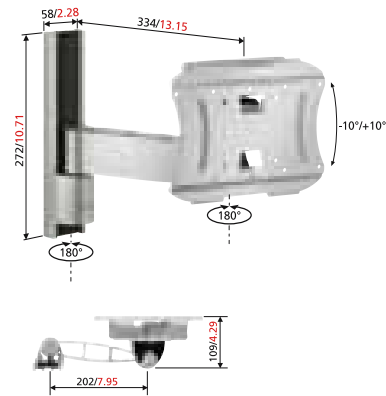

mm/inch

VFW 432 LCD wall support



- Three pivot points
- Tilt, turn and reach functions guarantee optimal viewing position
- Universal - complies with VESA MIS-D, 100, C, MIS-D, 75, C and VESA MIS-E, C
- Additional strips for VESA MIS-E 200x200 mm
- Cable clips for guiding your cables
- Spacesaving- free up space in your room
- Buffer rings prevent damage to display and wall
- Pre-assembled LCD support simplifies mounting

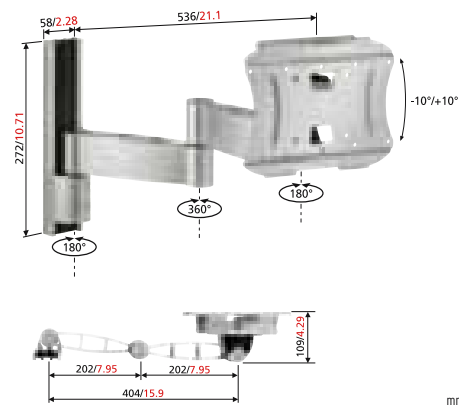

mm/inch

57-81 cm
23-32"

Max.

32 kg
70 lbs



57-81 cm
23-32"

Max.

32 kg
70 lbs



57-81 cm
23-32"

Max.

32 kg
70 lbs



VFW 030 LCD/TFT wall support



- Universal - complies with VESA MIS-D, 100, C and MIS-D, 75, C
- Fixed to the wall
- Minimal distance to the wall (26 mm/1")
- Easy mounting (mounting hardware included)

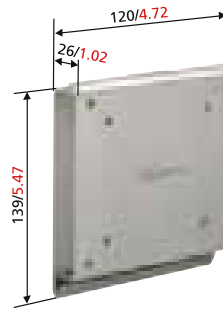

mm/inch



25-77 cm
11-30"

Max.

30 kg
66 lbs



VFW 130 LCD/TFT wall support



- Universal - complies with VESA MIS-D, 100, C and MIS-D, 75, C
- Tilt function 10°
- Minimal distance to the wall (50 mm/2")
- Easy mounting (mounting hardware included)

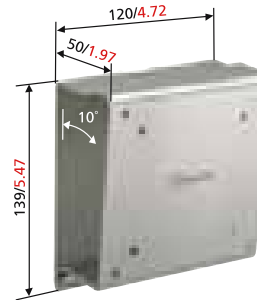

mm/inch



25-77 cm
11-30"

Max.

30 kg
66 lbs



VFW 032 LCD/TFT wall support



- Universal - complies with VESA MIS-D, 100, C, VESA MIS-D, 75, C and VESA MIS-E, C
- Strips included for 200x200 mm VESA mounting holes
- Fixed to the wall
- Minimal distance to the wall (30 mm / 1.2")
- Spacesaving - free up your space
- Easy mounting (mounting hardware included)

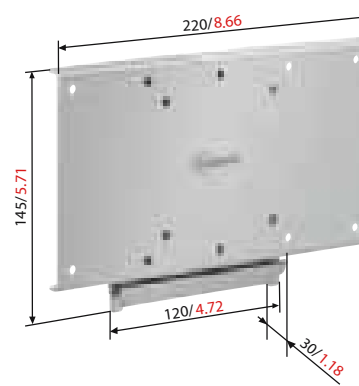

mm/inch



57-81 cm
23-32"

Max.

35 kg
77 lbs



VFW 132 LCD/TFT wall support



- Universal - complies with VESA MIS-D, 100, C, VESA MIS-D, 75, C and VESA MIS-E, C
- Strips included for 200x200 mm VESA mounting holes
- Tilt function 10°
- Minimal distance to the wall (51 mm / 2")
- Spacesaving - free up your space
- Easy mounting (mounting hardware included)

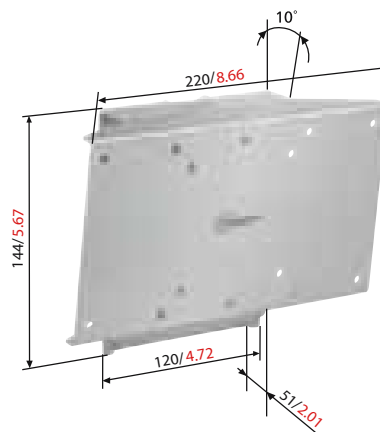

mm/inch







57-81 cm
23-32"

Max.

35 kg
77 lbs



ORIGINAL

-  66-107 cm
26-42"
-  Max.
35 kg
77 lbs
- 
- 

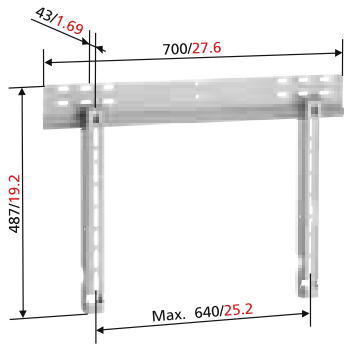





mm/inch

VFW 040 LCD/Plasma wall support

- Universal - complies with VESA MIS-F, 640, 360
- Fixed to the wall
- Minimal distance to the wall (43 mm/1.7")



-  66-107 cm
26-42"
-  Max.
35 kg
77 lbs
- 
- 

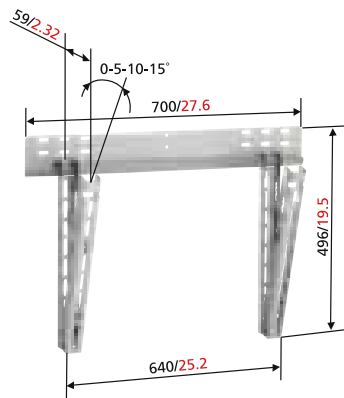



mm/inch

VFW 140 LCD/Plasma wall support

- Universal - complies with VESA MIS-F, 640, 360
- Distance to the wall (59 mm/2.3")
- Easy mounting (mounting hardware included)
- Tilt function max. 15°



-  103-165 cm
40-65"
-  Max.
70 kg
154 lbs
- 
- 

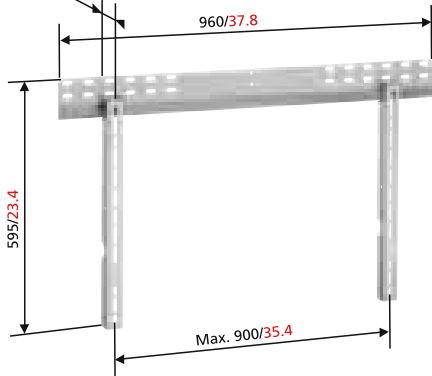

mm/inch

VFW 065 LCD/Plasma wall support

- Universal - complies with VESA MIS-F, 900, 510
- Fixed to the wall
- Minimal distance to the wall (43 mm/1.7")



-  103-165 cm
40-65"
-  Max.
70 kg
154 lbs
- 
- 

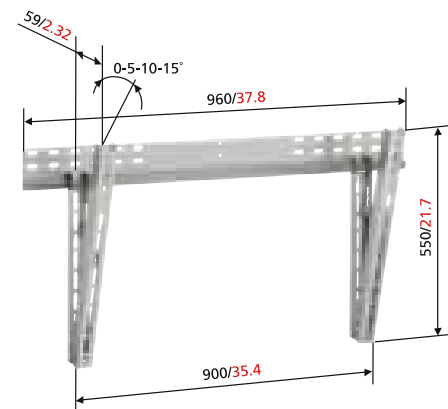

mm/inch

VFW 165 LCD/Plasma wall support

- Universal - complies with VESA MIS-F, 900, 510
- Minimal distance to the wall (59 mm/2.3")
- Easy mounting (mounting hardware included)
- Tilt function max. 15°



VFW 365 LCD/Plasma wall support

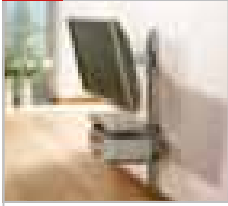

- Turn & tilt function guarantees optimal viewing position
- Cable Inlay System (CIS®) - all cables cleverly concealed
- Modular system – combine the wall support with cable covers and multi support to store A/V equipment

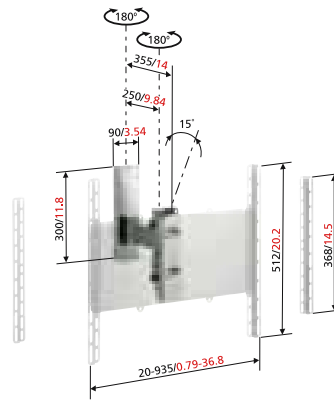

mm/inch

63-165 cm
25-65"

Max.

70 kg
154 lbs

mm/inch

LCD FLOOR STAND

VFF 624 LCD floor stand



- Universal - complies with VESA MIS-D, 100, C and MIS-D, 75, C
- Turn function guarantees optimal viewing position
- Integrated anti skid pads
- Sturdy design and construction provides extra stability
- Cable Inlay System (CIS®) - all cables cleverly concealed

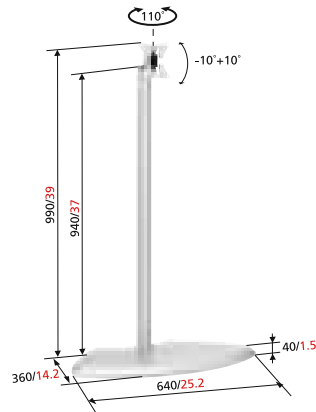

mm/inch

25-61 cm
10-24"

Max.

15 kg
33 lbs

mm/inch

ORIGINAL

Type nr.	Max.	Pivot points	VESA	Distance from wall	Tilt	
VFW 226	25-66 cm / 10-26"	15 kg / 33 lbs	1	MIS-D	7.0 cm / 2.76"	+/- 10°
VFW 326	25-66 cm / 10-26"	15 kg / 33 lbs	2	MIS-D	7.0 cm / 2.76"	+/- 10°
VFW 426	25-66 cm / 10-26"	15 kg / 33 lbs	3	MIS-D	7.0 cm / 2.76"	+/- 10°
VFW 232	57-81 cm / 23-32"	32 kg / 70 lbs	1	MIS-D / MIS-E + 200x200 mm	13.3 cm / 5.20"	+/- 10°
VFW 332	57-81 cm / 23-32"	32 kg / 70 lbs	2	MIS-D / MIS-E + 200x200 mm	10.9 cm / 4.29"	+/- 10°
VFW 432	57-81 cm / 23-32"	32 kg / 70 lbs	3	MIS-D / MIS-E + 200x200 mm	10.9 cm / 4.29"	+/- 10°
VFW 030	25-77 cm / 11-30"	30 kg / 66 lbs	1	MIS-D	2.6 cm / 1.02"	
VFW 130	25-77 cm / 11-30"	30 kg / 66 lbs	1	MIS-D	5.0 cm / 1.97"	-5° / +10°
VFW 032	57-81 cm / 23-32"	35 kg / 77 lbs	1	MIS-D / MIS-E + 200x200 mm	3.0 cm / 1.2"	
VFW 132	57-81 cm / 23-32"	35 kg / 77 lbs	1	MIS-D / MIS-E + 200x200 mm	5.1 cm / 2"	-5° / +10°
VFW 040	66-107 cm / 26-42"	35 kg / 77 lbs	1	MIS-F	4.3 cm / 1.69"	
VFW 140	66-107 cm / 26-42"	35 kg / 77 lbs	1	MIS-F	5.9 cm / 2.32"	15°
VFW 065	103-165 cm / 40-65"	70 kg / 154 lbs	1	MIS-F	4.3 cm / 1.69"	
VFW 165	103-165 cm / 40-65"	70 kg / 154 lbs	1	MIS-F	5.9 cm / 2.32"	15°
VFW 365	63-165 cm / 25-65"	70 kg / 154 lbs	2	MIS-F	12.5-35.6 cm / 4.92-14.0"	15°
VFF 624	25-61 cm / 10-24"	15 kg / 33 lbs	1	MIS-D		+/- 10°

Visit www.vogels.com for more information.

VPC 545 Projector ceiling support

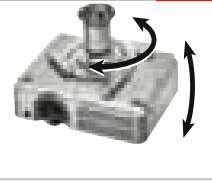

- Fits virtually all projectors weighing up to 10 kg/22 lbs
- Turn, tilt and roll functions guarantee optimal viewing position
- Special anti-theft screws
- Including 4 metal arms
- Easy mounting

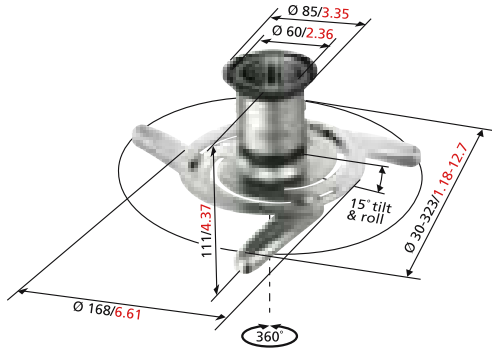

mm/inch

Max.

10 kg
22 lbs



VPW 565 Projector wall support



- Fits virtually all projectors weighing up to 10 kg/22 lbs
- Turn, tilt and roll functions guarantee optimal viewing position
- Reversible mounting
- Special anti-theft screws
- Including 4 metal arms
- Easy mounting

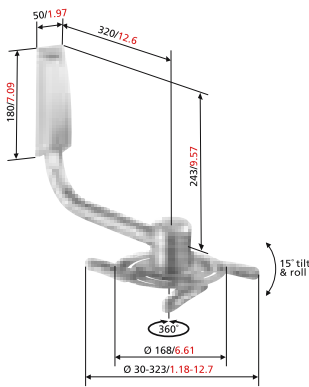

mm/inch

Max.

10 kg
22 lbs



Type nr.	Application	Max.	Pivot points		TILT
VPC 545	Fits virtually all projectors	10 kg / 22 lbs	1	●	15°
VPW 565	Fits virtually all projectors	10 kg / 22 lbs	1	●	15°

Visit www.vogels.com for more information.

TVB 2200 TV wall support



- 2 turning points to create optimal viewing angle
- Can be combined with Vogel's Evolution audio/video accessories
- Cable Inlay System (CIS®) - all cables cleverly concealed
- Available in silver

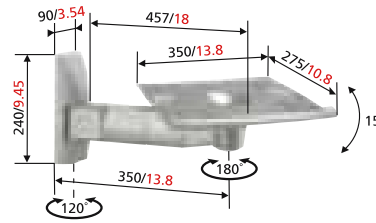

mm/inch



35-48 cm
14-19"

Max.

25 kg
55 lbs



TVB 2250 TV wall support



- 2 turning points to create optimal viewing angle
- Can be combined with Vogel's Evolution audio/video accessories
- Cable Inlay System (CIS®) - all cables cleverly concealed
- Available in silver

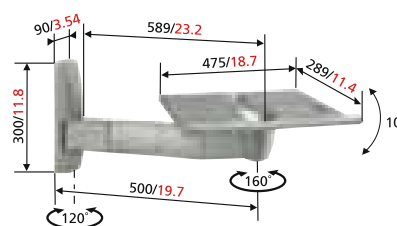

mm/inch



51-63 cm
20-25"

Max.

60 kg
132 lbs



TVB 2375 TV wall support



- 3 turning points to create optimal viewing angle
- Suitable for widescreen TVs
- Cable Inlay System (CIS®) - all cables cleverly concealed
- Available in silver

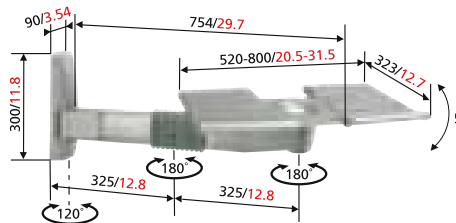

mm/inch



51-82 cm
20-32"

Max.

60 kg
132 lbs



TVA 2041 Cable cover



- Can be used in combination with a TVB or TVA 2046
- Cable Inlay System (CIS®) - all cables cleverly concealed
- Available in silver

mm/inch



TVA 2046 Audio/Video/DVD multi support

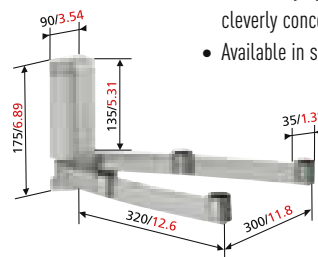

mm/inch

- Wall support for all kinds of audio/video hardware
- Cable Inlay System (CIS®) - all cables cleverly concealed
- Available in silver



Max.

20 kg
44 lbs



ORIGINAL

TVB 120 TV wall support

- One pivot point
- Available in silver and black

33-48 cm
13-19"

Max.
20 kg
44 lbs



mm/inch

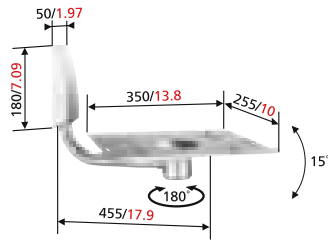

TVB 150 TV wall support

- One pivot point
- Available in silver and black

48-55 cm
19-22"

Max.
30 kg
66 lbs



mm/inch

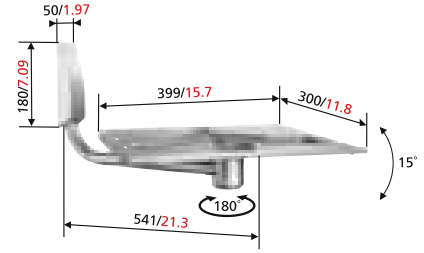

TVB 220 TV wall support

- Two pivot points
- Available in black

33-48 cm
13-19"

Max.
20 kg
44 lbs

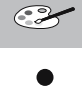

mm/inch

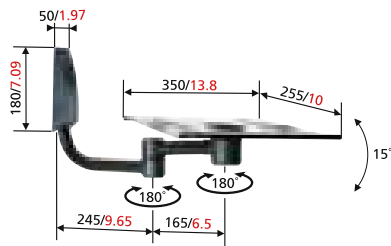

TVB 244 TV wall support

- Two pivot points
- Available in black

50-63 cm
20-25"

Max.
40 kg
88 lbs



mm/inch

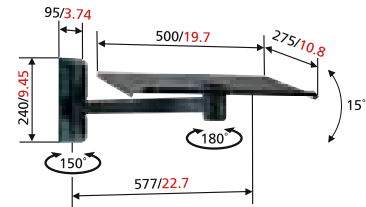

VRS 045 Video/DVD support

- Available in silver and black

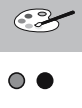

mm/inch

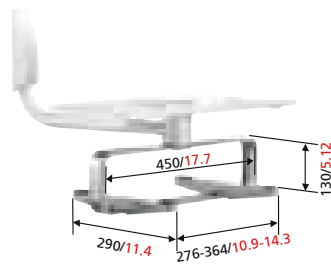

Type nr.	Max.	Pivot points	Widescreen	Modular system	CIS®
TVB 2200	35-48 cm / 14-19"	25 kg / 55 lbs	2	✓	✓
TVB 2250	51-63 cm / 20-25"	60 kg / 132 lbs	2	✓	✓
TVB 2375	51-82 cm / 20-32"	60 kg / 132 lbs	3	✓	✓

Visit www.vogels.com for more information.

Type nr.	Max.	Pivot points	Color
TVB 120	33-48 cm / 13-19"	20 kg / 44 lbs	1 ● ●
TVB 150	48-55 cm / 19-22"	30 kg / 66 lbs	1 ● ●
TVB 220	33-48 cm / 13-19"	20 kg / 44 lbs	2 ● ●
TVB 244*	50-63 cm / 20-25"	40 kg / 88 lbs	2 ● ●
VRS 045	Height video/DVD max. 12.5 cm / 4.9"	Width video/DVD max. 44 cm / 17.3"	2 ● ●

* Currently not available in renewed Original packaging.
Visit www.vogels.com for more information.

Type nr.	Color	Modular system	CIS®
TVA 2041	●	✓	✓
TVA 2046	●	✓	✓

Visit www.vogels.com for more information.

VLB 450 Loudspeaker support (2x)

- For surround speakers and hi-fi speakers
- Tilt & turn functions

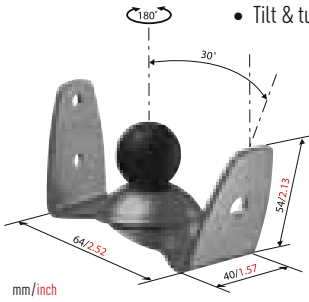

Max.

5 kg
11 lbs



VLB 500 Loudspeaker wall support (2x)

- For surround speakers and smaller hi-fi speakers <5 kg/11 lbs
- Tilt and turn functions guarantee optimal listening position
- Available in different colours

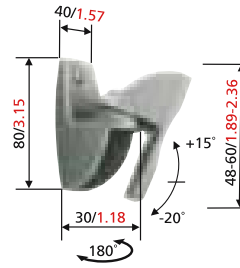

Max.

5 kg
11 lbs



VLS 615 Loudspeaker stand (2x)

- For Home Cinema front & surround speakers <1.5 kg/3.3 lbs
- Cable Inlay System (CIS®)
- Spiked feet (rubber feet included for delicate floors)
- Three speaker-mounting options - suitable for most brands of surround speakers

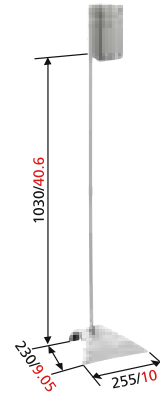

103 cm
40"

Max.

1.5 kg
3.3 lbs



Type nr.	I ↑	Max.	Mounting	Color
VLB 450		5 kg / 11 lbs	wall	●
VLB 500		5 kg / 11 lbs	wall	● ● ○
VLS 615	103 cm / 40"	1.5 kg / 3.3 lbs	floor	●

Visit www.vogels.com for more information.

ORIGINAL

MICROWAVE HOLDER

Micromaster Microwave holder

- Microwave support suitable for microwaves up to 50 kg/110 lbs
- Available in white
- Adjustable depth: fits all microwaves

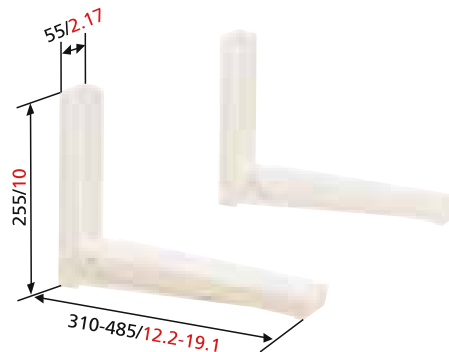

Max.

50 kg
110 lbs



FURNITURE COLLECTION

Our versatile range of mounting solutions helps you place your audio and video components where they best fit your space and where they will look and sound great. Vogel's extensive line of sophisticated furniture offers even more possibilities. It is specially designed to support and enhance your costly LCD/Plasma, Hi-Fi and audio/video components. Only the highest quality materials are used in their construction. These stylish mounting solutions give you more placement flexibility and they outperform and outlast most standard products.

The right style for every taste

Vogel's furniture is available in a variety of colours and finishes, including matte, high gloss and wood grain. For example, we offer contemporary styles with metallic finishes and glass components to fit every taste. You can choose from standalone cabinets and floor stands.

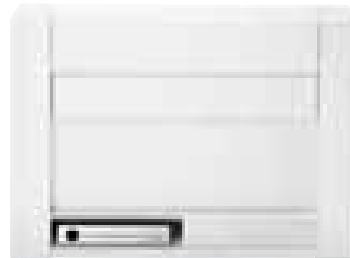

Drawer



Side cupboards



Doorstop



Cable Inlay Sistem (CIS®)

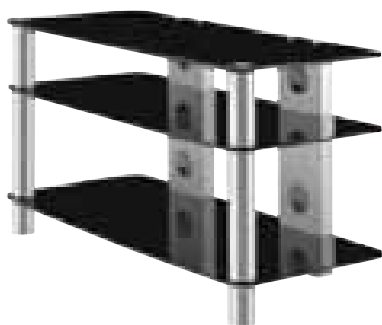

Professional solutions

Vogel's Professional offers a complete line of mounting solutions for the professional market. Over the years Vogel's products have found their way all over the world. We could not wish for a better endorsement of the quality and representative image of our products by the professional world. Vogel's supports for LCD and plasma displays and projectors have proved their worth over the years. At major airports, shopping centres, football stadiums and hospitals but also in filling stations, service organisations, department stores and in the hotel and catering industry.

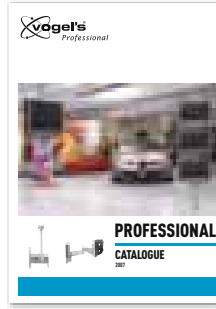

For more information ask for our brochure or visit www.vogels.com

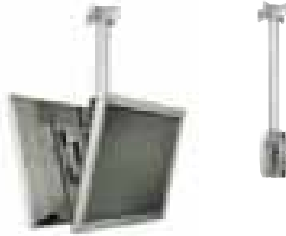

LCD/Plasma supports

Our range of modular universal flat display supports are internationally acknowledged as one of the best and most flexible systems on the market. They accommodate virtually all LCD and Plasma displays.



LCD/Plasma trolley/stands

This sturdy and stable trolley PFT 2100 allows flat screens to be positioned anywhere. It has a sleek modern design and includes an Autolock® locking system, Cable Inlay System (CIS®) and optional accessory tray.

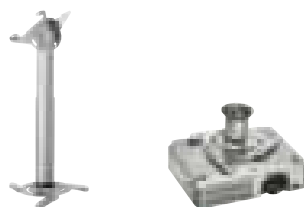

Universal projector supports

Vogel's offers a wide range of supports for projectors. Fixed or height adjustable, for compact or large projectors, Vogel's has a solution. Ask for our special projector supports brochure and/or our projector lift system leaflet.



TV wall and ceiling supports

Vogel's offers an extensive range of models with a solution for every size of TV in every situation. The stylish, award winning TV supports are available in various colours and show the TV off to its best advantage in every environment.

FLAT DISPLAY CEILING

PFC 900

LCD/Plasma ceiling support

- Incl. ceiling plate PFA 9005
- Incl. 80 cm extension tube PFA 9015
- Incl. turn & tilt unit PFA 9001
- Autolock® locking system
- Not including universal interface FAU 3150 or FAU 3125

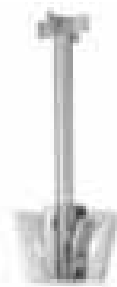

PFC 915

LCD ceiling support

- Sloping ceiling mounting plate
- Height adjustable, 52-80 cm
- Turn & tilt function
- Universal MIS-D interface

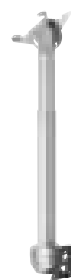

FLAT DISPLAY FLOOR

PFF 1500 + plateau

- Sturdy design
- Adjustable height 1300 -1700 mm (center display)
- NOT INCLUDING universal interface FAU 3125 or FAU 3150
- Easy and compact in transport (only 2 components)



FLAT DISPLAY WALL

PFW 910

LCD/Plasma wall support

- Fixed wall support
- Autolock® locking system
- Not including universal interface FAU 3150 or FAU 3125



PFW 920

LCD/Plasma wall support

- With tilt function
- Autolock® locking system
- Optional: wide wall mounting strips PFA 9017
- Not including universal interface FAU 3150 or FAU 3125



PFW 930

LCD/Plasma wall support

- With turn & tilt function
- Autolock® locking system
- Tilt mechanism with virtual pivot
- Not including universal interface FAU 3150 or FAU 3125



FLAT DISPLAY WALL

PFW 3220/3230/3240

- One, two or three pivot points
- Tilt and turn functions guarantee optimal viewing position
- Pre-assembled LED support simplifies mounting

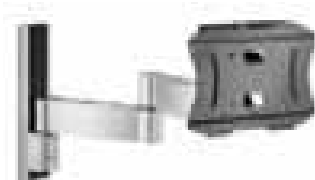

PROJECTOR CEILING

PPL 1515

Projector lift system

- Whisper-quiet operation
- Electronic adjustable height position
- Including universal projector adapter



PROJECTOR CEILING

PPC 150

Projector ceiling support

- Adjustable height 52-80 cm
- For projectors weighing up to 10 kg
- CIS® Cable Inlay System
- Ceiling plate suitable for sloping ceiling
- Also available in different dimensions: PPC 130 and PPC 180

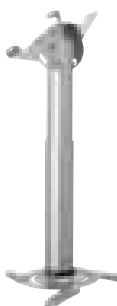

PPC 200

Projector ceiling support

- For projectors weighing up to 20 kg
- Special anti-theft screws
- Incl. four metal mounting arms
- Also available in different dimensions: PPC 230, PPC 250 and PPC 280



PPA 301

Projector anti-theft housing

- Heavy-duty steel housing
- For large projectors
- Padlocks not included
- Also available in compact version: PPA 300

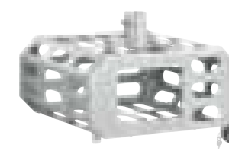



Cross selling (8 x 8 cm / 3.15 x 3.15")



Consumer brochure (A5)



Counter display DVDock™ (h x w x d)
(0.4 x 0.3 x 0.4 / 16" x 16" x 10") Limited edition

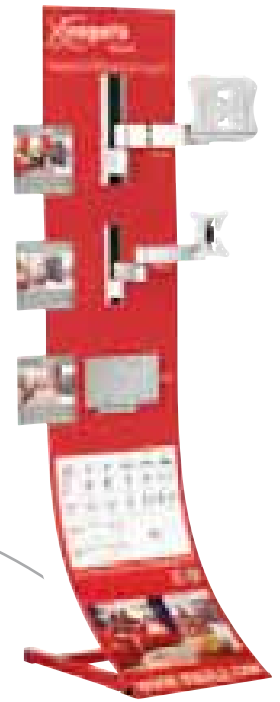

Original display (h x w x d)
(1.8 x 0.5 x 0.6 / 70" x 20" x 23") Limited edition



Floor display Maxi (h x w x d)
(2 x 0.8 x 0.6 m / 78.7 x 31.5 x 23.6")



Floor display Micro (h x w x d)
(1.6 x 0.8 x 0.6 m / 63 x 31.5 x 23.6")

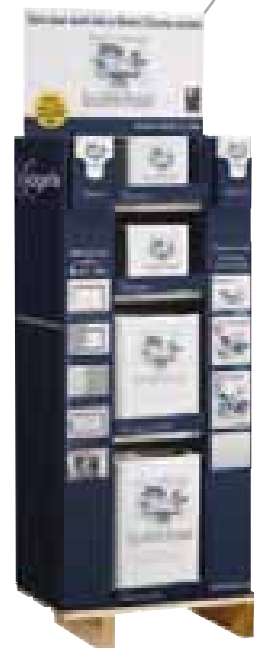

Stock display Mighty Brighty (h x w x d)
(1.4 x 0.6 x 0.4 / 54" x 23.4" x 15.5")

SUSTAINABLE PROFITABILITY

Profitable support

The exceptional sales and marketing support from Vogel's makes it easy to grow sales. Highlights from our broad assortment of sales tools are shown on this page:

- Easy to sell: Sales information is clear and easy to understand, so you can quickly sell the product to consumers in just a few minutes.
- Reliable distribution network ensures fast, accurate service that saves time and effort for retailers.
- Partnering with a leader in support equipment ensures a continuing stream of innovative solutions that satisfy the demanding consumer market
- Easy for consumers to choose the right product. There's a solution for virtually every screen and every size.
- Improved self-selling packaging has an attractive design that clearly identifies the hardware group and gives an overview of all choices for consumers.
- Helpful internet information, including an easy guide to find matching supports for specific screens. See www.flatscreenfitter.com.



Original packaging



Original shelf display (h x w x d)
(1 x 0.5 m / 39.4 x 19.7")



Evolution 6000 Series packaging



Evolution 6000 Series Projector supports packaging



Counter demo display (h x w x d)
(0.88 x 0.49 x 0.43 m / 34.6 x 19.3 x 16.9")



Shop presentation Evolution 6000 Series

PRODUCT CODES

LCD/Plasma:

- EFA** = Evolution Flat Accessory
EFF = Evolution Flat Floor
EFK = Evolution Flat Kitchen
EFT = Evolution Flat Table
EFW = Evolution Flat Wall
VFF = Vogel's Flat Floor
VFW = Vogel's Flat Wall

Projector:

- EPA** = Evolution Projector Accessory
EPC = Evolution Projector Ceiling
EPT = Evolution Projector Table
EPW = Evolution Projector Wall
MPW = Mighty Brighty Projector Wall
VPC = Vogel's Projector Ceiling
VPW = Vogel's Projector Wall

Audio:

- VLB** = Vogel's Loudspeaker Bracket
VLS = Vogel's Loudspeaker Stand

TV:

- TVB** = TV Bracket
TVS = TV Swivel

Accessories

- TVA** = TV Accessory
VRS = Vogel's Recorder Support

In car support

- EMC** = Evolution Mobile Car

ARTICLE INDEX

Type nr.	Page	Type nr.	Page
EFA 0040	23	TVB 150	48
EFA 6825	21	TVB 220	48
EFA 6830	21	TVB 2200	47
EFA 6835	21	TVB 2225	38
EFA 6840	21	TVB 2250	47
EFA 6875	21	TVB 2350	38
EFA 6895	21	TVB 2375	47
EFA 8001	27	TVB 244	48
EFF 1140	23	TVS 2025	38
EFK 1325	22	TVS 2032	38
EFT 2240	23	VFF 624	45
EFT 2265	23	VFW 030	43
EFW 1130	22	VFW 032	43
EFW 2001	26	VFW 040	44
EFW 2004	26	VFW 065	44
EFW 2009	26	VFW 130	43
EFW 6105	18	VFW 132	43
EFW 6125	18	VFW 140	44
EFW 6145	18	VFW 165	44
EFW 6205	19	VFW 226	41
EFW 6225	19	VFW 232	42
EFW 6245	19	VFW 326	41
EFW 6305	20	VFW 332	42
EFW 6325	20	VFW 365	45
EFW 6345	20	VFW 426	41
EPA 6505	32	VFW 432	42
EPC 6540	32	VLB 100	35
EPC 6545	33	VLB 1015	34
EPT 6520	32	VLB 1025	34
EPT 6525	33	VLB 200	35
EPW 6560	32	VLB 450	49
EPW 6565	33	VLB 50	34
Microwave holder	49	VLB 500	49
MPW 10	31	VLS 107	36
MPW 20	31	VLS 115	36
MPW 30	31	VLS 120	36
PFA 9017	27	VLS 45	37
PFW 185	26	VLS 60	37
Surround speaker		VLS 615	49
support 5-pack	34	VLS Glass	36
TVA 2041	47	VPC 545	46
TVA 2046	47	VPW 565	46
TVB 120	48	VRS 045	48

EXPLANATION OF ICONS 6000 SERIES FLAT SCREEN

**Spacesaving**

Mount your LCD or Plasma TV to the wall to free up space and give your interior a stylish look. Truly the best way to fully enjoy the benefits of your flat-screen TV.

**Close-to-wall**

The Evolution 6000 'fixed' support enables you to mount your LCD or Plasma screen close to the wall, while leaving sufficient room for air circulation.

**Tilt & turn**

The Evolution 6000 'adjustable' support lets you tilt and turn your screen any way you want for an optimal viewing experience.

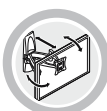
**Tilt, turn & reach**

Flexibility and freedom of movement are the key benefits of Evolution 6000 optimally adjustable support: tilt and turn your screen any way you want for an optimal viewing experience.

**Solid, steady & easy**

Your cherished LCD/Plasma TV deserves only the best possible wall mount. The Evolution 6000 Series optimally adjustable support combines high quality engineering and extreme strength, which brings you the benefit of many years of reliable and comfortable operation.

**Screen Protection System**

Don't worry about damaging your screen or wall: the Evolution 6000 'optimally adjustable' support has Vogel's unique Screen Protection System (SPS™) which protects both screen and wall.

**CIS®**

Get those unsightly cables out of sight using Vogel's unique Cable Inlay System (CIS®).

**CIS®**

Get those unsightly cables out of sight using Vogel's unique Cable Inlay System (CIS®).

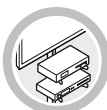
**Modular system**

Combine supports of the Evolution 6000 Series with our modular column system and Audio/DVD support to store all your audio and video equipment in one single, sleek-looking solution.

**AdvanCIS™**

The Column system features our flexible and unique AdvanCIS™, giving you the freedom to easily hide and guide cables at any height.

**Adjustable, fits all**

The adjustable arms of the Audio/DVD support, which are equipped with an anti-slip edge, fit a wide range of audio and video equipment sizes.

**Adjustable height**

The Audio/DVD support can be placed at any height in the column. You can also add up to three arms in a row.

EXPLANATION OF ICONS 6000 SERIES PROJECTOR

**Easy connect**

Simply move your projector from room to room by clicking it on the table, ceiling or wall module.

**Tilt, turn & roll**

Easily position the projected image using the flexible tilt, turn and roll feature.

**Anti-slip pads included**

Rubber anti-slip pads prevent your projector from slipping and protect furniture and flooring from scratches and damage.

**Easy connect**

Simply move your projector from room to room by clicking it on the table, ceiling or wall module.

**Easy connect**

Simply move your projector from room to room by clicking it on the table, ceiling or wall module.

**Cable inlay system**

Get those unsightly cables out of sight using Vogel's unique cable inlay system (CIS®).

**Adjust & secure**

Your projector can be locked in position to maintain a stable image while viewing. Even after removing your projector and putting it back.

**Ceiling cover**

When your projector is not connected to the support, the cables and support can be hidden from sight using the ceiling cover.

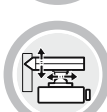
**Adjustable arm**

No matter what size your projector is, with the adjustable arm you can easily position your projector horizontally (near to the wall) and vertically (for the ideal height).

**Reversible mounting**

Mount your projector facing either straight up or upside down for the best projection at any height.

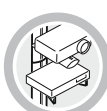
**Modular system**

Store all your audio and video equipment in one single, sleek-looking solution with our modular column system (EFA 6830 / 6835 / 6840) and additional accessories.

**Quick Release**

Slide the DVD player in the DVDock and click it into place. To take the DVD player with you or change a disc, just press the button and slide it out. It's quick and easy!

**Safety Arms**

Thanks to their unique design, our patented safety arms fold back upon impact.

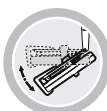
**Tilt**

The player can be tilted forward or backwards to eliminate reflections and get the best viewing angle.

**Easy Install**

Enjoy your DVDock in just three easy steps. All you need is a simple Allen key. It's stored on the back of the DVDock so you can always adjust the arms or remove the DVDock from the headrest.

EXPLANATION OF ICONS 6000 SERIES DVD DOCK

VOGEL'S IMPORTERS

Africa

Country	Importer	Telephone	E-mail	Website
TN	Epsilon 3	+21671960112	epsilon3@planet.tn	
ZA	Radionics Distributors Ltd.	+27117405573	mike@jamosa.co.za	www.jamosa.co.za

Americas

AN	Boolchand's Curacao	+59994612262	boolchandcs@bgate.net	
	Boolchand's St Maarten	+5995422245	avinash@boolchands.com	
BR	Linear Audio	+1155064668	linearaudio@linearaudio.com.br	www.linearaudio.com.br
CA	Precor Consumer Electronics	+9056606321	sales@precor.ca	www.precor.ca
CL	Audio plus	+5622176466	ac@audioplus.cl	www.audioplus.cl
MX	Embodiment S.A. de C.V.	+52-5555951312	embodiment_mx@hotmail.com	
US	Audiovox	+16312317750	aecustomerservice@audiovox.com	www.audiovox.com
VZ	JVG Hogar C.A.	+582122868118	cesarj10@cantv.net	www.jvg.com

Asia-Pacific / Asia

AU	Canohm	+61396454700	sales@canohm.com	www.canohm.com.au
HK	Soundtronics Ltd	+85221501360	nancy@soundtronics.com.hk	www.soundtronics.hk
IN	AV Optima	+911141680453	tpr.india@beomasterdealer.com	
JP	Osscreen Co. Ltd.		k.kobayashi@osscreen.com	www.osscreen.com
KZ	Samat	+7327582367	samatelectronics@nursat.kz	www.samatgroup.kz
SG	Enzer Electronics	+6565530988	boyd_au@enzer.com.sg	www.enzerglobal.com.sg
TW	Shouyo Electronics Co. Ltd	+886227995586	reishi@shouyo.com.tw	

Middle East

AE	A&M Trading	+97167456680	n_jaber@emirates.net.ae	
----	-------------	--------------	-------------------------	--



Europe

Country	Importer	Telephone	E-mail	Website
AM	Zigzag	+37410545588	shahen@zigzag.am	www.zigzag.am
AT	H.F. Dollmann Stefani Elektronik GmbH	+43522342130 +437229618710	info@dollmann.at info@stefani-elektronik.at	www.stefani-elektronik.at
AZ	Azel Azerbaijan Electronics	+99412974040	newmail@azel.net	
BE	Lucodex NV	+3238447282	admin@lucodex.be	www.lucodex.be
BG	Vigo	+359 2 9290301	contact@vigo-bg.com	
CH	Telion AG	+41447321770	shartmann@telion.ch	www.telion.ch
CY	M.Michael & S.Stavrou Electronics	+35725580611	info@mstronics.com	www.mstronics.com
CZ	EasyAV s.r.o.	+420261211521	vogels@easyco.cz	www.easyco.cz
DE	Fa Schnepel GmbH & Co KG	+49574134610	info@schnepel.com	www.schnepel.com
DK	Rudolph Schmidt A/S (Auroragroup)	+4544858200	slif@auroragroup.dk	www.auroragroup.dk
EE	Sandman Group	+3726512200	rainer@sandman.ee	www.sandman.ee
ES	ANMI (Andreu & Miriam) SA	+34933002618	info@anmi.es	www.anmielectronics.com
FI	FI Teletarvike Järvinen Oy (Auroragroup)	+358331430200	kek@auroragroup.fi	www.auroragroup.fi
FR	D.A.M.	+33164977400	dam@damdiff.com	
GB	BBG Distribution Ltd	+441923205605	info@bbg.eu.com	www.bbg.eu.com
GR	Kinotechniki	+302109601071	kinofath.forthnet.gr	www.kinotechniki.gr
HR	Dacco D.O.O. TD Elektronika D.O.O.	+38512456666 +38512431555	darko.vekic@dacco.hr td-elektronika@zg.tel.hr	www.dacco.hr
HU	Steelbird	+3614637163	vogels@axelero.hu	
IE	Hi Fidelity Marketing	+35351384120	hifidelity@eircom.net	
IS	Television Centre Ltd.	+3545689090	olafur@sm.is www.sm.is	
IT	Pozzi Italia s.r.l.	+390392785385	commerciale@pozziitalia.it	www.pozziitalia.it
LT	Ogmios Pulsas Ltd.	+37052741750	e.praleika@ogmios.lt	www.ogmios.lt
LU	Lucodex NV	+3238447282	admin@lucodex.be	www.lucodex.be
LV	Latsat Ltd.	+3717813311	latsat@latsat.com	www.latsat.com
MT	YAL Home and Electronics	+35621418947	adriang@donvol.net	
NL	Havoned B.V.	+31341359050	info@havoned.nl	www.havoned.nl
NO	O.S.K. (Auroragroup)	+4773969500	rtrf@osk.no	www.auroragroup.no
PL	Arkas Sp. Z o.o.	+48768711974	arkas@arkas.pl	www.arkas.pl
PT	Fimofer	+351261858534	fimofer@sapo.pt	
RO	VOG-Design Trade S.R.L.	+40213121909	office@vog-design.ro	www.vog-design.ro
RU	Optima Ltd.	+74957730553	info@vogels.ru	
SE	Orto Connex AB (Auroragroup)	+46856490850	jsv@ortconnex.se	www.auroragroup.se
SK	TT-Thais Trading	+4210905429926	info@vogels.sk	www.vogels.sk
SL	Technotop	+38615461850	technotop@siol.net	
SR	Av Max Group	+38132227469	avmax@ptt.yu	
TR	Aztek Teknoloji Ürünleri	+902122798889	info@aztekteknoloji.com	www.aztekteknoloji.com
UA	Dumka	+380567782500	import@dumka.net.ua	www.dumka.net.ua



Vogel's Products B.V.
Eindhoven, The Netherlands

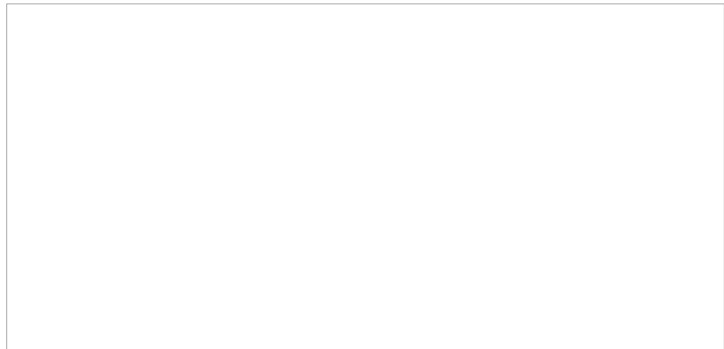

WWW.VOGELS.COM

Innovating the Audio/Video Experience