



**TURCK**  
*worx*

Industrial  
Automation

**Networks/  
Fieldbus**

**Overview Guide**



# SIGN UP FOR TURCK'S E-NEWSLETTER TODAY!



Industrial  
Automation

**...Sense It!...Connect It!...Bus It!**

**TURCK TIMES** [www.turck.com](http://www.turck.com)

**WHAT'S NEW**

**TURCK's NEW Proximity Sensors for High Temperatures**

TURCK's high temperature proximity sensors operate at up to 250°C (482°F), and are perfect for drying and curing ovens found in automotive painting systems.



Sensors of this type can be replaced as often as once per year in the auto industry. TURCK sensors are unique in that the more vulnerable sensing head is separate from the electronic amplifier. This means only the sensing head, not the electronic amplifier, needs replacement upon failure, resulting in a huge cost savings. Take, for example, 10 sensors in an installation:

Competitor's high temp. sensor	= \$1,000 x 10 sensors per year	= \$10,000
TURCK's high temp. sensor	= \$899* x 10 sensors per year	= \$8,990
<b>Savings incurred by using TURCK in the first year</b>		<b>= \$1,010</b>

\* \$242 for TURCK's electronic module + \$657 for the sensing head

Competitor's high temp. sensor year 2	= \$10,000
TURCK's high temp. sensor year 2	= \$6,570 (will only need new sensing heads)
<b>Saving incurred in year 2</b>	<b>= \$3,430</b>

**Using TURCK sensors for two years essentially results in 6 free sensing heads! Your third year purchasing TURCK sensors is essentially cut in half.**

**TIPS FROM TURCK**

Retractable cables function for more than just robotic applications. A great place to use retractable cables is on conveyors. When the conveyor needs to be moved for maintenance and other reasons, cables connected to the assembly must be disconnected and reconnected later on.

The much easier option: retractable cables that simply extend and retract with the conveyor.



**Issue 4 | Feb. 2007**



**Next issue...**

Alternative methods for SCADA.

Connectivity questions to ask before your next install.

**NEW PRODUCTS**

- \* Intelligent temperature sensors
- \* IP 67 power supply
- \* Low-cost I/O management

Register to receive the TURCK TIMES...

Our interactive e-newsletter full of exclusive insights, tips and tools to help make your manufacturing processes run smoothly. The TURCK Times is your source for news about TURCK products and industry updates.

Registering is easy and only requires your e-mail address. You are not obligated for future contact or purchase, and you may opt-in or out of the e-mail list at any time! We value your time and privacy, and will not share your information with another party.

Sign up today at [www.turck.com/elist!](http://www.turck.com/elist!)

<b>FOUNDATION™ fieldbus</b> . . . . .	<b>A3</b>	
<b>DeviceNet™</b> . . . . .	<b>B1</b>	
<b>AS-interface®</b> . . . . .	<b>C1</b>	
<b>PROFIBUS®</b> . . . . .	<b>D1</b>	
<b>Ethernet</b> . . . . .	<b>E1</b>	
<b>Process Wiring Environments</b> . . . . .	<b>F1</b>	

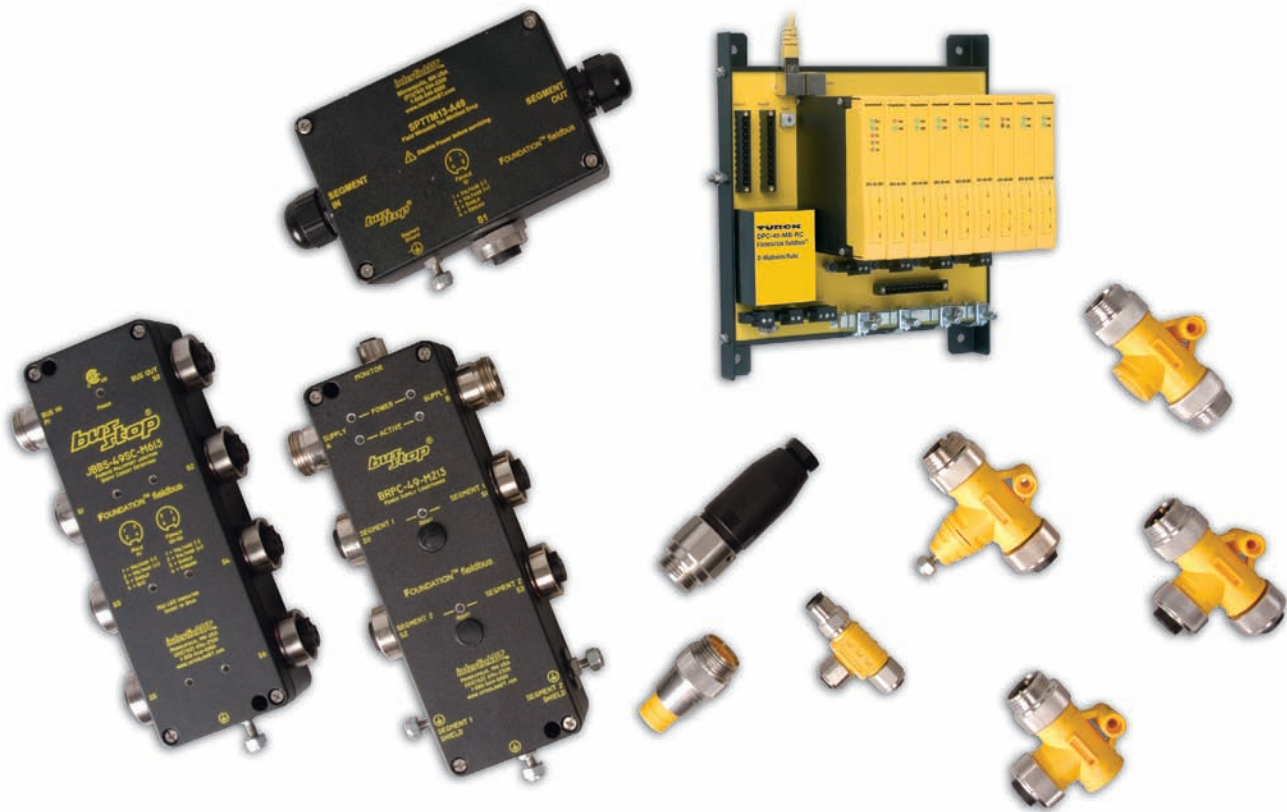

## What is FOUNDATION™ Fieldbus

FOUNDATION fieldbus is a networked serial bus system designed to replace the standard 4 to 20mA control system in the process industry. The transmission technology for the system was defined in 1994 with the publication of the international standard IEC 61158-2 (later integrated into the European standards as EN 61158-2). This same standard serves as the transmission technology for both FOUNDATION fieldbus and PROFIBUS®-PA, although the logical implementation of these two networks is significantly different. One of the key benefits of FOUNDATION fieldbus, as with network systems in general, is the dramatic reduction in wiring. The FOUNDATION fieldbus H1 system carries data and power for all devices on a single pair of wires, as opposed to the traditional need for a separate wire pair for each device. The physical wiring and electrical signal specification is also suitable for use in hazardous (classified) areas when appropriate energy limiting technology is incorporated. FOUNDATION fieldbus also supports a second physical communication specification, referred to as High Speed Ethernet (HSE). The HSE system is typically used as a higher-level communication network, acting as a backbone to link several H1 segments together through “linking devices” (referred to as LDs).

FOUNDATION fieldbus is unique among the popular open industrial networks in that it uses a true distributed control structure. I/O devices in the field communicate process variable and feedback information directly to each other and contain the necessary function blocks for the control scheme to operate. This makes it especially suitable for large scale process applications where reliability and continuous operation are more important than speed.

Another major benefit of FOUNDATION fieldbus over a traditional hard wired system is the reduction in installed material (wire). While the hard wired system requires that a pair of wires be pulled for each instrument in the field, the FOUNDATION fieldbus system uses a single pair of wires for all the devices in a particular segment. This results in significant savings on the cost of the wire itself, and more importantly the cost of installing the wire. Additionally, the system is able to be installed faster, resulting in the plant being commissioned sooner.

### Key benefits:

- Lower field wiring cost
- IS capability reduces cost of hazardous area installs
- Control loops performed by devices in the field
- Time stamp applied to data in the field
- High level of process information
- Standardized control function blocks
- 1900 m length (120 m spurs)
- Wide manufacturer support

FOUNDATION fieldbus supports up to 16 or 32 devices on a segment (depending on the host system), but in practice most segments are much smaller than this. Common practice is to keep essential control loops on separate segments from each other in order to enhance the security of the entire process (if a segment is lost the system may still continue to function).



The DPC-System (Diagnostic Power Conditioner System) is a power supply system for the installation of FOUNDATION™ fieldbus H1 segments. It provides comprehensive diagnostic functions for the monitoring of FOUNDATION fieldbus segments and supports asset management for the entire system.

A DPC system consists of one or more module racks (DPC-49-MB-RC) each with up to eight power supply modules (DPC-49-IPS) and one diagnostic module (DPC-49-ADU). Up to four H1 segments for each module rack can be operated and monitored redundantly. The diagnostic data from the H1 segments are transmitted via the HSE interface module (DPC-49-HSEFD/24VDC) to the higher level asset management system.

The diagnostic module (DPC-49-ADU) is used as a communication and diagnostic interface between the H1 segments and the power supply module. The diagnostics module monitors the electrical parameters and the communication parameters of the H1 segments. Operation without diagnostic module is possible. In this configuration, simple diagnostics are provided locally.

The diagnostic information is collected in the device and transmitted via the HSE interface module to the higher fieldbus level (e.g. to the host) as diagnostic and alarm data. The diagnostic module can be plugged and unplugged during operation (hot swappable).

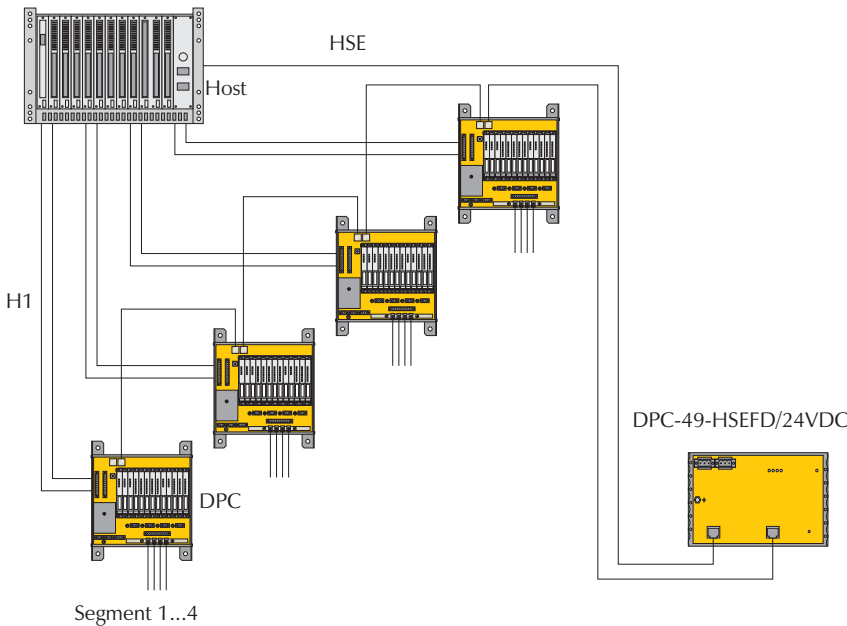
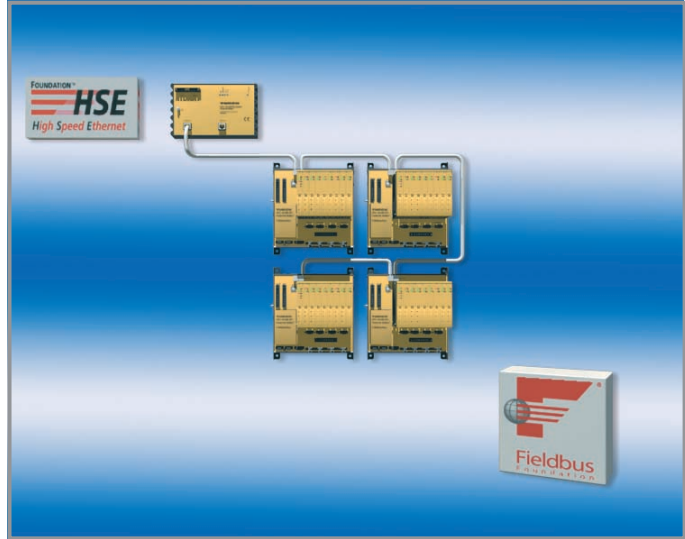

**DPC system configuration**



**Diagnostics via DTM**

## Fieldbus - The dynamic asset

Information concerning the components of the control system and field devices are typically stored and monitored by that system. Information on assets that make up the communication infrastructure (physical layer components) have been simply stored in an asset management system. With the DPC system, the physical layer components are continuously monitored providing virtually instantaneous information regarding the quality and the status of the communication link.

This aspect of the system is the key to achieving the main objective of asset management to minimize maintenance and lower system operating costs.

**TURCK** has drastically improved on existing physical layer components for use in FOUNDATION™ fieldbus applications. The introduction of this system allows the continuous monitoring of every physical layer component, thus treating the entire physical layer as an asset and providing the means for it to be managed as such.

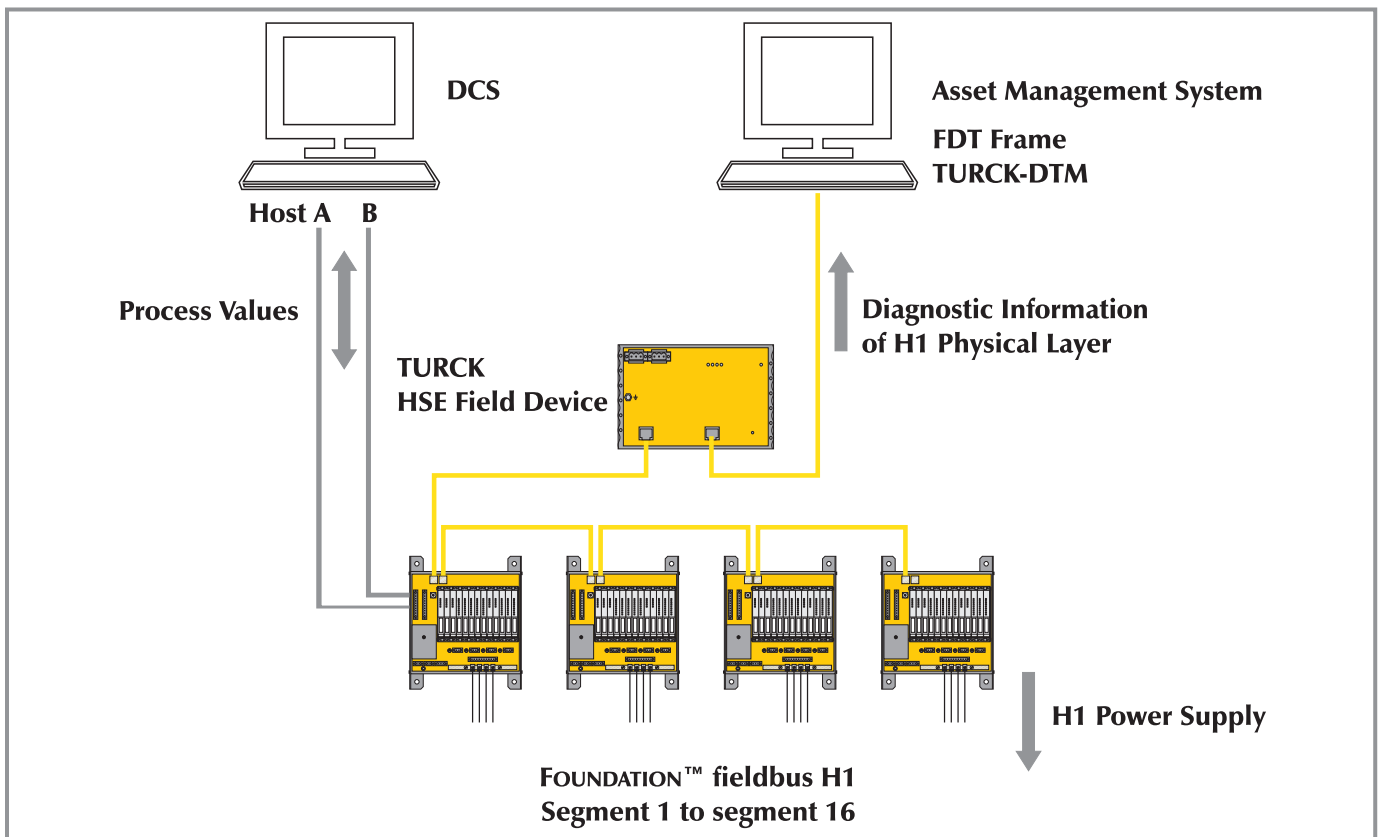

The DPC System detects errors that may develop over an extended period of time or through typical failure modes. These changes can occur due to many factors, such as environmental changes, deterioration of components over time, and any other factors that may affect the physical components of a fieldbus segment. Some of these factors may appear as changes in jitter, hum, noise levels etc. Alarm strategies may be employed that will warn of typical asset errors, potential errors or failures. Preventive measures can be implemented well in advance of a potential system failure. Most common failures can be completely avoided when a preventive maintenance schedule is implemented. The DPC system also supports the set-up of fieldbus assets by using expedient localization of error sources, as well as documentation indicating a "good condition" of the segment structure.

The DPC system provides an option for redundant segment supplies. The system, fully loaded, can accommodate up to 16 fully redundant FOUNDATION fieldbus segments each with an output of 800 mA and 30 VDC. Diagnostic data is available via a DTM, standard FOUNDATION fieldbus function block libraries or an embedded web server in the HSE field device.



### Conventional

In a traditional control system I/O devices in the field are individually wired to a central controller, which is responsible for all control function processing in the system. This type of system typically consumes a lot of physical space (due to the amount of wire and the number of I/O cards in the PLC or DCS) and requires a lot of design and labor to install. Additionally, finding errors in this kind of system can be very time consuming because of the number of possible error points (each physical wire termination).

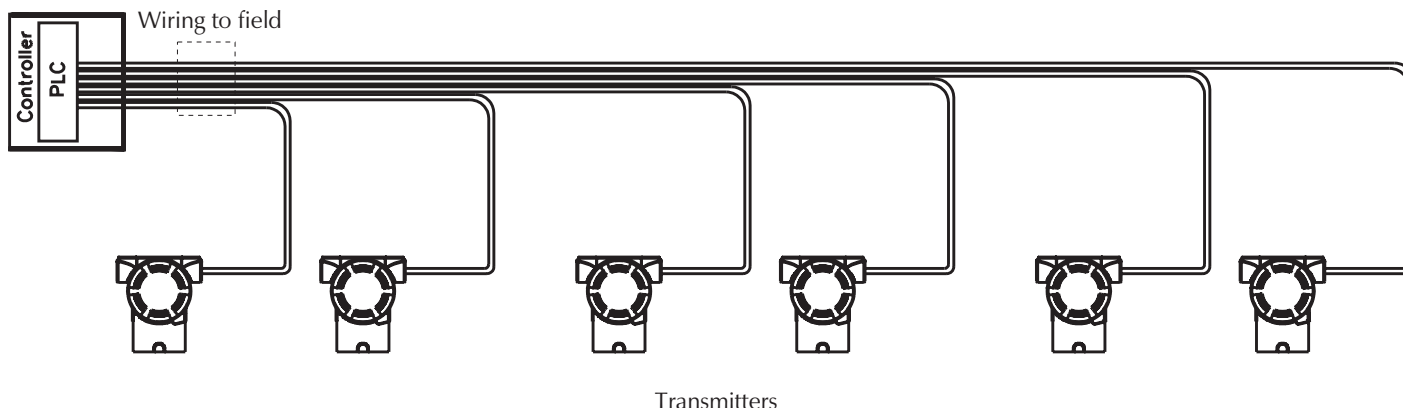

### FOUNDATION fieldbus

In the fieldbus system the I/O devices are wired to a trunk line (segment) using tee connectors or multi-drop boxes. Rather than separate pairs of wires carrying data to and from each I/O device, the devices use a common pair of wires for communication, with each having a turn to “talk” on the network. Instead of performing all the control functions in the host, the FOUNDATION fieldbus system allows for control blocks to be executed in the field devices themselves, creating an efficient, high integrity system. One device on the network is responsible for scheduling communication between the various devices on the system. This is called the Link Active Scheduler (LAS). It can be the host interface or a device in the field. In most FOUNDATION fieldbus systems at least one backup LAS is defined as well. This allows communication and control to continue in case the original LAS device fails. Most FOUNDATION fieldbus devices are powered completely from the network supply. In some cases a device may draw enough current to make it impractical to power it from the network. In these cases the device is typically powered from a separate (auxiliary) supply.

Another key benefit of using FOUNDATION fieldbus is the ease of adding I/O devices to the system in the future. Because it is a serial bus where all devices use the same wires for communication, a device can be added by simply splicing it onto the network. This eliminates the need to pull a new wire pair all the way back to the controller.

FOUNDATION fieldbus devices also typically include a multitude of parameters and diagnostic information, all accessible over the network. Advanced diagnostics and maintenance scheduling are made much easier with this feature.

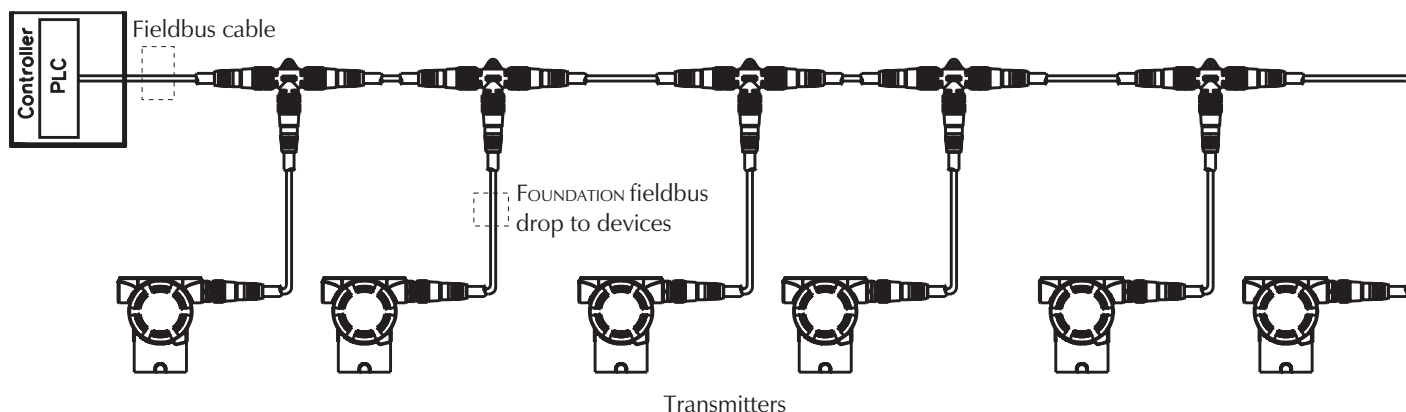



## Communication Signal

The FOUNDATION™ fieldbus H1 communication signal is a square waveform superimposed on a DC carrier. The frequency of the signal is 31.25 KHz. Although it is not a requirement, most devices derive their supply power from the fieldbus communications cable. The fieldbus specification states that devices must not be polarity sensitive. However, it is good electrical practice to have all devices wired with the same polarities. The voltage range allowed for proper operation is 9 to 32 VDC. A typical fieldbus device will consume 20 mA of current.

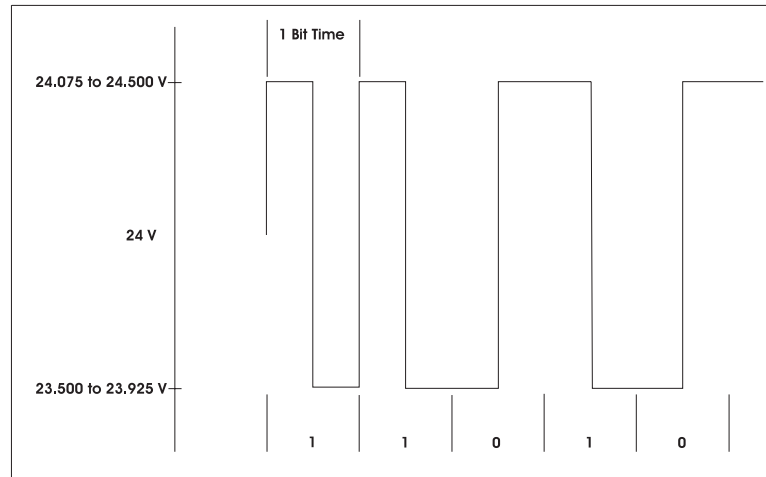

Idealized FOUNDATION fieldbus communication signal

## Fieldbus Cable Specifications

The specifications for fieldbus H1 physical media are defined by IEC 61158-2 and the ISA-S50.02 Part 2 Physical Layer Standards. The same standard is also listed in the FOUNDATION fieldbus specifications under 31.25 Kbps Physical Layer Profile FF-816-1.4. There are essentially four types of cable designations for fieldbus. Type A cable preferred for new installations, because it allows for the most versatile lengths. The other cable types are for installations where cable already exists from 4-20 mA systems. See table 1.

**Table 1**

Type	Cable Description	Conductor Size	Maximum Length
Type A	Shielded, Twisted Pair	18 AWG	1900 m (6232 ft.)
Type B	Shielded, Multi Twisted Pair	22 AWG	1200 m (3936 ft.)
Type C	Unshielded, Multi Twisted Pair	26 AWG	400 m (1312 ft.)
Type D	Shielded, Untwisted Pair	16 AWG	200 m (656 ft.)

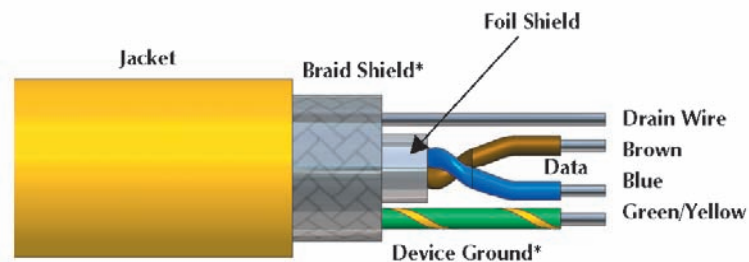

Typical FOUNDATION fieldbus cable, with ground wire



**TURCK** offers type A cables with both two conductors and three conductors, with the third conductor available for a centralized ground of devices if needed. **TURCK** cables meet or exceed the specifications of ANSI/ISA-SP50.02-1992, the fieldbus standard for use in industrial control systems.

The maximum spur length is determined by the number of devices in the segment.

Cable	Number of Devices	Maximum Spur Length
Trunk	25-32	0 m (0 ft.)
	19-24	30 m (98 ft.)
	15-18	60 m (197 ft.)
1900 meters	15-18	60 m (197 ft.)
	13-14	90 m (295 ft.)
	2-12	120 m (394 ft.)

## Termination

The FOUNDATION™ fieldbus communication signal requires that each end of the system be terminated with a 1 μF capacitor in series with a 100 Ω resistor across the communication lines. This termination must be installed at each extreme end of the network segment. Do not use more than two terminators on a communication segment.

## Hazardous Area Usage

FOUNDATION fieldbus networks may be used in hazardous areas as long as required energy limitations for the specific area are observed. One way to achieve this is to use the “entity” concept, which requires the network designer to calculate the voltage and current requirements for each device and determine the system limitations .

A simpler option is to use the Fieldbus Intrinsic Safety Concept (FISCO) or Fieldbus Non-Incendive Concept (FNICO). These concepts define the limitations required for devices on a network system to be used in a hazardous area (Class I, Div 1 for FISCO and Class I, Div 2 for FNICO). Many newer FOUNDATION fieldbus devices are rated to meet the requirements of FISCO and/or FNICO. As long as the devices used and the power supply are marked with FISCO or FNICO they may be connected together in the appropriate hazardous area. It is important to note that the cabling used must still meet the defined parameters.

## Using Connectorization

Plug-and-play connectorization has been standard practice for many years in industries ranging from appliance manufacturers to industrial sensors. These industries have found it necessary to compete in a business climate where speed and consistency of connection is king. Connectorization is the perfect complement to fieldbus systems. The concepts and goals are identical: reduce installation time, reduce troubleshooting and easy expansion. The fieldbus system minimizes point-to-point wiring that can be time consuming and difficult to troubleshoot. Connectorization takes that one step further, almost completely eliminating troubleshooting. Plants that have implemented plug-and-play connectorization claim up to a 75% reduction in start-up. This directly translates into real cost savings.

## Cost Savings

The initial capital cost is the major factor in selecting a method of connecting devices. These costs include material and installation. The cost of incorporating plug-and-play connectivity will be 10 to 60 percent less. Actual savings will depend on the size and complexity of the installation.

Other cost saving factors include reduced design cost, reduced maintenance cost, reduced troubleshooting cost and reduced expansion costs. Some of these cost savings are difficult to determine until the condition exists. However, these costs can quickly change from potential cost savings to real cost savings when the installation begins.

## Design Cost Savings

Most projects begin with a rough definition to develop the capital scope and then progress to detailed development. Development of the capital scope is often expressed in terms of segments, transmitters and tanks. The cabling can be expressed in the same way. Each transmitter requires one device gland and one cordset. Each tank requires one tee, one drop cordset and typically one brick. The home run or trunk cable can run in either conduit or cable tray, so either a field wireable tee or a conduit adapter is required at each tank. A terminating resistor is needed at the beginning and end of the network. A simple estimated bill of materials can be developed as follows:

For: 4 segments, 50 transmitters, 10 tank process

Description	Product Number	Quantity
Device Glands	RSFV 49-0.3m/14.5	50
Cordset	RSV RKV 490-6M	60 (50 Transmitters + 10 drops)
Multispur Bricks	JBBS-49SC-M613	10
Field Wireable Tee	SPTT1-A49	10
Terminating Resistor	RSV 49 TR	8
Bulk Cable	CABLE, 490-300M	1

Often for estimating purposes, an average length of cordset and segment length is assumed. In this example 6 m (20 ft.) cordsets and four 75 m (250 ft.) segments are estimated.

The cost and time of coping with continuous changes during the engineering design phase can be very expensive. However, with this model the changes are limited to the length of the cordset and spool of bulk cable. Design changes can even wait until all the transmitters are mounted. Simply taking physical measurements is as valid as any other design method.

## Material Costs

The cost of cordsets and bricks will be slightly lower than the cost of termination in enclosures. The plug-and-play junction bricks are IP 67 rated (equivalent NEMA 4X). This means they can be mounted indoors or outdoors without any secondary enclosures. A NEMA 4X enclosure can cost anywhere from \$75 for steel to \$275 for stainless steel. The cost can increase by another \$40 to \$60 for the design and installation time required to put mounting holes in the enclosure and installing cable glands. A cage clamp style termination block costs \$200 to \$450 depending on whether it has short circuit protection. The plug-and-play bricks cost only \$322 and \$486 depending on whether they have short circuit protection. A set of six cordsets costs only \$264 (RSV RKV 490-1M)\*.

The material cost comparison for a stainless steel installation is as follows:

Field Wiring		Plug-and-Play	
NEMA 4X Box (Hoffman® or equivalent)	\$ 275	Junction brick (JBBS 49SC-M613)	\$ 486
Cage Clamp Termination Block	450		
Installation of block in box	50		
Bulk cable (6 meters)	12	Cordsets (six RSV RKV 490-1M - \$44.00)	264
Device gland (1/2 NPT fitting - \$8)	48	Device gland (RSFV 49-0.3M/14.5 - \$30.30)	181
Total	\$ 835	Total	\$ 931

A junction brick system that is completely encapsulated for use indoors or outdoors is equivalent to or approximately 10% more expensive than a termination block mounted in an enclosure. The real savings are in the speed and ease of installation.

\* Costs given are examples only, and are subject to change.



### Installation Savings

The cost of installing a plug-and-play connector system can be 90% lower than terminating in cage clamps. The time required to make a plug-and-play connection is less than 30 seconds per connection. The time required to strip the jacket, prepare the conductors, feed the cable through a gland, insert the wires into the terminals and tighten the cable gland is 5 to 10 minutes per connection. This is further complicated when the installation is in a physically demanding location. At a labor cost of \$28/hour per NECA labor units, this adds up fast. Terminating this many connections on just a 6-port junction brick means a difference of \$38.73 as compared to \$2.80. Further savings are often hidden since the wiring errors are eliminated.

<u>Field Wiring</u>		<u>Plug-and-Play</u>	
Install 6 connectors to brick (1/2 min. ea)	\$ 1.40	Install 6 connectors to brick (1/2 min. ea)	\$ 1.40
Install 6 cables to device (10 min. ea)	28.00	Install 6 connectors to brick (1/2 min. ea)	1.40
Termination check of system (20 min.)	<u>9.33</u>	Termination check of system (n/a)	<u>-----</u>
Total	\$ 38.73	Total	\$ 2.80

### Maintenance Savings

One of the most important features with plug-and-play connectors is that transmitters can be taken on and off the bus very quickly - with little or no disruptions to operations and no disruptions to the bus. A device can be added to a junction brick spare port much more easily than any terminal strip. Any conceivable change required in the process can be made simply by planning a couple of spare ports.

**Notes:**



## DeviceNet™ System Description

DeviceNet is a low-cost communications protocol that eliminates hard wiring and connects industrial devices such as limit switches, photoelectric sensors, valve manifolds, motor starters, process sensors, bar code readers, variable frequency drives, panel displays and operator interfaces to a network. DeviceNet's direct connection provides improved communication between devices, as well as important device-level diagnostics not easily accessible or available through hard-wired I/O interfaces.

DeviceNet is based on the Controller Area Network (CAN) broadcast-oriented communication architecture. CAN uses a bus arbitration method, CSMA/BA, that assures the highest priority message always gets use of the bus in the event of a data collision. The DeviceNet protocol further defines message priorities such that I/O messages are given top priority and configuration messages have lower priority.

A DeviceNet network supports up to 64 nodes and virtually an unlimited amount of I/O. The bus uses a trunkline/dropline topology, where bus power and communication are supplied on a single cable. Bus power is 24 VDC and supplies current to operate the nodes and (typically) power input devices. Some **TURCK** stations require an additional 24 VDC auxiliary power to supply current for outputs.

DeviceNet allows peer-to-peer data exchange (where a DeviceNet node can initiate communication with other nodes or peers), and a master/slave configuration in which the master node initiates all communication and all other nodes, or slaves, respond to the master node's requests.

### Typical System Configuration

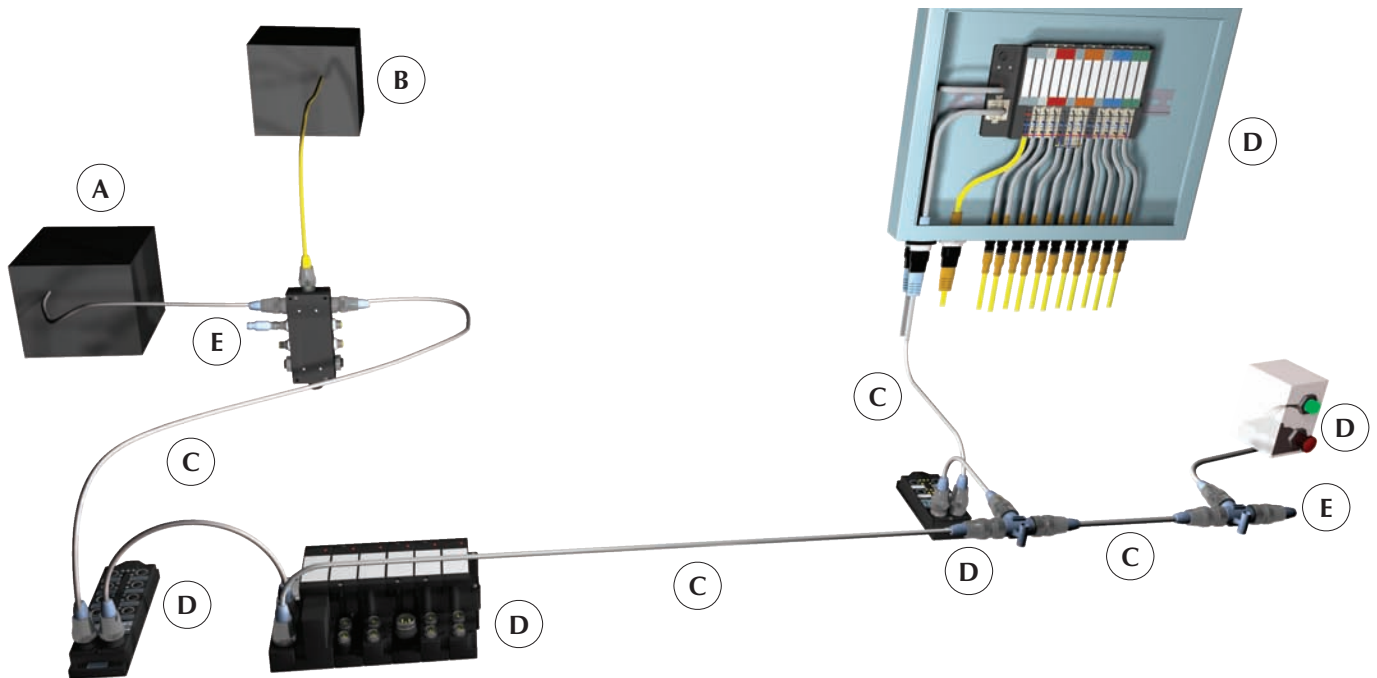

A typical DeviceNet system consists of the following parts:

- A - Controller
- B - Power Supply
- C - DeviceNet Cable
- D - DeviceNet I/O Modules (or Slaves)
- E - Terminating Resistors

DeviceNet stations require a network master (also called a scanner) to interface the stations to the host controller. **TURCK** DeviceNet stations are designed to be fully compatible with DeviceNet equipment from other manufacturers.

DeviceNet

## Communication Signal and Power

The DeviceNet™ signal conforms to the Controller Area Network (CAN) standard. This signal type is a differential square wave, allowing for very good common mode noise rejection. The network communication rate (baud rate) can be configured for 125, 250 or 500 kbaud. All stations on a DeviceNet system must be set for the same baud rate.

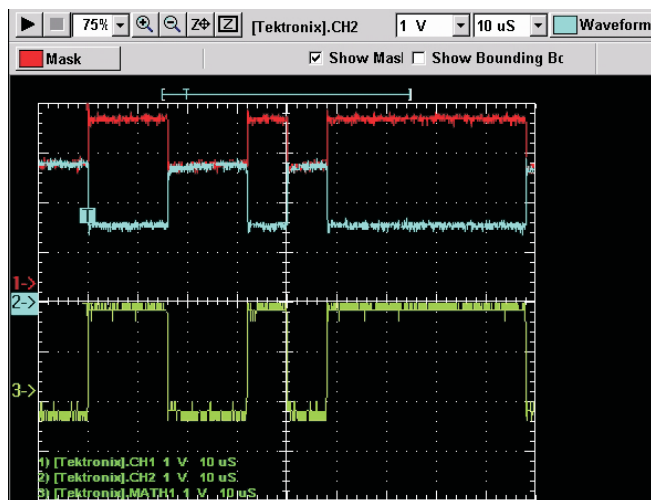

Oscilloscope capture of a typical DeviceNet signal, showing both the high and low components as well as the resulting difference.

Several factors must be considered when calculating the complete cycle time of a DeviceNet system, including:

- Number of nodes being scanned
- Amount of data produced and consumed by the nodes
- Type of I/O messaging (change of state, strobe, poll)
- Network communication rate
- Device time-out and explicit messaging traffic
- Cycle time of the control program

The DeviceNet cable also includes a wire pair for carrying 24 VDC power to all nodes on the network. This power supply is required for DeviceNet systems, as the signal lines are referenced to it. A key benefit of carrying supply voltage in the network cable is that many DeviceNet stations do not need a further supply, allowing the user to only need to run one cable to the station.

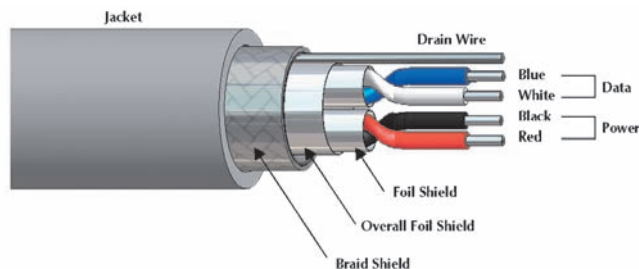

Typical DeviceNet cable.

Some stations, particularly those with high current outputs, can draw too much power from the DeviceNet power supply. These stations typically have an auxiliary power connection, allowing the user to use a second power supply for just the I/O. The bus power supply still powers the DeviceNet communication electronics.



**Cordsets**

**TURCK** offers a complete line of molded DeviceNet™ cordsets to facilitate network installation, resulting in a faster start-up and fewer wiring errors. The bus and drop cables are specially designed foil-shielded, high-flex cables with very low inductance and capacitance to minimize propagation delay time. DeviceNet cables consist of a shielded and twisted data pair, as well as a shielded and twisted power pair for the 24 VDC bus power, with an additional outer shield.

In most cases, bus cable connections are made using 5-pin *minifast*® (7/8-16 UN) or *eurofast*® (M12) connectors. A variety of stations are also available that support terminal-block type connections.

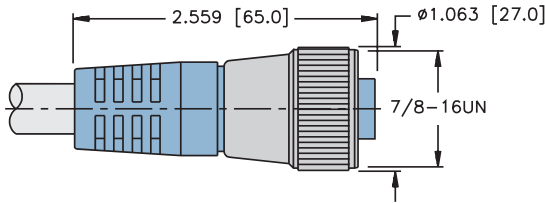

*minifast* connector

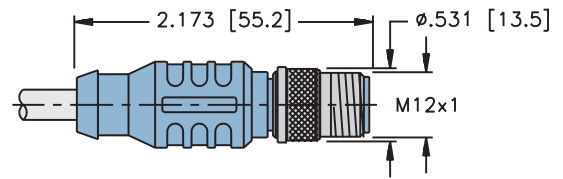

*eurofast* connector

**TURCK** cordsets for the DeviceNet system are available in standard lengths. Contact your local sales representative to order custom lengths.

**Maximum Ratings**

The DeviceNet bus uses trunk and drop topology. The trunk is the main communication cable, and requires a 121 ohm resistor at both ends. The maximum length of the trunk depends on the communication rate and the cable type. Drops are branches off the trunk, and may be from zero to 6 m (20 ft) in length. The cumulative drop lengths are dependent on the communication rate. The following table shows the maximum ratings for a trunk using thick, mid and thin cable. Thick and thin DeviceNet communication cable types are defined by the DeviceNet specification; mid cable is a hybrid of the two that is offered by **TURCK**.

Communication Rate	Thick Trunk Length (maximum)	Mid Trunk Length (maximum)	Thin Trunk Length (maximum)	Drop Length (maximum per drop)	Drop Length (cumulative)	Nodes (maximum)
125 kbps	500 m (1640 ft.)	300 m (984 ft.)	100 m (328 ft.)	6 m (20 ft.)	156 m (512 ft.)	64
250 kbps	250 m (820 ft.)	250 m (820 ft.)	100 m (328 ft.)	6 m (20 ft.)	78 m (256 ft.)	64
500 kbps	100 m (328 ft.)	100 m (328 ft.)	100 m (328 ft.)	6 m (20 ft.)	39 m (128 ft.)	64

**Diagnostics**

**TURCK** stations provide increased diagnostics when used with standard proximity or photoelectric sensors and discrete actuators. **TURCK** stations also serve as a buffer between I/O devices and the DeviceNet bus by detecting short-circuits without disrupting DeviceNet communication.

For deluxe style stations, each I/O point on the station provides state and status data. State data represents the real world value of the I/O device; for example, when the sensor is on or the actuator is off. Status data indicates short-circuits in the I/O device or in the wiring between the device and the station. Some models also use status data to indicate open circuits.

State and status data are transferred to the DeviceNet scanner where it is available for fault handling in the control program. Additionally, each input and output has a multicolored LED to indicate its state and status and pinpoint I/O problems quickly; for example the module status LED indicates the internal health of the station, and the network status LED indicates the station's communication on the DeviceNet network.

## **Addressing**

The valid range of DeviceNet™ node addresses is 0 to 63. The station's default node address is 63. Each node's address must be initially set, usually via rotary dials or switches on the node. The address can also be set with a DeviceNet configuration tool.

Changes to the address settings take effect when the station power is cycled. Care must be taken to prevent the same address from being assigned to more than one node in a system. If the same address is set on multiple nodes, one node will take control of the address and the others will go into "Critical Link Failure" state, indicated by the network status LED (solid red).

## **Electronic Data Sheets (EDS) Files**

Electronic Data Sheets, or EDS files, are files that contain detailed information about a DeviceNet device, including I/O data size and the device's configurable parameters. The information provided by EDS files guide a user through the steps necessary to configure a device. EDS files are available on the **TURCK** web site ([www.turck.com](http://www.turck.com)).

## Notes:





## AS-interface® System Description

AS-interface (commonly referred to as AS-i) is a low-level I/O interface system. It was originally intended to be a simple, low cost system that would be easy to install and maintain. With that philosophy in mind, the original developers designed AS-i as a discrete-only two-wire system. It incorporated features like automatic station addressing, and power and data were carried on a single untwisted pair of wires.

As the demand for AS-i grew, so did the demand for more complex devices. The next major version of AS-i, v2.1, extended the protocol to include seamless transfer of analog data, transmission of simple diagnostic data and an extended addressing scheme that effectively doubled the number of stations allowed on the network. The newest version of AS-i, v3.0, has gone even further, allowing more options for analog data and much more detailed diagnostic information to be communicated. New versions of AS-i are backward compatible and support slaves from earlier versions. Additionally, AS-i was one of the first network systems to incorporate a safety protocol, allowing emergency-stop and machine-stop systems to be seamlessly integrated with the network.

AS-i can be used as a stand alone network or can be connected to a higher level system, such as DeviceNet™ or PROFIBUS®-DP, through a gateway. The gateway acts as a slave to the higher system and a master to the AS-i system.

### Typical System Configuration

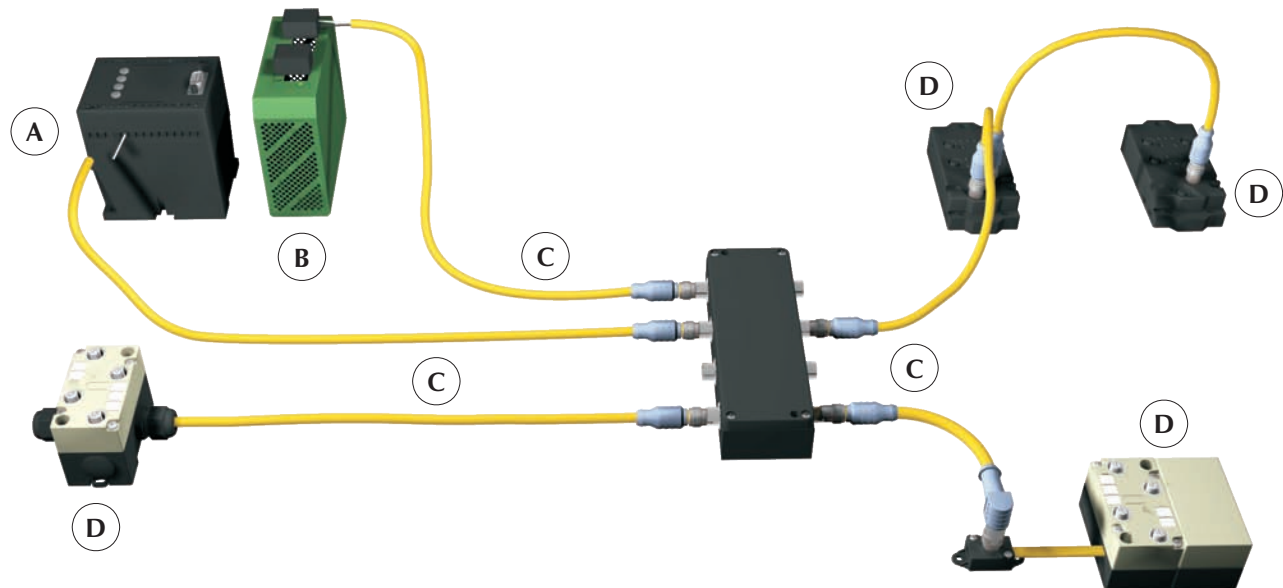

AS-interface

### Basic Parts List

A typical AS-i system consists of the following parts:

- A = Master
- B = AS-i Power Supply
- C = AS-i Cable
- D = AS-i I/O Modules (or Slaves)

AS-i stations require a network master (also called a scanner) to interface the stations to the host controller. In some cases the scanner and controller are packaged as a single unit; in other cases the scanner acts as a gateway to a higher level network or to a PLC. **TURCK** AS-i stations are designed to be fully compatible with AS-i equipment from other manufacturers.



## Communication Signal and Power

AS-i communication uses a Manchester encoded data signal, which results in a very noise immune system, even on the specified untwisted and unshielded cable. The communication media is a simple two-wire cable. Both power (30 VDC) for the stations and data are carried on the same wires. This means the DC supply must be "decoupled" from the network (the power supply cannot "see" the AC data component on the wire). Special AS-i power supplies are available, which incorporate this feature in a single package. Optionally, a separate AS-i decoupling component (power conditioner) can be purchased, allowing the user to use a standard 30 VDC supply.

In many cases the AS-i communication power supply is not sufficient to power higher current outputs on the network. In these cases most manufacturers make AS-i slaves which draw I/O current from a separate auxiliary supply. The station electronics are still powered from the AS-i network.

## Communication Rate/Cycle Time

AS-i communicates at a fixed data rate of 167 kbps. The system's cycle time is very predictable because of the simple communication scheme and fixed data rate. For example, a network with 31 slaves will have a cycle time of less than 5 ms. A network with 62 slaves (all A and B addresses used) will have a cycle time of less than 10 ms. If analog slaves are being used, the cycle time will change to account for the fact that an analog word takes multiple network cycles to transmit.

## Maximum Ratings

The AS-i system uses a freeform layout topology. Up to 100 m of cable can be used on a segment before a repeater or tuner needs to be installed to allow the network to be extended beyond the 100 m limit. No terminating resistors are required.

## Diagnostics

AS-i has limited field diagnostic capability, due to the limited amount of data transferred in each message. With v2.1, a peripheral fault bit can be reported by an AS-i station to indicate a fault with a field device. This allows the user to easily determine the location of a system fault down to the station level. AS-i v3.0 has even more diagnostic capabilities, allowing asynchronous "mailbox" messaging to receive more detailed error information.

Bihl+Wiedemann AS-i masters (provided by **TURCK**) provide comprehensive information about the status of each station on the network by using register based tables to display each occupied network address.

## Addressing

The original AS-i system allowed only 4 bits of data to be transferred in each message for a fast and efficient data transfer system. Slaves could be addressed from one to 31, but with the growth of the network more than 31 stations were often required. Beginning with AS-i v2.1 stations were available with "AB" addressing. This scheme allows the station to be addressed from 1A to 31A or 1B to 31B, with 62 total slaves with four discrete inputs and three discrete outputs each. The extended address range (and the limitation to three outputs) is achieved by using one output bit as an AB address.

When both A and B addressed slaves are on the same network, they are scanned on alternating cycles (first all the A slaves are scanned, then all the B slaves). Both AB and single-address slaves can be on the same network. In this case the single-address (non AB style) slaves are scanned every cycle. It's important to note that not all v2.1 slaves use this addressing scheme, although it is often referred to as v2.1 addressing.

## Analog Data

Although the original AS-i version only allowed discrete data transfer, v2.1 and higher support seamless analog data transfer. This is accomplished by sending a portion of the analog data on each of several consecutive network cycles; for example, a 16-bit word of data requires seven network cycles. Further, AS-i v3.0 allows analog data to be transferred in a single cycle by consuming more than one address for the analog slave.

## TURCK & Bihl+Wiedemann

Bihl+Wiedemann, considered the "AS-i masters", is the leading supplier of AS-i master and gateway products. Their broad product range enables users to select from a wide variety of higher level fieldbuses or PC/PLC control solutions. Additionally, Bihl+Wiedemann provides a wide variety of analog AS-i slaves, PC-board level devices for OEMs and sophisticated AS-i accessory products. **TURCK** has partnered with Bihl+Wiedemann to distribute and support their products in North America.

## Cordsets

**TURCK** offers a complete line of molded AS-i cordsets to facilitate network installation, resulting in a faster start-up and fewer wiring errors. The cables are specially designed, high-flex cables with very low inductance and capacitance to minimize propagation delay time. AS-i cables consist of a single untwisted and unshielded wire pair that carries both 30 VDC power and the network data. AS-i was originally designed for use with flat cable using an insulation displacement connection technology, but the use of round cables with sealed connectors has become more common. **TURCK** provides both cable options.



Typical AS-i cable

## AS-interface Masters and Gateways

AS-i networks can be controlled by stand-alone "masters" or by "gateways" to higher-level networks. The terms "master" and "gateway" as used here differ in the following way: A master is an AS-i controller that provides a direct link to the host (PLC, PC, DCS etc.); a gateway is an AS-i master, while also being a slave to a higher-level system (such as DeviceNet™, PROFIBUS®-DP or Ethernet). In the case of a gateway, the AS-i information is compiled by the AS-i master and communicated through the higher-level system as a standard slave data map. Gateways are often used to incorporate the flexibility of an AS-i system into an already planned or existing system using a different, higher-level system.





## PROFIBUS<sup>®</sup> System Description

PROFIBUS is an industrial network protocol that connects field I/O devices in order to eliminate hard wiring. The network connection increases device-level diagnostic capabilities, while also providing high-speed communication between devices.

PROFIBUS<sup>®</sup>-DP is the version of PROFIBUS that is normally used for factory automation and machine control solutions. It is based on the RS-485 serial data transfer standard. In most cases, the termination and physical media rules for PROFIBUS-DP are the same as those required for RS-485 communication. A PROFIBUS-DP network supports up to 126 nodes and virtually an unlimited amount of I/O. The bus uses a trunkline/dropline topology. Power and communication are provided via separate cables, allowing easy segmentation of the power structure to avoid overloading.

PROFIBUS-DP is capable of running at data rates as high as 12 Mbaud. When used at high data rates, the cable drop length from the trunk to a node is severely limited. For example, when used at 12 Mbaud, nodes must be directly connected to the trunk, with no drop length allowed.

Although PROFIBUS-DP is well suited to machine control applications it is also useful for process and hazardous area situations (in fact the name PROFIBUS is an abbreviation of PROcess Field BUS). Products like TURCK's Excom system allow connection from a PROFIBUS-DP network directly to I/O devices in classified areas, resulting in a huge potential savings on barriers and wiring.

PROFIBUS<sup>®</sup>-PA is another version of PROFIBUS, designed for hazardous area usage. It operates as an extension from the PROFIBUS-DP system. Using the same media specification as FOUNDATION<sup>™</sup> fieldbus (IEC 61158-2), it allows network communication directly in hazardous areas. All devices on a PROFIBUS-PA system are controlled by the PROFIBUS-DP master. The conversion from DP to PA is accomplished by a linking or gateway device, which converts from the high speed RS-485 DP communication to the lower speed (31.25 kbps) IEC 61158-2 communication required for PROFIBUS-PA. The logical communication structure is identical between the systems; only the physical media is different.

### A Typical PROFIBUS-DP Network

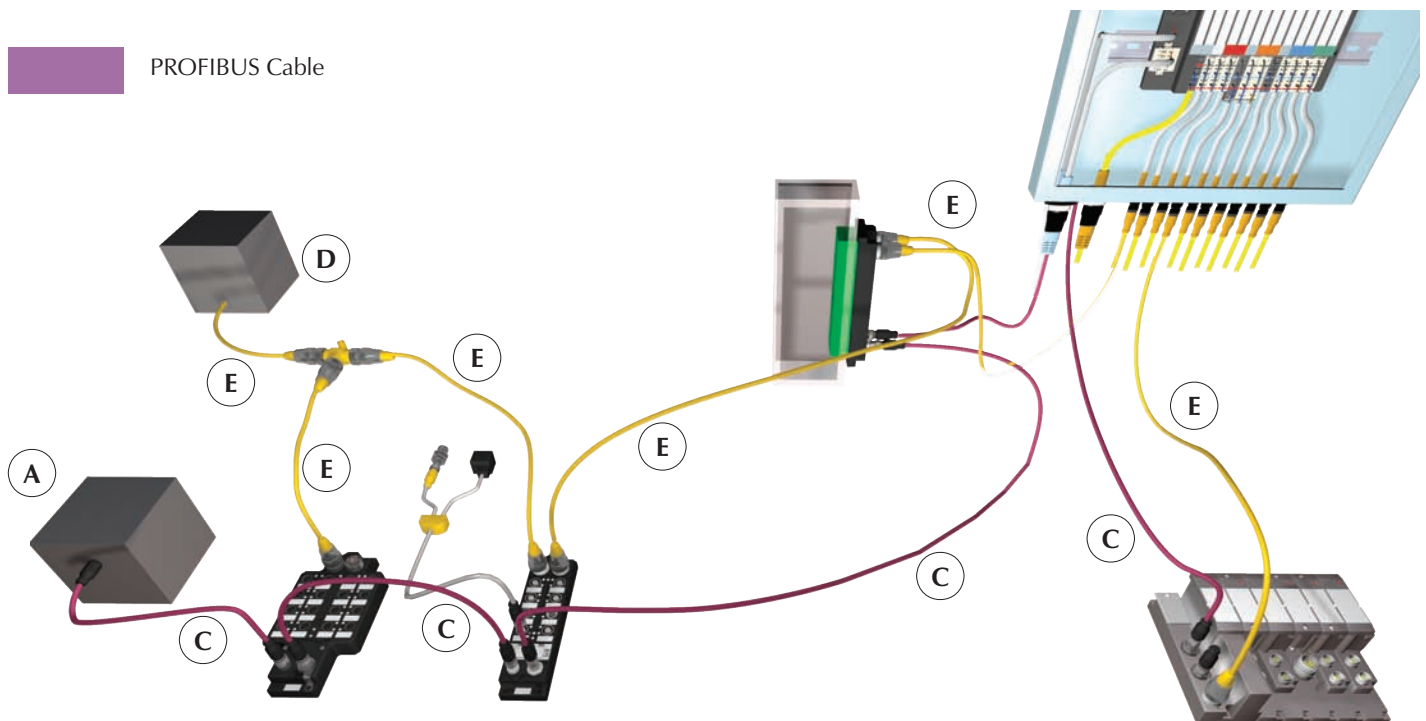

## A Typical PROFIBUS®-PA Network, Connected to a Higher-Level PROFIBUS®-DP System

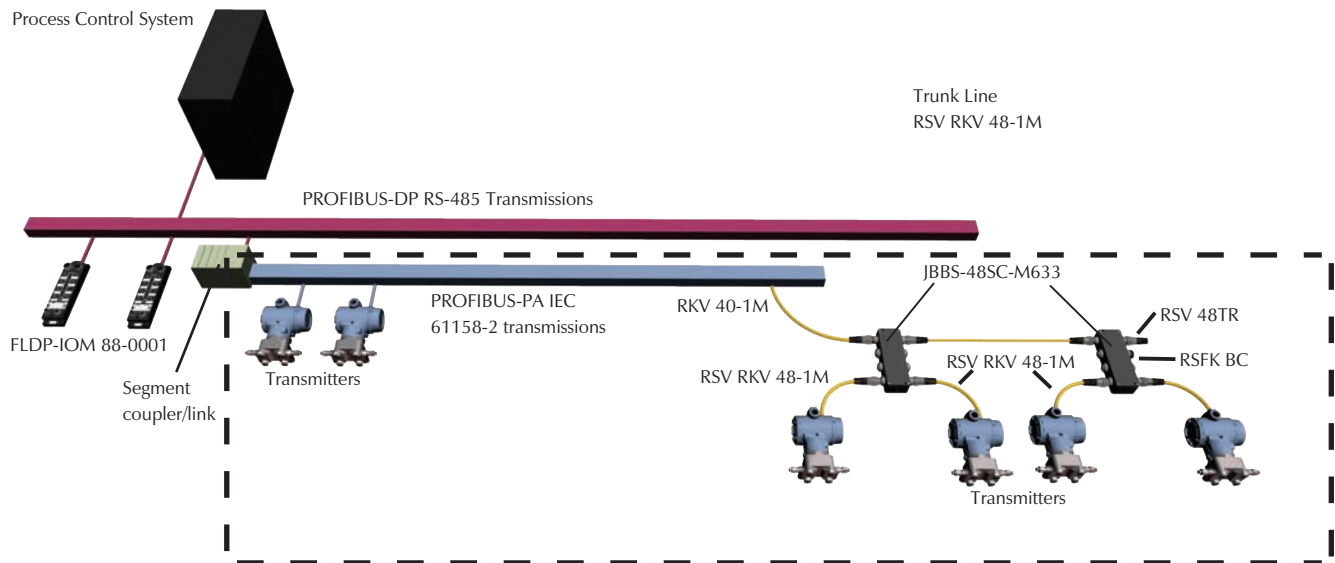

### Basic Parts List

A typical PROFIBUS® system consists of the following parts:

- A - Master
- B - Slaves
- C - Communication cable
- D - Power supply
- E - Power cable (PROFIBUS-DP)

PROFIBUS stations require a network master (also called a scanner) to interface the stations to the host controller. **TURCK** PROFIBUS-DP stations are designed to be fully compatible with PROFIBUS-DP equipment from other manufacturers.

### Communication Rate/Cycle Time

PROFIBUS-DP specifications define multiple transmission speeds ranging from 9.6 kbaud to 12 Mbaud. All nodes on a network must communicate at the same rate.

The complete cycle time of a PROFIBUS-DP system is affected by several factors:

- Number of nodes being scanned
- Amount of data produced and consumed by the nodes
- Network communication rate
- Cycle time of the control program

All of these factors must be considered when calculating the cycle time of a particular network.

## Maximum Ratings

The PROFIBUS<sup>®</sup>-DP bus uses a trunkline/dropline topology. The trunk is the main communication cable and requires the appropriate RS-485 termination at both ends of the trunk. Terminating resistors are available as plug-in **euromast**<sup>®</sup> modules or can be built into the D9 connectors. The length of the trunk depends on the communication rate. Drops or branches off the trunk are allowed, but are greatly limited as the communication rate increases. The table shows the maximum ratings for a PROFIBUS-DP trunk at different communication rates.

Communication Rate	Max. Segment Length
9.6 kbps	1200 m
19.2 kbps	1200 m
93.75 kbps	1200 m
187.5 kbps	1000 m
500 kbps	400 m
1.5 Mbps	200 m
12 Mbps	100 m

PROFIBUS<sup>®</sup>-PA has the same physical limitations as Foundation<sup>™</sup> fieldbus, identified in this table.

Cable	Number of Devices	Maximum Spur Length
Trunk	25-32	0 m (0 ft.)
	19-24	30 m (98 ft.)
	15-18	60 m (197 ft.)
1900 meters	15-18	60 m (197 ft.)
	13-14	90 m (295 ft.)
	2-12	120 m (394 ft.)

## Diagnostics

**TURCK** network stations provide increased diagnostics over using traditional hard-wired I/O systems. **TURCK** stations also serve as a buffer between I/O devices and the PROFIBUS-DP network by detecting short circuits without disrupting communication.

The PROFIBUS-DP system includes a provision for special diagnostic data messages. These messages are triggered when a fault occurs at the station (for example a short circuit on a sensor). When the master asks the station for data, the station responds and includes a flag to indicate that diagnostic data is present. The master then asks for the diagnostic data, which is mapped to a special location in the controller's memory.

## Addressing

The valid range of PROFIBUS<sup>®</sup> node addresses is 0 to 125. **TURCK** station's addresses are usually set via rotary dials or switches on the node. Changes to the address settings take effect when the station power is cycled or when the station receives a software reset. Care must be taken to prevent the same address from being assigned to more than one node in a system. Bihl+Wiedemann PROFIBUS-DP to AS-i gateways addresses are set in software using the on-unit display.

PROFIBUS

## Cordsets

**TURCK** offers a complete line of molded PROFIBUS<sup>®</sup>-DP and PROFIBUS<sup>®</sup>-PA cordsets to facilitate network installation, resulting in a faster start-up and fewer wiring errors. The bus and drop cables are specially designed foil-shielded, high-flex cables with very low inductance and capacitance to minimize propagation delay time. PROFIBUS-DP cables consist of a shielded and twisted data pair with a bare drain wire. PROFIBUS-PA cables feature a shielded, twisted pair for data and bus power and a drain wire.

In most cases, connections of the bus cable to the stations are made using 5-pin reverse-key **euromast**<sup>®</sup> (M12) connectors for PROFIBUS-DP. A variety of stations are also available that support D9 type connections. Power for most stations is provided through one or two 5-pin **minifast**<sup>®</sup> (7/8-16UN) connectors.

PROFIBUS-PA connections are typically made with **minifast** style connectors, though **euromast** connections are available as well.

**TURCK** cordsets for the PROFIBUS<sup>®</sup> system are available in standard lengths. Please contact your local sales representative to order custom lengths.

## Typical PROFIBUS-DP Cable

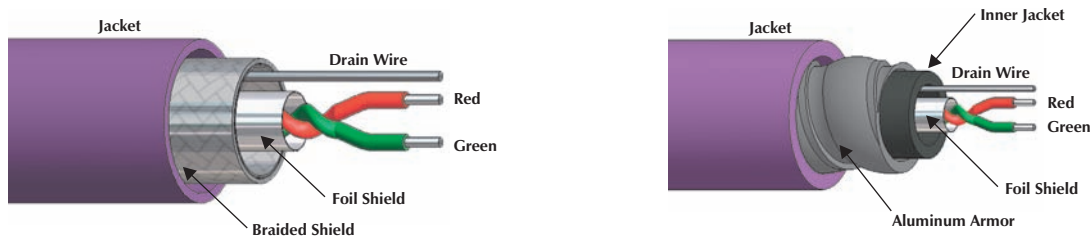

## Typical PROFIBUS-PA Cable



## GSD Files

GSD files contain detailed information about a PROFIBUS-DP device, including I/O data size and the devices configurable parameters. The information in an GSD file, when used with a PROFIBUS-DP configuration tool, guides a user through the steps necessary to configure a device. GSD files are available on the **TURCK** website ([www.turck.com](http://www.turck.com)).

## Notes:



## System Description

Ethernet is the most popular protocol used to connect office computers and peripherals today. It is increasingly finding its way into other applications, and is rapidly becoming the network of choice for higher level industrial control applications. Ethernet is primarily used to connect PLCs, computers, HMI displays and other high level components.

The term “Ethernet” actually refers to the lower level communication structure. Various different versions, or implementations, of Ethernet are available, such as Ethernet/IP™, Profinet and Modbus-TCP. It is important to note that while all of these different specifications use the same physical communication method and can operate on the same cable simultaneously, they cannot necessarily communicate with each other. For example, Modbus-TCP devices cannot communicate with Ethernet/IP devices. This is because the messages and communication protocol have been defined differently for these systems, even though the physical electrical structure is the same. Think of it as two people who speak different languages; they speak by moving air with their mouths, but the rules of the languages are different.

TURCK's BL67 Ethernet gateways provide a convenient way to connect industrial I/O devices directly to the Ethernet system, expediting monitoring and troubleshooting for the overall control scheme.

## Typical System Configuration

### Basic Parts List

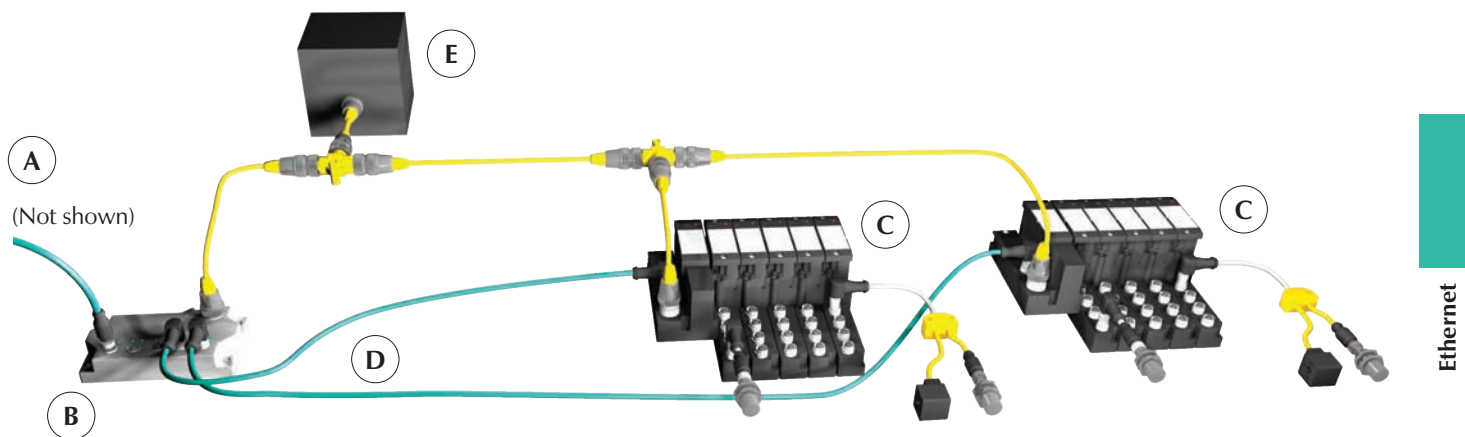

A typical Ethernet system consists of the following parts:

- A - Controller
- B - Switches
- C - Ethernet I/O modules
- D - Ethernet cable
- E - Power supply

Ethernet I/O modules act as servers on a network. A client device is needed to retrieve data from and post data to the server. This is analogous to an office network, where the client PC on a user's desk may actively connect with multiple servers to access information in different areas of the enterprise. TURCK Ethernet stations are designed to be fully compatible with established Ethernet standards for industrial use.

## Addressing

Industrial Ethernet stations use the IP addressing scheme. An address defined by this scheme consists of four byte values usually displayed in decimal form, for example, 192.168.1.254. Different classifications of networks require different portions of this address to be constant for all devices on the network (referred to as a “subnet”). This means that the number of stations allowed on a particular network varies depending on what class of subnet is being used. If the first three bytes of the IP address are constant (which is common), then the remaining byte may be addressed between 2 and 254, resulting in 253 possible addresses.

## Maximum Ratings

Ethernet allows different maximum cable lengths depending on the type of cable being used. Normally an Ethernet segment may be as long as 100 m, where 90 m must be solid core cable and the remaining 10 m can be stranded patch cords.

## Cordsets

**TURCK** offers a complete line of molded Ethernet cordsets to facilitate network installation, resulting in a faster start-up and fewer wiring errors. Cables are available with stranded or solid-core conductors, with or without shielding.

Most **TURCK** Ethernet equipment uses the 4 or 8-pin (M12) *euromast*® connector specifications. These connectors provide a tough, rugged seal, and are IP 67 rated. In some cases (mainly in the control cabinet) a traditional RJ45 Ethernet connector needs to be used. **TURCK** provides RJ45 cordsets, as well as a variety of devices made to convert between RJ45 and *euromast* connectors.

**TURCK** cordsets for the Ethernet system are available in standard lengths. Please contact your local sales representative to order custom lengths.

**8-Wire Ethernet Cable**

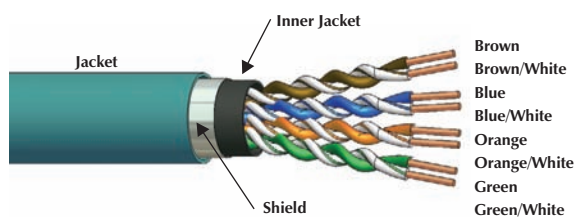

**4-Wire Ethernet Cable**

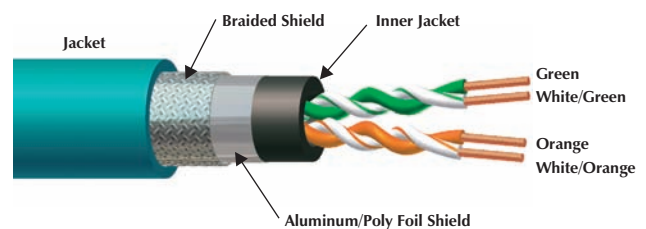



## Notes:

## Code Requirements for Flexible Process Wiring Products Ordinary (Nonhazardous) Locations

**Figure 1**



Type ITC cable, or Instrumentation Tray Cable, provides a cost effective alternative for installation of low power instrumentation and control circuits. The National Electrical Code's (NEC) Article 727 permits the use of ITC-rated cables "in industrial establishments where the conditions of maintenance and supervision ensure that only qualified persons service the installation". It may be used in "instrumentation and control circuits operating at

150 volts or less and 5 amps or less." Permitted uses include installation in cable trays or basket trays (Figure 1), or as Exposed Run wiring in specified circumstances.

One of the permitted uses as of ITC cable is illustrated in Figure 2. NEC's, Article 727.4(5) allows ITC cable without metallic sheath or armor between cable tray and equipment in lengths not to exceed 15 m (50 ft.), where the cable is supported and protected against physical damage using mechanical protection, such as struts, angles, or channels.

**Figure 2**

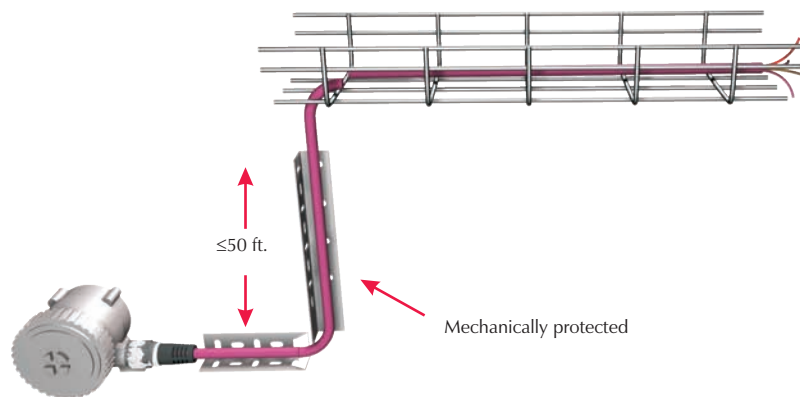

**Figure 3**

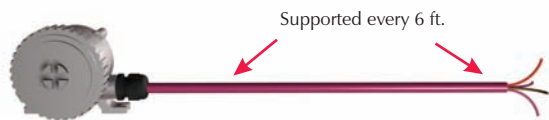

Another permitted use of ITC cable that increases flexibility is illustrated in Figure 3. NEC Article 727.4 (4) allows ITC cable to be used "as open wiring where enclosed in a smooth metallic sheath, continuous corrugated metallic sheath, or interlocking tape armor applied over the nonmetallic sheath in accordance with 727.6. The cable shall be supported and secured at intervals not exceeding 1.8 m (6 ft.)."

When using armored cable, there is no requirement for further mechanical protection or a length limitation. When using ITC cable that complies with the requirements of NEC 727.4(6) no further protection is required.

## Code Requirements for Flexible Process Wiring Products Ordinary (Nonhazardous) Locations

Requirements NEC 727.4(6) allows the installation of ITC cable that complies with the crush and impact of Type MC cable between the cable tray and equipment in lengths not to exceed 15 m (50 ft.) without additional protection. Cable meeting this requirement is identified as "Exposed Run" or "ER" (Figure 1).

This concept enables convenient wiring methods, given that drops from a cable tray may be made without additional auxiliary trays or raceways. Additionally, ITC cable uses 300 volt insulation, resulting in smaller diameter, more flexible cable, with no requirement for special (e.g. Class II) power supplies. When the ITC cable concept is combined with the **TURCK** process wiring system, the result is an extremely flexible and cost-effective system for process wiring. The basic building blocks of the system are device receptacles, junction boxes, and molded cordsets.

Figure 1

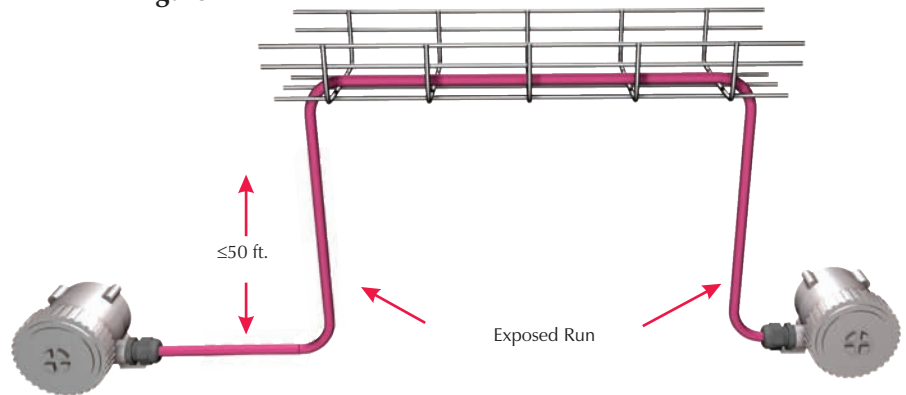
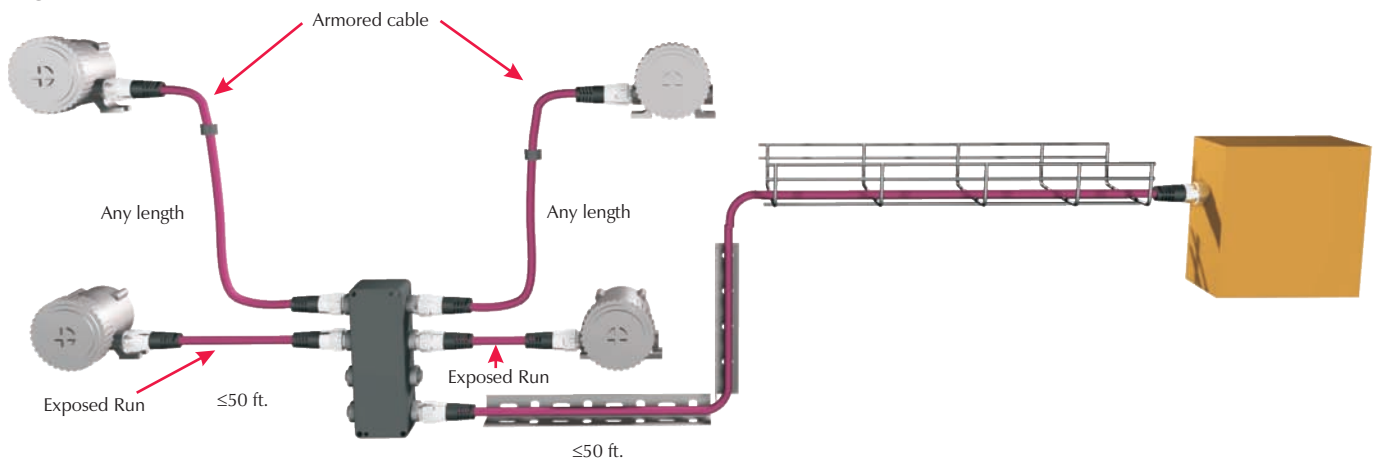

Figure 2



# TURCK

## Process Wiring Solutions



Receptacles with 1/2-14NPT and 3/4-14NPT threads, as well as M20x1.5, easily extend the benefits of quick-disconnect wiring to most process instruments.

Junction boxes can significantly consolidate field wiring. They are available in metal or nylon housings with 4 or 8 ports and home-run quick-disconnects or integral home-run cables.



The **TURCK** process wiring system provides an integrated, code-compliant wiring method that adds the benefits of quick-disconnects to the ITC cable installation concepts.

Molded quick-disconnect cordsets, using ITC cable, provide the ratings and performance characteristics required for process applications.



### Hazardous Locations



Even more value can be derived from the **TURCK** process wiring system in hazardous locations. The system is now FM approved for use in Class I, Divisions 1 and 2 when installed per **TURCK** drawing QCF-00147. Contact **TURCK** for a copy of the approval or visit [www.turck.com/fmcd](http://www.turck.com/fmcd). The following are the highlights of the approval.

### Intrinsically Safe Circuits

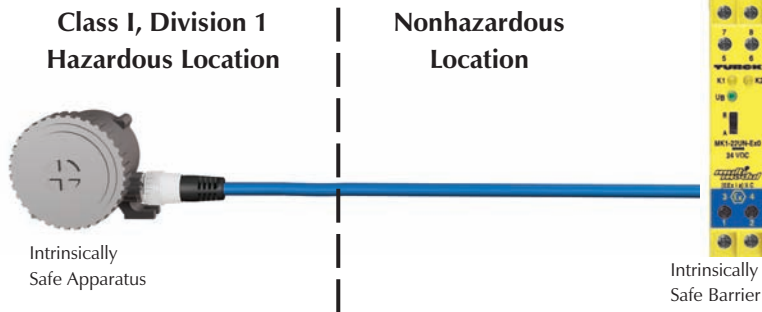

Intrinsically safe circuits may be wired using any of the wiring methods suitable for unclassified locations. The use of connectors is allowed as intrinsically safe circuits are safe against faults, including opening, shorting or grounding.

The same requirements for mechanical protection and length limitations apply as in nonhazardous locations.

### Nonincendive Equipment

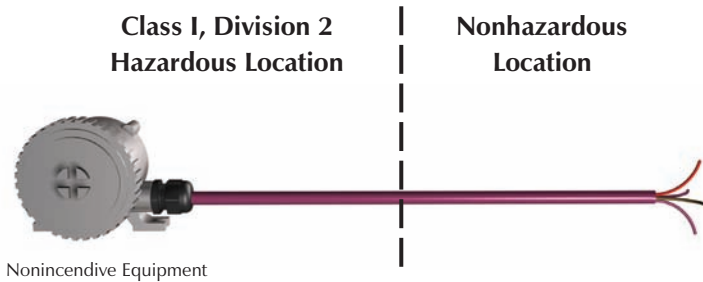

ITC cable is a recognized Division 2 wiring method. NEC in Article 501.10 (B)(1)(5) states "Type ITC cable as permitted in 727.4". This is further reinforced by Article 727.4 (3), which states that ITC cable is permitted "in hazardous locations as permitted in 501.10,...".

The same requirements for mechanical protection and length limitations apply as in nonhazardous locations.

# TURCK

## Process Wiring Solutions

Quick-disconnects require a tool to disengage and are considered “normally arcing”. They are not allowed to be used in Division 2 for incandive equipment without additional protection.

**lokfast™** guards enable the use of quick-disconnect technology in Class I, Division 2 hazardous locations.

**lokfast** guards render quick-disconnects not “normally arcing” by:

- Eliminating access to the coupling nut making disconnection impossible.
- Warning the user to disconnect power before removing.
- Requiring a tool for removal.

**lokfast** guards are available for 7/8-16UN **minifast®** and M12 **euromast®** molded and field-wireable connectors.

Optional M23 **multifast®** home-run connectors with set screw locks also render a connection not “normally arcing”.



**lokfast** guards (or integrally locked **multifast** connectors) on all quick disconnects in Division 2 (Figure 1).

The molded construction of the home-run connector and the gas/vapor tight continuous sheath meet the NEC Article 501-15(E)(2) requirements for cable seals in Division 2.

The same requirements for mechanical protection and length limitations apply as in to nonhazardous locations.

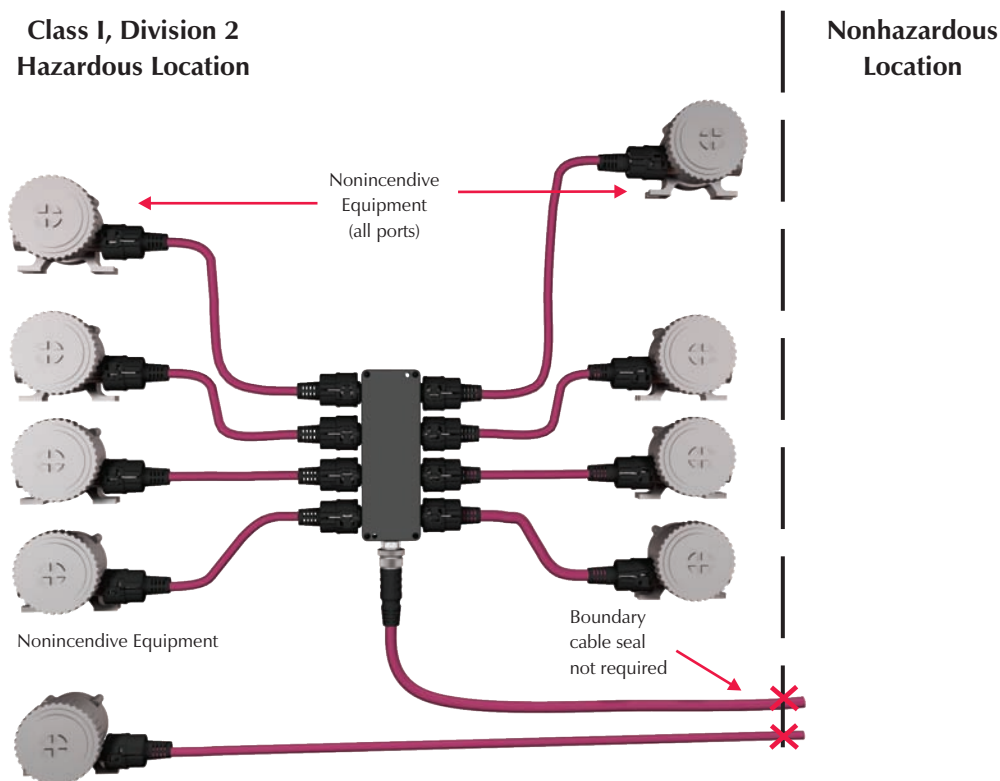

Figure 1

**Intrinsic Safety Summary**

Intrinsically safe circuits do not require additional protection for quick-disconnects.

Junction boxes must have FM-approved spacings and entity parameters for intrinsically safe circuits.

Boundary seals are not required for this location, as the molded home-run connector and the gas/vapor tight continuous cable sheath meet the NEC Article 501-15(C) requirements for cable seals in Class I, Divisions 1 and 2.

Requirements for mechanical protection and length limitations are equivalent to nonhazardous locations.

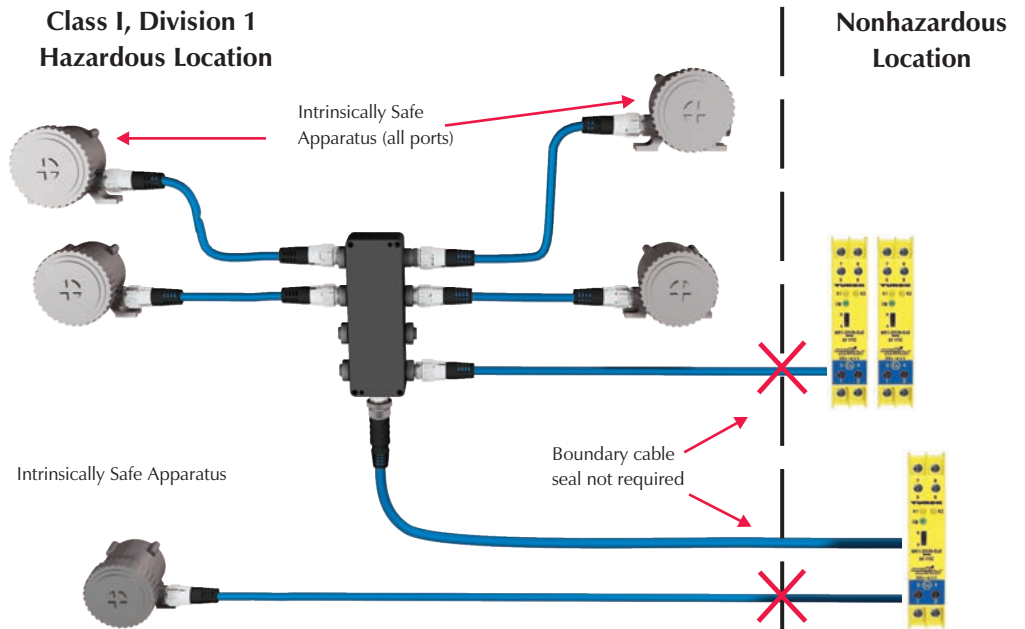

**Explosion Proof Equipment**

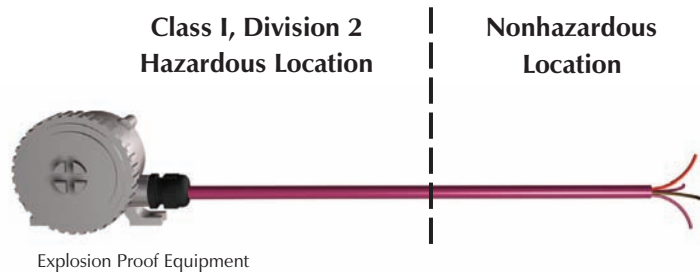

ITC cable, a recognized Division 2 wiring method, may be used to connect explosion proof equipment installed in Division 2 when used with an explosion proof feed-through receptacle. The extremely robust receptacle maintains the equipment's explosion containment protection scheme. The external wiring, however, is in Division 2, and can therefore be installed using Division 2 wiring methods.

# TURCK

## Process Wiring Solutions

### Installing Cable Products in Accordance with the National Electrical Code (NEC)

The NEC is a set of guidelines for installation of electrical devices, including cables, meant to reduce the risk of electrical shock, fire, etc. The NEC is simply a code and local laws may or may not require installation based on the NEC. Check local laws for applicability.

The NEC generally does not cover cables installed inside a machine. Any cables installed in an exposed manner, on the outside of a machine or from one machine to something else, must be an approved type and installed in accordance with the appropriate NEC articles.

UL (Underwriters Laboratory) and CSA (Canadian Standards Association) are the primary sources in North America for approving cables to specific standards. While a cable installed within a piece of machinery does not fall under the NEC, most people want to install an approved cable. **TURCK** cables have both UL and CSA approvals. Many of these approvals are the UL AWM (Appliance Wiring) approvals and are acceptable for use in a UL approved device. A UL Listed cable may be installed outside a machine per the NEC standards. UL Listed cables available from **TURCK** include NEC designations for hard duty cables (SOOW, SJOOW, STOOW, SEOW), armored cables (MC), and tray-rated cables (PLTC, ITC).

Hard duty cables designations are:

S - Service Grade (600V)

SJ - Service Grade Junior (300V)

ST - Service Grade Thermoplastic (600V)

SE - Service Grade Thermoplastic Elastomer (600V)

O - Oil resistant jacket material

OO - Oil resistant jacket and conductor insulation

W - Weather proof

**TURCK** armored cables are available in 3 different configurations. Type MC cables, type MC cables with ITC/PLTC approvals and simply ITC/PLTC approved. Armored cables with ITC/PLTC approvals may be installed in an exposed run without being offered additional mechanical protection.

Tray-rated cables from **TURCK** include Instrument Tray Cable (ITC) and/or Power Limited Tray Cable (PLTC).

**TURCK** NEC type approved cables are dual listed with other UL type approvals. For example, the RKM 126-\*M cordset has a 12 conductor 16 AWG cable with UL AWM 600V approval and ITC/PLTC approval.

Please refer to the NEC and local laws for specific installation requirements based on your environment.



## Cable Applications

Proper management of cabling systems can mean the difference between a dependable and smooth operating installation and costly reoccurring down time. The suggestions outlined below illustrate some of the common sources of problems and provide simple and effective solutions.

### Proper Bend Radius for Fixed and Moving Applications

Providing sufficient bend radius will allow the cable to absorb the energy of bending over a greater portion of its length, increasing its effective working life. Small increases in the radius of the bend can produce substantial increases in cable life.

Fixed Applications:  
Minimum bend radius 5x cable diameter

Moving Applications:  
Minimum bend radius 10x cable diameter



### Eliminating Stress Points in Cable Dress

Installing cables to allow for adequate stress loops and freedom of motion increase the life of the cables. TURCK cordsets incorporate molded strain reliefs that will assist in preventing stress.

Tie Down Loops

Strain Relief

Correct

Incorrect

Correct

Incorrect

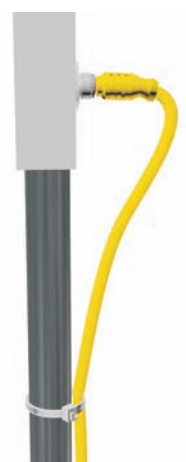

Process Wiring Environments

### Cable Bundling Techniques

When bundling several cables together, always keep the bundle loose enough to move within itself. Tightly tied bundles create both compression and tension stresses when the bundle is moved.

Correct

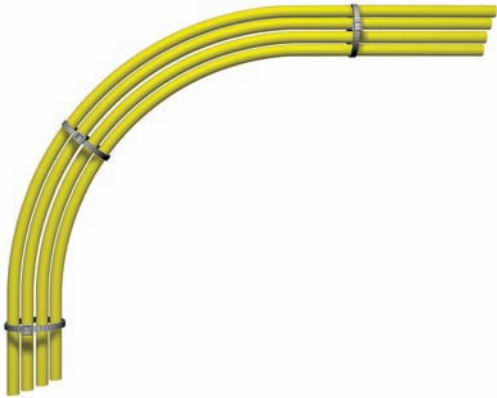

Incorrect

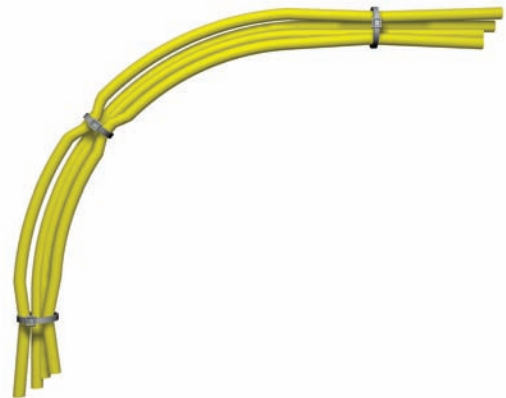

### Cabling for Motion Applications

Where cabling is subjected to linear, angular or rotational motion between two points, always allow adequate cable length to absorb the energy imparted by the motion. Use of coiled cords, mechanical support mechanisms, or large, well supported cable loops will maximize cable life.

Coil Cord

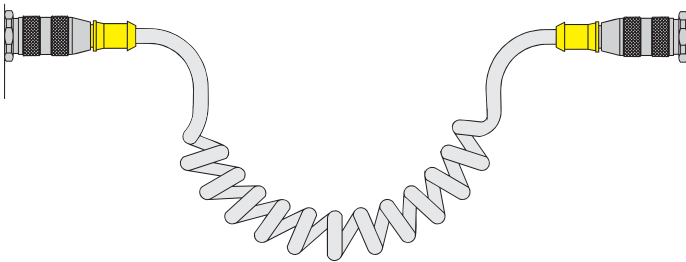

Cable Loop

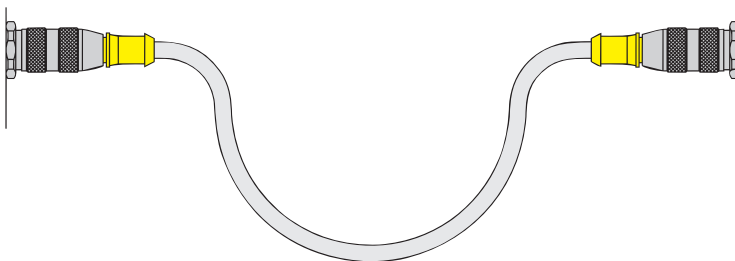

"C" Track

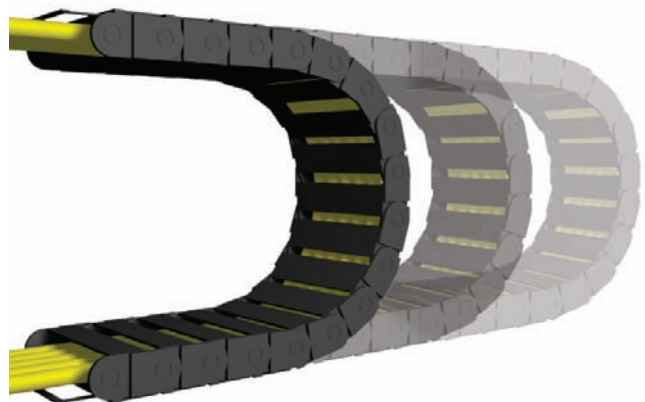

## Tying Cables with Cable Ties

When tying cable with self locking cable ties, always leave the ties loose enough for the cables to slide freely under the tie. Over tightening will create stress concentrations that can cause the conductors to fail prematurely. Never tighten the tie to the point where the cable jacket becomes deformed or pinched.

Correct

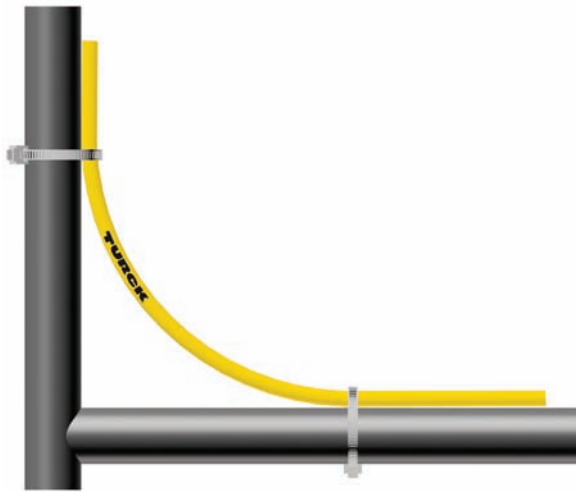

Incorrect

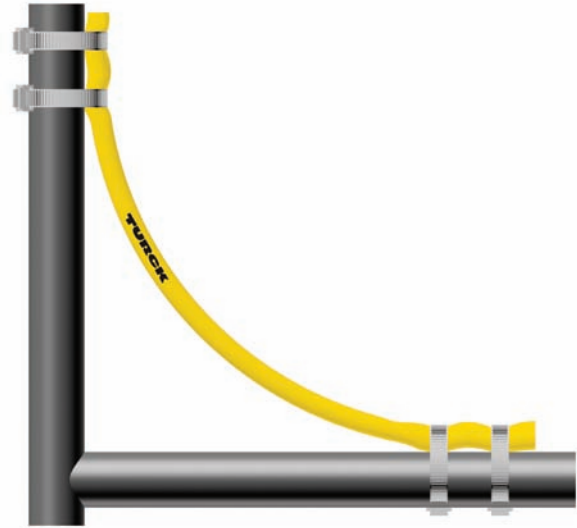

# ....Sense It!....Connect It!....Bus It!

Access to all TURCK catalogs, press releases, white papers and tutorials

Search for products by part number, ID number or key word

Complete category listing of TURCK products

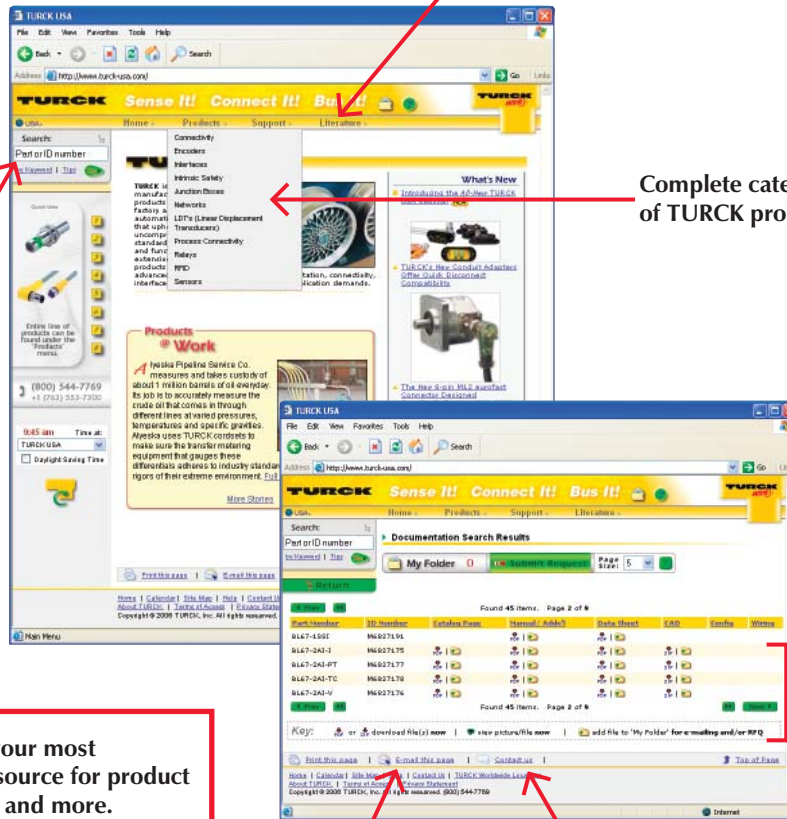

Access to CAD, wiring and pinout diagrams

Download or e-mail files, request for quote

TURCK's USA website is your most complete and up-to-date source for product documentation, CAD files and more. Search results produce downloadable documentation or request for quote (RFQ). Additional product information or CAD files are easily requested and promptly filled.

Visit our site for new product releases, approvals, white papers, application support and more.

Option to e-mail pages

Contact a TURCK representative

[www.turck.com](http://www.turck.com)

**TURCK USA**  
TURCK Inc.  
3000 Campus Drive  
Minneapolis, MN 55441  
Phone: (763) 553-7300  
Fax: (763) 553-0708  
Application Support:  
1-800-544-7769

**TURCK Mexico**  
TURCK MEXICO S. DE R.L. DE C.V.  
Carr Saltillo-Zacatecas km 4.5 s/n  
Parque Industrial "La Angostura"  
Saltillo, COAH. C.P. 25070  
MEXICO  
Phone: +52 (844) 411-6647/46  
Fax: +52 (844) 482-6926  
Toll Free: 01-800-01-88725 (Mexico only)  
email: ventasmexico@turck.com

**TURCK Canada**  
CHARTWELL  
ELECTRONICS, INC.  
140 Duffield Drive  
Markham, Ontario  
Canada, L6G 1B5  
Phone: (905) 513-7100  
Fax: (905) 513-7101  
Toll Free: 1-877-513-7769

**TURCK World Headquarters**  
Hans TURCK GmbH & Co. KG  
Witzlebenstrasse 7  
D-45472 Muelheim der Ruhr  
Federal Republic Of Germany  
Phone: (+49) 208-49 52-0  
Fax: (+49) 208-49 52 264