



# HP BladeSystem c3000 Enclosure

technology brief, 3<sup>rd</sup> edition

Abstract.....	3
Overview of HP BladeSystem c3000 Enclosure .....	3
Managing the c3000 enclosure .....	5
BladeSystem Onboard Administrator .....	5
Detecting component insertion and removal.....	6
Identifying components .....	6
Managing power and cooling .....	6
Controlling components.....	6
Redundant enclosure management .....	8
User interfaces for the BladeSystem Onboard Administrator .....	8
Security .....	8
Role-based user accounts.....	9
Enclosure linking .....	9
ProLiant Onboard Administrator (Integrated Lights-Out 2) for ProLiant server blades .....	10
Insight Display .....	10
HP Insight Control suite .....	11
BladeSystem Onboard Administrator cabling .....	11
Enclosure-based DVD ROM.....	12
Enclosure KVM Module .....	13
Interconnect options and infrastructure.....	13
Interconnect modules .....	15
Server blades .....	16
Storage options inside the BladeSystem enclosure.....	16
Direct attach storage blades .....	16
Shared storage .....	17
External SAS connectivity with direct connect SAS storage for HP BladeSystem.....	17
NAS/SAN Gateway .....	17
Storage server.....	17
Mezzanine cards .....	18
Virtual Connect.....	18
Fabric connectivity and port mapping.....	19
c3000 bay-to-bay crosslinks .....	22
Device bay crosslinks.....	22
Interconnect bay crosslinks .....	23
HP Thermal Logic technologies .....	23
Active Cool fans .....	23
HP PARSEC architecture.....	25
Parallel.....	25

Redundant and scalable .....	25
Thermal Logic for the server blade.....	26
Power supplies and enclosure power subsystem.....	27
Pooled power configuration and power redundancy options .....	29
Dynamic Power Saver mode .....	29
HP Power Regulator for ProLiant .....	30
Basic Power Capping for each server blade .....	30
HP Dynamic Power Capping .....	30
Power meter .....	31
HP BladeSystem Power Sizer .....	31
Summary .....	31
Appendix. Fan, power supply, and device bay population guidelines.....	32
For more information.....	37
Call to action .....	37

## Abstract

The HP BladeSystem c3000 Enclosure is an evolution of the entire rack-mounted infrastructure. It is designed for remote sites, small and medium-sized businesses, and data centers with special power and cooling constraints. This technology brief provides an overview of the HP BladeSystem c3000 Enclosure, Thermal Logic power and cooling technologies, and interconnect options.

It is assumed that the reader is familiar with HP ProLiant server technology and has some general knowledge of BladeSystem architecture. More information about the infrastructure components and BladeSystem technologies is available at [www.hp.com/go/bladesystem](http://www.hp.com/go/bladesystem).

## Overview of HP BladeSystem c3000 Enclosure

The HP BladeSystem c3000 Enclosure is the newest enclosure implemented using the BladeSystem c-Class architecture. While the BladeSystem c7000 enclosure is optimized for enterprise data center applications, the c3000 enclosure is optimized for other computing environments such as remote sites or small businesses. More information on c-Class architecture and the c7000 enclosure is available on the HP technology website at [www.hp.com/servers/technology](http://www.hp.com/servers/technology).

The c3000 enclosure is available in two different models, the c3000 rack model that fits into standard size HP and third-party racks, and the c3000 Tower model, which works well in sites without racks. Both models employ c-Class form-factor server blades, storage blades, and interconnect modules. The c3000 enclosure is optimized for computing environments such as remote sites, retail stores, small offices, oil platforms, ships, planes, trucks, or any site with limited power options. The c3000 enclosure is also designed for sites that may not have any special cooling capability; it can exist in environments of up to 35 degrees centigrade. The c3000 enclosure supports use of management devices such as local KVM switches for local administration.

The HP BladeSystem c3000 Enclosure has redundant signal paths between servers and interconnect modules. The NonStop signal midplane in the c3000 enclosure has no active components. The enclosure is available with a single-phase power subsystem that can run on either low-line (120 VAC) or high-line (240 VAC) power. Both c3000 models can be populated with the following components:

- Up to four full-height (FH) or eight half-height (HH) server and/or storage blades per enclosure
- Up to four interconnect modules simultaneously supporting a variety of network interconnect fabrics such as Ethernet, Fibre Channel (FC), InfiniBand (IB), Internet Small Computer System Interface (iSCSI), or Serial-attached SCSI (SAS)
- Active Cool fan kits for a maximum of six fans
- Up to six power supplies with either low-line or high-line power input<sup>1</sup>
- Single or dual BladeSystem Onboard Administrator (OA) management modules
- DVD drive
- Optional KVM enclosure module for connecting the c3000 to an in-rack KVM switch or HP TFT 7600 Rack Mount Keyboard/Monitor

Figures 1 and 2 show the front and rear views of both HP BladeSystem c3000 Enclosures.

---

<sup>1</sup> Typically, only four power supplies are required, especially in sites where non redundant AC input is acceptable.

Figure 1. HP BladeSystem c3000 Enclosure – front view

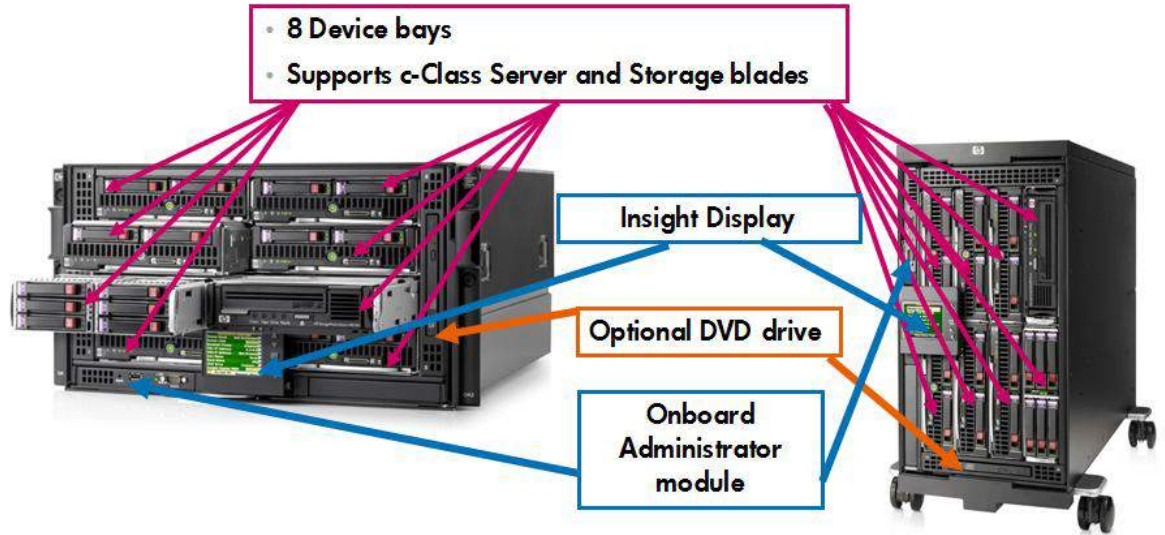
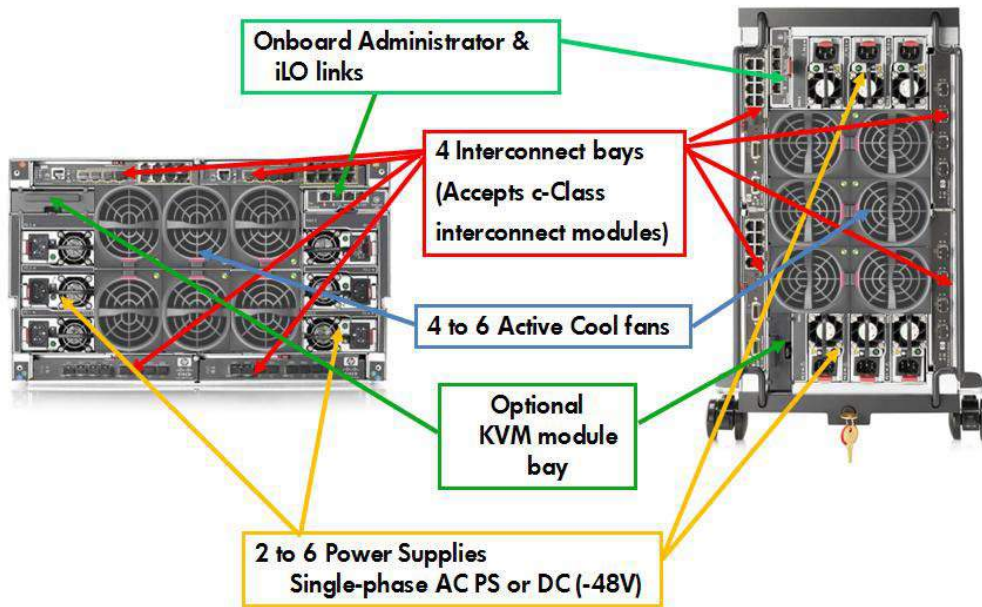

Figure 2. HP BladeSystem c3000 Enclosure – rear view



The c3000 and the c7000 enclosures have common critical components such as servers, interconnects, mezzanine cards, storage blades, power supplies, and fans. Table 1 lists components the two enclosures support.

**Table 1.** Components supported by HP BladeSystem c-Class Enclosures

Enclosure	c3000	c7000
Model	Rack (6U) or Tower	Rack (10U)
Blade orientation	Horizontal (rack) Vertical (Tower)	Vertical
Blades supported	8 HH , 4 FH, 6HH/1FH	16 HH, 8 FH
Interconnect bays	4	8
Power supplies	6 at up to 1200 watts each	6 at 2250 watts each
Active Cool fans	6	10
Enclosure KVM support	Yes	Yes
CD/DVD support	Enclosure-based available	External
OA support	Single or dual	Single or dual
Midplane speed	Tested up to 10 Gbit on Midplane	Tested up to 10 Gbit on midplane
OA Serial/USB connections	In front	In rear

## Managing the c3000 enclosure

The HP BladeSystem c3000 Enclosure has extensive embedded management capabilities based on three management elements:

- BladeSystem Onboard Administrator
- ProLiant Onboard Administrator powered by Integrated Lights-Out 2 (iLO 2) management processors that are integrated on the server blades
- Interconnect module management processors such as the HP Virtual Connect Manager

These integrated management elements provide powerful hardware management for remote administration and local diagnostics, as well as component and enclosure troubleshooting.

For detailed information about c-Class management technologies and capabilities, refer to the HP white paper titled “Managing HP BladeSystem c-Class systems”:

<http://h20000.www2.hp.com/bc/docs/support/SupportManual/c00814176/c00814176.pdf>.

### BladeSystem Onboard Administrator

The heart of c-Class enclosure management is the BladeSystem Onboard Administrator module located in the enclosure. It performs four management functions for the entire enclosure:

- Detecting component insertion and removal
- Identifying components and required connectivity
- Managing power and cooling
- Controlling components

An optional second BladeSystem Onboard Administrator in the c3000 enclosure provides complete redundancy for these functions.

IT administrators can access the BladeSystem Onboard Administrator in three different ways: remotely through the web browser graphical user interface (GUI), through the scriptable command line interface (CLI), or on site through the built-in Insight Display diagnostic LCD panel included in the front of every c-Class enclosure.

### **Detecting component insertion and removal**

BladeSystem Onboard Administrator provides component control in c-Class enclosures. When a component is inserted into a bay, the BladeSystem Onboard Administrator immediately recognizes and identifies the component through presence signals on each bay. If a component is removed from a bay, the BladeSystem Onboard Administrator deletes the information about that component.

### **Identifying components**

To identify a component, the BladeSystem Onboard Administrator reads a Field-Replaceable Unit (FRU) Electrically Erasable Programmable Read-Only Memory (EEPROM) that contains specific factory information about the component such as product name, part number, and serial number. All FRU EEPROMs in c-Class enclosures are always powered, even if the component is turned off, so the BladeSystem Onboard Administrator can identify the component prior to granting power. For devices such as fans, power supplies, and Insight Display, the BladeSystem Onboard Administrator reads the FRU EEPROMs directly. The BladeSystem Onboard Administrator accesses server blade FRU EEPROMs through their ProLiant Onboard Administrator (iLO 2) management processors.

Server blades contain several FRU EEPROMs: one on the server board that contains server information and embedded network interconnect controller (NIC) information, and one on each of the installed mezzanine option cards. Server blade control options include auto login to the ProLiant Onboard Administrator (iLO 2) web interface and remote server consoles, virtual power control, and boot order control. Server blade control options also include extensive server hardware information including BIOS and ProLiant Onboard Administrator (iLO 2) firmware versions, server name, NIC and option card port IDs, and port mapping. The BladeSystem Onboard Administrator provides easy-to-understand port mapping information for each of the server blades and interconnect modules in the enclosure.

From the NIC and mezzanine option FRU information, the BladeSystem Onboard Administrator determines the type of interconnects each server requires. Before granting power to a server blade, the BladeSystem Onboard Administrator compares this information with the FRU EEPROMs on installed interconnect modules to check for electronic keying errors. For interconnect modules, the BladeSystem Onboard Administrator provides virtual power control, dedicated serial consoles, and management Ethernet connections, based on the specific interconnect features that are included.

### **Managing power and cooling**

The most important BladeSystem Onboard Administrator tasks are power control and thermal management. The BladeSystem Onboard Administrator can remotely control the power state of all components in c-Class enclosures. For components in device bays in the front of each enclosure, the BladeSystem Onboard Administrator communicates with the ProLiant Onboard Administrator (iLO 2) to control servers and communicates with a microcontroller to control options such as storage blades. A separate microcontroller controls power to interconnect modules.

Once components are granted power, the BladeSystem Onboard Administrator begins thermal management with Thermal Logic. The Thermal Logic feature in the c3000 enclosure minimizes fan subsystem power consumption by reading “a sea of sensors.” Sensors are located throughout the enclosure. Thermal Logic adjusts fan speed in the four different cooling zones within the enclosure to minimize power consumption and maximize cooling efficiency.

### **Controlling components**

The BladeSystem Onboard Administrator uses embedded management interfaces to provide detailed information and health status for all bays in the enclosure (Figure 3). The BladeSystem Onboard



Administrator also reports firmware versions for most components in the enclosure and can be used to update those components.

**Figure 3.** Management communications between the BladeSystem Onboard Administrator and other components in an HP BladeSystem c3000 Enclosure

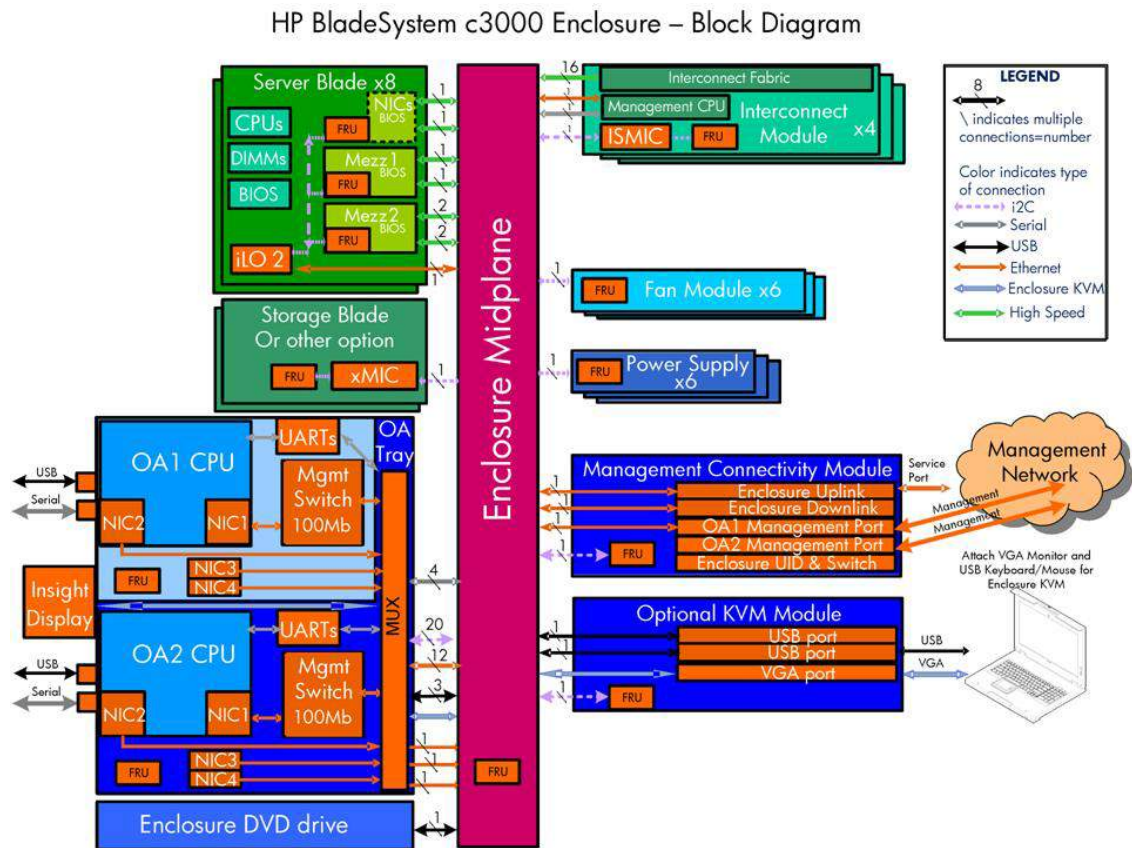

### c3000 internal management interfaces

The BladeSystem Onboard Administrator monitors and communicates with several hardware interfaces to each bay in the c3000 enclosure. The management hardware interfaces include unique presence pins, Inter-Integrated Circuit (I2C), serial, and Ethernet connections. These management interface connections are completely isolated from the server blade connections to interconnect modules.

### c3000 external management interfaces

Each c3000 enclosure has several external management interfaces connected to the BladeSystem Onboard Administrator. The primary external management interface is the management port for each BladeSystem Onboard Administrator, which is an RJ-45 jack providing Ethernet communications not only to each BladeSystem Onboard Administrator, but also to every device or interconnect bay with a management processor. This includes ProLiant Onboard Administrator (iLO 2) communication for the server blades and any interconnect module using the c-Class embedded Ethernet management network, such as Virtual Connect Manager. For redundant BladeSystem Onboard Administrators, both BladeSystem Onboard Administrator management ports are connected to the management network, providing redundant management network connections to each enclosure.

A serial port on the BladeSystem Onboard Administrator module provides full out-of-band CLI access to the BladeSystem Onboard Administrator and is used for BladeSystem Onboard Administrator firmware flash recovery. USB ports on the BladeSystem Onboard Administrator are used to connect external DVD drives to support the enclosure DVD feature. In addition, an optional internal DVD drive is available for the c3000 enclosure. All c-Class enclosures support two enclosure link connectors that provide private communications between enclosures linked with CAT5 cable. In addition, the enclosure link-up connector provides an enclosure service port that allows users to temporarily connect a laptop PC to any of the linked enclosure BladeSystem Onboard Administrators for local diagnostics and debugging.

### Updating firmware

The BladeSystem Onboard Administrator manages firmware updates for the enclosure's management devices. Updating server blade firmware including server BIOS, NIC and mezzanine BIOS, and ProLiant Onboard Administrator (iLO 2) is possible using HP System Update Manager or the blade firmware update maintenance CD. These utilities can be connected to all the server blades in the enclosure using the BladeSystem Onboard Administrator enclosure DVD feature. When the active BladeSystem Onboard Administrator detects an external USB DVD drive plugged into the USB port, it scans the DVD drive for a CD or DVD disk. This disk can then be connected to one or more server blades at the same time using the BladeSystem Onboard Administrator GUI, CLI, or Insight Display.

### **Redundant enclosure management**

Redundant enclosure management is an optional feature of the c3000. It requires installing a second BladeSystem Onboard Administrator module in the c3000 enclosure to act as a completely redundant controller in an active-standby mode. Using redundant modules in the c3000 enclosure provides complete fault tolerance. The redundancy logic is based on a continuous heartbeat between the two modules over a dedicated serial connection (Figure 3). If the period between heartbeats exceeds a timeout, the standby module automatically takes control of the enclosure and becomes the active BladeSystem Onboard Administrator.

### **User interfaces for the BladeSystem Onboard Administrator**

Three user interfaces to the BladeSystem Onboard Administrator allow control and provide information about the enclosure and installed components:

- Web browser GUI
- Scriptable CLI
- Insight Display diagnostic LCD panel

Remote network access to the GUI and CLI is available through the management Ethernet port. A serial port is available for local CLI access and flash recovery. The c-Class enclosure link-up port is also available as the service port for temporary local Ethernet access to the BladeSystem Onboard Administrators and devices in linked enclosures. Insight Display is accessed directly through the buttons on the display or remotely through the GUI. The optional KVM module provides access to the CLI through the external VGA monitor and USB keyboard.

### **Security**

User authentication maintains security for all user interfaces. User accounts created in the BladeSystem Onboard Administrator define three user privilege levels and the component bays to which each level is granted access. The BladeSystem Onboard Administrator stores the passwords for local user accounts and can be configured to use Lightweight Directory Access Protocol (LDAP) authentication for user group accounts. The Insight Display can be protected by an LCD PIN code or completely disabled. The optional KVM module protects against changes to server power or enclosure DVD



connection using the LCD PIN code. Use of the KVM module to access server consoles is protected by server operating system username/passwords.

### **Role-based user accounts**

The BladeSystem Onboard Administrator provides configurable user accounts that can completely isolate multiple administrative roles such as server, LAN, and SAN. User accounts are configured with specific device bay or interconnect bay permissions and one of three privilege levels: administrator, operator, or user. An account with administrator privileges including BladeSystem Onboard Administrator bay permission can create or edit all user accounts on an enclosure. Operator privileges allow full information access and control of permitted bays. User privileges allow information access but no control capability.

The BladeSystem Onboard Administrator requires user login to the web GUI or CLI with an account ID and password. For a local account, the password is stored on the BladeSystem Onboard Administrator. For an LDAP account, the BladeSystem Onboard Administrator contacts the defined LDAP server to check the user credentials. Two-factor authentication allows even tighter security for the user management session to the BladeSystem Onboard Administrator.

### **Enclosure linking**

Rather than requiring separate logins to access multiple management processors within each enclosure, the BladeSystem Onboard Administrator allows single point access. Thus, an administrator can use single sign-on to log in to a single BladeSystem Onboard Administrator and use the web GUI to graphically view and manage the HP BladeSystem c-Class components in up to seven linked enclosures. For example, an IT administrator could automatically propagate management commands—such as changing the enclosure power mode—throughout the linked enclosures.

The BladeSystem Onboard Administrator link module contains two enclosure link ports to allow any active BladeSystem Onboard Administrator module to access linked enclosures. On a standalone enclosure or upper enclosure in a series of linked enclosures, the upper enclosure link-up port functions as a service port for temporary connection to a PC with a CAT5 patch cable. It provides quick access to any BladeSystem Onboard Administrator module, ProLiant Onboard Administrator (iLO 2), or interconnect module with Ethernet management ability.

The enclosure link-down port connects to the enclosure link-up port on the enclosure below it. Linking the enclosures enables the rack technician to access all the enclosures through the open link-up/service port. If more c-Class enclosures are added to the rack, they can be linked through the open enclosure link-up port on the upper enclosure or the link-down port on the bottom enclosure.

---

### **NOTE**

The linked enclosures will enforce a common rack name on all the linked enclosures unless different rack names are established prior to linking the enclosures and are not changed after linking the enclosures.

---

### **IMPORTANT**

The HP BladeSystem c-Class Enclosure link ports are not compatible with the HP BladeSystem p-Class Enclosure link ports.

---

## ProLiant Onboard Administrator (Integrated Lights-Out 2) for ProLiant server blades

HP BladeSystem c-Class employs ProLiant Onboard Administrator (iLO 2) to configure, update, and operate individual server blades remotely. The c3000 enclosure includes an Ethernet management network to aggregate all ProLiant Onboard Administrator (iLO 2) management communications across the entire enclosure. This management network connects ProLiant Onboard Administrator (iLO 2) processors to the BladeSystem Onboard Administrator through the BladeSystem Onboard Administrator tray. The BladeSystem Onboard Administrator provides direct user access to each ProLiant Onboard Administrator (iLO 2) through the enclosure management network. The BladeSystem Onboard Administrator uses this network to manage pooled enclosure power and cooling, which results in substantial energy savings over the same number of individual rack-mounted servers.

### Insight Display

The Insight Display, Figure 4, is an ever-ready, enclosure-mounted information exchange device with access to all BladeSystem Onboard Administrator setup, management, and troubleshooting features. It is a quick and easy-to-use device that allows technicians to initially configure the enclosure. It also provides information about the health and operation of the enclosure. The Insight Display is effective mechanically because it is large enough to see ample information, and it rotates down to allow access to the blades that reside behind the display.

**Figure 4.** Insight Display on the c3000 enclosure



When the c3000 enclosure is initially powered on, the enclosure UID LED and the Insight Display are illuminated blue to identify the enclosure being configured. The Insight Display automatically launches an installation wizard to guide the user through the configuration process. After the enclosure is configured, the Insight Display verifies that there are no installation or configuration errors. The Installation Wizard turns off the enclosure UID when the installation is complete.

When an error or alert condition is detected, the total number of error conditions and their locations (in the order of error severity) appear on the Insight Display Health Summary screen (Figure 5). Failure alerts (if any) appear first and then caution alerts. Providing this level of diagnostic information for each enclosure dramatically reduces setup, repair, and troubleshooting time.

For example, in Figure 5 the Insight Display diagnostic screen reports an error in power supply bay five. The Health Summary screen shows the power supply in bay five as red. When the technician selects View Alert, the Device Error Summary screen indicates the same condition. The Device Error detail in the third screen shows that the power supply in bay five has failed. When the technician selects fix on the Device Error screen, suggestions for corrective action appear.

**Figure 5.** BladeSystem c-Class Insight Display diagnostic screens indicating an error and suggested corrective action



More information about the Insight Display is available in the technology brief entitled “Managing the HP BladeSystem c-Class” at

<http://h20000.www2.hp.com/bc/docs/support/SupportManual/c00814176/c00814176.pdf>.

## HP Insight Control suite

HP Insight Control suite delivers essential management for HP BladeSystem lifecycles, including proactive health management, lights out remote control, optimized power use, rapid server deployment, performance analysis, vulnerability scanning and patch management, and virtual machine management.

The software is delivered on DVD media. It includes an integrated installer to rapidly and consistently deploy and configure HP Systems Insight Manager (HP SIM) and essential infrastructure management software. The integrated installer includes a wizard-based interface that presents a series of configuration questions. When the user has answered the configuration questions, each of the selected components will be deployed in a single process. The HP Insight Software Advisor checks to ensure that the host central management server meets all installation pre-requisites before installation. When installation is complete, the Insight Software Update Utility will check for available software updates.

HP Insight Control suite installs and licenses the following components:

- HP Systems Insight Manager
- HP iLO Advanced for BladeSystem
- HP Insight Power Manager
- HP Insight Rapid Deployment Pack
- HP Insight Performance Manager module
- HP Insight Vulnerability and Patch Manager module
- HP Insight Virtual Machine Manager software

HP Insight Control suite integrates with leading enterprise management platforms through industry standards. It includes one year of 24 x 7 HP Software Technical Support and Update Service.

## BladeSystem Onboard Administrator cabling

The standard BladeSystem Onboard Administrator module is pre-installed in a front-loading tray that also houses the Insight Display. The module contains a serial connector to connect to a PC with a null-modem RS232 serial cable. A USB connector is also available for future USB connectivity. A separate rear-loading link module contains RJ-45 ports for enclosure link-up/link-down connectivity and BladeSystem Onboard Administrator network access (Figure 6).

**Figure 6.** BladeSystem Onboard Administrator link module

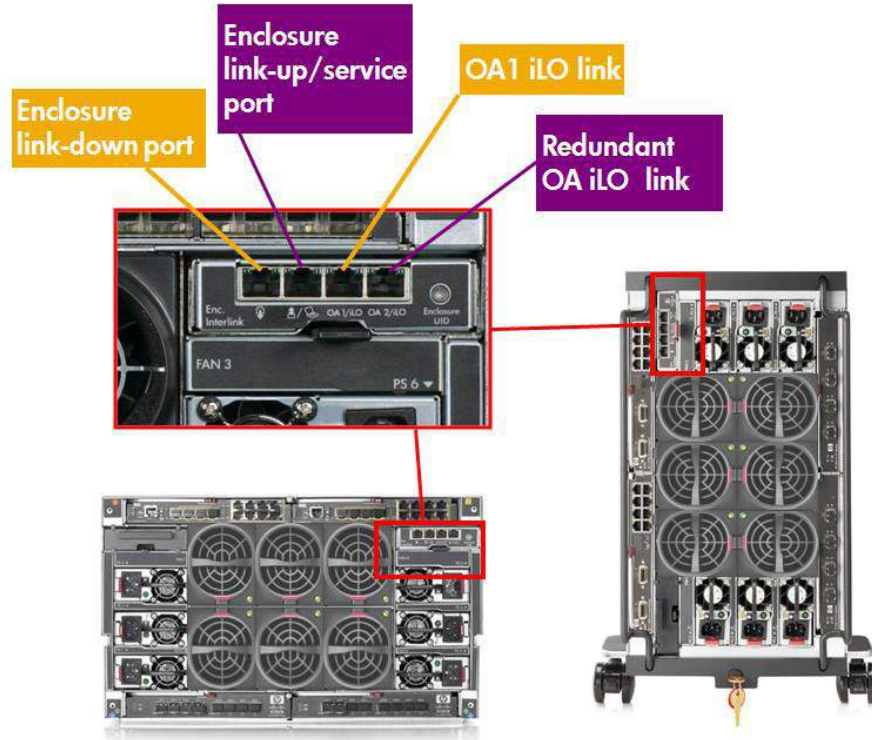

## Enclosure-based DVD ROM

The HP BladeSystem c3000 Enclosure has an optional CD/DVD ROM drive that installs in the front of the enclosure. The Insight Display and BladeSystem Onboard Administrator allow system administrators to connect (or disconnect) the media device to (from) one or multiple servers at a time. In addition, a browser-based console is available through the iLO functionality of each server blade. The console lets administrators perform numerous options:

- Use HP SmartStart to install system software and operating systems
- Install additional software
- Perform critical OS updates and patches
- Update server platform ROMs

The enclosure-based CD/DVD offers local drive access to server blades by using the BladeSystem Onboard Administrator or Insight Display. When media is loaded in the enclosure-based DVD ROM, local administrators can use the Insight Display to attach the media device to a single or to multiple server blades simultaneously. When the DVD Connect Status screen appears on the Insight Display, the user has the option to connect the media device to a server or group of servers. The user is then prompted either to connect and reboot the server, or just to connect.

When it is connected and no read operations have occurred for 16 seconds, the media device can be disconnected from server blades.

## Enclosure KVM Module

Another option for the c3000 enclosure is the KVM Module, which plugs into the rear bay adjacent to interconnect module 1 and provides a VGA connector and two additional USB connectors for the c3000 enclosure. An external VGA monitor and external USB keyboard/mouse can provide access not only to all server video consoles, but also to the Onboard Administrator command line interface (CLI), and/or to the Insight Display. Using *PrintScrn* as a hot key to switch consoles, the user can select a particular server console, control the server power, or connect to the enclosure DVD from the KVM menu screen (Figure 7). Besides allowing the user to select a server video console, the menu provides current server health status, power status, and DVD connect status. The BladeSystem Onboard Administrator automatically provides a server name, based on server information. From a server video console session, the user presses *PrintScrn* to return to the KVM menu. The CLI console provides a text screen to log in and run command-line commands to the BladeSystem Onboard Administrator. The Insight Display provides all the enclosure's Insight Display screens on the KVM monitor and uses the KVM keyboard to navigate those screens using the KVM station.

**Figure 7.** Optional c3000 KVM Module – KVM menu screen

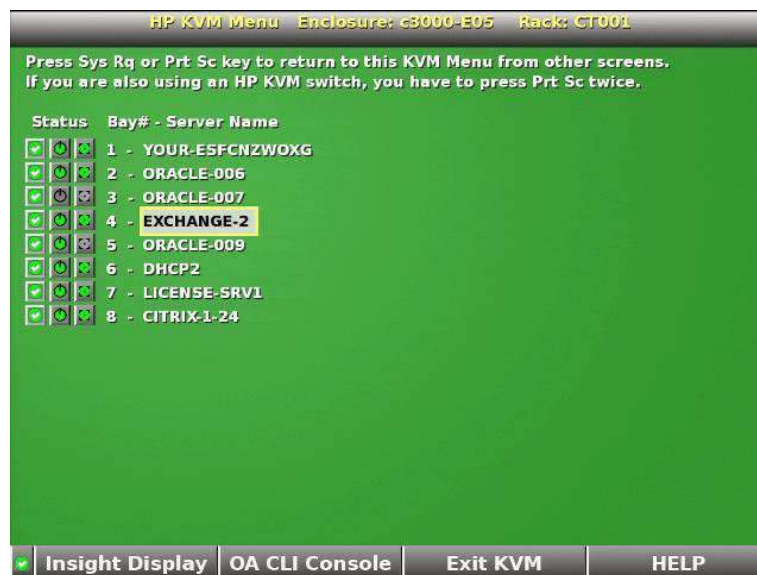

## Interconnect options and infrastructure

A key component of the c3000 enclosure is the I/O infrastructure—essentially, a NonStop signal midplane that provides the internal wiring between the server or storage blades and the interconnect modules. The NonStop signal midplane is an entirely passive board that takes advantage of serializer/deserializer (SerDes) technology to support multiple protocols and to provide point-to-point connectivity between device bays and interconnect bays. The term passive means there are no active electrical components on the board. With BladeSystem enclosures, it is easy to connect the ports of embedded devices to the interconnect bays. The c3000 enclosure NonStop signal midplane (Figure 8) acts as a PCI Express (PCIe) bus to connect interconnect ports on BladeSystem devices to interconnect modules. It has eight device bay signal connectors (one for each half-height server blade and two for each full-height server blade) and four interconnect module connectors (one for each interconnect bay). The device connections are in groups of lanes. Each port is a group of four pins (two sending traces and two receiving traces), resulting in two lanes of SerDes full-duplex



communication. This combination provides two lanes of up to 10-Gb per second transfer rate per port, based on the technology of the server port. Interfaces such as 1 GbE, 10 GbE, 4 Gb FC, and 8 Gb FC use one lane per port. InfiniBand DDR combines four lanes into a double-wide 4x port connected to a double-wide interconnect module. Serial Attached SCSI uses both lanes at 3 Gb per lane to achieve 6 Gb per second on a single port.

**Figure 8.** Diagram of the HP BladeSystem c3000 signal midplane

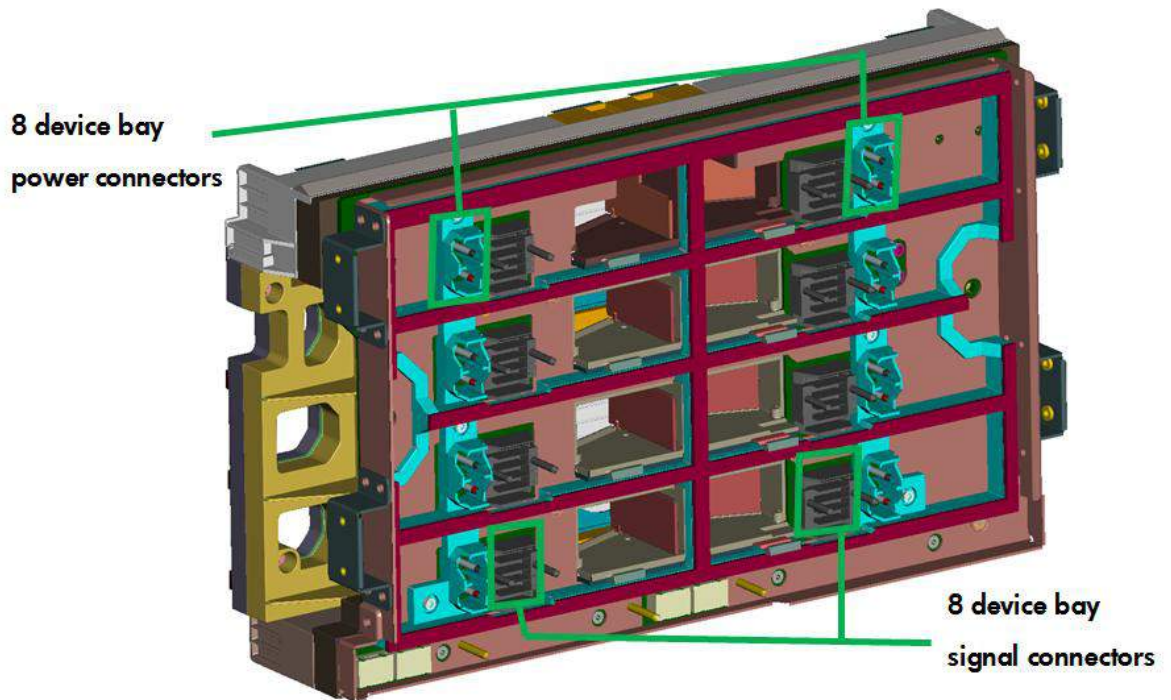

By taking advantage of the similar four-trace differential transmit and receive signals, the NonStop signal midplane can support either network-semantic protocols (such as Ethernet, Fibre Channel, and InfiniBand) or memory-semantic protocols (PCIe), using the same signal traces.<sup>2</sup> Figure 9 illustrates how the physical lanes can be logically overlaid onto sets of four traces. Interfaces such as Gigabit Ethernet (1000-base-KX) or Fibre Channel need only a 1x lane, or a single set of four traces. Higher bandwidth interfaces, such as InfiniBand DDR, use up to four lanes.

<sup>2</sup> Network-semantic interconnect protocols use network addresses in the packet headers to exchange data between two nodes such as MAC addresses and IP addresses for Ethernet, world-wide port name for FC, or GUID for InfiniBand. Memory-semantic interconnect protocols use memory addresses in the packet headers to deposit or retrieve data where these addresses can be memory-mapped registers of a chip or system memory location.



**Figure 9.** Logically overlaying physical lanes (right) onto sets of four traces (left)

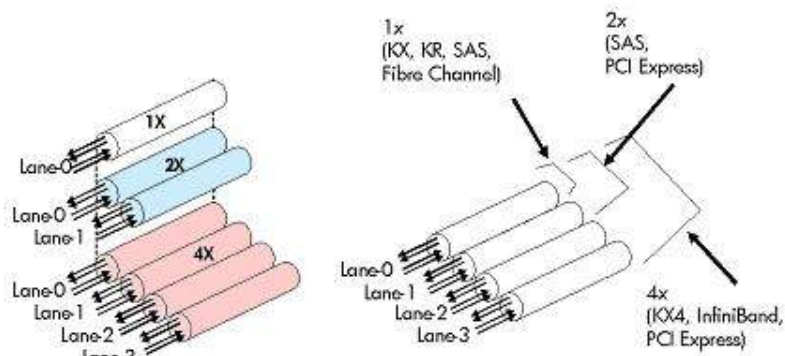

Each device bay connector has a 100-pin signal connector with 64 high-speed signal pins hard-wired from the device bay connector to the interconnect bays. This configuration results in 16 lanes ( $64 \div 4$ ) to each interconnect bay, which provides at least two lanes to each interconnect port for connectivity to LAN, SAN, InfiniBand, or any other interconnect type. Full-height servers occupy two half-height device bays and, therefore, have up to 32 lanes available.

A single lane supports up to 10-Gb signals, depending on the protocol requirement. Each lane provides the flexibility of 1x, 2x, or 4x connections from the server blade mezzanine cards, which connect the interconnect bays. The rear of the enclosure includes four interconnect bays that can accommodate four single or two redundant interconnect modules. All interconnect modules plug directly into these interconnect bays. Each HP BladeSystem c3000 Enclosure requires two interconnect switches or two pass-thru modules, side-by-side, for a fully redundant configuration.

The signal midplane also includes the management signals from each bay to the BladeSystem Onboard Administrator modules. These management signals are completely isolated from the high-speed server-to-interconnect signals. The BladeSystem Onboard Administrator is the terminating point for all interconnect bays. An interconnect module cannot use the connection to the BladeSystem Onboard Administrator to communicate with other interconnect modules.

## Interconnect modules

The BladeSystem c3000 enclosure supports a variety of interconnect options, including pass-thru modules, Ethernet and Fibre Channel switches, and high-bandwidth fabrics such as InfiniBand. The most up-to-date information about c-Class interconnect modules is available at this website: [www.hp.com/go/bladesystem/interconnects](http://www.hp.com/go/bladesystem/interconnects).

Switches offer a traditional approach to administering the network. The primary value in blade switches is cable consolidation through high-speed uplinks and the shared blade power and cooling infrastructure.

Ethernet and Fibre Channel pass-thru modules are available when direct one-to-one connections between servers and LAN or SAN are required. HP Ethernet and Fibre Channel Pass-Thru Modules provide 16-port, transparent, 1:1 port connectivity between the server and an external switch.

Interconnect modules in the c3000 enclosure are available in two widths: single- and double-wide. Single-wide interconnect modules provide 16 internal ports, each connected to a separate device bay in the front of the enclosure. Double-wide interconnect modules provide 16 internal ports, each double-wide, providing connectivity to DDR InfiniBand and other 4-lane, high speed interconnects.

Each interconnect module also provides external connectors that vary based on the particular design. In the c3000 enclosure, pairs of single-wide interconnect modules installed in adjacent horizontal

bays provide redundant connectivity for dual-port interfaces in each device bay. Adjacent interconnect modules also have high-speed cross-connect capability through the enclosure's NonStop signal midplane.

---

#### **NOTE**

The c-Class Ethernet Pass-Thru Module only supports fixed speed gigabit Ethernet. Because the server, storage, or other option blades are connected through SerDes to the interconnect bays, and SerDes Ethernet does not have an auto-negotiation protocol, a switch is required to connect to 10/100 networks outside of the enclosure. The NICs themselves are capable of different modes of operation, but the outbound wiring to which they are connected does not auto-negotiate. Note that this is a limitation of an Ethernet Pass-Thru Module only. The Fibre Channel Pass-Thru Module ports do auto-negotiate.

---

## Server blades

Server blades for the BladeSystem c3000 enclosure are built according to c-Class standard form-factors referred to as half-height and full-height. The enclosure can hold either full-height or half-height server blades or a combination of the two.

For connectivity, every server ships with at least two built-in Ethernet connections. To maintain flexibility, the server blades use optional mezzanine cards to provide additional interconnect fabric connections such as Gigabit Ethernet, InfiniBand, and Fibre Channel.

Half-height server blades typically have two embedded Gigabit NICs and two c-Class PCIe mezzanine option connectors. A half-height server configured with one dual-port Gigabit NIC mezzanine card and one quad-port Gigabit NIC mezzanine card provides eight independent Gigabit NICs. Full-height server blades typically have four embedded Gigabit NICs and three c-Class PCIe mezzanine option connectors. A full-height server blade configured with three quad-port Gigabit NIC mezzanine cards provides sixteen independent Gigabit NICs. The inherent flexibility of c-Class design allows customers to configure up to four different interconnect fabrics without sacrificing redundancy or performance.

The HP website ([www.hp.com/go/bladesystem/](http://www.hp.com/go/bladesystem/)) contains the most up-to-date information about c-Class server blades.

## Storage options inside the BladeSystem enclosure

Storage options inside the enclosure provide an alternative to local disk drives or SAN connectivity. The c3000 enclosure supports several types of storage solutions. Tape and PCI option blades are also available for c-Class. Each of these blades increases configuration flexibility by adding options that would not fit inside the server blade.

### **Direct attach storage blades**

The StorageWorks SB40c Storage Blade delivers direct attach storage for c-Class server blades, with support for up to six hot plug small form factor (SFF) SAS or SATA hard disk drives. The enclosure backplane provides a PCIe connection to the adjacent c-Class server blade and enables high performance storage access without any additional cables. The SB40c Storage Blade features an onboard Smart Array P400 controller with 256 MB battery-backed write cache, for increased performance and data protection. For mechanical compatibility, storage blades use the same half-height form factor as server blades. The SB40c direct attach storage blade must be paired with an adjacent server blade in the same cooling zone. This is because the physical connection between

the direct attach storage blade and its adjacent server blade is a dedicated x4 PCIe connection across the NonStop midplane that connects the adjacent bays. The half-height server blade and direct attach storage blade must be paired in specific bays. Refer to the appendix for bay number details.

A mezzanine card is not required to connect a half-height server blade to a direct attach storage blade. However, a mezzanine card is required to connect a full-height server blade to a direct attach storage blade. The card must be in the Mezzanine 3 connector to allow full use of the interconnect bays with Type I or Type II mezzanine cards, to be consistent with the half-height blades, and to enable mixing half-height and full-height server blades in the same enclosure.

---

## NOTE

When used with a full-height server blade, the direct attach storage blade must be in the bottom bay. To maintain essential airflow, a blank must be attached above the storage blade to block the empty upper bay, or a half-height server blade must be inserted into the upper bay. For this configuration, the storage blade should be installed before the half-height server blade is installed, and the half-height server blade should be removed before the storage blade is removed.

---

## Shared storage

HP LeftHand P4000 Virtual SAN Appliance (VSA) software turns the SB40c Storage Blade into an iSCSI SAN for use by all servers in the enclosure and any server on the network. HP LeftHand VSA software is installed in a virtual machine on a VMware ESX host server adjacent to the SB40c. HP LeftHand P4000 VSA supports storage clustering for scalability, network RAID for storage failover, thin provisioning, snapshots, remote replication, and cloning. Administrators can expand capacity within the same enclosure or to other BladeSystem enclosures by adding additional SB40c Storage Blades and HP LeftHand VSA licenses.

## External SAS connectivity with direct connect SAS storage for HP BladeSystem

With direct connect SAS storage for HP BladeSystem, administrators can build local server storage on the fly with zoned storage, or enable low cost shared storage within the rack with high performance 3Gb/s SAS architecture. Each HP server blade requires an HP Smart Array P700m controller installed in a mezzanine slot. Redundant HP StorageWorks 3Gb SAS BL switches are installed in the interconnect bays of the HP BladeSystem enclosure. The switches are then connected through a SAS cable to external storage depending on application requirements.

## NAS/SAN Gateway

The X3800sb Network Storage Gateway Blade is a ready-to-deploy SAN gateway solution, with Microsoft Storage Server 2008 Enterprise x64 Edition pre-installed. The X3800sb Network Storage Gateway Blade is used to access FC, SAS, or iSCSI SAN storage, translating file data from the server into blocks for storage to provide consolidated file, print, and management hosting services in a cluster-able package.

## Storage server

The X1800sb Network Storage Blade is pre-installed with Microsoft Windows Storage Server 2008 Standard Edition. The X1800sb can be paired with the SB40c Storage Blade to create shared storage and file serving within the enclosure. The X1800sb can also be used as a low cost gateway to external FC, SAS, or iSCSI storage.

For the most up-to-date information about the HP StorageWorks storage blade solutions, go to the HP website at <http://h18006.www1.hp.com/storage/bladestem/index.html>.

## Mezzanine cards

HP offers a variety of mezzanine card options to provide connectivity to outside networks and storage. HP ProLiant c-Class server blades use two types of mezzanine cards to connect to the various interconnect fabrics such as Fibre Channel, Ethernet, serial-attached SCSI, or InfiniBand. Type I and Type II mezzanine cards differ only in the amount of power allocated to them by the server and in the physical space they occupy on the server blade. Type I mezzanine cards have slightly less power available to them and are slightly smaller. Type I mezzanine cards are compatible with all ProLiant c-Class server blades in all mezzanine connectors (Table 2). Type II mezzanine cards are compatible with Mezzanine 2 or 3 connectors in full-height c-Class server blades. Type II mezzanine cards are also compatible with Mezzanine 2 connectors in half-height c-Class server blades.

**Table 2.** Compatibility of mezzanine cards and mezzanine connectors in ProLiant c-Class server blades

	c-Class server blades	Type I mezz card	Type II mezz card
Mezz connector 1	Full height	yes	no
	Half height	yes	no
Mezz connector 2	Full height	yes	yes
	Half height	yes	yes
Mezz connector 3	Full height	yes	yes
	Half height	yes	no

For the most up-to-date information about the c-Class mezzanine card options, go to the HP website: <http://h18004.www1.hp.com/products/blades/components/c-class-interconnects.html>.

## Virtual Connect

Virtual Connect technology is a set of interconnect modules and embedded software for c-Class enclosures that simplifies the setup and administration of server connections. HP Virtual Connect includes the following components:

- HP 1/10 Gb Virtual Connect Ethernet Module
- HP 1/10 Gb-F Virtual Connect Ethernet Module
- HP Virtual Connect Flex-10 10 Gb Ethernet Module
- HP Virtual Connect 4 Gb Fibre Channel Module
- HP Virtual Connect 8 Gb 24-Port Fibre Channel Module
- HP Virtual Connect Manager

Virtual Connect implements server-edge virtualization so that server administrators can upgrade, replace, or move server blades within their enclosures without changes being visible to the external LAN and SAN environments. HP recommends using Virtual Connect or managed switches to reduce cabling and management overhead.

Like other Ethernet and Fibre Channel switches, Virtual Connect modules slide into the interconnect bays of c-Class enclosures. To support Fibre Channel, the enclosure must have at least one Virtual Connect Ethernet module because the Virtual Connect Manager software runs on a processor that resides on the Ethernet module.

When the LAN and SAN connections are made to the pool of servers, the server administrator uses Virtual Connect Manager to define a server connection profile for each server. Instead of using the

default media access control (MAC) addresses for all NICs and default World Wide Names (WWNs) for all host bus adapters (HBAs), the Virtual Connect Manager creates bay-specific profiles, assigns unique MAC addresses and WWNs to these profiles, and administers them locally. Network and storage administrators can establish all LAN and SAN connections once during deployment. If servers are later deployed, added, or changed, no connection changes are needed because Virtual Connect keeps the profile for that LAN and SAN connection constant.

To help administrators fully utilize 10 GbE connection bandwidth, HP introduced Flex-10 technology in the BladeSystem c-Class architecture. Using Flex-10, administrators can partition the bandwidth of a single 10 Gb pipeline into multiple *FlexNICs*. In addition, administrators can regulate the bandwidth for each partition by setting it to a user-defined portion of the total 10 Gb connection. Speed can be set from 100 Mb per second to 10 Gb per second in 100 Mb increments.

There are advantages to partitioning a 10 GbE pipeline:

- More NIC connections per server, which is especially important in a virtual machine environment
- Ability to match bandwidths to the network function, such as management console or production data

Flex-10 technology uses two hardware components:

- The HP Virtual Connect Flex-10 10Gb Ethernet Module
- Either the 10 Gb Flex-10 LAN-on-motherboard (LOM) or the HP NC532m Flex-10 10 GbE Network Adapter mezzanine card

The HP Virtual Connect Flex-10 10 Gb Ethernet Module is required to manage the 10 GbE (Flex-10) server connections to the data center network. The 10 Gb Flex-10 LOM and mezzanine cards are NICs, each with two 10 Gb ports. Each 10 Gb port can be configured from one to a maximum of four individual FlexNICs. The server ROM and the operating system or hypervisor recognize each FlexNIC as an individual NIC.

Full details about Flex-10 technology are available in the technology brief titled “HP Flex-10 technology” on the HP technology website:

<http://h20000.www2.hp.com/bc/docs/support/SupportManual/c01608922/c01608922.pdf>.

Full details about Virtual Connect technology are available in the technology brief titled “HP Virtual Connect technology implementation for the HP BladeSystem c-Class” on the HP technology website:

<http://h20000.www2.hp.com/bc/docs/support/SupportManual/c00814156/c00814156.pdf>.

## Fabric connectivity and port mapping

Each enclosure requires interconnects to provide network access for data transfer. The interconnects reside in interconnect bays located on the rear of the enclosure (Figure 10). The server blades and enclosure support up to three independent interconnect fabrics, such as Ethernet, Fibre Channel, InfiniBand, and Virtual Connect modules.

**Figure 10.** HP BladeSystem c3000 interconnect bay numbering

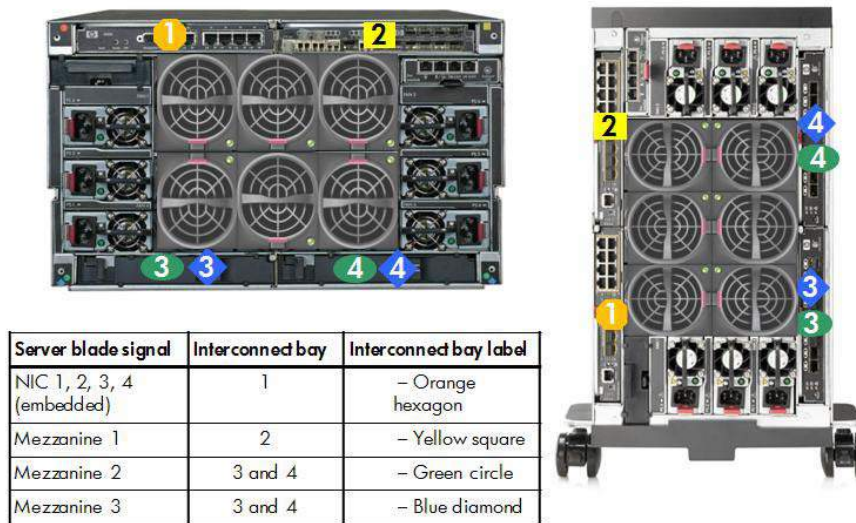

For interconnect bay mapping purposes, it does not matter in which device bay a server blade is installed. The mezzanine connectors always connect to the same interconnect bays. Because the connections between the device bays and the interconnect bays are hard-wired through the NonStop signal midplane, the server mezzanine cards must be matched to the appropriate type of interconnect module. For example, a Fibre Channel mezzanine card must be placed in the mezzanine connector that connects to an interconnect bay holding a Fibre Channel switch.

Embedded NICs and adapters installed in Mezzanine 1 are supported by single-wide interconnects in interconnect bays 1 and 2 respectively. Mezzanine 2 and 3 can be supported by single-wide or double-wide interconnects such as InfiniBand or 10 Gb Ethernet devices in interconnect bays 3 and 4.

An internal connection on the midplane between interconnect bays 1 and 2 and an additional connection between interconnect bays 3 and 4 provide an internal link for use as a crosslink port between interconnect bays 1 and 2 or interconnect bays 3 and 4. NIC teaming can be configured between embedded NICs and Mezzanine 1 NICs using the internal crosslinks between the switches through this internal connection.

Several port types are referenced in Figures 11 and 12:

- Examples of 1x ports are 1-Gb Ethernet (1-GbE) pass-thru modules and Fibre Channel interconnect modules.
- An example of a 2x port is a SAS interconnect module.
- Examples of 4x ports are 10-GbE pass-thru modules and InfiniBand interconnect modules.

A full-height server blade plugs into two device bay connectors and has 32 lanes available to the 4 interconnect bays (16 lanes x 2 in Figure 13). Interconnect bay 1 is reserved for Ethernet interconnects. It connects embedded Ethernet NICs to the internal facing ports on the Ethernet interconnect. Depending on the configuration requirements, additional mezzanine cards and interconnects can be employed:























- Mezzanine 1 and Interconnect Bay 2
- Mezzanine 2 and Interconnect Bays 3 and 4
- Mezzanine 3 and Interconnect Bays 3 and 4



The full-height server blade has four embedded NICs and can accept up to three mezzanine cards. Each embedded NIC and optional mezzanine port is mapped through the signal midplane to specific ports on interconnect bays. A full-height server blade installed in device bay 1 would have NICs mapped in the following manner:

- NIC 1 (PXE default) — Interconnect bay 1 port 5
- NIC 2 — Interconnect bay 1 port 13
- NIC 3 — Interconnect bay 1 port 1
- NIC 4 — Interconnect bay 1 port 9

**Figure 11.** Port mapping for HP BladeSystem c3000 full-height server blades to interconnect bays

Full-height server bay = n (1-4)	Interconnect bay	Interconnect bay port (server facing port numbers)
x4 NIC 1  NIC 2  NIC 3  NIC 4 	 Interconnect 1	Port = N+4
	 Interconnect 1	Port = N+12
	 Interconnect 1	Port = N
	 Interconnect 1	Port = N+8
Mezz 1 x4  Port 1 Port 2 Port 3 Port 4	 Interconnect 2	Port = N
	 Interconnect 2	Port = N+8
	 Interconnect 2	Port = N+4
	 Interconnect 2	Port = N+12
Mezz 2 x8  Port 1 Port 2 Port 3 Port 4	 Interconnect 3	Port = N
	 Interconnect 4	Port = N
	 Interconnect 3	Port = N+8
	 Interconnect 4	Port = N+8
Mezz 3 x8  Port 1 Port 2 Port 3 Port 4	 Interconnect 3	Port = N+12
	 Interconnect 4	Port = N+12
	 Interconnect 3	Port = N+4
	 Interconnect 4	Port = N+4

Half-height server blades connect to a single power and signal connector on the NonStop signal midplane. The remaining signal connector is allocated to the adjacent device bay (that is, device bays 1 and 5). As a result, half-height server blades do not support four-port mezzanine cards on connector 1, and they do not contain a Mezzanine 3 connector. The extra lanes on the NonStop signal midplane are allocated to the adjacent device bay. A four-port PCIe x8 mezzanine card installed in connector 2 PCIe x8 can send x2 signals to interconnect bays 3 and 4.

Figure 12 lists the available configurations for half-height devices installed in device bay N (1–8).

**Figure 12.** Port mapping for HP BladeSystem c3000 half-height server blades to interconnect bays

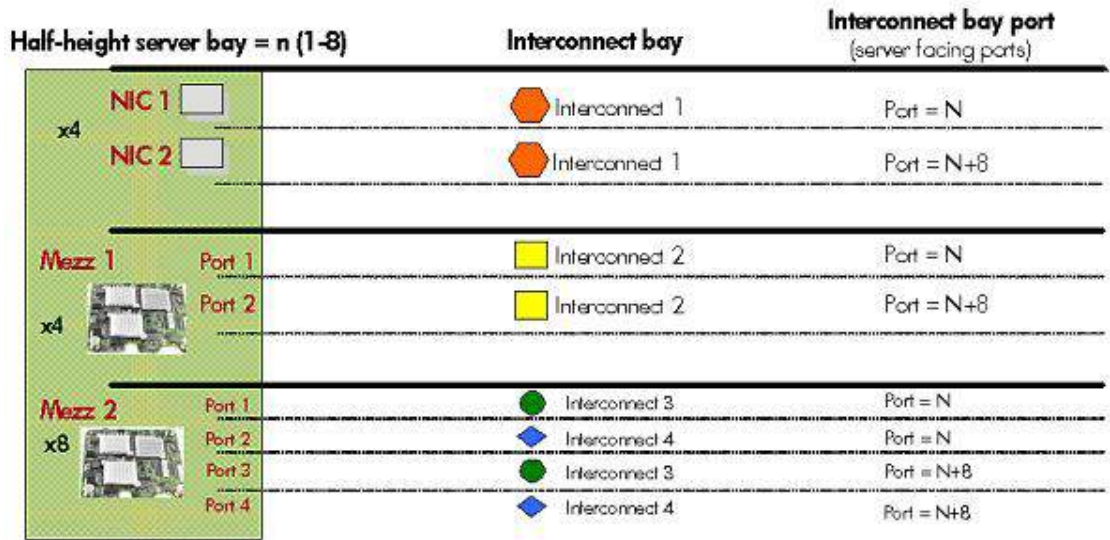

Port mapping differs slightly between full-height and half-height server blades due to the support for additional mezzanine cards on the full-height version. HP has simplified the process of mapping mezzanine ports to switch ports by providing management tools through the BladeSystem Onboard Administrator and HP SIM.

### c3000 bay-to-bay crosslinks

For bay-to-bay communication, the c3000 midplane provides four-trace SerDes signals between adjacent bays.

#### Device bay crosslinks

Device bay crosslinks are wired between adjacent horizontal device bay pairs as indicated by the arrows in the c3000 enclosure front view (Figure 13). The crosslink connectivity is identical in the c3000 Tower enclosure. For half-height server blades, these signals are used for four-lane PCIe connection to a partner blade such as a tape blade or PCI expansion blade. For full-height server blades, these signals are used for PCIe connection to a partner blade in the lower adjacent bay and require a PCIe pass-thru mezzanine card installed in mezzanine connector 3. The BladeSystem Onboard Administrator disables the device bay crosslinks in instances where they cannot be used, such as when two server blades reside in adjacent device bays.

**Figure 13.** HP BladeSystem c3000 device bay crosslinks as indicated by the arrows

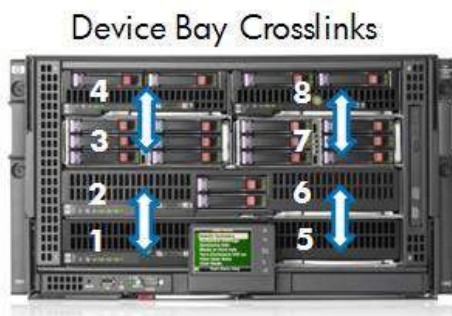

---

### Interconnect bay crosslinks

Interconnect bay crosslinks are wired between adjacent interconnect bay pairs as indicated by the arrows in the c3000 enclosure rear view (Figure 14). The crosslink connectivity is identical in the c3000 Tower enclosure. These signals can provide module-to-module connections (such as Ethernet crosslink ports between matching switches), or they can be used by Virtual Connect modules as stacking links. The BladeSystem Onboard Administrator disables the interconnect bay crosslinks in instances where they cannot be used, such as two different modules residing in adjacent horizontal interconnect bays.

---

**Figure 14.** HP BladeSystem c3000 interconnect bay crosslinks indicated by the arrows



---

## HP Thermal Logic technologies

The HP BladeSystem c3000 Enclosure incorporates a variety of HP Thermal Logic technologies, including mechanical design features, built-in intelligence, and control capabilities. Thermal Logic technologies provide significant power and cooling savings—as much as 40% compared to traditional rack and tower based servers. Thermal Logic provides an instant view of power use and temperature at the server, enclosure, or rack level. Thermal Logic automatically adjusts power and thermal controls to minimize power and cooling use while maintaining adequate cooling for all devices and ensuring high availability.

HP Thermal Logic technologies include many elements and capabilities:

- Active Cool fans
- Parallel Redundant Scalable Enclosure Cooling (PARSEC) design
- Instant power and thermal monitoring
- Pooled power for a variety of power redundancy modes
- Dynamic Power Saver mode
- Power Regulator
- Power Capping
- Power Meter

### Active Cool fans

Quite often, dense, full-featured, small-form-factor servers use very small fans designed to provide localized cooling in the specific areas needed by the server blade. Because such fans generate fairly low airflow (in cubic feet per minute, or CFM) at medium back pressure, a single server often requires

multiple fans to ensure adequate cooling. If each server blade contains several fans, installing many server blades together in an enclosure can result in a significant cost and space overhead.

A second solution for cooling is to use larger, blower-style fans that can provide cooling across an entire enclosure. Such fans generate high airflow, but they typically require higher power input and more space. They are loud and must be designed for the maximum load in an enclosure. As a result, designers may have to sacrifice server features to allow large, high-power fans to fit in the enclosure. Even then, ensuring adequate airflow to all the servers without leakage, over provisioning, or bypass is a challenge.

To overcome these issues in the c3000 enclosure, HP engineers designed a new type of fan that delivers high airflow and high pressure in a small form factor that can scale to meet future cooling needs. HP has 20 patents pending for its Active Cool fan technology and its implementation.

HP Active Cool fans can cool eight server blades using as little as 100 watts of power. Active Cool fans use ducted fan technology with a high-performance motor and impeller to deliver high CFM at high pressure (Figure 15). The fan includes a bell mouth inlet with a specially designed impeller and a stator section that also provides cooling fins for the motor and acoustic treatments at the rear of the fan. This design provides cooling capacity to support blade products beyond current roadmaps. The fan's unique shape allows for high-volume, high-pressure airflow at even the slowest fan speeds, while maintaining low noise levels and minimal power consumption.

---

**Figure 15.** Ducted fan cross-section and ducted fan blade compared to traditional server fan

Ducted fan cross-section

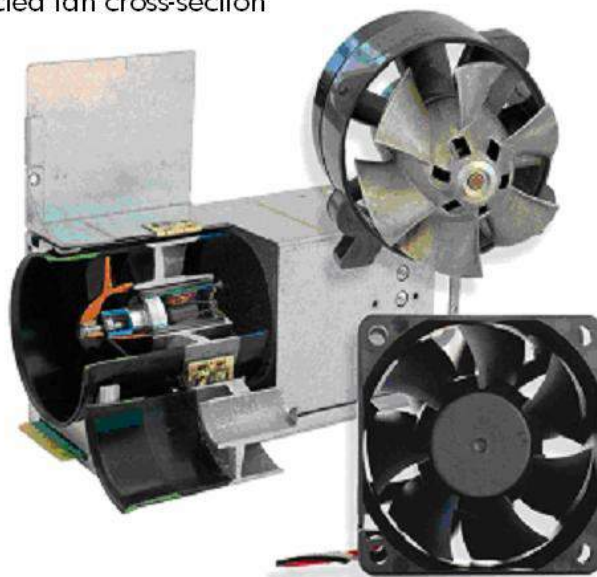

Ducted fan blade

Traditional server fan

---

Active Cool fans are controlled by the BladeSystem Onboard Administrator, which can ramp cooling capacity up or down based on system needs. Along with optimizing the airflow, the control algorithm optimizes acoustic levels and power consumption. As a result, the c3000 enclosure requires less airflow than traditional rack-mount servers to properly cool the server blades within the enclosure. As new Active Cool fans are introduced, they may not interoperate with older Active Cool fans. The BladeSystem Onboard Administrator will indicate a fan compatibility problem if an incompatible fan mix exists in an enclosure.

## HP PARSEC architecture

The c3000 enclosure uses PARSEC architecture—parallel, redundant, scalable, enclosure-based cooling.

### Parallel

In this context, *parallel* means that fresh, cool air flows over all the server blades (in the front of the enclosure) and all the interconnect modules (in the back of the enclosure). The enclosure is divided into four cooling zones with fans in each. The Active Cool fans provide cooling for their own zone and redundant cooling for the rest of the enclosure. To ensure scalability, HP designed both the fans and the power supplies with enough capacity to meet the needs of compute, storage, and I/O components well into the future.

To optimize thermal design, HP developed a relatively airtight center air plenum, or air chamber. In the c3000 enclosure, all device bays include a shutoff door that is normally closed to prevent air leakage through that device bay. When a server blade is inserted, it seals into the center air plenum docking collar, and the server shutoff door opens to allow airflow across that server blade. Similarly, the fan seals into the center air plenum docking collar. Each fan bay includes louvers that automatically open when a fan is installed. If a fan is not installed or is not functional, the pressure distribution around the fan changes. This pressure change causes the louvers to close, ensuring that cool air is not diverted through the inoperative fan (Figure 16).

**Figure 16.** HP BladeSystem c3000 self-sealing enclosure

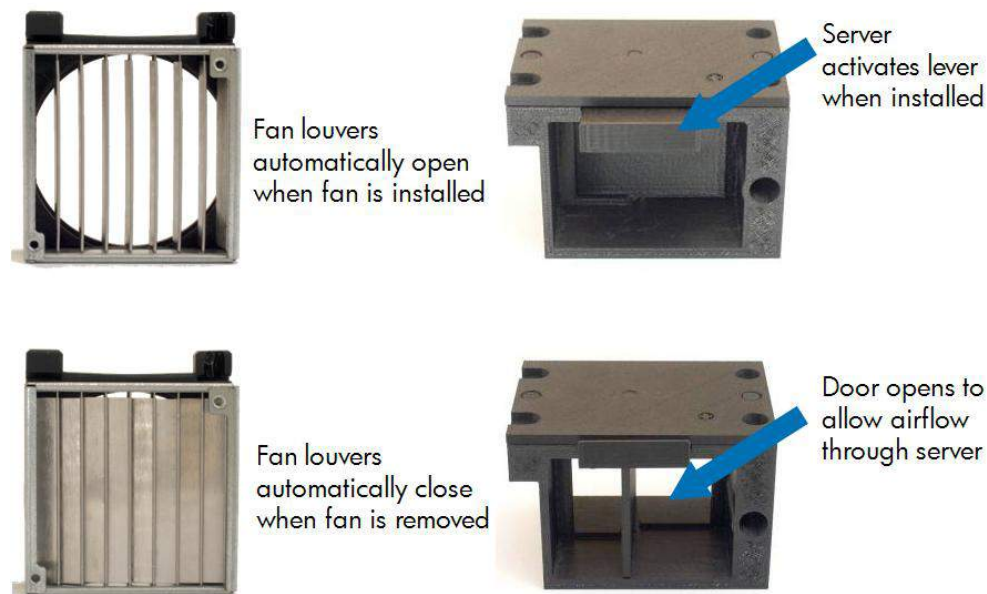

### Redundant and scalable



BladeSystem c3000 enclosures ship with four installed fans that provide redundancy and support up to four half-height devices in device bays 1, 2, 5, and 6, or two full-height server blades in device bays 1 and 2.

In a four-fan configuration, the BladeSystem Onboard Administrator prevents server and storage blades installed in device bays 3, 4, 7, and 8 from powering on until two additional fans are added into fan bays 1 and 3. To install blade devices in all eight device bays, it is necessary to install all six

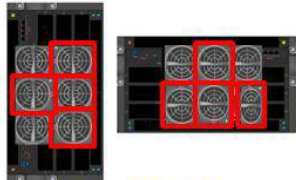
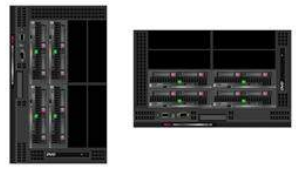
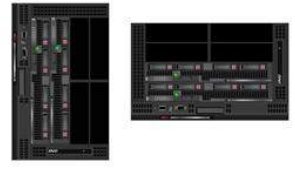
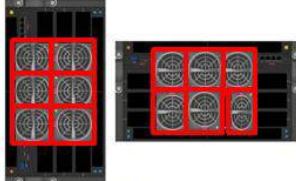

Active Cool fans. Figure 17 shows enclosure fan bay and device bay population guidelines. See the Appendix for more detailed fan and device bay installation guidelines.

**Figure 17.** The c3000 enclosure fan bay and device bay population guidelines

# of fans	Half-height blades	Full-height blades
<p>4 fans</p>  <p>Bays 2,4,5,6</p>	<p>4 half-height blades</p> <p>Bays 1,2,5,6</p> 	<p>2 full-height blades</p> <p>Bays 1,2</p> 
<p>6 fans</p>  <p>All bays</p>	<p>8 half-height blades</p> <p>All bays</p> 	<p>4 full-height blades</p> <p>All bays</p> 

## Thermal Logic for the server blade

Precise ducting on ProLiant server blades manages airflow and temperature based on the unique thermal requirements of all the critical components. The airflow is tightly ducted to ensure that no air bypasses the server blade and to obtain the most thermal work from the least amount of air. This concept allows much more flexibility in heat sink design. The heat sink design closely matches the server blade and processor architecture requirements. For example, in the HP BladeSystem BL460c server blade using Intel® Xeon® processors, HP was able to use a smaller, high-power processor heat sink than in rack-mount servers. These heat sinks have vapor chamber bases, thinner fins, and tighter fin pitch than previous designs. This creates the largest possible heat transfer surface in the smallest possible package (Figure 18). The smaller heat sink allows more space on the server blades for DIMM slots and hot-plug hard drives.



**Figure 18.** Processor heat sink using fully ducted design (left) and a traditional heat sink in a 1U rack-mount server (right)



Instant thermal monitoring provides a real-time view of heat, power, and cooling data. The BladeSystem Onboard Administrator retrieves thermal information from all server blades, storage blades, and interconnect modules in the enclosure to ensure an optimal balance between cooling, acoustic levels, and power consumption. The Thermal Logic technology in the BladeSystem Onboard Administrator keeps fan and system power at the lowest level possible. However, if the thermal load within the enclosure increases, the Thermal Logic feature instructs the fan controllers to increase fan speeds to accommodate the additional demand. If high temperature levels occur, the ProLiant Onboard Administrator (iLO 2) and BladeSystem Onboard Administrator modules provide alerts to various management tools such as HP Insight Control Environment and HP Systems Insight Manager. In addition, built-in failsafe procedures shut down devices in the enclosure if temperature levels exceed specified parameters. This prevents permanent damage to any devices within the enclosure.

HP Thermal Logic includes sophisticated algorithms in each BladeSystem ROM, ProLiant Onboard Administrator (iLO 2), and BladeSystem Onboard Administrator. In combination, these algorithms minimize the power and cooling required to maintain the proper HP BladeSystem environment.

## Power supplies and enclosure power subsystem

The HP BladeSystem c3000 Enclosure ships with two power supplies. However, up to six power supplies can be installed, depending on the AC redundancy level required and the number of devices installed in the enclosure. BladeSystem c3000 single-phase power supplies automatically switch between low-line (120 VAC) and high-line (240 VAC) to support both environments. A pooled power backplane delivers power to the enclosure. This ensures that the full capacity of the power supplies is available to all server blades.

Moving the power supplies into the enclosure reduced the transmission distance for DC power distribution allowing the use of an industry-standard 12V infrastructure. Using a 12V infrastructure eliminated several power-related components and improved power efficiency on the server blades and in the infrastructure. The control circuitry was stripped and put on the management board and fans.

High efficiency HP c3000 power supplies provide greater than 90% efficiency in AC to DC conversion. These power supplies are in the ProLiant universal form factor so they can also be used in other ProLiant servers. Each power supply ships with a standard power distribution unit (PDU) power cord (C13 to C14), and each enclosure includes c13 to c20 power cords for different types of PDUs. By purchasing proper wall outlet cords, users can connect the power supplies to standard wall outlets.

---

## CAUTION

Wall outlet power cords should only be used with low-line power sources. If high-line power outlets are required, safety regulations require either a PDU or a UPS between the c3000 enclosure power supplies and wall outlets.

---

The enclosure can contain up to six 1200-watt self-cooled power supplies. Most typically, the c3000 enclosure would be deployed at sites that would not normally have data center AC redundancy to racks. Therefore, the c3000 has been configured so that only four power supplies are needed in a Power Supply Redundant (N+1) mode, where the enclosure would be connected to a UPS, to a single PDU, or directly into 110V wall outlets. If there is a need for dual AC power feeds and data center-like AC redundancy, six power supplies can be configured to connect to a pair of PDUs (three connected to each PDU). A variety of PDUs are available, as indicated in the c3000 QuickSpecs: [http://h18004.www1.hp.com/products/quickspecs/12790\\_div/12790\\_div.html](http://h18004.www1.hp.com/products/quickspecs/12790_div/12790_div.html). The HP BladeSystem Power Sizer is a tool for sizing the PDU appropriately for the c3000 storage and server configuration.<sup>3</sup>

HP expects that in many of the markets targeted for the c3000 enclosure (midmarket and remote sites), the c3000 will be connected to an uninterruptible power supply (UPS) for power backup instead of to a PDU (Figure 19). HP recommends using HP BladeSystem Power Sizer to determine the number of power supplies needed in the c3000 and to determine the UPS capacity requirement.

---

**Figure 19.** Remote site solution including a c3000 enclosure with UPS and local KVM in a small 14U rack

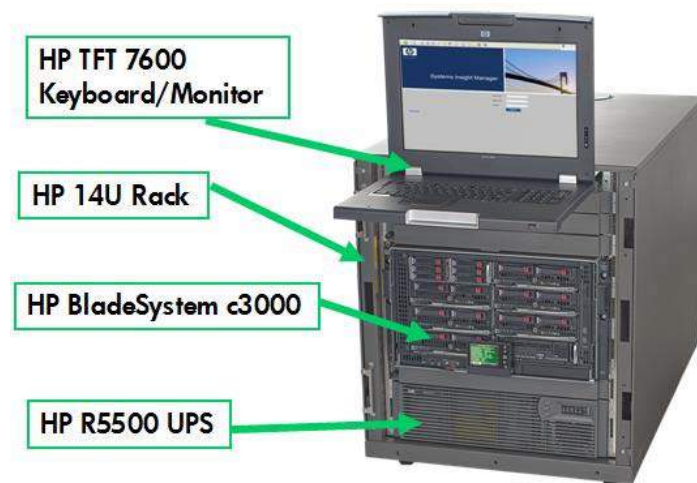

---

## NOTE

The rack-mountable HP R5500 UPS (5000VA/4500W) supports four power supplies in the power supply redundant (N+1) power mode.

---

<sup>3</sup> See the “For more information” section at the end of this document for a link to the HP BladeSystem Power Sizer.

## **Pooled power configuration and power redundancy options**

All the power in the enclosure is provided as a single power pool that any server blade within the enclosure can access. This provides maximum flexibility when configuring the power in the system so that customers can choose the required enclosure power mode. Because this power design has no zones, it facilitates both N+N and N+1 power modes, which future-proofs the enclosure for higher power requirements, if needed. Looking forward at least five years, HP believes there is sufficient power capacity to handle future power-hungry devices.

The c3000 enclosure has three configurable redundancy modes: power supply redundant, AC redundant, and no redundancy mode. The BladeSystem Onboard Administrator or the Insight Display can be used to select the power redundancy mode. For more information, consult the HP BladeSystem Onboard Administrator User Guide:

<http://h20000.www2.hp.com/bc/docs/support/SupportManual/c00705292/c00705292.pdf>.

### Typical power configuration connecting to UPS, wall outlets, or to a single non-redundant PDU (using Power Supply redundancy mode)

In a configuration with N+1 power supply redundancy connecting to a UPS, wall outlets, or to a single non-redundant PDU, the total power available equals the total power of N power supplies. Up to six power supplies can be installed, and one of them is always available to provide redundancy. In the event of a single power supply failure, the redundant power supply will take over the load of the failed power supply.

### Connecting to PDUs with AC redundancy to each rack

In an N+N AC redundancy configuration, the total power available in the power pool equals the amount from the A or B side, whichever contains fewer power supplies. In this configuration, N power supplies are used to provide power and the same number are used to provide redundancy. N can equal 1, 2, or 3. Any number of power supplies from 1 to N can fail without causing the enclosure to lose power. When correctly wired with redundant AC line feeds, this configuration will also ensure that a single AC line feed failure will not cause the enclosure to power off.

### Connecting with no power redundancy configured

In a configuration with no power redundancy, the total power available in the power pool equals the sum of the power generated by all installed power supplies. Any power supply failure will cause the system to power off if the remaining power supplies are unable to handle the full load.

The BladeSystem Onboard Administrator manages power allocation rules of various components and can limit overall power capacity for the enclosure. More information on power management is available in the technology brief entitled "Managing the HP BladeSystem c-Class":

<http://h20000.www2.hp.com/bc/docs/support/SupportManual/c00814176/c00814176.pdf>.

## **Dynamic Power Saver mode**

In the c3000, the BladeSystem Onboard Administrator module enables Dynamic Power Saver mode. When enabled, this feature monitors in real-time the total power consumed by the enclosure and automatically adjusts for changes in demand. For example, most power supplies operate more efficiently when heavily loaded and less efficiently when lightly loaded. Dynamic Power Saver mode shifts power load for maximum power supply efficiency and reliability. Maximizing power supply efficiency reduces operating costs. Power supply efficiency is simply a measure of DC watts output divided by AC or DC watts input. At 50% efficiency, 2000W input would yield 1000W output. The difference is costly wasted energy that generates unnecessary heat.

Dynamic Power Saver mode is active by default since it saves power in the majority of situations. When enabled, Dynamic Power Saver runs the required power supplies at a higher use rate and puts unneeded power supplies in standby mode. A typical power supply running at 20% load could have

an efficiency rating as low as 60%. However, at 50% load, the efficiency rating could be up to 90%, providing a significant savings in power consumption.

---

#### **NOTE**

In redundant environments using Dynamic Power Saver mode, a minimum of two power supplies are always active. The maximum load for any power supply is 50%. Once the 50% load is reached, another two power supplies are activated to ensure redundancy at all times.

---

#### **HP Power Regulator for ProLiant**

HP Power Regulator for ProLiant and BladeSystem servers provides iLO-controlled speed stepping for Intel x86 and recent AMD processors to improve server energy efficiency by giving processors full power when they need it and reducing power when they do not. This power management feature allows ProLiant servers with policy-based power management to control processor power states. Power Regulator can be configured for continuous Static Low Power mode or for Dynamic Power Savings mode in which power is automatically adjusted to match processor demand. Additional information on the HP Power Regulator is provided in the paper “Power Regulator for ProLiant servers”:

<http://h20000.www2.hp.com/bc/docs/support/SupportManual/c00300430/c00300430.pdf>.

#### **Basic Power Capping for each server blade**

Using ProLiant Onboard Administrator (iLO 2) firmware version 1.30 and System ROM/BIOS dated May 1, 2007, or later, ProLiant server blades can limit the amount of power consumed. Customers can set a limit in watts or BTUs per hour. The purpose of this limit is to constrain the amount of power consumed, which reduces heat output into the data center. The ProLiant Onboard Administrator (iLO 2) firmware monitors server power consumption, checks it against the power cap goal, and, if necessary, adjusts server performance to maintain an average power consumption that is less than or equal to the preset power cap. This functionality is available on all ProLiant server blades using Intel or recent AMD processors.

Using the Insight Power Manager (IPM) v1.10 plug-in to HP Systems Insight Manager v5.1, customers can set power caps on groups of supported servers. The IPM software statically allocates the group power cap among the servers in the group. The group cap is allocated equitably among all servers in the group based on a calculation using the idle and maximum measured power consumption of each server. In addition, IPM can track and graph over time the actual power use of groups of servers and enclosures. This provides data center facilities managers with measured power consumption for various time periods, reducing the need to install monitored PDUs to measure actual power use in data centers.

#### **HP Dynamic Power Capping**

HP launched Dynamic Power Capping in December 2008 with ProLiant Onboard Administrator (iLO 2) version 1.70. Supported servers contain an internal hardware circuit that monitors server power consumption on a sub-second basis. If consumption approaches the power cap set in ProLiant Onboard Administrator (iLO 2), the internal hardware circuit will limit power consumption quickly enough to protect PDU-level circuits from over-subscription and prevent power-related server outages.

At the enclosure level, HP Enclosure Dynamic Power Capping lets administrators set an enclosure level power cap. The BladeSystem Onboard Administrator manages the power distribution to the server blades and will change server caps over time as workloads change. Enclosure Dynamic Power Capping requires redundant power wired to separate A and B feeds, redundant BladeSystem

Onboard Administrator modules using firmware version 2.30 or later, and supported servers using ProLiant Onboard Administrator (iLO 2) version 1.70 or later.

### **Power meter**

In HP ProLiant c-Class server blades, an integrated power meter analyzes actual server power use. The BladeSystem Onboard Administrator can access the power meter through iLO 2 or through external power management software such as HP IPM. IPM also consolidates power data for multiple servers to a central location. This information can be used to charge business units or third parties for the actual energy costs associated with workload processing. The BladeSystem Onboard Administrator provides instant and time-averaged views of the power consumption of individual servers or of all servers within the c-Class BladeSystem enclosure.

### **HP BladeSystem Power Sizer**

The HP BladeSystem Power Sizer is a tool that assists facilities teams and IT staff in sizing their power and cooling infrastructures to meet the needs of an HP BladeSystem solution. The BladeSystem Power Sizer is based on actual component-level power measurements of a system stressed to maximum capability. The sizer allows customers to select the type and number of components within each server blade and enclosure so they can see the effect of changes on power consumption and heat loading.

Values obtained from the BladeSystem Power Sizer tool are based on heavy enterprise application loads and are intended as guidelines only. Actual measured power consumption may be significantly lower or higher than the numbers provided by the Power Sizer. Power consumption will vary with application type, application utilization, and ambient temperature. The BladeSystem Power Sizer is available at this website: <http://www.hp.com/go/bladesystem/powercalculator>.

## **Summary**

The HP BladeSystem c3000 Enclosure is a modular computing architecture that consolidates and simplifies infrastructure, reduces operational cost, and delivers IT services more effectively. The c3000 enclosure is designed for remote sites, small and medium-sized businesses, and data centers with special power and cooling constraints. Thermal Logic technologies provide the mechanical design features, built-in intelligence, and control capabilities throughout the BladeSystem c-Class that enable IT administrators to optimize the power and thermal environments. The shared, high-speed NonStop midplane and pooled-power backplane in the enclosure accommodate new bandwidths and new technologies. The BladeSystem Onboard Administrator supplies an intelligent infrastructure to provide essential power and cooling information and help automate infrastructure management. The BladeSystem c3000 enclosure provides all the power, cooling, and infrastructure to support c-Class modular servers, interconnects, and storage components, today and for the next several years.

## Appendix. Fan, power supply, and device bay population guidelines

---

**Figure A-1.** HP BladeSystem c3000 Enclosure – Fan population guidelines. For correct operation, fans and server blades must be installed in the correct fan bays. The BladeSystem Onboard Administrator will ensure that fans and server/storage blades are correctly placed before allowing systems to power on.

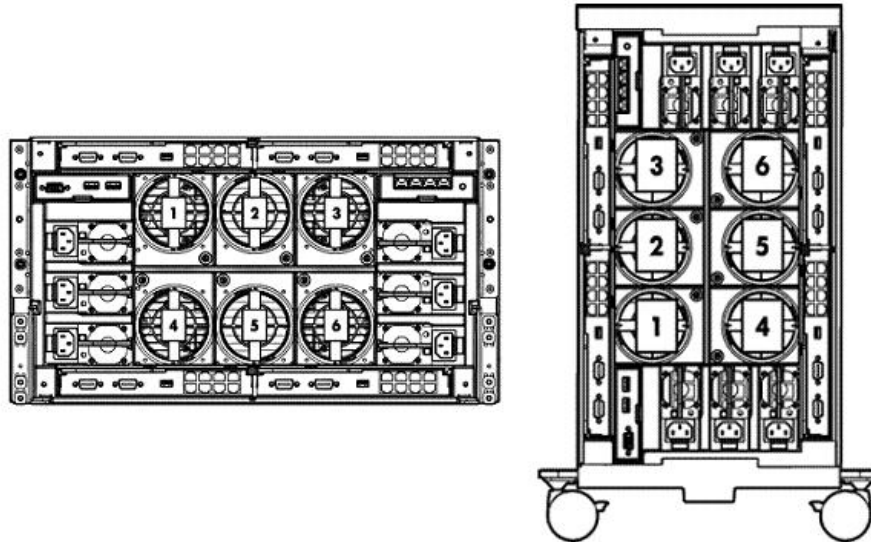

BladeSystem c3000 enclosures ship with four fans installed, supporting up to four half-height devices or two full-height server blades. Adding two additional fans to the enclosure allows population with eight half-height or four full-height devices:

- Four-fan configuration requires population of fan bays 2, 4, 5, and 6.
- Six-fan configuration enables population of all fan bays.

In a four-fan configuration, the BladeSystem Onboard Administrator prevents blade devices in device bays 3, 4, 7, and 8 from powering on and identifies the fan subsystem as degraded. To incorporate blade devices in these device bays, install six Active Cool fans.



**Figure A-2.** HP BladeSystem c3000 Enclosure – Power supply population guidelines

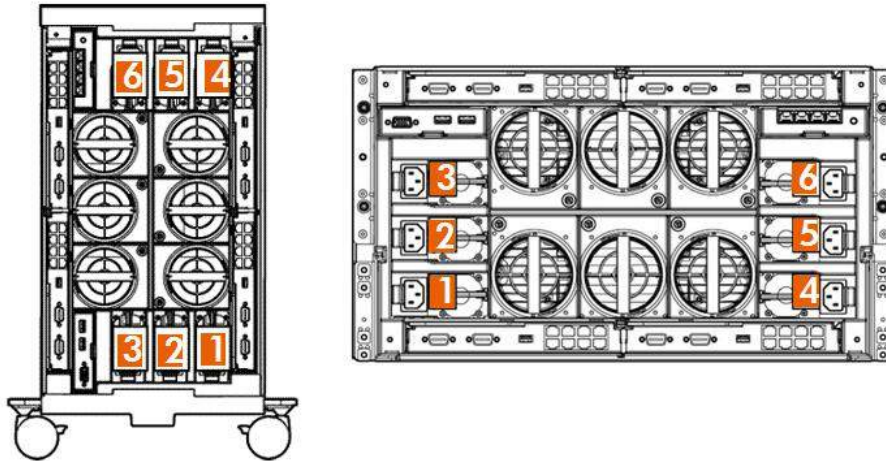

**Table A-1.** Power supply placement

Number of power supplies	Power supply bays used
2	1 and 4
4	1, 2, 4, and 5
6	All power supply bays filled

**Table A-2.** Power supply redundancy options

Number of power supplies	Power supply bays used
1+1	1 and 4
2+1	1, 4, and 2
3+1	1, 4, 2, and 5
4+1	1, 4, 2, 5, and 3
5+1	Populate all power supply bays

**Table A-3.** AC redundancy options

Number of power supplies	Power supply bays used
1+1	1 and 4
2+2	1, 2, 4, and 5
3+3	Populate all power supply bays

**Figure A-3.** HP BladeSystem c3000 Enclosure – Full-height server blade device bay numbering. Full-height servers should be populated from bottom to top (rack) or left to right (tower) when viewing from the front of the enclosure. With four fans, only the bottom or left two device bays can be used; with six fans, all device bays can be used.

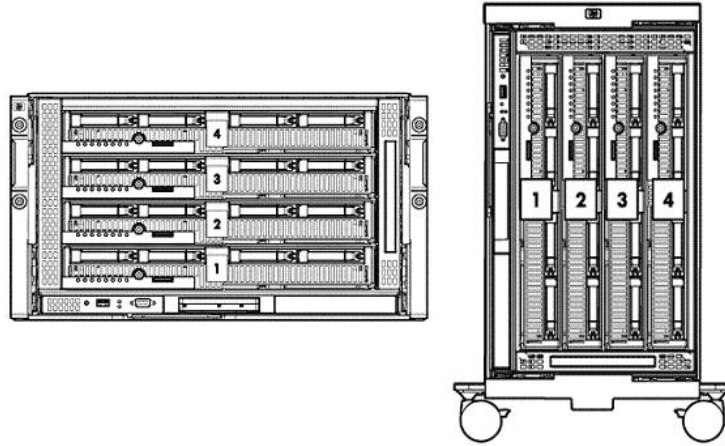

**Figure A-4.** HP BladeSystem c3000 Enclosure – Half-height server blade device bay numbering. Half-height servers should be populated in the following order: Device bays 1, 5, 2, 6, 3, 7, 4, 8.

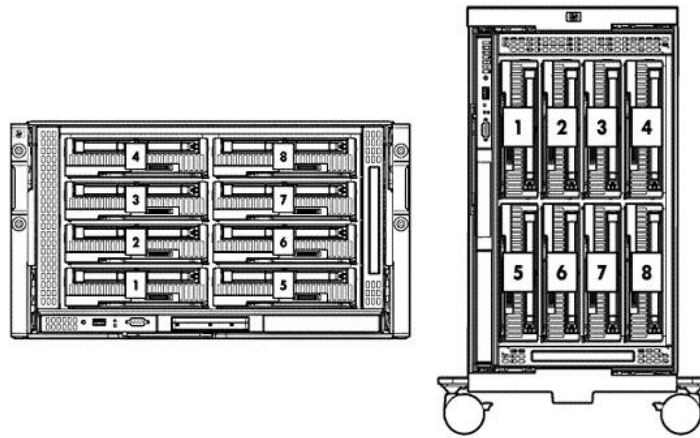

**IMPORTANT**

When looking at the rear of the enclosure, device bay numbering is reversed.

---

## CAUTION

To prevent improper cooling or thermal damage, do not operate the server blade or the enclosure unless all device bays are populated with either a component or a blank.

---

**Figure A-5.** The c3000 enclosure is divided by sheet metal panels into two full-height zones. Zone 1 and Zone 2 are divided in half by a removable shelf to accommodate a maximum of 8 half-height device bays per enclosure. These zones reflect the PCIe bus mapping in the signal midplane and limit placement of the server blade/storage blade combination. The signal midplane has a direct PCIe link connecting adjacent paired device bays.

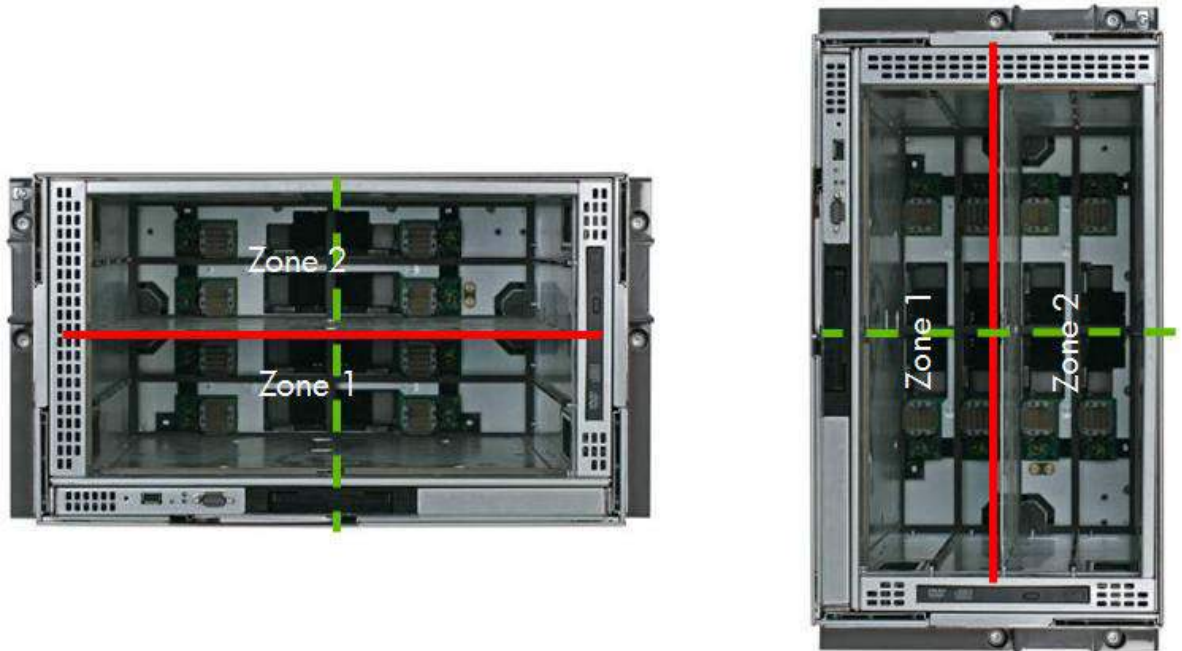

---

## IMPORTANT

The server blade/storage blade relationship cannot extend beyond the removable dividers between full height device bays, nor can it span the removable bay shelf dividing the zone into half-height device bays.

---

The enclosure comes preinstalled with removable full-height dividers between the four device bays in Zone 2 and the four device bays in Zone 1. In addition, a half-height divider is available for use between device bays 4 and 8 if the full-height divider is removed. Using these combinations of dividers, the following combinations of server blades can be installed:

- 8 half-height server blades with both full-height dividers installed
- 4 full-height server blades with both full-height dividers removed
- 4 half-height server blades in Zone 1 with 1 full-height divider installed
- 2 full-height server blades in Zone 1 with 1 full-height divider removed
- 4 half-height server blades in Zone 2 with 1 full-height divider installed

- 2 full-height server blades in Zone 2 with 1 full-height divider removed
- 1 full-height server blade and 2 half-height server blades in Zone 2 with 1 full-height divider removed and the half-height divider installed

---

**CAUTION**

If a full-height server blade is installed in device bay 1/5 and half-height server blades are installed in device bays 2 or 6, removing the full-height server blade leaves the server blades in device bays 2 and 6 unsupported. This might cause damage to the server blades and the enclosure connectors.

---

Removing the full-height divider in Zone 1 allows only full-height server blades to be installed in Zone 1.

Removing the full-height divider in the Zone 2 requires either installing only full-height server blades in Zone 2 or installing the half-height divider between device bays 4 and 8. With the half-height divider installed, two half-height devices (two server blades, one companion blade and one server blade, or one blade blank and one companion blade or server blade) can be installed in device bays 4 and 8 and one full-height server blade in device bay 3/7.

A companion blade (HP StorageWorks SB40c Storage Blade, HP PCI Expansion Blade, or HP StorageWorks Ultrium 448c Tape Blade) can be installed in either of the paired device bays (1/2, 3/4, 5/6, or 7/8) with a half-height server blade installed in the other paired device bay.

To install a companion blade with a full-height server blade, the companion blade must be installed in device bay 8 with the full-height server blade installed in device bay 3/7. The half-height divider must be installed between device bays 4 and 8, and either a blade blank or a half-height server blade can be installed in device bay 4.

## For more information

For additional information, refer to the resources listed below.

Resource description	Web address
General HP BladeSystem information	<a href="http://www.hp.com/go/bladesystem/">http://www.hp.com/go/bladesystem/</a>
HP BladeSystem c-Class documentation	<a href="http://h71028.www7.hp.com/enterprise/cache/316735-0-0-121.html">http://h71028.www7.hp.com/enterprise/cache/316735-0-0-121.html</a>
HP BladeSystem c3000 Enclosure Maintenance and Service Guide	<a href="http://h20000.www2.hp.com/bc/docs/support/SupportManual/c01126895/c01126895.pdf">http://h20000.www2.hp.com/bc/docs/support/SupportManual/c01126895/c01126895.pdf</a>
HP BladeSystem c3000 Enclosure QuickSpecs	<a href="http://h18004.www1.hp.com/products/quickspecs/12790_div/12790_div.html">http://h18004.www1.hp.com/products/quickspecs/12790_div/12790_div.html</a>
HP BladeSystem Onboard Administrator User Guide	<a href="http://h20000.www2.hp.com/bc/docs/support/SupportManual/c00705292/c00705292.pdf">http://h20000.www2.hp.com/bc/docs/support/SupportManual/c00705292/c00705292.pdf</a>
HP BladeSystem c-Class interconnects	<a href="http://www.hp.com/go/bladesystem/interconnects">www.hp.com/go/bladesystem/interconnects</a>
Technology briefs about HP BladeSystem	<a href="http://h18004.www1.hp.com/products/servers/technology/whitepapers/proliant-servers.html">http://h18004.www1.hp.com/products/servers/technology/whitepapers/proliant-servers.html</a>
HP BladeSystem Power Sizer	<a href="http://www.hp.com/go/bladesystem/powercalculator">http://www.hp.com/go/bladesystem/powercalculator</a>
HP BladeSystem c-Class firmware compatibility matrix	<a href="http://www.hp.com/go/bladesystemupdates">http://www.hp.com/go/bladesystemupdates</a>
iLO 2 firmware updates	<a href="http://www.hp.com/go/ilo">http://www.hp.com/go/ilo</a>
Server software and drivers	<a href="http://www.hp.com/go/proliant">http://www.hp.com/go/proliant</a>
Insight Power Manager software	<a href="http://www.hp.com/go/ipm">http://www.hp.com/go/ipm</a>

## Call to action

Send comments about this paper to [TechCom@HP.com](mailto:TechCom@HP.com).

© 2007, 2008, 2009 Hewlett-Packard Development Company, L.P. The information contained herein is subject to change without notice. The only warranties for HP products and services are set forth in the express warranty statements accompanying such products and services. Nothing herein should be construed as constituting an additional warranty. HP shall not be liable for technical or editorial errors or omissions contained herein.

Intel and Xeon are trademarks or registered trademarks of Intel Corporation in the U.S. and other countries and are used under license.

Linux is a U.S registered trademark of Linus Torvalds.

TC091007TB, October 2009

