

The New  
Benjamin Franklin House  
Publishing Company, Inc.

\$5.00

# DOPE, INC.

## Britain's Opium War against the U.S.

by a U.S. Labor Party Investigating Team

"In the war against drugs, as in all warfare, the essential point of a winning strategy is to strike the adversary's command structure while shattering his in-depth potentials for continued warring. No book could include every relevant detail of the drug network; the essential thing done here is to mark out the enemy's deployments and resources, for the purpose of crushing him with the aid of assaults on his most vulnerable flanks. After the war has been won, the courts and the historians will fill in the numerous details we have left out of account here."

—Lyndon H. LaRouche, Jr.  
Chairman, U.S. Labor Party

"Intriguing allegations ... not being ignored. 'It's got to be taken seriously,' says one HongKong and Shanghai bank official."

—Business Week

"Have you presented this evidence to the Justice Department for criminal prosecution yet?"

—Stewart L. Pittman  
Senior Partner in the law firm representing  
Hongkong and Shanghai Banking Corporation

"DOPE, INC. is a book of outstanding importance. It tells the history of a political strike against the United States in an undeclared war being waged by Great Britain."

—Mitchell WerBell  
former security and intelligence consultant to the  
U.S. government

"Unfortunately, the democratic right to be heard in the US demands that this flight of fancy be given due consideration, and the Hongkong bank's lawyers have had to formally deny the allegations and ask the Fed to refuse public hearings."

—Far Eastern Review

Cover design by Alan Yue

ISBN: 0-918388-08-2

# **DOPE, INC.**

**Britain's Opium War Against the U.S.**

by a U.S. Labor Party  
Investigating Team  
directed by  
Konstandinos Kalimtgis  
David Goldman  
Jeffrey Steinberg

The New Benjamin Franklin House  
Publishing Company, Inc.  
New York, New York  
1978

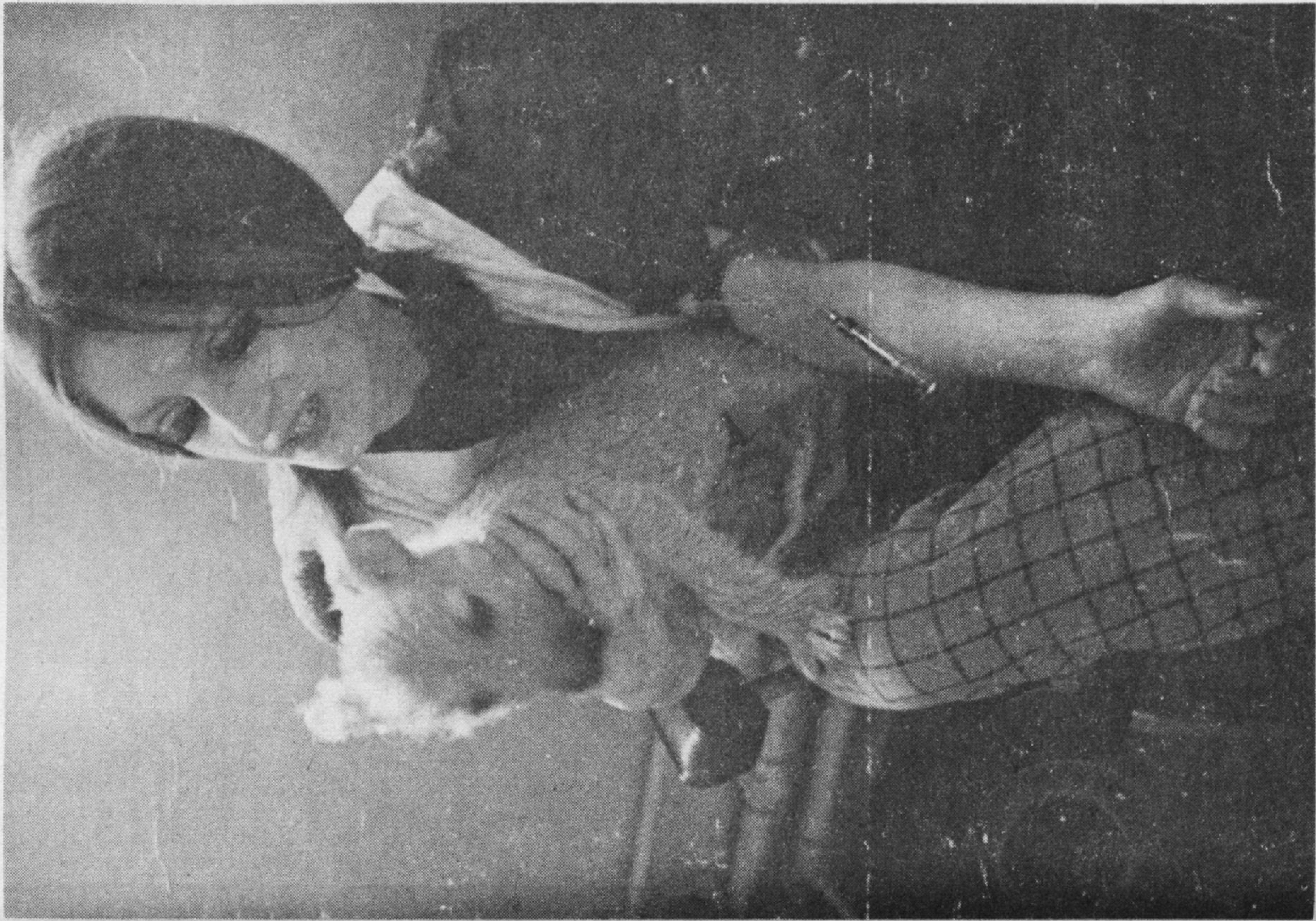

1

1. A victim of Britain's Opium War against the U.S.

# Contents

Dedication	iii
Acknowledgments	v
Introduction	1
Part I: History	7
Introduction	9
1. Britain's First Opium Wars	12
2. Palmerston's Fifth Column, USA	25
3. Britain's "Noble Experiment"	43
Part II: How the Drug Empire Works	57
Introduction	59
1. Banking and the World's Biggest Business	63
2. From Opium to Dirty Money	78
3. How the Drug Trade is Financed	83
4. Britain's Gold and Dirty Diamond Operations	92
5. Hong Kong: The World's Drug Capital	106
6. The Peking Connection	113
7. How the Royal Institute of International Affairs Runs Drugs and Dirty Money	139
8. Canada: North America's Hong Kong	160
9. All in the Family: The Real Syndicate	175
Part III: Organized Crime	261
Introduction	263
1. The Bronfman Gang	269
2. The Kennedys: Organized Crime in the Government	289
3. Britain's Assassination Bureau: Permindex	301
4. Permindex Unveiled: Resorts International Interrel	321
5. The Jacobs Family's Emprise: Sports and Crime	330
6. The Philadelphia Story	344

Published in the United States by The New Benjamin Franklin House  
Publishing Company

Copyright © 1978 by Konstandinos Kalimtgis, David Goldman, and Jeffrey Steinberg

All rights reserved.

For information address the publisher:

The New Benjamin Franklin House Publishing Company, Inc.

304 West 58th Street, 5th floor

New York, New York 10019

N. Spannaus, Editor-in-Chief; L. Frommer, Editor; P. Seawell, Designer;

A. Yue, Cover Design; D. Yue and V. Berg, Graphics Editors.

Library of Congress Cataloging in Publication Data

Kalimtgis, Konstandinos.

Dope, Inc., Britain's Opium War against the United States

Includes index.

1. Narcotics, Control of — Great Britain. 2. Narcotics, Control of. 3. Drug

abuse — United States. 4. Narcotics habit — United States. I. Steinberg,

Jeffrey, joint author. II. Goldman, David, 1951- joint author. III. United

States Labor Party. IV. Title. HV5850.G7K34 364.1'57'0941 78-

26712

ISBN: 0-933488-00-9

Printed in the United States of America

First Printing, December, 1978

Second Printing, February, 1979

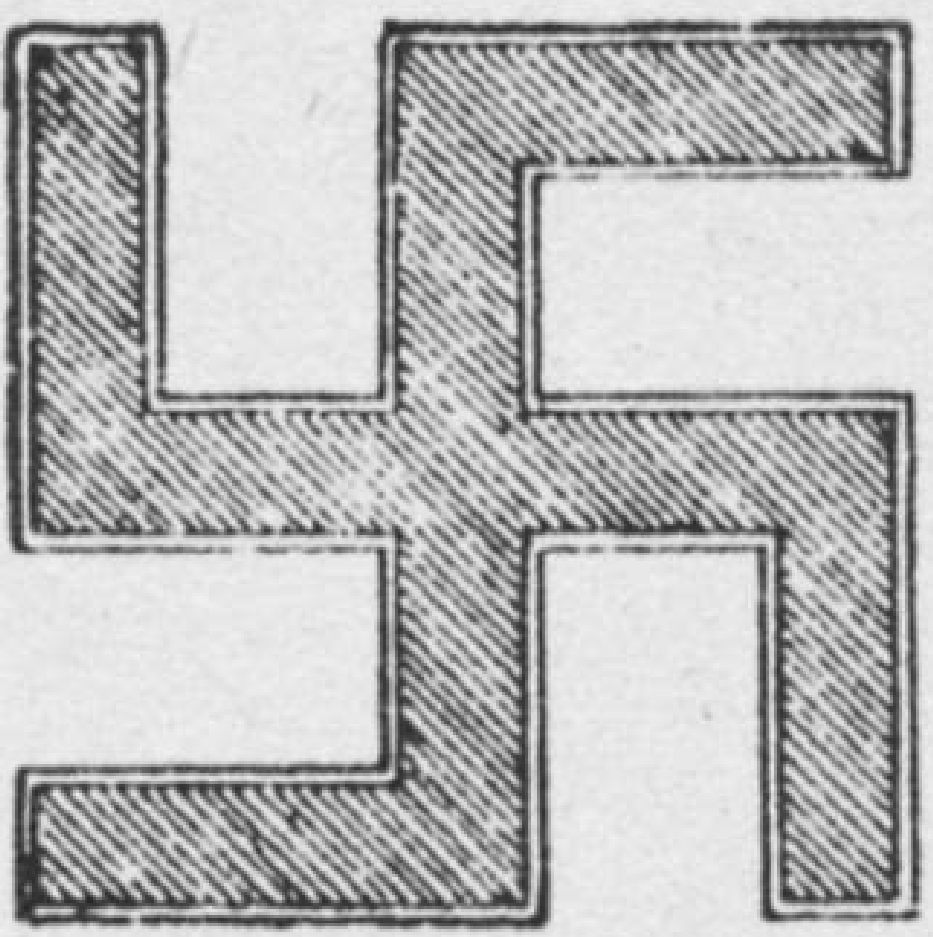

3



2



5



4

Part IV: Creating the Market: The British Origins of the Counterculture	361
Part V: The Drug Lobby: The Criminals Come Out in the Open	381
Epilogue	393
Index	396

# Dedication

Lyndon H. LaRouche, Jr.  
New York City  
October 18, 1978

It is with proper pride that we dedicate this book to the often-unsung U.S. intelligence and law enforcement officers who have so often, so obscurely, died or languished in undeserved imprisonment in the silent war of the United States against the British monarchy's illegal drug traffic into our nation.

This book is published with special thanks to those intelligence and law enforcement officials who have given us such extraordinary assistance in cross-checking facts in putting the story together. These have included officials not only in the USA, but our nation's French ally, and also patriots in Canada embittered against what the Bronfmans and others have done to their nation and our own.

It is no exaggeration to sum up the situation thus: the only proper comparison for today's British drug traffic into the USA is the British monarchy's 19th century Opium Wars against China. There is more than a parallel. The same HongShang and other banking interests that developed their wealth in the China opium trade are involved in the financial side of the traffic against the USA — aided by those leading elements of the Zionist Lobby which have controlled organized crime in the USA and the Caribbean since the early 1920s.

This is a calculated form of political warfare against the USA by the British monarchy. Not only are the London-centered Canadian, Hong Kong, Singapore, and British West Indies financial in-

## Illustrations

Introduction	
5 Figure 1. The Rate of Increase in Marijuana Use in the USA	
Part I	
24 Figure 1. Britain's Opium War Against China, 1820-1880	
Part II	
81 Figure 1. Opium. The Golden Triangle	
89 Figure 2. The Hongkong and Shanghai Control of Expatriate Drug Trade	
98 Figure 3. Illegal Gold Flows	
101 Figure 4. British Gold and Diamond Syndicate	
124 Figure 5. Hong Kong and Peking: Sharing the Drug Take	
154 Figure 6. London's Royal Institute for International Affairs: Drugs and Dirty Money	
170 Figure 7. Drug Running—The Canadian Connection	
223 The Dynasty of Robert Bruce: The Drug Family Tree	
Part III	
315 Figure 1. Dope, Inc. Assassination Bureau	

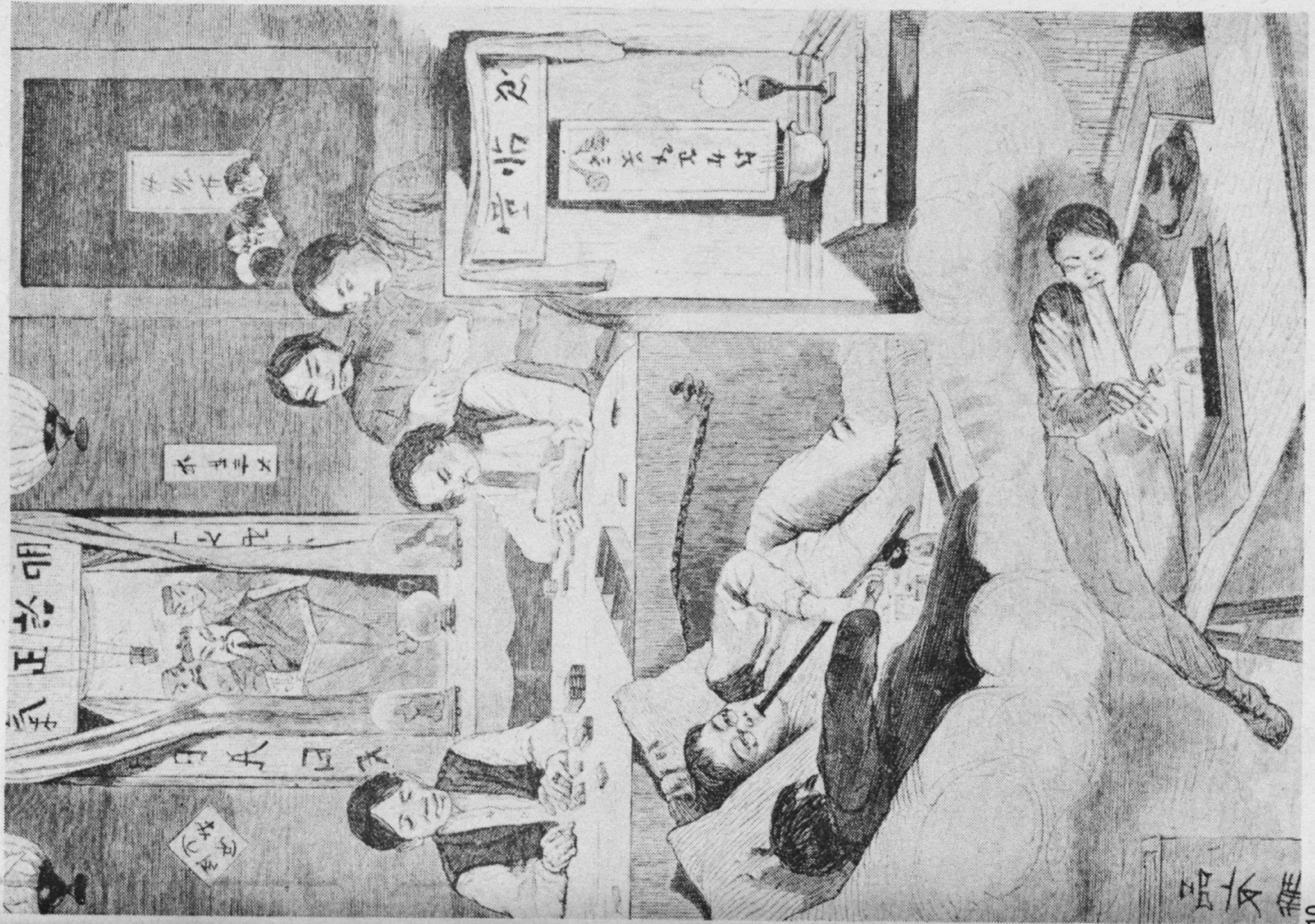

10

10. A Chinese-American opium den (by artist Winslow Homer) as depicted in Harper's, 1874

terests involved in pulling tens of billions out of the USA — our biggest source of balance-of-payments losses — but this is a pre-calculated political warfare. The evil British intelligence executive — and head of the Aristotle Society — Bertrand Russell proposed this use of drugs as political subversion back during the 1920s. Among Russell's most prominent collaborators in this effort was Aldous Huxley, coordinator of the 1960s introduction of psychedelic substances to U.S. youth.

The fight against illegal drugs and against the evil forces of “decriminalization” is nothing less than a war against Britain, to the purpose of saving our youth and our nation from the destruction the British monarchy has projected for us.

# Acknowledgments

Dope, Inc. was commissioned in September 1978 by U.S. Labor Party National Chairman Lyndon H. LaRouche, Jr., and was produced under his direction. At that time the Labor Party launched an international campaign against organized crime and drug traffic. As LaRouche has pointed out numerous times in the pages of the Labor Party's newspaper, *New Solidarity*, the forces that run the drug trade are the same forces that are now unleashing every capability — including scenarios for thermo-nuclear war — to halt the emergence of a new monetary system represented by the July 6 establishment of the European Monetary System in Bremen, West Germany, a system founded on the principles elaborated by LaRouche in his 1975 proposal for an International Development Bank. An October 1978 statement issued by LaRouche — “A National Strategy to Control Crime” — formed the kernel of this book.

This book is the product of a 100-person combined research team of the U.S. Labor Party in New York City, the Mexican Labor Party in Mexico City, and the European Labor Party in Wiesbaden, West Germany. The efforts of this team, since its founding in January 1974 under the direction of Lyndon LaRouche, drew the circle tighter around the perpetrators of narcotics traffic over a period of years. The authors particularly acknowledge the efforts of Marilyn James, Richard Schulman, and Alfred Ross, whose research supplied the core of this book, and the contributions of Kathy Burdman, Scott Thompson, Paul Goldstein, Harald Hermann, Joseph Brewda, Roger Moore, Michelle Steinberg, Peter Wyer, Karen Steiner, and Peter Ennis. Our appreciation also goes to Linda Frommer, the book's



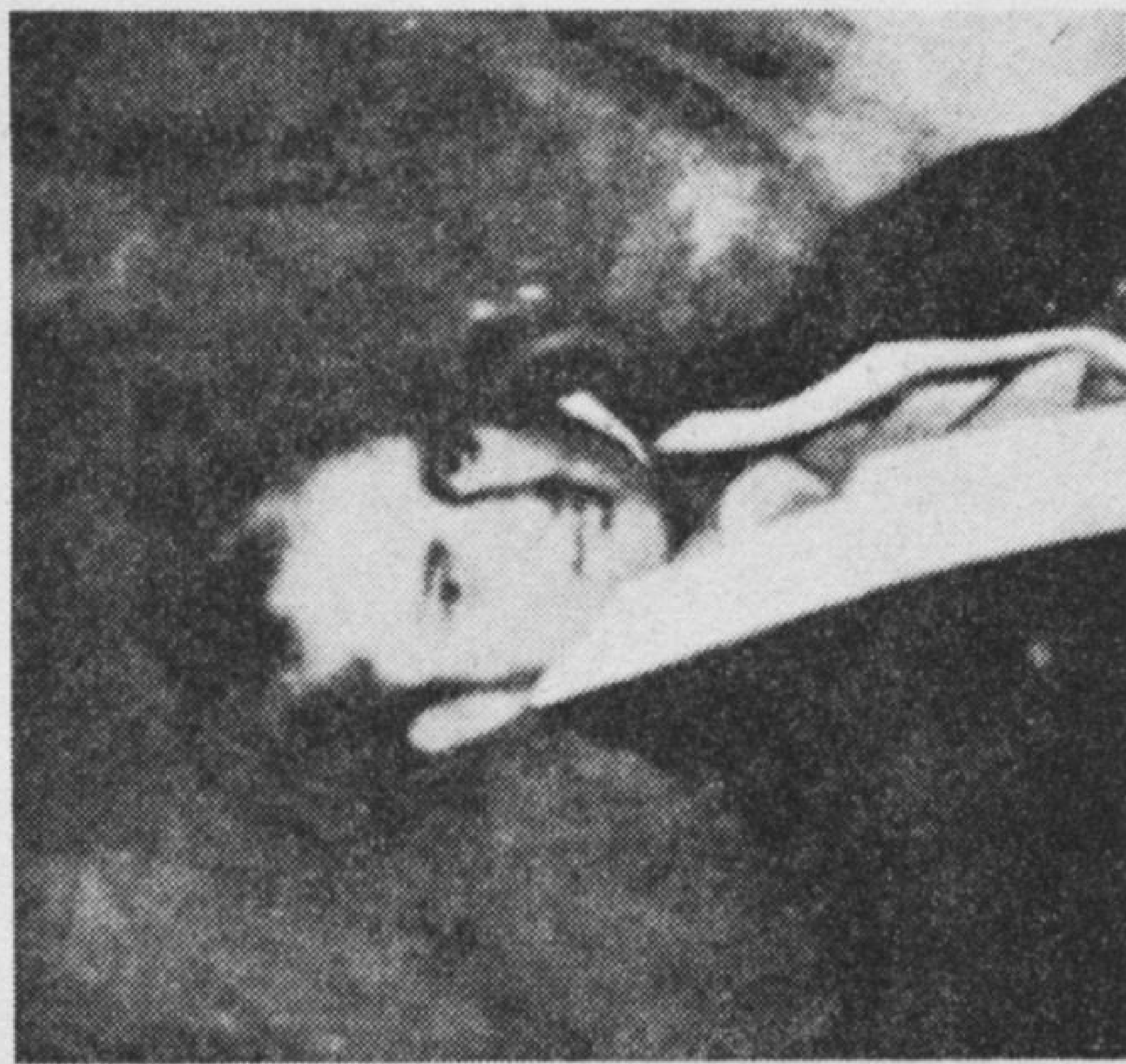
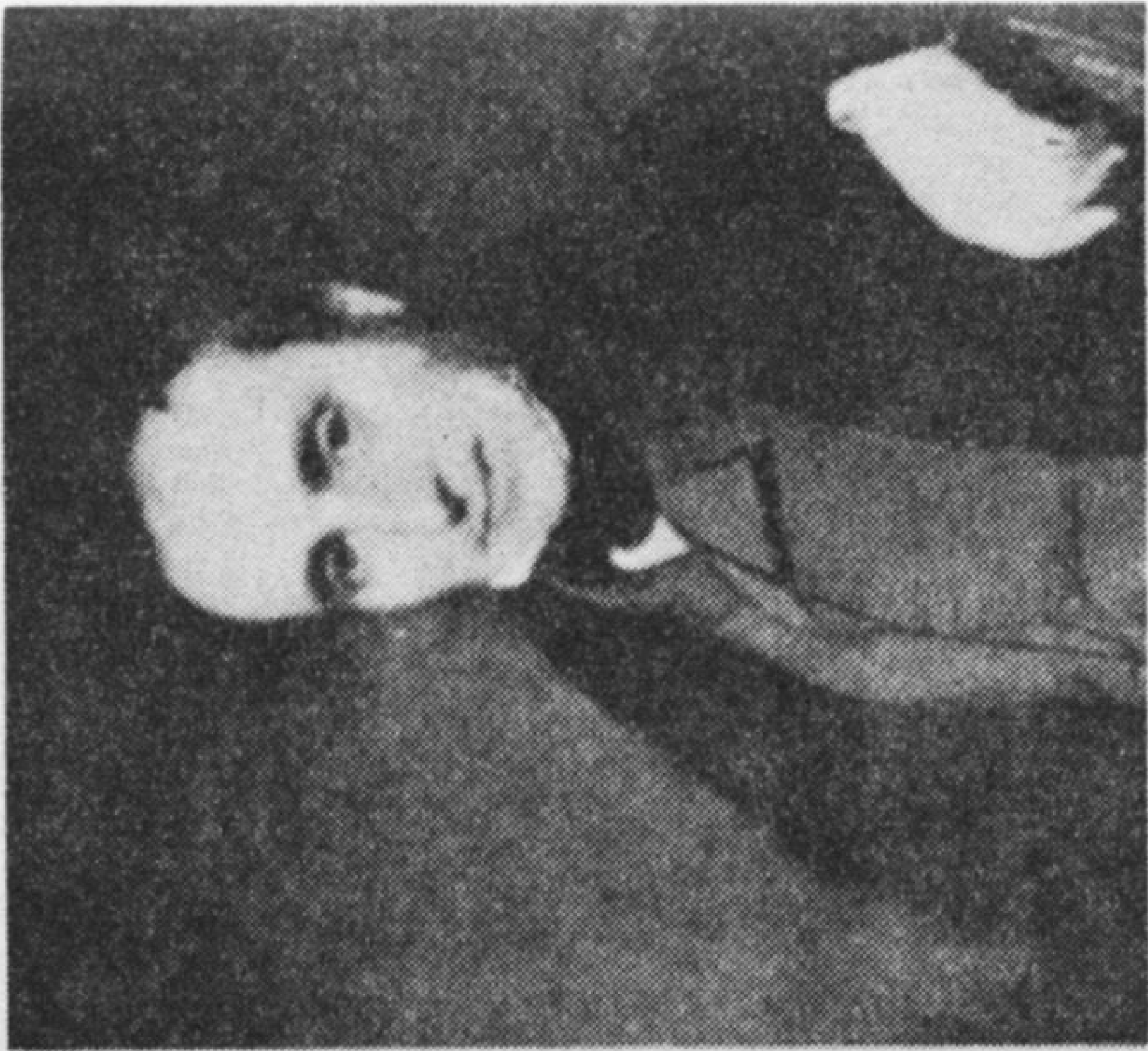

8

7



9

- 7. William Jardine
- 8. James Matheson
- 9. An artist's depiction of the First Opium War

editor, who accomplished the final stage of the manuscript's completion.

The authors are unfortunately unable to thank by name the many former and currently serving law enforcement officers of several nations who took the greatest risk in coming forward with information and experience to indict the most dangerous enemy of all.

# Introduction

America is at war. For the first time since 1865, the battleground is not abroad, but on the streets and schools of American cities. Casualties registered in the course of the conflict are incomparably higher than at any other time in American history. We are fighting for our lives, and in the most literal sense, for the lives of our children. Until now, we have been losing.

The enemy's most deadly weapon is dope.

Unlike most wars, which force both combatants deeply into debt, in this undeclared war the offensive power becomes wealthier and wealthier, while the stupefied victim becomes impoverished. In return for destroying the minds, and in many cases the lives, of the 48 million Americans hit by this weapon, the enemy exacts a payment of \$50 billion in retail drug sales alone in the United States, and \$200 billion worldwide. That \$200 billion, robbed from the world's productive sector, is the slush fund for everything evil in the world, including political terrorism — and including the murder of American Presidents.

There is not a parent, thinking over the destruction of a child, who really believes that drug abuse is a self-inflicted crime. Americans, no matter what else they have learned to tolerate, believe that the advancement of the next generation is part of the way things should be. If an entire generation of Americans is in jeopardy of being lost, then someone has done this to them.

We will tell you precisely who has done this — who has the ability to control the flow of dope from the mountains of the Far East and the valleys of Colombia to American high schools, who controls the banks which launder the \$200 billion in take, who puppeteers the crime syndicates in charge of retail distribution,

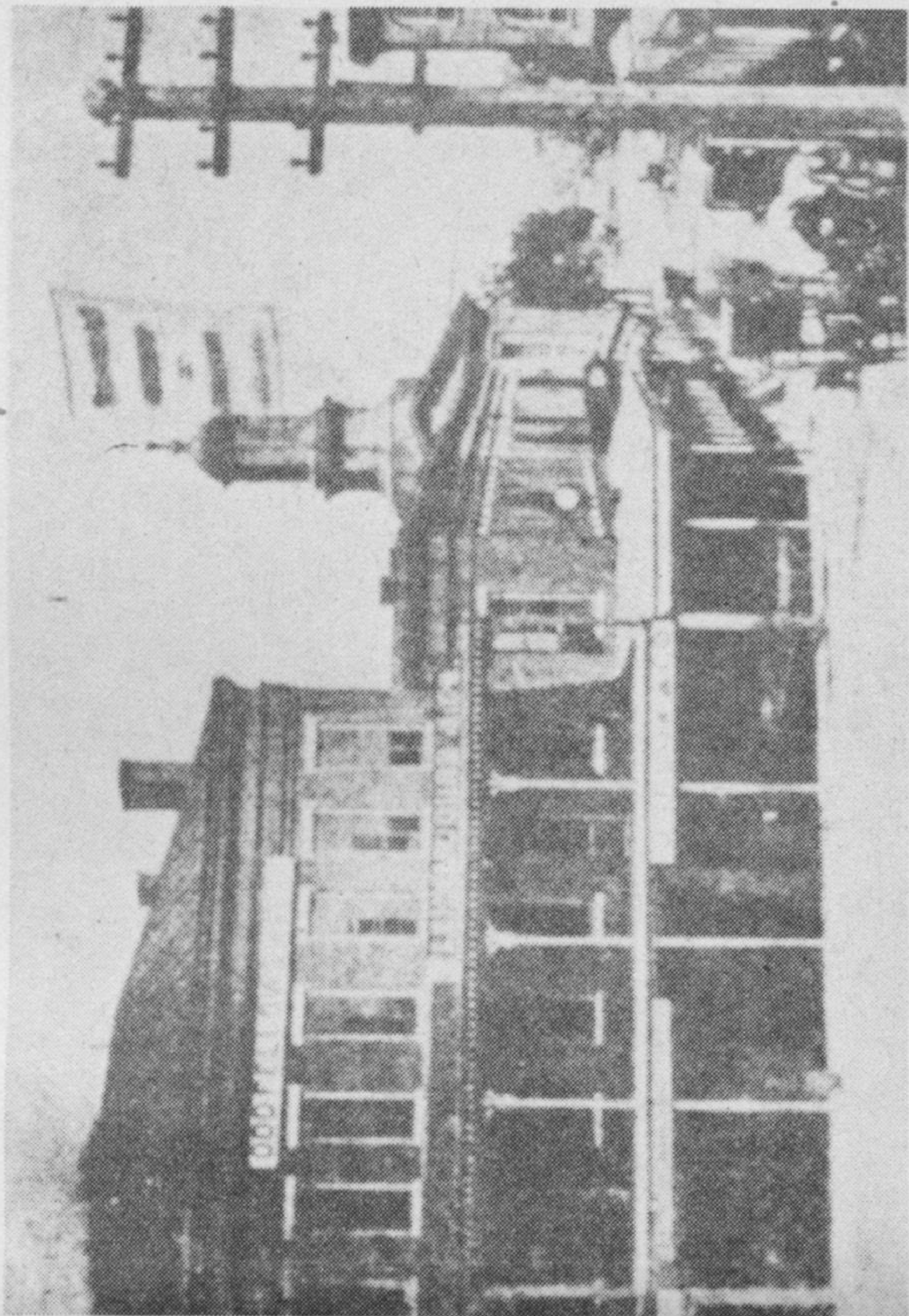

13

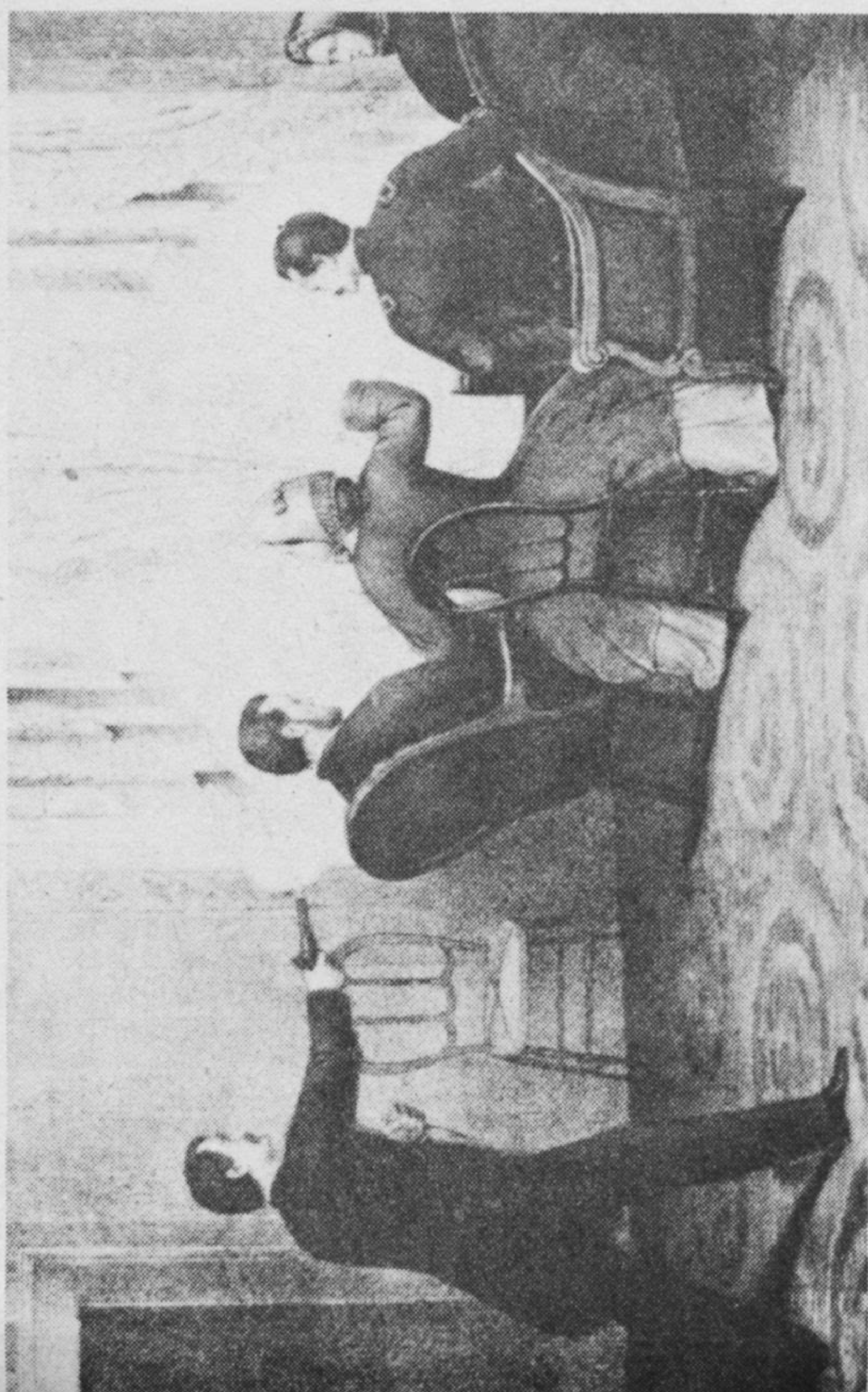

14

and who corrupts our political life. It is the same people against whom we fought the American Revolution, who set up the world opium trade a century and a half ago, and who run it today: the aristocratic and banking oligarchy of Great Britain.

Look into the motionless stupor of the mind of a youth who has been sapped and destroyed by addiction. Incapable of reason, incapable of thought, today's addicted youth lives for only one thing: his "fix," his "high." Then consider the body count of Britain's Opium War against the United States: Over 48 million Americans, mostly between the ages of 12 and 25 are officially known by the Drug Enforcement Administration to be frequent users of heroin, cocaine, and marijuana. Over one-fourth of the American people are severely wounded or dead in a war the country has not yet mobilized to fight.

The Drug Enforcement Administration has released these statistics on drug use by Americans:

#### Heroin

500,000 daily users (other sources place this hardcore addict figure at between 750,000 and 1 million)

4,000,000 occasional users

#### Cocaine

575,000 users between the ages of 12-17

4,500,000 users between the ages of 18-25

1,000,000 users over the age of 25

#### Marijuana

11,000,000 daily users

24,000,000 occasional users

These figures do not include that portion of the population addicted to amphetamines, barbiturates, and hallucinogens. This figure alone according to recent reports from the National Institute of Drug Abuse constituted between 12 and 25 percent of all patients admitted to federally funded drug clinics during 1977. The last census taken of drug abuse in 1974, issued as a Report to the President, calculated conservatively that close to one and a half million Americans had "gotten into trouble"—been

arrested, treated, or hospitalized — through the use of amphetamines or barbiturates. When calculated for only youth of high school age, the rate of amphetamine and barbiturate use was four times as great as that of the adult population.

Since the inauguration of Jimmy Carter, whole categories of drug abuse are no longer monitored. The computer system of the Drug Enforcement Administration has been shut down. Behind that action is the grim fact that many of Mr. Carter's domestic policy advisors are on record as being committed to decriminalization of deadly drugs — beginning with marijuana. If such policies go through, statistics will be meaningless: drug abuse will treble within months of legalization. The \$200 billion take for the British drug traders will climb to \$300 billion.

## The world's biggest business

How is the \$200 billion monstrosity of world drug revenues hidden? In the most important way, *it is not*. The flow of narcotics and dirty money is conducted in the full light of day, the same way rum-running was conducted during Prohibition. Only *misdirection* prevents the public from understanding who the enemy is. Massive crimes are not hidden under cover of darkness, but under the cover of an effective lie. The operative lie in this case is "Free Enterprise."

When Sam Bronfman sold his rotgut to American mobsters, supplied by the old British distillers and financed by the old British banks, it was a matter of free enterprise: what the mob did with it after it crossed the American border was of no concern to him. When Meyer Lansky made his first heroin connection with Britain's dope-trading Keswick family in Shanghai in 1920, the sale was legal and in the light of day; what the mob did with the heroin later was not the responsibility of Britain's Far East traders.

Now, when the Hongkong and Shanghai Bank "launders" the \$10 billion annual flow of narcotics money through Hong Kong, is it anything but a matter of "free enterprise" where their deposits come from and their loans go? When the Bronfmans in Canada



11

- 11. Giuseppe Mazzini
- 12. Chinese "coolies" — opium smokers — at work on U.S. railroad
- 13. Lehman Bros. (Lehman & Durr) office in Montgomery, Alabama shortly after the Civil War; the same building houses The Oddfellows secret society
- 14. Lincoln's assassination by John Wilkes Booth, a British agent (artist's depiction)

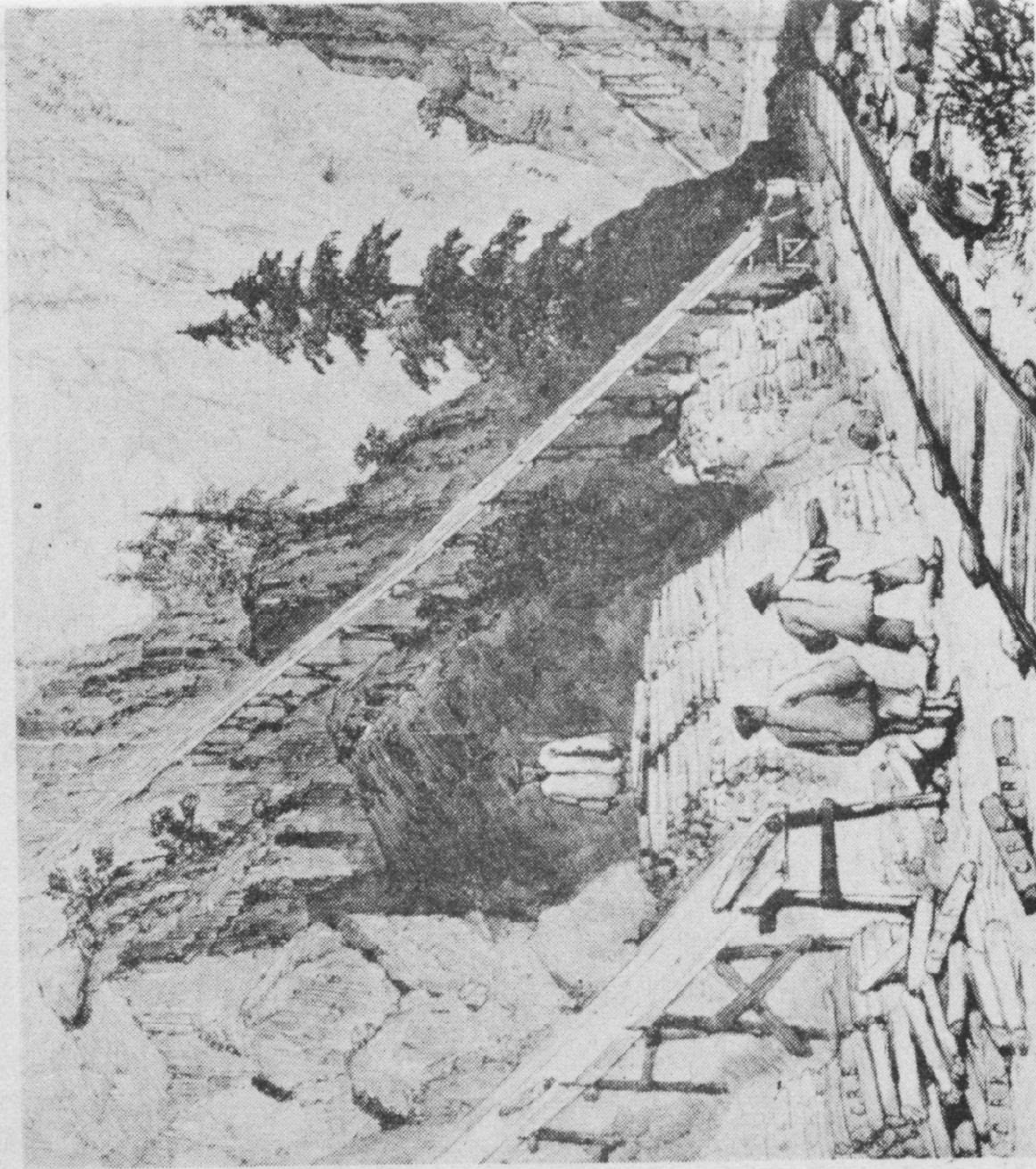

12

and the Jacobs family of Buffalo finance organized crime, is it anything more than a "free enterprise" business relationship? The entire army of the enemy was built, and functions, under the open view of the public.

In fact, the chain of interlocking "free enterprise" relationships that describes the flow of drugs and dirty money in and out of the United States only masks the type of conspiracies that Americans see not in pulp thrillers, but in nightmares. We will uncover these conspiracies, the spider's web of the British monarchy — the Italian-surname organized crime syndicates, London's Zionist-cover terrorist operation, the secrets of Peking's dope-running foreign intelligence organization. We will trace them all back to their common "mother," the great aristocratic families of Britain.

With this report, you will see your enemy as he is, behind the veils of misdirection, past the Hollywood parodies of organized crime. We are now in sight of the day when we will turn the tide against the dope warriors of Great Britain — by striking at the head of the beast.

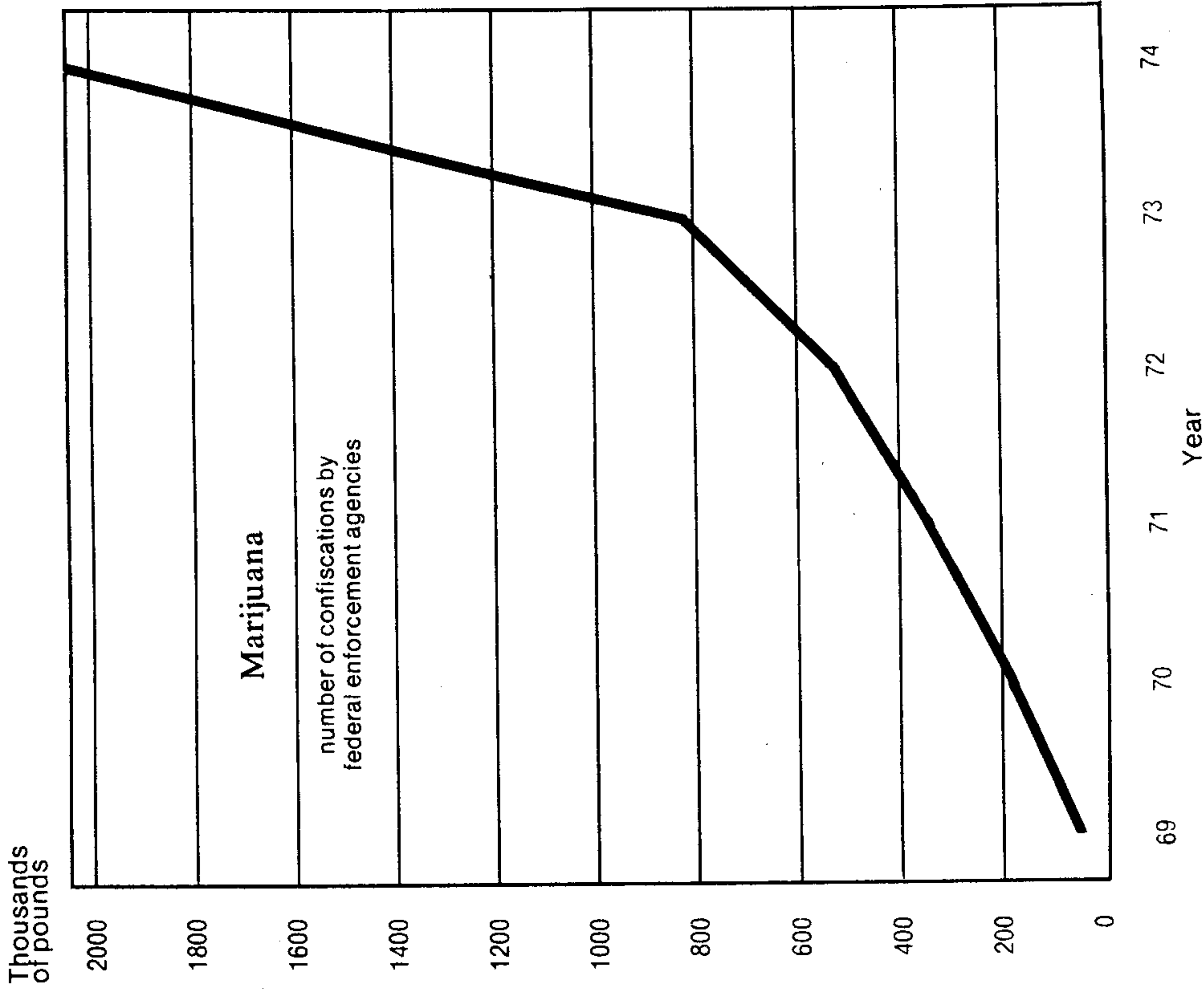

Fig. 1  
The Rate of Increase in Marijuana Use in the USA

The above graph of confiscations of marijuana by federal enforcement agencies provides only a rough barometer of the accelerated increase of marijuana smuggling into and use in the USA between 1969 and 1974. As is common knowledge, from 1974 to the present, marijuana use has gone up at a rate whose acceleration dwarfs that depicted above. In the past year alone, "drug decriminalization" campaigning by British agents-of-influence in the White House, and governors and Congressmen in the hip-pockets of Edgar Bronfman and Meyer Lansky, has caused marijuana use to increase at an astronomical rate.



17

17. A drug-stand in the open market place, Vientiane, Laos (1967)

**PART I**  
**History**  
**of Britain's**  
**First Opium Wars**





15

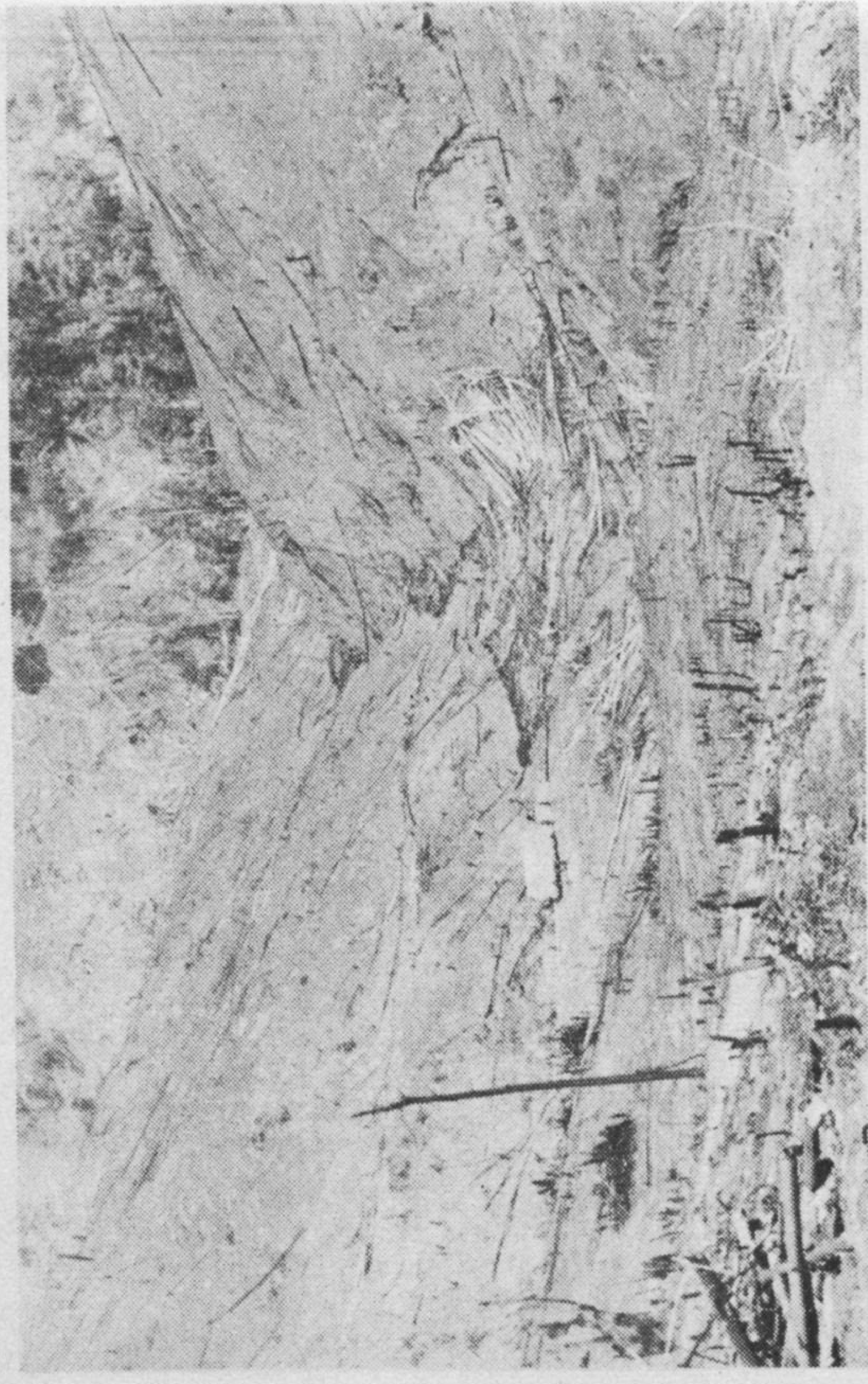

16

- 15. A mule-team convoy carrying opium through northern Thailand (1967)
- 16. Hillsides in northern Thailand devastated by the planting of opium poppies

---

# Introduction

This is the setting for what follows below: narcotics are pouring in from abroad through a well-organized, efficient group of smugglers. One-fifth of the population abuses drugs, an epidemic surpassing any known since the Great Plagues. Not only the poor, but the wealthy and the children of the wealthy have succumbed. Within the nation, organized crime displays its drug profits without shame, ruling local government, and threatening the integrity even of national government. None of their opponents is safe from assassins, not even the chief of state. Law enforcement is in shambles. The moral fiber of the nation has deteriorated past the danger point.

And one of the leading dope-traffickers writes to his superiors abroad, "As long as this country maintains its drug traffic, there is not the slightest possibility that it will ever become a military threat, since the habit saps the vitality of the nation." (1)

The description is familiar, but we are not writing of America in 1978, but China in 1838, on the eve of the first Opium War, when Great Britain landed troops to compel China to ingest the poison distributed by British merchants.

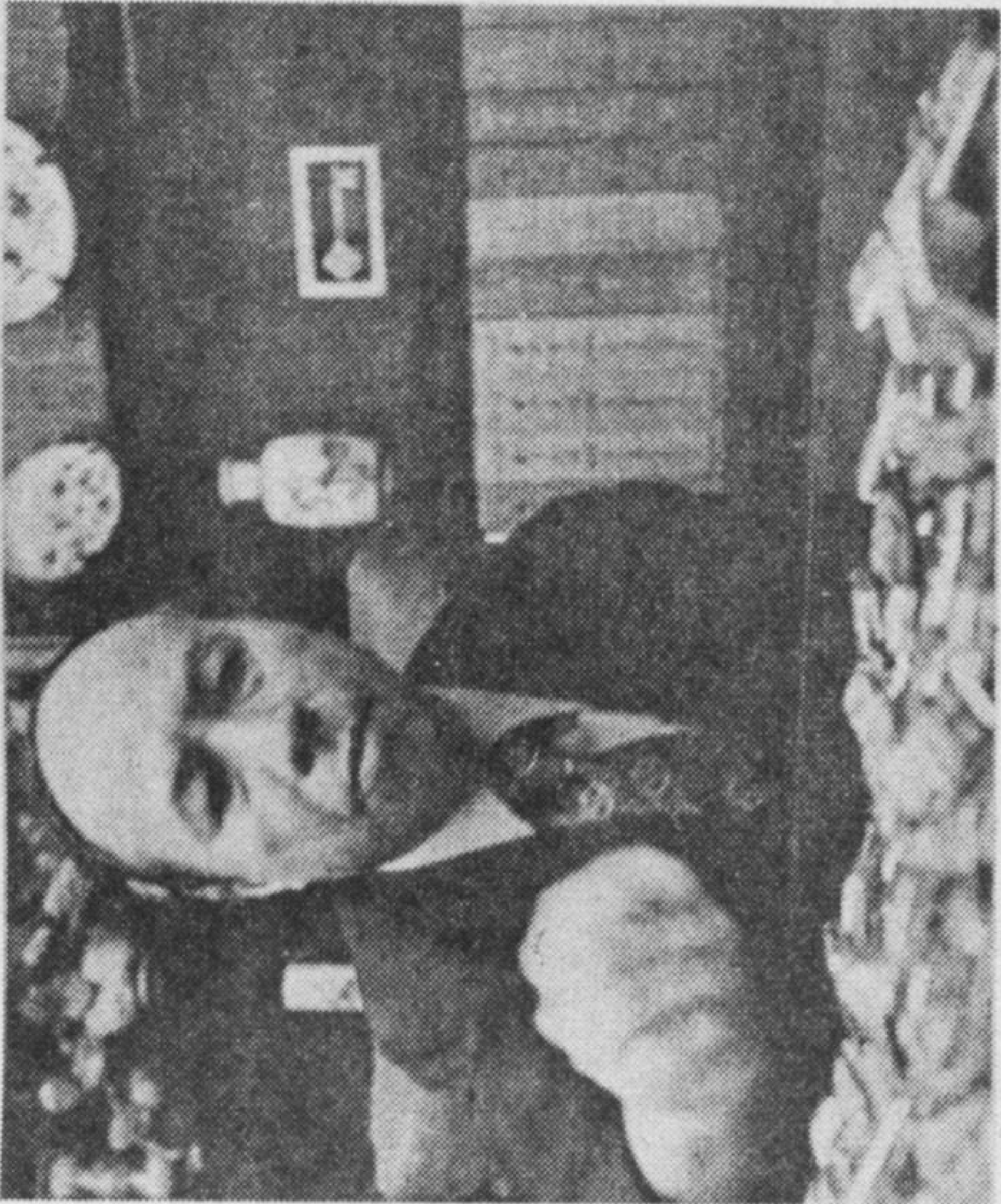

19

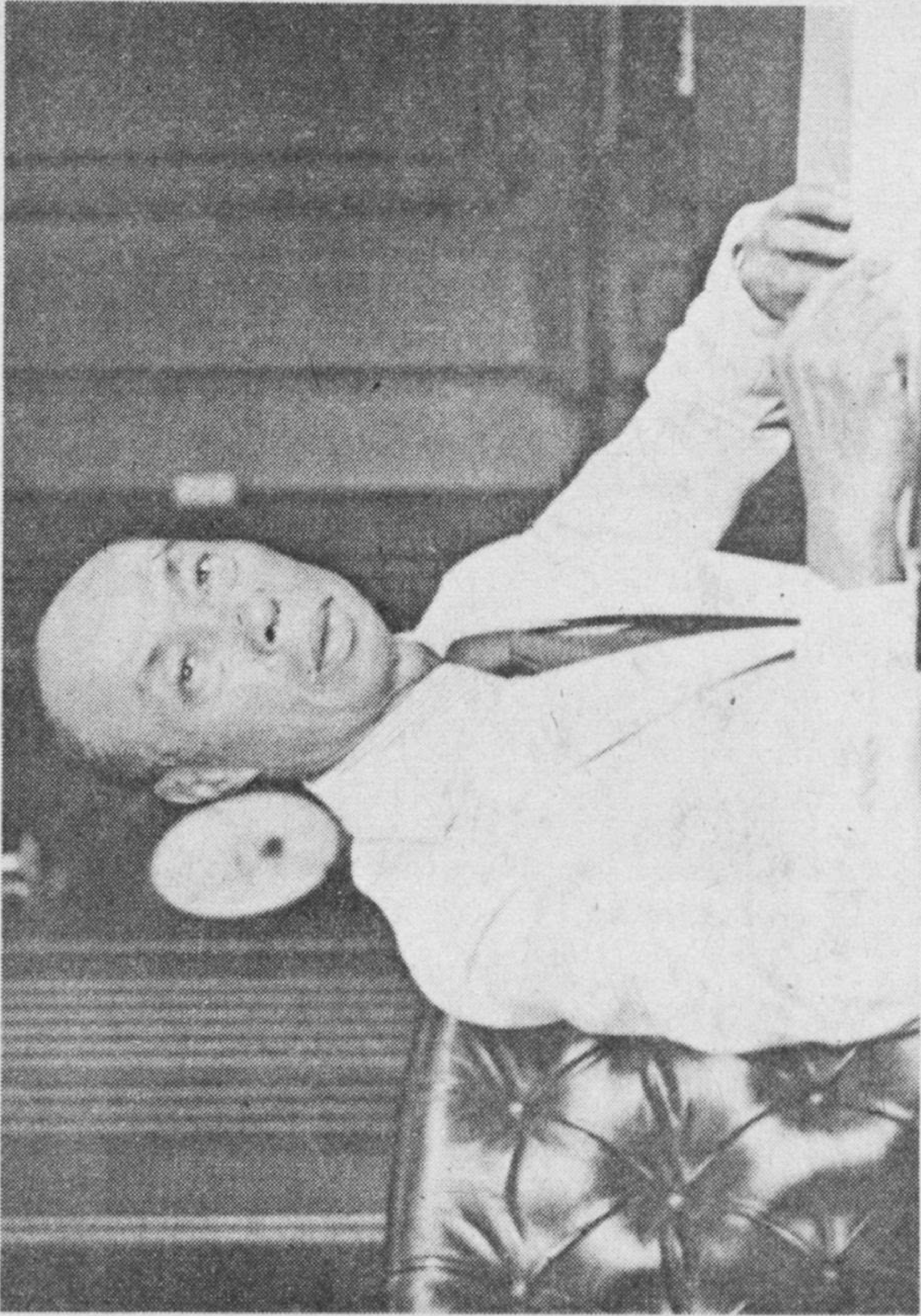

20

- 19. Chinese expatriate gold-dealer (Woo Hong-fai), Hong Kong, 1977
- 20. Udorn Tejapaibul, Chairman, Bangkok Metropolitan Bank

An American President lies dead of an assassin's bullet. Corrupt members of the Cabinet cover the tracks leading to a conspiracy, including the leading narcotics mobs, ethnic-based secret societies, and a foreign government. The public does not believe that the assassin acted alone, but the weight of the cover-up, the silence of the leading press, and the deaths of witnesses blur the trail from the public's view.

Was that the death of John F. Kennedy? It was also the death of Abraham Lincoln.

During the last century, British finance protected by British guns controlled the world narcotics traffic. The names of the families and institutions are known to the history student: Matheson, Keswick, Swire, Dent, Baring, and Rothschild; Jardine Matheson, the Hongkong and Shanghai Bank, the Chartered Bank, the Peninsular and Orient Steam Navigation Company. Britain's array of intelligence fronts ran a worldwide assassination bureau, operating through occult secret societies: the Order of Zion, Mazzini's Mafia, the "Triads" or Societies of Heaven in China.

Paging back over the records of the narcotics traffic and its wake of corruption and murder, the most uncanny feature of the opium-based Pax Britannica is how shamelessly, how publicly the dope-runners operated. Opium trading, for the British, was not a sordid backstreet business, but an honored instrument of state policy, the mainstay of the Exchequer, the subject of encomia from Britain's leading apostles of "Free Trade" — Adam Smith, David Ricardo, Thomas Malthus, James Mill, and John Stuart Mill. The poisoning of China, and later the post-Civil War United States, did not lead to prison but to peerages. Great sectors of the Far East became devoted to the growing of the opium poppy, to the exclusion of food crops, to the extent that scores of millions of people depended utterly on the growing, distribution and consumption of drugs.

The Keswicks, Dents, Swires and Barings *still* control the world flow of opiates from their stronghold in the British Crown Colony of Hong Kong. Jardine Matheson, the Hongkong and Shanghai Banking Corporation, and the Peninsular and Orient Steam Navigation Company *still* control the channels of

production and distribution of the drugs from the Far East, through the British dominion of Canada, into the United States. By an uninterrupted chain of succession, the descendants of the Triads, the Mafia, and the Order of Zion *still* promote drug traffic, dirty money transfers, political corruption, and an Assassination Bureau even more awesome than the conspiracy that claimed Abraham Lincoln's life. Of course, the drug revenues of this machine are no longer tallied in the published accounts of the British Exchequer. But the leading installations of the drug traffic are no more hidden than they were a hundred years ago. From the Crown Colony of Hong Kong, the "HongShang" Bank does what the Keswicks set it up to do: provide centralized redcounting facilities for the financing of the drug trade. Even the surnames of senior management are the same.

Even today, the grand old names of Prohibition liquor and dope-running rouse the deep awareness of Americans: Bronfman, Kennedy, Lansky. Are the denizens of the India opium trade, of the Prohibition mob, imprisoned in the history books and behind the movie screen? Not infrequently, the observer feels a momentary lapse in time, and sees not a history book, but the morning newspaper, not the late-night movie, but the evening television newscast.

The story we have to tell happened twice. It first happened to China, and now it is happening to the United States. Emphasizing that neither the names nor the hangouts of the criminals have changed, we begin by telling how it happened the first time.

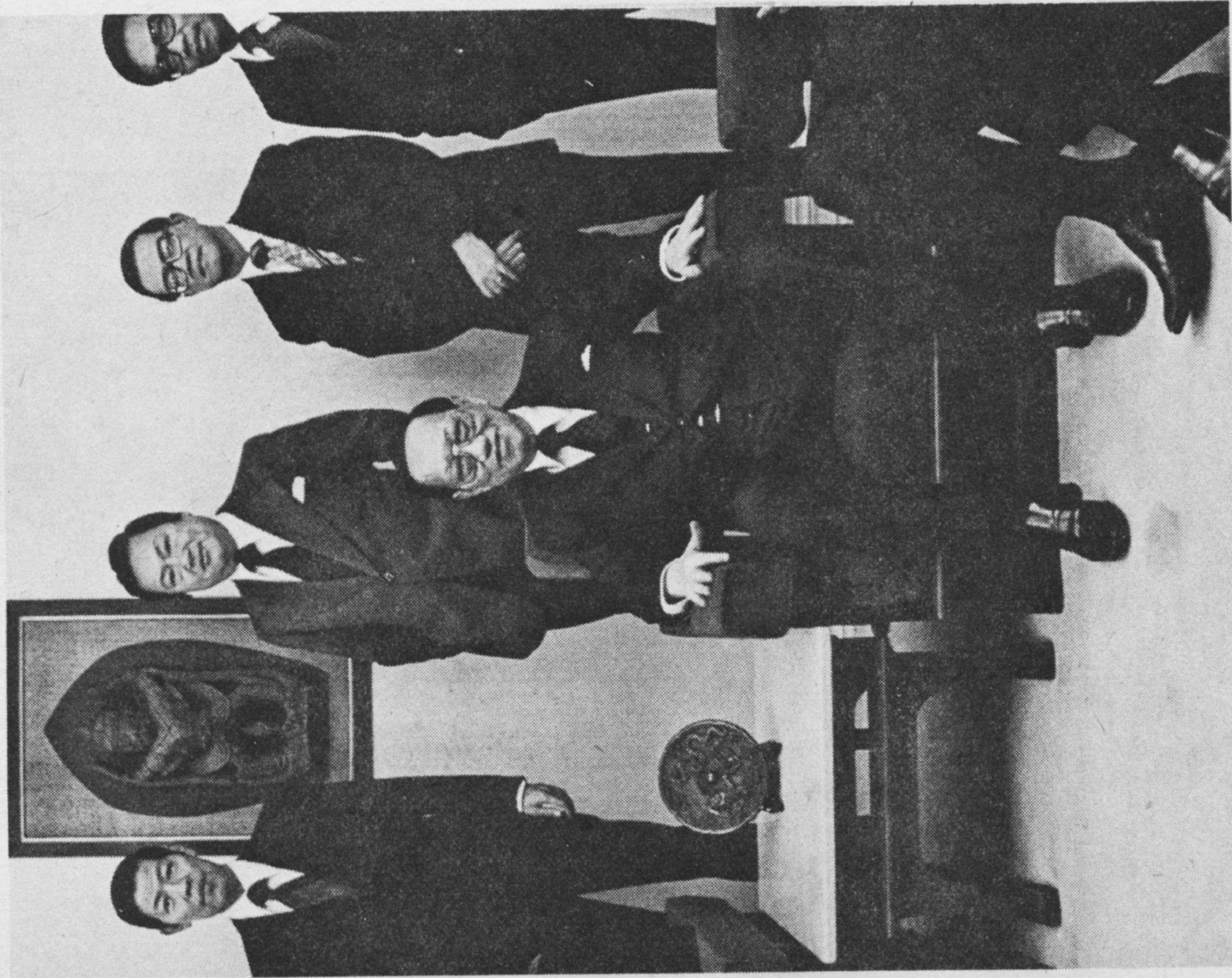

18. Chin Sophonpanich, Chairman, with other directors of the Bank of Bangkok

of the British Empire, King George III mandated the East India Company to begin shipping large quantities of opium from Bengal in the British Crown Colony of India into China. The dual objective was to favorably alter the balance-of-payments deficit and to foster drug addiction among China's mandarin class. By the time of the American Revolution, East India Company opium trafficking into China was officially reported to be at a scale 20 times the absolute limit of opium required for medical and related use.

In a very direct sense, the Founding Fathers of the United States fought the American Revolution against the British Crown's opium policy.

\* East India Company intelligence operative Adam Smith's *Wealth of Nations* spelled out the colonial looting policy against which the Founding Fathers rebelled. In that same document — as part of the same scheme to defend the Empire — Smith advocated a massive increase of East India Company opium exporting into China. (2)

\* The dirty money culled from that opium trade made up a sizable portion of the war chest that financed Britain's deployment of Hessian mercenaries into North America to attempt to crush the rebellion.

\* The "Secret Committee" of the East India Company — under the direction of Lord Shelburne and company chairman George Baring — coordinated British secret intelligence's campaign of subversion and economic warfare against the newly constituted American republic even before the ink had dried on the Treaty of Paris (1783). (3)

After the American Revolution, Smith's call for a dramatic increase in opium exporting into China was enacted with a vengeance. From 1801 to 1820, official British figures placed the opium trade at approximately 5,000 chests per year. By the late 1820s, a network of trading companies operating under overall East India Company "market control" was founded to facilitate the trade. Some of these British opium houses, including the biggest, Jardine Matheson & Co. Ltd., maintain an active hand in Far East heroin trafficking to this day.

The establishment of these trading companies — the core of

# 1 Britain's First Opium Wars

From 1715, when the British East India Company opened up its first Far East office in the Chinese port city of Canton, it has been *official British Crown policy* to foster mass-scale drug addiction against targeted foreign populations in order to impose a state of enforced backwardness and degradation, thereby maintaining British political control and looting rights. While the methods through which the British have conducted this Opium War policy have shifted over the intervening 250 years, the commitment to the proliferation of mind-destroying drugs has been unswerving.

It was the British Crown's categorical opposition to and hatred for scientific and technological progress that led it to adopt an Opium War policy during the last decade of the 18th century. Having stifled the development of domestic manufacturing during the previous century, the British Crown found its treasury rapidly being drained of silver reserves — the only payment the Chinese Emperor would accept in exchange for silk, tea, and other commodities Britain imported. To reverse the silver exodus, which threatened to collapse the financial underpinnings



23

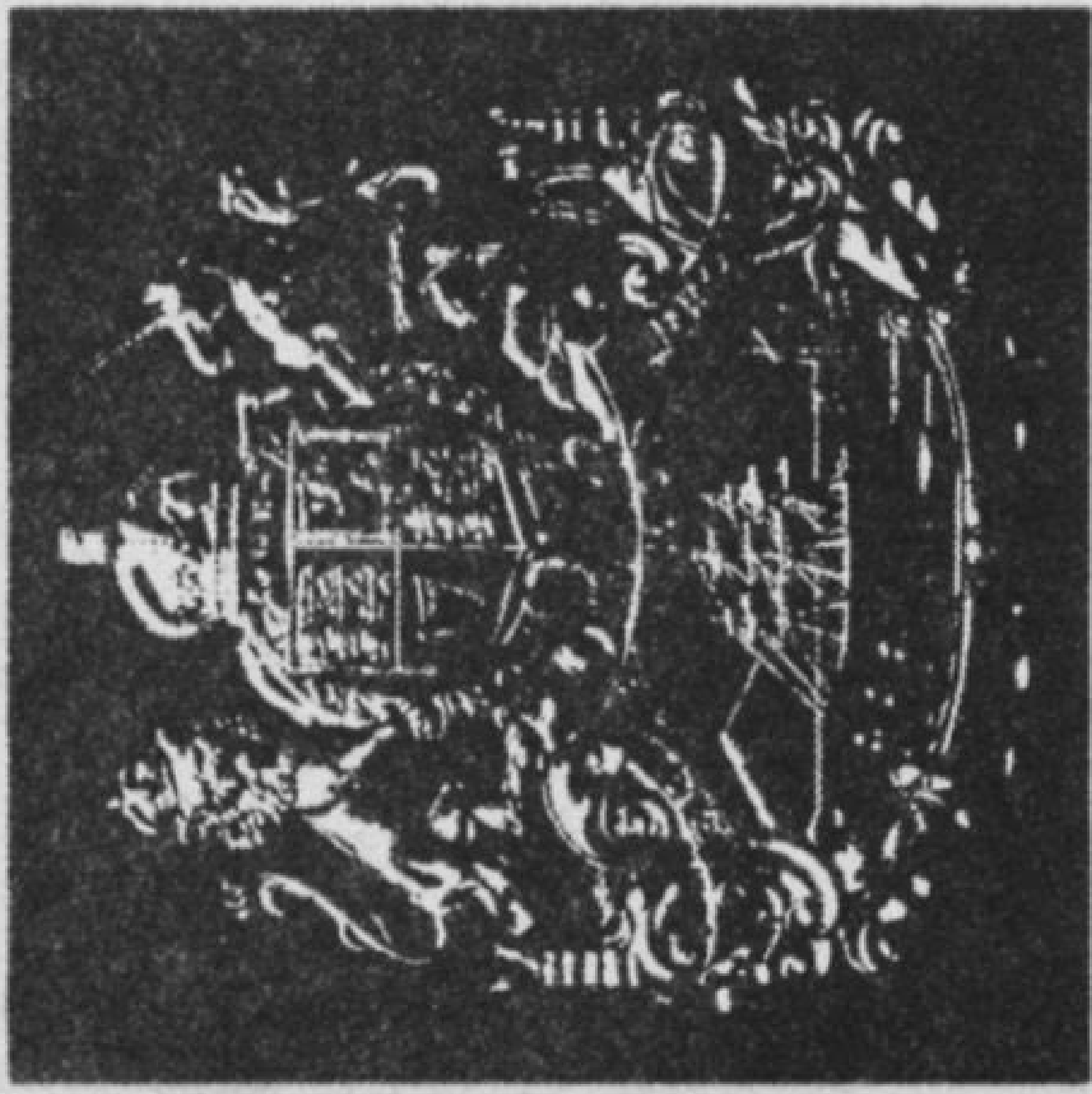

25

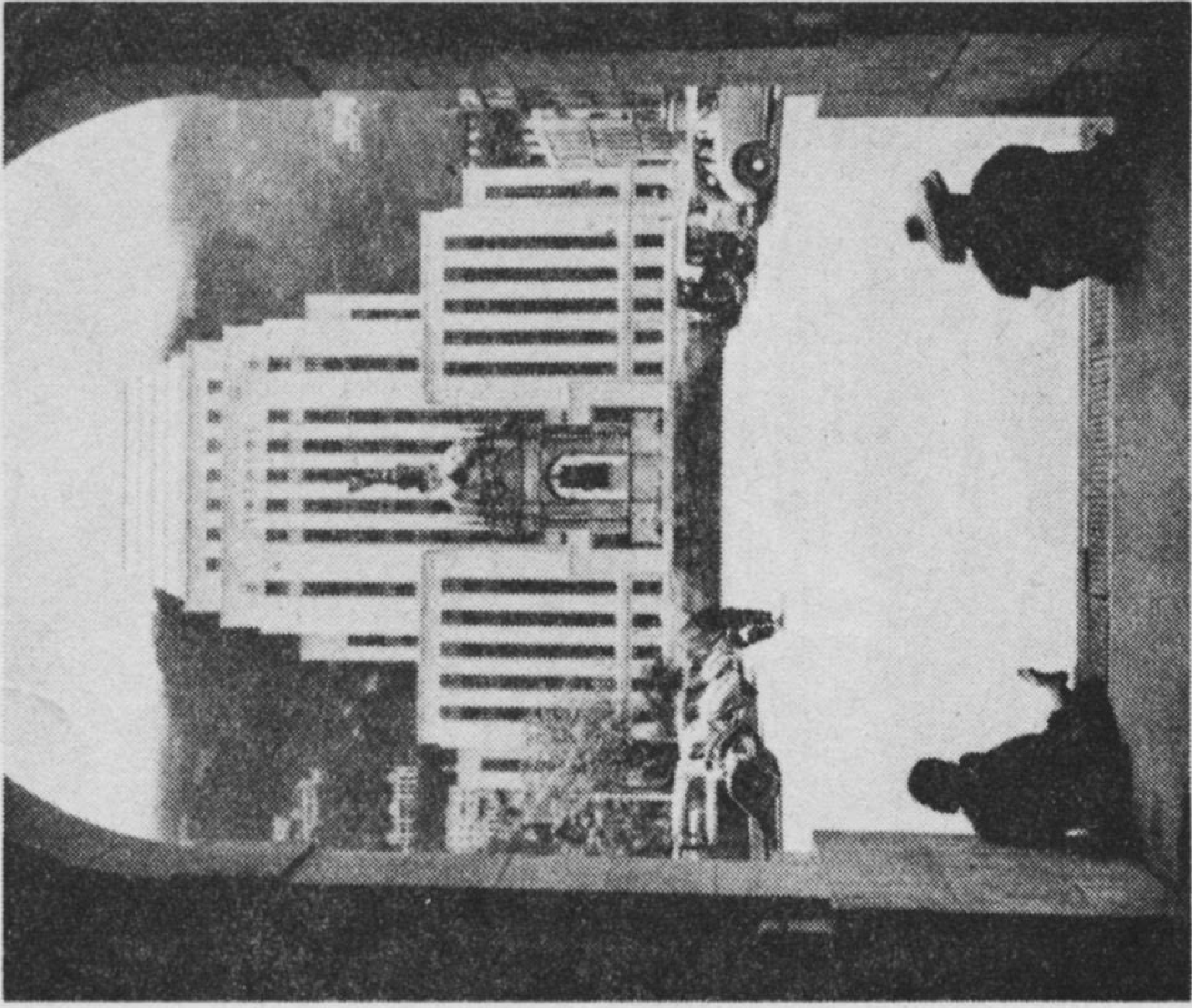

24



26

Britain's Opium War infrastructure — fostered an epidemic-scale increase in opium trafficking into China. By 1830-31, the number of chests of opium brought into China increased fourfold to 18,956 chests. In 1836, the figure exceeded 30,000 chests. In financial terms, trade figures made available by both the British and Chinese governments showed that between 1829-1840, a total of 7 million silver dollars entered China, while 56 million silver dollars were sucked out by the soaring opium trade. (4)

When the Chinese Emperor, confronted by a galloping drug addiction crisis, tried to crack down on the British trading companies and their dope smugglers, the British Crown went to war.

In 1839, the Chinese Emperor appointed Lin Tse-hsu Commissioner of Canton to lead a campaign against opium. Lin launched a serious crackdown against the Triad gangs sponsored by the British trading companies to smuggle the drugs out of the "Factory" area into the pores of the communities. The Triad Society, also known as the "Society of Heaven and Earth," was a century-old feudalist religious cult that had been suppressed by the Manchu Dynasty for its often violent opposition to the government's reform programs. The Triad group in Canton was profiled and cultivated by Jesuit and Church of England missionaries and recruited into the East India Company's opium trade by the early 19th century. (5)

When Lin moved to arrest one of the British nationals employed through the opium merchant houses, Crown Commissioner Capt. Charles Elliot intervened to protect the drug smuggler with Her Majesty's fleet. And when Lin responded by laying siege to the factory warehouses holding the tea shipments about to sail for Britain until the merchants turned over their opium stockpiles, Elliot assured the British drug pushers that the Crown would take full responsibility for covering their losses.

The British Crown had its "casus belli." Matheson of the opium house Jardine Matheson joyously wrote his partner Jardine — then in London, conferring with Prime Minister Palmerston on how to pursue the pending war with China:

... the Chinese have fallen into the snare of rendering

themselves directly liable to the Crown. To a close observer, it would seem as if the whole of Elliot's career was expressly designed to lead on the Chinese to commit themselves, and produce a collision.

Matheson concluded the correspondence: "I suppose war with China will be the next step." (6)

Indeed, on October 13, 1839, Palmerston sent a secret dispatch to Elliot in Canton informing him that an expeditionary force proceeding from India could be expected to reach Canton by March, 1840. In a follow-up secret dispatch dated November 23, Palmerston provided detailed instructions on how Elliot was to proceed with negotiations with the Chinese — once they had been defeated by the British fleet.

Palmerston's second dispatch was, in fact, modeled on a memorandum authored by Jardine dated October 26, 1839, in which the opium pusher demanded: 1) full legalization of opium trade into China; 2) compensation for the opium stockpiles confiscated by Lin to the tune of £2 million; and 3) territorial sovereignty for the British Crown over several designated offshore islands. In a simultaneous memorandum to the Prime Minister, Jardine placed J&M's entire opium fleet at the disposal of the Crown to pursue war against China. (7)

The Chinese forces, decimated by ten years of rampant opium addiction within the Imperial Army, proved no match for the British.

The British fleet arrived in force and laid siege in June of 1840. While it encountered difficulties in Canton, its threat to the northern cities, particularly Nanking, forced the Emperor to terms. Painfully aware that any prolonged conflict would merely strengthen Britain's bargaining position, he petitioned for a treaty ending the war.

When Elliot forwarded to Palmerston a draft Treaty of Chuenpi in 1841, the Prime Minister rejected it out of hand, replying, "After all, our naval power is so strong that we can tell the Emperor what we mean to hold, rather than what he should say he would cede." Palmerston ordered Elliot to demand "admission of opium into China as an article of lawful





21



22

- 21. The Crown Colony of Hong Kong, financial center of the drug trade
- 22. Brian Slevin, Hong Kong Chief of Police
- 23. M.G.R. Sandberg, Chairman, The Hongkong and Shanghai Bank
- 24. The Hongkong and Shanghai Bank building
- 25. Hongkong and Shanghai Bank emblem
- 26. Current notes issued by the Hongkong and Shanghai and the Standard Chartered banks in Hong Kong; at bottom, an 1879 issue of the Anglo-Egyptian Bank (Barclays)

commerce," increased indemnity payment, and British access to several additional Chinese ports. (8)

The Treaty of Nanking, signed in 1842, brought the British Crown an incredible sum of \$21 million in silver — as well as extraterritorial control over the "free port" of Hong Kong — which to this day is the capital of Britain's global drug-running.

The First Opium War defined the proliferation of and profiteering from mind-destroying drugs as a cornerstone of British Imperial policy. Anyone who doubts this fact need only consider this policy statement issued by Lord Palmerston in a January 1841 communiqué to Lord Auckland, then Governor General of India:

The rivalryship of European manufactures is fast excluding our productions from the markets of Europe, and we must unremittingly endeavor to find in other parts of the world new vents for our industry (i.e., opium — ed.). . . . If we succeed in our China expedition, Abyssina, Arabia, the countries of the Indus and the new markets of China will at no distant period give us a most important extension to the range of our foreign commerce. . . . (9)

It is appropriate to conclude this summary profile of Britain's first Opium War by quoting from the 15th edition of the *Encyclopedia Britannica*, published in 1977. What the brief biographical sketch of Lin Tse-hsu — the leader of the Chinese Emperor's fight to defeat British drugging of the Chinese population — makes clear to the intelligent reader is that British policy to this day has not changed one degree:

. . . he (Lin—ed.) did not comprehend the significance of the British demands for free trade and international equality, which were based on their concept of a commercial empire. This concept was a radical challenge to the Chinese world order, which knew only an empire and subject peoples. . . . In a famous letter to Queen Victoria, written when he arrived in Canton, Lin asked if she would allow the importation of such a poisonous substance into

her own country, and requested her to forbid her subjects to bring it into his. Lin relied on aggressive moral tone; meanwhile proceeding relentlessly against British merchants, in a manner that could only insult their government.

## Britain's opium diplomacy

Not a dozen years would pass from the signing of the Treaty of Nanking before the British Crown would precipitate its second Opium War offensive against China, with similar disastrous consequences for the Chinese and with similar monumental profits for London's drug-pushers. Out of the second Opium War (1858-1860), the British merchant banks and trading companies established the Hongkong & Shanghai Corporation, which to this day serves as the central clearinghouse for all Far Eastern financial transactions relating to the black market in opium and its heroin derivative.

Furthermore, with the joint British-French siege of Peking during October 1860, the British completed the process of opening up all of China. Lord Palmerston, the High Priest of the Scottish Rites, had returned to the Prime Ministership in June 1859 to launch the second war and thereby fulfill the "open China" policy he had outlined 20 years earlier.

Like the 1840 invasion of Canton, the second Opium War was an act of British imperial aggression — launched on the basis of the first flimsy pretext that occurred. Just prior to his ordering of a northern campaign against Peking (which permitted the British to maintain uninterrupted opium trafficking even while a state of war was underway), Lord Palmerston wrote to his close collaborator Foreign Secretary Lord John Russell (grandfather and guardian of the evil Lord Bertrand Russell). "We must in some way or other make the Chinese repent of the outrage," wrote Palmerston, referring to the defeat suffered by a joint British-French expeditionary force at Taku Forts in June 1859. The expeditionary fleet, acting on orders to seize the forts, had run aground in the mud-bogged harbor and several hundred



32

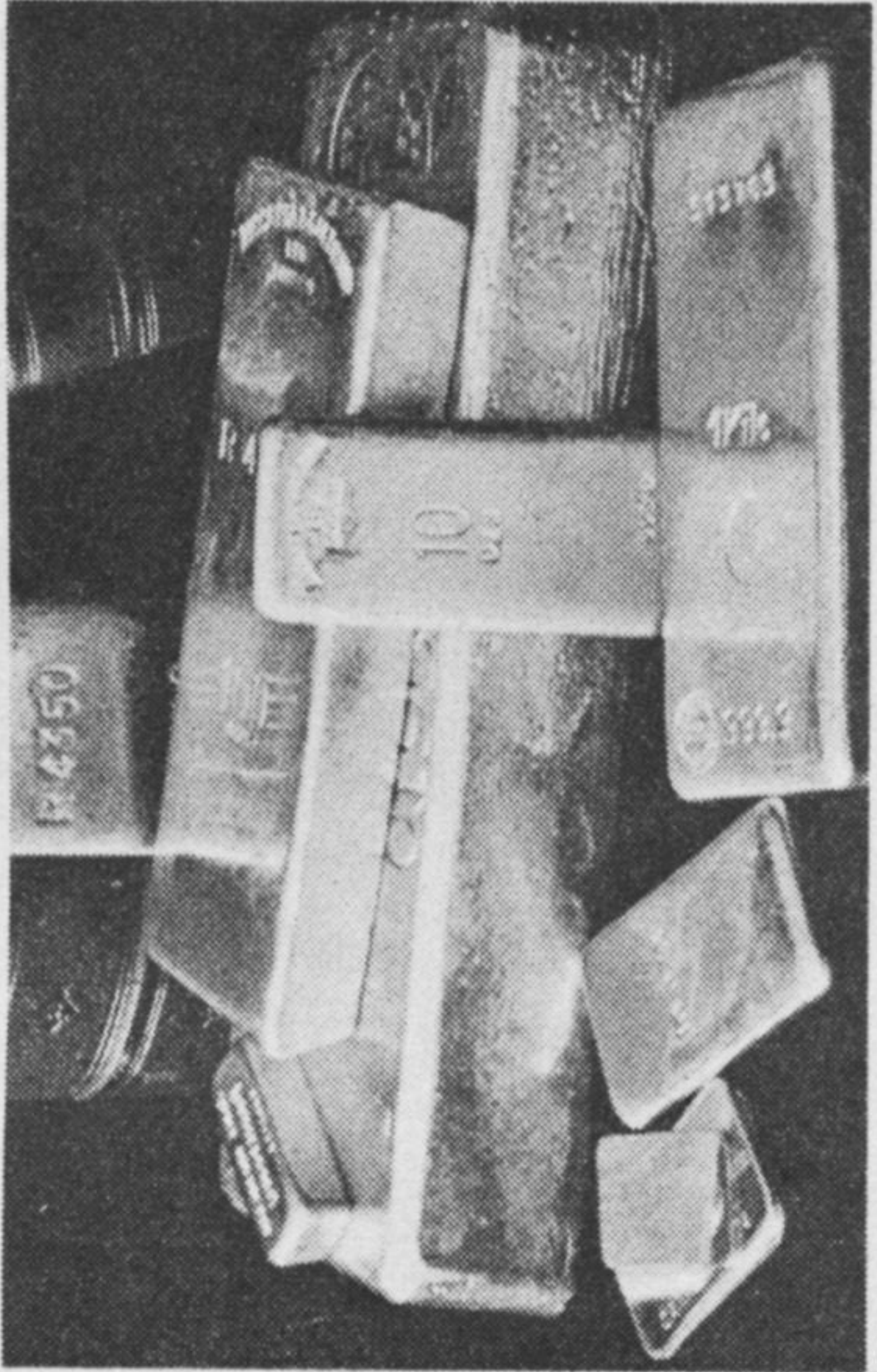

31

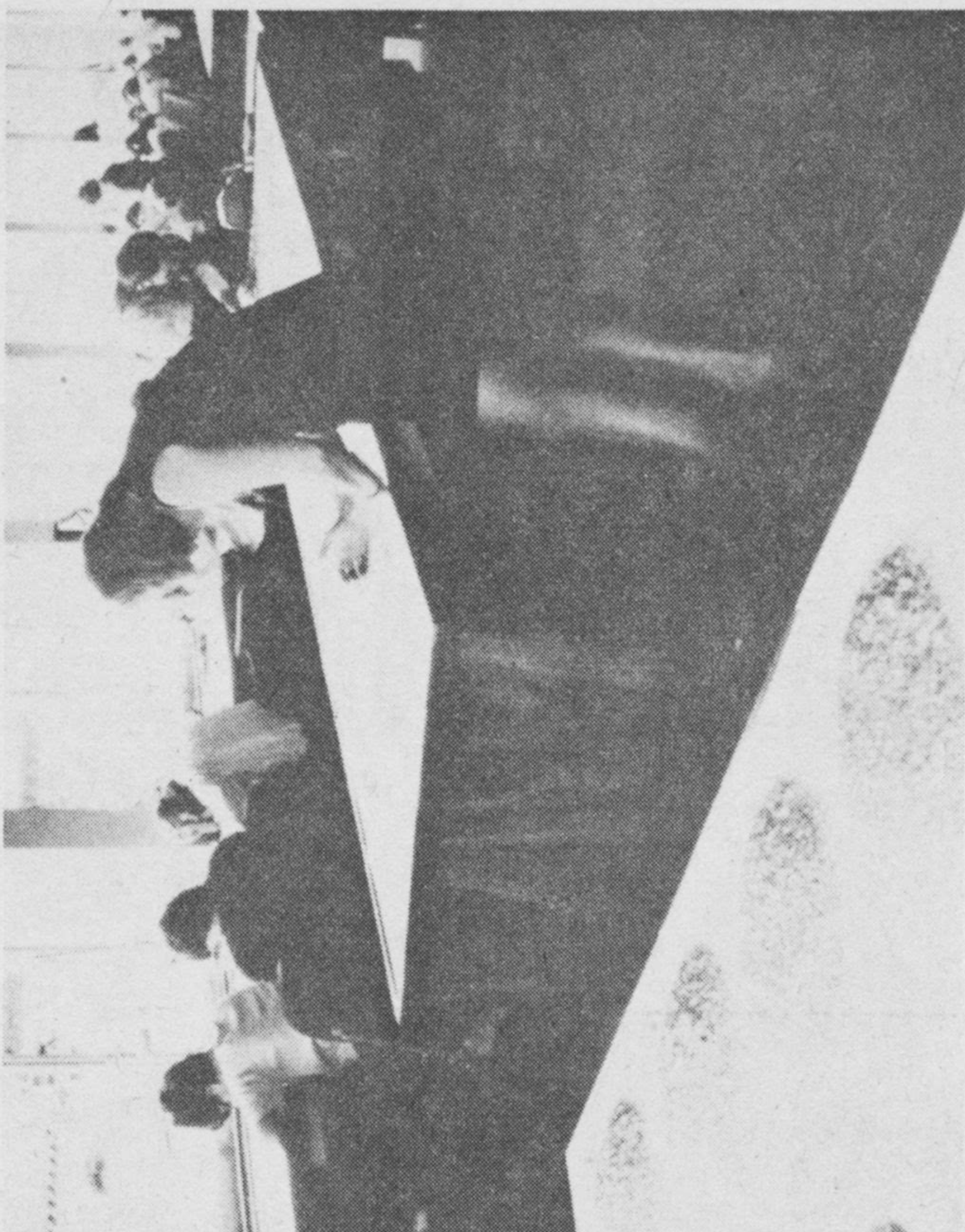

33

- 27. Henry Keswick, Sr., Managing Director, Jardine Matheson
- 28. Sir Mark Turner, Chairman Rio Tinto Zinc, and Governing Council, the Royal Institute of International Affairs
- 29. John Keswick, Director, Matheson and Co.
- 30. David Newbigging, Managing Director, Jardine Matheson
- 31. Bars of gold distributed by Mocatta Metals
- 32. Harry Oppenheimer
- 33. Diamonds sorted by quality, shape and color

sailors attempting to wade to shore through the mud were either killed or captured. "We might send a military-naval force to attack and occupy Peking," Palmerston continued. (10) Following Palmerston's lead, *The Times* of London let loose a bloodcurdling propaganda campaign:

England, with France, or England without France if necessary . . . shall teach such a lesson to these perfidious hordes that the name of Europe will hereafter be a passport of fear, if it cannot be of love throughout their land. (11)

In October 1860 the joint British-French expeditionary force laid siege to Peking. The city fell within a day with almost no resistance. Despite French protests, British commander Lord Elgin ordered the temples and other sacred shrines in the city sacked and burned to the ground — as a show of Britain's absolute contempt for the Chinese.

Within four years of the signing of the Treaty of Tientsin (October 25, 1860), Britain was in control of seven eighths of the vastly expanded trade into China. This trade amounted to over £20 million in 1864 alone. Over the next 20 years, the total opium export from India — the overwhelming majority of which was still funneled into China — skyrocketed from 58,681 chests in 1860 to 105,508 chests in 1880. (12)

Furthermore, the opening of China prompted the British opium traders to diversify into "legitimate business." The opium firms opened cotton traffic into China — to the point that cotton cloth shipments into China (like the opium shipments) quadrupled from 1856-1880 from 115 million yards of cloth to 448 million yards.

The London opium traffickers' diversification into the cotton trade at the close of the second Opium War intersected with the same London oligarchy's shifting of its principal strategic policy focus to the destruction of the United States — beginning with the efforts to wreck the republic via the British-sponsored Civil War. The massive expansion of cotton exporting was undertaken with *full knowledge* that U.S. cotton production — centered in the

Deep South slavocracy — would be severely disrupted with the pending "civil war" destabilization in North America. (13)

The slave and cotton trade in the South was run to a significant degree by the same Scottish-based families that also ran the opium traffic in the orient. The Sutherland family, which was one of the largest slave and cotton traders in the South, were first cousins of the Matheson family of Jardine Matheson. The Barings, who founded the Peninsular & Orient Steamship Line heavily involved in the opium trade, had been the largest investors in U.S. clipper shipping from the time of the American Revolution. The Rothschild family as well as their later "Our Crowd" New York Jewish banking cousins, the Lehmans of Lehman Bros., all made their initial entry into the United States through the pre-Civil War cotton and slave trade.

In the case of the U.S. Civil War, the British opium traffickers bet on the loser. By the mid-1860s, cotton goods from the southern United States were back on the international markets, triggering waves of bankruptcies among London speculators who bet on dramatic inflation in the prices of Indian and Egyptian cotton. As in the period immediately following Britain's loss of its American colonies during 1776-87, the oligarchy turned to an expanded opium traffic to paste over the losses.

To facilitate the planned expansion of the opium trade, the British banking and merchant circle founded the Hongkong & Shanghai Corporation in 1864. Almost simultaneously, the Matheson family founded Rio Tinto (now Rio Tinto Zinc), a tin mining venture in Spain which soon began shipping these ores as a method of payment for the opium.

Who founded the Hongkong and Shanghai Corporation? The same circle of merchant banking, trading, and shipping families — centered around the British monarchy — who opened the East India Company's opium trade as an instrument of British state policy during the previous century.

The following points summarize British Opium War policy against China through the 19th century:

\* Open sponsorship of mass-scale opium addiction of targeted colonial and neocolonial populations by the British Crown;



28



30

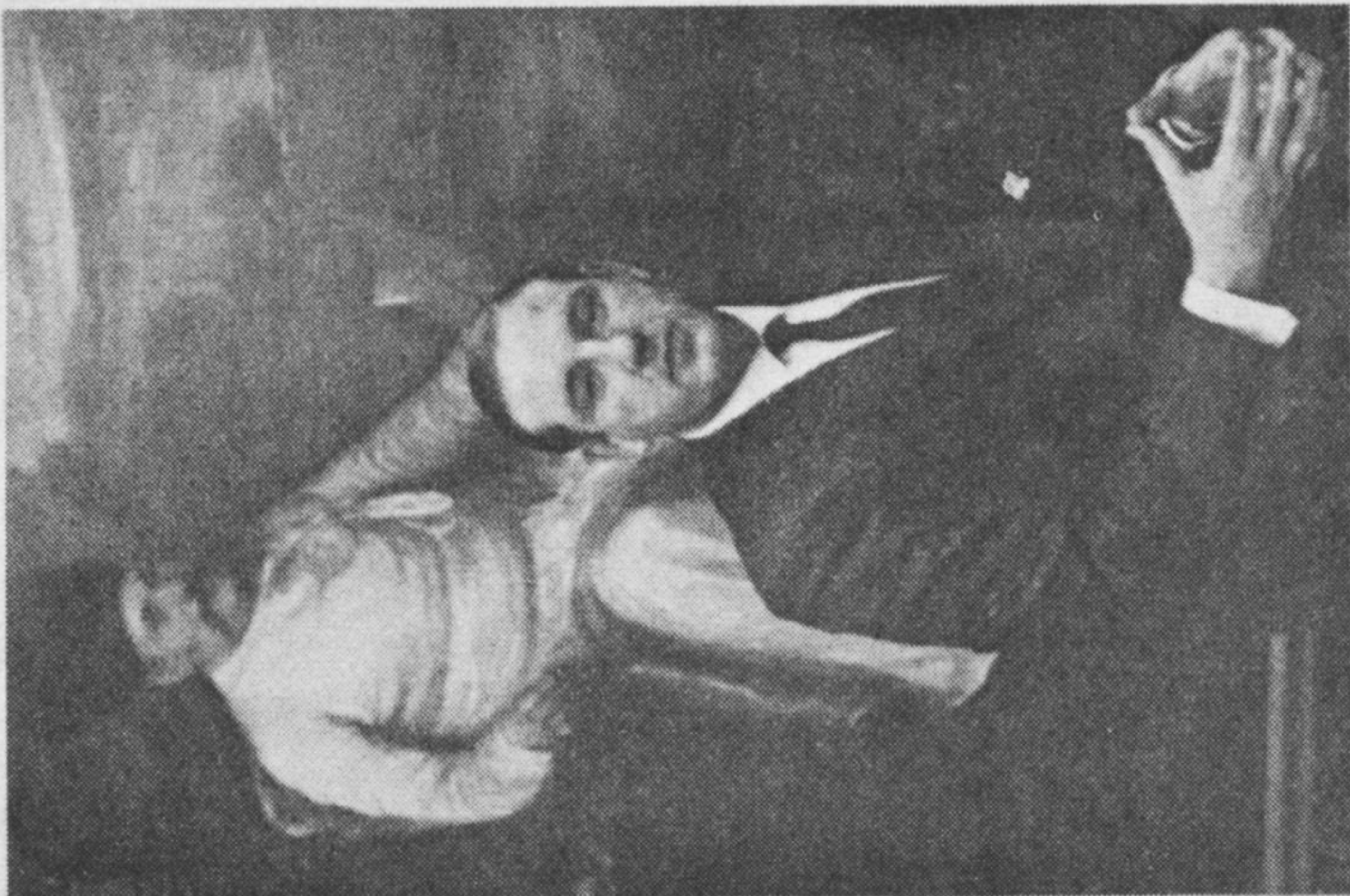

27



29

\* Willingness of Her Majesty's government to deploy military force up to and including full-scale conventional warfare in support of the opium trade;

\* Build-up of an allied terrorist and organized criminal infrastructure employing revenues gained from opium trade and related black market activities.

## Protecting the opium market

Even through the early decades of the present century, Britain retained an open diplomatic posture on behalf of unrestricted drug profiteering.

In 1911, an international conference on the narcotics problem was held at The Hague. The conference participants agreed to regulate the narcotics trade, with the goal in mind of eventual total suppression. The success of the Hague Convention, as it was called, depended on strict enforcement of the earlier Anglo-Chinese agreement of 1905. Under that agreement, the Chinese were to reduce domestic opium production, while the British were to reduce their exports to China from British India correspondingly.

The Chinese, who had subscribed enthusiastically to both the 1905 and 1911 protocols, soon discovered that the British were completely evading both by sending their opium to their extra-territorial bases, Hong Kong and Shanghai. Opium dens in the Shanghai International Settlement jumped from 87 licensed dens in 1911 at the time of the Hague Convention to 663 dens in 1914! (14) In addition to the trafficking internal to Shanghai, the Triads and related British sponsored organized crime networks within China redoubled smuggling operations — conveniently based out of the warehouses of Shanghai.

If anything, British profiteering from the opium trade jumped as the result of the reversion to a totally black-market production-distribution cycle. Ironically, the legalization of the opium trade into China forced upon the Emperor through the Opium Wars had cut into British profits on the drug. Legalization had brought with it the requirement that the British opium

merchants pay import duties, an overhead they did not have to absorb when the drug trade was illegal.

In yet another act of contempt for the Hague Convention, Britain issued a major new loan to Persia in 1911. The collateral on that loan was Persia's opium revenues. (15)

Even with the post-Versailles creation of the League of Nations, Britain flaunted its drug trafficking before the world community. During this period, Her Majesty's opium trafficking was so widely known that even the Anglophile U.S. newsweekly *The Nation* ran a series of documentary reports highly critical of the British role. (16)

At the Fifth Session of the League of Nations Opium Committee, one delegate demanded that the British government account for the fact that there were vast discrepancies between the official figures on opium shipments into Japan released by the Japanese and British governments. The British claimed only negligible shipments, all earmarked for medical use, during the 1916-1920 period; while the Japanese figures showed a thriving British traffic. When confronted with this discrepancy as prima facie evidence of large-scale British black market smuggling of opium into Japan, the British delegate argued that such black marketeering merely proved the case for creating a government owned opium monopoly.

As late as 1927, official British statistics showed that *government opium revenues* — excluding the far more expansive black market figures — accounted for significant percentages of total revenue in all of the major Far East Crown colonies. (17)

British North Borneo	23 percent
Federated Malay States	14 percent
Sarawak	18 percent
Straits Settlements	37 percent
Confederated Malay	28 percent

In India as well, official Crown policy centered on protection for the opium market. According to one recently published account, when Gandhi began agitating against opium in 1921

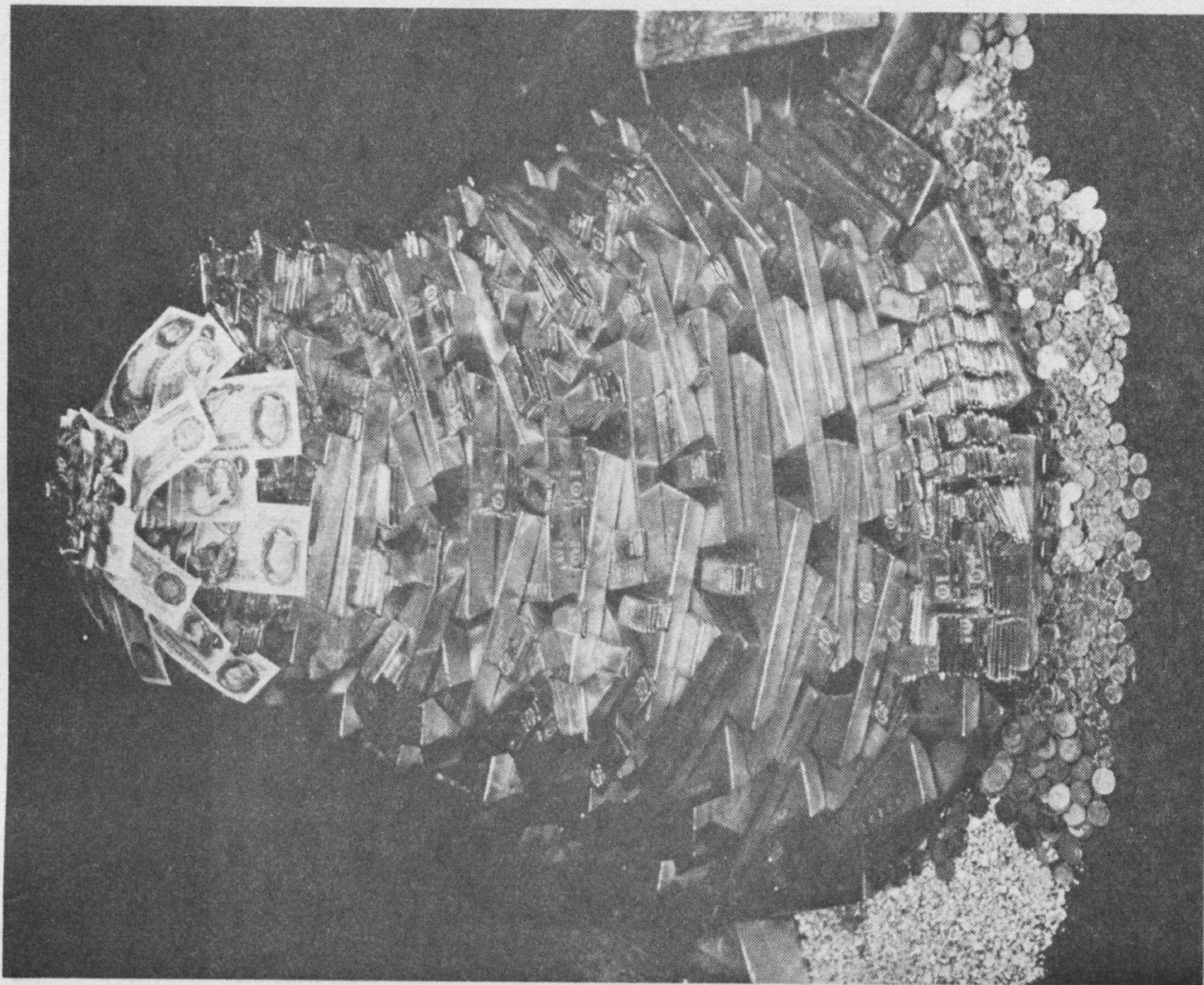

36

36. "Bullion Pile" prepared for a visiting Queen Elizabeth II by Mocatta's parent bank (valued at £6,000,000)

... his followers were arrested on charges of "undermining the revenue." So little concerned were the British about the views of the League of Nations that after a commission under Lord Inchcape had investigated India's finances in 1923, its report, while recognizing that it might be necessary to reduce opium production again if prices fell, went on to warn against diminishing the cultivated area, because of the need to safeguard "this most important source of revenue."

... while the British Government was professing to be taking measures to reduce consumption of opium and hemp drugs, its agents in India were in fact busy pushing sales in order to increase the colony's revenues. (18)

Lord Inchcape — who chaired the India Commission which endorsed continued opium production in British India — was a direct descendant of the Lord Inchcape who during the previous century founded the Peninsular & Orient Steamship Line and subsequently helped found HongShang as the clearinghouse bank for opium trade. Through to the present, a Lord Inchcape sits on the boards of P & O and the HongShang.

In 1923, the British-run opium black market represented such a seriously perceived international problem that Representative Stephen Porter, Chairman of the U.S. House of Representatives Foreign Affairs Committee, introduced and passed a bill through Congress calling for country-by-country production and import quotas to be set on opium that would reduce consumption to approximately 10 percent of then-current levels. The 10 percent figure represented generally accepted levels of necessary medical consumption.

Porter's proposal was brought before the League of Nations Opium Committee — where it was publicly fought by the British representative. The British delegate drafted an amendment to Porter's plan which called for increased quotas to account for "legitimate opium consumption" beyond the medical usage. This referred to the massive addict population in British colonies and spheres of influence (predominantly in Asia) where no

regulations restricted opium use. The enraged U.S. and Chinese delegations led a walkout of the plenipotentiary session; the British rubberstamped the creation of a Central Narcotics Board designated with authority to gather information and nothing more; and the journalists stationed in Geneva henceforth referred to what remained of the Committee as the "Smugglers Reunion." (19)



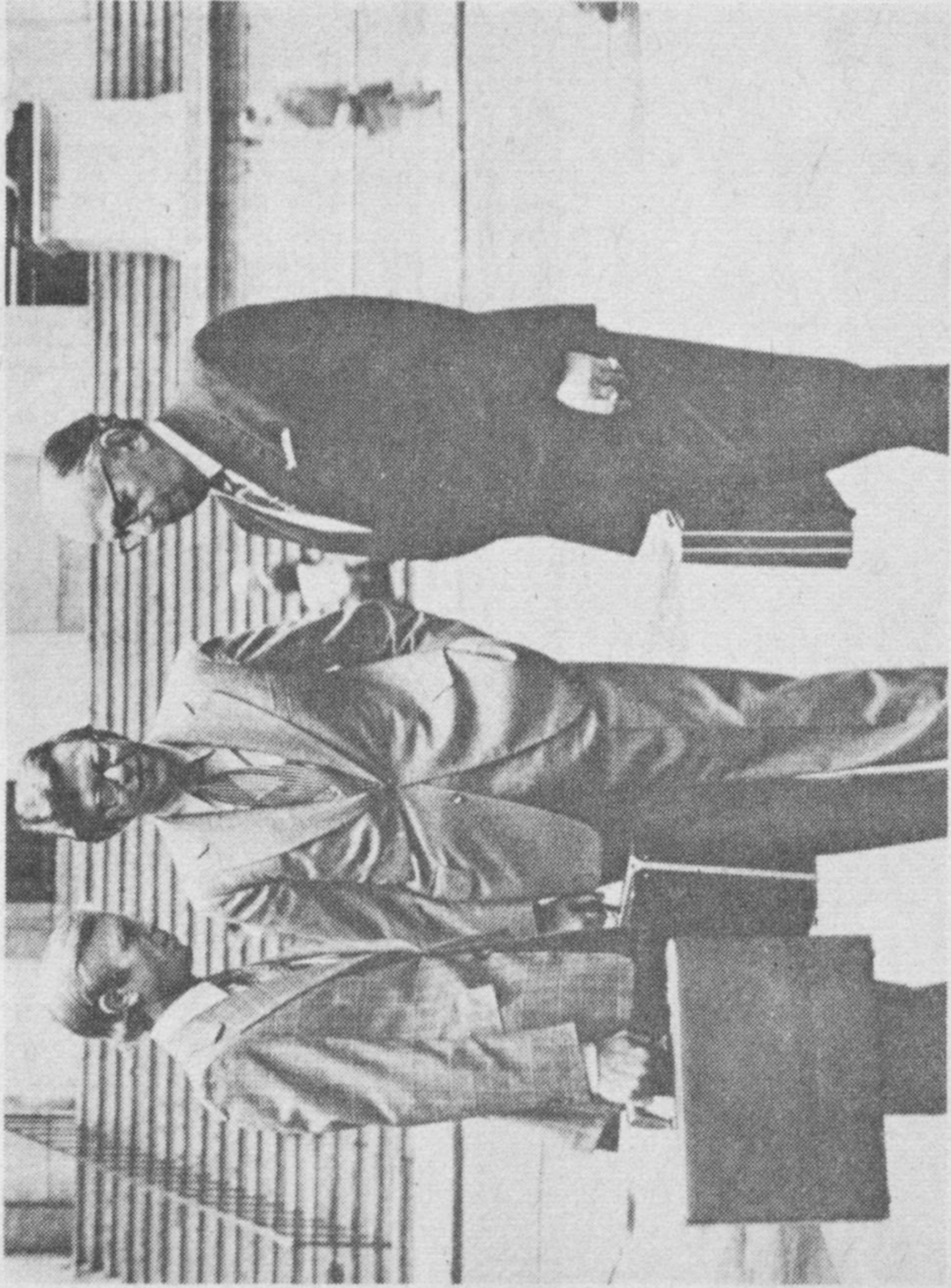

34

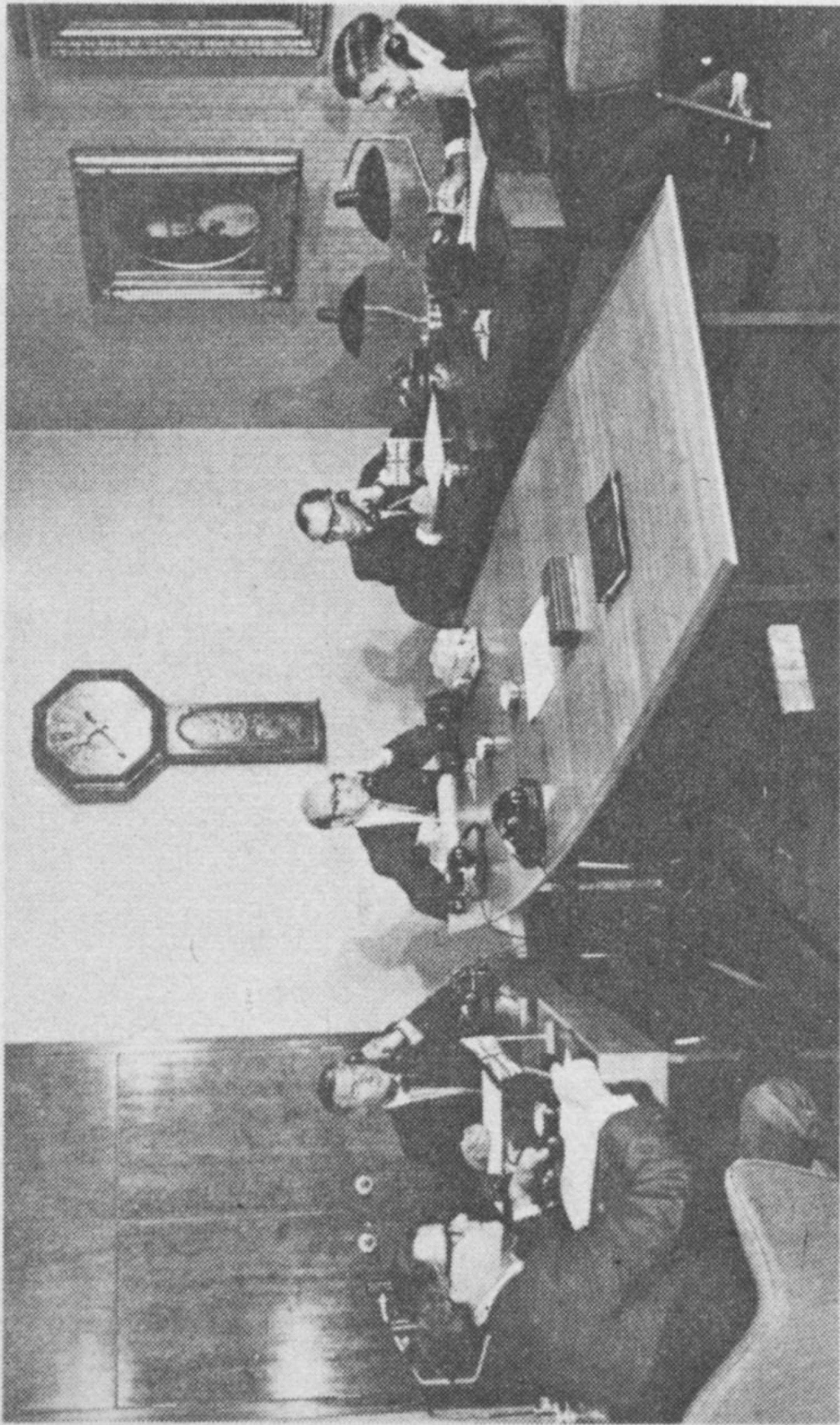

35

- 34. Henry Jarecki (c) with Edward Mocatta (r) and Keith S. Smith, Managing Director, Mocatta and Goldsmid
- 35. A morning gold-fixing, N.M. Rothschilds, London (second from right, Edward Mocatta)

## 2

# Palmerston's Fifth Column, USA

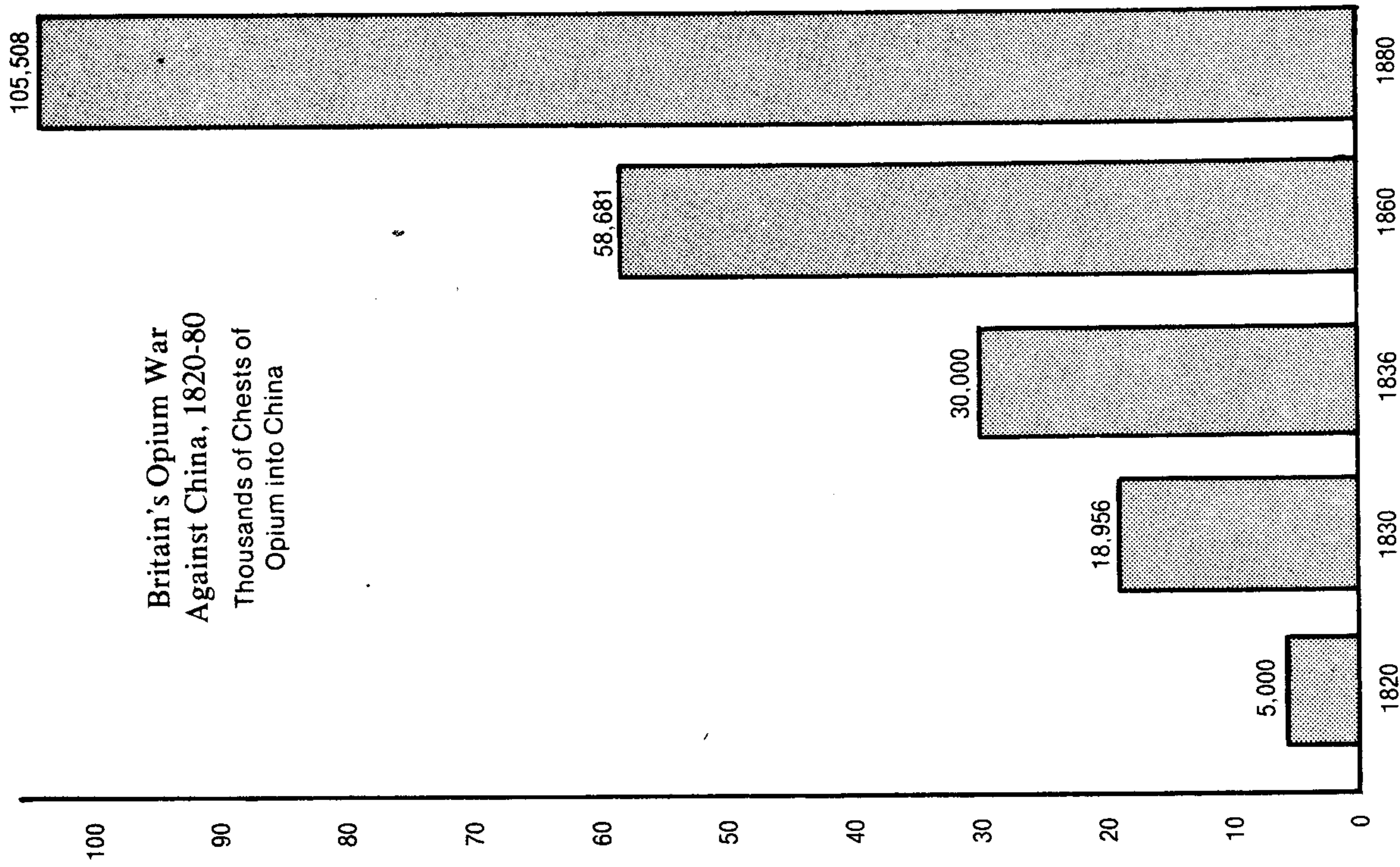

A chest of opium in 1820 sold for \$2,075 on arrival at the port of Canton. While this figure tended to drop marginally as the volume of traffic increased after 1830, any calculation of cash valuation of the opium trade into China establishes a figure that very nearly parallels the present \$100-200 billion (when appropriate calculations are made to account for differences in purchasing power of the dollar in ratio to total volume of world production) in annual "black" revenues.

## The assassination bureau

Narcotics traffic was the business of organized crime during the 19th century no less than in the 20th, and Britain's Opium War cabinet spun out a web of criminal connections that crisscrossed the globe. Prime Minister Palmerston conducted the opium business behind a screen of respectability, in full public view. What remained hidden — until the report of the Military Commission that heard evidence on the Lincoln Assassination — was the importance of Palmerston's secret life, as Patriarch of the Scottish Rite of Freemasonry.

It does not surprise the modern student that the perpetrators of the narcotics traffic show up in every element of the dirty side of 19th century politics, including presidential assassinations. But the extent of the web of criminal networks put in place by Palmerston could have come out of a Gothic horror story. American counterintelligence specialists of the time, such as Edgar Allan Poe and Samuel Morse (1), knew the problem well.

Palmerston's irregulars, employed in illegal dope trafficking,

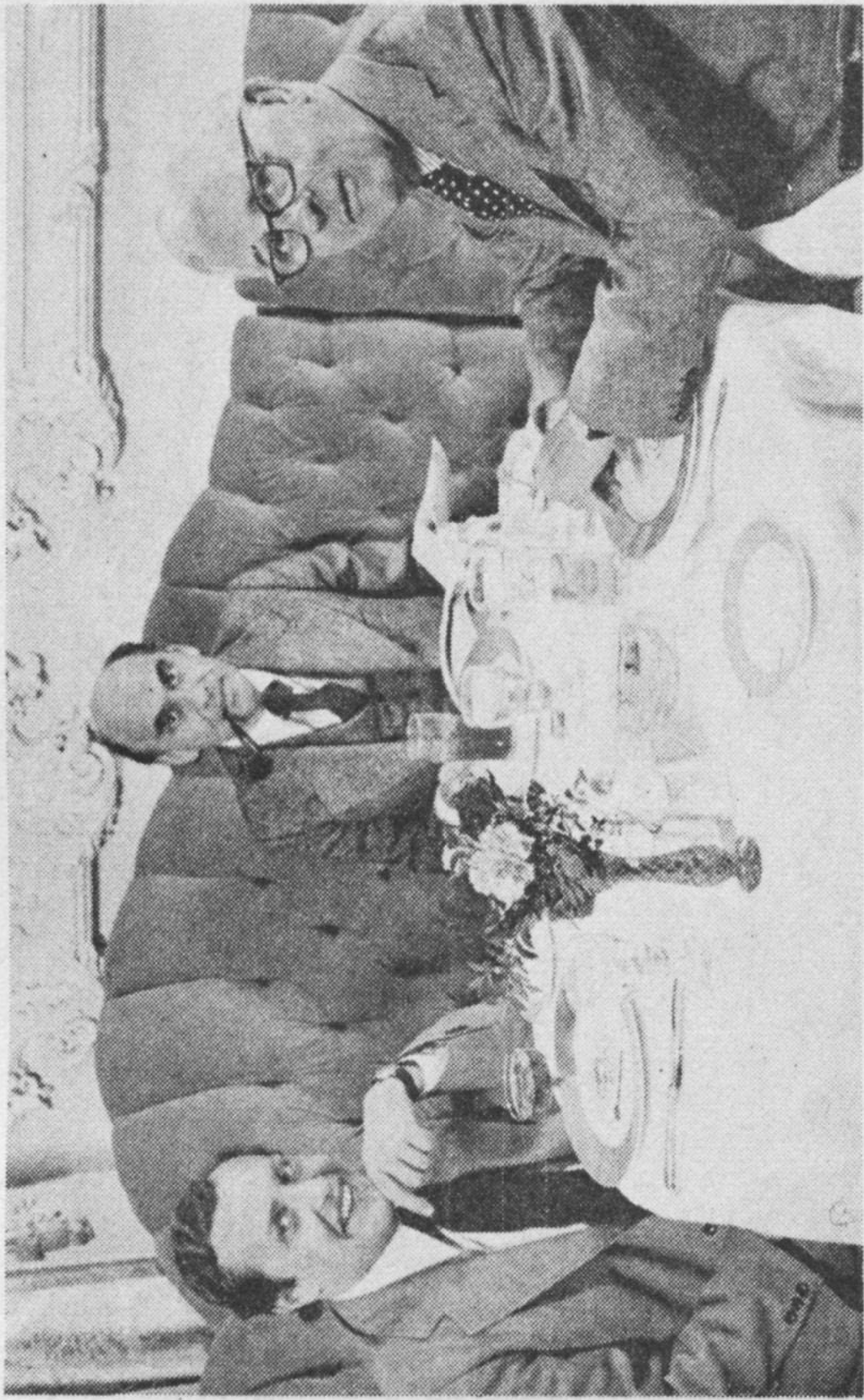

40



41

- 37. Mao Tse-tung with U.S. General Hurlley, 1949: double-cross
- 38. Chinese Premier Chou En-lai, 1949
- 39. Bertrand Lord Russell
- 40. Walter Lockhart Gordon (r) with Peter C. Newman (c) and Abraham Rotstein of Canada's "China Lobby"
- 41. Lord Amory, 31st Governor, G.T. Richardson, 32nd Governor, and A.J. MacIntosh, Deputy Governor of the Hudson's Bay Company in 1971

assassinations, and "Fifth Column" subversions against the United States in the period before and during the Civil War, are the linear ancestors of what is now called organized crime. The Chinese "Triads," or Societies of Heaven; the Order of Zion and its American spinoff, the B'nai B'rith; "Young Italy," whose Sicilian law enforcement arm became known as the Mafia; the Jesuit Order based in decaying Hapsburg Austria; Mikhail Bakunin's bomb-throwing anarchist gangs; and nearly every other inhabitant of Britain's political netherworld followed a chain of command that led through the Scottish Rite of Freemasonry directly to Lord Palmerston and his successors.

The model for the Scottish Rite operation is the ethnic secret society — Jewish, Italian, or Chinese. Closest to hand among Palmerston's agencies was the Order of Zion, a highly specialized dirty tricks operation founded by London-based *Hofjuden* ("Court Jew") families, whose close ties to the British oligarchy traced back to the founding of the Bank of England, and before that to an alliance with the piratical financiers of post-Renaissance Genoa. The names of these families will appear and re-appear throughout this report, including the Mocattas and Goldsmids, gold dealers in London before even the Bank of England was there, now the operators of one of the world's most sophisticated money-laundering devices; the Montefiores, now central figures in the modern Most Venerable Order of St. John of Jerusalem; and the de Hirsch family, whose tightly controlled colonization program for Jews in Canada brought the present leaders of organized crime to the New World.

Control over the Order of Zion rested in the British Board of Deputies, founded in 1763 and still in action. One of the board's earliest presidents was Sir Moses Montefiore, described in contemporary accounts as "Queen Victoria's favorite Jew." (2) When Montefiore took command of the board in 1835, its dirty tricks division, the Order of Zion, was on the verge of launching the covert campaign that would lead to both the Lincoln assassination, and the founding of organized crime, so-called, in the United States. Through the efforts of Montefiore, later Prime Minister Benjamin Disraeli (the Earl of Beaconsfield), and the

then nouveau riche Rothschilds, the Order of Zion nursed into being the leadership of the Confederacy.

Their starting point was the 1843 founding of the B'nai B'rith, also called the Constitutional Grand Lodge of the Order of the Sons of the Covenant, as a recognized branch of the Scottish Rite for American Jews. B'nai B'rith's first headquarters were at 450 Grand Street in Manhattan, at the house of Joseph Seligman, the wealthy "dry goods" merchant. (3) Seligman, whose name survives on Wall Street along with such of his contemporaries as August Belmont, Loeb, Schiff, and Lazard, was allied to the cotton-trading British oligarchy.

B'nai B'rith was a straightforward covert intelligence front for the Montefiores and Rothschilds. Its American house organ, the *Menorah*, could not disguise its relationship to the Rothschilds. It chose to flaunt it:

"The name Rothschild, in all countries is a synonym for honor and generosity, and no name in Europe has a popularity so great and so well merited. The Rothschilds in France occupy a social position even higher than that of the English branch of the family." (4)

The *Menorah* was also frank on the subject of the B'nai B'rith's relationship to the Scottish Rite Freemasons:

"Their reunions were frequent and several of them being members of then existing secret benevolent societies and especially of the Order of the Free Masons, and Odd Fellows, they finally concluded that a somewhat similar organization, but based upon the Jewish idea, would best obtain their object." (5)

Once in operation, the B'nai B'rith effectively merged its operations with another branch of the Scottish Rite, based in the Midwest and South — the Knights of the Golden Circle, the fore-runner of the Ku Klux Klan, the training ground for the entire Confederate military and political leadership. (6) Its most important American operative was Judah P. Benjamin, a British subject and leader of the B'nai B'rith, whose amazing career included a brief term as Confederate Secretary of War and then Secretary of State, during the closing phases of the Civil War. (7) Another British subversive agent later worked together with Benjamin to found the Ku Klux Klan. He was Dr. Kuttner

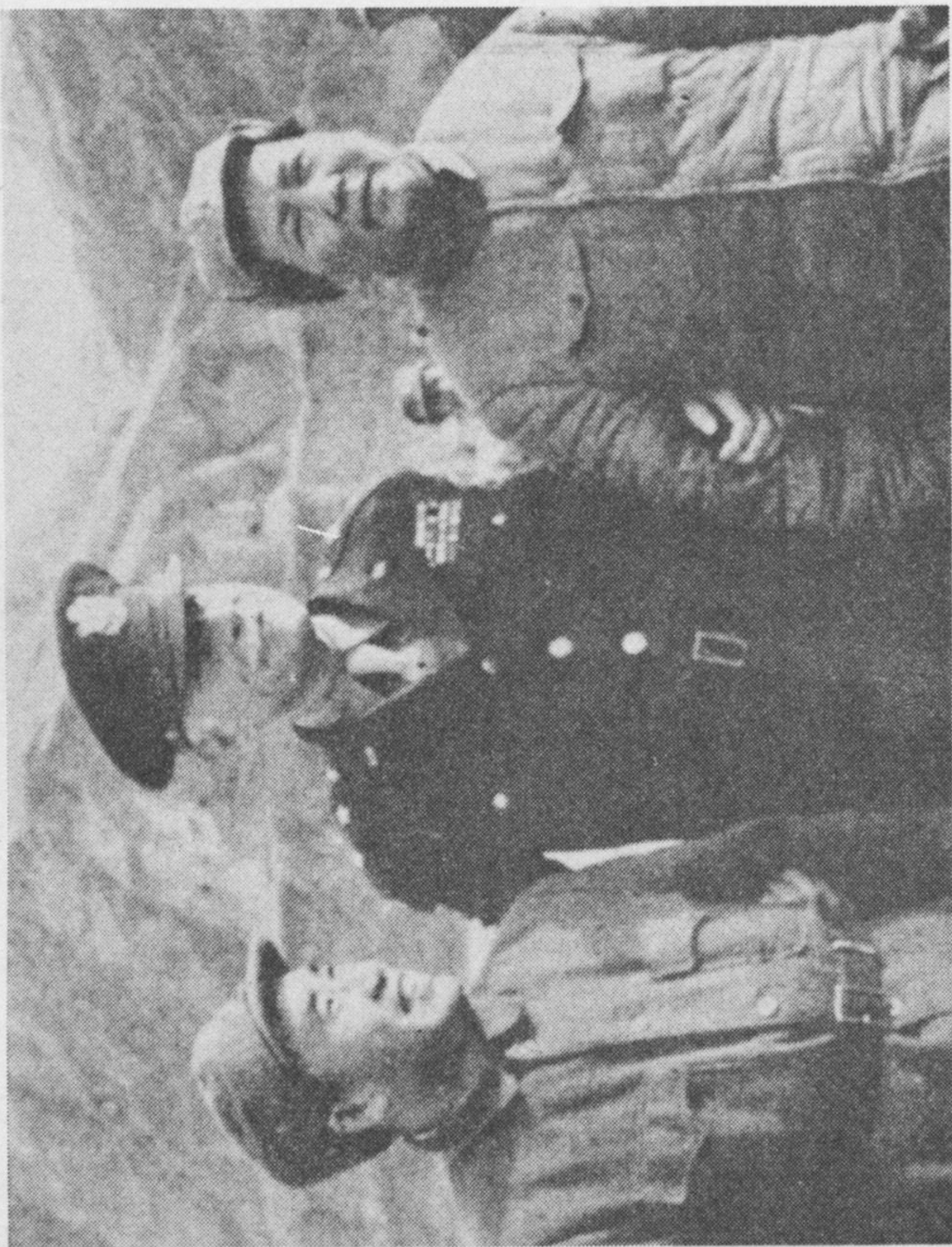

37



39



38

Baruch, B'nai B'rith leader and grandfather of Bernard Baruch, a leading Wall Street Anglophile. (8) Their colleagues in that venture included Confederate General Albert Pike, a Grand Commander of the Scottish Rite, and a Jesuit priest. (9) The same group carried out the Lincoln assassination — which raises questions concerning the Defense Department's refusal to release secret files concerning that assassination. Are they afraid to embarrass the now politically powerful B'nai B'rith?

The B'nai B'rith and its Confederate opposite numbers, the Knights of the Golden Circle and the Ku Klux Klan, were only three of the many parallel operations that Palmerston brought to life during the 1860s. In Britain, future Prime Minister Disraeli, the man who evaded debtors' prison through the help of the House of Rothschild, launched the "Young Englishers." (10) In Italy, the local leader of the Scottish Rite, Mazzini, organized and commanded "Young Italy." (11) Scottish Rite member and Rothschild agent Alexander Herzen initiated a similar group covertly, avoiding the watchful eyes of the Czarist secret police; his best-known protégé took the name Bakunin. (12) In China, as of the second Opium War, the long-established "Triad" secret societies had already taken the retail distribution franchise for the distribution of British opium imported from India, and had become an uncontrollable, paramilitary arm of British "free trade."

What Palmerston and his colleagues had at their disposal was an International Assassination Bureau, capable of eliminating any chief of state who resisted British policy objectives. Not much different from the Red Brigades of Italy or the Baader-Meinhof terrorists of Germany today, the Scottish Rite's rainbow gathering of secret societies took money from the narcotics traffic and orders from Lord Palmerston.

What must be judged, in the long run, as the most deadly of these organizations was organized on an international footing at the same time that B'nai B'rith appeared in the United States. Disraeli, Moses Montefiore, and other leading British *Hofjuden* founded a new masonic-style order called, in the original French, the "Alliance Universelle Israelite." It became known — and feared — under the name of its elite secret arm, the *Order of*

*Zion.* (13) Most of the Order of Zion's funding was provided through the London and Paris banking houses of Rothschild, Montefiore, and de Hirsch. In crucial respects, the Order of Zion and Palmerston's Scottish Rite of Freemasonry were indistinguishable. In France, for example, the head of both organizations was the same individual, Adolphe Isaac Cremieux. (14)

Order of Zion leader Judah P. Benjamin was the individual who gave the order for Lincoln's assassination, according to the one authoritative historical document in the public domain, the report of the Judge Advocate assigned to investigate the assassination and report to the Military Commission responsible. (15) The report cites the orders of Confederate President Jefferson Davis and Judah Benjamin. According to this document, Confederate secret intelligence had raised a dirty tricks slush fund of \$649,000 through the sale of Confederate bonds in Liverpool. At the time, the headquarters of this outfit, called the Secret Cabinet, were housed in St. Lawrence Hall in Montreal — in the same building occupied by the Commander in Chief of British forces in Canada, General Sir Fenwick Williams. (16) The report names George N. Sandis as the group's money mover; Sandis was an American citizen, formerly an advisor to Democratic presidential candidate Stephen Douglas, and Consul of the United States in Liverpool under the Pierce Administration.

Eight days before Lincoln's death, the chief of the Secret Cabinet — former Interior Secretary in the Buchanan Administration, Jacob Thompson — withdrew \$180,000 from the group's account at the Bank of Montreal in Montreal, to set the murder plot in motion. (17) His courier was one John Harrison Suratt, a British agent trained at Jesuit Georgetown College. Neither Thompson nor Benjamin was ever apprehended; both fled to England and remained there under the Crown's protection. (18) This evidence, heard on June 25 and June 26, 1865, ran up against a cover-up effort under the direction of Secretary of War Edward Stanton that compares in audacity with the work of the 1963 Warren Commission. The relevant raw documentary is not available to researchers. The documents



44



45

- 42. Queen Elizabeth II with Canadian Prime Minister Pierre Elliott Trudeau, 1978
- 43. Corporate emblems of the Canadian money-laundering banks: Bank of Montreal, Bank of Nova Scotia, Canadian Imperial Bank, Royal Canadian Bank, Toronto Dominion Bank
- 44. John Ruskin
- 45. Cecil Rhodes

relating to the Lincoln assassination are still locked up in the archives of the Defense Department. Jefferson Davis, who lived comfortably in Montreal after the collapse of the Confederacy, kept his papers in the Bank of Montreal, the same bank that conducted the funds for the assassination itself. If they are still in the vaults of the Bank of Montreal, the bank has not acknowledged this. (19)

These facts concerning the death of President Lincoln are more than a useful case history, illustrating the power of the dope trade's criminal networks. If the leads developed in New Orleans District Attorney Garrison's investigation of the Kennedy assassination were accurate, the two murderers were the work of the same operation. All that is necessary is to cross out the names "Secret Cabinet" and "Judah Benjamin," and write in: Permindez and Major Louis Bloomfield (see Part III, Section 3).

From what remains of the official record, there is no question that the death of Abraham Lincoln was traced to British-controlled and British-funded networks by American military intelligence. It must be underscored that much more than the central figure of Lord Palmerston brought these networks into the mainline of the narcotics traffic. Southern cotton, for which the British verged on invading the United States during the Civil War (20), was not merely a facet of the same trading operation that produced the dope trade; for all purposes, it was the dope trade. Opium was the final stage in the demand cycle for British-financed and slave-produced cotton. British firms brought cotton to Liverpool. From there, it was spun and worked up into cloth in mills in the north of England, employing unskilled child and female labor at extremely low wages. The finished cotton goods were then exported to India, in a process that destroyed the existing cloth industry, causing widespread privation. India paid for its imported cloth (and railway cars to carry the cloth, and other British goods) with the proceeds of Bengali opium exports to China. Without the "final demand" of Chinese opium sales, the entire world structure of British trade would have collapsed. Palmerston's above-cited remark concerning the future of British trade in opium-consuming China and other parts of the East was, in fact, a matter of hard contingency.

Britain's new instrument of subversion in the United States was controlled elements of Italian and Chinese immigration, combined with the Order of Zion entity that had been in place since 1843. By the turn of the century, the different ethnic networks became so intertwined that, for generic purposes, the name "organized crime" applies to all of them.

The implantation of the ethnic secret societies into the United States is a complex story, but may be centered accurately in a few case histories. One is the way that the family of Sam Bronfman — the man who shipped enough liquor to the United States to double the size of Lake Erie, in the testimony of Lucky Luciano — got to North America. Bronfman's story begins, in fact, in Romania, where the Order of Zion secret organization achieved its first major victory, a coup d'etat that brought King Charles of Romania to the throne in 1887. In the years following the Civil War, the Order of Zion merged with the much older Cult of Mizraem, a centuries-old covert organization that dated back to the days of Genoese and Hapsburg intrigue and assassination. (21) From the British side, Sir Moses Montefiore, and on the Romanian front itself, American Consul Benjamin Peixotto, aided the local secret society in installing a new monarch. (22) Peixotto held a leadership position in the American B'nai B'rith and was a member of the Order of Zion.

## The Elders of Zion

Romania became, in consequence, a nesting place for the most lurid form of Central European covert operations until the Second World War. The character of the political machine the Order of Zion installed in that country is perhaps best illustrated by the strong support Order of Zion elements gave to the Romanian Green Shirt Nazis, who seized power in Hitler's wake during the 1930s. (23) Romanian Jews show up prominently in American organized crime, as well as in the terrorist activities of the Israeli secret service, the Mossad.

The Order of Zion was simply the Jewish division of the Most Venerable Order of St. John of Jerusalem, the London-centered



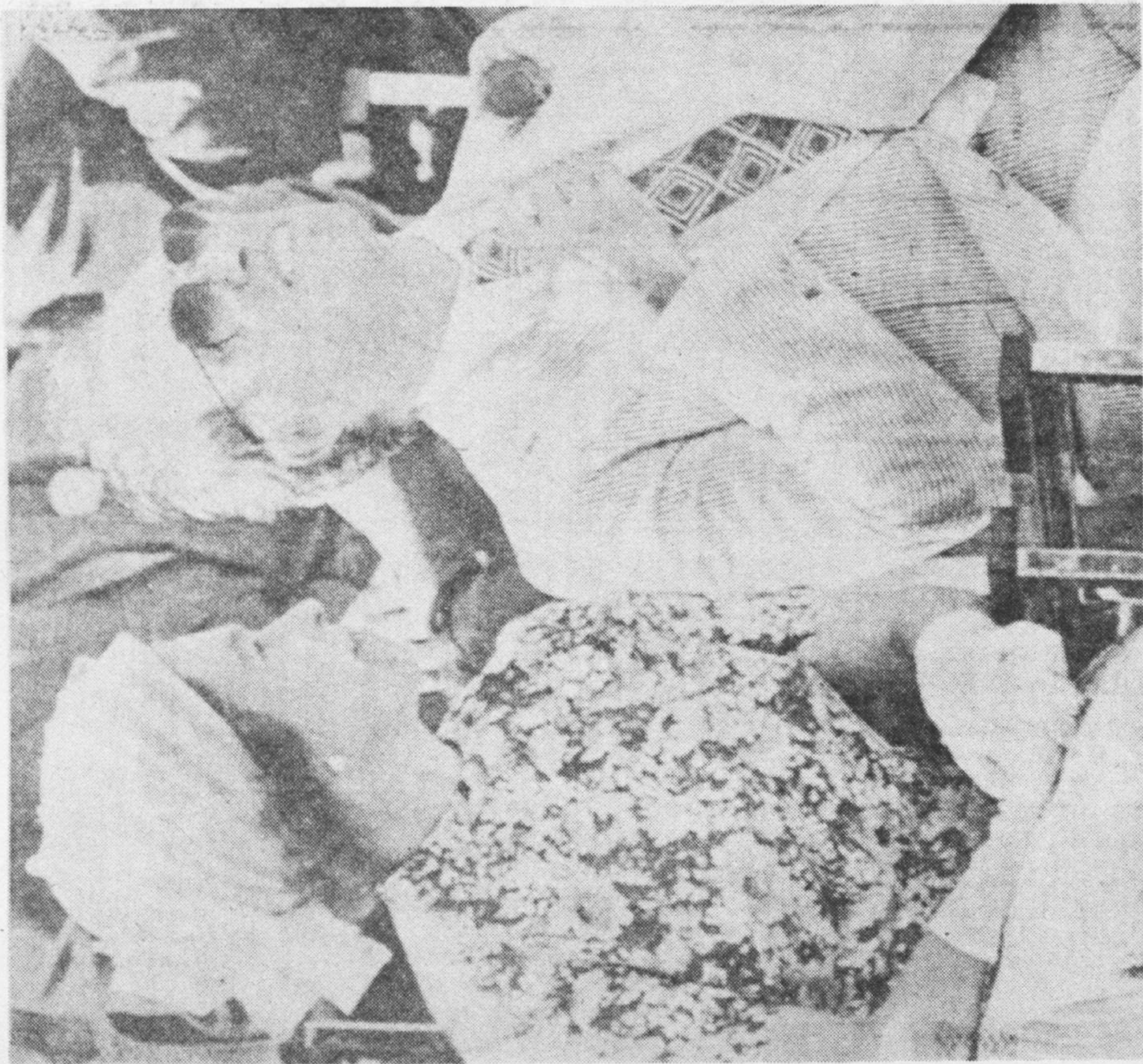

42



43

chivalric order and secret society, whose members swear — and act on — a blood oath. A secret meeting in Paris in 1884 yielded the famous minutes of the Order, published under the title, *Protocols of the Elders of Zion*. The minutes were intercepted and published by the Russian counterintelligence service, the Okhrana. (24) Probably, the decision to publish the captured minutes involved retaliation against the Order of Zion's role in fomenting a sweeping destabilization against the government of Russian Prime Minister Count Witte, whose government fell during the so-called 1905 Revolution. Witte had sought an alliance with Germany and France against Britain on a program that included the industrial development of Russia. The question of the authenticity of the *Protocols* has been a matter of fierce, even hysterical dispute. The question may be settled with dispatch by a textual comparison between the oaths of the Order of Zion printed in the *Protocols*, and the blood-curdling oaths sworn by initiates into the fourth Grade of the Knights of Columbus of Mexico, which maintains close ties to the Jesuits and to the Order of St. John of Jerusalem, which reads in part as follows: (25)

I, \_\_\_\_\_, in the presence of all-powerful God, the blessed Virgin Mary, the blessed St. John the Baptist . . . by the belly of the Virgin Mary, the womb of God and staff of Jesus Christ, I declare and swear that his holiness the Pope is vice regent of Christ and sole and true head of the universal Catholic Church on earth, and in virtue of the keys to do and undo given to your holiness by my savior Jesus Christ, (you) have the power to depose kings and heretics, princes, states, communities and governments and dismiss them from office without risk. . . .

I promise and declare that I will, when the opportunity presents itself to me, wage war without quarter, secretly or openly, against all the heretics, Protestant and Mason, such as I may be ordered to do, in order to extirpate them from the face of earth, and I will not take into account either age, sex or station, and I will hang, burn, strangle and bury alive those infamous heretics: I will cut open the

stomachs and wombs of their women and smash the heads of the babies against the rocks and walls, in order to annihilate the execrable race; that when this cannot be done openly, I will secretly employ the poison cut, strangulation, the sword, dagger or bullet, without consideration for the honor, rank, dignity or authority of the persons, whatever their status in public or private life may be, such as I may be ordered at any time. . . .

If I manifest falsity or weakness in my determination, I consent that my brothers and comrade soldiers in the army of the Pope may cut off my hands, my feet and slit my throat from ear to ear. . . .

I promise to execute and fulfill this oath, in testimony whereof, I take this sacred sacrament of the Eucharist and affirm it even with my name written with the point of this dagger, drenched in my own blood and sealed in the presence of this holy sacrament. Amen. (26)

Romania's Order of Zion stronghold produced, among other criminal elements, one Yechiel Bronfman, who emigrated to Canada in 1889. The circumstances of Bronfman's emigration are noteworthy. His passage was paid by the de Hirsch family fund for settlements in Canada — which conferred benefits with strings attached. De Hirsch political screening of new immigrants was so precise that a significant number of new arrivals were sent back without funds, for unreliability. (27).

The important features of the arrival of the Italian "Mafia" in the United States are inseparable from the story of the Order of Zion. Mazzini, the sponsor of the Mafia in Italy, reported directly to the most prominent of Britain's *Hofjuden*, Prime Minister Benjamin Disraeli, and received funding from the leading British *Hofjuden* bankers, Rothschild and Montefiore. (28) Correspondingly, when Mazzini sent his lieutenants into the United States, the veterans of the "Young Italy" movement moved into channels already carved out by the likes of ex-General Pike and B'nai B'rith. The combination of *Hofjuden* controlled crime networks and the Mafia provided the framework for organized crime on a big-business scale.



48



50



49

## Mazzini's mafia

The first arrivals of the Italian-speaking mob followed the tracks of the original "dry goods" merchants who figured so prominently in the B'nai B'rith, the grandfathers and fathers of the Our Crowd banking group in New York City. New Orleans, the first base of the Lehmans and Lazards in the United States, also became the receiving station for the Mazzini networks. Most important, the first recorded evidence of organized Mafioso activity in the United States identifies the Mazzini networks with General Pike's guerrilla war against the "Reconstruction" South.

Nothing depicts this arrangement better than the stories of the first New Orleans godfathers, Joseph Macheca and Charles Matrenga. Protégés of Mazzini, they took over the New Orleans franchise on behalf of the Palermo mob, which reported to Mazzini and thence to Disraeli. The chain of command was so well known that the joke made the rounds that the word "mafia" was really an acronym for "Mazzini autorizza furti, incendi, e attentati" — "Mazzini authorizes theft, arson, and kidnapping." (29) The first of the Mazzini networks drifted in before and during the Civil War. "The Mafias in New Orleans, New York, and Palermo were separate societies," wrote one leading historian of the period, "but they cooperated closely. A member who was properly sponsored could be transferred from one city to another, from one family to another." (30)

By the close of the Civil War, Disraeli's Mafia was in the hands of one Joseph Macheca. By contemporary accounts, the activities of the Macheca gang were indistinguishable from those of the Klan. In 1868, Macheca organized the New Orleans side of Democratic candidate Seymour's campaign against Ulysses S. Grant. Seymour's funding and political direction came from August Belmont, the Rothschilds' official business agent in the United States. The campaign, such as it was, was described as follows in the *New Orleans Picayune*:

This popular and pleasant-mannered gentleman (Macheca) organized and commanded a company of Sicilians, 150 strong, known as the Innocents. Their

uniform was a white cape bearing a Maltese Cross (the insignia of the British Royal Family's Order of St. John of Jerusalem — ed.) on the left shoulder. They wore sidearms and when they marched the streets they shot at every Negro that came in sight. They left a trail of a dozen dead Negroes behind them. General James E. Steadman, managing the (Seymour) campaign, forbade them from making further parades and they were disbanded. (31)

One historian of the Mafia notes, "This matter-of-fact account is the first report of a formal Sicilian organization in New Orleans, and it is likely that from the ranks of these armed Innocents came the nucleus of Macheca's Mafia." (32)

Belmont's presidential candidate ran on a program drafted at the Seligman and associated Our Crowd banking houses in New York: the repeal of Lincoln's Emancipation Proclamation. The same cousins of the British *Hofjuden* controlled General Pike and his hooded goons, the Ku Klux Klan, whom Macheca's gangsters took such great pains to imitate — along with the conceit of the Maltese Cross. Pike, Macheca, and their paramilitary irregulars unleashed a wave of violence across the South that buried Lincoln's Reconstruction policy not many years after the President himself.

The historical record shows that Macheca's group in New Orleans, which started out by shooting blacks for the copperhead Our Crowd banks in New York, had proved its mettle by the early 1870s. It became the jumping-off point for the organization of the mob throughout the United States. Macheca provided a base for Mazzini's syndicate organizer of the first years of the Mafia, Giuseppe Esposito. A close Mazzini associate, Esposito fled Sicily in the early 1870s, arriving in New Orleans to make contact with Macheca. Esposito traveled through the United States, pulling together Italian-speaking secret societies and establishing inter-city communications where none had existed before. From Esposito's tour onwards, the Sicilian-speaking secret societies became crime syndicates. Mazzini's representative on the scene had absolute authority over the local godfathers, even over the leader of the New Orleans base organiza-



46

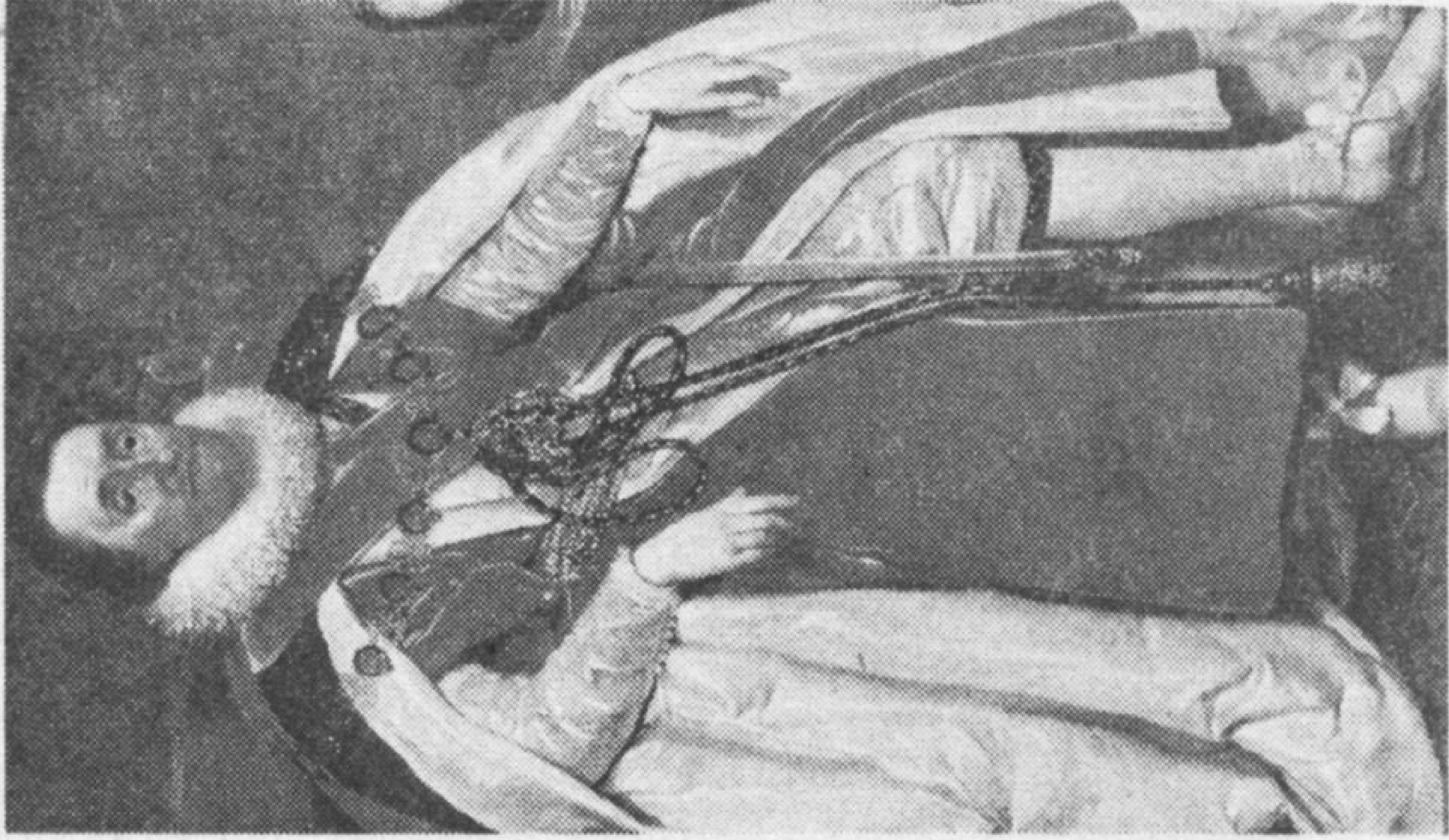

47

- 46. Robert Cecil, Lord Burghley, who delivered Tudor England to the Order of Malta's House of Stuart
- 47. Stuart James VI of Scotland, James I of England (1603-1625).
- 48. Grand Master of the Order of St. John of Jerusalem, Villiers de l'Isle-Adam entering Malta in 1530
- 49. The Seal of the Knights Templar
- 50. A 14th century Knight of St. John depicted kneeling before Rhodes, the order's home base before the Hapsburg gift of Malta

tion. Macheca's "Mafia leadership was eclipsed briefly," according to one historian, "from 1879 to 1881, when he temporarily deferred to Giuseppe Esposito." (33)

Macheca died at the hands of a New Orleans mob, which dragged him from a prison cell and lynched him, after he had been arrested for the murder of a policeman. (34) His old lieutenant Matrenga took over the reins. Macheca's death left a deep impression on the syndicates; possibly this is the point where the mob decided to "go legit," its strategy ever since. In order to do so, the Matrenga gang turned back to the *Hofjuden*.

The vehicle for the New Orleans mob's conversion to "legitimate business" in 1900 was another Romanian Jew, an immigrant from the Romanian province of Bessarabia, whence Yechiel Bronfman had migrated to Canada some ten years earlier. The new immigrant, one Samuel Zemurray, obtained financing from a group of Boston and New York Our Crowd banks, and bought out a portion of the Macheca gang's shipping interests. A historian comments, "Joe Macheca's shipping line merged with four others to form the great United Fruit Company, which remains one of the largest of all U.S. firms." (35) United Fruit — rechartered recently as United Brands Company — traditionally brought in Our Crowd bankers for its top management. Nonetheless, the Sicilian mob was remembered with nostalgia. When Charles Matrenga died in 1943, the entire board of United Fruit turned out for the funeral. (36)

From these most prominent among the Jewish and Italian ethnic crime stories of the formative years of the American syndicates, the roots of the narcotics traffic and associated evils are already evident. The Bronfmans, we will document later, founded and bankrolled the modern-day Murder Incorporated, Permindex, the firm that police agencies in the United States and Europe have suspected of organizing the murders of John F. Kennedy, Italian oil magnate Enrico Mattei, and former Italian premier Aldo Moro, as well as the many attempts on the life of Charles de Gaulle. It was in New Orleans that District Attorney Garrison linked the remnants of the old Macheca mob to the events in Dallas in November 1963.

As old Charles Matrenga withdrew into a "legitimate" back-

ground, the day-to-day operations of the New Orleans mob fell into the hands of Sylvestro Carolla, who, in turn, passed the godfather's mantle onto Carlos Marcello in the early 1950s. What had begun as a small secret cult, receiving direction from the London center of the Scottish Rite of Freemasonry and Prime Minister Disraeli's Order of Zion, had spread across the American South, the Caribbean, and Central America. It maintained close ties with Meyer Lansky and the British installations in the West Indies.

And, according to sources in the Drug Enforcement Administration, 20 percent of cocaine smuggled into the United States arrives on the ships of United Brands.

## The Chinese entry

Opium and morphine, in the early days of the mob, were not illegal drugs; heroin only came into circulation at the turn of the century and was not made illegal as a prescription drug until 1924. But the British dope-runners had a direct hand in the infiltration of narcotics into the United States, through the third wave of crime-tainted immigration, from China.

Not coincidentally, the first large-scale importing of opium into the United States commenced with the "coolie trade," referred to by its British Hong Kong and Shanghai sponsors as the "pig trade." Even before the Civil War, the same British trading companies behind the slave trade into the South were running a fantastic market in Chinese indentured servants into the West Coast. In 1846 alone, 117,000 coolies were brought into the country, feeding an opium trade estimated at nearly 230,000 pounds of gum opium and over 53,000 pounds of prepared (smoking) opium. (37) Although Lincoln outlawed the coolie trade in 1862, the black marketeering in Chinese (the term "Shanghai'd" referred to the merchant company kidnapping — through the Triad Society — of impoverished and often opium-addicted Chinese) continued at an escalating rate through to the end of the century. Often these Chinese "indentureds" would put their entire earnings toward bringing their families over to the

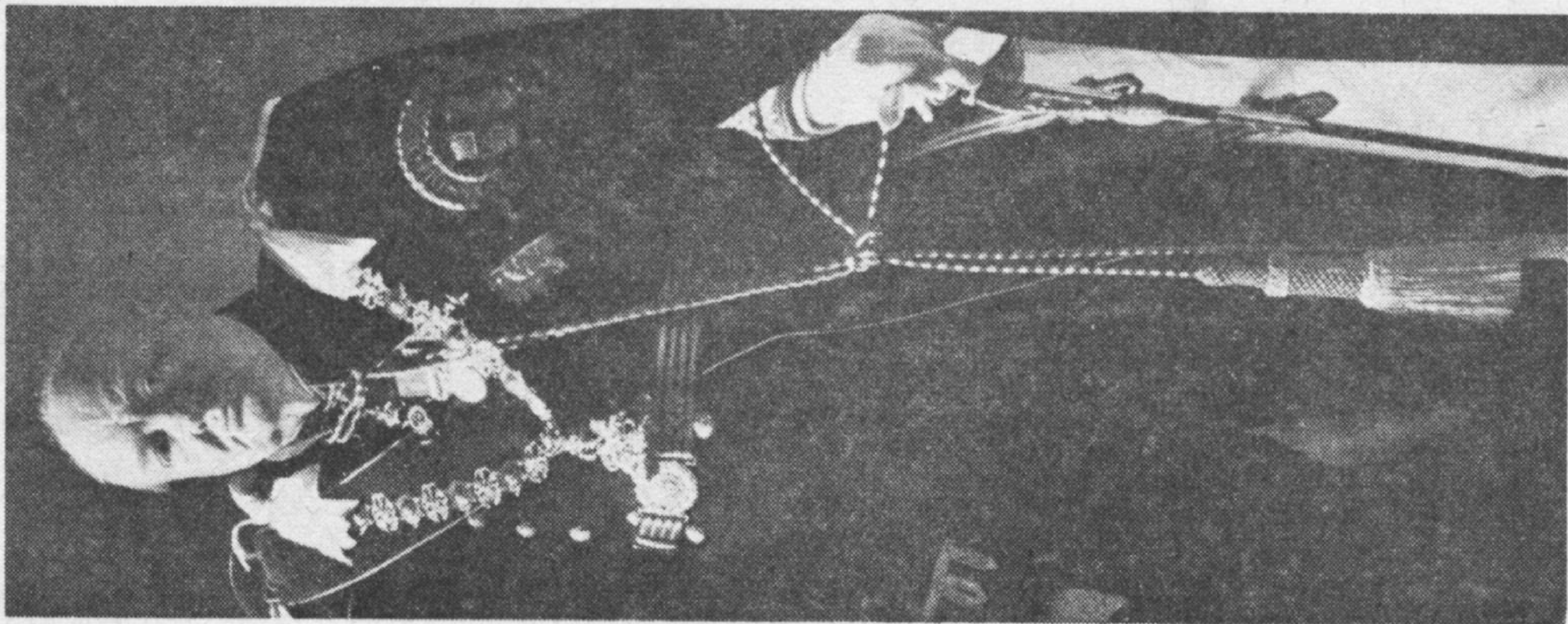

55

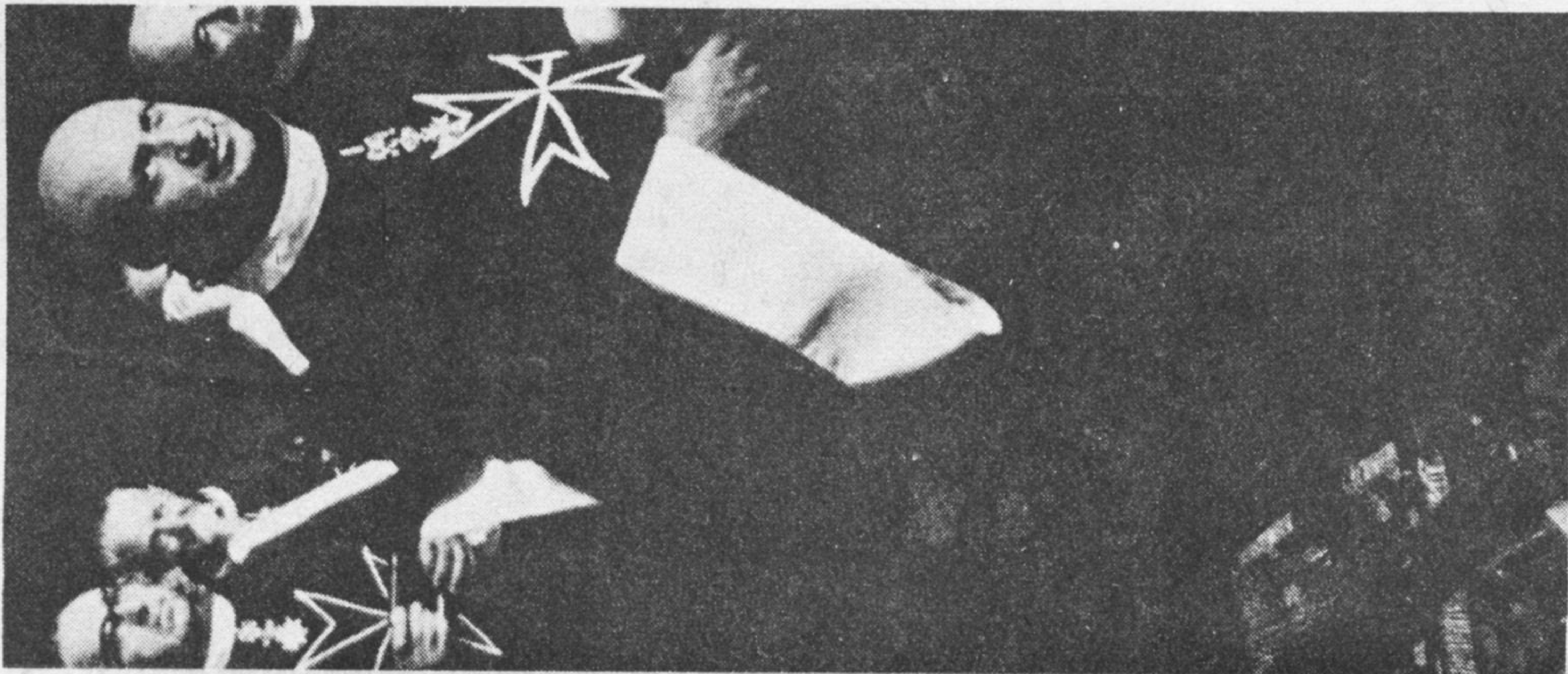

54

- 54. Modern rites of the Order of St. John of Jerusalem
- 55. Winston Churchill in Warden of Cinque Ports costume for the 1953 coronation of Elizabeth II

U.S. This traffic in Chinese immigrants represented one of the earliest channels of opium into the country, and laid the foundations for the later mass-scale drug trade out of the Chinatowns developed in San Francisco, Vancouver, and other West Coast cities during this period.

The amount of opium coming into the United States during the last quarter of the 19th century is measured by the fact that in 1875, official government statistics estimated that 120,000 Americans — over and above the Chinese immigrant population — were addicted to opium! (38)

Adding to the opium addiction was the fact that British pharmaceutical houses had begun commercial production of morphine in the years leading up to the Civil War and made large quantities available to both armies. The British firms misrepresented the morphine as a “nonaddictive” pain killer and even had the audacity to push it as a cure for opium addiction.

## The British Brahmins in the U.S.

The nature of the London-centered cycle of international trade from cotton to opium further cultivated a group of British financial allies in the United States. Some of these allies are comprador trading families whose activities span the entire period from the inception of the opium traffic through to the Second World War.

Most important among these groups is the Astor family dynasty, whose founder, John Jacob Astor (1763-1848) made his fortune in Chinese opium sales. One of his biographers reports, “We see that quicksilver and lead from Gibraltar and opium from Smyrna, as well as some iron and steel from the North of Europe, began in 1816 to take a conspicuous place in the list of Astor’s imports into China... Since according to Dr. Kenneth Scott Latourette, quicksilver and opium did not become regular articles of import into China by Americans till about 1816, Astor must have been one of the pioneers of their introduction.” (39)

Leveraged into investments in Manhattan real estate, John Jacob Astor’s opium earnings formed the basis of one of

America’s largest family fortunes. Participation in the China opium trade, a de facto monopoly of the East India Company at the time Astor took part in the traffic, was a privilege extended only to Americans the East India Company thought deserving. Other American firms active in the Canton trade did not touch opium. (40) Possibly, Astor’s trading privileges were a British pecuniary reward for services as a British intelligence operative in the United States. Astor provided funds for the escape of his attorney Aaron Burr after Burr murdered Alexander Hamilton; at the time, Burr was a British intelligence agent. Burr’s control, and the man to whom he fled after the murder of Hamilton, was East India Company employee Jeremy Bentham. (41)

Apart from the Astor group in New York City, the East India Company developed similar networks in Philadelphia and Boston, among other American cities. The leading British merchant bank Baring Brothers, which remodeled the old East India Company as an instrument for the opium traffic after William Pitt’s installation as British Prime Minister in 1783, acquired a group of business partners (and brothers-in-law) in Quaker Philadelphia. The family the Barings married into was William Bingham’s, reportedly the richest in the United States at the turn of the nineteenth century. Barings were prominent throughout the first years of the China traffic, founded the Hongkong and Shanghai Bank in 1864, and retained their family seat on its directing “London Committee” as of the HongShang’s 1977 annual report.

One historian describes how closely the Bingham group aped the British oligarchy:

Bingham was a most enthusiastic admirer of the British financial system which he desired to see copied in America... Immense wealth enabled the Binghams to import fashions, and copy the Duke of Manchester’s residence in Philadelphia... they gave the first masquerade ball in the city, encouraging what soon became a mania among the American rich — a passion for dressing up as aristocrats.

The Binghams finally achieved their ambitions by





51



52

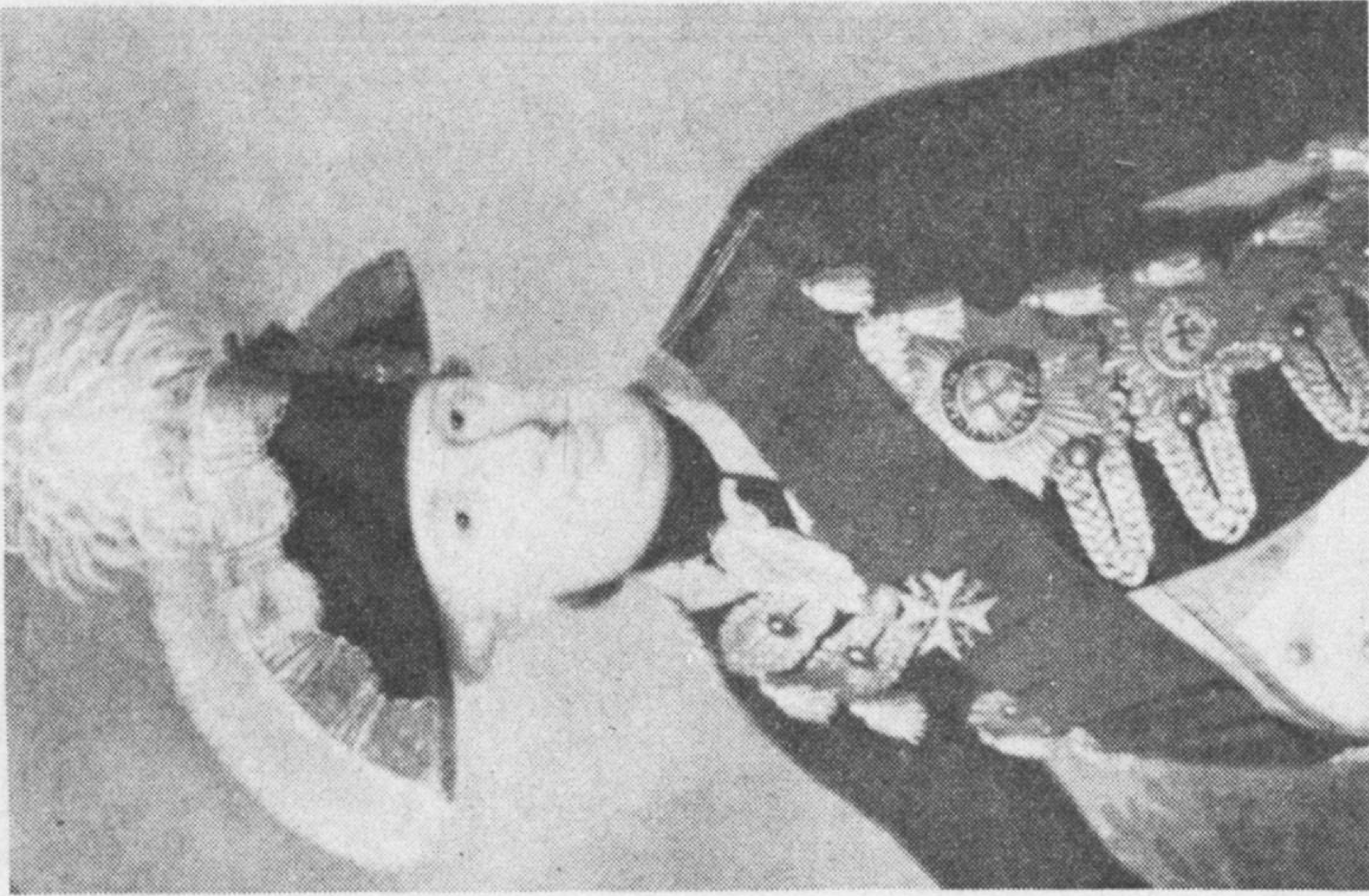

53

- 51. Amschel Rothschild, 18th century German founder of the family's financial empire
- 52. Nathan Rothschild, founder of the family's British branch
- 53. Prince William IX of Hesse Cassel, first patron of the Rothschilds, whose Prussian field marshal's uniform is decorated by a Cross of Malta

uniting two daughters to foreign aristocrats: one to Count de Tilly, and the other to a member of the London banking house of the Barings, who later became Lord Ashburton. (42)

Another Philadelphia family that united itself with Baring Brothers was that of millionaire Stephen Girard, (43) whose interests survived under the family name, in Philadelphia's multibillion dollar Girard Bank and Trust.

Several of the old "Boston Brahmin" families, however, made it into the mainstream of the 19th century opium traffic, alongside the well-remembered British names of Jardine, Matheson, Sassoon, Japhet, and Dent. The Perkins and Forbes families achieved notoriety in the traffic after the East India Company's monopoly expired in 1832, and after the Astors had ceased to be an important factor. William Hathaway Forbes became so prominent an associate of the British trading companies that he joined the board of directors of the Hongkong and Shanghai Bank in 1866, two years after its founding.

Hathaways, Perkins, and Forbes operated through a joint outlet, Russell and Company, formed around the Perkins family shipping empire, a "business reaching from Rio to Canton." (44) The fortunes of these families, as with the Philadelphia group, began with the slave trade — handed to them when the British dropped the slave trade as unprofitable in 1833. The China clippers of Russell and Company made not only Perkins's fortune, but most of the city of Boston's. A biographer reports, "By merging and creating Russell and Company, he was responsible to a large degree in the establishing of all of Boston's merchant families — Cabots, Lodges, Forbes, Cunninghams, Appletons, Bacons, Russells, Coolidges, Parkmans, Shaws, Codmans, Boystons and Runnewells." (45)

Baring Brothers, the premier merchant bank of the opium traffic from 1783 to the present day, also maintained close contact with the Boston families. John Murray Forbes (1813-98) was U.S. agent for Barings, a post occupied earlier by Philadelphia's Stephen Girard; he was the father of the first American on the HongShang board.

The group's leading banker became, at the close of the nineteenth century, the House of Morgan — which also took its cut in the Eastern opium traffic. Thomas Nelson Perkins, a descendant of the opium-and-slaves shipping magnate who founded Russell and Company, became the Morgan Bank's chief Boston agent, through Perkins's First National Bank of Boston. Morgan and Perkins, among other things, provided the major endowments for Harvard University. (46) Morgan's Far Eastern operations were the officially conducted British opium traffic. Exemplary is the case of Morgan partner Willard Straight, who spent the years 1901-12 in China as assistant to the notorious Sir Robert Hart, chief of the Imperial Chinese Customs Service, and hence the leading British official in charge of conducting opium traffic. Afterwards he became head of Morgan bank's Far Eastern operations. (47)

The above facts are necessary to round out the historical background to the opium traffic today. What makes them especially interesting is the intricate trail that leads investigators of present-day drug financing back to the same American families and American banks. In Part III, we will blow the cover of Philadelphia's old "Main Line" Quaker families, whose present generation controls not only the leading supply of illicit amphetamines in the United States, but funds a whole array of street-level drug-trafficking operations as well.

Morgan's case deserves special scrutiny from American police and regulatory agencies, for the intimate associations of Morgan Guaranty Trust with the identified leadership of the British dope banks (see Part II, Section 7). Jardine Matheson's current chairman David Newbigging, the most powerful man today in Hong Kong, is a member of Morgan's international advisory board. The chairman of Morgan et Cie., the bank's international division, sits on the Council of the Royal Institute of International Affairs. The chairman of Morgan Grenfell, in which Morgan Guaranty Trust has a 40 percent stake, Lord Catto of Cairncatto, sits on the "London Committee" of the Hongkong and Shanghai Bank.

But perhaps the most devastating example of continuity among the corrupted American families involves the descendants of old



59

**What the best drinks  
have in common.**

Seagram's 7 Crown makes any drink taste better, because it tastes better all by itself. Just pour 2 oz. over ice for a refreshing, invigorating drink. And enjoy our quality in moderation.

**Seagram's 7 Crown**  
Where quality drinks begin.

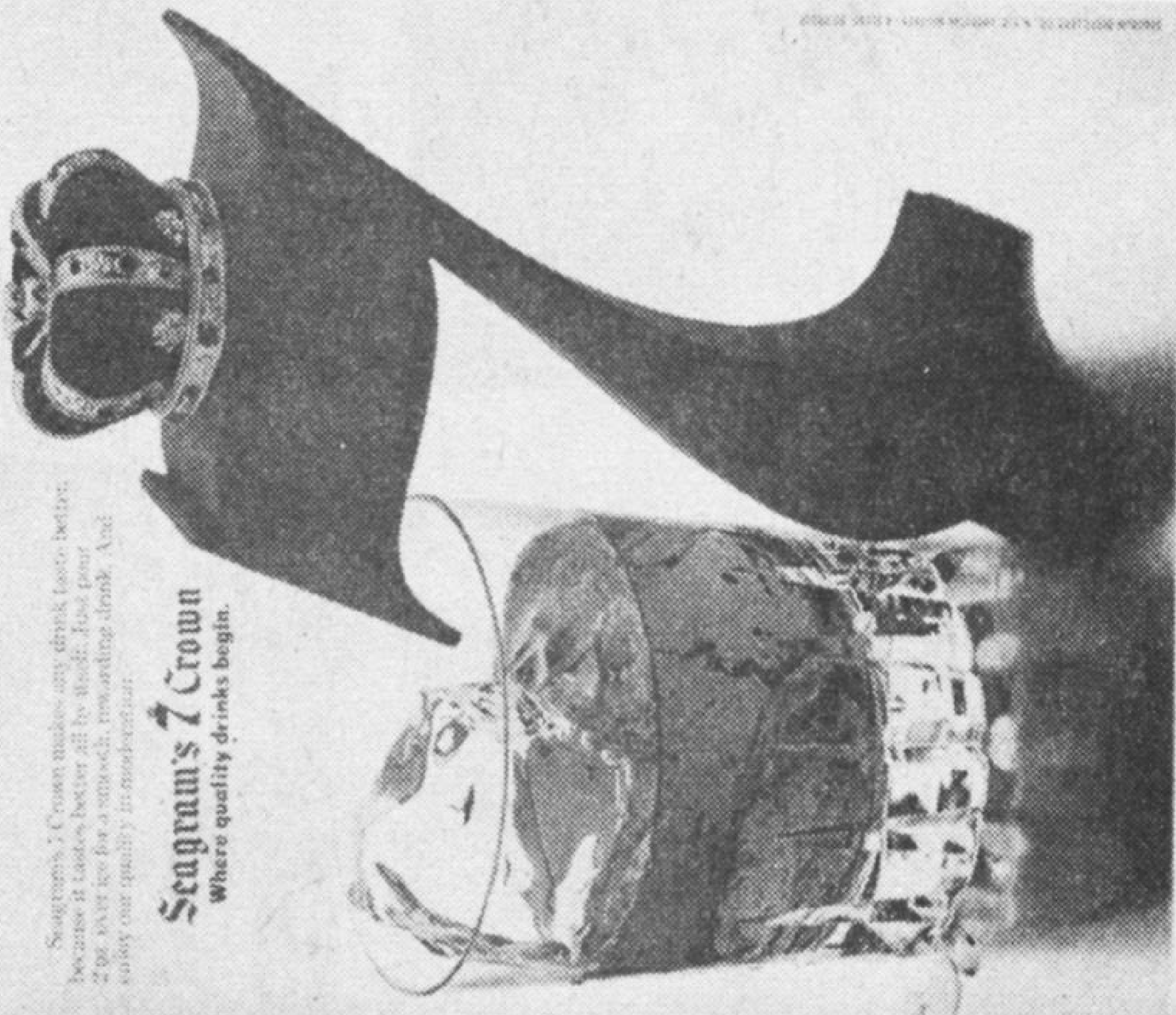

60

- 59. Edgar Bronfman
- 60. The whiskey his father Samuel ran into the USA during Prohibition

John Jacob Astor. American citizen Waldorf Astor, his direct descendant, was chairman of the Council of the Royal Institute of International Affairs during the Second World War, while Harvard-trained American citizens of the Institute for Pacific Relations smoothed the transition to People's Republic of China opium production (see Part II, Section 7).

The old Boston families who made their fortunes on the narcotics traffic were the ones whom old Joseph Kennedy strove to imitate when he obtained his British liquor delivery contacts during Prohibition, and the same ones who staffed his son's Administration.

---

### 3

## Britain's "Noble Experiment"

In the years 1919 and 1920, two events of critical strategic importance for Britain's opium war against the United States occurred. First, the Royal Institute of International Affairs was founded.

The purpose of this institution had been set forth over 40 years before in the last will and testament of empire-builder Cecil Rhodes. Rhodes had called for the formation of a "secret society" that would oversee the reestablishment of a British empire that would incorporate most of the developing world and recapture the United States (see Part II, Section 7). Toward this objective, Rhodes's circle, including Rudyard Kipling, Lord Milner, and a group of Oxford College graduates known as "Milner's Kindergarten," constituted the Round Table at the turn of the 20th century. In 1919, the same grouping founded the Royal Institute of International Affairs as the central planning and recruitment agency for Britain's "one world empire."

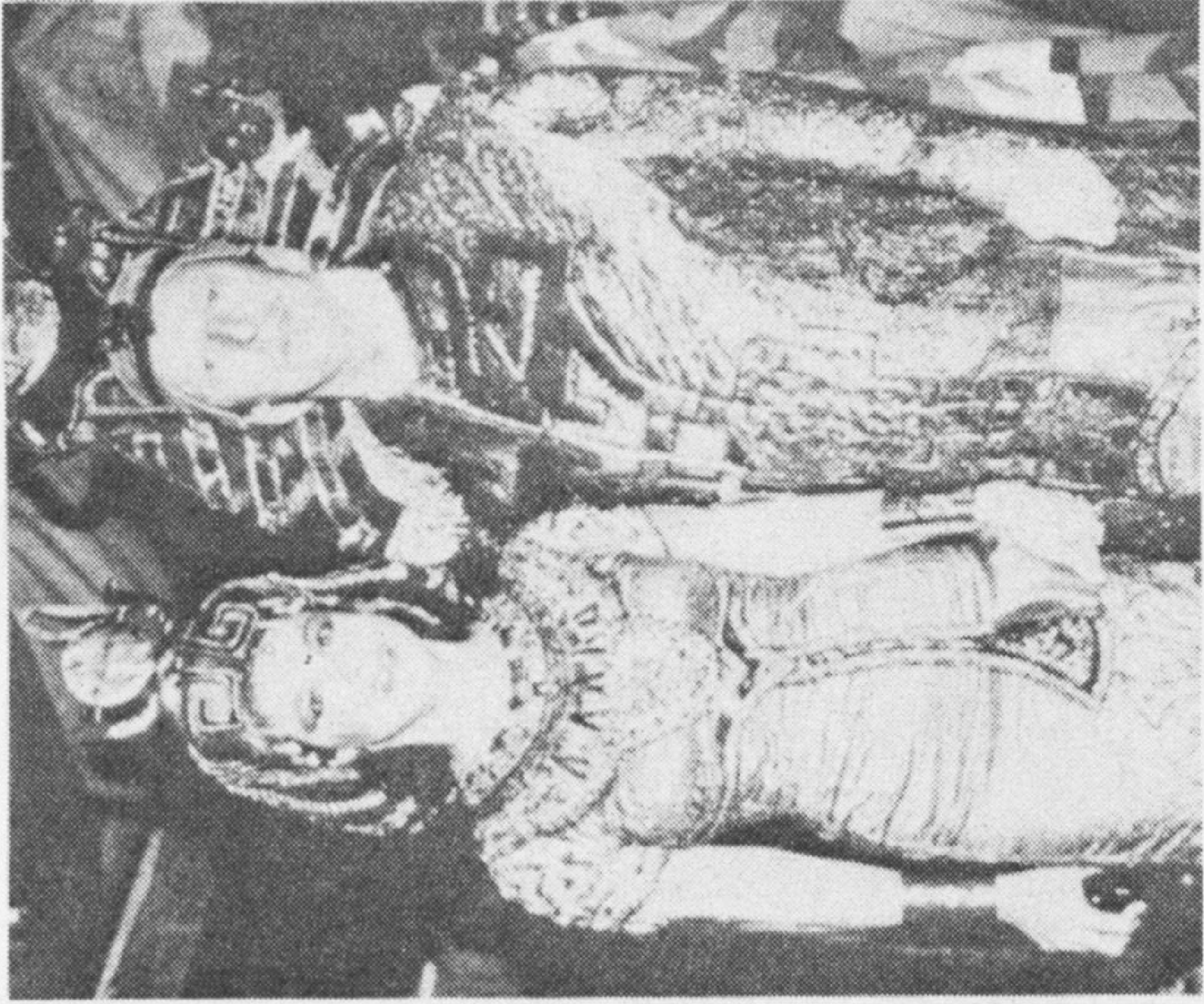

56

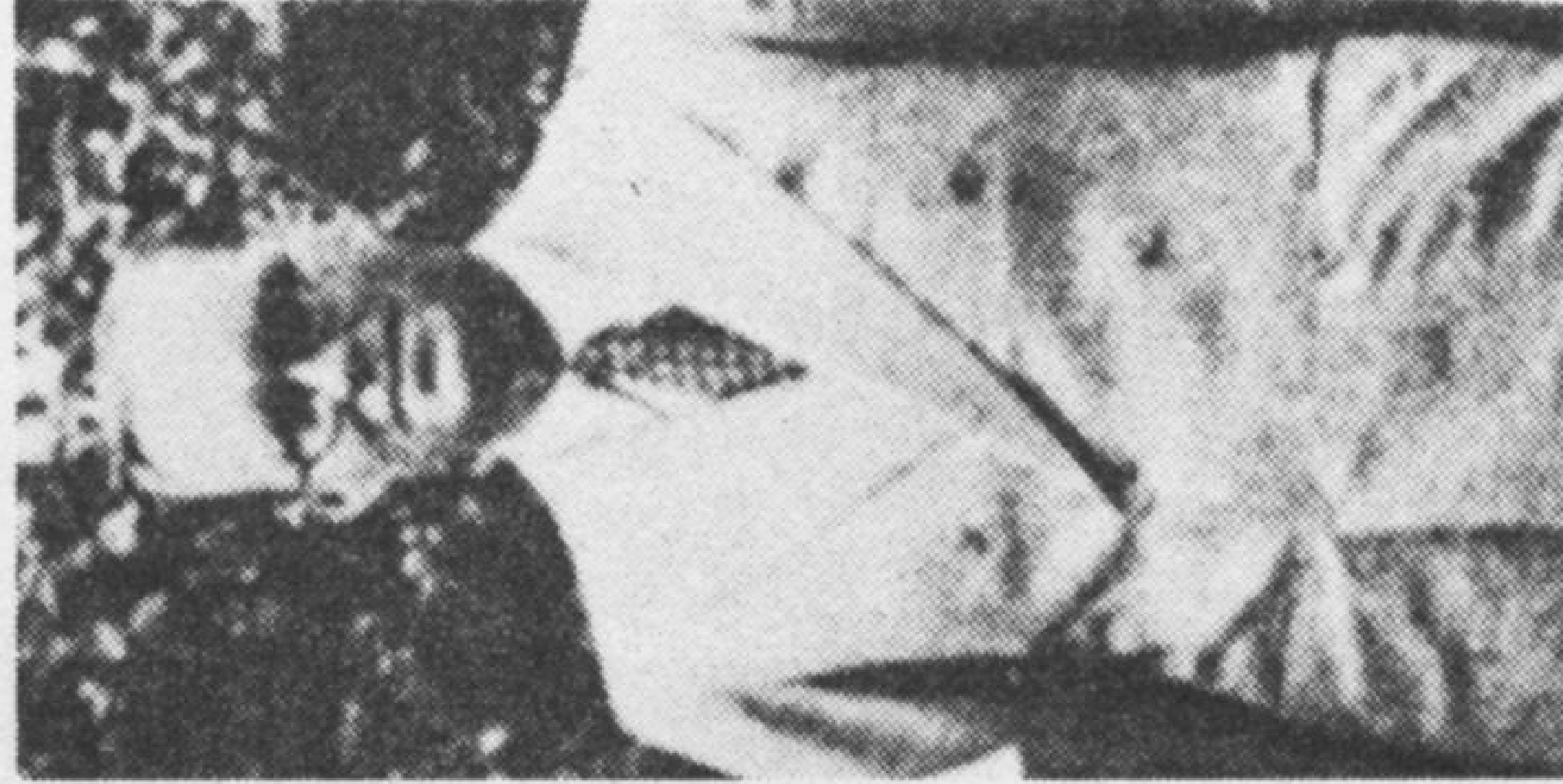

57



58

- 56. The current Cecil, Lord Harlech
- 57. Joseph P. Kennedy during the whiskey-running years
- 58. John Fitzgerald Kennedy and Robert Francis Kennedy

On January 6 of the next year, Britain declared its opium war against the United States. Americans knew it as Prohibition.

Prohibition brought the narcotics traffic, the narcotics traffickers, and large-scale organized crime into the United States. Illegal alcohol and illegal narcotics made up two different product lines of the same multinational firm. The British, through their distilleries in Scotland and Canada, and the British, from their opium refineries in Shanghai and Hong Kong, were the suppliers. The British, through their banks in Canada and the Caribbean, were the financiers. Through their political conduits in the United States, the British created the set of political conditions under which the United States might be won back by means other than the failed Balkanization plan of the Civil War period.

Two tracks led to the drug epidemic in the United States, one in the Far East, and the other in the United States and Canada. Against the outcry of the League of Nations and virtually all the civilized world, the British stubbornly fought to maintain opium production in the Far East, expanding the illegal supply of heroin, just as the drug went out of legal circulation in America in 1924. In North America, Canada — which had had its own period of Prohibition — went “wet” one month before the United States went dry.

In interviews with the authors, Drug Enforcement Administration officials have emphasized the similarity of the alcohol and narcotics modus operandi. When the agents of Arnold Rothstein and Meyer Lansky made their first trips to the Far East in the 1920s, they purchased heroin from the British with full legality. What the American gangsters did with the drug was their own business; the British opium merchants were merely engaging in “free enterprise.” When Britain’s leading distilling companies sold bulk quantities of liquor to Arnold Rothstein and Joseph Kennedy — for delivery either to the Bahamas or to the three-mile territorial limit of the United States coastal waters — they had no responsibility for what happened to the liquor once it reached American shores. (The identical explanation was offered by an official of the British Bank of the Middle East, which now services the Far East drug traffic through a smug-

glers’ market in gold bullion in Dubai, on the Persian Gulf. “We only sell the gold, old boy,” the banker said. “What those fellows do with it once they get it is up to them.”)

Which of the American syndicates obtained this month’s franchise for drug or liquor distribution was immaterial to the British traffickers. The greater the extent of intergang bloodshed, the less obvious their role would be. In fact, the British distillers could provoke such events at will by withholding needed inventory of bootleg alcohol.

The “Noble Experiment” was aimed at degrading the American people through popular “violation of the law” and association with the crime syndicate controlled by the Our Crowd banks of Wall Street — the Zionist Lobby of its day (see Part III). New York’s Our Crowd is an extension of the London Rothschild banking network and British Secret Intelligence into the United States. For example, Sir William Wiseman was the *official* head of British Secret Intelligence in the United States throughout the World War I period. He became a senior partner in the investment house of Kuhn Loeb immediately on demobilization. Wiseman was a personal protégé of Canadian Round Table founder Lord Beaverbrook and one of the most prominent public figures in the Zionist movement. (1)

With this lower Manhattan-Canada-centered grouping acting as the political control, the Prohibition project was launched during the early 1910s under the shadow of the United States’ entry into World War I. It should shock no one that the creation and rapid growth of an organized crime syndicate in the United States was the filthy business of the Our Crowd banks — employing the cults of Lord Palmerston and Disraeli that conducted the unsuccessful assault against the American republic during the Civil War.

It is a fraud of the highest order that Prohibition represented a mass social protest against the “evils” of alcohol. Like the environmentalist movement and other present day anti-progress cults, the Women’s Christian Temperance Union (WCTU) and its Anti-Saloon League offshoots were a small, well-financed and highly organized circle that enjoyed the financial backing of the Astors, the Vanderbilts, the Warburgs, and the Rockefellers. (2)

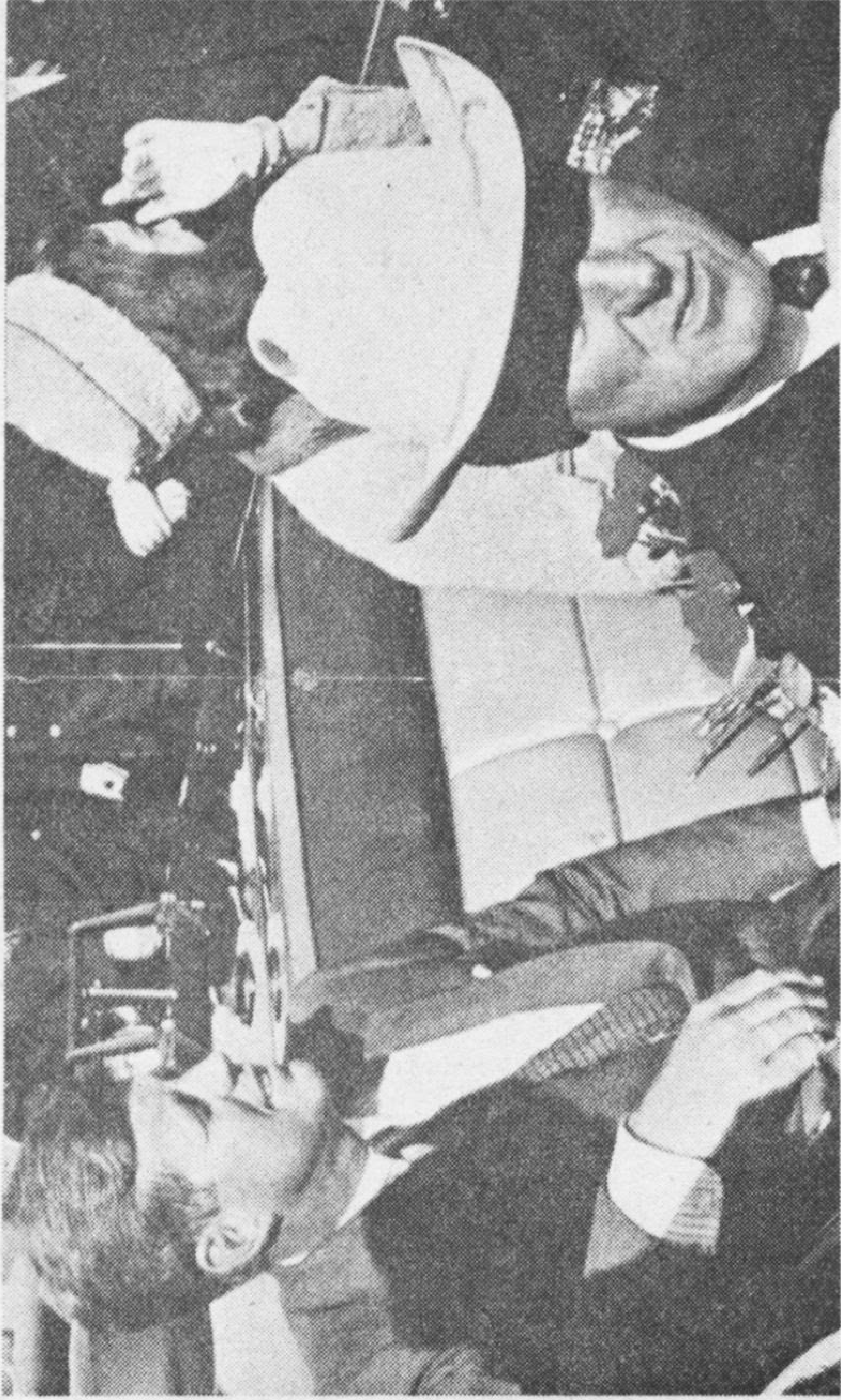

69

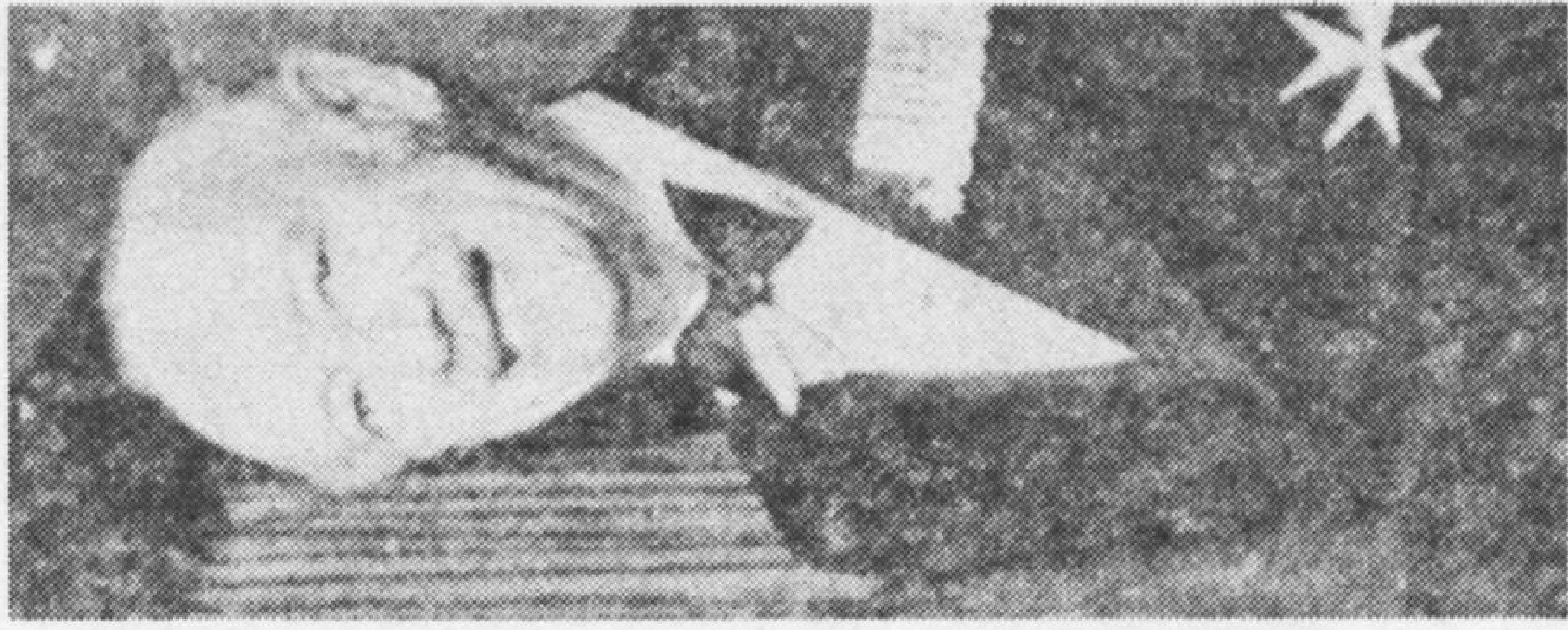

70

- 61. Arnold Rothstein
- 62. Meyer Lansky
- 63. Thomas E. Dewey, re-organizer of organized crime in the 1930s
- 64. Al Capone
- 65. Charles "Lucky" Luciano
- 66. Johnny Torrio
- 67. Abner "Longie" Zwillman
- 68. "Bugsy" Siegel
- 69. John F. Kennedy, beginning the 1963 motorcade in Dallas that ended in his assassination
- 70. Major Louis Bloomfield, wearing the Cross of Malta

Then as now, the funding conduits were principally the tax-exempt foundations — specifically the Russell Sage Foundation and the Rockefeller Foundation. John D. Rockefeller I was hoodwinked by Lord Beaverbrook colleague and former Canadian Prime Minister MacKenzie King into not only bankrolling the WCTU, but providing it with the services of the foundation's entire staff of private investigators. (3)

Who made up the Temperance Movement? It was run by Jane Addams, who studied the Fabian Society's London settlement house Toynbee Hall experiment and came to the United States to launch a parallel project which later produced the University of Chicago. (4) The "cadre" were drawn almost exclusively from three pools: 1) the settlement house and suffragette networks run by Addams and the Russell Sage Foundation; 2) the pro-terrorist synthetic religious cults operated out of Oberlin College in Ohio; and 3) the Ku Klux Klan in the South.

Oberlin College was founded by British "Christian missionaries" in the decades leading up to the Civil War. Like the ancient *anti-Christian* Manichean cult, Oberlin was organized around the principle that the material world was wholly evil; all students (i.e. initiates) were required to become vegetarians. From Oberlin's student body some of the most violent radical abolitionist terrorists were recruited, trained and deployed and safehoused during the Civil War. (5)

Like its predecessor radical abolitionist movement, the Temperance Movement was founded at Oberlin in the post-Civil War period as a violent cult (known at the time as "Organized Motherlove"). At the height of the Prohibition drive during the 1910s, bands of ax-wielding lesbians — the Susan Saxes and Bernadine Dohrns of their day — received banner headlines for their assaults against saloons throughout the Ohio Valley. Many of these women were drawn from the Manichean cult at Oberlin.

Once launched as a nationwide movement, WCTU founded a national headquarters in Evanston, Ill. Nearby Wilmette, Ill. (along with London and Tel Aviv) subsequently became the North American headquarters of the British Intelligence-organized Ba'hai terrorist cult. (6)

In the South, parallel "fundamentalist Christian" cultists had

been drawn together from the turn of the century under the direction of the Ku Klux Klan.

These three British cults agitated nationally for Prohibition. While the WCTU and Anti-Saloon League staged well-publicized and frequently violent raids against saloons, the more sophisticated Fabian Settlement House social workers of Jane Addams used the unique conjuncture of the recently passed Seventeenth Amendment certifying women's voting rights in national elections and the concentration of much of the adult male population on the war effort to vote up the Eighteenth Amendment making Prohibition the law of the land. The Amendment was fully ratified by 1917; however, the Volstead Act that defined the federal enforcement procedures was not scheduled for implementation until January 6, 1920.

The three-year lead time was critical for the establishment of a tightly organized crime syndicate, which was being organized out of Canada and Our Crowd banking circles in New York:

\* In Canada, a brief Prohibition period (1915-1919) was principally enacted by order of Her Majesty's Privy Council to create the financial reserves and bootlegging circuit for the U.S. Prohibition. In this period Canada's *Hofjuden* Bronfman family established the local mob contacts in the U.S. and consolidated contractual agreements with the Royal Liquor Commission in London.

\* Primarily out of Brooklyn, New York, teams of field agents of the Russell Sage Foundation conducted a reorganization and recruitment drive among local hoodlum networks — already loosely organized through Tammany Hall's New York City Democratic Party machine. "Legitimate" business fronts were established, replacing neighborhood nickel-and-dime loan sharking operations, and specially selected individuals — largely drawn from the Mazzini "Mafia" transplanted to the U.S. during the late 1800s Italian migrations — were sent out of Brooklyn into such major Midwest cities as Chicago, Detroit, and St. Louis in the 12 months leading up to the Volstead enforcement. One such Brooklyn recruit was Al Capone.

The British oligarchy did much more than supply the gutter elements of the crime syndicates with their stock in trade. To a





62



65



68



61



64



67



63



66

surprising extent, the Anglophile portion of America's upper crust joined the fun. The case of Joseph Kennedy, who owed his British contracts for liquor wholesaling to the Duke of Devonshire, and later married his daughter into the family, is notorious (see Part III). In some respects more revealing is the strange case of Robert Maynard Hutchins, the President of the University of Chicago from 1929 to 1950. Hutchins had American citizenship, but was so close to the British aristocracy that he became a Knight Commander of Her Majesty's Venerable Order of St. John of Jerusalem, swearing an oath of chivalric fealty to the head of the order, the British monarch.

Under the guise of "social studies research," several well-known Universities of Chicago postgraduate students received their apprenticeships in the service of the Capone gang:

\* In 1930, University of Chicago graduate student **Saul Alinsky**, the godfather of the "New Left," entered the Capone Mob in Chicago. Alinsky for several years was the accountant for the gang — at the height of the Prohibition profiteering. (7) Alinsky went on to be one of the most important British Fabian-modeled social engineers in the United States for the next 30 years, specializing in the creation of synthetic dionysian cults among the nation's youth and ghetto victims.

Alinsky, in fact, used the organizational model of the Capone Mob to build up a criminal youth gang infrastructure in Chicago during the early 1960s that assumed street-level control over drug trafficking and related criminal operations run 30 years earlier through the Capone gang. When the Our Crowd sponsors of Capone's initial deployment to Chicago determined at the close of Prohibition that a more "civilized" cutout was desired, Alinsky was the channel for bringing Frank Nitti into the Mob.

\* In the late 1940s, University of Chicago professor **Milton Friedman** was installed as President of the Gold Seal Liquor Company — the original Capone enterprise. Friedman soon also assumed the presidency of the Illinois Wholesale Liquor Dealers Association — a position from which he no doubt carried out his first experiments in "free market economics." (8)

\* As late as the 1960s, retired University of Chicago President Hutchins himself was under investigation for his involvement

with drug trafficking and other black market enterprises. Through the late 1960s his Center for the Study of Democratic Institutions was financed principally through Bernie Cornfeld's Investments Overseas Service (IOS) — an international pyramid swindle and drug money laundering enterprise (see Part III, Section 3). Furthermore, Hutchins was simultaneously the president of a little-known Nevada foundation called the Albert Parvin Foundation which several congressional committees investigating organized crime cited as a front for Las Vegas gambling receipts. (9)

## Mounting the drug invasion

The United States' fourteen-year experiment in Prohibition accomplished precisely what its British framers had intended. **Ralph Salerno**, an internationally recognized authority and historian on organized crime, a law enforcement consultant and former member of the New York City Police Department's intelligence division, succinctly summarized the effect of Britain's Prohibition gameplan in his book, *The Crime Confederation*:

The most crucial event in the history of the confederation (organized crime — ed.) was a legal assist called Prohibition. . . . Prohibition helped foster organized crime in several ways. It was the first source of real big money. Until that time, prostitution, gambling, extortion and other activities had not generated much capital even on their largest scale. But illegal liquor was a multibillion dollar industry. It furnished the money that the organization later used to expand into other illegal activities and to penetrate legitimate business. Prohibition also opened the way to corruption of politicians and policemen on a large scale. It began the syndicate connection with politics and it demoralized some law enforcement groups to the point where they have never really recovered. . . .

The manufacture and distribution of illegal liquor here and



73



74



75

- 73. Aldous Huxley
- 74. Aleister Crowley, in robes of the Order of the Golden Dawn
- 75. Ancient Egyptian wall-painting, depicting the death rites of the Cult of Isis (now in British Museum)

the importation of foreign-made liquor gave the men who were organizing crime experience in the administration and control of multibillion dollar world businesses with thousands of employees and long payrolls. Men who had never before managed anything bigger than a family farm or a local gang got on-the-job training that turned them into leaders developing executive qualities.

... Mass evasion of the Volstead Act also put the average citizen in touch with criminals, resulting in tolerance and eventually admiration and even romantic approval of them. It permanently undermined respect for the law and for the people enforcing it. Ever since Prohibition the man in the street has accepted the idea that cops can be bought. (10)

The combined revenues of the illicit whiskey and drug trade during Prohibition had constituted a multibillion dollar black market booty. While families like the Kennedys and Bronfmans "made out like bandits" in the early 1930s transition to "legitimate" liquor trade, the overall financial structure for maintaining an organized crime infrastructure demanded diversification into other areas of black market activity only marginally developed previously. The market for illicit drugs in the United States — though significantly expanded as the result of the Prohibition experience — was not to become the foundation of a multibillion dollar traffic for several decades.

In the interim, the Our Crowd-British crime syndicate turned to casino gambling and associated enterprises as the immediate area for expansion. The Lansky syndicate took the opportunity of Nevada's 1933 passage of specific regulations legalizing casino operations to turn that no-man's-land into a desert resort to house all the West Coast criminal operations that had previously been run on pleasure boats 12 miles off the coast of Hollywood. Lansky also moved into the Caribbean, preparing the way for the British offshore complex of unregulated banking.

Through the investment of the phenomenal profits derived from the Prohibition into gambling casinos, professional sports stadiums and racetracks, organized crime established the

foundations during the 1930s and 1940s for the drug trafficking that would begin in the mid-1950s — once a cultural climate had been created that was conducive to fostering drug addiction.

## Nixon's war on drugs

It is not widely known that President Nixon was a casualty in the war against Britain's drug invasion of the United States. Had Nixon not taken up the most basic interests of the nation in launching a wholesale effort to shut down the drug trafficking — from the top down — it is likely that he would not have been unceremoniously forced out of office by Henry Kissinger, Ted Kennedy, and their British masters.

By 1970 Nixon became profoundly aware that the proliferation of drug abuse among the nation's youth had become a problem of such monumental significance that all his efforts to institute a long-range program of peace-through-development would be meaningless unless combined with a ruthless crackdown on the poison that threatened to wreck the nation's future leadership and its productive sector. Documents are available in the public domain from the Drug Enforcement Administration and other executive agencies showing that Nixon's "War on Drugs" was directed *at the top* — at the banking institutions, the transportation grids, and only then at the distribution channels delivering the volumes of drugs onto the streets of the country.

At the same time that Nixon generically understood the top-down nature of the problem, he and his assistants scarcely understood that by going after the drug infrastructure they were taking on the entire British oligarchy and the entire underpinnings of the Eurodollar market and the People's Republic of China. Had Nixon understood the drug problem as a London-Peking problem, he would have perhaps been better prepared to deal with the "inside-outside" attack against his Presidency.

In Part II of this report, we will reveal the inner workings of the London-Peking Drug Empire the Nixon Administration ran up against when it declared its War on Drugs.



71



72

- 71. The Beatles are introduced to America
- 72. The British intelligence cult of Hare Krishna

## Notes

### 1. BRITAIN'S FIRST OPIUM WARS

1. As quoted in Jack Beeching, *The Chinese Opium Wars* (New York: Harvest Books, 1975), p. 258.
2. Adam Smith, *Wealth of Nations, Representative Selections* (New York: Bobbs-Merrill, 1961).
3. Richard Morris, *The Peacemakers: The Great Powers and American Independence* (New York: Harper & Row).
4. Beeching, *Chinese Opium Wars*, p. 43.
5. In addition to the Chinese Hong merchants who collaborated with the British opium houses and the run-of-the-mill pirates and river rats that the British recruited into their service as the "eyes and ears" in Canton and the interior, the Hakkas, a people living in the southern province of Kwangsi who were under the strong influence of the Heaven and Earth Society (Triads) were particularly important to the British operations. The Triads, devoted to the days of the Ming Dynasty — and who were very similar to the Freemason organizations in Europe and North America — wanted to overthrow the Manchu Dynasty. The Hakkas were used by both the British and their Triad allies as a grassroots bludgeon against the Emperor. The key figure in the joint Anglo-Triad venture was a religious fanatic named Hung Hsui-Ch'uan.

Hung, having suffered public "loss of face" on four occasions — he failed the examinations that would allow him to join the mandarin class and become a government official — suffered a nervous collapse. He was in a trance for 40 days in which he was supposedly born again and then, using a translation of the King James Bible, he created a new religion based on the notion of "The Chosen People." The Hakkas were to be the Chosen People, and the Triad identification of the Manchus as the enemy was fully incorporated into Hung's quasi-Protestant religion.

Hung served as the "prophet," and a Hakkas Triad member, Yang Hsin-Ch'ing, served as the recruiter and military commander of the movement. Yang was in the employ of the British as an opium runner on the Pearl River.

In 1851, Hung and Yang launched a full-scale assault against the Manchu Dynasty — called the Taiping Revolt, or "The Triad War" — which drained China's treasury, shook the government, and demoralized China's pathetic army. The Taiping-Triad forces also played a significant role in the 1911 overthrow of the Manchu Dynasty that led to the republic of China under its president Dr. Sun Yat-sen (also a member of the "Hung Society"), although the organization was outlawed as treasonous and terrorist in 1890.

For further reading on the Hung-Triad Societies see: Lady Queensborough, *Occult Theocracy, Volumes I and II* (France: The International League for Historical Research, 1931), pp. 441-42; Beeching, *Chinese Opium Wars*, pp. 180-205.

6. Beeching, *Chinese Opium Wars*, p. 80.
7. *Ibid.*, p. 98.
8. *Ibid.*, p. 127.
9. *Ibid.*, p. 95.
10. *Ibid.*, p. 272.
11. *Ibid.*, p. 272.
12. *Ibid.*, p. 264.
13. Karl Marx and Frederick Engels, *Civil War in the United States* (New York: International Publishing Co.).
14. Brian Ingles, *The Forbidden Game: A Social History of Drugs* (New York: Charles Scribner's, 1975), chapter 11.
15. *Ibid.*
16. *Ibid.*
17. *Ibid.*
18. *Ibid.*
19. *Ibid.*

### 2. PALMERSTON'S FIFTH COLUMN IN THE USA

1. Samuel Morse, "The Present Attempt to Dissolve the American Union: A British Aristocratic Plot" (New York: John F. Trow, 1862); Samuel Morse, "A Foreign Conspiracy against the Liberties of the United States" (New York: originally published by the *New York Observer*, 1835); see also the soon-to-be-published book, *The First American Intelligence Service* (New York: Campaigner Publications). Morse signed all his published articles under the name "Brutus."
2. C. Bernant, *The Cousinhood* (New York: Macmillan Company, 1972).
3. Benjamin Peixotto, ed., *The Menorah*, official organ of the B'nai B'rith, New York, 1 (Sept. 1886).
4. *Ibid.*
5. *Ibid.*
6. Official document recorded by Benn Pittman, *The Indianapolis Treason Trial*, 1865; *Official Report — A Western Conspiracy in the Aid of the Southern Rebellion* (Indianapolis: 1865); see also *An Authentic Exposition of the Knights of the Golden Circle or a History of Secession* (pamphlet), author unknown, believed to be Union counterespionage agent named Jim Pumfrey (Indianapolis: 1861); Mayo Fesler, "Secret Political Societies in the North during the Civil War," *Indiana Historical Magazine* 3 (Sept. 1918).
7. Burton Hendrick, *Statesman of the Lost Cause, Jefferson Davis and His Cabinet* (New York: Literary Guild of America, 1939), pp. 153-181; Max Kohler, *Judah Benjamin: Statesman and Jurist* (Baltimore, 1905).

8. Israel Joseph Benjamin, "Three Years in America, 1859-62" (New York: 1863), Vol. I; contains a profile of B'nai B'rith and 44 Jewish organizations.
9. Albert Pike, *Lectures of Arya and Indo-Aryan Deities and Worship*, published by the Ancient and Accepted Scottish Rite of Freemasonry of the Southern Jurisdiction of the U.S.A. on orders of the Grand Command of the Supreme Council 33°; see also Queensborough, *Theocracy*.
10. Queensborough, *Theocracy*.
11. *Ibid.*
12. *Ibid.*; see also Merle Curti, "Young America," *American Historical Review*, 1929.
13. *Menorah*, Sept. 1886; see also Queensborough, *Theocracy*.
14. Queensborough, *Theocracy*.
15. John A. Bingham, Special Judge Advocate, "Trial of the Conspirators for the Assassination of President Lincoln Delivered June 2-28, 1865, before the Military Commission of the Court Martial of the Lincoln Conspirators," War Department Records, Section Monograph 2257, Official Transcript.
16. Clayton Gray, *Conspiracy in Canada* (L'Atelier Press, 1957); David Balsiger and Charles Sellin, *The Lincoln Conspiracy* (Albuquerque: Sun Publishing Co., 1977).
17. Gray, *Conspiracy in Canada*.
18. *Ibid.*; see also Susan Davis, *Authentic History of the Ku Klux Klan, 1865-1877*, 1924.
19. Gray, *Conspiracy in Canada*.
20. A. R. Turner-Tyrnauer, *Lincoln and the Emperors* (New York: Harcourt, Brace and World, Inc., 1962).
21. Queensborough, *Theocracy*.
22. *Menorah*, Sept., 1886.
23. The Green Shirts emerged from the networks that the Order of Zion had put in place in Romania and consolidated with the coup to install King Charles in 1887; see also Paul Goldstein, "The Rothschild Roots of the KKK," *Executive Intelligence Review* 39: 50.
24. The political error the Okhrana made in its use of the *Protocols* was to generalize the notion of a Zionist conspiracy to include all of Jewry. The *Protocols* were then used by British intelligence operatives within the Okhrana to unleash pogroms against Russian Jews in conjunction with and following the "1905 Revolution" destabilization of the Witte government.
25. The *Protocols* have been published most recently in Herman Bernstein, *The Truth About the Protocols of Zion* (New York: Ktav Publishers, 1971).
26. Sources in Mexico made this oath available to the authors and have confirmed that it is authentic. It should be noted, however, that the Knights of Columbus in the United States is a very different organization from this Mexican branch, and the two should not be confused.
27. Canadian Jewish Congress report, 1967-68 (see Part III, Section 1).

28. Edyth Hinkley, *Mazzini: The Story of a Great Italian* (Port Washington, N.Y.: Kennikat Press, 1924).
29. Charles William Heckethorn, *The Secret Societies of All Ages and Countries*, Vol. I and II, 1875 (New York: University Books, Inc., 1965); see also David Leon Chandler, *Brothers in Blood* (New York: E.P. Dutton Co., Inc., 1975), p. 31.
30. Chandler, *Brothers in Blood*, p. 103.
31. *Ibid.*, p. 75.
32. *Ibid.*
33. *Ibid.*, p. 79.
34. *Ibid.*, pp. 95, 97.
35. *Ibid.*, p. 97.
36. *Ibid.*, p. 98.
37. Beeching, *Chinese Opium Wars*, p. 178.
38. *Ibid.*
39. Kenneth Wiggins Porter, *John Jacob Astor, Business Man* (New York: Russell and Russell, 1966).
40. Beeching, *Chinese Opium Wars*.
41. Porter, *John Jacob Astor*, p. 604.
42. Miriam Beard, *History of Business*, Vol. II (Ann Arbor: University of Michigan Press, 1963), p. 162ff.; see also Joseph Wechsberg, *The Merchant Bankers* (Boston: Little, Brown, and Company, 1966), 104 ff.
43. Wechsberg, *Merchant Bankers*, p. 123.
44. Beeching, *Chinese Opium Wars*.
45. Brett Howard, *Boston: A Social History* (New York: Hawthorn Books, Inc., 1976).
46. *Ibid.*
47. Ingles, *The Forbidden Game*.

### 3. BRITAIN'S NOBLE EXPERIMENT

1. *Who's Who in America and Who's Who in World Jewry*.
2. John Kobler, *Ardent Spirits* (New York: G. P. Putnam's Sons, 1973).
3. *Ibid.*
4. Jeffrey Steinberg, "Robert M. Hutchins: Shaper of an American Oligarchy," *The Campaigner*, Vol. II, 3-4:73-77.
5. Queensborough, *Occult Theocracy*.
6. Bruce Wood, "Cult and Terrorist Activities in the Detroit, Michigan Area Since the 1960s," an unpublished manuscript, September, 1976.
7. Saul Alinsky, *Reveille for Radicals* (New York: Random House, 1969).
8. John Kobler, *Capone: The Legacy* (New York: G. P. Putnam's Sons, 1972).
9. Hank Messick, *Lansky* (New York: Berkley Medallion Books, 1971), p. 152.
10. Ralph Salerno and John S. Tompkins, *The Crime Confederation* (New York: Doubleday and Company, Inc., 1969), pp. 275, 278-79.



76



76. The Drug Lobby: Senators Jacob Javits and Edward Kennedy



# **PART II**

## **How the Drug Empire Works**

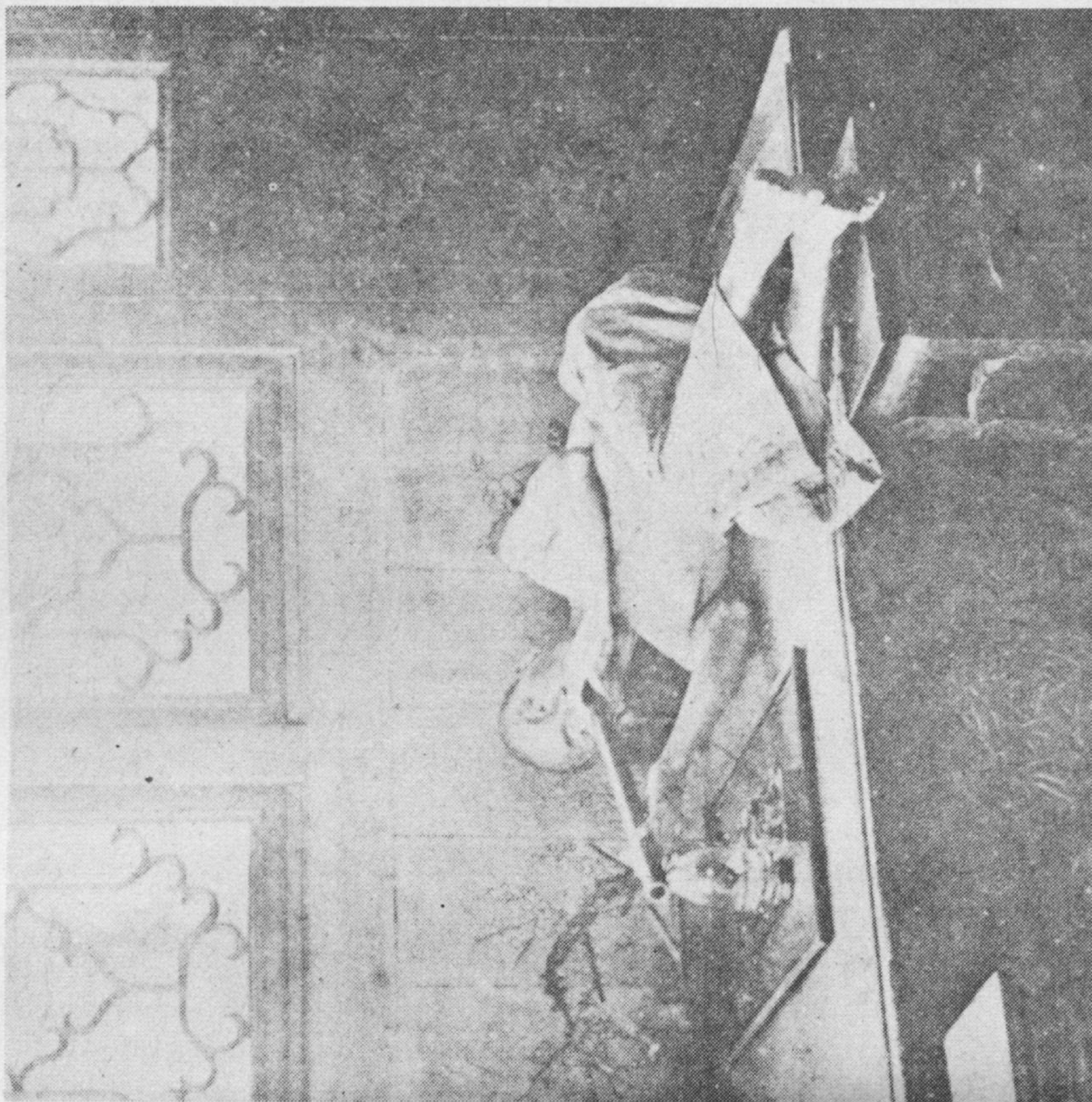

6

2. Rudyard Kipling
3. The symbols of the Scottish Rite of Freemasonry
4. Milton Friedman
5. Adam Smith
6. A 19th century Chinese opium smoker

---

# Introduction

## The basis of this investigation

In the following pages we will take the reader from the opium-growing mountains of the Far East's Golden Triangle, to the offices of opium wholesalers in the expatriate Chinese districts of Bangkok, Rangoon, and Singapore; we will take him through the bonded warehouses, shipping lines and air freight companies of old-line British trading companies who control the Chinese expatriate wholesalers; we will lead him through the maze of financial channels that fund the Far East's opium trade, to the august portals of Hongkong and Shanghai Banking Corporation and other top British banks who control the financing topdown; we will take him across the Pacific to the ports of entry for heroin into the United States, to the skyscraper offices of the Canadian banks and corporations who finance, ship, and protect the heroin en route to the United States; and, finally, we will guide the reader down the family trees of the Canada-based Zionist financiers, to their contact-points in the world of organized crime and heroin distribution. When this is done, we will have reconstructed the Annual Report of **Dope, Incorporated**, including balance sheet,

# DOPE, INC.

Britain's Opium War against the U.S.



by a U.S. Labor Party  
Investigating Team

U.S. Labor Party Investigating Team

# DOPE, INC. Britain's Opium War Against the U.S.

New Benjamin Franklin House

board of directors, senior operating officers, table of organization, and subsidiaries.

At the conclusion, the reader will know and understand more about the personnel and operations of illegal drugs — the world's biggest business since the days of opium-pusher Adam Smith — than the law enforcement authorities of the United States and other countries knew until recently. In the files of these agencies, in the minds of solitary investigators, and, to a surprising extent, in the public record itself, the pieces of the puzzle have existed for years. Fitting them together into a single picture is the task of this investigation. But the puzzle is not a jigsaw game, in which the picture is assembled by fitting the pieces together side-by-side. As a first approximation, it would be better for the reader to imagine a set of clear plastic overlays, each of which contains part of the picture; laid one on top of the other, they complete the puzzle.

The different overlays of this puzzle are these:

- 1) The detailed record assembled by American and other investigators of the mechanics of the opium trade from the Golden Triangle down to opium's ports of departure to the rest of the world;
- 2) Pinpointed identification of opium wholesalers, largely in the Chinese expatriate community, including the names of leading bankers;
- 3) A comprehensive profile of British finance in the Far East, revolving around the Hong Kong financial center and its leading bank, the Hongkong and Shanghai, including the web of British ties to the Chinese expatriate banking community throughout the area;
- 4) An exhaustive grid of the British control over means of laundering dirty money in the hundreds of billions of dollars, including "offshore" banking, gold, and diamonds;
- 5) A grid of the huge quantity of public record material showing the integration of British Far East and dirty money financial operations worldwide with the top level of British foreign policy-making, centered in the Royal Institute of International Affairs;
- 6) The similar public record of evidence of strategic agreement between Great Britain and the Maoist People's Republic of

China, going back to negotiations between British opium-runners and Mao Tse-tung, under the auspices of the Royal Institute of International Affairs;

7) Twenty years of official documentation — from American, Japanese, Taiwanese, and Soviet sources — that the People's Republic of China grows and exports opium not only to earn foreign exchange, but to fund secret intelligence operations, through Chinese expatriates;

8) A comprehensive grid of the intimate links between all these elements — British old-line opium-runners, British dirty money operations, Chinese expatriate overseas operations, British-Chinese policy agreement — with the "Canadian" connection to American organized crime;

9) The international web of the British-centered "Zionist lobby," and its special function in gold and diamond-related dirty money operations, laundering of dirty money, financing of international terrorism, and financial control of the Canada-U.S. drug channels;

10) Lastly, a gridding that demonstrates that the leading controllers of the opium war against the United States are not only connected by interlocking directorates and other business ties but by ties of "blood" that constitute this web under one family.

The resulting picture is comprehensive: the entire mass of detailed, documented evidence fits together into a single picture, stretching from the present day back through the British origins of the opium trade in the time of Adam Smith.

The Hongkong and Shanghai Bank and related companies finance the opium trade. In this, they are acting as designated agents of the British monarchy, through the Royal Institute of International Affairs. Not only do they control the expatriate Chinese legmen of the opium trade, but they do so as part of an agreement negotiated between Mao Tse-tung and the Royal Institute of International Affairs, by the Hongkong and Shanghai's leading representatives!

The gold and diamonds side of the dirty money laundering operations, under the immediate control of Britain's Zionist *Hofjuden* (Court Jews), is part of the same machine. Through the highest circles of British policy, all the important branches of the

drug machine — the Chinese connection, the old-line British opium traders, the dirty “offshore” banking sector, and the Zionist *Hofjuden* — run Canada from the top.

From there the trail leads directly into the American crime syndicate, through the *Hofjuden* Bronfman family.

The world illegal drug traffic is not only the world’s biggest swindle and subversive agency: it is controlled by a single group of evil men whose names and organizational affiliations are all printed below, and whose intimate ties of ownership, family, and political collaboration go back 200 years. We know their names and addresses, and know how to mop them up.

# Banking and the World’s Biggest Business

Assembled as one picture, the hard evidence available from the Drug Enforcement Administration and other law enforcement bodies leaves only one possible conclusion: The drug “industry” is run as a single integrated world operation, from the opium poppy to the nickel bag of heroin sold on an inner-city street corner. Not only is illegal drug traffic under the control of a single world network, but opiates traffic in particular is without doubt the best-controlled production and distribution system of any commodity in international trade, illegal or legal. De Beers’ Central Selling Organization’s 85 percent control of world diamond wholesaling — an example not irrelevant to the drug trade — pales by comparison to the orderly marketing arrangements for heroin demonstrated by the hardest figures available.

Investigators are daunted by the fact that the solution to the problem is so damned obvious. Imagine Edgar Allan Poe’s fictional purloined letter, photographically enlarged to 8 by 20 feet, and used as wallpaper; then, imagine the French police attempting to find it with magnifying glasses.

When we speak of the drug-related illegal economy — for drugs

are the pivot on which most other illegal activity turns — we are talking of a \$200 billion per year business, **the biggest business in the world.** That is net, not gross, annual sales of drugs, plus related illicit payments.

How can such activity avoid sticking out wildly, especially in areas of concentration such as the Far East? Because the British monarchy organized most of the Far East to conform to the drug traffic! How can \$200 billion in illegal payments get through the international banking system past the eyes of law enforcement authorities? The answer is: the Anglo-Dutch “offshore” banking system. This and related precious metals and gems trade were designed around illegal money in the first place!

Mere consideration of the obvious — or what will quickly become obvious when the evidence of the public record is assembled below — gives the financial specialist the equivalent of an inner-ear disorder. The financial world, remember, is one in which the stock market will do flips over a measly few hundred million dollars' difference in the weekly reported figures for the American money supply. Although most of the necessary evidence has long been available, both investigators and the public prefer to see world drug traffic and related illegal activity as a montage of movie villains: Far Eastern warlords, free-lance smugglers, jowly gangsters, and corrupt politicians. Such individuals figure into the world drug traffic, but as the arms and legs of a top-down operation, under the immediate control of the British and allied monarchies.

The most striking single fact for this conclusion is that **the price series for heroin at retail level in major American cities show virtually total uniformity.** Law enforcement records show that, within the acceptable range of 3 to 6 percent purity at the street level, the price of heroin has been constant between widely disparate distribution points during the past ten years. Arrests of local distribution chains, internecine warfare among drug-traffickers, interdiction of smuggling routes, the virtual elimination of the Turkish opium supply after 1972, the scouring of Asian and European transit points, and local changes in political and growing conditions in the Golden Triangle growing area, all have failed to have any effect on the single world heroin price! The few

exceptions prove the rule, and consist mainly of sharp temporary drops in some local retail prices, attributed to occasional free-lance supply through returning Vietnam War veterans and the like. (1)

## Where does it go?

Closely related to the striking uniformity of inner-city heroin prices at retail level in the United States is the gigantic discrepancy between known levels of opium production for illegal purposes and consumption by the world's addict population. Fairly reliable statistical data are available for both. Within great margins of fluctuation depending on weather, enforcement, and other conditions, available supply exceeds demand by roughly a factor of ten.

Approximately 700 tons annually are produced and transported out of the world's largest opium-growing area, the Golden Triangle. (2) Seven hundred tons of raw opium, in the form of balls of opium gum, are the equivalent of about 70 tons of refined heroin. In practice less than half this amount is refined into heroin; the remainder is sold in the form of either opium or morphine base, largely for smoking purposes, and largely to an addict population in the orient itself. However, by all estimates of the American addict population, approximately three tons per year of refined heroin are more than sufficient to meet annual consumption “requirements.” About that much again is required to maintain all other heroin addicts in the noncommunist advanced sector.

DEA and other official sources affirm the cited production figures through direct monitoring of opium shipments and other sophisticated intelligence methods. Consumption and sales are obviously limited by the possible size and financial resources of the addict population in the advanced sector. To use a rough example: If the full 30,000 kilograms of annual Golden Triangle heroin production obtained the full street price for heroin, the total retail value would be about \$150 billion. But most estimates of annual illegal purchases of retail heroin are under \$15 billion.

In short, most of it is never sold, because production capacity is enormous relative to the market's absorption capacity.

What happens to the rest of the heroin? Only a small portion of the total comes into the hands of law enforcement agencies, whose capture of a few pounds of heroin is a matter for celebration. We still must account for tens of tons. The law enforcement records indicate that the drug is warehoused in huge stockpiles against contingencies and to prevent oversupply on the market. For example, during the height of the crackdown on Southeast Asia heroin traffic in 1972 (immediately after U.S. troops withdrew), a single refinery captured by Thai police had on hand a stockpile of 3,000 kilograms; roughly one-tenth of Southeast Asian production. At the time, 21 refineries were known to be operational in the area. (3)

#### MARKET ANALYSIS

The law enforcement record shows that Dope, Incorporated does its best to avoid mishaps through careful research — on the streets of American cities — which is transmitted back to the poppy fields. Meo tribesmen in the Burmese or Yunnan Province mountains foothills do not plant what they feel like, but what they are told to plant. This facet of the production cycle is well known to law enforcement investigators. If for some reason the market research is off, chaos will ensue, as it did in 1972, when the Golden Triangle yielded a bumper harvest, after wholesalers told poppy-growing peasants to increase their acreage by 50 to 100 percent. The wholesalers counted on the continuing exponential expansion of heroin consumption among American soldiers in Vietnam. Nixon pulled the rug out from under them by pulling the troops out, leaving the world heroin market in an unprecedented state of oversupply.

Reckless price-cutting and competition for sales outlets in this case might have provoked serious consequences for Dope, Incorporated were it not for "government regulatory intervention." The Thai government stepped in and sold 22 tons of opium to the United States. The opium was burned in a public ceremony attended by giggling Thai officials, thus restoring "equilibrium" to the market. (In any case, the Thais were only repeating the

action of the Imperial Chinese in 1839, who purchased and burned more than 3,000 tons of opium to the great relief of oversupplied British traders, who sent special fleets to India to bring additional opium back to get the Imperial Government's attractive price.)

Once world illegal opiates traffic comes under scrutiny as an integrated, centralized "monopoly," the discrepancy between the huge oversupply and relatively restricted demand presents no further difficulties. We are looking at an "industry" based on the same principles as the world diamond cartel controlled by De Beers, or the so-called "club" among leading pharmaceutical manufacturers. Diamond production capacity is so large relative to the absorption capacity of the world market that De Beers' Central Selling Organization, running 85 percent of world diamond wholesale trade, limits availability in order to obtain essentially the price it wants. Pharmaceuticals are, ironically, an even better example. Since the knowledge to manufacture most of the commonly used prescription drugs is widespread among the pharmaceutical companies, and since the costs of production are insignificant compared to the retail prices of most drugs, elaborate legal arrangements are necessary to prevent a price collapse. Notoriously, the profits of the pharmaceuticals industry owe not to chemists but to patent lawyers.

#### How big an industry?

Heroin trade is the ideal commodity cartel; its price is more reliably controlled than that of crude oil, and its world volume of sales, at roughly \$25 billion for heroin alone and considerably more for smoking-opium and other derivatives, is substantially higher than that of most of the commodities UNCTAD is presently considering for cartelization. A couple of comparisons are in order. At the recent world gold price of \$225 per troy ounce, annual world gold mining production (outside the Soviet Union) yields less than \$7 billion. During 1977, after an unprecedented price run-up, world diamond output was under \$5 billion.

Allowing for the relative ease with which a large dollar value of



heroin may be transported — the drug is worth at street level 366 times its weight in gold (4) — the worth of the drug trade is still boggling. It is even more boggling when the retail value in the United States and other OECD countries of nonopiate illegal drugs comes into the picture. For example, the Colombia marijuana crop officially estimated for this year alone carries a retail value of \$40 billion. (5) Since marijuana smoking is so widespread in the OECD countries, there probably exists a much larger market in dollar terms than the relatively restricted market among heroin addicts.

Beyond such examples, no accurate data exist. The best that can be stated is that the total world cash flow of illegal drug traffic certainly exceeds \$100 billion, and almost certainly does not exceed \$200 billion.

The \$100 to \$200 billion figure includes heroin, opium, morphine, marijuana, cocaine, so-called hallucinogens, and abuse of otherwise-legal prescription drugs. It does not include the proceeds of other drug-related illegal activities, including gambling, theft, prostitution, smuggling, arms traffic, and so forth. It is almost meaningless to assign a total figure to the size of the world's illegal economy. It can only be stated confidently that the illegal economy, whose cornerstone is illegal drug traffic, exceeds the gross national product of most of the OECD countries! That is an extremely conservative projection of the hard data available.

To put the matter another way: all international traffic in controlled substances, including drugs, and also including means of barter for drugs — gold, diamonds, armaments, and so forth — the \$200 billion international narcotics trade is bigger than the world oil trade. "DOPEC" is bigger than OPEC. World trade volume is a mere trillion dollars.

## Where does the money go?

The question that emerges now is, "How is it possible that \$200 billion and up in dirty money, crisscrossing international borders, can remain outside the control of the law?" Again, only one possible answer can be admitted: **a huge chunk of international**

banking and related financial operations have been created solely to manage dirty money. More than that, this chunk of international banking enjoys the sovereign protection of more than a few governments.

These conclusions are obvious. If the entire resources of the largest private bank in the world, roughly \$70 billion, had no other use but the financing of illegal world drug traffic and related illegal activity, those resources would be insufficient. If the members of the New York Clearinghouse, the richest group of commercial banks in the world, applied their entire \$150 billion lending volume to the illegal economy, the volume might just be sufficient.

In the following sections of this report, the Anglo-Dutch banking operations that control illegal drug and related trade are documented in detail. Below, we will demonstrate through several chains of evidence that this is *the only possible banking network* that could handle the requisite volume of illegal traffic. The Anglo-Dutch oligarchy's banking operations have the following qualifications:

- 1) They have run the drug trade for a century and a half.
- 2) They dominate those banking centers closed off to law enforcement agencies.
- 3) Almost all such "offshore," unregulated banking centers are under the direct political control of the British and Dutch monarchies and their allies.
- 4) They dominate all banking at the heart of the narcotics traffic; the Hongkong and Shanghai Bank, created in 1864 to finance the drug trade, is exemplary.
- 5) They control world trade in gold and diamonds, a necessary aspect of "hard commodity" exchange for drugs.
- 6) They subsume — as documented below — the full array of connections to organized crime, the prodrug legislative lobby in the USA, and all other required elements of distribution, protection, and legal support.

## THE OFFSHORE COVERUP

Financial specialists, who have lived too long with the smell of the West Indies backwaters to mind it any longer, will choke on

the above assertion. The general reader, by contrast, only needs to know a few facts in order to realize that something is wrong. All the offshore international banking operations — including the clean side — are such a speculative whirlpool that virtually the entire deposit base changes hands every week. Hundreds of billions of dollars, including at least a hundred billion in the offshore centers and further hundreds of billions elsewhere, circle the world through teletyped bank transfers.

No banking reserves are kept on any of this, as insurance against sudden withdrawals; in the United States, by contrast, commercial banks must hold 15 percent of their checking account balances and 4 percent of their savings balances on reserve. The “offshore” banks just assume that if they are short of cash, they can borrow what they need on the enormous “interbank” market. This mind-boggling financial procedure involves banks lending funds to each other in order to obtain fractional advantages in interest rates. Perhaps 40 percent of the total market is interbank money. Deposit maturities are so short, and money transfers are so rapid, that \$50 billion changes hands every business day through the New York banks’ Clearinghouse system alone.

The “offshore” banking markets are precisely what the name implies: either Britain’s old island colonies refurbished for international banking, or inland feudal relics like Andorra and Liechtenstein. Federal bank regulators will only stare at their shoes when asked what goes on in these places.

In the Cayman Islands, one of the largest offshore centers, the only government is the official “Tax Haven Commission.” Law enforcement officers have absolutely no way of getting hold of bank records in such places. Repeatedly, they have identified the offshore centers as the place to look for dirty money. They have not been able to, because virtually all the centers are under British political protection (see below).

American banks do a land-office business in the offshore centers, precisely because no reserves are needed, and every dollar of deposits can be lent out for interest. Currently American banks have over \$35 billion in loans booked through Caribbean offshore islands, more than through their offices in London.

Even clean banking operations have moved offshore because present federal banking regulations virtually force them to. The

big movement offshore began under the Kennedy Administration, when Anglophile Treasury officials C. Douglas Dillon and Robert V. Roosa railroaded legislation through Congress that taxed loans made to foreigners by American banks. The tax did not apply to loans made offshore, so that is where the bankers went. By the time the Dillon-Roosa legislation was lifted in 1974, the banks were “hooked” through the difference in reserve requirements. In a recent interview in *Euromoney* magazine, Citibank’s chairman Walter Wriston denounced the Dillon-Roosa taxes as a “pure gift to London.” (6)

According to the estimates of the Bank of International Settlements, the total assets of so-called Group of Ten offshore banking centers, the unregulated islands and enclaves where “bank inspector” is a dirty word, amount to \$94.349 billion, or close to \$100 billion, as of February 1977. The figures break down as follows:

#### Deposits of Group of 10 Banks in Offshore Centers

	(in millions)
Andorra	\$ 3
Liechtenstein	466
Monaco	48
Bahamas	35,700
Barbados	70
Bermuda	900
Caymans	12,200
Netherlands Antilles	1,600
Panama	7,200
Trinidad and Tobago	154
Kuwait, Qatar, UAE	3,300
Bahrein, Iran, Iraq,	
Libya, Oman	9,300
New Hebrides	139
Singapore	10,000
Hong Kong	8,300
Lebanon	392
Liberia	4,577

Total \$94,349

Source: Bank for International Settlements

The above figures do not show the actual size of the offshore banking centers, because they include only the assets of branches domiciled in the largest ten industrial countries. They do not include such entities as the three large banks in Thailand's capital, Bangkok, which figure prominently in financing Golden Triangle opium production. Nor do they include thousands of smaller, "off-shore" finance companies based only in the offshore centers themselves. Expatriate Chinese banks in the Far East, which have long been known to be a key point of contact with illegal drugs and other contraband traffic in the Far East, also do not show up on these tables; there is no available data on these institutions at all. Furthermore, the above table does include a great deal of legitimate banking business which American and other industrial-country banks bring to the "offshore" market for tax and other reasons. However, the round figure of \$100 billion is a useful starting point.

Another set of figures is provided in the Bank of England's quarterly report, although it contains the same unwanted additions and deletions, and is thus relevant; it shows the large vol-

#### Deposits In or Loans From Britain By Overseas Banks (in millions)

	Deposits	Loans
Bahamas	\$3,000	\$6,200
Bermuda	262	17
Caymans	1,380	1,408
Hong Kong	1,333	1,910
Lebanon	867	16
Liberia	---	1
Netherlands		
Territories	151	83
New Hebrides	13	7
Panama	118	583
Singapore	833	3,173
Barbados	---	---
Trinidad and Tobago	179	23
Total	\$8,134	\$13,399

Source: Bank of England as published by Bank for International Settlements.

ume of interchange between London, which in major respects functions as the world's biggest "offshore" center, with the previously mentioned outposts for illegal money. Unfortunately the available figures mix in both British banks' dealings and those of American and other banks which have offices in London.

#### OWNED AND OPERATED BY LONDON

More important than these numbers — which give a meager understanding of the volume of business in the offshore centers and mix in the legitimate business of American and other institutions — is the political control of the unregulated banking centers. With very few exceptions, offshore banking as a whole is under the thumb of the Anglo-Dutch oligarchy.

The British pre-eminence makes the world picture of offshore banking and dirty money more comprehensible. If the world offshore banking sector appears to run as a single operation under British monarchy control, that is because the same group of people who run it also run the opium traffic whose proceeds this banking sector was created to handle.

One index of British muscle is the following breakdown of the offshore banking centers, comparing the number of banks in each center directly attached to the Royal Institute of International Affairs governing bodies with the number of other banks in each center:

Offshore Center	RIIA-linked Banks	Others
Bahamas	23	21
Bermuda	5	0
Antigua	5	0
Barbados	6	3
Cayman Islands	22	12
Trinidad and Tobago	6	3
Netherlands Antilles	10	5
Panama*	9	20
Singapore**	14	20

\*The only one of the above *not* under British government control.

\*\*Does not count overseas Chinese banks and other expatriates. (Source: Polk's Banking Directory.) See also Directory to RIIA Chart (Section 7).

London and Switzerland are not normally considered offshore banking centers, although in practice both centers function that way. Although Switzerland has signed a treaty with the United States permitting law enforcement officers to investigate and seize funds relating to illegal narcotics traffic (resulting in one recent \$250 million seizure), Swiss banks are still notorious depots for dirty money. However, the Swiss side of the operation, typified by Lombard Odier and Edmond de Rothschild's Banque Privée in Geneva, and the Zionist-controlled Baseler Handelsbank is more specialized. Their most important activity is conduiting funds for international terrorism. Most recently, European authorities traced the funding of the 1978 Aldo Moro assassination through Swiss channels back to Israel.

London is the largest center for Eurodollar banking under the encouragement of the Bank of England, which permits the foreign branches of U.S. and other banks to hold external accounts in London without reserve requirements, and with minimal inspection. At last count, international banks had \$90 billion in assets in London. The Bank of England can do as much or as little as it wants in the way of regulation, under British law.

For self-evident reasons, even the best-protected institutions of the British oligarchy prefer to launder their dirty money through Caribbean, Hong Kong, and similar branch operations, rather than in London itself.

Because the British suppliers of narcotics have ironclad control over offshore bank operations, American organized crime marketers of those narcotics have had a field day in the Cayman Islands and the Bahamas. American drug enforcement authorities know that most of the dirty money arising from the U.S. drug trade and related illegal activities ends up in the Bahamas. There has been, unfortunately, little public heat against the British officials who control the operations.

This level of control reaches the flagrant. For example, the chief of all banking regulation and licensing in the Cayman Islands, a close third behind Hong Kong and Macao in the big league of dirty money, is one Mr. Benbow. Mr. Benbow is a retired official of Britain's National Westminster Bank, which shares two directors, J.A.F. Binny and R.J. Dent, with the

Hongkong and Shanghai Bank. Benbow got his present job at the recommendation of the British-influenced International Monetary Fund, according to a source at the IMF's Exchange and Stabilization division. Direct British "hands-on" management of the Caribbean offshore operation dates back to the 1940s, when E.D. Sassoon, Ltd. of Hong Kong — which had made its fortune from the opium trade over the preceding century — picked up, moved, and became E.D. Sassoon, Ltd. of the Bahamas.

Virtually the only one of the offshore centers not under official British control is Panama; not coincidentally, Panama is the only offshore center where American banks strongly outnumber British banks. That is not to say that Panama is clean; on the contrary, most of the funds derived from the Colombian trade in marijuana and cocaine are laundered through Panama, through the three large Colombian banks resident there. However, American banks have a measure of maneuvering room that they do not have in the Cayman Islands or the Bahamas, under the snooping eyes of the British authorities.

West German banking sources believe that the British banks behind Drugs, Incorporated want to move in on Panama and close the gap. The West German sources identify a special feature of the drug-ridden Hongkong and Shanghai Bank's proposed takeover of a controlling share in New York's \$20 billion Marine Midland Bank: Marine Midland is the transactions agent for the central bank of Panama. All of the national accounts clear through Marine Midland. Should the Hongkong and Shanghai succeed in acquiring the American bank, it would exercise a decisive margin of control over the Panama offshore market, and bring British control over the offshore centers full circle.

Longstanding ties between Marine Midland and Panama were reflected in the fact that a former board member of Marine Midland Bank, Coudert Brothers lawyer Sol Linowitz, negotiated the Carter Administration's recent treaty concerning the Panama Canal.

#### FAREAST CHOKEPOINT

The next sections will concentrate on the Far East offshore banking connection to the drug traffic as a model for the world

operation, and follow the trail back to the controlling centers in London. British control over the world dirty money operation is no secret, and the British-Canadian-Caribbean connection to organized crime in the United States is so thoroughly documented that no doubt need remain.

However, it is the Far East that acts as a chokepoint for dirty money, in such volume that it dwarfs legitimate economic activity in the region, and in the British Crown Colony of Hong Kong in particular.

London has seduced and jostled American banking operations into the Caribbean to such an extent that there is a vast amount of legitimate money mixed in with the proceeds of the drug traffic. However, Hong Kong was set up by the British, literally from bare rock, as a center for the drug trade, and remains to this day purely British, and purely a center for the drug trade. In the Far Eastern example we can "prove" that Britain (and its Peking allies) run every phase of international drug traffic.

## The laundering cycle

The Drug Enforcement Administration and other law enforcement organizations know how the cycle of dirty money in the United States works. The \$50 billion retail proceeds of the total drug traffic in the United States are partly recycled into the drug operation in the United States itself, with large "offtake" by each level of the crime machine. The net profits, in cash, are laundered through hotels, restaurants, gambling casinos, and sports events — the "corporate profile" of the Max Jacobs family and other footsoldiers of the British drug machine.

After the cash is laundered through these nominally legitimate channels, it is transferred to offshore banking operations or their equivalent. Then, according to Drug Enforcement Administration officials, the funds take several trips around the world over the telex machines of offshore banks, passing through at least a half-dozen, and usually more, different bank accounts and corporate fronts, from the Caymans to Liechtenstein, from Liechtenstein to

the Bahamas, from the Bahamas to a "nonresident corporation" in Canada, from Canada to Panama, and so forth.

At various points in the process, the funds will purchase diamonds, gold, paintings, or similar portable valuables. At a further point, the valuables will be translated back into cash, eliminating even the trace of a bank transfer. For this reason, the use of undercover agents, in place even at fairly high levels in known branches of narcotics trafficking, has a poor record of detecting either the source or ultimate destination of narcotics-related funds.

Once laundered, the proceeds of the drug traffic and related illegal activities divide into three channels. First, between 10 and 20 percent of the total is recycled back to the opium wholesalers in the Far East and the marijuana wholesalers in the Caribbean and Latin America, constituting the net profits of the wholesale drug trade. A second part is invested in expansion of offshore operations, particularly gambling casinos, resorts, and other profitable operations that are also useful for further laundering of dirty money. The remainder is reinvested in the United States in "legitimate" racing, gambling, hotels, restaurants, and other business appropriate for cash-laundering and further expansion of the domestic drug traffic.

As noted, Hong Kong and related Far East operations are the chokepoint in the entire traffic, where dirty money is a way of life. We will focus on the Far East, the point of origin of world heroin traffic, and work backwards through the maze of Dope, Incorporated fronts and subsidiaries, to arrive at the British-controlled syndicates in the United States.

## 2 From Opium to Dirty Money

a pound. (2) At this point the opium is either refined into heroin at refineries located in the triborder area itself, or earmarked for the large Far Eastern market for smoking opium and related derivatives.

Existing data permit the estimate that a division of an average 700-ton crop into 300 tons for heroin refining and 400 tons for opium shipment for Far Eastern smoking purposes is usual. (3)

The \$200 pound price at the triborder area is the price paid to the local agent by a wholesaler based either in Bangkok, Rangoon, or Hong Kong. Any distinction among these cities is meaningless. The business structure of the area is under the control of two principal groups that straddle the Far East. The first is the old British banks and trading companies, including the HongShang, Jardine Matheson, Charterhouse Japhet, Swire's, and the Peninsular & Orient Lines. The second, their satellites, is the overseas Chinese networks, under the joint control of London and Peking.

The wholesale value of the 700 tons of annual opium product in the Golden Triangle, prepaid in the triborder area, is roughly \$280 million. The \$280 million figure, compared with the Gross National Product of Thailand, is considerable; it is like \$35 billion in terms of the American GNP.

3. But this wholesale figure is only a small portion of the cash flow of the Far East drug traffic. The next wholesaler, the Bangkok merchant who buys from the first wholesaler, pays about \$1 billion for the equivalent of 700 tons of opium in the form of either raw opium or refined heroin. This is roughly four times what the opium was worth at the first wholesale round. The majority of production is retailed locally at large markups (although the markups are much smaller than in the case of heroin retailed in Western countries).

While no hard estimates are possible, the cash flow in the Far East related to this first phase of opium production alone could not be less than \$1 billion. That by itself is 15 percent of the estimated assets of foreign banks in Hong Kong, or 10 percent of estimated bank assets of foreign banks in Singapore, or precisely Thailand's 1977 balance of trade deficit!

The starting point for the drug cash flow is the cash size of the opium and heroin traffic in the Far East itself, before the drugs obtain the stupendous price markups available in Western markets. The price pyramid is known to be the following:

1. Raw opium, the gum of syrup extracted from opium poppies, is produced in the Golden Triangle, the conjunction of the southern border of the People's Republic of China (Yunnan province), and the northern borders of Thailand, Burma, and Laos. The mountainous terrain, largely above 4,000 feet in elevation, provides ideal growing conditions. Mountain peoples, rather than ethnic Chinese (including those in Yunnan province), grow the opium and collect the gum. The merchant purchasing the gum pays roughly **\$100 a pound**, (1) at collection points such as Lashio or Misai in Burma.

2. By the time the merchant, typically a Yunnanese, has brought the gum by mule train to the triborder area, e.g. Tachilek or Chiengrai in Thailand, the price has doubled, to **\$200**

Measured against the size of economic activity in the regions, there is no possible way to chalk these numbers up in the "Errors and Omissions" column. The cash must go through nominally legitimate channels, in such volume that the nominally legitimate channels — like the HongShang — cannot possibly be unwitting as to the origin.

Even these numbers do not sufficiently reflect the scale of the cash flow derived from crude opium sales alone. It must be added that most of this cash flow is seasonal; virtually all wholesaling must be completed during the two months following the March poppy harvest. Correspondingly, the visible flow of drug-related funds is several times as large during those two months.

4. Finally, the wholesale and local retail cash figures presented above exclude what is possibly the largest component of Far Eastern narcotics money: the reflow of funds back to the Far East from sales made in the West. The narcotics wholesaler in Bangkok or Rangoon or Hong Kong with direct contacts with the growers and control of refineries has paid about \$2,000 a pound for the refined heroin. Between him and the street corner, the same pound of heroin will undergo three markups of 1,000 percent. Its ultimate retail value (for pure heroin) will be close to \$5,000,000 per kilogram, according to official DEA figures, or \$2.27 million a pound, with a total of \$25 billion for Western sales.

What portion of this markup, and in what quantity, accrues to the Far East wholesaler? There is no possible way to estimate this. According to the record of arrests of heroin smuggling, a substantial portion of such smuggling is conducted directly through expatriate Chinese channels, like the Hong Kong-to-Vancouver route, (4) and the notorious activities of the China Sailors' Union of Hong Kong. However, it is this markup that pays the wholesaler's out-of-pocket costs, including the original purchase from the highlands merchant, the refining, the huge quantity (perhaps 300 tons annually) of acetic anhydride used in heroin refining, security, bribes, transportation, warehousing, and so forth.

If the annual profit of the Golden Triangle operators is in the range of \$5 billion — or a mere one fifth of the annual retail sales

## GOLDEN TRIANGLE

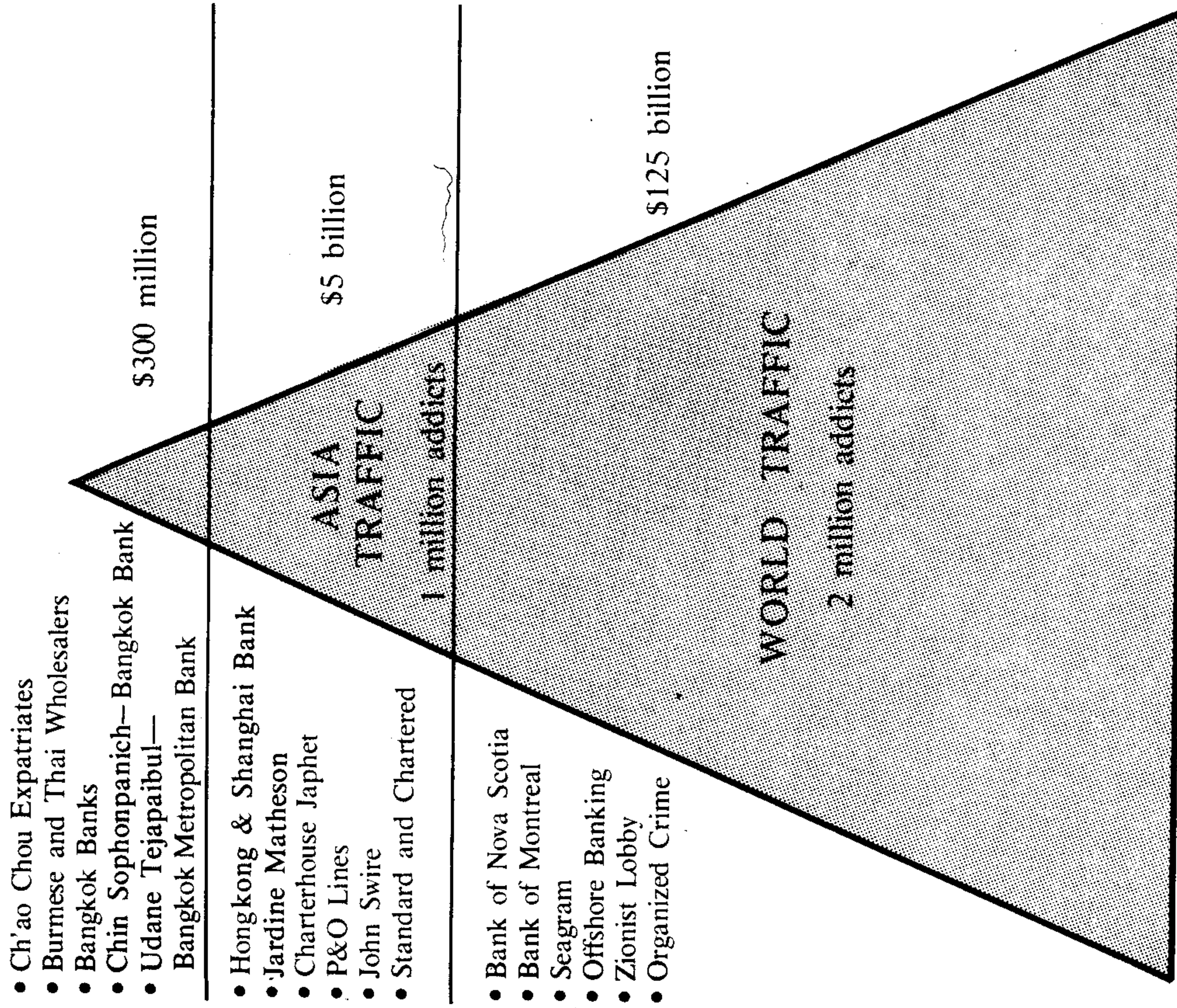

Figure 1

of heroin in the West — then the total cash flow in the Far East related to drugs is not \$1 billion, as above, but \$6 billion. The actual reflow is probably several times that sum. Some of the \$5 billion may be banked elsewhere than in the Far East. The comparisons to the size of the region's economic activity become all the more grotesque: Thailand's 1976 total exports were only \$2 billion. Even the \$6 billion figure does not include the huge Far Eastern market for opium and heroin consumption. Added in, the retail volume brings the total close to \$10 billion — twice Hong Kong's money supply.

There is another way to arrive at the same \$10 billion figure: the *official* estimate for bribes paid annually to Hong Kong police is an astonishing \$1 billion, more than the annual police budget. From a hard business standpoint, that \$1 billion in payoffs is a major part of the *overhead* cost of both wholesale and retail drug operations in Hong Kong, the area's drug capital. Since the known profit margin in the drug trade is 500 to 1,000 percent, it is fair to state that the \$1 billion bribe figure is no more than 10 percent of local drug revenues. If \$1 billion is 10 percent of the total, the total is \$10 billion.

### 3

## How the Drug Trade is Financed

The chain of financial control of world opium traffic begins in Hong Kong, with billions of dollars in Hong Kong dollar loans to expatriate Chinese operators in the drug-growing regions. These expatriates include two of Bangkok's best-known bankers, according to American law enforcement files.

Hong Kong also provides essential logistical support, including:

- 1) Smuggler-sized gold bars, obtainable through Hongkong and Shanghai Bank subsidiaries;
- 2) Diamonds, available through Hong Kong's Anglo-Israeli controlled diamond monopoly; and
- 3) Warehousing facilities, dominated by a subsidiary of the Hongkong and Shanghai Bank.

## The HongShang

Hongkong and Shanghai Bank is the semi-official central bank for the Crown Colony, regulating general market conditions.



holding excess deposits of the myriad smaller banks, providing rediscount facilities, and so forth. Clearly, the Hongkong and Shanghai Bank is also the financial hydra unifying the production, transportation, and distribution of Asia's opium.

Not only does it dominate financial activity in Hong Kong, with 50 percent of total banking business on the island, but "bank and government often work closely together," (1) the *London Financial Times* comments. The Colonial government in Hong Kong makes virtually no statistics on banking activity available. Commenting on the \$8.3 billion figure for Group of Ten bank operations in Hong Kong, the *Financial Times* notes that, "The official figures are also just the tip of an almost certainly greater volume of business, which is conducted by international banks with finance company subsidiaries in Hong Kong, or organized from Hong Kong but routed through entirely offshore accounts in such places as Vila (New Hebrides)." (2) To be precise, there are 213 deposit-taking finance companies in the Colony, as well as 34 local banks and 104 bank representative offices. Over these squats the HongShang.

## The Chinese middleman

The essence of the bank's drug control is its intimate relationship to scores of expatriate Chinese banking families scattered throughout the Far East. The British and Dutch connection to these families dates back to the first East India Company penetration of the region. The central banking role of the HongShang expresses an agreement that grew out of a century of official opium trade and continues through the present.

First, consider the financial and logistical requirements of the trade. Planning for the March opium harvest begins in September. The Bangkok or Hong Kong drug wholesaler must estimate the size of his market during the next summer, and, after market research is completed, inform his agents in the triborder area. (That market research must come from the United States and other retailers.) They, in turn, will communicate to the Yunnanese and other merchants who operate in the poppy-growing high-

lands to the north what the market will bear for the next harvest. The merchants then inform the Meo peasants what acreage they may plant.

At this point, the wholesaler must consider the following. First, the physical means of payment must be obtained, including American or Soviet armaments, gold in appropriate small-bar or jewelry form, or whatever, and this to the tune of \$140 million worth. Golden Triangle peasants can't use American dollars. Thousands of mules and muleteers must be made ready for the treks into the highlands. Bribes must be paid, routes monitored, border conditions observed, smuggling routes secured, contacts opened in the West, and other loose ends secured. The required seed money is in the range of the wholesaler's \$2,000 a pound price for refined heroin. (3)

What portion of the investment is made through "internal resources" of the drug wholesalers, and what portion borrowed, is a matter of guesswork. It is known that a very large amount is borrowed seasonally to finance drug wholesaling, largely from expatriate Ch'ao Chou Chinese banking networks. Since the Ch'ao Chou category includes Thailand's most prestigious bankers, who are known to engage in financing drug traffic, very considerable financial resources are at the traffic's disposal. It is a matter of a 200 percent annual rate of interest -- agreed and no questions asked.

Known "angels" of the narcotics trade include Chen Pi Chen, a.k.a. **Chin Sophonpanich**, Chairman of the Board of the Bangkok Bank, with \$5 billion in assets; and Udane Tejapaibul, former Chairman of the Board of the Bangkok Metropolitan Bank, with \$2.4 billion in assets. Significantly, Sophonpanich, whose name is a Thai pseudonym, is a Ch'ao Chou Chinese expatriate. (4)

Such scandalous relationships are not much of a surprise in the region. At the time of the 1973 Thai coup, the premier's son and chief of the narcotics bureau, Narong Kittikachorn, was found to be a prominent investor in drug wholesaling.

The annual credit line that must be extended to drug wholesalers, assuming they finance half their operations through credit, probably comes to about \$150 million. Through pure chance, that is the average annual growth of the Bangkok Bank's "Loans and

Advances" during each of the last ten years. Of course, Chin Sophonpanich competes with many of his Ch'ao Chou colleagues for this lucrative business.

#### THE CH'AO CHOU

Wherever the Ch'ao Chou expatriate banking community has surfaced in leading positions of influence, Peking, British, and opium trade connections are evident. In 1958, the Thai authorities issued a fraud warrant against Bangkok Bank's Sophonpanich. He fled to Peking and remained there until 1965, after which he returned, a deal with the Thai military in hand. According to area sources, Sophonpanich still maintains close contact with the Peking regime.

As one among several Bangkok financiers who finance the drug wholesalers in the volume of \$100-200 million per year, Sophonpanich's contacts include several names that have frequently appeared on the "Opium Watch List" of American law enforcement agencies: Ying Tsu-li, General Lo, and the brothers Hutien-Hsiang and Hutien-Fa, leading refiners of heroin in the triborder area.

In addition, area sources report that Sophonpanich has direct links to the so-called Triads, the expatriate Chinese secret societies that do most of the legwork in the opium traffic (see Part I).

Yet, Sophonpanich is actually nothing more than a subcontractor of the Hongkong and Shanghai Bank, as we now demonstrate.

### The HongShang-Chinese deal

Bangkok Bank illustrates the way the chain of financing leads back to the HongShang. Its current asset volume is \$5 billion, much larger than the savings capacity of the area could justify. Banking sources report that most of its credit-generating capacity comes from rediscounting of the trade paper of the Singapore and Hong Kong financial markets, and mostly with the HongShang itself. Since the HongShang controls 50 percent of Hong Kong deposits and acts as the ultimate rediscount agency

for the entire colony and much of the rest of Southeast Asia, the dependency of the Bangkok Bank and other Thai banks on the HongShang is virtually total. **Most of the Bangkok Bank's lending volume is subcontracted business, controlled by the HongShang.**

The British-Chinese expatriate link goes back as long as the British have been in the Far East. The British organized the systematic colonization of tens of thousands of Chinese expatriates throughout the area, and started them out in the lower levels of the business otherwise conducted by the East India companies and their successors. (5)

Even where Britain displaced early overseas Chinese financial interests from positions they had enjoyed in the precolonial period, they left them in local control or in a junior status in such areas as opium trading, and often virtually restricted them to those areas. As W.J. Cator notes in his book *The Economic Position of the Chinese in the Netherlands Indies* (6) and Purcell notes in *The Chinese in Malaya*, (7) Chinese monopolies of opium and alcohol local distribution continued in many Southeast Asian colonies, under the aegis of the colonial authorities, into the first decades of the 20th century.

Colonial powers divested Chinese merchants of control of many trading monopolies granted by the precolonial local authorities, but left them in control of gambling and local drug and alcohol distribution because Chinese secret societies were uniquely equipped to handle them. The secret societies, representing branches of societies operating in southern China, theoretically pursued the aim of their founding — the overthrow of the Manchu Ch'ing Dynasty in Peking. But as time wore on and the regime remained in power, the societies abroad became less interested in the politics of their homeland and more the instruments of overseas economic interests. As anthropologist William Skinner notes in his book *Chinese Society in Thailand, An Analytical History*, (8) the immigrant societies were usually headed by influential monopoly owners — opium traders, keepers of gambling and prostitution houses — who generally used the societies to further the interests of their monopolies.

In other economic sectors besides opium, it is common knowledge that overseas Chinese business interests were often

employed as compradors, middlemen in the service of colonial banking and trading operations, indispensable due to their knowledge of the local market and their language abilities. The close economic relationships that certain segments of the Chinese business community enjoy with particular British banking interests date from that experience. At every point in the postwar political history of the region, the Chinese expatriate financiers have acted as consistent allies of the British and Dutch. According to standard estimates, Chinese expatriate financiers currently control 60 to 80 percent of the economies of Indonesia, Thailand, and Malaysia.

### REGIONAL CONTROL

What the size of expatriate dependency on the Hong Kong market is can only be guessed. However, the existing financial data show that the Hong Kong financial market is enormously oriented to foreign lending, in roughly the same proportion as the American banking system. One-third of all Hong Kong-dollar denominated loans — excluding the so-called Asiadollar market — are to foreign borrowers. Foreign lending stood at HK \$18.47 billion in March 1978, against \$39 billion in local loans. (There are about 4.6 Hong Kong dollars to one U.S. dollar.) (9)

Since the borrowers' market for Hong Kong, rather than American, dollars is limited to the areas of the Far East still under British financial sway, the HK \$18.47 billion figure of overseas loans reflects the immense financial dependency of Burma, Thailand, and Malaysia on Hong Kong. The business is largely conducted through Chinese expatriate family ties. Most of Hong Kong's 250 locally registered finance companies, in fact, are owned by Chinese expatriates.

The scale of expatriate Chinese operations, centered in Hong Kong and dependent on the HongKong and Shanghai Bank, is gigantic; the overseas Chinese community controls 42 percent of the foreign trade of the Southeast Asian countries, compared to 32 percent of Western business, 18 percent of non-Chinese local firms, and only 8 percent of state-controlled trading companies. (10) As of the most recent figures available, Chinese expatriate investments in the area totalled only slightly less than

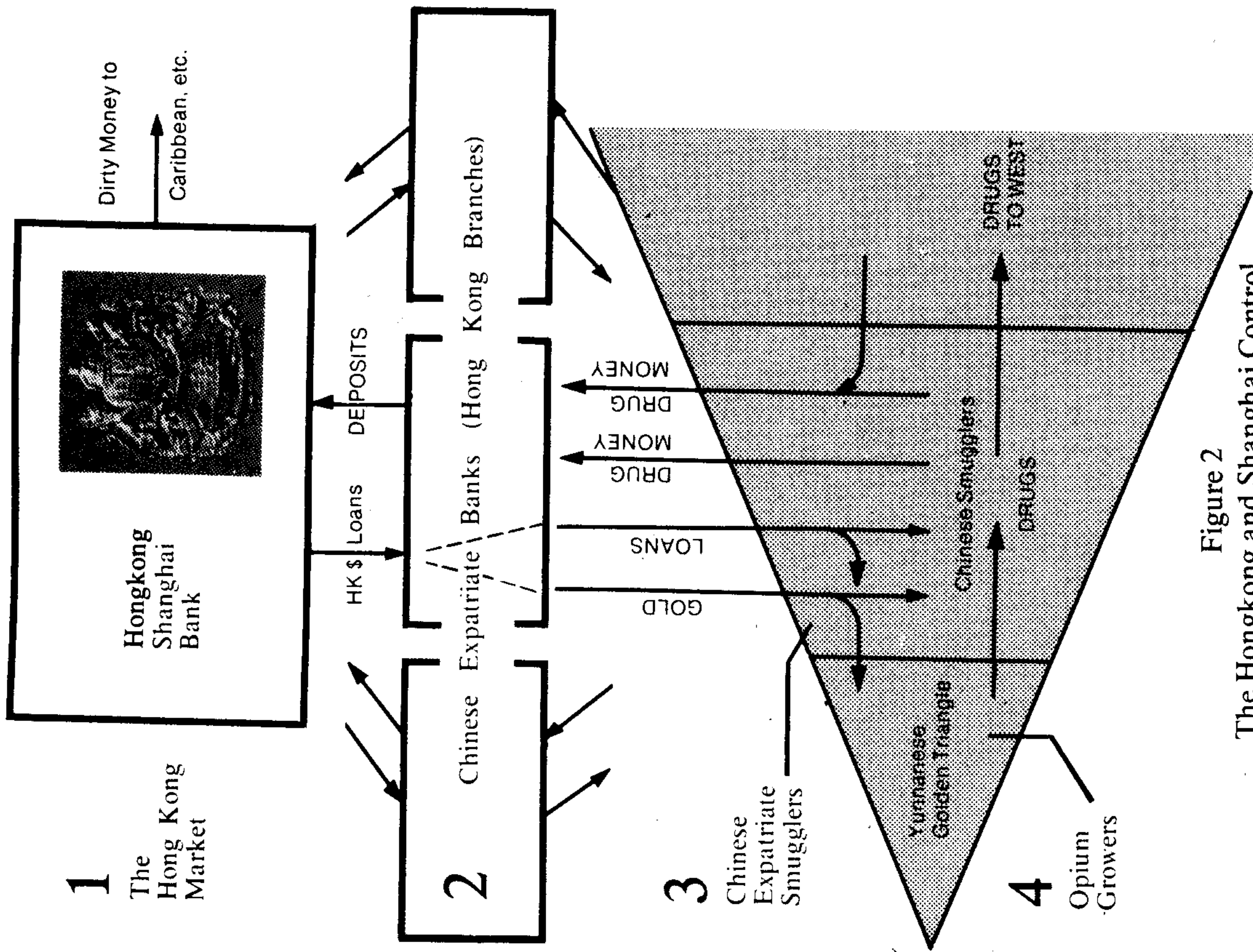

Figure 2  
The Hongkong and Shanghai Control  
of Expatriate Drug Trade

The Hongkong and Shanghai Bank, self-described as "a monument to British finance in Asia," is in full control of the Hong Kong money market (1), on which such Chinese expatriate institutions (2) as the Bank of Bangkok absolutely depend for rediscounting loans, etc. Opium smugglers and wholesalers (3) in turn depend on the expatriate banks to finance their barter-purchase, refining and transport of opium and heroin from the "Golden Triangle" peasants of Southeast Asia and China's Yunnan Province (4). From seed-money to dirty-money, the proceeds of the drug trade start and finish with the HongShang.

combined American, Western European, and Japanese investments (although recent Japanese expansion in the area may have shifted the proportion somewhat).

Country	Total Expatriate Chinese Investment
Indonesia	\$1.2 billion
Malaysia and Singapore	2.2 billion
Philippines	1.0 billion
Thailand*	.3 billion
Cambodia**	.12 billion
South Vietnam**	.25 billion

#### TOTAL

\$5.07 billion

\*Does not include investments of "assimilated" Ch'ao Chou bankers such as Udane Tejapaibul and Chin Sophonpanich.

\*\*Current status unknown.

The above figures only give a partial picture of overseas Chinese financier dominance of Southeast Asian economies, because the expatriate Chinese bourgeoisie is overwhelmingly in such strategic sectors as banking, insurance, shipping, warehousing, and other intermediary activities, rather than manufacturing or agriculture.

According to one of Stanford University's classic China studies, Thompson and Adloff's *Minority Problems in Southeast Asia*, "Foreign-exchange and other controls (imposed by national governments in the area — ed.) have transformed many of the Chinese into smugglers and black marketeers, and such operations have increased both their wealth and their unpopularity. Attempts to control the Chinese have almost everywhere run into the bewildering maze of overlapping Chinese organizations which exists in every country of the area, and they have been frustrated by Chinese evasion, ability, and indispensability." (11)

The activities of the corrupted section of the expatriate Chinese community in Southeast Asia have provoked a long series of clashes with national authorities — who have not generally been successful in limiting illegal traffic. The one exception is the Brit-

ish possession of Hong Kong, the center of illegal operations in the area, where the smugglers are members of Hong Kong's high society, e.g., Macao gambling overlord Stanley Ho, who made his career smuggling strategic materials from Hong Kong to China via Macao during the Korean War.

## 4 Britain's Gold and Dirty Diamond Operations

medium of exchange. They must be paid in food—which they do not produce themselves—goods, and gold or the equivalent.

Secondly, the People's Republic of China's share of Golden Triangle production is paid almost entirely in gold, shipped in bulk across the Burmese border. (1) PRC gold income on opium production probably absorbs around one-seventh of all gold traded in the orient (judging from data analyzed more closely in Section 6, The Peking Connection). There could be some double counting here, since Peking also sells gold on the Hong Kong market.

Third, and possibly most important, gold cannot be traced, although any bank transfer ultimately can. One bar of gold looks like any other; changing a bank balance into gold or diamonds, and then changing it back into a bank balance, is like crossing a river to avoid bloodhounds.

Gold is so important to the entire business that the metal's price is pegged to the price of raw opium in the Golden Triangle highlands. The dollar's fall in terms of the gold price from \$35 an ounce before 1971 to about \$225 recently has also dramatically escalated opium wholesale prices. The escalation of the gold price over the past year has been so steady that all the numbers regarding the size of the opium trade may already be gross *underestimates*. One indication of the closeness of the gold-opium relationship is the well-known story that the CIA fieldmen in northern Laos carried both gold and opium, to use as means of payment to the local Meo population in case of need.

### How illegal gold travels

The American public will be shocked at how openly the HongKong and Shanghai Bank uses its monopoly in the Far Eastern gold trade to feed smuggling operations. Prior to the official opening of the Hong Kong gold market in 1974, HongShang openly financed the gold markets of Macao, the flagrantly crime-ridden island that plays "offshore" to Hong Kong's own "offshore" operations. Today the Hong Kong market is run topdown by Sharps Pixley Wardley, a 51-percent owned subsidiary of the HongShang. The Hong Kong market's current daily trading

One feature of the financing chain of the Far Eastern drug traffic—the Asian gold market—is a tipoff of the British (and especially Hongkong and Shanghai Bank) control over the entire process. It might seem strange to the general reader, but the gold connection was one of a handful of critical clues that led investigators up the whole chain of evidence that will eventually put the management of the HongShang and a few other long-established institutions behind bars.

Vast quantities of gold are absorbed into the Asian drug trade—an inestimable percentage of the 400 to 600 tons of the metal that pass through the orient in a year, mainly through Hong Kong, and mainly through subsidiaries of the HongShang. The trade could not run without it and other precious, portable, untraceable substances—like diamonds.

First of all, peasants of the Golden Triangle poppy fields do not appreciate secret accounts in the Bahamas. Furthermore, since the end of the Vietnam War, and the end of the widespread traffic in contraband and American arms and American dollars, the U. S. dollar in the form of currency is no longer an acceptable

volume is in the hundreds of millions of dollars, on a par with London and Zürich.

Apart from Hong Kong, the other route for smuggled gold to the Far East is through the Persian Gulf sheikdom of Dubai. The dominant commercial and gold market force in Dubai is the British Bank of the Middle East, a 100 percent subsidiary of the Hongkong and Shanghai Bank.

A 1972 description from one of Britain's best-known experts, Timothy Green of Consolidated Gold Fields, Ltd., (2) is instructive on how the illegal flow of gold travels:

"It may indeed sound romantic, but it is a fact that both in 1970 and 1971 at least 500 tons of gold—that is to say half of all South Africa's production, or 40 percent of total gold production in the non-communist world—passed through unofficial channels on the way to its ultimate destination."

"Unofficial" channels, as the author proceeds to make clear, means *illegal channels*. Most of the world's existing gold is held by central banks; prior to 1971, gold was the basis of central bank reserves. With the advent of the new European Monetary System, gold is again becoming an official monetary reserve. Gold dealings among banks, industrial users such as jewelers, and so forth, are also counted as "official" channels.

Apart from the drug traffic and related money-laundering uses, gold smuggling has played a major role in aggravating the payments deficits of Third World countries such as India, where large numbers of private citizens hold gold. However, the Indian government in 1977 opened up direct sales to the Indian population. This largely eliminated India as a haven for gold smuggling by making gold available through official channels. Despite this, judging from the activity of the Hong Kong market, the proportion of gold running into illegal channels has, if anything, increased, and the drug-related proportion of the illegal gold increased as well.

#### "UNOFFICIAL" MEANS ILLEGAL

Green continues: "... these unofficial channels usually start in gold markets such as Beirut (since defunct—ed.), Dubai, Vientiane, Hong Kong and Singapore which I am discussing

today. Their chief role — their *raison d'être* — is as distribution centers for the smuggling; they are entrepôts convenient to nations, which for a variety of reasons, forbid the official import of gold for commercial or hoarding uses . . . .

"Dubai has become the largest gold market in the world, except for London and Zürich — no mean achievement for a sheikhdom with a population of around 60,000. Both in 1970 and 1971 Dubai had well over 200 tons of gold — indeed in 1970 the equivalent of a quarter of all South African production found its way along this golden pipeline to India and Pakistan (and further East. Since the beginning of official gold sales by the Indian government, and the reopening of the Hong Kong gold market, Dubai's importance has attenuated somewhat — ed.) . . .

"By contrast to Dubai, a gold market that developed very quickly to meet a special short term need was Vientiane in Laos. The market there really grew with the escalation of the war in South Vietnam. And it grew because it was the nearest and cheapest source of gold. . . . This gold which was bought as a hedge against the constant devaluations of the Vietnamese currency and to hide the vast black market profits made from pilfered American arms and equipment, was paid for almost entirely in cash. (Throughout the 1960s and 1970s, pilfered American arms and equipment formed a major part of the barter goods exchanged for opium in the Golden Triangle highlands — ed.) . . .

"Vientiane's short success made some impact on the oldest gold market in the Far East — Hong Kong, or more correctly Hong Kong-Macao, for the two are held together as it were by a golden chain. Hong Kong, as a British Crown Colony, forbids the private holding of gold bullion; only commercial gold of less than 945 purity may be traded. To get around this regulation, gold bullion has for more than twenty-five years made a curious sideways shuffle from Hong Kong to Macao and back again. The gold bullion — in 995 good delivery bars — that comes into Hong Kong by air from Europe and Australia . . . is transferred in Macao, where it is melted down into Chinese 1.5 and 10 tael bars. It then returns, stealthily, to Hong Kong. This traffic has been presided over for many years by the Wong Hong Hon Company which negotiated a series of two-year contracts with the Portuguese authori-

ties in Macao for exclusive rights for the gold traffic. **The traffic was financed by the Hongkong and Shanghai Bank.**" (emphasis added)

That is, in the testimony of Britain's leading gold expert, the HongShang financed illegal gold trade in Hong Kong itself, prior to the reopening of the Hong Kong gold market, after which the HongShang subsidiary Sharps Pixley Wardley took over the legal trade.

#### AN UNDERESTIMATION

Digging into the back archives, it is clear that Consolidated Gold Fields' 40 percent figure for smuggled gold in 1972 represents, if anything, a *moderation* of past trends. Earlier figures are much higher. For example, British author Paul Ferris in *The City* (3) claimed that in 1951 only 17 percent of all world gold production went through official channels; Ferris's report was based on interviews with the London gold pool. "What happens to the gold when it disappears into the economic undergrowth of the East is of no concern to the London bullion dealers," Ferris claimed, but as we will demonstrate, the London bullion dealers know precisely what happens to the gold in the Far East. The London bullion market is merely a subsidiary of Dope, Incorporated.

In the July 22, 1952 issue of *The Reporter*, an article under the byline of H.R. Reinhart, the then Far East correspondent of the *Neue Zuercher Zeitung*, estimated Asian gold smuggling at \$150 million in that year. At today's gold prices, the figure would be \$1 billion for the same quantity of gold. The account bears impressive credentials, since 1) the *Reporter* editor at the time was Harlan Cleveland, now a senior official of the Aspen Institute, and part of the present drug machine in the U.S.; and 2) the *Neue Zuercher Zeitung*, Switzerland's top daily paper, is linked through European aristocratic ties directly to the British monarchy. (4)

Reinhart identified a "Golden Loop, the circuitous path that leads from North Africa to the coast of Red China and back again as far west as India." The center of gold smuggling was the Portuguese-controlled island of Macao, where gold smuggling is

legal, and "anyone who dares call a smuggler a smuggler can be sued for libel." Then the gold is smuggled into Hong Kong, and thence to the rest of Asia.

A mere 3 percent of the smuggled gold is seized by Hong Kong authorities, Reinhart noted, even though customs officials receive a 20 percent commission on all seizures; presumably, bribes to customs officials are more substantial.

Standard Western and Soviet sources estimate the smugglers' commission at 30-50 percent in such transactions. Soviet economist M.A. Andreyev reports: "According to a Chinese businessman in Singapore, smuggling yields a profit of up to 100 percent on invested capital, which is several times higher than the profit received in the basic branches of the island's economy. In Hong Kong the commission paid to smugglers amounts to from 30 to 50 percent of the cost of the smuggled commodities." (5)

However, if the bribes paid to Hong Kong customs officials are substantial enough to overshadow the 20 percent kickback on seized contraband gold, the bribes must also be in the order of 30 to 50 percent. The point is that the gold trade itself would not be profitable, unless it were only a bridge transaction in a much more profitable operation — e.g., narcotics traffic! That is the case.

But as Reinhart reported, "British justice, as dispensed by the magistrates' court in Hong Kong, extends even the benefit of the doubt to a suspected smuggler caught with the goods." That should not be a surprise at this point; as noted before, it was a matter of public record for a quarter century that Britain's Hongkong and Shanghai Bank itself financed the gold smuggling!

#### PEKING'S GOLD

One further crucial point — whose full importance will only emerge in the following sections — is that the People's Republic of China has been in on the illegal gold market since the 1949 Maoist takeover.

Gold flown into Macao, as noted above, was (before Hong Kong opened up its gold markets in 1949) resmelted into bars of less than 95 percent purity, whose trading the Hong Kong authorities hypocritically endorsed. The resmelting, Reinhart reported, was

HOW THE DRUG EMPIRE WORKS

the business of the Kan Kuam Tsing Company in Macao. "On the Hong Kong exchange," the Swiss journalist added, "the buyer is not unlikely from the People's Republic of China." Since the PRC buyer wants metal of monetary-reserve purity, above 95 percent, he takes the gold back to the Kan Kuam Tsing Company, and reconverts the gold back to a higher purity level. Reinhart identified the firm Pao San and Co. as a regular vehicle for Peking gold purchases during the early 1950s. (6)

According to Reinhart, the PRC entered the Hong Kong gold market in 1950. Last July's announcement that 13 Communist-owned banks in Hong Kong would be permitted to trade directly in the Hong Kong gold market thus only extends an agreement that has been in force since the founding of the PRC.

### One big gold pool

Apart from a relatively insignificant flow of gold into Hong Kong from mines in Australia and the Philippines — insignificant

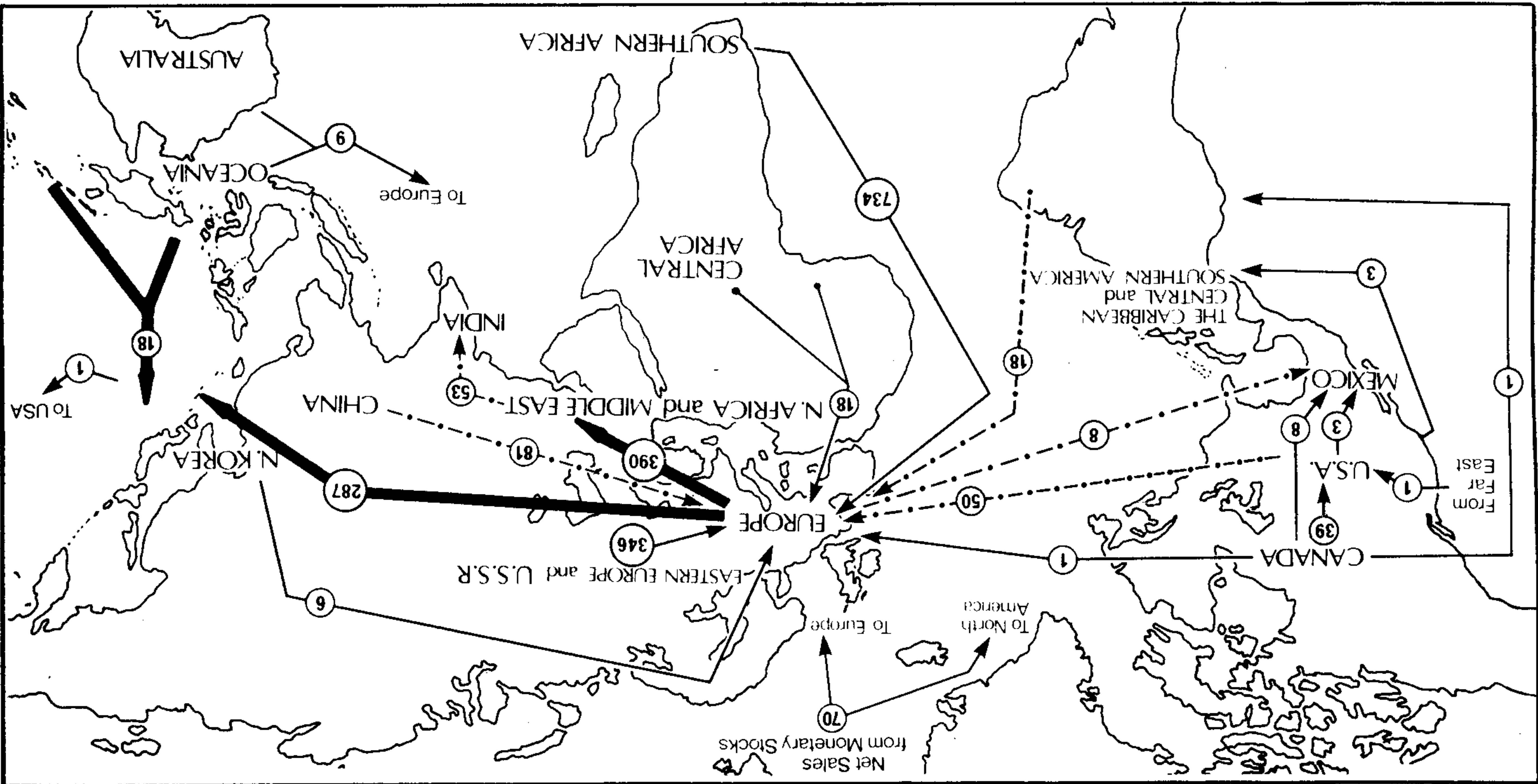

Figure 3

Adjacent map is based on one appearing in the 1977 annual report of Consolidated Gold Fields, Ltd. The world total of gold in metric tons was only approximately 1,500. Of this, 390 metric tons was distributed from Europe through Dubai and 287mt through China, primarily by British-controlled agencies, most of it ending up in Hong Kong. Another 18mt is directly exported to Hong Kong, for a total of 695mt. The vast proportion of this flow is "unofficial," and is put to use in drug-related dirty-money laundering. (Cf. Figure 5.)



compared to the 300 tons of gold traded in Hong Kong during 1977 and the 600 tons traded during 1978 (projected) — Hong Kong depends entirely on the London gold pool for its supplies.

Why do London's gold pool operators tolerate this situation? Because the London gold pool is the same operation as the Hongkong and Shanghai Bank, controlled by the same London families whose drug-running activities go back 150 years.

There are two major South African gold producers, **Anglo-American and Consolidated Gold Fields** (whose gold specialist was quoted above); there is one major South African diamond producer, **De Beers**, largely owned by Anglo-American; and five major London gold pool firms, who meet every day in the trading room of N.M. Rothschilds at New Court, St. Swithin Street, London, to set the world gold "fixing." Examining these firms individually, we discover such a manifold of connections that it is meaningless to speak of the London and Hong Kong gold markets as anything but branch offices of the same operation.

Hongkong and Shanghai's own gold-trading outlet is **Sharps Pixley Wardley**, of which they own 51 percent. One of the five London gold pool firms, **Sharps Pixley**, owns the remaining 49 percent. But **Sharps Pixley** itself is a fully owned subsidiary of the London merchant bank **Kleinwort Benson** whose deputy chairman is Sir Mark Turner, the chairman of **Rio Tinto Zinc**. **Rio Tinto Zinc** itself was founded a century ago with the opium-trading profits of **Jardine Matheson**, by a member of the Matheson family; the Mathesons are still large shareholders in the HongShang. The Matheson family's heirs, the Keswick family, still have their traditional seat on the HongShang board. Sir Mark Turner spent World War II at Britain's Ministry of Economic Warfare, which also employed Sir John Henry Keswick, and another HongShang board member, John Kidston Swire.

Hong Kong's second largest bank, the **Standard and Chartered Bank**, owns a majority share of another member of the London gold pool, **Mocatta Metals**. **Standard and Chartered's** predecessor, the **Standard Bank**, was founded a century ago by Cecil Rhodes, of whom we will have much to say later in Section 7. **Standard and Chartered** is not only a close collaborator of the HongShang in such matters as the transfer of Red Chinese opium

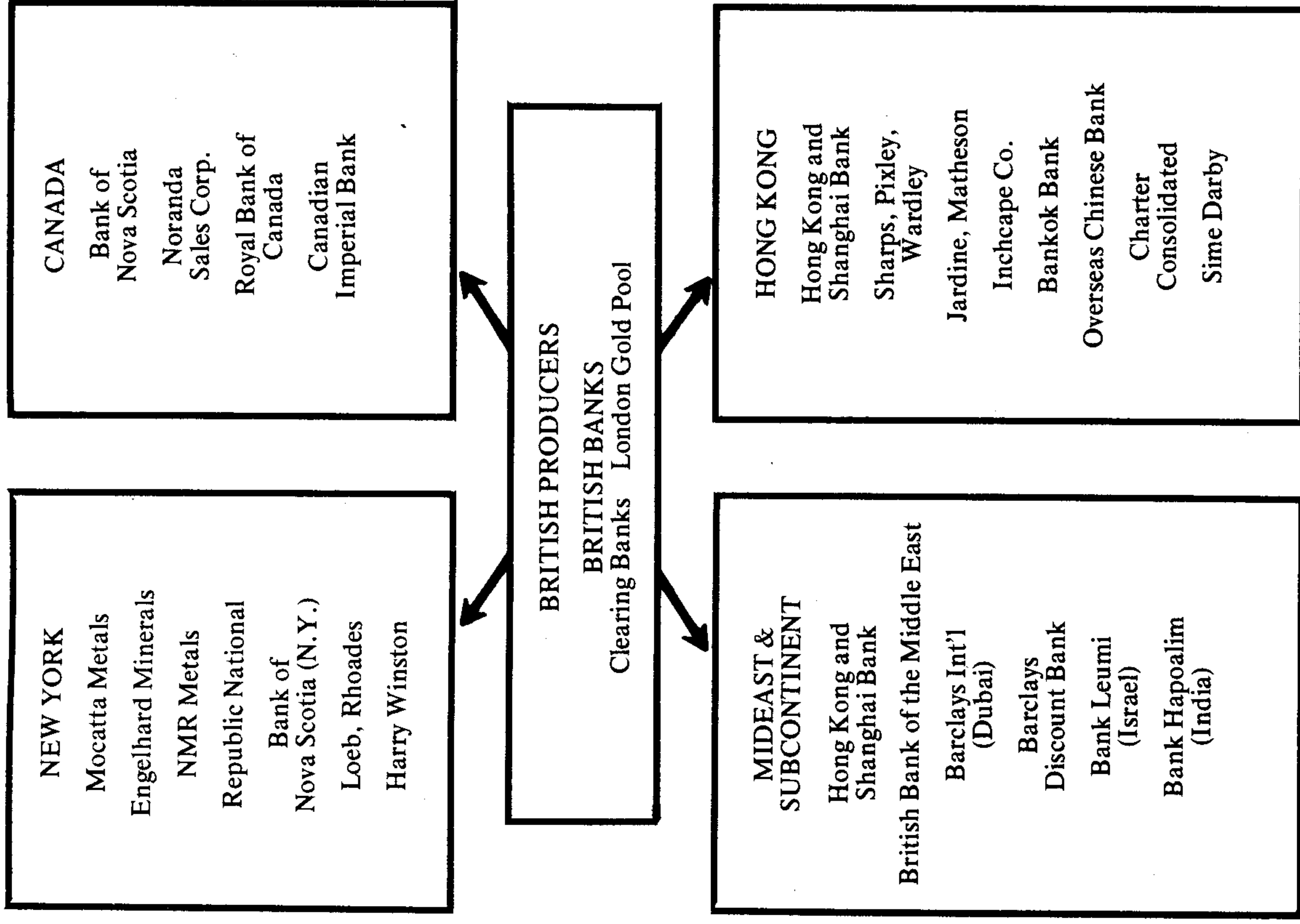

Figure 4. British Gold and Diamond Syndicate

money (see Section 6 below) — but is heavily interlocked since the days of the official British opium trade.

One of Standard and Chartered's directors is the current Lord Inchcape, of **Inchcape and Co.** and the **Peninsular and Orient Steam Navigation**, the latter dominating ocean freight in the Far East. Both companies are heavily represented on the HongShang board of directors. Inchcape's father wrote the notorious 1923 Inchcape Report recommending continued British sponsorship of the opium traffic — despite the outrage of the rest of the League of Nations — in order to "protect the revenues" of then-British colonies in the Far East.

This example also indicates why the London gold pool's dirty money operations are a worldwide, not merely a Far Eastern, problem. **Mocatta Metals**, a subsidiary of Standard and Chartered's **Mocatta and Goldsmid**, operates one of New York's biggest dirty money laundering operations.

Mocatta Metal's current chairman, Dr. Henry Jarecki, has been under investigation for years for illegal activities, although no indictment has yet been handed down. According to European intelligence sources, Jarecki's dirty money operation helps fund the activities of the Mossad, Israel's foreign secret intelligence service, in New York City, including assassination teams.

Jarecki is no small fry: he is a frequent gold columnist for British financial publications such as *Euromoney*, and rated a lengthy profile in the September 1978 issue of *Fortune* magazine. Nonetheless, he is eminently suited for the role of bag-man for Israeli intelligence hit squads. Jarecki began running drugs as a small-time pusher on the University of Michigan campus in 1950-51. In 1952, he spent six months in jail for suspected espionage in East Berlin. According to published sources, approximately half of Jarecki's present staff of 28 gold traders started out in the same Harvard Psychology Department that featured LSD-pushers Dr. Timothy Leary and "Baba Ram Dass" in the early 1960s. (7)

**Midland Bank** stands behind both Standard and Chartered and Mocatta and Goldsmid, with a 20 percent ownership of Standard and Chartered; it also wholly owns another London gold pool bank, **Samuel Montagu**. Sir Mark Turner is a director of both

Midland Bank and Samuel Montagu. The Montagu family, heavily intermarried with the Rothschilds, Montefiores, and Samuels, is the cream of Britain's Court Jews. One of their protégés is HongShang board member Philip de Zulueta.

**N.M. Rothschild and Sons**, which opened up operations in Hong Kong in 1975 to take advantage of the newly liberalized gold trading laws, and **Johnson Matthey**, the remaining members of the London gold pool, are also interlocked several times over with both the HongShang and the major South African gold producers, **Consolidated Gold Fields** and **Anglo-American** who control between them 90 percent of South Africa's gold output.

(For further details see Section 7 and 8.)

## The diamond black market

Second in importance in the money-laundering process is the world diamonds market, worth \$5 billion annually at wholesale value, whose single presiding manager is Sir Harry Oppenheimer of De Beers Corporation. Oppenheimer is also the chairman of the larger South African gold producers, Anglo-American. The Anglo-American and De Beers complex runs the Hong Kong side of the money-laundering diamonds operation on two levels — wholesale and retail. De Beers runs 85 percent of the wholesale diamonds market; through his intimate Israeli connections, Oppenheimer also runs the Hong Kong diamond market.

### WHY DIAMONDS

There are two points of special relevance for diamonds to the international heroin traffic. The first is that, in value relative to size and weight, diamonds are the closest approximation to heroin as a store of value for furtive use. Secondly, the De Beers-controlled international diamond cartel operates according to a pyramidal structure identical to that of the world heroin trade.

The use of expatriate ethnic networks for the dirtier side of the operations is also homologous, except that in the case of dia-

monds, Jews take the place of Ch'ao Chou Chinese. Not coincidentally, there is almost as little publicly available information on international diamonds trade as on the heroin traffic.

South Africa's largest producer, De Beers, was the 1888 creation of Rothschild legman Cecil Rhodes; in 1929, the company underwent reorganization by Sir Ernest Oppenheimer, of the Anglo-American family. De Beers controls the Central Selling Organization (CSO), which handles 85 percent of international diamond trade.

At ten "sights" each year, 300 clients purchase stones from the CSO. The list of these select clients is secret. Following their purchase by the secret list of clients, the diamonds are sent to cutting centers for further preparation. The two dominant cutting centers are Antwerp and Ashqelon, in Israel. Antwerp's diamond-cutting and related trade is financed by the **Banque Bruxelles-Lambert**, controlled by the Lambert family, the Belgian cousins of the Rothschilds. Israel's (and also New York's) diamond business is financed by Bank Leumi. (8)

Within the individual centers, dealers trade among themselves on such exchanges as the New York Diamond Dealers Club, the Ramat Gan in Tel Aviv, and the Antwerp Diamond Bourse. No written records are kept of any transactions on these exchanges; the agreements are sealed with a handshake. No aspects of this trade are available for scrutiny by law enforcement agencies, even under American law, before the diamonds reach the jewelry store level.

Hong Kong's own substantial wholesale diamond market is the virtual monopoly of the **Union Bank of Israel**; this bank is wholly owned by Israel's largest finance house, **Bank Leumi**. Bank Leumi, in turn, is under the control of **Barclays Bank**, on whose board sits Harry Oppenheimer and the Oppenheimer family itself. Bank Leumi's own chairman is Ernst Israel Japhet, of the **Charterhouse Japhet** family whose fortune derived from the official British opium trade during the nineteenth century!

Ten times a year, representatives from the Ramat Gan, Tel Aviv's diamond exchange, go with Union Bank financing to the De Beers Central Selling Organization "sights" in London, and purchase one-third of the world diamond output.

Like the Peking-British-controlled Ch'ao Chou Chinese networks in the Far East, Britain's Zionist financiers are a cult unto themselves, with their own family networks, cults, and language. New York's diamond market consists, at the lower levels, mainly of members of the extremist Hasidic sects resident in the area. This exotic feature of the diamond traffic achieved public notoriety after several unexplained thefts and murders occurred in the diamond trade during 1977.

Although there is an apparent division of labor between the *Hofjuden* precious metals and precious stones channels of the world dirty money operation, the various firms involved are so closely intermarried, interlocked, and interowned with the major dirty money banks, that the working of the dirty money apparatus is totally integrated.

A case in point is Canada, the dumping ground for all aspects of Dope, Incorporated that feed into the United States. The **Bank of Nova Scotia**, for example, is both the major gold dealer (and banker for the second largest gold dealer, **Noranda Mines**), and the major dirty money operator in the Caribbean.

The Nova Scotia is notorious for bribing its way into new branch offices in the Caribbean, violating local currency laws, running flight capital against currency restrictions, "investing" in local businesses known to be intelligence fronts, and so forth. Nova Scotia's branch network in the Caribbean is the largest of any bank in the world, save Barclays which has a similar pedigree. Gold is a specially useful medium for the special case of the Caribbean, where official restrictions make some bank transfers difficult. Conveniently, Nova Scotia leads the Toronto gold market.

The other leading gold market operator in Toronto is **Noranda Mines**; its chairman Powis is a member of the board of directors of the Bank of Nova Scotia. Powis is also a member of the board of **Sun Life Assurance**, the Rothschilds' insurance company.

island, illegal gambling, and other forms of illicit transactions, must yield a shockingly large number. With a drugged-up population of that size, the life of Hong Kong's population must be organized around illegal activity.

Shifting focus to New York City for a moment indicates the magnitude of the world's drug-centered illegal economy. Most estimates put the city's addict population at 500,000 (and another 250,000 nationally). Assuming a \$50 per day habit is average — which the federal estimates apparently do — this addict population must obtain \$9 billion a year out of New York City's faltering economy to meet its needs:

Where does it get \$9 billion? Not substantially through well-paying jobs. With rare exceptions that is physically impossible. Not from muggings; however bad matters seem, neither 500,000 muggings, nor a combination of muggings and burglaries, take place daily in New York City. Even prostitution could contribute only a small portion of the \$9 billion annual habit of New York City's addicts.

Where does the money come from? From organized crime activity: the numbers racket, bookmaking, protection rackets, auto theft, stolen auto parts distribution, prostitution, pornography, arson-for-hire, and similar occupations. Drug addiction could not possibly exist without organized crime to provide the means of financing addiction.

The National Education Television's recent series on the narcotics trade demonstrated irremonstrable nerve by repeatedly citing the view of the (well-paid) Royal Police of Hong Kong that the narcotics traffic will always exist as long as there is a market. The market for the worst form of human misery not only is the most centrally organized of any market in the world, but could not possibly exist in any other way. If the demand provokes the supply, one might ask, why do narcotics wholesalers produce roughly ten times what addicts can consume annually?

Hong Kong is the capital of the world's illegal drug economy. This explains some of its most notable characteristics: the biggest illegal market in dirty money, drugs, and gold; the world's biggest liquidity ratio; and the world's biggest bribe rate.

The annual exports of the colony this year will be no more than

## 5

# Hong Kong: The World's Drug Capital

Illegal drugs are the biggest business in the Far East — and by a close margin the biggest business in the world — but in Hong Kong, drugs do not merely dominate the economy: they are the economy. A look at the British colony of Hong Kong gives us a picture in microcosm of the drug-dirty money economy worldwide.

First, start with the fact that Hong Kong is the most drug-ridden place in the world, per capita. Official British police estimates have it that 10 percent of Hong Kong's population or 500,000 people, are hardcore addicts. Unofficial estimates run this figure up to 50 percent. A safe, conservative estimate is 20 percent or 1 million people — more than New York City's addicts. Assuming the daily cost of a serious opium or morphine habit in Hong Kong to run to about \$10 U.S., the annual cash-flow of retail drug sales at HongShang's back porch runs to about \$3.7 billion.

As the region's central bank, the Hong Kong and Shanghai bank provides banknotes to its clients, among other services. Any reasonable estimate of Hong Kong's dirty money operations including the retail drug trade, as well as the notorious bribes to police officers, international drug wholesaling based on the

\$8 billion; as we have seen, it will take in more than \$10 billion in drug and drug-related financial activity. There is no credence to the myth that Hong Kong's economy is booming on the basis of cheap electronics and textiles.

## The illegal market

Apart from retailing and wholesaling of drugs, huge sectors of the island's economy are indirectly dependent on the drug traffic. Exemplary is the booming gold market, whose turnover doubled from 305 tons in 1976 to 600 tons (worth \$43.6 billion) in 1977. Some several hundreds of millions of dollars of gold go directly to the Golden Triangle; hundreds of millions more absorb and hide the profits of drug traffickers across the Far East.

This is the place where the Hongkong and Shanghai Bank smuggled gold openly for a quarter-century, rigs the stock market in full public view, and promotes Chinese smugglers to the upper reaches of Hong Kong society. Nothing moves in the colony without the knowledge and approval of the Hongkong and Shanghai Bank and interlocked old-line opium trading companies. They set the island up as an opium center in the 1820s when it was bare rock, and they run it now.

A Soviet commentator, M.A. Andreyev, wrote in 1974:

**“In the Far East Hong Kong is the main center of illegal operations in gold and foreign exchange. Large-scale illegal transactions are carried on regularly there in Filipino pesos, Indonesian rupees, Malay and Singapore dollars, Burmese kyats, Thai bahts, South Vietnamese piastres, Cambodian riels, Laotian kips, Chinese yuans, British pounds and U.S. dollars. The foreign exchange transactions in Hong Kong daily involve several billion U.S. dollars (the figure is a gross underestimate, even for 1974 — ed.), with the larger part of these transactions carried on by businessmen from Southeast Asian countries. On a lesser scale such illegal transactions in foreign exchange and gold are conducted in Singapore and Bangkok . . .**

**“The overseas Chinese bourgeoisie actively finances the gold**

and foreign currency operations in Hong Kong and on the outskirts of Southeast Asia. Ever since the end of the Second World War much of the migrating capital from China has been used in the illegal gold and foreign exchange operations in Hong Kong. U.S. economists note that in the mid-1950s most of these operations in the Hong Kong black market were handled by Chinese brokers. Chinese businessmen are even more active in the gold and foreign exchange black markets in the Southeast Asian countries. Regarding the part played by Chinese financiers in the gold and foreign exchange market in the Philippines, a Hong Kong publication (Wong Po-Shang, *The Influx of Chinese Capital into Hongkong since 1937* — ed.) wrote: ‘Besides remitting through the regular free market, these people have made transfers of their money by trade transactions and devious means as well as by out and out smuggling. This is said to be the case with money from the Philippines where large underground organizations are said to be in operation with the object of helping to smuggle funds, gold bullion, and valuables out of the country.’” (1)

Andreyev adds: “Three types of transactions predominate among the innumerable and varied black market gold and foreign exchange operations. These are, first, the acquisition in the local market of gold and foreign exchange (mainly U.S. dollars) smuggled into the country concerned for local currency which devalues quickly. Next, the smuggling of local currency overseas, to countries with a relatively stable currency, for the subsequent exchange of that currency for gold or hard currency. Whereas these types of transactions involve the physical movement of gold and bank-notes from one country to another and are, thereby, closely connected with smuggling (in all Southeast Asian countries there are strict limitations on the inflow and outflow of gold, foreign exchange, and local currency), the third type of black market gold and foreign exchange operation is practically not linked with the movement of bank-notes or gold from country to country . . . (but rather with obtaining) funds in the black market from local businessmen desiring to build up large overseas hard currency or gold accounts.

“The existence of organizational links between numerous

Chinese companies in the different Southeast Asian countries makes it possible to export Chinese capital from country to country even without the physical movement of that capital. Take, for instance, a Chinese firm with branches in Hong Kong, Singapore, Djakarta, Kuala Lumpur and Bangkok. It can, if it so desires, pay for its operations conducted in its behalf by its Bangkok branch not through official channels but by transferring the necessary sum of money in foreign exchange to that branch's overseas bank account. In this case the Bangkok branch pays for these operations from its local currency fund and in exchange gets an addition to its hard currency account abroad." (2)

### Highest liquidity ratio

Hong Kong's drug traffic and the regionwide illegal dealings surrounding it undoubtedly account for the colony's chronic excess of liquidity (see *International Currency Review*, vol. 10, no. 4, for a descriptive analysis). Year-to-year growth in money supply as of April 1978 was 25 percent; however, some of that is attributable to inflows of foreign currency related to the opening of an offshore Hong Kong bond market. Over the past 15 years, the huge volume of external lending tended to suppress the otherwise huge money supply needed to finance several billions of illegal activity on an island whose reported money supply is now about \$4.5 billion, U.S. Offshore business booked through Hong Kong was formerly so large that the liquidity ratio of the banks (taking into account both cash and rediscounted offshore bills of exchange) stood at an extraordinary 50 percent. Most of the local money supply was in the form of cash. (3)

In effect, the cash-based local drug traffic in Hong Kong created a reserve base for offshore lending to finance the drug traffic in the rest of Asia! Since 1975, however, the development of the offshore bond market and the influx of foreign capital has led to the reduction of the liquidity ratio to a still-extraordinary 43 percent.

Understandably, even *public* business practice in Hong Kong is politically corrupt. The HongShang's entirely open role in gold

smuggling between Hong Kong and Macao was noted above. The *London Financial Times* of July 4, 1977 reported a 1977 scandal in which Wheelock Marden, a trading company listed on the Hong Kong Stock Exchange, provoked an investigation by the Securities Commission, after a "modestly optimistic statement" was followed by "revelation of huge profits drop, dividend cut, write-offs and liquidity problems."

The *Financial Times* wrote, "insider trading is rampant . . . These flurrries may be attributable to leaks by clerks, secretaries and translators, rather than to insider trading at the top. But who can blame these lesser lights when Mr John Marden is still chairman of Wheelock Marden, still sits on the board of the Hongkong and Shanghai Bank, is still a pillar of 'respectable' colonial society?" (4)

### Biggest bribe rate

Law enforcement sources report that the "lesser lights" are generally taken care of through the world's most efficient bribery system. At least \$1 billion is passed out to Hong Kong's officialdom.

According to a report in the same *London Financial Times* article cited above:

" 'Perhaps a billion dollars a year flow into the syndicates,' admits Mr Jack Cater, Hong Kong's head of the Independent Commission Against Corruption (ICAC) started in February. The sum gives one clue to the size of the problem the ICAC has to tackle. Another, Mr Cater points out, is the extent of official and in particular police corruption in the Colony. With membership varying from 10 to 300, there are at least 28 identifiable public sector syndicates, and 25 of them are in the Royal Hong Kong Police Force . . .

"The ICAC has considered about 9,500 reports on corruption, about 85 percent of them involving Her Majesty's service. Reports of police crime (4,000) have regularly accounted for more than half the reports of government crime . . . Mr Cater has failed to bring back the many wealthy and mostly Chinese

non-commissioned police officers who left Hong Kong before the ICAC cast its net." (5) (The largest concentration of the last-mentioned is in Vancouver, British Columbia, where they are still active in the narcotics traffic, according to law enforcement specialists.)

The \$1 billion figure cited can be counted as overhead on the narcotics and related drug traffic in the area. Earlier, the local Hong Kong retail drug traffic was estimated at about \$4 billion, and the area's drug wholesaling business at \$3 million and more. Assuming that bribes of police and other officials — what most of the \$1 billion cited represents — amount to no more than 10-15 percent of the volume of drug traffic, retail and wholesale combined, then the estimates for the size of the drug traffic already made are unquestionably on the low side. The \$1 billion in Hong Kong corruption annually estimated by the authorities — and it is not likely that this estimate is excessive — indicates drug traffic in and through Hong Kong of close to \$10 billion, by ordinary reasoning. That figure, of course, does not include bribes to customs officials at Bangkok, Rangoon, Singapore, and elsewhere, let alone bribes to Thai and Burmese army officials.

To the extent that limited efforts at giving the appearance of honesty have come to pass in Hong Kong, both the police and the Chinese expatriate community have risen in revolt against them. Last year police rioted uncontrollably against so-called anticorruption efforts. The July 4, 1977 *Financial Times* account notes that the crusade "enraged Chinese business in particular . . . In a rare display, the Chinese Manufacturers Association (pro-Peking) and the Kowloon Chamber of Commerce held a mass rally to protest against 'interference in Chinese ancient customs.'" (6)

Such ancient customs indicate the nature of Hong Kong and its bank. According to custom, no bribes are solicited, none offered. Instead, couriers make their rounds through Royal Hong Kong Police and other official buildings early each Monday morning, leaving an envelope containing between one and five hundred-dollar bills in the top drawer of every desk. Any policeman who refuses to take his envelope will probably be dead within 48 hours, according to law enforcement officials.

## The Peking Connection

*Some of them (U.S. troops in Vietnam) are trying opium. And we are helping them. . . . Do you remember when the West imposed opium on us? They fought us with opium. And we are going to fight them with their own weapons. . . . The effect this demoralization is going to have on the United States will be far greater than anyone realizes.*

*Chinese Prime Minister Chou En-lai,  
in conversation with Egyptian  
President Nasser, June 1965 (1)*

Only since Henry Kissinger's 1972 trip to China has the Chinese role in the world opium trade been out of the headlines. The American, European, Japanese, and Soviet authorities had long insisted that Peking was a major primary producer and exporter of opium and its derivatives, and the British, under extreme

pressure from abroad, had to assent. The highlights of the public record to this effect follow below in this section. However, even the most compelling documentation of Peking's role in opium production misses the point.

Red China's revenues from opium exports, as we will demonstrate, are a mere \$800 million annually. Peking makes its real profits in the wholesaling, retailing, and financing of the opium traffic, mainly through Hong Kong, where the big money is made. As noted in Section 4, the People's Republic of China has taken active part in the gold smuggling side of drug financing in the orient since 1950.

But since approximately the time of the Sino-Soviet split in the late 1950s, Peking has deliberately integrated its external financial affairs with the top British drug-running firms in Hong Kong, and the expatriate Chinese drug wholesaling and dirty money networks throughout the orient. Peking's financial policy coincides with strategic commitment — stated unambiguously by the late Premier Chou En-lai — to the full-scale use of the opium weapon against the White Devils of the United States.

Peking's financial dependence on Hong Kong is a matter of public record. On Oct. 2, 1978, Chase Manhattan Bank's newsletter *East-West Markets* estimated that the financial flow into mainland China this year (excluding exports) through Hong Kong would total \$2.5 billion, up from \$1.3 billion in 1977. This \$2.5 billion includes income on Peking's foreign investments in Hong Kong and other Southeast Asian centers, plus remittances back to relatives on the mainland from Chinese expatriates.

Apart from the purely financial offtake, most of Red China's exports pass through Hong Kong. In 1976, Peking earned \$2.4 billion in exports through the British colony, or sufficient to cover 40 percent of the PRC's total import requirements for that year. Peking does all its banking through Hong Kong, largely through the Hongkong and Shanghai Bank, and secondarily through the Standard and Chartered Bank. Peking conducts all its investments abroad through Hong Kong. That dependency is not merely established, but is increasing markedly.

The astonishing \$2.5 billion financial reflow back to the PRC this year represents the fruits of Peking's 20-year-old program of

moving into the higher echelons of the drug traffic, by agreement with the British. Combining American and Soviet sources, we will demonstrate that this estimation of foreign drug revenues through Hong Kong is a good approximation of Peking's income from drug wholesaling, retailing, and financing, as well as gambling, real estate, and other shady joint ventures with British and expatriate Chinese finance, closely related to the drug trade proper.

Even the \$2.5 billion figure does not include the \$800 million Peking earns as a primary opium producer. To estimate Peking's gross revenues from the drug traffic, an additional sum of several hundred millions of dollars must be added: the overhead cost of maintaining one of the largest and best-financed intelligence and sabotage operations in the world, the Chinese Communist Intelligence Service (CCIS).

In summary, we will demonstrate that **the People's Republic of China is a 40 to 60 partner with the British oligarchy in the Far Eastern narcotics trade.**

#### OLD TIES GROW STRONGER

Peking's current policy represents a direct line of continuity between the current regime and Britain's 19th century corrupt collaborators in China. Correspondingly, the fortunes of the Maoist Great Han Chauvinist faction in Peking are linked to the opium trade and the British oligarchy. They have staked China's economy — its capacity to import urgently needed foreign goods — on the opium trade.

In consequence, the factional importance of the opium issue inside China is enormous. One unmistakable indication that reached Western view is the peculiar case of the Chinese-made film *The Opium War*, now distributed throughout the West. *The Opium War* uses the 19th century events as a parable for contemporary China. The villains of the film are not so much the British, but the corrupt Chinese who enable the British to win the Opium Wars, by preventing the Emperor and his loyal intelligence chief Lin Tse-hsu from repelling the White Devils. The film was initially banned by Madame Mao and the rest of the "Gang of Four," allegedly because hero Lin Tse-hsu was an oblique refer-



ence to Gang of Four opponent Teng Hsiao-p'ing. Some observers, however, have speculated that the banning was related to a raging political battle over Peking involvement in drugs.

What political fireworks ensue every time a Japanese trade delegation, export-financing agreements in hand, shows up in Peking, can only be imagined. Japan's economic approach to China, embodied in the recent Sino-Japanese treaty, offers the PRC an alternative to dependence on drugs and the British. Correspondingly, the Japanese approach gives the anti-opium group in the PRC powerful factional arguments.

Despite the Japanese initiative, however, Peking's policy has taken dramatic new steps toward economic integration with British Hong Kong.

Among the first major foreign credit arrangements the Peking government has accepted was a \$200 million deposit last summer in the Bank of China by a consortium of banks led by Standard and Chartered. Then, in October 1978, the venerable opium traders Jardine Matheson concluded a \$300 million agreement with PRC firms in Hong Kong to develop a real estate complex adjoining a branch station of Hong Kong's new mass transit system. Apparently, the joint investment came as part of a package deal including the largest-ever export package to China, also announced at the beginning of October by Jardine Matheson, which handled the negotiations on behalf of a consortium of British firms. The \$300 million real estate development in Hong Kong's New Territories includes an 80 percent stake on the part of two PRC-owned firms in Hong Kong, the Sun Company and the Kui Kwing Company; a 15 percent stake from the Hong Kong Land Company Ltd., headed by Jardine Matheson's ex-chairman H. N. L. Keswick; and a 5 percent share from Jardine Matheson itself. (2)

The extraordinary leap in Peking's investment income in and through Hong Kong, and the haste in opening new operations in common with the British, including Peking's official entry into the Hong Kong gold market, mean one thing: Peking and London are jointly preparing a massive expansion of the opium and heroin traffic. Apparently, the market research that Dope,

Incorporated conducts in the United States shows that the push for decriminalization of drug use could open the U.S. market up like a clam.

In this section, we will show:

- (1) The content of Peking's activities in Hong Kong;
- (2) The documented record of Peking support for the drug traffic;
- (3) The activities of the grossly underestimated Chinese Communist Intelligence Service (CCIS). Peking intelligence and the expatriate, largely Ch'ao Chou Chinese networks who handle the drug traffic are the same entity. As we demonstrated in Section 3, the expatriate networks operate under financial control from London. In fact, the entire operation of these networks runs through Peking-London joint ventures.

Then, in the next section, we will report how the Royal Institute of International Affairs — which makes policy for the HongShang and the rest of the British banking establishment — negotiated the continuation of the old Anglo-Chinese drug traffic at the end of World War II.

## “Communist fat cats”

London's current view of Hong Kong's relationship to the mainland is rosy. “By its acceptance of the status quo, China shows that it is happy to keep the Kong Kong show on the road,” wrote the *London Financial Times*. “The existence of the communist banks (in Hong Kong) is an indication of the continuing commitment, as the establishment of a machinery manufacturing plant on Tsing Yi island, one purpose of which is to modify mainland machinery which fails to meet the requirements of potential buyers in the region.

“This sort of commitment is understood by even the most nervous businessmen and helps remove the cloud of uncertainty which would otherwise start to gather. . . . It may be the final irony of the Hong Kong paradox that to ensure Hong Kong's well-being, Peking will have to increase its own investment and participation in the colony.” (3)

The same *Financial Times* report then specified what it meant by increased Peking participation in the colony, citing the exemplary case of a leading Hong Kong and Macao entrepreneur, Mr. Stanley Ho:

"It is a widely accepted allegation that Mr Ho and his partner, Mr Henry Fok, started their fortunes at the time of the Korean War running strategic materials into China. Certainly, both men became prominent during that era of smuggling. Indeed, Mr Ho seems to have weathered the 1967 riots (following the Cultural Revolution — ed.) without taking sides, and he even managed to bolster his friendship with Peking authorities. The relationship, and Mr Ho's wealth, can be traced to the award of China's sand monopoly in Hong Kong to his partnership with Mr Fok. Later, in 1962, Mr Ho was awarded the 25-year gambling franchise in Macao, where he had worked during World War II for a Japanese company. It is fair to say that the gambling franchise was a present from Peking."

The *Financial Times* could have cited other cases, like the Shaw Brothers (Anglicized Chinese name), Hong Kong's premiere producers of Kung Fu films for distribution throughout the world. Apart from their chain of theaters in Chinese communities across the world, the Shaw brothers control most of Hong Kong's prostitution. (4)

In any corner of the world but Hong Kong, Peking's relationship to the British elite — Peking-owned businessmen and British bankers rub shoulders in the Hong Kong Jockey Club and other havens of Hong Kong's elite — would be a source of international outrage.

Peking controls the Chinese General Chamber of Commerce in the colony, the same organization that organized riots in 1977 to protest the Independent Commission Against Corruption's "interference in the ancient Chinese practice" of bribing police officers. Its chairman, Dr. Wang Kwan-cheng, is a frequent visitor to the mainland, and has been identified in intelligence reports as a PRC political intelligence operative. Wang's position has been described as "the most prestigious in the colony, along with the British Governor-General." Among other things, Wang is among the wealthiest men in Hong Kong, with interests in the

retail trade, restaurants, real estate, and transportation. According to his entry in *Who's Who in Hong Kong*, Wang is "chairman of the Board of Directors of Magna Development Company, Chinese Arts and Crafts (Hong Kong)," and a member of the Hong Kong Jockey Club.

The vice-chairman of the Chinese Chamber of Commerce is C. H. Kao, who, like Macao gambling czar Stanley Ho, amassed great wealth by running strategic materials into China during the Korean War. Other known Peking agents include Ho Yin, chairman of the Macao Chamber of Commerce, and Macao's representative to the PRC's People's Congress, the organization that centralizes the political activities of Chinese expatriates through Peking (see below). Another is K. C. Jay (or Choi), formerly with the Bank of China in Peking, and currently a resident financial intelligence operative and currency specialist for the Bank of China in Hong Kong.

As Richard Deacon, the British author of *The Chinese Secret Service*, puts it: "What is abundantly clear is that Peking has a great reservoir of strength and talent among its supporters in Hong Kong. Its Secret Service activities there are low-key, as in many other centers, and have avoided clashes with the authorities. Indeed the only espionage scandals to break in the colony for several years past are attributable to other powers altogether, some of them at least manufactured by the Chinese to embarrass another nation. Perhaps the subtlest of these was when in 1973 a Chinese Intelligence agent tipped off the British about two K.G.B. agents, who had been taught Chinese at the University of Vladivostok, arriving in Hong Kong. In their possession were found documents containing valuable information about the Soviet espionage network in the Far East."

And as Deacon remarks, "There may even be some unofficial contacts on an intelligence level between the British and Chinese secret services. . . ." (5)

Deacon also reports that when China's narcotics smuggling operations were at their height, they were controlled by the Central External Liaison Department and the Ministry of Investigation. According to Deacon, the major secret agents were employed through the pro-Peking China Sailors' Union in

Hong Kong. The union was responsible for bringing in a large shipment of heroin discovered by the New York police in January 1973. "The International United Front operations, controlled by the CFLD, included drug-pushing with the aim of creating disruption and demoralization in carefully selected target areas indicated by the CFLD."

Deacon adds: "From Italian sources, diplomatic and otherwise, comes confirmation that the heroin traffic between Hong Kong and Europe is master-minded by Chinese secret agents. It is even suspected that there may have been undercover deals between the Chinese and the Mafia for distribution of the stuff."

Deacon identifies Keng Biao as the chief of the cited Central External Liaison Department. Whether Keng, in fact, coordinates Chinese drug-pushing cannot be independently corroborated at this time. Since the 1974 publication of Deacon's account, however, Keng was elevated to the Politburo, China's highest political body, in August 1977. In August 1978, he toured some of the prime marijuana-growing regions of the Caribbean, including Jamaica. Keng also stopped in the island of Malta, the old base of the drug-pushing Maltese order, for unexplained reasons, on his return home.

The renowned Mr. Stanley Ho, mentioned above, who as controller of Macao gambling is the proprietor of what law enforcement agencies consider the world's dirtiest financial operation, is a bona fide member of Hong Kong's social elite. Macao's relationship to Peking became a public scandal in 1974, when the revolutionary Portuguese government offered to cede the colony to PRC. The Peking government refused, because Macao is much more useful to Peking as a source of illicit foreign exchange earnings through opium and other forms of smuggling than as a people's commune. (6)

Only in rare instances have the links between the Hong Kong opium firms, British intelligence, and the Chinese Communist Intelligence Service come to public light. Where they have, the results put the best pulp thrillers to shame. One illustration is the story of the luckless Rennie family, Scots traders who sold their operation to Jardine Matheson in 1975. The Rennies are old Africa and Asia hands both in merchant ventures and the British

colonial service, with major operations in South Africa, through Rennies Consolidated Holdings Ltd. (7) A relative, Sir John Rennie, resigned as head of Britain's foreign secret intelligence organization DI6. Normally the identity of the chief of DI6 — "M" in the James Bond movies — is one of Britain's best-guarded secrets. But Rennie's identity came to light after his son, Charles Tatham Ogilvy Rennie, was arrested for heroin trafficking in London on January 15, 1973. Official British press censorship, the infamous "D-notices" sent to newspaper editors, delayed press coverage of the blue-blooded drug bust until February 7, 1973, when London's *Evening Standard* reported that "the previously unnamed son of the head of DI6, who is facing drugs charges in London, is Charles Tatham Ogilvy Rennie."

Significantly, on the same day West Germany's *Stern* magazine blew Sir John Rennie's cover — in a dispatch from Hong Kong, the base of the Rennie family's business partners, Jardine Matheson. *Stern* magazine's information could have come either from Rennie family channels through Jardine Matheson, or through the Chinese Secret Service, or both. According to a Chinese Communist intelligence source cited by a British author, "In the case of Sir John Rennie I believe the Chinese were so cautious that they refused to accept their own suspicion (that Rennie was head of DI6) for a long time. Confirmation finally came when Sir John's son was arrested. They did not have far to look as his son's wife used Gerrard Street — almost a 100 percent Chinese quarter of London — as a rendezvous for obtaining Chinese heroin." The British author, Richard Deacon, commented, "I suspect that some of the leakages to the press of this information came from the Chinese, who have a very high regard for the British Secret Service."

Of course, nothing is proven; British author Deacon guards his version of this story with an elaborate description of the Chinese Communist Intelligence Service's purported method of discovering the chiefs of British intelligence branches through a careful reading of Who's Who. Nonetheless, we have the fact that the head of DI6 was a member of a family with intimate business ties to the core of the Hong Kong drug traffic; that his son dealt in narcotics through Peking intelligence agents in London; and that

the ultimate public announcement of his son's arrest came via Hong Kong sources, either British or Chinese.

More recent events provide a useful epilogue. On September 2, 1978, the *London Economist* reported, "One after another, top South African businessmen have been falling foul of the country's strict foreign exchange laws. This week's man in the spotlight was Mr Charles Fiddian Green, chief executive of the country's leading transport conglomerate, Rennies . . . He was convicted of currency offenses on Aug. 29 and fined Rand 10,000.

"Last week Mr Gordon Rennie (Sir John's relative and Rennie Consolidated chairman) cut his throat and wrists after police came to talk to him. He went to hospital and was charged with currency offenses. Four other Rennies executives have been questioned by police; another has already been charged with currency smuggling; and two, including Mr Laurence Parry, have been sacked after apparently leaving the country." (8)

Also significant is the implication of Laurence Parry in the recent Rennies scandal; Parry was chief of Rennies Holiday Inn franchise in Swaziland and Lesotho, where rich South Africans spend weekends gambling and watching fleshy floorshows that are prohibited in puritan South Africa. Rennies, since 1975 a 53 percent owned subsidiary of Jardine Matheson, has an almost classical dirty money profile, apart from its casino-gambling and fleshpot operations. Rennies's subsidiary in the security field, Fidelity Guards, is South Africa's leader in armored car services and payroll preparations, including its own computer facilities — tailor-made for the currency smuggling operations of which Rennies has just been accused. In addition, Rennies owns its own air and cargo shipping facilities, making it the leading transport group in South Africa. (9)

At the time of Rennies' merger with Jardine Matheson, South Africa's magazine *Management* wrote, "For both, it's a getting together of like people, like lifestyles, and remarkably similar management philosophies. Good solid Scots tradition abounds in both groups." Apart from its affinity to the leading Hong Kong dynasty, Rennies is part of the South African mining establishment. Two of its board members, the just-arrested Charles Fiddian-Green and Fred G. Wolmarans, were previously senior

officials of Consolidated Gold Fields of South Africa. Consolidated Gold, as quoted extensively in Section 4 above, wrote the book on currency smuggling — literally.

### THE MONEY LINKS

The PRC's financial intimacy with Hong Kong is a matter of public record. (Less public is the PRC's relationship to the Bangkok connection noted above, the seven-year residency of drug financier Chin Sophonpanich in Peking.)

The PRC's roughly \$3 billion in foreign exchange reserves are banked through HongShang, Standard and Chartered Bank, and other British banks through Hong Kong. In 1978 Peking began large purchases of gold through the Hong Kong gold market, according to the *London Economist's Financial Report*. (10)

The *International Currency Review* reported in September 1978: "China's increasingly open economic policies are likely to have a further impact on other Hong Kong balance-of-payments items . . . the Bank of China's announcement in early July that the 13 Communist-owned banks in Hong Kong would be able to purchase bullion, deventures and possibly equities, should generate further hard currency revenue for Hong Kong's financial community — and will also probably encourage a great deal of additional business. . . . The Chinese Government's initiative in this connection represents one of several financial liberalizing measures recently implemented by Peking. In June, for example, the Bank of China and the Vanying Bank issued guarantees for a real estate project in Tsuen Wan, located in the new territories." (11)

### Peking's opium weapon

Gold trading, banking, property, gambling — and roughly half of Peking's foreign trade. That is the bottom line of the Peking investment in Hong Kong. Since the early 1950s, it was the official view of American law enforcement agencies that Hong Kong was the main outlet for heroin grown in Red China. In 1961, just before the Kennedy Administration kicked him out, U.S. Narcotics

Bureau Chief Harry Anslinger stated, "One primary outlet for the Red Chinese traffic has been Hong Kong." (12)

The police blotter's record of Red Chinese opium traffic through Hong Kong is comprehensive. Even the British and Hong Kong police have been forced, on occasion, to admit this is the case. Scotland Yard attributed a large quantity of heroin seized in a 1969 bust in London's West End to PRC shipments through Hong Kong. On Oct. 15, 1970, the chief of Hong Kong's notoriously corrupt narcotics bureau, Shih Tieh-pi, told a press conference that his force had confiscated 10,500 pounds of raw opium, 320 pounds of heroin, and 250 pounds of morphine, all of Red Chinese origin, during 1969. The quantities just cited compare dramatically with the largest-ever U.S. bust of heroin — the so-called French Connection bust involved a mere 100 kilograms. (13)

Without knowing the quality of the heroin seized, or the veracity of Mr. Shih Tieh-pi, comparisons are difficult. But if the 320 pounds of heroin seized so close to the original source were fairly pure, which is likely, and the rule of thumb applies that roughly one-tenth of illegal narcotics shipped are seized by police — then 3,200 pounds of heroin passed through Hong Kong in 1969. That is roughly what American narcotics addicts consumed in 1969.

The PRC's Hong Kong connection is not a matter of convenience, but the expression of a quarter-century-long policy agreement between the Peking government and the highest levels of the British oligarchy. The best-known source for the unexpurgated views of China's elite is *Al Ahram* editor Mohamed Heikal. Heikal reported the following 1965 conversation between Nasser and visiting PRC Prime Minister Chou En-lai:

"One of the most remarkable statements Chou En-lai made on that evening (June 23, 1965 — ed.) during our discussion of the demoralization of American soldiers was that: 'Some of them are trying opium and we are helping them. We are planting the best kinds of poppies especially for the American soldiers in Vietnam.' Nasser appeared to be somewhat disturbed, but Chou continued: 'We want them to maintain a large army in Vietnam that will serve us as a hostage, and we wish to demoralize the

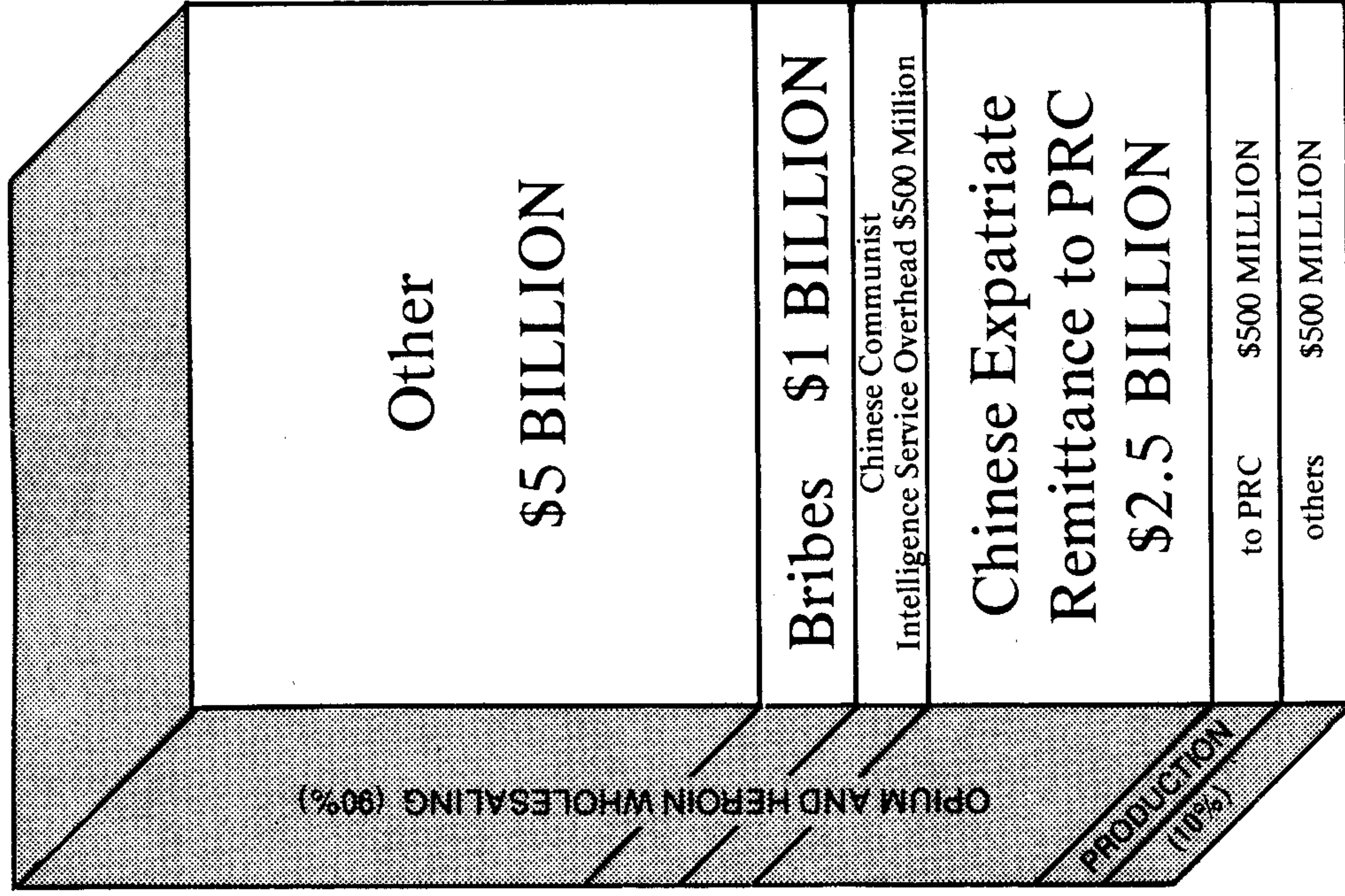

Figure 5

Hong Kong and Peking: Sharing the Drug Take

Roughly \$10 billion annually passes into and out of Hong Kong as payments related to the production and wholesaling of illegal opium. Of this, something under half is paid to or at the disposal of the People's Republic of China. The involvement of the Chinese Communist Intelligence Service in the dope trade may be considered self-financing, at a minimum; the Chinese also receive something on the order of a \$.5 billion directly for opium-growing. By far the largest part of Peking's drug-take assumes the form of remittances to the mainland by overseas expatriate Chinese, the bulk of this \$2.5 billion accounted for by those Ch'ao Chou drug-financiers and others in the Southeast Asian orbit of Britain's Hongkong and Shanghai Bank.

troops. The effect of this demoralization on the United States will be much greater than anyone can imagine.' Nasser thought that Chou might be exaggerating somewhat, but Chou's concept was clear. He left no doubt that this was his course of action." (14)

The Soviet government newspaper *Isvestia* of Feb. 17, 1978 cited a Chou En-lai speech in Wuhan in 1952 elaborating the same policy. According to *Isvestia*, the Chinese Prime Minister said:

"We are trying in every way to support the creation of opium poppy plants. From the standpoint of the revolution, opium is one of the means of helping the revolutionary cause and must be used actively. If the question is approached from a class standpoint, opium is one of the most powerful sorts of weapons of the proletarian revolution. . . . It is extremely important for us to export morphine and heroin in big quantities, use them to weaken the combat strength of the enemy and destroy the enemy without entering into war with him."

Whether or not the Soviet citation is accurate, the views expressed coincide with those reported by observers such as Heikal, who is far from pro-Soviet or anti-PRC, and conform to the practice of the PRC and its secret service, the CCIS.

Ironically, the British were quick to point an accusing finger at the PRC when it benefitted their policy, during the Korean War. In 1950, the British Mission to the United Nations made public a PRC offer to sell 500 tons of opium grown in Jehol (North China) and in storage in Canton, to a firm in Hong Kong. The British Mission said that the offer had been refused.

#### FROM HONG KONG

Until the "China Card" strategic policy found favor in Washington under Kissinger, the official American view, among others, was that the PRC grew and exported large quantities of opium. Harry Anslinger, the first chief of the U.S. Federal Bureau of Narcotics, said in 1961: "Heroin made in Chinese factories out of poppies grown in China is smuggled into Hong Kong and onto freighters and planes to Malaysia, Macao, the Philippines, the Hawaiian Islands, the United States, or, going the other direction, India, Egypt, Africa, and Europe. A prime 'target area' in the United States was California. The Los Angeles

area alone probably received 40 percent of the smuggled contraband from China's heroin and morphine plants. The syndicate crowd does not object to dealing with the Reds as long as the profits are big in terms of dollars." (15)

U.S. investigators have only succeeded in putting heat on the Hong Kong authorities, provoking token busts of local drug operations. The last major scandal raked up by American authorities — immediately before the "opening to Peking" slammed the lid down on further action — came in 1973, when U.S. Congressman Lester Wolff visited Hong Kong on behalf of the House Select Committee on Drug Abuse. Citing the Nixon Administration's effective crackdown on Turkish heroin entering the U.S. East Coast through the so-called French Connection in Marseilles, Wolff charged, "All the narcotics entering the United States must be coming from somewhere else, the center of which is Hong Kong." (16)

The Japanese authorities held the same view. Susai Sugahara, head of the Japanese Narcotics Bureau, maintained that China was the largest opium producer in the world. Taking the export figure Sugahara cited, the Soviet commentator V. Ovchinnikov estimated in 1964 that one-third of PRC opium production went to Japan. According to the Japanese Narcotics Bureau, the PRC was the source of the major influx of opium into Japan that began in the early 1950s, producing an estimated 40,000 addicts as of 1953. (17)

In 1969, the Soviet monthly *Liternatura Gazyeta* estimated Chinese opium export earnings at \$500 to \$800 million per annum. (18) There is no way to confirm this report, and Soviet estimates (as well as Taiwanese) of the size of the PRC's opium crop unquestionably exaggerate in many instances. However, there is a strong element of credibility in the 1969 Soviet report: the \$500 to \$800 million is within the range of the \$1 billion estimate developed independently (see Section 2) for the primary wholesaling revenue of the Far Eastern opium traffic. The Soviet estimate corresponds closely to what may be readily deduced from hard law enforcement agency data.

Why has no action been taken against Hong Kong, when the evidence is so well known? There are two reasons. First, no

American law enforcement or intelligence agency has ever had operational access to Hong Kong. Hong Kong, as British territory, was strictly off limits to American investigators. To our direct knowledge, American intelligence never tries to circumvent this feature of the "special relationship" between Britain and the United States. Secondly, the courageous work of Harry Anslinger and other American narcotics officials did succeed in putting some heat on the rotten little island. The British seizures of narcotics cited earlier are an indirect result of the pressure applied, in the context of Nixon's war against drugs.

The more important reason is that, to a great extent, the actual refining of heroin — which moved lock, stock, and barrel to Hong Kong from Shanghai after the Communist takeover in 1949 — is no longer done in Hong Kong. Rather, Hong Kong's importance is overwhelmingly in the sphere of dirty money operations, and secondarily in transshipment of heroin. The great shift of the production-refining cycle from the Shanghai to Hong Kong route to the Golden Triangle (including substantial portions of China's Yunnan province) occurred in the context of the Vietnam War. Vietnam, which Britain successfully advised the United States to enter, provided a gigantic captive market with easy access from the Burmese-Thai-Laotian growing areas, some of which had already grown substantial quantities of opium during the British colonial period.

For whatever reason, American intelligence ignored field reports throughout the 1960s that indicated a gigantic step-up of Peking's narcotics trafficking. One of the most extraordinary of the stories that got lost in the intelligence bureaucracy involved an airfield in northern Laos, 75 miles south of the PRC border, built by PRC troops during the summer of 1964. According to American intelligence sources, the airfield appeared in Phong Sally province, between Luang Prabang, Thailand's religious capital, and the border of Red China's Yunnan province. Meo guerrillas operating in the area under American direction discovered the Chinese building the airstrip far into Laotian territory, and reported back in June 1964. However, the intelligence chain-of-command showed little interest in those reports. An enterprising mercenary pilot flying

a T-28 aircraft obtained clear-as-daylight reconnaissance photographs of the airfield, including shots of Chinese soldiers pushing wheelbarrows. The photographs were duly sent through channels, where they disappeared. American officers, however, believed that the airstrip was intended to link up with an asphalt highway the Chinese had been building from Yunnan province into northern Laos for some time. Initially, thinking among American intelligence officers centered on the possibility that the airstrip had been intended as a forward fighter base for PRC involvement in the Indochinese conflict. Only later, when no Chinese fighters appeared, did the truth emerge: the Chinese road and connected airstrip were built to ship opium out of Yunnan province.

American investigators, who have always viewed the drug traffic from the bottom levels upward, never "cracked" the controlling financial relationship that Hong Kong exercises over the traffic.

## The Ch'ao Chou connection

**The key to the Far Eastern drug traffic — the link that ties the entire operational picture together — is the Chinese expatriate connection.** As noted in Section 3, law enforcement investigators have known for years what the Ch'ao Chou Chinese networks were up to. But the law enforcement agencies never followed through the maze of financial connections: to do so would have violated standing American intelligence agreements with British intelligence.

Crucial clues to the inner operation of drug traffic — the joint operations of the Chinese Communist Intelligence Service (CCIS), British intelligence, and Chinese and British finance — have been gathering dust in police files for years. One such clue is the 1972 arrest of a Chinese Communist Party official in Djakarta, the Indonesian capital, in 1972. The Indonesian authorities arrested a Ch'ao Chou Chinese, complete with Chinese Communist Party card and other documentary evidence, in possession of 30 kilograms of heroin — worth between \$60 and \$150

million in terms of American street value, depending on the quality. The investigation, employing the combined efforts of Indonesian and American drug enforcement officials, showed that the purpose of the heroin imports was the financing of the Indonesian Communist Party (PKI) through the creation of a drug ring in Djakarta. (19)

An interview by a U.S. Labor Party investigator with a Malaysian intelligence source made in November 1978 is worth printing in full here for the insight it gives into this particular type of operation:

Source: It is definitely a fact that China distributes narcotics to its fraternal Communist parties in Southeast Asia as a means or raising funds for their activities. The most recent case is that of North Korea. Their diplomats have been kicked out of several European countries for smuggling and distributing heroin. Opium is not grown in North Korea. It is obviously given to them by the Chinese. In Singapore Communist agents were reported selling narcotics to American students at the American school for lunch money. Imagine, they were giving fixes out for 20 or 30 cents — just to get the kids hooked for their return to the U.S.

Question: Can you substantiate that?

Source: It's on the Singapore official record. There is more information at the local Kiwanis Club. They keep a file on narcotics. Also there was a DFA report written on how the PRC distributes narcotics through local party functionaries in the region. The report was never released but photostats exist.

Question: There is a lot of accumulated evidence that the Hongkong and Shanghai Bank is at the center of the entire Far Eastern narcotics trade.

Source: HongShang is the largest bank in the region and particularly in Singapore. China's biggest agent is Pang Hock-lim. He is instrumental in trafficking Chinese opium into India, Thailand, Singapore, and Malaysia.

Question: Has he been arrested?

Source: Sure. He's been arrested plenty of times but every time a fix is made and he is released.

Question: Who makes the fix?

Source: He's directly linked with the Hongkong and Shanghai Bank. That's a fact.

A handful of similar incidents are on record. At the same time, American policy busted a Filipino diplomat carrying seven pounds of pure Number Four white heroin in his country's diplomatic pouch. He had been followed from the Philippines to a New York City hotel room. His contact man, arrested with him, was a Ch'ao Chou Chinese.

One of the very few things that American intelligence knows about the CCIS is that the majority of its operatives are ethnic Ch'ao Chou. The Ch'ao Chou — as in the case of leading Bangkok banker Chen Sophonpanich — are also the leading element in the expatriate Chinese community involved in the drug traffic. (20)

Published Soviet material documents the spider's web of links between the Peking government and expatriate Chinese; the cited M. A. Andreyev's recent book, *Overseas Chinese Bourgeoisie — A Peking Tool in Southeast Asia*, is the most comprehensive Soviet source available. What the Soviets either do not know, or have not chosen to publish, is that joint Chinese expatriate-British financial operations in the world narcotics traffic hold the entire structure of Chinese foreign intelligence together.

The Chinese expatriate population's close ties to the Peking regime are well documented. According to a British author writing in 1965, two-thirds of the Chinese expatriates in Southeast Asia supported the Peking regime, and only one-third Taiwan. (21) American authors like A. Doak Barnett have drawn the same conclusion. (22) These impressive figures are the result of assiduous cultivation of such ties on the part of the Peking government.

Peking's insistence on the continuity of ties between the 12 million Chinese residing abroad and the Great Han motherland is a matter of public record, and achieved notoriety through such incidents as the recent border disputes with Vietnam.



Andreyev complains, "Under the 1954 Constitution the overseas Chinese have 30 representatives in the National People's Congress, the highest legislative organ in China. . . . In 1953, representatives of overseas Chinese supporting the people's democratic system and actively opposing the Chiang Kai-shek regime met in Peking, where they had a preliminary discussion on the procedure for nominating deputies to the National People's Congress from the Overseas Chinese. . . . An enlarged sitting of the Overseas Chinese Affairs Committee, held in Peking in July 1954, was attended by 195 representatives of Chinese living in different countries. This meeting delegated 30 representatives of the overseas Chinese to the National People's Congress." (23) At that time, the Chairman of the Overseas Chinese Affairs Committee declared that "no one can rupture the bonds linking overseas Chinese with their homeland. China is the motherland of all overseas Chinese." Peking policy, as stated publicly, has not changed through to the present.

Andreyev documents a complex, tightly knit web of Peking connections to the expatriate Chinese, including foreign investment, trade, and, perhaps most important, expatriate remittances to relatives in the PRC. Andreyev writes, "By agreement with the Bank of China, two British banks — the Hong Kong and Shanghai Banking Corporation and the Chartered Bank — with their large network of branches in Southeast Asia — handle the remittances of overseas Chinese to China." (24)

The system of remittances from Chinese residents abroad to families on the mainland, and the more recent system of joint investments between the Peking regime and Chinese expatriates, are not only a major source of foreign exchange for China; they are the financial infrastructure of Chinese secret intelligence. The network of financial ties between Peking and the expatriates overlaps the networks that control the wholesale drug trade in the Golden Triangle.

Several examples make this conclusion inevitable. One is the cited fact that the biggest dope financier in the region, Bangkok Bank chief Chin Sophonpanich, fled a fraud charge in Thailand and spent the next seven years in Peking; since his return, Sophonpanich has kept up close contact with Peking. But the

most compelling evidence is the structure of the remittances transfers which — as noted — channel through the Hongkong and Shanghai Bank.

The cited Soviet commentator argues that the standard estimates of the flow of remittances back to China, which run to a few tens of millions of dollars a year, are grossly inadequate. "Most of these evaluations," Andreyev wrote, "are based on at least three assumptions. The first is that all the foreign exchange and commodities are sent via Hong Kong. Actually, this is not true. In particular, this assumption ignores Macao, through which pass considerable quantities of overseas Chinese capital. Moreover, in Southeast Asia and Hong Kong there are a number of official PRC agencies that have the possibility of secretly sending large sums of money directly to Peking. Considerable possibilities are opened for this by China's commercial dealings with Southeast Asian countries, and Peking, evidently, uses these possibilities." (25)

Andreyev continued, "Lastly, along the poorly controlled Sino-Burmese border there, probably, are loopholes through which considerable material values can drain to the PRC, at least from the countries in the Indochinese Peninsula. This is borne out by the flow of gold to China across that border." (26)

That report — matching the earlier-cited *Isvestia* estimate that the PRC's opium earnings were \$500 to \$800 million — is entirely credible, when matched to related evidence. This is in the general range of what the PRC's "take" should be if our earlier chain of evidence holds up. The Burmese border area is the ultimate destination of much of the gold that passes through the HongShang's gold market in Hong Kong, through the myriad of small Chinese banks. (With the 13 PRC-owned banks in Hong Kong now operating in the gold market, the PRC will be able to take an additional cut, in the form of trading commissions on gold that it will ultimately receive as payment for opium.)

Red China not only receives gold across the Yunnan province border in the Golden Triangle in return for opium going out, but indirectly intervenes among the competing opium warlord factions in Burma itself. During the early 1970s, the PRC armed the so-called White Flag Communist Party under the command

of Ping Chia-hsiang, supporting Ping's move to take over prime opium-growing areas in the neighborhood of the Suloween River. (27)

China is one primary factor in the opium growing regions; Britain is the other. Most of the Burmese opium-growing regions are subject to genial competition between the Maoist-controlled White Flag Communist Party and other armed gangs, and Self-Defense Forces under the control of British-trained and still British-influenced Burmese security forces. Anglo-Chinese cooperation on the Burmese border is one of the biggest scandals in the area.

## Forging the Hong Kong-Peking link

Until the Sino-Soviet split period, the ties that bound the expatriate Chinese to the mainland were the strongest of all: family. This link was expressed in the large-scale transmission of remittances back to families on the mainland. According to the limited available data, the largest volume of such remittances, for which special remittance transfer agencies had been created, was to the small city of Swatow on the northern Chinese coast; Swatow is the home city of the Ch'ao Chou Chinese. The Ch'ao Chou, seafaring and commercial people with a special dialect, evidently maintained the closest family links with the mainland. That is the background to the wholesale recruitment of expatriate Ch'ao Chou Chinese into Chinese secret intelligence during the postwar period. (28)

In the late 1950s, the volume of reported remittances dropped off sharply. Instead of paying remittances directly to relatives, expatriate Chinese invested heavily in both mainland China and in foreign joint ventures with the Peking government. The flow of remittances back home received dividends from these investments.

The volume of remittances is given in the following table:

1950	39.0	1958	15.6
1951	29.1	1959	9.1
1952	19.2	1960	8.6
1953	29.2	1961	8.4
1954	30.2	1962	8.4
1955	30.1	1963	8.4
1956	30.2	1964	8.4
1957	27.4		

(Based on published data for Thailand, Malaysia, and Singapore, projected to include the rest of Southeast Asia.)

(Source: Andreyev, *Overseas Chinese Bourgeoisie: A Peking Tool in Southeast Asia.*)

The point of decline of remittances (that is, legal remittances, as reported above) coincides with Peking's orientation to joint investments with expatriate Chinese. That policy goes back to 1951, when the South China Enterprise Company, the forerunner of the present Overseas Chinese Investment Corporation, sold 100,000 shares to Chinese businessmen in Hong Kong and Macao. However, until 1957, the attractions for such investors were limited; overseas Chinese investment could only find opportunities in agriculture, the least profitable sector of the economy.

But in 1957 new regulations came into effect that not only guaranteed a 12 percent dividend investment, against a normal 8 percent dividend in ordinary mixed companies. The Peking government also made provision for repatriation of part of the profits to the overseas Chinese investor.

By the mid-1950s, this capital was concentrated in the Overseas Chinese Industrial Construction Company and related companies, which merged into the Overseas Chinese Investment Corporation (OCIC) in 1955, with initial capitalization of \$50 million. The board of directors of the OCIC included leading Chinese businessmen resident in Southeast Asia. By 1966, there were 140 businesses under the OCIC aegis operating in China. (29)

By the mid-1960s, however, the policy of using the hard currency of expatriate Chinese to invest in China gave way to a much more efficient form of raising vitally needed foreign exchange. Peking took a stake in the expatriate Chinese community's expanding operations in drug-pushing and dirty money

operations, centering on the boomtown in Hong Kong. The result is the flagrant cohabitation between London and Peking noted in Section 4. (30)

#### THE \$2.5 BILLION TAKE

Despite the overwhelming weight of evidence showing Peking's integration into the Southeast Asian drug trade, there is no way to "prove" that the \$1.3 billion financial reflow into the PRC during 1977 estimated by Chase Manhattan and the projected \$2.5 billion flow during 1978 represent the revenues of the traffic. However, it can be demonstrated to the satisfaction of the reader that this estimate is entirely consistent with all the previous data.

By two independent types of estimate, our earlier data (Section 3) showed that the cash flow of the Far East drug trade broke down as follows:

Primary wholesaling of opium and heroin (Golden Triangle plus secondary PRC production)	\$1 billion
Secondary wholesaling of opiates to West (20 percent cash reflow of \$25 billion world opium/heroin market to Far East)	\$5 billion
Retail opiates consumption in Far East	\$3-4 billion

Assuming that the PRC's primary wholesaling profits are \$500 million, or half of the total — the lower range of apparently accurate Soviet estimates — then the PRC's secondary wholesaling profits would be in the ratio of 5 to 1 with respect to the first figure, or **\$2.5 billion**. That is the Chase Manhattan figure reported above. Since the PRC is undertaking major official investments in Hong Kong this year, it is fair to assume that it would repatriate illegal profits to be re-invested in legal enterprises to a greater extent than during 1977, when the reflow back to Peking was only \$1.3 billion.

Of course, the above calculations are hypothetical, but they do indicate that the \$2.5 billion net revenue suggested by the Chase Manhattan figure is well within the range of accuracy.

The same type of range can be obtained through an entirely different chain of reasoning. The Soviet economist Andreyev, using published sources of area governments, calculated that total expatriate Chinese capital flow into China amounted to \$1.66 billion in the years 1950-64 inclusive. Up through this period, the primary financial relationship between the PRC and expatriate Chinese was in the form of foreign investment inside China, through such vehicles as the Overseas Chinese Investment Corporation, as noted above. It is documented that after 1964, PRC policy shifted into a high-gear "Opium War in Reverse" posture, to use the phrase of British author Richard Deacon. At this time, Chou En-lai made his infamous confession to Nasser.

As noted, the financial relationship shifted into joint ventures in Southeast Asia between PRC-owned institutions and expatriate Chinese, with a heavy concentration in narcotics traffic and related activities.

Assume that the identical rate of expatriate Chinese financial support continued during the years 1965-78 in this form of investment, augmented only by a 10 percent inflation factor, highly conservative for the area. The aggregate investment during 1965-78 would amount to \$6.3 billion, in joint operations with the PRC. Assume a 40 percent annual profit margin on this investment, much lower than profits on the drug trade, but in the middle of the range of the 30-50 percent figure given above for smugglers' profits in the area. The annual income from this investment would be precisely **\$2.5 billion**.

The big move into Hong Kong transformed Red China from a mere producer of opium, into Britain's international partner in the distribution, and later the financing, of the opium trade in the Far East — if not elsewhere. (The Ch'ao Chou Chinese arrested in a New York hotel room with a Philippine diplomat and seven pounds of heroin carried the business card of the local New York Ch'ao Chou fraternal association.)

America's disastrous involvement in Vietnam gave the Mao regime the opportunity to make it big in the world of narcotics, and Peking jumped in — and into Hong Kong — with both feet. America paid the price of a skyrocketing rate of narcotics addiction. Nonetheless, the late 1960s were only a period of transition,

the fulfillment of a strategic design sketched out between Mao Tse-tung and the British old-line opium families in the early 1940s. That agreement, which united the highest level of British intelligence and finance with the Peking leadership, we turn to in the next section.

## 7

## How the Royal Institute of International Affairs Runs Drugs and Dirty Money

Now we will take the reader up through the chain of command of the world drug and dirty money business, to the top level of political control: to Chatham House, St. James Square, London, the headquarters of the Royal Institute of International Affairs. We have inspected the books of Drugs, Incorporated, met the operating personnel, visited its subsidiaries in Hong Kong, Bangkok, and Peking, as well as its farms and factories in the Golden Triangle, on the common border of Burma, Laos, Thailand, and the People's Republic of China. The Far East drug traffic emerges as a single business operation, a British-Chinese joint venture, in which Britain is the senior partner.

It is obvious, by now, that an operation of this scope could not exist without the political approval of the British government, nor without the gigantic supporting facilities of the world's offshore credit markets, the world's gold and diamonds trade, and "hands-on" management of the retail distribution, or organized crime aspects of the operation.

The next step is an introduction to the Board of Directors of Drugs, Incorporated, and an overview of their multifarious ties

to the Far East opium growing and wholesaling operation, the offshore dirty money operations, gold and diamonds mining and distribution, the Canadian connection, the Zionist Lobby dirty money installations, and the top levels of British policy-making.

The Hongkong and Shanghai Bank is not an independent malefactor, but a special operation of the British oligarchy's top banks, specializing in the Far Eastern drug traffic. The Hongkong and Shanghai Bank's governing body, the **London Committee**, is the British oligarchy's delegated group assigned to the Far East drug traffic.

More specifically, it is an economic warfare operation. Two of its directors, J.H. Keswick — of the family that founded Jardine Matheson in 1828 to trade opium — and J.K. Swire — of the Swire family of hereditary opium traders — were senior officials in Britain's Ministry of Economic War during World War II. Another senior official of that Ministry is Sir Mark Turner, the chairman of Rio Tinto Zinc, the HongShang's partner in numerous fields, including gold operations. Turner is now a key figure in the Royal Institute of International Affairs, founded by Lord Milner, an earlier chairman of Rio Tinto Zinc.

What we will show here is that the Royal Institute of International Affairs (RIIA) and its leading personnel control not only the Far Eastern drug traffic but every important dirty money operation on the surface of the globe.

The next section will further document the British monarchy's control of the Canadian banks and corporations, the same installations responsible for channeling drugs into and illegal funds out of the United States. It demonstrates that the direct agency of control over Canada's huge financial warfare apparatus is the Canadian Institute of International Affairs (CIIA), a mock-up of Britain's RIIA, created by the RIIA in the first place. Included in the Canadian operation are the Bank of Nova Scotia's domination of Canada's gold market, Canadian banks' huge role in Caribbean Silver Triangle dirty money operations, and — most important — the direct links between the hard-core Far East drug wholesalers, and the Canadian institutions that have participated in the wholesale drug traffic on the North American continent since the closing days of Prohibition. Through the

Canadian outpost of the British monarchy, the drug traders close the circle between the Keswick family of Hong Kong, the founders of Jardine Matheson in 1828, and the Bronfman family, the immediate sponsors of the top levels of so-called organized crime in the United States.

From their base in the \$200 billion dirty money traffic, the institutions assembled in force on the leading committees of the RIIA dominate:

- 1) All of Britain's top commercial banks *directly*;
- 2) Both big British oil companies, British Petroleum and Royal Dutch Shell *directly*;
- 3) All the leading British merchant banks, *directly* or *indirectly*;
- 4) The world gold and diamonds trade;
- 5) Every leading old-line opium trading firm, including the P&O Steamship Company, Jardine Matheson, John Swire and Sons, and Charterhouse Japhet, *directly*.

#### GOAL: REBUILD THE EMPIRE

Now that the command structure of the worldwide operation is evident, we are going to examine the content of the Royal Institute of International Affairs' subversive activities, following through the careers of some of its leading operatives — including Sir John Henry Keswick, member of the family which controls the Hongkong and Shanghai Bank, and from the old Jardine Matheson opium trading firm; and the current chairman of the Council of the RIIA, Lord Humphrey Trevelyan, member of the board of directors of HongShang's gold-smuggling subsidiary, the British Bank of the Middle East. These are the men who created the Peking Connection in its modern form.

According to the Charter of the RIIA published in 1920, the Royal Institute of International Affairs is "an unofficial and non-political body," whose object is "to advance the sciences of international politics, economics, and jurisprudence," to "provide and maintain means of information upon international questions," and "to promote the study and investigation of such questions." Few times in the history of the written word have so many lies appeared in so few lines.

However, a concise summary of the RIIA's purposes appears in its *de facto* founding document, Cecil Rhodes's 1877 bequest. Rhodes, who founded both the gold and diamond mining empire that still dominates world markets under the aegis of Anglo-American and De Beers, and also founded the dope-trading Standard Bank (the African partner of the Asian-based Charter-Bank, since merged), is the starting point for the present form of the disease. Rhodes left his wealth to the Rhodes Trust, administered by Lord Milner. Milner's collection of Oxford trainees, called the "Milner Kindergarten," made up most of the 1916 Lloyd George government, and formed the RIIA at a meeting in Versailles on May 30, 1919.

Rhodes's 1877 will was:

To establish a trust, to and for the establishment and promotion and development of a secret society, the true aim and object whereof shall be the extension of British rule throughout the world, the perfecting of a system of emigration from the United Kingdom and the colonization by British subjects of all lands wherein the means of livelihood are attainable by energy, labor, and enterprise, and especially the occupation by British settlers of the entire continent of Africa, the Holy Land, the valley of the Euphrates, the islands of Cyprus and Candia, the whole of South America, the islands of the Pacific not heretofore possessed by Great Britain, the whole of the Malay Archipelago, the seaboard of China and Japan, the ultimate recovery of the United States of America as an integral part of the British Empire, the consolidation of the whole Empire, the inauguration of a system of colonial representation in the Imperial Parliament which may tend to weld together the disjointed members of the Empire, and finally, the foundation of so great a power as to hereafter render wars impossible and promote the best interests of humanity. (1) (emphasis added)

The secret society concept was passed on by Milner, Rhodes's successor as High Commissioner in South Africa, through

Milner's trainees Lionel Curtis (of the Round Table Group), and Lord Robert Cecil — whose family dates back to the Genoese Amsterdam coup against Elizabethan humanism in 1601. Curtis and Cecil both participated in the May 1919 meeting at Versailles which founded the RIIA.

**The Royal Institute for International Affairs is the secret society.**

## 1949: The British-Peking deal

Let us backtrack, for a moment, to the point of origin of the London-Peking joint drug-running venture in the Far East, the wartime deal between the RIIA and Chou En-lai. Detailed records of the relevant years have recently been made available. In August 1978, the U.S. State Department released 1,300 pages of documents to the public dealing with American diplomacy in China at the time of the Maoist takeover. (2) From the British side, the RIIA in 1977 released its own records of its wartime and postwar operations group in the region, the Far East Committee — the real British Foreign Office. (3)

Both sets of documents yield the same interpretation: **the creation of the People's Republic of China included an alliance between the British dope-runners and the Chinese dope-runners.** This was negotiated from the British side by Sir John Henry Kewick and from the Chinese side by Chou En-lai. The Chinese team also prominently included top figures in the opium trade, such as the Bank of China's Chi Ch'ao-ting, Shanghai Commercial Bank's K.P. Chen (who also headed the Chinese wing of the Institute for Pacific Relations), and elements of the so-called Green Gangs. The Green Gangs, which could be called the Chinese mafia, ran the opium trade not only in the Far East but through the far-flung networks of the Chinese expatriate community.

From both the British and the Chinese side, the alliance was explicitly against the United States. The Chinese knew it, and said so, the British knew it, and said so, and American diplomats cabled home that the United States had been shafted. (4)

When the top representatives of Britain's RIIA began soundings in the Chinese Communist stronghold of Yen'an and at Chou En-lai's Chungking legation during the World War II period, they had reasons dating back a century to expect results. China lost the opium wars because such a large section of officialdom had been corrupted through opium dependency.

But the credit for the re-creation of the alliance between Britain and the modern equivalent of the Triad gangs must go to Sir John Henry Keswick, the RIIA's man-on-the-spot at the British Embassy in Chungking during the crucial period of World War II. It is known that Keswick was in regular contact with Chou En-lai in his capacity as a prominent businessman and through his attachment to the British embassy in Chungking. Chou was in Chungking from 1937 through the 1940s. (5)

Keswick, of the hereditary drug-trading family that founded and still controls Jardine Matheson, also represented the RIIA and its sub-branch, the Institute for Pacific Relations, to the United States. (6) Sir John Henry is still Britain's number one man for China policy, Chairman of Britain's China Association, Vice-President of the Sino-British Trade Council, and a member of the Great Britain-China Committee. (His predecessor at the China Association from 1951-55 was John Kidston Swire, of the old opium-trading Swire family, who still sits on the London Committee of the HongShang.)

Two pieces of eyewitness testimony from Mao Tse-tung's wartime hideout in China's northern Yen'an province bear comparison. The first is the report by Peter Vladimirov, the Soviet liaison to Mao's headquarters in Yen'an during 1941-45. According to the Soviet-published *Vladimirov Diaries*, the Chinese Communist Party operating in Yen'an grew opium for profit, not only for medicinal uses. Opium had been a major cash crop for Yen'an before Mao's arrival; Vladimirov claimed that Mao continued the practice. The Soviet representative also suspected the CPC's chairman's close contact with American visitors connected to the Institute for Pacific Relations. (7)

A second account appeared in the January 1978 issue of *International Affairs*, the journal of the RIIA:

Victor Farmer, who was a director of Imperial Chemical Industries (China) and who in 1944 had recently returned from a visit to the Far East (stated): "I have met some (Chinese) Communists and their ideas are very open-minded. If you could get rid of this ultra-nationalist clique in the saddle at present in Chungking, and many Government officials are extremely broad-minded, I think that the way would be open for a compromise with the Communists; and an effective compromise." (8)

The view Farmer expressed on behalf of the RIIA's Far Eastern Committee had already surfaced in the United States through the committee's American branch, the Institute for Pacific Relations (IPR), the institution that produced the pro-Maoist group in the U.S. State Department centered around John Stuart Service and John Carter Vincent. Although the IPR included American citizens and was funded through the Rockefeller and Carnegie Foundations, it functioned exclusively as a branch of the RIIA and British policy-making. The IPR's two most prominent general secretaries, Edward Carter and William Holland, had extensive British pedigrees. Carter, whose reign as IPR chief lasted until 1946, was a leader of the international YMCA, while his successor Holland was a citizen of New Zealand until 1943 and a member of London's Royal Institute.

The dead giveaway on the IPR's British character is the organization's move to Canada subsequent to the 1950 McCarran Committee investigation, which mistook pro-British treason for pro-Communist treason. With hearty British cheers, the disgraced Institute for Pacific Relations moved to Canada.

Britain's support for the IPR was further expressed by the chairman of the RIIA's Far Eastern Group, Sir Andrew McFadyean (who in 1947 became the chairman of S.G. Warburg's, the merchant bank). In a 1952 letter he wrote: "The fact that I have criticized certain activities and certain officers of the IPR entitles me to say with greater emphasis, firstly that it would have been a useless body if it had not represented a wide

variety of political views, and secondly that throughout my acquaintance with the Institute its governing body, while respecting the rights of free expression, has never encouraged or countenanced subversive views." (9)

Once in Canada, the IPR came under the official sponsorship of the Canadian Institute of International Affairs, the local RIIA subsidiary, and its chairman — now "honorary Chairman for Life" — Walter Lockhart Gordon. During the last 30 years, Gordon has been the most consistent North American apologist for Maoist China. Gordon currently has direct personal ties to Canada's "old China hands," including Dr. Paul Lin, Chester Ronning, and James Endicott. All three served as advisors to Chinese Premier Chou En-lai; Paul Lin's official duties as an aide to Chou terminated only in 1965. Lin, in turn, is a power in the expatriate Chinese community in Vancouver, the most important transshipment point for opium entering the United States.

The ties run back the other way across the Pacific as well. Gordon sponsored the initial founding of the Chinese People's Institute of Foreign Affairs in China, an official Red Chinese organization that currently maintains links with the Canadian Institute of International Affairs. Chester Ronning has been the Chancellor of the University of York in Canada; Walter Lockhart Gordon arranged funding for the Norman Bethune School at that university under Ronning's supervision, the most overtly pro-Maoist institution on the North American continent. That is the pedigree of the British-created, British-defended, and still British-run Institute for Pacific Relations. (10)

#### SQUEEZE PLAY

According to the RIIA's official account cited above, the RIIA-IPR's function at the close of World War II was to propose the John Service-John Keswick policy of fostering Maoism as the "alternative" to Britain's shrill insistence on her colonial rights in the area. Prime Minister Churchill still balked at the self-determination provisions of the Atlantic Charter, namely that Britain give up its Southeast Asian colonies. Anti-British feeling ran so high in the United States, the *International Affairs* study points out, that Henry Luce's *Life* magazine

urged the British people "to stop fighting for the British Empire and fight for victory . . . if you cling to the Empire at the expense of a United Nations victory you will lose the war because you will lose us." A poll taken in 1942 revealed that 56 percent of Americans questioned agreed that the British could rightly be described as "oppressors . . . because of the unfair advantage . . . they have taken of their colonial possessions."

The RIIA and the IPR's "alternative" posture was a retreat under fire from an imperial position in the Far East to an alliance with the Great Han chauvinists of the Communist Party of China. Any suggestion that an actual policy difference intervened between the "hidebound reactionary" Winston Churchill and the openly pro-Maoist Victor Farmer of the RIIA's Far Eastern Group, is made silly by the role of Jardine Matheson's John Henry Keswick.

Keswick was a prominent figure in the Shanghai International Settlements, of which his brother, Sir William Johnston Keswick, was chairman throughout the 1930s and until 1949. Britain had owned a chunk of the city of Shanghai by the treaty that ended the Second Opium War. The status of the Shanghai International Settlement was one of the major policy conflicts between Roosevelt and Churchill, since it represented a foreign colonial intrusion in an allied nation. Britain's concern for Shanghai may also have been motivated by the fact that it was the world's center for refining opium into heroin. Keswick and the refineries both picked up and moved to Hong Kong in 1949.

In January 1945, pro-Maoist Victor Farmer and John Henry Keswick (with Andrew McFadyean) together led Britain's delegation to the Institute for Pacific Relations's most important conference at Hot Springs, W. Va. Ten British officials went along in tow with the RIIA officials. The British delegation presented a softer front to the Americans than the Churchill government was then willing to officially concede. RIIA documents show that the queer combination of Chinese Communist Party apologist Victor Farmer and old-line opium trader John Keswick did the trick of mollifying the Americans.

"The general atmosphere here (at Hot Springs — ed.) is very much better than (at the last Institute for Pacific Relations con-



ference at) Mont Tremblant. . . . There is much less disposition to twist British tails just for the fun of seeing how the animal reacts," McFadyean wrote back to the RIIA in relief. (11) American delegates included Treasury official Harry Dexter White, responsible for selling to the United States John Maynard Keynes's British blueprint for the International Monetary Fund.

Not until Mao's army marched into Shanghai in 1949 did the Americans realize what they were in for. The new mayor of Shanghai, Chen Yi, summoned John Keswick for secret talks, the State Department documents reveal, virtually as soon as the mayor arrived in the city. After a lengthy round of talks, Keswick departed and called on the American consul-general. The stunned diplomat later telexed back to Washington that Keswick "made a statement that he did not expect Americans to fare well under the Communist regime, but did not indicate whether this opinion was formed as a result of the conversation with the mayor." Keswick was either threatening the United States or relaying what the Chinese had told him, the consul-general wrote. "He would hardly have invented this as a bluff to frighten away American competitors," the American concluded optimistically. (12)

How ingenuous that evaluation was became clear within days. Behind the backs of the Americans, the British negotiated a deal to keep Hong Kong under London's control, and opened up confidential lines of communications between the mainland and Hong Kong. In wires to Washington, American diplomats accused the British of tearing up the standing Anglo-American agreement that all decisions respecting the Communist government would be made in close consultations. "The Communists are obviously trying to play off the British against us and seem to have succeeded somewhat," one American official wrote. (13)

The British added insult to injury by maintaining an official pro-Maoist propaganda campaign, which began far before the Communists took over. British officials gave awards to leading members of the CCP, even while maintaining "official" diplomatic relations with Chiang Kai-shek, and gave lavish public receptions for dissident elements of the Kuomintang, such as the widow of Sun Yat-sen, the Chinese nationalist leader who

died in 1925. (Sun's wife is currently an official of the PRC government.) Shortly before the Communist takeover, one journalist wrote: "The British have a reputation for very smart diplomacy in Asia. Part of this comes from their ability to spot key groups and get on the right side of them. It is generally believed by observers that the British now figure the intellectual left wing to be one of the groups that will gain rather than lose strength in the political changes of the next few years, and are preparing for this eventuality." (14)

American intelligence dispatches from 1947 reprinted in the State Department release wrote: "It is significant to note that shortly after the Communist takeover of the key city of Shanghai, the Maoists halted all anti-British propaganda." (15)

## Creation of the Hong Kong drug nexus

Under the public cover of Anglo-Chinese mutual seduction, and before the horrified eyes of American observers, the British and Maoists created the financial infrastructure of what would later underwrite the Far East narcotics traffic. Keswick's opening of channels between Peking and Hong Kong permitted a division of the Shanghai banking families between mainland China and Hong Kong; this 1947 division founded the expatriate Chinese connection between Peking and London. (Apparently, other expatriate networks, like the Thai bankers who date back to the 1930s, were consolidated in the same fashion, although the same degree of documentation from the period is not yet available.)

The Senate investigation of the Institute for Pacific Relations revealed indirectly the role of the Royal Institute of International Affairs in the creation of the drug-financing networks. The McCarran Committee made public some of the correspondence of IPR General Secretary William Holland. Holland, before his ascendance as IPR chief in 1946, took over the China stations of the American Office of War Information, an organization closely tied to the wartime predecessor of the Central Intelligence Agency, the Office of Strategic Services. Holland was in frequent

touch with the head of the RIIA in London, which as noted above, had created Holland's IPR in the first place.

In one of the letters available from the 1950-51 McCarran proceedings, Holland informed the RIIA that a top Chinese Communist banking official "may turn out to be one of the best friends we have." (16) The official in question, Chi Ch'ao-ting, was a top officer in the Nationalist Bank of China, until the Maoist victory. At that moment, he shifted allegiance to the PRC Bank of China. Moreover, Chi's defection was preceded by that of a whole faction within the Nationalist Bank, which chose to "make a deal" with the Communists rather than flee to Taiwan. This faction, according to the 1949 State Department papers, made arrangements to communicate with Chinese IPR leader and Shanghai banker K.P. Chen, who had left Shanghai for Hong Kong, even after the Communist takeover. (17)

It should be added that, as a matter of public record, most of the Nationalist Bank of China's cash flow during the period of Chi's service came from the opium traffic, which the Chiang Kai-shek government continued throughout the war years. Chi's shift of allegiance was merely the poppy stem's bending with the wind of change.

Chi's defection to Mao's Bank of China began an illustrious career, during which he rose to a high position in the bank and participated in international conferences for the PRC as well. As noted, the Bank of China's financial connections to the West are through Hong Kong, its reserves were and still are held with the Hongkong and Shanghai Bank and the Standard and Chartered Bank, its remittances payments conducted through the same banks, and so forth. Chi's move — under the approving eyes of Holland — only typified what went on in the Shanghai banking community at large. In the same dispatch to the RIIA cited above, Holland reported on his contacts with leading Shanghai bankers, citing the case of Chinese Shanghai Commercial Bank chief K.P. Chen. Chen fled to Hong Kong shortly before the Communists took over, Holland reported, adding, "Impossible as it now seems, I have an idea Chen will later go to Shanghai." (18)

An entire section of the Shanghai bankers resisted pressure by the departing Nationalist forces to transplant their operations to

Taiwan. As in the case cited by Holland, they preferred to hedge their bets between the British and the People's Republic of China. At the lower levels of the narcotics traffic, the notorious Green Gangs, the footsoldiers of the traffic, broke en masse with the Kuomintang forces, and moved into the Communist camp. Neatly and speedily, the entire postwar opium apparatus had been redeployed between Shanghai and Hong Kong.

One of Holland's close associates during the period was the Canadian representative in Chungking, Chester Ronning — still prominent in the Canadian connection to the London-Peking drug apparatus. Utterly enamored of the Maoists, Ronning met almost weekly with Chou En-lai's chief deputy, Wang Ping-nan, during his 1945-47 tour of duty. (19)

Ronning's relationship with Wang Ping-nan has a special importance, which we will indicate momentarily. Ronning went on to act as midwife in the Institute for Pacific Relations's 1950 rebirth in Canada after the scandal.

Both the State Department and the RIIA releases make fools of those Americans who thought that the Institute for Pacific Relations had "betrayed" American ally Chiang Kai-shek to the red menace. The Kuomintang, a gang that couldn't shoot straight, was merely losing the battle for Far Eastern opium. (There has been substantial documentation, not immediately relevant to the present chain of evidence, that remnants of the Kuomintang army in Burma continued to grow opium for a quarter-century after the Communist victory, and that some of their friends in the China Lobby, e.g. AirAmerica, transported it for them.) In fact, the United States was sold down the Pearl River by our British "allies," in combination with the snickering Chinese. America's youth paid the terrible price of this deception.

At the outset of the Korean War, the public amity between Great Britain and China was reduced — for purposes of public consumption. However, the leading individuals who created the Peking Connection continued to hold all the important strings, and maintained the full continuity of the narcotics traffic. Despite the public hostilities, the PRC operated freely on Hong Kong's illicit gold exchanges, and present-day luminaries like

Stanley Ho (see Section 5) made their fortunes smuggling strategic goods into China from Hong Kong.

#### THE EMERGENCE OF THE "CHINA CARD"

In 1951, Lord Humphrey Trevelyan took his post as British Ambassador to China, the same man who today sits on the board of the British Bank of the Middle East. Public contacts between Lord Trevelyan and the Peking regime were necessarily low-key, by the dictates of what even the British and Chinese consider public decency. To cover their tracks the British claim that Trevelyan did not meet Premier Chou En-lai during the first two years of his stay in Peking, although they do admit that Trevelyan's fellow diplomat John Henry Keswick had had regular access to Chou during the early 1940s in Chungking.

However, Trevelyan's stay in Peking was not without great importance. Trevelyan set up the beginnings of the so-called American opening to China, laying the basis for the "China Card." His partner in this maneuver was Chester Ronning's old Maoist contact, Wang Ping-nan. By this time, Chou En-lai's old deputy of the Chungking days was the PRC's Ambassador to Poland. Trevelyan set up the first American diplomatic contacts with the People's Republic of China — through China's Embassy in Poland — during the mid-1950s. America's contact man with the Peking government was Ambassador Wang Ping-nan.

Trevelyan's further career is remarkable. After a brief stay in West Germany, he went on to become Britain's Ambassador to Egypt during the Suez Crisis — the British-French-Israeli invasion of Egypt that wrecked President Eisenhower's world development plan, the Atoms for Peace program. After a tour at the British Foreign Office, he was Britain's Ambassador to the Soviet Union during 1962-65, during the British-inspired Cuban missile crisis. Currently, he sits on the board of directors of British Petroleum, along with John Keswick's brother Sir William Johnston Keswick, and various other members of the boards of the HongShang and the RIIA council.

Lord Trevelyan completed the circle by taking the chairmanship of the Council of the RIIA, while keeping an active hand

in the opium business, through the British Bank of the Middle East.

Direct experience in the drug trade is apparently a standard qualification for chairmen of the Council of the RIIA. When Trevelyan, Keswick, Holland, and Ronning were young men setting up the Peking Connection during World War II, the chairman of the RIIA Council was Waldorf Astor. Astor's great-grandfather, John Jacob Astor, was a British agent-of-influence in the first years of the American republic; according to his biographer, J. J. Astor was the first American to get in on the drug trade alongside the British East India Company, starting in 1816.

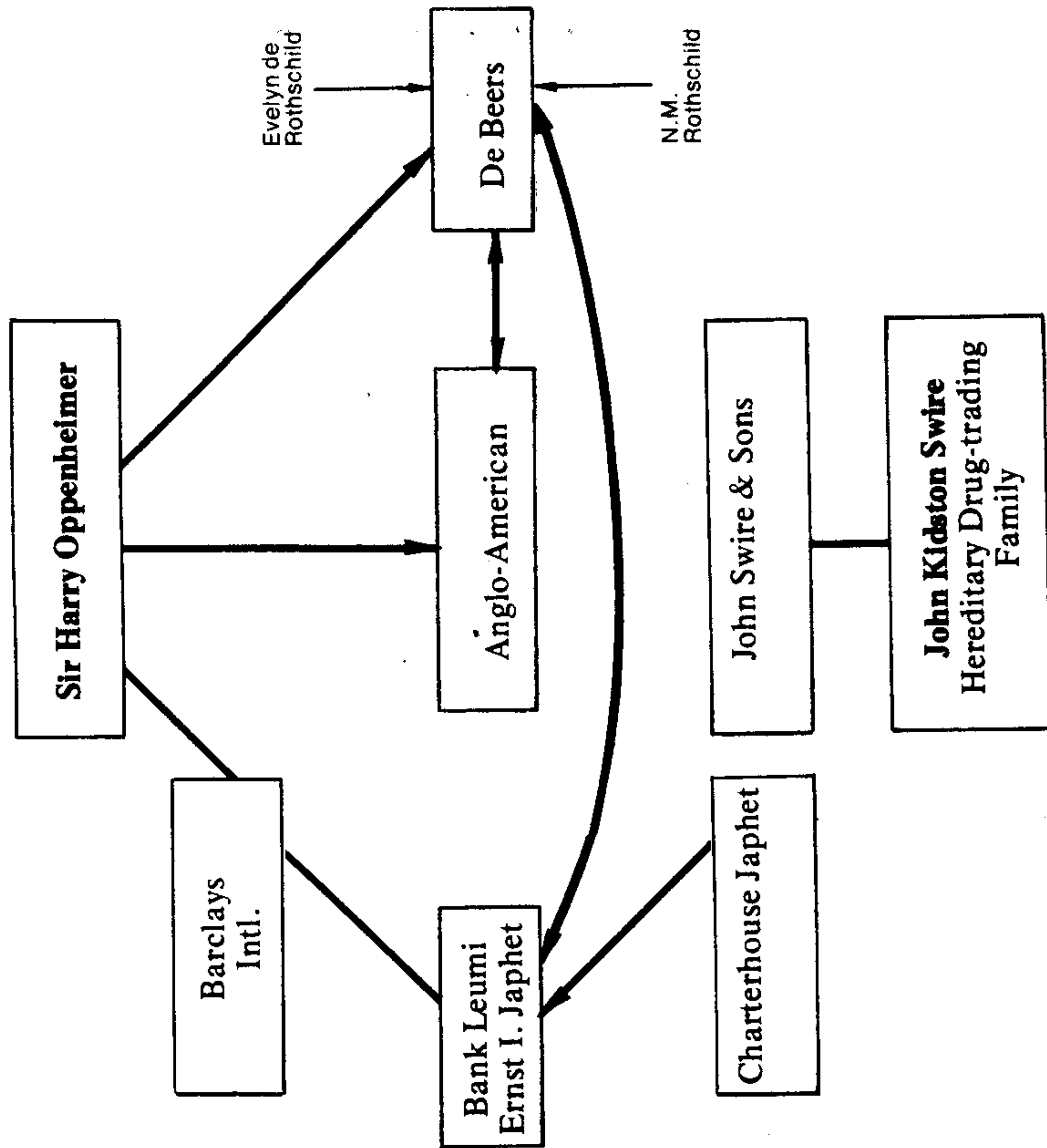
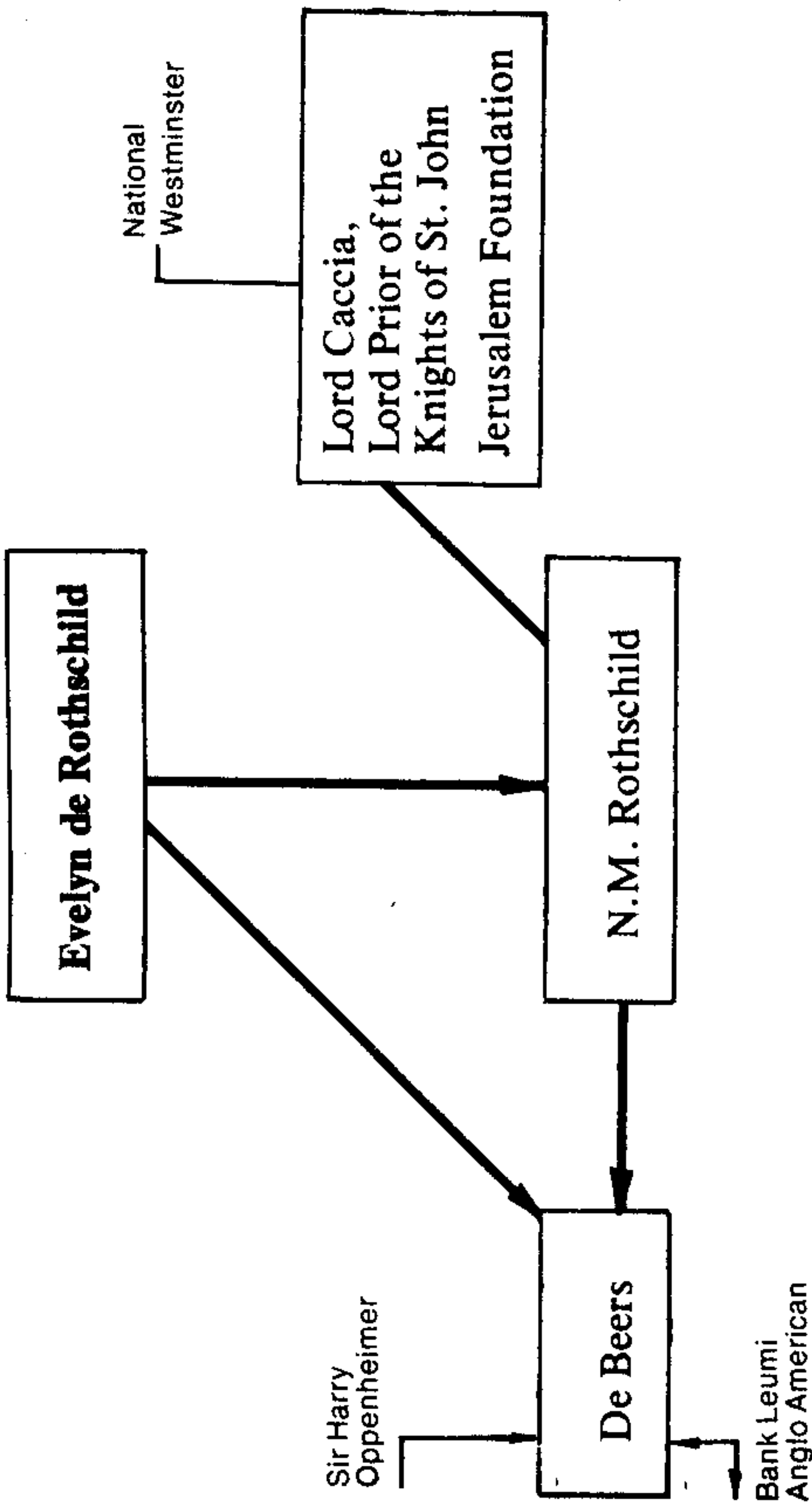

Figure 6  
London's Royal Institute for International Affairs—  
Drugs and Dirty Money

The RIIA is not composed of the most influential people in Great Britain — the inner circle of the British monarchy and the orders of nobility — but rather brings together the chief operating officers of the British monarchy's policies in various fields. Its leading members include the following:

**Lord Humphrey Trevelyan:** Son of the British historian George Trevelyan; Chairman of the Council of the RIIA; Chairman of the Trustees of the British Museum; Chairman of the Committee for the Tutankhamen Exhibit; Economic and Financial Advisor, United Kingdom High Commission for West Germany, 1951-53; Ambassador to Egypt, 1955-56; Undersecretary at the United Nations, 1958; Ambassador to Iraq, 1958-61; Deputy Undersecretary of State of the Foreign Office, 1962; Ambassador to the Soviet Union, 1962-65; High Commissioner in South Arabia, 1967. Director: British Petroleum Co., 1968-75; British Bank of the Middle East (100 percent owned by Hongkong and Shanghai Bank); General Electric Company Ltd., 1965-75; President, Council of Foreign Bondholders.

**Sir (Roland) Mark (Cunliffe) Turner:** Council RIIA, 1949-50; Chairman Rio

Tinto Zinc; Deputy Chairman of the merchant bank Kleinwort Benson Ltd.; Chairman, Bank of America International Ltd. (London), 1971-; Director, National Cash Register; Toronto Dominion Bank; Midland and International Banks Ltd.; formerly with Samuel Montagu and Co.; Ministry of Economic Warfare, 1939-44; Undersecretary, Control Office for Germany and Austria, 1945-57.

**Sir Frank Roberts:** Member of RIIA Council; Advisory Director Unilever; Advisor on International Affairs to Lloyds; British Embassy in Paris, 1932-35; Cairo, 1935-37; Chargé d'Affaires to Czech Government, 1943; Deputy High Commissioner to India, 1949-51; Ambassador to Yugoslavia, 1954-57; Representative to North Atlantic Council, 1957-60; Ambassador to the Soviet Union, 1960-62 (preceding RIIA Chairman Lord Humphrey Trevelyan); Ambassador to West Germany, 1963-68; Vice-President, German Chamber of Commerce in the United Kingdom, 1974.

**Sir Richard Powell:** Member of RIIA Council; Deputy Chairman, Permanent Committee on Invisible Exports, 1968-; Deputy Secretary Ministry of Defense, 1950-56; Permanent Secretary, Board of Trade, 1960-68; President, Institute for Fiscal Studies.

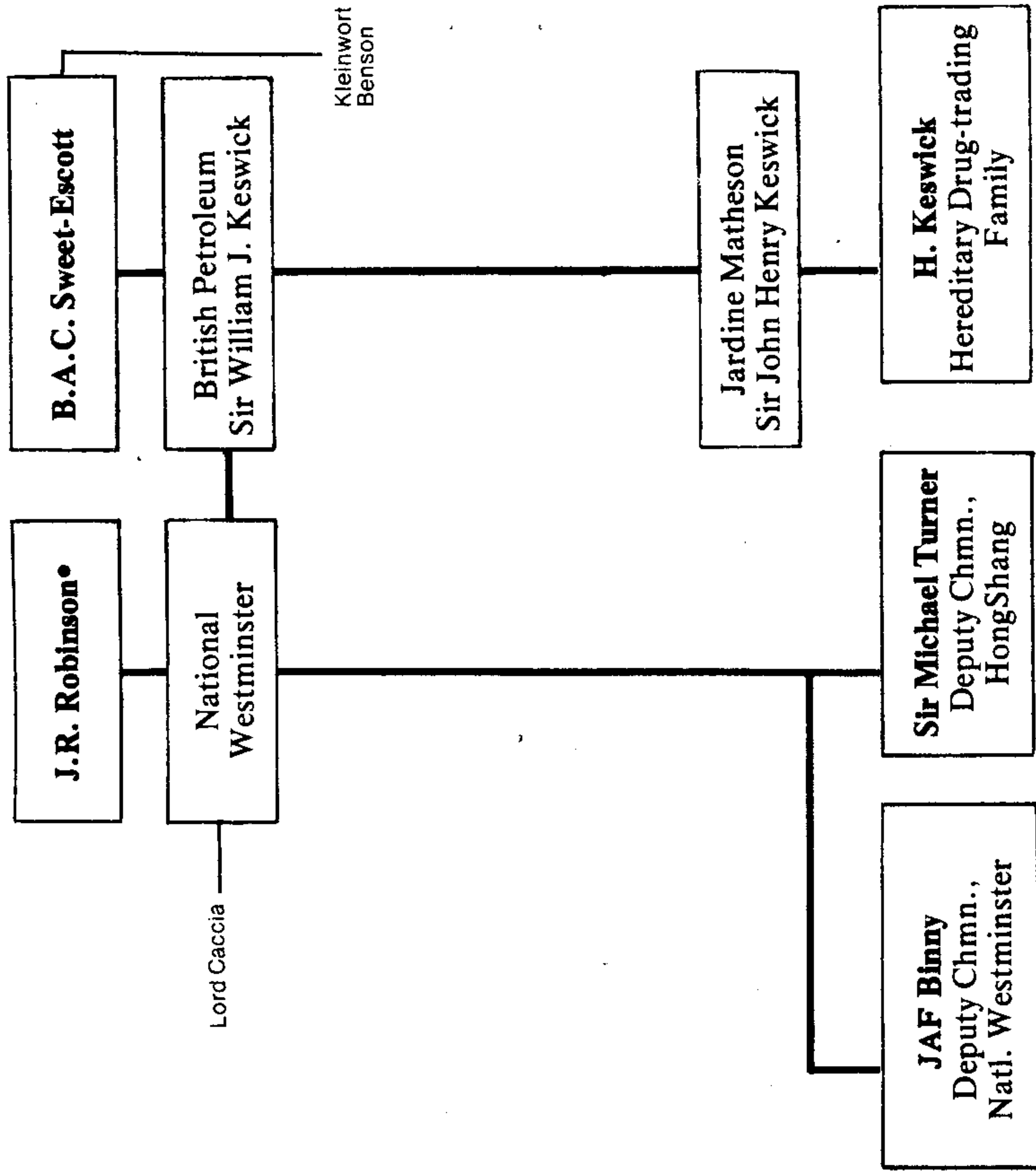

**Carmichael C.P. Pocock:** Member of Council, RIIA; Managing Director, Royal Dutch Shell, 1970-; joined Shell in 1946.

**Sir Arthur Knight** Member, RIIA Council; Chairman of Courtauld's since 1975; Director, Rolls Royce, 1971-; Member, Finance Committee of RIIA, 1971-; Court of Governors, London School of Economics, 1971-.

**Andrew Knight:** Member, RIIA Council; Editor of the *London Economist*, 1974-; J. Henry Schroeder and Wagg Co., 1962-; *Investors Chronicle*, 1964.

**Ronald Grierson:** *Economist* staffwriter, 1947-8; S.G. Warburg, 1948-58, executive director 1958-69; Chairman Orion Bank, 1971-75; Director, General Electric Ltd; member Trilateral Commission.

**William Malpas Clarke:** RIIA Council; Director, Committee on Invisible Exports since 1966; Director, Grindlays Bank Ltd.; Euromoney Publications; Brandt's Ltd.; *The London Times*, 1962-66.

**Baron Shawcross:** Member, RIIA Council; Director, Shell Transport and Trading Co., 1961-72; Morgan et Cie., International, 1966-; Times Newspapers Ltd., 1967-74; Hawker Siddeley Group Ltd., 1968-; Chairman, International Advisory Council, Morgan Guaranty Trust Co. of New York until 1978.

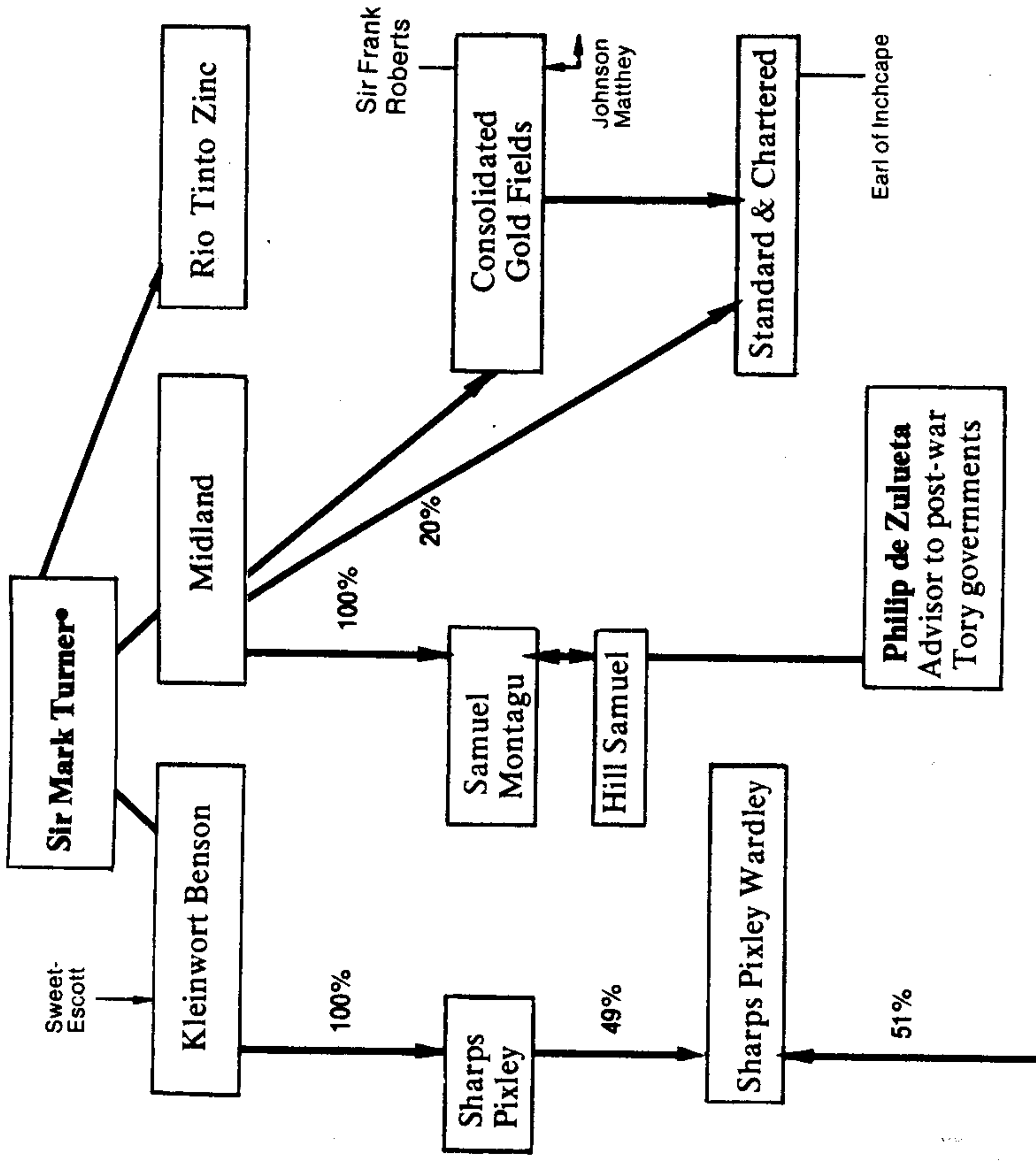

% percent ownership

**B.A.C. Sweet Escott:** Finance Committee, RIIA; Group Finance Co-ordinator, BP Co. Ltd., 1962-; Economic and Overseas Committees, Confederation of British Industries; Kleinwort Committee on Invisible Exports.

**J.R. Robinson:** Finance Committee, RIIA; director, Eagle Star Insurance; former director, National Westminster; Finance Director, Rio Tinto Zinc.

**J.P.G. Wathen:** Finance Committee, RIIA; General Manager, Barclays Bank Dominion, Colonial and Overseas; former manager, Lloyds Bank Ltd.

Again, Chart 2 shows that the leading members of the London Committee of the Hongkong and Shanghai Bank have extremely close ties to the core RIIA group. The chart also shows that these links continuously intersect two major groups whose activities are key to drug wholesaling and large-scale laundering of dirty money. The first is the old-line British opium traders, including the Peninsular and Oriental Steamship Lines, Jardine Matheson, John Swire and Sons, and Charterhouse Japhet. The second is the tightly knit complex of world gold and diamonds production and sales.

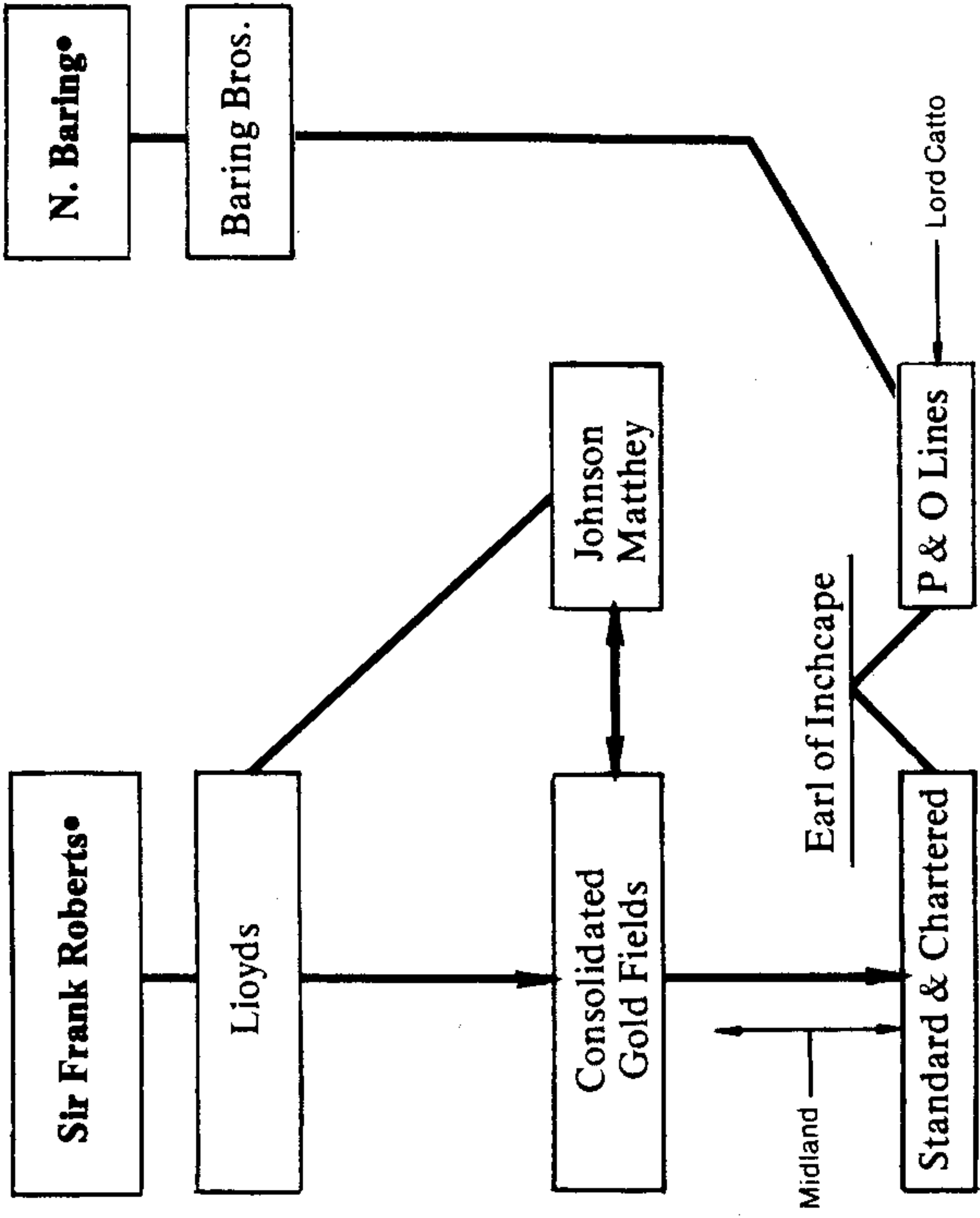

Lord Catto of Cairncatto is the chairman of the board of the prominent merchant bank Morgan Grenfell & Co., which has close ties of ownership to Morgan et Cie. International, one of Lord Shawcross's companies.

Philip de Zulueta, the private parliamentary secretary to Harold MacMillan when the latter was Prime Minister, advisor to every Tory Prime Minister since the war, spent most of his career with the leading British merchant bank Hill Samuel, also the largest merchant bank in South Africa; he is thus in close association with Sir Mark Turner, Rio Tinto Zinc's Chairman, and a director of Midland, and International Banks, Samuel Montagu (owned by the same families as Hill Samuel), and various gold and other mining ventures in which Zulueta has interests.

Henry Neville Lindley Keswick, of the family that controls Jardine Matheson, now occupies the traditional Jardine Matheson seat on the London Committee of the HongShang, a tradition that goes back to 1864. His father, Sir William Johnston Keswick, is also a director of British Petroleum, along with Lord Trevelyan, Chairman of RIIA, and B.A.C. Sweet-Escott of the RIIA Finance Committee. The elder Keswick is also the representative of drug wholesaling operations in the Far East with respect to drug retailing operations in Canada: he is a director of the Hudson Bay Company (see Section 8). H.N.L. Keswick's uncle David Johnston Keswick has been with

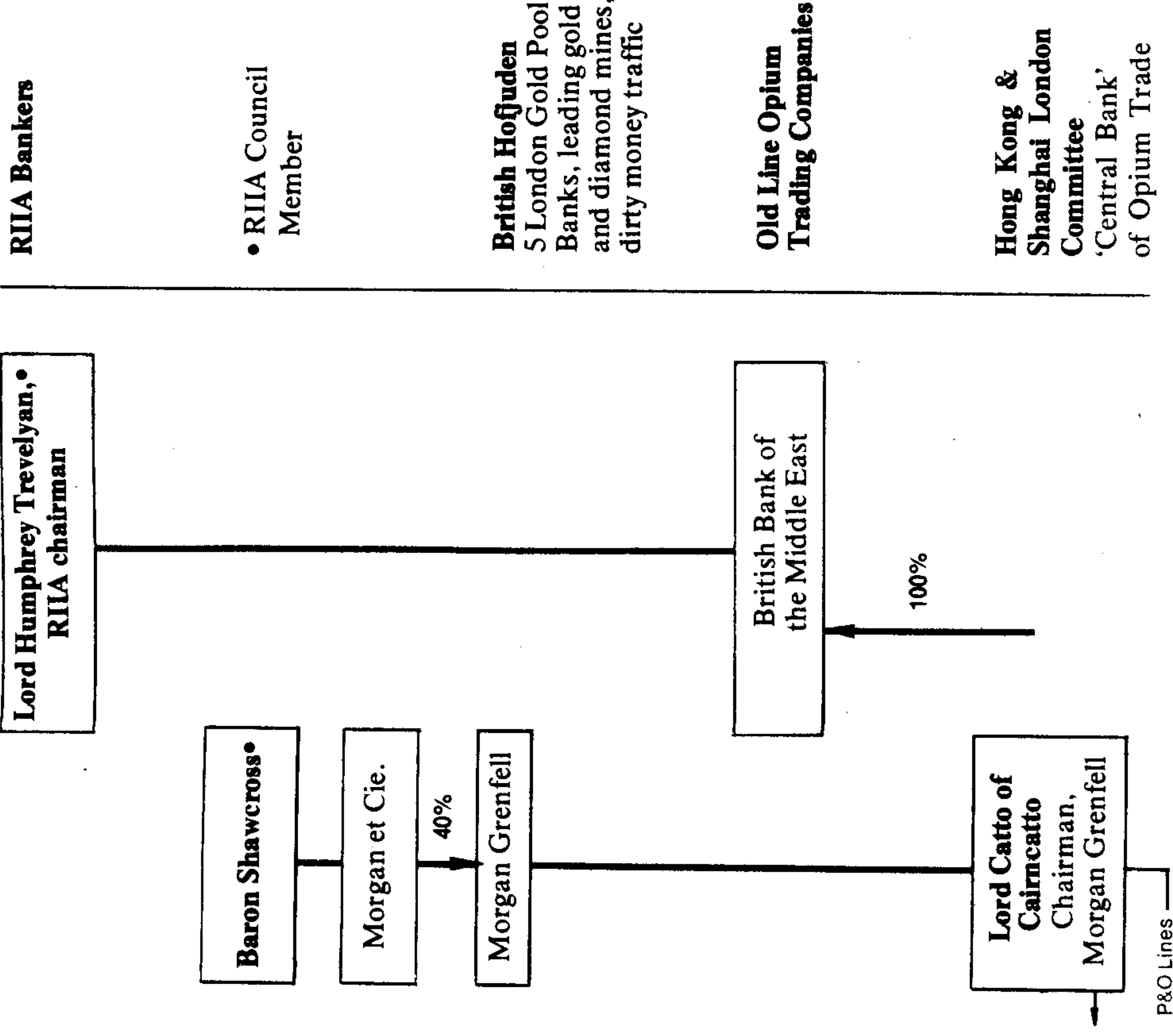

RIIA Bankers

• RIIA Council Member

**British Hofjuden**  
5 London Gold Pool Banks, leading gold and diamond mines, dirty money traffic

**Old Line Opium Trading Companies**

**Hong Kong & Shanghai London Committee**  
'Central Bank' of Opium Trade

Samuel Montagu, a core RIIA bank, since 1930, as well as with the family firms. Another uncle, Sir John Henry Keswick, is the top man for British corporate policy towards China. He is Chairman of the China Association, Vice-President of the Sino-British Trade Council, and a member of the Great Britain-China Committee.

John Kidston Swire, the Swire family's representative on the HongShang board, goes back to World War II with RIIA Council Member Sir Mark Turner and various other leading lights of the RIIA, when they all worked on the Ministry of Economic Warfare. Sir John Henry Keswick is another Ministry of Economics War veteran.

J.A.F. Binny and R.J. Dent are both directors of the National Westminster Bank, one of the core RIIA institutions.

Sir Michael Turner, who retired as Chairman of the Hongkong and Shanghai Bank in 1952 but remains on the London Committee, is still a director of National Westminster Bank.

## Canada: North America's Hong Kong

Most heroin entering North America comes through Canada. This is the estimate of authoritative law enforcement sources — despite the misleading publicity about Mexican supply routes, which are in any case mostly transshipment channels for Far Eastern dope.

Virtually everything the reader now knows about the British Crown Colony of Hong Kong applies to the British Dominion north of the American border. The idea that Canada is a nation — in the sense that Americans understand the term — is the product of low-grade, if persistent, public relations efforts. Politically and financially, Canada is run straight from the top by the British monarchy, starting with the Governor-General whom the Queen appoints, the Privy Council, and including the core group of Knights of St. John of Jerusalem who control the bulk of Canadian business.

Canada's role in the drug flow to the U.S. is not much different from its role during Prohibition — as we will document in Part III of this report. Canada transships most of the heroin entering the American market, because it was created and maintained as a

British Dominion on the northern flank of the United States to carry out precisely such operations.

Despite the British monarchy's iron grip over the highest levels of Canadian public life, there are a few individuals well placed in Canada, including in its law enforcement services, who look to America rather than Britain as a model for Canada's future. At great risk to themselves, they have fought a long rearguard action against criminal activities that enjoy near official sanction. The American public has heard little of their efforts because of Canada's Official Secrets Act, modeled on Great Britain's own 1911 Official Secrets Act. That legislation prevents any publication or public discussion of what the government — that is, the British-appointed Governor-General — chooses to regard as a state secret. Given Canada's make-up, most drug-running, dirty money laundering, and organized crime activity, including political terrorism, fall into that category. Anyone who writes about this in Canada will go to jail immediately and could, under the law, be executed. But without the help of Canadian citizens with access to official sources, willing to take the risk, this report could not have been written.

### Three crucial cases

Before examining the structure of Canada's drug and dirty money operations, a few leading examples will suffice to indicate the nature of the problem. One is the personage of **Walter Lockhart Gordon**, Honorary Chairman for Life of the **Canadian Institute of International Affairs (CIIA)**, the Canadian offshoot of the British Royal Institute of International Affairs. The CIIA receives most of its funding directly from the office of the Governor-General. Every Canadian Secretary of State for External Affairs since the CIIA's founding has been a CIIA member. The CIIA is also the official sponsor of the Institute for Pacific Relations, the nexus of Britain's Peking Connection (Sections 6 and 7), after public scandal forced the Institute for Pacific Relations to leave the United States after 1947.

### 1. WALTER LOCKHART GORDON

Walter Lockhart Gordon's fingerprints show up throughout this section. Apart from his lifetime post at the top of the CIA, he is a past chairman of the Privy Council, the Governor-General's select operations group for running Canadian politics (1967-68); he was finance minister from 1963 to 1965; and is a director of some of the dirtiest corporate operations in Canada.

But most important, he founded Clarkson and Gordon, the accountants firm that audits three of the five Canadian chartered banks: Bank of Nova Scotia (of which Gordon is a director), Toronto Dominion Bank, and Canadian Imperial Bank. Gordon's partner, Stephen Clarkson, is also a leading member of the Canadian Institute of International Affairs, as well as a leading sponsor of the Institute for Pacific Relations. Through a network of accountants dispersed through these banks, Clarkson and Gordon functions as a command center for the most extensive dirty money laundering operation in the world, stretching from the heroin receiving points in the Pacific Northwest, to the branch operations of the Canadian banks in the Caribbean Silver Triangle.

Gordon, as we shall detail below, is also Canada's chief contact-man for the Peking Connection (see Section 7).

### 2. THE EAGLE STAR INSURANCE COMPANY

A second example is the group of British "spooks" who run the **Eagle Star Insurance Company**, which heads the accompanying chart of the Canadian drug networks. Eagle Star is one of Britain's largest financial corporations, and a joint operation between Britain's top financial firms, including Barclays Bank, Lloyds, Hill Samuel, and N.M. Rothschild & Sons.

Eagle Star, as the chart shows, runs the **Bronfman** family operation from the top, through its control of English Properties, and English Properties' control of the "Bronfman" Trizec Corporations.

The Bronfmans are what is known in intelligence jargon as "cutouts," or controlled front-men. What is significant here is Eagle Star's special qualifications for controlling the Bronfman family's corporate group, which, in turn, has been the seat of

Canada's rum- and dope-running, dirty money, and terrorist operations since Prohibition.

**Eagle Star's management is British intelligence**, by an arrangement that traces back to World War II.

Two Eagle Star directors, **Sir Kenneth Strong** and **Sir Kenneth Keith**, were Number One and Number Two men, respectively, in British intelligence immediately after World War II — when the Bronfman family created its "legitimate" front Trizec with Eagle Star funding. (1) Both men have kept up their close ties to Britain's foreign intelligence service, MI6. Part III of this report tells the story of the Bronfman family's dope-running, organized crime, and terrorist activities. What is crucial to keep in mind here is that the men who own the Bronfmans sit in the highest councils of British covert operations.

In a pattern that has already become familiar, Sir Kenneth Keith moves between the secret world of British intelligence and the opium politics of the Far East. Keith is also a leading member of the Canadian Institute of International Affairs. Among other leading corporate positions, including a directorship at Canada's Bank of Nova Scotia, he is the chairman of the Hill Samuel group of companies, one of the leading British merchant banks, and an incarnation of the old Samuel banking family's interests.

Sitting with Sir Kenneth Keith on the board of directors of Hill Samuel is the Hongkong and Shanghai Bank's Sir Philip de Zulueta, member of the HongShang's controlling "London Committee." Zulueta was private parliamentary secretary to a string of British Conservative prime ministers while Sir Kenneth Strong was completing his career at British intelligence.

Eagle Star is a sterling example of Canada's role in drugs because it contains every element of the drug machine: the Bronfman family, which has spokes tying into the Zionist dirty money and terrorist apparatus; the top levels of British intelligence; and the core of the opium trade, the HongShang itself.

### 3. THE HUDSON'S BAY COMPANY

The **Hudson's Bay Company** is the appropriate starting point for a look inside the operations of Canada's drug machine. During



Prohibition, it was the Bronfman's Seagram's partner in the "Pure Drug Company," the main source of bootleg liquor during Canada's dry period.

The Hudson's Bay is also a front for the grand old families of the opium trade, the Incheape and Keswick families, the proprietors, respectively, of the Peninsular and Orient Steamship Company, the world's (and the Far East's) largest shipping fleets, and Jardine Matheson, Hong Kong's dominant trading company. The 2nd Earl of Incheape, whose son still runs the P&O lines, wrote the notorious 1923 Incheape report advocating the continuation of opium production in the Far East to maintain British revenues. The number two man today at the P&O, Vice-Chairman of the board Eric Drake, sits on the board of Hudson's Bay.

Jardine Matheson's Sir William Johnston Keswick — the chairman of the Shanghai Municipal Settlements during the 1930s peak of Shanghai heroin traffic — only recently retired as a director of the Hudson's Bay Company.

William Johnston Keswick and Sir Eric Drake also sit together on the board of British Petroleum, next to Lord Humphrey Trevelyan, the chairman of the council of the Royal Institute of International Affairs and Britain's charge d'affaires in Peking during the critical years 1951-53.

Drake is also a director of the top British merchant bank Kleinwort Benson. As noted in Section 7, Kleinwort Benson's wholly-owned subsidiary Sharps Pixley Ward jointly runs the Hong Kong gold market with the Hongkong and Shanghai Bank, a crucial support operation for the Far East drug traffic. Drake's fellow director, the deputy chairman of Kleinwort Benson, is Sir Mark Turner, of Rio Tinto Zinc. Rio Tinto Zinc, in turn, was founded by Matheson family money in the 1840s, and Mathesons ran Rio Tinto Zinc until the turn of the century. To complete the circle, William Johnston Keswick sits on the board of Jardine Matheson, along with several directors of Sir Eric Drake's P&O Steamship Company.

In other words, the Hudson's Bay Company, the most "Canadian" of companies, is run from the top by a combination of Far Eastern old-line drug traffickers and their closest London contacts.

The Hong Kong opium connection goes even further. Sir William Keswick's son, Henry Neville Lindley Keswick, a board member of the Hongkong and Shanghai Bank, is also a director of MacMillan Bloedel, one of Canada's biggest pulp and paper operations, closely tied to the Macmillan publishing interests. The Macmillans took off as a Canadian family when Harold Macmillan—later British prime minister at the time of the Kennedy Administration — married the daughter of Canada's Governor-General, the Queen's personal representative. The Governor-General in question was the 9th Duke of Devonshire, Victor C. W. Cavendish, who held office 1916-20 at the outset of Prohibition; his son-in-law Harold Macmillan became his chief assistant in Canada in 1919, the same year that Arnold Rothstein set up the big liquor delivery contacts in England. The Governor-General's son William helped Joe Kennedy make contacts among big English distilleries. The MacMillan interest started with Prohibition. Today, through their association with William Johnston Keswick — who personally ran the Shanghai heroin traffic during the 1930s — they are up to their necks in the drug trade.

Canadian Pacific Ltd., the biggest company in Canada, holds a controlling interest in MacMillan Bloedel.

## Dope goes in, dirty money goes out

According to high-level Canadian intelligence sources, most of the heroin that reaches North America is flown in through Canadian Pacific Air. There is no "smoking gun" evidence to substantiate this, but a November 1978 trial in Vancouver reveals evidence that Canadian Pacific was involved in the smuggling of 22 pounds of cocaine from Hong Kong.

Figure 7 neatly traces the flow of heroin and dirty money in Canada: the drugs come in through Canadian Pacific and then are conduited to points south of the border. Heavily interlocked with the Western Canada connection is the Bronfman group, whose corporate center is Seagram, and whose financial center is the Trizec group. Since Prohibition, Seagram has handled the flow of smuggling into the United States (see Part III).

Both Seagram (and its old Prohibition rum-running partner, Hudson's Bay) are interlocked through a maze of contacts with all five of the big Canadian chartered banks: the Bank of Montreal, the Royal Bank of Canada, the Bank of Nova Scotia, the Toronto Dominion Bank, and the Canada Imperial Bank. Thus the dirty money gleaned from the drug trade is conduited through these banks to points further south: the banks' offshore centers in the Caribbean and from there the money makes its whirlpool round of worldwide laundering.

Canada's Big Five dominate all Canadian banking as fiercely as the British Big Four — Barclays, National Westminster, Lloyds, and Midlands — do in Britain. Unlike the United States, which has a relatively broadly spread base of regional banking, Canadian and British banking is run from the top by the institutions named. The Canadian institutions are barely distinguishable in their current practice from the British buccaneers who plied the Caribbean during the 17th century. Along with the British banks, which have numerous joint ventures with the Canadians — e.g., the Royal Bank operates in the Bahamas under the "RoyWest" cover in a joint venture with National Westminster — they are the core of the dirty money operations offshore of the United States.

The Royal Bank of Canada has 21 affiliates in offshore banking and subsidiaries — more than any other bank in the world save Barclays Bank. Royal Bank's "RoyWest" connection to the National Westminster Bank ties it closely to the Hongkong and Shanghai bank itself; HongShang has two mutual directors with National Westminster, J.A.F. Binny and R.D. Dent. Dent is the descendant of the old-line British opium trading family that founded Lancelot Dent about the same time that Jardine Matheson appeared.

Among other links, the Royal Bank of Canada is tied to the Bronfman family through Neil Phillips — son of Lazarus Phillips, the Bronfman family's lawyer and most trusted aide from Prohibition until the 1950s.

#### CANADA'S SILVER TRIANGLE

Royal Bank has the dirtiest reputation of any bank in the Caribbean. According to authoritative diplomatic sources, the Royal

Bank of Canada directly ordered the Guyanese government to plant marijuana in order to raise foreign exchange income. In 1976, when Guyana went flat broke and applied to the International Monetary Fund for emergency assistance, Royal Bank of Canada officials met with senior members of the Guyana government. The Royal Bank insisted that Guyana transform its economy into a "cash crop" producer before it, or any other major bank, would issue loans. The Guyanese were desperate and did what they were told. Northwest Guyana, in consequence, has become a major producer of marijuana for the North American market.

Second in the Caribbean offshore centers to the Royal Bank is the Bank of Nova Scotia — Walter Lockhart Gordon's bank. A top Bronfman aide and figure in Canadian Zionist organizations, R.D. Wolfe, sits both on the board of Seagram and the Bank of Nova Scotia. Scotiabank has 13 branches in offshore centers, as well as innumerable joint ventures and similar fronts.

Banking and diplomatic sources agree that the Bank of Nova Scotia is the number one handler of flight capital out of Caribbean countries, especially troubled countries such as Jamaica. Apart from funds fleeing difficult political situations, much, if not most, of all illegal money transfers out of the Caribbean. A large portion of Jamaican illegal funds are conduited through a Jamaican national currently employed in a senior position at the big New York brokerage house Drexel Burnham Lambert. (2)

Scotiabank's Jamaican trade is a particularly filthy business, since it involves shifting funds earned in Jamaica by local criminals into safe havens. The cash side of the Jamaican operations, according to law enforcement sources, is done more with arms than drugs. Planes fly into Jamaica with loads of small arms, and take loads of marijuana out. The retail side in Jamaica is arms selling. The ultimate cash proceeds of the selling chain are then laundered through Scotiabank.

The Bank of Nova Scotia's role in Canadian gold markets, through its own trading operations and its interlock with the chairman of the second-largest Canadian gold trader, Noranda Mines, was already noted in Section 4. According to informed New York gold market sources, a substantial proportion of Nova

Scotia's flight capital operations are accomplished through illegal purchases of gold by Jamaican and other nationals. The same sources add that Dr. Henry Jarecki's Mocatta Metals in New York (see Section 4 again) has a substantial share of Caribbean dirty money traffic.

## The Canada-Peking connection

The starting point of any examination of Canadian drug traffic is Walter Lockhart Gordon's close relationship to Canadian Pacific. Gordon is Canada's grand old man, Honorary Chairman of the Canadian Institute of International Affairs for Life, top leader of the ruling Liberal Party, finance minister after 1963, and chief foreign policy-maker in Canada for the past 30 years.

Gordon sits on the board of directors of Canadian Pacific and the Bank of Nova Scotia; his accounting firm, Clarkson and Gordon, handles the accounts of the Bank of Nova Scotia, Toronto Dominion Bank, and Canadian Imperial Bank.

### THE GO BETWEEN

Authoritative Canadian intelligence sources further identify Gordon as the controller of Canada's three leading China specialists, Paul Lin, James Endicott, and Chester Ronning, whom we met earlier in Section 7. The association goes back in the cases of Endicott and Ronning to the end of World War II, when the two returned from close collaboration with Chou En-lai, to become the core of the transplanted Institute for Pacific Relations in Canada.

Based in Montreal, Paul Lin is the go-between for Walter Gordon and the Vancouver, British Columbia drug wholesaling and transshipment operations. Lin's most important contact is the former president of drug-shipping Canadian Pacific, John D. Gilmer. Gilmer is a Knight of St. John of Jerusalem, and the patron of People's Republic of China fronts on Canada's West Coast. Paul Lin is his personal attorney.

In turn, Gilmer is the attorney for two open representatives of the People's Republic of China in Vancouver, B.C., the Chinese Commercial Corporation and the Chinese Cultural Center. The

Chinese Cultural Center in Vancouver receives funding from another Knight of St. John, John Robert Nicholson, a close associate of Gilmer.

Both Gilmer and Nicholson are major funders of the Simon Fraser University in Vancouver, which became the home of the Institute for Pacific Relations after it was driven out of the United States. Paul Lin's brother, Dr. Tsing Lin, is currently employed at the Institute for Pacific Relations. All these men have been working together since the Institute for Pacific Relations, as detailed in Section 7, served as the Royal Institute of International Affairs bridgehead into the United States, and Chester Ronning was meeting weekly with Wang Ping-nan and occasionally with Chou En-lai in Chungking.

Endicott, now an old man, created the leading North American center of explicit Maoism, the Norman Bethune Institute at York University. Walter Gordon was the university's chancellor for many years. Gordon personally arranged the funding of the Bethune Institute, named after a Canadian doctor who served in Mao's armies.

Gordon's accounting firm Clarkson and Gordon tries to keep its nose clean of overt involvement in the drug trade. But one of its escapades caused a public scandal in Canada five years ago. Clarkson and Gordon put together the funding for Rochdale College in Toronto, an experimental university that quickly became the most drug-ridden college campus in Canada. By the early 1970s Rochdale College had become not only a main center of illegal drugs consumption, but also the retail distribution point for marijuana and hallucinogens throughout most of Eastern Canada. When the story inevitably became headline material in the early 1970s, Canadian police were compelled to shut it down, as a matter of public decency. Clarkson and Gordon, who had created Rochdale College, sadly took the drug-ridden remnant back, acting as its receiver and liquidator.

## Who rules Canada

But the company to which Gordon is closest is Canadian Pacific, which controls most of the dominion's air, sea, and land

Figure 7  
Drug-Running---The Canadian Connection

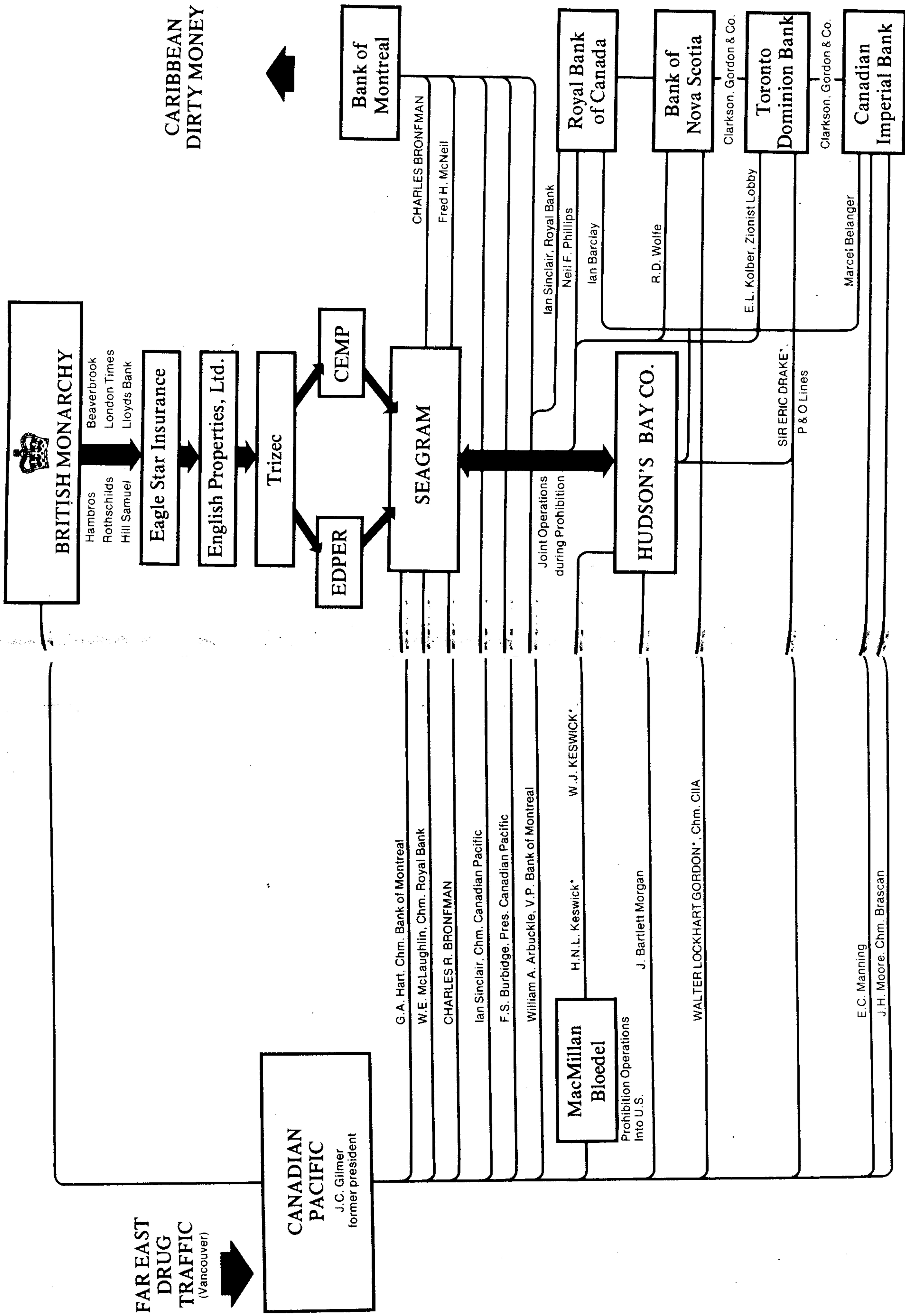

\*Far East Opium Runners

transportation. It has directors in virtually every industry it does not control. As the accompanying chart demonstrates, it is interlocked three ways with Seagram Ltd., the core of the Bronfman group. The chart only shows a handful of Canadian Pacific's links to the five major chartered banks; no fewer than 14 of its directors sit on their boards.

Most important, Canadian Pacific features no fewer than four members of the Most Venerable Order of St. John of Jerusalem on its board. They include the aforementioned J.C. Gilmer of Vancouver, the angel for every Maoist front in the city; W.E. McLaughlin, the chairman of the board of the aforementioned Royal Bank of Canada; and J.P.W. Ostiguy.

Only one other corporation in the world, Barclays Bank, contains more members of the British monarchy's most elite order among its directors. That fact alone establishes Canadian Pacific's vassalhood before the feudal rights of the British monarchy. In terms of Canada's real chain of command, it is an honor for Charles R. Bronfman to sit on Canadian Pacific's board.

The concentration of Knights of Malta on the council of the Canadian Pacific Company also clears up — *from a professional intelligence standpoint* — why that company has special access to the Far Eastern narcotics traffic. The chairman of the board of the HongKong and Shanghai Bank from 1962 to 1970 was Sir Michael Turner. When the current chairman, M.G. Sandberg, replaced Turner in 1970, he remained on the "London Committee" of the HongShang (as well as the board of directors of National Westminster Bank, with two of his fellow HongShang directors). Sandberg was created Commander of St. John, a high-ranking position in the elite order, in 1960. He is still the chairman of the Council of St. John — the organization of the Knights — in Hong Kong. The company most under the direction of the Knights of Malta in Canada deals directly with the chief of their order in Hong Kong.

At the other end of the Canadian drug cycle, the dirty money banks, each of the five Canadian dirty money banks has at least one Knight of Malta on its board. The Canadian Imperial Bank and the Bank of Nova Scotia are directed by three Knights of Malta each.

In addition, there is no question that the Canadian Institute of International Affairs — which has picked every Canadian foreign minister of this century — is not a Canadian institution, but the local branch of the British monarchy's most elite chivalric order. Canada's former Governor-General, Roland Michener, and current chairman of the CIIA is also a Knight of St. John. A board member of the Italian branch of the Order of St. John, the Order of St. Lazarus, is a member of the CIIA's board, Henry R. Jackson. J.J. Jodrey, another board member, is also a Knight of St. John.

The Order of St. John respects the same chain of command as do Canada's Governor-General and Privy Council: the Queen of England, who is the titular head of the Order, and the Queen's cousin, the Duke of Gloucester, who is Grand Prior to the Order. These men control the finances and logistics of Canada's economy. Through a series of "cutouts," like the Bronfman family, they also control the drug-running, the organized crime, and the political terrorism directed against the United States.

There has been little effective challenge to their rule of these forces in Canada since 1910, when then-Prime Minister de Laurier attempted to organize a counterweight from within the British dominions, including support from then Prime Minister of South Africa, Botha. Lord Milner, whom we profiled earlier in Section 7, traveled to Canada in 1908 to avert what would have been a catastrophe in the eyes of the British monarchy.

Milner's visit, which founded the Canadian Round Table Group — the mother organization of Walter Lockhart Gordon's Canadian Institute of International Affairs — was ultimately successful. Robert Borden, a Milner protégé, replaced de Laurier in 1910, and Canada was secured for the Prohibition offensive against the United States. Robert Borden's descendant Henry Borden still sits on the Council of the Canadian Institute of International Affairs.

The project is best summarized in a letter that Ruyard Kipling, the swastika-wielding racist who helped found Canada's Institute of International Affairs, wrote to Lord Milner after the de Laurier initiative failed:

"This busts the de Laurier-Botha liaison," Kipling wrote, "in

what are called our Imperial Councils. Additionally, Australia will be deprived of big sister's (i.e. Canada's — ed.) example as an excuse for nibbling after American 'protection' on her behalf . . . and I do believe it smashes French power for good. Seriously, don't you think it's the best thing that's happened to us in ten years? Also, we've worked very hard for it." (3)

## 9

# All in the Family: The Real Syndicate

Why, if so much detailed evidence on the world narcotics traffic exists in the public record or in the files of law enforcement agencies, has this picture remained hidden for so long? The answer put forward at the outset was that the "Purloined Letter" principle is in effect: the HongShang and other top traffickers who mingle freely in the business world were designed specifically to hide the drug trade behind a façade of legitimate finance. At bottom, that fraud may deceive the general public, but it could not—by itself—hold professional investigators at bay indefinitely. The more important answer lies deeper.

The answer takes the reader behind the corporate board rooms and precious metal exchanges to the inner life of the British elite. What we now present would be easier to explain in the format of fiction than of fact: **the entire world drug traffic has been run by a single Family since its inception.** That statement applies not merely to growing and distribution, but to political, intelligence, and ideological support as well. We will sketch out the animal in this section and in the accompanying chart.

Popular accounts of the Italian organized crime families, or

their counterparts in the Jewish and expatriate Chinese banking groups, give the reader a starting point whence to look at Great Britain's oligarchy. Britain's elite, in a superficial sense, runs along lines not much different from the organized crime families. The Keswick family of Jardine Matheson, the Inchcape family of the Peninsular and Orient Steamship Co., the Russells, the Dukes of Sutherland and Elgin, appear and reappear in this account, from the first Opium War to the directors' lists of the most prominent British banks. The same interbreeding dynasty controls every major bank, mining, and transportation company in London, including the HongShang, Jardine Matheson, Barclays Bank, Anglo-American Corporation, N.M. Rothschild, and Lazard Freres. As we will show, their cousins and in-laws also control Britain's political and intelligence establishments, and have done so throughout the entire time-frame of this report.

After a more careful look, however, the "Mafia" image turns out to be something like a pornographic negative: the Italian, Jewish, Ch'ao Chou Chinese, and other ethnic minorities that figure in aspects of the narcotics traffic are fitting allies of the British oligarchy because their tight-knit family networks parallel it. But the British dynasty is deeper, more sinister than that. The dynasty enjoys such power in Britain that a favored nephew can clear opium shipments through Hong Kong, while an uncle clears payments through a big London bank, a second cousin expedites necessary gold shipments through the Hong Kong market, and an in-law in British intelligence reassures the American drug enforcement authorities.

To call this a "conspiracy" would abuse the meaning of the term. Under examination is a dynasty that has controlled Britain for hundreds of years, enjoys virtually all major positions of corporate and political power, and believes that making events happen from behind the scenes is as natural and ordinary as afternoon tea. When the chairmen of the boards of Britain's leading banks, trading houses, and mining companies show up at the same weddings and christenings (and bar mitzvahs) as the chiefs of British intelligence and various government ministries, there is no need for the formal trappings of conspiracy. Conspira-

torial rituals are useful to bind together secret societies composed of otherwise unorganized individuals. But it doesn't work that way at the top. In a frank discussion, a Lazard Freres partner who is quite active in the Royal Institute of International Affairs exclaimed. "You seem to think that a group of men meets secretly in a room somewhere to hatch plots about this or that. I can assure you that it doesn't work that way!"

The British gentleman is entirely within his rights. Like the HongShang Bank itself, the British oligarchy is so much part of the bedrock of events that it does not need to act in conspiratorial fashion: by its own self-description, it merely *is*, and *always has been*. Its adherents have indulged in public self-examination only under the protective coloring of fiction, e.g. a famous novel by a member of one of the British secret societies, Bram Stoker's *Dracula*. Of that secret society, the "Order of the Golden Dawn," more will be said below.

### THE FAMILY RELIGION

The sinister element that sets the British oligarchy apart from the popular image of the Mafia family is its unshakable belief that it alone is fit to rule the world—the view reflected in Cecil Rhodes's 1877 Testament, cited in Section 7. Their religion is not the Anglican Christianity they publicly profess, but a hodge-podge of paganism, including satanic cults such as Theosophy and Rosicrucianism. The central, syncretic ideology of the oligarchy's inner cult life is the revived Egyptian drug cult, the myth of Isis and Osiris, the same anti-Christian cult that ran the Roman Empire. And like the ancient Isis-worshipping Egyptian dynasties, the British ruling family networks have maintained power for centuries by keeping the secrets of their intrigues *within the family*.

The Isis cult also formed the core of Lord Palmerston's Scottish Rite of Freemasonry. As Prime Minister during both Opium Wars, Palmerston employed variants of this ideology to spin a web of connections that stretched from the Order of Zion in Romania to the Ku Klux Klan in the United States. Parts I and III of this report document how Palmerston's Scottish Rite engendered the subterranean world of drug-related mysticism,

and its various secret societies, including what the public now calls "Organized Crime." (1)

The Cult of Isis, dredged up in modern format, was the *official* ideology of leading British politicians, financiers, and literary figures during the previous century. Its great public exponent was the colonial secretary during the Second Opium War, Edward Bulwer-Lytton, the author of *The Last Days of Pompeii*, which first popularized the Isis cult, and the mentor of Cecil Rhodes's whole generation of British imperialists.

The Royal Institute of International Affairs was the "secret society" called for in Rhodes's will and is the body that provides the command structure for the drug trade. But the Royal Institute itself was founded by an even more secret group: the "Circle of Initiates . . . devoted to the extension of the British Empire," in the description of one of its historians. (2) The Circle of Initiates included Lord Milner; Cecil Rhodes, the founder of Britain's African mining empire; future prime minister Arthur Balfour; Albert Grey; and Lord Rothschild.

All these men celebrated forms of the Isis cult. Their worldview was largely designed by Britain's leading exponent of the Isis cult, novelist Edward Bulwer-Lytton, and his protégé John Ruskin. Britain's High Priest of Isis, Bulwer-Lytton, was also the British government's chief drug-runner.

The words of American Founding Father Tom Paine to characterize British King George III, against whom America fought the Revolutionary War, thus are highly appropriate: "I rejected the hardened, sullen-tempered *Pharaoh of England* forever . . . and disdain the wretch." (3)

## The beginning: the Knights of St. John of Jerusalem

The elite of the elite in Britain's secret dynastic life is Her Majesty's Most Venerable Order of St. John of Jerusalem — the "Christians who are not really Christians." (4) We have already highlighted the Knights' prominence in the centers of the world

drug traffic: from the Hongkong and Shanghai Bank to the Canadian Pacific in Vancouver to Barclays Bank in London. Although Queen Victoria reconstituted the Most Venerable Order in the 1880s as the Protestant British branch of the Knights of Malta, our tale properly begins much earlier with the original order of the Knights of St. John, founded in Jerusalem in 1070. The order of St. John inherited what British authors smirkingly call "the wisdom of the East" from the Coptic, Gnostic, and Manichean networks of the Eastern Mediterranean. The Order of St. John thus maintained direct continuity with the ancient Cult of Isis.

However distant from the familiarity of the American reader, the area we have entered must be viewed the way the families themselves see it. The brooding evil of Walter Scott or Robert Louis Stevenson romances, or their cheap Gothic novel imitations, gives the reader a basis for insight into the inner history of the families, and the need to begin with cobwebbed history in order to get to the bottom of Dope, Incorporated.

To begin at the beginning: in the 14th century, the Order of St. John's emergence in England was part of a project to annihilate its humanist opposition, the Knights Templar. Total warfare had broken out on the continent. The oligarchists in France and Italy, Philip the Fair and Pope Clement V, slaughtered hundreds of Templars, and burned the Templars' courageous Grand Master, Jacques de Molay, at the stake in 1314.

A renegade group of Templars under the command of an adventurous thug, King Robert Bruce, grabbed Scotland — Europe's least civilized outpost — as an "offshore" stronghold, as a form of insurance against their uncertain fortunes on the European continent. King Robert Bruce is not only the spiritual founder of the Scottish Rite of Freemasonry but the direct ancestor, by unbroken lineage, of all the men of evil in England who figure in this report.

After the death of Jacques du Molay, some Scottish Templars . . . at the instigation of Robert Bruce ranged themselves under the banners of a New Order (The Royal Order of Scotland) instituted by this prince. . . *It is there*



that we must seek the origin of the Scottish masonry. (emphasis added) (5)

This statement by a leading historian of the Masonic movement is the standard interpretation of the origin of the Scottish rite.

## The Family's Opium Wars

As the accompanying Family Tree indicates, there is a direct lineage from the King Robert Bruce to the British officials who ran the first opium wars against China. James Bruce, the 8th Earl of Elgin — after supervising the Caribbean slave trade as Jamaican Governor General from 1842-46 — was appointed Ambassador and Minister Plenipotentiary to China from 1857 to 1861 — the period covering the Second Opium War against China. His brother Frederick Bruce had been Colonial Secretary at Hong Kong during the mopping-up operations following the First Opium War and returned to China in 1857 to assist his brother in delivering the British government's ultimatum to the Chinese emperor. (6)

The *British Dictionary of National Biography* summarizes the Chinese career of the elder Bruce succinctly:

In 1857 Elgin was sent as envoy to China. On reaching Singapore he was met by letters from Lord Canning informing him of the Indian mutiny, and urging him to send troops to Calcutta and from the force which was to accompany him to China. With this requisition he at once complied, sending in fact the whole of the force, but he proceeded himself to Hong Kong in the expectation that troops would speedily follow. . . .

He repaired to Calcutta. . . . Later in the year he returned to China, fresh troops having been sent out (to replace those which had been directed to India — ed.). . . . Canton was speedily taken and some months later a treaty was made at Tientsin, providing, among other matters, for the appointment of a British minister, for additional

facilities for British trade (i.e., opium — ed.). . . and for a war indemnity. (emphasis added)

Elgin returned to England in 1859.

In the following year he was again sent to China, the Emperor having failed to ratify the treaty of Tientsin and having committed other unfriendly acts. . . . The military opposition (to Elgin's mass addiction policy — ed.) was not effective, but the Chinese resorted to treachery. (Chinese forces killed some British troops enforcing opium distribution — ed.). In retribution for this treacherous act, the summer palace, the favorite residence of the Emperor at Peking, was destroyed. A few days later the treaty of Tientsin was formally ratified. (7)

The account concludes that Elgin's "letters show he was a man of warm affections, eminently domestic, with very decided convictions on religion. . . ."

Who was running England at the time? The prime minister was the same Lord Palmerston who turned the Scottish Rite into Britain's leading cash-producing export product. The foreign secretary was Lord John Russell, son of the 6th Duke of Bedford, and grandfather of Britain's most dangerous 20th century intelligence operative — Bertrand Russell.

Palmerston and Russell were relatives of the Bruce brothers, the Elgin peerage, by marriage into the direct line of Order of St. John control over England. The branch that encompasses Britain's two leading cabinet ministers during the Second Opium War is the Villiers line. The line began with George Villiers, who assisted Robert Cecil and Edward Bruce in seizing the English throne for another descendant of Robert Bruce — James I of Scotland — in 1603. (8)

Lord Russell's daughter, Victoria, married into the Villiers family. Russell's grandson, Bertrand, among his other covert operations, maintained liaison with Chou En-lai throughout the postwar period on behalf of British intelligence, at the height of the Anglo-Chinese drug traffic. (9)

Even more significant is the third member of the London team during the Opium Wars — Colonial Secretary **Edward Bulwer-Lytton**, a relation by marriage of the Duke of Wellington. His son married Edith Villiers, of the same branch of the leading Order of St. John dynasty.

## The imperial cultists and opium

Bulwer-Lytton is best known to Americans through his 1838 novel, *The Last Days of Pompeii*, but he is also both the spiritual father of the Rhodes-Milner secret societies and of Nazi fascism. A mystic and prenascent fascist, Bulwer-Lytton led the English Rosicrucians, a branch of the Scottish Rite Masons headed by his Prime Minister Palmerston.

Unlike the comparatively closed members of the British elite around him, Bulwer-Lytton was an outspoken exponent of the Isis cult, which formed the subject of his famous novel. His popularized Isis myth was the inspiration for an entire array of warped imitations.

Included among these was Helena Blavatsky's book, *Isis Unveiled*, and her Theosophist cult. Theosophy was the Satanic bible of the mystic secret societies, including Germany's "Thule" group, which produced most of Hitler's SS. (10)

Another Bulwer-Lytton protégé was satanist Aleister Crowley. of the "Thule" group's equivalent in England, the "Isis-Urania Hermetic Order of the Golden Dawn." Both of these groups traced their lineage back to Palmerston's Scottish Rite Masons through Bulwer-Lytton. (11)

Aleister Crowley was the tutor of Aldous Huxley, the prophet of mind control, who later introduced the LSD cult into the United States during the 1950s (see Part IV). (12)

Britain's imperial link to Nazi fascism is even more direct in the case of Bulwer-Lytton's other published work. His novel *Rienzi*, about the Knights of St. John, provided the text of Richard Wagner's first opera. His 1871 novel, *Vril: The Power of the Coming Race*, contained virtually everything that Houston Stewart Chamberlain later had to say on racial theory; Prof.



1. A victim of Britain's Opium War against the U.S.

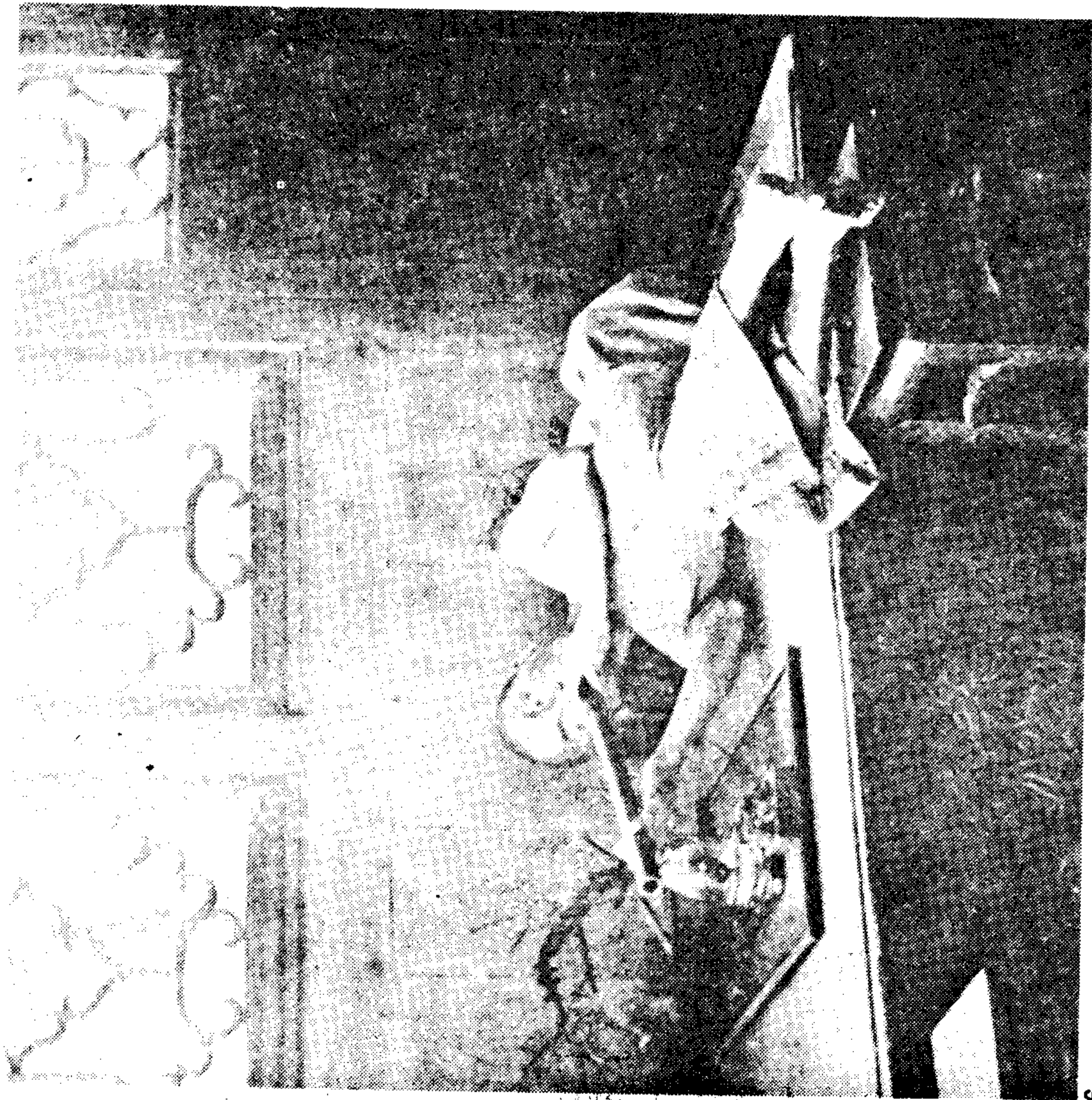

6

- 2. Rudyard Kipling
- 3. The symbols of the Scottish Rite of Freemasonry
- 4. Milton Friedman
- 5. Adam Smith
- 6. A 19th century Chinese opium smoker

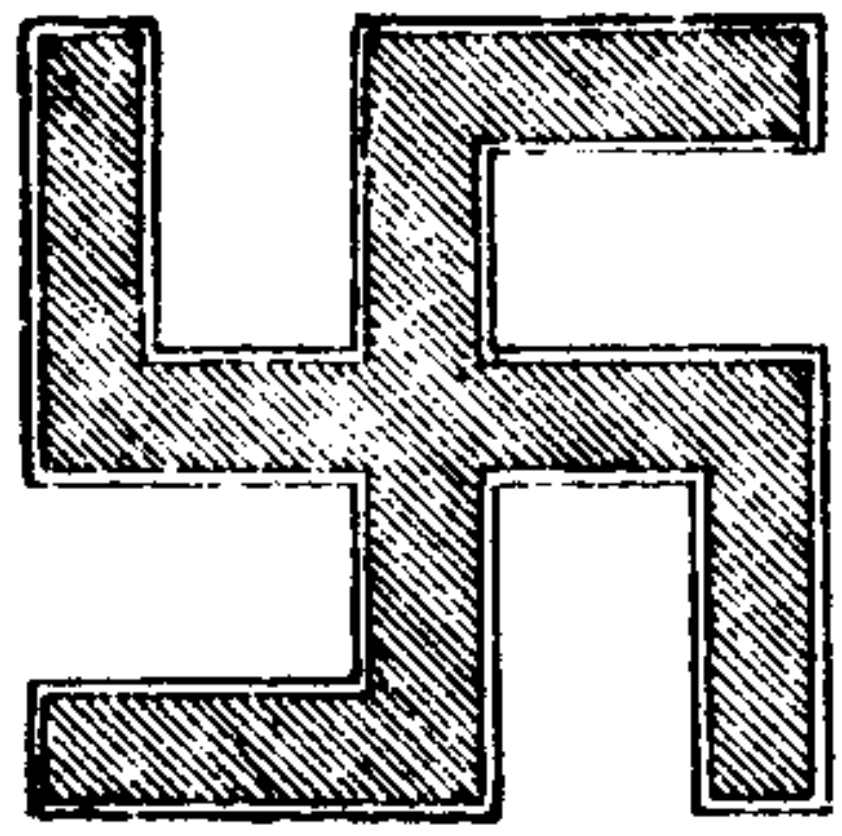

3



2



5



4



7



8

- 7. William Jardine
- 8. James Matheson
- 9. An artist's depiction of the First Opium War

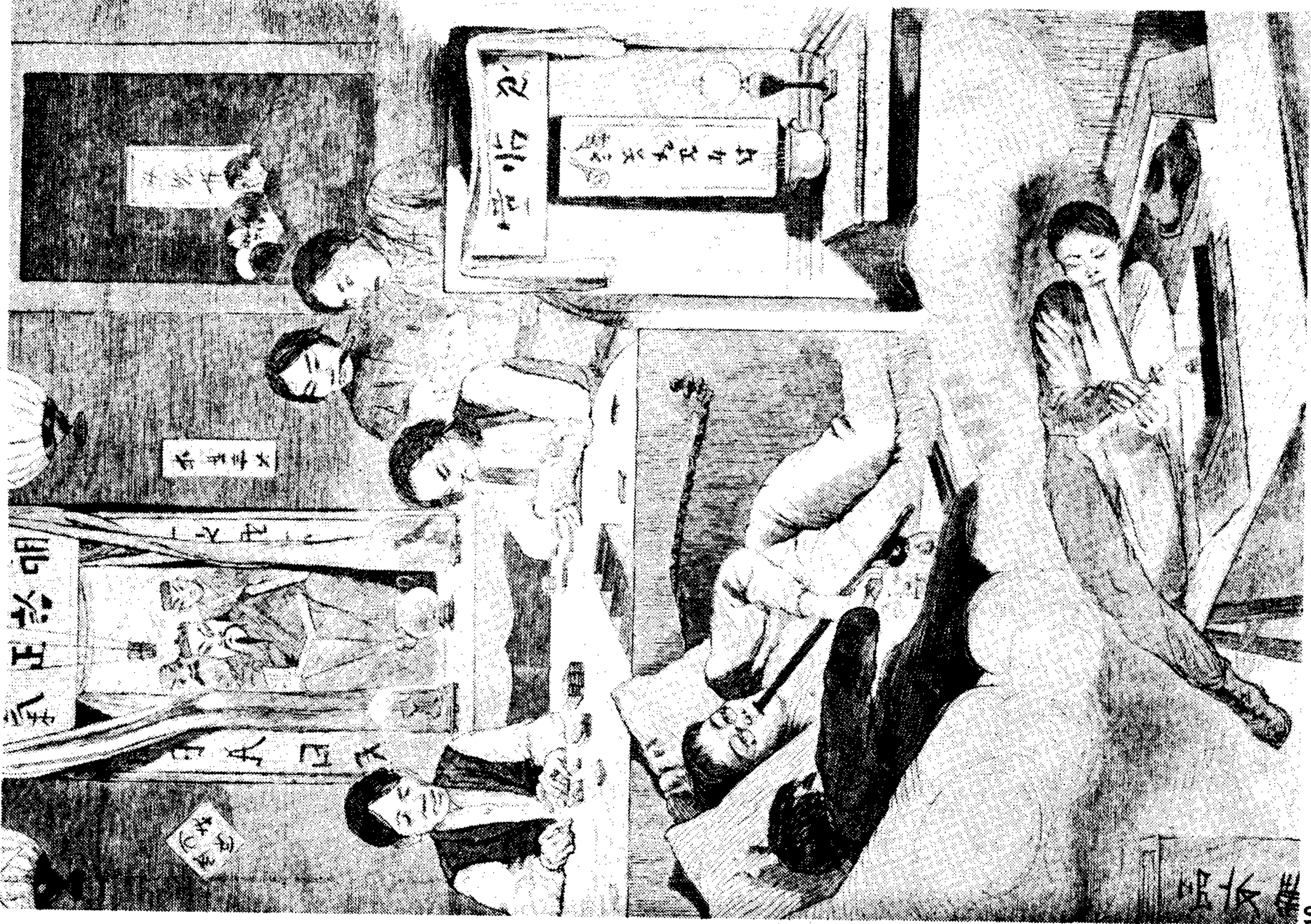

10

10. A Chinese-American opium den (by artist Winslow Homer) as depicted in Harper's, 1874



11

- 11. Giuseppe Mazzini
- 12. Chinese "coolies" — opium smokers — at work on U.S. railroad
- 13. Lehman Bros. (Lehman & Durr) office in Montgomery, Alabama shortly after the Civil War; the same building houses The Oddfellows secret society
- 14. Lincoln's assassination by John Wilkes Booth, a British agent (artist's depiction)

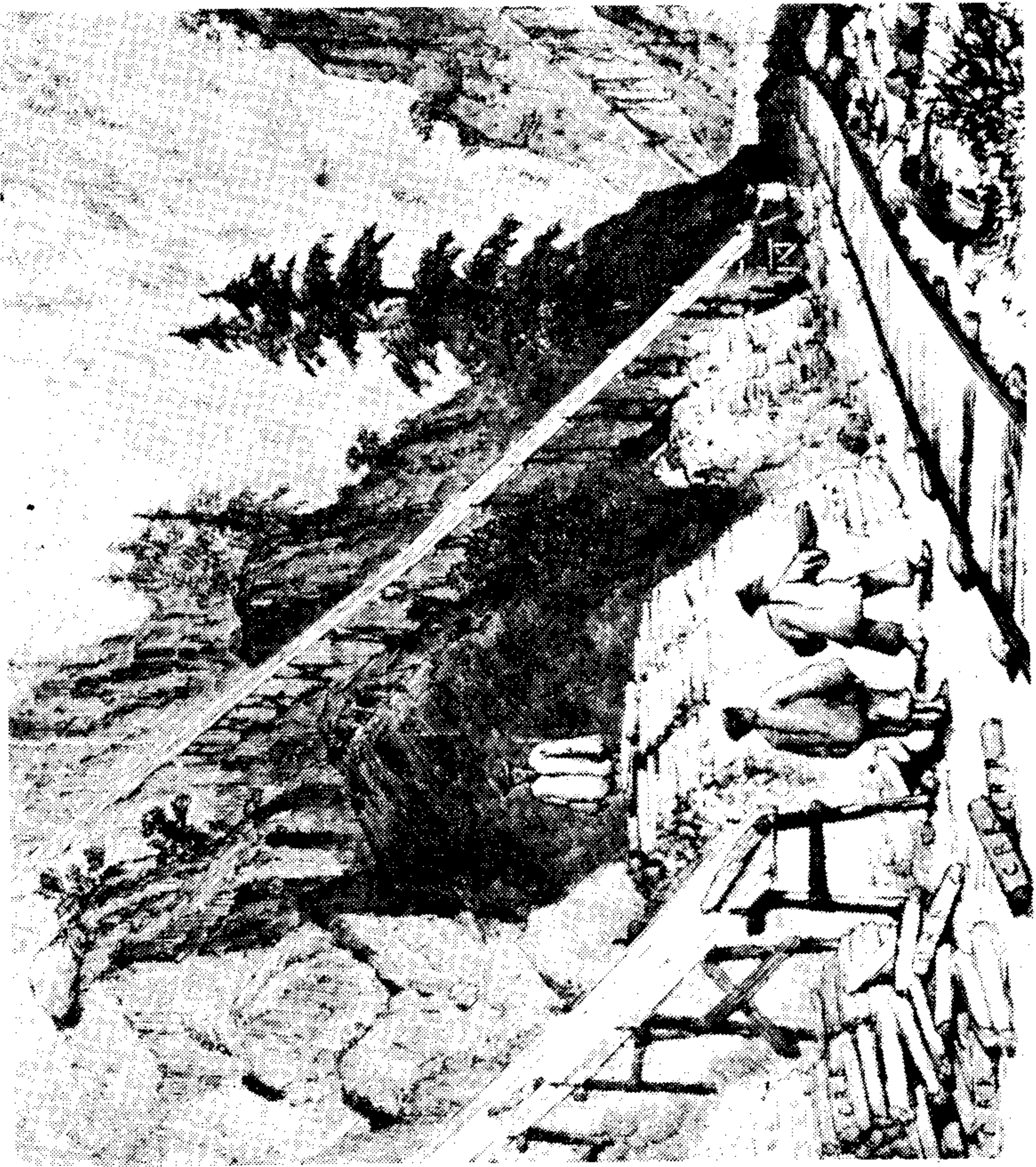

12

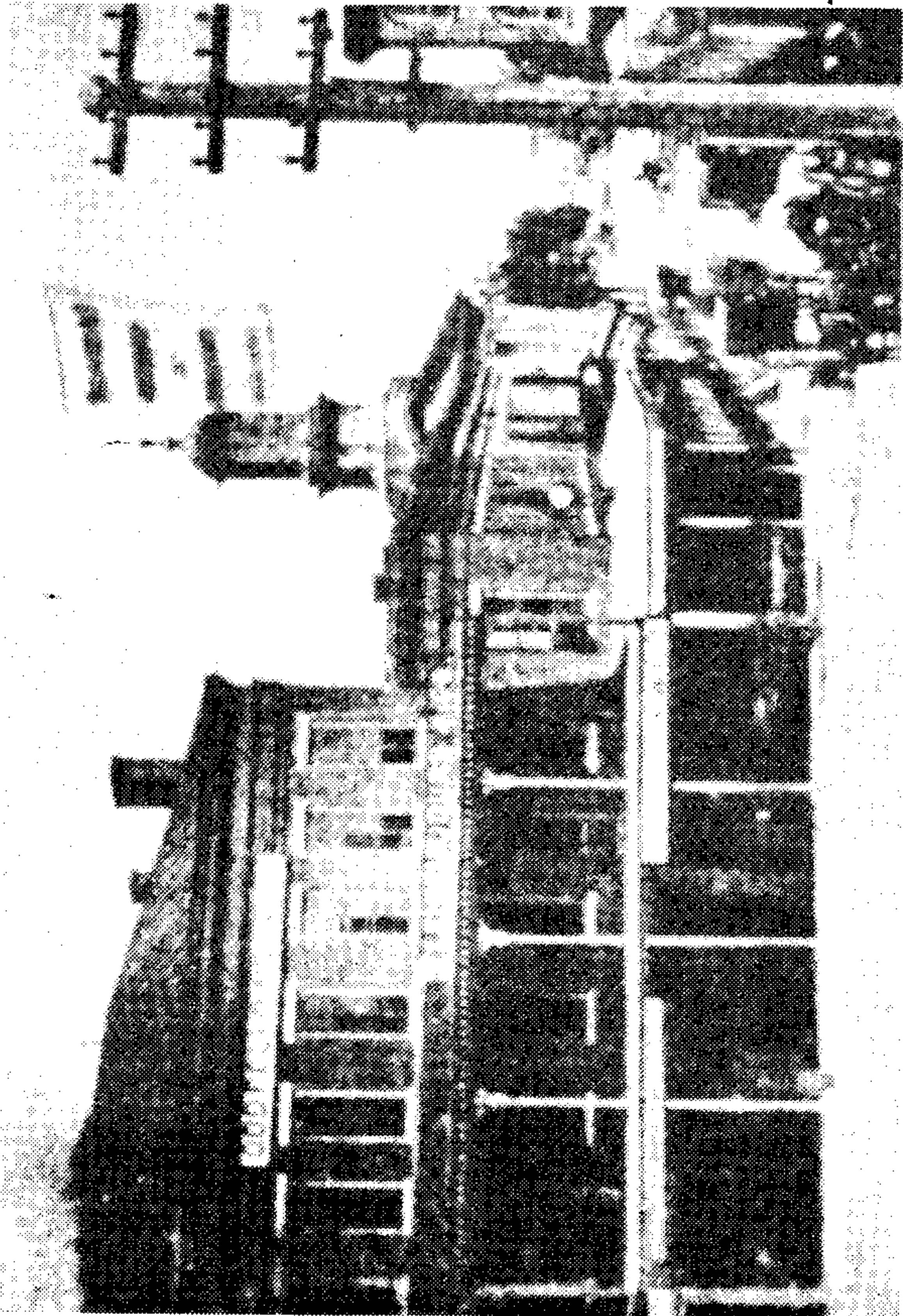

13



14



15



16

15. A mule-team convoy carrying opium through northern Thailand (1967)  
 16. Hillside in northern Thailand devastated by the planting of opium poppies



17

17. A drug-stand in the open market place, Vientiane, Laos (1967)



18

18. Chin Sophonpanich, Chairman, with other directors of the Bank of Bangkok

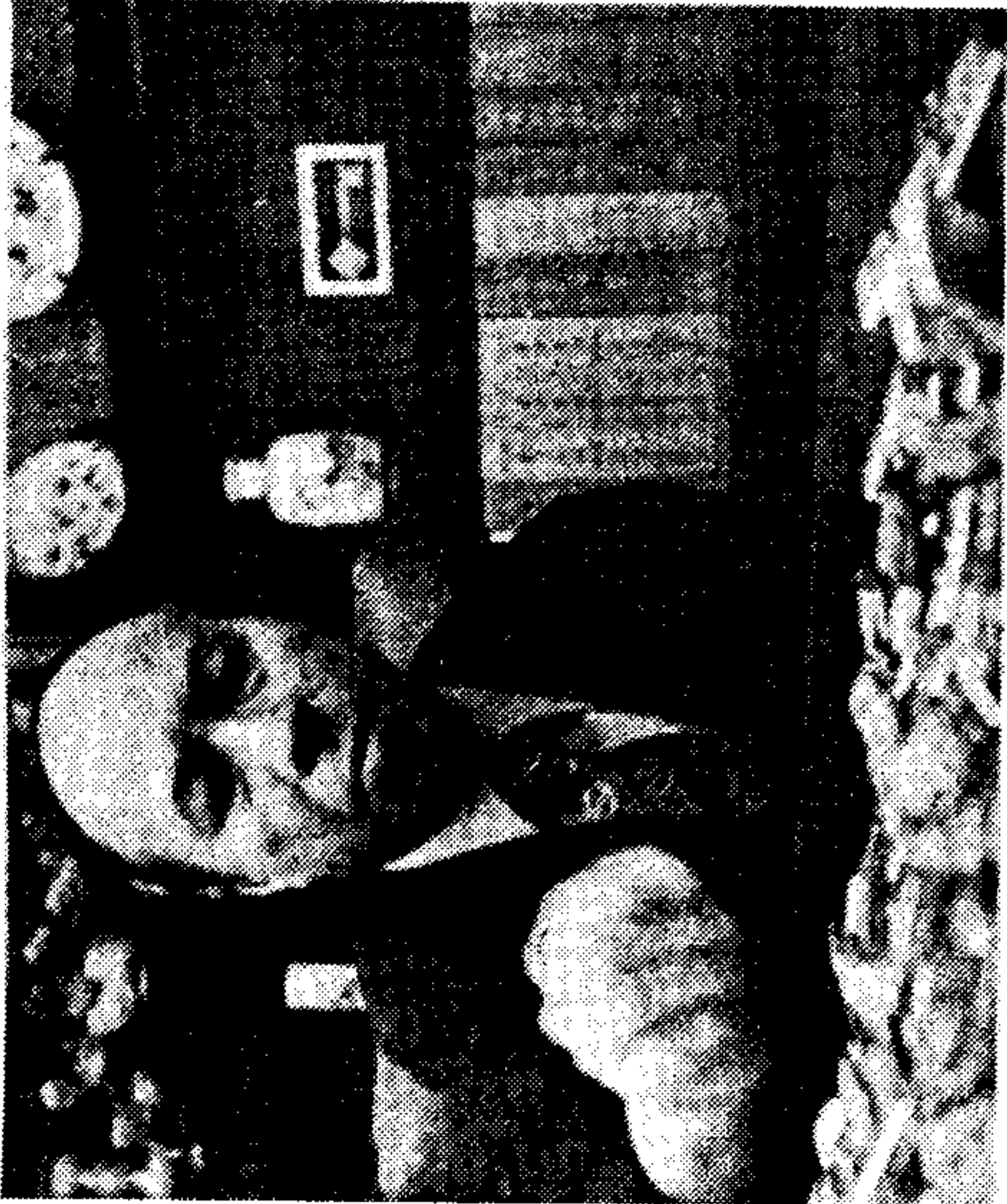

19

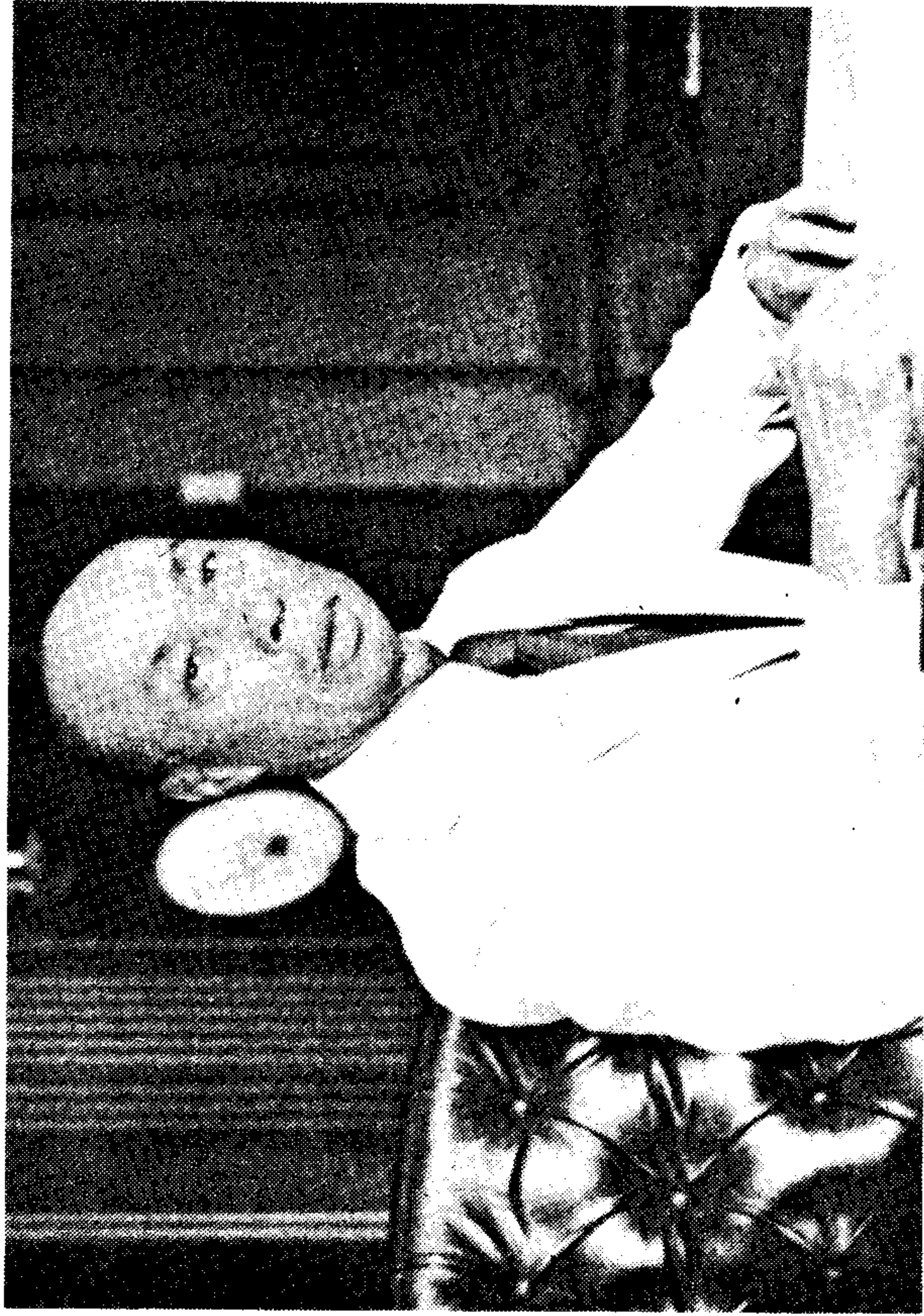

20

19. Chinese expatriate gold-dealer (Woo Hong-fai), Hong Kong, 1977  
20. Udon Tejapaibul, Chairman, Bangkok Metropolitan Bank

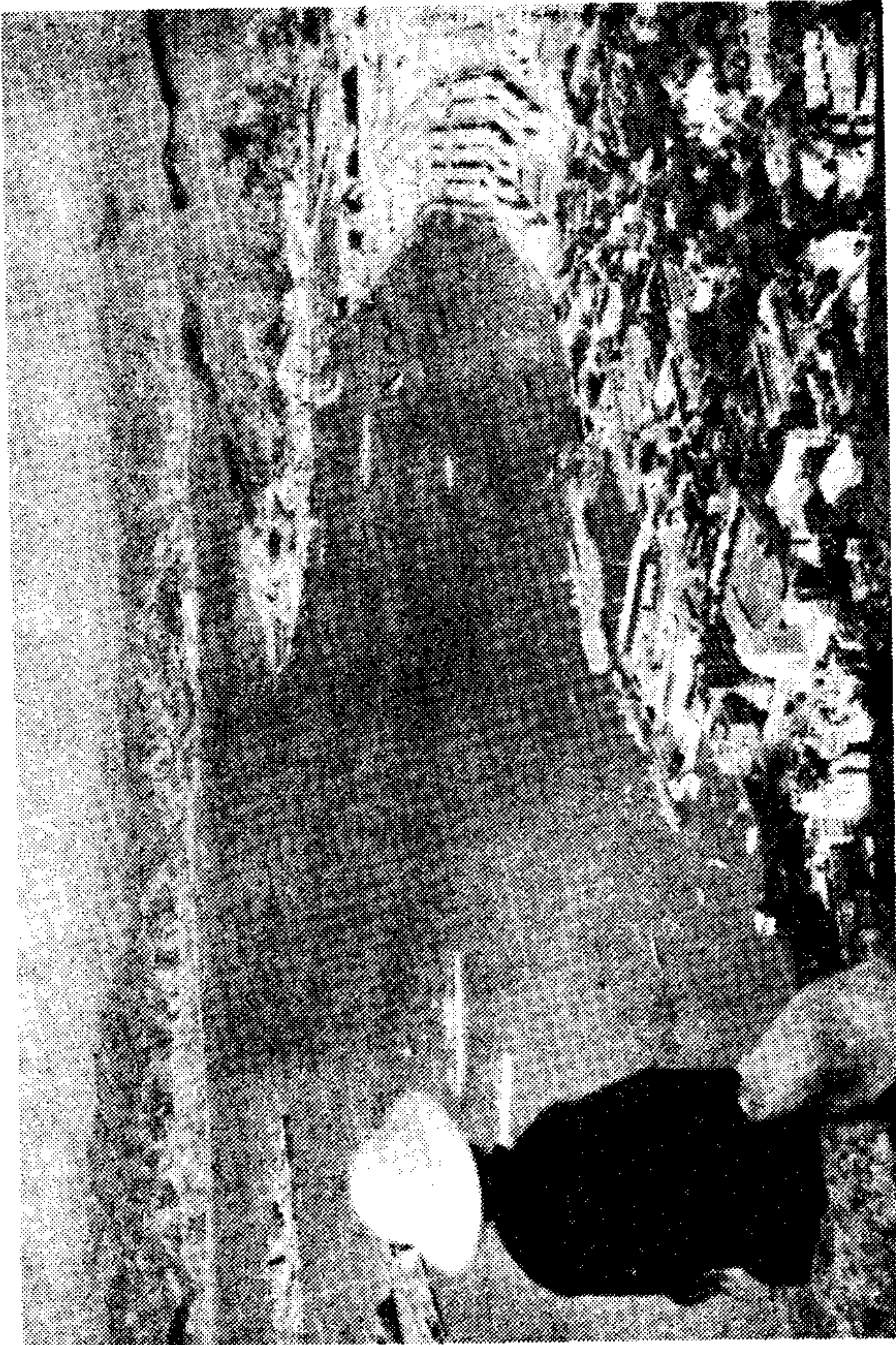

21



22

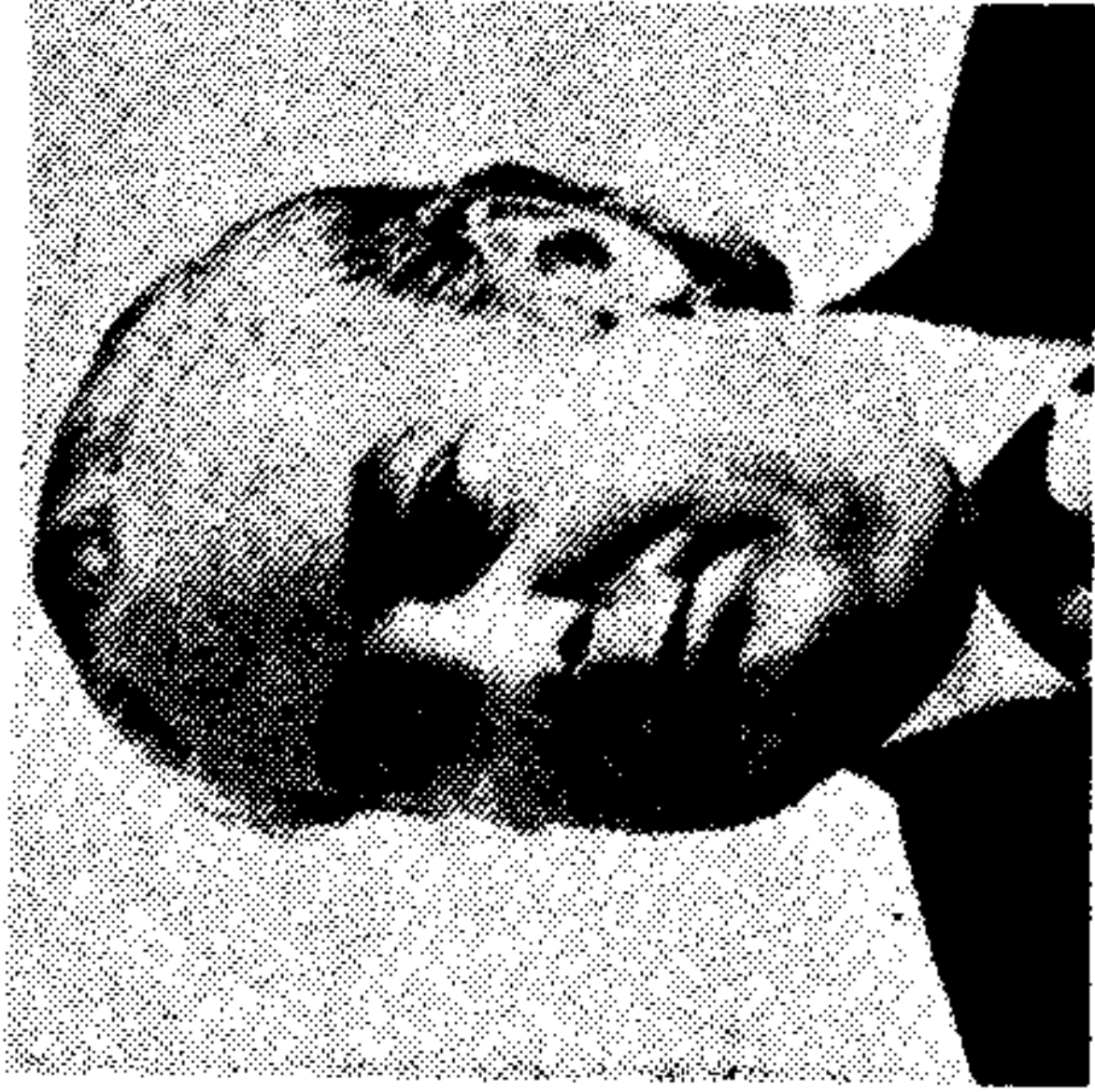

23

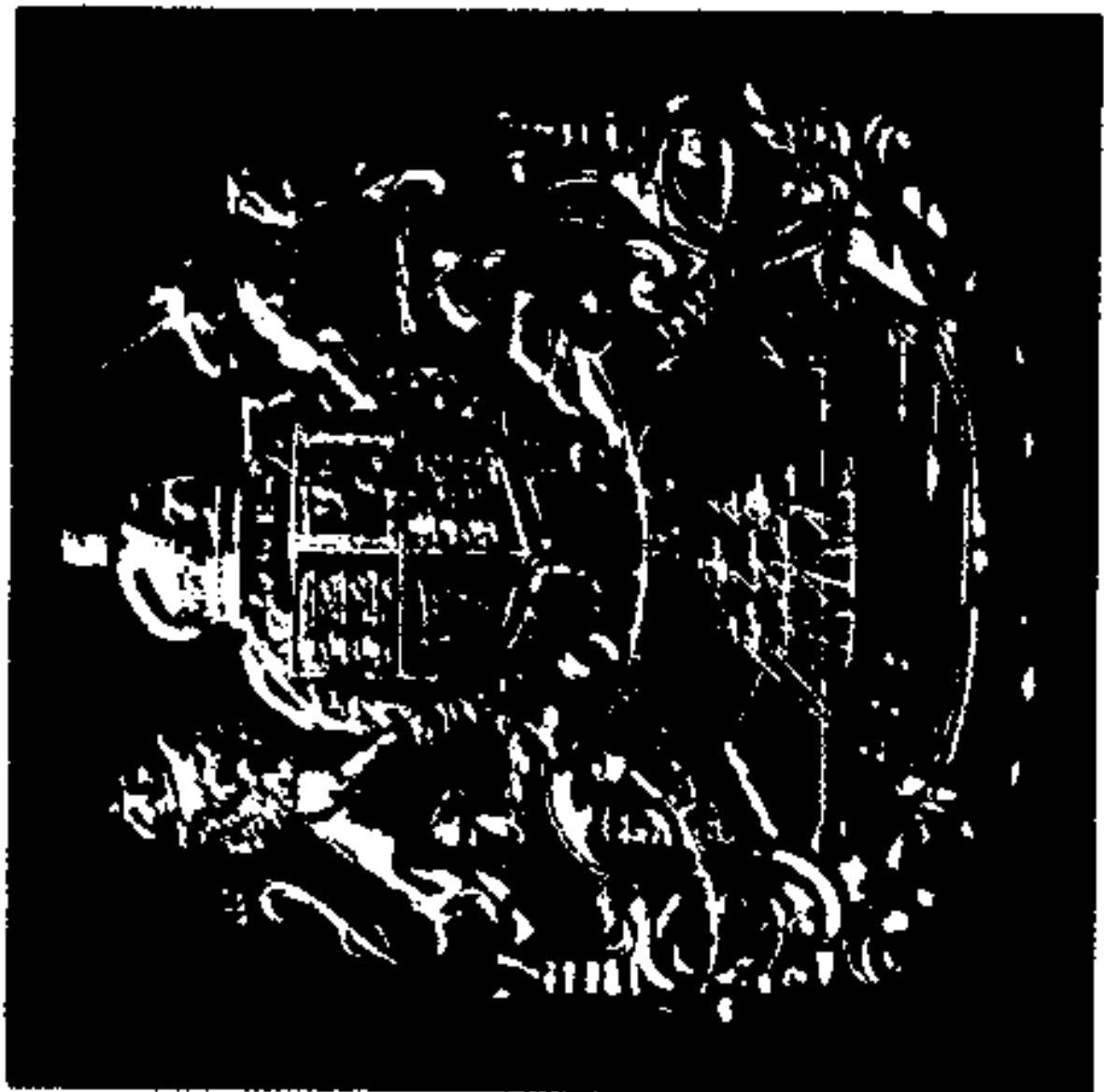

25

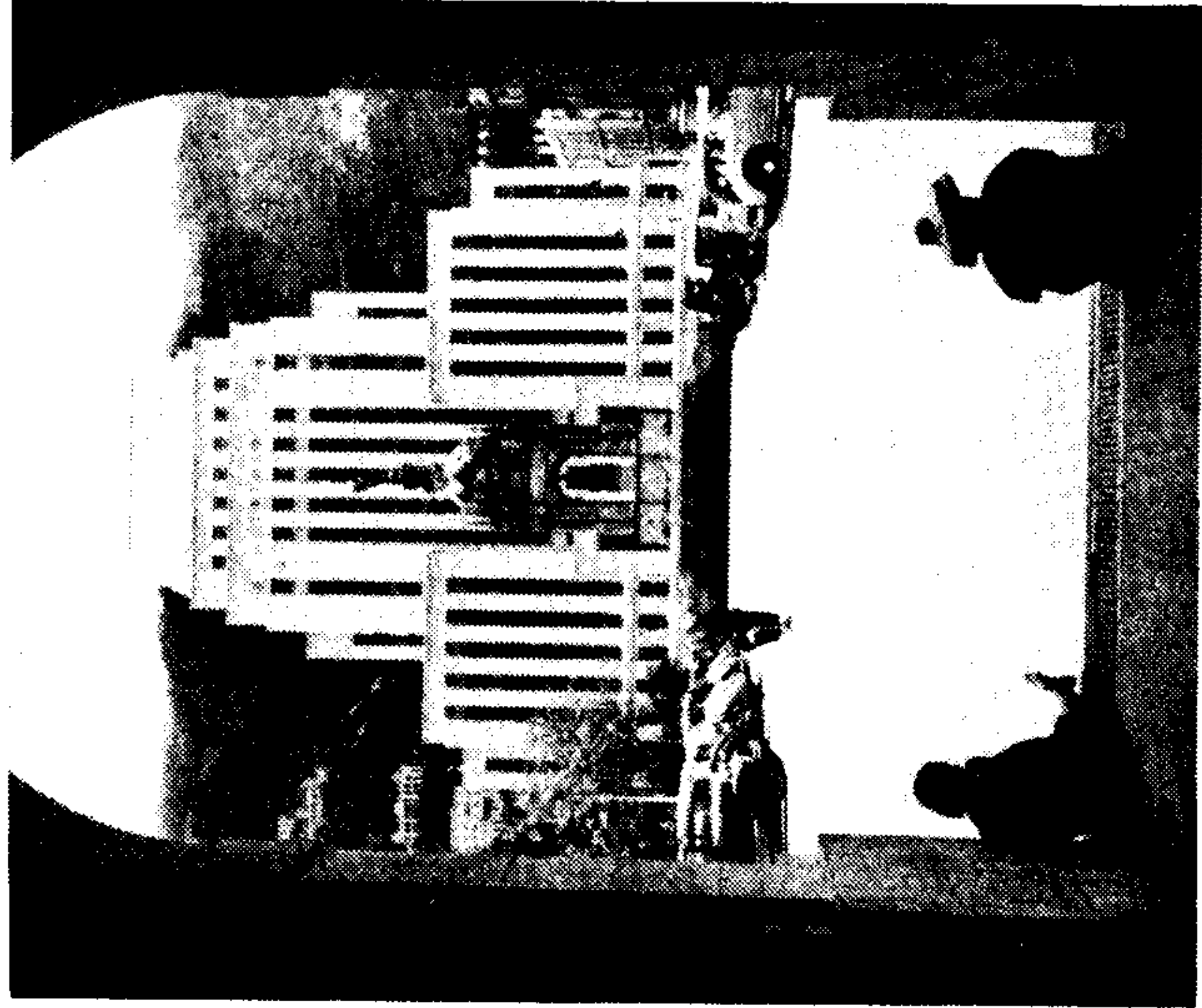

24

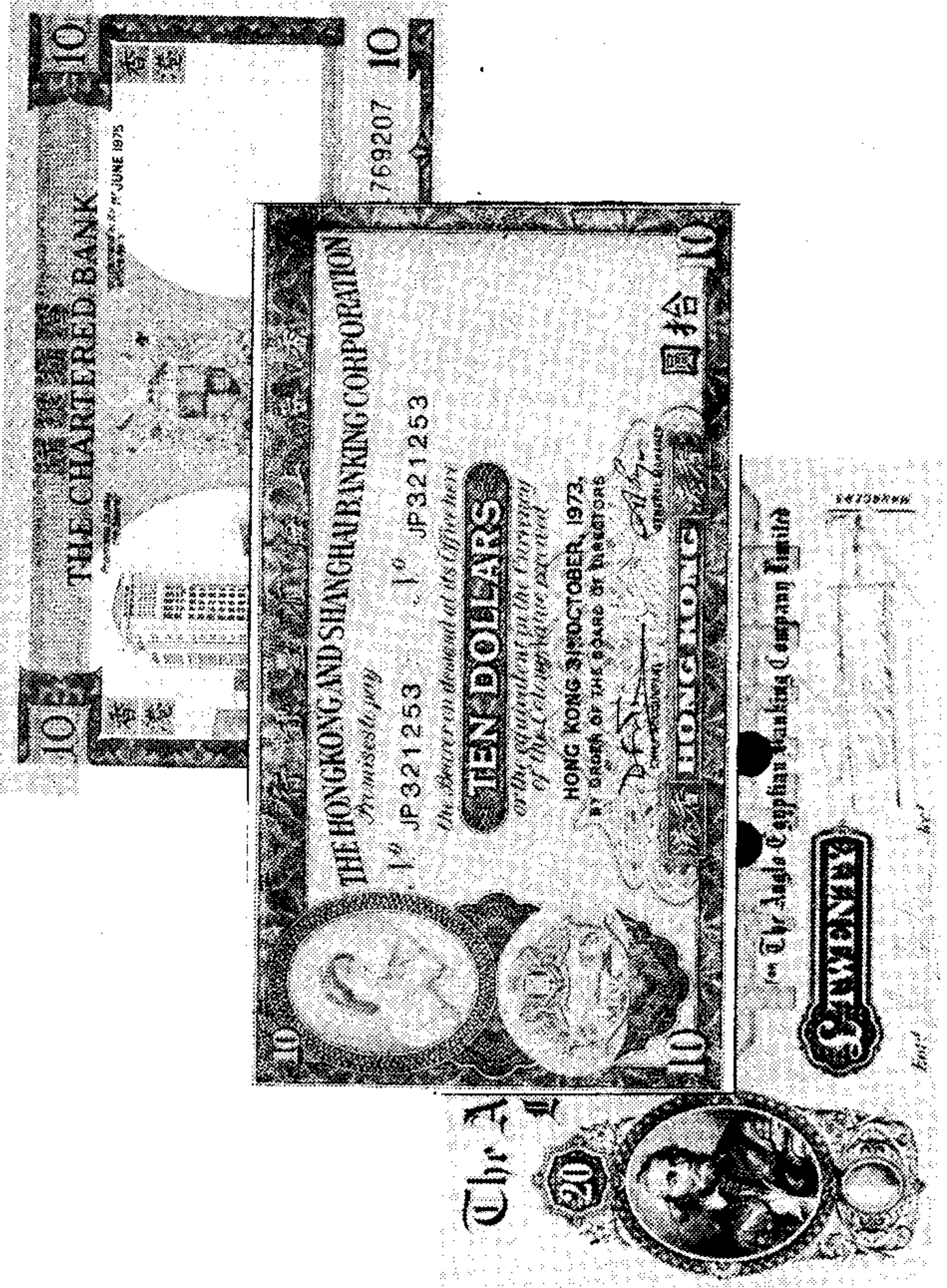

26

- 21. The Crown Colony of Hong Kong, financial center of the drug trade
- 22. Brian Slevin, Hong Kong Chief of Police
- 23. M.G.R. Sandberg, Chairman, The Hongkong and Shanghai Bank
- 24. The Hongkong and Shanghai Bank building
- 25. Hongkong and Shanghai Bank emblem
- 26. Current notes issued by the Hongkong and Shanghai and the Standard Chartered banks in Hong Kong; at bottom, an 1879 issue of the Anglo-Egyptian Bank (Barclays)



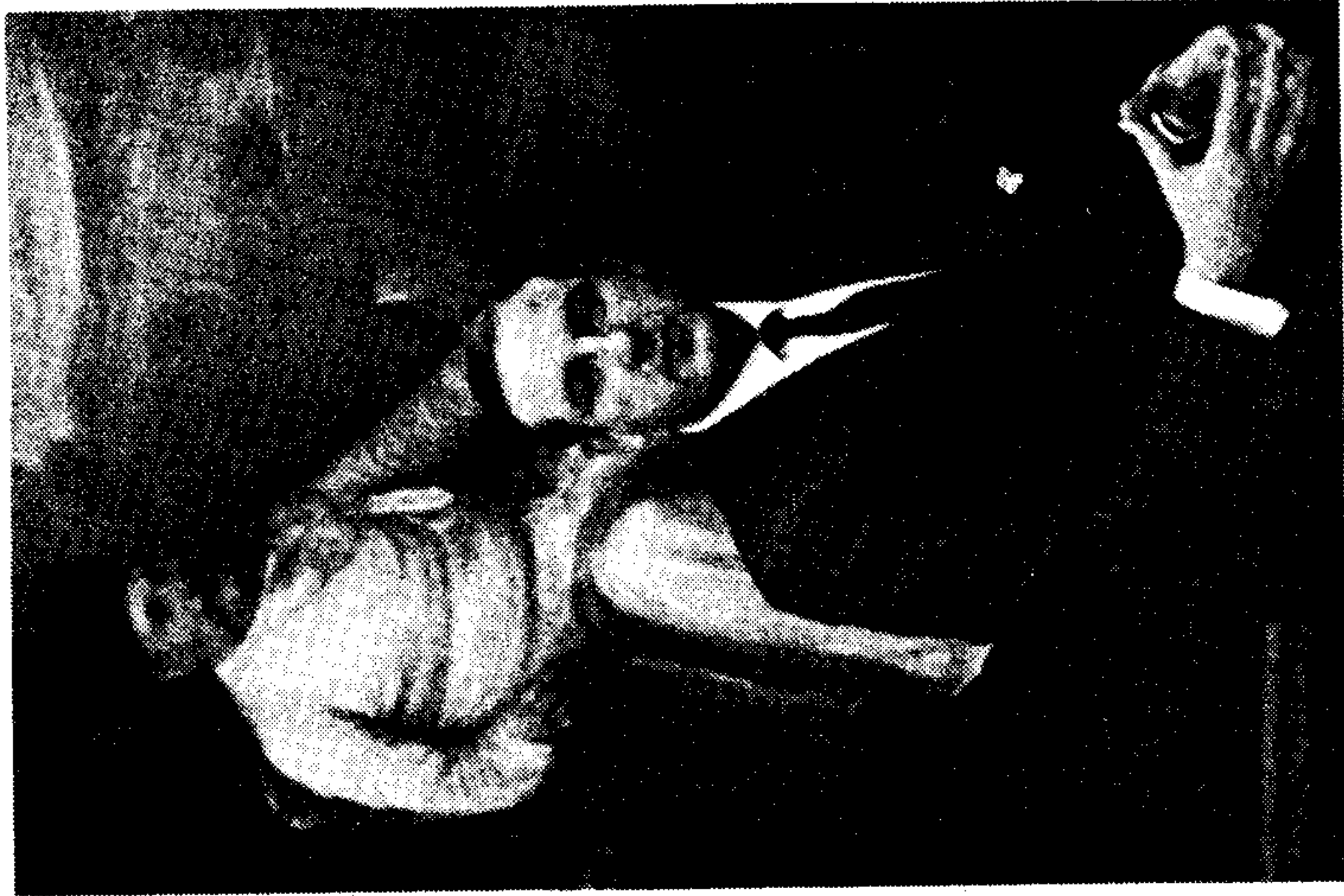

27



28



30



29

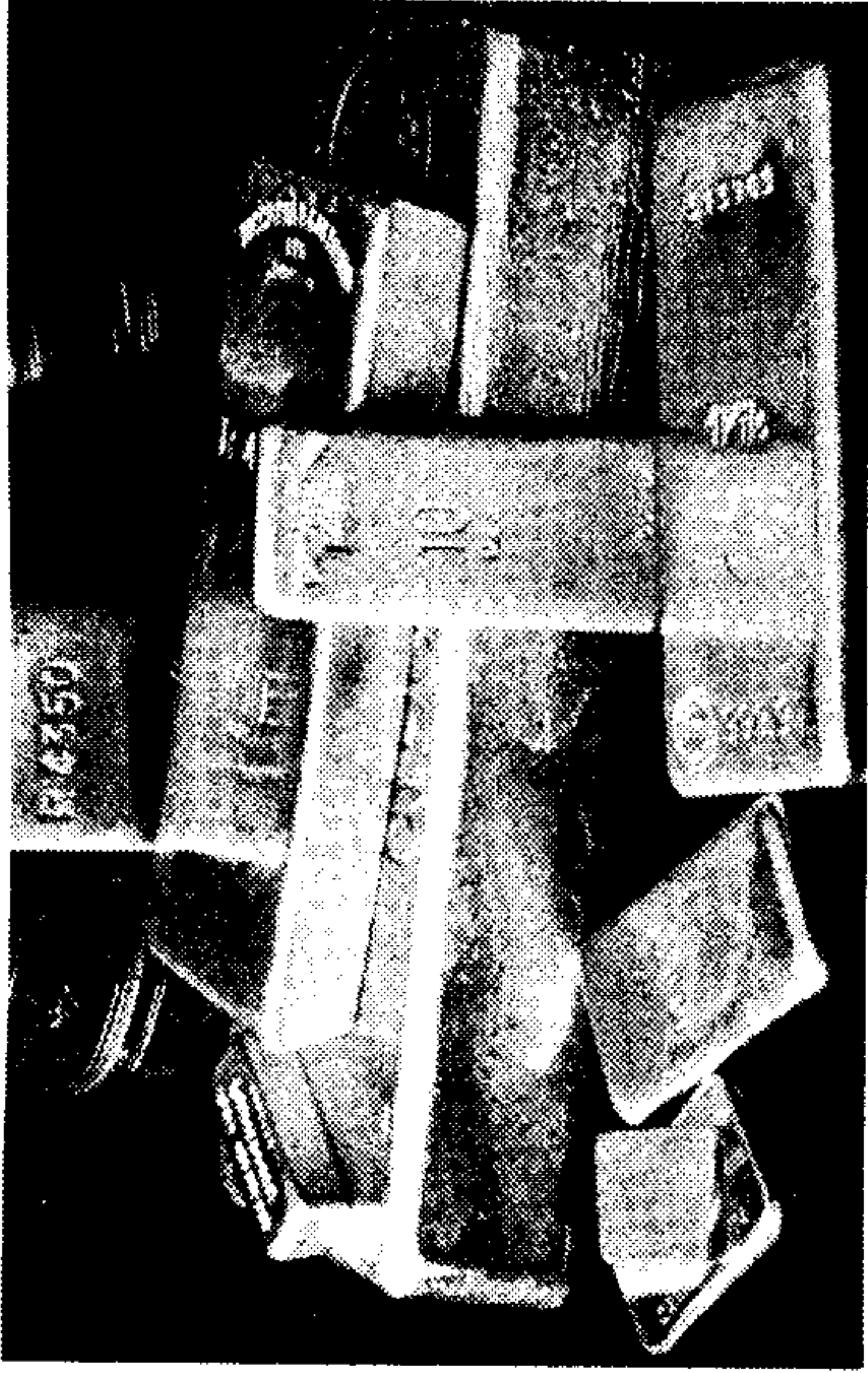

31



32

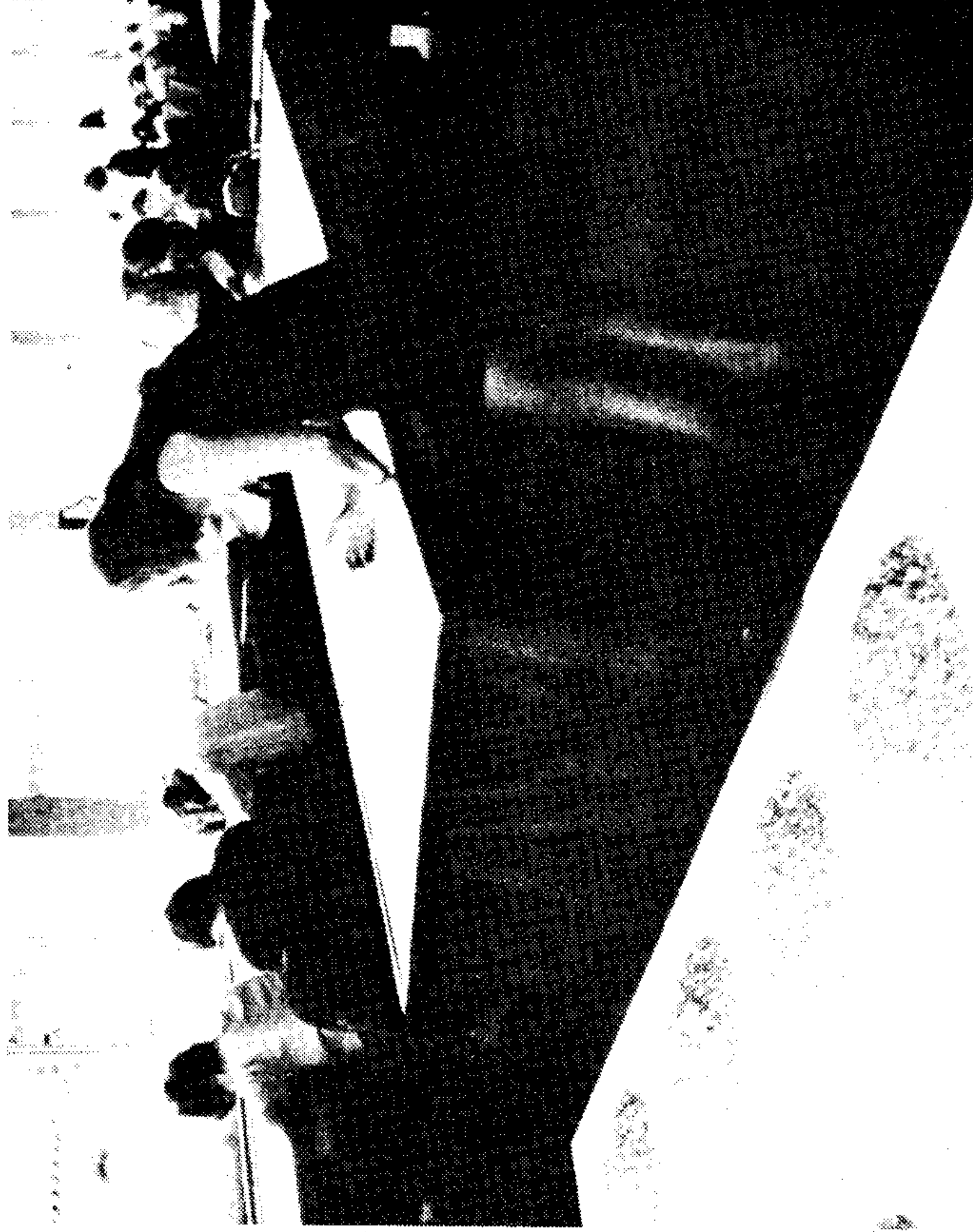

33

- 27. Henry Keswick, Sr., Managing Director, Jardine Matheson
- 28. Sir Mark Turner, Chairman Rio Tinto Zinc, and Governing Council, the Royal Institute of International Affairs
- 29. John Keswick, Director, Matheson and Co.
- 30. David Newbigging, Managing Director, Jardine Matheson
- 31. Bars of gold distributed by Mocatta Metals
- 32. Harry Oppenheimer
- 33. Diamonds sorted by quality, shape and color



34

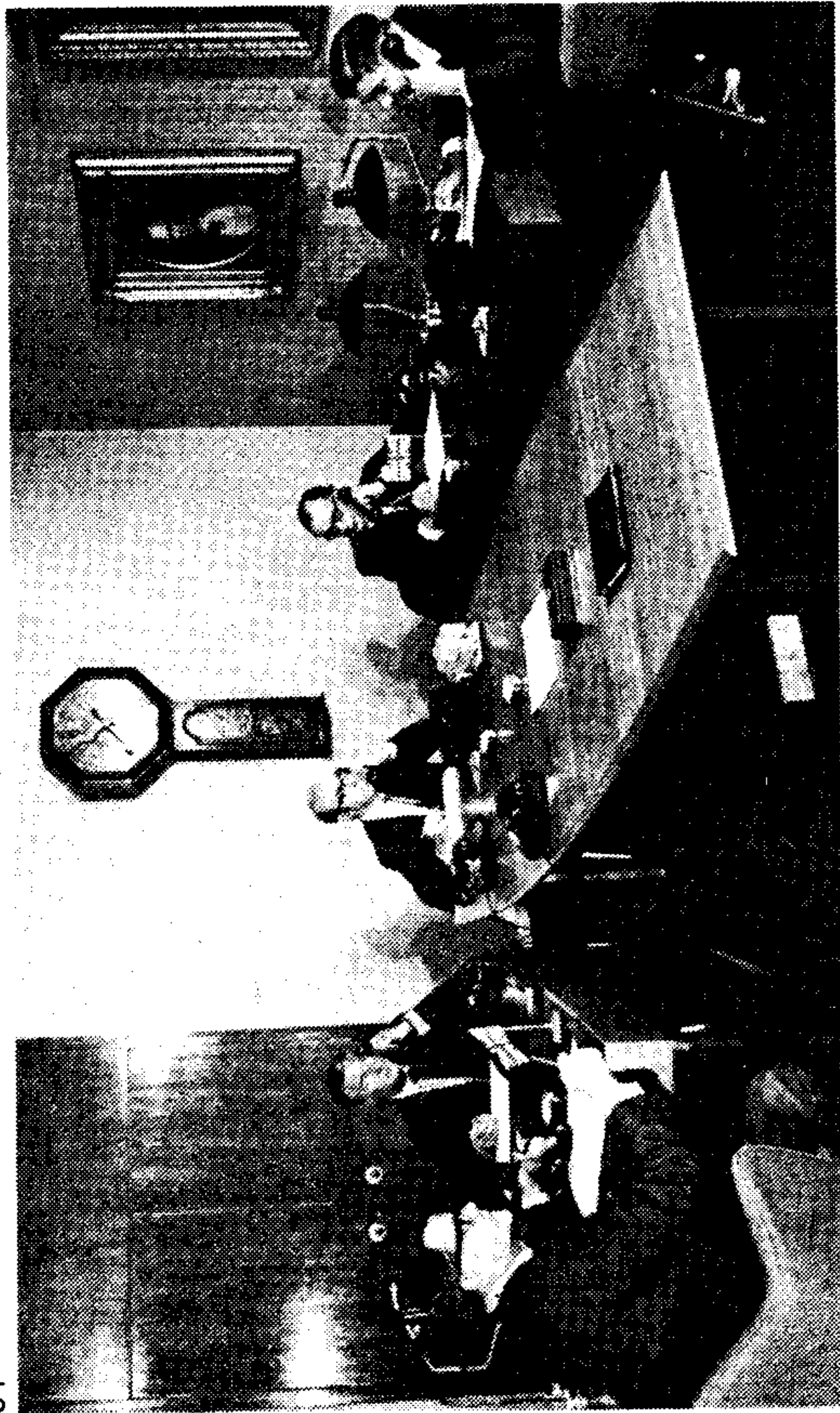

35

- 34. Henry Jarecki (c) with Edward Mocatta (r) and Keith S. Smith, Managing Director, Mocatta and Goldsmid
- 35. A morning gold-fixing, N.M. Rothschilds, London (second from right, Edward Mocatta)

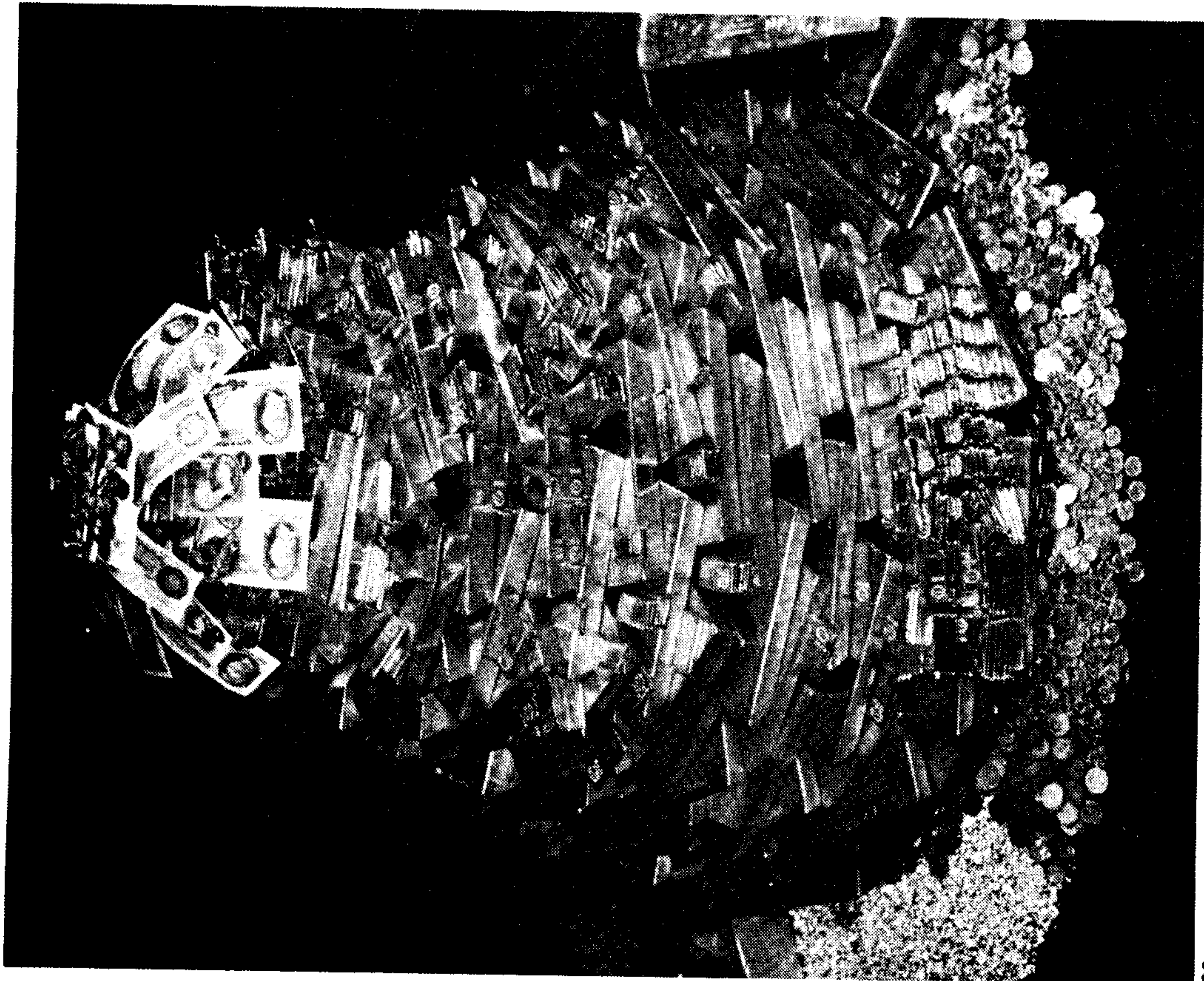

36

- 36. "Bullion Pile" prepared for a visiting Queen Elizabeth II by Mocatta's parent bank (valued at £6,000,000)



37



39



38



40



41

- 37. Mao Tse-tung with U.S. General Hurley, 1949: double-cross
- 38. Chinese Premier Chou En-lai, 1949
- 39. Bertrand Lord Russell
- 40. Walter Lockhart Gordon (r) with Peter C. Newman (c) and Abraham Rotstein of Canada's "China Lobby"
- 41. Lord Amory, 31st Governor, G.T. Richardson, 32nd Governor, and A.J. Macintosh, Deputy Governor of the Hudson's Bay Company in 1971

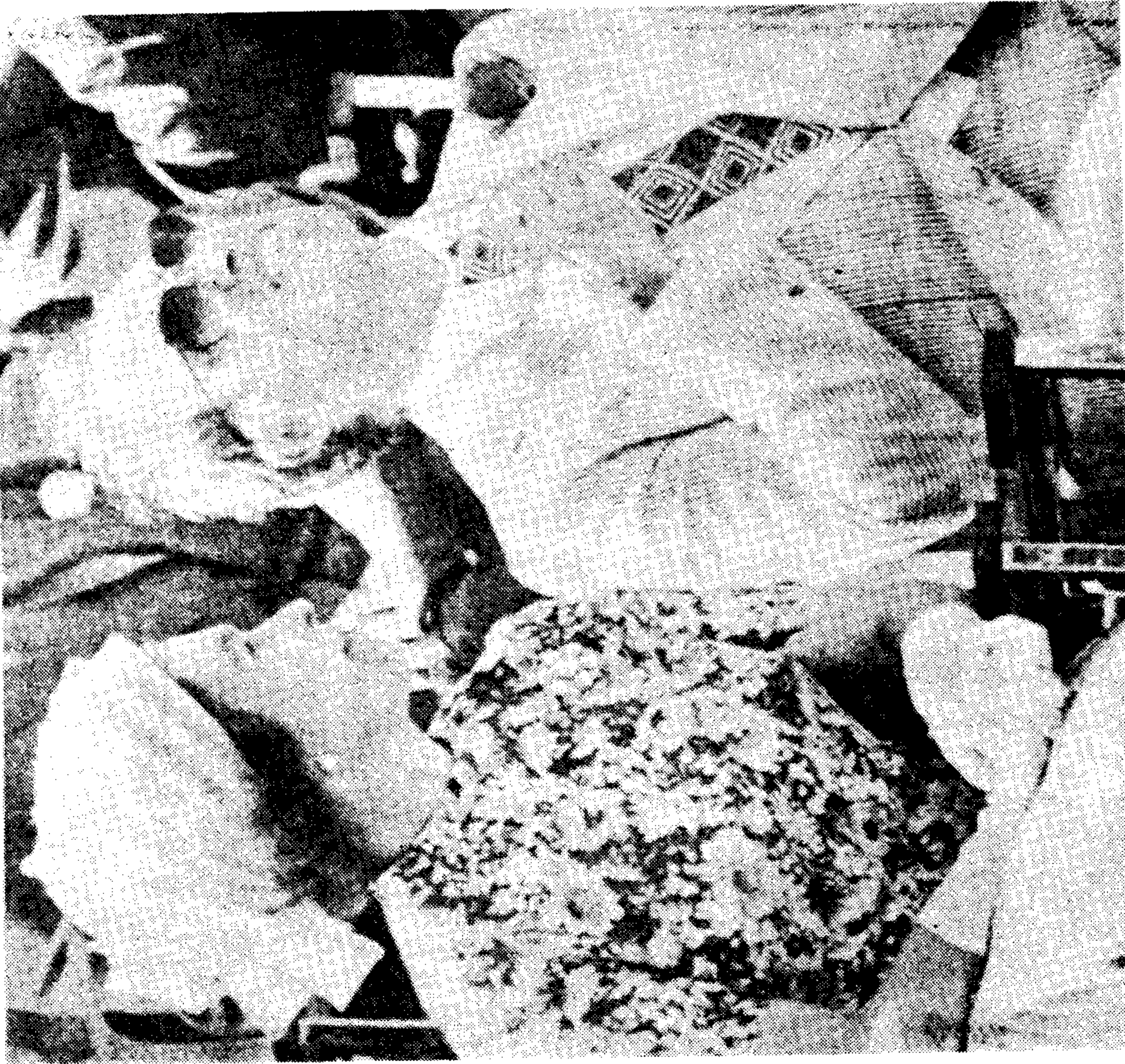

42



44



45

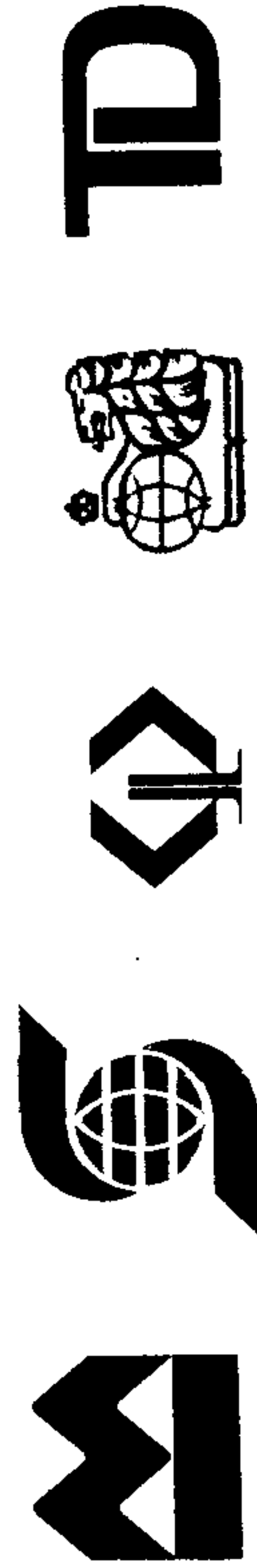

43

- 42. Queen Elizabeth II with Canadian Prime Minister Pierre Elliott Trudeau, 1978
- 43. Corporate emblems of the Canadian money-laundering banks: Bank of Montreal, Bank of Nova Scotia, Canadian Imperial Bank, Royal Canadian Bank, Toronto Dominion Bank
- 44. John Ruskin
- 45. Cecil Rhodes



46

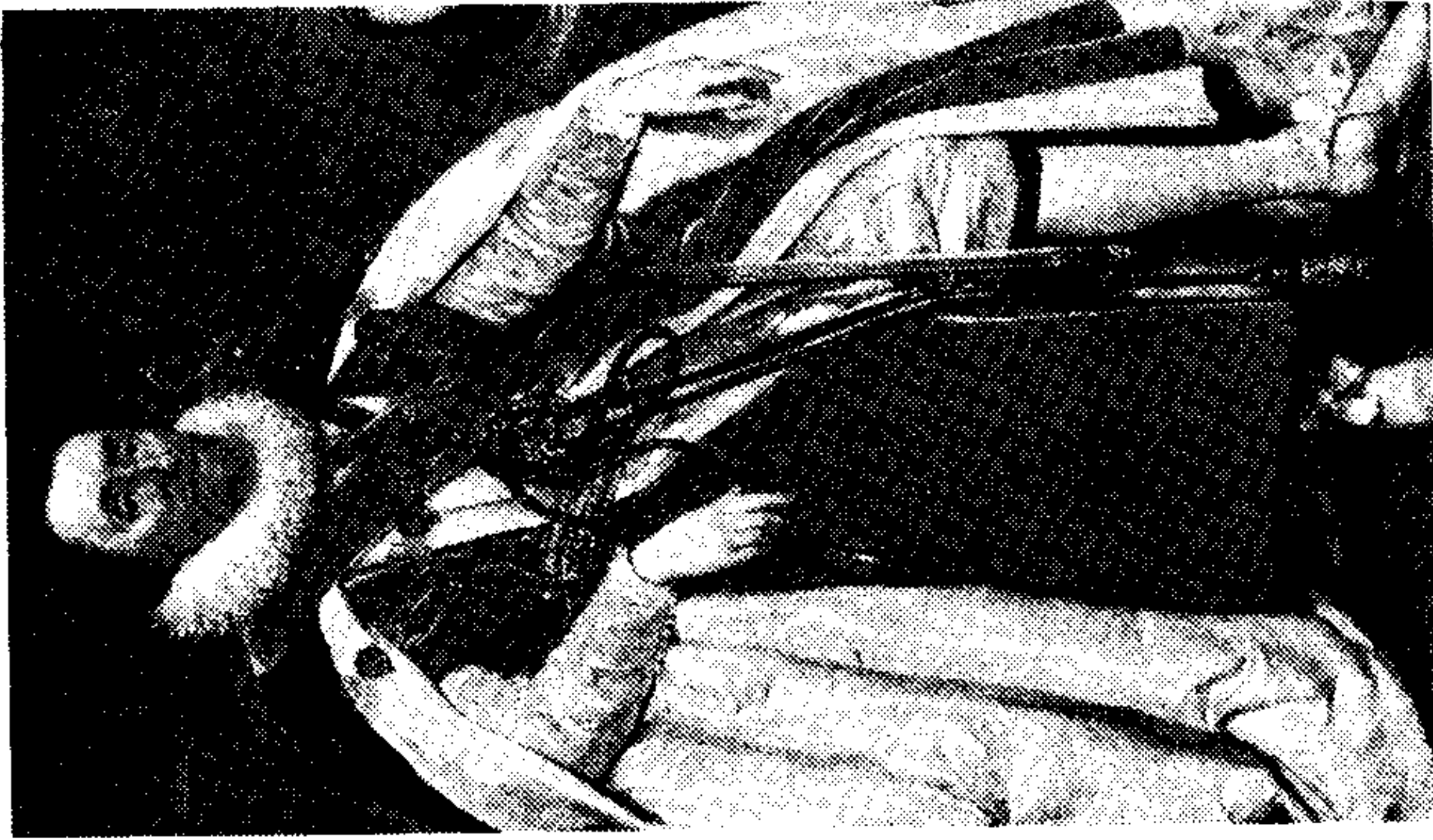

47



48



49



50

- 46. Robert Cecil, Lord Burghley, who delivered Tudor England to the Order of Malta's House of Stuart
- 47. Stuart James VI of Scotland, James I of England (1603-1625).
- 48. Grand Master of the Order of St. John of Jerusalem, Villiers de l'Isle-Adam entering Malta in 1530
- 49. The Seal of the Knights Templar
- 50. A 14th century Knight of St. John depicted kneeling before Rhodes, the order's home base before the Hapsburg gift of Malta



51



52

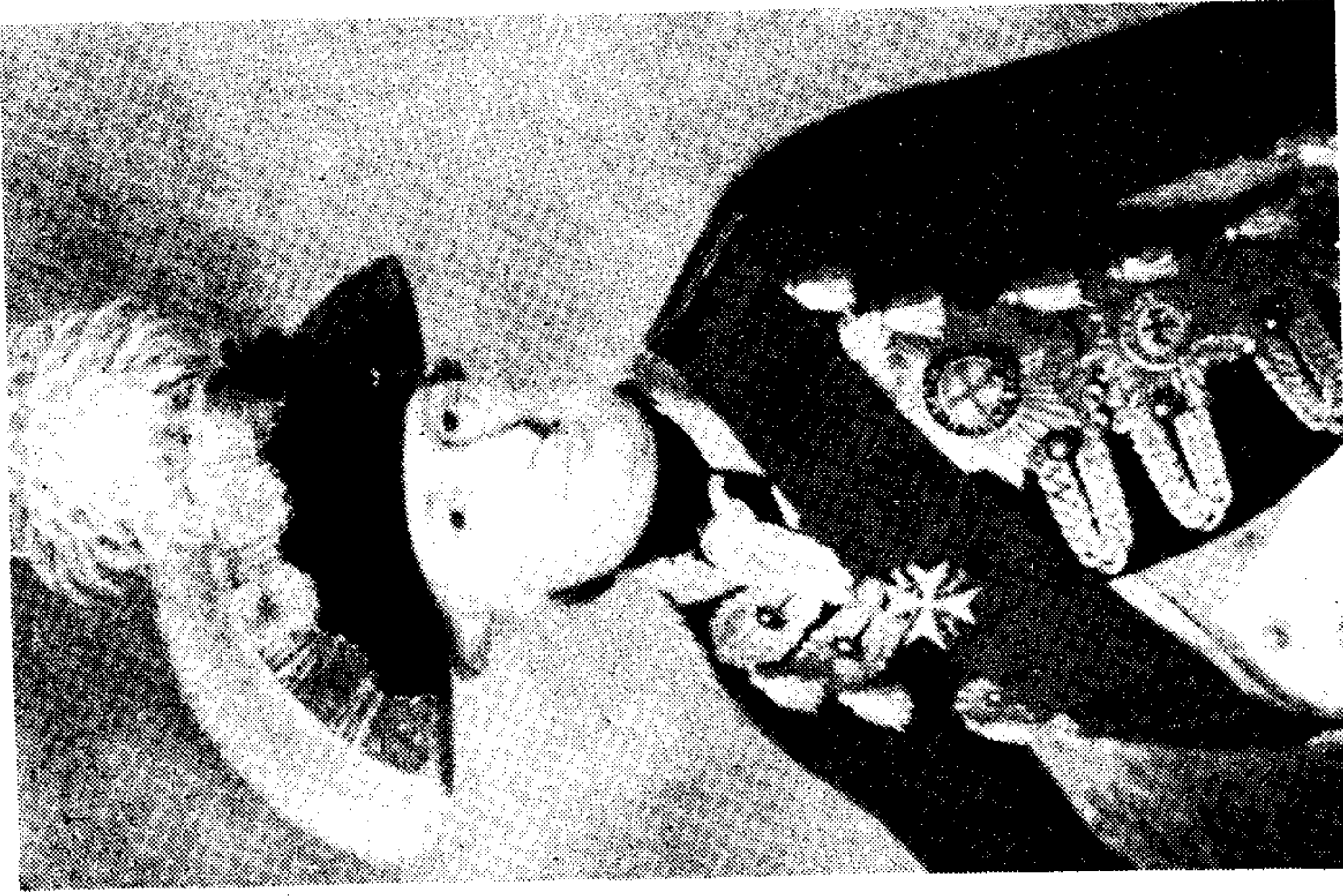

53

- 51. Amschel Rothschild, 18th century German founder of the family's financial empire
- 52. Nathan Rothschild, founder of the family's British branch
- 53. Prince William IX of Hesse Cassel, first patron of the Rothschilds, whose Prussian field marshal's uniform is decorated by a Cross of Malta

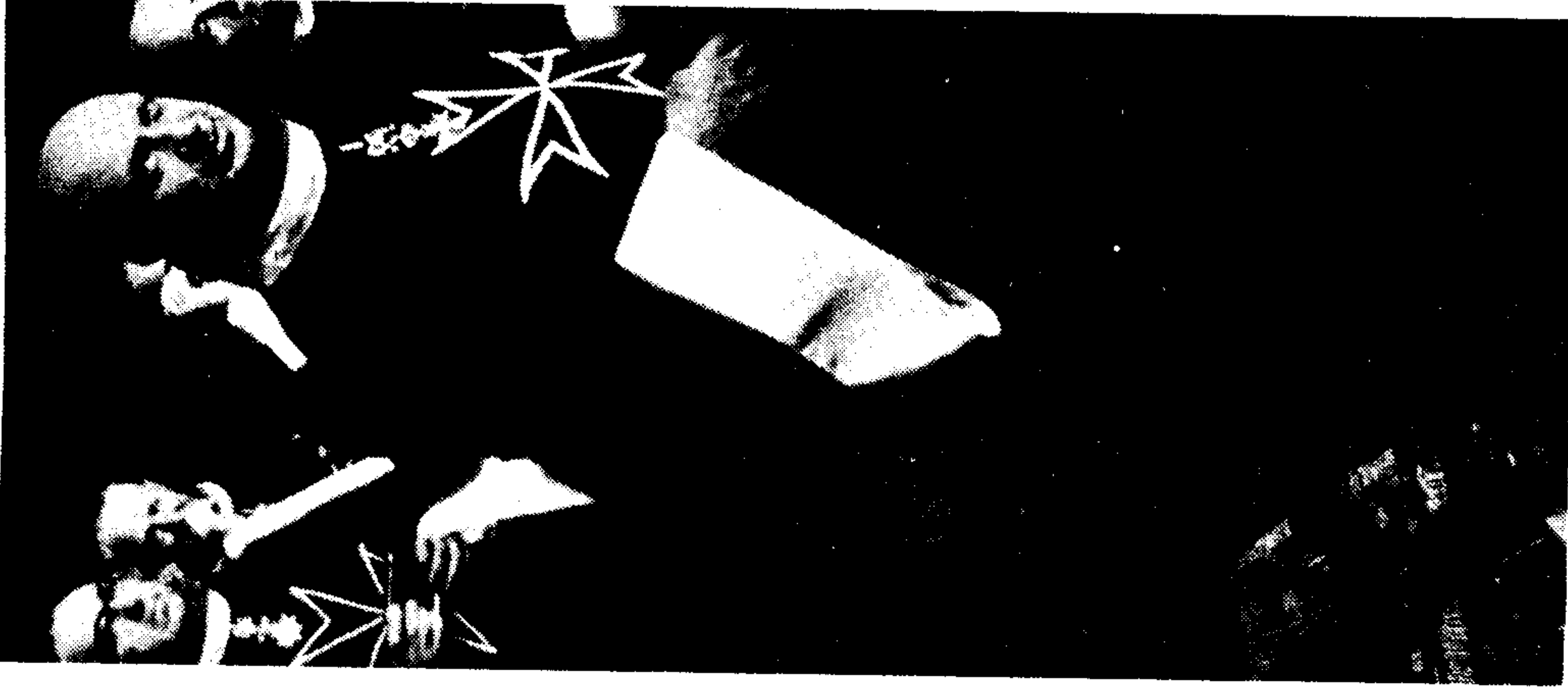

54

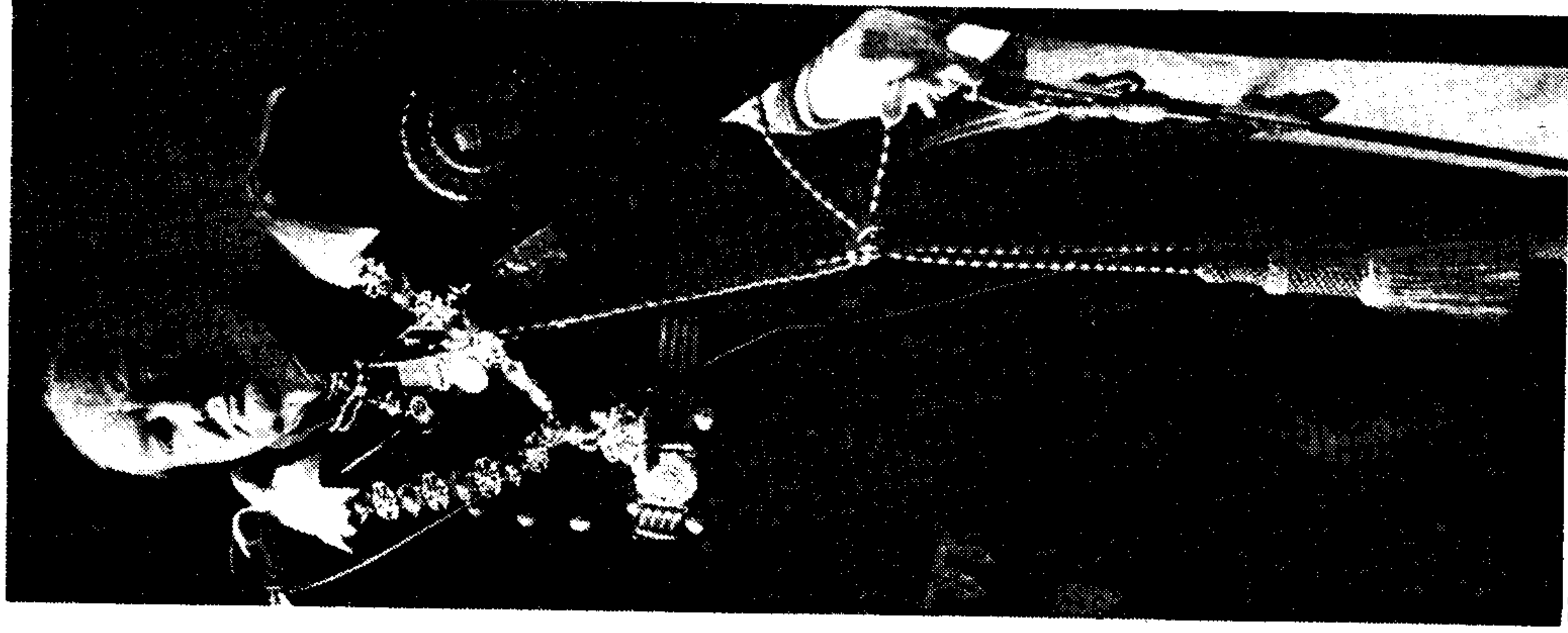

55

- 54. Modern rites of the Order of St. John of Jerusalem
- 55. Winston Churchill in Warden of Cinque Ports costume for the 1953 coronation of Elizabeth II

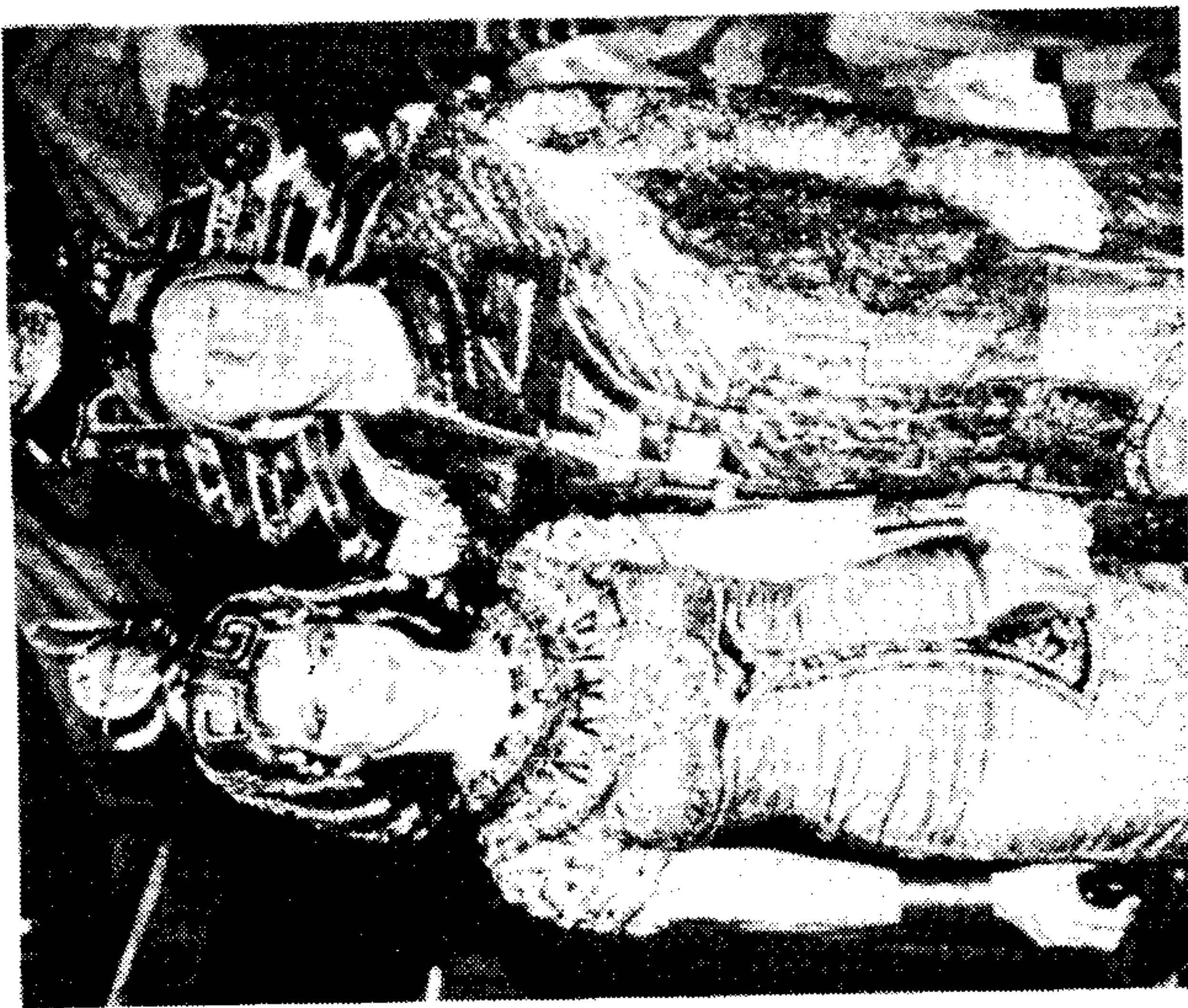

56



58



57

- 56. The current Cecil, Lord Harlech
- 57. Joseph P. Kennedy during the whiskey-running years
- 58. John Fitzgerald Kennedy and Robert Francis Kennedy



59

## What the best drinks have in common.

Scorpion's 7 Crown whiskey is the best because it has no better ally than you. For every sip, you're getting the most delicious, most satisfying drink. And you're not alone.

**Scorpion's 7 Crown**  
Where quality drinks begin.

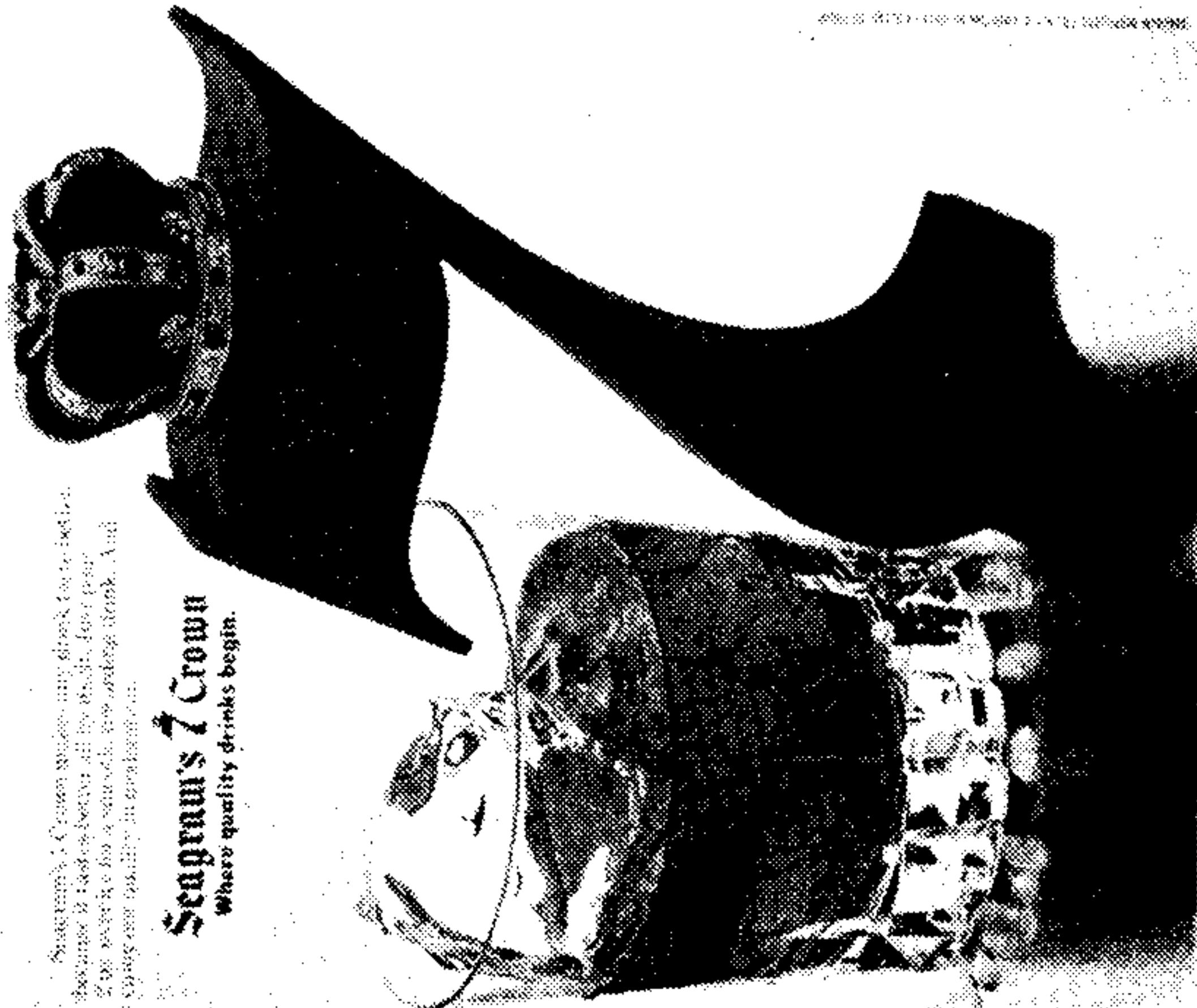

60

- 59. Edgar Brontfman
- 60. The whiskey his father Samuel ran into the USA during Prohibition



61



62



63



64



65



66



67



68



69

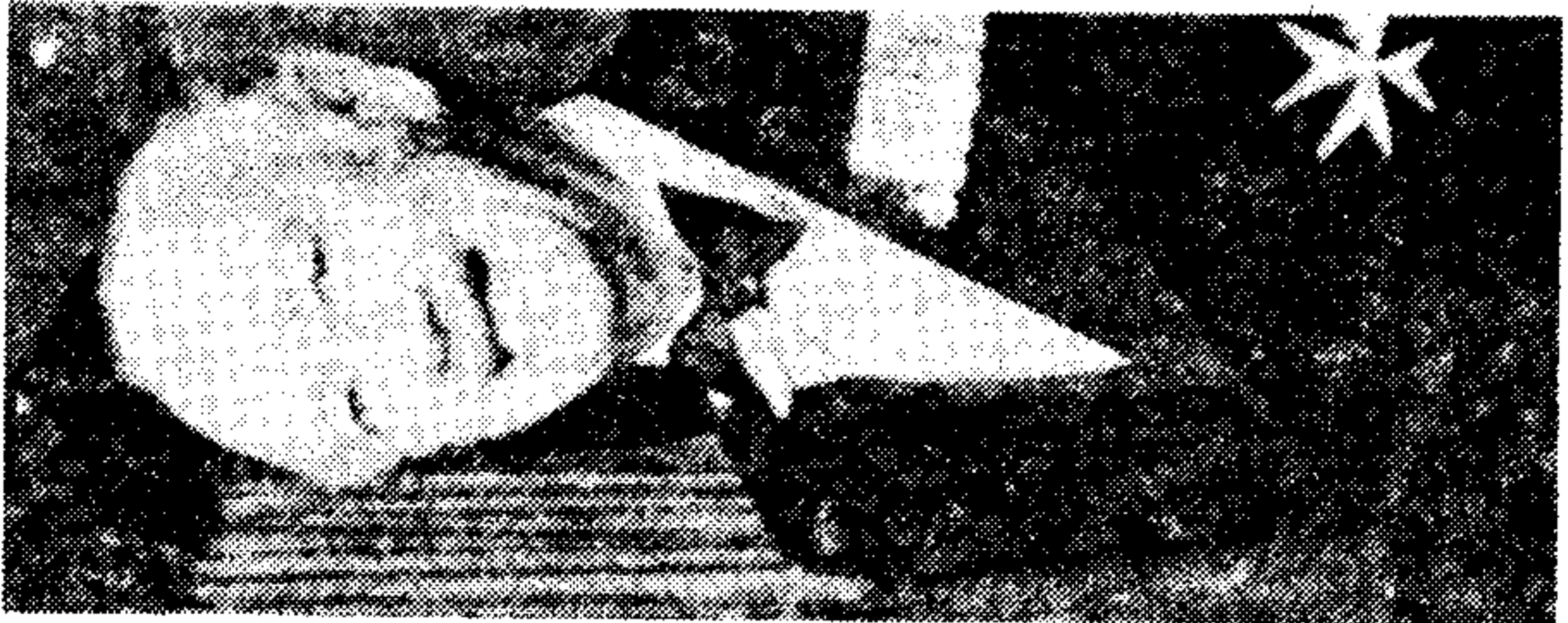

70

- 61. Arnold Rothstein
- 62. Meyer Lansky
- 63. Thomas E. Dewey, re-organizer of organized crime in the 1930s
- 64. Al Capone
- 65. Charles "Lucky" Luciano
- 66. Johnny Torrio
- 67. Abner "Longie" Zwillman
- 68. "Bugsy" Siegel
- 69. John F. Kennedy, beginning the 1963 motorcade in Dallas that ended in his assassination
- 70. Major Louis Bloomfield, wearing the Cross of Malta





71



74

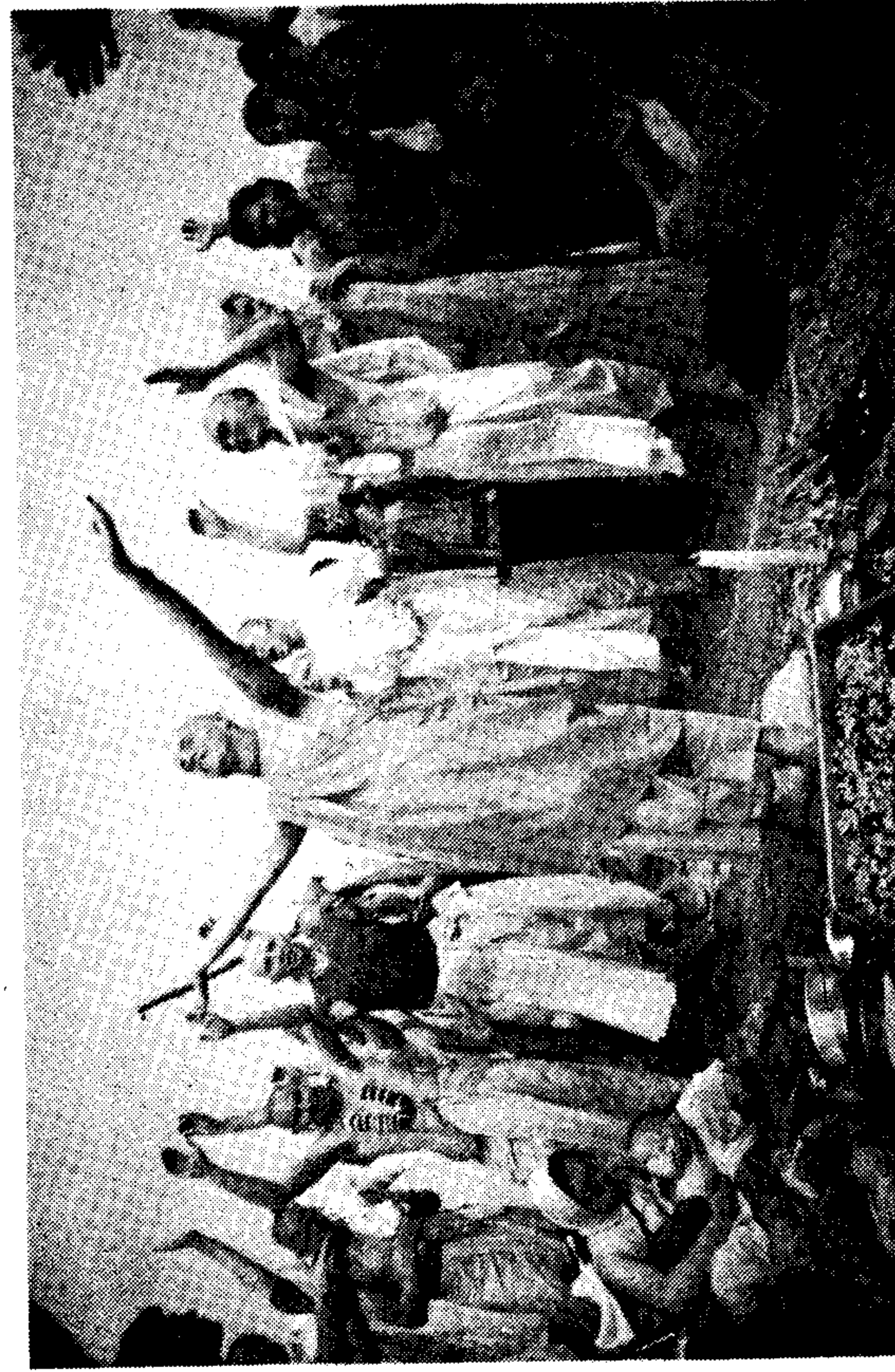

72

71. The Beatles are introduced to America  
72. The British intelligence cult of Hare Krishna



75

73. Aldous Huxley  
74. Aleister Crowley, in robes of the Order of the Golden Dawn  
75. Ancient Egyptian wall-painting, depicting the death rites of the Cult of Isis (now in British Museum)

Karl Haushofer, who ghost-wrote most of *Mein Kampf* in Hitler's prison cell 50 years later, named his first secret organization the "Vril Society." (13) Bulwer-Lytton's Nazi German and British secret societies met officially for the last time when Nazi minister Rudolf Hess attempted to make contact in 1941 by flying to Britain.

Bulwer-Lytton directly influenced **John Ruskin** at Oxford University and established the lineage that leads — through such names as Milner and Rhodes — to the present-day Royal Institute of International Affairs. Ruskin's students included Milner, Rhodes, Albert Grey, and the future director of research for the RIIA, **Arnold Toynbee**.

Ruskin's inaugural speech at Oxford in 1870, inspired by Bulwer-Lytton, left such an impression on Cecil Rhodes that he carried a handwritten version of it with him until he died. The speech — which set the tone for Rhodes's 1877 will quoted in Section 7 — stated in part:

There is a destiny now possible to us — the highest ever set before a nation, to be accepted or refused. We are still undegenerate in race; a race mingled of the best northern blood. . . . We are rich in an inheritance of honour, which it should be our daily thirst to increase with splendid avarice. . . . (England) must found colonies as fast and as far as she is able . . . seizing every piece of fruitful ground she can set her foot on, and teaching these her colonists that their . . . first aim is to advance the power of England by land and sea. . . . (14)

Bulwer-Lytton's son **Edward Lytton** was Viceroy and Governor-General in India 1876-80. Two aspects of the younger Lytton's rule in India are important to this report. First, Lytton supervised the **single greatest expansion period in the history of opium production in British India.** (15) As noted in Part I, Palmerston had set forth this task as a means of compensating for Britain's industrial decline relative to the United States. It was fitting that the son of his former cabinet colleague and fellow cultist personally carried out Palmerston's opium-expansion program.



76



76. The Drug Lobby: Senators Jacob Javits and Edward Kennedy

Secondly, Edward Lytton's rule in India provided a home for the most important of the crackpot cultists inspired by his father. Lytton himself was the closest friend of Rudyard Kipling's parents, members of the circle around A. P. Sinnett's Allahabad journal *The Pioneer*. (16) The elder Bulwer-Lytton's follower Madame Blavatsky, of the Theosophy Cult, appeared in India in 1879, and recruited A. P. Sinnett to her belief-structure. (17) Both Kipling and Blavatsky employed the swastika as their personal mystic symbol. From Kipling, Blavatsky, Haushofer, and others, the swastika found its way into the German cults that formed the core of later Nazism.

Kipling's last major official post was under press czar Lord Beaverbrook at the wartime Propaganda Ministry; working side-by-side with him was a relative of the Lyttons' by marriage, Sir Charles Hambro. Hambro went on to run Britain's dirty operations during World War II as chief of the Special Operations Executive from 1942 onwards. Kipling also served as a trustee of the Rhodes Trust from 1917-25.

Kipling's cousin, Stanley Baldwin, was prime minister from 1923-29 and 1935-37; during his second tenure, the Baldwin government groomed Hitler as a "marcher lord" against the Soviet Union, setting the stage for Munich 1938. (18)

Another well-known British literary figure, also with a mystical bent, deserves mention in this context: Alfred, Lord Tennyson. Tennyson married the niece of the 8th Lord of Elgin (James Bruce), and remained a close personal friend of the commander-in-chief of the Second Opium War. Tennyson was a founding member of the Metaphysical Society, with Bulwer-Lytton's protégé John Ruskin, Lord John Russell's uncle Lord Arthur Russell, future prime minister Arthur Balfour, and Thomas Huxley. (19) In 1880, the Metaphysical Society was reorganized, and became the Aristotelian Society. Lord John Russell's grandson Bertrand Russell became the Aristotelian Society's President 1913-14 and 1935-37; one of his successors was Sir Karl Popper. The Aristotelian Society remains the Apollonian side of British intelligence's High Priesthood.

Tennyson's unambiguous endorsement of opium abuse was expressed in his well-known poem, "The Lotus Eaters":

Let us swear an oath, and keep it with an equal mind,

In the hollow Lotus-land to live and lie reclined,

On the hills like Gods together, careless of Mankind. (20)

## Today's opium dynasty

The closing days of the Baldwin government and the opening days of World War II are an appropriate place to pick up the contemporary trail of the leading opium families — the Inchcapes and Keswicks. In 1939 the creation of Britain's Ministry for Economic Warfare offered a meeting place for the old families: Sir John Henry Keswick, later the architect of the Peking Connection; Sir Mark Turner, the current chairman of the old Matheson-Keswick firm Rio Tinto Zinc; Gerald Hyde Villiers, a leading scion of the evil old family; and John Kidston Swire, of the old Swire dope-trading family.

Starting from the Matheson family's role in the first Opium War and tracing through to the World War II period and up to the present, the fortunes of the Matheson and Keswick line of the dynasty run the entire gamut of political developments surrounding the drug trade.

The Rio Tinto Zinc Company was founded in 1873 by James Sutherland Matheson's nephew Hugh Matheson — taking the lineage of that firm all the way back to the days of George III and the American Revolution through then-Prime Minister Spencer Perceval. The younger Matheson founded the firm with his uncle's opium profits and help from the Schroeder banking family — who in 1931 funded Bulwer-Lytton's ideological spawn Adolf Hitler. The Lyttons and Mathesons are relatives by marriage, through the Villiers family and the Sutherland family.

Hugh Matheson's successor at Rio Tinto Zinc in 1898 was J. J. Keswick, a partner in the opium-running Jardine Matheson firm, and a relative of the Mathesons by marriage through the Fraser family.

Apart from their leading role in Jardine Matheson, J. J. Keswick's family had a leading role in the British governance of the official opium trade. His cousin, William P. Keswick, was

British Consul-General in Hong Kong during the same years that Edward Lytton, Governor-General in India, was expanding opium output according to the Palmerston program.

William P. Keswick's son Henry Keswick, a past chairman of the Hongkong and Shanghai Bank at the height of its dope-trading glory, had three sons: David, John H., and William J. David Keswick is still among the largest shareholders and a partner of the London merchant bank Samuel Montagu. Sitting with him on the board of directors of Samuel Montagu is Rio Tinto Zinc's current chairman Sir Mark Turner. Turner, as noted, also worked with brother Sir John Henry Keswick in the Ministry of Economic Warfare. Later, John Henry went on to the British embassy in Chungking, picking up the opium trail where World War II had cut it off (see Section 7).

The third brother, Sir William Johnston Keswick, is the protagonist of Section 8 dealing with Canada; as previously documented, Keswick ruled the Shanghai Municipal Settlements at the height of Shanghai's heroin traffic, and set up the first big heroin connection, via intermediary Jacob "Yasha" Katzenberg (see Part III Section 1).

The family history of the Keswicks intersects the story of the Russells, Villiers, and Bruces through their most senior political operatives, notably Lord Milner. Milner, Cecil Rhodes's protégé and one of racist John Ruskin's early trainees, bridged the gap between the establishment of the Rhodes Trust and the creation of the Royal Institute of International Affairs in 1920. Milner became a director of Rio Tinto Zinc in 1921, and served as chairman from 1922 until his death in 1925.

More important, however, is Milner's joint work with the Keswick family in setting forth the "geopolitical" policy that finds its most succinct expression today in Britain's proposed alliance with China against the Soviet Union. As documented above, that policy includes a free hand for British drug-running.

This option first saw the light of day through the World War I collaboration of Lord Milner, William Boyce Thompson, and wartime British Commissioner in St. Petersburg, Frederick Lindley. During his wartime mission to Russia, according to the *History of the London Times*, a documentary source, Lord Milner

worked closely with Frederick Lindley to install and then, unsuccessfully, to maintain in power, Alexander Kerensky. (21) This followed Britain's post-American-Civil War policy of fostering a weak and dependent Russia.

Frederick Lindley was the grandfather of Henry Neville Lindley Keswick, who currently occupies the traditional family seats at the head of Jardine Matheson's directors and on the board of the Hongkong and Shanghai Bank.

The third member of the Milner team, William Boyce Thompson, was the head of the Red Cross delegation in Russia; the Red Cross is, officially, the "charitable" side of the Order of St. John of Jerusalem. (22) After the war, Thompson, with funding from the Morgan bank, established the Anglo-American mining firm in South Africa — which now controls 60 percent of world gold output outside the Soviet Union, and, through its controlling interest in De Beers, virtually all the diamond output (see Section 4). That is the origin of London's top-down control over the precious metals and gems channels for laundering dirty money.

To tie these strands back into the main line of the narcotics traffic: Milner's hand-picked successor at Rio Tinto Zinc, whose original mines were in Spain, was Sir Auckland Geddes. Geddes, who ruled until 1952, was a sponsor of Francisco Franco's fascist coup in Spain. (23) His nephew, Ford Irvine Geddes, was a director and then chairman from 1971-72 of the Inchcape family's huge shipping complex, the P&O Steamship Company, which has shipped more opium than any other entity in the world.

One of P&O's officers, deputy chairman Sir Eric Drake, is a close associate of Sir William Johnston Keswick, also of the old Rio Tinto Zinc family (see Section 8). Drake and W. J. Keswick jointly control Canada's Hudson's Bay Company, which established the rum-running routes from Canada into the United States during Prohibition, together with the Bronfmans.

The old Inchcape family, whose current scion, the 3rd Earl of Inchcape, still is chairman of the P&O Lines, is closely related to the Matheson family of Jardine Matheson. The founder of Jardine Matheson, James Sutherland Matheson, was the son of Katherine Mackay and Donald Matheson; Mackay is the family name of the Earls of Inchcape. The 3rd Earl, J. W. Mackay, is the

son of the 2nd Earl of Inchcape, who authored the infamous 1923 Inchcape Report, insisting that the opium trade must be maintained to 'protect the revenues' of the British Empire — despite the outcry of the League of Nations.

Through the current Lord Inchcape, the old opium dynasty married into the highest level of British banking. The aforementioned J. W. Mackay of the P&O Lines married Aline Pease, his brother-in-law, Richard T. Pease, has been the vice-chairman of Barclays Bank since 1970. Barclays Bank, as noted above, is the controlling institution for the entire array of Israeli financial operations, through its control over the current Japhet family bank — Charterhouse Japhet. The current senior Japhet family member, Ernst Israel Japhet, is now the chairman of Israel's biggest commercial bank, Bank Leumi. Barclays Bank controls outright Israel's second-largest commercial bank, the Israel Discount Bank, also known as Barclays discount bank.

Taking together the Inchcapes, Keswicks, Peases and related families, control over London's banking establishment becomes a swirl of intermarriages, to the point that the top London banks and the scions of the drug trade appear as a single family entity, rather than competing or even parallel institutions. For example, the current deputy chairman of Inchcape and Co. — the family holding company that owns majority stock in the P&O Lines — is Sir Hugh Mackay-Tallack. Mackay-Tallack is also the deputy chairman of the Standard and Chartered Bank, the second-largest bank in the Far East after the HongShang. The 3rd Lord Inchcape himself, J. W. Mackay, is also a director of Standard and Chartered, along with cousin Sir Hugh.

As the reader can judge from the chart, the Pease branch of the Family is further closely related to:

\* The Schroeder Bank, whose chairman, the 10th Earl of Airlie, is the brother-in-law of A. D. F. Lloyd, of the bank that bears his name.

\* Kuhn Loeb, whose leading partner was Otto Kahn; his granddaughter is the wife of the 10th Earl of Airlie, the chairman of Schroeder Bank.

\* The family of Winston Churchill, whose mother-in-law is an Airlie;

\* The Lazard group, related to the Churchills by marriage; Lazard controls the *London Financial Times*, the *Economist*, Penguin books, as well as one of Britain's top merchant banks. It should be remembered that the Lytton family and the Keswick family are related to each other, via marriage through the Fraser family, whose current leading member is deputy chairman of Lazard.

The British and American *Hofjuden* are represented at the borders of this complex. As noted, the 10th Earl of Airlie married the granddaughter of Otto Kahn, *Capo* of American *Hofjuden*; his sister, Margaret Ogilvie, married into a branch of the dynasty (see chart) that, in turn, married into the Rothschilds.

The Rothschilds were the first of a number of leading families to come up the ladder through intermarriage with the leading families — an award for special service to the British monarchy. Other prominent examples are the Kennedys and Bronfmans. After a display of Anglophilia during his tenure as America's Ambassador to the Court of St. James, Joseph Kennedy achieved his ultimate social-climbing ideal: his daughter Kathleen married the son of the 10th Duke of Devonshire. After their elevation to the status of leading *Hofjuden* during the 1930s, the Bronfmans intermarried with the French de Gunzberg family and the Belgian Lambert family (the Belgian branch of the Rothschilds). However, Edgar Bronfman's attempt to wed Caroline Townshend, the direct descendant of the Lord Townshend who precipitated the American Revolution through a tea tax, came to naught. Shortly after their 1972 marriage, Edgar Bronfman sued for divorce, on the grounds that the English noblewoman had denied him connubial relations. Apparently, there are limits to what the British families will suffer from social-climbing *Hofjuden*.

Few even among specialist readers will appreciate how many significant historical and intelligence problems of the last hundred years are clarified, in one degree or another, by this summary description of the Family. Only a small portion of the names listed on the chart, or their historical significance, has been presented in this section. Nonetheless, the point is irrevocably established for the general reader that the

individuals named throughout this section are part of a single **family operation**, whose members take critical roles in furthering the opium trade, financing the opium trade, and directing the opium trade — wherever the opium trade is a matter of public record. This includes every crucial juncture of Dope, Incorporated: the period of opium production expansion in India, the Opium Wars against China, the Shanghai Connection of 1928, the Peking Connection of the World War II period and after, and the Opium War against the United States.

The point is also indisputably established that this has been and is the policy of the British government and, through the Most Venerable Order of the Knights of St. John of Jerusalem, the British Monarchy itself.

# The Dynasty of Robert Bruce

## THE DRUG FAMILY TREE

### List of Abbreviations

A.D.C., aide de camp	L.G. St. John, Lord of Grace of the Order of St. John
Aff., affairs	Lt., lieutenant
Amb., ambassador	Ltd., limited
B., baron	m., married
B.P., British Petroleum	Mem., member
Can., Canada	M.E.W., Ministry of Economic Warfare
Chan., chancellor	Min., minister
Chm., chairman	Mvmt., movement
Cons., consul	Neth., Netherlands
d., died	P.M., Prime Minister
Dau., daughter	Parl., parliamentary
Dir., director	Pres., president
Dpty., deputy	Ptnr., partner
Env., envoy	R.I.I.A., Royal Institute of International Affairs
Exch., exchequer	RTZ, Rio Tinto Zinc
Extr., Min. Plen., extraordinary, Minister Plenipotentiary	S.O.E., Special Operations Executive
Fin., financial, finances	Soc., society
G.C.M.G., Grand Cross of St. Michael and St. George	Tee., trustee
Geo., George	U-, under-
Gen., general	V., vice
Gov., governor	
HK, Hong Kong	
Intell., intelligence	
K.G., Knight of the Garter	
K.G. St. John, Knight of Grace of the Order of St. John	

• denotes chart overlap

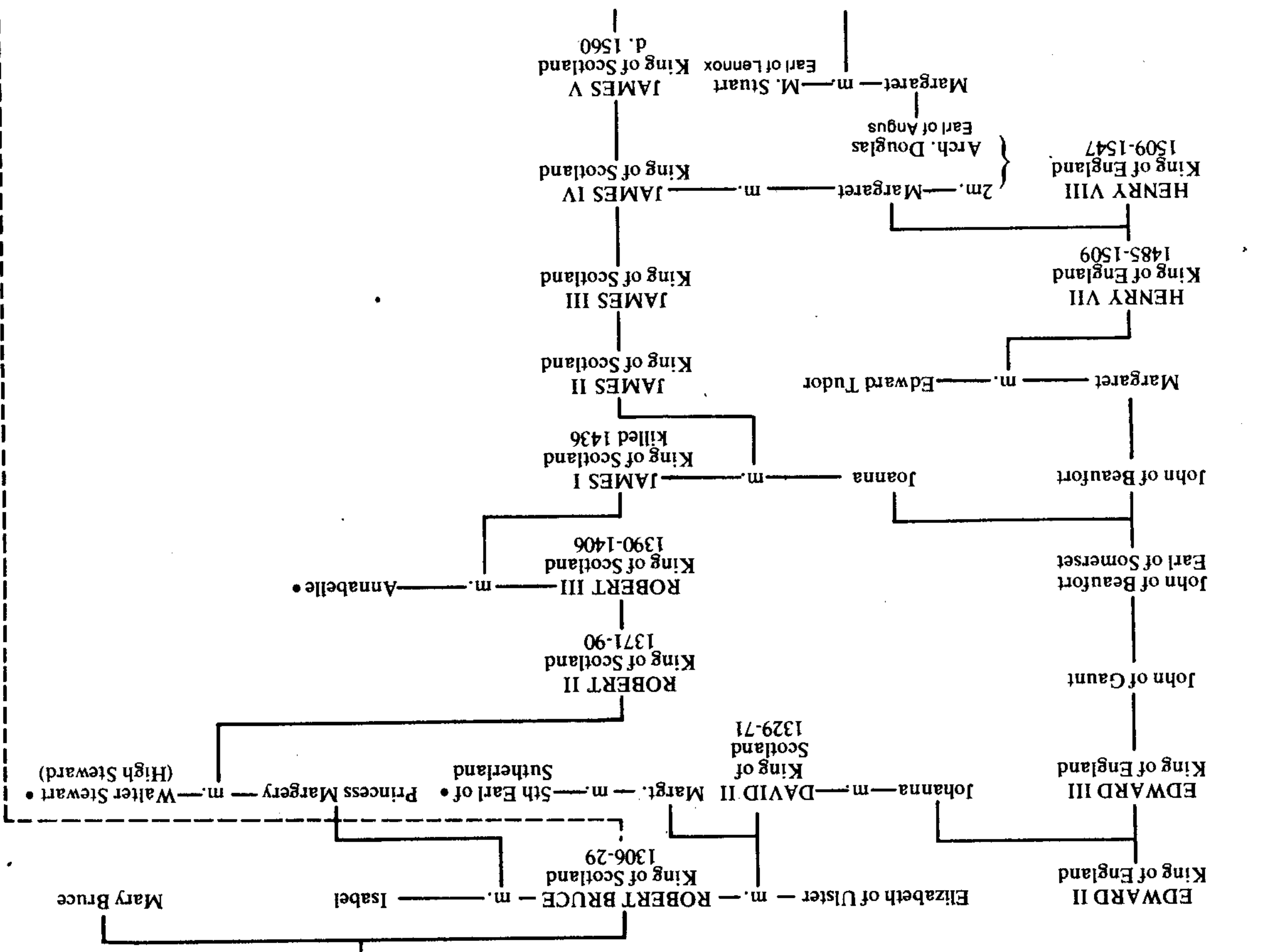
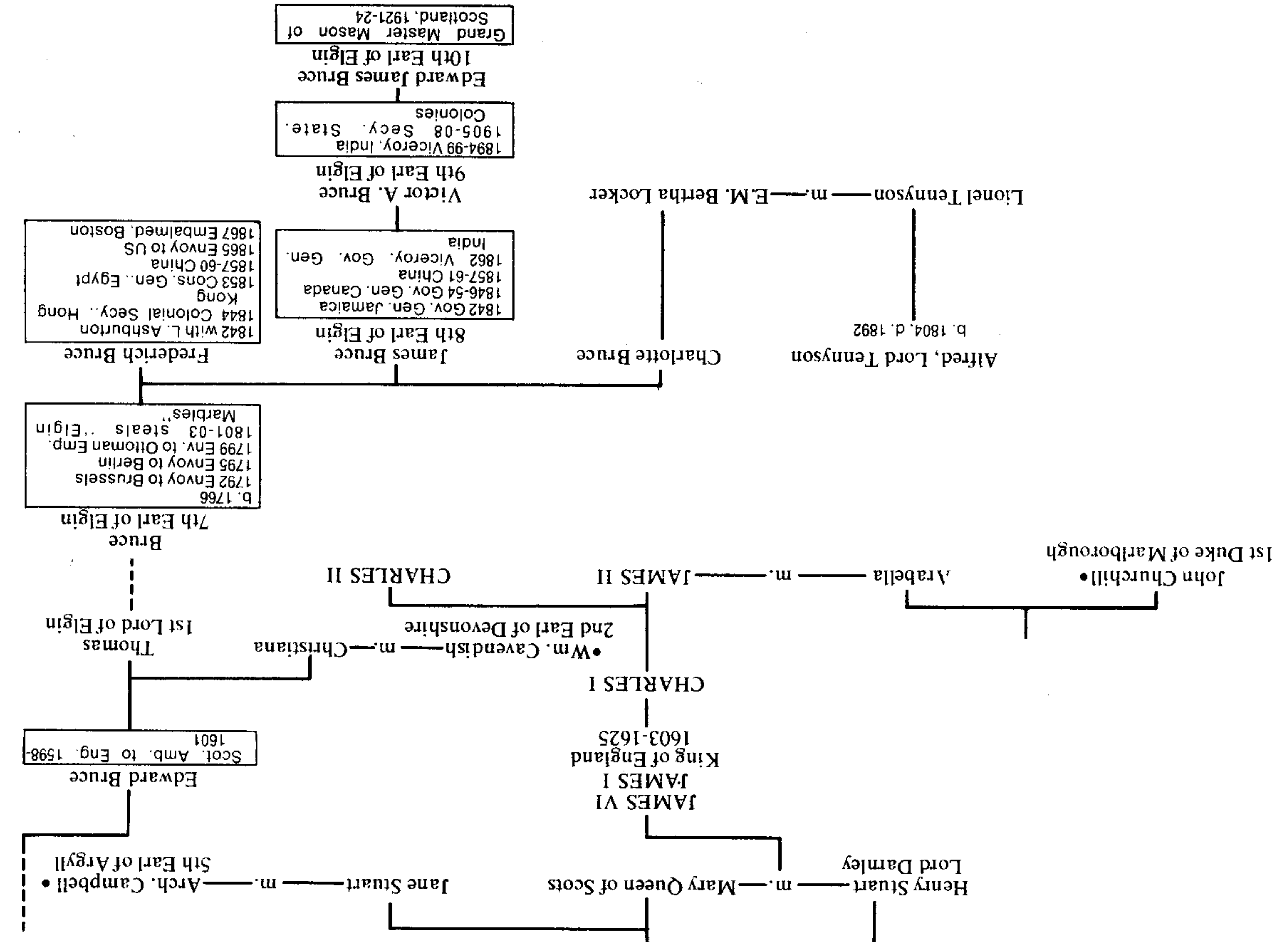







PEASE

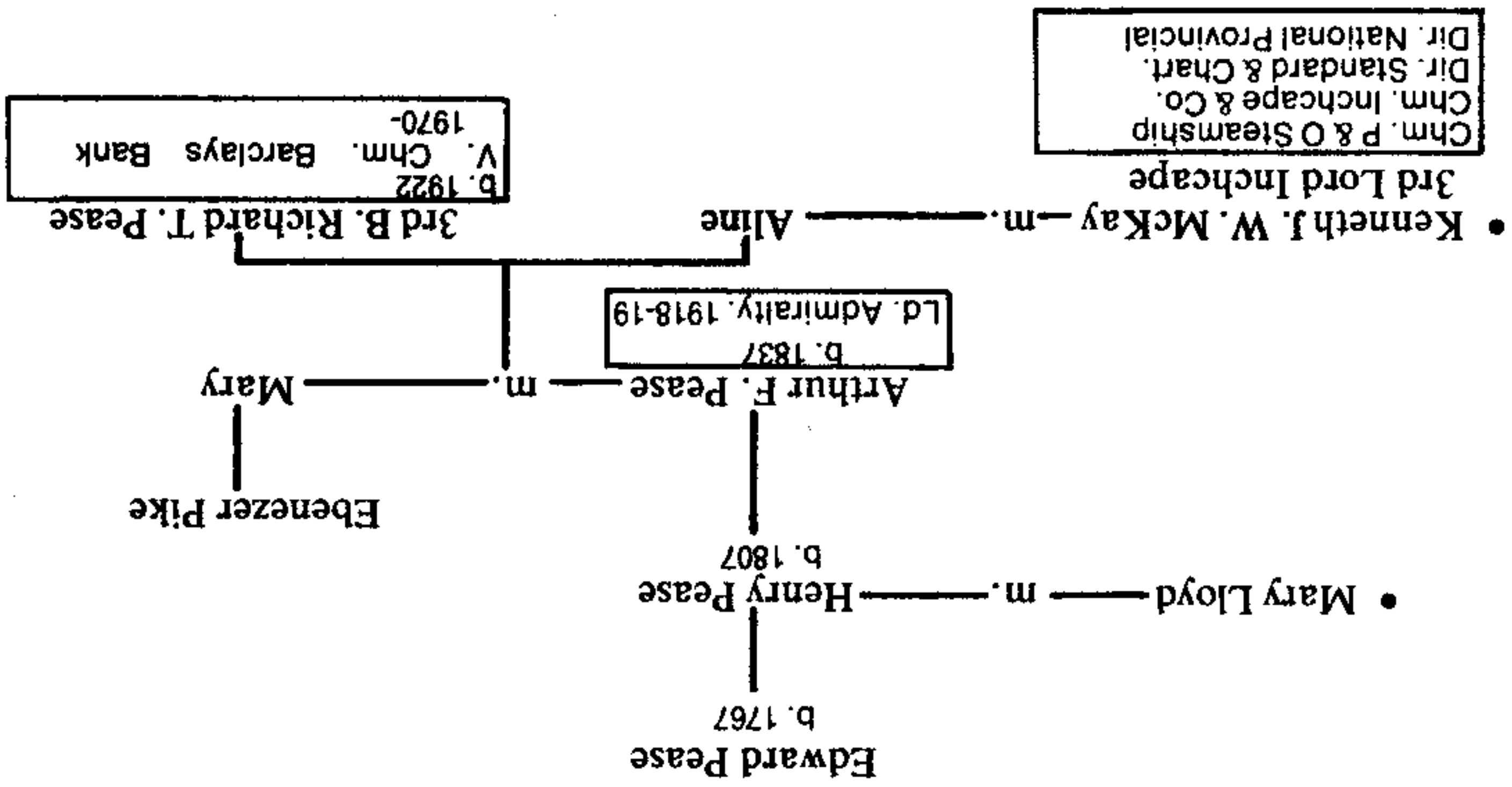

AIRLIE

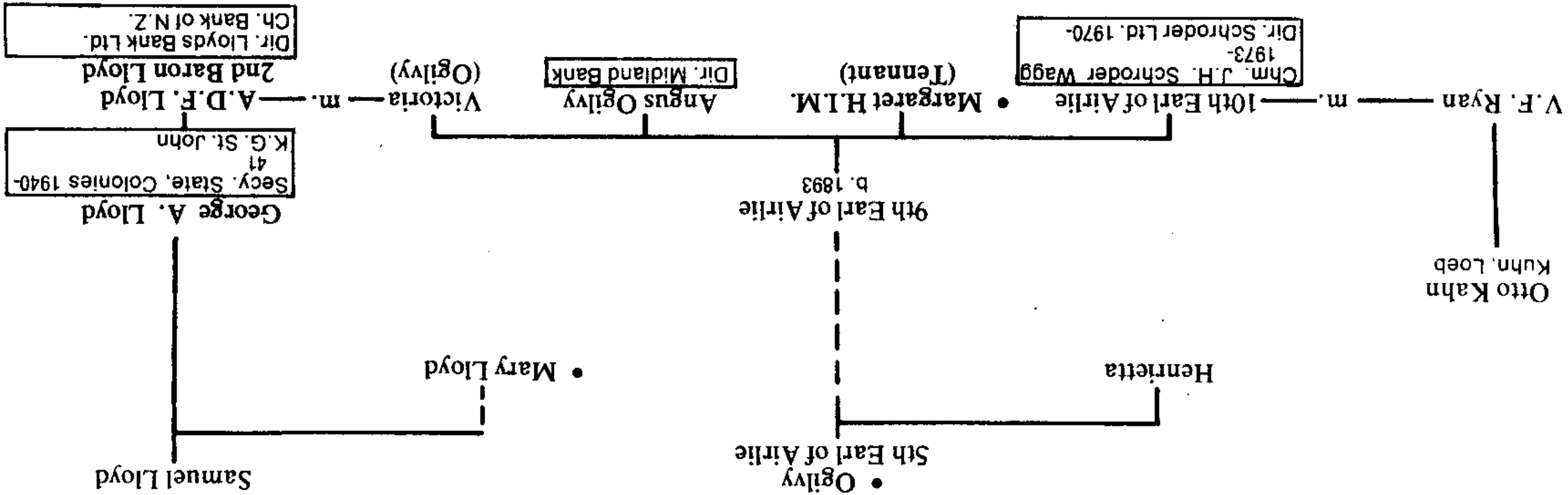

LLOYD



MARLBOROUGH

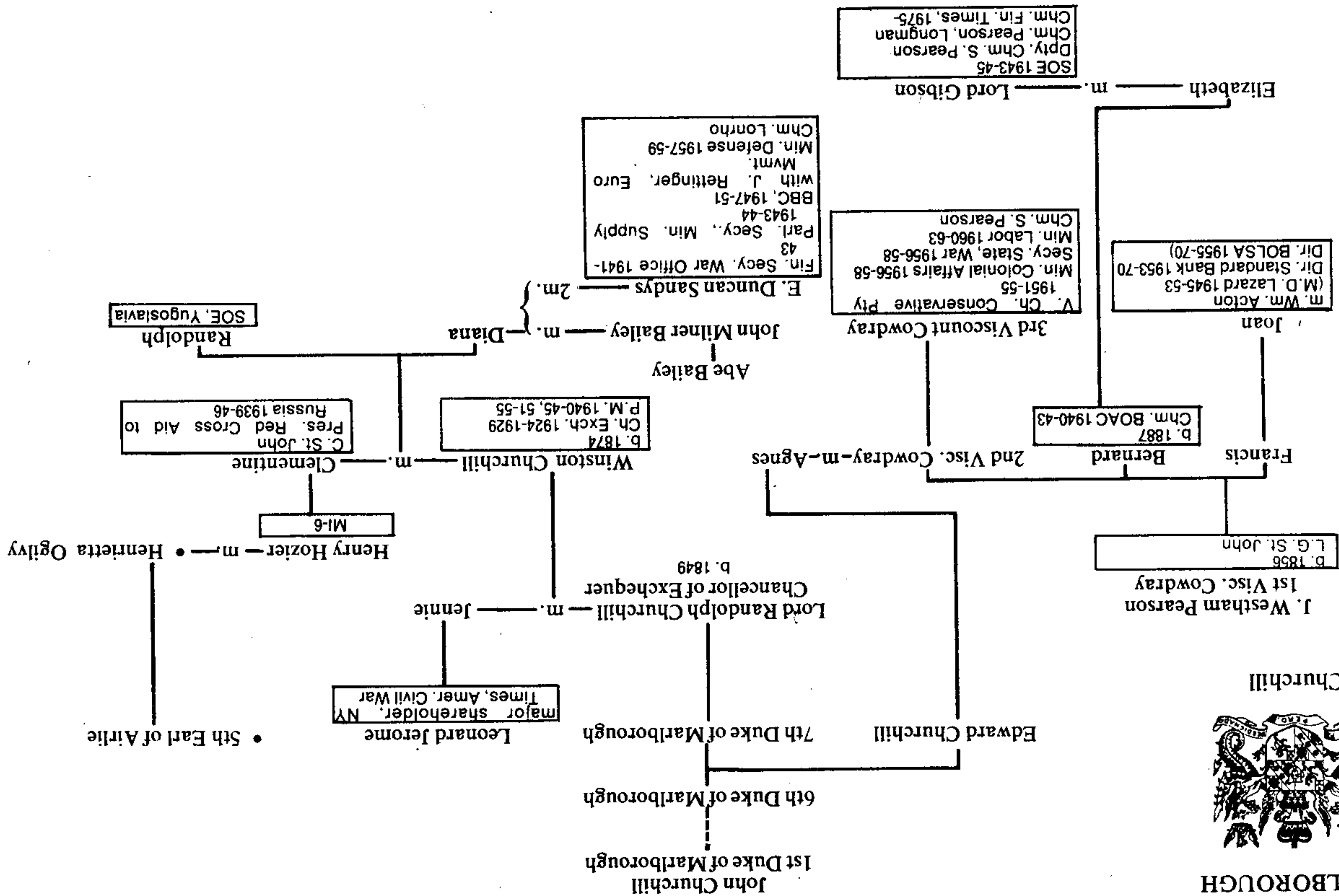

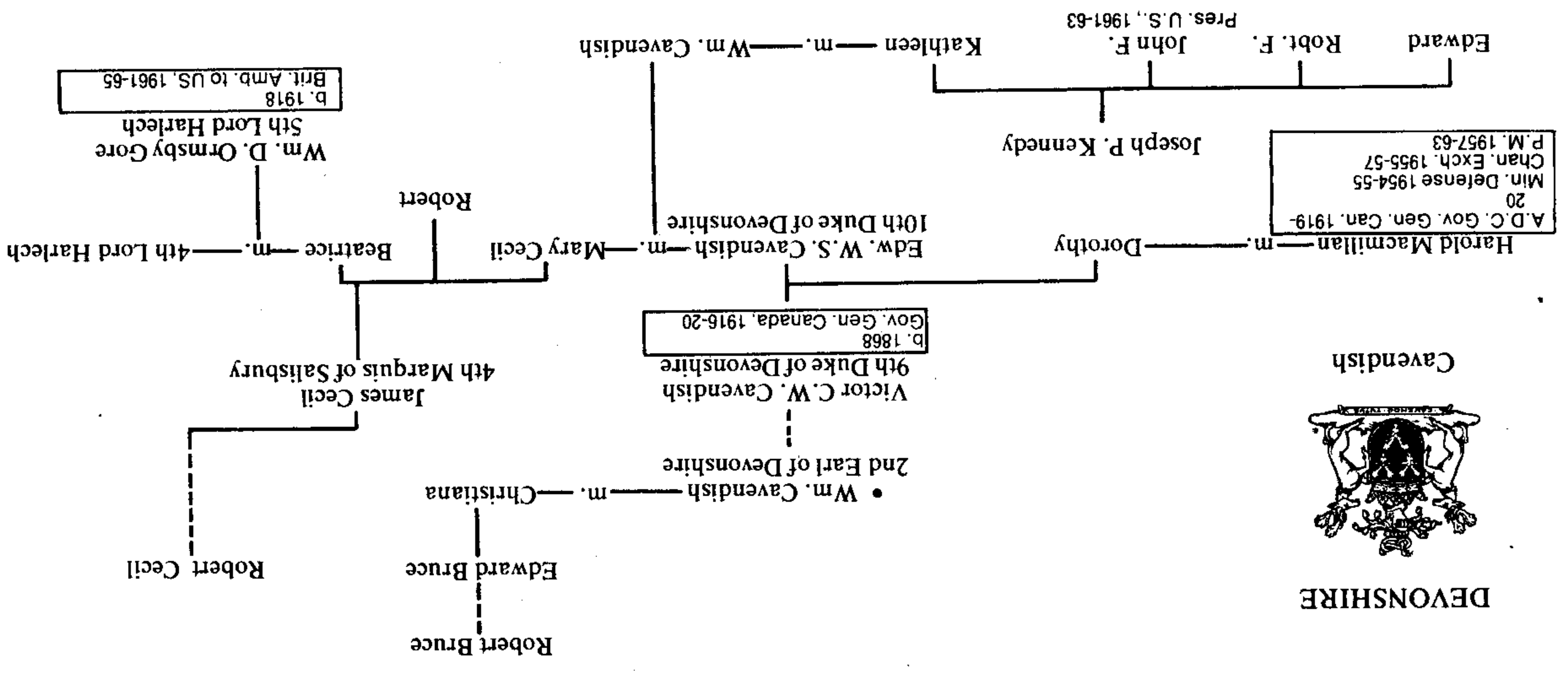
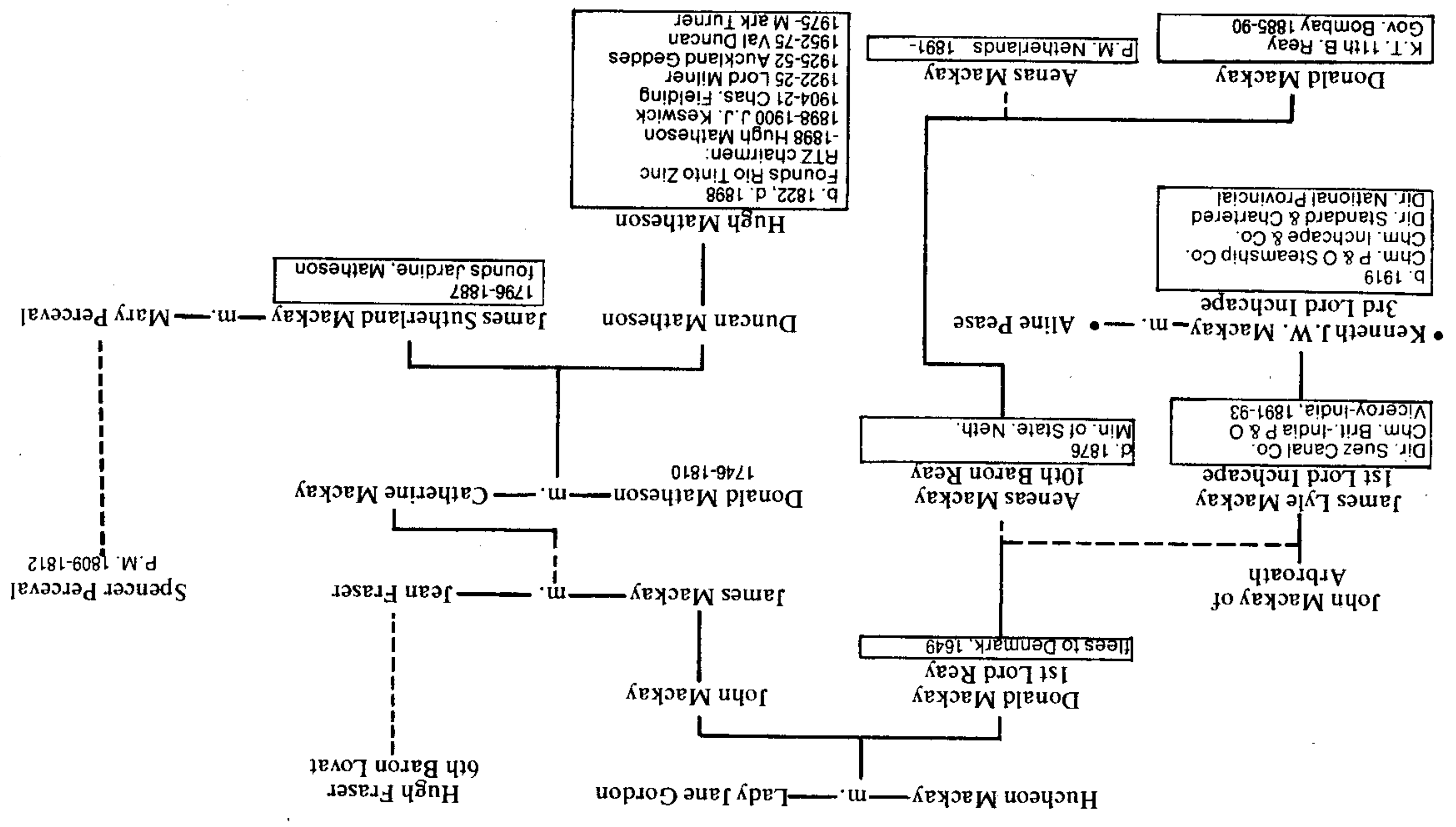

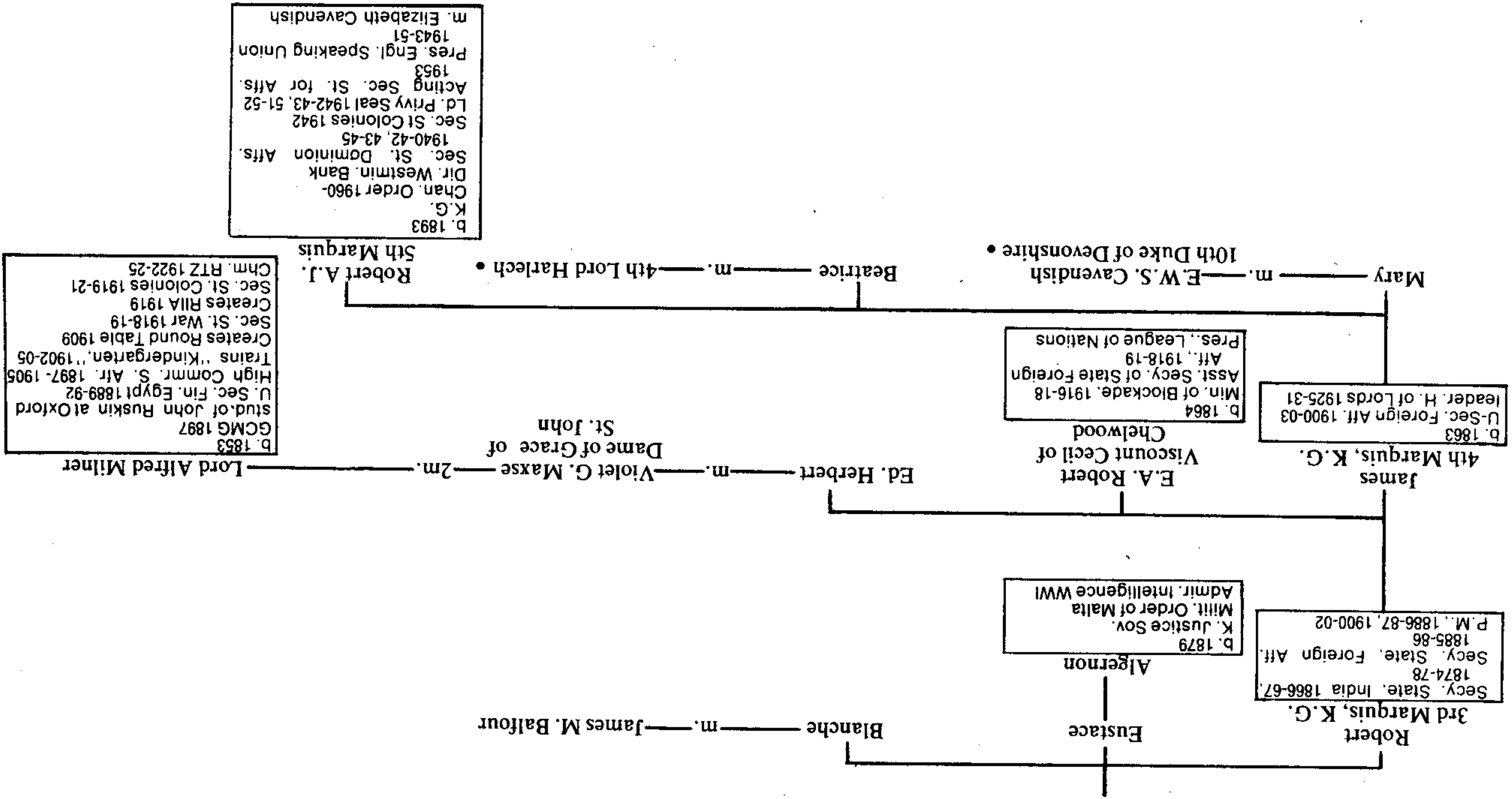
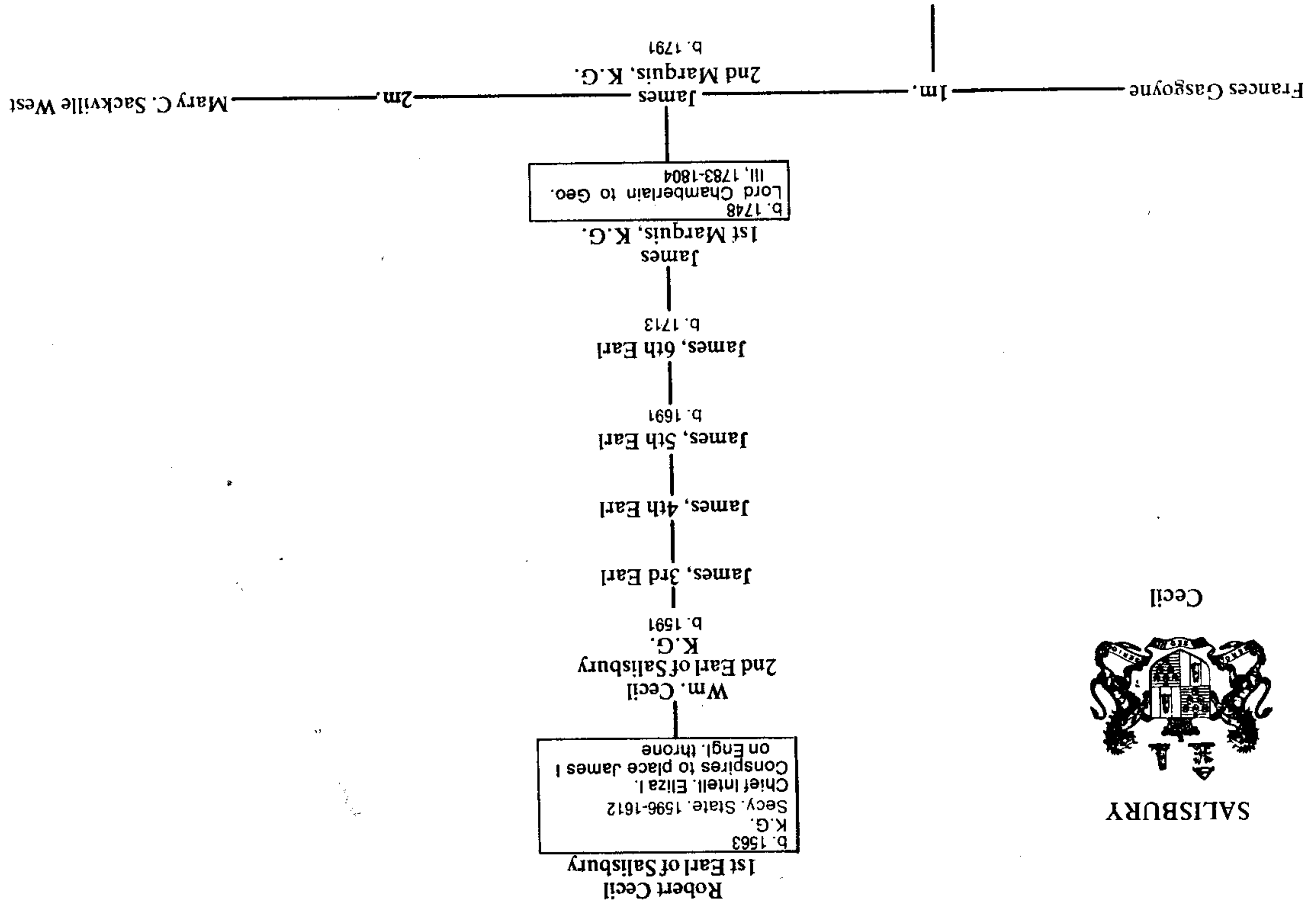

Clydesdale Bank - directors include: George Harvie-Watt Pres., Consolidated Gold Fields, 1973; Chm. Cons. Gold 1960-69; Dir. Standard Bank; Midland Bank; PPS W. Churchill 1941-45.

b. 1919  
Dir. Times Publ. 1962-66  
Clydesdale Bank, 68-

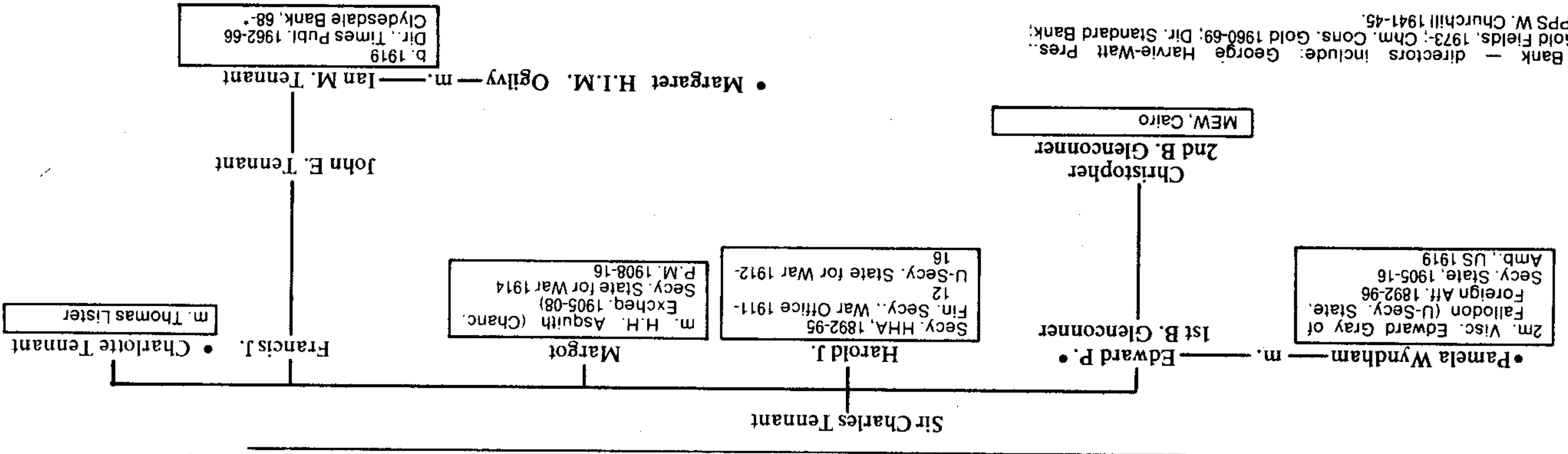

b. 1938  
Chm., Matheson & Co. 1975-1972-75  
Dir., BBME (with Lord Trevelyan, FIIA)  
Mem. London Ctee, HK Shanghai Bank

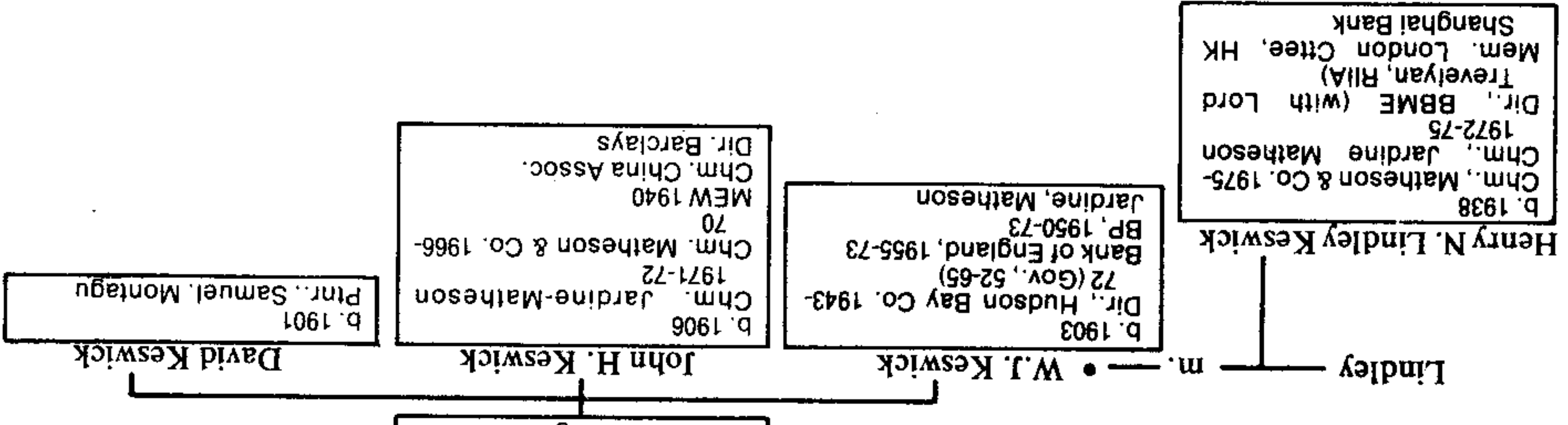

b. 1918  
Fin. Secy., War Office 1958-60  
U-Secy. Foreign Aff., May-Jul. 1945  
SOE, Yugoslavia

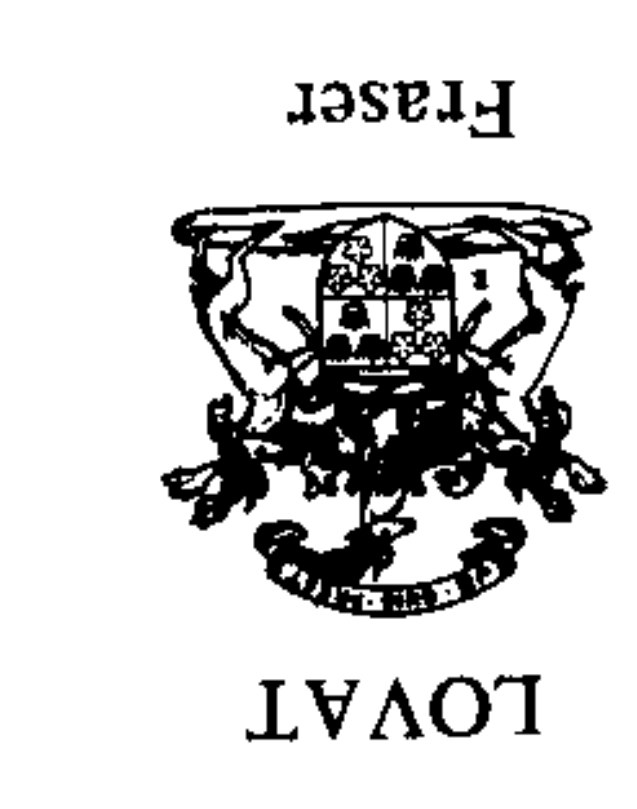
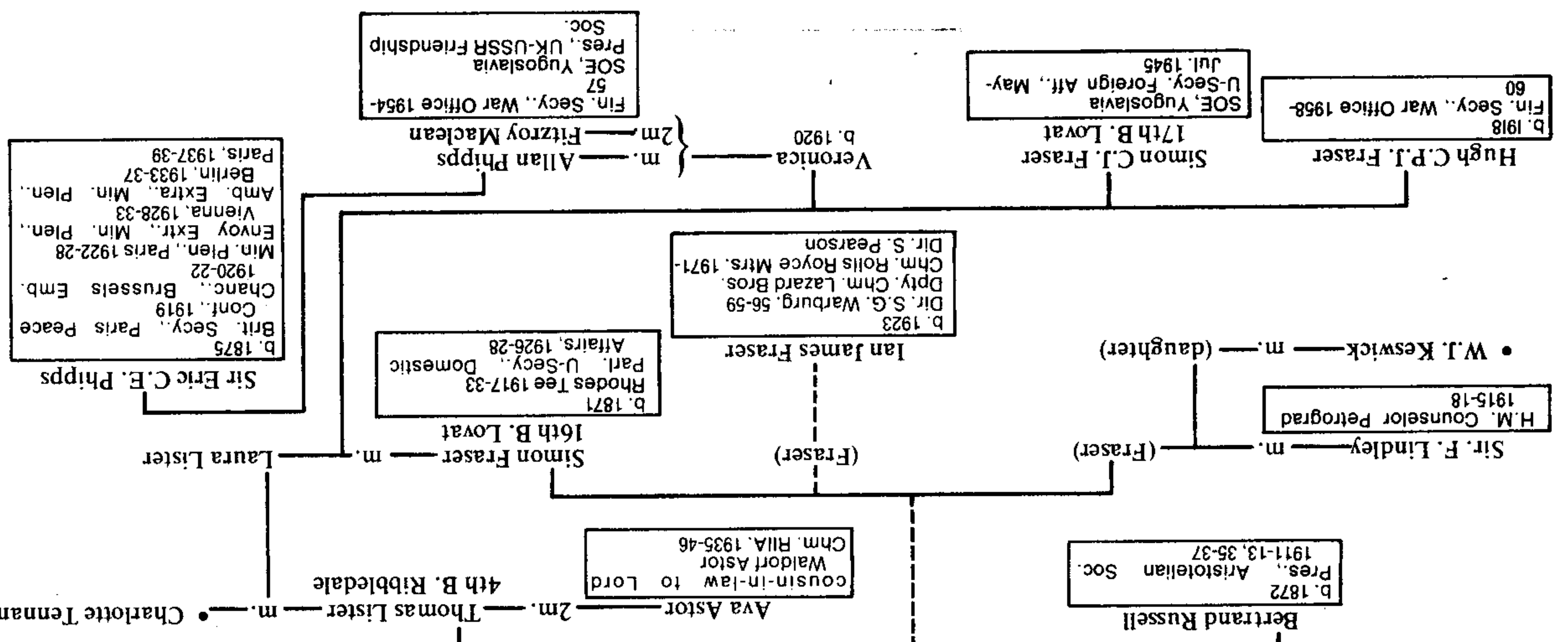

LOVAT



BEDFORD

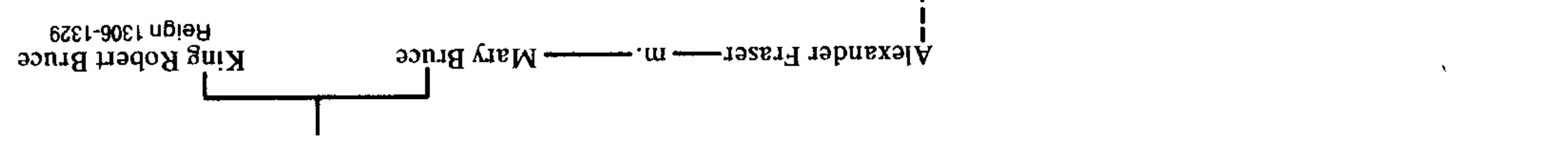

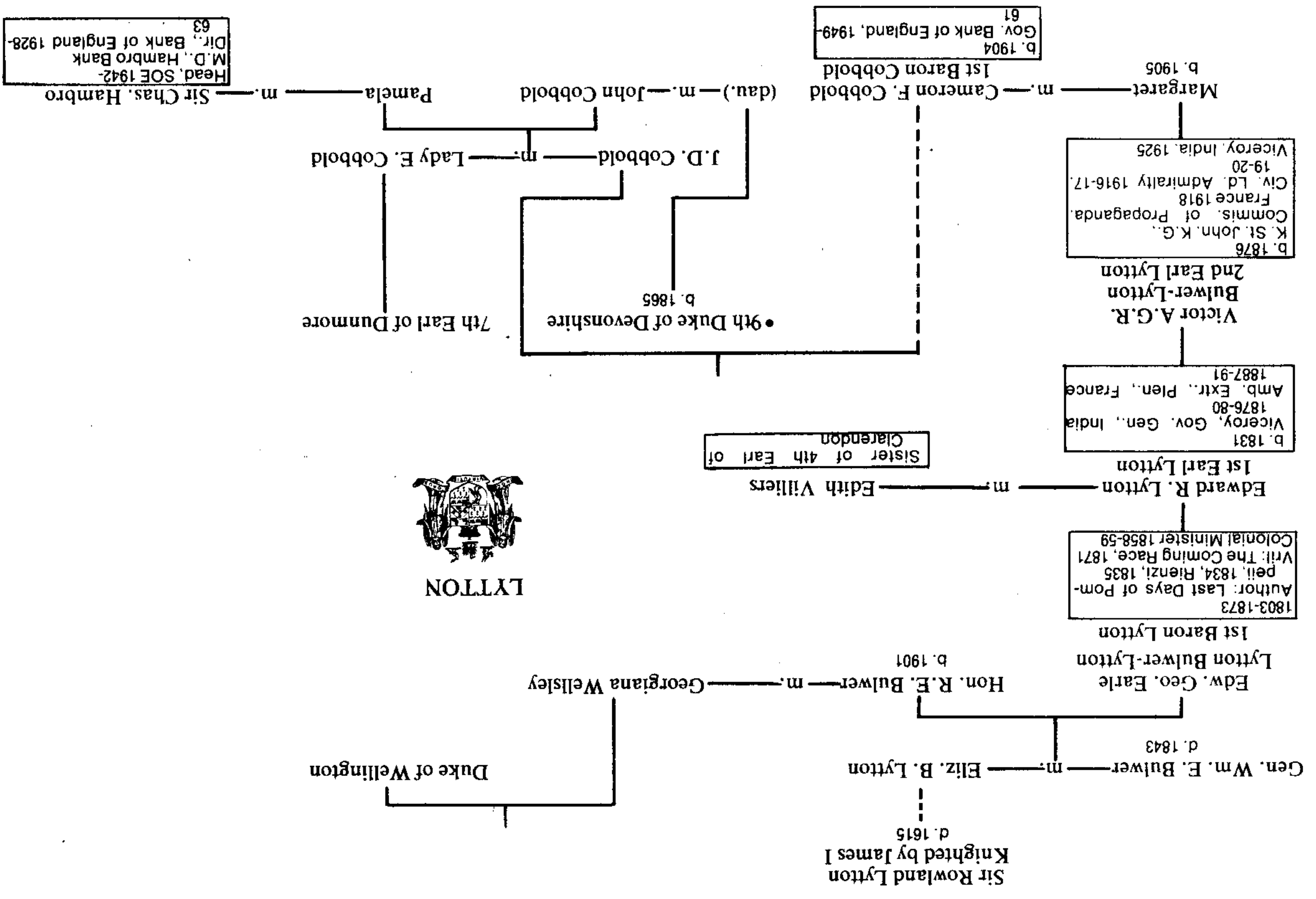
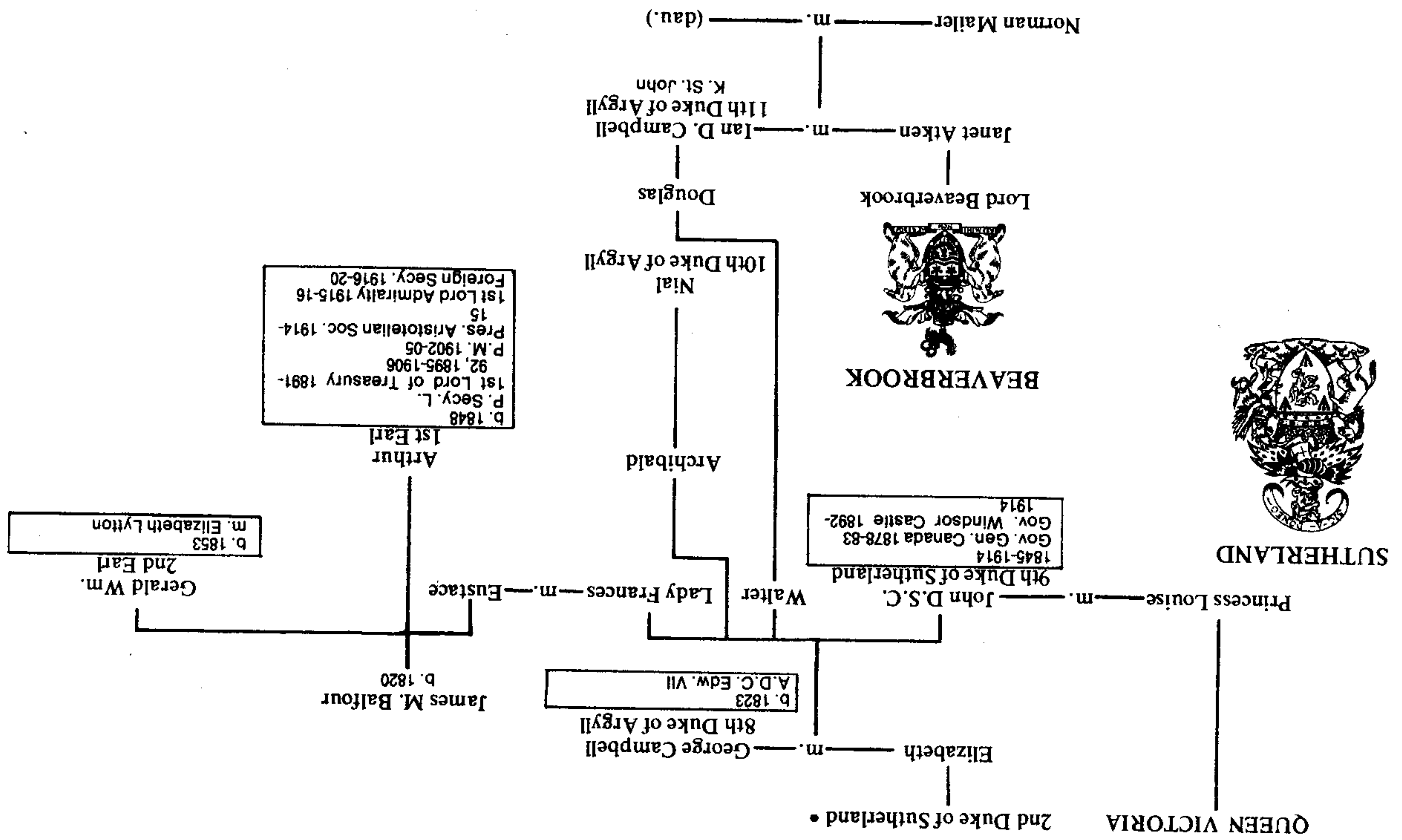



ROTSCHILD

Mayer Amtschel v. Rothschild  
1744-1812

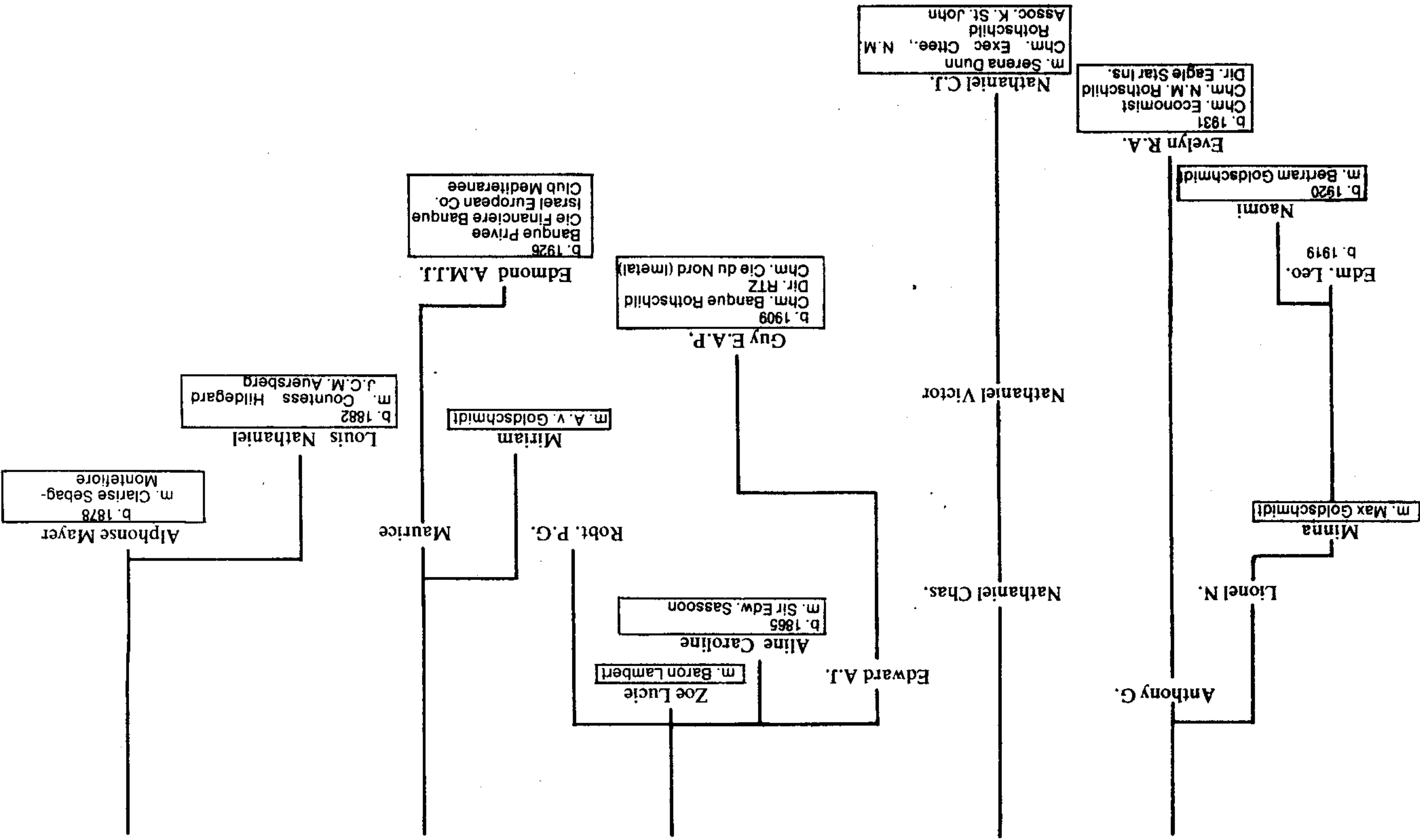
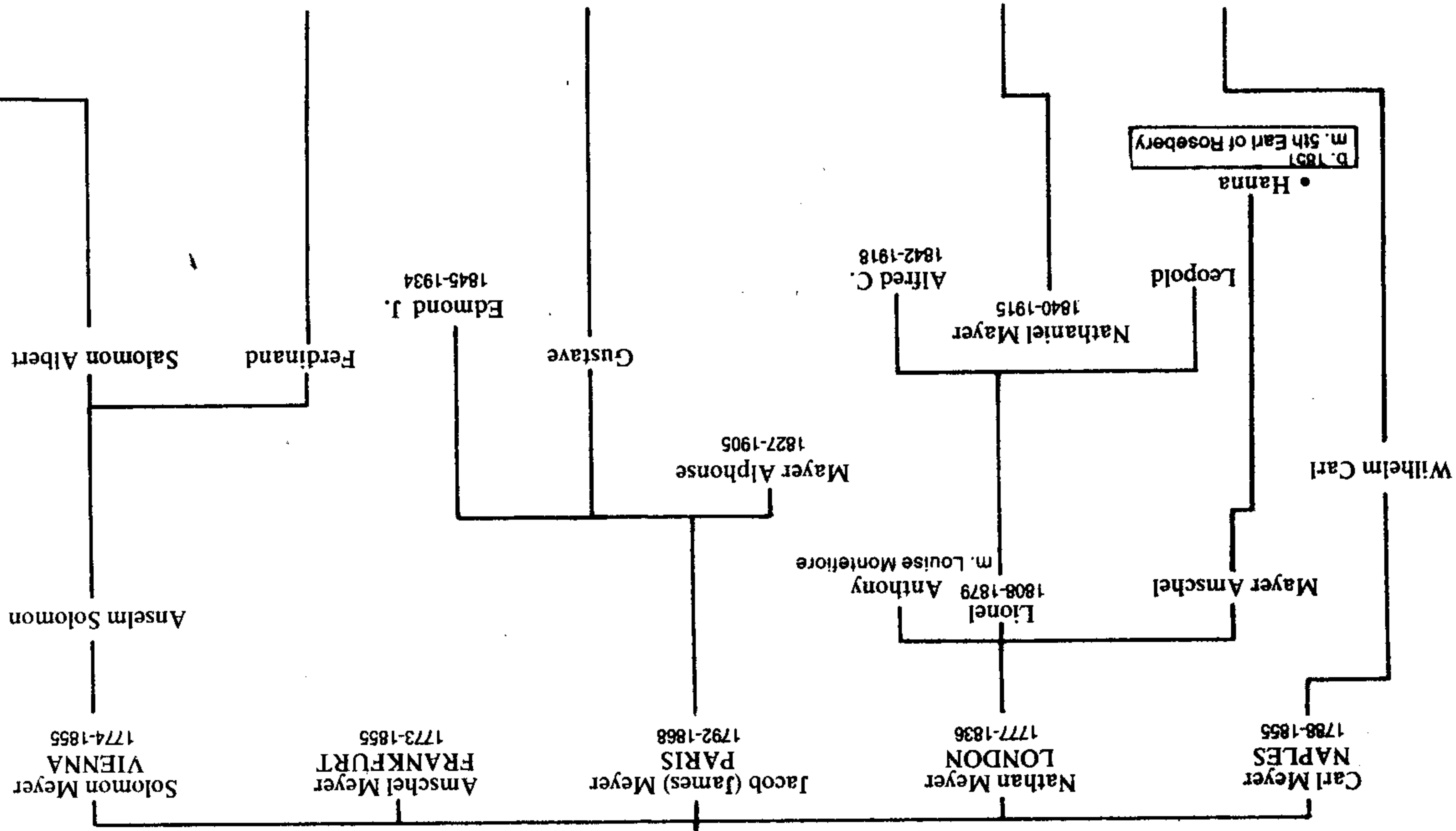

# Notes

## 1. BANKING AND THE WORLD'S BIGGEST BUSINESS

1. Based on interviews with Drug Enforcement Administration sources. The typical deviation from the price trend resulted from the importation of several kilograms of high-grade number four (85 to 95 percent pure) heroin from Vietnam by individual returning soldiers, who would attempt to start their own distribution chain. Such incidents stood out because the novice distributor tended to dilute the heroin too little — often distributing heroin at 30 percent purity and above, rather than 5 percent purity, the normal dilution. The free-lance pusher would therefore occasion an extraordinarily large number of drug overdoses, enabling the authorities to spot him quickly.
2. The 700 ton figure is also used by the most widely circulated sources on the subject, e.g., Alfred McCoy et al., *The Politics of Heroin in Southeast Asia*, (New York: Harper and Row, 1974).
3. *The New York Times*, January 20, 1971, p. 1.
4. According to Drug Enforcement Administration estimates.
5. The \$40 billion figure is almost certainly an exaggeration; it does not count attrition of the marijuana crop because of Colombian or U.S. government counteraction. Since Colombia is the primary supplier of the American market, the likely figure is half that.
6. *Euromoney* (London), April, 1978.

## 2. FROM OPIUM TO DIRTY MONEY

1. The \$100 per pound initial price is slightly higher than most estimates cited in studies which date back to 1971 or earlier. Since the opium price is principally measured in terms of gold, it is fair to assume a substantial increase since 1971 when gold went for \$42 an ounce. The \$100 figure is conservative, assuming that the raw opium price has doubled in reflection of local inflation. But if the opium price has risen in tandem with the gold price, the figure is much higher.
2. Calculated on the basis of price markups as reported by law enforcement sources in interviews with the authors.
3. The estimate was derived from the following calculations: At the 1971-72 peak of heroin production in the Golden Triangle, much of which was intended for American soldiers in Vietnam, 21 refineries were in operation; since then the number has declined. Assuming that ten are still in operation, and that the annual output of each is equivalent to the 3,000

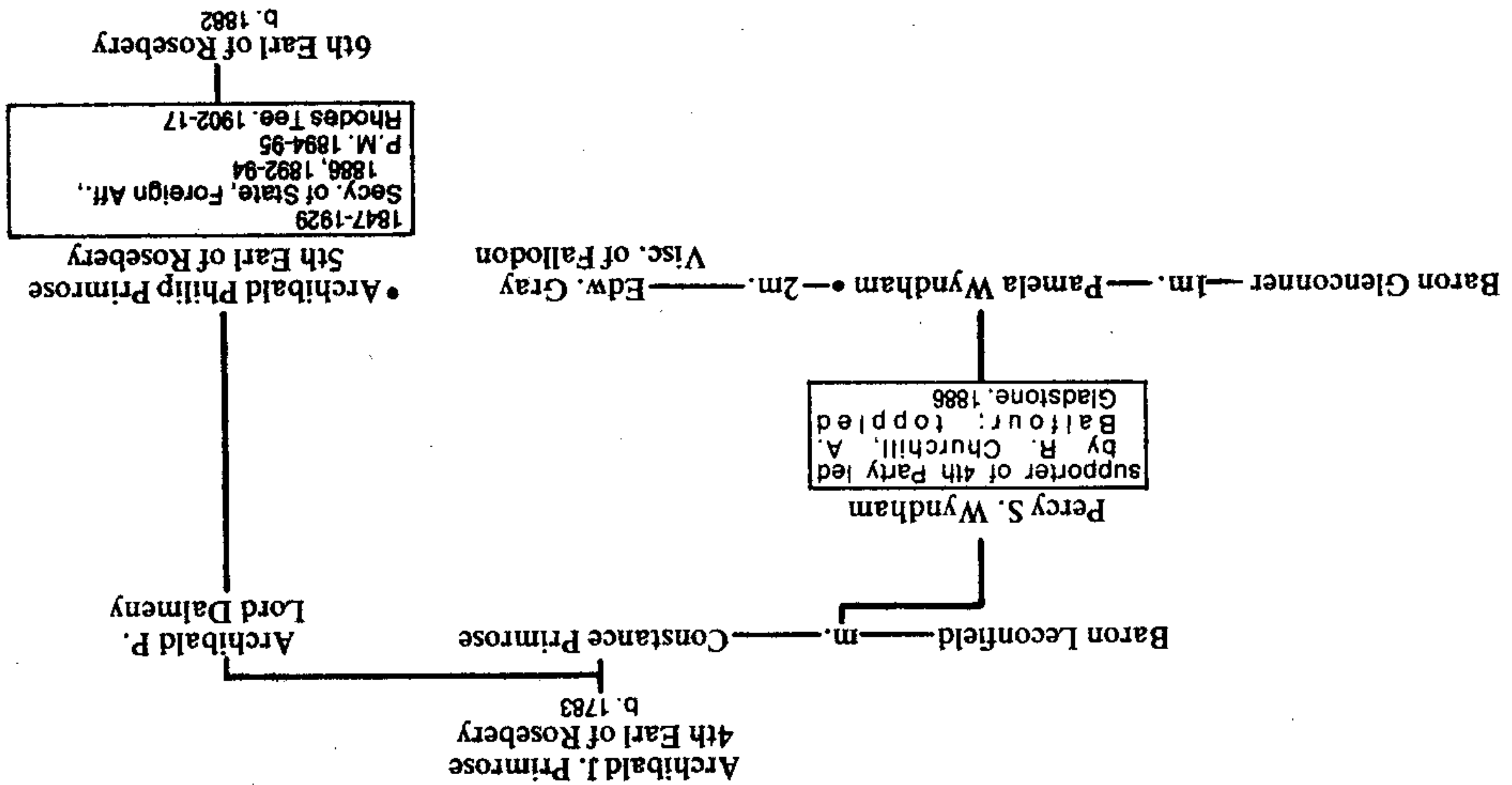
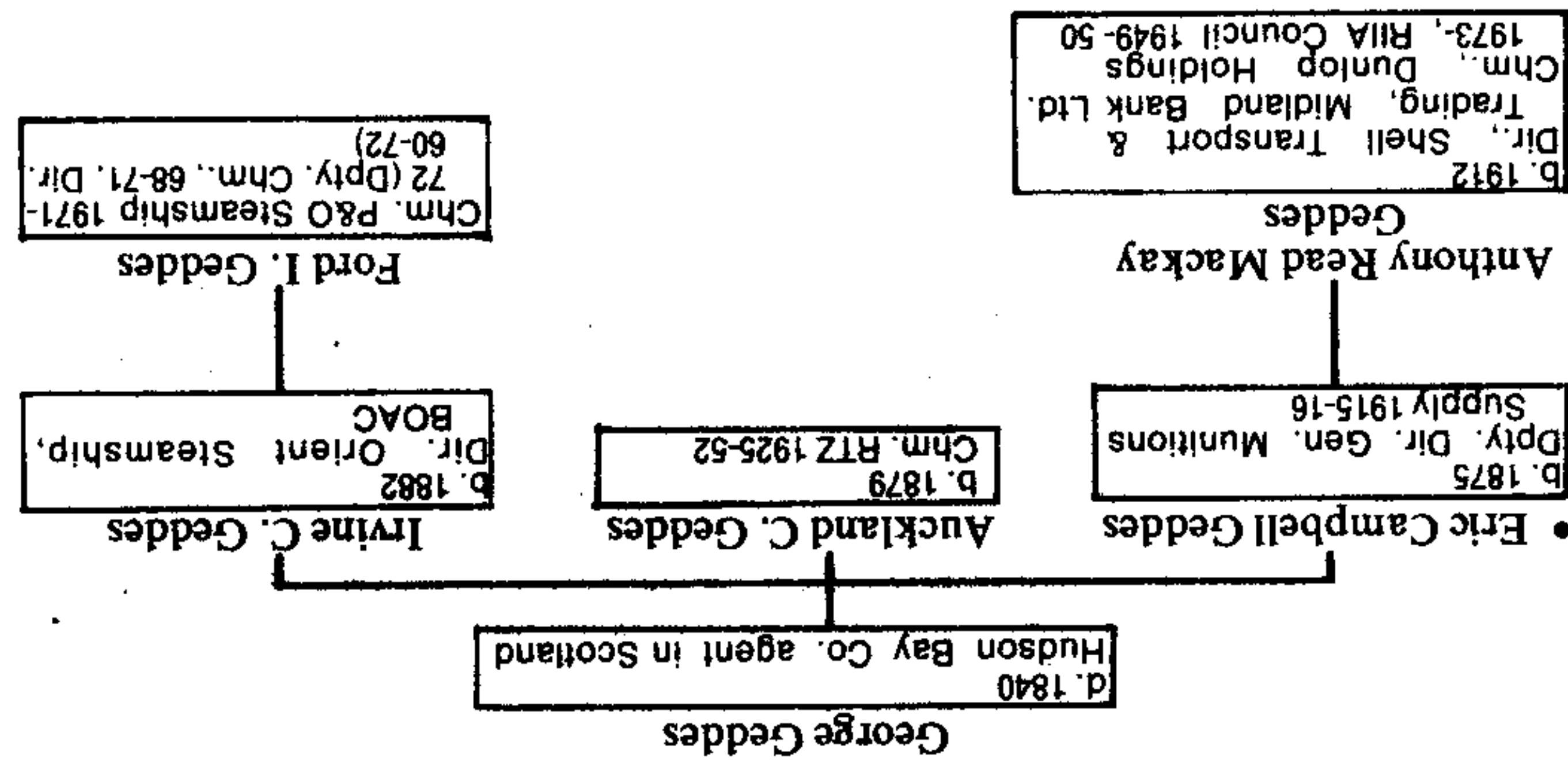

kilograms of heroin seized in one major bust on record, then they produce roughly 30,000 kilograms a year of heroin, derived from about 300 tons of raw opium.

4. Richard Deacon, *The Chinese Secret Service* (New York: Ballantine Books, 1976), p. 447.

### 3. HOW THE DRUG TRADE IS FINANCED

1. *London Financial Times*, April 24, 1978.
2. *Ibid.*
3. A close examination of the price markup structure of the Golden Triangle's primary wholesalers demonstrates that the increased prices at various stages merely account for substantial additional expenses, including the livelihoods of an inestimable number of Thai and Burmese policemen and customs officials. The real profitability — the enormous profits associated with the traffic — depends on the process of cutting the pure heroin into "decks" of street quality for sale in the West. The profits of the Hong Kong syndicates who wholesale heroin are not accrued through the difference between primary and secondary wholesale prices, but as a percentage of the profits obtained through distribution of the drugs in the West. In other words, the Hong Kong networks are directly represented in the Western "organized crime" segment of Dope, Inc. and take their cut in the form of a reflow of the retailing profits. Scattered bits of evidence — the most prominent of which is the activities of the expatriate Chinese community in Vancouver — indicate that this is, in fact, how these syndicates operate.

4. The authors obtained briefings concerning — but were not able to see — classified dossiers on Tejapaibul and Sophonpanich in the possession of the American, Malaysian, and Thai governments. As noted below in the text, they are "cut-outs" for the Hongkong and Shanghai Banking Corporation. Tejapaibul, whose bank handles most of Thailand's chemical imports, developed the Golden Triangle's major source of acetic anhydride, the chemical required to refine opium into heroin, through a Hong Kong subsidiary of the Bangkok Metropolitan Bank.

5. Certain aspects of the expatriate Chinese activity antedate the British. The relationship between Ch'ao Chou Chinese merchants and the Thai royal family, for example, dates back several centuries. The predominance of Chinese compradors in the region, however, dates to the turn of this century.

6. W. J. Cator, *The Economic Position of the Chinese in the Netherlands Indies*, p. 97-98.

7. Victor Purcell, *The Chinese in Malaya*, p. 189.

8. William Skinner, *Chinese Society in Thailand: An Analytical History*, p. 140.

9. *International Currency Review*, Vol. 10, No. 4, p. 145.
10. M. A. Andreyev, *Overseas Chinese Bourgeoisie — A Peking Tool in Southeast Asia* (Moscow: Progress Publishers, 1974), p. 30.
11. V. Thompson, R. Adloff, *Minority Problems in Southeast Asia* (Stanford: Stanford University Press, 1955), p. 13.

### 4. BRITAIN'S GOLD AND DIRTY DIAMOND OPERATIONS

1. Andreyev, *Overseas Chinese Bourgeoisie*, p. 120. In contrast to many Soviet publications on the subject, the Andreyev book is a scholarly monograph through nine-tenths of its extent, using quotations from Western sources for most of its material. The propaganda factor is comparatively small. Apart from the fact that it is a good survey of Western literature on the subject, there is a special feature of this short work that indicates its value to the investigator. The work is a classical example of careful Soviet "surfacing" of their on-the-ground intelligence reports, in such form as to make the conclusions politically useful, without compromising their operations. The clear intent of publication of the work is to put some heat on Chinese intelligence operations in the Far Eastern theater. The occasional "zingers" Andreyev includes, such as the report of Chinese import of gold through the Golden Triangle, are intended for a small professional audience in other intelligence services. To the extent the authors were able to cross-check Andreyev's facts with Western sources, they have checked out. Therefore the authors believe that the Andreyev work is an acceptable reference source.

2. Timothy Green, "Other World Markets," speech at the Gold Conference of the *London Financial Times* and *Investors Chronicle*, The London Hilton, October 24, 1972.

3. Paul Ferris, *The City* (London, 1951).

4. H. R. Reinhart, *The Reporter*, July 22, 1952.

5. Andreyev, *The Chinese Bourgeoisie*, p. 120.

6. Reinhart, *The Reporter*.

7. This information is a byproduct of a U.S. Labor Party counterintelligence investigation of the operations of the Israeli intelligence agency, Mossad, for which Jarecki appears to be a "bagman." The details were cross-checked with law enforcement officials.

8. According to interviews with leading diamond traders in New York.

### 5. HONG KONG: THE WORLD'S DRUG CAPITAL

Virtually all published sources identify Hong Kong as the world's center for transshipment of opiates from the Far East, and even as the center for heroin refining. For the most part, these admissions —



encouraged by the local British authorities — are in error. In fact, heroin is refined in the triborder area of the Golden Triangle itself. Once in the compact form of heroin, the drug may be shipped by air, through individual couriers using a multiplicity of different routes. It need not pass through Hong Kong at all, although Hong Kong is possibly the most important of these various routes, and may conduct significant refining operations. The British admissions concerning refining and transshipment of opium and heroin tend to distract the investigator from the more important issue: that Hong Kong is the *financial* center for the Far East drug trade, and hence the point of control for the Golden Triangle.

The most recent American congressional investigation into Hong Kong, in 1973, wrote:

The British Crown Colony plays a major role in the trafficking and refining of narcotics which originate in the "Golden Triangle":

- 1) It serves as a major target for the production area;
- 2) The criminal syndicates behind the Southeast Asian drug traffic are based in Hong Kong;
- 3) It serves as the refining center for "Golden Triangle" opium and morphine base; and
- 4) It is a major transshipment point for heroin coming into the U.S. and for transshipment to our 7th Army in Germany via The Netherlands.

... It is estimated that 48 tons of opium are smoked in Hong Kong annually and 4 tons of heroin are consumed. Local officials also estimate that 4 to 10 tons of heroin is transshipped from Hong Kong (primarily by body pack) to the United States annually, but accurate information is lacking. Ten thousand dollars worth of heroin in Hong Kong would retail for \$50 to \$60 million in the United States.

From reports we received in The Netherlands, it is also apparent that heroin is being transported by air and ship to The Netherlands from Hong Kong to supply the 7th Army in Germany. The potential for growth of these shipments is unlimited. . . .

Despite the recent steps to upgrade the enforcement effort, Hong Kong will continue to act as a funnel for heroin destined for the United States unless some fundamental changes take place.

Smuggling into Hong Kong is almost impossible to control because: 1) it is a free port and the economy of the Crown Colony is dependent upon its being easily accessible; 2) many drops are made outside of the jurisdictional waters of the Crown Colony; 3) personnel are not adequate; and 4) intelligence is lacking.

Since Hong Kong is a free port, there are no regularized customs inspections. Also, most goods coming into Hong Kong are in sealed containers. The Preventive Force, as a result, must rely primarily on tips to conduct searches. The searches, however, are only of

vessels entering the harbor; not those leaving which could be transmittting narcotics to the United States, The Netherlands, or other points.

A major obstacle, also, is the lack of cooperation from the People's Republic of China. Many of the drops are made in Chinese waters because the Chinese do not police their coasts for narcotics. We were told that a Chinese vessel will ignore a trawler smuggling narcotics. Moreover, since the British in Hong Kong are naturally sensitive to their relations with the People's Republic, they carefully observe territorial waters and are careful to avoid appearances that a crackdown on traffickers is a vendetta against the Chinese. . . .

The British in Hong Kong are also reluctant to recognize the severity of the problem evidenced by the increasing availability of narcotics, and to, correspondingly, take action. For instance, most officials we spoke with were "uptight" about the recent report of the House Foreign Affairs Committee which concluded that the Hong Kong Government has been lax. They also resented the fact that no one had talked to them before filing the report. (*Report* by Hon. Lou Frey, Jr., Hon. Peter N. Kyros, and Hon. James F. Hastings, Members of the Committee on Interstate and Foreign Commerce, Concerning Narcotic Enforcement Efforts in Hong Kong, Thailand, Burma, India, Lebanon, Greece, Turkey, France, and The Netherlands; April 1973, pp. 2-11 *passim*).

Like most such documents, this report is loaded with inconsistencies, although it contains occasional useful pieces of information. One such item concerns the Hong Kong police force's most successful means of discovering illicit heroin, noting that police "found drugs concealed in the rectums of 40 defendants referred to them by the courts in one week."

Also useful is the report that Hong Kong consumes 4 tons of heroin and 48 tons of opium (medically equivalent to 4.8 tons of heroin annually), from Hong Kong authorities. Taking this at the equivalent of 8.8 tons of heroin consumption, the figure corroborates the charge in this section that Hong Kong harbors one million drug addicts in a 5 million population. At standard 5 percent purity for street use, 1 kilogram of heroin will yield 150,000 "decks," or single doses; 8.8 U.S. tons will yield roughly 1.2 million doses. A serious addict requires more than one dose per day, so it is hard to estimate the precise number of addicts; but it is clear that the British figures, probably conservative, are in the required range.

The report that the PRC does not interfere with opiates transshipment in its territorial waters speaks for itself, as does the statement that Hong Kong serves as a base for the criminal syndicates behind the Southeast Asian drug trade. However, the failure of the Congressional investigators to cite police corruption at any point as an obstacle to narcotics enforcement in Hong Kong demonstrates how inadequate the effort was.

There is nothing in the published literature concerning the financial relationships between the Hongkong and Shanghai Bank and the Chinese syndicates; information had to be obtained from interviews with knowledgeable area sources, and compared to studies of financial market mechanisms.

1. Andreyev, *The Chinese Bourgeoisie*, pp. 146-147.
2. *Ibid.*
3. *Financial Times*, July 4, 1977, p. 24.
4. *Ibid.*
5. *Ibid.*, p. 19.
6. *Ibid.*

## 6. THE PEKING CONNECTION

Following Kissinger's 1972 trip to Peking, American public and private literature both have played down the "Peking Connection," to the point of ridiculing existing and current evidence of People's Republic of China involvement in the trade. However, an examination of these sources does not reveal a single piece of evidence that the PRC role has stopped.

The current "standard reference work" on the Far East traffic is *The Politics of Heroin in Southeast Asia*, by Alfred W. McCoy, with Cathleen B. Read and Leonard P. Adams II (New York: Harper and Row, 1972). In dismissing the claims of former Bureau of Narcotics and Dangerous Drugs chief Harry Anslinger, McCoy quotes an unnamed BNDD agent who dismisses Anslinger's accusations against Peking, saying that the People's Republic of China has no role whatsoever in the opium trade, and that Anslinger's accusations are substantiated by nothing more than Taiwanese propaganda. McCoy cites no other evidence, and merely brushes the issue aside.

In fact, McCoy and his co-authors went so far out on a limb that even sympathetic experts were forced to correct them. In a review published in the *Bulletin of Concerned Asian Scholars* in September 1973, Peter Dale Scott wrote:

"McCoy quotes U.S. narcotics officials today to ridicule the 1950s claims by then-U.S. Narcotics Commissioner Anslinger (and his government) about Communist China's 'twenty-year plan to finance political activities and spread addiction' in the United States. But McCoy subscribes to the equally dubious 'Turkey hypothesis' which replaced Anslinger's in the 1960s; namely, that all of the U.S. plague of heroin produced in the laboratories of Marseilles could be attributed to opium grown in the Middle East. McCoy even claims that

Throughout the 1960s . . . the U.S. Bureau of Narcotics paid almost no attention to Asia, there were few seizures of Asian heroin and

little awareness of the colony's growing role in the international traffic. It was not until American GIs serving in Vietnam began using . . . heroin refined in the Golden Triangle region that any attention was focused on the Asian heroin trade. (pp. 223-24)

"That is an important claim," reviewer Scott continued, "and it is quite false. In 1960, as he knows, the United States officially listed Hong Kong as the first of the 'principal sources' of the diacetylmorphine (heroin) seized in the United States; and the Federal Bureau of Narcotics showed its concern by opening a branch office in Hong Kong in 1963. Anslinger himself, while transmitting KMT (Kuomintang, or Taiwanese — ed.) propaganda about a Red Chinese opium conspiracy, proved himself to be well-informed about the world-wide significance of the Northern Thailand traffic, even to such details as the roles played by a Macao financial syndicate, and a Bangkok official of the Soong Bank of Canton." Peter Dale Scott's references are to Harry J. Anslinger, "The Opium of the People's Government," in U.S. Congress, House, *Soviet Total War*, 85th Congress, House Document No. 227, pp. 759-61.

The accuracy or inaccuracy of Harry Anslinger's presentation is not what is in question at the moment. Rather, it is a simple point of fact that McCoy and his co-authors have no facts whatever to indicate that the PRC is *not* involved in the drugs traffic; and furthermore, that their treatment of U.S. authorities who presented facts implicating the PRC is wildly inaccurate. As the Scott review demonstrated, that is a matter of the published record.

Experts on the Southeast Asian theater at the time McCoy wrote simply doubt the author's integrity. McCoy had available to him a mass of documentary evidence showing that roughly half of the Golden Triangle growing area lay within the confines of Communist China's Yunnan province. He also had available a substantial portion of corroborating facts contained in this report. McCoy simply chose to ignore this evidence, or, more accurately, to attempt to refute it with unsubstantiated assertions. According to individuals who knew McCoy when he was a regular in the anti-Vietnam War movement, McCoy was in close friendly contact with North Vietnamese legations in Western Europe at the time of writing of *The Politics of Heroin in Southeast Asia*, and intended his efforts to undermine the American war effort. In that context he deliberately excised references to PRC opium trafficking. Since the PRC and North Vietnam have come to blows over the status of the expatriate Chinese comprador community in the latter country, it may be that McCoy's political judgment, rather than North Vietnamese views, were faulty on this subject. *McCoy's book cannot be taken seriously as far as the PRC issue is concerned.*

McCoy, incidentally, does mention that expatriate Chinese syndicates are the main traffickers in the Far East, and that Hong Kong is the main transshipment center.

Typical of public sources is a Congressional investigation of 1973 which reported:

"There is no indication that the People's Republic of China is a source of illegal narcotics coming to or through Hong Kong. A former American missionary in China, now with SARDA (Society for Aid and Rehabilitation of Drug Addicts -- ed.), said that since 1965 not one addict from China has appeared in Hong Kong. Prior to 1965 they arrived in droves. Arrests and seizures also evidence no Red Chinese involvement whatsoever in narcotics traffic in Hong Kong.

"It was interesting to note the reaction of the Government officials regarding the 'Chinese connection.' They thought that such statements were 'rubbish and either made out of ignorance or by individuals seeking political gain.' To say they were emphatic would be an understatement.

"When the Communists came into power in 1949 in China, they imposed the death penalty on anyone producing or consuming opiates. Users were sentenced to long terms, which included building a road toward Siberia. This was, in effect, a death penalty. Their success and continuing interest in purging addiction from their society has removed China as a major source of narcotics."

The report says further, "All officials acknowledged the fact that most of the opium or morphine base coming into Hong Kong comes from either Bangkok or the Gulf of Siam." (*Report* by Hon. Lou Frey, Jr., Hon. Peter N. Kyros, and Hon. James F. Hastings, members of the Committee on Interstate and Foreign Commerce, Concerning Narcotic Enforcement Efforts in Hong Kong, Thailand, Burma, India, Lebanon, Greece, Turkey, France, and The Netherlands; April 1973, p. 4).

These claims are worth examining one by one.

First, the *Report* does not seek to determine whether opium coming into Hong Kong from Bangkok is, in fact, of Red Chinese origin. According to our expert sources, the main PRC transshipment route is southwards, through the Golden Triangle, to Bangkok.

Second, whether or not the "former missionary" source cited is accurate, the appearance or nonappearance of drug addicts from the PRC mainland is utterly irrelevant to the issue of PRC involvement in the wholesale drug traffic. Moreover, the citation of 1965 as the end-point of PRC traffic is suspicious, since the hardest evidence of all -- Chou En-lai's recorded boasts on the subject -- dates from that year.

Third, the authority cited by the Congressional delegation is the Hong Kong Government itself. The integrity of the Hong Kong authorities may be judged from material presented in Section 5 of this report. The utter ingenuousness of the Congressional document cited, however, may be gauged from its enthusiasm for the Hong Kong police: "We were impressed by the desire of the Service to do a job. Their frustration was also apparent. They'll give it 100 percent, but no matter how much they try -- or how good a job they do -- it's just too big for them" (p. 10).

Two years after the publication of this document, the Independent Commission Against Corruption in Hong Kong made its official estimate of a \$1 billion annual rate of police bribery in the colony.

The most complete British work on the subject, Richard Deacon's *The Chinese Secret Service* (New York: Ballantine Books, 1976) merely ignores the issue, and defends PRC motivations! He argues, "If opium could be introduced into a country that did not wish it in peacetime by a so-called civilized Western Power, with the connivance of its Government, how can the British adopt an outraged critical tone towards China for copying her own tactics, not by having opium forcibly imported this time, but by exporting the stuff to try to check such a war as that in Vietnam, which threatened to go on indefinitely. . . . Can one blame China, however intrinsically disgusting the tactic may be, for manipulating an 'opium war in reverse'?" (p. 441).

Deacon does admit, "Many nations and many individuals are in the drug game solely for sordid commercial gain. It is essentially an international problem, but that should not blind one to the fact that only in the hands of the Chinese Communists has it been used almost solely as a subversive weapon and for financing, by an opium war in reverse, a great many of their espionage operations."

After 1972, American officials accepted the official line that China had ceased to be an exporter of opiates, although they never liked it. A case in point was Gen. Lewis W. Walt, a retired Marine Corps officer who became the chief investigator for a set of hearings on "World Drug Traffic and Its Impact on U.S. Security" (see note 27 below). On September 14, 1972, Walt states, "The official U.S. position today is that we have no evidence that opium or opiates are coming out of Communist China." However, a specialist familiar with the intelligence reports that made up the raw material of Gen. Walt's briefing to the Subcommittee, said, "It is highly significant that he used the word evidence, rather than information. That is an intentional dodge. He is playing a word game: evidence is a legal term, and may exclude information. Had he used the word information, he would have had to explain away a couple of hundred reports coming in at the time."

Walt continued, "There can be no question that large quantities of opium were coming out of China in the 1950s and early 1960s. . . . The Director of British customs at Hong Kong also told us that they had no evidence that opiates were coming out of China. On the other hand, he informed us frankly that they were not looking for evidence -- that, for political reasons, they do not search ships or cargo coming out of mainland China. An identical situation prevails in Portuguese Macao."

1. Heikal, Mohammed Hassanein, *The Cairo Documents* (Garden City, N. Y.: Doubleday and Company, 1973), pp. 306-307.

2. The significance of the investment, which occasioned widespread com-

mentary in the Western press, is not so much the novelty of the joint-venture format, but the surfacing of longstanding business relationships between Jardine's and the PRC.

3. London *Financial Times*, July 4, 1977, p. 20.
4. Interviews with law enforcement officers. Law enforcement authorities suspect, but have never proven, that the Shaw Brothers' international film distribution network also conduits narcotics.
5. Deacon, *Chinese Secret Service*, pp. 437-438.
6. In 1949, according to recently released American diplomatic cables, the newly formed PRC was happy to permit Britain to retain control over Hong Kong for the same reason.
7. *Management Magazine* (South Africa), December 1975. The Rennie and Matheson families' relations go back much further than the recent merger of business operations. They are intermarried through the Ogilvie family, which is itself intermarried with the current British royal family. The Rennies are core members of the British establishment in South Africa. For example, relative Julian Ogilvie Thompson is a member of Anglo-American Corporation's three-man operating committee (see Section 4 for details on Anglo-American's role in dirty money operations). The Rennies show up prominently in British diplomatic and military posts throughout Africa and Asia, e.g., Sir John Shaw Rennie was Governor and Commander in Chief of Mauritius (1962-68), and Sir Gilbert McCall Rennie was Governor and Commander in Chief of Northern Rhodesia in 1952.
8. *The Economist*, September 2, 1978.
9. The authors benefited from an unpublished letter, "Jardine's Octopus in Southern Africa; Rennie's Consolidated Holdings," by David Cherry of the Africa staff of *Executive Intelligence Review*.
10. Peking's influence on the international gold market has been the subject of considerable commentary in the financial press; during 1977, the Bank of China suddenly released about 80 tons of gold onto the international markets, a move which commentators believed depressed the gold price. What commentators were then at a loss to explain is how the PRC, which runs a chronic balance-of-trade deficit, was able to obtain the gold in advance of selling it off. Peking's role in the gold-related aspects of opium financing provide some explanation.
11. *International Currency Review*, Vol. 10, No. 4, p. 146.
12. Harry J. Anslinger, *The Murderers* (New York: Farrar, Straus, and Cudahy, 1961).
13. "World Drug Traffic and Its Impact on U.S. Security," Hearings before the Subcommittee to Investigate the Administration of the Internal Security Act and Other Internal Security Laws of the Committee on the Judiciary, United States Senate; 92nd Congress, Second Session; Part 3, *The International Connection*; September 13, 15, 1972, p. 101.
14. Haikal, *Cairo Documents*.

15. Anslinger, *Murderers*.
16. Harold Chang, "U.S. Sanction Threat to HK Over Drugs," *South China Morning Post*, August 18, 1977.
17. *Isvestia*, February 17, 1978 (article by Bandura based on an article in the Japanese weekly, *Shukan Bunshun*, by N. Otiai).
18. According to interviews with Far Eastern and Soviet specialists, the figure *Liternatura* cited was "laundered" through a series of different Soviet conduits and publications during the 1960s, in a form typical of Soviet "surfacing" of hard intelligence for more general consumption. This particular report is taken much more seriously by Western specialists, than, for example, Soviet claims that the PRC at one point had 35,000 tons per year annual opium production — enough dope to keep the entire U.S. population addicted.
19. Reported in the Indonesian journal *Buana Minggu*, December 12, 1972. Many similar reports came through during the same period, including the following item from Indonesia as reported in the December 29, 1970 issue of *Foreign Broadcast Information Service Daily Report*:

Djakarta — The weekly CHAS has signaled the possibility that Adjitorop, former Brigadier General Suharjo, and other elements of remnants of the G-30-S/PKI who lived in communist China, the Soviet Union, or other communist countries, continue to operate in Indonesia. According to CHAS, they often come to Singapore using foreign passports and fake names and disguised, because of Singapore's proximity to Indonesia.

In view of the great risk of capture by Indonesia state agencies, these elements use Singapore for their subversion against Indonesia. The attempts to crush the Indonesian republic by remnants of the G-30-S/PKI also depend on assistance from and subversion by the above states.

This was the observation of a correspondent of the weekly CHAS who recently visited Singapore, North Sumatra, Riau, and West Kalimantan.

According to CHAS, Indonesia is one of the targets for subversion by communist China in fighting the Soviet Union and its allies, and in the struggle between the communists and the West.

To attain their purpose, all sides employ all kinds of methods to mobilize local forces, which in the current new order oppose and undermine the Indonesian republican government overtly and covertly. Among these forces are remnants of the G-30-S/PKI and groups which are defending the political principles of the old order.

In launching its subversion, communist China conspicuously combines trade activities with the dissemination of communist ideology and instigation to rebel against the Indonesian government, CHAS concluded.

20. U.S. intelligence agencies had the same problem with the Ch'ao Chou element in the Chinese Communist Intelligence Service that Japanese interpreters had with American radio dispatches during World War II; American military forces employed Sioux and other Indians for certain classified radio transmissions, for which the Japanese had no interpreters. The entire American government had, during the early 1970s, only two employees capable of translating the Ch'ao Chou dialect. How extensive this network is, therefore, remains a matter of mystery. One disturbing feature of the New York City incident is that the Ch'ao Chou contact had with him the business card of the local Ch'ao Chou fraternal association in New York's Chinatown (See Note 3, Section 3).

Virtually the only published source indicating the Ch'ao Chou operation is John Le Carre's *The Honourable Schoolboy* (New York: Alfred A. Knopf, 1977). Its leading character is Drake Ko, supposedly a Hong Kong kingpin of narcotics traffic with an Order of the British Empire and a brother in the Chinese Politburo. "They'd come up from Swatow, the two of them," a Le Carre character remarks of Ko and his brother. "They were boat people, Chiu Chow." Le Carre's novel, according to highly informed sources, is a straight *roman à clef* from the files of British intelligence; most of the individual characters are scarcely disguised real figures in the Far East drug traffic and mercenary scene. The book's apparent intent, to portray fictionally the replacement of British intelligence-power in the Far East by the CIA's, is patent nonsense. The interesting question is how Le Carre became so well-informed; his acknowledgements are to British intelligence and police sources.

21. Daniel Insor, *Thailand: A Political, Social, and Economic Analysis*, (London: 1965), p. 135.

22. A. Doak Barnett, *Communist China and Asia* (New York: 1960), p. 186.

23. *The Chinese Bourgeoisie*, p. 67.

24. *Ibid.*, p. 154.

25. *Ibid.*, p. 120.

26. *Ibid.*

27. Statement of Gen. Lewis W. Walt, before the Subcommittee to Investigate Administration of the Internal Security Act and Other Internal Security Laws of the Committee of the Judiciary, Hearings on "World Drug Traffic and its Impact on U.S. Security," Part 4, September 14, 1978, p. 160. "Communist guerrillas in Thailand are in control of an important stretch of opium-growing land on the Laos frontier," Walt testified. "The most serious insurgency is the White Flag Communist Party. . . it is Peking which has armed the insurgents and trained their leader, and supports them with a China-based radio operation. Over the past year, the White Flag Communist insurgency has grown to the point where it absorbs up to 80 percent of the counterinsurgency efforts of the Rangoon government. All the armed groups in Burma, pro-communist or anti-communist, have been involved in the drug trade. . . . The area that

the Communists control is estimated at 25 percent of Burma's total (opium) production. Burma produces 400 tons of opium a year." The authors cross-checked Walt's testimony with U.S. Foreign Service officers and found the above statement to be accurate.

28. Apparently, the relatively small city of Swatow was the center of an extraordinary prerevolution network of mainland financial links with expatriates that was maintained intact after the PRC was established. The remittance agencies, based in Swatow, Amoy, and Canton, had 1,000 branches throughout Southeast Asia as of 1950. After the revolution, the PRC government transformed them into an intelligence operation, employing the agents of the remittance companies abroad for intelligence-gathering purposes. Once the external financial operations of Peking's state banks got off the ground, however, the remittance companies were merged into the new apparatus.

29. Andreyev, *The Chinese Bourgeoisie*, p. 111.

30. *Ibid.*, p. 117. Much of this is of a directly political nature. "Mention must also be made," the Soviet author says, "of the large contribution made by overseas Chinese businessmen towards financing the operation of PRC representatives in Southeast Asian countries (Burma and — until recently — Cambodia and Indonesia). Although in the given case these large contributions are spent in the countries concerned, they are neither more nor less than a clandestine form of sending foreign exchange to the PRC. In some cases local Chinese businessmen helped to finance the propaganda campaigns of the PRC embassies, the current expenses of embassies and missions and even the implementation of the economic aid agreements signed by the PRC. For example, the building of four factories in Cambodia under an economic aid agreement signed with the PRC was financed by local pro-Peking businessmen." However, Andreyev's data, the most current available, drop off at the critical period; no figures are available for the joint venture investments. The more recent picture was filled out through interviews with American and Southeast Asian specialists on PRC external finances.

## 7. THE ROYAL INSTITUTE OF INTERNATIONAL AFFAIRS

1. John Flint, *Cecil Rhodes* (Boston: Little, Brown, and Co., 1974).

2. U.S. State Department, *Foreign Relations of the United States*, 1949, Vol. VII: "The Far East: China."

3. Christopher Thorne, "Chatham House, Whitehall, and Far Eastern Issues: 1941-45," *International Affairs*, January, 1978. The authors were compelled to rely on this summary rather than the original documents of the Royal Institute itself. However, the Thorne article is by a member of the RIIA, and published in the RIIA's own journal, and may be considered an authoritative representation of the RIIA's views

concerning its own history. The 1977 release of RIIA papers was, unfortunately, selective. Thorne notes, "The preparation of this article was greatly facilitated by a grant given to the Royal Institute of International Affairs by the Leverhulme Trust, which enabled the Institute to put its archives in an order more readily accessible to researchers. With the exception of papers dealing with the internal affairs of the Institute, those archives more than thirty years old are now open to bona fide research workers." The RIIA, of course, decides who is or is not bona fide.

4. State Department, *Foreign Relations*, pp. 1289-92.
5. Chou En-lai represented the CP in its "United Front" in Chungking with the Kuomintang during these years.
6. Thorne, "Chatham House," p. 20
7. Peter Vladimirov, *Vladimirov Diaries*, (Doubleday & Co.: 1976).
8. Thorne, "Chatham House," pp. 4-5.
9. Ibid.

10. The ties of Ronning and Endicott to China go back very far and have served as a crucial contact between British policy and the PRC. Endicott was born of missionary parents in China in 1899, and worked there as a Methodist minister for many years. By the time of the 1927 Shanghai massacre of communists by the KMT, Endicott admitted in a discussion that he was already working as an advisor to Chiang Kai-shek. In the early 1940s Endicott underwent a "Damascus Road" transformation to Marxism and became a supporter of the CCP. He became close to Chou En-lai during this time. Following his return to Canada, Endicott formed a newsletter which reported on the PRC and was a founding member of the Norman Bethune College at York University, working closely with Chester Ronning.

Ronning, also born in China of missionary parents, was in the Royal Canadian Air Force Intelligence during World War II. With the end of the War, Ronning became a Canadian foreign officer in China, during which time he developed close relations with CCP leaders, especially Chou En-lai, and current PRC Foreign Minister Huang Hua. Ronning argued strongly for Western recognition of the PRC after 1949, as did the leaders of the Far East Group of the RIIA, and was recognized as a friend by PRC leaders. Ronning served as translator for Huang Hua, who was the official spokesman for the PRC in the aftermath of the Communist victory. When China began diplomatic openings to the West in the early 1970s, Canada was one of the first countries chosen for normalization. Ronning's friend Huang Hua was the PRC's first ambassador to Canada.

Investigations have shown that both Paul Lin and Endicott maintain extensive ties to Canadian Maoist organizations, and through them, to international terrorist organizations. Ronning is known by professional intelligence officers to play a higher "coordinating" role at the government level of terrorist deployment; Endicott and Lin handle the

"field work" with the Maoists. (The information here is derived from team interviews with Endicott himself and associates of Paul Lin.)

11. Thorne, "Chatham House," p. 27.
12. State Department, *Foreign Relations*, pp. 1289-92.
13. Ibid.
14. Christopher Wren, *New York Herald Tribune*, January 16, 1948.
15. State Department, *Foreign Relations*, pp. 1289-92.
16. U.S. Senate, Committee on the Judiciary, 82nd Congress, First Session, Subcommittee on Internal Security, Hearings on the Institute for Pacific Relations, Part I.
17. State Department, *Foreign Relations*, pp. 331-332.
18. U.S. Senate, Hearings on the Institute for Pacific Relations, Part I.
19. Ibid.

## 8. CANADA: NORTH AMERICA'S HONG KONG

Most of the source material from this section came from analysis of bank and corporate annual reports and *Who's Who* entries; a simple cross-correlation of such information produced an unbroken trail of dope and dirty money from the Far East, through Canada, into the United States. The business, legal, and accounting relations noted here are all a matter of public record. In addition, the authors interviewed several former and serving Canadian and American law enforcement officers, who have had Walter Lockhart Gordon and his Canadian "China Lobby" under scrutiny for years.

1. An egregious example of British intelligence activity in Canada is the formation of the British Newfoundland Corporation (Brinco) in the early 1950s. This project was planned by Winston Churchill, the Rothschilds, and Newfoundland's Premier Joseph "Joey" Smallwood, a Master Scottish Mason. According to Virginia Cowles's book on the Rothschilds (1973):

In 1951 shortly after Winston Churchill had become Prime Minister for the second time, he received Mr. Smallwood, the Premier of Newfoundland. Smallwood unfolded plans for a vast development scheme in Labrador and Newfoundland. To carry it out British capital was needed on a truly mammoth scale. . . . When the consortium of firms was formed (Churchill) was delighted that N. M. Rothschild & Sons should head it.

Participation in the founding of Brinco included the leading firms involved in Dope, Inc., including Morgan, Grenfell, Kleinwort and Sons, Rio Tinto Zinc, Anglo-American Corp., and Prudential. Cowles adds, "Brinco's terms of reference were breathtaking: the exploratory right to

sixty thousand square miles in Newfoundland and Labrador, an area larger than England and Wales. . . ."

In Smallwood's autobiography (New American Library, 1973), he identified himself: "In 1967 (I) enjoyed immensely the distinction of being installed in office (as Master Mason) by the Grand Master Mason (Scottish Constitution) Lord Bruce, who came from Scotland especially for the purpose. So I met the direct descendant of King Robert the Bruce. Proud? Oh, yes."

Brinco's board of directors today includes Mark Turner, the chairman of Rio Tinto Zinc, former member of the RIIA Council; Edmund de Rothschild, the president of N. M. Rothschild and Sons; and Sam Harris, the New York lawyer who is a director of Rio Tinto Zinc and whose law firm represents RTZ as well as the Kaplan Foundation, a funder of environmentalist groups. In court papers filed by the Westinghouse Corporation, Harris was named a conspirator in a plan to raise artificially the price of the world's uranium 800 percent during the 1970s.

2. This piece of information was an incidental product of a Labor Party countersurveillance operation against a number of individuals associated with the top management of Drexel Burnham Lambert.

3. A. J. Colin, *Pro-Consul in Politics* (New York: Macmillan, 1964).

## 9. ALL IN THE FAMILY: THE REAL SYNDICATE

1. The cult of Isis was developed in ancient Egypt no later than the Third Dynasty of the Old Kingdom, approximately 2780 B.C., and represents one of the earliest formal articulations of the entropic and backward ideology of mother-worship. As known to the Priesthood of the Temple of Isis — true believers themselves — the Isis cult formalizes the elements of a capability for social control, exploitation, and destruction of creative free will in subject populations. The elements include:

- Use of various schizophrenia-inducing drugs;
- Use of repetitive, heteronomic sounds to supplement the effect of psychotropic drugs, and to create a societal aesthetic that endorses and encourages use of the drugs;

- Creation of synthetic cults based on the original reactionary Isis myth, but specific to the psychological profile of the population which the priesthood has targeted for subversion;

- Enforcement of a political-economic model antagonistic to general human progress, and containing targeted populations within non-creative, manual slave-labor projects (e.g., pyramid-building).

This combination of Pharaonic cult capabilities was taken as a model for further refinement in this century by the British Secret Intelligence Service's Tavistock Institute in London — an institution which launched the "counterculture" in the United States and Europe, based on the very

drugs, mescaline and hashish, the Ancient Priesthood had employed (see Part IV).

2. Carroll Quigley, *Tragedy and Hope* (New York: Macmillan Co., 1974), p. 131. The "Circle of Initiates" formation was explicitly modeled after the ancient Isis Priesthood.

3. R. S. Clymer, *The Book of Rosicruciae* (1947), Vol. II, p. 106.

4. See Lyndon H. LaRouche, Jr., "Is Jimmy Carter Truly a Christian?," *New Solidarity*, Vol. IX, No. 64, October 13, 1978.

5. Cited in Nesta H. Webster, *Secret Societies and Subversive Movements* (London: Boswell Printing and Publishing Co., 1924), p. 115.

6. Their father, the 7th Earl of Elgin, was famous for his theft of the "Elgin Marbles" from Greece, smuggling them to the British Museum.

7. *Dictionary of National Biography* (London: Oxford University Press, 1968), Vol. III, p. 104ff.

8. Jean de Villiershad was the Master of the Knights of St. John of Jerusalem from 1285-93, when the preparations for the slaughter of the Knights Templar were undertaken. Philippe Villiers de l'Isle Adam was the Grand Master of the Knights of St. John in France from 1521-22, and was the first Grand Master in Malta from 1530-34. Today Sir Charles Villiers, who was the managing director of J. Henry Schroder Wagg from 1960-68, is the chairman of the British Steel Corp. Sir John Michael Villiers, a Knight of St. John, was the Queen's Harbour Master Malta from 1952-54, and Lieutenant-Governor of Jersey, an offshore banking center, from 1964-69.

9. By his own testimony in various writings, Lord Russell was in periodic contact with the Communist Chinese regime and Premier Chou in particular after 1949.

10. For example, Rudolf Hess and Professor-General Karl Haushofer, ghost-writer of *Mein Kampf*; Alfred Rosenberg, Nazi Minister of Foreign Services; Max Amann, Editor in Chief of Nazi Publications; Hans Frank, Nazi Governor-General of Occupied Poland during World War II; and several members of the Wittelsbach family (the Bavarian royal family) who sponsored much of Adolf Hitler's career. Hitler himself was an associate of the society, known as a "Visiting Brother."

11. The connection is visible in the 1866 founding of the "Masonic Rosicrucian Society" whose leaders, Mathers, Wescott, and Woodman, also formed the Isis-Urania Temple of the Hermetic Students of the Golden Dawn in 1886. The Golden Dawn group, by 1890, included the mystic poet, William Butler Yeats, former Secretary of the Theosophist Society. Aleister Crowley was the order's historian during the period of Yeats's association with it.

12. The LSD cult was a creation of the Royal Institute of International Affairs and its psychological warfare arm, the Tavistock Institute (see Part IV).

During the late 1960s — at the height of the "counterculture" and

'hippy movement' in the United States — the Director of the RIIA, Andrew Schonfield, was a member of the Tavistock Institute's Governing Council. In 1967, during Schonfield's tenure at RIIA and Tavistock, Tavistock's leading Staff Psychologist, R. D. Laing, published his book, *The Politics of Experience*, which advocated schizizophrenia ("madness is the only sanity") and drug use. Laing writes:

I want you to taste and smell me, want to be palpable, to get under your skin, to be an itch in your brain and in your guts that you can't scratch out and that you can't allay, that will corrupt and destroy you and drive you mad.

During the 1960s, the Tavistock Institute received large grants from the Ford Foundation, the British Center for Environmental Studies, the British Defense Ministry, Harvard University, and at least £22,797 from the Social Science Research Council, of which Schonfield was chairman at the time.

13. See Robert Cohen and L. Wolfe, "Karl Haushofer's *Mein Kampf*," *New Solidarity*, Vol. IX, No. 45, August 7, 1978.
14. Cited in John Flint, *Cecil Rhodes*, p. 27.
15. Martin Fido, *Rudyard Kipling* (New York: Viking Press, 1974).
16. *Ibid.*, p. 35.
17. See Harbans Rai Bachchan, W. B. Yeats and *Occultism* (Delhi: Motilal Banarsidass, 1965).
18. See Lyndon H. LaRouche, Jr., "Hitler: Runaway British Agent," *New Solidarity*, Vol. VIII, No. 87, January 10, 1978.
19. Tennyson in 1820 had been a member of the "Cambridge Apostles" which initiated the Metaphysical Society in 1868-69. Other members of the Metaphysical Society included H. W. Ackland, the Duke of Argyle, Alexander Campbell Fraser, William Gladstone, Shadworth Hodgson, and Walter Bagehot. This group included prominent members of the Society for Psychical Research, *Mind* magazine, and the Fabian Society.
20. Verse 8 of the Choric Song of the poem.
21. *History of the Times*, Vol. IV: 1912-1920 (New York: Macmillan Co., 1952), p. 244. The relevant section reads:

On Jan. 19, 1917, Milner left London at the head of an Allied mission which, during three weeks in Petrograd, laid down a suitable scheme for keeping the Russian forces supplied with Western munitions. . . . It was widely believed at the time that the February Revolution (installing Kerensky — ed.) was hatched at the British Embassy.

22. After the destruction of the Knights Templar in the 14th century, the Knights of St. John appropriated the Templars' Red Cross symbol into their own iconography.

According to Ferdinand Lundberg, *America's 60 Families* (New York: Vanguard Press, 1937), p. 146ff:

The Russian Mission of the Red Cross was headed by Col. William Boyce Thompson and Col. Raymond Robbins . . . (who) used the Red Cross to forward the war aims of Wall Street in a way unsuspected by the American people. The purely political function of the Red Cross is not generally appreciated even today.

. . . Thompson and Robbins, according to their own statements, functioned in Russia as a political arm of the War Department. Their crowning achievement was the purchase of enough delegates to the All-Russian Democratic Congress (to support Kerensky — ed.). The cost of seducing this congress was \$1,000,000.

Winston Churchill's wife, Clementine, a Commander of the Order of St. John, served as the Chairman of the Red Cross Aid to Russia Fund from 1939-46. The same uses of the 'Red Cross' cover for intelligence operations is implicit in the fact that a direct descendant of King Robert Bruce of Scotland, David Bruce, was the Chief Representative of the American Red Cross in Britain in 1940, and one year later, in 1941, became head of Office of Strategic Services (OSS) Operations in the European Theatre; the same David Bruce, during the Nixon Administration years, was selected by Secretary of State Henry Kissinger to be Chief of the U.S. Mission to the People's Republic of China from 1973-74, and then became U.S. Ambassador to NATO from 1974-76.

23. For example, in his April 1938 Annual Report to the Shareholders of Rio Tinto, chairman Geddes noted that:

Our company has received recently a great deal of attention in the press of many countries. Propagandists possessed of lively imaginations but devoid of respect for accuracy have told the world of our doings. In result a lot of nonsense has been published, evidently designed to suggest that your Board is composed of violent fascists actively participating on the side of General Franco. I read the other day an article in which it was stated as a fact that we had sent in a year 300,000 tons of copper to Germany and 65,000 tons to Italy to pay for supplies from those two countries to General Franco. . . . This is just rubbish. . . . I have seen it stated in the press that we . . . your Board . . . "gave" . . . help to General Franco's cause. It depends on your meaning of the verb "to give."

Significantly, in 1923's Annual Report by then-Chairman Lord Alfred Milner, it was stated that "The constantly increasing burden of taxation, especially in Spain, where the (republican — ed.) government is evidently convinced that it can never kill the goose that lays golden



eggs. . . ." (See David Avery, *Not On Queen Victoria's Birthday: The Story of the Rio Tinto Mines*, London, 1973, pp. 371ff.)

Auckland Geddes' grandfather had been the Hudson's Bay Company's official agent in Scotland. His second nephew, Anthony, was a member of the Governing Council of the Royal Institute of International Affairs in 1949, alongside Sir Mark Turner, Rio Tinto's current chairman. The same Anthony is a director of the Midland Bank.

## PART III

# Organized Crime

---

# Introduction

We have now taken the reader through the production and wholesaling phase of Dope, Incorporated. We have introduced the Far East clearinghouse bank, the Hongkong & Shanghai Bank and the gold and diamond houses that with HongShang feed the black market with invisible forms of payment.

In the following pages we will concentrate on the distribution side of Dope, Incorporated's business cycle. We will first enter the Canadian board rooms where the Keswicks, the Inchcapes and their representatives brush shoulders with the wholesalers of the drug trade — the Zionist *Hofjuden* middlemen — whose assigned task is to ensure swift and secure delivery of that "most valuable source of revenue" to Britain's retail distributors: the mob. The Bronfman family of Canada is our leading case, since they are the top middlemen for the U.S. market which, in turn, is the richest in the world.

Beneath the respectable veneer of the Bronfmans' corporate financial empire we will uncover Dope, Incorporated subsidiaries that control the criminal underworld of North America. We will look closely at Meyer Lansky, the Marcello family, and other

“Mafia” figures and discover that like China’s Green Gang, the mob is a secret army, a fifth column controlled by Britain against the United States.

We will trace the drug money to the gambling casinos and other “legitimate” enterprises that are the syndicate’s indispensable storefront cover for the drug trade. From these respectable enterprises we will trace the drug money into the halls of the state assemblies, city councils, congressional offices, and into the pockets of America’s contemporary Benedict Arnolds and Aaron Burrs, among whom we will find Edward Kennedy, Jacob Javits, Henry “Scoop” Jackson, and other leading lights of the Zionist Lobby. We will find tainted heroin money being funneled into Zionist organizations and from Zionist fronts back into political machines for the dual purpose of buying protection for the drug trade and shaping U.S. policy.

We will then take a grand tour through the Anglo-Dutch offshore banking centers, watching money being laundered through Basel, Liechtenstein, Tel Aviv, and the Bahamas; tracing it carefully as it changes ownership from the mob, to the Bronfmans, to British banks, to the Israeli Mossad — finally ending up in dummy corporations to finance international terrorism and a privately owned worldwide assassination bureau.

By the time we finish, the reader will have a view of organized crime that tears to shreds all the fairy tales of the drugstore novels and Grade-B Hollywood productions. The image of gangsters and thieves lurking in the dark underworld will dissipate before the fact that we are dealing with the most highly integrated, top-down political machinery in the world.— one that enjoys the logistical support of a \$200 billion per annum international cartel and the “protection” of every political entity Britain has created through these vast “invisible earnings.”

## The cutouts

The police investigator has a problem in trying to track down the source of the drug trade: he invariably proceeds from the

bottom up and gets lost along the way long before he reaches the level of command that counts. Every year, local police arrest thousands of street corner and schoolyard pushers, yet it is a rare occasion when any of these arrests leads to the arrest of higher up syndicate figures who ply the street trade in the first place. And these local syndicate warlords are themselves usually several steps removed from the “Mr. Bigs.”

As Part II of this report demonstrated, at the top, *British banking* — through HongShang — controls the production and wholesaling side of Dope, Incorporated. This “outfront” activity in the Far East is protected by the legal technicality that the area is off-limits to U.S. investigative agencies. (As one experienced U.S. foreign service officer put it, “It would be easier for a white Anglo-Saxon Protestant to penetrate the Politburo of the Chinese Communist Party than it would be to gain access to the Hong Kong or Swiss bank accounts of the drug traders.”) At the retail, distribution end, there is no parallel way of *directly* linking the British oligarchy to the drug traffic — at least not with the ordinary tools of the police trade.

One of the ABCs of any covert operation is the time-tested practice of securing middlemen — or, to use the professional expression, “cutouts” — that effectively conceal the identities of the stage managers who run the show from behind the lace and velvet curtains. From the top all the way down to the street level, Dope, Incorporated is run through layer upon layer of such cutouts.

Even in China, where the British Crown brazenly pursued its opium policy, it operated through the corrupted Soong family which carried out the day-to-day business operations for Jardine Matheson.

**In the West, the prime cutout for Dope, Incorporated is the Zionist Lobby.**

This cutout begins at the top with the cohesive grouping of *Hofjuden* (“Court Jews”) who serve the British monarchy as loyal, wholly owned servants. These families, whom we will meet by name, have a centuries-long tradition of attaching themselves to the predominant noble houses of Europe, providing indispensable services as tax-farmers and errand boys for the

types of missions that the aristocrats would prefer to plan but not get caught in carrying out.

Many of these *Hofjuden* families migrated from Amsterdam to Britain after the "Glorious Revolution" (1688), which brought the Dutch House of Orange onto the British throne in alliance with the most bucolic, feudalist landed gentry of the Isles. That Anglo-Dutch merger of the late 17th century turned Britain into the most powerful center of the European oligarchical faction — a status it has maintained for three centuries. For these *Hofjuden* families, the relocation to Britain marked no shift in allegiance; they have functioned as servants for the *oligarchical system*, not for specific houses. Several of the *Hofjuden* families who converged on London during the 17th and 18th centuries had served the Genoese bankers in their takeover of Holland, had participated in the Dutch East India Company's first expeditions in opium trade, and had collaborated over the centuries with the British Jesuits against European humanist forces.

The *Hofjuden* should not be confused with the Jewish people. In much the same way that one would not condemn an entire nation for the crimes committed by its most deranged citizens, one cannot condemn the entire Jewish people for the centuries of crime committed by the *Hofjuden*. The only relationship the *Hofjuden* have had to Jewry is that of persecutors and tormentors. As the clandestine operations bureau for the oligarchy, they quickly learned that they could augment their capabilities tremendously by subjecting Jews to waves of persecutions and then recruiting terrorized Jews into Zionist organizations that had as their ostensible aim the "survival" of Jewry! In street parlance, the *Hofjuden* have run a six-century-long protection-extortion racket against the Jewish people — to the overall effect of building up a sizable "Zionist" network at the disposal of British Secret Intelligence. This traditional relationship to Jewry was carried to its lawful conclusion in the 20th century when the Rothschilds, Warburgs, Oppenheimers, Schroeders, and other *Hofjuden* became the leading financial backers of Adolf Hitler.

One of the greatest benefits that the *Hofjuden* gained by their complicity in Hitler's genocide of the East European population was that they could henceforth hide behind the memory of the

awesome fate of millions of Jews and conduct the filthiest sorts of operations — from drug-running to terrorism to genocide against Arab and related populations — without being exposed for these crimes against humanity. Whenever any critic attempted to expose these crimes, he was quickly assaulted as a "Nazi," a "fascist," or an "anti-Semite."

It is neither unrelated nor coincidental that these Zionist *Hofjuden* were delegated the role of cutouts between the inner circles of the British nobility and the filthiest gutters of organized crime. Even within the *Hofjuden*, we encounter two levels: one is the centuries-old families (the *Hofjuden* "elite") who rub shoulders with and are intermarried with the nobility; and the second, the "initiates" — "chosen" by the *Hofjuden* elite to be the drug-runners, the bootleggers, the murderers, and extortionists — who themselves hope that by slavishly serving the British oligarchy they will be placed among the ranks of the Zionist "respectables."

Within the first category, we find such "respectable houses" as these:

The Montefiores trace their origin as "special operations" experts for the European oligarchy to the 13th century in Spain, when they ran errands as tax farmers and Inquisitors for their masters, the Genoese. The Montefiores later moved to Holland to help found the Dutch East India Company and the Bank of Holland. After the Stuart Restoration of the mid-17th century, the Montefiores moved to England where they helped establish the Bank of England and the British East India Company. Under Sir Moses Montefiore, the family collaborated with Lord Palmerston and Prime Minister Disraeli in the founding of the present-day Zionist "movement."

The Goldsmids and Mocattas have been the leading bullion merchants for the royal family of England since the Stuart Restoration, predating the founding of the Bank of England. As we have seen, both families conduct a significant portion of the black marketeering in precious metals for the Hong Kong drug traffic.

The Oppenheimers control a large portion of the diamond and gold mining in South Africa and are interlocked with the

HongShang Bank to provide yet another means of exchange for drug transactions.

The Canadian de Hirsch family bankrolled much of the Jewish migration from Eastern Europe to Canada and is still a bank-roller of Zionist organizations.

The Sassoons were the first *Hofjuden* family to concentrate their resources primarily in opium production. Known as the "Rothschilds of the East," they settled in India at the beginning of the 18th century. The Sassoons relocated in 1949 to the Caribbean where they established themselves on the ground floor of casino gambling and unregulated offshore banking.

The Rothschields began their fortune in Hesse-Cassel, Germany by supplying Hessian mercenaries to the Hanoverian King George III of Britain against the American colonies. They are "johnny-come-latelys" to the *Hofjuden* circle, having only seriously gained a place in the oligarchical court with the Treaty of Vienna in 1815. From that point, however, the Rothschields have expended considerable resources toward the subversion of the American republic; they maintain an "investment" presence in Dope, Incorporated.

Immediately below the *Hofjuden* elite are those "initiate" families selected and sponsored to run the criminal underworld and its "legitimate" front organizations. Into this category falls the powerful Bronfman family of Canada, the Hong Kong of North America. By all accounts one of the richest families in the world, the Bronfmans are a sterling example of a family hand-picked and raised out of the gutter to become some of the best paid crooks in the world. A Bronfman illegal loan of \$350,000 to the Campaign to Re-Elect Hugh Carey as Governor of New York recently caused a public outcry, but as the story we now tell shows, the Bronfmans themselves are owned and operated by the British banking elite of Dope, Incorporated.

# 1 The Bronfman Gang

The Bronfman family is best known to Americans through its ownership of Seagram, the biggest liquor company in North America. The family's holdings stretch from whiskey, banking, mining, real estate, and — although somewhat less publicized — narcotics. Today they are regarded as respectable and outstanding "philanthropists" whose name is attached to everything important in Canada — and Israel — be it government, business, or "cultural" affairs.

This was not always the public profile of the Bronfman family. Less than 50 years ago, they were known to be the biggest bootleggers in North America and were referred to by the less prestigious title "the Bronfman gang."

The Bronfmans have always been beholden to the *Hofjuden* elite. The first member of the family to come to North America was Yechiel Bronfman, a grist mill owner from Bessarabia, Romania, who later anglicized his name to Ekiel. Yechiel emigrated to Canada in 1889 under the sponsorship of the Moses Montefiore Jewish Colonialization Committee. (1)

This enterprise had been initiated at an 1872 meeting between

Baron Maurice de Hirsch, Baron Alfred de Rothschild, and other Zionists that established a Jewish Colonialization Association to bring selected Russian and Eastern European Jews to agricultural settlements ("kibbutzim") in the Canadian provinces of Manitoba and Saskatchewan. (2) The same period marked the transfer of the Warburg, Kuhn, Loeb, and related Our Crowd migration from Germany and Britain into lower Manhattan. In 1912 William Sebag Montefiore himself arrived in Montreal where he spent the remainder of his life (d. 1950). Lord Harold Sebag Montefiore, current head of the Jerusalem Foundation (the Zionist wing of the Most Venerable Order of St. John of Jerusalem) was sent to Canada for his early education. In the same period, Baron de Hirsch established the De Hirsch Foundation in Canada as the umbrella for all Canadian Jewish "philanthropic" activities and the Montefiores created a club (named after the family) to service the resident Zionist elites. The Rothschilds, too, planted a branch of their family on Canadian soil.

Meanwhile, in Saskatchewan, the Bronfman family found little interest in eking a living out of the plains of midwestern Canada. The strenuously Orthodox Jewish family first turned to selling wood, then to horse trading, and then most successfully to the hotel business (and prostitution). (3)

In Yiddish Bronfman means "liquorman," and the hotel business put the Bronfmans in a good position to take advantage of the 1915 advent of Canadian prohibition. Bronfman hotels became "boozeries." Prohibition — enacted on orders from the Privy Council as the prelude to the 1920s U.S. Prohibition and birth of organized crime — catapulted the Bronfmans into the multimillionaire bracket and a status as the untouchable kingpins of crime in North America.

During Canada's four dry years from 1915 to 1919, the Bronfmans established their contacts with U.S. criminal figures for illegally importing liquor into Canada. In 1916, the Bronfmans established their first link with the opium trade proper. Samuel and Abe Bronfman, two of Ekiel's four sons, collaborated with the Hudson's Bay Company — in which the Keswick family of Jardine Matheson had controlling interest — to buy the Canadian Pure Drug Company. In this way the Bronfmans rushed into the

loophole in the War Measures Act that permitted the distribution by pharmacists of alcohol for "medicinal" purposes.

When prohibition in Canada ended in 1919 and Prohibition in the United States began, the Bronfmans simply turned from whiskey importing to whiskey exporting. After it was all over, in May 1936 the Bronfmans agreed to pay \$1.5 million to settle their account with the U.S. Treasury; the sum amounted to an admission that half the liquor that came into the United States during Prohibition was from the "liquormans." (4)

The "Seagram Chickencock" the family poured across the border was pure poison — a mixture of pure alcohol, sulfuric acid, caramel, water, and aged rye whiskey that paralyzed its victim. Between 1920 and 1930, 34,000 Americans died from alcohol poisoning.

Their control of liquor flow into Prohibition USA gave the Bronfmans literally life-and-death control over American crime. Refusing to play ball with the Bronfman gang usually spelled death, and independently minded gang bosses were often known to be executed by their lieutenants on the Bronfmans' behalf. One of the buyers best liked by the gang was New York City beer baron Arthur Flegenheimer, a.k.a. Dutch Schultz, who succeeded in wiping out his competition including the notorious killer Legs Diamond. Schultz himself was later rubbed out when he took it into his head to murder the reforming New York District Attorney Thomas Dewey. (We will meet up with Mr. Dewey later in regard to the Mary Carter Paint Company.) (5)

In the first years of Prohibition, Ekiel's four boys ran all bootlegging from the prairie states of Canada to major distribution sites south like Chicago. To secure the shipment lines, Harry set up a dummy firm, Transcanada Transport Company. Transcanada was a protective cover for the Canadian Pacific Railway owned by respectable gentlemen back in London, which ran the whiskey across the border. (6) The Bronfmans also bought up stretches of barren farmland along the border and even built an underground pipeline to pump their "chickencock" into the United States.

During these early years, the Bronfmans were scarcely under the protective wing of their Zionist sponsors. Thus, for example,

in 1932 Bronfman brother-in-law Paul Matoff was executed gangland-style by the Chicago mob in a dispute over profit splitting. A scandal ensued, public hearings were convened, and the Bronfman crimes came spilling out into the light of day. The Bronfmans received a mild reprimand from the Canadian government and relocated their operations to Montreal.

1922 also marks the year that the Bronfmans procured their own distillery, hauled with workmen included from Kentucky to Montreal.

Since 1920 the Bronfmans had been importing British whiskey from the Distillery Company of London (DCL), which controlled more than half the world market in scotch whiskey. Owned by the higher echelons of the British nobility including Field Marshal Haig, Lord Dewar, Lord Woolavington, and others, the dispensation of distribution rights was a decision made by HM the King. In 1926, upon the request of Samuel Bronfman, the DCL agreed to go 50-50 in the Bronfmans' distillery and the Distillery Corporation Limited was formed as a holding company with Bronfman and Seagram distilleries. Headquarters were established at the Bronfmans' corporate castle in Montreal, but it was the Distillery Company of London's William Ross who was installed as president with Sam Bronfman as vice-president. The British elite had made a decision to go with the Bronfman option.

Despite the massive infusion of capital and the newly gained legitimacy the link-up with DCL afforded them, the smell of Bronfman smuggling both into and out of Canada and their wholesale bribery of Canadian customs à la Hong Kong had gotten too strong. In 1928 the Royal Commission on Customs recommended the immediate prosecution of Harry Bronfman on charges of attempted bribery. Nothing happened, but shortly thereafter the Bronfmans created the Atlas Shipping Company and moved their smuggling operations to the French islands of St. Pierre and Miquelon, 15 miles off the Newfoundland coast. With licenses in Bermuda, Saint John, New Brunswick, and Belize, British Honduras, the Atlas Shipping Company was one of the first ties laid down in the dirty money-drug underground railway between Canada and the Caribbean. (7)

A little ditty popular during the time indicates the amusement with which the British viewed the entire operation:

Four and twenty Yanks  
Feeling very dry,  
Went across the border  
To get a drink of rye.  
When the rye was opened,  
The Yanks began to sing:  
"God bless America,  
But God save the King."

## Organized crime comes of age

With Prohibition, crime became a bigtime business. It was no longer based on small-scale prostitution, loan sharking, or petty protection rackets. Now it was centralized around the marketing of one precious and outlawed commodity whose supply was controlled from London and from the British colony of Canada. Crime was reorganized from top to bottom into an integrated wholesale and retail distribution chain with well-defined marketing districts, quotas, and uniform pricing. Crime became syndicated.

Hundreds of movies spewed out of Hollywood about the "Roaring Twenties" have glamorized the truth: with Prohibition, Britain — through its Bronfman Gang cutout — had created a nationally syndicated crime cancer. Within a decade of the Roaring Twenties, the Bronfman syndicate would be peddling heroin, cocaine, and every other available poisonous drug through the same wholesaling, transporting, and retailing system that bootlegged booze.

Bronfman's counterpart in the United States was one **Arnold Rothstein**. Just as Bronfman made it into the bigtime under the auspices of the *Hofjuden* elite, so Arnie Rothstein was sponsored by Our Crowd Zionist investment bankers who arrived in New York as the Montefiores were setting up business in Canada.

Arnold Rothstein — the godfather of organized crime — was the son of a wealthy Our Crowd dry goods merchant.

At the turn of the century, the Russell Sage Foundation had issued a well-publicized field study of loan sharking in New York City. (8) The report's wide publicity resulted in the bankrupting, jailing, or takeover of the petty gangsters by Rothstein, who emerged as a powerful Tammany Hall figure with a fabled loan sharking business estimated at several million dollars.

Regionwide combines were formed up and down the East Coast for smooth distribution. The **Reinfeld Syndicate** — named after the Newark, New Jersey bootlegger and accused murderer Joseph Reinfeld — functioned as the middleman between the British liquor distilleries and the "Rum Rows" of Boston and New York. Its controlling shareholders were the four Bronfman brothers, Allan, Sam, Edgar, and Charles. The U.S. leg was handled by Reinfeld and Abner "Longie" Zwillman, later the boss of Atlantic City, and Rothstein's gangs in New York. (9)

In 1927, the Big Seven combine consolidated the entire East Coast distribution system. Its organizer was **John Torrio** — a dapper little gentleman who without benefit of family, racket, or turf had gained notoriety for eliminating any local crime bosses who stood in the way of national syndication. Torrio was a Bronfman man who had murdered his own uncle to prove it. Brought into Chicago in 1910 by his uncle, racketeer "Big Jim" Colosimo, Torrio smelled the wind on the eve of Prohibition and demanded that his uncle start making the right contacts to get into the lucrative business of bootlegging. When "Big Jim" refused, Torrio had him murdered and took over the Chicago mob as the distribution point for the Bronfman liquor. (10)

In 1925, Torrio suddenly left Chicago heading first for Havana and then landing in Italy. Returning to the United States in 1927 after he miraculously "escaped" Mussolini's purges of the Mafia, Torrio came back with one goal: to build a nationally organized crime syndicate.

While the mad killers and punks like Dutch Schultz, Legs Diamond, and Al Capone made the headlines every day and provided good material for gangster movies, John Torrio quietly continued the work that Arnold Rothstein (assassinated in 1928)

had begun, now with the aid of Rothstein's successor Meyer Lansky. Torrio could do what Lansky and the Bronfmans were prohibited from doing for reasons of ethnicity: discipline the scores of family local crime chieftains and "moustache petes" into one centralized *business* that could penetrate every sector of the economy. Known as the "assassin who never carries a gun," Torrio presented himself as the elder statesman of organized crime and commanded respect from the Mafia locals. "Cooperation is good for business" was his slogan.

The Big Seven had been Torrio's first step. The cooperative of East Coast bootleggers controlled from the top down to the local levels all prices, membership, centralized distribution points, corruption, and protection.

By 1928 Torrio was able to call a Cleveland meeting to establish a nationwide crime syndicate. (11) The gathering was unique in that it had succeeded in bringing together into one room all the crime bosses of every major organized city. There were three items on the agenda. First, how to use the huge profits of Prohibition and invest them in legitimate business that would permit a steadily increasing take for the syndicate. Second, how to deal with the Italian question. The ritual vendetta murders of the Mafioso families were good for the newspapers, said Torrio, but bad for business. Immediately after the meeting the Castellammarese gang wars broke out in New York as the test case for Torrio's syndicate. Under the auspices of Lansky and Torrio, Lucky Luciano succeeded in wiping out all recalcitrant godfathers. During the last night of the war — the infamous "Night of the Sicilian Vespers" — over 40 people were gunned down. (12)

With cartelization came the need for more long-lasting regulation — gangland style. In the early 1930s Murder, Incorporated was formed as a regulatory commission of sorts to police any overzealous "free enterprise" advocates who might try to buck the syndicate. A special assassination bureau was set up by Meyer Lansky and Benjamin "Bugs" Siegel. The "Bugs and Meyer Gang" had been distinguished by the fact that they owed allegiance to no one (except maybe Arnold Rothstein); they had originally been used to protect Bronfman liquor shipments across the border against "freelance" hijackers. (13)



By 1932 Torrio was strong enough to pull together another meeting of the syndicate, this time in Atlantic City, where a National Commission — the board of directors of organized crime — was officially formed. Aside from the leading Italian mafiosi who had survived the transition, Meyer Lansky, now regarded as the financial and enforcement wizard of the syndicate, and Atlantic City's Zwillman were in attendance as honored guests.

Thus, for the British, Prohibition was a roaring success. What had begun as a three-way contract between Britain (the supplier), Bronfman (the cutout), and Rothstein (the distributor) had become within the space of a decade a nationally organized crime syndicate — a private, secret army under British banking and political control.

## The Rothstein-Hong Kong connection

To pick up the story of the modern-day Dope, Incorporated, let us return to Cleveland and John Torrio's first 1928 meeting of the syndicate. The third item on the agenda was what to do after Prohibition. The commodity, Torrio proposed, that would replace liquor as the black-market, big-profit taker was narcotics.

When Prohibition began in 1920 Arnold Rothstein had personally gone to Great Britain to establish the liquor pipeline with the British distilleries. Less known but more important is that at the same time he had dispatched his underling Jacob "Yasha" Katzenberg to Shanghai to begin negotiations for a dope pipeline from the Far East into the East Coast of the United States. (14) (The West Coast had been sewn up in the previous century with a pipeline from Shanghai straight into the Pacific Chinese coolie communities.)

It was projected that the same networks established to bootleg liquor could just as easily smuggle and retail narcotics. By 1926, U.S. narcotics agent-on-the-scene in the Far East, Ralph Oyler, wrote back to his boss Levi Nutt, chief of the U.S. Narcotics Division, that the opium market had expanded so tremendously that Britain was "even taking shipments of crude opium from the

Near East to add to her gigantic supply of Asian opium" in order to meet market demand. The traditional opium families of Keswick, Sassoon, and Inchcape were preparing for the future. (15)

One year after Oyler's report, the 1927 Shanghai massacre put an end to all challenges to the rule of opium. The Shanghai uprising had been an attempt by the nationalist factions within the Kuomintang and Communist Party to destroy the opium dealers, such as the Soong family, who had seized control over the government and had carved up China into drug-running "warlord" satrapies. The massacre was carried out by the Green Gang Syndicate, acting on orders and funding from the Extra-territorial International Settlements on Shanghai headed by Lord William Johnston Keswick. The British enclave harbored the Green Gang criminals at the time of the massacre, and the British-dominated Municipal Council (headed again by Lord Keswick) turned over trade union leaders and others to Green Gang criminals who executed them. (16) Had the Shanghai massacre occurred during the previous century, it would have been known as the Third Opium War; the consequence of the slaughter was yet another dramatic increase in British opium control over China.

The two principal Green Gang leaders involved in the massacre were Tu Yueh-sheng, "whose factories flooded the American market with narcotics" after the coup, and Huang Chin-jung, who was Arnold Rothstein's contact man. British-dominated post-1927 Shanghai was to become for the next 14 years the premier drug depot for the world.

This shift East in the production of the opium cycle has been documented by Jonathan Marshall in the *Bulletin of Concerned Asian Scholars*:

By the late 1920s, China was a net exporter of opium, and within a few years it replaced the Near East as the world's opium smuggling capital. By 1931, China produced seven-eighths of the world's narcotics. Chinese opium flooded the world markets through Hong Kong, Shanghai and Macao. . . . By the mid-1930s, Chinese heroin dominated the American market.

As documented by Marshall, Lord Keswick and the other controllers of the opium trade imposed the Green Gang dope merchants in power in China, making the production and distribution of opium the backbone of the Chinese economy. The consequences were predictable: unparalleled genocide against the Chinese population.

In early July, 1932, T.V. Soong, who had resigned (as Finance Minister — ed.) the month before after failing to raise enough money for the communist suppression campaign, hinted that he would return to office if a new source of revenue — such as opium — could be found. He picked up the support of the influential H.G.W. Woodhead, who, probably reflecting the sentiment of the British business community (i.e., Keswick, the HongShang, and Standard and Chartered — ed.) argued that only such a monopoly could solve China's financial crisis. An opium monopoly was a small price to pay to protect the stability of China's business climate. . . .

(Due to the forced cultivation of opium — ed.) millions of acres of land were taken out of food production. In food-short China, this reduced the margin of peasant survival . . . the most notorious case of famine brought on by over-cultivation of opium occurred in Shaanxi province between 1928 and 1933. It took as many as six million lives in four provinces, wiping out perhaps a third of the entire population of Shaanxi province. (17)

Let us now stand back and review — in light of this history — the jigsaw puzzle pieces that fall into place with Yasha Katzenberg's trip to Shanghai and the sealing of an opium pact.

First, Arnold Rothstein, Yasha Katzenberg's employer, was a product of the Rothschild "dry goods" empire that included the Seligman, Wannamaker, and Gimbel families. During Prohibition, according to the Bronfmans' own testimony, Rothstein, Meyer Lansky, and Lucky Luciano were the Bronfmans' main distributors. As Prohibition came to a close Bronfman associates traveled to Shanghai and Hong Kong to streamline and

expand the drug trade into the United States, negotiating with the foremost Chinese drug-runners who were not only encouraged but pressured by the British "business community" to pull together an opium cartel.

The man dictating the opium policy to China in this period, the man who sired the T.V. Soong opium monopoly, was Sir William Johnston Keswick of Jardine Matheson and the Hongkong and Shanghai Bank. From the period of the Shanghai massacre to 1942 when he was interned by the Japanese, Keswick directed the International Settlements of Shanghai — the period of gross expansion of Shanghai heroin into the United States. The same Sir William Keswick was until very recently the director of the Hudson's Bay Company of Canada, the same company, it will be recalled, that collaborated with Sam and Abe in 1916 to found the Pure Drug Company for illegal distribution of whiskey into Canada.

Working for Hudson's Bay along with Keswick is Sir Eric Drake, who not only sits on the board of several Bronfman-run banks and companies, but is also an employee of the Inchcape family and presently the deputy chairman of the Inchcape Peninsular & Orient Steamship Company. The current chairman of the board is the son of the Lord Inchcape who in 1923 called for the expansion of "that most valuable source of revenue" — the opium trade.

Sir Eric Drake is also a member of the board of Canadian Pacific, which plays a most vital role in the transshipment of drugs through Canada into the United States, just as they did with alcohol during the Prohibition. Along with Lord Trevelyan, who heads up the HongShang's "gold-for-dope" exchange from his position at the British Bank of the Middle East, and Lord Inchcape, Sir Eric Drake sits on the board of British Petroleum, as does Sir William Johnston Keswick.

Sitting on the board of the Bank of Montreal along with Charles Bronfman and two Seagram directors are J. Bartlett Morgan, William Arbuckle, and F.S. Burbridge, who in turn sit on the boards of Hudson's Bay, Canadian Pacific, and a host of other banks and corporations in which the drug families of the HongShang nexus play a policy-making role.

We are not charging "guilt by association" but rather making note of the fact that the series of "legitimate" enterprises the Bronfmans moved into toward the close of Prohibition are indistinguishable from and intermeshed with companies controlled by Keswick, Inchcape, and other leading opium traders. During the same period, these gentlemen openly supervised the drug trade into the United States. This association not only continues to this day but is the mainstay of the Bronfman empire.

### Going legit ain't necessarily kosher

With the repeal of Prohibition and with the Shanghai opium deal in operation, the Bronfmans, like so many of their partners across the border, "went legit." Organized crime sunk its millions in legitimate businesses that both acted as cover for illegal activities and set up the laundry networks for dirty money. The new phase of respectability signaled that the most successful bigtime whiskey bootleggers were switching to bigtime narcotics.

In the early days, the Bronfmans had to run all the risks of the smuggler's profession. They had to dodge the law, stay one step ahead of the desperadoes on the other side of the border, and whenever things went wrong, face the humiliation of public exposure and scandal. As a result, the family acquired a considerable reputation.

Looking expectantly toward the fast increase in drug trade in America, the British could not afford to leave their leading cutout in such an exposed and precarious position. Nor could they simply dispose of the Bronfmans after Prohibition. The family had become irreplaceable due to its in-depth control over the syndicate. Yet, they would be a liability if they continued to work as openly with their distributors in narcotics trafficking as they did running Prohibition.

The problem was resolved by bringing the Bronfmans into the lower rungs of the *Hofjuden* caste. Almost overnight, the Rothschilds, Montefiores, de Hirsch, et al. took "Mr. Sam," the crime czar of North America, and transformed him into a rising star of the Canadian Zionist movement.

\* In 1934, Mr. Sam was given his first "respectable post" as chairman of the National Jewish People's Relief Committee (Canada).

\* By 1939 he had been appointed head of Baron de Hirsch's Jewish Colonization Association, the same Association that had brought Yechiel to Canada.

\* In the same year, the Canadian Pacific Corporation invited Mr. Sam to establish a new refugee organization for Eastern European Jews.

\* Within five years, the prince of crime was transformed by the good grace of His Majesty's oligarchists into a Zionist "philanthropist." One post followed after another. He became head of the Canadian Jewish Committee, replacing Lyon Cohen, the son of Lazarus Cohen, the founder of the Jewish Colonialization Association and the official agent of the de Hirsch family interests.

After World War II, Mr. Sam established the National Conference of Israeli and Jewish Rehabilitation, using his considerable smuggling skills to run guns to the Haganah.

Similar posts were awarded to the other Bronfmans. Allan Bronfman was named president of the Zionist Organization of Canada, a member of the board of trustees of the Federation of Jewish Philanthropists and of the national council of the Canadian Jewish Congress. Abe Bronfman was posted to the Joint Distribution Committee and also to the national council of the Canadian Jewish Congress.

Finally, in 1969 the Bronfmans were given the highest reward issued by Her Majesty. Sam was made a Knight of Grace of the Most Venerable Order of St. John of Jerusalem — Her Majesty's official chivalric order. His brother Allan and his son Charles were appointed to the highest rank, Knight of Justice of the Order. These appointments are emphatically *not* ceremonial, but are only bestowed on those who have carried out the most dangerous and fruitful missions for the British Crown.

The Bronfmans' time had truly come. Sam's children were welcomed into the *Hofjuden* elite by intermarriage. Minda married Baron Alain de Gunzberg, himself an extension of the Rothschild family tree. De Gunzberg sits on the board of Seagram, is managing director of the Banque Louis Dreyfuss, and controls the Selig-

man-Louis Hirsch investment house which has close Rothschild ties. Edgar Bronfman's first marriage was to Ann Loeb, bringing him instantly into a command position within the Wall Street house of Loeb, Rhoades, and Co. While taking over the Seagram main branch in New York, Edgar's marriage clinched the tie to Our Crowd that had begun during Prohibition. His second marriage, to Lady Caroline Townshend, as we have seen, was unsuccessful. Phyllis Bronfman married Jean Lambert of the Belgian banking and mining interests.

Yet, despite their mountains of wealth, despite their hard-won entry into the realms of good breeding, it would be a mistake to think the Bronfmans were a power in their own right. When it comes to the question of control, they are treated as if the money were not their own.

Take, for example, the case of "Trizec," the holding company through which the Bronfman brothers ostensibly run their various corporations, including Seagram. Since it was formed in 1960, **the Bronfmans have never held a majority position within Trizec!** Trizec is run by Eagle Star Ltd. of London, a holding company whose directors have been described by one author as "the most notable of the British aristocrats." (18) Evelyn de Rothschild, the earls and dukes who control Lloyds of London and other banking and insurance firms, and leading lights of British intelligence such as Sir Kenneth Strong and Sir Kenneth Keith all converge on the board of Eagle Star. (See Part II, Section 8.) This extraordinary company in turn owns English Property Corp. Ltd. — whose principal individual shareholder Laurie Marsh has gained notoriety in Britain as the "Prince of Pornography" for his ownership of the majority of pornographic movie theaters, massage parlors, and "red light district" real estate in London. (19) English Property Corp. Ltd. owns majority holdings in Trizec.

Neither are the brains behind the Bronfman empire situated between the ears of members of the Bronfman family. The source lies elsewhere — in the family's law firm of Phillips, Bloomfield, Vineberg, and Goodman (now Phillips and Vineberg).

The personage of family arbiter and attorney Lazarus Phillips,

in particular, was a constant sore to Mr. Sam. Born into the upper crust of the Zionist elite, Lazarus Phillips succeeded in gaining all the *yeckus* — publicly recognized respect — that Mr. Sam could never seem to win. Phillips was a holder of the Order of the British Empire, a senator in the Canadian Congress, a member of the board of directors of the Royal Bank of Canada, invited into the exclusive Mount Royal Club as a member, and was a power-broker for the Liberal Party.

But without Phillips the Bronfman family empire could not survive. It is likely that through him the Bronfmans received the input of cash that allowed them to proceed steadily from bootlegging to the legitimate bigtime. Certainly it was Phillips who unfroze enough funds under export control from the grip of the Bank of Canada to finance Seagram's wartime expansion into the United States. As the final judge in all family matters — legal and otherwise — Phillips has sat on the board of Seagram since 1940 and on every other company and philanthropic front nominally run by Mr. Sam. He is still the codirector of Trizec and the other major Bronfman holding company Edper (named after Edgar and Peter Bronfman). Phillips is also the expert who managed to get the Bronfmans off every legal hook they ever got caught on. (20)

Phillip F. Vineberg is part of the Vineberg family of Abraham Moses Vineberg, chairman of the Moses Vineberg Investments firm and the de Hirsch Institute. Cochairman of all the Bronfman holding companies, Vineberg runs the Canadian Israeli Bond Drives and the Canadian Council of Christians and Jews. He is also a member of the *Hofjuden* elite's Montefiore Club.

Major Louis Mortimer Bloomfield, also of the firm Phillips, Vineberg, and Bloomfield, is however, without a doubt the most colorful of the Bronfman brains-behind-the-scenes and this may explain why his name was left out of Peter Newman's 1978 book *The Bronfman Dynasty* (rumored to have been commissioned by the Bronfmans themselves). In addition to his position up to the late 1960s as a Bronfman family lawyer, Bloomfield remains a close banking associate. The Major's Zionist activities are numerous: he is involved in a nest of corporations including the Israeli Continental Company, he is chairman of the Canadian

Histadrut Campaign, and a former president of the Israeli Maritime League. He also holds the post of Consul-General in Liberia, under whose flag vast quantities of opium and narcotics are shipped. He is a high-ranking member of the Most Venerable Order of St. John of Jerusalem and runs its subsidiary Canadian Red Cross Ambulance Corporation.

Major Bloomfield also runs Britain's International Assassination Bureau, an entity we will soon examine in detail.

## Are they really clean?

The answer, of course, is no. Since the days they sent their "chickcock" across the border to their claim as the world's finest whiskey blenders, the Bronfmans' ties to North America's crime syndicate have never been broken but merely undergone corporate reorganization. In Section 3 on the Bronfman company of Permindex, we will analyze their criminal activities in length. At this point a few examples will suffice.

Take the case of Bronfman family intimate Murray Koffler. A leader of the Jerusalem Foundation in Canada, Koffler was the subject of a major scandal in 1976 when his business associates, Starkman stores, were busted by Canadian police after its pharmacists were caught manufacturing illegal amphetamines and funneling them into the black market. (21)

Charles Bronfman's sister Phyllis Lambert was the subject of a simultaneous scandal for her involvement in Heritage Canada, a government funded "social service" program that got caught conduiting drugs onto Canadian college campuses. (22)

In 1975 the Bronfmans again made the front pages when Edgar Bronfman's eldest son, Samuel II, was reported kidnapped. The case revealed the kidnapper to be Sam II's homosexual lover. When the police found them, Sam's kidnappers pleaded that the Bronfman youth had blackmailed them into the hoax as a way of extorting money from his father. The jury agreed; the two abductors were declared innocent of kidnapping, but found guilty of the lesser charge of extortion. The press also aired the kid-

nappers' pleas that their lives were now in danger for having sung about Sam II.

Since he took over the reins of Seagram's New York branch in the 1950s, Sam II's father, Edgar, has built the Seagram distilleries network into a multinational global empire. The Bronfmans, for example, have entered into a most profitable business partnership with the Cuban rum Bacardi family. After Fidel Castro took over the island in 1959, the Bacardis switched their base of operations to Puerto Rico and Miami, taking along with them a small army of anti-Castro Cuban exiles. The Bacardis, headed by Manuel Cutilla Bacardi, have been pinpointed by law enforcement agencies as the funders and political controllers of entire networks of Cuban exiles. The "gusanos," as they are called, are not only involved in terrorism (Orlando Bosch's September 1976 bombing of a Cubana airlines plane killed over 70 people). Drug runners in the Bacardi-Cuban exile networks, José Medardo Alvero-Cruz and Antonio Cruz Vasquez, have been recently arrested for drug trafficking in the Caribbean and Mexico. (23)

Seagram has also staked a conglomerate empire in Mexico. Bronfman's contact is former Mexican President Miguel Aleman, who owns and operates Acapulco. Today Aleman is demanding the revival of casino gambling in Mexico; in the 1930s nationalist President Lazaro Cardenas threw the casinos, and with them Meyer Lansky, out of the country.

In short, wherever Seagram branches appear on the map, they are thoroughly intermeshed with narcotics runners, gambling, and crime.

On the public record, the Bronfmans' gutter connections are most visible in the case of Mitchell Bronfman. The son of Knight of Justice Allan Bronfman, Mitchell is reportedly never without his automatic strapped to his shoulder and his stiletto strapped to his left calf. He is on record with the Montreal Police, the Quebec Provincial Justice Ministry, and the Royal Canadian Mounted Police as a kingpin of organized crime in Montreal. (24)

A 1972 report by the Montreal Crime Commission names one Willie Obront as the head of the syndicate in the area and

describes the relationship between Obront and Mitchell Bronfman as "almost a brotherly relationship." (25)

This relationship extends into illegal activities in which they have mutually or jointly indulged . . . the special kinds of favors they did for each other and the resulting advantages of each in the fields of loan sharking, gambling, illegal betting, securities, tax evasion and corruption. (26)

Everything was on a strictly "friendly basis," claims Mitchell.

Obront first came to the attention of the authorities after two of his Quebec nightclubs used as hangouts for Montreal's underworld were raided. It was revealed that Mitchell's friend was one of Montreal's top movers of dirty money from narcotics, prostitution, and loansharking.

Together with Willie, Mitchell Bronfman is a minority partner in the Pagoda North, a Miami restaurant that has been identified by U.S. and Canadian law enforcement agencies as the headquarters for a continentwide illegal bookmaking syndicate run by Vito Genovese.

Willie Obront was convicted in 1976 of "tax evasion" and put behind bars. Mitchell Bronfman narrowly averted the same fate.

Another one of Mitchell Bronfman's business partners is Sidney Rosen, who was also arrested and convicted in 1975 for looting 35 Canadian and American companies of \$7 million through an asset-stripping clearinghouse called Value Trend Holding Company. Value Trend in turn laundered these stolen assets, along with other dirty revenues from illegal gambling, extortion and narcotics, through Corporate Bank and Trust Company of Freeport, Grand Bahamas and Flendon Ltd., of the same address. Both companies are jointly owned by Rosen and Mitchell Bronfman through another holding company called the "Milton Group." When Rosen went off to jail (again leaving Mitchell Bronfman scot free), the \$7 million passed unscathed into offshore accounts in Barclays Bank in Freeport. (27)

But the two major corporations that Mitchell operates out of

are the mysterious "Securex" and "Exeaire Aviation." The former was disbanded in 1977 by Quebec Provincial Justice Minister Delard. While the Official Secrets Act has kept the reasons behind this hidden, it can be stated with reasonable certainty that Mitchell Bronfman and the company were discovered to be up to their necks in the wave of FLQ (Front pour la Libération du Québec) terrorism that had plagued the province since 1970 — not to mention the narcotics trade.

The two directors of Securex at the time of its banning were Donald McCleary and Gilles Brunet, formerly RCMP sergeants in charge of the G-4 (Secret Service Division) of the Mounties. Both were fired from the Service in 1972 when it was discovered that they were close associates of Mitchell Bronfman. (28) McCleary and Brunet were in charge of the counterterror efforts in 1970 when the FLQ kidnapped a provincial official and a British government officer, an affair which led to the declaration of a state of emergency. The emergency period was used as a pretext to go after the French Canadian networks that had been built up by de Gaulle in conjunction with the Vatican to liberate Quebec from British colonial status.

In point of fact, the FLQ was itself funded by Bronfman family networks as an extension of earlier efforts to assassinate French President de Gaulle (the story will be told below). The Bronfmans' FLQ option was the North American version of the British Special Air Service's control over both the Provisional Wing of the Irish Republican Army and the British Army's counterterror efforts.

Securex advertises itself as a security "consulting firm specializing in anti-terrorism, anti-kidnapping, and guerrilla warfare training." (29) All things considered, it would have to be regarded as both a semi-official covert branch of British intelligence in Canada and as a bridge to the criminal underworld.

Its affiliated Exeaire Aviation emerges as yet another scarcely concealed front for crime. Exeaire is the largest private charter airline service in Canada specializing in jet service for business executives . . . and narcotics.

Is Mitchell Bronfman just the black sheep in the Bronfman family? It is unlikely. Cemp, the Bronfman family trust, signed a

guarantee for part of Exequire's line of credit at the Bank of Montreal.

Nevertheless, the high publicity the Bronfmans have received over the years for such exploits as Mitchell's has prevented the family from receiving that degree of respectability they have always coveted. In the 1950s Mr. Sam looked across the fence at the status of his friend Senator Jacob Javits and decided that he would buy the ultimate title to confer respectability to his name: he sought to become a Senator of the Canadian Congress. All told, he spent \$1.2 million in bribes. The Liberals took his money but wouldn't give him a seat. The Bronfman name was still too dirty to be permitted in the ranks of Canadian politics.

In this regard, the Kennedy family fared much better.

## 2

# The Kennedys: Organized Crime in the Government

There are some facts in the mind of the American public that hint at the reality behind the "Kennedy look": Ted's Chappaquiddick disaster, Judith Exner Campbell's revelations that Chicago mobster Sam Giancana had given her to Jack, and the well-known stories of Papa Joe's bootlegging days. The suspicions are there but Americans aren't really sure what the Kennedys are; after all, if they're so dirty, how do they stay so clean?

Dope, Incorporated supplies the answer. The Kennedys are clean because, beginning with Papa Joe, they were flea-dipped, scrubbed, and polished by the British to be the respectable front for organized crime. Whether or not a Kennedy crosses the British Crown in terms of policy — as Jack Kennedy did in 1963 — does not alter the fundamental content of the political machine that gives the Kennedy dynasty its power. **The Kennedy machine is organized crime in government.**

If Ted Kennedy becomes President in 1980, whom will he owe debts to? The same people who pay for him now. At the top of the list of contributors to Kennedy's 1976 senatorial campaign released by the Federal Elections Commission is one Joseph Linsey. (1) A Massachusetts bootlegger who maintains con-

nections to Meyer Lansky from the 1930s, Linsey sits on the board of International Airport Hotel Systems Inc., a Miami-based company whose board also includes Lansky. Hotel Systems is also connected to Resorts International, a firm we will soon hear more of. FBI wiretaps showed recently that Linsey also has dealings with Raymond Patriarcha, the titular godfather of New England narcotics trafficking. (2) Patriarcha is a partner of the Jacobs family (whom we will also encounter later) in several business ventures, including a multimillion dollar a year slot machine company in St. Louis. Although sentenced to jail for murder, Patriarcha was released over four years ago when doctors "discovered he was suffering from a case of terminal cancer" from which he presumably still suffers.

Among the business enterprises of Kennedy financier Joseph Linsey are two liquor distributing firms, Crown and Whitehall, and a dogracing track in Tauton, Massachusetts. Whitehall's chief "salesman" Mike Rocco was described by the McClellan Committee hearings on organized crime, in which both John and Robert Kennedy participated, as a "collection man for the mob." (3) Linsey's chief political lobbyist, Hirsch Freed, is a senior partner in the law firm of Brown, Rudnick, Freed, Gesmar and sits on the board of the Combined Jewish Philanthropies of Boston. Freed and all of his law partners are generous donors to the Kennedy campaign fund. (4)

It is the character of Kennedy's friends rather than his own low personal standard of morality that explains why as a leader of the powerful Senate Judiciary Committee he has come forward as the leading sponsor of federal legalization of marijuana and why he has given his approval to decriminalization of heroin "for experimental purposes." The job of the Kennedy dynasty is to usher in British dope and the criminals who distribute it — through the front door.

## The rise to power

Papa Joe Kennedy did not have to struggle like the Bronfmans did to make their name and money in the world of crime — he

was born into it. Joe's father P. J. Kennedy was one of the shantytown mobsters of late 19th century Boston.

P. J. began his rise to fortune as a tavern keeper who bought his way into the corrupt Democratic Party machine (a machine that, like the Jacob Astor-Aaron Burr power system in New York, had its roots in opium trafficking). Once he had obtained a seat on the ward's Democratic Committee at the age of 26, P. J. gave up his tavern and went into the more lucrative wholesale liquor business. Two years later in 1886 he began the first of five consecutive terms in the Massachusetts State Legislature. By 1896, he was part of the triumvirate of Kennedy-Donovan-Corbett, known as the Board of Strategy, which controlled the Democratic organization in Boston. But it was common knowledge that the secret to P. J. Kennedy's political success was his control of the local crime ring, the "McGuire Gang." (5)

Joe Kennedy's mother sadly recognized that with her husband, her social pretensions could never be realized for herself. Kennedy's public image was so filthy that he could not even qualify for entry into the "High Irish" social circles of Boston, let alone the Brahmin elite centered around the opium smuggling Perkins family. She set her hopes on her children. It was Joe Kennedy's marriage into the Fitzgerald family (over the vehement protests of his father-in-law, Boston's High Irish Mayor "Honey" Fitzgerald) that launched the Kennedy family into high society.

Nevertheless, when Joe Kennedy went to Harvard he was snubbed and ridiculed by his Brahmin classmates, who never missed a chance to remind him of his family's seedy history. Joseph bitterly referred time and again to his rejection by the exclusive "final clubs," Harvard's most desired status symbol. (6)

After World War I, Kennedy was employed by Galen Stone, a partner in the prestigious Hayden, Stone and Co., a Boston Hat Street investment house with ties to the Rothschilds. While there, he made his first contacts with the British aristocracy. Kennedy got wind that one of Hayden, Stone's clients, the British company of Robertson-Cole Pictures, was in the throes of a credit squeeze. The ambitious Irishman went to London to seek the purchase of



the company's U.S. distribution affiliate, the Film Booking Company. He was turned down flat. Within a month, however, Lord Inverforth arrived in Boston to take Kennedy up on the offer. Through a subsequent merger with Ideal Films Ltd. Kennedy founded what was described at the time as the "first genuinely reciprocal exchange of production and distribution facilities between British and American companies." (7) Kennedy's joint ventures with the British soon produced RKO studios, ushering in British financial and cultural domination of Hollywood.

Kennedy's film ventures were also noteworthy for another reason. Lord Inverforth later showed up during World War II working closely with British Secret Intelligence Services chief William Stephenson ("Intrepid"). (8) The Robertson-Cole deal was Kennedy's first contact with Britain's aristocratic high command.

In 1929, Kennedy joined with Blair and Co., a firm operated by Elisha Walker, later of Kuhn, Loeb, and Jacques Monnet, to bid for control of A. P. Giannini's Transamerican Co., the controlling company for the Bank of America. The attempt failed, but Kennedy gained another invaluable contact. Jacques Monnet had come to North America to represent his family's liquor business, Monnet et Cie., in dealings with the Hudson's Bay Company. In the period that Kennedy was working with Blair and Co., Monnet was traveling to Shanghai on a financial mission for the League of Nations. Since the delegation came on the invitation of notorious opium dealer T. V. Soong, and given Monnet's associations with the Hudson's Bay, it is likely that more was on the agenda than the financing of Chinese railroads.

Papa Joe also had business liaisons with the seamier side of the illegal distribution market. During his own bootlegging days in Prohibition, Kennedy entered into a coalition with Newark's Reinfield Syndicate, which it will be recalled was 50 percent owned by the Bronfman gang. Joe retained his business dealings with the syndicate thugs all the way until 1946. At that time, in preparation for the launching of his sons' political careers, Joe sold his liquor company, Somerset Importers Ltd., for \$8 million to the "Reinfield Importers" — a revised version of the Reinfield Syndicate. (9)

As the end of Prohibition approached, Kennedy again turned to London where Winston Churchill personally approved the grant to Joe of the British distillers' franchise for the American market. Through Kennedy's Somerset Importers Ltd. and Renfield Importers, Kennedy marketed Dewar's scotch, Gordon's gin, Ron Rico rum, and Haig and Haig. (10)

But as Papa Joe made clear early in the game, he was not in it for the money. His goal was to build a political dynasty, and his wife produced nine children in succession to get it going. Churchill's nod of approval and the cash flow accompanying it signalled that the British were ready to take advantage of Joe Kennedy's political ambitions.

Kennedy acknowledged the deal by placing his accumulated fortune in the hands of one of the inner circle of London finance: Lazard Brothers Ltd. André Meyer, head of the U.S. branch of that house, became the manager of the Kennedy Estates. Lazard Brothers Ltd. is owned by Viscount Cowdray (Weetman John Churchill Pearson), cousin of Winston Churchill.

In 1933, Kennedy was appointed by President Franklin Roosevelt to head the new Securities Exchange Commission. Kennedy's earlier association with the London banking circles had put him in the inside track to conduct a flurry of stock speculation on the eve of the 1929 stock market crash and walk away from it all with a pocket full of cash. When the SEC was created to regulate the market, Roosevelt returned Kennedy's 1932 favor of swinging the Boston Democratic machine behind the FDR candidacy at the 1932 nominating convention.

In 1936, FDR appointed Kennedy U.S. ambassador to Great Britain, a post Kennedy wanted more than life itself. As Joe's official biographer explained, "The old American aristocracy, with its Anglophilic leanings—the aristocrats that had rejected Kennedy at Harvard—regarded the post as the nation's highest social office." (11) Kennedy had at last succeeded in giving the Boston Brahmins a kick in the teeth. Once in London, the Royal Family further obliged the funny Irishman by posing with his family in full regalia for the newspapers.

Kennedy quickly attached himself to the most pro-Nazi British aristocrats centered around Lady Astor's Cliveden Set where

Round Table figures such as Lazard Brothers' Lord Robert Brand, the Marquess of Lothian, Fabian George Bernard Shaw, and the opium-trading Sassoon family congregated to dictate Britain's appeasement policy for the British Foreign Office.

Kennedy's antics in Britain soon got back to President Roosevelt who, by the outbreak of World War II, had developed a fairly accurate view of Britain's imperial designs. Kennedy's notoriety as a Nazi supporter — like his father's earlier underworld career — could not be covered over by even the most sympathetic biographer. Thus, David E. Koskoff in his commissioned biography of Joe Kennedy reported the following:

Kennedy had become intensely Anglophilic: "Indeed there are unfortunate signs that Kennedy is going by way of Page." They reported that he was one of the prime exhibits of Cliveden . . . that he was a partisan of England and should be watched carefully. . . .

From the beginning of the Ambassador's career to the end, the spectre of Walter Hines Page haunted Joseph Kennedy. From his position as Ambassador to England, Anglophile Page had literally conspired with the British to bring America into World War I. . . . Kennedy always resented the fact that his name was always linked with Page. . . . Even Roosevelt said before the outbreak of war, "He's more British than Walter Hines Page." (12)

Kennedy's unswerving loyalty to the British monarchy was rewarded; his daughter, Kathleen Kennedy, the sister of John, Robert, and Edward, married William Cavendish, the Marquess of Hartington. Hartington was the son and heir to the 10th Duke of Devonshire and his wife, Lady Mary Alice Cecil (daughter of the 4th Marquess of Salisbury), the Dutchess of Devonshire.

In the hierarchy of the British nobility, the dukes are the highest rank of royalty, taking second place only to the monarchy itself. The Duke of Devonshire is at the center of the interlocking families of the Cecils, Salisburys, and Macmillans who have run British politics since the Glorious Revolution.

Joseph Kennedy repeated the theme many times: "If Kathleen and her husband were living, I'd be the father of the Duchess of Devonshire (first Lady-in-Waiting to the Queen) and the father-in-law of the head of all the Masons in the world." (13) Later, his son John would marry Jacqueline Bouvier, whose sister Lee Radziwill married Prince Stanislaus Radziwill, a member of the Polish nobility who traces his titles back over 500 years. The Radziwill family, which resides in England, established the Order of St. John of Jerusalem in Poland in 1610 and was instrumental in transplanting the Order into the United States in the early 20th century. While serving as ambassador in Britain, Joseph Kennedy was made an initiate in His Majesty's Most Venerable Order of St. John of Jerusalem.

Despite Joseph Kennedy's eventual unceremonious recall from the Court of St. James at the beginning of World War II, the elder Kennedy had succeeded brilliantly in restoring his tarnished reputation. During his sojourn in Britain, he turned over his sons to the British Round Table for a "proper" education. Joseph Kennedy, Jr. and John F. Kennedy were trained at the London School of Economics, an institution founded by the Fabian Society dedicated to training and recruiting foreign cadre as future British agents within government, business, media, and educational posts in their respective countries. The Kennedy brothers were trained by Fabian Society Executive member Harold Laski.

At Harvard, on the Kennedys' return to the United States, further tutoring for son John was secured from Sir John Wheeler-Bennett, the founder and head of the research division of the Royal Institute of International Affairs. Wheeler-Bennett denies that he was the writer of Kennedy's Harvard master's thesis, later published in book form as *Why England Slept* — an apologia for the Cliveden Set's and his father's sympathies for Hitler. (14)

There is little doubt that Wheeler-Bennett was aware that he had been entrusted with the training of Britain's future political kingpins in the United States. As he recalls:

I was invited one evening to dine informally at the American embassy. We were a small party, not more than

ten, as I recall, and the three eldest Kennedy sons sat in a row on the far side of the table to myself. . . . "I'll tell you about these boys," said the Ambassador to me in his rasping nasal voice, as if they weren't there at all. "There's young Joe, he's going to be President of the United States. And there's Jack, he's going to be a university president; and there's Bobby (tapping his nose in a cunning manner), he's the lawyer." (15)

## Why the British killed Kennedy

When John F. Kennedy became President of the United States in 1960, it is reported that André Meyer of Lazard Brothers Ltd. went around Europe introducing himself as "the real President." Whether the story is true or not, it is the case that the Court of St. James had at least temporarily seized control of the Oval Office.

So had organized crime. The Kennedy *machine* moved into the Justice Department, specifically Robert Kennedy's Organized Crime Strike Force. The Organized Crime Drive, as it was called, was a highly irregular unit, even according to its nominal chief, Ed Silberling. The section was in fact run by non-lawyer Walter Sheridan, a former FBI man who had worked as Chief of the Counterintelligence Section, Special Operations Division, Office of Security, and the National Security Agency. It was Sheridan who had the ear of Robert Kennedy, often as much as three times a day. (16)

According to Victor Navasky's *Kennedy Justice*, the Sheridan crew "had free access to the files of the McClellan Committee. It was in touch with grand juries throughout the country. It had an undercover air of mystery about it. Its modus operandi was cloak and dagger. . . Its relations with the FBI were highly irregular in that it received little or no cooperation from the top, yet Sheridan, an ex-FBI man, had a degree of line cooperation in the field that was, in some respects, unparalleled. He actually coordinated FBI agents with his own men — told them where to go when, and they went.

"Unlike every other unit of the Justice Department, which is

organized around subject areas of responsibility," reports Navasky, "the Sheridan unit's *raison d'être* seemed to be not a subject area but a target: Jimmy Hoffa." (17)

If Kennedy himself was obsessed with getting Hoffa, the machine behind him found the campaign a convenient ruse for three reasons. First, it badly damaged the biggest and strongest trade union in the country, which had consistently used its power to press for industrial growth. Second, the publicity it engendered was a good diversion. And third, it was a good cover for going after local Mafiosi who might object to a tightened drug syndicate and the rise of the new black mafia to service the cities. The fanfare around the Valachi revelations served the same purpose.

A look at the ensuing careers of the Kennedy crimefighters underlines the point.

\*Henry Peterson of the Organized Crime and Racketeering Division joined Max Jacobs's Emprise Corporation, a money-laundering outfit examined in Section 4.

\*His boss William Hundley and Robert Peloquin of the Criminal Division left Justice, formed their own law firm, and now sit on the board of International Intelligence (Intertel), Meyer Lansky's crime clearinghouse (see Section 3).

\*Stanley Mills, head of the Kennedy Anti-Trust Division, became general counsel for Max Jacobs's Sportsystems.

\*William O. Bittman, prosecutor for the Justice Department against Hoffa, joined the board of Sportsystems.

\*Daniel Holloman and Thomas Kennedy of the Organized Crime Division joined the same board.

\*Horace Webb of the department's Public Informational Services Division is the public relations man for Sportsystems.

\*Thomas J. Mekeon, member of the Organized Crime Strike Force in Detroit, is assistant general counsel and vice-president of Intertel.

While Sheridan's "Terrible Twenty" burned the small fry, Meyer Lansky and Max Jacobs went untouched. Lansky's biographer, Hank Messick, could even report that "Lansky could deplore the loss of Newport and Hot Springs, but the attack on La Cosa Nostra caused him no loss of sleep. Instead, from 1960 to

1965, he succeeded in keeping his name completely out of the newspapers. That five-year period was for Lansky one of the most active, and profitable, eras he had known." (18)

#### DOUBLE-CROSS

Meanwhile, in the White House John Kennedy was being advised by the higher echelons of the same network that had invaded the Justice Department. Almost simultaneously with Kennedy's inauguration, Harold Macmillan moved into 10 Downing Street. Macmillan was himself part of the extended Devonshire family into which Kennedy's sister Kathleen had married. His Canada-based pulp and paper company, MacMillan Bloedel, as noted, was a component of the British Columbia drug-smuggling apparatus. (19)

Macmillan's newly appointed ambassador to the United States, David Ormsby-Gore (later Lord Harlech), was also a distant in-law of the President through the Cecil family. Ormsby-Gore had been a close friend of JFK's since their days together at the London School of Economics. The British ambassador had daily access to the President. He was the fourth member of Kennedy's inner policy-making core, "ExComm," along with Robert Kennedy and the Anglophile National Security advisor McGeorge Bundy (also a Harvard protégé of the Round Table's William Yandell Elliott). During the Cuban Missile Crisis, documents show that Ormsby-Gore and Macmillan made most of the minute-to-minute decisions at the point that the United States was on the brink of nuclear war.

Best estimates have it that up through the winter of 1962-63, British directives to the White House, transmitted through Ormsby-Gore, were carried out with only minor points of difference. That special relationship began to show signs of deterioration during early 1963. Policy differences between the Kennedy and the Macmillan governments began to surface, as the U.S. President took a series of initiatives toward detente with the Soviet Union and Cuba. (20)

The diaries of Macmillan testify that Kennedy had to be intensely arm-twisted at the famous Nassau summit in spring 1963 before he would agree to turn over the Polaris missile program

to the British. (21) That move precipitated French President Charles de Gaulle's vehement denunciation of the Anglo-American violation of the Atlantic Charter, followed by France's withdrawal from NATO.

A combination of factors was operating on Kennedy. Foremost among them was Papa Joe. Individuals, interviewed by the authors, who knew Joe Kennedy intimately during the 1920s report that he cherished a deep hatred for the British and the Anglophile society of Boston that had humiliated him; however, the same individuals report, Kennedy had made a decision that if he was going to make it, he would have to prove his usefulness to the British. With John Kennedy's accession to the Presidency, Joe Kennedy's dream of using the British to build a sufficient power base for himself was a reality. No astute political observer during the 1960s could ignore the possibility of a "Kennedy dynasty" installed in the White House for several uninterrupted decades.

During the spring and summer months of 1963, JFK began reversing previous policies. Plans were being prepared to devolve U.S. presence in Southeast Asia. Detente discussions were opened up with the Soviet Union; in the weeks prior to his assassination, Kennedy even sent a secret emissary to Havana to open up talks with Fidel Castro. The Kennedys were showing signs of bucking the machine that had put them in power. The British had him killed. To use the language of a Grade-B movie, "Kennedy tried to double-cross the syndicate and he got iced."

It is reported by Kennedy biographer Koskoff that upon JFK's death, Lord Beaverbrook (whom we shall encounter in regard to the International Assassination Bureau) sent a scarcely veiled warning to Joe Kennedy:

Perhaps he (Joe Kennedy—ed.) was a little comforted by the kind note that his dear friend Lord Beaverbrook sent to Rose: "May Joe find solace. . . in the assurance that Bobby will repeat Jack's career." (22)

When Robert Kennedy refused to back off from the track of his brother's assassins and began to prepare his own campaign for

the Presidency, he too was assassinated on British orders.

Playing by the rules of the game is Ted Kennedy's insurance policy. That's what makes him the foremost proponent of dope decriminalization; that's what makes him today's frontrunner for organized crime; that's what makes him the collaborator of the assassins of his brothers.

## Britain's Assassination Bureau: Permindex

Following the assassination of President John F. Kennedy in Dallas on November 22, 1963, New Orleans District Attorney James Garrison launched an investigation that led him to the doorstep of an obscure Montreal-based corporation called Permindex, headed by the Bronfman family's attorney, Major Louis Mortimer Bloomfield. One of the directors of Bloomfield's ostensibly small international trading company, Col. Clay Shaw of New Orleans, was Garrison's chief suspect in the Kennedy murder. Shaw ran the World Trade Mart in New Orleans, a subsidiary of Permindex that was described by a former Shaw associate (1) as a front for Mafia drug-running and organized crime activity centered in the Caribbean.

Shaw was the financial backer and controller of Lee Harvey Oswald during his lengthy stays in New Orleans. Garrison had established, and the District Attorney also had evidence that Shaw had been the safehouse channel out of the country (into Italy) for several unidentified persons believed to have been the real "triggers" in the Kennedy assassination. (2)

James Earl Ray, the "patsy" in the 1968 assassination of Martin Luther King in Memphis, was also a frequent visitor to Shaw's New Orleans' World Trade Mart during the month before King's murder. Ray escaped via Canada to London where he was traced and captured a month after King died. (3)

After more than a half dozen mysterious deaths of key witnesses against Perminindex and a national smear campaign against Garrison run by Kennedy Justice Department troubleshooter Walter Sheridan, the New Orleans investigation into Perminindex was terminated, and the entire affair quickly faded into obscurity.

After an estimated 30 to 40 aborted assassination attempts against French President General Charles de Gaulle during the 1960s, the French intelligence bureau, SDECE, exposed the same Perminindex as the financier and controller of the OAS (Secret Army Organization) death squads. (4) SDECE gathered reams of evidence showing that Perminindex had been the recipient of funds laundered into Geneva and Basel through Zionist "charitable organizations" and Israeli intelligence fronts such as the Bank Hapoalim of Histadrut, the Israeli trade union movement and Socialist International affiliate. These funds had been channeled into the OAS as well as into the neo-Nazi terrorist groups in West Germany and Italy.

De Gaulle issued vociferous personal protests to the Swiss and Italian governments. As a result, Perminindex was forced to shut down its offices in those countries and move to a more friendly location, Johannesburg, South Africa. (5) The Paris-based Western European branch headquarters of Israel's foreign intelligence service, the Mossad, was kicked out of France and reestablished its operations in Belgium and the Netherlands.

In 1970, the prestigious Italian newsweekly *Panorama* published an account of the mysterious death of Italian Oil Minister Enrico Mattei in an October 1962 plane crash on his way to a historic economic summit in Africa. (6) Mattei's plane was sabotaged during a contrived unscheduled stopover at an obscure airport in Sicily. Forty-eight hours before the crash, New Orleans

mobster and Perminindex associate Carlos Marcello had been identified by local police in Sicily as the mysterious American who showed up at the airport while a four-man team was tampering with Mattei's plane. Marcello owned a private fleet of chartered jets called the United Air Taxi Service, which shared its staff of pilots and mechanics with Perminindex. One such "shared employee," David Ferrie, was also a pilot for Marcello and Clay Shaw. Ferrie was found murdered days after he was subpoenaed to testify before Garrison's grand jury on the Kennedy killing. (7)

Within months of the April 1978 kidnapping and murder of former Italian President Aldo Moro, the Italian Carabinieri were in hot pursuit of evidence firmly implicating Italian Jewish banker George Mantello (aka George Mandel) in the affair. (8) It was believed that Mantello's Rome villa had been the first safehouse where Moro was brought after his abduction by the Red Brigades. Weapons found in a Carabinieri raid of Mantello's villa turned out to match the weapon used to kill Moro as well as that used in the 1977 Baader-Meinhof gang kidnapping-murder of West German industrialist Hanns-Martin Schleyer. An agent of the Black Guelph House of Savoy (the pretenders to the throne of Italy), Mantello is a board member of a Perminindex subsidiary, Centro Mondiale Commerciale (CMC). Mantello's Swiss holding company, Capocetto, was exposed by de Gaulle's SDECE as a conduit for Histadrut funds into Perminindex. (9)

## Who runs Perminindex?

Sixteen years have passed since Perminindex conducted its first known assassination deployment. Despite all the accumulated evidence, none of the principals has been brought to justice; Perminindex today is one of the best kept secrets in the world.

What is Perminindex? Who are the powerful forces protecting this nest of assassins from prosecution for crimes of high treason against no fewer than three sovereign states? As we shall soon learn, Perminindex is a top-secret branch of one of the most

sophisticated and well-financed intelligence agencies in the world and a convergence point for every filthy network that we have met so far — from the British Far East banking and shipping magnates who run the dope trade at the top to the gutters where Mafiosi, neo-Nazis, and the Order of Zion function as retailers for Dope, Incorporated.

The starting point to unravel the story behind this International Assassination Bureau is the office of the chairman of its board. The founder, president, and majority (50 percent) shareholder in Permindex since its incorporation in Montreal in 1958-59 is Major Louis Mortimer Bloomfield.

Bloomfield is a man of many hats. He was a founding partner of the prestigious *Hofjuden* law firm of Phillips, Vineberg, Bloomfield and Goodman, the firm that represents and controls the Bronfman family holdings. Bloomfield's name was formally removed from the firm's letterhead in 1968 after the de Gaulle exposures of his Permindex assassination bureau threatened to create an embarrassment. Such cosmetic gestures, however, have little significance in the murky world of Canadian politics where the most prestigious names all appear on the board of directors of Dope, Incorporated.

Among his business holdings, Major Bloomfield controls the Israeli Continental Corporation, the Canadian subsidiary of the Dutch Heinekens Breweries, and *Crédit Suisse* of Canada, a correspondent bank to the *Crédit Suisse* of Geneva that was among the holding agencies exposed by SDECE for laundering "hit money" to the OAS. (10) All these corporations are listed among the investors in Permindex.

Like his law partner, Lazarus Phillips, and his clients, the Bronfmans, Major L. M. Bloomfield is an outstanding Zionist philanthropist. Among his numerous honorary positions, Bloomfield is the annual chairman of the Histadrut Campaign of Canada, which collects "charitable contributions" and passes them on to the Israeli labor movement. Curiously, these funds have been discovered on several occasions to have found their way back to Permindex after recycling through the Histadrut's Bank Hapoalim. (11)

Bloomfield's charitable activities extend into his chairmanship

of the Canadian Red Cross ambulance service, a position traditionally held by a top-ranking Knight in the Queen's official chivalric order, the Most Venerable Order of St. John of Jerusalem. As an operating arm of the Sovereign Order, the Red Cross ambulance service has been a frequently called upon front for terrorism. (12)

Bloomfield's business interests extend into the field of transoceanic shipping. A former head of the Israeli Maritime League of Canada, Bloomfield has been the Consul-General in charge of the Western Hemisphere of the Liberian government since World War II. Liberia is notorious as both a tax shelter and smugglers' port-of-call. With no shipping regulations to speak of, Liberia is the flag of convenience under which the majority of ships bearing bulk shipments of Far East narcotics are registered, and also serves as one of the secondary (\$7 billion in average daily transfers) offshore banking centers through which British drug revenues are laundered.

The only other foreign-stationed Consul-General for Liberia is Bloomfield-Permindex associate and Israeli Mossad official (ret.) Tibor Rosenbaum, whom we shall meet shortly.

Beneath his various hats as banker, philanthropist, prominent attorney, and Permindex director, Bloomfield is first and foremost an agent of the most secretive branch of Her Majesty's intelligence service, the Special Operations Executive (SOE).

Bloomfield was recruited to the SOE by its director, Sir William Stephenson, in 1938. (13) Stephenson, a Canadian-born protégé of Round Table founder Lord Beaverbrook, appointed Bloomfield as the recruitment officer and "agent handler" for the newly created counterespionage and espionage branch of the U.S. Federal Bureau of Investigations (FBI), known as Division Five. (14)

Agents of Division Five, in turn, have been among the points of the New Orleans grand jury investigation into the Kennedy assassination. Guy Bannister, the head of the southeast regional office of Division Five (located in New Orleans) at the time of the Kennedy murder, died under mysterious circumstances shortly after the events in Dallas. (15) Bannister was the owner of a New Orleans office building that housed a number of Division Five

fronts and groups under close D-5 surveillance. These included the left-radical Fair Play for Cuba Committee and the violently anti-Castro Free Cuba Committee. Lee Harvey Oswald was alternately a member of both these groups during various stages of his "laundering." (16) According to one source, in 1962 Bannister was also the personal conduit of at least one \$100,000 payoff to the OAS for an assassination attempt against de Gaulle. One of his agents flew directly from New Orleans to Paris to deliver the funds. In 1966, that courier, who operated a Permindex front, the Caribbean Anti-Communist League, died when he was thrown out of a sixth floor window in a San Juan Puerto Rico, hotel. (17)

*How did Louis M. Bloomfield, a Canadian citizen, manage to assume a highly secretive top post within the Hoover FBI? And what's more, how did he manage to retain that post for over 30 years — even after his name had been raised in conjunction with assassinations against officials of three governments? Stephenson, using the "special relationship" that British Prime Minister Winston Churchill had cultivated with Franklin Roosevelt, arranged Bloomfield's commission as an officer in the U.S. Army (hence the rank of major) assigned to the Office of Strategic Services, the wartime predecessor of the Central Intelligence Agency. Bloomfield was only one of many Canadians brought into the U.S. military under Stephenson's auspices. (18) Stephenson was creating an SOE in-depth penetration into the American services that could run clandestine operations under an American cover. This became a particularly important feature of SOE postwar activities in locations like Italy where Churchill's open role in installing Mussolini in power had engendered a profound hatred of the British.*

Unfortunately, very little of the publicly accessible information about the SOE is reliable. It is known that the SOE was created at the personal initiative of Sir Winston Churchill as an expansion of Section D (for "Destruction") of the British Secret Intelligence Service, the branch responsible for "aggressive espionage and sabotage" against enemies of the British Empire. (19) Evidently, after World War II, the United States, in Churchill's eyes, fit the definition of "enemy."

As the top secret action branch of British intelligence, the SOE operated through "cutouts," especially commercial and philanthropic fronts. Stephenson set up SOE headquarters in New York City's Rockefeller Center under the name of an importing-exporting company and established its communications and clandestine center at a resort complex at Montego Bay, Jamaica. (20) Under Major Bloomfield, Division Five's spies operated as a Christian missionary group, sending its devotees to every corner of the United States and Latin America. (21)

It should be noted that all the SOE's activities were conducted under the protective umbrella of Her Majesty's Official Secrets Act. Any British Commonwealth citizen releasing information about the SOE without the advance permission of the monarchy is liable to prosecution on charges of high treason, punishable by execution. No wonder that the reliable sources of information on the SOE are French, Italian, and West German intelligence agencies.

A relevant feature of the wartime Stephenson-Bloomfield team was its use of Mafiosi as "intelligence agents" for the U.S. OSS and FBI Division Five. Charles "Lucky" Luciano is the best-known case of a convicted drug-runner, pimp, and suspected murderer who was "rehabilitated" under OSS-SOE sponsorship. (22) Luciano was dispatched to Sicily to reconstitute old networks that had been dispersed or expatriated during the Mussolini period. Our point here is not to provide a biography of Luciano, but to show that Permindex's Major Bloomfield came into active collusion with Meyer Lansky's narcotics syndicate by no later than the close of World War II—when he was more openly under the official auspices of the British monarchy.

According to a four-part series of articles published in October 1978 in the Soviet youth magazine *Ogonyok* by Julian Semyonov, the Bloomfield-Luciano collaboration was still operational in 1962 when Luciano was the case officer on the scene in Sicily for the Mattei assassination. The decision to go with a plane crash was made by Luciano only after the options of hiring an OAS team or an American "leftist" controlled by a Texas oil company (invested in Permindex) were determined to be too politically explosive. (23)



Based on this profile of the many-sided Major Bloomfield, the first pieces of the Permindex puzzle fall into place. Far from being a small international trading company, Permindex is revealed to be a subsidiary branch of the most powerful, well-financed, and well-protected intelligence agency in the world — a subsidiary branch responsible for carrying out the most important political assassinations of the century. The next step in completing the Permindex puzzle is untangling the complex web of holding companies, dummy corporations, and offshore sealed bank accounts through which the Permindex Assassination Bureau works.

## The Bloomfield, Lansky, Rosenbaum circuit

Sufficient evidence has surfaced in the public record to show that Permindex is the courier channel through which the retail revenues of Dope, Incorporated are shuttled from the regional syndicates into designated secret bank accounts in Geneva, Basel, Liechtenstein, and the Caribbean.

Even in its official records, Permindex cites among its investors the regional crime czars of North America and the Caribbean, the lieutenants of Meyer Lansky. (24) From 1928, when he inherited the bootleg booze and narcotics trade from the deceased Arnold Rothstein, Lansky has been the undisputed "chairman of the board" of organized crime and the pusher behind the move into bigtime narcotics, offshore banking, and the Caribbean casino circuit. Lansky's biographer, Hank Messick, estimates that Lansky's personal fortune exceeds \$300,000,000. Messick describes the weekly ritual in which the regional syndicate couriers converge on the Singapore Hotel in Miami to deliver 60 percent of their take to the "financial wizard." From there money travels the route of Dope, Incorporated. Reports Messick:

The scope of Lansky's interests is illustrated by a trip his international courier, John Pullman, made in 1965. His first

stop was Bogota, Colombia. The Eden Roc in Miami was his next destination. In February he went to the Sands Hotel in Las Vegas, where Lansky's old bootlegging chum from Boston, Hy Abrams, was boss. In March he was conferring in Los Angeles with Mike Singer, an ex-Teamster official who had helped put together the Bank of World Commerce (a part of the Permindex infrastructure of offshore banks — ed.) with Alvin Malnik. Later in March he was in Honolulu, where the syndicate was attempting to get control of Ewa Plantation and hoped, eventually to legalize gambling. In April he was at the Peninsular Hotel in Hong Kong, where the syndicate had casinos and obtained much of its narcotics. Lebanon and its casinos were visited next. By June, Pullman was back in Switzerland where he conferred with Lansky in person. Together they visited the French Riviera to study plans for the ultimate takeover of the casinos there. (25)

The money is placed in initial deposits in any one of a number of Geneva, Basel, Liechtenstein, or Caribbean banks affiliated with Major Bloomfield's little "trading company." Several of these banks, like the Astaldo Vaduz of Miami, De Famaco Vaduz of Liechtenstein, and De Famaco Astaldo Vaduz of Geneva, are post office box fronts. These three, for example, are all listed as wholly owned subsidiaries of Permindex. As noted above, Cr dit Suisse, one of the more formidable laundering holes, maintains a Canadian subsidiary, also run by Major Bloomfield. (26) The Bank of World Commerce Ltd. of Nassau, Grand Bahamas, was a personal creation of Lansky's. The largest and most important banking entity in the Permindex-Lansky family was the Banque de Cr dit Internationale (BCI) of Basel, which was bankrupted in 1974 as part of a London upset of world financial markets. (27)

BCI was itself almost indistinguishable from the infamous Investors Overseas Services (IOS), an international "mutual fund" which garnered an excess of \$2 billion in investment capital on behalf of "unnamed subscribers." (28) According to Messick, there are strong indications that the majority of those unnamed subscribers were named Meyer Lansky. IOS gained

international notoriety for its army of salesmen who crisscrossed the globe carrying satchels of cash earmarked for sealed bank accounts in every unregulated banking port in Western Europe, Latin America, the Caribbean, and the Middle and Far East.

Any sleuth attempting to trace out the originating source for the IOS funds would do well to dig out the October 8, 1967, issue of *Life* magazine, which detailed the following interesting triangular business relationship. (29) Sylvain Ferdman, an officer of BCI, was the business agent for the Investors Overseas Service. U.S. law enforcement officials in turn identified Ferdman as the chief bagman for the Lansky syndicate. Ferdman, a Swiss citizen, and John Pullman, an American who transferred his citizenship to Canada after a 1950s federal conviction, carried money from the Caribbean to Lansky, and then on to the BCI and Bloomfield's *Crédit Suisse*. Pullman, in addition to his global travels, was the president and director of the Bank of World Commerce Ltd. of Nassau.

So far the picture is very neat. BCI-IOS was the Swiss side of a triangle composed of a dirty money professional hit bureau, and Meyer Lansky's retail drug business in North America and the Caribbean. Major Bloomfield's trading company in Montreal, with branch offices in Geneva and Rome (through its subsidiary *Centro Mondiale Commerciale*), ran the protection side of the courier operation and was on the receiving end of those funds earmarked for terrorism and political assassinations. (An assassination such as the John F. Kennedy hit or any one of the 30 plus tries on the life of de Gaulle would cost upwards of \$10 million between the preparatory work, the hit, and the cover-up, which have often involved further murders.) The remainder of the dirty money either went to the Far East to cover production costs, to maintain the internal machinery of organized crime, N.A., or to investment in "legitimate" business, and so forth.

The picture takes on additional political implications as we probe further into the *Banque de Crédit Internationale*.

BCI was originally established in 1959, at the same time Major Bloomfield founded *Permindex* as an intelligence and financial front for the Israeli Mossad.

BCI's founder and president was **Tibor Rosenbaum**, a close

associate of Bloomfield from at least the end of World War II when both smuggled weapons, money, and mercenaries into the Haganah. (30) Rosenbaum was subsequently appointed the first Director-General for Finance and Supply of the Mossad (1948).

An Austrian Jew who graduated from the economics department of the University of Vienna (31), Rosenbaum, in addition to his Mossad affiliation, was a cofounder of the World Zionist Congress and a director of the Jewish Agency. The Jewish Agency in turn created the Bank Hapoalim as the official agent for the Israeli labor movement, *Histadrut*.

With the exception of Major Bloomfield, Rosenbaum is the only foreign representative of the African smugglers' paradise, Liberia.

The BCI was ostensibly founded as a vehicle for financing illegal Israeli trade with Africa and the Third World; however, this half-truth served merely to justify its location in the world capital of secret banking, Switzerland, and its relationship to the Mossad.

**The picture emerges in full upon discovery of another member of the BCI board of directors: Ernst Israel Japhet.** Japhet brings us straight back to the London banking circuit that runs Dope, Incorporated.

Who is Ernst Israel Japhet in addition to his membership on the board of the bank that serviced Meyer Lansky's retail revenues from narcotics, gambling, prostitution? Japhet is the chairman of the Bank Leumi, the largest bank in Israel, which we have already identified as a link in the diamonds-for-dope trade into Hong Kong. The latest heir of a German *Hofjuden* banking family that traces its roots back centuries, Japhet was bought up by the Quaker Barclays Bank of London, that created the wholly owned subsidiary Charterhouse Japhet. The Japhet family's more recent roots go back to Hong Kong's opium trade, into which the family moved 150 years ago and never left (see Part II). The Japhet bank was the granddaddy of the Palestine-to-Hong-Kong dope-for-diamonds trade, now run by Bank Leumi under Mr. Japhet, now on behalf of his 100 percent owners in London at the staid offices of Barclays.

Joining Japhet on the board of Leumi is Baron Stormont

Bancroft, a member of the *Hofjuden* Samuel family, a former Lord-in-Waiting to the Queen and a director and deputy chairman of Cunard Lines, a shipping company heavily involved in the drug traffic over Middle East, India, and Far East routes. (32)

Bank Leumi keeps its hand in the drug trade through its 100 percent owned subsidiary, Union Bank, of which Ernst Israel Japhet is also chairman. Union Bank deals over one-third of the world's diamonds.

Under Japhet, Bank Leumi bought into international terrorism in 1976 when it took over the American and Argentinian subsidiaries of the Banque pour le Commerce Continentale following its bankruptcy. The BBC's branch in Montevideo, Uruguay was the investment vehicle for the Israeli-Argentinian financier David Graiver, who was the financial advisor for the Argentine Montaneros. Graiver disappeared under strange circumstances in 1976. It was publicly reported that he died in a plane crash; however, subsequent reports speculated that he had clandestinely moved to Israel. (33)

Bank Leumi was not the only Israeli bank to heavily invest in the Banque de Crédit Internationale. Even more heavily involved is the Bank Hapoalim. As chairman of the Canadian Histadrut Campaign, Major Louis Mortimer Bloomfield of Permindex maintained direct cash flow relations to Hapoalim. (34)

The Bank Hapoalim, the third largest bank in Israel, was founded by the Jewish Agency, which runs the bank today. Its founder and present board member, British High Commissioner Viscount Erwin Herbert Samuel, belongs to the same Samuel family that retains interests in Bank Leumi and Cunard Shipping Lines. Viscount Samuel presides as head of the Israeli Red Cross, an official branch of the Most Venerable Order of St. John of Jerusalem. (35)

Bank Hapoalim has been widely exposed in the Western European press as a dirty-money channel into Swiss and Liechtenstein banks. (36) The charge is corroborated by the presence of Bank Hapoalim director Zwi Rechter on the board of Rosenbaum's BCI.

Another channel of Bank Hapoalim's complicity in the

Permindex family of dope traders and assassins is the Israeli Continental Bank Ltd., a 50-50 joint venture between Bank Hapoalim and its West German Socialist International counterpart, Bank für Gemeinwirtschaft. The German bank is chaired by Walter Hesselbach, a member of the West German branch of the Jerusalem Foundation, the Zionist branch of the Order of St. John of Jerusalem. (37)

Stepping back for a moment, what have we now pieced together? Within the sealed accounts and well-guarded board room of the Banque de Crédit Internationale we have uncovered yet another point of convergence of the three divisions of Dope, Incorporated: the production-distribution wholesaling division represented by Bank Leumi director Ernst Israel Japhet, the criminally syndicated retail division represented by the Lansky bagmen Pullman and Ferdman, and the murder division represented by the cash flow into Permindex. We have now established that Israeli banking and the Israeli Mossad are cutouts — like their *Hofjuden* sponsors — of the British monarchy, which runs the whole show through its merchant banks and its Knights of St. John.

## The Nazi connection

Having set all the pieces in their appropriate places, we have sketched the outlines of both an operational flow chart for Dope, Incorporated (See Figure 1) and a global network of professional murderers, narcotics traffickers, secret intelligence officers, and portly London bankers and aristocrats.

Now let's return to the original question: what is Permindex? Working under SOE "case officer-in-charge" Major Louis Mortimer Bloomfield, at the executive offices of Permindex and its subsidiaries — the Centro Mondiale Commerciale, the Italo-American Hotel Corporation and Capocetto — is a rogue's gallery of Nazis and Fascists, underworld bosses, and feudal throwbacks — the sort of cast one would expect to encounter at the seat of International Murder, Inc.

Begin with **Prince Gutierrez de Spadafora**, the former

Figure 1. Dope Inc. Assassination Bureau

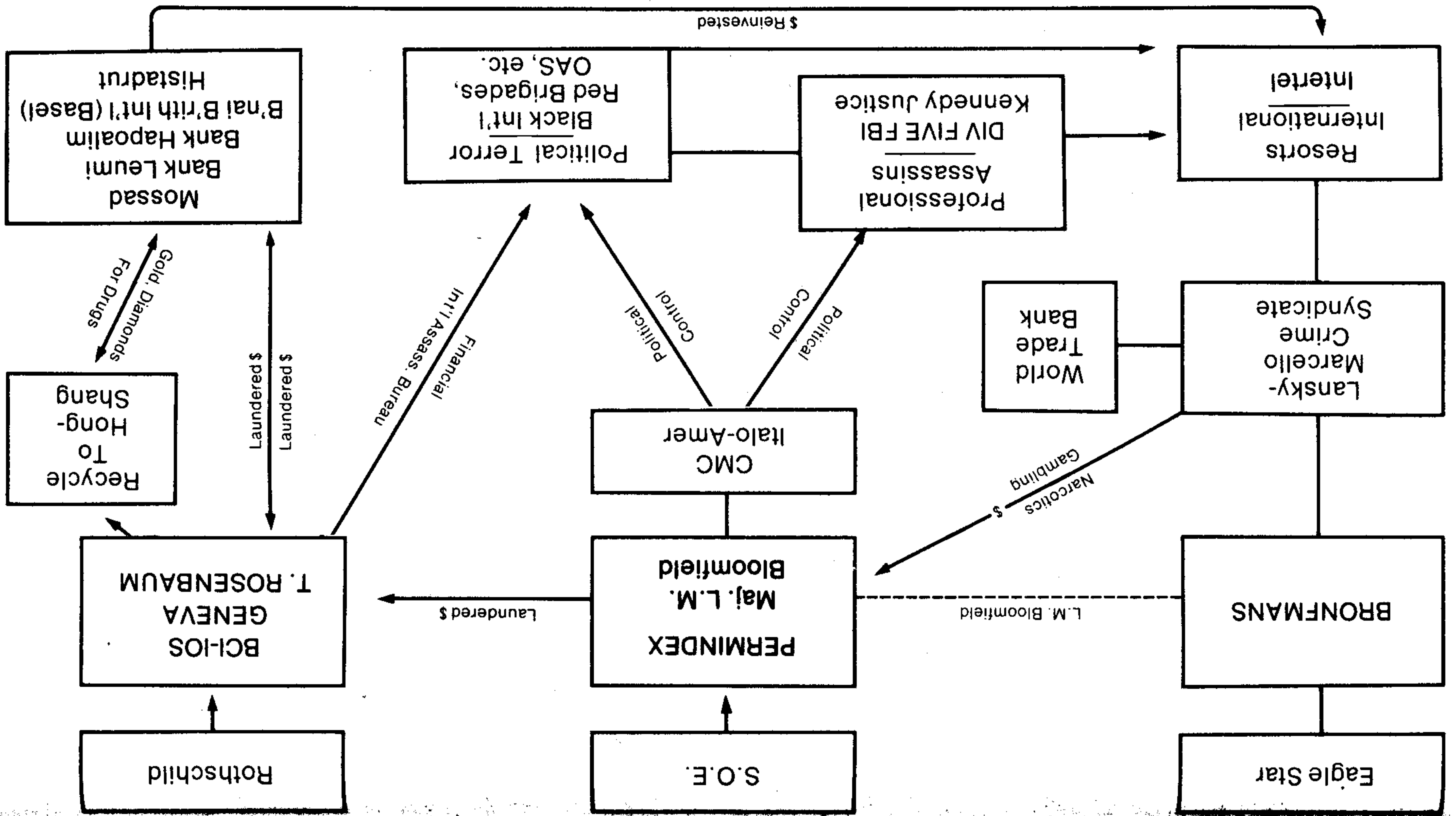

Undersecretary of Agriculture for Benito Mussolini. Spadafora is a director of Centro Mondiale Commerciale and the president of the Sicilian Compagnia Amatrice Industriale Petrolifera Armatoviole, a front for illegal arms smuggling. (38) The prince's son married the daughter of former Nazi Finance Minister Hjalmar Schacht, the architect of the Nazi economic policy that led to the extermination of millions of Jews. Schacht's other son-in-law was Nazi SS Colonel Otto Skorzeny, Hitler's Special Operations executive. After receiving a slap on the wrist for his wartime crimes against humanity, Skorzeny established the Spanish-based ADSAP Corporation, which hired out former Nazi SS paramilitary and intelligence specialists for projects arranged through Schacht. (39)

**George Mantello** (a.k.a. Mandel), the Romanian Jewish emigré whom we already encountered as a chief suspect in the Aldo Moro kidnapping-murder and who was under investigation by both the French SDECE and Garrison, is at once a board member of CMC and the owner of Permindex's Capocetto subsidiary. Capocetto was revealed by several Italian journalists (40) to be the liaison between the B'nai B'rith International and such terrorist gangs as the Red Brigades and the Baader-Meinhof, as well as a string of neo-Nazi groups in West Germany and Italy. Implicated B'nai B'rith officials included B'nai B'rith International Director Schlumberger, B'nai B'rith Continental (the West European branch housed in Basel) chief Erlich, B'nai B'rith France (also known as Ligue Internationale contre l'Anti-Sémitisme, or LICA) head Jean Pierre-Bloch, and B'nai B'rith Austria director George Bloch.

Mantello is the financial advisor and investment banker for the House of Savoy, the pretenders to the nonexistent throne of unified Italy and the black nobility sponsors of Mussolini. (41)

The administrative officer of Permindex is **Max Hagerman**, the editor of the West German right-wing newspaper *National-Zeitung*. Israeli media have denounced *National Zeitung* as a "neo-Nazi" publication.

**Ferenc Nagy** was the President of Hungary during the Nazi occupation. Nagy tendered his resignation as President in 1946

via an infamous telephone call placed from a bank lobby in Geneva. A member of the Eastern European branch (founded by the Radziwill family) of the Order of St. John of Jerusalem, Nagy relocated to the United States during the 1950s. Here he became the titular head of a number of White Russian-Eastern European groups which performed covert services for Allen Dulles and Division Five of the FBI in Eastern Europe, employing former members of the Hungarian fascist movement, Arrow Cross. (42)

According to one source, Nagy came under the close scrutiny of New Orleans District Attorney Garrison for possible involvement in the John Kennedy assassination. (43) Nagy was in Dallas for the four-week period leading up to November 22, 1963, as case officer for Permindex and Division Five. Along with Nagy, Garrison was investigating the simultaneous surfacing of George Mantello in Los Angeles. Garrison established that Nagy and Mantello were both business and personal associates of Carlos Marcello, the New Orleans lieutenant of Meyer Lansky who carried out the assassination of Enrico Mattei.

**Giuseppe Zigiotta**, on the board of CMC, is the head of the House of Savoy Italian neofascist movement called the Fascist National Association for the Militia Arms.

**Carlo D'Amelio**, another Permindex-CMC board member, is an agent for the Italian black nobility houses of Savoy and Pallavicino. From the Mussolini period, d'Amelio was the attorney representing the grouping of oligarchical families that imposed the fascist dictator in collaboration with Sir Winston Churchill. This grouping was known as Circo Rex ("Royal Circle") and is believed to exist today as the control point for the Red Brigades, the neofascist cells, and the Autonomi (a mass-based anarchist counterculture movement parallel to the youth movements out of which Mussolini recruited his Black Shirts.) The Pallavicini family, in addition to its sponsorship of terrorism and destabilization against the Italian government, is deeply involved in the Lebanese fascist movement, the Falange, through blood ties into the Coptic Christian families of Lebanon.

On November 11, 1978, the Italian government's antiterrorist director, General Della Chiesa, delivered a significant setback to

this oligarchical network by arresting Paolo Sebregondi on charges of conspiring with the Red Brigades in the assassination of Aldo Moro. Sebregondi is the son of Countess Viondi and grandson of Princess Resta-Pallavicino, the former maid-in-waiting to the Queen of Italy. Paolo's brother, Stefano Sebregondi, known to be presently hiding in Mexico, is also being sought by Della Chiesa in the same case. The exposure of this long-concealed link between the ostensibly gutter-level left radical Red Brigades and the Houses of Savoy and Pallavicini — the employers of d'Amelio and George and Enrico Mantello — establishes the chain of court admissible evidence for the Permindex role in carrying out the murder of Aldo Moro at the behest of the Black Nobility centered in London.

One of the principal channels of laundered money for Permindex-CMC's assassination teams is in the Seligman Bank of Zurich, a bank represented directly on the board of International Assassination Bureau by **Hans Seligman**, the director of the bank.

Although not an officially cited board member of any of the Permindex fronts, **John De Menil** bears special note as an indispensable business partner of Major Bloomfield. DeMenil is the president of the Schlumberger Corporation of Houston and southern Florida. The firm was implicated by Jim Garrison along with Permindex in smuggling guns and explosives to anti-Castro Cuban exiles who also came under investigation for the Kennedy assassination. DeMenil worked with a CIA Miami-based front called "Double-Chek," which in turn was a contact point for Major Bloomfield's FBI Division Five. (44)

DeMenil is a White Russian émigré who fled to France, married into the wealthy Schlumberger family, and eventually settled in Houston to open a U.S. branch of the family's heavy machinery firm. DeMenil was a close associate and contact man for Permindex case officer Nagy during the preparation period for the Kennedy assassination. (45)

One of DeMenil's closest associates is **Col. Clay Shaw**, a member of the Permindex-CMC board. Shaw was Garrison's chief suspect in the Kennedy killing and is the business partner of

Carlos Marcello. Shaw's circle of former associates who mysteriously died before they could testify before D.A. Garrison included: David Ferrie, Shaw's former pilot and employee at the World Trade Mart; Guy Bannister, the southeast regional chief of Major Bloomfield's Division Five of the FBI; and George de Mohrenschildt, a White Russian leader who allegedly committed suicide on the eve of his scheduled appearance before the House Assassination Panel. The day of his death he was interviewed by journalist Edward Jay Epstein, a self-admitted ghost writer and stringer for former Central Intelligence Agency counterintelligence director James Jesus Angleton. (46)

No discussion of Permindex, Division Five, or Major L.M. Bloomfield would be complete without a note on the controversial Mr. Angleton. This is not the time to reach any verdict on Angleton's place in the international hall of fame of assassins, dope pushers, and spies. We merely note a fantastic coincidence of facts. As head of counterintelligence for the CIA for nearly 30 years, Angleton was the official in charge of all activities relating to terrorism, assassinations, and international narcotics traffic. As the head of the Israeli Desk, he was also the liaison chief to the Mossad. Among his other responsibilities at the CIA, Angleton ran the Vatican desk, a position that placed him equally in touch with the House of Savoy. This last connection would have been solidified way back in the 1940s when Angleton was the OSS station chief for Italy, and therefore the officer in charge of OSS special agent Charles "Lucky" Luciano.

In short, Permindex's roster of directors and associates makes a mockery of everything the Zionist Lobby professes to stand for. The Montefiores, the de Hirschs, the Rothschilds, and their Bronfman and Bloomfield retainers are at once the most zealous leaders of the Zionist Lobby and the sponsors and controllers of a criminal network that extends to self-professed Nazis. It is time to bring before the courts the persons of Louis Bloomfield, Tibor Rosenbaum, the directors of Bank Leumi, of Bank Hapoalim, of B'nai B'rith International, of the Histadrut. Among the long list of indictments, one of the charges would be violation of the

Nuremberg statutes for crimes against humanity — for deploying drug-runners and convicted Nazis for assassinations of world-shaking importance. Before the Zionist Lobby shouts “anti-Semitism,” it must explain the composition and directorate of Permindex, which exposes once and for all the real controllers of the Nazi “Black” International.

## 4

# Permindex Unveiled: Resorts International - Intertel

In September, 1974 less than four weeks after President Richard Nixon was driven out of office, Evelyn de Rothschild, Walter Hesselbach, and a handful of others conspired to bring down the Banque de Crédit Internationale (1). The collapse caused a momentary panic on the international financial markets and more longterm financial problems for such people as Nixon and Michele Sindona, the Italian banker, whose poor judgment led them to place their money in the hands of IOS. Did this financial catastrophe spell the end of Permindex? After all, BCI had been one of the centerpieces of the dirty money side of Major Bloomfield's assassination bureau.

Not only did the International Assassination Bureau survive the September 1974 events, and the earlier shunting of Permindex to South Africa. Pulling the plug on the BCI appears to have been a loud diversionary maneuver to obscure the fact that quietly, systematically, over a period of years, the Permindex *capability* was upgraded, expanded, and relocated to a spot only miles off the coast of the United States: Paradise Island in the Grand Bahamas. Here stands the corporate headquarters of

Resorts International and its wholly owned subsidiary security division, International Intelligence ("Intertel").

Forget about the pictures of Resorts International in glossy travel brochures or the advertisements in the Travel Section of the Sunday *New York Times*. Scarcely concealed among the palm trees, the swimming pools, and the all-night casinos and nightclubs is Major Bloomfield's Royal Commission of High Excutioners — and billions of dollars in dope. Barely hidden behind the Resorts International letterhead is the *éminence grise* of organized crime, Meyer Lansky.

Beginning no later than 1960, Lansky hatched a grand scheme to create a "Hong Kong West" (2) in the Caribbean: an offshore center that would bring together gambling, narcotics, dirty money, and Murder Inc. under one unregulated and "highly respectable" roof.

First, Lansky picked the Grand Bahamas Island as the site for a plush casino-resort. Operating through a Canadian "cutout," longtime business associate Louis Chesler, Lansky negotiated a purchase of a large tract of land on the island and oversaw the construction of a grand hotel, the Lucayan Beach Hotel, which was completed and opened for business before the end of 1963. (3) At the time the venture began, casino gambling was illegal in the Grand Bahamas — except for those hotels that received a Certificate of Exemption from the Bahamian government. The most powerful political figure on the island, chief of the so-called "Bay Street Boys," was Sir Stafford Sands. Several meetings between Sands and Chesler and \$1,800,000 in bribery later, Lansky received his Certificate of Exemption on March 27, 1963. On January 22, 1964, the casino at Lucayan Beach was opened under festive circumstances that Hank Messick described as follows:

The international jetset was on hand to give the event some class, but Meyer Lansky's veterans were in complete control. Red Ritter was general manager; Max Courtney was credit manager; Charley Brudner was his assistant; Dino Cellini was supervisor, and so on. As a matter of fact, Dino had operated a school in London to train the dealers and stick men who came originally from Sicily by way of the syndicate casino on the Isle of Man in the Irish Sea. (4)

Phase One of Lansky's "Operation Respectable" completed, the old wizard proceeded with the next steps. First, he cleared the way for a consortium of "legitimate" investors headed by the Miami-based Mary Carter Paint Company to buy into Hog Island (renamed Paradise Island by its owner Huntington Hartford, the multimillionaire magnate of the Great Atlantic and Pacific Tea Company) and to receive a Certificate of Exemption for the construction of a hotel-gambling casino. Sir Stafford Sands, now in Lansky's hip pocket, saw these measures through and simultaneously announced that the Bahamian government was undertaking the construction of a bridge connecting Grand Bahamas to Hog Island, to be completed by December 31, 1967. (5)

What sort of weird entity was Mary Carter Paints and why had Meyer Lansky gone out of his way to open all the doors on Bay Street to it?

To begin with the obvious, Mary Carter Paint Company was involved in more than wall coverings. In 1958, it was effectively taken over by merger with the Crosby-Miller Co. — a Florida company about which little is known except that former New York Governor and two-time Republican presidential candidate Thomas Dewey was one of its biggest investors. (6) Dewey's "Mr. Clean" crimebuster reputation, dating back to his days as special prosecutor during the 1940s, was a perfect cover for Lansky's move to Paradise Island.

Via the 1958 merger, the president of Mary Carter Paint Company was James M. Crosby. Crosby's brother, Peter Crosby, was a convicted stock swindler and a close business associate of Dino Cellini. Cellini was the first lieutenant to Meyer Lansky and was known as Florida's "connection" to Canadian heroin trafficker Guiseppe Cotroni. So even with Gov. Thomas Dewey's Anglophile profile on the label of every can of Mary Carter Paint, the product was severely tarnished by bigtime crime.

Fidel Castro's takeover of Cuba in 1959 had been a bitter pill for the Lansky syndicate to swallow; however, it taught the old wizard a valuable lesson: don't take politics for granted. Before he socked tens of millions of dollars into his Grand Bahamas dreamland, Lansky would make absolutely certain that he was treading on solid political ground.

So, in 1964, Lansky arranged a small scandal centered around



the sudden "revelation" that Lucayan Beach promoter Lou Chesler had connections to organized crime boss Meyer Lansky! Chesler left the island no doubt laughing all the way to the bank, and Lansky became invisible.

Next, Lansky moved to overthrow the deeply entrenched and corrupted Bay Street Boys (the "Batistas of the Bahamas") and impose a new government committed to the public welfare of the Bahamian population — as long as the welfare was provided by revenues from lucrative gambling takes. Covertly, Lansky political operatives — often men like Big Mike McLaney, who had been Lansky's bagman for payoffs to Cuban dictator Batista — began to heavily bankroll the Progressive Liberal Party representing the islands' black majority. (7)

At the same time, Lansky began releasing blackmail dossiers on the Bay Street Boys. First, James Crosby went to the Justice Department to meet with Robert Pelouquin of the Organized Crime Strike Force. Crosby clinched a deal with Pelouquin (representing Robert Kennedy's "secret team"). Shortly thereafter Pelouquin launched a full-scale investigation into "corruption in the Grand Bahamas" — using the evidence provided through Lansky. Another Lansky frontman, Tex McCrary, began leaking material to the press. McCrary's leaks enabled the *Wall Street Journal* to win the 1966 Pulitzer Prize for a lengthy series of articles exposing the connections between organized crime and the ruling political elite of the island — the Bay Streeters. (8)

Following the Crosby-Pelouquin meeting, in 1965 the Internal Revenue Service — in conjunction with the Organized Crime section of the Justice Department — embarked on "Operation Tradewinds," ostensibly an investigation into "hot money" operations in the Bahamas. Heading the IRS side of the investigation was William Koler. Running the effort from the Justice Department was Robert Pelouquin, working in close contact with Organized Crime and Racketeering section head Henry Peterson and Criminal Division head William Hundley.

By Christmas, 1966, growing scandals had presented the Bay Street Boys with a fait accompli. They called for elections and, on January 10, 1967, were driven out of office by the Progressive Liberal Party. Progressive chairman Lynden O. Pindling

became Premier, and he petitioned for the convening of a Royal Commission of Inquiry to handle the organized crime penetration and control over Bay Street. The commission was convened in February 1967 under the chairmanship of Sir Ranulph Bacon, former head of Scotland Yard. Its investigation was based almost exclusively on the Lansky dossiers, which were passed on to Sir Ranulph by the Operation Tradewinds crew. (9)

By March 1967, all competitors with Mary Carter Paint Company had withdrawn their bids on the Hog Island land in fear that they would be exposed for their corrupt ties to Bay Street. Before the end of the month, Sir Stafford Sands packed his bags and retired to a castle in Spain.

Lansky, as the business agent for Dope, Incorporated, had completed a most silent coup d'état. In rapid succession, all the rats surfaced to claim their just rewards.

Pelouquin and Hundley "retired" from the Justice Department, opened up a law firm, and within a month were retained to manage the legal affairs of "Resorts International" — the new name adopted by Mary Carter Paints in 1966 when it made the bid for Hog Island. Both men became vice presidents of Paradise Enterprise, Inc., the Resorts International subsidiary that owns the island. By 1970, Resorts had created a wholly owned subsidiary private security army, Intertel. Its cofounders (who started off with a \$2,000,000 commission from Resorts) were Pelouquin, who became president, and Hundley, who became the secretary and the general counsel. Their initial recruits were drawn principally from the Operation Tradewinds taskforce, beginning with former IRS Intelligence Division head Koler. What Permindex had previously done under a shroud of secrecy and multiple layers of cover, Intertel was set up to do on a grand scale — before the public eye **under the cover of crime control!**

Before we look at Intertel and its personnel, more closely, it is important to set a few things straight about the investment capital that went into the construction of Resorts International.

Resorts International was financed largely with a transfer of funds from the Banque de Crédit Internationale of Tibor Rosenbaum and Major Louis Mortimer Bloomfield, and the Investors Overseas Service of Bernie Cornfeld and the Rothschild family.

An estimated \$14 million in transferred monies traveling through Meyer Lansky's World Trade Bank and the Fiduciary Trust Company of Nassau, a wholly owned subsidiary of IOS, found their way into Resorts during its half-dozen formative years. (10)

Furthermore, by the agreement that first cleared the way for the granting of the property title, the construction rights, and the vital Certificate of Exemption, 44 cents on every dollar of profit taken in at the Paradise Island casino goes to the Lucayan Beach Hotel and Casino Corporation — still largely owned by Meyer Lansky through his Canadian business partner Lou Chesler.

From its investors' side then, Resorts International is indistinguishable from the previously Geneva and Basel-headquartered Permindex-BCI-IOS — a nexus that we have shown to be founded on the revenues of Dope, Incorporated. Resorts International equals bigtime drug trafficking: cocaine and marijuana from the Caribbean and South America, LSD and hashish produced in factories in the Bahamas, Costa Rica, etc., with venture capital provided through IOS. Resorts International's stationing on Paradise Island created the "Silver Triangle" — a dope route up through the Caribbean that the U.S. Drug Enforcement Administration estimates to be the source of over \$7 billion a year alone in narcotics passed through the southernmost tip of Florida.

## Permindex moves to Bay Street

As the guts of BCI moved to Paradise Island, so the Permindex murder ring moved to Intertel. No longer was the Special Operations Executive to house its secret assassination teams in trading companies, Christian missionary schools, and commercial executive airline services. Murder, Inc. was to become part of the respectable, Kennedy "liberal establishment," flaunting itself as a private intelligence army for hire.

Of course, occasionally old methods of cover were demanded when inquiring reporters, grand juries, or congressional committees threatened to come a bit too close to the truth. Thus, when Intertel was brought before the Senate Watergate Committee for possible investigation, it was officially described as a

"commercial firm that specialized in the identification of type-writers." (11)

What is International Intelligence? A "Who's Who" listing of its board and senior staff reads like a printout of British intelligence, the Mafia, and Mossad.

Intertel President Robert Peloquin was a troubleshooter on the Kennedy Justice "secret team" under Walter Sheridan. A World War II naval intelligence officer assigned to the Office of Naval Intelligence, Peloquin was transferred to the National Security Agency where he remained until moving to the criminal division of the Justice Department. In 1966, Peloquin was sent to Buffalo to head up the first official Organized Crime Strike Force in the country. Peloquin's "no crime here" coverup of the Jacobs family syndicate (see Section 5) was so well received that his boss, Henry Peterson, was gratefully hired as general counsel for the Jacobs' Sportsystems Corporation and let loose with a \$1 million annual budget. Hundley and Peloquin run Intertel; Peterson runs Sportsystems; all three have been partners in the same law firm since 1976.

Hundley, the secretary and general counsel for Intertel, spent the 1951-57 years in the Internal Security section of the Justice Department. In that capacity, Hundley would have liaised with the Division Five of the FBI headed by Permindex's Major Louis Mortimer Bloomfield. From Internal Security, Hundley moved onto the Kennedy Justice "secret team" and participated in the prosecution of Teamster President James Hoffa.

Sir Ranulph Bacon, the former head of Scotland Yard who conducted the Royal Commission inquiry that cleaned out the Bay Street Boys for Lansky, cashed in his chips by moving on to the Intertel board.

John D. O'Connell is the executive vice-president of Intertel in charge of its New York City operations. A 24-year veteran of the FBI, O'Connell was the supervisor of all FBI intelligence activities related to organized crime.

Thomas J. McKeon, vice-president and assistant general counsel, was a supervisor with Major Bloomfield's FBI Division Five before he went to Detroit to head up the Organized Crime Strike Force.

David Belisle, a member of the board, was the Deputy Director

for Security at the State Department and subsequently the head of the Security section of the National Security Agency.

Edward M. Mullin, presently Intertel's director of intelligence operations, was with Division Five of the FBI and later with the CIA as an assistant deputy director in charge of clandestine services. Mullin's private security front in Washington, D.C., was infamous as the base of operations for E. Howard Hunt during the time of the Watergate breakin. Mullin is also directly tied into the Miami Double-Chek outfit that is implicated in several Permin-dex-run assassinations, including the JFK killing.

Among the other board members and ranking staff of Intertel are: a retired director of the Royal Canadian Mounted Police; a president of the Bronfman family's Royal Bank of Canada Trust Company; a president of the Dreyfus Corporation, an investment fund owned by the *Hofjuden* de Gunzberg family, into which the Bronfmans are intermarried.

What do we have here? First we have Resorts International, financed through the Geneva-Basel retail revenues of Dope, Inc. The manager of Paradise Island for its first half decade of operation (1968-73) was Eddie Cellini, the brother of Dino Cellini and another well-known lieutenant of Meyer Lansky. (When Cellini's criminal record became a potential sore spot for Resorts, he was discreetly shipped off to Miami where he now handles "charter flights" between Florida and Paradise Island — flights that may shuttle more than paying customers.) In 1972, Robert Vesco came a hairsbreadth away from buying majority holdings in Resorts International for \$60 million — a transaction that was heartily endorsed by the "supersleuths" at Intertel. (12)

If Resorts International is a glossy front for Meyer Lansky's retail end of the biggest business in the world then what does that say for its wholly owned subsidiary, Intertel? Is it conceivable that this collection of senior officials from the most prestigious and sophisticated intelligence services of the United States, Canada, and Britain could be oblivious to the fact that they are "riding shotgun" for one of the biggest channels of narcotics and hot money in the Western Hemisphere?

Intertel stands exposed as the successor to Major Bloomfield's Perminindex, drawing on the same SOE-Division Five capabilities,

the same "direct line" interface into the official intelligence branches of half the countries in the world, the same allegiance to the British oligarchy behind the \$200 billion a year Dope, Inc. While the motives may vary case by case, it is sufficient to say that anyone on the inside of Intertel attempting to break from its service and spill the beans would have about the same chance for survival as a Royal Hong Kong police officer who decided to turn down his weekly bribery envelope.

With the consolidation of Resorts International, we once again swing full circle. From a Prohibition-era jumping-off point of syndicated organized crime in the United States — fostered by the same British families that had ordered the Shanghai massacre to safeguard the rule of Dope, Inc. in China — we now find ourselves 50 years later confronted by a criminal infrastructure lobbying for the *decriminalization of crime itself!* The Kennedy Justice, Scotland Yard, and RCMP boys at Intertel sell their services as "experts in cleaning out undesirable criminal elements from your corporation." (13) Through this ruse they captured the Howard Hughes fortunes and are at present taking over "security services" for all the big Las Vegas casinos. (14) They moved into New Jersey and imposed gambling, horse racing, and numbers as the three "growth industries"; they are now posing New Jersey as the model to be followed by Florida, Arizona, Rhode Island, Massachusetts, and New York.

After World War II, one of the economic warfare specialists in Sir William Stephenson's SOE, a fellow named Ian Fleming, wrote a series of coded novels describing the efforts at world conquest of a "third force" — an ultramodern international crime syndicate housed in the resort islands of the Caribbean. The weapons of "third force" conquest were drugs, political assassinations, grand-scale blackmail, and economic war against the nations of the world. With Resorts International-Intertel, Fleming's "third force" — the British oligarchy's Dope, Inc. — put itself up for trade on the stock markets of the world.

sports complexes, race tracks, and food consortia. It is probably the biggest quasi-legitimate cover for organized crime's money laundering in the United States. Were it a public company, it would rank about 150 in the Fortune 500.

The Jacobs family's only concession to the numerous attempts by law enforcement agencies to shut them down was to change Emprise's name to Sportsystems in 1972.

The vast extent of the present Jacobs empire is approximated by Sportsystems' 1977 declared holdings. The pattern that emerges conforms to the requisites of an international laundering racket for narcotics, prostitution, and gambling receipts.

Sportsystems Corporation maintains:

- \*majority interest or significant minority interests in over 20 horse racing tracks in the United States and Canada;

- \*food concessions at over 40 horse racing tracks in the United States and Canada plus another 15 in England. Those in Great Britain are maintained in the name of Sportsystems' wholly owned subsidiary, Lethby and Christopher Ltd., chaired by a retired British Army colonel, Livingstone Learmouth;

- \*over ten greyhound racing tracks in the United States and Canada, including majority holdings in nearly every track in the heavily drug-trafficked state of Arizona;

- \*24 concession contracts with major-league baseball teams in the United States, including Chicago's Comiskey Park and Detroit's Tiger Stadium;

- \*ownership of the Boston Garden indoor professional sports complex and the Boston Bruins professional ice hockey team;

- \*ownership of Professional Sports Publications, Inc., the largest U.S. publisher of sports events programs;

- \*161 concessions at theaters and bowling alleys in the United States;

- \*15 airport concessions, including in-flight and ground-level concessions at Washington, D.C. airports and Palm Springs, Florida;

- \*two jai alai stadiums (legal gambling facilities) in Florida;

- \*industrial food catering services at such locations as the Gulf of Mexico oil drilling platforms; and

- \*one Alaska-to-Seattle cargo fleet comprised of six ships. This

## 5

# The Jacobs Family's Emprise: Sports and Crime

On June 2, 1976, moments after a bomb exploded in his car and inflicted fatal injuries, dying Arizona investigative reporter Don Bolles whispered three words to the rescue team that pulled him from the wreckage: "Mafia . . . Emprise . . . Adamson."

Bolles was on the verge of completing a seven-year investigation of laundered drug traffic money in the state of Arizona, including organized crime takeovers of dog tracks and horse racing—areas the Buffalo-based Jacobs family began moving into in 1959. A Phoenix resident, John Adamson, pleaded guilty to the murder in January 1977, naming a local real estate developer, Max Dunlop, as the man who hired him to murder Bolles. Mysteriously, no investigation ever took place of Emprise, the leading vehicle since 1916 of the Jacobs family, which had been the primary target of Bolles's investigation and the subject of his last words.

Emprise was one of the largest nonpublic, family-owned corporations in the world, a conglomerate with control or partial control over 450 separate companies. Its stated annual profit is \$350 million, from holdings in North American and British

route curiously parallels the prime entry point to the U.S. of Chinese heroin.

Within this maze of operations, each characterized by a high volume of cash turnover, the \$350 million figure is a fraud, published for tax purposes. Law enforcement sources estimate the annual flowthrough of tainted cash in the range of several billions of dollars.

That is not conjecture. Emprise and its incarnation, Sportsystems, left a broad trail of investigations, indictments, and convictions, occurring mainly during the years of Nixon's War on Drugs—a trail that ended with the Bolles murder. In 1972, the family firm was convicted of conspiracy to take over a gambling casino in Las Vegas by illegal means. That incident, among other things, provoked the change of the Emprise name. Indicted along with the Jacobs brothers were some of the best-known faces in the mug files of the Justice Department's Organized Crime Strike Force. Among the co-conspirators were top racketeers, drug traffickers, and the entire leadership of the Detroit mob, including

\*Anthony Zerilli, son of Joseph Zerilli, Detroit's mob boss and an official of the Emprise subsidiary, Hazel Park Racing Association;

\*Michael B. Polizzi of Grosse Point, Michigan, an owner of the Valley Die Cast Association, identified as a Detroit mob lieutenant in police files;

\*Anthony Giordano of the "St. Louis Banana Distributing Company," the kingpin of St. Louis drug traffic;

\*Peter J. Bellanca, also a director of the Emprise-owned Hazel Park Racing Association; and

\*Jacob Shapiro, a Detroit-Miami mobster, with interests in Las Vegas' Silver Slipper casino.

Conviction in the same dock with known mobsters did not deter the Jacobs family. Since 1972, they have continued to act as money-movers and bagmen for a whole list of organized crime figures. Several large loans to crime syndicates are on the record, including a \$2 million 1972 loan to the Montreal Expos—owned by their old sponsors and counterparts across the Canadian border, the Bronfman family of Montreal. An earl-

ier recipient was convicted murderer Raymond Patriarcha, the crime boss of Rhode Island. Louis Jacobs, one of the three brothers, brought Patriarcha into a partnership in the Chicago Lion Manufacturing Company, since renamed the Bally Manufacturing company, the largest American producer of pinball and slot machines and the source of supply for the mob's pinball distribution. Also on the list of the Jacobs' "loan" recipients are a number of associates of syndicate financier Meyer Lansky, including Morris Dalitz, according to testimony introduced into the Congressional Record (1).

A Michigan grand jury is currently hearing a case implicating the Jacobs' Sportsystems and the Jacobs brothers personally in an attempt to tamper with Michigan state criminal records involving members of the Zerilli mob and St. Louis crime figure Morris Shenker.

Despite a record of criminal activity stretching back to the 1910s—and never interrupted—the Jacobs family remains one of the open, "legitimate" fronts for Dope, Incorporated. Not only is the Jacobs family protected, but, as we will document below, it retains a group of veterans of the Kennedy Administration's Organized Crime Strike Force as its legal department.

Emprise appeared in 1916, the year that the Bronfmans and the Hudson's Bay Company began bootlegging through the "Pure Drug Distribution Company," using the three Jacobs brothers as contacts right across the border in Buffalo. The original Jacobs brothers, Louis, Marvin, and Charles, used the old smugglers' cover of "food concessions" for a chain of vaudeville theaters on the Canadian border crossing points at Buffalo and Cleveland. (2) The modus operandi is pretty much the one Mitchell Bronfman used during the early 1970s for smuggling heroin into the United States. Once established, the Jacobs machine became a leading distributor for Bronfman liquor as the United States went dry.

Functionally, Emprise represented the "throttle" through which shipments of liquor could be turned on or off to the American mob. The Jacobs family, enduring a half-dozen criminal indictments through the 1920s, controlled the supply and financing of illegal booze for most of American organized crime.

Their dependents included the Purple Gang of Detroit, the gang convicted with the Jacobs brothers in the 1972 Las Vegas incident; the Morris Dalitz Cleveland-Las Vegas crime syndicate; and the Crown-Lundheimer mob in Chicago, the Zionist controllers of the colorful "cutout" Al Capone. (3) Not only are these ties still in place; every man who tried to do something about them is either dead, like reporter Don Bolles, or broken, like former Arizona Congressman Sam Steiger.

## The Steiger investigation

Beginning in 1970, five-term Arizona conservative Congressman Sam Steiger began an investigation into Emprise's activities in his home state. Working closely with Bolles, Steiger prepared a series of reports for the House Select Committee on Crime, of which he was a member. Steiger placed two damning reports on Emprise in the Congressional Record in 1970 and 1972 (4). He also widely publicized the finding of an Arizona State Auditor General report charging Emprise with falsifying figures to get a tax-break bill through the State Legislature. By 1972, in conjunction with the Nixon Justice Department, he succeeded in getting grand jury charges and federal court convictions against Emprise and the six Detroit area mobsters already cited. On May 24, 1972, pressure on Emprise had reached such a public crescendo that even *Sports Illustrated* ran a lengthy exposé titled "Jacobs — Godfather of Sports"; the magazine was promptly sued for \$20 million and settled out of court.

At that point, Democratic Party politicians and prominent figures in the Zionist Lobby went into action on Emprise's behalf. Not coincidentally, the same forces that came forward for Emprise were also preparing the Watergate scandal to bring down President Richard Nixon. (5)

Democratic members of the House Select Panel on Crime denounced the majority report prepared by Steiger exposing Emprise's ties to organized crime. As admitted by Max and Jeremy Jacobs in congressional testimony, Emprise hired New York public relations man Hal Antin to defeat Steiger in his 1976

re-election bid. A Phoenix underworld figure, George H. Johnson, was paid to wiretap and survey Steiger and manufacture scandals against him. Arnold Weiss, a Buffalo attorney on the Emprise payroll, was sent to meet with Steiger and deliver a series of ultimatums. Weiss reportedly threatened to ruin Steiger by planting rumors that his marriage had broken up after his wife caught him in illicit relations with their three-year-old daughter. Such rumors, in fact, did appear in various Arizona media. (6)

In 1972, Senator Robert Dole, a Kansas Republican, publicly protested the House Select Panel's decision to terminate the hearings on Emprise. Dole revealed that the decision had followed a private meeting between Jeremy Jacobs and Democratic National Committee Chairman Larry O'Brien. O'Brien subsequently left his Democratic Party post and assumed a lucrative job as president of the National Basketball Association—an organization with heavy representation by the Jacobs family.

As the Watergate campaign broke down Nixon's resistance and dismantled the core of his efforts to suppress organized crime, the attack against Emprise faded. By June 1976, Don Bolles was dead. On November 3, 1976, in an election heavily shaped by nationwide vote fraud (7), Rep. Steiger lost his bid for a sixth term in Congress. By this time a broken man fearing for his life, Steiger met with Jeremy Jacobs to "apologize" for his accusations against Emprise. At this time Emprise-Sportsystems had three pending civil suits against Steiger. In a last act of humiliation, Steiger wrote to Attorney General Edward Levi as a *spokesman for Emprise* on behalf of a presidential pardon for the 1972 federal racketeering conviction. Incoming Attorney General Griffin Bell turned down the request as "not deserving." (8)

## Jacobs and Royal Crown

The second generation of Jacobs brothers, Max, Jeremy, and Lawrence, underwent the same "washing" into respectable society as their old Prohibition business partners, the Bronfmans. Ironically, the Jacobs brothers used their longstand-

ing association with the Bronfmans, since married into the upper reaches of the European *Hofjuden*, to lend them an air of respectability somewhat above that of the outright thugs with whom they still do most of their business. For example, a third-generation Jacobs, Jeremy, took his "higher education" not at a university, but at the Toronto Jockey Club, after his 1960 high school graduation. The Bronfman-run Toronto Jockey Club, like its counterpart in Hong Kong, is not only one of Canada's best protected dirty money-gathering outfits, but a place where *Hofjuden* and gangsters can amiably mix in safety. Regular denizens of the Toronto Club include Viscount Hardinge and Canadian organized-crime figure Murray Koffler. Koffler's role as a retail outlet for Bronfman dope-running came into the public domain in 1976, when an associate's chain of retail drug stores was indicted for maintaining an amphetamine factory and a national army of pill-pushers. That distinction did not prevent Koffler from attending the wedding of Britain's Princess Anne, or from maintaining his close friendship with Anne's husband, Captain Mark Phillips. (9)

So far the Jacobs have been barred from marriage into the leading *Hofjuden* circles. However, the Jacobs have been awarded a respectable role in the train of the British monarchy, in a service capacity. The "crown jewel" of the Jacobs' operations is the British firm, Letheby and Christopher Ltd.—the caterers, by Her Majesty's appointment, to "all events with a royal presence." (10) Their concessions through Letheby and Christopher include the Tate Gallery, the Ascot Races, and other gathering places of the Royal Family and the British aristocracy. L & C, as it is affectionately known in Britain, was awarded the management of Ascot through the Bank of Norfolk, whose trustees include the Marquis of Abergavemy and Lord Tyron—the Keeper of the Queen's Privy Purse, third in aristocratic rank to the Keeper of the Queen's Horse, and the Keeper of the Queen's Bedchamber.

Apart from its royal honors, the Jacobs subsidiary manages 12 other racetracks in Great Britain including the national track at Liverpool, the site of the Grand National, and Wembley Stadium, Britain's equivalent of Madison Square Garden.

More than their retailing services for British dope-peddlers, however, accounts for the Jacobs family's honored position at the British court. They have conducted crucial—and dangerous—political errands for the British oligarchy over a period of years. One such mission involved the successful sabotage of Richard Nixon's 1972 plan for detente with the Soviet Union. Their instrument for the act of sabotage—the man whose presidential campaign they funded lavishly—was Senator Scoop Jackson.

"Scoopie," Max Jacobs once said, "is the best friend Israel has in the Congress." Max and brother Jeremy were funders of their torpedo's run for the White House. (11)

Jackson authored the "Jackson-Vanik" Amendment to destroy the effectiveness of Nixon's 1972 treaty for expanded trade and scientific cooperation, which rested, among other things, on American credits for Siberian development. Jackson's operation prevented the United States from extending any credits to the Soviet Union until the Soviets "liberalized" their Jewish emigration policy. (Under the Nixon Administration, such emigration had already increased fourfold.)

The Jacobs brothers had hamstrung a treaty the British Crown viewed as a mortal enemy, one the Rothschild-owned *London Economist* denounced as a "waltz of the elephants." Jackson has continued to work as a pawn of the Jacobs crime family, advocating, among other projects, a military alliance with and weapons sales to China, Britain's partner in world dope traffic.

In the Jacobs group, America has its homegrown version of the Green Gangs, the fifth column Britain used to destroy China.

## Working for the HongShang

From available evidence, the British oligarchy rates the Jacobs group's political usefulness as an intermediary for control over organized crime sufficiently important to make major efforts to rebuild the Jacobs' tarnished image. The prize that motivates Britain in this regard is the Buffalo-based Marine

Midland Bank, which the Hongkong and Shanghai Bank now wants to buy out.

From the American side the most important "inside agents" pushing the HongShang takeover are Leonard Rochwarger and Paul Schoelkopf, since 1973 the closest business associates of Max and Jermy Jacobs. (12) Rochwarger is president of Firstmark Corporation, a heavy equipment leasing company and the American leg of an international conglomerate controlled by Britain's most important *Hofjuden*, the Rothschilds and Sebag-Montefiores.

Rochwarger was brought into the deal at a Paris meeting in 1971 with Edmond de Rothschild and Robin Sebag-Montefiore, who represented, respectively, the Isrop S.A. of Luxembourg and the Gilsyd Corporation of Liechtenstein. Under an intricate merger arrangement, Rochwarger emerged from the meeting as president of a new international subsidiary of the Rothschild and Montefiore companies, Israel-American Leasing of Tel Aviv, now the largest firm of its type in Israel.

Rochwarger is an old associate of Max Jacobs; both sit on the board of the Joint Distribution Committee, the funding center for American Zionist organizations. In addition, Rochwarger is the director of the National Jewish Centers and Youth Programs both in the United States and Canada, a regional board member of the Anti-Defamation League of B'nai B'rith, and fundraising chairman of the United Jewish Appeal.

Paul Schoelkopf, another Buffalo-based Zionist, is leading the local campaign in support of HongShang's bid for Marine Midland. Schoelkopf is chairman of Buffalo's Niagara Share Corporation, an investment company that pools the resources of wealthy local investors for large investments. Among Niagara's holdings is 246,000 shares in HongShang stock. Its other holdings include investments in the Swire family's Pacific A Corporation, and 400,000 shares in two Hong Kong holding companies, Cheung Kong Holdings Ltd., and the trading company Hutchinson Whampoa, also linked to HongShang.

Another Schoelkopf investment vehicle is the \$250 million per year food wholesaling-retailing group, Niagara Frontier Services, whose chairman is Armand Castellani, a member of Marine Midland's board of directors. A merger is currently in

process between Niagara Frontier Services and Sportsystems, which would double the stated "legitimate" revenue base of the Jacobs family empire.

If HongShang receives the Marine Midland Bank from the hands of Max Jacobs, the link between the retail cash laundering facilities of the American mob and the wholesale financing of the international dope traffic will be complete. As noted in Part II, Section 1, it will also complete the British oligarchy's takeover of the last remaining offshore center not wholly in its possession, Panama.

## Jacobs joins Intertel

In the aftermath of Congressman Steiger's investigation, Sportsystems underwent a corporate personnel reorganization. The result was that Sportsystems established an interface with the center of the crime syndicates and the reincarnated Assassination Bureau—Resorts International and its subsidiary, Intertel.

The entire executive team and legal staff brought into Sportsystems in 1975 was made up exclusively of veterans of the Kennedy Justice Department—the same Kennedy Justice Department that sent the man who is now president of Intertel, Robert Pelouquin, to Buffalo, to "investigate" the Emprise crime syndicate!

In early 1975, Donald Carmichael, a Kennedy Democrat who had served as a delegate both at the 1964 and 1968 Democratic conventions, as well as on the President's War on Poverty panel, became the president of Sportsystems. Carmichael ushered in a dozen Kennedy Justice Department hands over the next two years.

In 1976, Max and Jeremy Jacobs' close friend and "business associate" Max Fisher released the general counsel of his own corporation, United Brands (formerly United Fruit), so that he could accept Jacobs' offer of the post of general counsel to Sportsystems. Before his employment at United Brands, Stanley Mills had been a Justice Department aide to Attorney General Robert Kennedy. (13)

In 1977, when the Bolles murder temporarily threatened to



bring Emprise-Sportsystems under criminal investigation, Horace S. Webb joined the firm as public relations director. Webb, who assisted the Watergating of Richard Nixon on behalf of the Kennedy machine, had previously been Deputy Public Information Director for the Justice Department and later press secretary for Attorney General Elliot Richardson.

By the time the facelift of Sportsystems was finished, four other Kennedy Administration officials—each a member of Robert Kennedy's "secret team"—were brought into the firm's legal division:

Half the Kennedy "old boys" had moved into Resorts International and Intertel; the other half went over to the Jacobs group, for the same type of assignment.

Heading the "Intertel Team" at Sportsystems is Henry Peterson, the former chief of the Organized Crime and Racketeering Division of the Kennedy Justice Department. At Camelot, Peterson was the superior of Robert Pelouquin, now president of Intertel.

Peterson's entire staff from the old Robert Kennedy days came with him. At Sportsystems, his chief aides are William Bittman, Daniel Hollman, and Thomas Kennedy. Kennedy worked for Peterson in the Organized Crime Division of the Department of Justice. Their big assignment in the old days came when Peterson sent them to New York State—to investigate the mob connections of Emprise!

## "Bagman" Max Fisher

Max Fisher, today the chairman of United Brands, is the acknowledged "kingmaker" in the Michigan Republican Party, and a political power nationally. As president of the United Jewish Appeal, president of the Jewish Welfare Fund, and honorary chairman of the American Jewish Committee, Fisher holds rank next to his close friends Max and Jeremy Jacobs and the Bronfman brothers as one of the leading lights of the Zionist Lobby in North America. Fisher is also Henry Kissinger's contact man in the Michigan-Ohio area, and until recently was national fundraising chairman for the Republican Party.

Those are impressive credentials for a man who got his start as "bagman" for Prohibition's "Purple Gang." Max's job was to run advance payments for Bronfman liquor across the Canadian border and secure advance deliveries of Bronfman "rotgut" to the speakeasies that dotted Michigan's auto towns. Today, Max's headquarters, the Fisher Building, is owned by the Bronfmans.

Today Midwest law enforcement officials name Max Fisher as the prime candidate for arrest and conviction as the kingpin of the vast narcotics trade in the Midwest—including the tons of drugs that pour into the auto belt. Yet no indictments have been forthcoming. Freuhauf Trucking Company, based in both Canada and the United States, provides one channel for large-scale drug smuggling, these officials report. Max Fisher is a Freuhauf board member and large shareholder. Knowledge of Fisher's drug connection even includes the various parking lot "truck stops" — adjacent to Fisher's Detroit suburban headquarters — that are believed to serve as transshipment points for heroin, cocaine, and marijuana. Fisher's privately owned Marathon Oil Company, barging crude oil into the Midwest from ports of call in South America, is also suspected of joining Fisher's United Brands in running the "Silver Triangle" drug traffic.

Since its founding by the New Orleans Machecha mob and Montefiore-sponsored Jewish immigrant Zemurray, United Fruit-United Brands has dominated both licit and illicit trade in the Central and Latin American countries that produce cocaine and marijuana for the American market. In those same countries, the Israeli financial and intelligence networks identified earlier with the narcotics traffic have become the principal supplier of weapons. In Central America and in Chile, Israel has replaced the U.S. as the leading arms merchant for United Brands' "banana republic" governments. (14)

That none of the evidence has brought action against Fisher raises some interesting questions about who controls Michigan politics. Fisher, as noted, is not only the powerbroker for the Republican Party, but along with the Socialist International affiliate, the United Auto Workers (UAW), is on top of the ghetto and in-plant crime machine and Maoist-environmentalist gangs that push drugs and terrorism. This was the conclusion drawn

from an investigation involving federal law enforcement officials after a July 1978 attempted assassination of U.S. Labor Party Chairman Lyndon LaRouche in Detroit.

The "political cover" under which drugs and terror find their way into the floors of the auto plants is the Communist Labor Party of Michigan. This avowedly Maoist grouplet is an outgrowth of the nest of agents provocateurs who incited the late 1960s riots that left large sections of Detroit's working class districts in ruins. After the riots, Max Fisher and then-UAW President Leonard Woodcock (now U.S. Emissary to the People's Republic of China) stepped in to found the New Detroit Corporation as the "reforming" de facto ruling body over the region. New Detroit outflanked the constituency political machine in the city administration and police department, removing the chief impediment to the "liberal" proliferation of drugs, vote fraud, and fingertip-controlled political violence. The Communist Labor Party of Michigan provides the footsoldiers for all three.

According to records on file with Detroit City Clerk, the Communist Labor Party is financed by Max Fisher's Zionist Lobby. Among the campaign contributors to its 1976 and 1978 "electoral campaigns" are Avern Cohen, Fisher's personal attorney and his political lieutenant, and Richard Lobenthal, the head of the Michigan Anti-Defamation League of B'nai B'rith. The Communist Labor Party also gets money from a group called the Anti-Nazi Coalition, in which it joins the B'nai B'rith, and a Zionist umbrella group called the Jewish Community Council. The latter is financed by numerous Zionist philanthropies including the Jewish Welfare Fund, and by thousands of dollars in UAW membership dues. (15) The Anti-Nazi Coalition services a string of storefronts, bookstores, and other commercial enterprises that dish out dope to the auto plants and ghettos.

## Dope, Inc. goes 'legit'

The Jacobs family, Max Fisher, the Bronfman brothers: these figures stand behind organized crime, the drug traffic, and the systematic corruption of the political process in nearly every

precinct of the United States. A precise estimate cannot be given of the percentage of the \$200 billion of narcotics revenues diverted into political corruption and disruption. But the nearly \$1 billion the Jacobs family put up to oust Congressman Sam Steiger, the Bronfmans' multimillion dollar expenditure for political and economic warfare against the U.S. Labor Party, and the \$1 million "war chest" that Resorts International assembled to put across legalized casino gambling in New Jersey by legislative fiat, provide sufficient warning that the sums spent on illegitimate political activities exceed those spent under the Federal Election Law.

Corruption of politicians is more flagrant, more public, than streetcorner soliciting by prostitutes. Take the case of St. Louis Representative William Clay, now treasurer of the Black Caucus in Congress. Clay was selected for his job by Morris Shenker, the owner of the Dunes and Sands casinos in Las Vegas and the attorney for Anthony Giordano in the 1972 federal case against Emprise. (16) Clay's Black Caucus colleague Parren Mitchell of Baltimore, who has emerged as a leading spokesman for drug decriminalization, is another.

The roster of Britain's Green Gang thugs in the United States, stretching down to every populated center, is too extensive to bear further detail. The Jacobs, Bronfmans, Fishers have the same modus operandi: understand it, and nothing about organized crime elsewhere will be difficult to understand. Once this operation is cracked, drug traffic and corruption in cities across the country can be broken, assembly-line fashion.

Britain's agents of corruption are now beginning the final phase of opium warfare against the United States, as the dope-runners and money-launderers press for legalization of gambling and drug addiction. Under the transparent lie that legalization means the destruction of organized crime—rather than its enthronement in the state capital—gambling has opened up in New Jersey, under the aegis of Meyer Lansky's Resorts International and Intertel. Dope, Incorporated is preparing, in effect, to take its "rightful place" at the top of the Fortune 500. The American Green Gangs are preparing the final "Shanghai Massacre" of the American people.

## 6

## The Philadelphia Story

A long trail of indictments, fines and press stories leads to one of the most dramatic case histories of Dope, Incorporated, and to Philadelphia, the City of Brotherly Love. Under the direction of old Philadelphia Quaker families, whose roots in the opium traffic go back to the first years after the American Revolution, and with the cooperation of one of Britain's oldest opium-running families, the Philadelphia dope network can be charted from the wholesale production of illicit drugs down to the gutter.

Tucked away in the towering Sun Oil building in downtown Philadelphia are the small corporate headquarters of an obscure firm known as Paco Pharmaceuticals. Paco has only one line of business: it packages roughly two-thirds of the amphetamine tablets sold in the United States, under contract from the old Quaker pharmaceuticals companies in the Philadelphia area, including Smith, Kline and French, Rohm and Haas, and Pennwalt. It publishes no annual report or other information concerning its activities, except for one crucial fact: it is owned by Charterhouse Japhet, the present incarnation of the old Japhet family opium interests. Paco is also the source of most of

the "leakage" of amphetamines into illicit channels in the United States. (1)

Federal agencies have tried to crack down on the Paco nexus for years, but have succeeded only in wrist-slapping its local collaborators. The record of citations of the amphetamine producers is lengthy. It includes:

\*A \$200,000 fine imposed in October 1977 by the Drug Enforcement Administration on Pennwalt Pharmaceuticals, after Pennwalt was convicted of 17 counts of questionable practices in the production of medicines containing cocaine.

\*A 1972 accusation against Pennwalt by the predecessor organization of the Drug Enforcement Administration, the Bureau of Narcotics and Dangerous Drugs, involving Pennwalt's use of Mexican subsidiaries to provide illicit channels of drug traffic in the United States with amphetamines. The BNDD discovered major accounting discrepancies between the amounts of amphetamine Pennwalt claimed it shipped to Mexico and the amount of amphetamine that actually arrived in Mexico.

\*A recent order by the Food and Drug Administration compelling Pennwalt to close a warehouse housing opium, ostensibly for manufacture into licit morphine under federal license, due to "leakage" of the opium.

\*In November 1976, CBS's "Sixty Minutes" news feature program accused Pennwalt of marketing amphetamine-based diet pills, with the deliberate objective of creating a "hooked" market of dependent amphetamine users. Commentator Mike Wallace cited a 1970 Pennwalt internal memorandum to substantiate this allegation.

The hard evidence of illegal drug trafficking by the old-line drug firms in amphetamines, and strong suspicion of similar trafficking in cocaine and opium, is the starting point for a chain of control that ends with the retail drug trade, terrorism, and crime on the streets of Philadelphia, leading through individuals in high positions in the city's top banks and "charitable" foundations. A November 13, 1978, exposé of the Philadelphia Foundation in the *Philadelphia Daily News* brought to public light the incriminating information that had, independently, been gathered by a U.S. Labor Party investigative team.

One James Boudine, a director of Pennwalt Pharmaceuticals, is the leading connection between the wholesale and street-level sides of Philadelphia's narcotics traffic. Until 1977 he was president of the First Pennsylvania Bank, in charge, among other things, of its support of the Philadelphia Foundation. Despite his departure from the president's suite, he remains on the board of directors and continues to direct the bank's "charitable" activities.

What First Pennsylvania's and other Philadelphia banks' funds went for became clear in the summer of 1978, when a member of a local leftist cult, known as "MOVE," killed a Philadelphia policeman with an automatic rifle. Heavily oriented towards drugs and terrorism, MOVE is part of a family of similar groups that functions under the umbrella of the drug-oriented Movement for a New Society, one of the ugliest concoctions ever to appear on the streets of the United States. The Movement for a New Society and its more explicitly violence-prone outlets, such as MOVE, receive most of their funding from the Philadelphia Foundation and two associated funding conduits for the Quaker pharmaceuticals firm and the related Philadelphia banks. (3) The other conduits are the William Penn Foundation, controlled by the five members of the Haas pharmaceuticals family who sit on the foundation's board, and by the Philadelphia Yearly Meeting of the Religious Society of Friends (Quakers).

The Yearly Meeting is no more a religious Quaker institution than Seagram Liquors or Emprise are religious Jewish institutions, but serves as a front for leading British-allied banking and chemical companies of Quaker origin. The funds of the Yearly Meeting are controlled by Robert Boudine—of the same Boudine family—in two secret accounts held at James Boudine's First Pennsylvania Bank, and shunted to undisclosed activities. Among known contributions is a \$2,000 donation to the MOVE group, before the murder of the Philadelphia policeman attracted public attention. That contribution was only discovered after Philadelphia police moved in to clean out MOVE's headquarters, and discovered a receipt for \$2,000 from the Yearly Meeting of the Friends in MOVE's quarters.

The Movement for a New Society is the biggest law

enforcement problem in the city of Philadelphia. Not only has it produced killers like those from MOVE, but its combination of pro-drug, pro-homosexuality, pro-pederasty, pro-environmentalist ideology provides an environment that breeds terrorists. According to its own publications, the Movement for a New Society provided the cadre who led the "Clamshell Alliance" demonstration at New Hampshire's Seabrook nuclear reactor site in 1977. New Hampshire police conducted mass arrests of the demonstrators after receiving information that the demonstrators planned terrorist action.

This antisocial organization receives its funds from the pharmaceutical firms and their bankers, through the Philadelphia Foundation, the William Penn Foundation, and the Yearly Meeting's \$25 million secret slush fund. The William Penn Foundation funds the Movement to the tune of \$40,000 a year. The Foundation was established by Rohm and Haas. The Philadelphia Foundation provided the Movement's funding conduit, Neighborhood Resources West, with \$6,472 in recorded funds in 1977. That foundation was founded under the auspices of officials of the Fidelity Bank of Philadelphia Banking Corporation. On the Fidelity Bank's board is John C. Haas of Rohm and Haas; its chairman is Howard C. Petersen, who also sits on the board of Rohm and Haas.

How little the operations of the Philadelphia Society of Friends resemble the religious principles of Quakerism is evident from one fact: their Philadelphia offices house the headquarters of 1) the Venceremos Brigade, the mother organization for the terrorist Weathermen; 2) the Susan Saxe Defense Committee, which conducted legal efforts on behalf of Weatherwoman bank robber Susan Saxe; and 3) the Puerto Rican Socialist Party, which officially supports the terror-bombings of the so-called FALN. The "Religious Society of Friends" designation is a misnomer. The Philadelphia Quakers operate through the American Friends Service Committee, an organization that religious Quakers have despised since its founding.

The American Friends Service Committee's spawn, the Movement for a New Society, funded through Quaker accounts, is explicitly pro-violence. One of its publications, a 1976 pamphlet

entitled "Moving Towards a New Society," says: "There are a number, perhaps a growing number, of completely sincere humanist revolutionaries who believe that violence is necessary, although regrettable, and that only through armed struggle can the powerful American Empire be toppled...it is important that we express solidarity with all who share our goals," e.g. Susan Saxe and the Venceremos Brigade.

The Quaker-funded Movement for a New Society also published a series of frankly pornographic manuals for their "revolutionaries," including such titles as "Gay Oppression and Liberation," "Liberating Sexuality," and "Take Heart--All Those in the Struggle." These publications advocate pederasty, "multiple sexual relationships," and public masturbation. One of these publications, "Gay Oppression and Liberation," reports that "non-gays in the Movement for a New Society have made great strides recently in reducing their complicity with heterosexism." This is not only a breeding ground for the dope traffic and terrorism, but an expression of the cult existence prescribed by the original masters of the narcotics traffic (see Part IV). And it is the bottom line for the William Penn and Philadelphia Foundations.

Charterhouse Japhet's presence in the middle of this mid-Atlantic zoo is the link back to the highest levels of Dope, Incorporated, the queer alliance of Friends-who-are-not-Friends and Jews-who-are-not-Jews. The leading Quaker banking families in Philadelphia allied themselves with the Baring bank and the dope traffic in the first years of the American Republic. The top British banks include old Quaker families, who have been represented in the United States for two centuries. Britain's largest bank, Barclays, founded in its present form in 1835, has been in Quaker hands for 200 years. Its representative David Barclay lived in Philadelphia during the 18th century, at the same time that the Baring Bank set up shop there. Barclays' board, as noted earlier, includes five members of the Most Venerable Order of St. John of Jerusalem, the chivalric dirty tricks arm of the British and related monarchies.

Charterhouse Japhet today is controlled by Barclays Bank, through an intermediary. Barclays controls Slough Properties,

which functions as the de facto parent organization of Charterhouse Japhet. Through its hold on the Japhet family interests, Barclays controls Israeli finance, by way of Ernst Israel Japhet, the chairman of Israel's largest finance house, Bank Leumi. Bank Leumi has just applied to the American regulatory authorities for permission to open a branch office in Philadelphia.

Consequently, the joint appearance of "Quaker" and "Jewish" financiers at the center of the Philadelphia Story is no accident. Neither of them have anything more to do with the two religions than does the Movement for a New Society's perverted gibberish. Under the control of the British oligarchy and the Order of St. John, they are the instruments of a British subversion plan in Philadelphia that, in the words of the Movement for a New Society's badly printed tract, wants to "topple the American Empire."

## Notes

### 1. THE BRONFMAN GANG

1. Canadian Jewish Congress Report, 1967-68, in commemoration of Samuel Bronfman.
2. Ibid.
3. Peter C. Newman, *Bronfman Dynasty, The Rothschilds of the New World* (Toronto: McClelland and Stewart Ltd., 1978), pp. 66-73.
4. Newman, *Bronfman Dynasty*, p. 64.
5. Hank Messick, *Lansky* (New York: Berkley Medallion Books, 1971), pp. 230-31.
6. James H. Gray, *Booze* (Toronto: Macmillan Co. of Canada, Alger Press, 1972).
7. Newman, *Bronfman Dynasty*, p. 127.
8. *Russell Sage Foundation, 1907-1946* (New York: Russell Sage Foundation, 1947), Volume 1. Loanshark operation surveys were also conducted in Illinois and Kentucky.
9. Hank Messick, *Secret File* (New York: G.P. Putnam's Sons, 1969), pp. 277-78.
10. Torrio's rise to power has been chronicled in hundreds of books and press accounts dealing with the history of organized crime and with the "Capone" Chicago organization in particular. See Don Maclean, *Pictorial History of the Mafia* (New York: Pyramid Books, 1974); Ralph Salerno and John S. Tompkins, *The Crime Confederation* (New York: Doubleday & Company, Inc., 1969); Martin A. Gosch and Richard Hammer, *The Last Testament of Lucky Luciano* (New York: Dell Publishing Co., Inc., 1974). Additional insight was provided through numerous interviews with law enforcement officials at the U.S. Customs Bureau and Drug Enforcement Administration.
11. Maclean, *Pictorial History of the Mafia*, p. 150; see also Donald R. Cressey, *Theft of the Nation: The Structure and Operations of Organized Crime in America* (New York: Harper and Row, 1969), pp. 29-53.
12. Maclean, *Pictorial History of the Mafia*, p. 461. Figures vary for the death toll reached during the war period; however, on the night that New York boss Salvatore Maranzano — September 11, 1931 — was assassinated and the immediate 48-hour period following, it is estimated that 40 gang leaders were killed in the overall purge. See also: Donald R. Cressey, *Theft of the Nation*, pp. 29-53, and Peter Maas, *The Valachi Papers* (New York: Bantam Books, 1968).
13. Messick, *Secret File*, pp. 96-97. Corroboration of the analysis presented here was provided through numerous and exhaustive

interviews with law enforcement officials at the DEA and U.S. Customs Bureau.

14. Messick, *Lansky*, pp. 90, 97-98. Additional corroboration was provided by DEA officials in interviews in December 1977.
15. Report from Narcotics Division Agent Ralph Oyler to Narcotics Division Chief Levi Nutt, March 30, 1926 (DEA Library, Washington, D.C.).
16. Jonathan Marshall, "Opium and Politics of Gangsterism in Nationalist China—1927-45," *Bulletin of Concerned Asian Scholars* 3 (1976): 19-48.
17. Ibid.
18. Henry Aubin, *Who Owns Montreal*.
19. Ibid.
20. Newman, *Bronfman Dynasty*, pp. 55-61.
21. Starkman stores' connections to Koffler were widely publicized at the time in the *Toronto Globe and Mail*.
22. See also Newman, *Bronfman Dynasty*, pp. 167-169.
23. *The Washington Post*, November 6, 1978, p. 2.
24. Newman, *Bronfman Dynasty*, p. 233.
25. Ibid., p. 231.
26. Ibid., p. 225.
27. Ibid., p. 232.
28. Ibid., p. 227.
29. Ibid., p. 227.

### 2. THE KENNEDYS: ORGANIZED CRIME IN GOVERNMENT

1. Financial Campaign Report filed by the Kennedy for Re-Election Committee, 1976, with the Clerk of the Senate.
2. *Pictorial History of Mafia*; see also Clark R. Mollenhoff, *Strike Force: Organized Crime and the Government* (Englewood Cliffs, N.J.: Prentice-Hall, Inc., 1972).
3. Senate Committee Hearings on Organized Crime and Narcotics, 1963.
4. Financial Campaign Report filed by the Kennedy for Re-Election Committee, 1976.
5. David E. Koskoff, *Joseph P. Kennedy: A Life and Times* (Englewood Cliffs, N.J.: Prentice-Hall, Inc., 1974), p. 9. Additional insight and information on Kennedy was provided through interviews with law enforcement officials.
6. Koskoff, *Joseph P. Kennedy*, p. 19.
7. Ibid., pp. 28, 30.
8. Ibid., p. 28; see also William Stevenson, *A Man Called Intrepid* (New York: Ballantine Books, 1976), p. 325.
9. Interview with DEA officials, December 1977; see also Messick, *Secret File*, p. 197 and Koskoff, *Joseph P. Kennedy*, p. 53.

10. Koskoff, *Joseph P. Kennedy*, p. 53.
11. *Ibid.*, p. 115.
12. *Ibid.*, pp. 166, 394-95.
13. *Ibid.*, p. 378.
14. Sir John Wheeler-Bennett, *Special Relationships: America in Peace and War* (New York: St. Martin, 1976), pp. 34-35; see also Koskoff, *Joseph P. Kennedy*, pp. 403-4.
15. Wheeler-Bennett, *Special Relationships*, pp. 34-35.
16. Victor Navasky, *Kennedy Justice* (New York: Atheneum, 1970), p. 404.
17. *Ibid.*
18. Messick, *Lansky*, pp. 241-42. This viewpoint was also shared by numerous law enforcement officials who were interviewed in the course of researching the history of organized crime.
19. *Who's Who in Canada*.
20. Harold Macmillan, *At the End of the Day 1961-63* (London: MacMillan London, Ltd., 1973), 6:359-60. According to Macmillan: "The President did not want to give us Polaris on political grounds, for fear of upsetting all the European nations. . . . The arrangement finally agreed was that we should be supplied with the Polaris missile. . . . Our nuclear fleet was to be 'assigned' to NATO, except in cases 'where Her Majesty's government may decide that superior national interests are at stake.' . . . Three days' hard negotiating — nearly four days in reality. The Americans pushed us very hard. . . the discussions were protracted and fiercely contested. . . ."
21. *Ibid.*
22. Koskoff, *Joseph P. Kennedy*, p. 439.

### 3. BRITAIN'S ASSASSINATION BUREAU: PERMINDEX

1. The former Shaw associate was Gordon Novel. Novel, an associate of Clay Shaw and Carlos Marcello, was himself under investigation by Jim Garrison for possible involvement in the Kennedy assassination conspiracy. An expert in electronic devices (including highly sophisticated surveillance equipment), Novel was employed by the Marcello-Permindex group in New Orleans and apparently also by the CIA through its Miami-based Double-Chek commercial front. Novel was interviewed by the authors on several occasions during spring-summer 1977. In October or November 1977, Novel was arrested in an Atlanta, Ga. suburb on charges of violation of bail conditions. The conditions were set by a New Orleans Parish Judge after a 1976 arrest on charges of conspiring to burn down a commercial building in that city. Novel is presently in New Orleans Parish jail awaiting trial on the bomb-arson plot charges.
2. A series of articles appearing in *Paesa Sera* on March 4, 12, 14, 1967; see also *Les Echos* and *Le Figaro* during spring 1962 for numerous news

and editorial references to Permindex's role in the assassination attempts against President de Gaulle.

3. Anonymous, *The Permindex Papers*, 1970, p. 58. This unpublished manuscript was reviewed by the authors on condition that the title of the document and the biographical material provided on its author would be kept confidential. *The Permindex Papers* is not the actual title of the manuscript. The author or authors used documents prepared by the Justice Department and Treasury Department of the United States government. Additionally, they cited public sources including magazine articles, newspaper articles, and books. In cases where the original sources were cross-checked, the original sources will be cited directly.
4. *Ibid.*, pp. 141-49.
5. Louis Wiznitzer, "Will Garrison's Inquiry into Kennedy Assassination Lead to Montreal?" *Le Devoir*, March 16, 1967, Montreal; also *Canadian Dimension*, September-October, 1967 (reprint).
6. Giuseppe Pantaleone, "An Interview," *Panorama*, April, 1970.
7. Anon., *Permindex Papers*, p. 164.
8. From an unpublished interview with an anonymous Rome-based foreign correspondent conducted in Rome, August 15-16, 1978.
9. Wiznitzer, "Will Garrison's Inquiry."
10. *Ibid.*
11. *Ibid.*
12. In Italy, for example, the head of the Order of St. John Ambulance Squad was directly implicated in the assassination of former Italian President Aldo Moro. Baron Johann von Schwartzberg was under intensive investigation by Italian authorities as the suspected mastermind of the Moro murder. Schwartzberg was exempt from any prosecution, search, or interrogation due to his diplomatic status as an emissary of the Sovereign Order of St. John, Order of Malta, which is recognized by many governments, including the Italian government, as a sovereign state. Schwartzberg died within a month of Moro's death in an automobile accident.
13. Anon., *Permindex Papers*, p. 231.
14. *Ibid.*, pp. 231-32.
15. *Ibid.*, p. 161.
16. Allan J. Weberman, *Coup d'Etat in America* (New York: Joseph Okpaku, 1975) pp. 39-40.
17. Anon., *Permindex Papers*, p. 73. The name of the courier was Maurice Gatlin. According to testimony delivered by Jerry Milton Brooks before the New Orleans Grand Jury investigating the assassination of Kennedy, Gatlin was a "transporter" for both the CIA and Division Five of the FBI.
18. Virtually all the book-length material on Sir William Stephenson and the British Security Coordination-Special Operations Executive is "official cover story" commissioned by the SOE to provide limited exposure to aspects of its operations while withholding the most illegal

and anti-American activities. Two books that fit this "official cover story" description, but which provide numerous references to Stephenson's methods of operation, including his penetration into every level of the U.S. military command with his SOE agents, are: H. Montgomery Hyde, *Room 3603* (New York: Ballantine Books, 1962) and William Stevenson, *A Man Called Intrepid* (New York: Ballantine Books, 1976).

19. Richard Deacon, *A History of the British Secret Service* (New York: Taplinger Publishing Company, 1970), p. 296.

20. Anon., *Permindex Papers*, p. 265.

21. *Ibid.*, p. 196.

22. Rodney Campbell, *The Luciano Project* (New York: McGraw-Hill Book Company, 1977); see also Julian Semyonov, "Capriccio Siciliano," *Ogonyok* (Moscow), October-November, 1978.

23. Julian Semyonov, "Capriccio Siciliano," reprinted in English translation from *Ogonyok* in *Executive Intelligence Review* 43 (1978): 38.

24. As reported in the *Permindex Papers*, pp. 46-51, Permindex included among its investors: Morris Dalitz, the organized crime czar of Cleveland and Las Vegas and a personal associate of Lansky dating back to Prohibition; Joseph Bonanno, the New York City and Phoenix mobster who took control over the New York City-based Lionel Corporation and used it as a business front for a variety of criminal activities that included investment in Permindex; Carlos Prio Socarras, the President of Cuba from 1948-52 who subsequently became the chief of Meyer Lansky's gambling racket in Havana until the Castro takeover.

25. Messick, *Lansky*, p. 241.

26. *Canadian Who's Who* (Toronto: TransCanada Press) Vols. 7, 8, 9, 10; and (Toronto: Who's Who Canada Publishers) Vols. 11, 12, 13.

27. The most comprehensive documentation of the bankrupting of BCI is contained in an unpublished report by Richard Freeman, "The Case of Investors Overseas Services: Dirty Money International," August 12, 1978; see also Robert Hutchinson, *Vesco* (New York: Praeger Publishers, 1974).

28. Messick, *Lansky*, p. 248.

29. Anon., *Permindex Papers*, p. 105; and Messick, *Lansky*, p. 248.

30. George Nichols, "Exclusive: The Mossad — Who Is Behind This Secret, Global Gang of Political Terrorists Who Intimidate Presidents?" *The Spotlight* 39 (1978): 13-16.

31. The Economics Department of the University of Vienna, known as the Vienna School, was founded as a joint project of the British Fabian Society, the Rothschilds, and the Austrian royal Hapsburg family. In 1868, the British Foreign Office established the Royal Colonial Institute at the initiative of the Sassoon family, among others. Its principal sources of funding were the Hongkong and Shanghai Corp. and Barclays Bank. The head of the institute, Alfred Marshall, was also the chief economist for Cecil Rhodes. According to the *Official History of the Fabian Society*,

from 1884-92, Marshall, in collaboration with Fabian Executive members Beatrice and Sidney Webb, founded three institutes of economics. These three institutions to this day produce the membership for the Order of St. John's Mont Pelerin Society.

The Vienna School was established in 1884 on the strength of London School of Economics publications building the credibility of Karl von Menger, head of the University of Vienna Economics Department and the personal economic advisor to the Hapsburg court. Menger, an impoverished nobleman working as a journalist, had been turned into the personal economic tutor of Hapsburg Crown Prince Rudolph in 1876 by Baron Albert Rothschild, head of the family's Vienna House. Each of Menger's disciples was a Rothschild recruit from the Hapsburg nobility: Eugen Böhm von Bawerk was a member of the House of Lords and three times Austrian finance minister from 1896-1904; Friedrich von Weiser, also a Lord, was the Minister of Commerce.

In addition to Tibor Rosenbaum, some of the leading products of the Vienna School are Friedrich von Hayek, Herbert von Mises, and Nikolai Bukharin.

32. *Who's Who in Great Britain*; see also 1977 *Annual Report of the Bank Leumi*.

33. The U.S. government has recently gone on record as believing that David Graiver is indeed still alive. Graiver achieved notoriety when his American Bank and Trust Company in New York City went bankrupt in 1976, amid charges that Graiver had siphoned off some \$50 million from the bank and then disappeared. A federal indictment was sought and gotten. When Graiver was reported to have been killed in a plane crash, those charges were dropped. In June 1978, the U.S. Attorney for the South District of New York petitioned for the charges to be reinstated. The petition was granted the same month. See *The New York Times* and the *Wall Street Journal* of June 3-30, 1978.

Rosenbaum was a board member of the American Bank and Trust, which acted as the conduit for various illegal payments — including the \$5 million in bribes that Graiver paid to Argentine officials during 1975 to "persuade" them to purchase Canada's Candu nuclear reactor system rather than the originally preferred Westinghouse nuclear reactor. Graiver received these funds from the Canadian government's official broker in that matter, Israeli broker and foreign intelligence operative Shaul Eisenberg.

Graiver, Eisenberg, Rosenbaum, American Bank and Trust chairman Abe Feinberg, were all protégés of Nahum Goldmann, the man who brought most of them out of Europe through his 1938 deal with Heinrich Himmler to select out Jews from Nazi Germany and occupied Austria. Goldmann, the long-time head of the World Jewish Congress, was recently replaced by Chicago-based partner of Salomon Brothers, Phillip Klutznik; he is the man who sold the American Bank Trust to Graiver — he ran it on behalf of the Israeli government — in 1975.

34. *Who's Who in Canada*; see also Wiznitzer, "Will Garrison's Inquiry."



35. Col. Sir Edwin King and Sir Harry Luke, *The Knights of St. John in the British Realm — Being the Official History of the Most Venerable Order of the Hospital of St. John of Jerusalem* (London: Hills & Lacy, 1924).
36. See *New York Times* Index citation on "Banque de Credit Internationale" and "Tibor Rosenbaum," particularly covering the period of September through December, 1974, for numerous references to the exposure of Bank Hapoalim and related institutions' involvement in money laundering; see also Katherine Burdman, "The British Crown's Secret Financial Capability: Israeli Banking," *Executive Intelligence Review* 44 (1978).
37. Criton Zoakos, et al., "The Black International Terrorist Assassination Plot to Kill Lyndon H. LaRouche, Jr.," *Campaigner Special Report* (New York: Campaigner Publications, 1977), p. 29.
38. Anon., *Permindex Papers*, p. 87.
39. Ladislav Farago, *Aftermath: Martin Bormann and the Fourth Reich* (New York: Simon & Schuster, 1974); see also William Stevenson, *The Bormann Brotherhood* (New York: Bantam Books, Inc., 1973).
40. Two Rome interviews conducted from August 10-16, 1978, with prominent Italian journalists and one Austrian journalist who request to remain anonymous. The interviews were conducted by members of the Rome staff of the New Solidarity Press Service at the request of the authors.
41. Max Gallo, *Mussolini's Italy: Twenty Years of the Fascist Era* (New York: Macmillan Company, 1973).
42. Anon., *Permindex Papers*, p. 97.
43. *Ibid.*, p. 178.
44. *Ibid.*, p. 213.
45. *Ibid.*, p. 212.
46. Edward J. Epstein, *Agency of Fear — Opiates and Political Power in America* (New York: G.P. Putnam's Sons, 1977).

#### 4. PERMINDEX UNVEILED: RESORTS INTERNATIONAL

1. Hutchinson, Vesco.
2. Messick, Lansky, pp. 221-51. Lansky had had his eye on the Bahamas since the 1940s, but his attention was then fixed on his Cuban and Las Vegas casino empires. (Castro's refusal to play ball with the *Hofjuden* mob allegedly inspired Lansky to issue a \$1 million "contract" on Castro's life.) With the 1959 fall of the Batista government the Bahama option became an imperative. Thus, it was no accident that the British gave the go-ahead for legalized gambling not only for their Caribbean holdings but in Britain as well. Messick reports (p. 228): "All that was needed in 1960 was to find a semirespectable front from which he (Lansky — ed.) could operate."
3. *Ibid.*, p. 228.

4. *Ibid.*, p. 229.
5. *Ibid.*, pp. 230-32; see also Jim Hougan, "A Surfeit of Spies," *Harpers*, December 1974, p. 58; Frank J. Prial, "Concern Fights Crime in Business," *New York Times*, July 26, 1970, Business Section, p. 1, p. 11.
6. Messick, Lansky, pp. 230-231, 235.
7. *Ibid.*, pp. 232-233.
8. *Ibid.*, p. 232; see also Hougan, "Surfeit of Spies," pp. 58, 63.
9. Hougan, "Surfeit of Spies," pp. 58, 63.
10. Hutchinson, Vesco; see also James Hougan, *Spooks: The Haunting of America — The Private Use of Secret Agents* (New York: William Morrow and Co., 1978), pp. 390-392.
11. Hougan, "Surfeit of Spies," p. 54.
12. *Ibid.*, pp. 66-67; see also Hutchinson, Vesco.
13. Hougan, "Surfeit of Spies," pp. 54, 56; see also Prial, "Concern Fights Crime," p. 11.
14. Hougan, "Surfeit of Spies," p. 66; Hougan's information is corroborated by the authors' interviews with law enforcement officials.

#### 5. THE JACOBS FAMILY'S EMPIRE: SPORTS AND CRIME

1. Testimony of labor racketeer James Plumeri (Jimmy Doyle) before the McClellan Subcommittee on Criminal Laws and Procedures; see also Congressman Sam Steiger's insertion into the *Congressional Record* of the 91st Congress, "Empire: A Lesson in Corporate Calumny."
2. Testimony of Plumeri before the McClellan Subcommittee on Criminal Laws and Procedures.
3. From their positions in Cleveland and Buffalo, the Jacobs family was a Bronfman link into the United States in alliance with the Reinfield Syndicate and the Big Seven Combine (see Section 1).
4. "Empire: A Lesson in Corporate Calumny," 91st *Congressional Record*, p. 5888; "Empire: A Little More of the Iceberg Exposed," 91st *Congressional Record*, p. 6830.
5. Many of the Justice Department officials who worked with Robert Kennedy in the "Get Hoffa" campaign turned up playing supporting roles in forcing Richard Nixon out of office, particularly when Nixon demonstrated a commitment to go after organized crime. This includes most especially Horace S. Webb.
6. Jeremy Jacobs admitted to the activities directed against Steiger under questioning during 1972 hearings of the House Select Committee on Crime.
7. U.S. Labor Party Legal Division, "Evidence to Overturn the Fraudulent Election of James Earl Carter," *Campaigner Special Report* (New York: Campaigner Publications, November 26, 1976); U.S. Labor Party Legal Division, "Conclusive Evidence of Carter Vote Theft Goes Before Federal Court in Ohio and New York," *Campaigner Special Report* (New

York: Campaigner Publications, December 9, 1976). The Committee for Fair Elections, a nonpartisan citizens group representing participation from the U.S. Labor Party, the Democratic, Republican, and American Independent parties, initiated official investigations and selective court actions in Pennsylvania, Wisconsin, New York, and Ohio as the result of accumulated evidence of overwhelming fraud in the general elections of November, 1976. In addition to extensive regional press coverage of the specific legal actions, the investigations and legal actions received national coverage on CBS television news (The Seven O'Clock Report) by Walter Cronkite and in the *Washington Star* by Jack Germond.

During those same 1976 general elections, the following additional situations suggested similar evidence of election tampering on a large scale:

\* Rep. Richard Torney was convicted of vote fraud in the Louisiana Democratic primary following a federal grand jury investigation. Torney was removed from the congressional seat that he won in the subsequent November general election.

\* Ron Paul, a former U.S. congressman, contested the general elections in Austin, Texas, in which he was narrowly defeated by Democratic Party candidate Robert Gamage. Paul proved sizable fraud before the courts; however, the judge ruled that sufficient magnitude of fraud to turn the elections had not been shown and denied Paul's motion to be placed in Congress.

\* Two witnesses to massive fraud by Congressman William Clay (D-Mo.) in the November elections in St. Louis subsequently died under violent and mysterious circumstances. Clay is linked to the Jacobs family interests (see below in text).

8. "Critic Changes Tune," *Courier Express* (Buffalo, N.Y.), January 27, 1977.

9. According to a July 1978 edition of the *Toronto Globe-Mail*, Mark Phillips stayed at the residence of Koffler when he went to Canada.

10. *Courier Express*, December 28, 1970.

11. According to the June 15, 1972, *Buffalo Evening News*, Max Jacobs was a heavy contributor to Scoop Jackson.

12. The information presented here on the HongShang takeover attempt is on the public record and was reported in the *Courier Express*.

13. *Courier Express*, February 24, 1976.

14. The top Israeli purveyor of weapons to the Central American dictatorships is one Shaul Eisenberg, who operates behind a myriad of trading company fronts, of which the best known is "United Development, Inc." with headquarters in Panama. Eisenberg is the world's largest supplier of assassinating weapons, as well as the "godfather" of the Israel Aircraft Company, the manufacturer of Israel's Kfir fighter plane. According to the *Washington Post* of September 11, 1978, he is also one of the most senior operatives of the Israeli secret intelligence, the Mossad. With specializations in the Far East and Latin America, Eisenberg runs

the Zürich Mossad station, under the day-to-day control of the Zürich branch of Bank Leumi and his personal direction of a Swiss-based member of the Oppenheimer family. Apart from the arming of such entities as the Somoza dictatorship of Nicaragua, the capabilities of the Eisenberg operation include Israel's main illicit connections to the Far East, where Eisenberg spent World War II, and a significant portion of wholesale drug transshipments across the Mediterranean route. Eisenberg build (and paid for in cash) a building dubbed "Adia House" in Tel Aviv, housing most of the Asian countries' trade representatives in Israel. He also has a billion-dollar credit line in Hong Kong at the Standard Chartered Bank.

15. Zoakos, *Assassination Plot*, pp. 9-11. The information was originally developed in a July 15, 1978 telephone interview with Paul Bowden, the head of the Detroit Anti-Nazi Coalition and himself a retired UAW worker.

16. Jeffrey Steinberg, "Jacobs Family and Related Organized Crime Activities in the St. Louis, Mo. Area," an unpublished manuscript (New York), October 1978.

## 6. THE PHILADELPHIA STORY

1. Phone interview with official of Paco Pharmaceuticals. For Ernst Japhet control over Paco, see Charterhouse Japhet Annual Report, 1977.

2. *Proceedings and Yearbook, Philadelphia Yearly Meeting of the Religious Society of Friends*, 1978, cites "friendly presence group" activities to conduct nonviolent demonstrations in support of human rights for MOVE (p. 11-12) and operations request of \$2000 per month for work in conjunction with vigil at MOVE headquarters (p. 16). According to the *Philadelphia Inquirer*, a diary was found at MOVE headquarters after the September 1978 shootout citing support, including financial support, from the American Friends Service Committee.

3. William Penn Foundation Annual Report for 1977 cites \$120,000 to Neighborhood Resources West (p. 39). The wife of the director for the Movement for a New Society is on the board of directors of the NRW. NRW funds Movement houses in West Philadelphia for "community development," according to interviews with members of both the NRS and the Movement for a New Society. The Annual Report of the Philadelphia Foundation for the year ending April 1977 and also for 1976 cites over \$20,000 transferred to a "clearinghouse" which in turn funds community projects (p. 14); see also *Proceedings and Yearbook, Philadelphia Yearly Meeting*, pp. 183-84.

## **PART IV**

# **Creating the Market: The British Origins of the Counterculture**

*The acts or gestures that accompany the incantations constitute the rite (of Isis). In these dances, the beating of drums and the rhythm of music and repetitive movements were helped by hallucinatory substances like hashish or mescal; these were consumed as adjuvants to create the trance and the hallucinations that were taken to be the visitation of the god. The drugs were sacred, and their knowledge was limited to the initiated; their preparation and their gathering were surrounded with . . . secrecy. . . . In some cases, like the harvesting of the mandrake, they remained secret until the Middle Ages.*

*Possibly because they gave the illusion of satisfied desires, and allowed the innermost feelings to escape, these rites acquired during their execution a frenzied character that is conspicuous in certain spells: "Retreat! Re is piercing thy head, slashing thy face, dividing thy head, crushing it in his hands; thy bones are shattered, thy limbs are cut to pieces."*

*The House of Life: Magic and  
Medical Science in Ancient Egypt,  
by Paul Ghalioungui (I)*

If this description of pagan cult ceremonies dating back to the Egyptian Isis priesthood of the third millennium B.C. reads like a journalistic account of a "hippy be-in" circa 1969 A.D., it should. The counterculture that was foisted on the 1960s adolescent population is not merely *analogous* to the ancient Cult of Isis. It is a literal resurrection of the Isis cult — down to the popularization of the Isis cross as the counterculture's most frequently used symbol.

As we shall show here, the drug-rock counterculture was the result of Britain's 30-year Opium War against the United States, which included not only chemical and psychological warfare but the hideous military project called the Vietnam War.

The British fostered the creation of the bestial rock and drug cult for the same reason that their colonial policy enforced backwardness throughout the empire and for the same reason that the pharaohs of ancient Egypt and the Ptolemaic priests of the first century A.D. Egypt fostered the practice. As long as a population is organized around superstition, magic, hallucinogenic drugs, and animal-like pursuit of immediate sensory gratification ("if it feels good, do it"), it will remain incapable of acting on behalf of its own interests. It was for this reason that the oligarchies of ancient Egypt organized themselves into *priesthoods* and created dozens of apparently contending pagan cults, all characterized by the same bestialist outlook.

True religion, as opposed to the worship of magically endowed cult-gods, addresses man's capacity for reason, his "Godliness." Unlike the lower beasts, the human species is uniquely capable of creative thought — the ability to break out of the bounds of sense-certainty, develop new scientific knowledge, and socially apply that knowledge through technological innovations that uplift the material and cultural condition of man. Historically such true religion has been associated with the development of urban centers where science, culture, and commerce could flourish. Its sworn enemy has been the oligarchy and its priesthoods and cults which on countless occasions have mobilized to sack the cities, murder the city-builders, and bring on the "dark ages" of plague and ignorance.

The gentlemen at the Royal Institute of International Affairs responsible for charting Britain's global drug trafficking recognized that no mass-scale drug epidemic could be produced in the United States until the American people's fundamental commitment to scientific and technological progress had first been significantly undermined. The drug-rock counterculture was no mere "sociological phenomenon."

In his *City of God*, the great humanist St. Augustine described the degeneration into cultism that brought on the destruction of Rome, in terms that have direct bearing on the post-1963 degeneration of the United States:

The stage plays, those exhibitions of depravity and unbounded license, were not introduced in Rome by men's vices, but by the command of your gods. Far more justifiably might you have paid divine honors to your Scipio than worship gods such as those, for they were not more virtuous than their high priest.

Are your minds bereft of reason? You are not merely mistaken; this is madness. Here are people in the east bewailing Rome's humiliation, and great states in remote regions of the earth holding public mourning and lamentation — and you Romans are searching for theaters, pouring into them, filling them, behaving more irresponsibly than ever before. It is this spiritual disease, degeneration, decline into immorality and indecency that Scipio feared when he opposed the erection of theaters. He saw how easily ease and plenty would soften and ruin you. He did not wish you to be free from fear.

He did not think that the republic could be happy while walls were standing, yet morals were collapsing. But, you were more attached to the seductions of foul spirits than to the wisdom of men with foresight. That is why you take no blame for the evil you do, but blame Christianity for the evil you suffer. Depraved by prosperity, and unchastened by adversity, you desire, in your security, not the peace of the State, but liberty for license. (2)

## The high priesthood

The "case officer" for Britain's Opium War was Aldous Huxley, the grandson of Thomas H. Huxley, a founder of the Rhodes Round Table group and a lifelong collaborator of Arnold Toynbee. Toynbee himself sat on the RIIA council for nearly 50 years, headed the Research Division of British intelligence throughout World War II, and served as wartime briefing officer to Prime Minister Winston Churchill.

Toynbee's "theory" of history, expounded in his 20-volume history of Western civilization, was that its determining feature has always been the rise and decline of grand imperial dynasties. At the very point that these dynasties — the "thousand year Reich" of the Egyptian pharaohs, the Roman Empire, and the British Empire — succeed in imposing their rule over the entire face of the earth, they tend to decline. Toynbee argued that this decline could be abated if the ruling oligarchy (like that of the British Round Table) would devote itself to the recruitment and training of an ever-expanding priesthood devoted to the principles of imperial rule. (3)

Trained at Toynbee's Oxford, Aldous Huxley was one of the initiates in the "Children of the Sun," a dionysian cult comprised of the children of Britain's Round Table elite. (4) Among the other initiates were T.S. Eliot, W. H. Auden, Sir Oswald Moseley, and D. H. Lawrence, Huxley's homosexual lover. It was Huxley, furthermore, who would launch the legal battle in the 1950s to have Lawrence's pornographic novel *Lady Chatterley's Lover* allowed into the United States on the ground that it was a misunderstood "work of art." (5)

Aldous Huxley, along with his brother Julian, was tutored at Oxford by H. G. Wells, the head of British foreign intelligence during World War I. Wells's writings (*Time Machine*, etc.), along with those of his protégés Aldous Huxley (*Brave New World*) and George Orwell (*1984*, *Animal Farm*), were written as "mass appeal" organizing documents on behalf of Britain's "enlightened" world order. Only in the United States are these "science fiction classics" taught in grade school as *attacks*

against fascism. (A contemporary British intelligence operative-turned-author, Anthony Burgess, wrote *Clockwork Orange* in the Wells-Orwell-Huxley tradition as a pornographic celebration of the drug-rock counterculture.)

Under Wells's tutelage Huxley was first introduced to Aleister Crowley (see Part II, Section 9). Crowley was a product of the cultist circle that developed in Britain from the 1860s under the guiding influence of Edward Bulwer-Lytton — who, it will be recalled, was the colonial minister under Lord Palmerston during the Second Opium War. In 1886, Crowley, William Butler Yeats, and several other Bulwer-Lytton protégés formed the *Isis-Urania Temple of Hermetic Students of the Golden Dawn*. This Isis Cult was organized around the 1877 manuscript *Isis Unveiled* by Madame Helena Blavatsky, in which the Russian occultist called for the British aristocracy to organize itself into an Isis Priesthood. (6)

Crowley in turn initiated Aldous Huxley into the Isis-Golden Dawn Temple and introduced him to psychedelic drugs in 1929. (7)

In 1937, Huxley moved to the United States, where he remained throughout the period of World War II. Through a Los Angeles contact, Jacob Zeitlin, Huxley and pederast Christopher Isherwood were employed as script writers for MGM, Warner Brothers, and Walt Disney studios. As we have seen, Hollywood was already dominated by organized crime elements bankrolled and controlled through London. Joseph Kennedy was the front man for a British consortium that created RKO studios, and "Bugs" Siegel, the West Coast boss of the Lansky syndicate, was heavily involved in Warner Brothers and MGM.

Huxley was instrumental in founding a nest of Isis cults in southern California and in a San Francisco suburb called Ojai — which consisted exclusively of several hundred deranged worshippers of Isis and other cult gods. (8) Isherwood, during the California period, translated and propagated a number of ancient Zen Buddhist documents, inspiring Zen-mystical cults along the way. (9)

In effect, Huxley and Isherwood (joined soon afterwards by Thomas Mann and his daughter Elisabeth Mann Borghese) laid

the foundation during the late 1930s and the 1940s for the later LSD culture by recruiting a core of "initiates" into the Isis cults that Huxley's mentors Bulwer-Lytton, Blavatsky, and Crowley, had constituted while stationed in India.

## LSD: "visitation from the gods"

The next phase in the war involved the introduction of LSD for which Aldous Huxley was the designated Crown agent.

Lycergic acid diethylamide, or LSD, was developed in 1943 by Albert Hoffman, a chemist at Sandoz A.G. — a Swiss pharmaceutical house owned by S. G. Warburg. While precise documentation is unavailable as to the auspices under which the LSD research was commissioned, it can be safely assumed that British intelligence and its subsidiary U.S. Office of Strategic Services were directly involved. Allen Dulles, the director of the U.S. Central Intelligence Agency in 1952 when that agency began its covert LSD experiment, MK-ULTRA, was the OSS station chief in Berne, Switzerland throughout the early Sandoz research. One of his OSS assistants was James Warburg, of the same Warburg family, who was instrumental in the 1963 founding of the Institute for Policy Studies, and worked with both Huxley and Robert Hutchins. (10)

In 1952, Aldous Huxley returned to the United States from Britain, accompanied by Dr. Humphrey Osmond, the Huxleys' private physician. Osmond had been part of a discussion group Huxley had organized at the National Hospital, Queens Square, London. Along with another seminar participant, J. R. Smythies, Osmond wrote *Schizophrenia: A New Approach*, in which he asserted that mescaline — a derivative of peyote mushrooms used in ancient Egyptian and Indian pagan rites — produced a psychotic state identical in all clinical respects to schizophrenia. On this basis, Osmond and Smythies advocated experimentation with hallucinogenic drugs as a means of developing a "cure" for mental disorders.

Osmond was brought in by Allen Dulles to play a prominent role in MK-ULTRA. At the same time, Osmond, Huxley, and the

University of Chicago's Robert Hutchins held a series of secret planning sessions in 1952-53 for a second, private LSD-mescaline project under the Ford Foundation funding. (11) Hutchins, it will be recalled, was the program director of the Ford Foundation during this period. His LSD proposal incited such rage in Henry Ford II that Hutchins was fired from the foundation the following year.

It was also in 1953 that Osmond gave Huxley a supply of mescaline for his personal consumption. The next year, Huxley wrote *The Doors of Perception*, the first public manifesto of the psychedelic drug cult, which claimed that hallucinogenic drugs "expand consciousness."

Although, through the sane intervention of Henry Ford, the Ford Foundation rejected the Hutchins-Huxley proposal for private foundation sponsorship of LSD, it appears that the project was not dropped. Beginning in 1962, the RAND Corporation of Santa Monica California began a four-year experiment in LSD, peyote, and marijuana. The RAND Corporation was established simultaneously with the reorganization of the Ford Foundation during 1949-50. RAND was an outgrowth of the wartime Strategic Bombing Survey, a "cost analysis" study of the psychological effects of random bombings of German population centers. It is well known that RAND has been responsible for conducting such patently insane policies as "limited thermonuclear war" and the "insanity doctrine" into the U.S. Pentagon — most notably through RAND's James Schlesinger.

According to the 1962 *RAND Abstract*, W. H. McGlothlin conducted a preparatory study on "The Longlasting Effects of LSD on Certain Attitudes in Normals: An Experimental Proposal." The following year, McGlothlin conducted a year-long experiment on 30 human guinea pigs, called "Short-Term Effects of LSD on Anxiety, Attitudes and Performance." The study incredibly concluded that LSD improved emotional attitudes and resolved anxiety problems. (12)

## HUXLEY AT WORK

Huxley expanded his own LSD-mescaline project in California by recruiting several individuals who had been initially drawn

into the cult circles he helped establish during his 1937-45 stay. The two most prominent individuals were **Alan Watts** and **Dr. Gregory Bateson** (the former husband of Dame Margaret Mead).

Watts became a self-styled "guru" of a nationwide Zen Buddhist cult built around a series of his well-publicized books. Bateson, an anthropologist with the OSS, became the director of a hallucinogenic drug experimental clinic at the Palo Alto Veterans Administration Hospital. Under Bateson's auspices, the initiating "cadre" of the LSD cult — the hippies — were programmed. (13)

Watts at the same time founded the Pacifica Foundation, which sponsored two radio stations — WKBW in San Francisco and WBAI-FM in New York City. The Pacifica stations were among the first to push the "Liverpool Sound" — the British-imported hard rock twanging of the Rolling Stones, the Beatles, and the Animals. They would later pioneer "acid rock" and eventually the avowedly fascist-psychoic "punk rock."

During the fall of 1960, Huxley was appointed Visiting Professor at the Massachusetts Institute of Technology in Boston. Around his stay in that city, Huxley created a circle at Harvard parallel to his West Coast LSD team. The Harvard group included Huxley, Osmond, and Watts (brought in from California), Timothy Leary, and Richard Alpert.

The ostensible topic of the Harvard seminar was "Religion and its Significance in the Modern Age." The seminar was actually a planning session for the "acid rock" counterculture. Huxley established contact during this Harvard period with the president of Sandoz, which at the time was working on a CIA contract to produce large quantities of LSD and psilocybin (another synthetic hallucinogenic drug) for MK-ULTRA, the CIA's official chemical warfare experiment. According to recently released CIA documents, Allen Dulles, purchased over 100 million doses of LSD — almost all of which flooded the streets of the U.S. during the late 1960s. During the same period Leary began privately purchasing large quantities of LSD from Sandoz as well. (14)

From the discussions of the Harvard seminar, Leary put

together the book *The Psychedelic Experience*, based on the ancient cultist *Tibetan Book of the Dead*. It was this book that popularized Osmond's previously coined term, "psychedelic mind expanding."

#### THE ROOTS OF THE FLOWER PEOPLE

Back in California, Gregory Bateson had maintained the Huxley operation out of the Palo Alto VA hospital. Through LSD experimentation on patients already hospitalized for psychological problems, Bateson established a core of "initiates" into the "psychedelic" Isis Cult.

Foremost among his Palo Alto recruits was **Ken Kesey**. In 1959, Bateson administered the first dose of LSD to Kesey. By 1962, Kesey had completed a novel, *One Flew Over the Cuckoo's Nest*, which popularized the notion that society is a prison and the only truly "free" people are the insane. (15)

Kesey subsequently organized a circle of LSD initiates called "The Merry Pranksters." They toured the country disseminating LSD (often without forewarning the receiving parties), building up local distribution connections, and establishing the pretext for a high volume of publicity on behalf of the still miniscule "counterculture."

By 1967, the Kesey cult had disseminated such quantities of LSD that a sizable drug population had emerged, centered in the Haight-Ashbury district of San Francisco. Here Huxley collaborator Bateson set up a "free clinic."

Among the founders of the "free clinic" were:

**Dr. David Smith** — now a "medical advisor" for the National Organization for the Reform of Marijuana Laws (NORML), an entity we shall discuss in Part V;

**Dr. Ernest Dernberg** — an active-duty military officer, probably on assignment through MK-ULTRA;

**Roger Smith** — a street gang organizer trained by Saul Alinsky. During the Free Clinic period, Roger Smith was the parole officer (and probable controller) of the cultist mass murderer Charles Manson;

**Dr. Peter Bourne** — formerly President Carter's special



assistant on drug abuse. Bourne did his psychiatric residency at the clinic. He had previously conducted a profiling study of GI heroin addicts in Vietnam

The Free Clinic paralleled a project at the Tavistock Institute, the psychological warfare agency for British Secret Intelligence Service. Tavistock, founded as a clinic in London in the 1920s, had become the Psychiatric Division of the British Army during World War II under its director, Dr. John Rawlings Rees. (16)

During the 1960s, the Tavistock Clinic fostered the notion that no criteria for sanity exist and that psychedelic "mind-expanding" drugs are valuable tools of psychoanalysis. In 1967, Tavistock sponsored a Conference on the Dialectics of Liberation, chaired by Tavistock psychoanalyst Dr. R. D. Laing, himself a popularized author and advocate of drug use. That conference drew a number of people who would soon play a prominent role in fostering terrorism; Angela Davis and Stokely Carmichael were two prominent American delegates. (17)

Thus, by 1963, Huxley had recruited his core of "initiates." As the general reader is well aware, all of them — Leary, Osmond, Watts, Kesey, Alpert — were highly publicized promoters of the early LSD counterculture. By 1967, with the cult of "Flower People" in Haight-Ashbury and the emergence of the antiwar movement, the United States was ready for the inundation of LSD, hashish, and marijuana that hit American college campuses in the late 1960s.

### 'The beating of drums . . .'

In 1963, the Beatles arrived in the United States, and with their decisive airing on the Ed Sullivan Show, the "British sound" took off in the USA. For their achievement, the four rocksters were awarded the Order of the British Empire by Her Majesty the Queen. The Beatles and the Animals, Rolling Stones, and homocidal punk rock maniacs who followed were, of course, no more a spontaneous outpouring of alienated youth than was the acid culture they accompanied.

The social theory of rock was elaborated by British agent and musicologist Theodor Adorno, who came to the United States in 1939 to head the Princeton University Radio Research Project (18) Adorno writes:

In an imaginary but psychologically emotion-laden domain, the listener who remembers a hit song will turn into the song's ideal subject, into the person for whom the song ideally speaks. At the same time, as one of many who identify with that fictitious subject, that musical I, he will feel his isolation ease as he himself feels integrated into the community of "fans." In whistling such a song he bows to a ritual of socialization, although beyond this unarticulated subjective stirring of the moment his isolation continues unchanged . . . .

The comparison with addiction is inescapable. Addicted conduct generally has a social component: it is one possible reaction to the atomization which, as sociologists have noticed, parallels the compression of the social network. Addiction to music on the part of a number of entertainment listeners would be a similar phenomenon (emphasis added). (19)

The Hit Parade is organized precisely on the same principles used by Egypt's Isis priesthood and for the same purpose: the recruitment of youth to the dionysiac counterculture.

In a report prepared for the University of Michigan's Institute of Social Research, Paul Hirsch described the product of Adorno's Radio Research Project. (20) According to Hirsch, the establishment of postwar radio's Hit Parade "transformed the mass medium into an agency of sub-cultural programming." Radio networks were converted into round-the-clock recycling machines that repeated the top 40 "hits." Hirsch documents how all popular culture — movies, music, books, and fashion — is now run on the same program of preselection. Today's mass culture operates like the opium trade: the supply determines the demand.

## The Vietnam war and the antiwar trap

But without the Vietnam War and the British Secret Intelligence Services' "antiwar" movement, the Isis Cult would have been contained to a fringe phenomenon — no bigger than the beatnik cult of the 1950s that was an outgrowth of the early Huxley ventures in California. The Vietnam war created the climate of moral despair that opened the educated elite of America's youth — the first 20th-century generation raised in a climate free from depression and war — to drugs.

The reader has already been shown that the Kennedy Administration installed in the White House by the 1960 elections was sponsored by the British Round Table (see Part III). Under Kennedy, American involvement in Vietnam — which had been vetoed by the Eisenhower Administration — was initiated on a limited scale. Under Lyndon Johnson, American military presence in Vietnam began in earnest. Johnson's principal Vietnam advisor was *not even American*. He was a British officer, Sir Robert Thompson, whose entire career had been spent conducting counterinsurgency warfare in Southeast Asia. Playing on the President's "yahoo" anticommunist profile, Thompson convinced President Johnson that communist insurgency had to be stopped at all costs and that a strong U.S. military presence in South Vietnam was necessary for that containment. Johnson, a military and foreign policy incompetent whose other chief Vietnam advisor, National Security Council Director Walt Rostow, held the Cross of the Order of the British Empire, was dragged by the nose into Vietnam by the British.

The British, to put it simply, had two reasons for manipulating the United States into Vietnam. The first was to foster a "limited war" confrontation in Southeast Asia between the United States and the Soviet Union (through its North Vietnamese "surrogate") that would both refuel the Cold War and effectively undercut the influence of both powers in the region. The second and equally significant reason was to demoralize the American people to such a degree that the sense of national pride and

confidence in the future progress of the republic would be forever shattered.

Just as Aldous Huxley began the counterculture subversion of the United States 30 years before its consequences became evident to the public, Lord Bertrand Russell began laying the foundations for the antiwar movement of the 1960s before the 1930s expired. Lord Russell and Aldous Huxley cofounded the Peace Pledge Union in 1937 — just before both went to the United States for the duration of World War II. (21)

Russell's antiwar zeal, it should be noted, was a patent fraud. During World War II, Lord Russell opposed British and American warfare against the Nazis because he was a peripheral member of the pro-Nazi Cliveden Set. In 1947, when the United States was in possession of the atomic bomb and Russia was not, Russell loudly advocated that the United States preemptively commence World War III — against the Soviet Union. His 1950s "Ban the Bomb" aboutface was fundamentally an *antitechnology* movement against the peace-through-development potentials represented by President Eisenhower's "Atoms for Peace" initiative to the Soviets; Eisenhower's 1954 proposal to the United Nations was predicated on the development of thermonuclear fusion power and concomitant city-building projects throughout the underdeveloped sector.

From the mid-1950s on, Russell's principal assignment was to build an international antiwar and *anti-American* movement. Coincident with the escalation of U.S. involvement in Vietnam under British manipulation, Russell upgraded the old Peace Pledge Union (which had been used in West Germany throughout the postwar period to promote an anticapitalist "new left" wing of the Social Democratic Party, recruiting several future members of the Baader-Meinhof terrorist gang in the process) into the **Bertrand Russell Peace Foundation**.

In the United States, New York's Our Crowd banks provided several hundred thousand dollars to establish the Institute for Policy Studies (IPS), as effectively the U.S. branch of the Russell Peace Foundation. Among the founding trustees of the IPS was James Warburg, directly representing the family's interests.

IPS drew its most active operatives from a variety of British-

dominated institutions. IPS founding director Marcus Raskin was a member of the Kennedy Administration's National Security Council and also a fellow of the National Training Labs, a U.S. subsidiary of the Tavistock Institute founded by Dr. Kurt Lewin.

IPS in turn financed and ran the Students for a Democratic Society (SDS) — the student antiwar movement — up through and beyond its splintering into a number of terrorist and Maoist gangs in the late 1960s. (22) If one were to take the time to trace the pedigrees of all of the leaders of the antiwar movement in the United States, an almost unbroken pattern of either IPS or direct Russell Foundation control would emerge. This is not to say that the majority of antiwar protesters were paid, certified British agents. On the contrary, the overwhelming majority of antiwar protesters went into SDS on the basis of outrage at the developments in Vietnam and subsequently *got trapped*. Once caught in the environment defined by Russell and the Tavistock Institute's wartime psychological warfare experts, their sense of values and their creative potential were snatched up in a cloud of hashish smoke.

## The LSD connection

Who provided the drugs that swamped the antiwar movement and the college campuses of the United States in the late 1960s? The organized crime infrastructure — which had set up the Peking Connection for the opium trade in 1928 — provided the same services in the 1960s and 1970s it had provided during Prohibition. This was also the same network Huxley had established contact with in Hollywood during the 1930s.

The LSD Connection begins with one William "Billy" Mellon Hitchcock. Hitchcock was a graduate of the University of Vienna and a scion of the millionaire Mellon banking family of Pittsburgh. (Andrew Mellon of the same family had been the Treasury Secretary throughout Prohibition.) In 1963, when Timothy Leary was thrown out of Harvard, Hitchcock rented a 55-room mansion in Millbrook, New York where the entire Leary-Huxley circle of initiates was housed until its later move back to California. (23)

Hitchcock was also a broker for the Lansky syndicate and for the Fiduciary Trust Co., Nassau, Grand Bahamas — a wholly owned subsidiary of Investors Overseas Services. He was formally employed by Delafield and Delafield Investments where he worked on buying and selling vast quantities of stock in the Mary Carter Paint Co. — soon to become Resorts International.

In 1967, Dr. Richard Alpert put Hitchcock in contact with Augustus Owsley Stanley III. As Owsley's agent, Hitchcock retained the law firm of Rabinowitz, Boudin and Standard (24) to conduct a feasibility study of several Caribbean countries to determine the best location for the production and distribution of LSD and hashish.

During this period, Hitchcock joined Leary and his circle in California. Leary had established an LSD cult called the Brotherhood of Eternal Love and several front companies, including Mystics Art World, Inc. of Laguna Beach, California. These California-based entities ran lucrative trafficking in Mexican marijuana and LSD brought in from Switzerland and Britain. The British connection had been established directly by Hitchcock, who contracted the Charles Bruce chemical firm to import large quantities of the chemical components of LSD. With financing from both Hitchcock and George Grant Hoag, the heir to the J.C. Penney dry goods fortune, the Brotherhood of Eternal Love set up LSD and hashish production-marketing operations in Costa Rica in 1968. (25)

Toward the end of 1968, Hitchcock expanded the LSD-hashish production operations in the Caribbean with funds provided by the Fiduciary Trust Co. (IOS). In conjunction with J. Vontobel and Co. of Zürich, Hitchcock founded a corporation called 4-Star Anstalt in Liechtenstein. This company, employing "investment funds" (i.e., drug receipts) from Fiduciary Trust, bought up large tracts of land in the Grand Bahamas as well as large quantities of ergotamine tartrate, the basic chemical used in the production of LSD. (26)

Hitchcock's personal hand in the LSD connection abruptly ended several years later. Hitchcock had been working closely with Johann F. Parravacini of the Parravacini Bank Ltd. in Berne, Switzerland. From 1968, they had together funded even

further expansion of the Caribbean-California LSD-hashish ventures. In the early 1970s, as the result of a Securities and Exchange Commission investigation, both Hitchcock and Parravacini were indicted and convicted of a \$40 million stock fraud. Parravacini had registered a \$40 million sale to Hitchcock for which Hitchcock had not put down a penny of cash or collateral. This was one of the rare instances in which federal investigators succeeded in getting inside the \$200 billion drug fund as it was making its way around the "offshore" banking system.

Another channel for laundering dirty drug money — a channel yet to be compromised by federal investigative agencies — is important to note here. This is the use of tax-exempt foundations to finance terrorism and environmentalism. One immediately relevant case makes the point.

In 1957, the University of Chicago's Robert M. Hutchins established the Center for the Study of Democratic Institutions (CSDI) in Santa Barbara, California. Knight Commander Hutchins drew in Aldous Huxley, Elisabeth Mann Borghese, and some Rhodes Scholars who had originally been brought into the University of Chicago during the 1930s and 1940s.

The CSDI was originally funded (1957-61) through a several-million-dollar fund that Hutchins managed to set up before his untimely departure from the Ford Foundation. From 1961 on, the Center was principally financed by organized crime. The two funding conduits were the Fund of Funds, a tax-exempt front for Bernie Cornfeld's IOS, and the Parvin Foundation, a parallel front for the Parvin-Dohrman Co. of Nevada. IOS and Parvin-Dohrman held controlling interests in the Desert Inn, the Aladdin, and the Dunes — all Las Vegas casinos associated with the Lansky syndicate. IOS, as already documented, was a conduiting vehicle for LSD, hashish, and marijuana distribution throughout the 1960s. (27) In 1967 alone, IOS channeled between \$3-4 million to the center. Wherever there is dope, there is Dope, Inc.

## Notes

### IV. CREATING THE MARKET: THE BRITISH ORIGINS OF THE COUNTERCULTURE

1. Pául Ghalioungui, *The House of Life: Magic and Medical Science in Ancient Egypt* (New York: Schram Enterprises Ltd., 1974).
2. Saint Augustine, *The City of God* (New York: Oxford University Press, 1963).
3. Arnold Toynbee, *A Study of History* (New York: Oxford University Press, 1935).
4. Martin Green, *Children of the Sun: A Narrative of Decadence in England After 1918* (New York: Basic Books, Inc., 1976).
5. See Ronald William Clark, *The Huxleys* (New York: McGraw-Hill, 1968).
6. Helena P. Blavatsky, *Isis Unveiled, A Master Key to the Mysteries of Ancient and Modern Science and Theology* (Los Angeles: Theosophy Co., 1931).
7. Francis King, *Sexuality, Magic and Perversion* (New York: Citadel, 1974), p. 118.
8. Sybille Bedford, *Aldous Huxley: A Biography* (New York: Alfred A. Knopf and Harper & Row, 1974).
9. *Ibid.*
10. Institute for Policy Studies, "The First Ten Years, 1963-1973," Washington, D.C., 1974.
11. Humphrey Osmond, *Understanding Understanding* (New York: Harper & Row, 1974).
12. RAND Catalogue of Documents.
13. Gregory Bateson, *Steps to the Ecology of the Mind* (New York: Chandler, 1972).
14. Ralph Metzner, *The Ecstatic Adventure* (New York: Macmillan, 1968).
15. See Ronald William Clark, *The Huxleys* (New York: McGraw-Hill, 1968).
16. Michael Minnicino, "Low Intensity Operations: The Reesian Theory of War," *The Campaigner* (April, 1974).
17. R.D. Laing et al., *The Dialectics of Liberation* (London: Tavistock Press, 1967).
18. Theodor Adorno was a leading professor at the Frankfurt School of Social Research in Germany, founded by the British Fabian Society. A collaborator of twelve-tone formalist and British intelligence operative,

Arnold Schönberg, Adorno was brought into the United States in 1939 to head up the Princeton Radio Research Project. The explicit aim of this project, as stated in Adorno's *Introduction to the Sociology of Music*, was to program a mass "musical" culture that would steadily degrade its consumers. Punk rock is, in the most direct sense, the ultimate result of Adorno's work.

19. Theodor Adorno, *Introduction to the Sociology of Music* (New York: Seabury Press, 1976).

20. Paul Hirsch, "The Structure of the Popular Music Industry: The Filtering Process by Which Records are Preselected for Public Consumption," Institute for Social Research's Survey Research Center Monograph, 1969.

21. Ronald W. Clark, *The Life of Bertrand Russell* (New York: Alfred A. Knopf, 1976), p. 457.

22. *Illinois Crime Commission Report*, 1969. The Institute for Policy Studies (IPS) was established in 1963 by Marcus Raskin, a former National Security Advisor under NSC Director McGeorge Bundy, and Richard Barnett, a former State Department Advisor on Arms Control and Disarmament. Among the Board of Trustees of IPS were Thurmond Arnold, James Warburg, Philip Stern, and Hans Morgenthau, with seed money from the Ford Foundation (later to be headed by McGeorge Bundy). IPS has functioned as the "New Left" think tank and control center for local community control, community mental health centers and direct terrorist organizations. In its report "The First Ten Years," the Institute lists among its lecturers and fellows members of the Weathermen group, known associates of the Japanese Red Army, the Puerto Rican terrorist Armed Forces of National Liberation (FALN), and the Black Liberation Army. See also Carter and the Party of *International Terrorism*, Special Report by the U.S. Labor Party, August, 1976.

23. Mary Jo Warth, "The Story of Acid Profiteers," *Village Voice*, August 22, 1974.

24. *Ibid.*

25. *Ibid.*

26. *Ibid.*

27. Hutchinson, Vesco.

## PART V

# The Drug Lobby: The Criminals Come Out in the Open

In California, laws are now before the state legislature that would decriminalize all drug use on the grounds that this would free law enforcement and judicial agencies to deal with "more serious crime." The sponsor of that bill is State Representative Willie Brown, a paid lobbyist for Resorts International.

That's the tip-off to the real nature of the Drug Lobby. Britain's secret army of organized crime is now out in the open demanding the expansion of its dope market.

Since 1973, when Watergate finished off Nixon's attempt to shut down the drug trade, the Drug Lobby has succeeded in decriminalizing marijuana in nine states. In every case, the result has been an immediate outbreak of drug abuse of epidemic proportions. According to Dr. Peter Bensing, Director of the Drug Enforcement Administration, the decriminalization of marijuana in the state of Maine additionally opened the coastal area as a major smuggling center for marijuana, cocaine, and heroin.

By the open admission of the Drug Lobbyists, legalized proliferation of marijuana is just the foot-in-the-door for eventual

legal cocaine and heroin proliferation. Dr. Peter Bourne, who until 1978 was President Carter's special advisor on drug abuse, making him the highest ranking federal drug enforcement officer, has appeared on nationwide television to advocate national legalization of cocaine.

A systematic campaign to legalize heroin use has been underway since 1977. A bill was placed before the state legislature of Ohio and narrowly defeated in committee in 1977 removing heroin from the list of Category I drugs (those drugs outlawed for even medical use). New Mexico and Florida — both states identified by the DEA as major distribution points for heroin — have bills presently pending that would, like the Ohio bill, legalize the use of heroin under medical supervision in cases of terminal illness and for "experimental purposes." When a similar bill was briefly enacted in New York (in 1919, coincident with Prohibition), the widely documented consequences were an immediate jump in heroin addiction, far in excess of the number of "officially registered" patients.

At present, two Zionist Lobby sponsored bills are before the U.S. Congress that would nationally legalize marijuana: the Javits-Koch bill and the Kennedy-authored S.1437 which thoroughly overhauls the Federal Criminal Codes on a British "common law" basis.

## Kennedy's drug-death Cult

The U.S. Drug lobby is run out front by the Most Venerable Military and Hospitaller Order of St. John of Jerusalem.

In the 11th century, the Knights-Hospitallers had organized hospices as a "death cult" where the sick were administered hallucinogenic drugs *instead of medical treatment*. The hospices became known as the dissemination point for drugs and lethal poisons, often targeted at the Knights' humanist adversaries.

In 1967, the Order of St. John resurrected the 11th century hospice movement at St. Christopher's Hospice in London. Here, "patients" are administered a "pain-killer" called the Brompton Mixture. It consists of heroin, cocaine, alcohol, tranquilizers, and

chloroform water. It is administered every three hours — until the patient dies. (1)

In 1977, the Order of St. John launched a hospice movement in the United States. It advocates the decriminalization of heroin and cocaine — on the "humanitarian" grounds that everyone has the human right to die as he or she sees fit.

To propagate the hospice movement here, the Order founded the National Committee on the Treatment of Intractable Pain (NCTIP). Its honorary chairman is Lady Mary Ward, a British specialist in the hospice movement who founded Hospice, Inc. in Connecticut as the first operating "death clinic" in the U.S. The director of the NCTIP is another British national, Arthur Trebach. A professor at the Center for the Administration of Justice at the American University in Washington, D.C., Trebach is also the Director of the Institute on Drugs, Crime and Justice in Britain. For the past five years, Trebach has sponsored hundreds of U.S. medical students, professional physicians, and others for special indoctrination sessions at the Imperial College of Science and Technology, University of London. The theme of the session is the "success" of Britain's policy of legalizing heroin in curbing the illegal drug problem. (2)

In the United States, the Hospice, Inc. is financed by the Kaiser Foundation, which includes on its board Kingman Brewster, current U.S. Ambassador to the Court of St. James and also a member of the Order of St. John. The Kaiser Foundation's participation in Britain's Opium War dates back to at least 1958, when Dr. Timothy Leary conducted his first experiments with LSD at the Foundation's Kaiser Experimental Hospital in San Francisco.

The other institution currently involved in financing the hospice project is the Joseph and Rose Kennedy Institute for the Study of Human Reproduction and Bioethics at Georgetown University. (3)

In October, 1978, the first annual National Hospice Organizing Meeting took place in Washington, D.C.; the two keynote speakers were Senator Edward Kennedy, now chairman of the Senate Judiciary Committee and a ranking member of the Senate Public Health Committee, and Secretary of Health, Education and Welfare Joseph Califano.

The Order of St. John also maintains significant influence on the board of directors of the Ford Foundation, the world's largest tax exempt funding conduit for dionysian cults. On the board are John Loudon, a Commander in the Knights of St. John, the chairman of Royal Dutch Shell, and the present President of the World Wildlife Fund (the funding conduit for the terrorist component of the environmentalist movement worldwide) (4) and Eugene Black, another Knight and former director of the World Bank. The foundation's current policy thrust was charted during the 1951-54 period when its associate director and policy formulator was Knights Commander Robert M. Hutchins, whom we met earlier as a controller of the Capone mob.

The Ford Foundation gives multimillion dollar annual grants directly to the Royal Institute of International Affairs; it is also the principal funder of the Drug Lobby in the U.S. In 1972, the Foundation established the Drug Abuse Council with a \$1 million war chest which has been refilled every year since. (5)

As its first public act, the Drug Abuse Council issued a widely circulated report advocating the decriminalization of marijuana, a tenfold increase in methadone (synthetic heroin) clinics, and the British system of legalized government-sponsored heroin addiction. Following the release of that report, the Kaiser Foundation and the Commonwealth Fund established a matching fund that more than doubled the annual revenues available to the Drug Abuse Council to push drug legalization.

## Jacob Javits and organized crime

From this level down, the so-called "liberal" drug decriminalization lobby is *thoroughly interlocked with organized crime*, by those forces whose monetary interest lies in the expansion of the drug market.

The interlock is keyed around the Zionist Lobby, and more precisely around the person of Senator Jacob Javits (R-N.Y.).

It has been reported by several knowledgeable sources that Senator Javits gets his orders several times a week at private

planning briefing sessions at a number of exclusive New York City apartments. Among those present are Arthur Ross of London's International Institute for Strategic Studies and a sub-agent of Rio Tinto Zinc's Mark Turner, Rio Tinto Zinc's Sam Harris, Nahum Bernstein of the Jerusalem Foundation, and Warburg, Pincus's Henry Simon Bloch. This, in turn, is the same circle that maintains ownership of the Bronfman family.

Startling evidence of this Bronfman-Javits relationship surfaced in 1977 when bribery and extortion were employed to pass a marijuana decriminalization bill through the New York State Legislature and to subsequently cover up the findings of a legislative investigating committee that showed a 300 percent jump in adolescent marijuana abuse in the state following decrim. As the sponsor since 1968 of legislation to federally decriminalize marijuana, Javits (along with cosponsor Edward Koch, now Mayor of New York City) was the most outspoken organizer for the New York State marijuana legalization bill.

During the 1977 legislative session, the bill was defeated. In an unprecedented move pushed by the senior U.S. Senator, Governor Carey personally conducted a pressure campaign on behalf of a *reintroduced version of the same bill*, which passed by one vote in June, 1977. The decisive vote was cast by a severely ill hospitalized member of the legislature who was helicoptered back and forth from his sickbed by state police on personal orders from the Governor.

These extraordinary measures were perhaps clarified several weeks later when Edgar Bronfman made a personal "loan" to Carey of \$350,000 to pay off the Governor's outstanding 1974 campaign debts. The loan was in violation of state and federal campaign financing laws.

Like the Bronfman family itself, Javits's direct connections to organized crime and drug trafficking run deep. According to affidavits on file from the Internal Revenue Service and the Securities and Exchange Commission, Javits functions as a listening post and conduit of classified government information for the Lansky syndicate.

In one recently publicized incident, Javits provided Lansky and other crime figures with information on IRS moves to secretly



shut down a multibillion dollar tax loophole that enabled mob investors in the domestic coal industry to claim 500 percent tax writeoffs on their investments. Through Javits's "tip" Lansky and Co. made a huge, final move to take over the independent coal operators 24 hours before the new codes went into effect. Another crime figure implicated in the coal industry killing was Richard L. Herring, a Georgia-based intermediary of Robert Vesco. In addition to his involvement in the creation of the offshore Caribbean "dirty money" apparatus through Investors Overseas Services, Vesco is a known collaborator of Lansky's in running the Caribbean Silver Triangle drug traffic in heroin, cocaine, and marijuana. (6)

Javits's links to Lansky and Vesco surfaced in yet another context in October, 1978. After a several ton marijuana bust off the coast of Massachusetts, the defendants were represented in court by James Lawson, the head of the state chapter of the National Organization for the Reform of Marijuana Laws (NORML). NORML is the principal public lobby for the decriminalization of marijuana and addictive drugs in the U.S. Sitting on its Advisory Board is Sen. Jacob Javits. Evidence surfaced in the course of the trial that the front money for the captured marijuana shipment had been provided by Meyer Lansky and Robert Vesco. (7)

Should there be any lingering doubt in the reader's mind that Javits is a witting conspirator in the campaign to poison the country through drugs, the following should be considered. From 1940 to 1942 Javits was the Assistant to the Chief of Chemical Warfare, Office of Strategic Services. From 1954 to 1956, as New York State Attorney General, Javits administered a clandestine experiment on the effects of LSD in conjunction with the Central Intelligence Agency. At least one active duty military officer died as the result of being given an unsolicited dose of LSD — an incident which Javits covered up and which only came to light through recent Freedom of Information Act disclosures. (8)

Javits is, of course, the unofficial public head of the Zionist Lobby in the United States. He is the National Chairman of the Anti-Defamation League of B'nai B'rith, and a board member of the American Jewish Committee, the Zionist Organization of America, and the Amer-Israel Cultural Foundation.

## Kennedy's NORML

Next to Jacob Javits, the most outspoken drug lobbyist in Washington, D.C. is Senator Edward Kennedy, the sponsor of the other pending marijuana decriminalization bill. As the new chairman of the Senate Judiciary Committee, Kennedy has necessarily steered away from Javits's open lobbying posture on behalf of drugs in order to maintain a modicum of credibility among the powerful law enforcement lobby. Yet the Kennedy family is directly represented on NORML's advisory board by ex-brother-in-law Peter Lawford.

Like Javits, Kennedy too is up to his neck in Lansky-Vesco offshore criminal activities. At the top of Kennedy's 1976 campaign contributors list is Joseph Linsey, a leading Zionist Lobby "philanthropist," who is also known as the kingpin of organized crime in New England. Linsey is a business partner of Meyer Lansky in the International Airport Hotel Distributing, Inc.

The Kennedy fortunes are even more directly linked to Lansky through the already documented Resorts International-Intel interface. Nowhere is this interface more evident than in New Jersey, where a combination of Justice Department "water-gating specialists" teamed with a \$1 million Resorts International lobbying and payoff campaign to legalize casino gambling.

New Jersey Governor Brendan Byrne, who was recruited out of the Essex County Prosecutor's office by the Kennedy Justice hands and installed in the Governor's mansion, is a nationally prominent spokesman for drug decriminalization. As Chairman of the Law Enforcement Assistance Administration (LEAA) National Advisory Committee on Criminal Justice Standards and Goals, Byrne commissioned a series of studies supporting decriminalization of marijuana and casino gambling.

NORML, the clearinghouse organization for the various local Dionysian cults and Zionist Lobby "liberal" legislators, is itself a thinly veiled cover through which the poisoning influence of organized crime is extended into the high schools and neighborhoods of the country. NORML is virtually indistinguishable from the drug cult-pornographic magazine *High Times*, which boasts a

several hundred thousand circulation predominantly among high school age drug users. The magazine features dozens of pages of advertisements for drug paraphernalia, instructions on the production and use of legal and illicit drugs, and pornographic photographs and interviews with various "high priests" of the drug-rock cult. Through the revenues of *High Times*, through an average of \$100,000 per year in tax exempt grants from the Playboy Foundation, and through "frequent anonymous contributions from drug dealers," NORML is financed. (9)

The Advisory Board of NORML includes (in addition to Javits and Peter Lawford): Max Palevsky, chairman of the board of the Xerox Corporation; Hugh Hefner, owner of Playboy Enterprises, Inc.; William F. Buckley Jr.; Burton Joseph, Director of the Playboy Foundation; Canon Walter D. Dennis of the Cathedral of St. John the Divine in New York City, the "temple and headquarters" of the Order of St. John of Jerusalem in the United States; and Stewart Mott, heir to the General Motors fortune.

NORML's general counsels Michael Kennedy and Gerald Lefcourt, are also connected to terrorism through their defense of the Puerto Rican FALN (Armed Forces for National Liberation) and Weatherunderground leader Mark Rudd.

## Notes

### V. THE DRUG LOBBY

1. Karen Steinherz and Marie Mendez, "The Hospice Movement — Taking the Pain Out of Genocide," *New Solidarity*, Vol. IX, No. 62, October 6, 1978. See also Sandol Stoddard, *The Hospice Movement* (Briarcliff Manor, New York: Stein & Day, 1978).
2. Seminar listings for the Fifth Institute on Drugs, Crime and Justice in Britain, held in London in July 1978. The Institute has held five such annual conferences at the Imperial College of the University of London, bringing American university students and American public health officials to study drug abuse in Britain and the "British Model" of treatment.
3. Steinherz and Mendez, *op. cit.*
4. *Who's Who in America* (Chicago: Marquis, 1974); Annual Reports of the World Wildlife Fund of America, 1976 and 1977; see also, *The Foundation Directory*, 5th Edition (New York: The Foundation Center).
5. Ford Foundation Annual Reports, 1972-78, and The Drug Abuse Council Annual Reports, 1972-77.
6. NBC-TV News broadcast transcript, "Coal Fraud," Reporters Ross and Silverman, September, 1978.
7. Federal District Court Records of the First Circuit Court, Boston, Massachusetts. Additional information was provided on drug charges by New England-based officials of the Drug Enforcement Administration in September, 1978.
8. In 1976, following Congressional hearings into the intelligences community, the files pertaining to the Central Intelligence Agency's MK-ULTRA, BLUEBIRD and ARTICHOKE programs were released to the public. The FOIA documents reveal extensive details of the CIA and Army's experiments with mind control techniques including LSD. In 1977, Renée J. Roberts, the daughter of Harold Bauer who died as the result of a dosage of a hallucinogenic drug administered to him at the New York State Psychiatric Institute as part of an Army-contracted experiment, began a civil damages suit against officials responsible for failing to investigate the circumstances of her father's death. Sen. Jacob Javits is a defendant in that suit, stemming from his position as New York State Attorney General at the time of Bauer's death.
9. Interview with Keith Stroup, *Playboy Magazine*, 1978; see also issues of NORML Newsletter describing anonymous contributions.

# Epilogue

On October 18, 1978, the authors of this book met in Washington, D.C., with eight officials of the Federal Reserve Board of Governors, including Mr. John E. Ryan, director of Banking Supervision and Regulation, and Mr. Robert Mannion, director of the Board of Governors' legal department. Present were two lawyers for the Hongkong and Shanghai Bank, including the HongShang's chief legal counsel in the United States, Mr. Steuart L. Pittman. At this meeting, the authors presented evidence incriminating the HongShang in the international narcotics traffic and argued that the Federal Reserve should block HongShang's proposed acquisition of 51 percent of the shares of the \$20 billion Marine Midland Bank of New York. On October 25, a similar meeting was held with officials of the New York State Banking Authority, including New York State Deputy Superintendent of Banking William Heany.

Also, portions of the manuscript have circulated in photostat form for several weeks prior to publication through the State Department, Treasury Department, Drug Enforcement Administration, and related enforcement and regulatory agencies.

In public meetings and radio and television appearances in a dozen cities in the United States, the authors have outlined the contents of this book before a broad and diverse audience. Through these various channels, word has gotten out.

Most readers will have asked themselves the question that the authors have been asked often in the course of this report's preparation: "How will the powerful men who stand behind the narcotics traffic react to this exposure?" The answer is already evident, at least in part. On November 11, European collab-

orators of the U.S. Labor Party team conducted a public meeting in Paris to present the results of the investigation. The meeting was attacked by 20 hooded and armed members of the fascist organization, Betar. French police were on guard and prevented injuries to members of the audience, but one policeman was injured by the assault. The French authorities believe that the attack was ordered by the Mossad, Israel's foreign secret service. The Betar was founded in the 1930s by Yakob Jabotinsky, a Polish Zionist who modeled himself on Benito Mussolini, and who was the mentor of present Israeli Prime Minister Menachem Begin. Undoubtedly, the decision to launch an attack against not only the collaborators of the authors, but the French police — who know well how to deal with such matters — indicates a great fear in the perpetrators of the narcotics traffic.

What this report has intersected, however, goes far beyond the petty thuggery of the Mossad. Discreetly, officials of the HongShang warned the authors shortly after the cited meetings in Washington what would happen to the United States if they persisted: "You know, of course," an official said, "that the British government has made representations to the American authorities on behalf of the HongShang, which is after all a British bank. American banks have had pretty much a free run of it all in London, and we British rather feel that we should have the same privileges here. If the American authorities give us any trouble, the Bank of England will start exhuming skeletons from the closets of the American banks."

In fact, the British had already surfaced an undercover agent in New York's Citibank in mid-July, a junior official named David Edwards, who sued the bank for \$14 million and made numerous allegations of illegal money transfer operations. Recently, after the HongShang official made the statement quoted above, the Edwards case has taken a new turn. On November 5, Katharin Graham's *Washington Post* added major new exposé material to Edwards's original allegations, citing its own sources inside Citibank. The authors have learned that Katharin Graham is personally directing Edwards's appearances before one Senate and three House of Representatives committees.

Coming at a time when the British banks are making a massed bid to acquire American banking assets, the inside-outside job against Citibank is ominous. Apart from the HongShang's cited plan to acquire Marine Midland, the Canadian Bank of Montreal wants to buy out 81 retail branches of New York's Bankers Trust; Standard and Chartered Bank wants to buy up the \$3 billion Union Bank of California; and buy-out attempts or branch office openings are in the works involving Barclays Bank, National Westminster Bank, Bank Leumi, Bank Hapoalim, and other financial institutions implicated in the world narcotics traffic. An invasion is on against the already weakened American monetary system, and the evidence suggests that the British dope-runners are deliberately seeking to destabilize American banks to further this invasion.

Apart from the dirty tricks operations aimed at American banks, numerous other attempts will emerge from the dope-traffickers to cushion themselves from the impact of this report. Lower-level operatives, expendable portions of the network may be sacrificed, the way that assassins like Lee Harvey Oswald or Sirhan Sirhan were sacrificed by their masters.

But the enemy cannot recoup what it has lost. The \$200 billion dope trade cannot be hidden; it can only be protected through misdirection. The web of lies now hangs in tatters. If the American public forces its legislators and law enforcement officials to act, Dope, Inc.'s defense will no longer avail. The first blood has already been drawn from a group of gentlemen who have been long accustomed to working at a distance from the combat zone. The terms of the battle have been redrawn to make an American victory possible.

*Konstandinos Kalimtgis*

*David Goldman*

*Jeffrey Steinberg*

New York City

November 17, 1978

## Index

## A

- Abergavemy, Lord, 336  
 Addams, Jane, 46, 47  
 Adloff, R., 90  
 Adorno, Theodor, 373  
 Air America, 151  
 Airport Hotel Distributing, Inc., 389  
 Albert Parvin Foundation, 49  
 Aleman, Miguel, 285  
 Alinsky, Saul, 48, 371  
 Alpert, Richard, 370, 372, 377  
 American Friends Service Committee, 347-348  
 Andreyev, M.A., 97, 108, 109, 131-133, 137  
 Angleton, James Jesus, 319  
 Anglo-American Corp., 100, 101, 103, 142, 154, 155, 176  
 Anslinger, Harry, 125, 126, 128  
 Anti-Saloon League, 45, 47  
 Arbuckle, William, 279  
 Aristotelian Society, iv, 216  
 Aspen Institute, 96  
 Astor family, 38-39, 40, 45, 293  
 Astor, John Jacob, 38-39, 42, 153  
 Astor, Waldorf, 42, 153  
 Atlas Shipping Company, 272

## B

- "Baba Ram Das," 102  
 Bacardi family, 285  
 Bacon family, 40  
 Bacon, Sir Ranulph, 325, 327  
 Ba'hai cult, 46  
 Bahamas, 44, 71-73, 74-77, 92, 264, 309, 322, 326, 377  
 Bakunin, Mikhail, 26, 28  
 Balfour, Arthur, 178, 216  
 Bancroft, Baron Stormon, 311-312  
 Bank of Bangkok, 81, 85, 86-87, 89  
 Bank of China, 116, 119, 123, 132, 145, 150  
 Bank of England, 26, 72, 74, 394  
 Bank für Gemeinwirtschaft, 313  
 Bank Hapoalim, 101, 302, 305, 311, 312, 313, 319, 395

- Bank Leumi, 101, 104, 154, 155, 219, 311, 312, 319, 349, 395  
 Bank of the Middle East, 44, 94, 101, 141, 159  
 Bank of Montreal, 29, 30, 81, 166, 170, 279, 395  
 Bank of Norfolk, 336  
 Bank of Nova Scotia, 81, 101, 105, 140, 162, 163, 166, 167, 168, 171, 172  
 Bank of World Commerce, 309, 310, 326  
 Bannister, Guy, 305-306, 319  
 Banque de Crédit Internationale (BCI), 309, 312, 313, 321, 325  
 Banque Bruxelles-Lambert, 104  
 Banque Louis Dreyfuss, 281  
 Banque Privée, 74  
 Barbados, 71-73  
 Barclays Bank, 101, 104, 105, 153, 162, 166, 172, 176, 219, 311, 348, 395  
 Baring Brothers, 158  
 Baring family, 10, 19, 39, 40, 348  
 Baring, George, 13  
 Baring, N., 158  
 Barnett, A. Doak, 131  
 Baruch, Dr. Kuttner, 27-28  
 Baruch, Bernard, 28  
 Basel, 264, 302, 308, 309  
 Baseler Handelsbank, 74  
 Bateson, Gregory, 370, 371-372  
 Beaverbrook, Lord, 45, 46, 299, 305  
 Belisle, David, 327  
 Belmont, August, 27, 34, 35  
 Benjamin, Judah P., 27, 29, 30  
 Bensinger, Peter, 383  
 Bentham, Jeremy, 39  
 Bernstein, Nahum, 387  
 Betar, 394  
 Bingham, William, 39-40  
 Binny, J.A.F., 74, 156, 159, 166  
 Bittman, William, 297, 340  
 Black, Eugene, Sr., 386  
 Blair and Co., 292  
 Blavatsky, Helena, 182, 216, 367, 368  
 Bloch, George, 316  
 Bloch, Henry Simon, 387  
 Bloomfield, Major Louis Mor-timer, 30, 283, 301, 303-304, 305, 306, 307, 308, 310, 313, 318, 319, 325, 327

- Canadian Jewish Congress, 281  
 Canadian Pacific, Ltd., 165, 168, 169, 170, 172, 179, 271, 279, 281  
 Canadian Red Cross Ambulance Corporation, 284  
 Capocetto, 313, 316  
 Capone, Al, 47, 48, 274, 386  
 Caribbean Anti-Communist League, 306  
 Carolla, Sylvestro, 37  
 Carter, James Earl, 3, 75, 384  
 Castro, Fidel, 284, 299, 323  
 Cater, Jack, 111  
 Cator, W.J., 87  
 Catto, Lord, 41, 158, 159  
 Cavendish, C.W., Duke of Devonshire, 165  
 Cavendish, William, 165, 294  
 Cayman Islands, 70, 71-73, 74, 75, 76  
 Cecil, Lord Robert, 145, 181  
 Cellini, Dino, 322, 328  
 Cellini, Eddie, 328  
 Center for the Study of Democratic Institutions, 49, 378  
 Central External Liaison Department, 119, 120  
 Central Intelligence Agency (CIA), 93, 128, 149, 252, 318  
 Central Narcotics Board, 23  
 Central Selling Organization (CSO), 63, 67, 104  
 Centro Mondiale Commerciale (CMC), 303, 310, 313, 316  
 Chamberlain, Houston Stewart, 182  
 Ch'ao Chou Chinese, 81, 85-86, 90, 103, 104, 117, 124, 129-134, 137  
 Charterhouse Japhet, 79, 81, 104, 141, 154, 157, 311, 344, 348  
 Chartered Bank, 10, 132, 144  
 Chase Manhattan Bank, 114, 136  
 Chen, K.P., 145, 150  
 Chen Yi, 148  
 Chesler, Louis, 322, 324, 326  
 Chiang Kai-shek, 132, 148, 150, 151  
 Chi Ch'ao-ting, 143  
 China Association, 142, 159  
 China, People's Republic of, 42, 51, 60-61, 78, 93, 99, 113-138, 139, 145, 168, 221, 342  
 Chinese Arts and Crafts, 119  
 Chinese Communist Intelligence Service (CCIS), 115, 117, 119-120, 121, 126, 129, 131, 142  
 Chinese General Chamber of Commerce, 118, 119  
 Chinese People's Institute of Foreign Affairs, 146
- B'nai B'rith, 26, 27, 28, 31, 33, 34, 316, 319, 338, 342, 388  
 Bolles, Don, 330, 332, 334, 335, 339  
 Borghese, Elisabeth Mann, 367, 378  
 Boudine, James, 346-347  
 Boudine, Robert, 346-347  
 Bourne, Peter, 371, 384  
 Brewster, Kingman, 385  
 British Petroleum, 141, 152, 154, 156, 164  
 British Secret Intelligence Service, 45, 46, 121, 306  
 British Special Air Service, 287  
 Brompton mixture, 384  
 Bronfman, Abe, 270  
 Bronfman, Allan, 281  
 Bronfman, Charles, 170, 172, 279, 281  
 Bronfman, Edgar, 5, 220, 282, 283, 285, 387  
 Bronfman family, 11, 36, 47, 50, 62, 141, 162-163, 164, 165, 166, 172, 173, 219, 220, 268, 269-276, 280-288, 290, 319, 332, 333, 341, 343, 387  
 Bronfman, Harry, 272  
 Bronfman, Mitchell, 285-287  
 Bronfman, Phyllis, 284  
 Bronfman, Samuel, 3, 31, 270, 272, 280-283, 288  
 Bronfman, Samuel II, 284-285  
 Bronfman, Yechiel, 33, 36, 269-271  
 Brotherhood of Eternal Love, 377  
 Brown, Rudnick, Freed, Gesmar, 290  
 Brown, Willie, 383  
 Bruce, Charles, 377  
 Bruce, Edward, 181  
 Bruce family, 18, 176, 218; family tree, 223-240  
 Bruce, Frederick, 180  
 Bruce, James, 180, 216  
 Bruce, King Robert, 179, 180  
 Buckley, William F., Jr., 390  
 Bulwer-Lytton, Edward, 178, 181, 182, 215, 216, 217, 367, 368  
 Bundy, McGeorge, 298  
 Burbridge, F.S., 279
- Caccia, Lord, 155, 156  
 Campaign to Re-Elect Hugh Carey, 268  
 Canadian Imperial Bank, 101, 166, 168, 171, 172  
 Canadian Institute of International Affairs, 146, 161, 162, 163, 168, 173

## C

Chou En-lai, 113, 114, 126, 137, 142, 145, 146, 151, 152, 168, 169, 181  
 Churchill, Winston, 146, 147, 220, 221, 292, 306, 317, 366  
 Citibank, 71, 394, 395  
 Clarke, William Malpas, 156  
 Clarkson and Gordon, 162, 169  
 Clarkson, Stephen, 162  
 Clay, William, 343  
 Cleveland, Harlan, 96  
 Cliveden Set, 293, 375  
 Cliveden, Avern, 342  
 Cohen, Lazarus, 281  
 Cohen, Lyon, 281  
 Colosimo, Big Jim, 274  
 Combined Jewish Philanthropies of Boston, 290  
 Commonwealth Fund, 386  
 Communist Labor Party, 342  
 Consolidated Gold Fields of South Africa, 94, 96, 99, 103, 123, 157, 158  
 Consolidated Holdings, Ltd., 121  
 Cornfeld, Bernard, 49, 325, 378  
 Corporate Bank and Trust Company of Freeport, Grand Bahamas, 286  
 Cotoni, Giuseppe, 323  
 Coudert Brothers, 75  
 Crédit Suisse, 304, 310  
 Cremieux, Adolphe Isaac, 29  
 Crosby, James M., 323-324  
 Crosby-Miller Co., 323  
 Crowley, Aleister, 182, 367, 368  
 Crown-Lundheimer mob, 334  
 Cult of Mizraem, 31  
 Cunard Shipping Lines, 312

## D

D-16, 121  
 Dalla Chiesa, General Carlo, 317, 318  
 Dalitz, Morris, 333, 334  
 D'Amelio, Carlo, 317  
 Davis, Jefferson, 29, 30  
 Deacon, Richard, 119, 120, 121, 137, 249  
 De Beers, 63, 67, 100, 101, 103, 104, 144, 154, 155, 219  
 de Gaulle, Charles, 36, 287, 299, 302, 303, 306  
 de Gunzburg family, 221, 281, 328  
 de Hirsch family, 26, 29, 33, 270, 319  
 de Hirsch Foundation, 268, 280  
 DeMenil, John, 318  
 de Molay, Jacques, 179  
 Dennis, Canon Walter D., 390

## F

Fabian Society, 46  
 Fair Play for Cuba Committee, 306  
 Farmer, Victor, 143, 147  
 Federal Bureau of Investigation (FBI), 296, 327; Division Five, 305, 307, 317, 318, 328  
 Ferdman, Sylvain, 310, 313  
 Ferris, David, 319  
 Ferris, Paul, 96  
 Fidelity Bank of Philadelphia, 347  
 Fidelity Guards, 122  
 Fiduciary Trust Company, 326, 377  
 Firstmark Corporation, 338  
 First National Bank of Boston, 41  
 First Pennsylvania Bank, 346

Fisher, Max, 339, 341, 343  
 Fliegenheimer, Arthur, aka Dutch Schultz, 271, 274  
 Fleming, Ian, 329  
 Fok, Henry, 118  
 Forbes, John Murray, 40  
 Forbes, William Hathaway, 40  
 Forcas Aramadas de Liberación Nacional (FALN), 347  
 Ford Foundation, 378, 386  
 4-Star Anstalt, 377  
 "French Connection," 125  
 Freuhauf Trucking Company, 341  
 Friedman, Milton, 48  
 Front pour la Libération du Québec (FLQ), 287  
 Fund of Funds, 378

**G**

Gandhi, Mahatma, 21  
 Garrison, Jim, 30, 36, 301, 303, 316, 317, 318  
 Geddes, Sir Auckland, 219  
 George III, 13, 178  
 Gilmer, John, 169, 172  
 Gilsyd Corporation, 338  
 Giordano, Anthony, 332, 343  
 Girard, Stephen, 40  
 Gold Seal Liquor Company, 48  
 Golden Triangle, 59, 60, 64-65, 66, 72, 78-80, 81, 85, 92-95, 108, 128, 132, 133, 136, 139  
 Goldsmid family, 26, 101, 267  
 Gordon, Walter Lockhart, 146, 161, 162, 166, 168, 169, 170, 173  
 Graiver, David, 312, 355  
 Great Britain-China Committee, 142, 159  
 Green, Charles Fiddian, 122  
 Green Gangs, 145, 151, 277, 278, 337, 343  
 Green Shirt Nazis, 31  
 Green, Timothy, 94, 95  
 Grey, Albert, 178, 215  
 Grierson, Ronald, 156

**H**

Haganah, 281, 311  
 Hagerman, Max, 316  
 Hague Convention (1911), 20-21  
 Haig, Field Marshal, 272  
 Haight-Ashbury, 372  
 Hardinge, Viscount, 336  
 Harris, Sam, 387

Hart, Sir Robert, 41  
 Hartford, Huntington, 323  
 Harvard University, 41, 102, 370  
 Haushofer, Erich, 215, 216  
 Hayden, Stone and Co., 291  
 Hazel Park Racing Association, 332  
 Hefner, Hugh, 390  
 Heikal, Mohammed, 125, 126  
 Heritage Canada, 284  
 Herring, Richard L., 388  
 Herzen, Alexander, 28  
 Hesselbach, Walter, 322  
 High Times, 389-390  
 Hill, Samuel, 157, 158, 162, 163  
 Histadrut, 284, 302, 304, 311, 319  
 Hitchcock, William Mellon, 376-378  
 Hitler, Adolf, 31, 182, 215-216, 217, 266  
 Ho, Stanley, 91, 118, 119, 120, 152  
 Ho Yin, 119  
 Hoffa, Jimmy, 297  
 Hog Island, 323, 325  
 Holland, William, 143, 149, 152  
 Holloman, Daniel, 297, 340  
 Hong Kong, British Crown Colony of, 10-11, 16, 20, 37, 44, 60, 71, 72, 74, 75, 76, 77, 79, 80, 82-84, 88, 97, 99, 100, 104, 106, 112, 114, 116, 118, 123, 125, 126-129, 134-136, 139, 149, 153  
 Hongkong and Shanghai Banking Corporation, 10, 12, 17, 19, 22, 40, 59, 62, 69, 75, 79, 80, 81, 83-87, 92-94, 96-97, 99, 100, 101, 103, 106, 108, 110, 111, 114, 117, 123, 124, 130-133, 140, 141, 150, 152, 154, 156, 163, 164, 165, 166, 172, 175, 176, 177, 179, 181, 182, 218, 219, 220, 278, 279, 338, 339, 393, 394-395; London Committee of, 39, 41, 140, 142, 157, 158, 159, 172  
 Hong Kong Jockey Club, 118, 119  
 Hong Kong Land Company, 116  
 Hospice, Inc., 385  
 House Select Committee on Drug Abuse, 126  
 Hudson's Bay Company, 163-165, 166, 171, 219, 270, 279, 292, 333  
 Hundley, William, 297, 324, 325, 327  
 Hutchins, Robert Maynard, 48, 368-369, 378  
 Huxley, Aldous, iv, 182, 216, 366-371, 375, 376, 378  
 Huxley, Thomas, 366  
 Huiien-Fa, 86  
 Hutein-Hsiang, 86

## I

Illinois Wholesale Liquor Dealers Association, 48  
 Imperial Chemical Industries, 143  
 Imperial Chinese Customs Service, 41  
 Inchcape and Co., 102, 217  
 Inchcape family, 164, 176, 277  
 Inchcape, Earls of, 22, 102, 157-158, 219-220, 279  
 Inchcape Report, 22, 102  
 Independent Commission Against Corruption, 111-112, 118  
 India, British Crown Colony of, 13, 15, 16, 18, 20, 21, 28, 30, 94, 95, 96, 180, 215, 222  
 India Commission, 22  
 Indonesian Communist Party, 130  
 The Innocents, 35  
 Institute on Drugs, Crime and Justice, 385  
 Institute for Pacific Relations, 42, 141, 143, 145, 146, 147, 149, 150, 151, 159, 162, 168, 169  
 Institute for Policy Studies, 376  
 Institute of Social Research, 373  
 International Airport Hotel Systems, Inc., 290  
 International Institute for Strategic Studies, 387  
 International Intelligence (Interrel), 297, 321-329, 343  
 International Monetary Fund, 75, 148, 167  
 International Red Cross, 218  
 Inverforth, Lord, 292  
 Investors Overseas Service (IOS), 49, 309, 310, 325, 377, 378, 388  
 Isis-Urania Temple of Hermetic Students of the Golden Dawn, 367  
 Israeli-American Leasing, 338  
 Israeli Continental Corporation, 283, 303, 312  
 Isrop S.A., 338  
 Italo-American Hotel Corporation, 313

## J

Jackman, Henry R., 173  
 Jackson, Henry "Scoop," 264, 337  
 Jacobs family, 4, 290, 330-343  
 Jacobs, Jeremy, 334, 335, 338, 339, 340, 343  
 Jacobs, Max, 76, 297, 334, 335, 337, 338, 339

Keswick, Sir William Johnston, 147, 152, 156, 158, 164, 165, 170, 218, 279  
 King, William MacKenzie, 46  
 Kipling, Rudyard, 43, 173, 216  
 Kissinger, Henry, 51, 113, 126, 340  
 Kittikachorn, Narong, 85  
 Kiwanis Club of Singapore, 130  
 Kleinwort Benson, 156, 157, 164  
 Knight, Andrew, 156  
 Knight, Sir Arthur, 156  
 Knights of Columbus, 32, 54  
 Knights of the Golden Circle, 27, 28  
 Knights Templar, 179  
 Koch, Edward, 384, 387  
 Kottler, Murray, 284, 336  
 Koler, William, 324, 325  
 Koskoff, David E., 294  
 Kuhn Loeb, 45, 220, 270, 292  
 Kui Kwing Company, 116  
 Ku Klux Klan, 27-28, 34, 35, 46-47, 177  
 Kuomintang, 148, 151

## L

Lain, R.D., 372  
 Lambert family, 104  
 Lambert, Jean, 282  
 Lansky, Meyer, 3, 5, 11, 37, 44, 50, 263, 275, 278, 285, 290, 297, 307, 308-309, 313, 317, 322, 324, 325, 326, 327, 328, 333, 343, 367, 377, 378, 387, 388  
 LaRouche, Lyndon H., iii-iv, v, 342  
 Latourette, Dr. Kenneth Scott, 38  
 Lawford, Peter, 389-390  
 Lawson, James, 388  
 Lazard family, 27, 34, 221  
 Lazard Frères, 176, 177, 293  
 League of Nations, 21, 22, 44, 102, 220  
 Leary, Timothy, 102, 370, 372, 376, 385  
 Lefcourt, Gerald, 390  
 Lehman Brothers, 19  
 Lehman family, 19, 34  
 Lethby and Christopher, Ltd., 331, 336  
 Levi, Edward, 335  
 Lewin, Dr. Kurt, 376  
 Liechtenstein, 70, 71, 76, 264, 308, 309, 338, 377  
 Ligue Internationale contre l'Anti-Sémitisme (LICA), 316  
 Lin, Dr. Paul, 146, 168-169  
 Lin Tse-hsu ping, 14, 15, 16, 145  
 Lin, Dr. Tsing, 169

## M

Macheca, Joseph, 34-36, 341  
 Mackay, J.W., 3rd Earl of Inchcape, 157-158, 219-220, 279  
 Mackay-Tallack, Sir Hugh, 220  
 MacMillan Bloedel, 165, 170, 298  
 Macmillan, Harold, 165, 298  
 Magna Development Company, 119  
 Malnik, Alvin, 309  
 Malthus, Thomas, 10  
 Manichaean cult, 46  
 Mantello, Enrico, 303, 318  
 Mantello, George, aka George Mandel, 303, 316  
 Mao Tse-tung, 61, 137, 142, 148  
 Marathon Oil Company, 341  
 Marcello, Carlos, 37, 265, 317  
 Marden, John, 111  
 Marine Midland Bank, 75, 337-339, 393, 395  
 Mary Carter Paint Company, 271, 322, 325, 377  
 Matheson family, 10, 14-15, 19, 40, 100, 164, 217, 219  
 Matheson, Hugh, 217  
 Matrenga, Charles, 34, 36  
 Mattei, Enrico, 36, 302-303, 307, 317  
 Mazzini, Guisepe, 10, 28, 33, 34-35, 47  
 McCarran Committee, 143, 149-150  
 McClellan Committee, 276  
 McCleary, Donald, 287  
 McCrary, Tex, 324  
 McFadyean, Sir Andrew, 143, 147, 148

## K

Kahn, Otto, 221  
 Kaiser Foundation, 385-386  
 Kan Kuam Tsing Company, 99  
 Kao, C.H., 119  
 Katzenberg, Yasha, 218, 276  
 Keith, Sir Kenneth, 163, 282  
 Keng Biao, 120  
 Kennedy, Edward, 5, 266, 289, 300, 384, 385, 389-390  
 Kennedy family, 11, 50, 221, 289-300  
 Kennedy, John F., 10, 30, 36, 71, 123, 165, 289, 295, 296, 298-299, 301, 376  
 Kennedy, Joseph P., Sr., 43-44, 48, 165, 290-296, 299, 367  
 Joseph and Rose Kennedy Institute for the Study of Human Reproduction and Bioethics, 385  
 Kennedy, Kathleen, 294  
 Kennedy, P.J., 291  
 Kennedy, Robert F., 290, 296-297, 299, 327  
 Kennedy, Michael, 390  
 Kennedy, Thomas, 297  
 Kelsey, Ken, 371, 372  
 Keswick family, 3, 10, 11, 141, 164, 176, 217, 218, 221  
 Keswick, Henry Neville Lindley, 116, 156, 158, 165, 170, 218, 219  
 Keswick, Sir John Henry, 100, 140-141, 142, 145, 146, 147, 148, 149, 152, 153, 156, 158, 159, 217, 218, 277, 278

## L

Lain, R.D., 372  
 Lambert family, 104  
 Lambert, Jean, 282  
 Lansky, Meyer, 3, 5, 11, 37, 44, 50, 263, 275, 278, 285, 290, 297, 307, 308-309, 313, 317, 322, 324, 325, 326, 327, 328, 333, 343, 367, 377, 378, 387, 388  
 LaRouche, Lyndon H., iii-iv, v, 342  
 Latourette, Dr. Kenneth Scott, 38  
 Lawford, Peter, 389-390  
 Lawson, James, 388  
 Lazard family, 27, 34, 221  
 Lazard Frères, 176, 177, 293  
 League of Nations, 21, 22, 44, 102, 220  
 Leary, Timothy, 102, 370, 372, 376, 385  
 Lefcourt, Gerald, 390  
 Lehman Brothers, 19  
 Lehman family, 19, 34  
 Lethby and Christopher, Ltd., 331, 336  
 Levi, Edward, 335  
 Lewin, Dr. Kurt, 376  
 Liechtenstein, 70, 71, 76, 264, 308, 309, 338, 377  
 Ligue Internationale contre l'Anti-Sémitisme (LICA), 316  
 Lin, Dr. Paul, 146, 168-169  
 Lin Tse-hsu ping, 14, 15, 16, 145  
 Lin, Dr. Tsing, 169

## L

Lain, R.D., 372  
 Lambert family, 104  
 Lambert, Jean, 282  
 Lansky, Meyer, 3, 5, 11, 37, 44, 50, 263, 275, 278, 285, 290, 297, 307, 308-309, 313, 317, 322, 324, 325, 326, 327, 328, 333, 343, 367, 377, 378, 387, 388  
 LaRouche, Lyndon H., iii-iv, v, 342  
 Latourette, Dr. Kenneth Scott, 38  
 Lawford, Peter, 389-390  
 Lawson, James, 388  
 Lazard family, 27, 34, 221  
 Lazard Frères, 176, 177, 293  
 League of Nations, 21, 22, 44, 102, 220  
 Leary, Timothy, 102, 370, 372, 376, 385  
 Lefcourt, Gerald, 390  
 Lehman Brothers, 19  
 Lehman family, 19, 34  
 Lethby and Christopher, Ltd., 331, 336  
 Levi, Edward, 335  
 Lewin, Dr. Kurt, 376  
 Liechtenstein, 70, 71, 76, 264, 308, 309, 338, 377  
 Ligue Internationale contre l'Anti-Sémitisme (LICA), 316  
 Lin, Dr. Paul, 146, 168-169  
 Lin Tse-hsu ping, 14, 15, 16, 145  
 Lin, Dr. Tsing, 169

## L

Lain, R.D., 372  
 Lambert family, 104  
 Lambert, Jean, 282  
 Lansky, Meyer, 3, 5, 11, 37, 44, 50, 263, 275, 278, 285, 290, 297, 307, 308-309, 313, 317, 322, 324, 325, 326, 327, 328, 333, 343, 367, 377, 378, 387, 388  
 LaRouche, Lyndon H., iii-iv, v, 342  
 Latourette, Dr. Kenneth Scott, 38  
 Lawford, Peter, 389-390  
 Lawson, James, 388  
 Lazard family, 27, 34, 221  
 Lazard Frères, 176, 177, 293  
 League of Nations, 21, 22, 44, 102, 220  
 Leary, Timothy, 102, 370, 372, 376, 385  
 Lefcourt, Gerald, 390  
 Lehman Brothers, 19  
 Lehman family, 19, 34  
 Lethby and Christopher, Ltd., 331, 336  
 Levi, Edward, 335  
 Lewin, Dr. Kurt, 376  
 Liechtenstein, 70, 71, 76, 264, 308, 309, 338, 377  
 Ligue Internationale contre l'Anti-Sémitisme (LICA), 316  
 Lin, Dr. Paul, 146, 168-169  
 Lin Tse-hsu ping, 14, 15, 16, 145  
 Lin, Dr. Tsing, 169

## L

Lain, R.D., 372  
 Lambert family, 104  
 Lambert, Jean, 282  
 Lansky, Meyer, 3, 5, 11, 37, 44, 50, 263, 275, 278, 285, 290, 297, 307, 308-309, 313, 317, 322, 324, 325, 326, 327, 328, 333, 343, 367, 377, 378, 387, 388  
 LaRouche, Lyndon H., iii-iv, v, 342  
 Latourette, Dr. Kenneth Scott, 38  
 Lawford, Peter, 389-390  
 Lawson, James, 388  
 Lazard family, 27, 34, 221  
 Lazard Frères, 176, 177, 293  
 League of Nations, 21, 22, 44, 102, 220  
 Leary, Timothy, 102, 370, 372, 376, 385  
 Lefcourt, Gerald, 390  
 Lehman Brothers, 19  
 Lehman family, 19, 34  
 Lethby and Christopher, Ltd., 331, 336  
 Levi, Edward, 335  
 Lewin, Dr. Kurt, 376  
 Liechtenstein, 70, 71, 76, 264, 308, 309, 338, 377  
 Ligue Internationale contre l'Anti-Sémitisme (LICA), 316  
 Lin, Dr. Paul, 146, 168-169  
 Lin Tse-hsu ping, 14, 15, 16, 145  
 Lin, Dr. Tsing, 169

## L

Lain, R.D., 372  
 Lambert family, 104  
 Lambert, Jean, 282  
 Lansky, Meyer, 3, 5, 11, 37, 44, 50, 263, 275, 278, 285, 290, 297, 307, 308-309, 313, 317, 322, 324, 325, 326, 327, 328, 333, 343, 367, 377, 378, 387, 388  
 LaRouche, Lyndon H., iii-iv, v, 342  
 Latourette, Dr. Kenneth Scott, 38  
 Lawford, Peter, 389-390  
 Lawson, James, 388  
 Lazard family, 27, 34, 221  
 Lazard Frères, 176, 177, 293  
 League of Nations, 21, 22, 44, 102, 220  
 Leary, Timothy, 102, 370, 372, 376, 385  
 Lefcourt, Gerald, 390  
 Lehman Brothers, 19  
 Lehman family, 19, 34  
 Lethby and Christopher, Ltd., 331, 336  
 Levi, Edward, 335  
 Lewin, Dr. Kurt, 376  
 Liechtenstein, 70, 71, 76, 264, 308, 309, 338, 377  
 Ligue Internationale contre l'Anti-Sémitisme (LICA), 316  
 Lin, Dr. Paul, 146, 168-169  
 Lin Tse-hsu ping, 14, 15, 16, 145  
 Lin, Dr. Tsing, 169

## L

Lain, R.D., 372  
 Lambert family, 104  
 Lambert, Jean, 282  
 Lansky, Meyer, 3, 5, 11, 37, 44, 50, 263, 275, 278, 285, 290, 297, 307, 308-309, 313, 317, 322, 324, 325, 326, 327, 328, 333, 343, 367, 377, 378, 387, 388  
 LaRouche, Lyndon H., iii-iv, v, 342  
 Latourette, Dr. Kenneth Scott, 38  
 Lawford, Peter, 389-390  
 Lawson, James, 388  
 Lazard family, 27, 34, 221  
 Lazard Frères, 176, 177, 293  
 League of Nations, 21, 22, 44, 102, 220  
 Leary, Timothy, 102, 370, 372, 376, 385  
 Lefcourt, Gerald, 390  
 Lehman Brothers, 19  
 Lehman family, 19, 34  
 Lethby and Christopher, Ltd., 331, 336  
 Levi, Edward, 335  
 Lewin, Dr. Kurt, 376  
 Liechtenstein, 70, 71, 76, 264, 308, 309, 338, 377  
 Ligue Internationale contre l'Anti-Sémitisme (LICA), 316  
 Lin, Dr. Paul, 146, 168-169  
 Lin Tse-hsu ping, 14, 15, 16, 145  
 Lin, Dr. Tsing, 169

## L

Lain, R.D., 372  
 Lambert family, 104  
 Lambert, Jean, 282  
 Lansky, Meyer, 3, 5, 11, 37, 44, 50, 263, 275, 278, 285, 290, 297, 307, 308-309, 313, 317, 322, 324, 325, 326, 327, 328, 333, 343, 367, 377, 378, 387, 388  
 LaRouche, Lyndon H., iii-iv, v, 342  
 Latourette, Dr. Kenneth Scott, 38  
 Lawford, Peter, 389-390  
 Lawson, James, 388  
 Lazard family, 27, 34, 221  
 Lazard Frères, 176, 177, 293  
 League of Nations, 21, 22, 44, 102, 220  
 Leary, Timothy, 102, 370, 372, 376, 385  
 Lefcourt, Gerald, 390  
 Lehman Brothers, 19  
 Lehman family, 19, 34  
 Lethby and Christopher, Ltd., 331, 336  
 Levi, Edward, 335  
 Lewin, Dr. Kurt, 376  
 Liechtenstein, 70, 71, 76, 264, 308, 309, 338, 377  
 Ligue Internationale contre l'Anti-Sémitisme (LICA), 316  
 Lin, Dr. Paul, 146, 168-169  
 Lin Tse-hsu ping, 14, 15, 16, 145  
 Lin, Dr. Tsing, 169

## L

Lain, R.D., 372  
 Lambert family, 104  
 Lambert, Jean, 282  
 Lansky, Meyer, 3, 5, 11, 37, 44, 50, 263, 275, 278, 285, 290, 297, 307, 308-309, 313, 317, 322, 324, 325, 326, 327, 328, 333, 343, 367, 377, 378, 387, 388  
 LaRouche, Lyndon H., iii-iv, v, 342  
 Latourette, Dr. Kenneth Scott, 38  
 Lawford, Peter, 389-390  
 Lawson, James, 388  
 Lazard family, 27, 34, 221  
 Lazard Frères, 176, 177, 293  
 League of Nations, 21, 22, 44, 102, 220  
 Leary, Timothy, 102, 370, 372, 376, 385  
 Lefcourt, Gerald, 390  
 Lehman Brothers, 19  
 Lehman family, 19, 34  
 Lethby and Christopher, Ltd., 331, 336  
 Levi, Edward, 335  
 Lewin, Dr. Kurt, 376  
 Liechtenstein, 70, 71, 76, 264, 308, 309, 338, 377  
 Ligue Internationale contre l'Anti-Sémitisme (LICA), 316  
 Lin, Dr. Paul, 146, 168-169  
 Lin Tse-hsu ping, 14, 15, 16, 145  
 Lin, Dr. Tsing, 169

## L

Lain, R.D., 372  
 Lambert family, 104  
 Lambert, Jean, 282  
 Lansky, Meyer, 3, 5, 11, 37, 44, 50, 263, 275, 278, 285, 290, 297, 307, 308-309, 313, 317, 322, 324, 325, 326, 327, 328, 333, 343, 367, 377, 378, 387, 388  
 LaRouche, Lyndon H., iii-iv, v, 342  
 Latourette, Dr. Kenneth Scott, 38  
 Lawford, Peter, 389-390  
 Lawson, James, 388  
 Lazard family, 27, 34, 221  
 Lazard Frères, 176, 177, 293  
 League of Nations, 21, 22, 44, 102, 220  
 Leary, Timothy, 102, 370, 372, 376, 385  
 Lefcourt, Gerald, 390  
 Lehman Brothers, 19  
 Lehman family, 19, 34  
 Lethby and Christopher, Ltd., 331, 336  
 Levi, Edward, 335  
 Lewin, Dr. Kurt, 376  
 Liechtenstein, 70, 71, 76, 264, 308, 309, 338, 377  
 Ligue Internationale contre l'Anti-Sémitisme (LICA), 316  
 Lin, Dr. Paul, 146, 168-169  
 Lin Tse-hsu ping, 14, 15, 16, 145  
 Lin, Dr. Tsing, 169

## L

Lain, R.D., 372  
 Lambert family, 104  
 Lambert, Jean, 282  
 Lansky, Meyer, 3, 5, 11, 37, 44, 50, 263, 275, 278, 285, 290, 297, 307, 308-309, 313, 317, 322, 324, 325, 326, 327, 328, 333, 343, 367, 377, 378, 387, 388  
 LaRouche, Lyndon H., iii-iv, v, 342  
 Latourette, Dr. Kenneth Scott, 38  
 Lawford, Peter, 389-390  
 Lawson, James, 388  
 Lazard family, 27, 34, 221  
 Lazard Frères, 176, 177, 293  
 League of Nations, 21, 22, 44, 102, 220  
 Leary, Timothy, 102, 370, 372, 376, 385  
 Lefcourt, Gerald, 390  
 Lehman Brothers, 19  
 Lehman family, 19, 34  
 Lethby and Christopher, Ltd., 331, 336  
 Levi, Edward, 335  
 Lewin, Dr. Kurt, 376  
 Liechtenstein, 70, 71, 76, 264, 308, 309, 338, 377  
 Ligue Internationale contre l'Anti-Sémitisme (LICA), 316  
 Lin, Dr. Paul, 146, 168-169  
 Lin Tse-hsu ping, 14, 15, 16, 145  
 Lin, Dr. Tsing, 169

## L

Lain, R.D., 372  
 Lambert family, 104  
 Lambert, Jean, 282  
 Lansky, Meyer, 3, 5, 11, 37, 44, 50, 263, 275, 278, 285, 290, 297, 307, 308-309, 313, 317, 322, 324, 325, 326, 327, 328, 333, 343, 367, 377, 378, 387, 388  
 LaRouche, Lyndon H., iii-iv, v, 342  
 Latourette, Dr. Kenneth Scott, 38  
 Lawford, Peter, 389-390  
 Lawson, James, 388  
 Lazard family, 27, 34, 221  
 Lazard Frères, 176, 177, 293  
 League of Nations, 21, 22, 44, 102, 220  
 Leary, Timothy, 102, 370, 372, 376, 385  
 Lefcourt, Gerald, 390  
 Lehman Brothers, 19  
 Lehman family, 19, 34  
 Lethby and Christopher, Ltd., 331, 336  
 Levi, Edward, 335  
 Lewin, Dr. Kurt, 376  
 Liechtenstein, 70, 71, 76, 264, 308, 309, 338, 377  
 Ligue Internationale contre l'Anti-Sémitisme (LICA), 316  
 Lin, Dr. Paul, 146, 168-169  
 Lin Tse-hsu ping, 14, 15, 16, 145  
 Lin, Dr. Tsing, 169

## L

Lain, R.D., 372  
 Lambert family, 104  
 Lambert, Jean, 282  
 Lansky, Meyer, 3, 5, 11, 37, 44, 50, 263, 275, 278, 285, 290, 297, 307, 308-309, 313, 317, 322, 324, 325, 326, 327, 328, 333, 343, 367, 377, 378, 387, 388  
 LaRouche, Lyndon H., iii-iv, v, 342  
 Latourette, Dr. Kenneth Scott, 38  
 Lawford, Peter, 389-390  
 Lawson, James, 388  
 Lazard family, 27, 34, 221  
 Lazard Frères, 176, 177, 293  
 League of Nations, 21, 22, 44, 102, 220  
 Leary, Timothy, 102, 370, 372, 376, 385  
 Lefcourt, Gerald, 390  
 Lehman Brothers, 19  
 Lehman family, 19, 34  
 Lethby and Christopher, Ltd., 331, 336  
 Levi, Edward, 335  
 Lewin, Dr. Kurt, 376  
 Liechtenstein, 70, 71, 76, 264, 308, 309, 338, 377  
 Ligue Internationale contre l'Anti-Sémitisme (LICA), 316  
 Lin, Dr. Paul, 146, 168-169  
 Lin Tse-hsu ping, 14, 15, 16, 145  
 Lin, Dr. Tsing, 169

## L

Lain, R.D., 372  
 Lambert family, 104  
 Lambert, Jean, 282  
 Lansky, Meyer, 3, 5, 11, 37, 44, 50, 263, 275, 278, 285, 290, 297, 307, 308-309, 313, 317, 322, 324, 325, 326, 327, 328, 333, 343, 367, 377, 378, 387, 388  
 LaRouche, Lyndon H., iii-iv, v, 342  
 Latourette, Dr. Kenneth Scott, 38  
 Lawford, Peter, 389-390  
 Lawson, James, 388  
 Lazard family, 27, 34, 221  
 Lazard Frères, 176, 177, 293  
 League of Nations, 21, 22, 44, 102, 220  
 Leary, Timothy, 102, 370, 372, 376, 385  
 Lefcourt, Gerald, 390  
 Lehman Brothers, 19  
 Lehman family, 19, 34  
 Lethby and Christopher, Ltd., 331, 336  
 Levi, Edward, 335  
 Lewin, Dr. Kurt, 376  
 Liechtenstein, 70, 71, 76, 264, 308, 309, 338, 377  
 Ligue Internationale contre l'Anti-Sémitisme (LICA), 316  
 Lin, Dr. Paul, 146, 168-169  
 Lin Tse-hsu ping, 14, 15, 16, 145  
 Lin, Dr. Tsing, 169

## L

Lain, R.D., 372  
 Lambert family, 104  
 Lambert, Jean, 282  
 Lansky, Meyer, 3, 5, 11, 37, 44, 50, 263, 275, 278, 285, 290, 297, 307, 308-309, 313, 317, 322, 324, 325, 326, 327, 328, 333, 343, 367, 377, 378, 387, 388  
 LaRouche, Lyndon H., iii-iv, v, 342  
 Latourette, Dr. Kenneth Scott, 38  
 Lawford, Peter, 389-390  
 Lawson, James, 388  
 Lazard family, 27, 34, 221  
 Lazard Frères, 176, 177, 293  
 League of Nations, 21, 22, 44, 102, 220  
 Leary, Timothy, 102, 370, 372, 376, 385  
 Lefcourt, Gerald, 390  
 Lehman Brothers, 19  
 Lehman family, 19, 34  
 Lethby and Christopher, Ltd., 331, 336  
 Levi, Edward, 335  
 Lewin, Dr. Kurt, 376  
 Liechtenstein, 70, 71, 76, 264, 308, 309, 338, 377  
 Ligue Internationale contre l'Anti-Sémitisme (LICA), 316  
 Lin, Dr. Paul, 146, 168-169  
 Lin Tse-hsu ping, 14, 15, 16, 145  
 Lin, Dr. Tsing, 169

</

- McLaney, Big Mike, 324  
 McLaughlin, W.E., 172  
 McKeon, Thomas J., 297, 328  
 Mellon, Andrew, 376  
 Messick, Hank, 308, 322  
 Metaphysical Society, 216  
 Meyer, André, 293, 296  
 Michener, Roland, 173  
 Midland Bank, 157, 158, 102-103, 166  
 Milner's Kindergarten, 43, 144  
 Milner, Lord, 43, 140, 144, 173, 178, 182, 215, 218, 219  
 Mills, Stanley, 297, 339  
 Mitchell, Parren, 343  
 MK-Ultra, 370  
 Mocatta family, 26, 267  
 Mocatta Metals, 100, 101, 103, 168  
 Monnet et Cie., 292  
 Montagu family, 101, 103  
 Samuel Montagu and Co., 101, 102, 103, 157, 159, 218  
 Montefiore family, 26, 27, 29, 33, 103, 270, 273, 280, 319  
 Montefiore, Lord Harold Sebag, 270  
 Montefiore, Sir Moses, 26, 28, 31, 267, 269  
 Morgan et Cie., 41, 156, 219  
 Morgan Grenfell, 41, 158  
 Morgan Guaranty Trust, 41  
 Morgan, J. Bartlett, 279  
 Morgan, J.P., 41  
 Moro, Aldo, 36, 74, 303  
 Morse, Samuel, 25  
 Mossad, 31, 102, 264, 302, 310, 311, 313, 327  
 Most Venerable Order of St. John of Jerusalem, 26, 31, 32, 35, 48, 168, 172, 173, 178, 179, 219, 222, 270, 281, 295, 312, 313, 348, 349, 384-385, 386, 390  
 Mott, Stewart, 390  
 "MOVE," 346-347  
 Movement for a New Society, 346-349  
 Mullin, Edward M., 328  
 Murder, Incorporated, 275, 326  
 Mussolini, Benito, 274, 306, 316  
 Mystics Art World, Inc., 377
- N**
- Nagy, Ferenc, 316, 317, 318  
 Nasser, Gamel Abdel, 113, 125-126, 137  
 National Basketball Association, 335  
 National Committee on the Treatment of Intractable Pain (NCTIP), 385  
 National Hospice Organizing Meeting, 1st Annual, 385  
 National Institute on Drug Abuse, 2  
 National Jewish People's Relief Committee (Canada), 281  
 National Organization for the Reform of Marijuana Laws (NORML), 388-390  
 National People's Congress, 132  
 National Security Agency (NSA), 327  
 National Westminster Bank, 155, 156, 166, 172, 395  
 Navasky, Victor, 296  
 New York Clearinghouse, 69, 70  
 New York Diamond Dealers Club, 104  
 Newbigging, David, 41  
 Newman, Peter, 283  
 Niagara Frontier Services, 338, 339  
 Nicholson, John Robert, 169  
 Nitti, Frank, 48  
 Nixon, Richard, 51, 66, 127-128, 332, 334, 337, 383  
 Noranda Mines, 101, 105, 167  
 Norman Bethune Institute, 146, 169  
 Nutt, Levi, 276
- O**
- Oberlin College, 46  
 O'Brien, Larry, 335  
 Obront, Willie, 285, 286  
 O'Connell, John D., 327  
 Odd Fellows, 27  
 Official Secrets Act (Canada), 161  
 Official Secrets Act (Great Britain), 161  
 Office of Strategic Services, 149, 388  
 Office of War Information, 149  
 "Operation Tradewinds," 324  
 Opium Wars, 9, 12-24, 222  
 Oppenheimer family, 104, 266  
 Oppenheimer, Sir Ernest, 104  
 Oppenheimer, Sir Harry, 103, 104, 154, 155  
 Order of the Golden Dawn, 177, 182  
 Order of the Sons of the Covenant, 27  
 Order of Zion, 10, 11, 26, 27, 28-29, 31, 32, 37, 177, 304  
 Organized Crime Strike Force, 296, 324, 327, 332, 333

- Organized Motherlove, 46  
 Ormsby-Gore, David (Lord Harlech), 298  
 Osmond, Dr. Humphrey, 368, 372  
 Ostiguy, J.P.W., 172  
 Oswald, Lee Harvey, 306  
 Overseas Chinese Affairs Committee, 132  
 Overseas Chinese Bank, 101  
 Overseas Chinese Industrial Construction Co., 135  
 Overseas Chinese Investment Corp., 135, 137  
 Oxford University, 43, 366  
 Oyler, Ralph, 276
- P**
- Pacific A Corporation, 338  
 Pacifica Foundation, 370  
 Paco Pharmaceuticals, 344-345  
 Pagoda North, 286  
 Paine, Thomas, 178  
 Palevsky, Max, 390  
 Pallavicini family, 317-318  
 Palmerston, Lord, 14-30, 45, 177, 181, 182, 215, 218, 367  
 Pang Hock-lim, 130-131  
 Pao San and Co., 99  
 Paradise Island, Grand Bahamas, 321, 323, 326, 328  
 Parravacini Bank Ltd., 377-378  
 Parravacini, Johann F., 377  
 Parry, Laurence, 122  
 Parvin-Dohrman Co., 378  
 Parvin Foundation, 378  
 Patriarcha, Raymond, 290, 333  
 Pease family, 220  
 Peixotto, Benjamin, 31  
 Pelouin, Robert, 297, 324, 325, 327, 339, 370  
 Peninsular and Orient Steam Navigation Company (P&O), 10, 19, 22, 79, 81, 141, 151, 164, 176, 219, 220, 279  
 J.C. Penney's, 377  
 Penwalt Pharmaceuticals, 344-345  
 Perceval, Spencer, 217  
 Perkins family, 40, 291  
 Perkins, Thomas Nelson, 41  
 Permindex, 30, 301-320, 321-329  
 Peterson, Henry, 297, 327, 340, 347  
 Philadelphia Foundation, 345-347, 348  
 Philadelphia Society of Friends, 346-347, 348-349
- Phillips, Bloomfield, Vineberg, and Goodman, 282, 304  
 Phillips, Captain Mark, 336  
 Phillips, Lazarus, 166, 282, 283, 304  
 Phillips, Neil, 166  
 Pierre-Bloch, Jean, 316  
 Pike, General Albert, 28, 33-35  
 Ping Chia-hsiang, 134  
 Pitt, William, 39  
 Playboy Foundation, 390  
 Pocock, Carmichael C.P., 156  
 Poe, Edgar Allan, 25, 63  
 Polizzi, Michael B., 332  
 Popper, Sir Karl, 216  
 Porter, Stephen, 22  
 Powell, Sir Richard, 155  
 Princess Anne, 336  
 Professional Sports Publications, 331  
 Progressive Liberal Party, 324  
 Prohibition, 3, 11, 42, 44-50, 140, 160, 164, 165, 166, 219, 376  
 "Protocols of the Elders of Zion," 32  
 Puerto Rican Socialist Party, 347  
 Pullman, John, 308, 313  
 Purcell, Victor, 87  
 Pure Drug Company, 164, 270, 279, 333  
 Purple Gang of Detroit, 334, 341
- R**
- Radziwill, Lee and Stanislaus, 295  
 RAND Corporation, 369  
 Raskin, Marcus, 376  
 Ray, James Earle, 302  
 Red Brigades, 28, 316, 317  
 Reinfeld Syndicate, 274, 292  
 Reinhart, H.R., 96, 97, 99  
 Rennie, Charles Tatham Ogilvy, 121  
 Rennie family, 120-122  
 Rennie, Gordon, 122  
 Rennie, Sir John, 121  
 Republic National Bank, 101  
 Resorts International, 290, 321-329, 343, 377, 383, 389  
 Rhodes, Cecil, 43, 100, 104, 144, 177, 178, 182, 218  
 Rhodes Trust, 216, 218  
 Rio Tinto Zinc, 19, 140, 154-155, 157, 158, 164, 217, 218, 219, 387  
 RKO Studios, 292, 367  
 Roberts, Sir Frank, 155, 157, 158  
 Robinson, J.R., 156, 157  
 Rocco, Mike, 290



- Rochdale College, 169  
 Rochwarger, Leonard, 338  
 Rockefeller family, 45  
 Rockefeller Foundation, 46  
 Rockefeller, John D., I, 46  
 Rohm and Haas, 344, 347  
 Romania, 31, 36, 177  
 Roosa, Robert V., 70  
 Roosevelt, Franklin D., 293, 306  
 Ronning, Chester, 146, 151, 152, 153, 168  
 Rosenbaum, Tibor, 305, 310, 311, 312, 319, 325  
 Rosicrucianism, 177, 182  
 Ross, Arthur, 387  
 Ross, William, 272  
 Rothschild, N.M. and Sons Ltd., 100, 101, 103, 154, 155, 162, 176  
 Rothschild, Edmond de, 74, 154, 155, 338  
 Rothschild family, 10, 19, 27, 28, 29, 33, 44, 103, 104, 105, 178, 221, 265, 268, 270, 280, 319, 325  
 Rothstein, Arnold, 44, 165, 273, 274, 277, 278, 308  
 Round Table, 43, 45, 145, 366, 374  
 Royal Bank of Canada, 101, 166, 167, 170, 172, 283, 328  
 Royal Commission on Customs, 272  
 Royal Dutch Shell, 141, 156, 386  
 Royal Institute of International Affairs (RIIA), 41, 42, 43, 60-61, 73, 117, 139-159, 164, 169, 177, 178, 215, 218, 295, 386  
 Royal Liquor Commission, 47  
 Rudd, Mark, 390  
 Ruskin, John, 178, 215, 216, 218  
 Russell and Company, 40, 41  
 Russell, Bertrand, iv, 17, 181, 216, 375  
 Russell, Lord John, 17, 181, 216  
 Bertrand Russell Peace Foundation, 376
- S**
- Russell Sage Foundation, 46-47  
 St. Christopher's Hospice, 384  
 Salerno, Ralph, 49  
 Sailors Union of Hong Kong, 80, 119  
 Samuel family, 103, 163  
 Samuel, Viscount Erwin Herbert, 312  
 Sandberg, M.G., 172  
 Sandis, George N., 29  
 Sandoz, A.G., 368, 370
- Sands, Sir Stafford, 322, 325  
 E.D. Sassoon, Ltd., 75  
 Sassoon family, 40, 268, 277  
 Savoy House of, 303, 317, 319  
 Saxe, Susan, 46, 347, 348  
 Schiff, Jacob, 27  
 Schlumberger Corporation, 316  
 Schoelkopf, Paul, 338  
 Schroeder family, 217, 220, 266  
 Scottish Rite of Freemasonry, 17, 25, 26-27, 28, 29, 37, 177, 180, 181, 182, 295  
 SDECE, 302, 303, 304  
 Seagram, 81, 164, 165-166, 167, 171-172, 269, 279, 281, 283, 285  
 Sebag-Montefiore, Robin, 338  
 Sebregondi, Paolo, 318  
 Sebregondi, Stefano, 318  
 Securex, 287  
 Seligman Bank of Zürich, 318  
 Seligman family, 278, 281, 282  
 Seligman, Hans, 318  
 Seligman, Joseph, 27  
 Semyonov, Julian, 307  
 Service, John S., 143, 146  
 Seymour, Horatio, 34-35  
 Shanghai, 20, 37, 44, 128, 147-150, 276-277  
 Shanghai Commercial Bank, 145, 150  
 Shanghai International Settlement, 20, 147, 279  
 Shanghai Municipal Settlements, 164, 218  
 Sharps Pixley Wardley, 93, 96, 100-101, 157, 164  
 Shaw brothers, 118  
 Shaw, Clay, 301-303, 318  
 Shaw, George Bernard, 294  
 Shwacross, Lord, 158, 159  
 Shenker, Morris, 333, 343  
 Sheridan, Walter, 296, 302, 327  
 Shih Tieh-pi, 125  
 Sicilian Compagnia Amatrice Industriale Petrolifera Armatrice, 316  
 Siegel, Benjamin "Bugs," 275, 367  
 Sime Darby, 101  
 Singer, Mike, 309  
 Singapore, 59, 71-73, 94, 108-109, 112  
 Sino-British Trade Council, 142, 159  
 Skinner, William, 87  
 Smith, Adam, 10, 13, 60-61  
 Smith, David, 371  
 Smith, Roger, 371  
 Smith, Kline and French, 344

- Socialist International, 302, 341  
 Society of Heaven and Earth — see Triad Society  
 Society of Jesus, 14, 26, 28  
 Somerset Importers, Ltd., 292-293  
 Soong family, 265, 278-279, 292  
 Sophonpanich, Chin, 81, 85-86, 89, 123, 131, 132  
 South China Enterprise Co., 135  
 Spadafora, Prince Gutierrez de, 313  
 Special Operations Executive (SOE), 216, 307  
 Sportsystems, 297, 327, 331, 339-340  
 Standard Bank, 100, 144  
 Standard and Chartered Bank, 81, 100, 101, 114, 116, 150, 157, 158, 220, 278, 395  
 Stanton, Edward, 29  
 Steiger, Sam, 334-335, 342  
 Stephenson, William, 305-307, 329  
 Stoker, Bram, 177  
 Straight, Willard, 41  
 Strong, Sir Kenneth, 163, 282  
 Students for a Democratic Society, 376  
 Sun Company, 116  
 Sun Life Assurance, 105  
 Sun Yat-sen, 148, 149  
 Suratt, John Harrison, 29  
 Susai Sugahara, 127  
 Swatow, 134  
 Sweet-Escott, B.A.C., 156-158  
 Swire family, 79, 140, 217, 338  
 Swire, John Kidston, 10, 81, 100, 140, 142, 154, 159  
 John Swire and Sons, 141, 154, 157
- T**
- Tammany Hall, 47, 274  
 Tavistock Institute, 372, 376  
 Tejapaibul, Udorn, 81, 85, 90  
 Teng Hsiao-p'ing, 116  
 Tennyson, Lord Alfred, 216  
 Theosophy, 177, 182, 216  
 Thompson, Jacob, 29  
 Thompson, Robert, 374  
 Thompson, V., 90  
 Thompson, William Boyce, 218, 219  
 Toronto Dominion Bank, 162, 166, 168, 171  
 Toronto Jockey Club, 336  
 Torrio, John, 274-276  
 Townshend family, 220, 282  
 Toynebee, Arnold, 215, 366  
 Toynebee Hall, 46
- Transcanada Transport Company, 271  
 Trebach, Arthur, 385  
 Trevelyan, Lord Humphrey, 141, 152-153, 154, 158-159, 164  
 Triad Society, 10, 11, 14, 20, 26, 28, 37, 86  
 Trizec Corporation, 162-163, 165, 171, 282  
 Tryon, Lord, 336  
 Turner, Sir Mark, 100, 102, 140, 154, 157, 158, 164, 217, 219, 387  
 Turner, Sir Michael, 156, 159, 172
- U**
- Union Bank of Israel, 104, 312  
 United Autoworkers (UAW), 18-19, 341  
 United Brands Company, 36, 37, 339, 340, 341  
 United Fruit Company, 36, 339, 341  
 United Jewish Appeal, 338, 340  
 U.S. Labor Party, v, 130, 342, 343, 394  
 University of Chicago, 46, 48
- V**
- Valley Die Cast Association, 332  
 Value Trend Holding Company, 286  
 Vancouver, 80, 112, 146, 168, 169, 170, 172  
 Vanying Bank, 123  
 Venceremos Brigade, 347, 348  
 Vesco, Robert, 328, 388  
 Villiers, George, 181  
 Villiers, Edith, 182  
 Villiers, Gerald Hyde, 217  
 Vincent, John Carter, 143  
 Vineberg, Phillip F., 283  
 Viondi, Countess, 318  
 Vladimirov, Peter, 142  
 J. Vontobel and Co., 377
- W**
- Wagner, Richard, 182  
 Walker, Elisha, 292  
 Wang Kwan-cheng, 118-119  
 Wang Ping-nan, 151, 152, 169  
 Warburg family, 45, 266, 270  
 Warburg, James, 368  
 Warburg Pincus, 387  
 Warburg, S.G., 156, 368  
 Ward, Lady Mary, 385

- Warren Commission, 29  
 Wathen, J.P.G., 157  
 Watts, Alan, 370, 372  
 Webb, Horace S., 297, 340  
 Weiss, Arnold, 335  
 Wheelock Marden, 111  
 Wheeler-Bennett, Sir John, 295-296  
 White Flag Communist Party, 133, 134  
 White, Harry Dexter, 148  
 William Penn Foundation, 346-347, 348  
 Williams, General Sir Fenwick, 29  
 Wiseman, Sir William, 45  
 Wolfe, R.D., 167  
 Wolf, Congressman Lester, 127  
 Wolmarans, Fred A., 122  
 Wong Hong Han Company, 95  
 Women's Christian Temperance Union, 45-47
- Wong Po-Shang, 108  
 World Wildlife Fund, 386  
 Woodcock, Leonard, 342  
 Woodhead, H.G.W., 278  
 Worlavington, Lord, 272  
 World Trade Mart, New Orleans, 301, 302, 319
- XYZ**
- York University, 146  
 Young Italy, 26, 28, 33  
 Yunnan Province, 66, 78, 84, 89, 128-129, 133  
 Zemurray, Samuel, 36, 341  
 Zerilli, Anthony, 332, 333  
 Zigiotto, Giuseppe, 317  
 Zionist Organization of Canada, 281  
 Zwillman, Abner "Longie," 274

**DOPE, INC.**

The New  
Benjamin Franklin House  
Publishing Company, Inc.

\$5.00

# DOPE, INC.

## Britain's Opium War against the U.S.

by a U.S. Labor Party Investigating Team

"In the war against drugs, as in all warfare, the essential point of a winning strategy is to strike the adversary's command structure while shattering his in-depth potentials for continued warfighting. No book could include every relevant detail of the drug network; the essential thing done here is to mark out the enemy's deployments and resources, for the purpose of crushing him with the aid of assaults on his most vulnerable flanks. After the war has been won, the courts and the historians will fill in the numerous details we have left out of account here."

—Lyndon H. LaRouche, Jr.  
Chairman, U.S. Labor Party

"Intriguing allegations ... not being ignored. 'It's got to be taken seriously,' says one HongKong and Shanghai bank official."

—Business Week

"Have you presented this evidence to the Justice Department for criminal prosecution yet?"

—Stewart L. Pittman  
Senior Partner in the law firm representing  
Hongkong and Shanghai Banking Corporation

"DOPE, INC. is a book of outstanding importance. It tells the history of a political strike against the United States in an undeclared war being waged by Great Britain."

—Mitchell WerBell  
former security and intelligence consultant to the  
U.S. government

"Unfortunately, the democratic right to be heard in the US demands that this flight of fancy be given due consideration, and the Hongkong bank's lawyers have had to formally deny the allegations and ask the Fed to refuse public hearings."

—Far Eastern Review

Cover design by Alan Yue

ISBN: 0-918388-08-2