

### Economic Growth

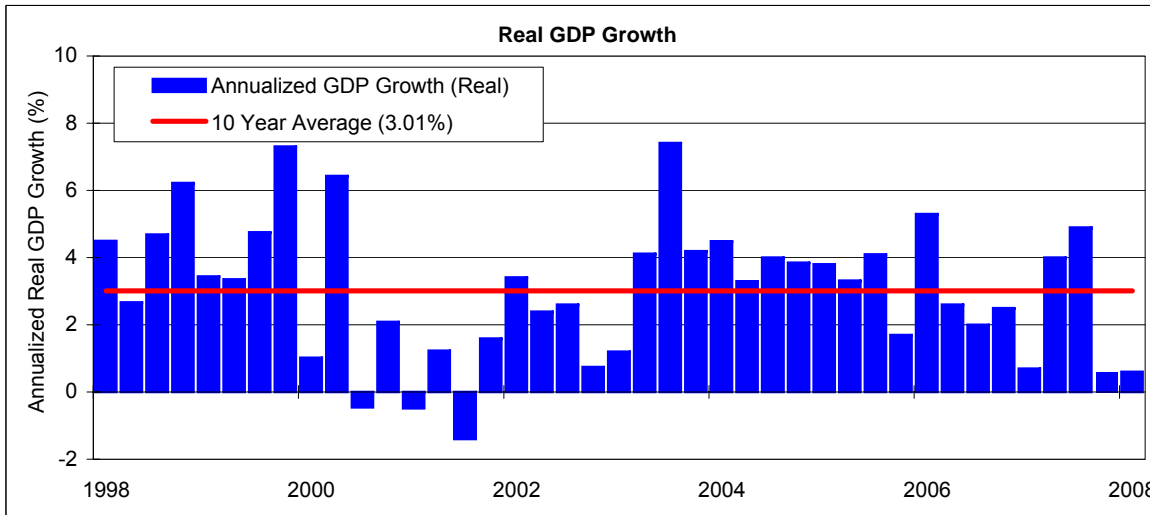

Source: Bureau of Economic Analysis. Green bar indicates preliminary estimate.

- According to preliminary estimates from the Commerce Department, real gross domestic product (GDP) increased at a 0.6% annualized rate during the first quarter. The positive growth was mostly attributed to higher exports and a build-up of business inventories. Without these two components, GDP would have fallen by 0.4% during the quarter.
- Consumer spending, which accounts for about 70% of GDP, rose only 1.0% during the first quarter, its slowest pace of growth since the second quarter of 2001.
- The housing market continued to weigh on GDP growth as residential fixed investment fell 26.7%, thereby reducing overall GDP by 1.23%.

### Inflation

- Consumer prices, as measured by the Consumer Price Index (CPI), rose at a 4.0% annual rate in March. The largest contributor to CPI was the energy index, which has risen 17.0% in the past year, largely as a result of higher oil prices.
- Excluding food and energy, consumer prices rose 2.4% year-over-year, reflecting smaller increases in the indices for shelter and medical care, coupled with a larger decline in the index for apparel.
- Within CPI, transportation and food experienced increases of 8.2% and 4.5% over the past year, respectively.

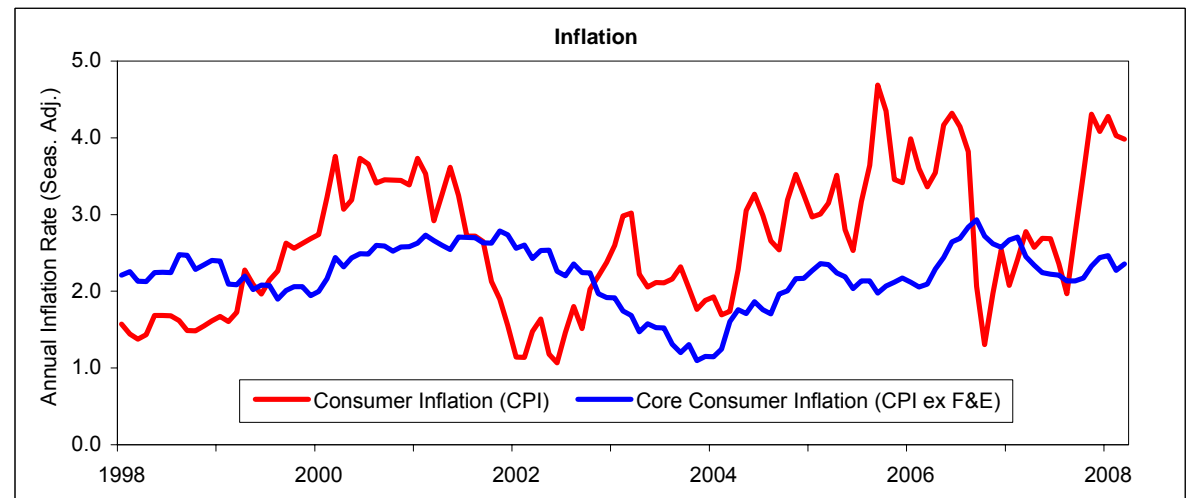

Source: Bureau of Labor Statistics; Federal Reserve Bank of St. Louis

Rev. 4/28/2008

### Consumer Confidence

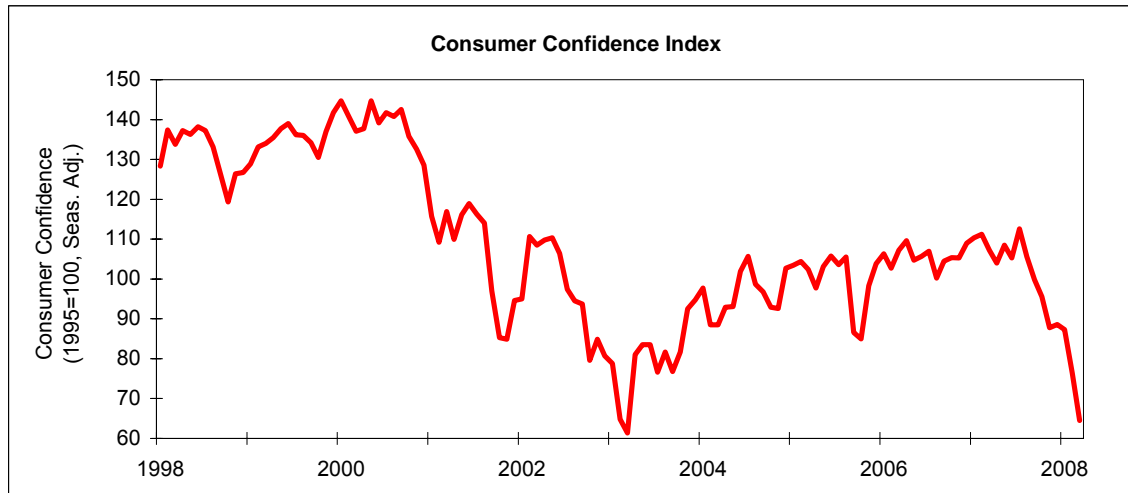

Source: The Conference Board

- The Conference Board's Consumer Confidence Index fell to 64.5 in March from 76.4 in February. This is the lowest reading of the index since March 2003 when the war in Iraq began.
- Consumers' appraisal of present-day conditions weakened further in March. Those claiming business conditions are "bad" increased to 25.4% from 21.3%, while those claiming business conditions are "good" dropped from 19.1% to 15.4%.
- The outlook for the labor market was also bleak. Consumers expecting fewer jobs in the months ahead increased to 29.0% from 28.0%, while those anticipating more jobs declined to 7.7% from 8.9%.

### Employment

- The number of unemployed persons increased by 434,000 to 7.8 million in March. In addition, the unemployment rate rose by 0.3% to 5.1%. Since March 2007, the number of unemployed persons has increased by 1.1 million while the unemployment rate has risen by 0.7%.
- Employment continued to fall in construction, manufacturing, and employment services, while health care, food services, and mining added jobs.
- The number of persons who worked part time for economic reasons was little changed in March at 4.9 million. However, the figure has risen by 629,000 over the past 12 months.

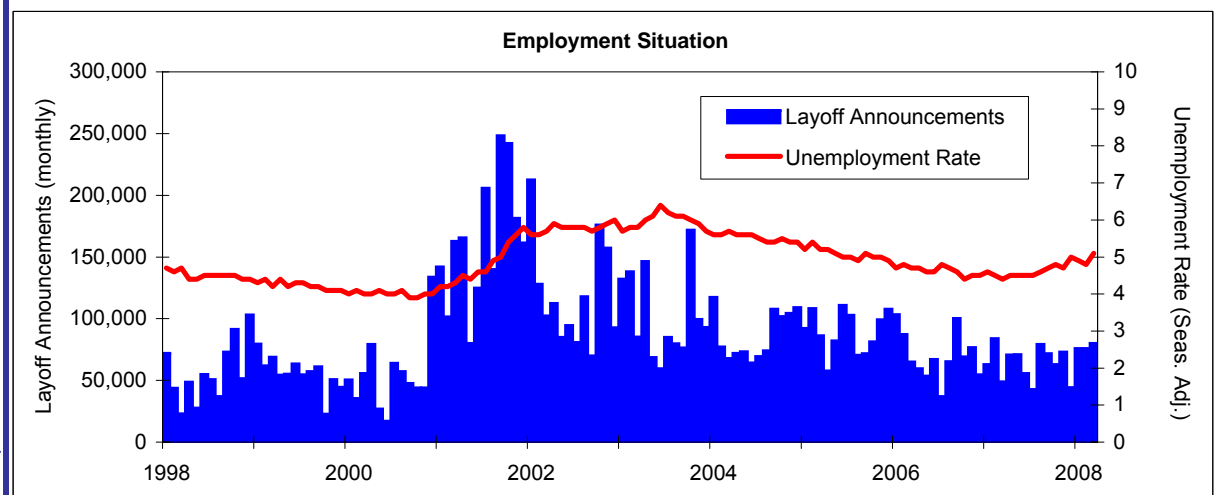

Source: Bureau of Labor Statistics; Challenger, Gray & Christmas, Inc.

Rev. 4/28/2008

# Market Environment

## U.S. Equity Market

First Quarter, 2008

### US Stock Market Highlights

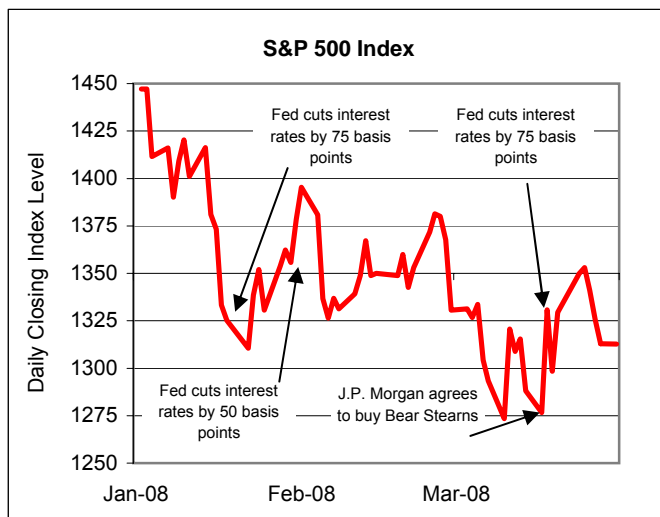

Source: Yahoo! Finance

### Sector Performance

	<u>Quarter</u>	<u>One Yr</u>
Consumer Disc.	(5.7)	(19.2)
Consumer Staples	(2.1)	9.3
Energy	(7.1)	21.7
Financials	(13.5)	(27.5)
Health Care	(11.5)	(6.1)
Industrials	(4.1)	6.1
Info. Technology	(15.2)	(0.2)
Materials	(3.6)	11.1
Telecom. Services	(13.7)	(10.0)
Utilities	(9.9)	(1.9)

- Despite the Federal Reserve's rate cuts, the S&P 500 fell 9.5% during the first quarter amid fears of a recession and credit crunch.
- During the quarter, information technology and telecom services were the worst performing sectors, returning -15.2% and -13.7% respectively. While consumer staples and materials were the top performing sectors, neither could not muster positive returns.
- Over the past year, the energy and materials sectors have benefited from higher commodity prices to return 22% and 11%, respectively.

### Equity Market Performance

- Value stocks made a recovery during the first quarter, outperforming growth stocks. This was a reversal from 2007 when growth outperformed value (as measured by the Russell 1000 indices) by 12%.
- Large and small caps performed roughly in line during the quarter with the Russell 1000 outperforming the Russell 2000 by only 40 basis points.
- In the first three months of 2008, the Dow Jones Industrial Average lost 1,001.93 points, its largest first-quarter drop since the inception of the index. In addition, the S&P 500 has experienced negative returns for five consecutive months, its longest losing streak since October 1990.

	<u>Quarter</u>	<u>YTD</u>	<u>One Yr</u>	<u>Three Yrs</u>	<u>Five Yrs</u>	<u>Ten Yrs</u>
<b><u>Core Index Performance:</u></b>						
Standard & Poor's 500	(9.5)	(9.5)	(5.1)	5.9	11.3	3.5
S&P 500 Equal Weighted	(8.6)	(8.6)	(9.8)	5.9	15.0	7.3
Dow Jones Industrial Average	(7.0)	(7.0)	1.6	7.8	11.4	5.5
Russell Top 200	(9.3)	(9.3)	(3.9)	5.7	10.3	2.6
Russell 1000	(9.5)	(9.5)	(5.4)	6.2	11.9	3.8
Russell 2000	(9.9)	(9.9)	(13.0)	5.1	14.9	5.0
Russell 3000	(9.5)	(9.5)	(6.1)	6.1	12.1	3.9
Russell Mid Cap	(10.0)	(10.0)	(8.9)	7.4	16.3	7.7
<b><u>Style Index Performance:</u></b>						
Russell 1000 Growth	(10.2)	(10.2)	(0.8)	6.3	10.0	1.3
Russell 1000 Value	(8.7)	(8.7)	(10.0)	6.0	13.7	5.5
Russell 2000 Growth	(12.8)	(12.8)	(8.9)	5.7	14.2	1.7
Russell 2000 Value	(6.5)	(6.5)	(16.9)	4.3	15.5	7.5

Rev. 4/28/2008

### Interest Rate Environment

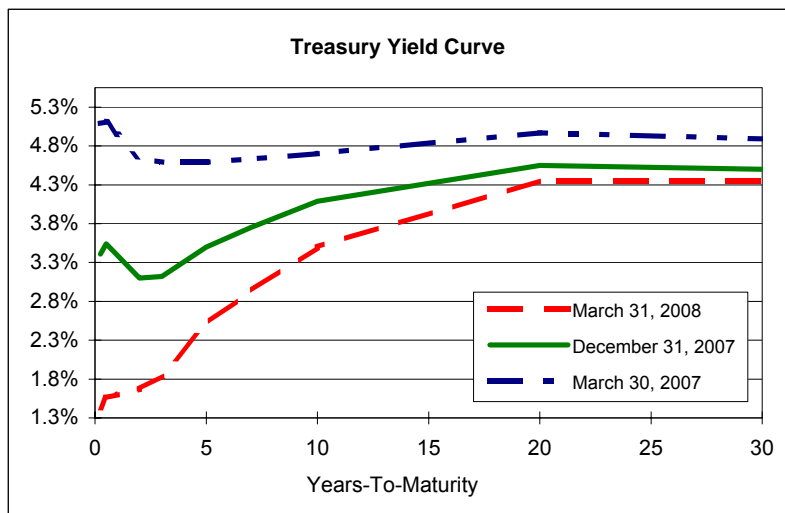

Source: State Street Corp.

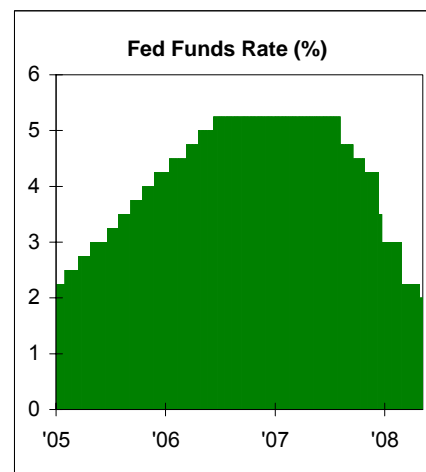

Source: Federal Reserve

- The Fed continued its rate-cutting during the quarter with a surprise 75 bps cut on January 22nd, a 50 bps cut on January 30th and 75 bps cut on March 18th. The two 75 bp cuts marked the first two occasions since 1990 that the Fed reduced rates by such a large margin.
- Yields fell across the entire curve, particularly along the short-end, resulting in a much steeper yield curve.
- The Fed cut rates an additional 25 basis points on April 30th and is expected to make another 25 bp cut at the June FOMC meeting.

### Bond Markets

- The LB Aggregate Index, benefiting from falling interest rates, continued its strong recent performance with a first quarter return 2.2%.
- The yield on TIPS and Treasuries fell as the Fed's rate cuts and overall market volatility spurred fears of higher inflation. Over the past year, the Lehman Brothers TIPS Index and Long Treasury Index have returned 14.5% and 13%, respectively.
- Given the credit crunch, the market for high yield bond issuances has virtually dried up. In addition, high yield bonds returned -3% during the quarter, making high yield one of the few bond sectors to experience negative performance.

	<u>Quarter</u>	<u>YTD</u>	<u>One Yr</u>	<u>Three Yrs</u>	<u>Five Yrs</u>	<u>Ten Yrs</u>
<b><u>Index Performance:</u></b>						
LB Aggregate	2.2	2.2	7.7	5.5	4.6	6.0
LB US TIPS	5.2	5.2	14.5	6.8	6.8	8.0
90 Day US Treasury Bills	0.9	0.9	4.6	4.4	3.2	3.7
<b><u>Maturity Evaluation:</u></b>						
LB 1-3 Yr Treasury	3.1	3.1	9.1	5.4	3.6	4.9
LB Intermediate Treasury	4.6	4.6	12.0	6.4	4.3	5.7
LB Long Treasury	4.0	4.0	13.0	7.2	6.2	7.4
<b><u>Issuer Performance:</u></b>						
LB Intermediate Agency	3.2	3.2	9.6	6.0	4.3	5.9
LB U.S. Credit	0.4	0.4	4.0	4.3	4.4	5.9
LB Mortgage	2.4	2.4	7.8	5.8	4.8	6.0
LB High Yield	(3.0)	(3.0)	(3.7)	4.9	8.6	4.9
JPM Emer Mkts Bond Plus	0.5	0.5	4.3	10.2	12.1	9.9

Rev. 4/28/2008

### International Market Environment

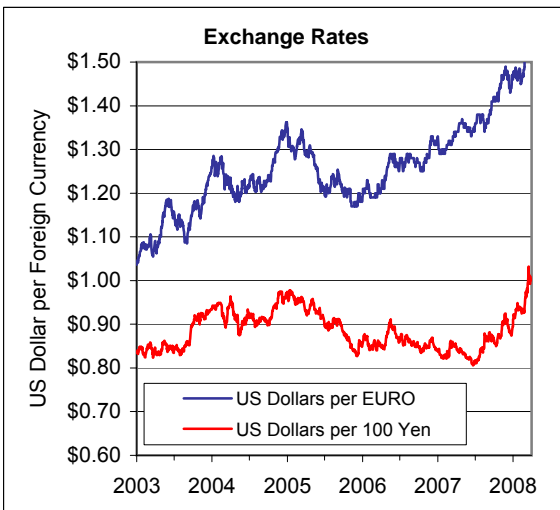

Source: Federal Reserve Bank, Daily Press

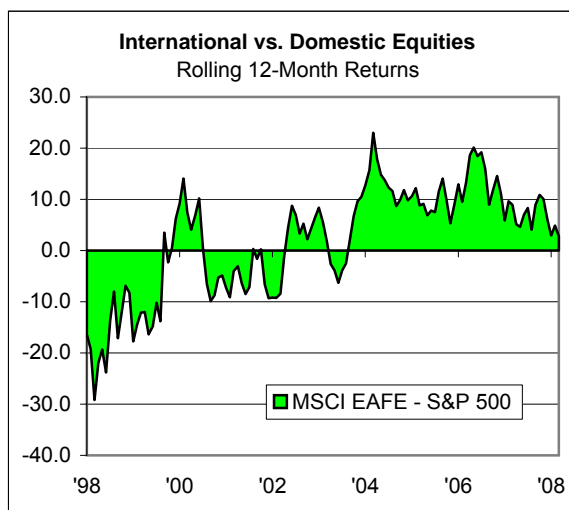

Source: Ibbotson

- International equities, despite outperforming the domestic market during the first quarter, still experienced substantial losses as fears of a U.S. recession spooked foreign markets.
- The US dollar fell 7.5% against the euro and 10.5% versus the yen in 1Q08. The fall relative to the yen is the largest quarterly decline since the third quarter of 1999, when it fell 12.3%.
- According to the International Monetary Fund, the world's economy is expected to expand at a 4.1% annualized rate in 2008. Growth is expected to be even higher in developing economies, whose growth is projected at 6.9%.

### International Equity Market Performance

- International developed markets recorded their second negative quarter since 2005. The MSCI EAFE ex Japan Index returned -9.1% while the MSCI Emerging Markets Index returned -10.9% (compared to -8.8% for the broad EAFE index).
- Developed markets managed to outperform emerging markets during the quarter. This marks only the fourth quarter in the past five years where developed markets have posted higher returns.
- Unlike the U.S. equity market, the international equity market continued to buck history with growth stocks outperforming value stocks for the quarter.

	<u>Quarter</u>	<u>YTD</u>	<u>One Yr</u>	<u>Three Yrs</u>	<u>Five Yrs</u>	<u>Ten Yrs</u>
<b><u>Broad Index Performance:</u></b>						
MSCI EAFE	(8.8)	(8.8)	(2.3)	13.8	21.9	6.6
MSCI World	(9.0)	(9.0)	(2.8)	10.2	16.5	5.0
MSCI EAFE ex. Japan	(9.1)	(9.1)	1.4	16.0	23.9	7.5
MSCI Emerging Markets	(10.9)	(10.9)	21.7	29.6	36.0	12.5
MSCI EAFE Small Cap	(6.2)	(6.2)	(10.9)	11.5	25.9	N/A
<b><u>Style Index Performance:</u></b>						
MSCI EAFE Growth	(8.1)	(8.1)	2.3	14.7	20.2	4.6
MSCI EAFE Value	(9.6)	(9.6)	(6.8)	12.8	23.5	8.3
<b><u>Regional Index Performance:</u></b>						
MSCI Europe ex-UK	(7.7)	(7.7)	3.9	18.1	26.2	8.2
MSCI United Kingdom	(10.5)	(10.5)	(5.8)	10.3	18.7	N/A
MSCI Japan	(7.8)	(7.8)	(14.6)	6.5	15.1	N/A
MSCI Asia	(14.1)	(14.1)	21.3	26.1	31.5	N/A
MSCI Latin America	(1.4)	(1.4)	40.1	46.4	50.7	17.8

Rev. 4/28/2008

# Market Environment

## Alternative Markets

First Quarter, 2008

### Real Assets

	<u>Quarter</u>	<u>YTD</u>	<u>One Yr</u>	<u>Three Yrs</u>	<u>Five Yrs</u>	<u>Ten Yrs</u>
<b><u>Real Estate:</u></b>						
NCREIF Property	1.6	1.6	13.6	16.8	15.1	12.6
NAREIT Equity	1.4	1.4	(17.4)	11.7	18.3	10.7
<b><u>Timber:</u></b>						
NCREIF Timberland	4.5	4.5	21.5	18.2	14.9	8.8
<b><u>Commodities:</u></b>						
Goldman Sachs Commodity	9.9	9.9	38.6	8.4	16.1	11.4
Dow Jones AIG	9.6	9.6	21.8	12.1	15.7	10.4
<b><u>Reference Benchmarks:</u></b>						
Inflation (CPI)	1.2	1.2	3.5	3.2	2.9	2.7
T-Bills + 3%	1.6	1.6	7.7	7.5	6.3	6.8
T-Bills + 5%	2.1	2.1	9.8	9.6	8.3	8.9

- REITs and Private Real Estate returned 1.4% and 1.6% during the first quarter, respectively. Over the past one and three year periods, private real estate has outperformed REITs by 31% and 5.1%.
- With oil topping \$100, commodity indices performed exceptionally well. The energy-laden Goldman Sachs Commodity Index returned nearly 10% during the quarter.
- Over the past year, given its heavy energy allocation, the Goldman Sachs Commodity index has outperformed its Dow Jones counterpart by nearly 17%.

### Hedge Funds & Private Equity

- The broad HFRI Fund of Funds Composite returned -4.2% during the period, its worst quarterly performance since September 1998 when the index shed 10%.
- Many hedge fund managers were whipsawed as broad deleveraging served as a headwind to performance. According to S&P, the first quarter was the most volatile period in 70 years.
- Among hedge fund styles, emerging markets and convertible arbitrage fell 7.5% and 6.9%. Equity market neutral funds, benefiting from abnormally high market volatility, fell only 0.3% during the quarter.

	<u>Quarter</u>	<u>YTD</u>	<u>One Yr</u>	<u>Three Yrs</u>	<u>Five Yrs</u>	<u>Ten Yrs</u>
<b><u>Broad Index Performance:</u></b>						
Cambridge Venture Capital*	16.0	7.0	16.0	13.8	10.6	15.2
Cambridge Private Equity*	3.3	19.7	19.7	24.4	24.3	14.2
HFRI Fund of Funds Comp.	(4.3)	(4.3)	2.3	7.5	8.1	6.3
HFRI FOF Diversified	(4.2)	(4.2)	1.8	7.3	8.0	6.1
<b><u>Hedge Fund Styles (HFRI):</u></b>						
Convertible Arbitrage	(6.9)	(6.9)	(4.7)	3.6	2.8	7.2
Emerging Markets	(7.5)	(7.5)	10.0	18.9	23.2	11.7
Equity Hedge	(5.7)	(5.7)	1.3	8.6	11.0	10.4
Equity Market Neutral	(0.3)	(0.3)	2.9	5.5	5.0	6.0
Event-Driven	(3.0)	(3.0)	(0.5)	8.2	12.6	9.6
Fixed Income Corporate	(4.9)	(4.9)	(7.6)	2.8	7.3	4.6

Rev. 4/28/2008

\*Venture Capital and Private Equity returns are preliminary and through December 31, 2007.

# Market Environment

## Asset Class Rankings Over the Past Twenty Years

First Quarter, 2008

	1988	1989	1990	1991	1992	1993	1994	1995	1996	1997	1998	1999	2000	2001	2002	2003	2004	2005	2006	2007	YTD 2008
Best	29.5	35.9	17.5	51.2	29.1	32.9	8.1	38.3	23.1	35.2	38.7	43.1	22.8	14.0	10.3	48.5	22.3	18.9	26.9	15.8	2.2
	28.6	25.2	8.9	41.7	13.8	26.3	6.4	37.2	21.6	31.8	20.3	33.2	12.3	8.4	6.7	46.0	20.7	14.0	23.5	11.8	1.6
	23.2	20.2	7.9	41.2	12.3	23.8	4.2	31.0	21.4	30.5	16.2	27.3	11.6	7.3	1.7	38.6	16.5	7.5	22.2	11.6	0.9
	20.4	18.8	2.6	24.6	8.0	18.1	2.7	25.8	14.4	18.6	15.6	26.5	7.0	4.1	1.0	30.0	14.3	7.1	16.1	9.9	-3.9
	11.7	14.5	2.3	21.7	7.8	13.4	-0.8	24.6	14.1	16.2	13.6	13.0	6.0	2.8	-8.6	29.7	13.1	7.1	13.4	7.9	-5.1
	11.3	12.4	-0.3	16.0	7.4	11.5	-1.5	18.5	11.3	13.9	8.7	11.4	4.1	-2.7	-11.4	21.6	11.1	5.3	12.8	7.1	-6.5
	9.6	10.8	-8.1	14.5	5.0	9.8	-2.0	11.6	10.3	12.9	5.1	7.3	1.9	-5.6	-15.5	11.6	6.9	4.7	10.4	7.0	-8.7
	7.9	8.6	-17.4	12.5	3.6	3.1	-2.4	11.1	6.4	9.7	1.2	4.7	-14.0	-9.2	-15.7	9.0	6.3	4.1	9.1	4.7	-8.8
	6.8	7.8	-21.8	5.8	-4.3	2.9	-2.9	7.5	5.3	5.3	-5.1	-0.8	-22.4	-20.4	-27.9	4.1	4.3	3.0	4.8	-0.2	-10.2
	Worst	N/A	N/A	-23.2	-5.6	-11.9	1.4	-3.5	5.8	3.6	2.1	-6.5	-1.5	-22.4	-21.2	-30.3	1.1	1.2	2.4	4.3	-9.8



Large Cap Growth US Stocks (Russell 1000 Growth Index)



Large Cap Value US Stocks (Russell 1000 Value Index)



Small Cap Growth US Stocks (Russell 2000 Growth Index)



Small Cap Value US Stocks (Russell 2000 Value Index)



Hedge Fund of Funds (HFRI Fund of Funds Index)



International Stocks (MSCI EAFE Index)



Domestic Fixed Income (Lehman Bro Aggregate Bond Index)



Real Estate (NCREIF Property Index)



Cash (Citigroup 3-Mo Treasury)



ICC Universe Median (Total Funds)

Data: Ibbotson Associates, 2008; Independent Consultants Cooperative.

Rev. 4/17/08

# Market Environment

## The Significant Impact of Currency

First Quarter, 2008

### Historical Currency Movements

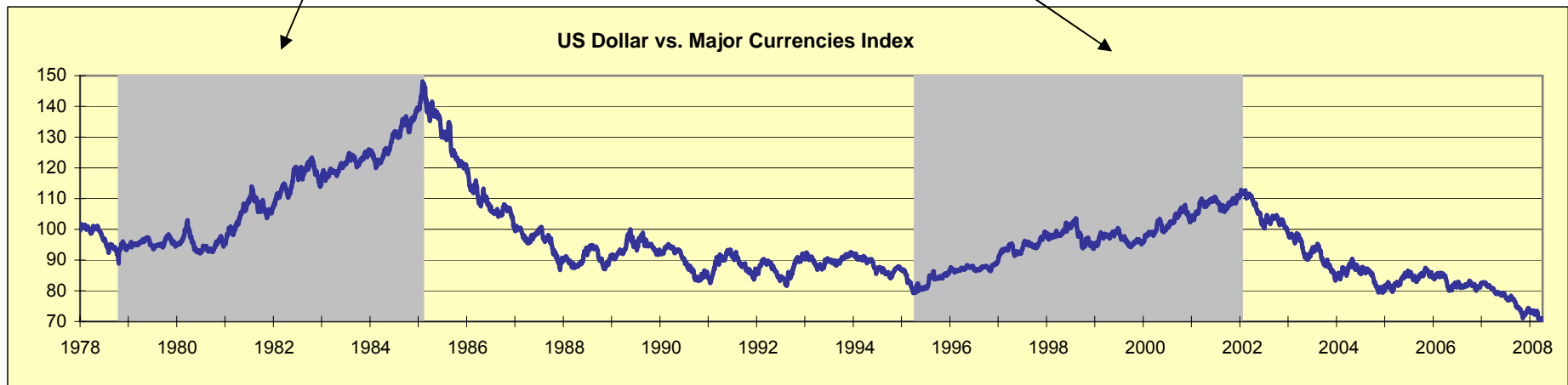
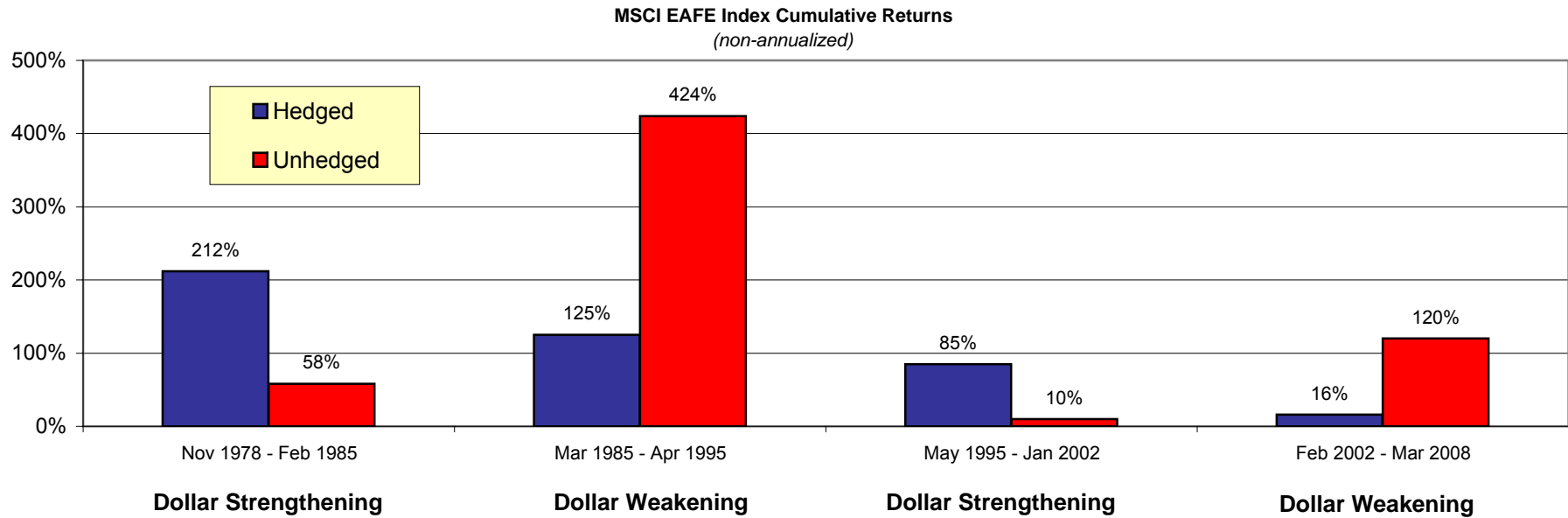

Source: Bernstein Investment Research & Management; DataStream; MSCI; Federal Reserve

Revised 4/17/2008 "Hedged" represented by MSCI EAFE Index in Local Currency; "Unhedged" represented by MSCI EAFE Index US \$



### S&P 500 Index Performance

- This chart was created using daily returns for the S&P 500 Index from January 1985 through March 2008.
- From January 1985 through March 2008, there have been 5,783 trading days. If an investor had remained invested in the S&P500 during the entire time period, their return would have been 9.44% annualized.
- If an investor attempted to time the market and happened to miss the 40 best trading days (or only 0.69% of all trading days), their return would have fallen by 726 basis points to 2.7%.
- The chart illustrates that the market's returns are highly dependent on a small number of trading days. Therefore, missing out on a small portion of the total trading days results in lower returns.

S&P 500 Index: January 1, 1985 -- March 31, 2008

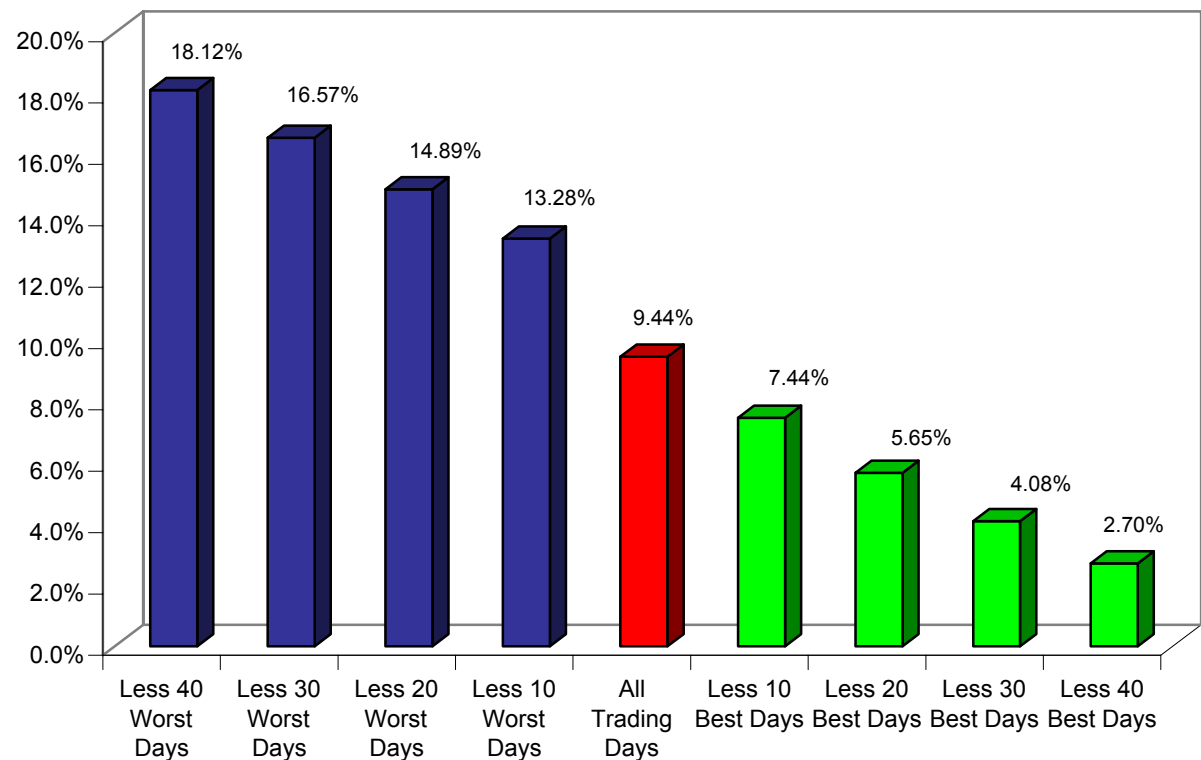

*Fresno County Employees' Retirement Association*

**Investment Performance Review**

Period Ending: March 31, 2008

999 Third Avenue, Suite 3650  
Seattle, Washington 98104  
(206) 622-3700

2321 Rosecrans Avenue, Suite 2250  
El Segundo, CA 90245  
(310) 297-1777

# Fresno County Employees' Retirement Association

## Executive Summary

Period Ending: March 31, 2008

	Quarter		YTD		One Year		Three Years		Five Years	
	Return	Rnk	Return	Rnk	Return	Rnk	Return	Rnk	Return	Rnk
<b>Total</b>										
Total Segment Return										
TOTAL FUND	-6.0	76	-6.0	76	0.3	53	9.2	18	13.0	16
TOTAL FUND - NET	-6.1	78	-6.1	78	-0.1	58	8.8	23	12.6	21
TOTAL FUND W OVERLAY	-6.0	77	-6.0	77	0.2	55				
Policy Index										
POLICY INDEX	-5.2	48	-5.2	48	-0.2	60	7.8	51	11.9	36
<b>Domestic Equity</b>										
Equity Segment Return										
TOTAL U.S. EQUITY	-10.4	59	-10.4	59	-8.5	64	4.5	78	12.4	65
RUSSELL 3000 INDEX	-9.5		-9.5		-6.1		6.1		12.1	
<b>International Equity</b>										
International Equity Segment Return										
TOTAL FOREIGN EQUITY	-8.2	37	-8.2	37	2.9	25	17.0	31	21.5	75
MSCI ACWI ex U.S. GROSS	-9.1		-9.1		2.6		16.5		24.0	
MSCI EAFE INDEX	-8.8		-8.8		-2.3		13.8		21.9	
MSCI EMER MKTS FREE	-10.9		-10.9		21.7		29.6		36.0	
<b>Domestic Fixed Income</b>										
Fixed Income Segment Return										
TOTAL U.S. FIXED	-0.1	77	-0.1	77	4.0	73	4.6	77	4.5	68
LB AGGREGATE INDEX	2.2		2.2		7.7		5.5		4.6	
<b>Global Fixed Income</b>										
Global Fixed Income Segment Return										
TOTAL GLOBAL FIXED	7.3	32	7.3	32	9.5	62	5.6	79	8.7	50
JPM GLOBAL GBI T/U	9.6		9.6		20.0		7.2		8.0	
<b>Real Estate</b>										
Real Estate Segment Return										
TOTAL REALTY	1.9	27	1.9	27	8.6	57	21.3	21	18.3	29
NCREIF PROPERTY INDEX	1.6		1.6		13.6		16.8		15.1	
<b>Alternative Investments</b>										
Alternative Investments Segment Return										
TOTAL ALT. INV	-6.6		-6.6		8.2		18.5		18.3	
S & P 500 + 4.47%	-8.3		-8.3		-0.8		10.5		16.2	
<b>Cash</b>										
Cash Segment Return										
TOTAL CASH	0.9	50	0.9	50	4.9	34	4.6	43	3.3	47
91-DAY T-BILLS	0.9		0.9		4.6		4.4		3.2	

### Asset Allocation By Style - (000's)

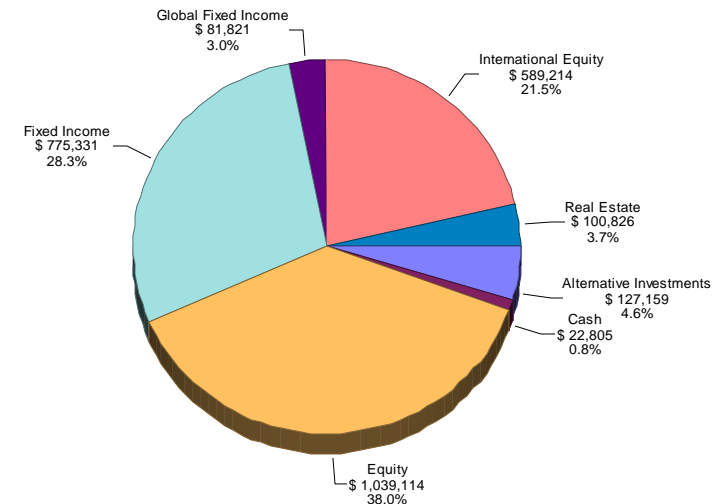

Market Value \$ 2,736,271

### Asset Allocation vs Policy As of 03/31/2008

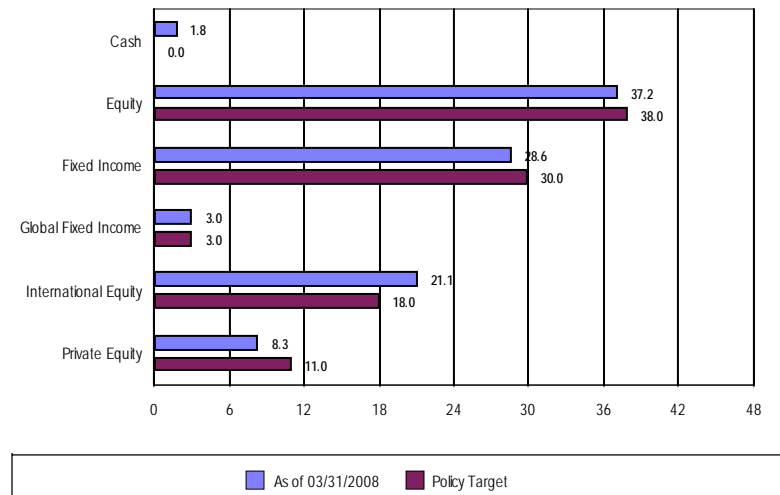

# Fresno County Employees' Retirement Association

## Executive Summary (Domestic Equity & Intl Equity)

Period Ending: March 31, 2008

	Quarter Rtn Rnk	One Yr Rtn Rnk	Three Yrs Rtn Rnk	Five Yrs Rtn Rnk	Since Incep Rtn Date
<b>Domestic Equity</b>					
<b>Equity Large Cap</b>					
S & P 500 FLAGSHIP	-9.4 51	-5.0 49	5.9 50		6.1 03/23/04
S & P 500 INDEX	-9.4 51	-5.1 50	5.9 58		6.1 03/23/04
<b>Equity Large Cap Growth</b>					
INTECH S&P BARRA	-11.0 53	-3.4 78	4.3 84		4.8 06/30/04
TCW CORE	-13.3 80	0.2 43	3.5 92		2.3 06/30/04
RUSSELL 1000 GROWTH	-10.2 39	-0.7 54	6.3 58		4.8 06/30/04
<b>Equity Large Cap Value</b>					
ARONSON PARTNERS	-10.5 56	-12.9 74	4.9 73	14.1 46	12.3 12/04/95
RUSSELL 1000 VALUE	-8.7 23	-10.0 40	6.0 43	13.7 60	9.8 12/04/95
WELLINGTON	-11.5 78	-10.1 42	5.2 62	13.2 73	6.3 04/30/00
RUSSELL 1000 VALUE	-8.7 23	-10.0 40	6.0 43	13.7 60	5.7 04/30/00
<b>Equity Small Cap Growth</b>					
ARTISAN MANAGEMENT	-14.1 61	-10.9 59	3.2 81		9.6 11/30/04
RUSSELL 2000 GROWTH	-12.8 50	-8.9 50	5.7 61		6.2 11/30/04
KALMAR MANAGEMENT	-10.5 24	-2.1 20	6.1 56		5.9 11/30/04
RUSSELL 2000 GROWTH	-12.8 50	-8.9 50	5.7 61		4.0 11/30/04
<b>Equity Small Cap Value</b>					
BRANDYWINE	-4.7 30	-16.6 62	1.9 79	14.7 82	11.5 08/21/95
RUSSELL 2000 VALUE	-6.5 54	-16.9 64	4.3 51	15.4 64	10.9 08/21/95
<b>International Equity</b>					
<b>Emerging Markets Equity</b>					
MONDRIAN INVESTMENT	-4.8 7	20.0 48			23.9 11/07/05
MSCI EMER MKTS FREE	-10.9 69	21.7 36			27.1 11/07/05
<b>International Equity</b>					
FRANKLIN	-11.1 91	-2.6 64	13.3 64	21.5 75	9.3 08/01/94
MSCI EAFE INDEX	-8.8 51	-2.3 61	13.8 58	21.9 69	7.2 08/01/94
OECHSLE INT'L	-7.3 23	-3.3 70			11.5 11/22/05
MSCI EAFE INDEX	-8.8 51	-2.3 61			13.8 11/22/05

### Asset Allocation By Manager - (000's)

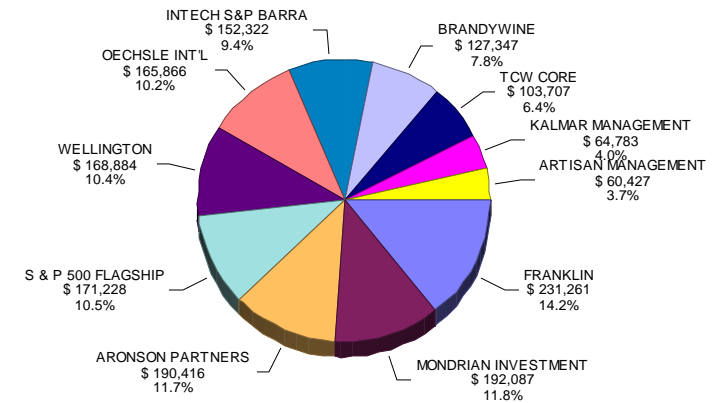

Market Value \$ 1,628,328

# Fresno County Employees' Retirement Association

## Executive Summary (Domestic & Global Fixed Income)

Period Ending: March 31, 2008

	Quarter Rtn Rnk		YTD Rtn Rnk		One Yr Rtn Rnk		Three Yrs Rtn Rnk		Five Yrs Rtn Rnk		Since Incep Rtn	Incep Date
<b>Domestic Fixed Income</b>												
Fixed Income												
BLACKROCK	0.7	64	0.7	64	5.8	59	4.9	69			5.0	06/25/04
LB AGGREGATE INDEX	2.2	37	2.2	37	7.7	40	5.5	50	4.6	63	5.4	06/25/04
BRADFORD	1.3	55	1.3	55	5.4	62	4.9	69	4.7	54	6.7	05/21/96
LB AGGREGATE INDEX	2.2	37	2.2	37	7.7	40	5.5	50	4.6	63	6.5	05/21/96
LOOMIS SAYLES	1.8	46	1.8	46	7.0	48	5.9	37	5.5	35	4.7	07/05/01
LB AGGREGATE INDEX	2.2	37	2.2	37	7.7	40	5.5	50	4.6	63	5.5	07/05/01
WESTERN ASSET MGMT	-1.5	92	-1.5	92	0.3	95					3.1	05/05/05
LB AGGREGATE INDEX	2.2	41	2.2	41	7.7	42	5.5	51	4.6	62	4.9	05/05/05

<b>Global Fixed Income</b>												
Global Fixed Income												
GRANTHAM	7.3	32	7.3	32	9.5	62	6.5	61	9.3	36	7.1	03/31/99
JPM GLOBAL GBI T/U	9.6	20	9.6	20	20.0	16	7.2	42	8.0	58	6.8	03/31/99

### Asset Allocation by Manager - (000's)

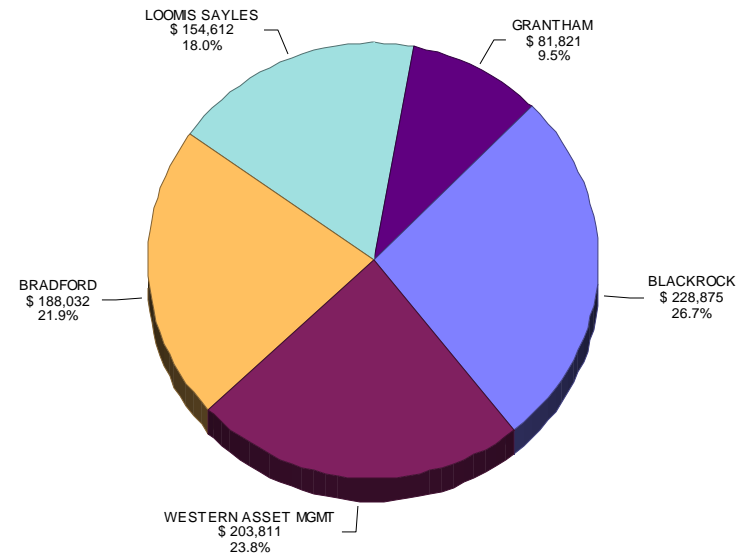

Market Value \$ 857,152

# Fresno County Employees' Retirement Association

## Asset Allocation: Total Fund vs. Universe Median

Period Ending: March 31, 2008

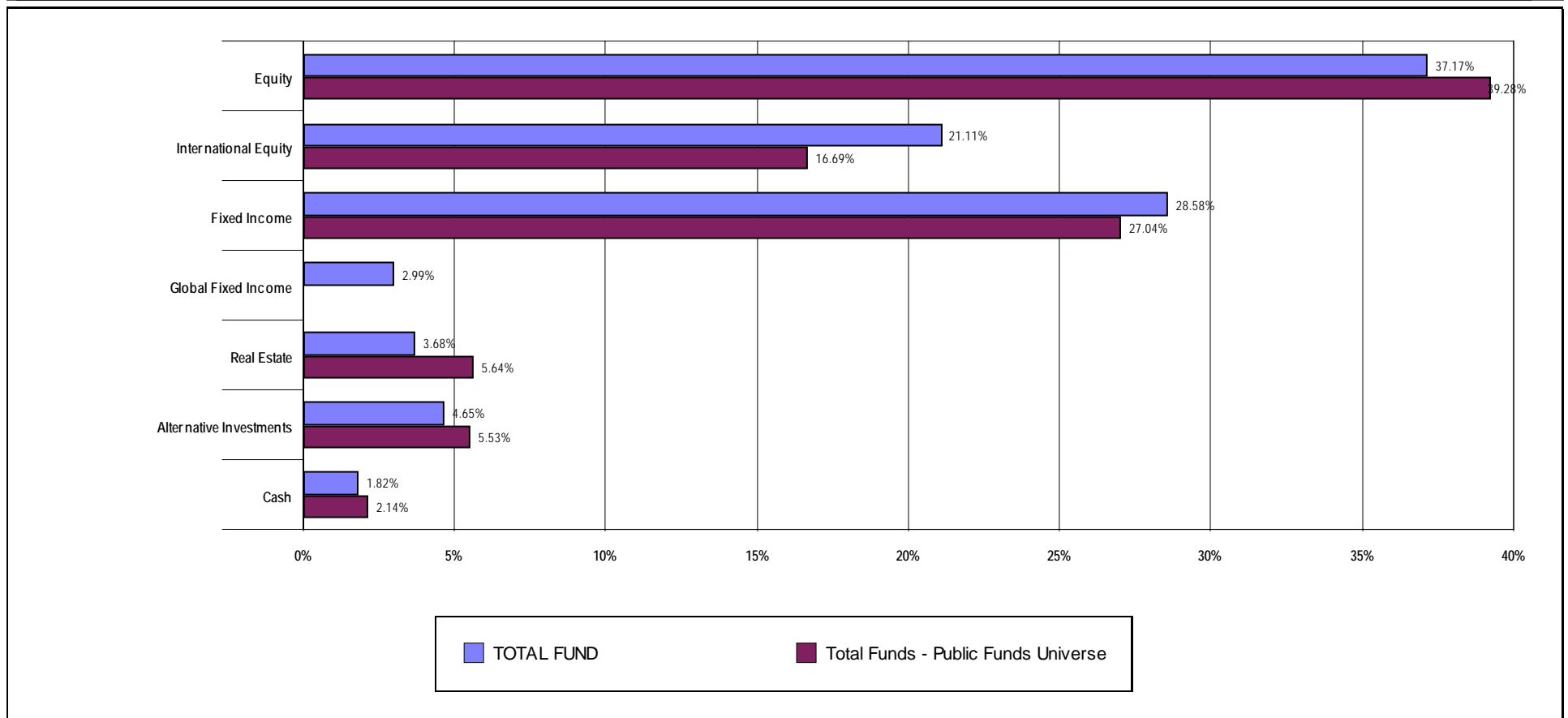

### TOTAL FUND

Segment	Market Value	Allocation
Equity	1,017,089	37.17%
International Equity	577,712	21.11%
Fixed Income	781,929	28.58%
Global Fixed Income	81,821	2.99%
Real Estate	100,826	3.68%
Alternative Investments	127,159	4.65%
Cash	49,734	1.82%
<b>Total:</b>	<b>2,736,271</b>	<b>100.00%</b>

### Total Funds - Public Funds Universe

Segment	Allocation
Equity	39.28%
International Equity	16.69%
Fixed Income	27.04%
Global Fixed Income	
Real Estate	5.64%
Alternative Investments	5.53%
Cash	2.14%

Note: All Values are expressed in thousands.

Figures above represent the median allocation for those plans that are invested in the respective asset class

# Fresno County Employees' Retirement Association

## Alternative Investments

Period Ending: March 31, 2008

Inception Date	Alternative Investment - Illiquid	Total Commitment (000's)	Capital Called (000's)	Capital Returned (000's)	Data as of March 31, 2008					
					Market Values (000's)	One Quarter Return	One Year Return	Three Years Return	Five Years Return	(IRR) Since Inception
05/15/99	BCI Growth V, L.P.*	\$20,000	\$18,949	\$6,798	\$3,092	-0.3	13.1	3.1	4.2	-10.6%*
12/12/01	Lone Star Fund IV	\$20,000	\$19,045	\$29,172	\$16,697	-12.9	21.1	50.2	47.3	53.8%
05/29/98	TCW Shop III	\$15,000	\$15,000	\$14,405	\$2,718	1.9	25.2	12.1	7.8	2.5%
02/27/02	TCW Shop IV	\$15,000	\$23,645	\$18,185	\$9,128	0.8	16.6	6.5	8.8	8.4%
08/31/01	WP Private Equity VIII, L.P.	\$25,000	\$25,000	\$184,245	\$27,508	-7.1	4.0	25.6	17.5	19.5%
10/05/07	WP Private Equity X, L.P.	\$25,000	\$4,175	\$0	\$3,575	-14.4	NA	NA	NA	-41.2%
06/26/98	WP Equity Partners, L.P.	\$20,000	\$20,000	\$26,026	\$4,305	-15.0	-24.8	23.0	24.5	9.8%
12/01/01	Blackstone Alternative Asset	\$10,000	\$10,000	\$0	\$15,533	-3.4	5.3	9.1	8.5	N/A
					Data as of December 31, 2007					
06/27/97	Blackstone III	\$15,000	\$15,387	\$15,450	\$4,332	-5.1	7.1	8.7	8.9	18.0%
11/11/02	Blackstone IV	\$20,000	\$16,948	\$18,026	\$15,989	-10.3	18.3	16.6	NA	64.0%
10/23/07	Hamilton Lane	\$70,000	\$8,400	\$0	\$7,693	-8.4	NA	NA	NA	-9.4
06/23/00	Landmark Equity X, L.P.	\$20,000	\$18,738	\$16,436	\$7,530	5.0	33.5	42.2	26.1	6.8%
12/22/99	New Mountain Partners, L.P.	\$20,000	\$18,996	\$18,293	\$9,060	-0.5	-3.4	5.7	19.7	35.2%

-----

**Total Alt. Investment - Illiquid**      \$295,000      \$214,283      \$347,035      **\$127,159**

**Total Alternative Investment**

**\$127,159**

**% of Total Fund (Market Value)**

**4.7%**

# Fresno County Employees' Retirement Association

Real Estate

Period Ending: March 31, 2008

Inception Date	Real Estate	Contributions (000's)	Distributions (000's)	Data as of March 31, 2008					
				Market Values (000's)	One Quarter Return	One Year Return	Three Years Return	Five Years Return	(IRR) Since Inception
10/01/07	INVESCO	\$80,000	\$7,397	<b>\$80,599</b>	1.3	NA	NA	NA	NA
04/12/89	JMB V	\$10,000	\$17,831	<b>\$9</b>	-3.0	-4.2	6.1	19.8	NA
06/06/86	Sentinel	\$7,500	\$2,726	<b>\$4,926</b>	-1.1	3.9	10.3	10.4	NA
				Data as of December 31, 2007					
04/15/99	TA Realty V	\$20,000	28,067	<b>\$13,868</b>	9.8	16.9	21.3	16.5	12.3%
09/15/97	JER I	\$11,611	\$8,448	<b>\$2</b>	-41.8	-42.1	-4.9	2.1	13.8%
05/27/99	JER II	\$20,698	\$19,513	<b>\$1,423</b>	-21.0	-17.1	33.2	21.8	11.6%

---

**Total Real Estate**      \$69,809      \$76,585      **\$100,826**

**Total Real Estate**

**\$100,826**

**% of Total Fund (Market Value)**

**3.7%**



# Fresno County Employees' Retirement Association

## Cumulative Performance Comparisons

Period Ending: March 31, 2008

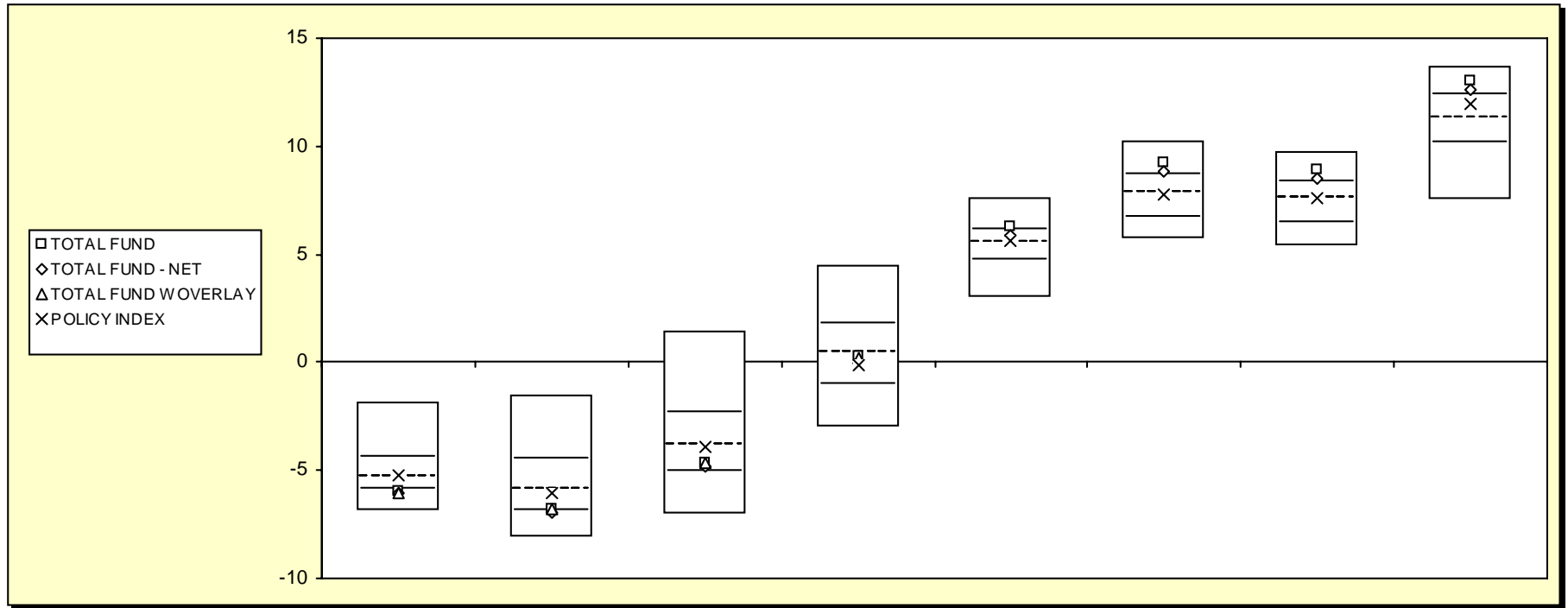

### Total Funds - Public Funds

	Last Quarter		Two Quarters		Three Quarters		One Year		Two Years		Three Years		Four Years		Five Years	
	Return	Rank	Return	Rank	Return	Rank	Return	Rank	Return	Rank	Return	Rank	Return	Rank	Return	Rank
5th Percentile	-1.9		-1.5		1.4		4.5		7.6		10.2		9.8		13.7	
25th Percentile	-4.4		-4.5		-2.4		1.7		6.1		8.7		8.4		12.4	
50th Percentile	-5.3		-5.9		-3.8		0.4		5.6		7.8		7.6		11.3	
75th Percentile	-5.9		-6.8		-5.1		-1.0		4.8		6.7		6.4		10.2	
95th Percentile	-6.9		-8.1		-7.0		-3.0		3.0		5.7		5.4		7.5	
TOTAL FUND	-6.0	76	-6.8	73	-4.6	66	0.3	53	6.3	23	9.2	18	8.9	17	13.0	16
TOTAL FUND - NET	-6.1	78	-6.9	76	-4.9	70	-0.1	58	5.9	35	8.8	23	8.5	22	12.6	21
TOTAL FUND W OVERLAY	-6.0	77	-6.8	74	-4.7	67	0.2	55								
POLICY INDEX	-5.2	48	-6.1	55	-3.9	52	-0.2	60	5.6	47	7.8	51	7.6	49	11.9	36

# Fresno County Employees' Retirement Association

## Consecutive Performance Comparisons

Period Ending: March 31, 2008

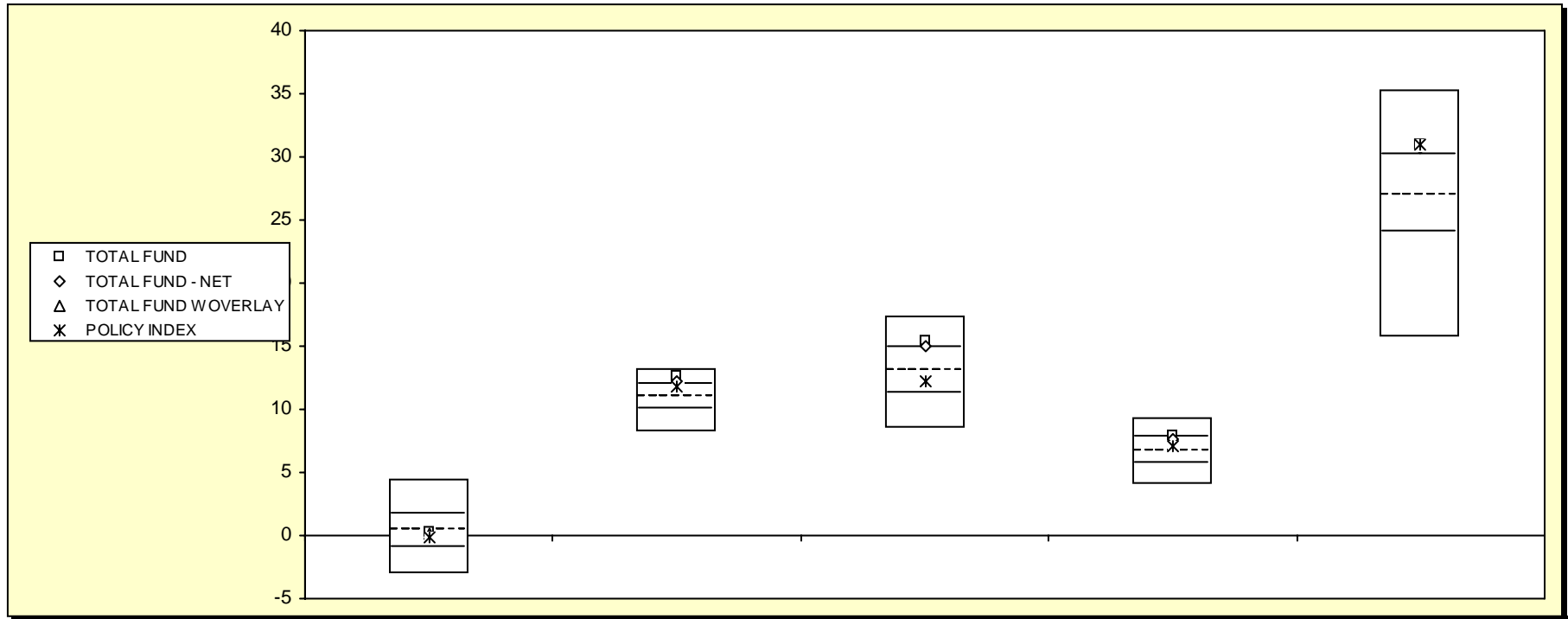

### Total Funds - Public Funds

	March 2008		March 2007		March 2006		March 2005		March 2004	
	Return	Rank	Return	Rank	Return	Rank	Return	Rank	Return	Rank
5th Percentile	4.5		13.3		17.4		9.4		35.3	
25th Percentile	1.7		11.9		14.8		7.7		30.1	
50th Percentile	0.4		10.9		13.1		6.7		26.9	
75th Percentile	-1.0		10.0		11.2		5.7		24.1	
95th Percentile	-3.0		8.2		8.5		4.0		15.7	
TOTAL FUND	0.3	53	12.6	14	15.4	21	7.9	23	31.0	22
TOTAL FUND - NET	-0.1	58	12.2	21	15.0	23	7.6	29	30.6	23
TOTAL FUND W OVERLAY	0.2	55								
POLICY INDEX	-0.2	60	11.8	28	12.2	62	7.1	40	31.0	22

# Fresno County Employees' Retirement Association

Consecutive Annual - Five Year

Period Ending: March 31, 2008

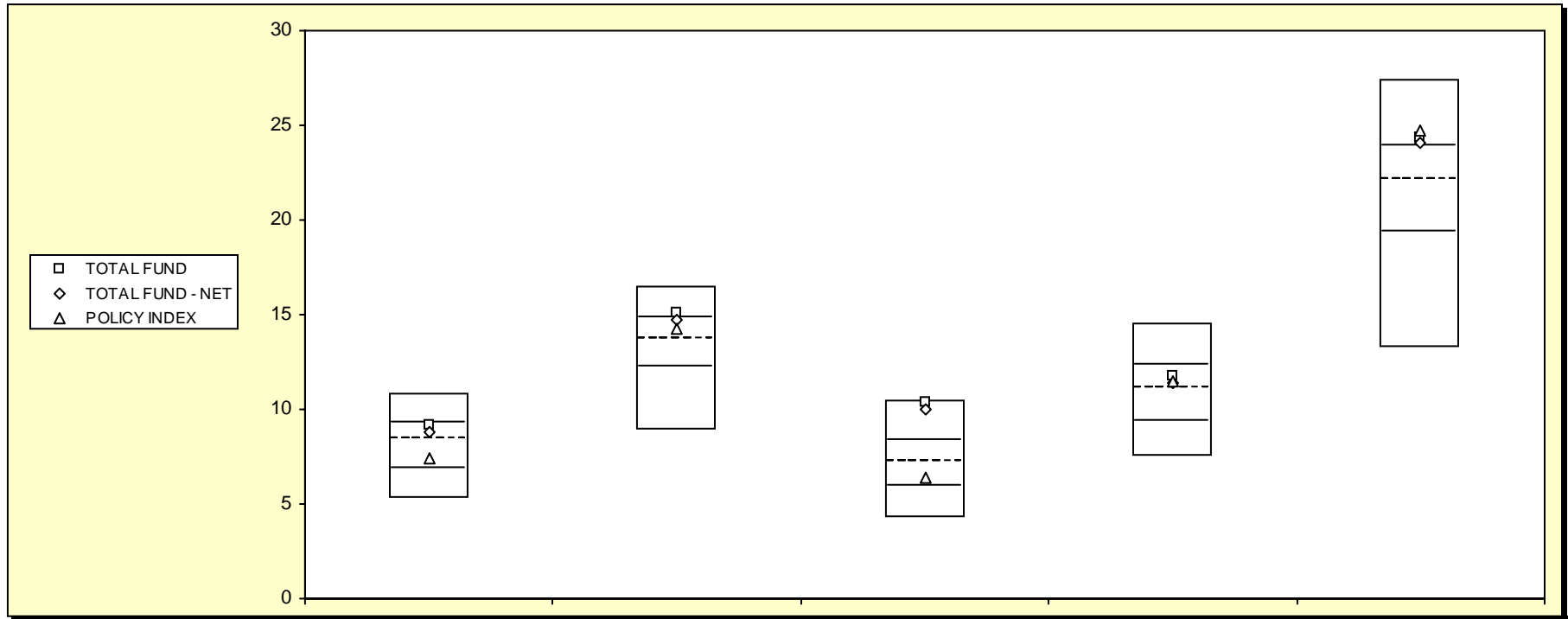

*Total Funds - Public Funds*

	December 2007		December 2006		December 2005		December 2004		December 2003	
	Return	Rank	Return	Rank	Return	Rank	Return	Rank	Return	Rank
5th Percentile	10.9		16.5		10.5		14.5		27.5	
25th Percentile	9.3		14.8		8.3		12.3		23.9	
50th Percentile	8.4		13.7		7.2		11.1		22.1	
75th Percentile	6.9		12.2		5.9		9.4		19.4	
95th Percentile	5.3		8.9		4.2		7.5		13.3	
TOTAL FUND	9.1	29	15.1	21	10.4	6	11.7	37	24.4	22
TOTAL FUND - NET	8.8	38	14.7	28	10.0	9	11.4	43	24.0	24
TOTAL FUND W OVERLAY										
POLICY INDEX	7.4	66	14.3	38	6.3	66	11.5	42	24.7	20

# Fresno County Employees' Retirement Association

## Three & Five Year Return vs. Risk

Period Ending: March 31, 2008

### Three-Year

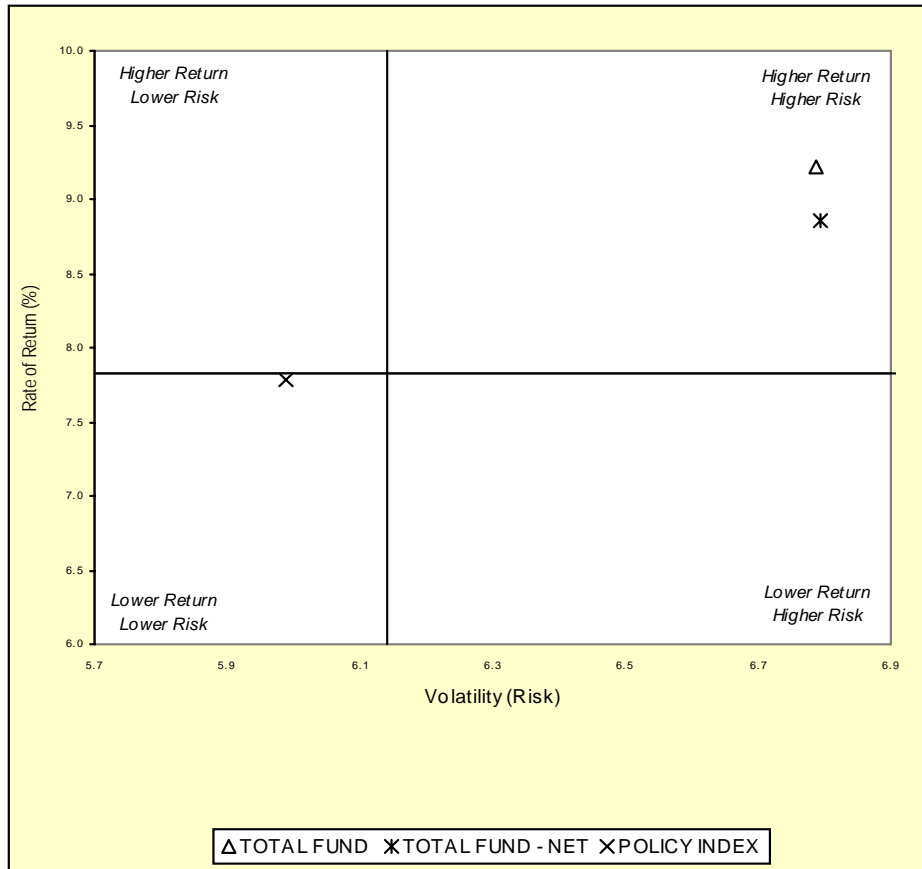

### Five-Year

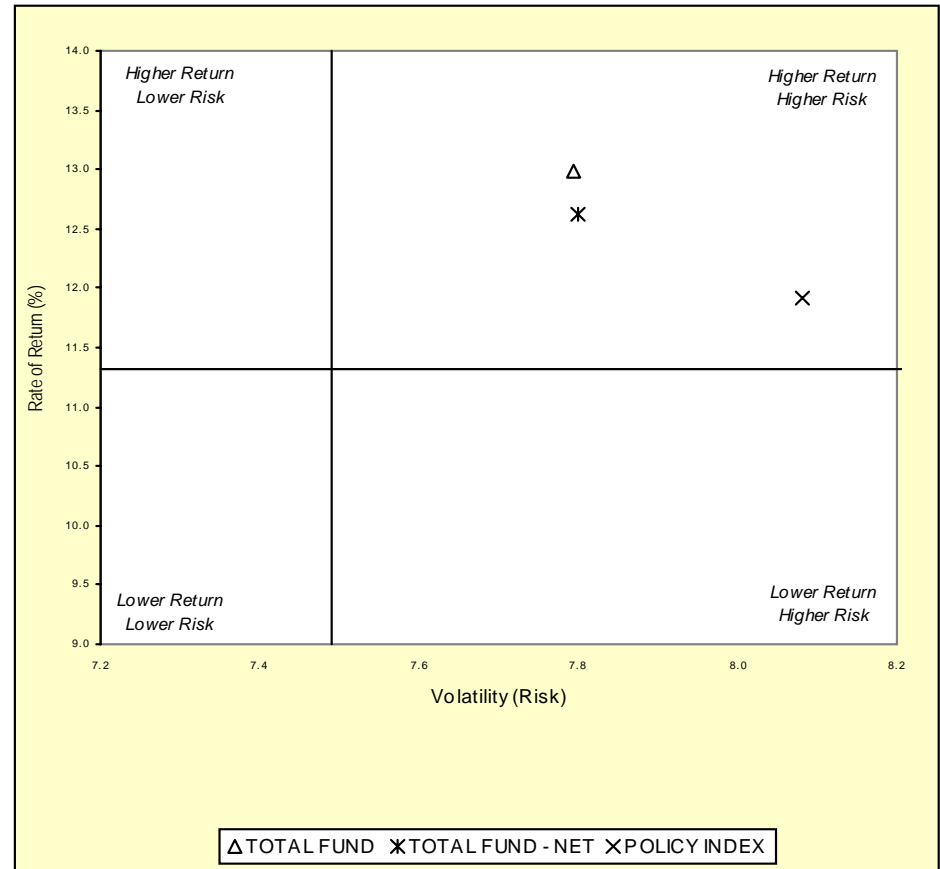

#### Three Year Return vs Risk

Annualized Return %	Standard Deviation %	Sharpe Ratio
9.2	6.8	0.7
8.8	6.8	0.7
7.8	6.0	0.6
7.8	6.1	0.6

#### Category

TOTAL FUND
TOTAL FUND - NET
POLICY INDEX
Total Funds - Public Funds Universe Median

#### Five Year Return vs Risk

Annualized Return %	Standard Deviation %	Sharpe Ratio
13.0	7.8	1.3
12.6	7.8	1.2
11.9	8.1	1.1
11.3	7.5	1.1

# Fresno County Employees' Retirement Association

## Rolling Return Ranking 3 & 5 Years

Period Ending: March 31, 2008

### Ranking Comparisons - Rolling 3 Years

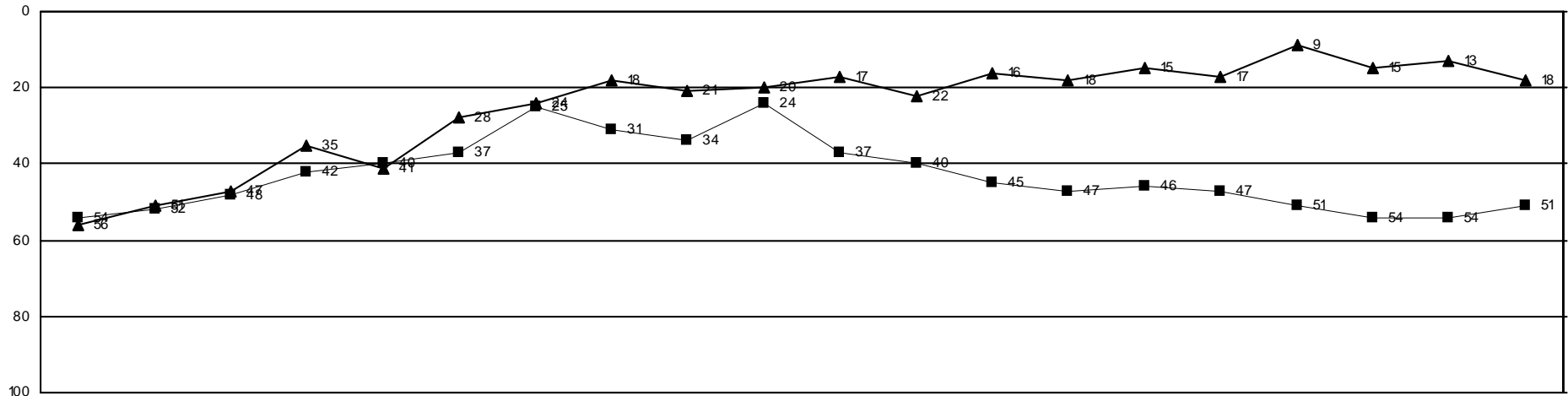

### Ranking Comparisons - Rolling 5 Years

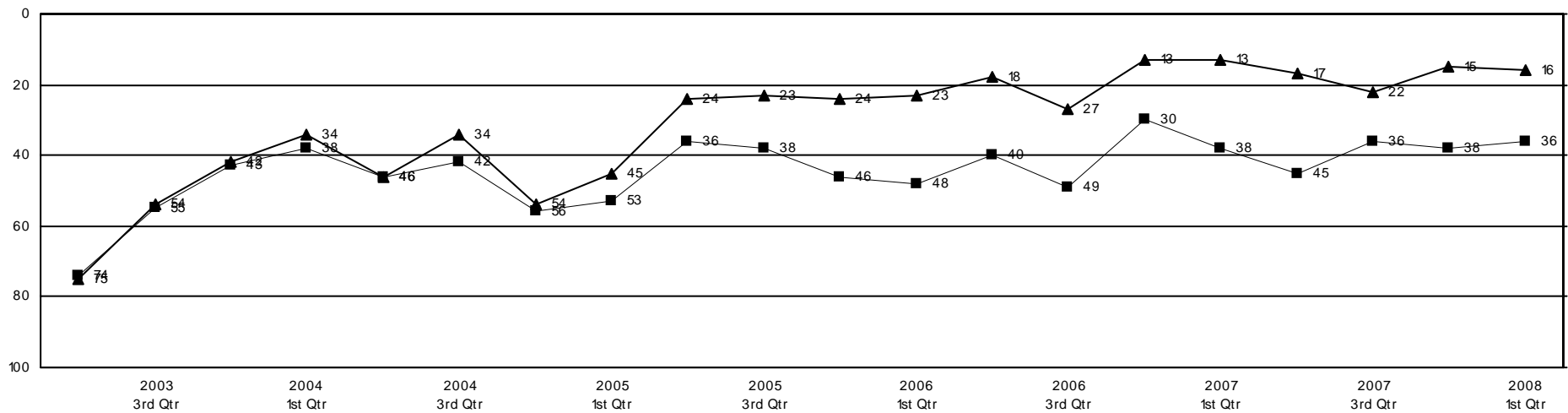

■ POLICY INDEX ▲ TOTAL FUND

# Fresno County Employees' Retirement Association

## Cross Holding Analysis - Equity Managers

Period Ending: March 31, 2008

Securities	ARONSON PARTNERS	ARTISAN MANAGEMENT	BRANDYWINE	INTECH S&P BARRA	KALMAR MANAGEMENT	TCW CORE	WELLINGTON	Total Shares	Total M. V.	% Total Eqt.
<b>3M</b>				2,700		9,200		11,900	\$941,885	0.09%
<b>ABBOTT LABS.</b>				70,900		13,700		84,600	\$4,665,690	0.45%
<b>ACTUANT 'A'</b>		38,300	11,800		10,290			60,390	\$1,824,382	0.17%
<b>ADVISORY BOARD</b>		18,300			13,450			31,750	\$1,744,345	0.17%
<b>AETNA</b>	37,200			15,400		15,400		68,000	\$2,862,120	0.28%
<b>AIR PRDS.&amp; CHEMS.</b>				4,100			20,200	24,300	\$2,235,600	0.21%
<b>ALLIS-CHALMERS ENERGY</b>		59,700	4,800					64,500	\$889,455	0.08%
<b>ALTRIA GROUP</b>						12,000	118,400	130,400	\$2,894,880	0.28%
<b>APPLE</b>				44,100		7,600		51,700	\$7,418,950	0.73%
<b>ARKANSAS BEST</b>			14,500				15,500	30,000	\$955,800	0.09%
<b>AT&amp;T</b>	167,170						251,111	418,281	\$16,020,162	1.57%
<b>AUTODESK</b>				900		5,600		6,500	\$204,620	0.02%
<b>AVOCENT</b>		53,400			18,530			71,930	\$1,215,617	0.11%
<b>BAKER HUGHES</b>				4,700		8,800	50,800	64,300	\$4,404,550	0.43%
<b>BANK OF AMERICA</b>	67,600						252,800	320,400	\$12,146,364	1.19%
<b>BARR PHARMACEUTICALS</b>				600		11,200		11,800	\$570,058	0.05%
<b>BJ'S RESTAURANTS</b>		30,300			13,425			43,725	\$630,077	0.06%
<b>BOEING</b>	17,000			7,700		14,800		39,500	\$2,937,615	0.28%
<b>BRISTOL MYERS SQUIBB</b>						27,700	49,000	76,700	\$1,633,710	0.16%
<b>BROWN-FORMAN 'B'</b>				3,200		7,700		10,900	\$721,798	0.07%
<b>CAMERON INTERNATIONAL</b>				9,900		14,100		24,000	\$999,360	0.09%
<b>CARDINAL HEALTH</b>	34,300					10,900		45,200	\$2,373,452	0.23%
<b>CATERPILLAR</b>	15,700			2,400				18,100	\$1,417,049	0.13%
<b>CELGENE</b>				27,500		11,700		39,200	\$2,402,568	0.23%
<b>CH ROBINSON WWD.</b>						3,400	33,800	37,200	\$2,023,680	0.19%
<b>CHEVRON</b>	86,800			18,300				105,100	\$8,971,336	0.88%
<b>CIGNA</b>	16,600			28,800				45,400	\$1,841,878	0.18%
<b>CISCO SYSTEMS</b>				45,300		95,200		140,500	\$3,384,645	0.33%
<b>COACH</b>				1,700		15,000		16,700	\$503,505	0.04%
<b>COCA COLA</b>				62,500		14,800		77,300	\$4,705,251	0.46%
<b>COMERICA</b>	23,700						15,400	39,100	\$1,371,628	0.13%
<b>CON-WAY</b>			25,400				16,100	41,500	\$2,053,420	0.20%
<b>CONCUR TECHS.</b>		12,900			14,890			27,790	\$862,880	0.08%
<b>CONOCOPHILLIPS</b>	77,700			36,800			72,596	187,096	\$14,258,586	1.40%
<b>Wurts &amp; Associates</b>				6						

# Fresno County Employees' Retirement Association

## Cross Holding Analysis - Equity Managers

Period Ending: March 31, 2008

Securities	ARONSON PARTNERS	ARTISAN MANAGEMENT	BRANDYWINE	INTECH S&P BARRA	KALMAR MANAGEMENT	TCW CORE	WELLINGTON	Total Shares	Total M. V.	% Total Eqt.
CORRECTIONS AMER NEW					38,224	22,500		60,724	\$1,671,124	0.16%
COSTCO WHOLESALE				10,400		9,800		20,200	\$1,312,394	0.12%
COVANCE					15,230	6,600		21,830	\$1,811,235	0.17%
CRANE	19,500		2,300					21,800	\$879,630	0.08%
CUMMINS	33,000			8,500				41,500	\$1,943,030	0.19%
CVS CAREMARK				59,517		12,900		72,417	\$2,933,613	0.28%
DELL				4,100		28,200		32,300	\$643,416	0.06%
ELI LILLY						12,300	28,000	40,300	\$2,079,077	0.20%
ELIZABETH ARDEN			11,900		22,650			34,550	\$689,273	0.06%
EMC				150,400		49,100		199,500	\$2,860,830	0.28%
EMERSON ELECTRIC				5,800		10,300		16,100	\$828,506	0.08%
EOG RES.				200			20,000	20,200	\$2,424,000	0.23%
EXPEDITOR INTL.				700		700		1,400	\$63,252	0.00%
EXPRESS SCRIPTS 'A'	11,500			33,100				44,600	\$2,868,672	0.28%
EXXON MOBIL	121,100			163,500		14,200	6,300	305,100	\$25,805,358	2.53%
FEDEX						7,000	3,200	10,200	\$945,234	0.09%
FREPORT-MCMOR.CPR.& GD.				5,500			16,900	22,400	\$2,155,328	0.21%
GAMESTOP				25,300	16,530			41,830	\$2,163,029	0.21%
GAP				11,000			75,800	86,800	\$1,708,224	0.16%
GARDNER DENVER	21,400		16,500					37,900	\$1,406,090	0.13%
GENERAL ELECTRIC	65,200					26,900		92,100	\$3,408,621	0.33%
GENERAL MILLS	32,400			1,400				33,800	\$2,023,944	0.19%
GENZYME				7,400		7,500		14,900	\$1,110,646	0.10%
GILEAD SCIENCES				600		15,000		15,600	\$803,868	0.07%
GOLDMAN SACHS GP.	17,500					4,200	11,000	32,700	\$5,408,253	0.53%
GOOGLE 'A'				1,300		3,400		4,700	\$2,070,209	0.20%
HALLIBURTON				7,300		14,000	36,200	57,500	\$2,261,475	0.22%
HEALTHCARE SER.GP.		43,900			30,300			74,200	\$1,531,488	0.15%
HEALTH EXTRAS		39,100			25,620			64,720	\$1,607,645	0.15%
HERCULES OFFSHORE		48,000	2,300					50,300	\$1,263,536	0.12%
HESS				300			73,200	73,500	\$6,481,230	0.63%
HEWLETT-PACKARD				31,500		42,400	23,900	97,800	\$4,465,548	0.43%
HONEYWELL INTL.				7,800		9,300	24,100	41,200	\$2,324,504	0.22%
INSIGHT ENTS.			26,800		48,290			75,090	\$1,314,075	0.12%

# Fresno County Employees' Retirement Association

## Cross Holding Analysis - Equity Managers

Period Ending: March 31, 2008

Securities	ARONSON PARTNERS	ARTISAN MANAGEMENT	BRANDYWINE	INTECH S&P BARRA	KALMAR MANAGEMENT	TCW CORE	WELLINGTON	Total Shares	Total M. V.	% Total Eqt.
INTEL				13,800		66,100		79,900	\$1,692,282	0.16%
INTERCONTINENTAL EX.				200		2,100		2,300	\$300,150	0.02%
INTERNATIONAL BUS.MACH.				35,900		11,200	15,300	62,400	\$7,184,736	0.70%
INVENTIV HLTH.		28,000			32,240			60,240	\$1,735,514	0.17%
JOHNSON & JOHNSON				36,800		13,900		50,700	\$3,288,909	0.32%
JOHNSON CONTROLS				4,300		15,400		19,700	\$665,860	0.06%
KENNAMETAL			14,600		16,520			31,120	\$915,862	0.09%
L3 COMMUNICATIONS	18,500			7,400		4,800		30,700	\$3,356,738	0.33%
LENNOX INTL.	21,500		26,700					48,200	\$1,733,754	0.17%
LIFECELL		16,600			22,040			38,640	\$1,624,039	0.15%
LIFETIME FITNESS		30,100			21,900			52,000	\$1,622,920	0.15%
LKQ		23,800			46,460			70,260	\$1,578,742	0.15%
LOCKHEED MARTIN				27,400		7,800	20,300	55,500	\$5,511,150	0.54%
MARATHON OIL	62,000			2,400			74,000	138,400	\$6,311,040	0.62%
MCDONALDS				40,700		8,600		49,300	\$2,749,461	0.27%
MCKESSON	18,700						23,700	42,400	\$2,220,488	0.21%
MEDCO HEALTH SLTN.				30,400		12,000		42,400	\$1,856,696	0.18%
MEDTRONIC				1,600		14,600		16,200	\$783,594	0.07%
MERCK & CO.				30,900		14,300	37,300	82,500	\$3,130,875	0.30%
MICROSEMI		45,700			31,790			77,490	\$1,766,772	0.17%
MICROSOFT	74,500			145,700		123,100		343,300	\$9,742,854	0.95%
MOBILE MINI		8,400	8,800		34,725			51,925	\$986,575	0.09%
MONSANTO				3,800		8,400		12,200	\$1,360,300	0.13%
NATIONAL FINL.PTNS.		47,100			7,570		19,500	74,170	\$1,666,600	0.16%
NATIONAL OILWELL VARCO				64,900		10,100		75,000	\$4,378,500	0.43%
NIKE 'B'	19,800			32,200				52,000	\$3,536,000	0.34%
O REILLY AUTOMOTIVE					21,650	20,100		41,750	\$1,190,710	0.11%
OCCIDENTAL PTL.				3,400			54,000	57,400	\$4,199,958	0.41%
ORACLE				1,800		67,900		69,700	\$1,363,332	0.13%
OVERSEAS SHIPLDG.			4,100				10,000	14,100	\$987,564	0.09%
PARKER-HANNIFIN	29,900			3,500				33,400	\$2,313,618	0.22%
PEPSI BOTTLING GP.	36,600			23,300				59,900	\$2,031,209	0.19%
PEPSICO	17,400			46,700		24,600		88,700	\$6,404,140	0.63%
PHASE FORWARD		53,100			40,750			93,850	\$1,602,958	0.15%



# Fresno County Employees' Retirement Association

## Cross Holding Analysis - Equity Managers

Period Ending: March 31, 2008

Securities	ARONSON PARTNERS	ARTISAN MANAGEMENT	BRANDYWINE	INTECH S&P BARRA	KALMAR MANAGEMENT	TCW CORE	WELLINGTON	Total Shares	Total M. V.	% Total Eqt.
PHILIP MORRIS INTL.						12,000	118,400	130,400	\$6,595,632	0.64%
PRAXAIR				300		7,100		7,400	\$623,302	0.06%
PRIDE INTL.						14,100	33,800	47,900	\$1,674,105	0.16%
PROCTER & GAMBLE	26,800			73,747		15,600		116,147	\$8,138,420	0.80%
PROGRESS SOFTWARE		26,200			27,520			53,720	\$1,607,302	0.15%
PRUDENTIAL FINL.				300		8,200		8,500	\$665,125	0.06%
PSS WORLD MED		58,500			45,825			104,325	\$1,738,055	0.17%
PSYCHIATRIC SLTN.		38,300			19,340			57,640	\$1,955,149	0.19%
QUALCOMM						33,300	25,200	58,500	\$2,398,500	0.23%
QUESTAR				2,400			14,000	16,400	\$927,584	0.09%
SCHERING-PLOUGH				93,600		26,100	116,600	236,300	\$3,405,083	0.33%
SCHWAB (CHARLES)	60,600			10,700				71,300	\$1,342,579	0.13%
STATE STREET						5,700	20,800	26,500	\$2,093,500	0.20%
SUNOCO	13,500					9,700		23,200	\$1,217,304	0.11%
SYMANTEC	104,000			5,000				109,000	\$1,811,580	0.17%
SYSCO	59,800					18,800		78,600	\$2,280,972	0.22%
TESSERA TECHS.		58,100			26,565			84,665	\$1,761,032	0.17%
TEXAS INSTS.				20,000		16,800		36,800	\$1,040,336	0.10%
TIFFANY & CO				9,000		16,600		25,600	\$1,071,104	0.10%
TIMKEN	9,300		20,100					29,400	\$873,768	0.08%
TRW AUTV.HDG.	37,700		17,500					55,200	\$1,290,024	0.12%
UNITED PARCEL SER.				2,300		13,400		15,700	\$1,146,414	0.11%
UNITED TECHNOLOGIES				2,700		8,400		11,100	\$763,902	0.07%
UNITEDHEALTH GP.	21,800			19,700		18,500		60,000	\$2,061,600	0.20%
VALERO ENERGY	41,400			16,700		11,300		69,400	\$3,408,234	0.33%
VARIAN MED.SYS.				2,300		14,200		16,500	\$772,860	0.07%
VERISIGN				9,500		10,200		19,700	\$654,828	0.06%
W-H ENERGY SERVICES		9,200	4,400					13,600	\$936,360	0.09%
WAL MART STORES						18,600	29,600	48,200	\$2,539,176	0.24%
WALGREEN				1,300		21,800		23,100	\$879,879	0.08%
WELLPOINT	19,000			2,000			23,250	44,250	\$1,952,753	0.19%
WINTRUST FINL.		21,100	5,800					26,900	\$940,155	0.09%
WYETH						17,100	34,000	51,100	\$2,133,936	0.20%
XTO EN.				17,600		13,800		31,400	\$1,942,404	0.19%

# Fresno County Employees' Retirement Association

## Cross Holding Analysis - Equity Managers

Period Ending: March 31, 2008

Securities	ARONSON PARTNERS	ARTISAN MANAGEMENT	BRANDYWINE	INTECH S&P BARRA	KALMAR MANAGEMENT	TCW CORE	WELLINGTON	Total Shares	Total M. V.	% Total Eqt.
<b>YUM! BRANDS</b>				4,300		13,900		18,200	\$677,222	0.06%
<b>Total Shares:</b>	1,558,170	808,100	218,300	1,773,664	662,324	1,365,300	1,884,057	8,269,915	\$364,467,352	35.16%

# Fresno County Employees' Retirement Association

## Cumulative Performance Comparisons

Period Ending: March 31, 2008

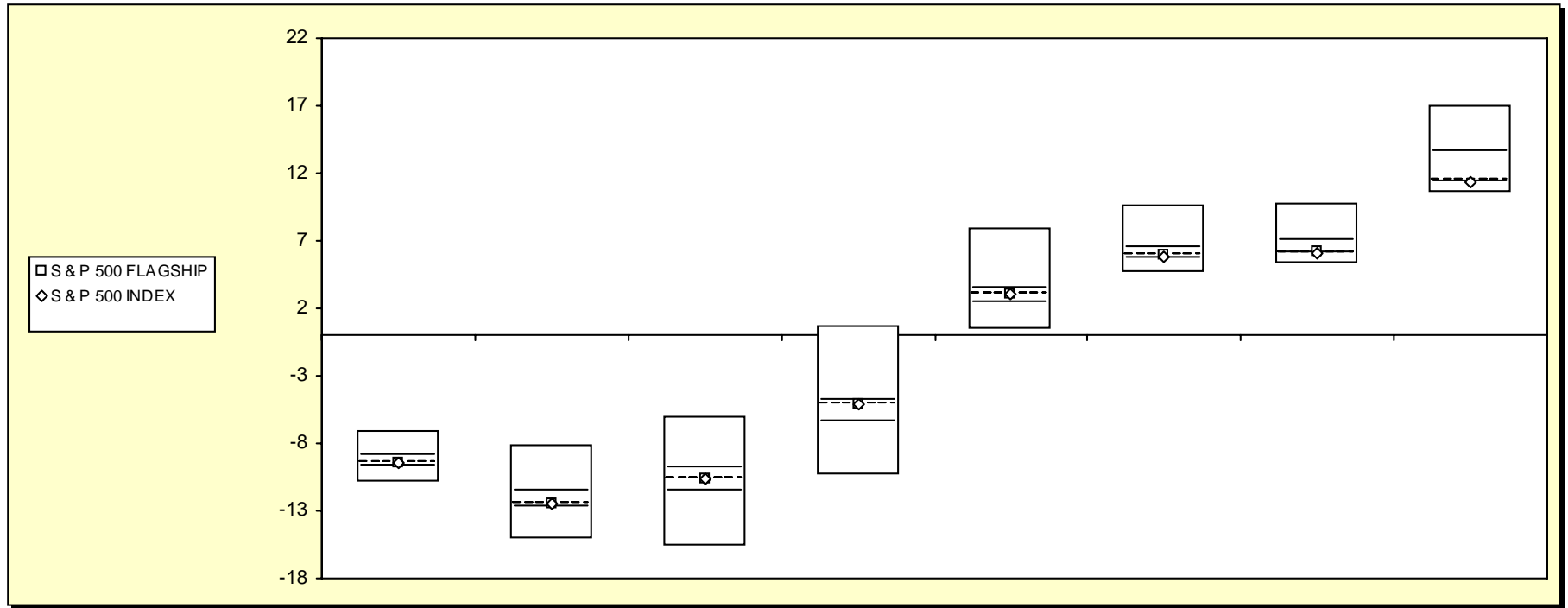

### Equity Style - Large Core

	Last Quarter		Two Quarters		Three Quarters		One Year		Two Years		Three Years		Four Years		Five Years	
	Return	Rank	Return	Rank	Return	Rank	Return	Rank	Return	Rank	Return	Rank	Return	Rank	Return	Rank
5th Percentile	-7.1		-8.1		-6.0		0.7		7.9		9.7		9.8		16.9	
25th Percentile	-8.9		-11.6		-9.9		-4.8		3.5		6.4		7.0		13.5	
50th Percentile	-9.4		-12.4		-10.7		-5.1		3.1		5.9		6.1		11.5	
75th Percentile	-9.7		-12.7		-11.6		-6.5		2.3		5.7		6.0		11.3	
95th Percentile	-10.9		-15.1		-15.7		-10.4		0.4		4.6		5.2		10.5	
S & P 500 FLAGSHIP	-9.4	51	-12.5	53	-10.7	50	-5.0	49	3.1	49	5.9	50	6.1	50		
S & P 500 INDEX	-9.4	51	-12.5	53	-10.7	51	-5.1	50	3.0	51	5.9	58	6.1	69	11.3	74

# Fresno County Employees' Retirement Association

## Consecutive Performance Comparisons

Period Ending: March 31, 2008

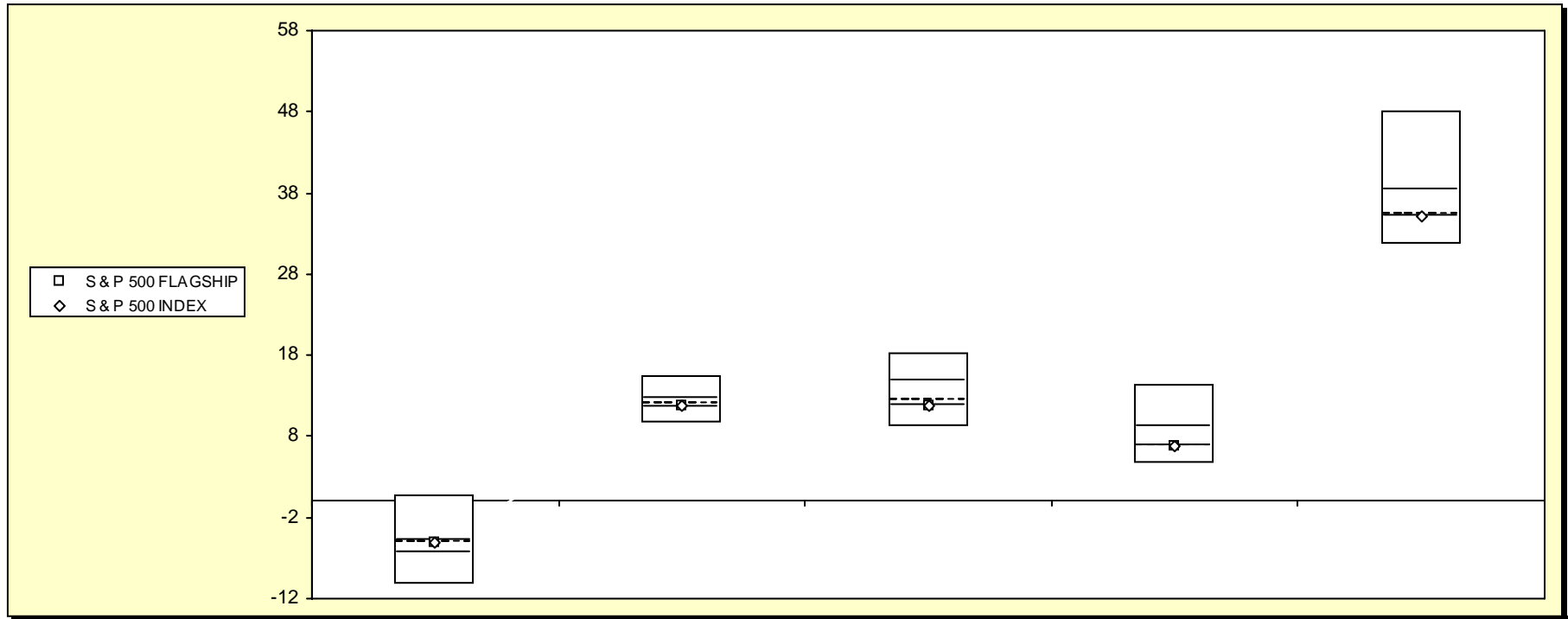

### Equity Style - Large Core

	March 2008		March 2007		March 2006		March 2005		March 2004	
	Return	Rank	Return	Rank	Return	Rank	Return	Rank	Return	Rank
5th Percentile	0.7		15.5		18.3		14.3		48.1	
25th Percentile	-4.8		12.6		14.8		9.3		38.4	
50th Percentile	-5.1		11.9		12.4		6.9		35.3	
75th Percentile	-6.5		11.6		11.7		6.7		35.1	
95th Percentile	-10.4		9.6		9.3		4.7		31.6	
S & P 500 FLAGSHIP	-5.0	49	11.9	51	11.8	71	6.9	50		
S & P 500 INDEX	-5.1	50	11.8	54	11.7	75	6.7	75	35.1	67

# Fresno County Employees' Retirement Association

Consecutive Annual - Five Year

Period Ending: March 31, 2008

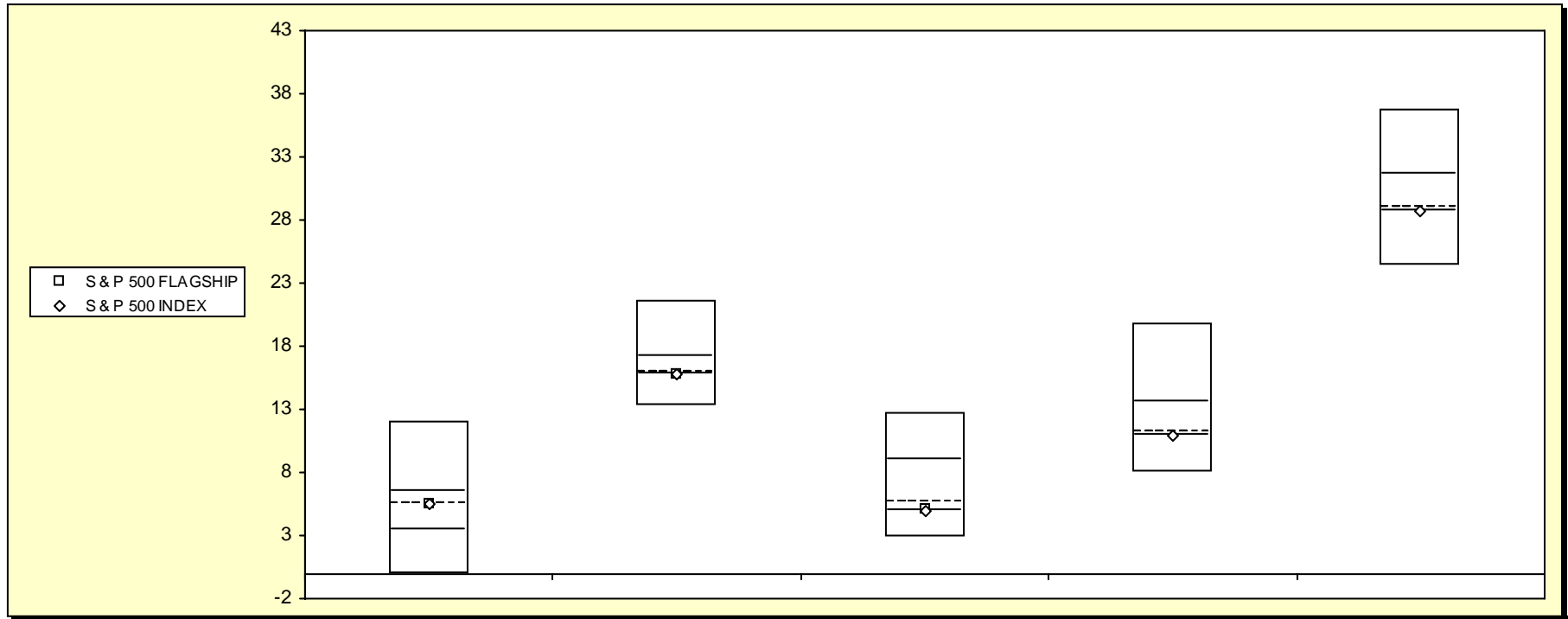

Equity Style - Large Core

	December 2007		December 2006		December 2005		December 2004		December 2003	
	Return	Rank	Return	Rank	Return	Rank	Return	Rank	Return	Rank
5th Percentile	12.0		21.7		12.7		19.8		36.7	
25th Percentile	6.5		17.2		9.0		13.6		31.7	
50th Percentile	5.6		15.9		5.6		11.1		28.9	
75th Percentile	3.4		15.7		4.9		10.9		28.6	
95th Percentile	0.0		13.3		2.8		8.1		24.4	
S & P 500 FLAGSHIP	5.5	50	15.8	57	5.2	66				
S & P 500 INDEX	5.5	51	15.8	62	4.9	75	10.9	75	28.7	70

# Fresno County Employees' Retirement Association

## Equity Only Summary Statistics

Period Ending: March 31, 2008

### S & P 500 FLAGSHIP

	Portfolio	S & P 500 INDEX
Total Number of Securities	475	500
Total Market Value	66,824,211,158	
Average Market Capitalization (000's)	80,801,003	95,340,000
Equity Segment Yield	2.47	2.20
Equity Segment Price/Earnings Ratio	18.89	15.24
Equity Segment Beta	1.00	1.00
Price/Book Ratio	3.54	3.60
5 Year Earnings Growth	16.9%	21.1%

#### Ten Largest Holdings

Security	Market Value	Weight
GENERAL ELECTRIC	2,410,326,416	3.61
AT&T	1,503,834,102	2.25
MICROSOFT	1,486,299,911	2.22
PROCTER & GAMBLE	1,410,525,356	2.11
JOHNSON & JOHNSON	1,197,471,583	1.79
CHEVRON	1,155,140,103	1.73
BANK OF AMERICA	1,102,064,058	1.65
INTERNATIONAL BUS.MACH.	1,038,493,246	1.55
JP MORGAN CHASE & CO.	950,301,028	1.42
APPLE	821,312,636	1.23

#### Ten Best Performers

Security	Return	Weight
BIG LOTS	39.5	0.02
PULTE HOMES	38.5	0.03
EOG RES.	34.6	0.29
CELGENE	32.6	0.26
RYDER SYSTEM	30.1	0.03
CSX	27.9	0.22
RANGE RES.	23.6	0.09
NABORS INDS.	23.3	0.09
PUBLIC STORAGE	21.5	0.11
D R HORTON	20.9	0.04

#### Ten Worst Performers

Security	Return	Weight
BEAR STEARNS	-88.1	0.01
AMBAC FINANCIAL	-77.5	0.01
MGIC INVESTMENT	-53.0	0.01
CIT GROUP	-50.2	0.02
WELLPOINT	-49.7	0.23
SPRINT NEXTEL	-49.1	0.19
SCHERING-PLOUGH	-45.7	0.23
TITANIUM METALS	-42.9	0.01
LEHMAN BROS.HDG.	-42.3	0.19
NVIDIA	-41.8	0.11

# Fresno County Employees' Retirement Association

## Portfolio Characteristics - Equity

Period Ending: March 31, 2008

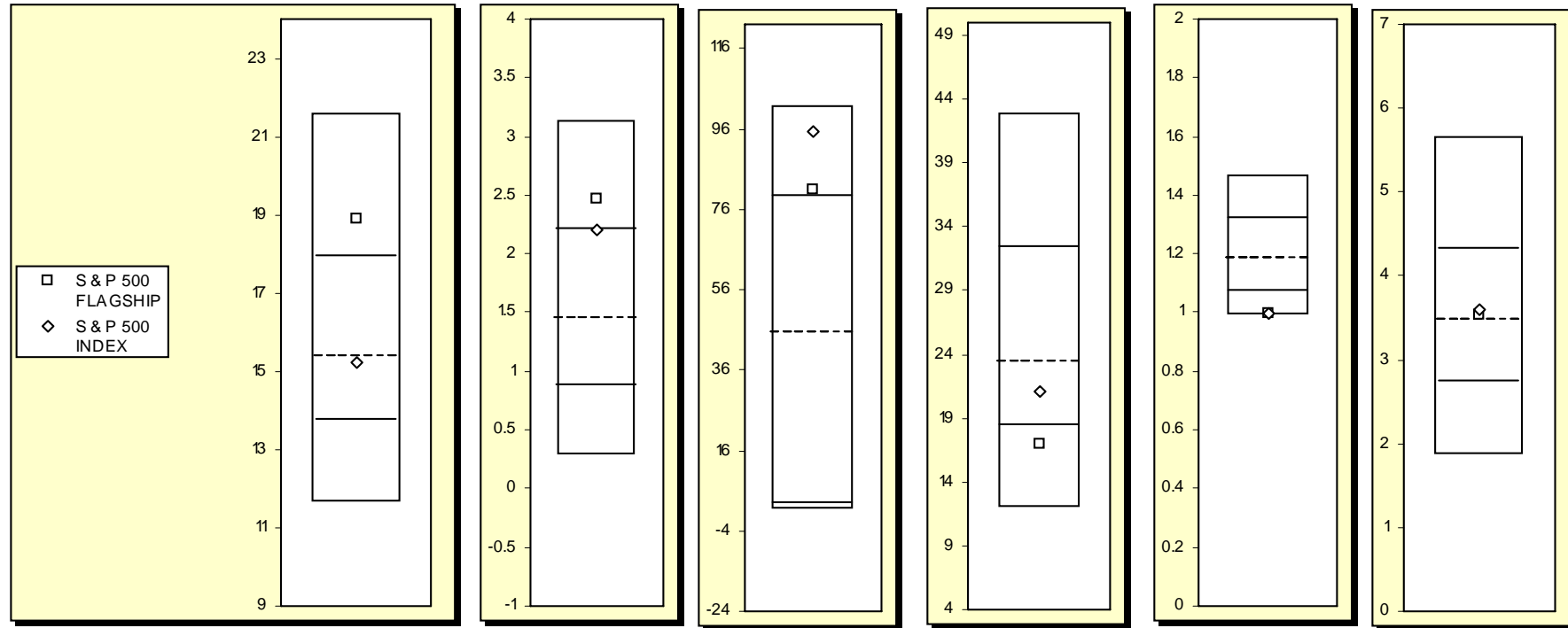

	Price/Earnings Ratio		Dividend Yield		Capitalization		5 Year Earnings		Beta		Price/Book Ratio	
	Value	Rank	Value	Rank	Value	Rank	Value	Rank	Value	Rank	Value	Rank
<i>Equity Funds - Equity Only</i>												
5th Percentile	21.57		3.13		101.51		42.95		1.47		5.66	
25th Percentile	17.93		2.20		78.86		32.34		1.32		4.32	
50th Percentile	15.38		1.45		45.26		23.34		1.18		3.47	
75th Percentile	13.75		0.88		2.83		18.43		1.07		2.72	
95th Percentile	11.66		0.28		1.13		11.93		0.99		1.86	
S & P 500 FLAGSHIP	18.89	20	2.47	19	80.80	23	16.90	80	1.00	93	3.54	48
S & P 500 INDEX	15.24	52	2.20	25	95.34	10	21.05	62	1.00	93	3.60	46

# Fresno County Employees' Retirement Association

## Top Ten Holding

Period Ending: March 31, 2008

As Of 6/30/06	
GENERAL ELECTRIC	3.8%
CITIGROUP	2.7%
MICROSOFT	2.3%
PROCTER & GAMBLE	2.0%
JOHNSON & JOHNSON	2.0%
ALTRIA GROUP INCO.	1.7%
JP MORGAN CHASE & CO.	1.6%
CHEVRON	1.5%
WAL MART STORES	1.3%
INTERNATIONAL BUS.MACH.	1.3%
<b>Top Ten Total: 20.4%</b>	

As Of 9/30/06	
GENERAL ELECTRIC	3.3%
CITIGROUP	2.2%
BANK OF AMERICA	2.2%
MICROSOFT	2.2%
PROCTER & GAMBLE	1.8%
JOHNSON & JOHNSON	1.7%
AMERICAN INTL.GP.	1.6%
JP MORGAN CHASE & CO.	1.5%
ALTRIA GROUP INCO.	1.5%
CHEVRON	1.3%
<b>Top Ten Total: 19.3%</b>	

As Of 12/31/06	
GENERAL ELECTRIC	3.9%
CITIGROUP	2.8%
MICROSOFT	2.6%
PROCTER & GAMBLE	2.1%
JOHNSON & JOHNSON	2.0%
ALTRIA GROUP INCO.	1.8%
JP MORGAN CHASE & CO.	1.7%
CHEVRON	1.7%
INTERNATIONAL BUS.MACH.	1.5%
AT&T	1.4%
<b>Top Ten Total: 21.6%</b>	

As Of 3/31/07	
GENERAL ELECTRIC	3.1%
CITIGROUP	2.1%
AT&T	2.1%
MICROSOFT	2.0%
BANK OF AMERICA	1.9%
PROCTER & GAMBLE	1.7%
AMERICAN INTL.GP.	1.5%
JOHNSON & JOHNSON	1.5%
JP MORGAN CHASE & CO.	1.4%
CHEVRON	1.4%
<b>Top Ten Total: 18.7%</b>	

As Of 6/30/07	
GENERAL ELECTRIC	4.0%
MICROSOFT	2.6%
CITIGROUP	2.6%
PROCTER & GAMBLE	2.0%
CHEVRON	1.9%
JOHNSON & JOHNSON	1.9%
JP MORGAN CHASE & CO.	1.7%
INTERNATIONAL BUS.MACH.	1.7%
AT&T	1.6%
ALTRIA GROUP	1.5%
<b>Top Ten Total: 21.6%</b>	

As Of 9/30/07	
EXXON MOBIL	3.8%
GENERAL ELECTRIC	3.2%
AT&T	1.9%
MICROSOFT	1.8%
CITIGROUP	1.7%
BANK OF AMERICA	1.7%
PROCTER & GAMBLE	1.6%
CISCO SYSTEMS	1.5%
CHEVRON	1.5%
JOHNSON & JOHNSON	1.4%
<b>Top Ten Total: 20.1%</b>	

As Of 12/31/07	
EXXON MOBIL	4.0%
GENERAL ELECTRIC	2.9%
MICROSOFT	2.2%
AT&T	2.0%
PROCTER & GAMBLE	1.8%
CHEVRON	1.5%
JOHNSON & JOHNSON	1.5%
BANK OF AMERICA	1.4%
APPLE	1.4%
CISCO SYSTEMS	1.3%
<b>Top Ten Total: 20.0%</b>	

As Of 3/31/08	
GENERAL ELECTRIC	3.6%
AT&T	2.3%
MICROSOFT	2.2%
PROCTER & GAMBLE	2.1%
JOHNSON & JOHNSON	1.8%
CHEVRON	1.7%
BANK OF AMERICA	1.6%
INTERNATIONAL BUS.MACH.	1.6%
JP MORGAN CHASE & CO.	1.4%
APPLE	1.2%
<b>Top Ten Total: 19.6%</b>	



# Fresno County Employees' Retirement Association

## Equity Only Summary Statistics Charts

Period Ending: March 31, 2008

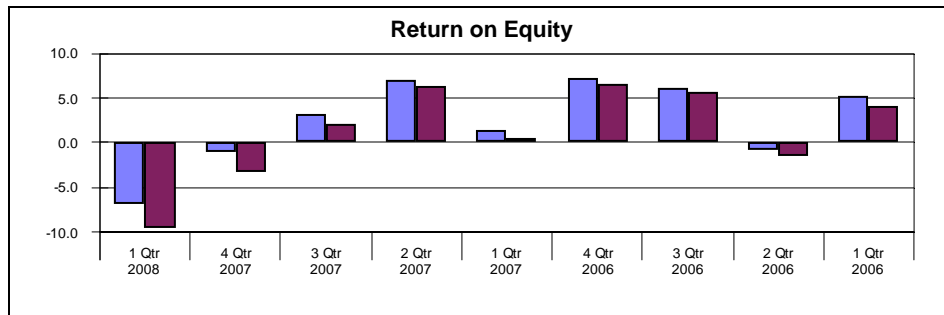
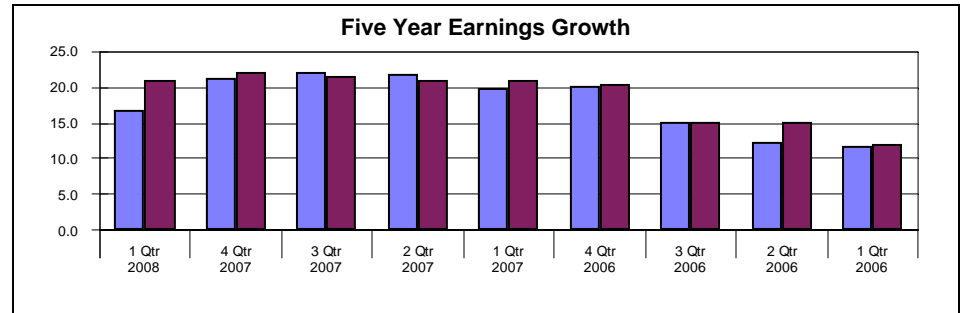
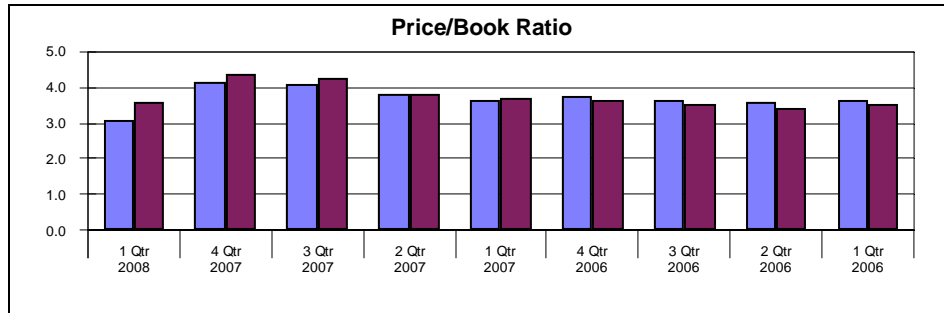
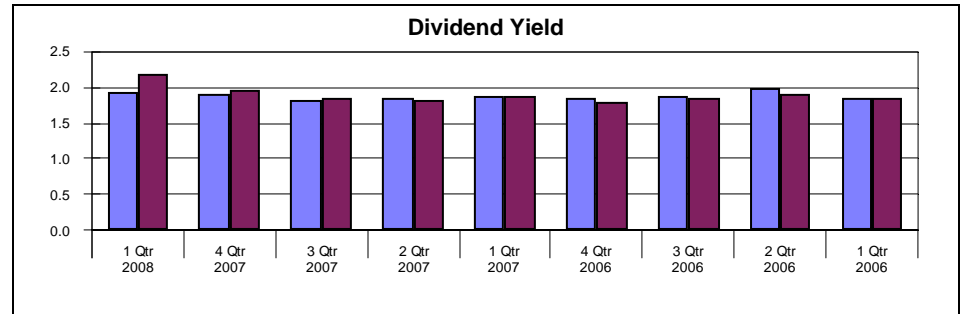
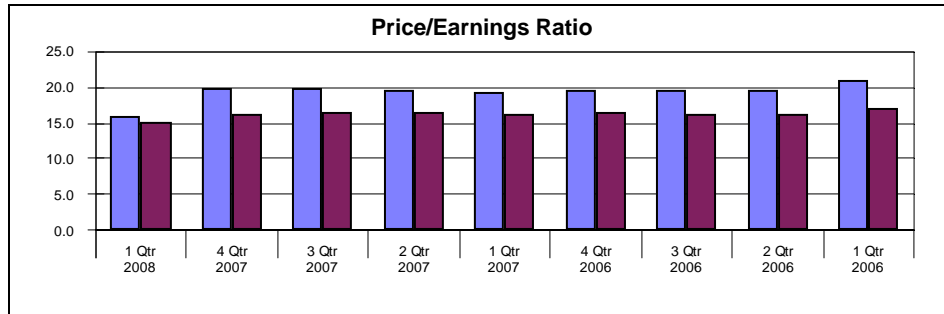
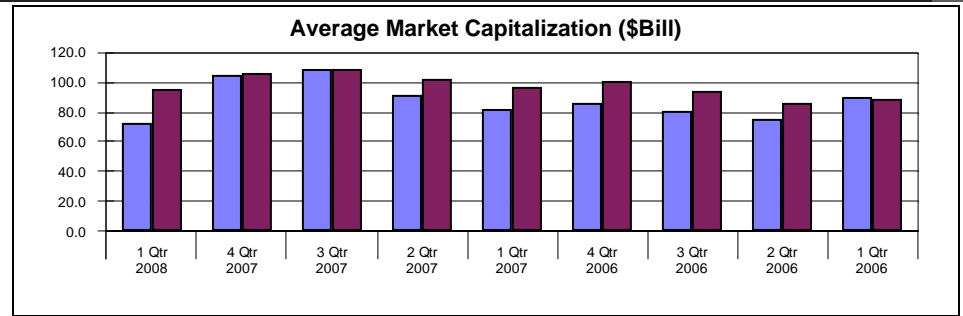
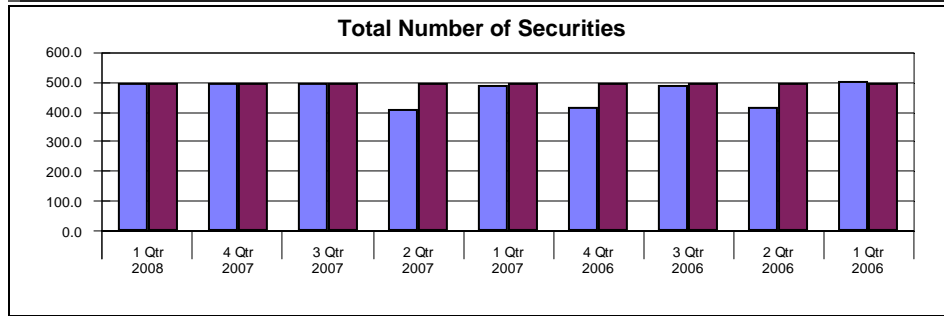

S & P 500 FLAGSHIP  
S & P 500 INDEX

# Fresno County Employees' Retirement Association

## Equity Only Sector Analysis Quarterly

Period Ending: March 31, 2008

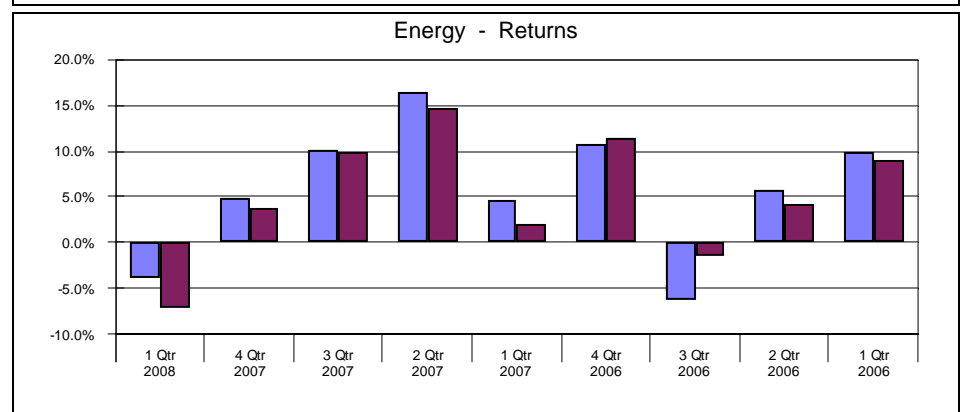
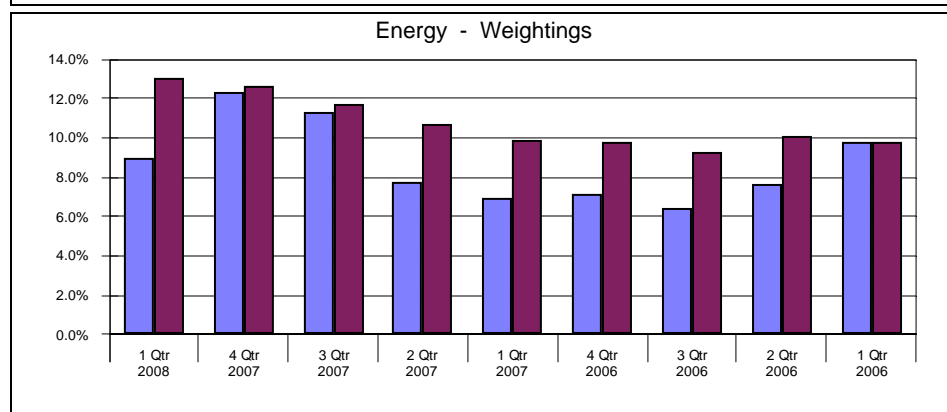
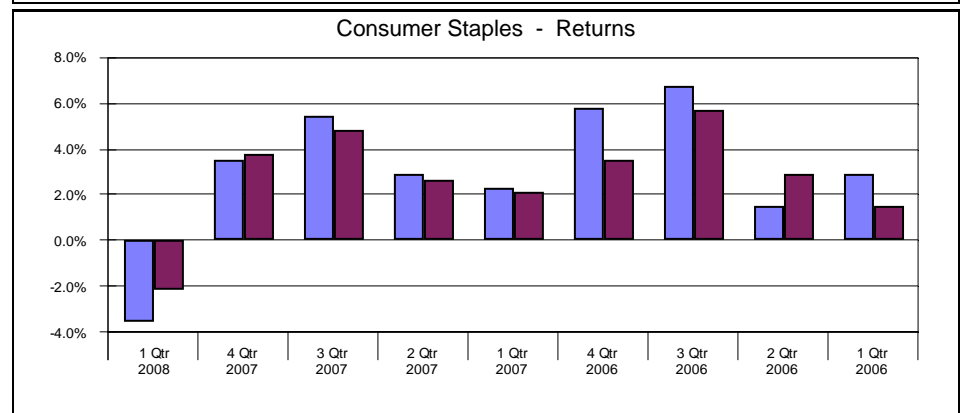
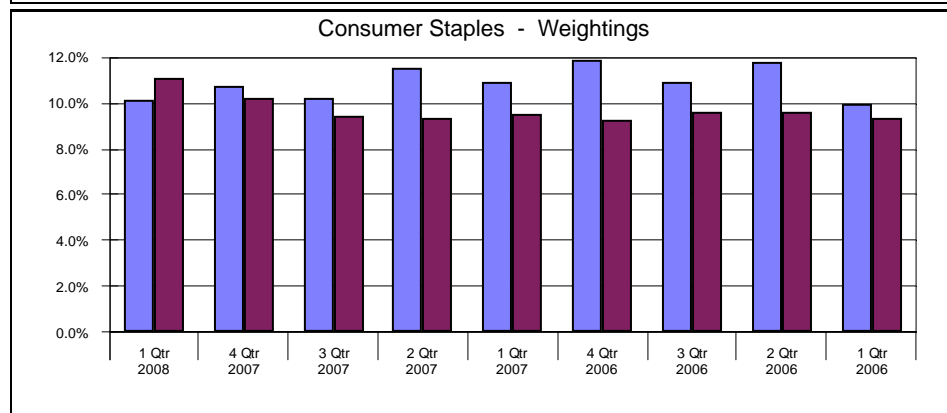
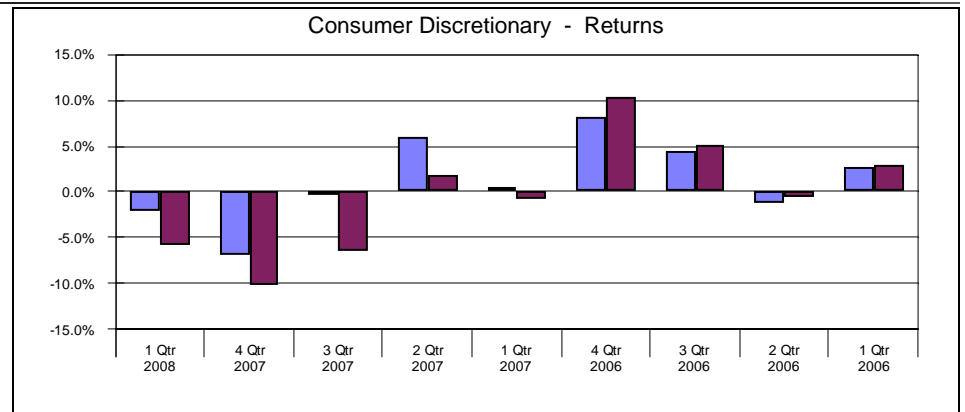
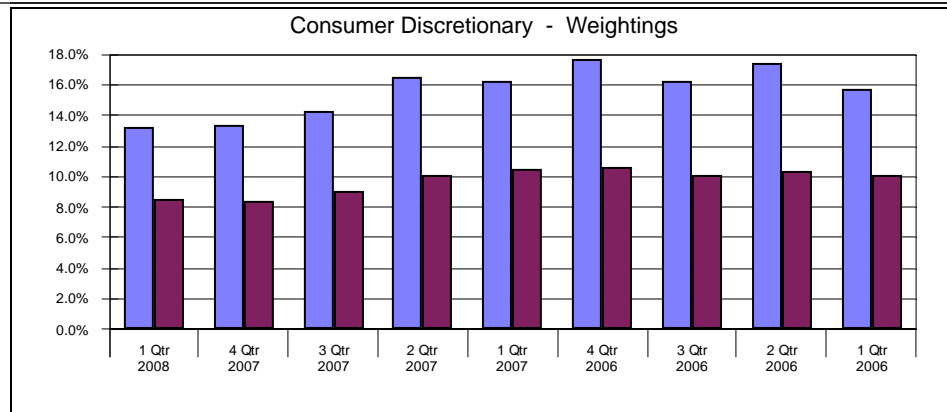

■ S & P 500 FLAGSHIP

■ S & P 500 INDEX

# Fresno County Employees' Retirement Association

## Equity Only Sector Analysis Quarterlyly

Period Ending: March 31, 2008

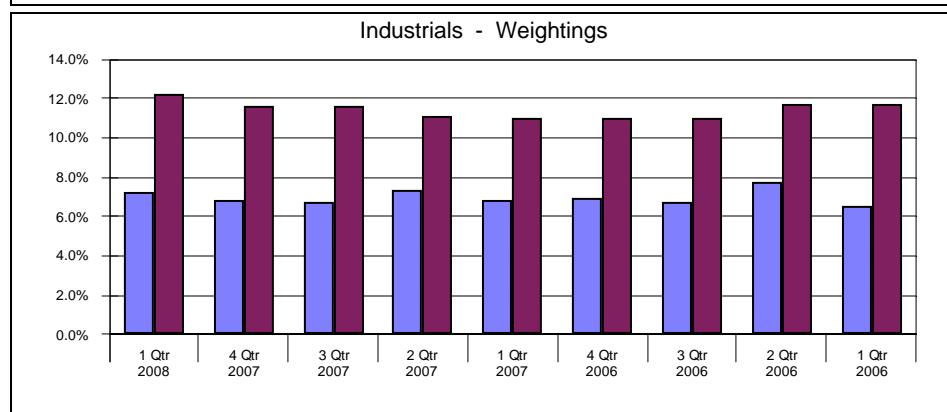
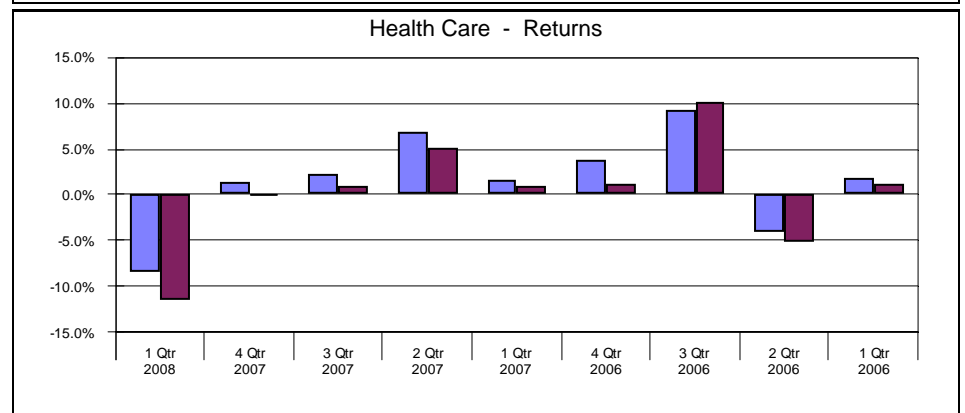
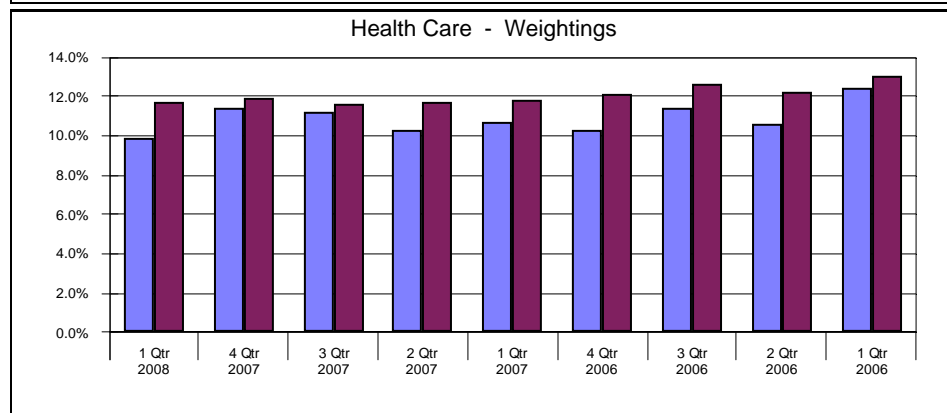
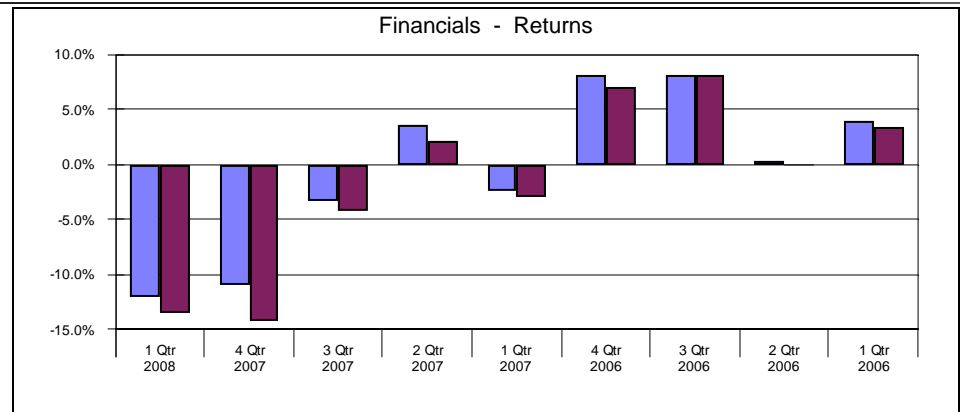
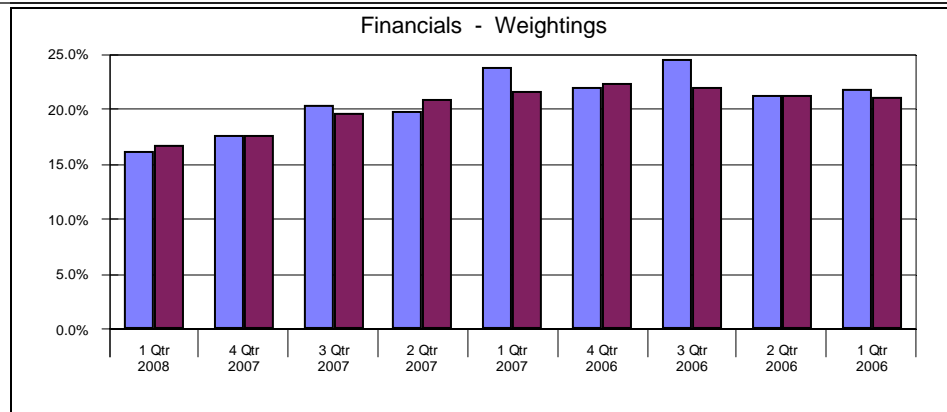

■ S & P 500 FLAGSHIP

■ S & P 500 INDEX

# Fresno County Employees' Retirement Association

## Equity Only Sector Analysis Quarterly

Period Ending: March 31, 2008

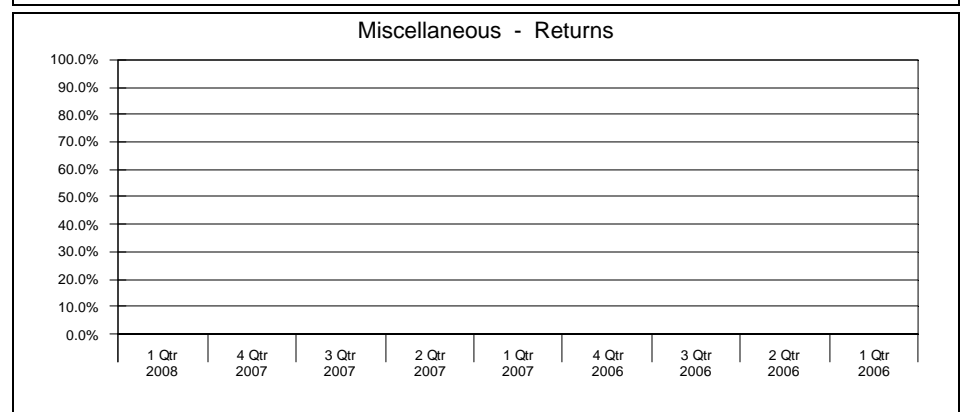
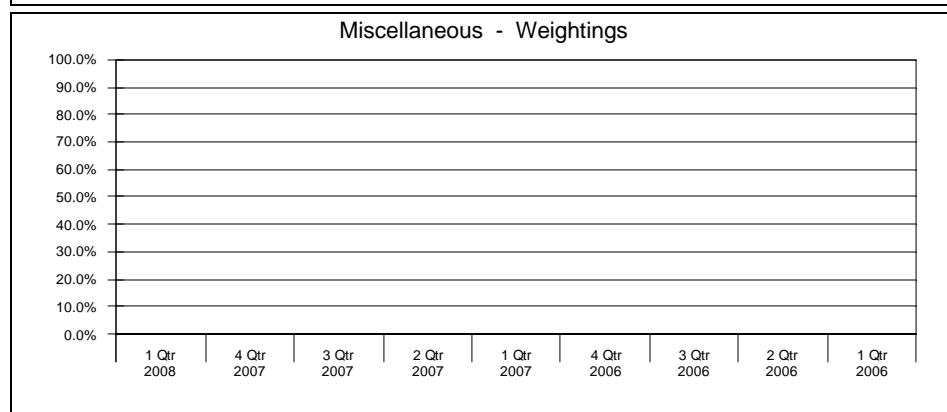
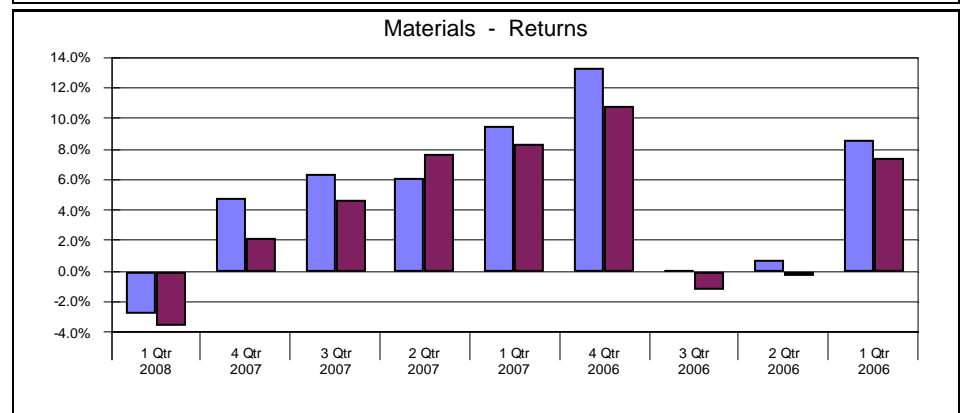
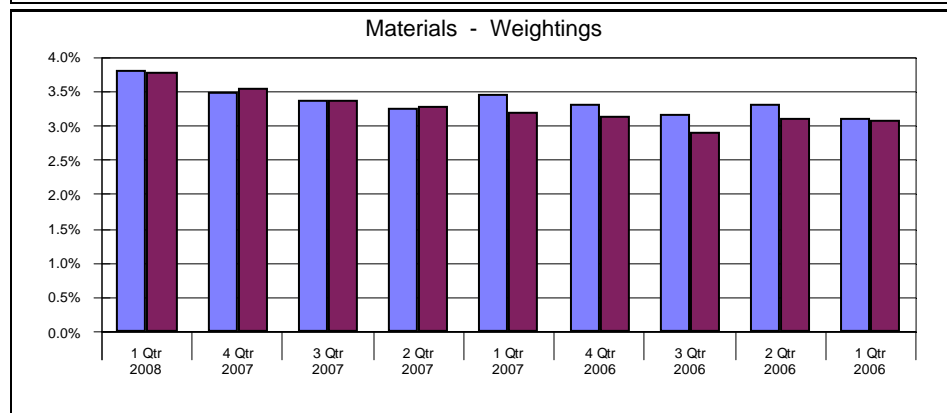
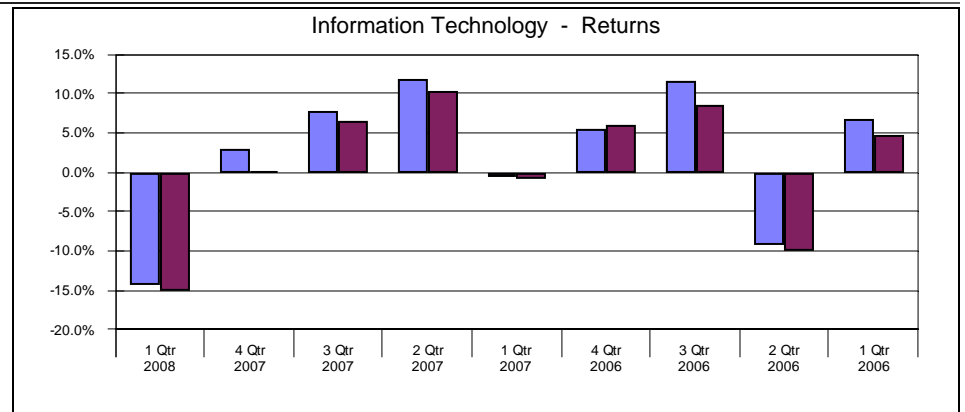
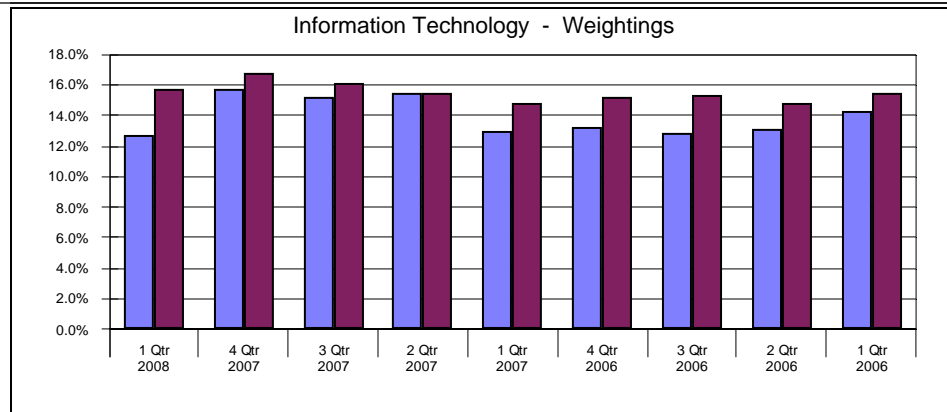

■ S & P 500 FLAGSHIP

■ S & P 500 INDEX

# Fresno County Employees' Retirement Association

## Equity Only Sector Analysis Quarterly

Period Ending: March 31, 2008

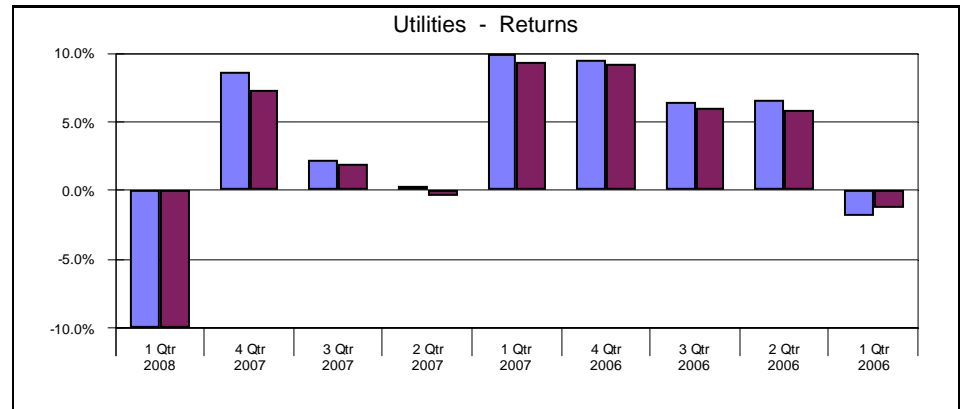
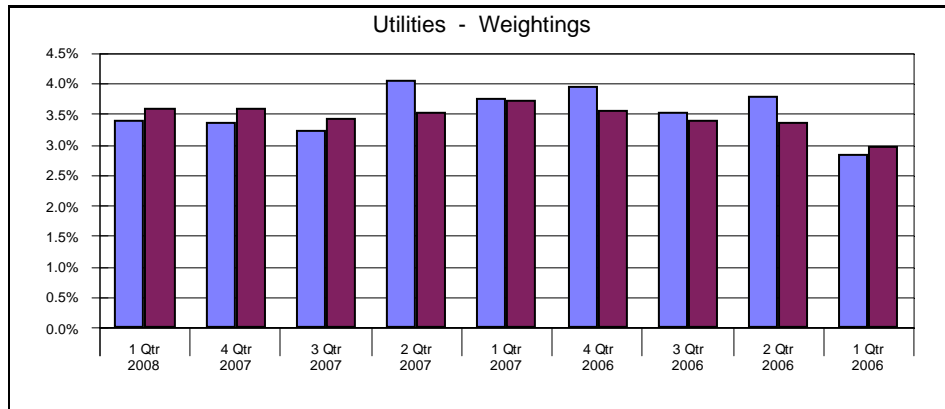
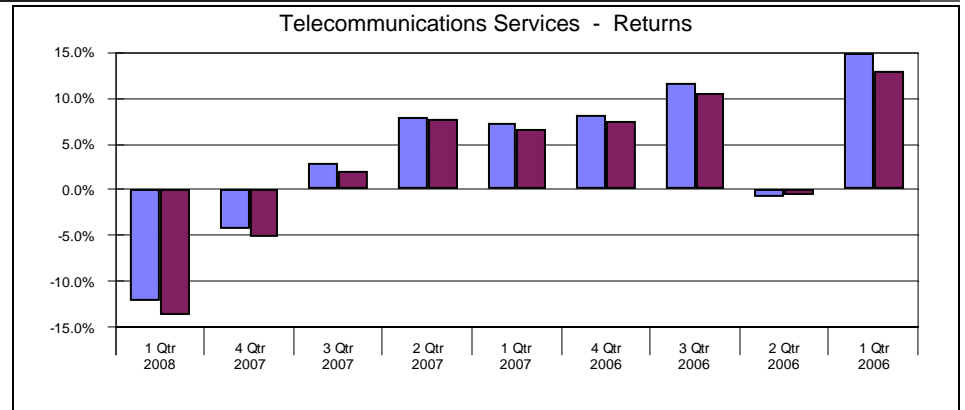
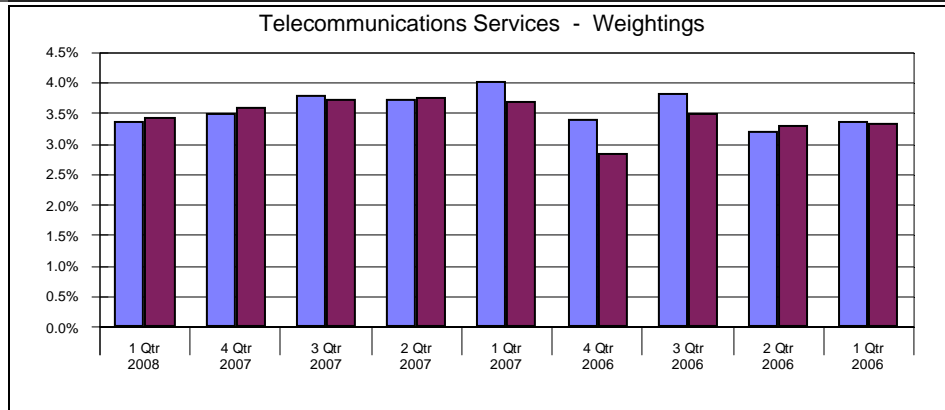

■ S & P 500 FLAGSHIP

■ S & P 500 INDEX

# Fresno County Employees' Retirement Association

## Performance Attribution Geometric

Period Ending: March 31, 2008

### S & P 500 FLAGSHIP

	Portfolio		S & P 500 INDEX		Selection		Total
	Market Value	Return	Market Value	Return	Stock	Industry	
	<b>A</b>	<b>B</b>	<b>C</b>	<b>D</b>	<b>E</b>	<b>F</b>	<b>G</b>
Consumer Discretionary	13.6	-3.6	8.4	-5.7	0.3	0.2	0.5
Consumer Staples	10.9	-4.0	10.2	-2.1	-0.2	0.1	-0.2
Energy	12.5	-7.1	12.6	-7.1	0.0	0.0	0.0
Financials	17.9	-13.9	17.6	-13.5	-0.1	0.0	-0.1
Health Care	11.6	-11.6	12.0	-11.5	0.0	0.0	0.0
Industrials	7.0	-4.9	11.6	-4.1	-0.1	-0.3	-0.3
Information Technology	16.0	-15.5	16.7	-15.2	-0.1	0.0	0.0
Materials	3.6	-3.3	3.6	-3.6	0.0	0.0	0.0
Telecommunications Services	3.6	-13.8	3.6	-13.7	0.0	0.0	0.0
Utilities	3.4	-10.3	3.6	-9.9	0.0	0.0	0.0
	100.0	-9.4	100.0	-9.4	-0.1	0.0	-0.1

#### Contribution

<b>Stock</b>	Consumer Discretionary
	Materials
<b>Industry</b>	Consumer Discretionary
	Consumer Staples

#### Detractors

<b>Stock</b>	Consumer Staples
	Financials
<b>Industry</b>	Industrials
	Financials

# Fresno County Employees' Retirement Association

## Cumulative Performance Comparisons

Period Ending: March 31, 2008

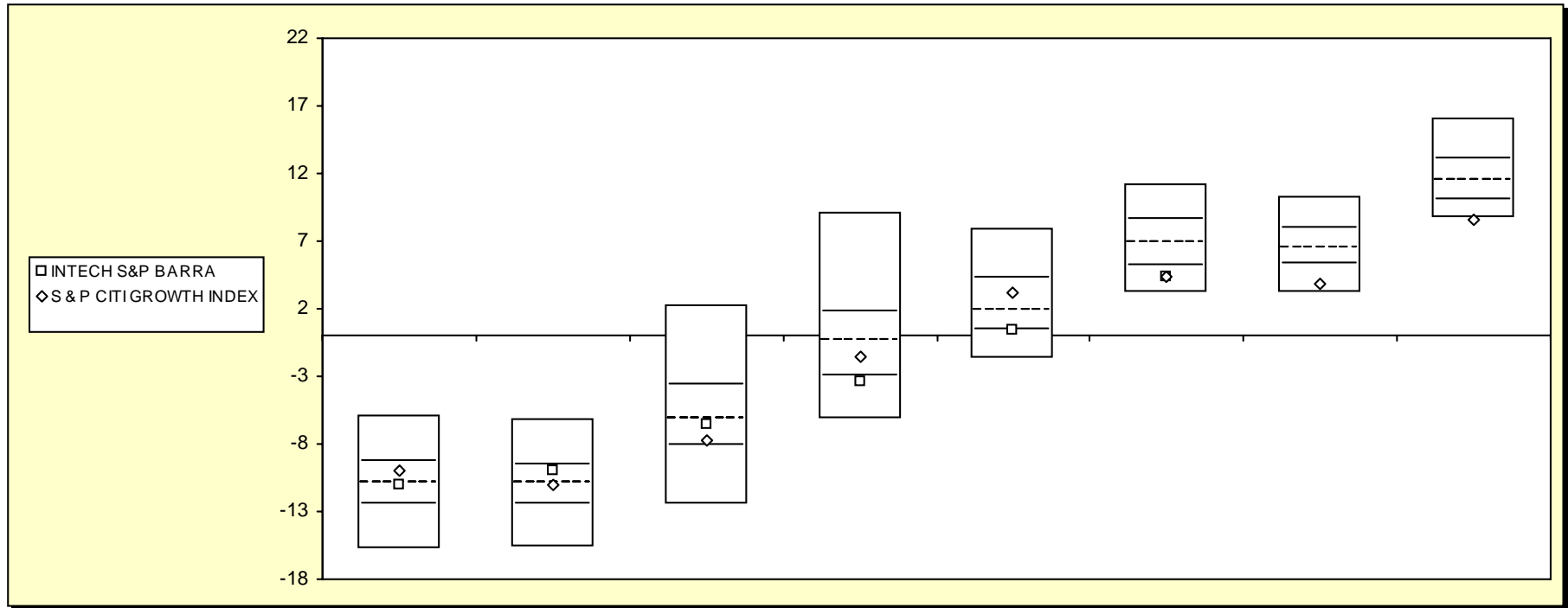

### Equity Style - Large Growth

	Last Quarter		Two Quarters		Three Quarters		One Year		Two Years		Three Years		Four Years		Five Years	
	Return	Rank	Return	Rank	Return	Rank	Return	Rank	Return	Rank	Return	Rank	Return	Rank	Return	Rank
5th Percentile	-5.9		-6.2		2.3		9.1		7.9		11.2		10.3		16.1	
25th Percentile	-9.3		-9.6		-3.7		1.8		4.3		8.5		8.0		13.0	
50th Percentile	-10.9		-10.9		-6.1		-0.4		1.9		6.8		6.5		11.5	
75th Percentile	-12.5		-12.5		-8.1		-3.0		0.4		5.2		5.3		10.0	
95th Percentile	-15.8		-15.6		-12.5		-6.2		-1.7		3.2		3.2		8.7	
INTECH S&P BARRA	-11.0	53	-9.9	32	-6.6	56	-3.4	78	0.4	74	4.3	84				
S & P CITI GROWTH INDEX	-9.9	35	-11.1	53	-7.7	70	-1.6	62	3.1	37	4.3	84	3.8	89	8.6	95

# Fresno County Employees' Retirement Association

## Consecutive Performance Comparisons

Period Ending: March 31, 2008

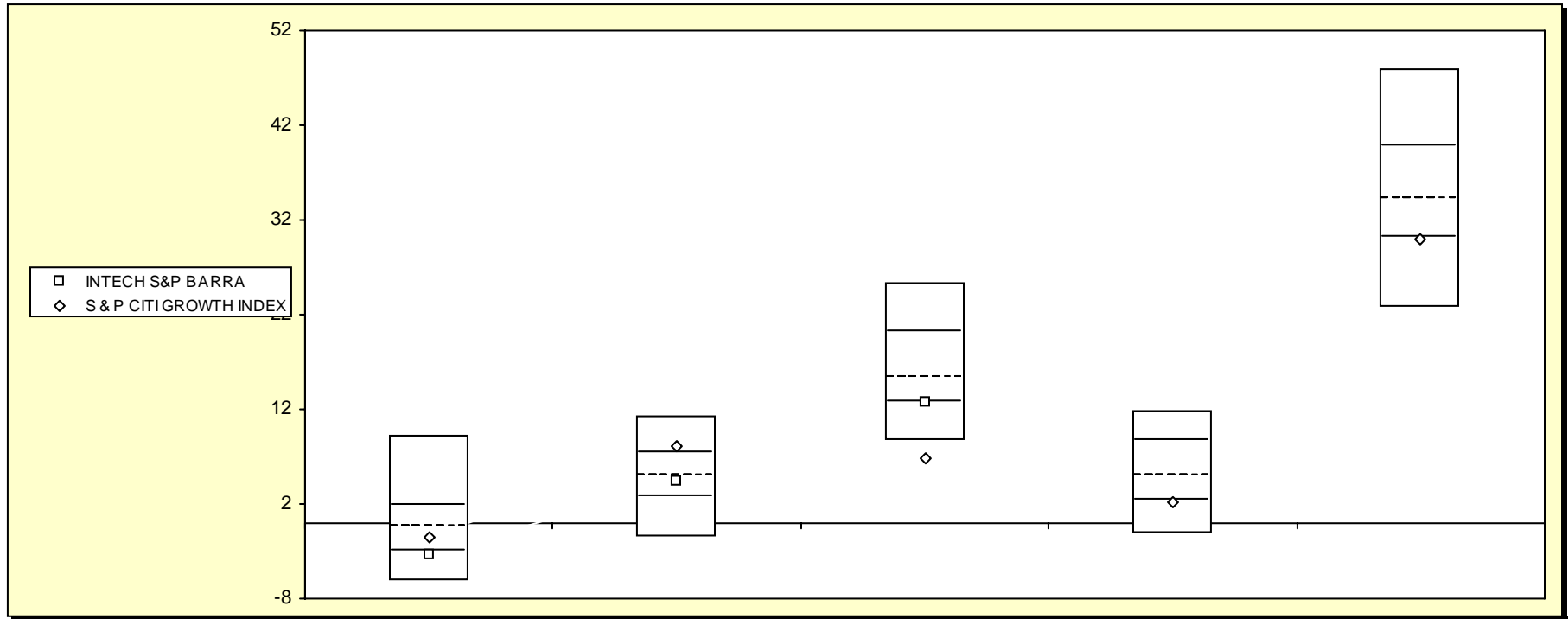

### Equity Style - Large Growth

	March 2008		March 2007		March 2006		March 2005		March 2004	
	Return	Rank	Return	Rank	Return	Rank	Return	Rank	Return	Rank
5th Percentile	9.1		11.3		25.3		11.8		47.9	
25th Percentile	1.8		7.3		20.2		8.6		39.7	
50th Percentile	-0.4		5.0		15.3		5.0		34.2	
75th Percentile	-3.0		2.7		12.8		2.3		30.1	
95th Percentile	-6.2		-1.4		8.7		-1.2		22.7	
INTECH S&P BARRA	-3.4	78	4.4	57	12.7	76	2.3	75	29.9	75
S & P CITI GROWTH INDEX	-1.6	62	8.1	21	6.8	97	2.3	75	29.9	75



# Fresno County Employees' Retirement Association

Consecutive Annual - Five Year

Period Ending: March 31, 2008

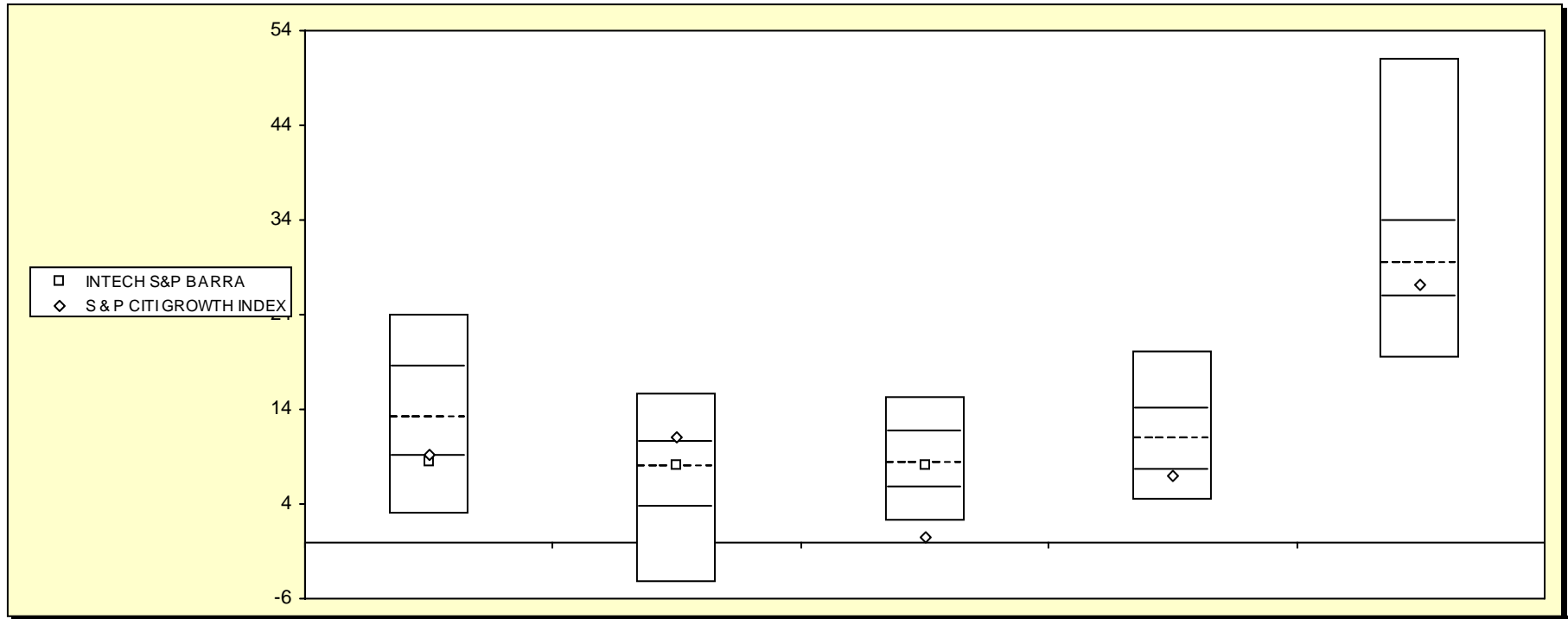

*Equity Style - Large Growth*

	December 2007		December 2006		December 2005		December 2004		December 2003	
	Return	Rank	Return	Rank	Return	Rank	Return	Rank	Return	Rank
5th Percentile	24.0		15.6		15.3		20.1		51.0	
25th Percentile	18.4		10.5		11.6		13.9		33.7	
50th Percentile	13.1		7.9		8.3		10.9		29.4	
75th Percentile	9.0		3.7		5.7		7.5		25.8	
95th Percentile	2.9		-4.3		2.1		4.4		19.4	
INTECH S&P BARRA	8.4	77	8.1	48	8.0	53				
S & P CITI GROWTH INDEX	9.1	74	11.0	23	0.4	97	7.0	78	27.1	66

# Fresno County Employees' Retirement Association

## Equity Only Summary Statistics

Period Ending: March 31, 2008

### INTECH S&P BARRA

	Portfolio	S & P GROWTH INDEX
Total Number of Securities	167	301
Total Market Value	144,024,840	
Average Market Capitalization (000's)	103,118,234	96,040,000
Equity Segment Yield	1.55	1.39
Equity Segment Price/Earnings Ratio	22.68	16.11
Equity Segment Beta	1.03	1.08
Price/Book Ratio	4.56	4.32
5 Year Earnings Growth	22.5%	26.7%

#### Ten Largest Holdings

Security	Market Value	Weight
EXXON MOBIL CORP	13,828,830	9.60
APPLE INC COM NPV	6,328,350	4.39
PROCTER AND GAMBLE CO	5,167,452	3.59
MICROSOFT CORP	4,134,966	2.87
INTERNATIONAL BUSINESS MACHS	4,133,526	2.87
AMAZON COM INC	4,056,970	2.82
ABBOTT LABS	3,910,135	2.71
COCA COLA CO	3,804,375	2.64
NATIONAL OILWELL VARCO INC	3,788,862	2.63
BAXTER INTL INC	3,538,584	2.46

#### Ten Best Performers

Security	Return	Weight
EOG RESOURCES INC	34.6	0.02
CELGENE CORP	32.6	1.17
RANGE RES CORP	23.6	0.00
XTO ENERGY INC	20.7	0.76
HUDSON CITY BANCORP INC	18.4	0.31
CHESAPEAKE ENERGY CORP	17.9	0.09
ZIMMER HOLDINGS INC	17.7	0.92
TJX COS INC NEW	15.4	0.23
APACHE CORP	12.6	0.16
GILEAD SCIENCES INC	12.0	0.02

#### Ten Worst Performers

Security	Return	Weight
WELLPOINT INC	-49.7	0.06
SCHERING PLOUGH CORP	-45.7	0.94
NVIDIA CORP	-41.8	0.27
MOTOROLA INC	-41.7	0.03
HARMAN INTL INDS INC NEW	-40.9	0.07
UNITEDHEALTH GROUP INC	-40.9	0.47
HUMANA INC	-40.4	0.21
APOLLO GROUP INC	-38.4	0.90
TESORO CORP	-36.9	0.08
AUTODESK INCORPORATED COM STK NPV	-36.7	0.02

# Fresno County Employees' Retirement Association

## Portfolio Characteristics - Equity

Period Ending: March 31, 2008

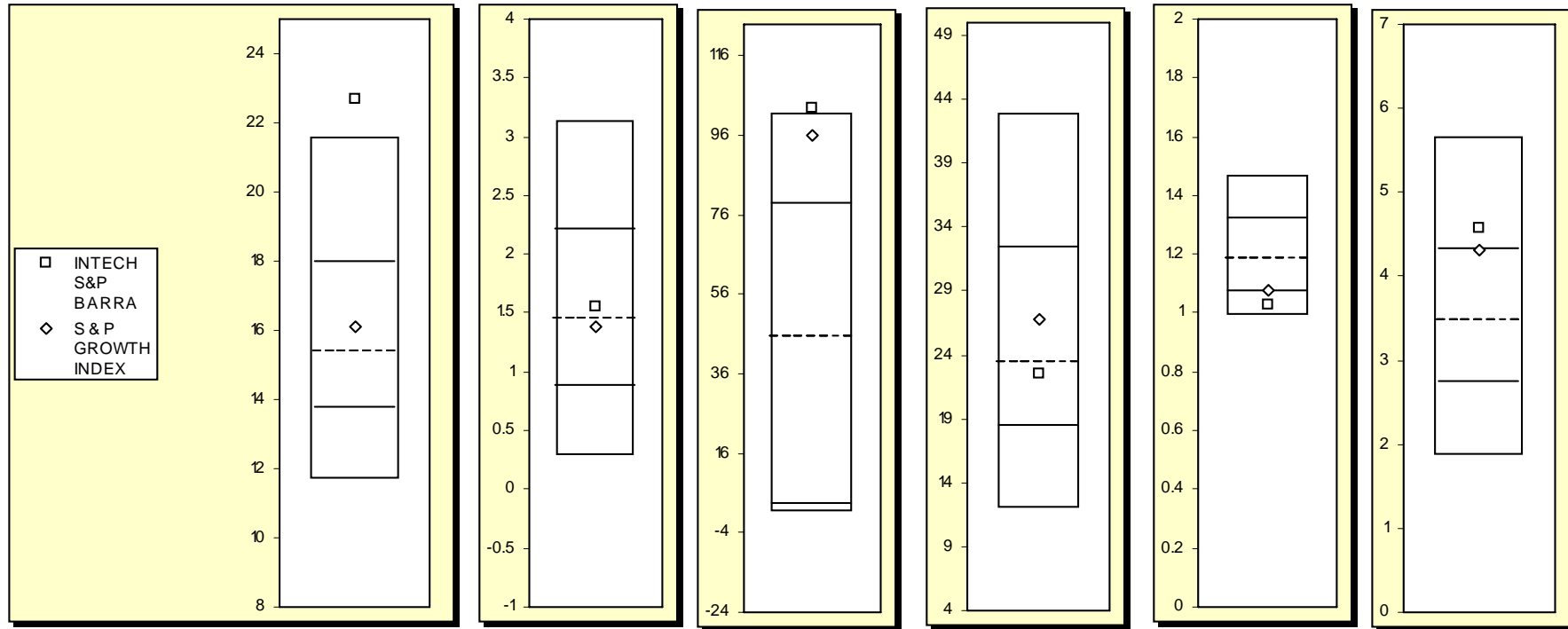

	Price/Earnings Ratio		Dividend Yield		Capitalization		5 Year Earnings		Beta		Price/Book Ratio	
	Value	Rank	Value	Rank	Value	Rank	Value	Rank	Value	Rank	Value	Rank
<i>Equity Funds - Equity Only</i>												
5th Percentile	21.57		3.13		101.51		42.95		1.47		5.66	
25th Percentile	17.93		2.20		78.86		32.34		1.32		4.32	
50th Percentile	15.38		1.45		45.26		23.34		1.18		3.47	
75th Percentile	13.75		0.88		2.83		18.43		1.07		2.72	
95th Percentile	11.66		0.28		1.13		11.93		0.99		1.86	
INTECH S&P BARRA	22.68	3	1.55	47	103.12	5	22.53	54	1.03	85	4.56	21
S & P GROWTH INDEX	16.11	43	1.39	53	96.04	10	26.74	41	1.08	73	4.32	25

# Fresno County Employees' Retirement Association

## Top Ten Holding

Period Ending: March 31, 2008

As Of 6/30/06	
MICROSOFT CORP.	3.7%
JOHNSON & JOHNSON	2.9%
GENERAL ELECTRIC CO.	2.7%
EXPRESS SCRIPTS INCORPORATED	1.9%
ALTRIA GROUP INCORPORATED	1.8%
EXXON MOBIL CORP.	1.8%
UNITEDHEALTH GROUP INC.	1.6%
WYETH	1.6%
WAL-MART STORES, INC.	1.6%
PEPSICO INC	1.5%
<b>Top Ten Total:</b>	<b>21.0%</b>

As Of 9/30/06	
JOHNSON & JOHNSON	2.9%
MICROSOFT CORP.	2.8%
GENERAL ELECTRIC CO.	2.5%
EXXON MOBIL CORP.	2.0%
ALTRIA GROUP INCORPORATED	2.0%
PEPSICO INC	1.9%
EXPRESS SCRIPTS INCORPORATED	1.7%
SCHLUMBERGER LTD	1.6%
BOEING COMPANY	1.6%
WYETH	1.5%
<b>Top Ten Total:</b>	<b>20.5%</b>

As Of 12/31/06	
JOHNSON & JOHNSON	2.9%
MICROSOFT CORP.	2.7%
GENERAL ELECTRIC CO.	2.5%
INTERNATIONAL GAME TECHNOLOGY	2.1%
ALTRIA GROUP INCORPORATED	2.1%
PEPSICO INC	2.0%
BOEING COMPANY	1.9%
NVIDIA CORPORATION	1.8%
COLGATE	1.8%
SCHLUMBERGER LTD	1.7%
<b>Top Ten Total:</b>	<b>21.4%</b>

As Of 3/31/07	
EXXON CORP	4.6%
JOHNSON & JOHNSON	3.0%
KOHL'S	2.5%
ALTRIA GROUP INCORPORATED	2.4%
COLGATE	2.1%
MICROSOFT CORP.	2.0%
PEPSICO INC	1.9%
ORACLE CORP.	1.9%
GENERAL ELECTRIC CO.	1.9%
INTERNATIONAL GAME TECHNOLOGY	1.9%
<b>Top Ten Total:</b>	<b>24.3%</b>

As Of 6/30/07	
EXXON MOBIL	4.7%
BAXTER INTERNATIONAL, INC.	2.6%
KOHL'S	2.3%
STRYKER CORPORATION	2.2%
APPLE COMPUTER, INCORPORATED	2.2%
JOHNSON & JOHNSON	2.1%
MICROSOFT CORP.	2.0%
ORACLE CORP.	2.0%
COLGATE	2.0%
ZIMMER HOLDINGS, INC.	1.9%
<b>Top Ten Total:</b>	<b>24.2%</b>

As Of 9/30/07	
EXXON MOBIL CORP.	9.7%
PROCTER & GAMBLE CO	4.1%
APPLE COMPUTER, INCORPORATED	2.9%
ABBOTT LABS	2.9%
STRYKER CORPORATION	2.9%
BAXTER INTERNATIONAL, INC.	2.8%
INTERNATIONAL BUSINESS MACHINES	2.7%
MCDONALDS CORPORATION	2.3%
ZIMMER HOLDINGS, INC.	2.2%
AMAZON. COM CORPORATION	2.1%
<b>Top Ten Total:</b>	<b>34.4%</b>

As Of 12/31/07	
EXXON MOBIL CORP.	9.1%
APPLE COMPUTER, INCORPORATED	4.2%
PROCTER & GAMBLE CO	3.0%
MICROSOFT CORP.	2.7%
INTERNATIONAL BUSINESS MACHINES	2.6%
ABBOTT LABS	2.6%
AMAZON. COM CORPORATION	2.5%
NATIONAL OILWELL, INCORPORATED	2.5%
STRYKER CORPORATION	2.4%
SCHLUMBERGER LTD	2.3%
<b>Top Ten Total:</b>	<b>34.0%</b>

As Of 3/31/08	
EXXON MOBIL CORP	9.6%
APPLE INC COM NPV	4.4%
PROCTER AND GAMBLE CO	3.6%
MICROSOFT CORP	2.9%
INTERNATIONAL BUSINESS MACHS	2.9%
AMAZON COM INC	2.8%
ABBOTT LABS	2.7%
COCA COLA CO	2.6%
NATIONAL OILWELL VARCO INC	2.6%
BAXTER INTL INC	2.5%
<b>Top Ten Total:</b>	<b>36.6%</b>

# Fresno County Employees' Retirement Association

## Equity Only Summary Statistics Charts

Period Ending: March 31, 2008

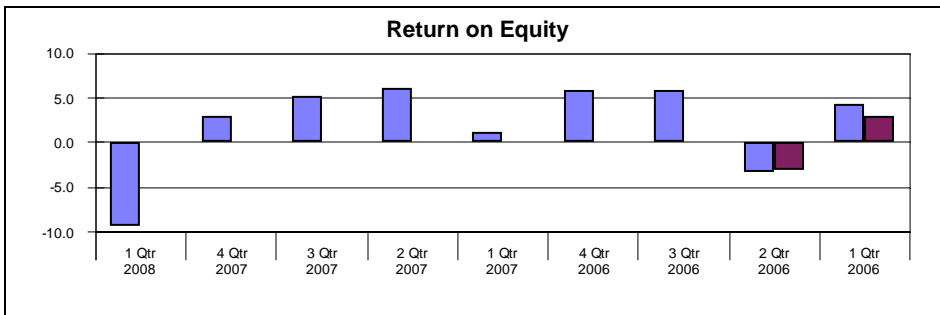
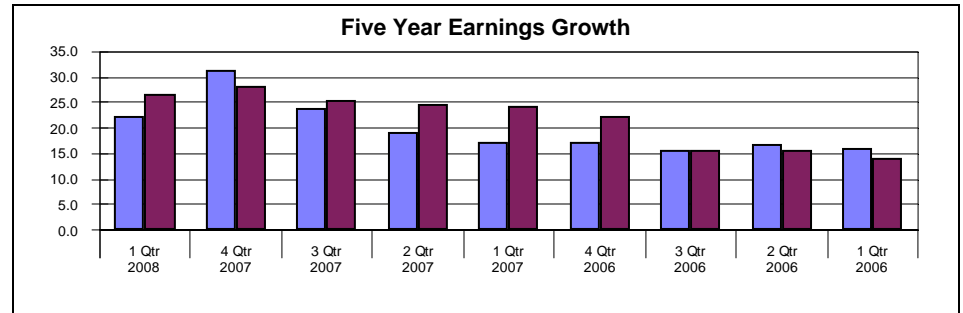
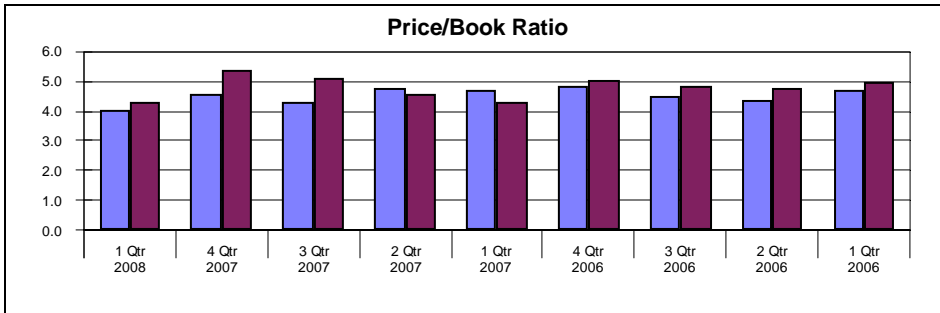
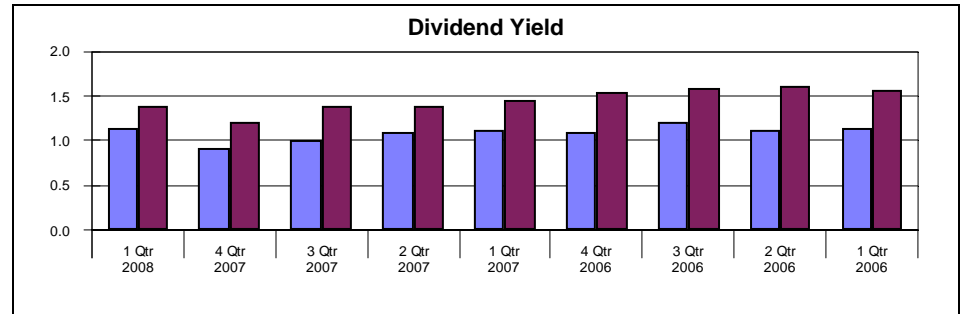
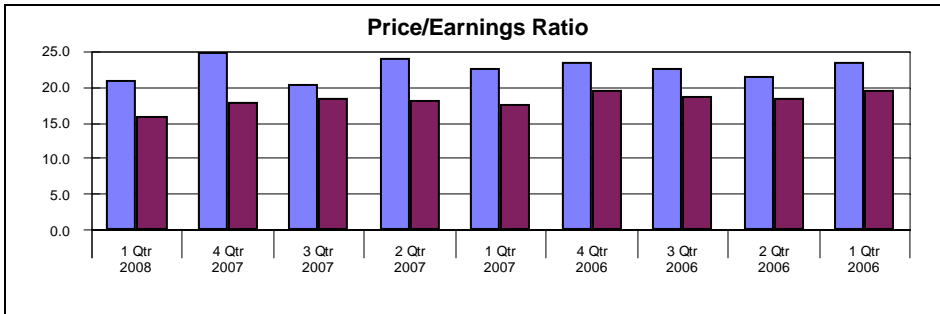
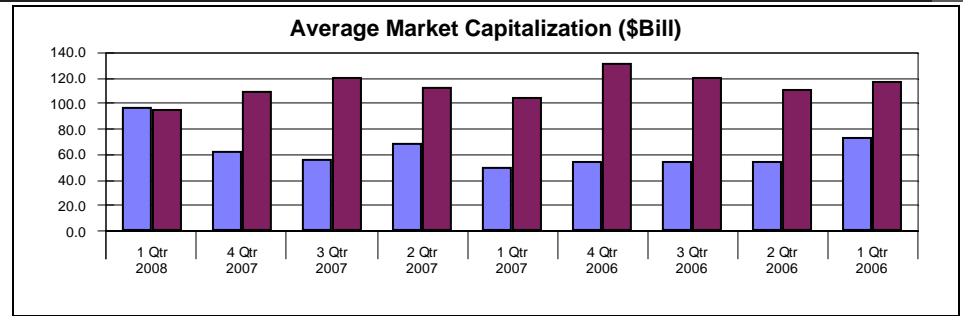
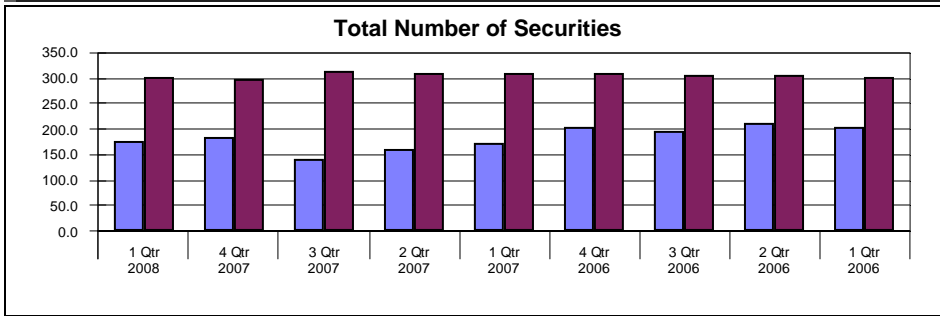

INTECH S&P BARRA  
S & P GROWTH INDEX

# Fresno County Employees' Retirement Association

## Equity Only Sector Analysis Quarterly

Period Ending: March 31, 2008

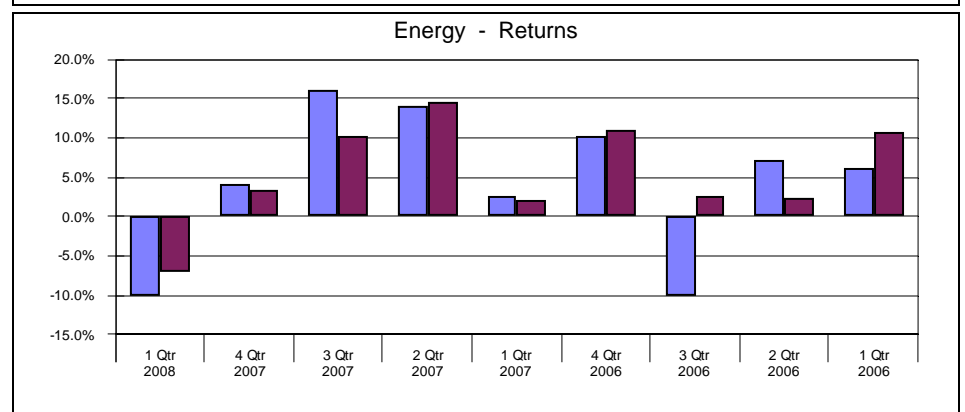
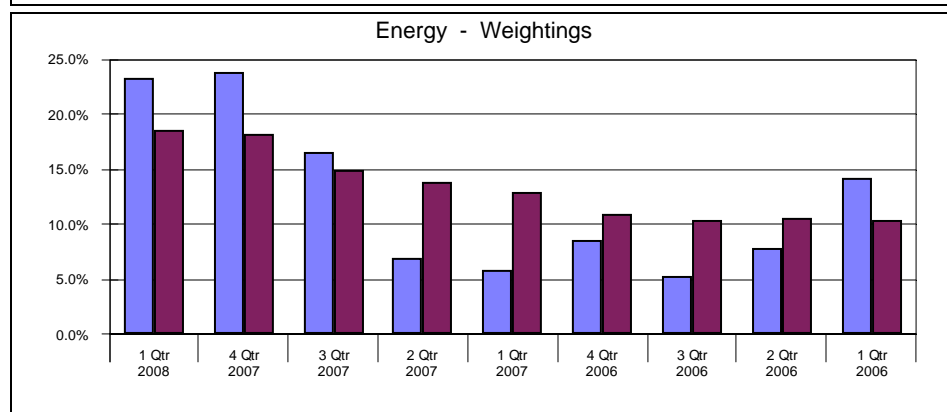
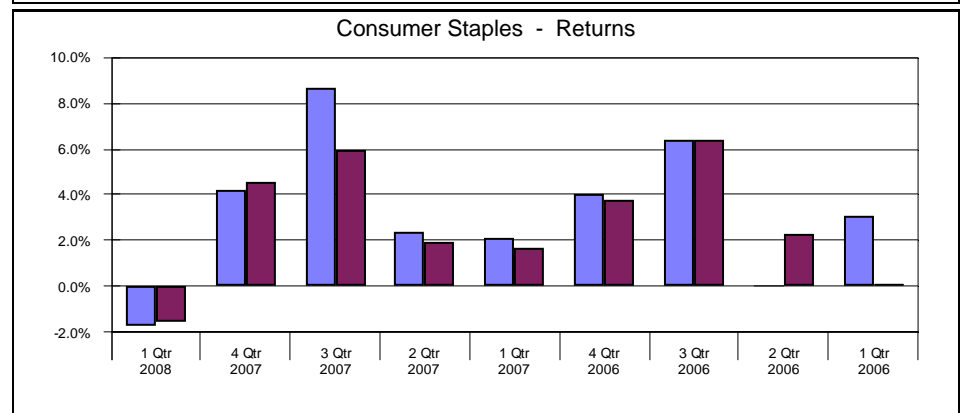
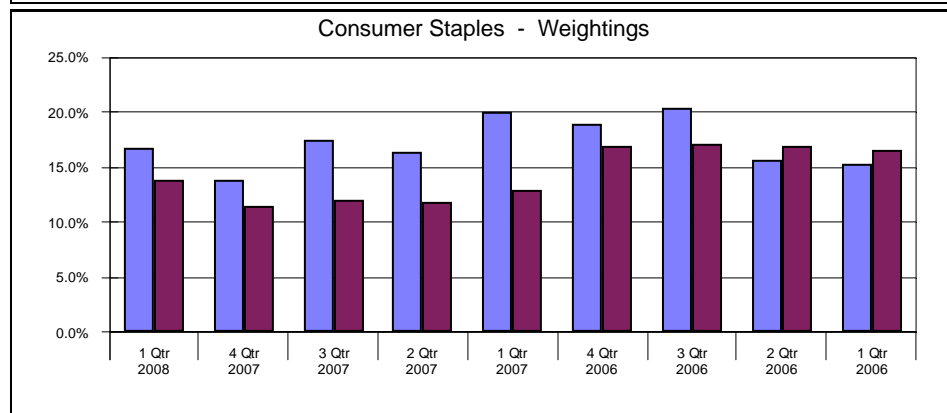
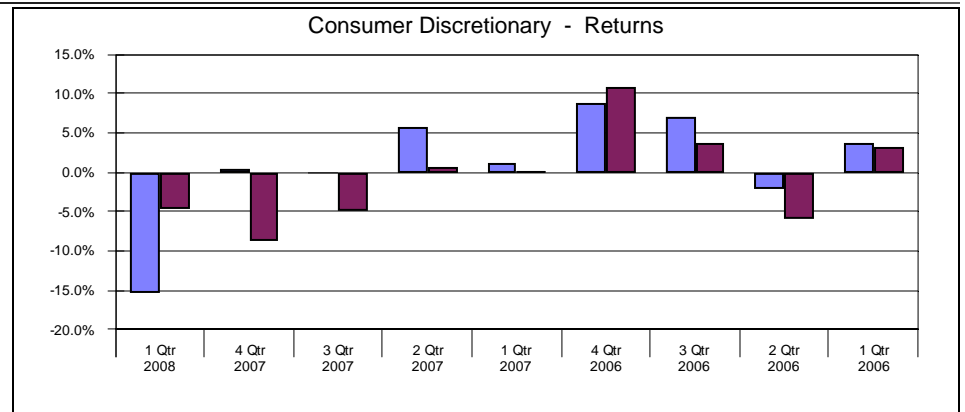
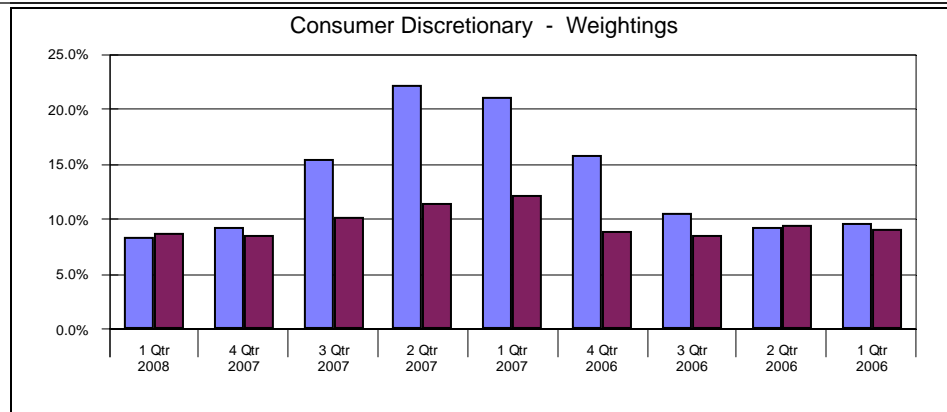

INTECH S&P BARRA

S & P GROWTH INDEX

# Fresno County Employees' Retirement Association

## Equity Only Sector Analysis Quarterlyly

Period Ending: March 31, 2008

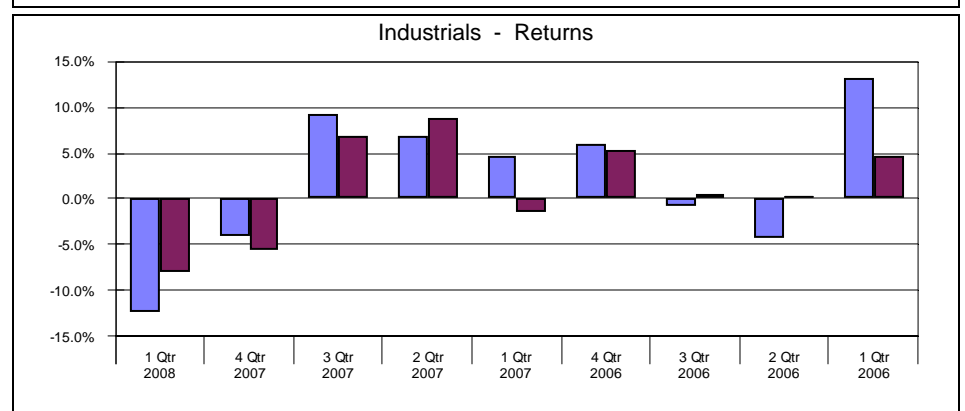
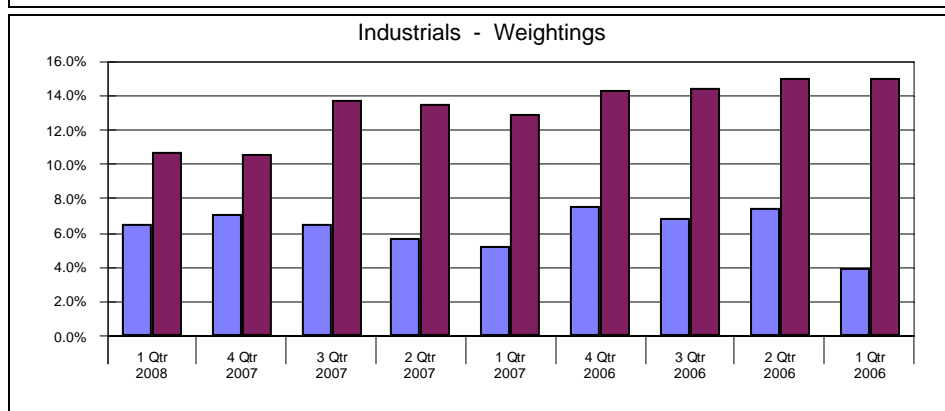
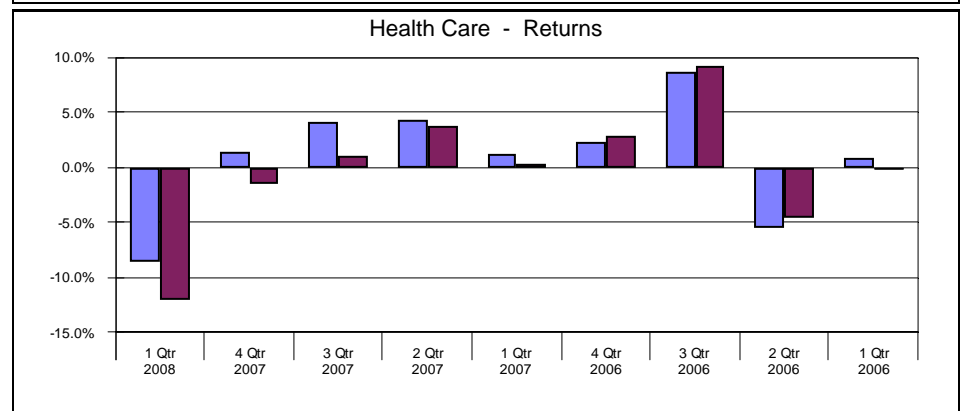
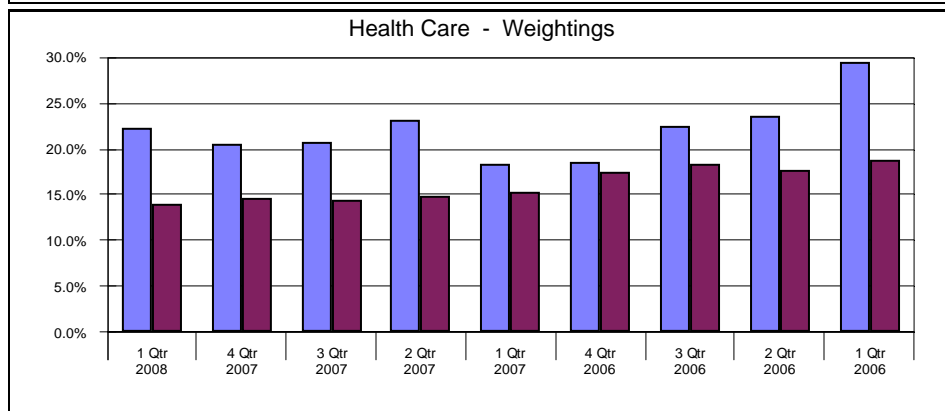
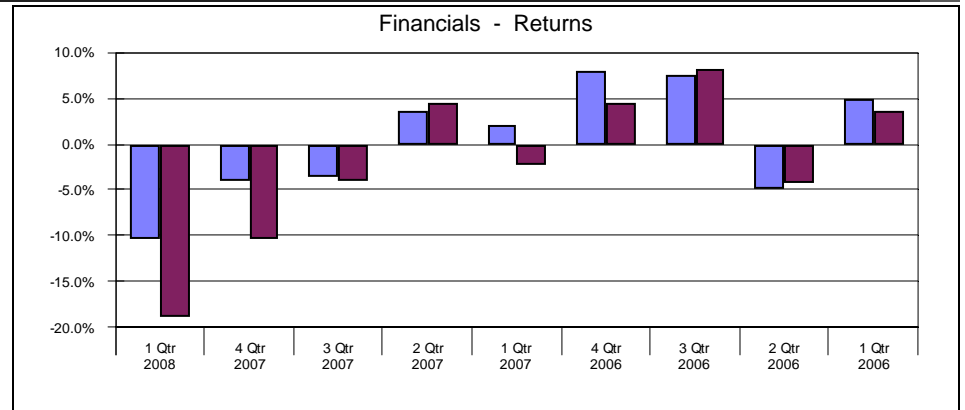
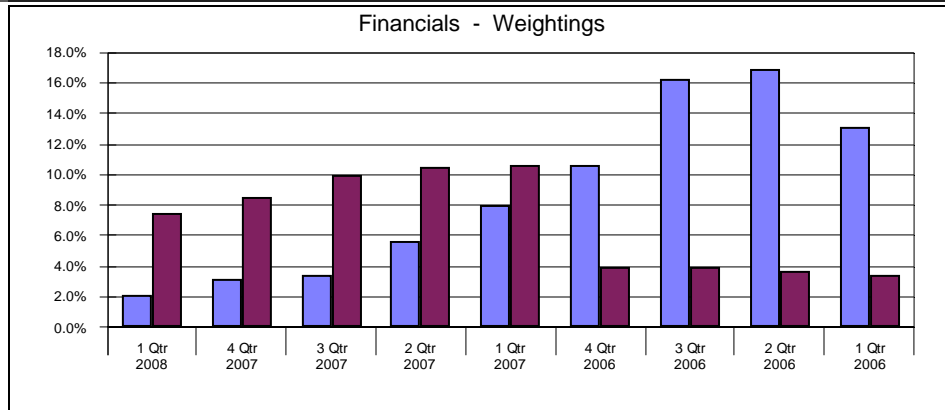

INTECH S&P BARRA

S & P GROWTH INDEX

# Fresno County Employees' Retirement Association

## Equity Only Sector Analysis Quarterly

Period Ending: March 31, 2008

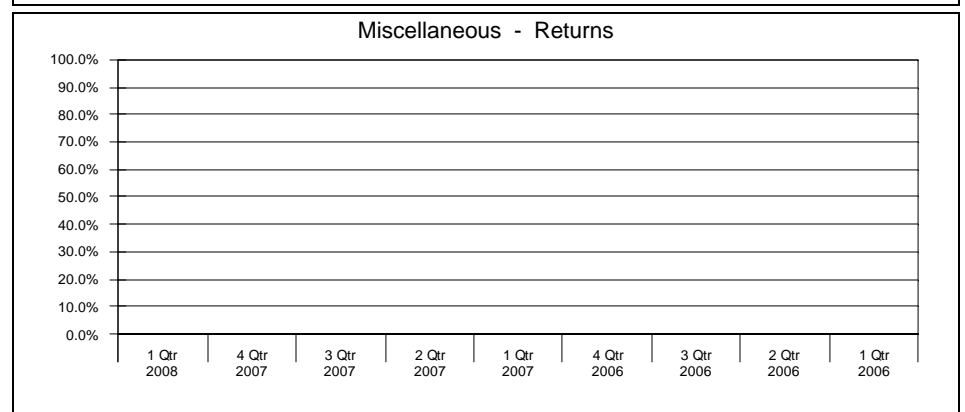
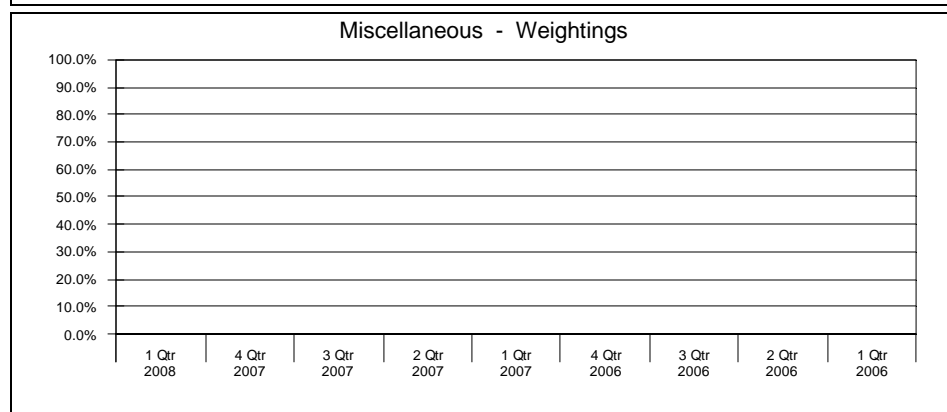
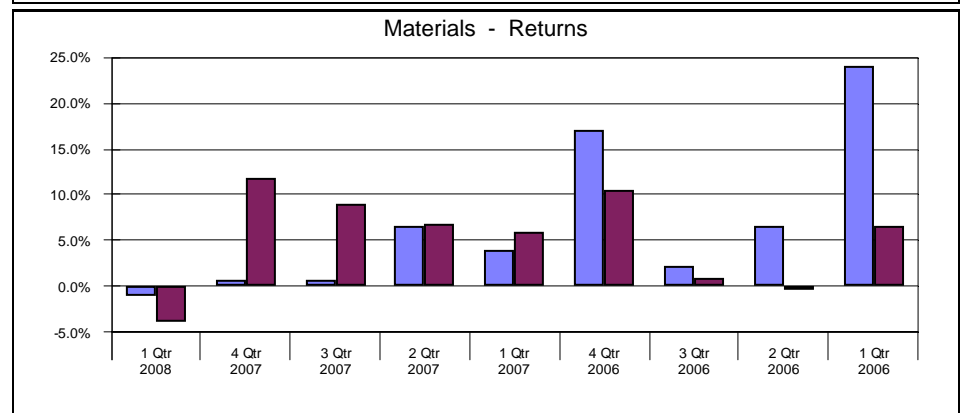
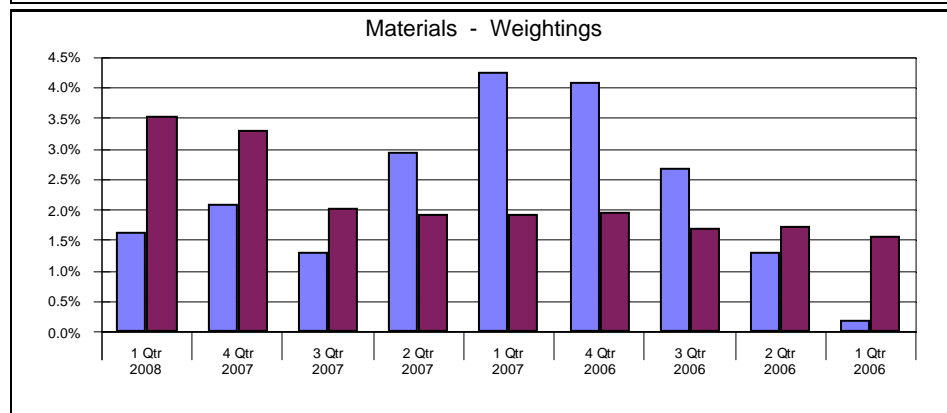
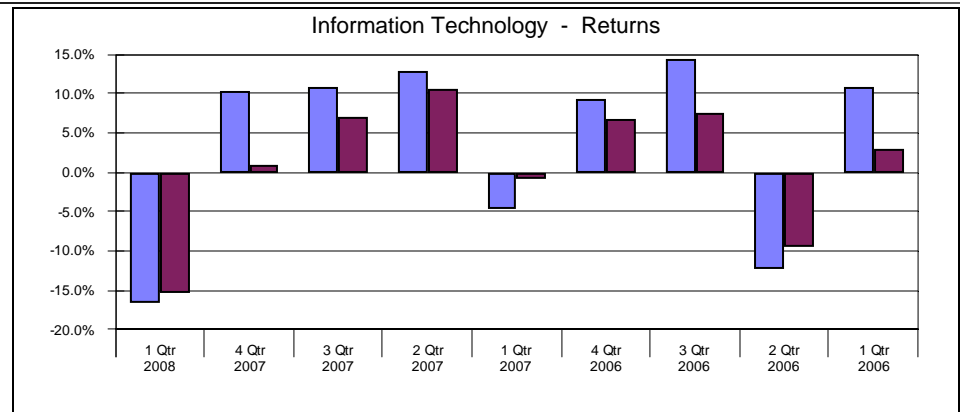
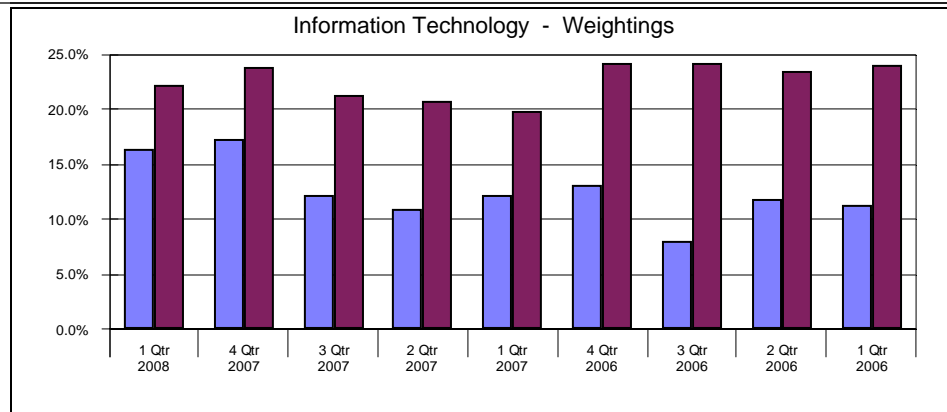

INTECH S&P BARRA

S & P GROWTH INDEX



# Fresno County Employees' Retirement Association

## Equity Only Sector Analysis Quarterly

Period Ending: March 31, 2008

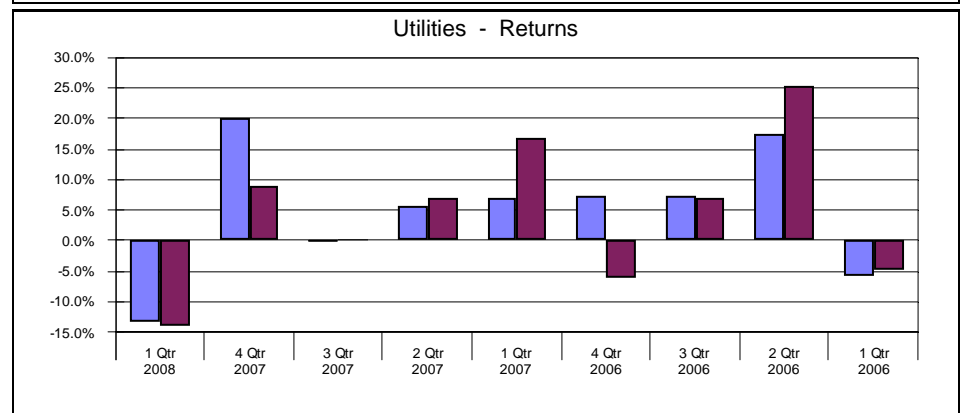
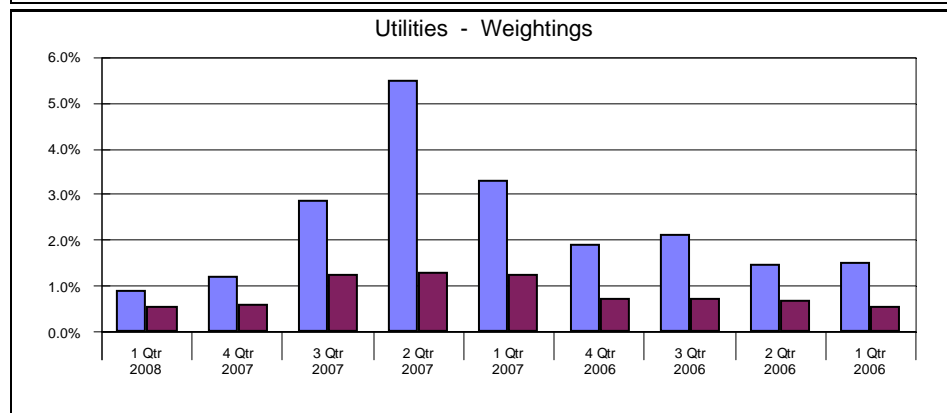
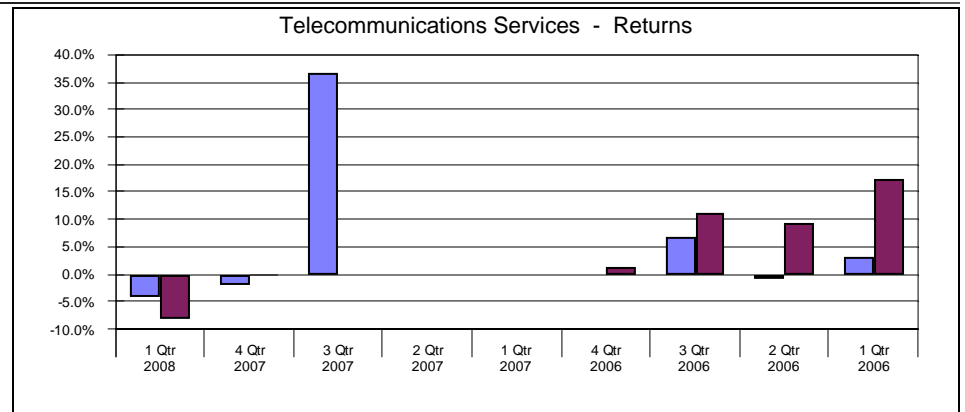
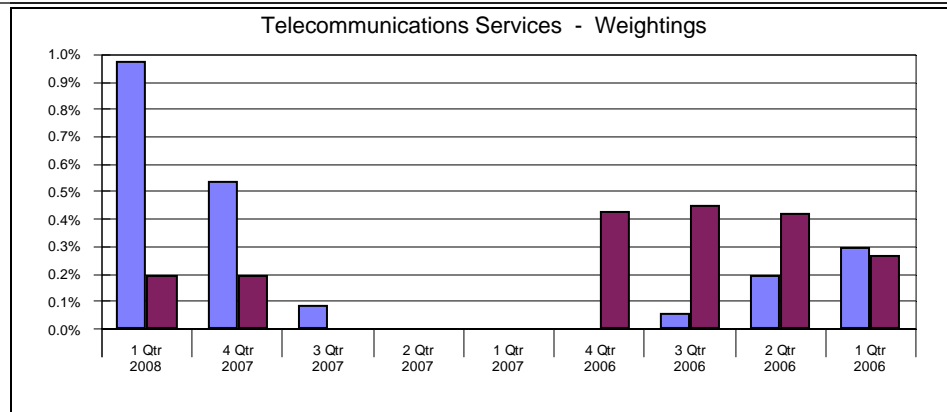

INTECH S&P BARRA

S & P GROWTH INDEX

# Fresno County Employees' Retirement Association

## Performance Attribution Geometric

Period Ending: March 31, 2008

### INTECH S&P BARRA

	Portfolio		S & P GROWTH INDEX		Selection		Total
	Market Value	Return	Market Value	Return	Stock	Industry	
	<b>A</b>	<b>B</b>	<b>C</b>	<b>D</b>	<b>E</b>	<b>F</b>	
Consumer Discretionary	10.4	-14.2	8.6	-4.7	-1.1	0.1	-1.0
Consumer Staples	15.6	-1.4	11.5	-1.5	0.0	0.4	0.4
Energy	16.6	-12.4	18.2	-7.1	-1.0	0.0	-1.0
Financials	3.4	-17.4	8.5	-18.9	0.1	0.5	0.6
Health Care	23.1	-11.1	14.6	-12.0	0.2	-0.2	0.0
Industrials	8.0	-15.0	10.6	-8.0	-0.6	-0.1	-0.7
Information Technology	18.5	-17.2	23.9	-15.3	-0.4	0.3	-0.1
Materials	2.4	-2.3	3.3	-3.8	0.0	-0.1	0.0
Telecommunications Services	0.6	-4.0	0.2	-8.0	0.0	0.0	0.0
Utilities	1.4	-13.5	0.6	-14.0	0.0	0.0	0.0
	100.0	-11.6	100.0	-9.978744	-2.7	0.9	-1.8

#### Contribution

<b>Stock</b>	Health Care
	Financials
<b>Industry</b>	Financials
	Consumer Staples

#### Detractors

<b>Stock</b>	Consumer Discretionary
	Energy
<b>Industry</b>	Health Care
	Materials

# Fresno County Employees' Retirement Association

## Portfolio Holdings And Characteristics - Equity

Period Ending: March 31, 2008

INTECH S&P BARRA	Shares	Price	Portfolio Weight	Market Cap	Dividend Yield	Price / Earnings	Price / Book	Beta	Quarterly Return
<b>Consumer Discretionary</b>									
3M CO	2,700	79.15	0.1	56.01	2.5	14.1	4.8	0.71	-5.5
AMAZON COM INC	56,900	71.30	2.7	29.72		63.7		2.03	-23.0
APOLLO GROUP INC	29,900	43.20	0.9	7.25		21.8	11.3	0.99	-38.4
AUTOZONE INC	400	113.83	0.0	7.20		12.6		1.11	-5.1
COACH INC	1,700	30.15	0.0	10.61		16.4	5.9	1.54	-1.4
COSTCO WHSL CORP NEW	10,400	64.97	0.4	28.15	0.9	24.5	3.3	0.77	-6.7
EXPEDIA INC DEL	34,100	21.89	0.5	5.69		23.3	1.3	1.74	-30.8
FORTUNE BRANDS INC	500	69.50	0.0	10.71	2.4	14.5	1.9	0.91	-3.4
GAMESTOP CORP NEW	25,300	51.71	0.9	8.32		29.5	5.7	1.41	-16.7
GAP INC	11,000	19.68	0.1	14.47	1.7	18.7	3.1	1.02	-7.2
HONEYWELL INTL INC	7,800	56.42	0.3	42.13	2.0	17.9	4.6	1.23	-7.9
JOHNSON CTLS INC	4,300	33.80	0.1	20.07	1.5	15.0	2.3	0.96	-5.8
MEREDITH CORP	1,100	38.25	0.0	1.45	2.2	10.9	2.2	1.27	-30.1
NIKE INC CL B	32,200	68.00	1.4	26.67	1.4	18.8	4.9	0.87	6.3
ROCKWELL AUTOMATION INC	400	57.42	0.0	8.52	2.0	15.3	4.9	1.24	-16.3
TEXTRON INC	4,500	55.42	0.2	13.78	1.7	15.4	4.0	1.32	-21.9
TIFFANY + CO NEW	9,000	41.84	0.2	5.28	1.4	17.4	3.2	1.43	-8.7
TJX COS INC NEW	9,800	33.07	0.2	14.15	1.1	19.9	6.6	0.49	15.4
TRANE INC	700	45.90	0.0	8.96	1.4	23.4		1.13	-1.4
WASHINGTON POST CO CL B	400	661.50	0.2	5.44	1.3	21.9	1.8	0.62	-16.2
			<b>8.4</b>	<b>21.39</b>	<b>1.4</b>	<b>34.8</b>	<b>5.3</b>	<b>1.38</b>	<b>-15.40</b>
<b>Consumer Staples</b>									
ANHEUSER BUSCH COS INC	5,400	47.45	0.2	33.93	2.8	17.0	10.9	0.51	-8.7
AVON PRODS INC	13,700	39.54	0.4	16.87	2.0	32.7		0.60	0.5
BROWN FORMAN CORP CLASS B	3,200	66.22	0.1	4.42	2.1	20.1	5.2	0.73	-10.2
COCA COLA CO	62,500	60.87	2.5	141.46	2.5	23.7	6.5	0.67	-0.2
COLGATE PALMOLIVE CO	33,400	77.91	1.7	39.72	2.1	24.3		0.50	0.4
CVS CAREMARK CORP	59,517	40.51	1.6	58.01	0.6	21.1	1.9	0.98	2.1
GENERAL MILS INC	1,400	59.88	0.1	20.06	2.7	15.7	3.8	0.43	5.8
KELLOGG CO	31,300	52.56	1.1	20.44	2.4	19.0	8.1	0.57	0.9
KIMBERLY CLARK CORP	4,200	64.55	0.2	27.13	3.6	15.8	5.9	0.85	-6.1
LAUDER ESTEE COS INC	1,600	45.85	0.0	5.24	1.2	20.5	7.4	0.73	5.1
MCDONALDS CORP	40,700	55.77	1.5	64.23	2.7	28.9	4.3	1.52	-4.7
OMNICOM GROUP	1,800	44.18	0.1	14.16	1.4	15.0	3.5	0.93	-6.7
PEPSI BOTTLING GROUP INC	23,300	33.91	0.5	7.50	2.0	14.8	2.9	0.80	-13.7
PEPSICO INC	46,700	72.20	2.2	115.65	2.1	21.2	6.7	0.58	-4.4
PROCTER AND GAMBLE CO	73,747	70.07	3.4	215.64	2.0	21.2	3.3	0.76	-4.1
UST INC COM USD0.50	2,400	54.52	0.1	8.15	4.6	16.7		0.50	0.7
WALGREEN CO	1,300	38.09	0.0	37.76	1.0	18.1	3.4	0.50	0.3
WRIGLEY WM JR CO	25,000	62.84	1.0	13.67	2.1	27.6	6.1	0.59	7.9
YUM BRANDS INC	4,300	37.21	0.1	17.69	1.6	22.1		1.12	-2.4
			<b>16.8</b>	<b>99.15</b>	<b>2.1</b>	<b>22.7</b>	<b>5.0</b>	<b>0.76</b>	<b>-1.72</b>
<b>Wurts &amp; Associates</b>					<b>Performance Measurement System</b>				

# Fresno County Employees' Retirement Association

## Portfolio Holdings And Characteristics - Equity

Period Ending: March 31, 2008

### Energy

ANADARKO PETE CORP	700	63.03	0.0	29.50	0.6	7.8	1.8	0.91	-3.9
APACHE CORP	1,900	120.82	0.2	40.23	0.5	14.4	2.6	0.91	12.6
BAKER HUGHES INC	4,700	68.50	0.2	21.19	0.8	14.5	3.4	1.17	-15.4
CAMERON INTL CORP	9,900	41.64	0.3	9.09		19.3	4.3	0.84	-13.5
CHESAPEAKE ENERGY CORP	2,900	46.15	0.1	23.73	0.6	17.6	2.1	1.01	17.9
CHEVRON CORP	18,300	85.36	1.0	177.27	2.7	9.7	2.3	0.96	-7.9
CONOCOPHILLIPS	36,800	76.21	1.9	119.00	2.5	10.6	1.4	0.86	-13.2
EOG RESOURCES INC	200	120.00	0.0	29.64	0.4	27.5	4.2	0.74	34.6
EXXON MOBIL CORP	163,500	84.58	9.1	452.51	1.7	11.6	3.7	0.90	-9.3
HALLIBURTON CO	7,300	39.33	0.2	34.62	0.9	10.7	6.1	1.20	4.0
HESS CORP	300	88.18	0.0	28.27	0.5	15.4	2.9	0.94	-12.5
MARATHON OIL CORP	2,400	45.60	0.1	32.33	2.1	8.0	1.7	1.31	-24.7
MURPHY OIL CORP	6,100	82.14	0.3	15.58	0.9	20.5	3.1	0.97	-2.9
NATIONAL OILWELL VARCO INC	64,900	58.38	2.5	20.84		15.5	3.1	1.15	-20.5
NOBLE CORPORATION SHS	22,400	49.67	0.7	13.34	0.3	11.1	3.1	1.08	-12.0
NOBLE ENERGY INC	2,100	72.80	0.1	12.51	0.7	13.4	2.6	0.94	-8.3
OCCIDENTAL PETE CORP	3,400	73.17	0.2	60.19	1.4	12.1	2.8	0.95	-4.7
QUESTAR CORP	2,400	56.56	0.1	9.77	0.9	19.6	3.8	0.70	4.8
RANGE RES CORP	100	63.45	0.0	9.51	0.3	41.2	5.5	1.22	23.6
SCHLUMBERGER LTD	41,600	87.00	2.4	104.20	1.0	20.7	7.0	1.26	-11.3
SMITH INTL INC	28,400	64.23	1.2	12.90	0.7	20.1	5.0	1.18	-12.9
TESORO CORP	3,800	30.00	0.1	4.13	1.3	7.4	1.3	1.42	-36.9
TRANSOCEAN INC SHS NEW	17,371	135.20	1.6	42.96		9.6	3.4	1.11	-5.6
VALERO ENERGY CORP	16,700	49.11	0.5	26.26	1.0	6.4	1.4	0.99	-29.7
WEATHERFORD INTERNATIONAL LTD	800	72.47	0.0	24.58		23.5	3.3	1.08	5.6
XTO ENERGY INC	17,600	61.86	0.7	29.91	0.8	17.5	3.8	0.90	20.7
			<b>23.5</b>	<b>213.04</b>	<b>1.5</b>	<b>13.5</b>	<b>3.7</b>	<b>1.01</b>	<b>-10.18</b>

### Financials

AFLAC INC	6,400	64.95	0.3	30.84	1.5	19.6	4.0	0.59	4.1
AMERICAN INTL GROUP INC	500	43.25	0.0	109.09	1.9	6.9	1.2	1.24	-25.5
AON CORP	18,000	40.20	0.5	12.28	1.5	14.9	2.0	1.19	-15.4
CME GROUP INC	1,000	469.10	0.3	25.57	1.0	31.4	2.0	1.61	-31.5
FIDELITY NATL INFORMATION SVC	12,600	38.14	0.3	7.42	0.5	14.7	2.0	0.63	-8.2
HUDSON CITY BANCORP INC	25,100	17.68	0.3	9.16	2.0	30.5	2.0	0.89	18.4
INTERCONTINENTALEXCHANGE INC	200	130.50	0.0	9.15		38.5	6.2		-32.2
NORTHERN TRUST CORP	4,500	66.47	0.2	14.66	1.7	20.5	3.3	1.02	-12.8
PLUM CREEK TIMBER CO INC	1,100	40.70	0.0	6.97	4.1	25.4	3.7	1.08	-10.7
PRICE T ROWE GROUP INC	1,600	50.00	0.1	13.19	1.9	20.8	4.8	1.66	-17.5
PRUDENTIAL FINL INC	300	78.25	0.0	34.74	1.5	10.3	1.5	1.36	-15.9
SCHWAB CHARLES CORP NEW COM STK	10,700	18.83	0.1	21.83	1.1	20.5	5.9	1.81	-26.1
SLM CORP	3,600	15.35	0.0	7.16			2.0	1.07	-23.8
TORONTO DOMINION BK ONT	414	61.35	0.0	44.17	4.0	10.8		1.36	-11.6
			<b>2.2</b>	<b>17.04</b>	<b>1.4</b>	<b>21.2</b>	<b>2.7</b>	<b>1.08</b>	<b>-10.37</b>

# Fresno County Employees' Retirement Association

## Portfolio Holdings And Characteristics - Equity

Period Ending: March 31, 2008

INTECH S&P BARRA	Shares	Price	Portfolio Weight	Market Cap	Dividend Yield	Price / Earnings	Price / Book	Beta	Quarterly Return
<b>Health Care</b>									
ABBOTT LABS	70,900	55.15	2.6	85.25	2.6	23.9	4.8	0.46	-1.3
AETNA INC	15,400	42.09	0.4	20.90	0.1	12.1	2.1	1.31	-27.1
ALLERGAN INC	1,600	56.39	0.1	17.34	0.4	34.8	4.6	0.93	-12.2
APPLERA CORP COM APPLIED BIOSYSTEMS GROU	3,500	32.86	0.1	5.50	0.5	20.2	3.8	0.94	-3.0
BARD C R INC	1,300	96.40	0.1	9.67	0.6	25.1	5.2	0.83	1.8
BARR PHARMACEUTICALS INC	600	48.31	0.0	5.21		36.9	2.8	0.92	-9.0
BAXTER INTL INC	61,200	57.82	2.3	36.68	1.5	22.2	5.3	0.85	0.0
BECTON DICKINSON + CO	13,600	85.85	0.8	20.95	1.3	21.9	4.8	0.84	3.1
BIOGEN IDEC INC	20,300	61.69	0.8	18.37		31.0	3.3	1.14	8.4
CELGENE CORP	27,500	61.29	1.1	24.75		113.5	8.7	0.87	32.6
CIGNA CORP	28,800	40.57	0.8	11.36	0.1	10.5	2.5	1.44	-24.4
COVENTRY HEALTH CARE INC	29,800	40.35	0.8	6.24		10.1	1.9	1.25	-31.9
EXPRESS SCRIPTS INC	33,100	64.32	1.4	16.26		29.9		0.99	-11.9
GENZYME CORP COM GEN DIV	7,400	74.54	0.4	19.95		42.8	3.0	0.88	0.1
GILEAD SCIENCES INC	600	51.53	0.0	47.86		30.7	13.9	1.07	12.0
HOSPIRA INC	16,900	42.77	0.5	6.79		50.3	3.9	0.65	0.3
HUMANA INC	6,900	44.86	0.2	7.63		9.1	1.9	1.25	-40.4
JOHNSON + JOHNSON	36,800	64.87	1.6	183.75	2.6	17.9	4.3	0.29	-2.1
MEDCO HEALTH SOLUTIONS INC	30,400	43.79	0.9	22.94		26.9	3.4	0.86	-13.6
MEDTRONIC INC	1,600	48.37	0.1	54.32	1.0	24.9	5.0	0.42	-3.5
MERCK + CO INC	30,900	37.95	0.8	82.17	4.0	25.5	4.5	0.70	-34.1
MILLIPORE CORP	600	67.41	0.0	3.71		27.2	3.2	1.02	-7.9
PATTERSON COS INC	1,100	36.30	0.0	4.70		22.3	3.4	0.62	6.9
QUEST DIAGNOSTICS INC	18,100	45.27	0.5	8.79	0.9	26.0	2.6	0.65	-14.3
SCHERING PLOUGH CORP	93,600	14.41	0.9	23.36	1.8		3.0	0.98	-45.7
STRYKER CORP	53,500	65.05	2.3	26.75	0.5	27.3	5.0	1.02	-12.9
THERMO FISHER SCIENTIFIC INC	13,900	56.84	0.5	23.79		32.3	1.6	1.35	-1.5
UNITEDHEALTH GROUP INC	19,700	34.36	0.4	43.00	0.1	10.0	2.2	0.76	-40.9
VARIAN MED SYS INC	2,300	46.84	0.1	5.89		24.8	7.1	0.98	-10.2
WATERS CORP	23,800	55.70	0.9	5.57		21.3	9.6	1.61	-29.6
WATSON PHARMACEUTICALS INC	3,500	29.32	0.1	3.04		23.1	1.6	1.26	8.0
WELLPOINT INC	2,000	44.13	0.1	23.92		7.9	1.1	1.02	-49.7
ZIMMER HOLDINGS INC	17,000	77.86	0.9	18.16		23.9	3.3	0.80	17.7
			<b>22.3</b>	<b>42.29</b>	<b>1.6</b>	<b>28.5</b>	<b>4.4</b>	<b>0.88</b>	<b>-8.59</b>

# Fresno County Employees' Retirement Association

## Portfolio Holdings And Characteristics - Equity

Period Ending: March 31, 2008

INTECH S&P BARRA	Shares	Price	Portfolio Weight	Market Cap	Dividend Yield	Price / Earnings	Price / Book	Beta	Quarterly Return
<b>Industrials</b>									
BOEING CO	7,700	74.37	0.4	56.88	2.2	14.1	6.3	1.22	-14.5
CATERPILLAR INC	2,400	78.29	0.1	48.85	1.8	14.6	5.5	1.24	8.5
COOPER INDUSTRIES LTD SHS A	1,300	40.15	0.0	7.08	2.5	10.8	2.5	1.21	-23.7
CUMMINS INC	8,500	46.82	0.3	9.47	1.1	25.3	5.6	1.46	-26.3
DEERE + CO	2,800	80.44	0.1	35.07	1.2	18.6	6.0	1.42	-13.3
EMERSON ELEC CO	5,800	51.46	0.2	40.44	2.3	18.6	4.6	1.09	-8.7
EXPEDITORS INTL WA INC	700	45.18	0.0	9.63	0.6	37.3	7.8	0.83	1.1
FLUOR CORP NEW	2,600	141.16	0.2	12.51	0.7	24.1	5.5	1.49	-3.0
GENERAL DYNAMICS CORP	4,800	83.37	0.3	33.53	1.7	16.3	3.4	0.93	-6.0
GOODRICH CORP	10,200	57.51	0.4	7.19	1.6	14.8	2.8	1.34	-18.3
GRAINGER W W INC	700	76.39	0.0	6.03	1.8	15.5	2.9	1.05	-12.3
HARMAN INTL INDS INC NEW	2,300	43.54	0.1	2.64	0.1	11.2	1.9	1.54	-40.9
ILLINOIS TOOL WKS INC	800	48.23	0.0	25.41	2.3	14.7	2.7	0.80	-9.4
JACOBS ENGR GROUP INC	6,800	73.59	0.3	8.93		28.0	4.8	1.20	-23.0
L 3 COMMUNICATIONS HLDG CORP	7,400	109.34	0.5	13.38	1.1	18.3	2.3	0.83	3.5
LOCKHEED MARTIN CORP	27,400	99.30	1.8	40.53	1.7	14.0	4.1	0.44	-5.3
MANITOWOC INC	100	40.80	0.0	5.30	0.2	15.5	3.9	1.63	-16.4
PALL CORP	600	35.07	0.0	4.31	1.5	20.9	3.6	1.35	-12.7
PARKER HANNIFIN CORP	3,500	69.27	0.2	11.67	1.2	13.9	2.6	1.33	-7.7
PRECISION CASTPARTS CORP	20,100	102.08	1.4	14.18	0.1	15.9	4.9	1.66	-26.4
UNITED PARCEL SVC INC CL B	2,300	73.02	0.1	50.55	2.5		6.2	0.79	3.9
UNITED TECHNOLOGIES CORP	2,700	68.82	0.1	67.55	1.9	16.1	3.2	1.03	-9.7
			<b>6.6</b>	<b>26.82</b>	<b>1.3</b>	<b>16.8</b>	<b>4.3</b>	<b>1.07</b>	<b>-12.37</b>

# Fresno County Employees' Retirement Association

## Portfolio Holdings And Characteristics - Equity

Period Ending: March 31, 2008

INTECH S&P BARRA	Shares	Price	Portfolio Weight	Market Cap	Dividend Yield	Price / Earnings	Price / Book	Beta	Quarterly Return
<b>Information Technology</b>									
ANALOG DEVICES INC	14,500	29.52	0.3	8.68	2.4	19.7	3.8	1.45	-6.3
APPLE INC COM NPV	44,100	143.50	4.2	126.12	0.1	31.5	8.6	1.72	-27.6
APPLIED MATERIALS INC	11,900	19.51	0.2	26.41	1.2	17.6	3.5	1.31	10.2
AUTODESK INCORPORATED COM STK NPV	900	31.48	0.0	7.25		21.4	6.5	1.53	-36.7
BMC SOFTWARE INC	400	32.52	0.0	6.25		22.9	6.2	1.22	-8.8
CISCO SYS INC	45,300	24.09	0.7	143.60		18.7	4.7	1.31	-11.0
CITRIX SYS INC	2,600	29.33	0.1	5.43		25.7	3.0	1.42	-22.8
DANAHER CORP	1,100	76.03	0.1	24.20	0.2	20.4	2.7	0.99	-13.3
DELL INC	4,100	19.92	0.1	44.64		15.2	10.2	1.34	-18.7
EMC CORP	150,400	14.34	1.4	30.12		18.6	2.4	1.65	-22.6
GOOGLE INC	1,300	440.47	0.4	104.28		33.1	6.1	1.39	-36.3
HEWLETT PACKARD CO	31,500	45.66	1.0	112.57	0.7	15.6	3.1	1.32	-9.4
INTEL CORP	13,800	21.18	0.2	122.59	2.6	17.9	2.9	1.56	-20.1
INTERNATIONAL BUSINESS MACHS	35,900	115.14	2.7	159.39	1.4	16.0	5.6	0.95	6.9
JUNIPER NETWORKS INC	53,300	25.00	0.9	13.09		40.3	2.4	1.51	-24.7
LINEAR TECHNOLOGY CORP	800	30.69	0.0	6.78	2.7	20.6		1.29	-2.9
MEMC ELECTR MATLS INC	10,000	70.90	0.5	16.19		19.9	8.0	1.54	-19.9
MICROSOFT CORP	145,700	28.38	2.7	264.13	1.6	16.1	8.6	0.89	-20.0
MOTOROLA INC	4,600	9.30	0.0	20.97	2.2		1.4	1.67	-41.7
NATIONAL SEMICONDUCTOR CORP	6,400	18.32	0.1	4.67	1.3	15.3	3.3	1.81	-18.8
NVIDIA CORP	19,300	19.79	0.3	10.98		15.1	4.2	2.14	-41.8
ORACLE CORP	1,800	19.56	0.0	100.47		20.0	5.9	1.23	-13.4
PERKINELMER INC	8,700	24.25	0.1	2.85	1.2	21.8	1.8	1.55	-6.6
SANDISK CORP	200	22.57	0.0	5.06		24.3	1.0	1.47	-32.0
SYMANTEC CORP	5,000	16.62	0.1	14.07		43.7	1.3	0.88	3.0
TEXAS INSTRS INC	20,000	28.27	0.4	37.50	1.4	15.4	3.8	1.72	-15.1
VERISIGN INC	9,500	33.24	0.2	7.09			4.8	1.90	-11.6
TERADATA CORP DEL COM	300	22.06	0.0	3.96		20.1	6.3		-19.5
			<b>16.5</b>	<b>124.72</b>	<b>1.0</b>	<b>22.4</b>	<b>6.1</b>	<b>1.37</b>	<b>-16.70</b>
<b>Materials</b>									
AIR PRODS + CHEMS INC	4,100	92.00	0.2	19.73	1.9	19.1	3.6	0.77	-6.3
BALL CORP	8,800	45.94	0.3	4.48	0.9	16.8	3.4	0.76	2.3
CONSOL ENERGY INC	900	69.19	0.0	12.63	0.6	47.7	10.4	1.48	-3.1
ECOLAB INC	700	43.43	0.0	10.74	1.2	25.5	5.5	0.61	-15.0
FREEMONT MCMORAN COPPER + GOLD COMMON	5,500	96.22	0.3	36.83	1.8	13.0	2.6	1.58	-5.6
INTRNTNL FLAVRS + FRAGRNCs INC	1,300	44.05	0.0	3.57	2.1	15.6	5.8	0.85	-8.0
MONSANTO CO NEW	3,800	111.50	0.3	61.10	0.6	57.2	8.1	1.29	0.0
NEWMONT MNG CORP	3,800	45.30	0.1	19.74	0.9		2.3	0.80	-7.1
PRAXAIR INC	300	84.23	0.0	26.39	1.8	23.3	5.2	0.91	-4.6
SIGMA ALDRICH	7,200	59.65	0.3	7.72	0.9	25.5	4.8	0.73	9.5
			<b>1.7</b>	<b>25.22</b>	<b>1.2</b>	<b>26.2</b>	<b>4.5</b>	<b>1.04</b>	<b>-1.11</b>

# Fresno County Employees' Retirement Association

## Portfolio Holdings And Characteristics - Equity

Period Ending: March 31, 2008

INTECH S&P BARRA	Shares	Price	Portfolio Weight	Market Cap	Dividend Yield	Price / Earnings	Price / Book	Beta	Quarterly Return
<b>Telecommunications Services</b>									
LEUCADIA NATL CORP	33,100	45.22	1.0	10.06	0.6	22.1	1.8	1.18	-4.0
			<b>1.0</b>	<b>10.06</b>	<b>0.6</b>	<b>22.1</b>	<b>1.8</b>	<b>1.18</b>	<b>-3.99</b>
<b>Utilities</b>									
CONSTELLATION ENERGY GROUP INC	16,100	88.27	0.9	15.95	2.2	19.6	2.9	0.85	-13.4
			<b>0.9</b>	<b>15.95</b>	<b>2.2</b>	<b>19.6</b>	<b>2.9</b>	<b>0.85</b>	<b>-13.44</b>
INTECH S&P BARRA			<b>100.0</b>	<b>101.45</b>	<b>1.5</b>	<b>22.3</b>	<b>4.6</b>	<b>1.04</b>	<b>-9.88</b>



# Fresno County Employees' Retirement Association

## Equity Activity

Period Ending: March 31, 2008

Start from Dec 31, 2007 **INTECH S&P BARRA**

Additions				Deletions			
Security Name	Shares	Market Value	New	Security Name	Shares	Market Value	Eliminated
3M CO	1,100	86,037	*	3M CO	400	31,500	
3M COMPANY	1,100	93,210		ABBOTT LABS	16,000	926,342	
AETNA INC	7,800	361,723	*	ALLEGHENY ENERGY INC	400	18,468	*
AETNA INCORPORATED	7,600	440,166		ALLEGHENY TECHNOLOGIES INC	500	40,217	*
AFLAC INC	4,700	291,686	*	ALTERA CORP	2,300	41,315	*
AIR PRODS + CHEMS INC	1,300	115,180	*	ALTRIA GROUP INCORPORATED	800	60,903	*
AIR PRODUCTS & CHEMICALS	2,300	233,096		AMAZON. COM CORPORATION	12,200	1,162,927	*
ALLERGAN INC	1,600	99,505	*	AMERICAN INTERNATIONAL GROUP, INC.	32,200	1,863,387	*
AMAZON COM INC	17,100	1,229,142	*	AMERICAN INTL GROUP INC	5,900	276,073	
AMERICAN INTL GROUP INC	700	30,114	*	AMERICAN TOWER CORP	2,400	88,590	*
ANADARKO PETE CORP	700	44,333	*	AMERICAN TOWER CORP A	1,100	46,444	*
AON CORP	9,700	411,977	*	ANALOG DEVICES INC	9,900	282,613	
AON CORPORATION	3,900	188,363		ANALOG DEVICES, INC.	2,100	66,078	*
APACHE CORP	1,900	208,508	*	ANHEUSER BUSCH COS INC	600	32,531	
APOLLO GROUP INC	16,800	1,056,337	*	ANHEUSER-BUSCH COMPANIES, INC.	800	42,386	*
APPLE COMPUTER, INCORPORATED	6,000	1,201,578		APOLLO GROUP INC	2,300	180,797	
APPLE INC COM NPV	13,600	1,990,036	*	APPLIED MATERIALS INC	2,300	46,852	
APPLERA CORP COM APPLIED BIOSYSTEMS GROU	3,500	112,464	*	AUTOZONE INC	2,800	318,612	
APPLIED MATERIALS INC	3,200	53,553	*	AVON PRODS INC	10,700	413,571	
AUTODESK INCORPORATED COM STK NPV	900	35,313	*	BAKER HUGHES INC	1,300	88,077	
BAKER HUGHES INC	2,600	186,281	*	BALL CORP	11,200	494,335	
BAKER HUGHES, INCORPORATED	3,400	281,575		BALL CORPORATION	2,600	118,037	*
BARD C R INC	1,300	121,637	*	BAXTER INTERNATIONAL, INC.	12,300	722,733	*
BARR PHARMACEUTICALS INC	600	27,605	*	BAXTER INTL INC	11,300	706,196	
BAXTER INTL INC	3,200	190,198	*	BECTON DICKINSON + CO	1,200	110,456	
BECTON DICKINSON + CO	2,800	247,165	*	BECTON, DICKINSON & COMPANY	900	76,641	*
BIOGEN IDEC INC	15,500	913,284		BMC SOFTWARE INC	2,300	77,717	
BMC SOFTWARE, INC.	2,700	97,343		BOEING CO	3,900	311,435	
BROWN FORMAN CORP CLASS B	1,200	78,734	*	BOEING COMPANY	1,600	140,229	*
BURLINGTON NORTHERN SANTA FE	400	33,512		BURLINGTON NORTHN SANTA FE	400	37,262	*
CAMERON INTL CORP	9,900	413,908	*	CARDINAL HEALTH, INC.	11,300	647,850	*
CATERPILLAR, INCORPORATED	6,800	499,146		CATERPILLAR INC	7,100	502,306	

# Fresno County Employees' Retirement Association

## Equity Activity

Period Ending: March 31, 2008

CB RICHARD ELLIS GROUP INC. - A	2,000	42,309		CB RICHARD ELLIS GROUP INC	2,000	40,490	*
CELGENE CORP	2,700	147,228	*	CELGENE CORP	4,500	259,544	
CHESAPEAKE ENERGY CORP	2,900	112,513	*	CHEVRON CORP	2,500	217,727	
CHEVRON CORP	1,400	114,413	*	CIENA CORP	4,400	150,915	*
CITRIX SYS INC	1,600	56,799	*	CIGNA CORP	4,200	231,778	
CME GROUP INC	500	250,129	*	CIGNA CORP.	4,100	223,146	*
COCA COLA CO	10,800	634,699	*	CISCO SYS INC	6,200	150,830	
COLGATE PALMOLIVE CO	2,200	167,011	*	CLEAR CHANNEL COMMUNICATIONS, INCORPORAT	64,700	2,234,809	*
COMMERCE BANCORP INC N J	1,000	35,893	*	CME GROUP INC	100	63,561	
CONOCO PHILLIPS COMMON STOCK	40,500	3,611,837		COACH INC	7,500	229,736	
CONSOL ENERGY INCORPORATED	2,300	165,000		COCA COLA COMPANY	2,700	168,618	*
COSTCO WHOLESALE CORP.	5,100	358,075		COLGATE PALMOLIVE CO	2,900	234,513	
COSTCO WHSL CORP NEW	5,900	368,971	*	COMMERCE BANCORP INC N J	1,000	35,232	*
COVENTRY HEALTH CARE INC	8,300	377,040	*	CONOCOPHILLIPS	3,700	306,987	
CUMMINS ENGINE	2,700	347,997		CONSOL ENERGY INC	1,400	100,849	
CUMMINS INC	4,800	245,996	*	CONSTELLATION ENERGY GROUP INC	4,700	457,395	
CVS CAREMARK CORP	2,500	97,431	*	COOPER INDUSTRIES INC.	1,100	58,761	*
DANAHER CORP	1,100	82,053	*	COSTCO WHSL CORP NEW	600	39,797	
DEERE & COMPANY	1,900	174,839		COVENTRY HEALTH CARE INC	3,700	227,579	
DEERE + CO	1,000	82,957	*	CUMMINS INC	1,700	85,357	
DELL INC	2,600	52,162	*	DEAN FOODS COMPANY COMMON STOCK	500	13,010	*
EASTMAN CHEMICAL COMPANY	1,100	67,688		DEERE + CO	1,200	106,184	
EATON CORPORATION	1,500	146,433		EASTMAN CHEM CO	1,100	71,386	*
ELECTRONIC ARTS INCORPORATED	600	35,052		EATON CORP	1,500	122,135	*
EMC CORP	20,200	319,326	*	EDISON INTERNATIONAL	31,500	1,704,761	*
EMERSON ELEC CO	3,200	160,245	*	ELECTRONIC ARTS INC	600	27,661	*
EMERSON ELECTRIC CO	2,600	148,100		ENSCO INTL INC	1,500	92,072	*
EQUIFAX INCORPORATED	1,200	43,617		EQUIFAX INC	1,200	41,715	*
EXPEDIA INC DEL	19,000	499,350	*	EXELON CORPORATION	1,200	98,649	*
EXPRESS SCRIPTS INC	10,200	628,299	*	EXPEDIA INC DEL	2,800	69,032	
EXXON MOBIL CORP	2,700	230,592	*	EXPEDITORS INTERNATIONAL WASH INC	1,100	50,004	*
FANNIE MAE	9,600	368,683		EXPEDITORS INTL WA INC	1,600	65,560	
FLUOR CORP NEW	1,700	216,647	*	EXPRESS SCRIPTS INCORPORATED	3,600	264,718	*
FLUOR CORPORATION	300	43,760		EXXON MOBIL CORP	5,300	462,349	
FRANKLIN RESOURCES, INC.	1,700	193,822		EXXON MOBIL CORP.	25,000	2,352,745	*

# Fresno County Employees' Retirement Association

## Equity Activity

Period Ending: March 31, 2008

FREEPORT - MCMORAN COPPER - B	9,700	1,015,800		FEDERAL NATL MTG ASSN	9,600	298,571	*
FREEPORT MCMORAN COPPER + GOLD COMMON	1,000	89,301	*	FIDELITY NATIONAL INFORMATION SERVICE	4,500	188,565	*
GAMESTOP CORP NEW	20,400	1,015,728	*	FIDELITY NATL INFORMATION SVC	19,400	761,926	
GAMESTOP CORPORATION	700	43,883		FLUOR CORP NEW	1,000	135,546	
GAP INC	9,000	181,423	*	FRANKLIN RES INC	1,700	162,066	*
GENZYME CORP COM GEN DIV	7,400	537,884	*	FREEPORT MCMORAN COPPER + GOLD COMMON	5,200	502,350	
GOLDMAN SACHS GROUP INCORPORATED	2,100	448,730		GENERAL DYNAMICS CORP	800	69,420	
GOODRICH (B.F.)	1,700	121,533		GENERAL ELECTRIC CO.	52,800	1,968,272	*
GOODRICH CORP	8,500	524,191	*	GENERAL MLS INC	1,300	72,654	
GOODYEAR TIRE & RUBBER	5,900	168,331		GOLDMAN SACHS GROUP INC	2,100	385,566	*
GOOGLE INC	1,100	530,314	*	GOODYEAR TIRE AND RUBBER	5,900	150,052	*
HALLIBURTON CO	1,800	61,659	*	GRAINGER W W INC	500	37,585	
HALLIBURTON COMPANY	8,200	312,261		HALLIBURTON CO	4,500	167,503	
HESS CORPORATION	3,400	351,349		HARMAN INTERNATIONAL INDUSTRIES, INCORPO	2,900	213,287	*
HEWLETT PACKARD	31,800	1,641,783		HARMAN INTL INDS INC NEW	12,700	571,050	
HEWLETT PACKARD CO	3,500	155,838	*	HARRAH'S ENTERTAINMENT, INCORPORATED	3,500	309,887	*
HONEYWELL INTERNATIONAL, INC.	7,000	428,535		HARRAHS ENTMT INC	26,800	2,406,607	*
HONEYWELL INTL INC	1,500	84,257	*	HESS CORP	3,100	285,445	
HUDSON CITY BANCORP INC	22,500	362,257	*	HEWLETT PACKARD CO	3,800	182,890	
HUMANA INC	6,100	394,808	*	HONEYWELL INTL INC	700	39,348	
INGERSOLL-RAND COMPANY CLASS A	2,600	121,406		HOSPIRA INC	1,100	46,506	
INTEL CORP	2,900	57,698	*	HUMANA INCORPORATED	500	37,950	*
INTEL CORP.	18,600	502,382		INGERSOLL RAND COMPANY LIMITED	1,900	76,942	*
INTERCONTINENTAL EXCHANGE	400	75,840		INGERSOLL RAND COMPANY LIMITED	700	30,715	*
JACOBS ENGR GROUP INC	2,900	219,912	*	INTEL CORP	9,100	191,434	
JOHNSON + JOHNSON	3,100	196,979	*	INTERCONTINENTALEXCHANGE INC	1,700	229,134	
JOHNSON CONTROLS INCORPORATED	7,200	265,375		INTERNATIONAL BUSINESS MACHINES CORP.	15,900	1,755,322	*
JUNIPER NETWORKS INC	18,700	535,743		INTERNATIONAL BUSINESS MACHS	5,700	632,543	
KELLOGG CO	3,300	157,588	*	INTERNATIONAL FLAVORS FRAGRANCE	700	33,813	*
L 3 COMMUNICATIONS HLDG CORP	4,400	467,831	*	INTRNTNL FLAVRS + FRAGRNCs INC	2,100	90,496	
LEUCADIA NATL CORP	13,200	600,787	*	JACOBS ENGINEERING GROUP, INCORPORATED	600	58,988	*
LOCKHEED MARTIN CORP	2,500	251,494	*	JACOBS ENGR GROUP INC	500	39,004	
LOCKHEED MARTIN CORPORATION	3,400	363,434		JOHNSON + JOHNSON	3,400	231,673	
MARATHON OIL CORP	10,200	637,624		JOHNSON CTLS INC	2,900	94,640	
MCDONALDS CORP	3,300	182,353	*	KIMBERLY-CLARK CORP.	1,100	76,890	*

# Fresno County Employees' Retirement Association

## Equity Activity

Period Ending: March 31, 2008

MEDCO HEALTH SOLUTIONS INC	24,600	1,458,648		KING PHARMACEUTICALS, INCORPORATED	38,800	396,665	*
MEDTRONIC INC	800	39,994	*	KLA INSTRUMENTS CORPORATIONS	1,300	63,487	*
MERCK & COMPANY, INCORPORATED	20,200	1,185,739		KLA TENCOR CORP	2,200	95,575	*
MERCK + CO INC	10,700	488,011	*	LAUDER ESTEE COS INC	8,800	372,217	
MICROSOFT CORP	30,900	895,444	*	LINEAR TECHNOLOGY CORP	4,400	126,476	
MICROSOFT CORP.	83,500	3,006,325		LOCKHEED MARTIN CORP	1,400	147,875	
MILLIPORE CORP	600	40,853	*	MANITOWOC INC	1,600	64,654	
MONSANTO CO NEW	2,300	258,171	*	MANITOWOC INCORPORATED	1,300	63,620	*
MONSANTO COMPANY NEW COMMON STOCK	1,500	169,752		MARATHON OIL CORP	7,800	390,679	
MOTOROLA, INC.	56,400	917,839		MATTELL INC.	11,900	227,539	*
MURPHY OIL CORP	4,000	306,018	*	MCDONALDS CORPORATION	4,100	243,882	*
NATIONAL OILWELL VARCO INC	7,800	473,603	*	MEMC ELECTR MATLS INC	11,900	915,402	
NEWMONT MNG CORP	2,900	147,560	*	MEREDITH CORP	2,700	118,124	
NEWS CORPORATION INCORPORATED-CL A WHEN	7,000	144,699		MICROCHIP TECHNOLOGY, INC.	6,400	201,616	*
NOBLE ENERGY INC	600	42,499	*	MICROSOFT CORP	21,300	654,328	
NORTHERN TRUST CORP	4,000	279,740	*	MONSANTO CO NEW	300	36,744	
NVIDIA CORP	16,500	397,158	*	MOTOROLA INC	51,800	562,981	
NYSE EURONEXT	2,300	198,089		N/A		1,117,605	*
OCCIDENTAL PETE CORP	3,400	241,127	*	NATIONAL OILWELL, INCORPORATED	10,500	780,402	*
PACCAR, INC.	5,500	308,270		NATIONAL SEMICONDUCTOR CORP	7,700	141,340	
PARKER HANNIFIN CORP	1,500	98,630	*	NEWS CORP	7,000	132,080	*
PARKER-HANNIFIN CORPORATION	2,500	190,194		NIKE INC CL B	1,600	96,553	
PEABODY ENERGY CORP.	1,100	67,795		NIKE INCORPORATED	4,500	289,683	*
PEPSI BOTTLING GROUP INC	22,400	780,039	*	NOBLE CORP.	7,700	439,019	*
PEPSI BOTTLING GROUP, INCORPORATED	900	36,228		NOBLE CORPORATION SHS	4,200	206,507	*
PEPSICO INC	3,800	262,920		NOBLE CORPORATION SHS	2,100	101,755	
PERKIN ELMER	1,600	41,881		NOBLE ENERGY INCORPORATED	1,400	113,083	*
PERKINELMER INC	5,700	144,944	*	NYSE EURONEXT	3,900	276,485	*
PLUM CREEK TIMBER CO, INC.	1,800	83,541		OMNICOM GROUP	900	39,765	
PRECISION CASTPARTS CORP	2,200	251,666	*	OMNICOM GROUP, INC.	700	33,508	*
PRICE T ROWE GROUP INC	700	34,610	*	PACCAR INC	5,500	248,775	*
PROCTER AND GAMBLE CO	3,400	226,688	*	PALL CORP	9,700	373,622	
PROLOGIS TRUST	2,300	141,854		PARKER HANNIFIN CORP	500	31,929	
PRUDENTIAL FINANCIAL, INC.	4,700	437,193		PAYCHEX	1,500	54,925	*
QUEST DIAGNOSTICS INC	10,700	513,576	*	PAYCHEX INC	1,000	31,656	*

# Fresno County Employees' Retirement Association

## Equity Activity

Period Ending: March 31, 2008

QUEST DIAGNOSTICS INC.	900	47,741		PEABODY ENERGY CORP	1,100	58,849	*
RANGE RESOURCES CORP	2,100	107,736		PEPSICO INC	4,700	360,697	
ROCKWELL INTERNATIONAL CORPORATION	2,400	167,742		POLO RALPH LAUREN CORP	5,500	326,506	*
SAFECO CORPORATION	2,200	122,911		PRAXAIR	500	45,617	*
SCHERING PLOUGH CORP	16,700	324,392	*	PRECISION CASTPARTS CORP	1,400	164,723	
SCHLUMBERGER LTD	21,600	1,993,353		PROCTER & GAMBLE CO	32,400	2,402,478	*
SCHWAB CHARLES CORP NEW COM STK	8,800	173,766	*	PROLOGIS SH BEN INT	1,600	92,023	*
SEARS HOLDING GROUP	1,800	182,786		PRUDENTIAL FINL INC	4,400	340,848	
SIGMA ALDRICH	4,200	221,328	*	QUESTAR CORP	1,300	70,113	
SMITH INTL INC	8,500	513,432	*	QUESTAR CORPORATION	700	38,087	*
SUNOCO INCORPORATED	1,200	86,266		RADIOSHACK CORP	32,800	525,771	*
SYMANTEC CORP	5,000	86,040	*	RADIOSHACK CORP.	9,000	152,805	*
TEREX CORP NEW	700	37,706	*	RALPH LAUREN POLO CORPORATION	800	49,511	*
TEREX CORPORATION	600	39,220		RANGE RES CORP	2,000	112,893	
TEXAS INSTRUMENTS, INC.	5,800	195,029		ROCKWELL AUTOMATION INC	2,000	112,975	
TEXTRON INC	2,100	114,562	*	SAFECO CORP	2,200	102,926	*
TEXTRON, INCORPORATED	2,400	170,609		SANDISK CORP	3,800	91,736	
TITANIUM METALS CORP	1,500	40,107		SCHERING PLOUGH CORP	46,300	985,561	
TJX COS INC NEW	8,300	264,210	*	SCHLUMBERGER LTD	3,700	307,359	*
TORONTO DOMINION BK ONT	414	24,732	*	SCHLUMBERGER LTD	3,900	320,256	
TRANOCEAN INC	1,500	221,740		SEARS HLDGS CORP	1,800	176,295	*
TRANSOCEAN INC SHS NEW	1,600	203,535	*	SMITH INTERNATIONAL, INCORPORATED	6,700	500,799	*
U S T INCORPORATED	1,100	60,082		SMITH INTL INC	6,100	383,284	
UNITED PARCEL SVC INC CL B	2,300	165,036	*	SOUTHWEST AIRLINES CO.	2,800	34,502	*
UNITED STATES STEEL CORPORATION	2,700	321,992		ST JUDE MED INC	900	37,395	*
UNITED TECHNOLOGIES CORP	1,800	127,199	*	STRYKER CORPORATION	7,000	531,439	*
UNITEDHEALTH GROUP INC	6,700	247,199	*	SUNOCO INC	1,200	67,796	*
UST INC COM USD0.50	600	33,046	*	TERADATA CORP	2,200	60,343	*
VALERO ENERGY CORP	3,600	193,749	*	TERADATA CORP DEL COM	11,000	270,291	
VALERO ENERGY CORPORATION	3,400	238,002		TEREX CORP NEW	5,700	347,529	*
VARIAN MED SYS INC	1,600	74,570	*	TESORO CORP	3,700	153,628	
VERISIGN INC	8,000	276,985	*	TEXAS INSTRS INC	5,300	161,294	
WASHINGTON POST CO CL B	400	295,104	*	TIFFANY & COMPANY	2,700	124,154	*
WATERS CORP	7,200	408,759	*	TIFFANY + CO NEW	10,000	381,481	
WEATHERFORD INTERNATIONAL LTD	800	53,795	*	TITANIUM METALS CORP	1,500	21,797	*

# Fresno County Employees' Retirement Association

## Equity Activity

Period Ending: March 31, 2008

WELLPOINT INCORPORATED	1,300	114,723		UNITED STS STL CORP NEW	2,700	293,465	*
WESTERN UNION CO	8,700	210,686		UNITED TECHNOLOGIES CORP.	2,000	153,764	*
WRIGLEY WM JR CO	5,300	307,721	*	UNITEDHEALTH GROUP INC	2,300	130,154	
XEROX CORPORATION	15,000	244,513		UNITEDHEALTH GROUP INC.	3,600	209,549	*
YUM BRANDS INC	4,300	152,374	*	UST INC COM USD0.50	500	28,247	
				V F CORPORATION	1,900	133,121	*
				VALERO ENERGY CORP	11,100	597,955	
				VULCAN MATERIALS COMPANY	1,000	78,105	*
				VULCAN MATLS CO	2,900	194,241	*
				WALGREEN CO	1,100	36,453	
				WATERS CORP	5,500	377,987	
				WATSON PHARMACEUTICALS INC	3,300	91,450	
				WELLPOINT INC	400	35,841	
				WESTERN UN CO	8,700	188,666	*
				WHOLE FOODS MKT INC	900	28,757	*
				XEROX CORP	15,000	220,451	*
				XTO ENERGY INC	9,400	526,412	
				ZIMMER HOLDINGS INC	21,400	1,579,260	
				ZIMMER HOLDINGS, INC.	2,900	191,422	*

# Fresno County Employees' Retirement Association

## Cumulative Performance Comparisons

Period Ending: March 31, 2008

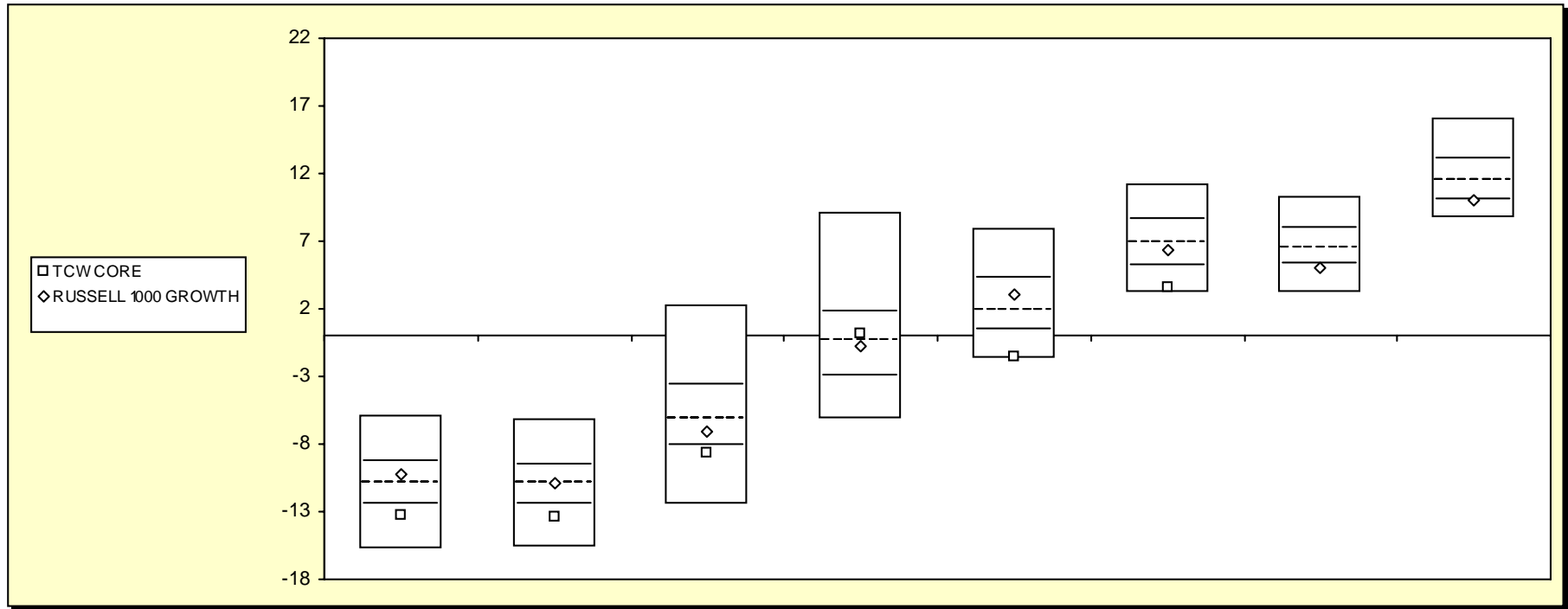

### Equity Style - Large Growth

	Last Quarter		Two Quarters		Three Quarters		One Year		Two Years		Three Years		Four Years		Five Years	
	Return	Rank	Return	Rank	Return	Rank	Return	Rank	Return	Rank	Return	Rank	Return	Rank	Return	Rank
5th Percentile	-15.8		-15.6		-12.5		-6.2		-1.7		3.2		3.2		8.7	
25th Percentile	-13.3		-13.4		-8.6		0.2		-1.5		3.5		5.0		10.0	
50th Percentile	-10.9		-10.9		-6.1		-0.4		1.9		6.8		6.5		11.5	
75th Percentile	-9.3		-9.6		-3.7		1.8		4.3		8.5		8.0		13.0	
95th Percentile	-5.9		-6.2		2.3		9.1		7.9		11.2		10.3		16.1	
TCW CORE	-13.3	80	-13.4	81	-8.6	77	0.2	43	-1.5	93	3.5	92				
RUSSELL 1000 GROWTH	-10.2	39	-10.9	50	-7.1	63	-0.7	54	3.1	37	6.3	58	5.0	78	10.0	76

# Fresno County Employees' Retirement Association

## Consecutive Performance Comparisons

Period Ending: March 31, 2008

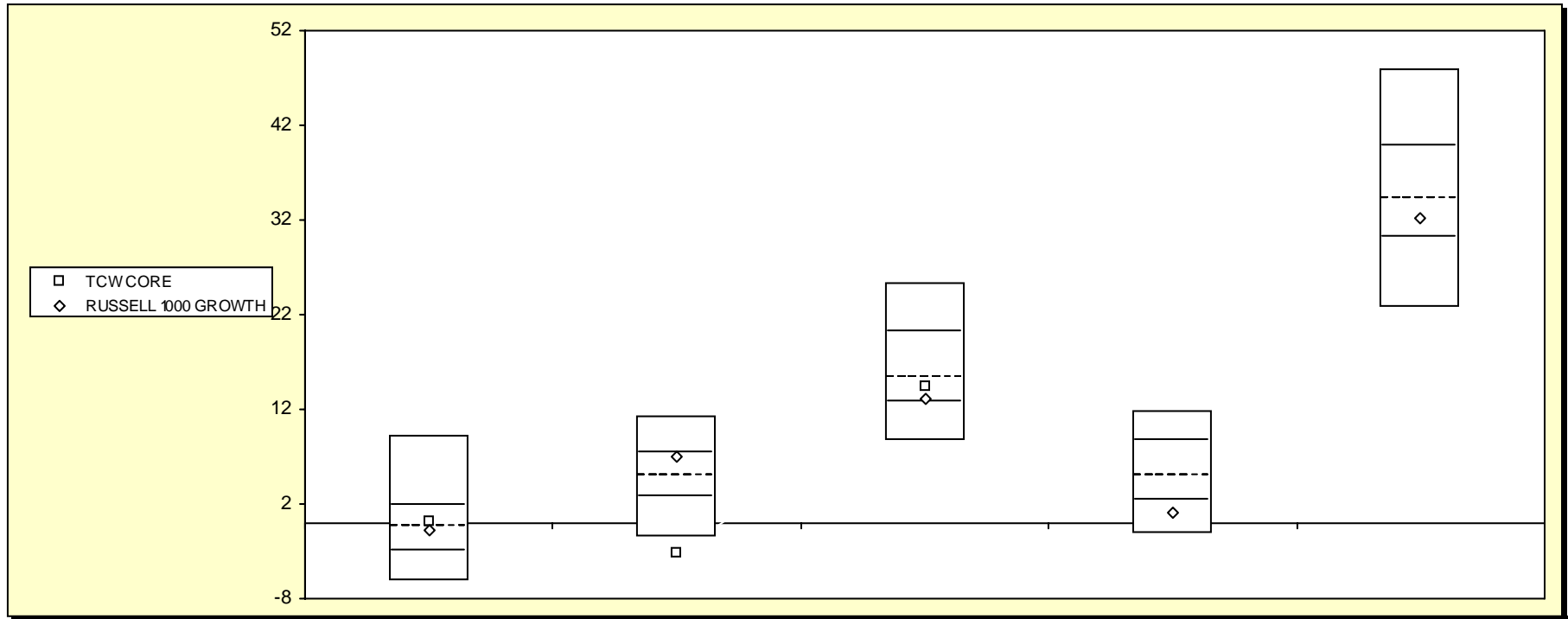

### Equity Style - Large Growth

	March 2008		March 2007		March 2006		March 2005		March 2004	
	Return	Rank	Return	Rank	Return	Rank	Return	Rank	Return	Rank
5th Percentile	9.1		11.3		25.3		11.8		47.9	
25th Percentile	1.8		7.3		20.2		8.6		39.7	
50th Percentile	-0.4		5.0		15.3		5.0		34.2	
75th Percentile	-3.0		2.7		12.8		2.3		30.1	
95th Percentile	-6.2		-1.4		8.7		-1.2		22.7	
TCW CORE	0.2	43	-3.2	97	14.3	59				
RUSSELL 1000 GROWTH	-0.7	54	7.1	28	13.2	72	1.2	81	32.2	62



# Fresno County Employees' Retirement Association

Consecutive Annual - Five Year

Period Ending: March 31, 2008

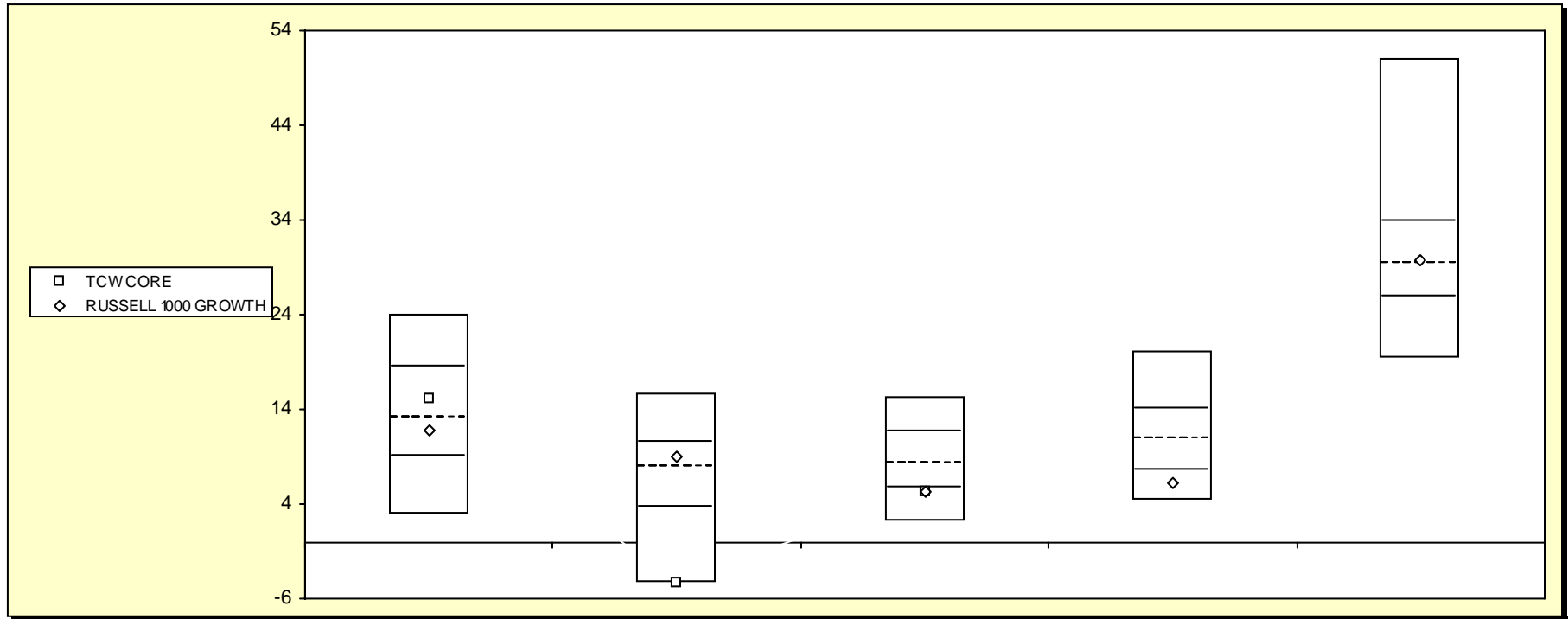

## Equity Style - Large Growth

	December 2007		December 2006		December 2005		December 2004		December 2003	
	Return	Rank	Return	Rank	Return	Rank	Return	Rank	Return	Rank
5th Percentile	24.0		15.6		15.3		20.1		51.0	
25th Percentile	18.4		10.5		11.6		13.9		33.7	
50th Percentile	13.1		7.9		8.3		10.9		29.4	
75th Percentile	9.0		3.7		5.7		7.5		25.8	
95th Percentile	2.9		-4.3		2.1		4.4		19.4	
TCW CORE	15.2	40	-4.3	95	5.2	78				
RUSSELL 1000 GROWTH	11.8	58	9.1	38	5.3	78	6.3	83	29.7	48

# Fresno County Employees' Retirement Association

## Equity Only Summary Statistics

Period Ending: March 31, 2008

### TCW CORE

	Portfolio	RUSSELL 1000 GROWTH
Total Number of Securities	130	687
Total Market Value	90,928,220	
Average Market Capitalization (000's)	65,416,992	66,240,000
Equity Segment Yield	1.60	1.29
Equity Segment Price/Earnings Ratio	23.36	17.22
Equity Segment Beta	1.11	1.16
Price/Book Ratio	4.66	4.78
5 Year Earnings Growth	20.7%	29.1%

#### Ten Largest Holdings

Security	Market Value	Weight
MICROSOFT CORP	3,493,578	3.84
CISCO SYS INC	2,293,368	2.52
HEWLETT PACKARD CO	1,935,984	2.13
PEPSICO INC	1,776,120	1.95
MGM MIRAGEINC	1,504,512	1.65
GOOGLE INC	1,497,598	1.65
INTEL CORP	1,399,998	1.54
QUALCOMM INC	1,365,300	1.50
ORACLE CORP	1,328,124	1.46
INTERNATIONAL BUSINESS MACHS	1,289,568	1.42

#### Ten Best Performers

Security	Return	Weight
CELGENE CORP	32.6	0.79
YAHOO INC	24.4	0.58
BEA SYS INC	21.4	0.62
GENENTECH INC	21.0	0.69
SOUTHWESTERN ENERGY CO	20.9	0.79
XTO ENERGY INC	20.7	0.94
ROSS STORES INC	17.6	0.66
GILEAD SCIENCES INC	12.0	0.85
WAL MART STORES INC	11.4	1.08
STEEL DYNAMICS INC	11.1	0.52

#### Ten Worst Performers

Security	Return	Weight
SCHERING PLOUGH CORP	-45.7	0.41
UNITEDHEALTH GROUP INC	-40.9	0.70
AUTODESK INCORPORATED COM STK NPV	-36.7	0.19
GOOGLE INC	-36.3	1.65
CYPRESS SEMICONDUCTOR CORP	-34.5	0.68
NII HLDGS INC CL B NEW	-34.2	0.61
MERCK + CO INC	-34.1	0.60
BE AEROSPACE INC	-33.9	0.68
CERNER CORP	-33.9	0.60
INTERCONTINENTALEXCHANGE INC	-32.2	0.30

# Fresno County Employees' Retirement Association

## Portfolio Characteristics - Equity

Period Ending: March 31, 2008

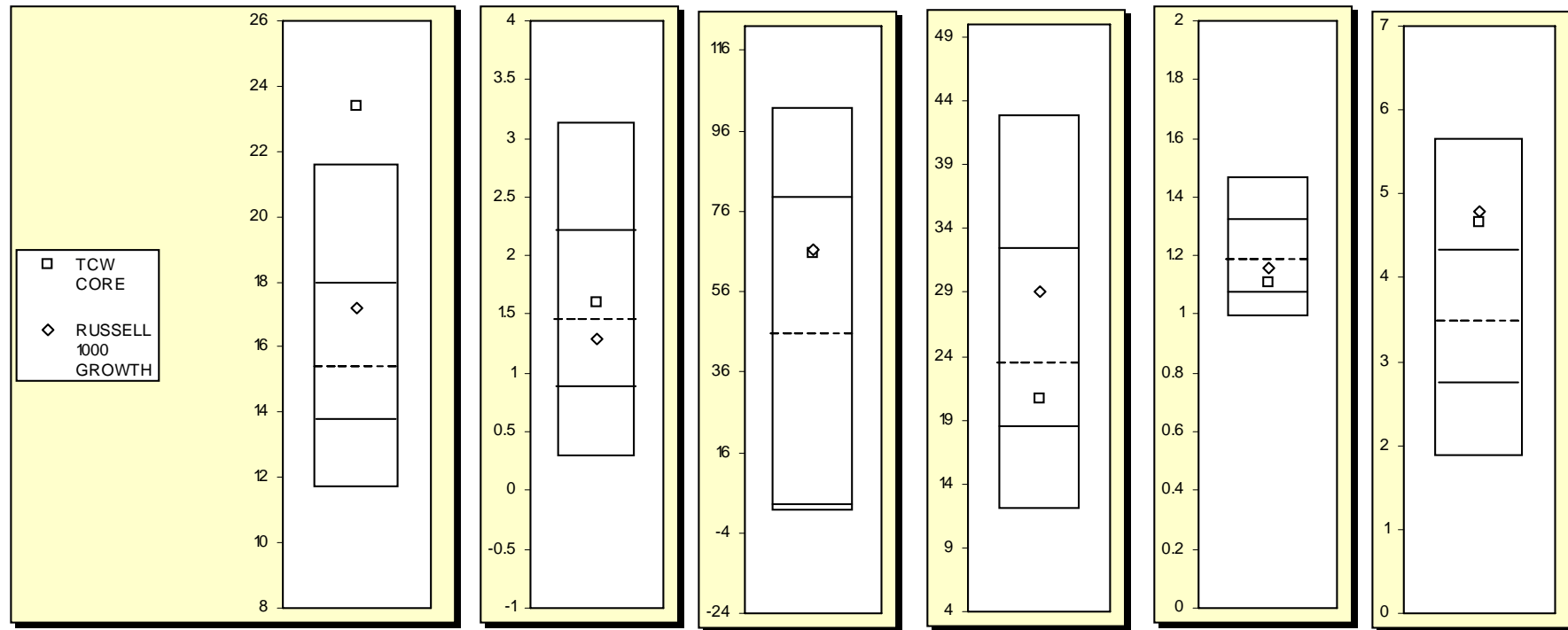

	Price/Earnings Ratio		Dividend Yield		Capitalization		5 Year Earnings		Beta		Price/Book Ratio	
	Value	Rank	Value	Rank	Value	Rank	Value	Rank	Value	Rank	Value	Rank
<i>Equity Funds - Equity Only</i>												
5th Percentile	21.57		3.13		101.51		42.95		1.47		5.66	
25th Percentile	17.93		2.20		78.86		32.34		1.32		4.32	
50th Percentile	15.38		1.45		45.26		23.34		1.18		3.47	
75th Percentile	13.75		0.88		2.83		18.43		1.07		2.72	
95th Percentile	11.66		0.28		1.13		11.93		0.99		1.86	
TCW CORE	23.36	3	1.60	45	65.42	35	20.68	64	1.11	66	4.66	20
RUSSELL 1000 GROWTH	17.22	32	1.29	57	66.24	34	29.12	34	1.16	55	4.78	18

# Fresno County Employees' Retirement Association

## Top Ten Holding

Period Ending: March 31, 2008

As Of 6/30/06	
PROGRESSIVE COMPANY	8.8%
GOOGLE INC.	6.4%
NETWORK APPLIANCE, INC.	6.2%
SCHLUMBERGER LTD	5.8%
EBAY INCORPORATED	5.8%
GENENTECH INCORPORATED	5.2%
AMAZON. COM CORPORATION	5.2%
COUNTRYWIDE FINANCIAL CORP.	4.9%
QUALCOMM, INC.	4.7%
SLM CORPORATION	4.5%
<b>Top Ten Total:</b>	<b>57.5%</b>

As Of 9/30/06	
GOOGLE INC.	7.3%
PROGRESSIVE COMPANY	7.1%
QUALCOMM, INC.	6.7%
NETWORK APPLIANCE, INC.	6.6%
SCHLUMBERGER LTD	5.6%
GENENTECH INCORPORATED	5.3%
SLM CORPORATION	4.7%
COUNTRYWIDE FINANCIAL CORP.	4.5%
AMAZON. COM CORPORATION	4.3%
EBAY INCORPORATED	4.1%
<b>Top Ten Total:</b>	<b>56.2%</b>

As Of 12/31/06	
QUALCOMM, INC.	8.3%
GOOGLE 'A'	7.5%
NETWORK APPLIANCE, INC.	6.7%
PROGRESSIVE COMPANY	6.7%
SCHLUMBERGER LTD	6.1%
SLM CORPORATION	5.9%
COUNTRYWIDE FINANCIAL CORP.	5.3%
AMAZON. COM CORPORATION	5.1%
GENENTECH INCORPORATED	5.0%
EBAY INCORPORATED	4.1%
<b>Top Ten Total:</b>	<b>60.6%</b>

As Of 3/31/07	
QUALCOMM, INC.	9.8%
SCHLUMBERGER LTD	9.0%
GOOGLE INC.	6.9%
NETWORK APPLIANCE, INC.	6.6%
AMAZON. COM CORPORATION	6.4%
PROGRESSIVE COMPANY	5.9%
EBAY INCORPORATED	4.5%
COUNTRYWIDE FINANCIAL CORP.	4.1%
GENENTECH INCORPORATED	4.0%
SALESFORCE.COM	4.0%
<b>Top Ten Total:</b>	<b>61.2%</b>

As Of 6/30/07	
SCHLUMBERGER LTD	9.9%
QUALCOMM, INC.	8.9%
AMAZON. COM CORPORATION	8.7%
GOOGLE INC.	7.1%
PROGRESSIVE COMPANY	5.8%
SALESFORCE.COM	5.5%
NETWORK APPLIANCE, INC.	4.7%
AUTODESK INCORPORATED	4.4%
COUNTRYWIDE FINANCIAL CORP.	4.0%
COMMERCE BANCORP INCORPORATED	3.9%
<b>Top Ten Total:</b>	<b>62.9%</b>

As Of 9/30/07	
QUALCOMM, INC.	8.6%
SCHLUMBERGER LTD	7.8%
GOOGLE INC.	7.6%
AMAZON. COM CORPORATION	6.9%
SALESFORCE.COM	6.5%
EBAY INCORPORATED	4.7%
AUTODESK INCORPORATED	4.6%
ALLEGHENY TECHNOLOGIES	4.2%
GENERAL ELECTRIC CO.	4.2%
PROGRESSIVE COMPANY	4.1%
<b>Top Ten Total:</b>	<b>59.1%</b>

As Of 12/31/07	
QUALCOMM, INC.	7.9%
SALESFORCE.COM	7.8%
SCHLUMBERGER LTD	7.2%
GOOGLE INC.	7.2%
AMAZON. COM CORPORATION	6.7%
GENZYME	4.6%
AUTODESK INCORPORATED	4.5%
INTERCONTINENTAL EXCHANGE	4.1%
PROGRESSIVE COMPANY	4.0%
CH ROBINSON WORLDWIDE	4.0%
<b>Top Ten Total:</b>	<b>58.1%</b>

As Of 3/31/08	
MICROSOFT CORP	3.8%
CISCO SYS INC	2.5%
HEWLETT PACKARD CO	2.1%
PEPSICO INC	2.0%
MGM MIRAGEINC	1.7%
GOOGLE INC	1.6%
INTEL CORP	1.5%
QUALCOMM INC	1.5%
ORACLE CORP	1.5%
INTERNATIONAL BUSINESS MACHS	1.4%
<b>Top Ten Total:</b>	<b>19.7%</b>

# Fresno County Employees' Retirement Association

## Equity Only Summary Statistics Charts

Period Ending: March 31, 2008

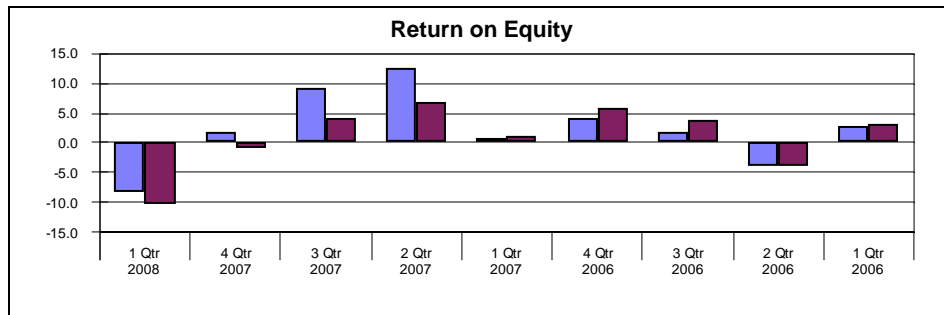
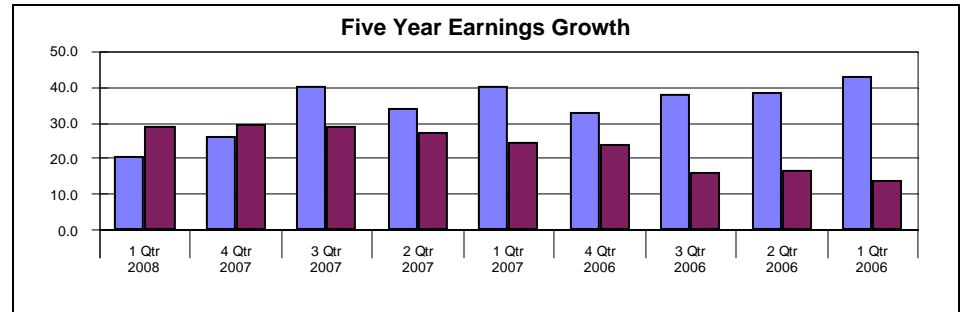
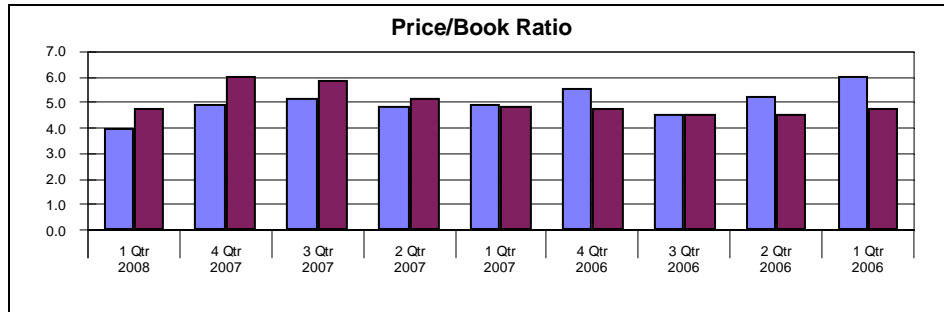
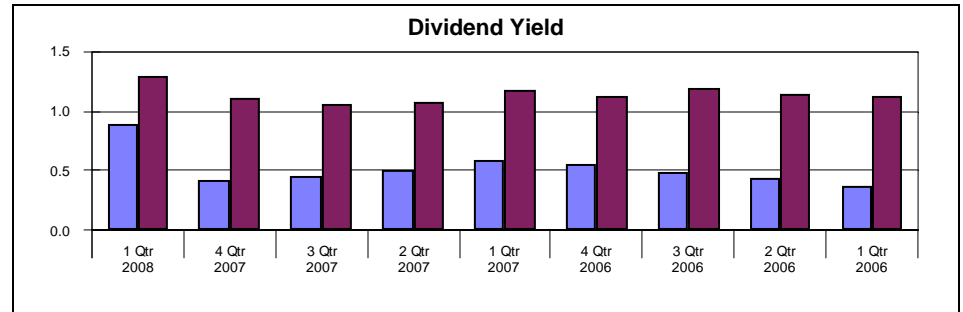
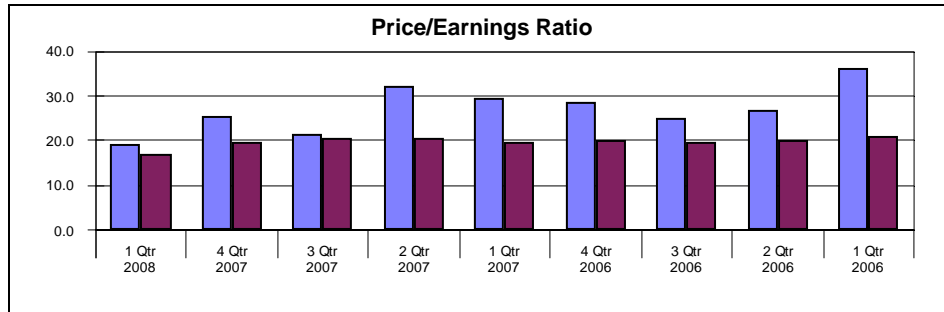
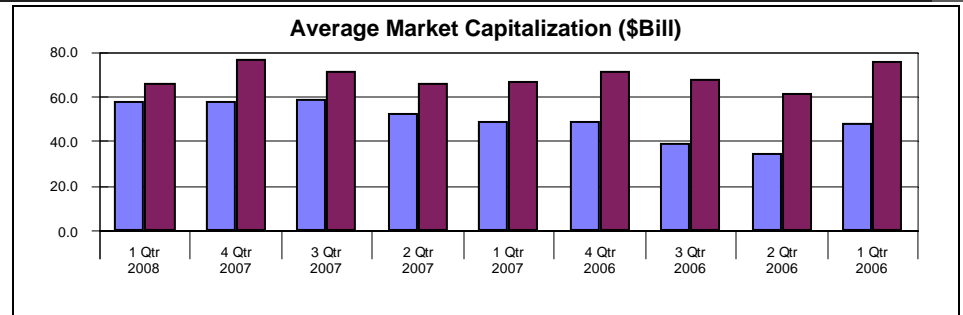
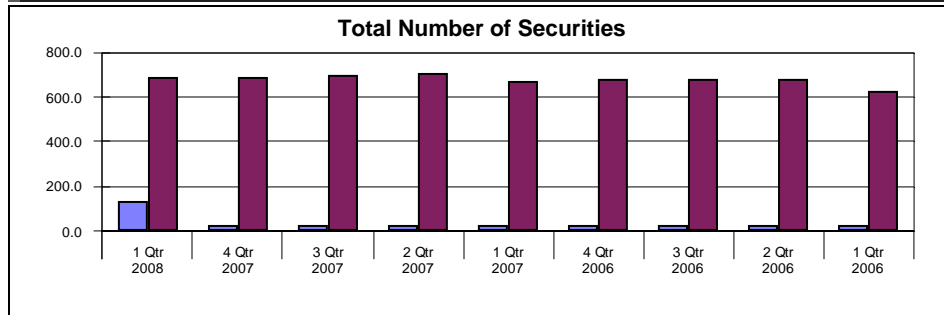

TCW CORE  
RUSSELL 1000 GROWTH

# Fresno County Employees' Retirement Association

## Equity Only Sector Analysis Quarterly

Period Ending: March 31, 2008

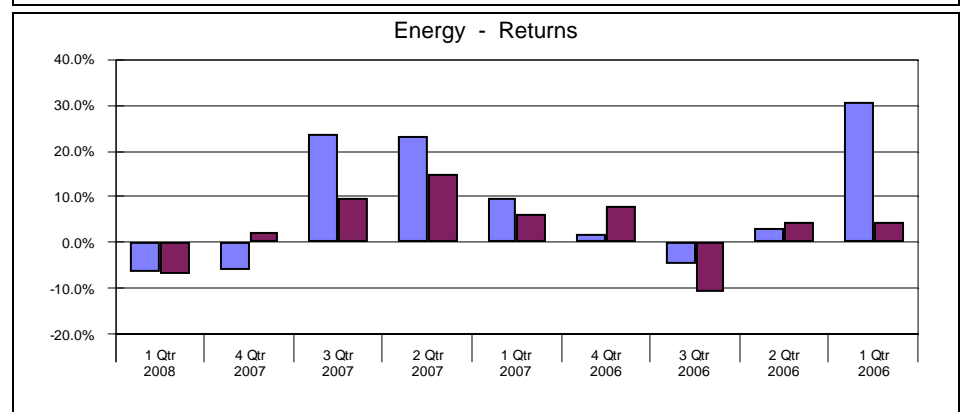
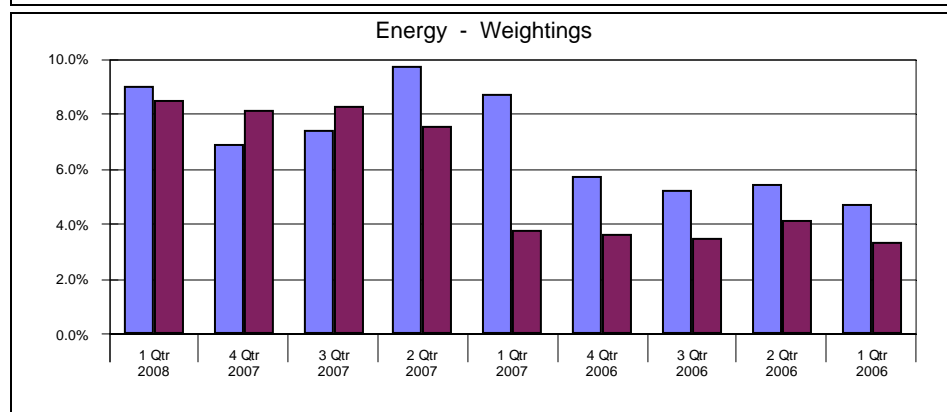
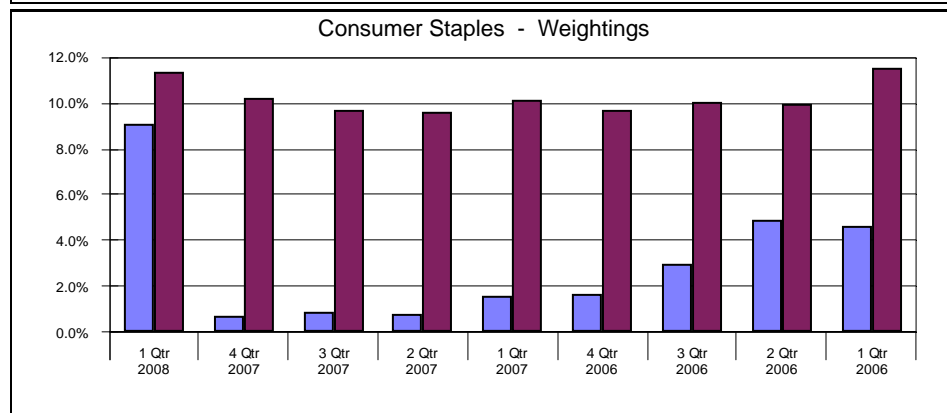
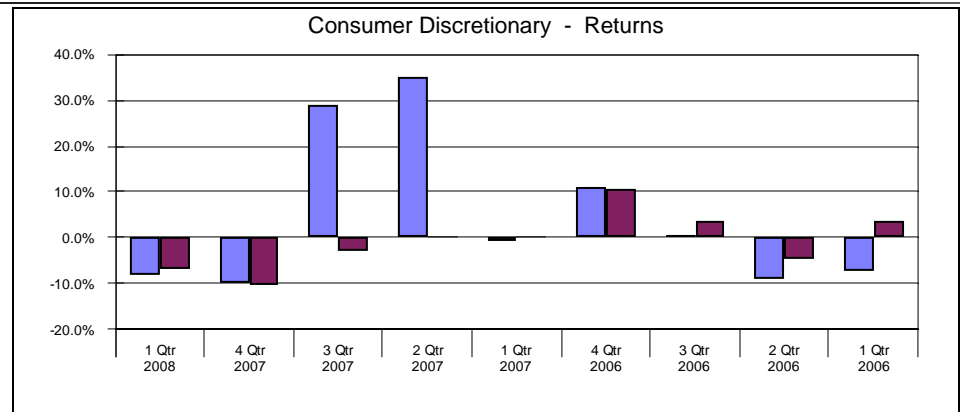
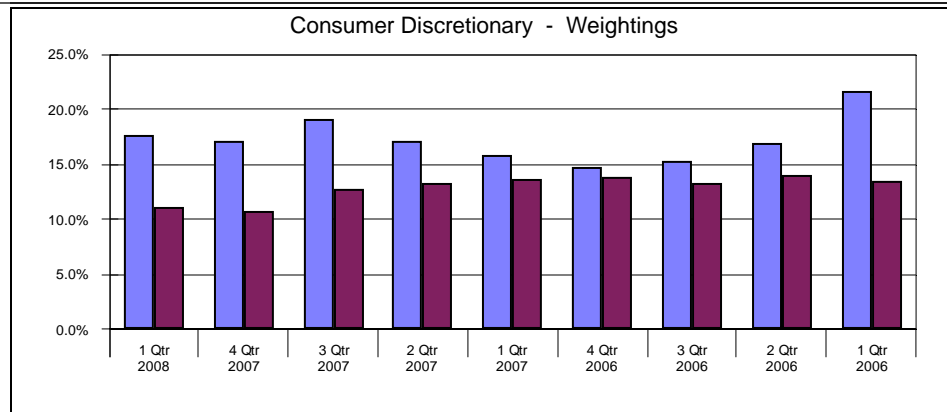

TCW CORE

RUSSELL 1000 GROWTH

# Fresno County Employees' Retirement Association

## Equity Only Sector Analysis Quarterlyly

Period Ending: March 31, 2008

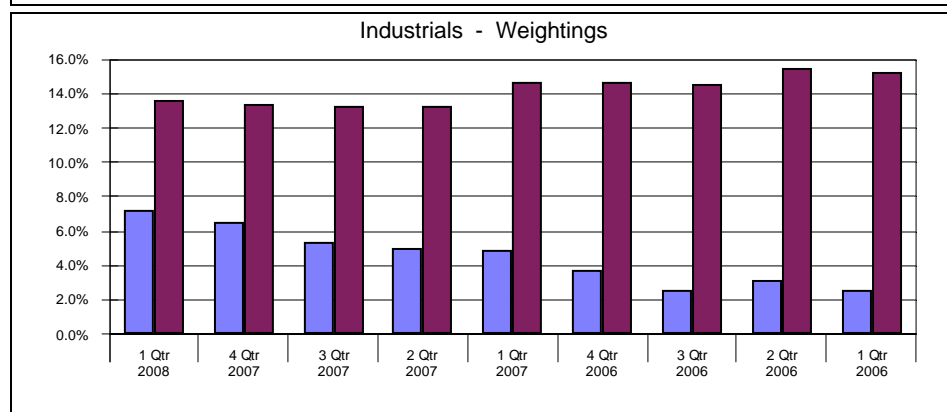
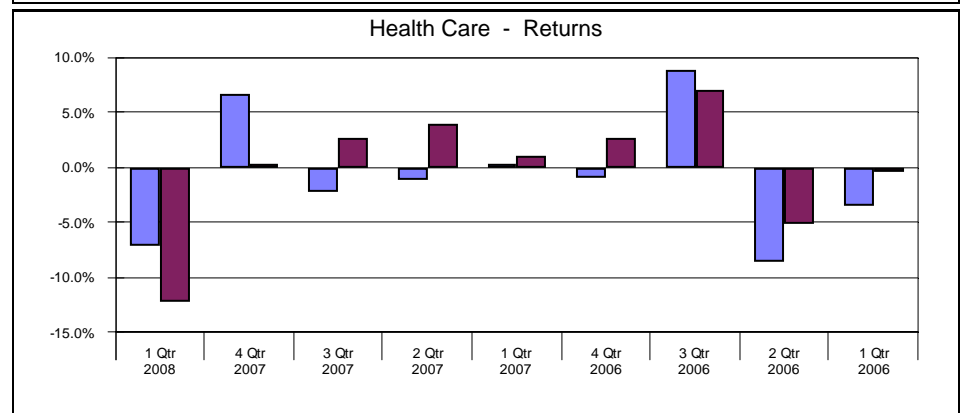
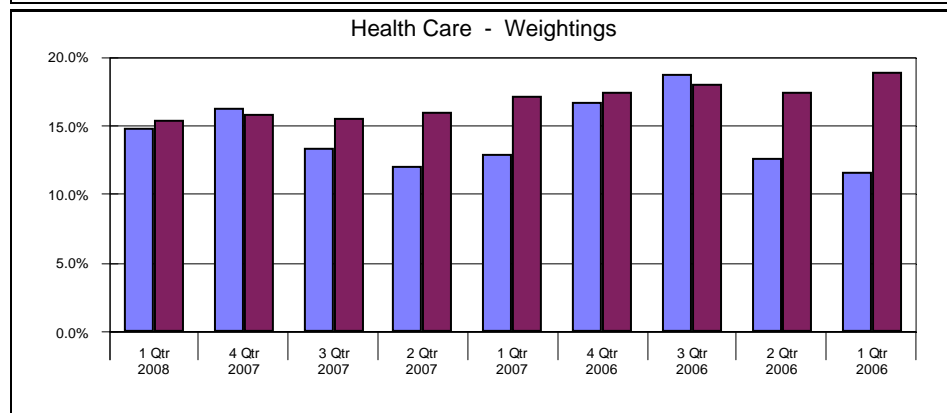
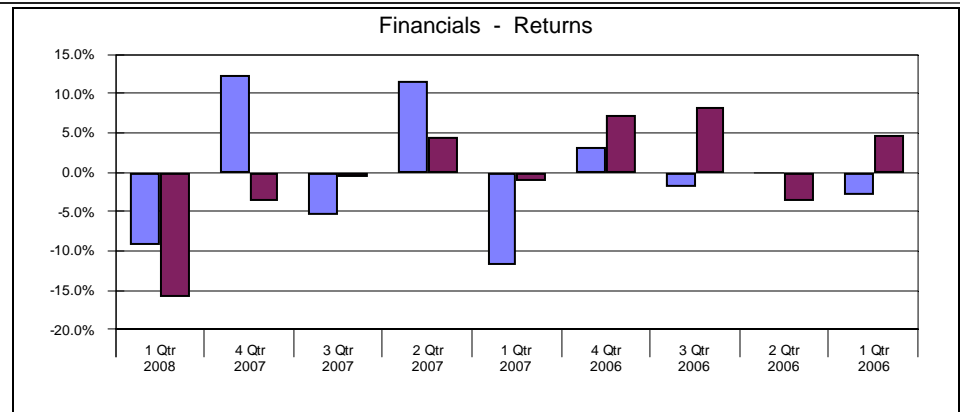
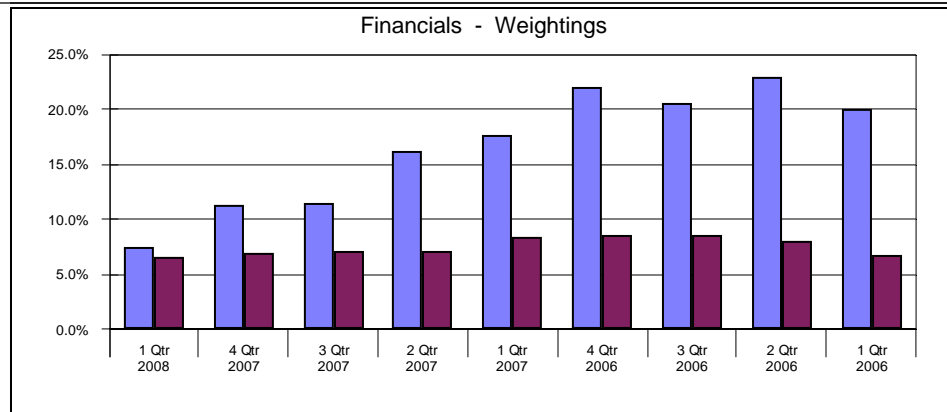

TCW CORE

RUSSELL 1000 GROWTH

# Fresno County Employees' Retirement Association

## Equity Only Sector Analysis Quarterly

Period Ending: March 31, 2008

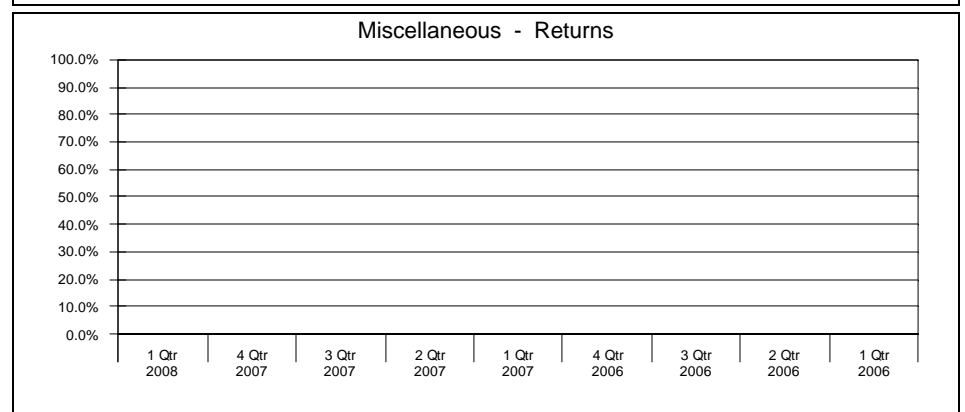
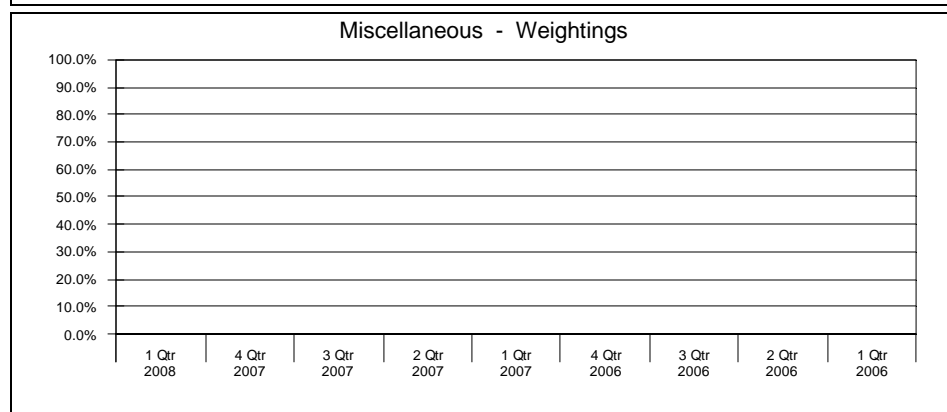
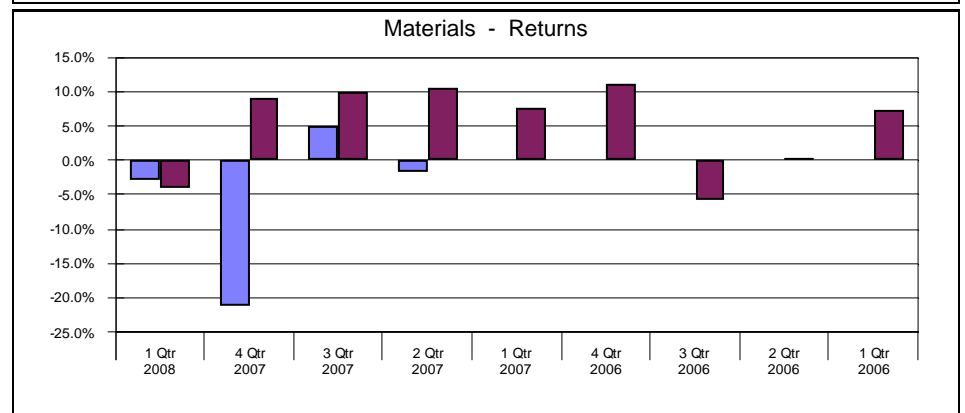
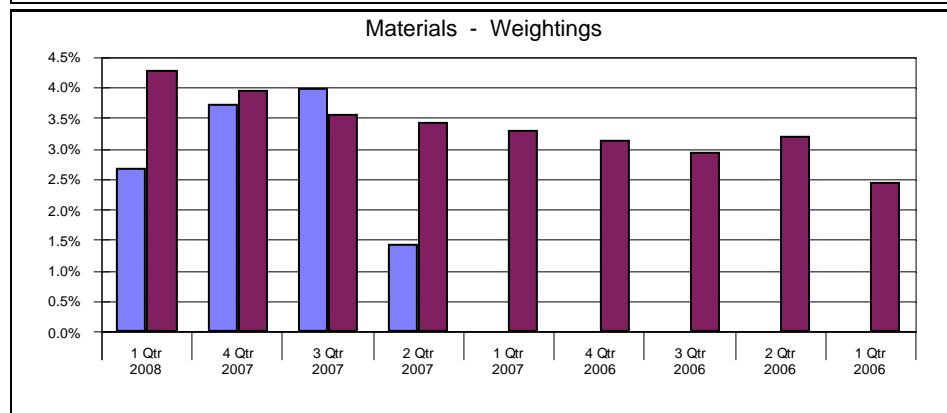
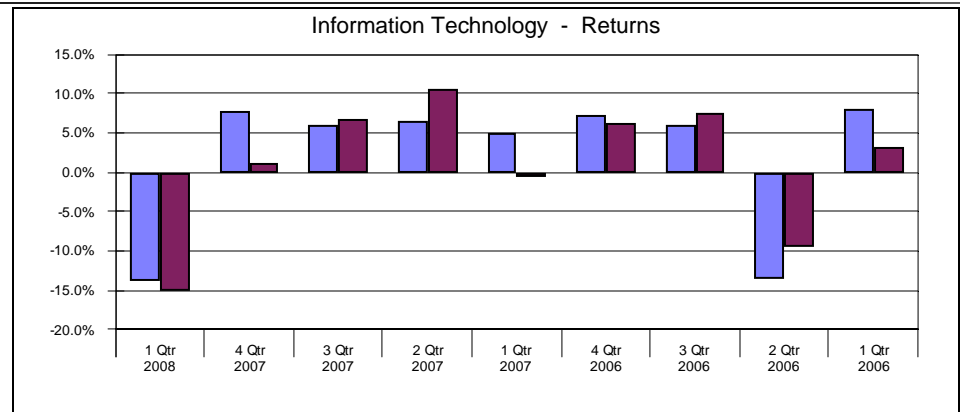
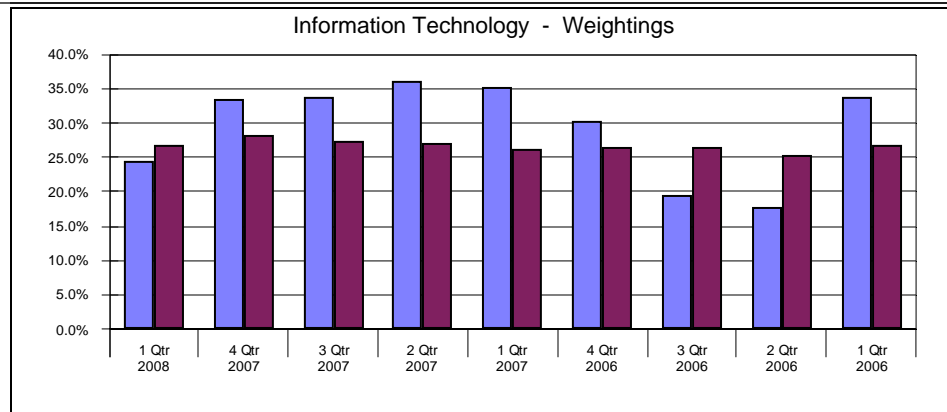

TCW CORE

RUSSELL 1000 GROWTH



# Fresno County Employees' Retirement Association

## Equity Only Sector Analysis Quarterly

Period Ending: March 31, 2008

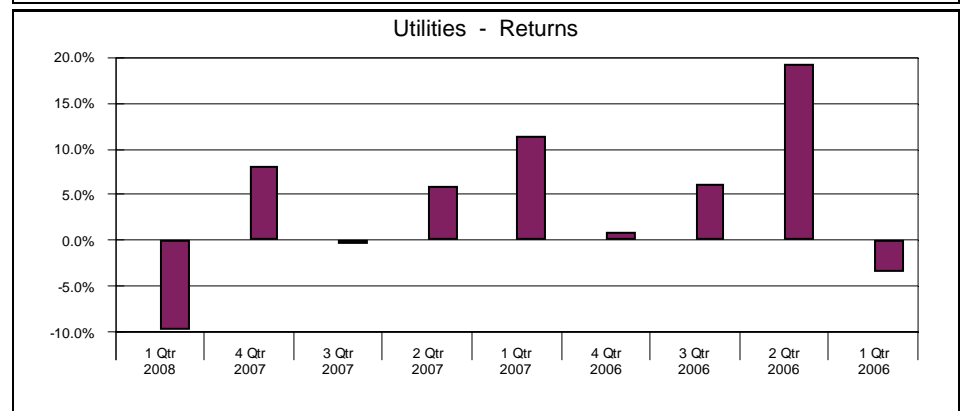
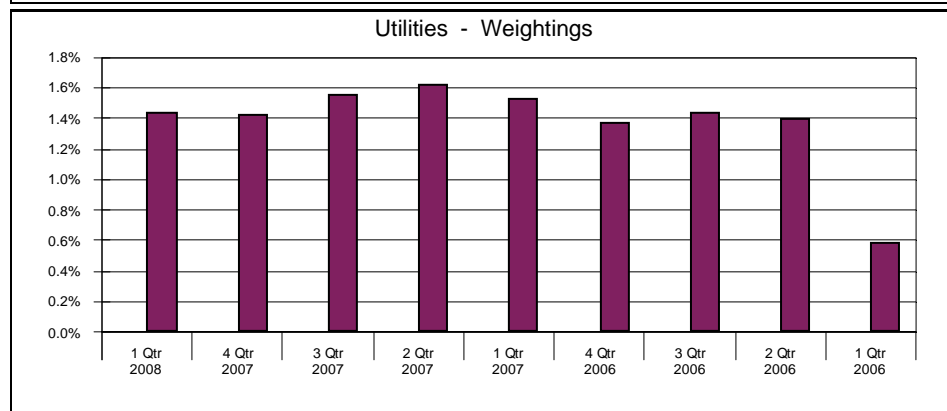
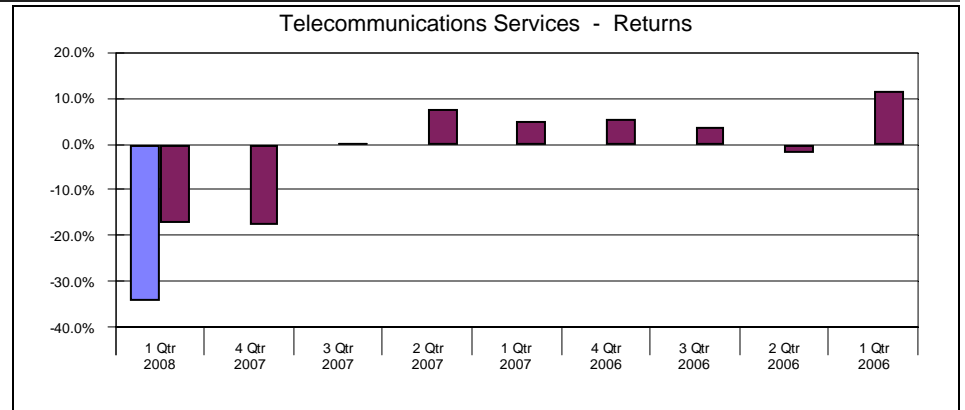
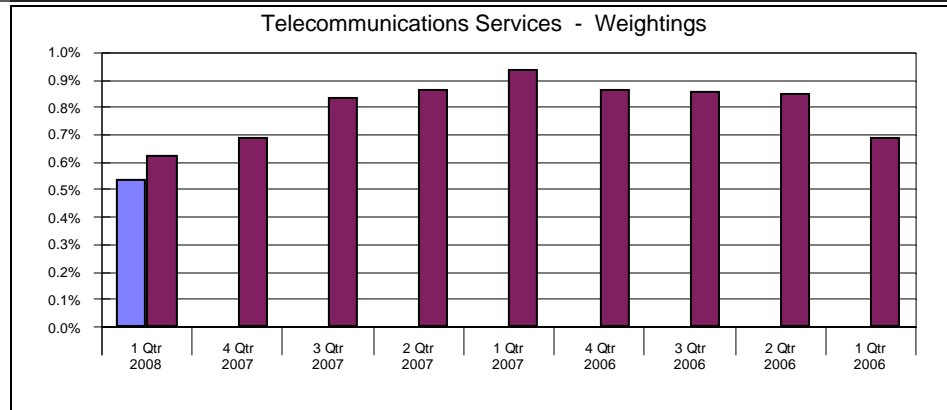

TCW CORE

RUSSELL 1000 GROWTH

# Fresno County Employees' Retirement Association

## Performance Attribution Geometric

Period Ending: March 31, 2008

### TCW CORE

	Portfolio		RUSSELL 1000 GROWTH		Selection		Total
	Market Value	Return	Market Value	Return	Stock	Industry	
	<b>A</b>	<b>B</b>	<b>C</b>	<b>D</b>	<b>E</b>	<b>F</b>	
Consumer Discretionary	17.8	-16.2	10.9	-6.9	-1.9	0.3	-1.6
Consumer Staples	0.7	0.3	10.3	-1.4	0.0	-0.9	-0.9
Energy	7.2	-11.3	8.2	-6.6	-0.4	0.0	-0.4
Financials	11.8	-19.7	7.0	-15.8	-0.5	-0.3	-0.8
Health Care	17.0	-12.0	15.9	-12.2	0.0	0.0	0.0
Industrials	6.8	1.0	13.4	-7.9	0.7	-0.2	0.5
Information Technology	34.8	-17.1	28.3	-15.1	-0.8	-0.4	-1.2
Materials	3.9	-17.2	4.0	-3.9	-0.6	0.0	-0.6
Telecommunications Services	0.0	0.0	0.7	-17.2	0.0	0.1	0.1
Utilities	0.0	0.0	1.4	-9.7	0.0	0.0	0.0
	100.0	-14.6	100.0	-10.2	-3.5	-1.5	-4.9

#### Contribution

<b>Stock</b>	Industrials
	Health Care
<b>Industry</b>	Consumer Discretionary
	Telecommunications Services

#### Detractors

<b>Stock</b>	Consumer Discretionary
	Information Technology
<b>Industry</b>	Consumer Staples
	Information Technology

# Fresno County Employees' Retirement Association

## Portfolio Holdings And Characteristics - Equity

Period Ending: March 31, 2008

TCW CORE	Shares	Price	Portfolio Weight	Market Cap	Dividend Yield	Price / Earnings	Price / Book	Beta	Quarterly Return
<b>Consumer Discretionary</b>									
3M CO	9,200	79.15	0.8	56.01	2.5	14.1	4.8	0.71	-5.5
ACTIVISION INC NEW	23,000	27.31	0.7	8.03		30.0	5.5	1.31	-8.1
AMERICAN EAGLE OUTFITTERS INC	28,500	17.51	0.5	3.75	2.3	9.6	2.7	0.96	-15.2
COACH INC	15,000	30.15	0.5	10.61		16.4	5.9	1.54	-1.4
CORRECTIONS CORP AMER NEW	22,500	27.52	0.7	3.44		26.0	2.8	1.06	-6.7
COSTCO WHSL CORP NEW	9,800	64.97	0.7	28.15	0.9	24.5	3.3	0.77	-6.7
EBAY INC	28,800	29.84	0.9	39.63		119.4	3.4	1.87	-10.1
GENERAL ELEC CO	26,900	37.01	1.0	369.57	3.4	16.8	3.2	0.79	0.8
HARSCO CORP	9,100	55.38	0.5	4.68	1.4	18.4	3.0	1.35	-13.3
HOME DEPOT INC	24,300	27.97	0.7	47.20	3.2	12.3	2.2	1.01	4.7
HONEYWELL INTL INC	9,300	56.42	0.6	42.13	2.0	17.9	4.6	1.23	-7.9
IRON MTN INC PA	20,200	26.44	0.6	5.31		34.8	2.9	0.63	-28.6
JOHNSON CTLS INC	15,400	33.80	0.5	20.07	1.5	15.0	2.3	0.96	-5.8
KOHL'S CORP	11,300	42.89	0.5	13.25		12.7	2.2	0.77	-6.4
LAS VEGAS SANDS CORP	9,100	73.64	0.7	26.17			11.6	1.96	-28.5
MGM MIRAGE INC	25,600	58.77	1.6	17.27	0.3	12.5	2.8	1.80	-30.1
NEWS CORP	36,900	18.75	0.7	40.14	0.6	17.2	1.8	0.96	-8.2
O REILLY AUTOMOTIVE INC	20,100	28.52	0.6	3.29		17.1	2.1	1.17	-12.1
OFFICE DEPOT INC	46,100	11.05	0.5	3.02		7.7	1.0	1.22	-20.6
POLO RALPH LAUREN CORP	8,900	58.29	0.5	3.41	0.3	15.8	2.6	1.37	-5.6
ROSS STORES INC	19,900	29.96	0.6	4.06	1.3	15.8	4.6	0.86	17.6
SIRIUS SATELLITE RADIO INC	203,400	2.86	0.6	4.22				1.42	-5.6
TARGET CORP	17,600	50.68	0.9	41.20	1.1	15.2	2.7	0.96	1.6
TIFFANY + CO NEW	16,600	41.84	0.7	5.28	1.4	17.4	3.2	1.43	-8.7
TIME WARNER CABLE INC CL A	18,800	24.98	0.5	22.53		21.7			-9.5
WAL MART STORES INC	18,600	52.68	1.0	210.97	1.8	16.8	3.5	0.37	11.4
WYNN RESORTS LTD	6,500	100.64	0.7	11.37		43.0	5.9	1.95	-10.3
			<b>19.0</b>	<b>49.84</b>	<b>1.6</b>	<b>23.5</b>	<b>3.6</b>	<b>1.19</b>	<b>-8.35</b>

# Fresno County Employees' Retirement Association

## Portfolio Holdings And Characteristics - Equity

Period Ending: March 31, 2008

TCW CORE	Shares	Price	Portfolio Weight	Market Cap	Dividend Yield	Price / Earnings	Price / Book	Beta	Quarterly Return
<b>Consumer Staples</b>									
ALTRIA GROUP INC	12,000	22.20	0.3	46.80	4.2	15.6	8.2	1.03	-3.7
BROWN FORMAN CORP CLASS B	7,700	66.22	0.5	4.42	2.1	20.1	5.2	0.73	-10.2
CARDINAL HEALTH INC	10,900	52.51	0.6	18.72	0.9	39.8	2.6	0.63	-8.9
COCA COLA CO	14,800	60.87	0.9	141.46	2.5	23.7	6.5	0.67	-0.2
CVS CAREMARK CORP	12,900	40.51	0.6	58.01	0.6	21.1	1.9	0.98	2.1
LOEWS CORP CAROLINA GROUP STK	8,600	72.55	0.7	7.87	2.5	9.2	11.5	1.10	-14.4
MCDONALDS CORP	8,600	55.77	0.5	64.23	2.7	28.9	4.3	1.52	-4.7
PEPSICO INC	24,600	72.20	1.9	115.65	2.1	21.2	6.7	0.58	-4.4
PROCTER AND GAMBLE CO	15,600	70.07	1.2	215.64	2.0	21.2	3.3	0.76	-4.1
SYSCO CORP	18,800	29.02	0.6	17.52	3.0	17.1	5.4	1.11	-6.3
WALGREEN CO	21,800	38.09	0.9	37.76	1.0	18.1	3.4	0.50	0.3
YUM BRANDS INC	13,900	37.21	0.5	17.69	1.6	22.1		1.12	-2.4
PHILIP MORRIS INTL ORD SHR	12,000	50.58	0.6	106.64					
			<b>9.7</b>	<b>83.81</b>	<b>2.0</b>	<b>21.5</b>	<b>5.4</b>	<b>0.81</b>	<b>-4.14</b>
<b>Energy</b>									
BAKER HUGHES INC	8,800	68.50	0.6	21.19	0.8	14.5	3.4	1.17	-15.4
CAMERON INTL CORP	14,100	41.64	0.6	9.09		19.3	4.3	0.84	-13.5
EXXON MOBIL CORP	14,200	84.58	1.3	452.51	1.7	11.6	3.7	0.90	-9.3
GRANT PRIDECO INC	11,000	49.22	0.6	6.16		12.3	3.6	1.02	-11.3
HALLIBURTON CO	14,000	39.33	0.6	34.62	0.9	10.7	6.1	1.20	4.0
NATIONAL OILWELL VARCO INC	10,100	58.38	0.6	20.84		15.5	3.1	1.15	-20.5
PRIDE INTERNATIONAL INC	14,100	34.95	0.5	5.84		14.2	1.7	1.11	3.1
SCHLUMBERGER LTD	16,400	87.00	1.5	104.20	1.0	20.7	7.0	1.26	-11.3
SOUTHWESTERN ENERGY CO	21,400	33.69	0.8	11.52	0.1	53.1	7.0	1.18	20.9
SUNOCO INC	9,700	52.47	0.5	6.17	2.3	7.1	2.4	1.26	-27.2
TRANSOCEAN INC SHS NEW	4,300	135.20	0.6	42.96		9.6	3.4	1.11	-5.6
VALERO ENERGY CORP	11,300	49.11	0.6	26.26	1.0	6.4	1.4	0.99	-29.7
XTO ENERGY INC	13,800	61.86	0.9	29.91	0.8	17.5	3.8	0.90	20.7
			<b>9.7</b>	<b>89.49</b>	<b>1.1</b>	<b>17.2</b>	<b>4.3</b>	<b>1.08</b>	<b>-6.51</b>

# Fresno County Employees' Retirement Association

## Portfolio Holdings And Characteristics - Equity

Period Ending: March 31, 2008

TCW CORE	Shares	Price	Portfolio Weight	Market Cap	Dividend Yield	Price / Earnings	Price / Book	Beta	Quarterly Return
<b>Financials</b>									
AMERICAN EXPRESS CO	21,000	43.72	1.0	50.54	1.6	13.0	4.6	1.23	-15.7
BANK NEW YORK MELLON CORP	12,200	41.73	0.5	47.63	2.3	17.5	1.6	1.09	-14.0
BLACKROCK INC	2,300	204.18	0.5	23.95	1.5	27.1	2.0	1.08	-5.5
BROADRIDGE FINL SOLUTIONS INC	28,500	17.60	0.5	2.46	1.4	11.9	4.6		-21.3
COVANTA HLDG CORP	19,700	27.50	0.6	4.23		32.4	4.1	1.51	-0.6
DUKE RLTY CORP	20,100	22.81	0.5	3.34	8.4	33.1	1.7	0.90	-10.7
GENERAL GROWTH PPTYS INC	14,100	38.17	0.6	9.31	5.2	32.3	6.4	1.40	-5.9
GLOBAL PMTS INC	14,000	41.36	0.6	3.29	0.2	22.5	3.5	1.00	-11.1
GOLDMAN SACHS GROUP INC	4,200	165.39	0.7	65.48	0.8	7.8	1.6	1.60	-23.0
INTERCONTINENTALEXCHANGE INC	2,100	130.50	0.3	9.15		38.5	6.2		-32.2
INVESTMENT TECHNOLOGY GROUP	11,000	46.18	0.5	2.02		18.6	2.9	1.20	-3.0
PRUDENTIAL FINL INC	8,200	78.25	0.7	34.74	1.5	10.3	1.5	1.36	-15.9
STATE STREET CORPORATION	5,700	79.00	0.5	30.61	1.2	22.9	2.7	0.97	-2.4
UDR INC	24,600	24.52	0.6	3.27	5.4		3.9	0.77	25.7
			<b>8.1</b>	<b>23.54</b>	<b>2.5</b>	<b>20.5</b>	<b>3.3</b>	<b>1.19</b>	<b>-9.31</b>
<b>Health Care</b>									
ABBOTT LABS	13,700	55.15	0.8	85.25	2.6	23.9	4.8	0.46	-1.3
AETNA INC	15,400	42.09	0.7	20.90	0.1	12.1	2.1	1.31	-27.1
BARR PHARMACEUTICALS INC	11,200	48.31	0.6	5.21		36.9	2.8	0.92	-9.0
BECKMAN COULTER INC	8,400	64.55	0.6	4.05	1.1	19.7	2.8	0.84	-11.1
BRISTOL MYERS SQUIBB CO	27,700	21.30	0.6	42.16	5.8	19.5	4.0	0.98	-18.7
CELGENE CORP	11,700	61.29	0.8	24.75		113.5	8.7	0.87	32.6
CEPHALON INC	11,100	64.40	0.8	4.36			3.3	0.93	-10.3
COVANCE INC	6,600	82.97	0.6	5.32		30.6	4.8	0.45	-4.2
DENTSPLY INTL INC NEW	16,100	38.60	0.7	5.83	0.5	23.0	3.8	0.73	-14.2
GENENTECH INC	7,700	81.18	0.7	85.49		31.3	7.2	1.21	21.0
GENZYME CORP COM GEN DIV	7,500	74.54	0.6	19.95		42.8	3.0	0.88	0.1
GILEAD SCIENCES INC	15,000	51.53	0.8	47.86		30.7	13.9	1.07	12.0
IDEXX LABS INC	11,000	49.26	0.6	3.00		33.7	6.9	0.55	-16.0
JOHNSON + JOHNSON	13,900	64.87	0.9	183.75	2.6	17.9	4.3	0.29	-2.1
LILLY ELI + CO	12,300	51.59	0.7	58.66	3.6	19.0	4.3	0.70	-2.5
MEDCO HEALTH SOLUTIONS INC	12,000	43.79	0.6	22.94		26.9	3.4	0.86	-13.6
MEDTRONIC INC	14,600	48.37	0.7	54.32	1.0	24.9	5.0	0.42	-3.5
MERCK + CO INC	14,300	37.95	0.6	82.17	4.0	25.5	4.5	0.70	-34.1
SCHEIN HENRY INC	10,700	57.40	0.6	5.14		22.2	2.9	0.93	-6.5
SCHERING PLOUGH CORP	26,100	14.41	0.4	23.36	1.8		3.0	0.98	-45.7
UNITEDHEALTH GROUP INC	18,500	34.36	0.7	43.00	0.1	10.0	2.2	0.76	-40.9
VARIAN MED SYS INC	14,200	46.84	0.7	5.89		24.8	7.1	0.98	-10.2
VERTEX PHARMACEUTICALS INC	30,700	23.89	0.8	3.18			11.7	1.50	2.8
WYETH	17,100	41.76	0.8	55.87	2.7	12.4	3.1	0.56	-4.8
			<b>16.0</b>	<b>40.84</b>	<b>2.2</b>	<b>28.7</b>	<b>5.2</b>	<b>0.82</b>	<b>-7.14</b>

# Fresno County Employees' Retirement Association

## Portfolio Holdings And Characteristics - Equity

Period Ending: March 31, 2008

TCW CORE	Shares	Price	Portfolio Weight	Market Cap	Dividend Yield	Price / Earnings	Price / Book	Beta	Quarterly Return
<b>Industrials</b>									
ALLIANT TECHSYSTEMS INC	4,700	103.53	0.5	3.40		16.8	6.1	0.67	-9.0
BE AEROSPACE INC	17,600	34.95	0.6	3.25		21.1	2.6	1.60	-33.9
BOEING CO	14,800	74.37	1.2	56.88	2.2	14.1	6.3	1.22	-14.5
C H ROBINSON WORLDWIDE INC	3,400	54.40	0.2	9.32	1.6	29.2	8.9	1.26	0.9
EMERSON ELEC CO	10,300	51.46	0.6	40.44	2.3	18.6	4.6	1.09	-8.7
EXPEDITORS INTL WA INC	700	45.18	0.0	9.63	0.6	37.3	7.8	0.83	1.1
FEDEX CORP	7,000	92.67	0.7	28.73	0.4	14.6	2.3	0.78	4.0
GARMIN LTD	7,600	54.01	0.4	11.72	1.4	13.9	5.0	1.54	-44.3
L 3 COMMUNICATIONS HLDG CORP	4,800	109.34	0.6	13.38	1.1	18.3	2.3	0.83	3.5
LOCKHEED MARTIN CORP	7,800	99.30	0.8	40.53	1.7	14.0	4.1	0.44	-5.3
UNION PAC CORP	4,300	125.38	0.6	32.69	1.4	18.1	2.1	0.95	0.2
UNITED PARCEL SVC INC CL B	13,400	73.02	1.0	50.55	2.5		6.2	0.79	3.9
UNITED TECHNOLOGIES CORP	8,400	68.82	0.6	67.55	1.9	16.1	3.2	1.03	-9.7
			<b>7.8</b>	<b>34.81</b>	<b>1.7</b>	<b>16.8</b>	<b>4.4</b>	<b>0.98</b>	<b>-8.80</b>
<b>Information Technology</b>									
APPLE INC COM NPV	7,600	143.50	1.1	126.12	0.1	31.5	8.6	1.72	-27.6
AUTODESK INCORPORATED COM STK NPV	5,600	31.48	0.2	7.25		21.4	6.5	1.53	-36.7
BEA SYS INC	29,500	19.15	0.6	7.93		38.3	5.6	1.09	21.4
CERNER CORP	14,600	37.28	0.6	3.00		24.4	2.6	1.02	-33.9
CIENA CORP	17,000	30.83	0.6	2.68		30.2	3.1	1.48	-9.6
CISCO SYS INC	95,200	24.09	2.4	143.60		18.7	4.7	1.31	-11.0
COGNIZANT TECHNOLOGY SOLUTIONS	18,500	28.83	0.6	8.31		25.1	5.7	1.29	-15.1
CROWN CASTLE INTL CORP	14,200	34.49	0.5	9.71			3.1	1.56	-17.1
CYPRESS SEMICONDUCTOR CORP	26,200	23.61	0.7	3.61		10.3	2.2	1.98	-34.5
DELL INC	28,200	19.92	0.6	44.64		15.2	10.2	1.34	-18.7
EMC CORP	49,100	14.34	0.7	30.12		18.6	2.4	1.65	-22.6
FIRST SOLAR INC	2,600	231.14	0.6	18.18		113.9			-13.5
GOOGLE INC	3,400	440.47	1.6	104.28		33.1	6.1	1.39	-36.3
HEWLETT PACKARD CO	42,400	45.66	2.0	112.57	0.7	15.6	3.1	1.32	-9.4
INTEL CORP	66,100	21.18	1.5	122.59	2.6	17.9	2.9	1.56	-20.1
INTERNATIONAL BUSINESS MACHS	11,200	115.14	1.4	159.39	1.4	16.0	5.6	0.95	6.9
MICROSOFT CORP	123,100	28.38	3.7	264.13	1.6	16.1	8.6	0.89	-20.0
NETAPP INC	29,700	20.05	0.6	6.89		24.2	3.7	1.56	-19.7
ORACLE CORP	67,900	19.56	1.4	100.47		20.0	5.9	1.23	-13.4
QUALCOMM INC	33,300	41.00	1.4	66.10	1.4	20.2	4.3	1.20	4.5
RED HAT INC	31,000	18.39	0.6	3.58		51.1	4.3	1.41	-11.8
SALESFORCE COM INC	12,700	57.87	0.8	6.83			15.3	1.74	-7.7
TEXAS INSTRS INC	16,800	28.27	0.5	37.50	1.4	15.4	3.8	1.72	-15.1
TRIMBLE NAVIGATION LTD	21,700	28.59	0.7	3.46		30.4	3.1	1.62	-5.5
VERISIGN INC	10,200	33.24	0.4	7.09			4.8	1.90	-11.6
YAHOO INC	18,300	28.93	0.6	38.68		61.6	4.0	1.10	24.4
			<b>26.2</b>	<b>100.34</b>	<b>1.3</b>	<b>24.9</b>	<b>5.5</b>	<b>1.33</b>	<b>-13.83</b>
<b>Wurts &amp; Associates</b>					<b>Performance Measurement System</b>				

# Fresno County Employees' Retirement Association

## Portfolio Holdings And Characteristics - Equity

Period Ending: March 31, 2008

<b>Materials</b>									
AIRGAS INC	12,600	45.47	0.6	3.75	1.1	18.6	3.2	1.25	-12.5
ALLEGHENY TECHNOLOGIES INC	2,300	71.36	0.2	7.30	1.0	9.8	3.3	2.08	-17.2
MONSANTO CO NEW	8,400	111.50	1.0	61.10	0.6	57.2	8.1	1.29	0.0
PRAXAIR INC	7,100	84.23	0.6	26.39	1.8	23.3	5.2	0.91	-4.6
STEEL DYNAMICS INC	14,200	33.04	0.5	6.23	0.6	16.4	4.1	1.76	11.1
			<b>2.9</b>	<b>28.92</b>	<b>1.0</b>	<b>31.9</b>	<b>5.5</b>	<b>1.33</b>	<b>-2.76</b>
<b>Telecommunications Services</b>									
NII HLDGS INC CL B NEW	17,400	31.78	0.6	5.40		15.1	2.5	1.90	-34.2
			<b>0.6</b>	<b>5.40</b>		<b>15.1</b>	<b>2.5</b>	<b>1.90</b>	<b>-34.23</b>
TCW CORE			<b>100.0</b>	<b>64.62</b>	<b>1.7</b>	<b>23.3</b>	<b>4.7</b>	<b>1.11</b>	<b>-9.11</b>

# Fresno County Employees' Retirement Association

## Equity Activity

Period Ending: March 31, 2008

Start from Dec 31, 2007 **TCW CORE**

Additions				Deletions			
Security Name	Shares	Market Value	New	Security Name	Shares	Market Value	Eliminated
APPLE INC COM NPV	16,700	2,151,215	*	ALLEGHENY TECHNOLOGIES INC	28,200	1,925,709	
BERKSHIRE HATHAWAY INC DEL	11	1,452,804	*	AMERICAN INTL GROUP INC	17,200	782,342	*
C H ROBINSON WORLDWIDE INC	4,320	224,452	*	AUTODESK INCORPORATED COM STK NPV	92,180	3,115,839	
CERNER CORP	23,600	1,052,536	*	C H ROBINSON WORLDWIDE INC	11,100	608,239	
GILEAD SCIENCES INC	70,500	3,145,927	*	DELL INC	67,800	1,348,349	
GOOGLE INC	2,500	1,110,050	*	EXPEDITORS INTL WA INC	18,300	751,688	
INTERCONTINENTALEXCHANGE INC	7,900	1,058,590	*	NETWORK APPLIANCE INC	12,900	300,259	*
N/A		343	*	PROGRESSIVE CORP OHIO	25,305	412,263	*
RESEARCH IN MOTION LTD	23,300	2,175,600	*	QUALCOMM INC	80,700	3,045,588	
SCHERING PLOUGH CORP	51,800	1,249,198	*	SALESFORCE COM INC	55,100	3,112,837	
VISA INC COM CL A	15,900	699,600	*	WALGREEN CO	22,100	796,041	
YUM BRANDS INC	35,920	1,286,850	*	WELLPOINT INC	31,900	1,503,539	*



# Fresno County Employees' Retirement Association

## Cumulative Performance Comparisons

Period Ending: March 31, 2008

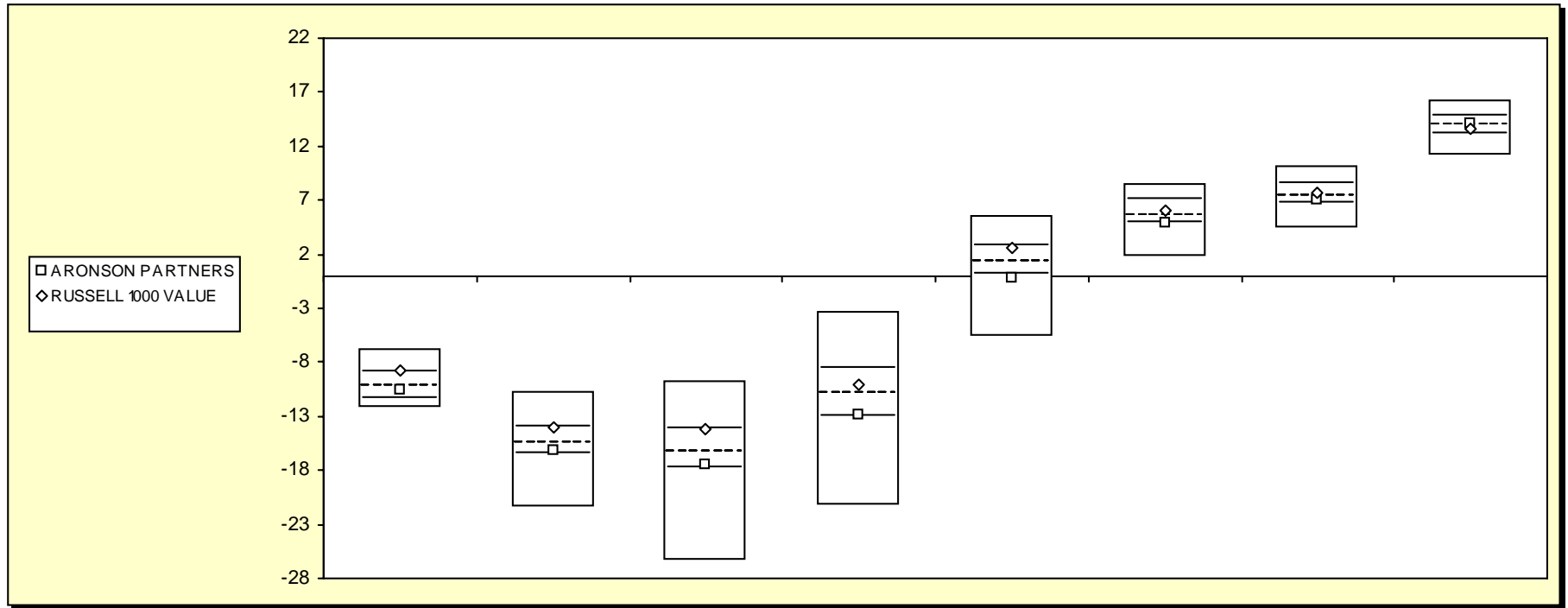

### Equity Style - Large Value

	Last Quarter		Two Quarters		Three Quarters		One Year		Two Years		Three Years		Four Years		Five Years	
	Return	Rank	Return	Rank	Return	Rank	Return	Rank	Return	Rank	Return	Rank	Return	Rank	Return	Rank
5th Percentile	-6.8		-10.7		-9.8		-3.3		5.6		8.5		10.1		16.3	
25th Percentile	-9.0		-14.0		-14.2		-8.6		2.8		7.1		8.5		14.7	
50th Percentile	-10.3		-15.4		-16.3		-10.9		1.3		5.6		7.4		14.0	
75th Percentile	-11.4		-16.4		-17.7		-13.0		0.2		4.9		6.8		13.2	
95th Percentile	-12.1		-21.4		-26.3		-21.2		-5.6		1.8		4.3		11.2	
ARONSON PARTNERS	-10.5	56	-16.1	67	-17.5	71	-12.9	74	-0.2	76	4.9	73	7.0	65	14.1	46
RUSSELL 1000 VALUE	-8.7	23	-14.0	26	-14.2	25	-10.0	40	2.5	29	6.0	43	7.7	42	13.7	60

# Fresno County Employees' Retirement Association

## Consecutive Performance Comparisons

Period Ending: March 31, 2008

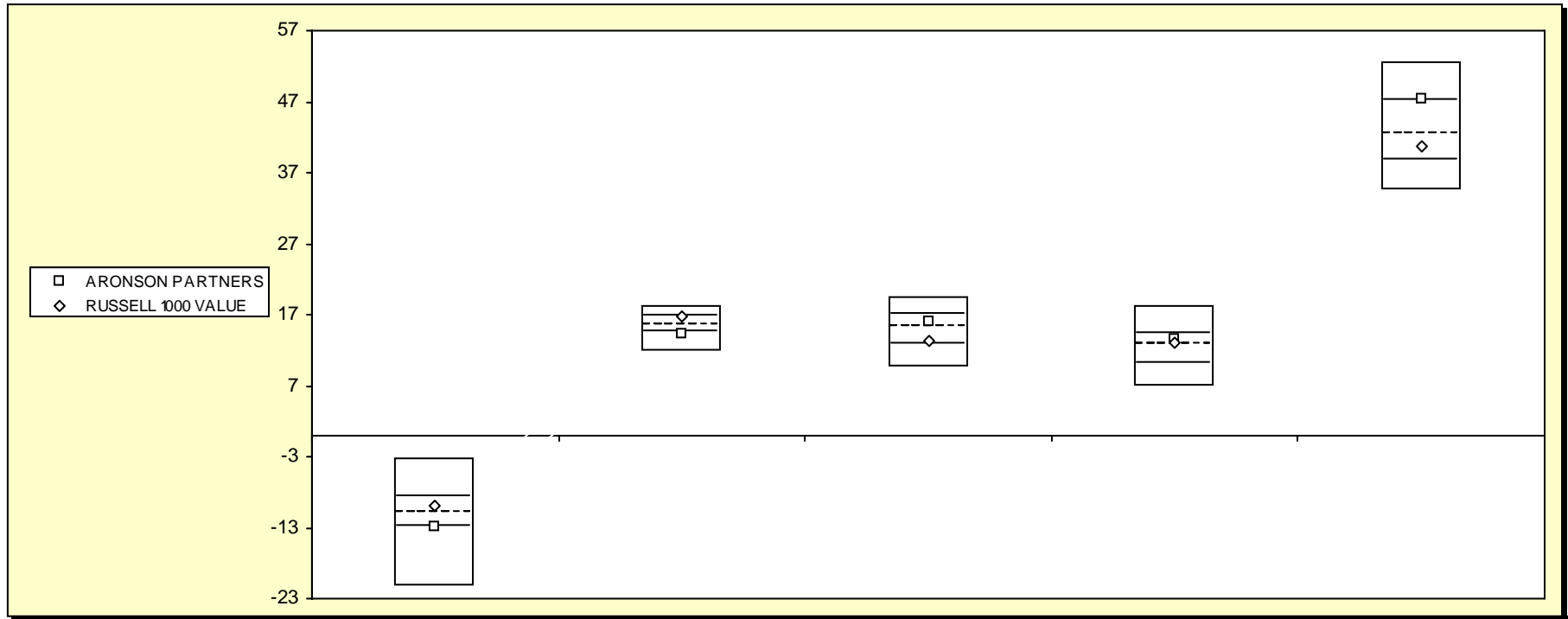

### Equity Style - Large Value

	March 2008		March 2007		March 2006		March 2005		March 2004	
	Return	Rank	Return	Rank	Return	Rank	Return	Rank	Return	Rank
5th Percentile	-3.3		18.3		19.6		18.2		52.5	
25th Percentile	-8.6		16.6		16.9		14.3		47.1	
50th Percentile	-10.9		15.4		15.2		12.8		42.4	
75th Percentile	-13.0		14.4		12.8		10.0		38.7	
95th Percentile	-21.2		11.8		9.6		6.9		34.6	
ARONSON PARTNERS	-12.9	74	14.4	75	15.9	39	13.5	38	47.5	23
RUSSELL 1000 VALUE	-10.0	40	16.8	23	13.3	70	13.2	43	40.8	61

# Fresno County Employees' Retirement Association

Consecutive Annual - Five Year

Period Ending: March 31, 2008

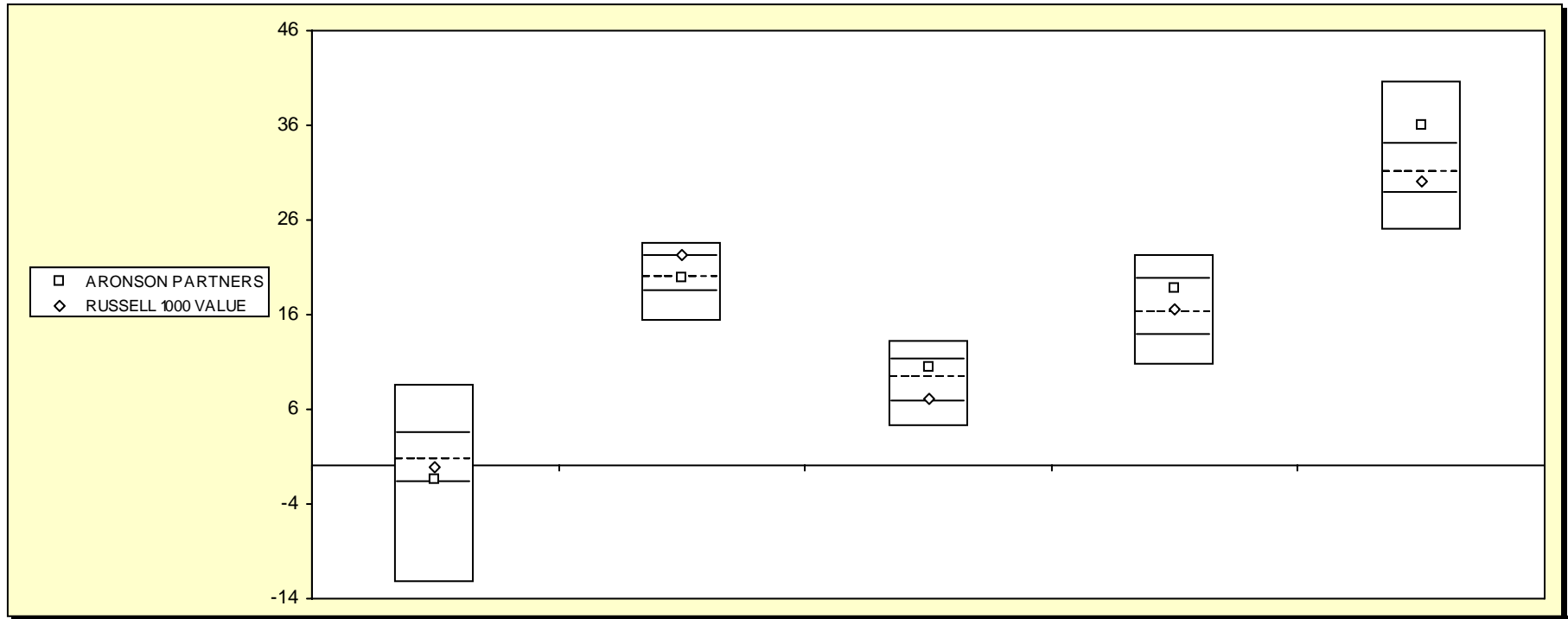

Equity Style - Large Value

	December 2007 Return Rank	December 2006 Return Rank	December 2005 Return Rank	December 2004 Return Rank	December 2003 Return Rank
5th Percentile	8.7	23.6	13.2	22.4	40.6
25th Percentile	3.5	22.1	11.2	19.7	33.9
50th Percentile	0.6	19.8	9.3	16.2	31.0
75th Percentile	-1.8	18.3	6.7	13.7	28.8
95th Percentile	-12.4	15.2	4.2	10.7	24.9
ARONSON PARTNERS	-1.4 71	19.8 51	10.4 35	18.7 32	35.9 19
RUSSELL 1000 VALUE	-0.2 58	22.2 24	7.1 72	16.5 48	30.0 61

# Fresno County Employees' Retirement Association

## Performance Review Summary

Period Ending: March 31, 2008

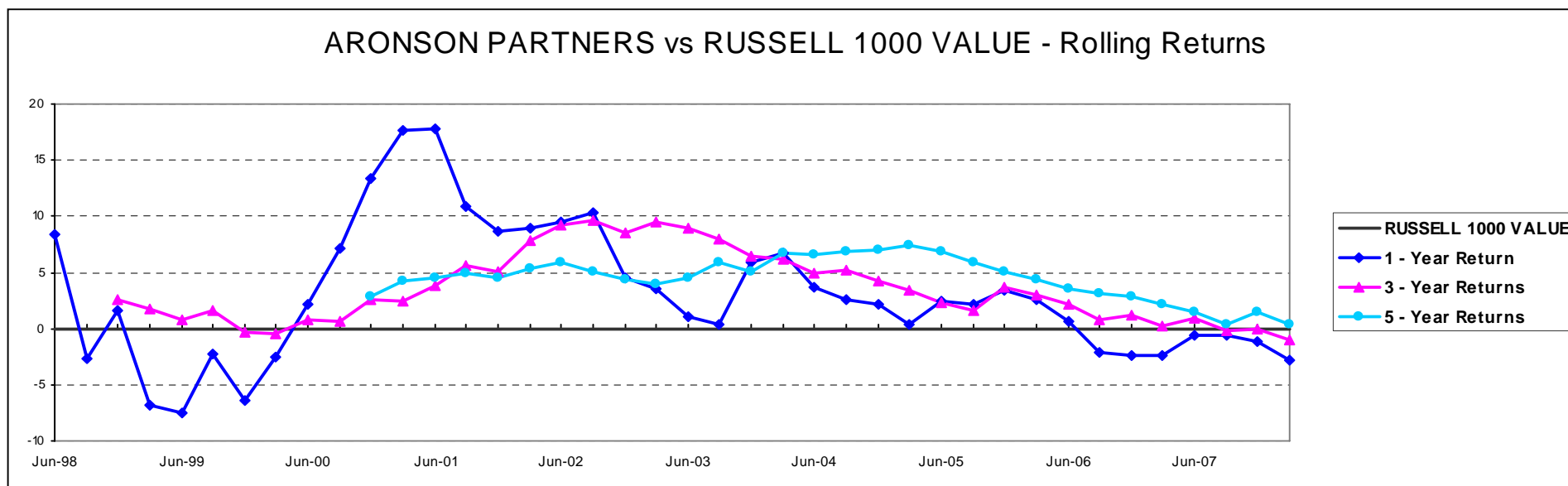

### Performance & Risk Measures

	Quarter		One Year		Three Years		Five Years		Standard Deviation		Sharpe Ratio		Beta	
	Return	Rank	Return	Rank	Return	Rank	Return	Rank	3-Years	5-Years	3-Years	5-Years	3-Years	5-Years
ARONSON PARTNERS	-10.5	56	-12.9	74	4.9	73	14.1	46	10.9	12.5	0.0	0.9	1.1	1.0
RUSSELL 1000 VALUE	-8.7	23	-10.0	40	6.0	43	13.7	60	9.8	12.0	0.2	0.9		
Equity Style - Large Value	-10.3		-10.9		5.6		14.0		10.7	12.5	0.1	0.9		

### Ten Largest Holdings

Security	Market Value	Weight
EXXON MOBIL CORP	10,242,638	5.91
CHEVRON CORP	7,409,248	4.28
JPMORGAN CHASE + CO	6,601,415	3.81
AT+T INC	6,402,611	3.70
PFIZER INC	5,979,701	3.45
CONOCOPHILLIPS	5,921,517	3.42
VERIZON COMMUNICATIONS COM USD 500	3,779,865	2.18
WELLS FARGO + CO NEW	3,265,020	1.88
TRAVELERS COS INC	3,067,185	1.77
GOLDMAN SACHS GROUP INC	2,894,325	1.67

### Sector Weights

Sector	Portfolio	Benchmark
Materials	3.9	4.3
Industrials	7.8	11.4
Telecommunications Services	6.0	6.1
Consumer Discretionary	10.9	6.9
Consumer Staples	10.9	9.3
Energy	17.9	16.7
Financials	27.7	28.0
Health Care	5.6	7.3
Information Technology	3.2	3.1
Utilities	6.2	6.7

### Portfolio Characteristics

	Portfolio	Benchmark
Average Market Cap	\$ 88,377	\$ 105,810
Median Market Cap	\$ 17,454	\$ 4,530
P/E	14.1	13.5
P/B	2.5	2.4
Dividend Yield	2.5	3.0
Earnings Growth	20.6	14.3

**Benchmark:** RUSSELL 1000 VALUE

**Total Assets**                      **% of Total Fund**

\$ 190,416

# Fresno County Employees' Retirement Association

Rolling Return: 3 year Annualized

Period Ending: March 31, 2008

## Rolling Return (3 Year Annualized)

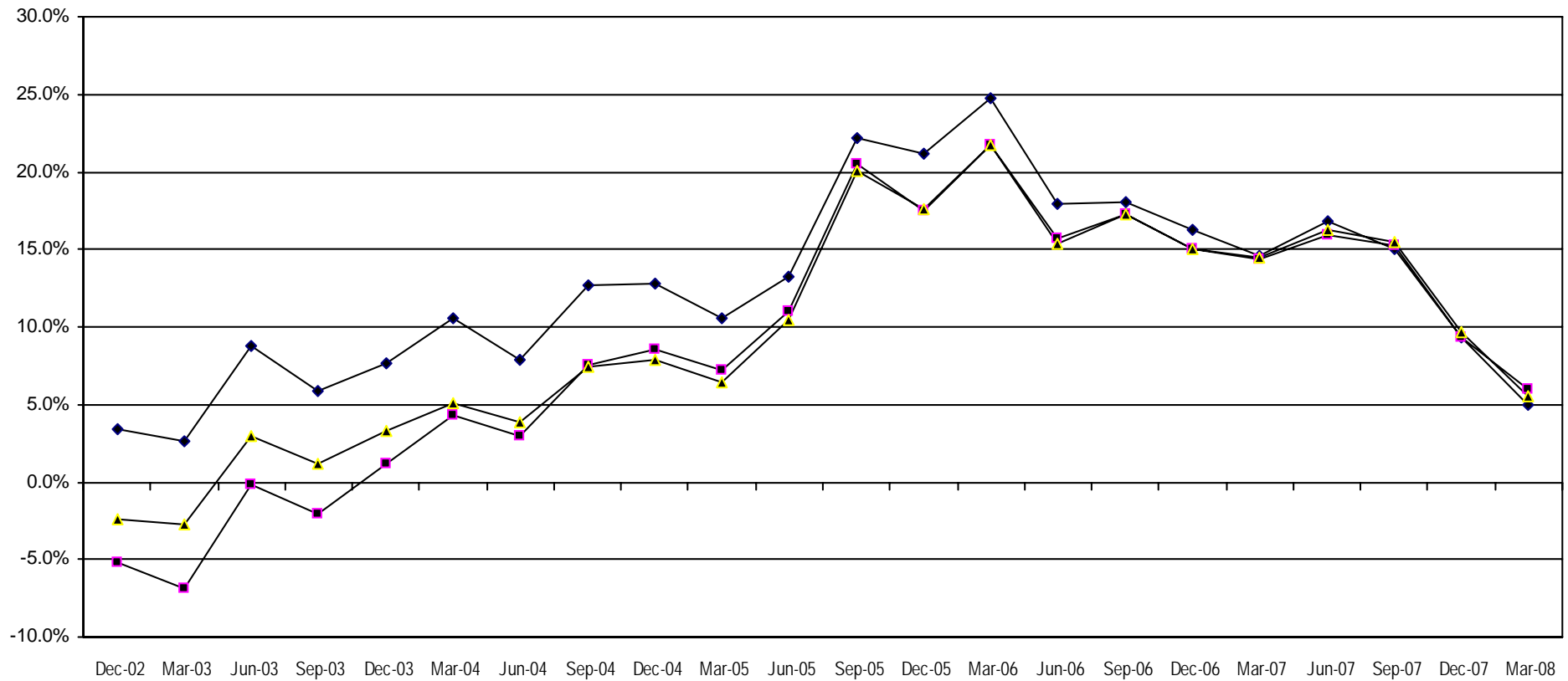

◆ ARONSON PARTNERS   
 ■ RUSSELL 1000 VALUE   
 ▲ Equity Style - Large Value

	03/31/01	03/31/02	03/31/03	03/31/04	03/31/05	03/31/06	03/31/07	03/31/08
ARONSON PARTNERS	6.3	11.5	2.6	10.5	10.6	24.7	14.6	4.9
RUSSELL 1000 VALUE	3.9	3.6	-6.9	4.3	7.2	21.8	14.4	6.0
Equity Style - Large Value	5.0	8.0	-2.7	5.1	6.4	21.7	14.4	5.6

# Fresno County Employees' Retirement Association

## Three & Five Year Return vs. Risk

Period Ending: March 31, 2008

**Three-Year**

**Five-Year**

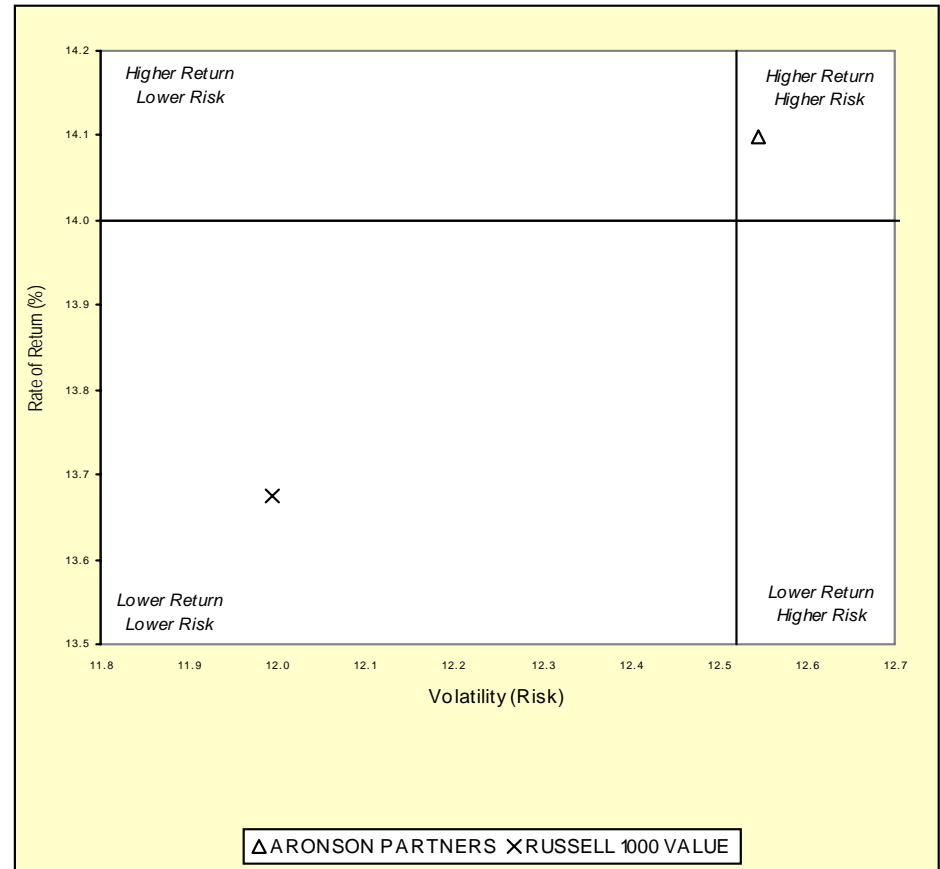
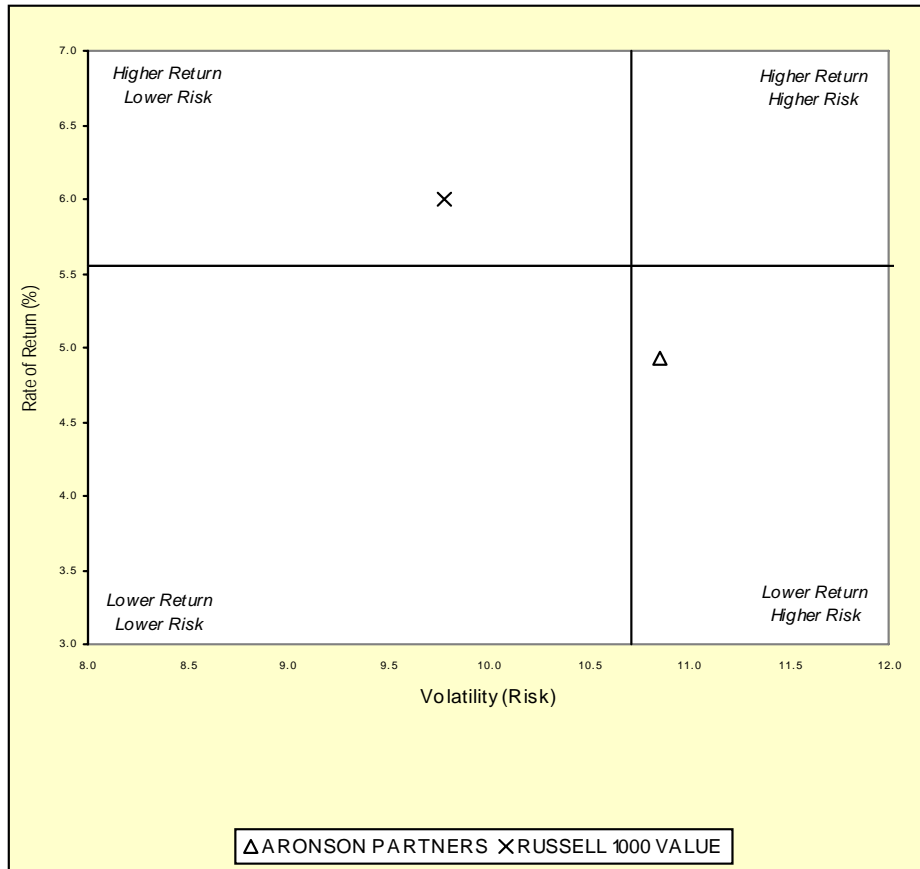

**Three Year Return vs Risk**

**Five Year Return vs Risk**

Annualized Return %	Standard Deviation %	Sharpe Ratio	Category	Annualized Return %	Standard Deviation %	Sharpe Ratio
4.9	10.9	0.0	ARONSON PARTNERS	14.1	12.5	0.9
5.6	10.7	0.1	Equity Style - Large Value Universe Median	14.0	12.5	0.9
6.0	9.8	0.2	RUSSELL 1000 VALUE	13.7	12.0	0.9

# Fresno County Employees' Retirement Association

## Equity Only Summary Statistics

Period Ending: March 31, 2008

### ARONSON PARTNERS

	Portfolio	RUSSELL 1000 VALUE
Total Number of Securities	92	618
Total Market Value	173,251,062	
Average Market Capitalization (000's)	88,377,050	105,810,000
Equity Segment Yield	2.69	2.97
Equity Segment Price/Earnings Ratio	14.38	13.48
Equity Segment Beta	0.98	1.00
Price/Book Ratio	2.50	2.36
5 Year Earnings Growth	20.6%	14.3%

#### Ten Largest Holdings

Security	Market Value	Weight
EXXON MOBIL CORP	10,242,638	5.91
CHEVRON CORP	7,409,248	4.28
JPMORGAN CHASE + CO	6,601,415	3.81
AT+T INC	6,402,611	3.70
PFIZER INC	5,979,701	3.45
CONOCOPHILLIPS	5,921,517	3.42
VERIZON COMMUNICATIONS COM USD 500	3,779,865	2.18
WELLS FARGO + CO NEW	3,265,020	1.88
TRAVELERS COS INC	3,067,185	1.77
GOLDMAN SACHS GROUP INC	2,894,325	1.67

#### Ten Best Performers

Security	Return	Weight
NETFLIX COM INC	30.2	0.43
CIMAREX ENERGY CO	28.9	1.10
NUCOR CORP	15.2	1.37
NVR INC	14.0	0.48
GARDNER DENVER INC	12.4	0.46
TRW AUTOMOTIVE HLDGS CORP	11.8	0.51
HASBRO INC	9.8	1.09
CATERPILLAR INC	8.5	0.71
NORFOLK SOUTHN CORP	8.3	0.97
QLOGIC CORP	8.1	0.44

#### Ten Worst Performers

Security	Return	Weight
WELLPOINT INC	-49.7	0.48
SPRINT NEXTEL CORP COM SER 1	-49.1	0.72
UNITEDHEALTH GROUP INC	-40.9	0.43
FRONTIER OIL CORP	-32.7	0.64
VALERO ENERGY CORP	-29.7	1.17
JANUS CAP GROUP INC	-29.2	0.37
WACHOVIA CORP 2ND NEW	-27.7	0.99
SUNOCO INC	-27.2	0.41
AETNA INC	-27.1	0.90
CUMMINS INC	-26.3	0.89

# Fresno County Employees' Retirement Association

## Portfolio Characteristics - Equity

Period Ending: March 31, 2008

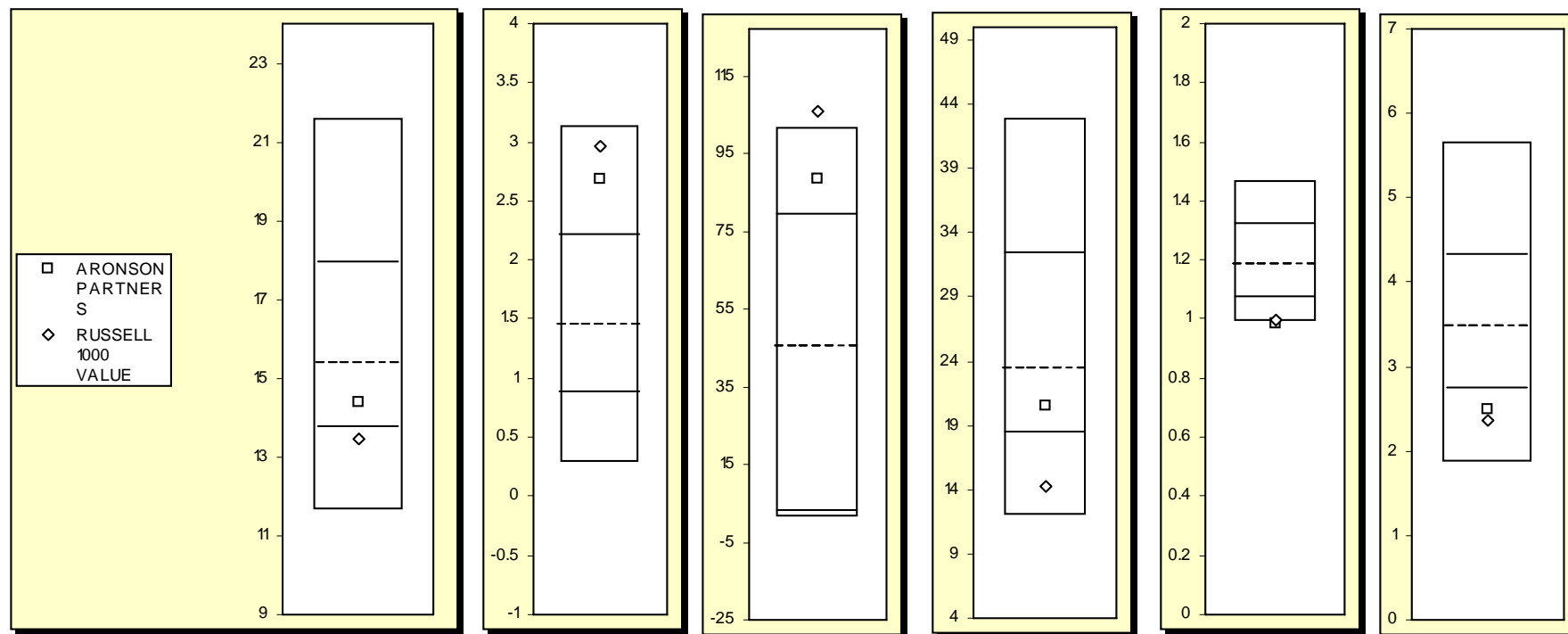

	Price/Earnings Ratio		Dividend Yield		Capitalization		5 Year Earnings		Beta		Price/Book Ratio	
	Value	Rank	Value	Rank	Value	Rank	Value	Rank	Value	Rank	Value	Rank
<i>Equity Funds - Equity Only</i>												
5th Percentile	21.57		3.13		101.51		42.95		1.47		5.66	
25th Percentile	17.93		2.20		78.86		32.34		1.32		4.32	
50th Percentile	15.38		1.45		45.26		23.34		1.18		3.47	
75th Percentile	13.75		0.88		2.83		18.43		1.07		2.72	
95th Percentile	11.66		0.28		1.13		11.93		0.99		1.86	
ARONSON PARTNERS	14.38	65	2.69	14	88.38	17	20.59	64	0.98	99	2.50	80
RUSSELL 1000 VALUE	13.48	78	2.97	8	105.81	4	14.31	88	1.00	93	2.36	83



# Fresno County Employees' Retirement Association

## Top Ten Holding

Period Ending: March 31, 2008

As Of 6/30/06	
EXXON MOBIL CORP.	5.6%
CITIGROUP INC	4.9%
PFIZER,INC.	2.9%
JP MORGAN CHASE & CO	2.6%
VERIZON COMMUNICATIONS	2.4%
MORGAN STANLEY	2.0%
CONOCO PHILLIPS COMMON STOCK	2.0%
TIME WARNER INCORPORATED	1.9%
MERRILL LYNCH & CO., INC.	1.9%
US BANCORP	1.8%
<b>Top Ten Total:</b>	<b>28.1%</b>

As Of 9/30/06	
EXXON MOBIL CORP.	6.4%
CITIGROUP INC	4.8%
JP MORGAN CHASE & CO	3.4%
PFIZER,INC.	3.4%
MORGAN STANLEY	2.2%
VERIZON COMMUNICATIONS	2.1%
MERRILL LYNCH & CO., INC.	2.0%
TIME WARNER INCORPORATED	2.0%
WELLS FARGO CO	1.8%
WACHOVIA CORP	1.8%
<b>Top Ten Total:</b>	<b>30.0%</b>

As Of 12/31/06	
EXXON MOBIL	6.8%
CITIGROUP INC	5.0%
JP MORGAN CHASE & CO	3.2%
PFIZER	2.8%
CHEVRONTEXACO CORP.	2.4%
MORGAN STANLEY	2.3%
TIME WARNER	2.2%
MERRILL LYNCH & CO., INC.	2.0%
CONOCO PHILLIPS COMMON STOCK	1.9%
BELLSOUTH CORP.	1.8%
<b>Top Ten Total:</b>	<b>30.5%</b>

As Of 3/31/07	
EXXON MOBIL	6.6%
CITIGROUP INC	4.6%
CHEVRONTEXACO CORP.	3.5%
JP MORGAN CHASE & CO	3.4%
AT&T INCORPORATED	3.0%
PFIZER	2.7%
MORGAN STANLEY	2.2%
TIME WARNER	1.9%
WELLS FARGO CO	1.9%
CONOCO PHILLIPS COMMON STOCK	1.8%
<b>Top Ten Total:</b>	<b>31.7%</b>

As Of 6/30/07	
EXXON MOBIL	4.9%
CITIGROUP INC	4.3%
CHEVRONTEXACO CORP.	3.5%
JP MORGAN CHASE & CO	3.2%
AT&T INCORPORATED	3.0%
PFIZER	2.6%
MORGAN STANLEY	2.2%
CONOCO PHILLIPS COMMON STOCK	2.0%
VERIZON COMMUNICATIONS	1.9%
WELLS FARGO CO	1.9%
<b>Top Ten Total:</b>	<b>29.4%</b>

As Of 9/30/07	
EXXON MOBIL CORP.	5.0%
CITIGROUP INC	3.8%
CHEVRONTEXACO CORP.	3.6%
AT&T INCORPORATED	3.1%
JP MORGAN CHASE & CO	3.1%
PFIZER,INC.	2.5%
CONOCO PHILLIPS COMMON STOCK	2.2%
VERIZON COMMUNICATIONS	2.0%
GOLDMAN SACHS GROUP	1.9%
WELLS FARGO CO	1.8%
<b>Top Ten Total:</b>	<b>29.1%</b>

As Of 12/31/07	
EXXON MOBIL CORP.	5.4%
CHEVRONTEXACO CORP.	3.8%
AT&T INCORPORATED	3.3%
CONOCO PHILLIPS COMMON STOCK	3.2%
JP MORGAN CHASE & CO	3.2%
PFIZER,INC.	2.5%
VERIZON COMMUNICATIONS	2.1%
MARATHON OIL CORP	1.8%
GOLDMAN SACHS GROUP	1.8%
MORGAN STANLEY	1.8%
<b>Top Ten Total:</b>	<b>28.9%</b>

As Of 3/31/08	
EXXON MOBIL CORP	5.9%
CHEVRON CORP	4.3%
JPMORGAN CHASE + CO	3.8%
AT+T INC	3.7%
PFIZER INC	3.5%
CONOCOPHILLIPS	3.4%
VERIZON COMMUNICATIONS COM USD	2.2%
WELLS FARGO + CO NEW	1.9%
TRAVELERS COS INC	1.8%
GOLDMAN SACHS GROUP INC	1.7%
<b>Top Ten Total:</b>	<b>32.1%</b>

# Fresno County Employees' Retirement Association

## Equity Only Summary Statistics Charts

Period Ending: March 31, 2008

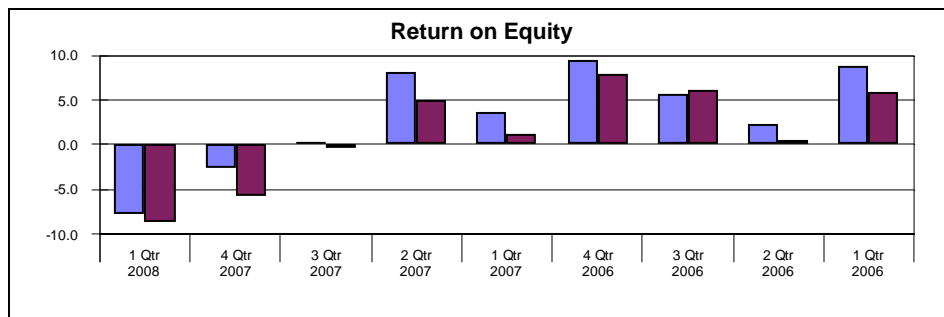
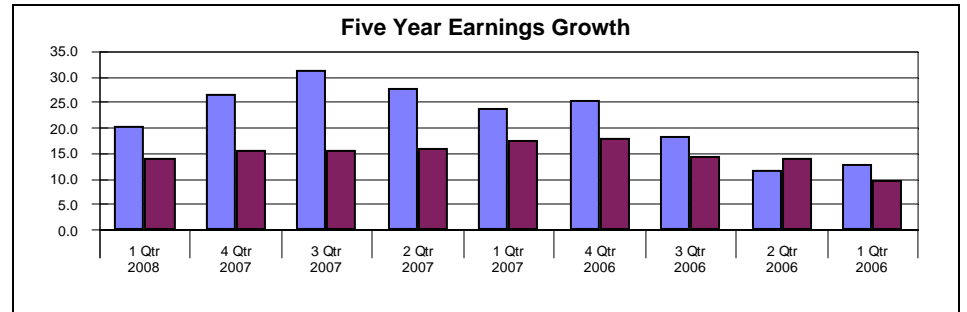
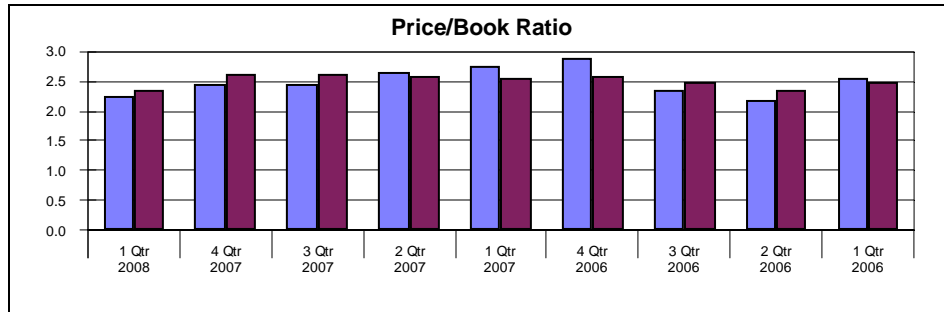
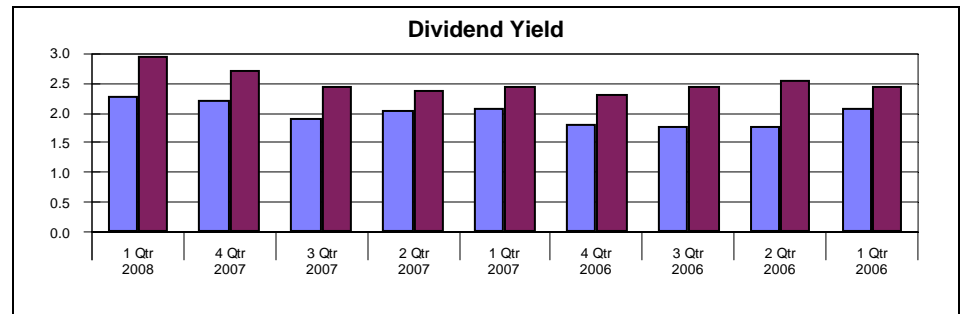
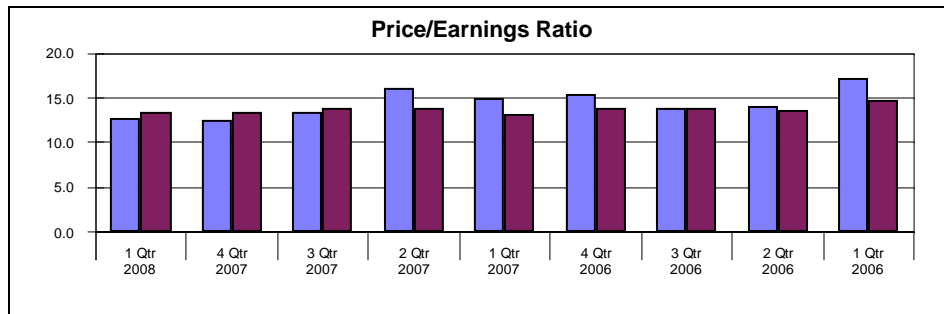
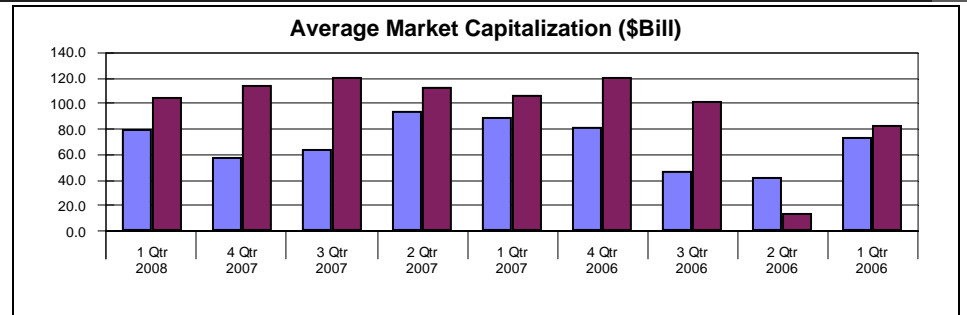
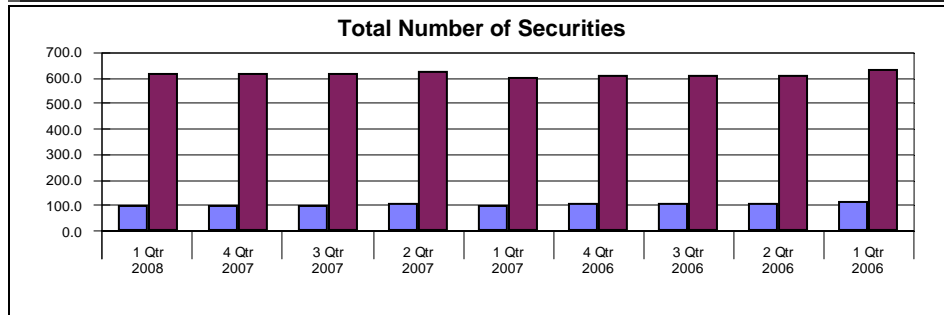

ARONSON PARTNERS  
RUSSELL 1000 VALUE

# Fresno County Employees' Retirement Association

## Equity Only Sector Analysis Quarterly

Period Ending: March 31, 2008

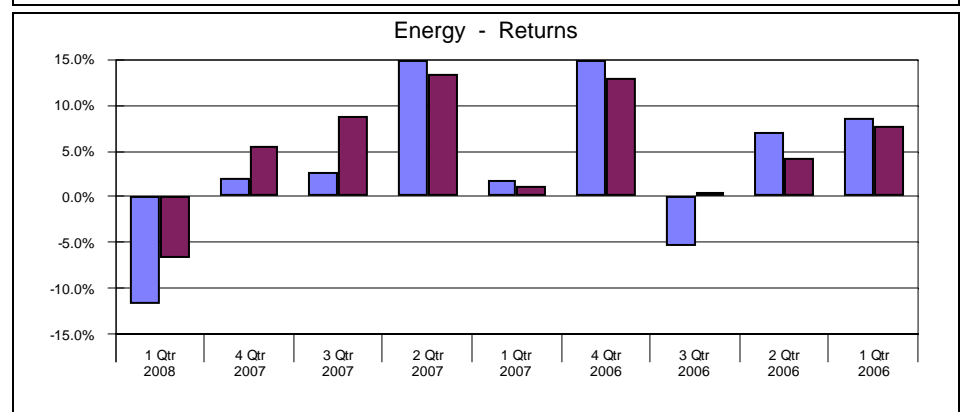
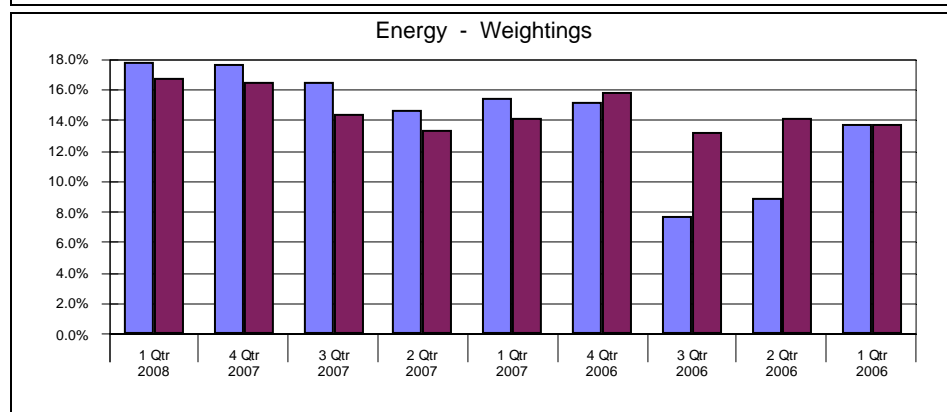
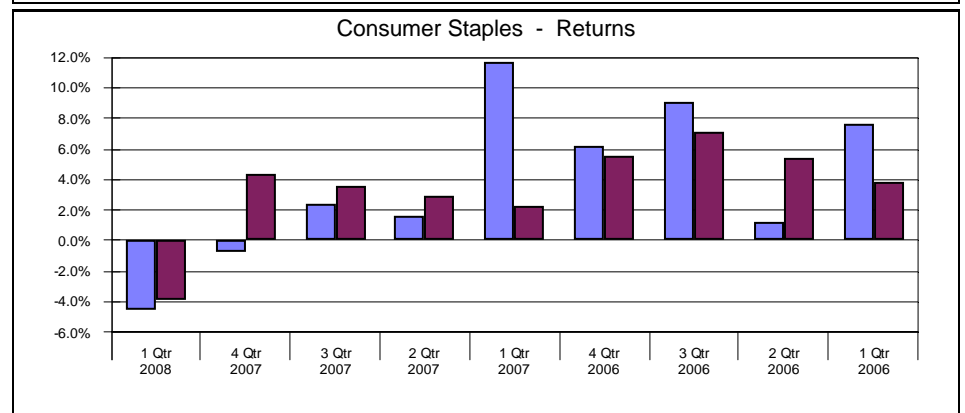
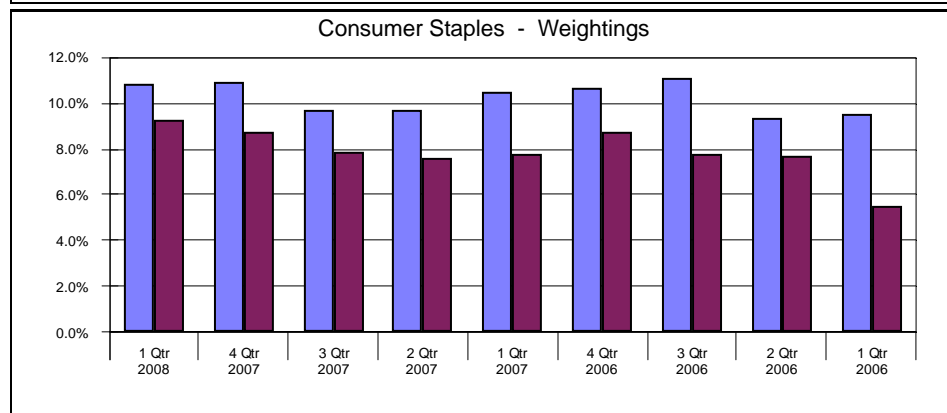
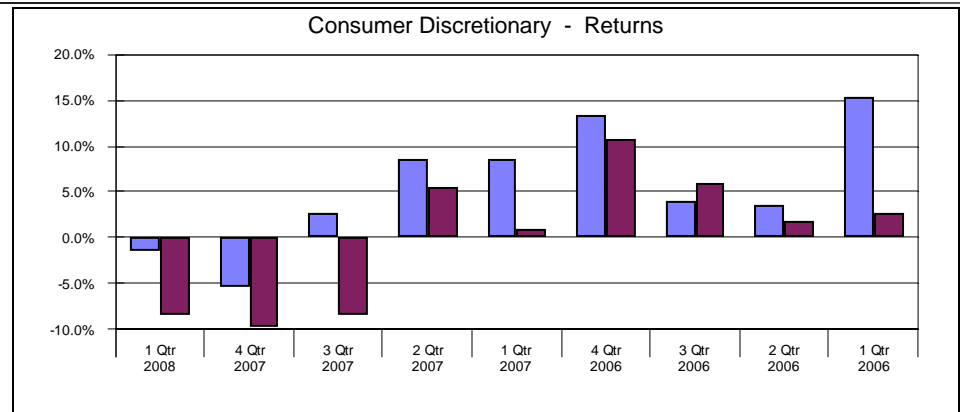
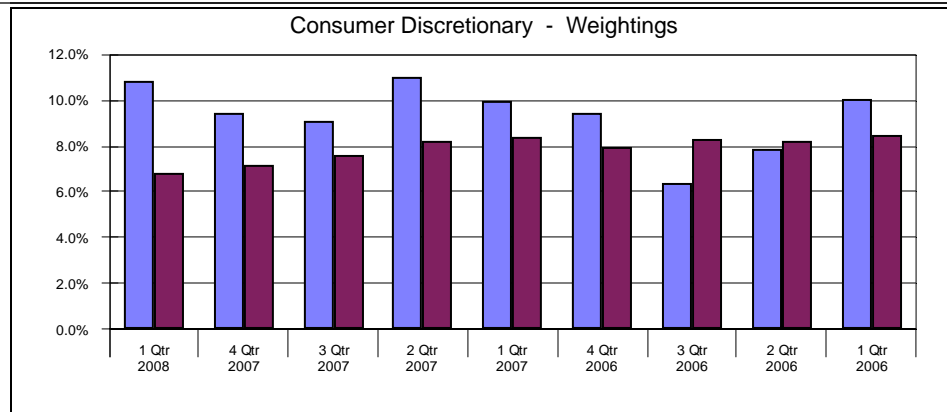

ARONSON PARTNERS

RUSSELL 1000 VALUE

# Fresno County Employees' Retirement Association

## Equity Only Sector Analysis Quarterly

Period Ending: March 31, 2008

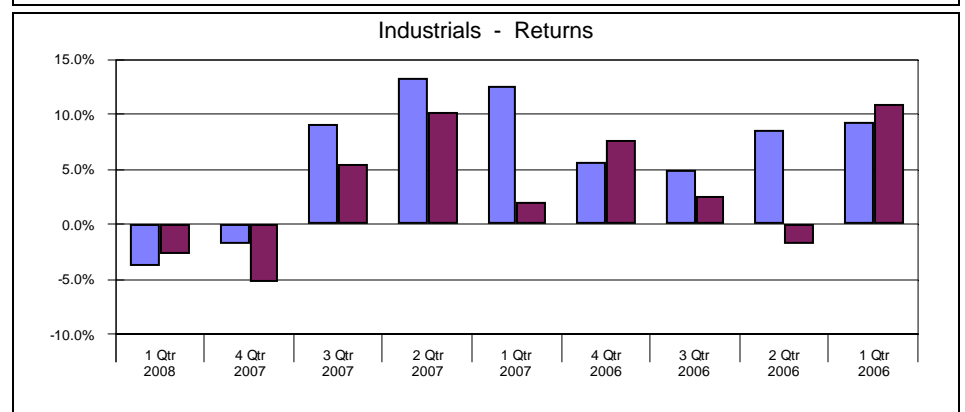
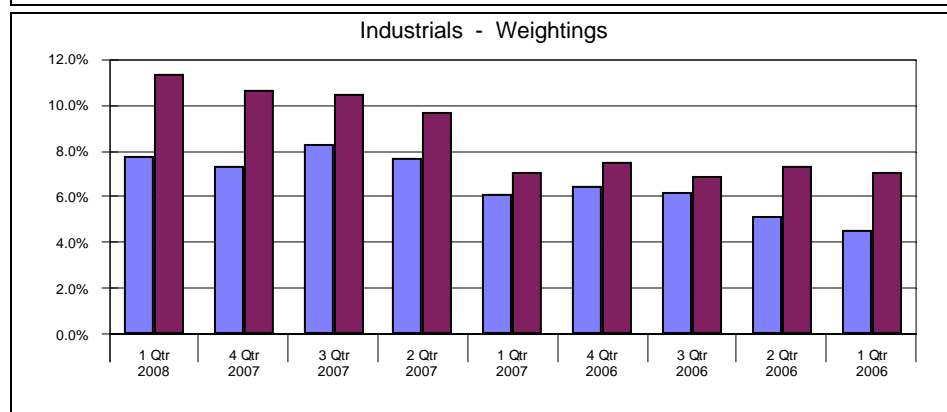
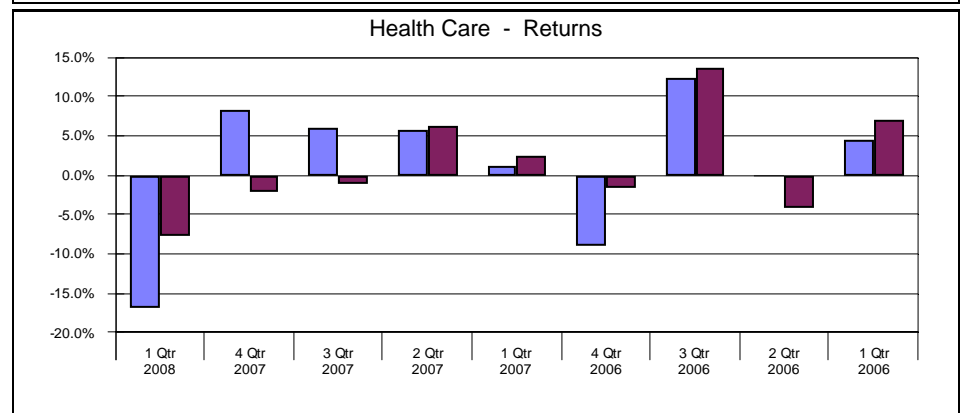
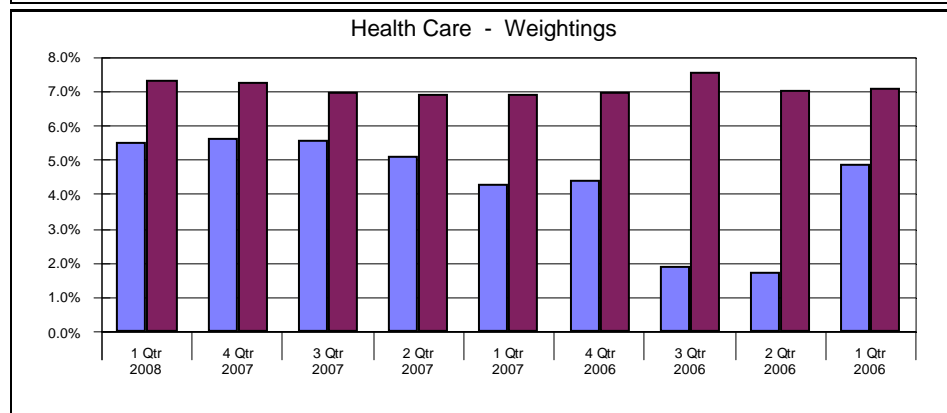
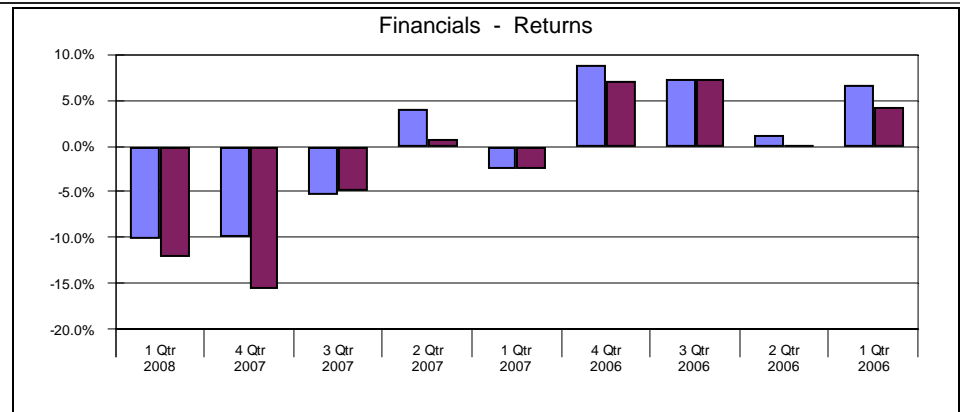
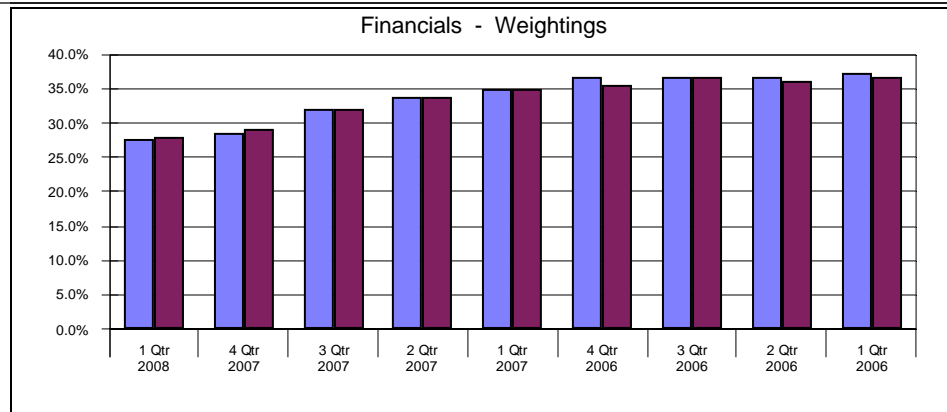

ARONSON PARTNERS

RUSSELL 1000 VALUE

# Fresno County Employees' Retirement Association

## Equity Only Sector Analysis Quarterly

Period Ending: March 31, 2008

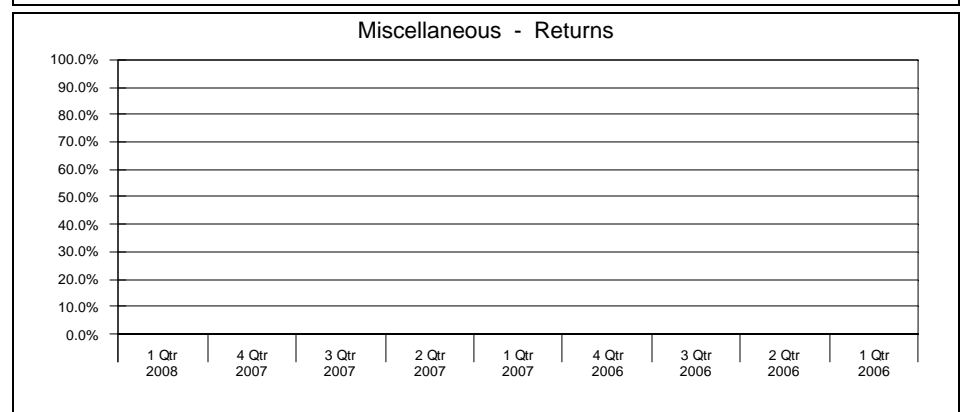
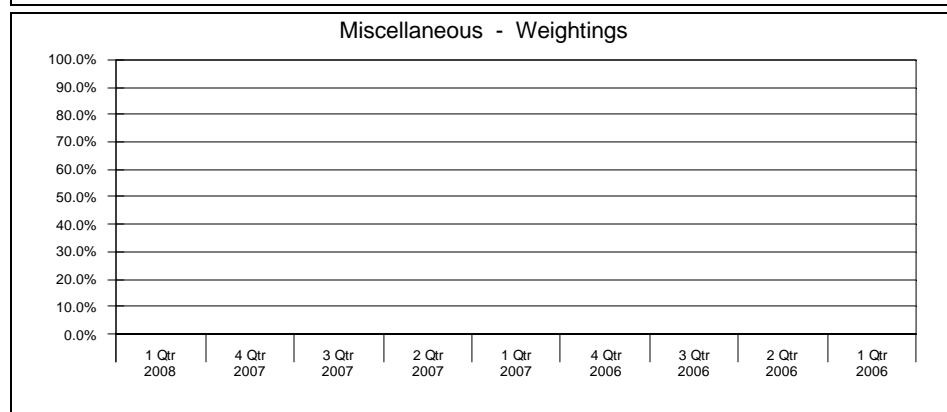
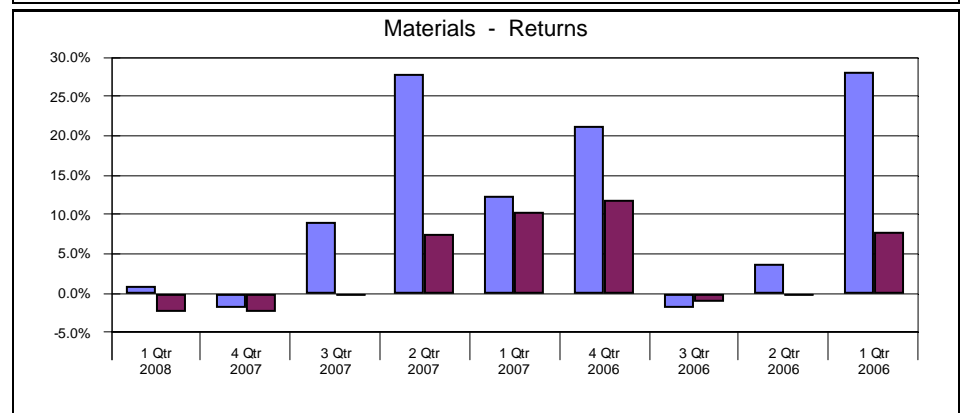
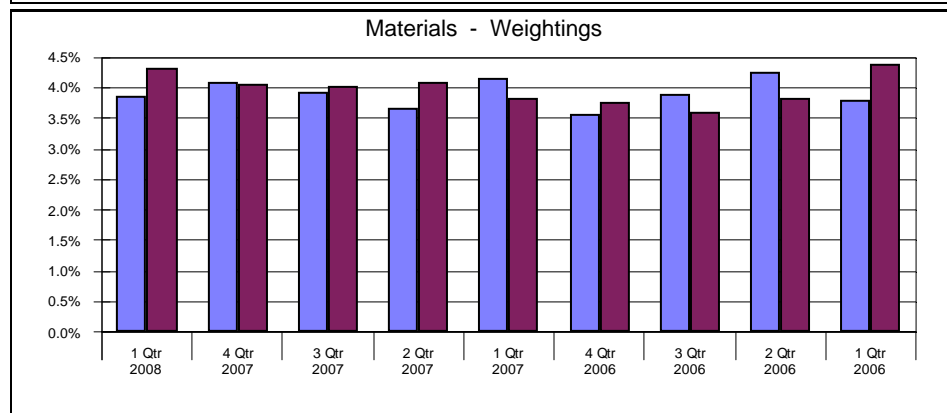
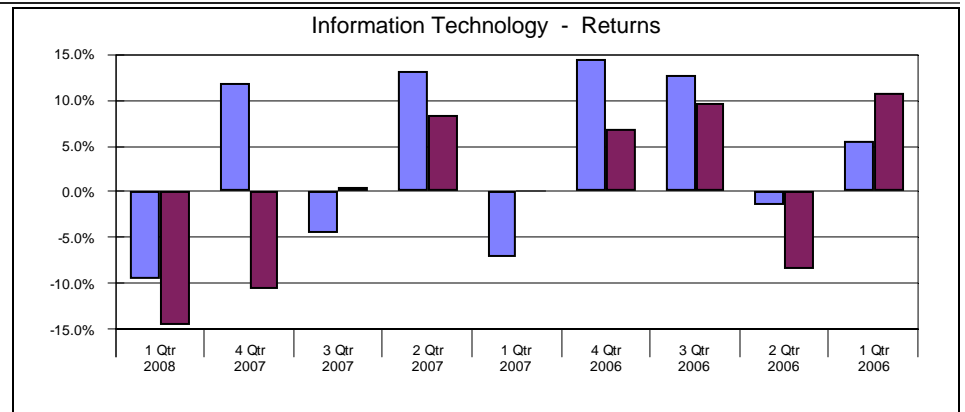
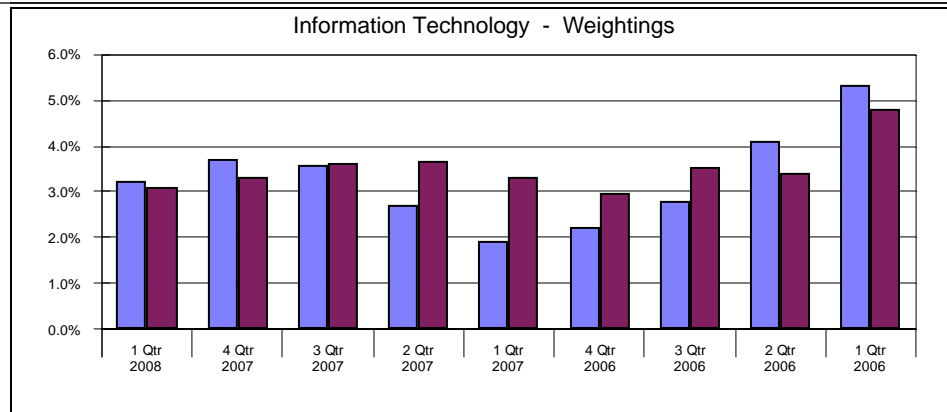

ARONSON PARTNERS

RUSSELL 1000 VALUE

# Fresno County Employees' Retirement Association

## Equity Only Sector Analysis Quarterly

Period Ending: March 31, 2008

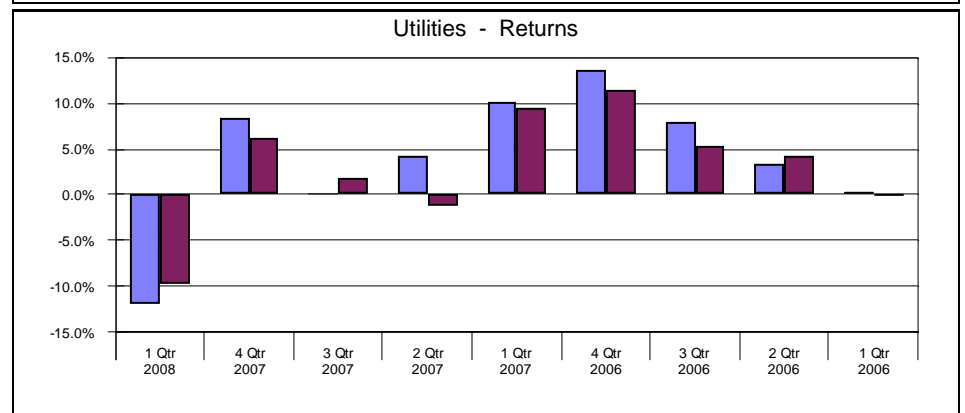
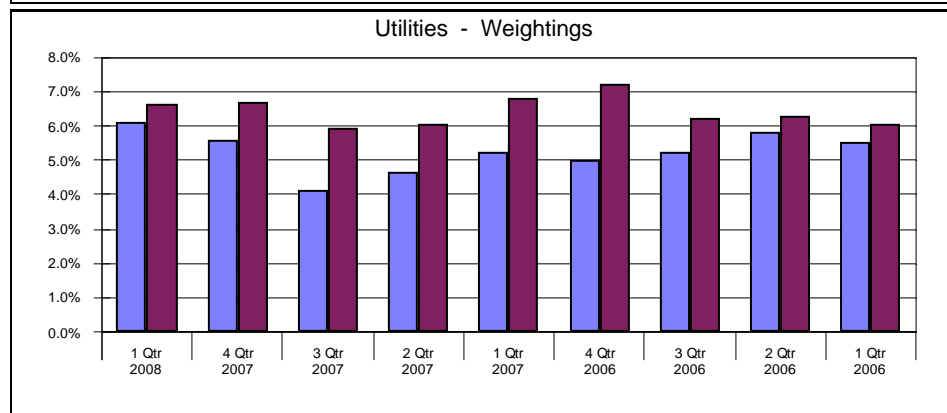
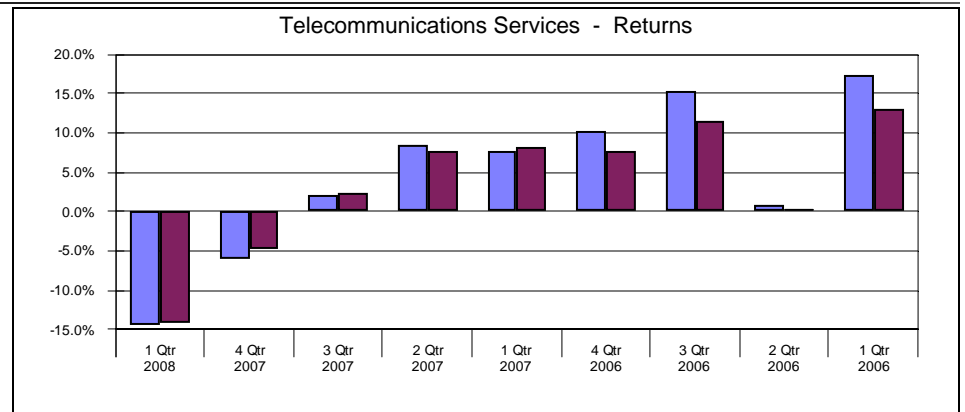
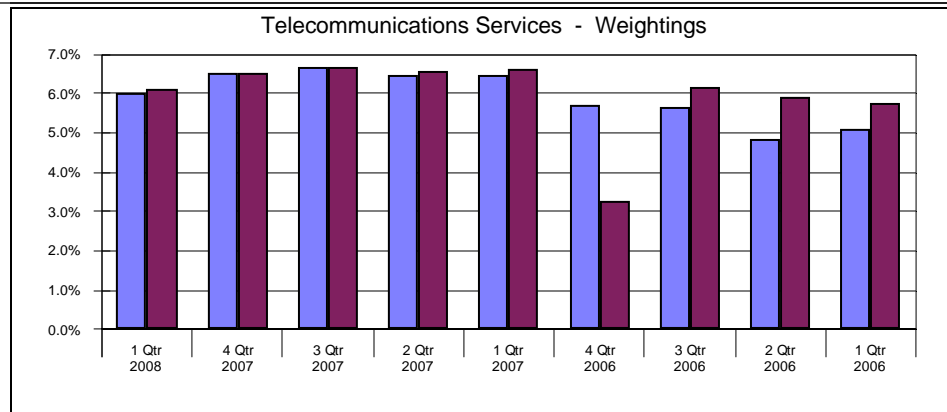

ARONSON PARTNERS

RUSSELL 1000 VALUE

# Fresno County Employees' Retirement Association

## Performance Attribution Geometric

Period Ending: March 31, 2008

### ARONSON PARTNERS

	Portfolio		RUSSELL 1000 VALUE		Selection		Total
	Market Value	Return	Market Value	Return	Stock	Industry	
	<b>A</b>	<b>B</b>	<b>C</b>	<b>D</b>	<b>E</b>	<b>F</b>	
Consumer Discretionary	8.8	-3.5	7.2	-8.4	0.5	0.0	0.5
Consumer Staples	12.1	-5.6	8.8	-3.9	-0.2	0.2	-0.1
Energy	13.7	-16.8	16.5	-6.7	-1.5	-0.1	-1.6
Financials	31.5	-11.5	29.1	-12.2	0.2	-0.1	0.1
Health Care	3.5	-27.5	7.3	-7.8	-0.8	0.0	-0.8
Industrials	8.2	-5.7	10.6	-2.6	-0.3	-0.2	-0.4
Information Technology	4.1	-13.4	3.3	-14.6	0.1	-0.1	0.0
Materials	4.6	-1.7	4.1	-2.4	0.0	0.0	0.1
Telecommunications Services	7.2	-17.2	6.5	-14.2	-0.2	0.0	-0.3
Utilities	6.2	-13.2	6.7	-9.7	-0.2	0.0	-0.2
	100.0	-11.0	100.0	-8.7	-2.5	-0.2	-2.7

#### Contribution

<b>Stock</b>	Consumer Discretionary
	Financials
<b>Industry</b>	Consumer Staples
	Materials

#### Detractors

<b>Stock</b>	Energy
	Health Care
<b>Industry</b>	Industrials
	Financials

# Fresno County Employees' Retirement Association

## Value Added Analysis 3 Yr Rolling for ARONSON PARTNERS

Period Ending: March 31, 2008

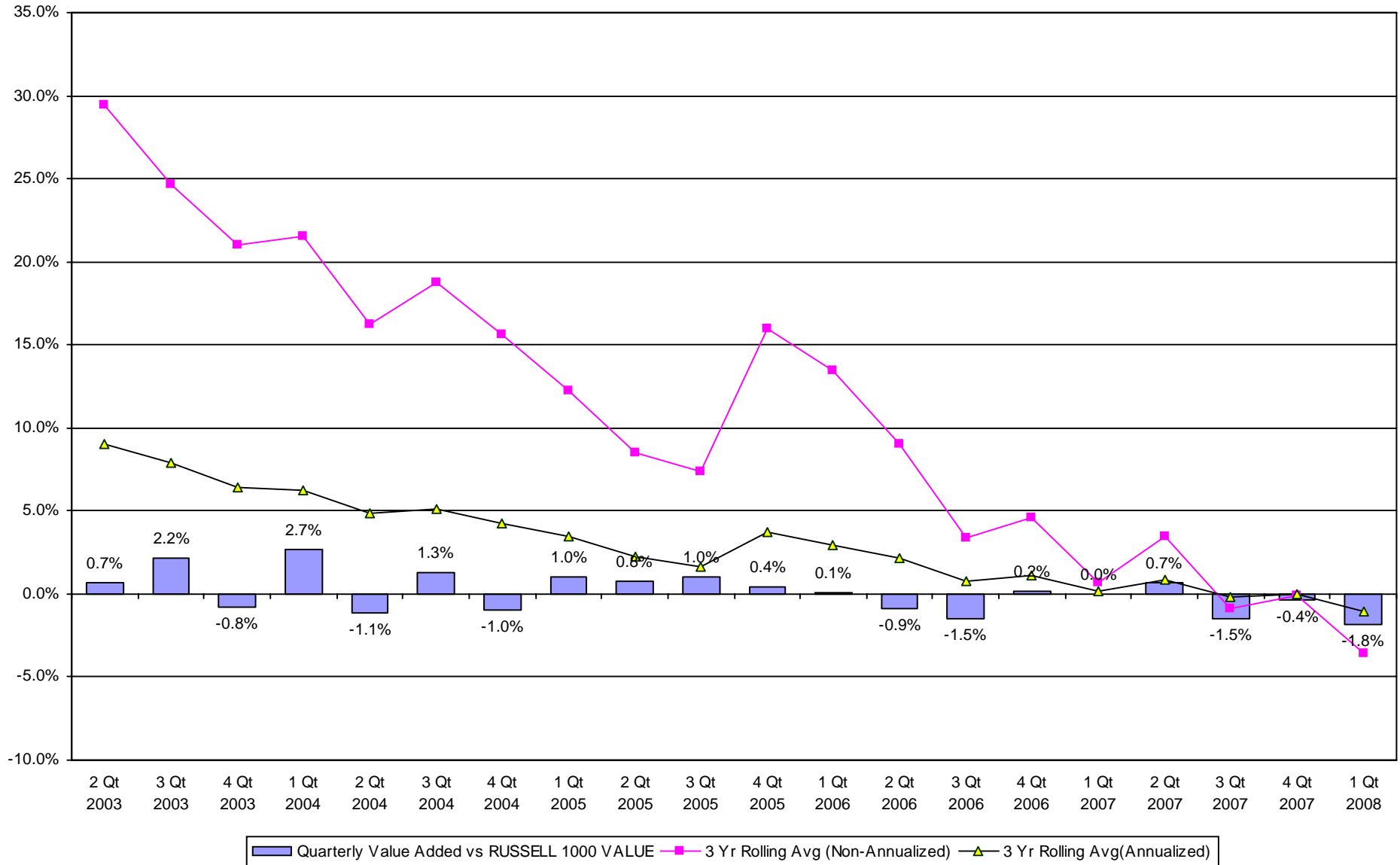



# Fresno County Employees' Retirement Association

## Rolling Return Ranking 3 & 5 Years

Period Ending: March 31, 2008

### Ranking Comparisons - Rolling 3 Years

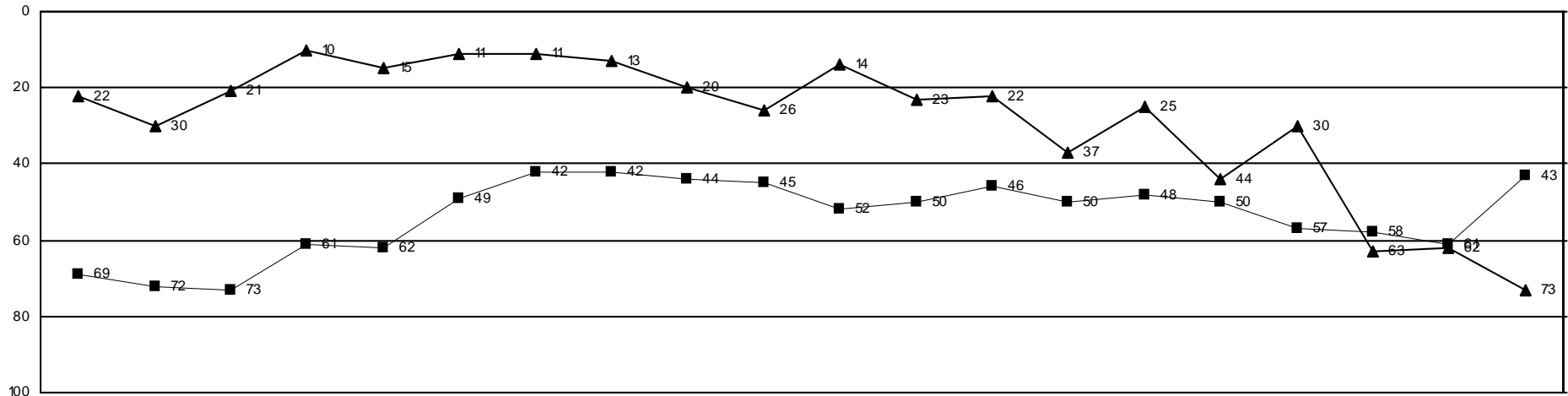

### Ranking Comparisons - Rolling 5 Years

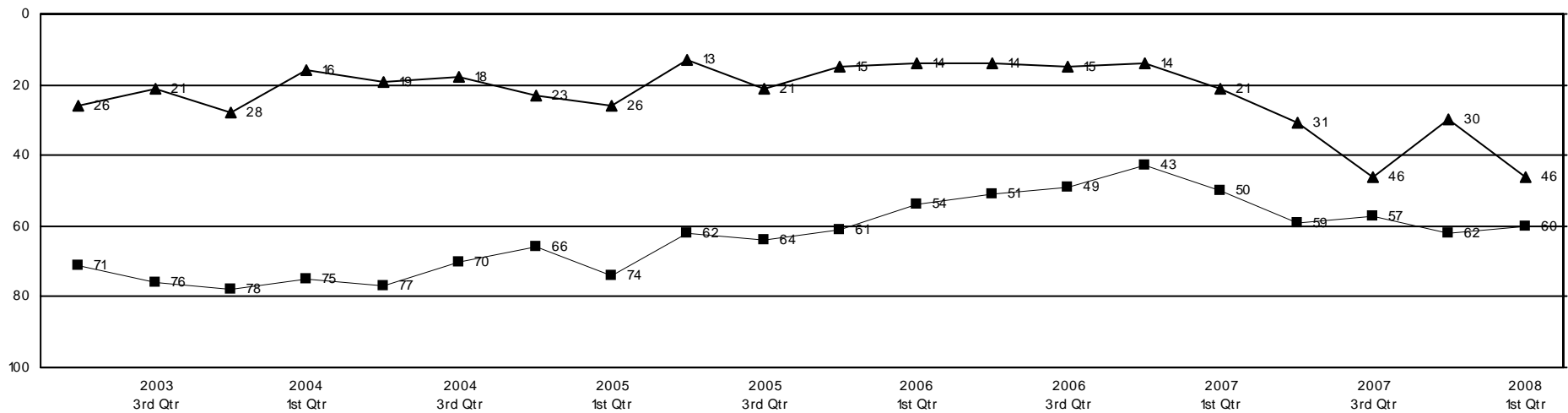

■ RUSSELL 1000 VALUE ▲ ARONSON PARTNERS

# Fresno County Employees' Retirement Association

## Up vs. Down Market Performance

Period Ending: March 31, 2008

Last 20 Quarters Ending 3/31/2008

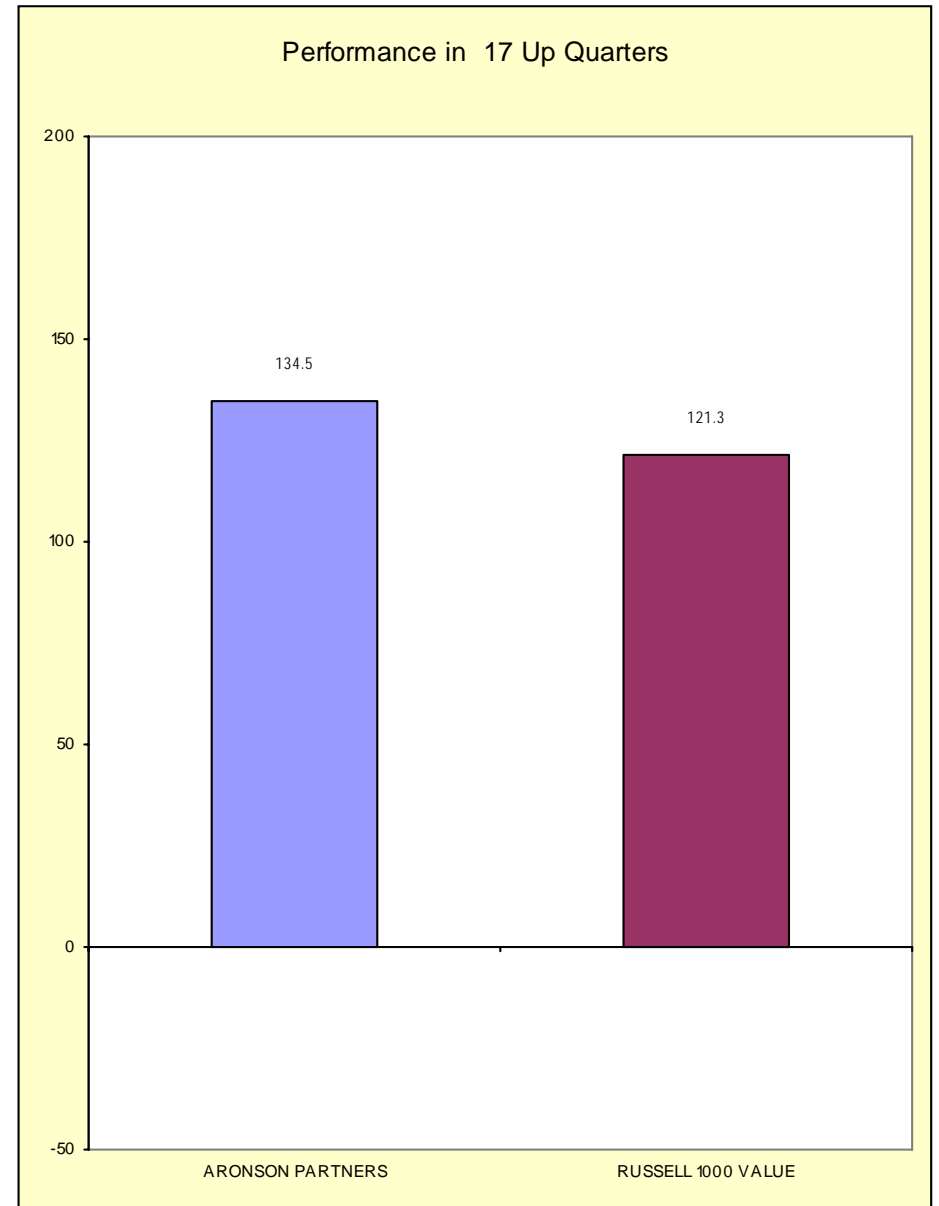
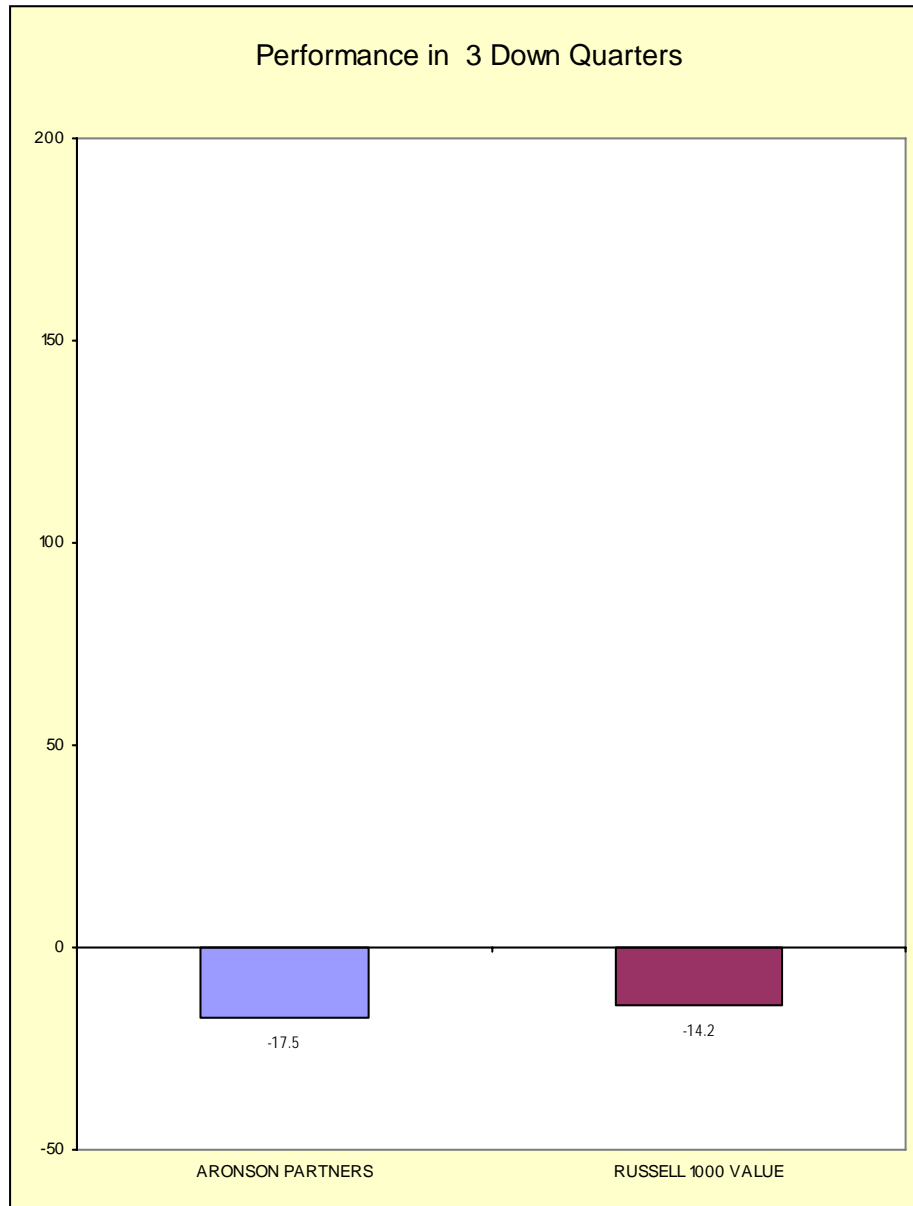

# Fresno County Employees' Retirement Association

## Portfolio Holdings And Characteristics - Equity

Period Ending: March 31, 2008

ARONSON PARTNERS	Shares	Price	Portfolio Weight	Market Cap	Dividend Yield	Price / Earnings	Price / Book	Beta	Quarterly Return
<b>Consumer Discretionary</b>									
ABERCROMBIE + FITCH CO COM CL A	11,400	73.14	0.4	6.30	1.0	14.1	4.6	1.13	-8.4
AUTOLIV	15,700	50.20	0.4	3.69	3.1	13.6	1.6	1.16	-4.0
BEST BUY CO INC COM STK USD0.10	18,700	41.46	0.4	17.39	1.3	13.7	3.2	1.57	-21.0
DIRECTV GROUP INC	74,400	24.79	1.0	28.49		20.7	4.5	0.65	7.2
DISNEY WALT CO DISNEY COM	24,500	31.38	0.4	59.09	1.1	14.9	2.0	0.93	-2.8
EATON CORP	11,800	79.67	0.5	11.67	2.5	12.5	2.2	1.41	-17.3
GENERAL ELEC CO	65,200	37.01	1.3	369.57	3.4	16.8	3.2	0.79	0.8
HASBRO INC	67,700	27.90	1.0	3.98	2.9	14.2	2.9	1.41	9.8
HEWITT ASSOCS INC CLASS A	41,900	39.77	0.9	4.10			4.1	0.42	3.9
LENNOX INTL INC	21,500	35.97	0.4	2.18	1.6	14.8	2.8	1.18	-12.8
NETFLIX COM INC	21,600	34.65	0.4	2.12		35.7	5.2	1.50	30.2
NIKE INC CL B	19,800	68.00	0.7	26.67	1.4	18.8	4.9	0.87	6.3
NVR INC	1,400	597.50	0.4	3.14		11.0	2.7	1.20	14.0
SHAW COMMUNICATIONS INC CL B NV	69,900	18.18	0.7	7.42	3.9	18.5		1.46	-22.5
TIME WARNER INC NEW	199,700	14.02	1.5	50.14	1.8	13.0	0.9	1.35	-14.8
TRW AUTOMOTIVE HLDGS CORP	37,700	23.37	0.5	2.35		26.6	0.7	1.03	11.8
			<b>10.9</b>	<b>59.80</b>	<b>2.3</b>	<b>16.8</b>	<b>3.0</b>	<b>1.09</b>	<b>-1.53</b>
<b>Consumer Staples</b>									
AMERISOURCEBERGEN CORP	45,600	40.98	1.0	6.66	0.7	15.4	2.2	0.76	-8.5
ARCHER DANIELS MIDLAND CO	23,300	41.16	0.5	26.49	1.3	12.0	2.4	0.83	-11.1
CARDINAL HEALTH INC	34,300	52.51	0.9	18.72	0.9	39.8	2.6	0.63	-8.9
CLOROX CO	25,800	56.64	0.8	7.86	2.8	17.1		0.37	-12.5
CONAGRA INC	95,000	23.95	1.2	11.68	3.2	12.9	2.6	0.69	1.6
GENERAL MILS INC	32,400	59.88	1.0	20.06	2.7	15.7	3.8	0.43	5.8
HERBALIFE LTD SHS	22,200	47.50	0.6	3.04	1.7			0.79	18.5
JACK IN THE BOX INC	12,400	26.87	0.2	1.60		13.6	3.9	1.36	4.3
KROGER CO	76,100	25.40	1.0	17.16	1.4	14.4	3.6	1.16	-4.6
MCKESSON CORP	18,700	52.37	0.5	15.12	0.5	16.7	2.5	0.69	-20.0
PEPSI BOTTLING GROUP INC	36,600	33.91	0.7	7.50	2.0	14.8	2.9	0.80	-13.7
PEPSICO INC	17,400	72.20	0.7	115.65	2.1	21.2	6.7	0.58	-4.4
PROCTER AND GAMBLE CO	26,800	70.07	1.0	215.64	2.0	21.2	3.3	0.76	-4.1
SYSCO CORP	59,800	29.02	0.9	17.52	3.0	17.1	5.4	1.11	-6.3
			<b>10.9</b>	<b>38.15</b>	<b>2.0</b>	<b>18.3</b>	<b>3.5</b>	<b>0.75</b>	<b>-4.58</b>

# Fresno County Employees' Retirement Association

## Portfolio Holdings And Characteristics - Equity

Period Ending: March 31, 2008

ARONSON PARTNERS	Shares	Price	Portfolio Weight	Market Cap	Dividend Yield	Price / Earnings	Price / Book	Beta	Quarterly Return
<b>Energy</b>									
CHEVRON CORP	86,800	85.36	3.9	177.27	2.7	9.7	2.3	0.96	-7.9
CIMAREX ENERGY CO	34,900	54.74	1.0	4.53	0.4	13.4	1.4	0.92	28.9
CONOCOPHILLIPS	77,700	76.21	3.1	119.00	2.5	10.6	1.4	0.86	-13.2
EXXON MOBIL CORP	121,100	84.58	5.4	452.51	1.7	11.6	3.7	0.90	-9.3
FRONTIER OIL CORP	40,400	27.26	0.6	2.82	0.7	5.9	2.8	1.07	-32.7
MARATHON OIL CORP	62,000	45.60	1.5	32.33	2.1	8.0	1.7	1.31	-24.7
PETRO CDA	39,700	43.41	0.9	20.99	1.2	7.6		1.25	-18.8
SUNOCO INC	13,500	52.47	0.4	6.17	2.3	7.1	2.4	1.26	-27.2
VALERO ENERGY CORP	41,400	49.11	1.1	26.26	1.0	6.4	1.4	0.99	-29.7
			<b>17.9</b>	<b>202.20</b>	<b>1.9</b>	<b>10.0</b>	<b>2.4</b>	<b>0.98</b>	<b>-11.66</b>
<b>Financials</b>									
ALLSTATE CORP	56,100	48.06	1.4	26.93	3.4	6.2	1.3	0.93	-7.2
AMERIPRISE FINL INC	41,700	51.85	1.1	11.77	1.2	15.3	1.5		-5.7
ASSURANT INC	22,900	60.86	0.7	7.19	0.8	11.3	1.8	1.29	-8.9
AXIS CAPITAL HOLDINGS LTD SHS	42,100	33.98	0.8	5.14	2.1	10.7	1.0	1.20	-12.3
BANK AMER CORP	67,600	37.91	1.4	168.40	6.8	11.5	1.2	0.48	-6.6
BERKLEY W R CORP	48,900	27.69	0.7	4.90	0.7	7.3	1.4	0.91	-6.9
CHUBB CORP	49,900	49.48	1.3	18.32	2.7	7.1	1.3	1.05	-8.7
COMERICA INC	23,700	35.08	0.4	5.28	7.5	8.0	1.0	0.95	-18.0
CREDICORP LTD SHS	9,500	71.74	0.4	6.77	2.1	24.9		1.17	-6.0
ENDURANCE SPECIALTY HOLDINGS SHS	45,800	36.60	0.9	2.21	2.7	11.2	0.9	0.81	-11.7
EVEREST REINSURANCE GROUP LTD SHS	19,500	89.53	0.9	5.63	2.1	6.8	1.0	1.21	-10.4
FAIRFAX FINL HLDGS LTD SUB VTG	5,100	287.10	0.8	4.97	1.7	4.4		1.77	2.1
FIFTH THIRD BANCORP COM STK	68,900	20.92	0.8	11.14	8.4	10.5	1.2	0.73	-15.0
FRANKLIN RES INC	15,600	96.99	0.8	23.11	0.8	13.0	3.2	1.35	-15.1
GOLDMAN SACHS GROUP INC	17,500	165.39	1.5	65.48	0.8	7.8	1.6	1.60	-23.0
JANUS CAP GROUP INC	27,200	23.27	0.3	3.82	0.2	35.8	2.2	1.63	-29.2
JPMORGAN CHASE + CO	153,700	42.95	3.5	145.88	3.5	9.8	1.2	1.16	-0.7
MORGAN STANLEY	37,500	45.70	0.9	50.51	2.4	27.9	1.6	1.40	-13.5
PARTNERRE LTD	13,200	76.30	0.5	4.13	2.4	6.4	1.2	0.86	-7.0
SAFECO CORP	32,600	43.88	0.8	3.94	3.6	6.3	1.4	0.69	-20.6
SCHWAB CHARLES CORP NEW COM STK	60,600	18.83	0.6	21.83	1.1	20.5	5.9	1.81	-26.1
SEI INVESTMENTS CO	45,400	24.69	0.6	4.80	0.6	19.3	6.3	1.30	-23.1
SUNTRUST BKS INC	33,000	55.14	1.0	19.23	5.6	12.1	1.1	0.69	-10.7
TRAVELERS COS INC	64,100	47.85	1.6	29.68	2.4	7.0	1.2	1.03	-10.5
UNIONBANCAL CORP	23,100	49.08	0.6	6.77	4.2	12.0	1.4	0.63	1.5
WACHOVIA CORP 2ND NEW	63,400	27.00	0.9	53.51	9.5	8.3	0.7	1.05	-27.7
WELLS FARGO + CO NEW	112,200	29.10	1.7	95.94	4.3	12.2	2.0	0.54	-2.6
WILLIS GROUP HOLDINGS LTD SHS	44,600	33.61	0.8	4.81	3.0	12.1	3.6	1.24	-10.8
			<b>27.7</b>	<b>47.79</b>	<b>3.2</b>	<b>11.1</b>	<b>1.7</b>	<b>1.06</b>	<b>-10.19</b>

# Fresno County Employees' Retirement Association

## Portfolio Holdings And Characteristics - Equity

Period Ending: March 31, 2008

ARONSON PARTNERS	Shares	Price	Portfolio Weight	Market Cap	Dividend Yield	Price / Earnings	Price / Book	Beta	Quarterly Return
<b>Health Care</b>									
AETNA INC	37,200	42.09	0.8	20.90	0.1	12.1	2.1	1.31	-27.1
CIGNA CORP	16,600	40.57	0.4	11.36	0.1	10.5	2.5	1.44	-24.4
EXPRESS SCRIPTS INC	11,500	64.32	0.4	16.26		29.9		0.99	-11.9
PFIZER INC	285,700	20.93	3.2	141.51	6.1	17.7	2.2	0.65	-6.6
UNITEDHEALTH GROUP INC	21,800	34.36	0.4	43.00	0.1	10.0	2.2	0.76	-40.9
WELLPOINT INC	19,000	44.13	0.4	23.92		7.9	1.1	1.02	-49.7
			<b>5.6</b>	<b>90.16</b>	<b>4.1</b>	<b>15.9</b>	<b>2.1</b>	<b>0.86</b>	<b>-17.02</b>
<b>Industrials</b>									
BOEING CO	17,000	74.37	0.7	56.88	2.2	14.1	6.3	1.22	-14.5
CATERPILLAR INC	15,700	78.29	0.6	48.85	1.8	14.6	5.5	1.24	8.5
CRANE CO	19,500	40.35	0.4	2.44	1.8		2.7	1.31	-5.6
CUMMINS INC	33,000	46.82	0.8	9.47	1.1	25.3	5.6	1.46	-26.3
DRYSHIPS INC SHS	9,500	59.91	0.3	2.20	1.3		4.7	1.30	-22.3
GARDNER DENVER INC	21,400	37.10	0.4	1.97		9.8	1.7	1.18	12.4
L 3 COMMUNICATIONS HLDG CORP	18,500	109.34	1.1	13.38	1.1	18.3	2.3	0.83	3.5
NORFOLK SOUTHN CORP	30,800	54.32	0.9	20.44	2.1	14.8	2.1	1.07	8.3
NORTHROP GRUMMAN CORP	33,100	77.81	1.4	26.29	1.9	15.2	1.5	0.41	-0.6
PARKER HANNIFIN CORP	29,900	69.27	1.1	11.67	1.2	13.9	2.6	1.33	-7.7
TIMKEN CO	9,300	29.72	0.1	2.85	2.3	13.0	1.5	1.23	-9.0
			<b>7.8</b>	<b>20.62</b>	<b>1.6</b>	<b>16.1</b>	<b>3.2</b>	<b>1.06</b>	<b>-3.71</b>
<b>Information Technology</b>									
COMPUWARE CORP	99,400	7.34	0.4	2.01		16.3	2.0	1.78	-17.3
MICROSOFT CORP	74,500	28.38	1.1	264.13	1.6	16.1	8.6	0.89	-20.0
QLOGIC CORP	49,200	15.35	0.4	2.06		24.8	2.7	1.57	8.1
SEAGATE TECHNOLOGY SHS	39,100	20.94	0.4	11.04	1.9	9.6	2.4	1.63	-17.5
SYMANTEC CORP	104,000	16.62	0.9	14.07		43.7	1.3	0.88	3.0
			<b>3.2</b>	<b>96.78</b>	<b>1.7</b>	<b>24.1</b>	<b>4.2</b>	<b>1.18</b>	<b>-9.43</b>
<b>Materials</b>									
ALCOA INC	20,200	36.06	0.4	29.37	1.9	12.2	1.9	1.41	-0.8
CARPENTER TECHNOLOGY CORP	12,600	55.97	0.4	2.70	1.1	11.9	2.7	1.94	-25.4
DOW CHEM CO	35,100	36.85	0.7	34.62	4.6	12.3	1.8	1.04	-5.5
LUBRIZOL CORP	15,100	55.51	0.4	3.80	2.2	13.7	1.9	0.89	3.1
METHANEX CORP	54,000	26.17	0.7	2.55	2.1	6.6		1.35	-4.7
NUCOR CORP	35,100	67.74	1.3	19.51	1.9	13.7	3.8	1.61	15.2
			<b>3.9</b>	<b>16.49</b>	<b>2.4</b>	<b>11.8</b>	<b>2.7</b>	<b>1.39</b>	<b>0.90</b>
<b>Telecommunications Services</b>									
AT+T INC	167,170	38.30	3.4	231.17	4.2	19.7	2.0	0.99	-6.9
SPRINT NEXTEL CORP COM SER 1	185,500	6.69	0.7	18.56	1.5		0.9	1.47	-49.1
VERIZON COMMUNICATIONS COM USD 500	103,700	36.45	2.0	104.16	4.7	19.2	2.1	0.93	-15.7
			<b>6.0</b>	<b>166.04</b>	<b>4.1</b>	<b>19.5</b>	<b>1.9</b>	<b>1.02</b>	<b>-14.40</b>

# Fresno County Employees' Retirement Association

## Portfolio Holdings And Characteristics - Equity

Period Ending: March 31, 2008

ARONSON PARTNERS	Shares	Price	Portfolio Weight	Market Cap	Dividend Yield	Price / Earnings	Price / Book	Beta	Quarterly Return
<b>Utilities</b>									
ALLIANT ENERGY CORP	45,100	35.01	0.8	3.92	4.0	9.3	1.4	0.85	-13.1
DTE ENERGY CO	17,900	38.89	0.4	6.35	5.5	8.4	1.1	0.52	-10.3
EDISON INTL	44,600	49.02	1.2	15.97	2.5	14.8	1.9	0.98	-7.6
ENERGY CORP NEW	11,300	109.08	0.7	21.34	2.8	19.5	2.7	0.72	-8.1
FIRSTENERGY CORP	35,800	68.62	1.3	20.92	3.2	16.3	2.3	0.56	-4.4
PUBLIC SVC ENTERPRISE GROUP	53,800	40.19	1.1	20.44	1.6	15.5	5.6	0.71	-17.6
SIERRA PAC RES NEW	109,600	12.63	0.7	2.95	2.5	14.2	1.0	1.65	-25.2
			<b>6.2</b>	<b>14.66</b>	<b>2.9</b>	<b>14.5</b>	<b>2.5</b>	<b>0.85</b>	<b>-11.81</b>
ARONSON PARTNERS			<b>100.0</b>	<b>81.32</b>	<b>2.6</b>	<b>14.0</b>	<b>2.5</b>	<b>1.00</b>	<b>-8.67</b>

# Fresno County Employees' Retirement Association

## Equity Activity

Period Ending: March 31, 2008

Start from Dec 31, 2007 **ARONSON PARTNERS**

Additions				Deletions			
Security Name	Shares	Market Value	New	Security Name	Shares	Market Value	Eliminated
ABERCROMBIE + FITCH CO COM CL A	11,400	821,157	*	AETNA INC	7,300	420,992	
ALCOA INC	20,200	769,364	*	AMGEN INC	17,000	816,324	*
AMERIPRISE FINL INC	41,700	2,123,931	*	BALL CORP	13,400	600,769	*
AMGEN INC	17,000	812,031	*	BANK AMER CORP	12,000	443,446	
CIMAREX ENERGY CO	34,900	1,839,001	*	BOEING CO	4,900	388,114	
CONAGRA INC	19,700	424,705	*	BRINKER INTL INC	60,500	992,907	*
CRANE CO	19,500	802,642	*	CATERPILLAR INC	14,500	1,055,210	
DIRECTV GROUP INC	42,300	905,062	*	CHECK POINT SOFTWARE	43,300	916,759	*
DISNEY WALT CO DISNEY COM	24,500	788,721	*	CIGNA CORP	26,900	1,324,513	
DTE ENERGY CO	17,900	714,117	*	CITIGROUP INC	94,000	2,528,136	*
ENTERGY CORP NEW	11,300	1,396,895	*	COGNOS INC	21,800	1,264,400	*
FAIRFAX FINL HLDGS LTD SUB VTG	2,500	680,543	*	COMERICA INC	17,900	679,679	
FRANKLIN RES INC	15,600	1,455,601	*	COMPUWARE CORP	53,600	406,522	
GARDNER DENVER INC	21,400	816,252	*	DIRECTV GROUP INC	16,700	434,359	
GENERAL ELEC CO	21,600	743,040	*	DOLLAR TREE STORES INC	20,300	503,850	*
L 3 COMMUNICATIONS HLDG CORP	5,700	595,644	*	EBAY INC	47,900	1,283,295	*
LENNOX INTL INC	21,500	829,387	*	ENERGEN CORP	12,800	818,944	*
LUBRIZOL CORP	15,100	888,537	*	GOODRICH CORP	11,700	733,629	*
N/A		757,311	*	JONES LANG LASALLE INC	17,800	1,240,371	*
NETFLIX COM INC	21,600	717,725	*	KEYCORP NEW	49,600	1,100,973	*
NORFOLK SOUTHN CORP	23,000	1,236,565	*	MASCO CORP	90,700	1,765,637	*
NVR INC	1,400	777,558	*	MORGAN STANLEY	32,500	1,306,164	
OCCIDENTAL PETE CORP	11,600	736,608	*	N/A		575,429	*
PETRO CDA	23,700	1,018,318	*	NORFOLK SOUTHN CORP	10,500	556,899	
PFIZER INC	50,500	1,154,164	*	NORTHROP GRUMMAN CORP	5,000	387,253	
QLOGIC CORP	49,200	807,261	*	NOVA CHEMICALS CORP	19,200	524,700	*
SCHWAB CHARLES CORP NEW COM STK	60,600	1,265,099	*	NUCOR CORP	7,000	466,125	
SEI INVESTMENTS CO	45,400	1,254,812	*	OCCIDENTAL PETE CORP	11,600	879,734	*
SYMANTEC CORP	58,100	1,042,024	*	PEPSI BOTTLING GROUP INC	16,200	547,893	
UNITEDHEALTH GROUP INC	21,800	741,091	*	PUBLIC SVC ENTERPRISE GROUP	6,000	610,497	
VALERO ENERGY CORP	10,100	473,135	*	SOUTHERN COPPER CORP DEL	11,200	1,131,654	*
WELLPOINT INC	8,000	606,688	*	SUNOCO INC	16,100	922,568	

# Fresno County Employees' Retirement Association

## Equity Activity

Period Ending: March 31, 2008

WILLIS GROUP HOLDINGS LTD SHS	44,600	1,625,898	*	UNION PAC CORP	6,900	837,547	*
				WASHINGTON MUT INC	127,400	1,921,647	*



# Fresno County Employees' Retirement Association

## Cumulative Performance Comparisons

Period Ending: March 31, 2008

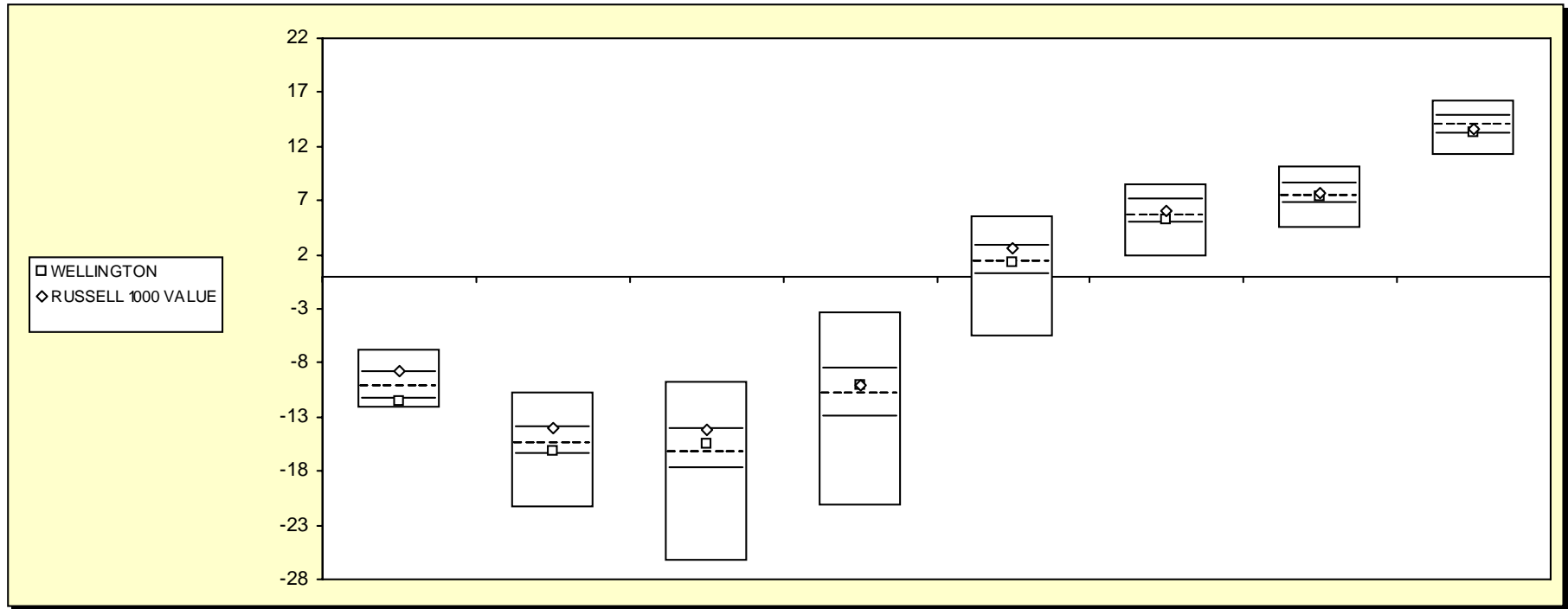

### Equity Style - Large Value

	Last Quarter		Two Quarters		Three Quarters		One Year		Two Years		Three Years		Four Years		Five Years	
	Return	Rank	Return	Rank	Return	Rank	Return	Rank	Return	Rank	Return	Rank	Return	Rank	Return	Rank
5th Percentile	-6.8		-10.7		-9.8		-3.3		5.6		8.5		10.1		16.3	
25th Percentile	-9.0		-14.0		-14.2		-8.6		2.8		7.1		8.5		14.7	
50th Percentile	-10.3		-15.4		-16.3		-10.9		1.3		5.6		7.4		14.0	
75th Percentile	-11.4		-16.4		-17.7		-13.0		0.2		4.9		6.8		13.2	
95th Percentile	-12.1		-21.4		-26.3		-21.2		-5.6		1.8		4.3		11.2	
WELLINGTON	-11.5	78	-16.1	67	-15.4	40	-10.1	42	1.2	52	5.2	62	7.4	52	13.2	73
RUSSELL 1000 VALUE	-8.7	23	-14.0	26	-14.2	25	-10.0	40	2.5	29	6.0	43	7.7	42	13.7	60

# Fresno County Employees' Retirement Association

## Consecutive Performance Comparisons

Period Ending: March 31, 2008

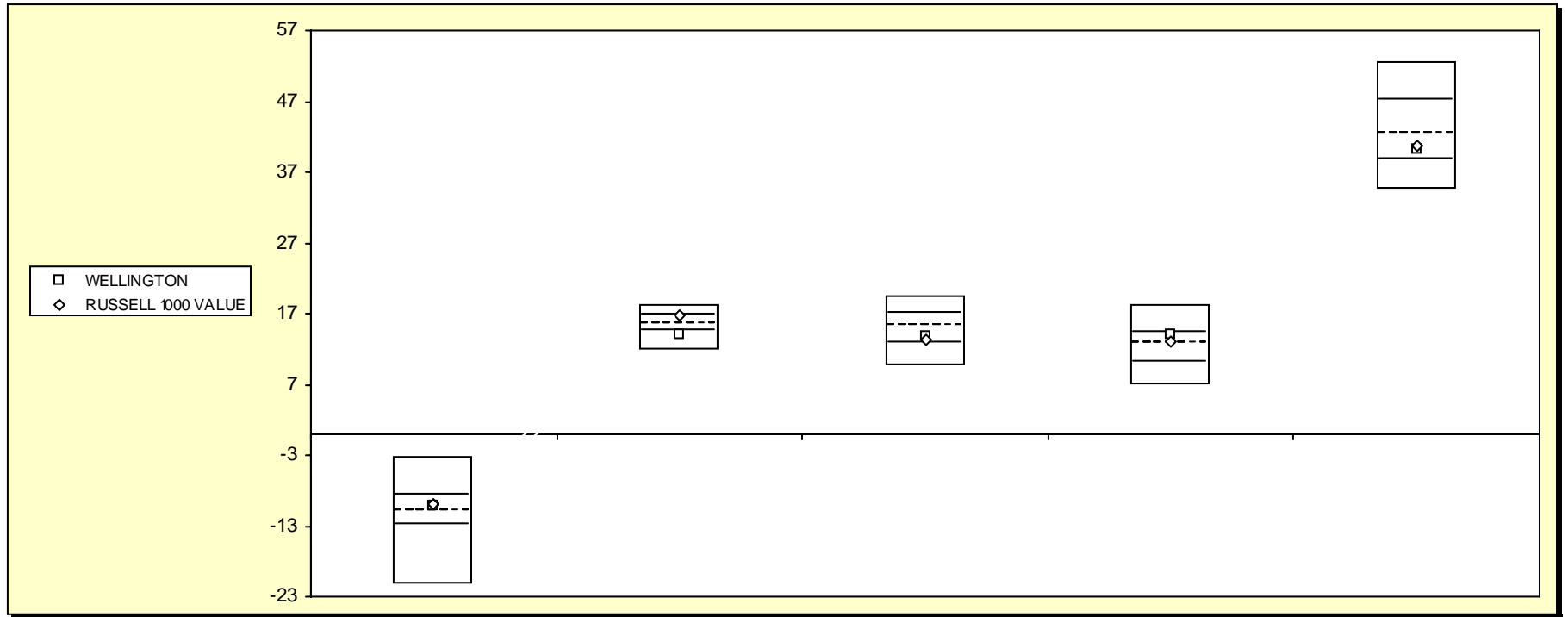

### Equity Style - Large Value

	March 2008		March 2007		March 2006		March 2005		March 2004	
	Return	Rank	Return	Rank	Return	Rank	Return	Rank	Return	Rank
5th Percentile	-3.3		18.3		19.6		18.2		52.5	
25th Percentile	-8.6		16.6		16.9		14.3		47.1	
50th Percentile	-10.9		15.4		15.2		12.8		42.4	
75th Percentile	-13.0		14.4		12.8		10.0		38.7	
95th Percentile	-21.2		11.8		9.6		6.9		34.6	
WELLINGTON	-10.1	42	14.0	78	13.7	65	14.1	29	40.1	65
RUSSELL 1000 VALUE	-10.0	40	16.8	23	13.3	70	13.2	43	40.8	61

# Fresno County Employees' Retirement Association

Consecutive Annual - Five Year

Period Ending: March 31, 2008

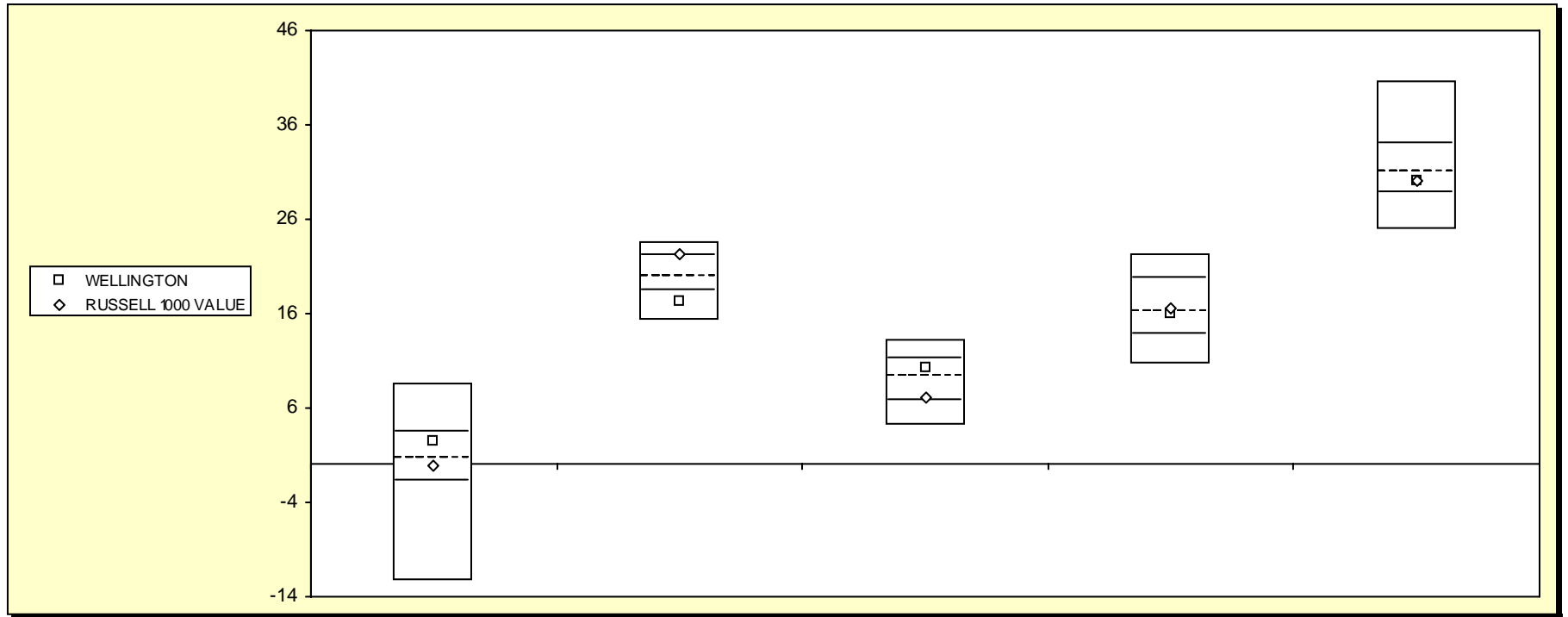

Equity Style - Large Value

	December 2007		December 2006		December 2005		December 2004		December 2003	
	Return	Rank	Return	Rank	Return	Rank	Return	Rank	Return	Rank
5th Percentile	8.7		23.6		13.2		22.4		40.6	
25th Percentile	3.5		22.1		11.2		19.7		33.9	
50th Percentile	0.6		19.8		9.3		16.2		31.0	
75th Percentile	-1.8		18.3		6.7		13.7		28.8	
95th Percentile	-12.4		15.2		4.2		10.7		24.9	
WELLINGTON	2.5	34	17.4	81	10.3	36	16.1	51	30.0	61
RUSSELL 1000 VALUE	-0.2	58	22.2	24	7.1	72	16.5	48	30.0	61

# Fresno County Employees' Retirement Association

## Performance Review Summary

Period Ending: March 31, 2008

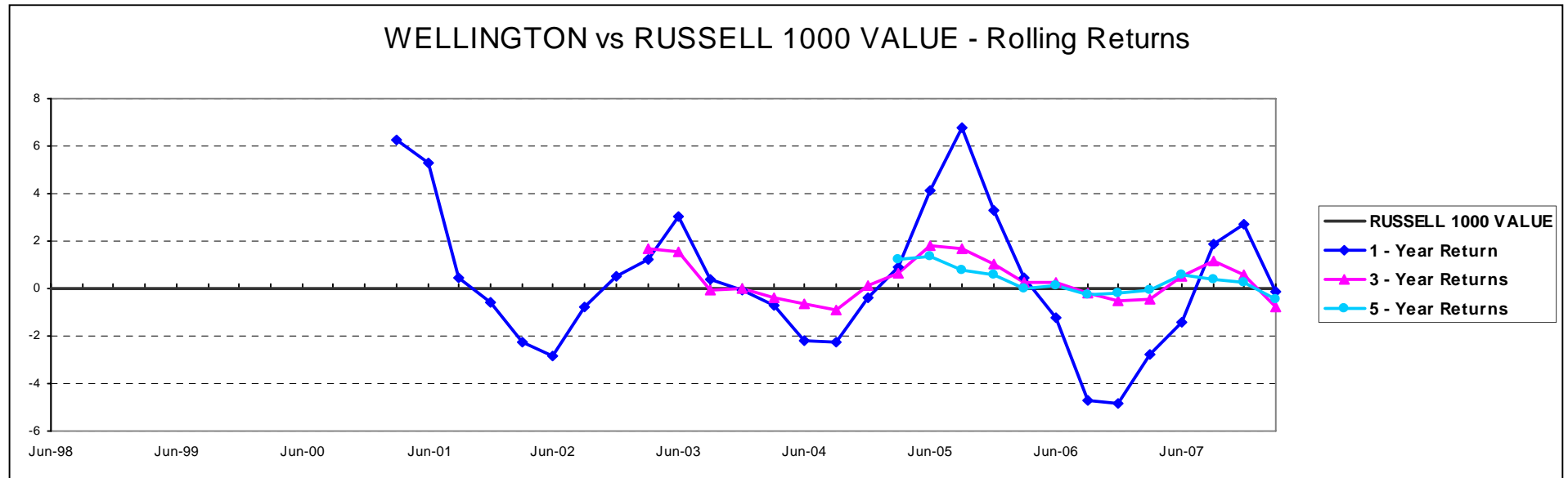

### Performance & Risk Measures

	Quarter		One Year		Three Years		Five Years		Standard Deviation		Sharpe Ratio		Beta	
	Return	Rank	Return	Rank	Return	Rank	Return	Rank	3-Years	5-Years	3-Years	5-Years	3-Years	5-Years
WELLINGTON	-11.5	78	-10.1	42	5.2	62	13.2	73	10.6	13.0	0.1	0.8	1.0	1.1
RUSSELL 1000 VALUE	-8.7	23	-10.0	40	6.0	43	13.7	60	9.8	12.0	0.2	0.9		
Equity Style - Large Value	-10.3		-10.9		5.6		14.0		10.7	12.5	0.1	0.9		

### Ten Largest Holdings

Security	Market Value	Weight
AT+T INC	9,617,551	6.57
BANK AMER CORP	9,583,648	6.54
HESS CORP	6,454,776	4.41
PHILIP MORRIS INTL ORD SHR	5,988,672	4.09
EXELON CORP	5,737,662	3.92
CONOCOPHILLIPS	5,532,541	3.78
VIACOM INC NEW CL B	4,039,259	2.76
OCCIDENTAL PETE CORP	3,951,180	2.70
BAKER HUGHES INC	3,479,800	2.38
MARATHON OIL CORP	3,374,400	2.30

### Sector Weights

Sector	Portfolio	Benchmark
Materials	7.7	4.3
Industrials	6.9	11.4
Telecommunications Services	5.7	6.1
Consumer Discretionary	8.5	6.9
Consumer Staples	8.9	9.3
Energy	18.4	16.7
Financials	27.8	28.0
Health Care	6.0	7.3
Information Technology	4.8	3.1
Utilities	5.3	6.7

### Portfolio Characteristics

	Portfolio	Benchmark
Average Market Cap	\$ 65,259	\$ 105,810
Median Market Cap	\$ 19,512	\$ 4,530
P/E	14.8	13.5
P/B	2.8	2.4
Dividend Yield	2.3	3.0
Earnings Growth	16.9	14.3

**Benchmark:** RUSSELL 1000 VALUE

**Total Assets**                      **% of Total Fund**

\$ 168,884

# Fresno County Employees' Retirement Association

Rolling Return: 3 year Annualized

Period Ending: March 31, 2008

## Rolling Return (3 Year Annualized)



WELLINGTON

RUSSELL 1000 VALUE

Equity Style - Large Value

03/31/01

03/31/02

03/31/03

03/31/04

03/31/05

03/31/06

03/31/07

03/31/08

# Fresno County Employees' Retirement Association

## Three & Five Year Return vs. Risk

Period Ending: March 31, 2008

**Three-Year**

**Five-Year**

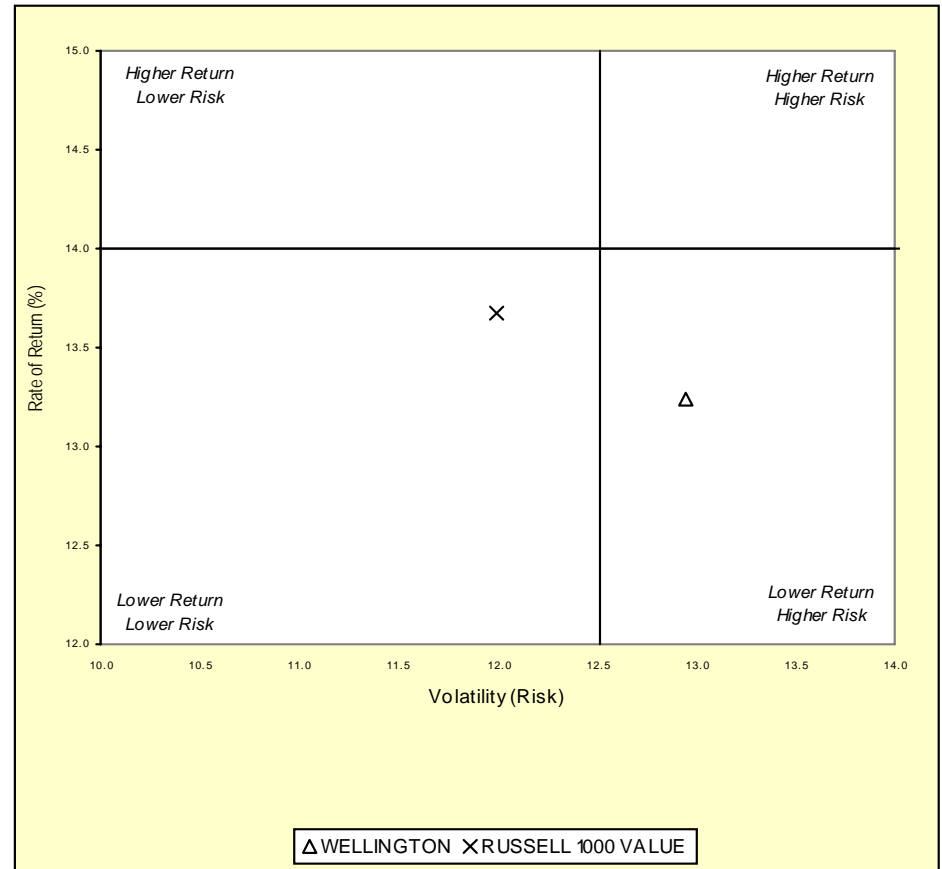
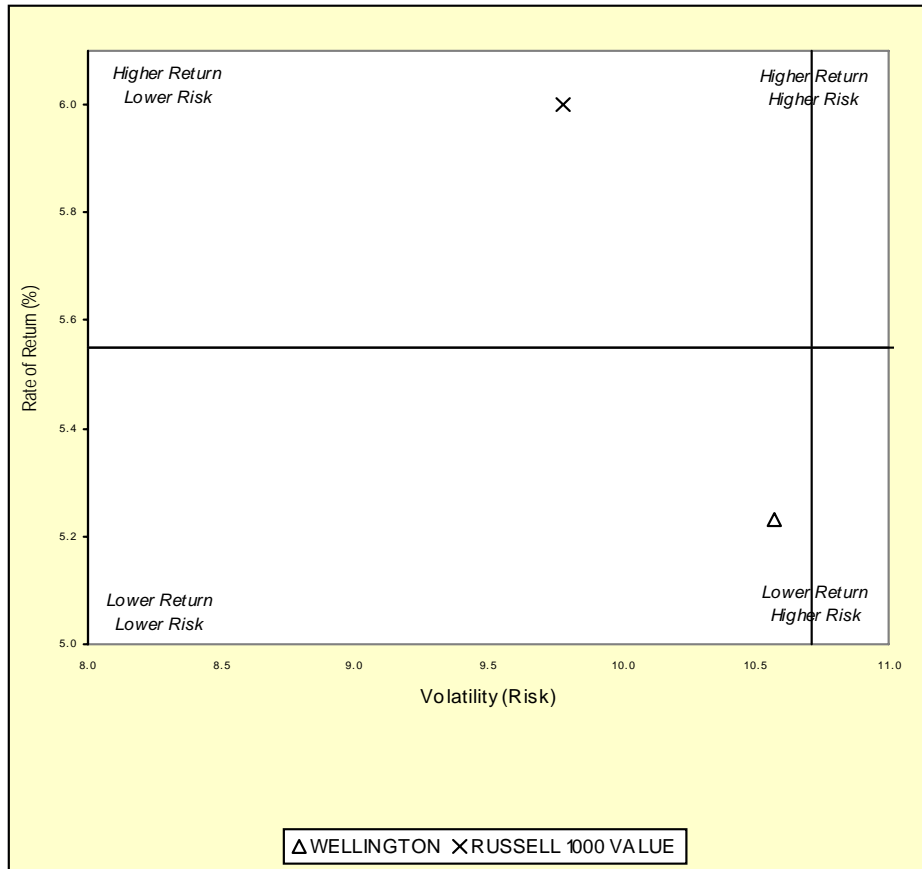

**Three Year Return vs Risk**

**Five Year Return vs Risk**

Annualized Return %	Standard Deviation %	Sharpe Ratio	Category	Annualized Return %	Standard Deviation %	Sharpe Ratio
5.2	10.6	0.1	WELLINGTON	13.2	13.0	0.8
5.6	10.7	0.1	Equity Style - Large Value Universe Median	14.0	12.5	0.9
6.0	9.8	0.2	RUSSELL 1000 VALUE	13.7	12.0	0.9

# Fresno County Employees' Retirement Association

## Equity Only Summary Statistics

Period Ending: March 31, 2008

### WELLINGTON

	Portfolio	RUSSELL 1000 VALUE
Total Number of Securities	80	618
Total Market Value	146,442,700	
Average Market Capitalization (000's)	65,259,133	105,810,000
Equity Segment Yield	2.68	2.97
Equity Segment Price/Earnings Ratio	16.22	13.48
Equity Segment Beta	1.01	1.00
Price/Book Ratio	2.92	2.36
5 Year Earnings Growth	16.9%	14.3%

#### Ten Largest Holdings

Security	Market Value	Weight
AT+T INC	9,617,551	6.57
BANK AMER CORP	9,583,648	6.54
HESS CORP	6,454,776	4.41
PHILIP MORRIS INTL ORD SHR	5,988,672	4.09
EXELON CORP	5,737,662	3.92
CONOCOPHILLIPS	5,532,541	3.78
VIACOM INC NEW CL B	4,039,259	2.76
OCCIDENTAL PETE CORP	3,951,180	2.70
BAKER HUGHES INC	3,479,800	2.38
MARATHON OIL CORP	3,374,400	2.30

#### Ten Best Performers

Security	Return	Weight
ARKANSAS BEST CORP	46.0	0.34
EOG RESOURCES INC	34.6	1.64
CON WAY INC	19.4	0.54
WAL MART STORES INC	11.4	1.06
FOREST LABS INC	9.8	0.24
MOSAIC CO	8.8	0.50
INTERNATIONAL BUSINESS MACHS	6.9	1.20
UNITED STS STL CORP NEW	5.2	1.02
CAPITAL ONE FINL CORP	4.9	1.45
QUESTAR CORP	4.8	0.54

#### Ten Worst Performers

Security	Return	Weight
MGIC INVT CORP WIS	-53.0	0.38
NATIONAL FINL PARTNERS CORP	-50.3	0.30
WELLPOINT INC	-49.7	0.70
SCHERING PLOUGH CORP	-45.7	1.15
LEHMAN BROTHERS HLDGS INC	-42.3	0.66
NORTHWEST AIRLS CORP	-38.0	0.59
MBIA INC	-34.4	0.21
MERCK + CO INC	-34.1	0.97
NYMEX HLDGS INC	-32.1	0.49
SIEMENS A G SPONSORED ADR	-29.8	0.89

# Fresno County Employees' Retirement Association

## Portfolio Characteristics - Equity

Period Ending: March 31, 2008

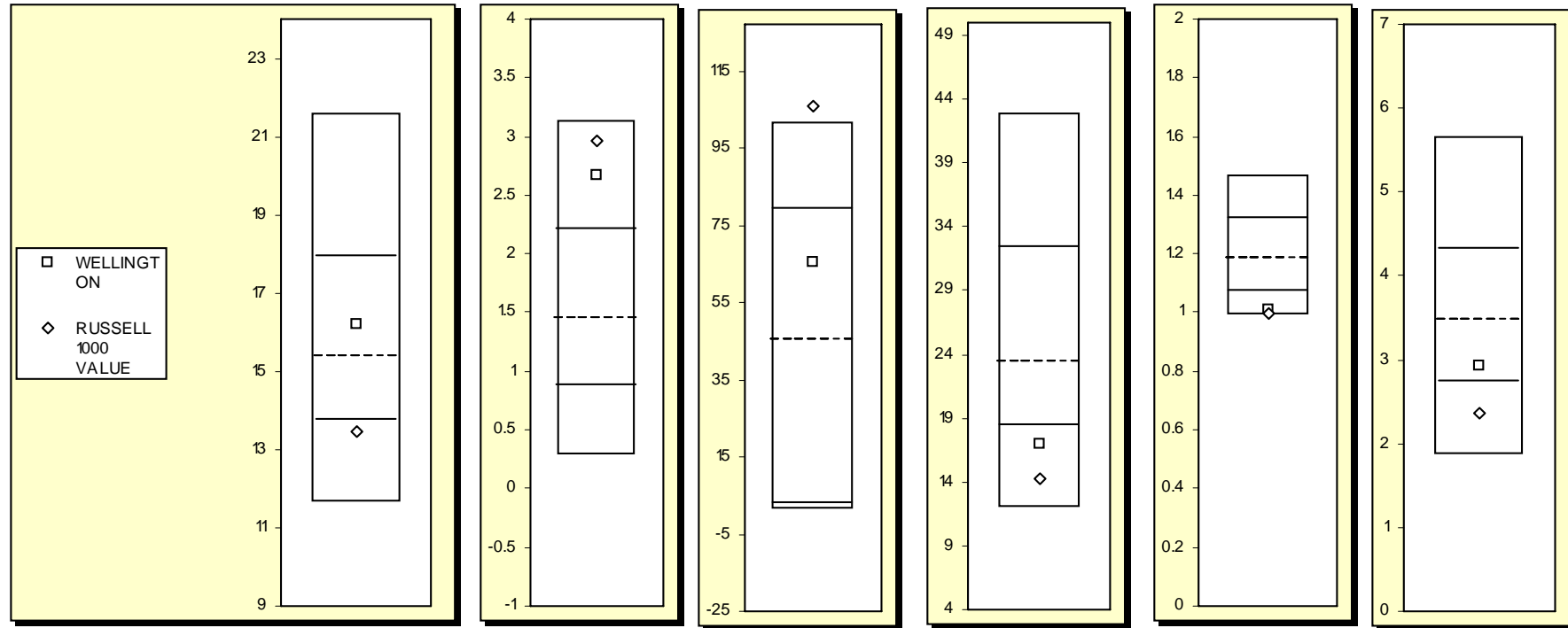

	Price/Earnings Ratio		Dividend Yield		Capitalization		5 Year Earnings		Beta		Price/Book Ratio	
	Value	Rank	Value	Rank	Value	Rank	Value	Rank	Value	Rank	Value	Rank
<i>Equity Funds - Equity Only</i>												
5th Percentile	21.57		3.13		101.51		42.95		1.47		5.66	
25th Percentile	17.93		2.20		78.86		32.34		1.32		4.32	
50th Percentile	15.38		1.45		45.26		23.34		1.18		3.47	
75th Percentile	13.75		0.88		2.83		18.43		1.07		2.72	
95th Percentile	11.66		0.28		1.13		11.93		0.99		1.86	
WELLINGTON	16.22	42	2.68	15	65.26	35	16.90	80	1.01	90	2.92	68
RUSSELL 1000 VALUE	13.48	78	2.97	8	105.81	4	14.31	88	1.00	93	2.36	83





# Fresno County Employees' Retirement Association

## Equity Only Summary Statistics Charts

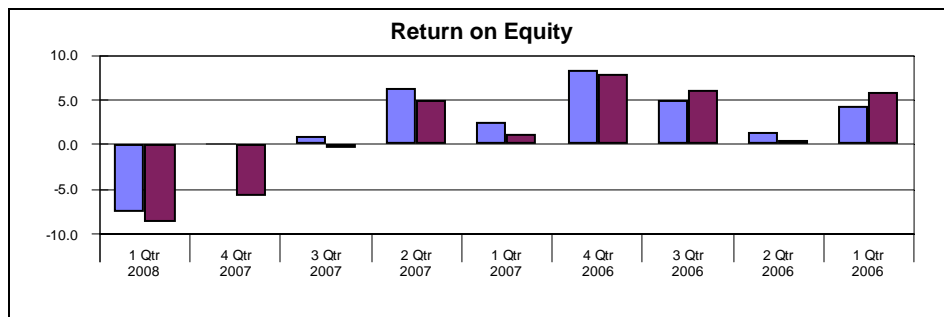
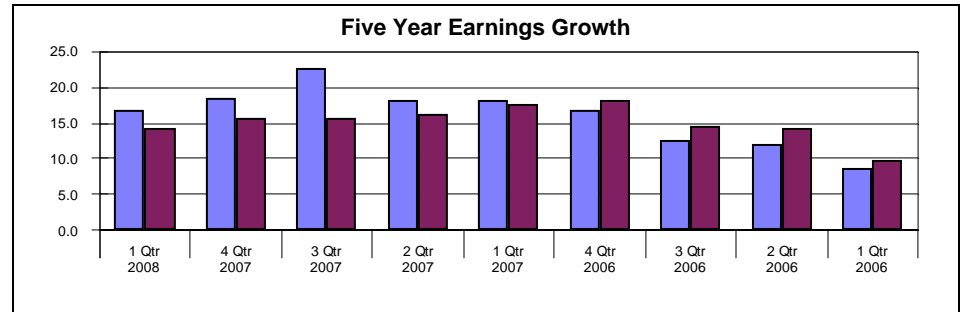
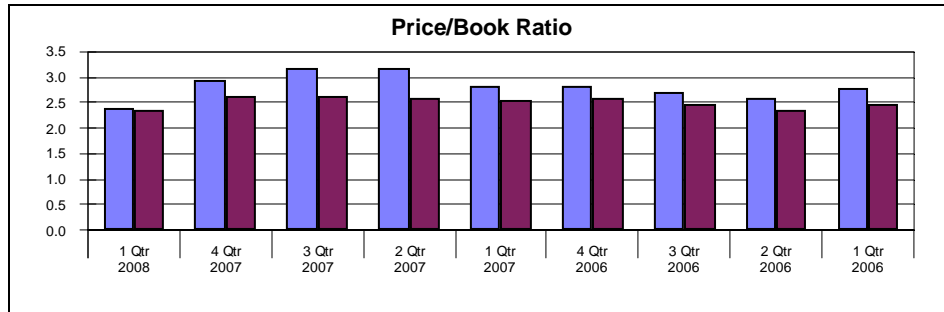
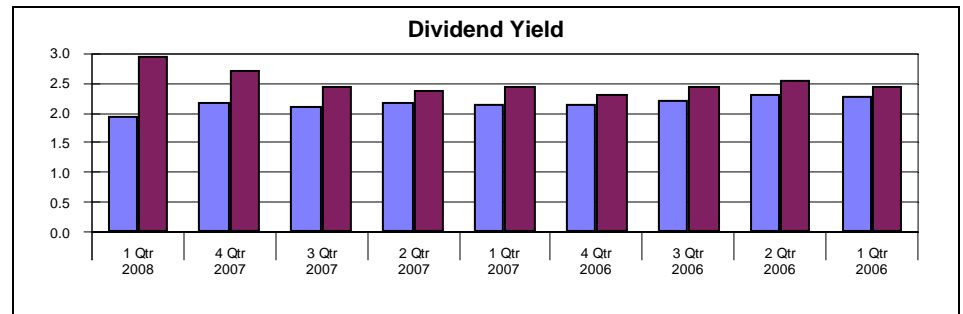
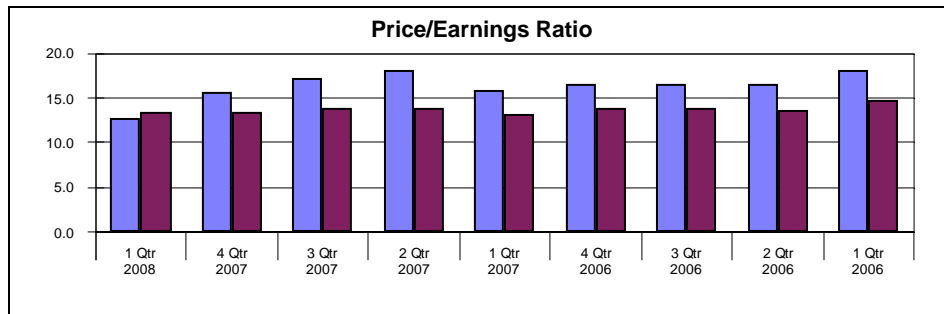
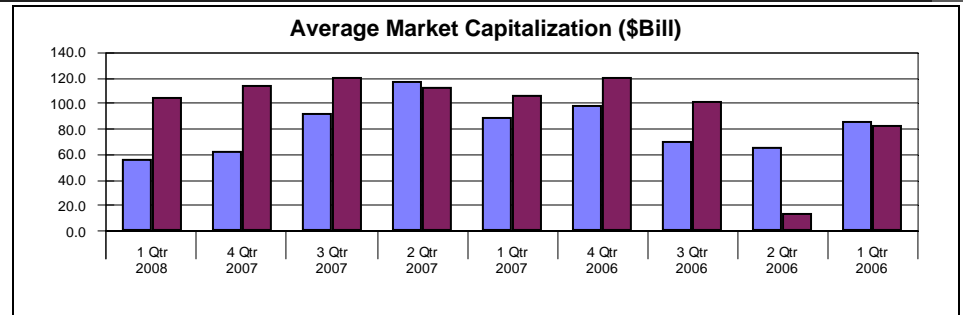
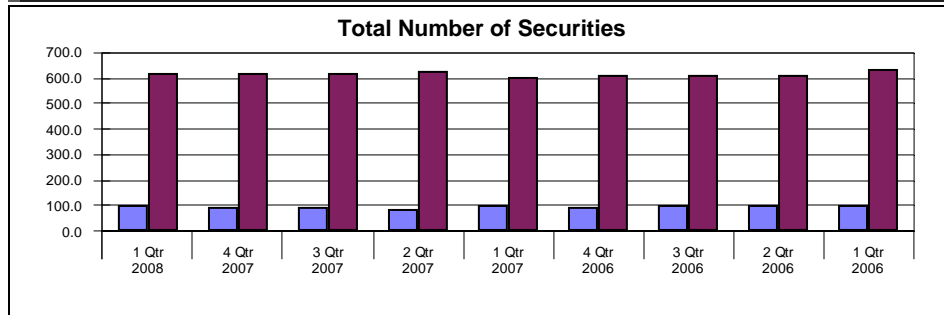
Period Ending: March 31, 2008



 WELLINGTON  
 RUSSELL 1000 VALUE

# Fresno County Employees' Retirement Association

## Equity Only Sector Analysis Quarterly

Period Ending: March 31, 2008

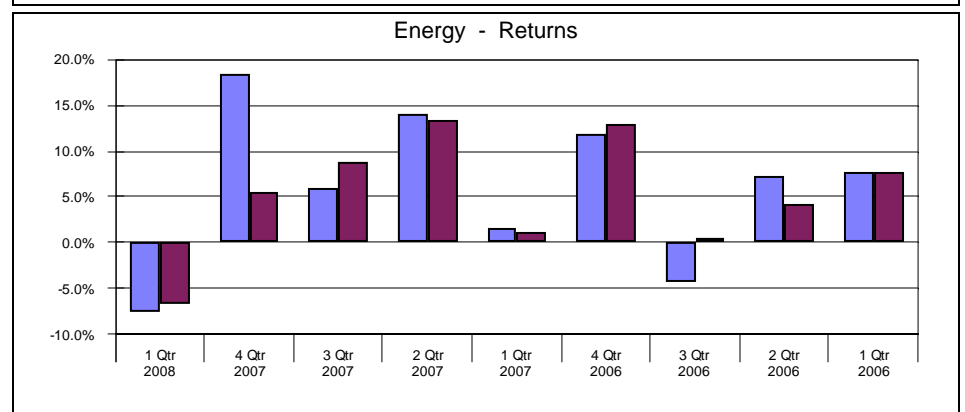
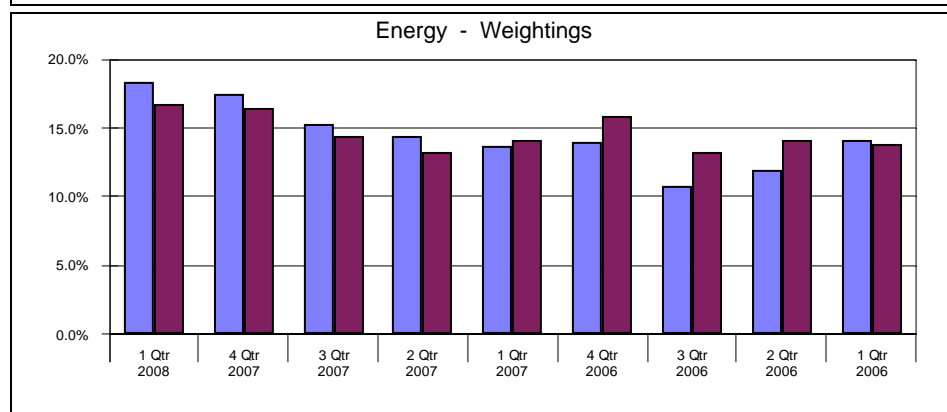
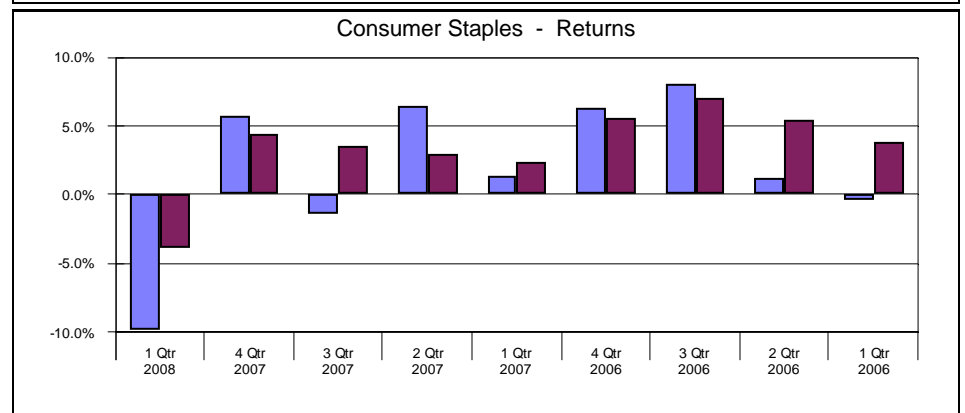
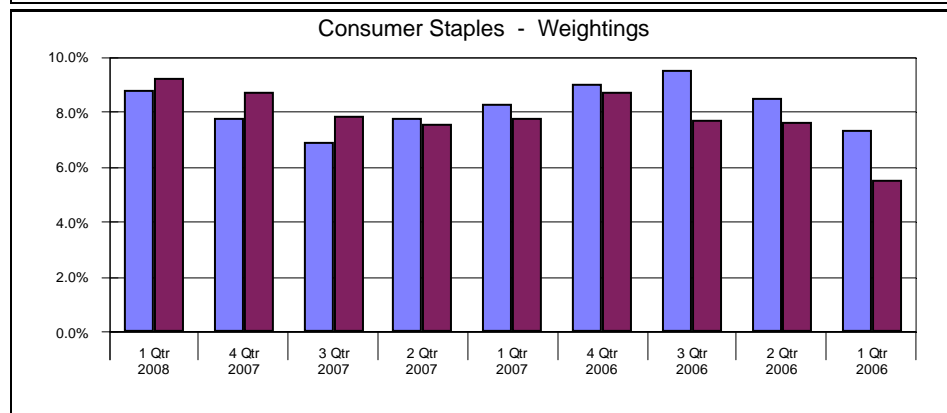
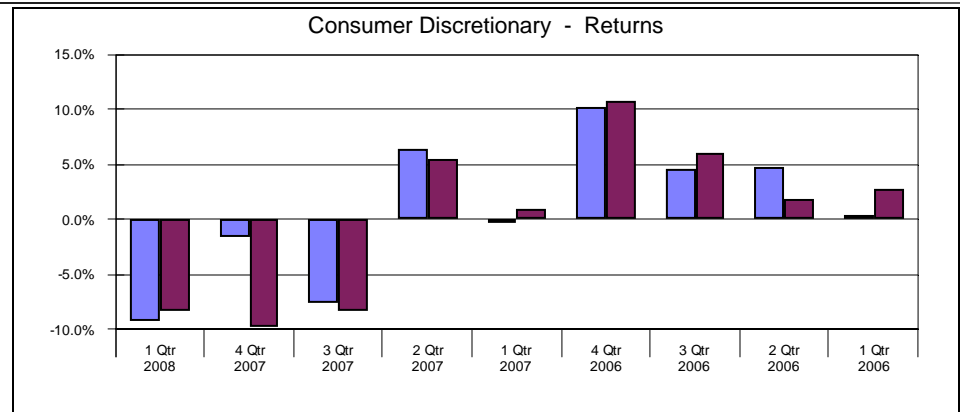
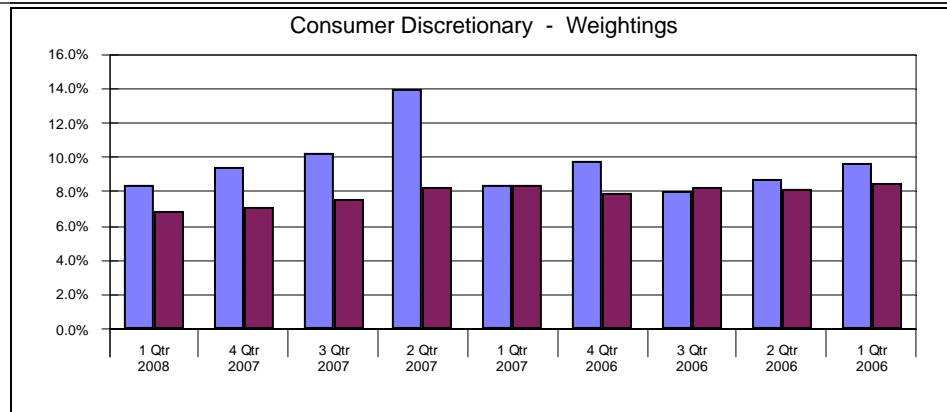

WELLINGTON

RUSSELL 1000 VALUE

# Fresno County Employees' Retirement Association

## Equity Only Sector Analysis Quarterly

Period Ending: March 31, 2008

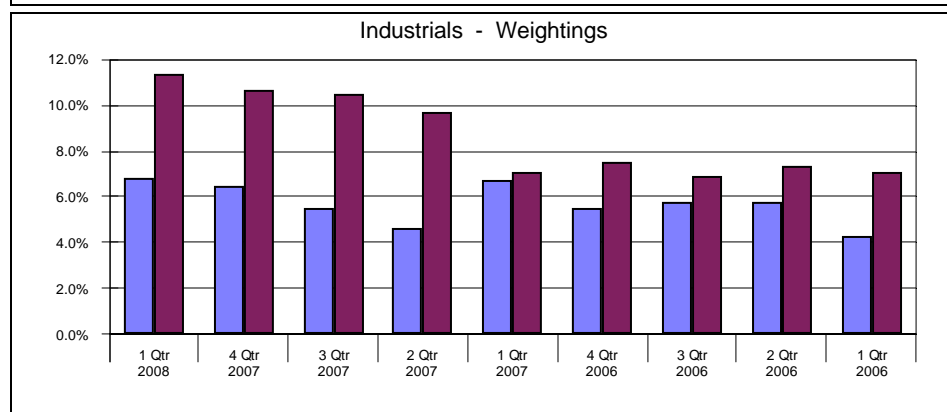
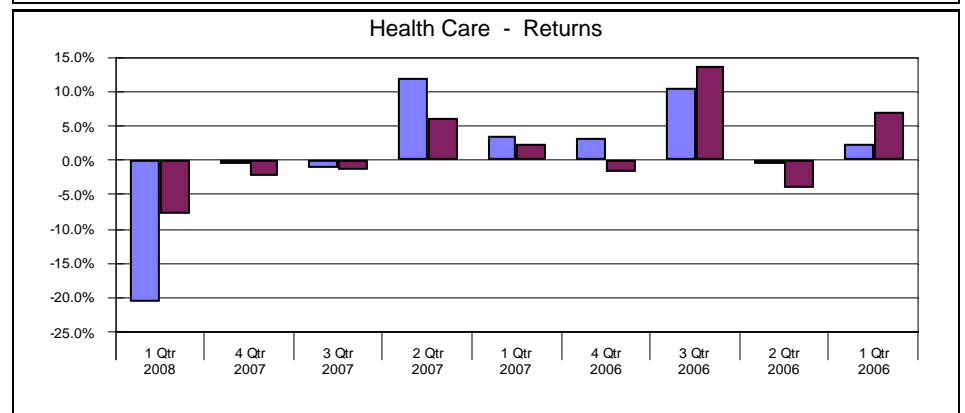
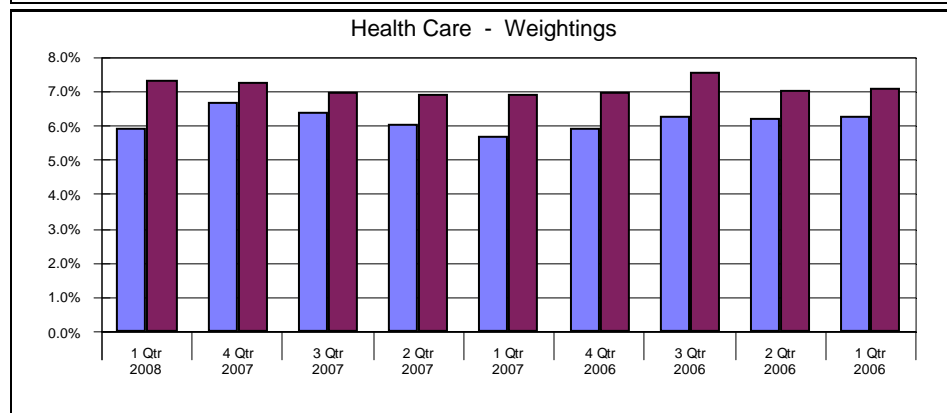
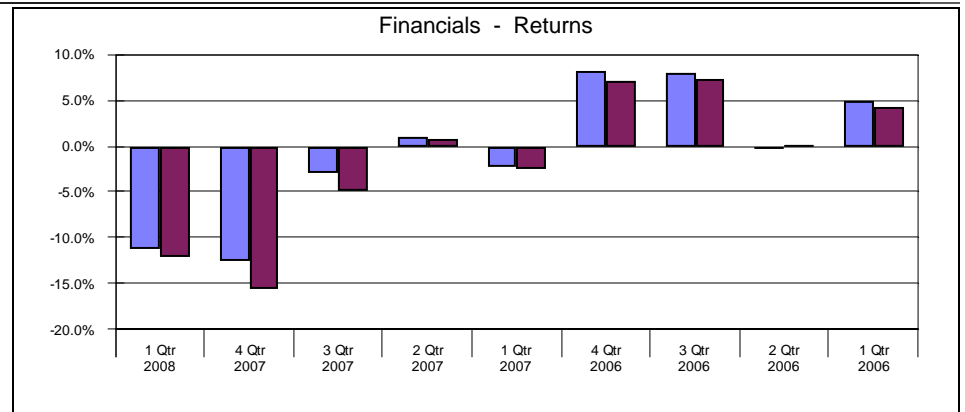
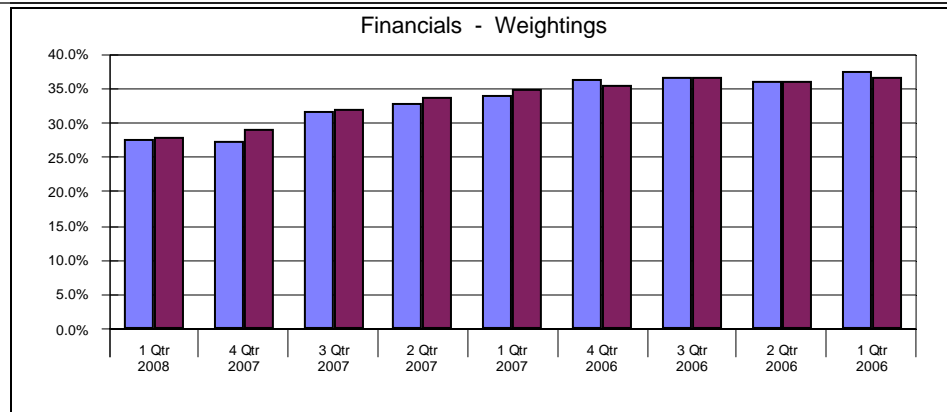

Wellington

Russell 1000 Value

# Fresno County Employees' Retirement Association

## Equity Only Sector Analysis Quarterly

Period Ending: March 31, 2008

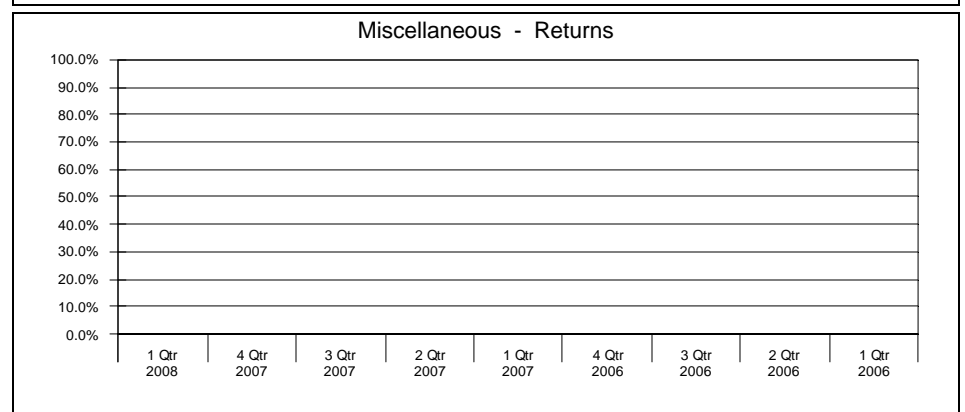
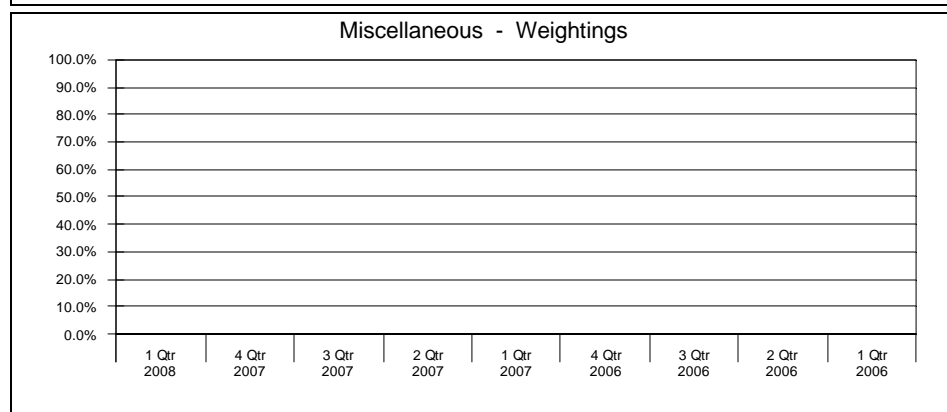
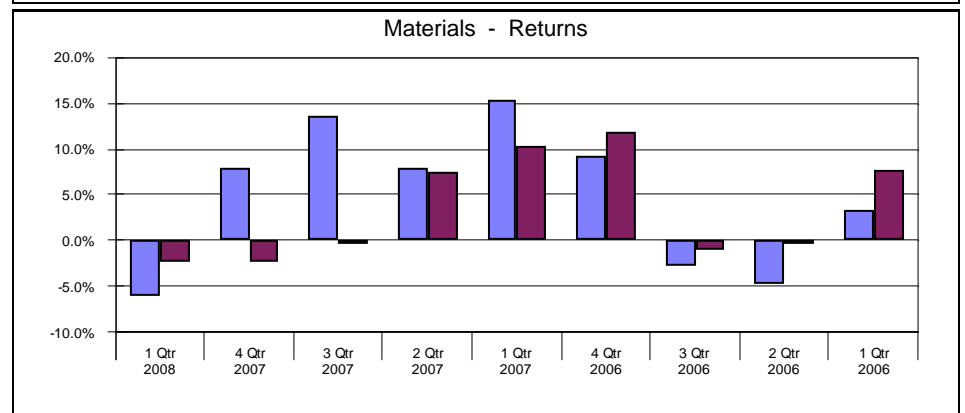
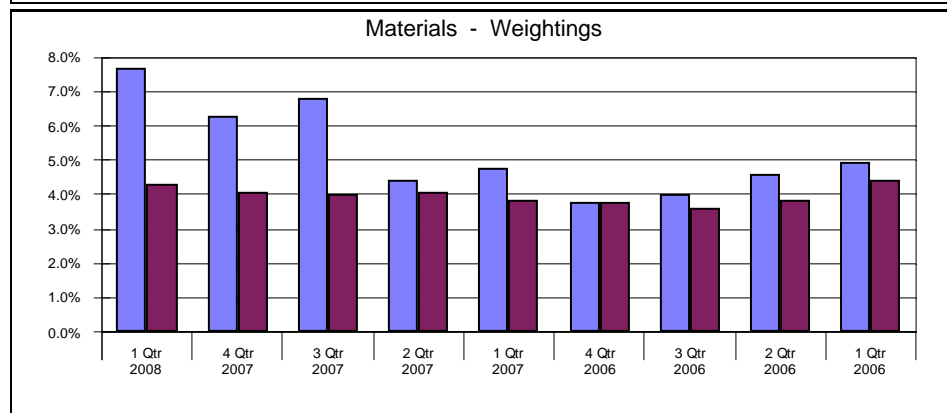
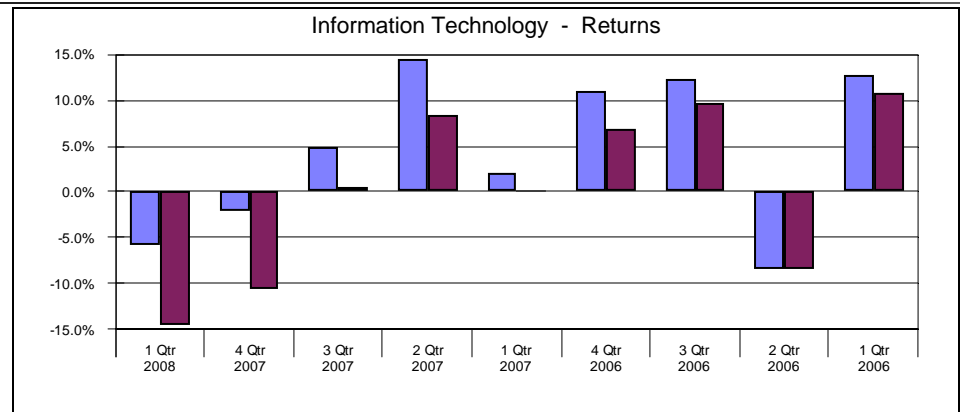
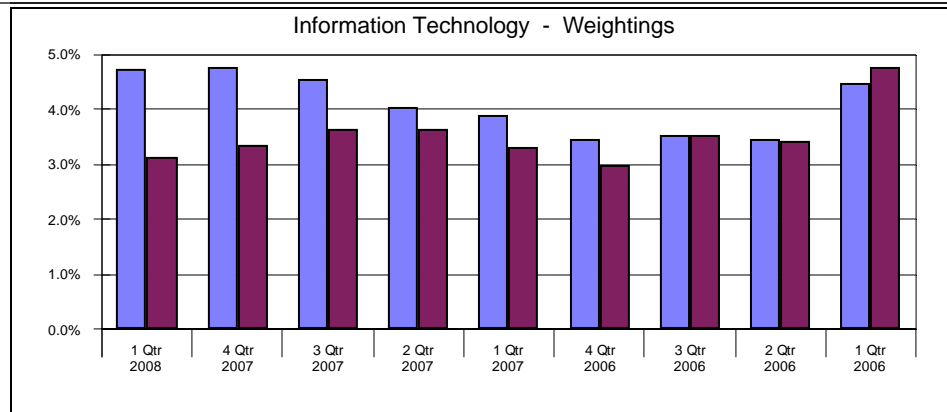

Wellington

Russell 1000 Value

# Fresno County Employees' Retirement Association

## Equity Only Sector Analysis Quarterly

Period Ending: March 31, 2008

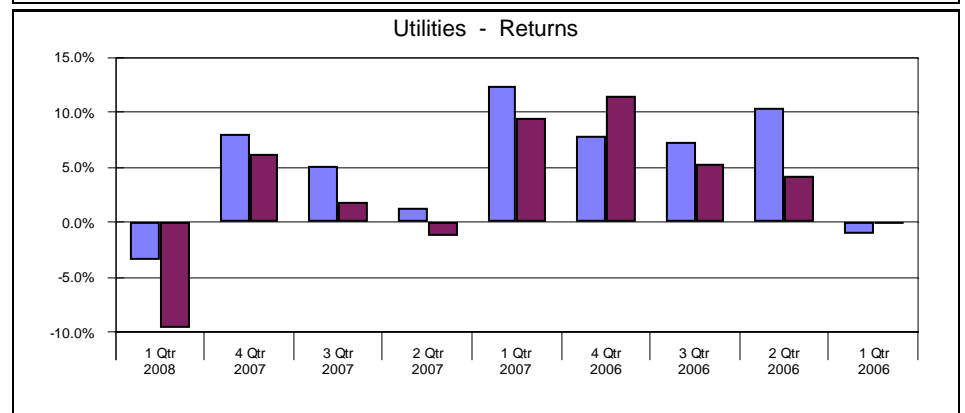
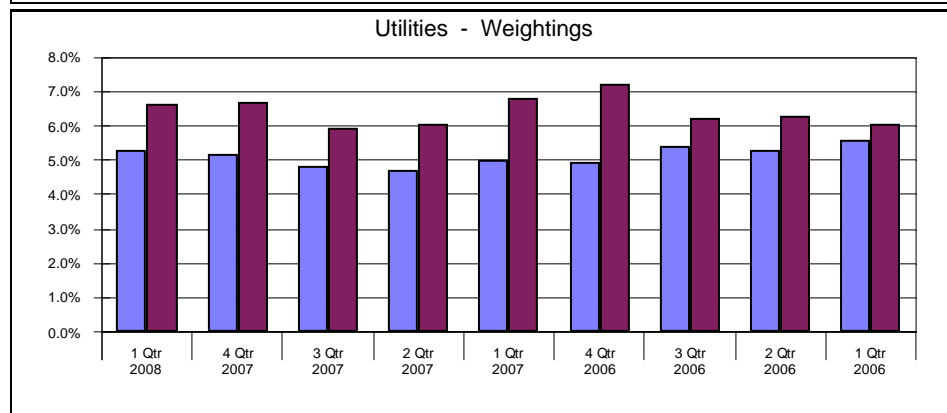
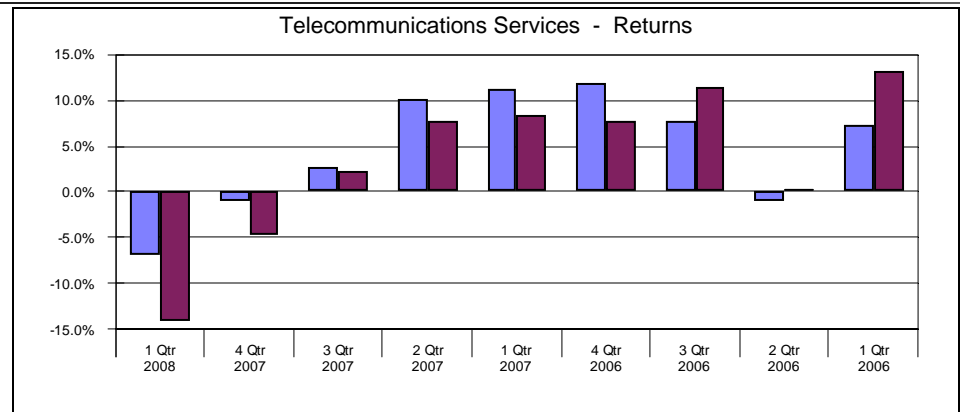
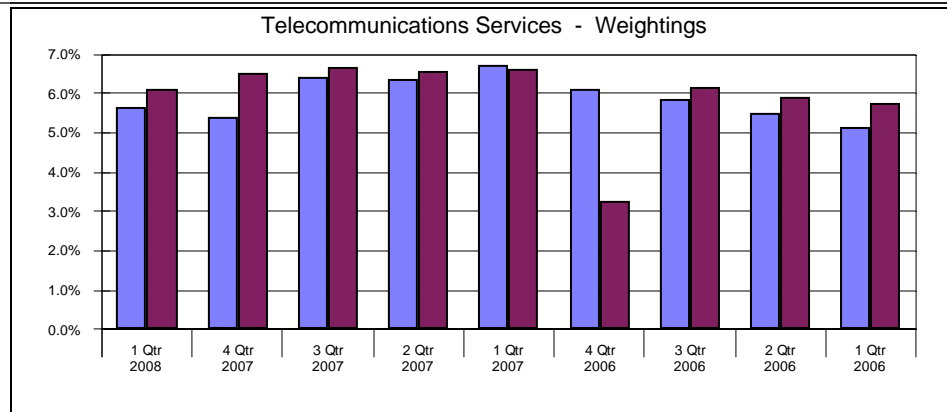

WELLINGTON

RUSSELL 1000 VALUE

# Fresno County Employees' Retirement Association

## Performance Attribution Geometric

Period Ending: March 31, 2008

### WELLINGTON

	Portfolio		RUSSELL 1000 VALUE		Selection		Total
	Market Value	Return	Market Value	Return	Stock	Industry	
	<b>A</b>	<b>B</b>	<b>C</b>	<b>D</b>	<b>E</b>	<b>F</b>	
Consumer Discretionary	9.2	-14.3	7.2	-8.4	-0.6	0.0	-0.6
Consumer Staples	8.3	-8.1	8.8	-3.9	-0.4	0.0	-0.4
Energy	14.7	-12.2	16.5	-6.7	-0.9	0.0	-0.9
Financials	29.0	-14.5	29.1	-12.2	-0.7	0.0	-0.7
Health Care	7.1	-28.7	7.3	-7.8	-1.6	0.0	-1.6
Industrials	6.9	-8.9	10.6	-2.6	-0.5	-0.2	-0.7
Information Technology	5.0	-7.7	3.3	-14.6	0.4	-0.1	0.3
Materials	6.7	-11.3	4.1	-2.4	-0.6	0.2	-0.5
Telecommunications Services	5.7	-6.9	6.5	-14.2	0.5	0.0	0.5
Utilities	5.5	-4.5	6.7	-9.7	0.3	0.0	0.3
Other	1.7	0.0	0.0	0.0	0.0	0.2	0.2
	100.0	-12.5	100.0	-8.7	-4.2	0.0	-4.2

#### Contribution

<b>Stock</b>	Telecommunications Services
	Information Technology
<b>Industry</b>	Materials
	Other

#### Detractors

<b>Stock</b>	Health Care
	Energy
<b>Industry</b>	Industrials
	Information Technology

# Fresno County Employees' Retirement Association

## Value Added Analysis 3 Yr Rolling for WELLINGTON

Period Ending: March 31, 2008

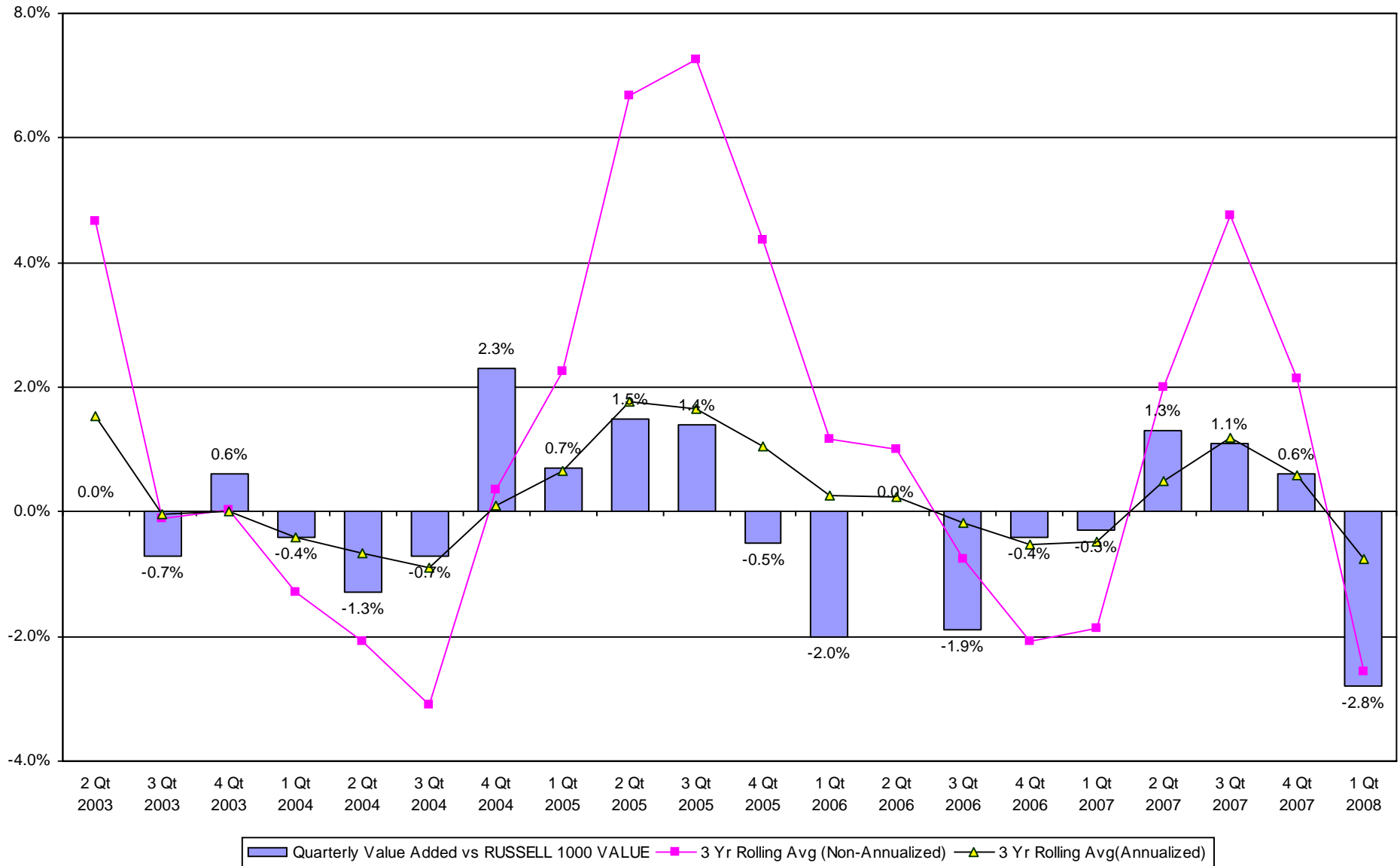

# Fresno County Employees' Retirement Association

## Rolling Return Ranking 3 & 5 Years

Period Ending: March 31, 2008

### Ranking Comparisons - Rolling 3 Years

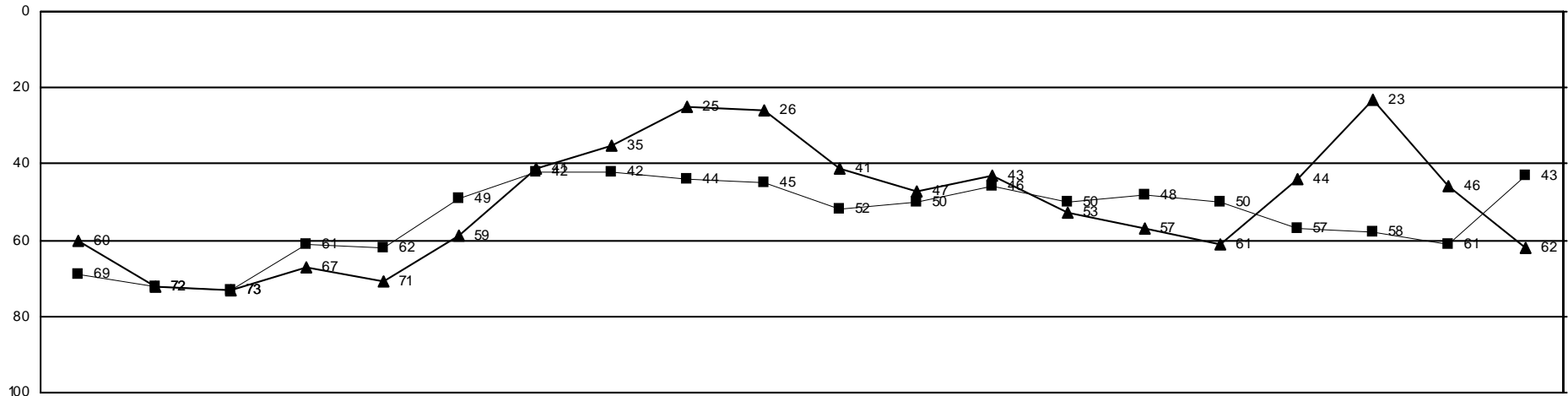

### Ranking Comparisons - Rolling 5 Years

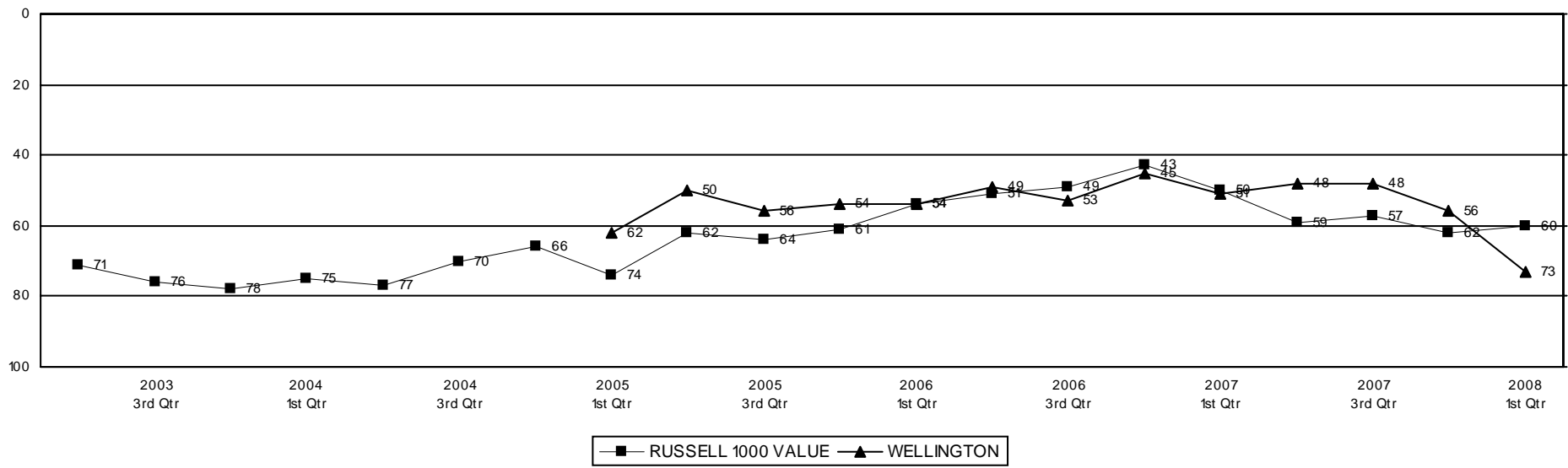



# Fresno County Employees' Retirement Association

## Up vs. Down Market Performance

Period Ending: March 31, 2008

Last 20 Quarters Ending 3/31/2008

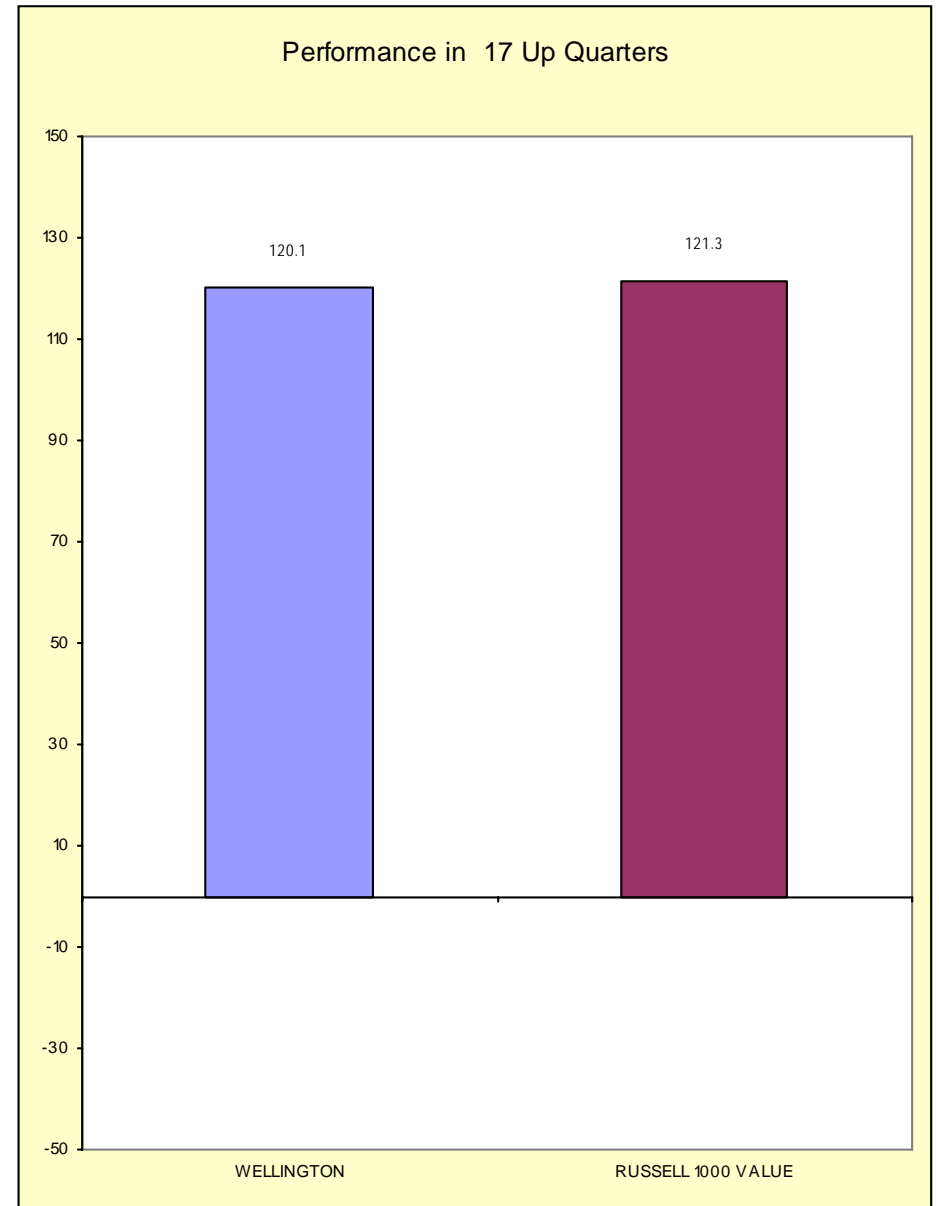
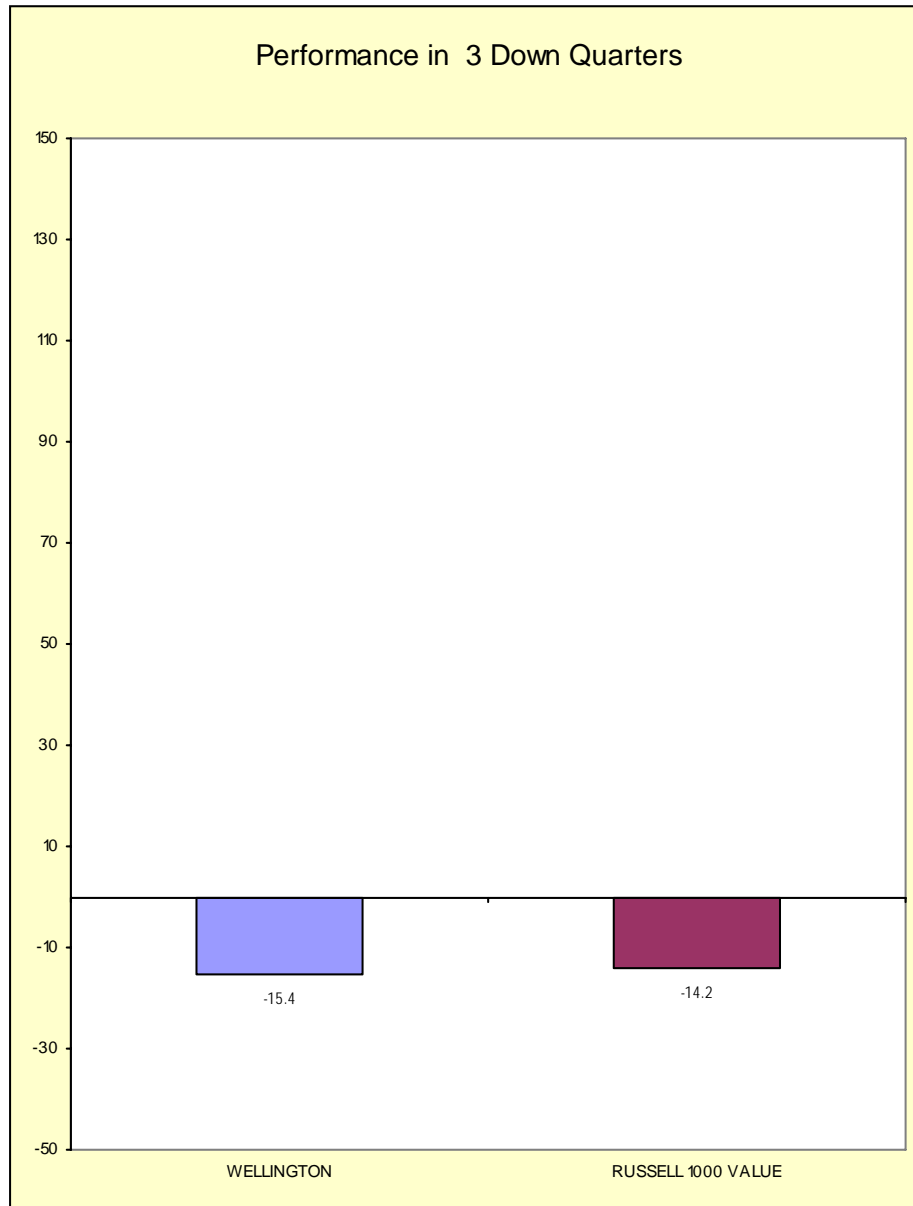

# Fresno County Employees' Retirement Association

## Portfolio Holdings And Characteristics - Equity

Period Ending: March 31, 2008

WELLINGTON	Shares	Price	Portfolio Weight	Market Cap	Dividend Yield	Price / Earnings	Price / Book	Beta	Quarterly Return
<b>Consumer Discretionary</b>									
ACCENTURE LTD BERMUDA SHS A	23,100	35.17	0.5	20.81	1.2	15.4	12.9	1.21	-2.4
CLEAR CHANNEL COMMUNICATIONS	40,800	29.22	0.7	14.55		18.7	1.7	0.89	-15.4
FORD MTR CO DEL COM PAR USD0.01	228,000	5.72	0.8	12.22			2.2	1.53	-15.0
GAP INC	75,800	19.68	0.9	14.47	1.7	18.7	3.1	1.02	-7.2
HONEYWELL INTL INC	24,100	56.42	0.8	42.13	2.0	17.9	4.6	1.23	-7.9
ROYAL CARIBBEAN CRUISES LTD SHS	18,300	32.90	0.4	7.02	1.8	11.7	1.0	1.78	-22.1
STAPLES INC	45,800	22.11	0.6	15.50	1.5	16.0	2.7	0.92	-2.8
VIACOM INC NEW CL B	101,950	39.62	2.4	23.12		16.4	3.6	0.84	-9.8
WAL MART STORES INC	29,600	52.68	0.9	210.97	1.8	16.8	3.5	0.37	11.4
NORTHWEST AIRLS CORP	96,800	8.99	0.5	2.10					-38.0
			<b>8.5</b>	<b>40.24</b>	<b>1.7</b>	<b>16.8</b>	<b>3.7</b>	<b>0.99</b>	<b>-9.29</b>
<b>Consumer Staples</b>									
PHILIP MORRIS INTL ORD SHR	118,400	50.58	3.6	106.64					
ALTRIA GROUP INC	118,400	22.20	1.6	46.80	4.2	15.6	8.2	1.03	-3.7
BUNGE LIMITED SHS	7,200	86.88	0.4	10.53	0.8	14.6	1.6	0.95	-25.3
MCKESSON CORP	23,700	52.37	0.7	15.12	0.5	16.7	2.5	0.69	-20.0
REYNOLDS AMERN INC	37,700	59.03	1.3	17.41	5.8	13.3	2.3	0.80	-9.3
UNILEVER N V NY SHS NEW	64,100	33.73	1.3	57.84	3.0	17.4	6.6	0.36	-7.5
			<b>8.9</b>	<b>63.94</b>	<b>3.5</b>	<b>15.5</b>	<b>5.1</b>	<b>0.76</b>	<b>-5.87</b>
<b>Energy</b>									
BAKER HUGHES INC	50,800	68.50	2.1	21.19	0.8	14.5	3.4	1.17	-15.4
CONOCOPHILLIPS	72,596	76.21	3.3	119.00	2.5	10.6	1.4	0.86	-13.2
EOG RESOURCES INC	20,000	120.00	1.4	29.64	0.4	27.5	4.2	0.74	34.6
EXXON MOBIL CORP	6,300	84.58	0.3	452.51	1.7	11.6	3.7	0.90	-9.3
HALLIBURTON CO	36,200	39.33	0.8	34.62	0.9	10.7	6.1	1.20	4.0
HESS CORP	73,200	88.18	3.8	28.27	0.5	15.4	2.9	0.94	-12.5
MARATHON OIL CORP	74,000	45.60	2.0	32.33	2.1	8.0	1.7	1.31	-24.7
OCCIDENTAL PETE CORP	54,000	73.17	2.4	60.19	1.4	12.1	2.8	0.95	-4.7
PRIDE INTERNATIONAL INC	33,800	34.95	0.7	5.84		14.2	1.7	1.11	3.1
QUESTAR CORP	14,000	56.56	0.5	9.77	0.9	19.6	3.8	0.70	4.8
SCHLUMBERGER LTD	10,800	87.00	0.6	104.20	1.0	20.7	7.0	1.26	-11.3
UGI CORP NEW	35,400	24.92	0.5	2.66	3.0	12.1	2.0	0.83	-7.9
			<b>18.4</b>	<b>56.16</b>	<b>1.3</b>	<b>14.0</b>	<b>2.9</b>	<b>1.00</b>	<b>-7.60</b>

# Fresno County Employees' Retirement Association

## Portfolio Holdings And Characteristics - Equity

Period Ending: March 31, 2008

WELLINGTON	Shares	Price	Portfolio Weight	Market Cap	Dividend Yield	Price / Earnings	Price / Book	Beta	Quarterly Return
<b>Financials</b>									
ACE LTD	15,500	55.06	0.5	18.16	2.0	7.2	1.1	1.28	-10.4
AFFILIATED MANAGERS GROUP INC	11,700	90.74	0.6	3.31		19.8	5.4	1.91	-22.8
ALLEGHANY CORP DEL	1,785	341.50	0.4	2.84		10.4	1.3	0.55	-13.4
ALLIED WORLD ASSURANCE COMPANY SHS	20,000	39.70	0.5	2.40	1.8		0.9		-20.5
ARCH CAP GROUP LTD SHS	16,500	68.67	0.7	5.04		6.1	1.2	0.95	-2.4
AXA SA SPONSORED ADR	56,700	36.11	1.2	74.41	3.9	10.4	1.4	2.35	-9.1
AXIS CAPITAL HOLDINGS LTD SHS	14,300	33.98	0.3	5.14	2.1	10.7	1.0	1.20	-12.3
BANK AMER CORP	252,800	37.91	5.7	168.40	6.8	11.5	1.2	0.48	-6.6
BANK MONTREAL QUE	28,300	44.81	0.8	22.38	6.3	11.1		1.00	-19.9
CAPITAL ONE FINL CORP	43,200	49.22	1.3	18.36	3.0	12.4	0.8	1.59	4.9
CITIGROUP INC	116,066	21.42	1.5	106.70	6.0	29.8	0.9	1.15	-26.4
COMERICA INC	15,400	35.08	0.3	5.28	7.5	8.0	1.0	0.95	-18.0
EVEREST REINSURANCE GROUP LTD SHS	11,500	89.53	0.6	5.63	2.1	6.8	1.0	1.21	-10.4
GENERAL GROWTH PPTYS INC	28,790	38.17	0.7	9.31	5.2	32.3	6.4	1.40	-5.9
GOLDMAN SACHS GROUP INC	11,000	165.39	1.1	65.48	0.8	7.8	1.6	1.60	-23.0
HOST HOTELS + RESORTS INC	53,600	15.92	0.5	8.33	5.0	15.8	1.6	1.19	-5.4
HUNTINGTON BANCSHARES INC	26,900	10.75	0.2	3.94	9.9	43.0	0.7	0.71	-25.5
ING GROEP N V SPONSORED ADR	62,600	37.37	1.4	83.88	5.0	5.5	1.6	1.87	-4.0
KIMCO RLTY CORP	52,300	39.17	1.2	9.90	4.1	29.5	3.0	1.04	7.6
LEHMAN BROTHERS HLDGS INC	25,700	37.64	0.6	19.97	1.8	6.2	0.9	1.62	-42.3
MBIA INC	25,650	12.22	0.2	2.89	11.1		0.4	1.67	-34.4
MGIC INVT CORP WIS	52,800	10.53	0.3	0.86	1.0		0.3	1.56	-53.0
NATIONAL FINL PARTNERS CORP	19,500	22.47	0.3	0.89	3.7	16.6	1.1	1.80	-50.3
NYMEX HLDGS INC	7,900	90.63	0.4	8.52	0.4	38.4	9.2		-32.1
POPULAR INC	107,472	11.66	0.7	3.27	5.5		1.0	1.06	10.0
REINSURANCE GROUP AMER INC	38,100	54.44	1.2	3.38	0.7	11.9	1.2	0.86	3.9
SOVEREIGN BANCORP INC	113,800	9.32	0.6	4.49			0.7	1.05	-18.3
STATE STREET CORPORATION	20,800	79.00	1.0	30.61	1.2	22.9	2.7	0.97	-2.4
UNUM GROUP	95,700	22.01	1.3	7.64	1.4	11.6	1.0	1.19	-7.2
WESTERN UN CO	82,800	21.27	1.0	15.94	0.2	19.2			-12.4
INVESCO LTD	30,700	24.36	0.4	10.35	1.8				-21.6
MF GLOBAL LTD COM STK USD1	58,800	9.91	0.3	1.19		10.4			-68.5
			<b>27.8</b>	<b>56.51</b>	<b>4.0</b>	<b>14.8</b>	<b>1.7</b>	<b>1.14</b>	<b>-11.23</b>

# Fresno County Employees' Retirement Association

## Portfolio Holdings And Characteristics - Equity

Period Ending: March 31, 2008

WELLINGTON	Shares	Price	Portfolio Weight	Market Cap	Dividend Yield	Price / Earnings	Price / Book	Beta	Quarterly Return
<b>Health Care</b>									
COVIDIEN LTD SHS	20,400	44.25	0.5	22.07	1.4		3.3		0.7
ASTRAZENECA PLC SPONSORED ADR	20,900	37.99	0.5	55.35	4.9	10.4	3.7	0.62	-8.2
BRISTOL MYERS SQUIBB CO	49,000	21.30	0.6	42.16	5.8	19.5	4.0	0.98	-18.7
FOREST LABS INC	8,800	40.01	0.2	12.46		22.7	4.2	0.84	9.8
LILLY ELI + CO	28,000	51.59	0.9	58.66	3.6	19.0	4.3	0.70	-2.5
MERCK + CO INC	37,300	37.95	0.8	82.17	4.0	25.5	4.5	0.70	-34.1
SCHERING PLOUGH CORP	116,600	14.41	1.0	23.36	1.8		3.0	0.98	-45.7
WELLPOINT INC	23,250	44.13	0.6	23.92		7.9	1.1	1.02	-49.7
WYETH	34,000	41.76	0.8	55.87	2.7	12.4	3.1	0.56	-4.8
			<b>6.0</b>	<b>45.29</b>	<b>3.3</b>	<b>16.8</b>	<b>3.4</b>	<b>0.80</b>	<b>-20.69</b>
<b>Industrials</b>									
ARKANSAS BEST CORP	15,500	31.86	0.3	0.80	1.9	14.1	1.3	0.64	46.0
C H ROBINSON WORLDWIDE INC	33,800	54.40	1.1	9.32	1.6	29.2	8.9	1.26	0.9
COMMSCOPE INC	40,500	34.83	0.8	2.34		12.5	1.8	1.49	-29.2
CON WAY INC	16,100	49.48	0.5	2.24	0.8	16.2	2.7	0.52	19.4
FEDEX CORP	3,200	92.67	0.2	28.73	0.4	14.6	2.3	0.78	4.0
LOCKHEED MARTIN CORP	20,300	99.30	1.2	40.53	1.7	14.0	4.1	0.44	-5.3
MANPOWER INC WIS	4,900	56.26	0.2	4.48	1.3	9.8	1.7	1.38	-1.1
OVERSEAS SHIPHOLDING GROUP INC	10,000	70.04	0.4	2.18	1.8	11.4	1.2	1.62	-5.5
ROLLS ROYCE GROUP PLC PLC ADR	20,700	40.36	0.5	14.70	1.7	12.3	2.8	1.99	-25.3
TSAKOS ENERGY NAVIGATION LTD SHS	19,316	30.76	0.4	1.17	5.9	7.9	1.6	1.26	-16.9
WILLIAMS COS INC	69,500	32.98	1.4	19.29	1.2	20.2	3.0	1.60	-7.6
			<b>6.9</b>	<b>14.96</b>	<b>1.7</b>	<b>16.9</b>	<b>3.7</b>	<b>1.20</b>	<b>-5.49</b>
<b>Information Technology</b>									
CORNING INC	53,500	24.04	0.8	37.85	0.8	17.9	4.0	1.52	0.4
FAIRCHILD SEMICONDUCTOR INTL	32,900	11.92	0.2	1.48		23.4	1.2	1.93	-17.4
HEWLETT PACKARD CO	23,900	45.66	0.6	112.57	0.7	15.6	3.1	1.32	-9.4
INTERNATIONAL BUSINESS MACHS	15,300	115.14	1.0	159.39	1.4	16.0	5.6	0.95	6.9
QUALCOMM INC	25,200	41.00	0.6	66.10	1.4	20.2	4.3	1.20	4.5
SIEMENS A G SPONSORED ADR	11,900	108.94	0.8	99.59	1.7	16.6	2.4	2.05	-29.8
XEROX CORP	76,600	14.97	0.7	13.74	1.1	12.6	1.6	1.15	-7.3
			<b>4.8</b>	<b>83.18</b>	<b>1.2</b>	<b>16.8</b>	<b>3.5</b>	<b>1.38</b>	<b>-5.82</b>

# Fresno County Employees' Retirement Association

## Portfolio Holdings And Characteristics - Equity

Period Ending: March 31, 2008

WELLINGTON	Shares	Price	Portfolio Weight	Market Cap	Dividend Yield	Price / Earnings	Price / Book	Beta	Quarterly Return
<b>Materials</b>									
AGRIUM INC	45,400	62.11	1.7	9.80	0.2	17.6		1.25	-14.0
AIR PRODS + CHEMS INC	20,200	92.00	1.1	19.73	1.9	19.1	3.6	0.77	-6.3
FMC CORP	23,300	55.49	0.8	4.17	0.8	27.5	3.9	1.47	1.9
FREEMPORT MCMORAN COPPER + GOLD COMMON	16,900	96.22	1.0	36.83	1.8	13.0	2.6	1.58	-5.6
MOSAIC CO	7,100	102.60	0.4	45.46		48.4	10.8	1.08	8.8
REXAM PLC SPONSERED ADR	44,100	42.35	1.1	5.44	4.6	15.4	2.0	0.78	-0.2
SMURFIT STONE CONTAINER CORP	163,700	7.70	0.8	1.97			1.1	1.44	-27.1
UNITED STS STL CORP NEW	11,800	126.87	0.9	14.95	0.8	17.1	2.7	2.32	5.2
			<b>7.7</b>	<b>15.27</b>	<b>1.6</b>	<b>19.8</b>	<b>3.3</b>	<b>1.31</b>	<b>-6.04</b>
<b>Telecommunications Services</b>									
AT+T INC	251,111	38.30	5.7	231.17	4.2	19.7	2.0	0.99	-6.9
			<b>5.7</b>	<b>231.17</b>	<b>4.2</b>	<b>19.7</b>	<b>2.0</b>	<b>0.99</b>	<b>-6.90</b>
<b>Utilities</b>									
AMERICAN ELEC PWR INC	17,400	41.63	0.4	16.67	3.9	14.6	1.7	0.84	-9.8
EXELON CORP	70,600	81.27	3.4	54.46	2.5	20.2	5.3	0.54	0.2
FPL GROUP INC	30,800	62.74	1.2	25.54	2.8	19.2	2.4	0.60	-6.8
NORTHEAST UTILS	24,000	24.54	0.4	3.80	3.3	15.4	1.3	0.77	-21.0
			<b>5.3</b>	<b>41.87</b>	<b>2.7</b>	<b>19.2</b>	<b>4.1</b>	<b>0.59</b>	<b>-3.51</b>
WELLINGTON			<b>100.0</b>	<b>59.50</b>	<b>2.7</b>	<b>16.2</b>	<b>2.9</b>	<b>1.05</b>	<b>-8.78</b>

# Fresno County Employees' Retirement Association

## Equity Activity

Period Ending: March 31, 2008

Start from Dec 31, 2007 WELLINGTON

Additions				Deletions			
Security Name	Shares	Market Value	New	Security Name	Shares	Market Value	Eliminated
AFFILIATED MANAGERS GROUP INC	5,200	545,425	*	ACE LTD	29,600	1,806,053	
ALTRIA GROUP INC	47,700	3,646,403	*	AGRIUM INC	21,100	1,500,278	
ARCH CAP GROUP LTD SHS	16,500	1,165,618	*	ALLEGHANY CORP DEL	800	301,616	
ARKANSAS BEST CORP	15,500	444,780	*	ALLIED WORLD ASSURANCE COMPANY SHS	400	19,996	
ASTRAZENECA PLC SPONSORED ADR	20,900	950,721	*	AMERICAN INTL GROUP INC	30,150	1,581,277	*
AXA SA SPONSORED ADR	40,300	1,396,529	*	BANK AMER CORP	1,500	60,899	
AXIS CAPITAL HOLDINGS LTD SHS	14,300	516,090	*	BANK MONTREAL QUE	4,100	223,916	
BAKER HUGHES INC	50,800	3,404,767	*	BEAR STEARNS COS INC	9,400	485,545	*
BANK MONTREAL QUE	7,200	389,514	*	BLACKROCK INC	5,200	1,070,572	*
BEAR STEARNS COS INC	9,400	752,467	*	CARLISLE COS INC	31,800	994,932	*
BUNGE LIMITED SHS	7,200	795,278	*	CF INDS HLDGS INC	6,300	750,041	*
C H ROBINSON WORLDWIDE INC	15,400	767,861	*	CITIGROUP INC	52,600	1,352,384	
CAPITAL ONE FINL CORP	9,900	471,044	*	CLEAR CHANNEL COMMUNICATIONS	7,000	241,829	
CF INDS HLDGS INC	6,300	747,896	*	COMMSCOPE INC	4,800	192,598	
CH ROBINSON WORLDWIDE	2,500	135,684		COUNTRYWIDE FINL CORP	72,400	459,204	*
CLEAR CHANNEL COMMUNICATIONS	47,800	1,504,200	*	E*TRADE GROUP, INCORPORATED	56,800	197,780	*
COMERICA INC	6,700	240,735	*	EQUIFAX INC	12,500	426,952	*
COMMSCOPE	1,100	53,444		EXXON MOBIL CORP	90,000	7,579,376	
COMMSCOPE INC	25,100	1,047,052	*	FEDEX CORP	2,800	235,688	
CON WAY INC	16,100	774,460	*	FEDEX CORPORATION	1,400	127,826	*
COVIDIEN LTD SHS	20,400	907,533	*	GAP INC	26,000	502,879	
EOG RESOURCES INC	20,000	1,808,244	*	GENERAL GROWTH PPTYS INC	4,800	191,752	
EVEREST REINSURANCE GROUP LTD SHS	11,500	1,178,548	*	GOLDMAN SACHS GROUP INC	900	179,485	
EXXON MOBIL CORP	22,600	2,026,018	*	LANDSTAR SYS INC	23,900	1,122,412	*
FMC CORP	23,300	1,264,339	*	LINCOLN NATL CORP IN	17,000	883,870	*
GOLDMAN SACHS GROUP INC	3,000	473,298	*	MARRIOTT INTL INC NEW	18,600	606,468	*
HOST HOTELS + RESORTS INC	11,200	191,509	*	MBIA INC	17,500	233,475	
HUNTINGTON BANCSHARES INC	26,900	330,500	*	MCKESSON CORP	3,400	181,666	
INVESCO LTD	3,400	87,516	*	N/A		1,538,579	*
LEHMAN BROTHERS HLDGS INC	25,700	989,460	*	NATIONAL CITY CORP	1,700	26,362	*
MANPOWER INC WIS	4,900	284,138	*	NATIONAL FINL PARTNERS CORP	900	22,539	
MARATHON OIL CORP	74,000	3,448,892	*	NII HOLDINGS INCORPORATED-CLASS B	800	38,374	*

# Fresno County Employees' Retirement Association

## Equity Activity

Period Ending: March 31, 2008

MCKESSON CORP	12,400	698,689	*	PG&E CORPORATION	6,200	270,741	*
MF GLOBAL LTD	7,100	221,255		PG+E CORP	12,800	558,292	*
MGIC INVT CORP WIS	33,000	371,250	*	PITNEY BOWES INC	11,400	420,255	*
MOSAIC CO	7,100	778,419	*	PNC FINL SVCS GROUP INC	8,100	478,446	*
N/A		4,440,587	*	RH DONNELLEY CORP	27,100	192,401	*
NYMEX HLDGS INC	7,900	784,804	*	ROBERT HALF INTL INC	11,200	292,361	*
POPULAR INC	13,372	125,024	*	SANOFI AVENTIS SPONSORED ADR	19,400	888,655	*
ROYAL CARIBBEAN CRUISES LTD SHS	18,300	718,176	*	SPDR TRUST UNIT SER1 STANDRD+POORS DEPOS	43,800	5,980,668	*
SCHLUMBERGER LTD	10,800	812,477	*	STAPLES INC	15,700	334,224	
SOVEREIGN BANCORP INC	66,400	700,880	*	STATE STREET CORPORATION	5,500	429,716	
STANDARD & POOR'S DEPOSITORY RECEIPT TRU	13,000	1,912,902		SUPERVALU INC	34,500	1,072,900	*
STAPLES INC	1,700	37,631	*	SYSCO CORP	81,300	2,291,739	*
UNITED STS STL CORP NEW	11,800	1,288,720	*	TEEKAY CORPORATION SHS	29,900	1,235,081	*
UNUM GROUP	37,100	849,059	*	TIME WARNER INC NEW	89,500	1,416,179	*
VIACOM INC NEW CL B	1,700	71,758	*	UBS AG SHS NEW	13,590	436,753	*
WAL MART STORES INC	11,900	564,156	*	VALERO ENERGY CORP	65,000	3,828,929	*
WASHINGTON MUT INC	15,400	169,192	*	WASHINGTON MUT INC	15,400	269,380	*
WELLPOINT INC	10,500	497,847	*	WELLPOINT INC	8,600	538,515	
WESTERN UN CO	36,400	784,989	*	XL CAPITAL LTD SHS A	4,600	205,443	*
XL CAPITAL LTD SHS A	9,000	454,885	*				

# Fresno County Employees' Retirement Association

## Cumulative Performance Comparisons

Period Ending: March 31, 2008

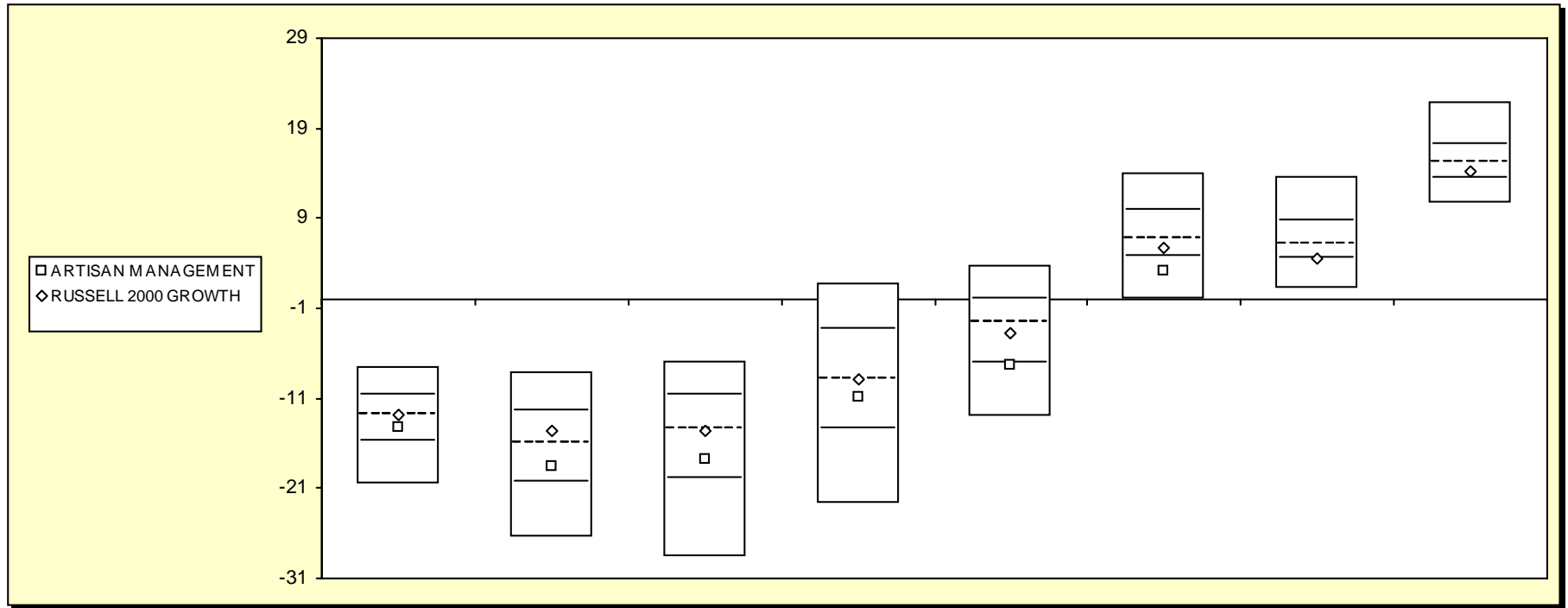

### Equity Style - Small Growth

5th Percentile	
25th Percentile	
50th Percentile	---
75th Percentile	
95th Percentile	

	Last Quarter		Two Quarters		Three Quarters		One Year		Two Years		Three Years		Four Years		Five Years	
	Return	Rank	Return	Rank	Return	Rank	Return	Rank	Return	Rank	Return	Rank	Return	Rank	Return	Rank
5th Percentile	-7.5		-8.1		-6.8		1.7		3.7		14.0		13.5		22.0	
25th Percentile	-10.7		-12.4		-10.7		-3.4		0.0		9.8		8.8		17.3	
50th Percentile	-12.8		-16.1		-14.3		-8.8		-2.6		6.6		6.0		15.3	
75th Percentile	-15.8		-20.4		-19.9		-14.4		-7.2		4.7		4.5		13.4	
95th Percentile	-20.6		-26.4		-28.6		-22.8		-13.0		-0.1		1.1		10.6	
ARTISAN MANAGEMENT	-14.1	61	-18.6	65	-17.8	66	-10.9	59	-7.4	76	3.2	81				
RUSSELL 2000 GROWTH	-12.8	50	-14.7	41	-14.6	51	-8.9	50	-3.8	57	5.7	61	4.5	75	14.2	64



# Fresno County Employees' Retirement Association

## Consecutive Performance Comparisons

Period Ending: March 31, 2008

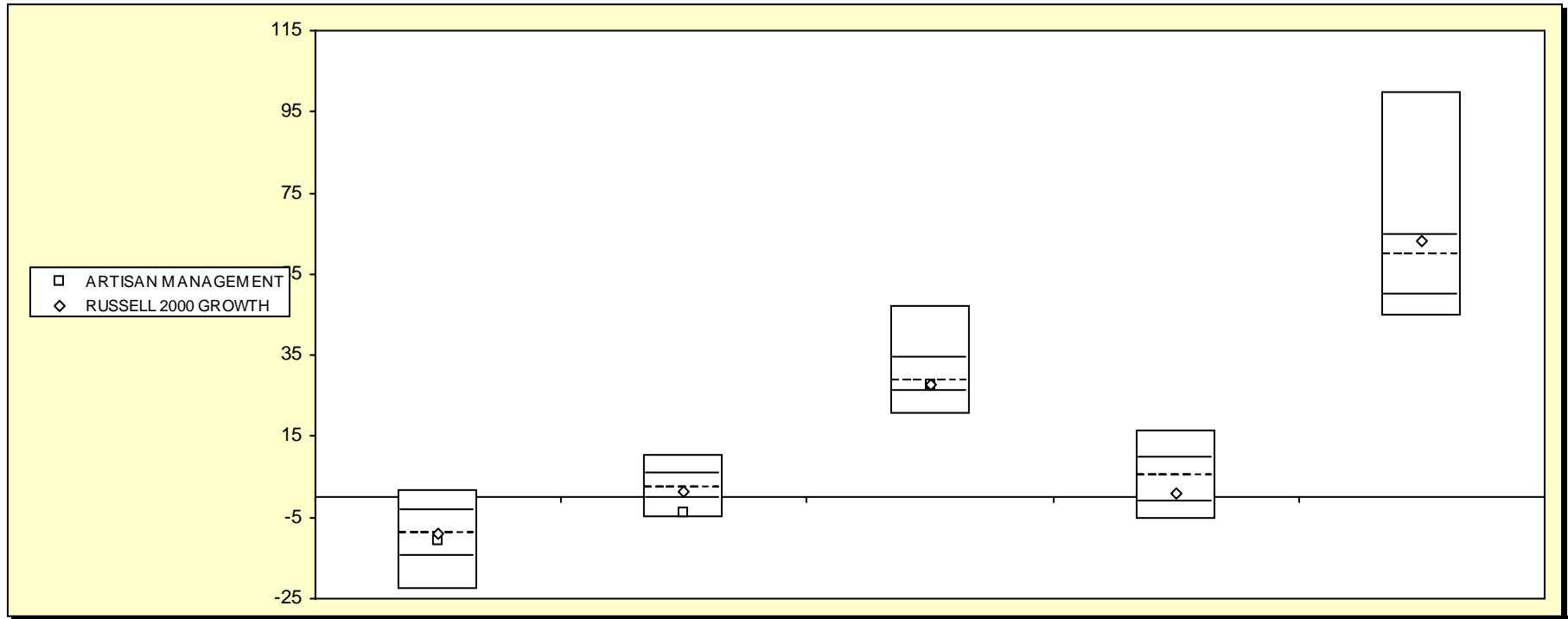

### Equity Style - Small Growth

	March 2008		March 2007		March 2006		March 2005		March 2004	
	Return	Rank	Return	Rank	Return	Rank	Return	Rank	Return	Rank
5th Percentile	1.7		10.4		47.2		16.3		99.7	
25th Percentile	-3.4		5.6		34.1		9.4		64.6	
50th Percentile	-8.8		2.1		28.7		5.2		59.6	
75th Percentile	-14.4		-0.2		25.8		-1.1		49.9	
95th Percentile	-22.8		-5.2		20.3		-5.5		44.4	
ARTISAN MANAGEMENT	-10.9	59	-3.7	89	27.9	57				
RUSSELL 2000 GROWTH	-8.9	50	1.6	56	27.8	57	0.9	67	63.2	32

# Fresno County Employees' Retirement Association

Consecutive Annual - Five Year

Period Ending: March 31, 2008

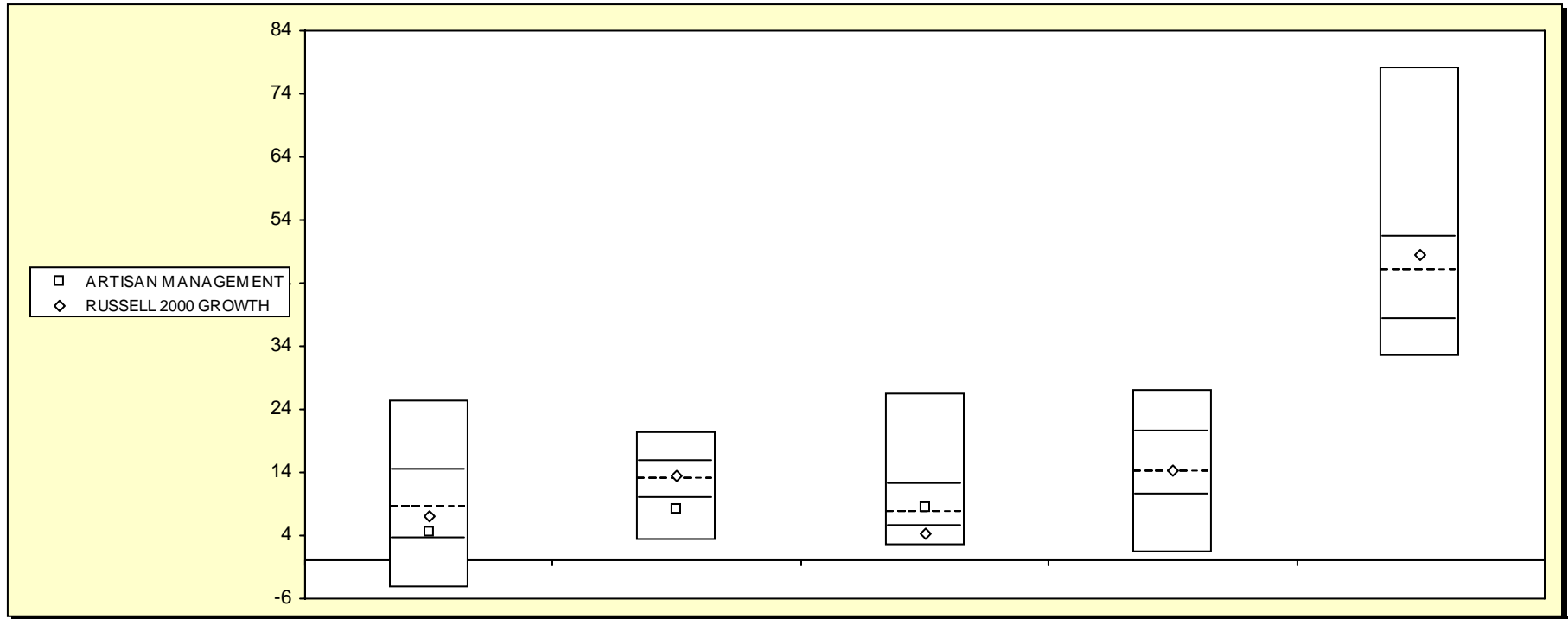

Equity Style - Small Growth

	December 2007		December 2006		December 2005		December 2004		December 2003	
	Return	Rank	Return	Rank	Return	Rank	Return	Rank	Return	Rank
5th Percentile	25.5		20.4		26.4		27.0		78.1	
25th Percentile	14.2		15.7		12.1		20.3		51.3	
50th Percentile	8.5		13.0		7.6		14.0		46.1	
75th Percentile	3.3		9.8		5.5		10.4		38.3	
95th Percentile	-4.5		3.1		2.4		1.2		32.4	
ARTISAN MANAGEMENT	4.6	69	8.0	80	8.4	46				
RUSSELL 2000 GROWTH	7.0	57	13.4	46	4.1	84	14.3	49	48.5	38

# Fresno County Employees' Retirement Association

## Performance Review Summary

Period Ending: March 31, 2008

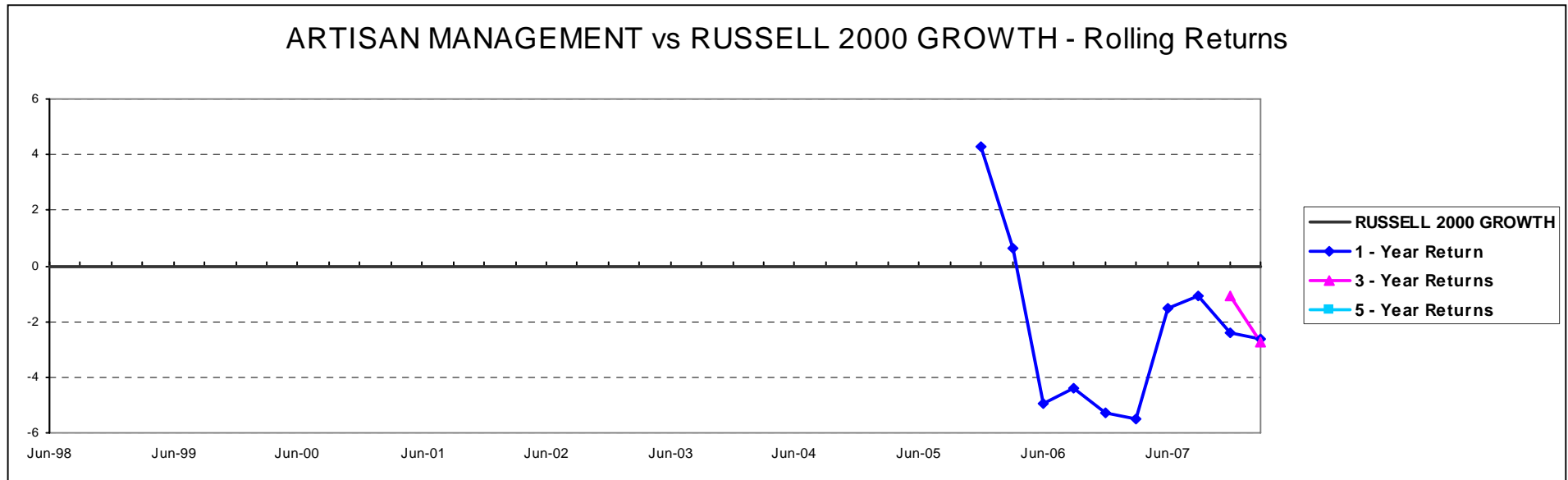

### Performance & Risk Measures

	Quarter		One Year		Three Years		Five Years		Standard Deviation		Sharpe Ratio		Beta	
	Return	Rank	Return	Rank	Return	Rank	Return	Rank	3-Years	5-Years	3-Years	5-Years	3-Years	5-Years
ARTISAN MANAGEMENT	-14.8	67	-11.5	62	3.0	82			16.0		-0.1			1.1
RUSSELL 2000 GROWTH	-12.8	50	-8.9	50	5.7	61	14.2	64	14.5	17.9	0.1	0.6		
Equity Style - Small Growth	-12.8		-8.8		6.6		15.3		14.9	17.0	0.1	0.7		

### Ten Largest Holdings

Security	Market Value	Weight
PSYCHIATRIC SOLUTIONS INC	1,299,136	2.35
GEO GROUP INC	1,254,204	2.27
TESSERA TECHNOLOGIES INC	1,208,480	2.19
HERCULES OFFSHORE INC	1,205,760	2.18
WASTE CONNECTIONS INC	1,203,471	2.18
ITC HLDGS CORP	1,181,762	2.14
ACTUANT CORP	1,157,043	2.09
AAR CORP	1,134,432	2.05
MIDDLEBY CORP	1,116,781	2.02
K V PHARMACEUTICAL COMPANY	1,105,728	2.00

### Sector Weights

Sector	Portfolio	Benchmark
Materials		4.6
Industrials	21.7	19.3
Telecommunications Services		1.0
Consumer Discretionary	20.7	13.1
Consumer Staples	3.5	2.5
Energy	7.6	7.9
Financials	5.9	8.6
Health Care	18.4	20.7
Information Technology	20.2	21.4
Utilities	2.1	0.6

### Portfolio Characteristics

	Portfolio	Benchmark
Average Market Cap	\$ 1,146	\$ 1,510
Median Market Cap	\$ 943	\$ 520
P/E	20.5	18.4
P/B	3.1	4.1
Dividend Yield	0.4	0.7
Earnings Growth	28.5	32.3

**Benchmark:** RUSSELL 2000 GROWTH

**Total Assets**                      **% of Total Fund**

\$ 57,632

# Fresno County Employees' Retirement Association

## Equity Only Summary Statistics

Period Ending: March 31, 2008

### ARTISAN MANAGEMENT

	Portfolio	RUSSELL 2000 GROWTH
Total Number of Securities	67	1249
Total Market Value	55,256,767	
Average Market Capitalization (000's)	1,145,941	1,510,000
Equity Segment Yield	2.48	0.65
Equity Segment Price/Earnings Ratio	21.98	18.38
Equity Segment Beta	1.30	1.46
Price/Book Ratio	3.17	4.14
5 Year Earnings Growth	28.5%	32.3%

#### Ten Largest Holdings

Security	Market Value	Weight
PSYCHIATRIC SOLUTIONS INC	1,299,136	2.35
GEO GROUP INC	1,254,204	2.27
TESSERA TECHNOLOGIES INC	1,208,480	2.19
HERCULES OFFSHORE INC	1,205,760	2.18
WASTE CONNECTIONS INC	1,203,471	2.18
ITC HLDGS CORP	1,181,762	2.14
ACTUANT CORP	1,157,043	2.09
AAR CORP	1,134,432	2.05
MIDDLEBY CORP	1,116,781	2.02
K V PHARMACEUTICAL COMPANY	1,105,728	2.00

#### Ten Best Performers

Security	Return	Weight
OLD DOMINION FREIGHT LINE INC	37.7	1.91
W H ENERGY SVCS INC	22.5	1.15
CARRIZO OIL + GAS INC	8.3	0.88
LKQ CORP	6.9	0.97
WINTRUST FINL CORP	6.0	1.33
HERCULES OFFSHORE INC	5.6	2.18
ICON PUB LTD CO SPONSORED ADR	4.9	1.94
PSYCHIATRIC SOLUTIONS INC	4.4	2.35
ASTEC INDS INC	4.2	1.05
MICROSEMI CORP	3.0	1.89

#### Ten Worst Performers

Security	Return	Weight
ARUBA NETWORKS INC	-65.1	0.71
OBAGI MEDICAL PRODUCTS INC	-52.7	0.74
NATIONAL FINL PARTNERS CORP	-50.3	1.92
TESSERA TECHNOLOGIES INC	-50.0	2.19
COMMVAULT SYS INC	-41.5	1.54
VCA ANTECH INC	-38.2	1.34
LIFE TIME FITNESS INC	-37.2	1.70
EURONET WORLDWIDE INC	-35.8	1.50
EQUINIX INC	-34.2	0.28
CRA INTL INC	-32.5	1.36

# Fresno County Employees' Retirement Association

## Portfolio Characteristics - Equity

Period Ending: March 31, 2008

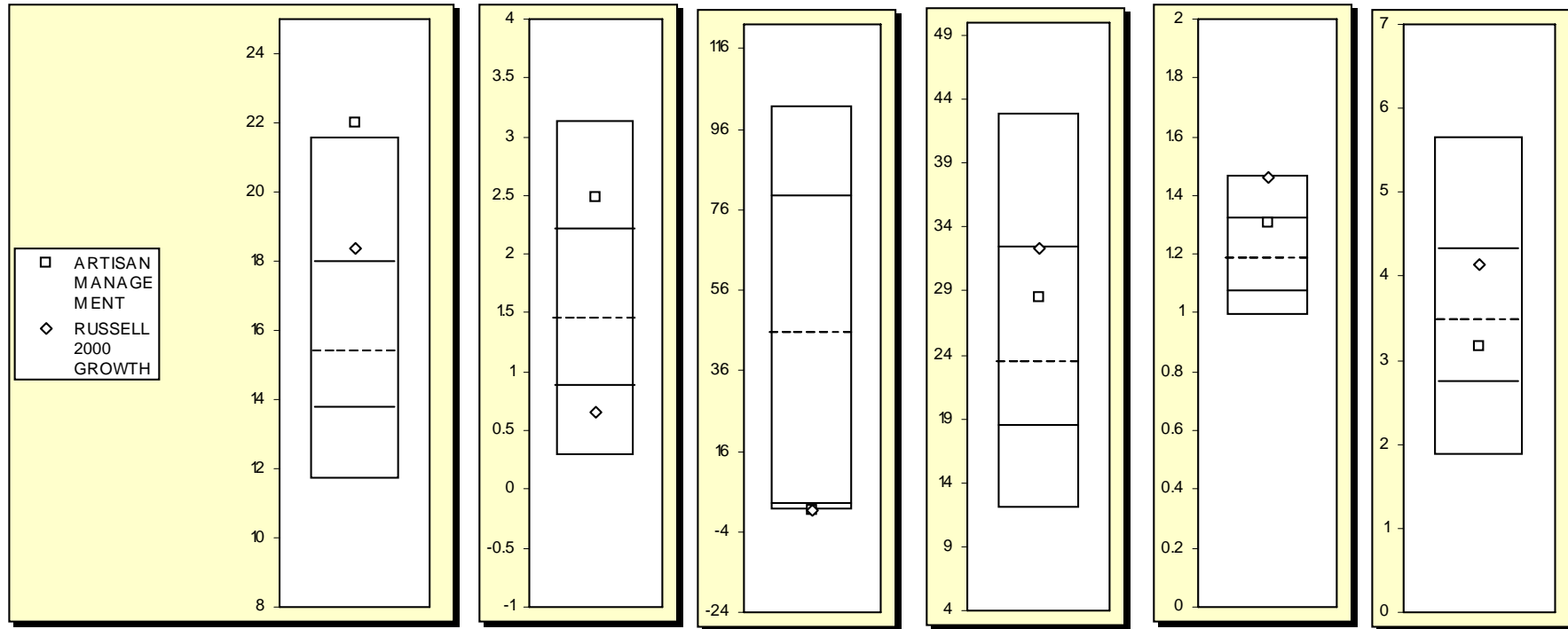

	Price/Earnings Ratio		Dividend Yield		Capitalization		5 Year Earnings		Beta		Price/Book Ratio	
	Value	Rank	Value	Rank	Value	Rank	Value	Rank	Value	Rank	Value	Rank
<i>Equity Funds - Equity Only</i>												
5th Percentile	21.57		3.13		101.51		42.95		1.47		5.66	
25th Percentile	17.93		2.20		78.86		32.34		1.32		4.32	
50th Percentile	15.38		1.45		45.26		23.34		1.18		3.47	
75th Percentile	13.75		0.88		2.83		18.43		1.07		2.72	
95th Percentile	11.66		0.28		1.13		11.93		0.99		1.86	
ARTISAN MANAGEMENT	21.98	4	2.48	19	1.15	95	28.47	36	1.30	29	3.17	60
RUSSELL 2000 GROWTH	18.38	23	0.65	83	1.51	91	32.28	25	1.46	6	4.14	30

# Fresno County Employees' Retirement Association

## Top Ten Holding

Period Ending: March 31, 2008

As Of 6/30/06	
ESCO TECHNOLOGIES INCORPORATED	1.9%
AVOCENT CORPORATION	1.9%
INTERLINE BRANDS INCORPORATED	1.9%
BRIGHT HORIZONS FAMILY SERVICES	1.9%
HEALTHEXTRAS INCORPORATED	1.8%
OPEN SOLUTIONS INC	1.7%
CENTRAL GARDEN & PET COMPANY	1.7%
PACER INTERNATIONAL	1.7%
SIERRA HEALTH SERVICES	1.7%
DSP GROUP	1.7%
<b>Top Ten Total:</b>	<b>17.9%</b>

As Of 9/30/06	
AVOCENT CORPORATION	2.2%
INTERLINE BRANDS INCORPORATED	2.1%
ESCO TECHNOLOGIES INCORPORATED	2.0%
CARTER'S INC	1.9%
HEALTHEXTRAS INCORPORATED	1.8%
GUITAR CENTER INCORPORATED	1.8%
OPEN SOLUTIONS INC	1.8%
BRIGHT HORIZONS FAMILY SERVICES	1.8%
PACER INTERNATIONAL	1.7%
KEYSTONE AUTOMOTIVE INDS	1.7%
<b>Top Ten Total:</b>	<b>18.8%</b>

As Of 12/31/06	
AVOCENT CORPORATION	2.2%
W-H ENERGY SERVICES INC	2.0%
HEALTHEXTRAS INCORPORATED	2.0%
ESCO TECHNOLOGIES INCORPORATED	1.9%
EURONET WORLDWIDE INC.	1.9%
PACER INTERNATIONAL	1.9%
ADAMS RESPIRATORY THERA INC	1.9%
DSP GROUP	1.9%
INTERLINE BRANDS INCORPORATED	1.8%
SIERRA HEALTH SERVICES	1.8%
<b>Top Ten Total:</b>	<b>19.3%</b>

As Of 3/31/07	
GLOBAL CASH ACCESS INC	2.0%
W-H ENERGY SERVICES INC	1.9%
HEALTHEXTRAS INCORPORATED	1.8%
OPTIONSXPRESS HOLDINGS	1.8%
KV PHARMACEUTICAL	1.8%
AVOCENT CORPORATION	1.8%
TRANSACTION SYSTEMS ARCHITECTS	1.8%
EURONET WORLDWIDE INC.	1.8%
MICROSEMI CORPORATION	1.8%
NATIONAL FINANCIAL PARTNERS	1.7%
<b>Top Ten Total:</b>	<b>18.2%</b>

As Of 6/30/07	
KV PHARMACEUTICAL	1.9%
AVOCENT CORPORATION	1.9%
EURONET WORLDWIDE INC.	1.9%
ADVISORY BOARD CO/THE	1.8%
OPTIONSXPRESS HOLDINGS	1.8%
HEALTHEXTRAS INCORPORATED	1.8%
GLOBAL CASH ACCESS INC	1.8%
TRANSACTION SYSTEMS ARCHITECTS	1.8%
INTERLINE BRANDS INCORPORATED	1.8%
NATIONAL FINANCIAL PARTNERS	1.8%
<b>Top Ten Total:</b>	<b>18.2%</b>

As Of 9/30/07	
KV PHARMACEUTICAL	2.0%
ICONIX BRAND GROUP INC	1.9%
ICON PLC-SPONSORED ADR	1.8%
ADVISORY BOARD CO/THE	1.8%
NATIONAL FINANCIAL PARTNERS	1.8%
EURONET WORLDWIDE INC.	1.8%
AVOCENT CORPORATION	1.8%
THE GEO GROUP INC	1.8%
BRIGHT HORIZONS FAMILY SERVICES	1.7%
HEALTHEXTRAS INCORPORATED	1.7%
<b>Top Ten Total:</b>	<b>18.2%</b>

As Of 12/31/07	
KV PHARMACEUTICAL	2.0%
ICON PLC-SPONSORED ADR	1.9%
MIDDLEBY CORPORATION	1.9%
ADVISORY BOARD CO/THE	1.9%
NATIONAL FINANCIAL PARTNERS	1.9%
WASTE CONNECTIONS, INC.	1.8%
UNITED NATURAL FOODS INC	1.8%
OLD DOMINION FREIGHT LINES	1.8%
HERCULES OFFSHORE INC	1.8%
THE GEO GROUP INC	1.8%
<b>Top Ten Total:</b>	<b>18.6%</b>

As Of 3/31/08	
PSYCHIATRIC SOLUTIONS INC	2.4%
GEO GROUP INC	2.3%
TESSERA TECHNOLOGIES INC	2.2%
HERCULES OFFSHORE INC	2.2%
WASTE CONNECTIONS INC	2.2%
ITC HLDGS CORP	2.1%
ACTUANT CORP	2.1%
AAR CORP	2.1%
MIDDLEBY CORP	2.0%
K V PHARMACEUTICAL COMPANY	2.0%
<b>Top Ten Total:</b>	<b>21.5%</b>

# Fresno County Employees' Retirement Association

## Equity Only Summary Statistics Charts

Period Ending: March 31, 2008

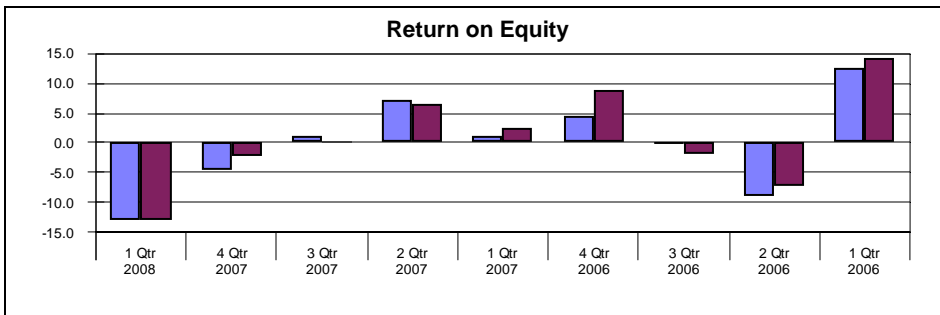
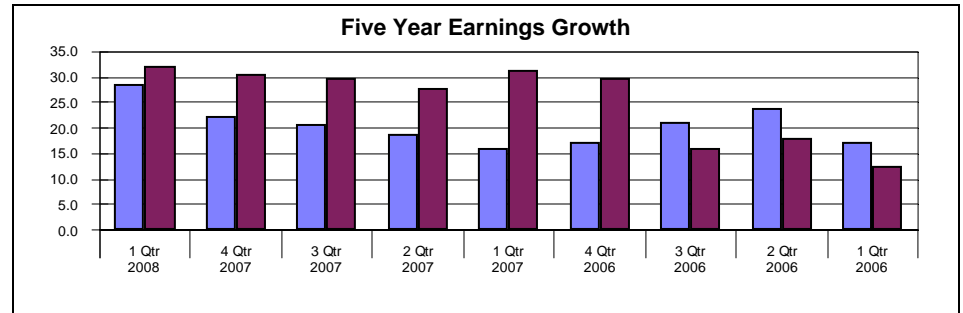
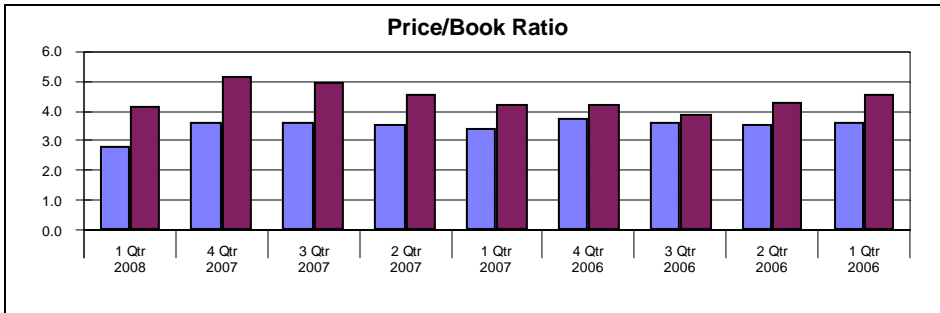
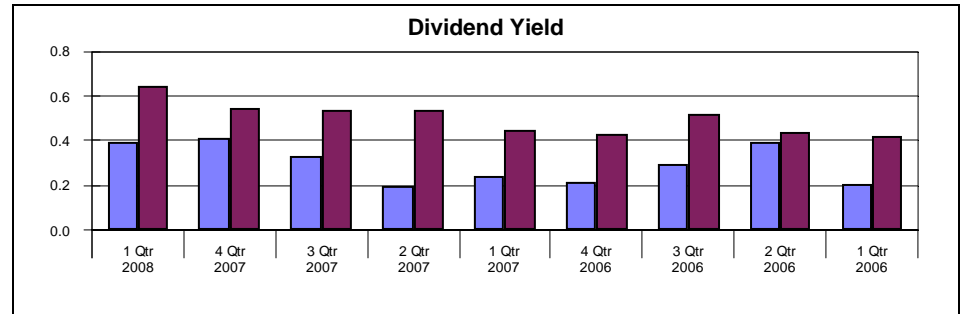
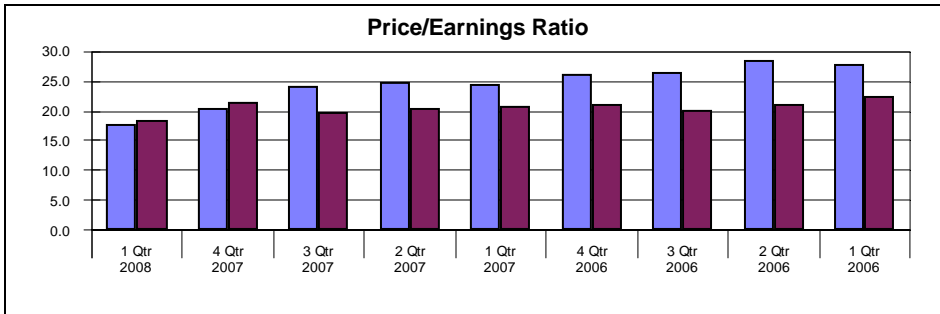
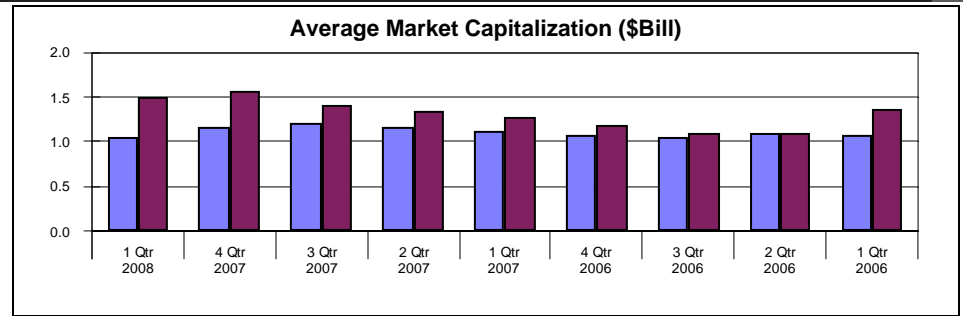
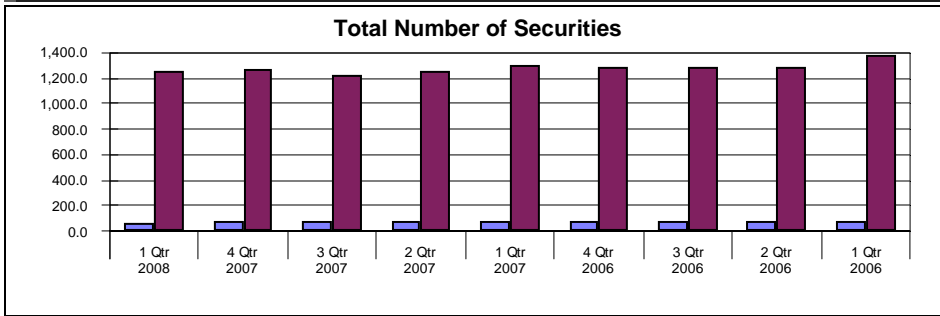

ARTISAN MANAGEMENT  
 RUSSELL 2000 GROWTH

# Fresno County Employees' Retirement Association

## Equity Only Sector Analysis Quarterlyly

Period Ending: March 31, 2008

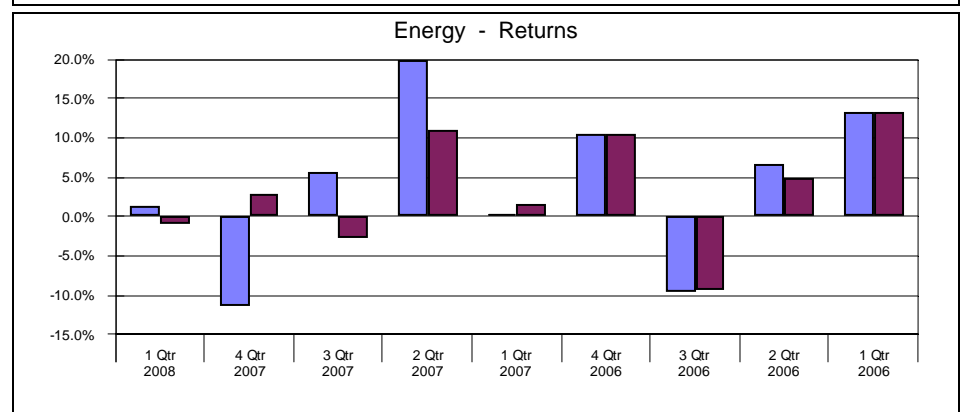
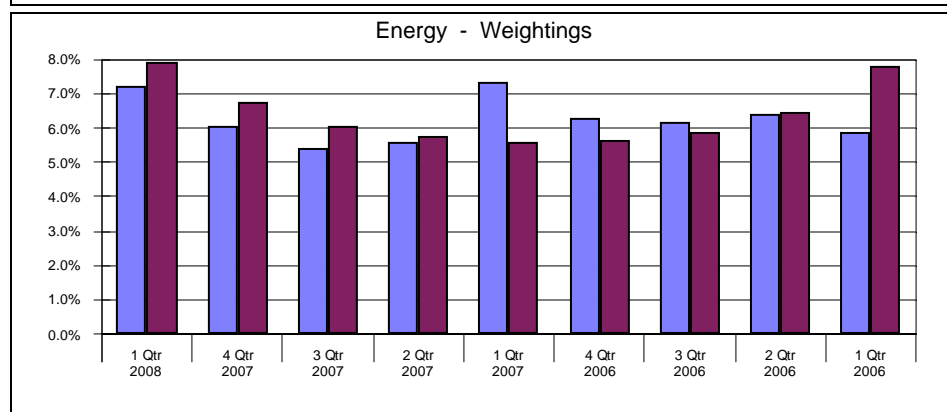
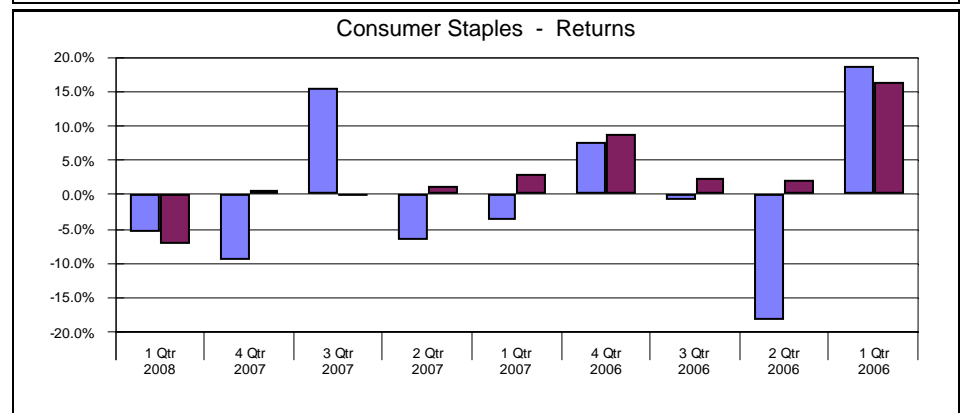
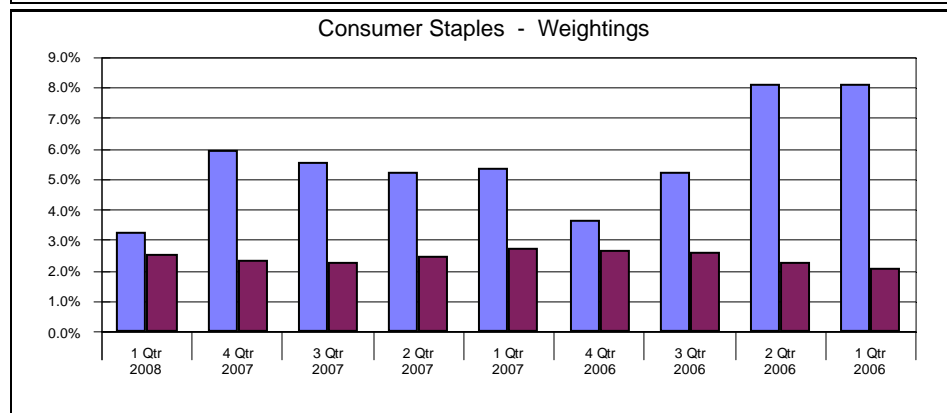
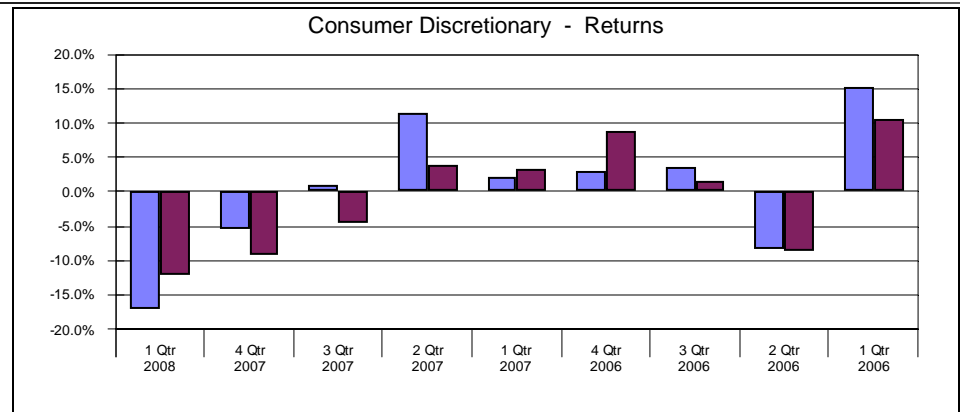
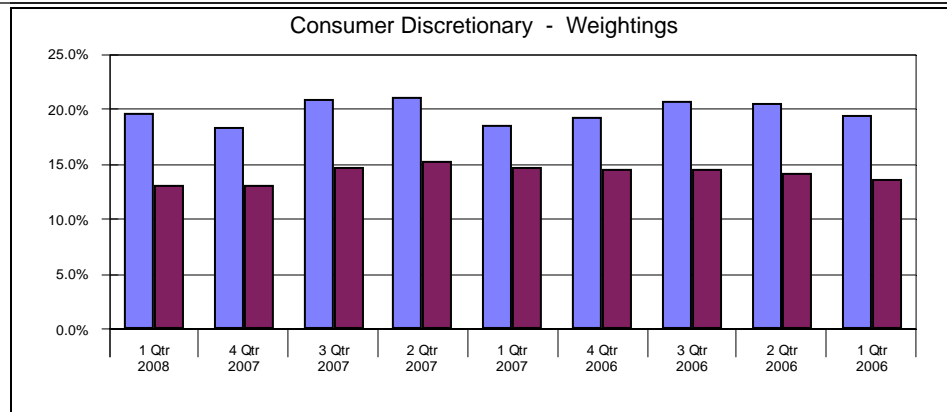

ARTISAN MANAGEMENT

RUSSELL 2000 GROWTH



# Fresno County Employees' Retirement Association

## Equity Only Sector Analysis Quarterly

Period Ending: March 31, 2008

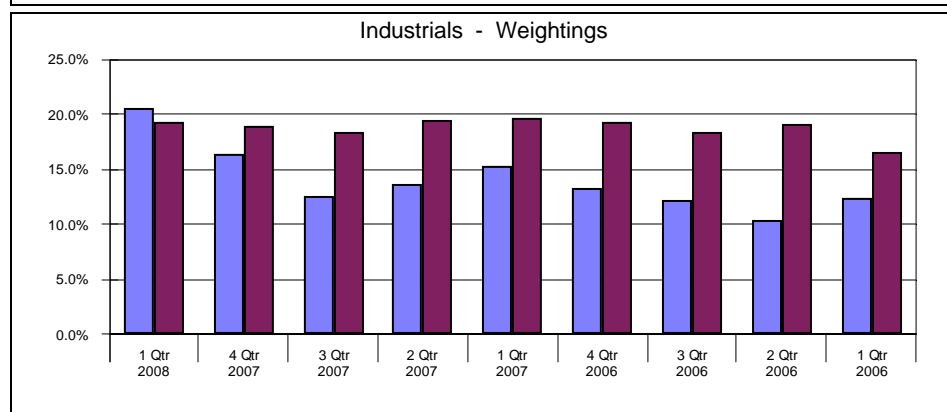
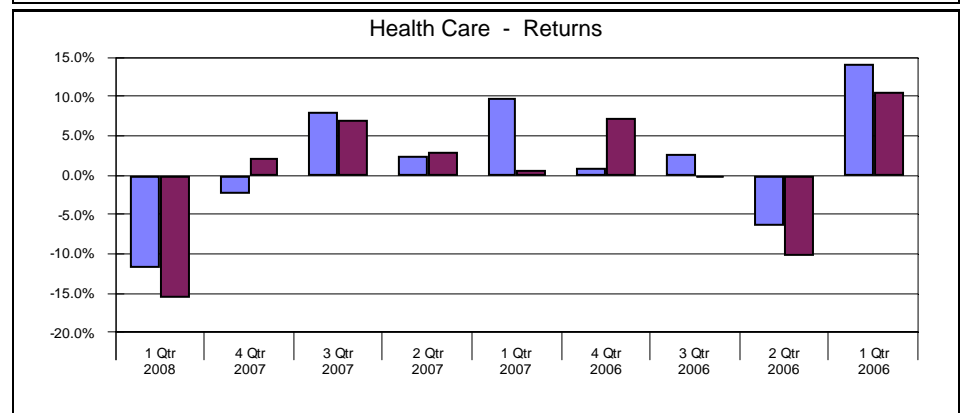
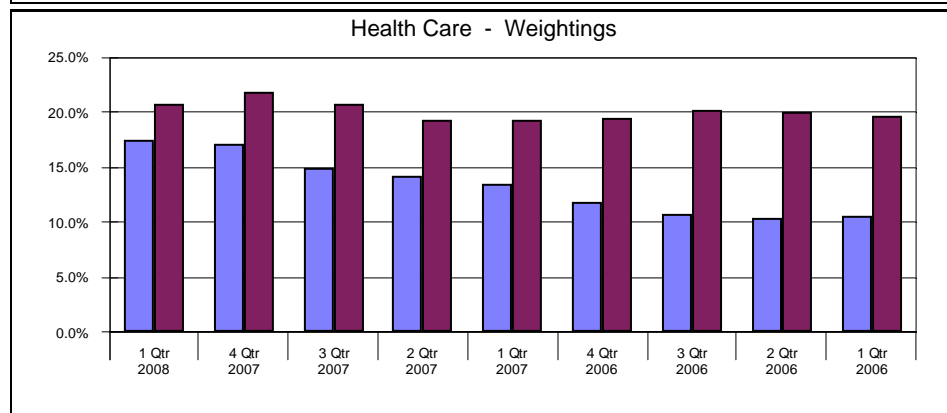
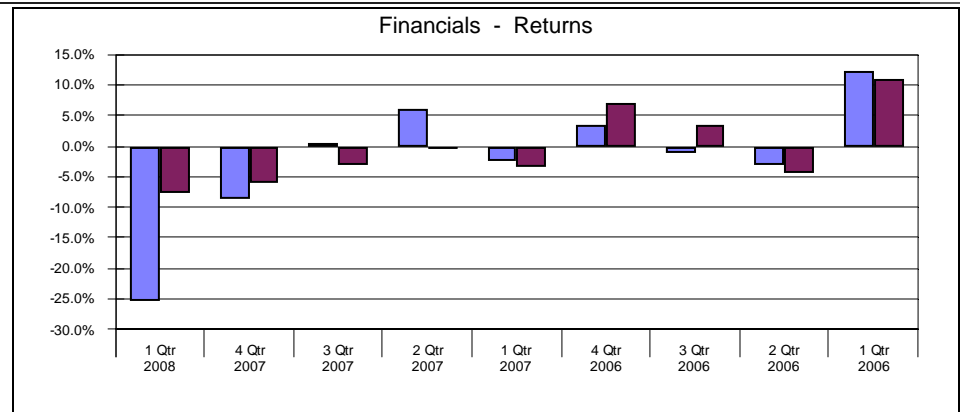
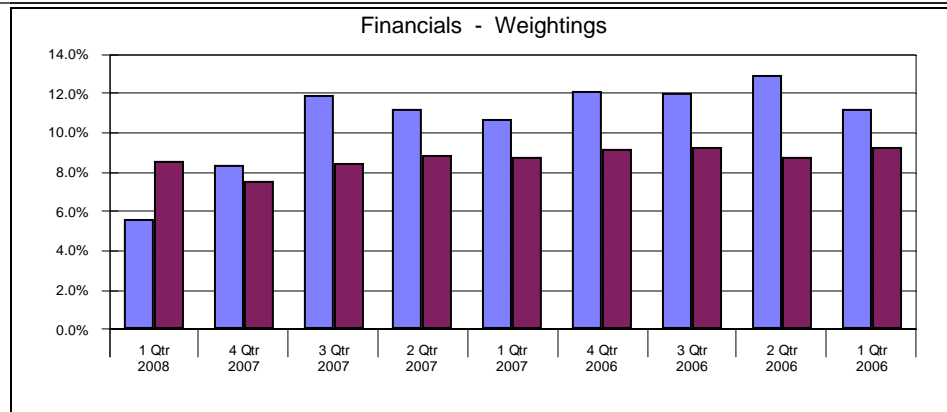

ARTISAN MANAGEMENT

RUSSELL 2000 GROWTH

# Fresno County Employees' Retirement Association

## Equity Only Sector Analysis Quarterly

Period Ending: March 31, 2008

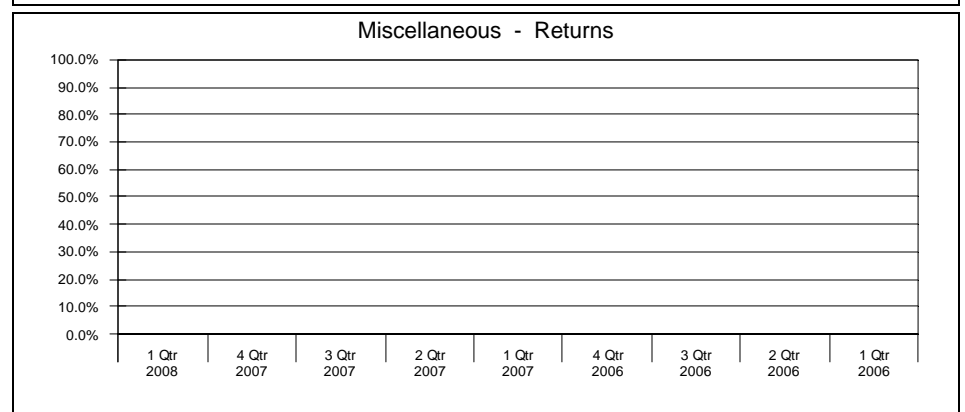
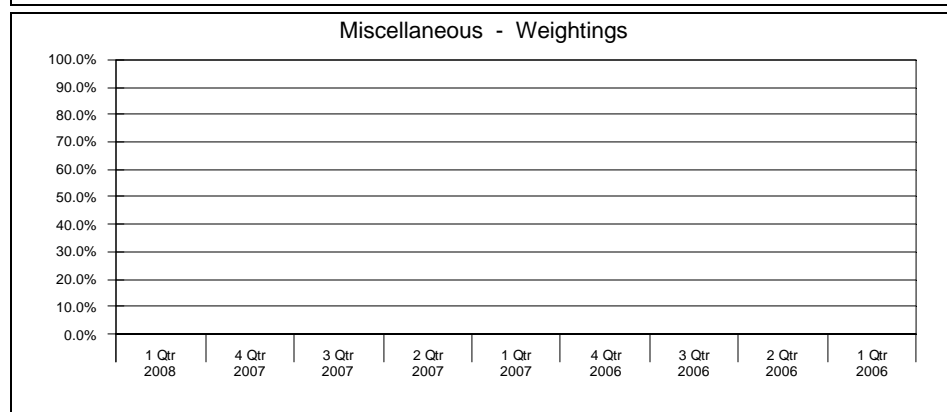
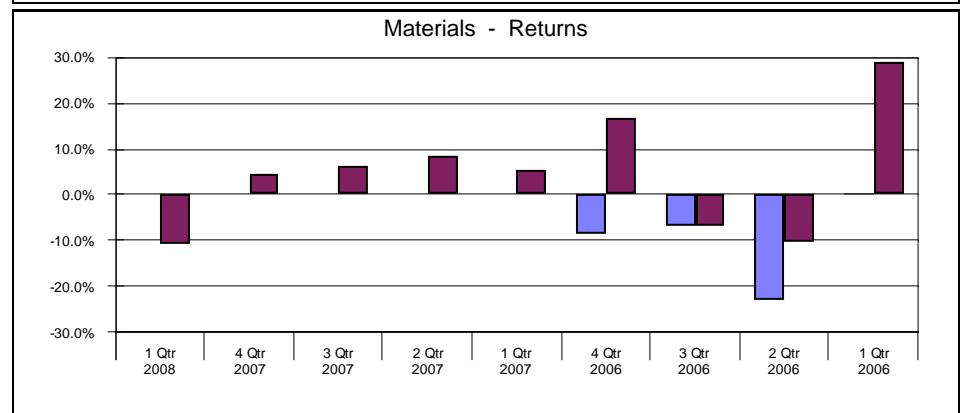
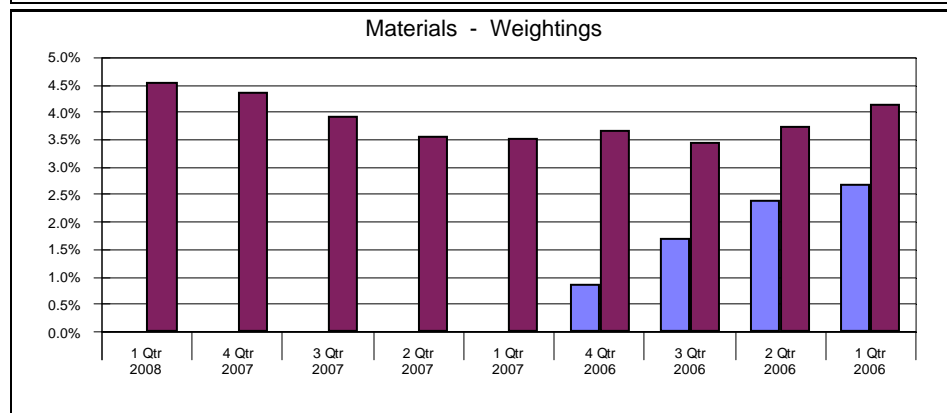
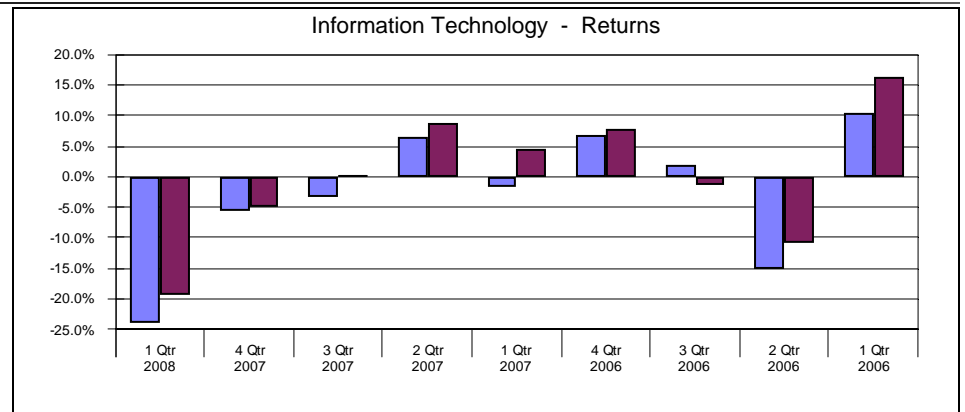
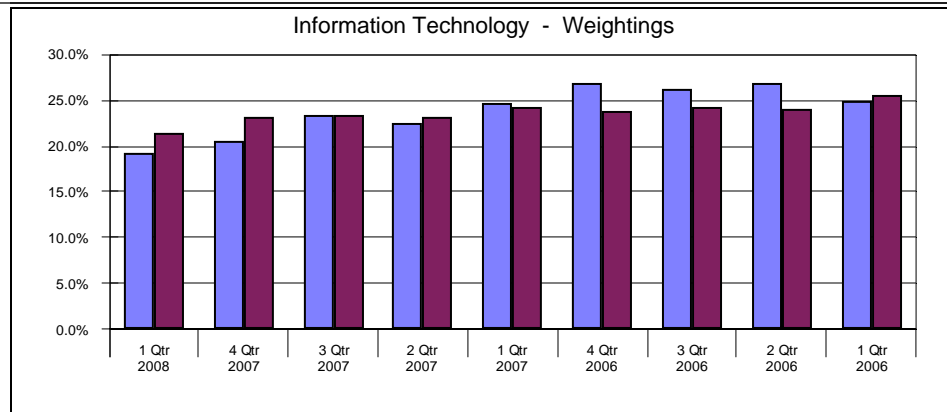

ARTISAN MANAGEMENT

RUSSELL 2000 GROWTH

# Fresno County Employees' Retirement Association

## Equity Only Sector Analysis Quarterly

Period Ending: March 31, 2008

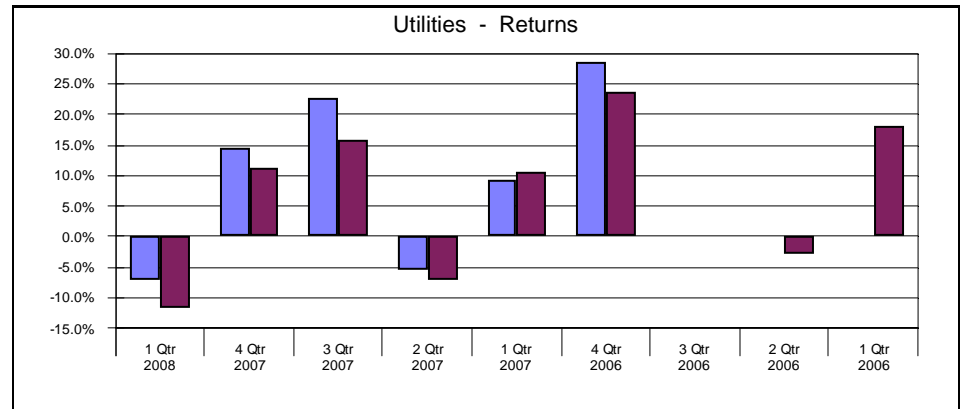
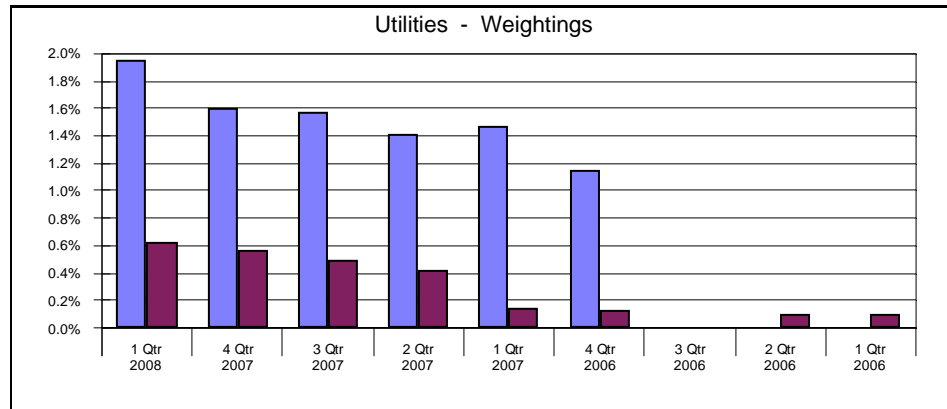
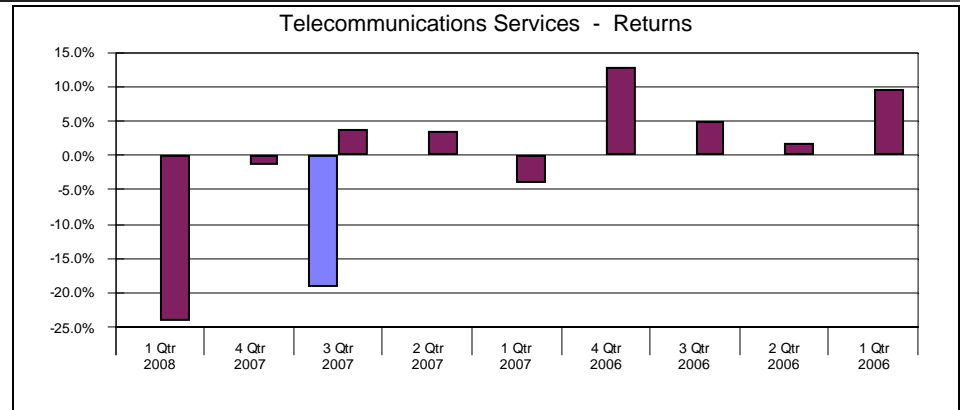
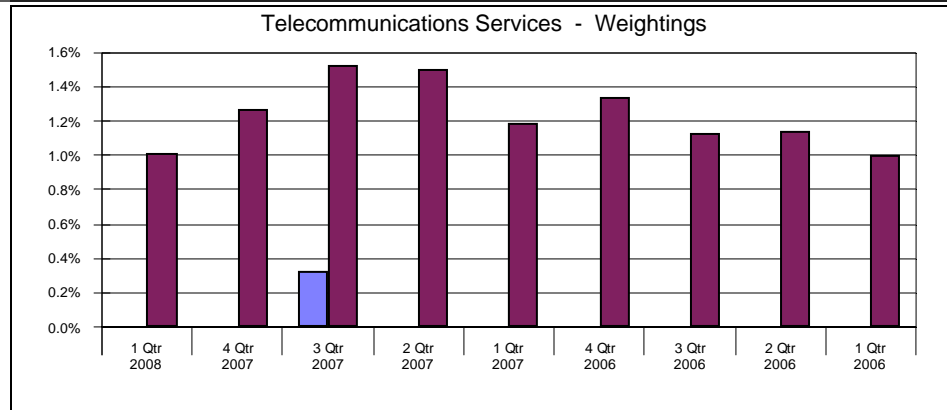

ARTISAN MANAGEMENT

RUSSELL 2000 GROWTH

# Fresno County Employees' Retirement Association

## Performance Attribution Geometric

Period Ending: March 31, 2008

### ARTISAN MANAGEMENT

	Portfolio		RUSSELL 2000 GROWTH		Selection		Total
	Market Value	Return	Market Value	Return	Stock	Industry	
	<b>A</b>	<b>B</b>	<b>C</b>	<b>D</b>	<b>E</b>	<b>F</b>	
Consumer Discretionary	19.5	-11.5	13.1	-12.2	0.1	0.1	0.2
Consumer Staples	6.3	-10.7	2.4	-7.2	-0.3	0.3	0.0
Energy	6.4	3.4	6.8	-1.0	0.3	-0.1	0.3
Financials	8.8	-18.9	7.6	-7.8	-1.1	0.1	-1.0
Health Care	18.1	-19.0	21.8	-15.7	-0.7	0.1	-0.6
Industrials	17.4	-7.5	19.0	-9.1	0.3	-0.1	0.2
Information Technology	21.7	-25.6	23.1	-19.4	-1.5	0.1	-1.4
Materials	0.0	0.0	4.4	-10.7	0.0	-0.1	-0.1
Telecommunications Services	0.0	0.0	1.3	-24.2	0.0	0.2	0.2
Utilities	1.7	-7.2	0.6	-11.8	0.1	0.0	0.1
	100.0	-14.8	100.0	-12.8	-2.7	0.6	-2.2

#### Contribution

<b>Stock</b>	Energy
	Industrials
<b>Industry</b>	Consumer Staples
	Telecommunications Services

#### Detractors

<b>Stock</b>	Information Technology
	Financials
<b>Industry</b>	Materials
	Industrials

# Fresno County Employees' Retirement Association

## Portfolio Holdings And Characteristics - Equity

Period Ending: March 31, 2008

ARTISAN MANAGEMENT	Shares	Price	Portfolio Weight	Market Cap	Dividend Yield	Price / Earnings	Price / Book	Beta	Quarterly Return
<b>Consumer Discretionary</b>									
ACTUANT CORP	38,300	30.21	2.0	1.69	0.1	17.1	3.3	1.81	-11.2
CARTER INC	57,800	16.15	1.6	0.93			2.4	1.42	-16.5
CRA INTL INC	23,400	32.14	1.3	0.35		13.3	1.4	1.04	-32.5
DSW INC	17,000	12.95	0.4	0.21		8.3		0.78	-31.0
GEO GROUP INC	44,100	28.44	2.2	1.45		33.9	2.7	1.24	1.6
HIBBETT SPORTS INC	65,400	15.44	1.8	0.47		15.8	3.6	1.75	-22.7
ICONIX BRAND GROUP INC	50,700	17.35	1.5	1.00		16.7	1.9	2.04	-11.8
LIFE TIME FITNESS INC	30,100	31.21	1.6	1.22		17.5	2.1	1.48	-37.2
LKQ CORP	23,800	22.47	0.9	3.02		40.9	3.5	1.09	6.9
MIDDLEBY CORP	17,900	62.39	1.9	1.05		20.1	5.8	1.44	-18.6
MORGANS HOTEL GROUP CO	61,300	14.82	1.6	0.52			3.8		-23.1
STRAYER ED INC	4,300	152.50	1.1	2.20	1.0	34.1	11.7	0.89	-10.4
TWEEN BRANDS INC	32,500	24.74	1.4	0.61		13.7	2.1	1.16	-6.6
VCA ANTECH INC	27,000	27.35	1.3	2.32		19.4	4.1	0.83	-38.2
			<b>20.7</b>	<b>1.21</b>	<b>0.4</b>	<b>21.2</b>	<b>3.6</b>	<b>1.38</b>	<b>-17.15</b>
<b>Consumer Staples</b>									
ANDERSONS INC	17,000	44.61	1.3	0.81	0.7	11.9	2.3	1.04	-0.3
BJS RESTAURANTS INC	30,300	14.41	0.8	0.38		32.8	1.7	1.09	-11.4
INVENTIV HEALTH INC	28,000	28.81	1.4	0.93		19.7	2.0	1.65	-6.9
			<b>3.5</b>	<b>0.77</b>	<b>0.7</b>	<b>19.6</b>	<b>2.0</b>	<b>1.29</b>	<b>-5.37</b>
<b>Energy</b>									
ALLIS CHALMERS ENERGY INC	59,700	13.79	1.4	0.48		9.5	1.2	0.89	-6.5
CARRIZO OIL + GAS INC	8,200	59.27	0.8	1.66		104.0	5.3	1.07	8.3
CORE LABORATORIES NV	4,800	119.30	1.0	2.74		31.7		1.33	-4.4
DRIL QUIP INC	14,100	46.47	1.1	1.90		17.7	3.2	1.16	-16.5
HERCULES OFFSHORE INC	48,000	25.12	2.1	2.23		11.0	1.1		5.6
W H ENERGY SVCS INC	9,200	68.85	1.1	2.12		14.6	3.2	1.05	22.5
			<b>7.6</b>	<b>1.84</b>		<b>25.3</b>	<b>2.4</b>	<b>1.08</b>	<b>1.46</b>
<b>Financials</b>									
ARES CAP CORP	62,224	12.57	1.4	1.22	13.4	9.3	0.8	1.28	-9.7
EURONET WORLDWIDE INC	43,000	19.26	1.4	0.94		17.4	1.3	1.59	-35.8
NATIONAL FINL PARTNERS CORP	47,100	22.47	1.8	0.89	3.7	16.6	1.1	1.80	-50.3
WINTRUST FINL CORP	21,100	34.95	1.3	0.82	1.0	15.6	1.1	0.84	6.0
			<b>5.9</b>	<b>0.96</b>	<b>5.9</b>	<b>14.9</b>	<b>1.1</b>	<b>1.42</b>	<b>-25.25</b>

# Fresno County Employees' Retirement Association

## Portfolio Holdings And Characteristics - Equity

Period Ending: March 31, 2008

ARTISAN MANAGEMENT	Shares	Price	Portfolio Weight	Market Cap	Dividend Yield	Price / Earnings	Price / Book	Beta	Quarterly Return
<b>Health Care</b>									
ARTHROCARE CORP	31,800	33.35	1.8	0.89		22.2	2.2	1.43	-30.6
HEALTHCARE SVCS GROUP INC	43,900	20.64	1.6	0.89	2.5	30.8	4.5	0.86	-2.0
HEALTHEXTRAS INC	39,100	24.84	1.7	1.06		27.3	3.5	1.34	-4.8
ICON PUB LTD CO SPONSORED ADR	16,500	64.89	1.9	1.86		30.9	6.1	0.81	4.9
K V PHARMACEUTICAL COMPANY	44,300	24.96	1.9	0.94		17.2		1.33	-12.5
LIFECCELL CORP	16,600	42.03	1.2	1.44		53.9	8.4	1.57	-2.5
OBAGI MEDICAL PRODUCTS INC	47,100	8.68	0.7	0.20		12.6			-52.7
PSS WORLD MED INC	58,500	16.66	1.7	1.06		21.1	2.9	1.03	-14.9
PSYCHIATRIC SOLUTIONS INC	38,300	33.92	2.3	1.87		24.8	2.5	1.51	4.4
WRIGHT MED GROUP INC	37,300	24.14	1.6	0.88			2.3	1.07	-17.2
GENOPTIX INC	12,600	25.01	0.5	0.40		32.1	4.4		-18.5
TOMOTHERAPY INC	62,600	14.35	1.6	0.72			3.0		-26.6
			<b>18.4</b>	<b>1.12</b>	<b>2.5</b>	<b>26.8</b>	<b>3.8</b>	<b>1.22</b>	<b>-11.77</b>
<b>Industrials</b>									
AAR CORP	41,600	27.27	2.0	1.03		16.3	2.1	1.83	-28.3
ADVISORY BRD CO	18,300	54.94	1.7	0.98		33.7	7.2	0.93	-14.4
AEGEAN MARINE PETROLEUM INC SHS	26,400	34.21	1.6	1.39	0.1	52.6	6.7		-10.9
AIRTRAN HOLDINGS INC	144,900	6.60	1.7	0.61		11.8	1.4	1.04	-7.8
ASTEC INDS INC	14,900	38.76	1.0	0.86		15.3	2.3	1.34	4.2
DYNAMIC MATLS CORP	20,500	43.20	1.5	0.54	0.3	21.6	5.5	0.91	-26.7
EAGLE BULK SHIPPING INC SHS	34,200	25.76	1.5	1.20	7.6	20.8	2.3	0.67	-1.0
INTERLINE BRANDS INC	46,100	18.55	1.5	0.60		11.9	1.6	1.44	-15.3
KAYDON CORP	24,300	43.91	1.9	1.22	1.4	18.2	2.5	1.36	-19.2
KENEXA CORP	47,000	18.48	1.5	0.43		19.9	1.5	1.03	-4.8
LADISH COMPANY INC	26,000	36.00	1.6	0.52		16.2	2.6	1.37	-16.7
MOBILE MINI INC	8,400	19.00	0.3	0.66		15.6	1.4	0.99	2.5
OLD DOMINION FREIGHT LINE INC	33,200	31.83	1.8	1.19		16.5	2.4	0.90	37.7
WASTE CONNECTIONS INC	39,150	30.74	2.1	2.06		21.6	2.7	0.68	-0.5
			<b>21.7</b>	<b>1.01</b>	<b>2.3</b>	<b>21.3</b>	<b>3.1</b>	<b>1.12</b>	<b>-7.98</b>

# Fresno County Employees' Retirement Association

## Portfolio Holdings And Characteristics - Equity

Period Ending: March 31, 2008

ARTISAN MANAGEMENT	Shares	Price	Portfolio Weight	Market Cap	Dividend Yield	Price / Earnings	Price / Book	Beta	Quarterly Return
<b>Information Technology</b>									
ARUBA NETWORKS INC	75,800	5.21	0.7	0.42		47.4	3.6		-65.1
ATHEROS COMMUNICATIONS INC	43,900	20.84	1.6	1.23		31.1	3.0	1.91	-31.8
AVOCENT CORP	53,400	16.90	1.6	0.77		18.8	1.0	1.96	-27.5
BLACKBAUD INC	19,200	24.28	0.8	1.09	1.6	34.2	9.7	0.73	-13.1
COMMVAULT SYS INC	68,800	12.40	1.5	0.54		6.2	6.6		-41.5
CONCUR TECHNOLOGIES INC	12,900	31.05	0.7	1.37			4.8	1.47	-14.3
EPICOR SOFTWARE CORP	53,200	11.20	1.0	0.65		15.8	2.5	1.99	-4.9
EQUINIX INC	2,300	66.49	0.3	2.44			3.0	1.52	-34.2
GLOBAL CASH ACCESS HLDGS INC	81,000	5.86	0.8	0.49		20.2	3.5		-3.3
INFORMATICA CORP	42,400	17.06	1.3	1.50		29.9	4.8	1.04	-5.3
MACROVISION SOLUTIONS CORP	70,200	13.50	1.6	0.73		16.7	1.3	1.43	-26.4
MICROSEMI CORP	45,700	22.80	1.8	1.78			3.1	1.93	3.0
OMNITURE INC	37,800	23.21	1.5	1.66			4.8		-30.3
PHASE FORWARD INC	53,100	17.08	1.6	0.72		23.7	3.4	1.40	-21.5
PROGRESS SOFTWARE CORP	26,200	29.92	1.4	1.27		28.5	2.4	1.29	-11.2
TESSERA TECHNOLOGIES INC	58,100	20.80	2.1	1.01		22.4	2.4	1.54	-50.0
			<b>20.2</b>	<b>1.07</b>	<b>1.6</b>	<b>23.2</b>	<b>3.5</b>	<b>1.56</b>	<b>-23.82</b>
<b>Utilities</b>									
ITC HLDGS CORP	22,700	52.06	2.1	2.57	2.2	31.0	4.0	0.93	-7.2
			<b>2.1</b>	<b>2.57</b>	<b>2.2</b>	<b>31.0</b>	<b>4.0</b>	<b>0.93</b>	<b>-7.24</b>
ARTISAN MANAGEMENT			<b>100.0</b>	<b>1.17</b>	<b>2.7</b>	<b>22.6</b>	<b>3.2</b>	<b>1.29</b>	<b>-13.97</b>

# Fresno County Employees' Retirement Association

## Equity Activity

Period Ending: March 31, 2008

Start from Dec 31, 2007 **ARTISAN MANAGEMENT**

Additions				Deletions			
Security Name	Shares	Market Value	New	Security Name	Shares	Market Value	Eliminated
	1,300	75,571	*		26,100	767,538	*
	1,900	69,740	*		60,500	275,374	*
	10,300	127,745	*	AAR CORP	1,900	69,941	
	7,500	106,261	*	ACI WORLDWIDE INC	32,800	481,560	*
AAR CORP	13,700	374,286	*	ACTUANT CORP	1,200	40,004	
ACTUANT CORP	7,700	202,055	*	ADVISORY BRD CO	4,100	256,263	
ADVISORY BRD CO	2,600	143,824	*	AEGEAN MARINE PETROLEUM INC SHS	900	30,885	
AEGEAN MARINE PETROLEUM INC SHS	11,300	328,897	*	AEGEAN MARINE PETROLEUM INC SHS	700	24,198	*
AEGEAN MARINE PETROLEUM INC SHS	2,900	84,519	*	AIRTRAN HOLDINGS INC	28,500	242,756	
AIRTRAN HOLDINGS INC	57,300	367,774		ALABAMA NATL BANCORPORATION DE	11,300	843,642	*
ALLIS CHALMERS ENERGY INC	12,100	157,162	*	ALLIS CHALMERS ENERGY INC	4,800	63,204	
ANDERSONS INC	9,100	403,950	*	ARES CAP CORP	10,800	150,062	
ARES CAPITAL CORPORATION	3,400	50,785		ASTEC INDS INC	800	31,102	
ARTHOCARE CORPORATION	700	34,264		AVOCENT CORP	3,300	59,090	
ARTHOCARE CORP	11,500	439,570	*	BARRETT BILL CORP	10,125	449,362	*
ARUBA NETWORKS INC	7,800	89,666		BJS RESTAURANTS INC	11,900	158,523	
ASTEC INDS INC	14,300	435,915	*	BRIGHT HORIZONS FAMILY SOLUT	29,100	1,276,568	*
ATHEROS COMMUNICATIONS INC	13,500	319,526	*	CARRIZO OIL + GAS INC	2,100	124,093	
AVOCENT CORP	13,300	210,948	*	CARTER INC	9,700	204,645	
BARRETT BILL CORP	10,125	0	*	CHART INDS INC COM PAR 0.01	600	16,740	*
BJS RESTAURANTS INC	1,200	14,547	*	COMMVault SYS INC	1,500	27,326	
BLACKBAUD INC	900	24,175	*	CORE LABORATORIES NV	1,400	168,887	*
BRIGHT HORIZONS FAMILY SOLUT	800	26,552	*	CRA INTL INC	2,200	93,022	
CARRIZO OIL + GAS INC	10,600	516,093	*	DRIL QUIP INC	1,500	87,586	
CARTER INC	19,900	328,245	*	DSP GROUP INC	34,900	405,150	*
CHART INDS INC COM PAR 0.01	600	16,435	*	DSW INC	13,700	262,120	
COMMVault SYS INC	15,700	230,865	*	DYNAMIC MATLS CORP	700	40,197	
CONCUR TECHNOLOGIES INC	12,900	348,790	*	EPICOR SOFTWARE CORP	15,500	182,946	
CORE LABORATORIES NV	1,300	152,745	*	EURONET WORLDWIDE INC	1,900	54,051	
CRA INTL INC	4,100	144,788	*	EV3 INC	8,700	106,395	*
DRIL QUIP INC	5,500	255,911	*	GLOBAL CASH ACCESS HLDGS INC	2,900	16,842	
DYNAMIC MATLS CORP	8,700	385,894	*	HEALTHEXTRAS INC	7,500	221,321	



# Fresno County Employees' Retirement Association

## Equity Activity

Period Ending: March 31, 2008

EAGLE BULK SHIPPING INC SHS	2,800	66,354	*	HERCULES OFFSHORE INC	6,000	160,258	
EAGLE BULK SHIPPING INC SHS	10,300	214,874	*	HIBBETT SPORTS INC	12,300	226,925	
EQUINIX INC	2,300	156,357	*	ICON PUB LTD CO SPONSORED ADR	5,500	360,389	
EURONET WORLDWIDE INC	9,500	220,289	*	ICONIX BRAND GROUP INC	12,700	268,556	
GENOPTIX INC	12,600	310,940	*	INFORMATICA CORP	7,500	135,839	
GEO GROUP INC	2,500	61,289	*	INVENTIV HEALTH INC	7,800	245,800	
GLOBAL CASH ACCESS HLDGS INC	6,000	33,848	*	ITC HLDGS CORP	900	47,732	
HEALTHCARE SVCS GROUP INC	42,100	893,567	*	K V PHARMACEUTICAL COMPANY	5,000	132,905	
HEALTHEXTRAS INC	2,300	66,886	*	KAYDON CORP	3,300	157,971	
HERCULES OFFSHORE INC	4,700	109,253		KENEXA CORP	3,200	67,811	
HIBBETT SPORTS INC	20,400	311,480		LADISH COMPANY INC	1,200	49,847	
ICON PUB LTD CO SPONSORED ADR	1,200	72,133	*	LKQ CORP	15,300	334,903	
ICONIX BRAND GROUP INC	14,900	267,478		MACROVISION CORP	2,000	34,356	*
ICU MEDICAL INC	1,200	43,104		MEDASSETS INC	21,500	345,382	*
INTERLINE BRANDS INC	3,600	68,084	*	MORGANS HOTEL GROUP CO	1,800	34,561	
INVENTIV HEALTH INC	900	29,357		OLD DOMINION FREIGHT LINE INC	19,300	568,178	
ITC HLDGS CORP	3,600	180,922	*	PERFORMANCE FOOD GROUP CO	33,000	1,044,350	*
K V PHARMACEUTICAL COMPANY	2,700	73,161	*	PROGRESS SOFTWARE CORP	5,300	168,434	
KAYDON CORP	6,700	277,075	*	PSS WORLD MED INC	3,200	61,864	
KENEXA CORP	5,500	101,766		PSYCHIATRIC SOLUTIONS INC	1,500	49,991	
KV PHARMACEUTICAL COMPANY-CLASS A	2,600	74,977		RESOURCES CONNECTION INC	35,600	601,993	*
LADISH COMPANY INC	16,900	616,374	*	RESOURCES CONNECTION, INC.	2,900	52,692	*
LIFE TIME FITNESS INC	30,100	1,072,026	*	SIRF TECHNOLOGY HLDGS INC	56,900	336,631	*
LIFECCELL CORP	16,600	642,625	*	STRAYER ED INC	1,000	169,459	
MACROVISION CORP	19,600	307,361	*	TESSERA TECHNOLOGIES INC	2,900	120,870	
MEDASSETS INC	4,600	100,235		THORATEC CORP	39,000	594,109	*
MICROSEMI CORP	3,200	67,108	*	TWEEN BRANDS INC	18,100	544,682	
MORGANS HOTEL GROUP CO	10,400	145,019		UNITED NAT FOODS INC	43,100	743,046	*
N/A		459,169	*	W H ENERGY SVCS INC	11,700	744,310	
NATIONAL FINANCIAL PARTNERS	1,200	55,483		WASTE CONNECTIONS INC	6,600	198,075	
NATIONAL FINL PARTNERS CORP	19,600	555,361	*	WESTAMERICA BANCORPORATION	17,000	846,458	*
OLD DOMINION FREIGHT LINE INC	1,500	33,224	*	WIND RIV SYS INC	83,300	544,169	*
OMNITURE INC	37,800	899,929	*	WINTRUST FINL CORP	9,100	330,101	
PHASE FORWARD INC	15,200	256,027		WRIGHT MED GROUP INC	2,100	58,851	
PROGRESS SOFTWARE CORP	3,600	103,086	*				

# Fresno County Employees' Retirement Association

## Equity Activity

Period Ending: March 31, 2008

PSS WORLD MED INC	5,600	100,902	*
PSS WORLD MEDICAL INCORPORATED	1,000	20,249	
PSYCHIATRIC SOLUTIONS INC	7,700	236,727	*
PSYCHIATRIC SOLUTIONS INC.	1,100	36,042	
SIRF TECHNOLOGY HLDGS INC	25,100	427,567	*
STRAYER ED INC	500	72,655	*
TESSERA TECHNOLOGIES INC	43,100	974,989	
TOMOTHERAPY INC	17,900	255,037	*
TOMOTHERAPY INC.	1,300	25,035	
TWEEN BRANDS INC	6,800	183,540	
UNITED NAT FOODS INC	5,400	137,864	*
VCA ANTECH INC	20,800	612,576	*
W H ENERGY SVCS INC	1,700	90,609	*
WASTE CONNECTIONS INC	6,200	188,521	*
WASTE CONNECTIONS, INC.	600	18,673	
WESTAMERICA BANCORPORATION	2,600	106,326	
WIND RIV SYS INC	2,000	16,425	*
WINTRUST FINL CORP	1,800	55,990	*
WRIGHT MED GROUP INC	1,200	34,904	*

# Fresno County Employees' Retirement Association

## Cumulative Performance Comparisons

Period Ending: March 31, 2008

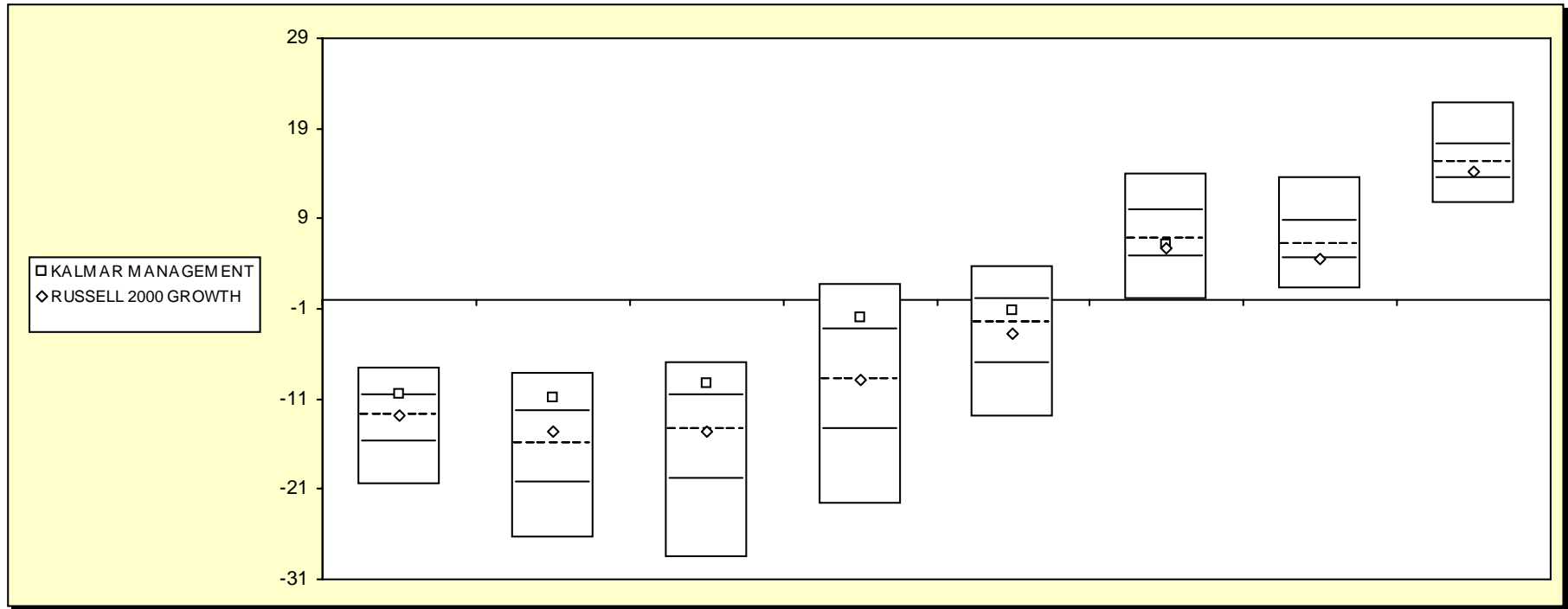

### Equity Style - Small Growth

	Last Quarter		Two Quarters		Three Quarters		One Year		Two Years		Three Years		Four Years		Five Years	
	Return	Rank	Return	Rank	Return	Rank	Return	Rank	Return	Rank	Return	Rank	Return	Rank	Return	Rank
5th Percentile	-7.5		-8.1		-6.8		1.7		3.7		14.0		13.5		22.0	
25th Percentile	-10.7		-12.4		-10.7		-3.4		0.0		9.8		8.8		17.3	
50th Percentile	-12.8		-16.1		-14.3		-8.8		-2.6		6.6		6.0		15.3	
75th Percentile	-15.8		-20.4		-19.9		-14.4		-7.2		4.7		4.5		13.4	
95th Percentile	-20.6		-26.4		-28.6		-22.8		-13.0		-0.1		1.1		10.6	
KALMAR MANAGEMENT	-10.5	24	-10.9	18	-9.3	18	-2.1	20	-1.3	37	6.1	56				
RUSSELL 2000 GROWTH	-12.8	50	-14.7	41	-14.6	51	-8.9	50	-3.8	57	5.7	61	4.5	75	14.2	64

# Fresno County Employees' Retirement Association

## Consecutive Performance Comparisons

Period Ending: March 31, 2008

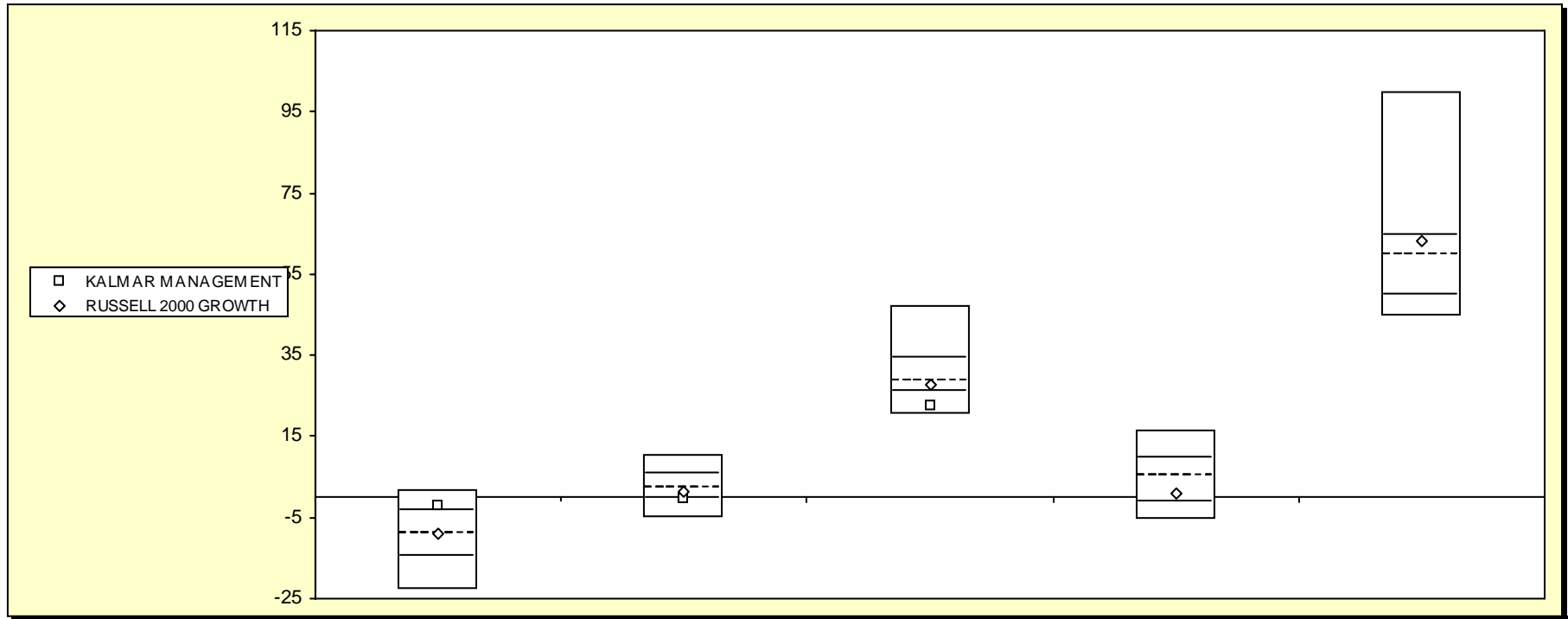

### Equity Style - Small Growth

	March 2008		March 2007		March 2006		March 2005		March 2004	
	Return	Rank	Return	Rank	Return	Rank	Return	Rank	Return	Rank
5th Percentile	1.7		10.4		47.2		16.3		99.7	
25th Percentile	-3.4		5.6		34.1		9.4		64.6	
50th Percentile	-8.8		2.1		28.7		5.2		59.6	
75th Percentile	-14.4		-0.2		25.8		-1.1		49.9	
95th Percentile	-22.8		-5.2		20.3		-5.5		44.4	
KALMAR MANAGEMENT	-2.1	20	-0.4	76	22.6	86				
RUSSELL 2000 GROWTH	-8.9	50	1.6	56	27.8	57	0.9	67	63.2	32

# Fresno County Employees' Retirement Association

Consecutive Annual - Five Year

Period Ending: March 31, 2008

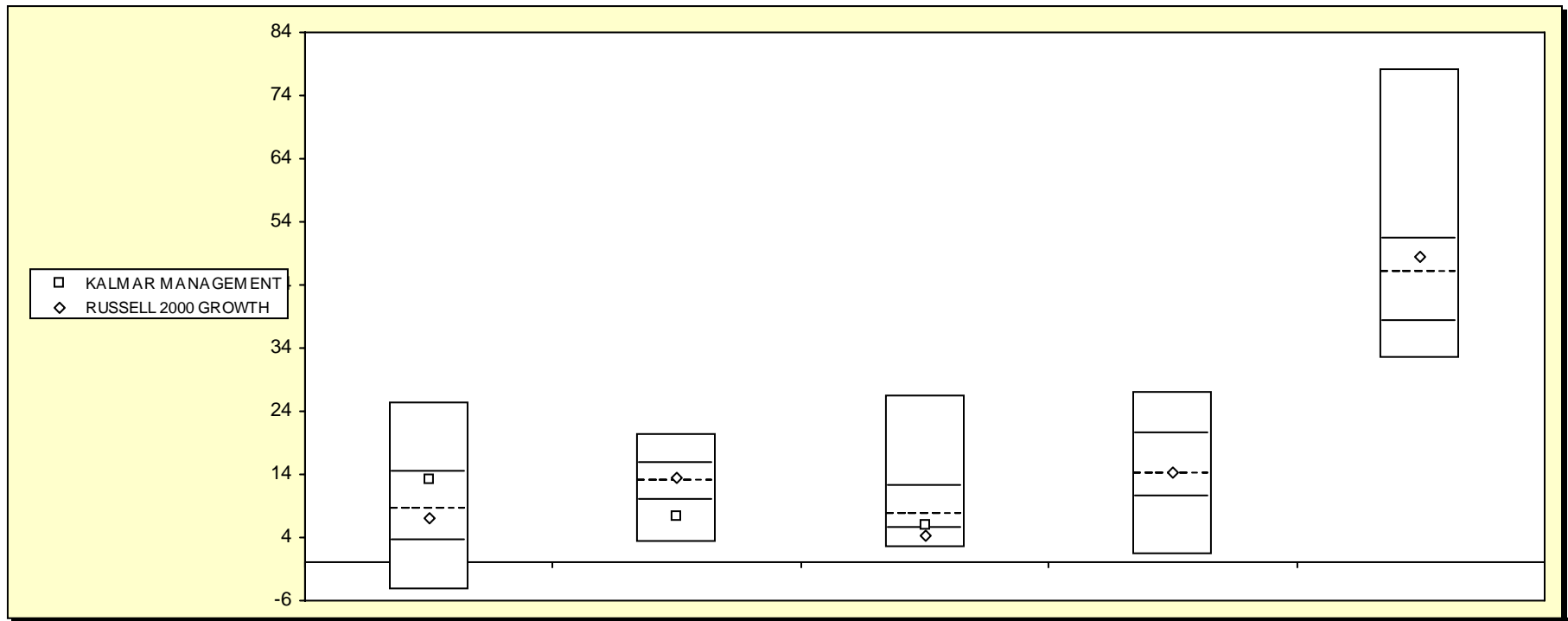

*Equity Style - Small Growth*

	December 2007		December 2006		December 2005		December 2004		December 2003	
	Return	Rank	Return	Rank	Return	Rank	Return	Rank	Return	Rank
5th Percentile	25.5		20.4		26.4		27.0		78.1	
25th Percentile	14.2		15.7		12.1		20.3		51.3	
50th Percentile	8.5		13.0		7.6		14.0		46.1	
75th Percentile	3.3		9.8		5.5		10.4		38.3	
95th Percentile	-4.5		3.1		2.4		1.2		32.4	
KALMAR MANAGEMENT	13.0	30	7.3	82	6.0	69				
RUSSELL 2000 GROWTH	7.0	57	13.4	46	4.1	84	14.3	49	48.5	38

# Fresno County Employees' Retirement Association

## Equity Only Summary Statistics

Period Ending: March 31, 2008

### KALMAR MANAGEMENT

	Portfolio	RUSSELL 2000 GROWTH
Total Number of Securities	85	1249
Total Market Value	51,810,876	
Average Market Capitalization (000's)	1,716,365	1,510,000
Equity Segment Yield	1.11	0.65
Equity Segment Price/Earnings Ratio	27.19	18.38
Equity Segment Beta	1.26	1.46
Price/Book Ratio	3.11	4.14
5 Year Earnings Growth	23.7%	32.3%

#### Ten Largest Holdings

Security	Market Value	Weight
CYBERSOURCE CORP DEL	1,303,504	2.52
COVANCE INC	1,263,633	2.44
ANALOGIC CORP COM PAR 0.05	1,257,939	2.43
CENTRAL EUROPEAN DISTR CORP	1,251,667	2.42
DELTA PETE CORP	1,208,595	2.33
PERFORMANCE FOOD GROUP CO	1,145,434	2.21
DEVRY INC DEL	1,082,819	2.09
CORRECTIONS CORP AMER NEW	1,051,924	2.03
LKQ CORP	1,043,956	2.01
ATMI INC	986,434	1.90

#### Ten Best Performers

Security	Return	Weight
GLOBAL TRAFFIC NETWORK INC	34.4	0.43
CHOICEPOINT INC	30.7	0.72
PERFORMANCE FOOD GROUP CO	21.6	2.21
DELTA PETE CORP	19.6	2.33
POLYPORE INTERNATIONAL INC OM	18.2	1.41
PARALLEL PETE CORP DEL	11.0	1.41
TRACTOR SUPPLY CO	10.0	1.74
SKILLSOFT PUB LTD CO SPONSORED ADR	9.5	0.93
GMX RES INC	8.2	1.54
MPS GROUP INC	8.0	1.03

#### Ten Worst Performers

Security	Return	Weight
CBEYOND INC	-51.8	0.76
NATIONAL FINL PARTNERS CORP	-50.3	0.33
TESSERA TECHNOLOGIES INC	-50.0	1.07
DEALERTRACK HOLDINGS INC	-39.6	1.09
HEALTHWAYS INC	-39.5	1.24
LIFE TIME FITNESS INC	-37.2	1.32
ALLIANCE DATA SYSTEMS CORP	-36.6	1.25
CONSTANT CONTACT INC	-32.7	0.50
SYNTEL INC	-30.7	0.57
AVOCENT CORP	-27.5	0.60

# Fresno County Employees' Retirement Association

## Portfolio Characteristics - Equity

Period Ending: March 31, 2008

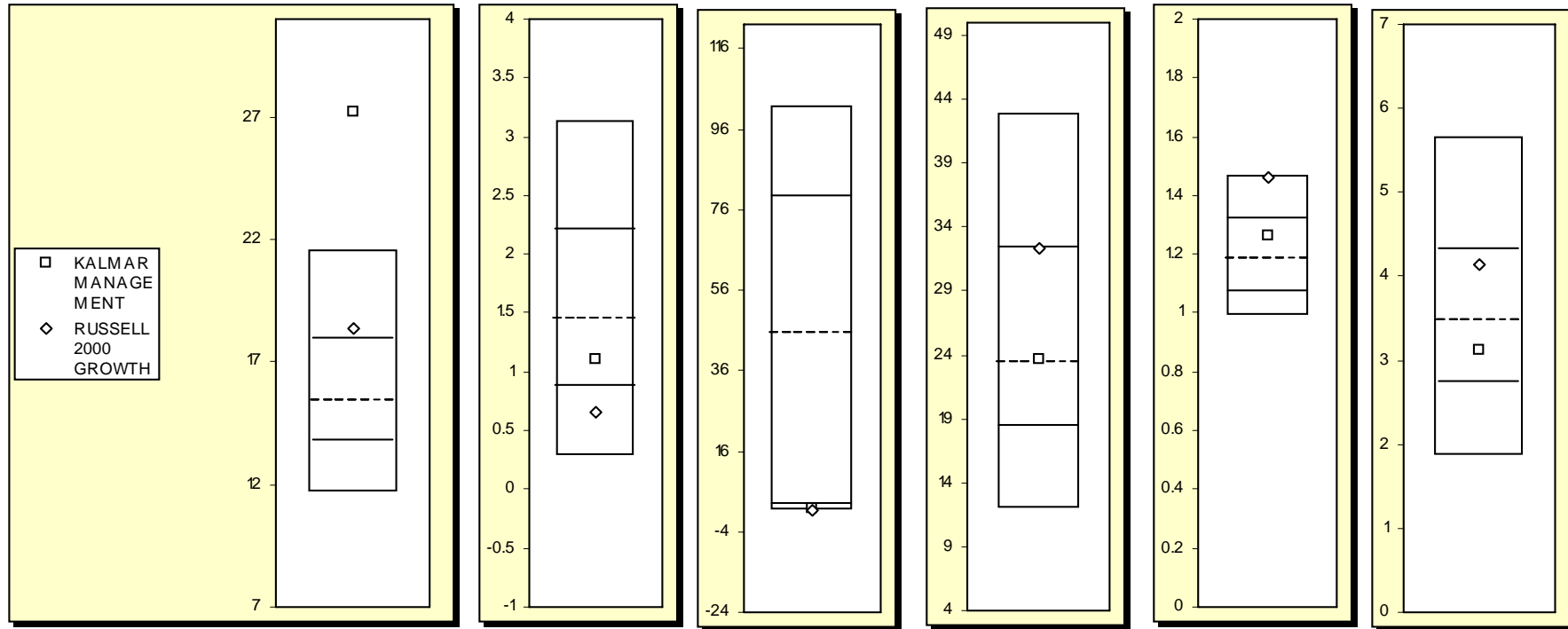

	Price/Earnings Ratio		Dividend Yield		Capitalization		5 Year Earnings		Beta		Price/Book Ratio	
	Value	Rank	Value	Rank	Value	Rank	Value	Rank	Value	Rank	Value	Rank
<i>Equity Funds - Equity Only</i>												
5th Percentile	21.57		3.13		101.51		42.95		1.47		5.66	
25th Percentile	17.93		2.20		78.86		32.34		1.32		4.32	
50th Percentile	15.38		1.45		45.26		23.34		1.18		3.47	
75th Percentile	13.75		0.88		2.83		18.43		1.07		2.72	
95th Percentile	11.66		0.28		1.13		11.93		0.99		1.86	
KALMAR MANAGEMENT	27.19	1	1.11	65	1.72	88	23.66	49	1.26	36	3.11	62
RUSSELL 2000 GROWTH	18.38	23	0.65	83	1.51	91	32.28	25	1.46	6	4.14	30

# Fresno County Employees' Retirement Association

## Top Ten Holding

Period Ending: March 31, 2008

As Of 6/30/06	
ULTRA PETROLEUM CORPORATION	2.3%
COVANCE INCORPORATED	2.3%
RESMED INCORPORATED	2.2%
INSIGHT ENTERPRISES	2.2%
AVOCENT CORPORATION	1.9%
TRACTOR SUPPLY COMPANY	1.9%
PARALLEL PETROLEUM INC	1.9%
PSS WORLD MEDICAL INCORPORATED	1.8%
ALLIANCE DATA SERVICES	1.8%
COLDWATER CREEK INC	1.8%
<b>Top Ten Total:</b>	<b>20.4%</b>

As Of 9/30/06	
INSIGHT ENTERPRISES	2.4%
AVOCENT CORPORATION	2.3%
PSS WORLD MEDICAL INCORPORATED	2.1%
CORRECTIONS CORPORATION OF	2.1%
ALBEMARLE CO.	2.1%
ROGERS CORP	2.0%
RESPIRONICS, INC.	2.0%
COLDWATER CREEK INC	2.0%
ULTRA PETROLEUM CORPORATION	1.9%
COVANCE INCORPORATED	1.8%
<b>Top Ten Total:</b>	<b>20.8%</b>

As Of 12/31/06	
ALBEMARLE CO.	2.7%
AVOCENT CORPORATION	2.5%
CORRECTIONS CORPORATION OF	2.2%
PSS WORLD MEDICAL INCORPORATED	2.0%
CERIDIAN CORP	1.9%
ALLIANCE DATA SERVICES	1.9%
RESPIRONICS, INC.	1.9%
ROGERS CORP	1.9%
ULTRA PETROLEUM CORPORATION	1.9%
LAUREATE EDUCATION INC	1.8%
<b>Top Ten Total:</b>	<b>20.6%</b>

As Of 3/31/07	
CERIDIAN CORP	2.4%
DEVRY, INC.	2.3%
PSS WORLD MEDICAL INCORPORATED	2.1%
LAUREATE EDUCATION INC	2.1%
RESPIRONICS, INC.	2.1%
ULTRA PETROLEUM CORPORATION	2.0%
TRACTOR SUPPLY COMPANY	1.9%
AVOCENT CORPORATION	1.9%
CHICAGO BRIDGE IRON-NY SHR	1.9%
ALLIANCE DATA SERVICES	1.8%
<b>Top Ten Total:</b>	<b>20.5%</b>

As Of 6/30/07	
DEVRY, INC.	2.4%
LIFE TIME FITNESS, INC.	2.2%
CERIDIAN CORP	2.1%
ALLIANCE DATA SERVICES	2.1%
CHICAGO BRIDGE IRON-NY SHR	2.1%
NIKO RESOURCES LTD	2.0%
LAUREATE EDUCATION INC	1.9%
KENNAMETAL INCORPORATED	1.9%
ULTRA PETROLEUM CORPORATION	1.9%
RESPIRONICS, INC.	1.9%
<b>Top Ten Total:</b>	<b>20.5%</b>

As Of 9/30/07	
DEVRY, INC.	2.6%
LIFE TIME FITNESS, INC.	2.5%
CHICAGO BRIDGE IRON-NY SHR	2.4%
RESPIRONICS, INC.	2.1%
ULTRA PETROLEUM CORPORATION	2.1%
ALLIANCE DATA SERVICES	2.1%
NIKO RESOURCES LTD	2.0%
KENNAMETAL INCORPORATED	2.0%
INSIGHT ENTERPRISES	1.9%
PSS WORLD MEDICAL INCORPORATED	1.9%
<b>Top Ten Total:</b>	<b>21.5%</b>

As Of 12/31/07	
RESPIRONICS, INC.	2.9%
DEVRY, INC.	2.9%
ULTRA PETROLEUM CORPORATION	2.4%
CHICAGO BRIDGE IRON-NY SHR	2.3%
GAMESTOP CORPORATION	2.1%
COVANCE INCORPORATED	2.0%
ANALOGIC CORPORATION	1.9%
CENTRAL EUROPEAN DISTRIBUTION	1.9%
NIKO RESOURCES LTD	1.8%
ATMI INCORPORATED	1.7%
<b>Top Ten Total:</b>	<b>21.9%</b>

As Of 3/31/08	
CYBERSOURCE CORP DEL	2.5%
COVANCE INC	2.4%
ANALOGIC CORP COM PAR 0.05	2.4%
CENTRAL EUROPEAN DISTR CORP	2.4%
DELTA PETE CORP	2.3%
PERFORMANCE FOOD GROUP CO	2.2%
DEVRY INC DEL	2.1%
CORRECTIONS CORP AMER NEW	2.0%
LKQ CORP	2.0%
ATMI INC	1.9%
<b>Top Ten Total:</b>	<b>22.4%</b>





# Fresno County Employees' Retirement Association

## Equity Only Summary Statistics Charts

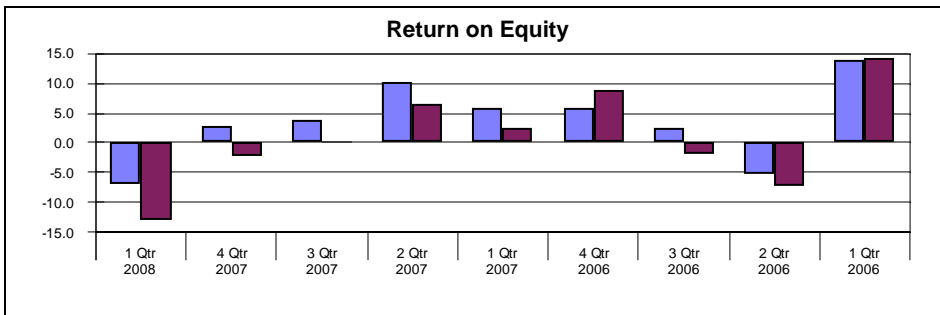
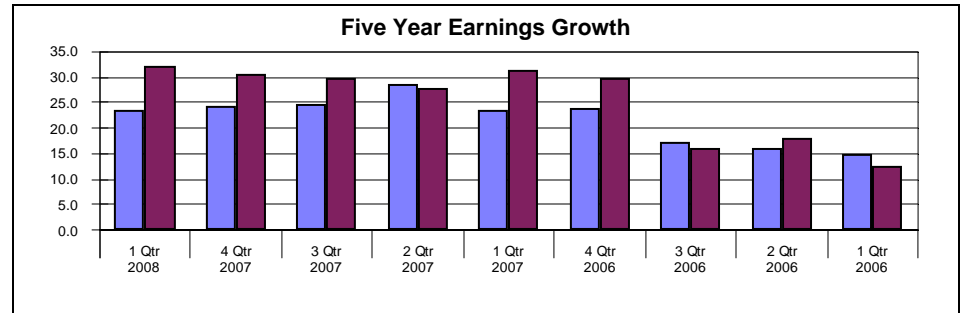
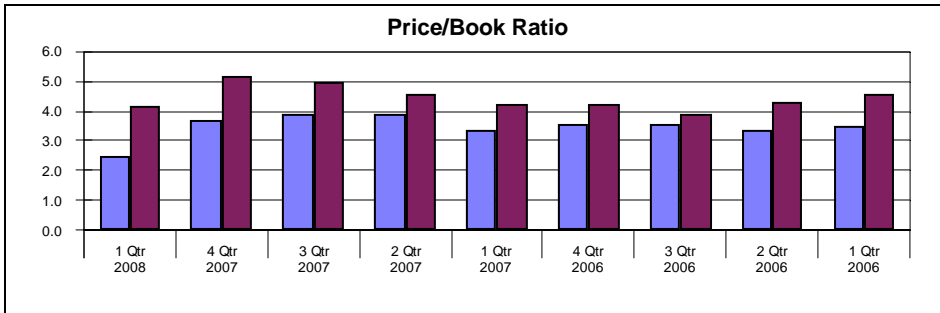
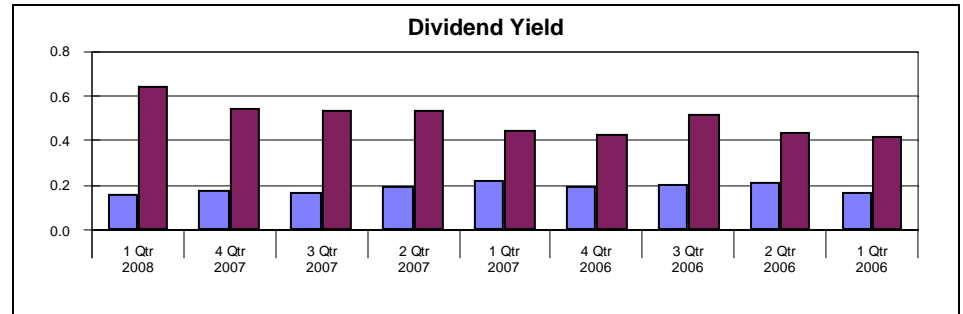
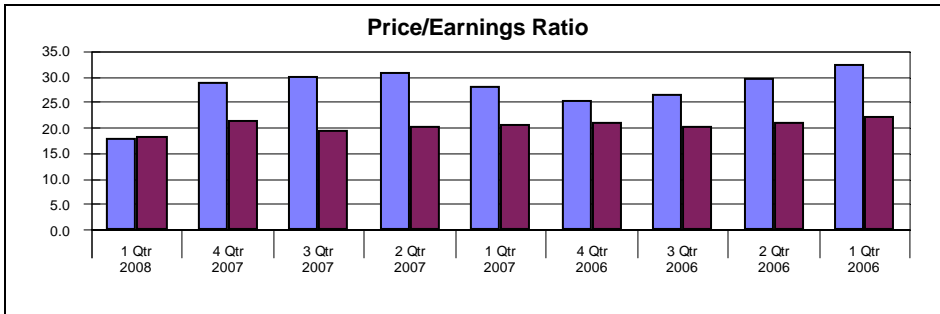
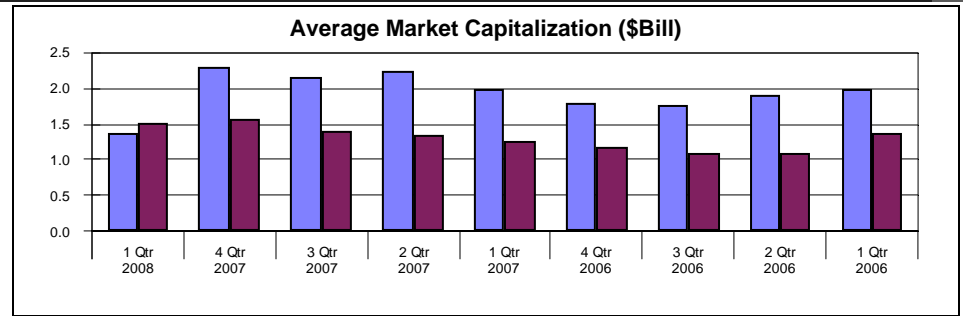
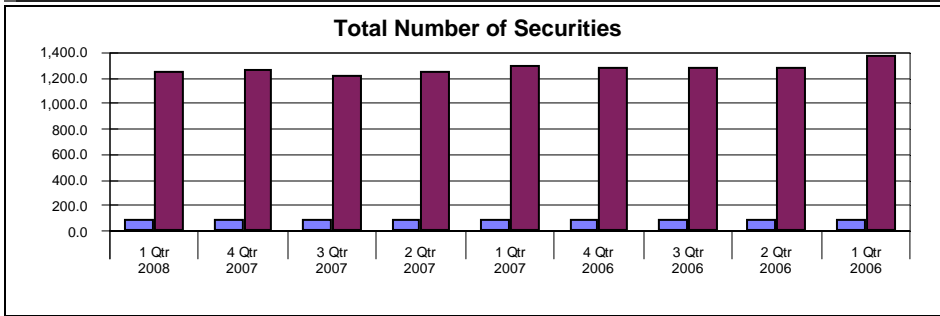
Period Ending: March 31, 2008



 KALMAR MANAGEMENT  
 RUSSELL 2000 GROWTH

# Fresno County Employees' Retirement Association

## Equity Only Sector Analysis Quarterly

Period Ending: March 31, 2008

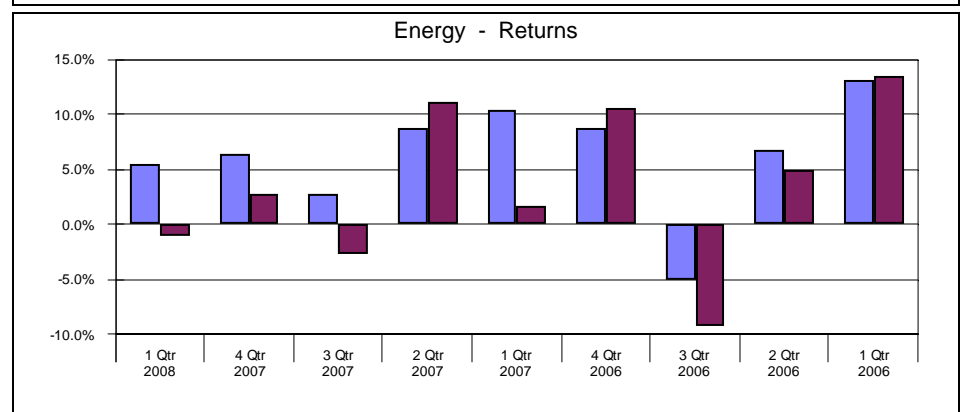
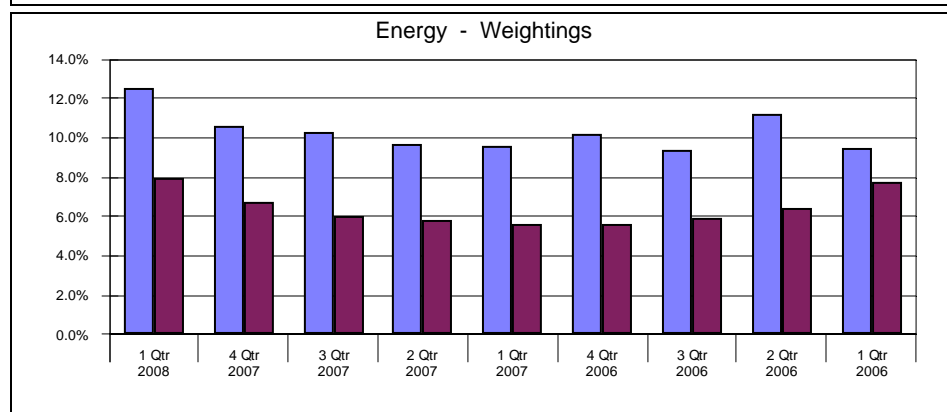
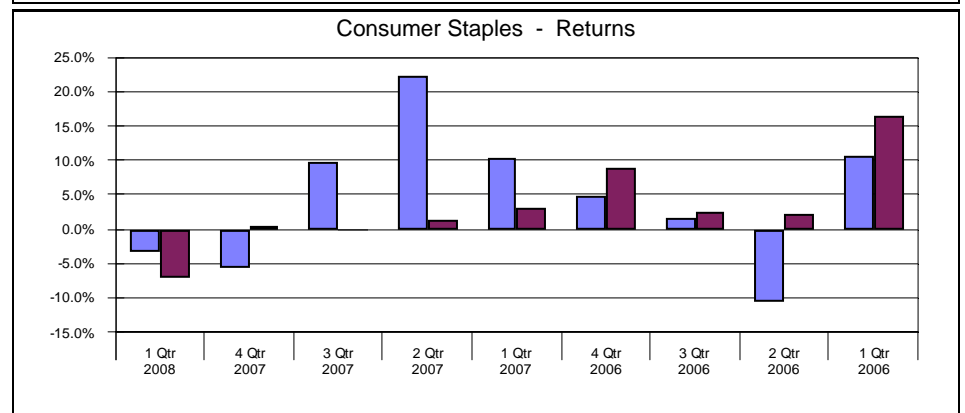
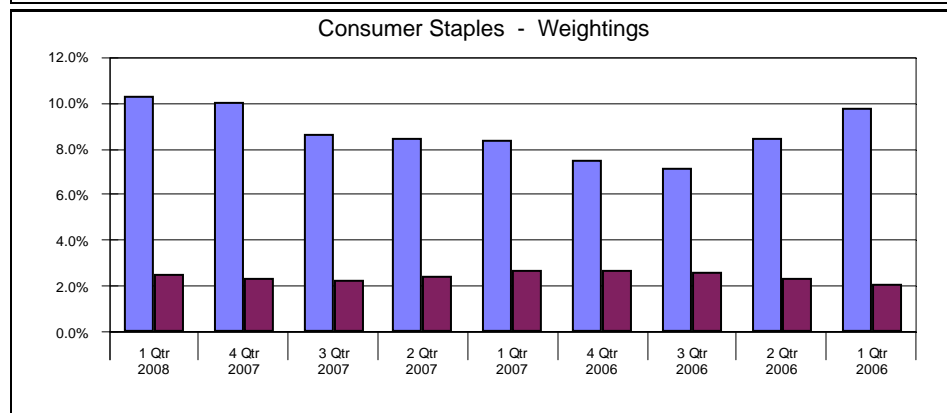
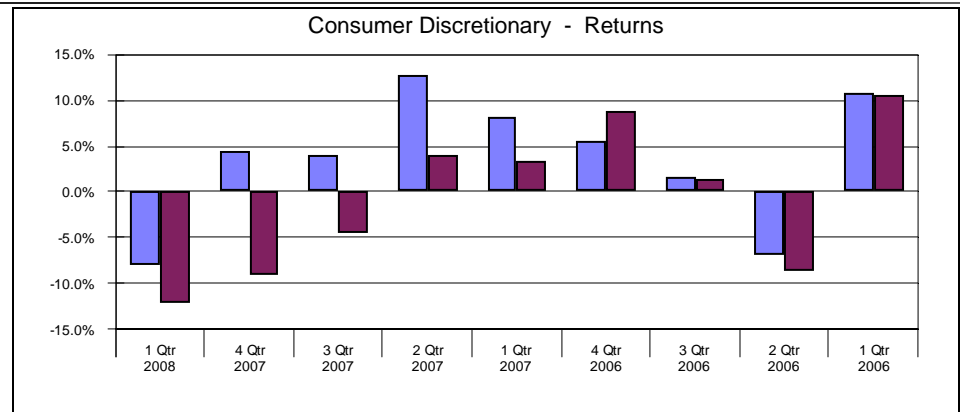
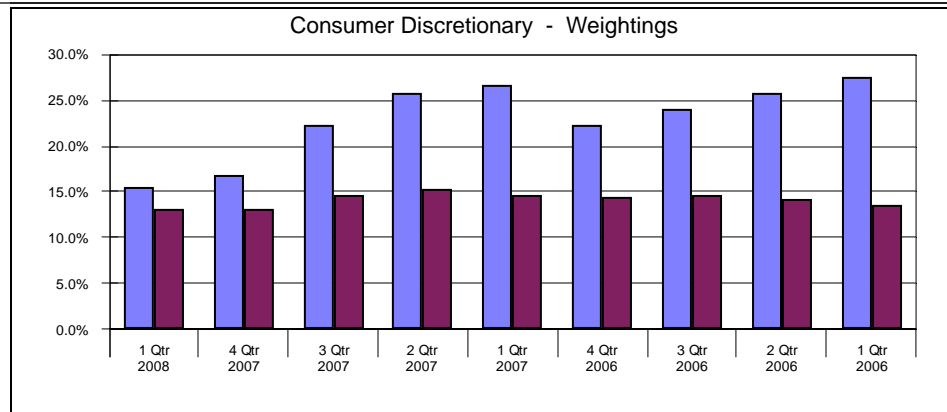

█ KALMAR MANAGEMENT

█ RUSSELL 2000 GROWTH

# Fresno County Employees' Retirement Association

## Equity Only Sector Analysis Quarterly

Period Ending: March 31, 2008

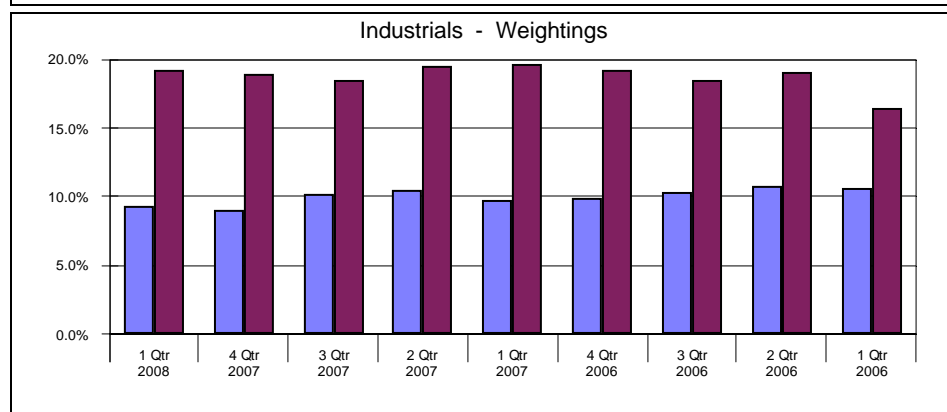
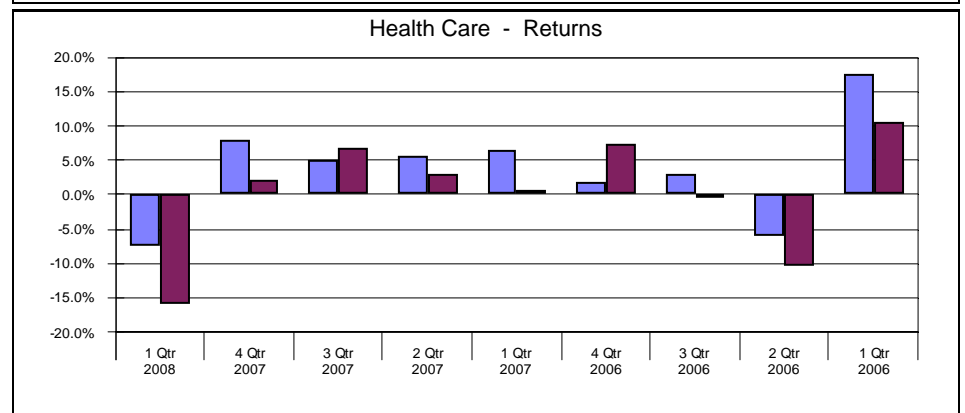
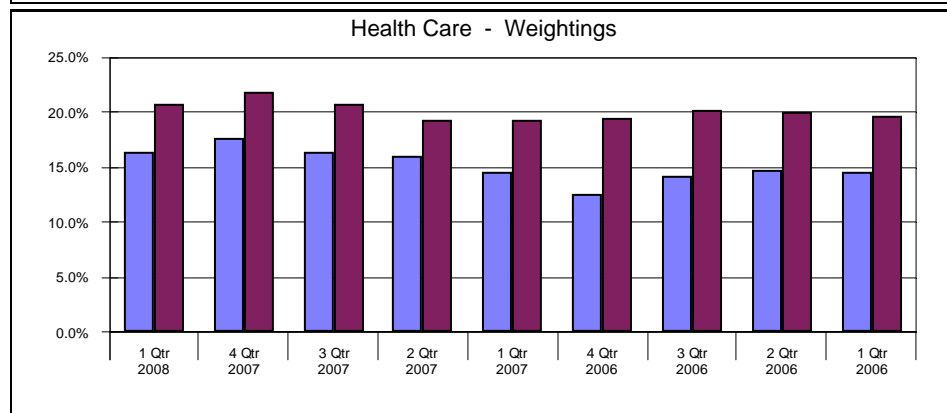
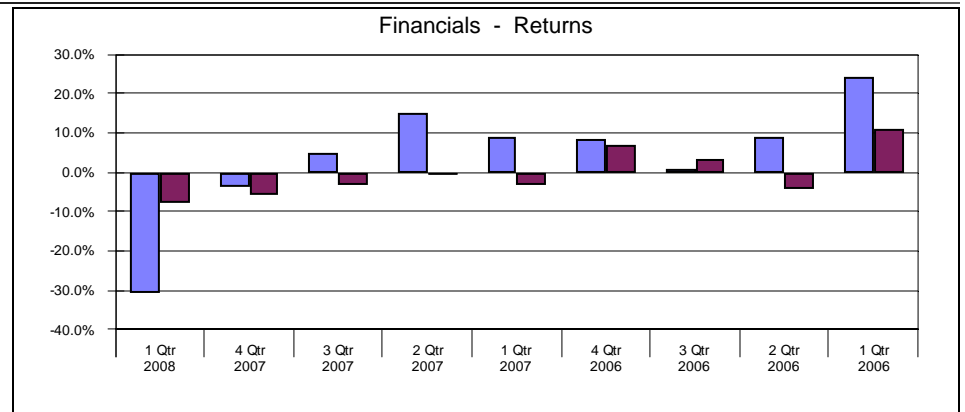
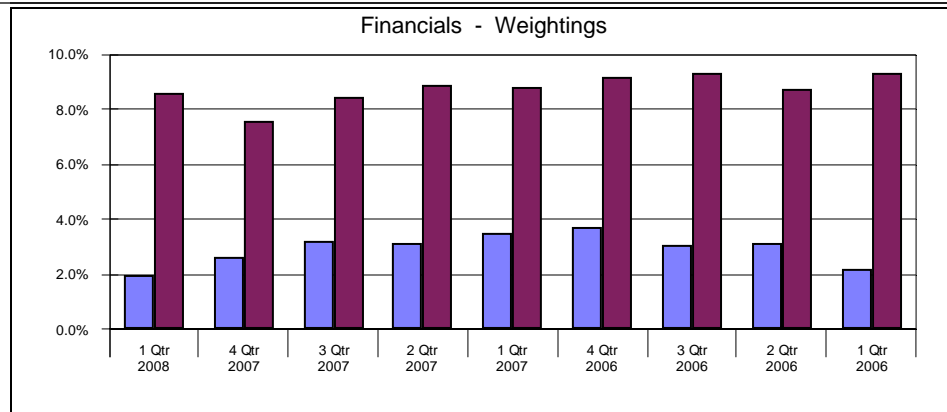

█ KALMAR MANAGEMENT

█ RUSSELL 2000 GROWTH

# Fresno County Employees' Retirement Association

## Equity Only Sector Analysis Quarterly

Period Ending: March 31, 2008

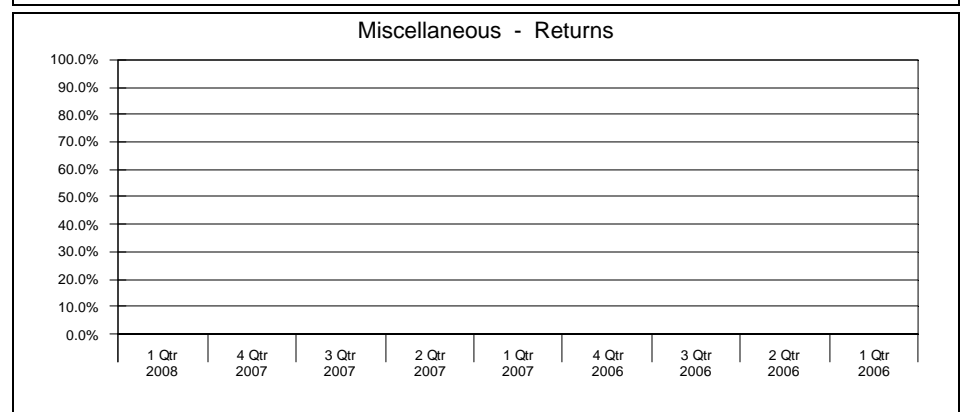
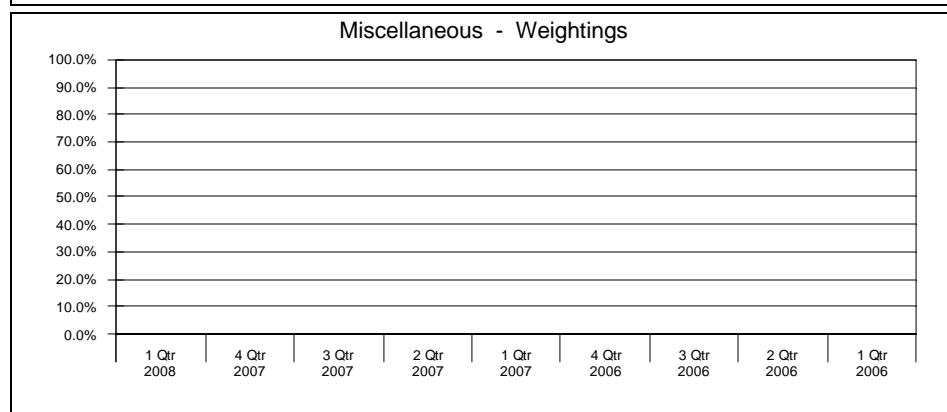
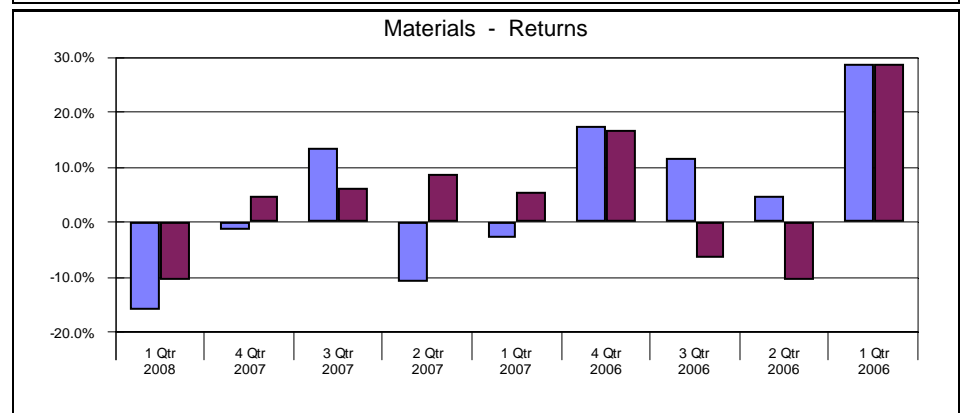
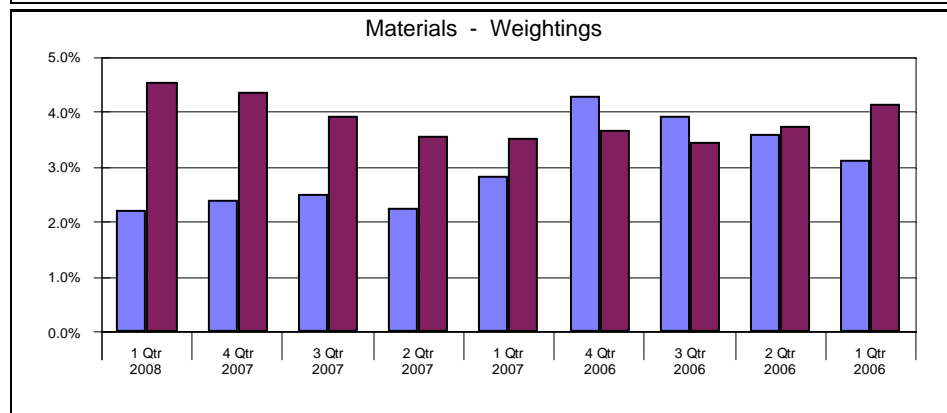
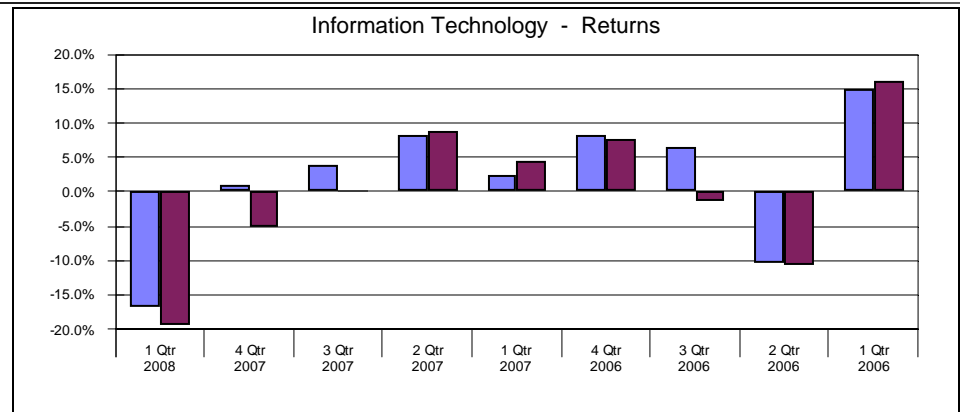
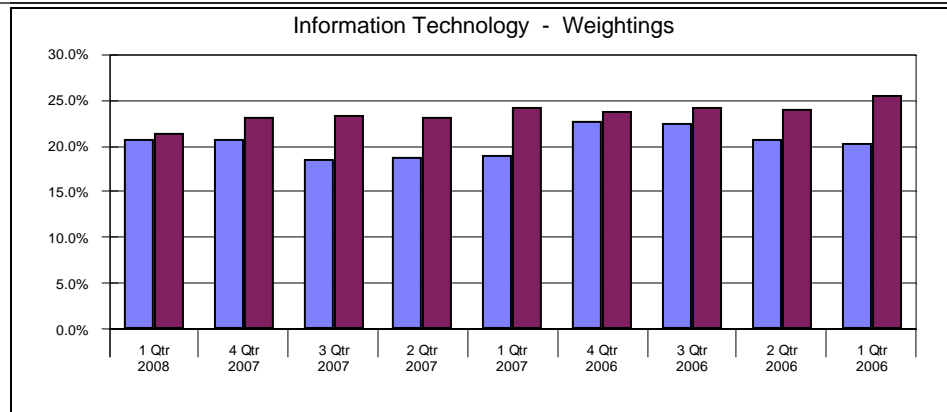

■ KALMAR MANAGEMENT

■ RUSSELL 2000 GROWTH

# Fresno County Employees' Retirement Association

## Equity Only Sector Analysis Quarterly

Period Ending: March 31, 2008

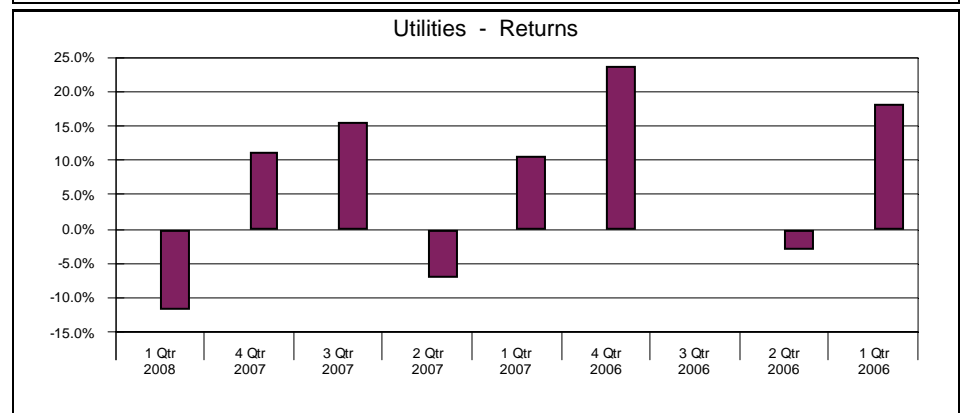
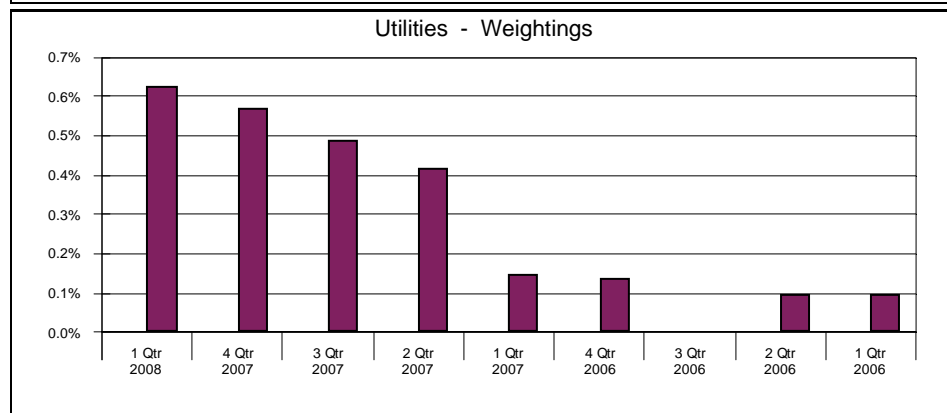
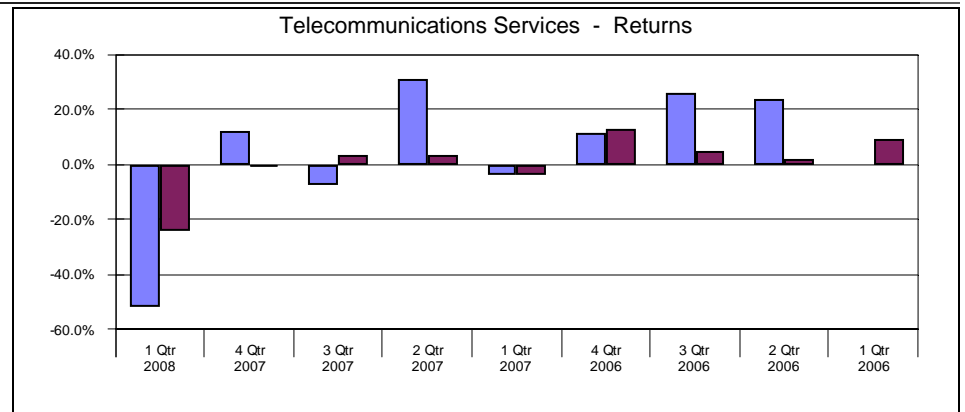
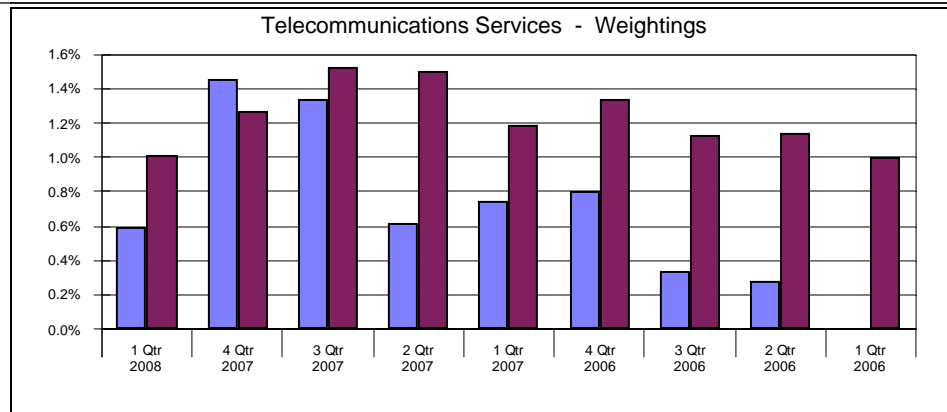

■ KALMAR MANAGEMENT

■ RUSSELL 2000 GROWTH

# Fresno County Employees' Retirement Association

## Performance Attribution Geometric

Period Ending: March 31, 2008

### KALMAR MANAGEMENT

	Portfolio		RUSSELL 2000 GROWTH		Selection		Total
	Market Value	Return	Market Value	Return	Stock	Industry	
	<b>A</b>	<b>B</b>	<b>C</b>	<b>D</b>	<b>E</b>	<b>F</b>	
Consumer Discretionary	18.5	-10.4	13.1	-12.2	0.4	0.0	0.4
Consumer Staples	11.0	-8.4	2.4	-7.2	-0.2	0.6	0.4
Energy	11.6	2.3	6.8	-1.0	0.4	0.7	1.1
Financials	2.9	-33.0	7.6	-7.8	-0.8	-0.3	-1.1
Health Care	19.3	-11.7	21.8	-15.7	0.9	0.1	1.0
Industrials	9.9	-9.7	19.0	-9.1	-0.1	-0.4	-0.5
Information Technology	22.7	-19.4	23.1	-19.4	0.0	0.0	0.0
Materials	2.6	-16.4	4.4	-10.7	-0.2	0.0	-0.2
Telecommunications Services	1.6	-11.1	1.3	-24.2	0.2	0.0	0.2
Utilities	0.0	0.0	0.6	-11.8	0.0	0.0	0.0
	100.0	-11.8	100.0	-12.8	0.7	0.6	1.3

#### Contribution

<b>Stock</b>	Health Care
	Energy
<b>Industry</b>	Energy
	Consumer Staples

#### Detractors

<b>Stock</b>	Financials
	Materials
<b>Industry</b>	Industrials
	Financials

# Fresno County Employees' Retirement Association

## Portfolio Holdings And Characteristics - Equity

Period Ending: March 31, 2008

KALMAR MANAGEMENT	Shares	Price	Portfolio Weight	Market Cap	Dividend Yield	Price / Earnings	Price / Book	Beta	Quarterly Return
<b>Consumer Discretionary</b>									
ACTUANT CORP	10,290	30.21	0.5	1.69	0.1	17.1	3.3	1.81	-11.2
CARLISLE COS INC	9,140	33.44	0.5	2.01	1.7	9.7	1.8	0.76	-9.4
CHOICEPOINT INC	7,835	47.60	0.6	3.23		110.7	10.2	0.63	30.7
CORRECTIONS CORP AMER NEW	38,224	27.52	1.8	3.44		26.0	2.8	1.06	-6.7
DEVRY INC DEL	25,880	41.84	1.9	2.99	0.3	29.5	4.6	1.32	-19.5
FLOWERS COM INC	41,570	8.51	0.6	0.22		26.6	2.6	1.38	-2.5
FREDS INC	28,675	10.25	0.5	0.41	0.8	16.8	1.1	1.39	6.7
GAMESTOP CORP NEW	16,530	51.71	1.5	8.32		29.5	5.7	1.41	-16.7
GEMSTAR TV GUIDE INTL INC	69,370	4.70	0.6	2.02		11.5	2.9	1.25	-1.3
GLOBAL TRAFFIC NETWORK INC	25,590	8.76	0.4	0.16			7.6		34.4
INNERWORKINGS INC	33,890	14.03	0.8	0.67		31.2	4.2		-18.7
KENNAMETAL INC	16,520	29.43	0.8	2.27	1.6	11.7	1.5	1.41	-22.0
LIFE TIME FITNESS INC	21,900	31.21	1.2	1.22		17.5	2.1	1.48	-37.2
LKQ CORP	46,460	22.47	1.8	3.02		40.9	3.5	1.09	6.9
O REILLY AUTOMOTIVE INC	21,650	28.52	1.1	3.29		17.1	2.1	1.17	-12.1
PENN NATL GAMING INC	11,250	43.73	0.8	3.80		24.2	3.4	1.21	-26.6
SUSSER HLDGS CORP	9,360	18.77	0.3	0.32		19.4	1.7		-8.4
TRACTOR SUPPLY CO	22,770	39.52	1.5	1.48		16.5	2.8	1.29	10.0
			<b>17.3</b>	<b>2.78</b>	<b>0.8</b>	<b>27.3</b>	<b>3.6</b>	<b>1.24</b>	<b>-7.94</b>
<b>Consumer Staples</b>									
BJS RESTAURANTS INC	13,425	14.41	0.3	0.38		32.8	1.7	1.09	-11.4
CENTRAL EUROPEAN DISTR CORP	21,510	58.19	2.2	2.35		30.5	2.9	1.32	0.2
ELIZABETH ARDEN INC	22,650	19.95	0.8	0.58		12.5	1.8	1.14	-2.0
INVENTIV HEALTH INC	32,240	28.81	1.6	0.93		19.7	2.0	1.65	-6.9
LONGS DRUG STORES CORP	22,640	42.46	1.7	1.54	1.3	16.8	1.9	0.77	-9.4
MARTEK BIOSCIENCES CORP	27,110	30.57	1.4	1.00		26.4	1.9	1.00	3.4
PERFORMANCE FOOD GROUP CO	35,050	32.68	2.0	1.16		22.5	1.3	0.73	21.6
SUNOPTA INC	57,540	5.10	0.5	0.33		15.7		1.63	-61.8
VALUECLICK INC	36,920	17.25	1.1	1.69		24.6	2.4	2.39	-21.2
			<b>11.5</b>	<b>1.34</b>	<b>1.3</b>	<b>22.8</b>	<b>2.0</b>	<b>1.24</b>	<b>-3.35</b>
<b>Energy</b>									
ATWOOD OCEANICS INC	8,090	91.72	1.3	2.91		18.7	4.7	1.21	-8.5
CORE LABORATORIES NV	6,350	119.30	1.3	2.74		31.7		1.33	-4.4
DELTA PETE CORP	53,620	22.54	2.1	2.32			2.9	1.03	19.6
GMX RES INC	22,790	34.93	1.4	0.46		37.6	2.9	0.86	8.2
PARALLEL PETE CORP DEL	37,360	19.57	1.3	0.81			3.4	0.89	11.0
TIDEWATER INC	9,565	55.11	0.9	2.90	1.1	8.7	1.7	1.06	0.7
ULTRA PETE CORP	22,800	77.50	3.0	11.81		68.0	13.8	1.45	8.4
CLEAN ENERGY FUELS CORP	33,900	13.36	0.8	0.59			2.6		-11.8
NIKO RESOURCES LTD COM(R1933)	13,925	81.14	1.9						
			<b>14.0</b>	<b>4.39</b>	<b>1.1</b>	<b>42.0</b>	<b>6.2</b>	<b>1.16</b>	<b>4.75</b>

# Fresno County Employees' Retirement Association

## Portfolio Holdings And Characteristics - Equity

Period Ending: March 31, 2008

KALMAR MANAGEMENT	Shares	Price	Portfolio Weight	Market Cap	Dividend Yield	Price / Earnings	Price / Book	Beta	Quarterly Return
<b>Financials</b>									
ALLIANCE DATA SYSTEMS CORP	13,655	47.51	1.1	3.76		23.4	3.1	1.61	-36.6
HEARTLAND PMT SYS INC	12,960	23.01	0.5	0.86	1.6	25.6	5.3	0.53	-13.8
NATIONAL FINL PARTNERS CORP	7,570	22.47	0.3	0.89	3.7	16.6	1.1	1.80	-50.3
ONLINE RES CORP	18,525	9.62	0.3	0.28			2.4	1.25	-19.3
			<b>2.2</b>	<b>2.23</b>	<b>2.4</b>	<b>23.0</b>	<b>3.2</b>	<b>1.34</b>	<b>-30.79</b>
<b>Health Care</b>									
ANALOGIC CORP COM PAR 0.05	18,905	66.54	2.2	0.89	0.6	31.4	2.2	1.05	-1.6
COOPER COS INC	23,265	34.43	1.4	1.55	0.2		1.1	1.06	-9.4
COVANCE INC	15,230	82.97	2.2	5.32		30.6	4.8	0.45	-4.2
ERESARCH TECHNOLOGY INC	33,560	12.42	0.7	0.63		42.8	5.5	1.33	5.1
HEALTHCARE SVCS GROUP INC	30,300	20.64	1.1	0.89	2.5	30.8	4.5	0.86	-2.0
HEALTHEXTRAS INC	25,620	24.84	1.1	1.06		27.3	3.5	1.34	-4.8
HEALTHWAYS INC	18,240	35.34	1.1	1.27		28.7	3.5	1.39	-39.5
LIFECCELL CORP	22,040	42.03	1.6	1.44		53.9	8.4	1.57	-2.5
OMNICELL INC	27,310	20.10	0.9	0.69		15.7	2.7	1.65	-25.4
PSS WORLD MED INC	45,825	16.66	1.3	1.06		21.1	2.9	1.03	-14.9
PSYCHIATRIC SOLUTIONS INC	19,340	33.92	1.1	1.87		24.8	2.5	1.51	4.4
RESMED INC	19,270	42.18	1.4	3.28		52.1	3.5	1.06	-19.7
SONOSITE INC	10,540	28.43	0.5	0.47		71.1	2.5	1.49	-15.6
SUNRISE SENIOR LIVING INC	8,830	22.28	0.3	1.12		55.7	1.7	1.09	-27.4
POLYPORE INTERNATIONAL INC OM	35,290	20.69	1.3	0.83			2.5		18.2
			<b>18.2</b>	<b>1.78</b>	<b>0.9</b>	<b>35.0</b>	<b>3.6</b>	<b>1.14</b>	<b>-7.56</b>
<b>Industrials</b>									
ADVISORY BRD CO	13,450	54.94	1.3	0.98		33.7	7.2	0.93	-14.4
CHICAGO BRDG + IRON CO N V N Y REGISTRY	25,770	39.24	1.7	3.80	0.4	31.3	5.2	1.69	-35.0
ENERSYS	24,170	23.92	1.0	1.16		22.8	2.1	0.77	-4.2
MOBILE MINI INC	34,725	19.00	1.1	0.66		15.6	1.4	0.99	2.5
MPS GROUP INC	45,165	11.82	0.9	1.13		13.7	1.2	1.07	8.0
MSC INDL DIRECT INC	22,075	42.25	1.6	2.00	1.7	15.6	3.8	1.34	4.9
TETRA TECH INC NEW	45,225	19.51	1.5	1.15		23.0	2.7	1.63	-9.3
UTI WORLDWIDE INC SHS	34,000	20.08	1.2	1.99	0.3	50.6		1.50	2.5
			<b>10.4</b>	<b>1.75</b>	<b>0.8</b>	<b>26.0</b>	<b>3.6</b>	<b>1.29</b>	<b>-7.38</b>



# Fresno County Employees' Retirement Association

## Portfolio Holdings And Characteristics - Equity

Period Ending: March 31, 2008

KALMAR MANAGEMENT	Shares	Price	Portfolio Weight	Market Cap	Dividend Yield	Price / Earnings	Price / Book	Beta	Quarterly Return
<b>Information Technology</b>									
ANSYS INC	17,280	34.52	1.0	2.70		33.8	4.2	1.39	-16.7
ATMI INC	35,445	27.83	1.7	0.92		24.0	2.1	1.84	-13.7
AVOCENT CORP	18,530	16.90	0.5	0.77		18.8	1.0	1.96	-27.5
CONCUR TECHNOLOGIES INC	14,890	31.05	0.8	1.37			4.8	1.47	-14.3
CYBERSOURCE CORP DEL	89,220	14.61	2.2	1.01			2.0	1.14	-17.8
DEALERTRACK HOLDINGS INC	27,940	20.22	1.0	0.86		42.1	2.0		-39.6
DIGITAL RIV INC	7,670	30.97	0.4	1.26		19.6	1.9	1.23	-6.4
DIODES INC	13,180	21.96	0.5	0.91		15.6	2.4	1.67	-27.0
ECLIPSYS CORP	30,220	19.61	1.0	1.06		25.8	4.1	1.17	-22.5
FEI CO	23,350	21.83	0.9	0.80	0.9	16.2	1.6	1.66	-11.9
INSIGHT ENTERPRISES INC	48,290	17.50	1.5	0.85		12.2	1.1	1.67	-4.1
IXIA	33,675	7.76	0.4	0.53		77.6	1.7	1.38	-18.1
MICROSEMI CORP	31,790	22.80	1.2	1.78			3.1	1.93	3.0
NIC INC	47,710	7.11	0.6	0.44		37.4	6.6	1.47	-12.5
NICE SYS LTD SPONSORED ADR	22,510	28.22	1.1	1.69	3.5	35.5	2.5	1.72	-17.1
OPNET TECHNOLOGIES INC	19,500	8.14	0.3	0.17		81.4	1.5	1.57	-10.2
PHASE FORWARD INC	40,750	17.08	1.2	0.72		23.7	3.4	1.40	-21.5
POLYCOM INC	33,460	22.54	1.3	2.05		33.6	2.0	1.82	-18.9
PROGRESS SOFTWARE CORP	27,520	29.92	1.4	1.27		28.5	2.4	1.29	-11.2
RIGHTNOW TECHNOLOGIES INC	28,705	11.90	0.6	0.40			10.4	1.11	-24.9
SKILLSOFT PUB LTD CO SPONSORED ADR	45,830	10.47	0.8	1.17			1.9	2.19	9.5
SYMMETRICOM INC	36,055	3.49	0.2	0.16			0.7	1.60	-25.9
SYNTEL INC	11,030	26.65	0.5	1.11	0.9	17.5	5.3	1.15	-30.7
TESSERA TECHNOLOGIES INC	26,565	20.80	1.0	1.01		22.4	2.4	1.54	-50.0
VOLTERRA SEMICONDUCTOR CORP	30,440	11.33	0.6	0.27			4.2	1.63	2.7
CONSTANT CONTACT INC	17,900	14.48	0.4	0.40			4.2		-32.7
			<b>23.2</b>	<b>1.12</b>	<b>2.1</b>	<b>28.3</b>	<b>2.9</b>	<b>1.54</b>	<b>-16.71</b>
<b>Materials</b>									
ALBEMARLE CORP	23,650	36.52	1.5	3.34	1.3	15.5	2.7	1.11	-11.2
ROGERS CORP	17,695	33.41	1.0	0.60		25.3	1.5	1.22	-23.0
			<b>2.5</b>	<b>2.22</b>	<b>1.3</b>	<b>19.5</b>	<b>2.2</b>	<b>1.16</b>	<b>-15.97</b>
<b>Telecommunications Services</b>									
CBEYOND INC	20,830	18.79	0.7	0.54		26.1	4.2		-51.8
			<b>0.7</b>	<b>0.54</b>		<b>26.1</b>	<b>4.2</b>		<b>-51.81</b>
KALMAR MANAGEMENT			<b>100.0</b>	<b>2.08</b>	<b>1.1</b>	<b>29.2</b>	<b>3.5</b>	<b>1.29</b>	<b>-8.56</b>

# Fresno County Employees' Retirement Association

## Equity Activity

Period Ending: March 31, 2008

Start from Dec 31, 2007 **KALMAR MANAGEMENT**

Additions				Deletions			
Security Name	Shares	Market Value	New	Security Name	Shares	Market Value	Eliminated
ALLIANCE DATA SYSTEMS CORP	60	4,724	*		26,670	430,052	*
CBEYOND INC	9,400	289,444	*		11,055	205,279	*
CENTRAL EUROPEAN DISTRIBUTION CORPORATIO	3,360	200,759			29,525	1,948,650	*
CLEAN ENERGY FUELS CORP	13,700	201,809		ANSYS INC	8,820	318,107	
COOPER COS INC	1,940	77,901	*	ATWOOD OCEANICS INC	2,810	247,263	
CYBERSOURCE CORP DEL	29,970	435,715	*	AVOCENT CORP	12,860	198,959	
DELTA PETE CORP	14,280	283,720	*	BENCHMARK ELECTRONICS, INCORPORATED	6,330	114,609	*
ECLIPSYS CORP	30,220	641,580	*	CHOICEPOINT INC	6,440	310,272	
ENERSYS	24,170	630,044	*	DEVRY INC DEL	10,850	634,208	
ERESearch TECHNOLOGY INC	33,560	330,180	*	DIVX INC	20,640	147,951	*
GEMSTAR TV GUIDE INTL INC	69,370	337,492	*	GAMESTOP CORP NEW	5,470	313,581	
GLOBAL TRAFFIC NETWORK INC	3,880	20,103		HEALTHEXTRAS INC	10,480	319,488	
N/A		4,724	*	INTERNAP NETWORK SVCS CORP COM PAR .001	19,730	75,376	*
NIC INC	47,710	337,124	*	N/A		116	*
PHASE FORWARD INC	23,660	405,880					
SUNOPTA INCORPORATED	20,770	270,126					
SYNTEL INC	11,030	307,999	*				

# Fresno County Employees' Retirement Association

## Cumulative Performance Comparisons

Period Ending: March 31, 2008

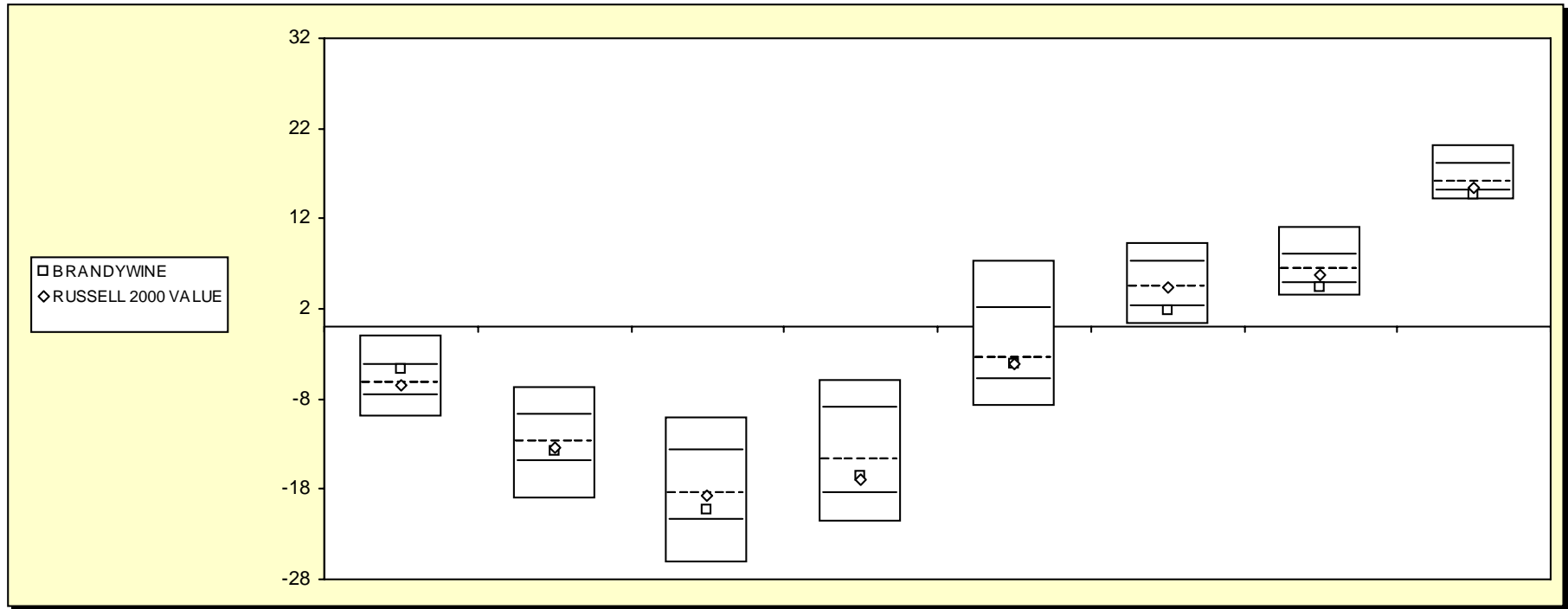

### Equity Style - Small Value

	Last Quarter		Two Quarters		Three Quarters		One Year		Two Years		Three Years		Four Years		Five Years	
	Return	Rank	Return	Rank	Return	Rank	Return	Rank	Return	Rank	Return	Rank	Return	Rank	Return	Rank
5th Percentile	-1.0		-6.8		-10.0		-5.8		7.4		9.3		11.1		20.1	
25th Percentile	-4.3		-9.8		-13.7		-9.0		2.0		7.2		8.0		18.0	
50th Percentile	-6.3		-12.9		-18.5		-14.8		-3.6		4.5		6.4		16.0	
75th Percentile	-7.6		-15.0		-21.6		-18.5		-5.8		2.3		4.8		15.0	
95th Percentile	-10.1		-19.2		-26.2		-21.8		-8.9		0.2		3.5		14.1	
BRANDYWINE	-4.7	30	-13.8	61	-20.2	64	-16.6	62	-4.1	55	1.9	79	4.4	81	14.7	82
RUSSELL 2000 VALUE	-6.5	54	-13.3	55	-18.7	52	-16.9	64	-4.2	57	4.3	51	5.7	61	15.4	64

# Fresno County Employees' Retirement Association

## Consecutive Performance Comparisons

Period Ending: March 31, 2008

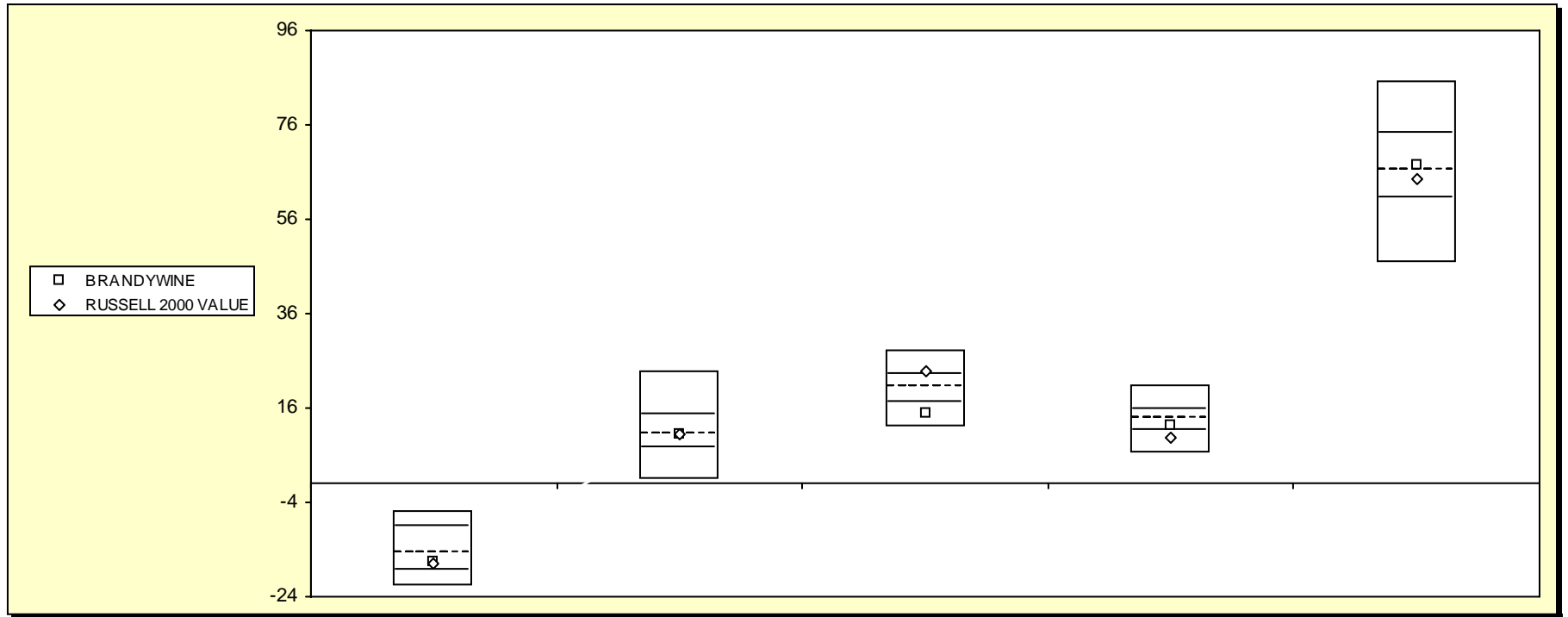

### Equity Style - Small Value

	March 2008		March 2007		March 2006		March 2005		March 2004	
	Return	Rank	Return	Rank	Return	Rank	Return	Rank	Return	Rank
5th Percentile	-5.8		23.7		28.2		20.7		85.4	
25th Percentile	-9.0		14.6		23.2		15.6		74.0	
50th Percentile	-14.8		10.3		20.5		13.6		66.4	
75th Percentile	-18.5		7.4		17.0		11.2		60.3	
95th Percentile	-21.8		0.8		12.0		6.5		46.9	
BRANDYWINE	-16.6	62	10.3	50	14.9	83	12.3	64	67.5	46
RUSSELL 2000 VALUE	-16.9	64	10.4	49	23.8	23	9.8	81	64.5	58

# Fresno County Employees' Retirement Association

Consecutive Annual - Five Year

Period Ending: March 31, 2008

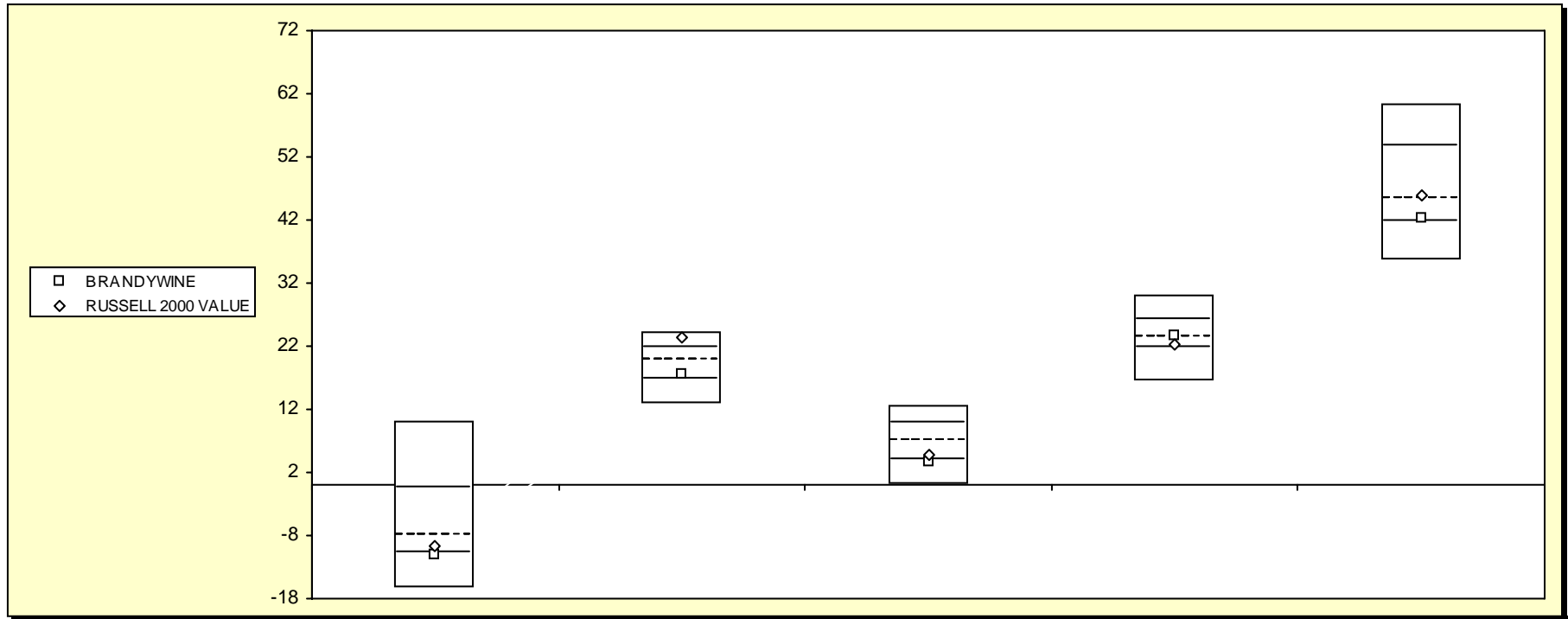

Equity Style - Small Value

	December 2007		December 2006		December 2005		December 2004		December 2003	
	Return	Rank	Return	Rank	Return	Rank	Return	Rank	Return	Rank
5th Percentile	10.0		24.2		12.6		30.1		60.3	
25th Percentile	-0.4		21.7		9.7		26.1		53.6	
50th Percentile	-7.9		19.8		7.0		23.5		45.4	
75th Percentile	-10.8		16.6		4.0		21.8		41.9	
95th Percentile	-16.3		12.9		-0.1		16.4		35.7	
BRANDYWINE	-11.2	76	17.7	67	3.8	76	23.6	48	42.3	72
RUSSELL 2000 VALUE	-9.8	66	23.5	11	4.7	69	22.2	68	46.0	48

# Fresno County Employees' Retirement Association

## Performance Review Summary

Period Ending: March 31, 2008

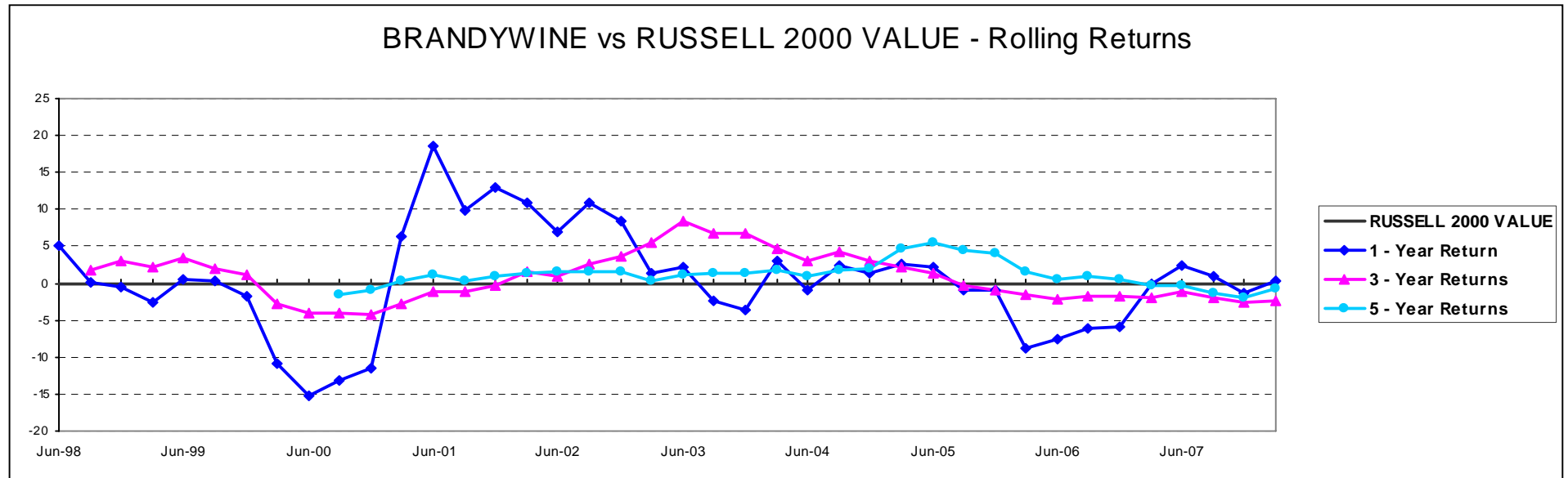

### Performance & Risk Measures

	Quarter		One Year		Three Years		Five Years		Standard Deviation		Sharpe Ratio		Beta	
	Return	Rank	Return	Rank	Return	Rank	Return	Rank	3-Years	5-Years	3-Years	5-Years	3-Years	5-Years
BRANDYWINE	-4.7	30	-16.6	62	1.9	79	14.7	82	11.6	16.4	-0.2	0.7	0.9	1.0
RUSSELL 2000 VALUE	-6.5	54	-16.9	64	4.3	51	15.4	64	12.6	16.1	0.0	0.8		
Equity Style - Small Value	-6.3		-14.8		4.5		16.0		12.6	16.3	0.0	0.8		

### Ten Largest Holdings

Security	Market Value	Weight
ODYSSEY RE HLDGS CORP	1,525,125	1.22
CON WAY INC	1,256,792	1.01
WESTSTAR ENERGY INC	1,247,796	1.00
STONE ENERGY CORP	1,192,668	0.96
WGL HLDGS INC	1,115,688	0.90
GRAFTECH INTL LTD	1,108,764	0.89
WASHINGTON FED INC	1,101,345	0.88
OLIN CORP COM PAR 1	1,090,752	0.88
DEL MONTE FOODS CO	1,075,937	0.86
STANCORP FINL GROUP INC	1,073,475	0.86

### Sector Weights

Sector	Portfolio	Benchmark
Materials	4.4	7.8
Industrials	13.7	13.3
Telecommunications Services	0.2	1.4
Consumer Discretionary	18.2	10.8
Consumer Staples	5.2	4.1
Energy	11.8	6.8
Financials	34.7	32.3
Health Care	2.2	5.7
Information Technology	5.5	11.9
Utilities	4.1	5.7

### Portfolio Characteristics

	Portfolio	Benchmark
Average Market Cap	\$ 1,117	\$ 1,140
Median Market Cap	\$ 470	\$ 480
P/E	13.8	14.0
P/B	1.7	1.8
Dividend Yield	2.0	2.2
Earnings Growth	12.3	13.9

**Benchmark:** RUSSELL 2000 VALUE

**Total Assets**                      **% of Total Fund**

\$ 127,347

# Fresno County Employees' Retirement Association

Rolling Return: 3 year Annualized

Period Ending: March 31, 2008

## Rolling Return (3 Year Annualized)

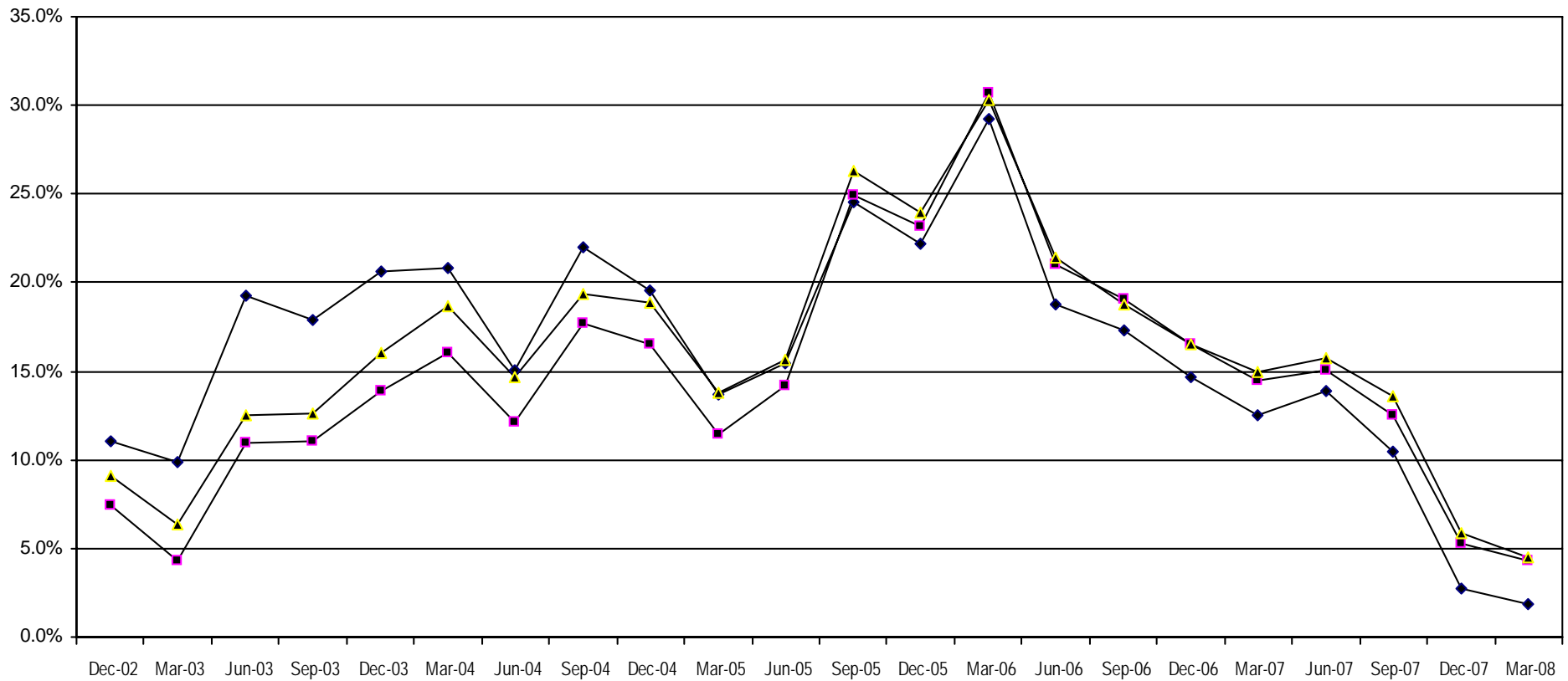

BRANDYWINE
  RUSSELL 2000 VALUE
  Equity Style - Small Value

	03/31/01	03/31/02	03/31/03	03/31/04	03/31/05	03/31/06	03/31/07	03/31/08
BRANDYWINE	-1.0	20.2	9.8	20.8	13.7	29.3	12.5	1.9
RUSSELL 2000 VALUE	1.8	18.8	4.3	16.0	11.5	30.7	14.5	4.3
Equity Style - Small Value	2.9	21.8	6.4	18.6	13.7	30.3	14.9	4.5

# Fresno County Employees' Retirement Association

## Three & Five Year Return vs. Risk

Period Ending: March 31, 2008

**Three-Year**

**Five-Year**

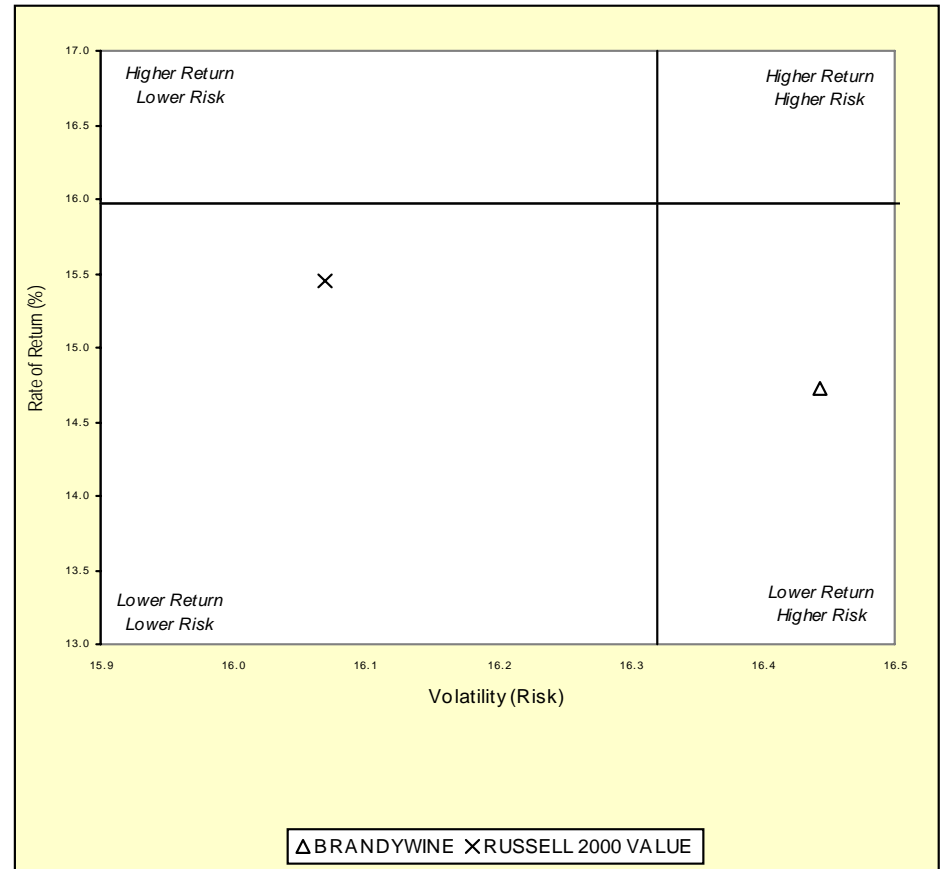
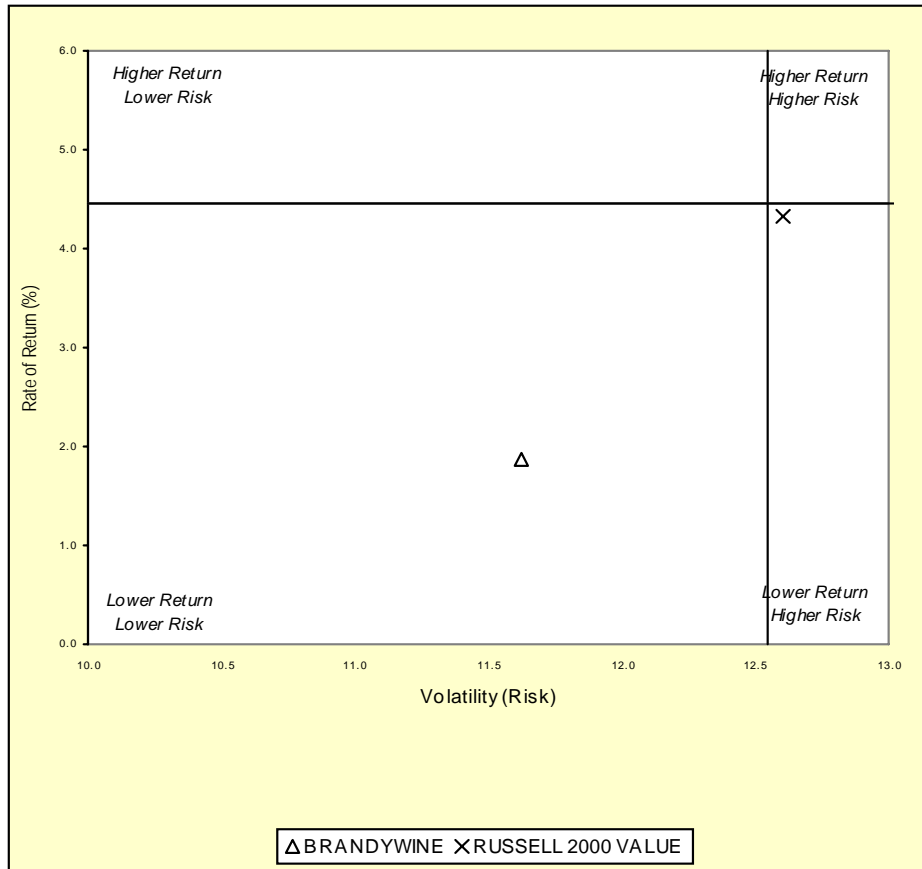

**Three Year Return vs Risk**

**Five Year Return vs Risk**

Annualized Return %	Standard Deviation %	Sharpe Ratio	Category	Annualized Return %	Standard Deviation %	Sharpe Ratio
1.9	11.6	-0.2	BRANDYWINE	14.7	16.4	0.7
4.5	12.6	0.0	Equity Style - Small Value Universe Median	16.0	16.3	0.8
4.3	12.6	0.0	RUSSELL 2000 VALUE	15.4	16.1	0.8



# Fresno County Employees' Retirement Association

## Equity Only Summary Statistics

Period Ending: March 31, 2008

### BRANDYWINE

	Portfolio	RUSSELL 2000 VALUE
Total Number of Securities	464	1284
Total Market Value	124,636,575	
Average Market Capitalization (000's)	1,117,352	1,140,000
Equity Segment Yield	3.04	2.18
Equity Segment Price/Earnings Ratio	14.32	14.02
Equity Segment Beta	1.10	1.25
Price/Book Ratio	1.70	1.76
5 Year Earnings Growth	12.3%	13.9%

#### Ten Largest Holdings

Security	Market Value	Weight
ODYSSEY RE HLDGS CORP	1,525,125	1.22
CON WAY INC	1,256,792	1.01
WESTSTAR ENERGY INC	1,247,796	1.00
STONE ENERGY CORP	1,192,668	0.96
WGL HLDGS INC	1,115,688	0.90
GRAFTECH INTL LTD	1,108,764	0.89
WASHINGTON FED INC	1,101,345	0.88
OLIN CORP COM PAR 1	1,090,752	0.88
DEL MONTE FOODS CO	1,075,937	0.86
STANCORP FINL GROUP INC	1,073,475	0.86

#### Ten Best Performers

Security	Return	Weight
ARKANSAS BEST CORP	46.0	0.37
ELLIS PERRY INTL INC	41.9	0.06
BASSETT FURNITURE INDS INC	34.2	0.07
PIONEER DRILLING CO	34.1	0.32
ROYAL BANCSHARES PA INC	33.7	0.06
INDUSTRIAL SVCS AMER INC FL	32.5	0.02
FIRST MERCHANTS CORP	31.8	0.25
OIL STATES INTL INC	31.3	0.49
RYDER SYS INC	30.1	0.15
STANDEX INTL CORP	29.4	0.11

#### Ten Worst Performers

Security	Return	Weight
JACKSON HEWITT TAX SVC INC	-63.3	0.07
SIGMA DESIGNS	-58.9	0.30
USEC INC	-58.9	0.06
UNIVERSAL AMERN FINL CORP	-58.6	0.08
ASTRONICS CORP	-54.5	0.04
RF MICRO DEVICES INC	-53.4	0.09
PROVIDENT BANKSHARES CORP	-48.9	0.12
UNIVERSAL INS HLDGS INC	-48.2	0.05
USA MOBILITY INC	-47.2	0.04
ASTA FDG INC	-47.1	0.01

# Fresno County Employees' Retirement Association

## Portfolio Characteristics - Equity

Period Ending: March 31, 2008

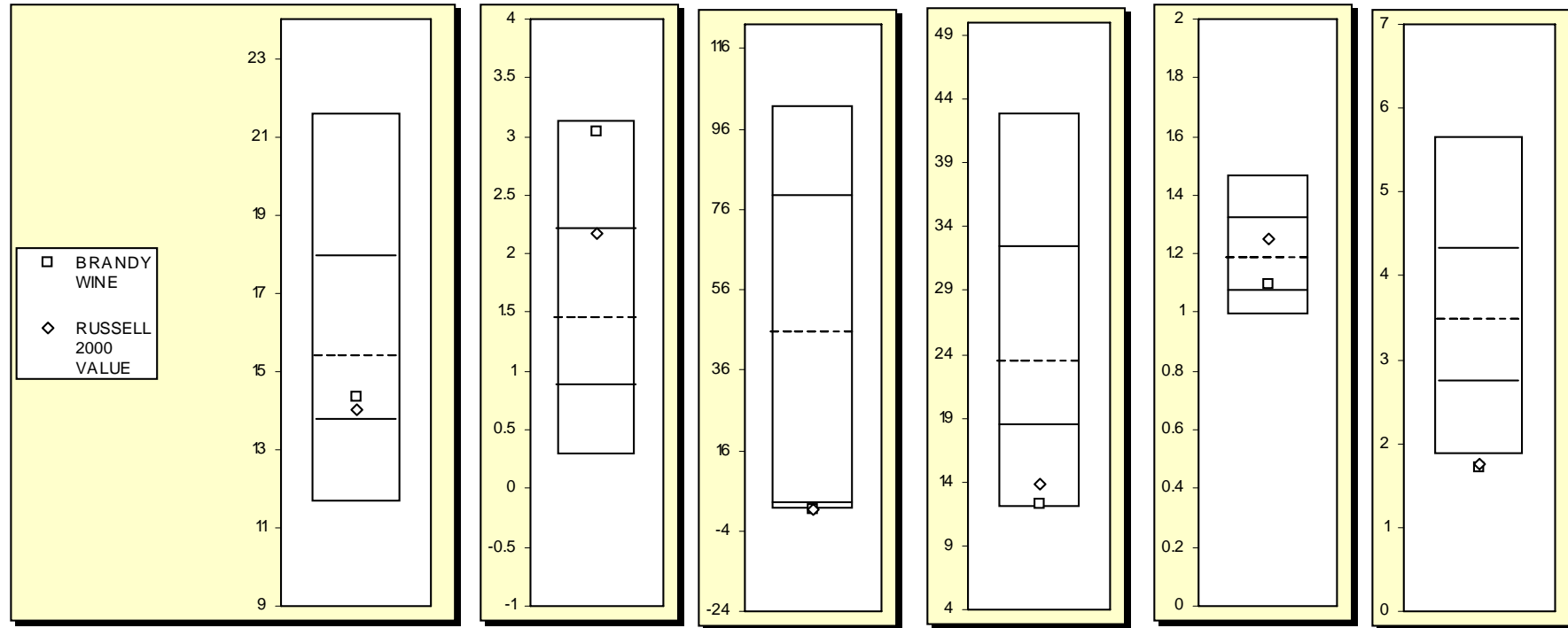

	Price/Earnings Ratio		Dividend Yield		Capitalization		5 Year Earnings		Beta		Price/Book Ratio	
	Value	Rank	Value	Rank	Value	Rank	Value	Rank	Value	Rank	Value	Rank
<i>Equity Funds - Equity Only</i>												
5th Percentile	21.57		3.13		101.51		42.95		1.47		5.66	
25th Percentile	17.93		2.20		78.86		32.34		1.32		4.32	
50th Percentile	15.38		1.45		45.26		23.34		1.18		3.47	
75th Percentile	13.75		0.88		2.83		18.43		1.07		2.72	
95th Percentile	11.66		0.28		1.13		11.93		0.99		1.86	
BRANDYWINE	14.32	66	3.04	7	1.12	99	12.29	94	1.10	68	1.70	99
RUSSELL 2000 VALUE	14.02	71	2.18	26	1.14	95	13.89	89	1.25	37	1.76	99

# Fresno County Employees' Retirement Association

## Top Ten Holding

Period Ending: March 31, 2008

As Of 6/30/06	
FIFTH THIRD US TREASURY MONEY	2.1%
INDYMAC BANCORP, INCORPORATED	1.4%
AMERUS GROUP COMPANY	1.3%
AGCO CORPORATION	1.2%
WPS RESOURCES CORP.	1.1%
ODYSSEY RE HOLDING CORP	1.1%
HOUSTON EXPLORATION COMPANY	1.0%
WORTHINGTON INDUSTRIES	1.0%
COMMERCE GROUP, INCORPORATED	1.0%
DOWNEY FINANCIAL CORPORATION	0.9%
<b>Top Ten Total:</b>	<b>12.3%</b>

As Of 9/30/06	
FIFTH THIRD US TREASURY MONEY	2.7%
ODYSSEY RE HOLDING CORP	1.3%
AMERUS GROUP COMPANY	1.3%
INDYMAC BANCORP, INCORPORATED	1.3%
JACK IN THE BOX	1.1%
WPS RESOURCES CORP.	1.1%
RENT-A-CENTER INC	1.1%
AGCO CORPORATION	1.0%
COMMERCE GROUP, INCORPORATED	1.0%
GREAT PLAINS ENERGY INC.	0.9%
<b>Top Ten Total:</b>	<b>12.8%</b>

As Of 12/31/06	
FIFTH THIRD US TREASURY MONEY	2.0%
ODYSSEY RE HOLDING CORP	1.3%
INDYMAC BANCORP, INCORPORATED	1.3%
JACK IN THE BOX	1.2%
WPS RESOURCES CORP.	1.1%
COMMERCE GROUP, INCORPORATED	1.0%
GREAT PLAINS ENERGY INC.	1.0%
RENT-A-CENTER INC	1.0%
DOWNEY FINANCIAL CORPORATION	0.9%
DELPHI FINANCIAL GROUP	0.9%
<b>Top Ten Total:</b>	<b>11.6%</b>

As Of 3/31/07	
FIFTH THIRD US TREASURY MONEY	2.6%
ODYSSEY RE HOLDING CORP	1.4%
JACK IN THE BOX	1.2%
INTEGRYS ENERGY GROUP INC	1.1%
TEMPUR-PEDIC INTERNATIONAL	1.0%
COMMERCE GROUP, INCORPORATED	1.0%
GREAT PLAINS ENERGY INC.	1.0%
RENT-A-CENTER INC	0.9%
WORTHINGTON INDUSTRIES	0.9%
INDYMAC BANCORP, INCORPORATED	0.9%
<b>Top Ten Total:</b>	<b>12.1%</b>

As Of 6/30/07	
FIFTH THIRD US TREASURY MONEY	2.6%
ODYSSEY RE HOLDING CORP	1.5%
COMMERCE GROUP, INCORPORATED	1.1%
DELUXE CORPORATION	1.0%
TEMPUR-PEDIC INTERNATIONAL	0.9%
WORTHINGTON INDUSTRIES	0.9%
ARVINMERITOR INCORPORATED	0.9%
TUPPERWARE CORPORATION	0.9%
GREAT PLAINS ENERGY INC.	0.9%
DELPHI FINANCIAL GROUP	0.9%
<b>Top Ten Total:</b>	<b>11.5%</b>

As Of 9/30/07	
FIFTH THIRD US TREASURY MONEY	3.3%
ODYSSEY RE HOLDING CORP	1.4%
TEMPUR-PEDIC INTERNATIONAL	1.3%
WORTHINGTON INDUSTRIES	1.1%
COMMERCE GROUP, INCORPORATED	1.0%
TUPPERWARE CORPORATION	1.0%
DELUXE CORPORATION	1.0%
WASHINGTON FEDERAL	0.9%
WESTAR ENERGY INCORPORATED	0.9%
FMC CORPORATION	0.9%
<b>Top Ten Total:</b>	<b>12.8%</b>

As Of 12/31/07	
FIFTH THIRD US TREASURY MONEY	2.2%
ODYSSEY RE HOLDING CORP	1.5%
TUPPERWARE CORPORATION	1.1%
WESTAR ENERGY INCORPORATED	1.1%
LENNOX INTERNATIONAL	1.0%
DELUXE CORPORATION	1.0%
W&T OFFSHORE INC	1.0%
SKYWEST INC	1.0%
GRAFTECH INTERNATIONAL LTD.	0.9%
WGL HOLDINGS INC	0.9%
<b>Top Ten Total:</b>	<b>11.5%</b>

As Of 3/31/08	
STATE STREET BANK + TRUST CO	3.0%
ODYSSEY RE HLDGS CORP	1.2%
CON WAY INC	1.0%
WESTSTAR ENERGY INC	1.0%
STONE ENERGY CORP	0.9%
WGL HLDGS INC	0.9%
GRAFTECH INTL LTD	0.9%
WASHINGTON FED INC	0.9%
OLIN CORP COM PAR 1	0.8%
DEL MONTE FOODS CO	0.8%
<b>Top Ten Total:</b>	<b>11.3%</b>

# Fresno County Employees' Retirement Association

## Equity Only Summary Statistics Charts

Period Ending: March 31, 2008

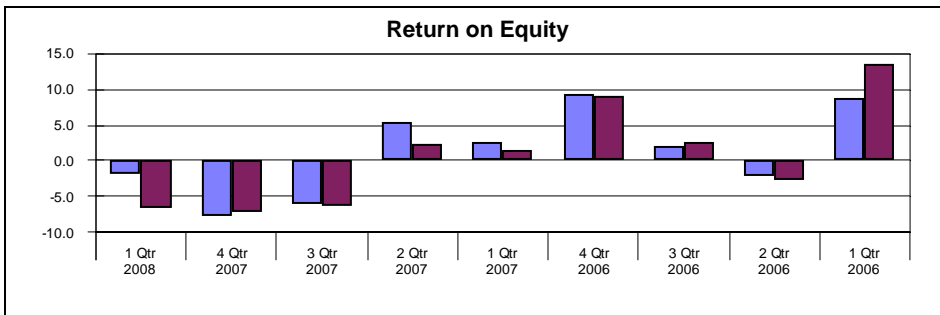
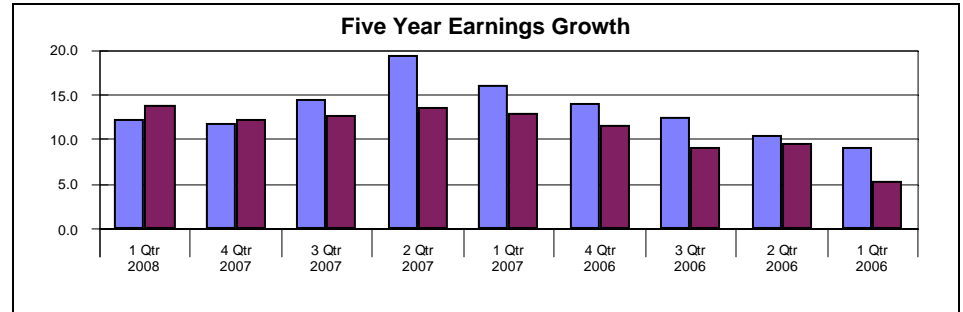
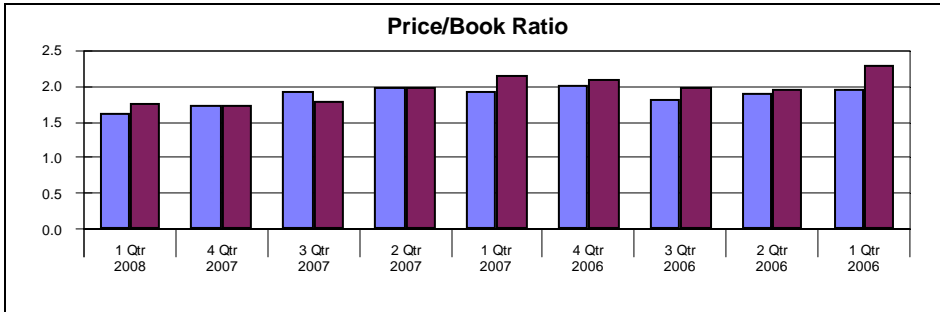
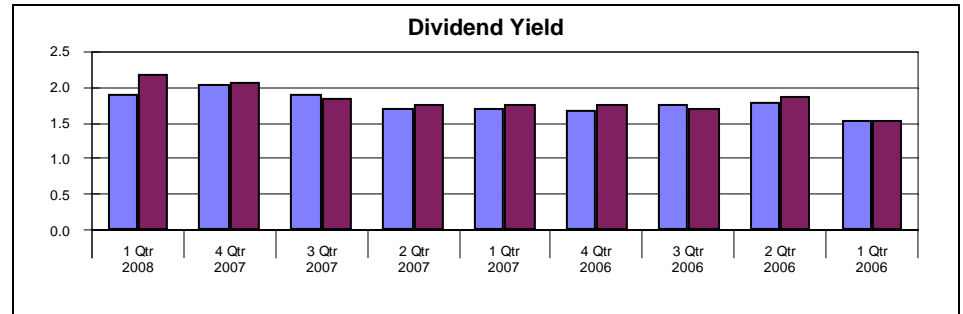
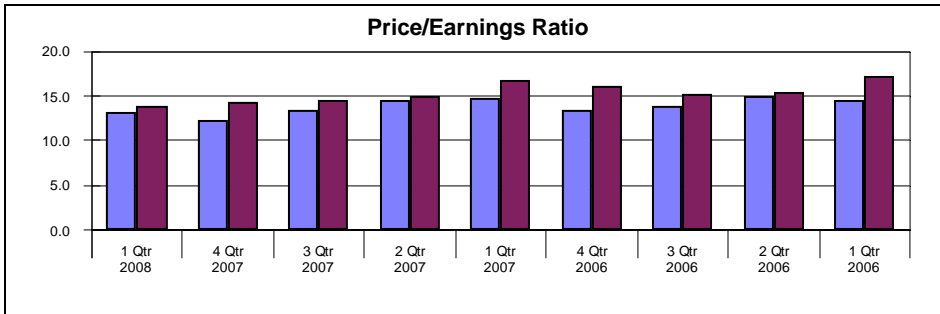
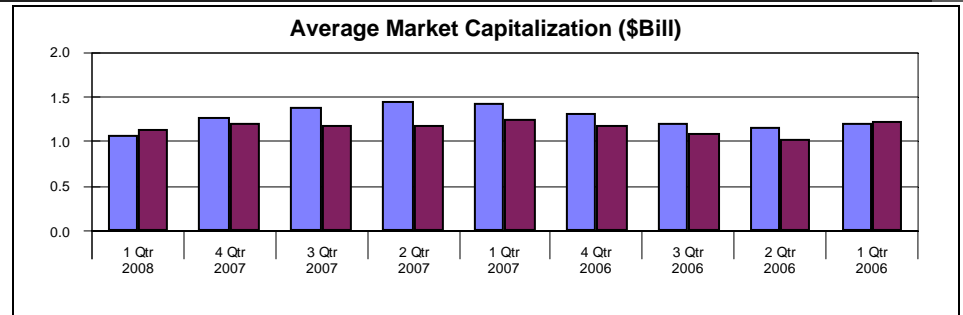
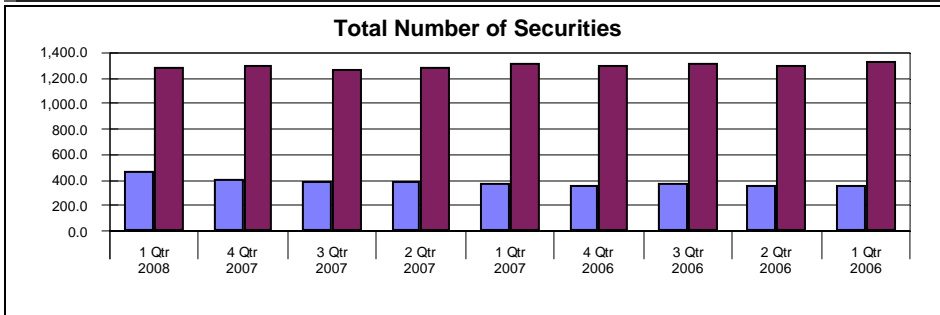

BRANDYWINE  
RUSSELL 2000 VALUE

# Fresno County Employees' Retirement Association

## Equity Only Sector Analysis Quarterly

Period Ending: March 31, 2008

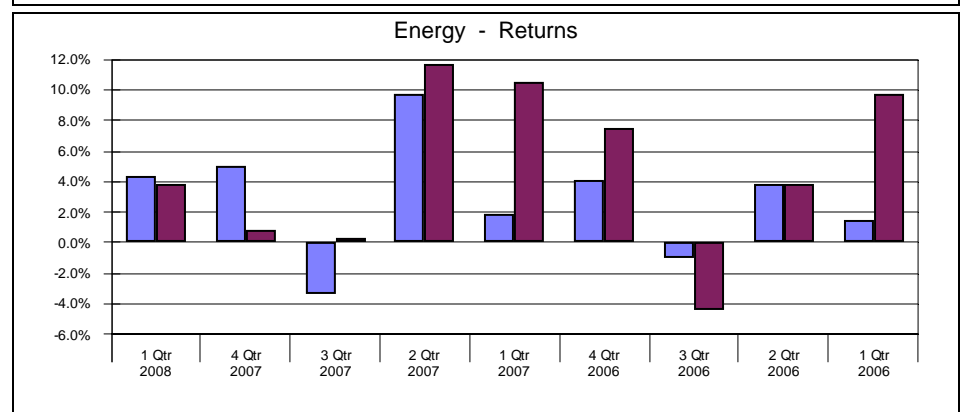
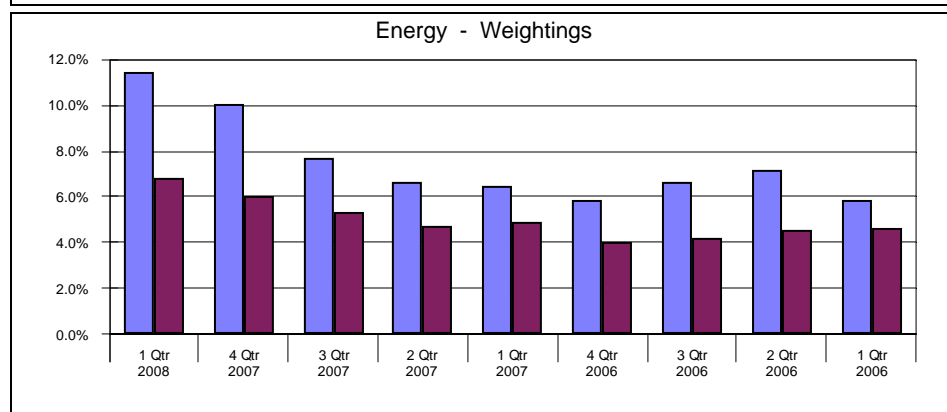
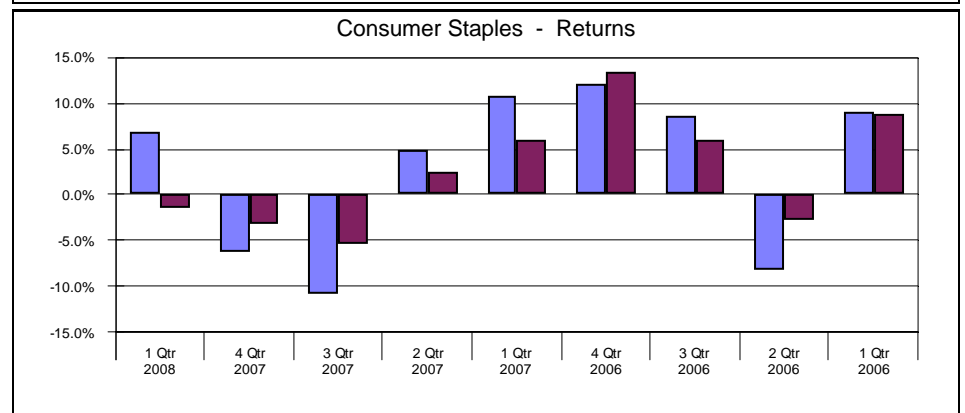
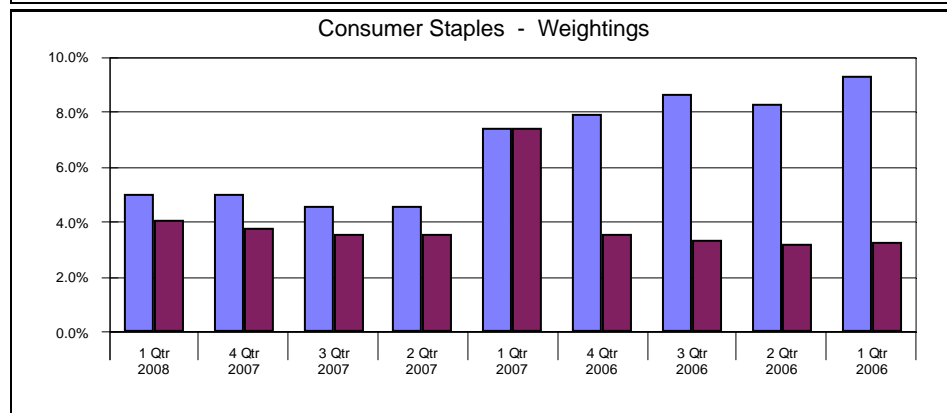
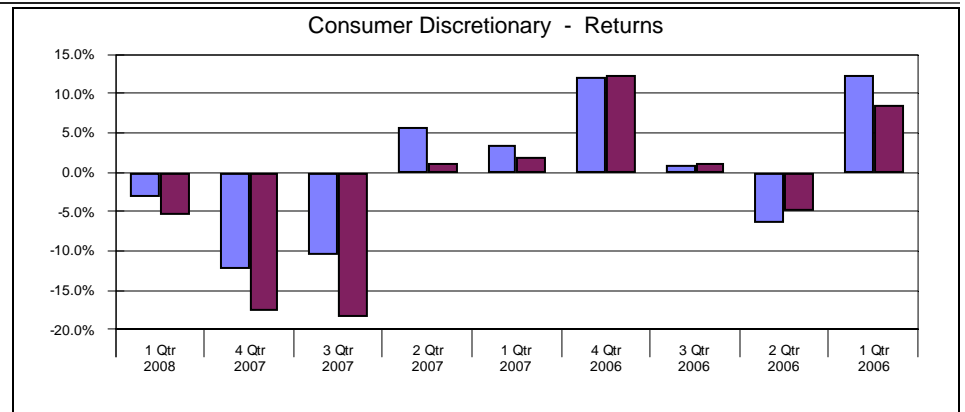
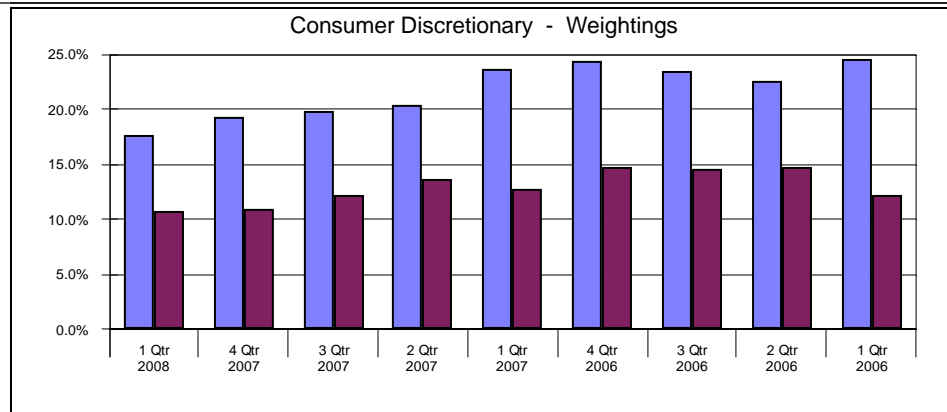

BRANDYWINE

RUSSELL 2000 VALUE

# Fresno County Employees' Retirement Association

## Equity Only Sector Analysis Quarterly

Period Ending: March 31, 2008

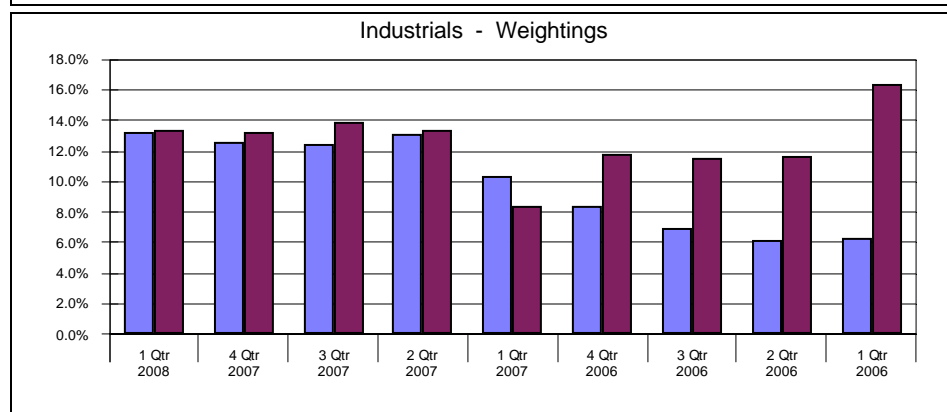
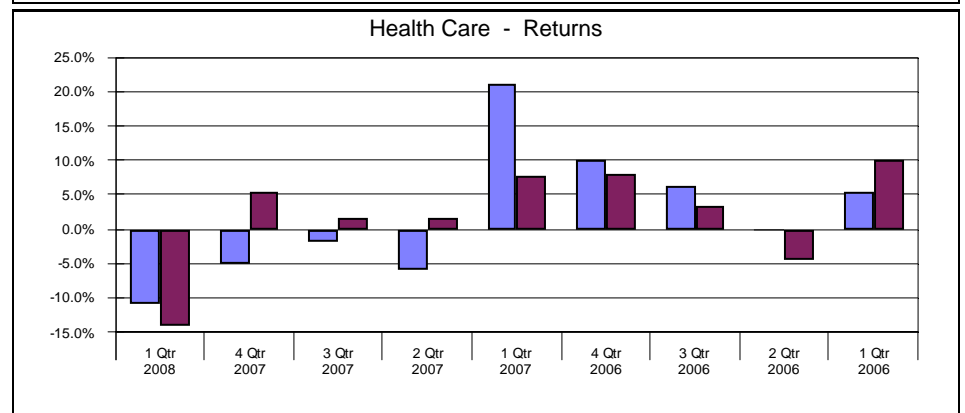
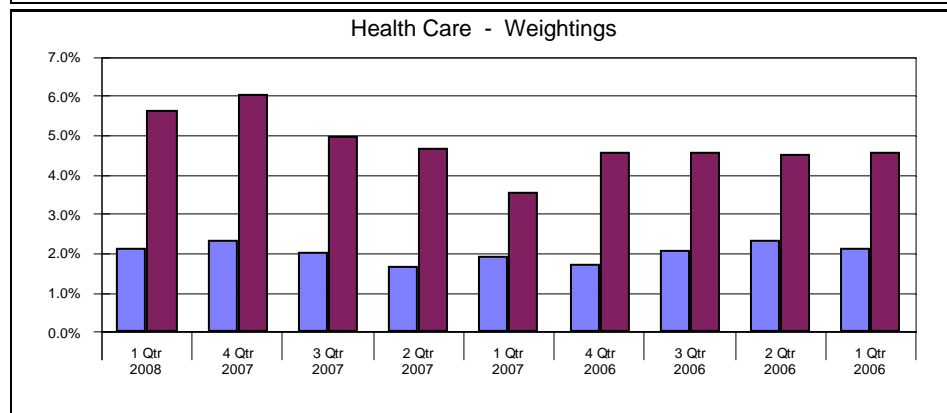
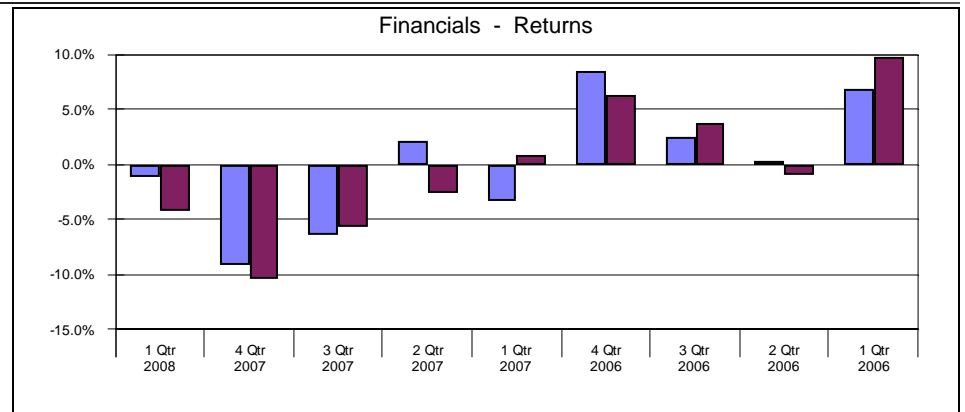
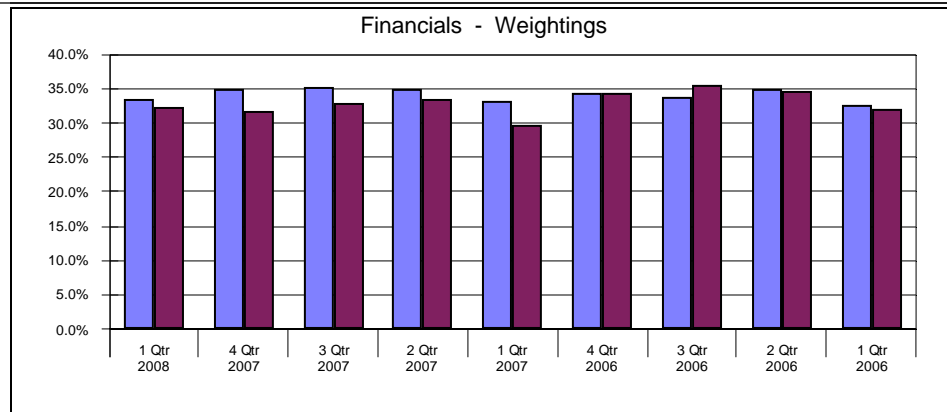

BRANDYWINE

RUSSELL 2000 VALUE

# Fresno County Employees' Retirement Association

## Equity Only Sector Analysis Quarterly

Period Ending: March 31, 2008

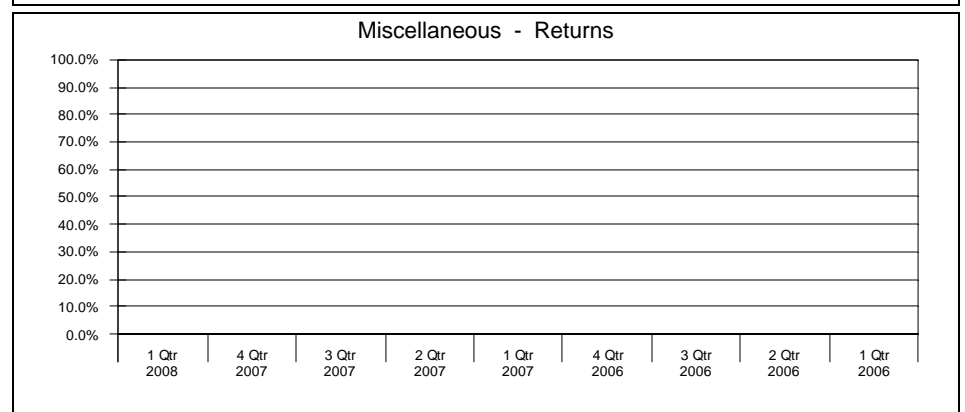
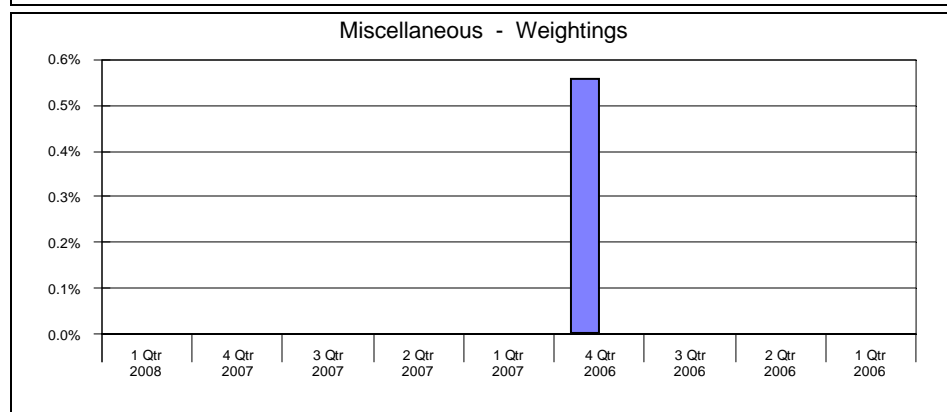
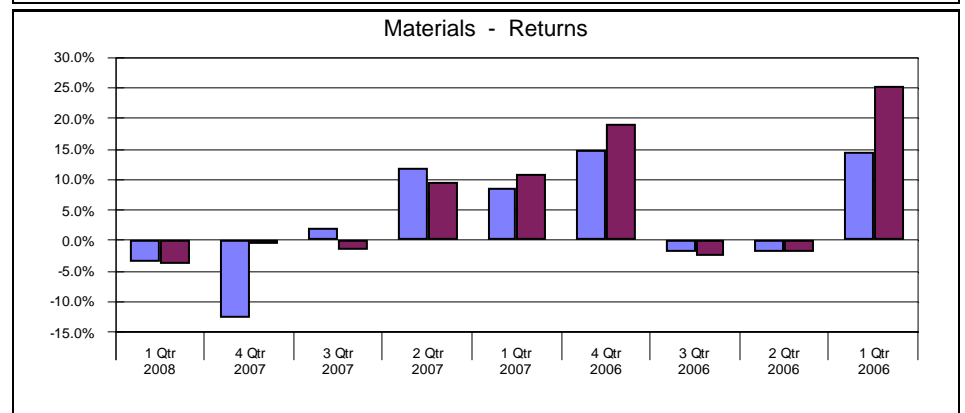
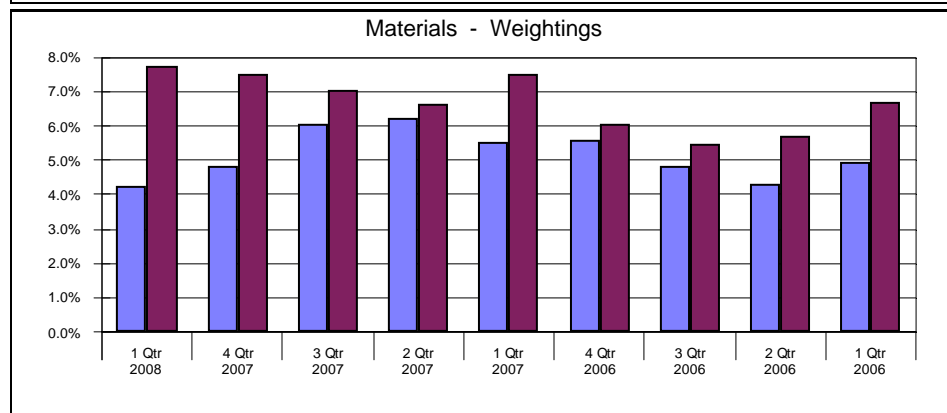
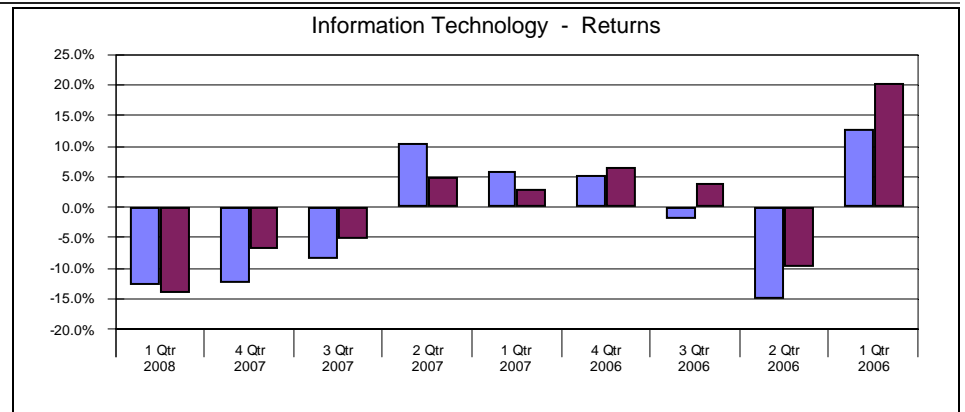
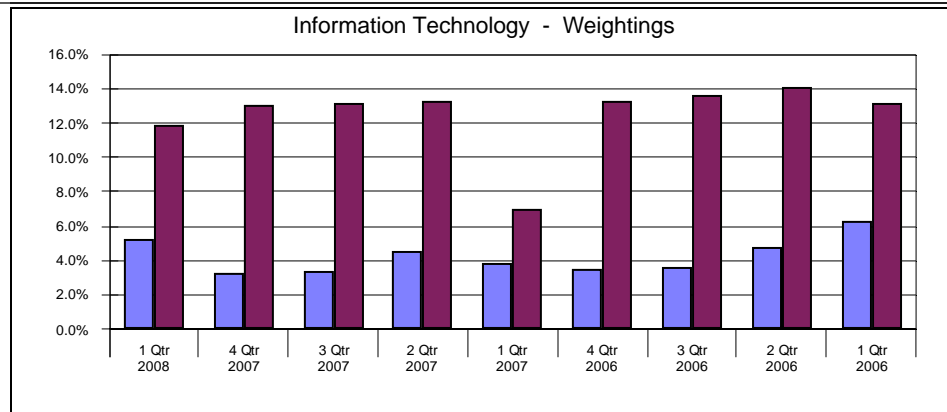

BRANDYWINE

RUSSELL 2000 VALUE

# Fresno County Employees' Retirement Association

## Equity Only Sector Analysis Quarterly

Period Ending: March 31, 2008

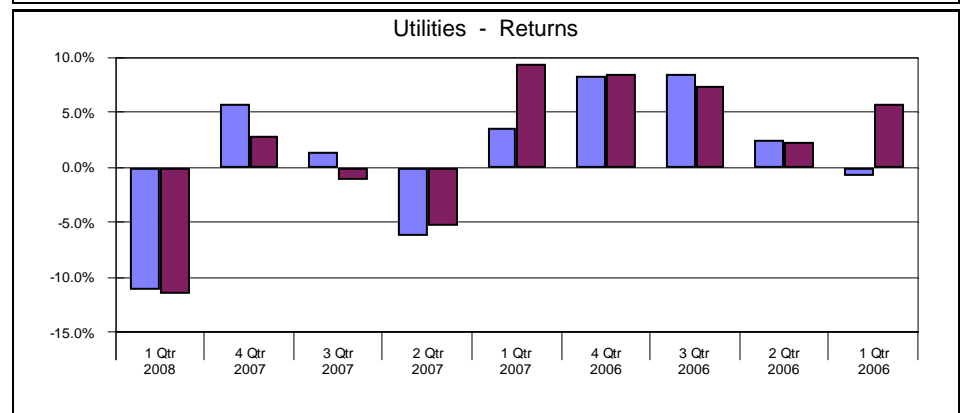
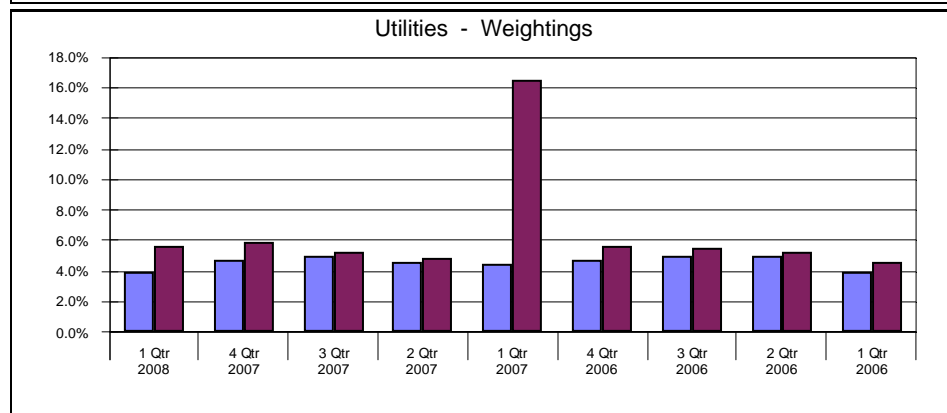
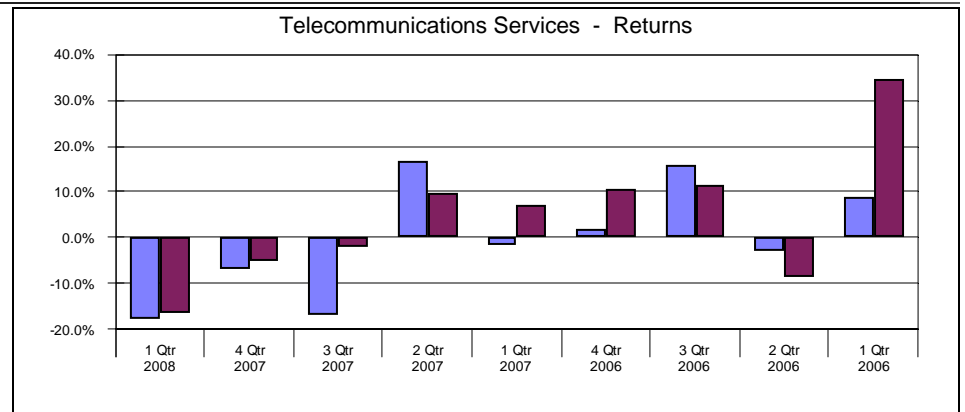
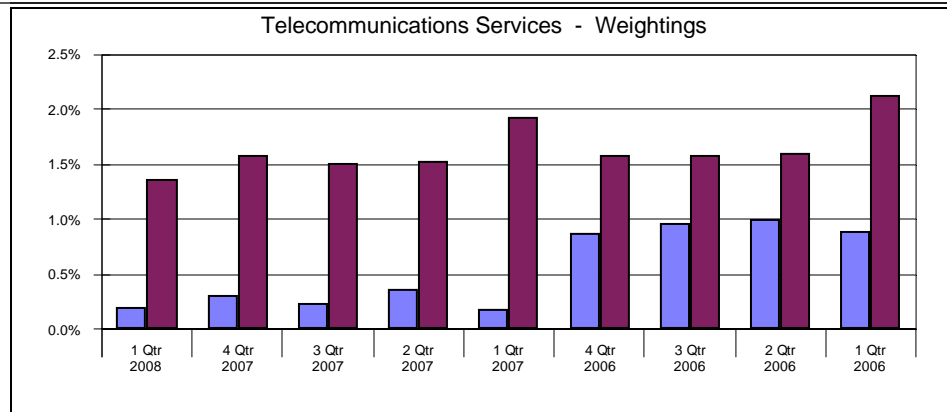

BRANDYWINE

RUSSELL 2000 VALUE



# Fresno County Employees' Retirement Association

## Performance Attribution Geometric

Period Ending: March 31, 2008

### BRANDYWINE

	Portfolio		RUSSELL 2000 VALUE		Selection		Total
	Market Value	Return	Market Value	Return	Stock	Industry	
	<b>A</b>	<b>B</b>	<b>C</b>	<b>D</b>	<b>E</b>	<b>F</b>	
Consumer Discretionary	19.4	-9.0	10.9	-5.5	-0.7	0.1	-0.6
Consumer Staples	5.2	6.8	3.8	-1.3	0.4	0.1	0.5
Energy	10.4	0.7	6.0	3.9	-0.3	0.5	0.1
Financials	36.1	-4.3	31.9	-4.2	-0.1	0.1	0.0
Health Care	2.4	-14.0	6.1	-14.2	0.0	0.3	0.3
Industrials	13.0	-4.7	13.3	-6.8	0.3	0.0	0.3
Information Technology	3.4	-12.0	13.0	-14.2	0.1	0.8	0.9
Materials	5.0	-6.4	7.5	-3.7	-0.1	-0.1	-0.2
Telecommunications Services	0.3	-23.5	1.6	-16.4	0.0	0.1	0.1
Utilities	4.8	-11.3	6.0	-11.5	0.0	0.1	0.1
	100.0	-5.2	100.0	-6.5	-0.5	2.0	1.5

#### Contribution

<b>Stock</b>	Consumer Staples
	Industrials
<b>Industry</b>	Information Technology
	Energy

#### Detractors

<b>Stock</b>	Consumer Discretionary
	Energy
<b>Industry</b>	Materials
	Industrials

# Fresno County Employees' Retirement Association

## Value Added Analysis 3 Yr Rolling for BRANDYWINE

Period Ending: March 31, 2008

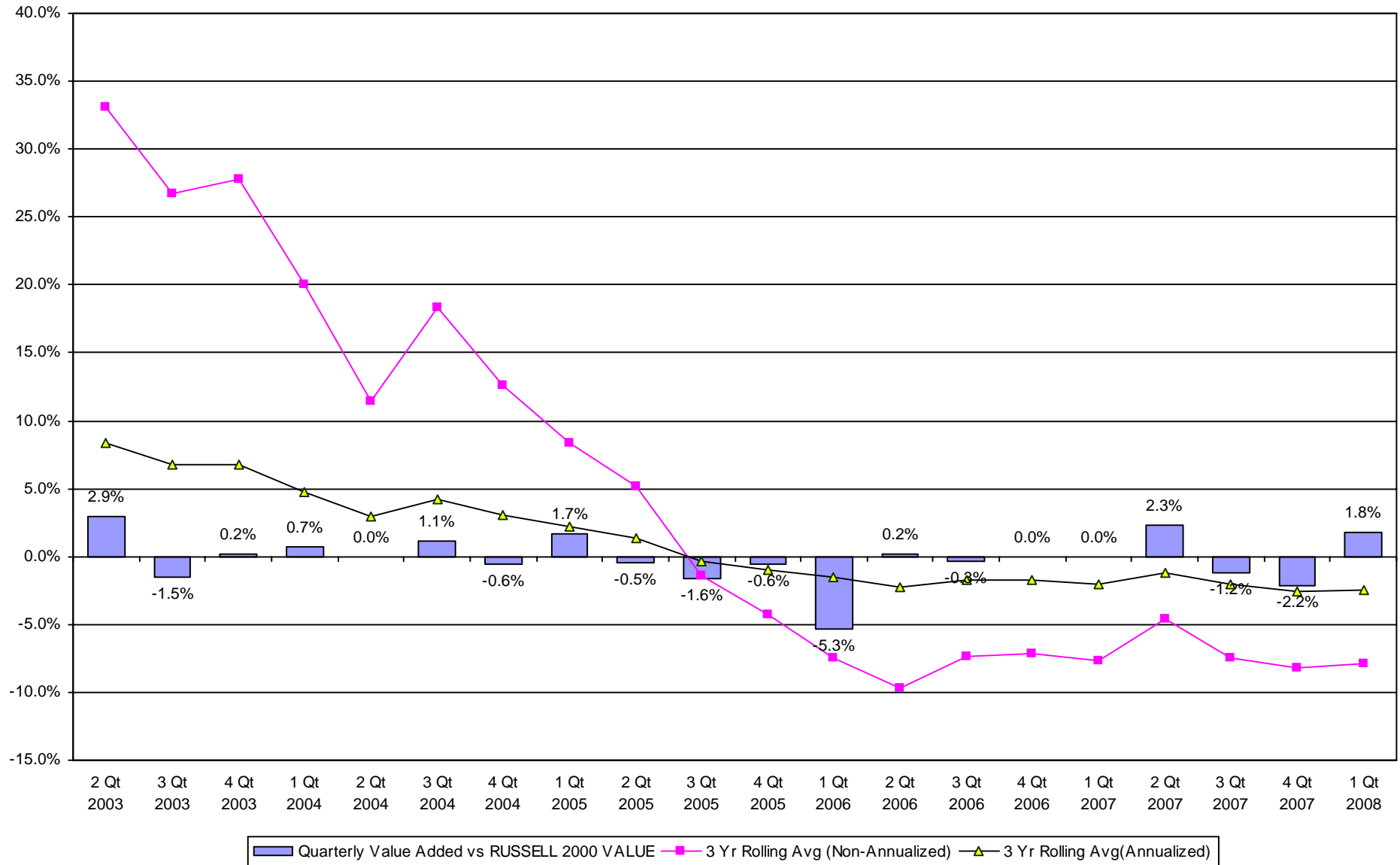

# Fresno County Employees' Retirement Association

## Rolling Return Ranking 3 & 5 Years

Period Ending: March 31, 2008

### Ranking Comparisons - Rolling 3 Years

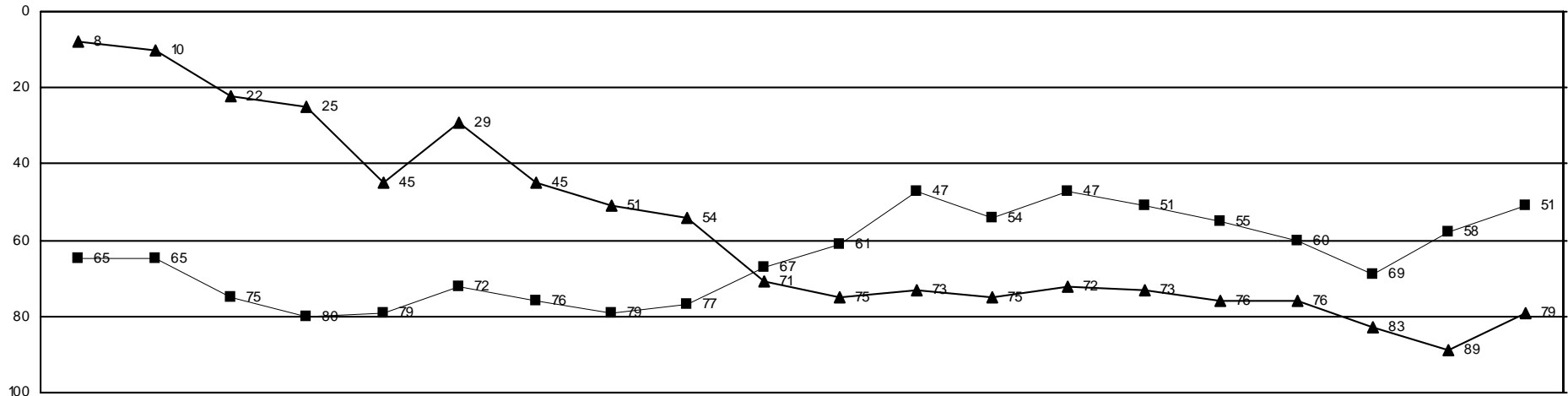

### Ranking Comparisons - Rolling 5 Years

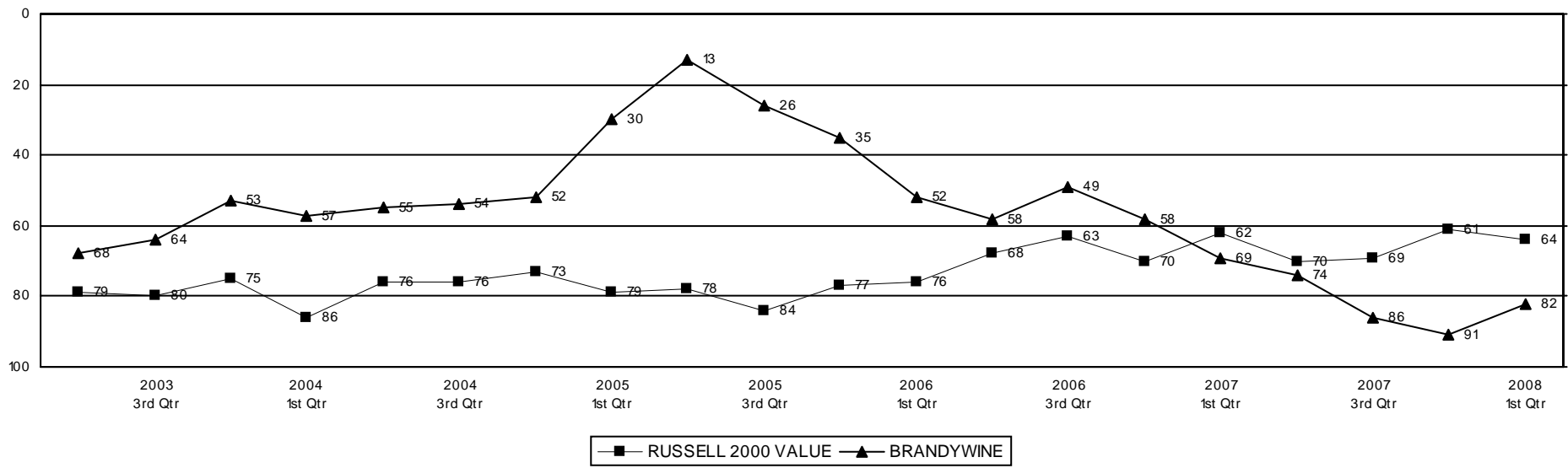

■ RUSSELL 2000 VALUE ▲ BRANDYWINE

# Fresno County Employees' Retirement Association

## Up vs. Down Market Performance

Period Ending: March 31, 2008

Last 20 Quarters Ending 3/31/2008

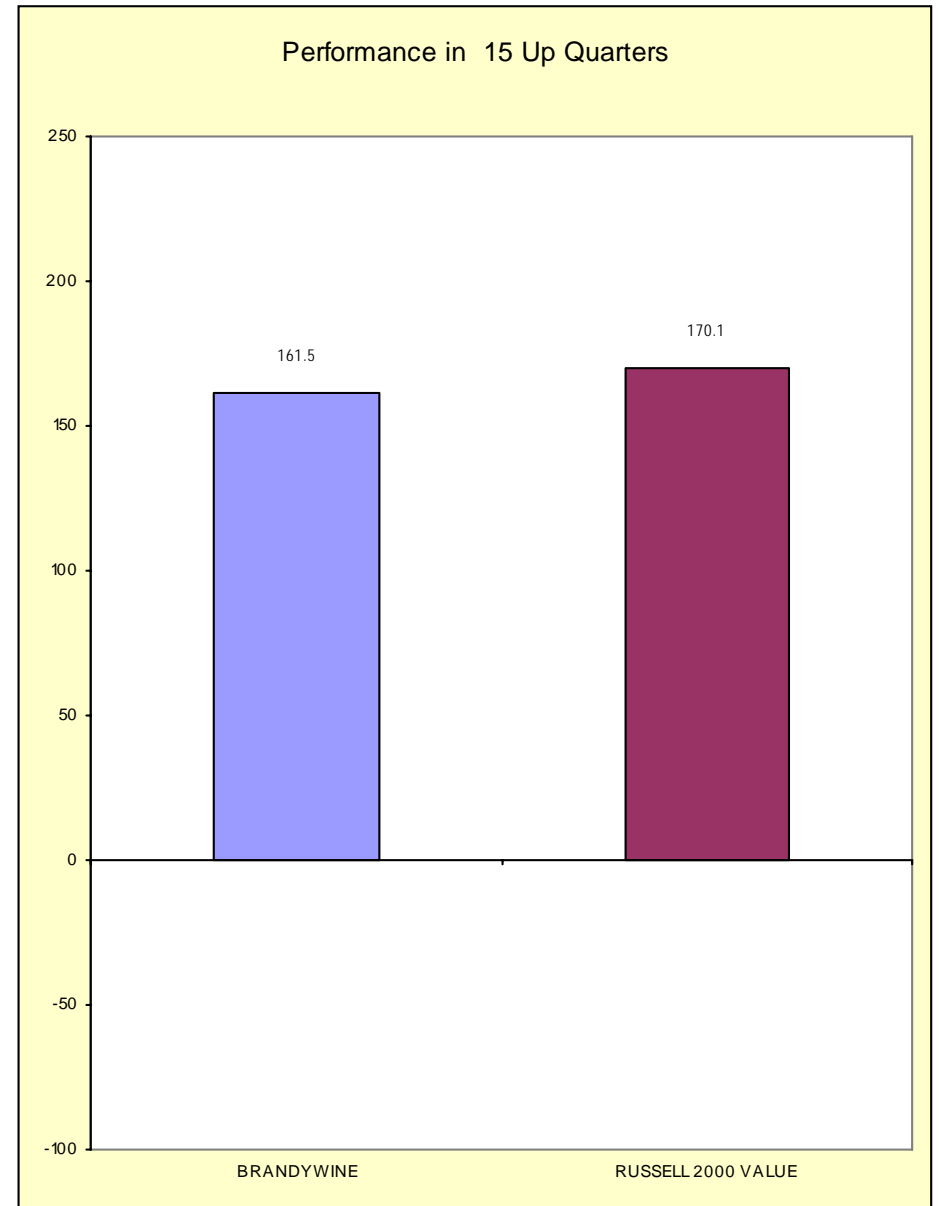
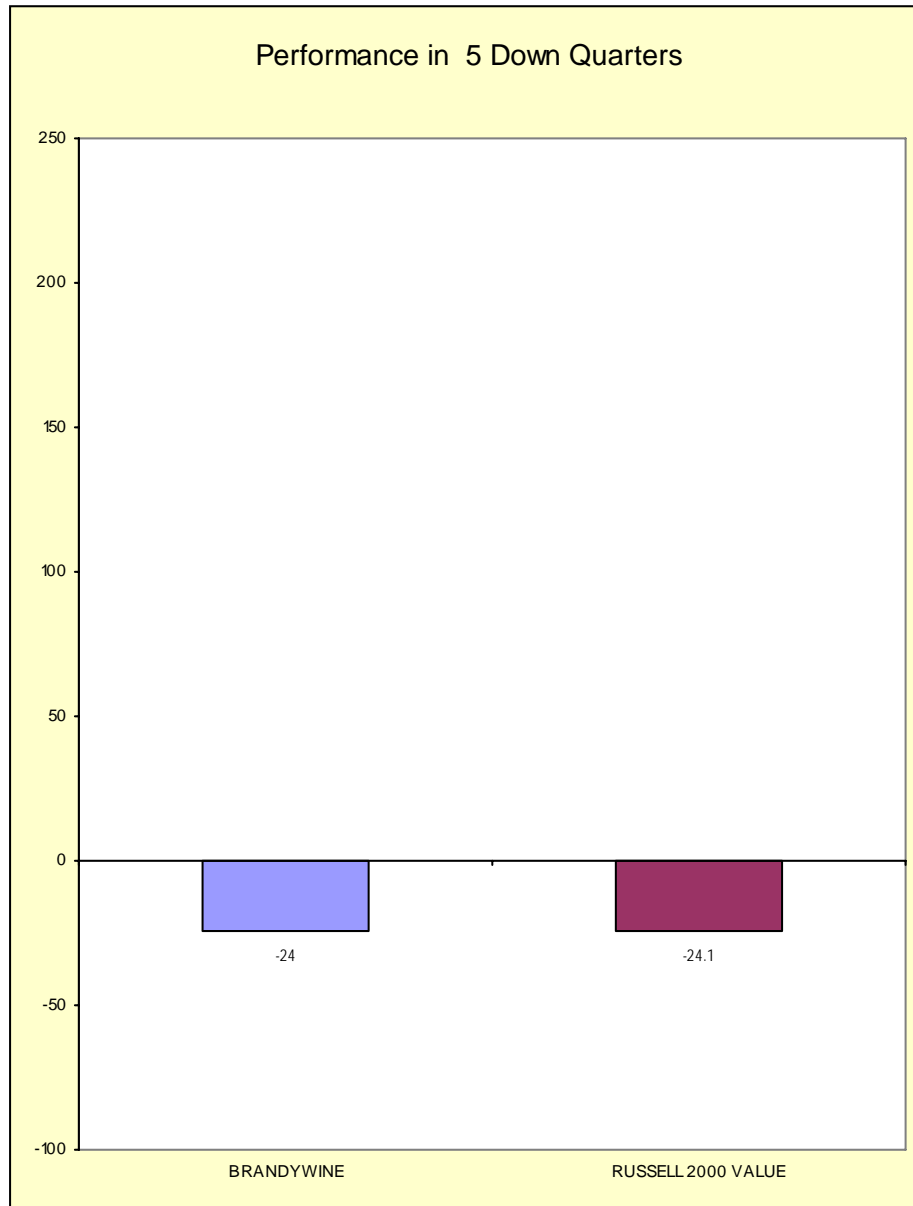

# Fresno County Employees' Retirement Association

## Portfolio Holdings And Characteristics - Equity

Period Ending: March 31, 2008

BRANDYWINE	Shares	Price	Portfolio Weight	Market Cap	Dividend Yield	Price / Earnings	Price / Book	Beta	Quarterly Return
<b>Consumer Discretionary</b>									
A H BELO CORP COM CL A	6,639	11.43	0.1	0.20	8.7				
AARON RENTS INC	11,800	21.54	0.2	0.98	0.3	14.8	1.7	1.30	12.0
ACTUANT CORP	11,800	30.21	0.3	1.69	0.1	17.1	3.3	1.81	-11.2
ACUITY BRANDS INC	10,962	42.95	0.4	1.76	1.2	13.0	3.3	1.67	-4.3
AFTERMARKET TECHNOLOGY CORP	16,201	19.44	0.3	0.43		10.7	1.5	1.31	-28.7
ALDILA INC	4,200	11.40	0.0	0.06	5.3	3.9	1.3	0.92	2.0
AMERICAS CAR MART INC	4,933	12.59	0.0	0.15		13.7	1.2	0.85	0.3
AMERON INTL CORP	6,400	93.53	0.5	0.86	1.3	13.9	1.9	1.28	1.8
ASBURY AUTOMOTIVE GROUP INC	27,000	13.76	0.3	0.44	6.5	9.0	0.7	1.41	-7.1
BAKER MICHAEL CORP	3,600	22.46	0.1	0.20		7.2	2.1	1.39	-45.4
BASSETT FURNITURE INDS INC	6,900	12.34	0.1	0.15	7.3		0.7	0.74	34.2
BELO CORP COM SER A	33,200	10.57	0.3	1.08	2.8		1.1	1.48	-23.6
BIG 5 SPORTING GOODS CORP	16,200	8.77	0.1	0.19	4.1	7.0	1.8	1.72	-38.7
BLUEGREEN CORP	17,200	6.70	0.1	0.21		6.6	0.5	1.53	-6.8
BROWN SHOE INC NEW	18,000	15.07	0.2	0.64	1.9	11.0	1.2	1.29	-0.2
BUILD A BEAR WORKSHOP INC	8,900	9.09	0.1	0.19		8.3	1.0	1.95	-34.8
CATO CORP NEW	19,000	14.94	0.2	0.44	4.4	14.5	1.7	1.07	-3.5
CHARLOTTE RUSSE HLDG INC	14,100	17.34	0.2	0.43		12.0	1.7	0.68	7.4
CHARMING SHOPPES INC	67,100	4.83	0.3	0.56			0.6	1.51	-10.7
COLLECTIVE BRANDS INC	11,100	12.12	0.1	0.79		18.6	1.1	1.11	-30.3
COLUMBIA SPORTSWEAR CO	8,800	44.03	0.3	1.55	1.5	11.1	1.6	1.22	0.2
CONNS INC	16,200	16.31	0.2	0.36		10.0	1.2	1.44	-4.7
COX RADIO INC	8,700	11.88	0.1	0.36			0.9	0.79	-2.2
CSS INDS INC	9,400	34.96	0.3	0.37	1.6	14.8	1.5	0.66	-4.4
CULP INC	5,600	7.52	0.0	0.10		29.0	1.2	0.61	8.1
DORMAN PRODS INC	6,600	10.75	0.1	0.19		10.1	1.1	1.08	-24.8
DOVER DOWNS GAMING + ENTMT INC	5,900	8.51	0.0	0.13	2.4	10.6	3.0	1.06	-24.0
DRESS BARN INC	20,500	12.94	0.2	0.78		10.5	1.6	1.01	3.4
EAGLE MATLS INC	2,700	35.55	0.1	1.54	2.3	12.7	3.1	1.49	0.8
ELLIS PERRY INTL INC	3,700	21.83	0.1	0.32		12.1	1.3	0.50	41.9
ENNIS INC	15,700	16.78	0.2	0.43	3.7	10.5	1.4	1.25	-6.0
ESCALADE INC	6,100	8.87	0.0	0.11	2.8	12.5	1.2	1.03	1.2
ETHAN ALLEN INTERIORS INC	23,700	28.43	0.5	0.83	3.1	11.6	2.1	1.06	0.6
FOOT LOCKER INC	14,200	11.77	0.1	1.82	5.1	35.7	0.8	1.12	-12.8
FTD GROUP INC	17,000	13.42	0.2	0.40	4.8	10.6	1.5	0.34	5.5
FURNITURE BRANDS INTL INC	28,600	11.70	0.3	0.57	1.4		0.7	1.35	16.8
GATX CORPORATION	19,800	39.07	0.6	1.87	2.8	11.4	1.6	0.97	7.3
GENESCO INC	3,400	23.11	0.1	0.53		70.0	1.3	1.50	-38.9
GETTY IMAGES INC	5,600	32.00	0.1	1.91		15.2	1.3	0.84	10.3
GIBRALTAR INDS INC	19,355	11.73	0.2	0.35	1.7	11.4	0.6	1.22	-23.6
GROUP 1 AUTOMOTIVE INC	20,400	23.48	0.4	0.54	2.4	8.1	0.8	1.17	-0.6
HASTINGS ENTMT INC	9,600	7.86	0.1	0.08		8.5	0.9	0.52	-15.8

# Fresno County Employees' Retirement Association

## Portfolio Holdings And Characteristics - Equity

Period Ending: March 31, 2008

BRANDYWINE	Shares	Price	Portfolio Weight	Market Cap	Dividend Yield	Price / Earnings	Price / Book	Beta	Quarterly Return
HAVERTY FURNITURE COS INC	10,000	10.64	0.1	0.19	2.5		0.8	0.76	19.2
HOOKEER FURNITURE CORP	10,100	22.34	0.2	0.27	1.8	15.1	2.0	0.89	11.7
INTERSTATE HOTELS + RESORTS IN	13,100	4.78	0.0	0.15		59.8	0.8	0.53	20.7
JACKSON HEWITT TAX SVC INC	7,379	11.47	0.1	0.33	6.3	10.2	1.2	1.03	-63.3
JAKKS PAC INC	19,436	27.57	0.4	0.79		10.0	1.1	1.15	16.8
JONES APPAREL GROUP INC	23,000	13.42	0.2	1.16	4.2	29.8	0.6	1.35	-15.3
JOS A BANK CLOTHIERS INC	8,200	20.50	0.1	0.37		7.8	1.8	1.25	-27.9
JOURNAL COMMUNICATIONS INC	27,200	7.38	0.2	0.32	4.3	11.4	0.8	1.10	-16.6
K SWISS INC A CL A	12,400	15.82	0.2	0.42	1.3	14.4	1.4	1.56	-12.3
KENNAMETAL INC	14,600	29.43	0.3	2.27	1.6	11.7	1.5	1.41	-22.0
KIMBALL INTL INC CL B	14,800	10.72	0.1	0.27	6.0	21.4	1.0	0.86	-20.6
KNOLL INC	19,000	11.54	0.2	0.57	4.2	8.0	7.6	0.98	-29.1
LA Z BOY INC	28,200	8.34	0.2	0.43	1.9	83.4	0.9	1.02	5.6
LAKELAND INDS INC	3,206	11.69	0.0	0.06		17.5	1.0	1.28	2.0
LENNOX INTL INC	26,700	35.97	0.8	2.18	1.6	14.8	2.8	1.18	-12.8
LITHIA MTRS INC	9,800	10.16	0.1	0.16	5.5	8.5	0.4	1.47	-25.2
MADDEN STEVEN LTD	5,137	17.13	0.1	0.34		10.2	1.6	0.96	-14.4
MAIDENFORM BRANDS INC	8,400	16.27	0.1	0.37		11.4	3.7	0.74	20.3
MARINEMAX INC	10,800	12.46	0.1	0.23		13.8	0.6	1.44	-19.6
MCCLATCHY CO	4,300	10.70	0.0	0.61	6.7		2.1	0.61	-12.8
MILLER HERMAN INC	14,900	24.57	0.3	1.39	1.4	10.4	10.0	1.13	-23.9
MODINE MFG CO	14,600	14.49	0.2	0.47	4.8		1.0	1.45	-11.1
NCI BLDG SYS INC	7,000	24.20	0.1	0.48		8.1	0.9	1.37	-15.9
NORTHWEST PIPE CO	4,900	42.49	0.2	0.38		18.8	1.5	0.94	8.6
PARK OH HLDGS CORP	10,400	15.71	0.1	0.18		8.6	1.0	1.40	-37.4
PENSKE AUTOMOTIVE GROUP INC	48,700	19.46	0.8	1.85	1.9	14.4	1.3	1.58	12.0
POLARIS INDS INC	5,800	41.01	0.2	1.38	3.7	13.4	8.1	1.34	-13.4
PRE PAID LEGAL SVCS INC	8,900	42.41	0.3	0.53	0.0	10.9		1.49	-23.4
RENT A CTR INC NEW	52,490	18.35	0.8	1.22		16.7	1.3	0.93	26.4
REX STORES CORP	11,700	19.67	0.2	0.20		10.1	0.9	0.92	24.7
RUSH ENTERPRISES INC	10,700	15.84	0.1	0.41		11.9	1.5	1.16	-12.9
SAGA COMMUNICATIONS	12,700	5.60	0.1	0.10		10.2	0.8	0.90	-4.9
SCHOLASTIC CORP	3,300	30.27	0.1	1.11		11.7	1.2	1.17	-13.2
SHOE CARNIVAL INC	5,600	13.53	0.1	0.17		13.9	0.9	1.32	-4.1
SIMPSON MFG INC	11,400	27.18	0.2	1.32	1.5	19.4	1.8	1.21	2.7
SKECHERS U S A INC	12,900	20.21	0.2	0.67		12.4	1.5	1.51	3.6
SONIC AUTOMOTIVE INC	26,500	20.55	0.4	0.59	2.3	8.1	0.9	1.10	6.8
SPEEDWAY MOTORSPORTSINC	14,600	25.07	0.3	1.09	1.3	28.8	1.3	1.14	-19.3
STARTEK INC	8,600	9.21	0.1	0.14			1.1	1.18	-1.1
SUPERIOR INDS INTL INC	15,600	20.75	0.3	0.55	3.1	53.2	1.0	0.98	15.2
THOR INDS INC	9,600	29.77	0.2	1.65	0.9	11.4	2.2	2.07	-21.5
TIMBERLAND CO	26,200	13.73	0.3	0.66		21.1	1.4	1.42	-24.1
TRW AUTOMOTIVE HLDGS CORP	17,500	23.37	0.3	2.35		26.6	0.7	1.03	11.8

# Fresno County Employees' Retirement Association

## Portfolio Holdings And Characteristics - Equity

Period Ending: March 31, 2008

BRANDYWINE	Shares	Price	Portfolio Weight	Market Cap	Dividend Yield	Price / Earnings	Price / Book	Beta	Quarterly Return
TUESDAY MORNING CORP	21,100	5.18	0.1	0.22	15.4	8.6	1.0	1.14	2.2
U S CONCRETE INC	24,700	3.80	0.1	0.15			0.7	0.92	14.1
U S HOME SYS INC	4,600	3.63	0.0	0.03		12.5	1.2	1.23	-32.3
UNIFI INC	28,800	2.89	0.1	0.18			0.6	1.04	19.4
UNITED RENTALS INC	30,200	18.84	0.5	1.62		5.8	1.0	1.32	2.6
UNIVERSAL FST PRODS INC	7,300	32.20	0.2	0.61	0.4	29.5	1.1	1.17	9.3
VIRCO MFG CO	10,700	5.23	0.0	0.08	1.9	3.4	1.5	1.01	-28.8
STAGE STORES INC	1,400	16.20	0.0						
AIR TRANS SVCS GROUP INC	37,300	2.94	0.1						
			<b>18.2</b>	<b>0.96</b>	<b>2.5</b>	<b>15.3</b>	<b>1.7</b>	<b>1.21</b>	<b>-3.14</b>
<b>Consumer Staples</b>									
ALLOY INC	8,200	7.35	0.0	0.10		33.4	0.6	1.40	-22.0
BLYTH INC	18,400	19.72	0.3	0.73	2.7	22.7	2.1	1.12	-10.1
CBRL GROUP INC	16,200	35.77	0.5	0.79	2.0	12.4	8.1	1.50	11.2
CCA INDS INC	2,600	9.08	0.0	0.06	4.8	11.7	2.1	0.77	-4.3
CEC ENTMT INC	12,700	28.88	0.3	0.77		16.4	3.5	1.24	11.3
CHIQUITA BRANDS INTL INC	13,400	23.11	0.2	0.99			1.1	1.26	25.7
CORE MARK HLDG CO INC	4,300	28.74	0.1	0.30		13.4	1.1	0.92	0.1
CRAFTMADE INTL INC	4,170	8.05	0.0	0.05	5.9	11.7	1.3	0.51	0.9
DEL MONTE FOODS CO	112,900	9.53	0.9	1.88	1.7	16.2	1.3	0.79	1.2
DOMINOS PIZZA INC	27,300	13.49	0.3	0.79		22.9		0.62	2.0
ELIZABETH ARDEN INC	11,900	19.95	0.2	0.58		12.5	1.8	1.14	-2.0
FRISCHS RESTAURANTS INC	3,200	23.00	0.1	0.12	2.1	13.8	1.1	0.68	-0.6
LANDRYS RESTAURANTS INC	7,300	16.28	0.1	0.26	1.2	17.5	0.8	1.55	-17.1
MANNATECH INC	13,500	7.13	0.1	0.19	5.0	28.5	2.2	1.24	14.1
MONTEREY GOURMET FOODS INC	5,000	3.06	0.0	0.05		30.8	1.0	0.66	-3.3
NBTY INC	16,400	29.95	0.4	2.00		10.2	1.9	1.13	9.3
NUTRACEUTICAL INTL CORP	7,900	13.00	0.1	0.14		11.5	1.4	0.91	-1.9
PARLUX FRAGRANCES INC	8,300	2.94	0.0	0.06			0.5	1.35	-27.9
PDI INC	1,800	8.42	0.0	0.12			0.9	0.58	-10.1
RUTHS CHRIS STEAK HSE INC	6,600	6.91	0.0	0.17		8.9	1.8	0.85	-22.7
SANDERSON FARMS INC	11,900	38.01	0.4	0.77	1.5	8.8	1.9	1.34	13.0
SANFILIPPO JOHN B + SON INC	4,700	8.91	0.0	0.07			0.6	0.93	5.8
SCHIFF NUTRITION INTL INC	7,600	5.99	0.0	0.07		14.6	1.3	1.09	4.4
SCHWEITZER MAUDUIT INTL INC	9,100	23.14	0.2	0.36	2.6	105.2	1.1	1.27	-10.2
UNIVERSAL CORP VA	13,400	65.53	0.7	1.78	2.7	16.2	2.2	0.98	29.1
VALASSIS COMMUNICATIONS INC	29,500	10.85	0.3	0.52		9.0	2.4	0.88	-7.2
			<b>5.2</b>	<b>1.09</b>	<b>2.2</b>	<b>18.3</b>	<b>2.4</b>	<b>1.06</b>	<b>6.83</b>

# Fresno County Employees' Retirement Association

## Portfolio Holdings And Characteristics - Equity

Period Ending: March 31, 2008

BRANDYWINE	Shares	Price	Portfolio Weight	Market Cap	Dividend Yield	Price / Earnings	Price / Book	Beta	Quarterly Return
<b>Energy</b>									
AGL RES INC	11,200	34.32	0.3	2.62	4.9	12.6	1.6	0.53	-7.8
ALLIS CHALMERS ENERGY INC	4,800	13.79	0.1	0.48		9.5	1.2	0.89	-6.5
ALON USA ENERGY INC	10,700	15.21	0.1	0.71	1.1	7.0	1.8	1.06	-43.9
ATMOS ENERGY CORP	39,600	25.50	0.8	2.29	5.1	14.1	1.2	0.79	-8.0
BASIC ENERGY SVCS INC NEW	23,400	22.08	0.4	0.90		10.4	1.7		0.6
BRIGHAM EXPL CO	32,000	6.07	0.2	0.28		27.6	1.0	0.70	-19.3
BRISTOW GROUP INC	14,400	53.67	0.6	1.28		14.5	2.0	1.03	-5.3
BRONCO DRILLING CO INC	14,500	16.11	0.2	0.42		11.2	1.1	0.84	8.5
CAL DIVE INTERNATIONAL INC	9,258	10.38	0.1	1.09		8.4	1.9		-21.6
CALLON PETE CO DEL	14,900	18.09	0.2	0.38		25.5	1.3	1.37	10.0
COMPLETE PRODTN SVCS INC	29,700	22.94	0.5	1.68		10.4	1.8		27.7
DELEK US HLDGS INC	27,000	12.67	0.3	0.68	1.2	7.0	1.3		-37.2
GREY WOLF INC	100,900	6.78	0.5	1.21		8.6	1.8	0.74	27.2
GULFMARK OFFSHORE INC	11,900	54.72	0.5	1.26		12.8	1.9	1.06	17.0
HERCULES OFFSHORE INC	2,300	25.12	0.0	2.23		11.0	1.1		5.6
HORNBECK OFFSHORE SVCS INC NEW	6,600	45.67	0.2	1.19		12.8	2.1	0.97	1.6
ICO INC NEW	16,100	6.94	0.1	0.19		8.7	2.2	1.71	-46.0
KEY ENERGY SVCS INC	4,700	13.42	0.1	1.72		10.6	2.0	1.39	-6.7
LUFKIN INDS INC	7,600	63.82	0.4	0.93	1.6	13.0	2.4	1.18	11.9
NICOR INC	22,500	33.51	0.6	1.51	5.6	11.2	1.6	0.87	-20.9
OIL STATES INTL INC	13,500	44.81	0.5	2.21		11.2	2.0	1.18	31.3
PARKER DRILLING CO	15,500	6.46	0.1	0.72		6.9	1.4	1.46	-14.4
PHI INC COM NON VTG	4,694	31.54	0.1	0.39		45.1	1.1	0.58	1.7
PIONEER DRILLING CO	25,400	15.93	0.3	0.79		23.1	1.7	1.14	34.1
ROSETTA RES INC	3,600	19.67	0.1	1.00		17.4	1.1		-0.8
SEACOR HLDGS INC	3,000	85.36	0.2	1.93		9.4	1.2	1.02	-8.0
SOUTHWEST GAS CORP	8,900	27.96	0.2	1.20	3.2	14.3	1.2	0.80	-5.4
ST MARY LD + EXPL CO	2,200	38.50	0.1	2.43	0.3	13.1	2.8	1.11	-0.3
STONE ENERGY CORP	22,800	52.31	1.0	1.48		8.0	1.6	1.00	11.5
SUPERIOR WELL SVCS INC	14,300	21.87	0.2	0.52		13.4	2.0	0.63	3.1
SWIFT ENERGY CO	17,800	44.99	0.6	1.36		65.2	1.6	1.25	2.2
TRICO MARINE SVCS INC	6,800	38.97	0.2	0.59		9.4	1.5	0.42	5.3
UNION DRILLING INC	12,200	17.49	0.2	0.38		12.4	1.9		10.9
UNIT CORP	2,700	56.65	0.1	2.67		9.9	1.9	0.77	22.5
VAALCO ENERGY INC	2,100	4.97	0.0	0.29		13.4	2.1	1.04	6.9
W H ENERGY SVCS INC	4,400	68.85	0.2	2.12		14.6	3.2	1.05	22.5
W+T OFFSHORE INC	21,300	34.11	0.6	2.60	0.4	18.0	2.3	0.84	14.0
WGL HLDGS INC	34,800	32.06	0.9	1.59	4.4	14.4	1.6	0.80	-1.1
			<b>11.8</b>	<b>1.44</b>	<b>3.5</b>	<b>15.9</b>	<b>1.7</b>	<b>0.94</b>	<b>4.38</b>



# Fresno County Employees' Retirement Association

## Portfolio Holdings And Characteristics - Equity

Period Ending: March 31, 2008

BRANDYWINE	Shares	Price	Portfolio Weight	Market Cap	Dividend Yield	Price / Earnings	Price / Book	Beta	Quarterly Return
<b>Financials</b>									
1ST SOURCE CORP	7,500	21.05	0.1	0.51	2.7	16.4	1.2	1.01	22.4
21ST CENTY HLDG CO	3,200	12.81	0.0	0.10	5.6	4.8	1.2	0.98	-3.3
AMERICAN EQUITY INVT LIFE	41,500	9.28	0.3	0.53	0.6	18.6	0.8	0.39	11.9
AMERICAN NATL BANKSHARES INC	3,774	21.43	0.1	0.13	4.3	11.4	1.3	0.33	7.7
AMERICAN PHYSICIANS CAP INC	5,400	46.36	0.2	0.49	0.9	9.8	1.8	0.93	12.1
AMERICREDIT CORP	39,400	10.07	0.3	1.15		5.6	0.6	2.23	-21.3
AMERIS BANCORP	4,500	16.06	0.1	0.22	3.5	14.5	1.1	1.05	-3.9
AMERISAFE INC	2,600	12.64	0.0	0.24		5.1	1.1		-18.5
AMTRUST FINANCIAL SERVICES	19,900	16.21	0.3	0.97	1.0	10.9	2.3		18.0
ANCHOR BANCORP WIS INC	18,300	18.97	0.3	0.40	3.8	11.9	1.2	1.09	-18.7
ARROW FINL CORP	7,252	22.49	0.1	0.24	4.3	14.0	2.0	1.07	5.8
ASSET ACCEP CAP CORP	22,000	9.63	0.2	0.29		15.3	2.4	1.24	-7.5
ASTA FDG INC	500	13.93	0.0	0.19	1.1	3.8	0.8	1.64	-47.1
BALDWIN + LYONS INC CL B	5,200	25.68	0.1	0.32	3.9	7.1		0.86	-5.6
BANCFIRST CORP	1,379	45.78	0.1	0.70	1.7	13.7	1.9	0.77	7.3
BANCORPSOUTH INC	25,600	23.16	0.5	1.91	3.6	13.7	1.6	0.82	-1.0
CADENCE FINL CORP	7,000	15.97	0.1	0.19	6.2	19.8	1.0	0.66	13.0
CAMDEN NATL CORP	6,800	33.84	0.2	0.26	3.0	10.9	1.8	0.93	18.5
CATHAY GENERAL BANCORP	22,600	20.73	0.4	1.02	2.0	8.4	1.1	0.94	-21.4
CHEMICAL FINL CORP	19,360	23.84	0.4	0.57	5.0	14.9	1.1	0.93	1.4
CITIZENS REPUBLIC BANKCORP INC	45,448	12.43	0.5	0.94	9.3	9.3	0.6	0.97	-12.5
CITY BK LYNNWOOD WASH CMT CAP STK	9,300	22.27	0.2	0.35	2.7	8.5	2.0	1.08	0.1
CITY HLDG CO	7,400	39.90	0.2	0.65	3.4	13.3	2.2	0.59	19.0
CNA SURETY CORP	29,100	15.38	0.4	0.68		7.4	1.0	1.35	-22.3
COLUMBIA BKY SYS INC	8,925	22.38	0.2	0.40	3.0	11.7	1.2	1.45	-24.2
COMMUNITY BK SYS INC	24,500	24.56	0.5	0.73	3.4	17.3	1.5	0.78	24.7
COMMUNITY TR BANCORP INC	8,664	29.30	0.2	0.44	4.0	12.3	1.5	0.82	7.5
CONSECO INC	44,700	10.20	0.4	1.88			0.4	1.23	-18.8
CORUS BANKSHARES INC	38,108	9.73	0.3	0.54	10.3	5.3	0.7	1.26	-6.8
CREDIT ACCEPTANCE CORP	12,300	15.53	0.2	0.47		9.0	1.8	1.56	-24.9
CVB FINL CORP	42,200	10.41	0.4	0.87	3.3	14.5	2.0	0.92	1.6
DELPHI FINL GROUP INC	32,175	29.23	0.7	1.24	1.2	9.2	1.2	1.34	-16.9
DELUXE CORP	24,100	19.21	0.4	0.99	5.2	7.0		1.28	-41.0
DONEGAL GROUP INC	8,922	17.40	0.1	0.34	2.1	11.6	1.3	1.10	1.9
DONEGAL GROUP INC CL B	2,210	18.72	0.0	0.10	1.7	12.0	1.3	0.87	-1.2
EASTERN INS HLDGS INC	4,300	14.48	0.0	0.14	1.9	8.2	0.9		-11.7
EMC INS GROUP INC	8,300	26.89	0.2	0.37	2.7	8.7	1.1	1.03	14.3
ENCORE CAP GROUP INC	11,700	6.80	0.1	0.16		10.6	0.9	1.60	-29.8
F N B CORP PA	36,200	15.61	0.5	0.95	6.2	13.6	1.7	0.90	7.9
FBL FINL GROUP INC	24,000	28.49	0.5	0.83	1.8	10.0	0.9	1.07	-17.1
FINANCIAL FED CORP	13,300	21.81	0.2	0.56	2.8	11.0	1.4	0.84	-1.4
FIRST BANCORP N C	7,989	19.93	0.1	0.29	3.8	13.2	1.6	1.08	6.5

# Fresno County Employees' Retirement Association

## Portfolio Holdings And Characteristics - Equity

Period Ending: March 31, 2008

BRANDYWINE	Shares	Price	Portfolio Weight	Market Cap	Dividend Yield	Price / Earnings	Price / Book	Beta	Quarterly Return
FIRST CMNTY BANCSHARES INC NEW	9,165	36.42	0.3	0.40	3.1	13.9	1.9	1.06	15.1
FIRST COMWLTH FINL CORP PA	25,500	11.59	0.2	0.85	5.9	18.4	1.5	0.85	10.4
FIRST DEFIANCE FINL CORP	5,300	18.35	0.1	0.15	5.7	9.5	0.8	0.69	-15.6
FIRST FINL HLDGS INC	9,526	23.46	0.2	0.27	4.3	12.7	2.1	1.14	-13.5
FIRST FINL SVC CORP	3,364	23.85	0.1	0.11	3.2	12.2	1.5	0.35	0.2
FIRST M+F CORP	4,978	14.50	0.1	0.13	3.6	9.1	0.9	0.28	-7.4
FIRST MERCHANTS CORP	11,000	28.54	0.3	0.53	3.2	16.5	1.5	0.82	31.8
FIRST MERCURY FINL CORP	7,400	17.41	0.1	0.32		7.7	1.4		-28.7
FIRST MIDWEST BANCORP INC DEL	17,100	27.77	0.4	1.35	4.5	17.1	1.9	0.99	-8.3
FIRST PL FINL CORP DEL	12,518	13.00	0.1	0.21	5.2	14.6	0.7	1.50	-6.0
FIRST UNITED CORP	3,600	19.82	0.1	0.12	4.1	9.4	1.2	0.42	-0.8
FIRSTBANK CORP MI	2,913	13.45	0.0	0.10	6.7	11.0	0.8	0.30	-1.9
FIRSTCITY FINL CORP	4,400	6.30	0.0	0.07		33.9	0.6	0.93	-20.7
FIRSTFED FINL CORP DEL	6,700	27.15	0.1	0.37		4.5	0.6	1.39	-24.2
FLUSHING FINL CORP	14,800	17.58	0.2	0.38	3.0	17.2	1.6	1.26	10.5
FNB UNITED CORPORATION	5,282	10.50	0.0	0.12	5.7	9.7	0.6	0.26	-12.0
FPIC INS GROUP INC	4,100	47.14	0.2	0.41		9.0	1.4	1.99	9.7
FULTON FINL CORP PA	70,700	12.29	0.7	2.13	4.9	14.0	1.4	0.64	10.9
GERMAN AMERN BANCORP INC	7,200	12.72	0.1	0.14	4.3	15.2	1.5	0.40	2.4
GREAT SOUTHN BANCORP INC	8,127	15.61	0.1	0.21	4.6	7.3	1.1	1.09	-28.1
GREENE BANKSHARES INC	6,626	17.69	0.1	0.23		8.5	0.7	0.76	-7.9
HALLMARK FINL SVCS INC	8,550	11.16	0.1	0.23		8.5	1.3	0.95	-29.6
HANCOCK HLDG CO	3,700	42.02	0.1	1.33	2.3	18.5	2.4	0.87	10.7
HANOVER INS GROUP INC	21,700	41.14	0.7	2.14	1.0	9.0	0.9	1.41	-10.2
HARLEYSVILLE GROUP INC	18,900	36.09	0.5	1.10	2.8	11.3	1.5	0.79	2.8
HARRINGTON WEST FINL GROUP INC	3,765	8.17	0.0	0.05	6.1	11.0	0.7	0.88	-26.5
HMN FINL INC	1,500	23.08	0.0	0.10	4.3	8.0	1.0	0.97	-5.1
HORACE MANN EDUCATORS CORP NEW NEW COM	33,500	17.48	0.5	0.71	2.4	9.4	1.1	1.07	-7.2
HORIZON FINL CORP WASH	4,800	13.81	0.1	0.17	3.9	8.7	1.4	1.27	-20.1
IBERIABANK CORP	4,250	44.25	0.1	0.56	3.1	13.5	1.1	1.21	-4.6
INDEPENDENT BK CORP MI	13,400	10.38	0.1	0.24	4.2	23.6	1.0	0.98	11.8
INFINITY PPTY + CAS CORP	17,800	41.60	0.6	0.67	1.1	10.7	1.1	1.27	15.4
INTERNATIONAL BANCSHARES CORP	35,055	22.58	0.6	1.55	2.9	12.9	1.7	0.99	9.4
IPC HOLDINGS LTD BERMUDA SHS	6,200	28.00	0.1	1.61	3.1	5.1	0.9	1.25	-2.2
LAKELAND FINANCIAL CORP	7,200	22.65	0.1	0.28	2.5	14.6	1.9	1.16	9.1
LEGACY BANCORP INC OC CL A	3,800	13.97	0.0	0.13	1.4	99.8	1.0		5.7
MACATAWA BK CORP	9,655	10.41	0.1	0.18	5.0	19.3	1.1	1.03	23.0
MAINSOURCE FINL GROUP INC	13,149	15.50	0.2	0.29	3.6	13.2	1.1	1.18	0.8
MARLIN BUSINESS SVCS CORP	7,300	7.54	0.0	0.09		5.1	0.6	0.56	-37.4
MAX CAPITAL GROUP LTD SHS	6,000	26.19	0.1	1.47	1.4		1.0	1.24	-6.1
MEADOWBROOK INS GROUP INC	23,700	7.81	0.1	0.29	1.0	9.2	0.8	1.31	-16.8
MEDALLION FINL CORP	7,200	9.04	0.1	0.16	8.4	10.4	0.9	1.54	-8.1
MERCANTILE BANKCORP	3,745	10.32	0.0	0.09	5.8	9.7	0.5	0.97	-32.7

# Fresno County Employees' Retirement Association

## Portfolio Holdings And Characteristics - Equity

Period Ending: March 31, 2008

BRANDYWINE	Shares	Price	Portfolio Weight	Market Cap	Dividend Yield	Price / Earnings	Price / Book	Beta	Quarterly Return
MERCER INS GROUP INC	3,900	17.39	0.1	0.11	1.2	7.7	0.9	0.33	-2.8
MERCHANTS BANCSHARES INC	2,550	22.88	0.0	0.13	4.9	13.0	1.8	0.48	-1.5
MERCURY GEN CORP	4,800	44.31	0.2	2.43	5.2	10.2	1.4	0.86	-9.9
MONTPELIER RE HOLDINGS LTD CDT SHS	10,400	16.05	0.1	1.56	1.9	2.7	1.0	0.93	-5.2
NATIONAL INTST CORP	9,455	23.35	0.2	0.45	1.0	10.4	2.1	1.05	-29.3
NATIONAL PENN BANCSHARES INC	26,265	18.19	0.4	1.45	3.7	13.9	1.6	0.98	21.4
NATIONAL WESTN LIFE INS CO	1,100	216.79	0.2	0.74	0.2	9.1	0.8	1.24	4.5
NAVIGATORS GROUP INC	8,351	54.40	0.4	0.92		9.7	1.4	0.66	-16.3
NBT BANCORP INC	26,800	22.20	0.5	0.71	3.6	14.7	1.8	1.22	-1.8
NELNET INC	14,800	11.75	0.1	0.45	2.4	16.5	1.0	1.33	-7.0
NEWALLIANCE BANCSHARES INC	14,600	12.26	0.1	1.33	2.1	53.3	0.9	0.94	7.0
NORTH CENT BANCSHARES INC	1,000	29.55	0.0	0.04	4.6	10.4	1.0	0.44	-3.8
NORTHRIM BANCORP INC	2,546	18.18	0.0	0.11	3.7	10.1	1.1	0.70	-14.1
NYMAGIC INC	6,300	22.71	0.1	0.20	1.4	15.6	0.7	1.11	-1.5
ODYSSEY RE HLDGS CORP	41,500	36.75	1.2	2.53	0.7	4.5	1.0	1.07	0.3
OLD NATL BANCORP IND COM RTS CALLABLE TH	6,900	18.00	0.1	1.19	5.1	15.8	1.8	0.69	22.0
PAB BANKSHARES INC CDT CAP STK	6,900	13.75	0.1	0.13	4.2	12.2	1.3	1.24	11.7
PACIFIC CAP BANCORP NEW	19,800	21.50	0.3	0.99	4.1	10.0	1.5	0.88	8.2
PARK NATL CORP	6,200	70.85	0.4	0.99	5.3	44.3	1.7	0.88	11.5
PARKVALE FINL CORP	3,600	26.84	0.1	0.15	3.3	11.1	1.2	0.82	-3.3
PENNS WOODS BANCORP INC	2,040	33.15	0.1	0.13	5.6	14.5	1.8	0.22	3.5
PEOPLES BANCORP INC	7,452	24.11	0.1	0.25	3.7	13.9	1.2	1.12	-2.2
PFF BANCORP INC	12,060	8.32	0.1	0.19	9.1		0.5	1.15	-30.9
PHOENIX COS INC NEW	58,400	12.21	0.6	1.40	1.3	11.1	0.6	1.57	2.9
PLATINUM UNDERWRITERS HOLDINGS SHS	4,700	32.46	0.1	1.71	1.0		1.0	0.94	-8.5
PMA CAP CORP	13,100	8.54	0.1	0.27			0.7	1.22	3.9
PORTFOLIO RECOVERY ASSOCS INC	2,000	42.89	0.1	0.65		14.0	2.8	1.29	8.1
PRESIDENTIAL LIFE CORP	20,000	17.44	0.3	0.52	2.9	8.1	0.9	0.99	0.3
PROASSURANCE CORP	5,500	53.83	0.2	1.73		11.3	1.4	1.29	-2.0
PROCENTURY CORP	8,500	18.00	0.1	0.24	0.9	9.7	1.4	0.60	17.5
PROSPERITY BANCSHARES INC	6,700	28.66	0.2	1.27	1.7	14.8	1.1	0.90	-2.1
PROVIDENT BANKSHARES CORP	13,800	10.74	0.1	0.34	12.1	10.7	0.6	1.37	-48.9
RENASANT CORP	10,700	22.50	0.2	0.47	3.0	13.7	1.2	1.02	5.2
REPUBLIC FIRST BANCORP INC	1,722	4.93	0.0	0.05		7.6	0.6	0.71	-29.1
RIVERVIEW BANCORP INC	4,500	10.00	0.0	0.11	3.6	11.0	1.2	0.69	-12.8
RLI CORP	11,500	49.57	0.5	1.08	1.9	6.8	1.6	0.86	-12.3
ROYAL BANCSHARES PA INC	4,800	14.47	0.1	0.16	4.1		1.1	0.77	33.7
S + T BANCORP INC	3,500	32.17	0.1	0.79	3.9	14.2	2.3	0.75	17.5
SAFETY INS GROUP INC	12,915	34.13	0.4	0.55	4.7	6.3	1.0	1.34	-5.8
SEABRIGHT INS HLDGS INC	14,400	14.73	0.2	0.31		7.8	1.0	0.75	-2.3
SELECTIVE INS GROUP INC	27,100	23.88	0.5	1.29	2.2	9.2	1.3	1.09	4.4
SIERRA BANCORP	4,846	21.61	0.1	0.21	3.1	10.3	2.1	0.96	-12.5
SIMMONS 1ST NATL CORP CL A 5 PAR	8,315	29.73	0.2	0.41	2.6	15.5	1.5	1.11	13.0

# Fresno County Employees' Retirement Association

## Portfolio Holdings And Characteristics - Equity

Period Ending: March 31, 2008

BRANDYWINE	Shares	Price	Portfolio Weight	Market Cap	Dividend Yield	Price / Earnings	Price / Book	Beta	Quarterly Return
SOUTHWEST BANCORP INC OKLA	4,500	17.51	0.1	0.25	2.2	12.0	1.2	0.95	-3.9
SPECIALTY UNDERWRITERS ALLIANC	8,800	4.26	0.0	0.06		5.2	0.5	1.07	-20.6
STANCORP FINL GROUP INC	22,500	47.71	0.9	2.34	1.5	11.0	1.7	0.97	-5.3
STATE AUTO FINL CORP	20,900	29.13	0.5	1.17	2.1	10.2	1.3	0.88	11.4
STELLARONE CORP	8,304	16.91	0.1	0.38	3.8	10.8	1.1	0.51	15.0
STEWART INFORMATION SVCS CORP	7,000	27.99	0.2	0.48	2.7		0.7	1.03	7.3
SUSQUEHANNA BANCSHARES INC PA	35,550	20.37	0.6	1.75	5.1	16.6	1.0	1.04	11.9
SWS GROUP INC	8,200	12.23	0.1	0.34	2.9	11.5	1.1	1.61	-2.8
TAYLOR CAP GROUP INC	7,741	16.42	0.1	0.17	2.4		0.7	0.84	-19.0
TCF FINANCIAL CORP	14,500	17.92	0.2	2.26	5.6	8.5	2.1	0.62	1.2
TIMBERLAND BANCORP INC	3,400	11.65	0.0	0.08	3.8	10.2	1.1	0.46	-3.5
TRICO BANCSHARES	9,400	17.31	0.1	0.27	3.0	11.0	1.5	1.11	-9.6
TRUSTMARK CORP	35,000	22.28	0.6	1.28	4.1	11.9	1.4	0.90	-11.2
UMPQUA HLDGS CORP	7,200	15.51	0.1	0.93	4.9	14.8	0.8	0.82	2.4
UNICO AMERN CORP	3,400	9.40	0.0	0.05		4.9	0.8	0.61	-10.0
UNION BANKSHARES CORP	7,900	19.37	0.1	0.26	3.8	13.2	1.2	1.26	-7.5
UNITED AMER INDY LTD	6,400	19.26	0.1	0.48		7.3	0.8	1.27	-3.3
UNITED BANKSHARES INC W VA	16,941	26.65	0.4	1.15	4.4	12.4	1.5	0.99	-3.8
UNITED FINL BANCORP INC MD	7,300	11.08	0.1	0.20	2.2	42.6	0.9	0.85	0.4
UNITED FIRE CAS CO	14,000	37.40	0.4	1.01	1.6	9.3	1.4	0.77	29.1
UNIVERSAL AMERN FINL CORP	9,000	10.60	0.1	0.79		9.0	0.8	1.64	-58.6
UNIVERSAL INS HLDGS INC	15,600	3.78	0.0	0.15	2.6	2.9	1.9	0.88	-48.2
UNIVEST CORP PA	7,700	26.19	0.2	0.34	3.1	13.2	1.7	1.26	25.3
WASHINGTON FED INC	48,220	22.84	0.9	2.00	3.7	14.8	1.5	0.67	8.2
WASHINGTON TR BANCORP INC	7,900	24.82	0.2	0.33	3.2	14.2	1.8	1.06	-0.9
WEBSTER FINL CORP WATERBURY	23,800	27.87	0.5	1.46	4.3	13.9	0.8	0.85	-12.0
WESBANCO INC	10,900	24.71	0.2	0.66	4.5	11.8	1.1	0.82	21.3
WEST BANCORPORATION INC CDT CAP STK	10,320	13.16	0.1	0.23	4.9	12.1	1.9	0.82	1.4
WEST COAST BANCORP ORE NEW	2,661	14.59	0.0	0.23	3.7	13.9	1.1	1.35	-20.4
WHITNEY HLDG CORP	34,600	24.79	0.7	1.61	5.0	11.1	1.3	0.92	-4.0
WILMINGTON TR CORP	5,600	31.10	0.1	2.11	4.3	11.8	1.9	0.70	-10.8
WINTRUST FINL CORP	5,800	34.95	0.2	0.82	1.0	15.6	1.1	0.84	6.0
WORLD ACCEPTANCE CORP	6,900	31.85	0.2	0.54		11.5	2.6	1.18	18.1
WSFS FINL CORP	2,000	49.28	0.1	0.31	0.8	10.8	1.4	1.13	-1.6
YADKIN VY FINL CORP	4,200	12.65	0.0	0.13	4.1	8.7	1.1	0.51	-16.4
ZENITH NATL INS CORP	8,800	35.86	0.3	1.33	5.6	5.7	1.3	1.65	-18.9
FIRSTBANK CORP MI FRAC CUSIP 33761G104	167,925	0.00	0.0						
			<b>34.7</b>	<b>1.04</b>	<b>3.3</b>	<b>12.1</b>	<b>1.3</b>	<b>1.02</b>	<b>-1.06</b>

# Fresno County Employees' Retirement Association

## Portfolio Holdings And Characteristics - Equity

Period Ending: March 31, 2008

BRANDYWINE	Shares	Price	Portfolio Weight	Market Cap	Dividend Yield	Price / Earnings	Price / Book	Beta	Quarterly Return
<b>Health Care</b>									
ADVOCAT INC	5,753	10.88	0.0	0.06		7.4	5.0	0.85	-0.7
ALBANY MOLECULAR RESH INC	19,200	12.14	0.2	0.40		45.0	1.2	1.08	-15.6
APRIA HEALTHCARE GROUP INC	27,600	19.75	0.4	0.87		10.1	1.7	1.02	-8.4
CARACO PHARMACEUTICAL LABS	4,100	17.95	0.1	0.55		20.4		1.25	4.7
CARDIAC SCIENCE CORP NEW	13,400	8.35	0.1	0.19		22.6	0.8	1.20	3.2
HEALTHSPRING INC	24,100	14.08	0.3	0.84		9.3	1.2		-26.1
HEALTHTRONICS INC	14,600	3.24	0.0	0.12			0.5	0.84	-29.4
KING PHARMACEUTICALS INC	17,200	8.70	0.1	2.14		11.6	0.9	0.88	-15.0
LIFEPOINT HOSPS INC	33,500	27.47	0.7	1.56		12.5	1.0	0.65	-7.6
LINCARE HLDGS INC	4,400	28.11	0.1	2.06		10.9	2.8	0.70	-20.1
NATIONAL DENTEX CORP	2,314	12.89	0.0	0.07		11.0	0.8	0.66	-19.0
THERAGENICS CORP	13,700	3.94	0.0	0.13		23.2	1.0	0.92	10.1
TRIMERIS INC	13,100	6.52	0.1	0.14		5.3	2.2	1.19	-6.6
			<b>2.2</b>	<b>1.06</b>		<b>14.8</b>	<b>1.4</b>	<b>0.87</b>	<b>-10.87</b>

# Fresno County Employees' Retirement Association

## Portfolio Holdings And Characteristics - Equity

Period Ending: March 31, 2008

BRANDYWINE	Shares	Price	Portfolio Weight	Market Cap	Dividend Yield	Price / Earnings	Price / Book	Beta	Quarterly Return
<b>Industrials</b>									
ACCURIDE CORP	22,100	8.18	0.1	0.29			1.1	0.89	4.1
ADVANTAGE MEDIA GROUP INC	4,800	3.46	0.0	0.04		5.5	1.6	1.18	-43.9
AIR T INC	600	9.62	0.0	0.02	2.6	7.6	1.6	0.63	6.2
ALASKA AIR GROUP INC	15,700	19.62	0.2	0.75		6.3	0.7	1.09	-21.6
AMERICAN RAILCAR INDS INC	6,000	20.33	0.1	0.43	0.6	11.7	1.5		6.0
ANIXTER INTL INC	9,600	64.04	0.5	2.28		10.7	2.2	0.84	2.8
APPLIED INDL TECHNOLOGIES INC	12,400	29.89	0.3	1.28	2.0	14.1	2.9	1.24	3.5
ARKANSAS BEST CORP	14,500	31.86	0.4	0.80	1.9	14.1	1.3	0.64	46.0
ASTRONICS CORP	2,700	19.32	0.0	0.13		10.7	3.2	1.56	-54.5
ATLAS AIR WORLDWIDE HLDGS INC	7,100	55.00	0.3	1.19		8.9	1.9	1.44	1.4
BENCHMARK ELECTRS INC	42,100	17.95	0.6	1.24		14.0	1.0	1.05	1.2
CASCADE CORP	5,500	49.31	0.2	0.57	1.5	10.0	2.2	1.20	6.1
CASTLE A M CO	3,300	27.00	0.1	0.60	0.9	11.2	1.5	1.68	-0.4
COLUMBUS MCKINNON CORP NY	4,113	30.98	0.1	0.59		14.8	2.4	1.68	-5.0
COMFORCE CORP	10,000	2.09	0.0	0.04		13.1		0.23	-4.6
COMSYS IT PARTNERS INC	5,900	8.46	0.0	0.17		5.1	1.2	1.63	-46.4
CON WAY INC	25,400	49.48	1.0	2.24	0.8	16.2	2.7	0.52	19.4
CRANE CO	2,300	40.35	0.1	2.44	1.8		2.7	1.31	-5.6
CTS CORP	13,900	10.70	0.1	0.36	1.1	16.2	1.1	1.41	8.1
DDI CORP COM PAR 0.001 NEW	9,200	4.64	0.0	0.10			0.9	0.52	-17.6
GARDNER DENVER INC	16,500	37.10	0.5	1.97		9.8	1.7	1.18	12.4
GEHL CO	6,900	16.94	0.1	0.20		8.5	0.8	1.28	5.6
GRAFTECH INTL LTD	68,400	16.21	0.9	1.66		11.7	14.8	1.63	-8.7
H + E EQUIP SVCS INC	1,300	12.57	0.0	0.46		7.4	1.6		-33.4
HEIDRICK + STRUGGLES INTL INC	5,300	32.53	0.1	0.56	1.6	11.0	1.8	0.84	-11.9
HERLEY INDUSTRIES INC	5,600	10.34	0.0	0.14			0.7	1.21	-24.8
HURCO CO INC	6,200	46.78	0.2	0.30		12.9	3.1	1.62	7.2
INDUSTRIAL SVCS AMER INC FL	2,400	9.98	0.0	0.04	1.0	13.3	3.7	1.16	32.5
INTERNATIONAL SHIPHOLDING CORP	6,600	19.18	0.1	0.15		9.2	0.7	0.96	-12.0
KELLY SVCS INC	18,500	20.56	0.3	0.65	2.6	14.0	0.9	0.84	10.9
KORN / FERRY INTL	11,800	16.90	0.2	0.78		12.1	1.8	1.05	-10.2
MESA AIR GROUP INC	29,400	2.35	0.1	0.06			0.5	1.10	-24.0
MOBILE MINI INC	8,800	19.00	0.1	0.66		15.6	1.4	0.99	2.5
MUELLER INDS INC	22,800	28.85	0.5	1.07	1.4	9.3	1.5	1.12	-0.2
NACCO INDS INC	500	80.94	0.0	0.54	2.5	7.5	0.8	1.67	-18.4
NN INC	12,200	9.73	0.1	0.16	3.3		1.2	1.14	3.3
OVERSEAS SHIPHOLDING GROUP INC	4,100	70.04	0.2	2.18	1.8	11.4	1.2	1.62	-5.5
P A M TRANSN SVCS INC	5,800	15.56	0.1	0.15		60.3	0.9	0.35	1.0
PACER INTL INC TN	19,900	16.43	0.3	0.57	3.7	10.9	1.9	1.35	13.6
PERINI CORP	9,700	36.23	0.3	0.98		10.2	2.7	1.57	-12.5
PINNACLE AIRL CORP	17,800	8.73	0.1	0.18		5.8	2.7	1.20	-42.8
PLUG PWR INC	36,300	3.11	0.1	0.27			1.1	1.24	-21.3

# Fresno County Employees' Retirement Association

## Portfolio Holdings And Characteristics - Equity

Period Ending: March 31, 2008

BRANDYWINE	Shares	Price	Portfolio Weight	Market Cap	Dividend Yield	Price / Earnings	Price / Book	Beta	Quarterly Return
REGAL BELOIT CORP	18,400	36.63	0.5	1.15	1.6	10.5	1.3	1.41	-18.2
REPUBLIC AWYS HLDGS INC	34,200	21.66	0.6	0.79		10.7	1.9	0.62	10.6
RYDER SYS INC	3,000	60.91	0.1	3.54	1.5	14.4	1.9	0.75	30.1
SAIA INC	8,100	15.86	0.1	0.21		13.0	1.1	1.13	19.3
SIFCO INDS INC	5,400	10.30	0.0	0.05		9.8	1.5	1.29	-38.1
SKYWEST INC	47,400	21.12	0.8	1.28	0.6	8.5	1.0	1.63	-21.2
SMITH A O CORP	13,000	32.87	0.3	0.72	2.2	11.5	1.3	0.84	-5.7
STANDEX INTL CORP	6,400	22.34	0.1	0.28	3.8	17.3	1.3	1.02	29.4
SUPERIOR ESSEX INC	8,200	28.12	0.2	0.56		9.6	1.6	1.03	17.2
TAL INTL GROUP INC	4,100	23.57	0.1	0.77	6.4	20.3	2.0		5.2
TBS INTRENATIONAL LTD SHS A	8,200	30.20	0.2	0.43			2.6	0.73	-8.7
TECHNOLOGY RESH CORP	337	2.85	0.0	0.02	2.8	21.9	0.9	1.35	-15.1
TIMKEN CO	20,100	29.72	0.5	2.85	2.3	13.0	1.5	1.23	-9.0
TRUEBLUE INC	21,500	13.44	0.2	0.59		9.3	2.1	1.81	-7.2
TSR INC	3,800	4.20	0.0	0.02	7.6	14.5	1.4	1.14	4.7
TTM TECHNOLOGIES	24,000	11.32	0.2	0.48		14.0	1.5	1.22	-2.9
USA TRUCK INC	4,200	12.91	0.0	0.13			0.9	1.05	-16.2
VISHAY INTERTECHNOLOGY INC	67,800	9.06	0.5	1.56		13.1	0.5	2.10	-20.6
VOLT INFORMATION SCIENCES INC	13,100	16.96	0.2	0.37		15.6	1.1	1.53	-7.1
WCA WASTE CORP	10,200	6.08	0.0	0.11			0.6	0.46	-5.9
WILLIS LEASE FIN CORP	649	12.57	0.0	0.11		8.3	0.9	0.96	0.2
YRC WORLDWIDE INC	24,600	13.12	0.3	0.75			0.5	0.99	-23.2
			<b>13.7</b>	<b>1.19</b>	<b>1.7</b>	<b>12.1</b>	<b>2.5</b>	<b>1.18</b>	<b>-1.23</b>

# Fresno County Employees' Retirement Association

## Portfolio Holdings And Characteristics - Equity

Period Ending: March 31, 2008

BRANDYWINE	Shares	Price	Portfolio Weight	Market Cap	Dividend Yield	Price / Earnings	Price / Book	Beta	Quarterly Return
<b>Information Technology</b>									
ADAPTEC INC	15,700	2.94	0.0	0.36			0.8	1.56	-13.0
ADC TELECOMMUNICATIONS INC	17,200	12.08	0.2	1.42		19.2	1.4	1.82	-22.3
ADVANCED ENERGY INDS INC	17,746	13.26	0.2	0.58		17.7	1.5	1.54	1.4
AXCELIS TECHNOLOGIES INC	42,200	5.60	0.2	0.57			1.2	1.26	21.7
COMMUNICATIONS SYS	3,500	10.77	0.0	0.09	4.5	13.8	1.1	0.58	-8.3
COMPUTER TASK GROUP INC	8,000	4.12	0.0	0.08		16.5	1.7	1.20	-25.5
CPI INTL INC	5,400	9.92	0.0	0.16		9.2	1.3		-42.0
DYNAMICS RESH CORP	3,900	10.11	0.0	0.10		13.7	1.0	0.53	-6.6
EDGEWATER TECHNOLOGY INC	5,500	5.27	0.0	0.07		7.9	0.6	1.25	-28.2
HAUPPAGUE DIGITAL INC	5,500	3.36	0.0	0.03		6.3	1.5	1.23	-29.3
HUTCHINSON TECHNOLOGY INC	15,500	15.91	0.2	0.42		113.6	0.7	1.00	-39.6
INSIGHT ENTERPRISES INC	26,800	17.50	0.4	0.85		12.2	1.1	1.67	-4.1
INTEGRATED SILICON SOLUTION	15,687	6.05	0.1	0.16		12.6	1.0	1.76	-8.6
KEY TRONIC CORP	7,900	2.59	0.0	0.03		5.0	0.6	0.85	-38.0
KULICKE + SOFFA INDS INC	30,100	4.78	0.1	0.26		6.1	3.1	1.76	-30.3
MKS INSTRS INC	33,600	21.40	0.6	1.11		14.2	1.2	1.59	11.8
NANOMETRICS INC	10,900	7.15	0.1	0.13			0.8	2.01	-27.5
NESS TECHNOLOGIES INC	22,400	9.49	0.2	0.37		36.5	1.0	0.92	2.8
ON SEMICONDUCTOR CORP	11,400	5.68	0.1	2.25		7.1		2.25	-36.0
PC CONNECTION INC	11,100	7.92	0.1	0.21		9.3	0.9	0.86	-30.2
PERFORMANCE TECHNOLOGIES INC	4,800	4.58	0.0	0.05		30.5	1.0	1.59	-16.7
PERVASIVE SOFTWARE INC	3,600	3.90	0.0	0.08		20.5	0.9	0.61	-3.2
PHOTRONICS INC	19,200	9.55	0.1	0.40		32.9	0.6	1.58	-23.4
RACKABLE SYS INC	12,200	9.12	0.1	0.27			1.0	0.74	-8.8
RADISYS CORP	10,893	10.09	0.1	0.23			1.0	1.31	-24.7
RCM TECHNOLOGIES INC	4,900	3.86	0.0	0.05		7.2	0.5	0.91	-33.8
REALNETWORKS INC	38,200	5.73	0.2	0.82		19.8	0.9	1.26	-5.9
RF MICRO DEVICES INC	42,300	2.66	0.1	0.78		11.1	0.7	1.28	-53.4
RUDOLPH TECHNOLOGIES INC	17,700	9.77	0.1	0.30		24.4	0.7	1.32	-13.7
SIGMA DESIGNS	16,700	22.67	0.3	0.67		9.2	9.8	1.92	-58.9
SYCAMORE NETWORKS INC	74,400	3.66	0.2	1.04		61.0	1.1	1.21	-4.7
SYNNEX CORP	24,000	21.22	0.4	0.68		10.6	1.1	0.96	8.3
SYSTEMAX INC	1,200	12.06	0.0	0.44		6.6	1.3	1.33	-34.8
TECH DATA CORP	11,900	32.80	0.3	1.73		16.7	1.1	1.28	-13.0
ULTRA CLEAN HLDGS INC	12,900	9.80	0.1	0.21		13.6	1.6	0.84	-19.7
UNITED ONLINE INC	52,200	10.56	0.4	0.72	7.6	12.7	1.9	1.58	-9.1
UNITED STATIONERS INC	1,400	47.70	0.1	1.12		12.5	2.0	1.34	3.2
VERSANT CORP	2,100	25.10	0.0	0.09		11.0	4.0	0.93	-13.7
WHITE ELECTR DESIGNS CORP	13,200	4.40	0.0	0.10		36.7	1.0	0.98	-5.2
WIRELESS TELECOM GROUP INC	17,600	1.55	0.0	0.03		9.9	0.7	0.79	-11.0
WIRELESS XCESSORIES GROUP INC	2,800	1.30	0.0	0.01		8.6	0.8	0.54	-16.8
ZORAN CORP	26,000	13.66	0.3	0.70		10.6	1.0	1.53	-39.3



# Fresno County Employees' Retirement Association

## Portfolio Holdings And Characteristics - Equity

Period Ending: March 31, 2008

			5.5	0.73	7.4	20.9	1.7	1.39	-12.68
<b>Materials</b>									
AMPCO PITTSBURGH CORP	5,300	42.99	0.2	0.44	1.7	11.1	2.3	0.96	13.2
BUCKEYE TECHNOLOGIES INC	31,600	11.16	0.3	0.44		8.7	1.2	1.53	-10.7
HEADWATERS INC	31,400	13.19	0.3	0.55		40.0	0.7	0.99	12.4
HERCULES INC	12,900	18.29	0.2	2.08	1.1	11.7	4.4	1.06	-5.2
MATERIAL SCIENCES CORP	5,900	7.76	0.0	0.11			0.9	0.92	4.4
OLIN CORP COM PAR 1	55,200	19.76	0.9	1.47	4.0	11.3	2.2	1.21	3.2
POLYONE CORP	54,400	6.37	0.3	0.59		53.1	0.9	1.03	-3.2
ROCK TENN CO COM CL A	4,300	29.97	0.1	1.14	1.3	14.0	1.9	1.21	18.4
RPM INTL INC	17,500	20.94	0.3	2.55	3.6	12.3	2.3	1.07	4.1
SILGAN HLDGS INC	19,600	49.63	0.8	1.87	1.4	15.4	3.7	1.44	-4.1
SPARTECH CORP	9,700	8.45	0.1	0.26	6.4	12.4	0.6	1.12	-39.5
UNIVERSAL STAINLESS + ALLOY PR	3,900	29.71	0.1	0.20		8.9	1.5	1.39	-16.5
USEC INC	20,200	3.70	0.1	0.41		3.9	0.3	1.56	-58.9
WESTLAKE CHEM CORP	27,700	13.05	0.3	0.85	1.5	7.4	0.7	1.22	-31.1
WORTHINGTON INDS IN	40,200	16.87	0.5	1.36	4.0	15.5	1.5	1.13	-4.7
			<b>4.4</b>	<b>1.27</b>	<b>2.8</b>	<b>17.0</b>	<b>2.1</b>	<b>1.21</b>	<b>-3.34</b>
<b>Telecommunications Services</b>									
CINCINNATI BELL INC NEW	52,100	4.26	0.2	1.06		17.8		1.53	-10.3
USA MOBILITY INC	7,800	7.14	0.0	0.20				1.26	-47.2
			<b>0.2</b>	<b>0.88</b>		<b>17.8</b>		<b>1.48</b>	<b>-17.71</b>
<b>Utilities</b>									
ALLETE INC	7,200	38.62	0.2	1.19	4.5	12.5	1.6	1.28	-1.3
AVISTA CORP	22,100	19.56	0.3	1.04	3.4	27.2	1.1	1.31	-8.4
BLACK HILLS CORP	11,700	35.78	0.3	1.35	3.9	13.6	1.4	0.95	-18.1
GREAT PLAINS ENERGY INC	11,400	24.65	0.2	2.12	6.7	13.3	1.4	0.82	-14.6
IDACORP INC	25,500	32.11	0.7	1.45	3.7	17.3	1.2	0.86	-8.0
PNM RES INC	2,300	12.47	0.0	0.96	7.4	13.0	0.6	1.26	-41.1
PORTLAND GEN ELEC CO	35,700	22.55	0.6	1.41	4.2	9.7	1.1		-18.0
PUGET ENERGY INC	2,300	25.87	0.0	3.35	3.9	16.6	1.3	0.47	-4.8
VECTREN CORP	29,400	26.83	0.6	2.05	4.8	14.3	1.7	0.79	-6.4
WESTSTAR ENERGY INC	54,800	22.77	1.0	2.23	5.1	12.4	1.2	0.98	-11.1
			<b>4.1</b>	<b>1.72</b>	<b>4.5</b>	<b>14.5</b>	<b>1.3</b>	<b>0.96</b>	<b>-11.07</b>
BRANDYWINE			<b>100.0</b>	<b>1.12</b>	<b>3.0</b>	<b>14.3</b>	<b>1.7</b>	<b>1.10</b>	<b>-1.81</b>

# Fresno County Employees' Retirement Association

## Equity Activity

Period Ending: March 31, 2008

Start from Dec 31, 2007 **BRANDYWINE**

Additions				Deletions			
Security Name	Shares	Market Value	New	Security Name	Shares	Market Value	Eliminated
	12,200	108,124	*		3,300	69,961	*
	2,251	125,358	*		3,700	37,421	*
	8,600	288,817	*		11,800	228,600	*
	8,300	26,015	*		3,098	42,469	*
	3,500	96,291	*	ABX AIR INC	5,900	17,740	*
21ST CENTY HLDG CO	3,200	39,911	*	ACCURIDE CORP	3,500	21,980	
ADVOCAT INC	5,753	68,825	*	ADVANTA CORP CL A COM	13,500	109,207	*
ALASKA AIR GROUP INC	5,400	123,959	*	AEROPOSTALE	10,100	269,547	*
ALBANY MOLECULAR RESH INC	13,600	147,732	*	AGL RES INC	16,700	576,323	
AMERICAN PHYSICIANS CAP INC	4,000	157,867	*	ALFA CORP	13,412	291,018	*
AMERICAS CAR MART INC	4,900	59,666	*	ALON USA ENERGY INC	5,200	63,070	
AMPCO PITTSBURGH CORP	1,100	38,441	*	AMCOMP INC NEW	6,900	82,867	*
AMTRUST FINANCIAL SERVICES	19,900	305,586	*	AMERIGROUP CORP	10,700	396,183	*
APPLIED INDL TECHNOLOGIES INC	12,400	351,963	*	AMERON INTL CORP	1,200	129,007	
ASTRONICS CORP	2,700	53,778	*	ARCTIC CAT INC	3,800	29,947	*
ATLAS AIR WORLDWIDE HLDGS INC	7,100	360,113	*	ARRIS GROUP INC	8,300	46,366	*
AVISTA CORP	10,000	181,694	*	ASSET ACCEP CAP CORP	2,800	24,514	
AXCELIS TECHNOLOGIES INC	42,200	231,232	*	ASTA FDG INC	1,400	21,497	
BAKER MICHAEL CORP	3,600	99,510	*	ASTORIA FINL CORP	6,100	151,703	*
BALDWIN + LYONS INC CL B	5,200	134,192	*	BIG 5 SPORTING GOODS CORP	2,400	19,665	
BANCFIRST CORP	945	38,676	*	BLOUT INTL INC NEW	18,500	211,174	*
BASSETT FURNITURE INDS INC	4,800	51,615	*	BRISTOW GROUP INC	3,300	168,773	
BUCKEYE TECHNOLOGIES INC	31,600	405,629	*	BUCKLE INC	950	39,462	*
CARDIAC SCIENCE CORP NEW	9,300	84,226	*	BUILD A BEAR WORKSHOP INC	2,100	24,486	
CENTURY ALUM CO	6,600	322,679	*	BUILDING MATLS HLDG CORP	24,800	149,334	*
CHIQUITA BRANDS INTL INC	8,800	175,487	*	CELADON GROUP INC	9,600	89,229	*
COLUMBUS MCKINNON CORP NY	3,015	75,335	*	CENTRAL GARDEN + PET CO CL A NON VTG	16,300	67,891	*
COMMUNICATIONS SYS	3,500	36,033	*	CENTURY ALUM CO	4,500	313,503	*
COMPLETE PRODTN SVCS INC	25,200	488,483	*	CHARMING SHOPPES INC	12,200	62,081	
COMPUTER TASK GROUP INC	8,000	33,462	*	CITI TRENDS INC	5,500	72,209	*
CORE MARK HLDG CO INC	4,300	105,733	*	COLLECTIVE BRANDS INC	6,900	104,240	
COX RADIO INC	8,700	101,384	*	COLONIAL BANCGROUPINC	16,900	193,551	*

# Fresno County Employees' Retirement Association

## Equity Activity

Period Ending: March 31, 2008

CTS CORP	13,900	134,250	*	COMMERCE GROUP INC MASS	14,400	520,695	*
CULP INC	300	2,226	*	COMMERCIAL VEH GROUP INC	17,300	165,775	*
DDI CORP COM PAR 0.001 NEW	9,200	45,665	*	COMMUNITY BANCORP NEV	1,400	15,729	*
DELEK US HLDGS INC	21,000	343,755	*	COMSYS IT PARTNERS INC	2,300	18,354	
DYNAMICS RESH CORP	3,900	38,643	*	CONNS INC	2,400	29,660	
EASTERN INS HLDGS INC	2,900	45,008	*	CPI INTL INC	2,000	19,962	
EDGEWATER TECHNOLOGY INC	5,500	30,635	*	CRANE CO	6,400	255,825	
ELIZABETH ARDEN INC	11,900	214,316	*	DELUXE CORP	5,300	103,082	
ENCORE CAP GROUP INC	8,600	66,804	*	DOWNEY FINL CORP	19,600	485,205	*
FINANCIAL FED CORP	2,000	48,030	*	EARTHLINK INC	31,200	201,962	*
FIRST MERCURY FINL CORP	7,400	110,856	*	EMERSON RADIO CORP	15,708	16,844	*
FIRSTCITY FINL CORP	4,400	33,786	*	FINISH LINE INC	29,400	49,918	*
FPIC INS GROUP INC	0	0	*	FIRSTFED FINL CORP DEL	1,100	32,968	
FPIC INSURANCE GROUP	500	21,615		FLAGSTAR BANCORP INC	0	0	*
FTD GROUP INC	3,800	50,106		FLAGSTAR BANCORP INCORPORATED	300	2,202	*
FURNITURE BRANDS INTL INC	13,000	153,261	*	FMC CORP	10,700	579,202	*
GARDNER DENVER INC	13,200	419,988	*	FRANKLIN BANK CORP	9,200	42,197	*
GATX CORPORATION	8,400	301,006	*	GENESCO INC	1,200	24,263	
GREY WOLF INC	30,200	178,563		GETTY IMAGES INC	6,000	191,701	
GULFMARK OFFSHORE INC	2,400	99,040		GIBRALTAR INDS INC	3,200	36,488	
H + E EQUIP SVCS INC	1,300	19,569	*	GYMBOREE CORP	3,400	127,387	*
HALLMARK FINANCIAL SERVICES INC	2,500	39,804		HANCOCK HLDG CO	7,400	286,827	
HALLMARK FINL SVCS INC	5,750	69,238	*	HICKORY TECH CORP	2,800	25,152	*
HAVERTY FURNITURE COS INC	7,300	69,834	*	IMPERIAL CAP BANCORP INC	3,800	59,014	*
HEALTHSPRING INC	1,500	25,246		INDYMAC BANCORP INC	42,100	190,761	*
HEALTHTRONICS INC	14,600	50,585	*	INTEGRYS ENERGY GROUP INC	2,300	111,027	*
HERCULES INC	4,000	70,198	*	JONES APPAREL GROUP INC	14,700	208,632	
HERCULES OFFSHORE INC	2,300	57,138	*	JOURNAL COMMUNICATIONS INC	4,700	32,104	
HERLEY INDUSTRIES INC	5,600	56,677	*	K SWISS INC A CL A	2,700	38,365	
HURCO CO INC	6,200	217,442	*	KING PHARMACEUTICALS INC	27,700	244,842	
HUTCHINSON TECHNOLOGY INC	10,900	186,643	*	KULICKE + SOFFA INDS INC	13,200	61,948	
ICO INC NEW	11,200	85,617	*	LACLEDE GROUP INC	12,000	403,534	*
INSIGHT ENTERPRISES INC	4,000	66,304	*	LANDAMERICA FINL GROUP INC	13,700	556,695	*
INTEGRATED SILICON SOLUTION	10,587	59,638	*	LENNOX INTL INC	6,000	211,662	
INTERNATIONAL BANCSHARES CORP	2,900	58,052	*	LINCOLN ELEC HLDGS INC	3,500	231,838	*

# Fresno County Employees' Retirement Association

## Equity Activity

Period Ending: March 31, 2008

INTERNATIONAL SHIPHOLDING CORP	6,600	142,260	*	LITHIA MTRS INC	1,500	14,626	
INTERSTATE HOTELS + RESORTS IN	13,100	61,075	*	LYDALL INC	4,800	43,688	*
IPC HOLDINGS LTD BERMUDA SHS	6,200	169,166	*	MADDEN STEVEN LTD	3,463	58,871	
KEY ENERGY SVCS INC	4,700	62,381	*	MANNATECH INC	2,500	18,698	
KIMBALL INTL INC CL B	10,400	106,853	*	MARLIN BUSINESS SVCS CORP	1,300	11,056	
LA Z BOY INC	21,200	177,459	*	MCCLATCHY CO	6,100	54,898	
LEGACY BANCORP INC OC CL A	3,800	53,624	*	MERCANTILE BANKCORP	1,300	15,185	
LUFKIN INDS INC	5,400	283,598	*	MESA AIR GROUP INC	2,800	7,085	
MATERIAL SCIENCES CORP	5,900	44,232	*	MIDLAND CO	4,500	287,638	*
MAX CAPITAL GROUP LTD SHS	6,000	161,699	*	N/A		17,479	*
MEDALLION FINL CORP	7,200	70,140	*	NACCO INDS INC	1,100	82,672	
MONTPELIER RE HOLDINGS LTD CDT SHS	10,400	163,852	*	NATIONAL ATLANTIC HLDGS CORP	467	2,069	*
NANOMETRICS INC	7,600	47,702	*	NATIONAL ATLANTIC HOLDINGS CORP	3,633	16,325	*
NESS TECHNOLOGIES INC	16,200	151,716	*	NCI BLDG SYS INC	2,000	42,974	
NEWALLIANCE BANCSHARES INC	14,600	164,066	*	NELNET INC	4,500	43,327	
OIL STATES INTL INC	9,800	337,781	*	NEW JERSEY RES CORP	4,900	226,823	*
ON SEMICONDUCTOR CORP	11,400	81,761	*	NEW YORK + CO INC	32,500	164,093	*
OVERSEAS SHIPHOLDING GROUP INC	4,100	265,853	*	NEW YORK TIMES CO	7,500	132,700	*
PARK OH HLDGS CORP	10,400	242,309	*	ODYSSEY RE HLDGS CORP	7,300	262,768	
PC CONNECTION INC	11,100	103,209	*	PFF BANCORP INC	2,500	15,610	
PDI INC	1,800	12,906	*	PNM RES INC	7,700	77,255	
PERFORMANCE TECHNOLOGIES INC	4,800	22,117	*	PROTECTIVE LIFE CORP	7,600	290,439	*
PERINI CORP	9,700	345,804	*	PUGET ENERGY INC	15,300	403,009	
PERVASIVE SOFTWARE INC	3,600	13,532	*	RF MICRO DEVICES INC	28,800	84,501	
PHI INC COM NON VTG	4,694	137,791	*	ROCKY BRANDS INC	1,900	11,542	*
PHOENIX COS INC NEW	6,600	72,521	*	RPM INTL INC	12,200	245,649	
PINNACLE AIRL CORP	15,000	208,729	*	RUBY TUESDAY INC	20,700	154,705	*
PIONEER DRILLING CO	2,900	31,919	*	RUTHS CHRIS STEAK HSE INC	2,500	17,219	
PLATINUM UNDERWRITERS HOLDINGS SHS	4,700	157,796	*	RYDER SYS INC	6,900	396,247	
PLUG PWR INC	36,300	108,749	*	SHOE CARNIVAL INC	1,600	19,276	
PMA CAP CORP	13,100	109,359	*	SIMPSON MFG INC	5,200	127,993	
PORTLAND GEN ELEC CO	4,000	97,471	*	SPARTECH CORP	3,300	46,431	
PROASSURANCE CORP	3,500	177,576		STANDARD PAC CORP NEW	600	1,280	*
PROSPERITY BANCSHARES INC	6,700	176,812	*	STEIN MART INC	17,300	69,897	*
RADISYS CORP	9,200	91,509	*	SWS GROUP INC	3,000	32,821	

# Fresno County Employees' Retirement Association

## Equity Activity

Period Ending: March 31, 2008

RCM TECHNOLOGIES INC	3,000	15,023	*	SYNTAX BRILLIAN CORP	29,300	67,196	*
RENASANT CORP	2,100	42,996	*	TEMPUR PEDIC INTL INC	43,900	471,434	*
RLI CORP	1,000	53,435	*	TIDEWATER INC	6,100	336,166	*
RUSH ENTERPRISES INC	10,700	154,960	*	TIMBERLAND CO	4,700	64,883	
SCHWEITZER MAUDUIT INTL INC	6,400	144,254	*	TIMKEN CO	10,300	296,951	
SEACOR HLDGS INC	3,000	278,572	*	TUESDAY MORNING CORP	3,800	18,757	
SELECTIVE INS GROUP INC	3,000	67,815	*	TUPPERWARE BRANDS CORP	43,700	1,564,167	*
SIERRA BANCORP	2,300	53,444		U S CONCRETE INC	3,800	14,706	
SIFCO INDS INC	5,400	69,550	*	UNIT CORP	4,600	252,357	
ST MARY LD + EXPL CO	2,200	81,824	*	UNITED SEC BANCSHARES INC CDT SHS	2,700	48,209	*
STARTEK INC	6,000	49,462	*	USA MOBILITY INC	2,900	24,072	
STATE AUTO FINL CORP	2,400	63,581	*	USEC INC	10,800	44,455	
STEWART INFORMATION SVCS CORP	7,000	190,836	*	W+T OFFSHORE INC	18,700	573,980	
SUPERIOR ESSEX INC	7,400	210,449	*	WEST COAST BANCORP ORE NEW	1,100	14,663	
SUPERIOR INDS INTL INC	11,000	198,317	*	WESTWOOD ONE INC	35,500	56,653	*
SUSQUEHANNA BANCSHARES INC PA	12,250	231,349	*	WGL HLDGS INC	1,400	47,228	
SWIFT ENERGY CO	11,900	528,561	*	WORTHINGTON INDS IN	7,100	121,479	
SYSTEMAX INC	1,200	19,113	*	XERIUM TECHNOLOGIES INC	26,400	31,447	*
THERAGENICS CORP	13,700	50,426	*	YRC WORLDWIDE INC	5,900	82,765	
TRIMERIS INC	2,600	16,302	*				
UNIFI INC	25,000	70,469	*				
UNITED AMER INDTY LTD	6,400	124,149	*				
UNITED FINL BANCORP INC MD	7,300	81,490	*				
UNITED FIRE CAS CO	1,600	50,168	*				
UNIVERSAL AMERN FINL CORP	9,000	118,821	*				
UNIVERSAL INS HLDGS INC	15,600	94,282	*				
USA TRUCK INC	4,200	54,429	*				
VAALCO ENERGY INC	2,100	10,415	*				
VIRCO MFG CO	10,700	65,806	*				
W H ENERGY SVCS INC	4,400	238,473	*				
WCA WASTE CORP	7,000	42,377	*				
WESBANCO INC	2,800	67,331					
WHITNEY HLDG CORP	3,900	97,466	*				
WILLIS LEASE FIN CORP	649	8,104	*				
WINTRUST FINL CORP	5,800	188,458	*				

# Fresno County Employees' Retirement Association

## Equity Activity

Period Ending: March 31, 2008

WORLD ACCEPTANCE CORP	6,900	204,792	*
-----------------------	-------	---------	---

# FRESNO COUNTY EMPLOYEES' RETIREMENT ASSOCIATION

## Mondrian Emerging Markets - Country Allocation & Returns

Period Ending: March 31, 2008

Countries	Mondrian		MSCI Emerging Markets Index		Difference %	
	Weight %	Return %	Weight %	Return %	Weight %	Return %
Mexico	7.5	-	5.2	5.1	2.3	-
Russia	8.2	-	10.0	-11.4	-1.8	-
Taiwan	16.6	-	11.7	5.2	4.9	-
Argentina	2.0	-	0.6	18.2	1.4	-
Turkey	1.4	-	1.2	-38.4	0.2	-
Canada	0.1	-	0.0	-11.0	-	-
Singapore	0.0	-	0.0	-11.0	0.0	-
Thailand	5.0	-	1.6	3.1	3.4	-
Malaysia	4.1	-	2.5	-9.1	1.6	-
United States	-	-	-	-	-	-
Pakistan	0.0	-	0.0	-10.4	0.0	-
Jordan	0.0	-	0.0	-2.4	0.0	-
India	2.7	-	7.0	-27.6	-4.3	-
Philippines	1.3	-	0.5	-17.0	0.8	-
Kazakhstan	0.0	-	0.0	-11.0	0.0	-
South Korea	7.9	-	13.8	-12.8	-5.9	-
Sweden	-	-	-	-	-	-
Morocco	0.0	-	0.0	33.8	0.0	-
Sri Lanka	0.0	-	0.0	-11.0	0.0	-
Vietnam	0.0	-	0.0	-11.0	0.0	-
Egypt	2.8	-	0.8	7.9	2.0	-
Colombia	2.2	-	0.4	-4.4	1.8	-
Oman	-	-	-	-11.0	-	-
Peru	0.0	-	0.0	5.3	0.0	-
United Kingdom	-	-	-	-11.0	-	-
Bermuda	0.0	-	0.0	-11.0	0.0	-
Luxembourg	-	-	-	-	-	-
Israel	2.6	-	2.3	-4.7	0.3	-
Netherlands	0.0	-	0.0	-11.0	0.0	-
Czech Republic	1.1	-	0.8	-0.4	0.3	-
Hong Kong	0.0	-	0.0	-11.0	0.0	-
Chile	1.2	-	1.4	9.8	-0.2	-
Poland	1.9	-	1.8	-3.9	0.1	-
South Africa	7.0	-	6.3	-14.9	0.7	-
Panama	0.3	-	0.0	-	0.3	-
Hungary	0.0	-	0.0	-13.7	0.0	-
Brazil	14.8	-	14.4	-5.0	0.4	-
China	8.4	-	13.9	-23.7	-5.5	-
Other	0.9	-	3.8	-	-2.9	-
	<b>100.0</b>	<b>-4.8</b>	<b>100.0</b>	<b>-10.9</b>		

# FRESNO COUNTY EMPLOYEES' RETIREMENT ASSOCIATION

## Mondrian Emerging Markets- Country Allocation & Returns

Period Ending: March 31, 2008

Sector	Weight %	Mondrian	MSCI Emerging Markets Index		Difference %	
		Return %	Weight %	Return %	Weight %	Return %
Cash	1.3	-	-	-	-	-
Information Technology	13.6	-	10.9	-4.3	2.7%	-
Financials	19.9	-	20.5	-16.8	-0.6%	-
Consumer Discretionary	4.8	-	4.9	-10.6	-0.1%	-
Telecommunication Services	20.0	-	11.6	-9.6	8.4%	-
Energy	13.1	-	17.4	-14.4	-4.3%	-
Health Care	0.0	-	1.7	-4.6	-1.7%	-
Consumer Staples	3.6	-	4.5	-4.6	-0.9%	-
Materials	12.0	-	16.1	-2.3	-4.1%	-
Utilities	4.1	-	3.4	-12.4	0.7%	-
Industrials	7.6	-	9.0	-16.6	-1.4%	-
	<b>100.0</b>	<b>-4.8</b>	<b>100.0</b>	<b>-10.9</b>	<b>-1.3</b>	



# Fresno County Employees' Retirement Association

## Cumulative Performance Comparisons

Period Ending: March 31, 2008

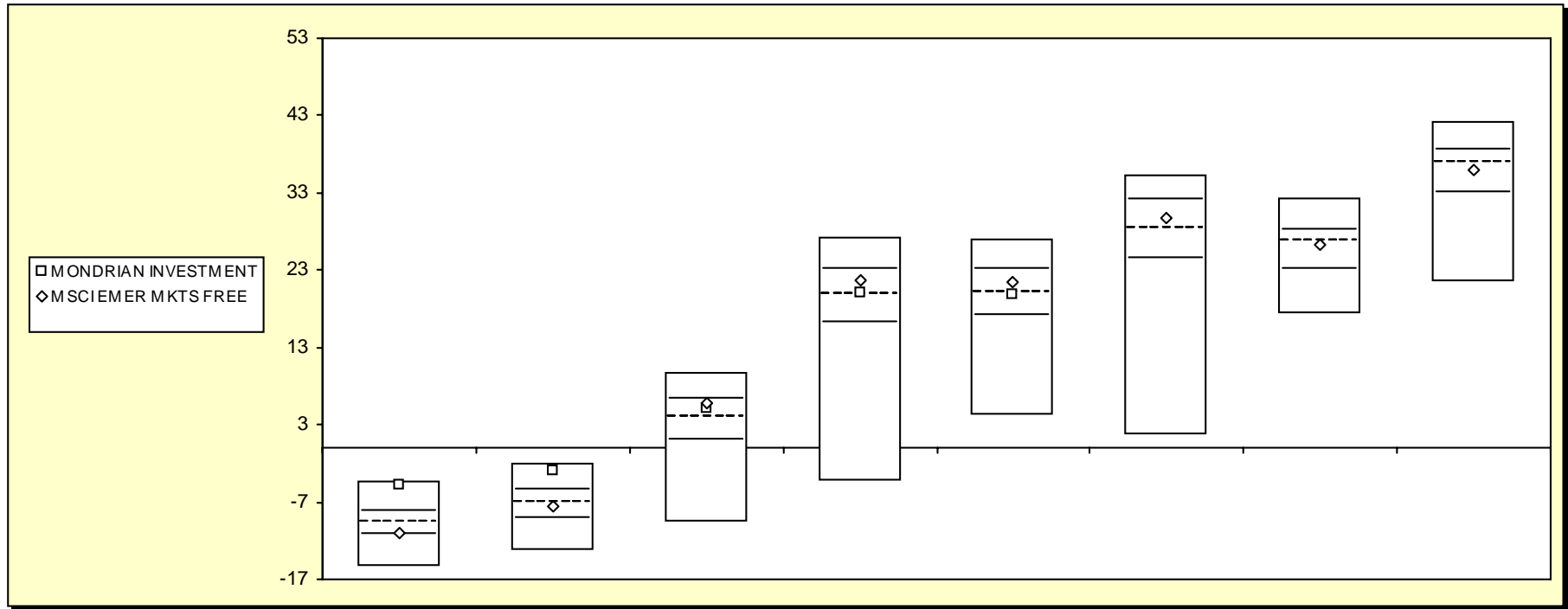

### Int'l Emerging Market Equity Funds

	Last Quarter		Two Quarters		Three Quarters		One Year		Two Years		Three Years		Four Years		Five Years	
	Return	Rank	Return	Rank	Return	Rank	Return	Rank	Return	Rank	Return	Rank	Return	Rank	Return	Rank
5th Percentile	-4.4		-2.0		9.7		27.3		26.9		35.4		32.4		42.1	
25th Percentile	-8.2		-5.4		6.3		23.1		23.0		32.1		28.1		38.5	
50th Percentile	-9.7		-7.1		3.9		19.7		20.1		28.4		26.8		36.8	
75th Percentile	-11.3		-9.1		0.9		16.2		17.0		24.5		23.1		33.1	
95th Percentile	-15.3		-13.3		-9.5		-4.3		4.1		1.6		17.2		21.4	
MONDRIAN INVESTMENT	-4.8	7	-2.9	10	5.2	37	20.0	48	19.8	52						
MSCI EMER MKTS FREE	-10.9	69	-7.7	57	5.8	31	21.7	36	21.3	39	29.6	41	26.4	53	36.0	56

# Fresno County Employees' Retirement Association

## Consecutive Performance Comparisons

Period Ending: March 31, 2008

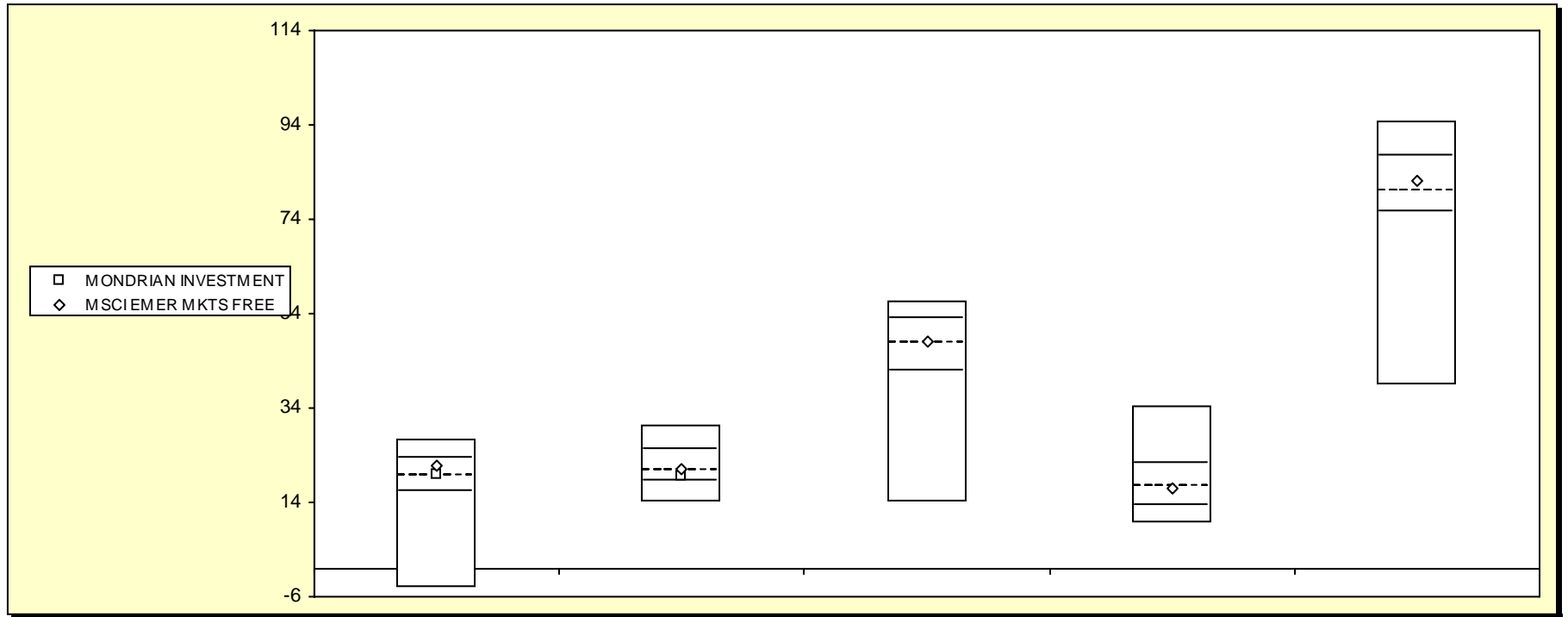

### Int'l Emerging Market Equity Funds

	March 2008		March 2007		March 2006		March 2005		March 2004	
	Return	Rank	Return	Rank	Return	Rank	Return	Rank	Return	Rank
5th Percentile	27.3		30.3		56.5		34.2		94.7	
25th Percentile	23.1		25.0		52.8		22.1		87.4	
50th Percentile	19.7		20.6		47.7		17.5		79.8	
75th Percentile	16.2		18.6		42.0		13.4		75.3	
95th Percentile	-4.3		14.1		14.0		9.4		38.7	
MONDRIAN INVESTMENT	20.0	48	19.5	63						
MSCI EMER MKTS FREE	21.7	36	21.0	48	48.0	48	17.0	53	82.2	42

# Fresno County Employees' Retirement Association

Consecutive Annual - Five Year

Period Ending: March 31, 2008

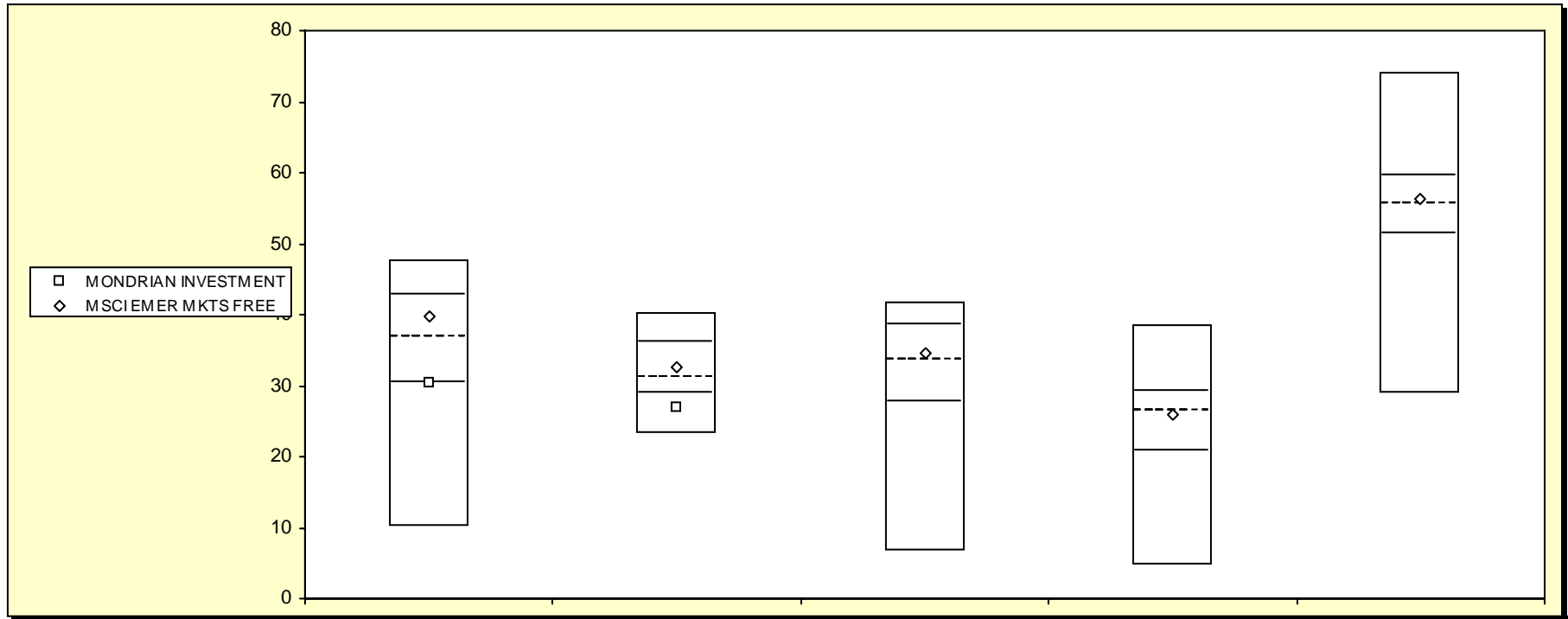

## Int'l Emerging Market Equity Funds

	December 2007		December 2006		December 2005		December 2004		December 2003	
	Return	Rank	Return	Rank	Return	Rank	Return	Rank	Return	Rank
5th Percentile	47.6		40.3		41.8		38.4		74.2	
25th Percentile	42.8		36.1		38.5		29.0		59.6	
50th Percentile	36.7		31.1		33.6		26.5		55.6	
75th Percentile	30.5		29.0		27.7		20.7		51.5	
95th Percentile	10.2		23.2		6.6		4.7		28.9	
MONDRIAN INVESTMENT	30.4	75	26.9	82						
MSCI EMER MKTS FREE	39.8	37	32.6	42	34.5	45	26.0	52	56.3	46

# FRESNO COUNTY EMPLOYEES' RETIREMENT ASSOCIATION

## Franklin Templeton - Country Allocation & Returns

Period Ending: March 31, 2008

Countries	Franklin		MSCI EAFE Index		Difference %	
	Weight %	Return %	Weight %	Return %*	Weight %	Return %
Netherlands	5.9	-2.7	2.8	-6.5	3.1	3.9
Germany	11.5	-18.2	9.0	-11.7	2.5	-6.5
Italy	4.9	-11.5	3.9	-11.7	1.0	0.2
Greece	-	-	0.7	-15.8	-	-
Portugal	0.9	-11.3	0.4	-13.2	0.5	1.9
Sweden	2.9	-1.7	2.4	-3.4	0.5	1.7
Finland	1.8	-12.9	1.9	-10.2	-0.1	-2.7
Austria	-	-	6.5	-11.4	-	-
Spain	5.7	-6.6	4.2	-5.5	1.5	-1.1
France	12.5	-12.7	10.6	-8.3	1.9	-4.4
Denmark	1.4	2.0	1.0	0.4	0.4	1.6
Norway	2.3	-19.8	1.0	-10.4	1.2	-9.4
Ireland	-	-	-	-	-	-
Switzerland	6.3	1.7	7.1	-1.8	-0.8	3.5
Belgium	-	-	1.3	-3.1	-	-
United Kingdom	24.4	-14.0	21.9	-10.5	2.5	-3.5
Japan	11.0	-13.6	20.6	-7.8	-9.6	-5.9
Bermuda	-	-	-	-	-	-
Singapore	3.7	-4.3	1.1	-7.4	2.6	3.2
Hong Kong	2.2	-20.8	2.3	-18.9	-0.1	-1.9
United States	-	-	-	-	-	-
Australia	1.3	-25.4	0.6	-9.9	0.7	-15.5
New Zealand	-	-	0.1	-14.4	-	-
Irish Republic	-	-	0.7	-1.0	-	-
Other	1.5	-	-	-	-	-
	<b>100.0</b>	<b>-11.1</b>	<b>100.0</b>	<b>-8.8</b>	<b>0.0</b>	<b>-2.3</b>

# FRESNO COUNTY EMPLOYEES' RETIREMENT ASSOCIATION

## Franklin Templeton - Country Allocation & Returns

Period Ending: March 31, 2008

Sector	Franklin		MSCI EAFE Index		Difference %	
	Weight %	Return %	Weight %	Return %	Weight %	Return %
Information Technology	7.1	-22.4	5.3	-13.5	1.8%	-8.9
Financials	20.9	-9.1	26.3	-10.5	-5.4%	1.4
Consumer Discretionary	15.4	-14.9	10.7	-10.0	4.6%	-5.0
Telecommunication Services	13.3	-13.3	6.1	-15.4	7.3%	2.2
Energy	8.8	-10.2	7.7	-10.7	1.1%	0.4
Health Care	8.4	-11.0	6.6	-5.6	1.8%	-5.4
Consumer Staples	4.8	-3.3	8.6	-3.7	-3.8%	0.4
Materials	1.8	-12.9	10.5	-3.5	-8.7%	-9.4
Utilities	4.1	-6.0	6.0	-7.0	-1.9%	0.9
Industrials	15.4	-11.3	12.1	-8.0	3.2%	-3.3
	<b>100.0</b>	<b>-11.1</b>	<b>100.0</b>	<b>-8.8</b>	<b>0.0</b>	<b>-2.3</b>

### Five Best Performers

Company	Country	Impact
Swiss Reinsurance	SWITZERLAND	0.3%
Atlas Copco AB	SWEDEN	0.3%
LG Electronics	SOUTH KOREA	0.2%
Compass Group	UNITED KINGDOM	0.2%
Samsung Electronics	SOUTH KOREA	0.2%

### Five Worst Performers

Company	Country	Impact
Rolls Royce Group	UNITED KINGDOM	-0.3%
Siemens AG	GERMANY	-0.3%
Infineon Technologies	GERMANY	-0.3%
Yell Group	UNITED KINGDOM	-0.3%
ICICI Bank	INDIA	-0.5%

# Fresno County Employees' Retirement Association

## Cumulative Performance Comparisons

Period Ending: March 31, 2008

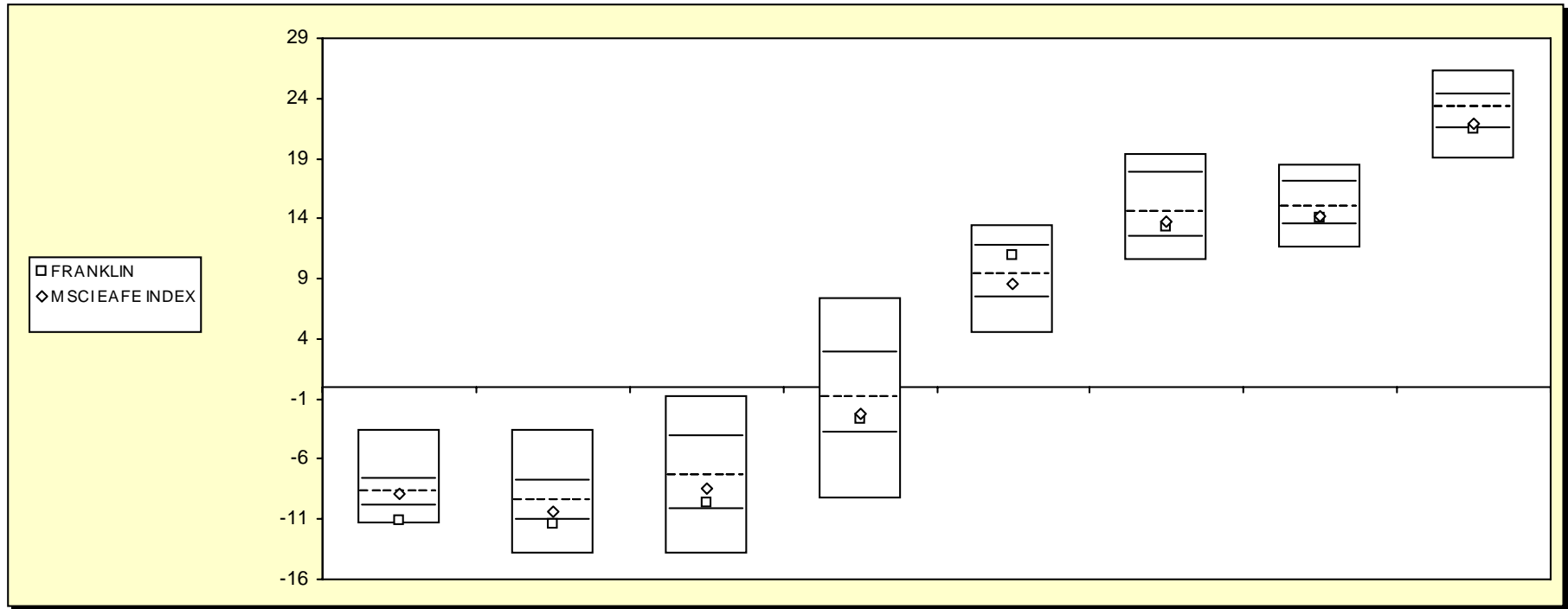

### Int'l Developed Market Equity Funds

	Last Quarter		Two Quarters		Three Quarters		One Year		Two Years		Three Years		Four Years		Five Years	
	Return	Rank	Return	Rank	Return	Rank	Return	Rank	Return	Rank	Return	Rank	Return	Rank	Return	Rank
5th Percentile	-3.5		-3.5		-0.8		7.4		13.5		19.4		18.6		26.4	
25th Percentile	-7.7		-7.8		-4.2		2.8		11.7		17.7		17.0		24.3	
50th Percentile	-8.8		-9.4		-7.4		-0.9		9.3		14.4		14.9		23.2	
75th Percentile	-9.9		-11.1		-10.3		-3.9		7.4		12.5		13.4		21.5	
95th Percentile	-11.4		-13.9		-14.0		-9.3		4.4		10.4		11.5		18.9	
FRANKLIN	-11.1	91	-11.4	77	-9.6	69	-2.6	64	10.9	33	13.3	64	14.1	64	21.5	75
MSCI EAFE INDEX	-8.8	51	-10.4	65	-8.4	58	-2.3	61	8.6	59	13.8	58	14.2	62	21.9	69

# Fresno County Employees' Retirement Association

## Consecutive Performance Comparisons

Period Ending: March 31, 2008

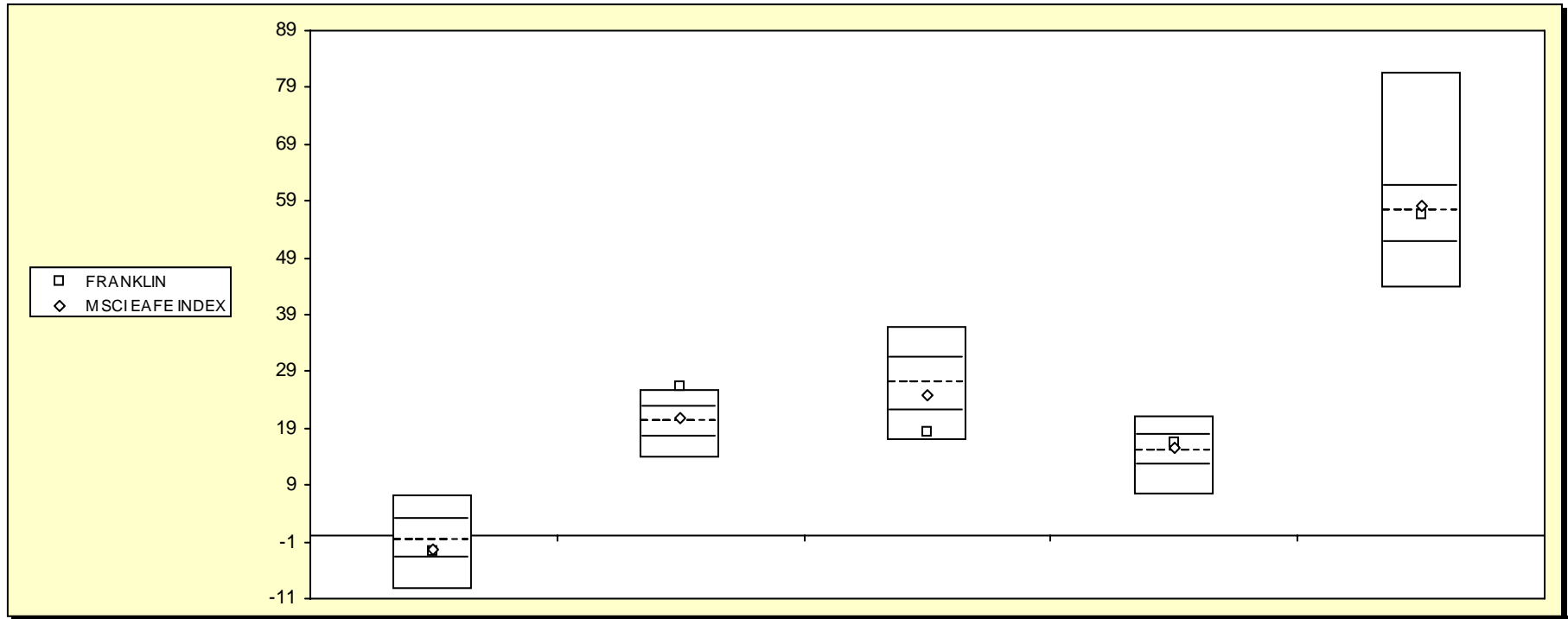

### Int'l Developed Market Equity Funds

	March 2008		March 2007		March 2006		March 2005		March 2004	
	Return	Rank	Return	Rank	Return	Rank	Return	Rank	Return	Rank
5th Percentile	7.4		25.7		36.8		21.2		81.7	
25th Percentile	2.8		22.7		31.3		17.7		61.5	
50th Percentile	-0.9		20.3		26.9		15.0		57.3	
75th Percentile	-3.9		17.4		22.0		12.6		51.8	
95th Percentile	-9.3		13.7		16.9		7.3		43.6	
FRANKLIN	-2.6	64	26.4	4	18.2	90	16.4	37	56.5	54
MSCI EAFE INDEX	-2.3	61	20.7	46	24.9	60	15.5	45	58.2	45

# Fresno County Employees' Retirement Association

Consecutive Annual - Five Year

Period Ending: March 31, 2008

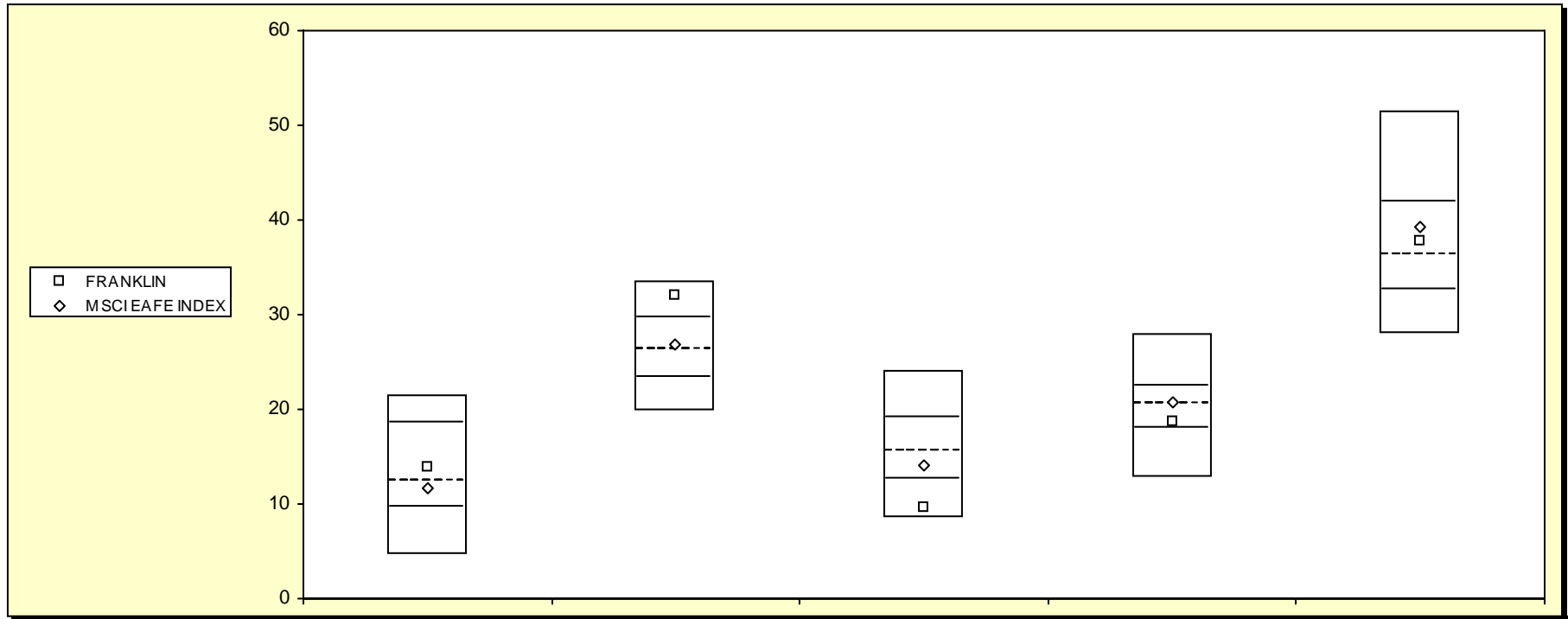

## Int'l Developed Market Equity Funds

	December 2007 Return Rank	December 2006 Return Rank	December 2005 Return Rank	December 2004 Return Rank	December 2003 Return Rank
5th Percentile	21.6	33.6	24.1	27.9	51.4
25th Percentile	18.5	29.6	19.1	22.4	41.9
50th Percentile	12.5	26.4	15.5	20.6	36.3
75th Percentile	9.6	23.3	12.5	18.0	32.6
95th Percentile	4.6	19.8	8.5	12.8	27.9
FRANKLIN	13.8 44	32.0 13	9.7 89	18.7 68	37.9 43
MSCI EAFE INDEX	11.6 57	26.9 46	14.0 63	20.7 48	39.2 37



# FRESNO COUNTY EMPLOYEES' RETIREMENT ASSOCIATION

## Oechsle International - Country Allocation & Returns

Period Ending: March 31, 2008

Countries	Oechsle		MSCI EAFE Index		Difference %	
	Weight %	Return %	Weight %	Return %*	Weight %	Return %
Netherlands	6.8	-13.5	2.9	-13.8	3.94	0.4
Germany	14.0	-17.4	9.2	-18.6	4.81	1.2
Italy	5.1	-14.8	3.9	-18.5	1.21	3.7
Greece	1.1	-28.7	0.7	-22.3	0.43	-6.3
Portugal	0.7	-14.1	0.3	-19.9	0.35	5.8
Sweden	2.1	-14.0	2.5	-11.4	-0.35	-2.6
Finland	1.7	-24.4	1.8	-17.4	-0.10	-7.0
Austria	-	-	0.6	-16.9	-	-
Spain	3.8	-12.2	4.4	-12.9	-0.61	0.7
France	14.6	-13.2	10.9	-15.4	3.72	2.3
Denmark	1.3	-2.6	1.0	-7.7	0.25	5.1
Norway	1.1	-9.7	1.1	-16.2	0.06	6.5
Ireland	-	-	0.7	-8.9	-	-
Switzerland	6.0	-10.8	7.2	-14.5	-1.28	3.7
Belgium	0.7	-29.1	1.3	-10.6	-0.65	-18.5
United Kingdom	15.1	-13.9	21.6	-10.4	-6.49	-3.6
Japan	22.8	-14.7	20.1	-17.9	2.65	3.2
Singapore	1.3	-13.0	1.2	-11.4	0.15	-1.7
Hong Kong	-	-	2.3	-19.0	-	-
United States	1.8	-	-	-	-	-
Australia	-	-	6.5	-15.1	-	-
Other	0.1	-	-	-	-	-
	<b>100.0</b>	<b>-7.3</b>	<b>100.0</b>	<b>-8.9</b>	<b>0.0</b>	<b>1.6</b>

# FRESNO COUNTY EMPLOYEES' RETIREMENT ASSOCIATION

## Oechsle International - Country Allocation & Returns

Period Ending: March 31, 2008

Sector	Weight %	Oechsle	MSCI EAFE Index		Difference %	
		Return %	Weight %	Return %	Weight %	Return %
Information Technology	-	-16.5	5.3	-21.6	-	5.1
Financials	-	-12.4	26.2	-16.1	-	3.7
Consumer Discretionary	-	-12.5	10.7	-17.0	-	4.5
Telecommunication Services	-	-18.2	6.2	-20.2	-	2.1
Energy	-	-15.1	7.8	-13.8	-	-1.2
Health Care	-	-13.9	6.6	-13.5	-	-0.4
Consumer Staples	-	-13.3	8.6	-9.7	-	-3.6
Materials	-	-12.7	10.3	-9.3	-	-3.3
Utilities	-	-15.2	6.1	-13.1	-	-2.1
Industrials	-	-20.9	12.0	-15.4	-	-5.5
	<b>0.0</b>	<b>-7.3</b>	<b>100.0</b>	<b>-8.9</b>	<b>0.0</b>	<b>1.6</b>

### Ten Best Performers

Company	Country	Impact
BUSINESS OBJECTS SA-SP ADR	FRANCE	0.22%
FAST RETAILING	JAPAN	0.22%
UBS	SWITZERLAND	0.21%
REPSOL YPF	SPAIN	0.20%
DEUTSCHE POSTBANK	GERMANY	0.19%
VODAFONE GROUP	UNITED KINGDOM	0.18%
MITSUBISHI ESTATE	JAPAN	0.17%
SAP	GERMANY	0.16%
NOVO NORDISK	DENMARK	0.14%
CASINO GUICHARD-PERRACHON	FRANCE	0.13%

### Ten Worst Performers

Company	Country	Impact
SIEMENS	GERMANY	-0.37%
PREMIER FOODS	UNITED KINGDOM	-0.22%
HELLENIC TELECOM	GREECE	-0.20%
HSBC HOLDINGS	UNITED KINGDOM	-0.17%
ROLLS-ROYCE GROUP	UNITED KINGDOM	-0.16%
UCB	BELGIUM	-0.12%
J SAINSBURY	UNITED KINGDOM	-0.12%
SUMCO	JAPAN	-0.11%
NISSAN MOTOR	JAPAN	-0.11%
VOLKSWAGEN	GERMANY	-0.10%

# Fresno County Employees' Retirement Association

## Cumulative Performance Comparisons

Period Ending: March 31, 2008

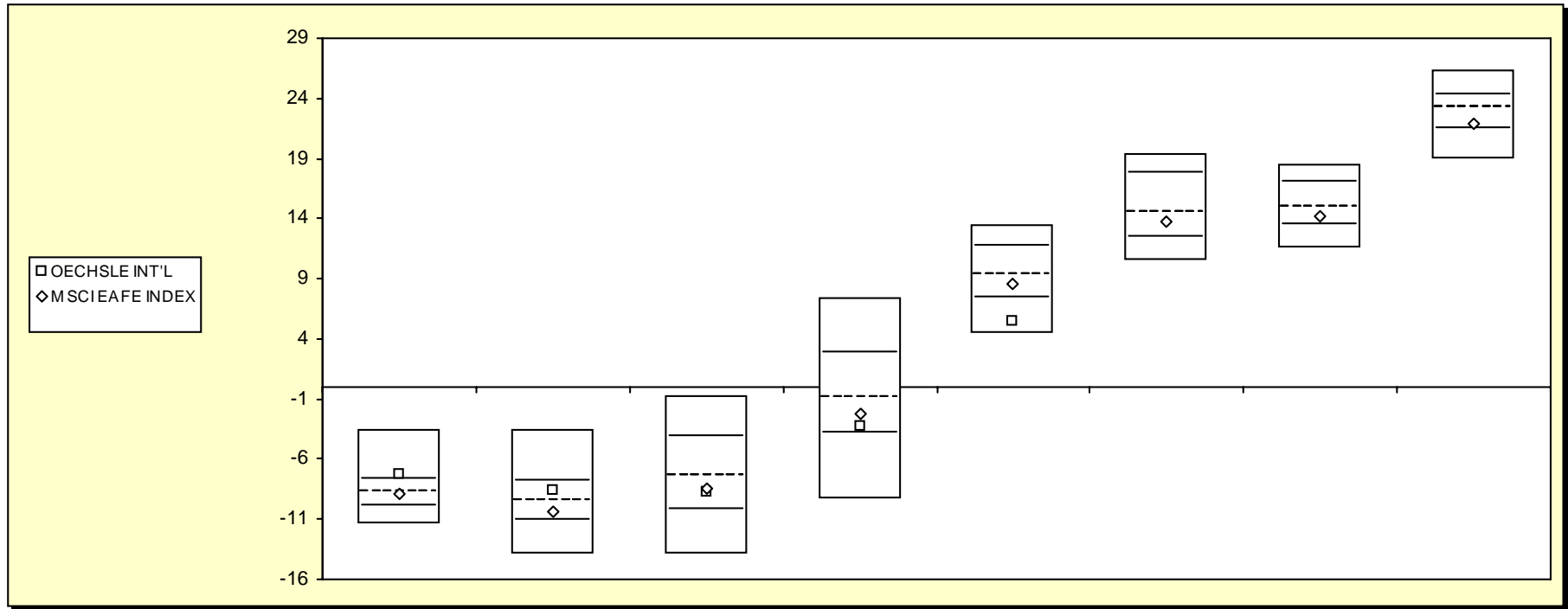

### Int'l Developed Market Equity Funds

	Last Quarter	Two Quarters	Three Quarters	One Year	Two Years	Three Years	Four Years	Five Years
	Return	Return	Return	Return	Return	Return	Return	Return
	Rank	Rank	Rank	Rank	Rank	Rank	Rank	Rank
5th Percentile	-3.5	-3.5	-0.8	7.4	13.5	19.4	18.6	26.4
25th Percentile	-7.7	-7.8	-4.2	2.8	11.7	17.7	17.0	24.3
50th Percentile	-8.8	-9.4	-7.4	-0.9	9.3	14.4	14.9	23.2
75th Percentile	-9.9	-11.1	-10.3	-3.9	7.4	12.5	13.4	21.5
95th Percentile	-11.4	-13.9	-14.0	-9.3	4.4	10.4	11.5	18.9
OECHSLE INT'L	-7.3	-8.6	-8.8	-3.3	5.5			
MSCI EAFE INDEX	-8.8	-10.4	-8.4	-2.3	8.6	13.8	14.2	21.9
	23	37	62	70	88			
	51	65	58	61	59	58	62	69

# Fresno County Employees' Retirement Association

## Consecutive Performance Comparisons

Period Ending: March 31, 2008

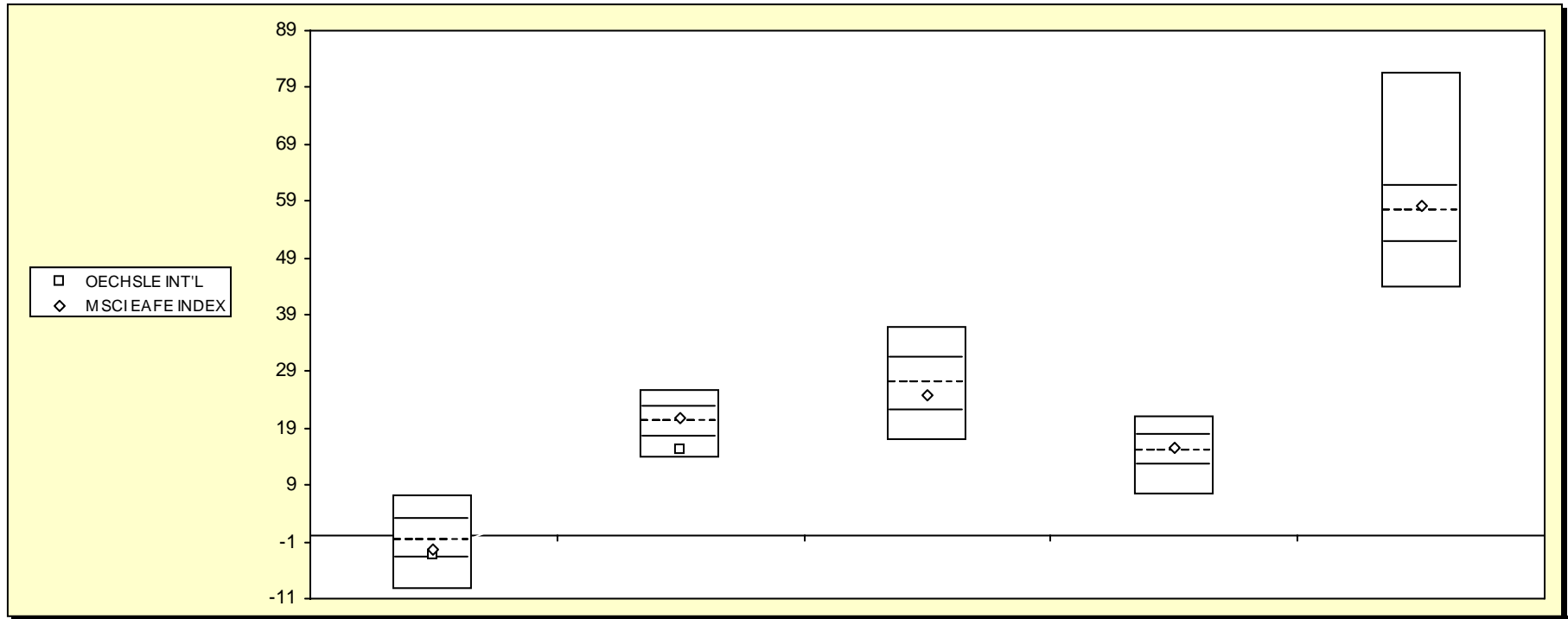

### Int'l Developed Market Equity Funds

	March 2008		March 2007		March 2006		March 2005		March 2004	
	Return	Rank	Return	Rank	Return	Rank	Return	Rank	Return	Rank
5th Percentile	7.4		25.7		36.8		21.2		81.7	
25th Percentile	2.8		22.7		31.3		17.7		61.5	
50th Percentile	-0.9		20.3		26.9		15.0		57.3	
75th Percentile	-3.9		17.4		22.0		12.6		51.8	
95th Percentile	-9.3		13.7		16.9		7.3		43.6	
OECHSLE INT'L	-3.3	70	15.1	87						
MSCI EAFE INDEX	-2.3	61	20.7	46	24.9	60	15.5	45	58.2	45

# Fresno County Employees' Retirement Association

Consecutive Annual - Five Year

Period Ending: March 31, 2008

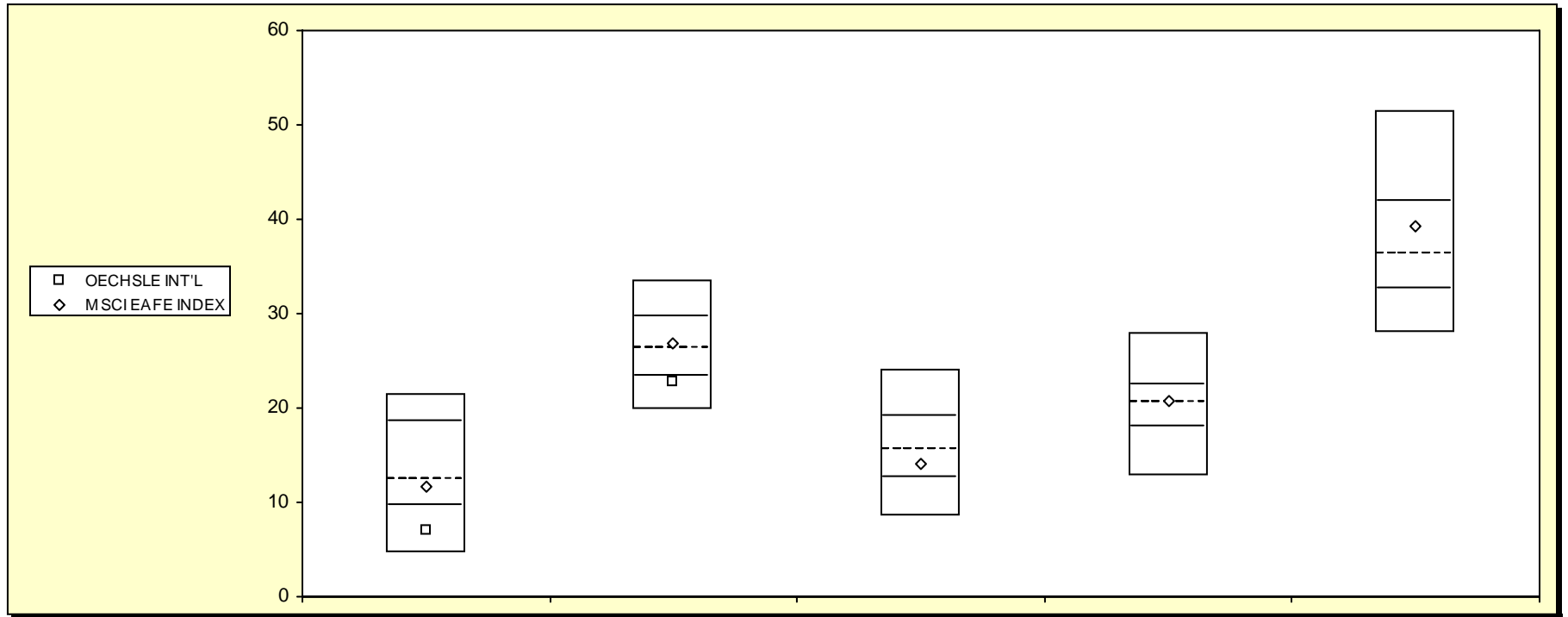

## Int'l Developed Market Equity Funds

	December 2007		December 2006		December 2005		December 2004		December 2003	
	Return	Rank	Return	Rank	Return	Rank	Return	Rank	Return	Rank
5th Percentile	21.6		33.6		24.1		27.9		51.4	
25th Percentile	18.5		29.6		19.1		22.4		41.9	
50th Percentile	12.5		26.4		15.5		20.6		36.3	
75th Percentile	9.6		23.3		12.5		18.0		32.6	
95th Percentile	4.6		19.8		8.5		12.8		27.9	
OECHSLE INT'L	7.1	85	22.7	79						
MSCI EAFE INDEX	11.6	57	26.9	46	14.0	63	20.7	48	39.2	37

# Fresno County Employees' Retirement Association

## Cumulative Performance Comparisons

Period Ending: March 31, 2008

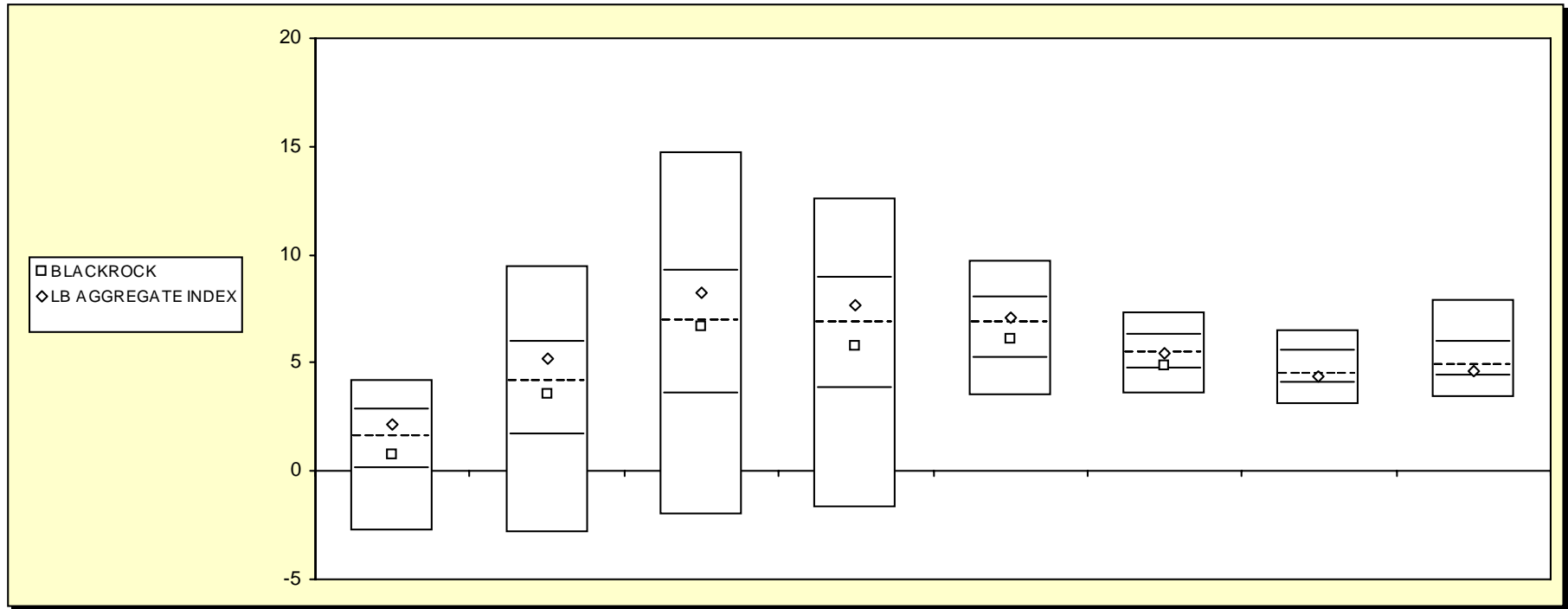

### Bond Funds

	Last Quarter		Two Quarters		Three Quarters		One Year		Two Years		Three Years		Four Years		Five Years	
	Return	Rank	Return	Rank	Return	Rank	Return	Rank	Return	Rank	Return	Rank	Return	Rank	Return	Rank
5th Percentile	4.2		9.5		14.7		12.6		9.7		7.4		6.5		7.9	
25th Percentile	2.8		5.9		9.2		8.9		8.0		6.3		5.5		6.0	
50th Percentile	1.5		4.1		6.9		6.8		6.8		5.5		4.5		4.8	
75th Percentile	0.1		1.7		3.5		3.8		5.2		4.7		4.0		4.4	
95th Percentile	-2.8		-2.8		-2.1		-1.7		3.5		3.5		3.1		3.4	
BLACKROCK	0.7	64	3.6	56	6.7	52	5.8	59	6.1	61	4.9	69				
LB AGGREGATE INDEX	2.2	37	5.2	34	8.2	36	7.7	40	7.1	44	5.5	50	4.4	54	4.6	63

# Fresno County Employees' Retirement Association

## Consecutive Performance Comparisons

Period Ending: March 31, 2008

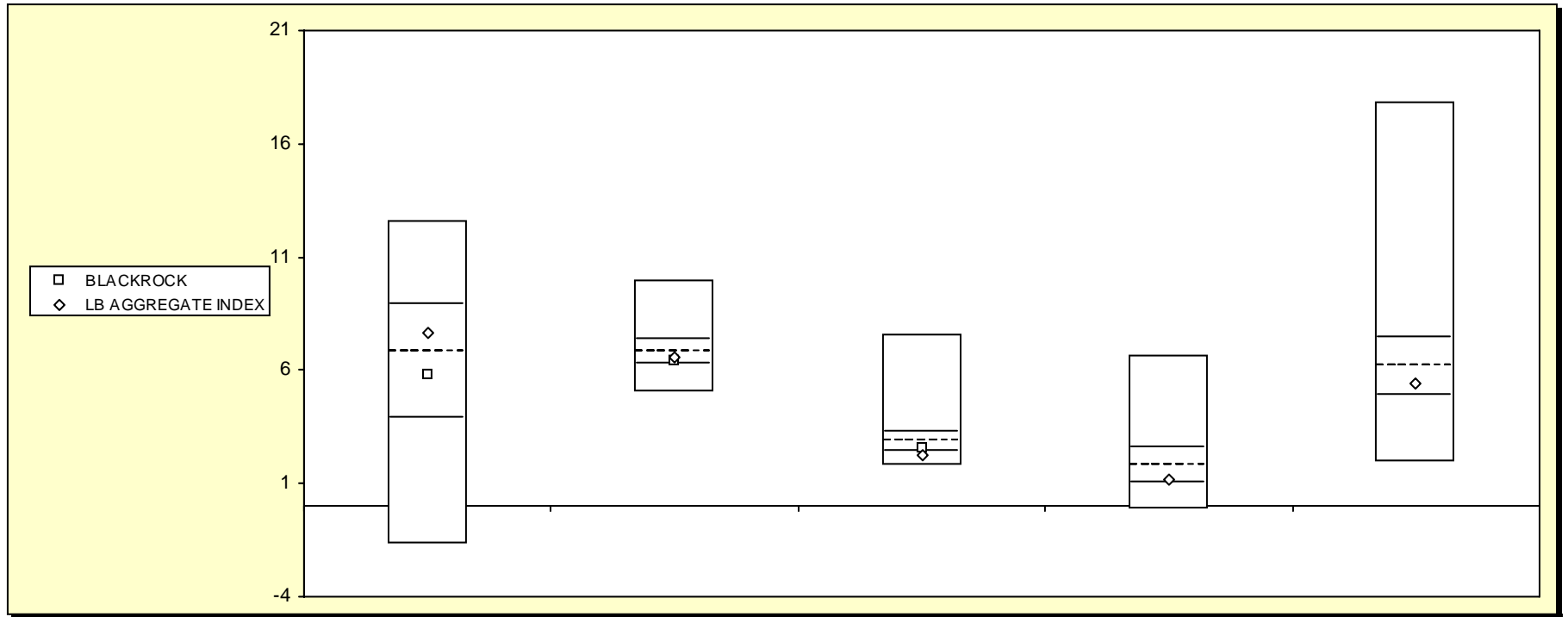

### Bond Funds

	March 2008		March 2007		March 2006		March 2005		March 2004	
	Return	Rank	Return	Rank	Return	Rank	Return	Rank	Return	Rank
5th Percentile	12.6		10.0		7.5		6.6		17.8	
25th Percentile	8.9		7.3		3.3		2.6		7.4	
50th Percentile	6.8		6.8		2.8		1.8		6.2	
75th Percentile	3.8		6.3		2.4		1.0		4.9	
95th Percentile	-1.7		5.0		1.8		-0.2		1.9	
BLACKROCK	5.8	59	6.4	68	2.6	66				
LB AGGREGATE INDEX	7.7	40	6.6	59	2.3	80	1.2	71	5.4	65

# Fresno County Employees' Retirement Association

Consecutive Annual - Five Year

Period Ending: March 31, 2008

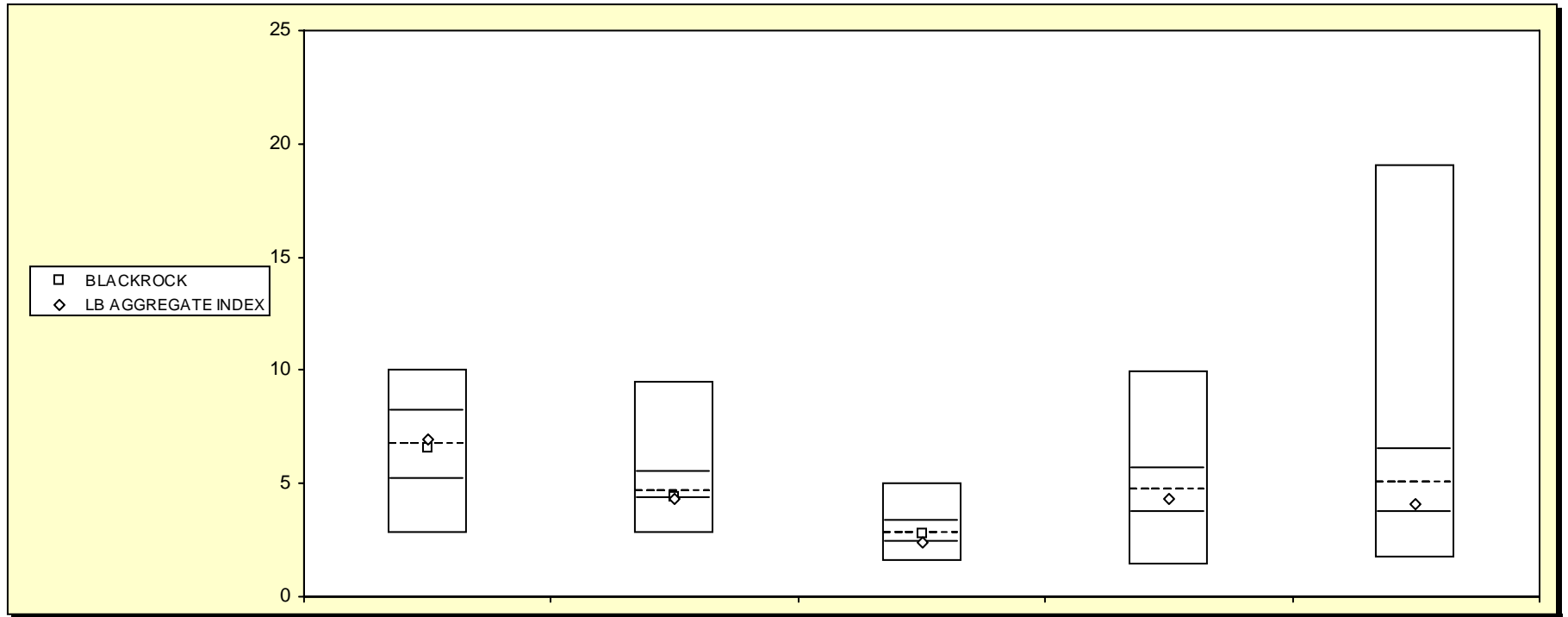

*Bond Funds*

	December 2007 Return Rank	December 2006 Return Rank	December 2005 Return Rank	December 2004 Return Rank	December 2003 Return Rank
5th Percentile	10.0	9.5	5.0	9.9	19.1
25th Percentile	8.2	5.5	3.3	5.6	6.5
50th Percentile	6.7	4.6	2.8	4.7	5.0
75th Percentile	5.2	4.3	2.4	3.7	3.7
95th Percentile	2.8	2.7	1.5	1.4	1.7
BLACKROCK	6.5 53	4.4 65	2.8 49	4.3 59	4.1 68
LB AGGREGATE INDEX	7.0 45	4.3 74	2.4 71	4.3 59	4.1 68



# FRESNO COUNTY EMPLOYEES RETIREMENT ASSO.

Periods Ending March 31, 2008

## Bond Portfolio Characteristics

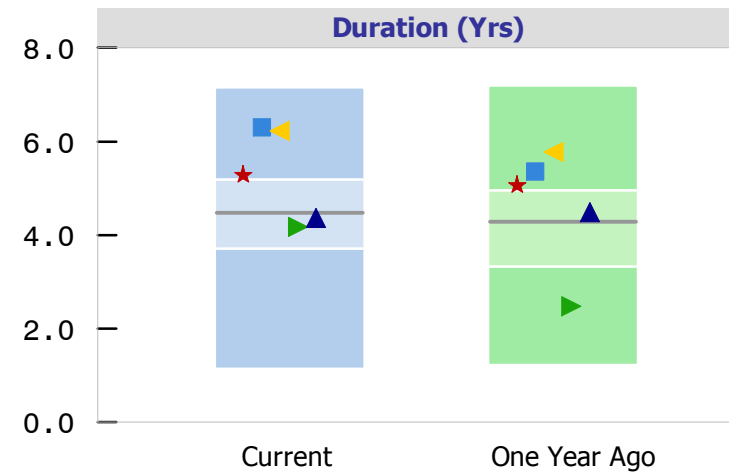
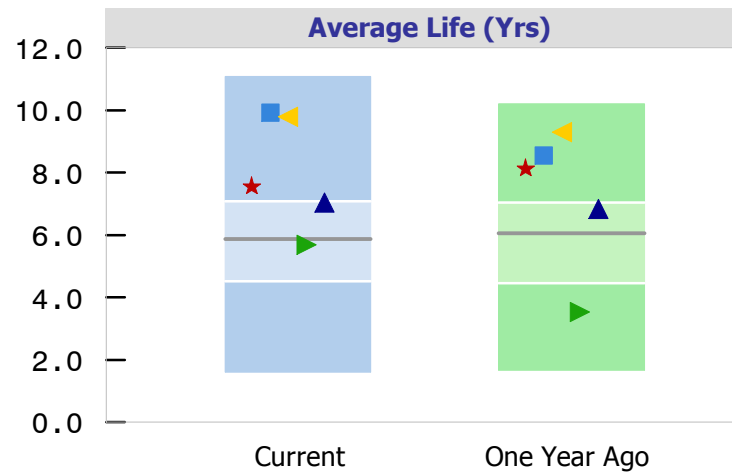

Effects  
On Return

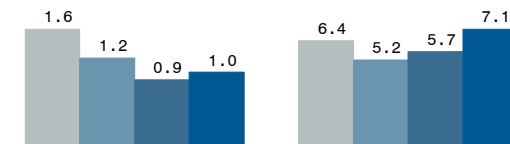
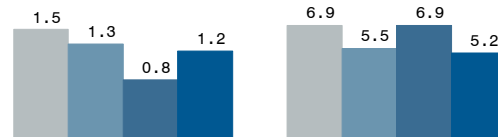

★ <b>BRADFORD</b>	7.57	18	8.14	13	5.29	21	5.07	22
■ <b>LOOMIS SAYLES</b>	9.93	7	8.55	10	6.30	8	5.36	18
▲ <b>WESTERN ASSET</b>	9.81	7	9.31	7	6.24	9	5.79	13
▶ <b>BLACKROCK</b>	5.71	54	3.54	86	4.19	61	2.49	86
▲ <b>LB AGGREGATE</b>	7.05	25	6.86	34	4.38	54	4.50	40
<b>Median</b>	5.88		6.06		4.48		4.29	

# FRESNO COUNTY EMPLOYEES RETIREMENT ASSO.

Periods Ending March 31, 2008

## Bond Portfolio Characteristics

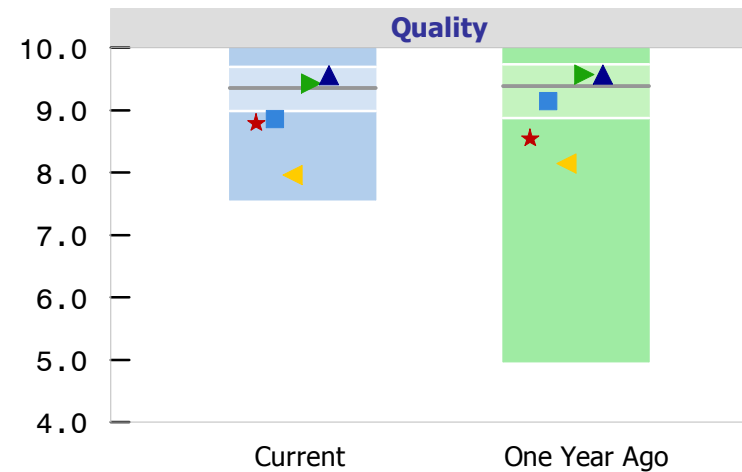
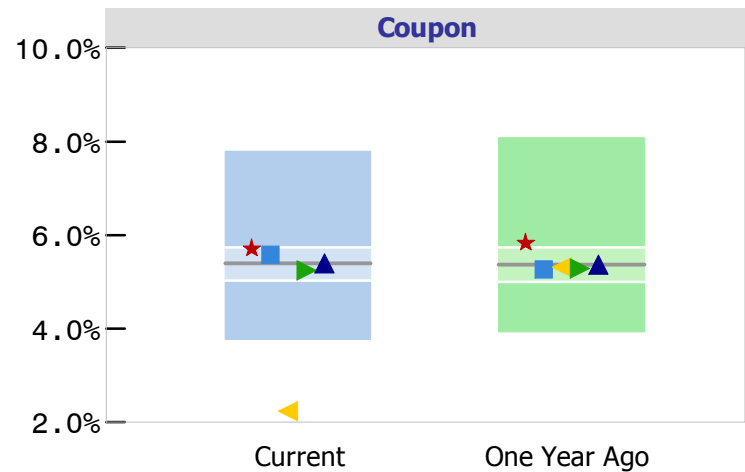

Effects  
On Return

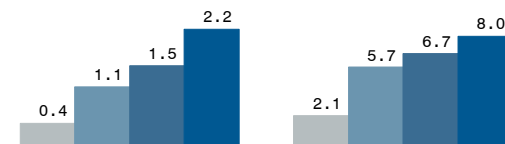
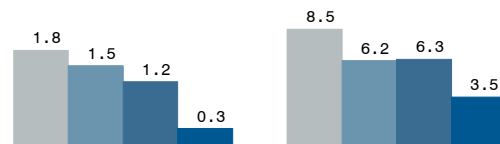

★ <b>BRADFORD</b>	5.72	26	5.85	21	8.80	82	8.56	79
■ <b>LOOMIS SAYLES</b>	5.58	33	5.27	55	8.86	80	9.15	64
▲ <b>WESTERN ASSET</b>	2.25	98	5.32	52	7.97	92	8.16	82
▶ <b>BLACKROCK</b>	5.26	59	5.30	53	9.44	42	9.58	36
▲ <b>LB AGGREGATE</b>	5.41	45	5.38	46	9.57	33	9.58	37
<b>Median</b>	5.39		5.36		9.36		9.39	

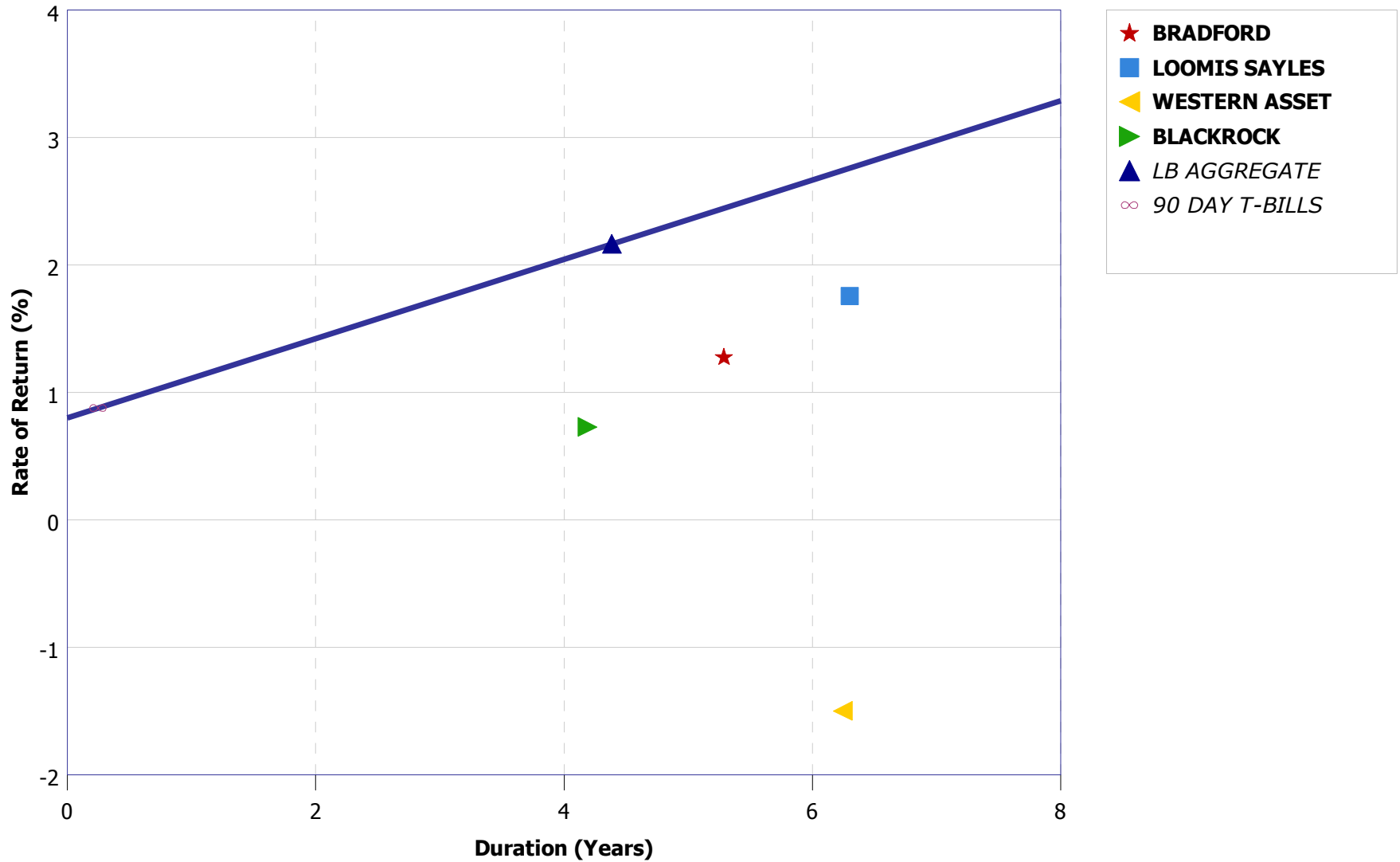

# FRESNO COUNTY EMPLOYEES RETIREMENT ASSO.

Quarter Ending March 31, 2008

## Fixed Income Attribution Bond Funds - Total Returns

	Return	Beginning Duration	Ending Duration	Average Duration	Return Due to Market	Interest Rate Anticipation	Security Selection
<b>Portfolio</b>							
<b>BRADFORD</b>	1.28	5.13	5.29	5.21	2.43	0.02	-1.17
<b>LOOMIS SAYLES</b>	1.76	6.13	6.30	6.22	2.74	0.03	-1.01
<b>WESTERN ASSET</b>	-1.50	5.65	6.24	5.95	2.66	0.09	-4.25
<b>BLACKROCK</b>	0.73	4.02	4.19	4.10	2.08	0.03	-1.38
<b>Benchmark</b>							
<i>LB AGGREGATE</i>	2.17	4.41	4.38	4.39			
<i>90 DAY T-BILLS</i>	0.88	0.25	0.25	0.25			
<b>Market Sensitivity</b>	0.31						

Return Due to Market = T-Bill Return \* (Relative Market Sensitivity x (Average Duration - TBill Duration))

Rate Anticipation = Relative Market Sensitivity x Current Duration - Average Duration

Selection Effect = (Account Return - TBill Return) - (Relative Market Sensitivity x (Current Duration - TBill Duration))

Relative Market Sensitivity = (Benchmark Return - TBill Return) / (Benchmark Current Duration - TBill Duration)

Duration = Duration Option Adjusted Incl Cash Equiv

**FRESNO COUNTY EMPLOYEES RETIREMENT ASSO.**

Quarter Ending March 31, 2008

**Fixed Income Attribution  
Bond Only Returns**

	<b>Return</b>	<b>Beginning Duration</b>	<b>Ending Duration</b>	<b>Average Duration</b>	<b>Return Due to Market</b>	<b>Interest Rate Anticipation</b>	<b>Security Selection</b>
<b>Portfolio</b>							
<b>BRADFORD</b>	1.28	5.13	5.29	5.21	2.43	0.02	-1.17
<b>LOOMIS SAYLES</b>	1.76	6.12	6.30	6.21	2.74	0.03	-1.01
<b>WESTERN ASSET</b>	-1.50	5.65	6.24	5.95	2.66	0.09	-4.25
<b>BLACKROCK</b>	0.73	4.02	4.19	4.10	2.08	0.03	-1.38
<b>Benchmark</b>							
<i>LB AGGREGATE</i>	2.17	4.41	4.38	4.39			
<i>90 DAY T-BILLS</i>	0.88	0.25	0.25	0.25			
<b>Market Sensitivity</b>	0.31						

Return Due to Market = T-Bill Return \* (Relative Market Sensitivity x (Average Duration - TBill Duration))  
 Rate Anticipation = Relative Market Sensitivity x Current Duration - Average Duration  
 Selection Effect = (Account Return - TBill Return) - (Relative Market Sensitivity x (Current Duration - TBill Duration))  
 Relative Market Sensitivity = (Benchmark Return - TBill Return) / (Benchmark Current Duration - TBill Duration)  
 Duration = Duration Option Adjusted

Portfolio Characteristics		
	Portfolio	LB AGGREGATE
Total Number of Securities	309	
Total Market Value	\$ 224,995,186	
Current Coupon	5.26	5.41
Yield To Maturity	5.77	4.55
Average Life	5.71	7.05
Duration	4.19	4.38
Quality	9.44	9.57

Duration (in Years)	
Range	%Held
0.0 to 1.0	14.5
1.0 to 3.0	18.7
3.0 to 4.0	10.6
4.0 to 6.0	12.6
6.0 to 8.0	13.8
Over 8.0	6.8
Unclassified	22.4

Quality	
Range	%Held
Govt (10)	19.9
Aaa (10)	28.8
Aa (9)	8.1
A (8)	2.8
Baa (7)	4.6
Below Baa	2.5
Other	33.2

Yield to Maturity	
Range	%Held
0.0 to 5.0	29.9
5.0 to 7.0	36.1
7.0 to 9.0	7.0
9.0 to 11.0	1.6
11.0 to 13.0	0.7
Over 13.0	2.2
Unclassified	22.4

Average Life	
Range	%Held
0.0 to 1.0	12.1
1.0 to 3.0	15.7
3.0 to 5.0	26.5
5.0 to 10.0	17.7
10.0 to 20.0	0.8
Over 20.0	4.7
Unclassified	22.4

Coupon	
Range	%Held
0.0 to 5.0	33.0
5.0 to 7.0	46.3
7.0 to 9.0	7.1
9.0 to 11.0	0.4
11.0 to 13.0	0.0
Over 13.0	0.0
Unclassified	13.2

# FRESNO COUNTY EMPLOYEES RETIREMENT ASSO.

As of March 31, 2008

## Fixed Income Sector Allocation BLACKROCK FINANCIAL MANAGEMENT

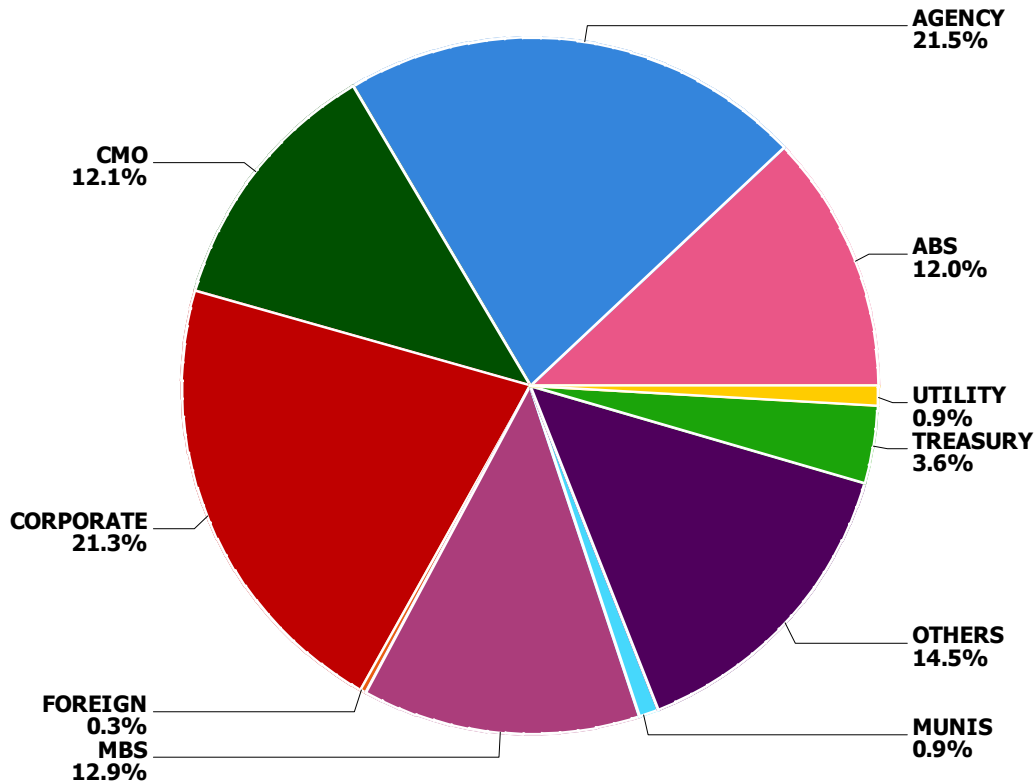

Sector	Account Weight	Index Weight	Difference
ABS	12.0%	6.2%	5.8%
Agencies	21.5%	9.9%	11.5%
CMO	12.1%	0.0%	12.1%
Corporates	21.3%	17.0%	4.3%
Foreign	0.3%	3.6%	-3.3%
MBS	12.9%	37.8%	-25.0%
Municipals	0.9%	0.0%	0.9%
Others	14.5%	0.0%	14.5%
Treasuries	3.6%	23.5%	-19.8%
Utilities	0.9%	1.9%	-1.1%
<b>Total</b>	<b>100.0%</b>	<b>100.0%</b>	<b>0.0%</b>

Benchmark: LB AGGREGATE

**FRESNO COUNTY EMPLOYEES RETIREMENT ASSO.**

As of March 31, 2008

**Bond Holdings  
BLACKROCK FINANCIAL MANAGEMENT**

Bond Name	Market Value	Coupon	Stated Maturity	Quality Rating	Duration	Yield to Maturity
<b>0-5 Years</b>						
AK STL CORP	76,711	7.75	6/15/12	B1	2.58	7.30%
AMERICAN REAL ESTATE PARTN	390,619	7.13	2/15/13	BA3	N/A	N/A
AMERICAN REAL ESTATE PARTN	44,868	8.13	6/01/12	BA3	N/A	N/A
ASIF GLOBAL FING XXIII 144	258,365	3.90	10/22/08	AA2	0.53	4.44%
AT&T BROADBAND CORP	245,274	8.38	3/15/13	BAA2	4.10	5.77%
AVALONBAY CMNTYS INC MTN B	160,666	7.50	12/15/10	BAA1	N/A	N/A
BANK_ONE_2004-1A- A	1,684,357	3.45	10/15/11	AAA	N/A	N/A
BEAR STEARNS COS INC MTN B	789,131	6.95	8/10/12	BAA1	3.70	6.93%
BEAR STEARNS COS INC MTN B	254,804	4.33	7/19/10	BAA1	-0.14	7.87%
BERKSHIRE HATHAWAY FIN COR	458,691	3.38	10/15/08	AAA	0.52	2.87%
BOWATER CDA FIN CORP	41,702	7.95	11/15/11	CAA2	2.73	20.72%
CAPITAL_AUTO_2006-001- A4	1,591,002	5.04	5/15/10	AAA	0.89	3.71%
CARAT_07-3 A2A	1,752,129		11/16/09			
CENTERPOINT ENERGY INC	331,614	7.25	9/01/10	BA1	2.21	4.48%
CITIBANK_CC_2006-A2- A2	1,663,498	4.85	2/10/11	AAA	0.84	3.01%
CITIGROUP INC	1,387,497	4.13	2/22/10	AA3	1.80	4.66%
CITIGROUP INC	743,549	5.30	10/17/12	AA3	3.93	5.24%
CITIZENS COMMUNICATIONS CO	77,196	6.25	1/15/13	BA2	3.98	8.71%
COX COMMUNICATIONS INC NEW	110,129	7.75	11/01/10	BAA3	2.29	4.66%
CSC HLDGS INC	56,396	8.13	8/15/09	B1	1.27	7.33%
CSC HLDGS INC	51,232	8.13	7/15/09	B1	1.19	7.28%
DAIMLER CHRYSLER NORTH AME	85,698	4.05	6/04/08	A3	0.17	3.79%
DAIMLERCHRYSLER_2005-00B- A3	194,092	4.04	9/08/09	AAA	0.10	2.81%
DAIMLERCHRYSLER_2006-D- A4	1,673,077	4.94	2/08/12	N/A	1.88	3.81%
DLJ_COM_MTG_2000-CKP1- A1B	1,226,934	7.18	8/10/10	AAA	1.87	5.36%
ENTERPRISE PRODS OPER LP	335,865	4.95	6/01/10	BAA3	2.01	3.96%



**FRESNO COUNTY EMPLOYEES RETIREMENT ASSO.**

As of March 31, 2008

**Bond Holdings  
BLACKROCK FINANCIAL MANAGEMENT**

Bond Name	Market Value	Coupon	Stated Maturity	Quality Rating	Duration	Yield to Maturity
EUR/USD	-63,879		4/23/08			
EUR/USD	-32,578		4/23/08			
FGOLD 15YR TBA(REG B)	1,593,272		4/17/08			
FGOLD 15YR TBA(REG B)	1,012,521		4/17/08			
FGOLD 30YR TBA(REG A)	-1,952,238		4/14/08			
FGOLD 30YR TBA(REG A)	6,981,620		4/14/08			
FGOLD 30YR TBA(REG A)	1,982,789		4/14/08			
FIRST UN CORP	267,839	6.30	4/15/08	A1	0.04	4.54%
FNMA 15YR TBA(REG B)	1,992,850		4/17/08			
FNMA 15YR TBA(REG B)	-3,376,122		4/17/08			
FNMA 15YR TBA(REG B)	-2,833,295		4/17/08			
FNMA 30YR TBA(REG A)	-10,243,167		5/13/08			
FNMA 30YR TBA(REG A)	-1,917,872		5/13/08			
FNMA 30YR TBA(REG A)	-9,610,855		4/14/08			
FNMA 30YR TBA(REG A)	16,296,565		4/14/08			
FNMA 30YR TBA(REG A)	-5,452,284		4/14/08			
FNMA 30YR TBA(REG A)	-2,053,106		4/14/08			
FORD_CR_AUTO_2006-B- A3	2,196,179	5.26	10/15/10	AAA	0.74	3.76%
GENERAL ELEC CAP CORP MTN	170,894	5.88	2/15/12	AAA	3.46	4.17%
GENERAL ELEC CAP CORP MTN	2,803,071	5.00	11/15/11	AAA	3.26	4.10%
GENERAL ELEC CAP CORP MTN	231,981	5.00	4/10/12	AAA	3.57	4.29%
GNMA 30YR TBA(REG C)	3,105,660		4/21/08			
GNMA 30YR TBA(REG C)	3,771,727		5/20/08			
GNMA 30YR TBA(REG C)	3,475,712		4/21/08			
GNMA2 30YR TBA(REG C)	2,755,481		4/21/08			
GNMA2 30YR TBA(REG C)	4,963,824		4/21/08			

**FRESNO COUNTY EMPLOYEES RETIREMENT ASSO.**

As of March 31, 2008

**Bond Holdings  
BLACKROCK FINANCIAL MANAGEMENT**

Bond Name	Market Value	Coupon	Stated Maturity	Quality Rating	Duration	Yield to Maturity
GNMA2 30YR TBA(REG C)	3,358,296		5/20/08			
GOLDMAN SACHS CAP II	220,869	5.79	6/01/12	A2	3.29	17.37%
HARLEY_DAV_EM_2006-3- A3	1,450,179	5.24	1/15/12	AAA	1.13	4.26%
HBOS TREAS SVCS PLC 144A	1,716,492	5.00	11/21/11	AAA	3.29	3.47%
HONDA_AUTO_2006-1- A3	974,767	5.07	2/18/10	AAA	0.39	2.63%
JPY/USD	215,225		4/11/08			
LEHMAN BROS HLDGS INC	192,874	7.88	8/15/10	A1	2.13	6.76%
LEHMAN BROS HLDGS INC MTN	604,558	6.00	7/19/12	A1	3.72	6.35%
LEHMAN BROS HLDGS INC MTN	192,782	5.25	2/06/12	A1	3.42	6.29%
LEHMAN CAP MTN	131,083	5.86	5/31/12	A3	3.24	19.01%
MBNA_CC_MSTR_TR_2006-1 A	1,626,956	4.90	7/15/11	AAA	0.84	3.15%
MBNA_MSTR_CC_03-011A- A	1,209,750	3.65	3/15/11	AAA	0.53	3.18%
MBNA_MSTR_CC_03-012A- A	880,557	2.93	5/15/11	AAA	0.04	3.62%
MBNA_MSTR_CC_2005-A07- A	1,648,267	4.30	2/15/11	AAA	0.45	2.66%
MORGAN STANLEY	291,788	6.75	4/15/11	AA3	2.67	5.02%
MORGAN STANLEY	467,194	5.05	1/21/11	AA3	2.58	4.92%
NATNWIDE BLDG SOC SRMTN 14	24,906	4.25	2/01/10	AA3	N/A	N/A
ROUSE CO	268,801	3.63	3/15/09	BA1	0.90	10.18%
SLM CORP MTN BOOK ENTRY	234,502	3.44	1/26/09	BAA2	0.02	16.95%
SLM CORP MTN BOOK ENTRY	273,849	5.40	10/25/11	BAA2	3.00	12.21%
SLM CORP MTN BOOK ENTRY	408,993	4.00	1/15/09	BAA2	0.72	18.08%
SUNTRUST BKS INC	307,646	4.00	10/15/08	AA3	0.52	4.26%
SWP: USD 2.744000 02/14/20	48,925		2/14/10			
SWP: USD 3.411860 03/06/20	-49,700		3/06/13			
SWP: USD 3.540000 02/14/20	-44,232		2/14/13			
SWP: USD 3.565000 01/08/20	-187,812		1/08/10			

**FRESNO COUNTY EMPLOYEES RETIREMENT ASSO.**

As of March 31, 2008

**Bond Holdings  
BLACKROCK FINANCIAL MANAGEMENT**

Bond Name	Market Value	Coupon	Stated Maturity	Quality Rating	Duration	Yield to Maturity
<b>SWP: USD 4.050000 12/11/20</b>	469,245		12/11/09			
<b>TIAA_CMBS_2001-C1- A4</b>	1,611,424	6.68	9/17/09	N/A	1.46	5.58%
<b>UNITED STATES TREAS NTS</b>	5,058,534	2.75	2/28/13	GOVT	4.61	2.45%
<b>USAA_AUTO_TR_2006-003- A3</b>	1,077,447	5.36	2/15/11	AAA	0.65	3.58%
<b>USAA_AUTO_TR_2006-004- A4</b>	1,472,103	4.98	10/15/12	AAA	2.27	3.96%
<b>USB CAPITAL IX</b>	428,196	6.19	4/15/11	A1	2.47	17.46%
<b>VERIZON NEW JERSEY INC</b>	20,898	5.88	1/17/12	A3	3.37	4.97%
<b>WACHOVIA BK NATL ASSN MTN</b>	40,367	4.38	8/15/08	AA1	0.36	4.35%
<b>WELLS FARGO &amp; CO NEW</b>	160,214	4.63	8/09/10	AA1	2.22	3.43%
<b>WELLS FARGO &amp; CO NEW</b>	384,633	4.20	1/15/10	AA1	1.71	3.23%
<b>WELLS FARGO &amp; CO NEW</b>	478,279	4.88	1/12/11	AA1	2.57	4.21%
	59,420,542	4.82			2.04	4.48%

**5-10 Years**

<b>ALERIS INTL INC</b>	56,362	9.00	12/15/14	B3	4.43	15.63%
<b>ARCH WESTN FIN LLC</b>	319,528	6.75	7/01/13	B1	N/A	N/A
<b>AT&amp;T INC</b>	640,872	5.50	2/01/18	N/A	7.68	5.78%
<b>BANK OF AMERICA CORPORATI</b>	870,022	8.00	1/30/18	21	N/A	N/A
<b>BANK OF AMERICA CORPORATIO</b>	1,595,237	5.75	12/01/17	AA1	N/A	N/A
<b>BANK OF AMERICA CORPORATIO</b>	394,642	6.00	9/01/17	AA1	N/A	N/A
<b>BARCLAYS BANK PLC 144A</b>	518,448	7.43	12/15/17	AA3	N/A	N/A
<b>BEAR STEARNS COS INC</b>	406,729	6.40	10/02/17	BAA1	7.01	6.58%
<b>BIO RAD LABS INC</b>	58,832	6.13	12/15/14	BA3	5.34	6.97%
<b>BIO RAD LABS INC</b>	20,292	7.50	8/15/13	BA3	3.89	7.41%
<b>CHASE_ISS_TR_2007-017A A</b>	1,434,307	5.12	10/15/14	AAA	3.98	4.34%
<b>CHUBB CORP</b>	360,250	6.38	4/15/17	A3	6.66	7.43%

**FRESNO COUNTY EMPLOYEES RETIREMENT ASSO.**

As of March 31, 2008

**Bond Holdings  
BLACKROCK FINANCIAL MANAGEMENT**

Bond Name	Market Value	Coupon	Stated Maturity	Quality Rating	Duration	Yield to Maturity
CINCINNATI BELL INC NEW	14,929	7.25	7/15/13	BA3	4.11	7.65%
COLORADO INTST GAS CO	31,789	6.80	11/15/15	BAA3	5.90	6.28%
COMCAST CORP NEW	362,934	6.50	1/15/17	BAA2	6.75	6.18%
COMPTON PETE FIN CORP	9,879	7.63	12/01/13	B2	4.39	8.58%
CREDIT SUISSE FIRST BOSTON	286,303	6.00	2/15/18	N/A	7.56	6.03%
CREDIT SUISSE GUERNSEY BR	701,373	5.86	5/15/17	AA3	6.75	8.28%
FEDERAL NATL MTG ASSN	507,062	4.63	5/01/13	AA2	4.46	4.29%
FHLMC_2825- VP	580,582	5.50	6/15/15	GOVT	2.98	4.25%
FNMA	3,948,465	5.32	6/01/15	GOVT	2.92	4.91%
FNMA	243,011	5.00	6/01/15	GOVT	3.09	4.91%
FNMA	1,569,309	4.00	6/01/15	GOVT	N/A	N/A
FREPORT-MCMORAN COPPER &	347,738	8.38	4/01/17	BA2	5.96	7.24%
FREPORT-MCMORAN COPPER &	183,750	8.25	4/01/15	BA2	4.73	6.93%
GENERAL ELEC CAP CORP MTN	551,344	6.38	11/15/17	AA1	7.12	6.68%
GEORGIA PAC CORP 144A	178,608	7.13	1/15/17	BA3	6.39	8.34%
GOLDMAN SACHS GROUP INC	1,425,690	5.25	10/15/13	AA3	4.69	5.37%
HARRAH S OPERATING CO INC	398,958		2/01/18			
INTERNATIONAL BUSINESS MAC	471,178	5.70	9/14/17	A1	7.54	5.06%
ISPAT INLAND ULC	234,451	9.75	4/01/14	BAA2	1.86	6.61%
JPMORGAN CHASE BK NEW Y 14	926,488	6.00	7/05/17	AA1	7.22	5.42%
KRAFT FOODS INC	583,116	6.13	2/01/18	BAA2	7.42	6.13%
KRAFT FOODS INC	662,878	6.50	8/11/17	BAA2	7.13	6.13%
L-3 COMMUNICATIONS CORP	30,282	6.38	10/15/15	BA3	5.76	6.76%
LEHMAN BROS HLDGS INC	660,521	6.75	12/28/17	A2	7.07	7.31%
LEHMAN BROS HLDGS INC	288,204	6.50	7/19/17	A2	6.92	7.25%
LINCOLN NATL CORP IND	242,547	7.00	5/17/16	BAA2	5.96	8.43%

**FRESNO COUNTY EMPLOYEES RETIREMENT ASSO.**

As of March 31, 2008

**Bond Holdings  
BLACKROCK FINANCIAL MANAGEMENT**

Bond Name	Market Value	Coupon	Stated Maturity	Quality Rating	Duration	Yield to Maturity
<b>MOMENTIVE PERFORMANCE MATL</b>	90,391	10.13	12/01/14	B3	4.46	13.10%
<b>MORGAN STANLEY</b>	420,222	5.95	12/28/17	AA3	7.38	6.42%
<b>MORGAN STANLEY</b>	77,627	5.55	4/27/17	AA3	7.00	6.43%
<b>MORGAN STANLEY</b>	997,645	5.75	10/18/16	AA3	6.64	6.25%
<b>MORGAN STANLEY</b>	550,185	5.45	1/09/17	AA3	6.92	6.42%
<b>NATIONSBANK CORP</b>	518,088	7.80	9/15/16	AA2	6.46	5.67%
<b>NRG ENERGY INC</b>	54,301	7.38	2/01/16	B1	5.85	7.72%
<b>PETROBRAS INTL FIN CO</b>	174,652	5.88	3/01/18	BAA1	7.59	6.39%
<b>QWEST COMMUNICATIONS INTL</b>	258,265	7.50	2/15/14	BA3	4.62	8.83%
<b>QWEST COMMUNICATIONS INTL</b>	68,221	7.50	2/15/14	BA3	4.62	8.83%
<b>QWEST CORP</b>	81,257	6.05	6/15/13	BA1	-0.13	8.39%
<b>REINSURANCE GROUP AMER IN</b>	170,999	6.75	12/15/15	BAA3	5.75	8.99%
<b>ROGERS WIRELESS INC</b>	108,593	7.50	3/15/15	BAA3	5.48	6.58%
<b>ROUSE CO</b>	321,169	5.38	11/26/13	BA1	4.55	10.57%
<b>ROUSE CO LP / TRC CO-IS 14</b>	158,075	6.75	5/01/13	BA1	4.02	10.31%
<b>ROYAL BK SCOTLAND</b>	606,817	7.64	9/29/17	AA2	6.55	9.93%
<b>ROYAL BK SCOTLAND GROUP 1</b>	242,879	6.99	10/05/17	AA3	6.47	9.43%
<b>SABINE PASS LNG L P</b>	263,399	7.50	11/30/16	BA3	6.23	8.07%
<b>SMALL BUSINESS ADMIN SER</b>	598,006	4.73	8/10/14		N/A	N/A
<b>SPRINT NEXTEL CORP</b>	159,500	6.00	12/01/16	BAA3	6.30	9.88%
<b>SWP: USD 4.545000 12/06/20</b>	-217,812		12/06/17			
<b>TCI COMMUNICATIONS INC</b>	518,219	8.75	8/01/15	BAA2	5.54	6.47%
<b>TEXAS COMPETITIVE ELEC 14</b>	457,817	10.25	11/01/15	B3	5.05	10.32%
<b>TRANSOCEAN SEDCO FOREX INC</b>	87,257	6.00	3/15/18	BAA2	7.71	5.62%
<b>TRAVELERS COMPANIES INC</b>	623,989	6.25	3/15/17	BAA1	6.74	8.13%
<b>UBS AG BRH MTN SR DEP NT B</b>	1,113,423	5.88	12/20/17	AAA	7.50	5.58%

**FRESNO COUNTY EMPLOYEES RETIREMENT ASSO.**

As of March 31, 2008

**Bond Holdings  
BLACKROCK FINANCIAL MANAGEMENT**

Bond Name	Market Value	Coupon	Stated Maturity	Quality Rating	Duration	Yield to Maturity
UNITED STATES TREAS NTS	974,691	3.50	2/15/18	GOVT	8.61	3.43%
VODAFONE GROUP PLC NEW	164,479	5.00	12/16/13	BAA1	4.89	5.42%
WIND ACQUISITION FIN SA 14	98,404	10.75	12/01/15	B2	5.08	10.36%
WINDSTREAM CORP	179,888	8.63	8/01/16	BA3	5.85	8.92%
WINDSTREAM CORP	144,427	8.13	8/01/13	BA3	4.23	8.54%
	32,181,983	6.04			5.65	6.27%
<b>10-20 Years</b>						
BA_MTG_ALT_2004-007- 4A1	353,992	5.00	8/25/19		N/A	N/A
CWABS_HEL_2006-019- 2A1	793,318	2.66	2/25/28	AAA	0.07	3.51%
CWALT_2006-OC9- A1	497,320	2.67	2/25/28	AAA	0.07	3.51%
FHLMC_2630- FJ	299,204	3.17	6/15/18	GOVT	-0.05	2.97%
FHLMC_3143- NA	1,340,071	5.50	7/15/26	GOVT	0.43	3.86%
FNMA_2004-101- HD	906,127	5.00	1/25/20	GOVT	7.02	4.73%
FNMA_2005-110- GH	275,229	5.50	6/25/18	GOVT	0.25	3.40%
HOMER CITY FDG LLC	103,305	8.73	10/01/26	BA2	7.10	7.85%
JP_MORGN_MTG_2006-S2- 2A2	145,970	5.88	6/25/21	AAA	3.40	6.14%
JP_MORGN_MTG_2007-S1- 1A2	156,746	5.50	3/25/22	N/A	5.06	7.66%
LB_MTG_TR_2000-OC3- A2	769,552	7.95	5/15/25	AAA	1.41	5.20%
LEHMAN BROS HLDGS INC MTN	304,154	7.00	9/27/27	A1	10.46	7.76%
NEWS AMER HLDGS INC	365,879	7.75	1/20/24	BAA2	9.57	6.69%
UNITED STATES TREAS BDS I/	457,382	2.38	1/15/25	GOVT	9.53	6.03%
	6,768,248	5.08			3.31	4.72%
<b>Over 20 Years</b>						
AEGIS_2006-01- A1	823,834	2.68	1/25/37	AAA	0.07	3.51%
AMERICA MOVIL SA	48,266	6.38	3/01/35	A3	N/A	N/A

**FRESNO COUNTY EMPLOYEES RETIREMENT ASSO.**

As of March 31, 2008

**Bond Holdings  
BLACKROCK FINANCIAL MANAGEMENT**

Bond Name	Market Value	Coupon	Stated Maturity	Quality Rating	Duration	Yield to Maturity
AMERIQUEST_2004-R11- A1	462,019	3.44	12/25/34	AAA	N/A	N/A
AT&T INC	832,163	6.30	1/15/38	A2	13.03	6.55%
ATLANTIC MARINE 5.34%	237,083	5.34	12/01/50		N/A	N/A
BAC CAPITAL TRUST XI	63,195	6.63	5/23/36	AA2	N/A	N/A
BANC_OF_AMER_2002-PB2 A4	1,139,959	6.19	6/11/35	AAA	N/A	N/A
BA_MTG_CMBS_2005-001- A4	968,580	4.88	11/10/42		N/A	N/A
BA_MTG_CMBS_2007-002- A4	1,345,599	5.69	4/10/49		N/A	N/A
BEAR_S_COMM_2007-PWR17 A4	1,013,090	5.69	6/11/50	N/A	6.97	6.06%
BELVOIR LD LLC	237,033	5.40	12/15/47		N/A	N/A
BRISTOL MYERS SQUIBB CO	122,906	5.88	11/15/36	A2	13.47	6.12%
BUNDESREPUB DEUTSCHLAND	475,840		7/04/39			
CD_COMM_2007-CD5- A4	575,656	5.89	11/15/44	AAA	6.94	6.09%
CD_COMM_TR_2007-CD4- A4	762,714	5.32	12/11/49	AAA	6.60	5.99%
CHASE_CMBS_1998-1 A2	60,363	6.56	5/18/30	AAA	0.05	2.98%
CHASE_CMBS_2000-003- A2	485,514	7.32	10/15/32	N/A	1.81	5.40%
CITIGROUP CAP XXI	730,123	8.30	12/21/37	A1	10.66	8.43%
CITIGROUP_MTG_07-AMC3- A2A	510,622	2.71	3/25/37	AAA	0.19	14.40%
CITIGROUP_MTG_2005-004 A	3,071,754	5.34	9/25/35	AAA	6.73	8.70%
CMALT_2007-A8- A1	1,280,408	6.00	10/25/37	N/A	11.07	12.43%
CMO COMM 2007-C9 MTG	2,925,465	0.00	12/10/49		N/A	N/A
COBALT_CMBS_2007-C003- A4	807,286	6.01	5/15/46	N/A	6.87	6.00%
COMCAST CORP NEW	653,621	6.95	8/15/37	BAA2	12.52	6.93%
COMCAST CORP NEW	72,750	6.50	11/15/35	BAA2	12.24	6.94%
COMCAST CORP NEW	15,230	7.05	3/15/33	BAA2	11.98	6.88%
COMMERCIAL_MTG_ACC_99 A2	1,808,676	7.03	6/15/31	AAA	0.84	5.21%
CSFB_2002-CP3 A3	1,347,665	5.60	7/15/35	AAA	3.48	5.80%

**FRESNO COUNTY EMPLOYEES RETIREMENT ASSO.**

As of March 31, 2008

**Bond Holdings  
BLACKROCK FINANCIAL MANAGEMENT**

Bond Name	Market Value	Coupon	Stated Maturity	Quality Rating	Duration	Yield to Maturity
CSFB_2002-CP5- A2	1,438,042	4.94	12/15/35	N/A	3.86	5.91%
CSFB_2003-C3- A5	1,274,949	3.94	5/15/38	AAA	4.25	6.03%
CSFB_2005-C2- A4	974,054	4.83	4/15/37	AAA	5.55	5.43%
CWABS_HEL_2006-12- 2A1	465,534	2.67	6/25/30	AAA	0.07	3.52%
CWALT_2004-18CB- 2A5	176,336	3.05	9/25/34	AAA	6.12	10.91%
CWALT_2006-OA10- 1A1	188,784	5.20	8/25/46		N/A	N/A
CWALT_2006-OA21- A1	475,506	2.73	3/20/47	AAA	0.55	21.25%
CWMBS_2004-029- 1A1	102,642	2.87	2/25/35	AAA	-0.26	4.23%
CWMBS_CHL_2006-OA5- 2A1	219,398	2.80	4/25/36	AAA	0.30	19.46%
CWMBS_CHL_2007-016- A1	834,112	6.50	10/25/37	N/A	6.77	9.06%
DEUTSCHE_ALT_2006-OA1- A1	250,396	2.80	2/25/47	AAA	2.22	24.66%
DEUTSCHLAND 4.00%	731,125	4.00	1/04/37		N/A	N/A
DLJ_COM_MTG_1999-CG1- A1B	1,104,327	6.46	3/10/32	AAA	0.59	5.13%
FGOLD 30YR	598,584		1/01/38			
FGOLD 30YR GIANT	296,973		8/01/37			
FGOLD 30YR GIANT	1,996,284		10/01/37			
FHLMC POOL - 1B2853	1,069,928	4.34	4/01/35	GOVT	1.25	4.08%
FHLMC_3200- AD	3,363,033	5.50	5/15/29	GOVT	2.01	4.48%
FIELDSTONE_MTG_2006-1- A1	255,323	2.68	5/25/36	AAA	0.07	3.52%
FIRST_UNION_1998-C2- A2	111,929	6.56	11/18/35	AAA	0.44	2.73%
FIRST_UNION_1999-0C4- A2	859,896	7.39	12/15/31	N/A	1.36	5.28%
FIRST_UNION_2001-C2- A2	1,298,163	6.66	1/12/43	AAA	2.34	5.51%
FLORIDA PWR & LT CO	379,813	5.95	2/01/38	AA3	13.97	5.92%
FLORIDA PWR & LT CO	71,836	5.63	4/01/34	AA3	13.26	5.92%
FNMA	6,010,596	5.32	6/01/30	GOVT	3.78	5.09%
FNMA	1,246	7.00	6/01/30	GOVT	2.92	5.00%



**FRESNO COUNTY EMPLOYEES RETIREMENT ASSO.**

As of March 31, 2008

**Bond Holdings  
BLACKROCK FINANCIAL MANAGEMENT**

Bond Name	Market Value	Coupon	Stated Maturity	Quality Rating	Duration	Yield to Maturity
FNMA	10,665,813	5.00	6/01/30	GOVT	4.99	5.13%
FNMA	290,661	6.32	6/01/30	GOVT	2.58	5.01%
FNMA	1,630,204	6.00	6/01/30	GOVT	3.71	5.09%
FNMA POOL - 783576	769,251	4.19	12/01/34	GOVT	0.86	3.29%
FNMA POOL - 806549	1,014,068	4.56	1/01/35	GOVT	0.85	3.54%
FNMA 30YR 6.0% Fixed IO 10	2,216,497		9/01/37			
FNMA 30YR 6.0% HLB 150K 20	4,941,283		9/01/37			
FNMA 30YR 6.0% LTV > 90 20	979,665		1/01/38			
FNMA_2004-060- LB	473,801	5.00	4/25/34	GOVT	3.73	4.65%
FNMA_2005-048- AR	698,303	5.50	2/25/35	GOVT	2.97	4.31%
GAZ CAP SA LUXEMBOURG 144A	351,161	7.29	8/16/37	A3	11.32	8.07%
GENERAL ELEC CAP CORP MTN	598,365	6.15	8/07/37	AAA	13.60	6.16%
GE_CAP_MTG_2000-001- A2	1,151,319	6.50	1/15/33	AAA	2.19	5.48%
GE_ELECTRIC_2005-C2- AAB	1,068,761	4.87	5/10/43	N/A	3.91	5.93%
GMACM_HEL_2000-C1- A2	596,659	7.72	3/15/33	AAA	1.42	5.31%
GMACM_HEL_2000-C2- A2	727,959	7.46	8/16/33	N/A	1.74	5.32%
GMACM_LOAN_2003-C2- A2	1,458,276	5.28	5/10/40	N/A	4.41	5.55%
GMAC_MTG_SEC_1999-C3- A2	627,326	7.18	8/15/36	AAA	0.99	4.93%
GNMA	968,487	6.32	6/01/30	GOVT	2.29	4.36%
GNMA POOL - 080916	811,757	4.75	5/20/34	GOVT	1.15	3.67%
GNMA2 30YR 2007 PRODUCTION	1,817,711		12/20/37			
GOLDMAN_MTG_1998-C1- A3	671,529	6.13	10/18/30	N/A	0.30	3.48%
GREENWICH_CAP_2005-GG3 A3	1,136,851	4.57	8/10/42	AAA	3.15	5.77%
GSAA_HEQ_TR_2006-010- AV1	528,432	2.68	6/25/36	AAA	0.19	8.40%
GSAA_HEQ_TR_2006-9- A1	444,082	2.65	6/25/36	AAA	0.07	3.51%
GSAMP_TRUST_2006-HE4- A2A	284,126	2.67	6/25/36	AAA	0.07	3.52%

**FRESNO COUNTY EMPLOYEES RETIREMENT ASSO.**

As of March 31, 2008

**Bond Holdings  
BLACKROCK FINANCIAL MANAGEMENT**

Bond Name	Market Value	Coupon	Stated Maturity	Quality Rating	Duration	Yield to Maturity
GSR_TRUST_2005-AR4- 6A1	3,378,387	5.25	7/25/35	N/A	2.60	3.41%
GSR_TRUST_2005-AR7- 6A1	653,035	5.25	11/25/35	N/A	6.97	8.48%
GSR_TRUST_2006-OA01- 2A1	628,209	2.79	8/25/46	AAA	-0.14	21.27%
GS_MTG_SEC_2004-GG2- A4	833,420	4.96	8/10/38	AAA	N/A	N/A
GTE CORP	51,300	6.94	4/15/28	BAA1	10.79	6.85%
HARVIEW_2006-011- A1A	972,338	2.73	12/19/36	AAA	12.15	37.57%
HARVIEW_2006-09- 2AA	376,944	2.77	11/19/36	AAA	0.68	21.23%
JP MORGAN CHASE COML MTG	567,298	0.00	5/15/47		N/A	N/A
JPMORGAN CHASE CAP XXV	1,201,576	6.80	10/01/37	AA3	11.63	7.53%
JPMRGN_CMBS_2007-LDP12 A2	429,937	5.83	2/15/51	AAA	3.61	6.22%
JP_MORGN_2007-LDP11- A2	514,038	5.99	6/15/49	AAA	3.57	6.11%
JP_MORGN_MTG_05-CIBC12 A4	1,011,486	4.89	9/12/37	AAA	5.77	5.48%
JP_MORGN_MTG_2001-C1 A3	1,169,792	5.86	10/12/35	N/A	2.93	5.39%
JP_MORGN_MTG_2001-CIB1 A3	798,352	6.26	3/15/33	N/A	2.20	5.47%
JP_MORGN_MTG_2005-LPD4 AJ	439,010	5.04	10/15/42	AAA	5.85	7.64%
JP_MORGN_MTG_2006-A01- 2A2	1,326,503	5.36	2/25/36	N/A	1.74	6.21%
JP_MORGN_MTG_2006-A2- 4A1	1,514,927	3.89	8/25/34	AAA	1.32	4.28%
JP_MORG_MTG_2001-CIBC2 A3	872,893	6.43	4/15/35	N/A	2.65	5.62%
LB_MTG_TR_1998-C4- A2	1,133,377	6.30	10/15/35	AAA	0.38	2.75%
LB_UBS_CMBS_2006-C6- A4	544,447	5.37	9/15/39	AAA	6.48	5.86%
LB_UBS_CMBS_2006-C7- A3	1,222,438	5.35	11/15/38	N/A	6.58	5.86%
LB_UBS_CMBS_2007-C2- A3	955,204	5.43	2/15/40	N/A	6.78	6.01%
LB_UBS_CMBS_2007-C7- A3	2,303,466	5.87	9/15/45	N/A	7.01	6.08%
METLIFE INC	190,896	6.40	12/15/36	BAA1	11.04	8.28%
MIDAMERICAN ENERGY HLDGS N	315,295	5.95	5/15/37	BAA1	13.17	6.43%
MIDAMERICAN ENERGY HLDGS N	254,149	6.50	9/15/37	BAA1	13.21	6.48%

**FRESNO COUNTY EMPLOYEES RETIREMENT ASSO.**

As of March 31, 2008

**Bond Holdings  
BLACKROCK FINANCIAL MANAGEMENT**

Bond Name	Market Value	Coupon	Stated Maturity	Quality Rating	Duration	Yield to Maturity
MLCC_MTG_TR_2005-A5- A3	546,699	4.44	6/25/35	N/A	7.74	5.21%
MORG_ST_CAP_2006-IQ12- A4	558,728	5.33	12/15/43	N/A	6.61	5.88%
MORG_ST_CAP_2007-HQ12- A2	190,033	5.81	4/12/49	N/A	3.58	6.04%
MORG_ST_CAP_2007-IQ015 A4	1,639,511	5.88	6/11/49	N/A	6.83	5.95%
MORG_ST_CAP_2007-IQ16- A4	751,701	5.81	12/12/49	N/A	6.97	6.07%
NATIONSTAR_HEL_2006-B- AV1	301,855	2.67	9/25/36	AAA	0.07	3.52%
NOMURA_2006-HE2- A1	229,739	2.66	3/25/36	AAA	0.07	3.52%
PERMA 3 3A 5.06%	1,918,067	5.06	9/10/33		N/A	N/A
RALI_2007-QO2- A1	260,932		2/25/47			
SAIL_TRUST_2006-2- A1	37,714	2.66	4/25/36	AAA	0.07	3.52%
SALOMON_BRO_2000-C3- A2	1,003,246	6.59	12/18/33	AAA	1.79	5.28%
SALOMON_BRO_VII-99-C1- A2	702,839	7.15	5/18/32	AAA	0.53	5.63%
SASC_2005-010- 3A5	654,132	5.00	12/25/34	AAA	0.73	4.85%
TENNESSEE GAS PIPELINE CO	71,537	7.00	10/15/28	BAA3	10.76	7.03%
TIME WARNER COMPANIES INC	447,983	6.63	5/15/29	BAA2	10.97	7.20%
TRANSOCEAN SEDCO FOREX INC	123,541	6.80	3/15/38	BAA2	13.01	6.63%
UNITED PARCEL SERVICE INC	886,412	6.20	1/15/38	AA2	14.09	5.71%
UNITED STATES TREAS BONDS	365,702	4.38	2/15/38	AAA	17.02	4.30%
UNITED STATES TREAS BONDS	1,333,973	5.00	5/15/37	GOVT	16.20	4.28%
VERIZON MD INC	24,291	5.13	6/15/33	A3	12.76	6.78%
WACHOVIA BK NATL ASSN MTN	1,103,436	6.60	1/15/38	AA2	12.23	7.20%
WACHOVIA_2007-C33- A4	611,697	6.10	2/15/51	AAA	6.82	5.96%
WAMU_2007-HY3- 4A1	1,258,515	5.35	8/25/36	N/A	4.57	7.48%
WAMU_2007-OA4- 1A1	283,603	5.29	5/25/47	AAA	0.08	2.50%
WAMU_2007-OA5- 1A	457,599	5.27	6/25/47	AAA	0.08	2.50%
WAMU_COMM_2005-C1- A2	1,473,938	5.15	5/25/36	N/A	1.44	5.17%

**FRESNO COUNTY EMPLOYEES RETIREMENT ASSO.**

As of March 31, 2008

**Bond Holdings  
BLACKROCK FINANCIAL MANAGEMENT**

<b>Bond Name</b>	<b>Market Value</b>	<b>Coupon</b>	<b>Stated Maturity</b>	<b>Quality Rating</b>	<b>Duration</b>	<b>Yield to Maturity</b>
<b>WELLPOINT INC</b>	129,794	5.95	12/15/34	BAA1	12.44	6.91%
<b>WELLS_FARGO_2006-AR4- IIA4</b>	365,176	5.77	4/25/36	N/A	9.80	10.04%
<b>XTO ENERGY INC</b>	348,260	6.75	8/01/37	BAA2	13.28	6.23%
	126,087,939	5.23			4.74	6.24%

# Fresno County Employees' Retirement Association

## Cumulative Performance Comparisons

Period Ending: March 31, 2008

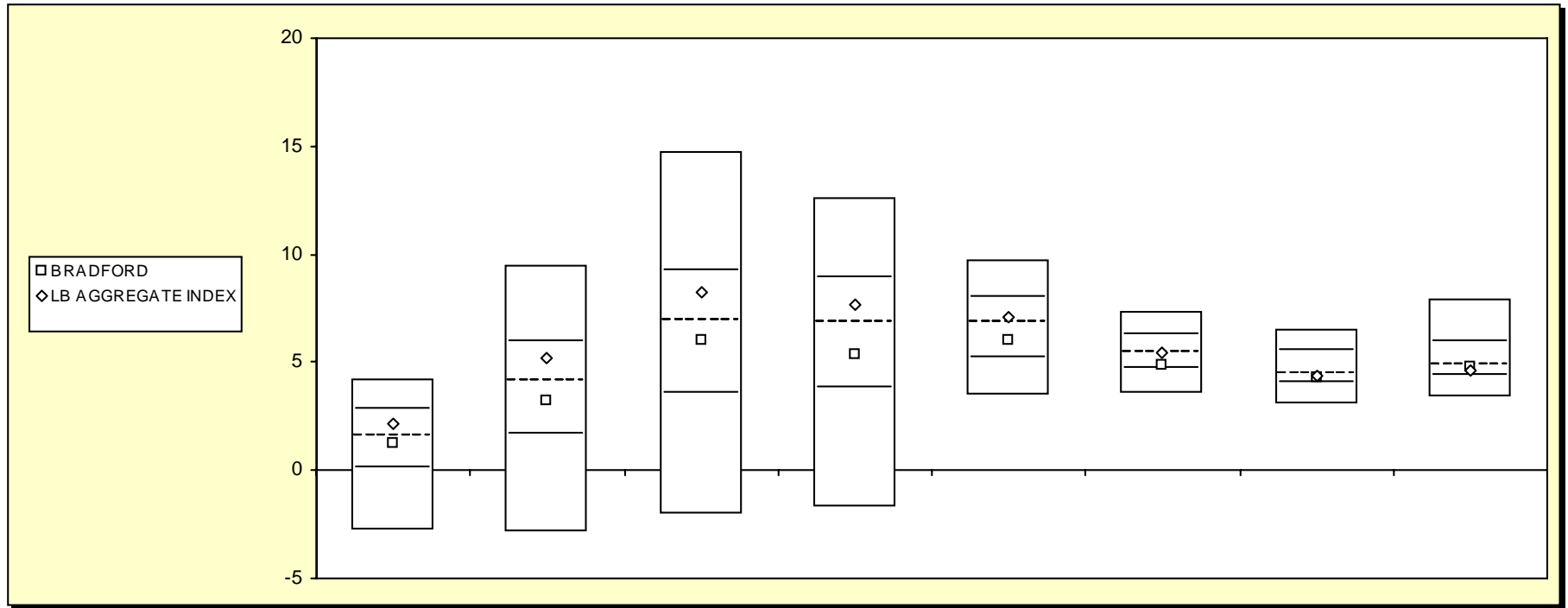

### Bond Funds

	Last Quarter		Two Quarters		Three Quarters		One Year		Two Years		Three Years		Four Years		Five Years	
	Return	Rank	Return	Rank	Return	Rank	Return	Rank	Return	Rank	Return	Rank	Return	Rank	Return	Rank
5th Percentile	4.2		9.5		14.7		12.6		9.7		7.4		6.5		7.9	
25th Percentile	2.8		5.9		9.2		8.9		8.0		6.3		5.5		6.0	
50th Percentile	1.5		4.1		6.9		6.8		6.8		5.5		4.5		4.8	
75th Percentile	0.1		1.7		3.5		3.8		5.2		4.7		4.0		4.4	
95th Percentile	-2.8		-2.8		-2.1		-1.7		3.5		3.5		3.1		3.4	
BRADFORD	1.3	55	3.3	59	6.0	57	5.4	62	6.0	63	4.9	69	4.3	62	4.7	54
LB AGGREGATE INDEX	2.2	37	5.2	34	8.2	36	7.7	40	7.1	44	5.5	50	4.4	54	4.6	63

# Fresno County Employees' Retirement Association

## Consecutive Performance Comparisons

Period Ending: March 31, 2008

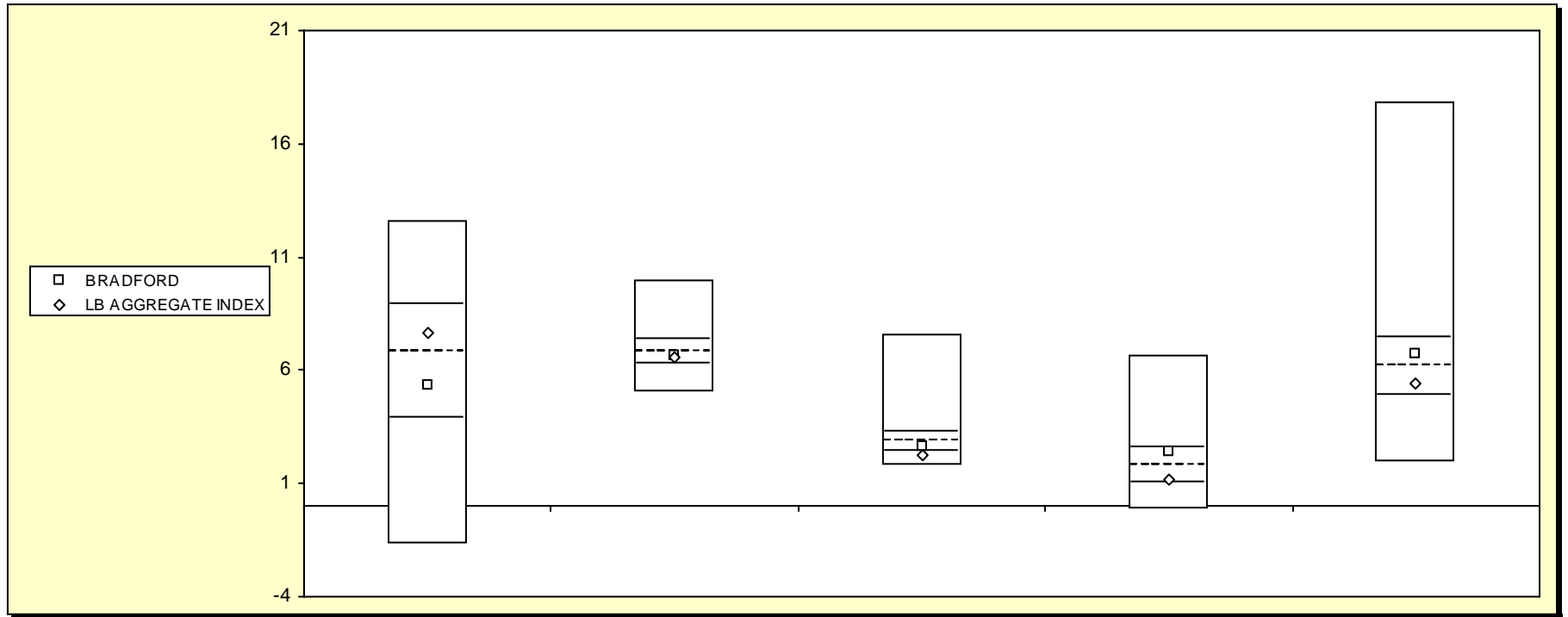

### Bond Funds

	March 2008		March 2007		March 2006		March 2005		March 2004	
	Return	Rank	Return	Rank	Return	Rank	Return	Rank	Return	Rank
5th Percentile	12.6		10.0		7.5		6.6		17.8	
25th Percentile	8.9		7.3		3.3		2.6		7.4	
50th Percentile	6.8		6.8		2.8		1.8		6.2	
75th Percentile	3.8		6.3		2.4		1.0		4.9	
95th Percentile	-1.7		5.0		1.8		-0.2		1.9	
BRADFORD	5.4	62	6.7	56	2.7	60	2.4	31	6.7	38
LB AGGREGATE INDEX	7.7	40	6.6	59	2.3	80	1.2	71	5.4	65

# Fresno County Employees' Retirement Association

Consecutive Annual - Five Year

Period Ending: March 31, 2008

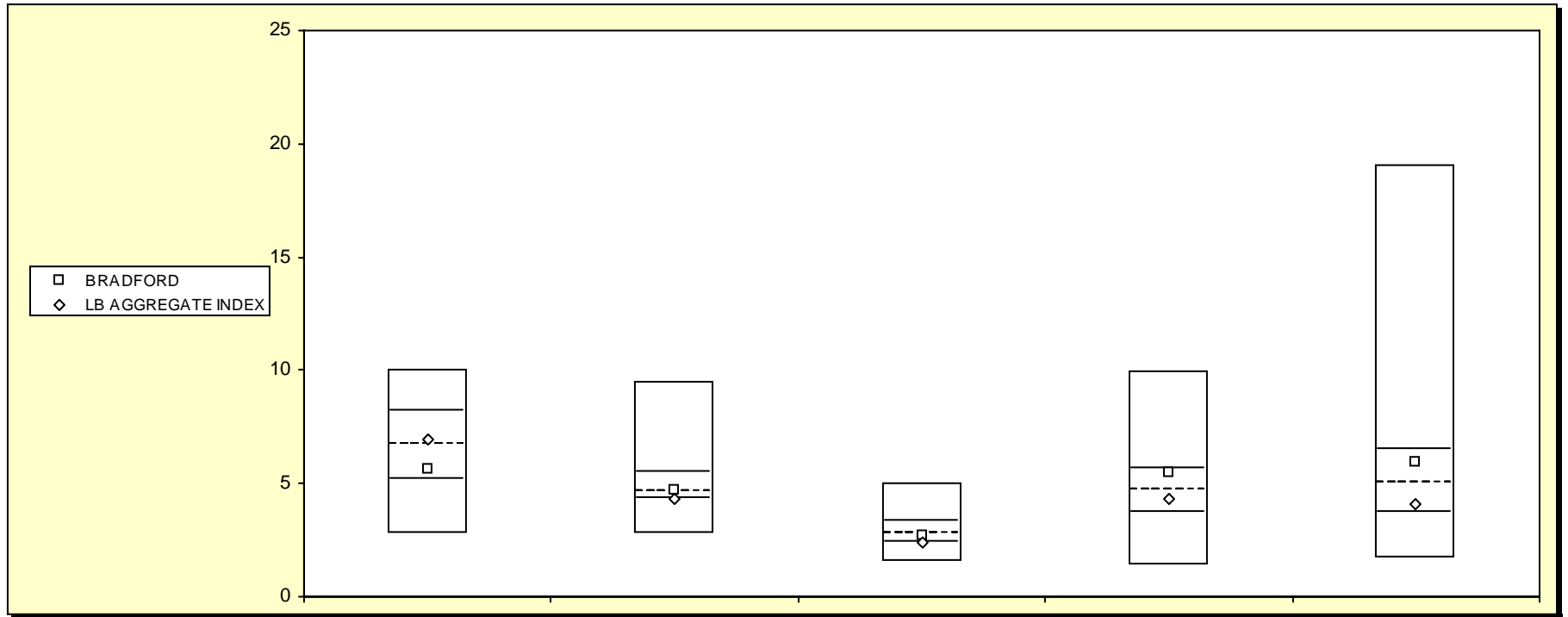

*Bond Funds*

	December 2007 Return Rank	December 2006 Return Rank	December 2005 Return Rank	December 2004 Return Rank	December 2003 Return Rank
5th Percentile	10.0	9.5	5.0	9.9	19.1
25th Percentile	8.2	5.5	3.3	5.6	6.5
50th Percentile	6.7	4.6	2.8	4.7	5.0
75th Percentile	5.2	4.3	2.4	3.7	3.7
95th Percentile	2.8	2.7	1.5	1.4	1.7
BRADFORD	5.6 68	4.7 48	2.7 56	5.5 29	6.0 33
LB AGGREGATE INDEX	7.0 45	4.3 74	2.4 71	4.3 59	4.1 68

# Fresno County Employees' Retirement Association

Rolling Return: 3 year Annualized

Period Ending: March 31, 2008

## Rolling Return (3 Year Annualized)

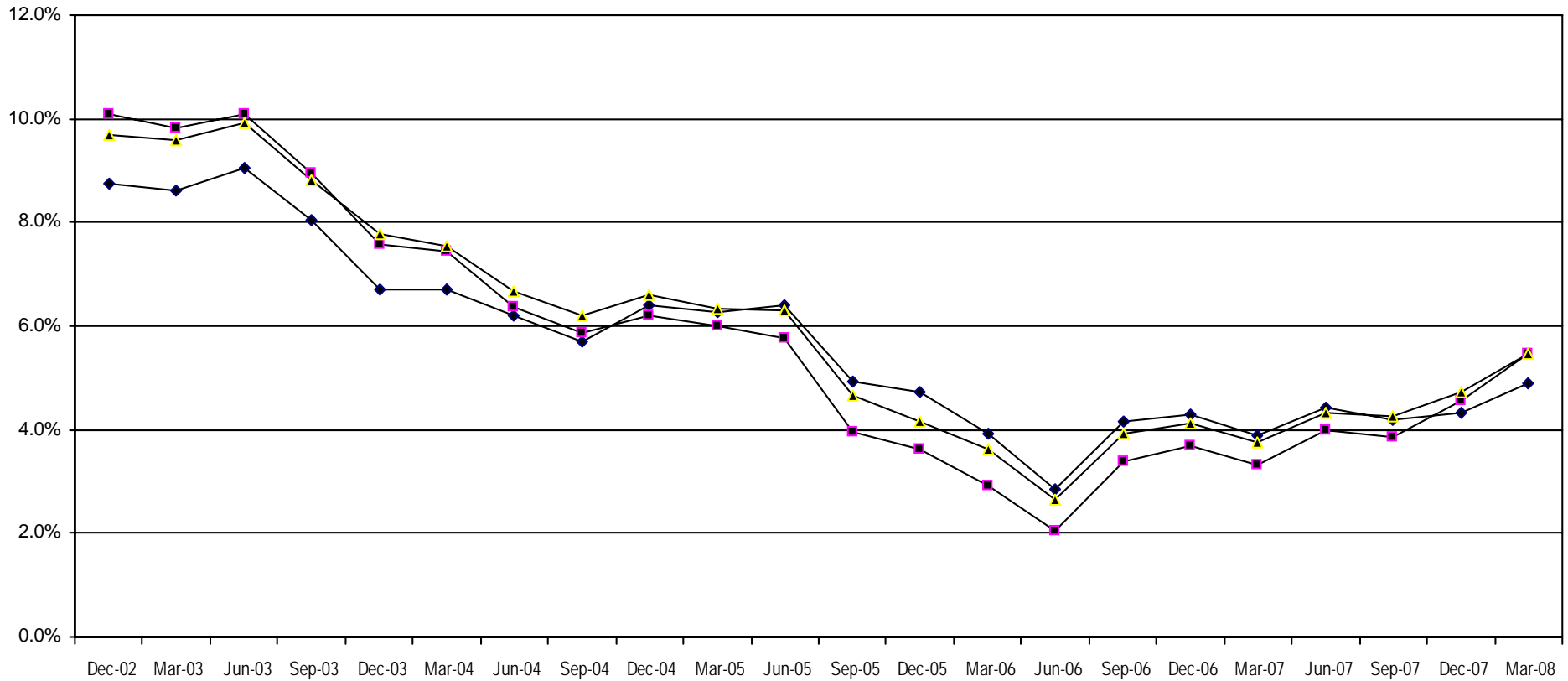

—◆— BRADFORD —■— LB AGGREGATE INDEX —▲— Bond Funds

	03/31/01	03/31/02	03/31/03	03/31/04	03/31/05	03/31/06	03/31/07	03/31/08
BRADFORD	7.3	6.1	8.6	6.7	6.3	3.9	3.9	4.9
LB AGGREGATE INDEX	6.9	6.5	9.8	7.4	6.0	2.9	3.3	5.5
Bond Funds	6.8	6.4	9.6	7.6	6.4	3.6	3.8	5.5



# Fresno County Employees' Retirement Association

## Three & Five Year Return vs. Risk

Period Ending: March 31, 2008

**Three-Year**

**Five-Year**

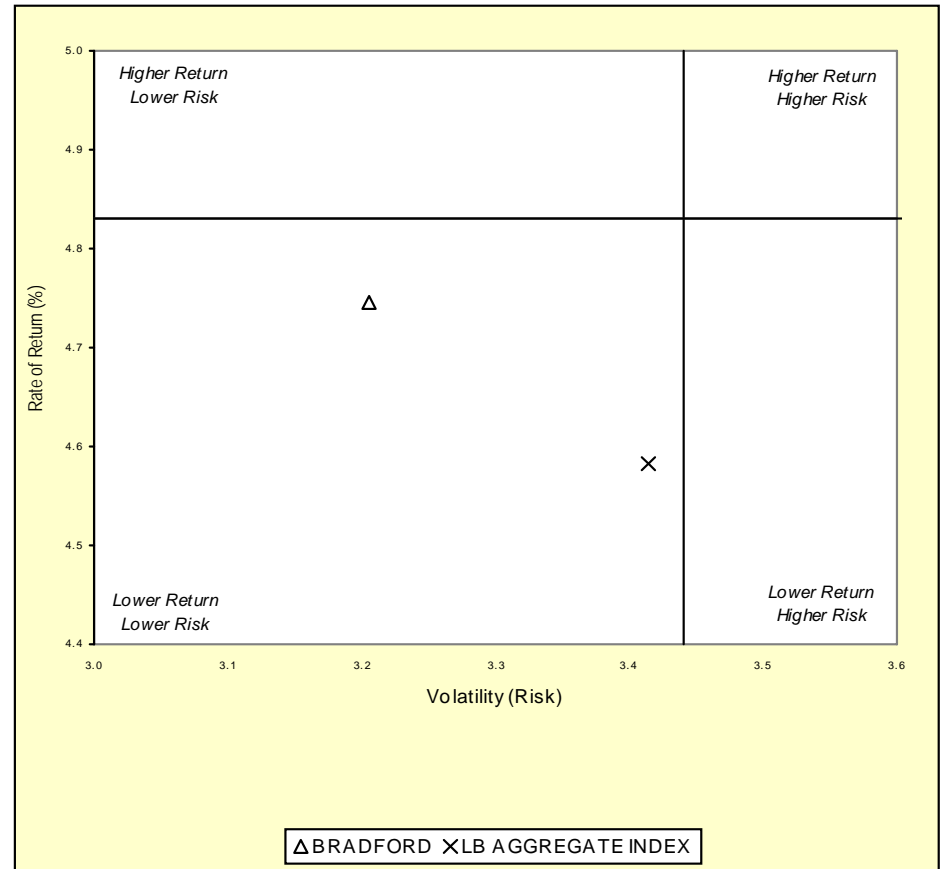
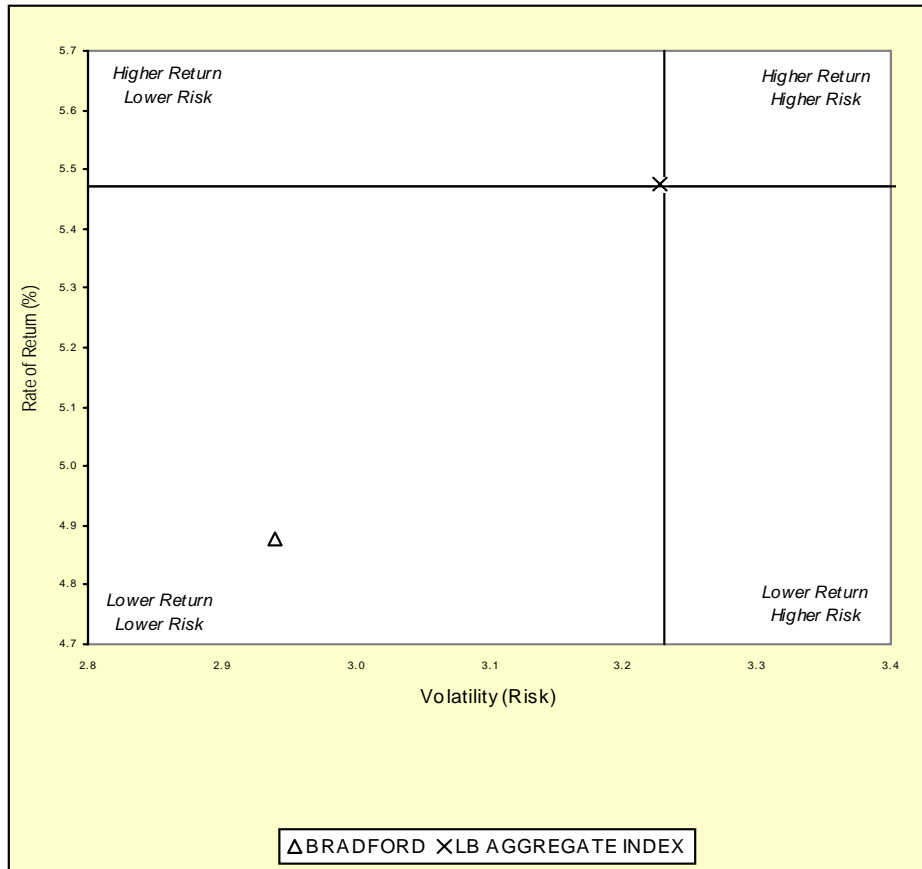

**Three Year Return vs Risk**

**Five Year Return vs Risk**

Annualized Return %	Standard Deviation %	Sharpe Ratio	Category	Annualized Return %	Standard Deviation %	Sharpe Ratio
4.9	2.9	0.2	BRADFORD	4.7	3.2	0.5
5.5	3.2	0.3	Bond Funds Universe Median	4.8	3.4	0.5
5.5	3.2	0.3	LB AGGREGATE INDEX	4.6	3.4	0.4

# Fresno County Employees' Retirement Association

## Value Added Analysis 3 Yr Rolling for BRADFORD

Period Ending: March 31, 2008

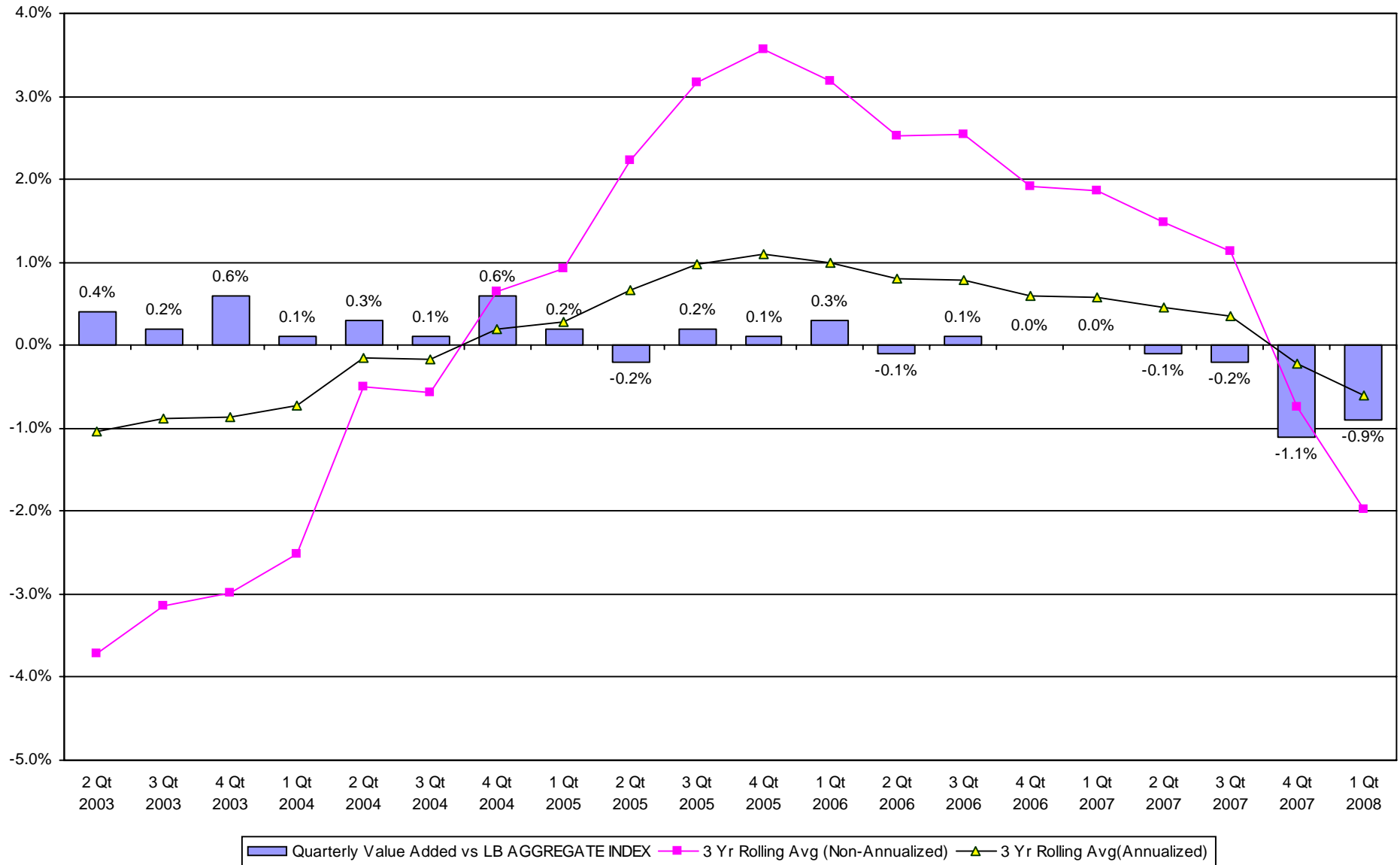

# Fresno County Employees' Retirement Association

## Rolling Return Ranking 3 & 5 Years

Period Ending: March 31, 2008

### Ranking Comparisons - Rolling 3 Years

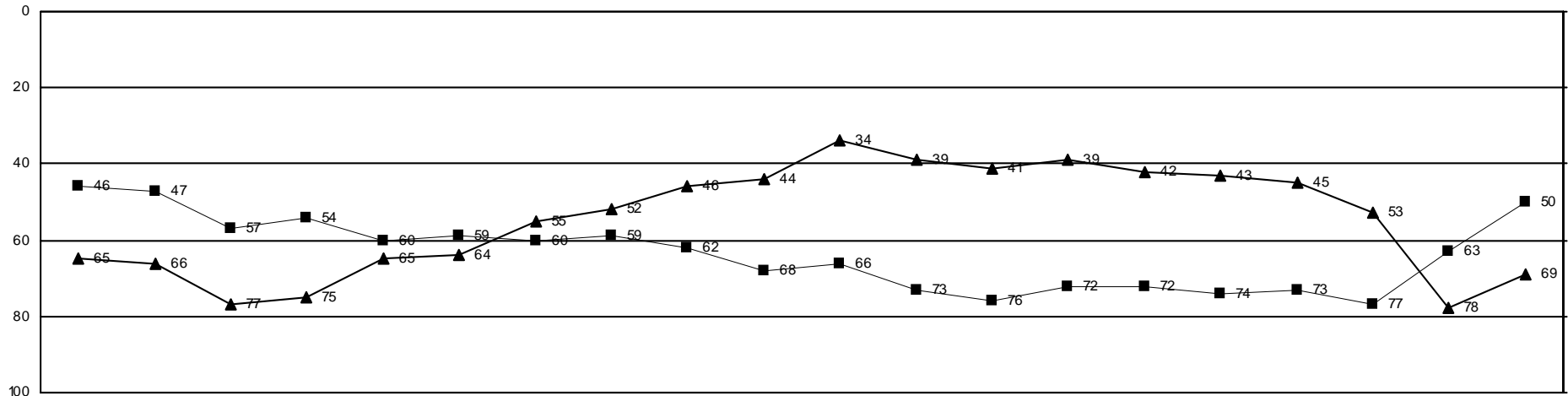

### Ranking Comparisons - Rolling 5 Years

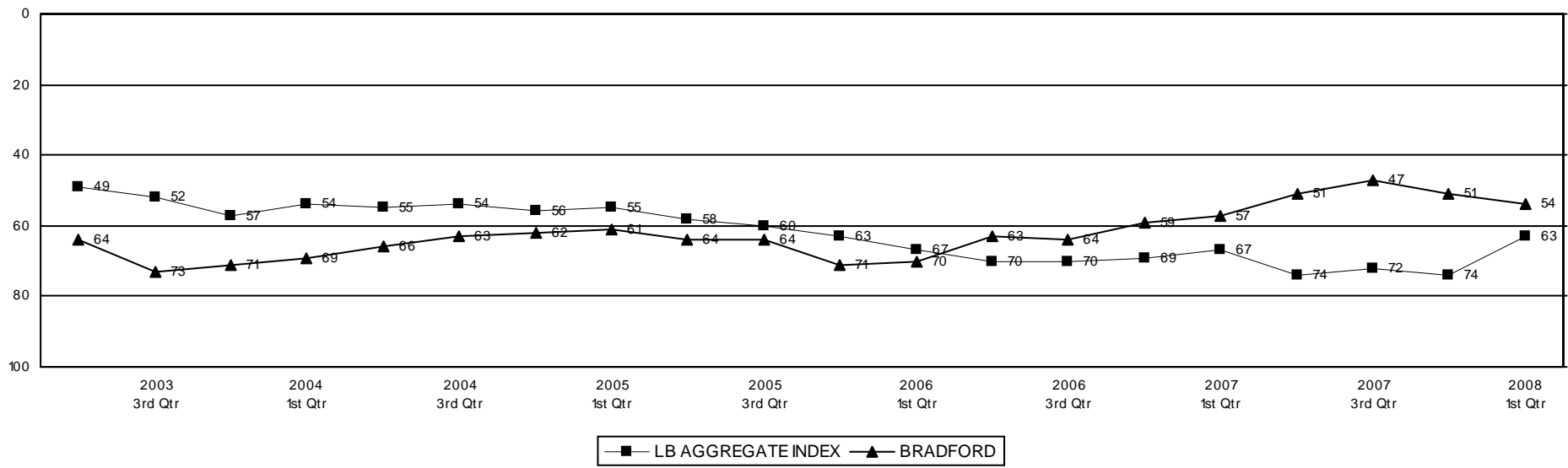

# Fresno County Employees' Retirement Association

## Up vs. Down Market Performance

Period Ending: March 31, 2008

Last 20 Quarters Ending 3/31/2008

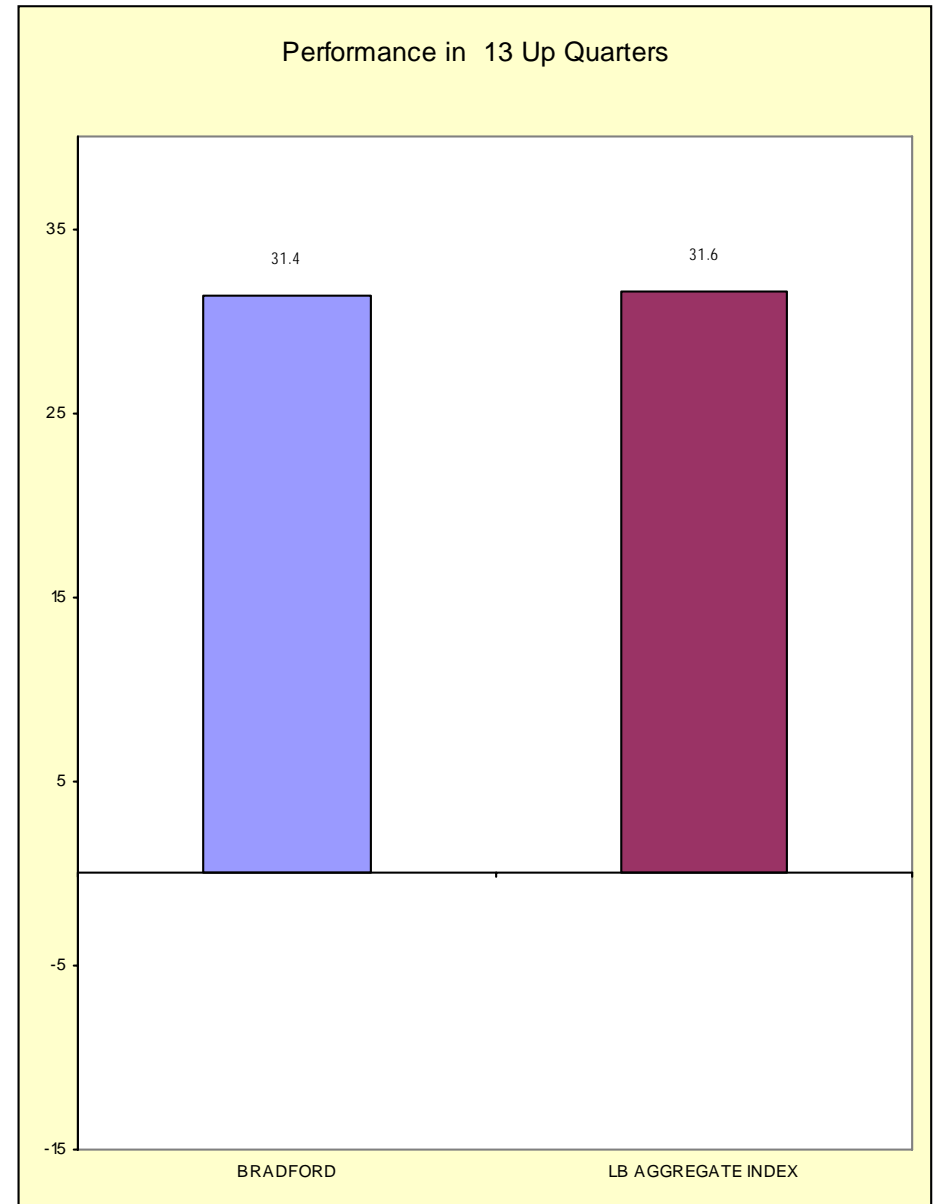
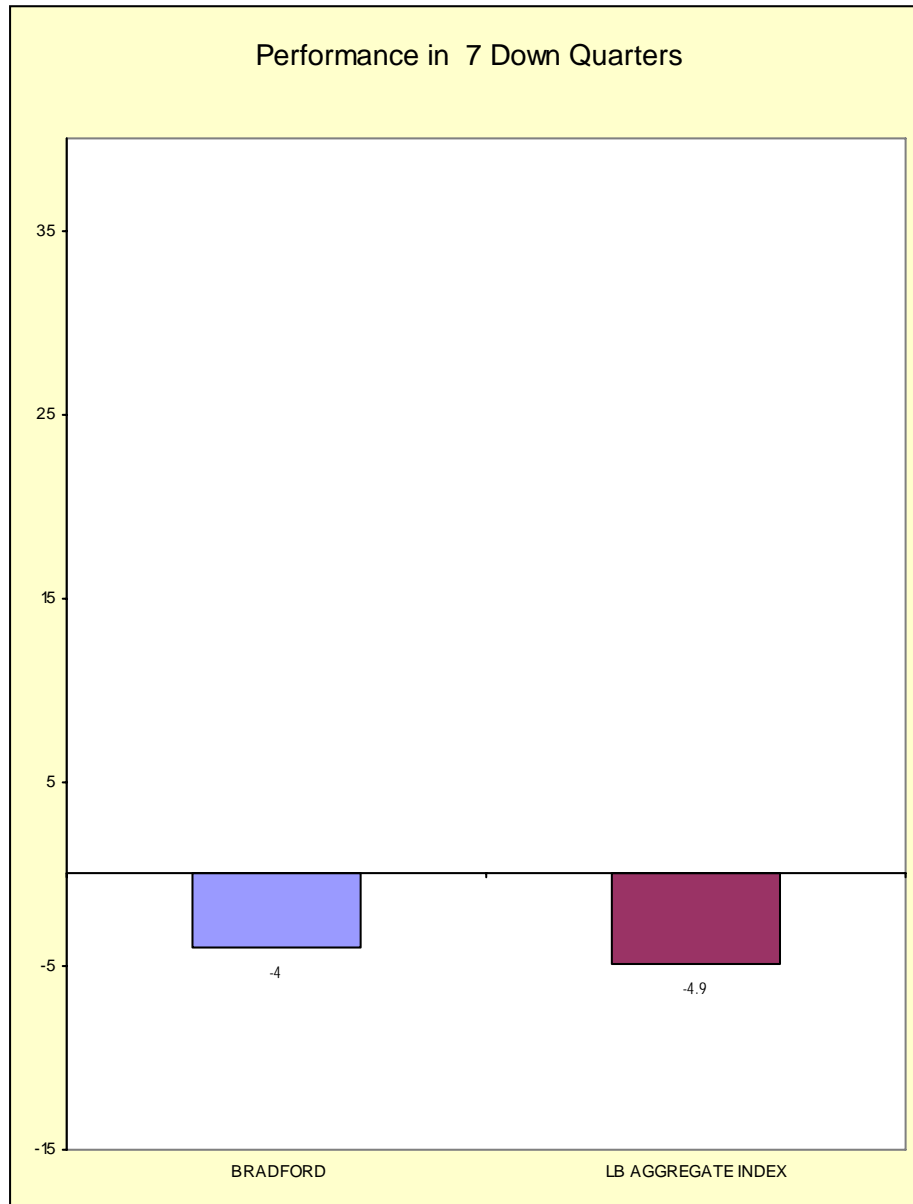

# FRESNO COUNTY EMPLOYEES RETIREMENT ASSO.

As of March 31, 2008

Bond Summary Statistics  
BRADFORD & MARZEC, INC

Portfolio Characteristics		
	Portfolio	LB AGGREGATE
Total Number of Securities	187	
Total Market Value	\$ 169,652,931	
Current Coupon	5.72	5.41
Yield To Maturity	5.31	4.55
Average Life	7.57	7.05
Duration	5.29	4.38
Quality	8.80	9.57

Duration (in Years)	
Range	%Held
0.0 to 1.0	1.7
1.0 to 3.0	23.1
3.0 to 4.0	7.8
4.0 to 6.0	11.4
6.0 to 8.0	11.0
Over 8.0	9.2
Unclassified	35.8

Quality	
Range	%Held
Govt (10)	20.4
Aaa (10)	20.2
Aa (9)	2.0
A (8)	4.9
Baa (7)	9.2
Below Baa	8.2
Other	35.1

Yield to Maturity	
Range	%Held
0.0 to 5.0	34.5
5.0 to 7.0	19.7
7.0 to 9.0	7.5
9.0 to 11.0	1.4
11.0 to 13.0	0.2
Over 13.0	0.8
Unclassified	35.8

Average Life	
Range	%Held
0.0 to 1.0	1.6
1.0 to 3.0	21.1
3.0 to 5.0	13.1
5.0 to 10.0	20.3
10.0 to 20.0	0.7
Over 20.0	7.5
Unclassified	35.8

Coupon	
Range	%Held
0.0 to 5.0	23.9
5.0 to 7.0	44.9
7.0 to 9.0	6.3
9.0 to 11.0	2.7
11.0 to 13.0	0.0
Over 13.0	0.0
Unclassified	22.3

# FRESNO COUNTY EMPLOYEES RETIREMENT ASSO.

As of March 31, 2008

## Fixed Income Sector Allocation

BRADFORD & MARZEC, INC

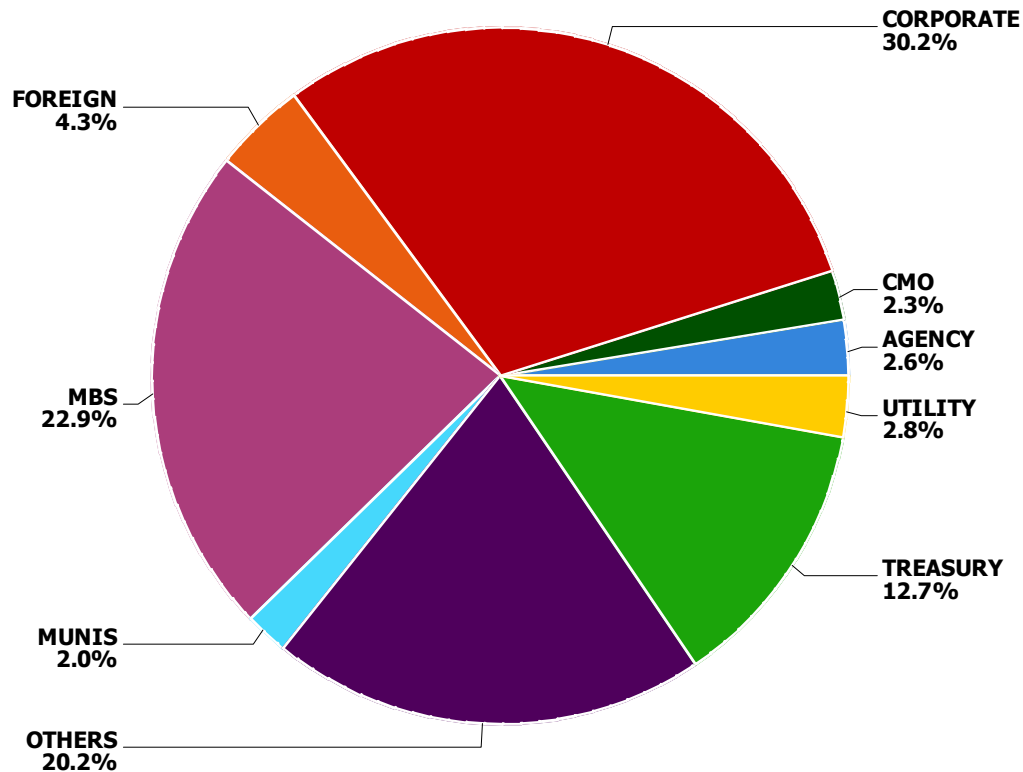

Sector	Account Weight	Index Weight	Difference
ABS	0.0%	6.2%	-6.2%
Agencies	2.6%	9.9%	-7.3%
CMO	2.3%	0.0%	2.3%
Corporates	30.2%	17.0%	13.2%
Foreign	4.3%	3.6%	0.7%
MBS	22.9%	37.8%	-15.0%
Municipals	2.0%	0.0%	2.0%
Others	20.2%	0.0%	20.2%
Treasuries	12.7%	23.5%	-10.7%
Utilities	2.8%	1.9%	0.8%
<b>Total</b>	<b>100.0%</b>	<b>100.0%</b>	<b>0.0%</b>

Benchmark: LB AGGREGATE

**FRESNO COUNTY EMPLOYEES RETIREMENT ASSO.**

As of March 31, 2008

**Bond Holdings  
BRADFORD & MARZEC, INC**

Bond Name	Market Value	Coupon	Stated Maturity	Quality Rating	Duration	Yield to Maturity
<b>0-5 Years</b>						
AK STL CORP	388,350	7.75	6/15/12	B1	2.58	7.30%
AMERICAN EXPRESS TRAVEL 14	788,533	5.25	11/21/11	AA3	N/A	N/A
AMERICAN GEN FIN MEDTM SRN	225,101	4.00	3/15/11	4	N/A	N/A
APPALACHIAN PWR CO	233,280	5.65	8/15/12	BAA2	N/A	N/A
ASIA ALUMINUM HLDGS LTD 14	234,000	8.00	12/23/11	B1	N/A	N/A
BAE SYS HLDGS INC 144A	819,566	4.75	8/15/10	BAA2	N/A	N/A
BUNDESREPUBLICM DEUTSHLD	3,223,395		7/15/03			
CASE NEW HOLLAND INC	396,975	6.00	6/01/09	BA3	1.10	5.54%
COMCAST HOLDINGS CORP	837,752	10.63	7/15/12	BAA3	3.48	5.65%
CONEXANT SYSTEMS	358,125	9.11	11/15/10		N/A	N/A
DAIMLERCHRYSLER CO	607,374	5.69	3/13/09		N/A	N/A
DOMINION RES INC VA NEW	461,610	5.69	5/15/08	BAA1	0.12	4.02%
FGLMC 30-YR POOL #G03871	5,330,258		2/01/38			
FHARM 30-YR POOL #1B3797	965,028		3/01/38			
FHLMC 30-YR POOL #G03891	3,605,615		2/01/38			
FHLMC 30-YR POOL #G03965	3,740,522		2/01/38			
FNARM 30-YR POOL #974864 5	1,098,888		3/01/48			
FNCL 30-YR POOL #735998	2,599,692		10/01/35			
FNCL 30-YR POOL #888131	4,999,077		2/01/37			
FNCL 30-YR POOL #889054	1,482,893		2/01/37			
FNCL 30-YR POOL #929185	1,781,864		1/01/36			
FNCL 30-YR POOL #962074	5,688,835		3/01/38			
GALAXY ENTMT FIN CO LTD 1	406,925	9.88	12/15/12	B1	3.51	10.07%
GENERAL ELEC CAP CORP MTN	1,194,235	5.25	10/19/12	AAA	3.97	4.29%
GENERAL MLS INC	440,461	4.02	1/22/10	BAA1	0.00	4.09%
GENERAL MLS INC	239,982	5.65	9/10/12	BAA1	3.93	4.64%

**FRESNO COUNTY EMPLOYEES RETIREMENT ASSO.**

As of March 31, 2008

**Bond Holdings  
BRADFORD & MARZEC, INC**

Bond Name	Market Value	Coupon	Stated Maturity	Quality Rating	Duration	Yield to Maturity
GOODYEAR TIRE & RUBR CO	429,967	8.63	12/01/11	N/A	2.97	7.09%
GSC HLDGS CORP / GAMESTOP	507,600	8.00	10/01/12	BA3	2.78	6.15%
HARTFORD FINL SVCS GROUP I	389,967	5.66	11/16/08	A2	0.61	3.11%
HEALTH CARE PPTY INVS INC	632,229	3.25	9/15/08	BAA3	0.19	7.60%
HONEYWELL INTL INC	161,648	4.25	3/01/13	A2	4.43	4.02%
IBM INTL GROUP CAP LLC	732,690	5.05	10/22/12	A1	4.01	3.97%
INTERNATIONAL LEASE FIN MT	579,911	5.35	3/01/12	A1	3.49	5.79%
JP MORGAN CHASE & CO	492,476	6.75	2/01/11	AA3	2.57	4.40%
KANSAS CITY SOUTHN RY CO	390,275	9.50	10/01/08	B3	0.46	6.66%
KELLOGG CO	249,744	5.13	12/03/12	A3	4.10	4.31%
NATIONWIDE HEALTH PPTYS IN	432,558	6.50	7/15/11	BAA3	2.93	5.05%
NEW ZEALAND GOV'T 6.00%	2,389,375	6.00	7/15/08		N/A	N/A
PROVINCE OF ONTARIO	2,414,900	2.75	2/22/11		N/A	N/A
SOUTHERN UN CO NEW	139,440	7.20	11/01/11	BA1	2.91	12.89%
STEEL DYNAMICS INC 144A	141,400	7.38	11/01/12	BA2	3.74	7.11%
UNION PAC CORP	484,738	5.45	1/31/13	BAA2	4.23	4.77%
UNITED KINGDOM TREASURY	1,762,398	5.75	12/07/09		N/A	N/A
UNITED STATES TREAS NTS	9,869,692	3.25	12/31/09	AAA	1.69	1.64%
UNITED STATES TREAS NTS	490,512	4.63	11/30/08	AAA	0.65	1.39%
UNITED STATES TREAS NTS	2,460,017	4.50	11/30/11	AAA	3.37	2.07%
	67,299,868	4.91			2.28	3.40%
<b>5-10 Years</b>						
5PCT 07SEP14	1,884,363	5.00	9/07/14		N/A	N/A
AGFC CAP TR I 144A	173,040	6.00	1/15/17	A3	6.53	8.93%
AHERN RENTALS INC	372,475	9.25	8/15/13	B3	3.89	15.00%
ALLIED WASTE NORTH AMER I	224,438	7.13	5/15/16	B1	5.96	7.16%



**FRESNO COUNTY EMPLOYEES RETIREMENT ASSO.**

As of March 31, 2008

**Bond Holdings  
BRADFORD & MARZEC, INC**

Bond Name	Market Value	Coupon	Stated Maturity	Quality Rating	Duration	Yield to Maturity
AMERICAN TOWER CORP 144A	280,000	7.00	10/15/17	BA1	N/A	N/A
ASBURY AUTOMOTIVE GROUP IN	387,150	8.00	3/15/14	B3	N/A	N/A
ASHTED HLDGS PLC 144A	372,000	8.63	8/01/15	B1	N/A	N/A
AT&T INC	453,836	5.50	2/01/18	N/A	7.68	5.78%
AUSTRALIA GOV'T 6.5%	3,813,120	6.50	5/15/13		N/A	N/A
AVAGO TECHNOLOGIES FIN LT	290,125	10.13	12/01/13	B2	N/A	N/A
AVNET INC	231,795	6.63	9/15/16	BA1	N/A	N/A
BALDOR ELECTRIC CO	633,600	8.63	2/15/17	B3	N/A	N/A
BANK OF AMERICA CORPORATIO	232,043	5.75	12/01/17	AA1	N/A	N/A
BRE PROPERTIES INC	242,324	5.50	3/15/17	BAA2	N/A	N/A
BUFFALO THUNDER DEV AUT 14	382,500	9.38	12/15/14	B2	4.40	15.49%
BUONI POLIENNALI DEL TES	1,896,650		2/01/18			
CBA CAP TR II 144A	411,504	6.02	3/15/16	AA3	6.16	8.53%
CHS / CMNTY HEALTH SYS IN	562,072	8.88	7/15/15	B3	5.21	8.78%
CHUO MITSUI TR & BKG CO 1	526,302	5.51	4/15/15	A2	5.50	8.68%
CIT GROUP INC	473,360	5.65	2/13/17	A3	6.63	9.44%
COMCAST CORP NEW	612,806	6.30	11/15/17	BAA2	7.22	6.13%
COMMONWEALTH EDISON CO	757,083	6.15	9/15/17	BAA2	7.35	5.78%
CONSTELLATION BRANDS INC	271,600	7.25	5/15/17	BA3	6.56	7.71%
CORPORACION ANDINA DE FOME	320,686	5.75	1/12/17	A1	6.90	6.08%
COVENTRY HEALTH CARE INC	562,576	6.30	8/15/14	BA1	5.23	6.21%
COVIDIEN INTL FIN S A 144A	970,968	6.00	10/15/17	BAA1	7.28	5.58%
DENBURY RES INC DEL	230,063	7.50	12/15/15	B1	5.51	7.01%
DEUTSCHE BK AG LONDON	264,818	6.00	9/01/17	AA1	7.39	5.44%
DRS TECHNOLOGIES INC	355,000	7.63	2/01/18	B3	6.75	7.62%
ECHOSTAR DBS CORP	300,300	6.63	10/01/14	BA3	5.00	8.45%

**FRESNO COUNTY EMPLOYEES RETIREMENT ASSO.**

As of March 31, 2008

**Bond Holdings  
BRADFORD & MARZEC, INC**

Bond Name	Market Value	Coupon	Stated Maturity	Quality Rating	Duration	Yield to Maturity
EMBRAER OVERSEAS LTD	618,450	6.38	1/24/17	BAA3	6.78	6.41%
ENTERPRISE PRODS OPER LP	496,548	7.03	1/15/18	BA1	6.76	9.43%
EQUITY ONE	209,503	6.00	9/15/17	BAA3	7.12	7.77%
EUROPEAN INVESTMENT BANK M	1,014,403		5/15/13			
FHLMC_2518- BD	981,746	5.00	10/15/17	GOVT	2.60	3.76%
FPL GROUP CAP INC	347,190	7.30	12/01/17	A3	6.97	7.63%
FREPORT MCMIRGAN	245,625	0.00	4/01/15		N/A	N/A
FREPORT-MCMORAN COPPER &	233,464	8.38	4/01/17	BA2	5.96	7.24%
FREESCALE SEMICONDUCTOR IN	185,625	10.13	12/15/16	B3	4.79	17.53%
GLENCORE FDG LLC 144A	254,046	6.00	4/15/14	BAA3	4.91	6.46%
GOLDMAN SACHS GROUP INC	194,396	5.95	1/18/18	AA3	7.48	6.08%
GTL TRADE FIN INC 144A	330,784	7.25	10/20/17	N/A	6.90	6.48%
HCA Inc	456,500	9.63	11/15/16		N/A	N/A
HEALTHNET INC	199,004	6.38	6/01/17	BA2	6.78	7.51%
HRPT PPTYS TR	281,400	6.25	6/15/17	BAA2	6.73	8.43%
HRPT PPTYS TR	211,112	6.65	1/15/18	BAA2	6.94	8.73%
INTELSAT LTD	266,988	9.25	6/15/16	B3	5.57	9.08%
INTUIT INC	209,088	5.75	3/15/17	BAA2	7.07	6.21%
ISPAT INLAND ULC	276,875	9.75	4/01/14	BAA2	1.86	6.61%
JP MORGAN CHASE & CO	516,731	6.00	1/15/18	AA2	7.53	5.43%
KINDER MORGAN ENERGY PARTN	272,646	5.95	2/15/18	BAA2	7.56	6.08%
KREDITANSTALT FUR WIEDERAU	1,987,832	4.38	3/15/18	AAA	8.33	4.09%
L-3 COMMUNICATIONS CORP	361,675	6.13	7/15/13	BA3	4.26	6.63%
LAZARD LLC	875,340	7.13	5/15/15	BA1	5.43	7.63%
LYON WILLIAM HOMES INC	161,200	10.75	4/01/13	CAA2	2.81	29.81%
MASHANTUCKET WESTERN PE 14	202,400	8.50	11/15/15	BA1	5.23	10.85%

**FRESNO COUNTY EMPLOYEES RETIREMENT ASSO.**

As of March 31, 2008

**Bond Holdings  
BRADFORD & MARZEC, INC**

Bond Name	Market Value	Coupon	Stated Maturity	Quality Rating	Duration	Yield to Maturity
<b>MOSAIC CO 144A</b>	215,000	8.63	12/01/16	B1	5.53	7.17%
<b>NATIONAL RETAIL PROPERTIES</b>	225,377	6.88	10/15/17	BAA3	6.81	7.17%
<b>NRG ENERGY INC</b>	320,938	7.25	2/01/14	B1	4.54	7.51%
<b>PIONEER NAT RES CO</b>	156,156	6.65	3/15/17	BA1	6.74	7.48%
<b>PPF FDG INC 144A</b>	212,424	5.70	4/15/17	A3	6.81	7.42%
<b>R H DONNELLEY CORP 144A</b>	281,250	8.88	10/15/17	B3	5.05	16.93%
<b>RESONA BK 144A</b>	436,275	5.85	4/15/16	A2	6.04	8.83%
<b>REYNOLDS AMERICAN INC</b>	313,534	6.75	6/15/17	BA1	6.87	6.58%
<b>ROGERS WIRELESS INC</b>	783,750	7.50	3/15/15	BAA3	5.48	6.58%
<b>SECURITY CAP LTD</b>	34,750	6.88	9/30/17	B3	0.73	99.99%
<b>SEMT 2007-3 1A1</b>	651,945	5.70	2/20/15		N/A	N/A
<b>SHINGLE SPRINGS TRIBAL 144</b>	57,525	9.38	6/15/15	B3	4.90	11.78%
<b>SHINSEI FIN CAYMAN LTD 14</b>	188,898	6.42	7/20/16	BAA1	5.66	12.95%
<b>SIERRA PAC RES NEW</b>	766,619	6.75	8/15/17	BA3	6.85	7.28%
<b>STEEL DYNAMICS INC</b>	191,100	6.75	4/01/15	BA2	5.41	7.12%
<b>SUMITOMO MITSUI BANKING 1</b>	321,404	5.63	10/15/15	AA3	5.81	8.43%
<b>TECO ENERGY INC</b>	561,590	6.75	5/01/15	BAA3	5.60	6.18%
<b>TESCO PLC 144A</b>	503,279	5.50	11/15/17	A1	7.52	5.23%
<b>TESORO CORP</b>	241,650	6.50	6/01/17	BA1	6.67	8.15%
<b>TEXTRON FINL CORP 144A</b>	465,658	6.00	2/15/17	BAA1	6.74	7.93%
<b>TYCO ELECTRONICS GROUP 144</b>	373,815	6.55	10/01/17	BAA2	7.08	5.88%
<b>UNION PAC CORP</b>	254,450	5.75	11/15/17	BAA2	7.41	5.58%
<b>UNITED STATES TREAS NTS</b>	871,528	4.75	8/15/17	AAA	7.88	3.41%
<b>UNITED STATES TREAS NTS</b>	221,760	4.88	8/15/16	AAA	7.12	3.23%
<b>VALE OVERSEAS LTD</b>	219,560	6.25	1/11/16	BAA3	6.14	6.29%
<b>VERIZON COMMUNICATIONS</b>	350,681	5.50	2/15/18	A3	7.70	5.85%

**FRESNO COUNTY EMPLOYEES RETIREMENT ASSO.**

As of March 31, 2008

**Bond Holdings  
BRADFORD & MARZEC, INC**

Bond Name	Market Value	Coupon	Stated Maturity	Quality Rating	Duration	Yield to Maturity
VERSO PAPER HLDGS LLC	130,975	9.11	8/01/14		N/A	N/A
WOORI BK KOREA 144A	233,729	6.21	5/02/17	A3	6.45	9.70%
	39,464,780	6.47			6.31	7.33%
<b>10-20 Years</b>						
CITICORP_MTG_2006-004- 3A1	1,146,415	5.50	8/25/21	AAA	1.83	4.29%
CITIZENS COMMUNICATIONS CO	137,200	7.88	1/15/27	BA2	9.03	9.51%
CVS CORP	366,491	6.25	6/01/27	BAA2	11.25	6.28%
FHLMC GOLD POOL - B17427	741,209	5.00	12/01/19	AAA	2.57	4.52%
FNMA POOL - 723748	371,978	5.00	8/01/18	GOVT	2.60	4.47%
FNMA POOL - 735315	1,329,833	4.50	3/01/20	GOVT	3.43	4.59%
GAZ CAP SA LUXEMBOURG 144A	377,650	6.51	3/07/22	A3	8.98	7.80%
GOLDMAN SACHS GROUP INC	518,266	6.15	4/01/18	N/A	7.63	6.17%
MORGAN STANLEY	763,154	6.63	4/01/18	N/A	7.47	6.62%
NCSLT 2007	1,442,645	5.36	6/25/25		N/A	N/A
WELLS_FARGO_2005-001- 3A1	737,599	5.25	3/25/20	AAA	4.31	6.80%
WELLS_FARGO_2005-13- A1	1,094,906	5.00	11/25/20	N/A	4.57	6.50%
WILLIAMS COS INC DEL	223,108	7.63	7/15/19	BAA3	7.77	6.76%
	9,250,455	5.48			4.85	5.70%
<b>Over 20 Years</b>						
CARGILL INC 144A	344,350	6.63	9/15/37	A2	12.76	6.88%
DELHAIZE AMER INC	403,173	9.00	4/15/31	BAA3	10.57	7.18%
ENEL FIN INTL S A 144A	296,475	6.80	9/15/37	A2	12.85	6.73%
FHLMC POOL - 1N0371	1,927,065	6.23	1/01/37	GOVT	1.06	4.39%
FHLMC POOL - 1Q0345	1,314,309	5.89	7/01/37	GOVT	1.58	4.65%
FHLMC GOLD POOL - A51588	903,900	6.00	8/01/36	AAA	2.32	4.85%

**FRESNO COUNTY EMPLOYEES RETIREMENT ASSO.**

As of March 31, 2008

**Bond Holdings  
BRADFORD & MARZEC, INC**

Bond Name	Market Value	Coupon	Stated Maturity	Quality Rating	Duration	Yield to Maturity
FHLMC GOLD POOL - C62870	79,941	7.00	1/01/32	GOVT	2.68	5.05%
FHLMC GOLD POOL - C62983	2,632	7.00	1/01/32	GOVT	2.47	5.12%
FHLMC GOLD POOL - G01584	2,292,930	5.00	8/01/33	GOVT	5.16	5.15%
FIFTH THIRD BANCORP	224,280	8.25	3/01/38	N/A	11.16	8.08%
FNMA POOL - 914475	1,417,255	5.79	4/01/37	AAA	1.58	4.61%
FNMA POOL - 256059	3,031,834	5.50	1/01/36	GOVT	3.90	5.13%
FNMA POOL - 709452	1,600,310	5.00	7/01/33	GOVT	5.28	5.13%
FNMA POOL - 720195	1,756,447	5.00	7/01/33	GOVT	5.32	5.13%
FNMA POOL - 787021	953,635	5.50	6/01/34	AAA	4.18	5.15%
FNMA POOL - 809706	1,130,284	5.50	3/01/35	AAA	4.09	5.15%
FNMA POOL - 831811	8,658,527	6.00	9/01/36	GOVT	2.33	4.78%
FNMA POOL - 878499	481,227	6.00	2/01/36	GOVT	2.86	4.95%
FNMA POOL - 888702	3,546,653	6.50	8/01/37	GOVT	2.59	4.84%
FNMA POOL - 940643	1,865,602	6.50	8/01/37	GOVT	2.68	4.84%
FNMA POOL - 946033	384,949	6.50	9/01/37	GOVT	2.90	4.84%
FNMA POOL - 948634	2,347,047	6.50	8/01/37	GOVT	2.63	4.84%
GE_CMBS_2007-C001- A4	548,850	5.54	12/10/49	AAA	6.69	6.02%
GNMA POOL - 605774	2,658,972	5.50	11/15/34	GOVT	3.82	4.93%
GOLDMAN SACHS GROUP INC	242,710	6.75	10/01/37	A1	11.86	7.33%
GRANM 07-1	817,298	5.42	12/20/54		N/A	N/A
GRANM 2007	441,750	5.43	12/20/54		N/A	N/A
GS_MTG_COMM_2007-GG10- A4	1,862,516	5.99	8/10/45	AAA	6.83	5.95%
HUTCHISON WHAMPOA INTL 144	441,739	7.45	11/24/33	A3	11.44	7.21%
JEFFERIES GROUP INC NEW	155,420	6.25	1/15/36	BAA1	11.01	8.55%
LIBERTY MUT GROUP INC 144A	214,965	7.80	3/15/37	BAA3	10.13	9.37%
LUBRIZOL CORP	623,768	6.50	10/01/34	BAA3	12.42	6.48%

**FRESNO COUNTY EMPLOYEES RETIREMENT ASSO.**

As of March 31, 2008

**Bond Holdings  
BRADFORD & MARZEC, INC**

<b>Bond Name</b>	<b>Market Value</b>	<b>Coupon</b>	<b>Stated Maturity</b>	<b>Quality Rating</b>	<b>Duration</b>	<b>Yield to Maturity</b>
<b>PACIFICORP</b>	591,831	6.25	10/15/37	A3	13.28	6.17%
<b>POTASH CORP SASK INC</b>	327,355	5.88	12/01/36	BAA1	13.13	6.48%
<b>SAN DIEGO GAS &amp; ELEC CO</b>	81,344	6.13	9/15/37	A1	13.92	5.97%
<b>SCIENCE APPLICATIONS</b>	206,640	5.50	7/01/33	A3	12.76	6.60%
<b>TEVA PHARMACEUTICAL FIN LL</b>	282,692	6.15	2/01/36	BAA2	13.17	6.34%
<b>UNITED STATES TREAS BDS</b>	5,564,859	4.50	2/15/36	AAA	16.40	4.29%
<b>UNITED STATES TREAS BONDS</b>	2,120,350	4.38	2/15/38	AAA	17.02	4.30%
<b>VALE OVERSEAS LTD</b>	170,051	6.88	11/21/36	BAA3	12.11	7.07%
<b>VIACOM INC</b>	213,570	6.88	4/30/36	BAA3	11.90	7.18%
<b>WAL MART STORES INC</b>	244,853	6.50	8/15/37	AA2	13.51	6.13%
	52,774,358	5.74			6.17	5.05%

# Fresno County Employees' Retirement Association

## Cumulative Performance Comparisons

Period Ending: March 31, 2008

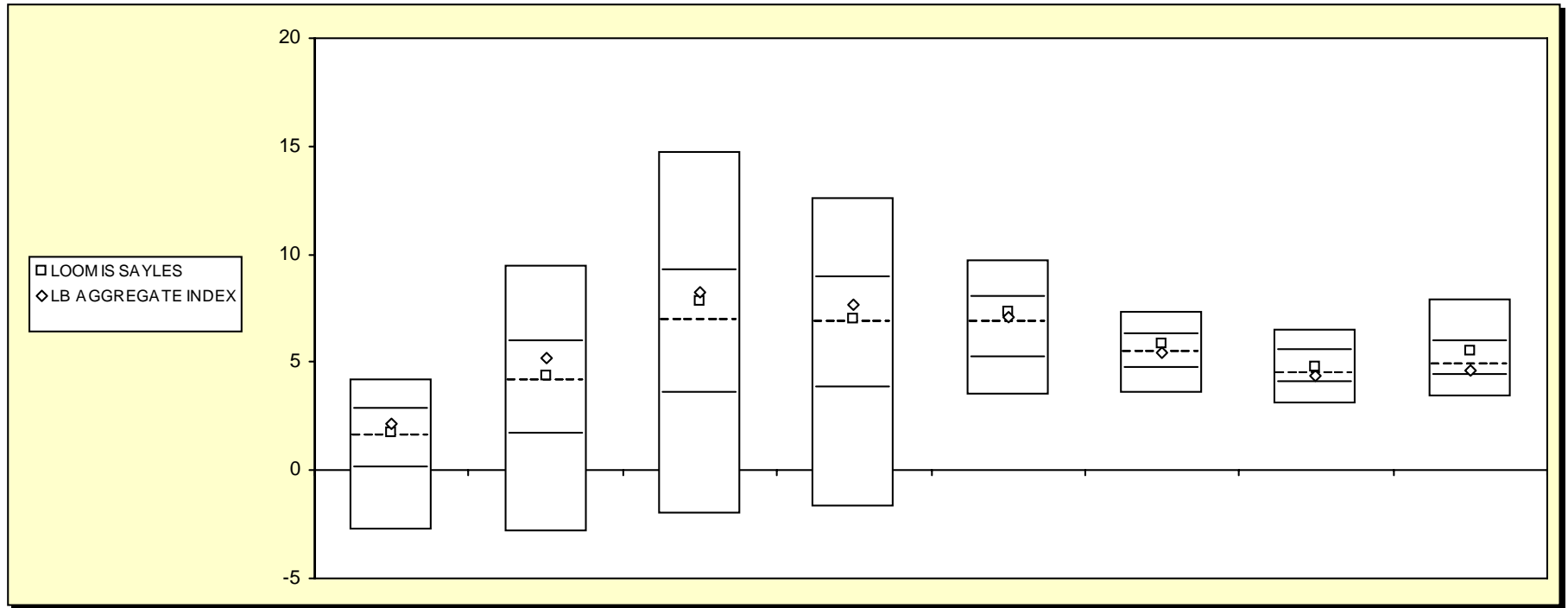

### Bond Funds

	Last Quarter		Two Quarters		Three Quarters		One Year		Two Years		Three Years		Four Years		Five Years	
	Return	Rank	Return	Rank	Return	Rank	Return	Rank	Return	Rank	Return	Rank	Return	Rank	Return	Rank
5th Percentile	4.2		9.5		14.7		12.6		9.7		7.4		6.5		7.9	
25th Percentile	2.8		5.9		9.2		8.9		8.0		6.3		5.5		6.0	
50th Percentile	1.5		4.1		6.9		6.8		6.8		5.5		4.5		4.8	
75th Percentile	0.1		1.7		3.5		3.8		5.2		4.7		4.0		4.4	
95th Percentile	-2.8		-2.8		-2.1		-1.7		3.5		3.5		3.1		3.4	
Loomis Sayles	1.8	46	4.4	46	7.9	40	7.0	48	7.4	38	5.9	37	4.8	41	5.5	35
LB Aggregate Index	2.2	37	5.2	34	8.2	36	7.7	40	7.1	44	5.5	50	4.4	54	4.6	63

# Fresno County Employees' Retirement Association

## Consecutive Performance Comparisons

Period Ending: March 31, 2008

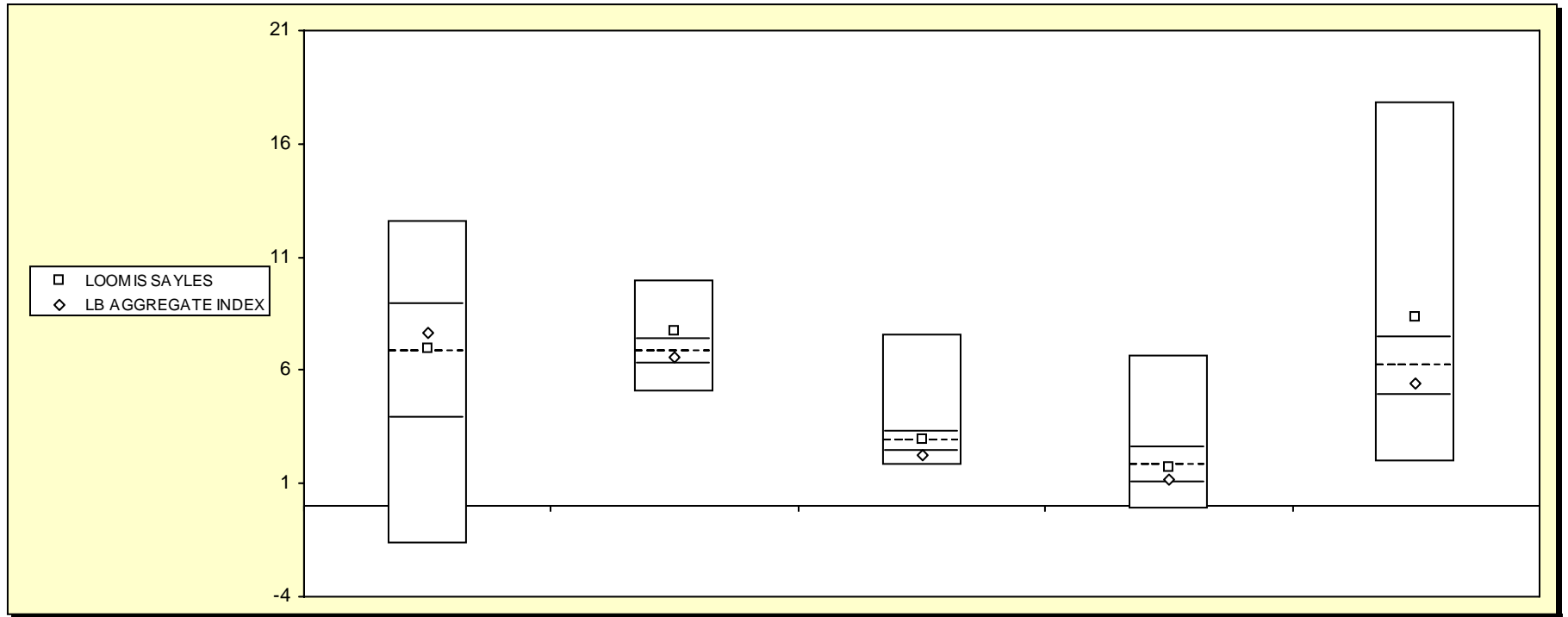

### Bond Funds

	March 2008		March 2007		March 2006		March 2005		March 2004	
	Return	Rank	Return	Rank	Return	Rank	Return	Rank	Return	Rank
5th Percentile	12.6		10.0		7.5		6.6		17.8	
25th Percentile	8.9		7.3		3.3		2.6		7.4	
50th Percentile	6.8		6.8		2.8		1.8		6.2	
75th Percentile	3.8		6.3		2.4		1.0		4.9	
95th Percentile	-1.7		5.0		1.8		-0.2		1.9	
LOOMIS SAYLES	7.0	48	7.8	22	3.0	43	1.7	51	8.3	23
LB AGGREGATE INDEX	7.7	40	6.6	59	2.3	80	1.2	71	5.4	65



# Fresno County Employees' Retirement Association

Consecutive Annual - Five Year

Period Ending: March 31, 2008

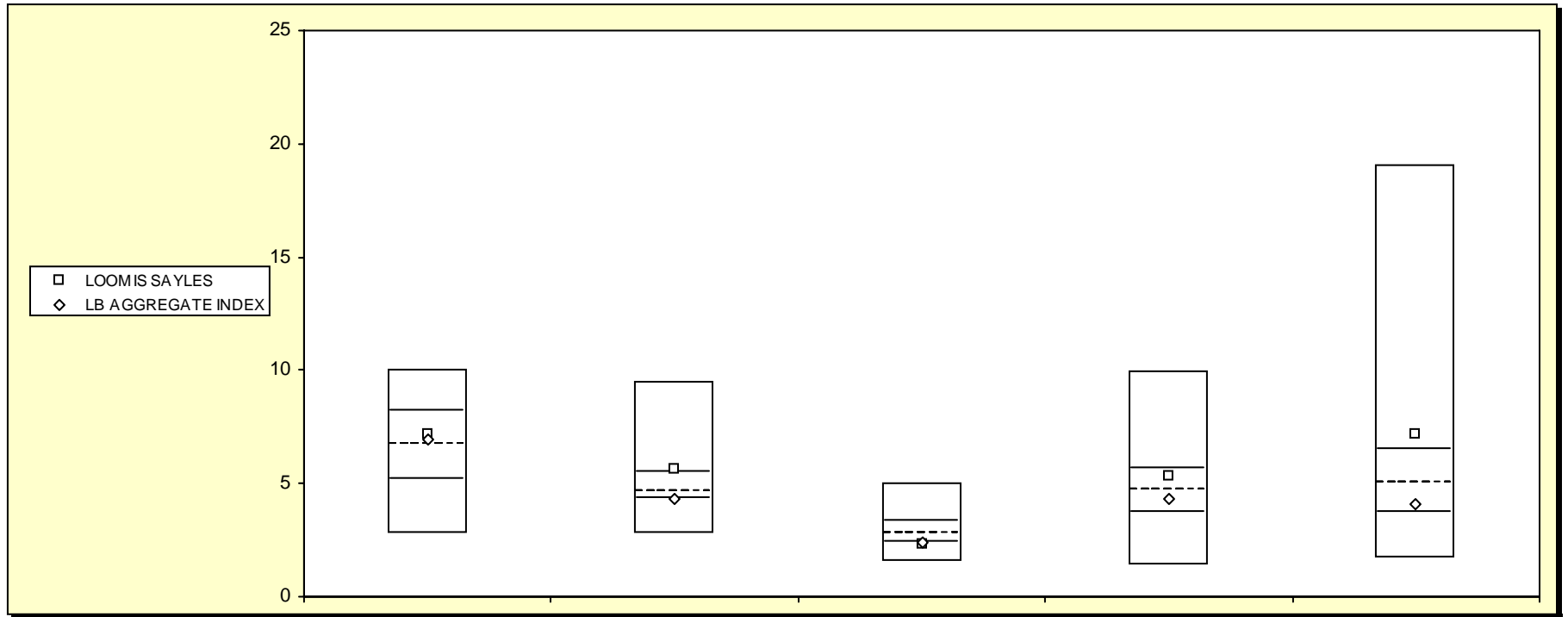

*Bond Funds*

	December 2007 Return Rank	December 2006 Return Rank	December 2005 Return Rank	December 2004 Return Rank	December 2003 Return Rank
5th Percentile	10.0	9.5	5.0	9.9	19.1
25th Percentile	8.2	5.5	3.3	5.6	6.5
50th Percentile	6.7	4.6	2.8	4.7	5.0
75th Percentile	5.2	4.3	2.4	3.7	3.7
95th Percentile	2.8	2.7	1.5	1.4	1.7
LOOMIS SAYLES	7.2 42	5.6 24	2.3 75	5.3 33	7.2 24
LB AGGREGATE INDEX	7.0 45	4.3 74	2.4 71	4.3 59	4.1 68

# Fresno County Employees' Retirement Association

Rolling Return: 3 year Annualized

Period Ending: March 31, 2008

## Rolling Return (3 Year Annualized)

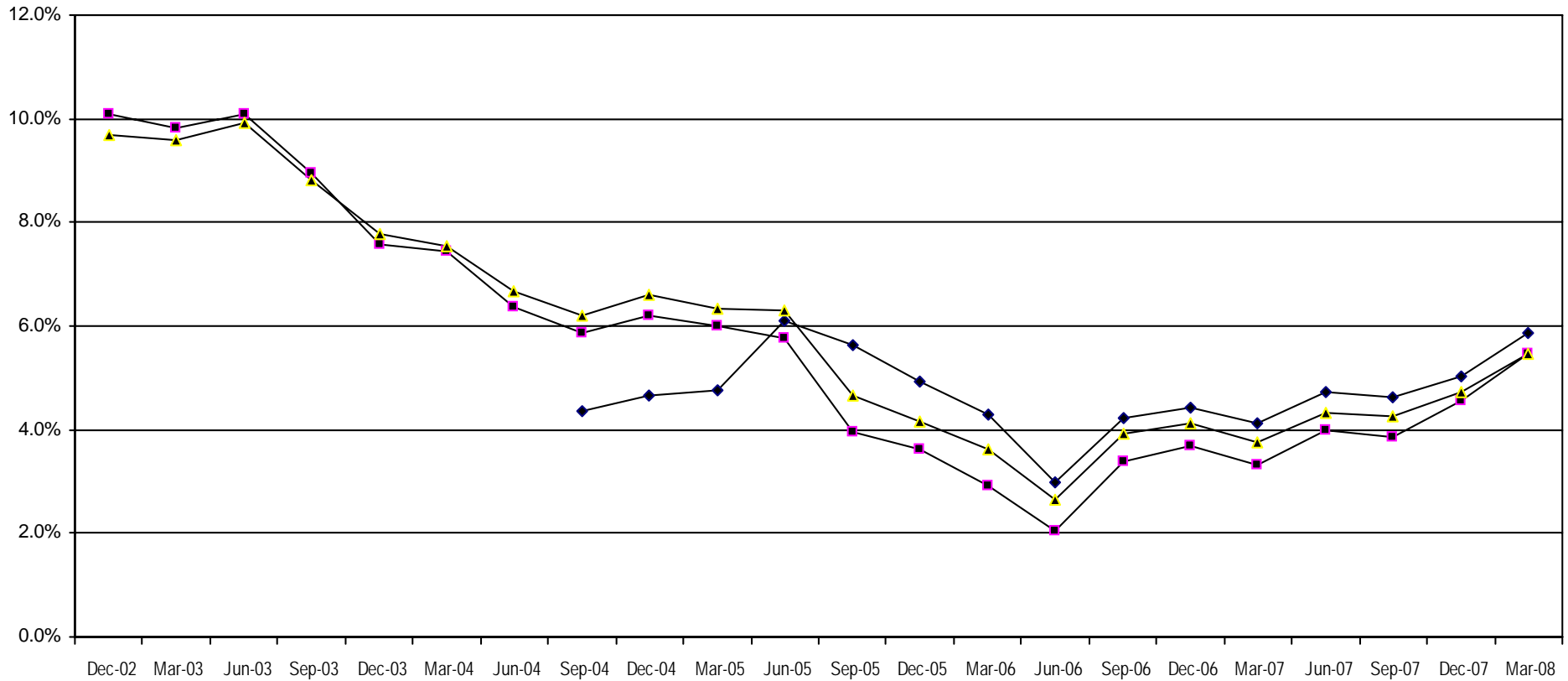

—◆— LOOMIS SAYLES —■— LB AGGREGATE INDEX —▲— Bond Funds

	03/31/01	03/31/02	03/31/03	03/31/04	03/31/05	03/31/06	03/31/07	03/31/08	
LOOMIS SAYLES						4.8	4.3	4.1	5.9
LB AGGREGATE INDEX		6.9	6.5	9.8	7.4	6.0	2.9	3.3	5.5
Bond Funds		6.8	6.4	9.6	7.6	6.4	3.6	3.8	5.5

# Fresno County Employees' Retirement Association

## Three & Five Year Return vs. Risk

Period Ending: March 31, 2008

**Three-Year**

**Five-Year**

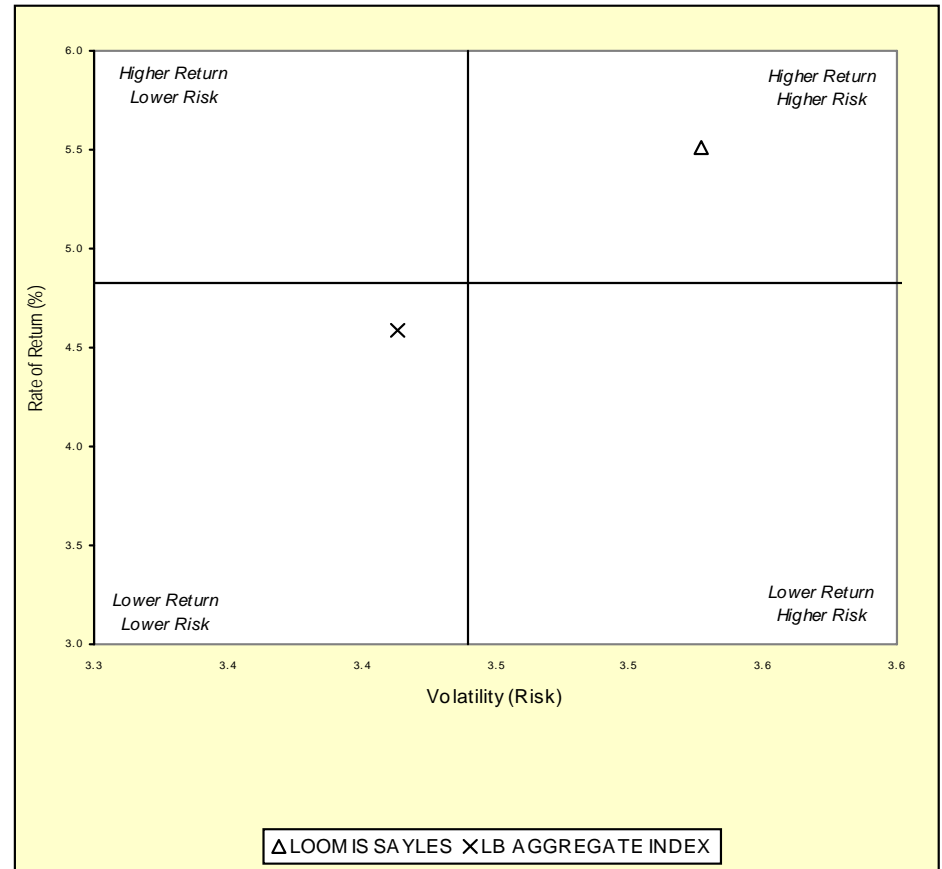
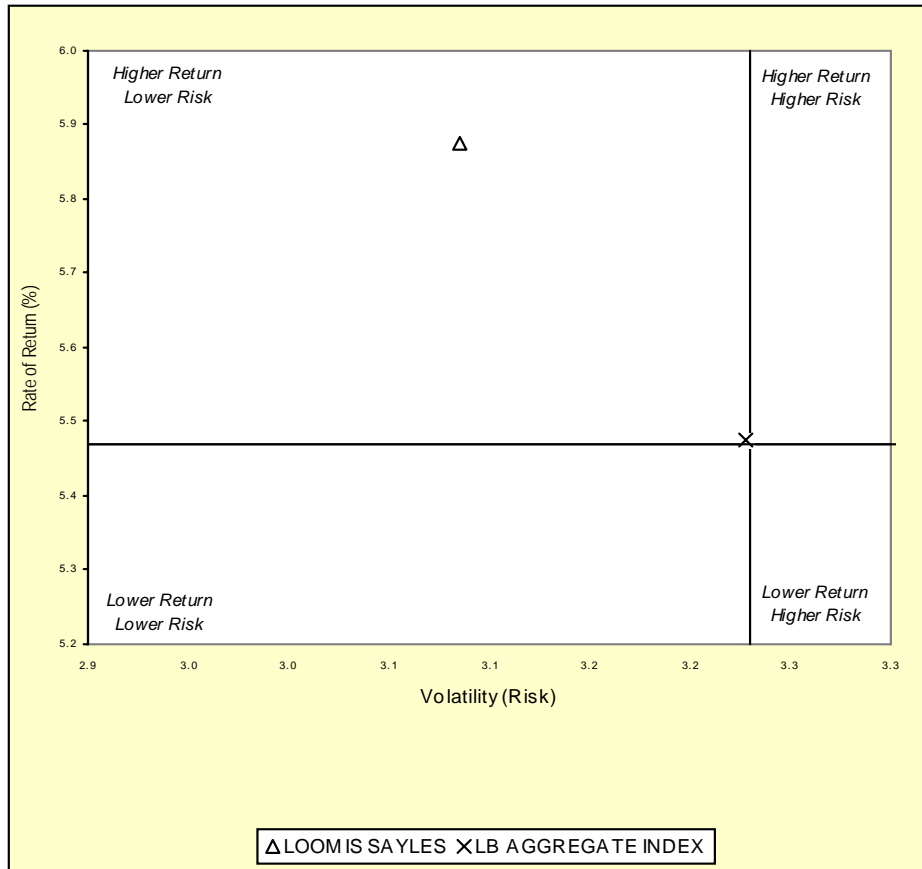

**Three Year Return vs Risk**

**Five Year Return vs Risk**

Annualized Return %	Standard Deviation %	Sharpe Ratio	Category	Annualized Return %	Standard Deviation %	Sharpe Ratio
5.9	3.1	0.5	LOOMIS SAYLES	5.5	3.5	0.7
5.5	3.2	0.3	Bond Funds Universe Median	4.8	3.4	0.5
5.5	3.2	0.3	LB AGGREGATE INDEX	4.6	3.4	0.4

# Fresno County Employees' Retirement Association

## Value Added Analysis 3 Yr Rolling for LOOMIS SAYLES

Period Ending: March 31, 2008

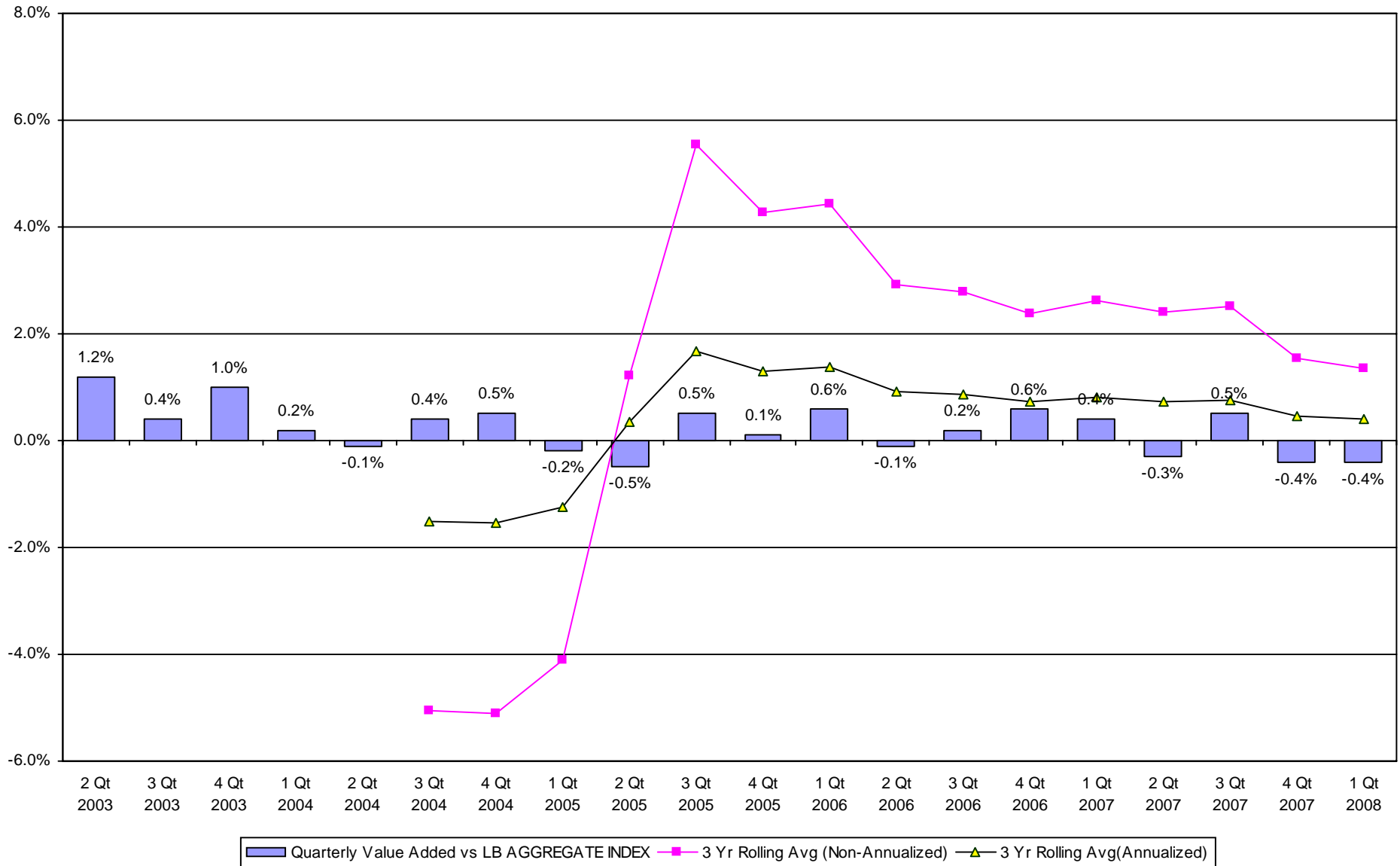

# Fresno County Employees' Retirement Association

## Rolling Return Ranking 3 & 5 Years

Period Ending: March 31, 2008

### Ranking Comparisons - Rolling 3 Years

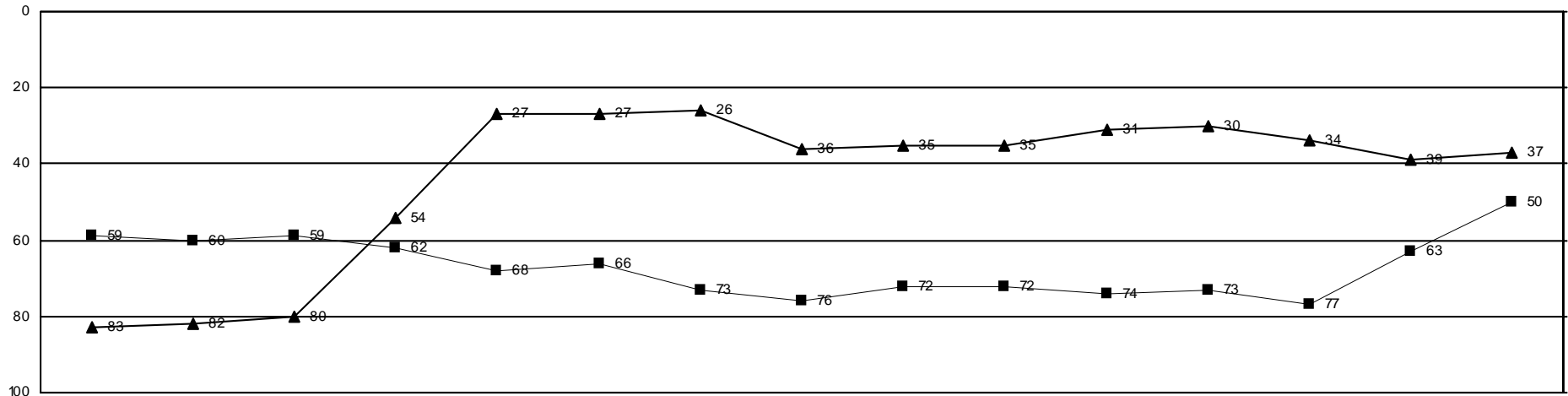

### Ranking Comparisons - Rolling 5 Years

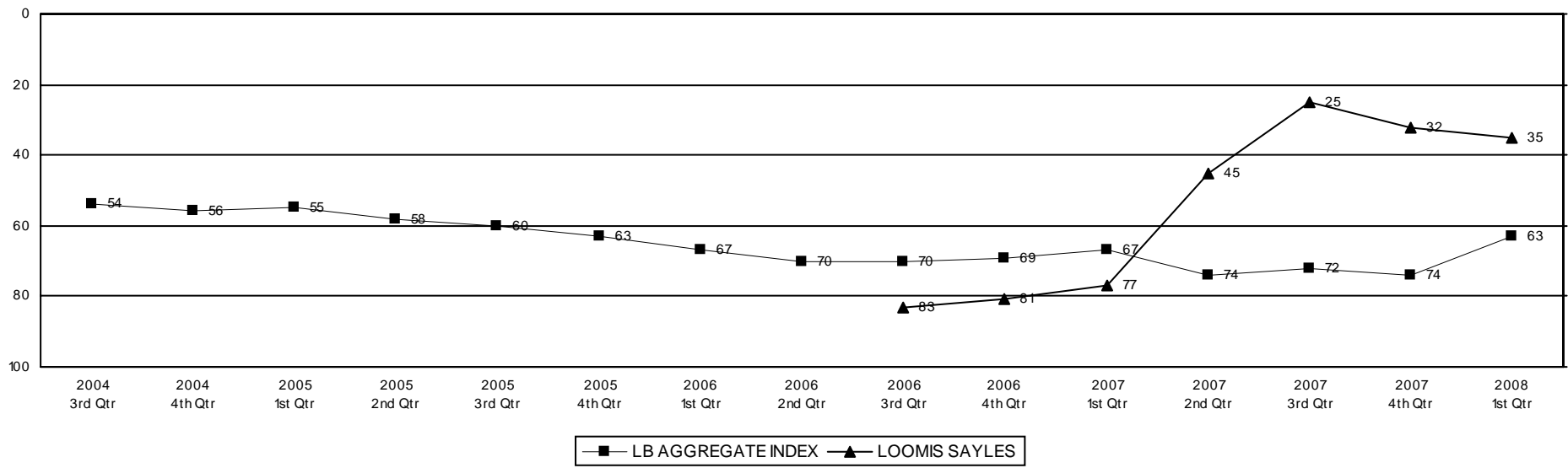

# Fresno County Employees' Retirement Association

## Up vs. Down Market Performance

Period Ending: March 31, 2008

Last 20 Quarters Ending 3/31/2008

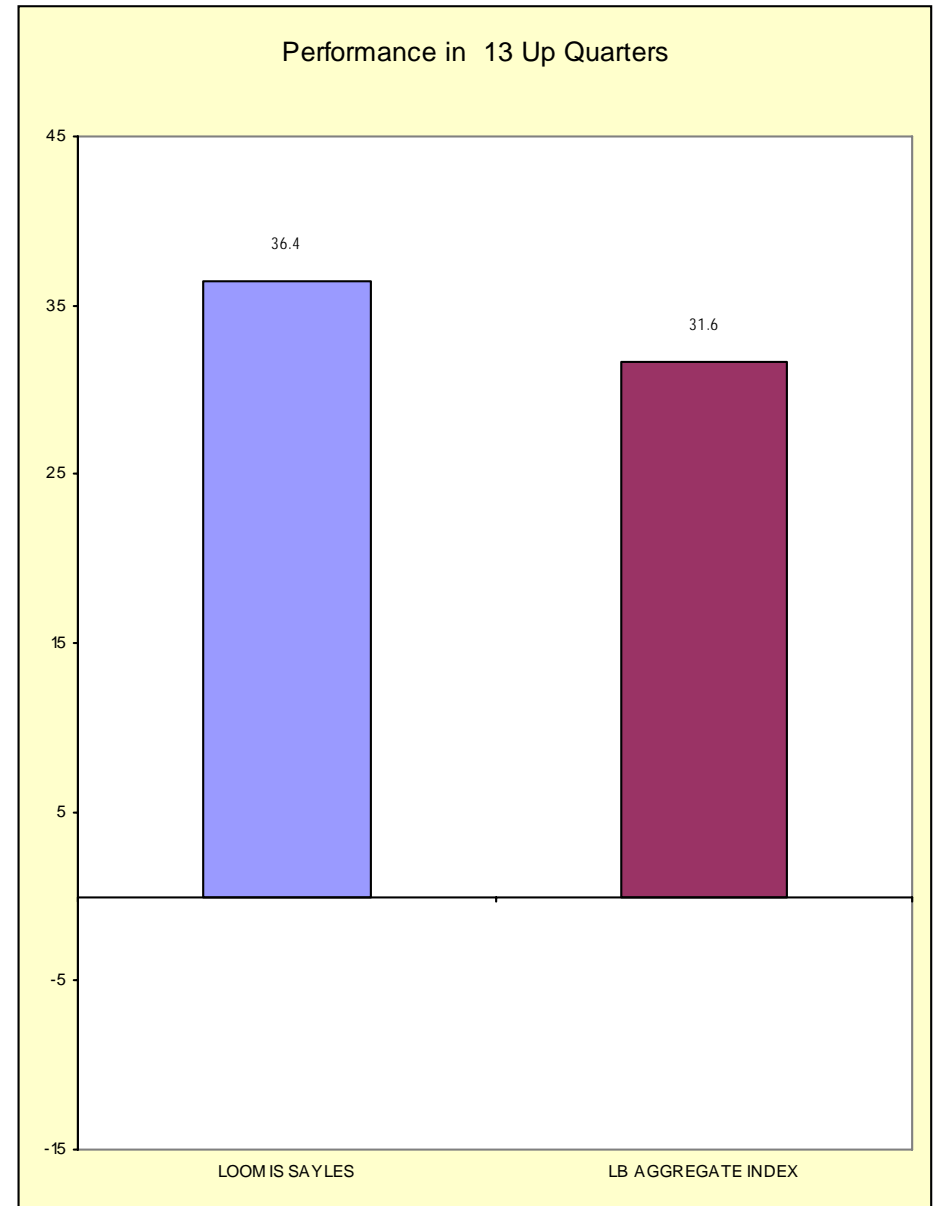
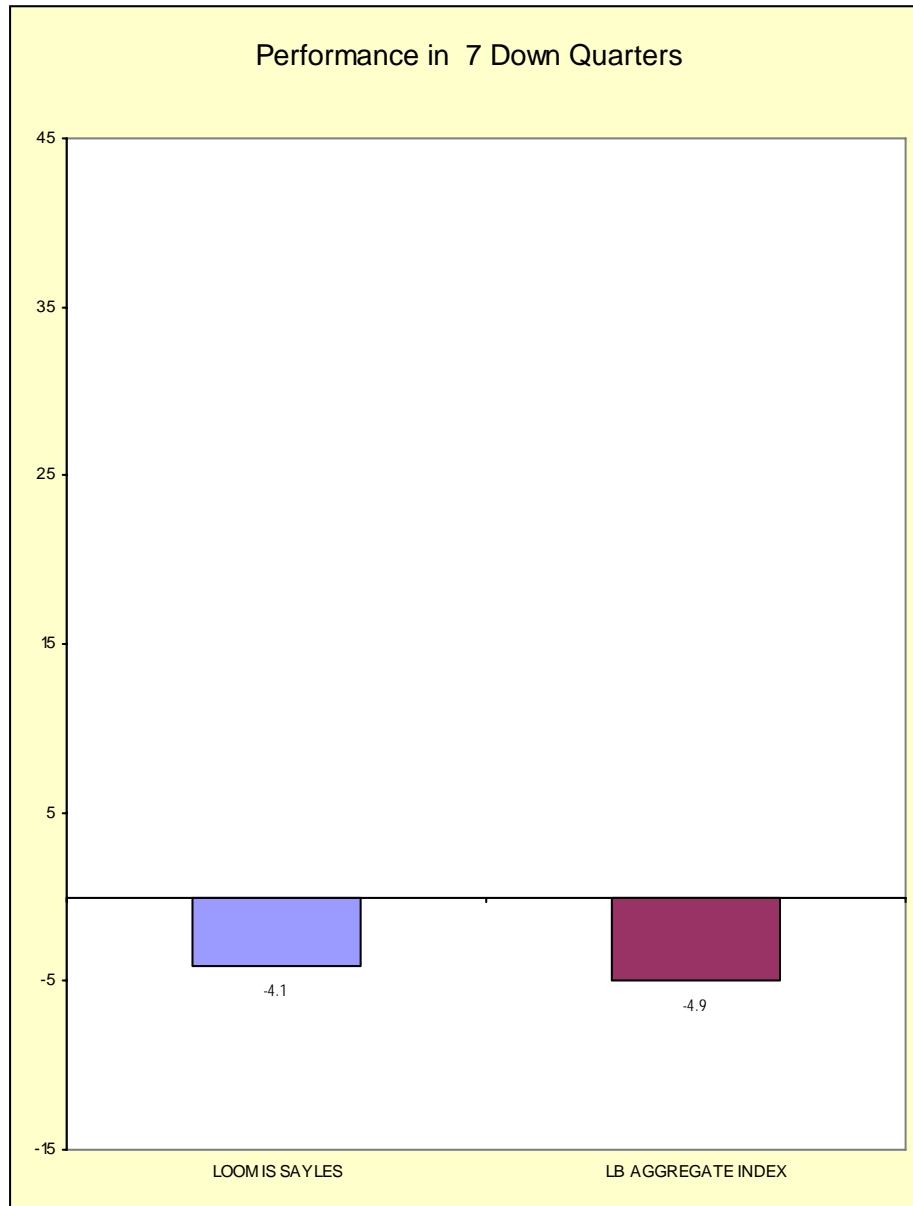

# FRESNO COUNTY EMPLOYEES RETIREMENT ASSO.

As of March 31, 2008

Bond Summary Statistics  
**LOOMIS, SAYLES & COMPANY, L.P.**

Portfolio Characteristics		
	Portfolio	LB AGGREGATE
Total Number of Securities	180	
Total Market Value	\$ 152,196,891	
Current Coupon	5.58	5.41
Yield To Maturity	5.97	4.55
Average Life	9.93	7.05
Duration	6.30	4.38
Quality	8.86	9.57

Duration (in Years)	
Range	%Held
0.0 to 1.0	4.1
1.0 to 3.0	10.6
3.0 to 4.0	12.8
4.0 to 6.0	20.9
6.0 to 8.0	13.9
Over 8.0	23.7
Unclassified	13.6

Quality	
Range	%Held
Govt (10)	44.9
Aaa (10)	12.5
Aa (9)	2.3
A (8)	5.0
Baa (7)	14.1
Below Baa	9.7
Other	11.5

Yield to Maturity	
Range	%Held
0.0 to 5.0	29.5
5.0 to 7.0	40.1
7.0 to 9.0	8.0
9.0 to 11.0	4.4
11.0 to 13.0	1.9
Over 13.0	2.5
Unclassified	13.6

Average Life	
Range	%Held
0.0 to 1.0	4.5
1.0 to 3.0	10.6
3.0 to 5.0	22.7
5.0 to 10.0	28.2
10.0 to 20.0	4.5
Over 20.0	15.9
Unclassified	13.6

Coupon	
Range	%Held
0.0 to 5.0	34.7
5.0 to 7.0	52.4
7.0 to 9.0	11.6
9.0 to 11.0	1.1
11.0 to 13.0	0.0
Over 13.0	0.0
Unclassified	0.2

# FRESNO COUNTY EMPLOYEES RETIREMENT ASSO.

As of March 31, 2008

## Fixed Income Sector Allocation LOOMIS, SAYLES & COMPANY, L.P.

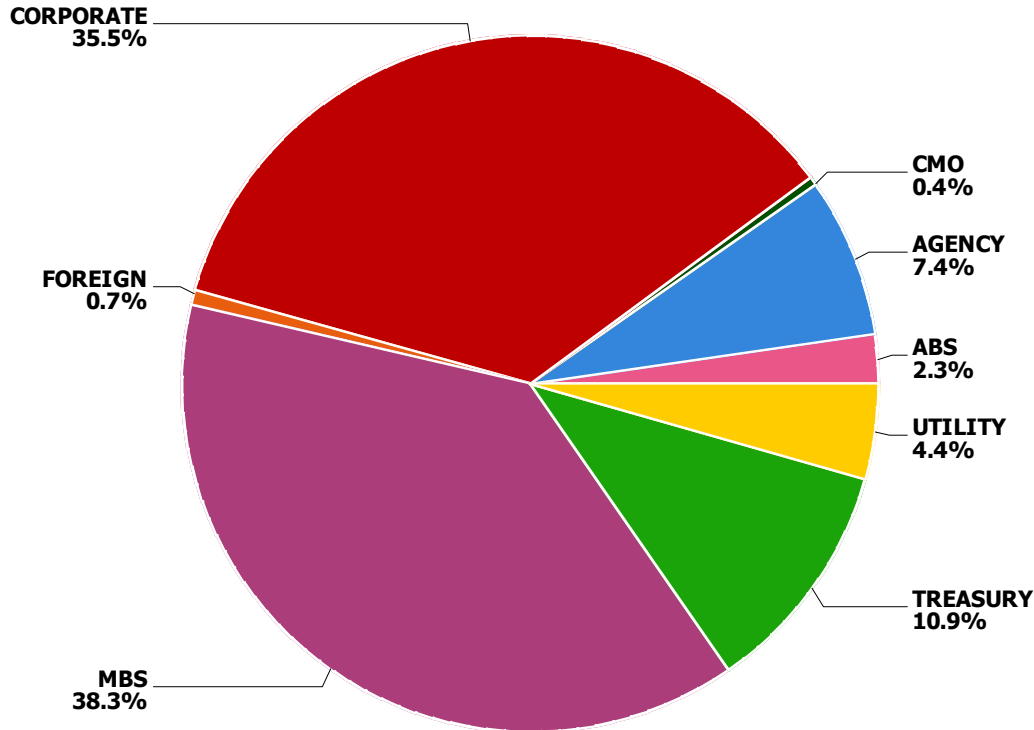

Sector	Account Weight	Index Weight	Difference
ABS	2.3%	6.2%	-3.9%
Agencies	7.4%	9.9%	-2.5%
CMO	0.4%	0.0%	0.4%
Corporates	35.5%	17.0%	18.5%
Foreign	0.7%	3.6%	-2.9%
MBS	38.3%	37.8%	0.5%
Municipals	0.0%	0.0%	0.0%
Others	0.0%	0.0%	0.0%
Treasuries	10.9%	23.5%	-12.5%
Utilities	4.4%	1.9%	2.5%
<b>Total</b>	<b>100.0%</b>	<b>100.0%</b>	<b>0.0%</b>

Benchmark: LB AGGREGATE



**FRESNO COUNTY EMPLOYEES RETIREMENT ASSO.**

As of March 31, 2008

**Bond Holdings  
LOOMIS, SAYLES & COMPANY, L.P.**

Bond Name	Market Value	Coupon	Stated Maturity	Quality Rating	Duration	Yield to Maturity
<b>0-5 Years</b>						
AMERICRDT_AUTO_2005-CF A3	135,908	4.47	5/06/10	AAA	N/A	N/A
CALENERGY INC	1,436,455	7.52	9/15/08	BAA1	0.45	4.06%
COLONIAL RLTY LTD PARTNERS	89,337	4.75	2/01/10	BAA3	1.72	5.63%
COX COMMUNICATIONS INC NEW	647,761	6.75	3/15/11	BAA3	2.67	5.21%
DUKE ENERGY CORP	645,444	4.20	10/01/08	A3	0.48	3.48%
FISERV INC	1,173,874	6.13	11/20/12	BAA2	3.96	5.37%
GENERAL ELECTRIC CAP	2,809,137	5.50	10/14/08		N/A	N/A
GMAC LLC	1,121,467	6.63	5/15/12	B1	3.27	14.70%
GOLDMAN SACHS GROUP INC	571,164	5.30	2/14/12	AA3	3.47	4.92%
HONDA_AUTO_2005-003- A4	1,219,786	4.03	12/18/10	AAA	0.85	3.72%
HOUSEHOLD INTL INC	651,884	8.00	7/15/10	AA3	2.06	5.39%
INTER AMERN DEV BK	1,104,738	1.90	7/08/09		N/A	N/A
IPALCO ENTERPRISES INC	595,159	8.38	11/14/08	BA1	0.58	6.27%
ISTAR FINL INC	332,256	4.88	1/15/09	BAA2	0.71	19.09%
ISTAR FINL INC	195,428	6.00	12/15/10	BAA2	2.28	16.38%
KFW INTL FINANCE	4,195,888	2.05	9/21/09		N/A	N/A
LEHMAN BROS HLDGS INC MEDI	752,107	5.63	1/24/13	A1	4.14	6.30%
MERRILL LYNCH CO INC MTN B	1,141,187	5.45	2/05/13	A1	4.20	5.83%
MORGAN STANLEY	697,529	4.00	1/15/10	AA3	1.70	4.70%
NGPL PIPECO LLC	1,162,302	6.51	12/15/12	BAA3	3.99	5.57%
OEST KONTROLLBANK	2,275,921	1.80	3/22/10		N/A	N/A
PEMEX PROJ FDG MASTER TR	1,075,026	7.88	2/01/09	BAA1	0.81	3.48%
SOUTHERN CALIF EDISON CO	501,873	7.63	1/15/10	A3	1.66	3.93%
SPRINT CAP CORP	594,149	6.13	11/15/08	BAA3	0.59	7.36%
STEEL DYNAMICS INC 144A	621,550	7.38	11/01/12	BA2	3.74	7.11%
VALEANT PHARMACEUTICALS IN	520,614	7.00	12/15/11	BA3	3.13	8.52%

**FRESNO COUNTY EMPLOYEES RETIREMENT ASSO.**

As of March 31, 2008

**Bond Holdings  
LOOMIS, SAYLES & COMPANY, L.P.**

Bond Name	Market Value	Coupon	Stated Maturity	Quality Rating	Duration	Yield to Maturity
<b>WFS_OWNER_TR_2004-004- A4</b>	313,131	3.44	5/17/12	AAA	0.45	2.61%
	26,581,077	4.92			2.27	6.21%
<b>5-10 Years</b>						
<b>AES CORP</b>	640,127	8.00	10/15/17	B1	6.65	7.81%
<b>AES CORP</b>	318,187	7.75	10/15/15	B1	5.63	7.62%
<b>CHESAPEAKE ENERGY CORP</b>	184,928	6.50	8/15/17	BA3	7.03	7.01%
<b>CIT GROUP INC</b>	16,009	5.40	1/30/16	A3	6.08	9.19%
<b>CIT GROUP INC</b>	97,873	5.65	2/13/17	A3	6.63	9.44%
<b>COLONIAL RLTY LTD PARTNERS</b>	607,450	5.50	10/01/15	BAA3	5.71	9.42%
<b>DEAN FOODS CO NEW</b>	345,858	7.00	6/01/16	B3	5.92	9.21%
<b>ENERSIS S A</b>	688,001	7.38	1/15/14	BAA3	4.74	5.28%
<b>FNMA POOL - 545015</b>	144,098	6.00	6/01/16	GOVT	2.23	4.64%
<b>FNMA POOL - 545732</b>	642,265	5.50	5/01/17	GOVT	2.42	4.54%
<b>FNMA POOL - 676653</b>	445,696	6.00	12/01/17	GOVT	2.17	4.74%
<b>FORD MOTOR CR CO</b>	580,580	8.00	12/15/16	B1	5.71	12.10%
<b>FREESCALE SEMICONDUCTOR IN</b>	818,287	10.13	12/15/16	B3	4.79	17.53%
<b>GENERAL ELEC CAP CORP MTN</b>	3,123,436	5.63	9/15/17	AAA	7.52	5.31%
<b>HOSPIRA INC</b>	312,258	6.05	3/30/17	BAA3	7.05	6.18%
<b>INTERNATIONAL LEASE FIN CO</b>	279,507	5.88	5/01/13	A1	4.27	6.06%
<b>JP MORGAN CHASE &amp; CO</b>	805,337	6.00	1/15/18	AA2	7.53	5.43%
<b>MEDCO HEALTH SOLUTIONS INC</b>	657,103	7.25	8/15/13	BAA3	4.51	4.62%
<b>NABORS INDS INC</b>	180,371	6.15	2/15/18	A3	7.56	5.83%
<b>NEXTEL COMMUNICATIONS INC</b>	7,823	7.38	8/01/15	BAA3	5.24	12.21%
<b>NEXTEL COMMUNICATIONS INC</b>	3,713	5.95	3/15/14	BAA3	4.69	12.22%
<b>SLM CORP MTN BOOK ENTRY</b>	19,269	5.38	5/15/14	BAA2	4.81	11.10%

**FRESNO COUNTY EMPLOYEES RETIREMENT ASSO.**

As of March 31, 2008

**Bond Holdings  
LOOMIS, SAYLES & COMPANY, L.P.**

Bond Name	Market Value	Coupon	Stated Maturity	Quality Rating	Duration	Yield to Maturity
SLM CORP MTN BOOK ENTRY	104,990	5.00	10/01/13	BAA2	4.41	11.13%
SLM CORP MTN BOOK ENTRY	132,404	5.00	4/15/15	BAA2	5.41	10.97%
SLM CORP MTN BOOK ENTRY	119,439	5.05	11/14/14	BAA2	5.18	10.95%
TRUE MOVE COMPANY LTD	883,932	10.75	12/16/13	B1	4.03	12.23%
U S G CORP	594,074	6.30	11/15/16	BA2	6.18	9.99%
UNITED STATES TREAS NTS	789,506	4.63	2/15/17	AAA	7.55	3.33%
UNITED STATES TREAS NTS	2,361,083	4.25	11/15/17	GOVT	8.11	3.43%
UNITED STATES TREAS NTS	461,650	4.75	8/15/17	AAA	7.88	3.41%
UNITED STATES TREAS NTS	5,106,582	3.50	2/15/18	GOVT	8.61	3.43%
WILLIS NORTH AMER INC	309,523	6.20	3/28/17	BAA2	7.01	6.23%
XEROX CORP	614,125	6.40	3/15/16	BAA2	6.34	5.85%
	22,395,485	5.67			6.80	6.00%

**10-20 Years**

CATERPILLAR FINL SVCS MTNS	1,552,324	5.45	4/15/18	A2	7.96	5.22%
CHESAPEAKE ENERGY CORP	244,013	6.88	11/15/20	BA3	8.33	7.24%
CITIZENS COMMUNICATIONS CO	773,601	7.88	1/15/27	BA2	9.03	9.51%
COLUMBIA HEALTHCARE CORP	266,403	7.50	12/15/23	CAA1	8.21	10.28%
CWABS_HEL_2004-S1- A2	110,941	3.87	3/25/20	AAA	1.18	8.32%
FHLMC GOLD POOL - B12461	480,433	5.50	11/01/18	GOVT	2.13	4.68%
FHLMC GOLD POOL - B15658	640,045	4.00	7/01/19	GOVT	3.95	4.78%
FHLMC GOLD POOL - E01490	1,858,707	5.00	11/01/18	GOVT	2.51	4.49%
FHLMC GOLD POOL - E01653	598,116	4.50	6/01/19	GOVT	3.42	4.63%
FNMA POOL - 705709	484,894	5.00	5/01/18	GOVT	2.47	4.44%
FNMA POOL - 767097	238,938	4.00	6/01/19	GOVT	3.92	4.69%
FNMA POOL - 885504	700,642	6.00	6/01/21	GOVT	1.49	4.23%

**FRESNO COUNTY EMPLOYEES RETIREMENT ASSO.**

As of March 31, 2008

**Bond Holdings  
LOOMIS, SAYLES & COMPANY, L.P.**

Bond Name	Market Value	Coupon	Stated Maturity	Quality Rating	Duration	Yield to Maturity
GEORGIA PAC CORP	439,476	8.00	1/15/24	B2	8.45	9.48%
GEORGIA PAC CORP	132,460	7.38	12/01/25	B2	8.95	9.36%
GOLDMAN SACHS GROUP INC	973,553	6.15	4/01/18	N/A	7.63	6.17%
NORTHERN TELECOM CAP CORP	359,744	7.88	6/15/26	B3	7.20	13.43%
NORTHERN TELECOM LTD	124,146	6.88	9/01/23	NR	7.70	12.59%
SK TELECOM LTD 144A	1,018,331	6.63	7/20/27	A2	10.95	6.78%
SLM CORP MTN BOOK ENTRY	54,729	5.00	6/15/18	BAA2	7.17	10.95%
SPRINT CAP CORP	12,244	6.90	5/01/19	BAA3	7.07	10.13%
U S WEST CAPITAL FUNDING I	262,885	6.50	11/15/18	B1	7.15	9.36%
US WEST COMMUNICATIONS INC	222,029	7.20	11/10/26	BA1	9.26	8.95%
US WEST COMMUNICATIONS INC	694,212	7.25	9/15/25	BA1	9.45	8.71%
	12,242,865	5.97			6.14	6.49%

**Over 20 Years**

ANADARKO PETE CORP	40,849	6.45	9/15/36	BAA3	N/A	N/A
BA_MTG_CMBS_2005-006- A2	438,755	5.17	9/10/47	AAA	N/A	N/A
BA_MTG_CMBS_2006-1- A2	501,716	5.33	9/10/45	AAA	N/A	N/A
BA_MTG_CMBS_2007-002- A2	968,424	5.63	4/10/49		N/A	N/A
BEAR_STEARNS_05-PWR10- A2	694,740	5.27	12/11/40	N/A	2.41	5.61%
BEAR_STEARNS_2006-PWR1 A4	1,338,000	5.71	9/11/38	AAA	6.28	5.74%
CD_MTG_2006-CD2- A2	407,939	5.41	1/15/46	AAA	2.55	5.94%
CIT GROUP INC	311,600	6.00	4/01/36	A3	11.05	8.33%
CITIGROUP INC	823,492	6.88	3/05/38	AA3	12.68	6.88%
COMCAST CORP NEW	1,440,512	6.95	8/15/37	BAA2	12.52	6.93%
COMM_MTG_2006-C7- A4	1,331,935	5.77	6/10/46	N/A	6.06	5.75%
CORNING INC	734,374	7.25	8/15/36	BAA1	11.25	6.51%

**FRESNO COUNTY EMPLOYEES RETIREMENT ASSO.**

As of March 31, 2008

**Bond Holdings  
LOOMIS, SAYLES & COMPANY, L.P.**

Bond Name	Market Value	Coupon	Stated Maturity	Quality Rating	Duration	Yield to Maturity
CRANE CO	992,422	6.55	11/15/36	BAA2	12.15	7.13%
CWABS_HEL_2004-S1- A3	327,521	4.62	2/25/35	AAA	5.36	8.82%
CWHEQ_HEL_TR_2006-S04- A3	1,043,335	5.80	7/25/34	AAA	6.71	14.53%
EMBARQ CORP	1,588,443	7.99	6/01/36	BAA3	10.24	8.83%
EQUIFAX INC	464,390	7.00	7/01/37	BAA1	11.40	7.94%
<b>FHLMC POOL - 782760</b>	1,187,873	5.95	11/01/36	GOVT	2.05	4.86%
<b>FHLMC GOLD POOL - A36141</b>	2,340,361	5.00	7/01/35	GOVT	5.20	5.17%
<b>FHLMC GOLD POOL - A38136</b>	2,186,905	5.00	10/01/35	GOVT	5.36	5.22%
<b>FHLMC GOLD POOL - A46044</b>	1,858,918	5.00	7/01/35	GOVT	5.10	5.22%
<b>FHLMC GOLD POOL - A46224</b>	417,758	5.00	7/01/35	GOVT	5.11	5.22%
<b>FHLMC GOLD POOL - A61786</b>	170,466	5.00	6/01/37	GOVT	5.39	5.20%
<b>FHLMC GOLD POOL - A67787</b>	519,089	5.00	4/01/37	GOVT	5.26	5.20%
<b>FHLMC GOLD POOL - C75066</b>	202,105	6.00	12/01/32	GOVT	3.96	5.15%
<b>FHLMC GOLD POOL - G01760</b>	967,422	4.50	12/01/34	GOVT	6.34	5.17%
<b>FHLMC GOLD POOL - G01843</b>	394,806	6.00	6/01/35	GOVT	2.97	5.07%
<b>FHLMC GOLD POOL - G02717</b>	1,094,069	5.50	2/01/37	GOVT	3.80	5.09%
<b>FNMA POOL - 922881</b>	954,750	6.05	2/01/37	GOVT	1.26	4.48%
<b>FNMA POOL - 252717</b>	15,702	7.50	9/01/29	GOVT	2.63	5.17%
<b>FNMA POOL - 256514</b>	1,348,587	6.00	12/01/36	GOVT	2.82	4.78%
<b>FNMA POOL - 357856</b>	2,346,794	5.00	7/01/35	GOVT	5.19	5.15%
<b>FNMA POOL - 545076</b>	201,709	7.50	7/01/31	GOVT	2.65	5.17%
<b>FNMA POOL - 545082</b>	43,504	7.50	6/01/31	GOVT	2.73	5.09%
<b>FNMA POOL - 545490</b>	66,386	7.50	3/01/32	GOVT	2.65	5.09%
<b>FNMA POOL - 555800</b>	1,051,695	5.50	10/01/33	GOVT	4.28	5.07%
<b>FNMA POOL - 555967</b>	457,088	5.50	11/01/33	GOVT	4.27	5.07%
<b>FNMA POOL - 569972</b>	44,541	7.50	3/01/31	GOVT	2.69	5.09%

**FRESNO COUNTY EMPLOYEES RETIREMENT ASSO.**

As of March 31, 2008

**Bond Holdings  
LOOMIS, SAYLES & COMPANY, L.P.**

Bond Name	Market Value	Coupon	Stated Maturity	Quality Rating	Duration	Yield to Maturity
<b>FNMA POOL - 575078</b>	140,642	6.50	5/01/31	GOVT	3.31	5.07%
<b>FNMA POOL - 669713</b>	1,137,635	6.00	11/01/32	GOVT	4.16	5.14%
<b>FNMA POOL - 688539</b>	485,119	5.50	3/01/33	GOVT	4.40	5.07%
<b>FNMA POOL - 723837</b>	269,614	5.50	6/01/33	GOVT	4.18	5.07%
<b>FNMA POOL - 725690</b>	1,363,818	6.00	8/01/34	GOVT	3.36	5.07%
<b>FNMA POOL - 766715</b>	505,568	5.50	3/01/34	GOVT	4.55	5.13%
<b>FNMA POOL - 772618</b>	1,182,882	5.50	8/01/34	GOVT	4.05	5.13%
<b>FNMA POOL - 783646</b>	1,233,615	5.50	6/01/34	GOVT	4.15	5.13%
<b>FNMA POOL - 796569</b>	496,249	6.50	9/01/34	GOVT	2.75	5.13%
<b>FNMA POOL - 807735</b>	483,936	5.50	12/01/34	GOVT	4.11	5.15%
<b>FNMA POOL - 822979</b>	837,223	5.50	4/01/35	GOVT	4.18	5.15%
<b>FNMA POOL - 824239</b>	690,358	5.50	4/01/35	GOVT	4.24	5.15%
<b>FNMA POOL - 830704</b>	735,591	5.50	7/01/35	GOVT	4.16	5.13%
<b>FNMA POOL - 834626</b>	1,429,425	5.50	8/01/35	GOVT	4.25	5.13%
<b>FNMA POOL - 835751</b>	1,091,034	4.50	8/01/35	GOVT	6.46	5.18%
<b>FNMA POOL - 835760</b>	2,095,189	4.50	9/01/35	GOVT	6.38	5.18%
<b>FNMA POOL - 848647</b>	1,079,551	5.50	1/01/36	GOVT	3.93	5.13%
<b>FNMA POOL - 868678</b>	85,357	6.50	4/01/36	GOVT	2.57	4.43%
<b>FNMA POOL - 880857</b>	334,430	6.50	4/01/36	GOVT	2.49	4.80%
<b>FNMA POOL - 956232</b>	1,919,098	6.50	11/01/37	GOVT	3.03	4.84%
<b>FORD MTR CO DEL</b>	591,081	7.45	7/16/31	CAA1	8.30	11.74%
<b>GENERAL MTRS ACCEP CORP</b>	648,772	8.00	11/01/31	B1	8.14	11.51%
<b>GEORGIA PAC CORP</b>	821,940	8.88	5/15/31	B2	8.80	10.11%
<b>GNMA 30YR 5.00% TBA - APR</b>	3,979,789	5.00	6/01/37	GOVT	N/A	N/A
<b>GNMA 30YR 5.50% TBA - APR</b>	3,869,900	5.50	6/01/37	GOVT	N/A	N/A
<b>GNMA POOL - 003515</b>	387,232	5.50	2/20/34	GOVT	3.88	4.75%

**FRESNO COUNTY EMPLOYEES RETIREMENT ASSO.**

As of March 31, 2008

**Bond Holdings  
LOOMIS, SAYLES & COMPANY, L.P.**

Bond Name	Market Value	Coupon	Stated Maturity	Quality Rating	Duration	Yield to Maturity
GNMA POOL - 003736	742,419	5.50	7/20/35	GOVT	3.69	4.76%
GNMA POOL - 563646	62,900	6.50	9/15/32	GOVT	4.04	5.20%
GNMA POOL - 587280	129,729	6.50	9/15/32	GOVT	4.19	5.20%
GNMA POOL - 676462	2,929,339	6.00	11/15/37	GOVT	3.69	4.87%
GNMA POOL - 676600	2,949,275	6.00	11/15/37	GOVT	3.70	4.87%
GNMA POOL - 683922	1,537,029	5.50	2/15/38	GOVT	4.95	4.87%
GREENWICH_CAP_2005-GG5 A2	978,127	5.12	4/10/37	AAA	2.20	5.54%
GS_MTG_SEC_2005-GG4- A4A	745,419	4.75	7/10/39	AAA	5.75	5.44%
JP_MORGN_MTG_2006-A7- 1A3	573,091	5.93	1/25/37	AAA	-1.01	3.97%
KRAFT FOODS INC	864,223	6.88	2/01/38	BAA2	12.36	7.00%
KROGER CO	1,173,476	6.90	4/15/38	BAA2	12.85	6.78%
LB_UBS_CMBS_2005-C3- A3	841,517	4.65	7/15/30	AAA	3.00	5.79%
MLCC_MTG_TR_2006-C1- A4	743,367	5.84	5/12/39	N/A	6.13	5.74%
MORG_ST_CAP_2005-TOP19 A4A	1,225,173	4.89	6/12/47	N/A	5.74	5.48%
MOTOROLA INC	48,286	6.50	11/15/28	BAA1	9.93	8.83%
MOTOROLA INC	64,086	6.63	11/15/37	BAA1	10.60	8.78%
OWENS CORNING NEW	544,894	7.00	12/01/36	BA1	9.59	9.93%
PITNEY BOWES INC GLBL MTN	1,145,913	5.25	1/15/37	A1	7.58	5.40%
RASC_2003-KS10- AI4	374,788	4.47	3/25/32	AAA	1.71	7.56%
REYNOLDS AMERICAN INC	1,142,716	7.25	6/15/37	BA1	11.87	7.33%
SLM CORP MTN BOOK ENTRY	196,525	5.63	8/01/33	BAA2	10.94	8.77%
SPRINT CAP CORP	1,418,589	6.88	11/15/28	BAA3	9.26	9.77%
TEPPCO PARTNERS L P	776,984	7.55	4/15/38	BAA3	11.96	7.48%
TIME WARNER CABLE INC	784,788	6.55	5/01/37	N/A	12.30	7.00%
UNITED STATES STL CORP NEW	563,855	6.65	6/01/37	BAA3	11.34	8.03%
UNITED STATES TREAS BDS	1,615,231	4.50	2/15/36	AAA	16.40	4.29%

**FRESNO COUNTY EMPLOYEES RETIREMENT ASSO.**

As of March 31, 2008

**Bond Holdings  
LOOMIS, SAYLES & COMPANY, L.P.**

<b>Bond Name</b>	<b>Market Value</b>	<b>Coupon</b>	<b>Stated Maturity</b>	<b>Quality Rating</b>	<b>Duration</b>	<b>Yield to Maturity</b>
<b>UNITED STATES TREAS BDS</b>	540,960	5.38	2/15/31	GOVT	14.29	4.29%
<b>UNITED STATES TREAS BONDS</b>	3,637,219	4.38	2/15/38	AAA	17.02	4.30%
<b>UNITED STATES TREAS BONDS</b>	813,404	5.00	5/15/37	GOVT	16.20	4.28%
<b>UNITED STATES TREAS BONDS</b>	1,281,636	4.75	2/15/37	GOVT	16.48	4.29%
<b>US WEST COMMUNICATIONS INC</b>	321,911	7.25	10/15/35	BA1	9.91	8.97%
<b>WEATHERFORD INTL LTD</b>	674,524	6.50	8/01/36	BAA1	12.57	6.88%
	90,655,414	5.70			6.99	5.83%



# Fresno County Employees' Retirement Association

## Cumulative Performance Comparisons

Period Ending: March 31, 2008

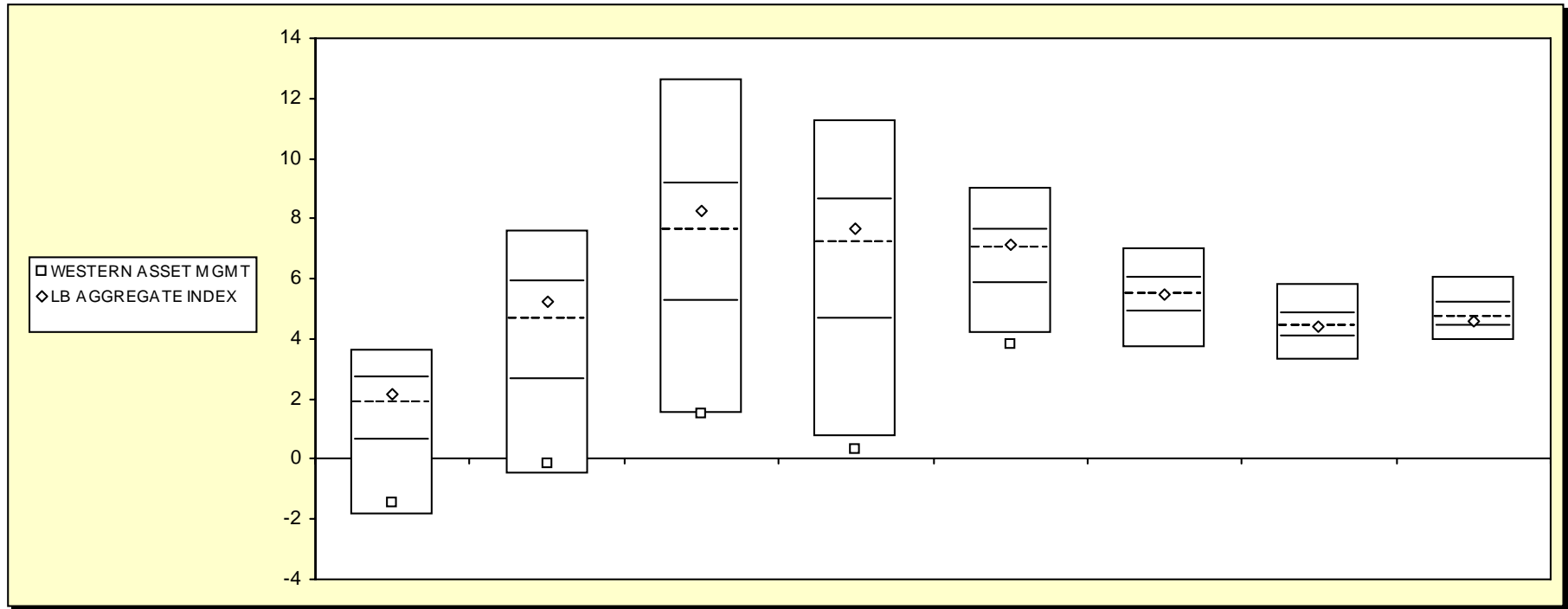

### Bond Style - Core

	Last Quarter		Two Quarters		Three Quarters		One Year		Two Years		Three Years		Four Years		Five Years	
	Return	Rank	Return	Rank	Return	Rank	Return	Rank	Return	Rank	Return	Rank	Return	Rank	Return	Rank
5th Percentile	3.6		7.6		12.7		11.3		9.0		7.0		5.9		6.1	
25th Percentile	2.7		5.9		9.1		8.6		7.6		6.0		4.8		5.2	
50th Percentile	1.9		4.7		7.6		7.2		7.0		5.5		4.4		4.7	
75th Percentile	0.6		2.7		5.3		4.6		5.8		4.9		4.1		4.4	
95th Percentile	-1.9		-0.5		1.5		0.7		4.2		3.7		3.3		3.9	
WESTERN ASSET MGMT	-1.5	92	-0.2	93	1.5	95	0.3	95	3.8	96			4.4	52	4.6	62
LB AGGREGATE INDEX	2.2	41	5.2	38	8.2	39	7.7	42	7.1	45	5.5	51	4.4	52	4.6	62

# Fresno County Employees' Retirement Association

## Consecutive Performance Comparisons

Period Ending: March 31, 2008

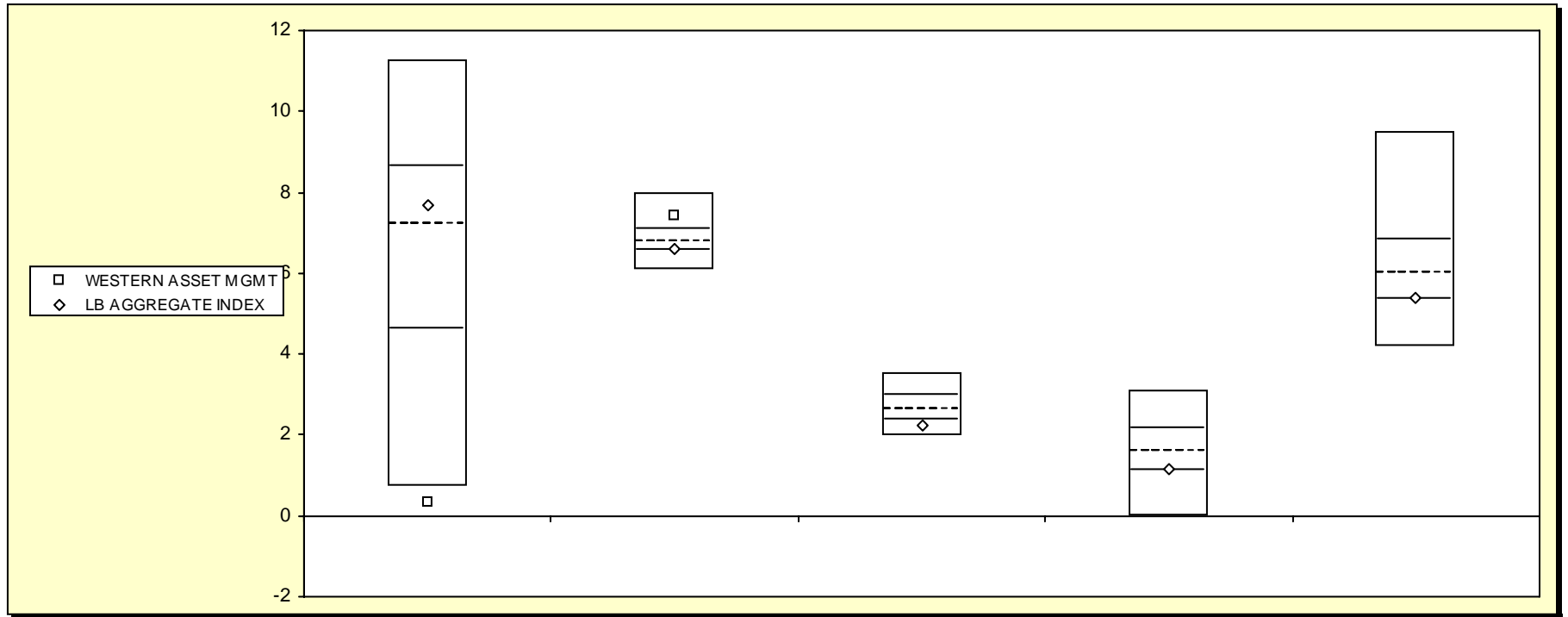

### Bond Style - Core

	March 2008		March 2007		March 2006		March 2005		March 2004	
	Return	Rank	Return	Rank	Return	Rank	Return	Rank	Return	Rank
5th Percentile	11.3		8.0		3.5		3.1		9.5	
25th Percentile	8.6		7.1		3.0		2.2		6.8	
50th Percentile	7.2		6.8		2.6		1.6		6.0	
75th Percentile	4.6		6.6		2.4		1.1		5.3	
95th Percentile	0.7		6.1		2.0		0.0		4.2	
WESTERN ASSET MGMT	0.3	95	7.4	18			1.2	72		
LB AGGREGATE INDEX	7.7	42	6.6	72	2.3	80			5.4	72

# Fresno County Employees' Retirement Association

Consecutive Annual - Five Year

Period Ending: March 31, 2008

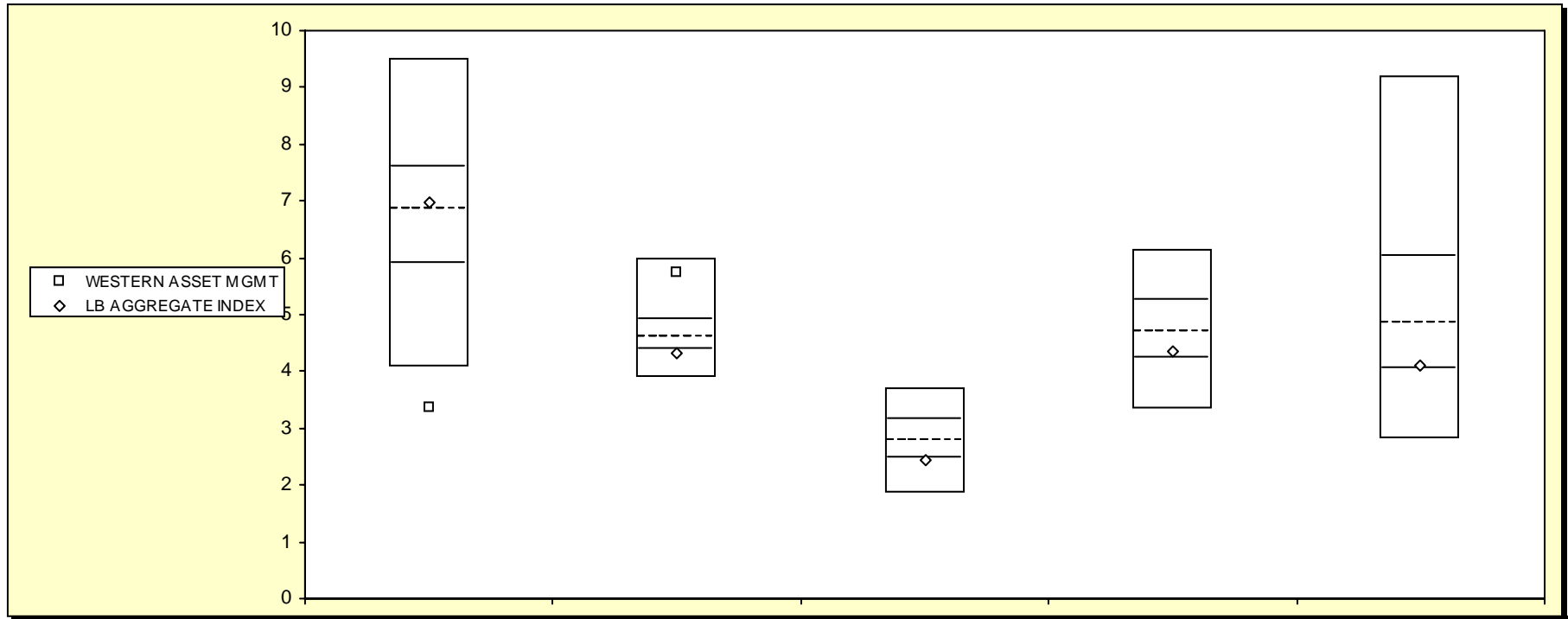

Bond Style - Core

	December 2007		December 2006		December 2005		December 2004		December 2003	
	Return	Rank	Return	Rank	Return	Rank	Return	Rank	Return	Rank
5th Percentile	9.5		6.0		3.7		6.1		9.2	
25th Percentile	7.6		4.9		3.2		5.3		6.0	
50th Percentile	6.9		4.6		2.8		4.7		4.8	
75th Percentile	5.9		4.4		2.5		4.2		4.0	
95th Percentile	4.1		3.9		1.9		3.3		2.8	
WESTERN ASSET MGMT	3.4	97	5.7	10						
LB AGGREGATE INDEX	7.0	46	4.3	77	2.4	76	4.3	70	4.1	73

# FRESNO COUNTY EMPLOYEES RETIREMENT ASSO.

As of March 31, 2008

# Bond Summary Statistics WESTERN ASSET MANAGEMENT

Portfolio Characteristics		
	Portfolio	LB AGGREGATE
Total Number of Securities	226	
Total Market Value	\$ 196,973,571	
Current Coupon	2.25	5.41
Yield To Maturity	7.54	4.55
Average Life	9.81	7.05
Duration	6.24	4.38
Quality	7.97	9.57

Duration (in Years)	
Range	%Held
0.0 to 1.0	3.9
1.0 to 3.0	4.6
3.0 to 4.0	3.7
4.0 to 6.0	10.1
6.0 to 8.0	6.2
Over 8.0	9.0
Unclassified	62.4

Quality	
Range	%Held
Govt (10)	5.9
Aaa (10)	7.4
Aa (9)	2.4
A (8)	3.4
Baa (7)	11.1
Below Baa	5.9
Other	63.8

Yield to Maturity	
Range	%Held
0.0 to 5.0	7.5
5.0 to 7.0	17.0
7.0 to 9.0	4.8
9.0 to 11.0	2.1
11.0 to 13.0	3.4
Over 13.0	2.7
Unclassified	62.4

Average Life	
Range	%Held
0.0 to 1.0	3.3
1.0 to 3.0	3.5
3.0 to 5.0	6.0
5.0 to 10.0	14.5
10.0 to 20.0	3.4
Over 20.0	7.0
Unclassified	62.4

Coupon	
Range	%Held
0.0 to 5.0	73.5
5.0 to 7.0	19.3
7.0 to 9.0	7.0
9.0 to 11.0	0.2
11.0 to 13.0	0.1
Over 13.0	0.0
Unclassified	0.0

# FRESNO COUNTY EMPLOYEES RETIREMENT ASSO.

As of March 31, 2008

## Fixed Income Sector Allocation WESTERN ASSET MANAGEMENT

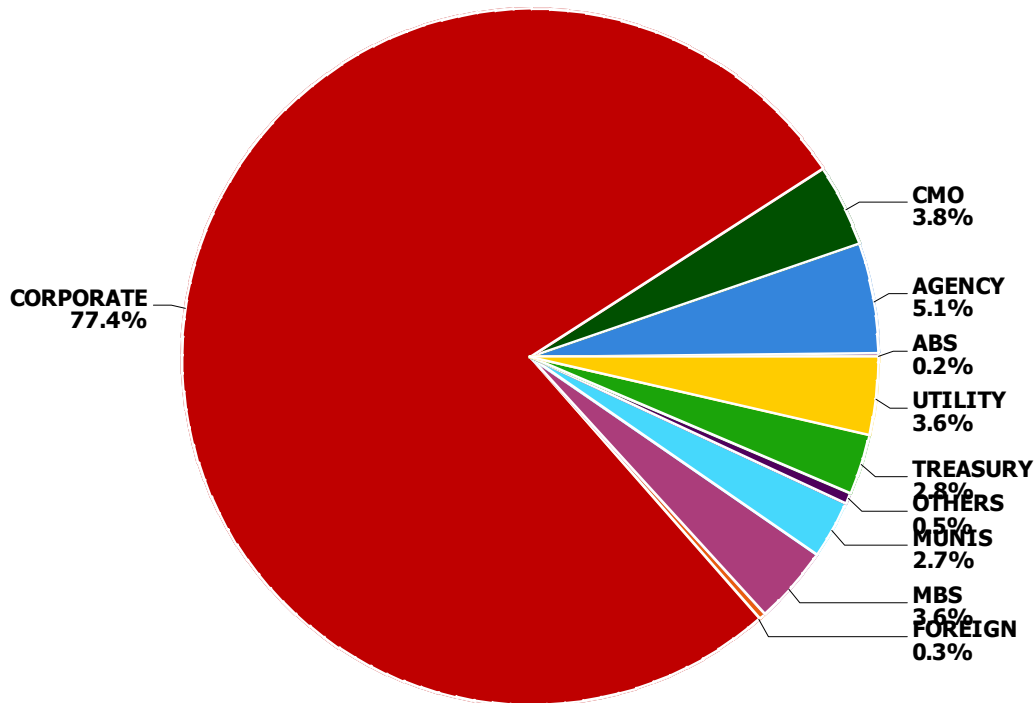

Sector	Account Weight	Index Weight	Difference
ABS	0.2%	6.2%	-6.1%
Agencies	5.1%	9.9%	-4.8%
CMO	3.8%	0.0%	3.8%
Corporates	77.4%	17.0%	60.4%
Foreign	0.3%	3.6%	-3.3%
MBS	3.6%	37.8%	-34.2%
Municipals	2.7%	0.0%	2.7%
Others	0.5%	0.0%	0.5%
Treasuries	2.8%	23.5%	-20.7%
Utilities	3.6%	1.9%	1.7%
<b>Total</b>	<b>100.0%</b>	<b>100.0%</b>	<b>0.0%</b>

Benchmark: LB AGGREGATE

**FRESNO COUNTY EMPLOYEES RETIREMENT ASSO.**

As of March 31, 2008

**Bond Holdings  
WESTERN ASSET MANAGEMENT**

Bond Name	Market Value	Coupon	Stated Maturity	Quality Rating	Duration	Yield to Maturity
<b>0-5 Years</b>						
AIFUL CORPORATION 144A	190,033	5.00	8/10/10	BAA2	2.16	7.68%
AOL TIME WARNER INC	647,200	6.88	5/01/12	BAA2	3.46	5.97%
ASIF GLOBAL FING XIX 144A	49,747	4.90	1/17/13	AA2	N/A	N/A
BAC CAP TR XIV	14,674	5.63	3/15/12	AA3	N/A	N/A
BANK OF AMERICA CORPORATIO	52,496	5.38	8/15/11	AA1	N/A	N/A
BELLSOUTH CORP	20,417	4.75	11/15/12	A2	4.07	4.68%
COUNTRYWIDE FINL CORP MTN	39,949	3.34	5/05/08	BAA3	0.09	10.24%
COUNTRYWIDE FINL CORP MTN	1,220,218	4.50	6/15/10	BAA3	1.99	10.15%
COX COMMUNICATIONS INC NEW	305,427	3.88	10/01/08	BAA3	0.48	4.14%
DAIMLER CHRYSLER NORTH AME	304,059	4.05	6/04/08	A3	0.17	3.79%
DAIMLER CHRYSLER NORTH AME	307,457	5.88	3/15/11	A3	2.70	5.05%
DELTA_AIR_2000-001- A1	143,049	7.38	11/18/11	BA2	1.02	8.73%
DELTA_AIR_2000-001- A2	409,939	7.57	5/18/12	N/A	2.29	7.64%
DOMINION RES INC	430,260	5.70	9/17/12	BAA2	3.95	4.52%
DOMINION RES INC VA NEW	114,116	4.75	12/15/10	BAA2	2.50	3.83%
ELECTRONIC DATA SYS CORP	21,055	7.13	10/15/09	BAA3	1.40	5.75%
FEDERAL AGRIC MTG CORP MNT	303,954	4.25	7/29/08	GOVT	0.32	2.43%
FHLMC GOLD POOL - A01812	12	8.25	9/01/08	GOVT	0.24	3.79%
FHLMC POOL - 183340	104	8.75	11/01/08	GOVT	N/A	N/A
FIRSTENERGY CORP	289,204	6.45	11/15/11	BAA3	3.17	5.02%
FNMA POOL - 006024	3,647	8.00	9/01/09	GOVT	0.30	4.01%
FNMA POOL - 373920	1,157	8.00	12/01/10	GOVT	0.22	4.15%
FORD MOTOR CR CO	273,412	7.38	10/28/09	B1	1.37	13.83%
FORD MOTOR CR CO	64,009	7.25	10/25/11	B1	2.87	13.75%
FORD MOTOR CR CO	3,321,619	5.80	1/12/09	B1	0.72	12.31%
GENERAL MTRS ACCEP CORP	1,720,218	5.85	1/14/09	B1	0.72	15.25%

**FRESNO COUNTY EMPLOYEES RETIREMENT ASSO.**

As of March 31, 2008

**Bond Holdings  
WESTERN ASSET MANAGEMENT**

Bond Name	Market Value	Coupon	Stated Maturity	Quality Rating	Duration	Yield to Maturity
GENERAL MTRS ACCEP CORP	20,287	5.13	5/09/08	B1	0.10	10.54%
GLITNIR BANKI HF 144A	371,575	6.69	9/15/11	A3	2.85	13.96%
GLITNIR BANKI HF GLBL M 14	234,848	6.33	7/28/11	A2	2.84	11.56%
GMAC LLC	743,036	6.63	5/15/12	B1	3.27	14.70%
GNMA POOL - 462418	95,543	7.50	12/15/12	GOVT	1.77	4.90%
GNMA POOL - 780763	3,097	7.50	12/15/10	GOVT	0.32	3.29%
GOLDMAN SACHS CAP II	20,562	5.79	6/01/12	A2	3.29	17.37%
GOLDMAN SACHS GROUP INC	285,832	4.50	6/15/10	AA3	2.06	4.13%
GOLDMAN SACHS GROUP INC	124,498	5.45	11/01/12	AA3	3.95	5.13%
HCA INC	12,971	6.30	10/01/12	CAA1	3.68	9.35%
KAUPTHING BK HF 144A	82,651	5.75	10/04/11	A1	2.91	13.11%
KINDER MORGAN ENERGY PARTN	315,185	6.75	3/15/11	BAA2	2.67	5.00%
KINDER MORGAN ENERGY PARTN	72,104	6.30	2/01/09	BAA2	0.81	3.88%
LANDSBANKI IS HF 144A	598,233	6.10	8/25/11	A2	2.94	10.62%
LEHMAN BROS HLDGS INC MTN	327,952	4.50	7/26/10	A1	2.14	6.55%
LEHMAN BROS HLDGS INC MTN	165,403	5.25	2/06/12	A1	3.42	6.29%
LEHMAN CAP MTN	228,322	5.86	5/31/12	A3	3.24	19.01%
MORGAN STANLEY	469,333	5.63	1/09/12	AA3	3.35	5.40%
MORGAN STANLEY	132,356	3.63	4/01/08	AA3	0.00	3.87%
QWEST COMMUNICATIONS 1.00%	167,566	1.00	2/15/09		N/A	N/A
RESIDENTIAL CAP CORP	23,591	5.10	4/17/09	B2	-0.01	67.00%
RESIDENTIAL CAP CORP	536,533	8.00	2/22/11	B2	2.08	38.83%
RESIDENTIAL CAP LLC	63,986	4.18	5/22/09	B2	0.08	61.14%
SANTANDER ISSUANCES S A 1	363,098	5.80	6/20/11	AA2	2.86	6.07%
SPRINT CAP CORP	334,340	8.38	3/15/12	BAA3	3.26	10.75%
TYCO INTL GROUP S A	462,895	6.38	10/15/11	BAA1	3.05	6.49%

**FRESNO COUNTY EMPLOYEES RETIREMENT ASSO.**

As of March 31, 2008

**Bond Holdings  
WESTERN ASSET MANAGEMENT**

Bond Name	Market Value	Coupon	Stated Maturity	Quality Rating	Duration	Yield to Maturity
VERIZON GLOBAL FDG CORP	198,816	7.38	9/01/12	A3	3.80	4.87%
VERIZON NEW YORK INC	390,988	6.88	4/01/12	BAA3	3.40	5.42%
WACHOVIA CAP TR III	193,071	5.80	3/15/11	A2	2.46	18.94%
WASTE MGMT INC DEL	478,150	6.38	11/15/12	BAA3	3.93	5.42%
WEYERHAEUSER CO	453,402	6.75	3/15/12	BAA2	3.47	5.29%
XTO ENERGY INC	148,480	7.50	4/15/12	BAA2	3.43	4.55%
	18,366,135	5.93			2.08	10.63%
<b>5-10 Years</b>						
AES CORP	125,788	7.75	10/15/15	B1	5.63	7.62%
AES CORP	674,809	8.00	10/15/17	B1	6.65	7.81%
AGFC CAP TR I 144A	83,672	6.00	1/15/17	A3	6.53	8.93%
AMERICA MOVIL S A DE C V	192,320	5.63	11/15/17	A3	N/A	N/A
AMERICAN EXPRESS CO	255,392	6.80	9/01/16	A3	N/A	N/A
AMERICAN GEN FIN MEDTM SRN	119,665	6.90	12/15/17	A1	N/A	N/A
AMERICAN INTL GROUP INC MT	69,934	5.85	1/16/18	AA2	N/A	N/A
AT&T INC	197,661	5.50	2/01/18	N/A	7.68	5.78%
BEAR STEARNS COS INC	292,733	7.25	2/01/18	BAA1	7.15	6.78%
BEAR STEARNS COS INC	289,112	5.55	1/22/17	BAA2	6.84	7.21%
CLEAR CHANNEL COMMUNICATIO	137,702	4.90	5/15/15	BAA3	5.44	11.90%
CLEAR CHANNEL COMMUNICATIO	151,713	5.50	9/15/14	BAA3	5.08	11.82%
COMCAST CABLE COMMUNICATIO	236,168	8.88	5/01/17	BAA2	6.36	6.73%
COMCAST CORP NEW	31,051	6.50	1/15/17	BAA2	6.75	6.18%
COMCAST CORP NEW	446,246	6.50	1/15/15	BAA2	5.47	6.06%
COMCAST CORP NEW	39,262	5.88	2/15/18	BAA2	7.57	6.23%
CREDIT SUISSE GUERNSEY BR	156,468	5.86	5/15/17	AA3	6.75	8.28%



**FRESNO COUNTY EMPLOYEES RETIREMENT ASSO.**

As of March 31, 2008

**Bond Holdings  
WESTERN ASSET MANAGEMENT**

Bond Name	Market Value	Coupon	Stated Maturity	Quality Rating	Duration	Yield to Maturity
DEUTSCHE TELEKOM INTL FIN	178,191	5.75	3/23/16	A3	6.46	5.93%
EDISON MISSION ENERGY	102,644	7.00	5/15/17	B1	6.64	7.07%
EL PASO CORP	632,472	7.00	6/15/17	BA3	6.82	6.58%
FARMER MAC 144A	982,235	5.13	4/19/17	AAA	7.33	4.34%
FNMA POOL - 006222	6,654	9.00	4/01/16	GOVT	0.37	5.37%
FNMA POOL - 070508	21,989	8.50	8/01/17	GOVT	1.78	4.67%
GENERAL ELEC CAP CORP MTN	671,744	6.38	11/15/17	AA1	7.12	6.68%
GENERAL MTRS ACCEP CORP	219,320	6.75	12/01/14	B1	4.80	13.54%
GNMA POOL - 186654	22,444	8.00	4/20/17	GOVT	2.35	5.22%
GNMA POOL - 216386	17,329	8.00	6/20/17	GOVT	2.23	5.22%
GNMA POOL - 476329	15,803	7.50	6/15/13	GOVT	1.63	4.90%
GNMA POOL - 509187	83,210	7.50	8/15/14	GOVT	2.12	5.62%
GNMA POOL - 780859	68,381	7.50	9/15/13	GOVT	1.51	4.24%
GNMA POOL - 780899	40,680	7.50	10/15/13	GOVT	1.67	4.90%
HCA INC	271,275	6.75	7/15/13	CAA1	4.25	9.57%
HCA INC	32,009	9.13	11/15/14	N/A	4.56	8.32%
HCA INC	8,558	6.50	2/15/16	CAA1	5.92	9.37%
HCA INC	236,488	9.25	11/15/16	N/A	5.70	8.49%
HCA Inc	39,825	9.63	11/15/16		N/A	N/A
ILFC E-CAPITAL TR I 144A	391,726	6.25	12/21/15	A3	5.92	8.13%
JP MORGAN CHASE & CO	554,584	5.13	9/15/14	AA3	5.51	5.35%
JP MORGAN CHASE & CO	796,346	5.15	10/01/15	AA3	6.12	5.44%
KAUPTHING BANK HF	995,704	7.63	2/28/15	N/A	5.35	7.62%
KAUPTHING BK HF MED TM 144	112,142	7.13	5/19/16	A2	5.37	13.93%
KINDER MORGAN ENERGY PARTN	311,602	6.00	2/01/17	BAA2	6.91	6.07%
LIBERTY MEDIA CORP NEW	36,083	5.70	5/15/13	BA2	4.21	8.76%

**FRESNO COUNTY EMPLOYEES RETIREMENT ASSO.**

As of March 31, 2008

**Bond Holdings  
WESTERN ASSET MANAGEMENT**

Bond Name	Market Value	Coupon	Stated Maturity	Quality Rating	Duration	Yield to Maturity
NEXTEL COMMUNICATIONS INC	736,953	6.88	10/31/13	BAA3	4.23	12.16%
PETROBRAS INTL FIN CO	402,099	6.13	10/06/16	BAA1	6.54	6.17%
RABOBANK CAP FDG III 144A	42,193	5.25	10/21/16	AA2	6.64	8.03%
RABOBANK CAP FDG TR II 14	17,435	5.26	12/31/13	AA2	4.76	8.41%
REALOGY CORP	167,331	12.38	4/15/15	CAA2	3.04	33.20%
RESONA PFD GLOBAL SECS 14	64,503	7.19	7/30/15	BAA1	5.39	9.44%
ROYAL BK SCOTLAND	86,140	7.64	9/29/17	AA2	6.55	9.93%
ROYAL BK SCOTLAND GROUP 1	158,988	6.99	10/05/17	AA3	6.47	9.43%
SBC COMMUNICATIONS INC	268,849	5.10	9/15/14	A2	5.52	5.22%
SHINSEI FIN CAYMAN LTD 14	283,024	6.42	7/20/16	BAA1	5.66	12.95%
SIGMA FIN MTN TR	470,228	8.50	8/11/16		N/A	N/A
SLM CORP MTN BOOK ENTRY	59,720	5.05	11/14/14	BAA2	5.18	10.95%
SLM CORP MTN BOOK ENTRY	7,356	5.00	4/15/15	BAA2	5.41	10.97%
SLM CORP MTN BOOK ENTRY	547,251	5.38	5/15/14	BAA2	4.81	11.10%
SLM CORP MTN BOOK ENTRY	295,526	5.00	10/01/13	BAA2	4.41	11.13%
SOUTHERN NAT GAS CO 144A	60,422	5.90	4/01/17	BAA3	6.87	6.23%
TELECOM ITALIA CAP	271,080	5.25	10/01/15	BAA2	5.98	6.83%
TNK-BP FINANCE	383,583	7.50	7/18/16	BAA2	6.02	8.72%
TNK-BP FINANCE 144A	88,492	6.63	3/20/17	BAA2	6.60	8.83%
TNK-BP FINANCE 144A	139,153	7.88	3/13/18	BAA2	6.81	9.05%
TRAVELERS COMPANIES INC	460,097	6.25	3/15/17	BAA1	6.74	8.13%
TXU CORP	250,110	5.55	11/15/14	CAA1	5.16	10.18%
TYCO INTL GROUP S A	991,723	6.00	11/15/13	BAA1	4.67	5.91%
UNION PAC CORP	189,296	5.38	5/01/14	BAA2	5.12	4.81%
UNITED MEXICAN STS MTN BE	59,605	5.63	1/15/17	BAA1	7.07	4.90%
UNITED STATES TREAS BDS	86,145	8.88	8/15/17	GOVT	7.09	3.52%

**FRESNO COUNTY EMPLOYEES RETIREMENT ASSO.**

As of March 31, 2008

**Bond Holdings  
WESTERN ASSET MANAGEMENT**

Bond Name	Market Value	Coupon	Stated Maturity	Quality Rating	Duration	Yield to Maturity
UNITED STATES TREAS NTS	122,365	4.75	8/15/17	AAA	7.88	3.41%
UNITED STATES TREAS NTS I/ WACHOVIA CORP 2ND NEW	1,784,081	2.63	7/15/17	AAA	5.69	5.30%
WELLPOINT INC	936,695	5.25	8/01/14	A1	5.36	5.48%
	29,881	5.88	6/15/17	BAA1	7.10	6.18%
	19,809,459	6.08			5.81	7.48%
<b>10-20 Years</b>						
DELTA_AIR_2007-001- A	188,412	6.82	2/10/24	BAA1	6.39	4.91%
EDISON MISSION ENERGY	48,690	7.63	5/15/27	B1	9.60	8.25%
EDISON MISSION ENERGY	132,561	7.20	5/15/19	B1	7.54	7.36%
FHLMC GOLD POOL - A01592	57,105	8.00	11/01/21	GOVT	0.53	4.19%
FHLMC GOLD POOL - G11605	921,205	5.50	9/01/19	GOVT	2.13	4.66%
FNMA 15YR 6.00% TBA - APR	493,950	6.00	6/01/22	GOVT	1.40	3.91%
FNMA POOL - 231669	4,950	8.00	5/01/18	GOVT	0.31	4.68%
FNMA POOL - 517384	12,263	8.00	11/01/20	GOVT	1.82	4.77%
GENERAL MTRS CORP	223,949	8.25	7/15/23	CAA1	7.21	12.75%
GNMA POOL - 352057	77,834	8.00	10/15/23	GOVT	3.37	5.62%
GNMA POOL - 354566	112,675	7.50	4/15/23	GOVT	3.08	5.56%
GNMA POOL - 398921	4,533	8.00	10/15/26	GOVT	3.05	5.59%
GNMA POOL - 437021	1,336	8.00	8/15/27	GOVT	2.82	5.59%
GNMA POOL - 780973	39,199	8.25	5/15/20	GOVT	2.49	5.24%
ICICI BK LTD 144A	211,473	6.38	4/30/22	BAA2	8.78	8.05%
KERR MCGEE CORP	312,475	6.95	7/01/24	BAA3	10.06	6.35%
TXU CORP	25,887	6.50	11/15/24	CAA1	8.66	10.14%
U S TREAS BD STRIPPED PRIN	1,716,675	0.00	11/15/24	GOVT	17.63	4.59%
UNITED STATES TREAS BDS I/ UNITED STATES TREAS BDS I/	460,558	1.75	1/15/28	AAA	11.37	6.07%
	974,371	2.38	1/15/27	AAA	10.45	6.07%

**FRESNO COUNTY EMPLOYEES RETIREMENT ASSO.**

As of March 31, 2008

**Bond Holdings  
WESTERN ASSET MANAGEMENT**

Bond Name	Market Value	Coupon	Stated Maturity	Quality Rating	Duration	Yield to Maturity
WILLIAMS COS INC DEL	218,063	7.88	9/01/21	BAA3	8.66	6.91%
	6,238,167	3.76			9.70	5.62%
<b>Over 20 Years</b>						
AMERADA HESS CORP	386,241	7.30	8/15/31	BAA3	N/A	N/A
AMERADA HESS CORP	110,350	7.88	10/01/29	BAA3	N/A	N/A
ANADARKO FIN CO	497,229	7.50	5/01/31	BAA3	N/A	N/A
AOL TIME WARNER INC	5,424	7.70	5/01/32	BAA2	11.07	7.23%
BA_MTG_CMBS_2004-004 A6	748,633	4.88	7/10/42	AAA	N/A	N/A
CITIGROUP INC	532,257	6.88	3/05/38	AA3	12.68	6.88%
CONOCO INC	292,682	6.95	4/15/29	A1	11.69	5.80%
CVS CORP	444,502	6.94	1/10/30	BAA2	11.47	6.54%
CWABS_TRUST_2005-004- AF3	317,426	4.46	9/25/32	AAA	0.88	6.05%
CWALT_2005-036- 3A1	582,785	4.93	8/25/35	AAA	13.69	19.52%
EL PASO ENERGY CORP MTN BE	94,356	7.75	1/15/32	BA3	10.98	7.50%
EL PASO ENERGY CORP MTN BE	136,861	7.80	8/01/31	BA3	10.90	7.55%
EL PASO NAT GAS CO	524,407	8.38	6/15/32	BAA3	11.05	7.18%
EXELON CORP	80,633	5.63	6/15/35	BAA1	12.97	6.58%
FEDERAL HOME LN BKS	1,104,471	5.50	7/15/36	GOVT	15.09	4.89%
FIRSTENERGY CORP	608,036	7.38	11/15/31	BAA3	11.58	6.63%
FNMA POOL - 801516	936,339	4.70	8/01/34	GOVT	0.41	3.62%
FNMA 30YR 5.00% TBA - APR	3,859,783	5.00	6/01/37	GOVT	5.47	5.22%
FNMA 30YR 5.50% TBA - APR	201,875	5.50	6/01/37	GOVT	4.21	5.13%
FNMA POOL - 252925	11,904	7.50	12/01/29	GOVT	2.61	5.17%
FNMA POOL - 585680	27,021	7.50	6/01/31	GOVT	2.28	5.13%
FORD MTR CO DEL	530,806	7.45	7/16/31	CAA1	8.30	11.74%

**FRESNO COUNTY EMPLOYEES RETIREMENT ASSO.**

As of March 31, 2008

**Bond Holdings  
WESTERN ASSET MANAGEMENT**

Bond Name	Market Value	Coupon	Stated Maturity	Quality Rating	Duration	Yield to Maturity
GENERAL MTRS ACCEP CORP	285,590	8.00	11/01/31	B1	8.14	11.51%
GENERAL MTRS CORP	14,554	8.38	7/15/33	CAA1	7.95	12.14%
GMACM_LOAN_2005-AR1- 3A1	1,210,818	4.72	3/18/35	AAA	2.93	4.42%
GNMA POOL - 173777	920	8.00	8/15/30	GOVT	3.02	5.30%
GNMA POOL - 527094	6,127	8.00	2/15/30	GOVT	2.05	5.22%
GNMA POOL - 528178	5,632	8.00	3/15/30	GOVT	2.94	5.30%
GNMA POOL - 531211	3,878	8.00	6/15/30	GOVT	2.95	5.41%
GS_MTG_SEC_2005-GG4- AABA	673,673	4.68	7/10/39	AAA	3.74	5.94%
JP_MORGN_MTG_05-CIB13- A4	1,306,496	5.29	1/12/43	AAA	5.90	5.46%
JP_MORGN_MTG_05-CIBC12 A4	78,443	4.89	9/12/37	AAA	5.77	5.48%
KERR MCGEE CORP	1,632,576	7.88	9/15/31	BAA3	11.79	6.45%
KINDER MORGAN ENERGY PARTN	129,485	6.95	1/15/38	BAA2	12.32	7.10%
LB_UBS_CMBS_2005-C3- A5	1,652,986	4.74	7/15/30	AAA	5.59	5.46%
LB_UBS_CMBS_2005-C5- A4	393,605	4.95	9/15/30	N/A	5.80	5.45%
LEHMAN BROS HLDGS 5.953%	126,983	5.95	8/19/65		N/A	N/A
METLIFE INC	601,979	6.40	12/15/36	BAA1	11.04	8.28%
MLCC_MTG_TR_2005-A04- IIA2	1,741,667	4.46	7/25/35	AAA	4.34	3.99%
MLCC_MTG_TR_2005-A5- A3	1,683,181	4.44	6/25/35	N/A	7.74	5.21%
MLCC_MTG_TR_2006-C1- A4	596,716	5.84	5/12/39	N/A	6.13	5.74%
MLMI_SERIES_2004-A03- IVA3	511,017	5.03	5/25/34	N/A	6.35	7.67%
MORG_ST_CAP_2005-HQ6 A4A	296,033	4.99	8/13/42	N/A	5.73	5.47%
MUFG CAPITAL FIN 6.346%	162,567	6.35	7/29/49		N/A	N/A
NEWS AMER INC 144A	20,676	6.65	11/15/37	BAA2	12.78	6.58%
PACIFIC GAS & ELEC CO	275,905	6.05	3/01/34	A3	13.10	6.20%
PACIFIC GAS & ELEC CO	76,073	5.80	3/01/37	A3	13.70	6.20%
PEMEX PRJ FDG MSTR TR M 14	411,210	6.63	6/15/35	BAA1	12.77	6.35%

**FRESNO COUNTY EMPLOYEES RETIREMENT ASSO.**

As of March 31, 2008

**Bond Holdings  
WESTERN ASSET MANAGEMENT**

Bond Name	Market Value	Coupon	Stated Maturity	Quality Rating	Duration	Yield to Maturity
PEMEX PROJ FDG MASTER TR	44,284	6.63	6/15/35	BAA1	12.77	6.35%
ROYAL KPN NV	391,434	8.38	10/01/30	BAA2	10.67	7.08%
SASC_2004-006- 3A2	653,546	4.78	6/25/34	AAA	3.63	4.36%
SLM CORP MTN BOOK ENTRY	41,472	5.63	8/01/33	BAA2	10.94	8.77%
SOUTHERN NAT GAS CO	22,085	8.00	3/01/32	BAA3	11.27	7.18%
SUNTRUST CAP VIII	145,757	6.10	12/15/36	A1	11.59	7.95%
TENNESSEE GAS PIPELINE CO	54,270	7.63	4/01/37	BAA3	11.67	7.23%
TENNESSEE VALLEY AUTH	1,016,377	5.98	4/01/36	GOVT	14.29	5.13%
TIME WARNER ENTMT CO LP	34,286	8.38	7/15/33	BAA2	11.20	7.28%
TURANALEM FIN B V 144A	436,111	8.25	1/22/37	BA1	8.96	10.67%
TXU CORP	342,111	6.55	11/15/34	CAA1	9.82	9.63%
UNITED MEXICAN STS MTN BE	500,438	6.75	9/27/34	BAA1	13.26	5.88%
UNITED STATES TREAS BONDS	71,218	4.38	2/15/38	AAA	17.02	4.30%
UNITED STATES TREAS BONDS	237,941	4.75	2/15/37	GOVT	16.48	4.29%
VALE OVERSEAS LTD	645,025	6.88	11/21/36	BAA3	12.11	7.07%
WAMU_2005-AR4- A5	1,126,618	4.67	4/25/35	AAA	7.33	4.97%
WELLS FARGO CAP X	229,627	5.95	12/15/36	AA2	12.87	6.73%
WESTERN ASSET FLOAT RT	5,404,253	0.00	12/31/99		N/A	N/A
WESTERN ASSET HIGH YIELD	6,972,548	0.00	12/31/99		N/A	N/A
WESTERN ASSET MBS PORTFOLI	100,334,583	0.00	12/31/99		N/A	N/A
WESTERN ASSET OPPORT INTL	4,806,946	0.00	12/31/99		N/A	N/A
WESTERN ASSET OPPORT YANKE	1,884,572	0.00	12/31/99		N/A	N/A
WILLIAMS COS INC DEL	249,623	7.75	6/15/31	BAA3	11.04	7.19%
WILLIAMS COS INC DEL	635,000	7.50	1/15/31	BAA3	11.16	7.12%
WILLIAMS COS INC DEL	34,767	8.75	3/15/32	BAA3	10.99	7.36%
WYETH	312,110	5.95	4/01/37	A3	13.40	6.12%
	152,559,811	1.25			8.23	6.16%

# Fresno County Employees' Retirement Association

## Cumulative Performance Comparisons

Period Ending: March 31, 2008

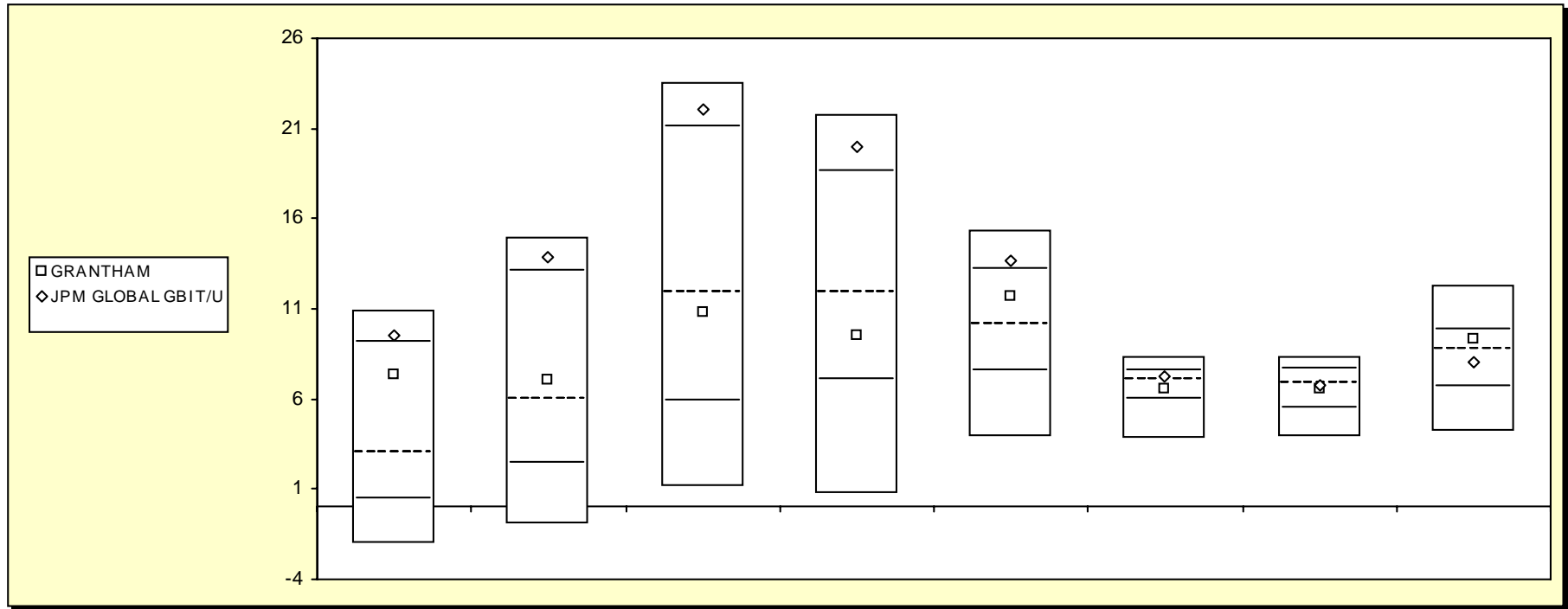

### Global Bond Funds

	Last Quarter		Two Quarters		Three Quarters		One Year		Two Years		Three Years		Four Years		Five Years	
	Return	Rank	Return	Rank	Return	Rank	Return	Rank	Return	Rank	Return	Rank	Return	Rank	Return	Rank
5th Percentile	11.0		14.9		23.5		21.7		15.3		8.4		8.4		12.3	
25th Percentile	9.1		13.1		21.0		18.6		13.2		7.6		7.7		9.8	
50th Percentile	3.0		5.9		11.9		11.9		10.2		7.0		6.9		8.7	
75th Percentile	0.4		2.4		5.9		7.0		7.6		6.0		5.5		6.6	
95th Percentile	-2.0		-0.9		1.1		0.8		3.9		3.8		3.9		4.2	
GRANTHAM	7.3	32	7.0	46	10.8	55	9.5	62	11.7	37	6.5	61	6.6	55	9.3	36
JPM GLOBAL GBI T/U	9.6	20	13.9	16	22.1	17	20.0	16	13.6	21	7.2	42	6.7	52	8.0	58

# Fresno County Employees' Retirement Association

## Consecutive Performance Comparisons

Period Ending: March 31, 2008

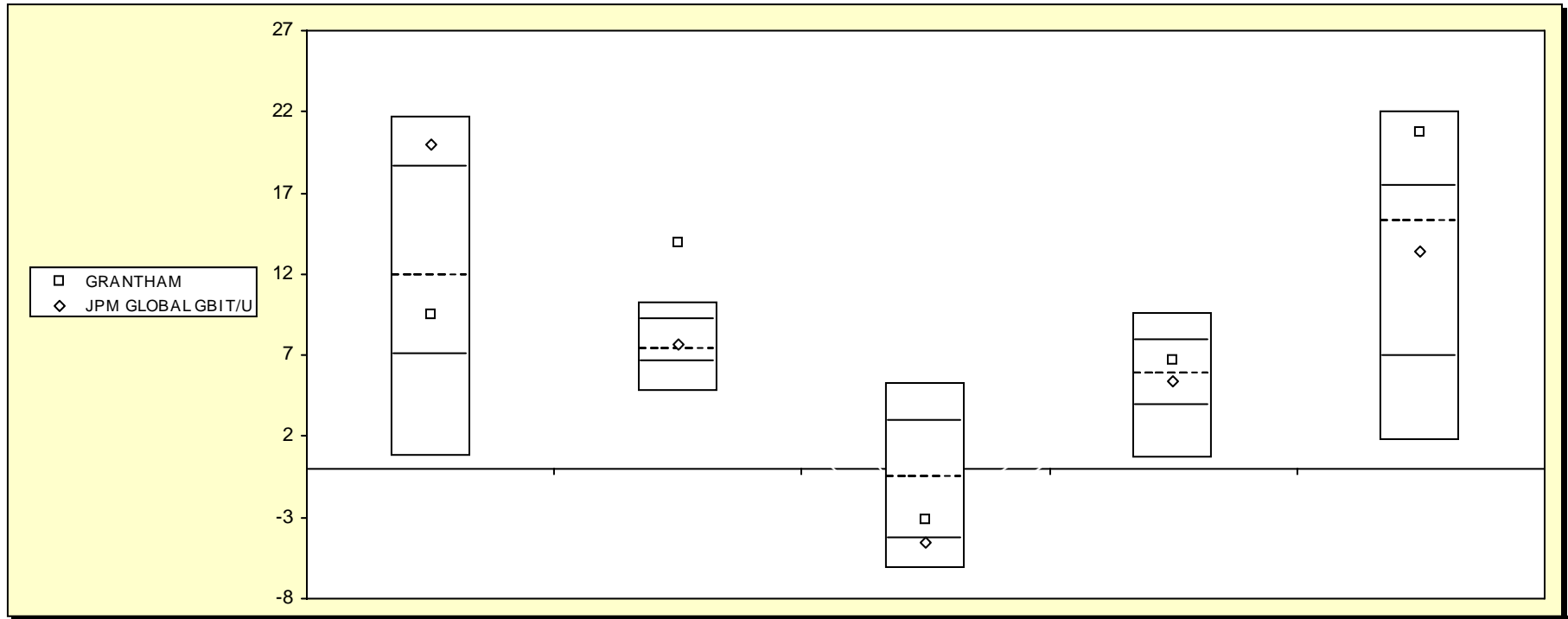

### Global Bond Funds

	March 2008		March 2007		March 2006		March 2005		March 2004	
	Return	Rank	Return	Rank	Return	Rank	Return	Rank	Return	Rank
5th Percentile	21.7		10.3		5.3		9.6		22.0	
25th Percentile	18.6		9.2		3.0		7.9		17.4	
50th Percentile	11.9		7.4		-0.6		5.8		15.2	
75th Percentile	7.0		6.6		-4.3		3.9		6.9	
95th Percentile	0.8		4.7		-6.2		0.6		1.7	
GRANTHAM	9.5	62	14.0	1	-3.1	67	6.7	39	20.8	10
JPM GLOBAL GBI T/U	20.0	16	7.6	46	-4.6	78	5.3	56	13.3	56



# Fresno County Employees' Retirement Association

Consecutive Annual - Five Year

Period Ending: March 31, 2008

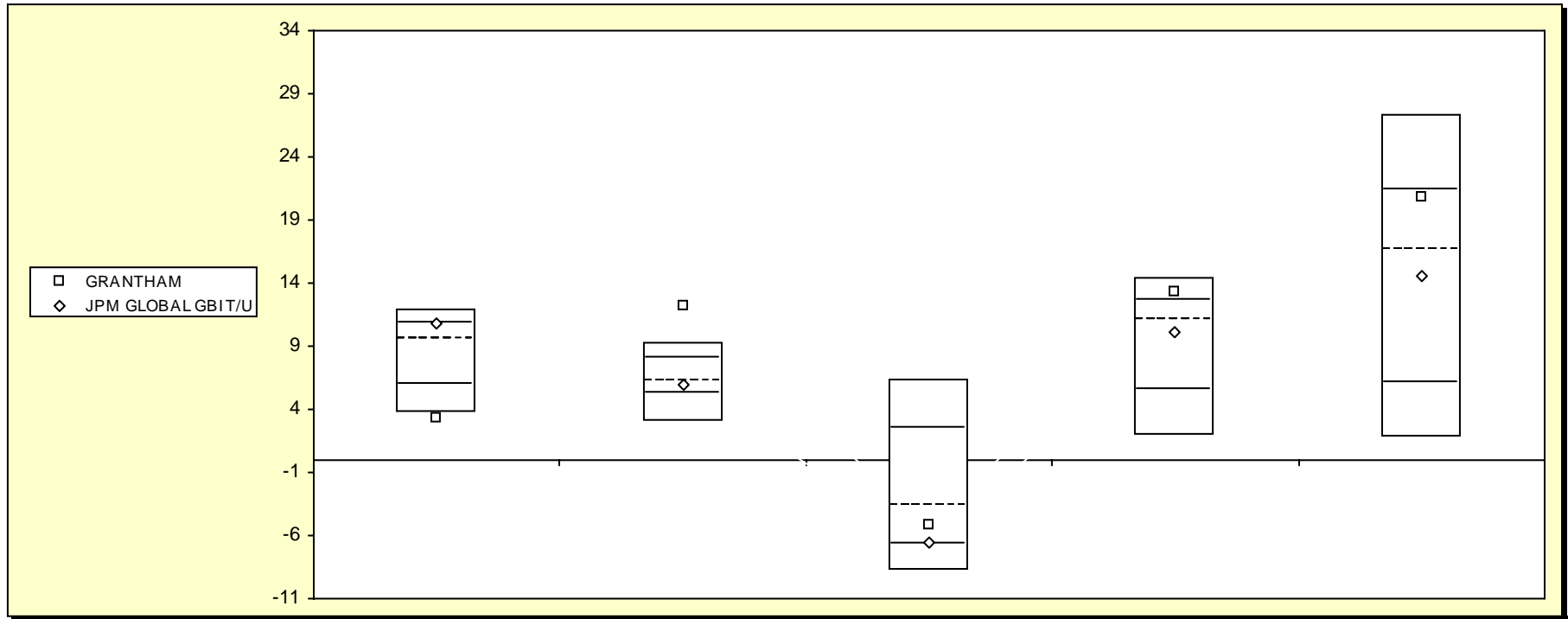

Global Bond Funds

	December 2007 Return Rank	December 2006 Return Rank	December 2005 Return Rank	December 2004 Return Rank	December 2003 Return Rank
5th Percentile	12.0	9.2	6.4	14.5	27.4
25th Percentile	10.8	8.0	2.5	12.7	21.4
50th Percentile	9.6	6.2	-3.6	11.1	16.6
75th Percentile	6.0	5.2	-6.6	5.5	6.0
95th Percentile	3.7	3.1	-8.8	2.0	1.8
GRANTHAM	3.4 95	12.2 1	-5.2 63	13.3 18	20.9 28
JPM GLOBAL GBI T/U	10.8 24	5.9 57	-6.5 74	10.1 54	14.5 55

# Fresno County Employees' Retirement Association

Rolling Return: 3 year Annualized

Period Ending: March 31, 2008

## Rolling Return (3 Year Annualized)

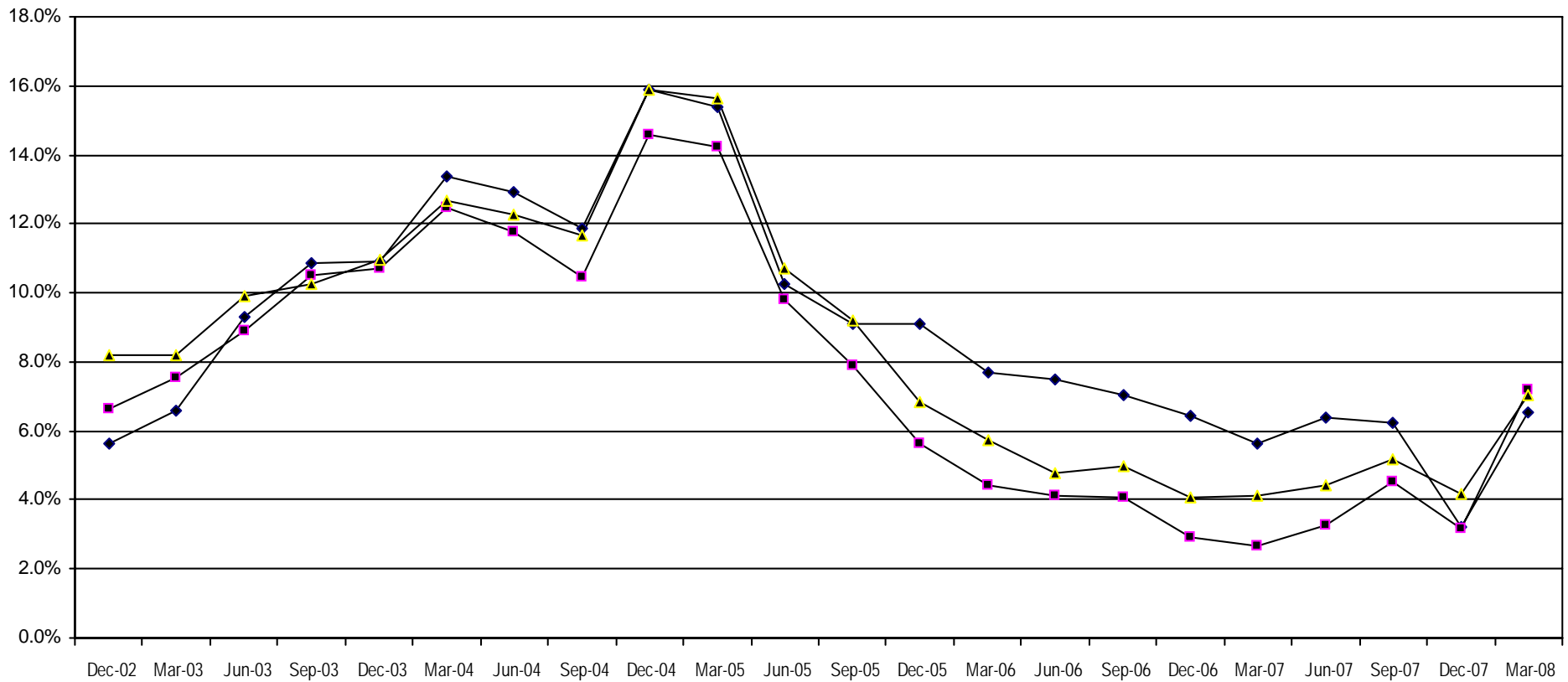

—◆— GRANTHAM —■— JPM GLOBAL GBI T/U —▲— Global Bond Funds

	03/31/01	03/31/02	03/31/03	03/31/04	03/31/05	03/31/06	03/31/07	03/31/08
GRANTHAM		.6	6.6	13.3	15.4	7.7	5.6	6.5
JPM GLOBAL GBI T/U	2.5	-.4	7.5	12.5	14.2	4.4	2.7	7.2
Global Bond Funds	2.2	.7	8.2	12.7	15.6	5.7	4.1	7.0

# Fresno County Employees' Retirement Association

## Three & Five Year Return vs. Risk

Period Ending: March 31, 2008

**Three-Year**

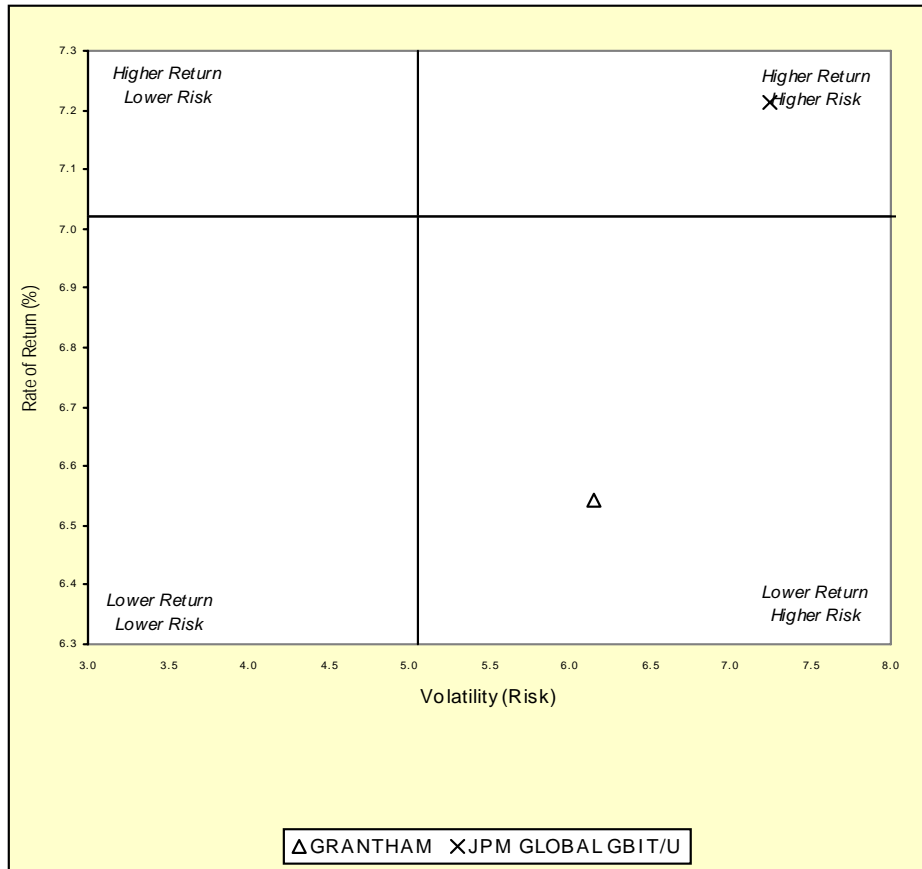

**Five-Year**

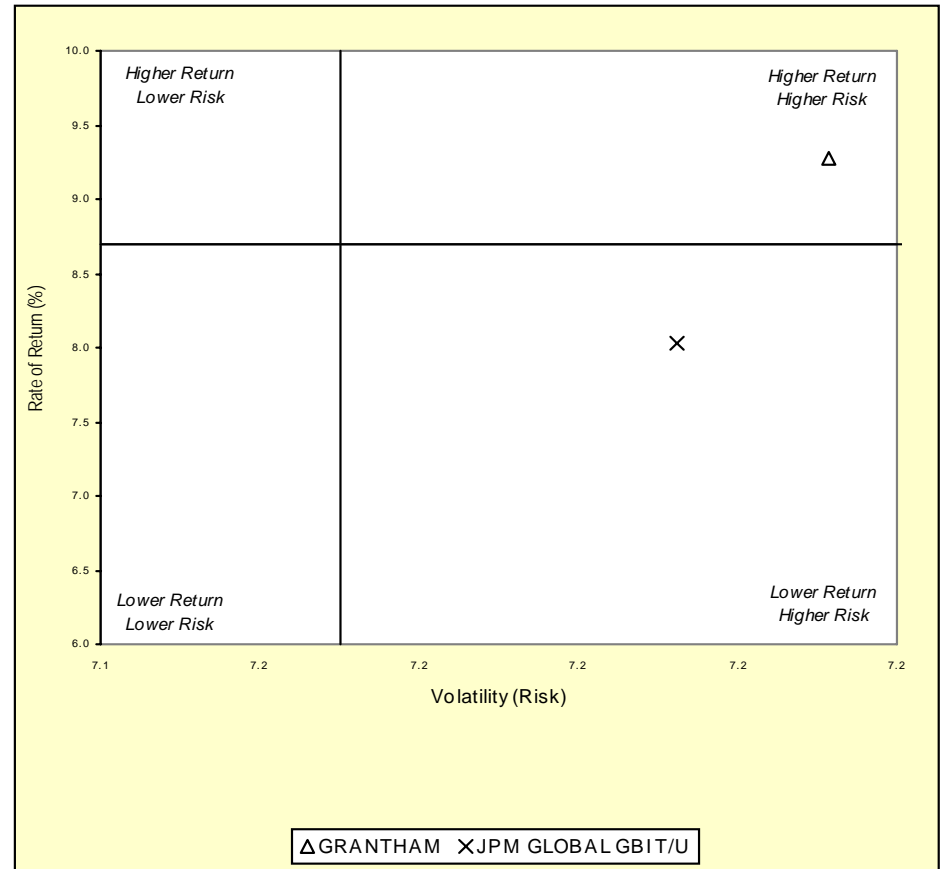

**Three Year Return vs Risk**

Annualized Return %	Standard Deviation %	Sharpe Ratio
6.5	6.1	0.3
7.0	5.1	0.5
7.2	7.2	0.4

**Five Year Return vs Risk**

Category	Annualized Return %	Standard Deviation %	Sharpe Ratio
GRANTHAM	9.3	7.2	0.8
Global Bond Funds Universe Median	8.7	7.2	0.8
JPM GLOBAL GBI T/U	8.0	7.2	0.7

# Fresno County Employees' Retirement Association

## Value Added Analysis 3 Yr Rolling for GRANTHAM

Period Ending: March 31, 2008

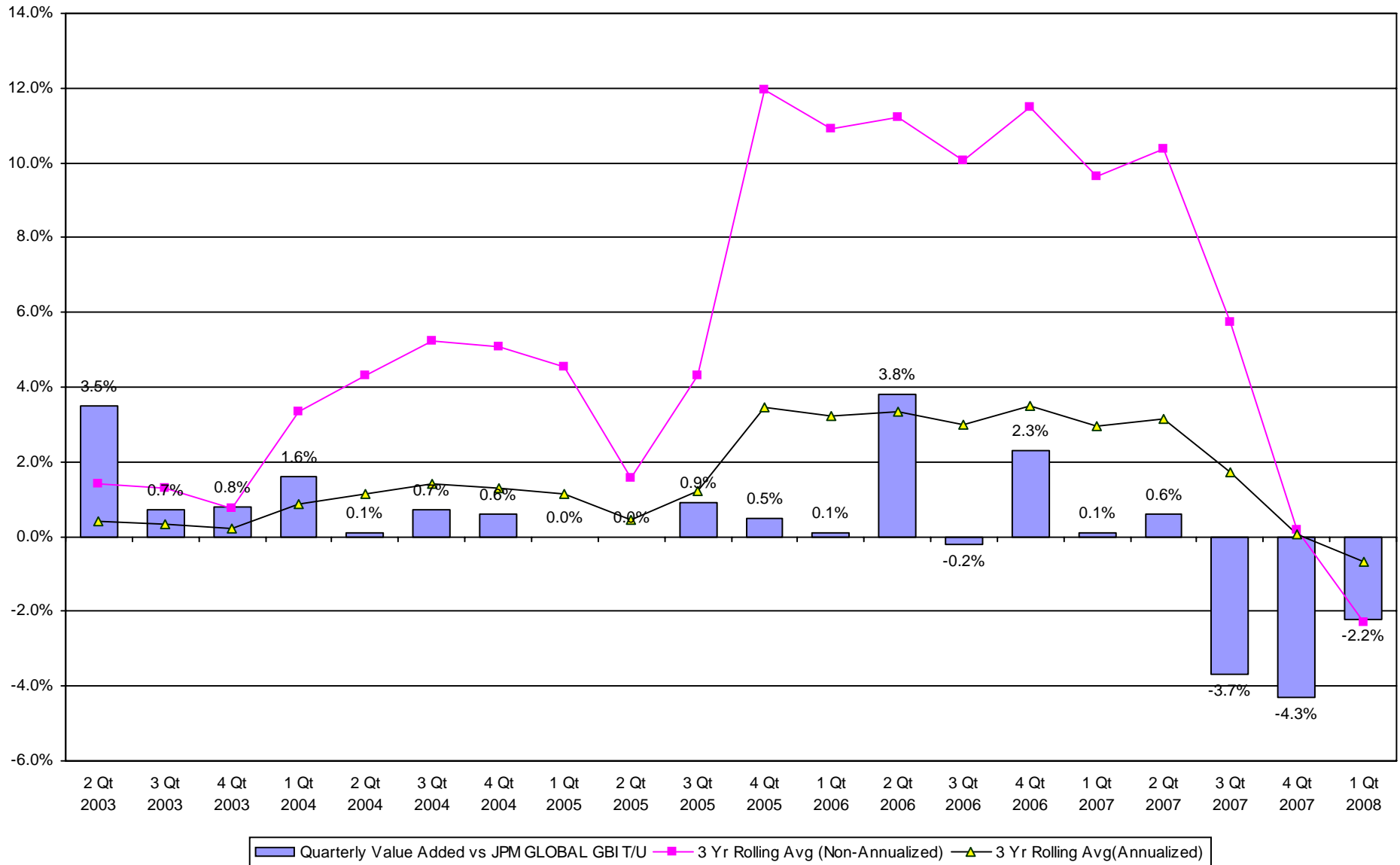

# Fresno County Employees' Retirement Association

## Rolling Return Ranking 3 & 5 Years

Period Ending: March 31, 2008

### Ranking Comparisons - Rolling 3 Years

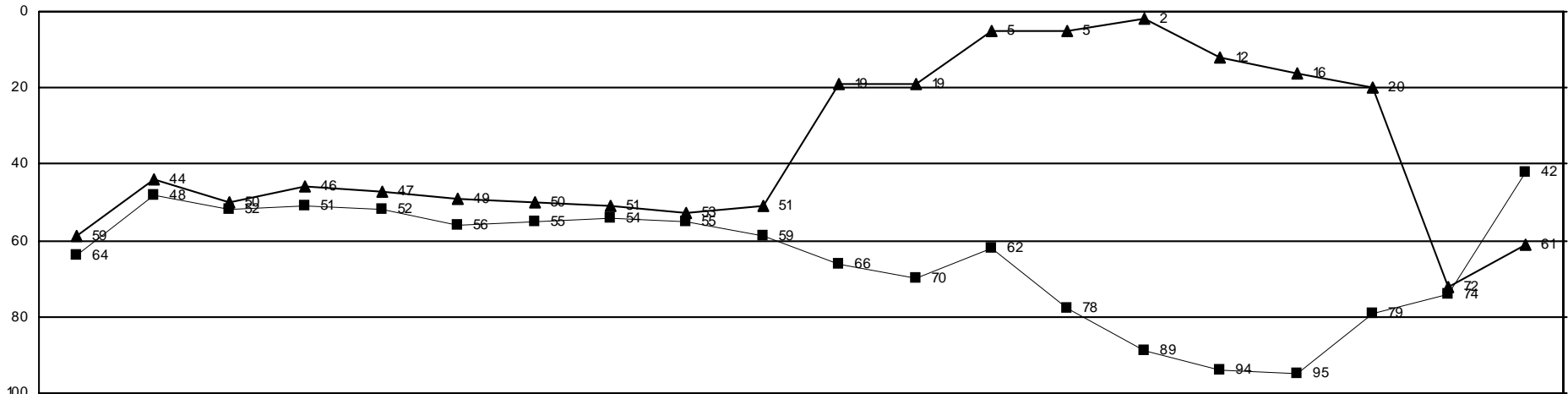

### Ranking Comparisons - Rolling 5 Years

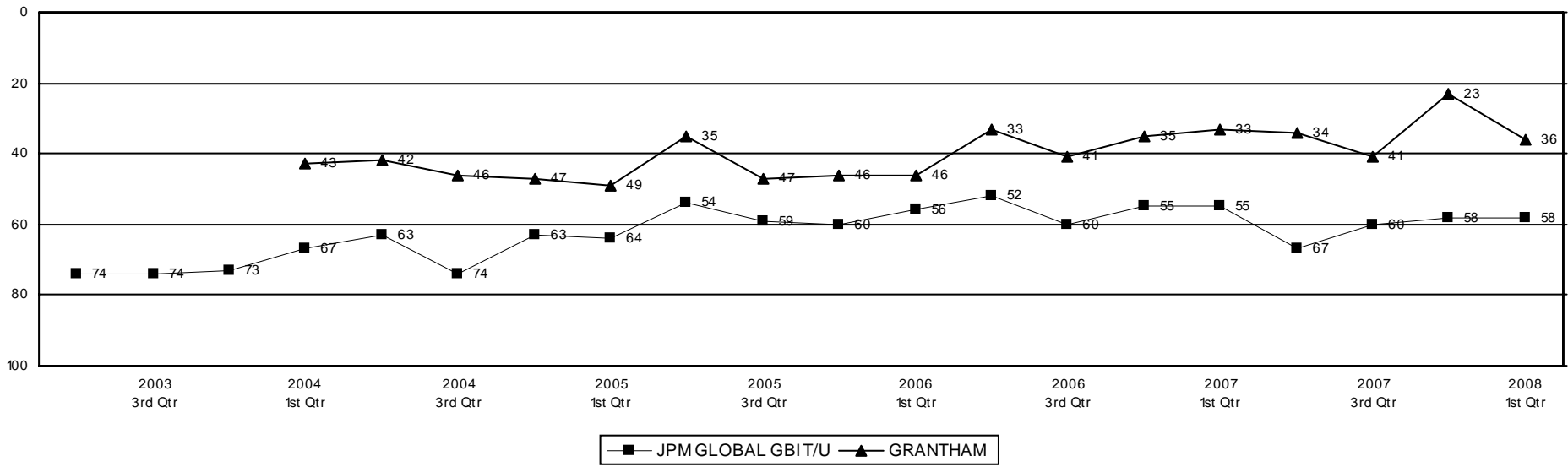

# Fresno County Employees' Retirement Association

## Up vs. Down Market Performance

Period Ending: March 31, 2008

Last 20 Quarters Ending 3/31/2008

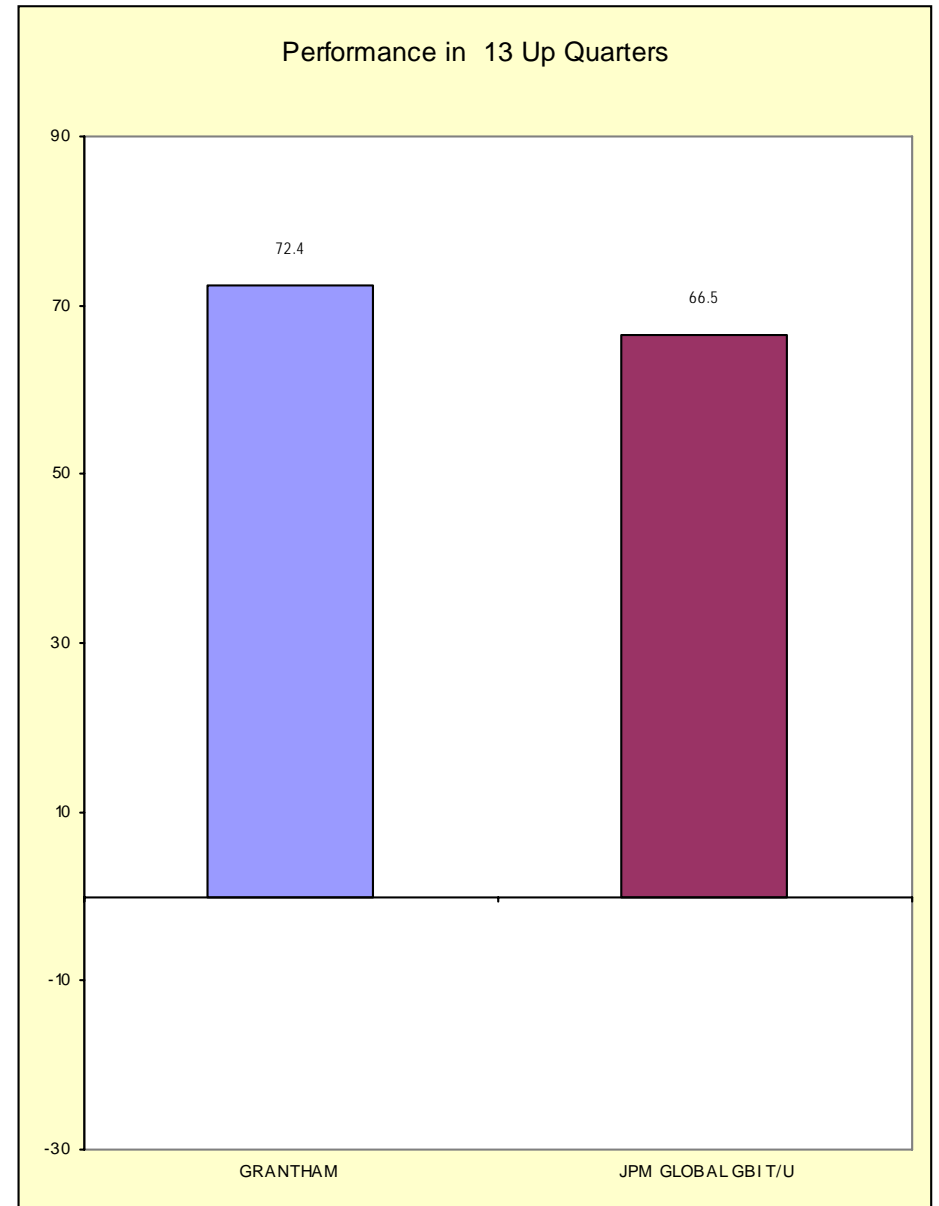
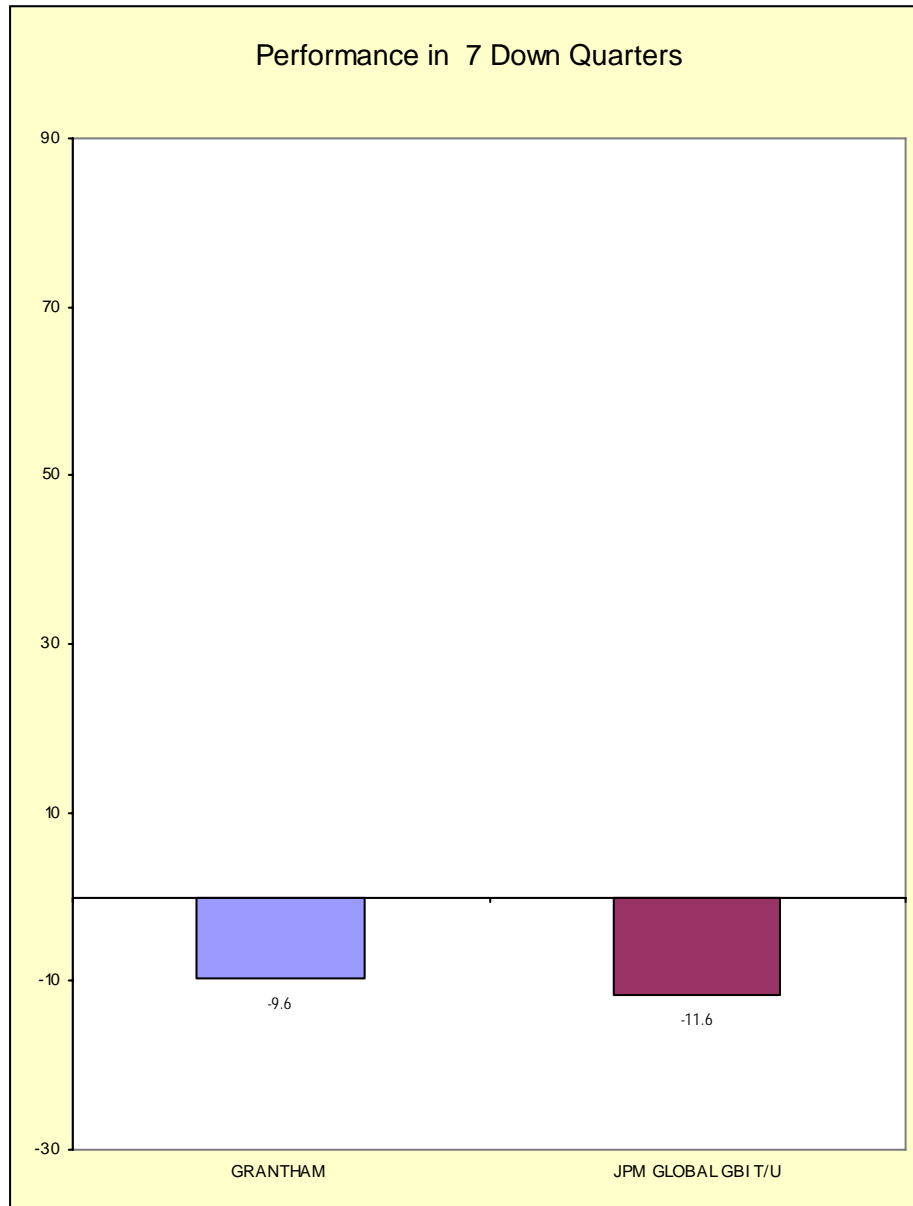

# Fresno County Employees' Retirement Association

## Cumulative Performance Comparisons

Period Ending: March 31, 2008

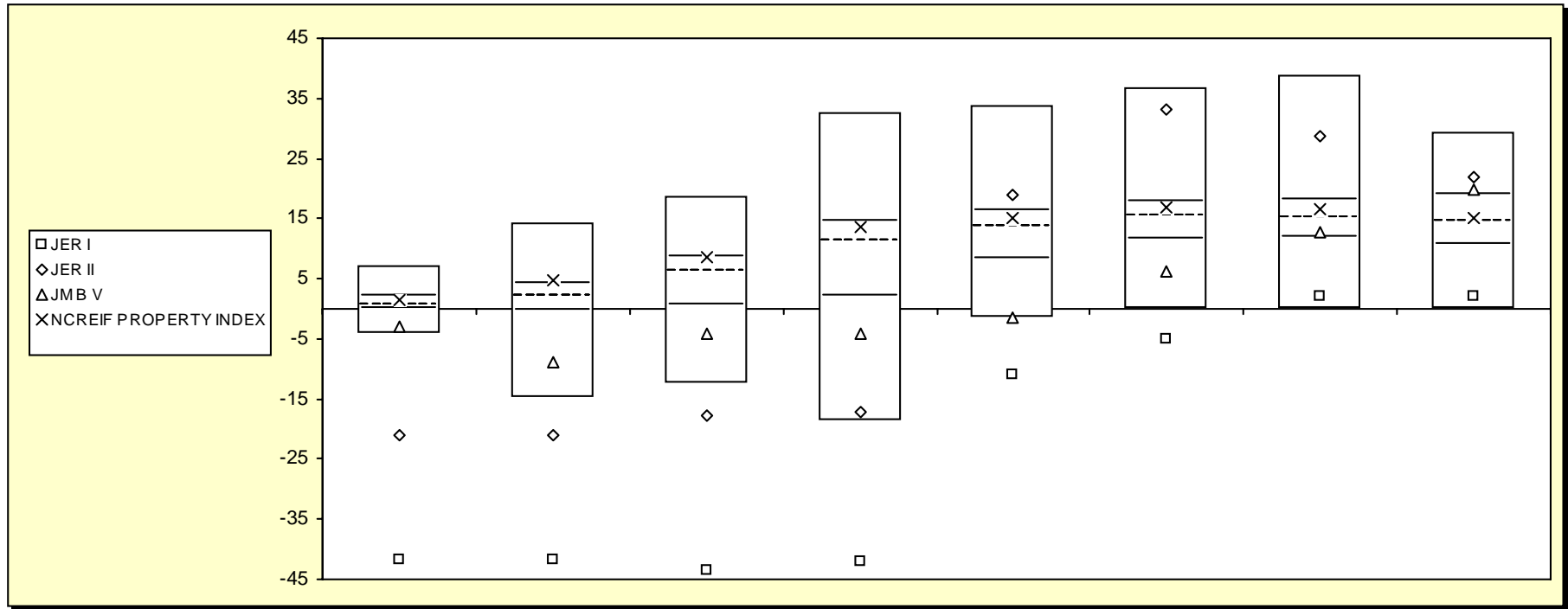

### Real Estate Funds

	Last Quarter	Two Quarters	Three Quarters	One Year	Two Years	Three Years	Four Years	Five Years
	Return	Return	Return	Return	Return	Return	Return	Return
	Rank	Rank	Rank	Rank	Rank	Rank	Rank	Rank
5th Percentile	7.2	14.2	18.8	32.4	33.6	36.6	38.9	29.3
25th Percentile	2.0	4.2	8.5	14.6	16.2	17.9	18.0	19.0
50th Percentile	0.7	2.0	6.1	11.2	13.6	15.4	15.2	14.6
75th Percentile	-0.1	-0.3	0.7	2.2	8.2	11.5	11.8	10.7
95th Percentile	-4.2	-14.9	-12.4	-18.5	-1.6	0.0	0.0	0.0
JER I	-41.8	-41.8	-43.5	-42.1	-11.0	-4.9	1.9	2.1
JER II	-21.0	-21.0	-17.9	-17.1	19.1	33.2	28.6	21.8
JMB V	-3.0	-8.9	-4.2	-4.2	-1.4	6.1	12.8	19.8
NCREIF PROPERTY INDEX	1.6	4.9	8.6	13.6	15.1	16.8	16.5	15.1

# Fresno County Employees' Retirement Association

## Consecutive Performance Comparisons

Period Ending: March 31, 2008

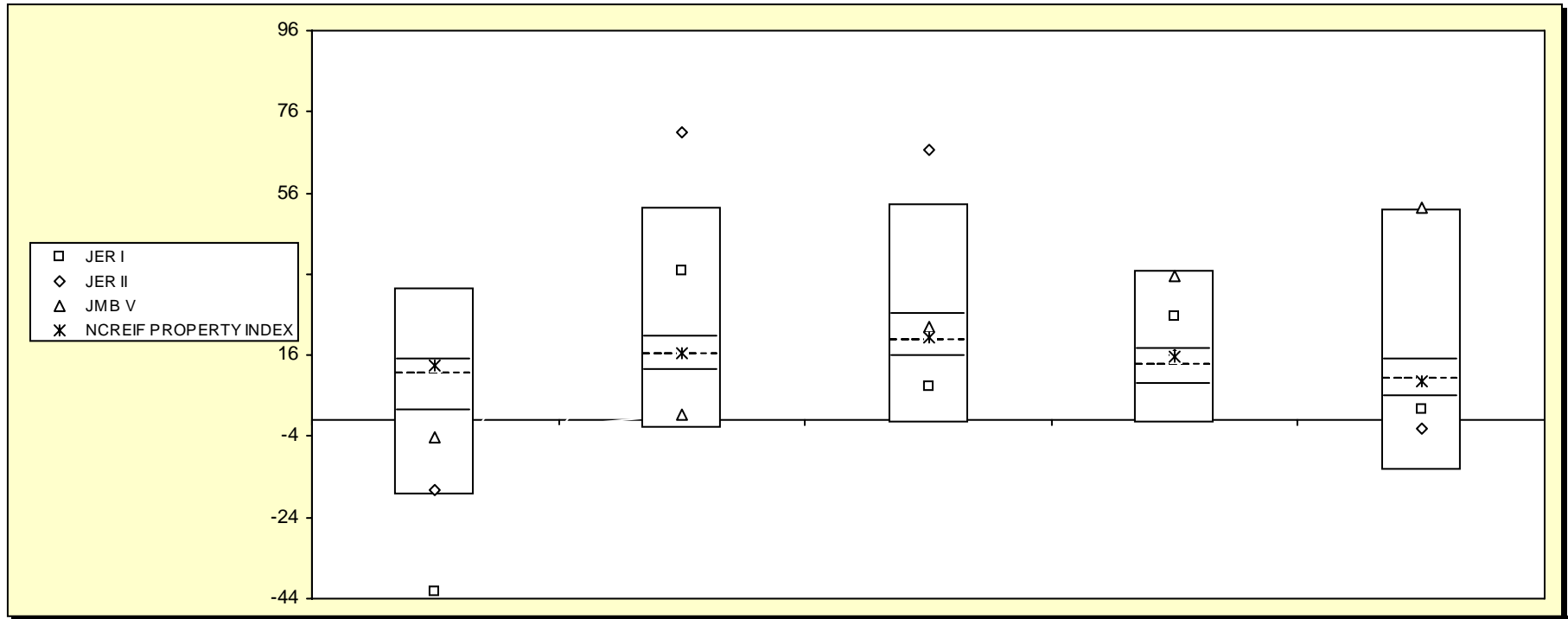

### Real Estate Funds

	March 2008		March 2007		March 2006		March 2005		March 2004	
	Return	Rank	Return	Rank	Return	Rank	Return	Rank	Return	Rank
5th Percentile	32.4		52.4		53.1		36.9		52.1	
25th Percentile	14.6		20.4		26.1		17.4		14.8	
50th Percentile	11.2		16.0		19.4		13.7		9.9	
75th Percentile	2.2		12.1		15.7		8.9		5.5	
95th Percentile	-18.5		-2.0		-0.8		-1.0		-12.3	
JER I	-42.1	99	36.7	15	8.5	84	25.7	17	2.7	78
JER II	-17.1	94	70.9	2	66.7	3	15.9	35	-2.2	84
JMB V	-4.2	81	1.5	90	23.0	36	35.6	6	52.3	5
NCREIF PROPERTY INDEX	13.6	33	16.6	47	20.2	47	15.5	37	9.7	51



# Fresno County Employees' Retirement Association

Fbox Annual - Five Year

Period Ending: March 31, 2008

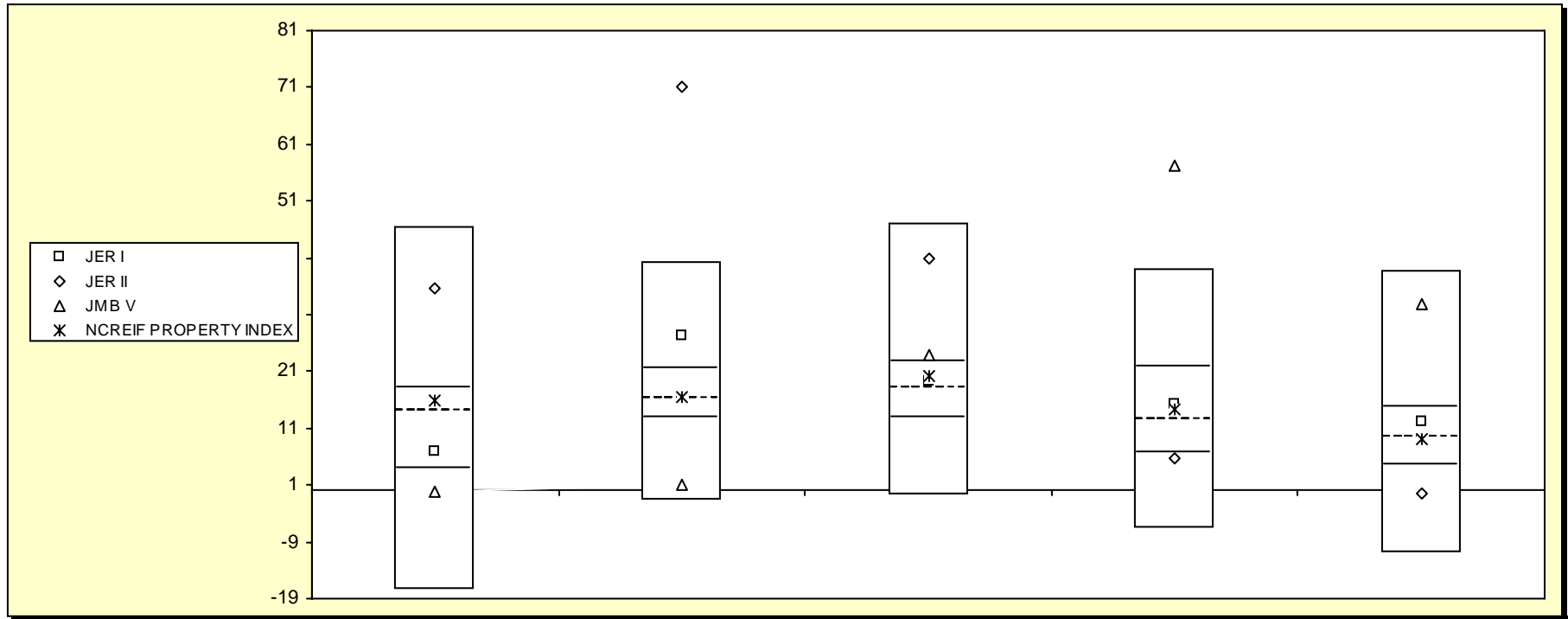

Real Estate Funds	December 2007		December 2006		December 2005		December 2004		December 2003	
	Return	Rank	Return	Rank	Return	Rank	Return	Rank	Return	Rank
5th Percentile	46.4		40.2		47.0		38.9		38.6	
25th Percentile	18.1		21.4		22.6		21.8		14.6	
50th Percentile	13.9		16.2		18.2		12.5		9.4	
75th Percentile	3.8		12.7		12.6		6.7		4.4	
95th Percentile	-17.5		-1.6		-0.7		-6.6		-10.9	
JER I	7.0	67	27.2	19	19.2	44	15.3	42	12.0	37
JER II	35.5	13	71.2	1	41.0	10	5.7	76	-0.6	82
JMB V	-0.2	79	1.0	91	23.8	24	57.3	2	32.9	10
NCREIF PROPERTY INDEX	15.8	39	16.6	48	20.1	39	14.5	45	9.0	52

# Fresno County Employees' Retirement Association

## Cumulative Performance Comparisons

Period Ending: March 31, 2008

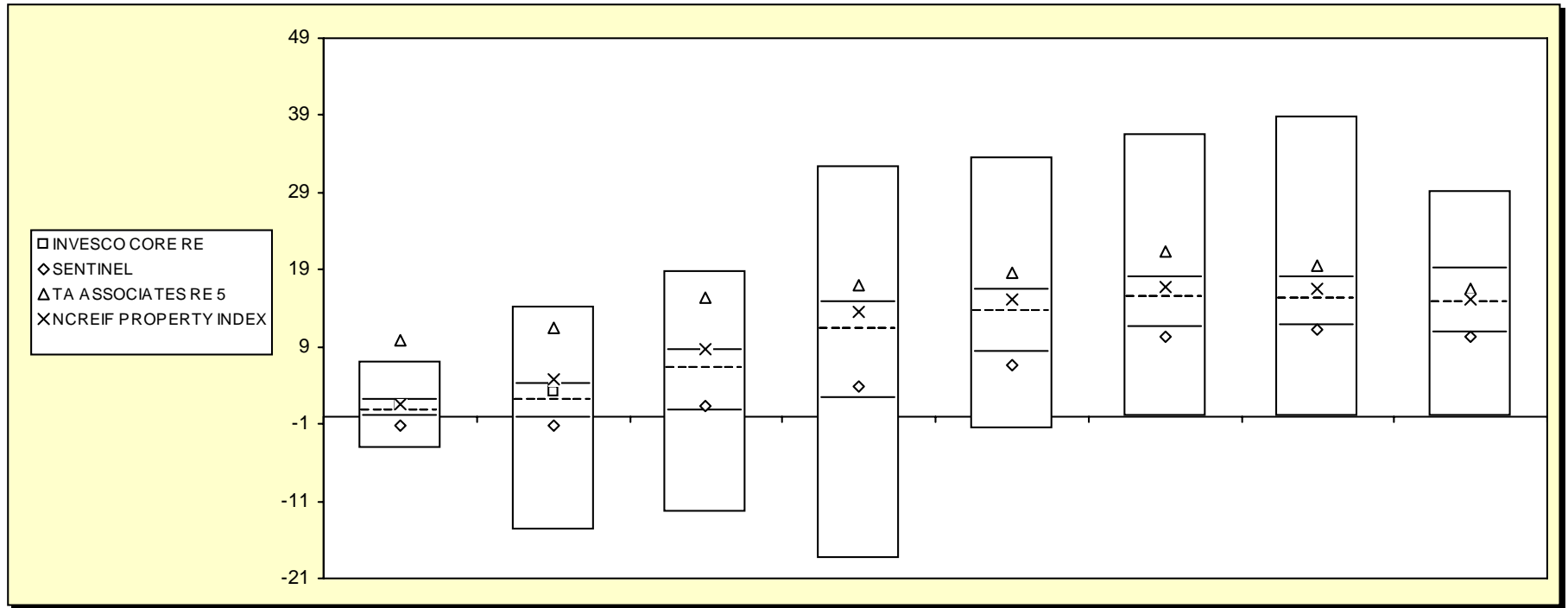

### Real Estate Funds

	Last Quarter		Two Quarters		Three Quarters		One Year		Two Years		Three Years		Four Years		Five Years	
	Return	Rank	Return	Rank	Return	Rank	Return	Rank	Return	Rank	Return	Rank	Return	Rank	Return	Rank
5th Percentile	7.2		14.2		18.8		32.4		33.6		36.6		38.9		29.3	
25th Percentile	2.0		4.2		8.5		14.6		16.2		17.9		18.0		19.0	
50th Percentile	0.7		2.0		6.1		11.2		13.6		15.4		15.2		14.6	
75th Percentile	-0.1		-0.3		0.7		2.2		8.2		11.5		11.8		10.7	
95th Percentile	-4.2		-14.9		-12.4		-18.5		-1.6		0.0		0.0		0.0	
INESCO CORE RE	1.3	38	3.1	38												
SENTINEL	-1.1	80	-1.2	76	1.3	72	3.9	70	6.5	78	10.3	77	11.3	76	10.4	76
TA ASSOCIATES RE 5	9.8	3	11.4	10	15.3	12	16.9	22	18.6	22	21.3	21	19.6	23	16.5	39
NCREIF PROPERTY INDEX	1.6	32	4.9	24	8.6	25	13.6	33	15.1	36	16.8	36	16.5	39	15.1	47

# Fresno County Employees' Retirement Association

## Consecutive Performance Comparisons

Period Ending: March 31, 2008

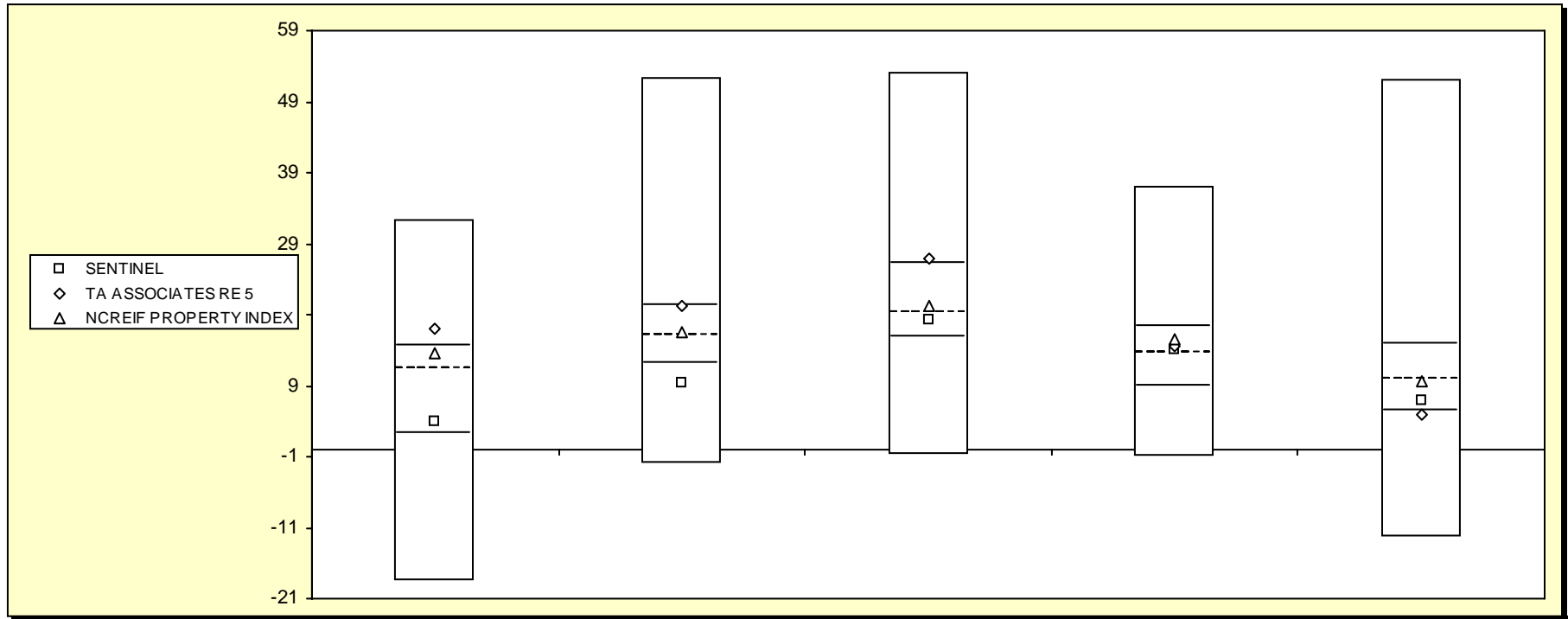

Real Estate Funds	March 2008		March 2007		March 2006		March 2005		March 2004	
	Return	Rank	Return	Rank	Return	Rank	Return	Rank	Return	Rank
5th Percentile	32.4		52.4		53.1		36.9		52.1	
25th Percentile	14.6		20.4		26.1		17.4		14.8	
50th Percentile	11.2		16.0		19.4		13.7		9.9	
75th Percentile	2.2		12.1		15.7		8.9		5.5	
95th Percentile	-18.5		-2.0		-0.8		-1.0		-12.3	
SENTINEL	3.9	70	9.3	79	18.4	57	14.1	47	6.9	67
TA ASSOCIATES RE 5	16.9	22	20.3	25	26.8	24	14.7	43	5.0	75
NCREIF PROPERTY INDEX	13.6	33	16.6	47	20.2	47	15.5	37	9.7	51

# Fresno County Employees' Retirement Association

Consecutive Annual - Five Year

Period Ending: March 31, 2008

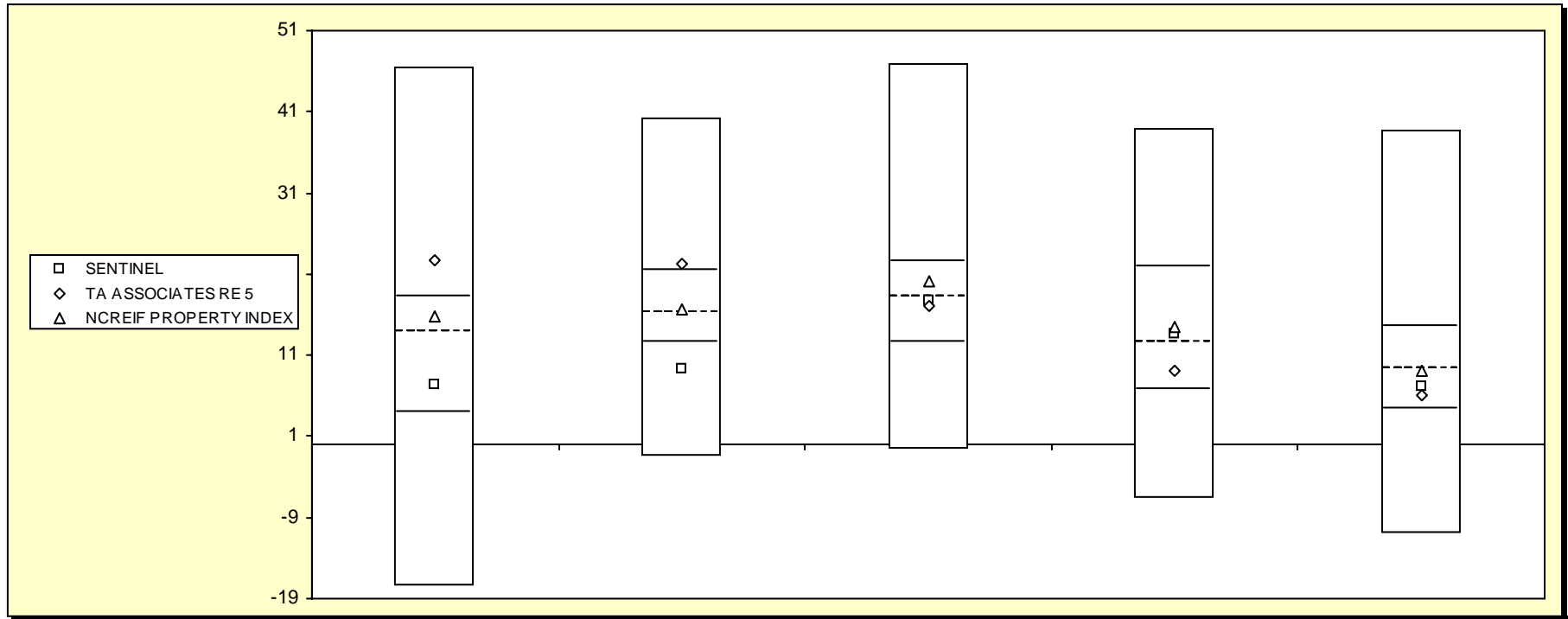

Real Estate Funds	December 2007		December 2006		December 2005		December 2004		December 2003	
	Return	Rank	Return	Rank	Return	Rank	Return	Rank	Return	Rank
5th Percentile	46.4		40.2		47.0		38.9		38.6	
25th Percentile	18.1		21.4		22.6		21.8		14.6	
50th Percentile	13.9		16.2		18.2		12.5		9.4	
75th Percentile	3.8		12.7		12.6		6.7		4.4	
95th Percentile	-17.5		-1.6		-0.7		-6.6		-10.9	
SENTINEL	7.4	66	9.4	80	17.8	52	13.7	47	7.1	61
TA ASSOCIATES RE 5	22.6	22	22.2	24	17.2	55	9.1	65	6.1	66
NCREIF PROPERTY INDEX	15.8	39	16.6	48	20.1	39	14.5	45	9.0	52