



PHONES

(044) 360-7-130
(050) 336-0-130
(063) 788-0-130
(067) 233-0-130
(068) 282-0-130

130
COM.UA

Internet store of
autogoods



ICQ
294-0-130
597-0-130

SKYPE
km-130

CAR RECEIVERS — Receivers • Media receivers and stations • Native receivers • CD/DVD changers • FM-modulators/USB adapters • Flash memory • Facia plates and adapters • Antennas • Accessories |
CAR AUDIO — Car audio speakers • Amplifiers • Subwoofers • Processors • Crossovers • Headphones • Accessories | TRIP COMPUTERS — Universal computers • Model computers • Accessories |
GPS NAVIGATORS — Portable GPS • Built-in GPS • GPS modules • GPS trackers • Antennas for GPS navigators • Accessories | VIDEO — DVR • TV sets and monitors • Car TV tuners • Cameras • Videomodules
• Transcoders • Car TV antennas • Accessories | SECURITY SYSTEMS — Car alarms • Bike alarms • Mechanical blockers • Immobilizers • Sensors • Accessories | OPTIC AND LIGHT — Xenon • Bixenon • Lamps
• LED • Stroboscopes • Optic and Headlights • Washers • Light, rain sensors • Accessories | PARKTRONICS AND MIRRORS — Rear parktronic • Front parktronic • Combined parktronic • Rear-view mirrors
• Accessories | HEATING AND COOLING — Seat heaters • Mirrors heaters • Screen-wipers heaters • Engine heaters • Auto-refrigerators • Air conditioning units • Accessories | TUNING — Vibro-isolation
• Noise-isolation • Tint films • Accessories | ACCESSORIES — Radar-detectors • Handsfree, Bluetooth • Windowlifters • Compressors • Beeps, loudspeakers • Measuring instruments • Cleaners • Carsits
• Miscellaneous | MOUNTING — Installation kits • Upholstery • Grilles • Tubes • Cable and wire • Tools • Miscellaneous | POWER — Batteries • Converters • Start-charging equipment • Capacitors
• Accessories | MARINE AUDIO AND ELECTRONICS — Marine receivers • Marine audio speakers • Marine subwoofers • Marine amplifiers • Accessories | CAR CARE PRODUCTS — Additives • Washer fluid •
Care accessories • Car polish • Flavors • Adhesives and sealants | LIQUID AND OIL — Motor oil • Transmission oil • Brake fluid • Antifreeze • Technical lubricant



In store "130" you can find and buy almost all necessary goods for your auto in Kyiv and other cities, delivery by ground and postal services. Our experienced consultants will provide you with exhaustive information and help you to chose the very particular thing. We are waiting for you at the address

<http://130.com.ua>

Technology: Art & Sound
Manufactured by
elettromedia Italy

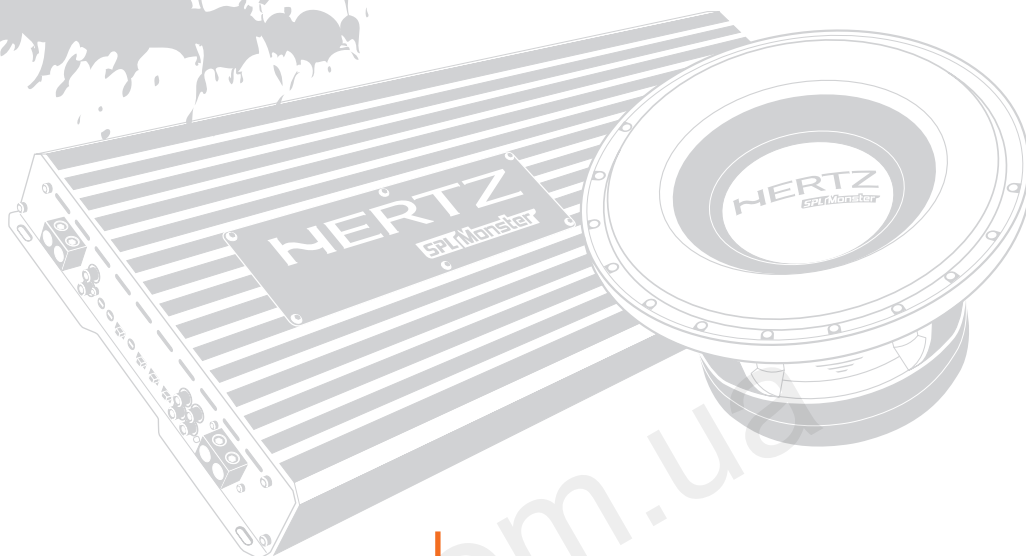

SPL Monster

Product Information

Elettromedia - October 2008

HERTZ

www.hertzaudiovideo.com



SPL Monster

Product Information

Elettromedia - October 2008

Hertz SPL Monster	04
MP 15K UNLIMITED	07
M 12 UNLIMITED	08
M 15 UNLIMITED	09
About us	10
CD contents	11

HERTZ

Visit www.hertzaudiovideo.com in order to find more information



SPL Monster: extreme pressure and power

Undeniably powerful, devastatingly robust, the new **Hertz SPL Monster** product range from the monstrous minds of the Elettromedia R&D department. These new products will soon be annihilating the competition at SPL events near you! The Elettromedia R&D experience, combined with the use of the most advanced technologies enabled the Hertz team to build subwoofers and amplifiers with explosive SPL performance; created to dominate in competition.

The **Hertz SPL Monster** line features three products: the **MP 15K UNLIMITED**, an amplifier able to deliver over 15.000 W of power; the **M 12 UNLIMITED** and **M 15 UNLIMITED**, customizable subwoofers with four optional mobile assemblies designed to achieve the best results in any application. In order to **make the unique SPL Project a reference**, our team of designers created a system where a full synergy exist between the amplifier and subwoofer; the combination capable of delivering staggering performance.



The **Hertz MP 15K UNLIMITED** can deliver over **15.000 W**. The enormity of this project amazes; both in terms of the physical “size” of the product itself and of the sheer energy it generates!

Within its electronics product range, the SPL MONSTER line offers a **main board** which is ahead of the time in the SPL amplifier market.

Elettromedia decided to develop and manufacture the MP 15K UNLIMITED amplifier in partnership with an outsourced, highly qualified production unit, thus eliminating the low production run limit that penalizes the evolution of unique products such as this. When compared to other companies who have acquired similar technology, the Hertz project boasts special features and extensive enhancements which distinguishes itself. Among them, uninterrupted power supply transfer and an input circuit specifically designed for SPL competitions, featuring integrated Hi-Pass and Lo-Pass filters.

A unique power supply connection system, **Direct Current**[®], transfers power between the battery and amplifier with very low contact resistance.

4 - 1/0 AWG cables (2 for the positive and 2 for the negative) are terminated with ring terminals on the supply side and secured to the amplifier with 4 - 2,5 mm thick copper buss bars connected directly to the printed circuit board. This differs completely from the high resistance terminal blocks found on traditional amplifiers that when are called upon to pass high current, generate heat and high power loss. **Direct Current**[®] is fundamental to achieve the current transfer required for high SPL systems.

In order to deliver such extraordinarily high power, the **power supply stage** features 8 toroidal transformers, 20 - 3300uF-105°Low ESR primary capacitors for a total of 66 000uF; 32 - 160A TO247 Mosfets and 10 - 820uF secondary capacitors capable of 200 V.

The **output stage**, settable in bridged or stereo mode, features 20 -190A/360V impulsive current Mosfets: solid, robust power and thermal dissipation without compromise.

For extreme SPL professionals, the **MP 15K UNLIMITED** is the ideal choice as a foundation to create a system that will achieve new records.

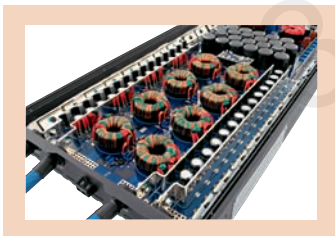

HERTZ

SPL Monster

The **Hertz SPL Stack System**[®] provides the ability to stack multiple **MP 15K UNLIMITED** amplifiers, using the supplied 2 mm thick robust iron **Brackets**. These six brackets are secured to each amplifier via threaded mounting points directly on the heatsink, providing solid integrity. With the **Hertz SPL Stack System**[®] your system can deliver **15.000 W, 30.000 W, 45.000 W**, or more, just stack and connect!



The **M 12 UNLIMITED** and **M 15 UNLIMITED** subwoofers are designed for true SPL competitors and their valuable Teams.

The sole mission of SPL subwoofers offered to date has been to “burp” huge SPL numbers. Hertz SPL UNLIMITED subwoofers “out-burp” the competition, yet still “play music”.

Just like in Formula 1 racing where the best Teams have the “perfect set-up” ready to go to achieve the best performance on each individual race circuit, the **M 12 UNLIMITED** and **M 15 UNLIMITED** offer the ability to choose the moving assembly which is most appropriate for the overall system design and conditions, achieving **maximum SPL in every competition**. The innovative **RMA (Removable Moving Assembly)** provides the ability to replace the entire mobile assembly in few seconds, without removing the speaker from its mounting position. For each configuration you can choose the mobile assembly which is most effective, differing in the number of spiders, cone material and voice coil impedance.

The advantages are plain to see both when tuning the system and when on the competition field; perfect for the seasoned SPL competitor.

Proving the synergy of the magnetic assembly, featuring a proprietary vented cooling system and the aluminium voice coil wound on a four layer former, power handling is rated at an amazing **8000 W**.

Performance not even imaginable with traditional designs: the **M 12 UNLIMITED** and **M 15 UNLIMITED** feature high thermal dissipation plates, massive double magnet assemblies and water-repellent, non-pressed paper or layered kevlar cones (according to the selected RMA).

Hertz SPL Monster subwoofers are most of all.... **Evolution!**

A product born to dominate in SPL circuits must be continuously improved to keep the pace as the competition catches up: the **SPL Monster** subwoofers will undergo **continued modifications and upgrades**, thanks to our ongoing research and the feedback we welcome from the competition field!

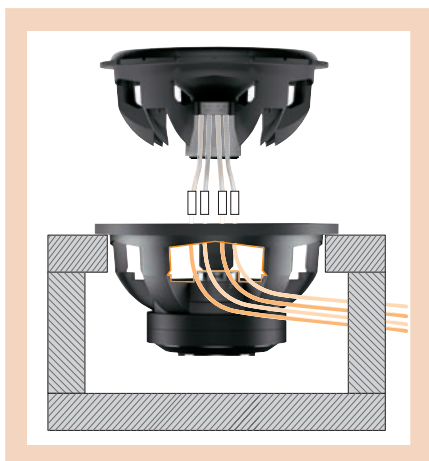

HERTZ

AMPLIFIER

SPL Monster FIER

MP 15K UNLIMITED
15000 W



Power Supply

Power supply voltage:	8 ÷ 18 VDC
Idling current:	8 A
Idling current when off:	3 mA

Amplifier stage

Distortion THD (A weighted, 100Hz @ 4Ω):	0.15 %
Bandwidth (-3 dB):	10 ÷ 500 Hz
S/N Ratio (A weighted @ 1 V):	69 dB
Damping factor (100Hz @ 4Ω):	> 950
Pre-In sensitivity:	0.3 ÷ 7 V
Pre-In impedance:	15 kΩ

OUTPUT POWER (RMS) @ 12 VDC, THD 1%:

Load Impedance	Stereo	Bridge
4 Ω	1000 W x 2	4000 W x 1
2 Ω	2000 W x 2	6000 W x 1
1 Ω	3000 W x 2	8000 W x 1

OUTPUT POWER (RMS) @ 14,4 VDC, THD 1%:

Load Impedance	Stereo	Bridge
4 Ω	1500 W x 2	5600 W x 1
2 Ω	2800 W x 2	9000 W x 1
1 Ω	4500 W x 2	12000 W x 1

OUTPUT POWER (RMS) @ 16 VDC, THD 1%:

Load Impedance	Stereo	Bridge
4 Ω	1800 W x 2	6800 W x 1
2 Ω	3400 W x 2	11000 W x 1
1 Ω	5500 W x 2	15000 W x 1

OUTPUT POWER (RMS) @ 18 VDC, THD 1%:

Load Impedance	Stereo	Bridge
4 Ω	2300 W x 2	8800 W x 1
2 Ω	4400 W x 2	12000 W x 1
1 Ω	6100 W x 2	15500 W x 1

The Hertz MP 15K UNLIMITED, with its 15.000 W of destructive power, the enormity of this project is intimidating to your eyes and for the sheer energy it generates!

1. In order to deliver such extraordinarily high power, the power supply stage features 8 toroidal transformers, 20 - 3300uF 105°Low ESR primary capacitors for a total of 66 000uF; 32 160A TO247 Mosfets and 10 - 820uF secondary capacitors capable of 200 V.
2. The output stage, settable in bridged or stereo mode, features 20 -190A/360V impulsive current Mosfets: robust power and thermal dissipation without compromise.
3. **Direct Current**®: 4 - 1/0 AWG cables (2 for the positive and 2 for the negative) terminated with ring terminals on the supply side and secured to the amplifier with 4 - 2,5 mm thick copper buss bars connected directly to the printed circuit board, providing the ability to transfer power between battery and amplifier with very low contact resistance.
4. **Hertz SPL Stack System**® stacks multiple amplifiers thanks to the 6 supplied 2 mm robust iron Brackets. The threaded mounting points on the heatsink let your SPL power plant to grow without limits.
5. An input circuit specifically designed for SPL competitions featuring selectable output mode settings that extend the range of the mobile assemblies the Hertz M 12 UNLIMITED and M 15 UNLIMITED subwoofers offer, letting your system be adaptable to any competition category.

Filters & Controls

Lo-Pass:	OFF / Lo-pass: 40 ÷ 150 Hz @ 24 dB/Oct.
Subsonic:	OFF / Hi-pass: 10 ÷ 50 Hz @ 24 dB/Oct.
Output Mode:	Stereo By-Pass / Bridge / L+R Mix
Chain Mode:	Master / Slave

Measure

Max size (mm/inches):	323 x 830 x 68,5 12 ^{3/4} x 32 ^{11/16} x 2 ^{3/4}
Weight (kg/lb):	25,5 / 56.2

HERTZ

SUB *SPL Monster* WOOFER

M 12 UNLIMITED 8000 W



Technical Specifications

Component	SPL Dual Coil Subwoofer	
Size	mm	300 (12")
Power Handling	W peak	8000
	W continuous	2000
Impedance	Ω	1,2 + 1,2
Frequency response	Hz	32 ÷ 1000
Sensitivity	dB/SPL	95
Outer diameter	mm	324
Mounting diameter	mm	280
Magnet size	mm	230
Total depth	mm	229
Mounting depth	mm	192
Total driver displacement	l	7,1
Weight of one speaker	kg	19,8
Voice coil \varnothing	mm	75
Magnet	Double magnet, High density flux ferrite	
Cone	Non-pressed Paper Cone	
X-mech*	mm	28

*X-mech maximum mechanical excursion: it indicates the motion range in the speaker linear functioning area, in both ways.

Electro-Acoustic Parameters

D	mm	245
Xmax	mm	10
Re	Ω	2,1
Fs	Hz	39
Le	mH@1kHz	1,16
Le	mH@10kHz	0,38
Vas	l	21,70
Mms	g	236,7
Cms	mm/N	0,07
BL	T-m	21,58
Qts		0,25
Qes		0,26
Qms		5,08
Spl (1m/2,83V)	dB	95

*Coils in series

HERTZ

1. High thermal dissipation and magnetic permeability plates; provides constant, even flux.
2. Large double magnet; for perfect control under high power, very high excursion conditions for top SPL performance.
3. Aluminium voice coil wound on four layer former; for unheard of thermal and mechanical capacity.
4. Back plate vent holes; for optimal thermal dissipation.
5. Back Vented Spider support; for perfect symmetry under high excursion while providing increased thermal dissipation.
6. DSS; Double Symmetrical Spider system.
7. RMA; easily Removable Moving Assembly.
8. Internally reinforced basket; protected from abrasions with high resistance paint.
9. Connections ending with high current cables (8 AWG).
10. Tinned lead wires are integrated into the spider; for maximum reliability and conductivity.
11. Basket and motor are coupled and damped through special epoxy glue.
12. Wide-wave, resin-bonded fibre spider; for consistent parameters and mechanical consistency.
13. High density foam surround; for linear movement even under extreme excursion.
14. Water-repellent, non-pressed paper cone.

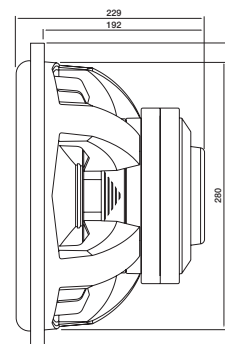
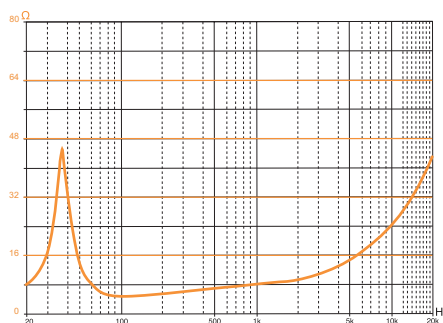

SUB *SPL Monster* WOOFER

M 15 UNLIMITED 8000 W



Technical Specifications

Component	SPL Dual Coil Subwoofer	
Size	mm	380 (15")
Power Handling	W peak	8000
	W continuous	2000
Impedance	Ω	1.2 + 1.2
Frequency response	Hz	28 ÷ 700
Sensitivity	dB/SPL	98
Outer diameter	mm	399
Mounting hole diameter	mm	350
Magnet size	mm	230
Total depth	mm	246
Mounting depth	mm	209
Total driver displacement	l	9,2
Weight of one speaker	kg	22,9
Voice coil \varnothing	mm	75
Magnet	Double magnet, High density flux ferrite	
Cone	Non pressed Paper Cone	
X-mech*	mm	28

*X-mech maximum mechanical excursion: it indicates the motion range in the speaker linear functioning area, in both ways.

Electro-Acoustic Parameters

D	mm	320
Xmax	mm	10
Re	Ω	2,1
Fs	Hz	36
Le	mH@1kHz	1,14
Le	mH@10kHz	0,38
Vas	l	61
Mms	g	295,3
Cms	mm/N	0,07
BL	T-m	21,87
Qts		0,28
Qes		0,29
Qms		5,38
Spl (1m/2,83V)	dB	98

*Coils in series

1. High thermal dissipation and magnetic permeability plates; provide constant, even flux.
2. Large double magnet; for perfect control under high power, very high excursion conditions for top SPL performance.
3. Aluminium voice coil wound on four layer former; for unheard of thermal and mechanical capacity.
4. Back plate vent holes; for optimal thermal dissipation.
5. Back Vented Spider support; for perfect symmetry under high excursion while providing increased thermal dissipation.
6. DSS: Double Symmetrical Spider system.
7. RMA: easily Removable Moving Assembly.
8. Internally reinforced basket; protected from abrasions with high resistance paint.
9. Connections ending with high current cables (8 AWG).
10. Tinned lead wires are integrated into the spider; for maximum reliability and conductivity.
11. Basket and motor are coupled and damped through special epoxy glue.
12. Wide-wave, resin-bonded fibre spider; for consistent parameters and mechanical consistency.
13. High density foam surround; for linear movement even under extreme excursion.
14. Water-repellent, non-pressed paper cone.

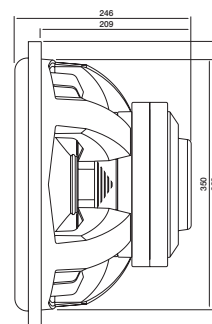
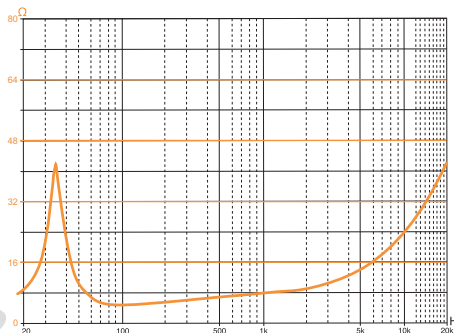

HERTZ

About us

Elettromedia, an Italian company, is a leader within the world-wide car Hi-Fi market.

Born in 1987 in Potenza Picena by a group of friends who shared the same passion for in-car high fidelity, throughout the past years Elettromedia has been walking the path of excellence: its products are distributed in more than 50 countries; the company has received many awards and acknowledgements from the most authoritative leaders within the car audio industry; it also can boast reviews of more than 2000 pages published in 27 different languages (visit: www.elettromedia.it/press_area.asp).

The Elettromedia brands are Audison, Hertz, Connection and AZaudiocomp. Through a co-branding strategy, the company offers all of the components required for a complete, top level car audio system.



Contacts: Elettromedia s.r.l.
Strada Regina km 3,500 - 62018 Potenza Picena (Mc) - Italy
T +39 0733 870 870 - F +39 0733 870 880 - www.elettromedia.it

Awards



HERTZ



CD contents

SPL Monster Technical Data Sheets (PDF version, 150 dpi resolution)

Logos: Hertz, SPL Monster (Adobe Illustrator version, 300 dpi resolution)

Photos (JPEG version, 300 dpi resolution)



MP 15K UNLIMITED



M 12 UNLIMITED



M 15 UNLIMITED



Elettromedia_headquarter



SPL Monster_Technologies





www.hertzaudiovideo.com

HERTZ

PART OF **ELETTROMEDIA** - 62018 Potenza Picena (MC) Italy - T +39 0733 870 870 - F +39 0733 870 880 - www.elettromedia.it