

---

# CATALOGUE





## Ladies and Gentlemen,

It is our pleasure to present to you the new 2015 DURABLE catalogue. In here you will find an extensive range of products for office and business organisations which all feature the quality, functionality and design of high grade products that DURABLE is well-known for. Our prime concern is to ensure that our various solutions help you to perform your daily work more successfully. Therefore, we have continued to develop the DURABLE product range over the last few years, primarily by adding our own product developments, which are innovative in both functionality and design.

To make it easier for you to find the products you are looking for, we have revised the structure and layout of our catalogue. It covers six areas of application with detailed descriptions of the product groups in each category. The new catalogue is divided into:

- Filing and organisation
- Office equipment
- Display and presentation systems
- Name badges and signage
- Security and safety
- Waste management

We have now been operating successfully for almost a century. A success story we owe first and foremost to you, our loyal customers. We see this as an obligation for the future to continue to keep our business sustainable as well as the economically successful management of our business.

Thank you for your continued support.

Yours Sincerely,

*H.-W. Maier-Hunke*

Horst-Werner Maier-Hunke



*Matthias Laue*

Matthias Laue



The corporate development team	Page 06	Our company staff	Page 14
The locations	Page 08	Sustainability	Page 16
Innovation	Page 10	Service	Page 18
The brand	Page 12	Customised manufacturing	Page 20



## Filing and Organisation

Page 22



## Office equipment

Page 70



## Display and presentation systems

Page 128



## Name Badges and Signage

Page 162

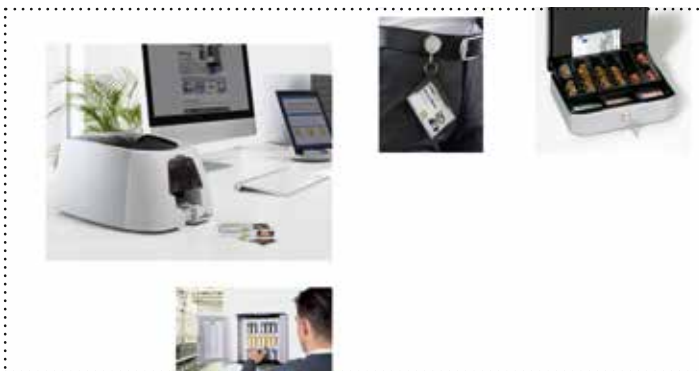

## Safety and security

Page 206



## Waste Management

Page 224

Small furniture – detailed information Page 240

Contents by product name Page 244

Contents by product number Page 250

## The corporate development team

**DURABLE was established in 1920 by Karl Hunke and Wilhelm Jochheim in Iserlohn to manufacture metal tabs.**

Today, the company is still family-owned and the corporate headquarters are still located on the original site, even after 95 years. In 1965, a new production plant was opened in Kamen-Methler.

In later years, more production facilities were added in Iserlohn-Sümmern (1997), in Gotha (2000), in Szczecin/Poland (2004) and Coevorden/Netherlands (2010). In 1994, the various DURABLE shipping departments were all brought together at the newly constructed distribution centre in Iserlohn-Sümmern. Also in 1994, DURABLE was one of the first companies from the office supplies industry to be certified according to the international ISO 9001 quality standard. This was followed in 2010 by environmental management certification according to ISO 14001.

Following its start as a manufacturer of metal products, the company's product portfolio underwent a fundamental change after World War II. DURABLE was the first company to develop and manufacture office organisation and presentation products made of plastics. In 1959, the DURACLIP® clip folder was invented... the solution for filing documents without punching.

Over the last 20 years, more and more product lines have been developed and added, which can also be used in areas other than offices: display panel systems, cash boxes, key boxes, door signs, magnetic frames, office furniture and waste bins. In 2015, an innovative lighting system with a biological light effect is being introduced under the independent brand name of LUCTRA®.

Over half of DURABLE sales occur outside of Germany. Therefore, sales subsidiaries were opened in the UK (1980), Sweden (1980), the Netherlands (1991), Belgium (1997), France (2000), Austria (2001) and the USA (2001). In addition, representative offices in Russia (2002), Poland (2004), Italy (2005) and Switzerland (2014) are now operational.

With approximately 700 employees, we see ourselves as a medium-sized enterprise with a German manufacturing tradition and global presence.

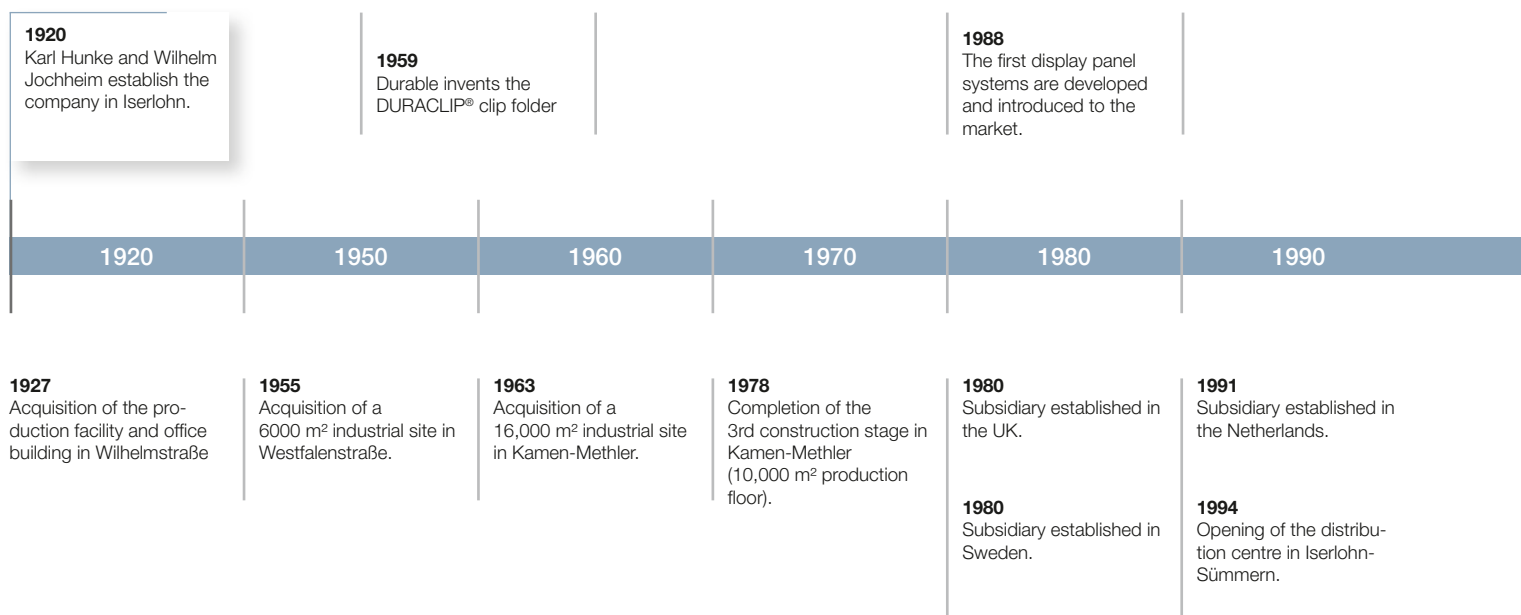



**2001**  
Newcomers to the range:  
EUROBOXX cash boxes.

**2003**  
DURABLE develops  
KEY BOX, the innovative  
key boxes

**2009**  
DURABLE launches the  
multiple award-winning  
DURAFRAME® range.

**2009**  
Extension of our range  
by the addition of waste  
management products.

**2011**  
Extension of our range  
by adding small furniture.

**2015**  
Market launch of the innovative  
LUCTRA® lighting system

1990

2000

2010

2015

**1997**  
Official opening of the pro-  
duction plant in Iserlohn-  
Sümmern.

**2000**  
Subsidiary established in  
France.

**2000**  
Official opening of the  
production plant in  
Gotha.

**2010**  
Official opening of the  
production plant in  
Coevorden/the Nether-  
lands.

**1997**  
Subsidiary established in  
Belgium.

**2001**  
Subsidiary established in  
the USA.

**2001**  
Subsidiary established in  
Austria.

**2004**  
Official opening of the  
production plant in  
Szczecin/Poland.

## The locations

● Head office Iserlohn



● Logistics centre Iserlohn



○ Production plant Coevorden



○ Subsidiary USA/Canada



○ Subsidiary UK



○ Subsidiary France



○ Production plant Kamen



○ Production plant Szczecin



○ Production plant Gotha

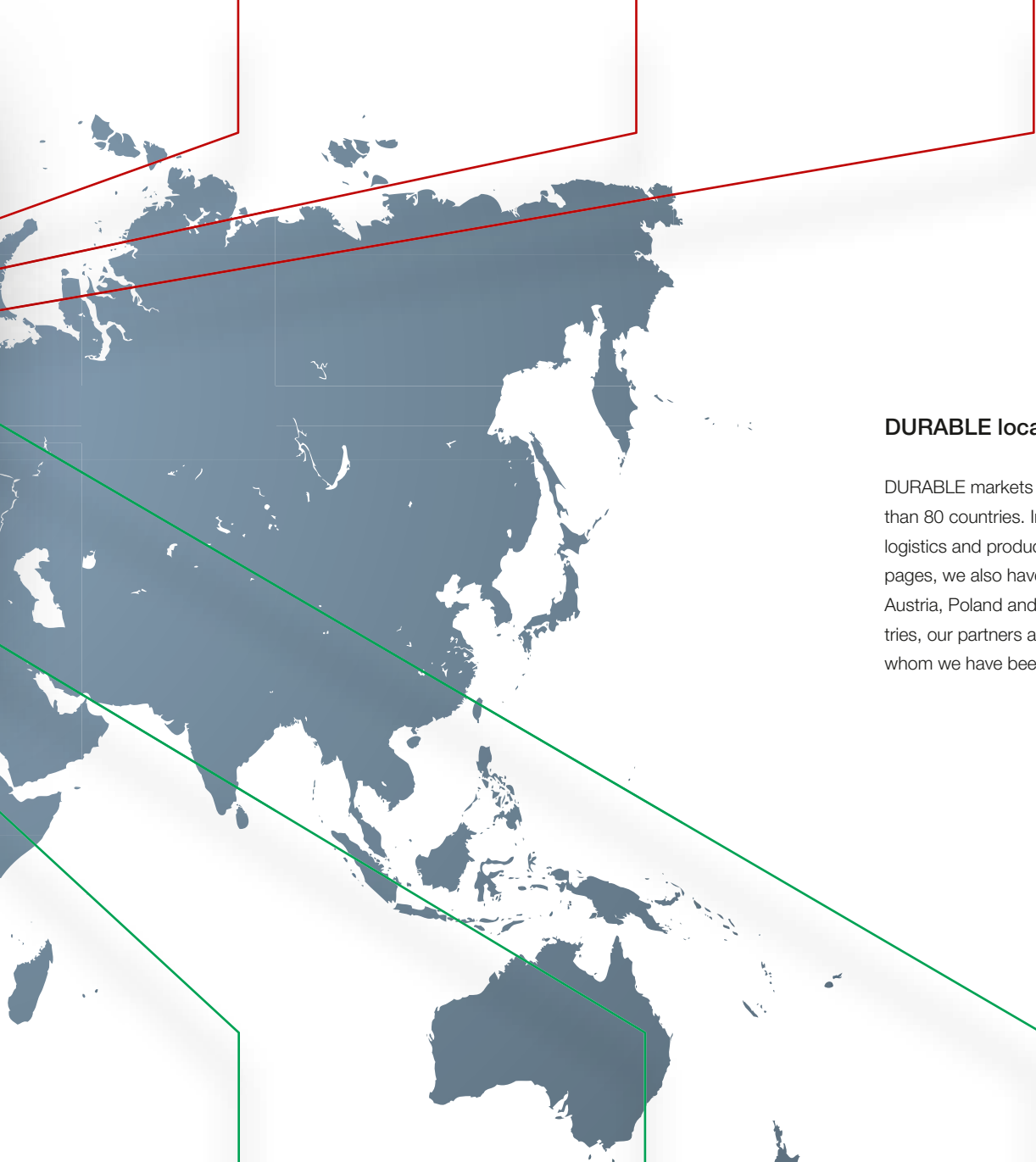

## DURABLE locations

DURABLE markets its product portfolio in more than 80 countries. In addition to the administration, logistics and production facilities named on these pages, we also have representative offices in Italy, Austria, Poland and Russia. In many other countries, our partners are importers or distributors with whom we have been cooperating for many years.



○ Subsidiary Belgium



○ Subsidiary Netherlands



○ Subsidiary Scandinavia



**DURABLE**  
THE STYLE OF SUCCESS

---

Our brand mission:

“DURABLE has set itself the task of developing office organisation and presentation systems that optimise the professional image and therefore the success of their users through perfect functionality, outstanding design and visible premium quality materials.”

---

Horst-Werner Maier-Hunke, Managing Director of DURABLE, expresses how we see our brand:

“DURABLE is the superior brand for premium-quality office materials whenever an impression of distinction and professionalism is called for. DURABLE is invariably characterised by superior and tasteful, yet unpretentious design and well thought-out solutions.”





Brands provide solutions and create identity. With an extremely high awareness level and a clear profile, the DURABLE brand fulfils these functions in an ideal way.

The public experiences DURABLE as a professional and reliable problem solver, offering dynamic and intelligent solutions. The DURABLE brand also contributes to enhancing the competitive profile of its customers.

Standing still means no progression, which also applies to brands. This is why we continue to develop the profile of the DURABLE brand. The claim of this brand, THE STYLE OF SUCCESS, expresses its aspiration and its promise:

**DURABLE supports its customers in efficient organisation of their work and successful presentation of the results.**



As a brand manufacturer, we feel an obligation to meet our customers' expectations and satisfy their demands.

With newer and better products as well as improved processes, we constantly strive to set new benchmarks. 20 customer awards and 30 famous design awards are visible evidence of such efforts. For us, this only provides us with further incentive.

At DURABLE, innovation means exploiting market potentials by continually modernising our product lines and opening up new segments. Permanent exchange of information with our partners, with consumers and stakeholders enables us to continuously develop our range of products and services.

Some of our product lines are even multiple award winners:

## DURAFRAME®



## VARICOLOR®



## SHERPA®



The innovative LUCTRA® lamp range is the most recent example of innovations created by DURABLE.

**LUCTRA**  
PERFECT · DAY · LIGHT

LUCTRA® is the first individual, biologically effective lamp system for the workplace. Individual light sequences and intensity of light can be controlled via the patented VITACORE® electronic system which can also work with Bluetooth technology via smartphones and tablets.

More information about LUCTRA® is available on [www.luctra.eu](http://www.luctra.eu)



reddot award 2015  
winner



## Our company staff

Our staff members are characterised by competence, dedication and outstanding loyalty. To maintain this standard, DURABLE continuously invests in its human resources and offers a wide range of incentives in the areas of health, childcare, education and training.

### Internal social commitment

DURABLE currently employs approximately 700 people. Supporting its employees in the area of preventive healthcare is an important corporate concern.

### Health days

Health days are regularly held at various corporate facilities. The range of individual services is wide, including blood sugar and body fat tests as well as blood pressure measurements and cardio scans, and even a workshop about the burnout syndrome. Almost all counselling sessions and tests offered are fully booked, showing that the staff members' interest in their own state of health is very high.

### Physiotherapy

A regular, free-of-charge physiotherapy programme has also been running for a number of years, to benefit all staff members interested, to improve their health and their physical performance.

### Childcare for under-threes

In September 2013, DURABLE opened a major day care centre for children under the age of 3. Under the title of "durable-minis", children aged from 0 to 3 years are taken care of for up to 45 hours per week. 9 durable-minis are currently on site, and DURABLE supports their mothers with a contribution to the costs as well, thus enabling them to go about their work with the child care centre in the immediate neighbourhood.



### Training

About 30 young men and women are currently being trained at DURABLE. There are roughly 15 recognised occupations for which training is offered which include vocations such as industrial sales management assistant, business administrator, warehouse logistics manager, or even technical product designer, tool mechanic and process technician for plastics and rubber technology.

The commercial training programme includes an internship of several weeks at one of DURABLE's international subsidiaries, for example in France, the UK, Sweden or Belgium.



### Advanced education and training

DURABLE offers its staff members an extensive programme of further training opportunities. In 2014, some 700 days were taken for advanced education and training.

The programme includes traditional Microsoft Office training and instruction in injection moulding technology, but also support in the correct style of correspondence using electronic media, training in modern etiquette and even anti-stress seminars or courses on time management and self-management. Intercultural training to improve the understanding and cooperation between international DURABLE facilities is also a part of the programme.



### Sustainability at DURABLE

We live in a world of change and the consequences of globalisation, the threat of climate change, retrenchment of jobs, the debate about top executives as role models, or inappropriate behaviour in major companies are vital issues which people are concerned about. In times of growing disorientation, our society longs for security and a system of fixed rules. People set out to rediscover traditional values, and there is an increasing demand for companies to accept comprehensive responsibility.

We are aware of the fact that, apart from a positive bottom line, corporate success also means great ecological and social responsibility. This cannot and must not be reduced to a mere short-lived trend, but rather practised on a permanent basis. This is why sustainable management and social commitment have become a part of our daily routine.

Use of high-quality, recyclable materials, avoidance of waste and energy-saving production processes have already been a part of our daily routine for a considerable time. This underlines our determination to accept ecological and social responsibility.

Of course this also includes our social responsibility towards staff members and society in general, which is reflected in many different projects. One example is our cooperation with a local school, where some of our staff members visit science classes to illustrate theoretical learning content with practical examples.

Our aim is to develop products which are generally recyclable. Of course they should also be cost-efficient to produce and yield a fair return on investment. To come as close as possible to this ideal, we continuously carry out critical analyses on the environmental compatibility of our products and on our production processes as well. We also meet the requirements for documentation of our quality management system and our environmental responsibility in accordance with the international DIN EN ISO 9001 standard and the environmental management certification according to DIN EN ISO 14001. Moreover, DURABLE is a member of B.A.U.M. e.V., the German Environmental Management Association.

### Environment Focus

At DURABLE we have committed ourselves to careful use of all resources. Only 0.3% of our production waste actually goes into waste disposal. 99.7% is recycled or used to produce energy. We realise that this is not enough. We are eager to save energy at every workplace in production as well as in administration. In this way, we have continuously reduced our average power consumption per production unit over the last few years. Thanks to our ultra-modern production equipment, we have significantly increased our production volume without consuming more energy. Our end users are pleased; after all, they receive excellent product quality and elegant product design, without causing harm to the environment.





### Waste avoidance and resource recovery

New production techniques which minimise waste and environmental impact: today, virtually 100% of waste and/or scraps produced are returned to the production process. Waste is collected and re-used, resources are saved.

### “Success should be shared with others”.

This is a basic principle at DURABLE. Social commitment has a long tradition at our company. National and international projects are not only initiated by the company, but also actively supported by our staff members or even launched on their own initiative. It is our primary concern that social values should play an important part at DURABLE and that we put them into practice. At our facilities in Germany, we sponsor local projects financially as well as by product

donations and donations in kind. In this way we support, for example, the „Werkstatt im Hinterhof“ (“backyard workshop”) in Iserlohn, a project to counteract social indifference, with various kinds of assistance for people seeking help. At all our production plants, we cooperate with workshops for disabled persons as material suppliers for selected products.

On the international level, too, DURABLE is active in well-known projects of humanitarian aid. Cooperation with SOS children’s villages has been in existence for several decades. We support SOS children’s villages, for example in Kenya, Nepal, Pakistan, Peru, Sri Lanka, Estonia and in our local Sauerland region. We have established a long-term cooperation to assist the Stargard children’s home in Poland. One of our annual highlights is the Christmas campaign, in which staff members each pack a Christmas gift bag for one of the children.



#### This is how we define sustainability:

For many years, DURABLE has been taking into account important environmental aspects in the areas of resource planning, production and waste disposal. An overview of our products and their respective sustainability can be found on the Internet under [www.durable.eu](http://www.durable.eu)



#### DURABLE

Selected raw materials and efficient manufacturing processes result in very high quality and durability of our products.



#### BIODEGRADABLE

Products which break down or decompose through biological processes.



#### OVER 30% RECYCLED MATERIAL

The products are made from over 30% recycled starting material.



#### RECYCLABLE

Single-material products or products whose individual materials can be separated by hand.



#### REFILLABLE/REFILL

Prevention of excess packing material.



#### MATERIAL RE-USE

Separated waste material is recycled back into the production process.



#### HFC-FREE

These products have no hydrofluorocarbons (HFCs) as propellants.



#### CHLORINE-FREE BLEACHED PAPER

The labelling strips and insertable badges of all products are bleached without the use of chlorine.



#### Made in Eu

Over 95% of our products are manufactured in the EU.

Our online service:

DURABLE offers a great variety of online tools to ensure an open dialogue and easy access to information with distributors and consumers.

Website

Equipped with an intuitive search function, cross-referencing and optimised product presentations.



Online communication

Regular newsletters to distributors and consumers, informative micro sites for important product segments, product videos – our service portfolio covers a wide range.



Scan here for the DURABLE YouTube channel



**DURABLE-LIVE  
DURABLE-IDENTITY**

With micro-sites such as **DURABLE-LIVE** for the facility sector and **DURABLE-IDENTITY** for our range of name badges, we have created attractive online worlds that demonstrate the superiority of our products.

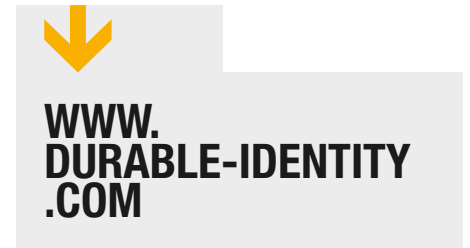

**Commerce connector**

The ecommerce tool that provides an option to buy your favourite products.



**Online shop**

www.durable-business.com offers direct purchase of personalised DURABLE products



Creation in just three simple steps:

- 1** Select a product
- 2** Add your individual design
- 3** Place your order

# WE CAN DO MORE THAN JUST STANDARD

We appreciate that sometimes you need something a little different.

From something as simple as matching your corporate colours to making alterations to a standard product to make its distinctive design meet your specific needs.

Should you find that one of our products doesn't meet your special requirements...

No problem!

Make use of the wide range of options we offer to help you achieve your ideas and needs



**We supply solutions made to measure with various production processes to meet your needs:**

Injection moulding

Extrusion

Screen, offset and pad printing

Punching/stamping

Cutting

High-frequency/ultrasound welding





**Our strengths:**

- Expert advice and continuous contact all the way from your enquiry to delivery
- Sampling close to the real product
- Premium quality from DURABLE
- Fast customised production and on-schedule delivery
- Technical expertise

Your customised production is in the best hands with us – this is ensured by our wide range of manufacturing facilities, our many years of experience and our competent technical staff who are at your disposal for a personal advice.







**Products**

**Page**

Clip folders	24–29
Spine bars and report covers	30–31
Job application folder	32–33
Folders with elastic corner holders	34–35
Display books	36–37
Clear view folder/document folder	38–45
Special folders and accessories	46–47
Index Sets	48–51
Clipboard folders/clipboards	52
Suspension folders and accessories	54–55
Address management	56–62
Self-adhesive products	64–69

# Filing and Organisation





## CLIP FOLDERS

Good preparation and professionally presented documents are vital for making a good impression. DURACLIP®, SWINGCLIP®, DURASWING® and DURAQUICK® are featured names of the dynamic clip folder range from DURABLE to present and protect unpunched documents in the best possible way.





## DURA CLIP®

- The most successful business folder worldwide
- No need for punched holes
- For successful presentation, effective order and safe storage
- For documents up to A4
- Made of hard-wearing plastics
- Transparent front cover
- Coloured spine, 3 or 6 mm wide
- Capacity 30 or 60 pages
- With clip made of special steel
- 5 year clip guarantee



Patented

**5 YEAR**  
CLIP  
GUARANTEE

[www.duraclip.com](http://www.duraclip.com)

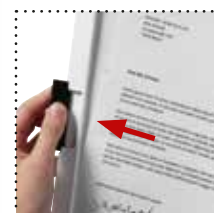

### DURA CLIP® 30

- Capacity: 1-30 A4 sheets

# 2200

☞ 25 per box

- ▲ 01 black, 02 white, 03 red, 04 yellow, 05 green, 06 blue, 07 dark blue, 09 orange, 10 grey, 12 light purple, 28 midnight blue, 31 aubergine/dark red 32 petrol/dark green, 57 anthracite/grey, 00 assorted

### DURA CLIP® 30 RETAIL PACK

- Bag containing 5 clip folders product # 2200
- Per bag

# 2227

☞ 5 per bag

- ▲ 01 black, 02 white, 03 red, 07 dark blue, 00 assorted

### DURA CLIP® 60

- Capacity: 1-60 A4 sheets

# 2209

☞ 25 per box

- ▲ 01 black, 02 white, 03 red, 04 yellow, 05 green, 06 blue, 07 dark blue, 10 grey, 28 midnight blue, 31 aubergine/dark red, 32 petrol/dark green, 57 anthracite/grey, 00 assorted

### DURA CLIP® 60 RETAIL PACK

- Bag containing 5 clip folders product # 2209
- Per bag

# 2238

☞ 5 per bag

- ▲ 01 black, 02 white, 07 dark blue, 32 petrol/dark green



## DURACLIP® 30 LANDSCAPE

- For presentation, organisation and storage
- For unpunched documents in landscape format
- Ideal for spreadsheets, presentations and quotations etc.
- Capacity: 1-30 A4 sheets in landscape format

# 2246      07 dark blue  
 25 per box



## DURACLIP® 30 PLUS

- With transparent pocket on front cover
- To store documents in A4 format
- Capacity: 1-30 A4 sheets

# 2213      02 white  
 25 per box



## DURACLIP® 30 EASY FILE

- With flexible archiving mechanism
- For filing in lever arch files and ring binders
- Capacity: 1-30 A4 sheets

# 2229      07 dark blue  
 25 per box



## DURACLIP® 30 FOLIO FORMAT

- Capacity: 1-30 sheets
- Folio format: 210 x 330 mm (W x H)

# 2201      03 red, 05 green, 06 blue, 10 grey  
 25 per box



## DURACLIP® 50 INDEX

- With integrated 5 part coloured index
- Capacity: 1-50 A4 sheets

# 2234      01 black  
 25 per box



## DURACLIP® A3

- With two clips for additional security of loose sheets
- Capacity: 1-60 A3 sheets

# 2218      06 blue  
 10 per box



## DURACLIP® A5

- Capacity: 1-30 A5 sheets

# 2217      01 black  
 25 per box



## DURACLIP® FILE

- Self-adhesive filing strip for DURACLIP® clip folders
- Permits storage in files and ring binders
- Punching: 80 mm

# 8098      01 black  
 10 per bag

## SWINGCLIP®

- User friendly
- Curved swivelling plastic clip
- Made of flexible polypropylene
- For A4 documents

### SWINGCLIP®

- With opaque or translucent clip
- Capacity: 1-30 A4 sheets

# 2260  
📦 25 per box

🔦 01 black, 02 white, 03 red, 04 yellow, 05 green, 06 blue\*, 07 dark blue, 09 orange\*, 14 light blue\*, 32 petrol/dark green\*, 35 crimson\*, 00 assorted

### SWINGCLIP® RETAIL PACK

- 5 clip folders with translucent clip
- Product # 2260 in a bag

# 2284  
📦 5 per bag

🔦 00 assorted



### SWINGCLIP® COLOR

- User friendly
- Made of flexible polypropylene
- For A4 documents
- Curved, swivelling plastic clip



### SWINGCLIP® COLOR

- In translucent colours
- With light grey clip
- Capacity: 1-30 A4 sheets.

# 2266  
📦 25 per box

🔦 04 yellow, 06 blue, 10 grey, 12 light purple, 20 turquoise



### SWINGCLIP® JOB APPLICATION PACK

- SWINGCLIP® clip folder
- Dark blue plastic clip
- Cardboard-backed envelope
- For 1-30 A4 sheets

# 2286  
📦 1 bag

🔦 07 dark blue

## DURASWING® PROJECT

- Safe storage of written documents
- Without punching and tacking
- Clip folder made of transparent or coloured polypropylene sheet
- With high-quality, laterally swivelling plastic clip
- Several different models available
- Ideal for unpunched sheets



### DURASWING®

- Capacity: 1-30 A4 sheets

# 2290

▲ 37 graphite

📦 25 per box



### DURASWING®

- Opaque
- Capacity: 1-30 A4 sheets

# 2295

▲ 02 white, 07 dark blue, 31 aubergine/dark red, 57 anthracite/grey

📦 25 per box

### DURASWING® JOB

- With imprint "BEWERBUNG" (JOB APPLICATION)
- Capacity: 1-30 A4 sheets

# 2289

▲ 02 white, 07 dark blue, 31 aubergine/dark red, 57 anthracite/grey

📦 25 per box



### DURASWING® PLUS

- With filing cut-outs, to hold memos or covering letters
- Capacity: 1-30 A4 sheets

# 2288

▲ 19 transparent

📦 25 per box



### DURASWING® PROJECT

- Three-compartment clip folder
- With flap closure and clip lock
- Transparent inside pocket on back cover
- Capacity: 1-30 A4 sheets

# 2287

▲ 19 transparent

📦 25 per box



## DURAQUICK®

- Quick organising
- Without punching
- Practical handling



### DURAQUICK®

- Made of polypropylene
- Flat, plastic clip
- Capacity: 1-20 A4 sheets

# 2270  
📦 20 per box

🔹 01 black, 02 white, 03 red,  
07 dark blue, 10 grey

### DURAQUICK® RETAIL PACK

- 10 clip folders
- Material: polypropylene
- Product # 2270

# 2274  
📦 10 per bag

🔹 01 black, 02 white, 07 dark blue



### CLIP FILE ECO

- Clip folder made of recycled cardboard.
- Clip made to 70% of renewable materials.
- Environmentally friendly
- Capacity: 1-30 A4 sheets

# 2815  
📦 20 per box

🔹 01 black



### CLIP FILE ECO PP

- Clip folder made of recycled polypropylene.
- Clip made to 70% of renewable materials.
- Environmentally friendly
- Capacity: 1-30 A4 sheets

# 2816  
📦 25 per box

🔹 57 anthracite/grey



# SPINE BARS AND REPORT COVERS

DURABLE spine bars and report covers offer simple binding of documents and loose sheets. Featured aspects of the design include rounded ends to facilitate insertion of sheets, grooved surfaces to ensure a good grip, self adhesive filing strips to fit into any folder and various capacities for different quantities of paper. Transparent and coloured covers are also available to create high quality folders.

### SPINE BARS

- Various capacities (different widths)
- Wide range of colours
- For presentations with variable numbers of pages
- For filing magazines and brochures
- Capacities calculated for standard paper, A4 format, 80g/sqm
- \*With filing strip and universal punching

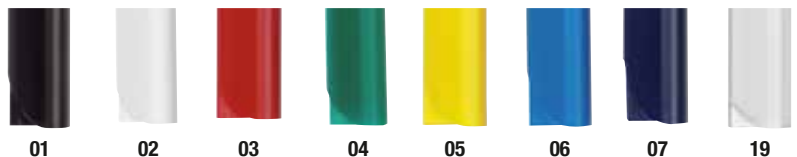

Colour Code/Colour: 01 black, 02 white, 03 red, 04 green, 05 yellow, 06 blue, 07 dark blue, 19 transparent

Product Code	Length mm	Capacity (sheets)	Capacity mm	Length mm	Col. Code	Packing
2900	297 (A4)	ca. 30	3	13	01-07, 19	100 per pack
2930	297 (A4)	ca. 30	3	13	01, 02, 03, 07, 19	50 per pack
2901	297 (A4)	ca. 60	6	13	01-07, 19	100 per pack
2931	297 (A4)	ca. 60	6	13	01, 02, 03, 05, 06, 07, 19	50 per pack
2902*	297 (A4)	ca. 30	3	14,5	19	50 per pack
2904*	297 (A4)	ca. 60	6	14,5	19	50 per pack
2909	297 (A4)	ca. 80	9	13	01, 02, 19	25 per pack
2912	297 (A4)	40 – 100	12	13	01, 02, 19	25 per pack
2910	210 (A5)	ca. 30	3	13	19	100 per pack
2911	297 (A4)	ca. 50	5	13	19	100 per pack

### Cross-sections



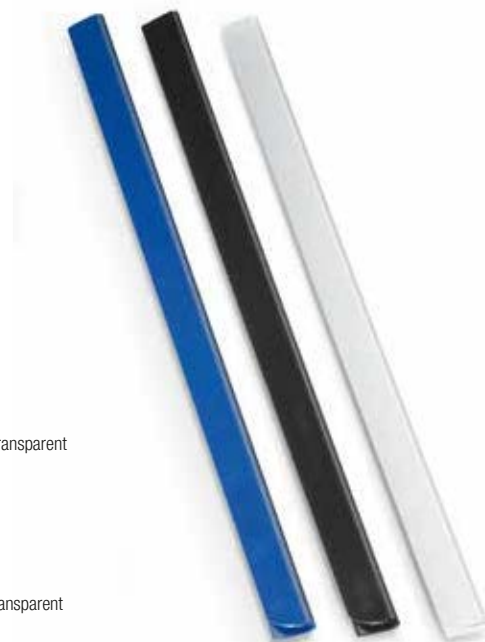

**SPINE BARS RETAIL PACK**

- With filing strip
- Universal punching
- Capacity: 1-30 A4 sheets

# 2929      19 transparent  
 8 per pack

**SPINE BARS RETAIL PACK**

- Capacity: 1-30 A4 sheets

# 2932      01 black, 07 dark blue, 19 transparent  
 10 per pack

**SPINE BARS RETAIL PACK**

- Capacity: 1-60 A4 sheets

# 2933      01 black, 07 dark blue, 19 transparent  
 10 per pack



**FILING BARS**

- With filing strip
- Universal punching
- For archiving brochures, catalogues and documents
- For A4 format

# 2935      01 black, 02 white  
 50 per pack

**REPORT COVER**

- To protect unpunched documents
- For A4 spine bars
- Made of polypropylene
- Capacity: 1-100 A4 sheets

# 2926      19 transparent  
 10 per bag

# 2939      19 transparent  
 50 per pack

**REPORT COVER**

- For A4 spine bars
- Capacity: 1-100 A4 sheets

# 2919      06 blue, 19 transparent  
 50 per pack



**A4 COVER SHEETS**

- To protect unpunched documents
- For use in combination with spine bars
- Suitable for all A4 spine bars from DURABLE

# 2943      19 transparent  
 100 per pack

**SPINE BARS + REPORT COVERS 5 & 5**

- 5 spine bars
- 5 transparent report covers
- Capacity: 1-60 A4 sheets

# 2917      19 transparent  
 1 bag

**DURAGRIP®**

- Fast binding system for documents in A4 format, capacity: 1-15 sheets
- Spine bars with excellent binding strength thanks to flexible profiles on the inside
- Each set contains: 5 coloured spine bars, 5 transparent and 5 coloured cover sheets

# 2942      01 black  
 1 set



# JOB APPLICATION FOLDER

Make your job application stand out from the crowd. DURABLE offers the right products to make the best impression - for filing or clamping, with or without overprinting.



## SWINGCLIP® JOB APPLICATION PACK

- SWINGCLIP® clip folder
- Dark blue plastic clip
- Cardboard-backed envelope
- For 1–30 A4 sheets

# 2286  
📦 1 bag

🔹 07 dark blue



**WWW.  
BEWERBERTAGE  
.COM**



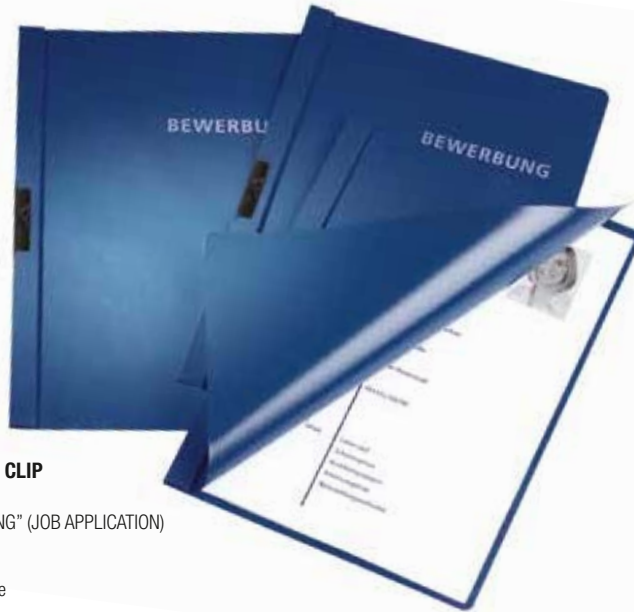

**JOB APPLICATION FOLDER WITH CLIP**

- Opaque
- With front cover imprint "BEWERBUNG" (JOB APPLICATION)
- For 1–30 A4 sheets

# 2244      07 dark blue  
 25 per box



**DURACLIP® JOB APPLICATION PACK**

- Two job application folders
- Opaque
- With front cover imprint "BEWERBUNG" (JOB APPLICATION)
- Two cardboard-backed envelopes
- For 1–30 A4 sheets

# 2249      07 dark blue  
 1 bag



**DURASWING® JOB**

- With imprint "BEWERBUNG" (JOB APPLICATION)
- Capacity: 1-30 A4 sheets

# 2289      02 white, 07 dark blue, 31 aubergine/dark red, 57 anthracite/grey  
 25 per box



**JOB APPLICATION PACK PROFESSIONAL**

- Three DURACLIP® clip folders
- Nine sheets of premium-quality paper
- Four address labels
- 12-page job application brochure
- For 1-30 A4 sheets

# 2586      02 white, 07 dark blue  
 1 bag



**JOB APPLICATION FOLDER ECO PP**

- Environmentally friendly job application folder with lateral swivel clip and imprint "BEWERBUNG" (JOB APPLICATION) on front cover.
- Film made of 100% recycled PP, clip to 70% of renewable materials.
- Capacity: 1-30 A4 sheets

# 2817      57 anthracite/grey  
 25 per box



# FOLDERS WITH ELASTIC CORNER HOLDERS

For work or study; clear view and opaque document folders from DURABLE are designed to meet your every requirement. Available in a wide choice of colours and labelling options.



### MULTIFILE

- Quotation folder for A4 documents
- Documents held firmly thanks to fastener flap
- With two inner flaps for attaching a letter
- Slots for inserting a business card
- Archive in lever arch files and ringbinders via the flexible filing mechanism

# 2533  
📦 15 per box

💧 19 transparent



**INDEX FILE 15**

- Index file for archiving unpunched documents in A4 format
- Quick access and organisation via 5 compartments
- With exchangeable, PC-printable cover sheet and style sheet available for download
- Additional compartment for loose documents
- CDs and business cards can be stored inside the front cover
- Colour coding of projects/topics is possible as this folder is available in 3 colours
- tear-resistant thanks to polypropylene

# 2475    07 dark blue, 31 dark red, 57 anthracite/grey  
 5 per box



**FOLDER WITH ELASTIC CORNER HOLDERS**

- Documents held in position thanks to elasticated holders
- Capacity: 1-150 A4 sheets

# 2322    01 black, 07 dark blue, 19 transparent  
 25 per box



**BOX WALLET**

- Archiving of unpunched documents in A4 format
- Extra-wide version for transparent pockets and folders
- Secure storage via three inside flaps and an elastic band
- Capacity: 1-150 A4 sheets

# 2323    01 black, 07 dark blue, 19 transparent  
 5 per box



**DOCUMENT FILES**

- Archiving of unpunched documents in A4 format
- Capacity: 1-200 A4 sheets
- Secure storage of documents with 3 inside flaps
- Secure closure through elasticated folders over two corners
- Labelling through labelling field
- Material: cardboard

# 24007    01 red, 02 blue, 03 green, 05 yellow  
 25 per box



**FOLDER WITH ELASTIC CORNER HOLDERS**

- Documents held in position thanks to elasticated holders
- Labelling window in business card size (90 x 57 mm)
- Capacity: 1-150 A4 sheets

# 2320    01 black, 03 red, 07 dark blue  
 10 per box



# DISPLAY BOOKS

Display books are a flexible solution for the safe transport and storage of personalised presentations or documents. With exchangeable or welded-in transparent pockets.



## DURABIND®

- Simple and quick system for permanent binding of documents
- Transparent front cover, coloured PVC back cover
- Filing in ring binders through fold-out tabs (punched: 70/80 mm)
- Capacity: 1-30 A4 sheets

# 2250  
 25 per box

🔥 01 black, 02 white, 06 blue, 10 grey

## DURABIND®

Effortlessly transform stacks of loose sheets into perfectly bound, professional folders in seconds with DURABIND®.



The DURABIND® method:  
 1. Insert the documents and staple at the four marked points.



2. Remove the protective backing from the self-adhesive strip.



3. Fold the front cover over to the left so that the adhesive strip covers the stapled edge. Press firmly in place!



4. Fold the front cover back to the right along the scored line. Repeat steps 2 and 3 for the back cover.

## DURALOOK®

- Professional presentation at trade fairs, in the office and in sales presentations
- The display book system for documents in A4 format
- With tear resistant, welded-in transparent pockets



### DURALOOK® EASY WALK

- 20 exchangeable pockets
- For documents in A4 format.

# 2453    07 dark blue  
 1 unit



### DURALOOK® VISIFIX® WALK

- 12 exchangeable pockets
- For 96 business cards in 90 x 57 mm format

# 2452    07 dark blue  
 1 unit



### DURALOOK® EASY

- 20 exchangeable display pockets

# 2426    01 black  
 1 unit

### DURALOOK® EASY PLUS

- Transparent front cover pocket
- 20 exchangeable display pockets

# 2427    01 black  
 1 unit

### DURALOOK® PLUS

- Spine label
- Transparent pocket on front cover
- 10 display pockets/spine width: 9 mm

# 2431    01 black    5 per box

# 2432    01 black    5 per box

· 20 display pockets/spine width: 17 mm

# 2434    01 black    2 per box

### DURALOOK®

- Printable spine label
- 10 display pockets/spine width: 9 mm

Prod. Code	Colour	Packing	Display Pockets	Width
2421	01 black	5 per box	10	9 mm
2422	01 black	5 per box	20	17 mm
2423	01 black	5 per box	30	20 mm
2424	01 black	2 per box	40	25 mm
2425	01 black	2 per box	50	30 mm



### DURALOOK® COVER

- Extension set with 10 display pockets.
- To fit all DURALOOK® EASY display books.

# 2428    19 transparent  
 10 per bag

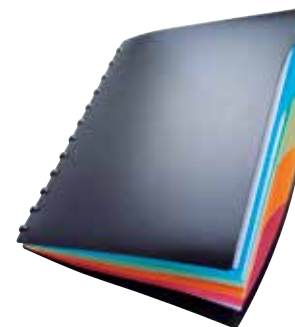

### DURALOOK® STYLE

- 20 exchangeable pockets
- Integrated, multicoloured 4-part index

# 2435    01 black  
 1 unit



# CLEAR VIEW FOLDER/DOCUMENT FOLDER

For all industries, businesses, schools and many other applications. Clear view and opaque document folders from DURABLE are designed to meet their users various needs from reports and quotations to notes and document storage. With a wide choice of contemporary colours and labelling options.



## CLEAR VIEW FOLDERS

- View of documents through transparent front cover
- Differentiation due to coloured back cover

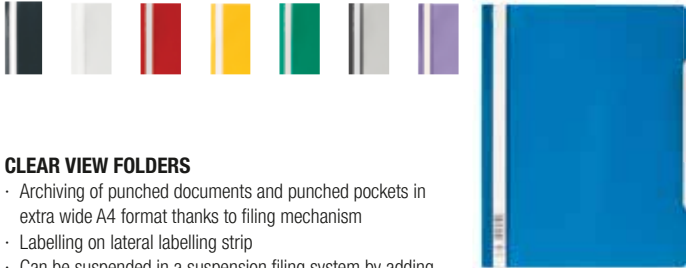

### CLEAR VIEW FOLDERS

- Archiving of punched documents and punched pockets in extra wide A4 format thanks to filing mechanism
- Labelling on lateral labelling strip
- Can be suspended in a suspension filing system by adding product # 1531

# 2570      ▲ 01 black, 02 white, 03 red, 04 yellow, 05 green, 06 blue, 10 grey, 33 lilac  
 ☞ 50 per box



### CLEAR VIEW FOLDERS

- Suitable for filing punched pockets thanks to extra wide A4 format
- Protection against tearing through plastic-coated filing mechanism
- Labelling by means of narrow labelling window on front cover
- Storage of unpunched documents in inside pocket on back cover
- Can be suspended by adding suspension rail, product # 1531

# 2510      ▲ 01 black, 02 white, 03 red, 04 yellow, 05 green, 06 blue, 07 dark blue  
 ☞ 25 per box



### CLEAR VIEW FOLDERS

- Archiving of punched documents in A4 format thanks to filing mechanism
- Labelling through lateral labelling strip
- Access via finger cut-out
- View on documents through transparent front cover
- Differentiation through coloured back cover
- Can be retrofitted with filing strip insert product # 2996, for filing in lever arch files and ring binders.

# 2573      ▲ 01 black, 02 white, 03 red, 04 yellow, 05 green, 06 blue, 07 dark blue, 09 orange, 10 grey, 11 brown, 12 light purple, 35 crimson  
 ☞ 50 per box



### CLEAR VIEW FOLDERS

- Suitable for filing punched pockets thanks to extra wide A4 format
- View documents through transparent front cover
- Coloured back cover
- Protection against tearing through plastic-coated filing mechanism
- With three-part labelling window on the front side
- Storage of unpunched documents in inside pockets
- Can be suspended by adding suspension rail, product # 1531
- Can be filed by adding filing strip insert, product # 2996
- Filing mechanism can be covered with cover bar, product # 2924

# 2681      ▲ 01 black, 02 white, 04 yellow, 06 blue, 09 orange, 12 light purple, 34 crimson  
 ☞ 25 per box



### CLEAR VIEW FOLDER WITH FILING STRIP INSERT

- Suitable for filing punched pockets thanks to extra wide A4 format
- View documents through transparent front cover
- Differentiation through coloured back cover
- Labelling through lateral labelling strip
- Optional filing in ring binders through retractable filing strip insert
- Can be suspended by adding suspension rail product # 1531

# 2580      ▲ 01 black, 02 white, 03 red, 05 green, 06 blue, 10 grey  
 ☞ 25 per box

## FOLDERS

- Suitable for filing punched pockets thanks to oversize A4 format
- A small labelling window features on the front side in business card format 90 x 57 mm
- Storage space for unpunched documents in inside pocket on the back
- Protection against tearing due to plastic-coated filing mechanism
- Can be suspended by adding suspension rail product # 1531



### OPAQUE DOCUMENT FOLDERS

- Privacy protection through coloured front and back cover

# 2500      ▲ 01 black, 02 white, 03 red, 04 yellow, 05 green, 06 blue, 07 dark blue  
 ☞ 25 per box



### TRANSLUCENT DOCUMENT FOLDER

- Coloured, translucent front and back cover

# 2680      ▲ 01 black, 02 white, 03 red, 04 yellow, 05 green, 06 blue, 07 dark blue,  
 09 orange, 10 lilac, 34 crimson  
 ☞ 25 per box

## PRESENTATION FOLDER



### DURAPLUS® PRESENTATION FOLDER

- Suitable for filing punched pockets thanks to extra wide A4 format
- View documents through transparent front cover
- Differentiation through coloured back cover
- Labelling through lateral labelling strip
- Storage of unpunched documents through inside pockets
- Can be suspended by adding suspension rail, product # 1531
- Can be filed by adding filing strip insert product # 2996
- Filing mechanism can be concealed by adding cover bar, product # 2924

# 2579      ▲ 01 black, 02 white, 03 red,  
 04 yellow, 05 green, 06 blue,  
 07 dark blue, 10 grey, 00 assorted  
 ☞ 25 per box



### PRESENTATION FOLDER

- For A4 documents
- Transparent cover
- Storage of unpunched documents in inside pockets in both front and back cover
- Optional filing in lever arch files and ring binders with retractable filing strip insert
- Ideal for mailing sales and presentation materials

# 2512      ▲ 19 transparent  
 ☞ 25 per box

### DURAPLUS® DE LUXE PRESENTATION FOLDER

- Suitable for filing punched pockets thanks to extra wide A4 format
- View documents through transparent front cover
- Differentiation through coloured back cover
- Protection against tearing through plastic-coated filing mechanism
- Storage of unpunched documents in inside pockets
- Can be filed using the filing strip insert
- Filing mechanism can be concealed with cover bar
- Can be suspended by adding suspension rail product # 1531

# 2589      ▲ 01 black, 02 white, 07 dark blue  
 ☞ 25 per box



## POLYPROPYLENE PUNCHED POCKETS

- For efficient filing of unpunched documents in folders and ring binders
- Tear resistant
- With reinforced punched holes

### PUNCHED POCKETS STANDARD

A4 portrait, standard quality, open at the top, universal punching

- # 2660 19 transparent 100 per pack
- # 2656 19 transparent 10 per bag
- # 2652 19 transparent 40 per bag
- # 2659 19 transparent 100 per bag
- # 2661\* 19 transparent 100 per pack

\* = für Folio-Format



### PUNCHED POCKETS BUSINESS

A5 portrait, open at top, punching: 45 x 65 x 45 + 80 mm

- # 2650 19 transparent 25 per bag

A5 portrait, open at top, punching: 45 x 65 x 45 + 80 mm, crystal-clear quality

- # 2651 19 transparent 25 per bag

A4 portrait, crystal-clear quality, open at top, universal punching

- # 2662 19 transparent 10 per bag
- # 2673 19 transparent 40 per bag
- # 2672 19 transparent 100 per bag
- # 2668 19 transparent 100 per pack

A4 portrait, open at the top, universal punching

- # 2658 19 transparent 100 per bag



### PUNCHED POCKETS PREMIUM

A4 portrait, premium quality, 80µ, crystal-clear quality, open at the top, universal punching

- # 2676 19 transparent 100 per bag
- # 2677 19 crystal-clear 50 per bag
- # 2678 19 crystal-clear 10 per bag

A4 portrait, open at the top, universal punching

- # 2682 19 transparent 50 per bag
- # 2683 19 transparent 100 per bag



### SPECIAL PUNCHED POCKETS

A4 Maxi portrait for catalogues up to approx. 100 sheets, 180µ, PP film, universal punching

- # 2667 19 transparent 5 per bag

Maxi A4 portrait, top and punched side open, universal punching

- # 2663 19 transparent 10 per bag

Maxi A4 portrait, outer side open, with flap to close

- # 2664 19 transparent 5 per bag

Maxi A4 portrait, open at the top, with side flap for 2 CDs/DVDs

- # 2675 19 transparent 5 per bag

A3 landscape, folded to A4 portrait, open at the top, universal punching on left narrow side

- # 2670 19 transparent 50 per pack
- # 2671 19 transparent 10 per bag

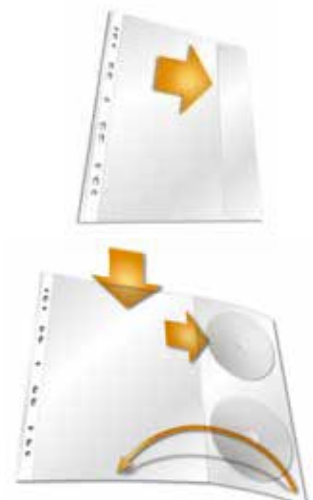

## DISPLAY POCKETS

- For protection and storage
- Extremely hard-wearing and tear-resistant
- With practical punched gripping recess

### STANDARD DISPLAY POCKETS

A4 portrait, open to the top and right side, with punched gripping recess, 0.12 mm thickness

Material: polypropylene

# 2337      ▲ 03 red, 04 yellow, 05 green,  
 ☞ 100 per box      ▲ 06 blue, 19 transparent, 00 assorted

Material: polypropylene

# 2334      ▲ 19 transparent      ☞ 10 per bag

Crystal-clear quality made of polypropylene

# 2335      ▲ 19\* transparent      ☞ 100 per box

Design made from polyethylene

# 2313      ▲ 19\* transparent      ☞ 10 per bag



### BUSINESS DISPLAY POCKETS

A4 portrait, open to the top and right side, with punched gripping recess, 0.12 mm thickness

Crystal-clear quality design made from hard film

# 2315      ▲ 19 crystal-clear      ☞ 100 per bag

Crystal-clear quality made of polypropylene

# 2318      ▲ 19\* transparent      ☞ 10 per bag

Crystal-clear quality design made from hard film

# 2319      ▲ 19\* transparent      ☞ 50 per box

Design made from hard film

# 2339      ▲ 03 red, 04 yellow, 05 green,  
 ☞ 50 per box      ▲ 06 blue, 19 transparent



### PREMIUM DISPLAY POCKETS

Open to the top and right side, with punched gripping recess

A4 portrait, Crystal-clear quality design made from hard film, 0.30 mm thickness

# 2314      ▲ 19\* transparent      ☞ 10 per bag

A4 portrait, front part made from transparent flexible film,  
 backing made from hard film, 0.20 mm thickness

# 2196      ▲ 06 blue, 19 transparent  
 ☞ 10 per bag

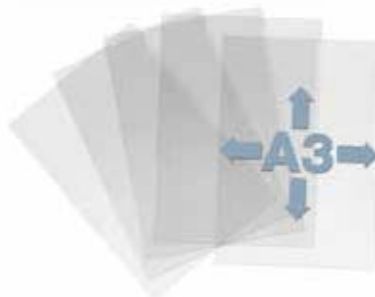

## TRANSPARENT POCKETS

- Reinforced punched holes
- For notices
- In portrait format
- Open at the top on the narrow side
- Made of extra strong, hard-wearing plastic
- With protective flap
- Tear resistant

### A4 TRANSPARENT POCKET

# 2307      ▲ 19 transparent      ☞ 10 per bag

### A5 TRANSPARENT POCKET

# 2306      ▲ 19 transparent      ☞ 10 per bag

### A6 TRANSPARENT POCKET

# 2302      ▲ 19 transparent      ☞ 10 per bag



## SPECIAL PURPOSE POCKETS

- To protect all kinds of documents
- Extremely hard-wearing and tear-resistant
- Indelible

### LABELS FOR PROTECTIVE POCKETS

- Central suspension hole
- Portrait format
- Open at the top
- Tear resistant

### LABELS FOR PROTECTIVE POCKETS

- A8 format
- # 2294
- 19 transparent
- 100 per box

### LABELS FOR PROTECTIVE POCKETS

- A7 format
- # 2296
- 19 transparent
- 100 per box

### LABELS FOR PROTECTIVE POCKETS

- A6 format
- # 2297
- 19 transparent
- 100 per box

### LABELS FOR PROTECTIVE POCKETS

- A5 format
- # 2298
- 19 transparent
- 100 per box



### PROTECTIVE ID CARD HOLDER

- Made of extra strong, hard-wearing plastic
- Tear resistant
- Open at the top on the narrow side



Prod. Code	Inside Dim. (W x H)	Suitable for
2131	DIN A4 210 x 297 mm	documents, contracts, certificates, insurance policies, invoices and other A4 format documents
2132	DIN A5 148 x 210 mm	documents, cards, photos, leaflets and other A5 format documents
2133	DIN A6 105 x 148 mm	documents, cards, photos, leaflets and other A6 format documents
2134	DIN A7 74 x 105 mm	PID cards, security cards, contact cards and other A7 format documents
2137	DIN A8 52 x 74 mm	photos and stamps
2135	59 x 86 mm	notes, photos and other documents
2136	54 x 86 mm	driving licenses, E111 cards, train tickets and other cards

### PUNCHED DOUBLE POCKET

- Made of extra-strong, hard-wearing plastic
- Tear resistant
- Tuck-in flap on right and left



Prod. Code	Inside Dim. (W x H)	Suitable for
2141	DIN A5 296 x 210 mm	brochures, leaflets and other documents in A5 format
2140	DIN A6 210 x 148 mm	brochures, leaflets and other documents in A6 format
2138	DIN A7 148 x 105 mm	accounting books, wage books and other documents in A7 format
2139	176 x 125 mm	national and international passports
2142	Three sections 210 x 105 mm	vehicle registration certificates (Germany)



### SCAN/FAX/COPYING CARRIER POCKET

- For faxing, scanning or copying
- For originals in small formats
- Transparent front cover and white back cover
- Dimensions: 212 x 316 mm (W x H)

# 2346      02 white  
 2 per bag



### 3 PART FOLDER

- With five practical sections
- For A4 documents
- Coloured self-adhesive labels for labelling tabs

# 2316      19 transparent  
 5 per bag



### DICTIONARY WALLET

- With pouch
- For all standard dictation cassettes
- Labelling window in business card format on front cover
- Transparent front cover and coloured back cover

# 2347      06 blue, 16 beige  
 20 per bag



### CREDIT CARD WALLET

- With welded pockets
- For 10 credit, loyalty, ID or membership cards
- Formats up to 85 x 54 mm

# 2394      58 charcoal  
 50 units in display boxes



### ID CARD AND CREDIT CARD HOLDERS

- With welded pockets
- For 4 credit, loyalty ID or membership cards
- For formats up to 85 x 54 mm
- For 4 identification documents in formats up to 80 x 115 mm

# 2397      58 charcoal  
 25 units in display boxes



### ZIP BAGS

- Zip bag for archiving or transport of documents and utensils

#### ZIP BAG A4

# 2479      01 black  
 5 per bag

#### ZIP BAG A5

# 2480      01 black  
 5 per bag



**WWW.  
DURABLE  
.EU**

## ACCESSORIES



### COVER BARS

- For covering and protecting the filing mechanism
- Suitable for all DURABLE folders in A4 format

# 2924      ♪ 02 white  
📦 50 per pack



### FILING STRIP INSERT

- Filing strip for filing mechanisms
- For efficient filing in folders and ring binders
- To fit product # 2512, 2570, 2573, 2579, 2580 and 2589.

# 2996      ♪ 02 white  
📦 50 per pack



### SUSPENSION RAIL

- To be inserted into all suitable DURABLE folders for storage in suspension filing systems
- Made of robust metal

# 1531      ♪ 26 nickel  
📦 25 per pack

### FLEXI® FILING STRIPS

- For quick assembly of punched documents
- Archiving in lever arch files and ring binders
- Dimensions: 38 x 150 mm (W x H)
- Punching: 60/80 mm

# 6901      ♪ 01 black, 02 white, 03 red, 04 yellow, 05 green, 06 blue,  
07 dark blue, 00 assorted

📦 250 per pack

# 6910      ♪ 00 assorted

📦 25 per bag



### FLEXIFIX®

- Self-adhesive filing strips for quick assembly of punched documents
- Stick to smooth surfaces
- Dimensions: 38 x 150 mm (W x H)

# 6906      ♪ 02 white, 06 blue

📦 100 per pack



### FLEXIFIX® RETAIL PACK

- Self-adhesive filing strips for quick assembly of punched documents
- Stick to smooth surfaces
- Dimensions: 38 x 150 mm (W x H)

# 6916      ♪ 02 white

📦 10 per bag



### FLEXIFIX® ECONOMY

- Self-adhesive filing strips for quick assembly of punched documents
- Varnished filing mechanism made of metal
- Stick to smooth surfaces
- Dimensions: 38 x 150 mm (W x H)

# 6908      ♪ 02 white

📦 100 per pack



# SPECIAL FOLDERS AND ACCESSORIES

The ultimate filing accessory, a folder with 5 compartments and separate filing mechanisms facilitates clear organisation of project materials. The printable cover sheet and partly printable tabs turn these folders into a perfect document organisation tool.



### PERSONNEL FOLDER

- Organisation folder with five compartments equipped with separate filing mechanisms guarantees effective organisation
- Labelling of the cover sheet by placing an insert into the transparent front pocket
- Additional labelling on lateral labelling strip and variable tabs
- Can be suspended with variable suspension rail
- Easy professional labelling with the free DURAPRINT® printing software available from [www.duraprint.eu](http://www.duraprint.eu)



### PERSONNEL FOLDER

- Can be used as a compact, well-organised personnel file
- Pre-printed cover sheet and tabs for immediate use as a personnel file
- Back cover with inside pocket for additional unpunched documents
- Complete with suspension rail

# 2554      06 blue  
 1 per box

# 2555      06 blue, 10 grey  
 5 per box

### PLASTIC CLIP-ON TABS

- With blank insert labels
- Head height 15 mm
- Head width 60 mm
- Insert labels also available separately under product # 1816

# 1893      19 transparent  
 25 per pack



### ORGANISER FILE

- Can be used as a compact, well-organised project file
- Pre-printed cover sheets and tabs for use as machine, motor vehicle or rental files
- Back cover with inside pocket for additional unpunched documents
- Complete with suspension rail

# 2556      06 blue  
 5 per box

### DIVISOFLEX® ORGANISER FILE

- Compact, well-organised project file thanks to five coloured compartments
- Can be suspended in a suspension filing system by adding product # 1531

# 2557      06 blue  
 5 per box





# INDEX SETS

Save time through better organisation. The DURABLE index set range stands out by the high quality of its materials and an enormous variety of models. Individual customisation is also available.

## PUNCHED POCKET INDEX WITH INSERT-WELDED, COLOURED TABS AND INSERT LABELS

- For visual sorting and quick finding of information materials.
- Special punched pockets with reinforced punched holes.
- Ideal for filing loose documents.



6630



6632



6631



6633

Format	Division	Blank insert labels*	printed	Punching mm	Product #	Colour code/colour
A4 portrait	5	x	1–5	Universal punching	6630	19 transparent
	8	x	1–8	Universal punching	6631	19 transparent
	10	x	1–10	Universal punching	6632	19 transparent
	12	x	1–12, Jan.–Dez.	Universal punching	6633	19 transparent

For professional labelling visit [www.duraprint.eu](http://www.duraprint.eu)

1 Unit(s)



### INDEX SETS WITH INSERT-WELDED TABS AND INSERTED, IMPRINTED INSERT LABELS

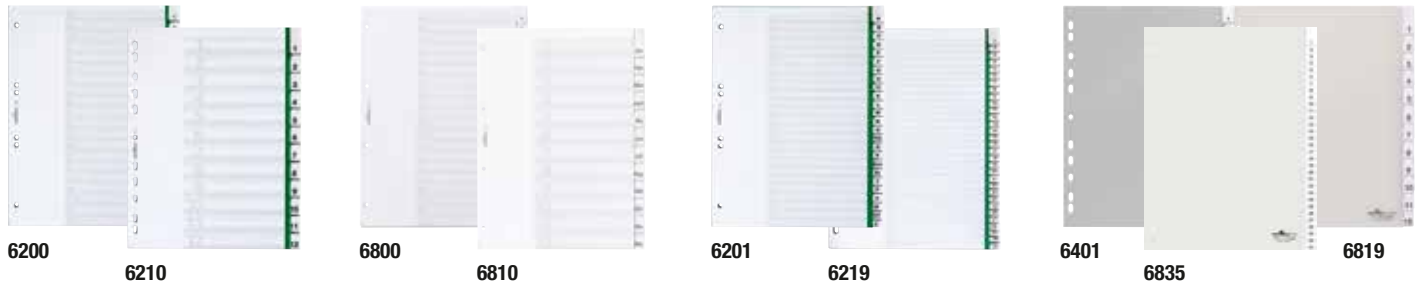

Format	Insert labels		Division	Cover sheet*	PP	Punching mm	Product #	Colour code/colour
	pre-inserted	blanko*						
A4 portrait	A-Z	x	20	x		60/80 + 80x80x80	6200	05 green
		x	20	x		80x80x80	6800	19 transparent
		x	25	x		60/80 + 80x80x80	6201	05 green
		x	20		x	universal punching	6401	10 grey
	1-12	x	12	x		universal punching	6210	05 green
	Jan. - Dez.	x	12	x		80x80x80	6810	19 transparent
	1-31	x	31	x		universal punching	6219	05 green
	1-31	x	31			80x80x80	6819	19 transparent
A4 portrait, extra wide	1-12	x	12			80x80x80	6835	19 transparent

For professional labelling visit [www.duraprint.eu](http://www.duraprint.eu)

 1 Unit(s)

### INDEX SETS WITH INSERT-WELDED TABS AND INSERT LABELS



Format	Division	Blank insert labels		Cover sheet*	PP	Punching mm	Product #	Colour code/colour
		blanko*	printed					
A4 portrait	5	x	1-5	x		universal punching	6220	05 green
		x	1-5		x	universal punching	6440	10 grey
		x	1-5	x		80x80x80	6820	19 transparent
	10	x	1-10	x		universal punching	6221	05 green
		x	1-10		x	universal punching	6441	10 grey
		x	1-10	x	x	universal punching	6441	02 white
		x	1-10	x		80x80x80	6821	19 transparent
	12	x	1-12, Jan. - Dez.		x	universal punching	6410	10 grey
		x	1-12, Jan. - Dez.	x	x	universal punching	6410	02 white
	15	x	1-15, A-Z	x		60/80 + 80x80x80	6222	05 green
		x	1-15, A-Z		x	universal punching	6442	10 grey
		x	1-15, A-Z	x		80x80x80	6822	19 transparent
	20	x	1-20, A-Z	x		60/80 + 80x80x80	6223	05 green
		x	1-20, A-Z		x	universal punching	6443	10 gray
		x	1-20, A-Z	x		80x80x80	6823	19 transparent
	25	x	1-25, A-Z	x		60/80 + 80x80x80	6224	05 green
		x	1-25, A-Z	x		80x80x80	6824	19 transparent
	A4 portrait, extra wide	10	x	1-10		x	80x80x80	6831
12		x	1-12, Jan. - Dez.			universal punching	6446	10 grey
20		x	1-20, A-Z			80x80x80	6833	19 transparent

For professional labelling visit [www.duraprint.eu](http://www.duraprint.eu)

 1 Unit(s)

## INDEX SETS WITH PRINTED TABS



Format	Tab/imprint	Division	Cover sheet*	PP	Punching mm	Product #	Colour code/colour	
A4 portrait	A-Z	20	x	x	60/80 + 80x80x80	6150	02 white	
		20		x	60/80 + 80x80x80	6510	10 grey	
		20		x	universal punching	6513**	10 grey	
		20		x	universal punching	6168	01 black, 02 white	
		24	x	x	universal punching	6164	02 white	
		24		x	universal punching	6508	10 grey	
	1-5	5		x	universal punching	6505	10 grey	
	1-10	10		x	universal punching	6511	10 grey	
	1-12	12	x	x	universal punching	6162	02 white	
	1-12	12		x	universal punching	6512	10 grey	
		12	x	x	universal punching	6112	02 white	
	1-15	15		x	universal punching	6524	10 grey	
	1-20	20	x	x	universal punching	6163	02 white	
	1-20	20		x	universal punching	6522	10 grey	
	1-31	31		x	universal punching	6523	10 grey	
		31	x	x	universal punching	6160	02 white	
	1-52	52			universal punching	6157***	05 green	
	1-52	52		x	universal punching	6504***	10 grey	
	Jan. - Dez.	12			x	universal punching	6514	10 grey
		12	x	x	universal punching	6114	02 white	
Dez. - Jan.	12			x	universal punching	6507	10 grey	
A4 portrait, partly covered	A-Z	20		x	60/80	6100	02 white	
		20		x	60/80	6500	10 grey	
		20		x	60/80	6503**	10 grey	
A4 portrait, extra wide	A-Z	20		x	universal punching	6520	10 grey	
A5 portrait	A-Z	20		x	45x65x45 + 80	6550	10 grey	

\* For professional labelling visit [www.duraprint.eu/](http://www.duraprint.eu/)\*\* international alphabet\*\*\* with 2 sequences (1-26, 27-52), PP = polypropylene 1 piece

## INDEX SET WITH COLOURED TABS

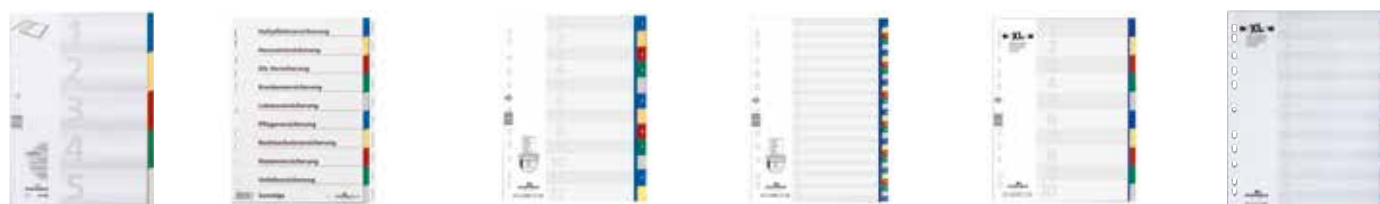

Format	Tab/imprint	Division	Cover sheet*	PP	Punching mm	Product #	Colour code/colour
A4 portrait	blank	5	x	x	universal punching	6730	27 5 colours
		10	x	x	universal punching	6740	27 5 colours
		10			universal punching	6741**	27 5 colours
	A-Z	20		x	universal punching	6755	27 5 colours
	1-12	12	x	x	universal punching	6750	27 5 colours
	blank	20	x	x	universal punching	6758	27 5 colours
	1-31	31		x	universal punching	6756	27 5 colours
A4 portrait, extra wide	blank	5	x	x	universal punching	6737***	27 5 colours
	blank	10	x	x	universal punching	6747***	27 5 colours
	blank	20	x	x	universal punching	6759***	27 5 colours

\* For professional labelling visit [www.duraprint.eu/](http://www.duraprint.eu/)\*\* with printed cover sheet and additional index sheet with list of all important insurances (car, household etc.)\*\*\* Extra wide cover sheet is not PC-printable/PP = polypropylene 1 piece



### INDEX CARDS WITH INSERT-WELDED TABS

Format	Division	Material thickness mm	Tab width mm	Prod. Code	Colour
DIN A4	5/5	0,3	40	3141	11 brown
DIN A5	5/5	0,3	40	3151	11 brown
DIN A6	5/5	0,3	25	3160	11 brown

25 pieces per pack with blank and printed (Jan.–Dez., 0–31\*, A–Z) inserts  
 \* Two index sets are required when using these insert labels.



### PRESSBOARD GUIDE INDEX CARDS AND INDEX GUIDES

Format	Division	Material thickness mm	Tab width mm	Prod. Code	Colour
DIN A4	5/5	0,6	40	4245	11 brown
DIN A5	5/5	0,6	40	4255	11 brown

25 pieces per pack with pre-inserted, printed inserts A–Z (25-piece)  
 + insert sheet with blank and printed (Jan.–Dez., 0–31\*, A–Z) inserts  
 \* Two index sets are required when using these insert labels.

### GUIDE CARDS WITH PRINTED A-Z TABS

Format	Division	Tab imprint	Material thickness mm	Tab width mm	PP	Prod. Code	Colour
DIN A5	5/5	A–Z (25 piece)	0,3	40	x	3650	02 white, 03 red, 04 yellow, 05 green, 06 blue
DIN A6	5/5	A–Z (25 piece)	0,3	25	x	3660	02 white, 03 red, 04 yellow, 05 green, 06 blue
DIN A7	5/5	A–Z (25 piece)	0,3	20	x	3670	02 white, 03 red, 04 yellow, 05 green, 06 blue

25 pieces per pack/PP = polypropylene

### CARD BOXES

- Lockable
- Made of powder-coated steel
- Stackable
- With grip and label holder
- 1 black card support



#### CARDBOX A4

- Lockable, with lock
- For A4 cards, 210 x 297 mm
- Capacity approx. 1,500 index cards
- With handle and labelling window
- 1 black card support
- External dimensions: 351 x 271 x 455 mm (W x H x D)
- Internal dimensions: 300 x 230 x 380 mm (W x H x D)

# 3351    10 grey  
 1 unit

#### CARDBOX A5

- For A5 cards, 148 x 210 mm
- Capacity approx. 1.500 index cards
- External dimensions: 260 x 207 x 420 mm (W x H x D)
- Internal dimensions: 215 x 160 x 350 mm (W x H x D)

# 3353    10 grey  
 1 unit

#### CARDBOX A5 DUO

- With 2 drawers
- For A5 cards, 148 x 210 mm
- Capacity approx. 2 x 1,500 index cards (3000 cards)
- External dimensions: 520 x 207 x 420 mm (W x H x D)
- Internal dimensions: 215 x 160 x 350 mm (W x H x D)

# 3354    10 grey  
 1 unit

#### CARDBOX A6

- For A6 cards, 105 x 148 mm
- Capacity approx. 1,500 index cards
- External dimensions: 199 x 155 x 420 mm (W x H x D)
- Internal dimensions: 155 x 115 x 335 mm (W x H x D)

# 3352    10 grey  
 1 unit

#### CARDBOX 170/235

- For card size 170 x 235 mm
- Capacity approx. 1,500 index cards
- External dimensions: 284 x 225 x 420 mm (W x H x D)
- Internal dimensions: 235 x 170 x 350 mm (W x H x D)

# 3355    10 grey  
 1 unit



### CARD SUPPORT A4

- For A4 index card boxes made of steel

# 3356    01 black  
 1 unit



### SORTER

- Metal spine with tear-resistant PP compartments
- For efficient organisation of documents
- With alphabetical (A–Z) and numerical (1–31) classification
- Complete with suspension eye

# 3700    06 blue  
 1 unit



### CLIPBOARD FOLDER

- For A4 format
- With pocket in the back cover to secure the writing pad
- Large, triangular pocket inside front cover

# 2355      01 black, 03 red, 06 blue  
 5 per box

### CLIPBOARD FOLDER

- For A4 format
- With inside pocket on front cover

# 2357      01 black, 07 dark blue, 10 grey  
 5 per box

### CLIPBOARD FOLDER

- For A5 format
- With large triangular pocket inside front cover

# 2359      01 black  
 5 per box



### CLIPBOARD FOLDER A4+

- For A4 and extra wide documents
- With inlay sheet to separate forms
- Pen holder
- Insert pockets in front cover

# 2332      01 black  
 5 per box

### CLIPBOARD

- For A4 format
- With strong, anti-slip spring clip
- Pocket to secure the back of the writing pad
- Pull-out suspension eye

# 2350      01 black, 07 dark blue  
 5 per box



# CLIPBOARD FOLDERS/CLIPBOARDS

Clipboard folders and clipboards from DURABLE are the ideal solution for holding all documents securely in place. Available in a variety of styles and finishes.



### CLIPBOARD A4

- With spring clip
- For A4 documents
- Made of recycled aluminium
- Coated with transparent varnish
- Dimensions: 227 x 344 x 1 mm (W x H x D)

# 3390      23 metallic silver      1 unit



### CLIPBOARD A4 L

- With spring clip
- For A4 documents
- With lateral opening for loose sheets
- Made of recycled aluminium
- Coated with transparent aluminium varnish
- Dimensions: 230 x 325 x 9 mm (W x H x D)

# 3391      23 metallic silver      1 unit

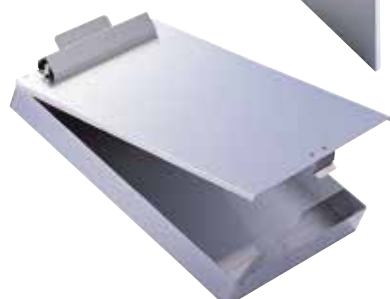

### CLIPBOARD A4 BOX

- With spring clip
- For A4 documents
- Can be opened at the bottom for storage of documents
- Made of recycled aluminium
- With transparent varnish coating
- Capacity 25 mm
- Dimensions: 230 x 350 x 40 mm (W x H x D)

# 3392      23 metallic silver      1 unit



### LEVER CLAMP FILE

- Inside pocket on front cover
- For unpunched documents in A4 format
- Simply press the lever to insert or remove documents
- Capacity: 1-100 A4 sheets

# 2230      01 black      5 per box



### LEVER CLAMP FILE

- With self-adhesive labelling strip
- For unpunched documents
- Simply press the lever to insert or remove documents
- Capacity: 1-100 A4 sheets

# 2245      06 blue      10 per box



### CARRY® SUSPENSION FILE BASKET

- Suspension basket holding approx. 30 suspension files in A4 format
- Quick access to documents required every day
- Fits flexibly into desk drawers and cabinets



### CARRY® SUSPENSION RACK "BLUE ANGEL"

- Folds flat for space-saving storage
- Sturdy and break-proof
- Dimensions: 362 x 260 x 320 mm (W x H x D)
- Suspension width: 330 mm

# 2600      ♪ 058 charcoal  
 📦 1 unit

### CARRY® PLUS

- Can be folded to save space
- Can be stacked
- Easy assembly with snap connectors
- Dimensions: 360 x 270 x 320 mm (W x H x D)
- Suspension width: 330 mm

# 2611      ♪ 01 black, 06 blue  
 📦 1 unit

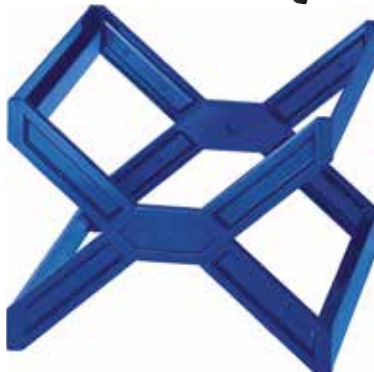
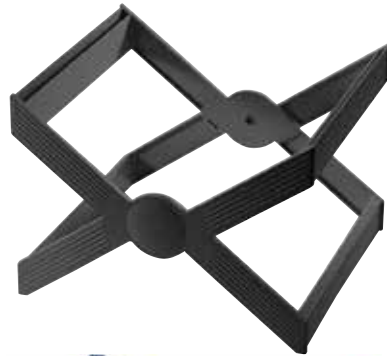

# SUSPENSION FOLDERS AND ACCESSORIES

Suspension files and folders are the perfect way to maintain order and save space in document archives. They are hardwearing and can be stored flexibly in cabinets and drawers, or on desks with the help of appropriate accessories.



### SUSPENSION FILE RACK

- Suspension file rack made of metal for 30 to 40 suspension files (delivery without suspension files)
- Suitable for A4 and folio formats
- Delivery: flat packed with assembly instructions
- Dimensions: 350 x 285 x 370 mm (W x H x D)

# 3123      ♪ 23 metallic silver  
 📦 1 unit



### SUSPENSION FILE STAND

- Metal suspension file rack for up to 25 suspension files (delivery without suspension files)
- Suitable for A4 and folio formats
- Delivery: flat packed with assembly instructions.
- Dimensions: 420 x 250 x 285 mm (W x H x D)

# 3124      ♪ 10 grey  
 📦 1 unit



### CLEAR-VIEW SUSPENSION FOLDER

- Filing of documents in A4 format
- Storage of unpunched documents in inside pocket
- Transparent front cover and coloured back cover
- Optional filing in ring binders possible thanks to universal-punching
- Can be retrofitted with suspension rail product # 1531, 50 mm tab, product # 2569 and schedule strip product # 1866

# 2560      ♪ 03 red, 06 blue, 10 grey  
 📦 25 per box



### CLEAR-VIEW SUSPENSION FOLDER ECONOMY

- Archiving of punched documents in A4 format thanks to filing mechanism
- With universal punching for filing in folders and ring binders
- Transparent front cover allows view on documents
- Differentiation through coloured back cover
- Storage of loose documents in inside pocket on back cover
- Can be suspended in a suspension filing system by adding product # 1531

# 2561      ♪ 06 blue  
 📦 50 per box



**SUSPENSION FOLDER**

- Archiving of unpunched documents in A4 format through filing mechanism
- Gusset adapts itself to filling quantity
- Stability thanks to a sturdy plastic suspension rail
- Suspension folder is open on one side
- Complete with 60 mm tabs as well as blank insert labels and A-Z insert labels
- Can be retrofitted with schedule strip, product # 1867

# 2563      10 grey  
 25 per box



**SUSPENSION FOLDER**

- Archiving of punched documents in A4 format through filing mechanism
- Stability thanks to a sturdy plastic suspension rail
- Suspension folder is open on one side
- Complete with 60 mm tabs as well as blank insert labels and A-Z insert labels
- Can be retrofitted with schedule strip, product # 1867

# 2565      10 grey  
 25 per box



**SUSPENSION FOLDER**

- Archiving of unpunched documents in A4 format
- Gusset adapts itself to filling quantity
- Stability thanks to a solid plastic suspension rail
- Lateral flaps prevent documents from falling out
- Easy removal of documents through fold-back front cover
- Complete with 60 mm tabs, blank insert labels and A-Z insert labels
- Can be retrofitted with schedule strip product # 1867

# 2601      10 grey  
 25 per box



**TRANSPARENT SUSPENSION POCKET**

- For storing small quantities of unpunched documents in A4 format
- Stability thanks to a solid plastic suspension rail
- Includes 60 mm tabs as well as blank insert labels and A-Z insert labels
- Can be retrofitted with schedule strip product # 1867

# 2604      19 transparent  
 25 per box



**SUSPENSION FOLDER**

- Archiving of unpunched documents in A4 format through filing mechanism
- Stability thanks to a solid plastic suspension rail
- Archiving of additional loose sheets through inside pocket in the rear section
- View on documents through transparent front cover, back cover is grey-coloured
- Includes 60 mm tabs as well as blank insert labels and A-Z insert labels
- Can be retrofitted with schedule strip product # 1867

# 2602      10 grey  
 25 per box



**PLASTIC TABS**

- 60 mm wide
- With blank and printed A-Z insert labels, 25 parts
- To fit product # 2563, 2565, 2601, 2602 and 2604.

# 1868      19 transparent      25 per pack



**PLASTIC TABS**

- For labelling of the DURABLE folder product # 2560
- Width: 50 mm

# 2569      19 transparent      25 per pack

**SCHEDULE STRIP**

- For schedules and deadlines
- To fit suspension folders, product # 2563, 2565, 2601, 2602 and 2604
- With printed inserts
- Front side calendar weeks 1-53
- Rear side months 1-12 and days 1-31



# 1867      19 transparent      25 per box

**SUSPENSION RAIL**

- To be inserted into all suitable DURABLE folders for storage in suspension filing systems
- Made of robust metal

# 1531      26 nickel      25 per pack

Matching suspension files from DURABLE can be found on page 118.





# ADDRESS MANAGEMENT

Handwritten records of contacts are still important, even in our modern era of PCs, tablets, etc. DURABLE offers the right products for successful, organised address management.

## VISIFIX®

- Professional organisation of business cards
- With ring binders, albums and business card dispensers



### VISIFIX® PRO

- Business card ring binder
- Matt-finished surface with silver-coloured decor
- With 25 pockets
- For 200 business cards in 90 x 57 mm format
- 12-part A-Z index
- Extension set product # 2387
- Extendable by 80 cards

# 2461      ▲ 58 charcoal  
 ☞ 1 unit



### VISIFIX® PRO A4

- Business card ring binder
- Matt-finished surface with silver-coloured decor
- With 20 pockets
- For 400 business cards in 90 x 57 mm format
- 12-part A-Z index
- Extension set product # 2389
- Extendable by 200 cards

# 2462      ▲ 58 charcoal  
 ☞ 1 unit





**VISIFIX® PLUS**

- Ring binder
- Matt-finished surface with decorative silver stripes
- For business cards, telephone and fax numbers
- 2 x A-Z index
- 12 pockets for business cards in 90 x 57 mm format
- 12 card inserts for 72 telephone and fax number entries
- With product # 2387 extendable by 80 cards, or with product # 2449 by 60 entries
- Dimensions: 145 x 255 mm (W x H)

# 2372      58 charcoal  
 ☞ 1 unit



**VISIFIX®**

- Business card ring binder
- Matt-finished surface with decorative silver stripes
- With 25 pockets
- For 200 business cards in 90 x 57 mm format
- 12-part A-Z index
- With product # 2387 extendable by 80 cards.
- Dimensions: 145 x 255 mm (W x H)

# 2385      07 dark blue, 58 charcoal  
 ☞ 1 unit



**VISIFIX® 96**

- Business card binder
- Matt finish with silver decorative strips
- Welded pockets
- For 96 business cards 90 x 57 mm
- Dimensions: 118 x 250 mm (W x H)

# 8581      07 dark blue, 58 charcoal  
 ☞ 1 unit



**VISIFIX® A4**

- Business card ring binder
- Matt-finished surface with decorative silver stripes
- 20 pockets
- For 400 business cards in 90 x 57 mm format
- 12-part A-Z index
- With product # 2389 extendable by 200 cards.
- Dimensions: 255 x 315 mm (W x H)

# 2388      07 dark blue, 58 charcoal  
 ☞ 1 unit



**EXTENSION SET FOR PRODUCT # 2372, 2383, 2385, 2403, 2441 AND 2461**

- 10 business card pockets
- For 80 business cards in 90 x 57 mm format

# 2387      19 transparent  
 ☞ 10 per bag



**A4 BUSINESS CARD POCKETS**

- 10 business card pockets
- For 200 business cards in 90 x 57 mm format
- Extension set for product # 2384, 2388, 2409 and 2462
- Fits all A4 ring binders and folders.

# 2389      19 transparent  
 ☞ 10 per bag



**WWW.  
DURABLE  
.EU**



## VISIFIX® CENTIUM

- Business card ring binder
- Satin finish with decorative numbers
- 25 pockets
- For 200 business cards in 90 x 57 mm format
- 12-part A-Z index
- With product # 2387 extendable by 80 cards.
- Dimensions: 145 x 255 mm (W x H)

# 2403      01 black  
 1 unit



## VISIFIX® CENTIUM A4

- Business card ring binder
- Satin finish with decorative numbers
- 20 pockets
- For 400 business cards in 90 x 57 mm format
- 12-part A-Z index
- With product # 2389 extendable by 200 cards.
- Dimensions: 315 x 255 mm (W x H)

# 2409      01 black  
 1 unit



## VISIFIX® 400

- Business card album
- A4 format
- Synthetic leather finish
- Welded pockets
- For 400 business cards in 90 x 57 mm format
- Dimensions: 230 x 310 mm (W x H)

# 2445      01 black  
 1 unit



## VISIFIX®

- Business card ring binder
- Synthetic leather finish
- 25 pockets
- For 200 business cards in 90 x 57 mm format
- 12-part A-Z index
- With product # 2387 extendable by 80 cards
- Dimensions: 145 x 255 mm (W x H)

# 2383      01 black, 11 brown  
 1 unit



## VISIFIX® A4

- Business card ring binder
- Synthetic leather finish
- 20 pockets
- For 400 business cards in 90 x 57 mm format
- 12-part A-Z index
- With product # 2389 extendable by 200 cards.
- Dimensions: 255 x 315 mm (W x H)

# 2384      11 brown  
 1 unit



## VISIFIX® 72

- Business card album
- Synthetic leather finish
- Welded pockets
- For 72 business cards in 90 x 57 mm format
- Dimensions: 115 x 195 mm (W x H)

# 2400      01 black  
 1 unit



## VISIFIX® 96

- Business card album
- Synthetic leather finish
- Welded pockets
- For 96 business cards in 90 x 57 mm format
- Dimensions: 115 x 253 mm (W x H)

# 2380      01 black, 11 brown  
 1 unit



## VISIFIX® 128

- Business card album
- Synthetic leather finish
- Welded pockets
- For 128 business cards in 90 x 57 mm format
- Dimensions: 115 x 253 mm (W x H)

# 2308      01 black  
 1 unit



## VISIFIX® 192

- Business card album
- Synthetic leather finish
- Welded pockets
- For 192 business cards in 90 x 57 mm format
- Dimensions: 115 x 253 mm (W x H)

# 2402      01 black  
 1 unit



**VISIFIX® ECONOMY**

- Business card ring binder
- Matt-finished surface
- 12 pockets
- For 96 business cards in 90 x 57 mm format
- 6-part A-Z index
- With product # 2387 extendable by 80 cards.
- Dimensions: 145 x 255 mm (W x H)

# 2441      ♪ 01 black  
📦 1 unit

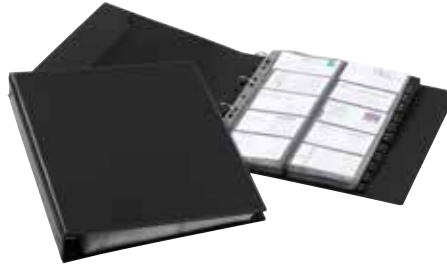

**VISIFIX® A4 ECONOMY**

- Business card ring binder
- Matt-finished surface
- 20 pockets
- For 400 business cards in 90 x 57 mm format
- 12-part A-Z index
- With product # 2389 extendable by 200 cards.
- Dimensions: 255 x 315 mm (W x H)

# 2444      ♪ 01 black  
📦 1 unit



**VISIFIX® DESK VEGAS**

- Business card file
- 100 pockets in 104 x 72 mm format
- For 200 business cards
- With 12-part A-Z index
- Dimensions: 131 x 67 x 245 mm (W x H x D)

# 2413      ♪ 01 black, 02 white, 23 metallic silver  
📦 1 unit



**VISIFIX® FLIP VEGAS**

- Rotary index file
- For storage of business cards
- 200 business card pockets in 104 x 72 mm format
- For 400 cards
- 25-part A-Z index
- Quick, selective access through rotary mechanism
- Easy removal and insertion of pockets
- Dimensions: 215 x 120 x 185 mm (W x H x D)

# 2417      ♪ 01 black, 02 white, 23 metallic silver  
📦 1 unit



**VISIFIX® FLIP DUO VEGAS**

- Rotary file
- Double capacity
- For storage of business cards
- 300 business card pockets in 104 x 72 mm format
- For 600 cards
- Extendable to 800 business cards
- 25-part A-Z index
- 40 index cards printed on both sides for hand-written addresses
- Dimensions: 330 x 120 x 185 mm (W x H x D)

# 2443      ♪ 01 black  
📦 1 unit



**VISIFIX® CUBO**

- Rotary file
- 150 pockets in 104 x 72 mm format
- For 300 business cards
- 25-part A-Z index
- Dimensions: 215 x 120 x 185 mm (W x H x D)

# 2447      ♪ 01 black  
📦 1 unit



**EXTENSION SET FOR VISIFIX® FLIP/VISIFIX® DESK/  
VISIFIX® CUBO**

- 40 business card pockets
- For product # 2413, 2417 and 2447

# 2418      ♪ 19 transparent  
📦 40 per bag



**VISIFIX® ROTARY FILE**

- Rotary file
- For storage of business cards
- With 200 business card pockets in 104 x 72 mm format
- For 400 cards
- 25-part A-Z index
- Quick, selective access through rotation mechanism
- Easy removal and insertion of pockets

# 2481      ♪ 01 black, 23 metallic silver  
📦 1 unit





### DURALOOK® VISIFIX® WALK

- 12 exchangeable pockets
- For 96 business cards in 90 x 57 mm format

# 2452      07 dark blue  
 1 unit



### A4 BUSINESS CARD POCKETS

- 10 business card pockets
- For 200 business cards in 90 x 57 mm format
- Extension set for product # 2384, 2388, 2409 and 2462
- Fits all A4 ring binders and folders.

# 2389      19 transparent  
 10 per bag



### BUSINESS CARD BOX

- Made of aluminium
- For 20 business cards
- Fits business card formats up to 90 x 55 mm

# 2415      23 metallic silver  
 1 unit



### BUSINESS CARD BOX DUO

- Made of aluminium
- With divider
- For 10 individual and 10 customer business cards
- Business card format 90 x 55 mm

# 2433      23 metallic silver  
 1 unit



### BUSINESS CARD BOX CHROME

- Chrome-plated steel sheet
- For 15 business cards
- Business card formats up to 95 x 58 mm

# 2440      23 metallic silver  
 1 unit



### ACRYLIC BUSINESS CARD DISPENSER

- For 50 business cards
- Cards in widths of up to 100 mm
- Textured grooves keep individual cards safely in place
- Adhesive pads for fastening at the back included in the delivery

# 2414      19 transparent  
 1 unit



### BUSINESS CARD DISPLAY BOX

- Made of crystal-clear plastic material
- With four levels
- For 240 business cards
- Combination of several display boxes possible

# 2439      19 transparent  
 1 unit



**WWW.  
DURABLE  
.EU**

## TELINDEX®

- Telephone book ring binders with matt-finished surface
- For well-organised address management
- For use in the office and home
- For names, telephone, fax and mobile phone numbers, email and Internet addresses



### TELINDEX®

- Telephone ring binder
- 25 address inserts
- For 150 entries
- 12-part A-Z index
- Matt-finished surface with decorative silver stripes
- With product # 2449 extendable by 60 entries
- Dimensions: 145 x 255 mm (W x H)

# 2375      07 dark blue, 58 charcoal  
 1 unit



### TELINDEX® A5

- Telephone ring binder with notepad
- 25 address inserts
- For 200 entries
- 12-part A-Z index
- Matt-finished surface with decorative silver stripes
- With product # 2456 extendable by 80 entries
- Dimensions: 175 x 230 mm (W x H)

# 2377      07 dark blue, 58 charcoal  
 1 unit



### EXTENSION SET FOR PRODUCT # 2377

- 10 address inserts for 80 entries

# 2456      10 grey  
 10 per bag



### TELINDEX® ECONOMY

- Telephone ring binder
- With 18 address inserts for 108 entries
- 6-part A-Z index
- With product # 2449 extendable by 60 entries
- Dimensions: 145 x 255 mm (W x H)

# 2442      01 black  
 1 unit



### EXTENSION SET FOR PRODUCT # 2372, 2375 AND 2442

- 10 address inserts for 60 entries

# 2449      10 grey  
 10 per bag



### TELINDEX® ROTARY FILE

- Rotary file
- For telephone number and address entries
- 500 index cards in 104 x 72 mm format printed on both sides
- 25-part A-Z index
- Quick, selective access through rotation mechanism
- Easy removal and insertion of cards

# 2482      ♀ 01 black, 23 metallic silver  
 ☞ 1 unit



### TELINDEX® CUBO

- Rotary file
- With 350 index cards printed on both sides
- For entry of addresses and telephone numbers
- 25-part A-Z index
- Dimensions: 215 x 120 x 185 mm (W x H x D)

# 2446      ♀ 01 black  
 ☞ 1 unit



### TELINDEX® FLIP VEGAS

- Rotary index file
- For entries of telephone numbers and addresses
- 500 index cards printed on both sides in 104 x 72 mm format
- 25-part A-Z index
- Quick, selective access through rotary mechanism
- Easy removal and insertion of cards
- Dimensions: 215 x 120 x 185 mm (W x H x D)

# 2416      ♀ 01 black, 02 white, 23 metallic silver  
 ☞ 1 unit



### TELINDEX® DESK VEGAS

- Address card file
- With 500 index cards printed on both sides in 104 x 72 mm format
- 25-part A-Z index
- For filling in entries quickly and easily
- Easy removal and insertion of the cards
- Dimensions: 131 x 67 x 245 mm (W x H x D)

# 2412      ♀ 01 black, 23 metallic silver  
 ☞ 1 unit



### EXTENSION SET FOR TELINDEX® FLIP/TELINDEX® DESK/TELINDEX® CUBO

- 100 index cards printed on both sides
- For product # 2412, 2416 and 2446

# 2419      ♀ 02 white  
 ☞ 100 per bag







## SELF-ADHESIVE PRODUCTS

DURABLE's extensive range of self-adhesive products are ideal for a number of applications. Multiple uses include protection, display and storage of business cards, CD/DVD's, marking and labelling of documents, brochures and files etc via tabs and pockets. Extremely practical and easy to use.



### BADGEFIX

- Self-adhesive name badge made of acetate silk
- Printable with laser printers and copiers.
- Not suitable for silk, suede, leather and sensitive textiles.

### BADGEFIX

- Format: 30 x 60 mm. Contents: 540 units

# 8333      ☾ 02 white  
📦 20 sheets per pack

### BADGEFIX

- Format: 40 x 75 mm. Contents: 240 units

# 8334      ☾ 02 white  
📦 20 sheets per pack



WWW.  
DURAPRINT  
.EU



### LABELFIX®

- Self-adhesive labelling window
- Ideal for labelling filing trays, shelves, drawers, cabinets and technical appliances.
- Open on both sides.
- 200 mm wide, can be cut to size.
- With PC-printable blank inserts. Easy, professional labelling with the help of free DURAPRINT® printing software, available for download from [www.duraprint.eu](http://www.duraprint.eu).

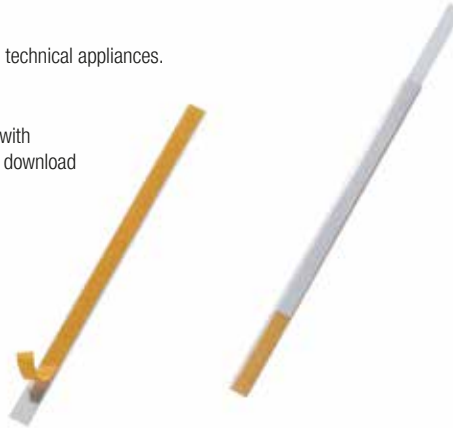

Prod. Code	Colour	Width mm	Height mm	Packing
8010	19 transparent	200	10	10 per bag
8015	19 transparent	200	15	10 per bag
8020	19 transparent	200	20	10 per bag
8030	19 transparent	200	30	5 per bag
8040	19 transparent	200	40	5 per bag

### SCANFIX

- Self-adhesive scanner tracks for individual labelling.
- Ideal for price and product tags.
- Open at the top and one side, 200 mm wide, can be cut to size.
- With PC-printable blank inserts. Easy, professional labelling with the help of free DURAPRINT® printing software, available for download from [www.duraprint.eu](http://www.duraprint.eu).



Prod. Code	Colour	Width mm	Height mm	Packing
8044	19 transparent	200	20	5 per bag
8045	19 transparent	200	30	5 per bag
8046	19 transparent	200	40	5 per bag



### CD/DVD FIX

- For 1 CD/DVD with booklet or 2 CDs/DVDs.
- Self-adhesive pocket with protective lining

# 5210      19 transparent  
 10 per bag



### REINFORCEMENT STRIPS

- Self-adhesive, transparent reinforcement strips
- Tear protection for 60 mm or 80 mm punchings
- With easily removable protective strip on the reverse

# 8078      19 transparent  
 50 per bag



## POCKETFIX

- Self-adhesive pockets
- For labelling files, folders and ring binders
- Open on one side

### POCKETFIX®

- Self-adhesive pocket for labelling folders and files and for the presentation of business cards
- With PC-printable blank inserts, easy professional labelling with DURAPRINT® available to download from [www.duraprint.eu](http://www.duraprint.eu)
- Internal dimensions: 75 x 18 mm (W x H)
- External dimension: 81 x 22 mm (W x H)



Prod. Code	Colour	WxH outside mm	WxH inside mm	Packing
8072	19 transparent	81 x 22	75 x 18	10 per bag
8021	19 transparent	76 x 35	74 x 32	10 per bag
8022	19 transparent	76 x 46	74 x 43	10 per bag
8073	19 transparent	104 x 32	100 x 28	10 per bag
8019	19 transparent	105 x 65	101 x 61	10 per bag
8319	19 transparent	105 x 65	101 x 61	100 per pack
8074	19 transparent	129 x 42	125 x 38	10 per bag
8075	19 transparent	154 x 62	150 x 58	10 per bag
8076	19 transparent	152 x 109	148 x 105	20 per bag
8276*	19 transparent	152 x 109	148 x 105	100 per pack
8077	19 transparent	110 x 78	105 x 74	10 per bag
8079				
(business card format)	19 transparent	94 x 63	90 x 57	10 per bag
8379	19 transparent	94 x 63	90 x 57	100 per pack
8279				
(business card format)	19 transparent	94 x 63	90 x 57	100 per pack



### POCKETFIX 212 X 88/122

- With raised edge
- For right-aligned fixing of the documents.

# 8284      19 transparent  
 100 per pack

### POCKETFIX 212 X 122/88

- With raised edge
- For left-aligned fixing of the documents.

# 8285      19 transparent  
 100 per pack

### POCKETFIX®

- Self-adhesive pockets for labelling folders and files individually and for the presentation of business cards
- Open to the top
- With PC-printable blank inserts, easy professional labelling with DURAPRINT® available to download from [www.duraprint.eu](http://www.duraprint.eu)
- Internal dimensions: 90 x 57 mm (W x H)
- External dimension: 94 x 61 mm (W x H)

# 8093      19 transparent  
 10 per bag

# 8293      19 transparent  
 100 per pack

### POCKETFIX® PLUS

- Self-adhesive pocket with closing flap
- For storing up to 15 business cards (90 x 57 mm format)
- Ideal for presentation documents, quotations or appointment diaries
- External dimensions: 106 x 65 mm (W x H)

# 8092      19 transparent  
 10 per bag



**POCKETFIX® A4**

- Self-adhesive pockets for storing or presenting A5 or A4 documents
- May be used in files, folders or ring binders, ideal for placards
- Open to the top
- Internal dimensions: A4
- External dimension: 302 x 216 mm (W x H)

Code	Colour	Packing
8095	19 transparent	3 per bag
8096	19 transparent	25 per bulk pack
8295	19 transparent	10 per bag
8296	19 transparent	50 per pack

**POCKETFIX® A5**

- Self-adhesive pockets for storing or presenting A5 or A4 documents
- May be used in files, folders or ring binders, ideal for placards
- Open to the top
- Internal dimensions: A5
- External dimension: 302 x 216 mm (W x H)

# 8094	19 transparent
📦 5 per bag	
# 8294	19 transparent
📦 25 per pack	

**POCKETFIX® CD/DVD**

- Self-adhesive CD/DVD pocket with closing flap
- Ideal for folders, ring binders and files etc.
- External dimensions: 127 x 127 mm (W x H)

# 8080	19 transparent
📦 10 per bag	
# 8280	19 transparent
📦 100 per pack	



# Filing and Organisation

## ORDOFIX®

- Self-adhesive spine labels
- With PC-printable blank inserts.
- Easy, professional labelling with the help of free DURAPRINT® printing software, available for download from [www.duraprint.eu](http://www.duraprint.eu). For ring binders in widths of 70 or 50 mm.



## ORDOFIX®

- For 70 mm wide ring binders
- Dimensions 60 x 390 mm (W x H)

# 8090     01 black, 03 red, 04 yellow, 05 green, 06 blue, 00 assorted  
 10 per pack

## ORDOFIX®

- For 50 mm wide ring binders
- Dimensions: 40 x 390 mm (W x H)

# 8091     01 black, 03 red, 04 yellow, 05 green, 06 blue, 00 assorted  
 10 per pack

## TABFIX®

- Self-adhesive tabs
- For the clear division and labelling of card files, project files, catalogues and suspension filing systems
- 200 mm wide, can be cut to size
- With blank, horizontally and vertically printed inserts (A–Z, 0–31, Jan.–Dec.)
- 3 lines
- Dimensions: 200 x 10 mm (W x H)



Prod. Code	Colour	Dimensions mm	packing
8402	19	81 x 22	5 per bag
8403	19	76 x 18	10 per bag

25 mm breit. Mit blanko Einsteckschildern.

Prod. Code	Colour	Dimensions mm	packing
8072	00	81 x 22	10 per bag

Farb-Nr./Farbe: 19 transparent, 00 farbig sortiert

## CORNERFIX

- Self-adhesive triangular pockets
- Ideal for storing loose documents in folders, ring binders files, etc.



Code	Colour	Dim. mm	Packing
8081	19 transparent	75x75	8 per bag
8281	19 transparent	75x75	100 per pack
8082	19 transparent	125x125	8 per bag
8282	19 transparent	125x125	200 per pack
8382	19 transparent	125x125	100 per pack
8083	19 transparent	175x175	8 per bag
8283	19 transparent	175x175	100 per pack

## QUICK TAB

- Self-adhesive index tabs
- For orderly subdivision and labelling of card boxes, project files, catalogues, books, etc.
- Can be labelled without smudging
- Width: 40 mm



## QUICK TAB

- Self-adhesive tabs for writing on, removable
- May be labelled on one side

# 8405     02 white, 00 assorted  
 48 per pack

## QUICK TAB DUO

- Self-adhesive tabs for writing on
- May be labelled on both sides

# 8406     00 assorted  
 24 per pack

## QUICK TAB PERMANENT

- Can be labelled on both sides
- Permanent adhesive

# 8404     00 assorted, 02 white  
 48 per pack



**FLEXIFIX®**

- Self-adhesive filing strips for quick assembly of punched documents
- Stick to smooth surfaces
- Dimensions: 38 x 150 mm (W x H)

# 6906      02 white, 06 blue  
 100 per pack

**FLEXIFIX® RETAIL PACK**

# 6916      02 white  
 10 per bag



**FLEXIFIX® ECONOMY**

- Self-adhesive filing strips for quick assembly of punched documents
- Varnished filing mechanism made of metal
- Stick to smooth surfaces
- Dimensions: 38 x 150 mm (W x H)

# 6908      02 white  
 100 per pack



**FLEXIFIX® FILING STRIPS**

- Folders for quick assembly of punched documents
- Archiving in lever arch files and ring binders
- Dimensions: 38 x 150 mm (W x H)
- Punching: 60/80 mm

# 6901      01 black, 02 white, 03 red, 04 yellow, 05 green, 06 blue, 07 dark blue, 00 assorted  
 250 per pack

# 6910      00 assorted  
 25 per bag



**FILEFIX®**

- Self-adhesive filing strips
- With universal punching
- For unpunched documents such as catalogues, brochures, photos or drawings
- For filing in folders or ring binders

Code	Colour	Width mm	Height mm	For	Packing
8061	19 transparent	25	295	DIN A4	10 per bag
8064	19 transparent	25	295	DIN A4	50 per bag
8261	19 transparent	25	295	DIN A4	250 per pack
8063	19 transparent	25	280	US Letter Size	25 per bag
8062	19 transparent	25	145	DIN A5	25 per bag

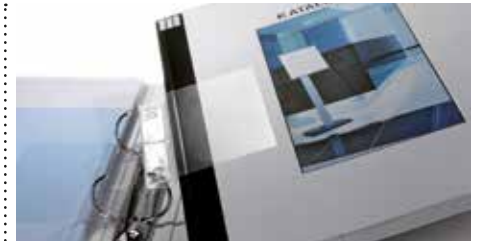

**FILEFIX® MAXI**

- Self-adhesive filing strips with large adhesive area (60 x 100 mm)
- Ideal for the storage of heavy, unpunched documents
- Space between punchings: 65/80 mm

# 8069      19 transparent  
 10 per bag

# 8070      19 transparent  
 50 per bulk pack



**SEAL IT A4**

- Transparent self-laminating cards for protection against creasing or soiling
- For quickly laminating A4 documents such as menus or work instructions
- No laminator needed

# 8236      19 transparent      # 8435      19 transparent  
 10 per bag                      50 per pack

**SEAL IT A6**

- For documents up to A6.

# 8434      19 transparent      # 8433      19 transparent  
 50 per pack                      100 per pack

**SEAL IT A7**

- For documents up to A7.

# 8433      19 transparent  
 100 per pack



**SEAL IT 54 X 90 MM**

- Transparent self-lamination cards for protection against creasing or soiling
- For quick lamination of ID cards, photos or photographs
- Up to 54 x 90 mm without a laminating machine.

# 8438      19 transparent  
 100 per pack

# 8231      19 transparent  
 10 per bag



**SEAL IT A4 ADHESIVE**

- Transparent self-lamination cards for protecting A4 documents against soiling and creasing
- Can be applied to practically any smooth supporting surface in landscape or portrait format
- May be removed and repositioned
- For permanent notices such as work instructions or operating instructions

# 8237      19 transparent  
 10 per bag



<b>Products</b>	<b>Page</b>
Desktop range	72–91
Drawer boxes	92–94
Desk mats	95–99
IT accessories	100–106
Cleaning products	107–111
Small furniture	112–127

# Office equipment





## DESKTOP RANGE

The desktop range from DURABLE provides high quality, stylish and colourful accessories for a pleasant, organised working environment. Pens, paper clips and other items of office stationery are close to hand thanks to useful storage solutions. With various design features and contemporary colour options, the desktop range coordinates with a number of pieces and different interiors.







# VARICOLOR®

VARICOLOR® is the series for modern, flexible workplaces. This series is characterized by premium-quality materials and workmanship combined with elegant, modern design. Coloured highlights not only create variety, but also provide intuitive order and structure. In addition to modern classics such as drawer boxes and sorting trays for fixed offices, VARICOLOR® goes a step further by offering innovative solutions for mobile and digital work with tablet PCs and smart phones.



# Office equipment

## VARICOLOR®

- Drawer box with coloured drawers
- Made from high quality plastics
- Fine coloured lines serve as organisation and orientation aids
- Drawers open smoothly and soundlessly
- With drawer stop
- For formats up to A4, C4, and for folio and letter-size formats
- With transparent labelling windows and computer-printable, easily exchangeable insert labels included in the delivery
- Stackable on non-slip plastic pads
- Storage in rows possible in all standard office cabinets and sideboards



reddot design award  
winner 2013



product design award  
2013



DESIGNPREIS  
DER  
BUNDESREPUBLIK  
DEUTSCHLAND  
2013  
NOMINIERT

GIO award 2012



### VARICOLOR® 5

- With 5 coloured drawers
- Dimensions: 280 x 292 x 356 mm (W x H x D)

# 7605    27 multi-coloured  
1 unit



### VARICOLOR® 7

- With 7 coloured drawers
- Dimensions: 280 x 292 x 356 mm (W x H x D)

# 7607    27 multi-coloured  
1 unit



### VARICOLOR® 10

- With 10 coloured drawers
- Dimensions: 280 x 292 x 356 mm (W x H x D)

# 7610    27 multi-coloured  
1 unit





**VARICOLOR® TRAY SET DUO**

- 2 letter trays
- Stackable in vertical and staggered directions
- Different-coloured, large grip sections
- For easy organisation
- High quality
- Dimensions: 255 x 55 x 330 mm (W x H x D)

# 7702    🔥 03 red, 09 orange, 12 light purple  
📦 1 set

**VARICOLOR® TRAY SET**

- 5 letter trays
- Stackable in vertical and staggered directions
- Different-coloured, large grip sections
- For easy organisation
- High quality
- Dimensions: 255 x 55 x 330 mm (W x H x D)

# 7705    🔥 57 anthracite/grey  
📦 1 set



Fits all types of power sockets

**VARICOLOR® PHONE HOLDER**

- Multi-purpose mobile phone holder for battery charging
- Fits all sizes of mobile phone plugs and power sockets
- Adjustable to fit different plug sizes through detachable inner ring
- Non slip base ensures stability of mobile phone
- Extremely compact due to folding mechanism
- Ideal for travelling
- Dimensions: 84 x 134 x 4.5 mm (W x H x D)

# 7735    🔥 03 red, 04 yellow, 08 pink, 09 orange, 12 light purple  
📦 1 unit



Patent pending

**VARICOLOR® TABLET BASE**

- Innovative rotating stand for tablet PCs
- Place the tablet flat or upright for working and for presentations
- Lockable and smooth rotation
- For tablet PCs with or without protective cover
- High stability
- Dimensions: 145 x 59 mm (Ø x H)

# 7611    12 light purple  
 1 piece



Also for tablets with protective cover

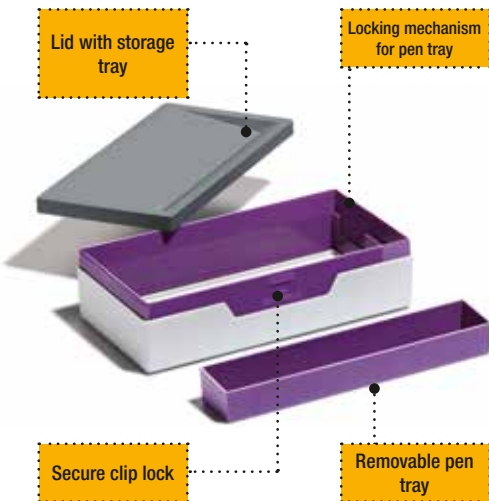

**VARICOLOR® JOB CASE**

- Compact storage box
- For use at the workplace and on travel
- With internal pen tray
- For the storage of small items
- For charger cables of tablet PCs and smart phones, plugs, USBs, pens, post-it labels, marker pens and SD cards
- Dimensions: 122 x 62 x 235 mm (W x H x D)

# 7612    12 light purple  
 1 piece



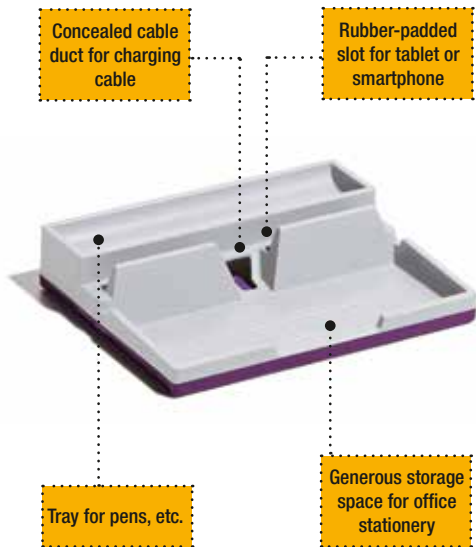

**VARICOLOR® DESK ORGANIZER**

- Stylish and user-friendly storage tray
- For desks and drawers as well as for the VARICOLOR® Drawer Box
- Two ample storage areas
- Smart phone and tablet PC can be placed in the middle
- Smart cable management
- Equipped with non-slip rubber pads
- Dimensions: 190 x 50 x 240 mm (W x H x D)

# 7613    12 light purple  
1 piece

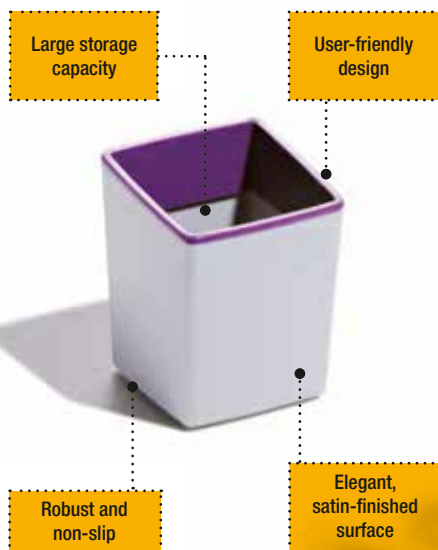

**VARICOLOR® PEN CUP**

- Generous storage capacity
- High-quality
- Non-slip rubber pads
- For pens, scissors, marker pens etc.
- Dimensions: 79 x 100 x 79 mm (W x H x D)

# 7614    12 light purple  
1 piece



## DESKTOP SERIES VEGAS

- Timeless modern design
- Two-tone colour scheme
- Premium quality

Patented

### VISIFIX® FLIP VEGAS

- Rotary index file
- For storage of business cards
- 200 business card pockets in 104 x 72 mm format
- For 400 cards
- 25-part A-Z index
- Quick, selective access through rotary mechanism
- Easy removal and insertion of pockets
- Dimensions: 215 x 120 x 185 mm (W x H x D)

# 2417    01 black, 02 white, 23 metallic silver  
 1 unit



### TELINEDEX® FLIP VEGAS

- Rotary index file
- For entries of telephone numbers and addresses
- 500 index cards printed on both sides in 104 x 72 mm format
- 25-part A-Z index
- Quick, selective access through rotary mechanism
- Easy removal and insertion of cards
- Dimensions: 215 x 120 x 185 mm (W x H x D)

# 2416    01 black, 02 white, 23 metallic silver  
 1 unit



### VISIFIX® FLIP DUO VEGAS

- Rotary file
- Double capacity
- For storage of business cards
- 300 business card pockets in 104 x 72 mm format
- For 600 cards
- Extendable to 800 business cards
- 25-part A-Z index
- 40 index cards printed on both sides for hand-written addresses
- Dimensions: 330 x 120 x 185 mm (W x H x D)

# 2443    01 black  
 1 unit



### EXTENSION SET FOR TELINDEX® FLIP/ TELINEDEX® DESK/TELINEDEX® CUBO

- 100 index cards printed on both sides
- For product # 2412, 2416 and 2446

# 2419    02 white  
 100 per bag



### EXTENSION SET FOR VISIFIX® FLIP/ VISIFIX® DESK/VISIFIX® CUBO

- 40 business card pockets
- For product # 2413, 2417 and 2447

# 2418    19 transparent  
 40 per bag





**VISIFIX® DESK VEGAS**

- Business card file
- 100 pockets in 104 x 72 mm format
- For 200 business cards
- With 12-part A-Z index
- Dimensions: 131 x 67 x 245 mm (W x H x D)

# 2413    01 black, 02 white, 23 metallic silver  
 1 unit



**TELINDEX® DESK VEGAS**

- Address card file
- With 500 index cards printed on both sides in 104 x 72 mm format
- 25-part A-Z index
- For filling in entries quickly and easily
- Easy removal and insertion of the cards
- Dimensions: 131 x 67 x 245 mm (W x H x D)

# 2412    01 black, 23 metallic silver  
 1 unit



**PEN HOLDER VEGAS**

- 5 different size compartments
- Stores pens, scissors, paper clips, etc.

# 7720    01 black, 23 metallic silver  
 1 unit

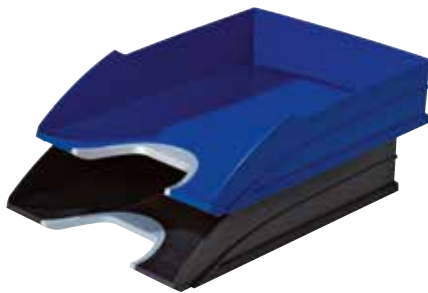

**LETTER TRAY VEGAS**

- Can be stacked vertically or staggered
- For formats A4 to C4 and Folio
- With practical recess
- Internal dimensions: 255 x 55 x 330 mm (W x H x D)

# 7711    01 black, 07 dark blue  
 1 unit



**DESK MAT VEGAS**

- Oval shape
- Integrated pen holder
- Transparent overlay
- Non-slip
- Dimensions: 690 x 510 mm (W x H)

# 7208    01 black, 23 metallic silver  
 1 unit



**PAPER CLIP BOX VEGAS**

- Magnetised finger recess
- Complete with 100 paper clips
- Dimensions: 92 x 63 x 144 mm (W x H x D)

# 7713    01 black, 23 metallic silver  
 1 unit



**TAPE DISPENSER VEGAS**

- Stable weighted base
- For tape rolls up to 33 m long and 19 mm wide
- Complete with 1 tape roll

# 7717    01 black, 23 metallic silver  
 1 unit



**NOTE BOX VEGAS**

- 500 notes- 90 x 90 mm
- Pen holder
- Easy removal of single sheets thanks to slightly angled holder
- Dimensions: 116 x 70 x 153 mm (W x H x D)

# 7714    01 black, 23 metallic silver  
 1 unit



**PAPER NOTES**

- 500 notes
- 90 x 90 mm
- For NOTE BOX product # 7714 and product # 7724

# 7716    02 white  
 500 sheets per pack

## DESKTOP SERIES TREND

- Modern design
- Various accessories available
- High-gloss finish
- Easy handling



### MAGAZINE RACK TREND

- For A4 formats
- With grip hole
- With carry opening for simple handling and transport
- With labelling strips to label the documents
- Dimensions: 74 x 305 x 244 mm (W x H x D)

Prod. Code	Colour	Packing
1701625010	white	1 piece
1701625060	black	1 piece
1701625400	transparent	1 piece
1701625540	translucent blue	1 piece



### LETTER TRAY TREND

- Stackable
- For formats A4 to C4
- Variable opening angle when Stackable
- Easy access to the filed documents
- Dimensions: 250 x 70 x 337 mm (W x H x D)

Prod. Code	Colour	Packing
1701626010	white	1 piece
1701626060	black	1 piece
1701626400	transparent	1 piece
1701626540	translucent blue	1 piece



### PAPER CLIP BOX TREND

- With magnetic edge
- With paper clips
- Dimensions: Ø 72 mm, height 75 mm

Prod. Code	Colour	Packing
1709051060	black	1 piece
1709051400	transparent	1 piece
1709051540	translucent blue	1 piece



### PEN CUP TREND

- For pens, scissors, marker pens, etc.
- Dimensions: Ø 80 mm, height 102 mm

Prod. Code	Colour	Packing
1701235017	translucent light green	1 piece
1701235020	green	1 piece
1701235034	pink	1 piece
1701235040	blue	1 piece
1701235080	red	1 piece
1701235009	translucent orange	1 piece
1701235008	translucent pink	1 piece
1701235010	white	1 piece

Prod. Code	Colour	Packing
1701235060	black	1 piece
1701235400	transparent	1 piece
1701235540	translucent blue	1 piece
1701235992	translucent purple	1 piece
1701235012	opaque light purple	1 piece
1701235003	translucent red	1 piece
1701235909	opaque orange	1 piece





### NOTE BOX TREND

- Note box with 800 notes, 90 x 90 mm
- Easy removal of notes due to opened removal space
- Dimensions: 100 x 105 x 100 mm (W x H x D)

Prod. Code	Colour	Packing
1701682017	translucent light green	1 piece
1701682034	pink	1 piece
1701682992	translucent purple	1 piece
1701682012	opaque light purple	1 piece
1701682909	opaque orange	1 piece
1701682003	translucent red	1 piece
1701682009	translucent orange	1 piece
1701682008	translucent pink	1 piece

Prod. Code	Colour	Packing
1701682010	white	1 piece
1701682020	green	1 piece
1701682040	blue	1 piece
1701682060	black	1 piece
1701682080	red	1 piece
1701682400	transparent	1 piece
1701682540	translucent blue	1 piece

### PAPER NOTES TREND

- 800 blank paper notes
- 93 x 93 mm
- Refill pack for TREND note box



# 1700381682 white  
 1 unit



### CATALOGUE FILE TREND

- Three compartment subdivisions of 65 mm
- For magazines and brochures
- Dimensions: 215 x 165 x 210 mm (W x H x D)

Prod. Code	Colour	Packing
1701395010	white	1 piece
1701395050	050 grey	1 piece
1701395060	black	1 piece
1701395400	transparent	1 piece
1701395540	translucent blue	1 piece

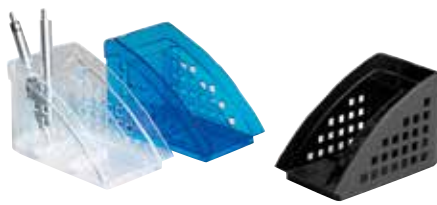

### DESK ORGANIZER TREND

- For pens, scissors, paper clips, erasers etc.
- Dimensions: 82 x 106 x 180 mm (W x H x D)

Prod. Code	Colour	Packing
1701627060	black	1 piece
1701627400	transparent	1 piece
1701627540	translucent blue	1 piece



### TAPE DISPENSER TREND

- Non-slip
- For tape rolls up to 33 m long and 19 mm wide
- Filled with tape roll
- Dimensions: 147 x 70 x 62 mm (W x H x D)

Prod. Code	Colour	Packing
1709054060	black	1 piece
1709054400	transparent	1 piece
1709054540	translucent blue	1 piece

### WASTE BASKET TREND

- Waste bin for the office.
- Capacity 16 litres.
- With carry handles for simple transport.
- Various colours including translucent.
- Matches Trend desk series.
- Dimensions: 330 x 315 mm (H x Ø)



Prod. Code	Colour	Packing
1701710017	translucent light green	1 piece
1701710020	green	1 piece
1701710034	pink	1 piece
1701710040	blue	1 piece
1701710080	red	1 piece
1701710992	translucent purple	1 piece
1701710008	translucent pink	1 piece
1701710010	white	1 piece
1701710060	black	1 piece
1701710400	transparent	1 piece
1701710540	translucent blue	1 piece
1701715003	translucent red	1 piece
1701715009	translucent orange	1 piece
1701710012	light purple	1 piece
1701710909	orange	1 piece

## DESKTOP SERIES BASIC

- A variety of contemporary colours
- Economical
- Classic design
- Optimised basic dimensions and minimised volume



### MAGAZINE RACK BASIC

- For A4 formats
- With grip hole
- For magazines, catalogues and brochures etc.
- Dimensions: 73 x 306 x 241 mm (W x H x D)



Prod. Code	Colour	Packing	Prod. Code	Colour	Packing
1701711020	green	1 piece	1701711400	transparent	1 piece
1701711034	opaque pink	1 piece	1701712017	translucent light green	1 piece
1701711040	blue	1 piece	1701712540	translucent blue	1 piece
1701711050	grey	1 piece	1701712992	translucent purple	1 piece
1701711080	red	1 piece	1701712012	opaque light purple	1 piece
1701712008	translucent pink	1 piece	1701712909	opaque orange	1 piece
1701711010	white	1 piece	1701711003	translucent red	1 piece
1701711060	black	1 piece	1701711009	translucent orange	1 piece



### HEIGHT SPACER ELEMENTS FOR LETTER TRAY BASIC

- Plastic
- For additional height spacing

# 1701723060    ♪ black  
 📦 4 per bag

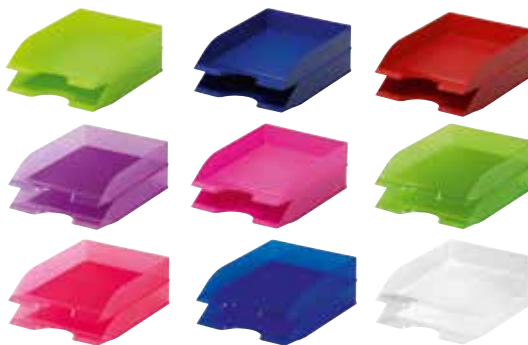

### LETTER TRAY BASIC

- Stackable
- Height spacers also available
- For formats A4 to C4
- Dimensions: 253 x 63 x 337 mm (W x H x D)

Prod. Code	Colour	Packing	Prod. Code	Colour	Packing
1701672010	white	1 piece	1701673017	translucent light green	1 piece
1701672020	green	1 piece	1701673540	translucent blue	1 piece
1701672034	crimson	1 piece	1701673992	translucent purple	1 piece
1701672040	blue	1 piece	1701673012	opaque light purple	1 piece
1701672060	black	1 piece	1701673909	opaque orange	1 piece
1701672080	red	1 piece	1701672003	translucent red	1 piece
1701672400	transparent	1 piece	1701672009	translucent orange	1 piece
1701673008	translucent pink	1 piece			



### WASTE BASKET BASIC

- Waste bin for the office.
- Capacity 13 litres.
- Matches BASIC desk series
- Dimensions: 320 x 290 mm (H x Ø)

# 1701572010    ♪ white    # 1701572221    ♪ black  
 📦 1 unit                      📦 1 unit

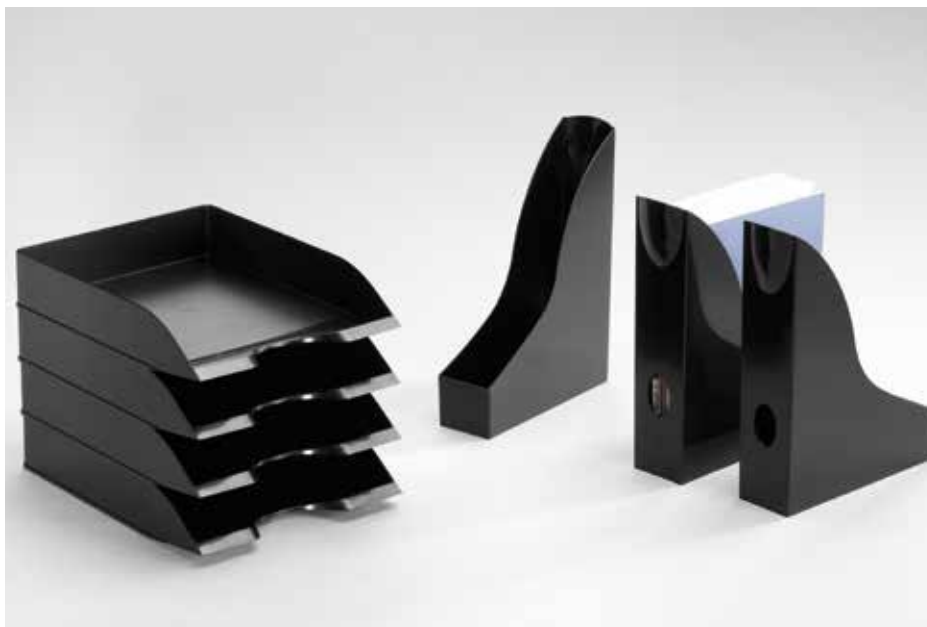



## DESKTOP SERIES OPTIMO

- Use of recycled plastics in "Blue Angel" quality
- Robust and premium-quality plastic
- Particularly long service life
- Various accessories available



### LETTER TRAY OPTIMO A4 "BLUE ANGEL"

- Stackable
- Height spacer pins are also available
- Dimensions: 255 x 62 x 334 mm (W x H x D)

# 1700801058 ♻️ charcoal  
📦 1 unit



### HEIGHT SPACER PINS FOR LETTER TRAY OPTIMO

- Metal
- For additional height distance between trays
- For all formats

# 1700132001 ♻️ assorted  
📦 1 bag



### LETTER TRAY OPTIMO A3, LANDSCAPE "BLUE ANGEL"

- Letter tray for A3 landscape formats
- Choice between two A4 portrait formats
- Stackable
- Height spacer pins are also available
- Dimensions: 436 x 105 x 333 mm (W x H x D)

# 1700786058 ♻️ 058 charcoal  
📦 1 unit



### MAGAZINE RACK OPTIMO "BLUE ANGEL"

- For A4 formats
- With grip hole
- For magazines and brochures
- Dimensions: 71 x 315 x 246 mm (W x H x D)

# 1701504058 ♻️ charcoal  
📦 1 unit



### DESK ORGANIZER OPTIMO "BLUE ANGEL"

- Five compartments
- For pens, scissors, paper clips etc.
- Additional area for envelopes
- Dimensions: 162 x 110 x 118 mm (W x H x D)

# 1701588058 ♻️ charcoal  
📦 1 unit



### CATALOGUE FILE OPTIMO "BLUE ANGEL"

- Variable, width-adjustable sub-dividers
- For magazines and brochures
- Dimensions: 300 x 180 x 250 mm (W x H x D)

# 1709018058 ♻️ charcoal  
📦 1 unit



### WASTE BASKET OPTIMO

- Square waste bin for the office.
- Capacity 18 litres.
- Matches OPTIMO desk series
- Dimensions: 300 x 320 x 300 mm (W x H x D)

# 1701579221 ♻️ black  
📦 1 unit

## DESKTOP SERIES ECONOMY

- Use of recycled plastics in "Blue Angel" quality
- Economical
- Large storage capacities
- Basic design



### LETTER TRAY ECONOMY "BLUE ANGEL"

- Stackable
- Height spacer pins are also available
- For formats up to C4
- Dimensions: 263 x 66 x 358 mm (W x H x D)

# 1701567058 ♻️ charcoal

📦 1 unit

### MAGAZINE RACK ECONOMY "BLUE ANGEL"

- For A4 formats
- With grip hole
- For magazines, catalogues and brochures etc.
- Dimensions: 65 x 305 x 235 mm (W x H x D)

# 1701569058 ♻️ charcoal

📦 1 unit



## DESKTOP SERIES CUBO

- Contemporary square design
- Suitable for modern offices
- High-gloss finish



### NOTE BOX CUBO

- 500 notes
- 90 x 90 mm
- Dimensions: 115 x 60 x 115 mm (W x H x D)

# 7724    ▲ 01 black  
 ☞ 1 unit



### PAPER CLIP BOX CUBO

- Large recessed grip
- Dimensions: 75 x 35 x 75 mm (W x H x D)

# 7723    ▲ 01 black  
 ☞ 1 unit



### PEN HOLDER CUBO

- To store markers, letter openers, scissors, etc.
- Dimensions: 75 x 90 x 75 mm (W x H x D)

# 7722    ▲ 01 black  
 ☞ 1 unit

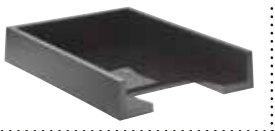

### LETTER TRAY CUBO

- Stackable
- For documents in A4 and extra wide
- Dimensions: 350 x 60 x 265 mm (W x H x D)

# 7726    ▲ 01 black  
 ☞ 1 unit



### MAGAZINE RACK CUBO

- For magazines, brochures, files etc.
- Dimensions: 85 x 320 x 255 mm (W x H x D)

# 7727    ▲ 01 black  
 ☞ 1 unit

Matching extension sets on pages 59 and 62.



### VISIFIX® CUBO

- Rotary file
- 150 pockets in 104 x 72 mm format
- For 300 business cards
- 25-part A-Z index
- Dimensions: 215 x 120 x 185 mm (W x H x D)

# 2447    ▲ 01 black  
 ☞ 1 unit



### TEINDEX® CUBO

- Rotary file
- With 350 index cards printed on both sides
- For entry of addresses and telephone numbers
- 25-part A-Z index
- Dimensions: 215 x 120 x 185 mm (W x H x D)

# 2446    ▲ 01 black  
 ☞ 1 unit

## CUBO ECO

- Contemporary square design
- Environmentally friendly
- Made of 70% renewable materials



### NOTE BOX CUBO ECO

- 500 paper notes
- 90 x 90 mm format
- PEFC certified paper
- Dimensions: 115 x 60 x 115 mm (W x H x D)

# 7744    ♻️ 16 beige  
📦 1 unit



### PAPER CLIP BOX CUBO ECO

- Large recessed grip
- Dimensions: 75 x 35 x 75 mm (W x H x D)

# 7743    ♻️ 16 beige  
📦 1 unit



### PEN HOLDER CUBO ECO

- To store markers, paper knives, scissors, etc.
- Dimensions: 75 x 90 x 75 mm (W x H x D)

# 7742    ♻️ 16 beige  
📦 1 unit



**WWW.  
DURABLE  
.EU**



# THE BLUE ANGEL FOR YOUR OFFICE

Products bearing the "Blue Angel" eco label are particularly eco-friendly and create trust. The main focus lies on comprehensive consideration of the products' environmental attributes. All products are made of recycled plastics in compliance with the RAL-UZ 30a directive.



RECYCLED PLASTICS



ENERGY-SAVING PRODUCTION PROCESSES



WASTE PREVENTION

## Certified protection of the environment





**CARRY® SUSPENSION FILE BASKET**

- Suspension basket holding approx. 30 suspension files in A4 format
- Quick access to documents required every day
- Fits flexibly into desk drawers and cabinets

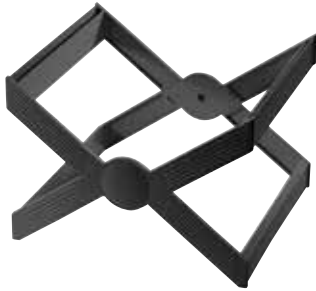

**CARRY® SUSPENSION RACK "BLUE ANGEL"**

- Folds flat for space-saving storage
- Sturdy and break-proof
- Dimensions: 362 x 260 x 320 mm (W x H x D)
- Suspension width: 330 mm

# 2600    🔥 058 charcoal  
📦 1 unit



**LETTER TRAY OPTIMO A3, LANDSCAPE "BLUE ANGEL"**

- Letter tray for A3 landscape formats
- Choice between two A4 portrait formats
- Stackable
- Height spacer pins are also available
- Dimensions: 436 x 105 x 333 mm (W x H x D)

# 1700786058    🔥 058 charcoal  
📦 1 unit



**LETTER TRAY OPTIMO A4 "BLUE ANGEL"**

- Stackable
- Height spacer pins are also available
- Dimensions: 255 x 62 x 334 mm (W x H x D)

# 1700801058    🔥 charcoal  
📦 1 unit



**WWW.  
DURABLE  
.EU**

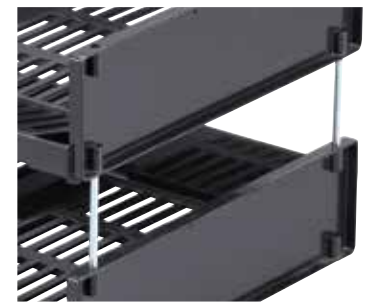

**HEIGHT SPACER PINS FOR LETTER TRAY OPTIMO**

- Metal
- For additional height distance between trays
- For all formats

# 1700132001    🔥 assorted  
📦 1 bag



**MAGAZINE RACK OPTIMO "BLUE ANGEL"**

- For A4 formats
- With grip hole
- For magazines and brochures
- Dimensions: 71 x 315 x 246 mm (W x H x D)

# 1701504058    🔥 charcoal  
📦 1 unit



**DESK ORGANIZER OPTIMO "BLUE ANGEL"**

- Five compartments
- For pens, scissors, paper clips etc.
- Additional area for envelopes
- Dimensions: 162 x 110 x 118 mm (W x H x D)

# 1701588058    🔥 charcoal  
📦 1 unit



**CATALOGUE FILE OPTIMO "BLUE ANGEL"**

- Variable, width-adjustable sub-dividers
- For magazines and brochures
- Dimensions: 300 x 180 x 250 mm (W x H x D)

# 1709018058    🔥 charcoal  
📦 1 unit





### IDEALBOX BASIC 7 "BLUE ANGEL"

- Drawer box for documents in formats up to C4
- With seven open drawers
- For usage in office cabinets, shelves or in counter cabinets
- Dimensions: 250 x 332 x 322 mm (W x H x D)

# 1712002058 ♻️ charcoal  
📦 1 unit



### IDEALBOX BASIC 5 "BLUE ANGEL"

- For storing written documents
- Up to C4 format
- 5 open-ended drawers
- For office cupboards, shelves or counter cabinets
- Dimensions: 250 x 332 x 322 mm (W x H x D)

# 1712003058 ♻️ charcoal  
📦 1 unit



### IDEALBOX PEN TRAY "BLUE ANGEL"

- Pen tray
- For use in desk drawers
- For use in the IDEALBOX PLUS drawer box
- Dimensions: 240 x 36 x 340 mm (W x H x D)

# 1712004058 ♻️ charcoal  
📦 1 unit



### LETTER TRAY ECONOMY "BLUE ANGEL"

- Stackable
- Height spacer pins are also available
- For formats up to C4
- Dimensions: 263 x 66 x 358 mm (W x H x D)

# 1701567058 ♻️ charcoal  
📦 1 unit



### MAGAZINE RACK ECONOMY "BLUE ANGEL"

- For A4 formats
- With grip hole
- For magazines, catalogues and brochures etc.
- Dimensions: 65 x 305 x 235 mm (W x H x D)

# 1701569058 ♻️ charcoal  
📦 1 unit







## DRAWER BOXES

Intelligent office organisation makes use of modern filing systems that offer a clear overview and quick access. Latest generation drawer boxes come with subtle coloured lines which serve to facilitate organisation and ensure you have immediate access to all information and documents.



**VARICOLOR®**

- Drawer box with coloured drawers
- High-quality plastics
- Fine coloured lines serve as organisation and orientation aids
- Drawers running smoothly and soundlessly
- With drawer stop
- For formats up to A4, C4, and for folio and letter-size formats
- Complete with transparent labelling windows and easy to exchange, computer printable inserts labels
- Stackable on non-slip plastic pads
- Storage in rows possible in all standard office cabinets and sideboards



reddot design award  
winner 2013



product design award  
2013



DESIGNPREIS  
DER  
BUNDESREPUBLIK  
DEUTSCHLAND  
2013  
NOMINIERT

GIO award 2012



**VARICOLOR® 5**

- With 5 coloured drawers
- Dimensions: 280 x 292 x 356 mm (W x H x D)

# 7605    27 multi-coloured  
1 unit



**VARICOLOR® 7**

- With 7 coloured drawers
- Dimensions: 280 x 292 x 356 mm (W x H x D)

# 7607    27 multi-coloured  
1 unit



**VARICOLOR® 10**

- With 10 coloured drawers
- Dimensions: 280 x 292 x 356 mm (W x H x D)



# 7610    27 multi-coloured  
1 unit





## IDEALBOX BASIC 5



- For storing written documents
- Up to C4 format
- 5 open-ended drawers
- For office cupboards, shelves or counter cabinets
- Dimensions: 250 x 332 x 322 mm (W x H x D)

# 1712003050  grey  
 1 unit



## IDEALBOX BASIC 5 "BLUE ANGEL"



- For storing written documents
- Up to C4 format
- 5 open-ended drawers
- For office cupboards, shelves or counter cabinets
- Dimensions: 250 x 332 x 322 mm (W x H x D)



# 1712003058  charcoal  
 1 unit



## IDEALBOX

- For storing written documents
- Up to C4 format
- 7 open-ended drawers
- For desks and assembly below the desk or on a wall
- Dimensions: 250 x 322 x 365 mm (W x H x D)

# 1712000050  grey  
 1 unit



# 1712000400  transparent  
 1 unit

# 1712000540  translucent blue  
 1 unit



## IDEALBOX BASIC 7



- For storing written documents
- Up to C4 format
- 7 open-ended drawers
- For office cupboards, shelves or counter cabinets
- Dimensions: 250 x 332 x 322 mm (W x H x D)

# 1712002050  grey  
 1 unit



## IDEALBOX BASIC 7 "BLUE ANGEL"



- Drawer box for documents in formats up to C4
- With seven open drawers
- For usage in office cabinets, shelves or in counter cabinets
- Dimensions: 250 x 332 x 322 mm (W x H x D)

# 1712002058  charcoal  
 1 unit





## IDEALBOX PLUS

- Lowering front plate
- For storing written documents up to C4 format
- 7 open-ended drawers
- For desks and assembly below the desk or on a wall
- Dimensions: 250 x 322 x 365 mm (W x H x D)

# 1712001050  grey  
 1 unit





# 1712001060  black  
 1 unit



## IDEALBOX PEN TRAY "BLUE ANGEL"

- Pen tray
- For use in desk drawers
- For use in the IDEALBOX PLUS drawer box
- Dimensions: 240 x 36 x 340 mm (W x H x D)

# 1712004058  charcoal  
 1 unit





# DESK MATS

DURABLE desk mats are available in many varieties and finishes to suit the requirements of a modern office. Innovative design combined with style results in a range of attractive desk mats to protect the many surfaces in the workplace.



## LEATHER DESK MAT

- Handmade
- Extremely high quality
- Made from the finest soft grained leather
- Comes with stitched edging
- Non-slip
- With high-quality fleece coating on the underside
- Dimensions: 650 x 450 mm (W x H)

# 7305    01 black  
1 unit



## PREMIUM QUALITY DESK MAT

- Premium quality
- For extremely comfortable writing
- Non-slip
- Back with high-quality fleece coating
- Dimensions: 650 x 520 mm (W x H)

# 7224    01 black, 07 dark blue, 10 grey  
1 unit

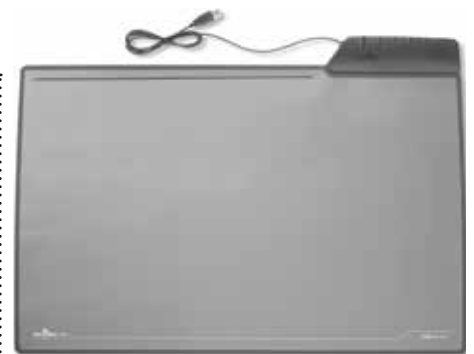

## DESK MAT WITH 4-PORT USB HUB

- With transparent overlay
- Integrated USB 2.0 hub
- 4 Plug & Play ports
- For use via USB port on your PC
- No mains adapter required
- For card readers, camcorders, digital cameras, USB printers, USB scanners, external hard disks, etc.
- Dimensions: 680 x 435 mm (W x H)

# 7215    01 black  
1 unit



Patented

## WORK PAD

- Space-saving desk mat
- With 3 transparent work levels
- Can be used in portrait or landscape format
- Can also be used as a mouse pad
- Dimensions: 390 x 440 mm (W x H)

# 7209    01 black, 07 dark blue, 10 grey  
 1 unit

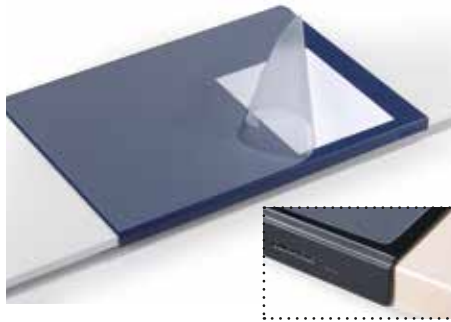

## DESK MAT WITH EDGE PROTECTOR

- Edge protector
- Transparent overlay
- For keeping notes and messages to hand
- With self-adhesive strips for easy fixing to table edges
- Non-slip
- Dimensions: 650 x 500 mm (W x H)

# 7293    01 black, 07 dark blue, 10 grey  
 1 unit



## DESK MAT WITH CONTOURED EDGES

- Flexible writing surface
- Non-slip
- Dimensions: 530 x 400 mm (W x H)

# 7102    01 black, 03 red, 07 dark blue, 10 grey  
 1 unit

· Dimensions: 650 x 520 mm (W x H)  
 # 7103    01 black, 03 red, 07 dark blue, 10 grey  
 1 unit



## DESK MAT

- With transparent overlay
- Non-slip
- Dimensions: 530 x 400 mm (W x H)

# 7202    01 black, 07 dark blue, 10 grey  
 1 unit

· Dimensions: 650 x 520 mm (W x H)

# 7203    01 black, 07 dark blue, 10 grey  
 1 unit



## DESK MAT WITH REMOVABLE OVERLAY

- Anti-glare, replaceable overlay
- With annual calendar
- For keeping notes to hand
- Non-slip
- Dimensions: 650 x 520 mm (W x H)

# 7205    01 black, 07 dark blue, 10 grey  
 1 unit

## CRYSTAL-CLEAR OVERLAY

- Crystal-clear, anti-glare overlay for desk mat # 7205
- Dimensions: 630 x 500 mm (W x H)

# 7206    19 transparent  
 1 unit



## DESK MAT FOR CONFERENCE ROOMS

- Transparent
- Anti-glare
- Non-slip
- Dimensions: 420 x 300 mm (W x H)

# 7111    19 transparent  
 1 piece

# 7101    01 black  
 1 piece



## LEATHER DESK MAT FOR CONFERENCE ROOMS

- High-quality soft grain leather
- With hand stitched decorative edge
- Hand made
- Non-slip with high-quality fleece on the reverse
- Dimensions: 420 x 300 mm (W x H)

# 7304    01 black  
 1 piece



## DURAGLAS®

- Transparent
- Anti-glare
- For keeping notes and messages to hand
- Non-slip
- Dimensions: 530 x 400 mm (W x H)

# 7112    19 transparent  
 1 unit

· Dimensions: 650 x 500 mm (W x H)

# 7113    19 transparent  
 1 unit





**SEMI-CIRCLE DESK MAT WITH TRANSPARENT OVERLAY**

- Semi-circular
- With transparent overlay
- Non-slip
- Dimensions: 650 x 520 mm (W x H)

# 7290    01 black, 07 dark blue  
 1 unit



**SEMI-CIRCLE DESK MAT**

- Semi-circle
- Non-slip
- Dimensions: 650 x 520 mm (W x H)

# 7295    01 black, 07 dark blue  
 1 unit



**DESK MAT VEGAS**

- Oval shape
- Integrated pen holder
- Transparent overlay
- Non-slip
- Dimensions: 690 x 510 mm (W x H)

# 7208    01 black, 23 metallic silver  
 1 unit



**DESK MAT WITH CALENDAR PAD**

- 2-years calendar
- 25 sheets
- The sheets are glued at the bottom
- Sheets resistant to crumpling and creasing
- With overview of public holidays in nine countries
- Ideal for making notes
- Non-slip
- Dimensions: 590 x 420 mm (W x H)

# 7291    01 black  
 1 unit



**CALENDAR BLOCK**

- For desk mat product # 7291
- With double annual calendar
- 25 sheets
- Calendar with overview of public holidays in nine countries
- Ideal for making notes
- Dimensions: 570 x 410 mm (W x H)

# 7292    02 white  
 1 unit

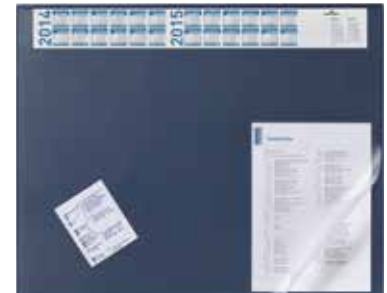

**DESK MAT WITH ANNUAL CALENDAR**

- Transparent overlay
- Non-slip
- Dimensions: 650 x 520 mm (W x H)

# 7204    01 black, 03 red, 07 dark blue, 10 grey  
 1 unit



**ARTWORK DESK MAT**

- Attractive desk mat
- With transparent overlay
- For keeping notes, messages, etc. to hand
- Non-slip.
- Dimensions: 650 x 520 mm (W x H)

# 7201    01 black, 07 dark blue, 10 grey  
 1 unit



**DESK MAT WITH WORLD MAP**

- Transparent
- Fully welded
- Non-slip
- Dimensions: 530 x 400 mm (W x H)

# 7211    19 transparent  
 1 unit



**TABLE MATS FOR ARTS AND CRAFTS**

- High-quality and heavy duty
- Non-slip, easy to clean
- Can be wiped clean with damp cloth
- Non-toxic mat
- Suitable for children
- Dimensions: 420 x 300 mm (W x H)

# 7011    03 red, 07 dark blue  
 1 unit

· Dimensions: 300 x 210 mm (W x H)  
 # 7012    03 red, 07 dark blue  
 1 unit

## PAPER CLIPS AND SCISSORS

- Paper clips in various lengths
- Copper-plated, zinc-plated, varnished or coated in plastic
- High-quality scissors "Made in Germany"
- Ice-tempered, rust-proof stainless steel

### PAPER CLIPS

Prod. Code	Colour	Packing	Dim.
1204	24 copper-plated	100 per pack	26 mm
1205	24 copper-plated	1000 per pack	26 mm
1206	25 zinc-plated	100 per pack	26 mm
1207	25 zinc-plated	1000 per pack	26 mm
1208	24 copper-plated	100 per pack	32 mm
1209	24 copper-plated	1000 per pack	32 mm
1210	25 zinc-plated	100 per pack	32 mm
1211	25 zinc-plated	1000 per pack	32 mm
1224	25 zinc-plated	100 per pack	50 mm
1225	24 copper-plated	100 per pack	50 mm



### PAPER CLIPS PAINTED

# 1241      00 assorted  
 500 per pack

### PAPER CLIPS PLASTIC COATED

# 1253      00 assorted  
 100 per pack

# 1254      00 assorted  
 1000 per pack

### PAPER CLIP DISPENSER WITH MAGNET

- Made of acrylic
- With 125 paper clips in 26 mm size, varnished in different colours.

# 1240      00 assorted  
 1 unit



### PAPER CLIPS

Prod. Code	Colour	Packing	Dim.
1212	24 copper-plated	100 per pack	50 mm
1213	24 copper-plated	100 per pack	77 mm
1226	25 zinc-plated	100 per pack	50 mm
1227	25 zinc-plated	100 per pack	77 mm



**SUPERCUT**

- Multi-purpose scissors
- Ice-hardened
- Made of stainless steel
- For cardboard, paper, film, textiles and other hard materials
- With adjustable screw, finely adjusted, and precise guidance
- For a clean, easy cut
- Made in Germany
- Colour: black/blue
- Size: 8" = 20 cm

Prod. Code	Colour	Packing	Dim.
1715	01 black	1 unit	5" = 13 cm
1716	01 black	1 unit	6" = 15 cm
1718	01 black	1 unit	8" = 20 cm
1720	01 black	1 unit	10" = 25 cm



**PAPERCUT**

- Office scissors
- Made of tempered stainless steel
- For cardboard, paper, film, textiles and adhesive tape
- With adjustable screw, finely adjusted, and precise guidance
- Pleasant and easy to handle
- Made in Germany
- Size: 6" = 15 cm



Prod. Code	Colour	Packing	Dim.
1736	01 black	1 unit	6" = 15 cm
1737	01 black	1 unit	7" = 18 cm
1738	01 black	1 unit	8" = 20 cm
1739	01 black	1 unit	9" = 23 cm

**STANDARD SCISSORS**

- Rust-proof
- For paper and thin textiles
- Plastic handles
- Rounded tips
- Size: 6" = 15.5 cm

Prod. Code	Colour	Packing	Dim.
1771	01 black	1 unit	6" = 15,5 cm
1772	01 black	1 unit	7" = 18 cm
1773	01 black	1 unit	8" = 21 cm
1774	01 black	1 unit	10" = 25 cm



## IT ACCESSORIES

Permanent access to important data speeds up processes and makes work easier. DURABLE supplies professional IT accessories for optimal support for tablet PCs, smart phones and CD/DVD organisation.



## TABLET PC AND SMARTPHONE ACCESSORIES

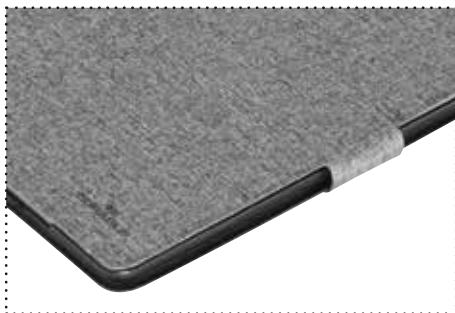

### TABLET CASE TRAVEL

- Protective cover for iPad Air which folds into a stand
- Allows access to buttons, switches, ports, camera etc.
- Support function for various viewing angles when giving presentations or surfing the internet
- Magnetic closure on the back

# 5304

12 light purple, 37 graphite

1 unit



Front pocket for accessories

### TABLET SLEEVE PROTECT

- Padded protective sleeve for 10" tablet PCs with two-way zip
- Front pocket for accessories such as mobile phone, pens etc.
- Integrated neoprene lip to protect against the zip

# 5305

01 black, 37 graphite

1 unit





### ACRYLIC TABLE NAME HOLDER FOR TABLET PCS

- Premium-quality tablet PC holder and table place name holder
- Made of crystal-clear acrylic
- Easy upright insertion and removal of tablet PCs
- With printing label
- Optimal reading and presentation angle
- For conventions, conferences, seminars and training sessions
- Dimensions: 210 x 83 x 138 mm (H x W)

# 8029

19 transparent

1 unit



### ACRYLIC TABLET STAND

- Premium-quality tablet PC base made of crystal-clear acrylic
- Easy upright insertion and removal of the tablet PC
- Optimal reading and presentation angle
- For conventions, conferences and reception desks or displays in shop windows and showrooms
- Dimensions: 210 x 83 x 106 mm (H x W)

# 8028

19 transparent

1 unit

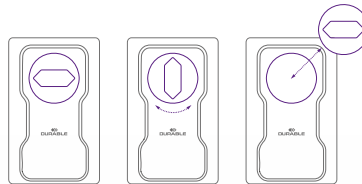

Fits all types of power sockets



### VARICOLOR® PHONE HOLDER

- Multi-purpose mobile phone holder for battery charging
- Fits all sizes of mobile phone plugs and power sockets
- Adjustable to fit different plug sizes through detachable inner ring
- Safe mobile phone base thanks to non-slip surface
- Extremely compact due to folding mechanism
- Ideal for travelling
- Dimensions: 84 x 134 x 4,5 mm (W x H x D)

# 7735

03 red, 04 yellow, 08 pink, 09 orange, 12 light purple

1 unit

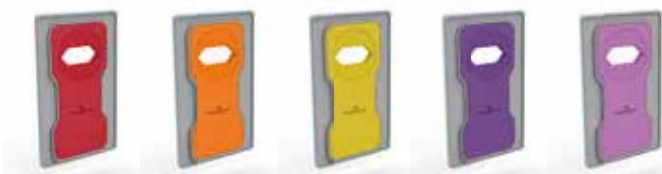

## MOUSEPADS

- Pads for easy, accurate mouse movements.
- Choice of different materials for individual needs.
- Some with ergonomically designed supports to reduce strain on the wrist.
- Non-slip



### MOUSE PAD

- Extra thin
- With soft surface
- Dimensions: 300 x 2 x 200 mm (W x H x D)

# 5700      07 dark blue  
 ☞ 10 per box



### MOUSE PAD

- With non-slip foam underside and fabric surface.
- Dimensions: 260 x 6 x 220 mm (W x H x D)

# 5701      06 blue  
 ☞ 20 per box



### MOUSE PAD PLUS

- Extra thin with see-through pocket.
- Can be personalised by inserting photos, information such as telephone lists or notes, etc.
- Dimensions: 300 x 2.5 x 200 mm (W x H x D)

# 5747      19 transparent  
 ☞ 1 unit

## WRIST SUPPORTS

- Supports to reduce strain on the wrists while working with PC keyboards.
- Different materials and formats.
- Non-slip.



### MOUSE PAD ERGOTOP®

- With integrated wrist support.
- With non-slip foam underside and fabric surface.
- Dimensions: 257 x 8.5 x 310 mm (W x H x D)

# 5703      06 blue  
 ☞ 1 unit



### MOUSE PAD ERGOTOP® WITH GEL

- Ergonomical, with integrated wrist support.
- The gel filling adapts itself perfectly to the shape of the wrist.
- Fabric surface pleasant to the touch.
- Matches product # 5749).
- Dimensions: 230 x 26 x 260 mm (W x H x D)

# 5748      58 charcoal  
 ☞ 1 unit



### WRIST SUPPORT

- With non-slip foam underside and fabric surface.
- Dimensions: 450 x 15 x 100 mm (W x H x D)

# 5704      06 blue  
 ☞ 1 unit



### WRIST SUPPORT WITH GEL

- With gel filling for ergonomical adaptation to the wrist.
- Fabric surface pleasant to the touch.
- Matches product # 5748.
- Dimensions: 460 x 20 x 61 mm (W x H x D)

# 5749      58 charcoal  
 ☞ 1 unit



## DATA MEDIA STORAGE

- CD/DVD cases for storing in lever arch files and ring binders
- Ring binders with pockets as a complete solution for archiving CD/DVDs
- Drawer boxes for storing data media



### CD/DVD INDEX 20

- With 10 pockets for storage of 20 CDs/DVDs.
- Extendable with product # 5203 to 20 pockets for storage of 40 CDs/DVDs.
- Dimensions: 185 x 273 x 55 mm (W x H x D)

# 5204

58 charcoal

1 unit



### CD/DVD INDEX 40

- With 10 covers for storage of 40 CDs/DVDs.
- Extendable with product # 5222 to 15 covers for storage of 60 CDs/DVDs.
- Dimensions: 270 x 315 x 65 mm (W x H x D)

# 5227

58 charcoal

1 unit



### CD/DVD COVER M

- For 4 CDs/DVDs.
- With protective lining.
- 4 additional pockets for enclosed printable index labels.
- Universal punching for filing in format A folders and ring binders.
- Style sheets available from [www.durable.eu](http://www.durable.eu)
- Extension set for product # 5227

# 5222

19 transparent

5 per bag



### CD/DVD COVER S

- For 2 CDs/DVDs.
- With protective lining
- Punched margin for filing in folders and ring binders.
- Also as extension set for product # 5204.

# 5203

19 transparent

5 per bag



### CD/DVD COVER LIGHT S

- For 4 CDs/DVDs
- Universal punching for filing in folders and ring binders.

# 5282

19 transparent

5 per bag



### CD/DVD COVER LIGHT M

- For 4 CDs/DVDs
- Universal punching for filing in folders and ring binders.
- Pockets for personal labelling.

# 5238

19 transparent

10 per bag



### CD/DVD COVER FILE

- For 1 CD/DVD with booklet or 2 CDs/DVDs.
- With protective lining
- Punched margin for filing in folders and ring binders.

# 5239

19 transparent

10 per bag





#### CD/DVD ALBUM 96

- Ring binder with 12 covers for 96 CDs/DVDs.
- Insert label for spine labelling.

# 5277  
📦 1 unit

💧 01 black\*, 23 metallic silver\*



#### CD/DVD COVER EASY

- For 1 CD/DVD with booklet or 2 CDs/DVDs.
- Extra-strong film for heavy-duty applications.
- With protective lining.
- Punched margin for filing in folders and ring binders.

# 5223  
📦 10 per bag

💧 19 transparent



#### CD/DVD FIX

- For 1 CD/DVD with booklet or 2 CDs/DVDs.
- Self-adhesive pocket with protective lining

# 5210  
📦 10 per bag

💧 19 transparent



#### CD/DVD COVER

- For 1 CD/DVD with booklet or 2 CDs/DVDs.
- With protective lining.

# 5202  
📦 10 per bag

💧 19 transparent



#### POCKETFIX® CD/DVD

- Self-adhesive CD/DVD pocket with closing flap
- Ideal for folders, ring binders and files etc.
- External dimensions: 127 x 127 mm (W x H)

# 8080  
📦 10 per bag

💧 19 transparent



#### CD/DVD COVER LIGHT PLUS

- For 1 CD/DVD
- With flap closure

# 5245  
📦 25 per bag

💧 19 transparent



#### CD/DVD TOP COVER

- For 1 CD/DVD with booklet or 2 CDs/DVDs.
- With protective lining
- Also equipped with tab and PC-printable insert label.
- Style sheets available from [www.durable.eu](http://www.durable.eu)

# 5200  
📦 10 per bag

💧 19 transparent



#### QUICKFLIP® COMPLETE

- For 1 CD/DVD
- With snap-on clip for filing in folders and ring binders.
- Removal of CDs/DVDs possible without opening the ring mechanism.

# 5269  
📦 5 per pack

💧 06 blue



#### QUICKFLIP® STANDARD

- For 1 CD/DVD

# 5267  
📦 5 per pack

💧 06 blue

# 5288  
📦 10 per pack

💧 06 blue



### CD/DVD MAIL

- Cardboard mailing envelope for 1 CD/DVD with booklet.
- Format: 140 x 125 mm

# 5211      02 white  
 5 per pack

### MULTIMEDIA BOX

- Extendable archiving system for various data media and small accessories such as cables and plugs
- The boxes can be combined
- Can be firmly connected with each other either horizontally or vertically
- Lockable



### MULTIMEDIA BOX I

- For storage of 26 CDs/DVDs in hard boxes, 136 x 3.5" disks.
- With 5 dividers
- Dimensions: 195 x 165 x 325 mm (W x H x D)

# 5256      10 grey  
 1 unit



### MULTIMEDIA BOX II

- For storage of approx. 53 CDs/DVDs in hard boxes, 230 x 3.5" disks
- With 8 dividers.
- Dimensions: 290 x 165 x 325 mm (W x H x D)

# 5257      10 grey  
 1 unit



### DISCOFLEX®

- A4 disk cover, universal punching for filing in folders and ring binders, with insert labels.
- For 4 x 3.5" disks.

# 5243      19 transparent  
 5 per bag



### MEMORY CARD BOX

- Memory card box made of aluminium.
- For safe storage of 3 SD/MM digital cards or 2 CF/micro drive digital cards.
- With two interchangeable inlays.

# 5309      23 metallic silver  
 1 unit



**WWW.  
 DURABLE  
 .EU**



# CLEANING PRODUCTS

By introducing a simple daily cleaning routine, office equipment can be kept in optimum condition. DURABLE offers specialised solutions to keep everyday items such as pc's, printers, telephones and desks clean, preventing the build up of germs and bacteria and maintaining a pleasant and healthy office environment.

## POWERCLEAN

- Compressed air cleaner with adjustable spraying jet strength.
- Especially for hard to reach parts of office equipment and other electronic appliances, and photo and video cameras.
- With practical spray tube for precise application.



Art.-Nr. 5819



Art.-Nr. 5738



Art.-Nr. 5715



Art.-Nr. 5796



Art.-Nr. 5797

Product	Code	Colour	Packing	Extra-strong	Flammable	Can also be used upside down	Content
<b>POWERCLEAN PLUS</b>	5819	19 transparent	1 can	Yes	No	No	350 ml
<b>POWERCLEAN 400</b>	5738	19 transparent	1 can	No	No	No	400 ml
<b>POWERCLEAN 150</b>	5715	19 transparent	1 can	No	No	No	150 ml
<b>POWERCLEAN STANDARD</b>	5796	19 transparent	1 can	No	Yes	No	400 ml
<b>POWERCLEAN INVERTIBLE</b>	5797	19 transparent	1 can	No	Yes	Yes	200 ml

## SUPERCLEAN

- For gentle cleaning of plastic surfaces.
- Especially for keyboards, computer mice, housings of printers, IT appliances and office machinery.
- Alcohol-free fluids with long-lasting antistatic effect.
- Biodegradable wet wipes.



### SUPERCLEAN BOX

- 100 wet wipes
- Closing dispenser tub
- Refillable with product # 5709

# 5708    ♀ 02 white  
 ☞ 1 can



### SUPERCLEAN REFILL

- 100 wet wipes in refill pack.
- Environmentally friendly.
- Matches product # 5708.

# 5709    ♀ 02 white  
 ☞ 1 bag



### SUPERCLEAN FLUID

- Pump spray.
- Can be used with DRY CLEAN wipes (product # 5734).
- Contents: 250 ml

# 5781    ♀ 19 transparent  
 ☞ 1 bottle



### SUPERCLEAN FOAM

- CFC-free foam cleaner.
- Non drip.
- Can be used with DRY CLEAN wipes (product # 5734).
- Contents: 400 ml

# 5739    ♀ 02 white  
 ☞ 1 can



### SUPERCLEAN 50

- 50 wet wipes, packed individually.
- Ideal for travelling.

# 5788    ♀ 02 white  
 ☞ 1 pack



### PC CLEANING KIT

- Complete set for gentle cleaning of office equipment, monitors, laptops etc.
- Contents: SUPERCLEAN FOAM 150 ml cleaning foam, SCREENCLEAN FLUID 125 ml pump spray, 10 lower lint fleece wipes, 1 keyboard cleaner

# 5834    ♀ 00 assorted  
 ☞ 1 set

## SCREENCLEAN

- For streak-free cleaning of monitor and TV screens, laptops, tablets and navigation devices.
- Ideal for cleaning glass surfaces, e.g. of copiers and scanners.
- Alcohol-free fluids with long-lasting antistatic effect.
- Biodegradable wet wipes.



### SCREENCLEAN TUB

- 100 wet wipes
- Closing dispenser tub.
- Can be refilled with product # 5737

# 5736    ♀ 02 white  
 ☞ 1 tin



### SCREENCLEAN REFILL

- 100 wet wipes in refill pack.
- Environmentally friendly.
- Matches product # 5736.

# 5737    ♀ 02 white  
 ☞ 1 bag



### SCREENCLEAN SET

- Cleaning set
- Contents: 125 ml SCREENCLEAN FLUID pump spray and 20 lower lint fleece wipes

# 5707    ♀ 00 assorted  
 ☞ 1 set



**SCREENCLEAN FLUID**

- Pump spray.
- Can be used with DRY CLEAN wipes (product # 5734).
- Contents: 250 ml

# 5782    19 transparent  
 ☞ 1 bottle



**SCREENCLEAN FOAM**

- 200 ml foam cleaner for screens, tablet PCs, etc.
- The foam does not run and removes fingerprints, dust and grime from the sensitive surfaces.
- For use with DRY CLEAN wipes, product # 5734, or microfiber cloths (such as TECHCLEAN CLOTH, product # 5794).

# 5824    00 assorted  
 ☞ 1 unit



**SCREENCLEAN DUO**

- 10 sets of wet and dry wipes packed individually.
- Dry wipes made of high-quality fleece.
- Especially suitable for sensitive displays and smart phones.
- Ideal for travelling.

# 5721    02 white  
 ☞ 1 pack



**SCREENCLEAN 50**

- 50 wet wipes, packed individually.
- Ideal for travelling.

# 5787    02 white  
 ☞ 1 pack



**SCREENCLEAN SPRAY**

- 200 ml pump spray for cleaning screens.
- Including a microfiber cloth integrated in the lid to save space.
- Cleaning fluid easily removes fingerprints, dust and grime from monitor screens or tablet PCs.

# 5823    00 assorted  
 ☞ 1 can



**SCREENCLEAN MINI + MICROFIBRE GLOVE 8 ML**

- Kit specifically designed to clean smart phones and tablet PCs
- Contents: Microfibre glove, 8 ml cleaning liquid

# 5825    00 assorted  
 ☞ 1 set



**SCREENCLEAN PRO**

- Special cleaning set.
- Ideal for Smartphones and tablets.
- Forms a protective film to prevent the screen getting dirty.
- Contents: 25 ml SCREENCLEAN PRO pump spray and 1 microfiber cloth

# 5798    19 transparent  
 ☞ 1 pack



## TELEPHONE CLEAN

- For regular cleaning of telephones, mobile phones and smart phones, etc.
- Alcohol-free fluids with a long-lasting disinfecting effect.
- Biodegradable wet wipes.



### TELEPHONE CLEAN BOX

- 100 wet wipes
- Closing dispenser tub

# 5758    ♀ 02 white  
 📦 1 can



### TELEPHONE CLEAN 50

- 50 wet wipes packed individually.
- Ideal for travelling.

# 5785    ♀ 02 white  
 📦 1 pack

## WHITEBOARD

- For protective cleaning of whiteboards.
- Suitable for dry wipe whiteboard markers.
- Alcohol-free fluids.
- Biodegradable wet wipes.



### WHITEBOARD BOX

- 100 wet wipes
- Closing dispenser tub

# 5759    ♀ 02 white  
 📦 1 can



### WHITEBOARD FOAM

- Foam cleaner for whiteboards.
- No running after spraying on.
- Can be used, for example, with DRY CLEAN wipes (product # 5734).
- Contents: 400 ml

# 5756    ♀ 02 white  
 📦 1 can



### WHITEBOARD CLEANING KIT

- Cleaning set.
- The fluid cleans and protects whiteboard surfaces lastingly.
- Contents: 250 ml pump spray, high-quality microfiber cloth 25 x 25 cm.

# 5833    ♀ 00 assorted  
 📦 1 set



### INTERACTIVE WHITEBOARD CLEAN KIT

- Special cleaning set for interactive whiteboards.
- Contents: 250 ml INTERACTIVE WHITEBOARD CLEAN pump spray and 1 microfiber cloth

# 5814    ♀ 00 assorted  
 📦 1 set



**WWW.  
 DURABLE  
 .EU**

## SPECIAL CLEANERS

· Cleaners and accessories for special applications

### SMART CLEAN

- 10 pre moistened cleaning wipes for tablet PCs, smart phones and laptops etc
- Special wipes for streak-free cleaning.
- Gentle and thorough removal of dust and fingerprints.

# 5872    02 white  
1 pack



### LAPTOP CLEANING KIT

- Cleaning set.
- Ideal for travelling.
- Contents: 25 ml SCREENCLEAN PRO pump spray, 1 microfibre cloth, 6 wet SUPERCLEAN wipes packed individually.

# 5863    00 assorted, 22 multi-coloured  
1 set



### LABEL REMOVER

- Cleaning for easy removal of paper labels.
- After a short reaction time, the label can be pulled off.
- Contains alcohol.
- Contents: 200 ml

# 5867    00 assorted  
1 tin



### WET WIPES FOR GLASSES

- 50 pairs of wet wipes.
- Specially recommended for glasses, car mirrors, optical appliances such as camera lenses or binoculars.
- Packed individually in sets of two, ideal for travelling.

# 5853    02 white  
1 pack



### DRY CLEAN 50

- Lower lint, highly absorbent fleece wipes.
- For cleaning plastic surfaces and screens.
- Ideal for DURABLE cleaning fluids
- Cut to size individually in 145 x 197 mm format.
- Contents: 50 wipes

# 5734    02 white  
1 bag



### TECHCLEAN CLOTH

- Microfibre cloth for cleaning sensitive surfaces.
- Washable to 95° C.
- Dimensions of cloth: 200 x 200 mm

# 5794    06 blue  
1 unit



### COTTON BUDS

- 100 long cotton buds.
- Ideal for cleaning hard-to-reach parts of office equipment.

# 5789    02 white  
1 bag



### CD/DVD LENS CLEAN

- Cleaning CD with special brushes for laser lenses of CD/DVD-ROM drives and CD/DVD audio players.

# 5723    00 assorted  
1 unit



## SMALL FURNITURE

With its mobile furniture series, the DURABLE office furniture range provides solutions for every need and every setting to fit in seamlessly with every office environment. The small furniture range comprises of a variety of products such as computer workstations, suspension file trolleys and multifunctional trolleys that offer a multitude of solutions for every need.





**OVERVIEW OF RANGE AND RECOMMENDED AREAS OF USE**

**MULTI-FUNCTIONAL TROLLEYS**

**SUSPENSION FILE TROLLEYS**

**MULTIMEDIA TROLLEYS**

**EVOLUTION**

**Features at a glance:**

- hardwearing, melamine shelves in a light maple finish
- made of premium-quality, epoxy resin-coated steel
- Smart-Click lid on lockable suspension file trolley for fast retrieval of files
- With 4 castors, 2 with brakes for stability



**DESIGN LINE**

**Features at a glance:**

- Made of high quality epoxy resin-coated steel with stylish perforation design
- Premium-quality melamine in maple finish or anthracite grey
- Handles for easy manoeuvring
- With 4 castors, 2 with brakes for stability



**SYSTEM**

Patent pending

**Features at a glance:**

- Made of high quality, scratch-proof, epoxy resin-coated steel
- With fibreglass-reinforced plastic corners
- 19mm melamine covered hardboard shelves
- With 4 castors, 2 with brakes for stability



**Economy**

**Features at a glance:**

- Made of epoxy resin-coated, scratch-proof steel
- With 4 castors, 2 with brakes for stability





# MULTIFUNCTIONAL TROLLEYS

The mobile, multifunctional trolleys from DURABLE offer many solutions for all types of organisational tasks. They are the addition to standard office furniture with ample space for items such as printers, ringbinders or letter trays.



## EVOLUTION MULTIFUNCTIONAL TROLLEY

- Lower, fixed shelf
- 3 hard-wearing, melamine coated shelves
- 4 castors, 2 with brakes offering stability
- Metal parts made of high-quality steel with epoxy resin coating
- Delivered flat packed with assembly instructions



adjustable



## EVOLUTION MULTIFUNCTIONAL TROLLEY

- With 2 fixed shelves and one adjustable shelf
- Dimensions: 670 x 790 x 480 mm (W x H x D)

# 3100  
📦 1 unit

🌳 120 metallic silver/maple

### DESIGN LINE MULTIFUNCTIONAL TROLLEY

- Sturdy lateral parts made of steel with perforation look
- 3 hardwearing coated shelves
- Middle shelf height-adjustable
- 4 castors, 2 with brakes
- Handles for convenient handling
- Delivery: flat packed

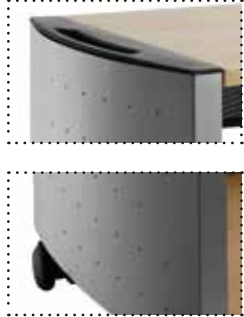

adjustable

adjustable



Detailed information from page 240 onwards.  
Assembly instructions available from [www.durable.eu](http://www.durable.eu)

Scan here for 3D animation  
Art.-Nr.: 3103



### DESIGN LINE MULTIFUNCTIONAL TROLLEY L

- For approx 8 wide ring binders in A4 format or office devices.
- Dimensions: 770 x 820 x 440 mm (W x H x D)

# 3101

120 metallic silver/maple, 125 metallic silver/antracite

1 unit

### DESIGN LINE MULTIFUNCTIONAL TROLLEY

- For approx 6 wide ring binders in A4 format or office devices.
- Dimensions: 575 x 820 x 380 mm (W x H x D)

# 3103

120 metallic silver/maple, 125 metallic silver/antracite

1 unit

### SYSTEM MULTI TROLLEYS

- Multifunctional and printer trolleys
- With space for paper, ring binders or as service trolleys
- Sturdy frame made of scratch-proof steel with fibreglass-reinforced plastic corners.
- Hardwearing 19 mm shelf boards.
- Raised horizontal edges on shelves to prevent tilting of ring binders, etc.
- With 4 castors, 2 with brakes
- Delivery: flat packed

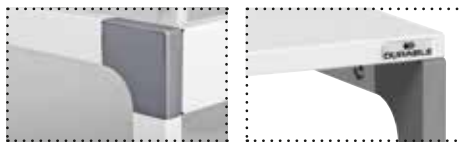

adjustable



Detailed information from page 240 onwards.  
Assembly instructions available from [www.durable.eu](http://www.durable.eu)

Scan here for 3D animation  
Art.-Nr.: 3710



Art.-Nr.: 3711



### SYSTEM MULTI TROLLEY 48

- With two fixed shelves
- Dimensions: 600 x 477 x 432 mm (W x H x D)

# 3710

10 grey, 124 silver/beechn

1 unit

### SYSTEM MULTI TROLLEY 88

- With two additional shelves
- Individually height-adjustable in 32-mm intervals.
- Dimensions: 750 x 879 x 432 mm (W x H x D)

# 3711

10 grey

1 unit

### MULTIFUNCTIONAL TROLLEY

- Made of hardwearing 16 mm boards
- Storage space partly lockable with double wing door
- 4 castors, of which 2 with brakes
- Delivery: flat packed



### MULTIFUNCTIONAL TROLLEY 74/59 OPEN

- Open on three sides
- 6 shelves for folders, paper and office equipment etc and an extra compartment offering additional storage
- Holds up to 25 kg per shelf.
- Dimensions: 528 x 748 x 592 mm (W x H x D)

# 3113    10 grey, 47 beech  
 1 unit



### MULTIFUNCTIONAL TROLLEY 74/53

- With 3 shelves: upper and middle shelf open, lower shelf with double wing doors.
- Holds up to 30 kg per shelf.
- Dimensions: 528 x 748 x 400 mm (W x H x D)

# 3114    10 grey, 47 beech  
 1 unit



### MULTIFUNCTIONAL TROLLEY 74/53 CLOSED

- To be closed with 2 double wing doors.
- 2 adjustable shelves
- Holds up to 30 kg per shelf.
- Dimensions: 528 x 748 x 400 mm (W x H x D)

# 3115    10 grey, 47 beech  
 1 unit



### MULTIFUNCTIONAL TROLLEY 74/53 L

- With 2 compartments and a drawer, lower compartment closed by 2 double wing doors.
- Holds up to 30 kg per shelf.
- Dimensions: 528 x 748 x 400 mm (W x H x D)

# 3116    10 grey, 47 beech  
 1 unit



More information from page 240 onwards.

Find detailed product information, photos, product videos and animated films, dimensional drawings and assembly instructions on [www.durable.eu](http://www.durable.eu)







# SUSPENSION FILE TROLLEYS

DURABLE suspension file trolleys offer an extensive range of options for different filing systems. Various solutions are available for suspension files and folders in A4, folio and foolscap formats. There is also a choice of different finishes



## EVOLUTION SUSPENSION FILE TROLLEY

- Lower, fixed shelf
- 3 hard-wearing, melamine coated shelves
- 4 castors, 2 with brakes offering stability
- Metal parts made of high-quality steel with epoxy resin coating
- Delivered flat packed with assembly instructions



## EVOLUTION SUSPENSION FILE TROLLEY 80 MULTI

- For approx. 80 suspension files in A4, Folio or Foolscap format
- With additional shelf
- Dimensions: 670 x 790 x 480 mm (W x H x D)

# 3072

120 metallic silver/maple

1 unit



## EVOLUTION SUSPENSION FILE TROLLEY 100 TOP

- For approx. 100 suspension files in A4, Folio or Foolscap format
- With additional shelf
- Lockable cover with smart click function for safe storage
- Dimensions: 860 x 790 x 480 mm (W x H x D)

# 3074

120 metallic silver/maple

1 unit

**DESIGN LINE SUSPENSION FILE TROLLEY**

- Sturdy lateral parts made of steel with perforation look
- 4 castors, of which 2 with brakes
- Handles for convenient handling
- Delivery: flat packed



Detailed information from page 240 onwards.  
Assembly instructions available from [www.durable.eu](http://www.durable.eu)

Scan here for 3D animation  
Art.-Nr.: 3076



**DESIGN LINE SUSPENSION FILE TROLLEY 80 A4**

- For approx. 80 A4 suspension files.
- With additional shelf.
- Dimensions: 738 x 695 x 380 mm (W x H x D)

# 3076    121 anthracite/metallic silver  
1 unit



adjustable



adjustable

lockable



additional storage shelf



Detailed information from page 240 onwards.  
Assembly instructions available from [www.durable.eu](http://www.durable.eu)

Scan here for 3D animation  
Art.-Nr.: 3079



Art.-Nr.: 3080



**DESIGN LINE SUSPENSION FILE TROLLEY 100 MULTI**

- For approx. 100 suspension files, adjustable suspension frames for formats A4, Folio or Foolscap.
- With additional shelf
- Dimensions: 990 x 695 x 440 mm (W x H x D)

# 3079    121 anthracite/metallic silver  
1 unit

**DESIGN LINE SUSPENSION FILE TROLLEY 100 TOP**

- For approx. 100 suspension files
- Adjustable suspension frames for formats A4, Folio or Foolscap.
- With a lockable lid for safe storage.
- With additional shelf.
- Dimensions: 985 x 695 x 440 mm (W x H x D)

# 3080    121 anthracite/metallic silver  
1 unit

## SYSTEM FILE TROLLEYS

- Sturdy frame made of scratch-proof steel with fibreglass-reinforced plastic corners.
- Hardwearing 19 mm shelf boards
- Partly with raised, anti-tilt edges for ring binders, magazine files, etc.
- 4 castors, of which 2 with brakes
- Delivery: flat packed.



lockable hinged lid, maximum opening angle 90°



additional storage shelf

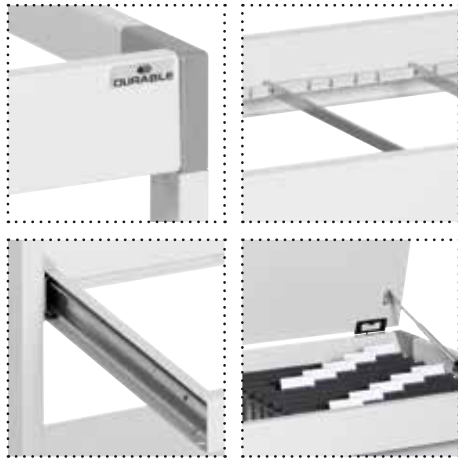

### SYSTEM FILE TROLLEY 100 MULTI TOP

- Lockable
- For approx. 100 suspension files or approx. 10 standard suspended lever arch files (spine width 80 mm) as well as approx. 18 small suspended lever arch files (spine width 40 mm) in A4 format.
- Suitable for all common sizes such as A4, Folio or Foolscap
- With additional shelf.
- When opened, the lid stays at a 90 degree angle
- Dimensions: 897 x 736 x 432 mm (W x H x D)

# 3787    ♣ 01 black, 10 grey  
 ☞ 1 unit

### SYSTEM FILE TROLLEY 90 A4 S

- For storing approx. 90 suspension files or approx. 8 standard suspended lever arch files (spine width 80 mm) as well as approx. 15 small suspended lever arch files (spine width 40 mm) in A4 format.
- Rail distance 330 mm
- Dimensions: 750 x 715 x 432 mm (W x H x D)

# 3770    ♣ 01 black, 10 grey  
 ☞ 1 unit



### SYSTEM FILE TROLLEY 100 MULTI S

- For approx. 100 suspension files or approx. 10 standard suspended lever arch files (spine width 80 mm) as well as approx. 18 small suspended lever arch files (spine width 40 mm) in A4 format.
- Suitable for sizes like A4, Folio or Foolscap
- Dimensions: 897 x 715 x 432 mm (W x H x D)

# 3783    ♣ 01 black, 10 grey  
 ☞ 1 unit



additional storage shelf

### SYSTEM FILE TROLLEY 90 A4

- For approx. 90 suspension files or approx. 8 standard suspended lever arch files (spine width 80 mm) as well as approx. 15 small suspended lever arch files (spine width 40 mm) in A4 format.
- Base shelf for storing approx. 8 standard files
- Rail distance 330 mm
- Dimensions: 750 x 715 x 432 mm (W x H x D)

# 3784    ♣ 01 black, 10 grey  
 ☞ 1 unit



retractable

### SYSTEM FILE TROLLEY 80 MULTI DUO

- With two levels, each for storing approx. 40 suspension files or approx. 4 standard suspended lever arch files (spine width 80 mm) as well as approx. 8 small suspended lever arch files (spine width 40 mm) in A4 format.
- Retractable lower suspension frame.
- Suitable for sizes such as A4, Folio or Foolscap
- Dimensions: 487 x 715 x 432 mm (W x H x D)

# 3791    ♣ 10 grey  
 ☞ 1 unit



Detailed information from page 240 onwards.  
 Assembly instructions available from [www.durable.eu](http://www.durable.eu)  
 Scan here for 3D animation    Art.-Nr.: 3787



Art.-Nr.: 3770



Art.-Nr.: 3784



Art.-Nr.: 3791







### SYSTEM FILE TROLLEY 200 MULTI DUO

- With two levels, each for storing approx. 100 suspension files or approx. 10 standard suspended lever arch files (spine width 80 mm) as well as for approx. 18 small suspended lever arch files (spine width 40 mm) in A4 format.
- Retractable lower suspension frame.
- Suitable for sizes such as A4, Folio or Foolscap
- Dimensions: 897 x 715 x 432 mm (W x H x D)

# 3792    10 grey  
 ☐ 1 unit



### SYSTEM FILE TROLLEY 100 MULTI

- For approx. 100 suspension files or approx. 10 standard suspended lever arch files (spine width 80 mm) as well as approx. 18 small suspended lever arch files (spine width 40 mm) in A4 format.
- Suitable for sizes A4, Folio or Foolscap
- A shelf at the base for storing approx. 10 standard files
- Dimensions: 897 x 715 x 432 mm (W x H x D)

# 3785    01 black, 10 grey  
 ☐ 1 unit



### SYSTEM FILE TROLLEY 200 MULTI DUO TOP

- With two levels, each for storing approx. 100 suspension files or approx. 10 standard suspended lever arch files (spine width 80 mm) as well as approx. 18 small suspended lever arch files (spine width 40 mm) in A4 format.
- Retractable lower suspension frame.
- Suitable for sizes such as A4, Folio or Foolscap
- When opened the lid stays at a 90 degree angle
- Dimensions: 897 x 736 x 432 mm (W x H x D)

# 3788    10 grey  
 ☐ 1 unit



Detailed information from page 240 onwards.  
 Assembly instructions available from [www.durable.eu](http://www.durable.eu)  
 Scan here for 3D animation    Art.-Nr.: 3792



## ECONOMY SUSPENSION FILE TROLLEY

- Made of scratch-proof steel
- 4 castors, of which 2 with brakes
- Delivery: Flat packed.

Matching suspension files from DURABLE can be found on page 54.



### ECONOMY SUSPENSION FILE TROLLEY 80 FOLIO

- For approx. 80 suspension files in Folio format.
- Dimensions: 655 x 592 x 405 mm (W x H x D)

# 3096    01 black, 10 grey  
 ☞ 1 unit



### ECONOMY SUSPENSION FILE TROLLEY 80 A4

- For approx. 80 A4 suspension files.
- Dimensions: 655 x 592 x 368 mm (W x H x D)

# 3095    01 black, 10 grey, 23 metallic silver  
 ☞ 1 unit



### ECONOMY SUSPENSION FILE TROLLEY 80 FOOLSCAP

- For approx. 80 suspension files in Foolscap format.
- Dimensions: 655 x 592 x 425 mm (W x H x D)

# 3097    10 grey  
 ☞ 1 unit

 More information from page 240 onwards. Find detailed product information, photos, product videos and animated films, dimensional drawings and assembly instructions on [www.durable.eu](http://www.durable.eu)



### ECONOMY SUSPENSION FILE TROLLEY 80 A4 TOP

- For approx. 80 A4 suspension files.
- With lockable lid.
- Dimensions: 655 x 592 x 404 mm (W x H x D)

# 3098    01 black, 10 grey  
 ☞ 1 unit



### ECONOMY SUSPENSION FILE TROLLEY 80 MULTI

- For approx. 80 suspension files in A4, Folio or Foolscap format.
- With lockable lid.
- Dimensions: 655 x 592 x 457 mm (W x H x D)

# 3099    01 black, 10 grey  
 ☞ 1 unit



### ECONOMY SUSPENSION FILE TROLLEY 100 DUO

- For approx. 100 A4 suspension files.
- Dimensions: 760 x 592 x 425 mm (W x H x D)

# 3082    01 black, 10 grey, 23 metallic silver  
 ☞ 1 unit





## MULTIMEDIA TROLLEYS

DURABLE offers premium-quality multimedia trolleys for all types of requirements. The PC workstations are the perfect combination for every office. The projector trolley is also ideal as a companion during presentations when overhead projectors are required.



**DESIGN LINE PC WORKSTATION**

- Sturdy lateral parts made of steel with perforation look
- 4 castors, of which 2 with brakes
- Handles for convenient handling
- Delivery: Flat packed.



Detailed information from page 240 onwards.  
Assembly instructions available from [www.durable.eu](http://www.durable.eu)

Scan here for 3D animation  
Art.-Nr.: 3190



**DESIGN LINE PC WORKSTATION**

- With height-adjustable keyboard shelf.
- The bottom shelf can be moved backwards for more leg room.
- Dimensions: 985 x 820 x 440 mm (W x H x D)

# 3190    120 metallic silver/maple, 125 metallic silver/anthracite  
1 unit

**PC WORKSTATION STANDARD**

- Made of scratch-proof steel and hardwearing shelf boards
- With retractable keyboard shelf
- 4 castors, of which 2 with brakes
- Delivery: Flat packed.



**PC WORKSTATION STANDARD**

- With working surface for keyboard and mouse
- Dimensions: 750 x 750 x 450 mm (W x H x D)

# 3197    10 grey, 120 metallic silver/maple, 127 black/beechn  
1 unit

**CPU STAND**

- Adjustable.
- Made of scratch-proof steel.
- With 4 castors, 2 with brakes.
- Dimensions: 205- 355 x 401 x 285 mm (W x H x D).

# 3231    10 grey, 58 charcoal  
1 unit



## SYSTEM FILE MULTIMEDIA TROLLEY

- Sturdy frame made of scratch-proof steel with fibreglass-reinforced plastic corners.
- Hardwearing 19 mm melamine shelf board.
- 4 castors, 2 with brakes for stability
- Delivery: Flat packed.

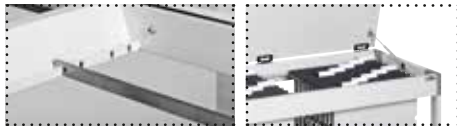

Height adjustable storage shelf and keyboard shelf



retractable

Height adjustable storage shelf and keyboard shelf

## SYSTEM COMPUTER TROLLEY 80 FH

- With height adjustment of the monitor and keyboard shelf
- Lower shelf can be used as additional tray
- Dimensions: 800 x 920-1220 x 564 mm (W x H x D)

# 3718    10 grey, 124 silver/beech  
 1 unit

## SYSTEM COMPUTER TROLLEY 75 FH

- Height-adjustable monitor shelf
- Retractable keyboard shelf allows for comfortable working
- Two additional shelves for printer or documents
- Flexible height adjustment allows working whilst sitting or standing
- Dimensions: 750 x 950-1150 x 534 mm (W x H x D)

# 3720    10 grey, 124 silver/beech  
 1 unit

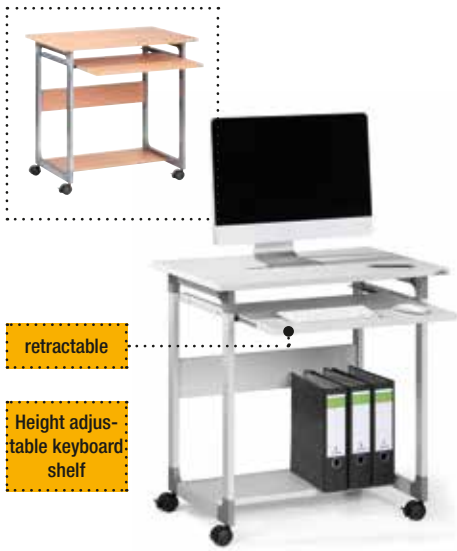

retractable

Height adjustable keyboard shelf



additional storage shelf



## SYSTEM COMPUTER TROLLEY 75 FH

- With two shelves and a retractable keyboard shelf
- With height adjustment of the monitor shelf between 550-630 mm
- Dimensions: 750 x 770 x 534 mm (W x H x D)

# 3796    10 grey, 124 silver/beech  
 1 unit

## SYSTEM OVERHEAD/BEAMER TROLLEY

- For beamers or overhead projectors
- Top shelf has an adjustable tilt angle
- Top shelf can be moved sideways by 180° if overhead projectors are to be used.
- The middle shelf is adjustable in 32-mm intervals.
- Dimensions 508 x 882 x 432 mm (W x H x D)

# 3701    10 grey  
 1 unit



Detailed information from page 240 onwards.  
 Assembly instructions available from [www.durable.eu](http://www.durable.eu)

Scan here for 3D animation

Art.-Nr.: 3718



Art.-Nr.: 3720



Art.-Nr.: 3796



Art.-Nr.: 3701











# Display and presentation systems

Products	Page
DURAFRAME®	130–141
Display panel systems	142–153
Table flipcharts/Accessories	154–155
Brochure presenters	156–161





# DURAFRAME®

Presenting information simply and attractively, creating optimal framing conditions - this is what DURAFRAME® has to offer.

DURAFRAME®  
Self adhesive with magnetic front panel



DURAFRAME® MAGNETIC  
magnetic frames for metal surfaces



## DURAFRAME® SELF ADHESIVE WITH MAGNETIC FRONT PANEL

The frame is identical in appearance from both sides and can be used in either portrait or landscape format. DURAFRAME® can be adhered to smooth, solid surfaces including glass and can be removed and repositioned. A total of 11 different colours are available to suit all environments and uses.

### FOR OPTIMAL VIEWING



Remove the protective backing paper



Affix the frame in the desired position.



Fold back the magnetic frame to insert materials.



Simple! DURAFRAME® stays permanently in place on all smooth, solid surfaces and can easily be repositioned. Can be viewed from both sides when applied to glass. Does not leave a residue.

### ADVANTAGES



Quick, easy exchange of information materials through magnetic panel.



Frames are identical front and back and can be read from both sides when applied to glass

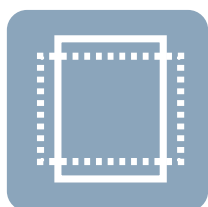

Suitable for use in either portrait or landscape format.



reddot design award  
winner 2011



product  
design  
award

2011



# Display and presentation systems

## DURAFRAME®

- Quick and easy exchange of information materials through fold-back magnetic frame
- For materials in A3, A4, A5 or A6 formats
- Can be used in either portrait or landscape format
- With 2 inserts readability from both sides on glass surfaces
- Frame looks identical from both sides
- Can be affixed to solid surfaces and removed again, e.g. from glass.

Scan here for the DURABLE YouTube channel



### DURAFRAME® A6

- For information in A6 format



### DURAFRAME® A5

- For information materials in A5 format



### DURAFRAME® A4

- For information materials in A4 format



### DURAFRAME® A3

- For information materials in A3 format



Format	Code	Colour	Piece	Code	Colour	Piece	Code	Colour	Piece
A6	4897...	01 23	1	4870...	01 23	2			
A5	4898...	01 23	1	4871...	01 23	2	4881...	01 23	10
A4	4899...	01 03 07 23	1	4872...	01 02 03 05 07 09 23 30	2	4882...	01 02 03 05 07 09 23	10
A3				4873...	01 03 05 07 23	2	4883...	01 03 05 07 09 23	6

01 black

02 white

03 red

05 green

07 dark blue

09 orange

23 silver

30 gold

**EASY TO WRITE ON**

The DURAFRAME® NOTE frame for information materials makes it possible to write directly on notices, lists of participants or signatures, or cleaning schedules in A4 format – it is quickly affixed and easy to handle and conveys a professional image.

**DURAFRAME® NOTE**

- Attractive frame
- Easy insertion and replacement of information by lifting the magnetic front
- Write directly onto the inserts within the frame
- For information in A4 portrait or landscape format
- Can be filled with up to 5 sheets of 80g/sqm paper
- Pen holder with fastening clip for all pens



Writing utensils  
not included



**DURAFRAME® NOTE A4**

- For information materials in A4 format
- Self-adhesive backing facilitates sticking to smooth, solid surfaces



Format	Code	Colour	Piece
A4	4993...	01 23	1

01 black

23 silver



## Display and presentation systems

### GREAT ADVERTISING WITH A GREAT EFFECT

DURAFRAME® POSTER is the professional solution for visual merchandising – in shop windows, in showrooms or at service points. With its many features, the self-adhesive magnetic frame is the ultimate advertising tool.

### DURAFRAME® POSTER

- Quick and easy exchange of posters and large notices through fold-back magnetic frame
- For A1, A2 and 50 cm x 70 cm formats
- UV-stabilised, low-reflection film prevents discolouration of posters
- Protection against theft and weathering by affixing the frame to a shop window pane on the inside for visibility on the outside
- Can be used in either portrait or landscape format
- Can be read from both sides when applied to glass with 2 inserts
- Frame looks identical from both sides
- Can be affixed to smooth, solid surfaces, e.g. glass.

Scan here for the DURABLE YouTube channel



### DURAFRAME® POSTER

Format	Code	Colour	Piece
A2	4995...	01 23	1
50 x 70	4996...	01 23	1
A1	4997...	01 23	1

01 black

23 silver



### THE EASY WAY TO FRAME YOUR FAVOURITE PHOTOS

In the age of digital photography, more pictures are being taken than ever before and printed at home. Now the presentation of photos in picture frames has become just as quick and easy thanks to DURAFRAME® PHOTO. These frames provide pictures with an attractive look and long-term protection and can be used either in portrait or landscape format. The frames are magnetic, so pictures can be exchanged quickly with ease.

### DURAFRAME® PHOTO

- Quick and easy exchange of pictures and photographs through fold-back magnetic frame
- For pictures in 9x13, 10x15 or 13x18 formats.
- Can be used in either portrait or landscape format
- Visibility from both sides for insertion of 2 pictures
- Frame looks identical from both sides
- Can be affixed to smooth, solid surfaces and removed again, e.g. from glass.



#### DURAFRAME® PHOTO

Format	Code	Colour	Piece
9 x 13	4884...	01 23	1
10 x 15	4885...	01 23	1
13 x 18	4886...	01 23	1

01 black

23 silver



### DURAFRAME® PHOTO PLUS

- Quick and easy exchange of pictures and photographs through fold-back magnetic frame
- For pictures in 10x15, 15x10, 13x18 or 18x13 formats
- With additional blank strip for adding captions
- Style sheet available for download from [www.durable.eu](http://www.durable.eu)
- Visibility on both sides for insertion of 2 pictures
- Frame looks identical from both sides
- Can be affixed to smooth, solid surfaces and removed again, e.g. from glass.



#### DURAFRAME® PHOTO PLUS

Format	Code	Colour	Piece
10 x 15	4964...	01 23	1
15 x 10	4965...	01 23	1
13 x 18	4966...	01 23	1
18 x 13	4967...	01 23	1

01 black

23 silver

### DURAFRAME® PHOTO DESK

- Quick and easy exchange of pictures and photographs through fold-back magnetic frame
- For pictures in 10x15 or 13x18 formats
- Sturdy aluminium frame with base
- Can be used in either portrait or landscape format
- For use on table-tops or walls



#### DURAFRAME® PHOTO DESK

Format	Code	Colour	Piece
10 x 15	4942...	23	1
13 x 18	4943...	23	1

01 black

23 silver

## Display and presentation systems

### BE ON THE SAFE SIDE

Display health & safety instructions, directions and warning signs with DURAFRAME® SECURITY, twin coloured magnetic frames designed in accordance with ISO 3864-4 for safety colours. DURAFRAME® SECURITY can be used in landscape or portrait format and read from both sides when applied to glass.

### DURAFRAME® SECURITY

- Quick and easy exchange of information materials through fold-back magnetic frame
- Frame colour complies with ISO 3864-4 for safety colours
- Can be read from both sides when applied to glass with 2 inserts
- Frame looks identical from both sides
- For materials in A4 format
- Can be used in either portrait or landscape format
- Can be affixed to smooth, solid surfaces and removed again, e.g. from glass.



### DURAFRAME® SECURITY A4

Format	Code	Colour	Piece	Code	Colour	Piece
A4	4944...	 130  131  132	2	4946...	 130  131  132	10

 130 yellow/black

 131 green/white

 132 red/white



## DURAFRAME® MAGNETIC - MAGNETIC FRAMES FOR METAL SURFACES

DURAFRAME® MAGNETIC can be used in either portrait or landscape format, on whiteboards, display boards, lockers or machines. Thanks to the magnetic backing, information can be exchanged quickly and easily, without leaving a residue.



**Attaches to metal surfaces, leaving no residue.**

Simply lift the frame away from the surface to insert information.

### ADVANTAGES



Quick, easy exchange of information materials through magnetic front.

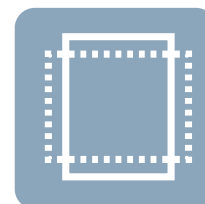

Suitable for use in either portrait or landscape format.

## DURAFRAME® MAGNETIC

- Quick and easy exchange of information materials through magnetic frame
- Adheres to all magnetic surfaces
- Can be used in either portrait or landscape format
- Sticks to all kinds of magnetic surfaces



### DURAFRAME® MAGNETIC



Format	Code	Colour	Piece
A6	4948...	01 23	5
A5	4947...	01 23	5
A4	4869...	01 03 07 09 23	5
A3	4868...	01 03 07 23	5

01 black    03 red    07 dark blue    09 orange    23 silver

## Display and presentation systems

### INSERT INFORMATION MATERIALS AND HOLD THEM IN PLACE MAGNETICALLY

A4 magnetic frame with folding magnetic front panel. DURAFRAME® MAGNET PLUS is the professional and easy way to display notices, information, literature and signage which can easily be replaced and removed by simply lifting the front panel and sealing shut. The frame secures onto any smooth, magnetic surface such as filing cabinets, metal walls in production areas and whiteboards.

### DURAFRAME® MAGNETIC PLUS

- Quick, easy exchange of information materials due to magnetic front
- For information materials in A4 portrait or landscape format

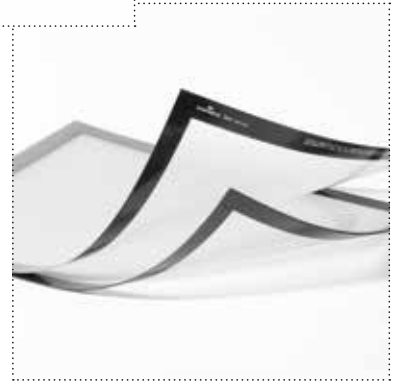

### DURAFRAME® MAGNETIC PLUS A4

- Quick, easy exchange of information materials due to magnetic front
- For information materials in A4 portrait or landscape format



Format	Code	Colour	Piece
A4	4985...	01 23	2

01 black

23 silver

## DURAFRAME® MAGNETIC SECURITY

- Quick and easy exchange of information materials through magnetic frame
- Frame colour complies with ISO 3864-4 for safety colours
- Adheres to all metal surfaces
- Can be used in either portrait or landscape format
- Sticks to all kinds of magnetic surfaces



### DURAFRAME® MAGNETIC SECURITY A4

- For safety instructions in A4 format



Format	Code	Colour	Piece
A4	4945...	130  131  132	5

130 yellow/black

131 green/white

132 red/white

# Display and presentation systems

## DURAVIEW®

### STYLISH AND MULTIFUNCTIONAL, FOR ALL YOUR SIGNAGE NEEDS.

DURAVIEW® is a premium-quality sign unit made of powder-coated steel, for use as a table/desktop, wall or floor presenter in A4 and A3 formats. Its concave design offers a comfortable, ergonomic reading angle. It takes only a few easy steps to change DURAVIEW® from portrait to landscape format.



Quick, easy exchange of information materials through detachable magnetic frame.

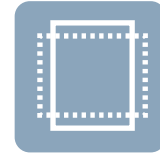

For information materials in portrait or landscape format.

## DURAVIEW®

- Mobile information system for application on tables, on walls or on the floor.
- For display of information materials in A3 or A4 formats
- Quick exchange of information materials through detachable DURAFRAME® MAGNETIC frame in silver
- Can be used in either portrait or landscape format
- Additional DURAFRAME® MAGNETIC frames in other colours available, to be ordered separately
- Assembly kit and instructions included



Comfortable, variable reading angle



Height-adjustable



## DURAVIEW® TABLE A3

- Table sign for information materials in A3 format
- Ergonomic reading angle thanks to adjustable information display

Format	Portrait BxHxT	Landscape BxHxT	Code	Colour	Piece
A4	235 x 335 x 150 mm	320 x 235 x 170 mm	4979...	23	1
A3	325 x 445 x 200 mm	445 x 330 x 215 mm	4980...	23	1

23 silver



## DURAVIEW® WALL A4

- Table sign for information materials in A4 format
- Ergonomic reading angle thanks to adjustable information display



Format	Portrait BxHxT	Landscape BxHxT	Code	Colour	Piece
A4	235 x 320 x 30 mm	320 x 235 x 30 mm	4983...	23	1
A3	325 x 445 x 40 mm	445 x 325 x 40 mm	4984...	23	1

23 silver

## DURAVIEW® STAND A3

- Floor stand for information materials in A3 format.
- Ergonomic reading angle thanks to adjustable information display
- Optimal readability through variable height adjustability



Format	Portrait BxHxT	Landscape BxHxT	Code	Colour	Piece
A4	300 x 770 – 1300 x 300 mm	320 x 725 – 1245 x 300 mm	4981...	23	1
A3	375 x 820 – 1360 x 375 mm	445 x 765 – 1300 x 375 mm	4982...	23	1

23 silver



## MAGNETIC POCKETS

- Transparent pockets for information materials
- Quick exchange of materials through fold-back front film
- Adheres to metal surfaces with 2 magnetic strips
- Can be used in portrait or landscape format

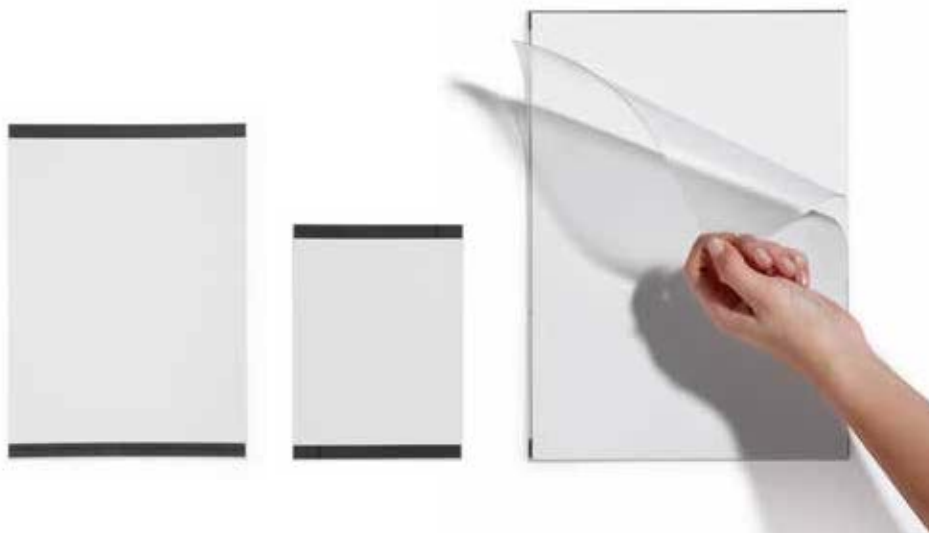

### MAGNETIC POCKET A4

- For information materials in A4 format

# 4874      19 transparent  
 2 per bag

### MAGNETIC POCKET A5

- For information materials in A5 format

# 4875      19 transparent  
 2 per bag



## DISPLAY PANEL SYSTEMS

Display panel systems SHERPA®, FUNCTION and VARIO®, provide quick and easy access to information and documents. For use on table tops, walls or on the floor – the information and presentation units from DURABLE with their matching display panels offer a great variety of solutions for all areas including offices, industrial settings, kitchens, showrooms and much more.



**WWW.  
DURABLE-LIVE  
.COM**

## OVERVIEW OF COMPLETE DISPLAY PANEL SETS

### TABLE-SETS

### WALL-SETS

### SPECIAL-SETS

#### SHERPA®

**At a glance:**

- premium-quality plastic modules
- table sets partly extendable
- A4 or A5 display panels made of polypropylene complete with tabs and blank insert labels
- With pin mechanism for quick exchange of panels
- Ideal for applications in offices, hotels, etc.



#### FUNCTION

**At a glance:**

- Hard-wearing modules made of powder-coated steel sheet
- A4 display panels made of crystal-clear hard film with welded tab in 5/5 partition
- With pin mechanism for quick exchange of panels
- Robust and long-lasting, therefore ideal for long-term use in industry and workshops



#### VARIO®

**At a glance:**

- Modules made of powder-coated steel sheet
- With A5 or A4 SHERPA® display panels made of polypropylene
- With pin mechanism for quick exchange of panels
- With tabs and blank insert labels
- Ideal for use in situations of intensive wear



## SHERPA



### SHERPA® MOTION 10

- Easy-rotating table stand.
- With 10 SHERPA® display panels in A4 format, incl. tabs with blank insert labels.
- The galvanised ball allows rotation by 360°.
- Reading angle adjustable from 25° to 70°.
- Ideal for workplace combinations with high desks and standard desks, arranged facing each other or side by side

# 5587    01 black, 37 graphite  
 1 set



reddot design award

### SHERPA® BACT-O-CLEAN

- Complete antibacterial sets for use on tables or walls
- With 10 A4 polypropylene display panels open on two sides (SHERPA® PANEL BACT-O-CLEAN)
- The antibacterial additive prevents growth of microorganisms
- Ideal wherever information materials are handled by large numbers of people e.g healthcare providers, catering kitchens etc



### SHERPA® BACT-O-CLEAN TABLE 10

- For table applications

# 5912    00 assorted  
 1 set



### SHERPA® BACT-O-CLEAN WALL 10

- For wall applications

# 5911    00 assorted  
 1 set



**SHERPA® STYLE**

- Complete sets for use on tables or walls
- With 10 polypropylene display panels in A4 format
- 10 index tabs for easy organisation
- Panels and brackets in black



**SHERPA® STYLE TABLE 10**

- For table applications.
- The skid-proof base finished in black and grey ensures maximum stability.

# 5855    ▲ 01 black  
📦 1 set

**SHERPA® STYLE WALL 10**

- For wall applications.
- Easy assembly.

# 5854    ▲ 01 black  
📦 1 set



**SHERPA® SOHO 5**

- Space-saving table stand.
- With 5 SHERPA® display panels for A4 information materials.

# 5540    ▲ 01 black  
📦 1 set



**WWW.  
DURABLE  
.EU**



**SHERPA® CAROUSEL 40**

- Easy-rotating table stand.
- With 40 SHERPA® display panels for information materials in A4 format and tabs with blank insert labels.
- Extremely stable and non-slip.
- Ergonomically designed foldaway handle assists the rotation of the display panel system and facilitates transport.

# 5633    ▲ 01 black  
📦 1 set



**SHERPA® CAROUSEL BASIC 40**

- Rotating table stand
- For 40 SHERPA® display panels in A4 format.
- Panels are not included.

# 5767    ▲ 01 black  
📦 1 unit

## SHERPA® TABLE

- Complete sets for use on tables.
- For A4 information materials.
- Equipped with 10, 20 or 30 SHERPA display panels.
- Complete including index tabs with blank insert labels.
- Extremely stable, non-slip table stands.
- Extendable with Prod. Code 5624 SHERPA EXTENSION MODULE 10 or 5811 SHERPA TABLE MODULE 10

Patented



### SHERPA® TABLE 10

- With 10 SHERPA® display panels in A4 format (5 panels each in red and black or grey and black).

# 5632    00 assorted, 22 multi-coloured  
 1 set

00 assorted: 5 panels each in red and black  
 22 multicoloured: 5 panels each in black and grey



### SHERPA® TABLE 20

- With 20 SHERPA® display panels in A4 format (10 panels each in grey and black).

# 5519    22 multi-coloured  
 1 set



### SHERPA® TABLE 30

- With 30 SHERPA® display panels in A4 format (with 15 panels each in grey and black).

# 5520    22 multi-coloured  
 1 set



### SHERPA® TABLE MODULE 10

- Modular table stand for 10 SHERPA® display panels in A4 format.
- Extremely stable and non-slip.
- Can be extended on both sides by 10 additional display panels with extension module product # 5624 or product # 5811.
- Panels are not included.

# 5623    57 anthracite/grey  
 1 unit



### SHERPA® EXTENSION SET 10

- Extension module with 10 SHERPA® display panels in A4 format (5 panels in grey and black)
- Incl. tabs with blank insert labels.

# 5811    22 multi-coloured  
 1 set



### SHERPA® EXTENSION MODULE 10

- Extension module without display panels.
- For extension of the capacity by 10 additional SHERPA® display panels in A4 format.
- To fit product # 5519, 5520, 5623 and 5632.

# 5624    57 anthracite/grey  
 1 unit

## SHERPA WALL

- Complete set for use on walls
- Consisting of a wall bracket and 5 or 10 SHERPA display panels in A4 format incl. index tabs.
- Ideal for reception areas, showrooms and exhibition rooms
- Easy assembly



Patented



00 assorted: 5 panels each in red and black  
22 multicoloured: 5 panels each in black and grey



### SHERPA® WALL 5

- Wall bracket with 5 SHERPA® display panels in A4 format (5 panels in black).

# 5810    ▲ 01 black  
📦 1 set

### SHERPA® WALL 10

- Wall bracket with 10 SHERPA® display panels in A4 format (5 panels each in red and black or grey and black).
- Can be combined with table clamp product # 5627.

# 5631    ▲ 00 assorted, 22 multi-coloured  
📦 1 set



### SHERPA® WALL MODULE 5

- Bracket for 5 SHERPA® display panels in A4 format.

# 5622    ▲ 10 grey  
📦 1 unit



### SHERPA® WALL MODULE 10

- Bracket for 10 SHERPA® display panels in A4 format.
- Can also be combined with table clamp product # 5627.

# 5621    ▲ 10 grey  
📦 1 unit

## SHERPA® PANEL

- Made of polypropylene
- With coloured frame around the edge.
- Low-reflection film, also suitable for scanners
- For A4 or A5 information materials
- Can be retrofitted with index tabs product # 5603 or 5609

Patented



### SHERPA® PANEL A4

- For information materials in A4 format.
- Opening for paper insertion at the top.

# 5606      ▲ 01 black, 03 red, 04 yellow, 05 green,  
07 dark blue, 09 orange, 10 grey,  
37 graphite, 44 violet blue, 00 assorted

📦 5 per bag

### SHERPA® PANEL A5

- For A5 information materials.
- Insertion of paper from the top

# 5812      ▲ 01 black

📦 5 per bag



### SHERPA® PANEL A4 BACT-O-CLEAN

- For A4 information materials.
- Frames and plastic with antibacterial finish.
- Open at the top and on the left.

# 5913      ▲ 06 light blue

📦 5 per bag



### SHERPA® PANEL PLUS A4

- For information materials in A4 format.
- Open at the top and on the left.

# 5590      ▲ 01 black

📦 5 per bag



### SHERPA® PANEL PIN A4

- For information materials in A4 format.
- With insert-moulded pin for insertion into brackets with perforated strip.
- Insertion of paper from the top

# 5582      ▲ 01 black

📦 5 per bag



### SHERPA® INFOPANEL A4

- Information panel made of polypropylene in A4 format with coloured frame
- Ideal for safety information, operating instructions, telephone lists, etc.
- Low reflection, suitable for scanners and tear-resistant.
- With adjustable suspension, can be used in portrait or landscape format.

# 5613      ▲ 03 red

📦 5 per bag



### INDEX TABS

- 12-colour sequence, 23 mm wide
- # 5603      ▲ 19 transparent
- 📦 10 per bag

- 5-colour sequence, 58 mm wide
- # 5609      ▲ 19 transparent
- 📦 10 per bag



### ADAPTER PIN

- Enables the use of SHERPA® and FUNCTION display panels in storage systems without pivot mechanism

# 5611      ▲ 16 beige

📦 20 per bag



**SHERPA® FLOOR 10**

- Floor stand with 10 SHERPA® display panels in A4 format.
- Height-adjustable telescopic rod (87–138 cm)
- Weighted cast-iron base for maximum stability.
- Reading angle adjustable from 5° to 90°.

# 5817    00 assorted  
 ☞ 1 set



**SHERPA® FLOOR MODULE 10**

- Floor stand for 10 SHERPA® display panels in A4 format.
- Height-adjustable telescopic rod (87–138 cm).
- With weighted cast-iron base for extra stability.
- Reading angle adjustable from 5° to 90°.
- Panels are not included.

# 5626    57 anthracite/grey  
 ☞ 1 unit



Patented



**SHERPA® INFOBASE TELESCOPE**

- Floor stand with crystal-clear information panel made of acrylic.
- Height-adjustable (92–147 cm).
- With adjustable reading angle +/-14°.
- Ideal for trade fairs, exhibition areas, showrooms and applications in hotels and restaurants.

# 5589    57 anthracite/grey  
 ☞ 1 set



**SHERPA® STAND PRO 10**

- Aluminium floor stand with weighted cast-iron base.
- Bracket with 10 SHERPA® display panels.
- The bracket can be rotated easily by 90°.
- Can be used for information materials in either portrait or landscape format.

# 5910    01 black  
 ☞ 1 set



**SHERPA® INFOPANEL ACRYLIC**

- Information panel in A4 format made of crystal-clear acrylic to match floor stand SHERPA® INFOBASE TELESCOPE (product # 5589).

# 5619    19 transparent  
 ☞ 1 unit



**SHERPA® DESK CLAMP 10**

- Desk clamp with 10 SHERPA® display panels in A4 format.
- Height-adjustable up to 78 cm. Reading angle adjustable from 5° to 90°.
- With screw clamp for fastening on table edges, etc., up to 50 mm thickness.

# 5818    00 assorted  
 ☞ 1 set



**SHERPA® DESK CLAMP MODULE**

- Desk clamp for SHERPA® WALL 10 brackets (product # 5631) and SHERPA® WALL MODULE 10 (product # 5621).
- Height-adjustable up to 78 cm.
- Reading angle adjustable from 5° to 90°.
- With screw clamp for fastening on table edges, etc. up to 50 mm thick.
- Panels and brackets are not included.

# 5627    57 anthracite/grey  
 ☞ 1 unit



**SHERPA® SWING ARM MODULE 10**

- Sturdy swing arm for 10 SHERPA® display panels in A4 format.
- Hinged brackets made of aluminium profiles, and three joints with adjustable holding force.
- Fastening with desk clamp.
- Pivoting range: 360°
- Radius: 316–714 mm.
- Jaw opening of desk clamp: 19–74 mm.
- Panels are not included.

# 5636    10 grey  
 ☞ 1 unit

## FUNCTION

### FUNCTION TABLE

- Complete set for use on tables.
- Made of powder-coated sheet steel, with 10, 20 or 30 FUNCTION display panels.
- Display panels made of crystal-clear hard film with welded-on tab in 5/5 partition and blank insert label.
- Robust and hardwearing, therefore ideal for long-term use in manufacturing and warehouse environments.

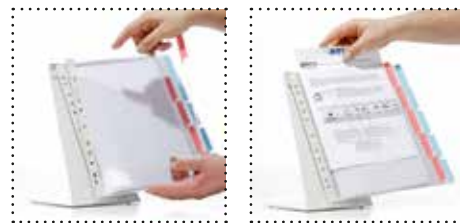

#### FUNCTION TABLE 10

- Table stand with 10 FUNCTION display panels in A4 format (5 panels each in red and blue).

# 5693    00 assorted  
 1 set



#### FUNCTION TABLE 20

- Table stand with 20 FUNCTION display panels in A4 format (5 panels each in red, yellow, green and blue).

# 5688    00 assorted  
 1 set



#### FUNCTION TABLE 30

- Table stand with 30 FUNCTION display panels in A4 format (5 panels each in red, yellow, green and blue, plus 10 units in transparent).

# 5694    00 assorted  
 1 set

### FUNCTION WALL

- Complete set for use on walls.
- Wall bracket made of powder-coated sheet steel with 10 or 20 FUNCTION display panels in A4 format.
- Easy assembly.



#### FUNCTION WALL 10

- With 10 FUNCTION display panels in A4 format (5 panels each in red and blue).

# 5691    00 assorted  
 1 set



#### FUNCTION WALL 20

- With 20 FUNCTION display panels in A4 format (5 panels each in red, yellow, green and blue).

# 5692    00 assorted  
 1 set



#### FUNCTION PANEL A4

- Display panel made of crystal-clear hard film for A4 information materials.
- Ideal for price lists, catalogue pages, illustrations, photos, etc.
- Can be filed thanks to universal punching in profile strip.
- tear-resistant and suitable for scanners.
- With welded-on 60 mm tab in 5/5 partition for visual distinction and blank insert labels.
- For use with base elements equipped with a pivot mechanism.

# 5607    03 red, 04 yellow, 05 green, 06 blue,  
 19 transparent  
 5 per bag



#### FUNCTION SAFE WALL 10

- Complete set made of powder-coated steel sheet for use on walls.
- Wall bracket with 10 FUNCTION SAFE display panels in A4 format.
- With welded-on tabs in 5/5 division and zip closure for optimal protection of documents.
- Ideal for use in kitchens, production plants etc.

# 5831    🔥 00 assorted  
📦 1 set



#### FUNCTION PANEL SAFE A4

- Display panel made of hard plastic in A4 format.
- With lateral zip closure.
- Protects documents reliably against moisture and soiling.
- Welded-on tab in 5/5 division.
- For use in base elements with pivot mechanism.

# 5832    🔥 19 transparent  
📦 5 per bag



#### FUNCTION STAINLESS WALL 10

- Complete set with stainless steel wall bracket
- With 10 FUNCTION SAFE display panels in A4 format
- With welded-on tabs in 5/5 division and zip closure for optimal protection of documents
- Ideal for use in rooms with high humidity levels such as kitchens, production plants or shops

# 5843    🔥 00 assorted  
📦 1 set

#### FUNCTION TABLE MODULE

- L-shaped table stand made of powder-coated sheet steel for display panels in A4 format.
- Display panels not included

#### FUNCTION TABLE MODULE 10

- Number of panels: 10
- Dimensions: 170 x 295 x 165 mm (W x H x D)

# 5683    🔥 10 grey  
📦 1 unit

#### FUNCTION TABLE MODULE 20

- Number of panels: 20
- Dimensions: 190 x 295 x 165 mm (W x H x D)

# 5684    🔥 10 grey  
📦 1 unit

#### FUNCTION TABLE MODULE 30

- Number of panels: 30
- Dimensions: 260 x 295 x 165 mm (W x H x D)

# 5685    🔥 10 grey  
📦 1 unit

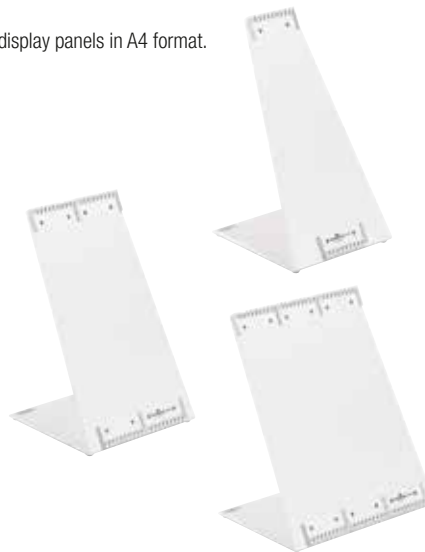

#### ADAPTER PIN

- Enables the use of SHERPA® and FUNCTION display panels in storage systems without pivot mechanism

# 5611    🔥 16 beige  
📦 20 per bag

#### FUNCTION WALL MODULE

- Wall bracket made of powder-coated sheet steel.
- For 5, 10, 15 or 20 display panels in A4 format.
- Easy assembly on walls or perforated display walls in showrooms.
- Wall brackets can be mounted in rows.
- Display panels not included.



#### FUNCTION WALL MODULE 5

- Number of panels: 5
- Dimensions: 40 x 322 mm (W x H)

# 5840    🔥 10 grey  
📦 1 unit

#### FUNCTION WALL MODULE 10

- Number of panels: 10
- Dimensions: 73 x 322 mm (W x H)

# 5674    🔥 10 grey  
📦 1 unit

#### FUNCTION WALL MODULE 15

- Number of panels: 15
- With adjustable side hinges to set the reading angle.
- Dimensions: 160 x 330 mm (W x H)

# 5672    🔥 10 grey  
📦 1 unit

#### FUNCTION WALL MODULE 20

- Number of panels: 20
- Dimensions: 148 x 322 mm (W x H)

# 5676    🔥 10 grey  
📦 1 unit



## VARIO®



### VARIO® TABLE

- Complete set for use on tables.
- Made of powder-coated sheet steel, with SHERPA® display panels in A5 or A4 format.
- With index tabs and blank insert labels for organisation.
- Ideal for long-term use.

#### VARIO® TABLE 30

- With 30 SHERPA® display panels in A4 format (5 panels each in black, red, yellow, green, dark blue and grey) and tabs with blank insert labels.

# 5510    00 assorted  
 ☞ 1 set



#### VARIO® A5 TABLE 10

- With 10 SHERPA® display panels in A5 format (10 panels in black) and tabs with blank insert labels.

# 5506    01 black  
 ☞ 1 set



#### VARIO® TABLE 10

- With 10 SHERPA® display panels in A4 format and tabs with blank insert labels.

# 5570    00 assorted, 01 black  
 ☞ 1 set



#### VARIO® TABLE 20

- With 20 SHERPA® display panels in A4 format (5 panels each in red, yellow, green and dark blue) and tabs with blank insert labels.

# 5699    00 assorted  
 ☞ 1 set

Patented



#### VARIO® PRO 10

- Multi-purpose display panel system made of powder-coated steel sheet.
- For use on tables or walls.
- Can be used in portrait or landscape format through 90° rotation of the bracket.
- With 10 SHERPA® display panels in A4 format and tabs with blank insert labels.
- 2 panels each in black, red, yellow, green and dark blue.

# 5579    00 assorted  
 ☞ 1 set





### VARIO® WALL

- Complete set for use on walls.
- Made of powder-coated sheet steel, with SHERPA® display panels in A5 or A4 format.
- With index tabs and blank insert labels for organisation.
- Ideal for long-term use.
- Easy assembly.



### VARIO® WALL 5

- With 5 SHERPA® display panels in A4 format and tabs with blank insert labels.

# 5551     ▲ 03 red, 07 blue, 09 orange  
📦 1 set



### VARIO® A5 WALL 10

- With 10 SHERPA® display panels in A5 format (10 panels in black) and tabs with blank insert labels.

# 5507     ▲ 01 black  
📦 1 set



### VARIO® WALL 10

- With 10 SHERPA® display panels in A4 format (2 panels each in black, red, yellow, green and dark blue) and tabs with blank insert labels.

# 5567     ▲ 00 assorted  
📦 1 set



### VARIO® WALL 20

- With 20 SHERPA® display panels in A4 format (5 panels each in red, yellow, green and dark blue) and tabs with blank insert labels.

# 5512     ▲ 00 assorted  
📦 1 set



### VARIO® MAGNET WALL 5

- Metal wall bracket with magnetic backing.
- With 5 SHERPA® display panels in A4 format.
- Can be fastened quickly and easily to metal surfaces such as shelves or machine frames.

# 5914     ▲ 01 black  
📦 1 set



## Display and presentation systems

### DURASTAR®

- Table flipcharts with sturdy plastic spine and Velcro fastening
- Can be placed upright like folders
- Can be labelled on labelling strip insert
- 4-ring mechanism, delivered with 10 anti-glare, premium-quality punched pockets with reinforced holes
- Extendable by approx. 20 additional pockets
- Ideal for trade fairs and exhibitions, as well as training seminars and presentations in small groups.



#### DURASTAR® Table Flipcharts with 10 premium-quality punched pockets

for Format	Size mm
DIN A4 portrait	360 high x 240 wide, 40 spine thickness, depth 320 (open)
DIN A4 landscape	265 high x 330 wide, 40 spine thickness, depth 260 (open)
DIN A3 portrait	465 high x 330 wide, 40 spine thickness, depth 415 (open)
DIN A3 landscape	360 high x 450 wide, 40 spine thickness, depth 320 (open)

Prod. Code
8564
8567
8568
8569

#### Punched Pockets\* for Extra Capacity

Punching mm	Prod. Code
45 x 65 x 45 + 80	8565
80 x 80 x 80	8566
80 x 80 x 80	8575
80 x 80 x 80	8577

Packing: 1 per box · Colour/Col. Code: 39 graphite grey

Packing: 10 per bag – Col. Code/Colour: 19 transparent  
Pockets in portrait format = opening on the long side  
Pockets in landscape format = opening on the short side

# TABLE FLIPCHARTS / ACCESSORIES

Table flipcharts are extremely versatile, low-cost units for the professional display of information. Whether displaying charts, texts or pictures, the desired information is professionally presented. For use on reception desks, in waiting areas, at seminars, meetings and on visits to customers, at trade fairs and exhibitions. To present your materials, simply fold them open and place them on the table.

### TABLE FLIPCHARTS

- Table flipcharts with Velcro fastener
- Stability through stand-up edge and reinforcement of the film at the ring mechanism
- 4-ring mechanism incl. 10 anti-glare, premium quality punched pockets with reinforced punched holes
- Can be extended by adding approx. 20 more pockets
- Ideal for trade fairs and exhibitions, as well as training seminars and presentations in small groups.



#### Table Flipcharts with 10 premium-quality punched pockets

for Format	Size mm
DIN A4 portrait	345 high x 225 wide, 38 spine thickness, depth 300 (open)
DIN A4 landscape	290 high x 320 wide, 38 spine thickness, depth 290 (open)
DIN A3 landscape	365 high x 450 wide, 38 spine thickness, depth 330 (open), with carry handle

Packing: 1 per box; Colour/Col. Code: 01 black

Prod. Code
8560
8561
8572

#### Punched Pockets for Extra Capacity

Punching mm	Prod. Code
45 x 65 x 45 + 80, DIN A4 portrait	8565
80 x 80 x 80, DIN A4 landscape	8566
80 x 80 x 80, DIN A3 portrait	8575
80 x 80 x 80, DIN A3 landscape	8577

Packing: 10 per bag · Col. Code/Colour: 19 transparent

### TABLE FLIPCHART ECONOMY

- A4 landscape format with 4-ring mechanism
- Firm grip through Velcro fastener
- With 10 punched pockets
- Extendable by another 20 punched pockets

# 8574    ♠ 57 anthracite/grey  
📦 1 unit



## PRESENTER

- Table sign with aluminium stand
- Crystal-clear acrylic panel with clamping system for a firm hold
- Readable from both sides
- Easy removal and exchange of inserts



### PRESENTER 1/3 A4

- For information in 1/3 A4 format or DIN long format
- Dimensions: 107 x 237 x 85 mm (W x H x D)

# 8587    19 transparent  
 ☞ 1 unit

### PRESENTER A5

- For information in A5 format
- Dimensions: 150 x 237 x 85 mm (W x H x D)

# 8588    19 transparent  
 ☞ 1 unit

### PRESENTER A4

- For information in A4 format
- Dimensions: 212 x 323 x 85 mm (W x H x D)

# 8589    19 transparent  
 ☞ 1 unit

## PRESENTATION STANDS

- Quick and easy exchange of information materials through lateral removal
- Optimal readability through crystal-clear acrylic and ergonomic reading angle
- Skid-proof and stable through self-adhesive rubber pads, non-slip
- Optimal positioning of information in reception areas, at trade fairs and exhibitions



### PRESENTATION STAND A5

- For information in A5 format
- Dimensions: 150 x 210 x 80 mm (W x H x D)

# 8597    19 transparent  
 ☞ 2 unit

### PRESENTATION STAND A4

- For information in A4 format
- Dimensions: 210 x 290 x 90 mm (W x H x D)

# 8596    19 transparent  
 ☞ 2 unit

## MAGNETS

- Coloured plastic cap
- Practical gripping edge
- Easy positioning and removal



Ø mm	Magnetic force/p	Blister Pack		Pieces per Blister Pack	Industrial Pack		Pieces per Pack
		Prod. Code	Col. Code		Prod. Code	Col. Code	
15	75	4701	01-06	8	4751	01-06	20
21	210	4702	01-06	6	4752	01-06	20
32	720	4703	01-06	4	4753	01-06	20
37	1000	4704	01-06	2	4754	01-06	20
37	3000				4755	01-06	20

Packaging: 10 blister packs / 1 industrial pack = 1 packaging unit  
 Col. Code/Colour.: 01 black, 02 white, 03 red, 04 yellow, 05 green, 06 blue, 07 dark blue, 14 light blue, 19 transparent, 46 brass plated, 00 assorted

## EISBÄR® ROUND-HEADED PINS



Visual planning aids for maps, charts, organisation plans and notice boards. With high quality steel pin firmly anchored in the plastic head.

Description	Prod. Code	Pin/Length mm	Col. Code	Pcs./Pack
EISBÄR®-round head pins	1924	4/15	01-05, 07, 19, 00	100
	1926	6/15	01-05, 07, 19, 00	50
EISBÄR®-flag pins	1929	25	01-05, 07, 14, 19, 00	25

### PAPER CLIPS/PINS/ELASTIC BANDS

Description	Prod. Code	Pin/Length mm	Col. Code	Pcs./Pack
Push pins	1274	6/15	00	100
Pins	1275	9/23	00	40
Drawing pins	1276	Ø 10 mm	46	200
	1277	Ø 10 mm	00	120
	1278	Ø 10 mm	02	120



# BROCHURE PRESENTERS

Excellent for self-service: with the help of brochure presenters, catalogues, magazines, brochures, flyers and product brochures can be presented clearly and professionally within a minimal space. DURABLE offers three brochure presenter ranges which all boast flexibility, robust quality, timeless design and the ability to be extended.



# COMBIBOXX

- Brochure presenter system for portrait/landscape A4 formats and A6/DIN long
- Filling capacity 24 mm
- Can be used as wall or table presenters
- Extendable to approx. 6 kg load capacity
- A4 and A6/DIN long formats can be combined with each other
- Ideal for information materials at reception desks, in showrooms, in waiting areas and at trade fairs

Patented

All trays are quick and easy to clean.



1x  
A4



3x  
A4



5x  
A4

## COMBIBOXX A4

- Literature display for information in A4 format up to a format of 311 x 240 mm
- Includes one tray, two carrier elements and one front plate.
- Extendable with COMBIBOXX A4 EXTENSION (product # 8579).
- Dimensions of stand: 242 x 291 x 162 mm (W x H x D)
- Dimensions of wall: 242 x 300 x 152 mm (W x H x D)

# 8578    19 transparent  
1 set

## COMBIBOXX A4 SET L

- Set of three literature displays for information in A4 format up to a format of 311 x 240 mm.
- Includes three trays, two carrier elements and one front plate.
- Extendable with COMBIBOXX A4 EXTENSION (product # 8579).
- Dimensions of stand: 242 x 291 x 217 mm (W x H x D)
- Dimensions of wall: 242 x 445 x 152 mm (W x H x D)

# 8580    19 transparent  
1 set

## COMBIBOXX A4 SET XL

- Set of literature displays for information in A4 format up to 311 x 240 mm
- Includes five trays, two carrier elements and one front plate
- Extendable with COMBIBOXX A4 EXTENSION (product # 8579)
- Dimensions of stand: 242 x 288 x 259 mm (W x H x D)
- Dimensions of wall: 242 x 580 x 155 mm (W x H x D)

# 8586    19 transparent  
1 set



1x  
A4



1x  
1/3 A4  
A6



3x  
1/3 A4  
A6

## COMBIBOXX A4 LANDSCAPE

- Literature display for information in A4 landscape format up to 330 mm width.
- Includes one tray, two carrier elements and one front panel.
- Extendable by using COMBIBOXX A4 EXTENSION LANDSCAPE (product # 8685).
- Dimensions of stand: 339 x 200 x 95 mm (W x H x D)
- Dimensions of wall: 339 x 210 x 100 mm (W x H x D)

# 8684    19 transparent  
1 set

## COMBIBOXX 1/3 A4

- Literature display for 1/3 DIN A4 and A6-sized information up to a format of 210 x 116 mm
- Consists of a tray, two carrier elements, an adapter bar for combined use with A4 modules and a front panel
- Can be extended by adding the COMBIBOXX 1/3 A4 EXTENSION (product # 8598)
- Dimensions of stand: 121 x 198 x 117 mm (W x H x D)
- Dimensions of wall: 121 x 208 x 111 mm (W x H x D)

# 8590    19 transparent  
1 unit

## COMBIBOXX 1/3 A4 SET L

- Set of literature display for presenting 1/3 A4 or A6-sized information up to a format of 210 x 116 mm.
- Includes three trays, two carrier elements, one adapter bar for combined use with A4 modules and one front plate.
- Extendable with COMBIBOXX 1/3 A4 EXTENSION (product # 8598).
- Dimensions of stand: 121 x 198 x 181 mm (W x H x D)
- Dimensions of wall: 121 x 353 x 111 mm (W x H x D)

# 8599    19 transparent  
1 set

### EXTENDABLE

Individual A4 and 1/3 A4 literature holders can be extended using EXTENSION units. Simply add the required number of extension units to the original literature holder, insert the front cover and lock into place.

### ADAPTABLE

Whether a space saving table stand or wall mounted literature holder – the base elements simply push and lock into place to complete the unit. The table stand can be quickly converted into a wall unit by simply turning the base 180°, and vice versa to transform the wall unit to a table stand.

### MODULAR

An adapter is available to quickly and easily combine A4 and 1/3 A4 literature holders. Simply attach the required number of literature holders onto the adapter, insert the front cover(s) and lock into place.

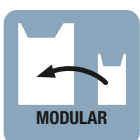



## COMBIBOXX PRO

- Set of literature displays for information in A4 format (up to 311 x 240 mm) and 1/3 A4 or A6 format (up to 210 x 116 mm).
- Includes one A4 tray and four 1/3 A4 trays, one adapter bar and two front plates.
- Extendable with COMBIBOXX A4 EXTENSION (product # 8579).
- Dimensions of stand: 242 x 291 x 229 mm (W x H x D)
- Dimensions of wall: 242 x 445 x 150 mm (W x H x D)

# 8613    19 transparent  
 1 set



## COMBIBOXX A4 EXTENSION

- Literature display tray for extending the COMBIBOXX A4 (product # 8578), COMBIBOXX A4 SET L (product # 8580), COMBIBOXX A4 SET XL (product # 8586) or COMBIBOXX PRO (product # 8613)
- Dimensions: 424 x 320 x 34 mm (W x H x D)

# 8579    19 transparent  
 1 unit



## COMBIBOXX 1/3 A4 EXTENSION

- Literature display tray for extending the COMBIBOXX 1/3 A4 (product # 8590), COMBIBOXX 1/3 A4 SET L (product # 8599) or COMBIBOXX PRO (product # 8613)
- Dimensions: 121 x 215 x 34 mm (W x H x D)

# 8598    19 transparent  
 1 unit



## COMBIBOXX A4 EXTENSION LANDSCAPE

- Literature display tray in landscape format for extending COMBIBOXX A4 LANDSCAPE (product # 8684)
- Dimensions: 339 x 210 x 35 mm (W x H x D)

# 8685    19 transparent  
 1 unit



## COMBIBOXX STAND A4 L

- Rotating floor stand with 30 literature display trays for presenting information in A4 format up to 311 x 240 mm.
- 15 trays are mounted on each of the two levels.
- Both levels can be rotated separately.
- 5 twin castors allow easy manoeuvrability
- Firm position thanks to weighted base and two locking devices
- Total height: approx. 178 cm

# 8616    19 transparent  
 1 unit



## COMBIBOXX TABLE 1/3 A4 XL

- Rotating table stand complete with 36 literature display trays for information in 1/3 A4 or A6 formats up to 210 x 116 mm.
- Firm position thanks to weighted base.
- 12 trays are mounted on each side.
- Dimensions: 440 x 620 mm (W x H)

# 8615    19 transparent  
 1 unit



## COMBIBOXX TABLE A4 XL

- Rotating table stand with 15 literature display trays for information in A4 format up to 311 x 240 mm.
- Firm position thanks to weighted base.
- 5 trays are mounted on each side.
- Dimensions: 520 x 650 mm (W x H)

# 8614    19 transparent  
 1 unit

## FLEXIPLUS

- Brochure presenter system for A4 portrait/landscape and A5 formats
- Filling capacity 23 mm
- Extendable up to a load capacity of approx. 6 kg
- Ideal for information materials at reception desks, in showrooms, in waiting areas and at trade fairs

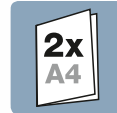
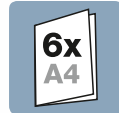

### FLEXIPLUS 6 A4

- Set of literature displays in A4 format
- Consists of six literature displays
- Dimensions: 247 x 745 x 100 mm (W x H x D)

# 1700008061 black 1 set  
# 1700008401 transparent 1 set

### FLEXIPLUS 2 A4

- Set of literature displays in A4 format
- Consists of two literature displays
- Dimensions: 247 x 360 x 100 mm (W x H x D)

# 1709008060 black 1 set  
# 1709008400 transparent 1 set

### FLEXIPLUS 2 A5

- Set of literature displays for information in A5 format
- Consists of two literature displays in A5 format
- Dimensions: 180 x 250 x 105 mm (W x H x D)

# 1709013400 transparent 1 set

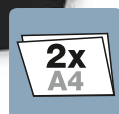

### FLEXIPLUS 2 A4 LANDSCAPE FORMAT

- Set of literature displays for information in A4 landscape format
- Consists of two literature displays in A4 landscape format
- Dimensions: 340 x 250 x 100 mm (W x H x D)

# 1709014060 black 1 set  
# 1709014400 transparent 1 set

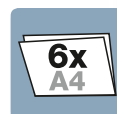

### FLEXIPLUS 6 A4 LANDSCAPE FORMAT

- Set of six literature displays for information in A4 landscape format
- Dimensions: 340 x 520 x 100 mm (W x H x D)

# 1700014061 black 1 set  
# 1700014401 transparent 1 set

## FLEXIBOXX

- Brochure presenter system for A4 portrait/landscape formats
- Filling capacity 24 mm
- Extendable up to a load capacity of approx. 6 kg
- Ideal for information materials at reception desks, in showrooms, in waiting areas and at trade fairs

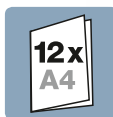

### FLEXIBOXX 12 A4

- Set of literature displays for information in A4 format.
- Consists of a module of twelve literature displays.
- Dimensions: 240 x 1115 x 135 mm (W x H x D)

# 1709763010	▲ white	📦 1 set
# 1709763060	▲ black	📦 1 set
# 1709763400	▲ transparent	📦 1 set

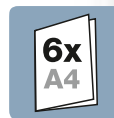

### FLEXIBOXX 6 A4

- Set of literature displays for information in A4 format
- Consists of a module of six literature displays
- Dimensions: 240 x 690 x 135 mm (W x H x D)

# 1709760010	▲ white	📦 1 set
# 1709760060	▲ black	📦 1 set
# 1709760400	▲ transparent	📦 1 set

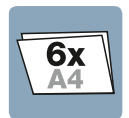

### FLEXIBOXX 6 A4 LANDSCAPE FORMAT

- Set of literature displays for information in A4 landscape format
- Consists of a module of six literature displays in A4 landscape format
- Dimensions: 348 x 620 x 95 mm (W x H x D)

# 1709785010	▲ white	📦 1 set
# 1709785060	▲ black	📦 1 set
# 1709785400	▲ transparent	📦 1 set

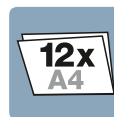

### FLEXIBOXX 12 A4 LANDSCAPE FORMAT

- Set of literature displays for information in A4 landscape format
- Consists of a module of 12 literature displays in A4 landscape format
- Dimensions: 348 x 1140 x 95 mm (W x H x D)

# 1709781010	▲ white	📦 1 set
# 1709781060	▲ black	📦 1 set
# 1709781400	▲ transparent	📦 1 set



### FLEXIBOXX A4 FRONT PLATE LANDSCAPE FORMAT

- Front plate for the literature display FLEXIBOXX A4 EXTENSION LANDSCAPE FORMAT
- Dimensions: 348 x 220 x 7 mm (W x H x D)

# 1701522010	▲ white	📦 1 unit
# 1701522060	▲ black	📦 1 unit
# 1701522400	▲ transparent	📦 1 unit

### FLEXIBOXX A4 FRONT PLATE

- Front plate for the literature display FLEXIBOXX A4 EXTENSION
- Dimensions: 240 x 300 x 7 mm (W x H x D)

# 1701498010	▲ white	📦 1 unit
# 1701498060	▲ black	📦 1 unit
# 1701498400	▲ transparent	📦 1 unit





**FLEXIBOXX A4 EXTENSION**

- One literature display for information in A4 format
- Dimensions: 240 x 340 x 135 mm (W x H x D)

- # 1700760010 🌊 white 📦 1 unit
- # 1700760060 🌊 black 📦 1 unit
- # 1700760400 🌊 transparent 📦 1 unit

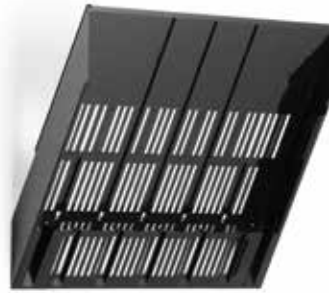

**FLEXIBOXX A4 EXTENSION LANDSCAPE FORMAT**

- One literature display for information in A4 landscape format
- Dimensions: 348 x 280 x 35 mm (W x H x D)

- # 1700761010 🌊 white 📦 1 unit
- # 1700761060 🌊 black 📦 1 unit
- # 1700761400 🌊 transparent 📦 1 unit



**FLEXIBOXX DIVIDER A4 LANDSCAPE**

- Transparent divider for FLEXIBOXX A4 LANDSCAPE FORMAT
- One dividers turns the A4 format into two A5 formats
- Two dividers turn the A4 format into three 1/3 A4 formats or three DIN long formats
- Dimensions: 30 x 210 x 5 mm (W x H x D)

- # 1700580400 🌊 transparent 📦 1 unit



**LITERATURE DISPLAY**

- For information materials and brochures in A4 format
- Dimensions: 212 x 306 x 125 mm (W x H x D)

- # 8594 🌊 19 transparent 📦 2 unit



**LITERATURE DISPLAY**

- For information materials and brochures in A5 format
- Dimensions: 150 x 227 x 85 mm (W x H x D)

- # 8595 🌊 19 transparent 📦 2 unit



**ACRYLIC TABLET STAND**

- Premium-quality tablet PC base made of crystal-clear acrylic
- Easy upright insertion and removal of the tablet PC
- Optimal reading and presentation angle
- For conventions, conferences and reception desks or displays in shop windows and showrooms
- Dimensions: 210 x 83 x 106 mm (H x W)

- # 8028 🌊 19 transparent 📦 1 unit



**SORTER RACK, 5 PARTS**

- Made of powder-coated steel sheet
- 5 compartments for effective sorting of documents
- Wall-mounting possible
- Lateral labelling window
- For A4 / Folio format
- Dimensions: 360 x 330 x 250 mm (W x H x D)

- # 3360 🌊 01 black, 10 grey 📦 1 unit



**SORTER RACK, 8 PARTS**

- Made of powder-coated steel sheet
- 8 compartments for effective sorting of documents
- Wall-mounting possible
- Lateral labelling window
- For A4 / Folio format
- Dimensions: 360 x 540 x 250 mm (W x H x D)

- # 3361 🌊 01 black, 10 grey 📦 1 unit







# Name Badges and Signage



## Products

## Page

Name badges	164–185
Name badge accessories	186–189
Table place name holders	190–193
BADGEMAKER® insert labels	194–195
Door signs	196–200
Floor stands/Pictograms	201–205



# NAME BADGES

As a name badge expert, DURABLE offers a wide range of high quality, flexible products with various fastening options to provide the right solution for every field of application. Micro-perforated BADGEMAKER® inserts are available that enable the simple labelling of name badges via handwritten entries or printed professionally using the free DURAPRINT® software available from the website – a professional finish is always guaranteed.

Name badges and recommended fields of application		Hotels, restaurants & tourism, etc.	Banks, insurance companies, etc.	Sales & service	Doctors' surgeries	Industry & production	Hospitals
<b>CLASSIC</b> Prestigious and sturdy	Specially recommended for continuous use.	● ● ●	● ● ●	● ● ●	● ●	●	● ●
<b>ACRYLIC</b> Discreet and elegant		● ● ●	● ● ●	● ● ●	● ● ●	●	● ●
<b>BASIC</b> Functional and individual		● ● ●	● ● ●	● ● ●	● ● ●	●	● ● ●
<b>SELECT</b> Professional and stylish		● ●	● ● ●	● ● ●	● ●	●	● ●
<b>FRAME</b> Modern and discreet		● ●	● ●	● ●	● ● ●	●	● ● ●
<b>CLIP CARD</b> Durable and flexible		● ● ●	● ● ●	● ● ●	● ● ●	●	● ● ●
<b>CLICK FOLD</b> Versatile and functional	Specially recommended for frequently changing names.	● ●	● ●	● ●	● ●	● ●	● ●
<b>UNIVERSAL</b> Simple and convenient	Specially recommended for large-scale events.	● ●	●	●	●	● ● ●	●
<b>SELF-ADHESIVE BADGES</b> Simply one time	Specially recommended for one-time use.						

**OVERVIEW OF RANGE AND RECOMMENDED AREAS OF USE**

● ● ●	Specially recommended
● ●	Recommended
●	Suitable



Direct link to the DURABLE YouTube channel:

**UNIVERSAL**  
Simple and convenient



**CLICK FOLD**  
Versatile and functional



**CLIP CARD**  
Durable and flexible



**FRAME**  
Modern and discreet



**SELECT**  
Professional and stylish



**BASIC**  
Functional and individual



**ACRYLIC**  
Discreet and elegant



**CLASSIC**  
Prestigious and sturdy



Trade fairs & exhibitions, staff	Trade fairs & exhibitions, visitors	Conferences and conventions	Large-scale events	Seminars	Name badges and recommended fields of application	
● ● ●	/	●	/	●	Specially recommended for continuous use.	<b>CLASSIC</b> Prestigious and sturdy
● ● ●	/	●	/	●		<b>ACRYLIC</b> Discreet and elegant
● ● ●	/	/	/	●		<b>BASIC</b> Functional and individual
● ●	/	●	●	●		<b>SELECT</b> Professional and stylish
● ●	/	●	●	●		<b>FRAME</b> Modern and discreet
● ●	/	●	●	●		<b>CLIP CARD</b> Durable and flexible
● ●	● ●	● ● ●	● ● ●	● ● ●	Specially recommended for frequently changing names.	<b>CLICK FOLD</b> Versatile and functional
●	● ● ●	● ● ●	● ● ●	● ● ●	Specially recommended for large-scale events.	<b>UNIVERSAL</b> Simple and convenient
/	● ●	● ● ●	● ●	● ● ●	Specially recommended for one-time use.	<b>SELF-ADHESIVE BADGES</b> Simply one time



# CLASSIC

As elegant as a piece of jewellery, the galvanised CLASSIC name badges with their stylish aluminium look add a touch of style to your name badges. The unobtrusive, slightly curved frame combines clear design with high quality, long-lasting materials and perfect functionality - a genuine long-term companion!



### Product advantages

- Scratch-proof galvanised frame.
- A unique system for quick, easy exchange of insert labels. (Patent pending)
- Convex shape for better readability.



## CLASSIC

- Name badge with galvanised frame in aluminium look
- Extremely long-lasting material
- Ideal for long-term use at trade fairs, in hotels or retail stores
- Inserts can be exchanged quickly thanks to unobtrusive flap at the back



Patent pending

### CLASSIC WITH MAGNET

- For a simple fastening that will not damage clothes
- Also for delicate fabrics
- Securely held by two magnets
- Internal dimensions: 30 x 65 mm (H x W)

# 8540      23 metallic silver  



### CLASSIC WITH MAGNET

- Internal dimensions: 34 x 74 mm (H x W)

# 8542      23 metallic silver  



### CLASSIC WITH COMBI CLIP

- With pin and clip fastening
- Internal dimensions: 30 x 65 mm (H x W)

# 8541      23 metallic silver  

### CLASSIC WITH COMBI CLIP

- Internal dimensions: 34 x 74 mm (H x W)

# 8543      23 metallic silver  

### Applications for CLASSIC

- Thanks to hardwearing, sturdy materials particularly recommended for long-term use.
- Elegant, unobtrusive, prestigious design which fits particularly well into distinguished environments such as hotels & restaurants, banks or trade fair stands.
- Fastening systems (magnet and combi clip) are designed for long-term use.



Printable with DURAPRINT®



DURAPRINT® video





# ACRYLIC

The virtually invisible, frameless name badges have been reduced to essentials and specially highlight the names thanks to their slightly convex form. Thanks to the extremely transparent, crystal-clear surface, the names and logos take on an appearance both elegant and rich in contrasts.



### Product advantages

Crystal-clear, slightly convex surface for optimal readability.

Thumb slot at the back for easy exchange of insert labels.

With patented rotatable combi clip and raised backing for optimal fixing





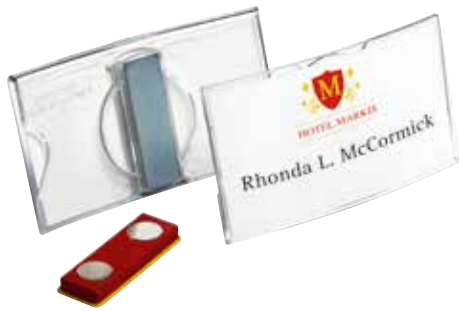

Patented

**CONVEX NAME BADGE WITH MAGNET**

- High-quality acrylic name badge in a curved design
- For a simple fastening that will not damage the clothes
- Also for delicate fabrics
- Securely held by two magnets
- Internal dimensions: 40 x 75 mm (H x W)

# 8123      19 transparent  
 25 per pack



**CONVEX NAME BADGE WITH COMBI CLIP**

- With rotating plastic clip and pin
- Attractive shape
- Convex, crystal-clear acrylic window
- Internal dimensions: 40 x 75 mm (H x W)

# 8128      58 charcoal  
 25 per pack



Patented

**CONVEX NAME BADGE WITH COMBI CLIP**

- High-quality acrylic name badge
- Curved design
- Fastening by plastic clip with pin
- Internal dimensions: 40 x 75 mm (H x W)

# 8124      19 transparent  
 25 per pack



**NAME BADGE WITH COMBI CLIP**

- Made of acrylic
- With pin and clip for pinning or clipping on
- Tuck-in flap for shirt or breast pocket
- Internal dimensions: 40 x 75 mm (H x W)

# 8121      19 transparent  
 25 per pack



**NAME BADGE WITH TUCK FLAP**

- Made of acrylic
- For breast or shirt pockets
- Tuck-in flap height: 65 mm
- Internal dimensions: 40 x 75 mm (H x W)

# 8120      19 transparent  
 25 per pack

**Features of ACRYLIC**

- High quality name badge.
- Hardwearing, robust material, therefore particularly recommended for long-term use.
- Simple, prestigious design, which fits particularly well into distinguished environments such as hotels & restaurants, banks or trade fair stands.
- Rotatable combi clip for extremely flexible use.



Printable with DURAPRINT®



DURAPRINT® video







# BASIC

The premium-quality BASIC name badges attract attention from everyone and, thanks to personalized print, invariably highlight the names of their wearers. With rounded corners and a matt-finished surface, the aluminium badges make a lasting good impression everywhere.



### Product advantages

 Elegant design with rounded corners.

 Easy design and order facility via the (German) DURABLE BUSINESS online shop. [www.durable-business.com](http://www.durable-business.com)

 Printing is solvent and scratch resistant.

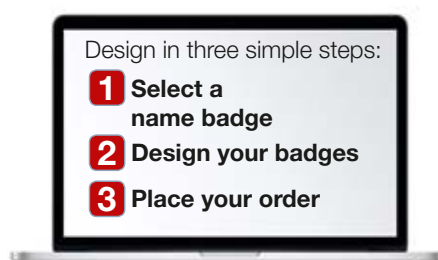

### BASIC fastening options

The fastenings are designed for long-term use.

#### Magnet:

- Specially recommended for fastening on fine fabrics, since the magnet leaves no traces.
- Thanks to its strong adhesive force, it can also be used on thicker fabrics such as jackets.
- Ideal for business meetings and events.



#### Combi Clip:

- Combination of pin and clip.
- Offers optimal attachment and is ideal for use on textiles such as jackets or executives' garments.



### Applications for BASIC

- Thanks to the sturdy material with high quality printing, ideal for long term use.
- Elegant, discreet and representative design that fits perfectly in high-end surroundings like hotel & gastronomy, banks or trade-fair booths.
- The fastenings (magnet or combi clip) are designed for long-term use.
- Delivery of ready to use name badges after easy design and order process via the DURABLE BUSINESS onlineshop in Germany. For further information visit [www.durable-business.com](http://www.durable-business.com)

### The DURABLE onlineshop\* and further information:



[www.durable-business.com](http://www.durable-business.com)

### Original insert sizes

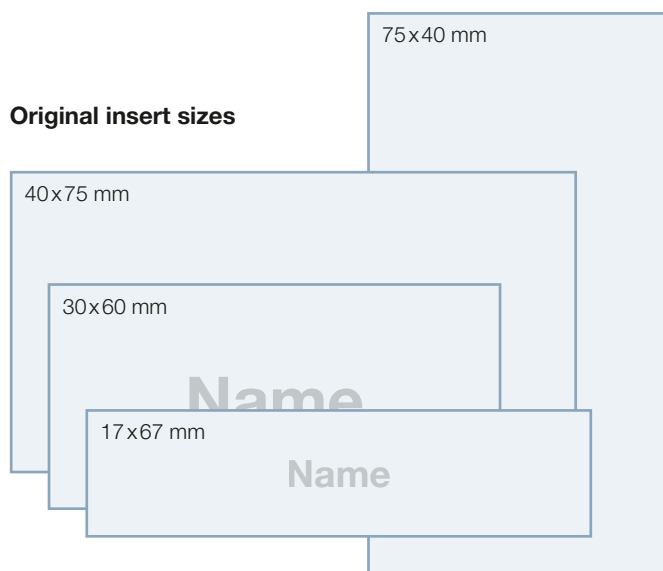

Personalized products are available in our (German) Onlineshop: [www.durable-business.com](http://www.durable-business.com)

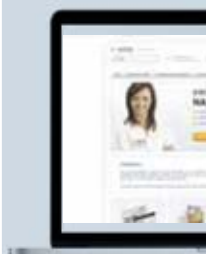

#### Overview of BASIC name badges

Name:	BASIC
Formats (HxW):	17x67 mm 30x60 mm 40x75 mm 75x40 mm
Fasteners:	magnet combi-clip
Colour code/colour:	01 black, 03 red, 04 yellow 07 dark blue, 10 grey 23 metallic silver
Style:	silk-matt, glossy



# SELECT

With their strikingly prominent black bar and highly transparent window, SELECT name badges highlight the personalities of their wearers in a very stylish way. This straightforward design signals professionalism combined with elegance and ensures the name is especially eye catching.



### Product advantages

■ A touch of elegance through the black bar.

■ Insert labels are protected behind the transparent window and can be exchanged quickly and easily.

■ Sturdy material.



## SELECT

- Name badge with black bar and transparent window
- With magnet or combi clip



### SELECT WITH MAGNET

- For a simple fastening that will not damage clothes
- Also for delicate fabrics
- Securely held by two magnets
- Internal dimensions: 17 x 67 mm

# 8505      🔥 01 black  
📦 25 per pack



### SELECT WITH MAGNET

- Internal dimensions: 30 x 60 mm

# 8507      🔥 01 black  
📦 25 per pack



### SELECT WITH COMBI CLIP

- With pin and clip fastening
- Internal dimensions: 30 x 60 mm

# 8506      🔥 01 black  
📦 25 per pack



### SMARTCLIP

- Elegant name badge with injection-moulded clip
- For easy fastening, e.g. on shirt collar, lapel or tie
- Format: 13 x 53 mm (H x W)

# 8126      🔥 57 anthracite/grey  
📦 25 per pack

## Features of SELECT

- Elegant bar in a muted colour fits perfectly into the ambience of banks and insurance companies.
- The slim badges (13x53 mm and 17x67 mm) can be printed with just a name
- Hardwearing, sturdy materials are ideal for long-term use.
- SMARTCLIP name badges (13x53 mm) can also be fastened laterally on lapels, on ties, or as an image bearer on shirt collars.



Printable with DURAPRINT®



DURAPRINT® video





# FRAME

The unpretentious FRAME name badges with their coloured frames offer maximum individuality. Once inserted, the view window fits snugly into the frame and signals openness and congenial discretion by its unusual U shape.

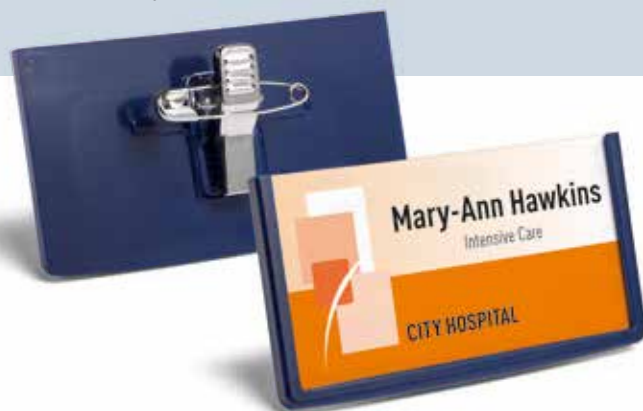

### Product advantages

■ The frame is available in four different colours, for example to distinguish between different departments.

■ Easy exchange of insert labels through frame which is open at the top.

■ Rounded corners.

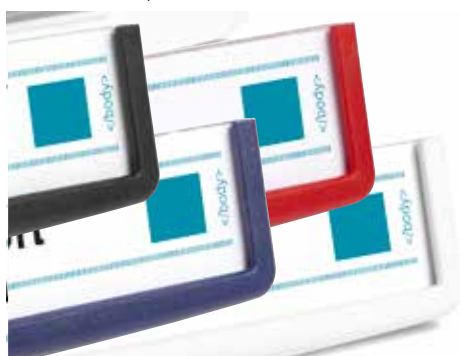

## FRAME

- Name badge with coloured frame
- Individually printable insert label, protected by transparent window
- With magnet or combi clip
- Ideal for making a distinction between different departments or groups



### FRAME WITH MAGNET

- For a simple fastening that will not damage clothes
- Also for delicate fabrics
- Securely held by two magnets
- Internal dimensions: 17 x 67 mm

# 8500      ▲ 01 black, 02 white, 03 red,  
📦 25 per pack      07 dark blue



### FRAME WITH MAGNET

- Internal dimensions: 30 x 60 mm

# 8502      ▲ 01 black, 02 white, 03 red,  
📦 25 per pack      07 dark blue



### FRAME WITH MAGNET

- Internal dimensions: 40 x 75 mm

# 8504      ▲ 01 black, 02 white, 03 red,  
📦 25 per pack      07 dark blue



### FRAME WITH COMBI CLIP

- With pin and clip fastening
- Internal dimensions: 30 x 60 mm

# 8501      ▲ 01 black, 02 white, 03 red, 07 dark blue  
📦 25 per pack



### FRAME WITH COMBI CLIP

- Internal dimensions: 40 x 75 mm

# 8503      ▲ 01 black, 02 white, 03 red, 07 dark blue  
📦 25 per pack

## Features of FRAME

- Different colours to distinguish between departments or positions.
- White badge particularly recommended for persons in healthcare services.
- Colours matching those of DURABLE CLICK SIGN door signs – for perfect combination.
- Hardwearing, sturdy materials.
- Frame holds insert label safely in place. Combi clip ensures optimal fixing, which is vital when fastened to doctors' or nurses' white coats in hospitals.



Printable with DURAPRINT®



DURAPRINT® video





# CLIP CARD

Rounded corners and smooth transitions between the frame and the view window make the insert labels of CLIP CARD name badges virtually disappear inside the basic frame. The coloured frame sets deliberate highlights to accentuate the name in an optimal way.



### Product advantages

Simple clip mechanism to fasten the viewing window.

Thumb slot at the back for quick, easy exchange of insert labels.

View window of 17x67 mm badges with magnifying effect.





## CLIP CARD

- Name badge with coloured frame
- With practical clip mechanism for easy exchange of inserts
- With several different fastening options



### CLIP CARD WITH MAGNET

- For a simple fastening that will not damage clothes
- Also for delicate fabrics.
- Securely held by two magnets.
- With convex, crystal-clear acrylic window with magnifying effect
- Internal dimensions: 17 x 67 mm (H x W)

# 8132      ♾ 01 black  
📦 25 per pack



### CLIP CARD WITH FLAT PIN

- With pin fastener
- With convex crystal-clear acrylic window with magnifying effect
- Internal dimensions: 17 x 67 mm (H x W)

# 8133      ♾ 01 black  
📦 25 per pack



### CLIP CARD ECO

- Name badge made of 70% sustainable raw materials
- Window made from at least 70% recycled polyethylene
- With combi clip
- Internal dimensions: 40 x 75 mm (H x W)

# 8140      ♾ 16 beige  
📦 25 per pack



### CLIP CARD WITH MAGNET

- For a simple fastening that will not damage clothes
- Also for delicate fabrics.
- Securely held by two magnets
- Internal dimensions: 40 x 75 mm (H x W)

# 8129      ♾ 01 black, 10 grey  
📦 25 per pack



### CLIP CARD WITH COMBI CLIP

- With a choice of pin or clip fastening.
- Internal dimensions: 40 x 75 mm (H x W)

# 8130      ♾ 01 black, 10 grey  
📦 25 per pack



### CLIP CARD WITH CLIP

- With rotating clip fastener
- Internal dimensions: 40 x 75 mm (H x W)

# 8131      ♾ 10 grey  
📦 25 per pack

## Features of CLIP CARD

- With rounded corners
- Premium-quality acrylic glass window of the small badges (17 x 67 mm) with magnifying effect for excellent readability of the name.
- The enclosing frame holds the insert label safely in place.
- Labels with safety pin or combi clip lend themselves in particular for use in healthcare services thanks to their optimal fixing.
- Name badges also available in a wood look, made of renewable materials (material: lignin).



Printable with DURAPRINT®



DURAPRINT® video





# CLICK FOLD

Timeless, minimalist design combined with ultimate functionality: CLICK FOLD name badges recommend themselves by their perfect wearing comfort, optimal readability and uniquely simple locking system.



### Product advantages

- One-part name badges made of hardwearing PP. Patented.
- Unique click mechanism for easy exchange of insert labels.
- Slightly convex form for excellent readability.

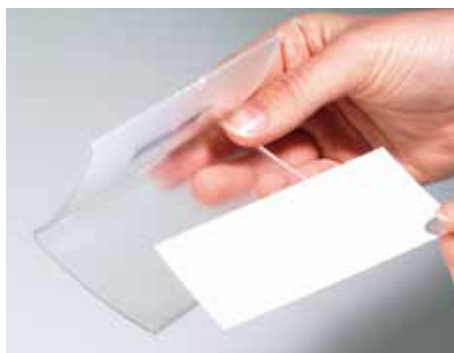

## CLICK FOLD

- Convex name badge made of PP in one piece
- Can be simply folded open to exchange inserts
- Available in two formats
- With several different fastening options

Patented



### CLICK FOLD WITH COMBI CLIP

- Internal dimensions: 54 x 90 mm (H x W)

# 8214      19 transparent  
📦 25 per pack

### CLICK FOLD WITH COMBI CLIP

- With a pin or clip fastening
- Internal dimensions: 40 x 75 mm (H x W)

# 8211      19 transparent  
📦 25 per pack

### CLICK FOLD WITH COMBI CLIP

- Internal dimensions: 54 x 90 mm (H x W)

# 8693      19 transparent  
📦 Small package 5 per pack



### CLICK FOLD WITH MAGNET

- For simple fastening that will not damage clothes
- suitable for use on delicate fabrics
- Securely held by two magnets
- Internal dimensions: 40 x 75 mm (H x W)

# 8212      19 transparent  
📦 10 per pack

### CLICK FOLD WITH MAGNET

- Internal dimensions: 54 x 90 mm (H x W)

# 8215      19 transparent  
📦 10 per pack



### CLICK FOLD BADGE WITH TEXTILE NECKLACE

- With 20 mm-wide textile necklace with safety lock
- Opens if trapped or caught
- Loops on the reverse allows combination with chain or ID card holder
- Internal dimensions: 54 x 90 mm (H x W)
- Length: 44 cm

# 8217      19 transparent  
📦 10 per pack



### CLICK FOLD WITH CLIP

- With rotating clip fastener
- Loops on the reverse allows combination with chain, textile necklace or ID card holder
- Internal dimensions: 54 x 90 mm (H x W)

# 8216      19 transparent  
📦 25 per pack

## Features of CLICK FOLD

- Ideal for major events thanks to easy exchange of insert labels.
- Quick and easy to prepare.
- The enclosing frame ensures that the insert label cannot slip out of place.
- Can be used for a great variety of application areas, such as conferences, meetings, seminars or trade fairs - for stand personnel and visitors.



Printable with DURAPRINT®



DURAPRINT® video

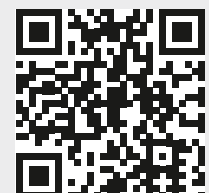



# UNIVERSAL

These name badges made of hard film stand out by their clear, slender lines and the high functionality of every single variant. They are virtually unbeatable in terms of variety and suitable for quick, flexible use at any time.



### Product advantages

■ Thumb slot at the back for easy removal of insert labels.



■ Pin with covered tip – safe and without risk of injury.



■ Open and closed version.





Printable with DURAPRINT®

**NAME BADGE WITH PIN**

- With pin attachment
- Internal dimensions: 40 x 75 mm (H x W)

# 8601 19 transparent  
📦 Small package 5 per pack

# 8001 19 transparent  
📦 100 per pack

**NAME BADGE WITH PIN**

- With curved pin.
- Internal dimensions: 30 x 60 mm (H x W)

# 8006 19 transparent  
📦 100 per pack

# 8606 19 transparent  
📦 Small package 10 per pack



**NAME BADGE WITH PIN**

- With curved pin
- Internal dimensions: 40 x 60 mm (H x W)

# 8100 19 transparent  
📦 100 per pack

**NAME BADGE WITH PIN**

- With curved pin.
- Internal dimensions: 40 x 75 mm (H x W)

# 8008 19 transparent  
📦 100 per pack

# 8608 19 transparent  
📦 Small package 10 per pack

**NAME BADGE WITH PIN**

- With curved pin.
- Internal dimensions: 54 x 90 mm (H x W)

# 8004 19 transparent  
📦 50 per pack

# 8604 19 transparent  
📦 Small package 10 per pack



**NAME BADGE SET WITH PIN 40 X 60 MM**

- Fastening: Pin
- Internal dimensions: 40 x 60 mm (H x W)
- Number of name badges: 20

# 8696 00 assorted  
📦 20 per set

**NAME BADGE SETS**

- Fastening: Pin
- Internal dimensions: 40 x 75 mm (H x W)
- Number of name badges: 20

# 8180 00 assorted  
📦 20 per set

**NAME BADGE SET WITH PIN 54 X 90 MM**

- Fastening: Pin
- Internal dimensions: 54 x 90 mm (H x W)
- Number of name badges: 20

# 8697 00 assorted  
📦 20 per set

## Name Badges and Signage



### NAME BADGE WITH MAGNET

- Simple fastening that will not damage clothes
- Also for delicate fabrics
- Securely held by two magnets
- With tuck-in flap for shirt or breast pocket
- Internal dimensions: 40 x 75 mm (H x B)
- Internal dimensions: 54 x 90 mm (H x B)

# 8116    19 transparent  
 ☞ 25 per pack

# 8117    19 transparent  
 ☞ 25 per pack



### CROCODILE CLIP NAME BADGE

- With rotating crocodile clip and tuck-in flap for attaching to shirts or breast pockets.
- Internal dimensions: 40 x 75 mm (H x B)
- Internal dimensions: 54 x 90 mm (H x B)

# 8110    19 transparent  
 ☞ 25 per pack

# 8111    19 transparent  
 ☞ 25 per pack



### NAME BADGE WITH COMBI CLIP

- With pin or clip fastening
- Internal dimensions: 54 x 90 mm (H x B)

# 8101    19 transparent  
 ☞ 50 per pack

# 8610    19 transparent  
 ☞ Small package 5 per pack



### NAME BADGE WITH COMBI CLIP

- Pin or clip fastening
- Internal dimensions: 40 x 75 mm (H x B)

# 8157    19 transparent  
 ☞ 50 per pack

# 8694    19 transparent  
 ☞ Small package 5 per pack



### NAME BADGE SET WITH COMBI CLIP

- Complete solution for quick and perfect organisation
- Name badge set with 20 name badges with combi clip fastening
- With 3 PC-printable BADGEMAKER insert label sheets
- Easy professional labelling of the name badges with the free DURAPRINT software available from [www.duraprint.eu](http://www.duraprint.eu)

# 8699    00 transparent  
 ☞ 20 per set



### NAME BADGE SETS

- Fastening: Combi Clip
- Internal dimensions: 54 x 90 mm (H x W)
- Number of name badge: 20
- Number of sheets: 3 sheets (10 badges/sheet.)

# 8182    00 assorted  
 ☞ 20 per set



**NAME BADGE WITH CLIP**

- With rotating clip fastener
- Closed design to protect the insert
- Clip cut-out allows combination with chain, badge reel or textile necklace
- Internal dimensions: 90 x 60 mm (H x B)

# 8002    19 transparent  
 25 per pack

- Internal dimensions: 60 x 90 mm (H x B)

# 8003    19 transparent  
 25 per pack



**NAME BADGE WITH CLIP**

- With rotating clip
- Closed design to protect the insert
- Combine with a chain, badge reel or textile necklace
- Internal dimensions: 60 x 90 mm (H x B)

# 8603    19 transparent  
 Small package 5 per pack



**NAME BADGE WITH CLIP**

- With rotating clip fastener.
- Open design for quick removal of insert.
- Clip cut-out allows combination with chain, badge reel or textile necklace
- Internal dimensions: 60 x 90 mm (H x B)

# 8106    03 red, 06 blue, 19 transparent  
 25 per pack

- Internal dimensions: 90 x 60 mm (H x B)

# 8107    19 transparent  
 25 per pack



**NAME BADGE WITH CLIP**

- With rotating clip
- Open design allows quick replacement of inserts
- Combine with chain, badge reel or textile necklace
- Internal dimensions: 60 x 90 mm (H x B)

# 8612    19 transparent  
 Small package 5 per pack



**NAME BADGE SET WITH CLIP 60 X 90 MM**

- Fastening: Clip
- Internal dimensions: 60 x 90 mm (H x W)
- Number of name badges: 20
- Number of sheets: 4 sheets

# 8695    00 assorted  
 20 per set



**NAME BADGE SETS**

- Fastening: Clip
- Internal dimensions: 60 x 90 mm (H x B)
- Number of name badges: 20
- Number of sheets: 4 sheets (8 badges/sheet.)

# 8181    00 assorted  
 20 per set



**WWW.  
DURABLE-  
IDENTITY  
.COM**



## NAME BADGE WITH HEAVY DUTY BADGE REEL

- Closed design to protect the insert
- Combined with a badge reel
- With a metal clip on the reverse and snap button strap
- Internal dimensions: 60 x 90 mm (H x W)
- Length: 80 cm

# 8138    19 transparent  
 ☞ 10 per pack



## SECURITY NAME BADGE

- Closed design to protect the insert
- Clip cut-out allows combination with chain, clip, badge reel or textile necklace
- Internal dimensions: 60 x 90 mm (H x W)

# 8135    19 transparent  
 ☞ 20 per pack



## SECURITY NAME BADGE

- Closed design for quick removal of insert
- Clip cut-out allows combination with chain, clip, badge reel or textile necklace
- Internal dimensions: 60 x 90 mm (H x W)

# 8136    19 transparent  
 ☞ 20 per pack



## NAME BADGE WITH TEXTILE BADGE NECKLACE 10

- Open design for quick removal of insert
- Combined with a 10 mm-wide textile necklace
- With safety lock which opens if trapped or caught
- Internal dimensions: 60 x 90 mm (H x W)
- Length: 44 cm

# 8139    01 black, 03 red, 07 dark blue, 10 grey  
 ☞ 10 per pack



## NAME BADGE WITH TEXTILE BADGE NECKLACE 20

- Closed design to protect the insert
- With 20mm textile necklace with safety clip that opens if caught
- Internal dimensions: 60 x 90 mm (H x B)
- Length: 44 cm

# 8600    01 black  
 ☞ Small package 5 per pack



## EVENT NAME HOLDER A6 WITH TEXTILE NECKLACE DUO

- Event name badge made of PP film with 20 mm-wide textile necklace.
- Fastening with two snap hooks
- Ideal for equipping large numbers of people (at conferences, trade fairs, conventions)
- Insert label in A6 format

# 8525    01 black, 07 dark blue  
 ☞ 10 per pack



## EVENT NAME HOLDER A6

- Event name badge made of PP film
- Portrait format with Euro punching and punching for double fastening
- Ideal for equipping large numbers of people at major events (conferences, trade fairs, conventions)
- Can be combined with DURABLE textile necklaces, badge reels and chains
- Insert label in A6 format

# 8526    19 transparent  
 ☞ 10 per pack





#### LAMINATING NAME BADGE WITH COMBI CLIP

- Transparent self laminating name badge
- With self-adhesive combi clip
- Ideal for quick lamination of business cards or ID cards up to 54 x 90 mm
- Can be used in either portrait or landscape format

# 8230    19 transparent  
 25 per pack



#### LAMINATED NAME BADGE

- With rotating clip fastener
- For rapid self-lamination of business cards and ID cards in 54 x 90 mm format (H x W)

# 8102    19 transparent  
 25 per pack

#### BADGEFIX

- Self-adhesive name badge made of acetate silk
- Printable with laser printers and copiers.
- Not suitable for silk, suede, leather and sensitive textiles.

#### BADGEFIX

- Format: 30 x 60 mm. Contents: 540 units

# 8333    02 white  
 20 sheets per pack

#### BADGEFIX

- Format: 40 x 75 mm. Contents: 240 units

# 8334    02 white  
 20 sheets per pack



#### TEXTILE NAME BADGE

- Self adhesive and can be written on
- With coloured frame
- Not suitable for silk or leather
- Internal dimensions: 30 x 60 mm (H x B)

# 8605    06 blue  
 50 per pack

#### VISITOR BOOK

- Visitor book for maximum security
- For smooth coordination of visits
- Provides overview of visitors to the company
- Easy administration of visitors' passes

#### VISITORS BOOK 100

- Visitors book for 100 name badges
- Ideal for making visitor passes
- Confidential recording of visitor data thanks to three-part, micro-perforated set of papers
- Includes a form for entering departure time
- Format of insert labels: 90 x 60 mm (W x H)

# 1463    61 German  
 1 unit



#### VISITORS BOOK 100 REFILL

- Refill for VISITORS BOOK 100
- For 100 name badges

# 1464    61 German  
 1 unit

#### VISITORS BOOK 300

- Visitors book for 300 name badges
- Ideal for making visitor passes
- Confidential capturing of visitor data thanks to three-part, micro-perforated set of papers
- Includes a form for entering departure time
- Format of insert labels: 90 x 60 mm (W x H)

# 1465    00 assorted  
 1 piece

#### VISITORS BOOK 300 REFILL

- Refill for VISITORS BOOK 100
- For 300 name badges

# 1466    00 assorted  
 1 piece



# ACCESSORIES

Whether it be badge reels, textile necklaces, clips or chains, high wearing comfort combined with proven mechanisms makes the flexible fastening devices ideal companions for all kinds of ID cards and name badges. Accessory products can be combined with all DURABLE name badge models which are fitted with a clip slot.





**TEXTILE NECKLACE/LANYARD 10 WITH SAFETY RELEASE**

- 10 mm-wide textile necklace
- With safety lock which will open if the necklace gets trapped or caught
- Clip enables combination with all DURABLE name badges that either have a punched hole for a clip or a pin
- Length: 44 cm

# 8119    01 black, 03 red, 07 dark blue, 10 grey  
 10 per pack

**TEXTILE NECKLACE/LANYARD WITH BADGE REEL AND SNAP HOOK**

- 10 mm-wide textile necklace
- With safety lock which will open if the necklace gets trapped or caught
- Combined with a badge reel and spring hook
- May be used with all DURABLE name badges that have either a punched hole for a clip or a pin
- Length of ribbon: 44 cm
- Length of badge reel: 80 cm

# 8223    01 black  
 10 per pack



**TEXTILE NECKLACE/LANYARD 20 WITH SAFETY RELEASE**

- 20 mm-wide textile necklace
- With safety lock which will open if the necklace gets trapped or caught
- Clip enables combination with all DURABLE name badges that either have a punched hole for a clip or a pin
- Length: 44 cm

# 8137    01 black, 03 red, 04 yellow, 05 green, 07 dark blue  
 10 per pack

**20-MM-WIDE TEXTILE NECKLACE, RETAIL PACK**

# 8682    01 black, 03 red, 07 dark blue  
 1 unit

**TEXTILE NECKLACE DUO**

- 20 mm-wide textile necklace
- With two snap hooks
- Length: 100 cm

# 8527    01 black, 07 dark blue  
 10 per pack

**TEXTILE NECKLACE**

- Printed textile ribbons
- With safety lock and snap hook
- Printed individually, e.g. with company logo or name
- Perfect advertising media for trade fairs and other events
- Small production runs from 100 units
- Further information and quotes upon request



**WWW.  
DURABLE-  
BUSINESS  
.COM**

## Name Badges and Signage

### BADGE REEL

- Badge reels with roll-up mechanism
- For quick access to safety and access control passes
- Can be combined with all DURABLE name badges or ID card holders with clip punching
- With several different fastening options



#### BADGE REEL WITH SNAP HOOK

- With plastic crocodile clip on reverse
- With spring hook
- Length: 80 cm

# 8221    ♪ 58 charcoal  
 ☞ 10 per pack



#### BADGE REEL WITH SNAP BUTTON

- With metal clip fastening mechanism and secured by press fastener.
- Length: 80 cm

# 8226    ♪ 58 charcoal  
 ☞ 1 unit  
 # 8152    ♪ 58 charcoal  
 ☞ 10 per pack



#### BADGE REEL WITH KEY RING

- With plastic crocodile clip on reverse
- With key ring.
- Ring diameter: 25 mm
- Length: 80 cm

# 8227    ♪ 58 charcoal  
 ☞ 1 per box  
 # 8222    ♪ 58 charcoal  
 ☞ 10 per pack



#### BADGE REEL STYLE

- With adjustable textile necklace (up to 90 cm)
- With safety lock
- Opens if trapped or caught
- With press fastener
- Length: 60 cm

# 8229    ♪ 01 black  
 ☞ 10 per pack



#### BADGE REEL CHROME

- Chrome badge reel
- With extra-strong metal clip fastening mechanism on reverse
- With press fastener
- Size Ø: 40 mm
- Length: 80 cm

# 8228    ♪ 23 metallic silver  
 ☞ 1 unit  
 # 8225    ♪ 23 metallic silver  
 ☞ 10 per pack



**JOJO STYLE**

- Oval badge reel
- With metal clip fastener
- With snap button strap
- May be combined with all DURABLE name badges or security pass holders that either have a punched hole for a clip or a pin
- Length: 80 cm

# 8324    01 black, 07 dark blue, 10 grey  
 10 per pack



**BADGE REEL STYLE WITH SPRING HOOK**

- Length: 80 cm

# 8327    01 black, 03 red, 04 yellow, 05 green, 07 dark blue, 10 grey, 12 light purple  
 1 unit



**BADGE REEL CHROME QUADRO**

- Chrome square badge reel
- With extra-strong metal clip fastening mechanism on reverse
- With snap button strap
- May be combined with all DURABLE name badges or security pass holders that either have a punched hole for a clip or a pin
- Length: 80 cm

# 8325    23 metallic silver  
 10 per pack

**BADGE REEL CHROME QUADRO**

- Length: 80 cm

# 8328    23 metallic silver  
 1 unit



**BADGE REEL STYLE LED WITH KEY RING**

- Oval badge reel
- With metal clip
- With key ring
- Bright LED light highlights key holes in the dark
- Length: 80 cm

# 8198    01 black  
 1 unit



**CLIP**

- With rotating clip fastener
- For combination with all DURABLE name badges and security pass holders that have a clip or a pin

# 8103    26 nickel  
 25 per pack



**CHAIN FOR NAME BADGES**

- With press down fastener
- Combine with virtually all DURABLE name badges
- Length: 85 cm

# 8104    23 metallic silver  
 10 per bag





# TABLE PLACE NAME HOLDERS

Making the best impression: the elegant table place name holders from DURABLE signal professionalism and competence at press conferences, training sessions, conventions, trade fairs and at the reception desk.



Printable with DURAPRINT®



DURAPRINT® video



### DESK PRESENTER DE LUXE

- High quality table place name holder
- Made from crystal clear acrylic and aluminium
- A clamping system ensures that the acrylic plate fits securely
- Inserts are easy to insert and replace
- For conferences, receptions and counters and for price notices in shop windows and sales areas

Patented



Code	Colour	Inserts	Packing
8200	19 transparent	52/104 x 100 mm	2 per pack
8201	19 transparent	61/122 x 150 mm	2 per pack
8202	19 transparent	61/122 x 210 mm	2 per pack
8203	19 transparent	105/210 x 297 mm	1 per pack
8204	19 transparent	149/298 x 420 mm	1 per pack



### Product advantages

- Unique design with sturdy aluminium base and crystal-clear acrylic.



- Highly transparent surface for optimal readability.



- Easy exchange of insert labels.

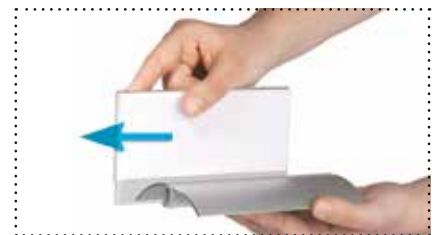

### TABLE PLACE NAME HOLDER PLUS

- Table place name holder in XXL format
- With pen tray
- Ideal for large rooms
- Can be placed upright or hung over the edge of the table
- Dimensions of the insert label: 148.5 x 420 mm (H x W)

# 8058    19 transparent  
2 per pack



### ACRYLIC TABLE PLACE NAME HOLDER

- Stable L presenter. Made of crystal-clear acrylic
- Dimensions of insert labels: 52 x 100 mm (H x W)

Code	Colour	Inserts	Packing
8055	19 transparent	52 x 100 mm	10 per pack
8054	19 transparent	61 x 150 mm	10 per pack
8031	19 transparent	61 x 210 mm	10 per pack



- Crystal-clear surface. High stability thanks to long base.



## Name Badges and Signage



### TABLE PLACE NAME HOLDER

- Tent presenter for inscription on both sides

Code	Colour	Inserts	Packing
8051	19 transparent	52/104 x 100 mm	25 per pack
8050	19 transparent	61/122 x 150 mm	25 per pack
8052	19 transparent	61/122 x 210 mm	25 per pack
8053	19 transparent	105/210 x 297 mm	25 per pack
8036	19 transparent	150/300 x 297 mm	5 per pack



### R-PET TABLE PLACE NAME HOLDER

- Table place name holder made from recycled polyethylene
- Tent form for labelling on both sides
- At least 70% recycled material
- Dimensions: 61/122 x 150 mm

# 8270    19 transparent  
 25 per pack



### TABLE PLACE NAME HOLDER

- Stable tent presenter for inscription on both sides

Code	Colour	Inserts	Packing
8032	19 transparent	52/104 x 100 mm	10 per pack
8033	19 transparent	61/122 x 150 mm	10 per pack
8034	19 transparent	61/122 x 210 mm	10 per pack
8035	19 transparent	105/210 x 297 mm	10 per pack



### R-PET TABLE PLACE NAME HOLDER

- Table place name holder made from recycled polyethylene
- Tent form for labelling on both sides
- At least 70% recycled material
- Dimensions: 61/122 x 210 mm

# 8271    19 transparent  
 25 per pack

### Product advantages

- Highly transparent surface for optimal readability from both sides.
- Easy exchange of insert labels.
- High stability.





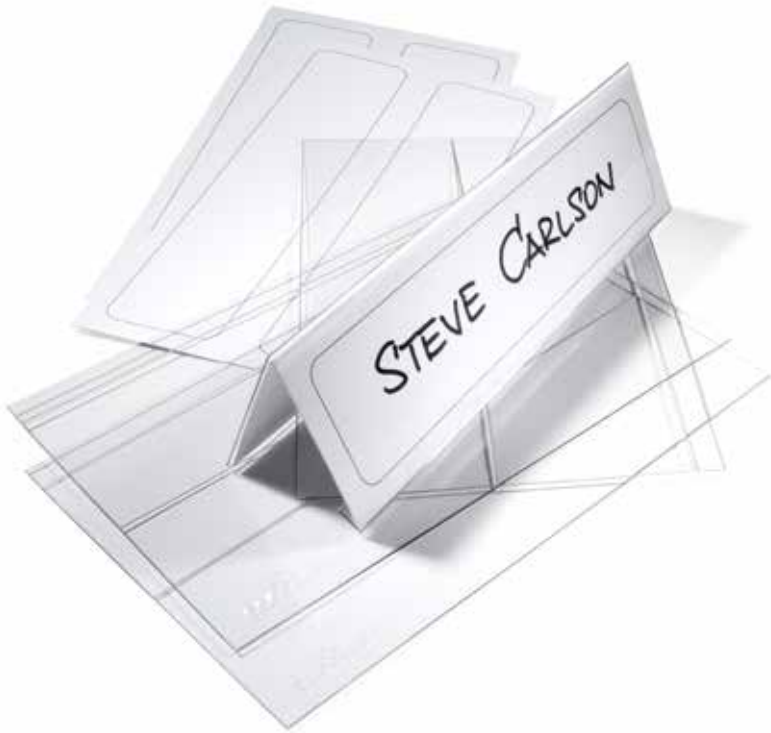

**Product advantages**

■ Roof-shaped design for labelling on both sides.



■ Can be folded open for storage to save space.



**PET TABLE PLACE NAME HOLDER**

- Pre-folded and flat
- Made from polyethylene
- To set up in tent form
- Dimensions of insert labels: 52/104 x 100 mm (H x W)

# 8047     ▲ 19 transparent  
📦 10 per bag

**PET TABLE PLACE NAME HOLDER**

- Pre-folded and flat
- Made from polyethylene
- To set up in tent form
- Dimensions of insert labels: 61/122 x 210 mm (H x W)

# 8048     ▲ 19 transparent  
📦 10 per bag



**WWW.  
DURABLE-  
IDENTITY  
.COM**



**ACRYLIC TABLE NAME HOLDER FOR TABLET PCS**

- Premium-quality tablet PC holder and table place name holder
- Made of crystal-clear acrylic
- Easy upright insertion and removal of tablet PCs
- With printing label
- Optimal reading and presentation angle
- For conventions, conferences, symposia and training sessions
- Dimensions: 210 x 83 x 138 mm (H x W)

# 8029     ▲ 19 transparent  
📦 1 unit

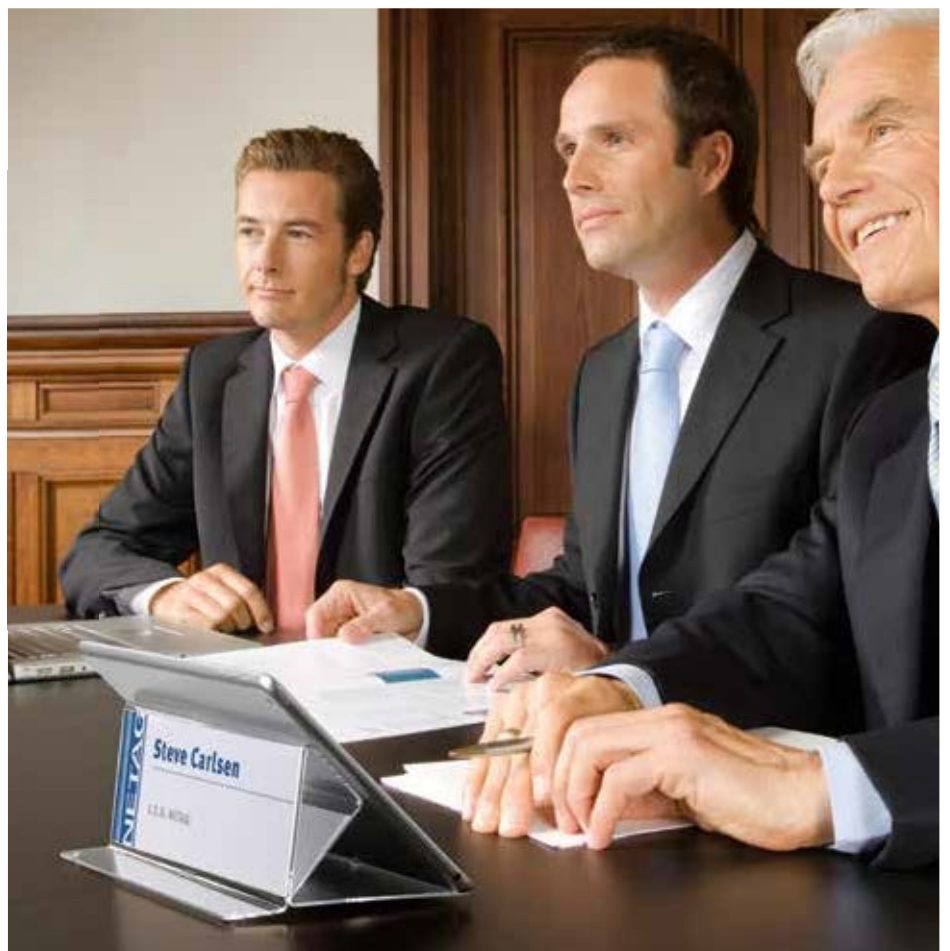



# BADGEMAKER® INSERT LABELS

The micro-perforated BADGEMAKER® insert labels make labelling child's play, thus lending themselves as the perfect companions for all name badge and table place name holder models from DURABLE.

DURAPRINT® & BADGEMAKER® – an unbeatable team!



### DURAPRINT® printing software:

There is no easier way! Design and professionally print – with the free DURAPRINT® software, personal designs can be prepared, printed out and saved for later use in next to no time. With the practical database function, names, pictures, etc. can be transferred into ready-made designs for major events with just a few clicks.

[www.duraprint.eu](http://www.duraprint.eu)

## BADGEMAKER

- Micro-perforated insert labels in A4 format
- For professional printing of name badges
- Suitable for laser and ink jet printers or copiers
- Easy design through free software with database function available from [www.duraprint.eu](http://www.duraprint.eu)
- BADGEMAKER® inserts for table place name holders can also be used separately as place cards.



### FOR NAME BADGES

Prod. Code	Col.Code/Colour	Insert size (H x W)	Packing	Inserts per pack
1422	02 white	30 x 65 mm for product code 8525, 8526	1 pack	80
1423	02 white	30 x 65 mm for product code 8540, 8541	1 pack	360
1425	02 white	34 x 74 mm for product code 8542, 8543	1 pack	280
1449	02 white	13 x 53 mm for product code 8126	1 pack	600
1461	02 white	17 x 67 mm for product code 8132, 8133	1 pack	600
1451	02 white	30 x 60 mm for product code 8006, 8606	1 pack	540
1452	02 white	40 x 60 mm for product code 8100	1 pack	360
1453	02 white	40 x 75 mm for product code 8001, 8008, 8110, 8116, 8120, 8121, 8122, 8123, 8124, 8128, 8157, 8180, 8210, 8211, 8212, 8601, 8608, 8694	1 pack	240
1454*	02 white	40 x 75 mm for product code 8129, 8130, 8131, 8140	1 pack	240
1455	02 white	54 x 90 mm for product code 8004, 8101, 8102, 8111, 8117, 8182, 8213, 8214, 8215, 8216, 8217, 8604, 8610, 8693	1 pack	200
1456	02 white	60 x 90 mm for product code 8003, 8106, 8135, 8136, 8138, 8139, 8181, 8600, 8603, 8612	1 pack	160
1457	02 white	90 x 60 mm for product code 8002, 8107	1 pack	180

1427	02 white	-> 1453
1428	02 white	-> 1455
1429	02 white	-> 1456

20 sheets per pack \* with rounded corners

# RECYCLED



### FOR TABLE PLACE NAME HOLDERS

Prod. Code	Col.Code/Colour	Insert size (H x W)	Packing	Inserts per pack
1458	02 white	52/104 x 100 mm for product code 8032, 8047, 8051, 8055, 8200	1 pack	40
1459	02 white	61/122 x 150 mm for product code 8033, 8050, 8054, 8201, 8270	1 pack	40
1460	02 white	61/122 x 210 mm for product code 8031, 8034, 8048, 8052, 8202, 8271	1 pack	20
1471	02 white	75/130 x 210 mm for product code 8029	1 pack	40
1480*	02 white	150/300 x 297 mm for product code 8036	1 pack	10
4856	02 white	105/210 x 297 mm for product code 8035, 8203, 8053	1 pack	10

20 sheets per pack \*10 sheets per pack

BADGEMAKER® inserts for table name holders can also be used separately as place cards.



# DOOR SIGNS

Showing visitors and customers the right way. DURABLE signage systems offer a wide range of door signs and direction signs which are available in an extensive range of designs, sizes and finishes.





## CRYSTAL SIGN

- CRYSTAL SIGN range of acrylic door signs in 7 different formats
- Easy exchange of inserts by separating the two acrylic plates
- Suitable for use in offices, conference rooms, lobbies and many other types of formal interiors
- For screwing on, including assembly kit, drilling template and instructions
- Matching PC-printable inserts to be ordered separately
- Free template software available from [www.duraprint.eu](http://www.duraprint.eu)

Patented



Can be fastened with only two screws.



4820-19



4821-19



4822-19



4823-19



4824-19



4825-19



4826-19

## CRYSTAL SIGN

Product Code	Col.Code/Colour	Packing	Dimensions W x H*
4820	19 transparent	1 per box	105 x 105 mm
4821	19 transparent	1 per box	148 x 105 mm
4822	19 transparent	1 per box	148 x 148 mm
4823	19 transparent	1 per box	210 x 148 mm
4824	19 transparent	1 per box	210 x 210 mm
4825	19 transparent	1 per box	210 x 297 mm (A4 portrait)
4826	19 transparent	1 per box	297 x 420 mm (A3 portrait)

\*size of insert



**WWW.  
DURAPRINT  
.EU**



## CRYSTAL SIGN STAND

- Aluminium stand with heavy cast-iron base
- Crystal clear acrylic "CRYSTAL SIGN" for materials in A4 or A3 formats
- incl. 2 semi-translucent, PC-printable sheets
- For use in either portrait or landscape format
- Ergonomic reading thanks to height adjustability and rotation of reading angle by 10 degrees
- Can be combined with A4 brochure presenter (product # 4864) or 1/3 A4 (product # 4865)
- Instructions for easy assembly included

Patented



### CRYSTAL SIGN STAND A4

- Transparencies in A4 format available separately (product # 4835)
- Height A4 portrait: 1.18 m/1.11 m
- Height A4 landscape: 1.13 m/1.06 m

# 4818    23 metallic silver  
 1 unit



### CRYSTAL SIGN STAND A4

- Transparencies in A3 format available separately (product # 4837)
- Height A3 portrait: 1.25 m/1.18 m
- Height A3 landscape: 1.20 m/1.13 m

# 4819    23 metallic silver  
 1 unit

### CRYSTAL SIGN REFILL

- PC-printable A4 sheets with microperforation
- Suitable for use with colour and black-and-white laser printers
- Labelling templates available free of charge from [www.duraprint.eu](http://www.duraprint.eu)

Product Code	Col. Code/Colour	Contents	Packing
4830	19 transparent	10 sheets (40 sign inserts) for # 4820	1 bag
4831	19 transparent	10 sheets (20 sign inserts) for # 4821	1 bag
4832	19 transparent	10 sheets (20 sign inserts) for # 4822	1 bag
4833	19 transparent	10 sheets (10 sign inserts) for # 4823	1 bag
4834	19 transparent	10 sheets (10 sign inserts) for # 4824	1 bag
4835	19 transparent	10 sheets (10 sign inserts) for # 4825	1 bag
4836	19 transparent	10 sheets (10 sign inserts) for # 4826	1 bag



## INFO SIGN

- INFO SIGN door sign range made of aluminium in 9 formats
- Easy exchange of card inserts by sliding out the non-reflective acrylic panel
- Suitable for use in offices, conference rooms, lobbies and many other formal interiors
- For screwing on to walls
- With assembly kit, drilling template and instructions
- Matching PC-printable transparent inserts to be ordered separately
- Free printing templates available from [www.duraprint.eu](http://www.duraprint.eu)



4800-23



4801-23



4802-23



4805-23



4803-23



4806-23



4807-23



4804-23



4808-23

Patented

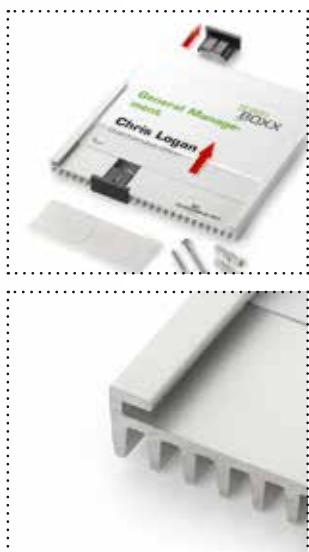

With adhesive pads enclosed.

## INFO SIGN STAND

- Aluminium stand and heavy cast-iron base
- Crystal-clear "INFO SIGN" acrylic sign with aluminium finish for materials in A4 or A3 format
- Can be used in either portrait or landscape format
- Ergonomic reading through height adjustability and rotation or the reading angle by 10 degrees
- Can be combined with A4 brochure presenter (product # 4864) or 1/3 A4 (product # 4865)
- Free template software available from [www.duraprint.eu](http://www.duraprint.eu)
- Instructions for easy assembly included



Patented

### INFO SIGN STAND A4

- Matching PC-printable insert labels for A4 format (product # 4856) available separately
- Height A4 portrait: 1.18 m/1.11 m
- Height A4 landscape: 1.13 m/1.06 m

# 4812    23 metallic silver  
 1 unit

### INFO SIGN STAND A3

- Height A3 portrait: 1.25 m/1.18 m
- Height A3 landscape: 1.20 m/1.13 m

# 4813    23 metallic silver  
 1 unit

## INFO SIGN

Code	Colour	Packing	Dimensions W x H*
4800	23 silver	1 per box	149 x 52,5 mm
4801	23 silver	1 per box	149 x 105,5 mm
4802	23 silver	1 per box	149 x 148,5 mm
4803	23 silver	1 per box	149 x 210,5 mm
4804	23 silver	1 per box	149 x 297 mm
4805	23 silver	1 per box	210 x 148,5 mm
4806	23 silver	1 per box	210 x 297 mm (A4 portrait)
4807	23 silver	1 per box	297 x 210 mm (A4 landscape)
4808	23 silver	1 per box	297 x 420 mm (A3 portrait)

\*size of insert

## INFO SIGN REFILL CAPS

- Replacement caps for INFO SIGN door signs and floor stands

# 4816    01 black    5 per bag

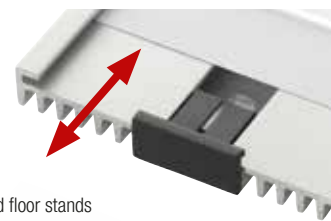

## DOOR SIGN REFILL

- PC-printable A4 sheets with micro perforation for door signs
- Suitable for use with laser and inkjet printers or copiers

Code	Colour	Contents	Packing
4850	02 white	10 sheets (50 sign inserts) for # 4800	1 bag
4851	02 white	10 sheets (20 sign inserts) for # 4801	1 bag
4852	02 white	10 sheets (20 sign inserts) for # 4802	1 bag
4853	02 white	10 sheets (10 sign inserts) for # 4803	1 bag
4854	02 white	10 sheets (10 sign inserts) for # 4804	1 bag
4855	02 white	10 sheets (10 sign inserts) for # 4805	1 bag
4856	02 white	10 sheets (10 sign inserts) for # 4806	1 bag
4856	02 white	10 sheets (10 sign inserts) for # 4807	1 bag



## CLICK SIGN

- CLICK SIGN range of plastic door signs in 5 different formats
- Choice of 4 different colours for distinction between different departments
- Easy exchange of inserts through complete extraction of the viewing window
- Suitable for large-scale applications such as in educational institutions, hospitals, restaurants, etc.
- For screwing or, alternatively, gluing on.
- With assembly kit, drilling template and instructions.
- Matching PC-printable cardboard inserts to be ordered separately
- Name badges in matching colours available
- Free template software available from [www.duraprint.eu](http://www.duraprint.eu)

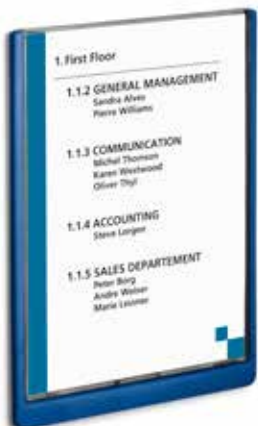

4867

Insert easy to exchange, without dismantling.



4866



4862



4861



4860



**WWW.  
DURAPRINT  
.EU**

## CLICK SIGN

Code	Colour	Packing	Dim. W x H*
4860	02 white, 03 red, 07 dark blue, 37 graphite	1 per box	149 x 52,5 mm
4861	02 white, 03 red, 07 dark blue, 37 graphite	1 per box	149 x 105,5 mm
4862	02 white, 03 red, 07 dark blue, 37 graphite	1 per box	149 x 148,5 mm
4866	02 white, 03 red, 07 dark blue, 37 graphite	1 per box	210 x 148,5 mm
4867	02 white, 03 red, 07 dark blue, 37 graphite	1 per box	210 x 297 mm

\*size of inserts.

## DOOR SIGN REFILL

- PC-printable A4 sheets with micro perforation for door signs
- Suitable for use with laser and inkjet printers or copiers

Code	Colour	Contents	Packing
4850	02 white	10 sheets (50 sign inserts for # 4860)	1 bag
4851	02 white	10 sheets (20 sign inserts for # 4861)	1 bag
4852	02 white	10 sheets (20 sign inserts for # 4862)	1 bag
4855	02 white	10 sheets (20 sign inserts for # 4866)	1 bag
4856	02 white	10 sheets (10 sign inserts for # 4867)	1 bag







# FLOOR STANDS

Floor stands from DURABLE are suitable for use at any time, since they are easy to move around, offering visitors and guests reliable information. The extensive choice of designs and variations can be used as brochure presenters or carriers of information in A3 or A4, portrait or landscape formats ensuring a suitable product for multiple uses.

## COMBIBOXX STAND

- Rotatable table and floor stands with high-quality aluminium frames
- For brochures in A4 and A6/DIN long formats
- Rotation elements with ball bearings facilitate easy rotation of the brochure presenters



## COMBIBOXX STAND A4 L

- Rotating floor stand with 30 literature display trays for presenting information in A4 format up to 311 x 240 mm.
- 15 trays are mounted on each of the two levels.
- Both levels can be rotated separately.
- 5 twin castors allow easy manoeuvrability
- Firm position thanks to weighted base and two locking devices
- Total height: approx. 178 cm

# 8616    ▲ 19 transparent  
📦 1 unit

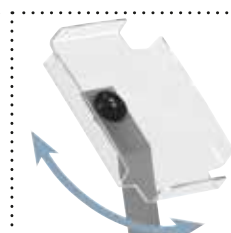

## DISPLAY STAND A4

- Aluminium floor stand with weighted, cast-iron base
- Crystal-clear acrylic literature display tray in 315 x 223 mm format
- Filling capacity: 35 mm
- Can be rotated from portrait to landscape format
- Ergonomic reading angle of 30°
- Can be combined with brochure presenter A4 (product # 4864) or 1/3 A4 (product # 4865)
- Easy assembly thanks to assembly instructions
- Height A4 portrait/landscape: 1.05 m

# 4863    ▲ 23 metallic silver  
📦 1 unit





### SHERPA® FLOOR MODULE 10

- Floor stand for 10 SHERPA® display panels in A4 format.
- Height-adjustable telescopic rod (87–138 cm).
- With weighted cast-iron base for extra stability.
- Reading angle adjustable from 5° to 90°.
- Panels are not included.

# 5626    ▲ 57 anthracite/grey  
 ☞ 1 unit



### SHERPA® FLOOR 10

- Floor stand with 10 SHERPA® display panels in A4 format.
- Height-adjustable telescopic rod (87–138 cm)
- Weighted cast-iron base for maximum stability.
- Reading angle adjustable from 5° to 90°.

# 5817    ▲ 00 assorted  
 ☞ 1 set



### SHERPA® INFOBASE TELESCOPE

- Floor stand with crystal-clear information panel made of acrylic.
- Height-adjustable (92–147 cm).
- With adjustable reading angle +/-14°.
- Ideal for trade fairs, exhibition areas, showrooms and applications in hotels and restaurants.

# 5589    ▲ 57 anthracite/grey  
 ☞ 1 set



**WWW.  
DURABLE-LIVE  
.COM**



Bracket  
rotatable by 90°

Patented

### SHERPA® STAND PRO 10

- Aluminium floor stand with weighted cast-iron base.
- Bracket with 10 SHERPA® display panels.
- The bracket can be rotated easily by 90°.
- Can be used for information materials in either portrait or landscape format.

# 5910    ▲ 01 black  
 ☞ 1 set

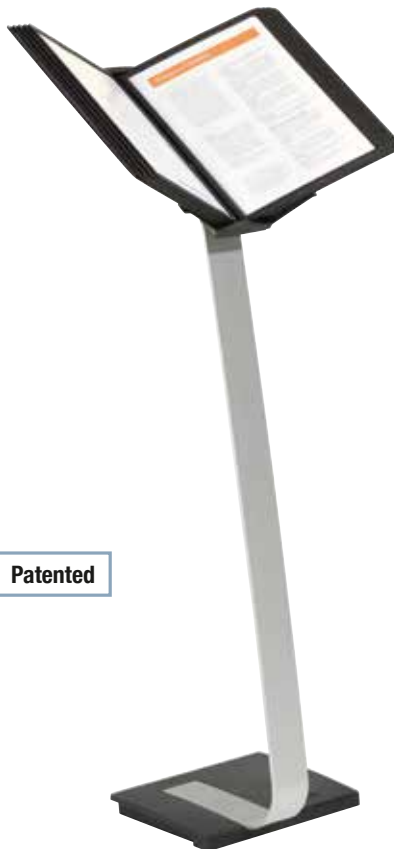

### DURAVIEW® STAND A4

- Floor stand for information materials in A4 format.
- Ergonomic reading angle thanks to adjustable information display
- Optimal readability through variable height adjustability

# 4981    ▲ 23 metallic silver  
 ☞ 1 unit

# 4982    ▲ 23 metallic silver  
 ☞ 1 unit

**INFO SIGN STAND**

- Aluminium stand and heavy cast-iron base
- Crystal-clear "INFO SIGN" acrylic sign with aluminium finish for materials in A4 or A3 format
- Can be used in either portrait or landscape format
- Ergonomic reading through height adjustability and rotation or the reading angle by 10 degrees
- Can be combined with A4 brochure presenter (product # 4864) or 1/3 A4 (product # 4865)
- Free template software available from [www.duraprint.eu](http://www.duraprint.eu)
- Instructions for easy assembly included

Patented



**PRESENTER 1/3 A4**

- For fastening to the floor stands INFO SIGN STAND (product # 4812 and 4813), CRYSTAL SIGN STAND (product # 4818 and 4819) and DISPLAY STAND A4 (product # 4863)
- Easy assembly through screw fitting
- Dimensions: 115 x 150 x 35 mm (W x H x D)

# 4865      ▲ 23 metallic silver  
📦 1 unit

**BROCHURE PRESENTER A4**

- Dimensions: 230 x 220 x 35 mm (W x H x D)

# 4864      ▲ 23 metallic silver  
📦 1 unit



Matching DURABLE insert labels can be found on page 199.



**INFO SIGN STAND A4**

- Matching PC-printable insert labels for A4 format (product # 4856) available separately
- Height A4 portrait: 1.18 m/1.11 m
- Height A4 landscape: 1.13 m/1.06 m

# 4812      ▲ 23 metallic silver  
📦 1 unit

**INFO SIGN STAND A3**

- Height A3 portrait: 1.25 m/1.18 m
- Height A3 landscape: 1.20 m/1.13 m

# 4813      ▲ 23 metallic silver  
📦 1 unit

**CRYSTAL SIGN STAND**

- Aluminium stand with heavy cast-iron base
- Crystal clear acrylic "CRYSTAL SIGN" for materials in A4 or A3 formats
- incl. 2 semi-translucent, PC-printable sheets
- For use in either portrait or landscape format
- Ergonomic reading thanks to height adjustability and rotation of reading angle by 10 degrees
- Can be combined with A4 brochure presenter (product # 4864) or 1/3 A4 (product # 4865)
- Instructions for easy assembly included

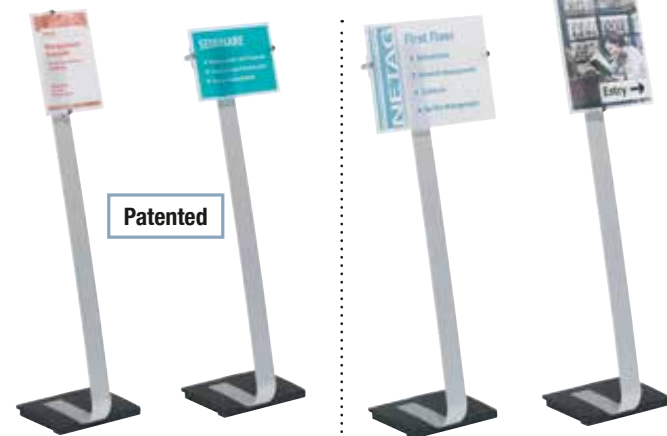

Patented

**CRYSTAL SIGN STAND A4**

- Transparencies in A4 format available separately (product # 4835)
- Height A4 portrait: 1.18 m/1.11 m
- Height A4 landscape: 1.13 m/1.06 m

# 4818      ▲ 23 metallic silver  
📦 1 unit

**CRYSTAL SIGN STAND A3**

- Transparencies in A3 format available separately (product # 4837)
- Height A3 portrait: 1.25 m/1.18 m
- Height A3 landscape: 1.20 m/1.13 m

# 4819      ▲ 23 metallic silver  
📦 1 unit

# Name Badges and Signage

## PICTO

- Made of high-quality brushed stainless steel
- Scratch-proof, hardwearing print
- Versatile and easy to understand
- With adhesive pad for fastening to a great variety of surfaces.



4900-61



4900-65



4901-61



4901-65



4902-23

Description	Code	Colour	Size
"Drücken"	4900	61 German	Ø 65 mm
"Ziehen"	4901	61 German	Ø 65 mm
"Push"	4900	65 English	Ø 65 mm
"Pull"	4901	65 English	Ø 65 mm
"Wash hands"	4902	23 silver	Ø 83 mm
"Disinfect hands"	4903	23 silver	Ø 83 mm
WC Women	4904	23 silver	Ø 83 mm
WC Men	4905	23 silver	Ø 83 mm
WC Disabled	4906	23 silver	Ø 83 mm
"WC"	4907	23 silver	Ø 83 mm
Smoking	4910	23 silver	Ø 83 mm
No Smoking	4911	23 silver	Ø 83 mm
"Kein Zutritt"	4912	61 German	Ø 83 mm
Cloakroom	4914	23 silver	Ø 83 mm
No Mobile Phones	4917	23 silver	Ø 83 mm
Women's/Mens WC	4920	23 silver	Ø 83 mm
Please be seated	4921	23 silver	Ø 83 mm
"Büro"	4923	61 German	Ø 83 mm
"Privat"	4924	61 German	Ø 83 mm
Arrow	4927	23 silver	Ø 83 mm
Shower	4938	23 silver	Ø 83 mm

1 piece



4903-23



4904-23



4905-23



4906-23



4907-23



4910-23



4911-23



4912-61



4914-23



4917-23



4920-23



4921-23



4923-61



4924-61



4927-23



4938-23



## PICTO SQUARE

- Made of high-quality brushed stainless steel
- Large, square format for easy reading from a distance
- Scratch-proof, hardwearing print
- Versatile and easy to understand
- With adhesive pads for fastening to a great variety of surfaces.



Description	Code	Colour	Size
No smoking	4953	23 silver	1 piece
WC Men	4954	23 silver	1 piece
WC Women	4956	23 silver	1 piece
"WC"	4957	23 silver	1 piece
WC Women/Men	4958	23 silver	1 piece
WC Disabled	4959	23 silver	1 piece



### WOMEN'S WC SYMBOL

- Motif: Women's WC Symbol
- Dimensions: 90 x 120 mm (W x H)

# 4950    23 metallic silver  
 1 unit

### MEN'S WC SYMBOL

- Motif: Men's WC Symbol
- Dimensions: 90 x 120 mm (W x H)

# 4951    23 metallic silver  
 1 unit



## TABLE SIGN

- Table signs with different motifs
- To be placed on tables, counters, reception desks, etc.
- Printed on both sides for optimal readability
- Made of high-quality brushed stainless steel



### TABLE SIGN

- Motif: „Reserviert“
- Dimensions: 85 x 50 x 36 mm (W x H x D)

# 4960    61 German  
 1 unit

### TABLE SIGN

- Motif: „No Smoking“
- Size: 85 x 50 x 36 mm (W x H x D)

# 4962    23 metallic silver  
 1 unit



### INKJET FILM A4

- For ink-jet printers
- With pull-off paper strip at the top.

# 8326    19 transparent  
 pack of 50 pcs.



### COPY/LASER FILM A4

- For laser printers and dry photocopiers

# 8331    19 transparent  
 pack of 100 pcs.



### PRESENTATION COVER

- Presentation covers
- With universal punching
- For OHP A4 format transparencies.

# 8552    19 transparent  
 pack of 100 pcs.



**WWW.  
DURABLE  
.EU**





# Safety and security

<b>Products</b>	<b>Page</b>
DURACARD card printer	208–211
Card holder	212–217
Key boxes	218–221
First aid products	222
Cash and document boxes	223



# DURACARD CARD PRINTER

Ready-to-use card printer for quick, easy printing of ID, membership and loyalty cards etc. Includes YMCKO colour ribbon and 100 blank plastic cards. Give your corporate cards a professional finish with photography quality, monochrome or colour printing. Free DURAPRINT® online software under [www.durable.eu](http://www.durable.eu) for PC and MAC for easy design of cards.



## DURACARD ID 300

- Card printer for printing of plastic cards in format 53.98 x 85.60 mm (ISO 7810, CR80)
- Sublimation printing (multi-coloured), thermal transfer printing (monochrome black)
- Photo-quality printing by means of 260 x 300 dpi resolution
- 16 MB memory (RAM)
- Edge-to-edge colour printing with protective varnish
- USB 2.0 (compatible with USB 1.1 and 3.0)

# 8910      € 00 EU, 65 UK  
☞ 1 unit

## SYSTEM REQUIREMENTS

MAC:  
MAC OS X 10.6 OR HIGHER  
INTEL PROCESSOR ONLY  
512MB OF RAM  
1024 X 768 PIXELS MONITOR RESOLUTION  
1 USB PORT

PC:  
WINDOWS™ XP SP3, VISTA, 7 AND 8 (32 & 64 BIT)  
512MB OF RAM  
1024 X 768 PIXELS MONITOR RESOLUTION  
1 USB PORTSYSTEM REQUIREMENTS





**DURACARD CONSUMABLES**



**DURACARD COLOUR RIBBON COLOUR RIBBON**

- YMCKO full colour ribbon to print 100 plastic cards in photo quality
- Transparent protective coating for additional sealing of the cards
- With RFID code for fast recognition of the ribbons by the DURACARD ID 300 card printer

# 8911    22 multi-coloured  
 1 unit



**DURACARD LIGHT CARDS (CARDS, BLANK)**

- 100 thin plastic cards, 0.5 mm.
- For printing with the DURACARD ID 300 card printer
- Format 53.98 x 86.60 mm

# 8914    02 white  
 100 units



**DURACARD PRINTING SET (COLOUR RIBBON + CARDS)**

- Set of one YMCKO full colour ribbon with plastic cards (0.76 mm) to print 100 cards in photo quality
- Transparent protective coating for additional sealing of the cards
- Colour ribbon with RFID code for fast recognition of the ribbons by the DURACARD ID 300 card printer

# 8913    00 assorted  
 1 set



**DURACARD BLACK RIBBON COLOUR RIBBON**

- Black ribbon to print 500 plastic cards
- With RFID code for fast recognition of the ribbons by the DURACARD ID 300 card printer

# 8912    01 black  
 1 unit



**DURACARD STANDARD CARDS (CARDS BLANK)**

- 100 thick plastic cards, 0.76 mm.
- For printing with the DURACARD ID 300 card printer
- Format 53.98 x 86.60 mm

# 8915    02 white  
 100 units

**EASY EXCHANGE OF CONSUMABLES**



## THE DURACARD CONCEPT

You want to organise an event professionally? Prepare personal membership cards for your customers quickly? Print out student ID cards as plastic cards yourself? You have to wait up to two weeks for the delivery of printed plastic cards? You only need to print two to three individual cards daily, but the minimum order quantity required by your printing partner is 100 cards?

DURABLE has the answers to your questions. Print out plastic cards quickly, easily and professionally – with the new DURACARD ID 300 card printer.

Organise your plastic cards independently of advertising agencies and printers. You can reach your goal in three easy steps:

### 1 Design Cards



### 2 Print Cards



### 3 Select card holder



#### A selection of suitable card holders



#### RIGID BOX WITH BADGE REEL FOR 1 ID CARD/ SECURITY PASS

- Thumb slot on reverse for easy removal and exchange of the card
- Combined with a badge reel
- With metal clip on the reverse and snap button strap
- Length: 80 cm
- Internal dimensions: 54 x 87 mm (H x W)

# 8012      19 transparent  
 10 per pack

also suitable for portrait format



#### RIGID BOX WITH CLIP FOR 1 ID CARD/SECURITY PASS

- With rotating clip fastener and thumb slot
- Easy removal and exchange of the card
- Can be combined with chain, textile necklace or badge reel
- Internal dimensions: 54 x 87 mm (H x W)

# 8005      19 transparent  
 25 per pack

More card holders from page 212.



Patentiert

#### CARD FIX WITH TEXTILE NECKLACE

- With 20mm wide textile necklace
- With safety closure
- Opens if the name badge gets trapped or caught
- Length: 44 cm

# 8187      01 black  
 10 per pack

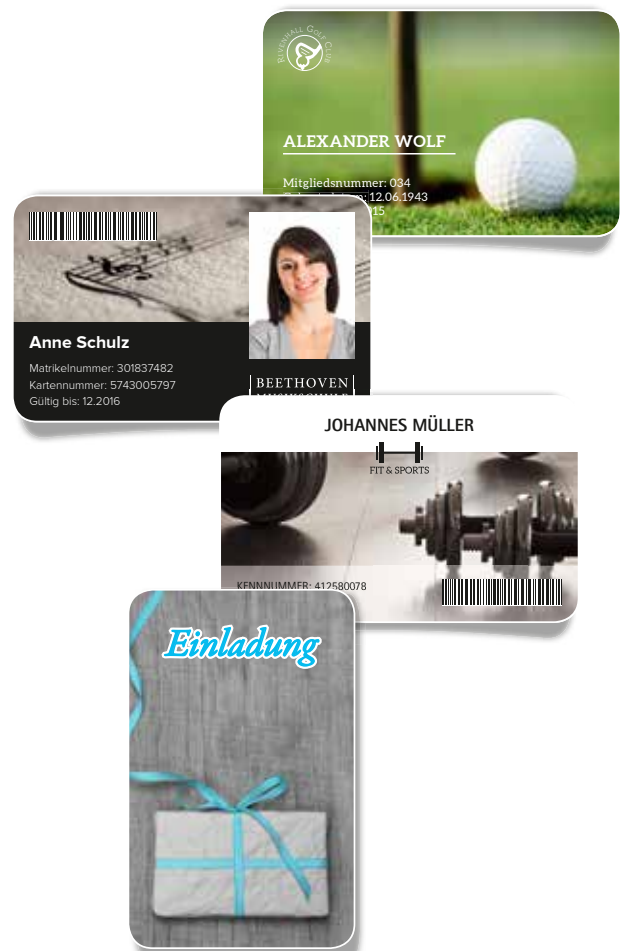



## CARD HOLDER

Being on the safe side: magnetic strips and storage chips of ID cards and safety passes must be well protected. DURABLE offers a wide portfolio of practical solutions for daily use.



## CARD HOLDER DE LUXE

- Elegant ID card holder made of crystal-clear acrylic
- For cards in portrait or landscape format
- With textile necklace or badge reel

Patented

### CARD HOLDER DE LUXE

- Security pass holder with textile necklace
- For an ID/security pass
- Internal dimensions: 54 x 87 mm (H x W)

# 8207    58 charcoal  
 10 per pack



### CARD HOLDER DE LUXE DUO

- Security pass holder with textile necklace
- For two ID/security passes
- Internal dimensions: 54 x 87 mm (H x W)

# 8208    58 charcoal  
 10 per pack



### CARD HOLDER DE LUXE PRO

- Security pass holder with chrome badge reel
- With metal clip on reverse
- For an ID/security pass
- Length: 80 cm
- Internal dimensions: 54 x 87 mm (H x W)

# 8307    58 charcoal  
 10 per pack



### CARD HOLDER DE LUXE PRO DUO

- Security pass holder with chrome badge reel
- With metal clip on reverse
- For two ID/security passes
- Length: 80 cm
- Internal dimensions: 54 x 87 mm (H x W)

# 8308    58 charcoal  
 10 per pack



### Product advantages

Unique design.

With highly transparent surface and thumb slot for easy removal of the card.

Unique, patented fastening system holds cards safely in place.



## HARD BOXES – CLOSED CARD HOLDERS

- Crystal-clear surface for optimal readability and easy scanning of barcodes.
- Closed version provides optimal protection for all types of cards.
- Attractive curved design.



### ENCLOSED PASS HOLDER WITH BADGE REEL FOR 1 ID CARD/SECURITY PASS

- Thumb slot on reverse for easy removal and exchange of the card
- Combined with a badge reel
- With metal clip on the reverse and snap button strap
- Length: 80 cm
- Internal dimensions: 54 x 87 mm (H x W)

# 8012    19 transparent  
 10 per pack



### ENCLOSED CARD HOLDER WITH CLIP FOR 1 ID CARD/SECURITY PASS

- With rotating clip fastener and thumb slot
- Easy removal and exchange of the card
- Can be combined with chain, textile necklace or badge reel
- Internal dimensions: 54 x 87 mm (H x W)

# 8005    19 transparent  
 25 per pack

# 8698    19 transparent  
 10 per bag

### DUAL ENCLOSED CARD HOLDER WITH BADGE REEL FOR 2 ID CARDS/SECURITY PASSES

- With thumb slot for quick access
- Can be used in either portrait or landscape format
- Combined with a badge reel
- Badge reel with a metal clip on the reverse and snap button strap
- Length: 80 cm
- Internal dimensions: 54 x 87 mm (H x W)

# 8224    19 transparent  
 10 per pack



### SECURITY PASS HOLDER WITH CLIP FOR 2 ID CARDS

- With rotating clip fastener
- Thumb slot for quick access
- Can be used in either portrait or landscape format
- Can be combined with a chain, textile necklace or badge reel
- Internal dimensions: 54 x 87 mm (H x W)

# 8013    19 transparent  
 25 per pack

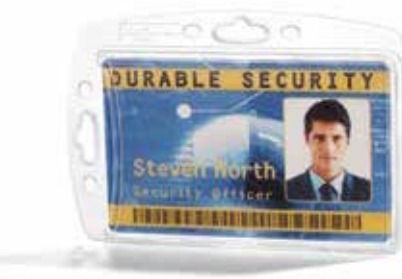

### ENCLOSED CARD HOLDER FOR 1 ID CARD/SECURITY PASS

- Rigid box with thumb slot
- For easy removal and exchange of the card
- Can be used in portrait or landscape format
- Can be combined with clip, chain, textile necklace or security badge reel
- Internal dimensions: 54 x 87 mm (H x W)

# 8905    19 transparent  
 10 per pack



### DUAL SECURITY PASS HOLDER FOR 2 ID CARDS/SECURITY PASSES

- Rigid box with thumb slot
- For easy removal and exchange of the cards
- Can be used in portrait or landscape format
- Can be combined with clip, chain, textile necklace or security badge reel
- Internal dimensions: 54 x 87 mm (H x W)

# 8924    19 transparent  
 10 per pack

## ID CARD HOLDERS – OPEN CARD HOLDERS

- Open version in attractive design.
- Suitable for one or two cards in portrait or landscape format.
- Also available as an antibacterial model.



### ID CARD HOLDER WITH CLIP FOR 1 ID CARD/SECURITY PASS

- With rotating clip fastener
- Can be used in either portrait or landscape format
- Can be combined with a chain, textile necklace or badge reel
- Internal dimensions: 54 x 87 mm (H x W)

# 8118    03 red, 06 blue, 19 transparent  
 ☞ 25 per pack

### ID CARD HOLDER FOR 1 ID CARD/SECURITY PASS, RETAIL PACK

# 8683    01 black, 19 transparent  
 ☞ 1 unit



### ID CARD HOLDER BACT-O-CLEAN WITH CLIP

- With rotating clip fastener
- Can be used in either portrait or landscape format
- Can be combined with a chain, textile necklace or badge reel
- With antibacterial properties
- Internal dimensions: 54 x 87 mm (H x W)

# 8418    10 grey  
 ☞ 25 per pack



### DUAL SECURITY PASS HOLDER WITH CLIP FOR 2 ID CARDS/SECURITY PASSES

- With rotating clip fastener
- Can be used in either portrait or landscape format
- Can be combined with a chain, textile necklace or badge reel
- Internal dimensions: 54 x 87 mm (H x W)

# 8218    03 red, 06 blue, 19 transparent  
 ☞ 25 per pack



### ID CARD HOLDER WITH BADGE REEL FOR 1 ID CARD/SECURITY PASS

- Can be used in portrait or landscape format
- Combined with a badge reel
- Badge reel with metal clip on the reverse and snap button strap
- Length: 80 cm
- Internal dimensions: 54 x 87 mm (H x W)

# 8011    19 transparent  
 ☞ 10 per pack



### DUAL SECURITY PASS HOLDER WITH BADGE REEL FOR 2 ID CARDS/SECURITY PASSES

- Dual box in either portrait or landscape format
- Combined with a badge reel
- Badge reel with a metal clip on the reverse and press fastener
- Length: 80 cm
- Internal dimensions: 54 x 87 mm (H x W)

# 8219    19 transparent  
 ☞ 10 per pack

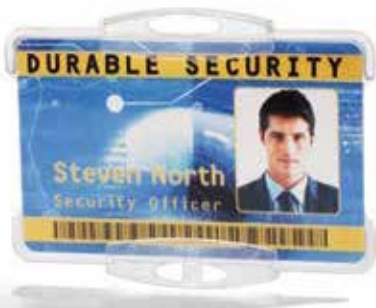

### ID CARD HOLDER FOR 1 ID CARD/SECURITY PASS

- ID card holder open on one side
- Can be used in portrait or landscape format
- Can be combined with clip, chain, textile necklace or security badge reel
- Internal dimensions: 54 x 87 mm (H x W)

# 8918    19 transparent  
 ☞ 10 per pack

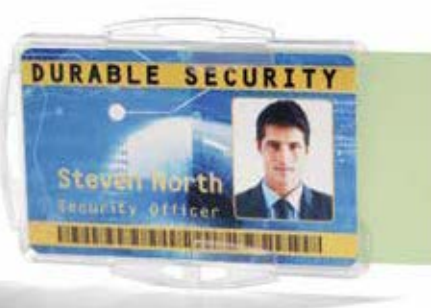

### SECURITY PASS HOLDER FOR 2 ID CARDS

- ID card holder open on two sides
- Can be combined with a clip, textile necklace, badge reel or chain
- Can be used in portrait or landscape format
- Internal dimensions: 54 x 87 mm (H x W)

# 8919    19 transparent  
 ☞ 10 per pack



**WWW.  
DURABLE-  
IDENTITY  
.COM**

## LICENCE HOLDERS – FILM CARD HOLDERS

- Extremely light-weight, flexible material offers ultimate stability and optimal protection.
- Simple design with thumb slot for easy removal of cards.
- Available in four different versions with badge reel or clip.

### PASS HOLDER WITH CLIP FOR 1 ID CARD/SECURITY PASS

- Rotating metal clip
- Thumb slot on reverse enables easy removal of pass.
- Internal dimensions: 85 x 54 mm (H x W)

# 8112      ▲ 19 transparent  
 ☞ 25 per pack

### PASS HOLDER WITH CLIP FOR 1 ID CARD/SECURITY PASS

- Internal dimensions: 54 x 87 mm (H x W)

# 8113      ▲ 19 transparent  
 ☞ 25 per pack



### PASS HOLDER WITH BADGE REEL FOR ID CARD/SECURITY PASS

- With thumb slot
- Easy removal and exchange of the card
- Combined with a badge reel
- With metal clip on the reverse and snap button strap
- Length: 80 cm
- Internal dimensions: 87 x 54 mm (H x W)

# 8014      ▲ 19 transparent  
 ☞ 10 per pack



### PASS HOLDER WITH BADGE REEL FOR 1 ID CARD/SECURITY PASS

- Internal dimensions: 54 x 87 mm (H x W)

# 8016      ▲ 19 transparent  
 ☞ 10 per pack



## CARD HOLDER CARD FIX

- Card holder for quick fastening of ID cards, safety passes, visitors' passes and business cards
- With internal rubber pad to keep the card safely in place
- For cards with max. 1 mm thickness

Patented

### CARD FIX WITH TEXTILE NECKLACE

- With 20mm wide textile necklace
- With safety closure
- Opens if the name badge gets trapped or caught
- Length: 44 cm

# 8187      ▲ 01 black  
 ☞ 10 per pack



internal rubber pad



### CARD FIX

- Combine with chain, textile necklace or a badge reel

# 8188      ▲ 01 black  
 ☞ 50 per pack







# KEY BOXES

Keep keys secure and close to hand with the professional key management range. DURABLE offers an innovative range of convenient solutions for efficient key management for numerous areas of application.



Patented

## KEY CLIP

- Key Clip with permanently visible label, the key is positioned flat behind it
- Easy opening of the labelling area without taking off the key ring
- To fit all KEY BOX models and the KEY BOARD key panel
- Free templates for card inserts available for download from [www.durable.eu](http://www.durable.eu)

# 1957      🔸 01 black, 03 red, 04 yellow, 07 dark blue, 00 assorted  
 📦 6 per bag



## KEY BOX

- Designer key boxes made of aluminium with cylinder lock or turn lock
- Available in different sizes
- Safe attachment and quick access to key holders through special key rails
- Individual use through variable pinning heights
- 6 KEY CLIP key holders and assembly kit included
- Clear list of contents through PC-printable index sheet
- Free labelling templates for KEY CLIP cardboard inserts and index sheet available for download from [www.durable.eu](http://www.durable.eu)

Patented



### KEY BOX 12

- Key box with turn lock
- For 12 KEY CLIP holders
- 6 KEY CLIPS in assorted colours included
- Dimensions: 302 x 160 x 118 mm (W x H x D)

# 1960    23 metallic silver  
 1 unit



AUSZEICHNUNG  
 PRODUKTE  
 DES JAHRES  
 WETTBEWERB DES  
 FACHVERBANDES  
 KUNSTSTOFF  
 KONSUMWAREN  
 FV



INCL.  
 6 KEY HOLDERS  
 KEY CLIP



### KEY BOX 18

- Key box with cylinder lock
- For 18 KEY CLIP holders
- 6 KEYCLIPS in assorted colours included
- Dimensions: 302 x 280 x 118 mm (W x H x D)

# 1951    23 metallic silver  
 1 unit



### KEY BOX 36

- Key box with cylinder lock
- For 36 KEY CLIP holders
- The front panel is equipped with key rails on one side
- 6 KEY CLIPS in assorted colours included
- Dimensions: 302 x 280 x 118 mm (W x H x D)

# 1952    23 metallic silver  
 1 unit



### KEY BOX 48

- Key box with cylinder lock
- For 48 KEY CLIP holders
- The front panel is equipped with key rails on one side
- 6 KEY CLIPS in assorted colours included
- Dimensions: 302 x 400 x 118 mm (W x H x D)

# 1954    23 metallic silver  
 1 unit



### KEY BOX 54

- Key box with cylinder lock
- For 54 KEY CLIP holders
- The front panel is equipped with key rails on two sides
- 6 KEY CLIPS in assorted colours included
- Dimensions: 302 x 280 x 118 mm (W x H x D)

# 1953    23 metallic silver  
 1 unit



### KEY BOX 72

- Key box with cylinder lock
- For 72 KEY CLIP holders
- The front panel is equipped with key rails on two sides
- 6 KEY CLIPS in assorted colours included
- Dimensions: 302 x 400 x 118 mm (W x H x D)

# 1955    23 metallic silver  
 1 unit



### KEY BOARD 24

- Key board for mounting on the wall
- With 4 key rails for 24 KEY CLIP key tags
- Complete with mounting set and 6 sample KEY CLIPS in assorted colours
- Dimensions: 212 x 362 x 32 mm (W x H x D)

# 1956    10 grey  
 1 unit

## KEY BOX CODE

- Designer key boxes made of aluminium with combination lock
- Available in different sizes
- Safe attachment and quick access to key holders through special key rails
- Individual use through variable pinning heights
- 6 KEY CLIP key holders with permanently visible labelling window and assembly kit included
- Clear list of contents through PC-printable index sheet
- Free labelling templates for KEY CLIP inserts and index sheet available for download from [www.durable.eu](http://www.durable.eu)

Patented

### INCL. 6 KEY HOLDERS KEY CLIP



#### KEY BOX CODE 18

- Key box with combination lock
- For 18 KEY CLIP holders
- The combination code can be individually set from a choice of up to 1000 combinations
- 6 sample KEY CLIPS in assorted colours included

# 1969

▲ 23 metallic silver

📦 1 unit



#### KEY BOX CODE 36

- Key box with combination lock
- For 36 KEY CLIP holders
- The combination code can be individually set from a choice of up to 1000 combinations
- The front panel is equipped with key rails on one side
- 6 sample KEY CLIPS in assorted colours included
- Dimensions: 302 x 280 x 118 mm (W x H x D)

# 1966

▲ 23 metallic silver

📦 1 unit



#### KEY BOX CODE 48

- Key box with combination lock
- For 48 KEY CLIP holders
- The combination code can be individually set from a choice of up to 1000 combinations
- The front panel is equipped with key rails on one side
- 6 sample KEY CLIPS in assorted colours included

# 1976

▲ 23 metallic silver

📦 1 unit



#### KEY BOX CODE 54

- Key box with combination lock
- For 54 KEY CLIP holders
- The combination code can be individually set from a choice of up to 1000 combinations
- The front panel is equipped with key rails on two sides
- 6 sample KEY CLIPS in assorted colours included

# 1977

▲ 23 metallic silver

📦 1 unit



#### KEY BOX CODE 72

- Key box with combination lock
- For 72 KEY CLIP holders
- The combination code can be individually set from a choice of up to 1000 combinations
- The front panel is equipped with key rails on two sides
- 6 sample KEY CLIPS in assorted colours included
- Dimensions: 302 x 400 x 118 mm (W x H x D)

# 1967

▲ 23 metallic silver

📦 1 unit

## KEY BOX PLUS

- Designer key boxes made of aluminium for quick return of keys or other materials
- With opening in the lid and combination lock
- Easy removal of inserted objects thanks to swivel-mounted collection tray inside
- Firm attachment and quick access to key holders through special key rails
- Individual use through variable pinning heights
- 6 KEY CLIP key holders and assembly kit included
- Clear list of contents through PC-printable index sheet
- Free labelling templates for KEY CLIP cardboard inserts and index sheet available for download from [www.durable.eu](http://www.durable.eu)

Patented



INCL.  
6 KEY HOLDERS  
KEY CLIP



### KEY BOX PLUS

- Key box with combination lock
- For 54 KEY CLIP holders
- Quick return of keys through chute in the lid
- Swivel tray inside for easy removal of inserted objects
- Code can be set individually, up to 1,000 combinations possible
- The front panel is equipped with key rails on two sides
- 6 sample KEY CLIPS in assorted colours included
- Dimensions: 302 x 400 x 118 mm (W x H x D)

# 1968

23 metallic silver

1 unit



### FIRST AID BOX

- Aluminium first-aid boxes for quick first-aid care
- Available in different sizes
- Supplied filled or empty
- Depending on size, suitable for first-aid material fillings according to DIN 13157 (for administrative and commercial companies with up to 50 employees, manufacturing and processing plants with up to 20 employees or building sites with up to 10 employees), or DIN 13164 (for private use)
- Incl. self-adhesive green-and-white first aid cross, cylinder lock with two keys and assembly kit

Patented



#### FIRST AID BOX M

- First Aid box with cylinder lock
- With two fold-out inside compartments
- Supplied without content
- Can be equipped with dressing set FIRST AID KIT M (product # 1972) according to DIN 13164
- Dimensions: 302 x 280 x 118 mm (W x H x D)

# 1970    23 metallic silver  
 1 unit



#### FIRST AID SET M

- First Aid box with cylinder lock
- With two fold-out inside compartments
- Complete with First Aid kit according to DIN 13164
- Dimensions: 302 x 280 x 118 mm (W x H x D)

# 1971    23 metallic silver  
 1 set



#### FIRST AID KIT M

- 36-part first aid kit according to DIN 13164
- To fit First Aid BOX M (product # 1970)
- Refill for First Aid SET M (product # 1971)

# 1972    00 assorted  
 1 pack

## FIRST AID PRODUCTS

The first aid range from DURABLE is a safe, stylish and secure option. Available in two practical sizes, the stylish cases finished in high quality aluminium provides practical storage of first aid materials for use in the home, work or in school environments.



#### FIRST AID BOX L

- First Aid box with cylinder lock
- With three fold-out inside compartments
- Supplied without content
- Can be equipped with First Aid KIT L according to DIN 13157
- Dimensions: 302 x 400 x 118 mm (W x H x D)

# 1973    23 metallic silver  
 1 unit



#### FIRST AID SET L

- First Aid box with cylinder lock
- With three fold-out inside compartments
- Complete with First Aid kit according to DIN 13157
- Dimensions: 302 x 400 x 118 mm (W x H x D)

# 1974    23 metallic silver  
 1 set



#### FIRST AID KIT L

- First Aid kit
- With 72 parts according to DIN 13157
- To fit First Aid BOX L (product # 1973) or as refill for First Aid SET L (product # 1974)

# 1975    00 assorted  
 1 pack

## €UROBOXX

- Silver-grey cash boxes made of sturdy, powder-coated steel
- With retractable, ergonomically designed handle
- Sturdy compartments for coins and bank notes
- Optimal security through tightly closed lid, concealed hinges and double deadbolt lock
- Safe and easy replacement of key thanks to individual key number

Patented



### €UROBOXX® S

- Metal cash box
- With removable coin sorting tray for all cent and euro coin denominations, incl. 2 combination compartments for 1 and 2 euro coins, and 1 and 2 cent coins respectively, a banknote compartment for interim storage and a tray with 3 banknote compartments.
- Coin capacity: 102.05 €
- Weight: approx. 1.4 kg
- Dimensions: 283 x 100 x 225 mm (W x H x D)

# 1778    🔥 57 anthracite/grey  
📦 1 unit



### €UROBOXX®

- Metal cash box
- Incl. removable coin sorting tray with 8 compartments for all cent and euro coin denominations, a banknote compartment for interim storage and a tray with 4 banknote compartments
- Arched base for safe Stackable of several cash boxes
- Coin capacity: 233.90 €
- Weight: approx. 4 kg
- Dimensions: 352 x 120 x 276 mm (W x H x D)

# 1782    🔥 57 anthracite/grey  
📦 1 unit



### CASHBOX S

- Metal cash box
- With tray subdivided into 4 coin and 2 banknote compartments, one multi-purpose compartment and pen and paper clip sections.
- Incl. ticket dispenser slot
- Weight: approx. 1.4 kg
- Dimensions: 283 x 100 x 225 mm (W x H x D)

# 1777    🔥 57 anthracite/grey  
📦 1 unit

# CASH AND DOCUMENT BOXES

It's Safe: Thanks to robust materials and excellent workmanship, combined with professional design and various models, DURABLE cash and document boxes are the ideal solution for the secure storage of coins, bank notes and important documents.

## €UROBOARD

- Sturdy money sorting trays for all cent and euro coins or Swiss centimes and francs
- Quick overview of cash balance thanks to staggered coin compartments
- With separate bank note compartment
- Easy removal and insertion of the tray through lateral recessed grips
- Skid-proof stand through rubber pads



### €UROBOARD® L

- Coin sorting tray
- With 8 Stackable compartments for all cent and euro coin denominations, complete with banknote compartment for interim storage
- Coin capacity: 233.90 €
- Dimensions: 324 x 34 x 190 mm (W x H x D)

# 1780    🔥 58 charcoal  
📦 1 unit

### €UROBOARD® XL P

- Plastic tray
- Incl. 4 compartments for banknotes, a coin sorting tray with 8 Stackable compartments for all cent and euro coin denominations, and a banknote compartment for interim storage
- Coin capacity: 233.90 €
- Dimensions: 326 x 45 x 233 mm (W x H x D)

# 1878    🔥 58 charcoal  
📦 1 unit

### €UROBOARD® XL

- Metal tray
- With 8 banknote compartments and a coin sorting tray subdivided into 8 Stackable compartments for all cent and euro coin denominations. Complete with banknote compartment for interim storage
- Coin capacity: 233.90 €
- Dimensions: 328 x 59 x 286 mm (W x H x D)

# 1781    🔥 57 anthracite/grey  
📦 1 unit



For all Swiss franc and centime coins.



### CASH BOX S FOR CHF

- Metal cash box
- Combined with removable coin sorting tray
- With Stackable compartments for all cent and franc coins
- Incl. banknote compartment for interim storage and a tray with 3 compartments for banknotes
- Weight: approx. 1.4 kg
- Dimensions: 283 x 100 x 225 mm (W x H x D)

# 1760    🔥 57 anthracite/grey  
📦 1 unit

### CASH BOX M FOR CHF

- Incl. banknote compartment for interim storage and a tray with 4 compartments for banknotes
- Weight: approx. 4 kg
- Dimensions: 352 x 120 x 276 mm (W x H x D)

# 1761    🔥 57 anthracite/grey  
📦 1 unit





# Waste Management

**Products**

**Page**

Waste bins

226–239





# WASTE BINS

DURABLE waste bin systems are versatile equipment for waste management as well as transport and storage of raw materials in industry and commerce. These products are manufactured exclusively from high-quality materials such as long-lasting plastics and sturdy sheet steel. Available in different colours, sizes, designs and finishes, these containers provide ideal storage solutions for a great variety of applications.



### WASTE COLLECTION AND SORTING

Where collection and sorting of corporate waste is concerned, organisation is vital. DURABIN from DURABLE makes it easy to sort waste into the correct containers via colour-coded systems and appropriate labelling. Which means: order with a system. Or simply: DURABIN



### STORAGE AND TRANSPORT

For safe storage and transport of corporate raw materials, the quality of the various containers must be reliable. For this purpose, DURABIN offers containers made of top-quality plastics in a great variety of sizes and colours, which are particularly suitable for storing loose, pourable bulk materials, even including food ingredients. Their rectangular form facilitates space-saving storage and reliable transport on matching trolleys.



### ORDER IN FORM AND FUNCTIONALITY. WASTE PAPER BASKETS FOR THE OFFICE AND FOR THE HOME.

Even though our world is turning more digital, a lot of waste paper still accumulates in offices. DURABLE offer a great variety of designs made out of high quality plastics and elegant sheet steel for both corporate and home office.



### MORE PRODUCTS FOR TRADE AND COMMERCE.

Professionalism of materials is a top priority in the cleaning trade. The sturdy buckets from DURABLE made of high-quality, heavy-duty plastics are available in three convenient sizes and offer high functionality together with ergonomic handling - attributes also present in our shopping baskets. Trolleys facilitate their transport and handling in the supermarket.



## DURABIN

- Plastic containers for collecting and sorting of waste and recyclables
- Round or rectangular formats
- Multiple colours available
- Easy identification of different waste categories possible with coloured lids



Food-safe according to EU Regulation no. 1935/2004/EC

### DURABIN ROUND 40

- Circular container for waste and recyclable material.
- Capacity: 40 litres.
- With carrying handles for easy transportation.
- Food-safe in all colours (according to EU Regulation no. 1935/2004/EC), except for the colour black.
- Dimensions: Ø 425 mm, height 520 mm

- # 1800519050 ♁ grey ☐ 1 unit
- # 1800519221 ♁ black ☐ 1 unit



### DURABIN LID ROUND 40

- Cap for DURABIN ROUND 40 including grips for easy removal.
- Food-safe in all colours (according to EU Regulation no. 1935/2004/EC), except for the colour black.

- # 1800520050 ♁ grey ☐ 1 unit
- # 1800520221 ♁ black ☐ 1 unit



### DURABIN SQUARE 40

- Rectangular shape.
- Capacity: 40 litres.
- Dimensions: 320 x 590 x 360 mm (W x H x D)

- # 1800798010 ♁ white ☐ 1 unit
- # 1800798050 ♁ grey ☐ 1 unit



### DURABIN FLIP 40

- Container with lid for waste and recyclable material.
- Flip lid.
- Capacity: 40 litres.
- Dimensions: 320 x 747 x 366 (W x H x D)

- # 1809798010 ♁ white ☐ 1 set
- # 1809798050 ♁ grey ☐ 1 set



### DURABIN SQUARE TROLLEY DUO 40

- Transportation trolley made of white-painted metal with four castor wheels.
- For two DURABIN SQUARE 40 containers for waste and recyclable material.
- Dimensions: 270 x 185 x 665 mm (W x H x D)

- # 1801622010 ♁ white ☐ 1 unit



### DURABIN LID SQUARE 40

- Lid for DURABIN SQUARE 40
- Dimensions: 330 x 40 x 360 mm (W x H x D)

Code	Colour	Packing
1801621020	green	1 unit
1801621030	yellow	1 unit
1801621040	blue	1 unit
1801621050	grey	1 unit
1801621080	red	1 unit



### DURABIN FLIP LID SQUARE 40

- Flip lid for DURABIN SQUARE 40
- Dimensions: 330 x 170 x 330 mm (W x H x D)

Code	Colour	Packing
1801574011	white	1 unit
1801574012	green	1 unit
1801574013	yellow	1 unit
1801574014	blue	1 unit
1801574018	red	1 unit
1801574051	grey	1 unit



**WWW.  
DURABLE  
.EU**



**DURABIN 60**

- Rectangular shape.
- Capacity: 60 litres.
- With robust carrying handles for easy transportation
- Retaining recesses on the base bottom side for safe emptying.
- With clamp slots for waste bags.
- Food-safe in all colours (according to EU Regulation no. 1935/2004/EC), except for the colour black.
- Dimensions: 590 x 600 x 282 mm (W x H x D)

Code	Colour	Packing
1800496010	white	1 unit
1800496020	green	1 unit
1800496040	blue	1 unit
1800496050	grey	1 unit
1800496221	black	1 unit



**DURABIN LID 60**

- Lid for DURABIN 60 including recessed grip for easy removal.
- Food-safe in all colours (according to EU Regulation no. 1935/2004/EC), except for the colour black
- Dimensions: 501 x 58 x 272 mm (W x H x D)

Code	Colour	Packing
1800497010	white	1 unit
1800497020	green	1 unit
1800497030	yellow	1 unit
1800497040	blue	1 unit
1800497050	grey	1 unit
1800497210	brown	1 unit
1800497221	black	1 unit





### DURABIN FLIP-TOP LID 60

- Hinged lid for DURABIN 60.
- Clip connections grip into the upper edge of the container.
- Easy handling through fixable aperture angle of the lid.
- Food-safe (according to EU Regulation no. 1935/2004/EC).
- Dimensions: 510 x 285 x 73 mm (W x H x D)

Code	Colour	Packing
1800500050	grey	1 unit
1800500020	green	1 unit
1800500030	yellow	1 unit
1800500040	blue	1 unit



### DURABIN HINGED LID WITH HOLES 60

- Hinged lid for DURABIN 60
- With two circular cut-out's for cans and bottles.
- Clip connections grip into the upper edge of the container.
- Easy handling through fixable aperture angle of the cap.
- Food-safe (according to EU Regulation no. 1935/2004/EC).
- Dimensions: 510 x 285 x 73 mm (W x H x D)

# 1800501020 ▲ green  
 📦 1 unit



### DURABIN HINGED LID WITH SLOT 60

- Hinged lid for DURABIN 60
- With slot for paper and cardboard.
- Clip connections grip into the upper edge of the container.
- Easy handling through fixable aperture angle of the lid.
- Food-safe (according to EU Regulation no. 1935/2004/EC).
- Dimensions: 510 x 285 x 73 mm (W x H x D)

# 1800502040 ▲ blue  
 📦 1 unit



### DURABIN 60 WALL MODULE

- Fastening set for wall-fastening of a DURABIN 60 container.

# 1801665010 ▲ white  
 📦 1 unit



### DURABIN TROLLEY 60

- Carriage made of white-painted metal with four castor wheels
- For a DURABIN 60 container for waste and recyclable material.
- Dimensions: 260 x 180 x 470 mm (W x H x D)

# 1801666010 ▲ white  
 📦 1 unit



### DURABIN TROLLEY DUO 60

- Transport trolley made of white-painted metal with four castor wheels
- For two DURABIN 60 containers for waste and recyclable material.
- Dimensions: 480 x 180 x 540 mm (W x H x D)

# 1801667010 ▲ white  
 📦 1 unit



**DURABIN LID 90**

- Cover for DURABIN 90 with handles for easy removal.
- Food grade in all colours (pursuant to EU Directive 1935/2004/EU), with the exception of black.
- Dimensions: 507 x 470 x 60 mm (W x H x D)

Code	Colour	Packing
1800475010	white	1 unit
1800475020	green	1 unit
1800475030	yellow	1 unit
1800475040	blue	1 unit
1800475050	grey	1 unit
1800475210	brown	1 unit
1800475221	black	1 unit



**DURABIN 90**

- Square
- Capacity 90 litres.
- With carry handles for easier transport.
- Food grade in all colours (pursuant to EU Directive 1935/2004/EU), with the exception of black.
- Dimensions: 520 x 610 x 490 mm (W x H x D)

Code	Colour	Packing
1800474010	white	1 unit
1800474020	green	1 unit
1800474040	blue	1 unit
1800474050	grey	1 unit
1800474221	black	1 unit



**DURABIN SQUARE SET 40 WITH TROLLEY**

- Complete DURABIN SQUARE 40 kit.
- With two containers for waste and recyclable material in basic colour grey, one trolley and two lids coloured green and yellow.
- Dimensions: 680 x 704 x 376 mm (W x H x D)

# 1809816050 ♯ grey  
📦 1 set



**DURABIN TROLLEY 90**

- Transport Trolley made of white-painted metal with four castor wheels
- For a DURABIN 90 container for waste and recyclable material.
- Dimensions: 395 x 385 x 180 mm (W x H x D)

# 1801668010 ♯ white  
📦 1 unit



**DURABIN TROLLEY DUO 90**

- Transport trolley made of white-painted metal with four castor wheels
- For two DURABIN 90 containers for waste and recyclable material.
- Dimensions: 400 x 180 x 870 mm (W x H x D)

# 1801669010 ♯ white  
📦 1 unit



**WASTE SORTING PICTOGRAMS**

- Simple, easy-to-understand circular pictogram stickers for quick identification of individual waste categories
- The stickers can be attached to all types of waste containers or waste container lids
- Label dimensions: ø 9.5 cm
- Format of the entire sheet: A3

# 1422 ♯ 19 transparent  
📦 1 bag



**LABELS FOR WASTE SEGREGATION**

- High-quality labels to aid sorting of waste
- Can be attached to all types of waste containers or waste container lids
- Self-adhesive, coloured or black-and-white labels with printed-on text for various waste categories
- Label dimensions: 144 x 26 mm
- Format of the entire sheet: A3

# 1421 ♯ 61 German  
📦 1 bag

## METAL WASTE BINS

- Waste bins made of sheet steel or stainless steel.
- Ideal for use in offices and hotels
- In rectangular or classic round formats.
- Some models with additional perforation rings, with hole patterns in two widths.

### WASTE BASKET METAL ROUND 15 D

- Round waste bin.
- With decorative ring.
- Made of scratch-proof, epoxy resin-coated steel.
- Capacity: 15 litres
- Dimensions: 315 x 260 mm (H x Ø)

# 3304    ▲ 01 black, 16 beige  
 📦 1 unit



### WASTE BASKET METAL ROUND 9

- Circular waste basket.
- Made of scratch-proof steel coated with epoxy resin.
- Capacity: 9 litres
- Dimensions: 295 x 225 mm (H x Ø)

# 3309    ▲ 01 black, 10 grey  
 📦 1 unit



### WASTE BASKET METAL ROUND 15

- Round waste bin.
- Made of scratch-proof, epoxy resin-coated steel.
- Capacity: 15 litres
- Dimensions: 315 x 260 mm (H x Ø)

# 3301    ▲ 01 black, 10 grey, 23 metallic silver,  
 58 charcoal  
 📦 1 unit



### WASTE BASKET STAINLESS STEEL ROUND 15

- Round waste bin
- Premium-quality brushed stainless steel
- Environmentally friendly: made of at least 50% recycled material and up to 100% recyclable.
- 5-year warranty
- Capacity: 15 litres
- Dimensions: 315 x 260 mm (H x Ø)

# 3372    ▲ 23 metallic silver  
 📦 1 unit



### WASTE BASKET METAL ROUND 15/P 30 MM

- Round waste bin.
- With 30 mm wide decorative ring of perforations.
- Made of scratch-proof, epoxy resin-coated steel.
- Capacity: 15 litres
- Dimensions: 315 x 260 mm (H x Ø)

# 3300    ▲ 01 black, 10 grey, 23 metallic silver,  
 58 charcoal  
 📦 1 unit



### WASTE BASKET METAL ROUND 15/P 165

- Round waste bin.
- With 165 mm wide decorative ring of perforations.
- Made of scratch-proof, epoxy resin-coated steel.
- Capacity: 15 litres
- Dimensions: 315 x 260 mm (H x Ø)

# 3310    ▲ 01 black, 10 grey, 23 metallic silver,  
 58 charcoal  
 📦 1 unit



### WASTE BASKET STAINLESS STEEL ROUND 15/P 165

- Round waste bin.
- Premium-quality brushed stainless steel.
- With 165 mm wide decorative ring of perforations.
- Environmentally friendly: made of at least 50% recycled material and up to 100% recyclable.
- 5-year warranty.
- Capacity: 15 litres
- Dimensions: 315 x 260 mm (H x Ø)

# 3381    ▲ 23 metallic silver  
 📦 1 unit



### WASTE BASKET METAL ROUND 30

- Round waste bin.
- Made of scratch-proof, epoxy resin-coated steel.
- Capacity: 30 litres
- Dimensions: 450 x 315 mm (H x Ø)

# 3303    ▲ 01 black, 10 grey  
 📦 1 unit





#### WASTE BASKET METAL SQUARE 18.5

- Square metal waste bin with rounded corners.
- With scratch-proof epoxy resin coating.
- Capacity: 18.5 litres
- Dimensions: 240 x 320 x 240 mm (W x H x D)

# 3315    🔥 01 black  
📦 1 unit



#### WASTE BASKET METAL SQUARE 18.5/P 30

- Square steel waste bin with rounded corners.
- With 30 mm wide, decorative perforation ring
- With scratch-proof epoxy resin coating.
- Capacity: 18.5 litres
- Dimensions: 240 x 320 x 240 mm (W x H x D)

# 3320    🔥 01 black, 23 metallic silver  
📦 1 unit



#### WASTE BASKET METAL SQUARE 18.5/P 165

- Square steel waste bin with rounded corners.
- With 165 mm wide decorative perforation ring
- With scratch-proof epoxy resin coating.
- Capacity: 18.5 litres
- Dimensions: 240 x 320 x 240 mm (W x H x D)

# 3321    🔥 01 black, 23 metallic silver  
📦 1 unit



#### WASTE BASKET HALFROUND 20/P 30

- Semi-circular waste bin made of steel.
- With 30 mm perforation ring and wall-mounting bracket.
- With scratch-proof epoxy resin coating.
- Capacity: 20 litres
- Dimensions: 415 x 320 x 210 mm (W x H x D)

# 3316    🔥 23 metallic silver  
📦 1 unit



#### WASTE BASKET HALFROUND 20/P 165

- Semi-circular waste bin made of steel.
- With 165 mm wide perforation ring and wall-mounting bracket.
- With scratch-proof epoxy resin coating.
- Capacity: 20 litres
- Dimensions: 415 x 320 x 210 mm (W x H x D)

# 3317    🔥 23 metallic silver  
📦 1 unit

#### PEDAL BIN

- Available in 3 capacities (5, 12 or 20 litres)
- Made of powder-coated metal or stainless steel
- Removable inside bin with handle
- Bag held in place with rubber ring
- Silent closing lid
- Plastic base surround lends stability and protects against corrosion
- Lid hinge with integrated carry handle



#### PEDAL BIN METAL ROUND 5

- 5-litre inner container
- Dimensions: 260 x 290 mm (D X H); Ø 205 mm

# 3410    🔥 58 charcoal  
📦 1 unit

#### PEDAL BIN METAL ROUND 12

- 12-litre inner container
- Dimensions: 310 x 400 mm (D X H); Ø 250 mm

# 3411    🔥 58 charcoal  
📦 1 unit

#### PEDAL BIN METAL ROUND 20

- 20-litre inner container
- Dimensions: 360 x 455 mm (D X H); Ø 292 mm

# 3412    🔥 58 charcoal  
📦 1 unit



#### PEDAL BIN STAINLESS STEEL ROUND 5

- 5-litre inner container
- Fingerprint-proof coating
- Dimensions: 260 x 290 mm (D X H); Ø 205 mm

# 3400    🔥 23 silver metallic  
📦 1 unit

#### PEDAL BIN STAINLESS STEEL ROUND 12

- 12-litre inner container
- Scratch-proof
- Dimensions: 310 x 400 mm (D X H); Ø 250 mm

# 3401    🔥 23 silver metallic  
📦 1 unit

#### PEDAL BIN STAINLESS STEEL ROUND 20

- 20-litre inner container
- Scratch-proof
- Dimensions: 360 x 455 mm (D X H); Ø 292 mm

# 3402    🔥 23 silver metallic  
📦 1 unit



## WASTE BIN WITH ASHTRAY

- Metal waste bin with integrated ashtray
- Fire protection through tray filled with sand with a wire tray insert, or through fire extinguishing lid.
- Waste bin with high-quality epoxy resin coating, or made of stainless steel.
- Some with removable zinc tray for easy emptying.
- Ideal for use in smoking areas or entrance areas.



### WASTE BASKET METAL WITH ASHTRAY ROUND

- 17-litre metal waste bin with integrated 2-litre ashtray.
- With removable zinc insert for easy emptying and cleaning.
- Aluminium ashtray with wire insert, complete with 1.5 kg sand filling.
- Dimensions of removable ashtray: 60 x 240 mm (H x Ø)
- Dimensions of paper aperture: 190 x 125 mm (W x H)
- Dimensions of inside container: 380 x 220 mm (H x Ø)
- Product dimensions: 620 x 260 mm (H x Ø)

# 3330    🔥 01 black, 23 metallic silver, 58 charcoal  
 📦 1 unit



### WASTE BASKET STAINL. STEEL WITH ASHTRAY ROUND

- 17-litre waste bin made of brushed stainless steel with integrated 2-litre ashtray.
- Removable inside container and wire insert for easy cleaning.
- Environmentally friendly: made of at least 50% recycled material and up to 100% recyclable.
- Complete with 1.5 kg sand filling for the ashtray.
- 5-year warranty.
- Dimensions of removable ashtray: 60 x 240 mm (H x Ø)
- Dimensions of paper aperture: 190 x 125 mm (W x H)
- Dimensions of inside container: 380 x 220 mm (H x Ø)
- Product dimensions: 620 x 260 mm (H x Ø)

# 3373    🔥 23 metallic silver  
 📦 1 unit



### WASTE BASKET METAL WITH ASHTRAY SQUARE

- 17-litre metal waste bin with integrated 2-litre ashtray.
- With 2 apertures at the front and at the rear.
- Removable inside container and ashtray
- Ashtray with wire insert, complete with 1.5 kg sand filling.
- Dimensions of removable ashtray: 240 x 50 x 240 mm (W x H x D)
- Dimensions of paper aperture: 180 x 130 mm (W x H)
- Dimensions of inside container: 380 x 220 mm (H x Ø)
- Product dimensions: 250 x 620 x 250 mm (W x H x D)

# 3331    🔥 01 black, 23 metallic silver, 58 charcoal  
 📦 1 unit



### WASTE BASKET WITH ASHTRAY SAFE ROUND

- 17-litre metal waste paper basket with 2-litre ashtray and fire extinguishing lid.
- The self-extinguishing aluminium lid cuts off the oxygen supply inside the ashtray and quenches the flames.
- Removable inside container and ashtray for easy emptying and cleaning.
- Dimensions of fire extinguishing lid: 60 x 240 mm (H x Ø)
- Dimensions of paper aperture: 150 x 125 mm (W x H)
- Dimensions of inside container: 380 x 220 mm (H x Ø)
- Product dimensions: 630 x 250 mm (H x Ø)

# 3332    🔥 01 black, 23 metallic silver, 58 charcoal  
 📦 1 unit

### SAND REFILL

- Sand refill for ashtray insert.
- Refill pack (contents 1.5 kg) for ashtrays with product # 3330, 3331 and 3373

# 3335    🔥 16 beige  
 📦 1 unit



### ASHTRAY KULAN

- Ash tray with closed, removable cover.
- Made from special, fire-resistant plastic.
- Odourless
- Smoke is retained within the unit.
- Dimensions: 60 x 130 mm (H x Ø)

# 1799021000    🔥 black  
 📦 1 unit



**ASHTRAY WALL METAL 2.5**

- Made of epoxy resin-coated metal.
- Capacity: 2.5 litres
- Dimensions: 205 x 275 x 80 mm (W x H x D)

# 3333    🔴 01 black  
📦 1 unit



**ASHTRAY WALL METAL 4**

- Made of epoxy resin-coated metal.
- Removable inside container
- Capacity: 4 litres
- Dimensions: 310 x 450 x 107 mm (W x H x D)

# 3334    🔴 23 metallic silver  
📦 1 unit



**ASHTRAY WALL STAINLESS STEEL 4**

- Made of stainless steel.
- Removable inside container
- Capacity: 4 litres
- Dimensions: 310 x 450 x 107 mm (W x H x D)

# 3382    🔴 23 metallic silver  
📦 1 unit

**UMBRELLA STANDS**

- Elegant, high-quality umbrella stands with perforated decorative strip.
- Ideal for entrance areas, offices, retail stores or private homes.
- Capacity 28.5 litres
- Dimensions: 620 x 260 mm (H x Ø)



**UMBRELLA STAND METAL ROUND 28.5**

- Made of epoxy resin-coated metal.

# 3350    🔴 01 black, 23 metallic silver, 58 charcoal  
📦 1 unit



**UMBRELLA STAND STAINLESS STEEL ROUND 28.5**

- Made of stainless steel
- Environmentally friendly: made of at least 50% recycled material and up to 100% recyclable.
- 5-year warranty

# 3371    🔴 23 metallic silver  
📦 1 unit



## WASTE BINS WITH FIRE EXTINGUISHING LID

- Round metal waste bin with fire extinguishing lid.
- With scratch-proof epoxy resin coating or made of stainless steel
- Fire extinguishing lids made of aluminium or sheet steel.
- Fire self-extinguishing lid interrupts the oxygen supply and reduces the risk of fire
- TÜV-certified.



### WASTE BASKET SAFE+ ROUND 15

- With fire extinguishing lid made of aluminium.
- Capacity: 15 litres
- Dimensions: 375 x 260 mm (H x Ø)

# 3325    🔥 01 black, 03 red, 10 grey, 16 beige  
 📦 1 unit

### WASTE BASKET SAFE+ ROUND 30

- With fire extinguishing lid made of aluminium.
- Capacity: 30 litres
- Dimensions: 510 x 315 mm (H x Ø)

# 3326    🔥 01 black, 03 red, 10 grey, 16 beige  
 📦 1 unit

### WASTE BASKET SAFE+ ROUND 60

- With fire extinguishing lid made of aluminium.
- Capacity: 60 litres
- Dimensions: 680 x 375 mm (H x Ø)

# 3327    🔥 01 black, 03 red, 10 grey, 16 beige  
 📦 1 unit



### WASTE BASKET SAFE 40

- Capacity: 30 litres
- Dimensions: 492 x 315 mm (H x Ø)

# 3306    🔥 01 black, 10 grey  
 📦 1 unit

### WASTE BASKET SAFE 60

- Capacity: 60 litres
- Dimensions: 662 x 375 mm (H x Ø)

# 3307    🔥 01 black, 10 grey  
 📦 1 unit

### WASTE BASKET SAFE 15

- Capacity: 15 litres
- Dimensions: 357 x 260 mm (H x Ø)

# 3305    🔥 01 black, 10 grey, 23 metallic silver  
 📦 1 unit

### WASTE BASKET STAINLESS STEEL ROUND 15

- Round waste bin with fire extinguishing lid.
- Premium-quality brushed stainless steel for lifelong use.
- Capacity: 15 litres
- Environmentally friendly: made of at least 50% recycled material and up to 100% recyclable.
- 5-year warranty.
- Dimensions: 375 x 260 mm (H x Ø)

# 3376    🔥 23 metallic silver  
 📦 1 unit



## PLASTIC WASTE PAPER BINS

- Made of robust plastic materials
- In different colours and designs
- To fit every office interior
- Different sizes available

### WASTE BASKET OPTIMO

- Square waste bin for the office.
- Capacity 18 litres.
- Matches OPTIMO desk series
- Dimensions: 300 x 320 x 300 mm (W x H x D)

# 1701579221 ♠ black  
📦 1 unit



### WASTE BASKET BASIC

- Waste bin for the office.
- Capacity 13 litres.
- Matches BASIC desk series
- Dimensions: 320 x 290 mm (H x Ø)

# 1701572010 ♠ white  
📦 1 unit

# 1701572221 ♠ black  
📦 1 unit



### WASTE BASKET TREND

- Waste bin for the office.
- Capacity 16 litres.
- With carry handles for simple transport.
- Various colours including translucent.
- Matches Trend desk series.
- Dimensions: 330 x 315 mm (H x Ø)

Code	Colour	Packing	Code	Colour	Packing
1701710017	translucent light green	1 unit	1701710060	black	1 unit
1701710020	green	1 unit	1701710400	transparent	1 unit
1701710034	crimson	1 unit	1701710540	translucent blue	1 unit
1701710040	blue	1 unit	1701715003	translucent red	1 unit
1701710080	red	1 unit	1701715009	translucent orange	1 unit
1701710992	translucent purple	1 unit	1701710012	light purple	1 unit
1701710008	translucent pink	1 unit	1701710909	orange	1 unit
1701710010	white	1 unit			



### DURABIN MINI

- Mini bin for recycling.
- Capacity approx. 1 l
- Dimensions: Ø 140 mm, height 150 mm

# 1701707060 ♠ black  
📦 1 unit



**WWW.  
DURABLE  
.EU**

## BUCKETS

- Heavy-duty rectangular buckets
- With ergonomically designed handles



### BUCKET 9.5

- Capacity: 9.5 litres.
- Dimensions: 250 x 245 x 250 mm (W x H x D)

- # 1809413040 🟦 1 unit
- # 1809413080 🟥 1 unit



### BUCKET 14

- Capacity: 14 litres.
- Dimensions: 285 x 280 x 285 mm (W x H x D)

- # 1809414040 🟦 1 unit
- # 1809414080 🟥 1 unit



### BUCKET 28

- Capacity: 28 litres.
- With two hand grips
- Dimensions: 530 x 280 x 320 mm (W x H x D)

- # 1809643040 🟦 1 unit
- # 1809643080 🟥 1 unit

## SHOPPING BASKET

- Stackable heavy-duty shopping baskets.
- With large carrying handle for easy transport.



### SHOPPING BASKET 19

- For a volume of 19 litres.
- Dimensions: 400 x 249 x 300 mm (W x H x D)

- # 1801565040 🟦 1 unit
- # 1801565060 🟦 1 unit
- # 1801565080 🟥 1 unit



### SHOPPING BASKET 27

- For a volume of 27 litres.
- Dimensions: 480 x 249 x 330 mm (W x H x D)

- # 1801696060 🟦 1 unit



## TROLLEY

- Storage trolley with 4 castors.
- For the transportation of heavy and/or stackable storage boxes.
- Loading capacity of up to 250 kg.
- Dimensions: 400 x 160 x 600 mm (W x H x D)

- # 1809693060 🟦 1 unit
- # 1809693180 🟥 1 unit



**WWW.  
DURABLE  
.EU**



## Small furniture – detailed information

### EVOLUTION MULTIFUNCTIONAL TROLLEY

- Lower, fixed shelf
- 3 hard-wearing, melamine coated shelves
- 4 castors, 2 with brakes offering stability
- Metal parts made of high-quality steel with epoxy resin coating
- Delivered flat packed with assembly instructions

### EVOLUTION MULTIFUNCTIONAL TROLLEY

- Dimensions: 670 x 790 x 480 mm (W x H x D)

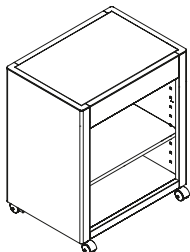

### DESIGN LINE MULTIFUNCTIONAL TROLLEY

- Sturdy lateral parts made of steel with perforation look
- 3 hardwearing coated shelves
- Middle shelf height-adjustable
- 4 castors, 2 with brakes
- Handles for convenient handling
- Delivery: flat packed

### DESIGN LINE MULTIFUNCTIONAL TROLLEY L

- Dimensions: 770 x 820 x 440 mm (W x H x D)

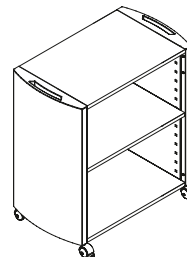

### DESIGN LINE MULTIFUNCTIONAL TROLLEY

- Dimensions: 575 x 820 x 380 mm (W x H x D)

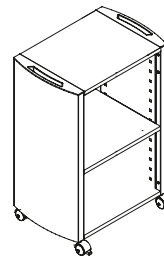

<b>Code</b>	<b>3100</b>	<b>Code</b>	<b>3101</b>	<b>3103</b>
<b>Colour</b>	120 metallic silver/maple	<b>Colour</b>	120 metallic silver/maple, 125 metallic silver/anthracite	120 metallic silver/maple, 125 metallic silver/anthracite
<b>Packing</b>	1 unit	<b>Packing</b>	1 unit	1 unit

### SYSTEM MULTI TROLLEYS

- Multifunctional and printer trolleys
- With space for paper, ring binders or as service trolleys
- Sturdy frame made of scratch-proof steel with fibreglass-reinforced plastic corners.
- Hardwearing 19 mm shelf boards.
- Raised horizontal edges on shelves to prevent tilting of ring binders, etc.
- With 4 castors, 2 with brakes
- Delivery: flat packed

### SYSTEM MULTI TROLLEY 48

- Top shelf dimensions: 600 x 432 mm (W x D)
- Bottom shelf dimensions: 560 x 413 mm (W x D)
- Dimensions: 600 x 477 x 432 mm (W x H x D)

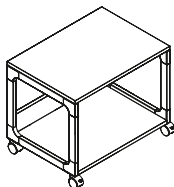

### SYSTEM MULTI TROLLEY 88

- Dimensions of top shelf: 750 x 432 mm (W x D)
- Middle shelf dimensions: 710 x 413 mm (W x D)
- Dimensions of bottom shelf: 710 x 413 mm (W x D)
- Dimensions: 750 x 879 x 432 mm (W x H x D)

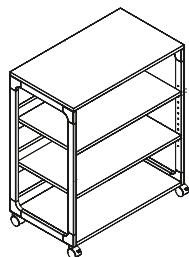

<b>Code</b>	<b>3710</b>	<b>3711</b>
<b>Colour</b>	10 grey, 124 silver/beech	10 grey
<b>Packing</b>	1 unit	1 unit

### MULTIFUNCTIONAL TROLLEY

- Made of hardwearing 16 mm boards
- Storage space partly lockable with double wing door
- 4 castors, of which 2 with brakes
- Delivery: flat packed

### MULTIFUNCTIONAL TROLLEY 74/59 OPEN

- Holds up to 25 kg per shelf.
- Dimensions: 528 x 748 x 592 mm (W x H x D)

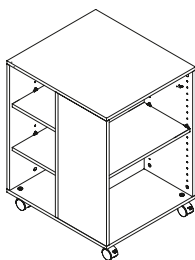

### MULTIFUNCTIONAL TROLLEY 74/53

- Holds up to 30 kg per shelf.
- Dimensions: 528 x 748 x 400 mm (W x H x D)

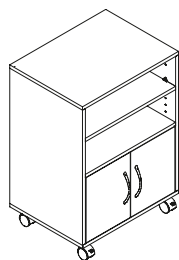

### MULTIFUNCTIONAL TROLLEY 74/53 CLOSED

- Holds up to 30 kg per shelf.
- Dimensions: 528 x 748 x 400 mm (W x H x D)

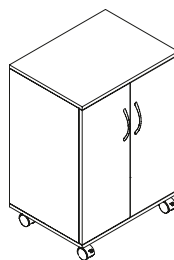

### MULTIFUNCTIONAL TROLLEY 74/53 L

- Holds up to 30 kg per shelf.
- Dimensions: 528 x 748 x 400 mm (W x H x D)

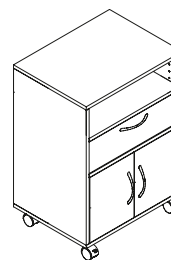

<b>Code</b>	<b>3113</b>	<b>3114</b>	<b>3115</b>	<b>3116</b>
<b>Colour</b>	10 grey, 47 beech	10 grey, 47 beech	10 grey, 47 beech	10 grey, 47 beech
<b>Packing</b>	1 unit	1 unit	1 unit	1 unit



**EVOLUTION SUSPENSION FILE TROLLEY**

- Lower, fixed shelf
- 3 hard-wearing, melamine coated shelves
- 4 castors, 2 with brakes offering stability
- Metal parts made of high-quality steel with epoxy resin coating
- Delivered flat packed with assembly instructions

**EVOLUTION SUSPENSION FILE TROLLEY 80 MULTI**

- Dimensions: 670 x 790 x 480 mm (W x H x D)

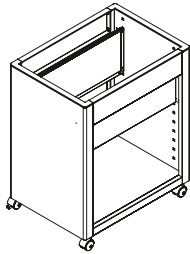

**EVOLUTION SUSPENSION FILE TROLLEY 100 TOP**

- Dimensions: 860 x 790 x 480 mm (W x H x D)

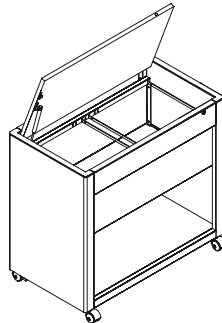

<b>Code</b>	<b>3072</b>	<b>3074</b>
<b>Colour</b>	120 metallic silver/maple	120 metallic silver/maple
<b>Packing</b>	1 unit	1 unit

**DESIGN LINE SUSPENSION FILE TROLLEY**

- Sturdy lateral parts made of steel with perforation look
- 4 castors, of which 2 with brakes
- Handles for convenient handling
- Delivery: flat packed

**DESIGN LINE SUSPENSION FILE TROLLEY 80 A4**

- Dimensions: 738 x 695 x 380 mm (W x H x D)

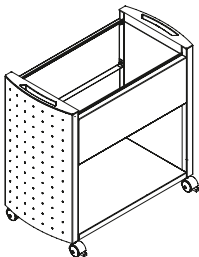

**DESIGN LINE SUSPENSION FILE TROLLEY 100 MULTI**

- Dimensions: 990 x 695 x 440 mm (W x H x D)

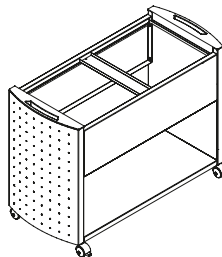

**DESIGN LINE SUSPENSION FILE TROLLEY 100 TOP**

- Dimensions: 985 x 695 x 440 mm (W x H x D)

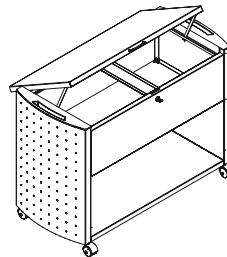

<b>Code</b>	<b>3076</b>	<b>3079</b>	<b>3080</b>
<b>Colour</b>	121 anthracite/metallic silver	121 anthracite/metallic silver	121 anthracite/metallic silver
<b>Packing</b>	1 unit	1 unit	1 unit

## Small furniture – detailed information

### ECONOMY SUSPENSION FILE TROLLEY

- Made of scratch-proof steel
- 4 castors, of which 2 with brakes
- Delivery: Flat packed.

### ECONOMY SUSPENSION FILE TROLLEY 80 FOLIO

- For approx. 80 suspension files in Folio format.
- Dimensions: 655 x 592 x 405 mm (W x H x D)

### ECONOMY SUSPENSION FILE TROLLEY 80 A4

- For approx. 80 A4 suspension files.
- Dimensions: 655 x 592 x 368 mm (W x H x D)

### ECONOMY SUSPENSION FILE TROLLEY 80 FOOLSCAP

- For approx. 80 suspension files in Foolscap format.
- Dimensions: 655 x 592 x 425 mm (W x H x D)

### ECONOMY SUSPENSION FILE TROLLEY 80 A4 TOP

- For approx. 80 A4 suspension files.
- With lockable lid.
- Dimensions: 655 x 592 x 404 mm (W x H x D)

### ECONOMY SUSPENSION FILE TROLLEY 80 MULTI

- For approx. 80 suspension files in A4, Folio or Foolscap format.
- With lockable lid.
- Dimensions: 655 x 592 x 457 mm (W x H x D)

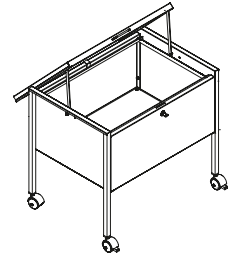
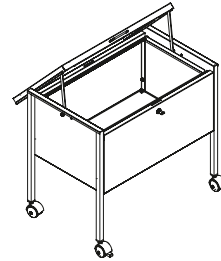
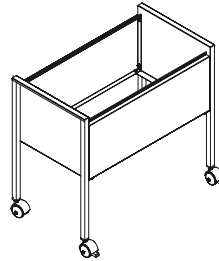
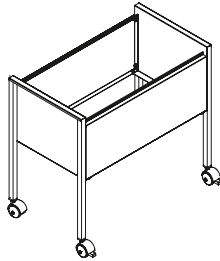
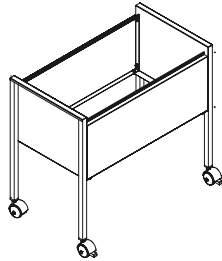

<b>Code</b>	3096	3095	3097	3098	3099
<b>Colour</b>	01 black, 10 grey	01 black, 10 grey, 23 metallic silver	10 grey	01 black, 10 grey	01 black, 10 grey
<b>Packing</b>	1 unit	1 unit	1 unit	1 unit	1 unit

### ECONOMY SUSPENSION FILE TROLLEY 100 DUO

- For approx. 100 A4 suspension files.
- Dimensions: 760 x 592 x 425 mm (W x H x D)

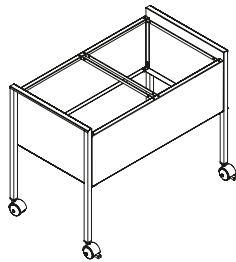

### SUSPENSION FILE TROLLEYS

- Sturdy frame made of scratch-proof steel with fibreglass-reinforced plastic corners.
- Hardwearing 19 mm shelf boards
- Partly with raised, anti-tilt edges for ring binders, magazine files, etc.
- 4 castors, of which 2 with brakes
- Delivery: flat packed.

### SYSTEM FILE TROLLEY 100 MULTI TOP

- Dimensions: 897 x 736 x 432 mm (W x H x D)

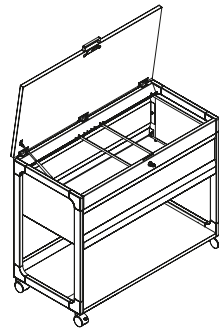

### SYSTEM FILE TROLLEY 90 A4 S

- Dimensions: 750 x 715 x 432 mm (W x H x D)

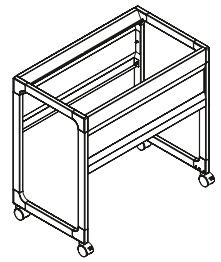

### SYSTEM FILE TROLLEY 100 MULTI S

- Dimensions: 897 x 715 x 432 mm (W x H x D)

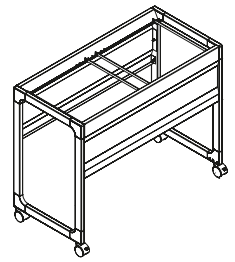

<b>Code</b>	3082	3787	3770	3783
<b>Colour</b>	01 black, 10 grey, 23 metallic silver	01 black, 10 grey	01 black, 10 grey	01 black, 10 grey
<b>Packing</b>	1 unit	1 unit	1 unit	1 unit

### SYSTEM FILE TROLLEY 90 A4

- Dimensions: 750 x 715 x 432 mm (W x H x D)

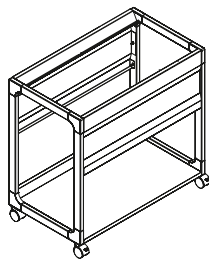

### SYSTEM FILE TROLLEY 80 MULTI DUO

- Dimensions: 487 x 715 x 432 mm (W x H x D)

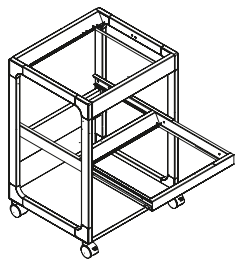

### SYSTEM FILE TROLLEY 200 MULTI DUO

- Dimensions: 897 x 715 x 432 mm (W x H x D)

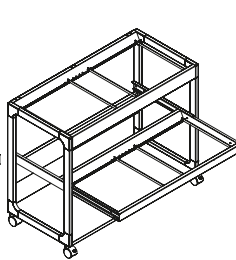

### SYSTEM FILE TROLLEY 100 MULTI

- Dimensions: 897 x 715 x 432 mm (W x H x D)

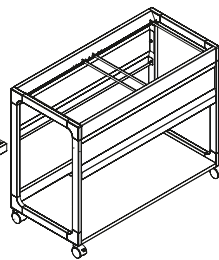

### SYSTEM FILE TROLLEY 200 MULTI DUO TOP

- Dimensions: 897 x 736 x 432 mm (W x H x D)

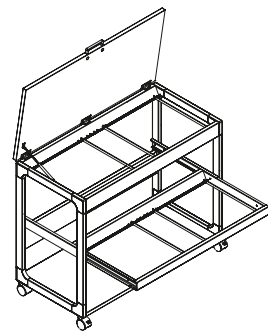

<b>Code</b>	3784	3791	3792	3785	3788
<b>Colour</b>	01 black, 10 grey	10 grey	10 grey	01 black, 10 grey	10 grey
<b>Packing</b>	1 unit	1 unit	1 unit	1 unit	1 unit

**DESIGN LINE PC WORKSTATION**

- Sturdy lateral parts made of steel with perforation look
- 4 castors, of which 2 with brakes
- Handles for convenient handling
- Delivery: Flat packed.

**DESIGN LINE PC WORKSTATION**

- Dimensions of monitor shelf: 842 x 439 (W x D)
- Dimensions keyboard shelf: 824 x 403 mm (W x H)
- Dimensions of lower shelf: 834 x 439 mm (W x H)
- Dimensions: 985 x 820 x 440 mm (W x H x D)

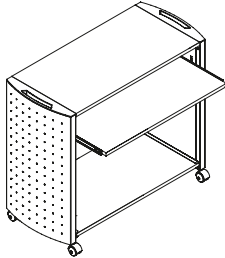

**PC WORKSTATION STANDARD**

- Made of scratch-proof steel and hardwearing shelf boards
- With extractable keyboard shelf
- 4 castors, of which 2 with brakes
- Delivery: Flat packed.

**PC WORKSTATION STANDARD**

- Dimensions of monitor shelf: 750 x 450 mm (W x D)
- Dimensions keyboard shelf: 685 x 310 mm (W x D)
- Dimensions of lower shelf: 710 x 400 mm (W x D)
- Dimensions: 750 x 750 x 450 mm (W x H x D)

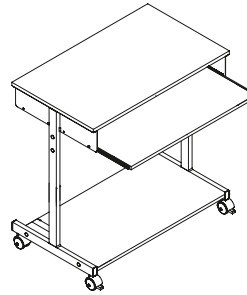

<b>Code</b>	<b>3190</b>	<b>Code</b>	<b>3197</b>
<b>Colour</b>	120 metallic silver/maple, 125 metallic silver/anthracite	<b>Colour</b>	10 grey, 120 metallic silver/maple, 127 black/beech
<b>Packing</b>	1 unit	<b>Packing</b>	1 unit

**SYSTEM FILE MULTIMEDIA TROLLEY**

- Sturdy frame made of scratch-proof steel with fibreglass-reinforced plastic corners.
- Hardwearing 19 mm melamine shelf board.
- 4 castors, 2 with brakes for stability
- Delivery: Flat packed.

**SYSTEM COMPUTER TROLLEY 80 FH**

- Dimensions of monitor shelf: 800 x 250 mm (W x D)
- Dimensions of keyboard shelf: 800 x 564 mm (W x D)
- Dimensions of bottom shelf: 660 x 272 mm (W x D)
- Dimensions: 800 x 920-1220 x 564 mm (W x H x D)

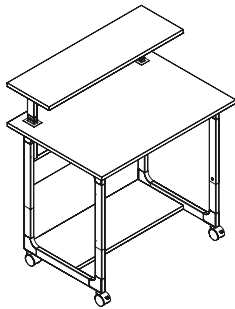

**SYSTEM COMPUTER TROLLEY 75 FH**

- Monitor shelf dimension: 750 x 534 mm (B x T), height-adjustable in 2-cm steps from 950 to 1150 mm
- Dimensions of keyboard shelf: 586 x 420 mm (B x T), height-adjustable in 3-cm steps up to 1005 mm
- Dimensions of middle shelf: 610 x 434 mm (B x T), height-adjustable in 3-cm steps.
- Dimensions of bottom shelf: 610 x 464 mm (W x D)
- Dimensions: 750 x 950-1150 x 534 mm (W x H x D)

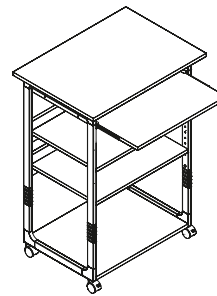

<b>Code</b>	<b>3718</b>	<b>Code</b>	<b>3720</b>
<b>Colour</b>	10 grey, 124 silver/beech	<b>Colour</b>	10 grey, 124 silver/beech
<b>Packing</b>	1 unit	<b>Packing</b>	1 unit

**SYSTEM COMPUTER TROLLEY 75 FH**

- Dimensions: 750 x 770 x 534 mm (W x H x D)

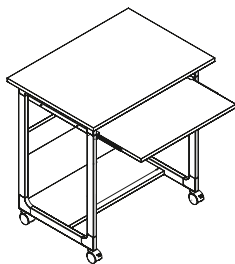

**SYSTEM OVERHEAD/BEAMER TROLLEY**

- Top shelf dimensions: 508 x 432 mm (W x D)
- Dimensions of middle shelf: 468 x 413 mm (W x D)
- Dimensions of bottom shelf: 468 x 413 mm (W x D)
- Dimensions 508 x 882 x 432 mm (W x H x D)

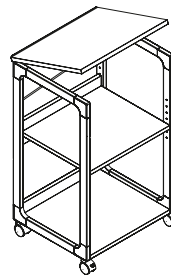

<b>Code</b>	<b>3796</b>	<b>Code</b>	<b>3701</b>
<b>Colour</b>	10 grey, 124 silver/beech	<b>Colour</b>	10 grey
<b>Packing</b>	1 unit	<b>Packing</b>	1 unit

Product	Page	Product	Page
€UROBOARD L	223	CLIP FILE ECO	29
€UROBOARD XL	223	CLIP FILE ECO PP	29
€UROBOARD XL P	223	CLIPBOARD	52
€UROBOXX®	223	CLIPBOARD A4	52
€UROBOXX® S	223	CLIPBOARD A4 BOX	52
3 PART FOLDER	44	CLIPBOARD A4 L	52
		CLIPBOARD FOLDER	52
		CLIPBOARD FOLDER A4+	52
		COMBIBOXX 1/3 A4	157
<b>A</b>		COMBIBOXX 1/3 A4 EXTENSION	158
A4 BUSINESS CARD POCKETS	57, 60	COMBIBOXX 1/3 A4 SET L	157
A4 COVER SHEETS	31	COMBIBOXX A4	157
A4 TRANSPARENT POCKET	42	COMBIBOXX A4 EXTENSION	158
A5 TRANSPARENT POCKET	42	COMBIBOXX A4 EXTENSION LANDSCAPE	158
A6 TRANSPARENT POCKET	42	COMBIBOXX A4 LANDSCAPE	157
ACRYLIC BUSINESS CARD DISPENSER	60	COMBIBOXX A4 SET L	157
ACRYLIC TABLE NAME HOLDER FOR		COMBIBOXX A4 SET XL	157
TABLET PCS	102	COMBIBOXX PRO	158
ACRYLIC TABLE PLACE NAME HOLDER	191	COMBIBOXX STAND A4 L	158, 201
ACRYLIC TABLET STAND	102, 161	COMBIBOXX TABLE 1/3 A4 XL	158
ADAPTER PIN	148	COMBIBOXX TABLE A4 XL	158
ARTWORK DESK MAT	97	CONVEX NAME BADGE WITH COMBI CLIP	169
ASHTRAY KULAN	234	CONVEX NAME BADGE WITH MAGNET	169
ASHTRAY WALL METAL 2.5	235	CORNERFIX	68
ASHTRAY WALL METAL 4	235	COTTON BUDS	111
ASHTRAY WALL STAINLESS STEEL 4	235	COVER BARS	44
		CPU STAND	124
		CREDIT CARD WALLET	44
		CROCODILE CLIP NAME BADGE	182
		CRYSTAL SIGN	197
<b>B</b>		CRYSTAL SIGN REFILL	198
BADGE REEL CHROME	188	CRYSTAL SIGN STAND A3	198, 203
BADGE REEL CHROME QUADRO	189	CRYSTAL SIGN STAND A4	198, 203
BADGE REEL STYLE LED WITH KEY RING	189	CRYSTAL-CLEAR COVER	96
BADGE REEL STYLE WITH SPRING HOOK	189		
BADGE REEL WITH KEY RING	188		
BADGE REEL WITH SNAP BUTTON	188	<b>D</b>	
BADGE REEL WITH SNAP HOOK	188	DESIGN LINE SUSPENSION FILE	
BADGEFIX	64, 185	TROLLEY 80 A4 S	119, 241
BADGEMAKER®	195	DESIGN LINE MULTIFUNCTIONAL	
BADGEMAKER® RECYCLED	195	TROLLEY	115, 240
BASIC	171	DESIGN LINE MULTIFUNCTIONAL	
BOX WALLET	35	TROLLEY I	115, 240
BROCHURE PRESENTER A4	203	DESIGN LINE PC WORKSTATION	124, 243
BUCKET 14	238	DESIGN LINE SUSPENSION FILE	
BUCKET 28	238	TROLLEY 100 MULTI	119, 241
BUCKET 9,5	238	DESIGN LINE SUSPENSION FILE	
BUSINESS CARD BOX	60	TROLLEY 100 TOP	119, 241
BUSINESS CARD BOX CHROME	60	DESIGN LINE SUSPENSION FILE	
BUSINESS CARD BOX DUO	60	TROLLEY 80 A4	119, 241
BUSINESS CARD DISPLAY BOX	60	DESK MAT	96
BUSINESS DISPLAY POCKETS	42	DESK MAT FOR CONFERENCE ROOMS	96
		DESK MAT VEGAS	79, 97
<b>C</b>			
CALENDER BLOCK	97		
CARD FIX	216		
CARD FIX WITH TEXTILE NECKLACE	210, 216		
CARD HOLDER DE LUXE	213		
CARD HOLDER DE LUXE DUO	213		
CARD HOLDER DE LUXE PRO	213		
CARD HOLDER DE LUXE PRO DUO	213		
CARD SUPPORT A4	51		
CARDBOX 170/235	51		
CARDBOX A4	51		
CARDBOX A5	51		
CARDBOX A5 DUO	51		
CARDBOX A6	51		
CARRY® PLUS	54		
CARRY® SUSPENSION RACK „BLUE ANGEL“	54		
CASH BOX M FOR CHF	223		
CASH BOX S FOR CHF	223		
CASHBOX S	223		
CATALOGUE FILE OPTIMO „BLUE ANGEL“	84, 89		
CATALOGUE FILE TREND	81		
CD/DVD ALBUM 96	105		
CD/DVD COVER	105		
CD/DVD COVER EASY	105		
CD/DVD COVER FILE	104		
CD/DVD COVER LIGHT M	104		
CD/DVD COVER LIGHT PLUS	105		
CD/DVD COVER LIGHT S	104		
CD/DVD COVER M	104		
CD/DVD COVER S	104		
CD/DVD FIX	65, 105		
CD/DVD INDEX 20	104		
CD/DVD INDEX 40	104		
CD/DVD LENS CLEAN	111		
CD/DVD MAIL	106		
CD/DVD TOP COVER	105		
CHAIN FOR NAME BADGES	189		
CLASSIC WITH COMBI CLIP	167		
CLASSIC WITH MAGNET	167		
CLEAR VIEW FOLDER WITH FILING STRIP INSERT	39		
CLEAR VIEW FOLDERS	39		
CLEAR-VIEW SUSPENSION FOLDER	54		
CLEAR-VIEW SUSPENSION FOLDER ECONOMY	54		
CLICK FOLD BADGE WITH TEXTILE NECKLACE	179		
CLICK FOLD WITH CLIP	179		
CLICK FOLD WITH COMBI CLIP	179		
CLICK FOLD WITH MAGNET	179		
CLICK SIGN	200		
CLICK SIGN REFILL	200		
CLIP	189		
CLIP CARD ECO	177		
CLIP CARD WITH CLIP	177		
CLIP CARD WITH COMBI CLIP	177		
CLIP CARD WITH FLAT PIN	177		
CLIP CARD WITH MAGNET	177		

Product	Page	Product	Page	Product	Page
DESK MAT WITH 4-PORT USB HUB	95	DURACLIP® 30 EASY FILE	26	<b>E</b>	
DESK MAT WITH ANNUAL CALENDAR	97	DURACLIP® 30 FOLIO-FORMAT	26	ECONOMY SUSPENSION FILE	
DESK MAT WITH CALENDAR BLOCK	97	DURACLIP® 30 LANDSCAPE	26	TROLLEY 100 DUO	122, 242
DESK MAT WITH CONTOURED EDGES	96	DURACLIP® 30 PLUS	26	ECONOMY SUSPENSION FILE	
DESK MAT WITH EDGE PROTECTOR	96	DURACLIP® 30 RETAIL PACK	25	TROLLEY 80 A4	122, 242
DESK MAT WITH REMOVABLE OVERLAY	96	DURACLIP® 50 INDEX	26	ECONOMY SUSPENSION FILE	
DESK MAT WITH WORLD MAP	97	DURACLIP® 60	25	TROLLEY 80 A4 TOP	122, 242
DESK ORGANIZER OPTIMO „BLUE ANGEL“	84, 89	DURACLIP® 60 RETAIL PACK	25	ECONOMY SUSPENSION FILE	
DESK ORGANIZER TREND	81	DURACLIP® A3	26	TROLLEY 80 FOLIO	122, 242
DESK PRESENTER DE LUXE	191	DURACLIP® A5	26	ECONOMY SUSPENSION FILE	
DICTATION WALLET	44	DURACLIP® FILE	26	TROLLEY 80 FOOLSCAP	122, 242
DISCOFLEX®	106	DURACLIP® JOB APPLICATION PACK	33	ECONOMY SUSPENSION FILE	
DISPLAY STAND A4	201	DURAFRAME® A3	132	TROLLEY 80 MULTI	122, 242
DIVISOFLX® ORGANISER FILE	47	DURAFRAME® A4	132	EISBÄR® ROUND-HEADED PINS	155
DOCUMENT FILES	35	DURAFRAME® A5	132	EISBÄR®-flag pins	155
DOOR SIGN REFILL	199, 200	DURAFRAME® A6	132	EVENT NAME HOLDER A6	184
Drawing pins	155	DURAFRAME® MAGNETIC A3	137	EVENT NAME HOLDER A6 WITH	
DRY CLEAN 50	111	DURAFRAME® MAGNETIC A4	137	TEXTILE NECKLACE DUO	184
DUAL BOX FOR 2 ID CARDS/SECURITY PASSES	214	DURAFRAME® MAGNETIC A5	137	EVOLUTION MULTIFUNCTIONAL TROLLEY	114, 240
DUAL BOX WITH BADGE REEL FOR		DURAFRAME® MAGNETIC A6	137	EVOLUTION SUSPENSION FILE	
2 ID CARDS/ SECURITY PASSES	214	DURAFRAME® MAGNETIC PLUS A4	138	TROLLEY 100 TOP	118, 241
DUAL SECURITY PASS HOLDER WITH BADGE		DURAFRAME® MAGNETIC SECURITY A4	139	EVOLUTION SUSPENSION FILE	
REEL FOR 2 ID CARDS/SECURITY PASSES	215	DURAFRAME® NOTE A4	133	TROLLEY 80 MULTI	118, 241
DUAL SECURITY PASS HOLDER WITH		DURAFRAME® PHOTO	135	EXTENSION SET FOR PRODUCT # 2372,	
CLIP FOR 2 ID CARDS/SECURITY PASSES	215	DURAFRAME® PHOTO DESK	135	2375 AND 2442	61
DURABIN 60	229	DURAFRAME® PHOTO PLUS	135	EXTENSION SET FOR PRODUCT # 2372,	
DURABIN 60 WALL MODULE	230	DURAFRAME® POSTER	134	2383, 2385, 2403, 2441 AND 2461	57
DURABIN 90	231	DURAFRAME® SECURITY A4	136	EXTENSION SET FOR PRODUCT # 2377	61
DURABIN FLIP 40	228	DURAGLAS®	96	EXTENSION SET FOR TELINDEX® FLIP/	
DURABIN FLIP LID SQUARE 40	228	DURAGRIP®	31	TELINDEX® DESK/TELINDEX® CUBO	62, 78
DURABIN FLIP-TOP LID 60	230	DURALOOK®	37	EXTENSION SET FOR VISIFIX® FLIP/	
DURABIN HINGED LID WITH HOLES 60	230	DURALOOK® COVER	37	VISIFIX® DESK/ VISIFIX® CUBO	59, 78
DURABIN HINGED LID WITH SLOT 60	230	DURALOOK® EASY	37		
DURABIN LID 60	229	DURALOOK® EASY PLUS	37		
DURABIN LID 90	231	DURALOOK® EASY WALK	37		
DURABIN LID ROUND 40	228	DURALOOK® PLUS	37		
DURABIN LID SQUARE 40	228	DURALOOK® STYLE	37		
DURABIN MINI	237	DURALOOK® VISIFIX® WALK	37, 60	<b>F</b>	
DURABIN ROUND 40	228	DURAPLUS® DE LUXE		FILEFIX®	69
DURABIN SQUARE 40	228	PRESENTATION FOLDER	40	FILEFIX® MAXI	69
DURABIN SQUARE SET 40 WITH TROLLEY	231	DURAPLUS® PRESENTATION FOLDER	40	FILING BARS	31
DURABIN SQUARE TROLLEY DUO 40	228	DURAQUICK®	29	FILING STRIP INSERT	45
DURABIN TROLLEY 60	230	DURAQUICK® RETAIL PACK	29	FIRST AID BOX L	222
DURABIN TROLLEY 90	231	DURASTAR®	154	FIRST AID BOX M	222
DURABIN TROLLEY DUO 60	230	DURASWING®	28	FIRST AID KIT L	222
DURABIN TROLLEY DUO 90	231	DURASWING® JOB	28, 33	FIRST AID KIT M	222
DURABIND®	36	DURASWING® PLUS	28	FIRST AID SET L	222
DURACARD BLACK RIBBON COLOUR RIBBON	209	DURASWING® PROJECT	28	FIRST AID SET M	222
DURACARD COLOUR RIBBON COLOUR RIBBON	209	DURAVIEW® STAND	140, 202	FLEXI® FILING STRIPS	45, 69
DURACARD ID 300	208	DURAVIEW® TABLE	140	FLEXIBOXX 12 A4	160
DURACARD LIGHT CARDS (CARDS, BLANK)	209	DURAVIEW® WALL	140	FLEXIBOXX 12 A4 LANDSCAPE FORMAT	160
DURACARD PRINTING SET				FLEXIBOXX 6 A4	160
(COLOUR RIBBON + CARDS)	209			FLEXIBOXX 6 A4 LANDSCAPE FORMAT	160
DURACARD STANDARD CARDS (CARDS BLANK)	209			FLEXIBOXX A4 EXTENSION	161
DURACLIP® 30	25			FLEXIBOXX A4 EXTENSION	
				LANDSCAPE FORMAT	161

## Contents by product name

Product	Page	Product	Page	Product	Page
FLEXIBOXX A4 FRONT PLATE		ID CARD HOLDER FOR 1 ID CARD/ SECURITY PASS, RETAIL PACK	215	<b>L</b>	
LANDSCAPE FORMAT	160	ID CARD HOLDER WITH BADGE REEL FOR 1 ID CARD/ SECURITY PASS	215	LABEL REMOVER	111
FLEXIBOXX A4 FRONTPLATTE	160	ID CARD HOLDER WITH CLIP FOR 1 ID CARD/SECURITY PASS	215	LABELFIX	65
FLEXIBOXX DIVIDER A4 LANDSCAPE	161	IDEALBOX	94	LABELS FOR PROTECTIVE POCKETS	43
FLEXIFIX®	45, 69	IDEALBOX BASIC 5	94	LABELS FOR WASTE SEGREGATION	231
FLEXIFIX® ECONOMY	45, 69	IDEALBOX BASIC 5 „BLUE ANGEL“	90, 94	LAMINATED NAME BADGE	185
FLEXIFIX® RETAIL PACK	45	IDEALBOX BASIC 7	94	LAMINATING NAME BADGE WITH COMBI CLIP	185
FLEXIPLUS 2 A4	159	IDEALBOX BASIC 7 „BLUE ANGEL“	90, 94	LAPTOP CLEANING KIT	111
FLEXIPLUS 2 A4 LANDSCAPE FORMAT	159	IDEALBOX PEN TRAY „BLUE ANGEL“	90, 94	LEATHER DESK MAT	95
FLEXIPLUS 2 A5	159	IDEALBOX PLUS	94	LEATHER DESK MAT FOR CONFERENCE ROOMS	96
FLEXIPLUS 6 A4	159	INDEX CARDS WITH INSERT-WELDED TABS	51	LETTER TRAY BASIC	82
FLEXIPLUS 6 A4 LANDSCAPE FORMAT	159	INDEX FILE I 5	35	LETTER TRAY CUBO	86
FOLDER WITH ELASTIC CORNER HOLDERS	35	INDEX SET WITH COLOURED TABS	50	LETTER TRAY ECONOMY „BLUE ANGEL“	85
FRAME WITH COMBI CLIP	175	INDEX SETS WITH INSERT-WELDED TABS AND INSERT LABELS	49	LETTER TRAY ECONOMY „BLUE ANGEL“	90
FRAME WITH MAGNET	175	INDEX SETS WITH INSERT-WELDED TABS AND INSERTED, IMPRINTED INSERT LABELS	49	LETTER TRAY OPTIMO A3, LANDSCAPE „BLUE ANGEL“	84, 89
FUNCTION PANEL A4	150	INDEX SETS WITH PRINTED TABS	50	LETTER TRAY OPTIMO A4 „BLUE ANGEL“	84, 89
FUNCTION PANEL SAFE A4	151	INDEX TABS	148	LETTER TRAY TREND	80
FUNCTION SAFE WALL 10	151	INFO SIGN	199	LETTER TRAY VEGAS	79
FUNCTION STAINLESS WALL 10	151	INFO SIGN REFILL CAPS	199	LEVER CLAMP FILE	52
FUNCTION TABLE 10	150	INFO SIGN STAND A3	199, 203	LICENCE HOLDER WITH BADGE REEL FOR 1 ID CARD/ SECURITY PASS	216
FUNCTION TABLE 20	150	INFO SIGN STAND A4	199, 203	LICENCE HOLDER WITH CLIP FOR 1 ID CARD/ SECURITY PASS	216
FUNCTION TABLE 30	150	<b>J</b>		LITERATURE DISPLAY	161
FUNCTION TABLE MODULE 10	151	JOB APPLICATION FOLDER ECO PP	33		
FUNCTION TABLE MODULE 20	151	JOB APPLICATION FOLDER WITH CLIP	33	<b>M</b>	
FUNCTION TABLE MODULE 30	151	JOB APPLICATION PACK PROFESSIONAL	33	MAGAZINE RACK BASIC	82
FUNCTION WALL 10	150	JOJO PLUS	188	MAGAZINE RACK CUBO	86
FUNCTION WALL 20	150	JOJO STYLE	189	MAGAZINE RACK ECONOMY „BLUE ANGEL“	85, 90
FUNCTION WALL MODULE 10	151			MAGAZINE RACK OPTIMO „BLUE ANGEL“	84, 89
FUNCTION WALL MODULE 15	151	<b>K</b>		MAGAZINE RACK TREND	80
FUNCTION WALL MODULE 20	151	KEY BOARD 24	219	MAGNETIC POCKET A4	141
FUNCTION WALL MODULE 5	151	KEY BOX 12	219	MAGNETIC POCKET A5	141
		KEY BOX 18	219	MAGNETS	155
<b>G</b>		KEY BOX 36	219	MEMORY CARD BOX	106
GUIDE CARDS WITH PRINTED A-Z TABS	51	KEY BOX 48	219	MEN'S WC SYMBOL	205
		KEY BOX 54	219	MOUSE PAD	103
<b>H</b>		KEY BOX 72	219	MOUSE PAD ERGOTOP®	103
HEIGHT SPACER ELEMENTS FOR LETTER TRAY BASIC	82	KEY BOX CODE 18	220	MOUSE PAD ERGOTOP® WITH GEL	103
HEIGHT SPACER PINS FOR LETTER TRAY OPTIMO	84, 89	KEY BOX CODE 36	220	MOUSE PAD PLUS	103
		KEY BOX CODE 48	220	MULTIFILE	34
<b>I</b>		KEY BOX CODE 54	220	MULTIFUNCTIONAL TROLLEY 74/53	116, 240
ID CARD AND CREDIT CARD HOLDERS	44	KEY BOX CODE 72	220	MULTIFUNCTIONAL TROLLEY 74/53 CLOSED	116, 240
ID CARD HOLDER BACT-O-CLEAN WITH CLIP		KEY BOX PLUS	221	MULTIFUNCTIONAL TROLLEY 74/53 L	116, 240
ID CARD HOLDER FOR 1 ID CARD/ SECURITY PASS	215	KEY CLIP	218	MULTIFUNCTIONAL TROLLEY 74/59 OPEN	116, 240
				MULTIMEDIA BOX I	106
				MULTIMEDIA BOX II	106

Product	Page	Product	Page	Product	Page
<b>N</b>				<b>R</b>	
NAME BADGE SET WITH CLIP 60 X 90 MM	183	PEN HOLDER VEGAS	79	REINFORCEMENT STRIPS	65
NAME BADGE SET WITH PIN 40 X 60 MM	181	PERSONNEL FOLDER	47	REPORT COVER	31
NAME BADGE SET WITH PIN 54 X 90 MM	181	PET TABLE PLACE NAME HOLDER	193	RIGID BOX FOR 1 ID CARD/SECURITY PASS	214
NAME BADGE SETS	181, 182	PICTO	204	RIGID BOX WITH BADGE REEL	
NAME BADGE WITH CLIP	183	PICTO SQUARE	205	FOR 1 ID CARD/ SECURITY PASS	210, 214
NAME BADGE WITH COMBI CLIP	169, 182	Pins	155	RIGID BOX WITH CLIP FOR	
NAME BADGE WITH HEAVY DUTY		PLASTIC CLIP-ON TABS	47	1 ID CARD/SECURITY PASS	210, 214
BADGE REEL	184	PLASTIC TABS	55	R-PET TABLE PLACE NAME HOLDER	192
NAME BADGE WITH MAGNET	182	POCKETFIX®	66		
NAME BADGE WITH PIN	181	POCKETFIX® 212 X 122/88	66	<b>S</b>	
NAME BADGE WITH TEXTILE		POCKETFIX® 212 X 88/122	66	SAND REFILL	234
BADGE NECKLACE 10	184	POCKETFIX® A4	67	SCAN/FAX/COPYING CARRIER POCKET	44
NAME BADGE WITH TEXTILE		POCKETFIX® A5	67	SCANFIX	65
BADGE NECKLACE 20	184	POCKETFIX® CD/DVD	67, 105	SCHEDULE STRIP	55
NAME BADGE WITH TUCK FLAP	169	POCKETFIX® PLUS	66	SCREENCLEAN 50	109
NOTE BOX CUBO	86	POWERCLEAN 150	107	SCREENCLEAN DUO	109
NOTE BOX CUBO ECO	87	POWERCLEAN 400	107	SCREENCLEAN FLUID	109
NOTE BOX TREND	81	POWERCLEAN INVERTIBLE	107	SCREENCLEAN FOAM	109
NOTE BOX VEGAS	79	POWERCLEAN PLUS	107	SCREENCLEAN MINI + MICROFIBRE	
		POWERCLEAN STANDARD	107	GLOVE 8ML	109
		PREMIUM DISPLAY POCKETS	42	SCREENCLEAN PRO	109
		PREMIUM QUALITY DESK MAT	95	SCREENCLEAN REFILL	108
		PRESENTATION COVER	205	SCREENCLEAN SET	108
		PRESENTATION FOLDER	40	SCREENCLEAN SPRAY	109
		PRESENTATION STAND A4	155	SCREENCLEAN TUB	108
		PRESENTATION STAND A5	155	SEAL IT 54 X 90 MM	69
<b>O</b>		PRESENTER 1/3 A4	155	SEAL IT A4	69
OPAQUE DOCUMENT FOLDERS	40	PRESENTER 1/3 A4	203	SEAL IT A4 ADHESIVE	69
ORDOFIX®	68	PRESENTER A4	155	SEAL IT A6	69
ORGANISER FILE	47	PRESENTER A5	155	SEAL IT A7	69
		PRESSBOARD GUIDE INDEX CARDS AND		SECURITY NAME BADGE	184
		INDEX GUIDES	51	SECURITY PASS HOLDER FOR 2 ID CARDS	215
		PROTECTIVE ID CARD HOLDER	43	SECURITY PASS HOLDER WITH CLIP	
		PUNCHED DOUBLE POCKET	43	FOR 2 ID CARDS	214
		PUNCHED POCKET INDEX WITH INSERT-WELDED,		SELECT WITH COMBI CLIP	173
		COLOURED TABS AND INSERT LABELS	48	SELECT WITH MAGNET	173
		PUNCHED POCKETS BUSINESS	41	SEMI-CIRCLE DESK MAT	97
		Punched Pockets for Extra Capacity	154	SEMI-CIRCLE DESK MAT WITH	
		PUNCHED POCKETS PREMIUM	41	TRANSPARENT OVERLAY	97
		PUNCHED POCKETS STANDARD	41	SHERPA® BACT-O-CLEAN	144
				SHERPA® BACT-O-CLEAN WALL 10	144
		<b>Q</b>		SHERPA® CAROUSEL 40	145
		QUICK TAB	68	SHERPA® CAROUSEL BASIC 40	145
		QUICK TAB DUO	68	SHERPA® DESK CLAMP 10	149
		QUICK TAB DUO PERMANENT	68	SHERPA® DESK CLAMP MODULE	149
		QUICKFLIP® COMPLETE	105	SHERPA® EXTENSION MODULE 10	146
		QUICKFLIP® STANDARD	105	SHERPA® EXTENSION SET 10	146
				SHERPA® FLOOR 10	149, 202
				SHERPA® FLOOR MODULE 10	149, 202
				SHERPA® INFOBASE TELESCOPE	149, 202
				SHERPA® INFOPANEL A4	148
<b>P</b>					
PAPER CLIP BOX CUBO	86				
PAPER CLIP BOX CUBO ECO	87				
PAPER CLIP BOX TREND	80				
PAPER CLIP BOX VEGAS	79				
PAPER CLIP DISPENSER WITH MAGNET	98				
PAPER CLIPS	98				
PAPER CLIPS PAINTED	98				
PAPER CLIPS PLASTIC COATED	98				
PAPER CLIPS/PINS/ELASTIC BANDS	155				
PAPER NOTES	79				
PAPER/CUT	99				
PC CLEANING KIT	108				
PC WORKSTATION STANDARD	124, 243				
PEDAL BIN METAL ROUND 12	233				
PEDAL BIN METAL ROUND 20	233				
PEDAL BIN METAL ROUND 5	233				
PEDAL BIN STAINLESS STEEL ROUND 12	233				
PEDAL BIN STAINLESS STEEL ROUND 20	233				
PEDAL BIN STAINLESS STEEL ROUND 5	233				
PEN CUP TREND	80				
PEN HOLDER CUBO	86				
PEN HOLDER CUBO ECO	87				

## Contents by product name

Product	Page	Product	Page	Product	Page
SHERPA® INFOPANEL ACRYL	149	SYSTEM FILE TROLLEY 200 MULTI DUO TOP	121, 242	<b>V</b>	
SHERPA® MOTION 10	144	SYSTEM FILE TROLLEY 80 MULTI DUO	120, 242	VARICOLOR® 10	74, 93
SHERPA® PANEL A4	148	SYSTEM FILE TROLLEY 90 A4	120, 242	VARICOLOR® 5	74, 93
SHERPA® PANEL A4 BACT-O-CLEAN	148	SYSTEM FILE TROLLEY 90 A4 S	120, 242	VARICOLOR® 7	74, 93
SHERPA® PANEL A5	148	SYSTEM MULTI TROLLEY 48	115, 240	VARICOLOR® DESK ORGANIZER	77
SHERPA® PANEL PIN A4	148	SYSTEM MULTI TROLLEY 88	115, 240	VARICOLOR® JOB CASE	76
SHERPA® PANEL PLUS A4	148	SYSTEM OVERHEAD/BEAMER TROLLEY	126, 243	VARICOLOR® PEN CUP	77
SHERPA® SOHO 5	145			VARICOLOR® PHONE HOLDER	75, 102
SHERPA® STAND PRO 10	149, 202			VARICOLOR® TABLET BASE	76
SHERPA® STYLE TABLE 10	145			VARICOLOR® TRAY SET	75
SHERPA® STYLE WALL 10	145			VARICOLOR® TRAY SET DUO	75
SHERPA® SWING ARM MODULE 10	149	<b>T</b>		VARIO® A5 TABLE 10	152
SHERPA® TABLE 10	146	TABFIX®	68	VARIO® A5 WALL 10	153
SHERPA® TABLE 20	146	TABLE FLIPCHART ECONOMY	154	VARIO® MAGNET WALL 5	153
SHERPA® TABLE 30	146	TABLE FLIPCHARTS	154	VARIO® PRO 10	152
SHERPA® TABLE MODULE 10	146	TABLE MATS FOR ARTS AND CRAFTS	97	VARIO® TABLE 10	152
SHERPA® WALL 10	147	TABLE PLACE NAME HOLDER	192	VARIO® TABLE 20	152
SHERPA® WALL 5	147	TABLE PLACE NAME HOLDER PLUS	191	VARIO® TABLE 30	152
SHERPA® WALL MODULE 10	147	TABLE SIGN	205	VARIO® WALL 10	153
SHERPA® WALL MODULE 5	147	TABLET CASE TRAVEL	101	VARIO® WALL 20	153
SHOPPING BASKET 19	238	TABLET SLEEVE PROTECT	101	VARIO® WALL 5	153
SHOPPING BASKET 27	238	TAPE DISPENSER TREND	81	VISIFIX®	57, 58
SMART CLEAN	111	TAPE DISPENSER VEGAS	79	VISIFIX® 128	58
SMARTCLIP	173	TECHCLEAN CLOTH	111	VISIFIX® 192	58
SORTER	51	TELINDEX®	61	VISIFIX® 400	58
SORTER RACK, 5 PARTS	161	TELINDEX® A5	61	VISIFIX® 72	58
SORTER RACK, 8 PARTS	161	TELINDEX® CUBO	62; 86	VISIFIX® 96	57
SPECIAL PUNCHED POCKETS	41	TELINDEX® DESK VEGAS	62, 78	VISIFIX® A4	57, 58
SPINE BARS	30,31	TELINDEX® ECONOMY	61	VISIFIX® PLUS	57
SPINE BARS + REPORT COVERS 5 & 5	31	TELINDEX® FLIP VEGAS	62, 78	VISIFIX® PRO	56
SPINE BARS RETAIL PACK	31	TELINDEX® ROTARY FILE	62	VISIFIX® PRO A4	56
STANDARD SCISSORS	99	TEXTILE NAME BADGE	185	VISIFIX® ROTARY FILE	59
STANDARD SICHTHÜLLEN	42	TEXTILE NECKLACE DUO	187	VISIFIX® CENTIUM	58
SUPERCLEAN 50	108	TEXTILE NECKLACE/LANYARD 10 WITH		VISIFIX® CUBO	59; 86
SUPERCLEAN BOX	108	SAFETY RELEASE	187	VISIFIX® DESK VEGAS	59, 79
SUPERCLEAN FLUID	108	TEXTILE NECKLACE/LANYARD 20 RETAIL PACK	187	VISIFIX® ECONOMY	59
SUPERCLEAN FOAM	108	TEXTILE NECKLACE/LANYARD 20 WITH		VISIFIX® FLIP DUO VEGAS	59, 78
SUPERCLEAN REFILL	108	SAFETY RELEASE	187	VISIFIX® FLIP VEGAS	59, 78
SUPERCUT	99	TEXTILE NECKLACE/LANYARD WITH		VISITORS BOOK 100	185
SUSPENSION FILE RACK	54	BADGE REEL AND SNAP HOOK	187	VISITORS BOOK 100 REFILL	185
SUSPENSION FILE STAND	54	TRANSLUCENT DOCUMENT FOLDER	40	VISITORS BOOK 300	185
SUSPENSION FOLDER	55	TRANSPARENT SUSPENSION POCKET	55	VISITORS BOOK 300 REFILL	185
SUSPENSION FOLDER	55	TROLLEY	238		
SUSPENSION RAIL	45, 55			<b>W</b>	
SWINGCLIP®	27			WASTE BASKET BASIC	82, 237
SWINGCLIP® COLOR	27	<b>U</b>		WASTE BASKET HALFRound 20/P 165	233
SWINGCLIP® JOB APPLICATION PACK	27, 32	UMBRELLA STAND METAL ROUND 28.5	235	WASTE BASKET HALFRound 20/P 30	233
SWINGCLIP® RETAIL PACK	27	UMBRELLA STAND STAINLESS STEEL		WASTE BASKET METAL ROUND 15	232
SYSTEM COMPUTER TROLLEY 75 FH	126, 243	ROUND 28.5	235	WASTE BASKET METAL ROUND 15 D	232
SYSTEM COMPUTER TROLLEY 75 VH	126, 243			WASTE BASKET METAL ROUND 15/P 165	232
SYSTEM COMPUTER TROLLEY 80 FH	126, 243			WASTE BASKET METAL ROUND 15/P 30 MM	232
SYSTEM FILE TROLLEY 100 MULTI	121, 242			WASTE BASKET METAL ROUND 30	232
SYSTEM FILE TROLLEY 100 MULTI S	120, 242				
SYSTEM FILE TROLLEY 100 MULTI TOP	120, 242				
SYSTEM FILE TROLLEY 200 MULTI DUO	121, 242				



Product	Page
WASTE BASKET METAL ROUND 9	232
WASTE BASKET METAL SQUARE 18.5	233
WASTE BASKET METAL SQUARE 18.5/P 165	233
WASTE BASKET METAL SQUARE 18.5/P 30	233
WASTE BASKET METAL WITH ASHTRAY ROUND	234
WASTE BASKET METAL WITH ASHTRAY SQUARE	234
WASTE BASKET OPTIMO	84, 237
WASTE BASKET SAFE 15	236
WASTE BASKET SAFE 30	236
WASTE BASKET SAFE 60	236
WASTE BASKET SAFE STAINLESS STEEL ROUND 15	236
WASTE BASKET SAFE+ ROUND 15	236
WASTE BASKET SAFE+ ROUND 30	236
WASTE BASKET SAFE+ ROUND 60	236
WASTE BASKET STAINLESS STEEL WITH ASHTRAY ROUND	234
WASTE BASKET STAINLESS STEEL ROUND 15	232
WASTE BASKET STAINLESS STEEL ROUND 15/P 165	232
WASTE BASKET TREND	81, 237
WASTE BASKET WITH ASHTRAY SAFE ROUND	234
WASTE SORTING PICTOGRAMS	231
WET WIPES FOR GLASSES	111
WOMEN'S WC SYMBOL	205
WORK PAD	96
WRIST SUPPORT	103
WRIST SUPPORT WITH GEL	103

**Z**

ZIP BAG A4	44
ZIP BAG A5	44



## Contents by product #

Product code	Page	Product code	Page	Product code	Page
<b>1</b>		1738	99	2196	42
1204	98	1739	99	2200	25
1205	98	1760	223	2201	26
1206	98	1761	223	2209	25
1207	98	1771	99	2213	26
1208	98	1772	99	2217	26
1209	98	1773	99	2218	26
1210	98	1774	99	2227	25
1211	98	1777	223	2229	26
1212	98	1778	223	2230	52
1213	98	1780	223	2234	26
1224	98	1781	223	2238	25
1225	98	1782	223	2244	33
1226	98	1867	55	2245	52
1227	98	1878	223	2246	26
1240	98	1893	47	2249	33
1241	98	1924	155	2250	36
1253	98	1926	155	2260	27
1254	98	1929	155	2266	27
1274	155	1951	219	2270	29
1275	155	1952	219	2274	29
1276	155	1953	219	2284	27
1277	155	1954	219	2286	27
1278	155	1955	219	2287	28
1421	231	1956	219	2288	28
1422	195, 231	1957	218	2289	28, 33
1423	195	1960	219	2290	28
1425	195	1966	220	2294	43
1427	195	1967	220	2295	28
1428	195	1968	221	2296	43
1429	195	1969	220	2297	43
1449	195	1970	222	2298	43
1451	195	1971	222	2302	42
1452	195	1972	222	2306	42
1453	195	1973	222	2307	42
1454	195	1974	222	2308	58
1455	195	1975	222	2313	42
1456	195	1976	220	2314	42
1457	195	1977	220	2315	42
1458	195			2316	44
1459	195			2318	42
1460	195			2319	42
1461	195	<b>2</b>		2320	35
1463	185	2131	43	2322	35
1464	185	2132	43	2323	35
1465	185	2133	43	2332	52
1466	185	2134	43	2334	42
1480	195	2135	43	2335	42
1531	45, 55	2136	43	2337	42
1715	99	2137	43	2339	42
1716	99	2138	43	2346	44
1718	99	2139	43	2347	44
1720	99	2140	43	2350	52
1736	99	2141	43	2355	52
1737	99	2142	43	2357	52

Product code	Page	Product code	Page	Product code	Page
2359	52	2480	44	2900	30
2372	57	2481	59	2901	30
2375	61	2482	62	2902	30
2377	61	2500	40	2904	30
2380	58	2510	39	2909	30
2383	58	2512	40	2910	30
2384	58	2533	34	2911	30
2385	57	2554	47	2912	30
2387	57	2555	47	2917	31
2388	57	2556	47	2919	31
2389	57, 60	2557	47	2924	44
2394	44	2560	54	2926	31
2397	44	2561	54	2929	31
2400	58	2563	55	2930	30
2402	58	2565	55	2931	30
2403	58	2569	55	2932	31
2409	58	2570	39	2933	31
2412	62, 79	2573	39	2935	31
2413	59, 79	2579	40	2939	31
2414	60	2580	39	2942	31
2415	60	2586	33	2943	31
2416	62, 78	2589	40	2996	45
2417	59, 78	2600	54, 89		
2418	59, 78	2601	55		
2419	62, 78	2602	55		
2421	37	2604	55	<b>3</b>	
2422	37	2611	54	3072	118, 241
2423	37	2650	41	3074	118, 241
2424	37	2651	41	3076	119, 241
2425	37	2652	41	3079	119, 241
2426	37	2656	41	3080	119, 241
2427	37	2658	41	3082	122, 242
2428	37	2659	41	3095	122, 242
2431	37	2660	41	3096	122, 242
2432	37	2661	41	3097	122, 242
2433	60	2662	41	3098	122, 242
2434	37	2663	41	3099	122, 242
2435	37	2664	41	3100	114, 240
2439	60	2667	41	3101	115, 240
2440	60	2668	41	3103	115, 240
2441	59	2670	41	3113	116, 240
2442	61	2671	41	3114	116, 240
2443	59, 78	2672	41	3115	116, 240
2444	59	2673	41	3116	116, 240
2445	58	2675	41	3123	54
2446	62; 86	2676	41	3124	54
2447	59, 86	2677	41	3141	51
2449	61	2678	41	3151	51
2452	37, 60	2680	40	3160	51
2453	37	2681	39	3190	125, 243
2456	61	2682	41	3197	125, 243
2461	56	2683	41	3231	125
2462	56	2815	29	3300	232
2475	35	2816	29	3301	232
2479	44	2817	33	3303	232

## Contents by product #

Product code	Page	Product code	Page	Product code	Page
3304	232	3784	120, 242	4855	199, 200
3305	236	3785	121, 242	4856	195, 199, 200
3306	236	3787	120, 242	4860	200
3307	236	3788	121, 242	4861	200
3309	232	3791	120, 242	4862	200
3310	232	3792	121, 242	4863	201
3315	233	3796	126, 243	4864	203
3316	233			4865	203
3317	233			4866	200
3320	233			4867	200
3321	233	<b>4</b>		4868	137
3325	236	4245	51	4869	137
3326	236	4255	51	4870	132
3327	236	4701	155	4871	132
3330	234	4702	155	4872	132
3331	234	4703	155	4873	132
3332	234	4704	155	4874	141
3333	235	4751	155	4875	141
3334	235	4752	155	4881	132
3335	234	4753	155	4882	132
3350	235	4754	155	4883	132
3351	51	4755	155	4884	135
3352	51	4800	199	4885	135
3353	51	4801	199	4886	135
3354	51	4802	199	4897	132
3355	51	4803	199	4898	132
3356	51	4804	199	4899	132
3360	161	4805	199	4900	204
3361	161	4806	199	4901	204
3371	235	4807	199	4902	204
3372	232	4808	199	4903	204
3373	234	4812	199, 203	4904	204
3376	236	4813	199, 203	4905	204
3381	232	4816	199	4906	204
3382	235	4818	198, 203	4907	204
3390	52	4819	198, 203	4910	204
3391	52	4820	197	4911	204
3392	52	4821	197	4912	204
3400	233	4822	197	4914	204
3401	233	4823	197	4917	204
3402	233	4824	197	4920	204
3410	233	4825	197	4921	204
3411	233	4826	197	4923	204
3412	233	4830	198	4924	204
3650	51	4831	198	4927	204
3660	51	4832	198	4938	204
3670	51	4833	198	4942	135
3700	51	4834	198	4943	135
3701	126, 243	4835	198	4944	136
3710	115, 240	4836	198	4945	139
3711	115, 240	4850	199, 200	4946	136
3718	125, 243	4851	199, 200	4947	137
3720	126, 243	4852	199, 200	4948	137
3770	120, 242	4853	199, 200	4950	204
3783	120, 242	4854	199, 200	4951	204

Product code	Page	Product code	Page	Product code	Page
4953	204	5520	146	5748	103
4954	204	5540	145	5749	103
4956	204	5551	153	5756	110
4957	204	5567	153	5758	110
4958	204	5570	152	5759	110
4959	204	5579	152	5767	145
4960	204	5582	148	5781	108
4962	204	5587	144	5782	109
4964	135	5589	149, 202	5785	110
4965	135	5590	148	5787	109
4966	135	5603	148	5788	108
4967	135	5606	148	5789	111
4979	140	5607	150	5794	111
4980	140	5609	148	5796	107
4981	140, 202	5611	148, 151	5797	107
4982	140, 202	5613	148	5798	109
4983	140	5619	149	5810	147
4984	140	5621	147	5811	146
4985	138	5622	147	5812	148
4993	133	5623	146	5814	110
4995	134	5624	146	5817	149, 202
4996	134	5626	149, 202	5818	149
4997	134	5627	149	5819	107
		5631	147	5823	109
		5632	146	5824	109
		5633	145	5825	109
		5636	149	5831	151
<b>5</b>		5672	151	5832	151
5200	105	5674	151	5833	110
5202	105	5676	151	5834	108
5203	104	5683	151	5840	151
5204	104	5684	151	5843	151
5210	65, 105	5685	151	5853	111
5211	106	5688	150	5854	145
5222	104	5691	150	5855	145
5223	105	5692	150	5863	111
5227	104	5693	150	5867	111
5238	104	5694	150	5872	111
5239	104	5699	152	5910	149, 202
5243	106	5700	103	5911	144
5245	105	5701	103	5912	144
5256	106	5703	103	5913	148
5257	106	5704	103	5914	153
5267	105	5707	108		
5269	105	5708	108		
5277	105	5709	108		
5282	104	5715	107	<b>6</b>	
5288	105	5721	109	6100	50
5304	101	5723	111	6112	50
5305	101	5734	111	6114	50
5309	106	5736	108	6150	50
5506	152	5737	108	6157	50
5507	153	5738	107	6160	50
5510	152	5739	108	6162	50
5512	153	5747	103	6163	50
5519	146				

## Contents by product #

Product code	Page	Product code	Page	Product code	Page
6164	50	6824	49	7723	86
6168	50	6831	49	7724	86
6200	49	6833	49	7726	86
6201	49	6835	49	7727	86
6210	49	6901	45, 69	7735	75, 102
6219	49	6906	45, 69	7743	87
6220	49	6908	45, 69	7744	87
6221	49	6910	45, 69		
6222	49	6916	45, 69		
6223	49				
6224	49				
6401	49				
6410	49	<b>7</b>		<b>8</b>	
6440	49	7011	97	8001	181
6441	49	7012	97	8002	183
6442	49	7101	96	8003	183
6443	49	7102	96	8004	181
6446	49	7103	96	8005	210, 214
6500	50	7111	96	8006	181
6503	50	7112	96	8008	181
6504	50	7113	96	8010	65
6505	50	7201	97	8011	215
6507	50	7202	96	8012	210, 214
6508	50	7203	96	8013	214
6510	50	7204	97	8014	216
6511	50	7205	96	8015	65
6512	50	7206	96	8016	216
6513	50	7208	79, 97	8019	66
6514	50	7209	96	8020	65
6520	50	7211	97	8021	66
6522	50	7215	95	8022	66
6523	50	7224	95	8028	102, 161
6524	50	7290	97	8029	102
6550	50	7291	97	8030	65
6630	48	7292	97	8031	191
6631	48	7293	96	8032	192
6632	48	7295	97	8033	192
6633	48	7304	96	8034	192
6730	50	7305	95	8035	192
6737	50	7605	74, 93	8036	192
6740	50	7607	74, 93	8040	65
6741	50	7610	74, 93	8044	65
6747	50	7611	76	8045	65
6750	50	7612	76	8046	65
6755	50	7613	77	8047	193
6756	50	7614	77	8048	193
6758	50	7702	75	8050	192
6759	50	7705	75	8051	192
6800	49	7711	79	8052	192
6810	49	7712	87	8053	192
6819	49	7713	79	8054	191
6820	49	7714	79	8055	191
6821	49	7716	79	8058	191
6822	49	7717	79	8061	69
6823	49	7722	86	8062	69
				8063	69
				8064	69

Product code	Page	Product code	Page	Product code	Page
8069	69	8157	182	8328	189
8070	69	8180	181	8333	64, 185
8072	66, 68	8181	183	8334	64, 185
8073	66	8182	182	8379	66
8074	66	8187	210, 216	8382	68
8075	66	8188	216	8402	68
8076	66	8198	189	8403	68
8077	66	8200	191	8404	68
8078	65	8201	191	8405	68
8079	66	8202	191	8406	68
8080	67, 105	8203	191	8418	215
8081	68	8207	213	8433	69
8082	68	8208	213	8434	69
8083	68	8211	179	8435	69
8090	68	8212	179	8438	69
8091	68	8214	179	8500	175
8092	66	8215	179	8501	175
8093	66	8216	179	8502	175
8094	67	8217	179	8503	175
8095	67	8218	215	8504	175
8096	67	8219	215	8505	173
8098	26	8221	188	8506	173
8100	181	8222	188	8507	173
8101	182	8223	187	8525	184
8102	185	8224	214	8526	184
8103	189	8225	188	8527	187
8104	189	8226	188	8540	167
8106	183	8227	188	8541	167
8107	183	8228	188	8542	167
8110	182	8229	188	8543	167
8111	182	8230	185	8560	154
8112	216	8231	69	8561	154
8113	216	8236	69	8564	154
8116	182	8237	69	8565	154
8117	182	8261	69	8566	154
8118	215	8270	192	8567	154
8119	187	8271	192	8568	154
8120	169	8276	66	8569	154
8121	169	8279	66	8572	154
8123	169	8280	67	8574	154
8124	169	8281	68	8575	154
8126	173	8282	68	8577	154
8128	169	8283	68	8578	157
8129	177	8284	66	8579	158
8130	177	8285	66	8580	157
8131	177	8293	66	8581	57
8132	177	8294	67	8586	157
8133	177	8295	67	8587	155
8135	184	8296	67	8588	155
8136	184	8307	213	8589	155
8137	187	8308	213	8590	157
8138	184	8319	66	8594	161
8139	184	8324	189	8595	161
8140	177	8325	189	8596	155
8152	188	8327	189	8597	155

## Contents by product #

Product code	Page	Product code	Page	Product code	Page
8598	158	1700761010	161	1701673008	82
8599	157	1700761060	161	1701682003	81
8600	184	1700761400	161	1701682008	81
8601	181	1700786058	84, 89	1701682009	81
8603	183	1700801058	84, 89	1701682010	81
8604	181	1701235003	80	1701682012	81
8605	185	1701235008	80	1701682017	81
8606	181	1701235009	80	1701682020	81
8608	181	1701235010	80	1701682034	81
8610	182	1701235012	80	1701682040	81
8612	183	1701235017	80	1701682060	81
8613	158	1701235020	80	1701682080	81
8614	158	1701235034	80	1701682400	81
8615	158	1701235040	80	1701682540	81
8616	158, 201	1701235060	80	1701682909	81
8682	187	1701235080	80	1701682992	81
8683	215	1701235400	80	1701707060	237
8684	157	1701235540	80	1701710008	81, 237
8685	158	1701235992	80	1701710010	81, 237
8693	179	1701395010	81	1701710012	81, 237
8694	182	1701395050	81	1701710017	81, 237
8695	183	1701395060	81	1701710020	81, 237
8696	181	1701395400	81	1701710034	81, 237
8697	181	1701395540	81	1701710040	81, 237
8698	214	1701498010	160	1701710060	81, 237
8699	182	1701498060	160	1701710080	81, 237
8905	214	1701498400	160	1701710400	81, 237
8910	208	1701504058	84, 89	1701710540	81, 237
8911	209	1701522010	160	1701710909	81, 237
8912	209	1701522060	160	1701710992	81, 237
8913	209	1701522400	160	1701711010	82
8914	209	1701567058	85	1701711020	82
8915	209	1701569058	85, 90	1701711034	82
8918	215	1701572010	82, 237	1701711040	82
8919	215	1701572221	84, 237	1701711050	82
8924	214	1701579221	84, 237	1701711060	82
		1701588058	84, 89	1701711080	82
		1701625010	80	1701711400	82
		1701625060	80	1701712003	82
		1701625400	80	1701712008	82
		1701625540	80	1701712009	82
		1701626010	80	1701712012	82
		1701626060	80	1701712017	82
		1701626400	80	1701712540	82
		1701626540	80	1701712909	82
		1701627060	81	1701712992	82
		1701627400	81	1701723060	82
		1701627540	81	1709008060	159
		1701672010	82	1709008400	159
		1701672020	82	1709013400	159
		1701672034	82	1709014060	159
		1701672040	82	1709014400	159
		1701672060	82	1709018058	84, 89
		1701672080	82	1709051060	80
		1701672400	82	1709051400	80
<b>24</b>					
24007	35				
<b>170</b>					
1700008061	159				
1700008401	159				
1700014061	159				
1700014401	159				
1700132001	84, 89				
1700381682	81				
1700580400	161				
1700760010	161				
1700760060	161				
1700760400	161				



Product code	Page	Product code	Page
1709051540	80	1800496221	229
1709054060	81	1800497010	229
1709054400	81	1800497020	229
1709054540	81	1800497030	229
1709760010	160	1800497040	229
1709760060	160	1800497050	229
1709760400	160	1800497210	229
1709763010	160	1800497221	229
1709763060	160	1800500020	230
1709763400	160	1800500030	230
1709781010	160	1800500040	230
1709781060	160	1800500050	230
1709781400	160	1800501020	230
1709785010	160	1800502040	230
1709785060	160	1800519050	228
1709785400	160	1800519221	228
		1800520050	228
		1800520221	228
		1800798010	228
		1800798050	228
<b>171</b>		1801565040	238
1712000050	94	1801565060	238
1712000400	94	1801565080	238
1712000540	94	1801574011	228
1712001050	94	1801574012	228
1712001060	94	1801574013	228
1712002050	94	1801574014	228
1712002058	90, 94	1801574018	228, 229
1712003050	94	1801574051	228
1712003058	90, 94	1801621020	228
1712004058	90, 94	1801621030	228
		1801621040	228
		1801621050	228
<b>179</b>		1801621080	228
1799021000	234	1801622010	228
		1801665010	230
		1801666010	230
		1801667010	230
		1801668010	231
<b>180</b>		1801669010	231
1800474010	231	1801696060	238
1800474020	231	1809413040	238
1800474040	231	1809413080	238
1800474050	231	1809414040	238
1800474221	231	1809414080	238
1800475010	231	1809643040	238
1800475020	231	1809643080	238
1800475030	231	1809693060	238
1800475040	231	1809693180	238
1800475050	231	1809798010	228
1800475210	231	1809798050	228
1800475221	231	1809816050	231
1800496010	229		
1800496020	229		
1800496040	229		
1800496050	229		



Официальный дистрибьютор Durable в России  
125212 Москва, Головинское шоссе, дом 5, строение 1  
Тел\Факс: +7 (495) 232-07-42  
info@durable-shop.ru · www.durable-shop.ru