



MOTOROLA

User's Guide

MBP20

Baby Monitor

The features described in this user's guide are subject to modifications without prior notice.

Welcome...

to your new Motorola Baby Monitor!

Thank you for purchasing the MBP20. Now you can see and hear your baby sleeping in another room or you can monitor your older children in their play room.

Please retain your original dated sales receipt for your records. For warranty service of your Motorola product, you will need to provide a copy of your dated sales receipt to confirm warranty status. Registration is not required for warranty coverage.

For product-related questions, please call:

UK	0845 218 0890
ROI	08187 62092
On the Web: www.motorola.com	

This User's Guide provides you with all the information you need to get the most from your product.

Before you can use the baby monitor, you MUST insert the battery in the parent unit, and we recommend you fully charge the battery so that it continues to work if you disconnect it from the mains power to carry it to another location. Please read the Safety Instructions on page 8 before you install the units.

Got everything?

- 1 x Parent unit
- 1 x Baby unit
- 1 x Rechargeable Ni-MH battery pack for the Parent unit
- 1 x Belt clip / stand for parent unit (already attached)
- 1 x Battery door for parent unit (already attached)
- 1 x Power adapter for the parent unit
- 1 x Power adapter for the baby unit

Overview of your Parent unit

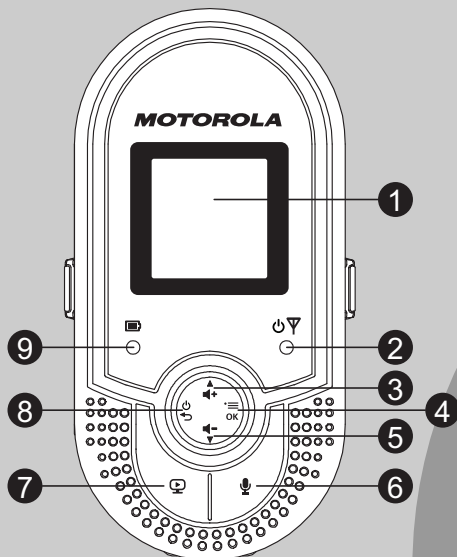

1 LCD Display

2 Link Indicator

On when the parent unit is powered on and linked to the baby unit.

Flashes when the parent unit is out of range of the baby unit.

Off when the parent unit is powered off.

3 UP / Volume +

In idle mode: Press to increase the speaker volume.

In menu mode: Press to move up the menu list.

4 Menu / OK

In idle mode: Press to access the main menu.

In menu mode: Press to access the sub-menu, or confirm the settings.

5 DOWN / Volume -

In idle mode: Press to decrease the speaker volume.

In menu mode: Press to move down the menu list.

6 Talk

Press and hold to talk back through the baby unit.

Release to quit the talk mode.

7 Video On / Off

Press to deactivate/activate the video feed and turn on/off the LCD display.

8 Power / Back

In idle or menu mode: Press and hold to power on/off the parent unit.

In menu mode: Press to cancel settings or go back to the previous level.

9 Charging Indicator





On steadily when in charging mode.







Flashes when low battery is detected.

NOTE

Off if the battery pack is not installed, even if the power adapter is connected.

Parent Unit Display

Icons	Behaviour Description
	Indicates the signal strength between the baby unit and parent unit. The more blocks, the stronger the connection signal.
	Flashes when the parent unit is out of range.
	Indicates no connection between the baby unit and parent unit.
	Indicates the parent unit speaker is muted.
	Indicates the parent unit speaker volume level, from 1 (quiet) to 5 (loud).

	Indicates the baby unit is playing a lullaby.
	Indicates the timer alarm is activated.
	Indicates the sound alert is set on.
	Low battery, needs charging.
	1/2 battery level. More internal bars mean a higher battery level.
	Full battery level.
	Internal bars cycling indicates the battery is charging.

Menu Structure of the Parent Unit

MAIN MENU	LANGUAGE	TIMER	BRIGHTNESS	SOUND ALERT	ALERT TONES	RESET
SUB MENU	English Français Español Deutsch Italiano Português	Activation Set Timer	Level 1 ~ 5	On Off	Low Battery No Link	

Overview of your Baby unit

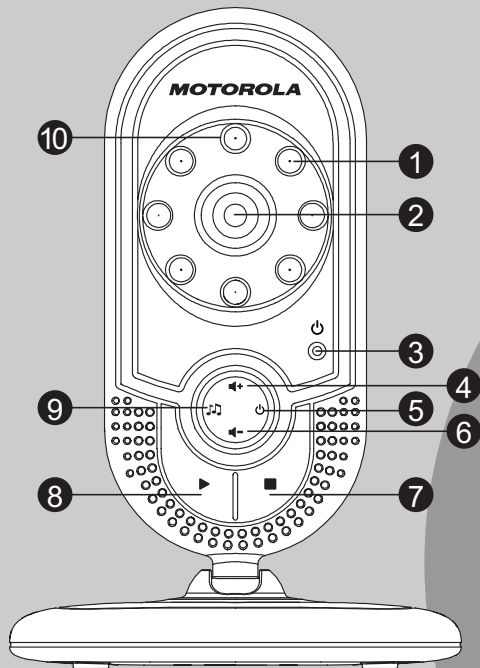

- 1 Infrared Light**
4 x Infra-red LEDs for night vision illumination
- 2 Camera Lens**
- 3 Power Indicator**
On when the baby unit is switched on.
Off when the baby unit is switched off.
- 4 UP / Volume +**
Press to increase the speaker volume.
- 5 Power**
Press and hold to power on/off the baby unit.
- 6 DOWN / Volume -**
Press to decrease the speaker volume.
- 7 Stop**
Press to stop the lullaby playing.
- 8 Play**
Press to start playing the selected lullaby.
- 9 Lullaby**
Press to start playing the selected lullaby.
During lullaby playing, press to select and play the other lullabies.
- 10 Photo sensor**
Light sensor to detect when night vision required.

Important guidelines for installing your Baby Monitor

- To use your baby unit and parent unit together, you must be able to establish a radio link between them, and the range will be affected by environmental conditions.
- Any large metal object, like a refrigerator, a mirror, a filing cabinet, metallic doors or reinforced concrete, between the baby and parent unit may block the radio signal.
- The signal strength may also be reduced by other solid structures, like walls, or by radio or electrical equipment, such as TV's, computers, cordless or mobile phones, fluorescent lights or dimmer switches.
- If the signal is poor, try moving the parent and/or the baby unit to different positions in the rooms.

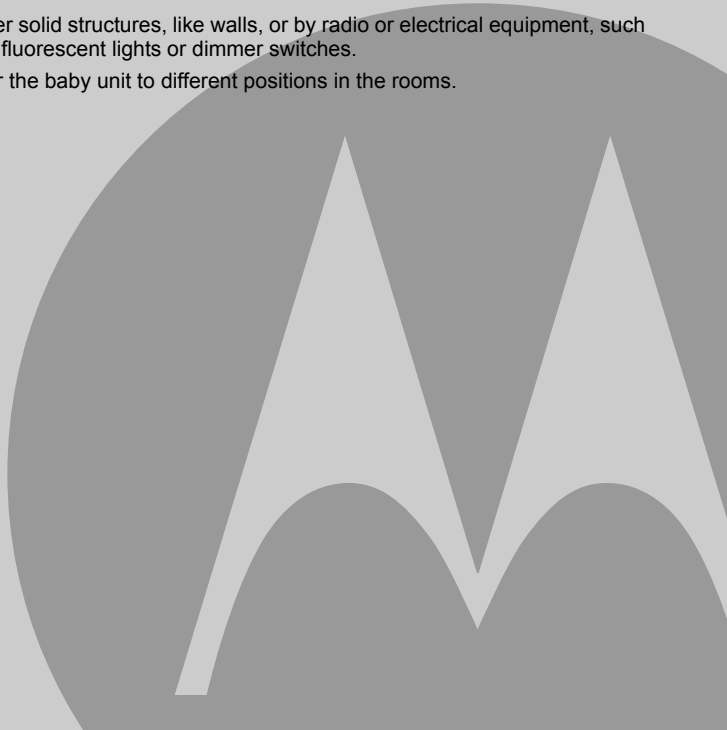



1. SAFETY INSTRUCTIONS	8	5. DISPOSAL OF THE DEVICE (ENVIRONMENT).....	15
2. GETTING STARTED.....	9	6. CLEANING.....	16
2.1 Baby unit power supply.....	9	7. TROUBLESHOOTING.....	16
2.2 Parent unit battery installation.....	9	8. GENERAL INFORMATION.....	18
2.3 Belt clip / stand on the parent unit.....	10	9. TECHNICAL SPECIFICATIONS.....	21
3. USING YOUR BABY MONITOR.....	11	EC DECLARATION OF CONFORMITY	22
3.1 Power on/off the parent unit.....	11		
3.2 Power on/off the baby unit	11		
3.3 Adjust speaker volumes of the parent unit and baby unit	11		
3.4 Talk Back	11		
3.4.1 Adjust talk back volume	12		
3.5 Temperature	12		
3.6 Lullaby.....	12		
3.7 Monitoring management for multi-parent system.....	12		
4. Parent unit settings.....	13		
4.1 Set the language.....	13		
4.2 Timer.....	13		
4.2.1 Turn on the timer	13		
4.2.2 Set the timer	14		
4.3 Set the brightness	14		
4.4 Sound alert.....	14		
4.5 Alert tones.....	14		
4.6 Reset.....	15		

1. SAFETY INSTRUCTIONS



WARNING:

STRANGULATION HAZARD - Keep the adapter cord out of the baby's reach.

NEVER place the baby monitor or its cord within the cot.

Secure the cord well away from the baby's reach.

Never use extension cords with AC Adapters. Only use the AC Adapters provided.

CAMERA SET UP & USE:

- Determine a location for the CAMERA that will provide the best view of your baby in the cot.
- Place the CAMERA on a flat surface, such as a dresser, bureau, or shelf, or wall-mount it securely using the keyhole slots in the base.
- NEVER place the camera or cords within the cot.
- Secure the cord to the wall to keep it away from the baby's reach.

This baby monitor is compliant with all relevant standards regarding electromagnetic fields and is, when handled as described in the User's Guide, safe to use. Therefore, always read the instructions in this User's Guide carefully before using the device.

- Adult assembly is required. Keep small parts away from children when assembling.
- This product is not a toy. Don't allow children to play with it.
- This baby monitor is not a substitute for responsible adult supervision.
- Keep this User's Guide for future reference.
- Do not cover the baby monitor with a towel or blanket.
- Never use extension cords with power adapters. Only use the power adapters provided.
- Test this monitor and all its functions so that you are familiar with it prior to actual use.
- Do not use the baby monitor near water.
- Do not install the baby monitor near a heat source.
- Only use the chargers and power adapters provided. Do not use other chargers or power adapters as this may damage the device and battery pack.
- Only insert a battery pack of the same type.
- Do not touch the plug contacts with sharp or metal objects.

CAUTION

Risk of explosion if battery is replaced by an incorrect type. Dispose of used batteries according to the instructions. Use only a battery pack with rating: 2.4V 600mAh.

2. GETTING STARTED

2.1 Baby unit power supply

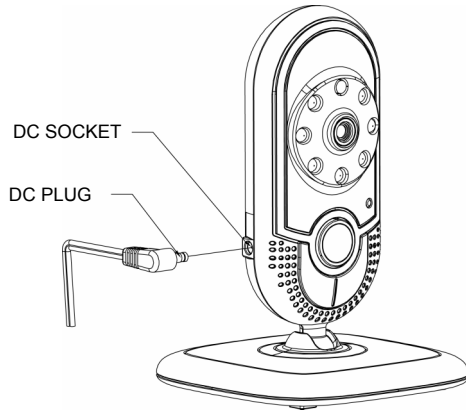

1. Insert the DC plug of the power adapter with smaller DC plug into the DC socket in the side of the baby unit, as shown.
2. Connect the other end of the power adapter to a suitable mains power socket.

NOTE

Only use the provided power adapter.

2.2 Parent unit battery installation

A rechargeable battery pack is supplied and **MUST** be fitted in the parent unit in order for the parent unit to work. Charge the parent unit before you use it for the first time or when the parent unit indicates that the battery is low.

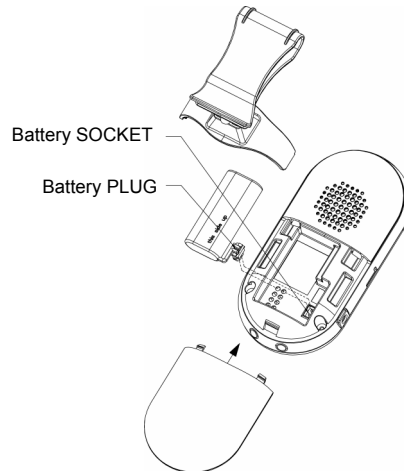

1. Take off the belt clip / stand.
2. Slide off the battery compartment cover.

3. Insert the plug of the battery pack into the socket inside the battery compartment, and fit the battery pack into the compartment.
4. Replace the battery compartment cover, and reinstall the belt clip / stand (refer to section 2.3).
5. Insert the DC plug of the power adapter with the larger DC plug into the DC socket in the side of the parent unit.
6. Connect the other end of the power adapter to a suitable mains power socket.
7. The **Charging Indicator** comes on.

NOTE

Only use the provided power adapter.

2.3 Belt clip / stand on the parent unit

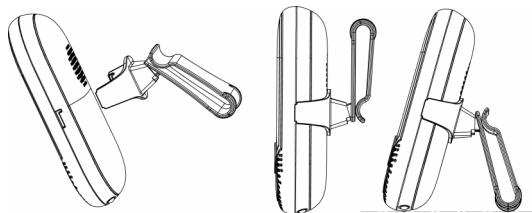



1. The belt clip/stand attaches to the back of the parent unit and clips into the locking slots on each side.
2. The unit comes with the accessory fitted in belt clip mode.
3. You can convert it into stand mode by pulling the clip out slightly and then rotating it by half a turn, as shown.





3. USING YOUR BABY MONITOR

Please read these instructions carefully, and be aware that this baby monitor is only intended as an aid. It is not a substitute for responsible, correct parental supervision.

3.1 Power on/off the parent unit

1. When the parent unit is off, press and hold  until the **Link Indicator** is on. The parent unit is now powered on and will search for and link itself to the baby unit.
2. When the parent unit is on, press and hold  until the **Link Indicator** turns off. The parent unit is now powered off, although the display may take a few seconds to go off fully.

3.2 Power on/off the baby unit





1. When the baby unit is off, press and hold  until the **Power Indicator** is on. The baby unit is now powered on.
2. When the baby unit is on, press and hold  until the **Power Indicator** turns off. The baby unit is now powered off.

NOTE

Do not place the parent and baby units too close together, or you may hear a high pitched noise. This is not a fault. The units are designed to be operated at some distance apart, e.g. in separate rooms.

3.3 Adjust speaker volumes of the parent unit and baby unit

There are 5 volume levels on the baby unit, and 6 levels on the parent unit, including **VOLUME OFF**. The volume level of parent unit will be shown on the status bar when you adjust the volume.

1. Press  or  on the parent unit or  or  on the baby unit to adjust the respective volume level.
2. The  will be displayed if the volume of the parent unit is turned off.
An audible alert is emitted if you try to adjust beyond the highest or lowest volume level.

Changing the volume setting on the baby unit affects the volume at the baby unit when you use the Talk Back feature or when playing a lullaby.

3.4 Talk Back



You can use the Talk Back feature to comfort and reassure your baby.

Whilst using Talk Back you will not be able to hear your baby until you release the button.

1. Press and hold  on the parent unit to speak to your baby. **Talk** will be displayed on the parent unit.
2. Release to hear your baby again.

3.4.1 Adjust talk back volume

The baby unit has 5 volume levels from Level 1 to Level 5.

Press  or  on the baby unit to increase or decrease the volume respectively.

NOTE

If a lullaby is playing, it will stop during **Talk Back**, but will restart from the beginning when the **Talk Back** ends.

3.5 Temperature

The baby unit constantly monitors the temperature in your baby's room and alerts you if it gets lower than 14°C (or 57°F), by emitting a warning beep and showing the alert message "Too cold!" on the parent unit screen, or if it gets higher than 39°C (or 102°F), it will show "Too hot!".





Although this is for reference only, and there may be a small difference between the baby monitor reading and the actual temperature, please check your baby immediately if such an alert message is triggered.

Note

The current temperature at the baby unit is shown on the parent unit status bar whenever it is displayed.

3.6 Lullaby

There are 3 lullabies available to play for your baby, either repeating one melody or repeating through all three melodies.

1. Press  on the baby unit to select the lullaby and start playing.
2. During playback, press  to step between different lullabies.
OR
Press  on the baby unit to start playing the selected lullaby.
3. During playback, press  to stop playing.

3.7 Monitoring management for multi-parent system



The system allows pairing up to two parent units to a baby unit. However, only one parent unit can receive video image at a time. You can switch the video feed between these two parent units.

The first powered up parent unit will connect to the baby unit automatically, and the next powered up parent unit will turn up on screen ANOTHER PU IS VIDEO MONITORING! for around 30 seconds and then goes blank. Press once the  to turn off the screen.

**NOTE**







The parent unit still carries on audio monitoring even if the video capture is turned off.

To switch the video feed from the current monitoring parent unit to the other parent unit which is not in video monitoring mode:

1. Press  on the current video monitoring parent unit, the screen will be blank without video image received.
2. Press  on the other parent unit which is NOT in video monitoring mode, the video feed will be transferred to that parent unit.

4. Parent unit settings













4.1 Set the language

1. Press  to access the main menu.
2. Press  or  to select LANGUAGE.
3. Press  to enter the sub-menu.
4. Press  or  to select the desired language.
5. Press  to confirm.









4.2 Timer

The timer function serves as an alarm to remind you of things-to-do for the baby such as feeding, or medication.

4.2.1 Turn on the timer

1. Press  to access the main menu.
2. Press  or  to select TIMER.
3. Press  to enter the sub-menu.
4. Press  or  to select ACTIVATION.
5. Press  and then  or  to select ON or OFF.
6. Press , and then if ON was selected, press  or  to select the timer mode
7. Press  to confirm.







4.2.2 Set the timer

1. Repeat steps 1 to 3 in section 4.2.1.
2. Press + or  to select SET TIMER.
3. Press  and then set the number of hours (00 to 12) using the + or  keys.
4. Press  and then set the number of minutes (00 to 59) using the + or  keys.
5. Press  to confirm.

NOTE

When the timer period is reached, the unit will emit an alert beep and 00:00 on the screen. You can press any button to stop the beeps. If the timer mode was set to ONCE, the timer will be cancelled, but if set to REPEATED, it will reset and start another timer period.

4.3 Set the brightness







1. Press  to access the main menu.
2. Press + or  to select BRIGHTNESS.
3. Press  to enter the sub-menu to set the brightness level.
4. Press + or  to select from LEVEL 1 to LEVEL 5. The screen brightness changes as the options are selected.
5. Press  to confirm.

NOTE

A lower brightness level will reduce the power consumption.











4.4 Sound alert

When the sound alert is set ON, and the parent unit speaker volume is off, it will cause the parent unit to beep and flash "Sound alert" on the display, whenever the sound at the baby unit goes above a preset threshold.

1. Press  to access the main menu.
2. Press + or  to select SOUND ALERT.
3. Press  to enter the sub-menu.
4. Press + or  to select ON or OFF.
5. Press  to confirm.

4.5 Alert tones





You can set the parent unit to give a warning when the battery is low and/or if the radio link to the baby unit is lost. When activated, an alert screen will be displayed on the parent unit with an alert tone emitted simultaneously.

1. Press  to access the main menu.
2. Press + or  to select ALERT TONES.
3. Press  and + or  to select LOW BATTERY or NO LINK.
4. Press  and + or  to select ON or OFF for the alert tone.
5. Press  to confirm.



4.6 Reset

You can restore all the adjustable settings back to their original factory settings.

1. Press  **OK** to access the main menu.
2. Press  **+** or  to select **RESET**.
3. Press  **OK** to display **CONFIRM?**.
4. Press  **OK** to confirm the reset.

5. DISPOSAL OF THE DEVICE (ENVIRONMENT)

At the end of the product lifecycle, you should not dispose of this product with normal household waste. Take this product to a collection point for the recycling of electrical and electronic equipment. The symbol on the product, user's guide and/or box indicates this.



Some of the product materials can be re-used if you take them to a recycling point. By reusing some parts or raw materials from used products you make an important contribution to the protection of the environment.

Please contact your local authorities in case you need more information on the collection points in your area.

Dispose of the battery pack in an environmentally-friendly manner according to your local regulations.

6. CLEANING

Clean your MBP20 with a slightly damp cloth or with an anti-static cloth. Never use cleaning agents or abrasive solvents.

Cleaning and care

- Do not clean any part of the product with thinners or other solvents and chemicals - this may cause permanent damage to the product which is not covered by the warranty.
- Keep your MBP20 away from hot, humid areas or strong sunlight, and do not let it get wet.
- Every effort has been made to ensure high standards of reliability for your MBP20. However, if something does go wrong, please do not try to repair it yourself - contact Customer Service for assistance.

7. TROUBLESHOOTING

Link light on the parent unit does not come on

- Check whether the parent unit is powered on.
- Check whether the supplied battery pack is correctly installed and that they are not drained.
- Recharge the battery in the parent unit by connecting it to the power supply.

Link light on the parent unit flashes

- The parent unit and the baby unit may be out of range with each other. Reduce the distance between the units, but not closer than 5 feet.
- The baby unit may be switched off. Press and hold the  key on the baby unit to switch on the baby unit.

Low battery light or on the parent unit screen flashes

- Battery pack in the parent unit is running low. Connect the parent unit to the mains power with the supplied power adaptor for recharging.

The parent unit beeps

- Lost connection with the baby unit. Reduce the distance between the parent unit and the baby unit, but not closer than 5 feet.
- The baby unit may be switched off. Press and hold the  key on the baby unit to switch on the baby unit.



- Battery pack in parent unit may be running low. Connect the parent unit to the mains power with the supplied power adaptor for recharging.

Cannot view the video image of baby from the parent unit

- Video feed maybe turned off. Activate the video feed by pressing .
- The parent unit and the baby unit may be out of range with each other. Reduce the distance between the units, but not closer than 5 feet.
- Battery pack in parent unit may be drained. Connect the parent unit to the mains power with the supplied power adaptor for recharging.

Cannot hear sound or baby cry from the parent unit

- The volume level in the parent unit may be set too low, increase the volume level of the parent unit. Refer to section 3.3 for volume level settings.
- The parent unit and the baby unit may be out of range with each other. Reduce the distance between the units, but not closer than 5 feet.

The baby monitor system produces a high-pitched noise

- The parent unit and the baby unit are too close to each other. Make sure the parent unit and baby unit are at least 5 feet away from each other.
- The speaker volume of the parent unit maybe set too high. Decrease the volume of the parent unit.

Battery pack in the parent unit is running low quickly

- The brightness level of the parent unit screen may be set too high, which consumes more power. Reduce the brightness level of the screen - see section 4.3.
- The volume level of the parent unit may be set too high which consumes power. Decrease the volume level of the parent unit. Refer to section 3.3 for volume level settings.

Talk back feature is not working

- Make sure the baby unit is powered on, and the link between the parent unit and baby unit is normal.
- Check that the volume is loud enough at the baby unit, refer to section 3.4.

8. GENERAL INFORMATION

If your product is not working properly...

1. Read this User's Guide.
2. Visit our website: www.motorola.com
3. Contact Customer Service at
UK 0845 218 0890
ROI 08187 62092

To order a replacement battery pack for the parent unit, contact customer service.

Consumer Products and Accessories Limited Warranty ("Warranty")

Thank you for purchasing this Motorola branded product manufactured under license by Binatone Electronics International LTD ("BINATONE").

What Does this Warranty Cover?

Subject to the exclusions contained below, BINATONE warrants that this Motorola branded product ("Product") or certified accessory ("Accessory") sold for use with this product that it manufactured to be free from defects in materials and workmanship under normal consumer usage for the period outlined below. This Warranty is your exclusive warranty and is not transferable.

Who is covered?

This Warranty extends only to the first consumer purchaser, and is not transferable.

What will BINATONE do?

BINATONE or its authorised distributor at its option and within a commercially reasonable time, will at no charge repair or replace any Products or Accessories that does not conform to this Warranty. We may use functionally equivalent reconditioned/ refurbished/ pre-owned or new Products, Accessories or parts.

What Other Limitations Are There?

ANY IMPLIED WARRANTIES, INCLUDING WITHOUT LIMITATION THE IMPLIED WARRANTIES OF MERCHANTABILITY AND FITNESS FOR A PARTICULAR PURPOSE, SHALL BE LIMITED TO THE DURATION OF THIS LIMITED WARRANTY, OTHERWISE THE REPAIR OR REPLACEMENT PROVIDED UNDER THIS EXPRESS LIMITED WARRANTY IS THE EXCLUSIVE REMEDY OF THE CONSUMER, AND IS PROVIDED IN LIEU OF ALL OTHER WARRANTIES, EXPRESS OR IMPLIED. IN NO EVENT SHALL MOTOROLA OR BINATONE BE LIABLE, WHETHER IN CONTRACT OR TORT (INCLUDING NEGLIGENCE) FOR DAMAGES IN EXCESS OF THE PURCHASE PRICE OF THE PRODUCT OR ACCESSORY, OR FOR ANY INDIRECT, INCIDENTAL, SPECIAL OR CONSEQUENTIAL DAMAGES OF ANY KIND, OR LOSS OF REVENUE OR PROFITS, LOSS OF BUSINESS, LOSS OF INFORMATION OR OTHER FINANCIAL LOSS ARISING OUT OF OR IN CONNECTION WITH THE ABILITY OR INABILITY TO USE THE PRODUCTS OR



ACCESSORIES TO THE FULL EXTENT THESE DAMAGES MAY BE DISCLAIMED BY LAW.

Some jurisdictions do not allow the limitation or exclusion of incidental or consequential damages, or limitation on the length of an implied warranty, so the above limitations or exclusions may not apply to you. This Warranty gives you specific legal rights, and you may also have other rights that vary from one jurisdiction to another.

Products Covered	Length of Coverage
Consumer Products	One (1) year from the date of the products original purchase by the first consumer purchaser of the product.
Consumer Accessories	Ninety (90) days from the date of the accessories original purchase by the first consumer purchaser of the product.
Consumer Products and Accessories that are Repaired or Replaced	The balance of the original warranty or for ninety (90) days from the date returned to the consumer, whichever is longer.

Exclusions

Normal Wear and Tear. Periodic maintenance, repair and replacement of parts due to normal wear and tear are excluded from coverage.

Batteries. Only batteries whose fully charged capacity falls below 80% of their rated capacity and batteries that leak are covered by this Warranty.

Abuse & Misuse. Defects or damage that result from: (a) improper operation, storage, misuse or abuse, accident or neglect, such as physical damage (cracks, scratches, etc.) to the surface of the product resulting from misuse; (b) contact with liquid, water, rain, extreme humidity or heavy perspiration, sand, dirt or the like, extreme heat, or food; (c) use of the Products or Accessories for commercial purposes or subjecting the Product or Accessory to abnormal usage or conditions; or (d) other acts which are not the fault of MOTOROLA or BINATONE, are excluded from coverage.

Use of Non-Motorola branded Products and Accessories. Defects or damage that result from the use of Non-Motorola branded or certified Products or Accessories or other peripheral equipment are excluded from coverage.

Unauthorised Service or Modification. Defects or damages resulting from service, testing, adjustment, installation, maintenance, alteration, or modification in any way by someone other than MOTOROLA, BINATONE or its authorised service centres, are excluded from coverage.

Altered Products. Products or Accessories with (a) serial numbers or date tags that have been removed, altered or obliterated; (b) broken seals or that show evidence of tampering; (c) mismatched board serial numbers; or (d) nonconforming or non-Motorola branded housings, or parts, are excluded from coverage.

Communication Services. Defects, damages, or the failure of Products or Accessories due to any communication service or signal you may subscribe to or use with the Products or Accessories is excluded from coverage.

How to Obtain Warranty Service or Other Information?

To obtain service or information, please call:

UK **0845 218 0890**

ROI **08187 62092**

You will receive instructions on how to ship the Products or Accessories at your expense and risk, to a BINATONE Authorised Repair Centre.

To obtain service, you must include: (a) the Product or Accessory; (b) the original proof of purchase (receipt) which includes the date, place and seller of the Product; (c) if a warranty card was included in your box, a completed warranty card showing the serial number of the Product; (d) a written description of the problem; and, most importantly; (e) your address and telephone number.

These terms and conditions constitute the complete warranty agreement between you and BINATONE regarding the Products or Accessories purchased by you, and supersede any prior agreement or representations, including representations made in any literature publications or promotional materials issued by BINATONE or representations made by any agent, employee or staff of BINATONE, that may have been made in connection with the said purchase.

9. TECHNICAL SPECIFICATIONS

Baby Unit:

Frequency	1881.792 MHz - 1897.344 MHz
Channels	10
Operating temperature	5°C - 45°C
Image sensor	Colour CMOS 30M Pixels
Lens	f 3.6mm, F 2.4
IR LED	4 pcs
Baby unit voltage (Adapter rating)	Input 100-240VAC 50/60Hz 150mA; Output 6VDC @600mA < Tenpao S004LV0600060 / S004LB0600060 EU / UK>

Parent Unit :

Frequency	1881.792 MHz - 1897.344 MHz
Channels	10
Operating temperature	5°C - 45°C
Display	1.5" CSTN LCD
Display colour	65K colour LCD
Brightness control	5 steps
Parent unit voltage	2.4V 600mAh Ni-MH battery pack <BYD H-AAA600Bx2-LE23; GPI VTRHC063N011>
Parent unit voltage (Adapter rating)	Input 100-240VAC 50/60Hz 150mA; Output 6VDC @600mA <Tenpao S004LV0600060 / S004LB0600060 EU / UK>

EC Declaration of Conformity

We the manufacturer / Importer : Binatone Telecom Plc
1 Apsley Way London
NW2 7HF, United Kingdom.

Declare under our sole responsibility that the following product

Type of equipment: Digital Baby Monitor

Model Name: MBP 20

Country of Origin: China

Brand: Motorola

complies with the essential protection requirements of R&TTE Directive 1999/5/EC on the approximation of the laws of the Member States relating to **Radio Spectrum Matters**, the Council Directive 2004/108/EC on the approximation of the laws of the Member States relating to **electromagnetic compatibility (EMC)** and the European Community Directive 2006/95/EC relating to **Electrical Safety**. Assessment of compliance of the product with the requirements relating to the essential requirements according to Article 3 R&TTE was based on Annex III of the Directive 1999/5/EC and the following standard:

Radio Spectrum:	EN301406 V2.1.1 (2009-07)
EMC:	EN301489-6 V1.3.1 (2008-08) EN301489-1 V1.8.1 (2008-04)
Electrical Safety:	EN60950-1:2006+A11:2009+A1:2010

The product is labelled with the European Approval Marking CE as show. Any Unauthorized modification of the product voids this Declaration.



Manufacturer / Importer
(Signature of authorized person)



London, 10 Jun 11

Signature: (Paul Tsui/ Product Operation
Director)

Place & Date :



Manufactured, distributed or sold by Binatone Electronics International LTD., official licensee for this product. MOTOROLA and the Stylized M Logo are trademarks or registered trademarks of Motorola Trademark Holdings, LLC. and are used under license. All other trademarks are the property of their respective owners.

© 2011 Motorola Mobility, Inc. All rights reserved.



Version 3.0

Printed in China

